



HAL
open science

**La maturité intégrée dans un méta modèle de
connaissances pour aider à la prise de décision en
conception préliminaire collaborative de systèmes
mécaniques**

Nicolas Dremont

► **To cite this version:**

Nicolas Dremont. La maturité intégrée dans un méta modèle de connaissances pour aider à la prise de décision en conception préliminaire collaborative de systèmes mécaniques. Autre. Université de Technologie de Compiègne, 2013. Français. NNT : 2013COMP2117 . tel-01002393

HAL Id: tel-01002393

<https://theses.hal.science/tel-01002393v1>

Submitted on 6 Jun 2014

HAL is a multi-disciplinary open access archive for the deposit and dissemination of scientific research documents, whether they are published or not. The documents may come from teaching and research institutions in France or abroad, or from public or private research centers.

L'archive ouverte pluridisciplinaire **HAL**, est destinée au dépôt et à la diffusion de documents scientifiques de niveau recherche, publiés ou non, émanant des établissements d'enseignement et de recherche français ou étrangers, des laboratoires publics ou privés.

Par **Nicolas DREMONT**

Maturity integrated in a meta model of knowledge to help decision making in preliminary collaborative design of mechanical systems

Thèse présentée
pour l'obtention du grade
de Docteur de l'UTC

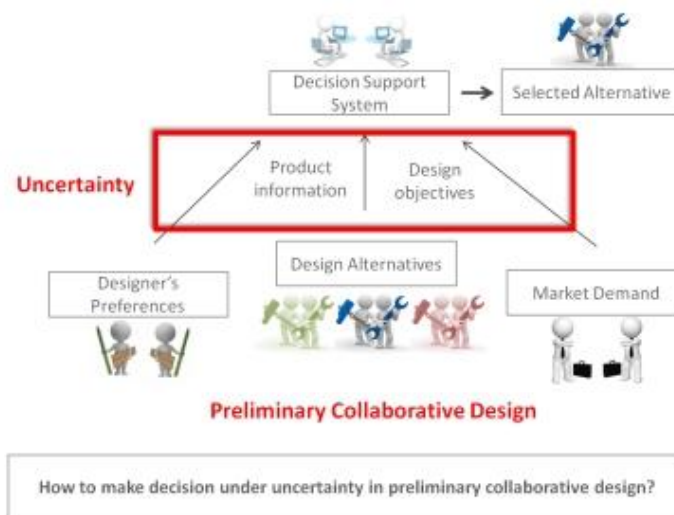

Soutenue le 26 novembre 2013
Spécialité : Mécanique avancée

D2117

N°d'ordre :

Ecole doctorale n° 71 : Sciences pour l'Ingénieur

THÈSE DE DOCTORAT

pour obtenir le grade de docteur délivré par

L'UNIVERSITE DE TECHNOLOGIE DE COMPIEGNE

Spécialité Mécanique Avancée

Présentée et soutenue publiquement par

Nicolas DREMONT

le 26 Novembre 2013

Maturity integrated in a Meta Model of Knowledge to help decision making in preliminary collaborative design of mechanical systems

Directeur de thèse : **Nadège TROUSSIER**

Professeur à l'Université de Technologie de Troyes, ICD / UMR-CNRS Sciences et
Technologies de la Maîtrise des Risques

Co-directeur de thèse : **Alex DUFFY**

Professeur à l'University of Strathclyde, Department of Design, Manufacture and Engineering
Management

JURY

Prof. Lionel ROUCOULES	Examineur	ENSAM, CER d'Aix-en-Provence
Prof. Michel TOLLENAERE	Rapporteur	Grenoble - INP
Prof. Bernard YANNOU	Rapporteur	Ecole Centrale Paris
Prof. Nadège TROUSSIER	Directeur	Université de Technologie de Troyes
Prof. Alex DUFFY	Co-directeur	University of Strathclyde, Glasgow
Ian Whitfield	Encadrant	University of Strathclyde, Glasgow
Laurent PETIT	Examineur	PSA Peugeot Citroën
Benoît EYNARD	Examineur	Université de Technologie de Compiègne

To my sister and parents...

English PhD presentation / Présentation en anglais

Title

A meta-model of knowledge integrating maturity to help decision making in engineering design: application of preliminary collaborative design to mechanical systems.

Resume

The design of mechanical systems, due to their multi-disciplinary and technological aspects, involves different people who, together, work and make decisions and jointly participate in the development of the product. They work in a collaborative manner; however, they may have different strategies, geographical positions, cultures and do not know the other members of the team. Preliminary design represents the early stages of the design cycle or product definition. A number of uncertainties regarding the parameters and product information are very important. There is an important lack of knowledge at this stage of the design process that must be managed or filled in order to improve and support the decision making in the early phases. It is this lack of knowledge that I propose to qualify and characterise, providing an answer to the question: how does one take into account the lack of knowledge in decision making during the preliminary design collaboration? To do so, we propose a meta-model for structuring product information and knowledge by integrating product maturity. A metric allows this maturity to be defined, to identify the level of knowledge of the product designers and to guide the decision making, thanks to the use of a qualitative and quantitative approach. Finally, we evaluate the ability of the meta-model to generate the different models produced and its relevance to the implementation in an industrial case.

Keywords

Maturity, Decision Making, Preliminary Collaborative Design, Knowledge Management, Uncertainty, Product Lifecycle Management (PLM)

Laboratoire Roberval, UTC-CNRS, UMR 7337

Université de Technologie de Compiègne

Centre de Recherches de Royallieu

BP 20529

60205 COMPIEGNE cedex

FRANCE

French PhD presentation / Présentation en français

Titre

Un méta-modèle de connaissances intégrant la maturité pour aider à la prise de décision en conception: application en conception collaborative préliminaire de systèmes mécaniques.

Résumé

La conception de systèmes mécaniques, de par son aspect pluridisciplinaire et technologique, fait intervenir et interagir différentes personnes qui travaillent et prennent des décisions ensemble, et, participent ensemble à l'élaboration du produit. Elles travaillent de manière collaborative cependant elles ne se connaissent pas obligatoirement, ne se situent pas forcément géographiquement sur un site commun, n'ont peut-être pas la même culture et n'appartiennent pas systématiquement à la même entreprise. La conception préliminaire représente les premières phases du cycle de conception où le produit est en cours de définition. Le nombre d'incertitudes sur les paramètres et les informations produit sont très importantes. Il y a un manque de connaissances important à cette étape du processus de conception qui doit être considéré afin d'améliorer et d'aider les prises de décisions dans les phases amonts. C'est ce manque de connaissances que je me propose de qualifier et caractériser en apportant une réponse à la question résultante: comment prendre en compte le manque de connaissances pour prendre des décisions durant la conception préliminaire collaborative ? Pour se faire, nous proposons un méta-modèle de connaissances permettant de structurer les informations du produit et les connaissances en intégrant la maturité du produit. Cette maturité est définie par une métrique et permet d'identifier le niveau de connaissances des concepteurs sur le produit et d'orienter la prise de décision grâce à l'utilisation d'une approche mixte, à la fois qualitative et quantitative. Enfin, nous évaluerons la capacité de ce méta-modèle à générer différents modèles produit, puis sa pertinence avec l'implémentation sur un cas industriel.

Résumé détaillé

La conception de systèmes mécaniques est le cadre de mes travaux et de mon contexte de recherche. Un système mécanique est un système complexe intégrant des technologies multi-physiques et des expertises pluridisciplinaires (automatique, électronique, informatique, mécanique, etc.) [Aublin et al. 1993]. La conception de systèmes mécaniques, de par son aspect pluridisciplinaires et pluri-technologiques, fait intervenir et interagir différentes personnes dans le processus de conception. Ces personnes travaillent et prennent des décisions ensemble, elles participent ensemble à l'élaboration du produit [Ullman 2001]. Elles travaillent de manière collaborative cependant elles ne se connaissent pas obligatoirement, ne se situent pas forcément au même endroit, n'ont peut-être pas la même culture et n'appartiennent pas systématiquement à la même entreprise [Besharatia and al. 2006] [Kvan 2000].

Le processus de définition de produit dans le domaine de la conception manufacturière propose une représentation en phases ou en étapes de ce processus [Blessing 1995]. La définition d'un produit peut être représentée par quatre sous processus principaux [Grebici 2007] qui sont la définition du problème (1), la conception conceptuelle (2), la conception détaillée et la production. La conception préliminaire représente les premières phases du cycle de conception (1 et 2). Ce qui nous intéresse particulièrement à ce niveau est le fait que le produit soit en cours de définition [Grebici et al. 2005]. Le nombre d'incertitudes sur les paramètres et les informations du système mécanique est très important [Blessing 1996]. Il y a un manque de connaissances à cette étape du processus de conception qui doit être considéré afin d'aider les prises de décisions dans les phases amont de conception de systèmes mécaniques.

C'est ce manque de connaissances que je me propose de caractériser et qualifier en proposant un méta modèle de connaissances et une métrique pour évaluer la maturité d'un système mécanique, permettant d'aider à la prise de décision dans les phases amonts de conception et, en gérant les performances du produit. Ce méta-modèle est couplé à cette métrique évaluant le niveau de maturité et de connaissances sur le produit grâce à l'utilisation d'une approche mixte qui est l'association d'approches qualitatives et quantitatives. Cette approche est basée sur un état de l'art divisé en deux parties. La première est axée sur la modélisation des incertitudes avec la présentation de différentes approches et échelles telles qu'ensembles flous, théorie de l'évidence, pérennité, etc. La seconde partie est consacrée aux modèles

produit et connaissances. Le méta modèle proposé sera basé sur cet état de l'art et, la validation se fera selon deux niveaux distincts appelés faisabilité et pertinence.

La validation de la faisabilité consiste à montrer et vérifier que le méta modèle de connaissances est capable d'implémenter des modèles produits et connaissances existant afin d'intégrer par la suite la maturité. Le second niveau, quand à lui est une implémentation complète du méta modèle de connaissances sur un cas industriel définit dans le cadre d'un projet scientifique national (ADN : Alliance des Données Numériques – FUI14). Cette implémentation a pour but de montrer l'aide apportée par la métrique et le méta-modèle dans la prise de décisions pour les prochaines itérations de conception et dans les prochaines conceptions de produits similaires.

Enfin, nous clôturerons l'exercice de thèse sur un état des travaux réalisés et les futurs recherches, implémentations et développement à mener.

Mots clés

Maturité, Prise de décision, Conception Collaborative Préliminaire, Gestion de la connaissance, Incertitude, Gestion du Cycle de vie du Produit (PLM)

Laboratoire Roberval, UTC-CNRS, UMR 7337

Université de Technologie de Compiègne

Centre de Recherches de Royallieu

BP 20529

60205 COMPIEGNE cedex

FRANCE

Abstract

A mechanical system is a complex system integrating technology, multi-physics and multi-disciplinary expertise (automation, electronics, computer, mechanical, etc.) (Aublin, et al. 1993). The design of mechanical systems, because of their appearance and multi-disciplinary technology, involves different people and interaction in the design process. These people work and make decisions together, they form part of the product development (D. Ullman, *The Ideal Engineering Decision Support System* 2001). They work in a collaborative manner; however, they do not necessarily know each other, may not necessarily be geographically located on a common site, may not have the same culture and do not belong to the same company (Besharatia, Azarm et Kannan 2006) (Kvan 2000).

The process of product definition in the field of manufacturing design is defined in phases or stages of the process (Blessing 1996). The definition of a product can be represented by four main subprocesses (Grebici 2007): defining the problem, conceptual design, detailed design and production. Preliminary design represents the early stages of the design cycle. Of interest to us, particularly at this level, is the fact that the product is being defined (Grebici, Blanco et Rieu 2005).

The number of uncertainties in the parameters and information on the mechanical system is very important (Blessing 1996). There is a lack of important knowledge at this stage of the design process that must be filled in order to improve and support decision making in the early phases of the design of mechanical systems.

Acknowledgements

The work presented in this thesis was conducted within the Department of Mechanical Design Engineering of the Laboratory Roberval at the University de Technologie de Compiègne (UTC). It is an experience that would not have been possible without the contribution and encouragement of many people.

I address my acknowledgments to Professor Jean-Marc ROELANDT, Professor and Director of the Roberval Research Centre, for welcoming me into the Centre and for putting at my disposal all the necessary means to carry out this work.

I express thanks also to Mister Benoît EYNARD, Senior Lecturer and Director of the Department of Mechanical Systems Engineering, for welcoming me into his department and allowing me to carry out this work in the best conditions.

This subject was proposed by Miss Nadège TROUSSIER, Senior Lecturer at the UTC, and was jointly directed by her and Mister Alex DUFFY, Professor and Head of the Department of Design, Manufacture and Engineering Management (DMEM) at the University of Strathclyde, in collaboration with Mister Ian WHITFIELD, Lecturer in the DMEM at the University of Strathclyde, Glasgow, UK. Here I express my sincere gratitude for the confidence they placed in me by offering me this collaboration. Particular acknowledgement is necessary to these three people who have contributed so much by their guidance, human qualities, commitment and availability in the frame of this thesis.

To Mister Lionel ROUCOULES, Professor at the Ecole Nationale Supérieure des Arts & Métiers (ENSAM) and Mister Bernard YANNOU, Professor at the Ecole Centrale Paris, I express my gratitude for all their advice, help and constructive comments that enriched my work.

Moreover, I address my acknowledgments to Mister Hugo FALGARONNE (Innovation Works, European Aero Defense and Space Group) and Mister Laurent PETIT (PSA Peugeot

Citroën), for their time, help, constructive comments and, more particularly, their professional experiences that enriched my work.

I wanted to thank the reviewers, namely Mr. Bernard YANNOU, Professor at the Ecole Centrale Paris, and Michel TOLLENAERE, Professor at the Institut National Polytechnique de Grenoble, for agreeing to bring my work thesis. It is an honour for me to extend my thanks to the members of the jury for the time and attention they devoted to reading this work and their criticism of it.

I wish to express my sincere gratitude to Mister Nikolaos LIMNIOS, Professor in the Laboratory of Applied Mathematics in Compiègne (LMAC) at the UTC, for all his help and advice that facilitated the completion of this work.

I would not fail to acknowledge the members of the ADN project, for their participation in my research work, all their constructive comments and advice that have enriched my work, the different exchanges of ideas and interpretations, the time devoted to interviews and their professional experiences and knowledge in the domain of design.

I really enjoyed working in the friendly atmosphere in this department. I thank all of the students, professors, secretaries and staff for the friendly spirit, cheerfulness and availability.

It would be ungrateful of me to finish this acknowledgement without remembering those who have contributed through their encouragement, moral support, even remotely, to the completion of this thesis. I speak here of all my family members, my sister, my parents and all my friends.

Table of contents

English PhD presentation / Présentation en anglais	4
Title.....	4
Resume	4
Keywords.....	4
French PhD presentation / Présentation en français	6
Titre	6
Résumé	6
Résumé détaillé.....	7
Mots clés.....	8
Abstract	9
Acknowledgements	10
Table of contents	12
List of figures	16
List of tables	20
Introduction	22
1. Decision making in preliminary collaborative design	30
1.1. Preliminary collaborative design	30
1.1.1. Product lifecycle and design process	30
1.1.2. Design activity.....	32
1.1.3. Collaborative aspect	34
1.2. Decision making	35
1.2.1. The need for decision in design activity.....	35
1.2.2. The decision pyramid	36
1.2.3. Decision-making information	38
1.2.4. The ideal decision support system	40

1.3.	Lack of knowledge	42
1.3.1.	Types of uncertainty	42
1.3.2.	Maturity and uncertainty	45
1.4.	Product and knowledge representation	46
1.4.1.	System dimension	47
1.4.2.	Model diversity	47
1.4.3.	Multi-representation and data consistency	49
1.5.	An industrial problem and need.....	49
1.5.1.	ADN project	50
1.5.2.	Identification of an industrial problem and need	51
1.6.	A need to take into account the lack of knowledge in decision making	55
2.	Maturity, data qualification and knowledge models.....	58
2.1.	Introduction	58
2.2.	Qualitative approaches	59
2.2.1.	Data qualification	60
2.2.2.	Model qualification	64
2.3.	Quantitative approaches	67
2.3.1.	Fuzzy sets	68
2.3.2.	Possibility theory.....	68
2.3.3.	Evidence theory.....	69
2.4.	Knowledge and product models	71
2.4.1.	PPO: Product process organisation	74
2.4.2.	CPM: Core product model	76
2.4.3.	MOKA: Methods and tools oriented to knowledge acquisition.....	78
2.4.4.	KCM: Knowledge configuration model.....	80
2.4.5.	Colibri.....	82
2.4.6.	Other models	87
2.5.	Towards a mixed approach.....	89
3.	Indicators of the learning process to manage collaborative design activities.....	97
3.1.	Positioning	97

3.2.	Implementation methodology of the metric	99
3.3.	A metric to define the maturity of a mechanical system	101
3.4.	Illustration of the metric's use: an aero engine.....	102
3.4.1.	Use of the metric in the case study.....	103
3.4.2.	The obtained results	106
3.5.	Meta-model of knowledge to help decision making	112
3.5.1.	Knowledge meta-modelling	113
3.5.2.	Data meta-modelling	115
3.5.3.	Collaboration meta-modelling.....	116
3.5.4.	Meta-model of specification.....	117
3.5.5.	Application of the meta-model to the KCM.....	119
4.	Feasibility and relevance: two levels of validation.....	127
4.1.	Feasibility: case study.....	127
4.1.1.	Industrial case study	127
4.1.2.	Design iterations.....	128
4.1.3.	Knowledge structure point of view	139
4.2.	Relevance: expert evaluations: scientific and industrial.....	144
4.2.1.	Scientific experts	145
4.2.2.	Industrial experts	148
5.	Conclusion	152
5.1.	Summary of the contribution.....	152
5.2.	Future work and perspectives	157
	References	161
6.	Appendices.....	173
6.1.	Interview 1	173
6.2.	Interview 2.....	181
6.3.	Realised presentation to the researchers	189
6.4.	Feedback by researcher 1	198

6.5.	Feedback by researcher 2	202
6.6.	Presentation during the ADN project (PhD and metric).....	206
6.7.	Presentation during the ADN project (MMK).....	214
6.8.	Reviews	222
6.8.1.	INCOM'12	222
6.8.2.	ICED'13	224
6.8.3.	PLM'13	228

List of figures

Figure 1: Structure of the PhD thesis	26
Figure 2: Whole product lifecycle (Jun, Kiritsis et Xirouchakis 2007)	30
Figure 3: Design process (Pahl et Beitz 1996)	31
Figure 4: The value of information (Ullman et D’Ambrosio 1995)	37
Figure 5: Decision-making information (D. Ullman 2001)	38
Figure 6: Uncertainty classification for the design of complex systems (Thunnisen 2005)....	43
Figure 7: Uncertainty of information from transmitter to receiver (Grebici, Blanco et Rieu 2005).....	63
Figure 8: Schema of the representation of the PEPS of a model of an ideal architectural design (Vernat 2004).	67
Figure 9: The views project, process and organisation of the IPPOP project (Noel, Roucoules et Teissandier 2004)	74
Figure 10: The product model in the IPPOP project (Noel, Roucoules et Teissandier 2004). 75	
Figure 11: The CPM (Sudarsan, et al. 2005).....	77
Figure 12: The MOKA product model.....	79
Figure 13: KCM positioning relative to product models and the PLM approach (translated from (Badin 2011)).....	81
Figure 14: The three parts of the KCM meta-model.....	81
Figure 15: Interdisciplinary constraints between product models	83
Figure 16: System architecture of Colibri	84
Figure 17: DMU of the innovative service vehicle	85
Figure 18: Design of a wheel suspension assisted by Colibri	86
Figure 19: Hanari’s product model (Harani 1997).....	88
Figure 20: Research methodology.....	92
Figure 21: Decision making in preliminary design and under uncertainty (learning process) 98	
Figure 22: Case study: Full assembly	103
Figure 23: Obtained results: Maturity level	107
Figure 24: Obtained results: Performance level	108
Figure 25: Obtained results: Sensitivity/sustainability (user point of view).....	109
Figure 26: Obtained results: Shaft.....	110

Figure 27: Obtained results: Vane wheel	111
Figure 28: Obtained results: Product.....	111
Figure 29: MMCore package and its extensions.....	114
Figure 30: MMCore package description.....	114
Figure 31: DMM package description	115
Figure 32: CMM package description.....	117
Figure 33: Description of the meta-model of specifications	118
Figure 34: Application of the MMD in the KCM	122
Figure 35: Application of the CMM in the KCM	123
Figure 36: Application of the KMM to represent the knowledge process.	125
Figure 37: Scenario of the case study defined in the ADN project and in partnership with industry (automotive and aeronautic).....	128
Figure 38: CAD model of the actual case (iteration 1)	129
Figure 39: FEM of the actual case (iteration 1)	130
Figure 40: Second design iteration of the industrial case.....	134
Figure 41: CAD model of the actual case (iteration 1)	137
Figure 42: FEM model of the actual case (iteration 1)	138
Figure 43: Object diagram of the KMM application to the scenario (iteration 1)	140
Figure 44: Object diagram of the KMM application to the scenario (iteration 2)	141
Figure 45: Instantiation of the KMM in the case study.....	142
Figure 46: Instantiation of process knowledge in the case study	143
Figure 47: Slide 1 of the presentation	189
Figure 48: Slide 2 – Personal presentation.....	190
Figure 49: Slide 3 – Content of the presentation.....	190
Figure 50: Slide 4 – Preliminary design.....	191
Figure 51: Slide 5 – The collaborative dimension	191
Figure 52: Slide 6 – Uncertainties in decision making	192
Figure 53: Slide 7 – Presentation of the identified problematic.....	192
Figure 54: Slide 8 – Research questions	193
Figure 55: Slide 9 – Principle and scientific locks.....	193
Figure 56: Slide 10 – Definition of maturity.....	194
Figure 57: Slide 11 – Proposal: start point of the methodology.....	194
Figure 58: Slide 12 – Proposal: methodology and metric	195

Figure 59: Slide 13 – Proposal: methodology and metric	195
Figure 60: Slide 14 – Proposal: methodology and metric	196
Figure 61: Slide 15 – Proposal: metric composition	196
Figure 62: Slide 16 – Application and results	197
Figure 63: Slide 17 – Questions	197
Figure 64: Slide 1 – Data and knowledge qualification: to evaluate the maturity of a system	206
Figure 65: Slide 2 – Content	207
Figure 66: Slide 3 – Decision making in preliminary collaborative design	207
Figure 67: Slide 4 – Context presentation and problematic	208
Figure 68: Slide 5 – Research questions	208
Figure 69: Slide 6 – Metric principle	209
Figure 70: Slide 7 – State of the art.....	209
Figure 71: Slide 8 – Maturity definition.....	210
Figure 72: Slide 9 – Evaluation of the maturity of a system.....	210
Figure 73: Slide 10 – Association sensitivity and sustainability.....	211
Figure 74: Slide 11 – PDM view of the metric	211
Figure 75: Slide 12 – Design iteration	212
Figure 76: Slide 13 – Result of the metric	212
Figure 77: Slide 14 – Acknowledgements	213
Figure 78: Slide 1 – Meta-model of knowledge.....	214
Figure 79: Slide 2 – Content	215
Figure 80: Slide 3 – Part 1.....	215
Figure 81: Slide 4 – Definition of maturity.....	216
Figure 82: Slide 5 – The factors of the metric.....	216
Figure 83: Slide 6 – Part 2.....	217
Figure 84: Slide 7 – Implementation on the academic scenario	217
Figure 85: Slide 8 – Implementation on the academic scenario: iteration 1	218
Figure 86: Slide 9 – Implementation on the academic scenario: iteration 2	218
Figure 87: Slide 10 – Part 3.....	219
Figure 88: Slide 11 – Meta-model of knowledge.....	219
Figure 89: Slide 12 – Meta-model of knowledge: description.....	220
Figure 90: Slide 13 – Impact of the ADN heart	220

Figure 91: Slide 14 - Impact of the ADN heart (2) 221

Figure 92: Slide 15 - Conclusion..... 221

List of tables

Table 1: State of the art of the approaches	59
Table 2: Sustainability levels (Gaudin 2001).....	60
Table 3: Variation levels of an activity (adapted from Krishnan (1996)).....	61
Table 4: Sensitivity levels of information (adapted from Yassine, Falkenburg et Chelst (1999)).....	61
Table 5: Levels of completeness of information (Grebici, Ouertani, et al. 2006)	62
Table 6: State of the art synthesis and positioning.....	91
Table 7: Representation of the data at the end of the first iteration	103
Table 8: Representation of the data at the end of the second iteration.....	104
Table 9: Representation of the data at the end of the third iteration	104
Table 10: Representation of the data at the end of the fourth iteration	105
Table 11: Representation of the data at the end of the fifth iteration.....	105
Table 12: Representation of the data at the end of the sixth iteration	106
Table 13: Positioning of the different modelling levels.....	113
Table 14: Design iteration number one	132
Table 15: Performance and maturity levels at the end of the first design iteration.....	133
Table 16: Design iteration number two.....	135
Table 17: Performance and maturity levels at the end of the second design iteration.....	138
Table 18: Synthesis of the scientific experts' evaluations	145
Table 19: Synthesis of the industrial experts' evaluations.....	148

Introduction

Introduction

Today, collaboration, integration and simultaneous engineering are keywords in product design. The design process is complex and dynamic, due, in part, to the volume of manipulated data and models, the number of exchanges among the different design and business teams interacting during the process, and the product development requirements within concurrent engineering (CE) (Belson et Nickelson 1992). There is an increasing tendency for design teams to anticipate the later phases of the product lifecycle by making assumptions and by taking into consideration their experiences and “know-how”. Robust design of systems, distributed design and integration necessity constitute major challenges that necessitate the use of quality approaches for the control of product performance, collaborative engineering tools to support CE and collective decision making.

Product data management (PDM) systems (Tony Liu et William Xu 2001) assist in the management of product data, the process of product development, and product realisation and documentation. Through the integration of data, models and generated knowledge, PDM systems are valuable in supporting the design of multi-disciplinary systems that involve a number of collaborative distributed organisations.

Product development cycles, and more generally product lifecycles, are becoming increasingly complex (Tony Liu et William Xu 2001). By complexity we mean that they involve a large number of different businesses using specific vocabulary and work methods. These businesses operate simultaneously and must integrate different viewpoints, creating problems relating to the management of modifications and consideration of the impacts of change. It is, therefore, a necessity to be able to qualify the data or information in the upstream phases of product design.

Moreover, in collaborative design, the involved designers are working together to design the product according to customer specifications (Maranzana et Gartiser 2008). The project leader and the project group (a set of designers from different companies, with knowledge and skills in various fields) try to build and maintain a shared vision of the problem and solve it together (Dillenbourg et Baker 1996). Everyone contributes according to their specific knowledge (Kvan 2000). Milestones can be programmed to bring together the work of each one, to obtain

the approval of the hierarchy, and to define the following tasks to be performed, but the goals or subgoals of these tasks are not defined beforehand (Darses et Falzon 1996). During the different stages of the design process, designers from different fields work together to exchange information, expertise, ideas and resources and together to build and solve the problem; in this context, communication among members, in addition to coordination, is seen as vital (Sun et Bakis 2003). The collaborative activity is synchronised and coordinated through the collaborative process in order to build and maintain a shared vision of a problem or situation among all stakeholders to jointly address the problem (Dillenbourg et Baker 1996). However, this is not enough; we must not neglect the social and organisational aspects necessary for collaborative design (Detienne 2006).

Again, using the terms defined above, we can conclude that in collaborative design at least two mechanisms are involved:

- Coordination of all the designers' knowledge requires the definition of shared knowledge repositories to support the problem-solving process. This coordination is different from the organisation of the distributed design because it is based more on the management of knowledge to contribute together to the common goal. That is why we have termed it cognitive coordination (De la Garza et Weill-Facina 2000).
- Collaboration among actors, that is to say, working together to achieve a common task (De la Garza et Weill-Facina 2000).

The success of any collaboration process is strongly linked to the need for shared knowledge among the actors which ensures that a common representation of the problem is built and solved. However, the shared data is composed of a set of fragments that are created by various actors according to their expertise domain. An important aspect to be considered is then the consistency of interconnected data coming from different sources and the structure of this data, that is, the rational design of all the essential elements to allow the data to make sense.

In the literature, the definition of knowledge is still concerned with divergence. However, different disciplines seem to converge today on a characteristic key of knowledge: knowledge does not exist outside of an individual; it is the order of cognitive performance (Ganascia 1996). For Prax (2000), knowledge is the result of the acquisition of information and action, it is a representation of both memory and process construction.

The distinction between knowledge and information is not always obvious. According to (Murray 1996), similarly to information, knowledge answers the “what”, but also responds to the “why” and “how”. Other authors, such as (Skyrme 1994), believe that knowledge, with respect to information, specifically depends on a cognitive human activity. It is a combination of the meaning from context, personal memory and the cognitive process. This definition is similar to that proposed in (Ermine 1996) where knowledge is seen as “information that is of some significance in a given context”. According to (Gardoni 1999), “knowledge materialised by processed information must be synthesised in order to systematize and reuse”.

For Nonaka et Takeuchi (1995), “knowledge is a true belief and justified by the context, assigns true belief in an individual or a community”. In 1995, these authors published a book on the formation of knowledge and its use in Japanese companies (Nonaka et Takeuchi 1995). In this book, the authors propose the creation of a model and the transfer of knowledge using four modes:

- Combination is the process of creating explicit knowledge from the restructuring of a set of explicit items of knowledge already acquired.
- Internalisation is the process of converting explicit knowledge and tacit knowledge with the learning process.
- Socialisation is the process of transmitting tacit knowledge by verbal exchanges, by observation, imitation and especially by practice.
- Outsourcing is the process that allows the passage of tacit knowledge into explicit knowledge in the form of concepts, models or assumptions.

This model involves two types of knowledge: explicit knowledge (or explainable) is the knowledge that can be easily retrieved and displayed on sharable media. In contrast, tacit knowledge is difficult to explain or impossible to imitate (Polanyi 1996). These two categories are associated respectively with concepts of knowledge and expertise (Grundstein 2001).

We do not return to the details of these types that pose questions about the boundaries between tacit and explicit knowledge, the boundaries between knowledge and know-how (Bonjour, Micaelli et Dulmet 2005). We hold that knowledge is storable in the memory of the individual and must be reconstructed at each reuse. All the other storage media are “knowledge-based” systems. They can, in no case, have knowledge (in the proper sense of the

word), but they manipulate a specific form of information and descriptive data of explicit knowledge. If information is a set of data which is associated with semantics, knowledge, in turn, is associated with a cognitive structure for interpreting a set of information to conduct an argument in a particular situation (or context of use) and for a stated purpose (finalised, problem-solving activity, decision ...).

In this PhD, we try to understand the way of structuring data for decision making. We focus on the early phases of collaborative design when uncertainty and lack of knowledge have to be considered. We propose a meta-model for knowledge representation, integrating maturity to support decision making in preliminary collaborative design. Maturity is defined and a metric, based on a mixed qualitative and quantitative approach, is proposed to qualify and characterise the lack of knowledge during the decision making in the preliminary collaborative design of mechanical systems. The PhD thesis is structured as illustrated by Figure 1.

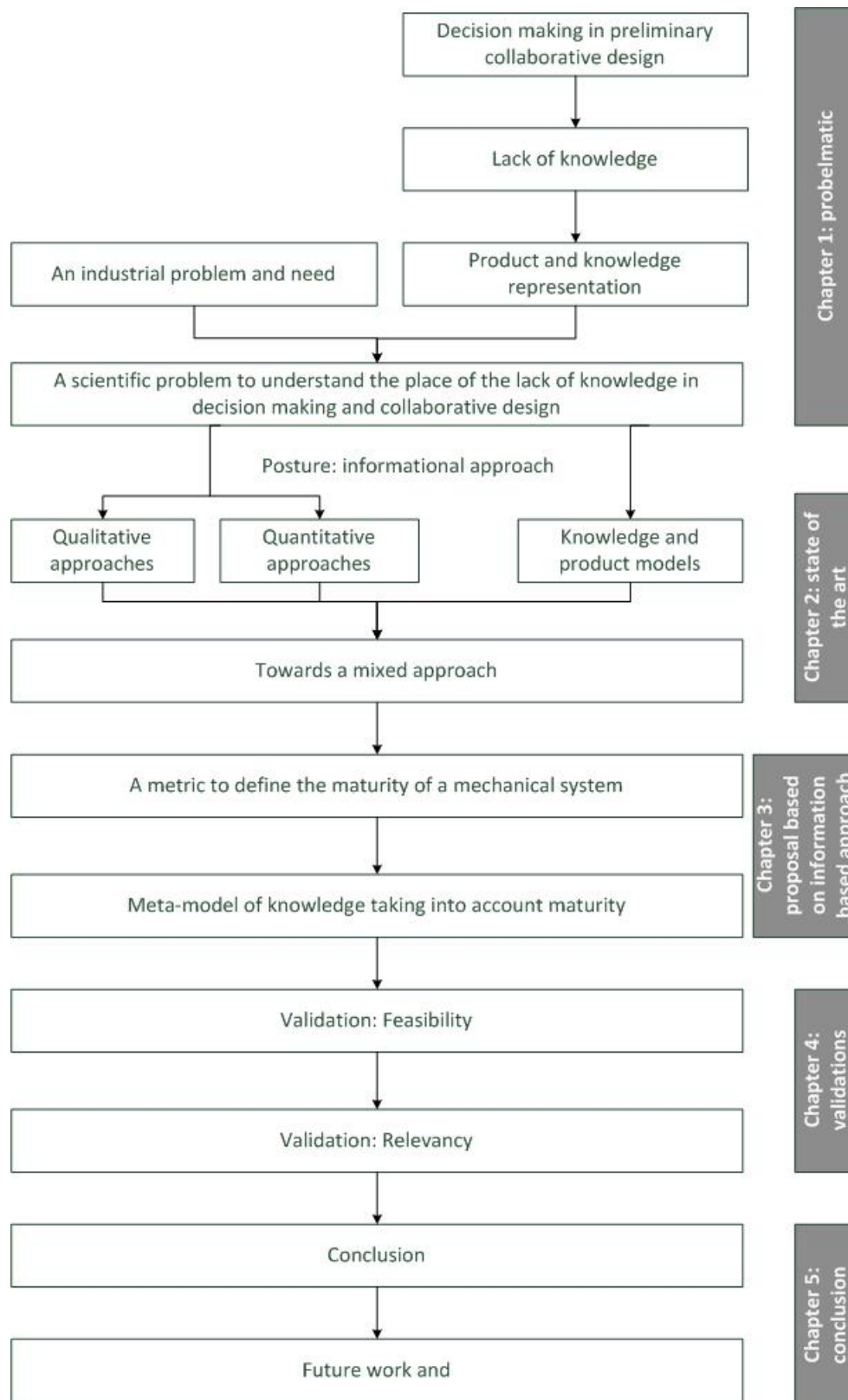

Figure 1: Structure of the PhD thesis

Chapter 1 presents the decision making in preliminary collaborative design. Context and problem definition are presented and illustrated based upon two aspects: a scientific literature review and the industrial need as identified in the ADN¹ project. Scientific literature, analysis of the current work, observations, discussions and meetings are the basis of the realisation of this part. We start with a description of the design activity and the collaborative aspect of design, we then define decision making. We identify the lack of knowledge, especially in preliminary design, and define different types of uncertainties. We identify several problems relative to product and knowledge representation, data consistency, collaborative aspect and multi-representation. At the same time, we focus on industrial problems and needs, using the ADN project and other collaborations, especially in the aeronautics industry. Finally, we conclude this first chapter with the need to understand how to take into account the lack of knowledge in decision making in the context of preliminary collaborative design (problematic and research questions).

Chapter 2 presents the state of the art, answering the identified problematic and research questions. Maturity, data qualification and knowledge models are identified and presented. An analysis of these concepts is achieved and structured in three parts: qualitative approaches, quantitative approaches and knowledge and products models. We conclude this second chapter by our positioning based upon the analysis of these concepts, the choice of the mixed approach to evaluate maturity and the applied methodology used to build the proposal.

Chapter 3 presents an information-based approach, a knowledge meta-model taking into account data maturity to help decision making in preliminary collaborative design. We start this chapter by presenting and explaining the proposed metric to define the maturity of a mechanical system and then we present the implementation methodology allowing this metric to be built. We illustrate these two parts by an implementation of the metric in an actual case (an aero engine). Once we have the metric (the basis of the proposal), we present the meta-model of knowledge to help decision making, taking into account maturity (metric) in order to qualify and characterise the lack of knowledge in the upstream phase of the design of mechanical systems. This meta-model is decomposed into three parts (knowledge, data and collaboration).

¹ ADN : Alliance des Données Numériques, FUI9 project funded by local communities Franc-comtoises and FEDER, and co-labelled with clusters System@tic (Ile de France) and ITrans (Nord Pas de Calais - Picardie).

Chapter 4 is the validation of the proposal. We present two levels of validation: feasibility and relevance. Feasibility represents the implementation of the meta-model in an actual industrial case by the use of an existing product model, KCM (knowledge configuration model). This actual case has been developed in partnership with industry in the context of the ADN project. The second level of validation is relevance and justifies the scientific and industrial interests and the adequacy of the proposed meta-model integrating the maturity concept.

Finally, we close this manuscript with the chapter on the conclusions and perspectives. It is divided into two parts. The first is a summary of the current work, analysis and criticism. The second is a presentation of future work and perspectives.

Chapter 1: Decision making in preliminary collaborative design

1. Decision making in preliminary collaborative design

1.1. Preliminary collaborative design

1.1.1. Product lifecycle and design process

Product lifecycle management (PLM) is the process of managing the entire lifecycle of a product from its first concept, through design and manufacture, to service and disposal (Figure 2) (Jun, Kiritsis et Xirouchakis 2007). PLM integrates people, data, processes and business systems and provides a product information backbone for companies and their extended enterprises (Saaksvuori 2008). PLM systems help organisations coping with increasing complexity and engineering challenges to develop new products for global competitive markets.

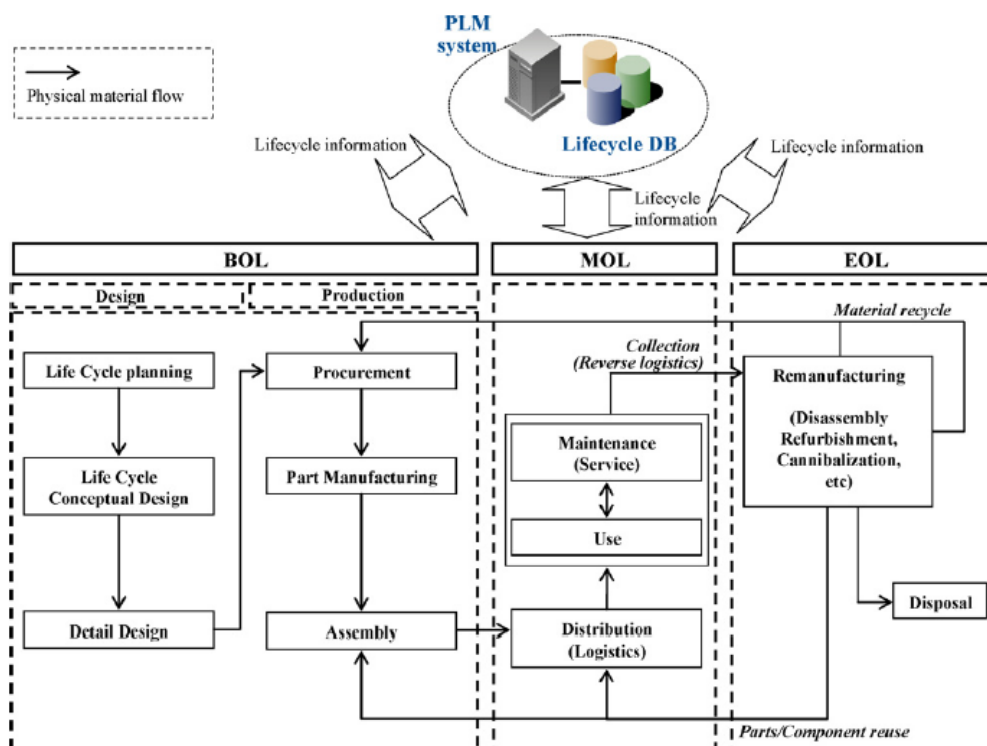

Figure 2: Whole product lifecycle (Jun, Kiritsis et Xirouchakis 2007)²

We distinguish five main steps in the product lifecycle: design, production, use and maintenance, end of life and extraction or elimination (Jun, Kiritsis et Xirouchakis 2007).

² BOL: Beginning Of Life // MOL: Middle Of Life // EOL: End Of Life // DB: DataBase // PLM: Product Lifecycle Management

This cycle is very complex due to the various integrated factors, such as data, processes, resources, recycling, and so on. We focus our research work on product design. It is the first step of the product lifecycle because we must make strategic decisions that influence the entire lifecycle of the product.

In their book, Pahl et Beitz (1996) have proposed a theoretical model structuring the progressive course of the design process. This model has four phases. It has proven its effectiveness and has been adopted as a baseline by different companies and research and development centres. The AFNOR³ standard used this model as the basis to develop standard definitions of the design process. Figure 3 shows the four phases of the design process.

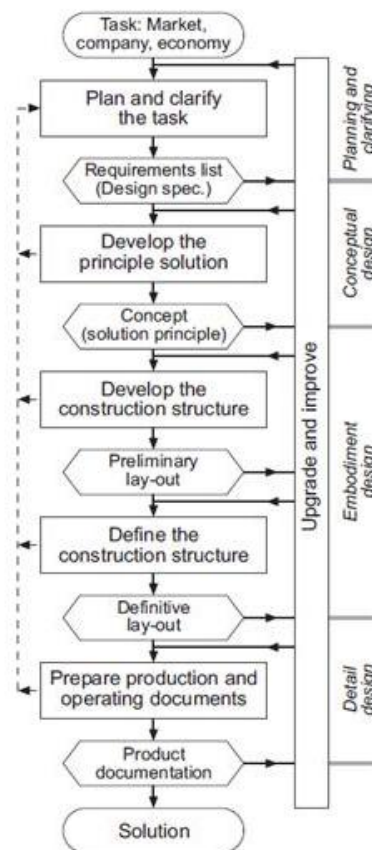

Figure 3: Design process (Pahl et Beitz 1996)

³ AFNOR: Association Française de Normalisation

- Analysis and clarification of the need (product planning and clarifying the task) can re-express the need in technical language, understandable by all design stakeholders. The specifications, the result of this phase, include all functional specifications of the expected product.
- The principle of design (conceptual design) specifies the set of principles and technological options to meet the specifications. This phase is complemented by a functional analysis and technical evaluation of all the solutions and principles found so that only the best are retained.
- The overall design (embodiment design) focuses on achieving the retained solution, starting with developing the main axes of the adopted solution (preliminary plans) and, thereafter, gradually improving this solution. This is to provide the calculations and size of the general structure and consolidate the plans.
- The detailed design consists of making the final changes to the product structure, defining the tolerances, specifying the manufacturing process, identifying and designing all the components and all the links that connect them, and finally defining the means and modes of production. At the end of this stage, the product is finalised. In addition, reliability testing in prototype experiments can be performed.

The upstream phases of design are represented by problem definition, conceptual design and embodiment design (ceasing at product documentation). We focus on the design activity to highlight its complexity, before describing more precisely the collaborative dimension and the need to make decisions in preliminary collaborative design,

1.1.2. Design activity

Design is a complex activity and its characteristics have been identified by several researchers (Blanco 1998), (Lhote, Chazelet et Dulmet 1999), (Darses 2001), (Micaëlli et Forest 2003) (Perrin 2001). The design is a creative, projective and complex activity. The design content should devise, implement and validate a solution better than an existing solution. It involves heterogeneous constraints and many contexts. It must be solved in finite time, so that the solutions are more or less acceptable: there is no single “best” solution and there is no predetermined path to reach the solution. Design activities are organised and managed. The

design of complex systems requires structuring processes to meet customer expectations and the organised mobilisation of many actors belonging to different departments or trades. The organisation of the design is the result of a design activity driven primarily by organisational managers. The role of project management at the operational level is to plan the progress of activities, to monitor performance (measurement of differences between actual and projected goals), to validate the results of project reviews and take corrective action when deviations occur.

Design is based on a progressive, iterative and interactive informational process, and is a decision-making process. The system design is imagined, developed, produced and refined and so on, step by step. The designer must repeat some tasks several times to adjust the values of the parameters of the solutions. Design is a process in which there is a permanent interaction between the actors and the producers of intermediate objects. The role of these intermediate objects, as shown by Blanco (1998), is mainly to keep track during the project design and to serve as a means of understanding among the different actors. This activity requires many decisions, choices and trade-offs in all phases. We can distinguish the technical decisions that bear on the choice of solutions, conflict management decisions, project review decisions and management decisions. Most of the time, these decisions are critical being both unreliable and expensive, or weakly reversible. Design mobilises and develops skills. Managers must not only ensure the adequate allocation of tasks, the operational management of projects or that designers design, they must also develop and manage a process of skills development to ensure the future competitiveness of the company.

Moreover, design is subject to a double evaluation: outcome and follow-up. In the first case, the design activity can be evaluated using different criteria: degree of innovation, respect for the constraints of the design problem, or development of skills. In the second case, assessment is used to guide the project and manage the uncertainty inherent in the problem (the triptych quality, cost, time, robustness of the solution...). The designer must be able to assess the robustness of the current technical solution, deal with any changes in the constraints and measure the maturity of the design process. Effectively, design is an instrumented and cognitive activity, manipulating and generating knowledge, based on different representations (models, diagrams, models, prototypes ...). This instrumentation must also enable designers to manage marketing, technical and industrial aspects (product families, modules, platforms ...).

It is focused on the designed object (knowledge), the process of conception, organisation or its management.

A consequence of the complexity of the design activity is that this activity needs to integrate multiple perspectives (cognitive, technical, social, economic, organisational, etc.). It is collective and not individual, as we shall see below, a collective activity with often strong interdependencies among the actors who come from several different disciplines. Two other major characteristics are also considered. They concern respectively the variety and the use of a large body of knowledge and the various skills needed to address this complexity, requiring the development of methods and tools to help designers to improve the performance of their activities.

1.1.3. Collaborative aspect

Design is unanimously regarded as a collective activity that builds-in “reciprocal relationship requirements” (De Terssac 1996). Each actor develops their own representation of the problem and treats it as a problem that is specific to their level. However, at the top level, areas of common representation are needed for consistency during integration (Perrin 1999). Identities or subjects of design come from different cultural and disciplinary fields requiring mutual understanding mechanisms. The satisfaction of this need requires interaction with its prescribers.

The role of cooperation is crucial in the design process (Boujut 2000). A collective effort is needed from all stakeholders in the design team. These efforts must be coordinated effectively. Therefore, new approaches, called global design, must take into account several aspects summarised according to Bernard’s four points (Bernard 2000):

- better integration among product models to avoid conflicts,
- integration of manufacturing constraints and use in the design,
- taking into account the opinion of the consumer, as well as the economic and socio-technical considerations, upon completion of the specifications,
- the integration of distributed and multi-character views of the design.

Different objectives of cooperation in design can be identified, namely:

- Achieve better project organisation, and therefore better management of it. This organisation seeks to better optimise the efficiency of all the skills involved.
- Have as much information and knowledge available within the company and outside the company. This knowledge is distributed over different levels and by different actors with specific businesses (Mer et Laureillard 1998).
- Harmonise decisions (coordination and synchronisation) among collaborating centres to take into account the impact of a decision from centres upstream and downstream and conversely, feedback to the upstream centre after a given decision downstream.
- Contribute to the integration and regulation of the dynamic of the activities involved in the design. This dynamic is often disrupted by three factors (Lefebvre, Roos et Sardas 2002): the dynamics of knowledge, the creation of new skills and the influence of the professional identity and experience of each designer.

However, despite the interest given to the collaborative aspect of design, there is difficulty in finding a unified glossary in this area. The term “cooperation” is used in different ways and many types of collaboration formats are thus proposed, based on disciplines and needs (De la Garza et Weill-Facina 2000).

This first section has defined the context of preliminary collaborative design. Each actor develops their own representation of the problem and works on it. Different views are developed by each actor as a function of their activity and experience. Put simply, these different views necessitate making decisions and choices. The following section defines decision making, the information needed and the ideal decision support system.

1.2. Decision making

1.2.1. The need for decision in design activity

Decision making in preliminary collaborative design implies selecting an alternative design and moving towards the next design iteration. Several factors are considered in order to make the decision, such as market demand, design alternatives, designer’s preferences and uncertainties (Besharatia, Azarm et Kannan 2006) (Antonsson et Otto 1995) (D. Ullman, The ideal engineering decision support system 2001). We focus on the “uncertainties” factor

because we hypothesise that they can represent the lack of knowledge in decision making (for epistemic uncertainties). Decision making enables a new definition of the mechanical system to be obtained. Maturity level is a characteristic often used to qualify information in design (Grebici, Blanco et Rieu 2005). It can be defined as the degree of improvement through a predefined set of process domains in which all objectives of the set are completed (Beth, Konrad et Shrum 2007).

Decision making is needed to solve a problem, but different values of information exist that are not equal in solving the problem. In the following section, the value of the information in the decision pyramid among decision, judgement, knowledge, behaviour, models, relationships and data is presented.

1.2.2. The decision pyramid

Not all types of information are of equal value in decision making. In Figure 4, seven classes of information are shown (D. Ullman 2001). The most basic form of information is raw data. Raw data comprises numbers, textual clauses or other descriptive information about some object or idea. Models are a form of information that represent the relationships among data. These relationships may be mental pictures of a situation, maths equations, full sentences or paragraphs, or graphic images that relate basic data resulting in a richer form. These models are static relationships among the data. During evaluation, if an alternative is found that does not meet a criterion, there is no guidance as to how to change the alternative to better fit the need. The behaviour of models must be understood and interpreted. It is the knowledge gained during evaluation that we use to refine the alternatives and criteria. Finally, when knowledge is enough, decisions using judgement based on this knowledge can be made. Thus, according to this argument, the most valuable type of information is a decision, as it is based on all the valuable information types. In other words, decision-making support requires the management of data, models and knowledge, and the associated judgement on which decisions are based.

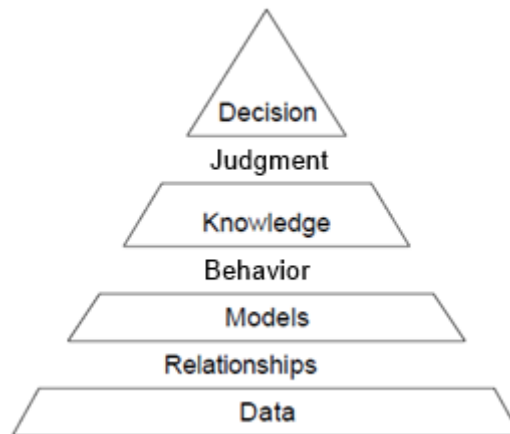

Figure 4: The value of information (Ullman et D'Ambrosio 1995)

If, for example, someone interested in buying a new computer system looks online or in a catalogue and finds all kinds of data on processor clock speed and memory size for each alternative computer under consideration, if the relationships among these data are known, there is a model of how a potential computer might perform. In fact, some of the computer magazines generate measures based on such models. Someone who has worked with computers enough (i.e. has enough knowledge of computer systems), can use the data and models to actually predict the performance of the computers under consideration. Furthermore, knowledge helps to determine the criteria for selecting the new computer from among the alternatives. Based on this knowledge, data and models, individual judgement is used to make a decision about which computer is best to buy. Decisions are dependent on the weaker types of information (D. Ullman 1997) (D. Ullman, The ideal engineering decision support system 2001). “Problem solving is generating and refining information punctuated by decision-making”, both generation and refinement use data, models and knowledge coupled through relationships and behaviours.

Each piece of information has a different value in problem solving and decision making, but different types of information exist (categorised in different classes). The following section presents these different classes and the articulation and relationships among them to define decision-making information.

1.2.3. Decision-making information

The types of information used in decision making are shown in Figure 5 (D. Ullman, The Ideal Engineering Decision Support System 2001). Each of the classes of information and their relationships shown in the figure are defined in the text below.

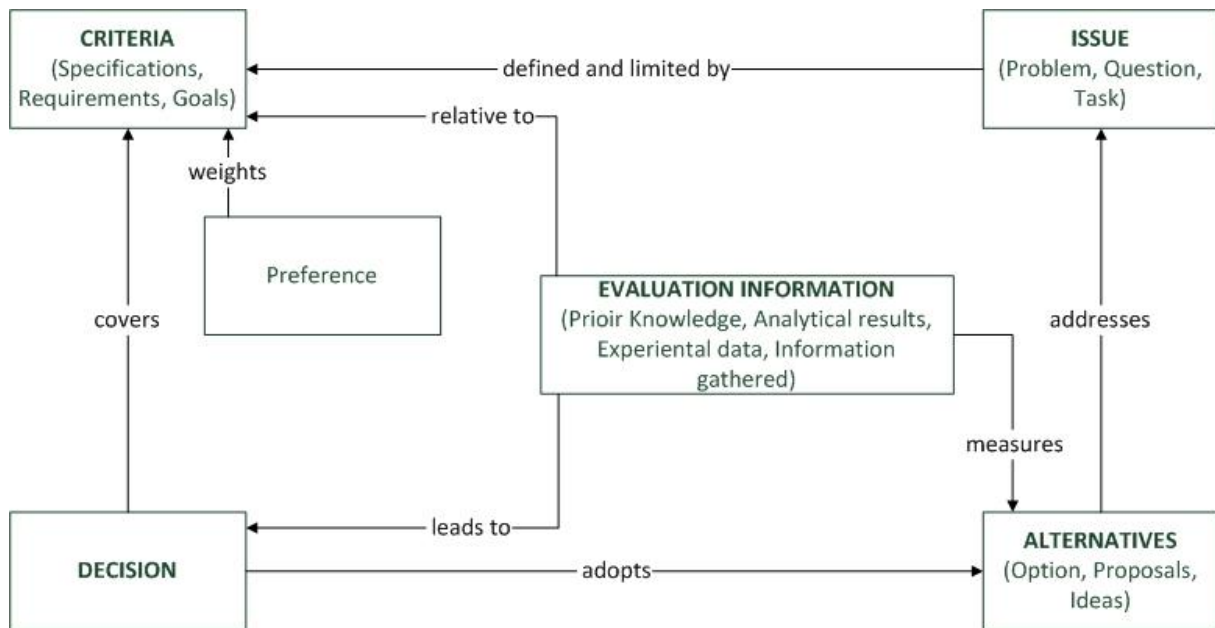

Figure 5: Decision-making information (D. Ullman 2001)

Issue: An issue is a call for action to resolve some questions or a problem. An issue is defined and limited by the criteria used to measure its resolution (D. Ullman, The Ideal Engineering Decision Support System 2001). Issues are generally expressed as the desire to change, design, redesign, create, fix, develop, or choose an object which meets a number of stated and unstated criteria. The term “object” in the previous definition can mean any technical or business system, assembly, part, or feature. It can refer to hardware, electric device or software. It can refer to the form or function of the object.

Criteria: Criteria limit solutions raised by an issue. There are two major parts to a criterion, the attribute of the alternative measured and a target value for the attribute. The term “criterion” is used synonymously with “requirement”, “goal” or “specification” as all limit the space of acceptable solutions for the issue (D. Ullman, The ideal engineering decision support

system 2001). *Criteria are developed by the issue stakeholders, those individuals responsible for or affected by the resolution of the issue.* Each stakeholder has a preference as to the importance of each criterion to the successful resolution of the issue. The combination of the criteria and the preference for them is often called the *value model* because their combination is used to measure or place a value on the alternatives.

Alternatives: *An Alternative is an option generated to address or respond to a particular issue. The goal of the decision making is to find an alternative that the decision makers agree to adopt.* Alternatives are often called “options”, “ideas”, “proposals”, or “positions”. Any number of alternatives may be developed to resolve a design issue.

Evaluation: *Evaluation information comprises the results of determining how well the alternatives resolve the issue.* Evaluation is the activity of argumentation supported by information developed through prior knowledge, analysis, experimentation, or information gathering (e.g. expert advice). *An argument is the rationale for either supporting or opposing a particular alternative.* Argumentation measures alternatives with respect to criteria, and these arguments lead to agreements.

Decision: *A decision is the agreement to adopt an alternative(s) to resolve the issue.* Decisions are dynamic; they may later be changed as criteria and preferences change, and as new alternatives are generated (D. Ullman, The Ideal Engineering Decision Support System 2001).

The activities that generate and manage the various types of information have been studied by Ullman, Dietterich et Stauffer (1988), Stauffer et Ullman (1991), Nagy et Ullman (1992), McGinnis et Ullman (1992), Herling (1997) and many others Hales (1987), Blessing (1994). Recent papers by Girod (Girod, Elliot, et al. 2000b) (Girod, Elliot, et al. 2000a) summarise these activities well. The listing below is based on his work, but has been condensed to better serve this document.

- **Issues**
 - Generating issues
 - Organising issues to be worked on
- **Criteria**
 - Identifying criteria

- Refining criteria to ensure understanding
- Weighting criteria (establishing preference)
- **Alternatives**
 - Identifying alternatives
 - Clarifying the alternatives' working principles
 - Clarifying the alternatives' environment
- **Evaluation**
 - Establishing alternative performance relative to a particular criterion
 - Gathering external information
 - Generating analytical or experimental results
- **Decision**
 - Choosing the best alternative
 - What to do after the decision making
- **The Process**
 - Controlling the decision making process

Decision making needs different parameters, such as we have seen in this section, with a specific role. Decision allows the best alternative and the next action to be chosen. The following section presents the different criteria of an ideal decision support system in order that it can be explained to and understood by the user.

1.2.4. The ideal decision support system

An ideal decision support system should help a team to reach a better decision than they would without its use (Naude, Lockett et Holms 1997) (Payne, Bettman et Johnson 1993) and should not require an increased cognitive load. An ideal system should provide sufficient value added to the team that they want to use it. Effectively, decision making is becoming increasingly distributed, thus an ideal decision support system needs to support a team of people, complete with their inconsistent, incomplete, uncertain and evolving input. Moreover, most decisions in industry are either totally unrecorded or, at best, only the conclusion is noted in a memo. As a consequence, the logic behind the decision, the alternatives considered, the criteria used and the arguments made are all lost. This flow of decision making is often

called design rationale in engineering research (D. Ullman 1994). The importance of capturing decision information can be appreciated by looking at the results from a simple experiment (Plous 1993). The result of this experiment reinforces the point that memory is reconstructive and cannot be relied on to explain how a decision was reached or for reuse of a decision-making process in future decisions. As a consequence, an ideal decision support tool should have a traceable logic trail and information should be recorded for justification and reuse.

Information inconsistency can occur in three ways: viewpoints, evaluation and abstraction. One of the causes of the viewpoint inconsistency occurs because different people on a team represent different corporate functions or stakeholders (Naude, Lockett et Holms 1997). The second occurs when the evaluation of an alternative, relative to a criterion, is different across team members, when information is not well refined or when there is good experimental or analytical data. The last is abstraction inconsistency; the natural mix of qualitative and quantitative information found in most problems. Not all the features of a problem are based on physical laws and they cannot be easily represented quantitatively (Ehrlenspeil et Lenk 1993).

Regardless of all the other factors, decision making is always based on uncertain information. As information evolves the uncertainty usually decreases. The quality of the decision reached is dependent on the amount the team discusses previously unshared information (Winqvist et Larson 1998). But even in the most refined engineering models there are inaccuracies, variations and noise that cannot be ignored (D. Ullman 1997). Moreover, the maturing of information has been documented in a study on the evolution of constraints (McGinnis et Ullman 1992) based on the same data as used by Stauffer and Ullman (Stauffer et Ullman 1991) (Ullman, Dietterich et Stauffer 1988) (Ullman et D'Ambrosio 1995). The results of this study led the author to the statement "Problem solving is the evolution of information punctuated by decisions". Moreover, a second study (Ahmed, et al. 2000) has shown that experienced designers perform more intermediate evaluations than novices. Novices generate alternatives, implement them, evaluate how well the alternatives meet the requirements and then iterate back to generating new or refined alternatives.

Many commercially available "decision support" tools actually provide analysis that models or simulates the performance of an alternative. This type of analysis helps the user to

understand the behaviour of the proposed alternative in building knowledge. However, beyond providing information on alternative performance for specified criteria, product analysis does not directly support decision making. Thus, it has not been included in this listing. A good overview of the use of product analysis in design is provided by Fertig et al. (1997).

Decision making is needed in collaborative design, but the upstream phases of design are particularly complex, due to the lack of knowledge. It is this lack of knowledge that is introduced in the following section.

1.3. Lack of knowledge

To design a product means to integrate several technologies with strong interactions and to take into consideration different aspects, such as mechanical, electronic, and so on. Moreover, in a collaborative or an extended enterprise context, several people must work together in order to design a mechanical system efficiently (D. Ullman, *The Ideal Engineering Decision Support System* 2001) (Kvan 2000). This collaborative aspect is very important because each person has a specific point of view and way of thinking, but these people must make decisions together in order to achieve compromises and to be able to keep moving to the next design iteration until the design objectives and required technical specifications are met.

The preliminary design in the collaborative design of mechanical systems provides still more difficulties because the mechanical system is under definition (Grebici, Blanco et Rieu 2005) (Blessing 1996) (Pahl et Beitz 1996). It means that uncertainties about design data and unknown data have to be considered.

1.3.1. Types of uncertainty

Different types of uncertainty exist in the design of mechanical systems. It is necessary to classify, explain and describe them before specifying the types of uncertainty on which we will focus.

Figure 6, below, presents the classification of uncertainty in the design of complex systems (Thunnisen 2005).

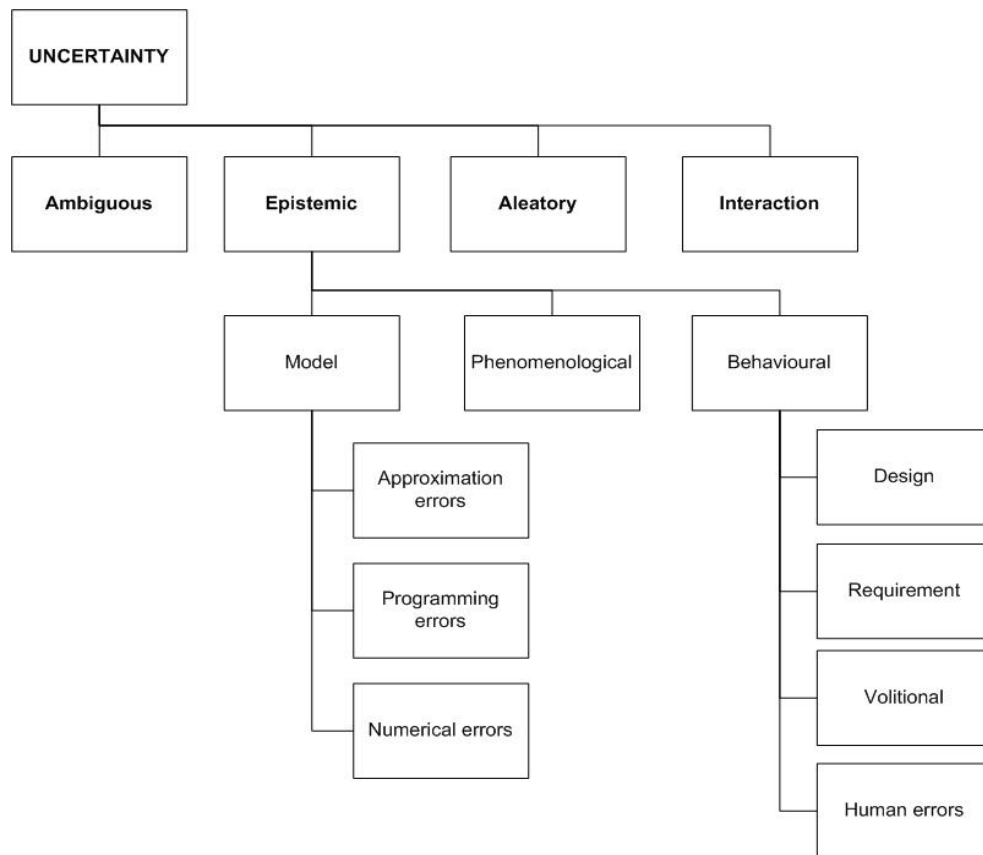

Figure 6: Uncertainty classification for the design of complex systems (Thunnisen 2005)

The classification of uncertainties for the design of complex systems, based on the classification made by Thunnisen (Thunnisen 2005) is presented in four main categories.

The first category identified by Thunnisen (Thunnisen 2005) is ambiguity. Individuals often fall into the habit of using imprecise expressions or words. When used by others who are not familiar with the intended meanings or in a setting where exactitude is important, this imprecision may result in ambiguity. Ambiguity has also been called imprecision, design imprecision, linguistic imprecision and vagueness (Antonsson et Otto 1995) (Morgan et Henrion 1990) (Klir et Folger 1988). We may note that there is some debate as to whether ambiguity is a form of uncertainty (Bedford et Cooke 2001). Different methods exist to represent ambiguity. Fuzzy logic is a formal method used for this representation (L. Zadeh 1984).

Following the classification of Thunnisen, epistemic is the second category of uncertainty. Epistemic uncertainty is also called reducible uncertainty, subjective uncertainty, model form uncertainty, state of knowledge, type B uncertainty and *de dicto* (Oberkampf, Helton et and Sentz 2001) (Bedford et Cooke 2001) (Hacking 1984). Epistemic uncertainty can be further classified, based on the work of Thunnisen (Thunnisen 2005), into model, phenomenological and behavioural uncertainty.

Aleatory uncertainty, the third category of Thunnisen's classification (Thunnisen 2005), is inherent variation associated with the physical system or environment under consideration. Aleatory uncertainty is also called variability, irreducible uncertainty, inherent uncertainty, stochastic uncertainty, intrinsic uncertainty, underlying uncertainty, physical uncertainty, probabilistic uncertainty, noise, risk, type A uncertainty, uncontrolled variations, and *de re* (Oberkampf, Helton et and Sentz 2001) (Otto et Antonsson 1994) (Bedford et Cooke 2001) (Luce et Raiffa 1957) (Hacking 1984). The mathematical representation most commonly used to represent it is a probability distribution (Oberkampf, DeLand, et al. 1999).

The last category of uncertainty is interaction. It arises from the unanticipated interaction of many events and/or disciplines. It can also arise due to disagreement among informed experts about a given uncertainty (such as a design or requirement) when only subjective estimates are possible or when new data are discovered that can update previous estimates. Interaction uncertainty is significant in complex multi-disciplinary systems, such as spacecraft, which may have many subsystems, variables and experts involved in the design.

Although the classifications provided in the computational modelling and aerospace engineering fields are thorough (Oberkampf, DeLand, et al. 1999) (Oberkampf, Helton et and Sentz 2001) (DeLaurentis et Mavris 2000) (Walton 2002) they still lack important uncertainty types. Thunnisen's classification stresses that uncertainty is a condition of not knowing. His work formally defines uncertainty as the difference between an anticipated or predicted value (behaviour) and a future actual value (behaviour). He, by his classification, has allowed uncertainties to be defined and has classified them into four categories. To follow the rest of this work, it is important to explain and understand the difference between maturity and uncertainty, because each one contributes to knowledge in a specific way. This distinction is presented in the following section.

1.3.2. Maturity and uncertainty

We define maturity based on the work of Beth, Konrad et Shrum (2007), as the association of knowledge and performance. This means that the judgement of an actor on information (transmitter and receiver) and the state of the information from the actor user of the information must be taken into consideration.

We define knowledge as a cognitive structure allowing information to be interpreted in order to follow reasoning in a particular situation (or context of use) and for a stated purpose (Ganascia 1996) (Prax 2000). The lack of knowledge, in this case, is represented by the uncertainty about the parameters of the product, for example uncertainty regarding the diameter of a part, more or less than 10 millimetres. Designers and users of the parameters define this uncertainty. Two types of uncertainty are identified in this context:

- Epistemic: uncertainty related to a lack of knowledge or information in any phase or activity of the design process. (Thunnisen 2005).
- Aleatory: uncertainty related to the variation inherent in a physical system or environment in question (Thunnisen 2005).

The link between the two uncertainties in the context of preliminary collaborative design (where the lack of knowledge is very high) is also particularly interesting because it allows past knowledge through probabilities and knowledge of the information transmitter/receiver (that represents the collaborative dimension) to be used.

Performance is the ratio between specifications of the product and the specifications achieved in the current design iteration (Boucher 2003). If no specification is respected then the performance is “0” and, in the opposite case, if they are all achieved then the level is “100%”.

In order to manage the collaborative aspect and data consistency among the different activities of the design process, a product may be decomposed into a system and subsystem and may be multi-represented (at least one representation per design activity). This product and knowledge representation allows the collaborative aspect of the design activity to be modelled and represented, as shown in the next section.

1.4. Product and knowledge representation

In system design, a product may be represented in modules, currently called modular design (cf. 1.4.1 System dimension), and allowed to share the work among different actors. Each of these actors has their own activities in the design process, such as electrical, simulation, design, and so on. These activities have their own linguistic specification;

as a consequence and in order to ensure collaboration among the different actors, an important diversity of models representing the product in the different activities exists in the activity of design,

multi-representation, collaborative aspects and product definition must be undertaken with respect to product data consistency during the decision making and design processes.

The following sections present more deeply different elements starting with system design, model diversity and multi-representation, and data consistency.

1.4.1. System dimension

Modular design is a strategy that may be used to support the design of complex products (Mtopi-Fotso, Dulmet et Bonjour 2007). Modules, as defined by Wang and Nnaji (Wang et Nnaji 2001), are elements of the product that have their own independent functionalities. Modular design provides the opportunity to reduce the design development time by sharing the work among several actors. It is a method that is closely associated with system engineering, using top-down and bottom-up approaches in its definition. The top-down phase describes the decomposition of the system and the product definition; whereas the bottom-up phase consists of the integration of modules and in the validation of the integration steps. In the top-down phase, design and simulation at higher levels provide specifications for lower levels. In the bottom-up phase, the definition is integrated by successive subassemblies: components are integrated into the product modules. At each phases of integration, a validation step is undertaken to control the process.

1.4.2. Model diversity

The upstream phases of design are characterised by the steps that define and provide the final definition of a product. Conceptual and detailed design phases use various different models to represent the product (Scheidl et Winkler 2010), the diversity of which arises from several factors:

- the diversity of activities associated with the design phases (a geometrical model from the design office, simulation models for each domain of expertise, etc),
- the complexity of the product being designed requiring a wide range of different types of expertise,
- the dynamic nature of the design process which is a learning process leading to the evolution of the models over time.

Design can generate many models, due to the diversity of activities associated with the design phases (geometric and simulation meaning 3D geometric representations, FEA⁴ models, etc.), and with respect to the behaviour to be studied, the components and the configuration of the product, as illustrated by (Scheidl et Winkler 2010) on a beam, where the different models are

⁴ FEA: Finite Element Analysis

clearly in the conceptual design phase. During these design phases, the models that are used aim to provide a representation of the product in terms of its physical description (geometric) as well as simulating its behaviour. The design of complex systems can necessitate a significant number of models, specific for each discipline and requiring a multi-view approach. Different engineering domains require different viewpoints about the product. Within an electro-mechanical product, the structural decomposition depends on the engineering domain of the expert analysing the product: an electrician models the gaps among the parts while these are of no concern to a mechanical analyst, and, typically, they will not use the same product decomposition (Noel, Roucoules et Teissandier 2004).

Another reason for model diversity is related to the complexity of the actual systems being developed (Mtopi-Fotso, Dulmet et Bonjour 2007). The complexity of the product being designed may require a wide range of different types of expertise, such as thermodynamic, electric, and so on. The aeronautic, automotive and naval industries generate increasingly complex systems. These systems are characterised by independent functionalities that, together, comprise the product (systems of systems). Complex systems are an association of several functionalities and several experts using diverse technologies and methods to achieve the required operation of the product.

During the conceptual design phase, the main activity is related to the study of concepts which offer different technological solutions with respect to the requirements and will compose the system. The architecture of the product and a preliminary sizing (shape and material) result from this activity. During the detailed design, the physical representation model has a finer level of granularity, as detailed by Scaravetti et al. (2005). The design environment can generate many models (geometric and simulation), with respect to the concept to be studied, the components and configuration of the product. All of these models evolve over time due to the different decision-making and design iterations. The design process has a dynamic nature and is a learning process leading to the evolution of the models over time.

Upstream phases of design need important model diversity in order to assure a good representation of the product in the different activities of the design process. But, the collaborative dimension, as previously seen, uses this model diversity in order to perform. In this context, it is necessary to ensure the data consistency of the product.

1.4.3. Multi-representation and data consistency

The design of complex systems can necessitate a significant number of models, specific for each discipline and that require a multiple-view approach. The models' diversity and the different points of view that interact in the design process use the same data and particular data. In this context, it is important to ensure data consistency in order to allow the different designers to collaborate efficiently and to be sure to use the right data. Moreover, in order to support knowledge mapping and to ensure consistency among different models, meta-models can be proposed within generic semantic and rich representations of the concepts and relationships among them. The goal is to propose a conceptual framework that facilitates the definition of heterogeneous knowledge models, integrating maturity in order to help in the decision making. In this way, data consistency will be ensured and the decision-making process will be sure to use the right information for the right design activities.

To conclude, lack of knowledge is a key point in decision making and the objective of this PhD thesis is to better understand decision making during the upstream phases of design in order to help designers in their decision making. We have seen and identified different problems and difficulties, making decision making difficult and complex. Effectively, the collaborative dimension, model diversity, lack of knowledge, uncertainties and multi-representation of the product are factors contributing to decision making complexity. All these points are based on a scientific perspective but the following section identifies similar problems from the industrial point of view.

1.5. An industrial problem and need

The industrial point of view and the identification of the similar problem in decision making has been realised due to a French national project: ADN⁵. This project has been chosen because it deals with a product model (KCM⁶) to manage models consistency along design and provides an actual case study, with industrial collaboration, with respect to my PhD. Effectively, the objective is to propose a meta-model (implemented in a demonstrator) able to identify the conflicts among the different activities of the design process. It allows the time at

⁵ ADN: Alliance des Données Numériques

⁶ KCM: Knowledge Configuration Model

which the decision making is needed, in a collaborative context, to be identified. This context is also oriented by my home laboratory, Roberval at the UTC. Effectively, my position is at the intersection of the numerical mechanics and the integrated mechanics systems. The team with which I work defines information systems such as PLM. In this context, my PhD work contributes to define new IS⁷ for preliminary collaborative design.

In the first instance, we present this project in order to better understand the different activities and objectives. In the second instance, we present the results of the different interviews with the industrial representatives (see Appendices 6.1 Interview 1 and 6.2 Interview 2), who are members of the project, in order to establish a link and identify similar problems from the scientific and industrial points of view.

1.5.1. ADN project

ADN is a French national project directed by the company DPS⁸ (specialists in digital product simulation) with the following partners: PSA Peugeot Citroën, EADS and FAURECIA.

The ADN project fits into the context of manufacturing industry, particularly in the automotive and aerospace industries, where the process of designing mechanical systems has evolved from sequential engineering towards CE to improve product quality and also reduce costs and development time. To limit the number of physical prototypes and models, the use of complex methods of modelling and simulation (finite element analysis, simulation of manufacturing processes, etc.) is wide spread, and this by integrating very diverse expertise (mechanical phenomena, thermal, acoustic, etc.). Despite the existence on the market and in the companies of tools and neutral exchange formats dedicated to the management of data and models of the product (PDM⁹, SDM¹⁰, SLM¹¹, IGES¹², STEP¹³, etc.), these problems of lack of quality and low productivity in design and simulation persist and worsen, to the extent that the use of computer aided design (CAD¹⁴) modellers and variation and parametric calculation

⁷ IS: Information System

⁸ DPS: Digital Product Simulation

⁹ PDM: Product Data Management

¹⁰ SDM: Simulation Data Management

¹¹ SLM: Service Level Management

¹² IGES: Initial Graphics Exchange Specification

¹³ STEP: STandard for the Exchange of Product model

¹⁴ CAD: Computer Aided Design

tools have become generalised without any communication structure with regard to guiding the parameters of design and simulation (and business rules that underlie them) being provided. Several factors, such as unequal duration and the number of iterations between the various stages of design and simulation, mean that, very often, designers work on models whose functional (loads, thermal loads, etc.), geometric (length, width, volume, etc.) and physical parameters (Young's modulus of the material, Poisson's ratio, effort, etc.) are no longer updated or are no longer synchronised at different stages of the design process. Moreover, it appears that, in the research and calculation offices, many problems of poor quality or low productivity in design/simulation, related to the lack or absence of synchronisation parameter settings, and business rules are considered by each business working on the same parts or subassemblies and not considered together.

The purpose of the ADN project is to improve the quality and productivity of the engineering upstream phase of the product–simulation pair by stepping in early in the design process. Thus, the goal is to answer this problematic of the management of key engineering knowledge (parameters, business rules, instances of parameters, etc.), by the development of concepts and methodologies allowing a new generation of software solutions to be created.

The project provides the opportunity to access both industries in charge of new methodologies for engineering design and academic experts in engineering design methods and tools. It enables the industrial problems and requirements to be identified and discussions to take place with academic experts.

1.5.2. Identification of an industrial problem and need

EADS and PSA are two major companies in the aeronautic and automotive industries. I have met three experts from these companies in order to capitalise on a part of their knowledge and identify the current state of the design process and their problems in making a decision. They have allowed me to more precisely produce an industrial characterisation of the context and to identify the industrial requirements and the problems relative to decision making and lack of knowledge in collaborative design. This knowledge from industry has been captured due to the interviews, comprising high-level questions regarding the knowledge and decision-making process, to the use of maturity factors and their impact on the design activity. We present the interview results starting with the problem and needs identification in order to ensure that

industry and academia have the similar problems. Afterwards, we try to understand how the designer's knowledge is capitalised and represented. Based on this context, later in the interviews we focus on decision making within the process and the different indicators that could assist it. We conclude these interviews by identifying the impact of the lack of knowledge and difficulties in decision making in preliminary collaborative design in order to identify the industrial consequences. These questions allowed us to lead the interviews and to generate a discussion. Each interview is fully presented in the appendices (Appendices 6.1 Interview 1 and 6.2 Interview 2). Each interview lasted about one hour.

The interviews started with an initial observation. In decision making, industries have different deficiencies (data, information, resource, etc.) during the upstream phases of product design. They highlight that, in the upstream phases, a very important number of design choices, possibilities and alternatives exist. It is impossible to evaluate, test and analyse all these possibilities but the goal is to identify the optimum alternatives to meet the design needs and requirements. Designers write documents and reports to keep track and maintain traceability of the "good ideas" that have not been evaluated or tested in more detail for the current products, in order to capitalise knowledge and keep a set of solutions for future product design. By analysing this industrial feedback we may conclude that industry and science have similar problems with an important lack of knowledge. Moreover, in this context, a global indicator of the maturity of alternative designs or solutions will allow the number of solutions to be reduced and design choices to be more efficient.

In the interviews we focus on how the expert's knowledge is capitalised, represented and taken into consideration during decision making. In the two cases, the automotive and aeronautical industries, knowledge is capitalised in the same way, the use of shared repositories. These repositories include all the rules considered necessary for each specific design activity, like maturity, certainty and the standards. Moreover, as long as a rule is not considered as certain or mature (with reference to the TRL (Technology Readiness Level) scale composed of nine levels of maturity), it is not added to the shared repository. Another way to capitalise knowledge is by the different reports, presentations, meeting notes and communications among the different designers who, in this way, convey knowledge among the different actors (collaborative dimension). This collaborative dimension is managed, thanks, in part, to the realisation of a "tray". A "tray" is the reuniting of geographically dispersed people of different professions in the same place and in small groups over a given

period. In general, a number from 10 to 15 people meet for a maximum period of a month. This concept allows decisions to be made and collaboration to be improved among different persons, especially for future work.

Moreover, we note that a specific process to make decision does not exist (among the interviewed people) during the upstream phases of product design. Decisions are made during project meetings, discussions, milestones or presentations and two key factors are taken into consideration in making decisions: cost and time. We note, due to this feedback, that it is important to understand where this lack arises. We have seen that a decision-making process does not exist and, as a consequence, the lack of capitalised knowledge may be important. It is interesting, as a consequence, to know how maturity and uncertainty are considered in the decision-making method.

We continue the presentation of the interview results with an understanding of the process of decision making, taking into consideration maturity and uncertainty. Based on Interviews 1 and 2 (in Appendices 6.1 and 6.2) we have identified two opposing visions concerning the use of maturity and uncertainty factors in making decisions in the upstream phases of product design. The first does not use any factors, but the design and values are cadenced and fixed by several milestones. The most important values are fixed first and the others after. Parameters not fixed are, as a consequence, uncertain and if a parameter does not change during the design, this does not necessarily mean that this parameter is mature or certain. The second vision consists of evaluating the technological choices by intervals (uncertainties) and supports them by feasibility ideas provided by the experts. The problem is that this feasibility is not clearly mentioned and written down by the experts because it is relative to knowledge and experience. Moreover, a global indicator is obtained by the sum of all intervals but its interpretation, understanding and reuse are very difficult (see Question 1, Interview 1 in the appendices). We have seen in this section that the decision making, taking into consideration maturity and uncertainty, is different. In order to clarify this difference, we focus the following section on the perception of maturity factors in order to identify the deficiencies, problems and benefits that it may offer.

As mentioned by one of the industrial representatives in an interview, maturity may be a real obstacle to innovation, because designers do not want to propose their ideas without a certain and mature solution. Different indicators and factors (weight indicators (Airbus, expert

interview 1), sustainability (Gaudin 2001), sensitivity (Yassine, Falkenburg et Chelst 1999), completeness (Grebici, Ouertani, et al. 2006), etc.) exist in the literature and are needed for discussions and decision making during project meetings. The problem with these factors is their degrees of abstraction in comparison with the global product. There is meaning and utility for a specific activity but none at all for a global level. The maturity notion is really present and needed but not explicitly represented in order to provide a usable indicator. Moreover, designers strongly influence the design choices and, in fact, they voluntarily amplify the design parameter values in order to self-maintain a margin of error. This has been highlighted during the interviews. We can conclude, based on the discussions with industrial representatives and the analysis of the interviews, that the lack of maturity factor represents an obstacle to innovation.

We have seen the difficulties in making decisions in the context of preliminary collaborative design by feedback from industrial representatives and the use of factors such as maturity and uncertainty. This last point of the interviews presents the impact of the lack of knowledge in decision making in preliminary collaborative design. The obtained results are similar and presented in three thematics, corresponding to the thematic provided by the industrial representatives. These three points are based on the industrial feedback and interview analysis.

- Time and cost

These two factors are the most important because design iterations in the automotive or aeronautic industries are very expensive and the solution scope is very large. It is important to know and manage the impacts of modifications realised during the upstream phases of design before the detailed design and manufacturing start. Fixing maturity as soon as possible represents a saving in time and optimisation of the design process.

- Data, information, knowledge redundancy

Few experts know the design problematic of the specific part of product design; as a consequence, people often ask the same or the same kind of questions. As a consequence, time is wasted. Data qualification and reuse could solve this problem.

- Communication and human aspect

Integration of data in the shared repository is something quite complicated because information must have a very high level of justification. This is yet more difficult

when all experts do not have the same access to information and other experts' experiences. This is the case, and as a consequence, data qualification could be a way of validating the integration of data in the trade repository.

As a result, we have seen that the state of the art with respect to industrial need and the problems identified with deficiencies are the same as the problems in the literature. Industry has a real need to find a solution to take into account the lack of knowledge in decision making during the preliminary collaborative design of mechanical systems in order to capitalise on knowledge, improve the quality and reliability of decisions, justify and evaluate their choices and to structure the decision-making process.

1.6. A need to take into account the lack of knowledge in decision making

In this first chapter, we have presented the preliminary collaborative design. We have shown the importance of decision making in this context. This explanation had been reinforced with a presentation and analysis of the ideal decision support system. From this analysis, we deduce that the lack of knowledge is a problem in decision making in preliminary collaborative design. We have identified that we need to better understand the decision-making process. We have defined maturity and uncertainty that represent this lack of knowledge. Moreover, we have presented and analysed the main different types of uncertainty to focus on a special type. We have developed this analysis and presentation by presenting the collaborative aspect with model diversity, system dimension and multi-representation of the product. We have illustrated the presentation of the context and the identification of the problem by demonstrating the identification and justification of similar problems in the aeronautic and automotive industries.

From there, the main hypothesis for my work is that the qualification of information of product definition allows system evolution to be managed more easily and helps in decision making. We assume that the maturity level and the uncertainties in the product design data facilitate the next design decision. In innovative design, the lack of knowledge is offset, in the industrial sector, by experience and the feelings of the designer during the first design parameter definitions and decision making. In other words, the main question that may be asked is:

How should information be structured and how should the lack of knowledge in decision making during preliminary collaborative design be taken into account?

Today there is no global indicator that assists designers to make decisions and take into consideration and evaluate the importance of the lack of knowledge. Effectively, different indicators exist but are specific and not global. We hypothesise that a global indicator is able to represent the level of knowledge of the product and to help in decision making. Based upon the context and to address this problematic, three research questions were identified. The first two are:

- What are maturity and uncertainty in design data? **(Q1)** (Antonsson et Otto 1995). By this question we hypothesise that maturity and uncertainty are distinct. Uncertainty allows knowledge to be represented and maturity is the association between knowledge and performance. These hypotheses are developed later.
- Which information is needed for decision making in collaborative design? **(Q2)** (Middler 1993) (D. Ullman, The Ideal Engineering Decision Support System 2001). By this question we hypothesise that maturity helps decision making in preliminary collaborative design.

My PhD context, the ADN project and the Roberval laboratory, place information at the centre of product design and focus on how to manage it. In this context and due to an informational approach, we achieve the third and main question:

- How should product information and uncertainty in preliminary collaborative design be modelled? **(Q3)**

Chapter 2: Maturity, data qualification and knowledge models

2. Maturity, data qualification and knowledge models

Decision making in preliminary collaborative design may be supported by uncertainty modelling and product and knowledge modelling. Such modelling represents a collaborative and learning dimension. Effectively, uncertainty modelling allows the lack of knowledge to be qualified and represents the learning dimension. It is composed of different quantitative and qualitative approaches. The product and knowledge models represent the collaborative dimension and the way to use, structure and share information. Different product and knowledge models are presented from the organisational process through to the technical system. Following these two dimensions, this chapter presents the state of the art of the current indicators and models allowing the data and model knowledge to be qualified in order to aid decision making. We conclude this chapter with a critical analysis and the presentation of the adopted approach.

2.1. Introduction

Qualitative and quantitative approaches provide an answer to Questions 1 and 2 (Q1 & Q2 previously mentioned // Chapter 1). Qualitative approaches are based on the concept of preliminary information, introduced by Clark and Fujimoto (Clark Kim et Fujimoto 1991). From a quantitative point of view, we can identify different approaches for the representation and processing of uncertainties: sets and fuzzy logic (L. Zadeh 1965), possibility theory (L. Zadeh 1978) and the theory of evidence (A. Dempster 1967) (G. Shafer 1976).

Table 1 presents the structure of the state of the art. Different qualitative and quantitative approaches are presented and allow the data uncertainty to be qualified and quantified, and the questions identified in the previous chapter to be answered. The key points, such as sustainability, sensitivity and collaborative dimension, are presented in more detail below.

Still in Table 1, the product and knowledge models allow the different design activities of mechanical systems to be decomposed, structured and taken into account in order to support PLM. However, it should be underlined that none of them considers uncertainty.

Table 1: State of the art of the approaches

Decision making in preliminary collaborative design				
Research questions	Uncertainty modelling			Product and knowledge models
	Qualitative approaches		Quantitative approaches	
What are maturity and uncertainty in design data?	X		X	
Which information is needed for decision making in collaborative design?				X
How should the product information and uncertainty in preliminary collaborative design be modelled?				

2.2. Qualitative approaches

As we have just seen, qualitative approaches are based on the preliminary information concept introduced by (Clark Kim et Fujimoto (1991) and allow the parallel execution of activities in product development processes. Eppinger et al. (Eppinger, Krishnan et Whitney 1997) defined the concept of preliminary information as a parameter that is in continual evolution before it achieves its final value. The status of the parameter in its evolution refers to its maturity (Hanssen 1997).

Sustainability, variation, sensitivity and completeness are different aspects included in the qualification and characterisation of the model and information (Grebici 2007).

2.2.1. Data qualification

2.2.1.1. Sustainability

Information within a design office can be classified with respect to the level of sustainability (Gaudin 2001); that is to say, the longevity of the information. A scale from “1” to “5” is used and refers to the information validity degree. The ranking below (Table 2) represents the sustainability level and corresponding qualification.

Table 2: Sustainability levels (Gaudin 2001)

Levels	Qualification
1	Information not sustainable.
2	Information valid for about a week until the next change.
3	Information valid for the duration of the study, about six months.
4	Information valid for several programme.
5	Information valid for the currently used technologies.

2.2.1.2. Variation

The ranking below (Table 3) represents the different levels of qualification of the variation which defines the probability that information reaches its final value, as proposed by Krishnan (1996). These levels range from “0” for a variation that is very unstable, to “3” that is stable, meaning that the probability that the object approaches its final value is high.

Table 3: Variation levels of an activity (adapted from Krishnan (1996))

Variation levels	Level description of the attribute
0	Very unstable: The probability that an object approaches its final value is zero.
1	Unstable: The probability that an object approaches its final value is low.
2	Moderately unstable: The probability that an object approaches its final value is moderately high.
3	Stable: The probability that the object approaches its final value is high.

2.2.1.3. Sensitivity

Sensitivity levels define the impact of change on information. According to Yassine, Falkenburg et Chelst (1999) they are classified along a scale from “0” corresponding to not sensitive, to “3” corresponding to sensitive. The ranking (Table 4) is detailed below.

Table 4: Sensitivity levels of information (adapted from Yassine, Falkenburg et Chelst (1999))

Sensitivity Levels	Level description of the attribute
0	Not sensitive: The activity is insensitive to any change in the incoming object.
1	Weakly sensitive: The activity is not very sensitive to any change in the incoming object.
2	Moderate Sensitivity: The activity is moderately sensitive to the slightest change in the incoming object.
3	Sensitive: The activity is very sensitive to the slightest change in the incoming object.

2.2.1.4. *Completeness*

The last presented ranking is the completeness level (Table 5) which represents the association of the combination of depth (nature of change) with the magnitude of information. The depth is the nature of the change incident on the object (vagueness, abstraction, level of detail). The magnitude is the importance of information relative to its state of development expected by the user. Completeness represents the amalgamation of these two dimensions. The table below presents this scale ranging from “0” to “3”. The levels of completeness in Table 5 were proposed in the works of Gebrici et al. (Grebici, Ouertani, et al. 2006).

Table 5: Levels of completeness of information (Grebici, Ouertani, et al. 2006)

Completeness levels	Level description of the completeness
0	Incomplete: The object has no depth or zero magnitude.
1	Very partial: The object has small magnitude and depth. (The object does not meet most expectations and the majority of its parts have not been finalised).
2	Partial: The object has moderate depth and magnitude. (The object meets most expectations and most of its parts are finalised).
3	Complete: The object has a high magnitude and depth. (The object meets all expectations and all its parts are finalised).

2.2.1.5. *Characterisation and qualification*

The schema below (Figure 7) from Grebici, Blanco et Rieu (2005) shows the process of characterisation and qualification of data/information from the transmitter to the receiver or user.

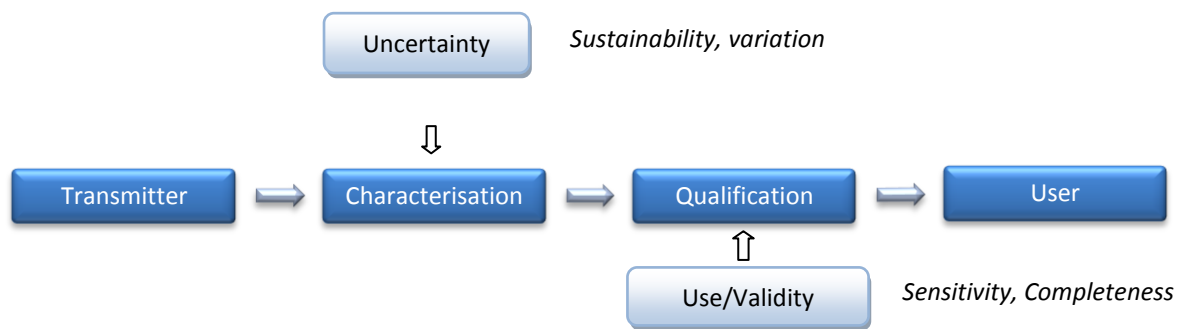

Figure 7: Uncertainty of information from transmitter to receiver (Grebici, Blanco et Rieu 2005)

The first stage within Figure 7 is the characterisation of information uncertainty by its transmitter. The uncertainty characterisation supports the development of answers to the following questions. What is the nature of the change? What is the expected frequency of the change? What is the rate of change? The answers to these three questions are associated with the instability or degree of evolution of information (Krishnan 1996) (Yassine, Falkenburg et Chelst 1999) (Terwiesch et Loch 1999). Additional questions are: what are the possible reasons for the change? and, what is the degree of confidence that the information transmitter has in this information? The answers to these two questions determine the degree of knowledge that the transmitter has on the information that is produced (Goh, Booker et McMahon 2005).

The second stage within Figure 7 is information qualification, which is an evaluation of the information's use/validity by its transmitter and is characterised by the levels of pertinence, completeness and confidence previously presented. The following questions require consideration. Is the information produced/transmitted by an expert? Does it support the user-defined objectives? What are the risks associated with the use of this information?

2.2.2. Model qualification

Qualification allows the help provided by models in the choice of a relevant design solution to be evaluated. This is a method that allows the physical behaviour of the system to be seen in order to estimate the degree of confidence that the designer may give to the results of the representation obtained by these models (Vernat, Nadeau, et al. 2006) (Pailhes, Sallaou et Nadeau 2007).

The result of this qualification will allow satisfactory decision making if the results are acceptable or, in the opposite case, insufficiently satisfactory results will generate a redesign of the system.

According to the PEPS (Parcimonie Exactitude Précision Spécialisation) method, in order to evaluate the operability of the models to aid decision making, the qualification of a model consists of estimating and determining the values of the four following parameters: parsimony, accuracy, precision and specialisation. Thanks to PEPS, the methodology of model qualification has been proposed by Vernat, (Vernat 2004). In the following, we present the main points that must be considered in the qualification of a model.

2.2.2.1. Parsimony (Parcimonie)

Parsimony is defined as the parameter characterising the capacity of a model to describe the physical behaviour of the system that it represents with a minimum number of relative variables. Parsimony, defined as the inverse measure of the complexity of a model, may be calculated thanks to the following relation (Eq 1) where P_a is parsimony, n_{rel} is the number of relations implied in the model and n_{var} is the number of variables implied in the model.

$$P_a = \frac{1}{n_{rel} + n_{var}} \quad (Eq\ 1)$$

It is obvious that parsimony increases with the number and level of the couplings among the variables of the model. As a consequence, a model will be more parsimonious than the number of variables and the relationships will be reduced.

This estimation procedure for parsimony has the advantage of being simple to implement and allows a quick comparison among different models. However, it is not adapted to other types of models other than those expressed thanks to algebraic relations.

2.2.2.2. Accuracy (*Exactitude*)

Accuracy is defined as a measure of the distance between the solution space of the model and the reference behaviour.

The main objective of modelling is to allow a choice among different solutions, characterised by combinations of design variables (VCO) based on the evaluation criteria (Cr). These are the criteria which, by comparison with reference values, will allow the accuracy of a model to be checked.

The comparison of the model to be qualified can be achieved by taking as the reference the tests available and an existing model deemed to be correct for a clearly defined range of validity, or an existing model that is a benchmark in the field of application.

Measuring the gap between reference values and model results can be undertaken on a local or a global scale. An overall assessment, which seeks to minimise the influence of outliers, and a local estimation are achieved by evaluating the maximum or minimum absolute error to the measured points. We have measured this distance using the estimate of the absolute maximum error to the local scale:

$$E_M = \max_i |\tilde{X}_i - X_i| \quad (Eq\ 2)$$

where \tilde{X}_i represents the value in a point “i” of the solution set and X_i is the value of the reference variable to compare with \tilde{X}_i .

This method also has the advantage of allowing an assessment in an imprecise context, in not considering \tilde{X}_i and X_i as values, but as ranges of values.

The steps considered for the estimation of the accuracy of a model are:

- the definition of a reference,
- the definition of the comparison variables for the model (criteria) and for the reference,

- the definition, via an experience plan if needed, of the points of the solution set that will be used as evaluation points,
- calculation of the maximum error for each comparison variable.

2.2.2.3. Precision (*Précision*)

The precision of a model can be defined as the extent of the domain of possible values for a given variable. Precision is the dissociation of the exactitude, because it is a measure of the quality with which the result is determined, unrelated to a reference value.

The imprecision of a model may be due to uncertainty about the values of some variables or uncertainty of the relationships among several variables. Criteria (Cr) are considered as the output variables of the model. We evaluate the precision of a model by the fluctuation in the values of Cr associated with the variable sources of imprecision.

Precision corresponds to a measurement of the size of the interval of possible values for a variable source of imprecision.

To estimate the precision we need to take into account:

- identification of the variable sources of inaccuracies in the results of the model,
- the choice of criteria used for calculating the variable,
- the definition of the calculation point in the solution set,
- the calculation of the precision for each chosen variable.

2.2.2.4. Specialisation (*Spécialisation*)

The specialisation of a model is characterised by the set of assumptions and information that restrict the scope. According to the systemic level which we set (OTE) and considering the restrictive assumptions, a model will be more or less specialised.

The proposed estimation is not encrypted. It is qualitative and subjective. It allows models with equivalent levels for the other three parameters to be separated.

2.2.2.5. Model qualification

The capacity of a model to provide help with decision making depends of the global analysis of the four parameters: parsimony, accuracy, precision and specialisation. A model of architectural design will help the design still more when it presents:

- strong parsimony, to allow a fast and inexpensive easy process,
- strong accuracy, as close as possible to reality,
- strong precision, to minimise the risk linked with decision making,
- low specialisation, to take into account the maximum design space.

To illustrate this feature, the PEPS' model can be represented in a qualitative way using Figure 8.

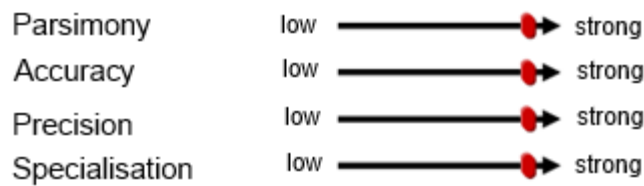

Figure 8: Schema of the representation of the PEPS of a model of an ideal architectural design (Vernat 2004).

Qualitative approaches allow uncertainties and maturity to be modelled for a particular context or activity but not on a global scale. Effectively, each one of these factors (completeness, variation, sensitivity, accuracy or sustainability) is used in a specific case in order to gain specific information, but they do not represent a qualification of the global product, allowing a decision to be taken and the level of knowledge to be evaluated by the designers of the product. Moreover, these factors do not take into consideration the collaborative dimension. They are defined by one designer and are used to help him in his choice. We have seen different approaches to qualifying uncertainty and, in the following, we present other approaches to quantify uncertainty.

2.3. Quantitative approaches

Quantitative approaches are mathematical and probabilistic theories allowing to measure uncertainties. Fuzzy sets, possibility theory and evidence theory are some examples of quantitative approaches presented in this work.

2.3.1. Fuzzy sets

Zadeh introduced the theory of fuzzy sets, as an extension of classical set theory (L. Zadeh 1965). In the theory of classic sets, the membership of an element within a set has a binary value; it is either in the set, or it is not. The theory of the fuzzy sets allows partial adhesion, which means that the membership of an element may be any real number of the closed set $[0, 1]$. Fuzzy set theory is, therefore, closely associated with fuzzy logic. In traditional Boolean logic, a statement is either true or false. In classical set theory, the proposition “the element B is a member of the set F” could have a truth value of 0 or 1; whereas in fuzzy logic it can take a truth value of any real number in the interval $[0, 1]$. For example, if we suppose that a truth value of 0.3 is attributed to the proposition “the element B is a member of the set F”, then we determine that element B is partially a member of set F, which makes set F fuzzy.

Fuzzy logic has been used extensively within the context of fuzzy controllers which aim to generalise the operation of expert controllers (C. Lee 1990). Due to the inherently vague nature of language, another notable application of the theory of fuzzy sets is in linguistics. Language can also be regarded as ambiguous, meaning that a phrase or word can be understood in different senses / meanings (Merriam-Webster 1993). For example, if a man is described as tall, what is his height? What is the minimum height that he may have to be qualified as tall? There is no universal answer that can be accepted since it depends on the person’s interpretation.

2.3.2. Possibility theory

Possibility theory was proposed by Zadeh (L. Zadeh 1978) as a tool for representing information expressed in terms of fuzzy measures. Possibility theory defines a transformation $\Pi: 2\Omega \rightarrow [0,1]$ called the possible measure, defined on a space Ω with $\Pi(A)$ for $A \subseteq \Omega$ being the degree of possibility that A occurs (or is true if A is a logical proposition). One argument in favour of its use in design is the simplicity of its operations (see for example Du and Choi (Du et Choi 2006). They are concise and fast, and there is no joint distribution or other complex relationships. Some research also argues that there is a clear relationship between a probabilistic approach and the theory of possibility. Possibility theory is typically used when

there is little available information, whereas probability theory is preferable when there is a lot of available information (Du et Choi 2006).

2.3.3. Evidence theory

Evidence theory, also called Dempster–Shafer theory was presented by Shafer (G. Shafer 1976) when he expanded the work of Dempster (A. Dempster 1967). However, its origins date back to Hooper, Bernoulli and Lambert (Shafer 1978) (Shafer 1986). The theory of evidence takes n possible outcomes (or states) and forms an exclusive and exhaustive set $\{a_1, \dots, a_n\}$ of n results. This set is called the frame of discernment Θ , and the set members are called focal elements. This is no different from the formulation of the probability of n exclusive and exhaustive events $\{E_1, \dots, E_n\}$ constituting the sample space S . The difference is the way in which the evidence or probability is assigned through these results. Rather than assigning probabilities to events or individual exclusive beliefs, the theory of evidence assigns belief to any element in the result set. For example, consider the case with $n = 3$. Then $\Theta = \{a_1, a_2, a_3\}$, the complete list of subsets within the set is $\{a_1\}, \{a_2\}, \{a_3\}, \{a_1, a_2\}, \{a_1, a_3\}, \{a_2, a_3\}, \{a_1, a_2, a_3\}$. According to the available data, each of these subsets will be supported to some degree. For example, there may be evidence that supports $\{a_1\}$ and $\{a_2\}$ but not $\{a_3\}$ and also does not distinguish between $\{a_1\}$ and $\{a_2\}$. Thus, the evidence is for the subset $\{a_1, a_2\}$ and is assigned using the function of basic belief mass.

Qualitative and quantitative approaches allow uncertainties and maturity to be modelled for a particular context or activity but not on a global scale. Today, there is not global indicator, such as maturity, for mechanical systems. The qualitative and quantitative approaches that have been selected are sustainability, sensitivity and fuzzy sets, but they only apply to data and a specific activity. One issue is associating and generalising these factors in order to define a global level of maturity for the product. These factors have been identified and selected because they allow the interval of value in comparison with the initial one, the importance of the data in the global system (collaborative aspect) and the time notion to be taken into consideration.

These three factors must be integrated in a product and knowledge model in order to support the system dimension, the global aspect and the collaborative dimension. Effectively, collaborative decision making in preliminary collaborative design, under uncertainty,

represents the learning dimension. The Roberval Research Centre context, justifying the use of an informational approach, leads to the second dimension of the state of the art: the collaborative dimension. Effectively, this research centre is interested by the computer tools that aid the design. This dimension is represented by product and knowledge models. The logic of presentation of these models is from the organisational/decisional process to the technical system and its definition is with the product model because we try to understand the decision-making process of the organisation among data through to the structure of the product data.

Moreover, the integration of these three factors is also a way to integrate indicators in the methods and tools of integrated design.

2.4. Knowledge and product models

The spectrum covered by the product models is as wide as can be taken into account, both the information related to the organisation and process (image product process and organisation (PPO)), and the product (component structure of the product), features and requirements, and so on. In this way, effective support is provided for applications and data management information, such as PDM and SDM, for the better organisation of the work of project participants and reduction of the dependence on tools and business models.

For example, without using a model or a PDM system, commonly the start of modelling (usually geometric) is the basis of the structure of a project and the first cutting of the components of a product. This means that these business models are carriers of information from which they are created and that this information is not present anywhere else outside these models.

The use of product models can capitalise on this information and make it available to developers before there is a business model. In this way, a project can be properly structured according to several points of view. It is then from this information that the design activities begin and the business models are made.

Considering the spectrum covered by the models and product information taken into account, they are mainly based on the functional and structural organisation of the product. Consequently, the information and knowledge of a fine granular level, such as parameters and constraints used in the different business models, are generally not sufficiently taken into account. That is to say, this knowledge is encapsulated in the business models. Thus, current models do not allow products to offer their own parameters and they structure the organisation outside of the business models and thus the processing of knowledge is limited. For example, it is not possible to monitor the use of parameters and constraints in the activities of the design process or to monitor changes in parameter values or rules, and it cannot be verified with certainty whether knowledge is manipulated consistently.

Generally, three main categories of knowledge are distinguished in a development process: product engineering knowledge, manufacturing process knowledge and organisational knowledge (Lohse, et al. 2005) (Uschold, et al. 1998) (Matta, Corby et Ribière 1999).

Another kind of knowledge concerns the capitalisation of decision justification during the development project (Belkadi, Bonjour et Dulmet 2005).

In the literature, existing works deal with models to represent product, process and organisational knowledge. These works have been principally developed in three scientific fields: development of domain ontology in order to identify the main concepts of a domain and the relationships among these concepts (Lohse, et al. 2005) (Uschold, et al. 1998); the development of projects memory that aims to achieve traceability of project evolution for the reuse perspective (Matta, Corby et Ribière 1999) (Belkadi, Bonjour et Dulmet 2005) and finally, the development of business tools, such as PDM and CAx¹⁵ tools, in order to support the technical activities of designers (Sudarsan, et al. 2005) (Eynard, Gallet, et al. 2004).

The commonly accepted approach for structuring product knowledge has been through the construction of product models (Stokes 2001). The meta-object facility (MOF) standard is located on top of a modelling architecture in four layers: M3: the MOF meta-meta-model (self-descriptive); M2: meta-models; M1: models and M0: the real world. The different models representing the design activity and the different product and knowledge models presented in this chapter belong to the M1 level. As an example of such models, Fiorentini et al. (Fiorentini, et al. 2007) translated the NIST's (National Institute of Standards and Technology's) core product model (Sudarsan, et al. 2005) and proposed an ontology for the open assembly model (OAM) implementing several OWL (ontology web language) capabilities. Lee et Suh (2007) developed a model for sharing product knowledge of the beginning of life (BOL) on the web. Terzi, Cassina et Panetto (2005) proposed using the concept of Holon for the description of product knowledge. Holon is defined as a composition of a physical entity and all related information.

In parallel, the process knowledge definition is based on activity models: activities allow the creation of the links between products and resources (facilities, humans...) and their characteristics (behaviour, task, properties...). They structure and define the behaviour of the processes. An activity aggregates several kinds of knowledge, such as sequences, functions, rules, states... (Hugo, et al. 1989). It concerns process scheduling, the set of resources (human resources, machines, tools and tooling), the organisation of the production unit (work centres) and manufacturing know-how (Fortin et Huet 2007).

¹⁵ CAx: Computer Aided technologies

Other categories of models are developed with a generic perspective in order to cover heterogeneous knowledge fields (Moka s.d.). For instance, Nowak et al., (Nowak, et al. 2004) presented the architecture of a collaborative aided design framework integrating PPO models for engineering improvement. The PPO information kernel stores persistent data on interoperable files that might be reached by several external applications on the collaborative PLM system among the whole product lifecycle (Roucoules, et al. 2006). Danesi et al., (Danesi, et al. 2008) proposed the P4LM methodology, which allows the management of projects, products, processes and proceeds in collaborative design. It aims to allow the integration of information coming from the different partners involved in a PLM application. The KCM is another example of a knowledge model, which is developed with the aim of managing knowledge, using configurations synchronised with expert models that enable designers to use parameters consistently in a collaborative design process (Badin, Chamoret, et al. 2011). The KCM approach is based on the concept of “knowledge configuration”, which is a virtual object composed of a set of parameters and rules instantiated from the generic baseline and contextualised into an expert model for a specific milestone of the project in order to ensure consistency and decision making among all experts’ knowledge.

All of these models allow the product or knowledge to be represented and ensure data consistency, but any of them can take into consideration uncertainty and maturity of the data and the mechanical systems in order to help with decision making. The four models presented later are classified from an organisational and decisional process point of view with respect to the technical system process and its definition. We move from organisation with the PPO to simulation with the KCM. Following this logic, we present these models, describing them and showing their limits. Different points of view are presented in the following sections, always oriented towards product and knowledge. We start this presentation with the organisational process and the presentation of the PPO model.

2.4.1. PPO: Product process organisation

In the context of a national network of software technologies, the IPPOP project (Product Integration, Process, Organisation to the improvement of Performances in engineering) has been launched (Nowak, et al. 2004). The objective is to develop a collaborative system to support and share information among stakeholders throughout the lifecycle of a project, with, on the one hand, integration of the dimensions product, process and organisation and on the other, extensions of existing CAD/CAM¹⁶ and TDM¹⁷ software, taking into account the technological aspects related to the design (Figure 9).

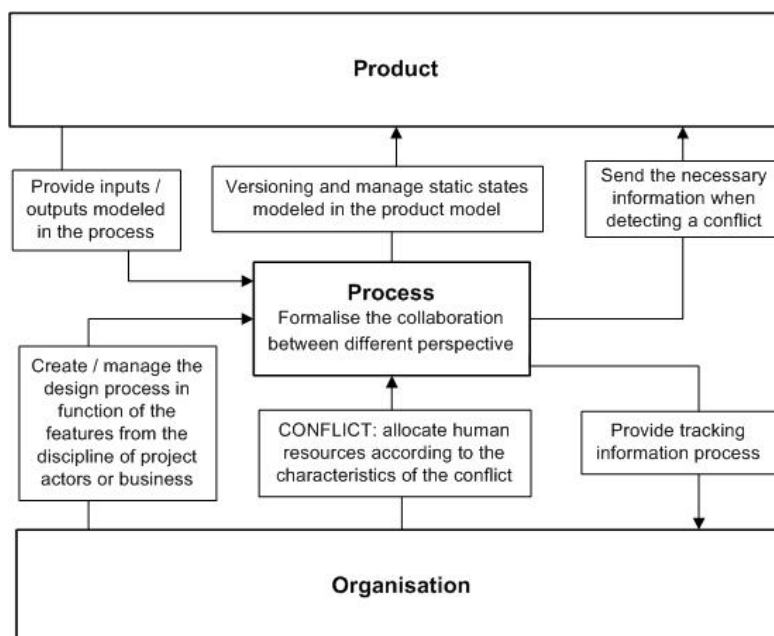

Figure 9: The views project, process and organisation of the IPPOP project (Noel, Roucoules et Teissandier 2004)

The IPPOP system is based on the core model PPO with a description of the project information in terms of process, organisation of resources and conflict management, as well as a section describing the product model. The product model of the PPO core is shown in Figure 10. This model has four subclasses generalised in the superclass Modelled Entity

¹⁶ CAM: Computer Aided Manufacturing

¹⁷ TDM: Tool Data Management

(Noel, Roucoules et Teissandier 2004). All information about the product is considered as entity modelling that can be a component (Component), an interface (Interface), a function (Function) or a behaviour (Behaviour).

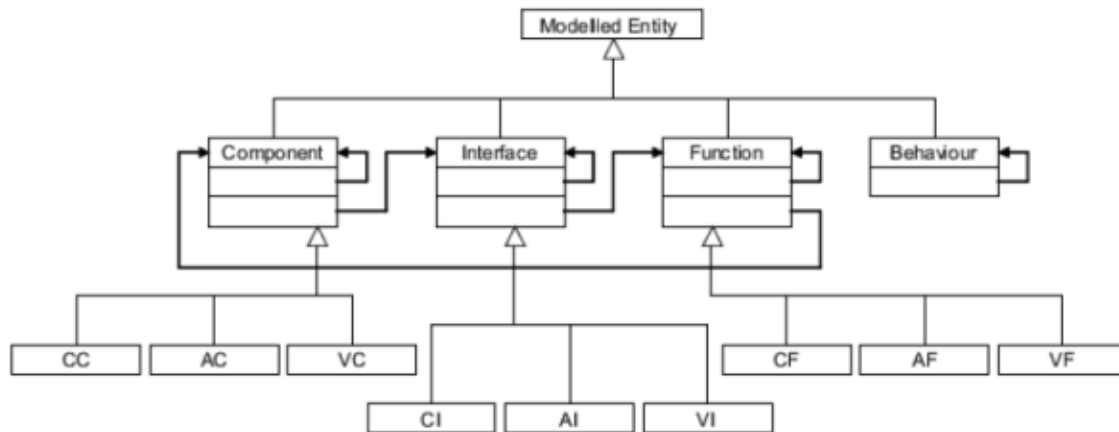

Figure 10: The product model in the IPPOP project (Noel, Roucoules et Teissandier 2004).

- The class “Component” describes the physical structure of the product through its components and subcomponents. Three views are available with regard to this information: a component can be a “Common Component” (Class CC) the real components of the product, an “Alternative Component” (Class AC) the components that can be substituted for the real components to ensure the same role, and a “View Component” another custom definition of a component in a particular trade.
- The class “Interface” describes the different possible relationships that may exist among the components to form the product. As for the component class, there are three complementary views on the class Interface: Common Interface (CI), Alternative Interface (AI) and View Interface (VI).
- The class “Function” defines the objectives for the product and its components with respect to some criteria. Again, three complementary views are available.
- The class “Behaviour” describes the state changes of the product throughout its lifecycle. An instance of “Behaviour” is defined by a set of components, functions and interfaces.

In the first model, we present a model based on an organisational point of view, being able to support and share information among stakeholders throughout the lifecycle of a project, taking into consideration the product and the organisation and making the link between both via the process dimension. The second model is more focused on the product information management as a function of the business by providing support to represent information related to the management of the product. It is the core product model. We move from the organisational point of view towards a product point of view.

2.4.2. CPM: Core product model

The NIST modelling platform has been developed by researchers at the National Institute of Standards and Technology, (NIST) (Sudarsan, et al. 2005) (Fenves, et al. 2004). The aim is to provide support, rather than generic, extensible and easy to represent information, related to the management of the lifecycle of the product regardless of the business applications which will use such information. The modelling platform uses the unified modelling language (UML) graphical language to represent a broad spectrum of information handled in a PLM system (Sudarsan, et al. 2005). This information is structured in four models:

- The « Core Product Model »: enables the representation of different information relating to the product description.
- The « Open Assembly Model »: enables the representation of different information on the assembly relationships among the components of the final product.
- The « Design Analysis Integration Model »: connects the product to the functional and behavioural aspects to help the analysis in the design phase.
- The « Product Family Evolution »: enables the product families and possible configuration diversities to be represented.

Among the various models, the CPM provides a multi-view representation through the notion of artefacts, allowing, among others, representation of manufactured products and contains a wide variety of concepts used in product engineering. Besides geometric concepts, this representation includes the notions of form, function, behaviour, materials, physical and

functional decompositions, mapping between function and form and many other relationships among these concepts.

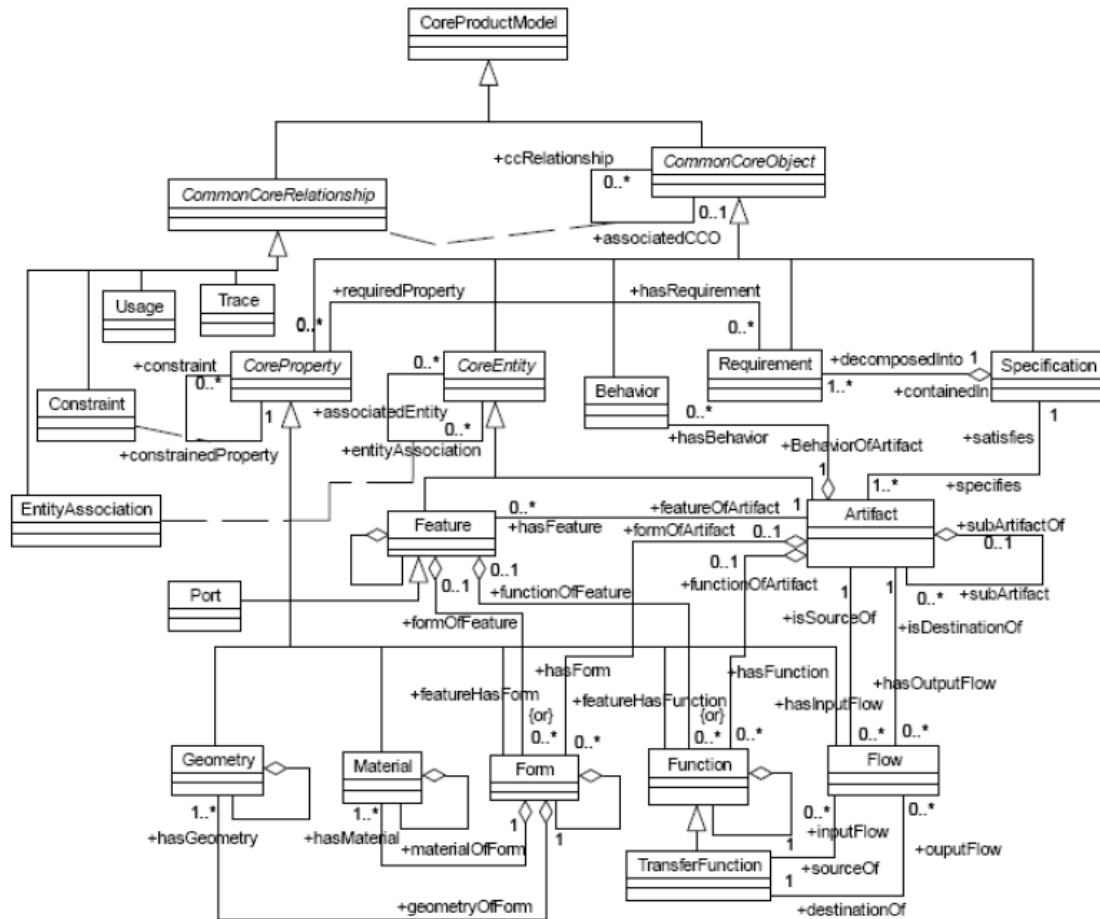

Figure 11: The CPM (Sudarsan, et al. 2005).

Figure 11 shows the UML class diagram of the CPM. The CPM classes are grouped into different categories according to the nature of the information contained in these models:

- The abstract classes (abstract classes) include generic objects that, thanks to the inheritance relationships, allow the classification of product information. The main class is “CoreProductModel”. The class “CommonCoreObject” is divided into “CoreEntity” for physical objects and “CoreProperty” for the properties. Finally, “CoreRelationship” describes the different types of relationships.

- The object classes (object classes) are all classes that inherit from the classes “CommonCoreObject” and its heir classes (e.g. class specification, feature, form, etc.).
- The relationship classes (relationship classes) are classes that inherit from the class “CoreRelationship”. In other words, they are the different types of relationship among objects of the product.
- The useful classes (utility classes) are not visible in this figure. They have different attributes associated with each class of object.

The artefact class is the main class of the CPM. It represents a separate entity in a product, that is, a component, a part, a subassembly or an assembly. All these entities can be represented and interconnected through the inks “sub-artefact” and “sub-artefact of” modelled by a reflexive relation on the class artefact (relationship subArtefacts / subArtefactOf). A characteristic shape (class feature) is a part of the physical form of an artefact, designed to provide a specific function. Depending on its function, it is called a characteristic shape design, analysis, manufacturing, and so on. The specification class provides a description derived from customer needs and / or engineering needs. It represents all the data relevant to the design of an artefact and incorporates specific needs such as function, form, geometry and materials of an artefact. A need (class requirement) is a particular specification of an artefact that determines a particular aspect relating to the function, form, geometry or materials of the product.

In this section, we have presented the CPM that is able to represent information related to the management of the lifecycle of the product regardless of the business application. Information is the basis of knowledge and it is important to know how to represent methods able to acquire knowledge. This is the objective of the MOKA model (see below). MOKA allows the product to be represented through four complementary views in order to acquire knowledge. We move towards product-view oriented knowledge acquisition.

2.4.3. MOKA: Methods and tools oriented to knowledge acquisition

The MOKA model (Methods and tools Oriented to Knowledge Acquisition) has been developed within the Esprit project (Moka s.d.). This project aims to propose methods

dedicated to knowledge engineering. The MOKA model uses UML formalism and proposes to represent the product through four complementary views as shown in Figure 12:

- The Structure view is the main view of the model from which the other connections are made. It includes the classes: structure, product assembly, and composite feature.
- The Representation view describes the geometric representation of the structure of the product.
- The Function view includes classes for function, solution principle and technical solution.
- The Behaviour view is attached to the structure of the product. It includes classes and state transition behaviour.
- The Technological view describes the technologies, manufacturing processes and materials used in the manufacture of the product.

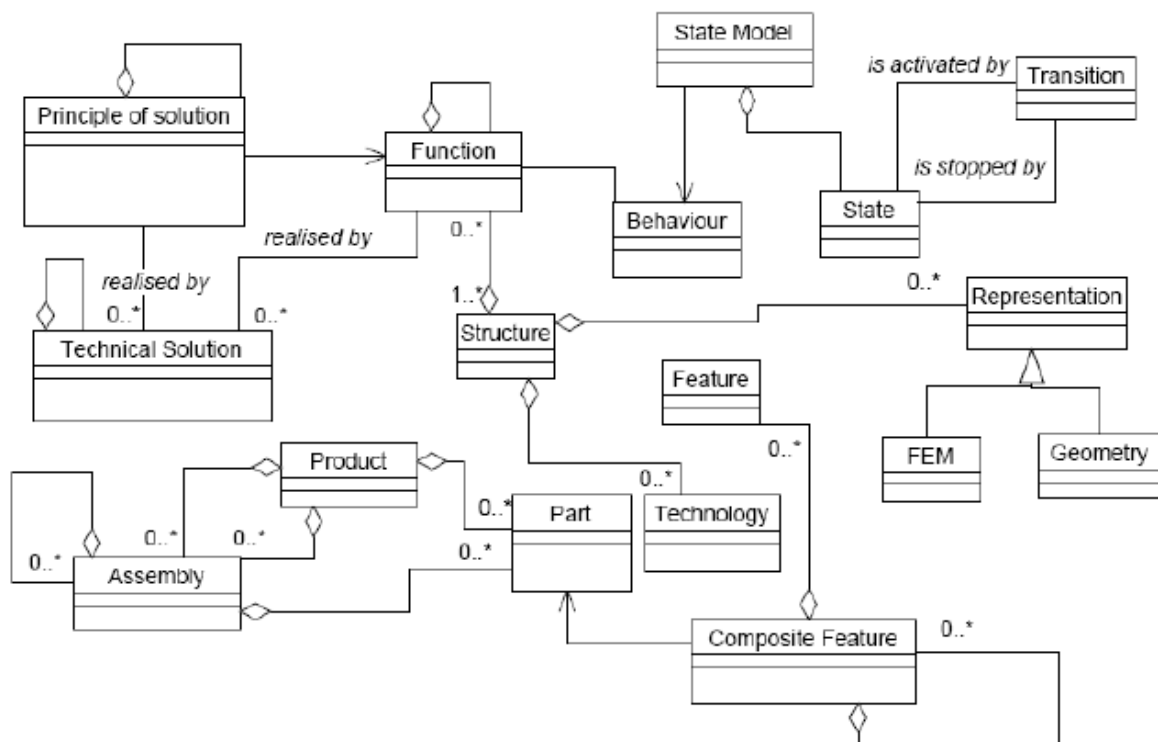

Figure 12: The MOKA product model.

We have seen how to structure product information in order to acquire knowledge based on four complementary views of the same product. The model presented in the next section (KCMModel) is based on the multi-representation of the same product in order to detect conflict and make decisions. Effectively, the KCM allows the design and simulation activities to be linked and the conflicts due to the product's multi-representations to be detected. This model is presented in the following section.

2.4.4. KCM: Knowledge configuration model

Many product models are defined in the literature. These models define the information management structures of the product throughout its lifecycle. In this context, we consider that they support the PLM approach for the better consideration of information, greater reuse, and better interoperability among the stakeholders and the tools used in the design process. The positioning the KCM (Badin, Chamoret, et al. 2011), compared to the product models and the PLM approach, is illustrated by Figure 13. In fact, the area covered by the KCM is much less important than the literature on the product models. On the other hand, it allows fine management knowledge to foster collaboration and interoperability among the business models used in the activities of the design process. The link between design and simulation is also one of the objectives.

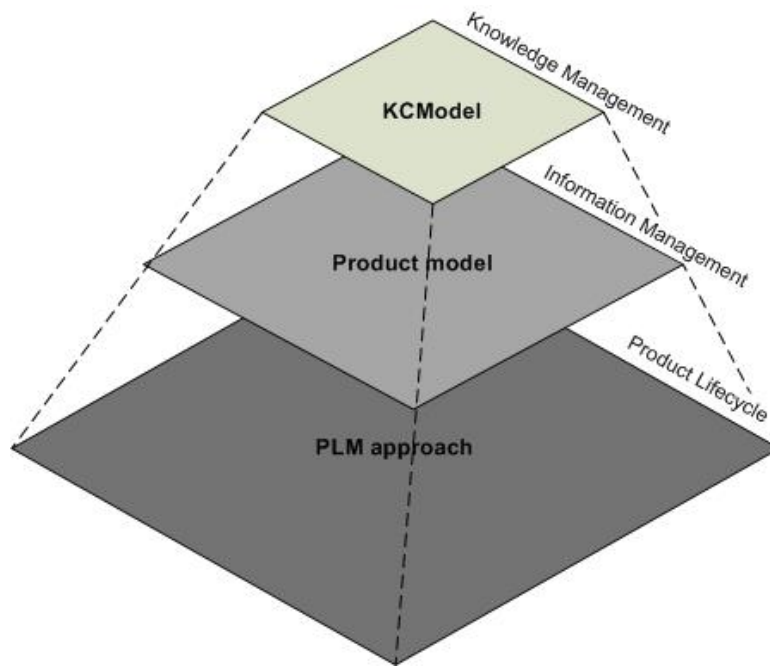

Figure 13: KCM positioning relative to product models and the PLM approach (translated from (Badin 2011))

The KCM is a generic meta-model that is decomposed into three parts (Figure 14), each comprising several packages corresponding to different concerns. These packages are independent but related to each other (by binding relations) to form a coherent whole.

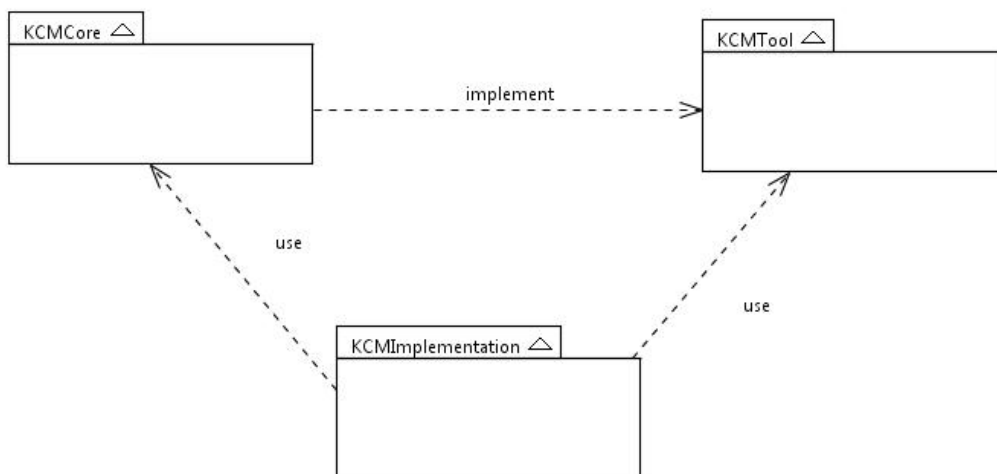

Figure 14: The three parts of the KCM meta-model

The first part, called KCMCore, is the heart of the KCM meta-model; it gives the main definitions of the semantic concepts. It describes the main structure of the KCM and the relationships; for example, the definition of the structure of “Knowledge Configuration”, “ICE¹⁸”, and so on.

The second part, "KCMTool", provides a description of the desired platform for implementing the meta-model “KCMCore” to concretely realise the functionality. This model defines the structure of the cross platform functionality and tools; for example, the GUI¹⁹, access management, configuration management, performance management, and so on. These transverse tooling features are generic and can be provided by different platform implementations such as “Futon” in the ADN project.

The third part, "KCMImplementation", helps to explain the implementation of the meta-model “KCMCore” in the platform “KCMTool”. Unlike the first two parts that contain only class diagrams, this third part contains diagrams of structures and activities to illustrate the operation of the KCM. In these diagrams each element “KCMCore” will be attached to an element of “KCMTool”.

The KCM is an approach, not an alternative to but complementary to existing product designs. It can be considered as a brick or a plug-in that can be added to manage knowledge configuration more finely to ensure consistency in the design process. In this way, it is possible to make the link between management applications and data knowledge management (KMS) difficult. KCM is based on configuration management, but other principles exist to link the different businesses (design and simulation for example) in product design. Colibri is another example of an information model based on interdisciplinary constraints among product models. It is presented in the following section.

2.4.5. Colibri

The fundamentals for the development of neutral, parametric information structures for the integration of product models are provided by existing product data models or data models

¹⁸ ICE: Information Core Entity

¹⁹ GUI: Graphical User Interface

from on-going development, as well as concepts from constraint logic programming (ISO 2001) (Donges, Krastel et Anderl 1999) (Frühwirt et AbdennadherR 1997). The design of an extended, parametric information model could consider only a few basic entities of STEP data models, for example units of functionality (UoF) like product_management_data (S1), element_structure (S2), item_definition_structure (S3) and kinematics (K1). An information model for parameters and constraints has been developed because standardisation activities in the area of parametrics are in operation and are restricted to relations among geometric information (as illustrated by Figure 15).

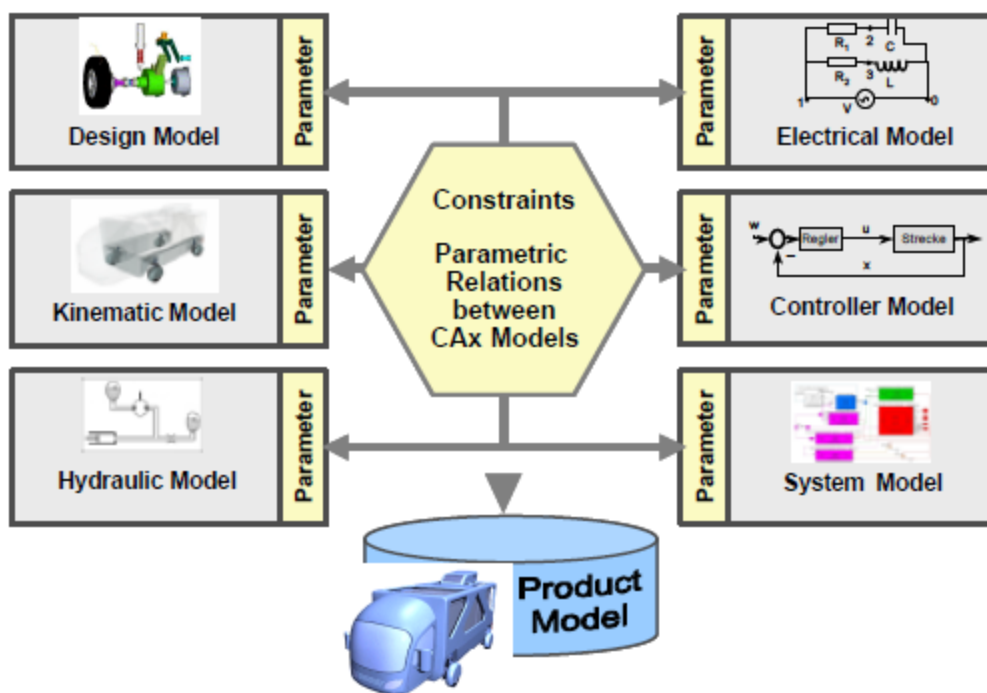

Figure 15: Interdisciplinary constraints between product models

The extended parametric information model was developed using the UML. The model contains the class Item, which represents real or virtual objects, such as parts, assemblies, and models. Every object Item has a version (class ItemVersion) and specific views (class DesignDisciplineItemDefinition). A view is relevant for the requirements of one or more lifecycle stages and application domains and collects product data of the Item and ItemVersion object. The extension of STEP product data models considers the inclusion of general product characteristics (class Property), attributes (class Parameter) and restricted relationships (class Constraint). The developed information model is based on the integration

of independent CAx models using its parameters. The links among CAx models are implemented using the class Constraint, which can set the parameters of different product models in relation to each other. On the one hand, a constraint restricts at least one parameter and, on the other, the parameter may be restricted by several constraints, which are building a constraint net. Different types of constraints are implemented in subclasses in order to characterise in detail the relationships among the parameters. For example, equal constraints, equal except unit constraints, lower and higher constraints, approximately constraints, and interval constraints are predefined constraints. Constraint nets and hierarchical constraints are represented by the subclass CompositeConstraint.

The application of Colibri is described by the design of an integrated wheel suspension for an innovative service vehicle (Figure 16). This vehicle has been designed in order to check interactions among different engineering disciplines during the product development process. The final physical DMU²⁰ of the service vehicle, which was animated in a virtual scene, is illustrated in Figure 17.

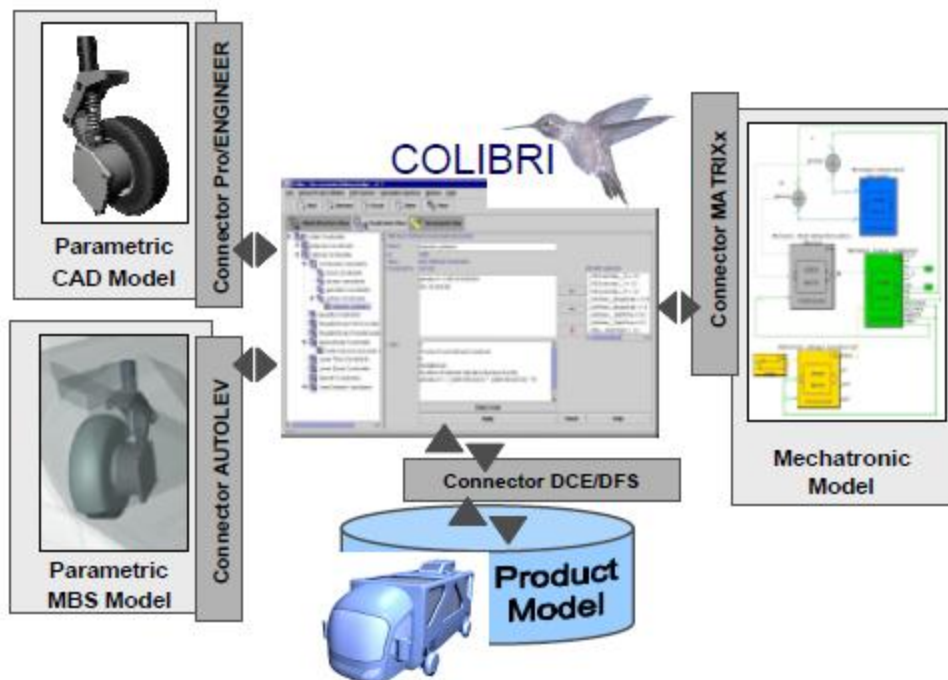

Figure 16: System architecture of Colibri

²⁰ DMU: Digital MockUp

For the development of mechatronic systems, a software environment is needed that allows cooperative design, simulation and optimisation based on an integration platform. New engineering design methods for mechatronic products as well as CAx systems, like Pro/ENGINEER, IDEAS, SIMPACK, AUTOLEV, MATRIXx/SystemBUILD, and CAMEL-View, were used during development and optimisation without there being any hardware prototype of the wheel suspension in the early design stages. Students of mechanical engineering, industrial engineering and electrical engineering were involved to support the researchers during the design of the selected vehicle components and optimisation of the system behaviour, for example, vertical dynamics of the vehicle.

Parametric CAD models of the wheel module were designed with the CAD system Pro/ENGINEER, the dynamics of the passive wheel module were investigated with the MBS models using AUTOLEV and mechatronic models of the active wheel module were created and simulated, assisted by MATRIXx/SystemBUILD. Colibri supported the virtual product development according to the constraint based integration of the product models. Further, it was used to extract geometrical and technical parameters from one CAx model and to link them to parameters of other CAx models in order to keep data consistent across the domain specific product models.



Figure 17: DMU of the innovative service vehicle

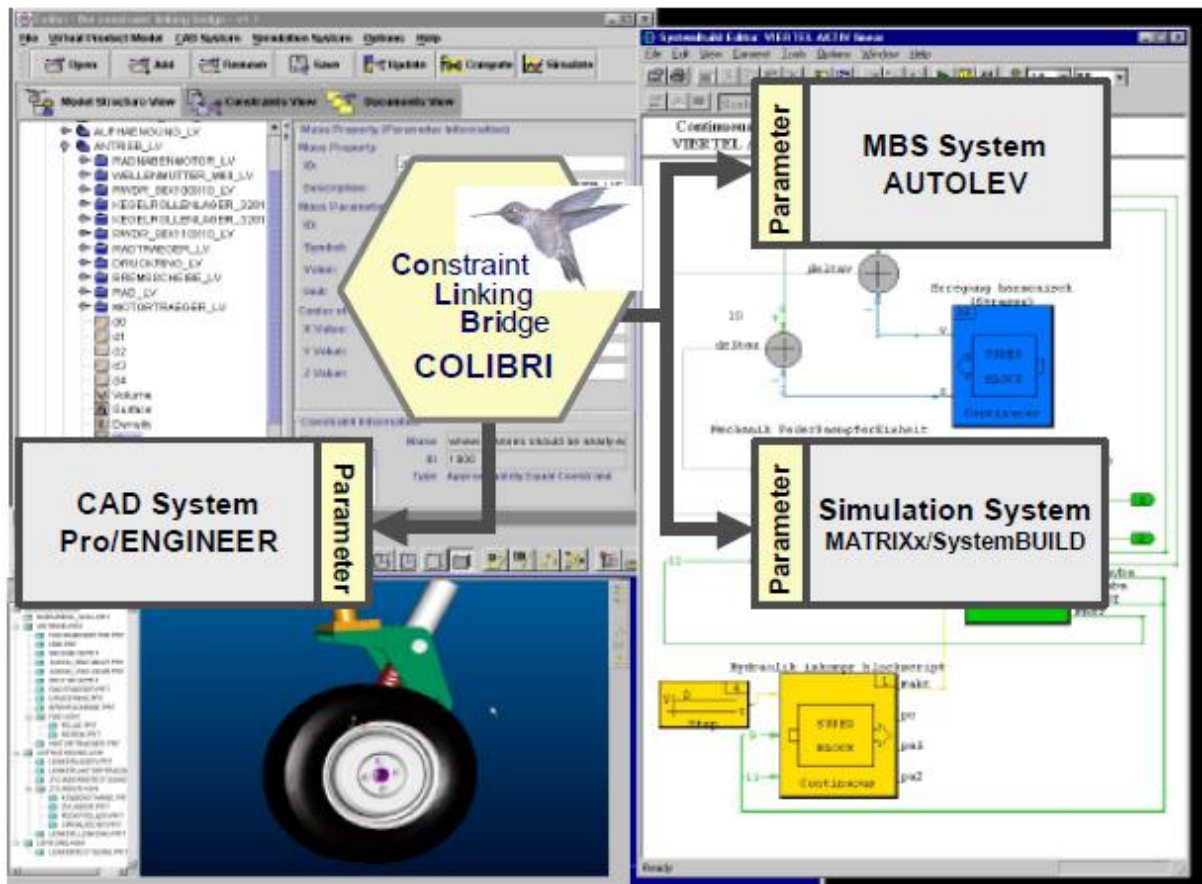

Figure 18: Design of a wheel suspension assisted by Colibri

In addition, engineering data management (EDM) systems could be used to support cooperative design and to realise an integrated consistent product structure management (Anderl, Gräß et Kleiner 2001). As a result of the application of Colibri, an interdisciplinary integration model of the wheel module was generated. Figure 18 shows a screenshot of Colibri and the mentioned CAx systems.

KCM, like Colibri, is an example of an information model based on configuration management and interdisciplinary constraints among product models. But other models exist for specific uses. Different examples of these models are presented in the following section.

2.4.6. Other models

Other types of product models are proposed in the literature for specific uses. The diagram FAST (Functional Analysis System Technique) is a modelling tool best-known for its ease of implementation. The FAST model focuses on the hierarchical decomposition of the product, featuring a horizontal axis and simultaneous sequences on the vertical axis. In the project DEKLARE, Saucier (1997) proposed a model linking functional aspects to the physical aspects of technical solutions by integrating a representation of the propagation of constraints between the two views. Other more comprehensive models are listed in industrial engineering and mechanical engineering, such as the product graph model (Dupinet 1991), the chromosomal model (Andreasen 1991) and the entity-based model (Eynard 1999).

Harani (1997) introduced the notion of perspective to take into account, on the one hand, the different representations used by designers of the product (functional, behavioural and structural) and, on the other, the technological field as the mechanical, electrical and so on points of view. The Harani model has been developed using a tool in the Merise optical design of an information system. Figure 19 shows an example of the model proposed by the Harani product. Other models produced were made in the same vein as the UML tool, such as Menand's "MULTI" model (Menand 2002) structured on three levels (generic, product and project area) and connecting the different phases of the product's lifecycle.

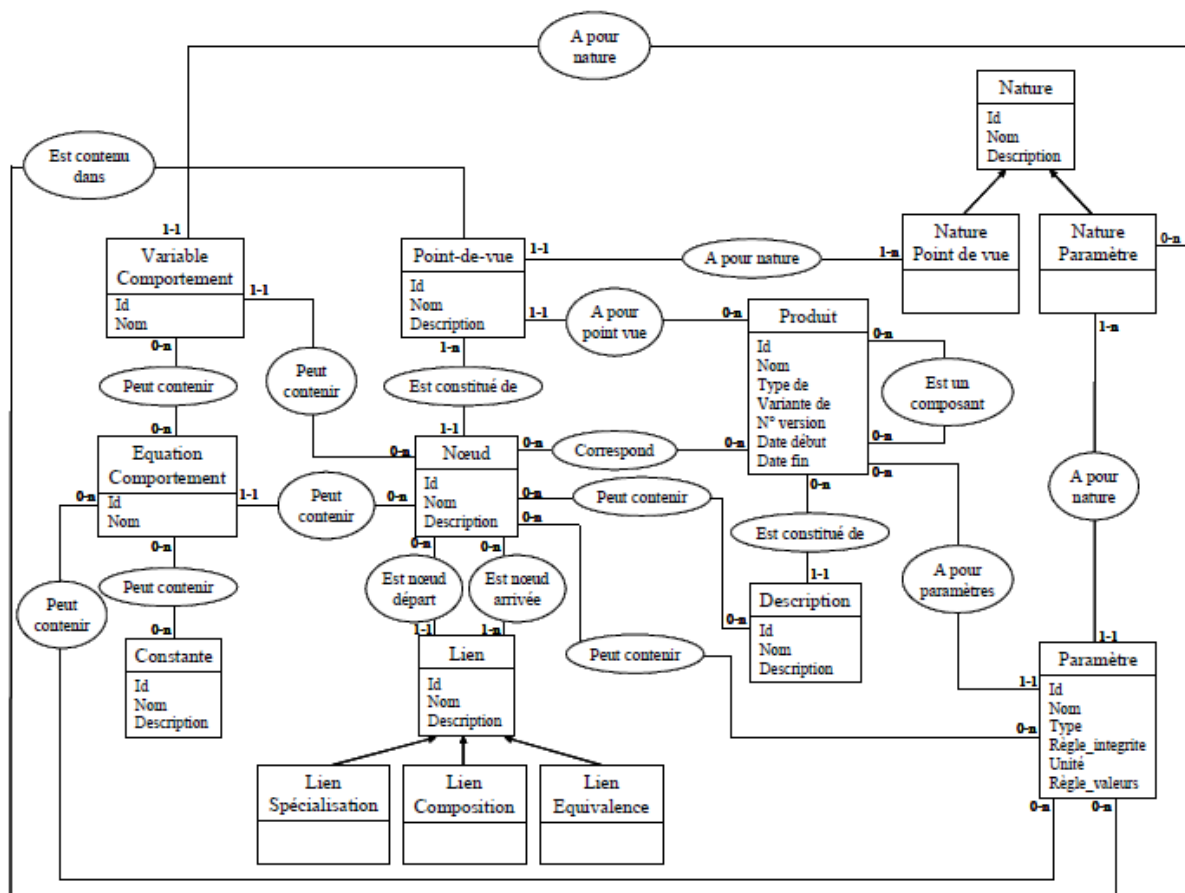

Figure 19: Hanari's product model (Harani 1997).

A third type of product model incorporates the concept of trade view. Tichkiewitch (1996) offers a model for structuring the product data of each activity involved in product design and product data classification according to their usefulness for the trades identified. Belloy's product model (Belloy 1994) follows the same logic and focuses specifically on the integration of knowledge in the art of manufacturing in the early phases of design.

Today, different product and knowledge models exist, such as those presented above. For example, PPO allows products to be modelled via product, process and organisation and, KCM allows the conflicts among the different representations of the products to be identified. Each one of these models has its own specificities and methods but a common objective, to model the product and knowledge. All of these models enable interaction of the different product models for different design activities, such as simulation or design. All these product and knowledge models are oriented on product representation during its lifecycle, the multi-

representation of the product as a function of the different design activities and conflict detection based on constraints and activities. These models highlight knowledge capitalisation and the collaborative aspect of the product design. PPO, KCM, Colibri, and so on are able to represent the interactions among the designers during the design activity. KCM also contributes to highlighting decision making during the design process but does not manage it. In this case, decision making remains an action of the decision maker and is not managed by the model itself. Moreover, none of these models take into consideration the lack of knowledge of uncertainty and maturity during decision making by management. They are product representations to help the collaborative aspect and the process of design but they do not manage the uncertainties of the product. One of the objectives of this PhD is to integrate maturity and uncertainty in a product and knowledge model.

Based on the analysis in the previous paragraph, two aspects must be taken in consideration in this PhD in order to answer correctly the problematic presented at the end of Chapter 1. The first aspect is the lack of knowledge of maturity and uncertainty which is represented by qualitative and quantitative approaches to measure and describe maturity. This first part of the contribution will allow the uncertainties and maturity dimensions to be integrated into the product and knowledge models. The second aspect is the system dimension, the multi-representation of the product and the collaborative factor. This second aspect is represented by the product and knowledge models. As a consequence, we use a mixed approach using quantification and qualification (a metric) which will be integrated into a product model in order to ensure the collaborative dimension. Moreover, in order to have a generic approach, independent of a specific data model, we will use a MDE²¹ approach which is a higher abstraction level, necessary in the product and knowledge modelling. We will integrate the first aspect of the contribution in a meta-model of knowledge in order to be able to integrate the uncertainty and maturity aspects in different product and knowledge models and to ensure a greater representation of these aspects in the existing models.

2.5. Towards a mixed approach

Different aspects are taken in consideration and quantitative and qualitative approaches exist. Table 6 represents a synthesis of the current responses to model uncertainty and

²¹ MDE: Model-Driven Engineering

product/knowledge in accordance with the three research questions mentioned at the end of Chapter 1. The first two research questions presented (What is maturity and uncertainty in design data? and which information is needed for decision making in collaborative design?) allow uncertainty in design data and the information needed to help in decision making to be identified. Uncertainty modelling allows these questions to be answered from two approaches: qualitative and quantitative. We have previously shown that the quantitative aspect allows maturity to be defined with a quantifiable value and a qualitative aspect allows the subjectivity of the designers based on information needed for decision making to be taken into consideration. Product and knowledge models represent the structure of the product and its information, and are necessary to know which information is needed for the designers make the decisions. The last research question (How to model the product information and uncertainty in preliminary collaborative design?) is represented by the different product and knowledge models, but they do not integrate the uncertainties. One of the main contributions of my PhD is, as a consequence, the integration of maturity and uncertainty in product and knowledge models in order to help the decision making in preliminary collaborative design.

As a consequence, the proposed indicator uses a mixed approach in order to define the maturity level of the product. This indicator defines a level of maturity based on the information of sustainability, intervals and sensitivity. By this approach we hypothesise that the data qualification of the product helps in making the decision because we have previously identified that the lack of knowledge is one of the problems in decision making.

Table 6: State of the art synthesis and positioning

Decision making in preliminary collaborative design								
Research questions	Uncertainties modelling						Product and knowledge models	
	Qualitative approaches				Quantitative approaches			
What are maturity and uncertainty in design data?	Sustainability	Variation	Sensitivity	Completeness	PEPS	Fuzzy sets	Probability – Possibility theory	
Which information is needed for decision making in collaborative design?								Evidence theory
How should the product information and uncertainty in preliminary collaborative design be modelled?								
							PPO: Product Process Organisation KCM: Knowledge Configuration Model CPM: Core Product Model MOKA: Methods and tools Oriented to Knowledge Acquisition ... Without uncertainties	

Figure 20 presents the research methodology. As a result of the analysis in the current work and several interviews with industrial representatives, we have mapped the scientific and industrial needs in order to define and analyse the problem. Based on this analysis and mapping, we have identified two dimensions: collaborative and learning. Collaborative represents the fact that designers work and interact together in order to design a product. The presented state of the art is therefore presented on two axes, collaborative and learning. The collaborative aspect presents and defines the main specific concept of knowledge and product models. The learning aspect defines the main specific concepts of uncertainty modelling. The analysis of these two aspects brings us to the following question: “how should the two

dimensions be integrated to enable decision making throughout the design process?” To answer it, we present the proposal in two parts: the indicators to represent maturity and the collaborative dimension (product and knowledge model). In the first part we propose a solution to characterise the lack of knowledge in decision making. Moreover, we have demonstrated in Chapter 1 that decision making is a collaborative process where different product representations are taken into consideration; that is why it is important to introduce this indicator (and the uncertainty) into the product and knowledge model. The indicator must respect a mixed approach, taking into consideration the creator and receiver points of view, uncertainties, performance, sustainability and the sensitivity of the information. All these factors are presented, explained and illustrated in the rest of this PhD thesis. As previously introduced, calculation of the global level of maturity includes several parameters, such as sensitivity, sustainability, tolerance, importance of the tolerance as a function of the nominal value, wished maturity and performance. The level of performance is based upon the technical specifications of the need. It is the percentage of the technical specifications of the need achieved at the end of a design iteration compared to the total number of specifications. This level of performance assumes that all the technical specifications of need are known from the beginning of the design. Of course, it is possible that the values of these specifications evolve during the design activity and between two design iterations. But, the specifications must be known and the specification can be validated or invalidated. We hypothesised that there are no uncertainties about these specifications and that the designers know the obligatory state of validation. The fact that all technical specifications of the need are known means that designers are able to list the specifications for each level of system decomposition of a mechanical system. This assumption is one of the greatest within the framework of this thesis, and the list of technical specifications of the need is not always clearly defined or known for each level of mechanical system decomposition in the industrial domain.

Figure 20: Research methodology

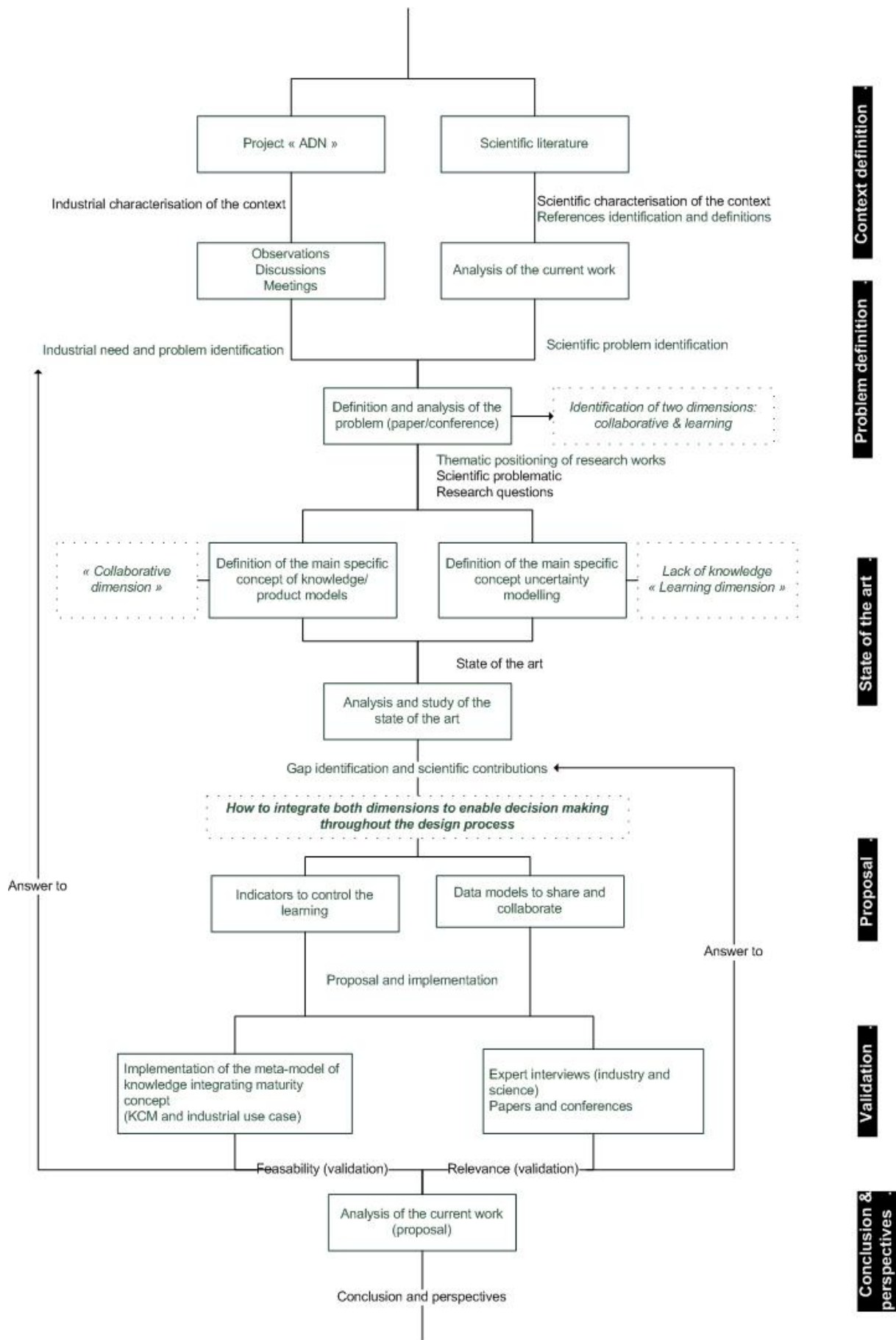

The second part is the collaborative dimension, it is characterised by a product model and integrates the metric in this final aspect. Several product models have been presented and studied in the state of the art but none includes maturity and uncertainty. We present a knowledge meta-model developed (in part by myself) in the case of the project ADN with industrial and scientific validations. This meta-model, as opposed to the different product models, allows the generation of different knowledge and product models, such as the KCM. This choice allows several models to be covered not just one. In the rest of this thesis, I present the final version of the meta-model of knowledge integrating the level of maturity. In this way, the collaborative dimension and the level of maturity are taken into consideration in order to help designers to make decisions during the upstream phases of product design. This meta-model has been validated by its capacity to be instanced on the KCM and on a case study that has been validated by different members of the project, industrial representatives and academics (Belkadi, et al. 2012).

This proposal (indicators and meta-model of knowledge including maturity (MMK)) is validated in two steps and on two levels. The first is named “Feasibility” and is the application of the proposal to an actual case. This is the capacity of the proposal to generate the KCM (existing model in the literature), including maturity of the product. This level of validation is represented by the implementation of the metric and MMK in an industrial case. This stage starts with a presentation of the actual case validated by industrial organisations, such as EADS, PSA and FAURECIA. This actual case represents a design process with two design iterations, specification of the need, several design activities and decision making. It is a representation of the design process in industry and the industrial representatives (previously named) have certified this representation by their acceptance. It presents fixation support with two representation models Computer Aided Design and Finite Element Analysis; two design iterations and a list of required technical specifications. After implementation on a demonstrator, the process and results were presented to experts for validation in addition to industrial feedback on the use of this meta-model of knowledge (proposal).

The second level of validation is called “Relevance”, it is the validation of the metric and MMK by expert evaluations (industrial and scientific) and different scientific communications.

The two following chapters present the proposal (metric and collaborative dimension) and the validations (feasibility and relevance), before concluding the current work and describing the perspectives for future work.

Chapter 3: Indicators of the learning process to manage collaborative design activities.

3. Indicators of the learning process to manage collaborative design activities

This third chapter presents the indicators measuring the maturity of a mechanical system to help decision making in preliminary collaborative design. We start this section by an explanation of the place of the proposal in the design process, its positioning in comparison with the identified models in the state of the art and several hypotheses. Subsequently, we present the different dimensions of the proposal, learning and collaborative (in accord with these identified in the previous chapter).

3.1. Positioning

We propose a metric based on the literature survey realised in the previous chapter, that is, integrated in the decision-making system via a meta-model of data, such as PDM. This metric presented in the next part takes into consideration the system dimension and the collaborative dimension (subjective). It is based upon the qualitative and quantitative approaches presented in the previous chapter. Its integration via a meta-model such as PDM allows data consistency and knowledge capitalisation to be ensured. Different meta-models have been presented and analysed in the previous chapter and we have seen that none integrate the uncertainty.

Figure 21 is a representation of the place of the proposed metric in the design process. We make the assumption that the design process is iterative with at least two iterations. As a consequence, we assume that the decision making sets off a new iteration of design. A system can be decomposed into subsystems that can interact with each other, and a subsystem is composed of different interacting elements. With the objective of supporting decision making in a collaborative context for preliminary design under uncertainty, the metric (presented in detail in the next part) based on the qualitative and quantitative approaches presented in the previous chapter, will describe and characterise the information to support product designers in making a decision. Collaboration, which is the joint development of a negotiated and consensual solution, requires many decisions, especially in preliminary design. Figure 21 illustrates the context for the development of the metric which shows different people working together on a project (to fix the value of the piston diameter, for example) while taking into account, for example, the views of design, manufacturing and thermodynamics specialists. The proposed metric is intended to support decision making by describing and

characterising information. As a consequence, we assume that this metric helps to make decisions for the next design iteration by highlighting the parameters where the unknown is the most important. Once the decision is made, the item can be updated (iteration +1). We assume that describing and characterising information, to add to the maturity evolution (results of the metric), help in considering the lack of knowledge and help in decision making. Moreover, the metric is applied at the bottom level of the system, that is to say, the data design part (value of a parameter for example). As a consequence, we assume the characterisation of the bottom level of the system decomposition, and, due to a bottom-up approach, that it is possible to characterise the top level (global system itself).

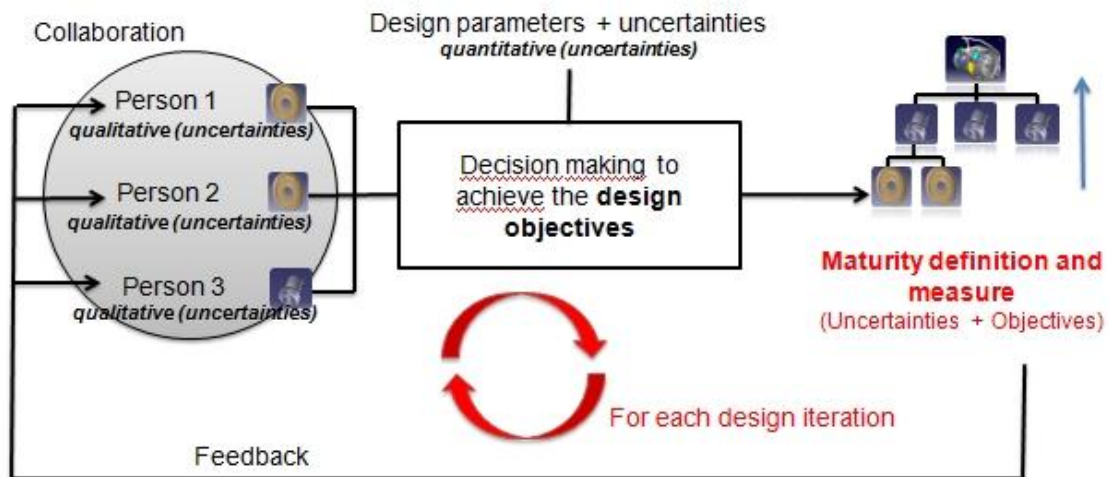

Figure 21: Decision making in preliminary design and under uncertainty (learning process)

We presented different qualitative and quantitative approaches that may be used to qualify the information maturity and to manage modification during the product pre-design phases. We focused on qualitative approaches by considering the information transmitter as well as the receiver, which can be two people addressing the same information but with two different viewpoints. One generates the information and the second uses this information.

The proposed metric is based on the state of the art presented and analysed in Chapter 2. The subjective aspect is represented by the use of indicators, such as sensitivity and sustainability. We hypothesised that the qualification of product design information and data contributes to a

reduction in the lack of knowledge in the upstream phases of design. Moreover, based on the collaborative dimension presented and analysed in the state of the art, we made the choice to use a meta-model of knowledge in order to be able to integrate the indicators in different product and knowledge models and to improve the collaborative aspect. We will demonstrate that at least a product model (KCM) is able to be implemented on this meta-model and we hypothesise that the major product and knowledge models may be implemented from this meta-model of knowledge. The proposed metric is a way to integrate the different specific concepts of uncertainty modelling to form a global indicator of maturity able to represent the maturity and knowledge of a product and not only on specific product data. Moreover, the collaborative aspect presented and analysed in the state of the art represents the different product and knowledge models oriented from the process through to the design activities. We have seen that these models have their own specificities but do not take into consideration uncertainty modelling about the product. We made the choice, as a consequence, in order to ensure the collaborative dimension and a larger scope, to work on a meta-model of knowledge based on the KCM (ADN project framework) analysis and to be able to generate different product and knowledge models.

3.2. Implementation methodology of the metric

The first step to build and use the metric is undertaken by the first designer when he defines the design parameters in CAD software such as CREO ®²² or CATIA ®²³. More than the nominal value of the parameter, he defines the interval of possible values (“tolerance”) and the level of sustainability based on a qualitative scale like that described by Gaudin (2001).

This part (parameters, values, tolerances and level of sustainability) is integrated into a PDM system, as metadata, in order to capitalise knowledge. This will also allow the information to be traced and the previous information to be traced in the next design iteration.

The second point of the methodology is the definition of the level of performance for the different parts comprising the system.

²² <http://www.ptc.com/product/creo/>

²³ <http://www.3ds.com/products/catia/welcome/>

The third step of the proposed methodology is the simulation of the assembly behaviour of the different parts comprising the system. The simulation of the assembly behaviour allows approval of it. This study is undertaken thanks to simulation software such as EXCEL, ANSYS, NASTRAN, SIMULIA, and so on. The designer does not only simulate the behaviour of the assembly but undertakes three tasks:

- Adjusts the tolerances using the results of the simulation.
- Checks whether the requirements are met.
- Defines the level of sensitivity of the results of the calculation (design parameters including tolerances).

The level of sensitivity is the impact importance of the data on the assembly. The designer qualifies this result thanks to a sensitivity level based on a qualitative scale like that described by Yassine, Falkenburg et Chelst (1999).

At this stage, all needed factors are defined to calculate the level of system maturity. These factors are levels of sensitivity and sustainability of information, importance of tolerances as a function of the nominal value and the level of performance. Maturity is translated as a percentage of the association of these three factors, taking into consideration the goals to be achieved, the user experience and knowledge, and the precision of the tolerance.

This metric helps to make decisions for the next design iteration in highlighting the parameters where the unknown is the most important. For example, the designer could devote more effort to a design parameter with a low level of sustainability and high sensitivity in comparison with a parameter having a high level of sustainability and lower level of sensitivity; in this way, it may be easier to make decisions between different points of view and design activities.

This methodology must be respected in order to apply the metric and get the right value of the parameters comprising it. This methodology is made up of several steps that have been presented in this section. The following section presents how the global indicator of maturity is calculated based on the presented methodology.

3.3. A metric to define the maturity of a mechanical system

The presented metric allows the maturity of a mechanical system to be evaluated by calculating the maturity of each component at each iteration of the design. The equation (Eq 3) presents how the maturity of a component (C_i) is defined, where “i” is the number associated with the component. The metric evolves to each design iteration and, as a consequence, each parameter is constantly updated until the full technical specification of the need is met.

The structure of the equation is obtained thanks to the need to take into account the level of maturity of each parameter, the performance and the wished level of maturity. We assume that all design parameters have the same importance in the calculus of maturity. Moreover, the maturity of the part depends of the “maturity” of each parameter composing the part. Global maturity is oriented in part by the level of maturity that designers want to achieve. We have made the choice that all criteria taken into consideration in the definition of maturity have exactly the same importance; that is why we define maturity by the following equation:

$$C_i = \frac{1}{Co_i} \times \frac{\frac{\sum_{x=1}^n \left[1 - \left(\frac{\text{tolerance}}{\text{value}} \right) \times \text{SusSen} \right] + Perf}{n}}{2} \quad (\text{Eq 3})$$

where “n”, “value”, “tolerance”, “SusSen”, “Perf” and “Co_i” are the factors.

- “n” is the number of design parameters that contain a part such as diameter, length, and so on.
- “value” is the nominal value of the design parameter, for example diameter = 25mm.
- “tolerance” is the possible domain of the nominal value, for example diameter = 25 +/- 5mm.
- “SusSen” represents the user point of view which is placed at the centre of the metric because, in the upstream phases of design, the main problem is the lack of knowledge retained by the designers. The parameter “SusSen” is only defined by the user/designer and is directly influenced by his experience, knowledge and confidence. This parameter represents the association of the sensitivity and sustainability of the

information. A first designer who has created this information (design parameter and tolerance) characterises it using a sustainability level based on a qualitative scale like that described by Gaudin (2001). This level of sustainability is the time during which information may be considered as valid. The level of sensitivity is the impact importance of the data on the assembly. The designer qualifies this result thanks to a sensitivity level based on a qualitative scale like that described by Yassine, Falkenburg et Chelst (1999).

- “Perf” is the level of performance defined by the ratio of requirement at the end of the design iteration in comparison with the number of total requirements of the concerned part. For example, if a part has three requirements and only two are achieved by the end of the design iteration, then the level of performance for this part is 66%. When 100% is achieved, this means that all technical specifications of the need are completed.
- “Co_i” is the level of maturity that we wish to achieve at the end of the design iteration. This is a constant that allow the obtained maturity (C_i) as a function of the user objectives at this stage of design to be adjusted.

The result of the metric (level of maturity) is actualised at each end of the design iteration in order to help the decision making for the next design iteration.

In order to better understand how the metric is built and works, we illustrate its use on an aero engine, in the context of preliminary collaborative design.

3.4. Illustration of the metric’s use: an aero engine

The case study is a subpart of an aero engine including a shaft and a vane wheel (Figure 22). This case is particularly interesting because it concerns a system decomposition and collaborative design process. Moreover, different activities are represented in this case study, such as design and simulation. Two designers are involved in this design during the preliminary collaborative design. The first one, designer 1, designs the CAD model of the different parts. The second, designer 2, tests and evaluates the behaviour of the assembly with FEA models.

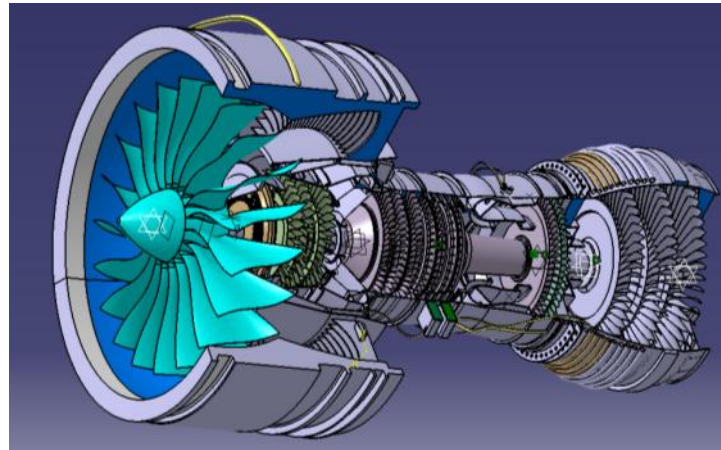

Figure 22: Case study: Full assembly

3.4.1. Use of the metric in the case study

Tables 7 to 12 synthesise the different factors and data of the assembly, at the end of each iteration. The first designer provides the level of sustainability and the second, the level of sensitivity. The performance is null because no requirements have been met at this stage of the design. Association represents the association between sensitivity and sustainability. This value represents the user point of view, experience and confidence in the information and is expressed in percentage terms.

Table 7: Representation of the data at the end of the first iteration

ITERATION 1					oct-11	
Part	Attributes	Values	Intervals	Sustainability	Sensitivity	Association
Shaft	Weight (kg)	10	8	3	2	50
	Length (mm)	150	100	2	1	35
	Diameter (mm)	40	25	2	2	30
	Performance (%)	0,0	-	-	-	-
	Maturity (%)	17,2	-	-	-	-
	Average association	-	-	-	-	38,3
Vane wheel	Weight (kg)	140	80	2	2	30
	Vane number	24	12	2	1	35
	Performance (%)	33,3	-	-	-	-
	Maturity (%)	36,4	-	-	-	-
	Average association	-	-	-	-	32,5
Assembly	Performance (%)	16,7	-	-	-	-
	Maturity (%)	26,8	-	-	-	-
	Average association	-	-	-	-	35,4

Table 8: Representation of the data at the end of the second iteration

ITERATION 2					nov-11	
Part	Attributes	Values	Intervals	Sustainability	Sensitivity	Association
Shaft	Weight	10	8	3	2	50
	Length	150	90	2	1	35
	Diameter	40	25	2	2	30
	Performance	33,3	-	-	-	
	Maturity	34,4	-	-	-	
	Average association					38,3
Vane wheel	Weight	140	60	2	2	30
	Vane number	24	8	2	1	35
	Performance	50,0	-	-	-	
	Maturity	48,6	-	-	-	
		Average association				
Assembly	Performance	41,7				
	Maturity	41,5				
	Average association					35,4

Table 9: Representation of the data at the end of the third iteration

ITERATION 3					déc-11	
Part	Attributes	Values	Intervals	Sustainability	Sensitivity	Association
Shaft	Weight	10	6	3	2	50
	Length	150	90	4	1	75
	Diameter	40	20	3	2	50
	Performance	33,3	-	-	-	
	Maturity	42,1	-	-	-	
	Average association					58,3
Vane wheel	Weight	140	50	2	2	30
	Vane number	24	4	3	1	55
	Performance	66,7	-	-	-	
	Maturity	62,4	-	-	-	
		Average association				
Assembly	Performance	50,0				
	Maturity	52,2				
	Average association					50,4

Table 10: Representation of the data at the end of the fourth iteration

ITERATION 4					janv-12	
Part	Attributes	Values	Intervals	Sustainability	Sensitivity	Association
Shaft	Weight	10	4	3	2	50
	Length	160	30	4	1	75
	Diameter	40	20	3	2	50
	Performance	66,7	-	-	-	
	Maturity	63,9	-	-	-	
	Average association					58,3
Vane wheel	Weight	140	40	2	1	35
	Vane number	24	4	3	1	55
	Performance	83,3	-	-	-	
	Maturity	72,3	-	-	-	
	Average association					45
Assembly	Performance	75,0				
	Maturity	68,1				
	Average association					51,7

Table 11: Representation of the data at the end of the fifth iteration

ITERATION 5					févr-12	
Part	Attributes	Values	Intervals	Sustainability	Sensitivity	Association
Shaft	Weight	10	2	3	1	55
	Length	160	15	4	1	75
	Diameter	40	10	3	1	55
	Performance	66,7	-	-	-	
	Maturity	69,2	-	-	-	
	Average association					61,7
Vane wheel	Weight	140	25	2	1	35
	Vane number	24	4	4	1	75
	Performance	83,3	-	-	-	
	Maturity	76,1	-	-	-	
	Average association					55
Assembly	Performance	75,0				
	Maturity	72,7				
	Average association					58,3

Table 12: Representation of the data at the end of the sixth iteration

ITERATION 6					mars-12	
Part	Attributes	Values	Intervals	Sustainability	Sensitivity	Association
Shaft	Weight	10	2	3	1	55
	Length	160	10	4	0	80
	Diameter	40	10	4	1	75
	Performance	100,0	-	-	-	
	Maturity	88,2	-	-	-	
	Average association					70,0
Vane wheel	Weight	140	10	3	0	60
	Vane number	24	4	4	1	75
	Performance	100,0	-	-	-	
	Maturity	88,9	-	-	-	
	Average association					67,5
Assembly	Performance	100,0				
	Maturity	88,6				
	Average association					68,8

Sustainability is defined by the first user creating and defining the data (CAD model). Sensitivity is the impact of the data on the assembly during the simulation. This value is defined by a second designer from the simulation model (CAE software). This process is realised for each main parameter of each part constituting the assembly.

This methodology is applied to each design iteration of the system until the level of performance is equal to 100%, which means that all the requirements are achieved.

3.4.2. The obtained results

The proposed metric and methodology allow different results to be represented in graphs (Figures 23, 24 and 25). The three factors of the metric are represented for each part of the assembly and for the assembly itself (the system). The figures show the evolution of maturity for the system and its components. It enables it to be known if the evolution is constant and how the maturity of each part evolves in comparison to that of the system. This graph also enables the problematic parts to be defined during the design iteration. For example, if the maturity of one part but not the other decreases during the design process, then there is perhaps a problem or a point that must be carefully considered.

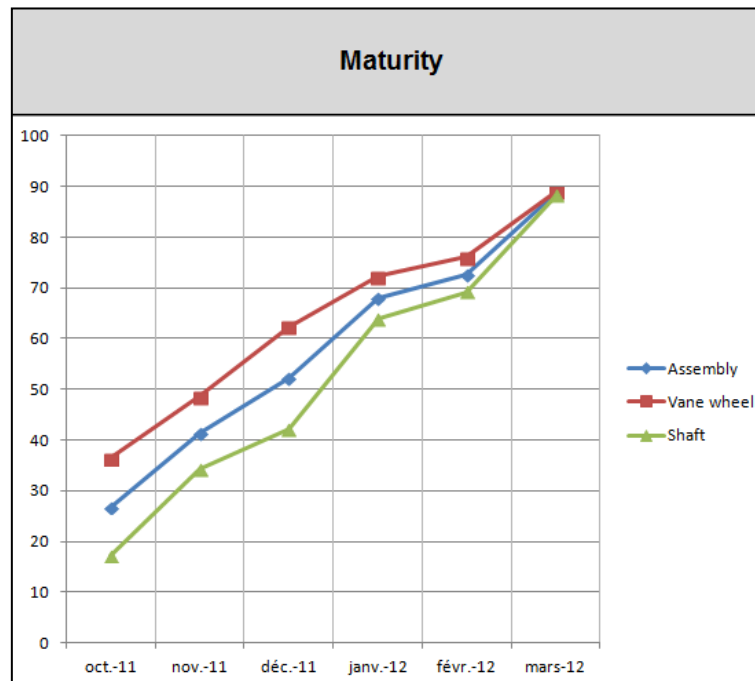

Figure 23: Obtained results: Maturity level

Figure 23 represents the maturity level for the different subsystems and the global system. This level is calculated for each design iteration and for each part. These results are obtained due to the application of the equation of metric (Eq 3). They allow a global vision of the evolution of maturity and knowledge about the system and subsystem. They also allow it to be known which part of the system is the most in difficulty (the most important lack of knowledge). As a consequence, designers know the important periods of the design process for each part of the system as a function of the augmentation speed of the curve.

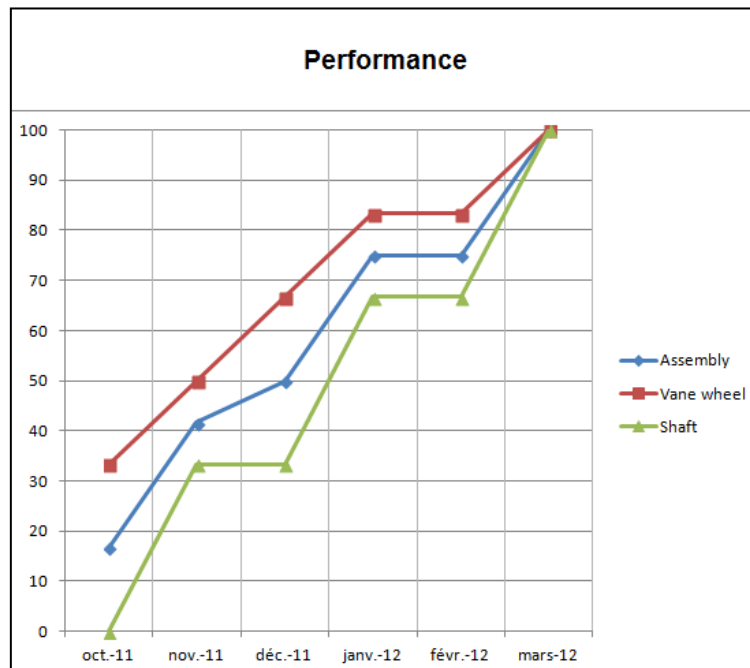

Figure 24: Obtained results: Performance level

The evolution of performance (Figure 24) represents the achieved requirements for each iteration of the design. Requirements are defined before the start of the embodiment design and the part or system may be considered as designed when all the requirements are completed. It is defined by the ratio of requirements at the end of the design iteration in comparison with the number of total requirements of the relevant part. This ratio is taken into account in the calculation of the maturity indicator presented in Section 3.3. The analysis of this graph allows it to be known which subsystem meets the least requirements. As a consequence, decision makers may choose to concentrate their efforts more on one subsystem than another.

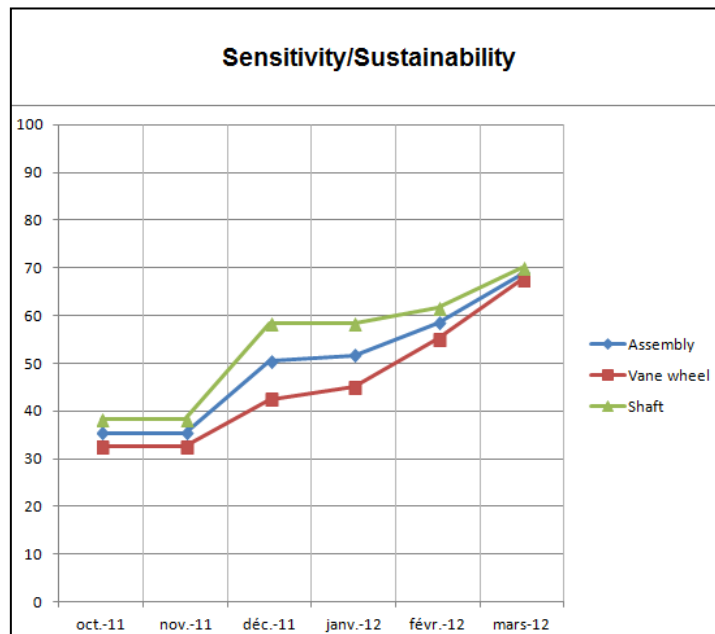

Figure 25: Obtained results: Sensitivity/sustainability (user point of view)

The third factor of the proposed metric is the association of sensitivity and sustainability (Figure 25) that represent the point of view of the user, his experience and knowledge. Effectively, sensitivity and sustainability are only defined by designers based on the system that must be qualified and characterised by user experience and knowledge. The global indicator defined in Section 3.3 takes into consideration this user knowledge to calculate the maturity level. The SusSen factor is a representation of how certain and mature the designer is with regard to what he is designing. These graphs illustrate the designers' lack of knowledge (curve with the smallest percentage in comparison with the other curves at a specific design iteration). This allows the subsystem which is the cause of this lack of knowledge to be identified. Subsequently, the decision maker must check the level of sensitivity and sustainability in order to identify precisely which parameter has the least knowledge and is the least mature. By this method, the decision maker may orientate his decision in order to reach an admissible maturity level as soon as possible (with fewer design iterations).

The obtained results show the evolution of the designer's point of view, and also the level of achievement with respect to the requirements. It enables the way in which the design evolves during the design upstream phases to be analysed in a collaborative context. This also allows a more precise decision to be made under new criteria in order to plan the following design steps, such as that explained at the end of the previous paragraph.

Thanks to the analysis of these results, the designer can see the difficulties he has to face. Graphics (Figures 23, 24, 25, 26, 27 and 28) help decision makers and designers to have a global vision of the evolution of the work and “qualification and characterisation” helps them to know which design parameters are central and have great impact on product design, due to lack of knowledge or experience. Effectively, Figures 26, 27 and 28 represent the evolution of maturity, sensitivity/sustainability and performance for each decision making (five in the design process) and for each part of the product (vane wheel, shaft and the product itself).

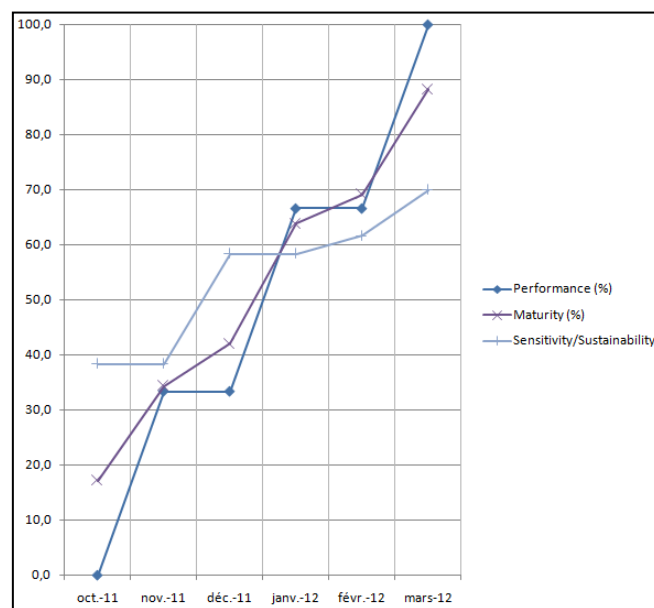

Figure 26: Obtained results: Shaft

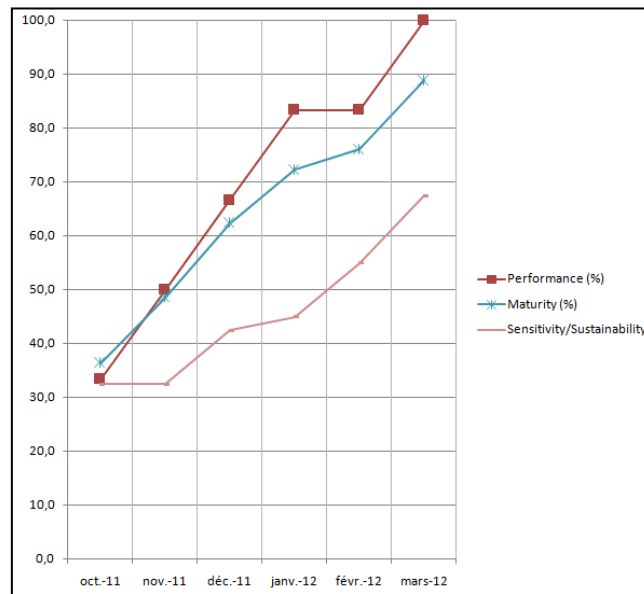

Figure 27: Obtained results: Vane wheel

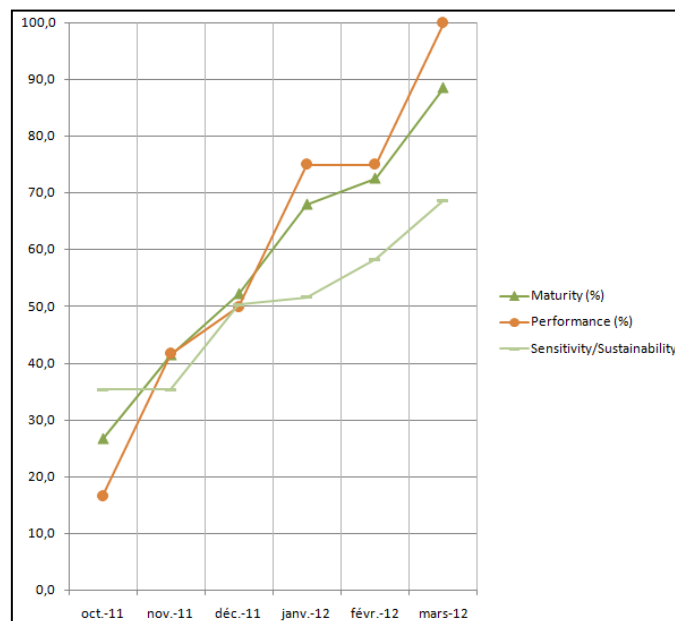

Figure 28: Obtained results: Product

For example, without the application of this metric on this case study, no knowledge would be capitalised about the importance of the key parameters of this kind of design for a future similar design. As a consequence, designers and decision makers may cope with identical

decisions and problems in future similar designs. Moreover, in this case study, only six iterations have been needed in order to meet the requirements with the application of the metric. At least the height iteration would be needed to meet the requirement without these indicators and metric because it is less easy for the decision makers to orientate their decisions, especially when the designer teams are multi-disciplinary, collaborative and scattered.

In order to ensure the collaborative aspect of the metric, its full integration into the different system decomposition levels, data consistency and knowledge capitalisation, we integrate this metric in a decision support system via a data model of the PDM type.

3.5. Meta-model of knowledge to help decision making

We have seen that the use of a knowledge and product model is needed to ensure the collaborative dimension of the metric. We presented and analysed different models in Chapter 2 and we remarked that none integrate the uncertainties. The different models representing the design activity and the different product and knowledge models presented in Chapter 2 belong to the M1 level. In order to take into consideration the maturity and uncertainty in a collaborative context, and to be able to address any product models, it is necessary to address the M2 level: meta-models (presented in Chapter 2). Effectively, each design activity is represented by models and the collaborative dimension is the communication of each of these different models with others. As a consequence, in order to ensure the integration of maturity and uncertainty (metric) in each design activity and product and knowledge model, it is necessary to ascend a level. The goal of the proposed meta-models is to provide a tool able to federate data, ensure consistency and integrate maturity in order to help in the decision making (Belkadi, et al. 2012). The data meta-model (DMM) generates a data model (DM) and the collaboration meta-model (CMM) a collaboration model (CM). These meta-models are instances of the so-called knowledge meta-model (KMM). They are described thereafter. The MOF is the standard of the object management group (OMG) interesting for the representation of meta-models and manipulations. In order to integrate maturity and uncertainty into any existing data and knowledge models, the presented meta-model is based on the different models presented and analysed in the previous chapter.

3.5.1. Knowledge meta-modelling

The KMM is a conceptual framework allowing the creation of knowledge models (KMs) through instantiation of the KMM. This way, the collaboration among KMs is eased. In broad outline, the various levels of modelling and their involvement in the lifecycle are described in Table 13.

As pointed out in the previous section, there are numerous KMs. Therefore, the KMM must be user-friendly and generic for the purpose of bringing consistency within one conceptual representation in order to open the possibility of combining different models and then build the most appropriate one.

Table 13: Positioning of the different modelling levels

Life span	Model level	
Modelling	UML	
Meta-modelling	Meta-Classes KMM (MMCore + DMM + CMM)	
Development	Classes KM (DM + CM)	
Run Time	DM Instance	CM Instance
	Business Model (CATIA v5 for example)	Collaboration Model (synchronisation between a CASTEM mesh and a CATIA v5 for example)

Figure 26 shows a package diagram representing the meta-models' organisation. The MMCore package (meta-model core) is the heart of the modelling approach. It contains all generic classes that are common for the different meta-models. The specific meta-model classes are then obtained by means of specification relations from the MMCore classes. This solution allows any activity due to the DMM to be represented and the collaboration among the different activities is represented by the CMM.

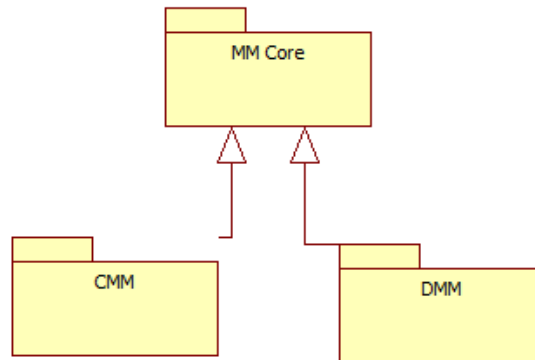

Figure 29: MMCore package and its extensions

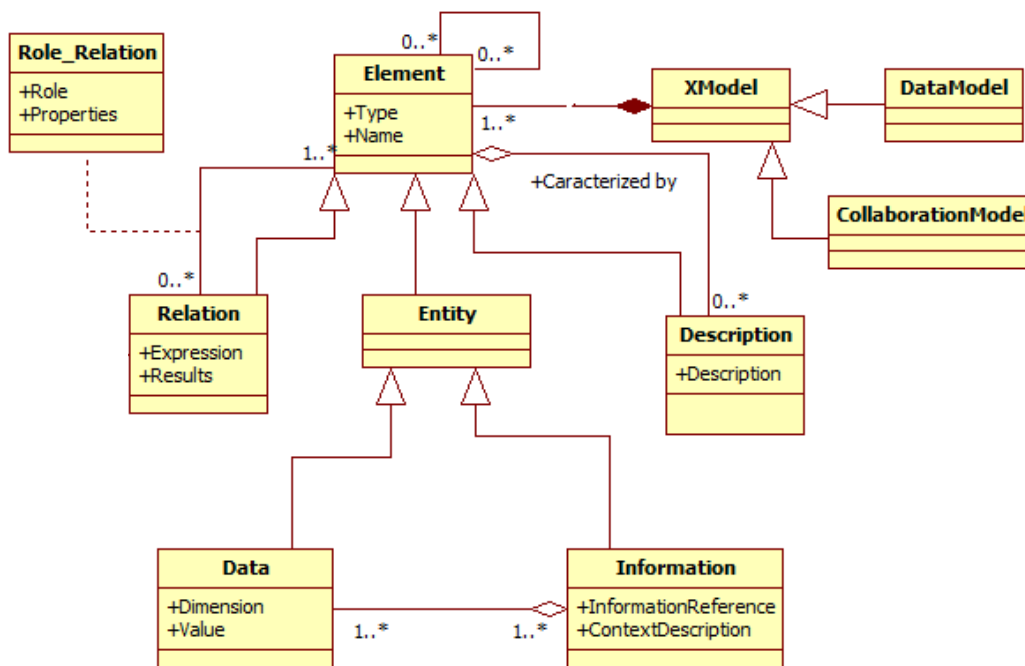

Figure 30: MMCore package description

Figure 30 presents the UML diagram of the MMCore package. The MMCore includes six main classes:

- The Element class is the most generic level of the KMM.

- The XModel class defines the type of model (data, collaboration or process) linked to an element.
- The Description class enables a specification to be formulated as any quantifiable property.
- The Entity class capitalises on and structures the main data extracted from business models or from experts.
- The Relation class provides a link between the components of the Entity class.
- The RoleRelation class manages the relations, namely to give direction to the relation, to handle the spread of the modifications using a tree approach instead of CSP²⁴.

3.5.2. Data meta-modelling

The DMM puts the concepts allowing the representation of business knowledge within a common and simplified semantic. In particular, it includes the parameters, their relationships and the maturity information. This meta-model is completed by the designers, due to their business software such as CATIA, CREO and so forth, and the decision maker may see all of the information of the meta-model.

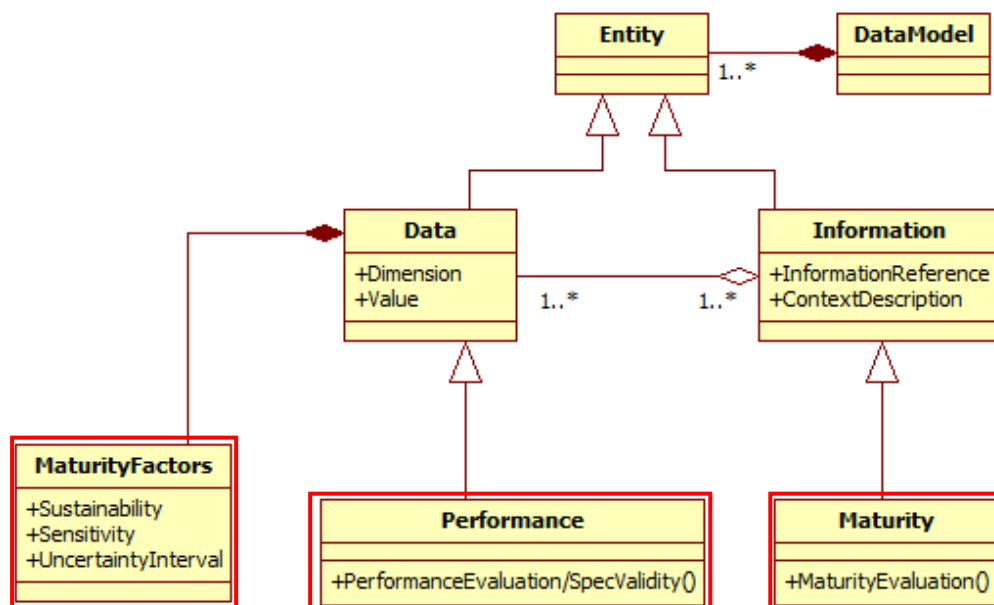

Figure 31: DMM package description

²⁴ CSP: Constraint Satisfaction Problem

Figure 31 details how the DMM package works. The content of the Entity class will be described later. The Data and Information classes inherit from the Entity class. For a given use context, parameters and their values are enclosed in the Data class. The Information class defines the knowledge configuration structure and the level of Maturity.

The modifications established in the DMM to integrate the maturity concept are composed of three classes: *MaturityFactors*, *Performance* and *Maturity*. The *MaturityFactors* class composes the Data class and allows the level of maturity (*Maturity* class) to be defined. It contains the main parameters needed for the metric and allows the global level of maturity to be calculated. The *Performance* class allows the level of performance based upon the *SpecValidity* relation (see CMM) to be determined. The *Maturity* class represents the maturity evaluation, that is to say, the metric previously defined.

3.5.3. Collaboration meta-modelling

The CMM (Figure 32) proposes the concepts representing the collaboration among the business models, in the sense of flipping from one to another, and the Specification Model. This includes inter-business parametric relationships and model transformations. The Constraint class holds the business rules. The Transformation class outlines the transformation rules, that is to say, the identification elements of equivalence relationships.

The modification established in the CMM to integrate the maturity concept is composed of one class: *SpecValidity*. This class checks the state of the validation of the technical specification of the need. It allows it to be known whether or not a technical specification of the need is respected.

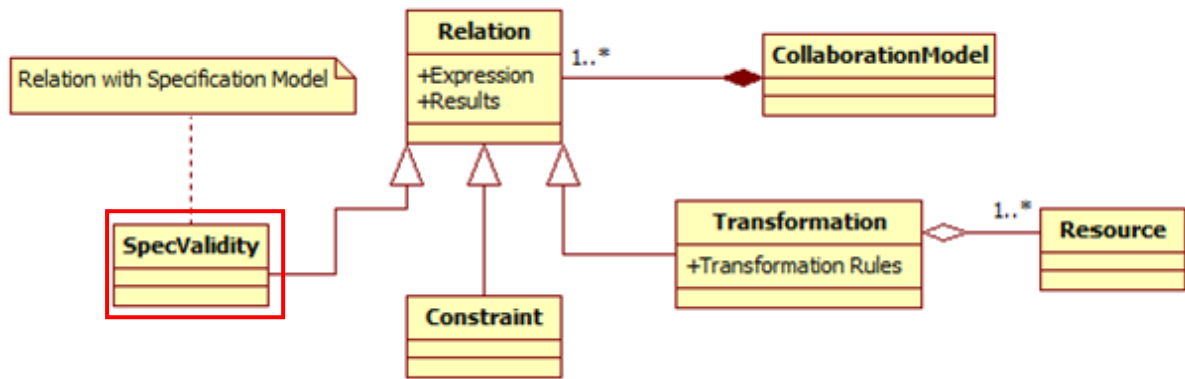

Figure 32: CMM package description

3.5.4. Meta-model of specification

The meta-model of specification (SMM) (Figure 33) suggests concepts allowing the technical specifications of the need to be represented. This meta-model is inevitably in relation to a DM in order to enable the parameters and their values to be identified. It should be remembered that the metric presented at the start of this chapter needs to be in relation to the technical specification of the need in order to be able to calculate the performance factor. This meta-model has been developed and add to the MMK in order to integrate the maturity concept. Specifications not integrating the maturity concept have not been modelled in the meta-model of knowledge. The SMM presented above allows the different technical specifications of the need to be defined and their validity checked.

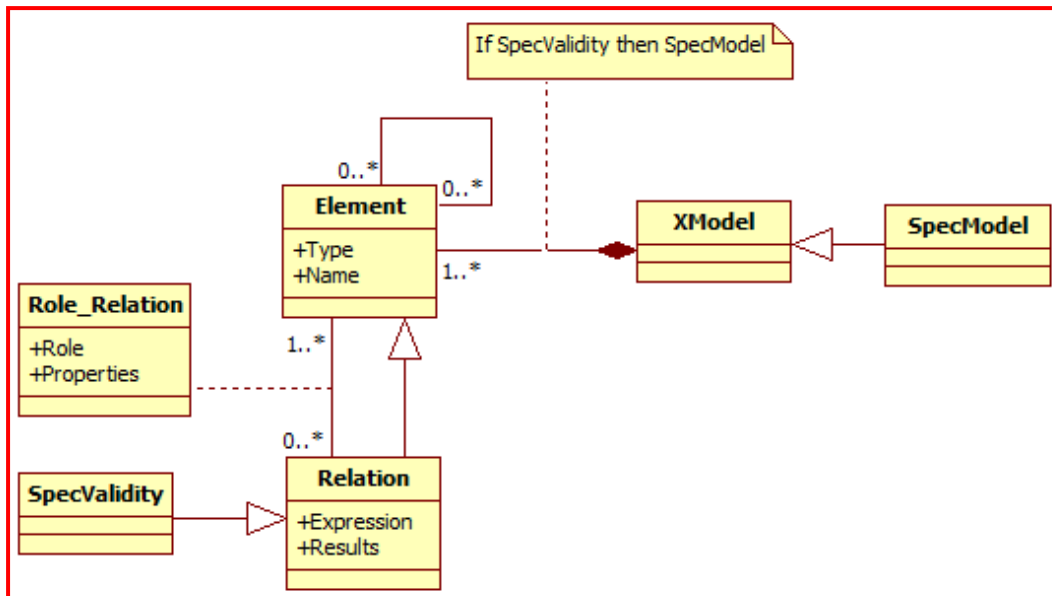

Figure 33: Description of the meta-model of specifications

The “SpecValidity” class checks the state of the validation of the technical specification of the need. It allows it to be known whether or not a technical specification of the need is respected. This class is and must necessarily be in relation to the “SpecModel” and “DataModel” classes.

The “Role_Relation” and “Relation” classes allow the technical specification of the need to be specified. The “Relation” class inherits from the “Element” class and allows several elements to be put in the relation. Figure 33 illustrates the links and class articulations of the meta-model of specification.

The presented meta-model allows maturity and uncertainty to be integrated in product knowledge and models. Moreover, it allows the metric to be integrated in a decision support system due to the DMs of the PDM type, such as those presented in the state of the art. As a consequence, this meta-model contributes to ensure data consistency in a collaborative context and in iterative design. The main contribution of this meta-model is to support decision making in a collaborative dimension and, due to the integration of the metric, take into consideration maturity and uncertainty. We instantiate the KCM from the MMK in order to illustrate the capacity of the presented meta-model to generate a model of knowledge especially for use in conflict detection to initiate decision making.

3.5.5. Application of the meta-model to the KCM

The objective of this section is to show the capacity of the developed meta-model to integrate the maturity concept (presented in the previous section) to generate a knowledge model. In order to demonstrate this, we use the KCM which is one of the models presented and analysed in Chapter 2 (state of the art) and from which the meta-model of knowledge (without integrating the maturity concept) has been built. The choice of this model is because it allows a product representation to provide different design activities (multi-representation of the same product) and, to detect conflict among these representations (different values of the same parameter represented in different activities or models). This conflict must be solved by decision making. We start our demonstration with a reminder of the KCM structure, followed by the implementation of the KCM class on the MMK (proposed meta-model of knowledge integrating maturity).

3.5.5.1. *The KCM, reminder*

The KCM is an interesting example of a knowledge model developed with the aim of managing knowledge using configurations synchronised with expert models that enable designers to use parameters consistently in a collaborative design process (Badin, Chamoret, et al. 2011). The KCM approach is based on the concept of “knowledge configuration”, that is, a virtual object composed of a set of parameters and rules. These elements are instantiated from the generic baseline and contextualised into an expert model for a specific milestone of the project to ensure consistency among all the experts’ knowledge.

The KCM is decomposed into three parts (KCMCore, KCMTool, KCMImplementation), each comprising several packages corresponding to different concerns. These packages are independent but linked to each other (relations binding) to form a coherent whole (Badin 2011).

The first part is called KCMCore. It is the heart of the KCM, and it gives the main definitions of semantic concepts and describes the structure of knowledge such as “Knowledge System”, “ICE”, and so forth, that are the manipulated classes. These classes are described later.

The second part, named “KCMTool”, provides a description of a computer platform used to implement the desired model “KCMCore” to concretely realise the functionality. This model defines the structure of the platform and features’ cutting tool. For example: the GUI, access management, configuration management, performance management, and so forth.

The third part, named KCMImplementation, helps explain the implementation of the model “KCMCore” in the platform “KCMTool”. Unlike the first two parts that contain only class diagrams, this third part contains diagrams of structures and activities to illustrate the behaviour of KCM classes. For instance, the following presents a short description of the relevant KCMCore classes. They are described because we implement them in the MMK.

- ICE class: an ICE is an indecomposable generic entity that can capitalise and organise critical data extracted from models and business experts.
- Parameter class: data expressed as a point of view using a measurable or quantifiable characteristic.
- Constraint class: a concept of duty by the rules in use in an environment where the law is specific to a domain.
- PhysicalQuantity class: describes any property that can be qualified or quantified by measurement or calculation.
- Expression class: a structured text based language that allows a specification to be expressed.
- ICEInstance class: is an application of an ICE that contains the parameter values (ParameterInstance) and instances of constraints (ConstraintInstance).
- ParameterInstance class: associated to the Parameter class to allow the multi-instantiation of parameter data.
- ConstraintInstance class: associated to the Constraint class to allow the multi-instantiation of constraints values.
- SkeletonConfiguration class: provides management and collaboration of all knowledge used in several design activities in a common goal.
- UserConfiguration Class: contains useful knowledge for a given design context; therefore it can be seen as a knowledge representation context.
- IDItem class: used to identify equivalence relations among different instances of ICEs.
- KCMProject class: includes necessary information to describe the design project.

- KCMilestone class; used to represent the temporal organisation of the project in different milestones (phases).
- KCMActivity class: used to describe an activity of the design process.

In the next three subparts, we present the implementation of the previously described classes in the MMK in order to illustrate the capacity of the proposed meta-model to generate knowledge and product models. These subparts are the presentation of a mapping between the meta-model of knowledge integrating maturity and an existing model (KCM).

3.5.5.2. Specification of the DM

In the KCM, the representation of data is realised thanks to several classes previously described, such as “ParameterInstance”, “Parameter”, “ICEInstance”, “PhysicalQuantity” and “UserConfig”.

The application of the data meta-model (DMM) in the KCM should be performed as shown in Figure 34. In this figure, the “UserConfig” class of the KCM is specified from the meta-class “DataModel” since it includes a set of useful knowledge for a given design context. In parallel, the “ICEInstance” class is specified from the meta-class “Information” because it capitalises and organises critical data to form a knowledge unit.

Finally, “ParameterInstance” and “Parameter” classes of the KCM are specified from the meta-class “Data” because it includes all measurable or quantifiable characteristics. The “PhysicalQuantity” class contains additional information that is not represented explicitly in the class attributes. Therefore, it should be specified from the meta-class “Description”.

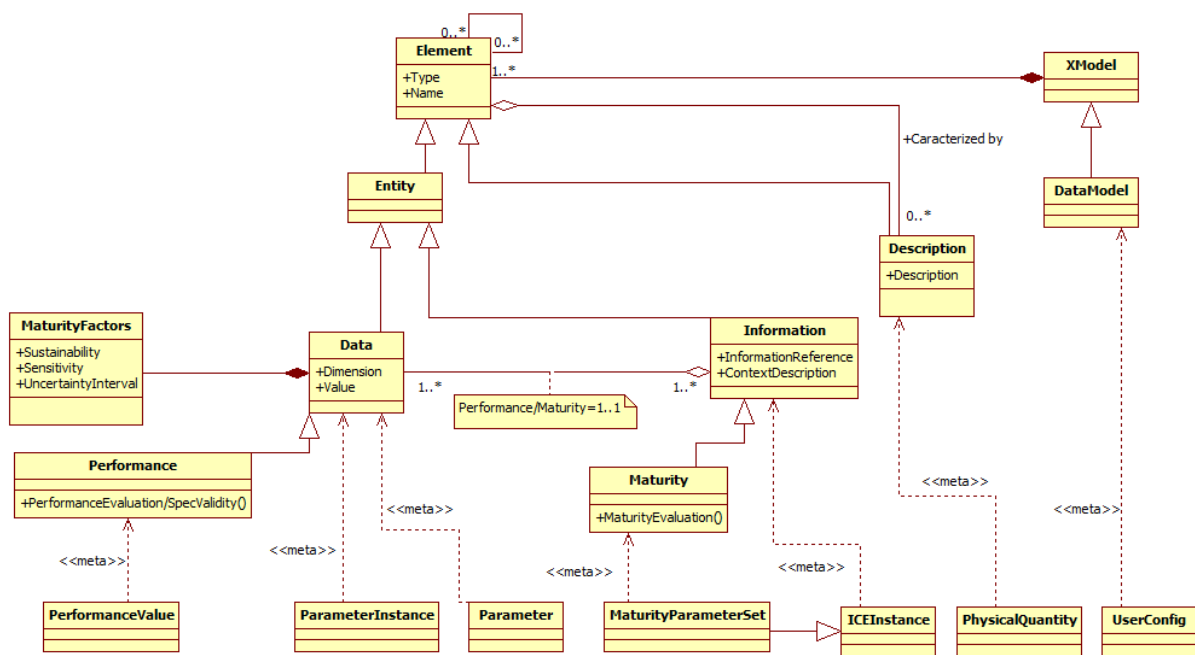

Figure 34: Application of the MMD in the KCM

Moreover, the “PerformanceValue” class allows the value of the corresponding performance for the product to be achieved. This class is an instantiation of “PerformanceEvaluation/SpecValidity”. This value is achieved due to the comparison between the total number of the technical specifications of the need and the number of technical specifications of the need that have been met or completed at the end of design iteration.

The “MaturityParameterSet” class allows a set of product parameters, having the necessary corresponding parameters for the maturity evaluation, to be regrouped. It is a derivation of the “ICEInstance” class and an instantiation of “MaturityEvaluation” class. This class must absolutely include a representative set of product parameters in order to evaluate the product maturity in a significant and accurate way.

3.5.5.3. Specification of the CM

In the KCM, the representation of collaboration is realised thanks to the classes “SkeletonConfiguration”, “IDItem”, “ConstraintInstance”, and “Constraint”. The application of the CMM in the KCM should be performed as shown in Figure 35.

In this figure, the “SkeletonConfiguration” class of the KCM is specified from the meta-class “CollaborationModel” because it provides a container for the management of entities contributing to representing the relations among heterogeneous knowledge or the collaboration among several design activities. In parallel, the “IDItem” class is specified from the meta-class “Transformation” of the CMM because this is a support for the identification of semantic equivalence relations among the different instances of ICEs.

The “ConstraintInstance” and “Constraint” classes of the KCM can be specified from the meta-class “Constraint” of the CMM since, by the rules in use in an environment where the laws are specific to a domain, this is a concept of duty. The “Expression” class is then specified from the meta-class “Description” because its role is to include additional information about the details of the constraint rules.

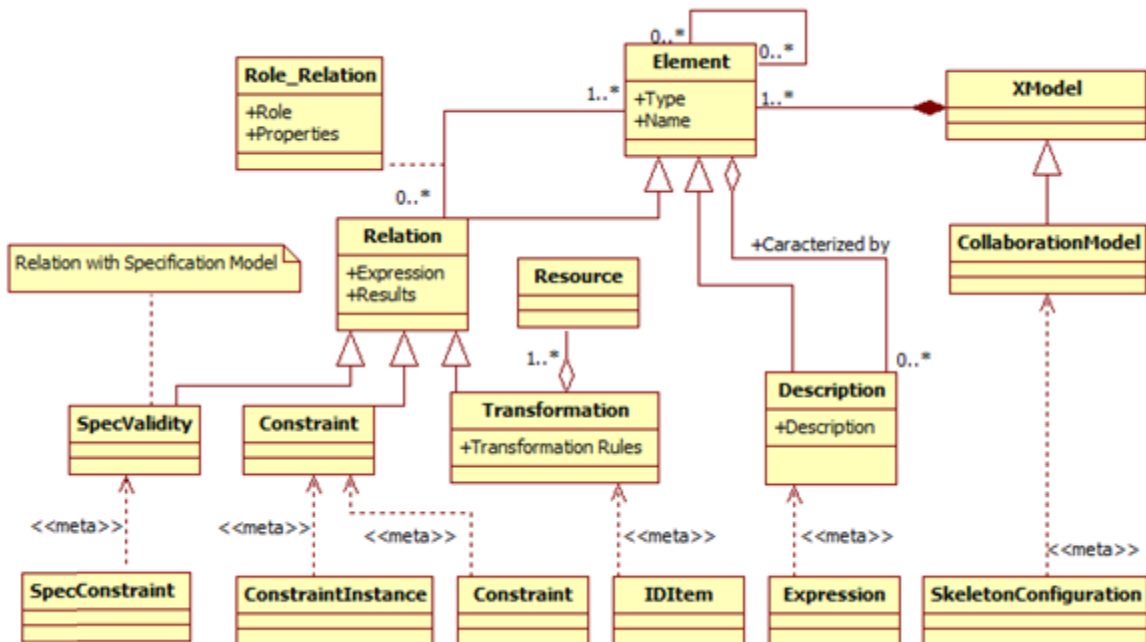

Figure 35: Application of the CMM in the KCM

Finally, the “SpecConstraint” class allows the validation state of the technical specification of the need for an iteration of design to be defined, namely *valid* or *invalid*, because only the specification in a valid state will be considered in the calculus of the level of performance. The “SpecConstraint” class is specified from the meta-class “SpecValidity” and not “Constraint” because it communicates inevitably and necessarily with an external model. This is not the case of the meta-class “Constraint” that can communicate externally of or internally in the model.

3.5.5.4. Specification of knowledge process

In the KCM, the representation of process knowledge is limited to the concepts of project, activity and milestone. In order to validate the capacity of the meta-model to represent process knowledge, we enrich the model by the UML notation of the activity diagram. Especially, we consider three main notations: decision node (represented by a diamond), fork and join transitions (represented by a bar). Within these considerations, the application of the KMM for the specification of process knowledge should be performed as shown in Figure 36.

In this figure, the “activity” class of the KCM is specified from the meta-class “Data”. The “project” class is specified from the meta-class “DataModel” since it is the space of activities achievements and milestones. In parallel, the class “Milestone” is used in the KCM to describe the temporal deadline to fulfil a set of activities according to the project planning. It describes the process knowledge context (a set of activities is performed with the aim of coping with the milestone goals). In this sense, the class “Milestone” is specified semantically from the meta-class “Information”.

Finally, the different activity diagram notations should be specified from the meta-class “Transformation” because it is a form of the third kind of relationship.

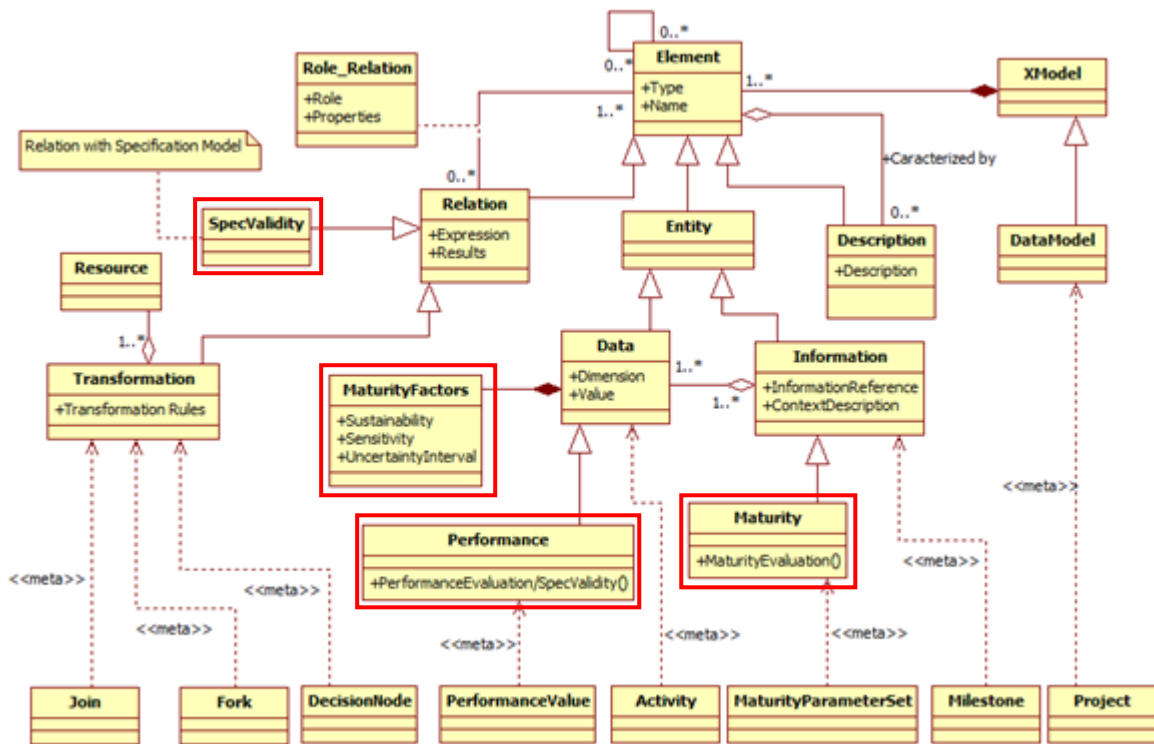

Figure 36: Application of the KMM to represent the knowledge process.

The third chapter has allowed the proposal to be presented, decomposed into two parts: metric and meta-model, each one accompanied by an illustration in order to better understand the concepts and their benefits. We have seen that the metric defines the maturity of a mechanical system and the meta-model ensures the collaborative aspect and allows the metric to be integrated into a decision support system. The next chapter presents the validation process we tried to follow to evaluate both the feasibility and the relevance of our proposal.

Chapter 4: Feasibility and relevance: two levels of validation

4. Feasibility and relevance: two levels of validation

The validation process is composed of two levels of validation: feasibility and relevance. Feasibility is the ability of the proposal to use and integrate into design methods and tools. Relevance is the ability of the proposal to help in early collaborative decision making. This chapter starts with the first level of validation, feasibility, consisting of the implementation of the proposal (meta-model of knowledge integrating maturity) in an industrial case with indicators and model points of view and is followed by a presentation of the second level of validation, relevance, that presents different scientific publications (reviewers' points of view) and industrial and scientific interviews.

4.1. Feasibility: case study

4.1.1. Industrial case study

This subsection presents the case study of a fixation support in order to illustrate the capacity of the meta-model to deal with concrete models. This actual case has been defined and chosen due to several criteria. The first is the necessity to have two design iterations with decision making. The second is the necessity to take into account different design activities in the design process (Figure 37), for example, design (CAD model) and simulation (finite element model (FEM)). The third criterion is the definition of the actual case in a collaborative context and in the upstream phases of design. Several actors interacting belong to the design process described in this actual case (design, simulation, decision maker). The last criterion is the validation of this actual case by the industrial representatives, members of the ADN project, to represent and illustrate their difficulties/problems and needs.

Figure 37 presents the design process of this product. This process focuses on the preliminary design phase and it ceases on validation of the models. It allows design interactions between the CAD and the simulation models, design iterations and decisions making to be shown.

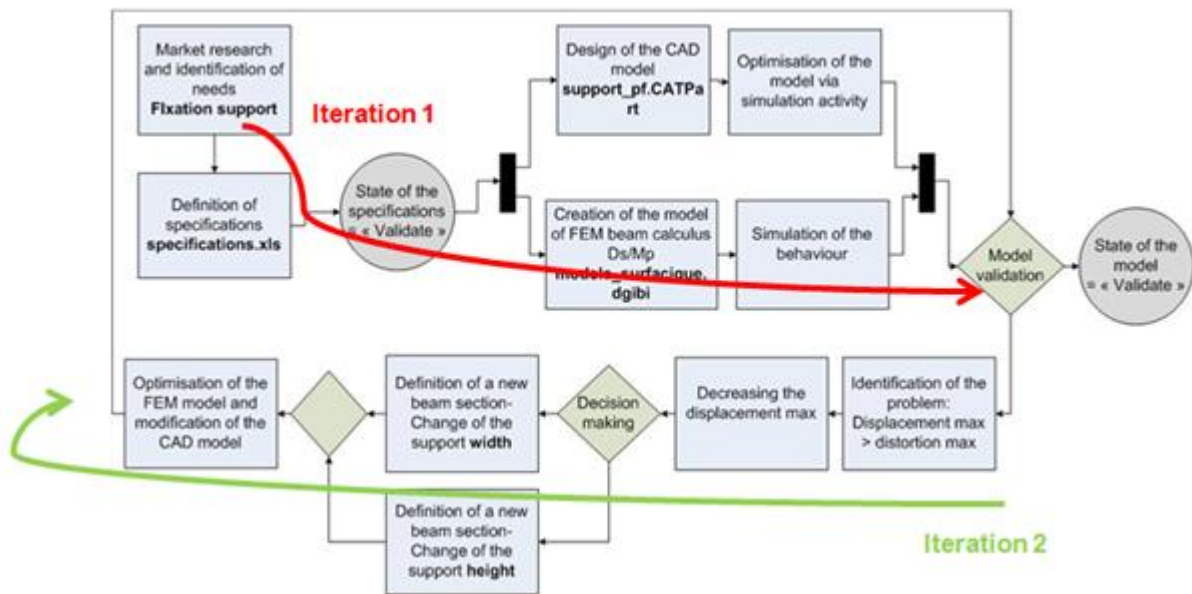

Figure 37: Scenario of the case study defined in the ADN project and in partnership with industry (automotive and aeronautic)

Two models are considered in this example, one CAD and one simulation. The process allows the way to design a product to be illustrated but the metric presented in this part is based directly on the product parameter and considers that the specifications of the product are certain. Two milestones (represented by circles) are considered in the process: validation of the specifications and validation of the design and simulation models.

The design process presented in this industrial case comprises two design iterations because simulation and design do not provide the same results as a function of the technical specification of the need. As a consequence, a decision must be made at the end of the first iteration. The results of these two design iterations are presented in the following section.

4.1.2. Design iterations

4.1.2.1. First design iteration

Tables 14 and 16 illustrate the capitalisation of different product data and the evolution of the different values linked during the design process. These tables comprise three parts. The first is the list of specifications, the second the list of parameters of the product design activity and

the third the list of product parameters of the simulation activity. The realisation of the relative models (CAD Figure 38, FEM Figure 39, etc.) is performed individually by different actors.

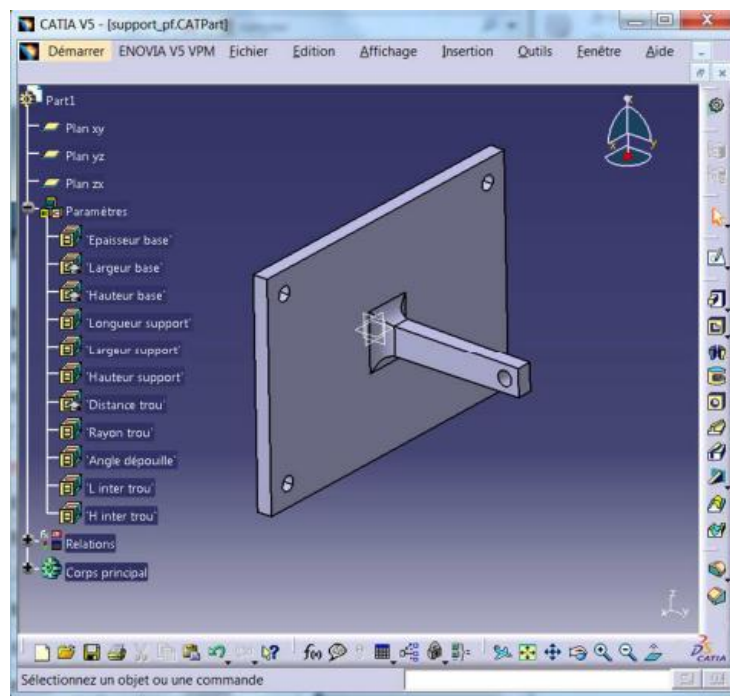

Figure 38: CAD model of the actual case (iteration 1)

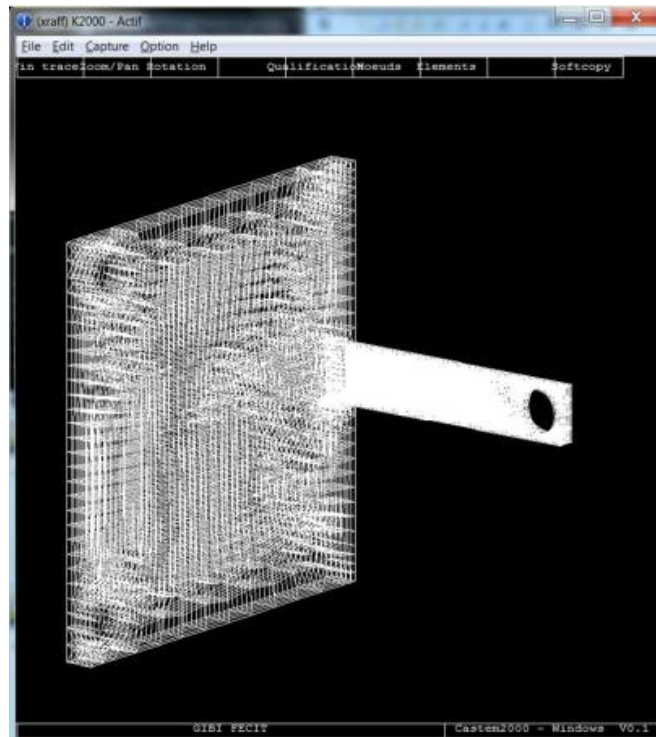

Figure 39: FEM of the actual case (iteration 1)

These actors are currently applied to work collaboratively to resolve conflicts related to one or more common parameter(s) value(s). For instance, in the current example, the designer creates the CAD model and attributes values to each parameter of the product (CAD part). The second expert creates the FEM to simulate the part behaviour. The data and parameters of these two models are presented in the Excel file (Tables 14 and 16).

These two tables represent a PDM view of the product. Excel allows the different parameters and their versions to be represented in a simple way in order to get an overview of the product. These tables have been built to illustrate the feasibility of the metric and are based on the industrial experts' activity descriptions. Like the case study, they have been validated by experts during a presentation to ensure that the established process represents well the real industrial activities. Different presentations during the ADN project have allowed this validation (see Appendices 6.6 and 6.7, Presentations during the ADN project).

It should be remembered that “I”, “Su”, “Se” and “as” are the needed parameters to calculate the level of maturity of the product. “I” corresponds to the tolerance with respect to the nominal value. “Su” is the level of sustainability defined by the designers in the creation of

information. “Se” is the sensitivity level defined by the designer and represents the importance of information impact on the whole product. Finally, “as” refers to the combination of sustainability and sensitivity that represent maturity from a user point of view.

Table 14: Design iteration number one

State of the parameter in end of phase v1

Technical Specification of the Need		CAD					Beam					Volume		
		Parameter	V1	I	Su	Se	as	Parameter	V1	I	Su	Se	as	
Checking: V1		Geometrical												
		Base thickness	5	3	5	3	0,85	EP_BA	5	2	3	3	0,45	EP_BA
		Support length	50	15	4	3	0,65	LO_SUP = Support height - base thickness/2	50	20	2	3	0,25	LO_SUP
		Support width (b)	6	4	3	3	0,45							LA_SUP
		Support height (h)	10	12	3	3	0,45							H_SUP
		Hole radius												R_TROU
		Draft angle												R_TROU2
		L Inter hole	130	-	-	-		LO_INT	130	-	-	-		LO_INT
		H Inter hole	60	-	-	-		H_INT	60	-	-	-		H_INT
	Maximum space	150 * 150 (Base) * 100 (Support)						SECT_SUP = b*h	60	-	-	-		
		Mechanical												
								MOD_E (Young)	#####					MOD_E (Young)
								MOD_POI (Poisson)	0,33					MOD_POI (Poisson)
								INRY_SUP --> Ix = b*h*h*h* / 12 (Inertie Y)	500					
								INRZ_SUP --> Iz = h*b*b*b* / 12 (Inertie Z)	180					
								TORS_SUP --> It = Ix + Iz (Inertie T)	680					
								FO (Loading)	100N					FO (Loading)
								Displacement Max	-0,248					
	Max load to support	10,2Kg												
	Displacement max	0.2mm												
	Cyclical load	No												
	Maximum support weight	10Kg												
	Maximum torsor to the fixings	{{400,500,400}};{ 200,200,200}}												
	Temperature of use	Current (18°)												
	Exterior use Y/N	No												

Table 15 below shows the levels of performance and maturity achieved at the end of the first design iteration. The level of performance is the number of validated specifications; here 75% of the technical specifications of the need are completed. As a consequence, an overall maturity level of 60% is attained.

Table 15: Performance and maturity levels at the end of the first design iteration

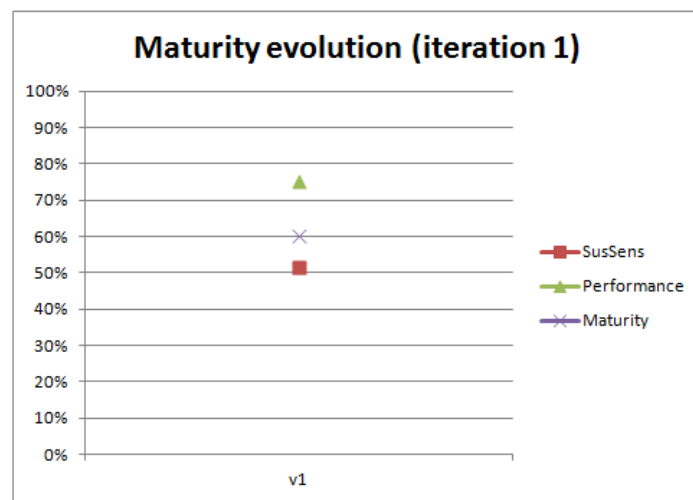

This level of maturity enables designers to guide their decisions for the next design iteration and thus achieve a performance level of 100%. Sustainability, sensitivity and tolerance indicators allow designers to define which parameters to modify to achieve their goals as quickly as possible according to their design wishes. It is up to them to choose whether they prefer a design parameter that is completely mastered and for which they know its evolution and impact on the entire product, or one poorly known where the important thing is to learn and study its behaviour (in the case of innovative design for example where there are many unknowns unlike a well-established design which is almost perfectly mastered).

At the end of the first design iteration, designers and decision makers have Tables 14 and 15 at their disposal to make the decision. Table 15 is a representation of the current state of the design. In this particular case (first iteration), it provides an initial reference state for the

decision makers. In this way, the decision maker will be able to analyse and compare the evolution of maturity and the quality of the taken decision at the end of the second iteration.

The level of performance presented in this first iteration (less than 100%) shows clearly that a second design iteration must be realised in order to attain a level of 100%. The decision maker must make a decision on which value to impact in order to attain the best performance with a minimum of time and design iterations. Here, we change the value of the support height (h) from 10mm to 16mm. This value has been modified because this is one with an important tolerance (interval). Moreover, the level of sustainability is quite low, indicating that the designer has low confidence in this value.

4.1.2.2. Second design iteration

We saw at the end of the first design iteration, that not all of the technical specifications of the need are validated; as a consequence, a second design iteration is realised.

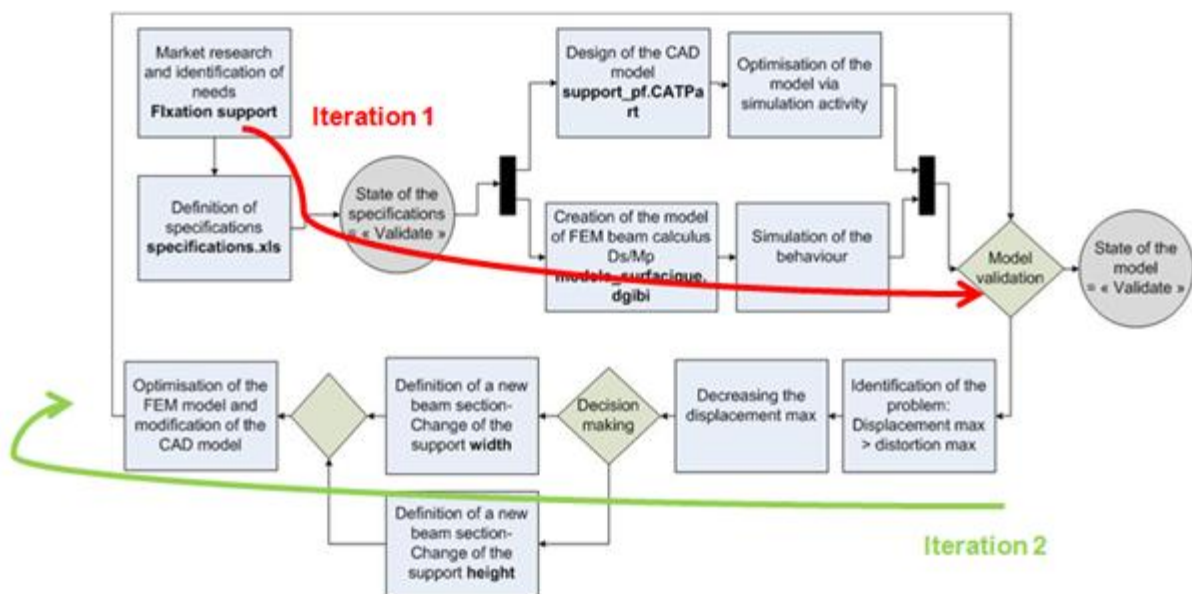

Figure 40: Second design iteration of the industrial case

The value of the maximum displacement is not met because the value obtained as a function of the design choices gives a value greater than the allowed value. As a consequence, a second iteration of the design must be undertaken to correct this problem and thus achieve a

performance level of 100%; corresponding to the compliance with all technical specifications of the need. A decision must then be taken, based on the design goals and wishes to change the parameter values necessary to achieve a performance level of 100% (in this actual case, support height or support width). Once this decision is made, a new characterisation of the product parameters takes place. This characterisation is presented in Table 16, denoted “V2”.

Table 16: Design iteration number two

State of the parameter in end of phase v2

Technical Specification of the Need		CAD										Beam										Volume				
		Parameter	V1	I	Su	Se	as	V2	I	Su	Se	as	Parameter	V1	I	Su	Se	as	V2	I	Su	Se	as			
	Checking: V1	V2																								
			Base thickness	5	3	5	3	0,85	5	2	5	3	0,85	EP_BA	5	2	3	3	0,45	5	2	4	3	0,65	EP_BA	
			Support length	50	15	4	3	0,65	50	6	4	3	0,65	LO_SUP = Support height - base thickness/2	50	20	2	3	0,25	50	10	3	3	0,45	LO_SUP	
			Support width (b)	6	4	3	3	0,45	6	3	4	3	0,65												LA_SUP	
			Support height (h)	10	12	3	3	0,45	16	2	4	2	0,7												H_SUP	
			Hole radius																						R_TROU	
			Draft angle																						R_TROU2	
			L Inter hole	130	-	-	-	-						LO_INT	130	-	-	-							LO_INT	
			H Inter hole	60	-	-	-	-						H_INT	60	-	-	-							H_INT	
	Maximum space	VRAI	150 * 150 (Base) * 100 (Support)											SECT_SUP = b*h	60	-	-	-								
Mechanical																										
			Max load to support	10,2Kg	TRUE	TRUE	TRUE	TRUE						MOD_E (Young)	#####										MOD_E (Young)	
			Displacement max	0,2mm	FALSE	TRUE	TRUE	TRUE						MOD_POI (Poisson)	0,33										MOD_POI (Poisson)	
			Cyclical load	No	TRUE	TRUE	TRUE	TRUE						INRY_SUP --> ix = b*h*h*h* / 12 (Inertie Y)	500											
			Maximum support weight	10Kg	TRUE	TRUE	TRUE	TRUE						INRZ_SUP --> iz = h*b*b*b* / 12 (Inertie Z)	180											
			Maximum torsor to the fixings	{{(400,500,400)}, {200,200,200}}	FALSE	TRUE	TRUE	TRUE						TORS_SUP --> it = ix + iz (Inertie T)	680											
			Temperature of use	Current (18°)	TRUE	TRUE	TRUE	TRUE						FO (loading)	100N										FO (loading)	
			Exterior use Y/N	No	TRUE	TRUE	TRUE	TRUE						Displacement Max	-0,248											

After simulation, we obtained an analysis and a calculation of the new levels of performance and maturity of the product. Table 17 presents these results in comparison with the first iteration and Figures 41 and 42 represent the updated CAD and FEM models.

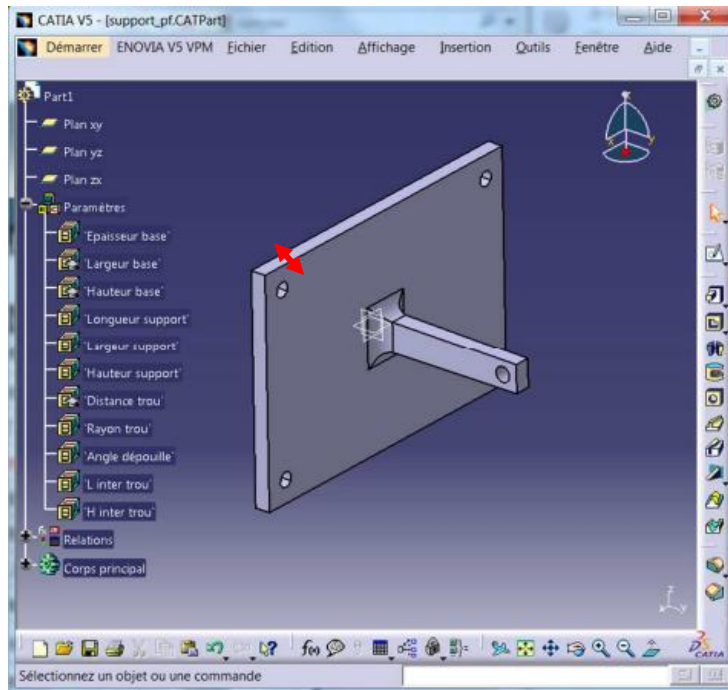

Figure 41: CAD model of the actual case (iteration 1)

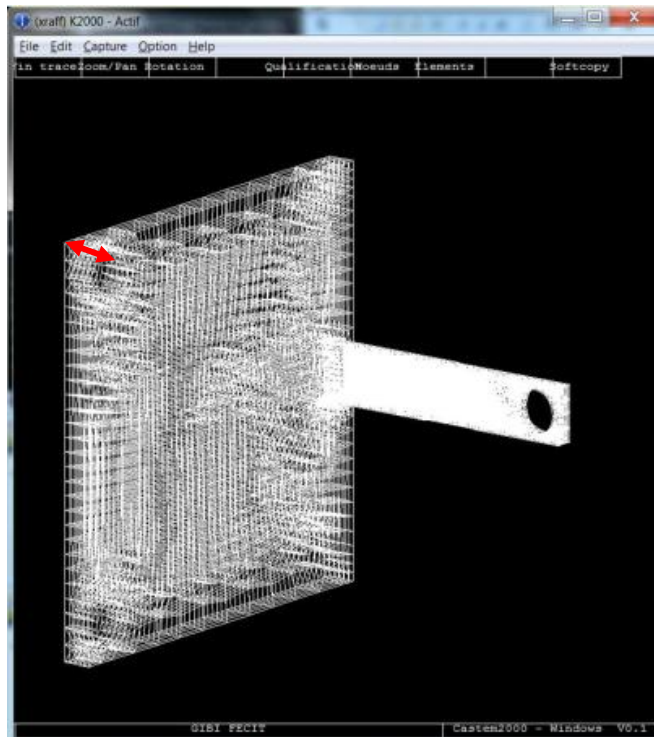
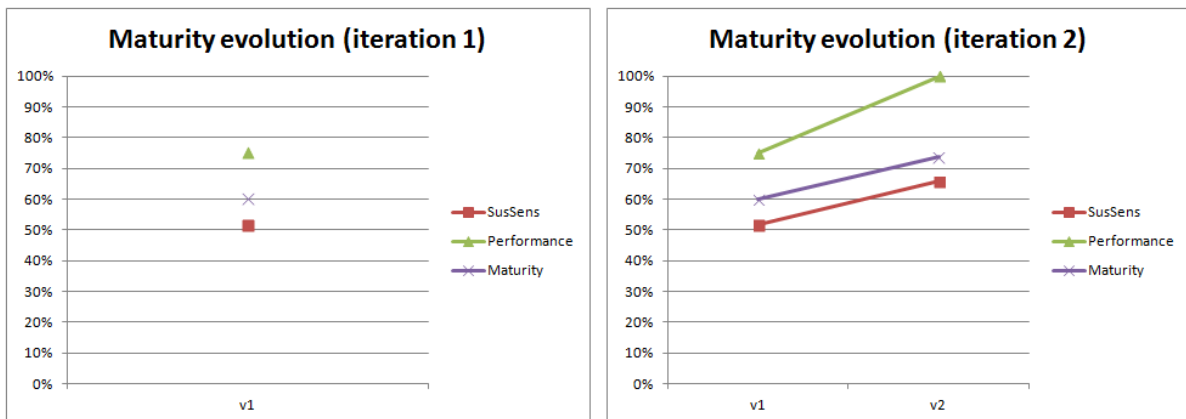

Figure 42: FEM model of the actual case (iteration 1)

Table 17: Performance and maturity levels at the end of the second design iteration



The level of performance achieved (100%) means that the product meets all technical specifications of the need. We also noted an increase in the level of maturity from 60% to 74%. This level represents the level of knowledge of the product. These factors, levels and

trends will refine strategies and design decisions for future designs of similar products (field of design routine).

This first part illustrates the application of the metric to the industrial case study. In the second, we are interested in the knowledge structure established in this case study from the model point of view in order to illustrate the feasibility of the proposed meta-model.

4.1.3. Knowledge structure point of view

The aim of the case study is not to describe the product development process and related collaborations for conflict resolution but to illustrate how the modelling framework can be applied for the representation of knowledge produced and shared in an actual case.

The case study knowledge is represented in the KCM by using the classes “UserConfig” for the description of individual experts’ knowledge and “SkeletonConfig” for the representation of collaborative knowledge. Figures 43 and 44 present a simplified view of the object diagram for the design and simulation activities. The presented objects depend directly on the actor (designer) and their knowledge. It is not possible to obtain different objects for different actors of the same “master object” because our hypothesis is that only one actor defines one object related to an activity. In this case, a unique object, in different states as a function of the design iteration, is defined by a master object, and, as a consequence, the valuation of each object is unique for each design iteration. For instance, the activity design contains two kinds of knowledge related to the “BEAM_Geometry” and “Base_Geometry” that are exploited by the simulation expert in his own activity. The object “item” is then used to guarantee coherence between the related data values of common parameters modified individually during the design and simulation activities.

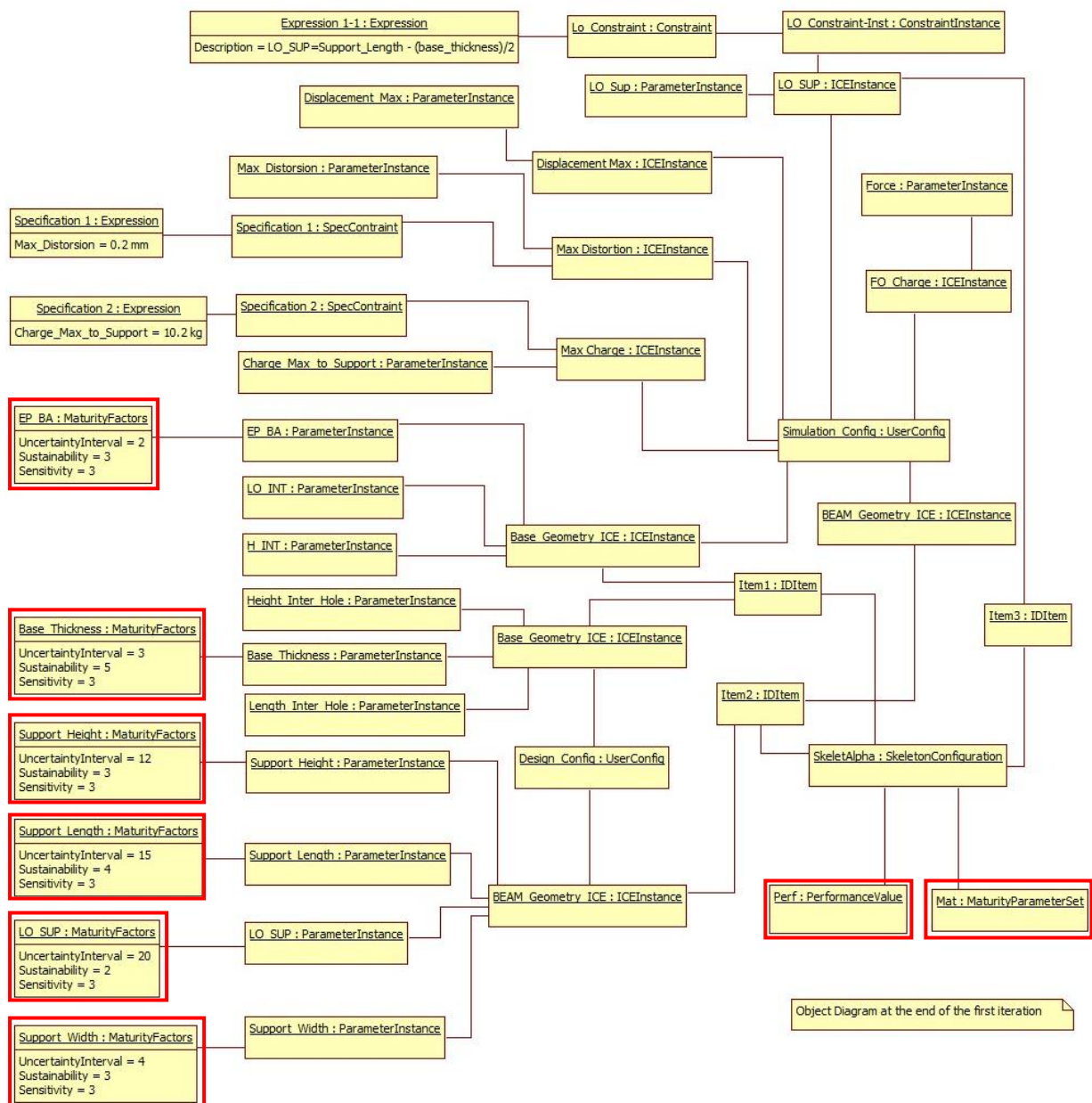

Figure 43: Object diagram of the KMM application to the scenario (iteration 1)

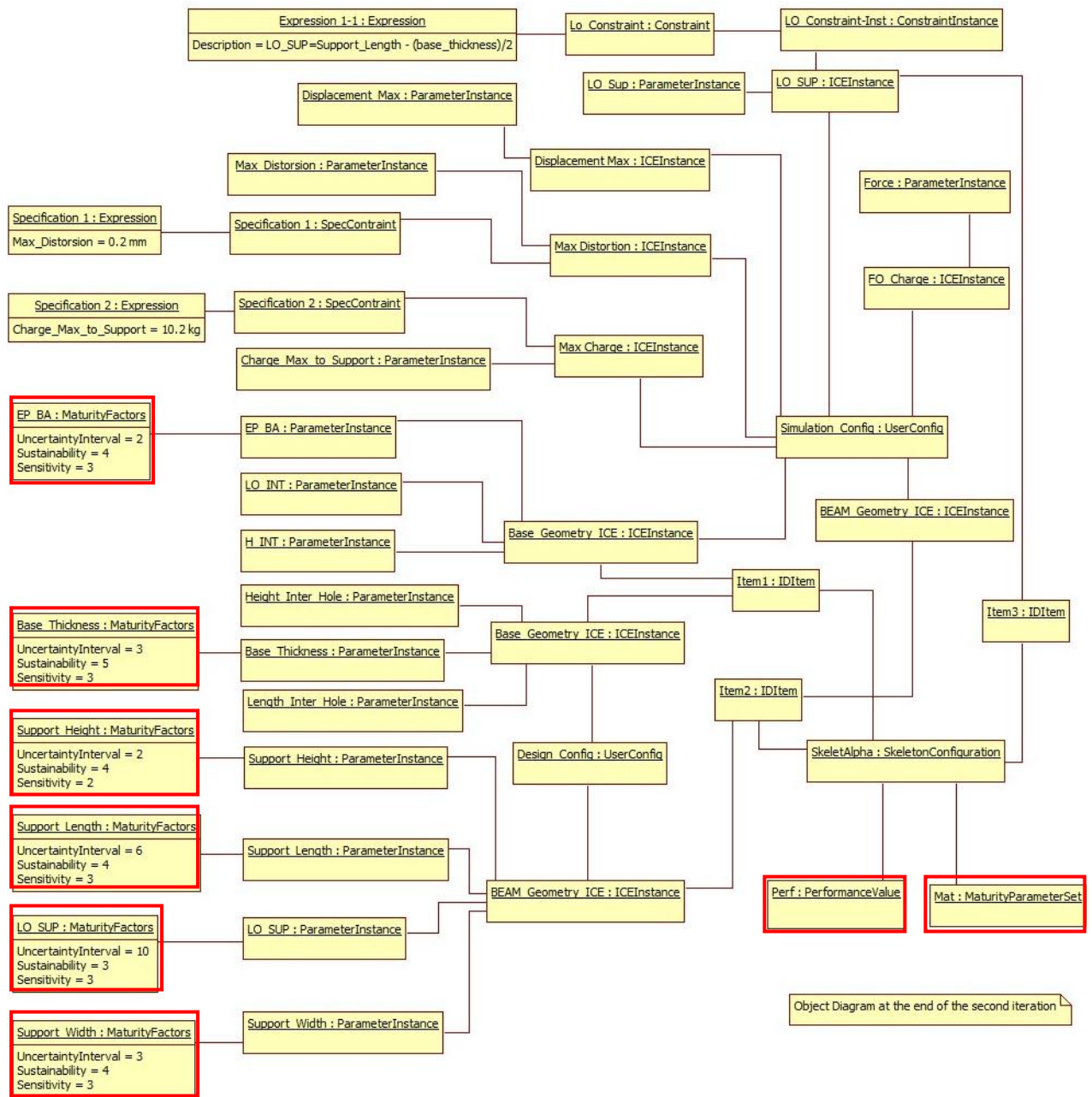

Figure 44: Object diagram of the KMM application to the scenario (iteration 2)

We also find in these figures, the instantiation of the class “MaturityFactors” which allows the sensitivity and sustainability levels and tolerances to be set. These object diagrams are snapshots of the state of instantiation of the KMM at the end of the first and second design iterations.

The proposed KMM framework can be used to represent the same knowledge within generic concepts. Figure 45 presents a partial view of the application of the KMM in the same case study to show the semantic equivalence between specific concepts of the KCM and those of the KMM expressed in more generic syntax. This figure focuses on the collaboration between design and simulation activities and, especially, on the interaction between the parameters of both the beam and the base geometries.

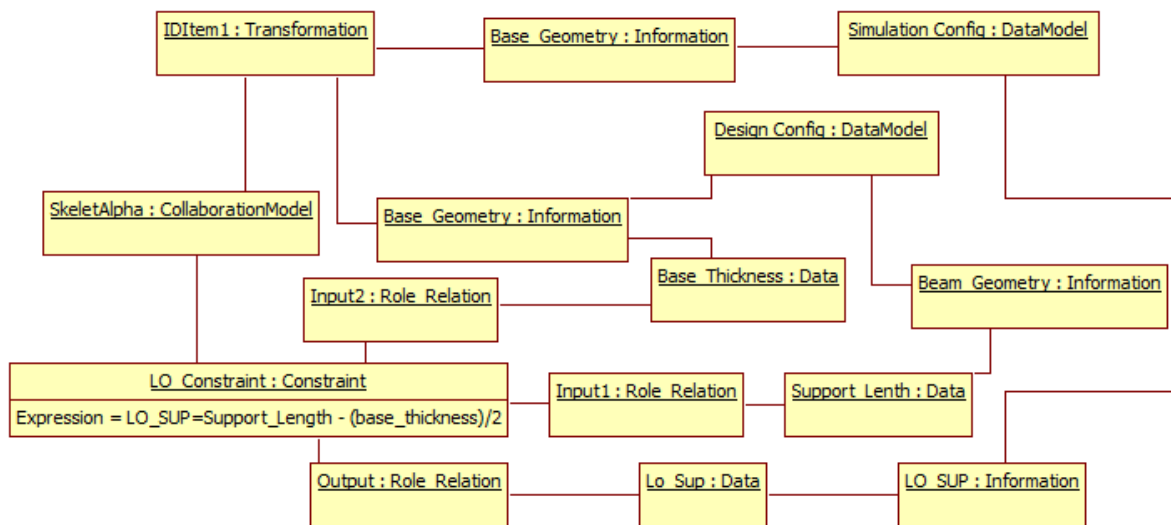

Figure 45: Instantiation of the KMM in the case study

According to the specification rules between the KMM and the KCM, defined previously, the object “idItem1” is considered as a part of the instance of CM “SkeletAlpha”. It represents transformation between the information “Base Geometry” (and its related data) manipulated in the activity and the equivalent information (and its related data) manipulated in the simulation activities.

With the difference from the KCM model, the representation of the relation among the objects in the CM can be enriched by the role of the object in the relation, such as the roles input/output of the relation LO_Constraint.

The main advantage of the KMM is its capacity to describe different knowledge categories with a unified semantic. For this need, the instance diagrams, presented in Figures 43 and 44,

show how the KMM framework can be used to represent, with similar logic, the process knowledge of the case study (expressed in Figure 46).

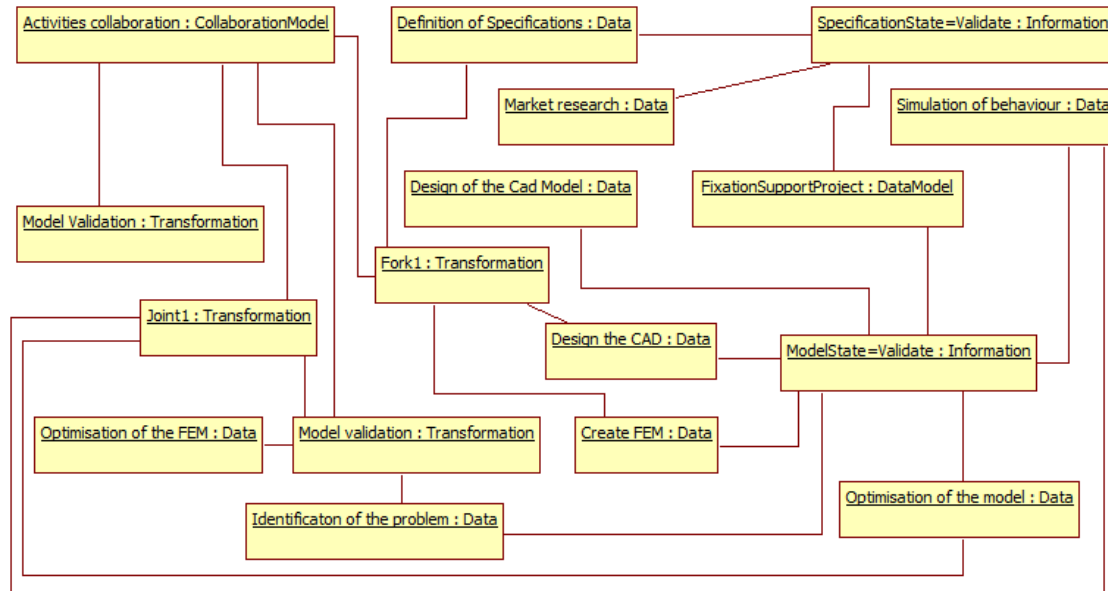

Figure 46: Instantiation of process knowledge in the case study

In this figure, the DM “FixationSupportProject” includes two main information objects related to the identified milestones. Each of these milestones is composed of a set of data that defines the real activities. For a semantic interoperability request, the milestone concept can be considered as similar to the concept of a process, which is currently used in the process KMs.

The different links among the activities are represented by a set of transformation objects as a part of the CM named “Activities collaboration”. The “role” relations are used to enrich the representation by the positioning of each entity relating to the transformation. For example, in Figure 46 that represents the instantiation of the process knowledge in the case study, the class named “Activities collaboration:CollaborationModel” allows the common parameters of the different transformations which are linked to the specific data, such as “Design the CAD”, “Create FEM”, “Identification of the problem”, and so on, to be linked

We note that the transformation relation (like the constraints) can make not only data and information relations but also other relations. For instance, in this case, the transformation object, “joint 1”, not only relates the two data objects “Optimisation of the model” and “Simulation of the behaviour” but is also linked to the data objects “optimisation of the FEM” and “Identification of the problem”.

In this first validation level (first level of both feasibility and relevance), we have demonstrated and illustrated the establishment of the metric on the academic scenario initially defined by the ADN project partners. We have also demonstrated the feasibility of the proposed metric to measure the maturity and the capacity of the modelling framework to be applied for the representation of knowledge produced and shared in an actual case.

This scenario is relatively simple compared to the potential capacities of the maturity metric included in the meta-model. This development would be meaningless if it was, for example, applied to the design of an airplane, or the development process was long and the number of parameters to take into account amounted to millions. In this type of design, it is important to justify characterising and quantifying each decision because the consequences can be significant. We have demonstrated not only a model to help in decision making in innovative design that is simple and quickly understood by all interested in maturity, but also the reuse of knowledge in the design routine.

This first step and level of validation, *feasibility*, is enriched by different expert evaluations. This enrichment represents the way we try to evaluate the relevance of the proposal.

4.2. Relevance: expert evaluations: scientific and industrial

Relevance is the second level of validation established in my PhD. It presents expert evaluations, scientific and industrial, about the proposed meta-model and metric. These evaluations have been undertaken by means of different paper submissions (conferences: ICED11²⁵, Qualita13, ICED13, INCOM12²⁶ and PLM13), acceptances and presentations, and by industrial expert interviews.

²⁵ ICED: International Conference of Engineering Design

²⁶ INCOM: Information Control Problems in Manufacturing

4.2.1. Scientific experts

A synthesis of the evaluations of scientific experts is presented in Table 18. This table is organised in three parts corresponding to the proposal, metric and meta-model integrating maturity. The addressed problematic allows the relevance and interest of the identified problematic in the context to be confirmed and ensures that the proposal addresses them correctly. The different evaluation criteria are based on the reviewer conferences.

Table 18: Synthesis of the scientific experts' evaluations

Proposal and works	Criteria						
	Interest	Validation	Contribution	Relevance	Originality	Quality	Significance
Addressed problematic	high	valid	-	high	-	-	-
Metric, indicators, and maturity evaluation	major interest	confirmed	relevant and pragmatic	high	high	high	high
Meta-model of knowledge integrating maturity	substantial	confirmed	clearly identified	high	high	high	substantial

The expert feedback confirms the interest in the addressed problematic in describing the paper content as dealing with a wide-spread problem in collaborative design where various DMs co-exist. Moreover, due to the high number of references to related work, the work bases are correctly defined in order to provide a good overview of the scope. Furthermore, the proposal answers correctly the addressed problematic (see Reviewer 2, 6.8.1, in the appendices) but the global framework presented must be clarified.

Effectively, the INCOM conference allowed the direction taken and the presented meta-model to be evaluated in advance of the conference for the version currently presented in this PhD, taking into consideration the expert evaluations. We note that major improvements have been made, such as the implementation and realisation of the case study and the integration of the

main part of the proposal in this meta-model to ensure data consistency and maturity definition of a system.

These first expert evaluations (based on the synthesis of Appendix 6.8.1, Reviewers 1, 2 and 3) are concluded with a very good motivation and problem statement, a good literature survey and a proposal presenting a global framework to ensure data consistency and knowledge capitalisation that correctly answers the addressed problematic. But, an example of an industrial case, clarifying the proposed approach for non-expert people, would be needed and that is what has been done in the PhD.

The metric was also validated by the experts (see Appendix 6.8.2. Expert evaluations: ICED'13) because it represents a real contribution with regard to the problematic addressed. Effectively, the key contributions of the paper and, as a consequence, of my PhD, are a review of the uncertainty modelling technique and a proposal for a pragmatic metric for the maturity evaluation of a mechanical system (based on Reviewers 1 and 3, Appendix 6.8.2).

In addition to the clear validation of and interest in the proposed metric in evaluating the maturity of a mechanical system, other interesting questions have been raised and answered in this PhD. An example of a questions (based on the third reviewer, see Appendix 6.8.2) is “Is the Sustainability, Sensitivity and Performance factor information stored for future reuse beyond the individual application of the metric? Or does the designer have to redefine those values each time they use the metric on their design?” Effectively, the metric factors are stored for knowledge capitalisation and reuse and in order to obtain evolution of maturity throughout the design process (lifecycle). But, each design is different and people (designers for example) evolve, their knowledge and experience evolve continually, and the metric factors must be redefined at each new product design.

Another interesting question addressed by an expert based on Reviewer 1 (see Appendix 6.8.2) is: “What if parameters of the metric are affected by the judgement of more than one expert?” This question addresses a limitation of the metric. Currently, only the judgement of one expert is possible and taken into account for the definition of the metric parameters but the process of definition of the multi-activity parameters are evaluated by two experts. For example, in design, the first expert designs the part and defines the first values of the parameter. Subsequently, the second expert simulates the behaviour of the part and adjusts the common parameter between the activities of design and simulation. Nevertheless, the metric,

in the current state, cannot take into account the point of view of several experts on the same factor in the same design iteration.

The expert evaluations, based on the reviewers of the PLM'13 paper (see Appendix 6.8.3), are really positive and may be resumed like the second reviewer: "The proposal is clearly presented showing a good survey of the state of the art". The contribution of the proposal is well identified by experts and the presented work represents a significant interest in the problematic addressed.

Moreover, different remarks and questions have been addressed by the experts during their evaluations. For example, the second reviewer (see Appendix 6.8.3) provides some advice on improving the quality of the presented work, such as trying to distinguish the notion of the interval of value that reduce the solution space and uncertainty. This remark has been taken into account in that the interval of value represents the tolerance of the parameters and we measure the confidence of the designer on this information (value of the parameter and tolerance).

Another interesting question is about how maturity could be displayed in a collaborative CAD or PLM environment. Would it be possible to display all the maturity values of all the parameters for decision making? (The asked question appeared in a remark by an expert, see Appendix 6.8.3). The current state of my work does not provide a definitive answer to this question. Effectively, displaying all the maturity values of all the parameters is not a current solution because all the parameters are not important in design and the time consumed by designers to define the parameters of the metric would be too long. As a consequence, only the main parameters are qualified and characterised. Moreover, the integration of the maturity values for the concerned parameters in a CAD or PLM/PDM system is possible via the creation and development of specific attributes that do not exist today in the products/software available on the market. The development time of an attribute in a PDM system is really expensive and a long process. That is why, the values of the metric and design parameters have been presented, in the actual case, in an Excel file and not directly in Windchill or Enovia, for example. It is a technical limitation of my PhD.

The expert evaluations presented in this part represent a total of nine people. All these experts are scientists. Please remember that we identified, at the start of this PhD, that the problematic

is scientific and industrial. The link between both has been realised during all the phases of the exercise. The following section presents the industrial experts' evaluations.

4.2.2. Industrial experts

This work (proposal and case study implementation) were presented to different industrial representatives, partners of the ADN project. Industrial expert evaluations are available in the appendices of this report (see Appendices 6.1 and 6.2). The discussions and exchanges are based on two presentations, one on the metric and the second on the proposed meta-model. The two presentations are available in the appendices (see Appendices 6.6 and 6.7 Presentations during the ADN project). A synthesis of the evaluations of the industrial experts is presented in the Table 19. This table is organised in three parts corresponding to the proposal, metric and meta-model integrating maturity (learning and collaborative dimensions). The addressed problematic allows the relevance and interest in the identified problematic to be confirmed in the context of comparison with the identified industrial needs and to be sure that the proposal correctly addresses them.

Table 19: Synthesis of the industrial experts' evaluations

Work	Criteria					
	Interest	Validation	Feasibility	Relevance	Quality	Significance
Addressed problematic in comparison with industrial needs	high	correspond to the needs	-	high	-	-
Metric, indicators and maturity evaluation (learning dimension)	substantial	confirmed	yes, but need to create new attributes (may take time)	high	high	high
Meta-model of knowledge integrating maturity (collaborative dimension)	real	confirmed		high	substantial	high

The feedback of the industrial experts is quite similar to that of the scientific experts. Effectively, the proposed approach with the definition and calculation of the maturity of a mechanical system addresses their problematic and is viewed as a very interesting factor in aiding decision making. Maturity factors allow knowledge evolution during the design

process to be traced and analysed and the decision making process to be improved. Moreover, the maturity factor also has another contribution not identified with the scientific point of view. It allows the confidence of the decision makers and designers in their choices to increase and provides a more robust design. In fact, the metric factors are also viewed by the industrial experts as a way to justify the new proposal and to be more innovative. The designers may propose a new solution or direct their choices using the metric and its factors as a justification and not merely use the metric to help them to make decisions.

Moreover, the collaborative dimension and the use of the meta-model in order to integrate the metric in decision support and PDM systems are adequate for the industrial experts' identified problematic. Nevertheless, the industrial experts highlighted that the major work outstanding is the integration, from a technical point of view, of this proposal into PDM and CAD software, such as Windchill, Enovia, CATIA or Cre/Elements. The proposal needs the creation of new attributes in PDM systems and new metadata in CAD software. These modifications in the current systems are expensive processes and take a long time. Effectively, it is not possible to apply the metric to the design parameters of an airplane in an Excel file. The use of PDM and CAD software integrating the proposal is needed in order to be able to judge precisely the real feedback of this new aid to decision making and for collaborative design.

The industrial experts, like the scientific, justified their real interest in the proposal and have validated it. Nevertheless, they have pointed out and highlighted different limits due to different hypotheses that were realised in order to be able to provide the first answer to the problematic addressed throughout the PhD exercise. All of these communications, reviews and presentations (see Appendices 6.1, 6.2, 6.6, 6.7 and 6.8) constitute the current state of validation of my proposal to better understand the decision making in preliminary collaborative design. Scientists have validated the knowledge creation methodology established in my PhD and the relevance of the addressed problematic and proposal. The industrial experts have confirmed the adequacy of the problematic to meet their real current needs, and the capacity of the proposal to answer these needs. These scientific and industrial points of view, associated with the capacity of the proposal to be implemented in a real case, have provided levels of validation (feasibility and relevance) in order to confirm the knowledge creation and the interest in the proposal of the addressed problematic.

Chapter 5: Conclusion

5. Conclusion

5.1. Summary of the contribution

Today, collaboration, integration and simultaneous engineering are the focus of significant research effort in product design. The design process is complex and dynamic due, in part, to the volume of handled data and models, the number of exchanges among the the different design teams and businesses interacting. The design teams, organised in CE, do not wait for the results of the later phases of the design lifecycle; they anticipate them by making assumptions and by taking into consideration previous experiences and know-how. In that framework, quality approaches for the control of product performance, and collaborative engineering tools to support CE and collective decision making are required.

Based on the context definition (scientific point of view) and the interviews with different industrial experts to identify their needs and the problematic, and in order to support decision making in early design and product performance management, this PhD thesis provides an answer to the following problematic: how should information be structured and how should the lack of knowledge in decision making during preliminary collaborative design be taken into account? We have understood and learnt in this PhD what constitutes the maturity of a product, what information is needed to make a decision and how to structure this information to help decision making in preliminary collaborative design.

The objective of this work is to provide an answer to these questions. The ideal vision would be to know whether designers make an optimal decision under uncertainty and to be able to measure the impact of this decision on the product design. In this way, this PhD has allowed the decision-making process to be understood and the factors which must be considered to orientate the decision more efficiently to be known. The proposal, based on the understanding of this process of decision making, allows the decision making to be oriented on a specific design parameter and to capitalise designer knowledge (experience, way of thinking ...).

Based on the analysis of the literature survey and the industrial experience, we proposed two contributions. The first is a metric to take into account the lack of knowledge (uncertainty and maturity) in decision making during preliminary design in a collaborative environment. This metric defines maturity and uncertainty, and identified the data needed to make decisions in collaborative design. The designers' knowledge is capitalised due to the methodology used by

the metric and meta-modelling approach. The establishment of this proposition also enables the evolution of maturity in preliminary collaborative design of the system to be known as well as which part of the design has a critical aspect and a major impact on the global system.

The second part of the contribution is a new meta-modelling approach integrating maturity that aims to help to take into account the lack of knowledge (uncertainty and maturity) in decision making during preliminary design in a collaborative environment, but also to support the integration of multi-KMs and guarantee data consistency. It allows data consistency among different design activities, such as simulation and design, to be ensured.

Uncertainties are used to calculate the presented metric. We have seen in the context definition a variety of uncertainty types and, in the state of the art, the way to model them. We have made the choice, because, as a PhD thesis lasts only three years, we cannot take into consideration all the aspects at the same time, to focus our work only on the epistemic uncertainties. Please remember that epistemic uncertainty is any lack of knowledge or information in any phase or activity of the modelling process. The key feature that this definition stresses is that the fundamental cause is incomplete information or incomplete knowledge of some characteristic of the system or the environment. But other types of uncertainties exist, such as aleatory uncertainty, ambiguity or interaction. We have focused only on the epistemic not only due to the PhD timescale, but also because this is the largest type of uncertainty representing any lack of knowledge. This is what needs to be addressed (the lack of knowledge in decision making). It will be interesting in future work to develop the other types of uncertainty and integrate them into the metric. This is a possible perspective of the current realised work that will be developed in the second section of the concluding chapter.

Another constraint during this PhD thesis was the global framework: preliminary collaborative and innovative design of mechanical systems. The metric and the meta-model of knowledge have been developed, implemented and tested in this context but the structure of the metric allows us to go further. Effectively, the first presentations of the proposal in the scientific workshop and conference raised some questions and interest in extending this notion of maturity to other domains, such as, for example, the medical or project management domains. Effectively, different people in other sectors of activity have manifested a particular interest in the proposed metric. Due to my experience, and the requirements of this PhD

thesis, I have limited the domain of activity to the preliminary collaborative design of mechanical systems and, as a result of the link with the ADN project, I have structured the metric following a specific path that will facilitate its adaptation to others sectors. The metric has been created with the user as the centre of the metric and with different indicators that may be easily adapted to different activity sectors. The different factors are independent and may be interpreted as a function of the sector, the objective always being of helping in decision making.

We have seen during the explanation of the metric, that it is composed of different factors, such as sustainability, tolerance, sensitivity, wished maturity, and that different limits are linked to the use of these different factors. Effectively, the different indicators are stored in a PDM system in order to capitalise the knowledge and to help the next similar decision making and design. This PDM system is represented in this manuscript by the Excel file (see Chapter 4). If we undertake two similar product designs, then each one of these factors will be redefined for the first and second product designs. We may associate this with a loss of time in the case of repetitive design where the product and decision are similar. Based on the results and the applied methodology to establish the metric, we may identify the fact that the factors must be redefined at each new design and updated at each design iteration as a limitation. This choice is a necessary limitation because we suppose that each design, the same or similar, is a new product definition with a different choice. For example, in the case of two similar product designs, the second design must take into consideration the knowledge and experience acquired during the first design. A possible amelioration, in the specific case of repetitive design of similar products, will be to pre-fill indicators as a function of the previous similar design. In this way, the designer will be able to update only the needed parameter values and not redefine all the parameter values of the metric.

Moreover, to apply the metric to a product design based on the total number of design parameters is quite difficult. For example, a plane is composed of several millions of parameters and to qualify and characterise each one of them would be difficult. Effectively, we have limited the number of parameters in our case studies in order to be able to manage them. We have noted, as a result of the industrial feedback and case study, that it is difficult to manage a lot of design parameters without robust systems, such as PDM and CAD. To implement the metric in a PDM system, such as Windchill associated to CREO/Elements, takes more than three years' work. As a consequence, we hypothesised, in this PhD thesis,

that the metric is only applied to the main design parameters, that is to say, those that represent each part of the product. We have made the choice to limit the number of parameters to be qualified and characterised in order not to lose too much time and thus facilitate the change of the design activity by the establishment of this metric. The parameters to be qualified are chosen by designers based on the trade repository corresponding to the activity. A solution to decrease the time taken is to focus the designer efforts on the main parameters that are representative of the system, but, in order to attain the most exact level of maturity of the system, all parameters must be taken into account in future evolutions.

The proposed metric aids decision making in preliminary collaborative design but there is a specific case where this metric cannot achieve this objective. Effectively, the methodology used to build the metric has been presented in Chapter 3 of this PhD thesis, and requires the values of different factors, such as sensitivity, sustainability, tolerance and tolerance importance as a function of the nominal value. Each factor may be calculated and valued only after the first definition of the nominal value. This is illustrated by the case study provided in Chapter 4. It is, in this case, that is to say during the first design iteration, that it is impossible to help decision making based on the global level of maturity of the product because the indicators composing the metric have not been previously defined (in the previous design iteration because it does not exist). This proposal (metric) aids only the next decision making. This is different in the case of the repetitive design of a product and not in the case of innovative product design because there are already references (values of the indicators) based on previous similar designs. The only solution to solve this lack is to use the designer experience to make decisions because the level of maturity is unknown at this stage. In innovative design, only the user experience may help the designer to make decisions in this particular case. But, in repetitive design, designers may use previous similar designs to orient their decisions during the first iteration (before attaining the level of maturity of the current system being designed).

Moreover, a long time may elapse before obtaining the full interest of the establishment for this metric. Based on the illustration and case study presented in this PhD, and on the industrial feedback obtained, we know that several product designs are needed in order to obtain full interest in the proposal. As the results of the case study show, the metric helps decision making in the current design based on user experience, performance and level of maturity. But, after discussion and industrial feedback, we have identified that the metric

promotes innovation and continues to assist in decision making (because more knowledge and experience are capitalised) after several similar system designs. We know that this metric aids design and decision making in different ways: current and future designs. Effectively, the metric aids future decision making but in order to obtain the best interest in the metric, it is important to analyse the previous design where the metric has been applied and compare the maturity evolution in order to arrive at conclusions and establish improvements for future designs. The limitation of the second utility of the metric, that is to say the analysis of the previous designs where the metric has been applied, may take a very long time. If the product is a plane or a satellite, the time to design (several iterations, concepts and detail design phases until manufacture) may exceed several years. Waiting for sufficient feedback on several designs of a product (in this case satellite or plane) may be something that takes several years to plan, and, as a consequence, to measure the impact and benefits of the metric may take a very long time. In the automotive industry, for example, the development of a car takes “only” several months and, as a consequence, feedback and obtaining all the benefits of the metric are faster. Of course, this limitation concerns only a part of the interest in this metric and does not concern its aid to decision making in the current design.

Different limitations and impacts are presented in this conclusion and the major impact that we may identify is the establishment of a metric with the need to change the designers. We have tried to minimise the impact of the metric on the way designers design. The impacts are the creation of new indicators, such as sensitivity, sustainability and tolerance, which must be completed for each main designer parameter. The time taken will be more important in comparison with the current time taken because each indicator must be defined in more in terms of the value of the parameter itself. Moreover, the time to establish the metric infrastructure may be quite significant. Effectively, the metric must be associated with a PDM system and CAD/CAE software in order to be the most efficient and to capitalise the maximum amount of knowledge. One possible solution to improve the politics of change and the use of the metric by designers would be to train them in this new tool and show them how to use it and obtain the best feedback to make decisions. The training may be undertaken by using the presented actual case in this PhD thesis spending one day explaining and manipulating it. It is very important to explain precisely to what each factor corresponds and how to evaluate them in order to attain the most realistic as possible level of maturity because the location and experience of the user/designer is the centre of the metric.

As we have seen in the first section of this concluding chapter, the proposal has several limitations and impacts, but it addresses the fixed objective of aiding decision making in preliminary collaborative design. Moreover, it aids decision making in the current design (innovative design) and also in repetitive design where the previous design and maturity evolution may be taken into consideration in order to improve the efficiency of decision making. The following and last section of this conclusion concerns the validations of this proposal and the associated limitations.

5.2. Future work and perspectives

The current state of our research has shown us that there are different limitations and impacts with the current state of the proposal. It provides an initial answer to the addressed problematic but during the three years we have identified different possible ways to improve and continue the current work (presented in this PhD thesis). This last section of the global PhD conclusion presents the future work to be initiated and also the potential perspectives.

Based on the literature survey, current state of the work and limitation analysis, I have identified one problematic that represents one potential perspective of my PhD. The answer to this problematic is decomposed into four points presented later. I have provided an initial answer to the questions how should uncertain product data be structured, qualified and shared and how should it be used to make decisions in system design? In answering these questions, in building my proposal and in discussions with industrial experts, I have always been confronted with the problem of

How should the evolution of the designer's lack of knowledge in decision making in innovative preliminary collaborative design be taken into account, qualified and measured?

Effectively, the context of innovative preliminary collaborative design highlights the important lack of knowledge of designers and their capacity to innovate when the system design must be more innovative, faster and the cheapest. Designers must sometimes follow their feelings based on their experience without being able to explain why this choice has been made. The current state of my proposal and PhD allows information for decision making to be structured and the lack of knowledge of designers in decision making to be taken into

account. But, I have presented to you in this thesis different hypotheses and limitations to my proposal. The analysis of these limitations allows me to identify and present a methodology to be developed in a future PhD, based on four improvement points. They are:

1. Taking into account the lack of knowledge on the technical specification of the need
2. Taking into account the uncertainty of the designer point of view (judgement of experience and knowledge)
3. Taking into account the multi-designer views on a design parameter definition
4. Taking into account the evolution of product maturity and designer experience

It is difficult today to define precisely the technical specification of the need of each level of the system's decomposition. Moreover, the technical specifications of the need may evolve and change during the design phase. A solution would be to define the uncertainty of these specifications in order to be able to measure their impact on decision making and their importance to the knowledge designer.

The second point represents the different factors of the actual metric that the designers define. A potential solution to be established could be to take into account the possibility that a level of sustainability on a parameter is not 3 but may be 3 or 4. This consideration allows a more precise maturity level to be established and the knowledge and experience of the designer to be more exact. Taking into consideration this kind of uncertainty necessitates redefining the current metric in order to improve its performance.

The third point to take into consideration in order to decrease the lack of knowledge is to be able to manage the multi-designer view on a parameter. The limitation (one designer for one parameter) has been often highlighted by scientific and industrial experts. Effectively, in a collaborative context and in innovative design, designers often ask the opinion or advice of one or more persons in order to make the decision. The current metric does not take into account this process. A possible solution would be to attribute different objects to a same master object in the meta-model, and, as a consequence, to attribute different expert points of view to the same parameter in the metric by using average or specific id.

The last point is to consider not only the state of the current knowledge of the designers but also the evolution of this knowledge. In this way, we will be able to know the knowledge evolution between two design iterations, but also to define more precisely the level of

maturity of the system. The current metric represents the state of knowledge at each design iteration. The objective of future work is to be able to represent the state and the evolution of knowledge during the design iteration in order to be more representative of reality.

To establish these perspectives in a future PhD or research work, a methodology must be clearly defined and this is my proposal for guiding this future work. Based on the current work and metric, we may consider that the four improvement directions presented contribute to decreasing the lack of knowledge in decision making in preliminary collaborative design. The objective is to implement each one of these suggestions one by one and to compare them to the current metric. In this way it will be possible to identify clearly the impact of each factor on the contribution to the reduction of the lack of knowledge, and to be able to realise the state of the importance level of the factor composing the metric. The validation could be undertaken by comparing the metric including the current perspectives and the current metric presented in this PhD in a major case study, such as the development of a new airplane.

We have proposed a meta-model of knowledge that integrates a metric able to define the maturity of a mechanical system, in order to help designers, users or decision makers in decision making in preliminary collaborative design. This proposal is the initial answer to the problematic “how should information be structured and how should the lack of knowledge in decision making during the preliminary collaborative design be taken into account?” Two levels of validation have been presented in order to prove the relevance and feasibility of the meta-model of knowledge and the metric to manage data consistency, capitalise knowledge and help decision making in preliminary collaborative design. Finally, we have evaluated the state of the current work by presenting the limitations and impacts, and we have defined the future work and perspectives to initiate continued research and build more knowledge.

References

References

- Ahmed, S., K. Wallace, L. Blessing, and M. Moss. "Identifying the differences between novice and experienced designers." Edited by S Sivaloganathan and P.T.J. Andrews. *in Design for Excellence, the proceedings of the Engineering Design Conference 2000*, June 2000: 97-106.
- Anderl, R., and al. "Computer aided design of mechatronic systems exemplified by the integrated wheel suspension of an innovative service vehicle." *Proceedings of the 1st IFAC Conference of Mechatronic Systems*, 2003: 205-215.
- Anderl, R., R. Gräß, and S. Kleiner. "Integration Parametrischer Produktdaten als Grundlage der virtuellen Produktentwicklung." *Industrie Management* 17 (2001): 23-30.
- Andreasen, M.M. "The theory of domains." *Workshop on understanding function and function to form evolution*, 1991.
- Antonsson, E.K, and K.N Otto. "Imprecision in engineering design." *Trans ASME*, 1995: Vol.3, pp.117-125.
- Aublin, Michel, et al. *Systèmes Mécaniques : Théorie et Dimensionnement*. Dunod, 1993.
- Badin, J. "Using the Knowledge Configuration Model (KCMModel) to manage configured knowledge for upstream phases of the design Process." *Editorial Manager(tm) for International Journal on Interactive Design and Manufacturing (IJIDeM)*, 2011.
- Badin, J., D. Chamoret, S. Gomes, and D. Monticolo. "Knowledge configuration management for product design and numerical simulation." *In The 18th international conference on engineering design (ICED11)*, August 2011: 161-172.
- Bedford, T., and R. Cooke. "Different types of uncertainty." Edited by Cambridge University Press. *Probabilistic Risk Analysis: Foundations and Methods*, 2001: 17-38.
- Belkadi, F., E. Bonjour, and M. Dulmet. "Contribution to the development of a project memory: a new approach of traceability including the organization activity view." *In The 9th World multi-conference on systemic, cybernetics and informatics, (IEEE)*, July 2005.
- Belkadi, Farouk, Nicolas Drémont, Alban Notin, Nadège Troussier, and Mourad Messadia. "A meta-modelling framework for knowledge consistency in collaborative design." *Annual Reviews in Control* 36, no. 2 (December 2012): 346-358.
- Belloy, P. "Intégration de connaissances métier dans la conception : un modèle pour les pièces mécaniques, application à l'usinage et à l'estampage." *PhD Thesis Report*, 1994.
- Belson, D, and D. Nickelson. "Measuring concurrent engineering costs and benefits." *Îjroc. of the American Society of Mechanical Engineers* 59 (1992): 443-451.

Bernard, A. "Modèle et approches pour la conception et la production intégrée." *Journal Européen des Systèmes Automatisés, JESA*, no. 34 (2000): 163-193.

Besharatia, B, S Azarm, and P.K Kannan. "A decision support system for product design selection: A generalized purchase modeling approach." *Decision Support Systems - DSS*, 2006: Vol.42, N°.1, pp.333-350.

Beth, C.M., M. Konrad, and S. Shrum. *CMMI, Second Edition – Guidelines for Process Integration and Product Improvement*. Addison Wesley, 2007.

Blanco, E. "L'émergence du produit dans la conception distribuée, vers de nouveaux modes de rationalisation dans la conception de systèmes mécaniques." Edited by INP of Grenoble. *PhD Thesis report*, December 1998.

Blessing. "Comparison of Design Models Proposed in Prescriptive Literature." In: *The role of design in the shaping of technology, COST A3/ COST A4 International research workshop, Lyon February 1995, Perrin J. and Vinck, D. (eds), Social Sciences Series Vol.5, European Committee, pp 187-212, 1996.*

Blessing, L. *A Process-Based Approach to Computer-Supported Engineering Design*. Cambridge: Black Bear Press, Ltd, 1994.

Bonjour, E, J-M Micaelli, and M Dulmet. "Modélisation récursive des compétences d'acteurs collectifs en conception intégrée." *5ième congrès de génie industriel, Besançon*, juin 2005.

Boucher, C. "Towards the competency integration in performance piloting of enterprise." *European Journal of Automated Systems* 37, no. 3 (2003): 363-390.

Boujut, J.F. "Enjeux et formes des pratiques coopératives dans la conception." Edited by Ecole des mines de Paris. *PROSPER*, February 2000.

Bucciarelli, and L. Louis. "Designing Engineers." *The MIT Press: Cambridge, MA*, 1994.

Clark Kim, B, and T Fujimoto. "Product Development Performance." *Strategy, Organization, and Management in the World Auto Industry, Harvard Business School, Boston, Mass*, 1991.

Cook, G.J. "An Empirical Investigation of Information Search Strategies with implications for Decision Support System Design." *Decision Sciences* 24, no. 3 (1993): 683-697.

Danesi, F., F. Gardan, Y. Gardan, and M. Reimeringer. "P4LM: A methodology for product lifecycle management." *Computers in Industry* 59(2-3), 2008: 304-317.

Darses. "Assister la conception : perspectives pour la psychologie cognitive ergonomique." *EPIQUE'2001*, October 2001.

Darses, F., and P. Falzon. "La conception collective: une approche de l'ergonomie cognitive." In *De Terssac G. and Friedberg, E. (ed), Coopération et conception* (Octares Editions), 1996: 123-135.

De la Garza, C., and A. Weill-Facina. "Régulation horizontales et verticales du risque." Edited by Octares. In *Le travail collectif – perspectives actuelles en ergonomie* chap. 10 (2000): 217-234.

De Terssac, G. *Le travail de conception : de quoi parle-t-on ? in coopération et conception*. Octares, 1996.

DeLaurentis, D, and D Mavris. "Uncertainty modeling and management in multidisciplinary analysis and synthesis." *AIAA Paper 2000-0422*, January 2000.

Dempster, A.P. "Upper and Lower Probabilities Induced by a Multivalued Mapping." *The Annals of Statistics*, 1967: N°28, pp.325-339.

Dempster, A.P. "Upper and Lower Probabilities Induced by a Multivalued Mapping." *The Annals of Statistics* 28 (1967): 325-339.

Detienne, F. "Collaborative design: Managing task interdependencies and multiple perspectives." *Interacting with Computers* 18, no. 1 (2006): 1-20.

Dillenbourg, P., and M.J. Baker. "The evolution of research on collaborative learning." In *Reimann P. and Spada H. (ed), Learning in humans and machines: towards an interdisciplinary learning science*, 1996: 189-211.

Donges, C., M. Krastel, and R. Anderl. "MechaSTEP—STEP Datenmodelle zur Abbildung mechatronischer Systeme." *Produktdaten Journal* 1 (1999): 30-34.

Du, L., and K.K. Choi. "A New Fuzzy Analysis Method for Possibility-Based Design Optimization." *AIAA*, 2006.

Dupinet, E. "Contribution à l'étude d'un système informatique d'aide à la conception de produits mécaniques par la prise en compte des relations fonctionnelles." Edited by Ecole Centrale de Paris. *PhD thesis report*, 1991.

Dylla, N. "Experimental Investigation of the Design Process." *International Conference on Design Engineering* 1 (August 1989): 377/090.

Dylla, N. "Thinking Methods and Procedures in Mechanical Design." Edited by Technical University of Munich. *Dissertation*, 1991.

Ehrlenspeil, K., and E. Lenk. "Einflüsse auf den Bewertungsprozess beim Konstruieren." *Proceeding of the International Conference on Engineering Design, ICER 93*, 1993: 449-456.

Eppinger, S.D., V. Krishnan, and D.E. Whitney. "A model-based framework to overlap product development activities." *Management Science* 43, no. 4 (1997).

Ermine, J.L. "Les systèmes de connaissances." (Eds. Hermès) 1996.

Eynard, B. “Modélisation du produit et des activités de conception, contribution à la conduite et à la traçabilité des processus de conception.” *PhD thesis report*, 1999.

Eynard, B., T. Gallet, P. Nowak, and L. Roucoules. “UML based specifications of PDM product structure and workflow.” *Computers in Industry* 55, no. 3 (2004): 301-316.

Fenves, S. J., S. Fougou, C. Bock, R. Sudarsan, N. Bouillon, and D. Sriram R. “CPM2: A revised core product model for representing design information.” *National Institute of Standards and Technology*, 2004.

Fertig, K.W., D.G Ullman, and al. “Made Phase II Final Report, Flexible Environment For Conceptual Design, Geometric Modeling and Analysis, and Assembly Process Planning.” *Contract Number – F33615-94-C-4426, Rockwell Science Center*, January 1997.

Fiorentini, X., I. Gambino, V. C. Liang, S. Fougou, S. Rachuri, and C. Bock. “Towards an ontology for open assembly model.” *In International conference on product lifecycle management – PLM07*, July 2007.

Fortin, C., and G. Huet. “Manufacturing process management: Iterative synchronisation of engineering data with manufacturing realities.” *International Journal of Product Development*, 4(3–4), 2007: 280-295.

Frühwirt, T., and S. Abdennadher R. *Constraint-Programmierung*. Berlin: Springer, 1997.

Ganascia, J. *Les sciences cognitives*. éd. Flammarion, 1996.

Gardoni, M. “Maîtrise de l’information non structurée et capitalisation de savoir et savoir faire en ingénierie intégrée. Cas d’étude Aérospatiale Matra.” Edited by Grenoble INPG. *Thèse de doctorat*, 1999.

Gaudin, J. *Description and modeling of information flow within an integrated design team, to define a tool of help for designer*. INP Grenoble, 2001.

Girod, M., A.C. Elliot, I.C. Wright, and N.D. Burns. “A Descriptive Model of Collaborative Concept Selection Process in Engineering Design.” *Proceedings of the International Conference CE2000*, 2000a: 494-503.

Girod, M., A.C. Elliot, I.C. Wright, and N.D. Burns. “Activities in collaborative concept selection processes for engineering design.” *DETC2000/DTM-14548, The Design Theory and Methodology Conference, part of the ASM 2000 Design Engineering Technical Conferences*, September 2000b.

Goh, Y.M., J.D. Booker, and C.A. McMahon. “A framework for the handling of uncertainty in engineering knowledge management to aid product development.” *Proceedings ICED05, International Conference on Engineering Design*, August 2005.

Gräb, R. *Parametrische Integration von Produktmodellen für die Entwicklung mechatronischer Produkte (Aachen: Shaker)*. Berlin: Springer, 2001.

Grebici, K. "La Maturité de l'Information et le Processus de Conception Collaborative." *Thèse, Institut National Polytechnique de Grenoble*, 2007: pp.25-37.

Grebici, K, E Blanco, and D Rieu. "Framework for Managing Preliminary Information in Collaborative Design Processes." *International Conference on Product Lifecycle Management 2005 (PLM05)*, 2005: Vol.1, N°1.

Grebici, K, M.Z Ouertani, E Blanco, L Gzara-Yesilbas, and D Rieu. "Conflict management in design process: focus on change impact." *CE06, International Conference on Concurrent Engineering*, 2006.

Grundstein, M. "From capitalizing on Company Knowledge to Knowledge Management." Edited by Cambridge, Massachusetts The MIT Press. *chapter 12, In Morey D., M., Maybury, Thuraingham B., "Knowledge Management, Classic and Contemporary Works"*, 2001: 261-287.

Hacking, I. "The Emergence of Probability: A Philosophical Study of Early Ideas About Probability, Induction and Statistical Inference." Edited by Cambridge University Press. 1984.

Hales. *Analysis of the Engineering Design Process in an Industrial Context*. Hampshire: Gants Hill Publications, 1987.

Hanssen, R.W. "Reducing delivery times in engineer-to-order firms by using the concepts of concurrent engineering." Edited by The University of Nottingham. *Proceedings of the 4th International Conference on Concurrent Enterprising (ICE'97)*, October 1997: 495-508.

Harani, Y. "Une approche multi modèles pour la capitalisation des connaissances dans le domaine de la conception." Edited by INPG. *Phd thesis report in industrial engineering*, 1997.

Herling, D. *An Engineering Decision Support System (EDSS) with Alternative-Criterion Pair Evaluations*. Oregon State University: Department of Mechanical Engineering, 1997.

Howard, R., and J. Matheson. "Readings in the Principles and Practice of Decision Analysis, Strategic Decision Systems." Menlo Park, CA, 1984.

Hugo, J., W. Vliegen, H. Herman, and Van Mal. "The structuring of process knowledge: function, task, properties and state." *Robotics & Computer-Integrated Manufacturing*, 6(2), 1989: 101-107.

ISO. "Product data representation and exchange. Integrated application resource: Parameterization and constraints for explicit geometric product models." *Committee Draft (CD, ISO TC 184/SC4/WG12/N940)*, 2001.

Jun, Hong-Bae, Dimitris Kiritsis, and Paul Xirouchakis. "Research issues on closed-loop PLM." *Computers in Industry*, 2007: 855-868.

Kleinmuntz, D., and D.A. Schkade. "Information Displays and Decision Processes." *Psychological Science* 4, no. 4 (July 1993).

Klir, G., and T. Folger. "Types of uncertainty, Fuzzy Sets, Uncertainty, and Information." 138-139. Prentice Hall, Englewood Cliffs, NJ, 1988.

Krishnan, V. "Managing the simultaneous execution of coupled phases in concurrent product development." *IEEE Transactions on Engineering Management*, 1996: vol.43, n° 2, pp.210-217.

Kuipers, B., A.J. Moskowitz, and J.P. Kassirer. "Critical Decisions under Uncertainty: Representation and Structure." *Cognitive Science* #12, 1988: 177-211.

Kvan, T. "Collaborative design: what is it?" *Automation in construction*, 2000: Vol.9, N°.4, pp.409-415,.

Lee, C.C. "Fuzzy Logic in Control Systems: Fuzzy Logic Controller." *IEEE Transactions on Systems, Man, and Cybernetics* 20, no. 2 (1990): 419-435.

Lee, J. H., and H. W. Suh. "OWL-based product ontology architecture and representation for sharing product knowledge on a web." *In The 27th ASME international design engineering technical conferences and computers and information in engineering conference*, September 2007.

Lefebvre, P., P. Roos, and J-C. Sardas. "From the management of expertise to the management of design metier." *EURAM Conference*, May 2002.

Lhote, F., Ph. Chazelet, and M. Dulmet. "The extension of principles of cybernetics, towards engineering and manufacturing." *Annual Reviews in Control* 23 (1999): 139-148.

Lohse, L., H. Hirani, S. Ratchev, and M. Turitto. "An ontology for the definition and validation of assembly processes for evolvable assembly systems." *In The 6th IEEE international symposium on assembly and task planning: from nano to micro assembly and manufacturing*, July 2005.

Luce, R., and H. Raiffa. *Games and Decisions*. New York, NY: John Wiley & Sons, Inc., 1957.

Maranzana, N., and N. Gartiser. "From concurrent engineering to collaborative learning of design." *International Journal of Design and Innovation Research* 4, no. 1 (2008): 39-51.

Matta, N., O. Corby, and M. Ribière. "Méthodes de capitalisation de mémoire de projet." *INRIA, Rapport de recherche n°3819*, 1999.

- McGinnis, B., and D.G. Ullman. "The Evolution of Commitments in the Design of a Component." *Journal of Mechanical Design* 144 (March 1992): 1-7.
- Menand, S. "Modélisation pour la réutilisation du processus de conception multi acteur de produits industriels." Edited by INP GILCO laboratory. *PhD Thesis Report*, 2002.
- Mer, S., and P. Laureillard. "Partage des connaissances dans un système de conception." Edited by Hermès. *In Connaissances et savoir-faire en entreprise*, 1998.
- Merderer, C. "Evolution of Information in a Design Team." *Diplom Arbeit*, 1997.
- Merriam-Webster. *Merriam-Webster's Collegiate Dictionary*. 10th Edition; ed. Springfield, 1993.
- Micaëlli, J.P., and J. Forest. "Artificialisme, Introduction à une théorie de la conception." Edited by INSA de Lyon. *collection Epistémologie*, 2003.
- Middler, C. "L'auto qui n'existe pas : management des projets et transformation de l'entreprise." *Inter Edition, Paris*, 1993: Vol.2, N°1.
- Moka. *Moka user guide*. <http://www.kbe.coventry.ac.uk/moka/>.
- Morgan, M., and M. Henrion. *Uncertainty: A Guide to Dealing with Uncertainty in Quantitative Risk and Policy Analysis*. Cambridge, : Cambridge University Press, 1990.
- Mtopi-Fotso, B., M. Dulmet, and E. Bonjour. "Design of product families based on a modular architecture." *ASMDO*, 2007.
- Murray, P.C. "Who owns knowledge management?" Edited by KM Metazine. *Information, Knowledge and Document Management Technology*, 1996.
- Nagy, R.L., and D.G. Ullman. "A Data Representation for Collaborative Mechanical Design." *Research in Engineering Design* 3, no. 4 (1992): 233-242.
- Naude, P., G. Lockett, and K. Holms. "A Case study of Strategic Engineering Decision Making Using Judgmental Modeling and Psychological Profiling." *Transactions on Engineering Management* 44, no. 3 (August 1997): 237-247.
- Noel, F., L. Roucoules, and D. Teissandier. "Specification of a product modelling concepts dedicating to information sharing in a collaborative design context." Edited by Springer-Verlag. *in Advances in integrated design and manufacturing in mechanical engineering Part I* (2004): 135-146.
- Nonaka, I, and H Takeuchi. "The knowledge-Creating Company: How Japanese Companies Create the Dynamics of Innovation." *Oxford University Press*, 1995.
- Nowak, P., B. Rose, L. Saint-Marc, M. Callot, B. Eynard, and L. Gzara. "Towards a design process model enabling the integration of product, process and organization." *In The 5th*

international conference on integrated design and manufacturing in mechanical engineering, IDMME '04, April 2004.

Oberkampf, W., J. Helton, and K. and Sentz. "Mathematic representation of uncertainty." *AIAA Paper 2001-1645*, April 2001.

Oberkampf, W., S. DeLand, B. Rutherford, K. Diegert, and K. Alvin. "A new methodology for the estimation of total uncertainty in computational simulation." *AIAA Paper 99-1612*, April 1999.

Otto, K., and E. Antonsson. "Design parameter selection in the presence of noise." *Research in Engineering Design* 6, no. 4 (1994): 234-246.

Pahl, G., and W. Beitz. *Engineering Design: a Systematic Approach*. London: 2nd éd., Springer-Verlag, 1996.

Pailhes, J., M. Sallaou, and J. P. Nadeau. *Knowledge base formulation for aided design tool, in Trends and Recent Advances in Integrated Design and Manufacturing in Mechanical Engineering II*. Edited by Michel Tollenaere et Pascal Ray edited By Serge Tichkiewitch. Springer Verlag, 2007.

Payne, J., J. Bettman, and E. Johnson. "The Adaptive Decision Maker." *Cambridge University Press*, 1993.

Perrin, J. *Conception entre science et art*. Edited by INSA de Lyon. collection Epistémologie, 2001.

—. *Pilotage et évaluation des processus de conception*. L'Harmattan, 1999.

Plous, S. "The Psychology of Decision Making." *McGraw Hill*, 1993.

Polanyi, M. "The Tacit Dimension." *Routledge & Kegan, London*, 1996.

Prax, J.Y. *Le guide du Knowledge management – Concepts et pratiques de la gestion des connaissances*. éd. Dunod., 2000.

Roucoules, L., et al. "IPPOP: An open source collaborative design platform to link Product, design process and organisational information." *The 6th International Conference on Integrated Design and Manufacturing in Mechanical Engineering*, May 2006.

Saaksvuori, Antti. *Product Life Cycle Management*. Berlin: Springer-Verlag Berlin and Heidelberg GmbH & Co. K., 2008.

Saucier, A. "Un modèle multi-vues du produit pour le développement et l'utilisation de systèmes d'aide à la conception en ingénierie mécanique." Edited by E.N.S. de Cachan. *PhD Thesis report*, 1997.

Scaravetti, D., J. Pailhes, J.P. Nadeau, and P. Sebastian. "Aided Decision-Making for an Embodiment Design Problem." Edited by Springer. *In Advances in Integrated Design and Manufacturing in Mechanical Engineering*, 2005: 159-172.

Scheidl, and Winkler. "Relation between conceptual design and detail design." *Mechatronics*, 2010.

Sebastian, P., J.P. Nadeau, X. Fische, and R. Chenouard. "Knowledge modeling in mechanical embodiment design for real time simulation and decision support." *Proceedings of Virtual Concept 2005*, 2005.

Shafer. "Non-Additive Probabilities in the Work of Bernoulli and Lambert." *Archive for History of Exact Sciences* 19 (1978): 309-370.

Shafer. "The Combination of Evidence." *International Journal of Intelligent Systems* 1 (1986): 155-179.

Shafer, G. "A Mathematical Theory of Evidence." *Princeton, NJ: Princeton Univ. Press*, 1976.

Skyrme, D. "'The Knowledge Asset, Management Insight.'" *David Skyrme*, no. 11 (1994).

Stauffer, L.A., and D.G. Ullman. "Fundamental Processes of Mechanical Designers Based on Empirical Data." *Journal of Engineering Design* 2, no. 2 (1991): 113-126.

Stokes, M. "Managing engineering knowledge: MOKA methodology for knowledge based engineering applications." *MOKA Consortium*, 2001.

Sudarsan, R., S.J. Fenves, R.D. Sriram, and F. Wang. "A product information modelling framework for product lifecycle management." *Computer-Aided Design* 37 (2005): 1399-1411.

Sullivan, L.P. "Quality Function Deployment." *Quality Progress*, 1986: Vol.19, N°6, pp.39-50.

Sun, M., and N. Bakis. "A collaborative design appraisal system for water treatment engineering projects." *Advances in Engineering Software* 34, no. 11-12 (2003): 737-743.

Terwiesch, C., and C.H. Loch. "Measuring the effectiveness of overlapping development activities." *Management Sci* 45, no. 4 (1999): 455-465.

Terzi, S., J. Cassina, and H. Panetto. "Development of a meta-model to foster interoperability along the product lifecycle traceability." *In 1st International conference on interoperability of enterprise software and applications*, 2005: 21-25.

Thunnisen, D.P. *Propagating and Mitigating Uncertainty in the Design of Complex Multidisciplinary Systems*. Pasadena: California Institute of Technology, 2005.

Tichkiewitch, S. "Specifications on integrated design methodology using a multi-view product model." *Engineering System Design and Analysis Conference, ASME '96*, 1996.

Tony Liu, D, and X William Xu. "A review of web-based product data management systems." *Computers in Industry* 44, no. 3 (2001): 251-262.

Ullman, D, and B D'Ambrosio. "A Taxonomy for Classifying Engineering Decision Problems and Support Systems." *Artificial Intelligence for Engineering Design, Analysis, and Manufacturing, AI EDAM #9*, 1995: 427-438.

Ullman, D. "Issues Critical to the Development of Design History, Design Rationale and Design Intent Systems." *Design Theory and Methodology* 94, 68 (1994): 249-258.

Ullman, D. "The Mechanical Design Process." Edited by 2nd edition. (McGraw Hill) 1997.

Ullman, D., D. Herling, and B. D'Ambrosio. "What to do Next: Using Problem Status to Determine Course of Action." *Research in Engineering Design*, 1997: 214-227.

Ullman, D.G. "The ideal engineering decision support system." 2001.

Ullman, D.G. "The Ideal Engineering Decision Support System." 2001.

Ullman, D.G., T.G. Dietterich, and L. Stauffer. "A Model of the Mechanical Design Process Based on Empirical Data." *Artificial Intelligence in Engineering Design and Manufacturing* (Academic Press) 2, no. 1 (1988): 33-52.

Uschold, M., M. King, S. Moralee, and Y. Zorgios. "The enterprise ontology." *The Knowledge Engineering Review* 13, no. 1 (1998): 31-89.

Vernat, Y. *Formalisation et qualification de modèles par contraintes en conception préliminaire*. ENSAM, 2004.

Vernat, Y., J.-P. Nadeau, P. Sebastian, and X. Fisher. *Démarche de formalisation de modèles adaptés à la conception préliminaire, de Evaluation et Décision dans le Processus de Conception*. Vol. Chapitre 1. Paris: Hermès, 2006.

Walton, M. "Managing uncertainty in space systems conceptual design using portfolio theory." *Doctoral Dissertation, Massachusetts Institute of Technology, Department of Aeronautics/Astronautics*, June 2002.

Wang, Y., and Barthaolomew, O. Nnaji. "Functionality-Based Modular Design for Mechanical Product Customization over the internet." *Journal of Design and Manufacturing Automation*, 2001.

Winqvist, J.R, and J.R. Larson. "Information pooling: when it impacts group decision making." *Journal of Personality and Social Psychology* 74, no. 2 (February 1998): 371-378.

Yassine, A., D. Falkenburg, and K. Chelst. "Engineering design management: an information structure approach." (*International Journal of Production Research*) 37, no. 13 (1999): 2957-2975.

Zadeh, L. "Making computers think like people." *IEEE Spectrum* 21, no. 8 (August 1984): 26-32.

Zadeh, L.A. "Fuzzy Sets." *Information and Control*, 1965: Vol.8, pp.338-353.

Zadeh, L.A. "Fuzzy Sets as a Basis for a Theory of Possibility." *Fuzzy Sets and Systems* 1 (1978): 3-28.

Appendices

6. Appendices

6.1. Interview 1

The first interview and industrial feedback focused on the PhD context, problematic and proposal.

The objective of this interview was to identify the links between the industrial and scientific problematic, and also to obtain feedback (validation) on the PhD proposal.

La qualification des connaissances en phase amont de conception collaborative

Bilan de la présentation et de l'interview

Organisateur :

Nicolas DREMONT

Date :

Mardi 20 mars 2012 (environ 1h)

Versions :

1 - 27 mars 2012

Dénomination exacte du poste actuellement occupé :

Research Manager chez EADS Innovation Works

Nombre d'année d'occupation de ce poste :

12 ans

Nombre d'année d'expérience dans le domaine :

12 ans

Domaine d'expertises principales :

Simulation d'assemblage, usine numérique, CAO, CFAO, méthodes de conception, optimisation de gammes, Conception produit-process, analyse fonctionnelle

Descriptif du rôle occupé :

Etablissement de roadmap technologiques pour EADS

Montage et gestion de projet de recherches collaboratifs (européens et nationaux)

Spécification et développement de démonstrateurs

Question 1 : Utilisez-vous des facteurs de maturité et d'incertitudes des informations pour prendre des décisions en phases amont de conception produit ?

Les décisions prises en phases amont de conception produit sont basées sur différents « outils », et réalisées lors de présentations, revues de projets, etc. Des schémas fonctionnels, des points téléphoniques, des définitions d'exigences sont autant d'outils intervenant dans la prise de décisions.

Les choix technologiques sont évalués notamment par des intervalles de valeurs (incertitudes) et accompagnés par des idées de faisabilité (point de vue des experts). Cette faisabilité n'est pas clairement formalisée (c'est-à-dire écrite noire sur blanc) car elle est une connaissance, une expérience. Nous verrons plus tard dans cet interview que les intervalles dont il est question ici sont sommés afin d'obtenir un indicateur globale, cependant cela est sujet à des soucis d'interprétation et de réutilisation.

Question(s) soulevée(s) :

Utilisez-vous le principe que si une exigence ou règle métier n'est pas remise en cause (preuve du contraire) alors elle est considérée comme valable ? (Cela ne signifie pas que les données sont matures)

Utilisez-vous des échelles de type TRL pour la validation des règles métiers ?

Si oui, pouvez-vous décrire leur utilisation ?

Si non, pourquoi ?

Question 2 : Est-ce-que la maturité des informations est un problème durant la prise de décisions ?

Durant la prise de décisions en phase amont de conception produit, différents indicateurs sont utilisés comme des intervalles pour qualifier les incertitudes des valeurs ou résultats présentées. Il est à noter que ces valeurs (pris une à une) ont un intérêt particulier pour la discussion et la prise de décision.

Afin de déterminer le niveau global d'incertitude, ces différentes valeurs (intervalles) sont sommées. Un réel problème est soulevé par cet indicateur global qui est difficilement interprétable par les utilisateurs. Que représente réellement cette valeur ? Comment l'utiliser ?

Nous pouvons en conclure qu'aujourd'hui la maturité des informations est réellement un problème lors de la prise de décisions mais est essentielle. Il existe des intervalles spécifiques qui sont évalués mais nécessitent d'avantage de calculs pour gagner en précision. La notion de maturité est bien présente mais pas explicitement représentée afin de pouvoir en faire un indicateur utilisable. A un niveau supérieur, un indicateur correspondant à la somme des intervalles permet de définir le niveau de maturité du produit, mais un problème majeur réside dans l'utilisation, la signification et l'interprétation de cet indicateur.

Question(s) soulevée(s) :

Existe-t-il des études ou des travaux au sein de l'entreprise afin de rendre cet indicateur global (somme des intervalles) plus utilisable et significatif ?

Si oui, lesquels ?

Question 3 : Quels sont les manques (données, informations, ressources, etc) durant les phases amont de conception produit pour prendre des décisions ?

Aucune identification

Question(s) soulevée(s) :

Question 4 : Quel processus utilisez-vous pour prendre des décisions aujourd'hui, durant les phases amont de conception d'un produit ?

Durant les phases très amonts de conception produit les décisions sont prises durant des discussions, que se soit lors de revues projet afin de présenter l'avancement des travaux ou aux jalons de phases définis lors de la création du planning projet.

Question(s) soulevée(s) :

Disposez-vous de facteurs clés guidant vos prises de décisions (par exemple en aéronautique tout est traduit en équivalent masse, il est utilisé comme un critère déterminant) ?

Question 5 : Comment l'expérience des concepteurs est représentée et prise en compte durant la prise de décision en conception préliminaire collaborative ?

La principale prise en compte de l'expérience et des connaissances des concepteurs durant la prise de décision en conception collaborative préliminaire se fait grâce au référentiel métier.

Ce référentiel métier évolue moins rapidement que la connaissance des experts. Ce décalage entre l'évolution du référentiel et la connaissance des experts est dû principalement à des problèmes d'outils et de processus de validation. Effectivement, tant qu'une règle métier n'est pas certaine à un haut niveau, elle n'est pas ajoutée dans le référentiel métier.

A noter qu'un intérêt particulier a été identifié (besoin identifié) pour qualifier les données du référentiel métier. Chaque métier a ses « incontournables » (règles), c'est le chargé de conception qui a pour mission d'intégrer ces règles dans le référentiel métier. Le problème étant que ce chargé de conception a de nombreuses autres missions et par conséquent, l'intégration de ces règles dans le référentiel métier n'est pas une priorité majeure (importante charge de travail passant avant l'intégration).

Question(s) soulevée(s) :

Comment définissez-vous ce référentiel métier précisément ?

Que contient le référentiel métier (uniquement des règles métiers ?) ?

Comment définissez-vous une règle métier précisément ?

Quel lien faites-vous entre les règles métiers et les données (paramètres de conception) ?

Pour vous, existe-t-il un lien entre la maturité des données et celle des règles métiers présentes dans le référentiel ?

Question 6 : Comment est géré l'aspect collaboratif durant les prises de décisions en conception préliminaire collaborative ? (réunion, groupe de travail, plateau...)

Aucune identification

Question 7 : Quels sont les impacts du manque de connaissances durant les phases amont de conception collaborative pour la prise de décision en fonction des différents facteurs mentionnés ci-après : humain / temps / argent / productivité / connaissance / méthodologie de travail / prise de décisions / processus de conception ?

Les impacts sont divers et les principaux vont être présentés par mots clés ci-dessous.

-> Redondance

La connaissance à propos des problématiques de conception d'avant projet d'un moteur est détenue par une dizaine d'expert maîtrisant à eux seul ces problématiques. Il existe des outils afin de garder la connaissance de ces personnes comme les notes rédigées à la fin de chaque pré-étude moteur permettant de spécifier les problèmes rencontrés et les solutions abordées. Ceci entraîne une répétitivité de questions identiques à ces experts et par conséquent une perte de temps. Le gain que pourrait apporter la qualification des données (maturité) en phase amont de conception est très important ; par exemple une heure de réunion à 7 ou 8 personnes. Libération des personnes et de leur temps pour se consacrer à d'autres tâches, ce qui signifie un gain de temps, d'argent et de productivité.

-> Communication et aspect humain.

Ces aspects font déjà partis du précédent présenté ci-dessus mais il va être complété ici. La communication est un des facteurs clés pour prendre une décision et présenter ces travaux lors des revues projets par exemple. La connaissance est capitaliser notamment à travers le

référentiel métier cependant transgresser le référentiel est un acte nécessitant une justification très poussée et des calculs très lourds pour obtenir une validation. Il faut savoir que les données inscrites dans le référentiel sont certaines, les experts et concepteurs ne font pas évoluer le référentiel avec des données sur lesquelles le niveau de maturité n'est pas très haut. Cela pose un problème lorsque les données utilisées par le concepteur sont fiables mais pas dans le référentiel métier. Si les données d'entrée du référentiel métier pouvaient être qualifiées alors le concepteur aurait d'avantage de liberté dans l'utilisation de ces dernières et une justification moins lourde à produire. Cela, également pour capitaliser d'avantage la connaissance des experts et faciliter son utilisation au sein d'une entreprise étendue.

Par exemple la partie Chinoise (PSA) n'a pas accès aux experts situés en France mais uniquement au référentiel métier. C'est pour cette raison que plus le référentiel métier reflète la connaissance des experts et plus le développement moteur sera amélioré.

Autre exemple justifiant l'importance de la qualification des données en phases amont de conception. Aujourd'hui PSA et Général Motors ont signé un accord afin de travailler en collaboration aux développements de nouveaux produits. Deux pays différents et deux entreprises différentes avec des exigences différentes. La qualification des données pourrait donc contribuer, dans ce cas particulier, à la justification des exigences et des données utilisées par PSA lors de la prise de décision entre les deux firmes.

Question(s) soulevée(s) :

Question 8 : D'après vous, quels sont les impacts les plus importants et les moins importants parmi ceux mentionnés ci-dessus ?

Plus importants : humain et connaissance

-> Les impacts les plus importants du manque de connaissances durant les phases amont de conception collaborative d'un système mécanique pour la prise de décision est la circulation et transmission de l'information.

Si l'on compare les ressources d'un site France comparé à celles d'un site en Chine, il sera beaucoup plus difficile aux ingénieurs et concepteurs chinois d'accéder aux connaissances des experts comparé aux ingénieurs et concepteur se situant en France (site commun avec les experts / position géographique).

De plus la communication joue un rôle particulièrement important, un concepteur ne présentera que très rarement une règle métier dont il n'est pas certain à « 100% », il engage sa responsabilité et doit apporter un lourd travail de justifications. Cette justification peut être relativement délicate lorsqu'il s'agit de phases amont de conception et où plusieurs itérations de conception sont nécessaires afin de préciser les valeurs et les résultats de calculs.

Moins importants : argent

-> Le coût d'une itération de conception en phase amont de conception produit est moindre par rapport au cout que représenterait un changement à effectuer lorsque le produit est en phase de fabrication, il faudrait alors relancer une étude, modifier tous les processus de fabrications correspondants, etc.

Un intérêt particulier a été montré pour la qualification des intervalles (paramètres d'entrées) dans un cadre de gestion de conflits et d'aide à la prise de décision.

Question(s) soulevée(s) : aucune

6.2. Interview 2

Second interview and industrial feedback focused on the PhD context, problematic and proposal.

The objective of this interview was to identify the links between the industrial and scientific problematic, and also to obtain feedback (validation) on the PhD proposal.

La qualification des connaissances en phase amont de conception collaborative

Bilan de la présentation et de l'interview

Organisateur : Nicolas DREMONT

Date : Jeudi 22 mars 2012 (environ 1h)

Versions : 1 - 29 mars 2012

Dénomination exacte du poste actuellement occupé :

Chargé d'affaires en Modélisation Numérique

Nombre d'année d'occupation de ce poste :

7 ans

Nombre d'année d'expérience dans le domaine :

9 ans

Domaine d'expertises principales :

Intégration CAO/Calcul, simulation mécanique, développement logiciel

Descriptif du rôle occupé :

Faciliter le lien entre le monde de la conception et celui de la simulation, via le développement d'outils intégrés destinés tantôt au concepteur, tantôt à l'analyste.

Question 1 : Utilisez-vous des facteurs de maturité et d'incertitudes des informations pour prendre des décisions en phases amont de conception produit ?

Il n'existe pas de facteurs de maturité ou d'incertitudes en tant que tel. Les paramètres de conception produit sont figés au fur et à mesure du cycle de développement.

Un cycle de conception dispose environ de quinze jalons, et chaque jalon permet de fixer un certain nombre de paramètres. Les premiers paramètres étant figés (correspond aux premiers jalons du cycle de conception) sont les paramètres les plus impactant comme le poids.

Les paramètres n'étant pas fixes sont par conséquent incertains et si un paramètre n'est pas remis en cause alors il reste dans le même état mais cela ne signifie pas que la valeur de ce paramètre est mature.

Question(s) soulevée(s) :

Pouvez-vous citer les cinq premiers paramètres étant figés en général a chaque nouveau projet ? (ex la masse est un des premiers) (En expliquant juste avec quelques mots pourquoi ces paramètres parmi des milliers d'autres). ?

Question 2 : Est-ce-que la maturité des informations est un problème durant la prise de décisions ?

La maturité des informations n'est pas un problème en tant que tel durant la prise de décisions mais l'absence de cette maturité est un frein à la collaboration comme nous allons le voir par la suite.

Les informations utilisées en phase amont de conception ne sont pas mures (phases préliminaire de la conception produit) cependant une valeur est donnée et existe. La maturité de ces valeurs se fait avec l'évolution du cycle de conception et les jalons (explicités précédemment), cependant une perte de temps importante est constatée avec le nombre important d'itérations durant ces phases amont.

De plus il a été souligné que c'est l'utilisateur de l'information qui donne la tendance de conception. Par exemple pour un même problème un concepteur allemand favorisera le temps d'assemblage tandis qu'un concepteur français aura favorisé le poids. L'utilisateur de l'information va donc donner une tendance de conception en privilégiant certains paramètres par rapport à d'autres ; et donc clairement influencé la prise de décision.

Il n'existe pas de facteur de maturité ou d'incertitudes en tant que tel cependant cela représente un frein à la collaboration puisque les valeurs des paramètres sont volontairement amplifiées afin que le concepteur s'auto-garde une marge d'erreur.

Question(s) soulevée(s) :

Si demain une valeur de maturité venait qualifier ces paramètres (volontairement amplifié par l'utilisateur/concepteur), pensez-vous que cela l'influencerait à fournir la valeur proche du résultat réel obtenu, ou continuera-t-il à fournir la même valeur ? Et pourquoi ?

Remarque : Il n'existe pas d'incertitudes sur les règles métiers. L'échelle TRL (9 niveaux) permet d'approuver une règle et de l'utiliser par la suite.

Question 3 : Quels sont les manques (données, informations, ressources, etc) durant les phases amont de conception produit pour prendre des décisions ?

En phase amont de conception il existe un choix gigantesque de possibilités et d'alternatives de conception. Il est cependant impossible aujourd'hui de combiner la totalité de ces choix ; cela doit prendre en compte les nouvelles technologies ; et le but est de trouver/identifier les alternatives optimum afin de répondre aux mieux aux exigences et besoin.

Aujourd'hui la conception d'un avion (en phase amont) a un espace de solution difficilement représentable, qui est tout aussi difficile à évaluer. Les concepteurs rédigent des documents afin de tracer les bonnes idées qui n'ont pas eu le temps d'être évaluées ou travaillées plus en détails et qui ne sont pas utilisées pour la conception du produit courant. Cela leur permet de capitaliser la connaissance et de garder les pistes identifiées à explorer pour les futures conceptions.

A noter qu'une tendance est identifiée concernant la définition de plage de valeurs sur une donnée et dans une solution technique donnée et ainsi d'être capable de partager les espaces de possibles. Ceci est une tendance, cependant les outils actuels ne sont pas faits pour supporter ce genre de processus aujourd'hui.

Question(s) soulevée(s) :

Depuis combien de temps avez-vous identifié que la qualification des données en phases amont de conception serait bénéfique pour l'aide à la prise de décision et pour faciliter la collaboration dans la conception produit ?

Question 4 : Quel processus utilisez-vous pour prendre des décisions aujourd'hui, durant les phases amont de conception d'un produit ?

Il n'existe pas de processus réel aujourd'hui pour prendre des décisions en conception collaborative durant les phases amont (dans un contexte EADS/airbus). Les décisions sont prises de manière très « manuelle » et cela prend du temps (revues projet, présentations...). Les jalons définis dans le planning projet permettent de figer des valeurs comme cela a déjà été expliqué.

Il existe cependant trois facteurs clés pour prendre les décisions :

- Coût
- Masse
- Temps

La masse est un critère spécifique, on essaie de tout traduire en équivalent masse et de voir l'impact en masse d'une décision sur la solution technique mais aussi le temps de fabrication... Un objectif masse est déterminé en début de projet (une des données fixées en premier), ainsi qu'une cible masse pour chaque sous-ensemble composant un avion. La masse est calculée jusqu'au plus petit composant. Plus on avance dans le cycle de conception (phases amont) et plus on sera capable d'évaluer la masse finale précisément. Si cette masse finale est supérieure à l'objectif fixé en début de projet, alors des campagnes de réduction de masse sont organisées.

Question(s) soulevée(s) :

Il existe trois critères (coût/masse/temps) orientant la prise de décision ; la maturité des données participera-t-elle au même titre que ces trois critères lors de la prise de décision ou aurait-elle un rôle différent (une considération différente / utilité) ?

Question 5 : Comment l'expérience des concepteurs est représentée et prise en compte durant la prise de décision en conception préliminaire collaborative ?

L'expérience est retranscrite et capturée à travers des présentations power point, la communication entre les personnes, les divers échanges et les présentations de problèmes lors des réunions. Par exemple entre la France et l'Allemagne, il existe des compétences similaires mais des points de vues différents et donc des solutions sur un problème technique différent.

L'expérience est également prise en compte via le référentiel métier incluant les règles de conception. Le référentiel est défini à chaque nouveau projet. Par exemple, dans le cas de l'A380, la pression dans les circuits était beaucoup plus importante que dans ceux précédents, il a donc fallu revoir toutes les règles afin de dimensionner correctement le système en prenant en compte la taille et les capacités de l'appareil. L'utilisation de composites a également nécessité de nouvelles règles. Les règles utilisées sont validées grâce à une échelle de maturité de processus (TRL) composée de 9 niveaux de maturité.

Question(s) soulevée(s) :

Les documents présentés lors de réunions sont-ils stockés sur une base commune et accessible par les membres du projet ou sont-ils gardés en local ?

Comment définiriez-vous le référentiel métier ?

Comment définiriez-vous une règle métier ?

Question 6 : Comment est géré l'aspect collaboratif durant les prises de décisions en conception préliminaire collaborative ? (réunion, groupe de travail, plateau...)

Des plateaux sont réalisés afin de prendre des décisions et d'accroître la collaboration entre les personnes.

Un plateau est le fait de mettre des personnes géographiquement dispersées, de métiers différents au même endroit en petit groupe sur une période donnée. Un nombre variant de 10 à 15 personnes vari sur un mois maximum.

Question(s) soulevée(s) :

Comment son programmer les plateaux ? Rythme régulier, en fonction de l'importance du projet, à chaque prise de décision majeure ?

Question 7 : Quels sont les impacts du manque de connaissances durant les phases amont de conception collaborative pour la prise de décision en fonction des différents facteurs mentionnés ci-après : humain / temps / argent / productivité / connaissance / méthodologie de travail / prise de décisions / processus de conception ?

Les impacts du manque de connaissances durant les phases amont de conception collaborative pour la prise de décision sont le temps et l'argent. Il est important de gérer les impacts des modifications effectuées durant les phases amont et avant que la conception détaillée et la fabrication démarrent. C'est pourquoi il est important de fixer la maturité des données le plus tôt possible (gain de temps, optimisation du processus de conception). Il reste tout de même des modifications tardives et nécessaire, c'est le cas des campagnes de réduction de masse par exemple (expliqué précédemment).

Question(s) soulevée(s) :

Question 8 : D'après vous, quels sont les impacts les plus importants et les moins importants parmi ceux mentionnés ci-dessus ?

Les plus importants sont le temps et l'argent (les deux sont liés), cela est dû à un nombre important d'itérations et un espace de solutions possibles très vaste.

Il n'y a pas d'impacts moins importants.

Question(s) soulevée(s) :

Combien d'itérations sont réalisées en moyenne durant les phases amont de conception ?

Quelle est la durée moyenne d'un projet (phases monts jusqu'au lancement de la fabrication) en moyenne?

6.3. Realised presentation to the researchers

This section presents the presentation used with the interviewed researchers in order to validate the context, problematic and the orientation of the PhD proposal.

This presentation was made to two international experts. Their feedback is presented in Appendices 6.4 and 6.5.



Figure 47: Slide 1 of the presentation

Le doctorant 2 / 19

Nicolas DREMONT

- Diplômes obtenus :
 - DUT en Génie Mécanique et Productique - Reims, France, 2006
 - Master of sciences in Computer Aided Engineering Design - Glasgow, Ecosse, 2009
 - Ingénieur en Génie des Systèmes Mécanique - UTT - Troyes, France, 2010
- Seconde année de thèse en Mécanique Avancée - Laboratoire Roberval
- Directeurs de thèse :
 - Nadège TROUSSIER (UTC)
 - Alex DUFFY (University of Strathclyde, Glasgow)

Présentation générale 

Figure 48: Slide 2 – Personal presentation

Sommaire 3 / 19

1. **La prise de décision en conception préliminaire.**
 - La conception préliminaire
 - Dans un contexte collaboratif
 - Sous incertitudes
2. **Comment structurer les informations ?**
 - Problématique et questions de recherches
 - Etat de l'art
 - Verrous scientifiques
3. **Une métrique pour évaluer la maturité d'un système mécanique**
 - Définition de la maturité
 - Méthodologie & Calcul de la maturité
 - Application et Résultats

Présentation générale 

Figure 49: Slide 3 – Content of the presentation

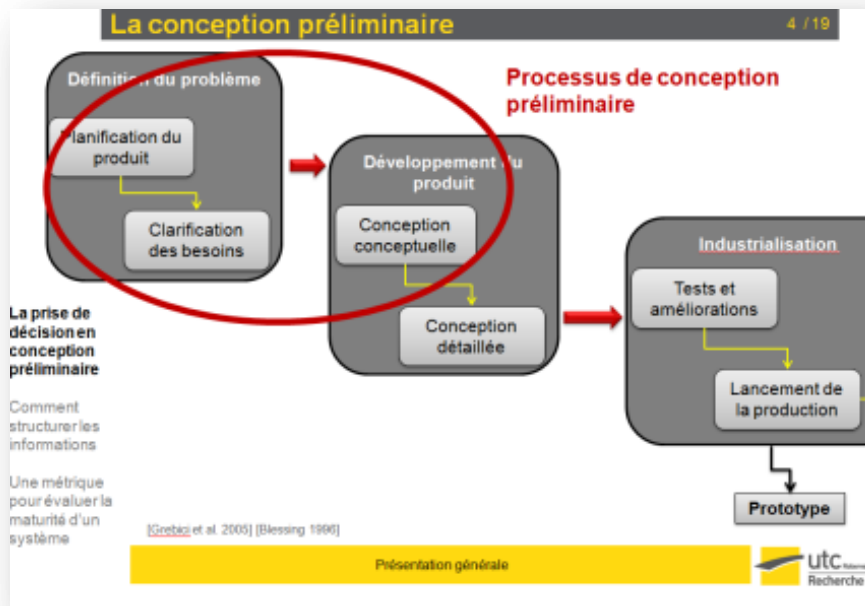

Figure 50: Slide 4 – Preliminary design

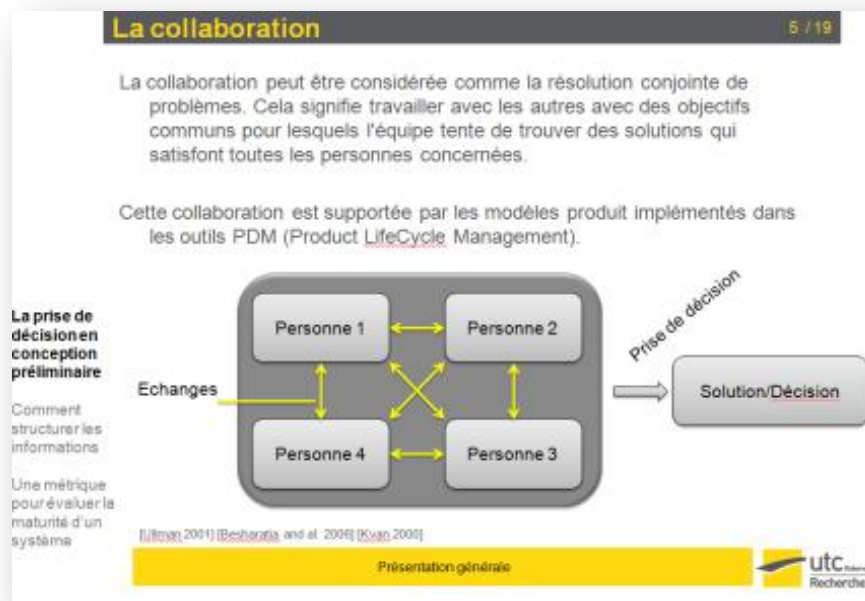

Figure 51: Slide 5 – The collaborative dimension

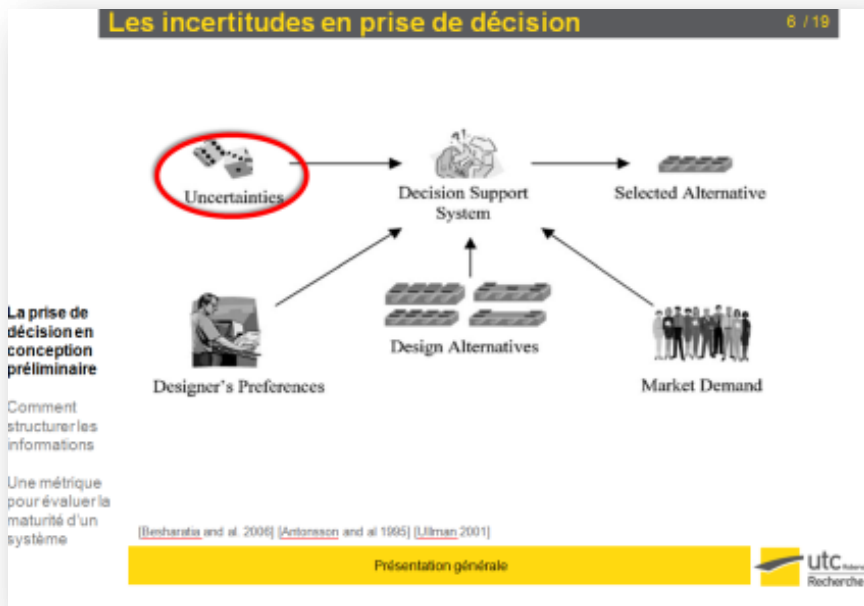

Figure 52: Slide 6 – Uncertainties in decision making

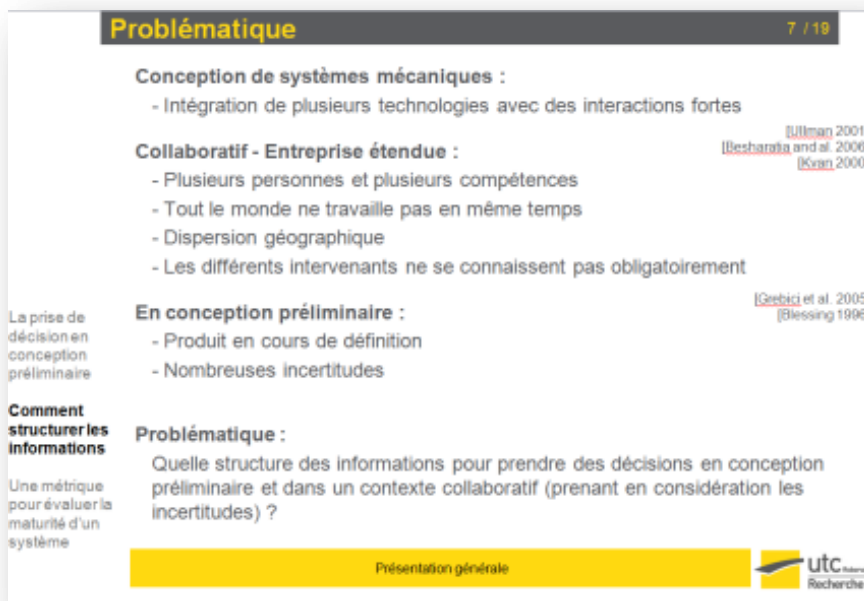

Figure 53: Slide 7 – Presentation of the identified problematic

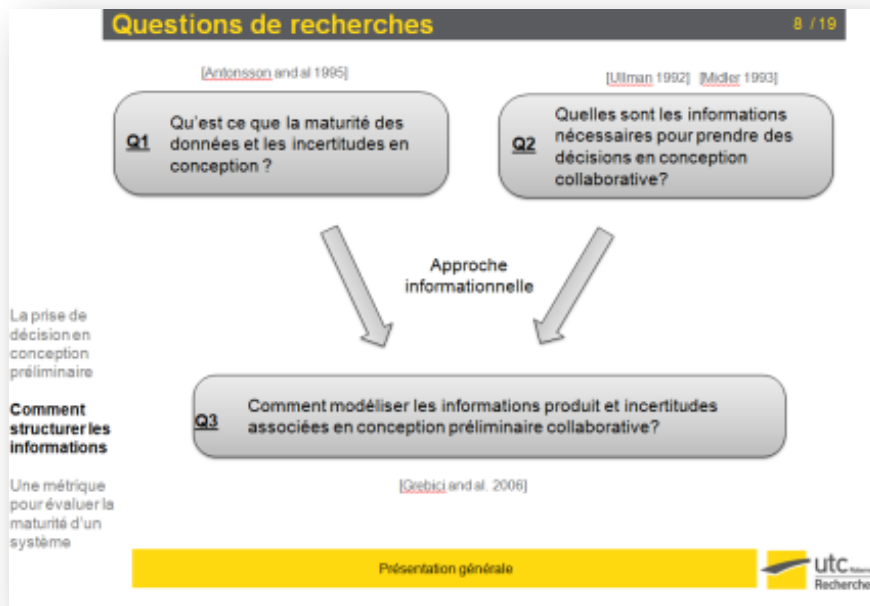

Figure 54: Slide 8 – Research questions

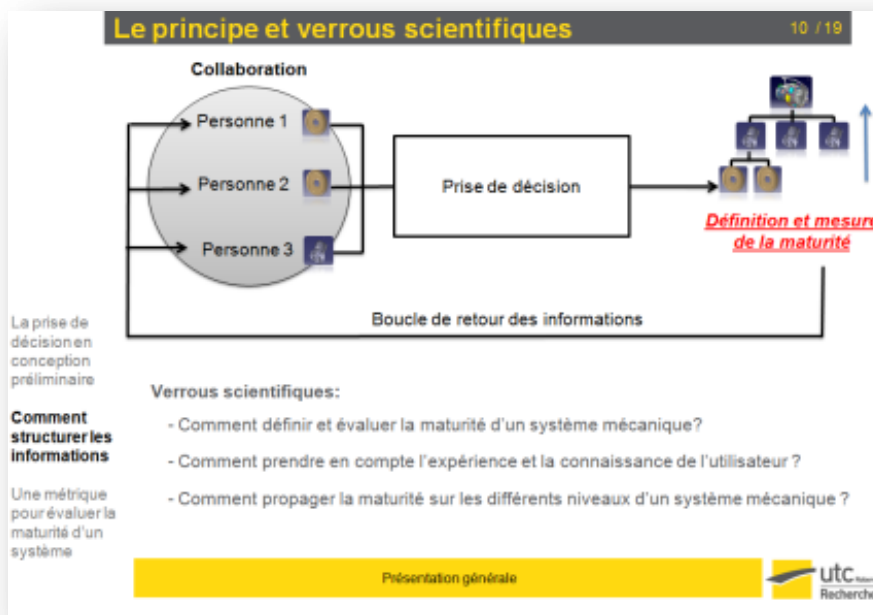

Figure 55: Slide 9 – Principle and scientific locks

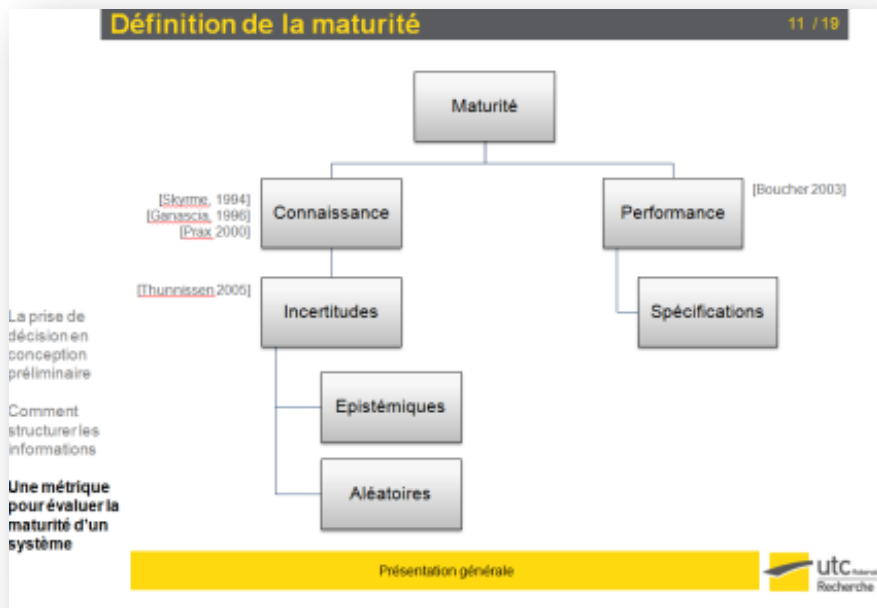

Figure 56: Slide 10 – Definition of maturity

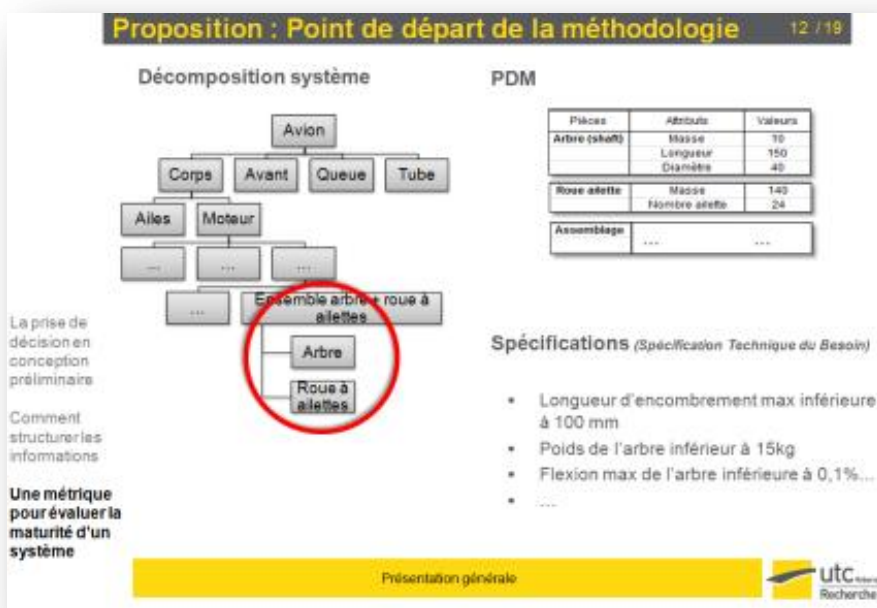



Figure 57: Slide 11 – Proposal: start point of the methodology

Proposition : Méthodologie et métrique 13 / 19

Logiciel de conception : (Catia, CreoElement, ...)

Aujourd'hui :



- Conception de l'arbre par l'utilisateur 1
- Définition de la cotation « diamètre = 40 mm »

Demain :



- **Définition de l'intervalle d'incertitude:**
« diamètre = 40 mm +/- 25 mm » [Huisissen 2005]
- **Définition du niveau de pérennité basé sur une échelle qualitative** de la valeur et de son incertitude
Temps pendant lequel l'information est valable

La prise de décision en conception préliminaire

Comment structurer les informations

Une métrique pour évaluer la maturité d'un système

Attribut	Description
1	Attribut de qualité
2	Attribut de qualité avec une plage de variation définie
3	Attribut de qualité avec une plage de variation définie et une incertitude
4	Attribut de qualité avec une plage de variation définie, une incertitude et un niveau de pérennité

[Gaudin 01]

Présentation générale 

Figure 58: Slide 12 – Proposal: methodology and metric

Proposition : Méthodologie et métrique 14 / 19

Réintégration de l'arbre dans le PDM et **définition du degré de performance**

Précis	Attributs	Valeurs	Intervalle	Pérennité
Arbre (shaft)	Masse	10	0	3
	Longueur	150	100	2
	Diamètre	40	25	2
	Performance	3,8	-	-

Idem avec la conception de la roue à ailette (deuxième composant de notre assemblage).

Degré de performance :

Pourcentage du nombre de spécifications atteint à la fin de l'itération de conception par rapport au nombre de spécification total. [Based on Boucher 2003]

1. Longueur d'encombrement max inférieure à 100 mm → OK
2. Poids de l'arbre inférieure à 15kg → FAUX
3. Flexion max de l'arbre inférieure à 0,1% → OK

Performance : 66%

La prise de décision en conception préliminaire

Comment structurer les informations

Une métrique pour évaluer la maturité d'un système

Présentation générale 

Figure 59: Slide 13 – Proposal: methodology and metric

Proposition : Méthodologie et métrique 15 / 19

Logiciel de simulation : (ANSYS, etc)

Aujourd'hui :

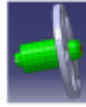

- Simulation du comportement de l'assemblage → Bilans

Demain :



Niveau de sensibilité	Description
0	Non sensible : L'impact est négligeable à tout chargement
1	Faiblement sensible : L'impact est peu sensible à tout chargement
2	Moyennement sensible : L'impact est sensible de façon moyenne à tout chargement
3	Sensible : L'impact est très sensible à tout chargement

- **Ajustement des intervalles d'incertitude:**
Ex: « diamètre = 40 mm +/- 25 mm » → « diamètre = 40 mm +/- 15 mm » [Thunissen 2006]
- **Vérification des spécifications**
- **Définition du niveau de sensibilité basé sur une échelle qualitative** (valeur et intervalle)

Importance de l'impact de la donnée sur l'assemblage [Krishnan et al. 1997]

↓

Réintégration dans le PDM et **calcul du niveau de maturité**

Présentation générale 

La prise de décision en conception préliminaire
Comment structurer les informations
Une métrique pour évaluer la maturité d'un système

Figure 60: Slide 14 – Proposal: methodology and metric

Proposition : Composition de la métrique 16 / 19

1/ Couplage Pérennité et Sensibilité

Niveau de sensibilité	Description
0	Non sensible : L'impact est négligeable à tout chargement
1	Faiblement sensible : L'impact est peu sensible à tout chargement
2	Moyennement sensible : L'impact est sensible de façon moyenne à tout chargement
3	Sensible : L'impact est très sensible à tout chargement

[Krishnan et al. 1997] [Gaudin 01]

Table de couplage

Importance	Niveau de sensibilité	Niveau de sensibilité	Description
0	0	0	Non sensible à tout chargement
0	1	0	Faiblement sensible à tout chargement
0	2	0	Moyennement sensible à tout chargement
0	3	0	Sensible à tout chargement
1	0	1	Faiblement sensible à tout chargement
1	1	1	Moyennement sensible à tout chargement
1	2	1	Sensible à tout chargement
1	3	1	Non sensible à tout chargement
2	0	2	Faiblement sensible à tout chargement
2	1	2	Moyennement sensible à tout chargement
2	2	2	Sensible à tout chargement
2	3	2	Non sensible à tout chargement
3	0	3	Faiblement sensible à tout chargement
3	1	3	Moyennement sensible à tout chargement
3	2	3	Sensible à tout chargement
3	3	3	Non sensible à tout chargement

2/ Définition du niveau final de maturité

Algorithme avec facteurs d'importance prenant en compte:

- **Couplage de la pérennité et sensibilité**
- **Importance de l'intervalle d'incertitude en fonction de la valeur**
- **Niveau de performance**

Présentation générale 

La prise de décision en conception préliminaire
Comment structurer les informations
Une métrique pour évaluer la maturité d'un système

Figure 61: Slide 15 – Proposal: metric composition

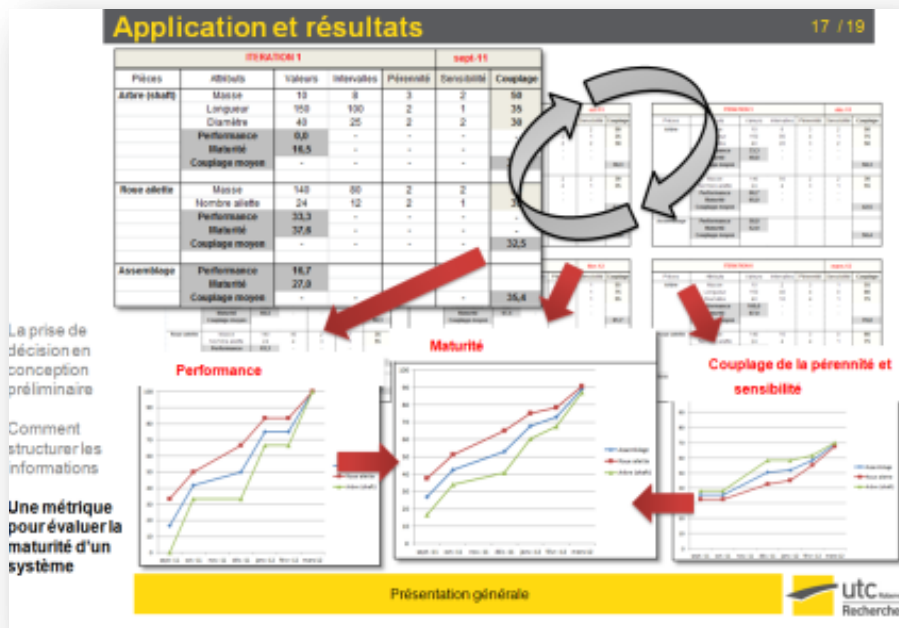

Figure 62: Slide 16 – Application and results



Figure 63: Slide 17 – Questions

6.4. Feedback by researcher 1

Presentation of the discussion is based on the slides presented as shown in Appendix 6.3. The objectives were to validate the context, problematic and proposal and obtain general feedback on the PhD and addressed thematic.

This researcher is currently a professor, previously an associate professor of design and manufacturing in a department of mechanical engineering. He received his PhD in 1999 from the National Polytechnic Institute of Grenoble on collaborative product modelling. He has been a professor since 2008. The context of his research is integrated design and the collaborative IT platform in a global PLM vision. His specific interest is product–process interface and he has proposed a DFM-synthesis approach which is now part of the larger DFX modelling for virtual prototyping with least commitment supported by the MDE platform.

Date de la présentation : Octobre 2012

Slide 1 :

Une métrique pour qualifier la maturité des données en conception préliminaire collaborative de systèmes mécanique.

→ Il serait plus intéressant de généraliser le titre “Une Métrique pour qualifier les données de conception pour aider à la prise de décision” et mettre en sous-titre le contexte particulier “application à la conception préliminaire collaborative de systèmes mécanique”.

Slide 3 :

La démarche scientifique est respectée et clairement identifiée. La définition du contexte est clair et vulgarisée pour être facilement compréhensible, les questions de recherche associées sont pertinentes et les verrous scientifiques identifiés.

Seul point à améliorer, il manque pour ma part un idéal qui décrit ce que nous aimerions avoir pour répondre à la problématique et ainsi pouvoir le comparer avec ce que nous proposons dans nos travaux de thèse.

Contexte

- Slide 4 : Description du processus préliminaire valide avec référence à Pahl & Beitz : positionnement en conception préliminaire
 - ✓ justification de la position en « phase préliminaire ». Il faut penser à bien expliciter et présenter clairement les hypothèse, référence et résultants.
- Slide 5 : Description de l'aspect collaboratif, positionnement et références correctes.
- Slide 6 : Aide à la décision.

Positionnement et description du contexte valide mais il serait important de spécifier dès le début les différents types d'incertitudes et commencer à se positionner. Les types d'incertitudes sont à présenter, décrire et illustrer clairement avec des exemples.

Problématique :

- Slide 7 : Il est important d'avoir un idéal qui sert de référence. La problématique présentée ne peut en être une si tu ne montres pas ce que tu veux faire et ce que le contexte ne traite pas aujourd'hui.
- Slide 8 : Il faut présenter les grandes fonctions de l'idéal, de ce que tu veux faire dans le but de faire ressortir les questions de recherche.

Etat de l'art

- Slide 9 : L'état de l'art est correctement présenté et bien structure cependant il faut mettre d'avantage en avant les fonctions qui ne sont pas traitées aujourd'hui et que tu abordes pour clarifier ton positionnement.
- Slide 10 : les verrous scientifique sont la différences entre les fonctions de ton idéal et l'état de l'art.

Proposition

- Slide 12 : D'accord pour l'illustration et la présentation de la métrique et méthodologie de mise en place associées mais les fonctions et solutions de ta proposition devrait pouvoir être lié à ton idéal.
 - ✓ Point de départ : BOM produit (Bill Of Materials) c'est à dire du niveau bas (pièce). Décomposition identifié dans un système PDM avec les articles associés pour capitaliser la connaissance.
 - ✓ Ensuite, modélisation CAO avec le nominal et l'incertitude avec retour vers PDM pour capitaliser. Définition par le concepteur des différent indicateurs de la métrique tels que niveaux de sensibilité, tolérance et pérennité.
 - ✓ Calcul du degré de performance. Attention, la performance n'a jamais été introduit avant, d'où l'importance de définir clairement l'idéal et de se justifier son positionnement par rapport à cet idéal. De plus, ne pas mettre « faux » mais « pas atteint » pour préciser l'état de la spécification technique du besoin.
- Slide 15 : Présentation de la métrique, et comment le niveau de maturité est obtenu mais il faut bien montrer la convergence de l'espace des « incertitudes » au fur et à mesure que les « concepteurs » ajoutent de la connaissance; cette espace de solution diminue ou augmente en fonctions des itérations de conception et des connaissances acquises.
- Slide 15 : Présentation du retour vers le PDM et calcul de maturité mais tu ne précises pas d'où viennent les modèles de pérennité et sensibilité. Il est important de préciser ce qui vient de l'état de l'art et ce qui vient de la proposition, cela est nécessaire pour identifier clairement le positionnement, la démarche scientifique utilise et quelles sont les connaissances créées et capitalisées.

Le calcul de la maturité : c'est ta proposition et il faudra illustrer et valider ce modèle.
- Slide 16 : Le retour fournit par la métrique est très intéressant mais il manque l'explication sur comment utiliser ces résultants dans la prise de décision et quand. Est ce de la réutilisation sur un autre cas de conception similaire ou plutôt en “temps réel” c'est à dire sur le cas de conception actuel. Il est nécessaire de clairement clarifier et expliquer cette partie.

Conclusion

Il est important de mettre en avant certains points même si la démarche et l'exercice sont compris.

- Présenter l'idéal
- Présenter la validation
- Positionner clairement les apports de la proposition et ceux de l'état de l'art
- Présenter l'utilisation des résultats

6.5. Feedback by researcher 2

Presentation of the discussion is based on the presented slides available in Appendix 6.3. The objectives were to validate the context, problematic and proposal and to obtain general feedback on the PhD and addressed thematic.

This researcher is a Professor of Industrial and Mechanical Engineering, and especially of design engineering and innovation engineering. He is the deputy director of the Industrial Engineering Laboratory of Ecole Centrale Paris, France, where he manages the Design Engineering Team (20 researchers). His area of expertise is design engineering, more specifically: design automation, artificial intelligence in design, system thinking, design under uncertainty, decision-based design, innovation management, ecodesign, design optimisation, design processes and organisation.

He received an M.S. (1988) in Mechanical Engineering from Ecole Normale Supérieure de Cachan (ENSC), an M.S. (1989) in Computer Science from Paris-6 University, and a PhD (1994) in Industrial Engineering from ENSC.

He is the director of the Innovative System Design and Development FCI final-year minor curriculum and of the Master of Science in Industrial Engineering. He also delivers the second year SE2200 course on Innovative Design of Products and Services. He has coordinated the publication of eight books on design engineering and innovation engineering in French.

He has conducted research for a number of industrial companies: Dassault Systemes, Renault, Schlumberger, Johnson Controls, EADS, Eurocopter, Snecma, Areva and Alstom Grid. He has supervised 18 PhD theses in design engineering and is currently supervising four PhD doctorates. He has been the author or co-author of more than 220 peer-reviewed papers (see citations SCOPUS and GOOGLE SCHOLAR), among 42 international journals.

He is a member of the Advisory Board of the Design Society. He is also a member of the ASME (American Society of Mechanical Engineers) for which he serves as an International Liaison of IDETC/DAC (International Design Engineering Technical Conferences / Design Automation Conference). He is also an Associate Editor of the Journal of Mechanical Design (JMD) and member of the Editorial Advisory Board of the International Journal of Design Creativity and Innovation (IJDCI). He is appointed by the French Ministry of Research to

undertake quality evaluation of laboratories and curricula in his domain. He is also an administrator of the innovation cluster on gerontechnologies Sol'iage and of the French research network on sustainable design EcoSD.

Date de la présentation : Octobre 2012

Différents points ont été discutés lors de cette seconde présentation afin d'améliorer la proposition et sa validation.

Tout d'abord il est important de préciser la nature de l'incertitude. Le contexte est clairement défini, il se situe en phase terminale de conception préliminaire de système mécanique paramétré. Il existe différents types d'incertitudes et il est important de se positionner clairement dessus. Le meilleur moyen de définir clairement les incertitudes est d'identifier leur source. Cela permettra de les définir.

Conseil: Thèse de Goh sur la modélisation des incertitudes pour aider au positionnement.

La seconde remarque concerne le type de prise de décision. Il doit être précisé qu'il s'agit de prise de décision pour du pré-dimensionnement de systèmes mécaniques. De cette façon l'aspect CAO doit être mis en avant et plus particulièrement l'aspect collaboratif de la conception qui ne ressort pas assez actuellement. Le scénario présenté, illustrant la méthodologie de construction et d'utilisation de la métrique ne met pas suffisamment l'aspect conception collaboratif en avant. D'autres problèmes sont liés à la conception collaborative comme la cohérence des données. Il est nécessaire de définir précisément le contexte et de se positionner.

Le travail collaboratif, due aux nombreux acteurs intervenant dans le cycle de conception des systèmes mécaniques, fait intervenir des incertitudes. Là encore, il s'agit d'un autre type

d'incertitude, ambiguïté. Effectivement quand deux concepteurs travaillant dans deux domaines différents tels que la conception et la simulation peuvent très bien parler de la même donnée et information mais utiliser des expressions et dénominations différentes. Ce type est-il traité dans les travaux de cette thèse?

Le contexte, la problématique et l'état de l'art sont clairement définis mais il est nécessaire de clarifier certains points comme l'utilisation de tolérances et le positionnement par rapport aux différents types d'incertitudes traitées. Quelles sont les sources de ces incertitudes? Manque de connaissance par exemple, ambiguïté des communications entre concepteurs. De plus, il est plus juste d'utiliser, dans le cas de la métrique proposée, la notion de tolérance et de valeur nominale plutôt que d'intervalle d'incertitude. Une fois ces points éclaircis, le positionnement de la métrique et de la proposition en sera plus précise et positivement impacté.

La seconde partie de la présentation a donné lieu à une discussion sur comment valider la proposition de thèse, c'est à dire la métrique présentée. Le meilleur moyen de validation serait l'implémentation de la métrique sur plusieurs conceptions de systèmes mécaniques les uns après les autres afin d'évaluer précisément les impacts de la métrique sur la prise de décisions. L'inconvénient d'un tel niveau de validation est le temps nécessaire pour la mise en place et le temps de traitement et d'analyse des résultats avant d'en tirer des préconisations. Une thèse dure trois années et cela demanderait plus de temps par conséquent un tel niveau de validation ne pourrait être implémenté dans la durée de l'exercice par contre il est important d'expliquer sa mise en place dans la conclusion et perspectives pour les travaux qui suivront. Une seconde solution serait de créer des cas d'utilisations pour des parties précises de la proposition et d'associer des questionnaires afin d'obtenir les retours positifs et possibilité d'amélioration sur la proposition.

Nous pouvons conclure que cette présentation a permis de valider l'intérêt des travaux de recherches (problématiques abordées et proposition) et a mis l'accent sur différents points à prendre en considération afin d'améliorer le positionnement des travaux de recherches ainsi que les valider. L'accent a été mis particulièrement sur le type d'incertitudes abordés et le positionnement des travaux par rapport à ces types d'incertitudes. La seconde partie de la

présentation a permis de clarifier différent moyen de validation des travaux présentés afin de justifier d'une réelle contribution à la connaissance scientifique qui reste l'intérêt premier de l'exercice de thèse.

6.6. Presentation during the ADN project (PhD and metric)

The first presentation was made to the ADN project partners in order to get their feedback, remarks and comments. The content of this presentation is based on the general context and problematic of the PhD, for the first time, and, on the metric to evaluate the maturity of a mechanical system on the second time. The objective of this presentation is to obtain validation from the industrial experts concerning the PhD proposal.



Figure 64: Slide 1 – Data and knowledge qualification: to evaluate the maturity of a system

Slide 2: Sommaire

1	La prise de décision en conception préliminaire collaborative
1.1	Comment structurer les informations?
1.2	Comment aborder le problème ?
1.3	La définition d'une métrique
1.4	Des approches et des modèles
1.4	Maturité, performance et incertitudes
2	Evaluer la maturité d'un système
2.1	Principe et démarche
2.2	Cas d'application et illustration
2.3	Les bilans

2

ADN

Figure 65: Slide 2 – Content

Slide 3: Partie 1

La prise de décision en conception préliminaire collaborative

3

ADN

Figure 66: Slide 3 – Decision making in preliminary collaborative design

Partie 1 : Comment structurer les informations ?

- ◆ **Conception innovante de systèmes mécaniques :**
 - Intégration de plusieurs technologies avec des interactions fortes.
 - Des connaissances à construire
- ◆ **Collaboratif - Entreprise étendue :**
 - Plusieurs personnes et plusieurs compétences.
 - Tout le monde ne travaille pas en même temps.
 - Dispersion géographique.
 - Les différents intervenants ne se connaissent pas obligatoirement.
- ◆ **En conception préliminaire :**
 - Produit en cours de définition.
 - Nombreuses incertitudes.

Problématique :
 Quelle structure des informations pour prendre des décisions en conception préliminaire et dans un contexte collaboratif (prenant en considération les incertitudes) ?

Figure 67: Slide 4 – Context presentation and problematic

Partie 1 : Comment aborder le problème ?

[Antonsson and al 1995] [Ulman 1992] [Milder 1993]

Q1 Qu'est ce que la maturité des données et les incertitudes en conception ?

Q2 Quelles sont les informations nécessaires pour prendre des décisions en conception collaborative?

Approche informationnelle

Q3 Comment modéliser les informations produit et incertitudes associées en conception préliminaire collaborative? [Grebici and al 2006]

Figure 68: Slide 5 – Research questions

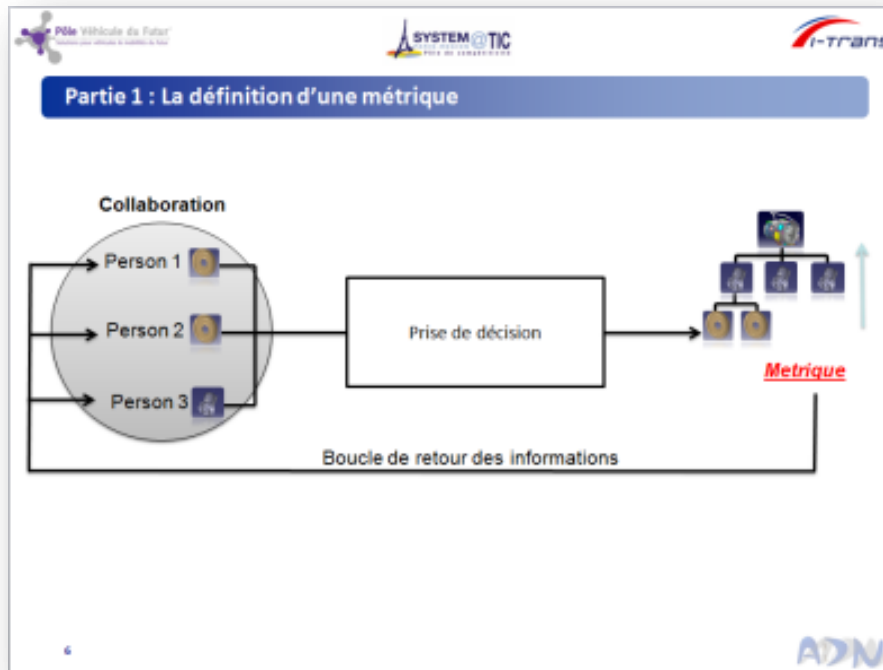

Figure 69: Slide 6 – Metric principle

Partie 1 : Des approches et des modèles

	Approches qualitatives					Approches quantitatives			Modèles produit et connaissance
Q1	Pérennité [Gaudin 2001]	Variation [Grebici and al. 2006]	Sensibilité [Krishnan 1996]	Complétude [Yassine and al. 1999]	PEPS	Ensemble flous*	Théorie de la possibilité *	Théorie de l'évidence*	PPO : Product Process Organisation [Noel et al., 2004]
Q2					Précision Exactitude Parcimonie Spécialisation				
Q3					[Sebastian et al. 2005]				CPM : Core Product Model [Sudarsan et al., 2005] MOKA: Methods and tools Oriented to Knowledge acquisition [Moka, 1999] PPR : Product Process Resource Sans Incertitudes

* [Dempster 1967] [Du and Choi 2006] [Shafer 1976] [Shafer 1978] [Shafer 1986] [Zadeh 1965] [Zadeh 1978]

Figure 70: Slide 7 – State of the art

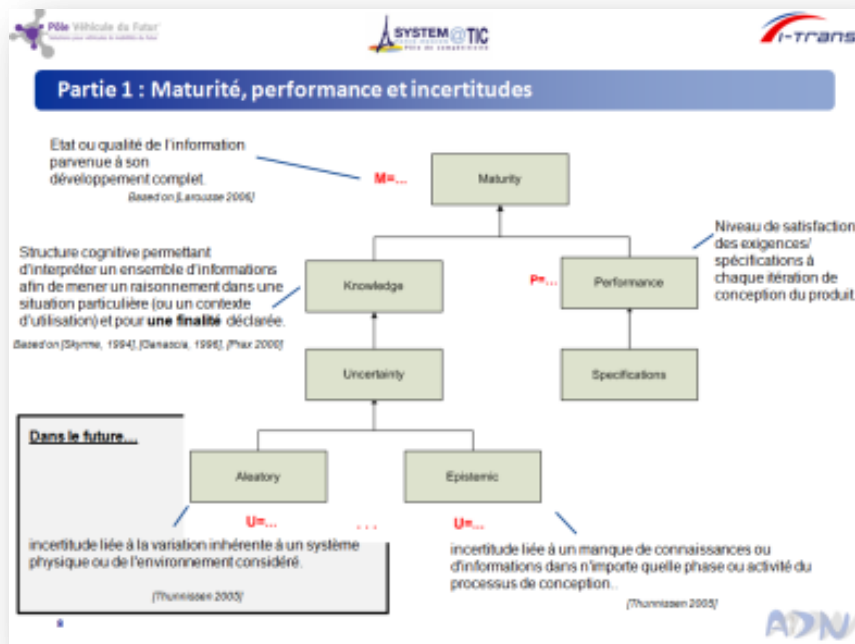

Figure 71: Slide 8 – Maturity definition

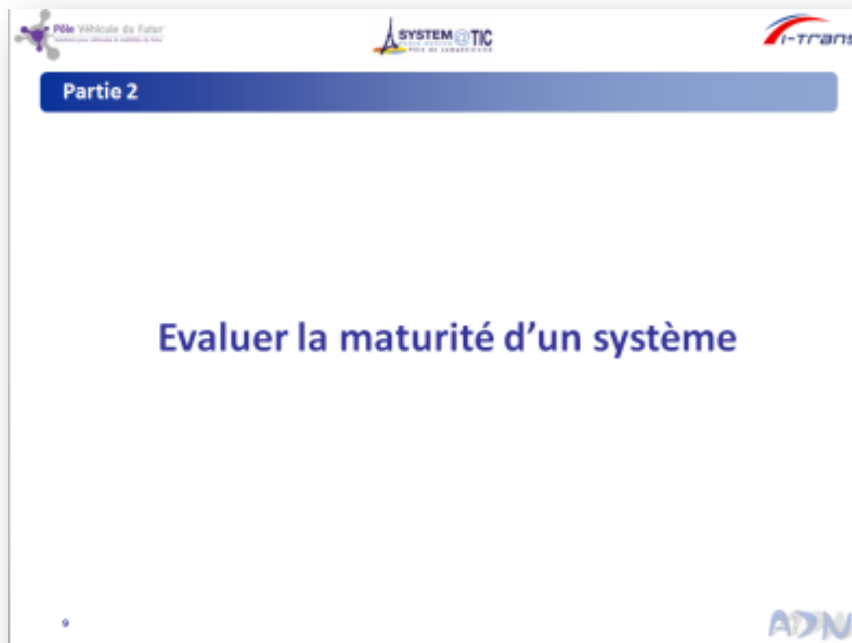

Figure 72: Slide 9 – Evaluation of the maturity of a system

Pôle Véhicule du Futur
Système Véhicule de l'ADN

SYSTEMATIC
METHODE DE CONCEPTION

i-trans

Partie 2 : Principe et démarche

Id	Niveau	Pré-étude	Etude	Conception	Description	Le langage	Niveau	Description
1	0	0	0	0	Pré-étude préliminaire: formaliser les besoins et les exigences de l'usage	Pré-étude préliminaire: formaliser les besoins et les exigences de l'usage	1	Pré-étude préliminaire
10	1	0	0	0	Pré-étude préliminaire: formaliser les besoins et les exigences de l'usage	Pré-étude préliminaire: formaliser les besoins et les exigences de l'usage	2	Pré-étude préliminaire: formaliser les besoins et les exigences de l'usage
15	1	1	0	0	Pré-étude préliminaire: formaliser les besoins et les exigences de l'usage	Pré-étude préliminaire: formaliser les besoins et les exigences de l'usage	3	Pré-étude préliminaire: formaliser les besoins et les exigences de l'usage
20	1	1	1	0	Pré-étude préliminaire: formaliser les besoins et les exigences de l'usage	Pré-étude préliminaire: formaliser les besoins et les exigences de l'usage	4	Pré-étude préliminaire: formaliser les besoins et les exigences de l'usage
25	1	1	1	1	Pré-étude préliminaire: formaliser les besoins et les exigences de l'usage	Pré-étude préliminaire: formaliser les besoins et les exigences de l'usage	5	Pré-étude préliminaire: formaliser les besoins et les exigences de l'usage
30	1	1	1	1	Pré-étude préliminaire: formaliser les besoins et les exigences de l'usage	Pré-étude préliminaire: formaliser les besoins et les exigences de l'usage	6	Pré-étude préliminaire: formaliser les besoins et les exigences de l'usage
35	1	1	1	1	Pré-étude préliminaire: formaliser les besoins et les exigences de l'usage	Pré-étude préliminaire: formaliser les besoins et les exigences de l'usage	7	Pré-étude préliminaire: formaliser les besoins et les exigences de l'usage
40	1	1	1	1	Pré-étude préliminaire: formaliser les besoins et les exigences de l'usage	Pré-étude préliminaire: formaliser les besoins et les exigences de l'usage	8	Pré-étude préliminaire: formaliser les besoins et les exigences de l'usage
45	1	1	1	1	Pré-étude préliminaire: formaliser les besoins et les exigences de l'usage	Pré-étude préliminaire: formaliser les besoins et les exigences de l'usage	9	Pré-étude préliminaire: formaliser les besoins et les exigences de l'usage
50	1	1	1	1	Pré-étude préliminaire: formaliser les besoins et les exigences de l'usage	Pré-étude préliminaire: formaliser les besoins et les exigences de l'usage	10	Pré-étude préliminaire: formaliser les besoins et les exigences de l'usage
55	1	1	1	1	Pré-étude préliminaire: formaliser les besoins et les exigences de l'usage	Pré-étude préliminaire: formaliser les besoins et les exigences de l'usage	11	Pré-étude préliminaire: formaliser les besoins et les exigences de l'usage
60	1	1	1	1	Pré-étude préliminaire: formaliser les besoins et les exigences de l'usage	Pré-étude préliminaire: formaliser les besoins et les exigences de l'usage	12	Pré-étude préliminaire: formaliser les besoins et les exigences de l'usage
65	1	1	1	1	Pré-étude préliminaire: formaliser les besoins et les exigences de l'usage	Pré-étude préliminaire: formaliser les besoins et les exigences de l'usage	13	Pré-étude préliminaire: formaliser les besoins et les exigences de l'usage
70	1	1	1	1	Pré-étude préliminaire: formaliser les besoins et les exigences de l'usage	Pré-étude préliminaire: formaliser les besoins et les exigences de l'usage	14	Pré-étude préliminaire: formaliser les besoins et les exigences de l'usage
75	1	1	1	1	Pré-étude préliminaire: formaliser les besoins et les exigences de l'usage	Pré-étude préliminaire: formaliser les besoins et les exigences de l'usage	15	Pré-étude préliminaire: formaliser les besoins et les exigences de l'usage
80	1	1	1	1	Pré-étude préliminaire: formaliser les besoins et les exigences de l'usage	Pré-étude préliminaire: formaliser les besoins et les exigences de l'usage	16	Pré-étude préliminaire: formaliser les besoins et les exigences de l'usage
85	1	1	1	1	Pré-étude préliminaire: formaliser les besoins et les exigences de l'usage	Pré-étude préliminaire: formaliser les besoins et les exigences de l'usage	17	Pré-étude préliminaire: formaliser les besoins et les exigences de l'usage
90	1	1	1	1	Pré-étude préliminaire: formaliser les besoins et les exigences de l'usage	Pré-étude préliminaire: formaliser les besoins et les exigences de l'usage	18	Pré-étude préliminaire: formaliser les besoins et les exigences de l'usage
95	1	1	1	1	Pré-étude préliminaire: formaliser les besoins et les exigences de l'usage	Pré-étude préliminaire: formaliser les besoins et les exigences de l'usage	19	Pré-étude préliminaire: formaliser les besoins et les exigences de l'usage
100	1	1	1	1	Pré-étude préliminaire: formaliser les besoins et les exigences de l'usage	Pré-étude préliminaire: formaliser les besoins et les exigences de l'usage	20	Pré-étude préliminaire: formaliser les besoins et les exigences de l'usage

19

ADN

Figure 73: Slide 10 – Association sensitivity and sustainability

Pôle Véhicule du Futur
Système Véhicule de l'ADN

SYSTEMATIC
METHODE DE CONCEPTION

i-trans

Partie 2 : Cas d'application et illustration

Pièces	Attributs	ITERATION 1			sept. 11		Coeffic
		Valeurs	Intervalle	Pérennité	Sensibilité	Coeffic	
Arbre (shaft)	Masse	10	8	3	2	50	
	Longueur	150	100	2	1	35	
	Diamètre	40	25	2	2	30	
	Performance	0,0	-	-	-	-	
	Maturité	10,5	-	-	-	-	
	Coeffic moyen	-	-	-	-	38,3	
Roue ailette	Masse	140	80	2	2	30	
	Nombre ailette	24	12	2	1	35	
	Performance	33,3	-	-	-	-	
	Maturité	37,8	-	-	-	-	
		Coeffic moyen	-	-	-	-	32,5
Assemblage	Performance	16,7	-	-	-	-	
	Maturité	27,0	-	-	-	-	
		Coeffic moyen	-	-	-	-	35,4

20

ADN

Figure 74: Slide 11 – PDM view of the metric

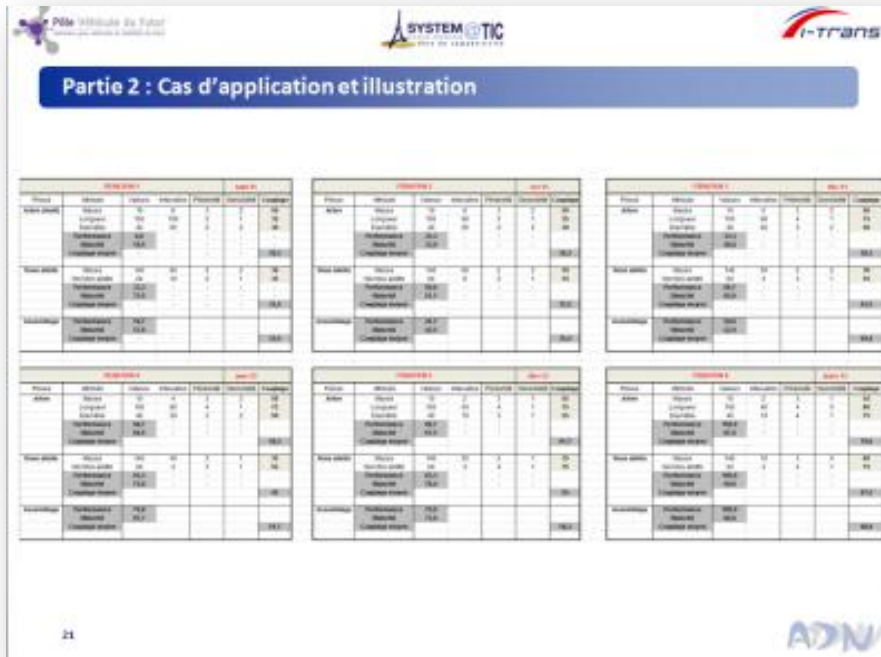

Figure 75: Slide 12 – Design iteration



Figure 76: Slide 13 – Result of the metric



Figure 77: Slide 14 – Acknowledgements

6.7. Presentation during the ADN project (MMK)

The second presentation was made to the ADN project partners in order to obtain their feedback, remarks and comments. The content of this presentation is based on the conceptual framework (meta-models) assuring the collaborative dimension of the PhD proposal and the integration of the maturity evaluation into a decision support system via PDM models. The objective of this presentation was to obtain validation from the industrial experts concerning the PhD proposal.

As with the previous presentation (see Appendix 6.6), this one presents the scientific proposal with a presentation of the concepts, for the first time, and an illustration of the presented concepts with their implementations in a case study developed in the project framework for the second time.



Figure 78: Slide 1 – Meta-model of knowledge

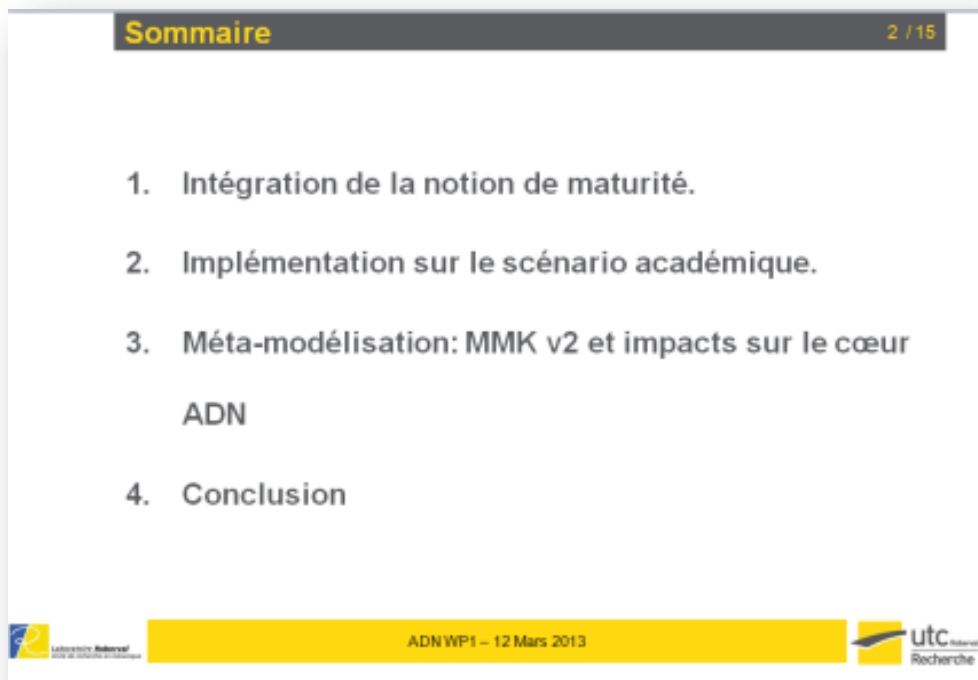

Slide 2: Sommaire

2 / 15

1. Intégration de la notion de maturité.
2. Implémentation sur le scénario académique.
3. Méta-modélisation: MMK v2 et impacts sur le cœur ADN
4. Conclusion

ADN WP1 – 12 Mars 2013

utc
Recherche

Figure 79: Slide 2 – Content

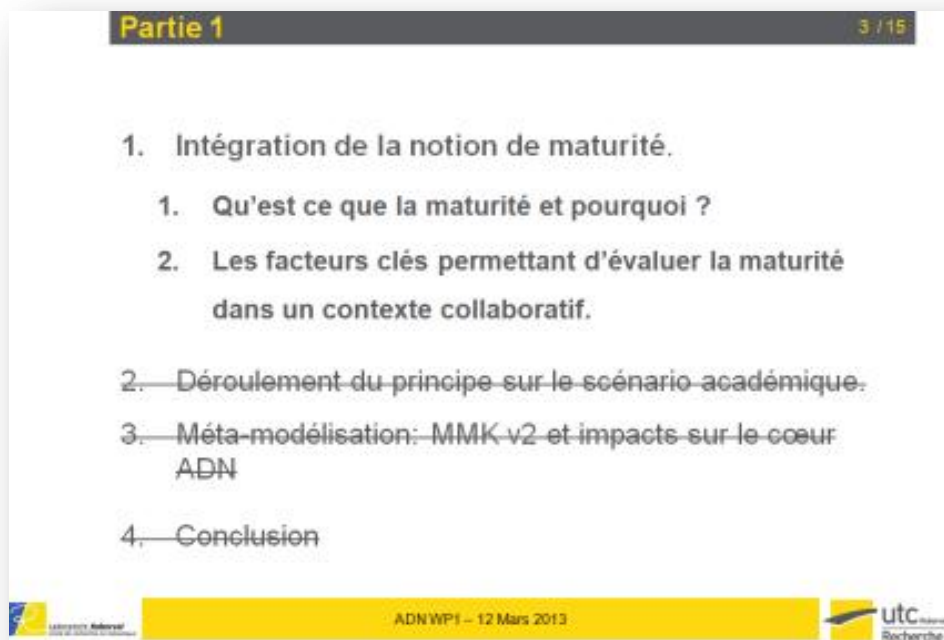

Slide 3: Partie 1

3 / 15

1. Intégration de la notion de maturité.
 1. Qu'est ce que la maturité et pourquoi ?
 2. Les facteurs clés permettant d'évaluer la maturité dans un contexte collaboratif.
2. ~~Déroulement du principe sur le scénario académique.~~
3. ~~Méta-modélisation: MMK v2 et impacts sur le cœur ADN~~
4. ~~Conclusion~~

ADN WP1 – 12 Mars 2013

utc
Recherche

Figure 80: Slide 3 – Part 1

Intégration de la notion de maturité 4 / 15

1. Qu'est ce que la maturité et pourquoi ?

Maturité = Connaissance + Performance

Structure cognitive permettant d'interpréter un ensemble d'informations afin de suivre un raisonnement dans une situation particulière et pour un état donné.
Ganascia/Prax

Lien entre les spécifications techniques du besoin initiales et les spécifications techniques du besoin complétées à la fin d'une itération de conception.
Boucher

Pour aider et orienter les décisions principalement dans les phases amonts de conception collaborative de systèmes mécaniques.

Mais aussi pour capitaliser la connaissance (expérience) du concepteur qui lui permet d'orienter sa décision.

ADN WP1 – 12 Mars 2013

utc
Recherche

Figure 81: Slide 4 – Definition of maturity

Intégration de la notion de maturité 5 / 15

2. Les facteurs clés permettant d'évaluer la maturité dans un contexte collaboratif.

- Un nombre représentatifs de paramètres de conception du produit.
- Un niveau de performance, basé sur les spécifications techniques du besoin.
- Un intervalle de valeurs lié à une valeur nominale.
- L'importance de cet intervalle de valeurs par rapport à la valeur nominale.
- Le niveau de pérennité permettant de définir la durée pendant laquelle l'information est considérée comme valable.
- Le niveau de sensibilité qui représente le niveau d'impact d'une information sur le reste du produit.
- Le coefficient directeur qui représente le niveau de maturité que le concepteur souhaite atteindre à la fin d'une itération de conception.

Les métriques permettant de définir les différents niveaux présentés, et le modèle « Maturité » sont des travaux de thèse non présentés ici

ADN WP1 – 12 Mars 2013

utc
Recherche

Figure 82: Slide 5 – The factors of the metric

Partie 2 6 / 15

1. ~~Intégration de la notion de maturité.~~
2. Implémentation sur le scénario académique.
3. ~~Méta-modélisation: MMK v2 et impacts sur le cœur~~
ADN
4. ~~Conclusion~~

ADN

ADNWP1 – 12 Mars 2013

utc
Recherche

Figure 83: Slide 6 – Part 2

2. Implémentation sur le scénario académique 7 / 15

Rappel du scénario académique: cas de conception d'un support de fixation avec une prise de décision et deux itérations de conceptions.

ADNWP1 – 12 Mars 2013

utc
Recherche

Figure 84: Slide 7 – Implementation on the academic scenario

Partie 3 10 / 15

1. Intégration de la notion de maturité.
2. Implémentation sur le scénario académique.
3. Méta-modélisation: MMK v2 et impacts sur le cœur ADN
4. Conclusion

ADN

ADN WP1 – 12 Mars 2013

 **utc**
Recherche

Figure 87: Slide 10 – Part 3

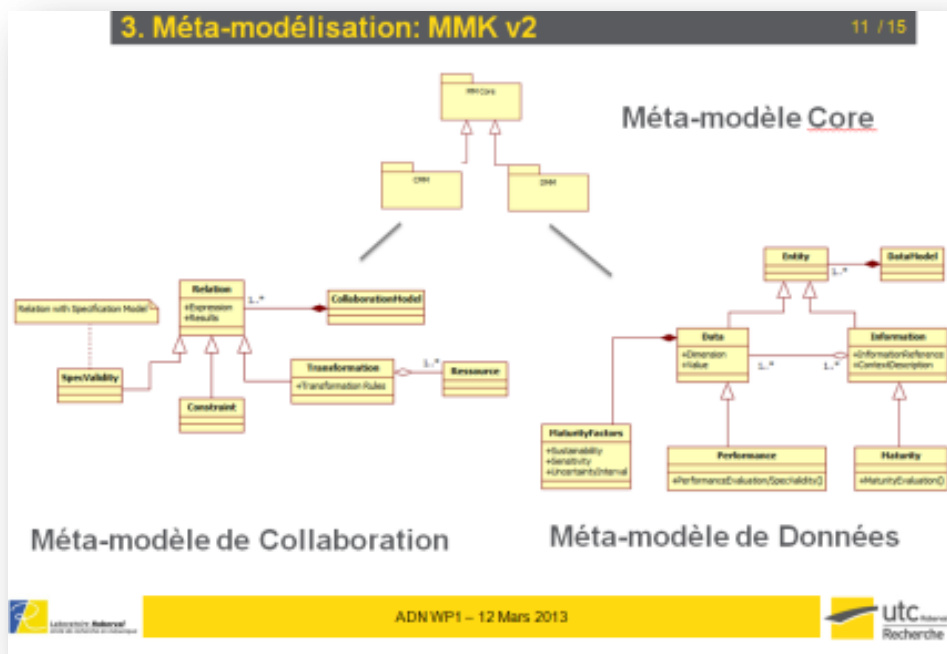

Figure 88: Slide 11 – Meta-model of knowledge

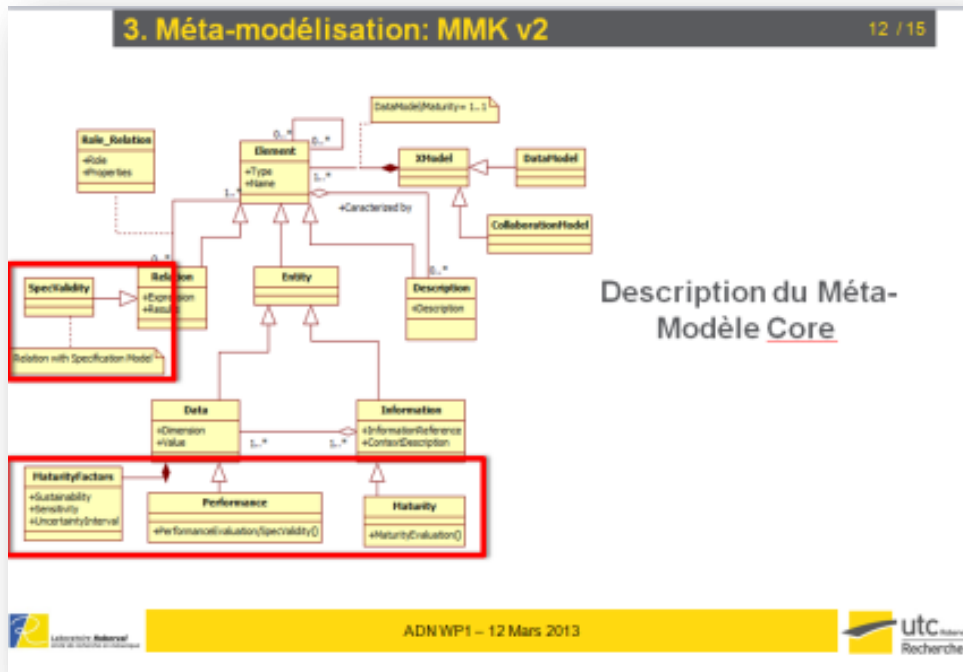

Figure 89: Slide 12 – Meta-model of knowledge: description

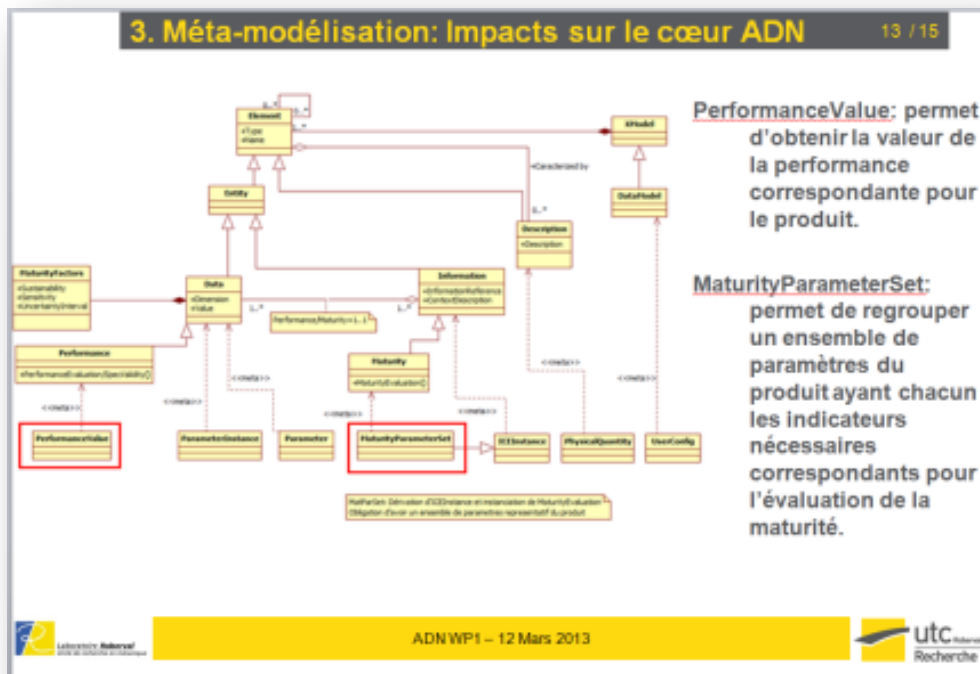

Figure 90: Slide 13 – Impact of the ADN heart

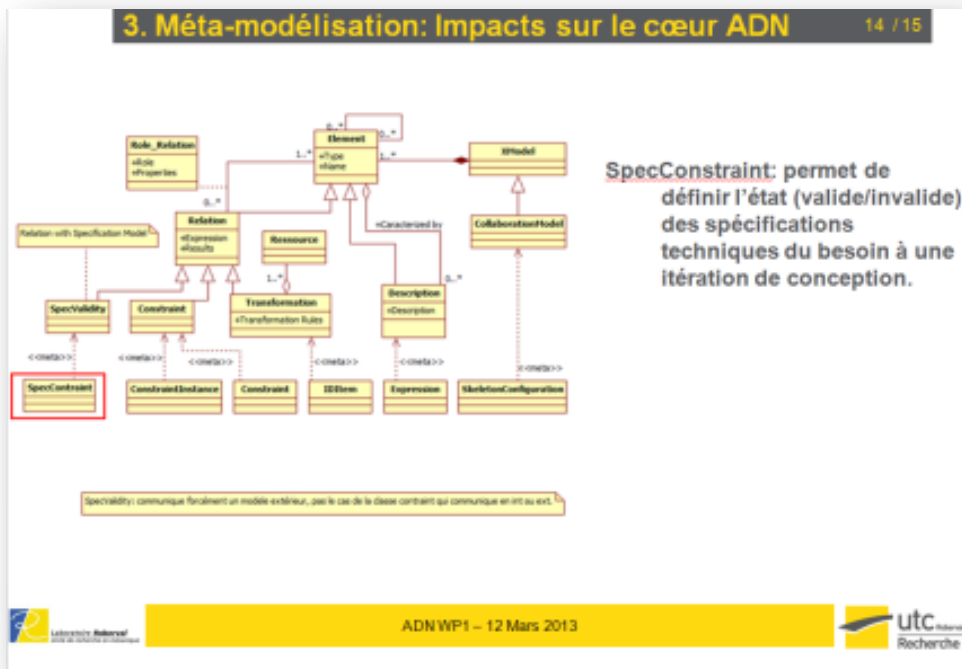

Figure 91: Slide 14 - Impact of the ADN heart (2)

4. Conclusion 15 / 15

Version 2 du MMK (Meta-Model of Knowledge) incluant la maturité afin d'aider les concepteurs dans la prise de décision, plus particulièrement en conception collaborative préliminaire; et non seulement la définition d'un cadre sémantique permettant de garantir la cohérence des données tout au long d'un projet de conception.

Bilan des livrables à venir:

- Livrable UTC - Impact de la qualification des données et connaissances sur le cœur ADN.
- Livrable UTC - v2 Méta-modèle de Collaboration Métier (doc) + démonstrateur (REGROUPER DANS LIV « MMK v2 »).
- Livrable DELTACAD - Scénario d'utilisation des méta-modèles v2 (doc).
- Livrable DELTACAD - MMDMv2 et MMCMv2 (REGROUPER DANS LIV « MMK v2 »)

ADN WP1 – 12 Mars 2013 utc
Recherche

Figure 92: Slide 15 - Conclusion

6.8. Reviews

This part presents the expert evaluations (scientific point of view) concerning the general context of the PhD, the identified problematic, the metric, the conceptual framework to ensure data consistency and the collaborative dimension, and the proposal in its final state (metric and meta-models). The objectives of these reviews were to obtain validation of the proposal based on scientific points of view.

Three reviews are presented for each one of the three papers submitted and presented during international conferences INCOM'12, PLM'13 and ICED'13.

6.8.1. INCOM'12

Reviewer 1 of INCOM 2012 submission 283

Comments to the author

The literature survey is good.

It is difficult to evaluate the proposals because it is difficult to clearly understand how it is practically used.

More precisely, the following questions may be answered:

- What models are derived from the meta-models?
- Within which steps of a project it is used?
- Is the consistency evaluated within one specific step or
- Is it possible to do so among several different steps?

...

Reviewer 2 of INCOM 2012 submission 283

Comments to the author

The paper deals with a wide-spread problem in collaborative design where various DMs co-exist. The paper is topical and fits into the conference scope. The paper involves a very high number of related work references which can provide the reader with a good overview of this area. On the other hand, the paper rather provides an introduction into this area. Although a meta-modelling technique is proposed, it is not described in full detail and, furthermore, there is no clear example of its usage. I would appreciate a definition of the limitations of that technique. Is it applicable for any models, such as the whole family of UML diagrams, or even for Petri nets, Grafccets?

I would suggest shortening the 2nd and 3rd sections, and including at least one paragraph about the usage of the proposed meta-modelling technique. In addition, there should be unified names of the models: Meta-Model of Data (in Section 4 denoted as: “MMD”; whereas in Section 4.1: “MMDM”), meta-model of collaboration (Section 4 “MMC”; Section 4.2: “MMCM”). I would suggest proofreading the submission carefully, there are several minor typos.

I appreciate the very good motivation and problem statement in the introduction, and the very good quality of the literature survey. An example of the industrial case clarifying the proposed approach for non-expert readers and a definition of the limitations are lacking.

Reviewer 3 of INCOM 2012 submission 283

Comments to the author

Accepted with minor revisions

Comments:

1. Please explain how the proposed meta-model works with existing tools (e.g. Catia). Are translators/interpreters needed?

2. The authors mentioned heterogeneous KMs. Does the proposed method handle problems caused by different data semantics, for instance information conflicts and data loss?
3. Abbreviations should be consistent in the context: meta-model of data is abbreviated as both “MMD” and “MMDM” in the paper; meta-model of collaboration is shortened as both “MMC” and “MMCM”.
4. Para 1, Section 1, Page 1: a hyphen is expected between “sub-goals”.
5. Figure 1: the letters in the figure are too small to read.
6. Figure 3: the direction of the words should be rotated 90 degrees anti-clockwise.
7. Para 3, Section 3, Page 3: Full name of “OWL” is expected.
8. Para 7, Section 3, Page 3: Left round bracket is expected before “Krause et al. 2007”.
9. Para 1, Section 4, Page 3: “There are described thereafter” should be “They are described thereafter”.

6.8.2. ICED’13

Review 1

Summary of contribution

The paper deals with the highly relevant topic of measuring the maturity of design knowledge for decision-making support. Key contributions are a review of uncertainty modelling techniques and a proposal for a quite pragmatic metric for the maturity of a mechanical system.

Evaluation of the contribution

RELEVANCE	(10%):	8
ORIGINALITY	(10%):	8

QUALITY	(20%):	8
VALUE	(10%):	8
PRESENTATION	(00%):	8
RECOMMENDATION	(50%):	9
Total points (out of 100):		85

Comments for the authors

The subject is relevant and the paper proposes a pragmatic metric that certainly needs to be assessed in real projects.

The authors should think about the handling and performance of their metric proposal in multi-disciplinary teams that are typical in integrated engineering design.

What if parameters of their metric are affected by the judgement of more than one expert?

How about uncertainty that is “discovered” during the process of identifying design constraints a just-need manner? (The introduction of constraints means increasing knowledge about the design solution space, but may decrease the level of maturity of the current design solution.)

The formal structure of the paper is OK, some proofreading should be done.

The list of references is sufficiently exhaustive and well formatted.

Review 2

Summary of contribution

The main contribution is the review of the literature on uncertainty and maturity models for collaborative decision making. .

Evaluation of the contribution

RELEVANCE	(10%):	8
ORIGINALITY	(10%):	6
QUALITY	(20%):	6
VALUE	(10%):	6
PRESENTATION	(00%):	2
RECOMMENDATION	(50%):	5
Total points (out of 100):		57

Comments for the authors

Research on modelling product information and uncertainties in collaborative preliminary design is a very valid topic that requires attention from researchers. However, the contribution the authors claim to make is not an easy-to-capture contribution. The rationale in developing the model, the process, its use in the case study and the outcomes should be explained in more precise ways than the authors chose. There is a lack of focus in the paper which I assume is due to the number of factors they are trying to link.

Simplification in the language and the amount of information is needed. The linkages have to be described in a concise manner. There are also errors in the grammar throughout the paper, in addition to quite a few missing words (e.g. during the... in the 4th line, and before the ‘the inter-relations’ in the 11th line).

It would be helpful if the authors could be clearer about what they mean by “more generally product lifecycles”. Is it the product’s development cycle, use cycle, shelf cycle, revision cycle, or the lifecycle? Also, the literature review is not straight to the point; there is too much information for such a short paper which distracts the reader from the main argument.

The question on improving the CAD comes rather late on in the paper. What is the authors’ reason for creating the connection of design decision-making maturity in collaborative settings and the improvement of CAD? This has to be articulated in advance to prepare the reader.

Review 3

Summary of contribution

The investigation of design uncertainty during collaborative design and the development of a metric to evaluate its impact.

Evaluation of the contribution

RELEVANCE	(10%):	8
ORIGINALITY	(10%):	8
QUALITY	(20%):	10
VALUE	(10%):	8
PRESENTATION	(00%):	6
RECOMMENDATION	(50%):	10
Total points (out of 100):		94

Comments for the authors

The work is well organised and has a clear focus.

To make the factor named interval clearer, it could be renamed as tolerance.

Is the sustainability, sensibility and performance factor information stored for future reuse beyond the individual application of the metric? Or does the designer have to redefine those values each time they use the metric on their design?

The writing needs improvement, but the underlying research is sound. There are grammatical and punctuation errors throughout. Statements such as “There to sum up” or “thanks to” are informal (and are distracting) and should be replaced with formal language. Section 5.1 states,

“Two designers interfere in this design...” the word interfere should be changed to interact. In Section 5.3 there is a sentence fragment, “It allows analysing how the evolution is” that needs to be addressed.

Please add units on the columns of data in Figure 3.

The authors should include references related to uncertainty in design by the Integrated Design Automation Laboratory directed by Wei Chen at Northwestern University (<http://ideal.mech.northwestern.edu>). Specific publications that are directly related are:

Du, X., Chen, W., and Garemella, R., “Propagation and Management of Uncertainties in Simulation-Based Collaborative Systems Design”, 3rd World Congress of Structural and Multidisciplinary Optimization, Niagara Falls, NY., May 17–21, 1999.

Du, X. and Chen, W., Collaborative Reliability Analysis under the Framework of Multidisciplinary Systems Design, *Journal of Optimization & Engineering*, 6(1), 63–84, 2005.

Chen, W.; Hoyle, C.; Wassenaar, Henk Jan, “Decision-based Design: Integrating Consumer Preferences into Engineering Design”, Springer, (2012).

The format is acceptable.

6.8.3. PLM’13

Review 1

Contribution of the submission

Evaluation of the contribution

Quality of Content	(10%):	6
Significance	(10%):	6
Originality	(10%):	6
Thematic Relevance	(10%):	10

Presentation	(10%):	8
Overall Recommendation	(50%):	9
Total points (out of 100):		81

Comments for the authors

Knowledge capturing, reusing and representation are important issues in design decision making. This paper attempts to consider the dimension of maturity. The concepts proposed in the paper are sufficient to warrant their presentation in a conference. The authors may want to validate the concepts in convincing examples and studies.

Review 2

Contribution of the submission

Decision-making meta-model for collaborative design process

Evaluation of the contribution

Quality of Content	(10%):	8
Significance	(10%):	8
Originality	(10%):	8
Thematic Relevance	(10%):	10
Presentation	(10%):	8
Overall Recommendation	(50%):	9
Total points (out of 100):		87

Comments for the authors

The paper is easy to read and understand. The proposal is clearly presented demonstrating a good survey of the state of the art. Despite several remarks (cf. below), the concepts are original and provide advances in the decision-making process during the collaborative product design phase.

Nevertheless it could be interesting to know how the maturity could be displayed in a collaborative CAD or PLM environment. Would it be possible to display all the maturity values of all the parameters for decision making?

Context:

- The design process is integrated, concurrent with a large amount of data.
- Complexity comes from the different levels of knowledge representation and the relation with behaviours.

Objective: take into account maturity in knowledge representation and decision making. Why is preliminary design taken as an assumption?

Section 2: OK introduction of maturity with respect to complexity and collaborative design.

Section 3: state of the art: very well-detailed. As several of those meta-models are generic, would it be possible to enrich them instead (OK in conclusion: enrichment of KCM)?

Section 4: proposal of a meta-model for taking into account maturity

- Is Equation 1 given by the literature or made part of the proposal? Is that equation validated?
- Remark: try to distinguish the interval of value (as in CSP) that reduces the solution space and uncertainty.

– In my opinion, you cannot merge DMM and DM on the same UML class diagram even with association relations. It has no sense since the level of modelling is not the same; one is the instance of the other.

Form remarks:

- respect the PLM conference format for paper writing
- Page 5: Equation 1 : the sum must be indexed with j where j is with respect to a parameter of the component i
- Page 5: “useris” => “user is”
- Page 6: “thedesicion” => “the decision”
- Replace [Roucoules 06] by “The PPO design model with respect to digital enterprise technologies among product lifecycle, Noël F., Roucoules L., in International Journal of Computer Integrated Manufacturing, DOI:10.1080/09511920701607782, 21 (2), pp. 139–145, 2008”.

Review 3

Contribution of the submission

The authors present a metric for the maturity of information in a PLM system and a knowledge model for associating the maturity measure with the said information.

Evaluation of the contribution

Quality of Content	(10%):	0
Significance	(10%):	2
Originality	(10%):	2

Thematic Relevance	(10%):	8
Presentation	(10%):	2
Overall Recommendation	(50%):	0
Total points (out of 100):		14

Comments for the authors

The proposed measure of information maturity is completely ad-hoc. It lacks any basis in a foundational theory. The meaning of the computed maturity number is unclear. Furthermore, the calculation itself is questionable. What if the nominal value for a design parameter is zero? One would wind up with a divide-by-zero error. The calculation also would seem to be messed up if the nominal value was negative.

It was very surprising that the authors did not mention probability theory as a quantitative method for modelling uncertainty. The methods mentioned in Table 1 (fuzzy sets, possibility theory and evidence theory) all have known problems from a fundamental perspective. Probability theory – the only theory not mentioned in the table – happens to be the only theory that is free from such problems.

What are “important knowledge” and “important population” (terms used in Section 3.1)? Their meaning is not at all clear.

The end of a beginning...

