



HAL
open science

Modeling and Analysing Propagation Behavior in Complex Risk Network : A Decision Support System for Project Risk Management,

Chao Fang

► **To cite this version:**

Chao Fang. Modeling and Analysing Propagation Behavior in Complex Risk Network : A Decision Support System for Project Risk Management,. Other. Ecole Centrale Paris, 2011. English. NNT : 2011ECAP0052 . tel-01018574

HAL Id: tel-01018574

<https://theses.hal.science/tel-01018574>

Submitted on 4 Jul 2014

HAL is a multi-disciplinary open access archive for the deposit and dissemination of scientific research documents, whether they are published or not. The documents may come from teaching and research institutions in France or abroad, or from public or private research centers.

L'archive ouverte pluridisciplinaire **HAL**, est destinée au dépôt et à la diffusion de documents scientifiques de niveau recherche, publiés ou non, émanant des établissements d'enseignement et de recherche français ou étrangers, des laboratoires publics ou privés.



ÉCOLE CENTRALE DES ARTS
ET MANUFACTURES
« ÉCOLE CENTRALE PARIS »

THÈSE
présentée par

Chao FANG

pour l'obtention du

GRADE DE DOCTEUR

Spécialité : **Génie Industriel**

Laboratoire d'accueil : **Laboratoire Génie Industriel**

SUJET :

**Modeling and Analyzing Propagation Behavior in Complex
Risk Network: A Decision Support System for Project Risk
Management**

soutenue le : **02 Décembre 2011**
devant un jury composé de :

M. John CLARKSON, Cambridge University
M. Didier GOURC, Ecole des Mines d'Albi-Carmaux
M. Min XIE, City University of Hong Kong
M. Jean-Claude BOCQUET, Ecole Centrale Paris
M. Franck MARLE, Ecole Centrale Paris
M. Enrico ZIO, ECP-Supélec, Politecnico de Milano

Rapporteur
Rapporteur
Examineur
Directeur de thèse
Co-encadrant de thèse
Membre invité

2011ECAP0052

Table of Contents

ABSTRACT	- 7 -
CHAPTER 1 - BACKGROUND AND RESEARCH PROBLEM	- 9 -
1.1 Introduction to project risk management	- 10 -
1.1.1 Project Management	- 10 -
1.1.2 Project risk management (adapted from (Marle 2008))	- 11 -
1.1.2.1 Project risk identification	- 12 -
1.1.2.2 Project risk analysis	- 12 -
1.1.2.3 Project risk response planning	- 14 -
1.1.2.4 Project risk monitoring and control	- 14 -
1.2 Increasing complexity of project and associated risks	- 15 -
1.2.1 Complexity of project	- 15 -
1.2.2 Complexity of project risks	- 17 -
1.3 Limitation of current methods for managing real complexity	- 19 -
1.4 Research questions	- 21 -
1.4.1 Risk analysis under complexity	- 22 -
1.4.2 Risk response planning under complexity	- 22 -
1.5 Research approach	- 23 -
1.5.1 A new integrated decision support system for PRM	- 23 -
1.5.2 Case studies	- 27 -
1.6 Conclusion	- 27 -
CHAPTER 2 - PROJECT RISK NETWORK MODELING	- 29 -
2.1 Building the risk network structure	- 30 -
2.1.1 Identification of project risks	- 30 -
2.1.2 Identification of risk interactions	- 31 -
2.1.2.1 Basics of the DSM tool for modeling interdependencies	- 31 -
2.1.2.2 Identifying and representing risk interactions in Risk Structure Matrix (RSM)	- 32 -
2.2 Assessment of the risk network	- 34 -
2.2.1 Project risk assessment	- 34 -
2.2.1.1 Risk assessment in terms of probability	- 34 -
2.2.1.2 Risk assessment in terms of impact	- 35 -
2.2.2 Risk interactions assessment	- 35 -
2.2.2.1 Direct assessment by experts	- 35 -
2.2.2.2 Relative assessment based on pairwise comparison	- 35 -
2.3 Case study	- 37 -
2.3.1 Introduction to the case study	- 37 -
2.3.2 Results	- 38 -

2.4	Conclusions	- 41 -
CHAPTER 3 - A SIMULATION-BASED RISK NETWORK MODEL FOR DECISION SUPPORT IN PRM..... - 43 -		
3.1	Brief description of the simulation model.....	- 44 -
3.2	Applications to support managerial decision-making	- 44 -
3.2.1	Risk network analysis.....	- 44 -
3.2.1.1	Risk re-evaluation	- 45 -
3.2.1.2	Risk prioritization.....	- 46 -
3.2.1.3	Sensitivity analysis.....	- 46 -
3.2.2	Mitigation actions planning and test	- 46 -
3.2.3	Risk network monitoring and control.....	- 47 -
3.3	Case study results and analysis	- 48 -
3.3.1	Simulation model of the project risk network.....	- 48 -
3.3.2	Risk network analysis.....	- 49 -
3.3.3	Mitigation actions planning and test	- 54 -
3.3.3.1	Local mitigation	- 54 -
3.3.3.2	Global mitigation.....	- 55 -
3.4	Conclusion.....	- 56 -
CHAPTER 4 - TOPOLOGICAL NETWORK THEORY-BASED PROJECT RISK ANALYSIS - 59 -		
4.1	Introduction.....	- 60 -
4.2	Definition of topological indicators for project risk analysis.....	- 60 -
4.2.1	Connectivity indicators	- 61 -
4.2.2	Interface indicators.....	- 62 -
4.2.3	Betweenness centrality.....	- 62 -
4.3	Eigenstructure analysis of risk network	- 63 -
4.4	Case study	- 65 -
4.4.1	Building the structure of project risk network.....	- 65 -
4.4.2	Classical project risk analysis	- 69 -
4.4.3	Topological network analysis.....	- 70 -
4.4.4	Eigenstructure analysis.....	- 75 -
4.4.5	Discussion of the results.....	- 75 -
4.5	Conclusion.....	- 80 -
CHAPTER 5 - MATRIX-BASED PROPAGATION MODELING FOR RISK ANALYSIS - 83 -		
5.1	Matrix-based risk propagation modeling	- 84 -
5.1.1	Basic concepts and assumptions	- 84 -
5.1.2	Risk propagation model	- 84 -
5.1.3	A simple example for illustration.....	- 86 -

5.2	Eigenstructure analysis on weighted risk network	- 88 -
5.3	Case studies	- 88 -
5.3.1	Musical staging project	- 89 -
5.3.2	Tramway construction project	- 90 -
5.4	Conclusion	- 93 -
CHAPTER 6 - OPTIMIZATION OF RISK RESPONSE PLAN UNDER RESOURCE CONSTRAINTS.....		- 95 -
6.1	An integrated framework for risk response planning.....	- 96 -
6.2	Step-by-step for the optimization of project risk response plan.....	- 97 -
6.2.1	Building project risk network.....	- 97 -
6.2.2	Defining objective function.....	- 98 -
6.2.3	Identifying budget constraints	- 98 -
6.2.4	Identifying potential response actions.....	- 98 -
6.2.5	Optimizing risk response plan.....	- 99 -
6.2.5.1	A greedy algorithm.....	- 99 -
6.2.5.2	A genetic algorithm	- 100 -
6.3	Case study	- 103 -
6.3.1	Build the action list	- 103 -
6.3.2	Greedy algorithm results	- 105 -
6.3.3	Genetic algorithm results	- 106 -
6.4	Conclusion.....	- 107 -
CHAPTER 7 - CONCLUSIONS AND PERSPECTIVES		- 109 -
PUBLICATIONS		- 113
BIBLIOGRAPHIES.....		- 115
LIST OF FIGURES		- 129
LIST OF TABLES		- 131

Abstract

Project risk management is a crucial activity in project management. Nowadays, projects are facing a growing complexity and are thus exposed to numerous and interdependent risks. However, existing classical methods have limitations for modeling the real complexity of project risks. For example, some phenomena like chain reactions and loops are not properly taken into account. This Ph.D. thesis aims at analyzing propagation behavior in the project risk network through modeling risks and risk interactions. An integrated framework of decision support system is presented with a series of proposed methods. The construction of the project risk network requires the involvement of the project manager and the team of experts using the Design Structure Matrix (DSM) method. Simulation techniques are used and several network theory-based methods are developed for analyzing and prioritizing project risks, with respect to their role and importance in the risk network in terms of various indicators. The proposed approach serves as a powerful complement to classical project risk analysis. These novel analyses provide project managers with improved insights on risks and risk interactions under complexity and help them to design more effective response actions. Considering resource constraints, a greedy algorithm and a genetic algorithm are developed to optimize the risk response plan and the allocation of budget reserves dedicated to the risk management. Two examples of application, 1) to a real musical staging project in the entertainment industry and 2) to a real urban transportation system implementation project, are presented to illustrate the utility of the proposed decision support system.

Keywords: project risk management, complexity, risk interaction, risk network, risk analysis, risk propagation, network theory, optimization, decision support system

Chapter 1 - Background and Research Problem

Abstract

Project risk management is crucial for the success of projects. In this chapter, we introduce the basics of project management and project risk management. We argue that the increasing complexity of projects leads to a complex risk network of interdependent risks. This increases the difficulty for the project manager to anticipate the propagation of risks and then to make reliable decisions with respect to risk management. An investigation of current methods and tools of project risk management in literature shows that they are not able to properly represent the real complexity of project risks. Research questions are put forward with regard to risk analysis and risk response planning under this introduced complexity.

An original framework of decision support system (DSS) is thus presented, which is the main purpose of this study. It consists of five phases: risk network identification, risk network assessment, risk network analysis, risk response planning, and risk monitoring and control. This DSS enables the project manager to model and analyze the risk network behavior and thus to re-evaluate risks taking into account their interactions under complexity. The DSS is also able to suggest risk mitigation actions and test their effects in the risk network. The decisions about risk response planning can be optimized under resource constraints. Finally, the conclusions are drawn and the organization of the following chapters is given.

Chapter Keywords

Project management, project risk management, complexity, risk network, risk propagation, decision support system

1.1 Introduction to project risk management

1.1.1 Project Management

A project is a temporary and unique endeavor undertaken to deliver a result, typically to bring about beneficial change or added value. The result of project is always a change in the organization, whatever it is in its processes, performance, products or services. This transformation consists then in a gap between a start and a final state. The final expected state is better than the initial, but the uncertainty of the future makes it risky. Each project is unique because there is always at least one of the following parameters that are dissimilar: targets, resources, management, methods, tools, and context. Examples of projects include, but are not limited to:

- Design and develop a new product or service
- Install a developed or acquired new information system
- Effect a change in the organization (structure, staffing or style) of an enterprise
- Constructing a building or infrastructure
- Implementing a new business process or procedure
- Conduct a series of marketing activities

All the kinds of projects in any fields need to be managed in order to keep them towards the predefined targets or objectives. Project management has been practiced since early civilization. Until 1900 civil engineering projects were generally managed by creative architects, engineers, and master builders themselves (Lock 2007). In the 1950s, organizations started to systematically apply project management tools and techniques to complex engineering projects (Carayannis et al. 2005). In this sense, the 1950s marked the beginning of the modern Project Management era where core engineering fields come together working as one. Project management became recognized as a distinct discipline arising from the management discipline with engineering model (Cleland and Gareis 2006).

According to the PMBOK[®] Guide from the Project Management Institute, Inc., project management is “the application of knowledge, skills, tools, and techniques to project activities to meet the project requirements” (PMI 2008). Project management is accomplished through the appropriate application and integration of a number of grouped project management processes comprising the five process groups. These five process groups are as follows:

- Initiating.
- Planning.
- Executing
- Monitoring and controlling

- Closing

Usually, a project manager and team members are assigned by the performing organization to conduct project management activities for achieving the project objectives. Key project management responsibilities include creating clear and attainable project objectives, building the project requirements, and managing the constraints of the projects, which are scope, schedule, cost, and quality, etc.

Many methods, tools, techniques, practices have been developed to date in the domain of project management (White and Fortune 2002; Dean 1985; Cleland and King 1983; Hendrickson and Au 2000; PMI 2008; IPMA 2006; Kerzner 1998; McManus and Wood-Harper 2003). Understanding and applying the specific and rigorous methodologies are recognized as good practice for effective project management.

1.1.2 Project risk management (adapted from (Marle 2008))

Project risk management (PRM) is an important aspect of the project management. It is crucial and indispensable to the success of projects. From the birth of project management, the notion of risk has grown within the field of project management, even if there are still a lot of theoretical problems and implementation lacks. The polysemous nature of risk may involve confusions about similar terms such as uncertainty, alea, danger, hazard, etc. The PMI, in its worldwide standard PMBOK[®], defines project risk as an uncertain event or condition that if it occurs, has an effect on at least one of the project objectives such as scope, schedule, cost and quality (PMI 2008).

According to Raz and Hillson, “the origins of operational risk management can be traced to the discipline of safety engineering” (Raz and Hillson 2005). Modern risk management has evolved from this issue of physical harm that may occur as a result of improper equipment or operator performance. Many risk management methodologies and associated tools have been developed now in the context of project management, with qualitative and/or quantitative approaches, often based on the two concepts of probability and impact (or severity) of the risky event. The objectives of project risk management are to increase the probability and impact of positive events, and decrease the probability and impact of negative events in the project (PMI 2008).

For all practical purposes, the growing interest in risk management is often pushed by law and regulation evolutions. Indeed, risks in projects have become higher in terms of number and global impact. Projects are more than ever exposed and averse to risks, and stakeholders are asking for more risk management to cover themselves against financial or legal consequences. People can be accountable during or after the project for safety, security, environmental, commercial, or financial issues. That is why it has become increasingly important to effectively and efficiently manage project risks, in order to give a higher guarantee of success and comfort to project stakeholders, or at least to warn them against potential problems or disasters (Cooper and Chapman 1987). Several standards have been developed in the field of risk management

and specifically in project risk management (APM 1996; BSI 2002; IEC 1995; IEEE 2001; ISO 2003; PMI 2008).

Because of the uncertainty nature and the potential for change, the project risk management process is iterative and goes through progressive elaboration throughout the project's life cycle. Classical PRM process is comprised of four major phases (shown in Figure 1): risk identification, risk analysis, risk response planning, and risk monitoring and control. These four phases will be described in the following paragraphs.

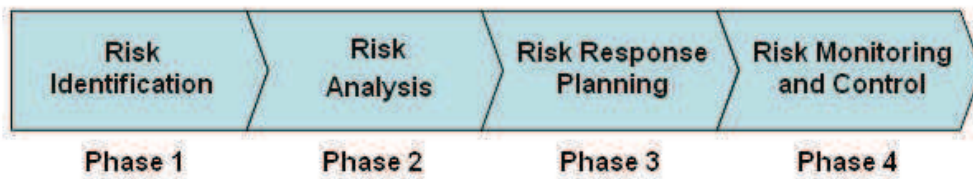

Figure 1. Classical steps of project risk management

1.1.2.1 Project risk identification

Risk identification is the process of determining events which, may they occur, could affect project objectives positively or negatively. Risk identification methods are classified into two different families:

- 1) Direct risk identification: The most classical tools and techniques are diagnosis and creativity-based methods, for assessment of present or future situation.
- 2) Indirect risk identification: The other way to identify risks is to collect data about problems that occurred during previous projects since problems of the past may be risks of the future.

This step normally generates a list of risks. The number of risks in this list may vary from some decades to some hundreds of risks, according to the scale and dimension of the project.

1.1.2.2 Project risk analysis

Risk analysis is the process of evaluating and prioritizing risks, essentially according to their characteristics like probability and impact. Criticality is another characteristic with which risks are prioritized. It is generally a combination of probability and impact, or is simply defined as the product of them. As shown in Table 1, it enables us to classify risks into different categories: high risk, moderate risk, and low risk.

Table 1. Definition of probability, impact, and criticality reference scales

Impact (or gravity)			Probability (or likelihood)		
Class	Name	Nature of consequences	Class	Name	Interval of occurrence
I 1	Minor	No disturbance	P 1	Extremely unlikely	< 0,01 %
I 2	Significant	Project is disturbed / Not known by customer	P 2	Very unlikely	< 5%
I 3		Project is disturbed / Customer upset	P 3		
I 4	Critical	Very difficult situation / Customer unsatisfied	P 4	Likely	[25%, 50%]
I 5	Disaster	Project in death hazard	P 5	Very likely	> 50%

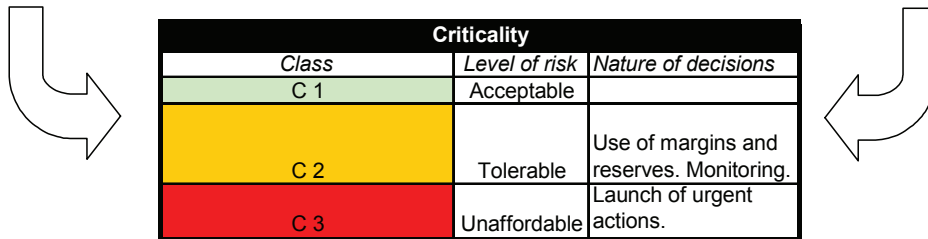

There are two main types of risk analysis, which are discussed hereafter: qualitative and quantitative analysis.

1) Qualitative analysis

It is the process of assessing by qualitative means the probability and impact of each risk. It assists in risk comparison and prioritization. It is applied when parameters are difficult to calculate, using qualitative scales, like in Table 1: from very low to very high, or from 1 to 5 for instance.

2) Quantitative analysis

The main difference with qualitative analysis is the possibility to give a quantitative value to a risk, regarding its probability and/or its impact (gravity value). For instance, the probability to get a “1” with a 6-faces dice is 1/6. The probability of a risk may sometimes be calculated by capitalization of previous data, as long as the size of data sample is statistically significant. Risk probability and impact are then assessed on a quantitative scale: €23,500, 3 weeks delay, 92% of occurrence, etc. Quantitative analysis principally consists of data gathering and data treatment. It is often conducted after a qualitative analysis, in order to refine or to validate some assumptions, because it has a higher cost.

Figure 2 shows several representations of the risk analysis results. The upper ones are the two-dimensional matrix and diagram of risk probability and impact; the left lower is an example of radar / Kiviat graph showing criticality of risks; the right lower is a cumulative risk frequency distribution chart.

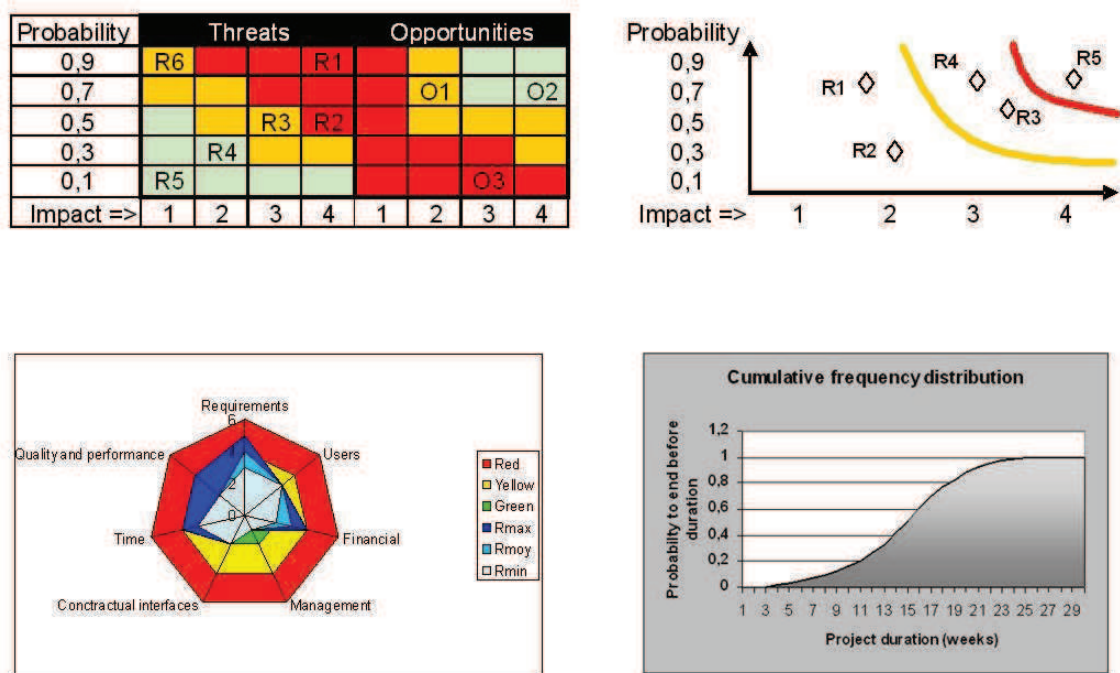

Figure 2. Representations of risk analysis results

1.1.2.3 Project risk response planning

The process of risk response planning aims to choose actions in order to reduce global risk exposure with least cost. It addresses project risks by priority, defining actions and resources, associated with time and cost parameters. Almost every method mentions the same possible treatment strategies, including the following:

- Avoidance,
- Probability or impact reduction (mitigation), including contingency planning,
- Transfer, including subcontracting and insurance buying, and
- Acceptance.

In the cases when the method includes the opportunity concept, the same strategies exist, but with opposite names: exploitation, probability or impact enhancement, and risk sharing. The method of acceptance does not change.

1.1.2.4 Project risk monitoring and control

Risk monitoring and control is, according to the PMBOK[®], the ongoing process of “identifying, analyzing and planning for newly arising risks, keeping track of the identified risks and those on the watch list, reanalyzing existing risks, monitoring trigger conditions for contingency plans, monitoring residual risks, and reviewing the execution of risk responses as well as evaluating their effectiveness” (PMI 2008). It includes six classical techniques and tools:

- Risk assessment: for new risks or for refinement of existing assessments;
- Risk audits: return on investment on the global risk management process;
- Variance and trend analysis: deviations from project plan may indicate potential threats for the project;
- Technical performance measurement: deviations from planned scope may indicate potential threats for future delivery and client acceptance;
- Reserve analysis: use of planned contingency reserves is tracked, in order to determine if the remaining reserves is adequate for the amount of risk remaining;
- Status meetings: project risk management should be an agenda item at periodic status meetings since it becomes easier the more often it is practiced.

1.2 Increasing complexity of project and associated risks

1.2.1 Complexity of project

According to systems analysis (Penalva 1997; Le Moigne 1990; Boulding 1956), a system is an object, which, in a given environment, aims at reaching some objectives (teleological aspect) by doing an activity (functional aspect) while its internal structure (ontological aspect) evolves through time (genetic aspect) without losing its own identity. Projects can thus be regarded as systems. Research works on the concept of system complexity have been conducted for years (L.-A. Vidal et al. 2011a). There are historically two main scientific approaches of complexity (Schlindwein and Ison 2005). The first one, usually known as the field of descriptive complexity, considers complexity as an intrinsic property of a system, a vision which incited researchers to try to quantify or measure it. An example of this vision is the study by Baccarini (D. Baccarini 1996). He considers project complexity through the concepts of technological complexity and organizational complexity. He regards them as the core components of project complexity which he tries to describe exhaustively. The other one, usually known as the field of perceived complexity, considers complexity as subjective, since the complexity of a system is improperly understood through the perception of an observer. Both approaches can apply to project complexity and project management complexity.

The difficulty is that there is actually a lack of consensus on what project complexity really is. As underlined in (Sinha et al. 2001), “there is no single concept of complexity that can adequately capture our intuitive notion of what the word ought to mean”. Complexity can be understood in different ways, not only in different fields but has also different connotations within the same field (Morel and Ramanujam 1999). Vidal and Marle propose the following definition of project complexity based on some additional works (D. Baccarini 1996; Edmonds 1999; Marle 2002; Austin et al. 2002; L. Vidal and Marle 2008): “Project complexity is the property of a project which makes it difficult to understand, foresee and keep under control its overall behavior, even when given reasonably complete information about the project system.

Its drivers are factors related to project size, project variety, project interdependence and project context (L.-A. Vidal et al. 2011a, 2011b).” Figure 3 shows an example of project complexity framework in the study of project complexity. It aims at being a reference for project managers to identify and characterize some aspects of the project complexity.

	Project System Size	Project System Variety	Interdependencies within the project system	Elements of context
Organisational complexity	<ul style="list-style-type: none"> • Duration of the project • Largeness of capital investment • Number of activities • Number of companies / projects sharing their resources • Number of decisions to be made • Number of deliverables • Number of departments involved • Number of hierarchical levels • Number of information systems • Number of investors • Number of objectives • Number of stakeholders • Number of structures / groups / teams to be coordinated • Staff quantity 	<ul style="list-style-type: none"> • Diversity of staff (experience, social span ...) • Geographic location of the stakeholders (and their mutual disaffection) • Variety of financial resources • Variety of hierarchical levels within the organisation • Variety of information systems to be combined • Variety of organisational interdependencies • Variety of organisational skills needed • Variety of project management methods and tools applied • Variety of the interests of the stakeholders • Variety of the stakeholders' status 	<ul style="list-style-type: none"> • Availability of people, material and of any resources due to sharing • Combined transportation • Dependencies between schedules • Dependencies with the environment • Dynamic and evolving team structure • Interconnectivity and feedback loops in the task and project networks • Interdependence between actors • Interdependence between sites, departments and companies • Interdependence of information systems • Interdependence of objectives • Level of interrelations between phases • Number of interfaces in the project organization • Processes interdependence • Relations with permanent organizations • Stakeholders interrelations • Team cooperation and communication 	<ul style="list-style-type: none"> • Competition • Cultural configuration and variety • Environment complexity (networked environment) • Institutional configuration • Local laws and regulations • New laws and regulations • Organisational degree of innovation
Technological complexity	<ul style="list-style-type: none"> • Number and quantity of resources • Largeness of scope (number of components, etc...) 	<ul style="list-style-type: none"> • Variety of resources to be manipulated • Variety of the product components • Variety of technological dependencies • Variety of technological skills needed • Variety of the technologies used during the project 	<ul style="list-style-type: none"> • Interdependence between the components of the product • Resource and raw material interdependencies • Specifications interdependence • Technological processes dependencies 	<ul style="list-style-type: none"> • Competition • Cultural configuration and variety • Demand of creativity • Environment complexity (networked environment) • Institutional configuration • Local laws and regulations • New laws and regulations • Scope for development • Significance on public agenda • Technological degree of innovation

Figure 3. An example of project complexity framework (adapted from (L.-A. Vidal et al. 2011b))

As a whole, projects are facing a growing complexity, in both their structure and context. In addition to the organizational and technical complexities described by Baccarini (D. Baccarini 1996), project managers have to consider a growing number of parameters (e.g., environmental, social, safety, and security) and a growing number of stakeholders, both inside and outside the project. The existence of numerous and diverse elements which are strongly interrelated is one of the main characteristics of complexity (Chu et al. 2003; Corbett et al. 2002; Jones and Anderson 2005). Project systems are then in essence complex and this complexity is undoubtedly a major source of risk, since the project organization may not be able to cope with it.

1.2.2 Complexity of project risks

With the growing complexity of projects, (i.e., projects are large in terms of size and stakes; and the structure of projects become more and more complex), an increasing number of components in the project (e.g., different tasks, different actors and different functions) are involved in the project management and their dependencies should be taken into account. As a consequence, the complexity of projects leads to the increasing complexity of project risks which are associated with the components. Figure 4 describes the relationship between project complexity and the complexity of project risks.

The complexity of project risks can be represented in terms of a risk network, describing how risks interact and propagate from one to another. For instance, there might be propagation from one “upstream” risk to numerous “downstream” risks; on the other side, a “downstream” risk may arise from the occurrence of several “upstream” risks which may belong to different categories. In such network, local risk occurrences may trigger global phenomena like the chain reaction or the “domino effect”.

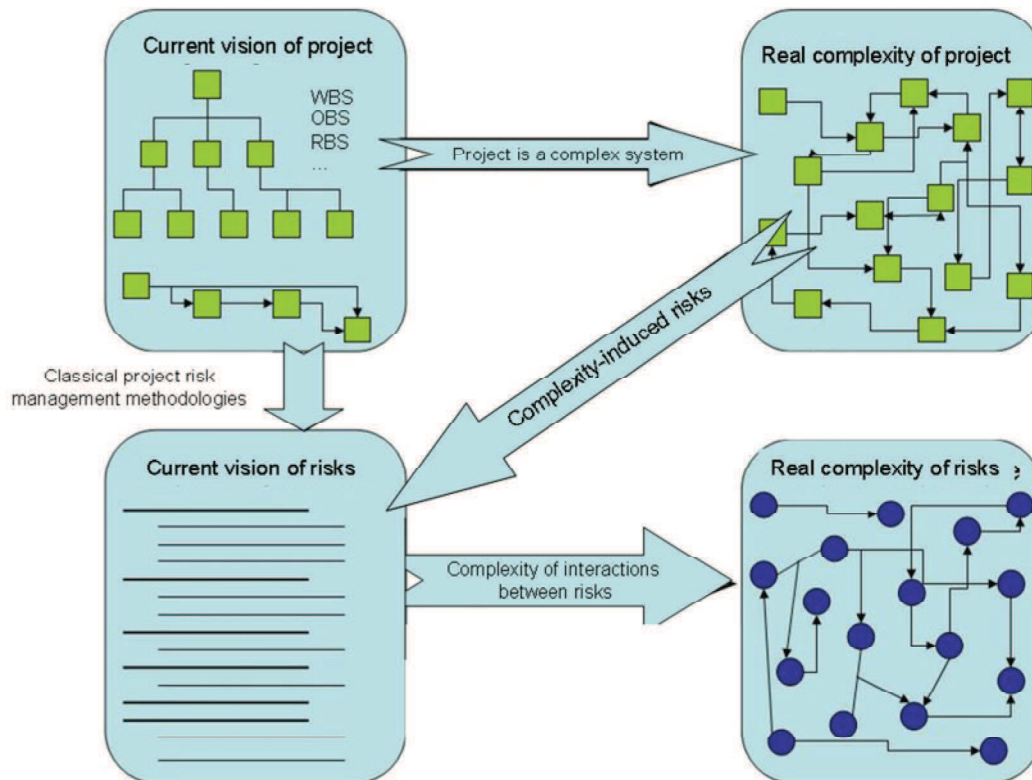

Figure 4. Complexity vision of project and project risks (Marle 2008)

Another phenomenon is the loop, namely a causal path that leads from the initial occurrence of an event to the triggering of subsequent consequences until the initial event occurs once more. An example of loop (shown in Figure 5) is that one initial risk, project schedule delay, may have an impact on a cost overrun risk, which will influence a technical risk, and then propagate to and amplify the original risk of schedule delay.

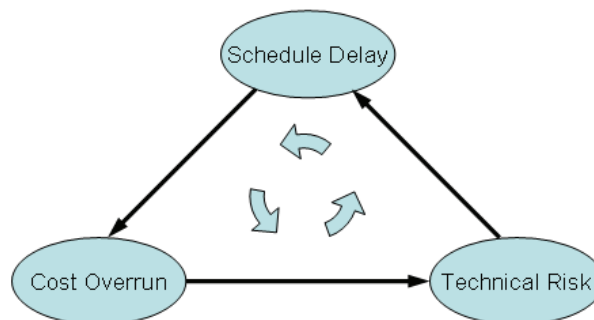

Figure 5. An example of loop phenomenon in risk propagation

Propagation effects throughout the project structure are likely to notably reduce the performance of the risk management process (Eckert et al. 2004). Particular attention should be paid to this performance since poor or delayed risk mitigation decisions may have great potential consequences in terms of crisis, underachievement of objectives and avoidable waste (Kloss-Grote and Moss 2008). In this regard, we argue that risk propagation behavior should be modeled and analyzed in the process of project risk management.

1.3 Limitation of current methods for managing real complexity

Many risk management methodologies and associated tools have been developed, for example, in (David Baccarini and Archer 2001; Bowles 1998; R. Chapman 2001; C. Chapman and Ward 2003; Gautier et al. 1997; Henley and Kumamoto 1992; Kaplan et al. 1999; Kawakita 1991; Keizer et al. 2002; Kerzner 1998; Klein and Cork 1998; Kurtoglu and Tumer 2008; Riek 2001; Shimizu and Noguchi 2005; P. Smith and Merritt 2002; Stamatelatos 2004; Stone et al. 2004; Tumer and Stone 2001). Some of them have become standards or norms, e.g., in (APM 1996; AFNOR 2003; BSI 2002; IEC 1995; IEEE 2001; IPMA 2006; MIL-STD-1629 1998; PMI 2008; PRINCE 1999). As mentioned earlier, they are usually based on the concepts of probability and impact, assessed qualitatively or quantitatively. Criticality is an aggregate characteristic used for risk prioritization.

However, many of these methodologies independently evaluate the characteristics of risks, and focus on analysis of individual risks. Risks are usually listed and ranked by one or more parameters (David Baccarini and Archer 2001; C. Chapman and Ward 2003; Ebrahimnejad et al. 2010). For the example in Table 2, common project risk lists exhibit each individual risk and its category or nature. A two-dimensional Farmer diagram, as shown in Figure 6, can visibly demonstrate characteristics of risks. We can also cite the creativity-based techniques or the expertise-based techniques, like expert judgment using Delphi, affinity diagram, peer interviews or risk diagnosis methodology (Kawakita 1991; Keizer et al. 2002; Kerzner 1998). Generally, these methods do not take into account the subsequent influence of risks and cannot represent the interrelation between them.

Table 2. Typical Project Risk List in Classical Methods

No.	Risk Title	Category
R1	Low budget	Cost and time
R2	Law and regulations infractions	Contracts
R3	Low communication and advertising	User/customer
R4	Unsuitable cast	Organization
R5	Unsuitable ticket price setting	Strategy
R6	Unsuitable rehearsal management	Controlling
R7	Cancellation or delay of the first performance	Cost and time
R8	Poor reputation	User/customer
...

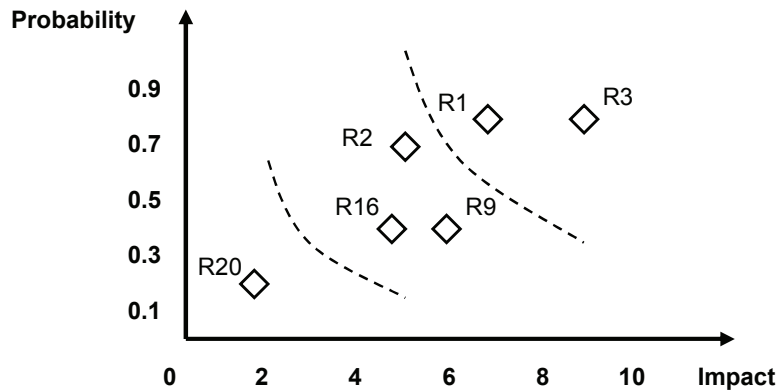

Figure 6. Diagram of risk probability and impact

To comprehensively understand a risk, it is helpful to identify its causes as well as its effects. Several methods include this principle, but they still concentrate on a single risk for simplifying the problem (Carr and Tah 2001; Heal and Kunreuther 2007). For instance, Failure Modes and Effects Analysis (FMEA) consists in a qualitative analysis of dysfunction modes followed by a quantitative analysis of their effects, in terms of probability and impact (Bowles 1998; MIL-STD-1629 1998); Fault Tree and Cause Tree analyses determine the conditions which lead to an event and link them through logical connectors in a tree-structure which clearly displays causes and effects of the particular risk analyzed (Pahl et al. 2007). As the tree structure shown in Figure 7, although causes and effects of one particular risk could be displayed, it is still single-risk oriented. Thus, these methods are unable to model complex interactions among different risks.

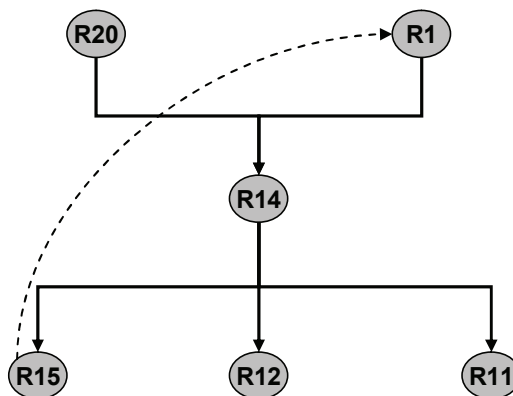

Figure 7. Tree structure of risk correlations

Few specific methods are able to model risk correlations with a network structure. For example, several papers on the application of the Bayesian Belief Network (BBN) have appeared in recent years in the field of project risk management (Fan and Yu 2004; E. Lee et al. 2008; Trucco et al. 2008), which could model risk interrelations, from multiple inputs to

multiple outputs. Figure 8 shows an example of BBN for risk management. Nevertheless, BBN demands oriented links, is inherently acyclic, and hence does not easily model the loop phenomenon. This oversight could potentially lead to a disaster in real projects. These methods are thus not always applicable for practical purpose and fail in some cases to represent the real complexity of the interdependencies among risks.

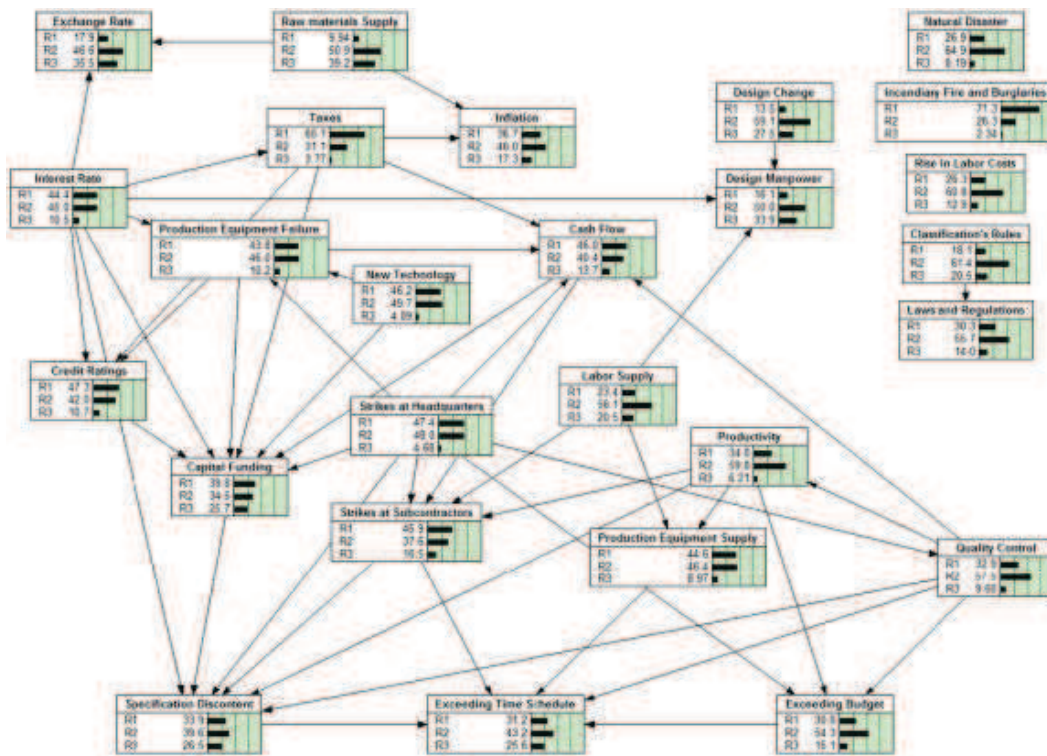

Figure 8. An example of Bayesian belief network for risk management in large engineering project (E. Lee et al. 2008)

Therefore, we conclude that current methods and tools have limitations for modeling the real complexity of project risks. For this reason, risk propagation behavior cannot be anticipated and the risk analysis results, such as risk evaluation and risk ranking, are not reliable. This would influence the subsequent decision-making, e.g., planning risk response actions.

1.4 Research questions

Due to the previously introduced complexity of project and project risks, associated to the investigation of limits of current PRM methods, we pose the research questions as follows. The first question is:

Q0: How to represent the complexity of interdependent risks?

The others are mainly concerning two major steps of PRM: risk analysis and risk response planning under complexity.

1.4.1 Risk analysis under complexity

Q1.1 What roles the risks act in the network?

Besides individual measure of project risks, their roles in the complex risk network in terms of the relationship with other risks should also be investigated.

Q1.2 Would risk characteristics be different taking into account propagation?

Because of the propagation behavior in the risk network, the risk characteristics (e.g., probability, impact and criticality) might become different from the original estimation by the project manager in the local point of view. To answer this question, this aspect of risk analysis should be conducted and calculated quantitatively.

Q1.3 Should we update the risk prioritization?

Depending on the first and second research questions, if risks play an unexpected role in the context of network and/or the re-evaluation of risk characteristics has changed, the risk prioritization should be adjusted correspondingly. This potential update will change the subsequent decision-makings.

1.4.2 Risk response planning under complexity

Q2.1 Should we redesign response actions based on the refined analysis results?

Risk response actions are designed based on the risk analysis results. The update of risk analysis results will certainly provide the project manager with new insights on risks and their relationships. This would help them design more targeted and hence more effective response actions.

Q2.2 Would the actions' global effects be different from what we expected after propagation?

The consequence of occurred risks will potentially propagate through the risk network. Thus, the effects of implemented actions, which are designed for mitigating the exposure of one or several risks, may also propagate through the network to impact other risks. The global effects of risk mitigation actions will be anticipated and tested in the developed network model.

Q2.3 How to allocate scarce resources under constraints?

Project manager face a challenge to allocate limited resources for managing a number of identified risks. In this regard, practical methods should be developed to help project manager optimize the risk response plan under constraints.

1.5 Research approach

To answer and find solutions to the posed research questions, a novel integrated decision support system, based on the classical PRM process, is proposed with a series of methods and tools. Two case studies on real projects are used for illustrating the application of the approach.

1.5.1 A new integrated decision support system for PRM

In order to manage a project with interdependent risks, it is mandatory to bring the modeling of risk interactions into the PRM process. Risk interactions should be modeled with a network structure instead of a classical list or tree structure for representing the real complexity of the project. Certainly, this involves using classical risk characteristics like probability and impact as inputs for this network (the nodes for individual risks).

We only consider negative risks in the scope of this study. The objectives of project risk management are thus to decrease the probability and impact of negative risks in the project. With the purpose of managing the complexity of project risks and based on the classical process of project risk management, we present an original framework of decision support system (DSS) for PRM.

This DSS includes five phases:

- (1) risk network identification;
- (2) risk network assessment;
- (3) risk network analysis;
- (4) risk response planning; and
- (5) risk monitoring and control.

Figure 9 illustrates this framework. The innovative steps based on the classical risk management process and the new generated outcomes are highlighted in the figure.

In phase (1), potential project risks are identified by classical methods and the result is a project risk list. Based on this list, risk interactions are identified and represented using a matrix-based method. In phase (2) of the risk network assessment, the probability and impact of identified risks are evaluated by classical methods; then the strength of risk interactions is assessed directly by experts or through pairwise comparisons, in terms of the cause-effect probability between risks. In addition to project risks, the identification and evaluation of risk interactions makes it possible to construct the project risk network.

In phase (3), one innovation of this framework is to introduce complementary methods to the classical ones to evaluate and prioritize individual risks. A network theory-based topological analysis is conducted to identify key factors (risks and risk interactions) with respect to their roles in the risk network. The originality is to apply network analysis in the context of project risk management, and particularly to tailor some network theory indicators, including

connectivity indicators, interface indicators and betweenness centrality. Besides, an eigenstructure analysis is adapted and performed based on both the topological structure of risk network and the weighted risk network, with the goal of measuring the importance of risks with respect to their position in the network. This measurement reflects the influence of a risk taking into account both its direct and indirect connections with the other risks in the network. Furthermore, the risk network can be modeled and run in a discrete-event simulation context. This enables an analysis of the propagation behavior in the network and thus a re-evaluation of risks considering their correlations. In addition, a matrix-based risk propagation model is developed to quantitatively calculate risk propagation and to re-evaluate risk characteristics for updating the risk prioritization. These innovative analyses serve as a powerful complement to classical project risk analysis. The outcomes of phase (3) provide project managers with re-evaluation and new insights on risks and risk interactions for supporting subsequent decision-making.

The response planning phase (4) consists of several activities: (a) potential mitigation actions are identified using the previous analyses, and they are preliminarily evaluated by experts (some unfeasible actions can be screened out through this activity); (b) candidate actions are tested in the risk network model for estimating their effects on a specific target or on the global risk network, i.e., the level of residual risks that is expected to remain after the implementation of these actions; and (c) under the identified resource constraints for conducting risk management, optimization algorithms can be developed and used to obtain an optimal portfolio of mitigation actions. Then, the project manager makes decisions about the risk response plan suggested by the DSS.

Finally in phase (5), the evolution of the risk network is monitored and the effectiveness of the actions is evaluated to keep the project under control. The phase of monitoring and control provides feedback for the previous phases, which allows the modification and improvement of their results.

This decision support system for project risk management is a cooperative DSS (Gachet and Haettenschwiler 2003; Adla et al. 2007; Bui and Lee 1999). Decision-makers (usually the project manager and the team of experts) are allowed to modify, complete, and refine the managerial suggestions proposed by the system. Their involvement is also required in each phase of the DSS to provide their knowledge, expertise and experience.

The mapping relationship between corresponding steps in the framework and the research questions put forward in Section 1.4 are shown in Figure 10. The following chapters will provide more details of the methods or tools which are used or developed for each phase of the PRM framework.

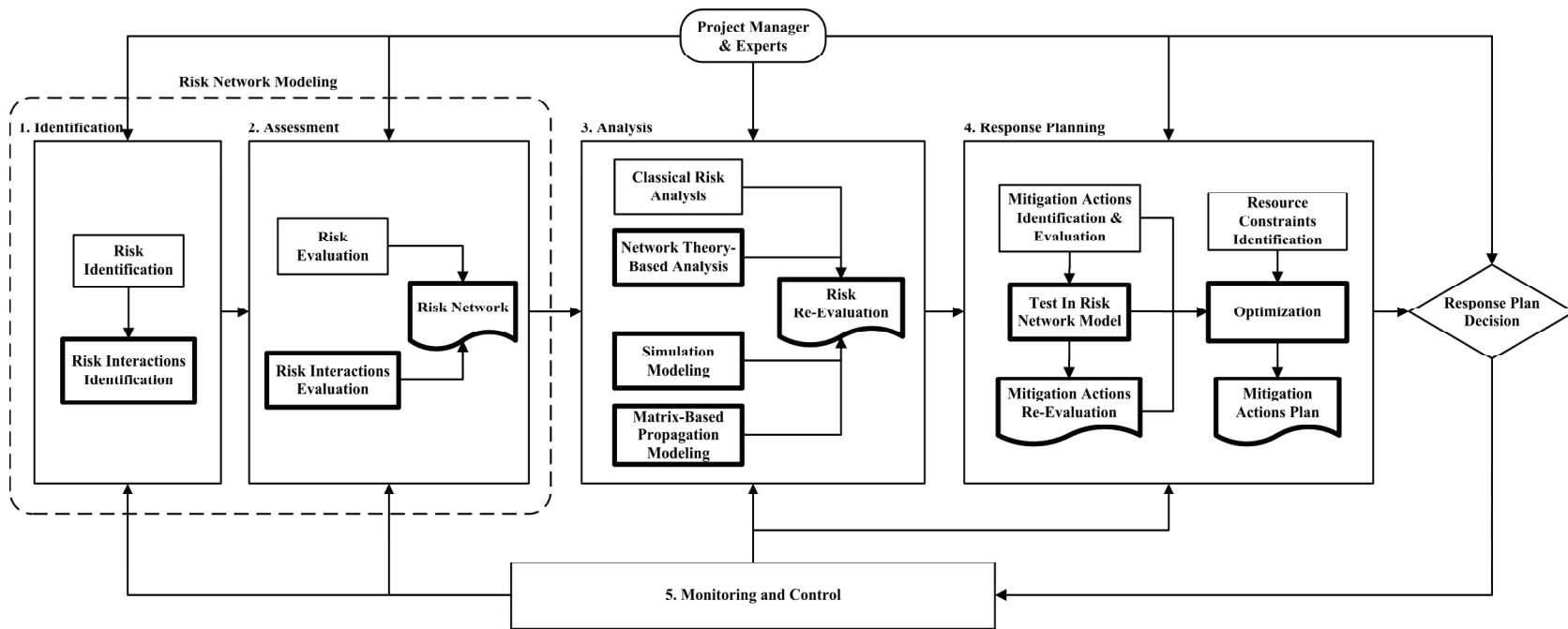

Figure 9. Framework of the decision support system for PRM

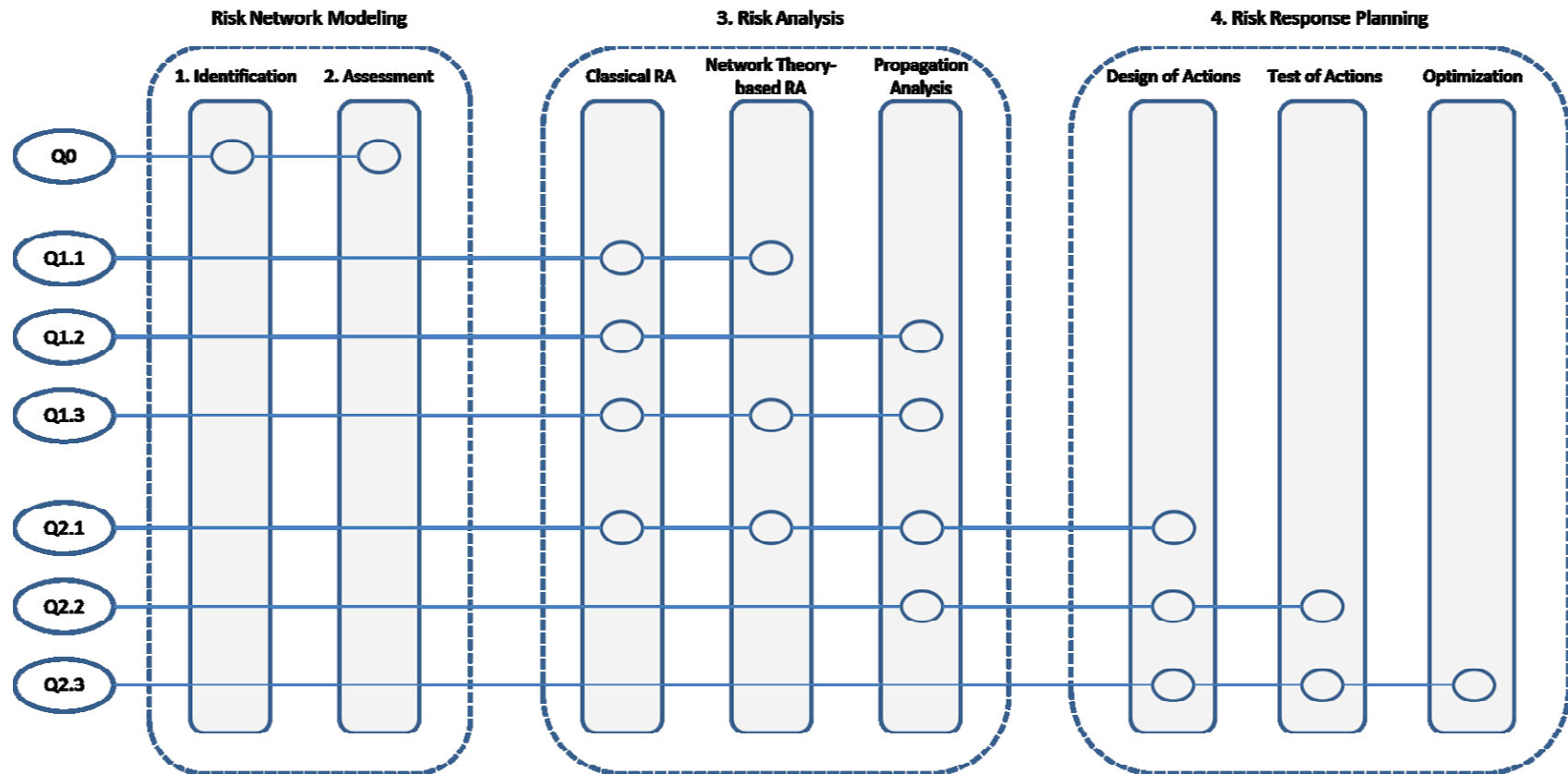

Figure 10. Steps in the DSS for addressing related research questions

1.5.2 Case studies

We apply and test this framework to two real projects. These case studies are used for illustration and validation of the proposed approach. The first one is a project in the entertainment industry of staging a musical play. The second one is an industrial project for implementing a tramway transportation system. These two case studies have different size in terms of identified risk numbers and different level of complexity in terms of risk interactions. The introduction and analysis results of the applications will be discussed in the following chapters.

1.6 Conclusion

This chapter discusses the background and research problem of the Ph.D. study. A brief introduction to project management and the classical process of project risk management is given. Unexpected conditions or planning errors may lead to delays, over-costs and other failures which can undermine the successful realization of the project. We refer to such events or conditions as project risks. This study mainly focuses on the conventional risks with negative effects.

The issue of growing project complexity is discussed. The associated complexity of project risks may undermine the effectiveness of project risk management. A literature review demonstrates that existing methods and tools have limitations for modeling the real complexity of project risks. For example, some propagation phenomena like chain reactions and loops are not properly taken into account. In this regard, research questions are posed mainly focusing on how to represent the complexity of project risk, risk analysis and risk response planning taking into account this complexity. To address these research questions, we propose an integrated decision support system framework, which enables the project manager to model and analyze the complex risk network. The aim is to support decision-makers in planning risk response actions with a structured and repeatable approach.

The details of the decision support system will be introduced in the following chapters. Chapter 2 describes the process of building the project risk network. Chapter 3 presents a prototype of simulation-based risk network model for decision support in PRM. In Chapter 3, a network theory-based topological analysis and an eigenstructure analysis are developed for analyzing structural properties in the risk network. Chapter 5 introduces a matrix-based risk propagation model and adapts the eigenstructure analysis on weighted risk network. In Chapter 6, a genetic algorithm-based model is developed for optimizing the risk response plan and it is compared with a greedy algorithm. Chapter 7 concludes the thesis and discusses the perspective on the future work.

Chapter 2 - Project Risk Network Modeling

Abstract

The overall purpose of this chapter is to propose an approach with available and useful tools for building the interactions-based project risk network. As discussed in Chapter 1, the existing methods in project risk management are not able to appropriately represent and model the real complexity of project and its underlying risks. Through modeling the interrelationship between project risks in the network structure, it permits us to conduct subsequent risk network analyses for analyzing the risk propagation behavior. The results can thus improve the project manager's insights for making decisions concerning risk management.

First, similar to the traditional project risk management, individual project risks are identified and their characteristics are assessed in terms of probability and impact. Based on the resulting project risk list, potential risk interactions are identified thanks to the use of Design Structure Matrix (DSM) tool. The strength of risk interactions can be assessed directly by experts or through a developed AHP-based algorithm. The obtained Risk Structure Matrix (RSM) and Risk Numerical Matrix (RNM) represent the risk network structure and the measurement of its edges (regarded as the transition probability between risks).

An application to a real project in the entertainment industry is provided to test and illustrate the approach. Some conclusions are drawn and some uncertainties in the modeling process are discussed.

Chapter Keywords

Risk interaction, risk network, design structure matrix (DSM), risk structure matrix (RSM), analytic hierarchy process (AHP), risk numerical matrix (RNM)

2.1 Building the risk network structure

As mentioned in Chapter 1, project managers are facing a growing complexity of project and interdependent risks. In order to understand and manage this complexity, project risk network needs to be built by modeling project risks and their interactions. The project risk network is a directed network and consisted of risks and risk interactions. Project risks are identified and represented as the nodes, and their potential interactions are directed edges in the network.

2.1.1 Identification of project risks

In order to establish and analyze the risk network of project, it is necessary to identify individual risks firstly. Risk identification is the process of determining which risks may potentially affect the project and documenting them for the next step of analysis. There are a number of classical methods for identifying individual project risks based on analogy (P. Smith and Merritt 2002; Riek 2001), on heuristics (R. Chapman 2001; Kerzner 1998) or analytically (Stamatelatos 2004; Shimizu and Noguchi 2005; L. Lee et al. 2007).

With the help of expertise and / or experience, we can identify risks which, for example, may occur during every phase, or in every department of the project. As described in PMBOK (PMI 2008), the following information or documents can be used as the inputs for identifying project risks:

- Risk management plan
- Activity cost estimates
- Activity duration estimates
- Scope baseline
- Stakeholder register
- Cost management plan
- Schedule management plan
- Quality management plan
- Project documents
- Enterprise environmental factors
- Organizational process assets

In our study, classical tools and techniques in project risk management such as documentation reviews, brainstorming, interviewing, and checklist analysis are used to identify project risks. The output of risk identification is a conventional project risk list.

2.1.2 Identification of risk interactions

Identification is the first step of determining the dependency relationship between the identified risks. The nature of risk interactions can be classified into several categories. Research on this subject has appeared in several papers, for example, ALOE model developed by Vidal and Marle (L. Vidal and Marle 2008) defines different kinds of relationship of links between project risks:

- Hierarchical link
- Contribution link
- Sequential link
- Influence link
- Exchange link

Several links with different natures might exist between two risks. They are all expressed with potential cause-effect relation in this study.

2.1.2.1 Basics of the DSM tool for modeling interdependencies

The Design Structure Matrix (DSM) method, which is also known as the dependency structure matrix or dependency structure method, was introduced by Steward (Steward 1981) for tasks-based system modeling and was initially used essentially for planning issues (Eppinger et al. 1992). Ever since then, it has been widely used for modeling the relationship between other types of objects, for example, product components, projects, people and activities (Browning 2001; Sosa 2008; Sosa et al. 2004; Eppinger and Salminen 2001; Danilovic and Browning 2007). A DSM is used to relate entities of one kind to each other, for example, the tasks that constitute a complete project. It can be used to identify appropriate teams, work groups, and an ideal sequence of how the tasks can be arranged.

Figure 11 displays a typical form of DSM. A DSM is a square matrix, i.e., it has an equal number of rows and columns. The labels both in rows and columns correspond to the finite number of elements in the system. Each cell in the matrix represents the directed dependency between the related elements in the system. If a DSM is defined to allow the self-loop (an element is directly linked to itself), the self-linked relationship should appear in the diagonal cells. A DSM could be binary (only indicates the existence of dependencies) or numerical (also shows the weighted measurement of dependencies).

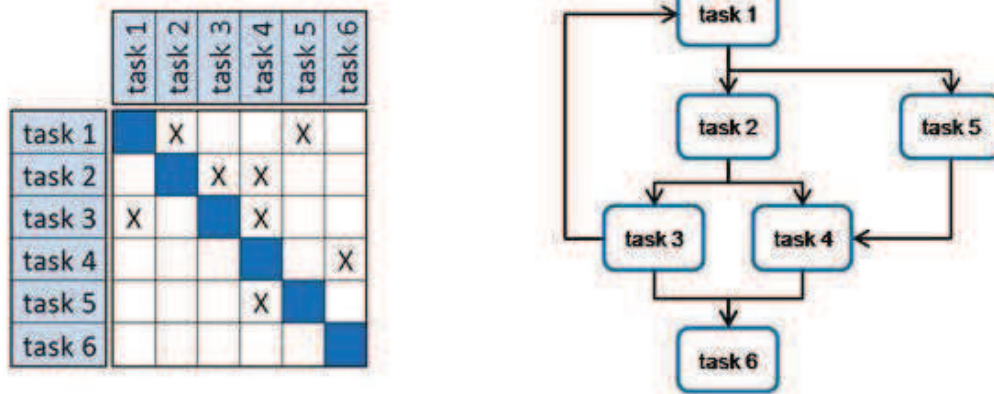

Figure 11. Illustration of DSM (DSM-Community 2009).

A procedure is proposed by Dong (Dong 2002) for building a credible DSM. The basic steps include:

- 1) Define the system and its scope
- 2) List all the system elements
- 3) Study the information flow between system elements
- 4) Complete the matrix to represent the information flow
- 5) Give the matrix to the engineers and managers to comment on and use

The DSM has proven to be a practical tool for representing and analyzing relations and dependencies among system components. It provides a concise and simple way to compactly and visually represent a complex system with a large number of elements which are interrelated.

In order to develop our approach of integrating complexity modeling into project risk management, we use the DSM for building the project risk network. This is presented in the following paragraphs.

2.1.2.2 Identifying and representing risk interactions in Risk Structure Matrix (RSM)

For our study, we use the concept of DSM with risks, in the context of project management. The interrelations between project objects such as tasks, actors and product components facilitate identifying the interrelations between the risks related to these objects. For instance, the project schedule gives information about task-task sequence relationships. This helps to identify the correlation between two risks of delay for these tasks. A component-component relationship (functional, structural or physical) means that the risks, which may be related to product functions, quality, delay or cost, can be linked, since one problem on one component may have an influence on another (e.g., budget limits). In a similar way, the domain mapping matrix (DMM) introduced by Danilovic and Browning (Danilovic and Browning 2007)

and the multiple-domain matrix (MDM) introduced by Lindemann, Maurer and Braun (Lindemann et al. 2008) are helpful in identifying risk interactions across different domains of the project.

Risk interaction is considered as the existence of a possible precedence relationship between two risks. We define the Risk Structure Matrix (RSM), which is a binary and square matrix with $RSM_{ij} = 1$ when there is a link from R_j to R_i . It does not address concerns about the probability or impact assessment of this interaction. We put a sanity check between R_i and R_j . Suppose we know that R_i declared R_j as a cause, if R_j did not declare R_i as a consequence, then there is a mismatch. Each mismatch is studied and solved, like the analogous works by Sosa about the interactions between project actors (Sosa et al. 2004). Figure 12 gives an example to show the use of such a RSM to represent the risk network.

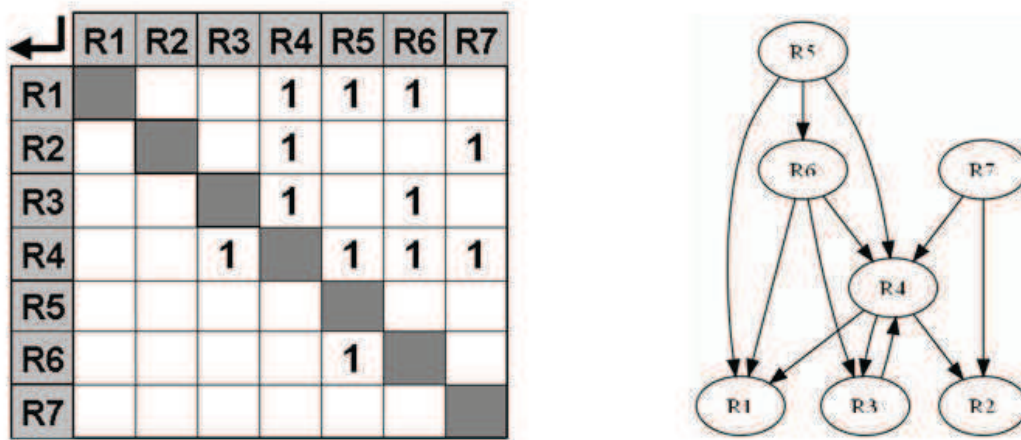

Figure 12. Illustration of risk structure matrix (RSM)

As we can see, the RSM permits to express the correlations of project risks in the built risk network structure. According to Thompson’s study on relationships in the organizational structure (Thompson 1967), there are three basic types of relationships between each pair of risks:

- Dependent: risks are engaged in a potential precedence relationship.
- Interdependent: risks are engaged in a mutually dependent relation, directly or within a bigger loop.
- Independent: risks are not related.

A fourth type of activity relationship – contingent is introduced by Browning in (Browning 2001).

The DSM tool also enables some powerful analyses on RSM, e.g., partitioning, tearing, banding and clustering (Browning 2001; Gunawan and Ahsan 2010; W. T. Lee et al. 2010).

However, these matrix theory-based analyses are not in the overall scope of this PhD thesis, which mainly concerns risk propagation modeling and analysis in the network.

2.2 Assessment of the risk network

In the assessment phase, the risk network parameters are evaluated. Project risk characteristics such as risk impact and risk probability are evaluated using classical methods in project risk management. The strength of risk interactions (edges in the risk network) is also assessed and regarded as the transition probability between risks.

2.2.1 Project risk assessment

2.2.1.1 Risk assessment in terms of probability

For the probability assessment, we make a distinction between the probability of a risk to be triggered by another risk inside the network and its probability caused by external events or risks which are outside the system. Spontaneous probability can be interpreted as the evaluated likelihood of a risk, which is not the effect from any other activated risks inside the system. For the example in Figure 12, Risk 5 occurs only in accordance with its spontaneous probability; and Risk 6 may arise from both its spontaneous probability and the transition probability between Risk 5 and Risk 6.

Qualitative scales are often used to express probability with 5 to 10 levels (e.g., very rare, rare, unlikely, etc.) which correspond to non-linear probability measures (e.g., 10^{-4} , 10^{-3} , 10^{-2} , etc.). Logarithmic scales have been used by statisticians for several decades (Fleiss 1981). They allow us to distribute probabilities unevenly. In practice, they devote more space to small values, imposing a compressed, logarithmic mapping. Based on this principle, we can use, for example, Equation (1) for converting qualitative scales into quantitative measures of risk spontaneous probability:

$$p = \alpha * 10^{\left(\frac{-\beta}{s}\right)} \quad (1)$$

where p indicates the quantitative probability measure, s indicates the qualitative scale value, with parameters $\alpha > 0$, $\beta > 0$. The parameters α and β are case-dependent. They are obtained by setting the mapping relationship between the qualitative scale and quantitative probabilities, namely the ceiling of probability of risk occurrence is predefined. For example, for some regular engineering projects, the project risks like schedule delay and cost overrun are usually encountered, thus the probability of them is relatively higher. In this manner, we may set the highest scale '9' which corresponds to for instance 40% of occurrence. While for some critical projects like nuclear engineering, the estimation of highest probability of risk occurrence is normally much lower. In the two case studies used in this thesis (a musical staging project and a tramway construction project) applies the former situation.

2.2.1.2 Risk assessment in terms of impact

Risk impact assessment investigates the potential effect of the occurrence of the risk on the project objective such as schedule, cost, or quality. We mainly focus on negative effects for threats in this work.

Risk impact can be assessed on a qualitative scale (e.g., ordinal or cardinal scale with 5 or 10 levels) or on a quantitative scale (e.g., financial loss). In this study, we use classical methods for the impact assessment, based upon a mix of previous experience and expert judgment.

2.2.2 Risk interactions assessment

A numerical structure matrix can provide more detailed information than a binary one about the risk network for assisting decision-making. Assessment is the process of measuring and estimating the strength of the link between risks. Two ways can be used for the estimation: direct assessment and relative assessment. In this section we describe the methods used in this study for assessing the strength of risk interactions.

2.2.2.1 Direct assessment by experts

Based on the established RSM, the weight of each non-zero element in the matrix (identified potential risk interaction) can be assessed during the interviews or meeting with the project manager and/or related experts involved.

Direct assessment is made for each potential interaction by one or more experts according to their experience and/or expertise. In the process of assessment, different experts may get outcomes with differences. To moderate this kind of confusion and divergence, particular experts are asked to be responsible for several rows and columns in the RSM according to their specialty. Finally, the assessment results from different experts need to be combined and consolidated.

2.2.2.2 Relative assessment based on pairwise comparison

Relative assessment consists in comparing the causes (or the effects) of a single risk which has multiple interactions. This involves using the principle of pairwise comparisons in the Analytic Hierarchy Process (AHP). The AHP developed by Saaty is a multi-criteria decision-making method based both on mathematics and human psychology (Saaty 1977, 1980 2000, 2003). It notably permits the relative assessment and prioritization of alternatives. The AHP is based on the use of pairwise comparisons, which lead to the elaboration of a ratio scale.

An AHP-based assessment has been developed by Marle and Vidal to obtain the numerical values of the strength of risk interactions (Marle et al. 2010). The main principles are introduced in the next paragraphs and displayed in Figure 13:

Step 1: Decomposing individual sub-problems

For each risk R_i , we isolate the risks which are related with R_i in column (possible effects) and in row (possible causes). This identification enables one to generate the Binary Cause (or Effect) Vectors, with regard to risk R_i , respectively called $BCV|R_i$ and $BEV|R_i$.

Step 2: Evaluating the relative strength

We build up two matrices (Cause or Effect Comparison Matrices) with regard to one risk R_i (respectively $CCM|R_i$ and $ECM|R_i$). The AHP is based on the use of pairwise comparisons, which lead to the elaboration of a ratio scale. In our case, we have two parallel pairwise comparison processes to run. The first one consists in the ranking in rows for each project risk. The criterion according to which the alternatives are evaluated is the contribution to R_i in terms of risk input. In other words, for every pair of risks which are compared, R_j and R_k (thus following $RSM_{ij}=RSM_{ik}=1$), the user should assess which one is more important to risk R_i in terms of the probability of triggering R_i . These assessments are expressed by numerical values thanks to the use of traditional AHP scales. The second one is the ranking in columns, according to the same principles.

Step 3: Calculating the eigenstructures

Eigenvectors of each matrix $ECM|R_i$ and $CCM|R_i$ are now calculated. It enables one to find the principal eigenvectors, corresponding to the maximal eigenvalue. They are called Numerical Cause or Effect Vectors and are relative to one risk R_i (NCV_i and NEV_i). The consistency of the results should be tested thanks to the AHP consistency index.

Step 4: Aggregating the eigenvectors

For each risk R_i , Numerical Cause or Effect vectors (NCV and NEV) are respectively aggregated into Numerical Cause or Effect Matrices (NCM and NEM). The i -th row of NEM corresponds to the eigenvector of $CCM|R_i$ which is associated to its maximum eigenvalue. The j -th column of NCM corresponds to the eigenvector of $ECM|R_j$ which is associated to its maximum eigenvalue.

Step 5: Compiling the results

The two previous matrices are aggregated into a single Risk Numerical Matrix (RNM), the values of which assess the relative strength of local interactions. The RNM is defined by a geometrical weighting operation in Equation (2) (based on the assumption that both estimations in terms of cause and effect can be considered equivalent). We choose the geometrical mean rather than arithmetic mean because it tends to favor balanced values (between the two assessments). RNM_{ij} is defined as the strength of the cause and effect interaction from R_j to R_i .

$$RNM(i, j) = \sqrt{NCM(i, j) \times NEM(i, j)}, \quad \forall(i, j), 0 \leq RNM(i, j) \leq 1 \quad (2)$$

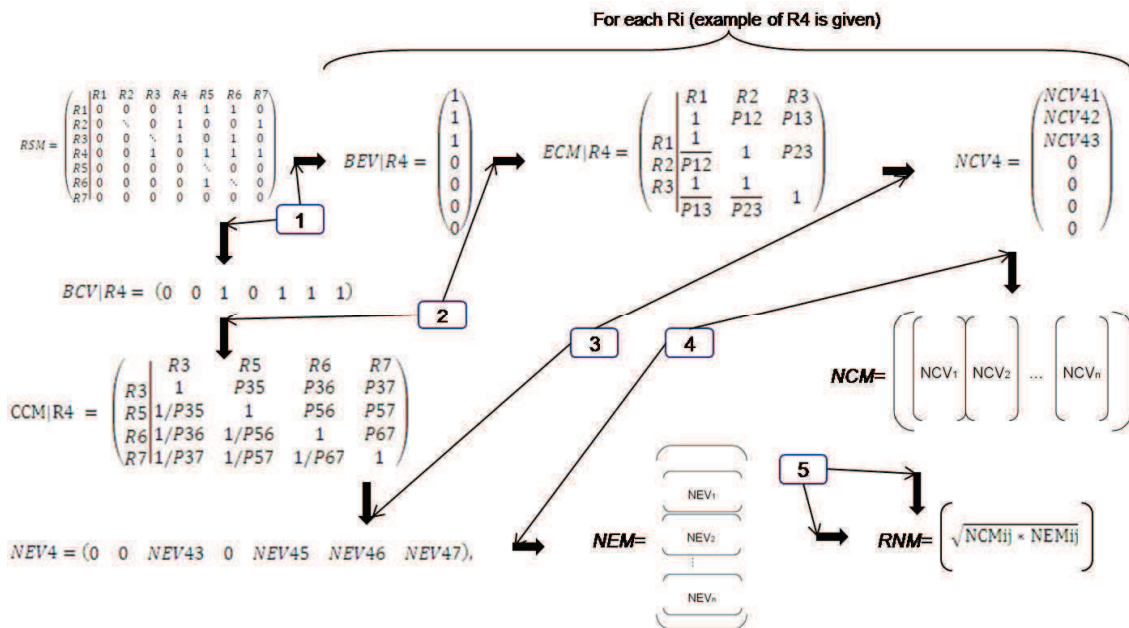

Figure 13. Description of the transformation process from RSM to RNM

The RNM thus permits to synthesize the existence and strength of local precedence relationships between risks, as it combines the cause-oriented vision and the consequence-oriented vision of an interaction. This is helpful to avoid any bias or misevaluation which can happen when looking at the problem with single vision.

RNM is a square matrix with identical rows and columns. The risks in column labels are causes while the ones in row are effects. An off-diagonal value signifies the strength of the link between two risks. In the risk network model, numerical values of cause-effect interactions in the RNM can also be interpreted as the transition probability between risks. For example, if the element $RNM(4,3)$ is equal to 0.25, then the probability of Risk 4 originating from Risk 3 is considered to be 25% under the condition that risk 3 is activated.

2.3 Case study

2.3.1 Introduction to the case study

We illustrate the proposed method of project risk network modeling to a project of staging a musical play in the entertainment industry. The project is the production of a family musical show in Paris, France, including costumes, lightning and sound design, casting management, rehearsal management, fund raising and overall project management. The duration of the project is 15 months and the team is composed of 18 people, plus the actors and actresses.

The first action of case study consisted in interviewing the persons directly involved in the project risk management process, namely the risk owners and the project manager. These participants were given a short background questionnaire on their experience in the organization and in this kind of project. They were also given a presentation of the method, including the analysis that will be made using the input data they were going to provide. To avoid potential differences among interviewers and their interviewing techniques, only one interviewer was used for all the interviews. Through the interviews and meetings we were able to perform the identification and assessment of risks and risk interactions. During the final meeting, the evaluations were exposed and discussed by all the participants. Some changes were made during the discussion and a consensus was reached at the meeting, which lasted about three hours. As a whole, three weeks were needed to build up the assessed project risk network.

2.3.2 Results

Working with the project management team on the steps of identifying and evaluating individual project risks, we acquire the original project risk list, shown in Table 3. The list comprises 20 identified risks at the main level which may occur and affect the delivery of the project. The risk ID, risk name, and their characteristics such as nature/domain, risk probability, risk impact and risk criticality are displayed in the list.

As we can see, the identified risks are categorized into different domains according to their nature. For instance, “Cost and time” risks such as R01 (Low budget) and R07 (Cancellation or delay of the first performance) are closely related to the project objectives like cost or schedule; “Controlling” risks such as R06 (Unsuitable rehearsal management), R19 (Low creative team leadership) and R20 (Low creative team reactivity) are mainly the responsibility of the project management team; and so on.

The assessment of individual risks is performed using the 10-level qualitative scale, both for risk probability and risk impact. Criticality of the risk is classified into different levels (e.g., negligible, acceptable and unacceptable) according to the product value of its evaluated probability and impact.

Table 3. Original project risk list with characteristic values of the musical staging project

ID	Risk Name	Nature/Domain	Criticality	Probability	Impact	P*I
R01	Low budget	Cost and time	Unacceptable	8	7	56
R02	Law and regulations infractions	Contracts	Unacceptable	7	5	35
R03	Low communication and advertising for the show	User/customer	Unacceptable	8	9	72
R04	Unsuitable cast	Organization	Unacceptable	5	9	45
R05	Unsuitable ticket price setting	Strategy	Unacceptable	7	6	42
R06	Unsuitable rehearsal management	Controlling	Acceptable	3	8	24
R07	Cancellation or delay of the first performance	Cost and time	Unacceptable	5	8	40
R08	Poor reputation	User/customer	Acceptable	3	7	21
R09	Lack of production teams organization	Organization	Acceptable	4	6	24
R10	Low team communication	Organization	Acceptable	3	6	18
R11	Bad scenic, lightning and sound design	Technical performance	Negligible	2	7	14
R12	Bad costume design	Technical performance	Acceptable	3	8	24
R13	Low complicity between cast members	Technical performance	Acceptable	3	7	21
R14	Too ambitious artistic demands compared to project means	Requirements	Acceptable	7	2	14
R15	Few spectators / Lukewarm reception of the show	User/customer	Acceptable	2	9	18
R16	Technical problems during a performance	Technical performance	Acceptable	4	5	20
R17	Low cast motivation	Organization	Negligible	2	4	8
R18	Childish direction (unsuitable for family audiences)	Strategy	Negligible	2	5	10
R19	Low creative team leadership	Controlling	Unacceptable	3	10	30
R20	Low creative team reactivity	Controlling	Negligible	2	2	4

The resulting project risk list with classical methods in PRM serves as an input for studying risk interactions so that we are able to build the project risk network. Thanks to the expertise and experience of the project manager and the team of experts, and using the DSM tool, the RSM of the project is built and shown in Figure 14. The RSM corresponds to the project risk network structure, displayed in Figure 15. The project risk network is a complex network with interdependent risks. A risk could have multiple input links and multiple output links. There might be several different paths from one risk to another.

Name	1	2	3	4	5	6	7	8	9	10	11	12	13	14	15	16	17	18	19	20
Low budget	1				1										1					
Law and regulations infractions	2	1																		
Low communication and advertising for the show	3	1						1	1											
Unsuitable cast	4	1	1																	
Unsuitable ticket price setting	5																			
Unsuitable rehearsal management	6									1									1	1
Cancellation or delay of the first performance	7								1	1	1					1				
Poor reputation	8		1					1							1					
Lack of production teams organisation	9																			
Low team communication	10		1	1	1		1	1		1							1			
Bad scenic, lightning and sound design	11	1												1						
Bad costume design	12	1												1						
Low complicity between cast members	13				1												1		1	
Too ambitious artistic demands compared to project means	14	1																		1
Few spectators / Lukewarm reception of the show	15													1	1				1	
Technical problems during a performance	16	1																		
Low cast motivation	17		1	1				1		1	1		1							
Childish direction (unsuitable for family audiences)	18																			1
Low creative team leadership	19																			
Low creative team reactivity	20																			

Figure 14. RSM of the musical staging project

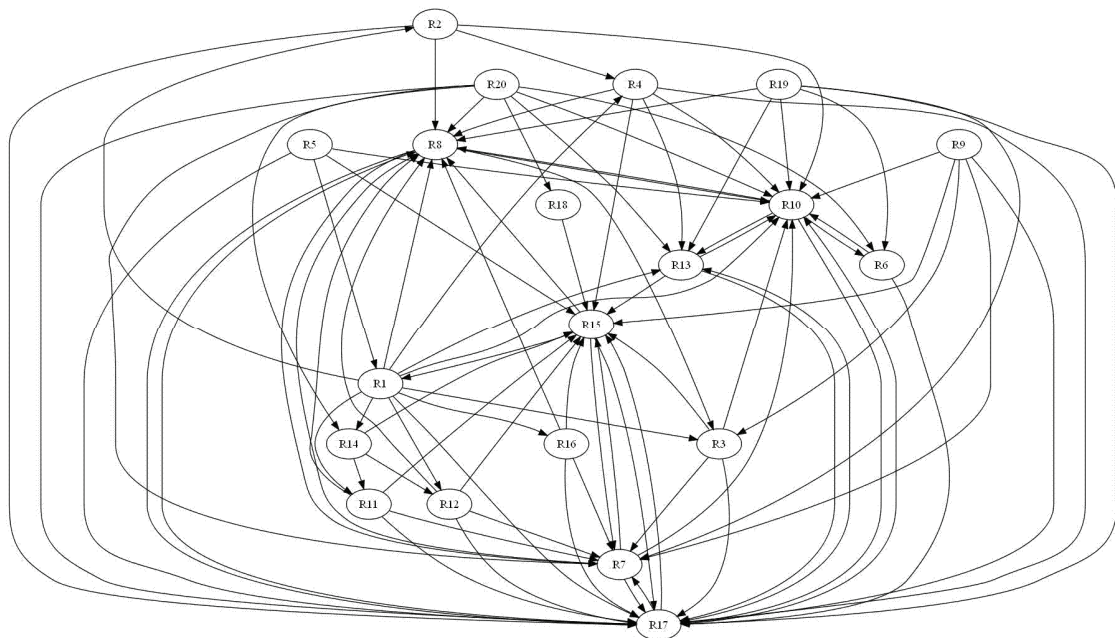

Figure 15. Interactions-based project risk network structure of the musical staging project

The strength of risk interactions is assessed using a developed AHP-based method, as described in Section 2.2.2. Due to the high level of expertise of interviewees, this step was done quite quickly (for several hours, including the interviews and two meetings). In order to get the spontaneous probability, they supposed that none of the identified cause risks would take place and then they were asked: “what is the remaining probability of this event to occur?”

Qualitative probability is converted into numerical probability through Equation (1):

$$p = \alpha * 10^{\left(\frac{-\beta}{s}\right)}, \text{ where the parameters are set as } \alpha = 5, \beta = 8 \text{ by experience.}$$

The only difficulty was that it appeared easier for the risk owners to consider the interactions with causes that could affect them, than to consider the interactions with effects of their own actions and decisions. But this potential bias was fixed by the meetings and the simultaneous presence of the different correlated owners. This approach enabled us to get the consistency on both the existence and the assessment of each interaction, because the two involved owners (respectively for the cause and effect risks) were present.

Figure 16 displays the RNM with evaluated transition probability of the risk interactions. For instance, in the (7, 11)-th item of the matrix, the value 0.327 denotes that the transition probability from risk 11 (Bad scenic, lightning and sound design) to risk 7 (Cancellation or delay of the first performance) is 32.7%.

	1	2	3	4	5	6	7	8	9	10	11	12	13	14	15	16	17	18	19	20
1					0.770										0.159					
2	0.410																			
3	0.243							0.137	0.391											
4	0.164	0.337																		
5																				
6										0.471									0.372	0.115
7									0.197		0.327	0.346				0.139				
8		0.311					0.287								0.193					
9																				
10		0.153	0.118	0.217		0.301	0.183		0.129								0.108			
11	0.415													0.129						
12	0.415													0.129						
13				0.173						0.394							0.175		0.154	
14	0.106																			0.203
15													0.311	0.157				0.184		
16	0.164																			
17		0.186	0.116				0.159		0.170	0.146			0.252							
18																				0.352
19																				
20																				

Figure 16. RNM of the musical staging project

2.4 Conclusions

As a whole, this chapter presents the innovative process of building the project risk network through risk interactions modeling (addressing the research question Q0). Classical techniques in project risk management and some sophisticated tools such as DSM and AHP are exploited to carry out the modeling process. Based on the resulting project risk network, subsequent analyses can be performed in order to study the risk propagation behavior in the network.

The whole process of project risk network modeling is tested and applied to a real project of musical staging. The generated outcomes are a conventional project risk list and the project risk network (or the equivalent RNM). This case study will also be used for illustration in several of the succeeding chapters.

However, during the steps of identification and assessment, there might be uncertainties. For example, in every identification process of risk interactions, there is a limit to the scope when considering risks inside or outside the project risk list. Downstream limits are generally the final expected project results. They may include immediate results like profit, delivery time or post-project results related to operation, maintenance or recycling phase. Upstream limits are generally decided depending on the influence or capacity of actions that the decision-makers have on these causes. The identification of risk interactions has been done on direct cause or effect relationship. In the end, the aggregation of local cause-effect relationships made it possible to display the global project risk network. This permitted us to organize a meeting where the interviewees had the possibility to add or remove nodes and edges in the risk network.

In the assessment steps, even with a mix of individual and collective work, misjudgments are possible and the estimations remain uncertain or unreliable. This is all the more true that we are not in a context with lots of experience, where estimations could be considered as quite reliable. This is why we decided to run a sensitivity analysis in the following step of risk network analysis, in order to consider the uncertainties on the inputs and their influence on the outputs. A preliminary work on this concern will be detailed in Section 3.2, Chapter 3.

Chapter 3 - A Simulation-Based Risk Network Model for Decision Support in PRM

Abstract

This chapter presents a risk network model as a decision support system (DSS) for project risk management. Existing classical PRM methods have limitations for modeling the complexity of project risks. Hence, some propagation phenomena like chain reactions and loops are not properly taken into account. This will influence the effectiveness of decisions for risk response planning and will lead to unexpected and undesired behavior in the project. An effort has been made in Chapter 2 to model project risks and their interdependencies into a risk network. The study in this chapter aims at analyzing behaviors like risk propagation in the built risk network and help project manager make more reliable decisions.

Simulation technique is used to run the risk network model and to imitate the occurrence of risks and risk propagation behavior. This enables us to re-evaluate risks in terms of different characteristics, to update the risk prioritization results, and to suggest and test risk mitigation actions. Thus, the risk network model can support project manager in making decisions with respect to risk response actions.

An application to the previously introduced real musical staging project is provided to illustrate the utility of the model. A preliminary sensitivity analysis is conducted to examine the effects of input uncertainties on the analysis results. Several examples of mitigation actions are tested in the prototype model to demonstrate the effectiveness of this decision support system. Finally some conclusions are drawn about the proposed risk network model and the case study.

Chapter Keywords

Risk propagation, risk network analysis, simulation, sensitivity analysis, risk mitigation, decision support system

3.1 Brief description of the simulation model

In the context of project management, it is costly and unfeasible to carry out concrete experimental studies on projects. In this sense, simulation is an alternative tool for empirical research in decision support systems (Arnott and Pervan 2008). Computer simulation refers to methods for studying a wide variety of models of real-world systems by numerical evaluation. It is achieved using computer software designed to imitate the system's operations or characteristics, often over time. Nowadays, simulation has become more popular and powerful than ever since computer and software technologies have significantly developed. Simulation techniques are widely used to build model-driven decision support systems (Power and Sharda 2007). They assist decision-maker in anticipating the effects of events, actions and resource allocations by assessing their potential consequences. Therefore, in this research, we apply simulation technique to model and analyze the project risk network.

Project risks and their identified dependency relationships are modeled with network structure by simulation. Parameters of the simulation model include spontaneous probability of each risk and transition probability of each interaction link, the concepts of which have been introduced in Chapter 2. During the simulation, a risk may occur randomly on the basis of its assessed spontaneous probability; it can be triggered by one of its predecessor risks according to a given transition probability; and it can also activate the successor risks in the network. In the running process of the risk network model, each iteration is to simulate one operation of the real project. The occurrence of every risk is recorded during the simulation thanks to statistical accumulators deployed in the model.

Modeling risk interactions by simulation enables us to analyze the propagation behavior in the risk network. A large number of iterations are conducted for each scenario of simulation. The simulation results can be analyzed to support decision-making for risk management.

3.2 Applications to support managerial decision-making

This section presents an analysis of the project risk network (Section 3.2.1) based on the simulation model described in Section 3.1. The results of this analysis help the project manager make decisions about risk mitigation actions (Section 3.2.2). Finally, the risks and the effects of actions are monitored for keeping the project under control (Section 3.2.3).

3.2.1 Risk network analysis

More than analyzing individual project risks in terms of the estimation of their probability and impact, modeling risk interdependencies enables us to analyze risk propagation in the network context. In this respect, project risks should be re-evaluated taking into account the propagation behavior through risk interactions. The risk prioritization results like risk ranking may change in the risk network analysis, which may affect the following step of risk response

planning. Sensitivity analysis is helpful in examining and mitigating the effects of uncertainties in the previous assessment phase.

3.2.1.1 Risk re-evaluation

Risks can be re-evaluated in terms of different characteristics. The definition and calculation of these characteristics are described as follows.

1) Re-evaluation of risk frequency

After taking into account the risk propagation behavior, risk probability can be re-evaluated and expressed as statistical risk frequency in the simulation. In practice, a risk may occur more than once during one replicate of the project simulation. This is consistent with the real-life situations. Simulated frequency represents the average occurrence of a risk during the project, which may be greater than 1. The relationship between simulated risk frequency and risk probability is expressed in Equation (3):

$$RF[i] = P_1(R_i) + 2 \cdot P_2(R_i) + 3 \cdot P_3(R_i) + \dots = \lim_{m \rightarrow \infty} \sum_{k=1}^m k \cdot P_k(R_i) \quad (3)$$

where $RF[i]$ indicates the simulated risk frequency of R_i , and $P_k(R_i)$ indicates the probability of R_i occurring k times during the project.

The statistics of risk frequency can be obtained during the simulation process.

2) Anticipation of risk consequences

The simulation model can also be used to anticipate the consequences of one particular risk or a certain scenario. We simulate the scenario by setting the appointed spontaneous probability of related risks, and then all the potential consequences of this scenario can be observed after simulation. For example, if we assign 100% spontaneous probability to one risk while all the other risks have the value of 0%, then the simulation shows both its direct and indirect impacts on other risks in the network. The consequences of a risk are defined in Equation (4) for re-evaluating its impact in the global scope:

$$CR[i] = \sum_{j=1}^n RF^i[j] \cdot RI[j] \quad (4)$$

Here $CR[i]$ is the consequences of R_i , and $RF^i[j]$ indicates the simulated risk frequency of R_j originating from R_i . $RI[j]$ is the evaluated risk impact of R_j , which may be expressed on qualitative or quantitative scales.

3) Re-evaluation of risk criticality

As introduced in Chapter 1, risk criticality is generally a combination of probability and impact, or is simply defined as the product of them. The local criticality of a risk can be re-evaluated by multiplying its simulated frequency and its local evaluated impact, as in the following equation:

$$LC[i] = RF[i] \cdot RI[i] \quad (5)$$

In a similar way, we can refine the estimation of risk criticality by incorporating all the consequences of the risk in the network. The simulated global criticality of R_i is defined by Equation (6):

$$GC[i] = RF[i] \cdot CR[i] \quad (6)$$

3.2.1.2 Risk prioritization

In the process of PRM, risk prioritization or risk ranking is relied on to plan response actions. Risks must be prioritized because no project has enough resources to mitigate every potential risk. Project manager therefore needs to know which risks pose greatest threat to the project success and concentrate their effort on those higher risks (David Baccarini and Archer 2001).

In classical methods, risks are prioritized according to their evaluated probability and impact. In this risk network model, we simulate risk propagation behavior to obtain several different indicators for risk prioritization, such as the refined risk frequency and criticality. The prioritization results based on the re-evaluated indicators provide the project manager with a new understanding of risks and their relative severity in the project. The shift of risk prioritization results also influence the planning of mitigation actions.

3.2.1.3 Sensitivity analysis

Uncertainties exist in the assessment phase of evaluating risks and risk interactions. The reliability of analysis results therefore needs to be considered. Sensitivity analysis regards the study of the behavior of a model to ascertain how much its outputs depend on the input parameters (Saltelli et al. 2000). In this respect, sensitivity analysis is performed to examine the effects of input uncertainties on the outputs.

An effort is made to conduct a preliminary sensitivity analysis in this study. For example, we evaluate risks with three-level spontaneous probabilities (optimistic, most likely, and pessimistic value). Depending on the varying input values, the corresponding criticality of each risk is obtained. Sensitivity analysis is a useful tool of decision support system to verify the final ranking of the alternatives (Mészáros and Rapsák 1996). It helps to enhance the robustness of the system and the reliability of its managerial suggestions.

3.2.2 Mitigation actions planning and test

In project risk management, mitigation is an important and common treatment strategy to reduce local or global risk exposure. Taking early action to reduce the probability and/or impact of a risk occurring on the project is often more effective than trying to repair the damage after the risk has occurred (PMI 2008). In classical methods, courses of action are carried out on risks having the highest ranking or priority, in other words, on risks with the highest criticality. These actions are in practice, for instance, internal or external communication actions, training of members, buying additional or superior material resources, choosing a cheaper, more stable

or closer supplier, or increasing the number of tests. Mitigation actions always consume time, money and resources. It requires a leader, or at least one project member accountable for them. They should be included in the project plan like every action contributing to the delivery of the project result.

Based on the simulation analysis of the risk network, we get the risk re-evaluation and updated prioritization results. Hence, a new risk response plan can be developed. The new actions include: (1) classical mitigation actions, but applied to risks with re-evaluated values and rankings (simulated values may be different from initial estimations); (2) non-classical mitigation actions, which mitigate risk propagation instead of risk occurrence. Strategies for mitigating risks in different categories are likely to be different. For example, risks without any input while leading to many outputs are likely to be source risks; risks with many inputs as well as many outputs can be considered as transition risks in a project; risks without output are accumulation risks, often related to project performance like schedule, cost or quality. In addition to the scope of local target on one or several specific risks, mitigation actions could also be proposed to achieve global effects on the risk network.

Simulation can be used to show the eventual effects of alternative conditions and courses of action (Rozinat et al. 2009). In our simulation-based risk network model, different kinds of mitigation actions can be tested by changing the values of the related parameters, so that the effects on a part of or on the global risk network can be observed.

For a particular risk, classical mitigation action is conducted by giving the risk a lower spontaneous probability without considering its interactions with other risks. A complementary preventive action is cutting off the input links or reducing their transition probability. This strategy is compatible with the accumulation or transition risks. Instead of acting on a risk, the action focuses on the sources of this risk. For instance, the choice of suppliers and the communication plan are potential sources of many risks in the project, so that paying enough attention to these points at the beginning of the project may help to avoid many subsequent risks. Blocking the output links of a risk can be regarded as the action for confining its further propagation in the network. This is suitable for the source and transition risks. Instead of acting on the risk, the action focuses on its consequences. For instance, even if it is not possible (or would involve huge overcosts) to avoid a small delay in the delivery of a part in a civil engineering project, it is possible to negotiate a contract in which the penalties will begin at a higher threshold. We do not avoid this risk, since uncertainty is inherent in that work, but we implement an action to avoid its propagation and amplification to the rest of the project.

3.2.3 Risk network monitoring and control

Planned risk response actions are executed during the project, but their performance needs to be measured, in order to make sure that they have the desired effects on risks, while not inducing secondary effects. Moreover, the project, its environment and therefore the risks in the network, are continuously evolving. The status of the risk network should thus be always monitored throughout the project. Risk network monitoring and control could result in periodic

risk reviews, identification of new risks, and reporting on response action performance and any unanticipated effects. This phase provides feedback for the previous phases of the decision support system. The project manager can use this information to modify the risk network structure and its parameters, to update the risk analysis reporting, and to amend the risk response plan.

3.3 Case study results and analysis

In this section, we illustrate the application of the risk network model to a project of staging a musical show in Paris, France. The project and the results of risk network modeling have been introduced in Section 2.3 in Chapter 2. This section presents an effort to show the implementation and the results of the risk network model in each phase of project risk management.

3.3.1 Simulation model of the project risk network

We conduct simulation analysis for this case study using the software ARENA. ARENA is a powerful and widely used simulation tool in industry. It is suitable for modeling complex system and simulating discrete events (Kelton et al. 2007). Figure 17 displays the appearance of the simulation model built in the environment of ARENA software.

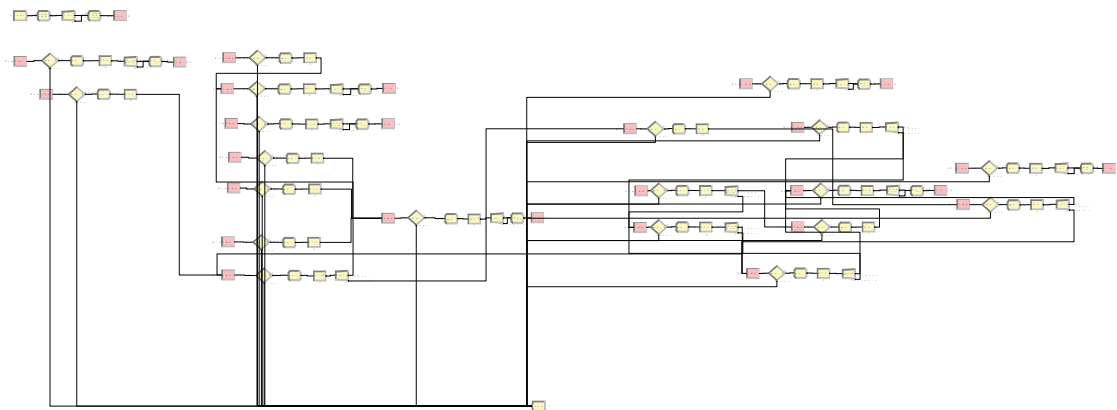

Figure 17. Simulation model of the project risk network using ARENA software

In the simulation, one important question is: “how many iterations are needed to reach a chosen level of precision of the results?” Reference (Banks et al. 2009) gives some formulas that can be used to estimate a minimal number of iterations. While for our study, it is difficult to estimate a satisfactory number of iterations because it depends on the size and the complexity of the risk network (particularly the influence of loops). However, we can still accomplish sufficient runs by increasing the number of iterations until the output, namely the simulated risk frequency, become stable enough.

In the case study, we increase the number of simulation iterations gradually from 1 000, 2 000, ... , to 10 000. The criterion for evaluating the stability of the output is defined as the following equation:

$$\sum_{i=1}^n \Delta RF[i]^2 < Threshold \quad (7)$$

where $\Delta RF[i]$ indicates the deviation of the simulated frequency of Risk i with the previous simulation. The threshold is set to be 10^{-6} in the test, which ensures that the output deviation with regard to each risk does not exceed 10^{-3} . The criterion is always achieved after 6 000 iterations. For statistical and computational convenience, 10 000 iterations are conducted in each scenario of the risk network model. The simulation time is not a limiting factor, since it costs less than 5 minutes for 10 000 iterations using the software ARENA on a normal PC.

3.3.2 Risk network analysis

The propagation behavior in the risk network is analyzed as described in Section 3.2.1. In Table 4, we consolidate the re-evaluation results of risks, and compare them with the results of classical method. The importance of each risk according to its characteristic value is marked in different gray scales.

Table 4. The comparison of re-evaluated simulation results with those of classical method

Risk ID	Risk Name	Evaluation Results by Classical Method					Re-Evaluation Results by Simulation			
		Qualitative Probability (Evaluated)	Spontaneous Probability (Eq (1))	Qualitative Impact (Evaluated)	Qualitative Criticality (QP*QI)	Evaluated Criticality (SP*QI)	Simulated Frequency (Statistic)	Consequences of Risk (Eq (4))	Simulated Local Criticality (Eq (5))	Simulated Global Criticality (Eq (6))
R01	Low budget	8	0.500	7	56	3.50	0.807	32.07	5.65	25.88
R02	Infractions against law	7	0.360	5	35	1.80	0.696	17.46	3.48	12.15
R03	Low communication and advertising for the show	8	0.500	9	72	4.50	0.771	12.36	6.94	9.53
R04	Unsuitable cast	5	0.126	9	45	1.13	0.495	15.53	4.45	7.69
R05	Unsuitable ticket price-setting	7	0.360	6	42	2.16	0.364	31.19	2.18	11.36
R06	Unsuitable rehearsal management	3	0.011	8	24	0.09	0.266	13.89	2.13	3.69
R07	Cancellation or delay of the first performance	5	0.126	8	40	1.01	0.425	15.40	3.40	6.55
R08	Poor reputation	3	0.011	7	21	0.08	0.388	8.73	2.72	3.39
R09	Lack of production teams organization	4	0.050	6	24	0.30	0.049	17.62	0.29	0.85
R10	Low team communication	3	0.011	6	18	0.07	0.529	19.11	3.18	10.11
R11	Bad scenic, lightning and sound design	2	0.001	7	14	0.01	0.393	12.07	2.75	4.75
R12	Bad costume design	3	0.011	8	24	0.09	0.400	13.50	3.20	5.40
R13	Low complicity between cast members	3	0.011	7	21	0.08	0.383	13.94	2.68	5.34
R14	Too ambitious artistic demands compared to project means	7	0.360	2	14	0.72	0.445	7.88	0.89	3.51
R15	Few spectators / Lukewarm reception of the show	2	0.001	9	18	0.01	0.196	15.88	1.76	3.11
R16	Technical problems during a performance	4	0.050	5	20	0.25	0.191	7.07	0.96	1.35
R17	Low cast motivation	2	0.001	4	8	0.00	0.469	8.63	1.88	4.05
R18	Unsuitable for family audiences	2	0.001	5	10	0.01	0.002	7.84	0.01	0.01
R19	Low creative team leadership	3	0.011	10	30	0.11	0.014	17.43	0.14	0.24
R20	Low creative team reactivity	2	0.001	2	4	0.00	0.001	7.91	0.00	0.01

Based on the results in Table 4, risks are prioritized by different indicators, shown in Table 5. It gives a different insight on risk priorities due to the changes in risk evaluations and risk rankings.

Table 5. Risk prioritization results by different indicators

Ranking	By Spontaneous Probability		By Simulated Frequency		By Evaluated Criticality		By Simulated Global Criticality	
	Risk ID	Value	Risk ID	Value	Risk ID	Value	Risk ID	Value
1	R01	0.500	R01	0.807	R03	4.50	R01	25.88
2	R03	0.500	R03	0.771	R01	3.50	R02	12.15
3	R02	0.360	R02	0.696	R05	2.16	R05	11.36
4	R05	0.360	R10	0.529	R02	1.80	R10	10.11
5	R14	0.360	R04	0.495	R04	1.13	R03	9.53
6	R04	0.126	R17	0.469	R07	1.01	R04	7.69
7	R07	0.126	R14	0.445	R14	0.72	R07	6.55
8	R09	0.050	R07	0.425	R09	0.30	R12	5.40
9	R16	0.050	R12	0.400	R16	0.25	R13	5.34
10	R06	0.011	R11	0.393	R19	0.11	R11	4.75
11	R08	0.011	R08	0.388	R06	0.09	R17	4.05
12	R10	0.011	R13	0.383	R12	0.09	R06	3.69
13	R12	0.011	R05	0.364	R08	0.08	R14	3.51
14	R13	0.011	R06	0.266	R13	0.08	R08	3.39
15	R19	0.011	R15	0.196	R10	0.07	R15	3.11
16	R11	0.001	R16	0.191	R15	0.01	R16	1.35
17	R15	0.001	R09	0.049	R11	0.01	R09	0.85
18	R17	0.001	R19	0.014	R18	0.01	R19	0.24
19	R18	0.001	R18	0.002	R17	0.00	R18	0.01
20	R20	0.001	R20	0.001	R20	0.00	R20	0.01

Eckert and co-authors defined (in the context of change propagation in design projects) the four following categories of risks: constants, absorbers, carriers and multipliers (Eckert et al. 2004). Some risks appear to be high accumulation risks, or “absorbers”, notably the risks R10 (Low team communication) and R17 (Low cast motivation). This can be seen in Figure 16 (in Section 2.3.2) of the RNM with an important number of inputs (in rows) for these risks. The changes on the risk occurrence assessment are visible in Table 4 and Table 5, both in the absolute value and in terms of ranking. The risks of this kind are unlikely to occur spontaneously, but some other identified risks may lead to them. Some risks have been moderately anticipated by the classical method, but they are still to some extent underestimated, such as R4 (Unsuitable cast) and R7 (Cancellation or delay of the first performance). Overall, a number of risks have increased occurrence frequency in varying degrees, which reflect their intensity of interactions in the network.

On the contrary, some risks engender many paths in the risk network. For example, R01 (Low budget), R02 (Infractions against law) and R10 (Low team communication) are called “multipliers” and they may be the original cause of numerous undesired effects. Their direct

consequences on other risks can be seen in Figure 16 (in columns), but their global consequences in the network are only visible in the simulation results in Table 4 and Table 5, with the gap between classically evaluated impacts and simulated consequences of the risks. Among these risks, R02 and R10 are some of the “leverage points” which are initially underestimated with low impact, nevertheless they should be mitigated because they have a large potential to trigger other risks. R05 (Unsuitable ticket price-setting) is another example of the “leverage points”, which does not have numerous direct outputs but has a high impact on some important risks like R01 (Low budget), with $RNM(I,5)=0.770$.

The risk prioritization results have changed after the simulation. Several risks have increased in the ranking in terms of frequency or criticality, while several other risks have decreased. For example, in the classical method, R03 (Low communication and advertising for the show) was considered to be the most critical risk, but the one with the highest simulated global criticality is R01 (Low budget). The value gap between risks has also changed. For example, R02 (Infractions against law) and R04 (Unsuitable cast) are evaluated with similar criticality. After re-evaluated by the simulation, R02 is still ranked above R04, and the relative gap between them has widened. This is the opposite situation for R05 (Unsuitable ticket price-setting) and R10 (Low team communication): R10 is still behind R05, but closer.

Our focus is then what Eckert and co-workers defined as the “avalanches”, i.e., the unpredictable propagation of initial events (Eckert et al. 2004). They and other co-authors also discussed some patterns defining local propagation motifs and defining relationships between two or three elements (Giffin et al. 2009). We are focusing on more global patterns, which are potentially the combinations of the local ones, like long propagation chains, heterogeneous propagation chains and loops. In these three cases, the anticipation and then the decision-making may be very hard, because of the difficulty to connect elements with different natures of risks, different actors, and different occurrence times.

Regarding the uncertainties of the estimated input values for the simulation, the spontaneous probability of each risk is assessed by the experts with three-level values: optimistic, most likely, and pessimistic, shown in Table 6.

Table 6. Evaluated three-level values of risk spontaneous probability

Risk ID	Spontaneous Probability		
	Optimistic	Most Likely	Pessimistic
R01	0.450	0.500	0.950
R02	0.100	0.360	0.600
R03	0.350	0.500	0.650
R04	0.010	0.126	0.200
R05	0.250	0.360	0.700
R06	0.005	0.011	0.200
R07	0.010	0.126	0.150
R08	0.010	0.011	0.100
R09	0.010	0.050	0.200
R10	0.010	0.011	0.050
R11	0.001	0.001	0.020
R12	0.005	0.011	0.020
R13	0.005	0.011	0.100
R14	0.100	0.360	0.900
R15	0.000	0.001	0.100
R16	0.045	0.050	0.070
R17	0.000	0.001	0.050
R18	0.000	0.001	0.002
R19	0.005	0.011	0.012
R20	0.000	0.001	0.002

Sensitivity analysis is performed on the three-level values of spontaneous probability. Each risk has a dissimilar range of simulated global criticality, as shown in Figure 18.

We can find, for example, R02 (Infractions against law) and R05 (Unsuitable ticket price-setting) have similar most likely values of criticality, but R05 has a larger potential range and thus it could be more unstable in the project. With respect to the risk prioritization, in all situations, R01 (Low budget) has higher simulated criticality than R02. Prioritized by the most likely value, R02 is superior to R03 (Low communication and advertising for the show); nevertheless, under certain circumstances, R03 will lead to higher impact and be more critical than R02.

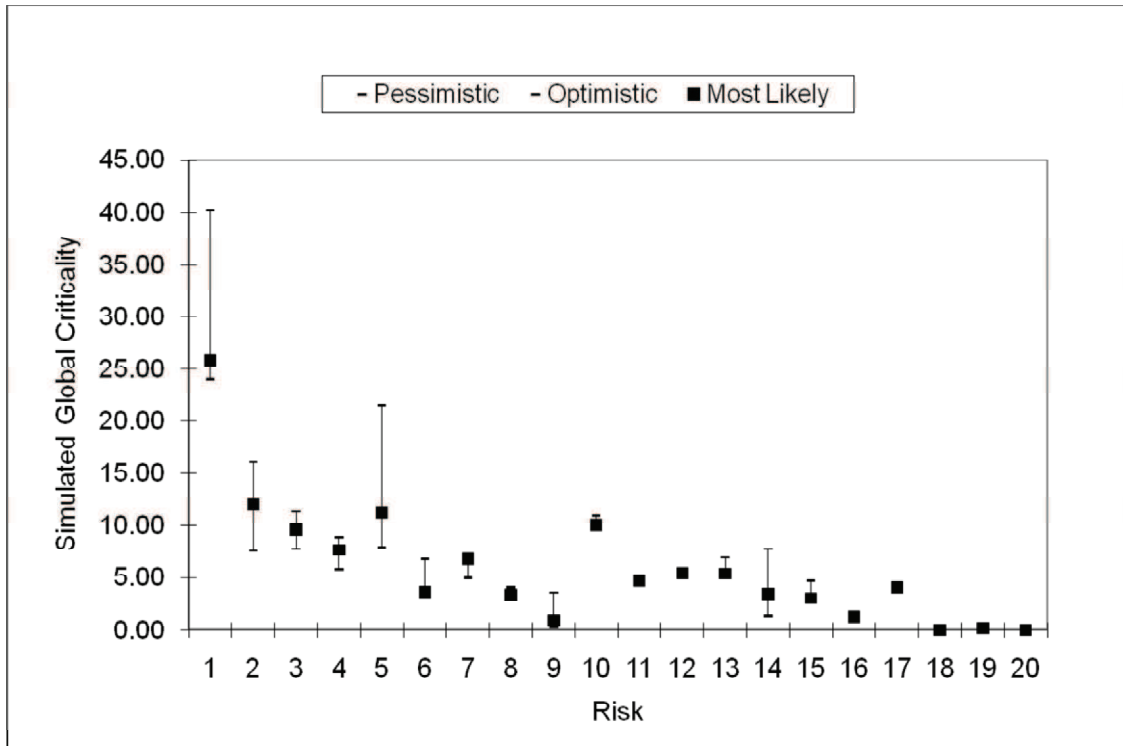

Figure 18. Sensitivity analysis results of project risks

3.3.3 Mitigation actions planning and test

The simulation model allows the project manager to test the actions, which are proposed based on the risk network analysis, before the implementation. Thus, the project manager can get the anticipation of their impacts on the network. The presented examples of actions are to achieve two different goals: the local mitigation of particular risks, and the global risk exposure mitigation of the risk network. This is a prototype which does not take into account all the desired information about the action, e.g., its cost and the difficulty or feasibility of its implementation.

3.3.3.1 Local mitigation

In the simulation results of the case study shown in Table 5, we find that some risks had a significant increase in terms of frequency and ranking, such as R10 (Low team communication) and R17 (Low cast motivation). For mitigating their occurrence, there are different possible strategies, which are displayed in Table 7.

In the first place, if we only apply classical actions by reducing their spontaneous probability to 0% (we suppose that the spontaneous probability can be reduced to 0% for the test in the prototype simulation model), R10 and R17 still have high simulated frequencies at the value of 0.516 and 0.468 respectively. In fact, the increase of simulated frequency is due to

their input links from other risks. This explains why we design and test the non-classical actions on the risk interactions.

By cutting several of their input links (links from R03, R04 and R07 to R10, and links from R03, R10 and R13 to R17), the frequency of these “absorber” risks has decreased a lot, as shown in Table 7. For instance, acting on the transition between R13 (Low complicity between cast members) and R17 (Low cast motivation) may involve finding other motivation drivers which make the cast less sensitive to team complicity. This new action on the link is different from reducing the occurrence of R13, for example, by proposing team-building activities.

Table 7. Effects of different mitigation actions on particular risks

Risk ID	Simulated Risk Frequency	Simulated Frequency after Taking Action	
		Classical Mitigation	New Mitigation
		Actions on Risks	Actions on Risk Interactions
R10	0.529	0.516	0.194
R17	0.469	0.468	0.205

3.3.3.2 Global mitigation

With regard to the global risk network, R03 (Low communication and advertising for the show) has the highest evaluated criticality using the classical method. In the simulation analysis, R01 (Low budget) becomes the top risk in terms of global criticality. Some mitigation actions are devised and tested in the risk network model. Figure 19 compares their effects on the global risk network, i.e., the residual simulated frequency of all the risks after the action is conducted. Action 1 mitigates R03 according to the classical analysis; action 2 mitigates R01 based on the new prioritization by the simulation model; in the third action, a new action is executed by cutting the link from R05 (Unsuitable ticket price-setting) to R01 (Low budget), together with the classical action 2 on R01. Concretely, this could be done by increasing the part of the budget which comes from sponsorship and external investors, independently of the sales income. The financial risk is then shared with different stakeholders. Even if the incomes from ticket presales are lower, this approach still ensures the normal operation of the project, while not to get the project stalled or to induce other risks for lack of funds. In this prototype model for mitigation actions test, we make the assumption that the risk interaction can be completely cut off, i.e., the transition probability can be reduced to the value at 0%.

The results in Figure 19 demonstrate the effectiveness of applying the risk network model to support mitigation actions planning.

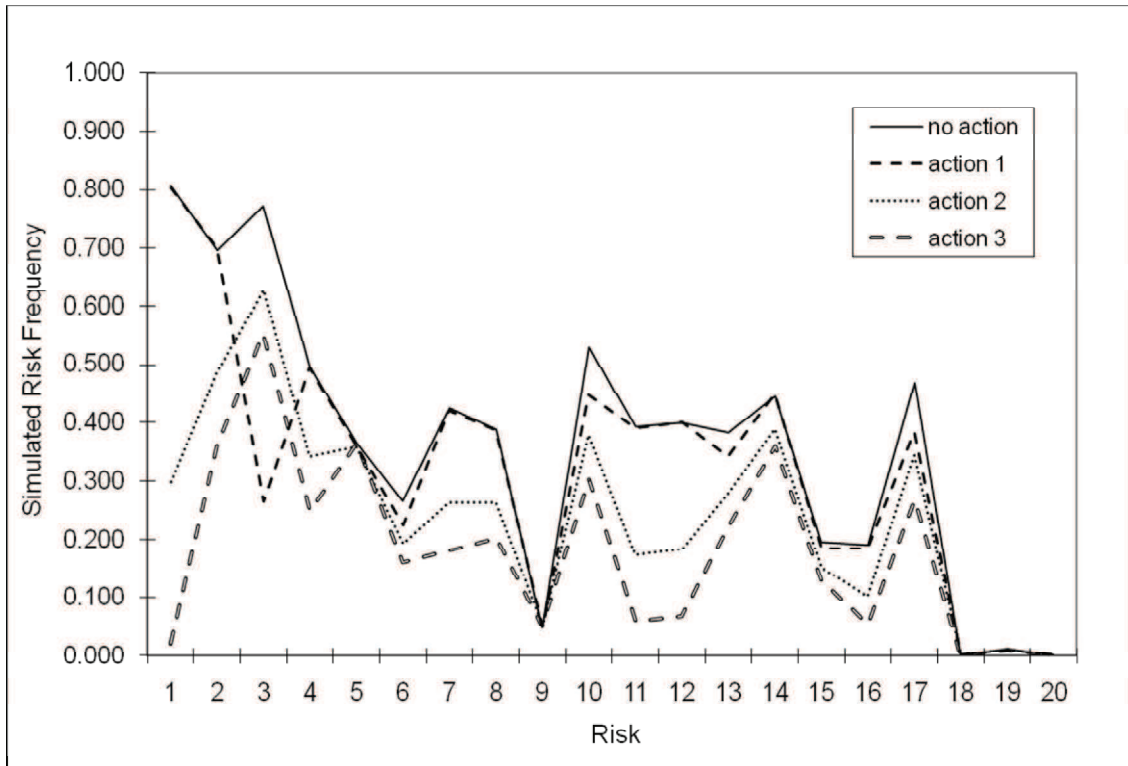

Figure 19. Comparison of effects on the global risk network by applying different mitigation actions

3.4 Conclusion

This chapter has presented an interactions-based risk network model using advanced simulation. The aim is to answer the research questions Q1.2 and Q1.3 concerning risk analysis, and also Q2.1 and Q2.2 for risk mitigation based on a preliminary case study. The model addresses the limitations of current methods regarding modeling complexity in project risk management. The performance of the model and the satisfaction of the users are validated by the project manager and the associated experts with whom we cooperated for the application to a real musical show project. The decision support system enables the project manager to save time for designing risk response plan, and to reduce the cost of dealing with contingencies. Proactive risk management can be achieved by monitoring the status of the risk network and adjusting the risk mitigation plan as the project progresses.

Through modeling the propagation behavior in the project risk network, the model enables the project manager to gain innovative insights into the risks, into the relationships between them, and into the global risk network behavior. The refined risk analysis and prioritization results support the project manager in making decisions, for instance, planning more effective mitigation actions. The model is also useful for testing and evaluating the proposed action plans. In addition to the examples of actions tested in Section 3.3.3, a complete list of mitigation

actions can be proposed to the project manager based on the risk network model. The project manager is able to choose a portfolio of actions to manage the project risks.

The selected case study analyzes a number of typical risks in a project of staging a musical show. Moreover, the approach manipulates values of risks and risk interactions, independently of their nature, their number and the type of project. In the risk management of any kind of project, generally risks are all assessed in terms of probability and impact, which are here included in the simulation model. This is why the approach can be generalized and applied to a much wider set of projects. Since the model uses matrix-based and simulation-based methods, the approach is possible to be applied in some very complex situations.

The effectiveness of the model also depends on the validity of the input estimations. At the end of Section 3.3.2, we performed a preliminary sensitivity analysis on the three-level estimations of risk spontaneous probability. The sensitivity analysis results demonstrate the influence of input uncertainties of the risk network assessment on the subsequent risk analysis results. In addition, there exist potential changes in the project and uncertainties in the external environment as the project advances. Therefore, considering the reliability of the analysis results and the uncertainties in the later phases of the project, the risk network should be monitored after the implementation of actions, and the response plans will be modified and improved. With regard to the example used in this chapter, the study took place at the end of the project in order to verify the usefulness of the developed prototype of the risk network model. The application of the monitoring phase will be included in future real-time case studies.

Furthermore, in practice, more parameters like cost of actions should be included so that the mitigation plan can be optimized under resource constraints. The work concerning this issue will be discussed in Chapter 6.

Chapter 4 - Topological Network Theory-Based Project Risk Analysis

Abstract

Complex engineering projects are exposed to interdependent risks of various natures. In this chapter, we present an analysis, based on network theory, for identifying key factors in the structure of interrelated risks potentially affecting a project. This original approach serves as a powerful complement to classical project risk analysis. The outcomes of the analysis provide a support for decision-making regarding project risk management.

The risk network structure is built using the methods described in Chapter 2. Some network theory-based indicators are tailored to project risk network. Their implications on project risk management are discussed. Eigenstructure analysis is performed based on the Risk Structure Matrix (RSM) with the goal of measuring the importance of risks in the network. This measurement reflects the influence of a risk taking into account both its direct and indirect connections with the other nodes in the network.

An example of application to a real complex engineering project, a tramway implementation project, is presented. The results of topological analysis provide more and new insights on risks and risk interactions in the network, which is beyond the capability of classical project risk analysis methods. A combination of several feasible actions is tested to show the usefulness of the proposed analysis.

Chapter Keywords

Network theory, topological analysis, organization interface, betweenness centrality, eigenvector centrality, decision support

4.1 Introduction

Network theory is in the area of mathematics and computer science, and has been built upon graph theory (Belevitch 1968; West 2001; Bondy and Murty 1976; Wilson and Wilson 1996). Because of its inherent simplicity, graph theory has a very wide range of applications in engineering, in physical, social and biological sciences, in linguistics, and in numerous other areas (Deo 2004). A graph can be used to represent almost any network structure involving discrete objects and the relationships among them.

As introduced in (Kröger and Zio 2011), topological analysis based on classical graph theory can unveil relevant properties of the structure of a network system (Albert et al. 2000; Strogatz 2001). It can be used to (1) highlight the role played by its components, nodes and connecting arcs (Crucitti et al. 2006; Zio and Sansavini 2008); (2) make preliminary vulnerability assessments based on the simulation of faults (mainly represented by the removal of nodes and arcs) and the subsequent re-evaluation of the network topological properties (Rosato et al. 2007; Zio et al. 2008). In the last decades, a number of studies have focused on the modeling of complex systems such as critical infrastructures from the standpoint of network theory. They aim at understanding how the network underlying the system influences its behavior, and eventually its characteristics of stability and robustness to faults and attacks (Zio 2007). Topological network analysis has been exploited to serve as a screening tool to identify key components in different types of infrastructure networks, like for instance power transmission systems (Eusgeld et al. 2009) and railway networks (Sen et al. 2003).

In our study, topological analysis derived from network theory is used to analyze the structural properties of the project risk network. The aim of this chapter is to identify important risks and risk interactions with respect to their roles in the network. This provides information which can complement the classical analysis based on the assessment of risk probability and impact. The originality is to apply network theory-based topological analysis and eigenstructure analysis in the context of project risk management, and particularly to tailor some network theory indicators. The application to a real complex engineering project enables us to validate the usefulness and practicality of the approach proposed.

4.2 Definition of topological indicators for project risk analysis

For the topological analysis of a project risk network, we represent the risk network by a graph $G(N, K)$, in which the identified risks are mapped into N nodes (or vertices) connected by K unweighted edges (or arcs). The risk network is a directed network: each edge from R_i to R_j represents the fact that there is a directed potential cause-effect link between them. In the jargon of graph theory, the RSM is the adjacency matrix of the risk network (West 2001).

Such representation enables us to study the structural properties of the risk network, by means of some topological indicators tailored to the problem at hand. These indicators can help

identifying key factors (important risks or risk interactions) and improve the project manager's understanding of the vulnerabilities in the network. In the next paragraphs, we will give the definition of some indicators and discuss their implications on project risk management.

4.2.1 Connectivity indicators

The numbers of nodes and risk natures/domains describe the size and diversity of the risk network. The density of the graph can be measured by Equation (8). Usually some pairs of nodes are disconnected and thus the risk network is not a fully connected graph. There may also be unconnected nodes representing isolated risks, i.e., risks having no correlation or negligible correlation with other risks in the network.

$$Den(G) = K / N(N-1) = \sum_{i,j \in G} RSM_{ij} / N(N-1) \quad (8)$$

The degree of nodes provides an indication of the local connectivity characteristic of a risk. The number of outgoing edges is the activity degree of a risk (Equation (9)) and the incident edges give the passivity degree (Equation (10)) of it (Kreimeyer 2010). These two metrics convey the relationship of a risk with its immediate neighbor risks:

$$Deg_i^A = \sum_{j \in G} RSM_{ji} \quad (9)$$

$$Deg_i^P = \sum_{j \in G} RSM_{ij} \quad (10)$$

There might be several different paths linking one risk (node) to another, via one or multiple steps (edges). Let d_{ij} indicate the length of the shortest path from R_j to R_i . The upper value of d_{ij} is called the diameter of the network (Albert and Barabási 2002). It can be thought of as the maximum number of steps necessary to spread the impact of a randomly chosen risk to another randomly chosen risk in the network.

In order to get further insights on the global connectivity property of the risks, we study the reachability degree of nodes. We introduce the concept of Risk Reachability Matrix (RRM), with $RRM_{ij} = 1$ if there exists at least one path from R_j to R_i .

Both the shortest path between each pair of risks and the RRM can be obtained using the Floyd's sequential shortest path iterative algorithm (Floyd 1962; Pallottino 1984). The reachability density defined in Equation (11) is a measure of the complexity of the risk network based on risk reachability:

$$Rea(G) = \sum_{i,j \in G} RRM_{ij} / N(N-1) \quad (11)$$

The number of reachable nodes (Equation (12)) indicates the number of other risks that a given risk can impact directly and indirectly. The number of possible sources (Equation (13)) accounts for the fact that the occurrence of a designated risk can possibly originate from many other risks in the network.

$$N_i^R = \sum_{j \in G} RRM_{ji} \quad (12)$$

$$N_i^S = \sum_{j \in G} RRM_{ij} \quad (13)$$

These indicators of reachability degree help us to understand the global consequences and sources of a risk, and enable us to classify the risks into different categories.

4.2.2 Interface indicators

In project management, risks are usually categorized into different domains such as technical, financial and managerial classes. Further, from the point of view of organization, different risk owners are usually assigned in charge of one or several risks. The number of interfaces between domains/owners is defined as the number of edges between each pair of them. In the local sense, the indicators $I_{D_{uv}}^L$ and $I_{O_{uv}}^L$ defined in Equations (14) and (15) below denote the number of local direct interfaces from D_v to D_u and from O_v to O_u respectively, where D_u and O_v stand for domain u and risk owner v :

$$I_{D_{uv}}^L = \sum_{R_i \in D_u, R_j \in D_v} RSM_{ij} \quad (14)$$

$$I_{O_{uv}}^L = \sum_{R_i \in O_u, R_j \in O_v} RSM_{ij} \quad (15)$$

On the other hand, the indicators $I_{D_{uv}}^G$ and $I_{O_{uv}}^G$ defined in Equations (16) and (17) indicate the number of global reachable interfaces from D_v to D_u and from O_v to O_u respectively:

$$I_{D_{uv}}^G = \sum_{R_i \in D_u, R_j \in D_v} RRM_{ij} \quad (16)$$

$$I_{O_{uv}}^G = \sum_{R_i \in O_u, R_j \in O_v} RRM_{ij} \quad (17)$$

The interface indicators help project managers identify the interconnections between different domains and enhance the intercommunication between correlated counterparts. It notably enables the grouping of risk owners in order to improve coordinated decision-making.

4.2.3 Betweenness centrality

For the purpose of anticipating the potential risk propagation and related needs for protection, another indicator is introduced. In general network theory, the betweenness centrality (Freeman 1977; Guimera and Amaral 2004) is based on the idea that a node or an edge in a network is central if it lies between many other nodes. In a risk network, if a risk node or a risk interaction edge lies in at least one of the paths connecting a pair of other nodes, we count that node or edge as lying between them. The betweenness centrality of R_k and the

betweenness centrality of the edge from R_p to R_q can then be calculated by the following equations:

$$B_k = \sum_{i,j \in G, i \neq j \neq k} RRM_{ki} \text{ AND } RRM_{jk} \quad (18)$$

$$B_{p \rightarrow q} = \sum_{i,j \in G, i \neq j \neq p \neq q} RRM_{pi} \text{ AND } RRM_{jq} \quad (19)$$

In practice, project risk networks are often quite sparse, with $K \ll N(N-1)/2$, hence we do not normalize the betweenness centralities by dividing by their possible upper values, i.e., $(N-1)(N-2)$ for nodes and $(N-2)(N-3)$ for edges. In this way, the betweenness centralities of nodes or edges denote the number of pairs of risks they lie between.

Knowledge of these centralities assists in identifying hubs in the network which play the role of key passages for risk propagation: the project manager should consider how to avoid propagation through these passages by controlling the risks and/or blocking their interactions.

4.3 Eigenstructure analysis of risk network

In mathematics, eigenvalues and eigenvectors are related concepts in the field of linear algebra, which describe characteristics of a matrix. Analyzing these eigenstructure properties gives important information about the adjacency matrix and its related network. The mathematical expression of eigenstructure decomposition is as follows: if M is a square matrix, a non-zero vector v is an eigenvector of M if and only if there is a scalar λ such that

$$Mv = \lambda v \quad (20)$$

The scalar λ is said to be the eigenvalue of M corresponding to v .

In our study, we perform eigenstructure analysis on the RSM with the intention of exploring importance measurement of project risks within the network context.

Let x_i denote the score of the i -th node, i.e., the measure of the importance of Risk i . We use the square matrix A to denote the adjacency matrix of the risk network. Hence, $A = (a_{ij}) = RSM(i, j)$ and

$$\begin{cases} a_{ij} = 1 & \text{if there is an edge joining node } j \text{ to } i \\ a_{ij} = 0 & \text{otherwise} \end{cases} \quad (21)$$

For the the i -th node, let its score be proportional to the sum of the scores of all the nodes which are directly connected to it. Here we take into account both the input and output links, i.e., both the immediate predecessor and successor risks of Risk i in the network. Thus, we get the following equation:

$$x_i = \frac{1}{\lambda} \sum_{j \in P(i)} x_j + \frac{1}{\lambda} \sum_{j \in S(i)} x_j = \frac{1}{\lambda} \sum_{j=1}^N (a_{ij} + a_{ji}) x_j \quad (22)$$

where $P(i)$ is the set of nodes that are direct predecessors of the i -th node and $S(i)$ is the set of nodes that are direct successors of the i -th node. In this way, the importance of R_i is equal to the average importance of all its neighbor risks. Then we can reformulate the Equation (22) as:

$$x = \frac{1}{\lambda}(A + A^T)x \quad (23)$$

where A^T is the transpose matrix of A , and then as the eigenvalue equation:

$$(A + A^T)x = \lambda x \quad (24)$$

In general, there will be many different eigenvalues λ for which an eigenvector solution exists. However, in linear algebra, the Perron–Frobenius theorem, proved by Oskar Perron (Perron 1907) and Georg Frobenius (Frobenius et al. 1912), asserts that a real square matrix with positive entries has a unique largest real eigenvalue and that the corresponding eigenvector has strictly positive components, and also asserts a similar statement for certain classes of nonnegative matrices. Usually, the Perron-Frobenius theorem applies to our case of risk network and the matrix $A+A^T$.

Bonacich in (Bonacich 1972) suggested that the eigenvector of the largest eigenvalue of an adjacency matrix could make a good network centrality measure. Unlike degree indicators, which weight every contact equally, the eigenvector weights contacts according to their centralities (Bonacich 2007).

We define the i -th element x_i of the eigenvector corresponding to the largest eigenvalue λ^* as the eigenvector centrality of R_i in the risk network. Eigenvector centrality is a measure of the importance of a node in the risk network. It assigns relative centrality scores to all nodes in the network based on the principles: (1) connections to more nodes contribute more to the score of the node; (2) connections to high-scoring, namely important nodes, contribute more to the score of the node.

In this sense, eigenvector centrality calculates not only direct connections but also indirect long-term propagations. Thus the complete risk network is taken into account. Mathematically, eigenvector centrality is closely related to the influence measures, such as those proposed in (Hadi 1992; Katz 1953; Taylor 1969; Friedkin 1991). The idea is that even if a node influences directly only one other node, which subsequently influences many other nodes (who themselves influence still more others), then the first node in that chain is highly influential (Borgatti 2005). For calculating the risk eigenvector centrality, besides the output links of a risk which contribute to its impact measure in the network, we also incorporate its input links for measuring its importance in terms of probability. That is why the matrix $A+A^T$ is used for the proposed eigenstructure analysis.

4.4 Case study

In this study, we implement the proposed approach to a real large project, aimed at building the infrastructure and associated systems of a tramway. This project takes place in a city in Europe with a population of 750 000. Both classical project risk analysis and the proposed network theory-based analysis on the topological structure are carried out.

The project includes the construction and implementation of tramway, equipments, and civil work, with 10 years duration and hundreds of millions € budget. The leading company is a designer and manufacturer of trains, which recently extended its scope by proposing “turn key” projects, including not only the trains, but also the complete infrastructure around the trains. The project thus comprises:

- The construction of a depot to stock trains and to execute their control and maintenance;
- The installation of tracks throughout the city, over land with many steep slopes;
- The delivery of the corresponding trains, including redesign activities if the current version does not fit with the city’s specific requirements;
- The establishment of a traffic signaling operating system, which gives priority to the tramway so as to guarantee travel time performance levels.

4.4.1 Building the structure of project risk network

The first step is to build the structure of project risk network. An original project risk list has been provided by the project manager and its expert team, which contains 42 project risks. The risk list has been updated when performing the risk interaction identification. Some new risks have been added into the list, for two reasons: some were a consequence or cause of other risks already present in the initial list; others were seen as intermediary risks which were useful to explain the link between two or more risks of the initial list. Thus, the resulting project risk list contains 56 identified risks at the main level, with their name, domain and risk owner information, as shown in Table 8.

Table 8. Project risk list with classical risk characteristics of the tramway project

Risk ID	Risk Name	Risk Domain	Risk Owner	Qualitative Risk Probability	Qualitative Risk Impact	Criticality
1	Safety studies	Technical	1	1	1	1
2	Liquidated damages on intermediate milestone and delay of Progress Payment Threshold	Contractual	2	7	8	56
3	Vehicle storage in another city	Contractual	1	9	5	45
4	Vandalism on site	Contractual	3	1	3	3
5	Traction/braking function : behaviour in degraded mode on slope	Technical	1	3	2	6
6	New local laws and regulations	Contractual	1	1	3	3
7	Traffic signalling, priority at intersections	Contractual	4	6	5	30
8	Unclear Interface with the Client, for Infrastructure equipment	Contractual	5	1	2	2
9	Delays due to client late decisions	Contractual	5	9	1	9
10	Travel Time performance	Technical	4	1	3	3
11	Limited Force majeure definition	Contractual	2	1	4	4
12	Operating certificate delay	Contractual	2	9	4	36
13	Reliability & availability targets	Technical	4	3	3	9
14	Permits & authorisations	Contractual	2	9	2	18
15	Insurance deductibles	Financial	6	1	3	3
16	Archeological findings	Contractual	2	9	3	27
17	Discrepancies Client / Operator / Concessionaire	Contractual	7	3	5	15
18	Civil Work delay & continuity	Contractual	8	9	4	36
19	Responsibility of client on Civil Work delay	Contractual	2	9	2	18
20	On board CCTV scope	Technical	9	5	1	5
21	Noise & vibration attenuation	Technical	4	3	6	18
22	Potential risks of claim from Civil Work subcontractor	Contractual	2	5	5	25
23	Harmonics level	Technical	5	1	2	2
24	Non compliance contractual Rolling Stock	Technical	1	1	6	6
25	Non compliance technical specifications Rolling Stock	Contractual	1	3	4	12
26	Exchange risk on suppliers	Financial	6	1	3	3
27	Track installation machine performance	Client/Partner/Subcontractor	10	3	2	6
28	Tax risk on onshore	Financial	6	1	2	2
29	Additional poles overcost for Tramway Company	Contractual	5	9	4	36
30	Overcost due to Security requirements for trains	Technical	4	5	4	20
31	Track insulation	Technical	9	1	1	1
32	Delay for energising	Project management, Construction site	5	3	2	6
33	Fare collection requirements	Contractual	7	5	3	15
34	Construction safety interfaces	Technical	3	1	1	1
35	Electromagnetic interferences	Technical	4	1	2	2
36	Exchange risk	Financial	6	1	2	2
37	Risk of partial rejection of our request for EOT (Extension Of Time)	Contractual	2	9	7	63
38	Interface rail / wheel	Technical	4	3	2	6
39	Risk on Certification of our equipment	Country	11	1	2	2
40	OCS installation	Project management, Construction site	3	7	5	35
41	Banks stop financing the project	Contractual	2	7	3	21
42	Costs of modifications not covered by EOT agreement	Contractual	2	1	4	4
43	Return profit decrease	Financial	2	9	8	72
44	Extra trains	Contractual	4	1	6	6
45	Pedestrian zones	Technical	4	1	2	2
46	Train performance	Technical	1	3	2	6
47	Waiting time at stations	Contractual	4	5	1	5
48	Depot delay	Technical	3	9	2	18
49	Error in the Survey (topography)	Technical	4	1	1	1
50	Ticketing design delays	Contractual	7	7	1	7
51	Track installation delay	Technical	3	7	2	14
52	Reengineering / Redesign	Technical	4	9	2	18
53	Slabs pouring delay	Technical	3	5	1	5
54	Initial specifications of CW (Civil Work)	Technical	3	5	1	5
55	Available cash flow decrease	Financial	2	9	7	63
56	Rolling stock delivery delay	Technical	1	3	1	3

Identification of the risk interactions defines the structure of the project risk network. Using the methods described in Section 2.1 in Chapter 2, we get the risk network structure (shown in Figure 21) and the corresponding risk structure matrix (RSM, shown in Figure 20) of this case study. Each marked cell in the matrix indicates that there is a related link in the network structure.

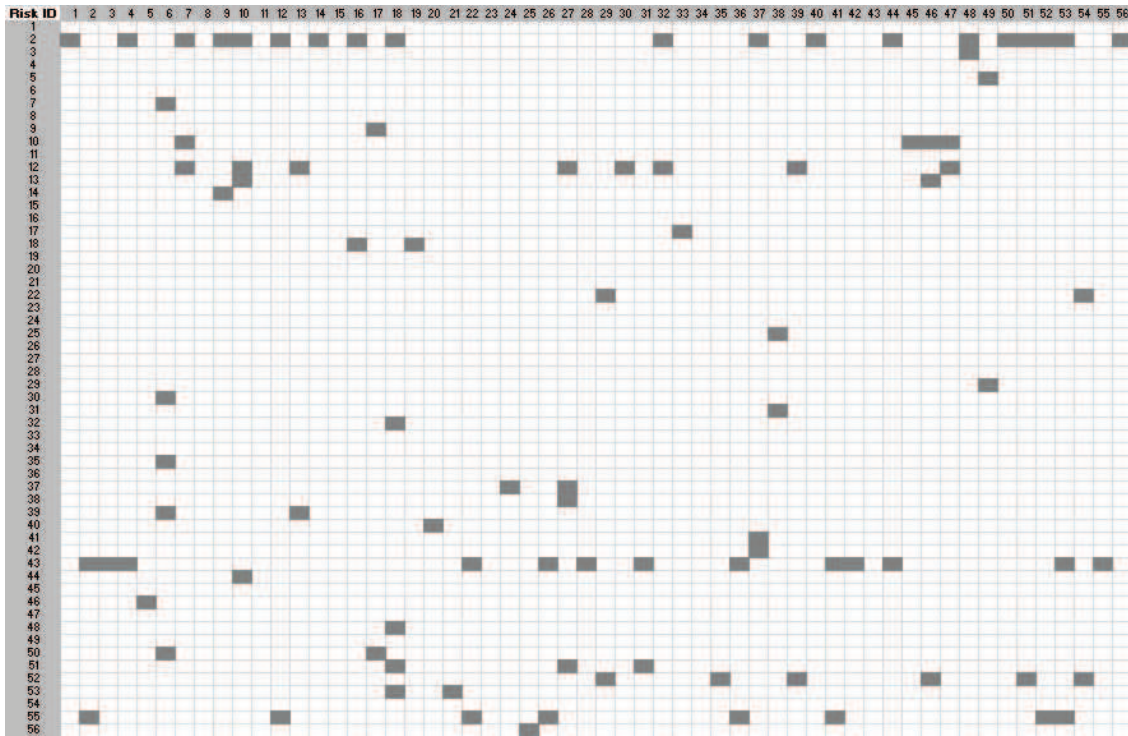

Figure 20. RSM of the tramway project

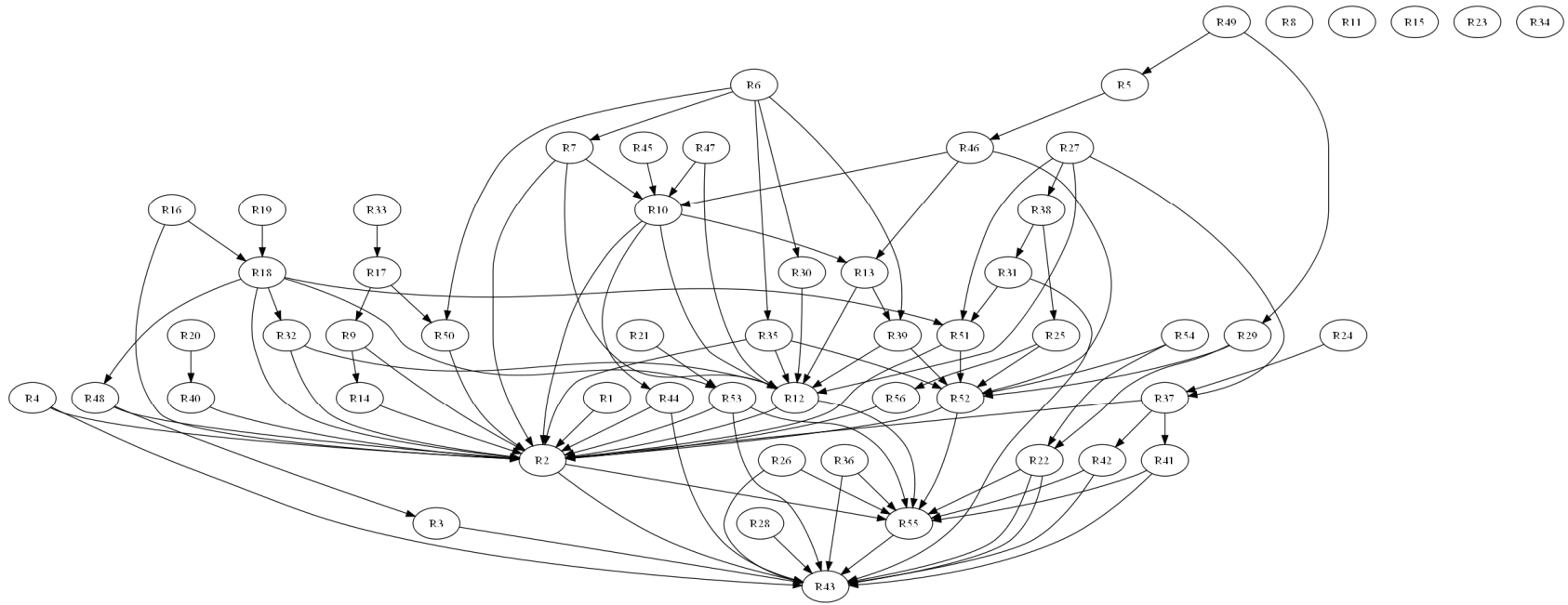

Figure 21. Project risk network structure of the tramway project

4.4.2 Classical project risk analysis

As we can see in the classical project risk list (Table 8), these potential negative risks are classified according to six domains (22 risks of D1-Technical, 24 risks of D2-Contractual, 6 risks of D3-Financial, 1 risk of D4-Client/Partner/Subcontractor, 2 risks of D5-Project management on construction site, 1 risk of D6-Country). Risk ownership in terms of responsibility is assigned to 11 actors in the project management team. Basic characteristics of risks have been assessed by the project manager and associated experts, as shown in Table 8, including qualitative probability (or likelihood) and impact (or severity) scales, as well as criticality (aggregation of probability and impact).

In classical project risk analysis, risks are considered most important if of both high probability and impact. Criticality is an aggregate characteristic used to prioritize risks (often the product of probability and impact, even if this has some issues (Marle 2008)). The results of this type of analysis are used by the project manager for risk response planning. Resources are firstly allocated to manage the risks prioritized with high criticality.

In Figure 22, the classical project risk analysis results are displayed in a risk impact vs. probability diagram, where each risk identified in Table 8 is represented by a dot. The limits between different criticality classes should be defined a priori, before the risk assessment. For example, risks can be categorized into several levels of criticality, such as critical, high, moderate and low risks. In Figure 22, we only highlight the top ten risks (display their IDs) according to their criticality value. The project is based on a contract including many contractual terms involving financial penalties in case of failure, whether on time or quality aspects. Almost every problem is then potentially transformed directly or indirectly into an additional cost and then a profit loss. It is thus not surprising to see that R2 (Liquidated damages on intermediate milestone and delay of progress payment threshold), R37 (Rejection of Extension Of Time), R43 (Return profit decrease) and R55 (Available cash flow decrease) are among the most critical risks. Other risks with high criticality are generally related to the final delivery, like R12 (Operating certificate), or some big parts of the project, like R18 (Civil Work delay) and R40 (Operating Center installation).

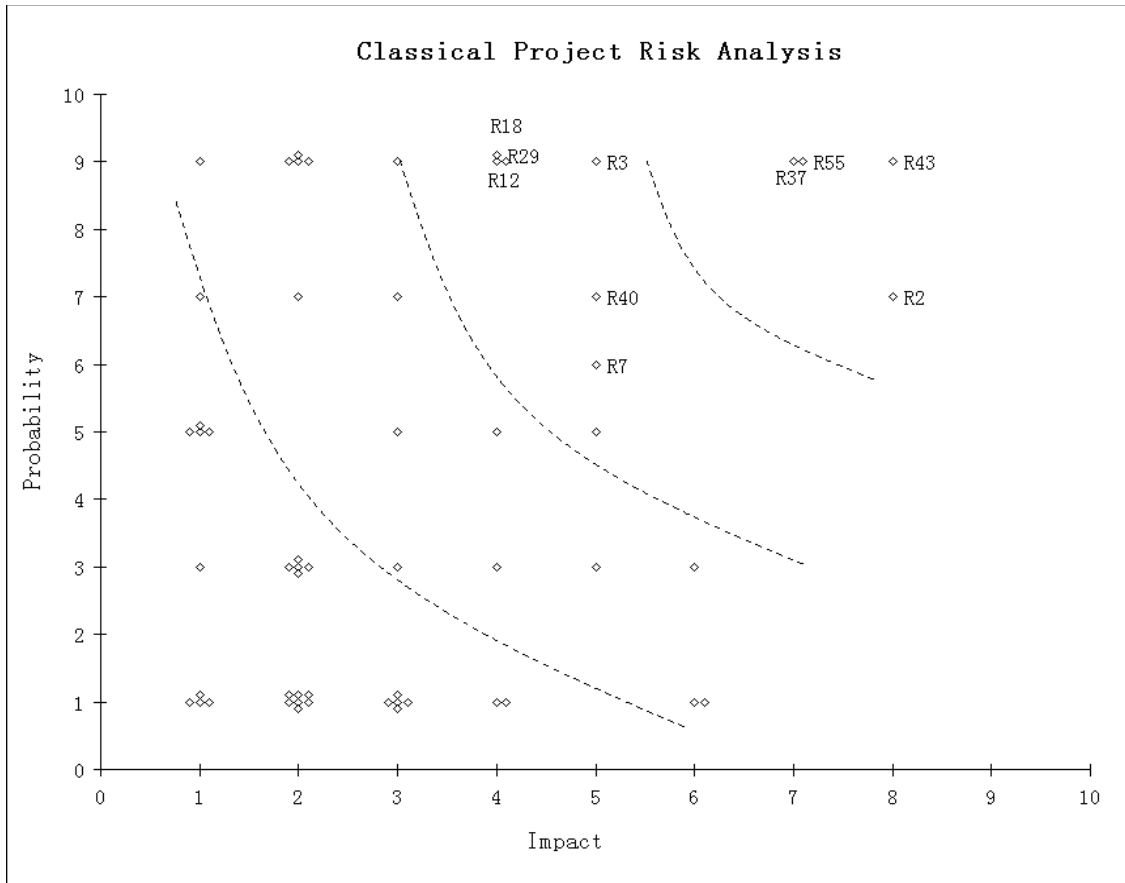

Figure 22. Display of classical project risk analysis results

4.4.3 Topological network analysis

Once we have built the project risk network structure, the topological network analysis can be done by computing and analyzing the indicators defined in Section 4.2.

The project risk network (Figure 21) is comprised of 56 nodes (risks) and 95 edges (risk interactions), with only 5 unconnected nodes (R8, R11, R15, R23 and R34). The graph density is equal to 0.0308, showing that the network is relatively sparse. The diameter of the risk network is equal to 4. This means that the hierarchy structure of the network is relatively flat. In other words, a risk can reach and impact another risk, for example, from an initial technical problem to a financial performance risk, through a shortest path of less than 4 steps.

In Figure 23, we display the activity degree and passivity degree of risks in a matrix diagram. As we can see, a risk can directly impact at most 5 other risks; the passivity degree varies from 0 to 19, while only several risks have a large number of direct predecessors. For example, R2 (Liquidated damages on intermediate milestone and delay of progress payment threshold) has 19 immediate predecessor risks. Most risks have 1 or 2 immediate inputs and outputs, implying that the local connectivity of this network is not significant.

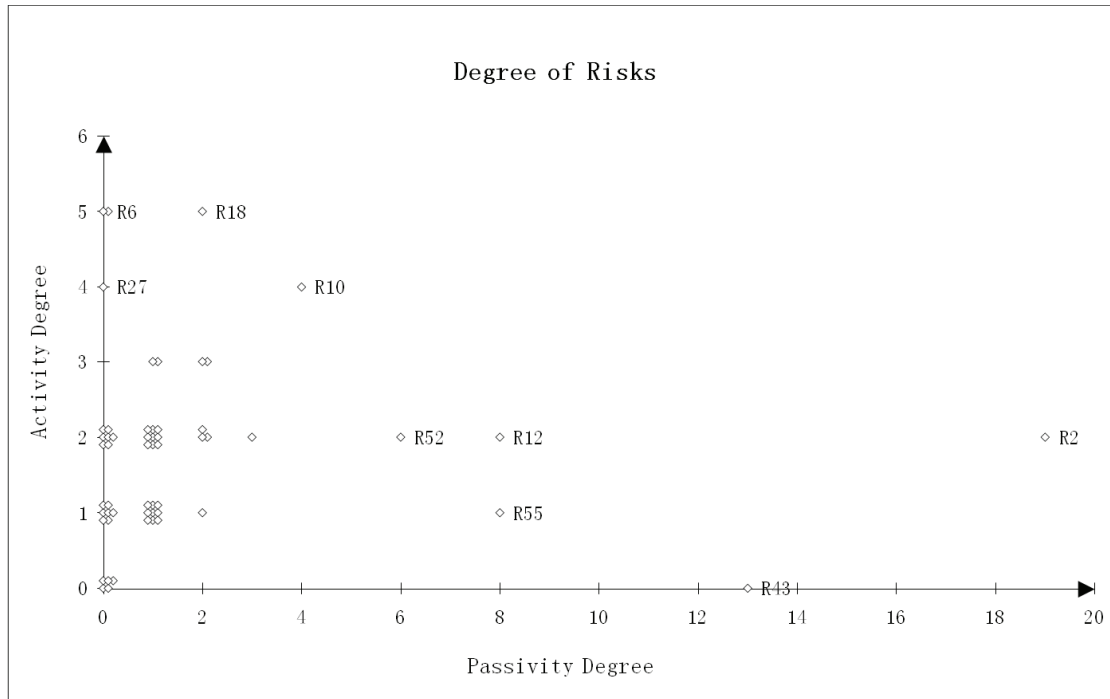

Figure 23. Diagram of degree of risks

Similarly, the reachability degree of risks, namely the number of reachable nodes and the number of possible sources are displayed in Figure 24. This gives a global view of the connectivity property of risks.

The reachability density of the network is equal to 0.0854. This shows that the risk network is more complex in the global view of reachability, compared with the low graph density of 0.0308 of the local scale. Some risks with few predecessors while leading to many others are likely to be source risks, such as R6 (New local laws and regulations), R49 (Error in the topography survey), R27 (Track installation machine performance), R16 (Archeological findings), and R19 (Responsibility of client on civil work delay). Some risks with few successors while stemming from many possible sources are regarded as accumulation risks, often related to project results like financial performance, e.g., R43 (Return profit decrease) and R55 (Available cash flow decrease). Risks in the middle area away from axes in Figure 24 act as transition risks. Some of the transition risks having more inputs and fewer outputs are closer to the accumulation risks, such as R2 (Liquidated damages on intermediate milestone and delay of progress payment threshold), R12 (Operating certificate delay) and R52 (Reengineering / Redesign); some of them are closely related to the source risks, for example, R5 (Traction/braking function: behavior in degraded mode on slope) and R18 (Civil work delay & continuity); other risks like R10 (Travel time performance), R13 (Reliability & availability targets) and R39 (Risk on certification of equipment) have approximately equal number of possible sources and reachable nodes. The roles of these risks in the network are marked with different shapes in the risk network structure shown in Figure 27. This classification of risks

depending of their respective number of inputs and outputs assist the project manager to decide how to treat them or not, independently of their individual assessment.

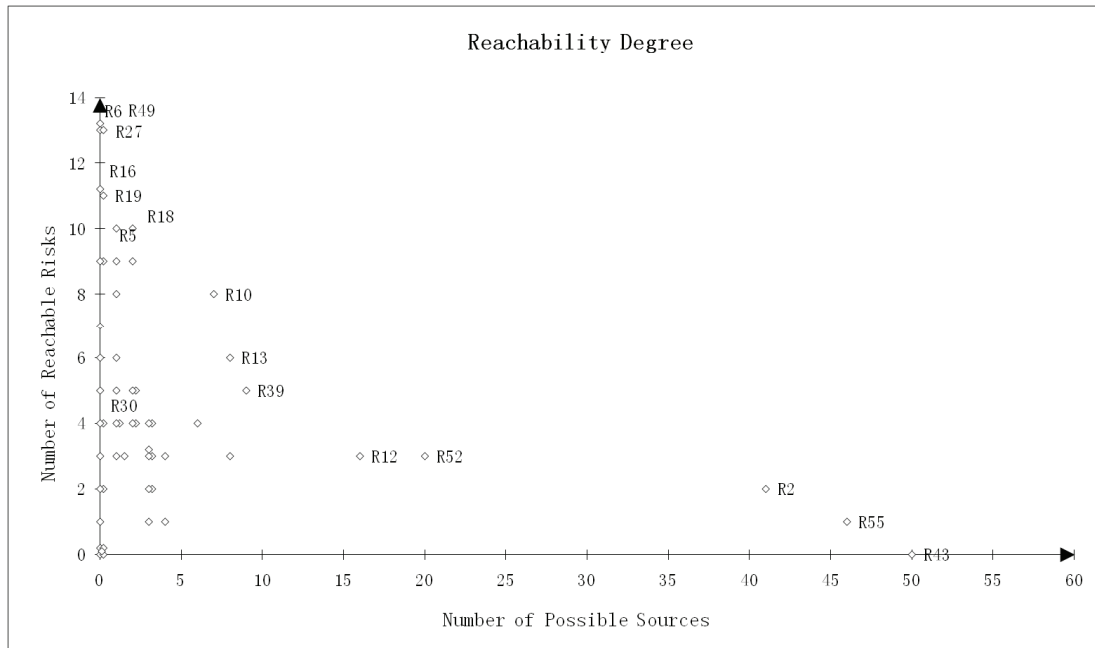

Figure 24. Diagram of reachability degree of risks

Figure 25 and Figure 26 show the number of interfaces between risk domains and owners respectively, from both local and global points of view. Since most risks are belonging to D1-Technical, D2-Contractual and D3-Financial, a large amount of interactions are related to them. In Figure 25, we can see that a large proportion of direct connections are inside a domain. However, many interfaces between different domains have emerged in the global vision. For instance, D1-Technical risks will indirectly cause more contractual and financial risks in D2 and D3; risks from D4-Client/Partner/Subcontractor, D5-Project management on construction site and D6-Country have no direct influence on financial risks but will reach them after propagation of several steps.

Local	D1	D2	D3	D4	D5	D6	Global	D1	D2	D3	D4	D5	D6
D1	13	9	0	2	0	1	D1	28	25	0	5	0	1
D2	16	23	0	2	3	1	D2	40	44	0	6	3	2
D3	4	11	6	0	0	0	D3	40	42	6	2	4	2
D4	0	0	0	0	0	0	D4	0	0	0	0	0	0
D5	1	1	0	0	0	0	D5	1	3	0	0	0	0
D6	1	1	0	0	0	0	D6	6	3	0	0	0	0

Figure 25. Interfaces between risk domains with local and global viewpoints

Similarly, many indirect interfaces between risk owners have appeared. On the left part of Figure 26, we find that the risk owner O2 receives direct impacts from each of the other owners. In the global perspective, shown on the right part of Figure 26, he/she should be more aware of the noticeably increased potential influences from several counterparts like O1 and O4. Moreover, some risk owners cannot identify the direct impact from other actors, but they should foresee and be prepared for the propagated consequences. For instance, the number of interfaces indicated in the cell O2 to O3 has increased from 0 to 6.

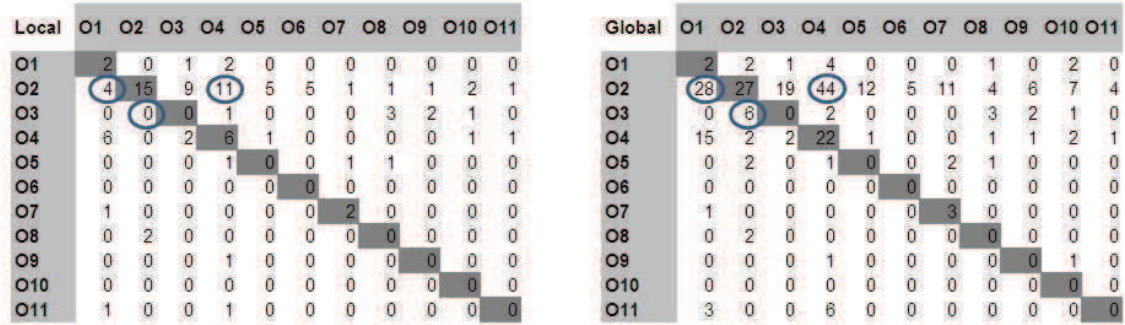

Figure 26. Interfaces between risk owners with local and global viewpoints

Table 9 displays the top five nodes and top five edges with the highest betweenness centrality. They are also highlighted in Figure 27, respectively with grey-filled nodes and bold edges. Risks with the highest betweenness centrality such as R2 (Liquidated damages on intermediate milestone and delay of progress payment threshold) and R52 (Reengineering / Redesign) act as hubs of connecting many pairs of risks. We can see that the most important edges are related to these top risks. R10 and R13 are the sources of many events and should be treated with caution, mainly with preventive actions or with confinement actions (edges from R10 or from R13, especially the R10->R13 edge). Confinement actions are quite new in the project management field, where the actions are focused on nodes only.

Table 9. The top risks and interactions according to the betweenness centrality

Rank	Risk ID	Betweenness centrality	Edge ID	Betweenness centrality
1	R2	82	R10->R13	42
2	R52	60	R2->R55	41
3	R10	56	R13->R39	40
4	R12	48	R52->2	40
5	R13	48	R12->R2	32

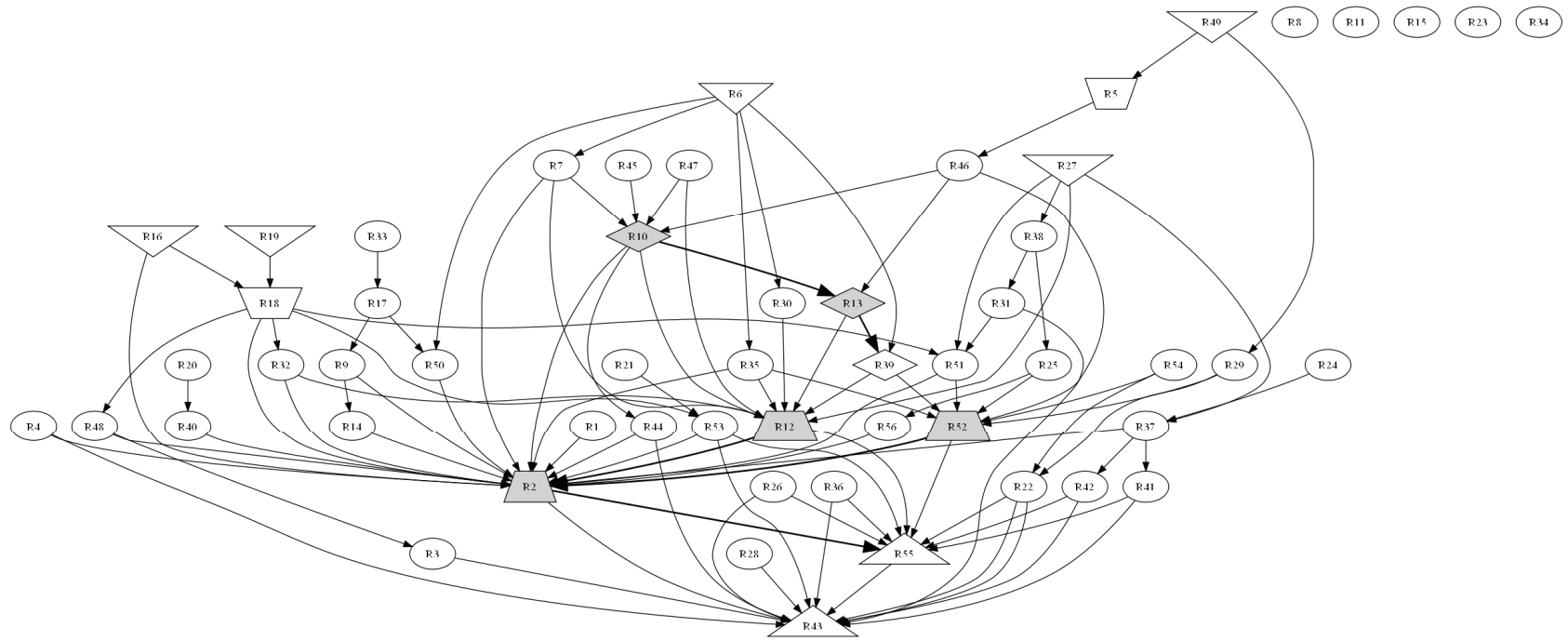

Figure 27. Structure of the project risk network (with highlighted important risks and interactions)

4.4.4 Eigenstructure analysis

We conduct the eigenstructure analysis described in Section 4.3 on this case study. The eigenvalues and eigenvectors of the matrix $A+A^T$ (A is the RSM of the project) are computed using Matlab software (version R2010b).

The unique largest real eigenvalue λ^* is equal to 6.4874. Here we only list the risks with top-ten eigenvector centralities, shown in Table 10.

Table 10. The top-ten risks according to eigenvector centrality

Rank	Risk ID	Eigenvector centrality
1	R2	0.5124
2	R43	0.2990
3	R55	0.2901
4	R12	0.2703
5	R10	0.2155
6	R53	0.2055
7	R18	0.1997
8	R52	0.1981
9	R51	0.1660
10	R7	0.1646

As we can see, most important risks in the sense of topological analysis (e.g., risks highlighted in Table 9 and Figure 27) are included in this list. Some risks like the accumulation risks R43 (Return profit decrease) and R55 (Available cash flow decrease) have high eigenvector centralities because they have many predecessor risks. Thus, the consequences of many other risks are revealed through them, either directly or after propagation of several steps. Some risks in Table 10 were not identified as important ones by topological analysis, such as R53 (Slabs pouring delay), R18 (Civil Work delay & continuity), R51 (Track installation delay) and R7 (Traffic signaling, priority at intersections). They have high eigenvector centrality values because they have direct contacts with some key nodes (e.g., R2, R12, R10, R52, etc.) and/or they can reach these important risks within short paths, which enhance the measure of their influence in the network.

4.4.5 Discussion of the results

The results obtained in the presented application prove the utility of the topological network theory-based approach and the eigenstructure analysis for risk analysis in project management. The proposed indicators provide the project manager with useful information for understanding identified risks and their relationships of both local and global scales.

Several critical risks identified by classical project risk analysis are confirmed by the topological analysis and eigenstructure analysis to play an important role in the risk network,

for instance, the financial risks like R43 and R55. In addition, more is learned about their relationship with other risks in the network. Taking into account the complexity-related phenomena, some new key risks are identified by the topological analysis and eigenstructure analysis, which are supplementary results to classical analysis. Risks can be classified into different categories according to their positions in the network. This information helps the project manager plan mitigation actions suitable for each particular type of risks. For example, many source risks like R16, R19, R6, R27, and R49 were not identified as critical in the classical analysis. Paying attention to these risks at the beginning of the project may help avoid many problems arising at later stages. Preventive or confinement actions are more likely to be effective for this kind of risks. Corrective or protection actions are often designed for accumulation risks like R43 and R55 to reduce losses. Avoidance or mix of strategies can be applied to transition risks for mitigating the risk propagation.

Moreover, important interactions with high betweenness degree are also identified. Cutting or easing this kind of key passages would mitigate the potential propagation between many risks in the network. For example, cutting the edge R10->R13 will act as a decoupling of two separate parts of the network. It means that if the internal nodes of one part are correctly managed, no risk of external origin has to be considered. This is all the more important since internal risks are generally easier to influence and to manage for the owners. Allocating resources and conducting actions on these key risks or interactions will be more efficient to mitigate the propagation phenomena and then to reduce the overall exposure of risks.

In this example, based on the topological and eigenstructure analysis, we tested a combination of four actions: 1) avoid R12 (Operating certificate delay); 2) avoid R27 (Track installation machine performance); 3) avoid R52 (Reengineering / redesign); and 4) cut the link between R10 (Travel time performance) and R13 (Reliability and availability targets). Applying these actions translates into removing the nodes (R12, R27, and R52) and the edge (R10->R13) in the risk network. The first interesting thing is that only R12 is in the top-ten list of critical risks according to classical project risk analysis. R12 is a transition risk with many causes and only two, but important direct consequences which are financial risks of R2 and R55. R27 is low in terms of classical criticality, but is a source of numerous and important risks, so it may be worthy to use a non-innovative but non-risky track installation machine, in order to estimate with more reliability the duration of track installation tasks. R52 with high betweenness and eigenvector centralities is a product-related risk, depending on multiple causes related to the train performance, the customer requirements and the interface rail-wheel. In order to prevent this risk, a more robust requirement definition should be made at the beginning of the project, including the specificities of the project (the city topography and the special needs of the customer). Of course this has to be done for every project, but in this case we contend that a particular effort should be put on the reliability of the initial product requirements, because of their multiple consequences. Finally, we propose to act on the link between R10 and R13, which is quite specific to a topological analysis, since we do not act on nodes, but on one edge. We do not avoid the problem caused by R10 and its other consequences, which are mainly related to customer and contract, but we avoid propagation to

another part of the network, where technical and product-related risks could have been activated. It is feasible to cut the transition between the two risks, since there are complementary means to reach reliability and availability targets (train size, train number) without redesigning the train and delaying the delivery of operating certificate. Further work will integrate the cost of actions and make the balance with the benefits of risk reduction. To conclude, all the proposed actions are feasible but three of them come directly from the topological network analysis and only one of them could be identified through classical analysis.

By undertaking the proposed actions, the graph density has been reduced from 0.0308 to 0.0265 by 14.0%, and the reachability density of the network has been reduced from 0.0854 to 0.0679 by 20.5%. The new top risks and interactions with the highest betweenness centrality are given in Table 11. Compared with Table 9, we can see that the ranking has changed and the values of betweenness centrality have significantly decreased. The updated top-ten risks and their eigenvector centralities are shown in Table 12. It is not surprising that the removed nodes R12 and R52 are no longer in the list. The top eigenvector centrality values have not decreased but to some extent have increased, which reflects that the eigenvector centrality is relative score of a node in terms of importance in the network. The ranking of R10 have decreased since one of its important links has been removed. R7 has fallen out of the list due to its close contact with R10.

The change of the risk network structure after taking the mitigation actions is shown in Figure 28.

Table 11. The top betweenness centralities after taking actions

Rank	Risk ID	Betweenness centrality	Edge ID	Betweenness centrality
1	R2	64	R2->R55	32
2	R55	39	R10->R44	21
3	R10	28	R18->R48	8
4	R44	24	R46->R10	8
5	R18	16	R5->R46	7

Table 12. The top risks according to eigenvector centrality after taking actions

Rank	Risk ID	Eigenvector centrality
1	R2	0.5326
2	R43	0.3860
3	R55	0.2857
4	R53	0.2551
5	R18	0.2385
6	R44	0.1849
7	R10	0.1592
8	R4	0.1576
9	R51	0.1486
10	R48	0.1480

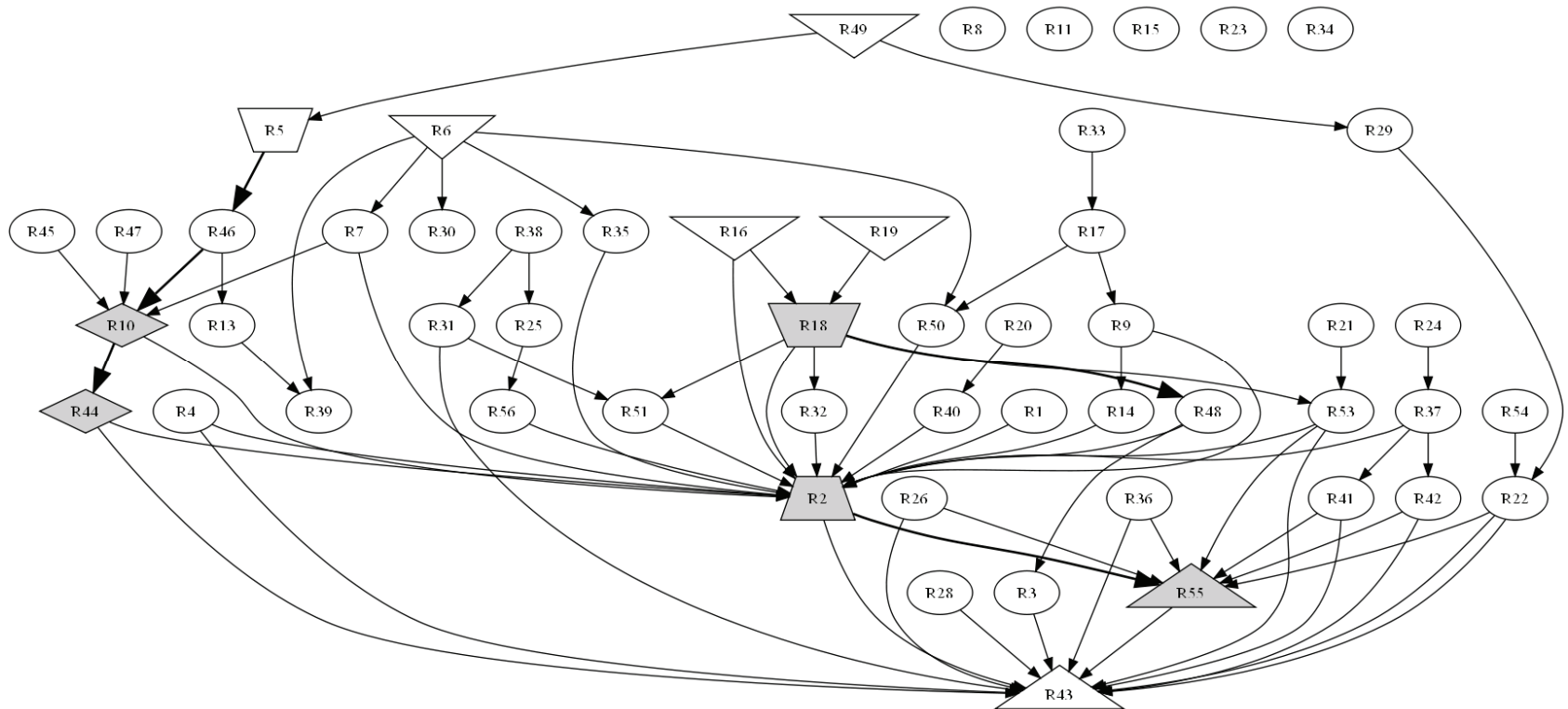

Figure 28. Structure of the project risk network after taking actions

Also, the interface degree between domains/owners gives the project manager knowledge of how to improve the structure of organization. Reassignment can be conducted so as to reduce the interfaces between different owners. In other words, closely related risks should be assigned when possible to the same owner, in order to mitigate the risk of information asymmetry or non-communication, and to reduce the cost of communication. These reassignments are identified through different sources. First, the right part of Figure 26 gives global information on the direct and indirect interfaces between owners. For instance, owners O2 and O4 are strongly related with indirect links, which means that their relation in terms of communication and coordination should be well formalized. Second, the potential chains or pieces of the network with several interrelated risks and some of the highlighted nodes and edges (Figure 28) that deserve particular attention for topological reasons (Table 11) assist in identifying more effective local reassignments. For a given couple, triplet or group of risks, decisions have to be made on the basis of the existing assignments (Table 8). It depends on the number of actors currently involved and on their skills, in terms of capacity to become the owner of the designated risk. For example, in order to get fewer people involved in potential propagation chains (Figure 28), we can reassign the ownership of:

- 1) risk R18 to actor O2 (instead of O8), since O2 is already the owner of R16 and R19.
- 2) risk R32 to actor O3 (instead of O5), since O3 is already the owner of R51 and R48. It permits also to have only one human interface between O2 and O3 for managing the interactions between several risks.
- 3) risks R5 and R46 to actor O4 (instead of O1). Indeed, actor O4 is in charge of managing several risks potentially triggering R10, which is an important hub in the technical area of train performance and customer satisfaction.

4.5 Conclusion

This chapter presents an original network theory-based analysis of project risk. The purpose is mainly to discuss “What roles the risks act in the network?” (research question Q1.1). First, the project risk network needs to be built up, as described in Chapter 2. One should be aware of the particularity of a project risk network, as compared to, for example, other physical networks of critical infrastructures, like a power transmission network. A project risk network links elements (nodes of risks), which can possibly be affected by the potential propagation (edges of risk interactions) of effects of different natures. The specificity of this network is to involve potential interactions between nodes which are not necessarily related to physical and material characteristics, like delay risk for instance.

Network theory indicators are specifically tailored to project risk analysis, in an effort to complement the classical approach with respect to modeling the complexity of interdependent risks. For example, some connectivity indicators and the betweenness centrality are introduced in order to identify the key risks and risk interactions in the network. Moreover, eigenstructure analysis is performed, i.e., by computing the eigenvector centrality, to measure the importance of risks taking into account the entire pattern of the network. The interface indicators, which

indicate the interconnections between different domains and between different owners in terms of risk propagation, are helpful for the project manager to make decisions like concerning organization.

A realistic application to a tramway implementation project is performed with the involvement of the project manager and the team of experts. The obtained results demonstrate that the topological risk network analysis adds value to the classical project risk analysis, in identifying both the important risks and the important risk interactions with respect to their role in the network behavior. This gives additional information for the next step of decision-making, since risks may be considered important for criticality and/or topological reasons. In other words, a risk taken individually may be non-critical, but through interactions could become the source of other risks and some critical ones. Based on the analysis outcomes, a combination of feasible risk mitigation actions are performed on the risk network and the results demonstrate the effectiveness of using network theory for project risk topological analysis. The method is expected to be applicable to a wide set of engineering projects for decision support, including designing risk mitigation actions and reassigning risk owners.

A further improvement of the proposed approach in this chapter is to analyze the weighted risk network. In other words, if we get the numerical assessment of the nodes and the strength of edges, we are able to quantitatively analyze risk propagation behavior in the network. This work will be introduced in the next Chapter.

Chapter 5 - Matrix-Based Propagation Modeling for Risk Analysis

Abstract

The overall ambition of this chapter is to propose a quantitative method for modeling the risk propagation behavior. This method is based on matrix calculation. It can be used as a supplement to the classical project risk analysis and the topological risk network analysis presented in Chapter 4. All these risk analysis results will assist project manager in planning more effective risk response actions.

A risk propagation model is presented with some assumptions. It can be used to calculate risk propagation and thus to re-evaluate risk probability and criticality taking into account its position in the network. Moreover, the eigenstructure analysis is extended to the weighted risk network which assesses the strength of risk interactions. Updated risk prioritization by various indicators provides project manager with improved insights on risks under complexity.

First, a simple example of risk network with 7 nodes is given to illustrate how to use the risk propagation model. Second, the application to the musical staging project (introduced in Chapter 2) allows us to validate this model through comparing with the simulation results. Third, both the risk propagation model and the eigenstructure analysis are implemented to the tramway construction project (introduced in Chapter 4) for risk analysis.

Chapter Keywords

Weighted network, stochastic matrix, risk propagation, eigenvector centrality, risk prioritization

5.1 Matrix-based risk propagation modeling

In this section we will present a matrix-based risk propagation model for risk re-evaluation. A simple example with seven risks will be used for illustration.

5.1.1 Basic concepts and assumptions

In the project risk network, the nodes (risks) are assessed in terms of spontaneous probability and impact (or severity); the edges (risk interactions) are assessed as the probability of transition from one risk to another. As described in Section 2.2 in Chapter 2, a distinction between the spontaneous probability of a risk, for example, caused for an external reason or by undefined risks outside the system, and the probability of this risk triggered by any other identified risk inside the system has been made during the assessment process. Thus in this matrix-based propagation model, we assign the original risk probability evaluated by classical methods without considering interactions to each risk as its spontaneous probability. For the same reason, the assessed values in the risk numerical matrix (RNM) are used as transition probability between the related risks in the column and row labels.

Some assumptions are made in order to calculate risk propagation in the network:

- 1) A risk may occur more than one time during the project (this does accord with the situation in reality). Risk frequency is thus accumulative if arising from different causes or if arising several times from the same cause.
- 2) The structure and values of RNM do not vary during the analysis time. In other words, there is no added or removed risk, and the transition probability between risks will not change during the analysis.

Hence, the RNM can be regarded as similar to the stochastic matrix or transition matrix used to describe the transition of a Markov chain (Bhat and Miller 2002; Meyn et al. 1993; Buzacott and Shanthikumar 1993; Latouche et al. 1999). This principle has been applied to industrial engineering, for example, Smith and Eppinger introduced a work transformation matrix based on the DSM method to model the engineering design iteration process (R. Smith and Eppinger 1997). However, different from conventional stochastic matrix, in our model the RNM is a square matrix where all entries are nonnegative real numbers and less than 1, but the sum of each row or column is not necessary to be 1.

5.1.2 Risk propagation model

Suppose there are N identified risks in the network. We use vector s to represent the spontaneous probability of risks. Let the N -order square matrix A denote the RNM of transition probabilities. $P(R)$ is the vector of risk probabilities after propagation analysis.

Vector s also represents the initial vector of risk probabilities. After m steps, the probability vector of risks propagated from initial state is thus equal to $A^m \cdot s$. If we only

consider m steps of propagation and according to the assumption of accumulative risk frequency, the re-evaluated risk probability vector can be obtained by the following equation:

$$P(R) = s + \sum_{i=1}^m A^i \cdot s = (I + \sum_{i=1}^m A^i) \cdot s = (\sum_{i=0}^m A^i) \cdot s \quad (25)$$

where I is the N -order identity matrix. If not considering the limit of stages in project, then we have:

$$P(R) = \lim_{m \rightarrow \infty} (\sum_{i=0}^m A^i) \cdot s \quad (26)$$

Multiplying both sides of Equation (26) by $(I - A)$, and then we get that

$$(I - A) \cdot P(R) = (I - A) \cdot (\sum_{i=0}^m A^i) \cdot s = (I - A^{m+1}) \cdot s \quad (27)$$

It is not guaranteed that the infinite power of the matrix A would converge to 0, as shown in the following equation:

$$\lim_{m \rightarrow \infty} A^{m+1} = 0 \quad (28)$$

Here 0 is the zero matrix or null matrix in linear algebra. Some research papers established sufficient conditions for the convergence of infinite product of matrix, e.g., in (Thomason 1977; Holtz 2000; Daubechies and Lagarias 1992; Bru et al. 1994; Daubechies and Lagarias 2001). In practice of project risk management, for example, if a risk is involved in several loops and the sum of the products of all the transition probabilities along these loops is greater than 1, the occurrence of this risk leads to chain reactions which will come back and trigger itself again with a probability of more than 100%. In this way, the risk propagation process does not converge. This type of risk propagation is not likely to occur in practice and is outside the scope considered by our model.

Nevertheless, since A is the risk numerical matrix which is usually sparse and composed of transition probabilities at small values less than 1, usually the condition of Equation (28) is satisfied. Thus, risk probability can be re-evaluated by the following equation:

$$P(R) = (I - A)^{-1} \cdot s \quad (29)$$

Moreover, it is possible to predict the consequences of the occurrence of one or more initial risks. In this model, we assign for instance 100% to the spontaneous probability of R_i , while all the other risks have 0% initial values. That is to say, the initial vector $s = I^i$, where I^i is the i -th column of the identity matrix I . We can then anticipate the occurrence of the rest of the network, and thus evaluate the global consequences of R_i . Criticality is another important indicator used for prioritizing risks and usually defined as the product of risk probability and impact. Similar to risk probability, we can refine risk criticality by integrating all the potential consequences in the network of a given risk. Giving R_i with its re-evaluated probability (risk frequency) instead of 100%, we redefine its criticality by:

$$C(R_i) = \sum_{j=1}^n G(R_j) \cdot P_{R_i}(R_j) \quad (30)$$

where $C(R_i)$ is the criticality of R_i ; $G(R_j)$ is the original evaluated impact (G for gravity) of R_j ; and $P_{R_i}(R_j)$ denotes the probability of R_j as the consequence of $P(R_i)$. According to Equation (29), the re-evaluated risk criticality is expressed by the equation:

$$C(R_i) = G^T \cdot (I - A)^{-1} \cdot (I^i \cdot P(R_i)) \quad (31)$$

The vector of risk criticalities can be calculated by the following equation:

$$C(R) = (I - A^T)^{-1} \cdot G \cdot * P(R) \quad (32)$$

Here A^T represents the transpose matrix of A ; and the symbol “.” denotes the array multiplication or the Hadamard product (Johnson 1974) of matrices. For example, the Hadamard product $c = a \cdot * b$ of two vectors $a = [a_1, a_2, \dots, a_n]$ and $b = [b_1, b_2, \dots, b_n]$ is still an n -order vector and its elements are defined as:

$$c(i) = a(i) \cdot b(i) \quad (33)$$

The re-evaluation of risk characteristics such as probability and criticality enables us to update the risk prioritization results and then to develop new risk response plans.

5.1.3 A simple example for illustration

In this section we use a simple example to illustrate how to use the risk propagation model for risk re-evaluation. Let us consider an example of a project with 7 identified risks. After the modeling of risk interactions as described in Chapter 2, we get the RSM of the example (Figure 29) and the RNM with numerical values. The RNM is denoted by matrix A in Equation (34).

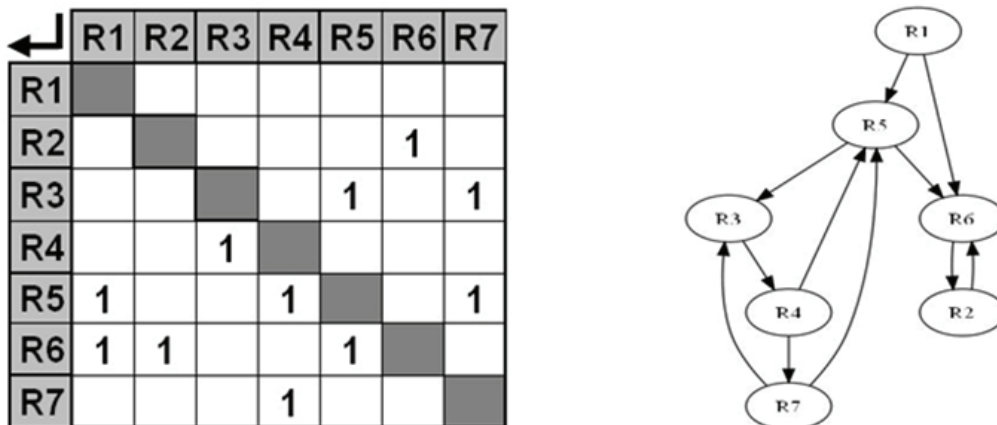

Figure 29. RSM and network structure of the example

$$A = \begin{bmatrix} 0 & 0 & 0 & 0 & 0 & 0 & 0 \\ 0 & 0 & 0 & 0 & 0 & 0.08 & 0 \\ 0 & 0 & 0 & 0 & 0.15 & 0 & 0.125 \\ 0 & 0 & 0.25 & 0 & 0 & 0 & 0 \\ 0.32 & 0 & 0 & 0.28 & 0 & 0 & 0.09 \\ 0.42 & 0.39 & 0 & 0 & 0.22 & 0 & 0 \\ 0 & 0 & 0 & 0.22 & 0 & 0 & 0 \end{bmatrix} \quad (34)$$

To interpret this matrix, for example, $A(4,3) = 0.25$ indicates that if Risk 3 is activated, then there is a transition probability of 25% originating from Risk 3 to trigger Risk 4. The spontaneous probability vector and gravity vector of risks are obtained through evaluation by classical methods, namely s and G given as follows:

$$s = [0.350 \quad 0.220 \quad 0.220 \quad 0.170 \quad 0.080 \quad 0.010 \quad 0.010]^T \quad (35)$$

$$G = [20.0 \quad 25.0 \quad 100.0 \quad 10.0 \quad 10.0 \quad 125.0 \quad 50.0]^T \quad (36)$$

Here the gravity values in G can be understood as potential impact of risks, such as capitalized loss. We are able to calculate the risk propagation according to Equation (29), and then get the re-evaluated risk probability vector:

$$P(R) = (I - A)^{-1} \cdot s = [0.350 \quad 0.245 \quad 0.267 \quad 0.237 \quad 0.264 \quad 0.311 \quad 0.062]^T \quad (37)$$

Equally, risk criticalities are calculated using Equation (32). Risks are prioritized according to different indicators. These refined results are consolidated and compared with original estimates, as shown in Table 13.

Table 13. Risk re-evaluation and prioritization results of the simple example

Ranking	By spontaneous probability		By re-evaluated probability		By classical criticality		By re-evaluated criticality	
	Risk ID	Value	Risk ID	Value	Risk ID	Value	Risk ID	Value
1	R1	0.350	R1	0.350	R3	22.0	R6	40.7
2	R2	0.220	R6	0.311	R1	7.0	R1	32.5
3	R3	0.220	R3	0.267	R2	5.5	R3	29.5
4	R4	0.170	R5	0.264	R4	1.7	R2	18.6
5	R5	0.080	R2	0.245	R6	1.3	R5	14.6
6	R6	0.010	R4	0.237	R5	0.8	R4	9.6
7	R7	0.010	R7	0.062	R7	0.5	R7	4.3

From the results in Table 13, we can see that the probability of some risks has notably increased after re-evaluation, such as R6 and R5. This kind of risks has little probability to happen spontaneously, but some other events may lead to them. The risk prioritization results have changed after taking into account risk interactions in the network. For example, in classical method R3 was considered to be the most critical risk, but the one with the highest re-

evaluated criticality is R6. Moreover, in the new prioritization results, the value gap between risks becomes different from that in the results of classical method. For instance, R5 and R7 are two risks with low criticalities and R5 is ranked superior to R7. After re-evaluation, R5 is still ranked superior to R7, but the gap between their relative criticality values becomes much larger. This is the opposite for R3 and R2. R2 is still behind after re-evaluation, but closer.

5.2 Eigenstructure analysis on weighted risk network

The eigenstructure analysis proposed in Section 4.3 in the previous chapter for topological analysis can be adapted to weighted risk network. We perform the eigenstructure analysis on the RNM instead of RSM to measure the importance of project risks in the network.

Hence, $A = (a_{ij}) = RNM(i, j)$ and a_{ij} denotes the strength of the edge $E_{j \rightarrow i}$, i.e., the transition probability from R_j to R_i . Let x_i denote the importance score of the i -th node, we have

$$x_i = \frac{1}{\lambda} \sum_{j \in P(i)} a_{ij} \cdot x_j + \frac{1}{\lambda} \sum_{j \in S(i)} a_{ji} \cdot x_j = \frac{1}{\lambda} \sum_{j=1}^N (a_{ij} + a_{ji}) x_j \quad (38)$$

where all the notations have the same meaning as in Section 4.3 while a_{ij} is no longer binary but numerical such that

$$a_{ij} \in [0, 1] \quad (39)$$

In this way, besides the two principles of eigenvector centrality in the topological viewpoint ((1) connections to more nodes contribute more to the score of the node; (2) connections to high-scoring, namely important nodes, contribute more to the score of the node), a third principle is included: (3) higher strength of the connection to other nodes contributes more to the score of the node.

We can reformulate the Equation (38) as:

$$(A + A^T)x = \lambda x$$

Similarly, we define the i -th element x_i of the eigenvector corresponding to the largest eigenvalue λ^* of RNM as the refined eigenvector centrality of R_i in the risk network.

5.3 Case studies

Both the musical staging project and the tramway construction project are used in this section as case studies. The musical staging project is analyzed for validating the matrix-based risk propagation model. On the other hand, both the risk propagation model and the numerical eigenstructure analysis are carried out on the tramway construction project with 56 identified risks.

5.3.1 Musical staging project

As described in Section 5.1.2, we use the risk propagation model to quantitatively calculate the risk propagation. The re-evaluated risk characteristics are compared with the related simulation results obtained in Chapter 3, shown in Table 14.

Table 14. Comparison of the results by risk propagation model and by simulation

Risk ID	Re-evaluated risk probability by risk propagation model	Risk frequency by simulation	Re-evaluated risk criticality by risk propagation model	Risk global criticality by simulation
R01	0.808	0.807	26.04	25.88
R02	0.691	0.696	12.10	12.15
R03	0.769	0.771	9.43	9.53
R04	0.491	0.495	7.68	7.69
R05	0.360	0.364	11.09	11.36
R06	0.265	0.266	3.65	3.69
R07	0.430	0.425	6.61	6.55
R08	0.386	0.388	3.35	3.39
R09	0.050	0.049	0.89	0.85
R10	0.530	0.529	10.22	10.11
R11	0.394	0.393	4.74	4.75
R12	0.404	0.400	5.38	5.40
R13	0.389	0.383	5.47	5.34
R14	0.446	0.445	3.46	3.51
R15	0.192	0.196	3.04	3.11
R16	0.182	0.191	1.30	1.35
R17	0.471	0.469	4.02	4.05
R18	0.001	0.002	0.01	0.01
R19	0.011	0.014	0.19	0.24

According to Table 14, we can see that the risk re-evaluated results based on the proposed risk propagation model are very similar to the corresponding results obtained by simulation. Thus, we conclude that the risk propagation model is valid and useful in re-evaluating risk characteristics taking into account risk interactions.

5.3.2 Tramway construction project

The project risk list (Table 8) and the risk network structure (Figure 21) of the tramway construction project have been presented in Chapter 4. In order to apply the proposed approach in this chapter, we assess the project risk network using the methods introduced in Section 2.2. The direct assessment by experts is used on this case study for evaluating the strength of risk interactions. The assessment of the potential risk interactions was then performed on a 10-level Likert scale (Likert 1932; Maurer and Pierce 1998), due to the high expertise of interviewees. Some difficulties while performing the assessment were encountered. In particular, this step requires the participation of several experts involved in the project since it necessitates a very wide overview of the project elements and stakes. In the end, the RNM of the project was obtained. It is displayed in Figure 30. Various gray scales are used to indicate the strength levels of the risk interactions.

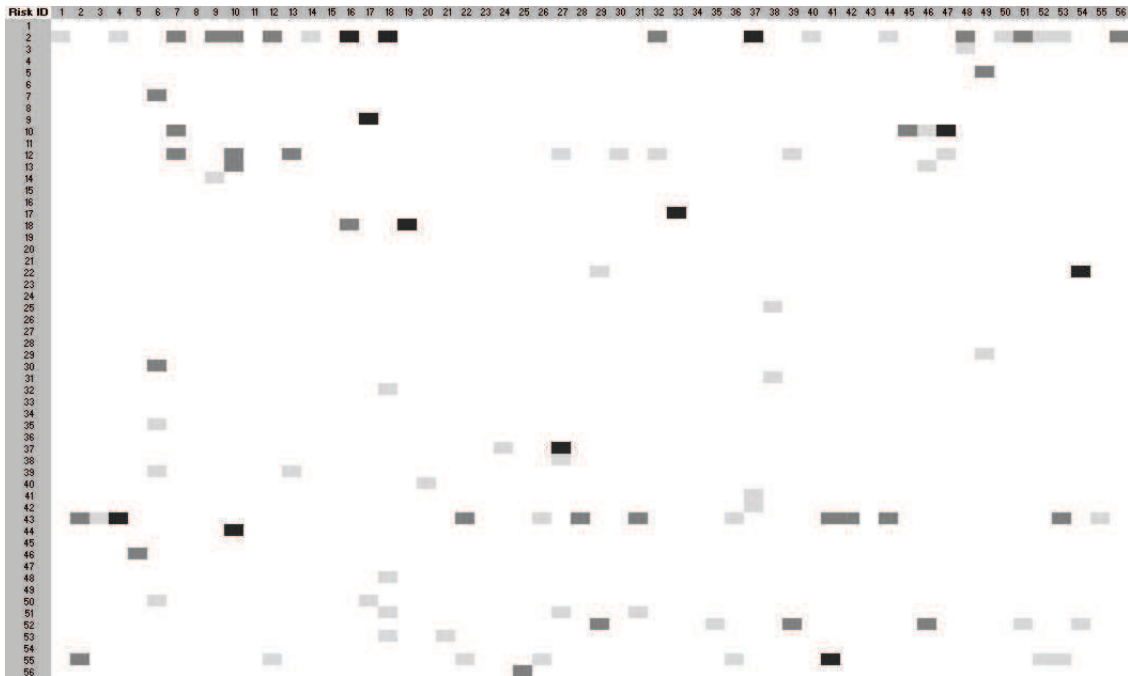

Figure 30. RNM of the tramway project

In Table 15, we consolidate the risk analysis results by the risk propagation model and compare them with the original risk estimates obtained by classical methods. In classical project risk analysis, risks are ranked upon their criticality value which is defined as the product of the evaluated probability and impact. Resources should be firstly allocated to manage the top risks with priorities. In our risk propagation model, risk probability can be re-evaluated through Equation (29) into risk frequency. As we can see in Table 15, the frequency of risks has increased to varying extent taking into account the interactions with other risks in the network. Some risks have high risk frequency which is greater than one. As we mentioned in previous chapters, this is consistent with the reality that one risk may occur more than once during the project. The examples are R2 (Liquidated damages on intermediate milestone and

delay of progress payment threshold), R43 (Return profit decrease) and R55 (Available cash flow decrease). Shown in Figure 21 of the risk network structure, many risks lead to these risks closely related to financial performance, consequently they have high probability to occur during the project, and even more than one time (accumulation).

Risk criticalities can also be refined through Equation (32). As a result, the risk rankings have also changed. From the column of ranking shift, we can see that some important risks based on classical risk analysis remain in high positions, such as R43, R2, R55, R37 (Risk of partial rejection of our request for extension of time)), R7 (Traffic signaling, priority at intersections), R12 (Operating certificate delay), R18 (Civil Work delay & continuity). On the other hand, some risks have dropped out of the top-ten rankings, such as R3 (Vehicle storage in another city), R40 (OCS installation), R29 (Additional poles overcost for Tramway Company). Several risks have greatly risen with respect to their rankings. For example, the ranking of R10 (Travel time performance) has increased from No.43 to No.10 with the upgrade of +33. The shift of priorities reflects the intensity of risk interactions in the network.

Table 15. Project risk analysis results of the tramway project

Risk ID	By Classical methods				By Risk Propagation Model				By Eigenstructure Analysis	
	Original Evaluated Risk Probability	Evaluated Risk Impact	Original Risk Criticality	Original Risk Ranking	Re-Evaluated Risk Frequency	Re-Evaluated Risk Criticality	Updated Risk Ranking	Ranking Shift	Eigenvector Centrality based on RSM	Eigenvector Centrality based on RNM
R1	0.001	1	0.001	53	0.001	0.00	55	-2	0.079	0.000
R2	0.308	8	2.465	4	1.737	23.36	1	+3	0.512	0.555
R3	0.381	5	1.905	5	0.381	2.17	14	-9	0.065	0.017
R4	0.001	3	0.003	41	0.001	0.01	43	-2	0.125	0.114
R5	0.086	2	0.173	35	0.086	0.22	39	-4	0.014	0.001
R6	0.001	3	0.003	42	0.001	0.01	42	0	0.070	0.062
R7	0.263	5	1.314	10	0.263	4.29	8	+2	0.165	0.238
R8	0.001	2	0.002	46	0.001	0.00	52	-6	0.000	0.000
R9	0.381	1	0.381	23	0.452	2.68	11	+12	0.098	0.144
R10	0.001	3	0.003	43	0.179	2.69	10	+33	0.216	0.325
R11	0.001	4	0.004	39	0.001	0.00	47	-8	0.000	0.000
R12	0.381	4	1.524	7	0.607	5.67	5	+2	0.270	0.297
R13	0.086	3	0.259	26	0.148	0.96	26	0	0.103	0.146
R14	0.381	2	0.762	15	0.420	1.33	21	-6	0.094	0.041
R15	0.001	3	0.003	44	0.001	0.00	49	-5	0.000	0.000
R16	0.381	3	1.143	11	0.381	4.46	7	+4	0.110	0.200
R17	0.086	5	0.432	22	0.172	1.28	23	-1	0.030	0.043
R18	0.381	4	1.524	8	0.655	6.79	4	+4	0.200	0.223
R19	0.381	2	0.762	16	0.381	2.38	12	+4	0.031	0.062
R20	0.210	1	0.210	27	0.210	0.32	35	-8	0.012	0.002
R21	0.086	6	0.518	21	0.086	0.52	31	-10	0.032	0.000
R22	0.210	5	1.052	12	0.297	2.22	13	-1	0.105	0.068
R23	0.001	2	0.002	47	0.001	0.00	53	-6	0.000	0.000
R24	0.001	6	0.006	37	0.001	0.01	44	-7	0.019	0.010
R25	0.086	4	0.346	24	0.093	0.45	32	-8	0.017	0.012
R26	0.001	3	0.003	45	0.001	0.00	46	-1	0.091	0.029
R27	0.086	2	0.173	31	0.086	0.67	29	+2	0.091	0.053
R28	0.001	2	0.002	48	0.001	0.00	48	0	0.046	0.042
R29	0.381	4	1.524	9	0.381	1.78	17	-8	0.048	0.006
R30	0.210	4	0.842	14	0.210	1.01	25	-11	0.052	0.030
R31	0.001	1	0.001	54	0.008	0.02	41	+13	0.076	0.042
R32	0.086	2	0.173	32	0.087	0.42	33	-1	0.151	0.079
R33	0.210	3	0.631	19	0.210	1.27	24	-5	0.005	0.012
R34	0.001	1	0.001	55	0.001	0.00	56	-1	0.000	0.000
R35	0.001	2	0.002	49	0.001	0.00	51	-2	0.041	0.006
R36	0.001	2	0.002	50	0.001	0.00	50	0	0.091	0.017
R37	0.381	7	2.667	2	0.416	5.45	6	-4	0.123	0.173
R38	0.086	2	0.173	33	0.086	0.23	38	-5	0.028	0.003
R39	0.001	2	0.002	51	0.014	0.04	40	+11	0.099	0.017
R40	0.308	5	1.541	6	0.326	2.01	16	-10	0.081	0.032
R41	0.308	3	0.925	13	0.308	2.76	9	+4	0.110	0.127
R42	0.001	4	0.004	40	0.037	0.24	37	+3	0.065	0.072
R43	0.381	8	3.048	1	1.422	11.37	2	-1	0.299	0.298
R44	0.001	6	0.006	38	0.074	0.69	28	+10	0.158	0.175
R45	0.001	2	0.002	52	0.001	0.01	45	+7	0.033	0.046
R46	0.086	2	0.173	34	0.104	0.28	36	-2	0.082	0.006
R47	0.210	1	0.210	28	0.210	1.68	18	+10	0.075	0.107
R48	0.381	2	0.762	17	0.438	2.12	15	+2	0.120	0.092
R49	0.001	1	0.001	56	0.001	0.00	54	+2	0.010	0.000
R50	0.308	1	0.308	25	0.308	0.67	30	-5	0.094	0.032
R51	0.308	2	0.616	20	0.316	1.53	20	0	0.166	0.082
R52	0.381	2	0.762	18	0.506	1.60	19	-1	0.198	0.039
R53	0.210	1	0.210	29	0.267	1.31	22	+7	0.205	0.110
R54	0.210	1	0.210	30	0.210	0.91	27	+3	0.047	0.021
R55	0.381	7	2.667	3	1.187	9.13	3	0	0.290	0.207
R56	0.086	1	0.086	36	0.106	0.40	34	+2	0.082	0.080

Conducting the eigenstructure analysis by Matlab software, we get the unique largest real eigenvalue $\lambda^* = 1.4866$ of the RNM. The eigenvector centralities (both based on the RSM and RNM) of each risk are also given in Table 15. The top-ten risks with the highest eigenvector centralities are listed in Table 16.

Since the eigenvector centrality conveys a relative score of risk importance in the network, we put more emphasis on the risk rankings other than on the change of centrality values. In Table 16, compared with the eigenvector centralities based on RSM, some new risks have appeared in the top-ten list according to RNM-based eigenstructure analysis, such as R16 (Archeological findings), R44 (Extra trains) and R37 (Risk of partial rejection of our request for extension of time). Some risk like R7 (Traffic signalling, priority at intersections) has also risen in the list. This is due to their relatively strong interactions with other nodes (especially important ones) in the network. For example, R16 have high-strength links with important risks like R18 and R2 ($RNM(18, 16) = 0.308$ and $RNM(2, 16) = 0.410$); R44 have intense contacts with important nodes like R10 as its predecessor ($RNM(44, 10) = 0.410$) and R43 as its successor ($RNM(43, 44) = 0.263$); R7 is closely related with R2, R10, R12 which are all in the top-ten list ($RNM(2, 7) = 0.210$, $RNM(10, 7) = 0.347$ and $RNM(12, 7) = 0.347$). The eigenvector centrality provides a measurement of risks in terms of their positions and importance in the network.

Table 16. Risk ranking results according to eigenvector centrality

Ranking	Eigenvector Centrality based on RSM		Eigenvector Centrality based on RNM	
	Risk ID	Value	Risk ID	Value
1	R2	0.5124	R2	0.5553
2	R43	0.2990	R10	0.3248
3	R55	0.2901	R43	0.2980
4	R12	0.2703	R12	0.2971
5	R10	0.2155	R7	0.2384
6	R53	0.2055	R18	0.2235
7	R18	0.1997	R55	0.2075
8	R52	0.1981	R16	0.1996
9	R51	0.1660	R44	0.1746
10	R7	0.1646	R37	0.1726

5.4 Conclusion

Improving the analytical approach presented in Chapter 4 based on topological network theory, in this chapter we propose a risk propagation model based on matrix calculation and adapt the eigenstructure analysis to weighted risk network. Research questions Q1.2 and Q1.3 have been examined at a quantitative level. First, the parameters in the project risk network can be assessed so that we are able to model and analyze the risk propagation behavior in the risk network in a quantitative manner. Based on some assumptions, the RNM can be regarded as a specific stochastic matrix describing the risk propagation process as the project progresses. Thanks to the risk propagation model, risk characteristics such as probability and criticality can be re-evaluated, which will lead to the update of risk prioritization.

The risk propagation model has been validated through the musical staging project case study by comparing with the simulation results. As an improvement to the risk network analysis in the previous Chapter 4, the proposed approach is applied to the tramway construction project with respect to the assessed risk network. Under the original risk propagation model for risk analysis, some risks have been upgraded in terms of criticality ranking. Insights have been gained on the shift of risk rankings according to their position in the network structure. The underestimation of some risks in classical methods is due to the neglect of this complexity-related information.

The eigenvector centrality of risks is also refined taking into account the strength of risk interactions. The changes in the top risks list help the project manager become more aware of intense interactions related to the important risks. Thus, more efforts should be made to enhance the communication between the corresponding risk owners.

This analysis can support project managers in designing more effective risk response actions. However, budget and resources are always tight for project implementation and particularly for managing risks as potential loss or threat to the project. For this reason, risk response actions should be selected in order to minimize the negative risk exposure while keeping the project within budget. The optimization of risk response plan under resource constraints will be discussed in the next chapter.

Chapter 6 - Optimization of Risk Response Plan under Resource Constraints

Abstract

In this chapter, a structured framework is presented for risk response planning under resource constraints. It includes five steps: 1) building project risk network; 2) defining the objective function; 3) identifying budget constraints; 4) identifying potential response actions; and 5) optimizing risk response plan. Two heuristic algorithms are developed, aimed at choosing response actions and optimizing the allocation of budget reserves dedicated to the risk management.

The greedy algorithm, in each step, adds one action having the highest mitigation effects into the portfolio, until there is not sufficient budget for any remaining action in the list. The genetic algorithm encodes the risk response plan as a chromosome of bit string and starts the search from a population of solutions. Integrating the budget constraint into the objective function enables the project manager to make a balance between the total cost of actions and their global effects on the risk network, by adjusting the parameters of the fitness function.

An example of application to the previously introduced tramway construction project is presented. First, a risk response action list with 21 candidates is established, based on the topological analysis of risk network (presented in Chapter 4) and the refined risk criticality analysis (presented in Chapter 5). The results by using the two algorithms are compared. It demonstrates that the genetic algorithm is more flexible and is more able to reach the global optimal solution.

Chapter Keywords

Risk response planning, resource constrains, optimization, greedy algorithm, genetic algorithm

6.1 An integrated framework for risk response planning

Managers of complex engineering projects face a challenge when deciding how to allocate scarce resources to minimize the risks of project failure. As resource constraints become tighter, balancing these risks is more critical, less intuitive, and can benefit from the power of quantitative analysis (Dillon et al. 2003). To solve this problem, based on the methods for risk network modeling and project risk analysis presented in the previous chapters, we introduce a practical five-step framework for project risk response planning, illustrated in Figure 31. It requires the involvement of the project manager and the team of experts in each step, to provide their knowledge and expertise and to make decisions.

As described in Chapter 2, the DSM method is used to facilitate identifying and assessing risk interactions, and thus to build the project risk network. This enables one to analyze the risk propagation behavior in the network, and also to anticipate the global effects of mitigation actions. Potential mitigation actions are proposed based on the project risk analysis results. These include actions for reducing the probability or impact of risks, and actions for mitigating the propagation through risk interactions. The expected costs of each potential action and the total budget constraints are evaluated by the project manager and experts. The risk response plan can be optimized based on different objective functions, whether local (e.g., mitigating the exposure of some particular risks) or global (e.g., minimizing the total financial loss). Optimization algorithms, for example, the genetic algorithm (GA) can be used to optimize the risk response plan achieving the defined objective function subject to the identified resource constraints.

The details of each step of the proposed framework will be introduced in the following section.

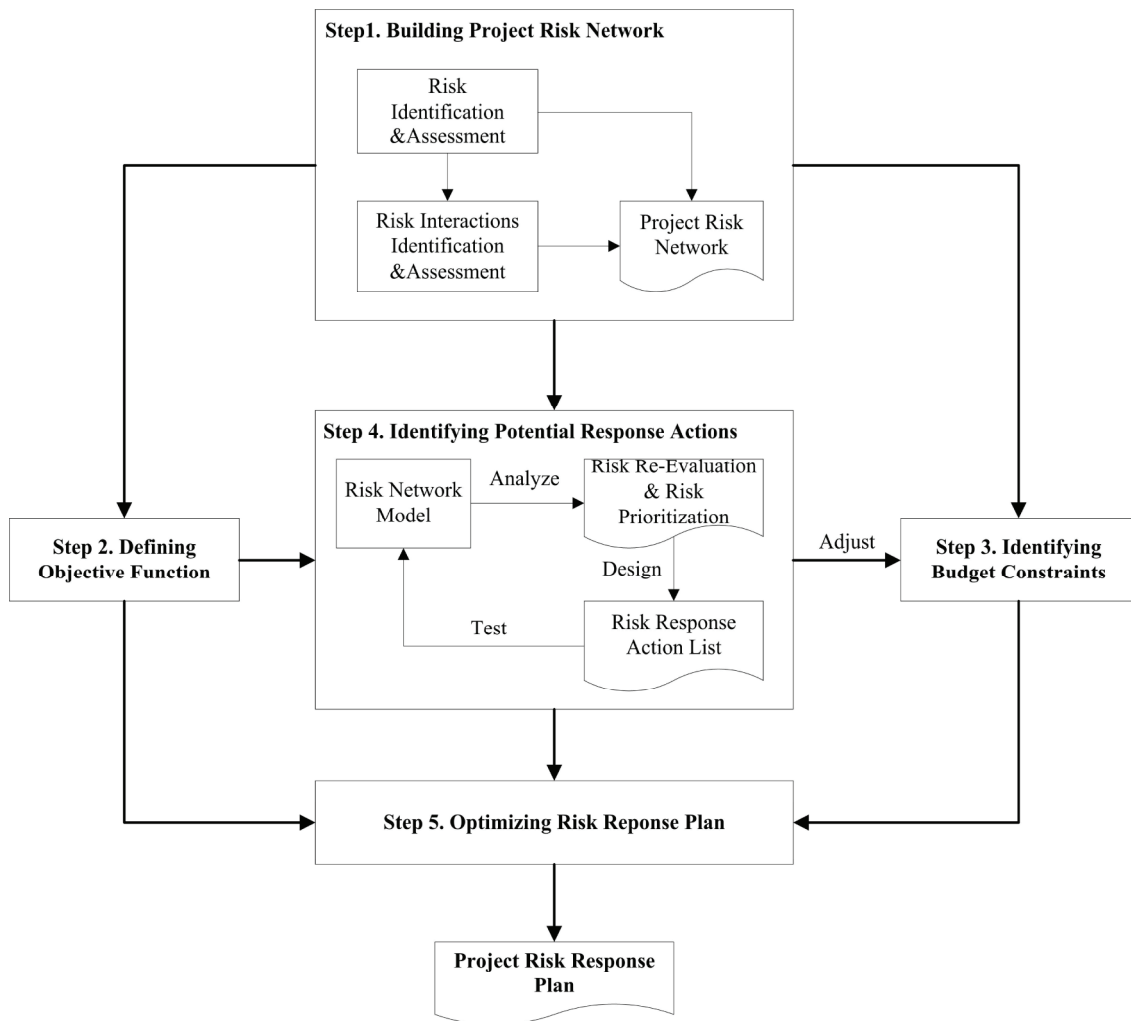

Figure 31. A framework for risk response planning

6.2 Step-by-step for the optimization of project risk response plan

6.2.1 Building project risk network

The process and methods of risk network modeling have been introduced in Chapter 2. The simulation-based risk network model presented in Chapter 3 and the risk propagation model introduced in Chapter 5 can be used to model propagation behavior in the risk network and to test the potential candidate actions. The global effects of the mitigation actions on the entire network can thus be anticipated, which is the foundation for the subsequent optimization step.

6.2.2 Defining objective function

The objective of risk response planning depends on the nature of the project and the manager's point of view. Generally, risk response actions with allocated budget are conducted to achieve two different goals: the local mitigation of particular risks, and the global risk exposure mitigation of the risk network. For example, the objective function in the global sense could be defined as follows:

$$\min OF = \sum_i P_i * G_i \quad (40)$$

where P_i and G_i indicate the probability and impact (G for gravity) of Risk i . The objective would be to minimize the overall financial loss, if G_i expresses the financial value of Risk i .

6.2.3 Identifying budget constraints

Given the project scope, a budget reserve for project risk management is initially established by the project manager. This budget is dependent on the total budget of the project, the evaluated overall level of risk exposure, and also the risk attitudes of the stakeholders.

The budget for risk management B_{RM} is normally comprised of three parts. Besides the expense for performing risk analysis B_{RA} (not significant compared with the other parts) and the reserve for risk contingency B_{RC} , the remaining budget is for the execution of the risk response plan, and needs to be allocated to designed actions:

$$B = B_{RM} - B_{RA} - B_{RC} \quad (41)$$

Moreover, after the risk network analysis and the evaluation of the costs of actions in Step 4 (Figure 31), the budget for performing the risk response plan B can be adjusted, according to the new knowledge on the risk management tasks.

6.2.4 Identifying potential response actions

Aiming at achieving the defined objectives for risk management, i.e., mitigating the global risk exposure, potential response actions can be identified based on both the refined risk criticality analysis taking into account risk propagation behavior (where risks are prioritized with respect to their re-evaluated probability and impact), and also the topological analysis of the risk network.

The response list includes different types of risk mitigation actions on risks and on the interactions. These actions are, for instance, adopting less complex processes, conducting more tests, enhancing internal communication, and choosing a more stable supplier, etc. Conducting the response actions translates into changing the values of parameters of the risk network model. For example, a classical mitigation action on a particular risk reduces its spontaneous probability or impact; a complementary preventive action is to cut off the input links or reduce their transition probabilities; blocking the output links can be regarded as the action of confining the further propagation of such risk to subsequent risks.

Risk mitigation actions always consume time, money and other resources. In order to perform the optimization, the cost of each identified action is evaluated by the project manager and the expert team. Actions should be worthwhile, less expensive than the expected value of the risk impact. Before the next step of optimization, the response action list shall be examined by the project manager to make sure that unfeasible actions are not included in the possible alternatives for optimization.

6.2.5 Optimizing risk response plan

For each identified risk response action in Step 4, the project manager can decide whether to apply it or not. Given a list of n candidate actions, there are $2^n - 1$ combinations for the risk response plan aiming at mitigating the exposure of risks in the entire network (global objective function). An exhaustive test of all the combinations is impractical for choosing the best risk response plan. Considering the resource constraints, some heuristic algorithms can be exploited to optimize the portfolio of response actions.

6.2.5.1 A greedy algorithm

A greedy algorithm is developed for the optimization of risk response plan under constraints, following the problem solving heuristic of making the locally optimal choice at each step with the hope of finding the global optimum (Cormen et al. 2001). In other words, we choose at each step the action with the best test performance until the budget is completely allocated. The process of the greedy algorithm is as follows:

```

Identify the budget constraint  $B$ ;
Prepare the action list  $L$ ;
Create the portfolio of actions  $A = \emptyset$ ;
WHILE  $L \neq \emptyset$  DO
  BEGIN
    FOR each  $A_i \in L$ 
      IF the cost of  $A_i$  exceeds the remaining budget  $B$  ( $C(A_i) > B$ )
        Remove  $A_i$  from  $L$  ( $L = L \setminus A_i$ );
      ELSE
        Test the global mitigation effects of  $A \cup A_i$  in the risk network model;
      END
    END
    Choose the best candidate  $A_i^*$ ;
    Add  $A_i^*$  into  $A$  ( $A = A \cup A_i^*$ );
    Remove  $A_i^*$  from  $L$  ( $L = L \setminus A_i^*$ );
    Allocate the corresponding amount of budget ( $B = B - C(A_i^*)$ );
  END
RETURN  $A$  as the optimized portfolio of actions;

```

However, the greedy algorithm for optimization under constraints can usually achieve only a local optimal solution. Namely, it may make commitments to certain choices too early which prevent it from finding the best overall solution later. For example, choosing an action with good effects but high cost in early stage would largely squeeze the remaining budget space and possibly sacrifice the opportunity of involving a combination of several low-cost actions in the portfolio.

6.2.5.2 A genetic algorithm

Genetic algorithm (GA) is a stochastic search method introduced by Holland in 1970s (Holland 1975). It has a wide range of applications, for example, to the optimization of system reliability (Marseguerra et al. 2006), index fund portfolio management (Oh et al. 2005) and project scheduling (Hartmann 2002).

In our study, a genetic algorithm is devised for the optimization of project risk response plan. It is able to get the global optimum or at least a near global optimal portfolio of actions by starting the search from a population of solutions. The budget constraint is integrated into the objective function (fitness) calculation and the algorithm allows random operations like mutation (Holland 1975). The co-effects (positive and negative synergy effects) of actions are taken into account because an entire portfolio is tested in the risk network model rather than single actions.

The basic genetic algorithm-based optimization process is described as follows:

1) Basic Scheme

```

GEN = 1;
Create initial population POP;
WHILE GEN < GEN* AND (Not Terminate-Condition) DO
BEGIN
    GEN = GEN + 1;
    Test in the risk network model, and compute fitness for individuals  $I \in POP$ ;
    Selection of parents PAs from POP;
    Produce children CHs from PAs by Crossover;
    Mutation operation on children  $I \in CH_s$ ;
    POP = POP  $\cup$  CHs;
    Reduce POP by fitness ranking;
END

```

2) Representation

A risk response plan is suitable to be encoded as a chromosome in the GA, represented as a string of bits. Each bit $x_i \in \{0,1\}$ in the chromosome x indicates whether the corresponding action A_i is chosen or not.

$$x = \{x_1, x_2, \dots, x_i, \dots, x_{n-1}, x_n\} \quad (42)$$

3) Fitness

We integrate the budget constraint into the optimization problem as an objective, which leads to the following definition of fitness:

$$\min Fitness = \lambda \left(\sum_i (P_i * G_i) \right) + (1 - \lambda) (C / \alpha B)^\beta \quad (43)$$

Here C is the total cost of the action plan; P_i and G_i are the probability and impact of Risk i after the response plan is performed. The penalty value $(C / \alpha B)^\beta$ will exponentially increase if the allocated costs C exceed αB ($0 < \alpha \leq 1$), e.g., 90% of the budget constraint. Thus, breaking constraints is penalized by the significant decrease of fitness. The parameter $\beta > 1$ reflects the project manager's degree of aversion to budget overruns. The project manager can adjust the parameter $\lambda \in [0,1]$ to balance the trade-off between budget constraints and mitigation effects.

4) Initial population

The initial population of individual solutions can be created randomly, of given size M . Each of these individuals is a possible risk response plan. Population diversity should be encouraged to make the search more efficient (Nsakanda et al. 2007).

5) Selection of the parents

During each successive generation, a proportion of the existing population is selected to breed a new generation. Individual solutions are selected through a fitness-based process, where fitter solutions (as measured by the fitness function) are typically more likely to be selected. We employ the Roulette Wheel Selection (Fogel 1994; Rajkumar and Shahabudeen 2009) method, where the chance of selecting a chromosome is proportional to its fitness. The rule is that the chromosome x_i is selected if:

$$\frac{\sum_{j=1}^{i-1} f(x_j)}{\sum_{j=1}^M f(x_j)} < r \leq \frac{\sum_{j=1}^i f(x_j)}{\sum_{j=1}^M f(x_j)} \quad (44)$$

where M is the given population size; $f(x_j)$ is the fitness value of the chromosome x_j ; and r is the generated random number with $r \in (0, 1]$.

6) Crossover and mutation

Crossover operation combines two individuals, or parents, to form a new individual, or child, for the next generation. The GA employs a conventional scattered crossover (Popov 2005). It creates a random binary vector as bit mask. It selects the genes where the mask bit is '1' from parent1, and the genes where the mask bit is '0' from parent2, and combines the genes to form the child. The example in Figure 32 illustrates the process of crossover. It should be noted that the symbols a~h and 1~8 are all replaced by a binary bit in this study. The crossover fraction specifies the portion of the next generation, other than elite individuals (the number of individuals that are guaranteed to survive to the next generation), that are produced by crossover.

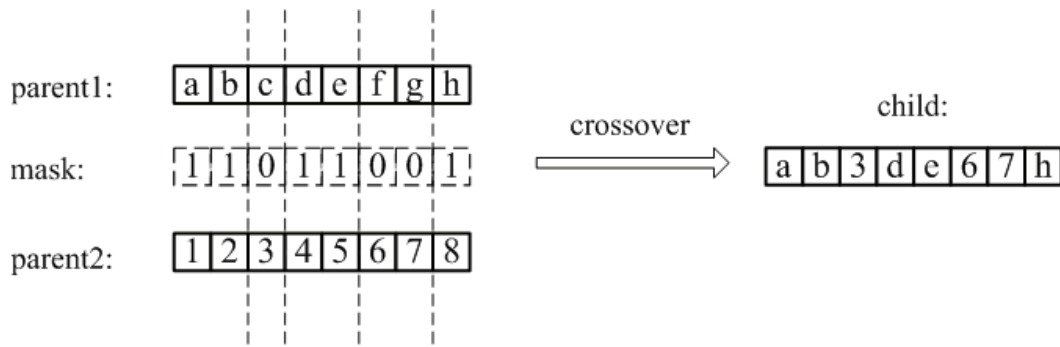

Figure 32. Illustration of the crossover operation

Mutation functions make small random changes in the individuals in the population, which provide genetic diversity and enable the GA to search a broader space (Goldberg 1989). The mutation rate is the chance that a bit within a chromosome will be reversed (0->1, 1->0). The mutation is performed on the basis of an assigned mutation rate for a single bit, which is usually very low for binary encoded genes (Senouci and Al-Derham 2008).

7) Reduction of population for the next generation

The fitness ranking is used for reducing the population to form the next generation. The individuals with the worst test performance are removed in order to return the population to its original size M (Marseguerra et al. 2006).

8) Termination condition

The iteration of GA is terminated when the a-priori fixed number of generations GEN^* is reached, or the highest ranking solution's fitness has reached a plateau such that the successive iterations no longer improve the results.

6.3 Case study

We apply the proposed approach to the tramway construction project, which has been introduced and analyzed in the previous Chapters 4 and 5. The aim is to optimize the risk response plan for minimizing the global objective function in Equation (40): $\min OF = \sum_i P_i * G_i$. The risk propagation model presented in Chapter 5 is used to test the mitigation actions and anticipate their effects on the risk network.

6.3.1 Build the action list

Based on the risk analyses results, with the help of the project management team, we propose a list of potential risk mitigation actions, shown in Table 17. The list contains 21 identified potential actions after eliminating some unfeasible ones. These actions are designed based on the risk criticality analysis (in Chapter 5), topological analysis of risk network (in Chapter 4), or based on both of them. The designed actions are intended to mitigate the risks

(reduce risk spontaneous probability or risk impact) or the risk interactions (reduce transition probability between risks). The cost of executing the actions is estimated by the project manager and some experts. The local effects of the mitigation actions are also evaluated at the qualitative level. Probabilistic effects can be converted into quantitative values through

Equation (1): $p = \alpha * 10^{\frac{-\beta}{s}}$, where the parameters are set as $\alpha = 0.8$, $\beta = 2.9$ by experience.

Table 17. The list of potential risk response actions

Action ID	Action Name	Analysis Source for Action Design	Cost Estimate (k€)	Evaluated Local Effect(s)
A1	Mitigate R2 by contract update	Comes from both	40	P'(R2)=5
A2	Mitigate R37 by formalizing a procedure for preparing Extension Of Time meetings	Comes from criticality analysis	10	P'(R37)=6; G'(R37)=6
A3	Mitigate R3 by preventing depot delay (R48)	Comes from both	50	P'(R48)= 5
A4	Avoid consequences of R29 by including flexibility in the contract	Comes from criticality analysis	20	P'(R29)=0
A5	Mitigating R7 by involving city stakeholders early in the project	Comes from criticality analysis	20	P'(R7)=3; G'(R7)=3
A6	Mitigating R40 by preventing bad scope definition (R20) => indirect action	Comes from criticality analysis	10	P'(R20)=3; P'(R40)=3
A7	Mitigating R22 by signing a Firm Fixed Price contract with Civil Work subcontractor	Comes from criticality analysis	30	G'(R22)=1
A8	Mitigating R22 by communicating with CW subcontractor and solving problems on a regular basis	Comes from criticality analysis	20	P'(R22)=3; G'(R22)=3
A9	Avoid R51 by keeping the same track installation machine (R27)	Comes from topological analysis	5	P'(R51)=1; P'(R27)=0
A10	Avoid R51 by introducing time buffers on this task, due to the uncertainty	Comes from both	10	TP'(R27->R51)=0
A11	Mitigating R48 by prioritizing Civil Work activities and then avoiding propagation R18->R48	Comes from criticality analysis	30	TP'(R18->R48)=0
A12	Avoid R30 by including security in contract definition	Comes from criticality analysis	20	P'(R30)=0
A13	Avoid R52 by specifying correctly the customer requirements and specificities of the context	Comes from topological analysis	60	P'(R52)=0
A14	Confine R10 consequences	Comes from topological analysis	40	TP'(R10->R13)=0
A15	Mitigate R12 by preventing some of its causes	Comes from both	20	P'(R12)=6
A16	Avoid R12 by decomposing Operating Certificate into smaller components and introducing flexibility in the contract	Comes from both	40	P'(R12)=0
A17	Mitigate R10 by proposing high performance trains	Comes from both	60	P'(R46)=1; TP'(R46->R10)=0; TP'(R46->R52)=1
A18	Avoiding extra trains overcost (R44) by contractual agreement	Comes from topological analysis	20	P'(R44)=0
A19	Avoiding extra trains overcost (R44) by train performance upgrade	Comes from topological analysis	40	P'(R44)=0
A20	Mitigating R13 by early involvement of stakeholders (scope definition)	Comes from topological analysis	20	P'(R13)=1
A21	Mitigating R13 by proposing high performance trains	Comes from topological analysis	40	P'(R13)=1; G'(R13)=1

6.3.2 Greedy algorithm results

The devised greedy algorithm is used to obtain the optimal portfolio of mitigation actions. Given the budget reserve for implementing the risk response plan $B = 300$ k€, we get the optimization results shown in Table 18.

In each round, one mitigation action with the highest added effects on the risk network is included into the current portfolio, until the remaining budget reserve is not sufficient for any remaining candidate in the action list. Finally, we get an optimal portfolio containing 11 actions: $A^* = [A1, A2, A3, A4, A5, A6, A8, A9, A12, A13, A16]$, with the total cost of **295 k€**. The value of the objective function has been reduced to **43.599** if all these actions are implemented.

Table 18. Optimization results using the greedy algorithm

Round	Chosed Action ID	Cost (k€)	Objective Function Value	Added Effects	Current Portfolio	Allocated Budget (k€)
Original Status	No	0	63.128	0.000	[No action]	0
1	A16	40	59.572	-3.556	[A16]	40
2	A5	20	56.521	-3.051	[A16,A5]	60
3	A9	5	54.367	-2.154	[A16,A5,A9]	65
4	A2	10	52.558	-1.808	[A16,A5,A9,A2]	75
5	A4	20	50.777	-1.781	[A16,A5,A9,A2,A4]	95
6	A6	10	49.222	-1.555	[A16,A5,A9,A2,A4,A6]	105
7	A1	40	47.910	-1.313	[A16,A5,A9,A2,A4,A6,A1]	145
8	A8	20	46.641	-1.269	[A16,A5,A9,A2,A4,A6,A1,A8]	165
9	A13	60	45.434	-1.208	[A16,A5,A9,A2,A4,A6,A1,A8,A13]	225
10	A12	20	44.424	-1.009	[A16,A5,A9,A2,A4,A6,A1,A8,A13,A12]	245
11	A3	50	43.599	-0.825	[A16,A5,A9,A2,A4,A6,A1,A8,A13,A12,A3]	295

In the greedy algorithm, actions with the highest performance in terms of decreasing the global objective function are always firstly chosen. In this sense, additional budget will not change the previous choices of actions, but only add new actions. Similarly, decreasing the budget reserve will only affect the last few actions added in the portfolio.

6.3.3 Genetic algorithm results

The developed genetic algorithm is performed for the optimization of risk response plan. The population size is set to 100, namely there are 100 individuals in each generation. Roulette wheel method is used for selecting the parents for the next generation. The crossover fraction is set to 0.8, and the mutation rate is set to 0.01. The termination condition of the algorithm is either 1) the iterations of the algorithm reach the maximum number of generations which is set to 100; or 2) there is no improvement in the best fitness value for the number of successive generations, specified by Stall Generations which is set to 20.

For the parameters of the optimization problem (parameters in Equation (43) of the fitness function), we set $\lambda=0.9$, $\alpha=0.95$ and $\beta=20$ by experience and test. In this context, the algorithm stops at the 48th generation and we get the best individual with the chromosome $\mathbf{x} = [1, 1, 0, 1, 1, 1, 1, 1, 1, 0, 0, 1, 1, 0, 0, 1, 0, 0, 0, 1, 0]$. It has the best fitness value equal to 39.373. The decoded optimal portfolio is $\mathbf{A}^* = [\mathbf{A1}, \mathbf{A2}, \mathbf{A4}, \mathbf{A5}, \mathbf{A6}, \mathbf{A7}, \mathbf{A8}, \mathbf{A9}, \mathbf{A12}, \mathbf{A13}, \mathbf{A16}, \mathbf{A20}]$. The total cost of implementing the action plan \mathbf{A}^* is **295 k€**. It may reduce the objective function to the value at **43.527**.

Compared with the results by the greedy algorithm (shown in Table 19), we find that in the optimal solution, the action A3 has been replaced by the combination of A7 and A20. In this case, the required budget for the portfolio is the same, but the optimal risk response plan generated by the genetic algorithm has better effects on the objective function in terms of mitigating the global risk exposure. Although the improvement is not significant for this example, it still shows that the genetic algorithm has greater ability to reach the global optimum than the greedy algorithm for this optimization problem.

Table 19. Comparison of the results by the greedy and genetic algorithms

Method	Optimal Portfolio	Number of Actions	Required Budget (k€)	Objective Function Value
Greedy Algorithm	[A1, A2, A3, A4, A5, A6, A8, A9, A12, A13, A16]	11	295	43.599
Genetic Algorithm	[A1, A2, A4, A5, A6, A7, A8, A9, A12, A13, A16, A20]	12	295	43.527

Furthermore, the parameters can be altered to reflect the adjustment of strategy for risk response planning. For example, if we set $\lambda=0.8$ to strengthen the control over budget, the best chromosome $\mathbf{x} = [1, 1, 0, 1, 1, 1, 0, 1, 1, 0, 0, 1, 1, 0, 0, 1, 0, 0, 0, 1, 0]$, and the optimal portfolio is $\mathbf{A}^* = [\mathbf{A1}, \mathbf{A2}, \mathbf{A4}, \mathbf{A5}, \mathbf{A6}, \mathbf{A8}, \mathbf{A9}, \mathbf{A12}, \mathbf{A13}, \mathbf{A16}, \mathbf{A20}]$. We can see that A7 has been removed from the action plan so that the required budget has decreased to **265 k€** while maintaining the objective function value at **43.872**.

On the other hand, if we increase the balance factor $\lambda=0.95$ for emphasizing the mitigation effects, the best chromosome $\mathbf{x} = [1, 1, 1, 1, 1, 1, 0, 1, 1, 0, 0, 1, 1, 0, 0, 1, 0, 0, 0, 1, 1]$,

0], and the optimal portfolio is $A^* = [A1, A2, A3, A4, A5, A6, A8, A9, A12, A13, A16, A20]$. In this case, A3 has replaced the place of A7. As a result, the objective function has improved to the value at **43.047**. However, extra budget is required to achieve such expectation, where the total cost for executing the risk response plan is accumulated to **315 k€**.

6.4 Conclusion

This chapter presents a practical framework for decision support in risk response planning. The aim is to provide the project manager with a solution and quantitative methods to deal with Q2.3 (how to allocate scarce resources for mitigating risks). First, building the risk network model makes it possible to analyze risk propagation behavior and anticipate the effects of response actions on the global risk network. The objectives of the risk response plan need to be clearly defined before carrying out the risk management activities. Project risk analyses introduced in the previous chapters can be relied on to design potential response actions so that an action list can be established. In this step, some impractical actions should be screened out by the project manager. The re-evaluation of risks and new understandings of the risk network may help the project manager adjust the budget constraints for risk management. Selecting the best risk response plan from many options based on the action list is often required. A greedy algorithm and a genetic algorithm are thus developed to optimize the risk response plan achieving the defined objective function subject to the identified budget constraints.

An application based on a transportation construction project is provided to demonstrate the utility of the approach. A list containing 21 potential risk mitigation actions is built based on the risk analysis results. The cost of each action is estimated by the project management team and the budget reserve for risk management is given as 300k€. Using the greedy algorithm, we obtain an optimal portfolio of 11 actions within the budget. Increasing or decreasing the budget will only add some new actions or remove the last few actions selected. The deficiency of the greedy algorithm is that only the effect rather than the cost of actions is considered as the basis for local searches, which may prevent it from finding the global optimal solution.

In the developed genetic algorithm, we integrate the budget constraint into the objective function to form the fitness function. Through testing the entire response plans in the risk network model, it considers the synergy effects of actions in reaching the optimal solution. The genetic algorithm generates a superior portfolio of actions, which requires the same budget but has better mitigation effects on the risk network. By adjusting the parameters of the fitness function, the project manager is able to make a trade-off between the better risk management results and the budget invested on it.

There are some potential improvements of the proposed framework and algorithms. We only consider the objective of mitigating the global risk exposure under the budget constraints. However, the stakeholders' or the project manager's preferences should also be included into the risk response planning process. For example, sometimes the mitigation of several particular risks is mandatory. Moreover, the portfolio of actions may be more complex. In practice, for

example, if more funds are allocated on the reinforcement of a component, the probability of its failure risk will decrease. In this sense, an action for mitigating risks, for example, A2 can be subdivided into several alternatives (e.g., A2.1, A2.2, and A2.3) with different levels of cost, which will undoubtedly generate different levels of mitigation effects. In this case, we need not only to decide whether to choose an action or not, but also to optimize the level of investment on each action and related risk.

Chapter 7 - Conclusions and Perspectives

This Ph.D. thesis is a synthesis of related research, aiming at modeling and managing the complexity of project risks. As a whole, an original framework of decision support system for project risk management is presented. It consists of five phases: risk network identification, risk network assessment, risk network analysis, risk response planning, and risk monitoring and control. The development and use of the DSS requires the involvement of the project manager, related experts and other team members assigned to the risk management process. The proposed structured approach improves the classical process of PRM and supports decision-making to achieve proactive risk management. A series of methods and tools are provided to the project manager with regard to each phase of the DSS. The research questions posed in S1.4 in Chapter 1 have been addressed.

As a result of the increasing complexity of projects, project risks become interdependent and their consequences may propagate from one risk to another in a complex network structure. The complexity of risk network causes the difficulty for the project manager to properly evaluate risks in terms of characteristics such as probability, impact and criticality. This may limit the project manager's ability to make reliable decisions with respect to risk management. To model the dependency relationships of risks, first, project risks are identified and assessed by classical methods of PRM; then some sophisticated methods like Design Structure Matrix (DSM) and Analytic Hierarchy Process (AHP) are used to identify and assess risk interactions. This makes us able to build the interactions-based risk network, which represents the real complexity of project risks. An example of application to a real musical staging project in the entertainment industry is provided to illustrate the process of project risk modeling.

A prototype risk network model is run using simulation techniques to imitate the occurrence of risks and risk propagation behavior. This enables the project manager to re-evaluate risks in terms of frequency, impact and criticality, taking into account risk interactions. Based on the updated risk prioritization, new risk mitigation actions are suggested and tested, including: (1) classical mitigation actions, but applied to risks with re-evaluated values and rankings (simulated values may be different from initial estimations); (2) non-classical mitigation actions, which mitigate risk propagation instead of risk occurrence. Thus, the simulation-based risk network model can support project manager in making decisions with respect to risk response actions. The application to the musical staging project demonstrates the effectiveness of this prototype model.

Furthermore, based on the project risk network, some innovative methods for project risk analysis are introduced. First, a network theory-based topological analysis is presented for analyzing the structural properties of the risk network. Tailoring some network theory-based indicators to the project risk network, we are able to identify key factors with respect to their

roles in the risk network. Particularly, identifying the interfaces between domains or owners gives the project manager knowledge for improving the structure of organization. For example, reassignment can be performed with the purpose of reducing the interfaces between different risk owners. Second, an eigenstructure analysis is introduced and performed based on both the topological structure and the weighted risk network which assesses the strength of risk interactions. The aim is to measure the importance of risks in the network. This measurement reflects the influence of a risk taking into account both its direct and indirect connections with the other risks in the network. Third, a matrix-based risk propagation model is introduced. It can be used to quantitatively calculate risk propagation and thus to re-evaluate risk characteristics. This model is validated through comparing with the simulation results. It is also an alternative of the simulation-based risk network model for analyzing risk propagation behavior and testing the effects of response actions. These new project risk analyses serve as a powerful complement to classical project risk analysis. The outcomes provide the project manager with more and new insights on risks and risk interactions in the network, which support in designing more effective risk response actions. An application to a real complex engineering project, an urban transportation system implementation project, is presented to illustrate the usefulness of these proposed project risk analyses.

Finally, a practical framework is presented for risk response planning under resource constraints. Two heuristic algorithms are developed, aimed at choosing response actions and optimizing the allocation of budget reserves dedicated to the risk management. This approach is applied to the tramway construction project. Compared with the greedy algorithm, the genetic algorithm-based method shows its greater ability to obtain the global optimal solution. By integrating the budget constraint into the objective function, the project manager can make a trade-off between the expected mitigation effects and the estimated costs using the genetic algorithm.

Some expected improvements have been discussed at the end of each chapter. There are still some limitations and potential extensions of the work in this Ph.D. thesis. The perspectives in the future work are described as follows.

1) Design-oriented research and development

This thesis mainly aims at addressing the posed research questions due to the introduction of complexity for PRM, and an effort has been made to propose a series of methods/tools at the academic level. However, a more design-led and rigorous research approach would enhance the robustness of the research and the development of methods/tools with respect to practical usage in industry. For example, the design research methodology proposed in (Blessing and Chakrabarti 2009) can be considered for improving this study.

2) Sensitivity analysis

As we discussed in Chapter 3, the effectiveness of the risk network model also depends on the validity of the input estimations. A preliminary sensitivity analysis is conducted to examine the effects of input uncertainties on the analysis results. Aven and Zio discusses the challenges involved in the representation and treatment of uncertainties in risk assessment, with regard to decision support (Aven and Zio 2011). This provides some guidance for our future work on the modeling of input assessment uncertainties and their propagation in the risk network for PRM. For example, some possibility theory and fuzzy logic-based methods might be exploited on this issue.

3) Positive risks in terms of opportunity

In this thesis, only the conventional negative risks are included in the scope of the study on PRM. In the future work, risks with positive effects will be considered and included in the network, such as risks with positive impact or so-called opportunities like surplus budget and some conditions like good team communication, which may mitigate some other negative risks.

4) Dependency of risk interactions

In this thesis, the identified risk interactions are assumed to be independent. However, sometimes the effect of an interaction is influenced by other related interactions. To address this limitation, more identification work about cross-impact between risk interactions by experts and decision-makers is required.

5) Dynamic risk network with monitoring and control

In practice, there exist potential changes in the project and uncertainties in the external environment as the project advances. In this regard, more research is needed to analyze the dynamics of the network of interacting risks. The risk network should be monitored and periodic reviews conducted, which may lead to the identification of new risks, termination of the lifecycle of some risks, update of analysis results, and evaluation of the effectiveness of the implemented actions. Thus, the risk analysis report and risk response plans can be modified and improved.

6) Extension of applications

The proposed decision support system will be applied to projects in different industries and with different levels of complexity. Moreover, beyond the context of project management, this approach and some original methods may find their usefulness in other research areas concerning risk management, e.g., critical infrastructures.

Publications

International journals with scientific committee review

Fang. C and Marle. F (2012), “A simulation-based risk network model for decision support in project risk management”, *Decision Support Systems*, 52(3), 635-644.

Fang. C, Marle. F, Zio. E and Bocquet. J.C, “Network theory-based analysis of risk interactions in large engineering projects”, accepted paper, to appear in *Reliability Engineering & System Safety*.

Fang. C and Marle. F, “Dealing with project complexity by matrix-based propagation modelling for project risk analysis”, under 2nd round review, submitted to *Journal of Engineering Design: Special Issue on Dependency Modelling in Complex System Design*. (Submission Nov. 2011)

International conferences with scientific committee review

Fang. C, Marle. F and Zio. E, “An integrated framework for the optimization of project risk response plan under resource constraints with genetic algorithm”, presented at *IEEE conference in Quality, Reliability, Risk, Maintenance, and Safety Engineering*, June 2011, Xi’an, China.

Fang. C and Marle. F, “Un modèle de simulation des interactions entre risques pour assister le management des risques projet”, presented at *Congrès Lambda Mu 17 Innovation et Maitrise des Risques*, Oct. 2010, La Rochelle, France.

Fang. C, Marle. F and Vidal. L.A, “Modelling risk interactions to re-evaluate risks in project management”, presented at *the 12th International Dependency and Structure Modelling Conference, DSM’10*, July 2010, Cambridge University, UK.

Fang. C and Marle. F, “Interactions-based risk network simulation for project risk prioritization”, presented at *the PMI (Project Management Institute) Research and Education Conference*, July 2010, Washington D.C., USA.

Fang. C and Marle. F, “Modeling and simulation of risk interactions in project management”, presented at the conference *Confere’09*, July 2009, Marrakech, Morocco.

Bibliographies

- Adla, A., Soubie, J. L., & Zarate, P. (2007). A cooperative intelligent decision support system for boilers combustion management based on a distributed architecture. *Journal of Decision Systems (JDS)*, 16(2), 241-263.
- AFNOR (2003). *Fd x 50-117: Management de projet, gestion du risque, management des risques d'un projet*: AFNOR.
- Albert, R., & Barabási, A. L. (2002). Statistical mechanics of complex networks. *Reviews of modern physics*, 74(1), 47.
- Albert, R., Jeong, H., & Barabási, A. L. (2000). Error and attack tolerance of complex networks. *Nature*, 406(6794), 378-382.
- APM (1996). *Project risk analysis & management (pram) guide* (2nd edition ed.). High Wycombe: ASSOCIATION FOR PROJECT MANAGEMENT.
- Arnott, D., & Pervan, G. (2008). Eight key issues for the decision support systems discipline. *Decision Support Systems*, 44(3), 657-672.
- Austin, S., Newton, A., Steele, J., & Waskett, P. (2002). Modelling and managing project complexity. *International Journal of Project Management*, 20, 191-198.
- Aven, T., & Zio, E. (2011). Some considerations on the treatment of uncertainties in risk assessment for practical decision making. *Reliability Engineering & System Safety*, 96(1), 64-74.
- Baccarini, D. (1996). The concept of project complexity – a review. *International Journal of Project Management*, 14(4), 201-204.
- Baccarini, D., & Archer, R. (2001). The risk ranking of projects: A methodology. *International Journal of Project Management*, 19(3), 139-145.

- Banks, J., Carson, J. S., Nelson, B., & Nicol, D. (2009). *Discrete-event system simulation* (5th Edition ed.): Prentice Hall.
- Belevitch, V. (1968). *Classical network theory*: Holden-Day.
- Bhat, U. N., & Miller, G. K. (2002). *Elements of applied stochastic processes* (Vol. 378): Wiley-Interscience.
- Blessing, L. T. M., & Chakrabarti, A. (2009). *Drm, a design research methodology*: Springer Verlag.
- Bonacich, P. (1972). Factoring and weighting approaches to status scores and clique identification. *Journal of Mathematical Sociology*, 2(1), 113-120.
- Bonacich, P. (2007). Some unique properties of eigenvector centrality. *Social Networks*, 29(4), 555-564.
- Bondy, J. A., & Murty, U. S. R. (1976). *Graph theory with applications* (Vol. 290): MacMillan London.
- Borgatti, S. P. (2005). Centrality and network flow. *Social Networks*, 27(1), 55-71.
- Boulding, K. E. (1956). General systems theory-the skeleton of science. *Management Science*, 3(3), 197-208.
- Bowles, J. The new sae fmeqa standard. In IEEE (Ed.), *PROCEEDINGS Annual RELIABILITY and MAINTAINABILITY Symposium, 1998*
- Browning, T. (2001). Applying the design structure matrix to system decomposition and integration problems: A review and new directions. *IEEE Transactions in Engineering Management*, 48(3), 292-306.
- Bru, R., Elsner, L., & Neumann, M. (1994). Convergence of infinite products of matrices and inner–outer iteration schemes. *Electronic Transactions on Numerical Analysis*, 2, 183-193.
- BSI (2002). *Iso/iec guide 73:2002. Risk management – vocabulary – guidelines for use in standards*. London: BRITISH STANDARD INSTITUTE.

- Bui, T., & Lee, J. (1999). An agent-based framework for building decision support systems. *Decision Support Systems*, 25(3), 225-237.
- Buzacott, J. A., & Shanthikumar, J. G. (1993). *Stochastic models of manufacturing systems*: Prentice Hall Englewood Cliffs, NJ.
- Carayannis, E. G., Kwak, Y. H., & Anbari, F. T. (2005). *The story of managing projects: An interdisciplinary approach*: Greenwood Publishing Group.
- Carr, V., & Tah, J. H. M. (2001). A fuzzy approach to construction project risk assessment and analysis: Construction project risk management system. *Advances in Engineering Software*, 32(10-11), 847-857.
- Chapman, C., & Ward, S. (2003). *Project risk management – processes, techniques and insights*. Chichester: John Wiley & Sons.
- Chapman, R. (2001). The controlling influences on effective risk identification and assessment for construction design management. *International Journal of Project Management*, 19, 147-160.
- Chu, D., Strand, R., & Fjelland, R. (2003). Theories of complexity – common denominators of complex systems. *Complexity*, 8(3).
- Cleland, D. I., & Gareis, R. (2006). *Global project management handbook*: McGraw-Hill.
- Cleland, D. I., & King, W. R. (1983). *Systems analysis and project management*: MCGRAW-HILL.
- Cooper, D. F., & Chapman, C. B. (1987). Risk analysis for large projects: Model, methods and cases. *Chichester, New-York*.
- Corbett, L. M., Brockelsby, J., & Campbell-Hunt, C. (2002). *Tackling industrial complexity*. Cambridge: Cambridge: Institute for Manufacturing.
- Cormen, T. H., Leiserson, C. E., Rivest, R. L., & Stein, C. (2001). *Introduction to algorithms* (2nd ed.): MIT Press.
- Crucitti, P., Latora, V., & Porta, S. (2006). Centrality in networks of urban streets. *Chaos: an interdisciplinary journal of nonlinear science*, 16, 015113.

- Danilovic, M., & Browning, T. (2007). Managing complex product development projects with design structure matrices and domain mapping matrices. *International Journal of Project Management*, 25, 300-314.
- Daubechies, I., & Lagarias, J. C. (1992). Sets of matrices all infinite products of which converge. *Linear algebra and its applications*, 161, 227-263.
- Daubechies, I., & Lagarias, J. C. (2001). Corrigendum/addendum to: Sets of matrices all infinite products of which converge. *Linear Algebra and its Applications*, 327(1-3), 69-83.
- Dean, B. V. (1985). *Project management: Methods and studies* (Vol. 11): Elsevier Science Ltd.
- Deo, N. (2004). *Graph theory with applications to engineering and computer science*: PHI Learning Pvt. Ltd.
- Dillon, R. L., Pate-Cornell, M. E., & Guikema, S. D. (2003). Programmatic risk analysis for critical engineering systems under tight resource constraints. *Operations Research*, 354-370.
- Dong, Q. (2002). *Predicting and managing system interactions at early phase of the product development process*. MIT,
- DSM-Community (2009). Dsm tutorial. <http://www.dsmweb.org/>.
- Ebrahimnejad, S., Mousavi, S. M., & Seyrafiyanpour, H. (2010). Risk identification and assessment for build-operate-transfer projects: A fuzzy multi attribute decision making model. *Expert Systems with Applications*, 37(1), 575-586.
- Eckert, C., Clarkson, P. J., & Zanker, W. (2004). Change and customisation in complex engineering domains. *Research in Engineering Design*, 15(1), 1-21.
- Edmonds, B. (1999). *Syntactic measures of complexity*. philosophy University of Manchester, Manchester.
- Eppinger, S., & Salminen, V. Patterns of product development interactions. In *International Conference on Engineering Design, Glasgow, Scotland, 2001*

- Eppinger, S., Whitney, D. E., & Gebala, D. A. Organizing the tasks in complex design projects: Development of tools to represent design procedures. In *NSF Design and Manufacturing Systems Conference, Atlanta GA, 1992* (pp. 301-309)
- Eusgeld, I., Kröger, W., Sansavini, G., Schläpfer, M., & Zio, E. (2009). The role of network theory and object-oriented modeling within a framework for the vulnerability analysis of critical infrastructures. *Reliability Engineering & System Safety*, *94*(5), 954-963.
- Fan, C., & Yu, Y. (2004). Bbn-based software project risk management. *Journal of Systems and Software*, *73*(2), 193-203.
- Fleiss, J. L. (1981). Statistical methods for rates and proportions. *New York: John Wiley&Sons*.
- Floyd, R. W. (1962). Algorithm 97: Shortest path. *Communications of the ACM*, *5*(6), 345.
- Fogel, D. B. (1994). An introduction to simulated evolutionary optimization. *Neural Networks, IEEE Transactions on*, *5*(1), 3-14.
- Freeman, L. C. (1977). A set of measures of centrality based on betweenness. *Sociometry*, *40*(1), 35-41.
- Friedkin, N. E. (1991). Theoretical foundations for centrality measures. *American journal of Sociology*, 1478-1504.
- Frobenius, G. F., Frobenius, F. G., Frobenius, F. G., & Frobenius, F. G. (1912). *Über matrizen aus nicht negativen elementen*: Königliche Akademie der Wissenschaften.
- Gachet, A., & Haettenschwiler, P. (2003). A jini based software framework for developing distributed cooperative decision support systems. *Software: Practice and Experience*, *33*(3), 221-258.
- Gautier, R., Truchot, P., & Gidel, T. (1997). Method of reliability analysis in the project information management process. In *Managing risks in projects* (pp. pp.195-203). London: A&FN SPON.
- Giffin, M., De Weck, O., Bounova, G., Keller, R., Eckert, C., & Clarkson, P. J. (2009). Change propagation analysis in complex technical systems. *Journal of Mechanical Design*, *131*, 081001.

- Goldberg, D. E. (1989). *Genetic algorithms in search, optimization, and machine learning*: Addison-wesley.
- Guimera, R., & Amaral, L. A. N. (2004). Modeling the world-wide airport network. *The European Physical Journal B-Condensed Matter and Complex Systems*, 38(2), 381-385.
- Gunawan, I., & Ahsan, K. (2010). Project scheduling improvement using design structure matrix. *International Journal of Project Organisation and Management*, 2(4), 311-327.
- Hadi, A. S. (1992). A new measure of overall potential influence in linear regression. *Computational statistics & data analysis*, 14(1), 1-27.
- Hartmann, S. (2002). A self-adapting genetic algorithm for project scheduling under resource constraints. *Naval research logistics*, 49(5), 433-448.
- Heal, G., & Kunreuther, H. (2007). Modeling interdependent risks. *Risk Analysis*, 27(3), 621-634.
- Hendrickson, C., & Au, T. (2000). Project management for construction. *Prentice Hall*.
- Henley, E., & Kumamoto, H. (1992). *Probabilistic risk assessment*. New York: IEEE Press.
- Holland, J. H. (1975). *Adaptation in natural and artificial systems: An introductory analysis with applications to biology, control, and artificial intelligence*: U Michigan Press.
- Holtz, O. (2000). On convergence of infinite matrix products. *Electron. J. Linear Alg*, 7, 178–181.
- IEC (1995). *Cei/iec 300-3-9:1995 risk management: Part 3 – guide to risk analysis of technological systems*. Geneva: INTERNATIONAL ELECTROTECHNICAL COMMISSION.
- IEEE (2001). *Ieee standard 1540-2001: Standard for software life cycle processes – risk management*. New York: INSTITUTE OF ELECTRICAL AND ELECTRONIC ENGINEERS.
- IPMA (2006). *Ipma competence baseline (icb), version 3.0, march 2006* International Project Management Association.
- ISO (2003). *Iso 10006 - quality management systems - guidelines for quality management in projects* (2nd edition ed.). Switzerland: International Organization for Standardization.

- Johnson, C. R. (1974). Hadamard products of matrices. *Linear and Multilinear Algebra*, 1(4), 295-307.
- Jones, B. S., & Anderson, P. (2005). Diversity as a determinant of system complexity. GIST technical report G 2005-1.
- Kaplan, S., Vishnepolschi, S., Zlotin, B., & Zusman, A. (1999). *New tools for failure and risk analysis, anticipatory failure détermination (afd) and the theory of scenario structuring*. South-field, Michigan: Monograph published by Ideation International Inc.
- Katz, L. (1953). A new status index derived from sociometric analysis. *Psychometrika*, 18(1), 39-43.
- Kawakita, J. (1991). *The original kj method* Tokyo: Kawakita Research Intitute.
- Keizer, J., Halman, J., & Song, M. (2002). From experience: Applying the risk diagnosing methodology. *The journal of product innovation management*, 19(3), 213-232.
- Kelton, W., Sadowski, R., & Sturrock, D. (2007). *Simulation with arena* (4th Edition ed.). New York: McGraw Hill.
- Kerzner, H. (1998). *Project management: A systems approach to planning, scheduling and controlling* New York: John Wiley & Sons.
- Klein, J., & Cork, R. (1998). An approach to technical risk assessment. *International Journal of Project Management*, 16, 345-351.
- Kloss-Grote, B., & Moss, M. A. (2008). How to measure the effectiveness of risk management in engineering design projects? Presentation of rmpass: A new method for assessing risk management performance and the impact of knowledge management—including a few results. *Research in Engineering Design*, 19(2), 71-100.
- Kreimeyer, M. F. (2010). *A structural measurement system for engineering design processes*. Universitätsbibliothek der TU Mnchen,
- Kröger, W., & Zio, E. (2011). *Vulnerable systems*: Springer.
- Kurtoglu, T., & Tumer, I. (2008). A gaph-based fault identification and propagation framework for functional design of complex systems. *Journal of Mechanical Design*, 130.

- Latouche, G., Ramaswami, V., & Kulkarni, V. G. (1999). Introduction to matrix analytic methods in stochastic modeling. *Journal of Applied Mathematics and Stochastic Analysis*, 12(4), 435-436.
- Le Moigne, J. (1990). *La théorie du système général. Théorie de la modélisation*: Presses Universitaires de France.
- Lee, E., Park, Y., & Shin, J. (2008). Large engineering project risk management using a bayesian belief network. *Expert Systems with Applications*, 36(3), 5880-5887.
- Lee, L., Ingegneri, A., Li, M., & Everett, D. (2007). Probabilistic risk assessment: A practical & cost effective approach.
- Lee, W. T., Deng, W. Y., Lee, J., & Lee, S. J. (2010). Change impact analysis with a goal - driven traceability - based approach. *International Journal of Intelligent Systems*, 25(8), 878-908.
- Likert, R. (1932). A technique for the measurement of attitudes. *Archives of psychology*.
- Lindemann, U., Maurer, M., & Braun, T. (2008). *Structural complexity management: An approach for the field of product design*: Springer Verlag.
- Lock, D. (2007). *The essentials of project management*: Ashgate Pub Co.
- Marle, F. (2002). *Modèle d'informations et méthodes pour aider à la prise de décision en management de projets*. Ecole Centrale Paris, Paris.
- Marle, F. (2008). Analysis of current project risk management methodologies and required improvements. (pp. Working Paper): Ecole Centrale Paris.
- Marle, F., Vidal, L. A., & Bocquet, J. C. (2010). Interactions-based risk clustering methodologies and algorithms for complex project management. *International Journal of Production Economics*.
- Marseguerra, M., Zio, E., & Martorell, S. (2006). Basics of genetic algorithms optimization for rams applications. *Reliability Engineering & System Safety*, 91(9), 977-991.
- Maurer, T. J., & Pierce, H. R. (1998). A comparison of likert scale and traditional measures of self-efficacy. *Journal of Applied Psychology*, 83(2), 324.

- McManus, J., & Wood-Harper, T. (2003). *Information systems project management: Methods, tools and techniques*: Pearson Education.
- Mészáros, C., & Rapcsák, T. (1996). On sensitivity analysis for a class of decision systems. *Decision Support Systems*, 16(3), 231-240.
- Meyn, S. P., Tweedie, R. L., & Glynn, P. W. (1993). *Markov chains and stochastic stability*: Springer London et al.
- MIL-STD-1629 (1998). *Procedures for performing fmeca (revision a [1998])*.
- Morel, B., & Ramanujam, R. (1999). Through the looking glass of complexity : The dynamics of organizations as adaptive and evolving systems. *Organization science*, 10(3), 278-293.
- Nsakanda, A. L., Price, W. L., Diaby, M., & Gravel, M. (2007). Ensuring population diversity in genetic algorithms: A technical note with application to the cell formation problem. *European Journal of Operational Research*, 178(2), 634-638.
- Oh, K. J., Kim, T. Y., & Min, S. (2005). Using genetic algorithm to support portfolio optimization for index fund management. *Expert Systems with Applications*, 28(2), 371-379.
- Pahl, G., Beitz, W., Feldhusen, J., & Grote, K. (2007). *Engineering design - a systematic approach* (3rd ed.): Springer.
- Pallottino, S. (1984). Shortest path methods: Complexity, interrelations and new propositions. *Networks*, 14(2), 257-267.
- Penalva, J.-M. (1997). *La modélisation par les systèmes en situations complexes*. Parix XI Orsay Paris.
- Perron, O. (1907). Zur theorie der matrices. *Mathematische Annalen*, 64(2), 248-263.
- PMI, S. C. (2008). *A guide to the project management body of knowledge (pmbok) (2008 ed.)*. Newton Square, PA, USA. : Project Management Institute.
- Popov, A. (2005). Genetic algorithms for optimization. *User Manual, Hamburg*.
- Power, D. J., & Sharda, R. (2007). Model-driven decision support systems: Concepts and research directions. *Decision Support Systems*, 43(3), 1044-1061.

- PRINCE (1999). *Managing successful projects with prince 2*: UK: Computers and Telecommunications Agency (CCTA).
- Rajkumar, R., & Shahabudeen, P. (2009). An improved genetic algorithm for the flowshop scheduling problem. *International Journal of Production Research*, 47(1), 233-249.
- Raz, T., & Hillson, D. (2005). A comparative review of risk management standards. *Risk Management: An international journal*, 7 (4), 53-66.
- Riek, R. (2001). From experience: Capturing hard-won npd lessons in checklists. *The Journal of Product Innovation Management*, 18, 301-313.
- Rosato, V., Bologna, S., & Tiriticco, F. (2007). Topological properties of high-voltage electrical transmission networks. *Electric Power Systems Research*, 77(2), 99-105.
- Rozinat, A., Mans, R. S., Song, M., & van der Aalst, W. M. P. (2009). Discovering simulation models. *Information Systems*, 34(3), 305-327.
- Saaty, T. (1977). A scaling method for priorities in hierarchical structures. *Journal of Mathematical Psychology*, 15, 234-281.
- Saaty, T. (1980). *The analytic hierarchy process: Planning, priority setting, resource allocation*: McGraw-Hill.
- Saaty, T. (2000). *Fundamentals of the analytic hierarchy process*. Pittsburgh, PA: RWS Publications.
- Saaty, T. (2003). Decision-making with the ahp: Why is the principal eigenvector necessary. *European Journal of Operational Research*, 145(1), 85-91.
- Saltelli, A., Chan, K., & Scott, E. M. (2000). *Sensitivity analysis* (Vol. 134). New York: John Wiley & Sons.
- Schlundwein, S., & Ison, R. (2005). Human knowing and perceived complexity: Implications for systems practice. *Emergence: complexity & organisation*, 6(3), 19-24.
- Sen, P., Dasgupta, S., Chatterjee, A., Sreeram, P. A., Mukherjee, G., & Manna, S. S. (2003). Small-world properties of the indian railway network. *Physical Review E*, 67(3), 036106.

- Senouci, A., & Al-Derham, H. R. (2008). Genetic algorithm-based multi-objective model for scheduling of linear construction projects. *Advances in Engineering Software*, 39(12), 1023-1028.
- Shimizu, H., & Noguchi, H. (2005). Reliability problem prevention method for automotive components-development of gd'3' activity and drbfm method for stimulating creativity and visualizing problems. *Transaction of Society of Automotive Engineers of Japan*, , 36(4), 163-168.
- Sinha, S., Thomson, A. I., & Kumar, B. A complexity index for the design process. In *International Conference on Engineering Design, Glasgow, 2001* (Vol. 1, pp. 157-163): Professional Engineering Publishing, Bury St Edmunds.
- Smith, P., & Merritt, G. (2002). *Proactive risk management. Controlling uncertainty in product development*. New York: Productivity Press.
- Smith, R., & Eppinger, S. (1997). Identifying controlling features of engineering design iteration. *Management Science*, 43(3), 276-293.
- Sosa, M. (2008). A structured approach to predicting and managing technical interactions in software development. *Research in Engineering Design*.
- Sosa, M., Eppinger, S., & Rowles, C. (2004). The misalignment of product architecture and organizational structure in complex product development. *Management Science*, 50(12), 1674-1689.
- Stamatelatos, M. A vision for system safety enhancement at nasa, . In *Safety Directors' Meeting, Cocoa Beach, Florida,, 2004*
- Steward, D. (1981). The design structure matrix: A method for managing the design of complex systems. *IEEE Transactions in Engineering Management*, 28(3), 71-74.
- Stone, R., Tumer, I., & Van Wie, M. (2004). The function–failure design method. *Journal of Mechanical Design*, 127(3), 397-407.
- Strogatz, S. H. (2001). Exploring complex networks. *Nature*, 410(6825), 268-276.
- Taylor, M. (1969). Influence structures. *Sociometry*, 490-502.

- Thomason, M. G. (1977). Convergence of powers of a fuzzy matrix. *Journal of mathematical analysis and applications*, 57(2), 476-480.
- Thompson, J. (1967). *Organizations in action*. New York: McGraw-Hill.
- Trucco, P., Cagno, E., Ruggeri, F., & Grande, O. (2008). A bayesian belief network modelling of organisational factors in risk analysis: A case study in maritime transportation. *Reliability Engineering & System Safety*, 93(6), 845-856.
- Tumer, I., & Stone, R. (2001). Mapping function to failure mode during component development. *Research in Engineering Design*, 14(1), 25-33.
- Vidal, L.-A., Marle, F., & Bocquet, J.-C. (2011a). Measuring project complexity using the analytic hierarchy process. *International Journal of Project Management*, 29(6), 718-727.
- Vidal, L.-A., Marle, F., & Bocquet, J.-C. (2011b). Using a delphi process and the analytic hierarchy process (ahp) to evaluate the complexity of projects. *Expert Systems with Applications*, 38(5), 5388-5405.
- Vidal, L., & Marle, F. (2008). Understanding project complexity: Implications on project management. *Kybernetes, the International Journal of Systems, Cybernetics and Management Science*.
- West, D. B. (2001). *Introduction to graph theory* (Vol. 1): Prentice Hall Upper Saddle River, NJ.
- White, D., & Fortune, J. (2002). Current practice in project management--an empirical study. *International Journal of Project Management*, 20(1), 1-11.
- Wilson, R. J., & Wilson, R. J. (1996). *Introduction to graph theory*: IMA.
- Zio, E. (2007). From complexity science to reliability efficiency: A new way of looking at complex network systems and critical infrastructures. *International journal of critical infrastructures*, 3(3), 488-508.
- Zio, E., & Sansavini, G. (2008). A systematic procedure for analysing network systems. *International Journal of Critical Infrastructures*, 4(1), 172-184.

Zio, E., Sansavini, G., Maja, R., & Marchionni, G. (2008). An analytical approach to the safety of road networks. *INTERNATIONAL JOURNAL OF RELIABILITY QUALITY AND SAFETY ENGINEERING*, 15(1), 67.

List of Figures

Figure 1. Classical steps of project risk management.....	- 12 -
Figure 2. Representations of risk analysis results.....	- 14 -
Figure 3. An example of project complexity framework (adapted from (L.-A. Vidal et al. 2011b))..	- 16 -
Figure 4. Complexity vision of project and project risks (Marle 2008)	- 18 -
Figure 5. An example of loop phenomenon in risk propagation	- 18 -
Figure 6. Diagram of risk probability and impact.....	- 20 -
Figure 7. Tree structure of risk correlations.....	- 20 -
Figure 8. An example of Bayesian belief network for risk management in large engineering project (E. Lee et al. 2008)	- 21 -
Figure 9. Framework of the decision support system for PRM.....	- 25 -
Figure 10. Steps in the DSS for addressing related research questions	- 26 -
Figure 11. Illustration of DSM (DSM-Community 2009).....	- 32 -
Figure 12. Illustration of risk structure matrix (RSM).....	- 33 -
Figure 13. Description of the transformation process from RSM to RNM	- 37 -
Figure 14. RSM of the musical staging project	- 40 -
Figure 15. Interactions-based project risk network structure of the musical staging project.....	- 40 -
Figure 16. RNM of the musical staging project.....	- 41 -
Figure 17. Simulation model of the project risk network using ARENA software	- 48 -
Figure 18. Sensitivity analysis results of project risks.....	- 54 -
Figure 19. Comparison of effects on the global risk network by applying different mitigation actions.....	- 56 -
Figure 20. RSM of the tramway project	- 67 -
Figure 21. Project risk network structure of the tramway project	- 68 -
Figure 22. Display of classical project risk analysis results	- 70 -
Figure 23. Diagram of degree of risks	- 71 -
Figure 24. Diagram of reachability degree of risks	- 72 -
Figure 25. Interfaces between risk domains with local and global viewpoints	- 72 -
Figure 26. Interfaces between risk owners with local and global viewpoints	- 73 -
Figure 27. Structure of the project risk network (with highlighted important risks and interactions).	- 74 -
Figure 28. Structure of the project risk network after taking actions	- 79 -
Figure 29. RSM and network structure of the example	- 86 -
Figure 30. RNM of the tramway project.....	- 90 -

Figure 31. A framework for risk response planning - 97 -
Figure 32. Illustration of the crossover operation..... - 103 -

List of Tables

Table 1. Definition of probability, impact, and criticality reference scales	- 13 -
Table 2. Typical Project Risk List in Classical Methods	- 19 -
Table 3. Original project risk list with characteristic values of the musical staging project	- 39 -
Table 4. The comparison of re-evaluated simulation results with those of classical method	- 50 -
Table 5. Risk prioritization results by different indicators	- 51 -
Table 6. Evaluated three-level values of risk spontaneous probability.....	- 53 -
Table 7. Effects of different mitigation actions on particular risks	- 55 -
Table 8. Project risk list with classical risk characteristics of the tramway project.....	- 66 -
Table 9. The top risks and interactions according to the betweenness centrality	- 73 -
Table 10. The top-ten risks according to eigenvector centrality.....	- 75 -
Table 11. The top betweenness centralities after taking actions.....	- 78 -
Table 12. The top risks according to eigenvector centrality after taking actions	- 78 -
Table 13. Risk re-evaluation and prioritization results of the simple example.....	- 87 -
Table 14. Comparison of the results by risk propagation model and by simulation.....	- 89 -
Table 15. Project risk analysis results of the tramway project	- 92 -
Table 16. Risk ranking results according to eigenvector centrality	- 93 -
Table 17. The list of potential risk response actions.....	- 104 -
Table 18. Optimization results using the greedy algorithm.....	- 105 -
Table 19. Comparison of the results by the greedy and genetic algorithms	- 106 -

Résumé :

La gestion des risques projet est une activité cruciale dans le management de projet. Aujourd'hui, les projets sont confrontés à une complexité croissante et sont ainsi exposés à de nombreux risques interdépendants. Cependant, les méthodes classiques ont des limites pour la modélisation de la complexité réelle des risques du projet. Par exemple, certains phénomènes comme les réactions en chaîne et des boucles ne sont pas correctement pris en compte. Cette thèse de doctorat vise à analyser le comportement du réseau de risques projet grâce à la modélisation des risques et des interactions entre risques. Un système d'aide à la décision est introduit avec une série de méthodes associées. La construction du réseau de risques projet nécessite l'implication du manager de projet et l'équipe d'experts en utilisant la méthode Design Structure Matrix (DSM). Des techniques basées sur la simulation et la théorie des réseaux sont développées pour analyser et hiérarchiser les risques du projet, en regard de leur rôle et leur importance dans le réseau des risques. L'approche proposée constitue un puissant complément à l'analyse classique des risques projet. Ces nouvelles analyses fournissent aux managers de projet une meilleure vision sur les risques et sur leurs interactions complexes et les aident à élaborer des réponses plus efficaces. Prenant en compte les contraintes de ressources, un algorithme glouton et un algorithme génétique sont développés pour optimiser le plan de réponse aux risques et l'allocation des réserves budgétaires. Deux exemples d'application, 1) à un projet réel de mise en scène musicale dans l'industrie du divertissement et 2) à un projet réel de construction d'un système de transport urbain, sont présentés pour illustrer l'utilité du système d'aide à la décision proposé.

Mots-clés: gestion des risques projet, complexité, interaction entre risques, réseau de risques, analyse des risques, propagation du risque, théorie des réseaux, optimisation, système d'aide à la décision

Abstract :

Project risk management is a crucial activity in project management. Nowadays, projects are facing a growing complexity and are thus exposed to numerous and interdependent risks. However, existing classical methods have limitations for modeling the real complexity of project risks. For example, some phenomena like chain reactions and loops are not properly taken into account. This Ph.D. thesis aims at analyzing propagation behavior in the project risk network through modeling risks and risk interactions. An integrated framework of decision support system is presented with a series of proposed methods. The construction of the project risk network requires the involvement of the project manager and the team of experts using the Design Structure Matrix (DSM) method. Simulation techniques are used and several network theory-based methods are developed for analyzing and prioritizing project risks, with respect to their role and importance in the risk network in terms of various indicators. The proposed approach serves as a powerful complement to classical project risk analysis. These novel analyses provide project managers with improved insights on risks and risk interactions under complexity and help them to design more effective response actions. Considering resource constraints, a greedy algorithm and a genetic algorithm are developed to optimize the risk response plan and the allocation of budget reserves dedicated to the risk management. Two examples of application, 1) to a real musical staging project in the entertainment industry and 2) to a real urban transportation system implementation project, are presented to illustrate the utility of the proposed decision support system.

Keywords: project risk management, complexity, risk interaction, risk network, risk analysis, risk propagation, network theory, optimization, decision support system