



HAL
open science

The life cycle assessment of the Milazzo peninsula (north-eastern Sicily, Italy) : geochemical impact assessment of water and soils

Morgane Mey

► **To cite this version:**

Morgane Mey. The life cycle assessment of the Milazzo peninsula (north-eastern Sicily, Italy) : geochemical impact assessment of water and soils. Earth Sciences. Université de Strasbourg; Università degli studi (Messine, Italie), 2013. English. NNT : 2013STRAH005 . tel-01018983

HAL Id: tel-01018983

<https://theses.hal.science/tel-01018983v1>

Submitted on 7 Jul 2014

HAL is a multi-disciplinary open access archive for the deposit and dissemination of scientific research documents, whether they are published or not. The documents may come from teaching and research institutions in France or abroad, or from public or private research centers.

L'archive ouverte pluridisciplinaire **HAL**, est destinée au dépôt et à la diffusion de documents scientifiques de niveau recherche, publiés ou non, émanant des établissements d'enseignement et de recherche français ou étrangers, des laboratoires publics ou privés.



UNIVERSITÉ DE STRASBOURG
Laboratoire d'Hydrologie et de Géo chimie de Strasbourg (UMR7517)

THESE

Pour l'obtention du diplôme de

DOCTEUR DE L'UNIVERSITÉ DE STRASBOURG

Spécialité : Environnement

Présentée par

Morgane Mey

*Analyse du Cycle de Vie des activités anthropiques de la
Péninsule de Milazzo (Nord-Est de la Sicile, Italie) : étude des
impacts environnementaux sur les eaux et les sols*

Soutenue le 23 avril 2013 devant le jury constitué de :

Joëlle DUPLAY	EOST-LHYGES Strasbourg	Directeur de thèse
Gaetana QUARANTA	EOST-LHYGES Strasbourg	Co-Directrice de thèse
Antonia MESSINA	Università di Messina	Co-Directrice de thèse
Marie-Noëlle PONS	Université de Lorraine	Rapporteur externe
Benedetto DEVIVO	Università di Messina	Rapporteur externe
Alessandro TRIPODO	Università di Messina	Examineur

Riassunto

La penisola di Milazzo, Sicilia nord-orientale, in Italia, è il sito di impianto potenzialmente inquinanti delle attività antropiche. Tra questi, una raffineria e una centrale termoelettrica. Uno studio epidemiologico ha mostrato una diminuzione della qualità della salute umana nella zona, ma non c'era ulteriori ricerche per quanto riguarda le ragioni di questa osservazione. Lo scopo di questo lavoro è quello di capire meglio come le emissioni delle attività antropiche della penisola di Milazzo impattano la salute umana e gli ecosistemi locali. La Valutazione del Ciclo della Vita (LCA) è un tipo di calcolo che è stato scelto al fine di studiare le conseguenze delle emissioni provenienti dalle seguenti attività locali antropiche: la centrale termoelettrica, la raffineria, il traffico stradale, la combustione illegale dei rifiuti domestici. L'Impact 2002+ e la ReCiPe 2008 su scala globale sono i modelli stati scelti, oltre a un sito-specifico approccio. Al fine di condurre questo sito-specifico calcolo, terreni e campioni di acqua di mare Milazzo sono stati raccolti e dei parametri specifici della zona sono state dedotte dalle loro analisi. Gli risultati da scala globale hanno evidenziato le emissioni della combustione e della centrale termoelettrica come le cause principali della diminuzione della qualità della salute umana, mentre la centrale termoelettrica è stato sottolineato come l'attività antropica che ha causato il più danni ambientali. Il sito-specifico studio applicato al terreno e l'ecotossicità acqua di mare hanno confermato il ruolo importante delle emissioni della centrale termoelettrica nei danni sull'ambiente, in particolare l'acqua di mare. Inoltre, il sito-specifico studio ha anche corretto i punteggi ecotossiche impatto del suolo, mostrando l'importanza sia centrale termoelettrica e contributi della combustione illegale dei rifiuti al danneggiamento dell'ambiente. In conclusione, lo studio LCA nel suo insieme illumina e spiega le precedenti osservazioni della salute umana e danni agli ecosistemi nel sito di studio mentre il sito-specifico studio ha dimostrato adeguata nel settore peculiare di Milazzo.

Abstract

The Milazzo peninsula, North-Eastern Sicily, Italy, is the implantation site of potentially polluting anthropogenic activities. Among them, a refinery and a thermoelectric plant. An epidemiological study has shown a decrease of human health quality in the area, but there was no further research as to the reasons of this observation. The aim of this work is to better understand how the Milazzo peninsula's anthropogenic emissions impact the local human health and ecosystems. The Life Cycle Assessment calculating approach was chosen in order to study the consequences of the emissions resulting from the following local anthropogenic activities: the thermoelectric plant, the refinery, the road traffic, the illegal combustion of domestic waste. The Impact 2002+ and the ReCiPe 2008 global-scale models were chosen, as well as a site-specific approach. In order to conduct this site-specific calculation, Milazzo soils and seawater samples were gathered and the specific local parameters were deduced from their analyses. The global-scale results pointed out the waste combustion emissions and the thermoelectric plant as the main causes of the human health quality decrease, while the thermoelectric plant was pointed out as the anthropogenic activity causing the most environmental damages. The site-specific study applied to the soil and seawater ecotoxicity confirmed the important role of the thermoelectric plant's emissions in the damages upon the environment, especially the seawater. Moreover, the site-specific study also corrected the soil ecotoxic impact scores, showing the importance of both thermoelectric plant and illegal waste combustion contributions to the damaging of the environment. As a conclusion, LCA study as a whole enlightens and explains the previous observations of human health and ecosystem damages in the site of study while the site-specific study proved relevant in the peculiar area of Milazzo.

Table of contents

General introduction and state of knowledge.....	1
1 Presentation of the site.....	6
1.1 Physical and geochemical presentation.....	7
1.1.1 Climate and sea currents.....	7
1.1.2 Geological and geomorphological presentation.....	8
<i>Geological and geomorphological presentation.....</i>	<i>9</i>
<i>A geosite.....</i>	<i>12</i>
1.1.3 Geochemical background.....	13
<i>The Mediterranean Sea.....</i>	<i>13</i>
<i>Influence of the Eolian Islands.....</i>	<i>14</i>
<i>The spring water in North-Eastern Sicily.....</i>	<i>15</i>
<i>The Milazzo Peninsula.....</i>	<i>16</i>
1.2 Anthropogenic activities presentation.....	17
1.2.1 Petrochemical areas.....	18
1.2.2 Road traffic.....	20
1.2.3 Illegal combustion of domestic solid waste.....	20
1.2.4 Other activities.....	20
1.2.5 Global knowledge regarding the pollutants of the area.....	20
2 Material and methods.....	22
2.1 Sampling and analysis methodologies.....	23
2.1.1 Sampling methodologies.....	23
2.1.2 Analyses methodology.....	25
<i>Water samples.....</i>	<i>25</i>
<i>Soil samples.....</i>	<i>26</i>
2.2 Impacts assessment methodology.....	27
2.2.1 Conceptual approach of Life Cycle Impact Assessment.....	27
<i>Goal and scope.....</i>	<i>28</i>
<i>Inventory of the pollutants, collection of data.....</i>	<i>29</i>
<i>Inventory classification by the Life Cycle Inventory.....</i>	<i>29</i>
<i>Characterization by the Life Cycle Impact Assessment.....</i>	<i>30</i>
<i>Normalization.....</i>	<i>31</i>
<i>Interpretation and analysis of the results.....</i>	<i>32</i>
<i>Running issues in the LCIA.....</i>	<i>32</i>
2.2.2 Global-scale evaluation methodologies.....	32
<i>Impact 2002+ v2.06.....</i>	<i>33</i>
<i>ReCiPe Endpoint v1.04.....</i>	<i>33</i>
2.2.3 Site-specific evaluation methodologies.....	35
<i>Present limitations of the global-scale methodologies.....</i>	<i>35</i>
<i>Calculation of site-dependent parameters.....</i>	<i>36</i>
2.3 Monte-Carlo analysis.....	38
3 Application of the Life Cycle Assessment methodology to the anthropogenic activities of the Milazzo Peninsula.....	39

3.1 Goal and scope.....	40
3.2 Inventory collection and analysis.....	42
3.2.1 Ecoinvent 2.0.....	42
3.2.2 Pollutants from illegal combustion of domestic waste.....	42
3.2.3 Pollutants from the Milazzo refinery.....	45
3.2.4 Pollutants from the thermoelectric plant.....	51
3.2.5 Pollutants from the road circulation in Milazzo.....	57
3.3 Comparison of global-scale calculation methodologies.....	61
3.3.1 Impact categories and number of chemical species.....	61
3.3.2 Models underlying the calculation methods.....	63
3.3.3 Conclusion.....	64
3.4 Yearly global-scale calculation.....	65
3.4.1 Impacts on the environment.....	65
<i>Aquatic ecotoxicity</i>	65
<i>Acidification and eutrophication</i>	67
<i>Terrestrial ecotoxicity</i>	70
<i>Global warming, climate change</i>	72
3.4.2 Impacts to the human health.....	74
<i>Inorganic matter, leading to particulate matter formation</i>	74
<i>Respiratory organics</i>	75
<i>Photochemical oxidant formation</i>	76
<i>Carcinogen impacts</i>	77
<i>Non-carcinogen and other toxic impacts</i>	78
<i>Radiations</i>	80
3.4.3 Total damages.....	82
3.4.4 Conclusion.....	84
3.5 Total global-scale calculations.....	85
3.5.1 Impacts on the environment.....	85
<i>Toxicity on aquatic ecosystems</i>	85
<i>Acidification and eutrophication</i>	89
<i>Terrestrial ecotoxicity</i>	92
3.5.2 Impacts to human health.....	94
<i>Inorganic matter, leading to particulate matter formation</i>	94
<i>Respiratory organics</i>	96
<i>Photochemical oxidant formation</i>	96
<i>Carcinogen impacts</i>	98
<i>Non-carcinogen and other toxic impacts</i>	98
<i>Radiations</i>	101
3.5.3 Total damages.....	102
3.5.4 Conclusions.....	110
4 Site-specific characterization	112
4.1 Introduction.....	113
4.2 Site specific geochemical data.....	115
4.2.1 Water analyses results.....	116
<i>Freshwater</i>	116
<i>Marine water</i>	118
4.2.2 Soil analyses results.....	122
<i>Analyses results</i>	122
<i>Enrichment factors</i>	124
<i>Geochemical background used in site specific impact assessment</i>	125
4.3 Site-specific characterization of the soil ecotoxicity.....	127
4.3.1 Fraction of air-emitted chemicals falling down towards the soil.....	127

4.3.2 Residence time.....	128
<i>Present concentration in the soils and chemical background.....</i>	<i>128</i>
<i>Mass of chemicals emitted towards the soil during the chosen timeframe.....</i>	<i>129</i>
<i>Residence time.....</i>	<i>130</i>
4.3.3 Effect factors.....	131
4.3.4 Bioavailable fraction.....	133
4.3.5 Terrestrial ecotoxicity potential results and interpretation.....	133
4.4 Site-specific characterization of the seawater ecotoxicity.....	137
4.4.1 Residence time.....	137
4.4.2 Effect factors.....	137
4.4.3 Fraction of air-emitted chemicals falling down towards the sea.....	138
4.4.4 Marine ecotoxicity potential results and interpretation.....	138
4.5 Uncertainty calculation.....	141
5 Comparison of the site-specific characterization with the global-scale results	143
.....	
5.1 Soil ecotoxicity.....	144
5.2 Marine ecotoxicity.....	145
5.3 Conclusion.....	146
6 Conclusions and recommendations.....	147
7 References.....	154
8 Annexes.....	175

Index of tables

Table 1: geological history of the Milazzo Peninsula (from Macaione et al., 2010)	9
Table 2: Ratio of pollution/background for five elements in the Mediterranean Sea (ENEA, 2003)	14
Table 3: Comparison of concentrations between oceanic water and the Mediterranean Sea according to different authors	14
Table 4: Average composition of Italian freshwater surging among metamorphic rocks (Dinelli et al., 2010)	15
Table 5: Trace elements contents in industrial sites and green spaces soils from Milazzo region and geochemical background, all in mg/kg (Agenda 21 Milazzo, 2009; Triolo et al, 2008)	16
Table 6: Number, location and coordinates of each water sampling point	24
Table 7: Species density per environmental compartment (ReCiPe report, 2009)	34
Table 8: Estimation of total waste collection in the Milazzo city for the years 2000-2010. An empty square indicates a lack of data.	
‡Average of the data for the other years	
*Estimation based upon the provincial per capita waste collection and the factor between the Messina and Milazzo per capita waste collection for years 2004 and 2005.....	44
Table 9: Emissions of Milazzo refinery for years 2001 to 2005 (APAT, 2010 (a); European Environment Agency, 2011)	46
Table 10: Emissions of Milazzo refinery for years 2007 to 2010 (European Environment Agency, 2011)	47
Table 11: Pollutant emissions of Milazzo refinery from year 1993 to 1996 (Bevilacqua & Braglia, 2002)	48
Table 12: Pollutant emissions of the Milazzo Refinery for year 2000 (Capilli, 2005a)	49
Table 13: Pollutant emissions from the refinery for years 1990, 1995, 2000 and 2005 (ISPRA, 2010). Empty squares translate lack of datapoint	50
Table 14: Emissions of the thermoelectric plant for years 2001 to 2005 (APAT, 2010 (a); European Environment Agency, 2011)	52
Table 15: Emissions of the thermoelectric plant for years 2007 to 2010 (European Environment Agency, 2011)	53
Table 16: Pollutant emissions of Termica di Milazzo, from year 2001 to 2008	

(Edipower, 2010).....	54
Table 17: Pollutant emissions from the thermoelectric power-plant, for years 1990, 1995, 2000 and 2005 (ISPRA, 2010). Empty squares translate lack of datapoint.....	55
Table 18: Estimation of the emissions from road circulation in the city of Milazzo, for the years 1990, 1995, 2000 and 2005. An empty square indicates a lack of data.....	60
Table 19: Comparison between impact classes used for both calculation methodologies, Impact 2002+ and ReCiPe. In brackets is indicated the number of chemical species used for each impact class (the same chemical in two different compartments is counted as two).	61
Table 20: Comparison between impact classes used for two calculation methodologies, Impact 2002+ and ReCiPe. In brackets is indicated the number of chemical species used for each impact class (the same chemical in two different compartments is counted as two).....	62
Table 21: Main possible sources of trace elements emissions in the Milazzo area, per compartment.....	116
Table 22: Chemical analyses results in freshwater samples, in µg/L, compared to the European guidelines for drinkable water (Council Directive 98/83/CE).....	117
Table 23: Comparison of trace elements concentrations between oceanic water (Holmes-Farley, 2010; Wilde, 2010) and the Mediterranean Sea (Okbah & Nasr, 2006; Faragallah et al., 2009; Yoon et al., 1999; Breder, 1987; La Pera et al., 2008; Sherrel & Boyle, 1988; Bernat et al., 1972; Voutsinou-Taliadouri et al., 1997; Morley et al., 1997).....	118
Table 24: Trace elements background contents in soils taken from the literature	126
Table 25: Calculation of the deposition surface areas and particulate matter mass in the zone of Milazzo (ENEA, 2003).....	127
Table 26: Baseline concentration, measured concentration and ΔC for selected metals and metalloids.....	129
Table 27: Total estimations of airborne emissions and soil depositions of selected trace elements.....	130
Table 28: Site-specific soil residence time for the studied chemicals.....	131
Table 29: HC50 in water and as calculated in soil for the chemicals molybdenum, cobalt, manganese, iron and aluminium, with their respective Kd.	132
Table 30: Collected HC50 in the soils for selected chemicals, and corresponding effect factors.	132
Table 31: Bioavailable fraction of chosen metals and metalloids in the soils of Milazzo.....	133
Table 32: Results of the site-specific soil ecotoxicological impact assessment parameters.....	134
Table 33: Gathered residence time of selected metals and metalloids in seawater	

..... 137
Table 34: HC50 in water and calculated effect factors for the selected metals and metalloids.....138
Table 35: Results of the site-specific seawater ecotoxicological impact assessment 139
Table 36: Touristic flux and admissions upon the Milazzo territory from year 1996 to year 2007 Agenda 21 Milazzo, 2009..... 197

Index of figures

Figure 1: Sea currents around the Milazzo Peninsula (Pepe et al., 2010) and disposition of the sampling points.....	8
Figure 2: geological map of the Calabrio-Peloritani arc, including the Milazzo Peninsula (from Macaione et al., 2010).....	10
Figure 3: geomorphological map of the Milazzo Peninsula (Macaione et al., 2010).....	12
Figure 4: Situation of the Peloritani Mounts (black and white diamonds form) and the Eolian Islands as well as relative flow directions of wind (Crisafulli, 2012; Dongarrà & Varrica, 1998) (simple arrow) and freshwater (Rivaro et al., 1998) (double arrow) towards the Milazzo Peninsula.....	13
Figure 5: Main anthropogenic activities in the vicinity of the Milazzo peninsula, together with the sampling points. Underground torrent drawn according to lithological maps (Regione Siciliana Assessorato Territorio e Ambiente, 2002 (a) and (b)).....	17
Figure 6: Map displaying the situation of the sampling points. Water samples are given numbers while soil samples are given letters.....	25
Figure 7: Relationship between the four steps of the Life Cycle Assessment, according to ISO 14 040 (2006).....	28
Figure 8: Diagram for the Life Cycle Inventory.....	29
Figure 9: Example of the different steps of Life Cycle Assessment.....	30
Figure 10:schema of the studied system.....	41
Figure 11: Pile of uncollected domestic waste observed in march 2010 in the city of Milazzo.....	43
Figure 12: Pile of domestic waste being illegally burned in the environment of the Milazzo Peninsula. Picture taken in may 2010.....	43
Figure 13: Toxic impacts on aquatic ecosystems according to Impact 2002+ from the anthropogenic activities in the Milazzo area: power plant (PP), road traffic (RT), illegal combustion of domestic waste (W) and refinery (R). For years 2000 to 2010.....	65
Figure 14: Toxic impacts on freshwater ecosystems according to ReCiPe 2008 from the anthropogenic activities in the Milazzo area: power plant (PP), road traffic (RT), illegal combustion of domestic waste (W) and refinery (R). For years 2000 to 2010.....	66
Figure 15: Toxic impacts on marine ecosystems according to ReCiPe 2008 from the anthropogenic activities in the Milazzo area: power plant (PP), road traffic	

(RT), illegal combustion of domestic waste (W) and refinery (R). For years 2000 to 2010.....	67
Figure 16: Eutrophication impacts on terrestrial ecosystems according to Impact 2002+ from the anthropogenic activities in the Milazzo area: power plant (PP), road traffic (RT), illegal combustion of domestic waste (W) and refinery (R). For years 2000 to 2010.....	68
Figure 17: Acidification impacts on terrestrial ecosystems according to ReCiPe 2008 from the anthropogenic activities in the Milazzo area: power plant (PP), road traffic (RT), illegal combustion of domestic waste (W) and refinery (R). For years 2000 to 2010.....	69
Figure 18: Eutrophication impacts on freshwater ecosystems according to ReCiPe 2008 from the anthropogenic activities in the Milazzo area: power plant (PP), road traffic (RT), illegal combustion of domestic waste (W) and refinery (R). For years 2000 to 2010.....	70
Figure 19: Toxic impacts on terrestrial ecosystems according to Impact 2002+ from the anthropogenic activities in the Milazzo area: power plant (PP), road traffic (RT), illegal combustion of domestic waste (W) and refinery (R). For years 2000 to 2010.....	71
Figure 20: Toxic impacts on terrestrial ecosystems according to ReCiPe 2008 from the anthropogenic activities in the Milazzo area: power plant (PP), road traffic (RT), illegal combustion of domestic waste (W) and refinery (R). For years 2000 to 2010.....	71
Figure 21: Global warming impacts according to Impact 2002+ from the anthropogenic activities in the Milazzo area: power plant (PP), road traffic (RT), illegal combustion of domestic waste (W) and refinery (R). For years 2000 to 2010.....	72
Figure 22: Climate change impacts on ecosystems according to ReCiPe 2008 from the anthropogenic activities in the Milazzo area: power plant (PP), road traffic (RT), illegal combustion of domestic waste (W) and refinery (R). For years 2000 to 2010.....	73
Figure 23: Climate change impacts on human health according to ReCiPe 2008 from the anthropogenic activities in the Milazzo area: power plant (PP), road traffic (RT), illegal combustion of domestic waste (W) and refinery (R). For years 2000 to 2010.....	73
Figure 24: Respiratory inorganics' impacts on human health according to Impact 2002+ from the anthropogenic activities in the Milazzo area: power plant (PP), road traffic (RT), illegal combustion of domestic waste (W) and refinery (R). For years 2000 to 2010.....	74
Figure 25: Particulate matter formation's impacts on human health according to ReCiPe 2008 from the anthropogenic activities in the Milazzo area: power plant (PP), road traffic (RT), illegal combustion of domestic waste (W) and refinery (R). For years 2000 to 2010.....	75
Figure 26: Respiratory organics' impacts on human health according to Impact	

2002+ from the anthropogenic activities in the Milazzo area: power plant (PP), road traffic (RT), illegal combustion of domestic waste (W) and refinery (R). For years 2000 to 2010.....	76
Figure 27: Photochemical oxidant formation's impacts on human health according to ReCiPe 2008 from the anthropogenic activities in the Milazzo area: power plant (PP), road traffic (RT), illegal combustion of domestic waste (W) and refinery (R). For years 2000 to 2010.....	77
Figure 28: Carcinogen impacts on human health according to Impact 2002+ from the anthropogenic activities in the Milazzo area: power plant (PP), road traffic (RT), illegal combustion of domestic waste (W) and refinery (R). For years 2000 to 2010.....	78
Figure 29: Non-carcinogen impacts on human health according to Impact 2002+ from the anthropogenic activities in the Milazzo area: power plant (PP), road traffic (RT), illegal combustion of domestic waste (W) and refinery (R). For years 2000 to 2010.....	79
Figure 30: Toxic impacts on human health according to ReCiPe 2008 from the anthropogenic activities in the Milazzo area: power plant (PP), road traffic (RT), illegal combustion of domestic waste (W) and refinery (R). For years 2000 to 2010.....	80
Figure 31: Ionizing radiation's impacts on human health according to ReCiPe 2008 from the anthropogenic activities in the Milazzo area: power plant (PP), road traffic (RT), illegal combustion of domestic waste (W) and refinery (R). For years 2000 to 2010.....	81
Figure 32: Ionizing radiation's impacts on human health according to Impact 2002+ from the anthropogenic activities in the Milazzo area: power plant (PP), road traffic (RT), illegal combustion of domestic waste (W) and refinery (R). For years 2000 to 2010.....	81
Figure 33: Total damages according to Impact 2002+ from the anthropogenic activities in the Milazzo area: power plant (PP), road traffic (RT), illegal combustion of domestic waste (W) and refinery (R). For years 2000 to 2010.....	82
Figure 34: Total damages according to ReCiPe 2008 from the anthropogenic activities in the Milazzo area: power plant (PP), road traffic (RT), illegal combustion of domestic waste (W) and refinery (R). For years 2000 to 2010.....	83
Figure 35: Total damages, CO2 not included, according to ReCiPe 2008 from the anthropogenic activities in the Milazzo area: power plant (PP), road traffic (RT), illegal combustion of domestic waste (W) and refinery (R). For years 2000 to 2010.....	83
Figure 36: Toxic damages to aquatic ecosystems according to Impact 2002+.....	86
Figure 37: Toxic damage to freshwater ecosystems according to ReCiPe.....	87
Figure 38: Toxic damages to marine ecosystems according to ReCiPe.....	88
Figure 39: Eutrophication damages on freshwater according to ReCiPe.....	90
Figure 40: Acidification and eutrophication damages on terrestrial ecosystems according to Impact 2002+.....	90

Figure 41: Acidification damages on terrestrial ecosystems according to ReCiPe	91
Figure 42: Toxic damages on terrestrial ecosystems according to Impact 2002+	92
Figure 43: Toxic damages on terrestrial ecosystems according to ReCiPe	93
Figure 44: Damages of inorganic chemicals on human respiratory system according to Impact 2002+	94
Figure 45: Damages of human health through the formation of particulate matter according to ReCiPe	95
Figure 46: Damages on human respiratory system by organic chemicals according to Impact 2002+	96
Figure 47: Damages to human health through the formation of photochemical oxidant substances according to ReCiPe	97
Figure 48: Damages of human carcinogenic substances according to Impact 2002+	98
Figure 49: Toxic damages of non-carcinogenic substances according to Impact 2002+	99
Figure 50: Human toxic damages according to ReCiPe	100
Figure 51: Damages from ionizing radiations according to Impact 2002+	101
Figure 52: Damages from ionizing radiations according to ReCiPe	102
Figure 53: Single-score, per-substance damages according to Impact 2002+	103
Figure 54: Single-score, per-impact damages according to Impact 2002+	
C: carcinogen	
NC: non-carcinogen	
RI: respiratory inorganic	
IR: ironizing radiations	
RO: respiratory organic	
AE: aquatic ecotoxicity	
TE: terrestrial ecotoxicity	
TA/E: terrestrial acidification/eutrophication	
GW: global warming	104
Figure 55: Single-score, per-substance damages according to ReCiPe	105
Figure 56: Single-score, per-impact damages according to ReCiPe	
CCHH: climate change human health	
HT: human toxicity	
POF: photochemical oxidant formation	
PMF: particulate matter formation	
IR: ionizing radiations	
CCE: climate change ecosystems	
TA: terrestrial acidification	
FE: freshwater eutrophication	
TEX: terrestrial ecotoxicity	
FEX: freshwater ecotoxicity	
MEX: marine ecotoxicity	106

Figure 57: Single-score, per-substance damages according to ReCiPe; CO2 not taken into account.....	107
Figure 58: Single-score, per-impact damages according to ReCiPe; CO2 not taken into account	
HT: human toxicity	
POF: photochemical oxidant formation	
PMF: particulate matter formation	
IR: ionizing radiations	
TA: terrestrial acidification	
FE: freshwater eutrophication	
TEX: terrestrial ecotoxicity	
FEX: freshwater ecotoxicity	
MEX: marine ecotoxicity.....	108
Figure 59: Map displaying the situation of the sampling points. Water samples are given numbers while soil samples are given letters.....	115
Figure 60: Chemical Analyses results for freshwater samples, june 2011, in µg/L	117
Figure 61: Results of chemical analyses in seawater for june 2011 and february 2012.....	119
Figure 62: Comparison of trace elements contents (expressed in µg/g) in the different studied soils of Milazzo peninsula at surface and depth (20cm).....	123
Figure 63: Average enrichment factor for Milazzo peninsula soils near industrial sites and 10 km away from them. Normalization to continental crust (crust), rocks from Peloritani Mounts (Pel) and limestone (Lim).....	125
Figure 64: Site-specific soil ecotoxic impact results for the anthropogenic activities in the area of Milazzo over the studied timeframe.....	135
Figure 65: Site-specific seawater ecotoxic impact results for the anthropogenic activities in the area of Milazzo over the studied timeframe.....	140
Figure 66: Uncertainties over the site-specific soil ecotoxicity.....	141
Figure 67: Uncertainties over the site-specific seawater ecotoxicity.....	141
Figure 68: Comparison between the global-scale and site-specific results for the soil ecotoxicity.....	144
Figure 69: Comparison between the global-scale and site-specific results for the marine ecotoxicity.....	145
Figure 70: map of Termica Milazzo site EMAS, 2009.....	209
Figure 71: functioning scheme of Termica di Milazzo EDISON, 2010.....	210

Definitions

*Evaluation

The evaluation is a setting of priorities according to the starting point, the approach and the objectives of the study. It is based upon the information given by the goal and scope, and logical rules. The evaluation is based upon different criteria e.g. toxicological criteria or mass criteria. It helps choosing the relevant criteria or combination of criteria upon which the impact assessment will be based (Grahl & Schmincke, 1996).

Different methods are needed according to the needs of the stakeholders in terms of environmental, social and economic consequences, as such as for the context of the study, the position of the decision-maker, the position and interests of the other parties (Wenzel, 1998).

*Life Cycle Impact Assessment

The Life Cycle Impact Assessment (LCIA) is a special part within the framework of LCA. It supplies with additional information which enable to interpret the results from the inventory, to draw the right conclusions concerning improvement approaches (Saur et al., 1996). It evaluates the relative importance of different environmental stressors (emissions, resource and land use...) related to a life cycle (Hertwich & Hammitt, 2001). It analyses the system's inputs and outputs using the data of the inventory in an environmental context (Owens, 1999) and it is determined by a social consensus as to what constitutes a damage, and what does no (Grahl & Schmincke, 1996). It uses indicators, themselves organized into different impact categories, to assess for the environmental impact of the studied functional unit.

The impact assessment has two components: normative and empirical. The empirical part is scientific information of environmental effects in terms of the characterization models chosen for the impact categories. It cannot be evaluated directly but only indirectly by assessing their further effects on items directly relevant for evaluation. These “endpoints” usually cannot be modeled adequately due to uncertainties of a scientific nature and to conditionality. The normative component consists of information about the social preferences attached to the different impact

categories. Together they lead to the definition of a set of weighting factors for the environmental problems that indicates the relative contribution of each problem to their combined effects on the safeguard subjects. Different sets of weighting already exist depending upon a set of preferences: individual preferences, collective preferences, societal preferences, policy preferences, plus an objective criterion regarding sustainability level and cross-category factors (Notarnicola et al., 1998).

In some applications, site-specific information are difficult to include and undesirable. But in other applications, there is a possibility and a need to include site specific and site dependent information to the LCA. In every application, the impact assessment must be done with caution, because it is possible to twist the LCA results to yield the desired consumption through assumptions regarding cutoffs, values etc. (Wenzel, 1998).

Because of non-linearities in the dose-response characteristics, it is needed to define calculation factors that are specific to the working point. This sometimes has to be done at different spatial and temporal conditions, e.g. indoor/outdoor characteristics, regional issues (Udo de Haes et al., 1999).

The evaluation of impacts cannot be absolute; it is necessarily relative and therefore comparative (Chevalier & Rousseaux, 1999).

*Impact categories

Impact categories are significant ecological, material and economic fields which might be influenced by waste treatment and disposal processes. Impact clusters characterize the impacts of the treatment or disposal process on the impact categories (Seum, 1998). The main impact categories are: Resources depletion, Ecological health, Human health (Chevalier & Rousseaux, 1999).

*Indicators

An indicator reflects an environmental attribute or an effect with an environmental consequence that is known about. They are needed by decision makers and other users. Various types of indicators have various utilities. The macrometrics show current or historic global situations such as the temperature, the atmosphere, the sea. The micrometrics or eco-indicators are oriented to a given product and industry. They can represent non-sustainable practices e.g. a single car can have a low burden but all cars together show a very high burden. A family of indicators is

needed for each dynamic or complex system. Intensive indicators are relative to a population, a country... when extensive indicator are absolute values without reference unit (Biswas et al., 1998).

***Midpoint indicator**

A midpoint indicator is a parameter in a cause-effect chain or network (environmental mechanism) for a particular impact category that is between the inventory data and the category endpoints (Bare et al., 2000).

***Endpoint indicator**

An endpoint indicator reflects differences between stressors at an endpoint in a cause-effect chain and may be of direct relevance to society's understanding of the final effect, such as measures of biodiversity change. In some impact categories, more than one endpoint exist (Bare et al., 2000).

***Geosite**

A geosite is a geological or geomorphological site that is remarkable at worldwide scale. This site have to display specific, special, typical, complex or unique features because of its space and/or time extend. It also must be representative in the geological column (Wimbledon et al., 2000).

***DALY**

A DALY is a Disability-Adjusted Life Year. It is a unit used to assess the impacts of pollutants upon human health. It includes the years lived with sickness or disability because of said pollutants and the years of life lost due to premature death because of said pollutants.

***PDF•m²•year**

Potentially Disappeared Fraction of species, integrated over space and time. It is a unit to assess for the impacts upon the ecosystems.

List of acronyms

ASI	Area di Sviluppo Industriale	PM _{2.5}	Particulates with a diameter inferior to 2.5 µm
HT	High Temperature		
LCA	Life Cycle Assessment	PM _{2.5-10}	Particulates with a diameter between 2.5 µm and 10 µm
LCI	Life Cycle Impact		
LCIA	Life Cycle Impact Assessment	PM ₁₀	Particulates with diameter inferior to 10 µm
LP	Low Pressure		
LT	Low Temperature	SF ₆	Sulfur hexafluoride
MP	Medium Pressure	SO _x	Sulfur oxides
MT	Medium Temperature	S.p.A.	Società per Azioni
NMHC	Non-Methane Hydrocarbons	TBT	Tributyltin
NMVOC	Non-Methane Volatile Organic Compounds	TOC	Total Organic Carbon
		TPS	Total Suspended Particulates
NO _x	Nitrogen oxides	VOC	Volatile Organic Compounds
PAH	Poly Aromatic Hydrocarbon		

General introduction and state of knowledge

The Life Cycle Assessment of the Milazzo Peninsula

Milazzo Peninsula, North West of Sicily (Italy) is a remarkable highly touristic place. It is a territory well-known for its landscapes and its geomorphology and therefore considered as a geosite (or geological site of special interest) according to UNESCO and the International Union of Geological Sciences (IUGS).

Moreover, Milazzo Peninsula is a Natura2000 site of great interest registered as a Natura 2000 Site of Community Importance under the number ITA030032; 47 hectares are covered (Ministro dell'Ambiente e della Tutela del Territorio e del Mare, décret 30/03/2009). It is one of 232 Natura 2000 sites in the Sicily region, and its area represents less than 0,08 % of the total Natura 2000 area for Sicily which on average covers 2 452 hectares. Many endangered species can be found in the Milazzo Peninsula, such as the laurestine (*Viburnum tinus*), belonging to the Regional Red List of Italian Plants; the *Bellevalia dubia*, endemic and registered in the Inventory of species at risk; the *Erucastrum virgatum* and the rare *Echinops spinosissimus* Turra, registered both in the regional and national Red List of species risking extinction; the Mediterranean painted frog (*Discoglossus pictus*), rigorously protected; the green whip snake (*Hierophis viridiflavus*); the Italian wall lizard (*Podarcis sicula*); the Western green lizard (*Lacerta bilineata*); the gonglio (*Chalcides ocellatus*). The common toad (*Bufo bufo*) has completely disappeared from the Milazzo territory (Agenda 21 Milazzo, 2009).

In addition, Milazzo city has always been part of the many industrial areas of north-eastern Sicily that at first enriched the localities. Indeed, many anthropogenic activities are located in this region, such as an oil refinery, a thermo-electric plant, agriculture, fisheries. But nowadays, because of inadequate planning, health and environmental issues are important and their rate is increasing (45th ERSA). The number of lung cancer and respiratory sicknesses in males is up to three times higher than in the other parts of Sicily, as shown by an epidemiological study (Fano et al., 2008), but these issues are more likely to concern the professional exposure within the industrial area (Triolo et al, 2008). However, Milazzo inhabitants suspect the refinery to be the cause of their health issues (see Annexes page 176), because this anthropogenic activity has a huge visual impact upon their environment (size of the buildings, emission of smoke, presence of the oil tankers). Moreover, kilometers of beach along the Milazzo city are forbidden to bathing and fishing, because of environmental issues (G.U.S.G. n7 del 18/02/05). There is therefore significant public concern of potential health hazards despite minimization of the risks by the industries themselves (Gatto et al, 2008).

Introduction

Studies on Gela area, South of Sicily (Bosco, 2005; Manno et al., 2006) have shown that petrochemical and thermoelectric power-plants activities are sources of pollution in many trace elements such as arsenic, chromium, copper, lead, molybdenum, nickel, zinc, vanadium. No scientific study has been carried out regarding the impacts of the anthropogenic activities upon the Milazzo Peninsula and no epidemiological studies considered all the impacts caused by the local pollution and impacts upon the fauna and flora. Therefore it is still unknown if the refinery is really the cause of the whole health and environmental issues or if other causes are to be looked for. In order to overcome this problem, it is necessary to compare the impacts of the different anthropogenic activities and find the source of the issues. There are tools which help cover this need, among them the Life Cycle Assessment tool (LCA).

The Life Cycle Assessment (LCA) is a normalized tool (ISO 14 040:2006 and 14 044:2006) used to assess the environmental impacts and potential impacts associated with a product, process, or service. It considers all steps of its life cycle from the extraction of the raw materials to the disposal of the garbage and helps evaluating the environmental impacts by quantifying the emissions of pollutants and use of resources for each stage of the product's life cycle. The LCA technique follows the ISO 14 040 and 14 044 guidelines and is divided into four steps: 1) the first step (goal and scope) defines the purpose and method of life cycle environmental impacts assessment, the type of information that is needed, how the results should be interpreted and displayed in order to be meaningful and usable. The second step is the inventory analysis (LCI) which is a process of quantifying energy and raw material requirements, emissions to air, soil and water and other releases for the entire life cycle of a product, process, or activity. The third step is the impact assessment (LCIA) phase which establishes a linkage between the product or process and its potential environmental impacts. During that step, environmental impact categories (e.g., global warming, acidification, terrestrial toxicity) are identified, classified and characterized using science-based conversion factors (CF) (e.g., modeling the potential impact of carbon dioxide and methane on global warming). The last step is the life cycle interpretation devoted to the analysis of the results and limitations from the previous phases (LCI and LCIA), and providing interpretation in a transparent manner and final recommendations.

The objectives of this study are to assess the impacts and damages upon human health and ecosystems caused by major anthropogenic activities' pollutant emissions in Milazzo area using the LCA standard methodology. The question is to verify if these activities may objectively be suspected to cause health issues, or if other sources of pollution should be looked for. Two

The Life Cycle Assessment of the Milazzo Peninsula

approaches will be considered: the so-called “global” and “local” approaches. Traditional LCA is a global scale approach which is site-, and time-independent (Udo de Haes 1996). There is no consideration to when and where emissions take place and the characterization factors in LCIA phase typically lack of site-dependent information. A “local” approach for impacts upon the delimited Milazzo area will also be used in this study in order to better assess the impacts of industrial emissions on this environment. Therefore, site-specific data were acquired which take into account the specific Milazzo peninsula climate and soil and water characteristics, and enable site-specific LCIA characterization factors to be calculated. The Life Cycle Impacts Assessment (LCIA) results from both approaches (global and local), will be compared and conclusions and recommendations will be driven.

The manuscript is subdivided in five chapters:

The first chapter is dedicated to the presentation of Milazzo Peninsula site, from a geological, geomorphological and hydrological point of view. A brief overview also gives the climatic context and geochemical background related to the regional geological context. This section provides also an indication of some of the major anthropogenic activities which may be sources of pollutants in Milazzo region.

The second chapter gives the material and methods used in this study, in particular the Life Cycle Assessment (LCA) methodology. The normalized LCA steps are presented and explained as well as the LCA methods Impact 2002+ and ReCipe used in this study. Both global and local methodologies are detailed, and a section is dedicated to the description of material and methods used to acquire site-specific data and calculate site-specific characterization factors.

The third chapter presents in detail the application of LCA methodology on a global scale. The study of the different anthropogenic activities of the Milazzo Peninsula and their impacts and damages are presented, and the detailed different shares of each activity and each emission in the different impact categories are given. A comparison between the thermoelectric plant and refinery’s emissions impacts on human health and ecotoxic damages is done. Impacts from other activities as illegal domestic waste combustion and road traffic are also estimated and the chemicals being the most toxic for the human health are identified.

Chapter IV is dedicated to the site specific impact assessment. The first section presents a short description of the analytical chemical results obtained on water and soil samples and a

Introduction

comparison with water and soil chemical data from the literature. Concerning soils, an enrichment factor is calculated to assess the level of trace elements contamination of Milazzo soils and identify the most enriched element. In order to determine site-specific characterization factor, parameters necessary to calculations are determined, such as residence time, trace element bio-available fraction, effect factor. The site-specific impact calculation results are then discussed to assess the impacts of trace elements on soil and marine water compartments, and identify the elements responsible of the highest ecotoxicity results in these compartments. Moreover, the possible sources (industrial activities and other activities) of these pollutants are presented.

Chapter V gives a comparison between global and local impact assessment results regarding the soil ecotoxicity, and the the marine ecotoxicity. Moreover the results from both calculation methods (Impact 2002+ and ReCiPe) are commented.

Finally, conclusions and recommendations are given as to the activities which should lower their emissions to reduce impacts on the different compartments.

1 Presentation of the site

1.1 Physical and geochemical presentation

This chapter will present the physical and geochemical context of the site of study. First, it will explore the climatic context together with the sea currents. Second, it will speak about the geology and the geomorphology of the peninsula. Third and last, it will explore the geochemical background.

1.1.1 Climate and sea currents

The Mediterranean Sea basin is separated into two sub-basins of similar size, connected by the Sicily Straits. Winds, thermic fluxes and straits force the global circulation. The South of the Tyrrhenian sea, North of Sicily, is a key place of mixing and transformation of the water masses (Robinson et al., 2001). In the Northern part of Sicily, the sea circulation follows a general West to East pattern with an inversion during the month of October and an interruption during the month of December (Istituto Idrografico, 1982).

The sea currents around the Milazzo Peninsula show two different and separate patterns. On the occidental side, the current flows from South-West to North-East (A. Messina, personal communication). On the oriental side, the current follows a whirl turning clockwise (Robinson et al., 2001; Istituto Idrografico, 1982; Pepe et al., 2010; Saccà et al., 2011). The streams and waves have a high energy level close to the coasts and lower in the open sea (Saccà et al., 2011).

The Life Cycle Assessment of the Milazzo Peninsula

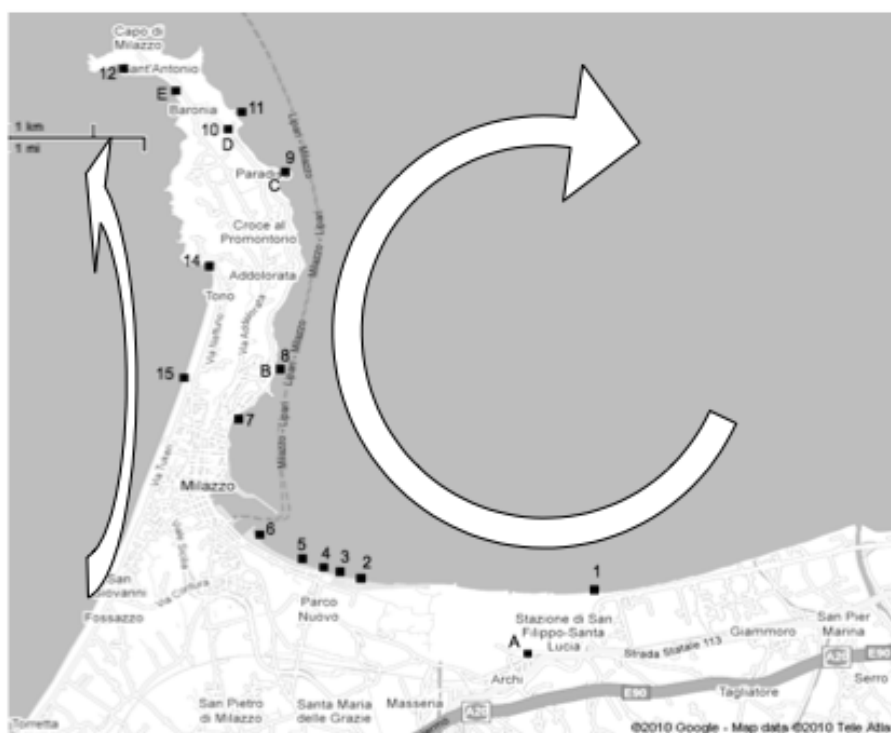

Figure 1: Sea currents around the Milazzo Peninsula (Pepe et al., 2010) and disposition of the sampling points.

Over the last 30 years, the Milazzo Peninsula received an average of 434 mm of rain per year according to the measures of the Reggio Calabria meteorological station (Il meteo, 2012). The average rainfall in Sicily is low and does not exceed 720 mm/year, but increases in autumn. In Milazzo region, rainfall distribution from October to March is rather homogeneous with a mean value of 60 mm/month (Cornet et al., 2005).

Rainfall comes from North-West with sometimes events such as violent downpours, torrential flow as was the case for example on October 2009 in Messina region (La Tribune, 2009).

The main winds come from the West (Crisafulli, 2012; Dongarrà & Varrica, 1998) (Ponente) and the South-East (Sirocco); they are stronger in autumn and winter (Messina A., personal communication).

1.1.2 Geological and geomorphological presentation

This paragraph will first speak about the geological history of the peninsula. Then it will describe the geomorphology of the site. Third and last it will explain why the peninsula is a geosite of interest.

Geological and geomorphological presentation

The Milazzo Peninsula is composed of a crystalline basement belonging to the Aspromonte Unit, with a marine terrace.

The geological history of the crystalline basement is very complex (Table 1 & Figure 2). Among the most remarkable events, there is a retrograde L-T granulite to L-T amphibolite facies Bosost-type process dated 300-340 Ma in amphibolites of the Proterozoic low crust, and 314 Ma in paragneisses. There was also an orogenic plutonic intrusion in the Late-Variscan (290 Ma) (Macaione et al., 2010; Carbone et al., 2011; Lentini et al, 2011; Messina et al., 2004a & b; Messina et al., 2012-2013).

Event	Age	Datation method	References
Ultramafic plutonism	1562-1771 Ma Paleo-Meso-Proterozoic	U/Pb Titanite	De Gregorio et al., 2003
Pan-african metamorphism with granulite facies	600-800 Ma Neo-Proterozoic	³⁹ Ar/ ⁴⁰ Ar Amphibole	De Gregorio et al., 2003
Late Pan-african intermediate plutonism	500-622 Ma	U/Pb Zircon	Schenk & Todt, 1989
	537-572 Ma Neo-proterozoic-Cambrian		Micheletti et al., 2007
Variscan metamorphism with amphibolite facies	330-340 Ma	³⁹ Ar/ ⁴⁰ Ar Amphibole	De Gregorio et al., 2003
	305-314 Ma Late Carboniferous	Rb/Sr Mica	Bonardi et al., 2008
Late Variscan plutonism, intermediate to acidic	290 Ma Late Carboniferous-Permian	Rb/Sr Mica	Rottura et al., 1990
Alpine metamorphism with greenschist to amphibolite facies	22-28 Ma (metamorphic peak at 25 Ma) Late Oligocene	Rb/Sr Mica	Bonardi et al., 2008

Table 1: geological history of the Milazzo Peninsula (from Macaione et al., 2010)

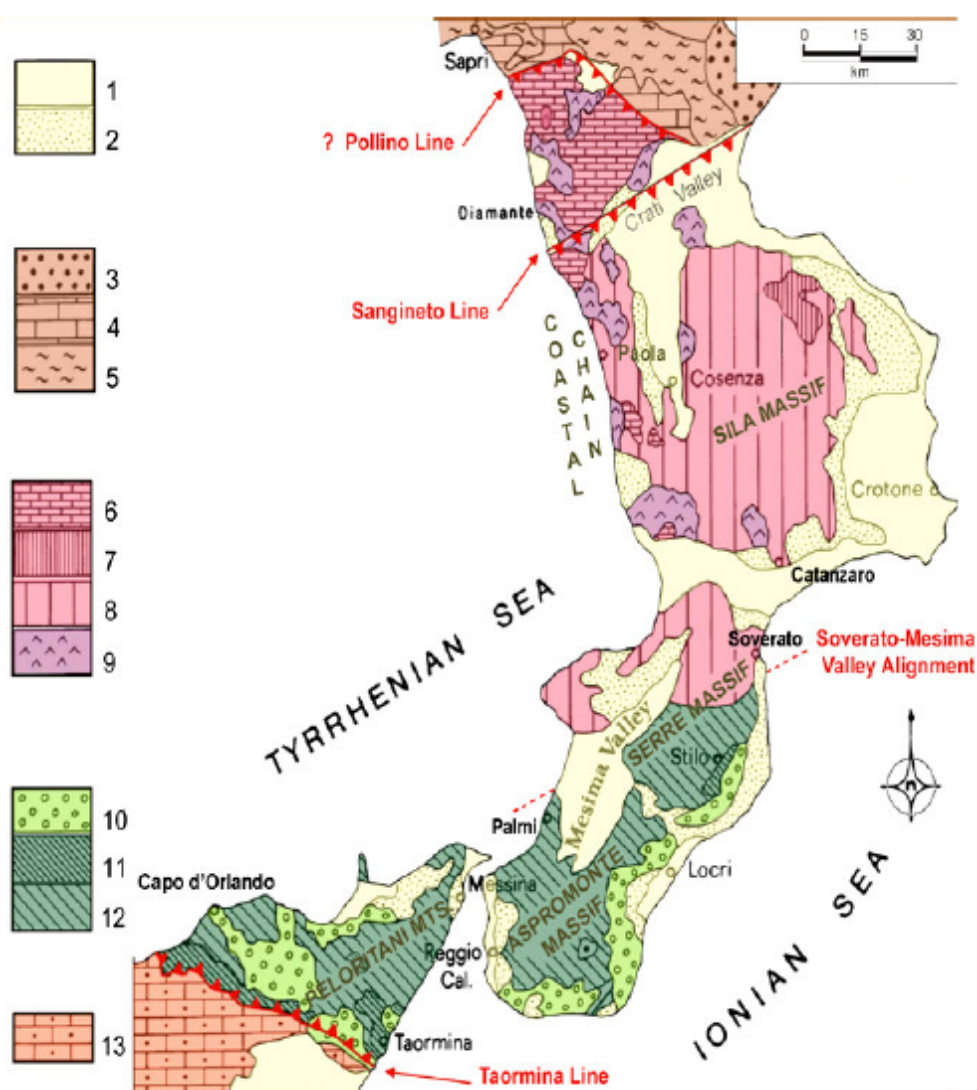

Figure 2: geological map of the Calabro-Peloritani arc, including the Milazzo Peninsula (from Macaione et al., 2010)

Legend: 1. Alluvial and beach deposits (Holocene); Etna volcanics (Middle Pleistocene-Holocene). 2. Clastics and evaporites (Upper Tortonian-Pliocene). 3-5. Apenninic Chain: 3. Clastics of the Cilento Group (Langhian-Lower Tortonian); 4. External mainly carbonate Units (Upper Triassic-Serravallian); 5. Lucanian oceanic Units (Upper Jurassic-Burdigalian). 6-9. **Calabria-Peloritani Chain, Northern Sector. Continental crust Units:** 6. Lungro-Verbicaro and Cetraro Units (Middle Triassic-Aquitania); 7. Paludi Fm. (Upper Oligocene-Lower Miocene) and Sila Unit sedimentary cover (Upper Triassic?-Lower Cretaceous); 8. Sila (Pre-Paleozoic and Paleozoic), Castagna (Pre-Paleozoic and Paleozoic) and Bagni (Paleozoic) Units basements; **Oceanic crust Units:** 9. Diamante-Terranova, Monte Reventino-Gimigliano and Malvito (Upper Jurassic-Lower Cretaceous) Units. 10-12. **Calabria-Peloritani Chain, Southern Sector. Continental crust Units:** 10. Floresta Calcarenes (Upper Burdigalian-Lower Langhian), Antisicilide Complex (Upper Cretaceous-Lower Miocene) and Capo d'Orlando Flysch (Upper Oligocene-Lower Burdigalian). **Oceanic crust Units:** 11. Stilo (Calabria - Upper Triassic?-Aquitania), Fondachelli (Sicily - Lower Kimmeridgian-Oligocene?), San Marco d'Alunzio (Sicily - Upper Triassic-Eocene); Longi-Taormina (Sicily - Upper Triassic-Lower Oligocene?); Capo Sant'Andrea (Sicily - Lower Lias-Lower Eocene) Units sedimentary covers; 12. Stilo (Calabria-Paleozoic), Aspromonte (Calabria and Sicily - Paleo-Proterozoic-Cambrian and Paleozoic), Cardeto, Africo (Calabria - Paleozoic), Mela, Piraino, Mandanici, Ali, Fondachelli, San Marco d'Alunzio, Longi-Taormina and Capo Sant'Andrea (Sicily - Paleozoic) Unit basements. 13. Maghrebain Chain Flysch Basin Units

Presentation of the site

The Late Miocene deposits consist of grey-whitish corals, algae and mollusks-bearing limestones lying unconformably on the metamorphic basement. This level is often represented by a breccia characterized by large calcareous elements and sandwiched between the basement and the Quaternary deposit. Yellowish calcareous sands, attributed to the Early Quaternary, rest unconformably on both the metamorphics and Late Miocene bioherms. The highest order of marine terraces is represented by a surface softly dipping northwards from 85 to 50 m a.s.l., consisting of shallow water sands and conglomerates (Tonnara to Cala Sant'Antonio; Punta Salto del Cavallo to Punta Cirucco zones). These deposits allowed Charles Depéret to introduce in 1918 the *Piano Milazziano*, successively ascribed, by Hearty et al. (1986), to the Tyrrhenian. A second order of marine terraces is located between 45 and 28 m a.s.l. (Carbone et al., 2011; Lentini et al 2001; Messina et al., 2012-13; Gringeri et al., 2004).

The area is affected by a post-Pleistocene uplift. Originally it was a small island.

On the Milazzo Peninsula, surf karren (Punta Gamba di Donna) and hypogean structures set in the migmatites ("Golden Cave" and "Punta Grottazza Cave") are also present (Messina et al., 2009).

The coast East of the Milazzo peninsula is mainly characterized by sandy and pebbly beaches, a low gradient, and high vulnerability to erosion, especially because of the presence, along the coast, of urban and industrial settlements. The critical area is situated around the industrial area of Milazzo. The causes of erosion can be found in the reduction of solid inputs of rivers. The coast West of Milazzo peninsula is made of pebble and pebbly beaches. The area between Milazzo and Barcelona is critical, showing signs of retreat of the coastline. The solid inputs of rivers and streams are diminished by the numerous interventions of embankment, causing a lowering of seabed and beach profiles and thus an easier attack by waves and storms (Lucchesi, 2004). A geomorphological map is displayed hereafter (Figure 3).

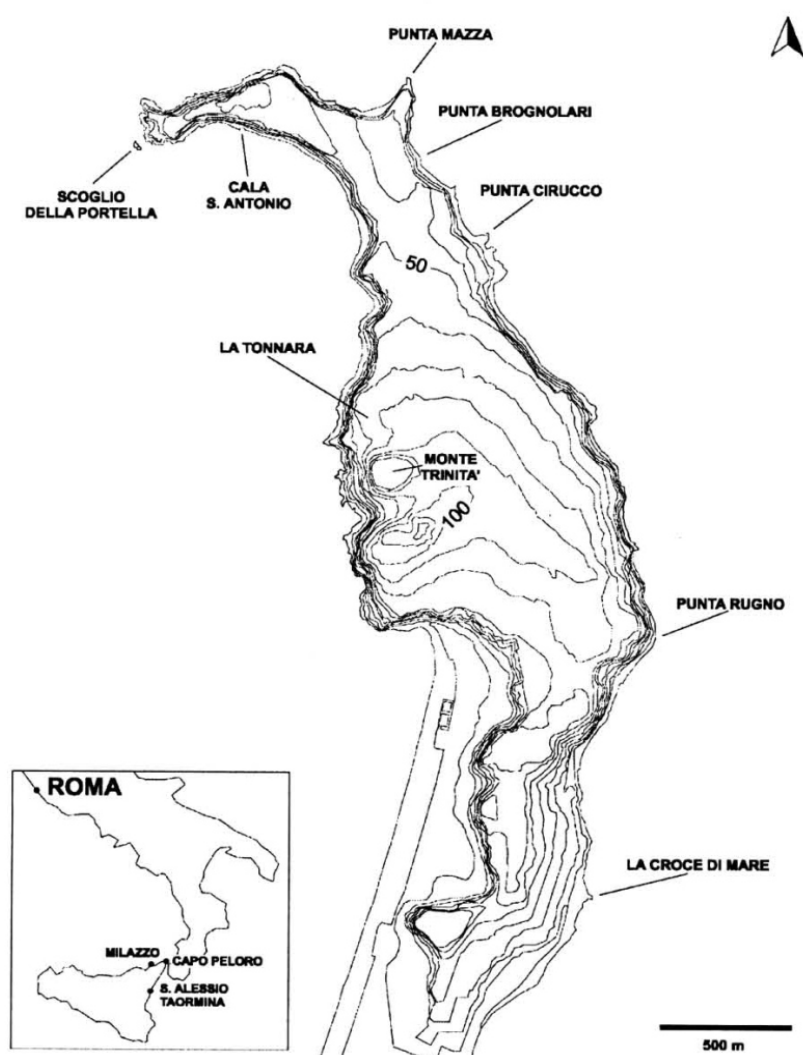

Figure 3: geomorphological map of the Milazzo Peninsula (Macaione et al., 2010)

A geosite

The Milazzo Peninsula corresponds to the definition of a geosite given by Wimbledon et al., 2000. This definition states that a geosite is needed for further research as well as teaching, education, training. Geosites are more vulnerable to changes than biological systems because geological sites can never adapt to change. They are fragile and need to be protected. The Milazzo Peninsula answers to this definition through the uniqueness of its geological and geomorphological features, its complex history, and its vulnerability to destruction through e.g. erosion.

1.1.3 Geochemical background

As mentioned in paragraph 1.1.2 page 8, different rocks compose Milazzo area: a crystalline basement and sedimentary rocks, mainly limestones, but also in some parts volcaniclastic deposits, all of them contributing to the geochemical nature of surface waters and soils. The main crystalline body near Milazzo is represented by the Peloritani mounts, from where the streams and rivers in Milazzo come. Moreover, Milazzo is situated downwind and downstream of emissions from the volcanic Eolian islands (Fois, 1990) (Figure 4).

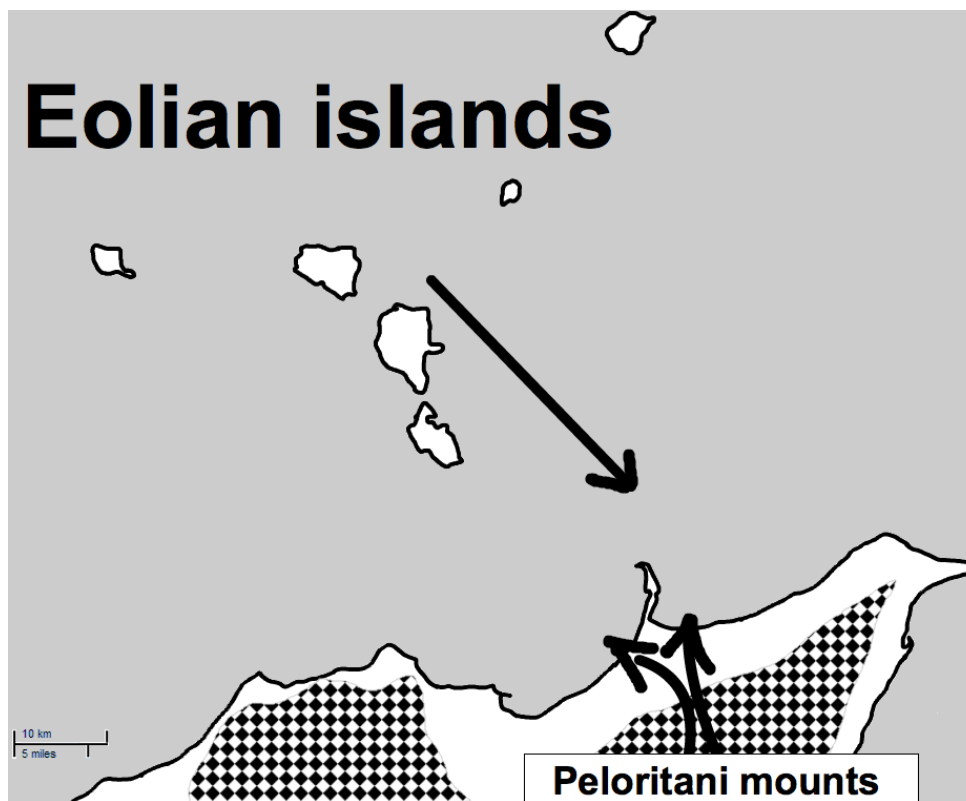

Figure 4: Situation of the Peloritani Mounts (black and white diamonds form) and the Eolian Islands as well as relative flow directions of wind (Crisafulli, 2012; Dongarrà & Varrica, 1998) (simple arrow) and freshwater (Rivarolo et al., 1998) (double arrow) towards the Milazzo Peninsula.

The Mediterranean Sea

The Mediterranean Sea is a highly polluted water body. The amount of phosphorus released by anthropogenic activities in its waters, for example, is more than twenty times the amount released through natural processes like erosion (see Table 2).

The Life Cycle Assessment of the Milazzo Peninsula

Pollutant	P	N	Hg	Pb	Cr	Zn
Polluting load/natural load	20.82	7.85	3.3	3.8	6	5.25

Table 2: Ratio of pollution/background for five elements in the Mediterranean Sea (ENEA, 2003)

The Mediterranean Sea is subject to a more intensive evaporation compared to other oceans. Consequently, the average Mediterranean concentrations in all elements is higher than in other marine water bodies. Table 3 reports the concentration for some elements in the North Atlantic Ocean and in the Mediterranean Sea in order to illustrate this peculiarity. Despite the important differences in chemistry between the different Mediterranean sub-basins, it can be seen that as a whole, the Mediterranean Sea can be up to twenty times more concentrated in trace elements than oceanic water.

Element	Oceanic water (Holmes-Farley, 2010)	Concentration in the Mediterranean Sea according to different authors			
		Okbah & Nasr, 2006	Faragallah et al., 2009	Yoon et al., 1999	Breder, 1987
Mn	0.165 µg/L	5.77-17.36 µg/L			
Fe	0.140 µg/L	11.92-30.45 µg/L	28.66-43.73 µg/L	0.0726 µg/L	
Ni	0.700 µg/L		0.10-0.20 µg/L	0.22890 µg/L	
Cu	0.380 µg/L	0.40-1.87 µg/L	2.00-6.74 µg/L	0.10167 µg/L	
Cd	0.124 µg/L			11.02 µg/L	
Pb	0.036 µg/L	1.53-10.31 µg/L	2.93-4.57 µg/L	0.02.24 µg/L	
Hg	0.002 µg/L				0.005-0.017 µg/L
Zn	0.590 µg/L	0.87-7.80 µg/L	25.94-38.22 µg/L	0.33359 µg/L	

Table 3: Comparison of concentrations between oceanic water and the Mediterranean Sea according to different authors

The Mediterranean Sea has also the peculiarity of being enriched in trace elements of anthropogenic origin. The elements that show enrichment in surface waters are the selenium, the cadmium, the antimony and the lead. Other elements with high enrichment are the arsenic and the zinc (Grousset et al., 1995; Morley et al., 1997; Voutsinou-Taliadouri et al., 1997).

Influence of the Eolian Islands

The Eolian Islands are volcanic islands; the actual active volcano is the Stromboli, while the Vulcano volcano still emits smoke. Even though the amount of anthropogenic emissions exceeds the amount of the volcanic ones at Mediterranean scale (Bagnato et al., 2007), volcanoes play a part in the definition of the geochemical background at a local or even a regional scale (Okuda et al., 2005). The Vulcano Island is enriched in antimony, lead, zinc, gold, copper and

Presentation of the site

arsenic, especially under the prevailing winds (W-NW) i.e. in the direction of Milazzo (Dongarrà & Varrica, 1998). Mercury, too, is emitted in high amounts by Mediterranean volcanoes (Ferrara et al., 2000). Consequently, the sediments offshore of Milazzo are enriched with trace elements (Saccà et al., 2011) and the seawater in the vicinity of Sicily contains up to twice as much mercury as the average for Mediterranean Sea (Horvat et al., 2003).

The spring water in North-Eastern Sicily

The hydrological basins of the rivers Corriolo and Mela, whose extreme limits are situated about 15 km away from the peninsula (Regione Siciliana, Assessorato Territorio e Ambiente, 2004 (a), (b), (c) and (d)) influence the geochemistry of the studied area.

Indeed, the North-Eastern region of Sicily is characterized mainly by metamorphic rocks. This peculiar lithology is reflected upon the composition of freshwater surging in those mountains. In particular, mafic and ultramafic rocks are enriched in chromium, and zinc reaches its higher freshwater levels in Sicily (up to 46.4 µg/L) (Dinelli et al., 2010). The concentration of Italian freshwater surging in sites with metamorphic rocks can be found in Table 4.

The streams coming down from the Peloritani mounts are charged in iron (Rivaro et al., 1998). Mercury is present a high anthropogenic level in the sediments South of Sicily because of anthropogenic activities releasing huge amounts of mercury in the Mediterranean Sea since the last century (Di Leonardo et al., 2006). Sicilian tap water is also charged with boron, bromine, rubidium, vanadium in volcanic areas, fluorine dissolved from metamorphic rocks, and iodine from marine spray (Dinelli et al., 2012).

Element	Average concentration
As	0.652 µg/L
B	5.68 µg/L
Ba	0.005 mg/L
Cd	0.00375 µg/L
Cr	0.149 µg/L
Cu	0.167 µg/L
Fe	0.155 µg/L
Mn	0.5 mg/L
Ni	0.0412 µg/L
Pb	0.0067 µg/L
Zn	0.263 µg/L

Table 4: Average composition of Italian freshwater surging among metamorphic rocks (Dinelli et al., 2010)

The Milazzo Peninsula

In the Agenda 21 Milazzo report, the trace elements' maximum content in soils from industrial sites and green spaces were compared to the geochemical background from the literature (Table 5). It shows relatively high contents in elements such as chromium, cobalt, nickel, copper, zinc, arsenic and lead compared to the geochemical background, and lower contents in mercury and cadmium.

Trace element	Cr	Mn	Co	Ni	Cu	Zn	As	Hg	Pb	Cd	V	Al
Green sites (Agenda 21)	150	–	20	120	120	150	20	1	100	2		
Industrial sites (Agenda 21)	800	–	250	500	600	1500	50	5	1000	15		
Measure in the Milazzo region (Triolo)	87.8	88	800	32.4			16.4		33	0.44	116	84 300
Geochemical background from the literature (Agenda 21)	70	--	8	50	30	90	6	0.06	35	0.35		

Table 5: Trace elements contents in industrial sites and green spaces soils from Milazzo region and geochemical background, all in mg/kg (Agenda 21 Milazzo, 2009; Triolo et al, 2008)

These data show that there is a significant enrichment in toxic elements especially around industrial sites.

Another study on air and soil contamination assessment in Milazzo region performed by Triolo et al, 2008 showed that toxic element residues in soils and in agroalimentary products were generally lower than the threshold values established by Italian and EU regulations. However concerning the metabolic profiles of soil microbial communities there seem to be a correlation with deposition of xenobiotic compounds from the industrial activities.

1.2 Anthropogenic activities presentation

The anthropogenic activities (see Figure 5) of the area are all potential sources of pollution for the Milazzo peninsula. We can count on Milazzo, a thermo-electric plant, a refinery producing low-sulfur gas oil and unleaded gasoline (Bevilacqua & Braglia, 2002), sewage treatment plants, boating activities (including sanding and blasting) but also illegal domestic waste incineration in the streets, cars circulation and direct discharge of municipal wastewater to the sea. The Giammoro industrial pole, a few kilometers on the East, also regroups polluting activities but the refinery is pointed out by a local association as the main and only cause of all the health issues faced in the Milazzo city (see). Among those activities there is ESI Ecological Scrap Industry SpA, a lead-acid batteries recycling plant.

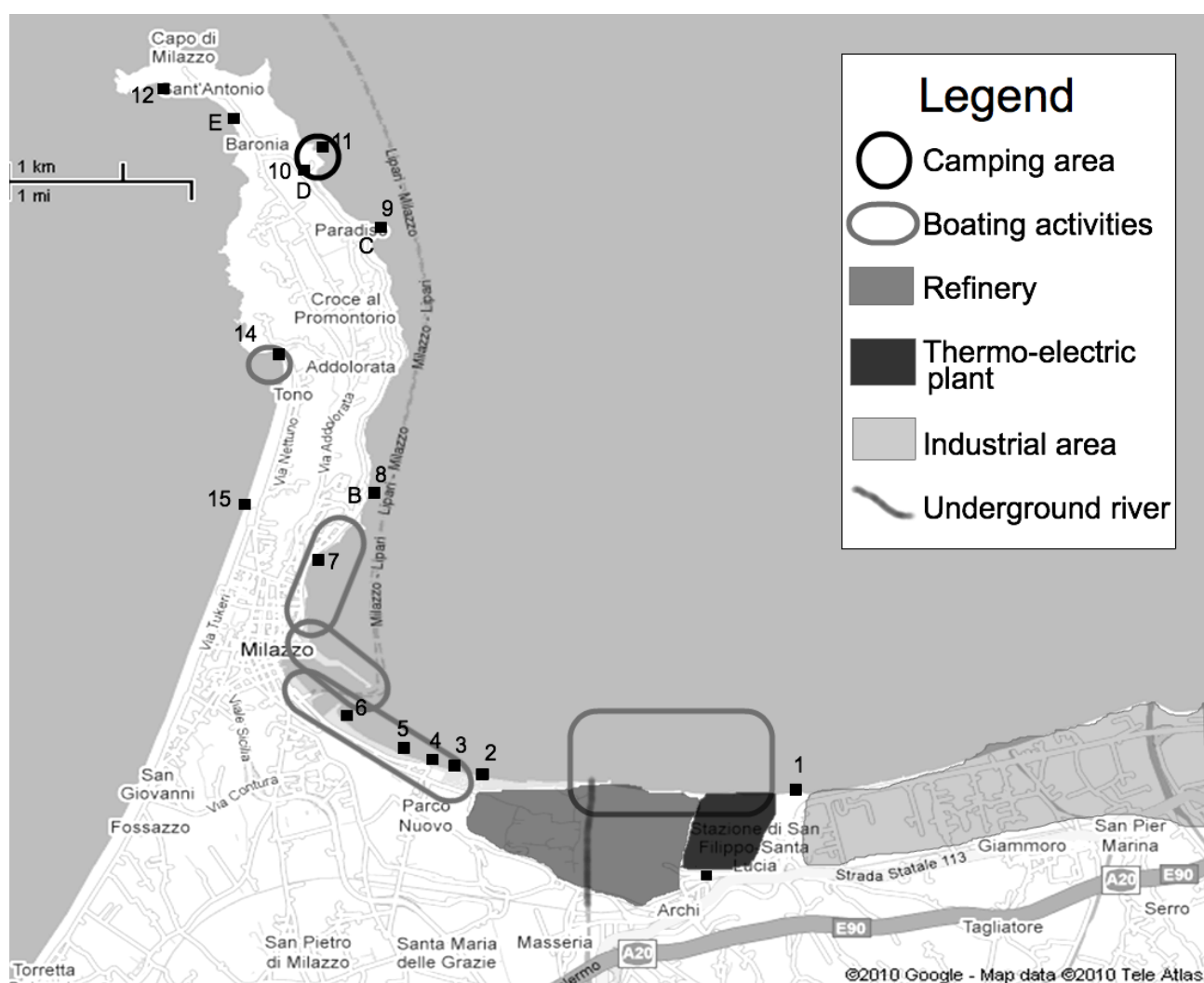

Figure 5: Main anthropogenic activities in the vicinity of the Milazzo peninsula, together with the sampling points. Underground torrent drawn according to lithological maps (Regione Siciliana Assessorato Territorio e Ambiente, 2002 (a) and (b))

The industrial pole as a whole is known to emit a large variety of pollutants, in particular: sulfur dioxide (SO₂), nitrogen oxides (NO_x), particles (PM₁₀, PM_{2.5}), benzene, polycyclic aromatic hydrocarbons (PAH), non-methane hydrocarbons (NMHC), heavy metals, ozone (O₃), styrene, carbon dioxide (CO₂) and carbon monoxide (CO) (Agenda 21 Milazzo, 2009).

1.2.1 Petrochemical areas

In Sicily, three industrial zones are of high ecological risk: the Milazzo area, the Syracuse area and the Gela area. The three of them are zones of intense petrol- and energy-based industrial activities. All three areas include zones of interest for the protection of the environment (Natura 2000 sites, wildlife parks).

In the Gela area, especially, studies have been made showing a local pollution by trace elements: barium, nickel, vanadium, copper, chromium, molybdenum, lead, tin, zinc, arsenic. The three first ones are linked to the petrochemical plant and the other ones to the road traffic (Manno et al., 2006; Bosco, 2005) but in Tarragona (Spain), arsenic, cadmium and manganese are linked to the petrochemical area while mercury and lead are linked to road traffic (Nadal et al., 2007). Chromium too is present in the Spanish soils at high concentration around the petrochemical complex (Nadal et al., 2009). The petrochemical plant is also responsible for increases in the concentration of airborne selenium and sulfur. Correlations are high between emissions of vanadium and nickel, arsenic and selenium, and lead and tin (Bosco, 2005) in Gela, vanadium emissions being linked to refinery processes and fossil combustibles (Nadal et al., 2007) in Tarragona. The type of pollutants emitted by a refinery depends on the refinery that is addressed, and on the production units which are in function. The area of pollution is often localized in the vicinity of the refinery; the level of pollution decreases when the distance increases (Wake, 2004).

Oil refineries' effluents contain toxic chemicals whose evolution within the water and sediments varies greatly from one site to the other, requiring specific studies to better understand a given site. Ecological diversity decreases drastically around refineries because of all the pollutant emissions. Polycyclic Aromatic Hydrocarbons, ammonia and sulphides seem to have the highest ecotoxic effect (Wake, 2004).

In Milazzo we have a situation similar to Gela's, Syracuse's or Tarragona's. Indeed, the petroleum refinery has similar emissions to a petrochemical plant. And a thermoelectric plant using gas as an energy source has similar emissions to those of road traffic.

Presentation of the site

Atmospheric pollutants emitted by the Milazzo refinery include dioxins, furans, polycyclic aromatic hydrocarbons (PAH), metal trace elements, non-methane hydrocarbons, NO_x, methane, PM₁₀, carbon monoxide, sulfur oxides (Capilli, 2005a).

The average level of hydrocarbons in the shore waters in the vicinity of petrol-based activities reaches 10 µg/L (5 µg/L in the open sea) (ERA, 2002).

Refineries in Belgium and Spain cause soil pollution with Polycyclic Aromatic Hydrocarbons (PAH), deposited very close to the site or quickly diluted into the atmosphere. The exposition to PAH is not very different between upwind and downwind sampling sites (Bakker et al., 2000) in Zelzate (Belgium) and the higher concentration of PAH in soils around a petrochemical plant in Tarragona is sometimes not significant compared to unpolluted zone (Nadal et al., 2007). In fact, in Tarragona PAH and PolyChlorinated Biphenyls (PCB) are found in higher concentrations in urban area than in industrialized area because of road traffic and of the close presence of a refinery (Nadal et al., 2009). On the whole, Volatile Organic Compounds (VOC) can reach high concentrations around a petrochemical complex with a high variability depending from wind speed and direction as well as from the temperature as is the case in Izmir (Turkey)(Cetin et al., 2003).

In soil irrigated by refinery's effluent we can find the following effects and pollutants: change of pH; change of electrical conductivity; change in water holding capacity; change in alkalinity; organic matter; chloride; sulphate; nitrogen; phosphorus; potassium; sodium; magnesium. Heavy metals such as zinc, iron, copper, manganese, chromium, lead, nickel are emitted, and they accumulate up to a toxic level (Rajesh et al., 2009). The wastewater contains oil, greases, phenols, polycyclic aromatics, sulfides, ammonia, suspended solids, cyanides, nitrogen compounds, heavy metals such as chromium, iron, nickel, copper, molybdenum, selenium, vanadium, zinc (Wake, 2004).

During combustion processes, like in thermoelectric plants, the elements cadmium, chromium, iron, selenium and zinc tend to be deposited further from the emission source than elements like cobalt, copper, manganese, nickel and lead (Srinivasa Reddy et al., 2005).

The pollutants will also be emitted by logistic activities such as transport, stocking etc. (Bevilacqua & Braglia, 2002).

1.2.2 Road traffic

Road traffic emits pollutants similar to those of a thermoelectric plant, as shown in the Gela area. There, studies have been made showing a local pollution by trace elements because of road traffic: copper, chromium, molybdenum, lead, tin, zinc, arsenic (Manno et al., 2006; Bosco, 2005) while in Tarragona (Spain), mercury and lead are linked to road traffic (Nadal et al., 2007).

1.2.3 Illegal combustion of domestic solid waste

The incineration of domestic solid waste causes emissions to the air as well as the creation of ashes. Those ashes contain 80% of the total pollutants emitted by the combustion of waste (Chimenos et al., 1999). The pollutants emitted are trace elements (lead, zinc, copper, manganese, tin, chromium, nickel, vanadium, cadmium, titanium, aluminium, magnesium, silicon, and strontium), glass, ceramics, minerals (quartz, calcium carbonates, lime, feldspars, gypsum), particulate matter, VOC, dioxins-furans, hydrogen chloride, and inorganic pollutants (CO, CO₂, SO_x, NO_x) (Chimenos et al., 1999; Lemieux et al., 2000; Hedman et al., 2005; Shibamoto et al., 2007; ENEA, 2003).

1.2.4 Other activities

The boating activities are not an environmental threat by themselves. Yet, studies have shown that the paints used on them are toxic for the environment (Turner & Radford, 2010; Turner et al., 2008). Chips of boat painting can be found in dust as well as in marine water. People repairing the boats, as well as people living next to the repair zones, are highly exposed to the emissions of paint chips and to the pollutants they contain. The emitted pollutants are mainly trace elements (silver, aluminium, barium, calcium, cadmium, chromium, copper, iron, manganese, nickel, lead, tin, titanium, vanadium, zinc) but also other biocidals such as TBT (ERA, 2002; Turner & Radford, 2010; Turner et al., 2008; Singh & Turner, 2009).

The lead-acid batteries recycling plant emits copper, arsenic, cadmium, lead, but also, in smaller amounts, chromium, mercury, selenium. Inorganic pollutants such as SO₂, PM, NO_x, CO and CO₂ are also emitted during the recycling process (Salmone et al., 2005).

1.2.5 Global knowledge regarding the pollutants of the area

Because of the low water turnover, the pollution in the Milazzo Gulf tends to accumulate (Yakimov et al., 2005). The hydrocarbons and urban waste are present in high concentrations in the

Presentation of the site

sediments. All the different compartments of the Milazzo area are polluted with trace elements, among other chemicals. The atmosphere of Milazzo is polluted by SO₂, NO_x, CO₂, O₃, hydrocarbons and particulate matter (Capilli, 2005a). The atmospheric pollution exceeds the thresholds for human health (Triolo et al, 2008). The ozone and sulfur dioxide pollution causes crops loss in the Milazzo area and the levels of those chemicals exceed Italian regulations for the protection of the flora while trace elements are not enriched in the soil, save for the vanadium (Triolo et al, 2008). In the groundwaters of the plain of Milazzo (south of the study area), hydrocarbons can be found at a concentration that can exceed the Italian limit, especially the chloroform used in pesticides (Pecoraino et al., 2008). The seawater contains high concentrations of arsenic of anthropogenic origins (La Pera et al., 2008) while the coastal sediments of the area are enriched in zinc, lead, cobalt, and copper (not in arsenic) because of anthropogenic activities (Pepe et al., 2010). In caged mussels, fluorene (a PAH) can reach 11.0 µg/kg in the area of Milazzo (Galgani et al, 2011).

2 Material and methods

2.1 Sampling and analysis methodologies

In this chapter we will speak about the methodologies used for the sampling of water and soils and about the methodologies applied for the analyses of the samples.

2.1.1 Sampling methodologies

The sampling of seawater is made at about 20 cm from the surface, in a place where the total depth is of about 50 cm. The sampling containers (polypropylene bottles) are rinsed with nitric acid and conditioned with seawater before filling. All the samples are kept within cooled thermal bags along the sampling day and are transferred into a fridge to be kept at a temperature of about 4°C prior to analysis.

Soil sampling is done using a plastic scoop, and samples are stored in polyethylene bags for transport to the laboratory, then disaggregated by hand, air-dried at room temperature (20-22°C) for seven days and sieved to 2 mm prior to analysis. Between two sampling, the scoop is cleaned using demineralized water and paper towels, so is the sieve.

There are sixteen sampling points for the water (see Table 6 and Figure 6), and five sampling points for the surface and deeper soils, all duplicated, which represent a total of fifteen samples.

The exact coordinates of the water sampling points are found in Table 6.

The Life Cycle Assessment of the Milazzo Peninsula

Number of the sampling point	Name of the sampling point	GPS coordinates (North)	GPS coordinates (East)
1	thermo-electric plant	38°12.411'	015°17.797'
2	refinery	38°12.497'	015°15.620'
3	blue bunker	38°12.542'	015°15.413'
4	freshwater pond	38°12.562'	015°15.299'
5	Casapiù	38°12.599'	015°15.216'
6	concrete jetty	38°12.771'	015°14.853'
7	port	38°13.635'	015°14.650'
8	Crocce di Mare	38°13.974'	015°14.999'
9	Paradiso	38°15.345'	015°15.023'
10	camping's fountain	38°15.653'	015°14.606'
11	camping	38°15.756'	015°14.683'
12	Capo di Milazzo	38°16.146'	015°13.758'
13	church's fountain	38°13.797'	015°14.599'
14	Baia del Tono	38°14.729'	015°14.417'
15	Castello	38°13.931'	015°14.242'
16	Bar	No GPS coordinates – tap water from the city	

Table 6: Number, location and coordinates of each water sampling point

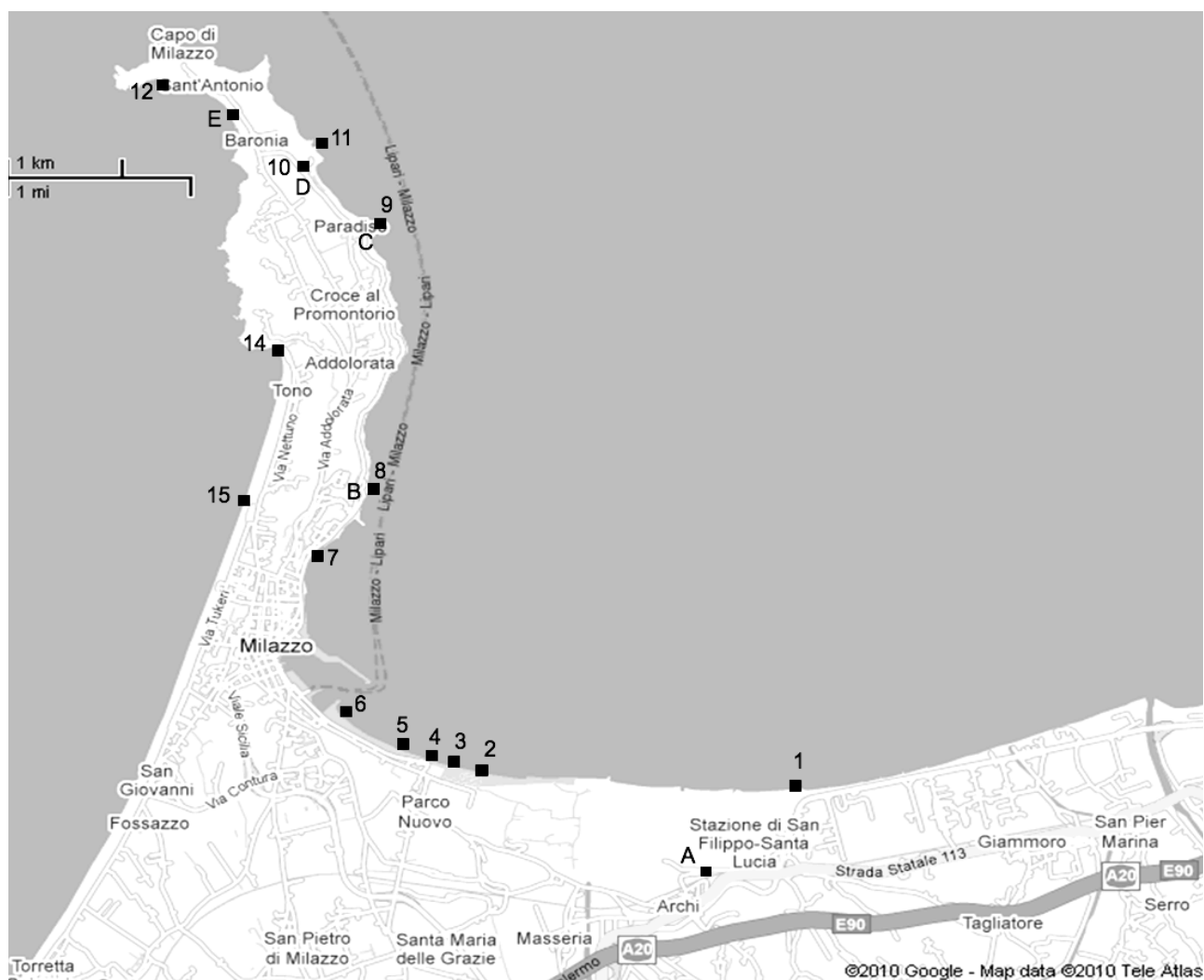

Figure 6: Map displaying the situation of the sampling points. Water samples are given numbers while soil samples are given letters.

2.1.2 Analyses methodology

In this paragraph, the methodologies used for the analyses of the water and soil samples are explained.

Water samples

The water analyses are made at Messina University by Inductively Coupled Plasma (ICP) Mass spectrometry (ICP-MS) and ICP atomic emission spectrometry (ICP-AES).

The samples are prepared with a prior filtration using PTFE filters of a 0.45 μm pore size. Freshwater samples are acidified with a solution of HNO_3 at 65% while seawater samples are diluted 1/25 with a solution of 2% HNO_3 .

The Life Cycle Assessment of the Milazzo Peninsula

First the calibration solutions are prepared in both distilled water (for freshwater samples) and artificial seawater (for seawater samples). This artificial seawater is composed of 1.10792 g of NaOH and 1.00997 g of HCl in 1 L of distilled water to obtain salted water at a concentration of 1.48 g/L (1/25 the average concentration of salt in Mediterranean Sea). All preparations are made in polypropylene containers.

The chosen elements are analyzed with ICP-MS using a Agilent 7500 CE mass spectrometer. Mercury is analyzed separately. The unit is left switched on during half an hour before use, in order to allow time for the different parameters to stabilize. This condition is verified using a tuning solution: standard derivation must be less than 5%.

Soil samples

The analyses of extractable trace elements in soil by Ethylenediaminetetraacetic acid (EDTA) will use polypropylene or polyethylene or polytetrafluoroethylene (PFTE) containers; centrifugations tube can be of PFTE only.

All the laboratory material that is in contact with the samples or any chemical used for the extraction is cleaned as follows: left in HNO₃ (4 mol/L) for at least 30 minutes, rinsed with distilled water, cleaned with EDTA 0.05 mol/L, rinsed a second time with distilled water.

The soil samples are dried at 105°C for 2 to 3 days, then left in a desiccator until they completely cool down. 3 grams of sample are then put in a PTFE bottle of 50 ml. 30 mL of EDTA (0.05 mol/L) is then added. The mixing is made using an end-over-end shaker, at temperature of 20 ± 2°C at a speed of 30 rpm. The centrifugation is made at 3 000 rpm during 10 minutes. The clear, liquid part is then separated and kept in a polyethylene bottle at 4°C prior to analysis using ICP-MS. The samples are turned upside-down a few times manually 5 minutes before the analysis.

The extraction using EDTA has advantages over the sequential extraction method used by Hadj Amor, 2008, in that it allows to directly measure the concentration of bioavailable metals.

2.2 Impacts assessment methodology

This chapter will explore the methodology specific to the impact assessment. First it explores the conceptual approach of the Life Cycle Impact Assessment. Second, it speaks about the global-scale evaluation methodologies. Third and last, it explains the site-specific evaluation methodologies.

2.2.1 Conceptual approach of Life Cycle Impact Assessment

The Life Cycle Assessment (LCA) is a methodology to assess the environmental impacts of a product or service, from the extraction of raw materials to the disposal of waste. It is a tool used to compare products and services, and also a tool for the identification of the opportunities for reducing the impacts consequent to the waste, resource extraction, and usage of those products and services (Pennington et al., 2004). It was developed with chemical engineering as well as energy analysis (Hertwich et al, 2002).

At first LCA was used by industries for claims of greener technologies, but in the 1980s the Society of Environmental Toxicology and Chemistry (SETAC) offered the methodology a better development with e.g. consistent terminology (Udo de Haes & Heijungs, 2007). The LCA normalization started in 1994 and its last update is dated back from 2006 with the ISO 14 040 (ISO, 2006a) and the ISO 14 044 (ISO, 2006b). It is separated into different phases (Figure 7): the definition of the goal and scope of the LCA, the life cycle inventory analysis (LCI), the life cycle impact assessment (LCIA), and the interpretation of the LCA.

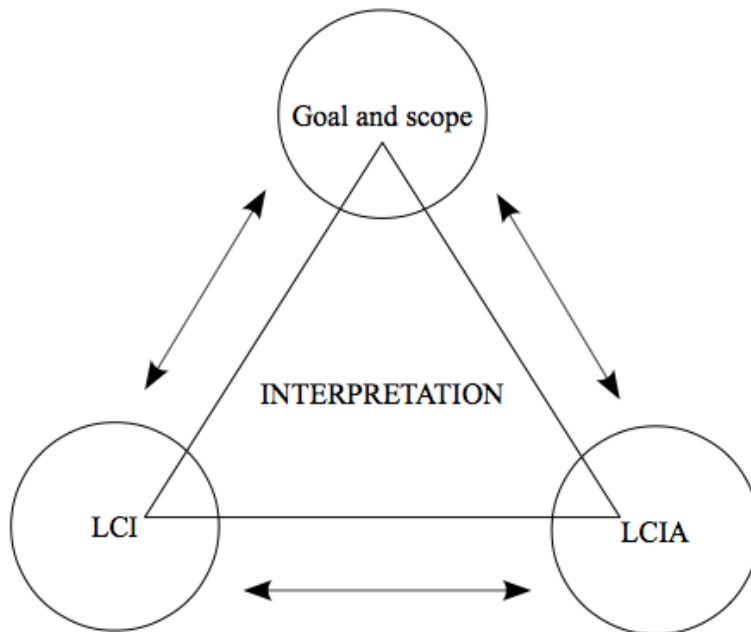

Figure 7: Relationship between the four steps of the Life Cycle Assessment, according to ISO 14 040 (2006)

The LCA, despite its damage-oriented methodology, is also used in environmental impact assessment (EIA). While the LCA focuses on the whole life cycle, the EIA studies the emissions of a given process and its consequent environmental impacts, but the LCIA is more specific than the EIA, with a better-defined framework (Tukker, 2000).

Goal and scope

In the goal step of the Life Cycle Assessment, the objectives are described. The person /organism for who and the reason why the LCA is conducted are described. It gives the reasons of doing the analysis, if it is meant to be private or public, and what will be studied. The scope is different according to the study: in a simplified method, the system is considered as a black box whereas in the detailed method, every step in the system is studied. The chosen approach depends on the goal of the study (Hogaas Eide et al., 1998). The system boundaries tell which unit processes are part of the product system and which are not (Finkbeiner et al., 2006). They also set the geographical and temporal limits of the study, and the marginal effects that are included, or not, in the study (e.g. life-cycles of other products and of waste) (Finnveden et al., 2009).

Inventory of the pollutants, collection of data

The inventory collection is usually done using forms to be filled in by the client requesting the Life Cycle Assessment. But when direct data is not available, public data can sometimes be found in scientific publication, public communications, official websites...

Organisms can also specialize in the collection and synthesis of data regarding any anthropogenic activities. Those databases, such as Ecoinvent, provide general information that can be used to fill in data gap in the study's inventory.

Inventory classification by the Life Cycle Inventory

The Life Cycle Inventory phase aims to examine the system from an environmental perspective using category indicators derived from the Life Cycle Inventory (LCI) results (Hospido et al., 2005). The data are gathered all along the study. All the emitted substances, all the material and energy flows are inventoried (Figure 8). The exposure, persistence and spatial range of substances is also taken into account. The time scale is important too, because the impacts of a given substance can vary through time (Beck, 2000). It is important to also account for the quality of data (May & Brennan, 2003). It should also be an appropriate description of the relevant parts of the technological system; what parts are relevant depends on the aim of the study (Ekvall & Weidema, 2004).

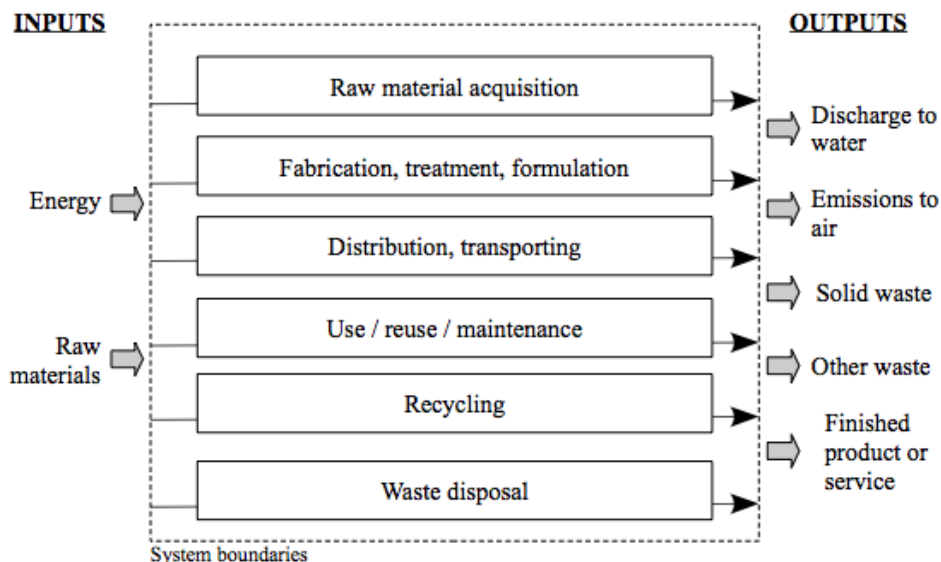

Figure 8: Diagram for the Life Cycle Inventory

The first stage is the classification (e.g, in Figure 9) during which the emissions and resources are sorted into different groups or impact categories according to their potential impact on

the environment (Hospido et al., 2005). The different families of criteria need to be coherent in order to allow comparison (Chevalier & Rousseaux, 1999). The categories proposed and maintained by the SETAC are: resource and land use; climate change; stratospheric ozone depletion; photo-oxidant formation; acidification; eutrophication; human toxicity; ecotoxicity (Bare, 2010).

In the same category – or family of criteria – the stressors have similar effects or endpoints (Hertwich & Hammitt, 2001). Different impact classes are suggested by the SETAC (Society of Environmental Toxicology and Chemistry) in order to cover all possible impacts. Among them, the one interesting this site-specific study are the terrestrial and aquatic ecotoxicity.

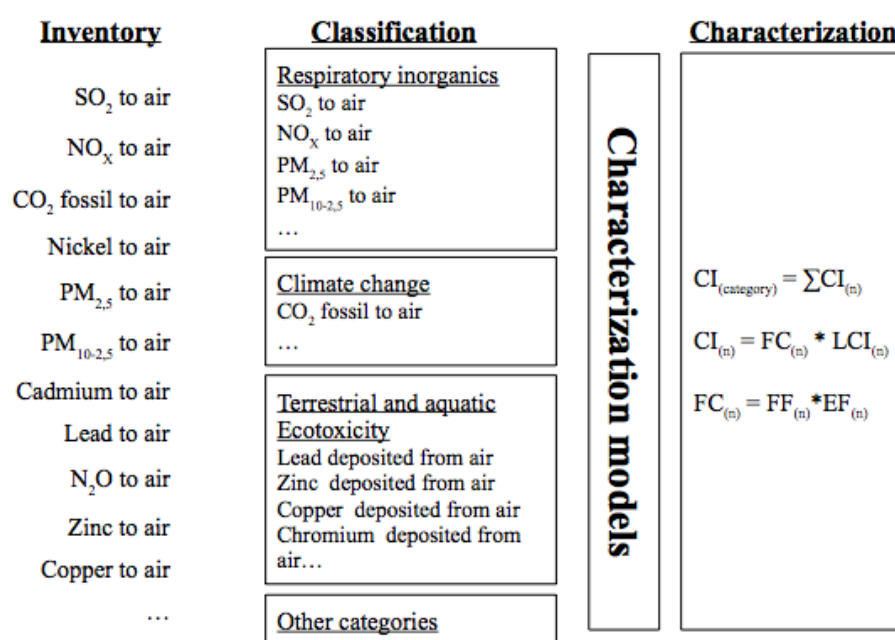

Figure 9: Example of the different steps of Life Cycle Assessment

Characterization by the Life Cycle Impact Assessment

The characterization is the transformation of a scientific measure into an indicator. Its aim is to provide and compare the values of the object considered (Ciroth et al., 2003). The different impact classes are characterized by a category indicator following the formula:

$$CI_c = \sum_n FC_n \cdot LCI_n$$

$$\text{with } FC_n = FF_n \cdot EF_n$$

where CI is the Category Indicator; (c) is a category; FC is the Factor of Characterization; LCI is the result found in the List of Classified Inventory; FF is the Fate Factor; EF is the Effect factor; (n) is a substance.

Material and methods

Or, as expressed by Jolliet:

$$S = \sum_{i,m,n} S_i^{nm}$$
$$\text{with } S_i^{nm} = E_i^m \cdot F_i^{nm} \cdot M_i^n$$

where S is the effect score; E is the effect factor; F is the fate and exposure factor; M is the total mass of emission; (i) is a chemical; (n) is the compartment of release; (m) is the exposure route.

Usually, E is calculated as $E = \frac{1}{PNEC}$ (predicted no-effect concentration) for ecotoxicity, or as $E = ADI$ (allowable daily intake) for human toxicity, or as a complex dose-response curve.

Different characterization models exist and are needed for each impact category (Toffoletto et al., 2005). The stressors within a single category are compared and aggregated (Hertwich & Hammitt, 2001). At this characterization level, the indicator is called a midpoint indicator (Bare et al., 2000).

Then, the midpoints are grouped into endpoints according to the relation between the means and the objectives, as decided in the goals of the study (Hertwich & Hammitt, 2001). The results are weighted in order to be aggregated in a single score result according to the following equation:

$$DK = \sum_c CI_c \cdot DF_c$$

Where: DK is the total damage score; CI is a Category Indicator; DF is the Damage Factor; (c) is a category.

While the midpoint indicators assess for the direct impacts, the endpoint indicators assess for the damages (to the environment, to the human health...) (Itsubo et al., 2004).

Different calculation methods exist, such as Eco-indicator 99, Impact 2002+, ReCiPe...

Normalization

Normalization is an option to the LCIA (Hertwich et al, 2002). The aim of normalization is to relate the calculated impacts to reference values, so that they can be compared with each-other. The formula used is (Finnveden et al, 2002):

$$N_i = \frac{S_i}{R_i}$$

where (i) is the impact category; N is the normalized result; S is the result prior to normalization; R is the reference value or substance.

But the normalization is not always necessary: when the results are collected using a panel approach, normalization is not needed (Finnveden et al., 2002).

Interpretation and analysis of the results

The interpretation is a crucial phase. It includes an analysis of the uncertainties, an analysis of the contribution of the diverse elements to the result, an identification of the sensitive parameters, a comparison of the different alternatives (Heijungs et al., 2005). It presents the results in a way that meets the requirements of the application as described in the goal and scope of the study (Hospido et al., 2005). It is also important to account for both midpoint and endpoint results, because they are complementary (Bare et al., 2000).

Running issues in the LCIA

For impact categories such as land use, it is important to have local information for a relevant study. This knowledge is not always available. The quality of data poses a complex issue, and no study provides a complete picture of this problem. Consensus is being reached thanks to study groups of the UNEP SETAC Life Cycle Initiative (Bare, 2010; Geyer et al., 2010; Reap et al., 2008). Economic and social aspects (Weidema, 2006) as well as soil salination, freshwater depletion, deforestation, indoor environment (Jolliet, 2006) still need to be integrated in the LCIA.

The selection of impact categories is also limited by its lack of standardization; some of these categories suffer from data gap (e.g. toxicity, land use). Different calculation methodologies can even provide diverging results. Moreover, different geographical zones have different sensibilities to each impact, asking for a spatial modeling of those factors (Reap et al., 2008).

The weighting is always very subjective and poses issues in the interpretation.

2.2.2 Global-scale evaluation methodologies

According to Jolliet, “Life Cycle Impact Assessment methods aim to connect, as far as possible, and desired, each life cycle inventory result to the corresponding environmental impact.” (Jolliet et al., 2003) The different calculation methodologies are different from each-other, every

Material and methods

one accounts for different chemical species and classifies the impacts and damages in a slightly different way. The normalization and weighting sets can also differ according to the relative importance that is given by the creators for each category. Most of the preexistent calculation methodologies allow the user to choose between different weighting sets, based upon the long-term perspectives that are the most commonly chosen.

For the present analysis, the methodologies Impact 2002+ and ReCiPe were chosen. The ReCiPe gives different ponderation sets, though the Impact 2002+ has only one. In order to facilitate the comparison of the results it was decided to choose the ponderation set for ReCiPe that is the closest from the Impact 2002+ ponderation.

Impact 2002+ v2.06

Impact 2002+ was first developed at the Swiss Federal Institute of Technology (Ecoinvent Centre, 2007) This methodology is a combination of four other methods: the IMPACT 2002 created in 2002 by Pennington *et al.*; the Eco-indicator 99, egalitarian version, created in 2000 by Goedkoop and Spriensma; the CML created in 2002 by Guinée *et al.*; the IPCC.

This methodology is separated in four damage-oriented impact categories that are: human health; ecosystem quality; climate change; resources. All the four categories are considered equal. Calculation is made at continental level for all Western Europe.

As a whole, the Impact 2002+ proposes a combined midpoint and damage approach with an aim to enable comparative assessment without using conservative assumptions and safety factors (ILCD handbook, 2010). It however has some limitations: it does not include marine environment, noise, and other impacts. The toxicity impacts are not fully developed, lacking bioavailability considerations (Jolliet *et al.*, 2003).

ReCiPe Endpoint v1.04

The ReCiPe methodology combines both mid-point (i.e. impact-oriented) and end-point (i.e. damage-oriented) methods. Its first aim was to harmonize the practices of LCA at European level but the method was redeveloped and updated in 2008. It has three areas of protection and eighteen impact category indicators based upon functions supporting life (Vesin, 2009; ILCD handbook, 2010).

The Life Cycle Assessment of the Milazzo Peninsula

The version of ReCiPe that is used here is the Endpoint method with an egalitarian perspective for Europe and an average weighting set. The normalization is different for Europe and for the World, while the weighting is different in egalitarian and hierarchist perspectives.

While the impacts upon human health are expressed in DALY like for Impact 2002+, the impacts upon ecosystems are expressed in species*year while they are expressed in PDF*m²*year (or m³, depending on the environmental compartment) in Impact 2002+. In order to enable a comparison between the two methodologies, the ReCiPe results must be divided by the species density in each environmental compartment. These densities are reported in Table 7.

Environmental compartment	Species density
Terrestrial	1.38•10 ⁻⁸ species/m ²
Freshwater	7.89•10 ⁻¹⁰ species/m ³
Marine	1.82•10 ⁻¹³ species/m ³

Table 7: Species density per environmental compartment (ReCiPe report, 2009)

Even though ReCiPe is said to be a “local” methodology, in fact, only the normalization and weighting differ between the points of view: it is too complicated to create local factors for absolutely every place on the planet. It also lacks some midpoints and endpoints of importance, like erosion, salination, noise, light, and the damages to man-made environment (ReCiPe report, 2009).

The ReCiPe method was created by RIVM, CML, PRé Consultants, Radboud Universiteit Nijmegen and CE Delft.

2.2.3 Site-specific evaluation methodologies

The result of the LCA is estimated at a worldwide scale: the traditional LCIA approach tends to disregard the local spatial differentiation, leading to inadequate modeling for the impacts (Hertwich et al, 2002). The concern regarding the local scale of some impacts such as ecotoxicity, compared to the worldwide scale of the calculation, is not new. It has been long noticed that to increase the relevance of LCA results, more site-dependent factors are needed for the small-scale impacts such as pesticide leaking to underground water, while an only standard is still relevant for global-scale impact categories such as global warming or ozone depletion. At the more local scale, characterization depends a lot on the characteristics of the receiving area (target, compartment of emission) causing a disaccord between the impacts calculated with global-scale characterization factors, and the on-site observed impact (Potting & Hauschild, 1997a and b).

Present limitations of the global-scale methodologies

One of the main reasons of the non-utilization of local-scale characterization factors is a feasibility reason. Gathering site-specific data for all the sites included within a LCA is rarely possible. Moreover, site-dependent characterization factors are not always relevant. It varies from one impact to the other. Sometimes, a country-level characterization factor is enough; sometimes, a more detailed grid is more relevant (Finnveden & Nilsson, 2005; Gallego et al., 2010).

Presently, for a more regional-specific analysis, the world is cut into nine regions that are homogeneous in their politics and in their development status. But this is not enough: the area impacted by the analyzed process or service is still extended to a world-wide scale. The spatial distribution of those impacts is lost in the process (Raugei & Ulgiati, 2009). Moreover, fate and exposure factors are calculated under three different sets of typical conditions; a study of the difference between the generic factors and more site-specific factors obtained with USES-LCA showed that there is a factor of 2 to 10 between the USES-LCA and the generic factor (Huijbregts et al., 2003).

The present study is focused on the impacts caused locally with local environmental conditions, therefore it would need site-specific factors. But such a grid of site-specific factors is difficult to obtain worldwide. It requires: a methodology that is applicable at a worldwide scale; to be accepted and widely used by the scientific community; worldwide available data; knowledge about the relationship between the different sites and the addressed risks and impacts; informations

available in digital format (Núñez et al., 2010). The already existing grids do not cover all impacts, and do not cover the whole world. Therefore, because they can not be found in the literature, the site-dependent parameters need to be calculated.

Calculation of site-dependent parameters

The method chosen in order to get more accurate allocation of damages to the impacted zones is to use site-dependent parameters such as the characteristics of the environmental compartment the substance is emitted to. Indeed, while for global-scale impacts such as climate change and ozone depletion, the global-scale approach is relevant enough. But the other impacts are more local or regional in nature, therefore they are site-dependent (Udo de Haes & Heijungs, 2007).

As explained earlier, the basic equation in the LCIA is the following:

$$CI_c = \sum_n FC_n \cdot LCI_n$$

$$\text{with } FC_n = FF_n \cdot EF_n$$

where CI is the Category Indicator; (c) is a category; FC is the Factor of Characterization; LCI is the result found in the List of Classified Inventory; FF is the Fate Factor; EF is the Effect factor; (n) is a substance.

In order to use it in a local-scale study, the factor of characterization FC needs to be recalculated.

First, the fate factor FF can be expressed as (Jolliet et al., 2003):

$$FF_n^s = F_n^s \cdot \theta_n^s$$

where F is, for the metals and metalloids, the bioavailable fraction of substance; θ is the residence time in years; (n) is a substance; (s) is the compartment.

The bioavailable fraction of substance is calculated as follows:

$$F_n^s = \frac{C_n^{s \text{ bioavailable}}}{C_n^{s \text{ TOTAL}}}$$

where C is a concentration.

The residence time of a substance in a compartment is calculated as follows (Jolliet et al., 2003):

Material and methods

$$\theta_n^s = \frac{\Delta C_n \cdot V \cdot \Delta t}{M_n}$$

where ΔC is the change of concentration of a substance in the compartment; V is the volume of the compartment into which the substance is emitted; Δt is the time during which the change of concentration occurs; M is the mass of substance emitted during that time of observation.

The Effect Factor is expressed as (Jolliet et al., 2003):

$$EF_n = \frac{0,5}{HC50_n^s}$$

where $HC50$ is the the concentration of substance affecting 50% of the species; (s) is the soil compartment. When not directly available for the soil compartment, it can be calculated after the $HC50$ in the water compartment using the following equation (Jolliet et al., 2003):

$$HC50_n^s = HC50_n^w (Kd_n^s \cdot \rho^s + fw)$$

where Kd is the partition coefficient of a chemical between the soil and the water; ρ is the density; fw is the fraction of water in the soil; (s) is the soil compartment; (w) is the water compartment.

2.3 Monte-Carlo analysis

The quality of the data used for the life cycle impact assessment influences greatly the quality of the results. It is therefore important to be able to judge the quality of each datapoint in a scientific and objective way. There is a methodology enabling to do so (Weidema & Wesnæs, 1996). For each of the different developed categories (e.g. geography, timeframe) a quality index is given, ranging from 1 (very good) to 5 (very bad) following the indications contained within a table. All together, these quality indexes make a quality vector, which can be used to better evaluate the life cycle inventory.

Based upon this quality vector, the uncertainty can be evaluated based upon the calculation of the geometrical standard deviation using the formula (Frischknecht et al., 2004):

$$SD_{g95} = e^{\sqrt{[\ln(U_1)]^2 + [\ln(U_2)]^2 + [\ln(U_3)]^2 + [\ln(U_4)]^2 + [\ln(U_5)]^2 + [\ln(U_6)]^2 + [\ln(U_b)]^2}}$$

According to the Monte-Carlo statistical method, the 95% confidence interval with a lognormal distribution for a datapoint is given by multiplying or dividing said datapoint by the SD_{g95} .

3 Application of the Life Cycle Assessment methodology to the anthropogenic activities of the Milazzo Peninsula

3.1 Goal and scope

The present study takes place as part of the “Territory, Tourism and Environment” project lead by Antonia Messina of the University of Messina, Sicily, Italy, as part of the “Environment” perspective of this project.

The goal of this study is to calculate the impacts of anthropogenic activities situated in the Milazzo area in order to determine the possible role of each of them for example in health damage.

The system of study is multifunctional (ILCD Handbook, 2010), including road traffic, disposal of domestic waste, production of electricity, production of oil refined products (see Figure 10). In order to enable a comparison between the different functions a common functional unit was decided. This functional unit is “the functioning of the selected Milazzo peninsula's anthropogenic activities during their whole lifetime (i.e. during the 47 last years)”. This functional unit is reported to a yearly observation in 3.4.

The geographical boundaries of the system are limited to the Milazzo Peninsula. The processes taken into account are: the thermoelectric plant's combustion process leading to electric energy production; the road traffic in the Milazzo city; the illegal combustion of domestic waste and the on-site illegal disposal of the ashes; the different processes of the refinery's functioning (flare, distillation process, furnaces). The emissions that are not taken into account are: from the production of the chemicals used by the industries; the production of the domestic waste that is burned; the production of the fuels used for the road traffic vehicles and industries functioning; the disposal of the industries' waste. The other potentially impacting anthropogenic activities of the area (sewage treatment plants, sanding and blasting of boat paint, agricultural activities) are not included in the LCA due to lack of data. See Figure 10 for a schematic representation of the LCA boundaries.

Once the emissions for accounted for processes are gathered, the LCA is conducted at different scales: 1) global-scale is done through two different timeframes: ten years with a yearly comparison, and 47 years timeframe assumed to cover the whole period of industrial activity of the Milazzo Peninsula. 2) local-scale is done with a timeframe of 47 years and focuses on the environmental (soil and seawater) ecotoxicity potential of trace elements.

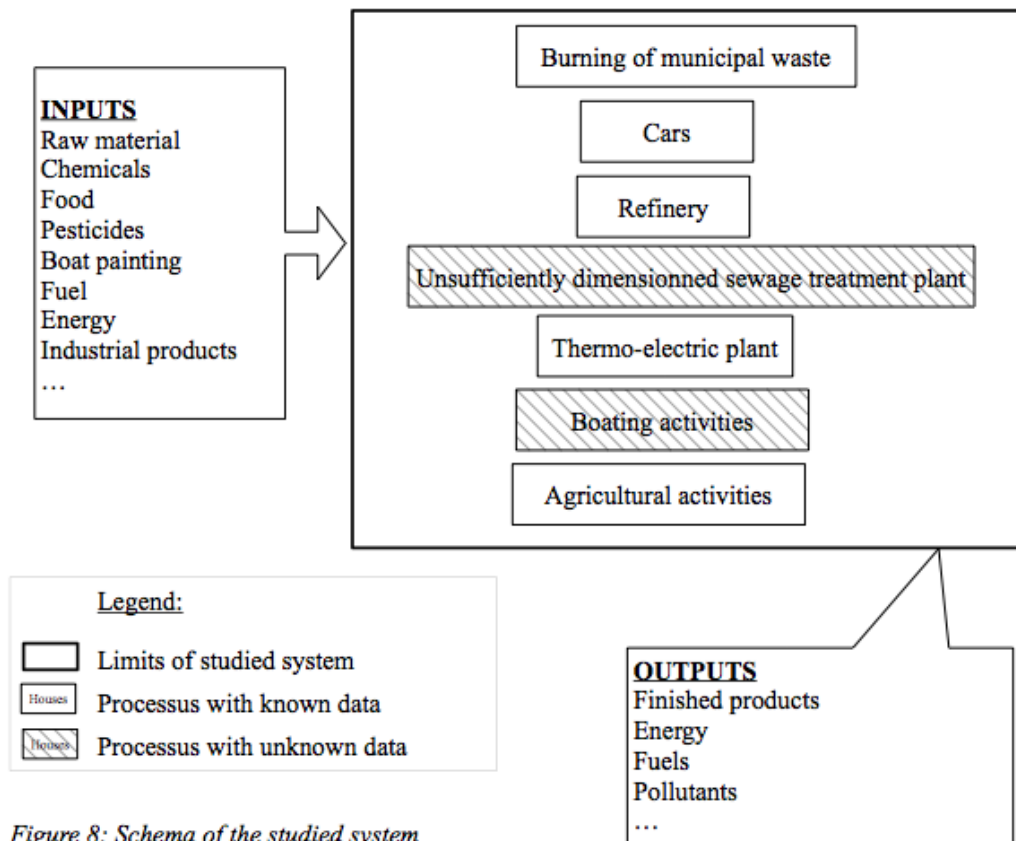

Figure 8: Schema of the studied system

Figure 10: schema of the studied system

The choice of the system was guided by the availability of data for modeling. Indeed, if it is easy to find data regarding the activities of the refinery and the thermoelectric-plant, road traffic and production of solid domestic waste, it is less easy to find data regarding the amount of paint blasted and sanded during the maintenance of ships, the road and private boats traffic, the defective (Agenda 21 Pace-Niceto, 2008) sewage treatment plants or the agricultural activities. Moreover, all data required for the assessment of the chosen anthropogenic activities may not always be available. Therefore the Ecoinvent 2.0 database will be used to fill in the data gaps in the inventory. Other processes of raw material extraction, chemicals production, finished products utilization, waste treatment and so on, will not be taken into account because they are not part of the system. The European or, when available, Italian emissions per unit of production will be linked to the yearly level of activity of each industry in order to fill in the gaps within the collected emissions data.

The Ecoinvent 2.0 is a database that combines different databases. It is showed in two versions: the Unit version, where the processes are linked to each-others and the System version, giving the calculated inventory results of all processes. The Unit version will be used in order to better understand the specificities of each step in the functioning of the anthropogenic activities.

3.2 Inventory collection and analysis

This chapter will speak about the different inventory sources used for the Life Cycle Impact Assessment. The first source that is spoken about is the database Ecoinvent 2.0. Second are gathered and criticized the datasources for the illegal combustion of domestic waste. Third, the datasources for the refinery are spoken about. The fourth paragraph is about the thermoelectric plant while the fifth and last is about the road circulation.

3.2.1 Ecoinvent 2.0

In the Ecoinvent 2.0 database, the data used for the power-plant are estimated for Europe. The energy conversion between Joule and kiloWatt-hour is of 9.43 MJ/kiloWatt-hour in Italy according to Ecoinvent 2.0.

For the refinery, the data in Ecoinvent 2.0 is also an average for Europe. It is linked to three other processes that are part of the functioning of the refinery itself: refinery gas burned in furnace; heavy fuel oil burned in refinery furnace; refinery gas burned in flare.

For both the refinery and the thermoelectric plant, the input data were not taken into account, because the production of the input materials is not done on-site and therefore, does not impact the local environment. Only the pollutant outputs were accounted for.

3.2.2 Pollutants from illegal combustion of domestic waste

In the Milazzo Peninsula, huge piles of domestic waste (Figure 11) were observed, being illegally burned in the city or in the neighboring environment (Figure 12), despite the existence of waste collection in this area. A worst-case scenario was assumed where half of the domestic waste is illegally incinerated on-site by the inhabitants and the other half is collected (Table 8 page 49 for the estimation of waste collection in the Milazzo city).

Global-scale calculation



Figure 11: Pile of uncollected domestic waste observed in march 2010 in the city of Milazzo.



Figure 12: Pile of domestic waste being illegally burned in the environment of the Milazzo Peninsula. Picture taken in may 2010

The Life Cycle Assessment of the Milazzo Peninsula

Year	Number of inhabitants in Milazzo	Average per capita waste collection in the Messina province	Calculated per capita waste collection in the Milazzo City	Calculated total waste collection in the Milazzo City
1961	24 137 in. (Comuni-Italiani.it, 2012)		678 kg/in.†	
1971	27 204 in. (Comuni-Italiani.it, 2012)		678 kg/in.†	18 444 tons
1981	30 607 in. (Comuni-Italiani.it, 2012)		678 kg/in.†	20 752 tons
1991	31 541 in. (Comuni-Italiani.it, 2012)		678 kg/in.†	21 385 tons
2001	32 083 in. (Urbistat, 2012)		678 kg/in.†	21 752 tons
2002	32 113 in. (Urbistat, 2012)		678 kg/in.†	21 773 tons
2003	32 327 in. (Urbistat, 2012)	443 kg/in. (ARPA, 2005)	631 kg/in.*	20 407 tons
2004	32 550 in. (Urbistat, 2012)	445 kg/in. (ARPA, 2005)	615 kg/in.	20 032 tons (Agenda 21 Milazzo, 2009)
2005	32 586 in. (Urbistat, 2012)	410 kg/in. (ARPA, 2006)	602 kg/in.	19 629 tons (Agenda 21 Milazzo, 2009)
2006	32 590 in. (Urbistat, 2012)	495 kg/in. (ARPA, 2008)	705 kg/in.*	22 988 tons
2007	32 676 in. (Urbistat, 2012)	525 kg/in. (ARPA, 2008)	748 kg/in.*	24 446 tons
2008	32 647 in. (Urbistat, 2012)	503 kg/in. (ARPA, 2009)	717 kg/in.*	23 401 tons
2009	32 655 in. (Urbistat, 2012)	510 kg/in. (ARPA, 2010)	727 kg/in.*	23 732 tons
2010	32 601 in. (Urbistat, 2012)		678 kg/in.†	22 104 tons

Table 8: Estimation of total waste collection in the Milazzo city for the years 2000-2010. An empty square indicates a lack of data.

†Average of the data for the other years

**Estimation based upon the provincial per capita waste collection and the factor between the Messina and Milazzo per capita waste collection for years 2004 and 2005*

The number of inhabitants for the year 2000 was estimated according to the average yearly evolution of the population over the years 2004-2010, which is of +0.03% (Urbistat, 2012). For the other years, a linear regression based on the closest datapoints was used (e.g. year 2010 to estimate the population in years 2011 and 2012; years 1971 and 1981 to estimate the population of years 1972-1980).

Global-scale calculation

In order to obtain an estimation of waste collections for the years for which no data was found, the average yearly per capita waste collection in the Milazzo City was used, together with the number of inhabitants for said years.

It was also assumed that the emissions resulting from the illegal incineration of domestic waste is at least the same as for the incineration of domestic waste in a waste incinerator of municipal solid waste in Switzerland, as found in the Ecoinvent 2.0 database. The emissions resulting from the disposal of incineration waste are assumed to happen on-site, without any treatment center.

3.2.3 Pollutants from the Milazzo refinery

The emissions of the Milazzo refinery, as found in the literature, are reported in Table 9, Table 10, Table 11, Table 12. These data were completed with the Ecoinvent 2.0 database.

The data from the European Pollutant Release and Transfer Register (E-PRTR) are assumed to be the more consistent ones and therefore, used before any other. They are collected yearly from the different facilities and industrial activities in Europe. These data are shown in Table 9 and Table 10.

Compartment of emission	Pollutant	2001	2002	2003	2004	2005
Air	CO ₂	2 320 kt/y	2 318 kt/y	2 449 kt/y	1 755 kt/y	1 822 kt/y
Air	As and compounds	41.5 kg/y	41 kg/y	31 kg/y	23.5 kg/y	28 kg/y
Air	Cl and inorganic compounds	59.6 t/y	60 t/y	80 t/y	49.1 t/y	18 t/y
Air	NMVOC	3 310 t/y	3 313 t/y	3 407 t/y	3 258 t/y	3 471 t/y
Air	Cr and compounds	670 kg/y	670 kg/y	904 kg/y	744 kg/y	-
Air	Ni and compounds	1 770 kg/y	1 770 kg/y	1 658 kg/y	1 356 kg/y	1 081 kg/y
Air	NO _x	1 870 t/y	1 869 t/y	2 254 t/y	2 124 t/y	2 440 t/y
Air	SO _x	6 000 t/y	6 001 t/y	6 391 t/y	5 340 t/y	6 522 t/y
Air	CO	-	-	1 273 t/y	-	527 t/y
Air	TSP	-	218 t/y	235 t/y	185 t/y	262 t/y
Air	PM ₁₀	81.3 t/y	81 t/y	113 t/y	88.5 t/y	77 t/y
Air	Se and compounds	-	1.2 kg/y	3 kg/y	2 kg/y	7 kg/y
Air	Zn and compounds	876 kg/y	876 kg/y	1 465 kg/y	954 kg/y	-
Water	N total	58.7 t/y	59 t/y	-	-	-
Water	Total organic carbon (TOC)	163 t/y	163 t/y	117 t/y	100 t/y	133 t/y
Water	Phenols	341 kg/y	341 kg/y	143 kg/y	94.8 kg/y	107 kg/y
Water	Ni and compounds	405 kg/y	405 kg/y	373 kg/y	36.9 kg/y	51 kg/y
Water	Pb and compounds	32 kg/y	32 kg/y	20 kg/y	23.2 kg/y	23 kg/y
Water	Zn and compounds	405 kg/y	405 kg/y	249 kg/y	-	244 kg/y

Table 9: Emissions of Milazzo refinery for years 2001 to 2005 (APAT, 2010 (a); European Environment Agency, 2011)

Compartment of emission	Pollutant	2006	2007	2008	2009	2010
Air	CO ₂	1 772.138 kt/y	1 830 kt/y	1 670 kt/y	1 620 kt/y	1 800 kt/y
Air	As and compounds	-	22 kg/y	-	-	25.4 kg/y
Air	Benzene	-	20.2 t/y	19.1 t/y	21.2 t/y	20.1 t/y
Air	Cl and inorganic compounds	20.4 t/y	30.9 t/y	16.6 t/y	14.0 t/y	19.7 t/y
Air	NMVOC	3 416.2 t/y	2 900 t/y	2 700 t/y	2 810 t/y	2 830 t/y
Air	Cd and compounds	-	142 kg/y	-	-	-
Air	Cr and compounds	129.6 kg/y	109 kg/y	-	-	-
Air	Cu and compounds	-	3.30 t/y	-	-	-
Air	Ni and compounds	1 072.5 kg/y	1 650 kg/y	869 kg/y	1 210 t/y	-
Air	NO _x	2 725.2 t/y	2 670 t/y	2 360 t/y	2 330 t/y	2 330 t/y
Air	SO _x	6 922.6 t/y	6 830 t/y	5 120 t/y	4 940 t/y	4 850 t/y
Air	CO	665.3 t/y	894 t/y	607 t/y	562 t/y	-
Air	PM ₁₀	104.3 t/y	60.1 t/y	56.6 t/y	67.9 t/y	65.5 t/y
Air	NH ₃	10.2 t/y	10.8 t/y	-	-	-
Air	Se and compounds	4 kg/y	-	-	-	-
Air	Zn and compounds	229.6 kg/y	200 kg/y	184 kg/y	-	341 kg/y
Air	Pb and compounds	-	3.15 t/y	-	-	-
Air	PAH	-	124 kg/y	-	-	-
Water	Cr and compounds	-	73.9 kg/t	-	104 kg/y	-
Water	Total organic carbon (TOC)	89.6 t/y	105 t/y	61.4 t/y	91.9 t/y	93.4 t/y
Water	F and inorganic compounds	-	2.18 t/y	2.45 t/y	2.01 t/y	-
Water	Phenols	75 kg/y	93.3 kg/y	60.5 kg/y	327 kg/y	365 kg/y
Water	Ni and compounds	39 kg/y	41.9 kg/y	-	-	-
Water	Pb and compounds	-	40.1 kg/y	62.1 kg/y	109 kg/y	183 kg/y
Water	Zn and compounds	177.5 kg/y	272 kg/y	184 kg/y	-	-

Table 10: Emissions of Milazzo refinery for years 2007 to 2010 (European Environment Agency, 2011)

The Life Cycle Assessment of the Milazzo Peninsula

We can see, through the amount of CO₂ emitted each year, a global decrease of the refinery's activity during the studied decade. A similar trend can be expected for all the other emissions, but it is not always the case.

Most chemicals do not seem to follow any regular trend. This may come from the composition of the crude oil, which is never exactly the same and may contain variable amounts of trace elements, sulfur, etc.

All data are of the same order of magnitude for each chemical; this indicates the consistency of this dataset.

The gaps of this dataset will be filled in according to the average ratio between said chemical's emissions and carbon dioxide's emissions.

Another dataset from Bevilacqua and Braglia is shown in Table 11.

Year	Oils processed (t/y)	SO ₂ (t/y)	NO _x (t/y)	TSP (t/y)	CO (t/y)	CO ₂ (kt/y)	NMVOC (t/y)
1993	4 324 000	5 200	1 400	340	275	720	2 000
1994	5 438 000	6 400	2 100	420	465	1 150	2 500
1995	5 448 000	6 000	2 400	420	495	1 300	2 620
1996	4 700 000	8 100	1 900	380	470	1 250	2 550

Table 11: Pollutant emissions of Milazzo refinery from year 1993 to 1996 (Bevilacqua & Braglia, 2002)

We notice an increase of SO₂ emissions during the year 1996; it is due to the beginning of the production of low-sulfur oils and gas (Bevilacqua & Braglia, 2002). The amount of oil processed being available for the years 1993-1996 together with the emissions of carbon dioxide, this enables to average the ratio between the two, and estimate the amount of oil processed in the other years accordingly.

Site-specific calculations

Pollutant	Amount emitted in ton/year
Dioxine-furane	0.28
Polycyclic Aromatic Hydrocarbons (PAH)	0.43
Cadmium	1.57
Arsenic	8.46
Mercury	8.57
Selenium	11.92
Non-methane Volatile organic compounds (NMVOC)	1 662.4
NO _x	2 216.39
Lead	27.62
Dinitrogen monoxide	35.59
Zinc	37.48
Methane	242.23
PM ₁₀	286.53
Copper	53.32
Chromium	60.84
Carbon monoxide CO	607.49
Nickel	311.25
SO _x	2 647.61
Carbon dioxide CO ₂	1 984 828.77

Table 12: Pollutant emissions of the Milazzo Refinery for year 2000 (Capilli, 2005a)

Complementary data were found for the year 2000. They are shown in Table 12. This dataset is assumed as not being reliable for the trace elements (cadmium, arsenic, mercury, selenium, lead, zinc, copper, chromium, nickel) because their emissions according to Table 12 can be up to two orders of magnitude higher than the data collected Table 9.

The inconsistent data found in Table 12 were not used, but replaced by more consistent estimations based upon the emissions of carbon dioxide for the year 2000 as well as the Ecoinvent 2.0 dataset.

In Table 13, the last dataset is shown. It comes from a top-down estimation and therefore is very likely to contain inaccuracies. In the treatment of this dataset, the values that are of a different order of magnitude than those of the other dataset are not used. It is the case e.g. for the heavy metals.

The Life Cycle Assessment of the Milazzo Peninsula

	1990	1995	2000	2005
PAH (kg)	0.24	0.55	0.30	1.73
Cd (kg)	0.62	1.03	1.25	1.90
Cr (kg)	150.55	126.67	43.33	72.67
Cu (kg)	26.81	34.68	41.98	64.45
Hg (kg)	3.37	5.59	6.78	10.37
Ni (kg)	124.12	204.62	250.09	377.16
Dioxines-furanes (g)	0.11	0.18	0.23	0.33
As (kg)	8.79	7.27	6.75	10.24
Pb (kg)	10.94	18.08	22.02	33.44
Se (kg)	4.55	7.65	9.14	14.37
NMVOOC (ton)	22.22	37.85	48.36	113.14
Zn (kg)	15.02	24.71	30.27	45.45
PM2.5 (ton)	183.49	320.56	185.05	51.16
NOx (ton)	1 304.00	1 741.00	1 877.00	1 351.00
CH4 (ton)	16.04	27.40	36.70	83.55
SOx (ton)	4 107.00	4 179.00	5 064.00	2 606.00
CO (ton)	111.36	189.88	237.25	545.39
CO2 (ton)	571 790.30	958 984.83	1 375 852.47	1 515 035.17
N2O (ton)				
NH4 (ton)	17.13	28.73	37.15	43.15
PM10	193.15	337.44	194.79	53.86

Table 13: Pollutant emissions from the refinery for years 1990, 1995, 2000 and 2005 (ISPRA, 2010). Empty squares translate lack of datapoint.

The last steps of the data collection and treatment was to fill in the gaps. Each time at least one data was found for a given chemical, the average ratio between this chemical and the carbon dioxide's emissions was used to estimate the missing data.

For years 1965 to 1989, the amount of refined petroleum and the corresponding emissions are assumed to be equal to those of year 1990 when no other site-specific data was found, or as an average of available datapoints for the 1990s. Years 1991 and 1992 are estimated as an average between year 1990 and year 1993. Years 1997 to 1999 are assumed to be an average of years 1993

Site-specific calculations

to 1996 because of the technological change of the year 2000 (Raffineria di Milazzo S.C.p.A., 2010 (a)). Years 2011 and 2012 are assumed to be an average of years 2000s.

For the particulate matter, data was found for years 2002 to 2006 as total suspended particulate matter (TSP), as well as PM₁₀. For the other years, only the PM₁₀ was found. Therefore the ratio between the different categories of PM according to Ecoinvent 2.0 was used, as well as the average ratio of PM₁₀ / TSP according to the other datasets, to estimate the amount of PM_{2.5} and PM_{>10}.

Ultimately, the Ecoinvent 2.0 database was used to estimate the remaining emissions when no other data was found.

3.2.4 Pollutants from the thermoelectric plant

The emissions of the Milazzo thermoelectric plant, as found in the literature, are reported in Table 14, Table 15, Table 16. These data were completed with the Ecoinvent 2.0 database.

The data from the European Pollutant Release and Transfer Register (E-PRTR) are assumed to be the more consistent ones and therefore, used before any other. They are collected yearly from the different facilities and industrial activities in Europe. These data are shown in Table 14 and Table 15.

Compartment of emission	Pollutant	2001	2002	2003	2004	2005
Air	CO ₂	4 810 kt/y	4 808.662 kt/y	4 290.773 kt/y	4 034.751 kt/y	3 595.975 kt/y
Air	As and compounds	292 kg/y	292.3 kg/y	78 kg/y	59 kg/y	61.5 kg/y
Air	Cl and inorganic compounds	-	-	122 t/y	105.2 t/y	-
Air	F and inorganic compounds	-	-	21 373 kg/y	12 724 kg/y	-
Air	Cd and compounds	17.9 kg/y	17.9 kg/y	-	-	-
Air	Cr and compounds	673 kg/y	673.3 kg/y	-	-	123 kg/y
Air	Cu and compounds	1.14 t/y	1142.7 kg/y	-	-	-
Air	Ni and compounds	33.6 t/y	33 628.4 kg/y	1 431 kg/y	2 102 kg/y	2 278 kg/y
Air	NO _x	5 710 t/y	5 711.3 t/y	3 848.9 t/y	3 944.9 t/y	3 476 t/y
Air	N ₂ O	37.1 t/y	37.1 t/y	-	-	-
Air	SO _x	26 800 t/y	26 807.8 t/y	14 145.4 t/y	11 716.9 t/y	9 217 t/y
Air	CO	-	-	819.7 t/y	709.4 t/y	-
Air	TSP	-	1 715 t/y	360.8 t/y	151.2 t/y	130 t/y
Air	NH ₃	29.7 t/y	29.7 t/y	-	-	-
Air	Se and compounds	-	360 kg/y	113 kg/y	84 kg/y	87.5 kg/y
Air	Zn and compounds	5.30 t/y	5 298.7 kg/y	1 306 kg/y	460 kg/y	-
Air	Pb and compounds	363 kg/y	363.3 kg/y	-	-	-
Air	Hg and compounds	33.9 kg/y	33.9 kg/y	-	-	-
Air	Polychlorobiphenols (PCB)	-	39.5 kg/y	-	1.3 kg/y	-
Water	F	-	-	2 450.3 kg/y	3 917 kg/y	2 208 kg/y
Water	Ni and compounds	59.2 kg/y	59.2 kg/y	78 kg/y	58.8 kg/y	50.9 kg/y
Water	Zn and compounds	-	-	140.5 kg/y	-	-

Table 14: Emissions of the thermoelectric plant for years 2001 to 2005 (APAT, 2010 (a); European Environment Agency, 2011)

Compartment of emission	Pollutant	2006	2007	2008	2009	2010
Air	CO ₂	3 211.772 kt/y	3 340 kt/y	3 070 kt/y	3 320 kt/y	1 730 kt/y
Air	As and compounds	-	50.5 kg/y	55 kg/y	565 kg/y	-
Air	Cl and inorganic compounds	-	11 t/y	-	-	-
Air	Cd and compounds	-	22.5 kg/y	-	-	-
Air	Cr and compounds	-	-	-	-	184 kg/y
Air	Ni and compounds	1.645 t/y	1.86 t/y	1.16 t/y	1.2 t/y	504 kg/y
Air	NO _x	3 086 t/y	3 200 t/y	2 710 t/y	2 690 t/y	854 t/y
Air	SO _x	8 664 t/y	8 700 t/y	4 780 t/y	3 890 t/y	1 140 t/y
Air	CO	-	570 t/y	521 t/y	-	-
Air	TSP	104 t/y	-	-	-	-
Air	PM ₁₀	-	87 t/y	55 t/y	65 t/y	-
Water	Pentachlorophenol (PCP)	-	-	1.53 kg/y	-	-
Water	Ni and compounds	-	60.9 kg/y	168 kg/y	787 kg/y	34.2 kg/y
Water	Pb and compounds	26 kg/y	-	-	-	-
Water	Zn and compounds	-	-	275 kg/y	118 kg/y	131 kg/y

Table 15: Emissions of the thermoelectric plant for years 2007 to 2010 (European Environment Agency, 2011)

The Life Cycle Assessment of the Milazzo Peninsula

We can follow the level of activity of the thermoelectric plant through the yearly release of CO₂. Over the studied decade, we can observe a global decrease. A similar trend for all the other emissions can be expected, but it is not always the case.

The same observation is made for the thermoelectric plant as for the refinery: most chemicals do not seem to follow any regular trend. This may come from the composition of the combustible oil, which is never exactly the same and may contain variable amounts of trace elements, sulfur, etc.

All data are of the same order of magnitude for each chemical except for the particulate matter; this indicates the consistency of this dataset. Regarding the particulate matter, the issue seems to come from the confusion, in the source, between the TSP and the PM₁₀, sometimes labelled the same way. If no complementary data can be found in the following datasets, a worst-case scenario was assumed where in Table 14, the TSP were wrongly labelled and represent in fact the PM₁₀, except for year 2002 where it really shows the TSP.

The gaps of this dataset will be filled in according to the average ration between said chemical's emissions and carbon dioxide's emissions.

In Table 16, another dataset is shown. It corresponds to a public communication from the thermoelectric plant.

Year	SO ₂ (t/y)	NO ₂ (t/y)	TSP (t/y)	CO (t/y)	CO ₂ (kt/y)	SF ₆ (emissions)	SF ₆ (kg/y presence)
2002	26 808	5 711	1 715	442	4 768	5.5 kg/y	330
2005	9 217	3 476	131	498	3 596	0	335
2006	8 662	3 086	104	471	3 212	0	354
2007	8 700	3 198	114	570	3 342	0	335
2008	4 781	2 710	88	521	3 066	0	354

Table 16: Pollutant emissions of Termica di Milazzo, from year 2001 to 2008 (Edipower, 2010)

According to this set of data, we can see that what was labelled in Table 14 and Table 15 as emissions of NO_x are in fact emissions of NO₂. We can also see that the TSP label was not wrong. Regarding the particulate matter, it gives data for both TSP and PM₁₀ for two years, enabling to calculate estimations of the amount of PM₁₀ emitted for the other years, based upon the amount of TSP and the ratio between TSP and PM₁₀.

Site-specific calculations

Regarding the sulfur hexafluoride, a worst case scenario was assumed where the emissions are cut only starting from year 2005, with, for years 2000-2004, a ratio of emissions of SF₆ compared to the emissions of CO₂ similar to the one of the year 2002.

In Table 17, the latest dataset is shown. It comes from a top-down estimation and therefore is very likely to contain inaccuracies. In the treatment of this dataset, the values that are of a different order of magnitude than those of the other dataset are not used. It is the case e.g. for the heavy metals.

	1990	1995	2000	2005
PAH (kg)	34.00	47.85	28.69	17.64
Cd (kg)	7.18	9.31	6.72	
Cr (kg)	1 480.76	1 160.89	615.48	338.86
Cu (kg)	276.47	304.42	239.58	155.72
Hg (kg)	41.21	52.92	41.20	32.95
Ni (kg)	1 111.64	1 555.27	1 001.79	2 379.48
Dioxines-furanes (g)	0.90	1.28	0.77	0.27
As (kg)	177.10	149.16	117.22	102.37
Pb (kg)	152.56	188.00	142.03	130.15
Se (kg)	105.64	118.86	110.39	87.50
NMVOOC (ton)	151.92	201.85	176.58	175.82
Zn (kg)	243.37	287.16	208.83	
PM2.5 (ton)	1 508.49	1 556.70	561.43	129.73
NOx (ton)	17 165.54	15 554.04	10 018.39	3 582.10
CH4 (ton)	165.25	213.62	165.72	183.04
SOx (ton)	20 113.55	32 220.00	38 707.00	9 237.88
CO (ton)	908.09	1 166.84	1 158.22	1 217.71
CO2 (ton)	4 500 504.49	5 695 017.49	4 883 836.28	4 850 443.14
N2O (ton)	44.20	52.37	39.45	1.31
NH4 (ton)	6.17	5.53	5.13	8.02
PM10	1 587.88	1 638.64	590.98	136.55

Table 17: Pollutant emissions from the thermoelectric power-plant, for years 1990, 1995, 2000 and 2005 (ISPRA, 2010). Empty squares translate lack of datapoint.

The Life Cycle Assessment of the Milazzo Peninsula

The last steps of the data collection and treatment was to fill in the gaps. As for the refinery, each time at least one data was found for a given chemical, the average ratio between this chemical and the carbon dioxide's emissions was used to estimate the missing data.

Because of the constant diminution of the thermoelectric plant's activity, the data for years 2011 and 2012 were estimated to be equal to those of year 2010 because a linear estimation based over years 2000 to 2010 would not be possible, the evolution between years 2009 and 2010 showing an activity reduced by half. The data for years 1996 to 1999 are estimated as an average of years 1995 and 2000; the data for years 1991 to 1994 are estimated as an average of years 1990 and 1995; and the data of years 1965 to 1989 are assumed to be equal to the data for year 1990.

For the particulate matter, data was found for years 2002 to 2008 as total suspended particulate matter (TSP), as well as PM₁₀ for 2007 and 2008. For 2009, only the PM₁₀ was found. First the TSP were estimated for every year, before using the ratio between the different categories of PM according to Ecoinvent 2.0, as well as the average ratio of PM₁₀ / TSP according to the datasets, to estimate the amount of PM_{2.5} and PM_{>10}.

Ultimately, the Ecoinvent 2.0 database was used to estimate the emissions for which no other data was found.

3.2.5 Pollutants from the road circulation in Milazzo

Pollutants for the years 1990, 1995, 2000 and 2005 are estimated using an average per-capita estimation based upon the data gathered in Table 18 page 68 and upon the number of inhabitants in the Milazzo city and Messina province (Urbistat, 2012).

The estimation is carried on for the other years based upon an average of one or two closest known datapoints and the yearly fraction of the Messina province's population living in the city of Milazzo.

Year	1990	1995	2000	2005
Percentage of Milazzo inhabitants in the Messina province	4.72 %	4.56 %	4.28 %	4.98 %
Ammoniac – Messina province (ISPRA, 2010)	10.89 ton/y	100.04 ton/y	339.87 ton/y	251.69 ton/y
Ammoniac – share of Milazzo city	0.51 ton/y	4.56 ton/y	14.55 ton/y	12.53 ton/y
Benzene – Messina province (ISPRA, 2010)	435.70 ton/y	355.73 ton/y	163.35 ton/y	74.86 ton/y
Benzene – share of Milazzo city	20.57 ton/y	16.22 ton/y	6.99 ton/y	3.73 ton/y
Cadmium – Messina province (ISPRA, 2010)	4.08 kg/y	4.91 kg/y	5.14 kg/y	5.56 kg/y
Cadmium – share of Milazzo city	0.19 kg/y	0.22 kg/y	0.22 kg/y	0.28 kg/y
NMCOV – Messina province (ISPRA, 2010)	11 242.11 ton/y	12 517.97 ton/y	8 265.93 ton/y	4 517.73 ton/y
NMCOV – share of Milazzo city	530.63 ton/y	570.82 ton/y	353.78 ton/y	224.98 ton/y
Chrome – Messina province (ISPRA, 2010)	20.38 kg/y	24.55 kg/y	25.71 kg/y	27.81 kg/y
Chrome – share of Milazzo city	0.96 kg/y	1.12 kg/y	1.1 kg/y	1.38 kg/y
Carbon dioxide – Messina province (ISPRA, 2010)	1 331 553.06 ton/y	1 602 831.04 ton/y	1 669 247.49 ton/y	1 779 415.68 ton/y
Carbon dioxide – share of Milazzo city	62 849.3 ton/y	73 089.1 ton/y	71 443.79 ton/y	88 614.9 ton/y
Sulfur dioxide – Messina province (ISPRA, 2010)	1929.16 ton/y	1192.59 ton/y	190.77 ton/y	37.47 ton/y
Sulfur dioxide – share of Milazzo city	91.06 ton/y	54.38 ton/y	8.16 ton/y	1.87 ton/y
Dioxines-furanes – Messina province (ISPRA, 2010)	0.10 g/y	0.11 g/y	0.06 g/y	0.04 g/y
Dioxines-furanes – share of Milazzo city	4.72 mg/y	5.02 mg/y	2.57 mg/y	1.99 mg/y
PAH – Messina province (ISPRA, 2010)	27.40 kg/y	30.63 kg/y	32.88 kg/y	42.21 kg/y
PAH – share of Milazzo city	1.29 kg/y	1.4 kg/y	1.41 kg/y	2.1 kg/y

Year	1990	1995	2000	2005
Methane – Messina province (ISPRA, 2010)	511.47 ton/y	573.93 ton/y	417.42 ton/y	251.46 ton/y
Methane – share of Milazzo city	24.14 ton/y	26.17 ton/y	17.87 ton/y	12.52 ton/y
Carbon monoxide – Messina province (ISPRA, 2010)	66 194.12 ton/y	65 889.46 ton/y	41 484.04 ton/y	23 241.65 ton/y
Carbon monoxide – share of Milazzo city	3 124.36 ton/y	3 004.56 ton/y	1 775.52 ton/y	1 157.43 ton/y
Nickel – Messina province (ISPRA, 2010)	28.53 kg/y	34.37 kg/y	35.99 kg/y	38.93 kg/y
Nickel – share of Milazzo city	1.35 kg/y	1.57 kg/y	1.54 kg/y	1.94 kg/y
NO _x – Messina province (ISPRA, 2010)			12 077.61 ton/y	9 909.78 ton/y
NO _x – share of Milazzo city			516.92 ton/y	493.51 ton/y
PM ₁₀ – Messina province (ISPRA, 2010)	828.62 ton/y	868.81 ton/y	784.45 ton/y	625.07 ton/y
PM ₁₀ – share of Milazzo city	39.11 ton/y	39.62 ton/y	33.57 ton/y	31.13 ton/y
PM _{2.5} – Messina province (ISPRA, 2010)	782.79 ton/y	813.44 ton/y	727.59 ton/y	566.5 ton/y
PM _{2.5} – share of Milazzo city	36.95 ton/y	37.09 ton/y	31.14 ton/y	28.21 ton/y
Lead – Messina province (ISPRA, 2010)	50 923.57 kg/y	22 977.38 kg/y	9 507.57 kg/y	
Lead – share of Milazzo city	2 404.57 kg/y	1 047.36 kg/y	406.92 kg/y	
Dinitrogen monoxide – Messina province (ISPRA, 2010)	45.15 ton/y	77.67 ton/y	85.4 ton/y	57.88 ton/y
Dinitrogen monoxide – share of Milazzo city	2.13 ton/y	3.54 ton/y	3.66 ton/y	2.88 ton/y
Copper – Messina province (ISPRA, 2010)	692.78 kg/y	834.79 kg/y	874.07 kg/y	945.54 kg/y
Copper – share of Milazzo city	32.71 kg/y	38.05 kg/y	37.41 kg/y	47.09 kg/y
Selenium – Messina province (ISPRA, 2010)	4.08 kg/y	4.91 kg/y	5.14 kg/y	5.56 kg/y
Selenium – share of Milazzo city	0.19 kg/y	0.22 kg/y	219.99 g/y	276.89 g/y

Year	1990	1995	2000	2005
Zinc – Messina province (ISPRA, 2010)	407.52 kg/y	491.05 kg/y	514.16 kg/y	556.2 kg/y
Zinc – share of Milazzo city	19.24 kg/y	22.38 kg/y	22.01 kg/y	27.7 kg/y

Table 18: Estimation of the emissions from road circulation in the city of Milazzo, for the years 1990, 1995, 2000 and 2005. An empty square indicates a lack of data

3.3 Comparison of global-scale calculation methodologies

The two calculation methodologies use different factors and different chemical species. They need to be compared in order to have a better understanding of their functioning so they can be used at their best.

The impact categories do not always cover the exact same impacts or compartments. Therefore the first step is to compare how the impact categories are aggregated into the damages categories, for human health and ecosystem quality. Then a bibliographic review is made regarding the peculiarities of each calculation method's modeling as well as the advices regarding the usage of each of them. The damage category of resources depletion will not be taken into account, because it is not relevant for the present study.

3.3.1 Impact categories and number of chemical species

The different impact categories accounting for the damages upon human health were compared for the two selected models. In Table 19 hereafter, the corresponding categories are situated on the same lines and the number of chemicals accounted for in said categories are indicated between brackets.

Human health	
Impact 2002+	ReCiPe
Respiratory organics (134)	Photochemical oxydant formation (134)
Respiratory inorganics (14)	Photochemical oxydant formation (134)
Respiratory inorganics (14)	Particulate matter formation (10)
Carcinogens (3482)	x
Non-carcinogens (2486)	x
	Human toxicity (1203)
<i>in a separate category</i>	Climate change (96)
Ionizing radiation (36)	Ionizing radiation (55)
Ozone layer depletion (96)	Ozone depletion (22)

Table 19: Comparison between impact classes used for both calculation methodologies, Impact 2002+ and ReCiPe. In brackets is indicated the number of chemical species used for each impact class (the same chemical in two different compartments is counted as two).

Reading this table, we can see that ReCiPe covers less categories than Impact 2002+. Impact 2002+ uses two different categories of human toxic substances, carcinogens and non-carcinogens, while ReCiPe 2008 uses only some non-carcinogen substances. The chemicals affecting the human respiratory system (according to Impact 2002+ categories) are not accounted

The Life Cycle Assessment of the Milazzo Peninsula

for in the same way by ReCiPe 2008 (which calculates the impacts of these chemicals through other reactive mechanisms). The corresponding impact categories are not at all overlapped.

Impact 2002+ takes the climate change into account in a separate category while ReCiPe includes the damages of a changing climate upon human health (diseases, rising sea level...) into the damage category of human health.

The different impact categories accounting for the damages upon the ecosystems were compared for the three selected models. In Table 20 hereafter, the corresponding categories are situated on the same lines and the number of chemicals accounted for in each categories are indicated between brackets.

Ecosystems	
Impact 2002+	ReCiPe
Aquatic ecotoxicity (2604)	Freshwater ecotoxicity (1343)
	Marine ecotoxicity (2093)
Terrestrial ecotoxicity (2596)	Terrestrial ecotoxicity (33)
Terrestrial acidification / eutrophication (7)	Terrestrial acidification (5)
	x
Aquatic acidification (29)	x
Aquatic eutrophication (41)	Freshwater eutrophication (12)
	x
Land occupation (28)	Agricultural land occupation (28)
	Urban land occupation (17)
	Natural land occupation (16)
Global warming (81)	Climate change (96)

Table 20: Comparison between impact classes used for two calculation methodologies, Impact 2002+ and ReCiPe. In brackets is indicated the number of chemical species used for each impact class (the same chemical in two different compartments is counted as two).

Reading this table, we can see that ReCiPe uses the most categories (9) while Impact 2002+ uses the most substances (5200).

The ReCiPe model separates acidification from eutrophication and terrestrial damages from aquatic damages, but it lacks some categories such as aquatic acidification and terrestrial eutrophication. Impact 2002+ also separates terrestrial and aquatic damages, but the final results for the aquatic damages are not given.

ReCiPe is the model giving the most detailed results for the land occupation (3 different categories instead of one).

3.3.2 Models underlying the calculation methods

Impact 2002+ focuses on four non-weighted damage categories: human health; ecosystem quality; climate change; resources. The characterization factors are averaged for Western Europe. The factors used to calculate damages upon human health are based upon dose-response slope factors while the ecotoxicological factors are based upon the EC50s of the most sensitive species. This method does not include marine environment, noise, and other impacts. The toxicity impacts are not fully developed, lacking bioavailability considerations. The acidification and eutrophication effects are united within the same category while they are two different effects by different chemicals, causing inaccuracies (Althaus et al, 2007; European Commission, 2010; Jolliet et al, 2003).

The ReCiPe methodology offers different perspectives and weighting sets. The characterization factors are different for Europe and for the World, while the weighting is different in egalitarian (long-term), individualist (short-term) and hierarchist (consensus model, default model) perspectives. It combines many different models like the USES model for the toxic impacts, and IPCC equivalency factors for the climate change. The version of ReCiPe that is used here is an egalitarian perspective for Europe and an average weighting set. Even though ReCiPe is said to be a “local” methodology, its smallest scale is at European level: it is too complicated to create local factors for absolutely every place on the planet. In ReCiPe, the Climate Change impacts correspond to all the consequences that a changing climate can have upon ecosystems and human health: species extinction, natural disasters, extending area of distribution of diseases, etc. (Vesin, 2009; European Commission, 2010; Goedkoop et al, 2009).

Both methods calculate the damages upon the ecosystems, and the damages upon human health. Both methods use the DALY, Disability-Adjusted Life Years, to characterize the impacts upon human health.

Despite these common points, they can not be easily compared. First, their impact categories are different, especially for the impacts on human health, where the overlaps are unclear (see Table 19 and Table 20). Second, Impact 2002+ calculates the impacts upon ecosystems as the potentially disappeared fraction of species, integrated over time and space ($\text{PDF} \cdot \text{m}^2 \cdot \text{year}$), while ReCiPe calculates it as a number of species integrated over time only ($\text{species} \cdot \text{year}$). Third, the chemical species they account for, and the models used to describe their impacts, are different. Fourth, Impact 2002+ accounts for the damages by climate change through a separate category

while ReCiPe includes them within the damages to human health and to the ecosystems. Therefore, any comparison between the three calculation methods has to be done carefully. To enable a better comparison, the damages by climate change should not be represented in the results of the present study.

Moreover, the models underlying the different calculation methods are not always the same. Those used in the ReCiPe 2008 method are more recent, complete, realistic and up-to-date than the models underlying the Impact 2002+ methodology. This Impact 2002+ model lacks consistency, and applies outdated and crude models. Therefore ReCiPe is more likely to best reflect reality than Impact 2002+. Also, ReCiPe gives a strong weight to the toxic impacts from the heavy metals, even though these impacts happen at a very long-term only, causing uncertainty. Regarding land use Impact 2002+ avoids double-counting, while this risk is not addressed in ReCiPe 2008 (Vesin, 2009).

3.3.3 Conclusion

We see that the impact categories of the different calculation methods do not overlap. It means that some methods take into accounts impacts that others do not take into account, and vice-versa. This makes it more difficult to pick up a single calculation methods for our present study. Therefore, all both methods will be used and their results will be compared and interpreted together.

3.4 Yearly global-scale calculation

This first application of the global-scale calculation methods explores the studied anthropogenic activities on a yearly basis, for years 2000 to 2010.

3.4.1 Impacts on the environment

In this first paragraph, the impacts done upon the environment are spoken about. Let us note the difference in unit used by Impact 2002+ and ReCiPe.

Aquatic ecotoxicity

According to Impact 2002+ (Figure 13) the refinery causes more ecotoxic impacts on the aquatic ecosystems while according to ReCiPe, it is the power-plant that causes more impacts (Figure 14, Figure 15). Both methods show a non-negligible share of the pollution resulting from the illegal combustion of domestic waste, which appears to be more important according to ReCiPe than according to Impact 2002+.

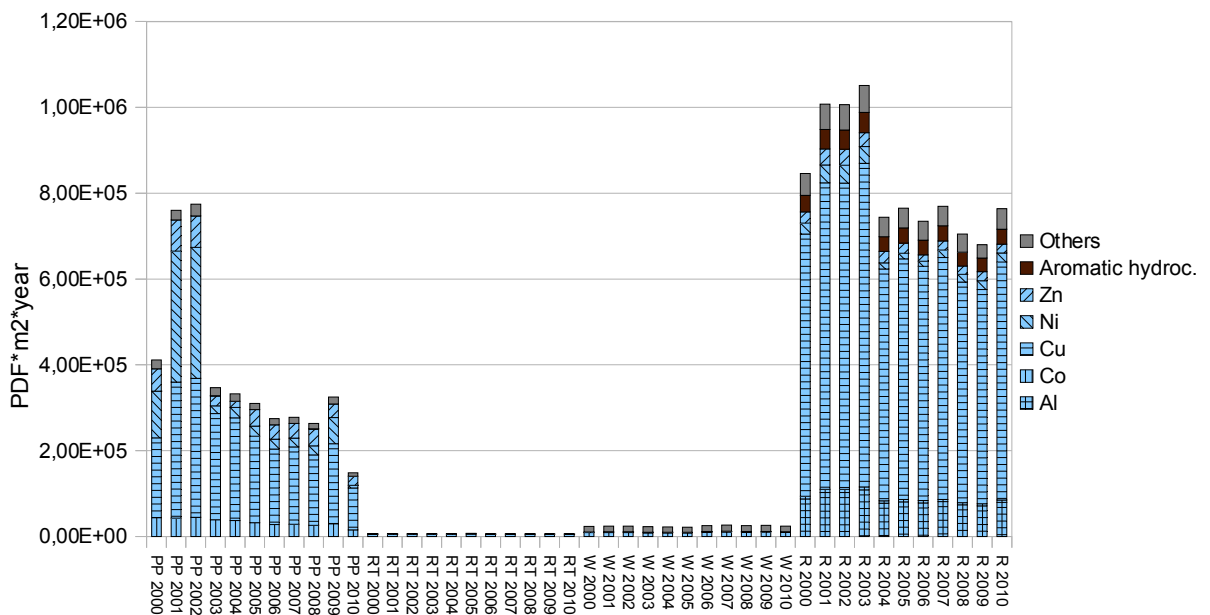

Figure 13: Toxic impacts on aquatic ecosystems according to Impact 2002+ from the anthropogenic activities in the Milazzo area: power plant (PP), road traffic (RT), illegal combustion of domestic waste (W) and refinery (R). For years 2000 to 2010.

The main pollutant is the copper according to Impact 2002+, and vanadium according to ReCiPe 2008. This difference is due to the underlying models: Impact 2002+ does not include

The Life Cycle Assessment of the Milazzo Peninsula

vanadium, while share of copper is smaller in the ReCiPe model. This explains the two opposite trends for the two different methods, as the refinery emits more copper and the power-plant, more vanadium. Therefore, no general conclusion can be drawn regarding the aquatic ecotoxicity.

The impacts on freshwater ecosystems are negligible compared to the impacts on marine ecosystems, according to ReCiPe 2008 (Figure 14, Figure 15).

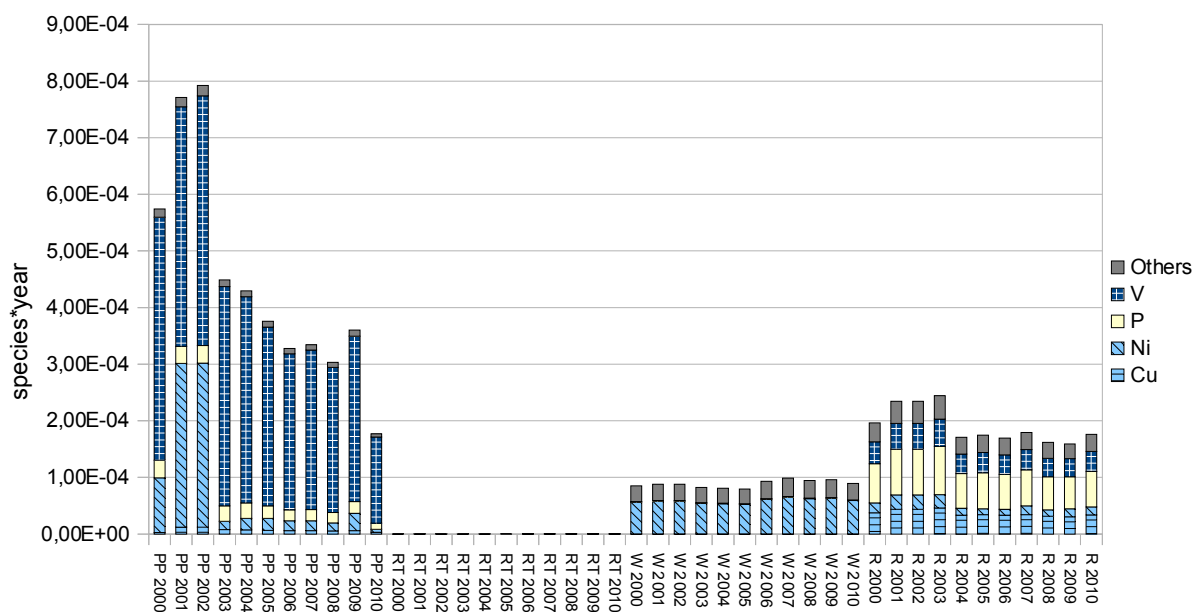

Figure 14: Toxic impacts on freshwater ecosystems according to ReCiPe 2008 from the anthropogenic activities in the Milazzo area: power plant (PP), road traffic (RT), illegal combustion of domestic waste (W) and refinery (R). For years 2000 to 2010.

Global-scale calculation

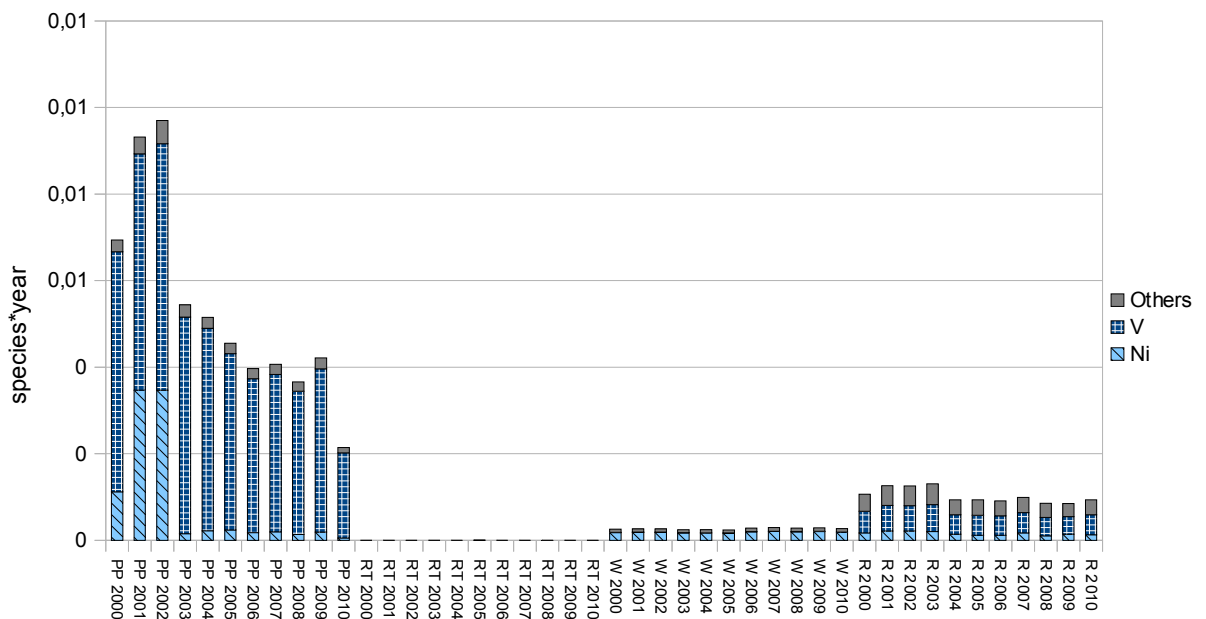

Figure 15: Toxic impacts on marine ecosystems according to ReCiPe 2008 from the anthropogenic activities in the Milazzo area: power plant (PP), road traffic (RT), illegal combustion of domestic waste (W) and refinery (R). For years 2000 to 2010.

Other important pollutants affecting the aquatic ecosystems are nickel, cobalt, aluminium, zinc, phosphorus and aromatic hydrocarbons. All of them are emitted during the combustion of heavy fuels in the power-plant's and refinery's furnaces.

Acidification and eutrophication

Let us note that if both methodologies calculate the impacts from the emissions of sulfur and nitrogen oxides on the terrestrial ecosystems, these impacts are of acidification according to ReCiPe 2008 (Figure 17) and of eutrophication according to Impact 2002+ (Figure 16).

The Life Cycle Assessment of the Milazzo Peninsula

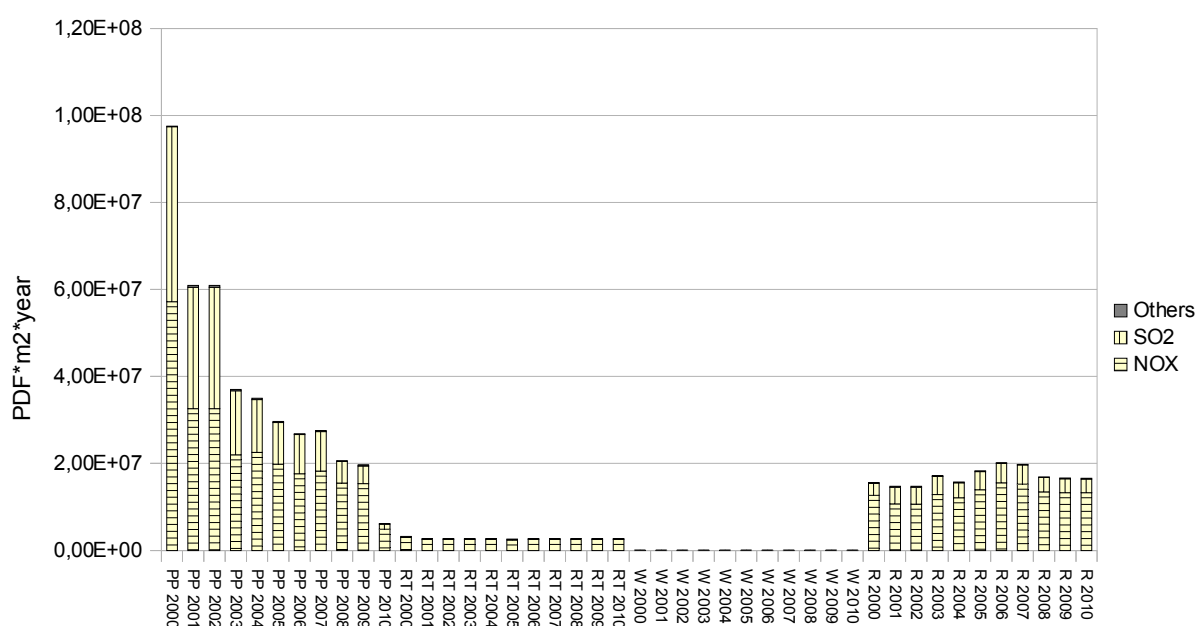

Figure 16: Eutrophication impacts on terrestrial ecosystems according to Impact 2002+ from the anthropogenic activities in the Milazzo area: power plant (PP), road traffic (RT), illegal combustion of domestic waste (W) and refinery (R). For years 2000 to 2010.

Both methods lead to similar conclusion regarding the terrestrial eutrophication impacts: the power-plant first caused more impacts than the refinery, but it decreased through time to reach a level similar to the one of the refinery (Figure 16, Figure 17). This is done through the reduction of the sulfur dioxide emissions compared to the emissions of nitrogen oxides, and can be explained by the European regulations concerning the desulfurization of fuels during the refining process. The reduction of sulfur emissions cannot be observed for the refinery while the emissions of nitrogen oxides remain at the same level through time, because the fuel used by both activities is different.

The road traffic in Milazzo also emits sulfur dioxides and nitrogen oxides, but at a lower level, because the amount of fuel consumed for road traffic is several orders of magnitude lower than the amount of fuel consumed for thermoelectric production by the power-plant or crude oil distillation by the refinery.

Global-scale calculation

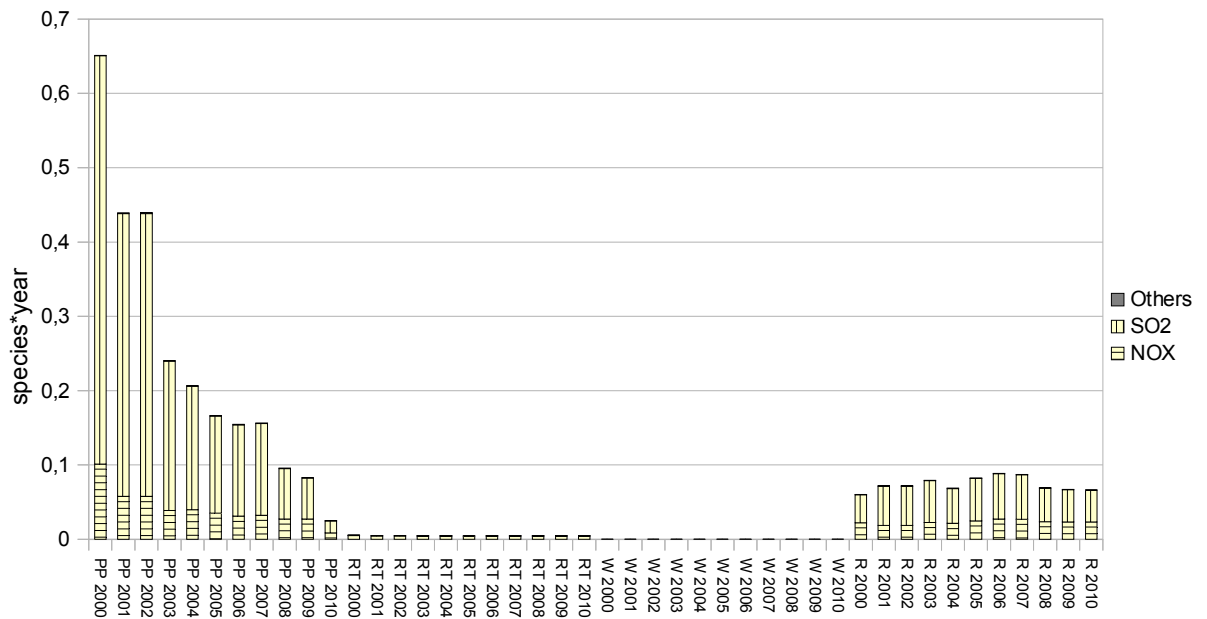

Figure 17: Acidification impacts on terrestrial ecosystems according to ReCiPe 2008 from the anthropogenic activities in the Milazzo area: power plant (PP), road traffic (RT), illegal combustion of domestic waste (W) and refinery (R). For years 2000 to 2010.

Regarding the freshwater eutrophication impacts as calculated by ReCiPe 2008 (Figure 18), we can see that the order of magnitude of these impacts is negligible compared to the order of magnitude of the acidification impacts calculated by the same method (Figure 17). The phosphorus is emitted by the refinery and the power-plant while the phosphates are emitted by the illegal combustion of domestic waste. The impacts of these emissions being negligible compared to other impacts such as the terrestrial acidification, they will not be investigated further.

The Life Cycle Assessment of the Milazzo Peninsula

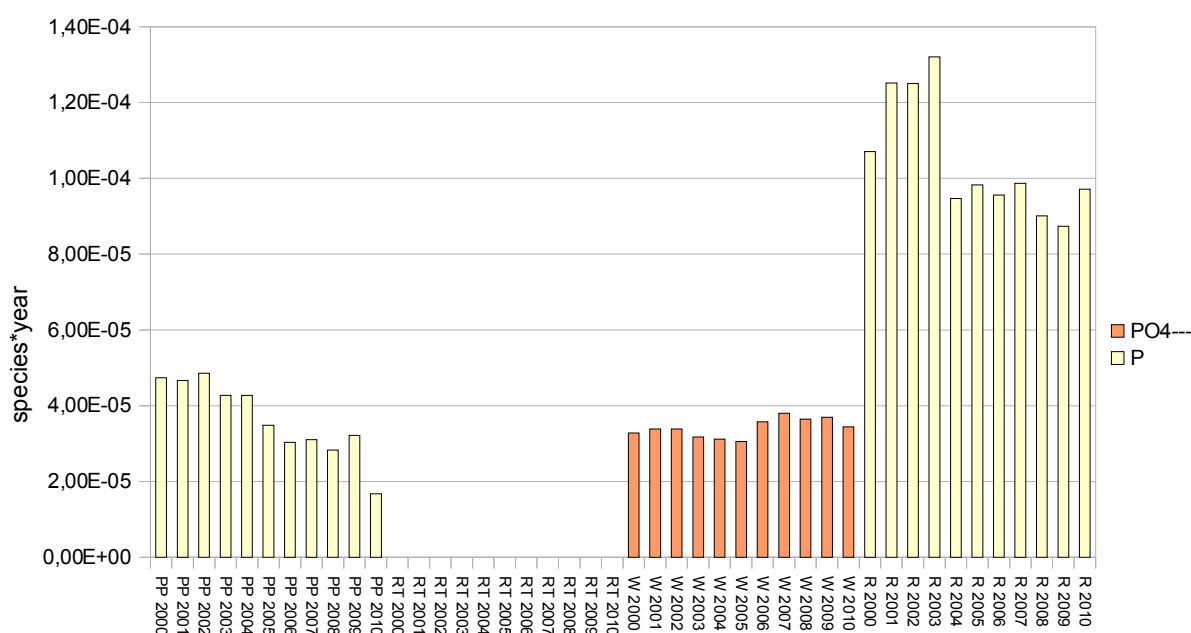

Figure 18: Eutrophication impacts on freshwater ecosystems according to ReCiPe 2008 from the anthropogenic activities in the Milazzo area: power plant (PP), road traffic (RT), illegal combustion of domestic waste (W) and refinery (R). For years 2000 to 2010.

Terrestrial ecotoxicity

The toxic impacts on terrestrial ecosystems are at least one order of magnitude higher than the toxic impacts on aquatic ecosystems, for both methods (Figure 13 and Figure 19 for Impact 2002+, Figure 14, Figure 15 and Figure 20 for ReCiPe 2008). Despite differences between the two models, the conclusions are the same. This can be explained by the accumulation of the elements in the soils together with a dilution in the water environment.

As for the toxic impacts on aquatic ecosystems, we can see that the refinery causes more impacts through the emissions of copper while the power-plant causes more impacts through the emissions of nickel (Figure 19) and vanadium (Figure 20).

The emissions of all these metals and metalloids causing toxic impacts to the ecosystems come from the combustion of fuel in the power-plant's and refinery's furnaces. The road traffic and illegal combustion of domestic waste also cause such impacts, but at a negligible level compared to both industries.

Because the refinery and the thermoelectric plant do not use the same fraction of the oil, the trace elements content of their emissions is not the same. This can be explained by a fractioning

Global-scale calculation

of the trace elements in the different levels of oil obtained during the distillation process (kerosene, fuel oil, gasoline etc.)

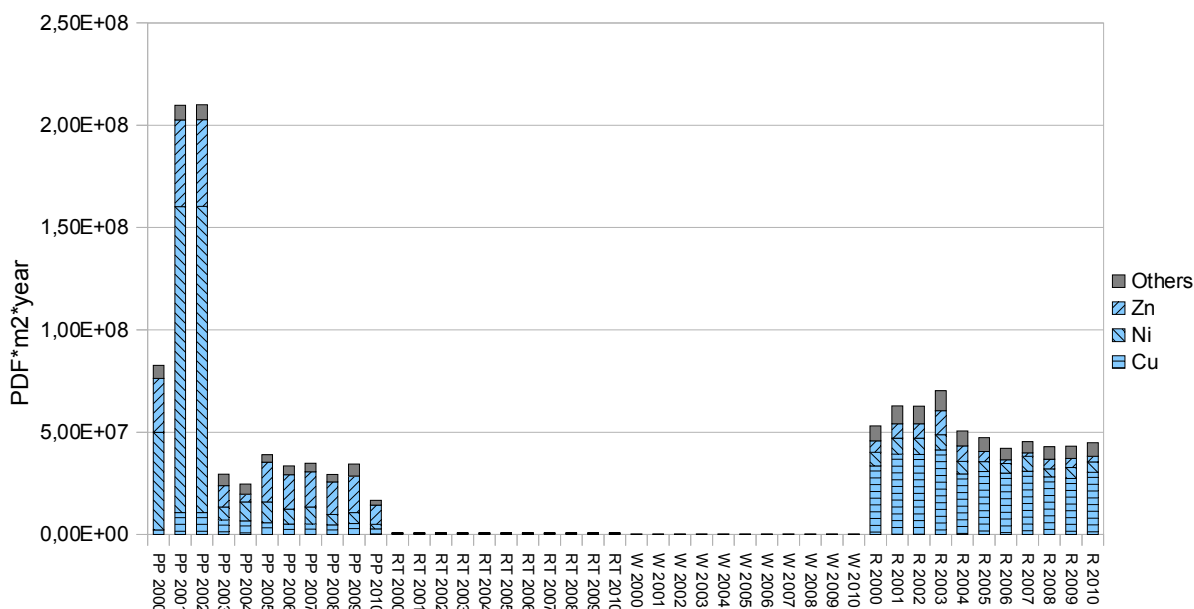

Figure 19: Toxic impacts on terrestrial ecosystems according to Impact 2002+ from the anthropogenic activities in the Milazzo area: power plant (PP), road traffic (RT), illegal combustion of domestic waste (W) and refinery (R). For years 2000 to 2010.

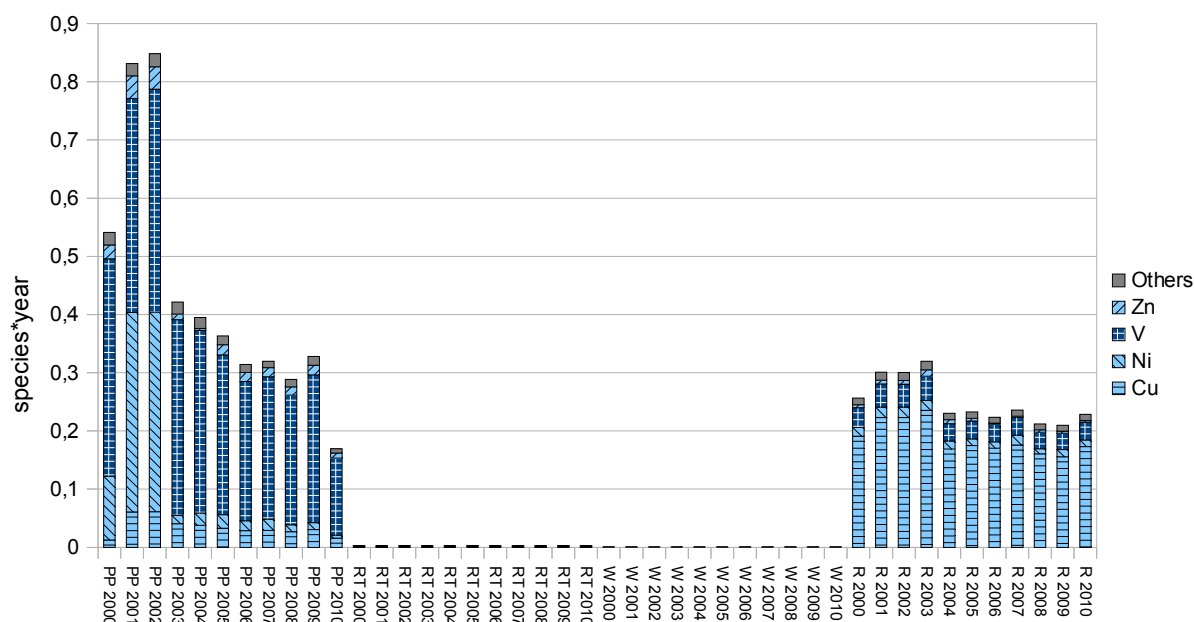

Figure 20: Toxic impacts on terrestrial ecosystems according to ReCiPe 2008 from the anthropogenic activities in the Milazzo area: power plant (PP), road traffic (RT), illegal combustion of domestic waste (W) and refinery (R). For years 2000 to 2010.

Global warming, climate change

Both calculation methods lead to similar results concerning the impacts caused by greenhouse gas emissions (Figure 21, Figure 22, Figure 23). These conclusions are: the power-plant causes more climate change / global warming impacts than the refinery. But the power-plant's impacts decrease through time due to a diminution of activity while the refinery's impacts remain at the same level through time. Also, all chemicals contributing to climate change are negligible compared to the CO₂.

According to ReCiPe 2008, the climate change impacts are 2 orders of magnitude higher than all the other impacts on the environment.

The road traffic and illegal combustion of domestic waste are also responsible for a limited range of climate change / global warming impacts (at least 1 order of magnitude lower than the refinery and the thermoelectric power-plant).

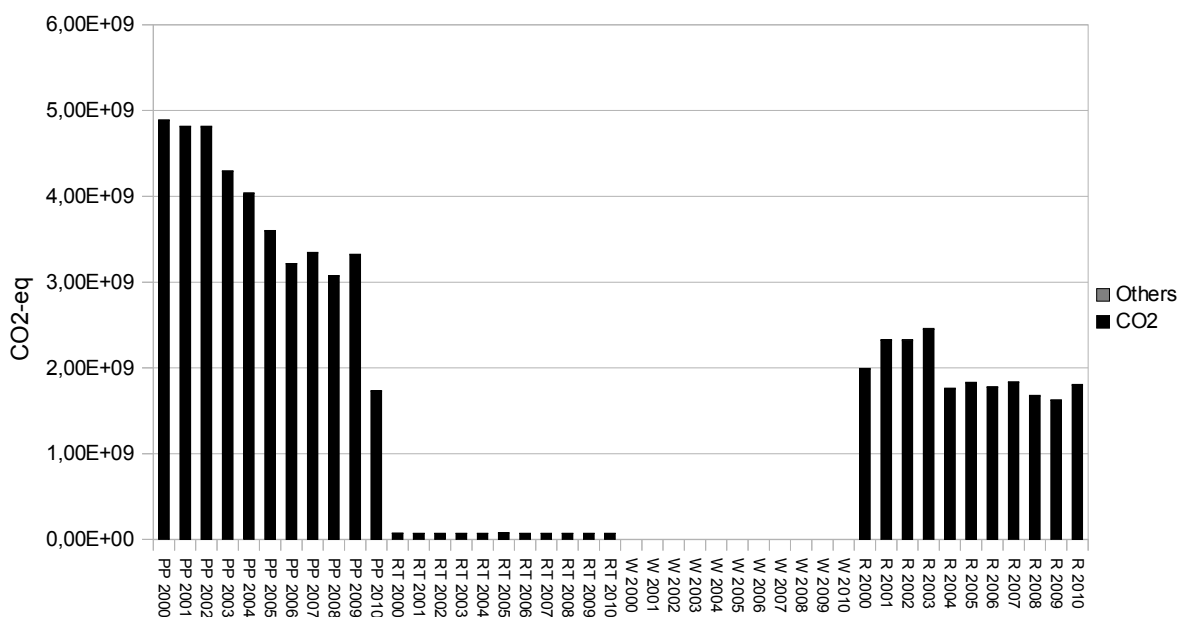

Figure 21: Global warming impacts according to Impact 2002+ from the anthropogenic activities in the Milazzo area: power plant (PP), road traffic (RT), illegal combustion of domestic waste (W) and refinery (R). For years 2000 to 2010.

Global-scale calculation

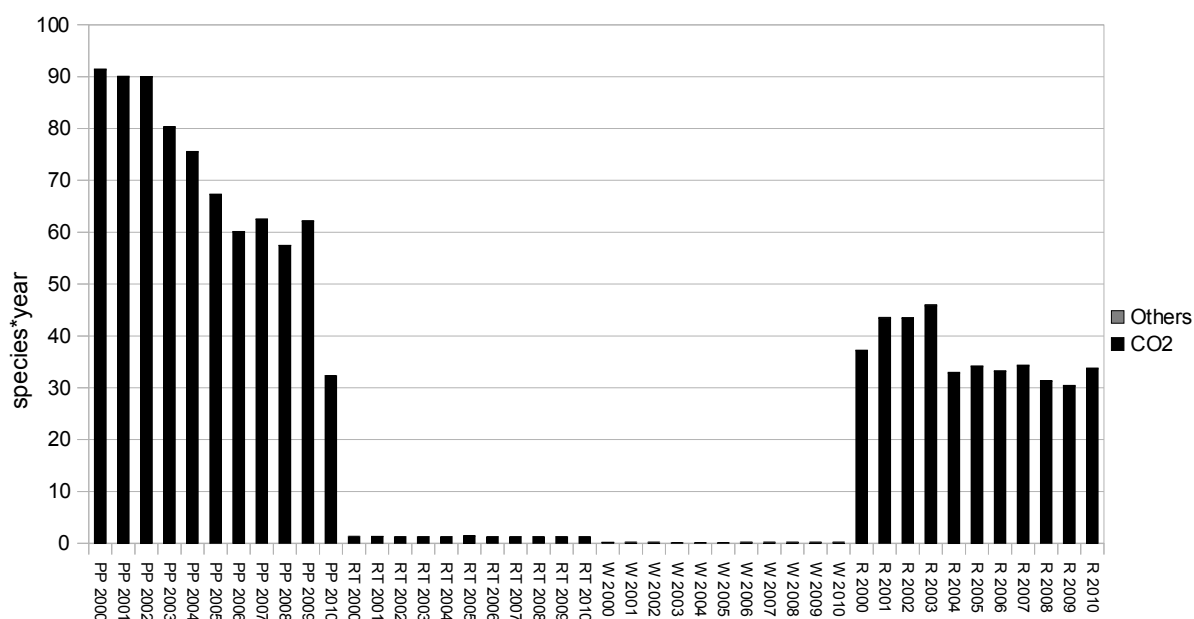

Figure 22: Climate change impacts on ecosystems according to ReCiPe 2008 from the anthropogenic activities in the Milazzo area: power plant (PP), road traffic (RT), illegal combustion of domestic waste (W) and refinery (R). For years 2000 to 2010.

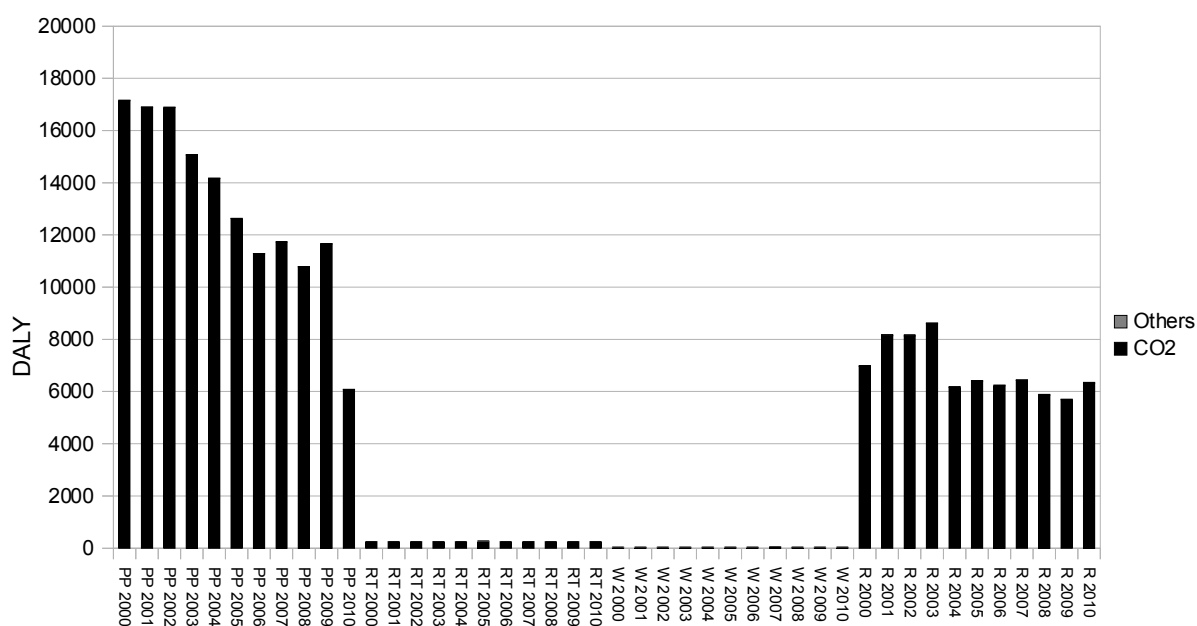

Figure 23: Climate change impacts on human health according to ReCiPe 2008 from the anthropogenic activities in the Milazzo area: power plant (PP), road traffic (RT), illegal combustion of domestic waste (W) and refinery (R). For years 2000 to 2010.

3.4.2 Impacts to the human health

This second paragraph is about the impacts done upon the human health. The two selected methods are uneasy to compare because of their differences in the inventory classification.

Inorganic matter, leading to particulate matter formation

Both methods lead to similar conclusions regarding the impacts on human health from the inorganic matter leading to particulate matter formation (Figure 24, Figure 25). Both methods show that the power-plant causes more impacts than the refinery, but the power-plant's impacts decrease through time due to a diminution of activity while the refinery's impacts remain at the same level through time.

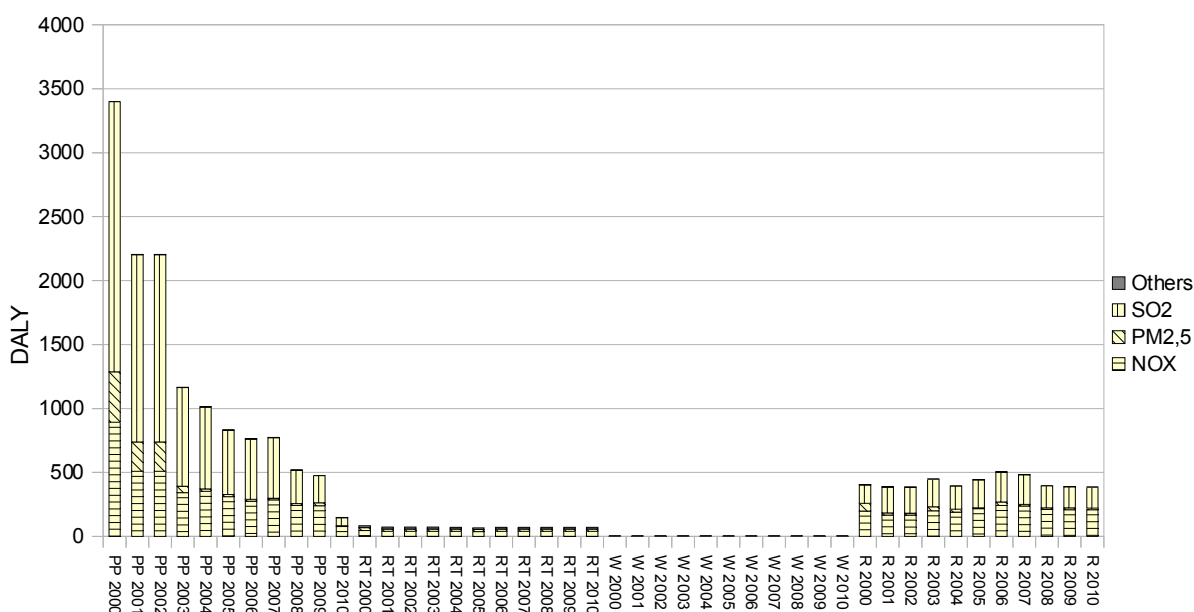

Figure 24: Respiratory inorganics' impacts on human health according to Impact 2002+ from the anthropogenic activities in the Milazzo area: power plant (PP), road traffic (RT), illegal combustion of domestic waste (W) and refinery (R). For years 2000 to 2010.

Global-scale calculation

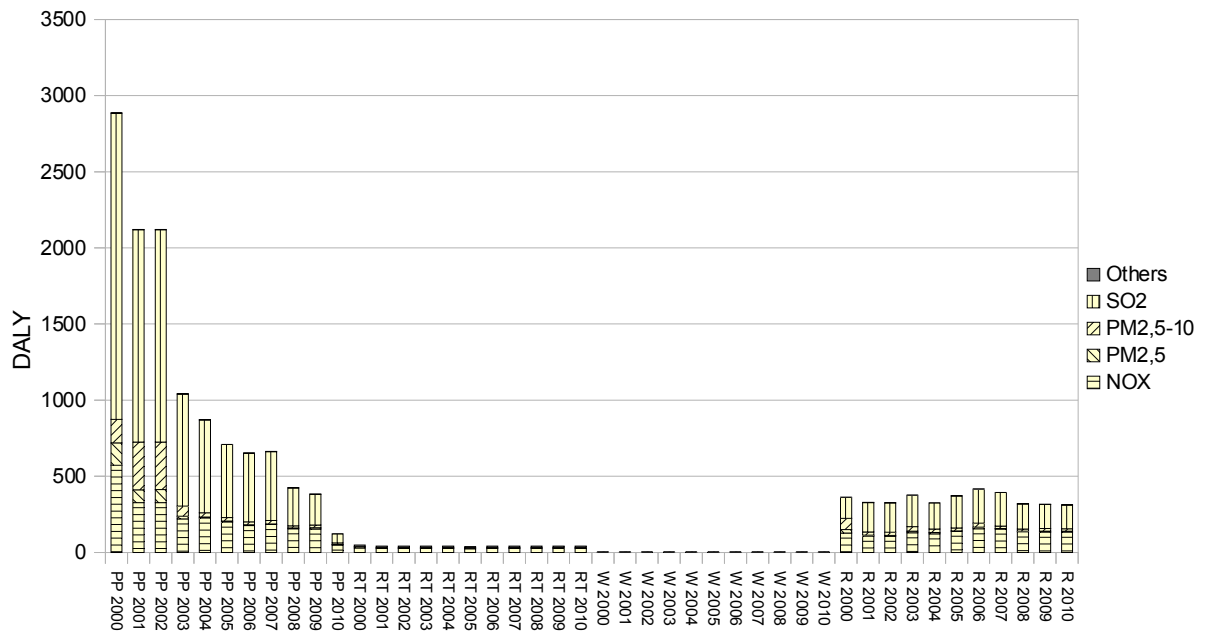

Figure 25: Particulate matter formation's impacts on human health according to ReCiPe 2008 from the anthropogenic activities in the Milazzo area: power plant (PP), road traffic (RT), illegal combustion of domestic waste (W) and refinery (R). For years 2000 to 2010.

For both methods, the chemicals causing the main impacts are sulfur dioxide and nitrogen oxide, then, particulate matter (smaller than $2.5\mu\text{m}$ according to Impact 2002+ (Figure 24) and smaller than $10\mu\text{m}$ according to ReCiPe 2008 (Figure 25)). All these chemicals are emitted during the combustion processes.

The road traffic and illegal combustion of domestic waste also cause impacts through the emission of these chemicals, but these impacts are at least 1 order of magnitude smaller than the impacts caused by the power-plant and the refinery.

Respiratory organics

According to Impact 2002+ (Figure 26), the refinery causes impacts through the emission of organic chemicals affecting the human respiratory system that are 1 order of magnitude higher than the impacts from the power-plant. The impacts from the power-plant are on the same level of magnitude than the impacts from the road traffic. The impacts from the illegal combustion of domestic waste are negligible.

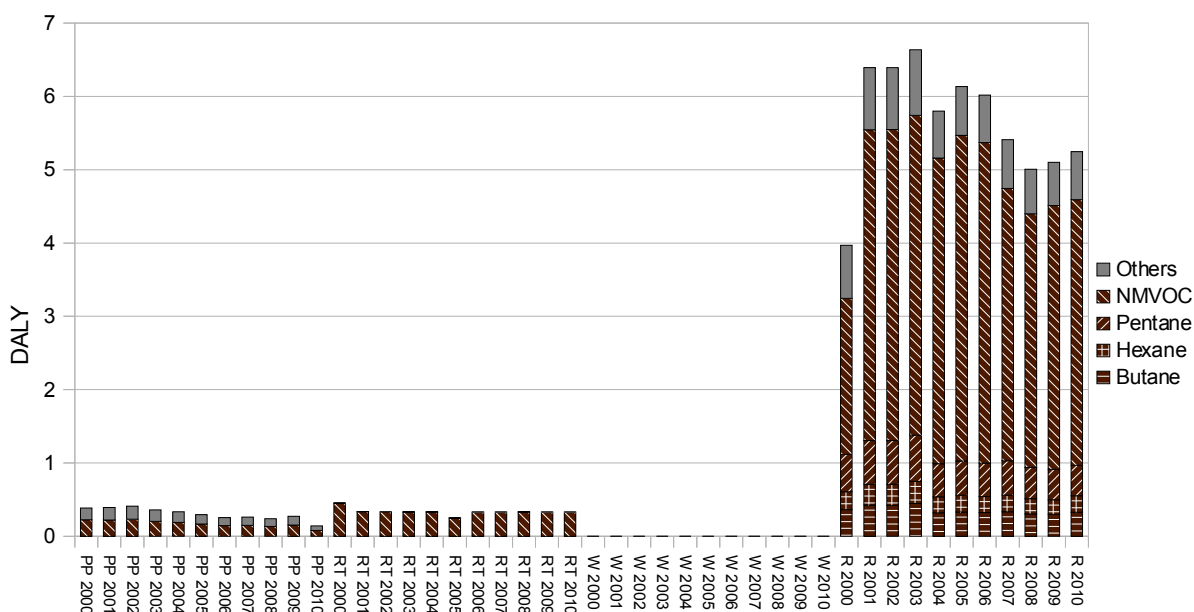

Figure 26: Respiratory organics' impacts on human health according to Impact 2002+ from the anthropogenic activities in the Milazzo area: power plant (PP), road traffic (RT), illegal combustion of domestic waste (W) and refinery (R). For years 2000 to 2010.

The chemicals causing the more impacts are the non-methane volatile organic compounds, followed by pentane, hexane, butane, and others. They are emitted partly during the fuel combustion processes, and partly during the different steps of the transformation of the crude oil into refined fuel.

The impacts caused by the emissions of respiratory organic compounds are negligible compared to the impacts caused by the emissions of inorganic matter (Figure 24).

Photochemical oxidant formation

The impacts on human health from the emissions leading to photochemical oxidant formation, as calculated with ReCiPe 2008, are negligible compared to the toxic effects of other chemicals (Figure 27, Figure 30). The refinery, as an average through time, causes twice as much impacts on human health than the power-plant does.

Global-scale calculation

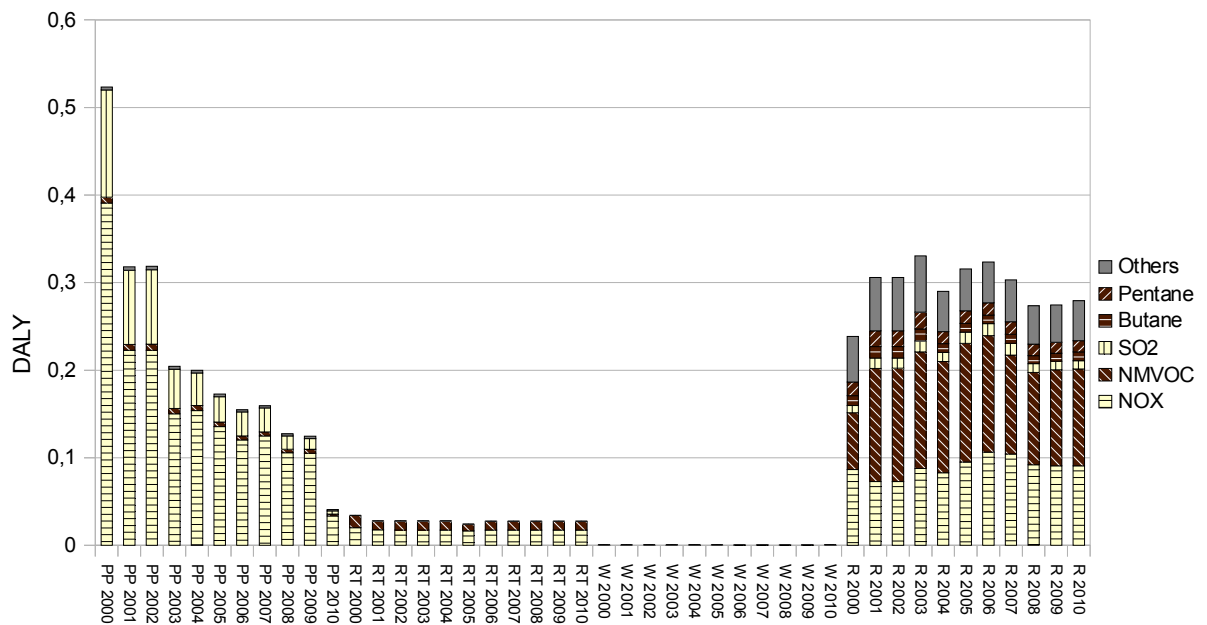

Figure 27: Photochemical oxidant formation's impacts on human health according to ReCiPe 2008 from the anthropogenic activities in the Milazzo area: power plant (PP), road traffic (RT), illegal combustion of domestic waste (W) and refinery (R). For years 2000 to 2010.

While the impacts from the power-plant are caused by nitrogen oxides and sulfur dioxide, the impacts from the refinery are done through the emissions of nitrogen oxides, non-methane volatile organic compounds, butane, pentane, and others. The road traffic also causes impacts through the emission of nitrogen oxides and non-methane volatile organic compounds, while the impacts from the illegal combustion of domestic waste are negligible.

The road traffic emits chemicals different from the power-plant. The nitrogen oxides come from the combustion processes, as well as the sulfur oxides. But the organic matter is emitted by the refinery during the distillation processes while road traffic emits NMVOC during low-temperature combustion, which is not observed in the industries. This is because the industries' furnaces are kept at high temperature all the time with a constant flow of air, while the quality of the combustion in a vehicle's motor changes each time the vehicle changes speed. In a city, the vehicles often slow down, hence an incomplete combustion and the emission of fuel with exhaust fumes occurs.

Carcinogen impacts

Both methodologies lead to the conclusion that the power-plant causes more toxic, carcinogen and non-carcinogen impacts on human health than the refinery does, and that the illegal

combustion of domestic waste causes at least half as much human health impacts than the refinery does (Figure 28, Figure 29, Figure 30).

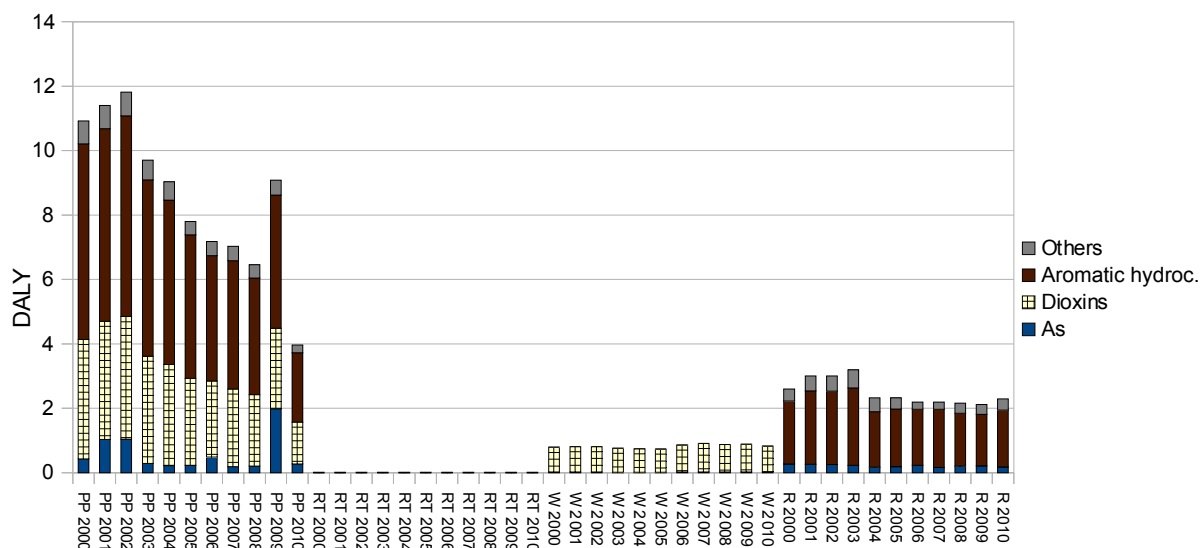

Figure 28: Carcinogen impacts on human health according to Impact 2002+ from the anthropogenic activities in the Milazzo area: power plant (PP), road traffic (RT), illegal combustion of domestic waste (W) and refinery (R). For years 2000 to 2010.

For both refinery and power-plant, the aromatic hydrocarbons cause the main carcinogen impacts upon human health. Dioxins come second and are emitted by the power-plant and the illegal combustion of domestic waste. Arsenic also causes non-negligible human carcinogenic impacts and is emitted by the power-plant and the refinery.

The carcinogenic impacts on human health are two orders of magnitude lower than the impacts from respiratory inorganics (Figure 24).

Non-carcinogen and other toxic impacts

The non-carcinogen impacts (Figure 29) are two orders of magnitude lower than the respiratory inorganics' impacts (Figure 24). The power-plant causes two to six times as much non-carcinogen impacts than the refinery, and the illegal combustion of domestic waste causes as much non-carcinogen impacts than the refinery does.

Global-scale calculation

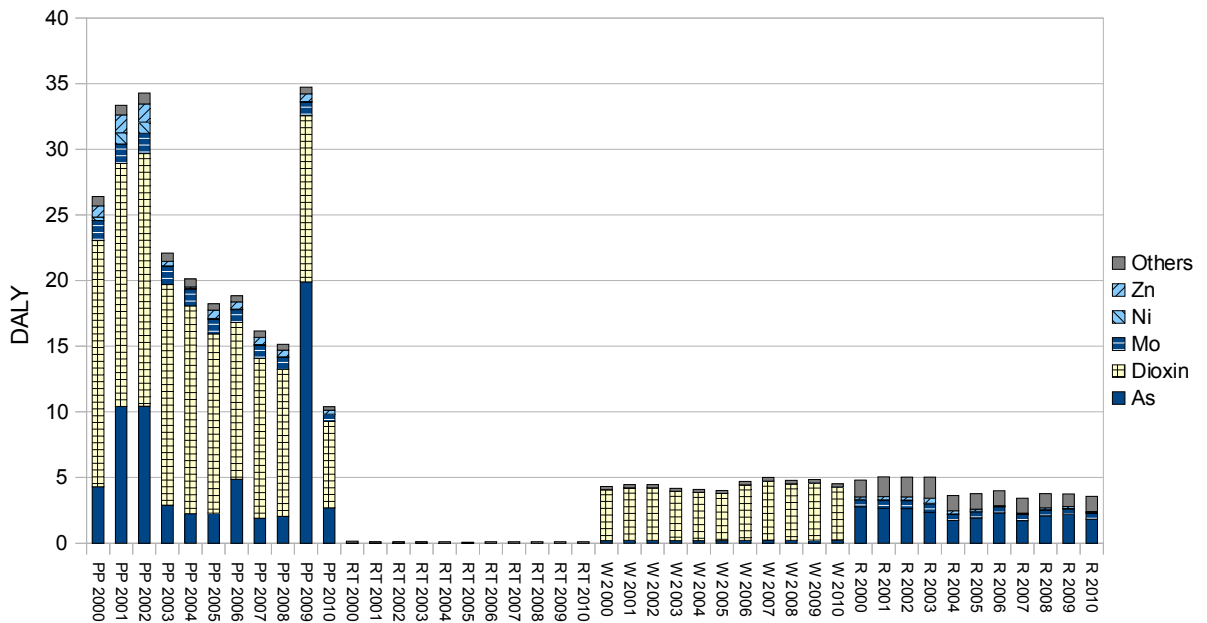

Figure 29: Non-carcinogen impacts on human health according to Impact 2002+ from the anthropogenic activities in the Milazzo area: power plant (PP), road traffic (RT), illegal combustion of domestic waste (W) and refinery (R). For years 2000 to 2010.

The chemicals causing most of non-carcinogen impacts are the dioxins; arsenic comes second. Dioxins are emitted during the combustion of fuels and waste while arsenic is emitted only during the combustion of heavy fuel oils. Because dioxins are formed only during incomplete combustions, they are emitted by the activities where the combustion of fuel is not optimal, i.e. the combustion of domestic waste and the combustion processes taking place in the power-plant.

Other toxic impacts on human health (Figure 30) are caused mainly by the power-plant and the refinery, secondary by the illegal combustion of domestic waste. While the power-plant caused impacts double than the refinery in the year 2000, in the year 2010 their respective levels of impacts are equivalent. This comes from the changing level of activity from the power-plant, that decreases through time.

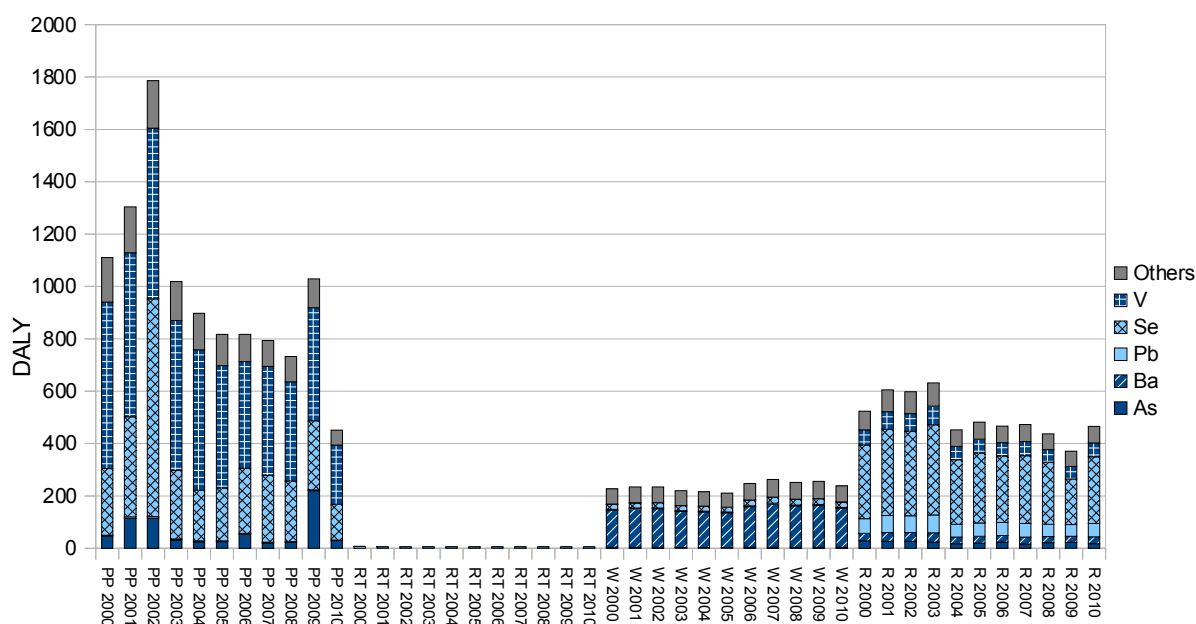

Figure 30: Toxic impacts on human health according to ReCiPe 2008 from the anthropogenic activities in the Milazzo area: power plant (PP), road traffic (RT), illegal combustion of domestic waste (W) and refinery (R). For years 2000 to 2010.

The impacts from the power-plant are caused by emissions of vanadium, selenium and arsenic. The impacts from the illegal combustion of domestic waste are caused by barium mostly while the impacts from the refinery are caused mainly by selenium and secondary by lead, arsenic, vanadium. All these pollutants are emitted towards the air during the combustion of heavy fuels in the refinery's and power-plant's furnaces, and during the combustion of waste, and fall down to the soil. Each activity emits different elements in different proportions according to the kind of fuel that is consumed.

Radiations

The only activity causing damages to human health through radiative emissions is the refinery (Figure 31, Figure 32). These radiations are emitted during the combustion of natural gas, containing traces of ²²²Radon.

The level of impacts caused by these radiative emissions is negligible compared to the other impacts upon human health, especially compared to the impacts from inorganic components upon the respiratory system (Figure 24, Figure 25).

Global-scale calculation

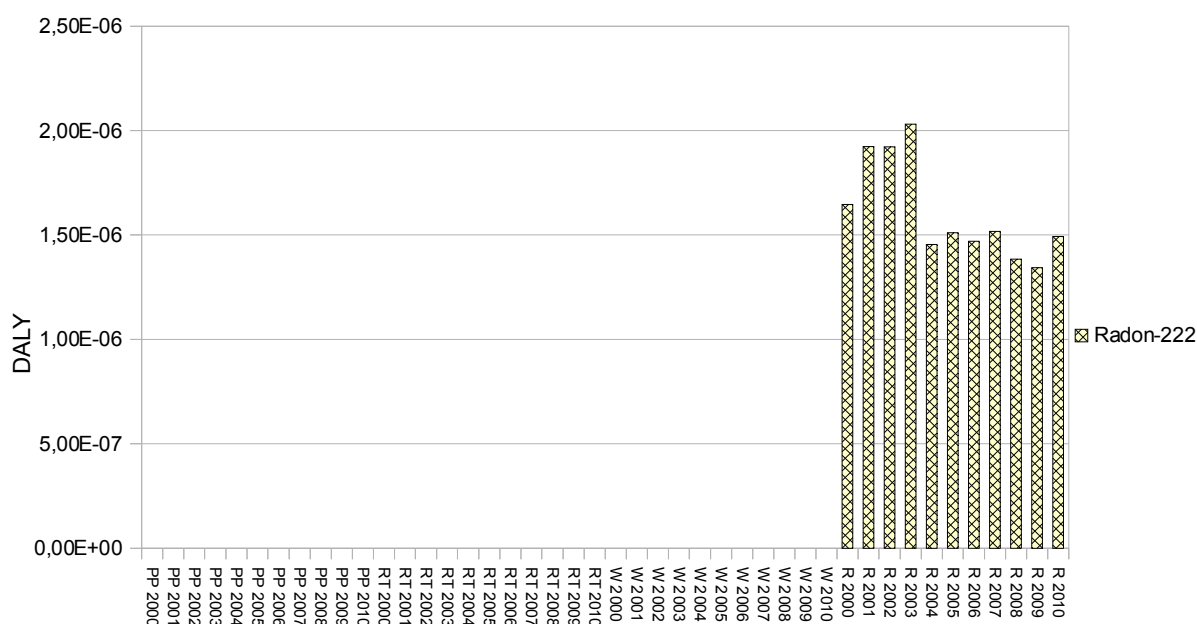

Figure 31: Ionizing radiation's impacts on human health according to ReCiPe 2008 from the anthropogenic activities in the Milazzo area: power plant (PP), road traffic (RT), illegal combustion of domestic waste (W) and refinery (R). For years 2000 to 2010.

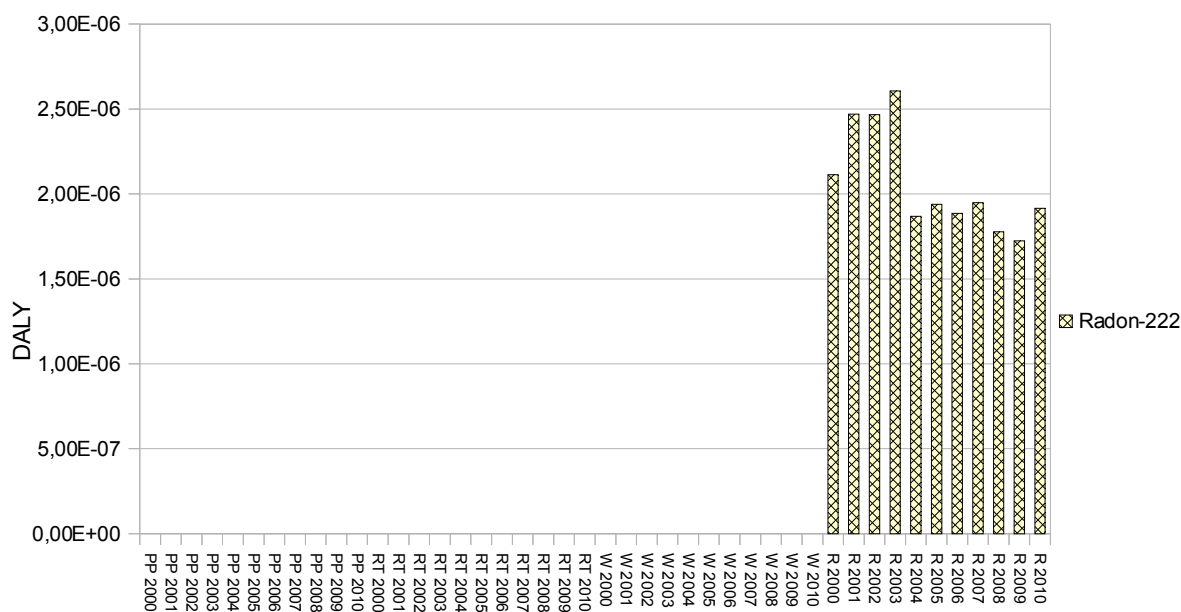

Figure 32: Ionizing radiation's impacts on human health according to Impact 2002+ from the anthropogenic activities in the Milazzo area: power plant (PP), road traffic (RT), illegal combustion of domestic waste (W) and refinery (R). For years 2000 to 2010.

3.4.3 Total damages

As a whole, according to calculations results, the anthropogenic activity in the Milazzo Peninsula that causes the most important average damages is the power-plant. The damages from the power-plant decrease through time while the level of damages from the other activities remains stable through time, meaning that in the present days, it is the refinery, and not the power-plant, that causes the most damages. The chemical causing the most damages is the carbon dioxide (Figure 33, Figure 34).

Apart from carbon dioxide, the other chemicals causing the most damages are the sulfur dioxide, the nitrogen oxides, the particulate matter (Figure 33, Figure 34) and metals such as vanadium, selenium, barium (Figure 35). As seen earlier, these chemicals have human toxic and ecotoxic effects.

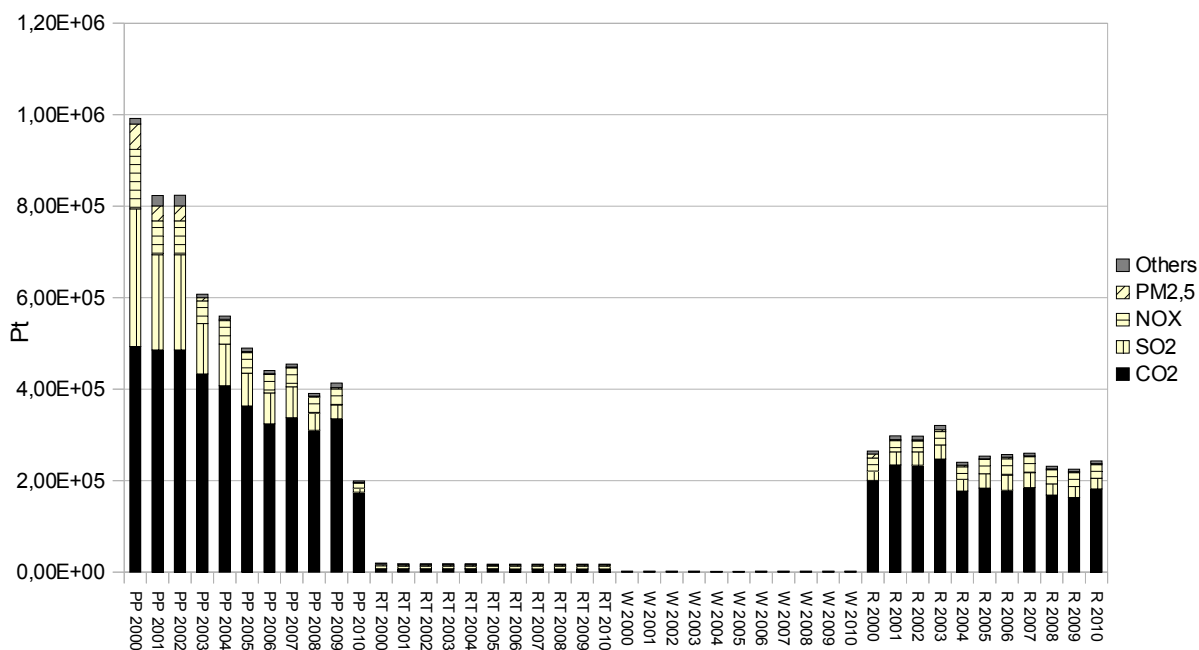

Figure 33: Total damages according to Impact 2002+ from the anthropogenic activities in the Milazzo area: power plant (PP), road traffic (RT), illegal combustion of domestic waste (W) and refinery (R). For years 2000 to 2010.

Global-scale calculation

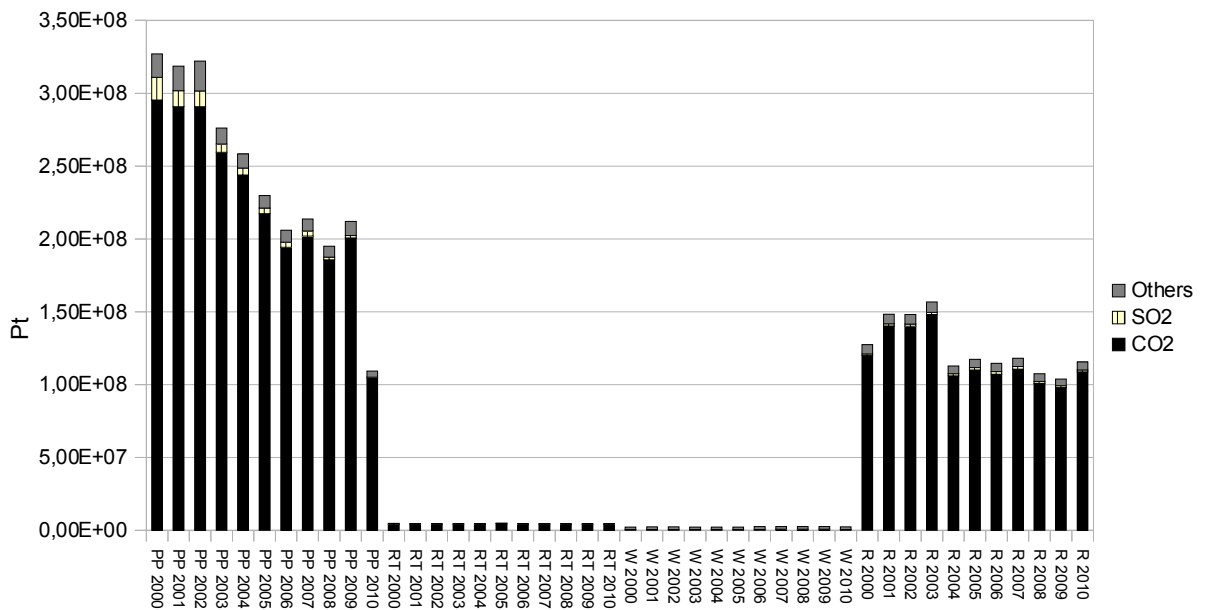

Figure 34: Total damages according to ReCiPe 2008 from the anthropogenic activities in the Milazzo area: power plant (PP), road traffic (RT), illegal combustion of domestic waste (W) and refinery (R). For years 2000 to 2010.

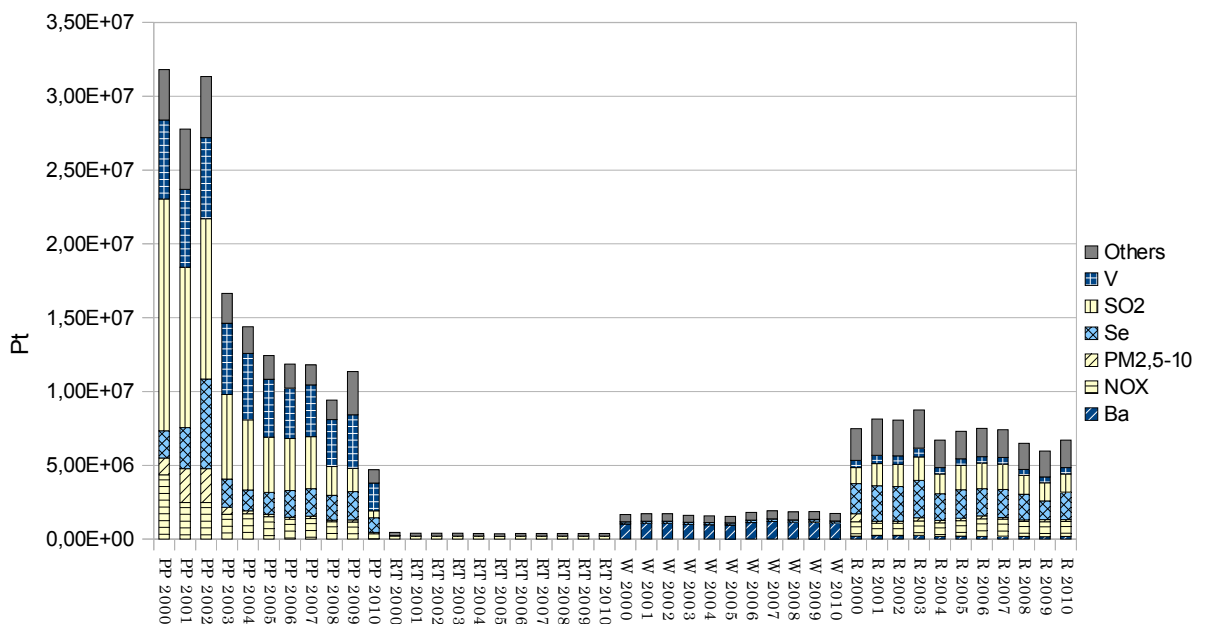

Figure 35: Total damages, CO₂ not included, according to ReCiPe 2008 from the anthropogenic activities in the Milazzo area: power plant (PP), road traffic (RT), illegal combustion of domestic waste (W) and refinery (R). For years 2000 to 2010.

The particulate matter is emitted during the combustion of heavy fuels and also during the combustion of gas in furnaces for refining processes such as distillation and catalytic cracking. The

sulfur dioxide is emitted during the combustion of heavy fuels while half the nitrogen oxides come from heavy fuels combustion and the other half, from the gas combustion.

These metals are emitted towards the air during the combustion of heavy fuels and domestic waste, and fall down to the soil.

The pollutants emitted to the water are either directly discharged during the transformation of petroleum through the different refining processes, or emitted to the air during the combustion of heavy fuels or domestic waste before being deposited in water.

3.4.4 Conclusion

This study of the polluting emissions in the Milazzo Peninsula and their impacts and damages showed that the main consequences of the anthropogenic activities in the area is the toxicity, for humans and for the ecosystems. It also showed that the refinery and the power-plant has an equivalent share in the total damages, though their emissions are of different nature.

This study also enabled to demonstrate the non-negligible consequences of poor waste management in the locality of Milazzo, the illegal combustion of domestic waste causing toxic impacts that can be, in some cases, as high as those caused by the refinery.

3.5 Total global-scale calculations

This chapter explores the impacts done by the selected anthropic activities over the totality of the chosen timeframe.

3.5.1 Impacts on the environment

This first paragraph speaks about the impacts that are done upon the environment.

Toxicity on aquatic ecosystems

After correction of the ReCiPe results (Figure 37, Figure 38) by the species density of freshwater and marine ecosystems, the comparison can be established with the Impact 2002+ results.

The ReCiPe freshwater results (Figure 37) are of the same order of magnitude than the Impact 2002+ aquatic results (Figure 36) except for the impacts caused by the emissions from road traffic, which are one order of magnitude higher according to Impact 2002+. As for the marine ecosystems results, they are up to five orders of magnitude higher according to ReCiPe than according to Impact 2002+ (Figure 36 and Figure 38, impacts from the thermoelectric power-plant).

The important difference between the two methodologies does not come from an over or underestimation of the impacts by one of them, but rather from the presence or absence of the element vanadium in the list of chemicals accounted for in the method. In fact, vanadium is accounted for in the ReCiPe method, but not in the Impact 2002+ method.

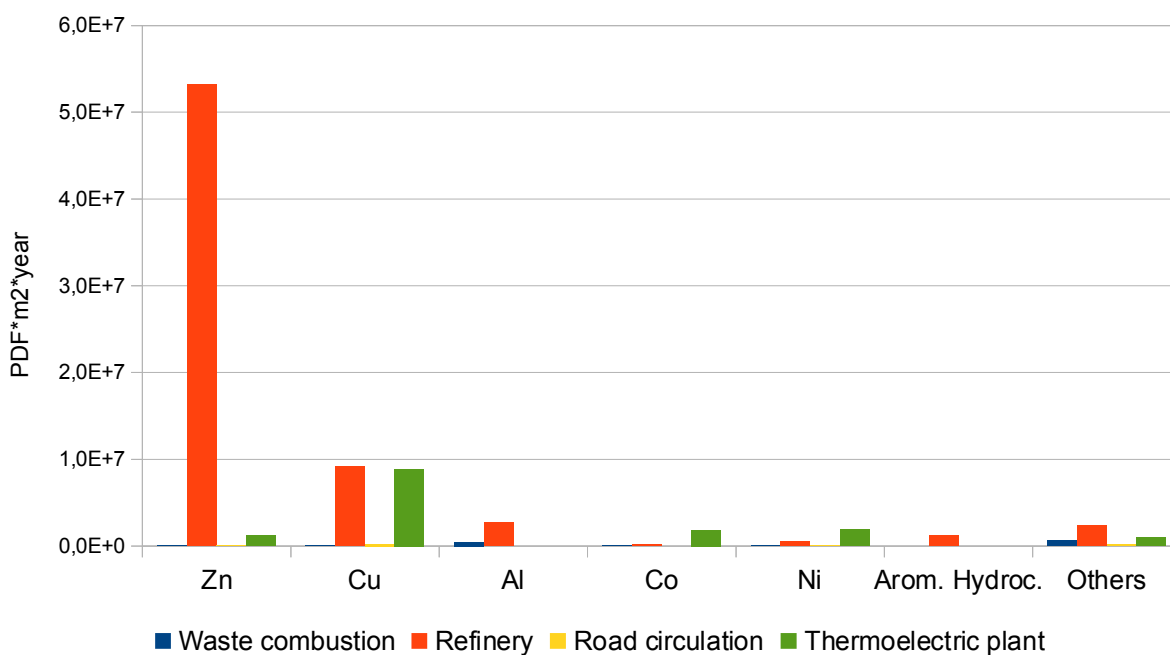

Figure 36: Toxic damages to aquatic ecosystems according to Impact 2002+

According to Impact 2002+ (Figure 36), the most aquatic ecosystem impacting chemical is the zinc (63.61% of total impact upon aquatic ecosystems). It is emitted during the combustion of heavy fuels in the refinery's furnaces, and is deposited on the water bodies while adsorbed on particulate matter. It is also the case for the copper (21.44%) and the aluminium (3.67%). Copper is also emitted by the thermoelectric plant during the combustion of fuels in the furnaces producing the thermic energy later converted into electricity. Cobalt (2.36%) and nickel (2.75%) are also produced during the combustion processes of the thermoelectric plant while the aromatic hydrocarbons (1.39%) are formed during the combustion of fuels in the refinery's furnaces. All other chemicals cause negligible impacts (less than 1% per chemical).

The anthropogenic activity impacting mostly the aquatic ecosystems is the refinery (80.95% of total impacts). Then comes the thermoelectric power-plant (17.31%) and the illegal combustion of domestic waste (1.27%). The impacts resulting from the emissions of road traffic are negligible (0.47% of total impact upon aquatic ecosystems).

The difference in the emissions resulting from the combustion of fuels in the refinery's and the thermoelectric plant's furnaces comes from the difference in the fuel's composition (heavy or light fraction, unleaded or not, etc.).

Global-scale calculation

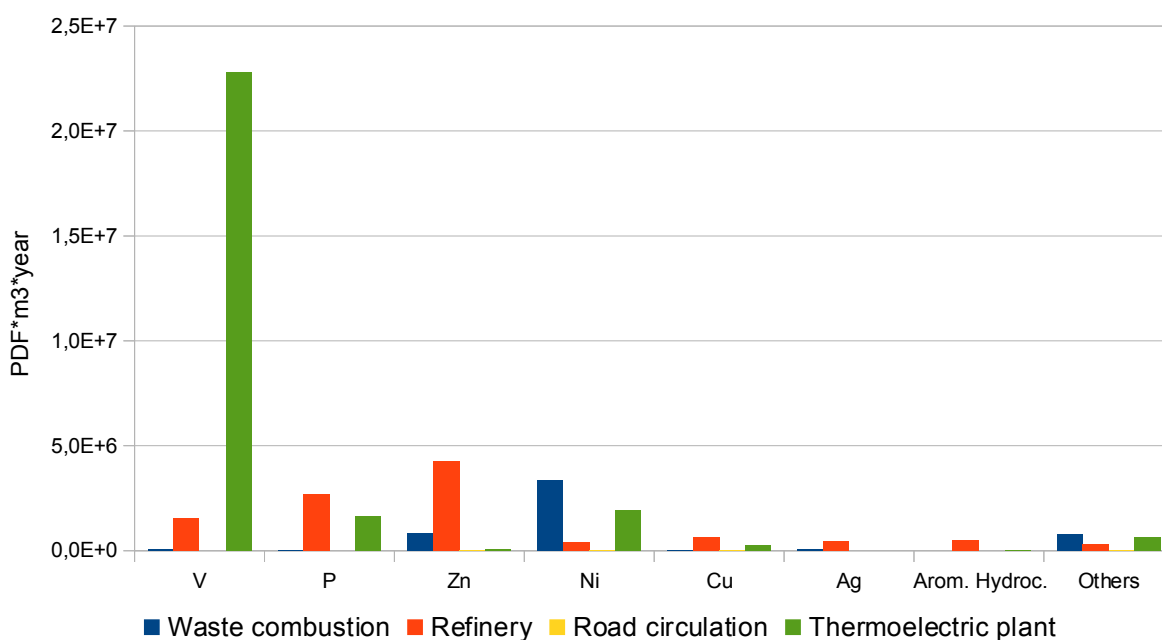

Figure 37: Toxic damage to freshwater ecosystems according to ReCiPe

The freshwater ecotoxic impacts, according to ReCiPe (Figure 37) are caused mainly (56.61%) by the emissions of vanadium. Vanadium is emitted during the combustion processes in the furnaces of the thermoelectric plant. Second comes nickel, also emitted during the illegal combustion of domestic waste, for a total share of 13.07% of freshwater ecotoxic impacts. The refinery's combustion processes also leads to zinc emissions (11.95% of freshwater ecotoxic impacts), while the thermoelectric plant's emits more nickel. The phosphorous (10.02%) is emitted by both thermoelectric plant and refinery's furnaces.

Because of the specificities of the fuels used by the refinery's furnaces, and the specificities of its combustion processes, this anthropogenic activity causes also impacts through the emission of copper (2.00%), silver (1.20%) and aromatic hydrocarbons (1.18%). All the other chemicals cause negligible impacts (<1% impacts per species).

On the contrary to what was shown by the use of Impact 2002+ model (Figure 36), the main impacting activity is not the refinery (24.91% of impacts) but the thermoelectric plant (63.32%). The illegal combustion of domestic waste displays a share one order of magnitude higher according to ReCiPe than according to Impact 2002+ (11.71% versus 1.27%). As for Impact 2002+, the freshwater ecotoxic impacts resulting from the emissions of road traffic are negligible (0.06%).

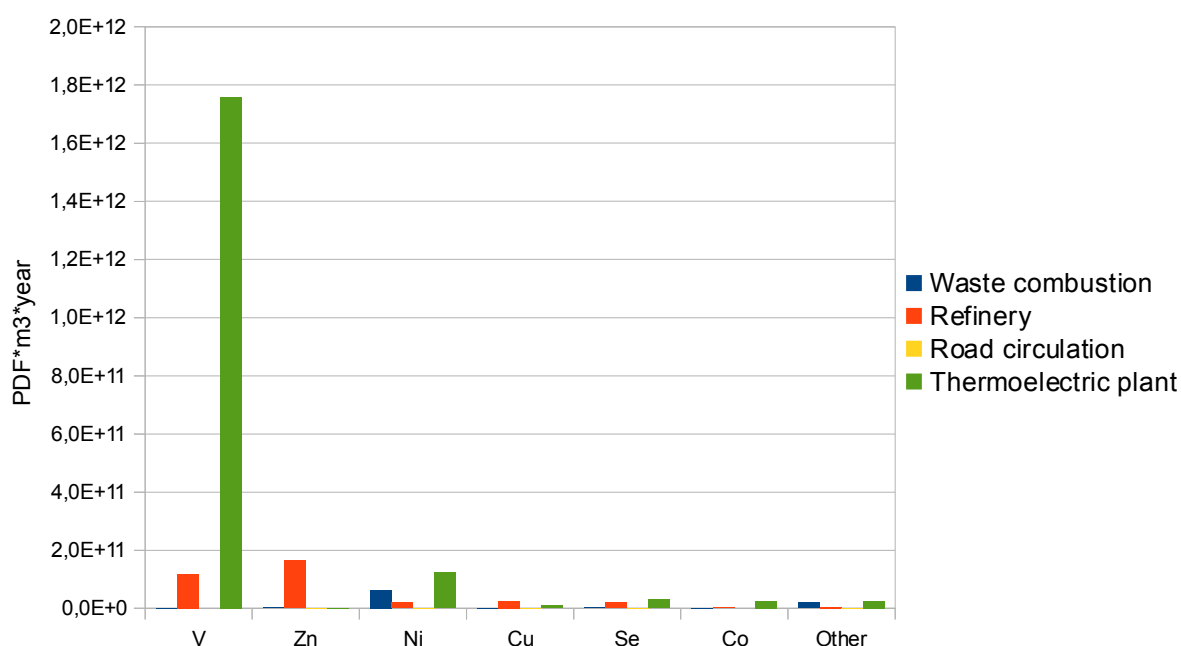

Figure 38: Toxic damages to marine ecosystems according to ReCiPe

According to the ReCiPe method (Figure 37, Figure 38) the impacts on the water bodies are caused by different elements depending on the nature of the water body (freshwater, Figure 37 or marine, Figure 38). This is because the sensitivity of the species are different from one compartment to the other. Also, the residence time of the chemical species, and their behavior, vary from compartment to compartment. This difference is not evidenced by Impact 2002+ method (Figure 36).

Similarly to what was estimated for the freshwater bodies, the marine water bodies are impacted mainly through the emissions of vanadium (77.52%) during the combustion processes in the thermoelectric plant's furnaces. Nickel (8.56%) comes second; it is emitted by both thermoelectric plant's furnaces and illegal combustion of domestic waste, while zinc (6.96%) is emitted mainly by the refinery. Other toxic metals impact the marine ecosystems: copper (1.50%), selenium (2.17%) and cobalt (1.21%). They are emitted during the combustion processes of the refinery and the thermoelectric plant. All other chemicals cause negligible impacts (less than 1% per chemical).

Similarly to the results obtained with Impact 2002+ (Figure 36), the results for the marine ecosystems with the ReCiPe method (Figure 38) show that the most important share of impacts is done by the thermoelectric plant (81.49%). Second comes the refinery (14.72%) and third, the

Global-scale calculation

illegal combustion of domestic waste (3.74%). Again, the impacts from road traffic are negligible (0.05%).

Acidification and eutrophication

After correction of the ReCiPe results (Figure 39, Figure 41) by the species density of freshwater and terrestrial ecosystems, the comparison can be established with the Impact 2002+ results based upon a common unit.

ReCiPe's freshwater results (Figure 39) are of a different order or magnitude than the terrestrial eutrophication results (Figure 41). The impacts from the illegal combustion of domestic waste is one order of magnitude lower for the terrestrial ecosystem than for the freshwater one. For the refinery, the terrestrial impacts are two orders of magnitude higher than for the freshwater environment. The road traffic emissions cause no impacts upon the freshwater environment while the thermoelectric power plant causes three orders of magnitude lower impacts upon the freshwater than upon the terrestrial ecosystems. No comparison can be established between the Impact 2002+ and ReCiPe results for the freshwater ecosystems, because Impact 2002+ method does not take the aquatic compartment into account for the acidification and eutrophication impacts.

The results of Impact 2002+ (Figure 40) and ReCiPe methods (Figure 41) upon terrestrial ecosystems are of the same order of magnitude for the refinery and the thermoelectric plant, and are one order of magnitude higher according to Impact 2002+ for the illegal combustion of domestic waste and the road traffic. This is due to the addition of terrestrial eutrophication to the acidification impacts in Impact 2002+ while ReCiPe takes only the terrestrial acidification impacts into account.

The Life Cycle Assessment of the Milazzo Peninsula

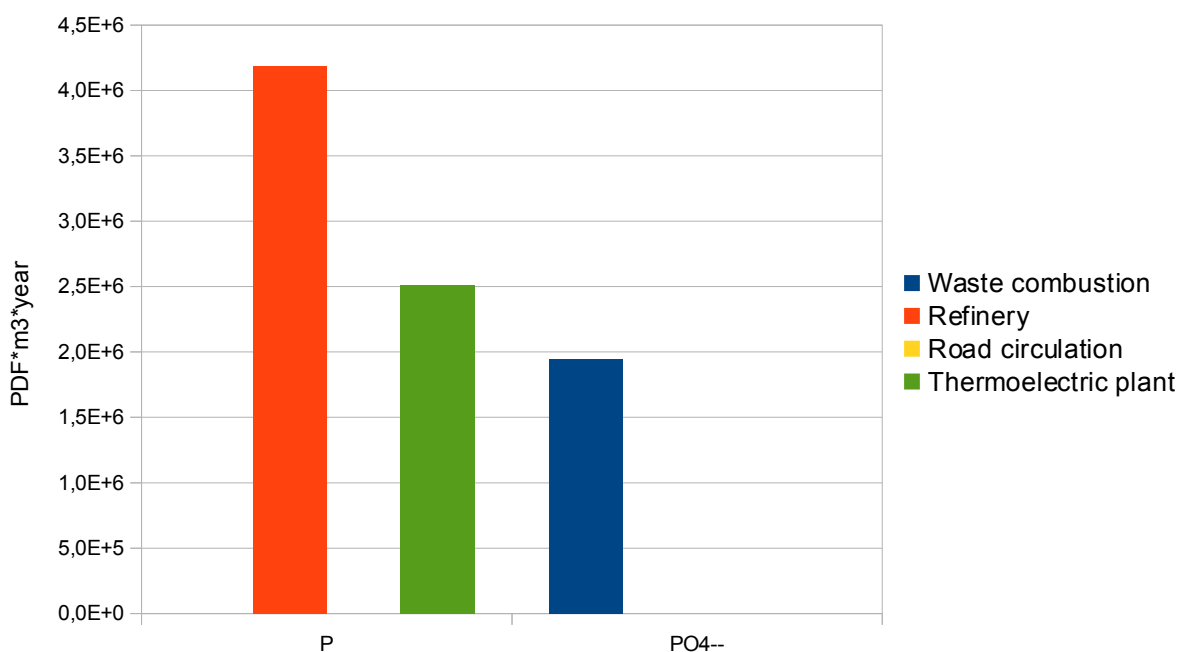

Figure 39: Eutrophication damages on freshwater according to ReCiPe

According to the ReCiPe results (Figure 39), the freshwater eutrophication is caused by two chemicals only: the phosphorous and the phosphate. Phosphorous (77.50% of impacts) is emitted by the combustion processes of the refinery (48.42%) and the thermoelectric plant (29.07%), while the phosphate (22.51%) comes from the illegal combustion of domestic waste.

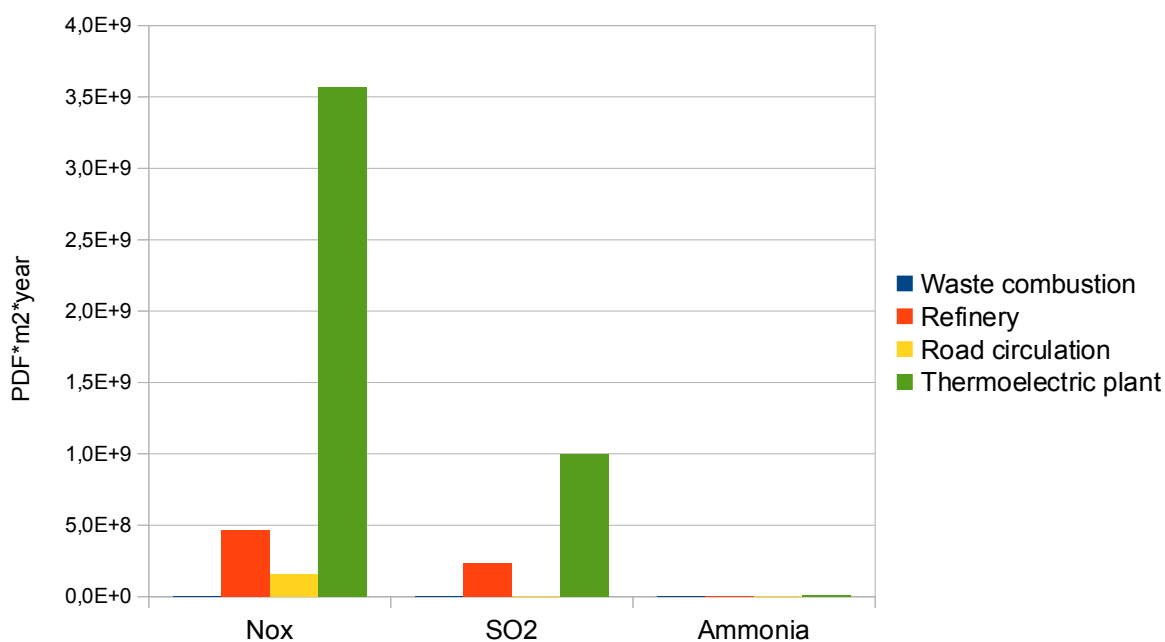

Figure 40: Acidification and eutrophication damages on terrestrial ecosystems according to Impact 2002+

Global-scale calculation

Impact 2002+ method gives impact results for both terrestrial acidification and eutrophication together (Figure 40). According to these results, the acidification and eutrophication of terrestrial ecosystems is done by three chemicals: nitrogen oxides (77.13% of impacts), sulfur dioxide (22.63%) and ammonia (0.23%, negligible). All these substances are mainly (83.96% of acidification / eutrophication impacts) emitted by the thermoelectric plant's furnaces during the combustion processes. The refinery's furnaces are responsible for 12.93% of these impacts while the road traffic emissions cause 3.06%. The impacts resulting from the illegal combustion of domestic waste are negligible (0.05%).

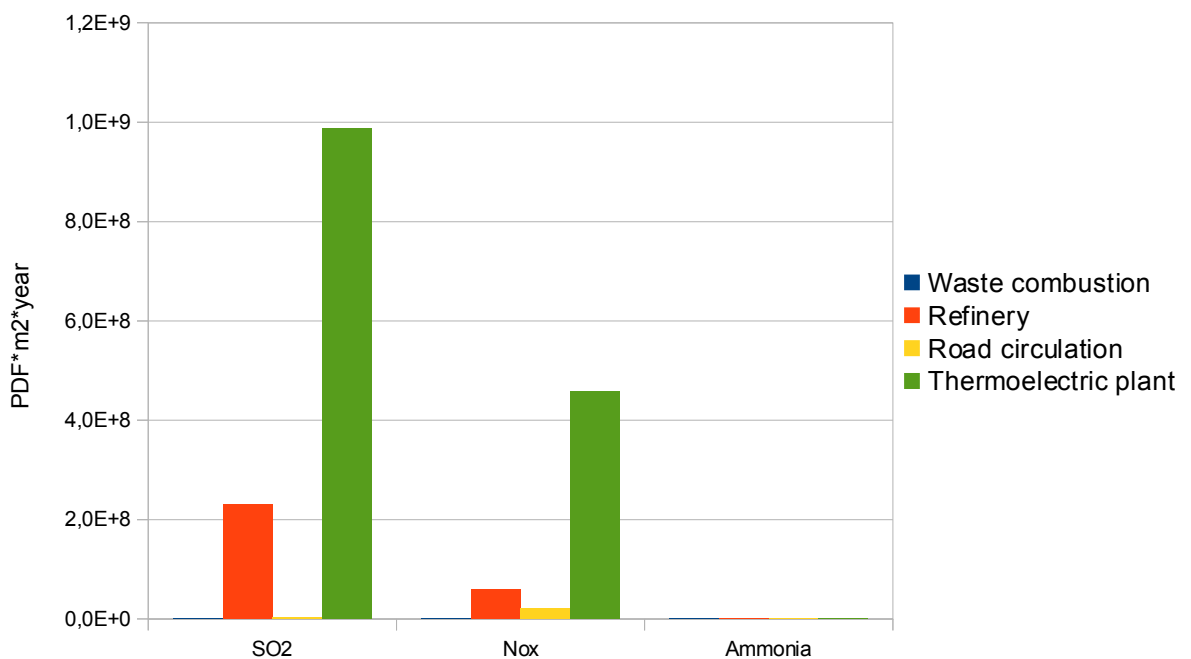

Figure 41: Acidification damages on terrestrial ecosystems according to ReCiPe

According to ReCiPe (Figure 41) and similarly to Impact 2002+ (Figure 40), the terrestrial acidification impacts are done by three chemicals: sulfur dioxide (69.27%), nitrogen oxides (30.59%) and ammonia (0.14%, negligible). On the contrary to Impact 2002+, ReCiPe gives a higher share to sulfur dioxide than to nitrogen oxides. This difference can be explained by the inclusion of eutrophication impacts from nitrogen oxides emissions in the Impact 2002+'s results.

Similarly to the results obtained with Impact 2002+ (Figure 40), the ReCiPe results show a higher share in the impacts for the thermoelectric plant (82.08%) while the refinery comes second (16.53%), the road traffic comes third (1.36%) and the illegal combustion of domestic waste is negligible (0.02%).

Terrestrial ecotoxicity

After correction of the ReCiPe results (Figure 42, Figure 43) by the species density of terrestrial ecosystems, the comparison can be established with the Impact 2002+ results based upon a common unit.

The results obtained with Impact 2002+ are two orders of magnitude higher than those obtained with ReCiPe for the impacts from illegal domestic waste combustion, and one order of magnitude higher for the impacts from the refinery and the road traffic. Regarding the impacts resulting from the activity of the thermoelectric plant, it has the same order of magnitude in both methodologies, even though it is double according to Impact 2002+ compared to ReCiPe. It is not intuitive to understand why the results with Impact 2002+ are higher than with ReCiPe, while ReCiPe takes one more highly toxic element (vanadium) into account than Impact 2002+. It seems that either ReCiPe underestimates the terrestrial ecotoxic impacts, or Impact 2002+ overestimates them.

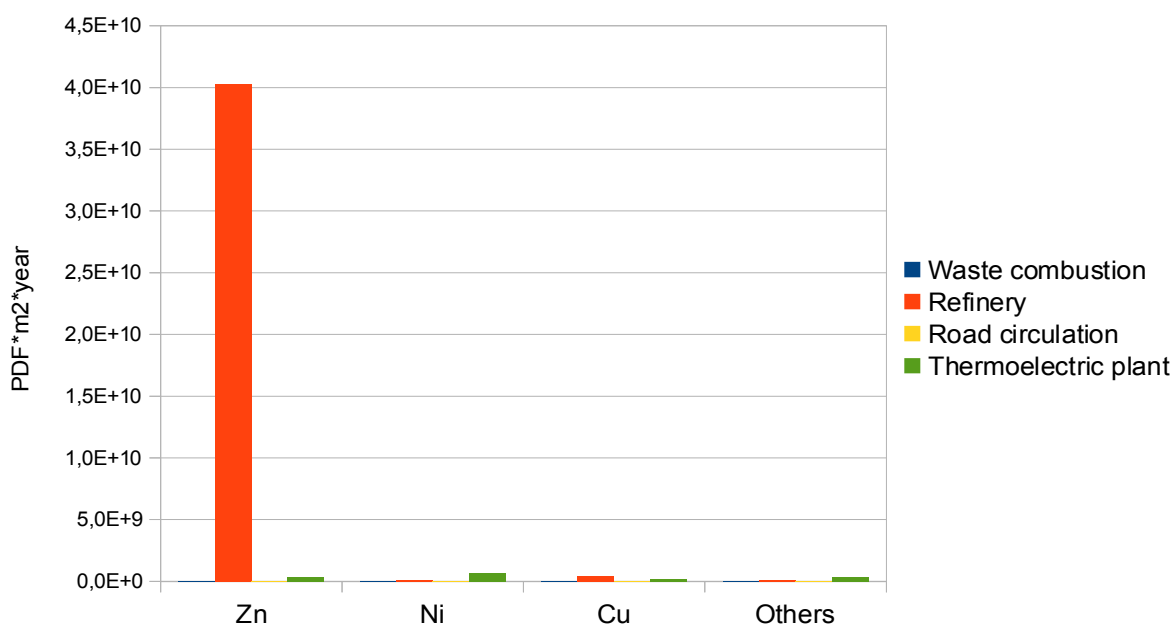

Figure 42: Toxic damages on terrestrial ecosystems according to Impact 2002+

According to Impact 2002+ (Figure 42), quite all (95.39%) terrestrial ecotoxic impacts are done by zinc emissions from the combustion processes in the refinery's furnaces. The resulting terrestrial ecotoxic impacts are done by nickel (1.83%), copper (1.44%) and other negligible chemicals (<1% per chemical).

Global-scale calculation

The refinery causes most (95.39%) terrestrial ecotoxic impacts, rendering the influence of illegal domestic waste combustion (0.03%) and road traffic (0.23%) negligible. The thermoelectric plant is responsible for a small but non-negligible part of the terrestrial ecotoxic impacts (3.66%).

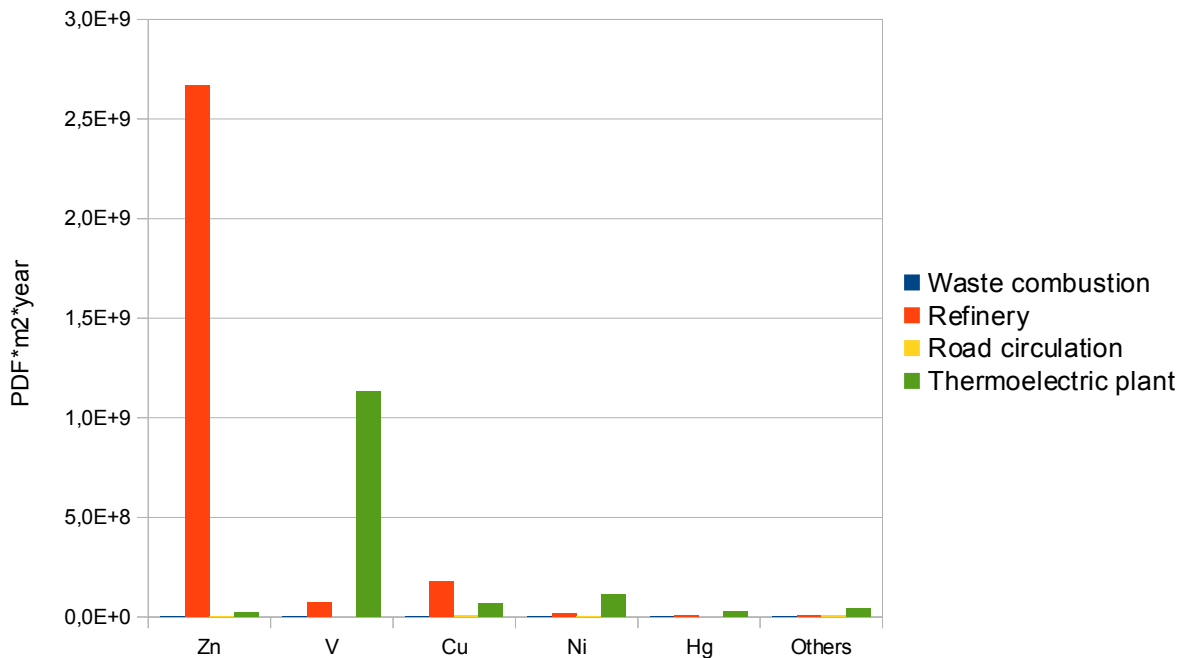

Figure 43: Toxic damages on terrestrial ecosystems according to ReCiPe

Similarly to the results obtained with Impact 2002+ (Figure 42), the results obtained with ReCiPe (Figure 43) give the higher share in terrestrial ecotoxic impacts to the emissions of zinc (61.53%) by the refinery. But on the contrary of Impact 2002+, ReCiPe shows the important (27.62%) share of vanadium in terrestrial ecotoxic impacts. This metal is emitted by the furnaces of the thermoelectric plant during the combustion processes. Other metals impacting the terrestrial ecosystems are copper (5.78%), nickel (2.95%) and mercury (0.82%). All the other chemicals' influence is negligible (<1% per single chemical). Copper's contribution is very low for Impact 2002+ (Figure 42) because of the differences in the models underlying both methodologies, giving copper a relative higher toxicity in ReCiPe than in Impact.

As for the results obtained with Impact 2002+, the refinery causes the most important share of terrestrial ecotoxic impacts (67.55%); the illegal combustion of domestic waste and road traffic emissions are negligible (0.01% and 0.29% of impacts respectively). But unlike the previous method, ReCiPe gives a higher share (32.15%) to the thermoelectric plant, because of the inclusion of vanadium in the ReCiPe method.

3.5.2 Impacts to human health

This second paragraph is about the impacts that are done upon human health.

Inorganic matter, leading to particulate matter formation

As a whole, Impact 2002+ (Figure 44) and ReCiPe (Figure 45) methods give similar results regarding impacts caused by emissions of inorganic matter, leading to particulate matter formation. The order of magnitude is the same for illegal waste combustion, road traffic emissions and thermoelectric plant, but the exact level of impacts is estimated higher by Impact 2002+ than by ReCiPe. Regarding the impacts from the refinery, they are two orders of magnitude higher according to Impact 2002+ than according to ReCiPe. The difference comes from the underlying models, ReCiPe assuming a lower human toxicity for nitrogen oxides and particulate matter than Impact 2002+ does.

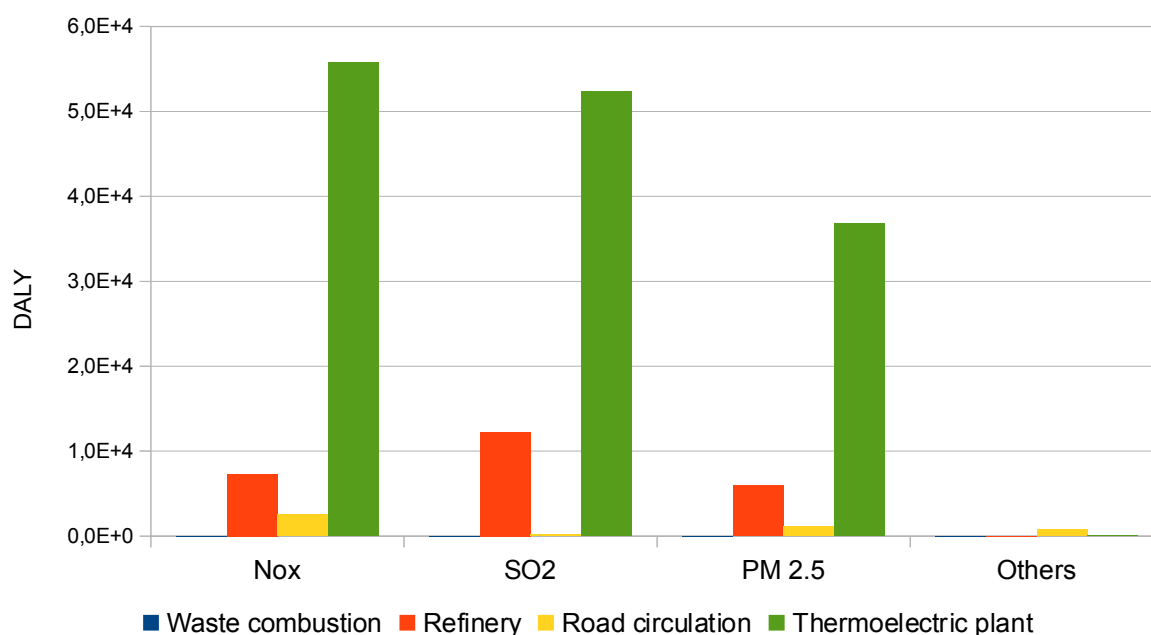

Figure 44: Damages of inorganic chemicals on human respiratory system according to Impact 2002+

According to the results obtained with Impact 2002+ (Figure 44) the inorganic chemicals causing the main impacts upon human health are nitrogen oxides (37.46%), sulfur dioxides (36.97%) and particulate matter thinner than 2.5 μm (25.09%). They are emitted mainly during the combustion processes in the thermoelectric plant's furnaces. As for the emissions resulting from the refinery's activity, the particulate matter is emitted during the combustion of heavy fuels and also during the combustion of gas in furnaces for refining processes such as distillation and catalytic

Global-scale calculation

cracking. The sulfur dioxide is emitted during the combustion of heavy fuels while half the nitrogen oxides come from heavy fuels combustion and the other half, from the gas combustion.

The majority (82.81%) of human toxic impacts caused by inorganic chemicals is due to the thermoelectric plant. The refinery shares another important part of these impacts (14.61%). The road traffic also has a non-negligible (2.56%) share while the illegal combustion of domestic waste's share is negligible (0.02%).

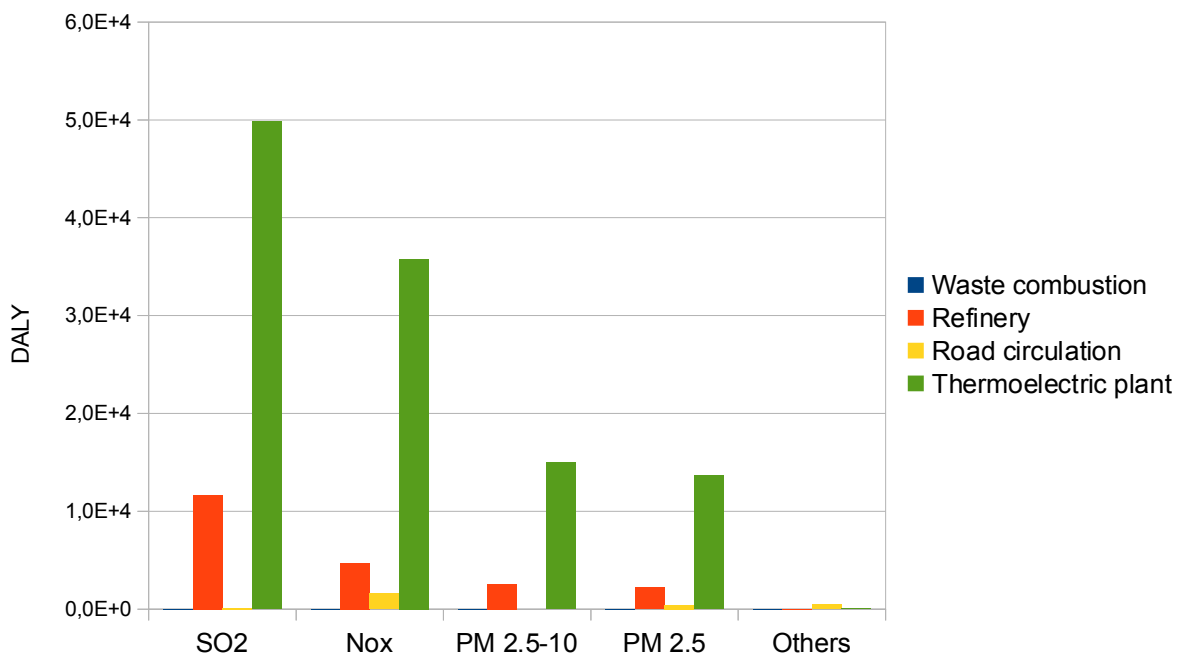

Figure 45: Damages of human health through the formation of particulate matter according to ReCiPe

According to the results from the ReCiPe method (Figure 45), the impacts on human health from the inorganic chemicals leading to the formation of particulate matter are mainly caused by the emissions of sulfur dioxide (44.62%). Nitrogen oxides also cause an important (30.48%) share of these impacts. Particulate matter itself, in the form of medium (2.5 to 10 μm) and thin (less than 2.5 μm) fractions, causes a non-negligible part of these impacts (respectively 12.72% and 11.81%). All the other chemicals have a negligible share in these impacts (<1% per chemical).

Regarding the share of each anthropogenic activity in these impacts, the ReCiPe method gives results similar to those of Impact 2002+: the majority (82.77%) of impacts is caused by the thermoelectric plant, the refinery has an important share (15.32%), the road traffic has a little non-negligible share (1.89%) and the illegal combustion of domestic waste's share is negligible (0.02%).

Respiratory organics

The organic chemicals impacting the human respiratory system are taken into account by Impact 2002+ in a separate category (Figure 46), while in ReCiPe they appear as part of the photochemical oxidant formation impact category (Figure 47). ReCiPe estimates their impacts as being of the same or lower order of magnitude than Impact 2002+ does.

According to Impact 2002+ (Figure 46), the organic chemicals causing the most impacts upon human health are the non-methane volatile compounds (69.00%). Other organic chemicals have similar shares in the impacts upon human health: pentane (7.51%), butane (5.38%), hexane (3.63%), propane (2.75%), heptane (1.97%). Most of these chemicals are emitted by the refinery (79.03% share of their impacts) during the fuel combustion processes and during the transformation of crude oil into refined products. The combustion processes of the road traffic vehicle motors' (12.98%) and the thermoelectric plant's furnaces (7.95%) also emit organic compounds, mainly NOMVOC. The impacts caused by the emissions of organic compounds resulting from the illegal combustion of domestic waste are negligible (0.04%).

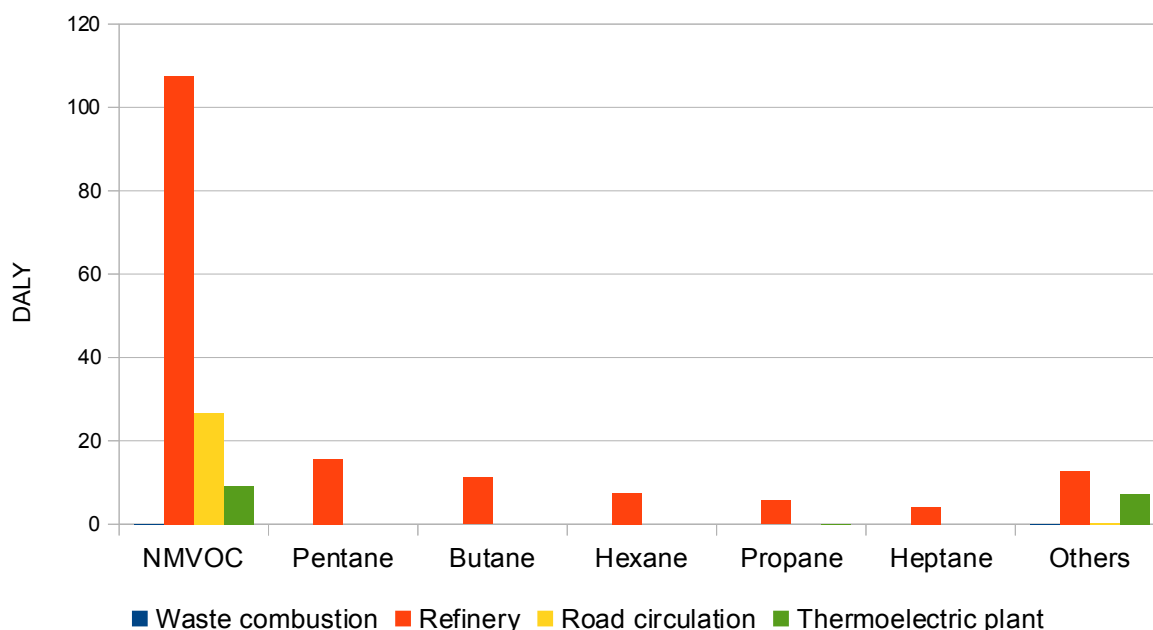

Figure 46: Damages on human respiratory system by organic chemicals according to Impact 2002+

Photochemical oxidant formation

The ReCiPe method classifies the organic chemicals with other non-organic chemicals as all of them cause photochemical oxidant formation (Figure 47). Compared to the impacts calculated

Global-scale calculation

by Impact 2002+ upon the respiratory system of humans (Figure 46), the impacts calculated by ReCiPe for the organic elements are one order of magnitude lower.

According to ReCiPe, the chemicals impacting human health the most through the formation of photochemical oxidants are the nitrogen oxides (73.35%) emitted during the combustion processes. The second chemicals are the non-methane volatile organic compounds (11.33%). Others, organic and non-organic, are sulfur dioxide (9.70%), pentane (1.24%), and diverse negligible species (<1% per individual species). The relative share of each compound in each anthropogenic activity depends on the composition of the fuel used in the combustion processes; they are of different nature in the refinery's furnaces, in the thermoelectric plant's, and in the vehicles.

On the contrary to the results obtained with Impact 2002+ and displayed in Figure 46, the anthropogenic activity causing the most impacts is not the refinery but the thermoelectric plant (72.18%). The refinery is second (22.79), the road traffic is of relative importance (4.98%) and the illegal incineration of domestic waste is negligible (0.05%).

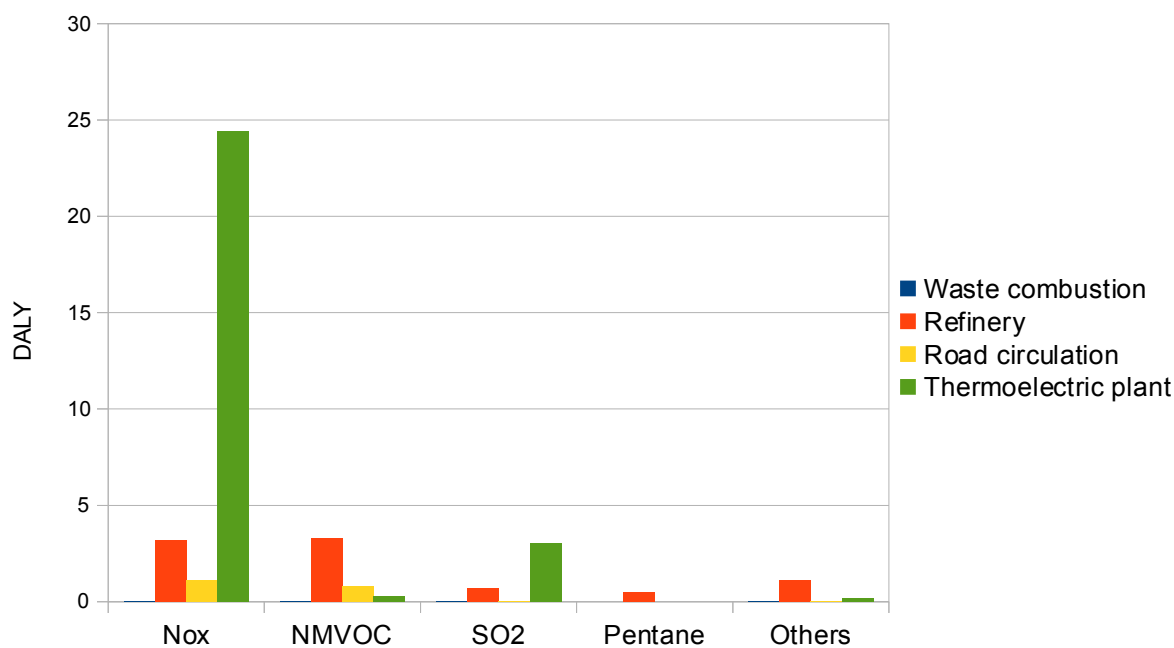

Figure 47: Damages to human health through the formation of photochemical oxidant substances according to ReCiPe

Carcinogen impacts

According to Impact 2002+ (Figure 48), all the carcinogen impacts are done through cadmium emissions, most of them (94.97%) originating from the illegal combustion of domestic waste. The shares of the refinery (3.77%) and thermoelectric plant (1.26%) are small in comparison, while the share of the road traffic is negligible (<0.01%).

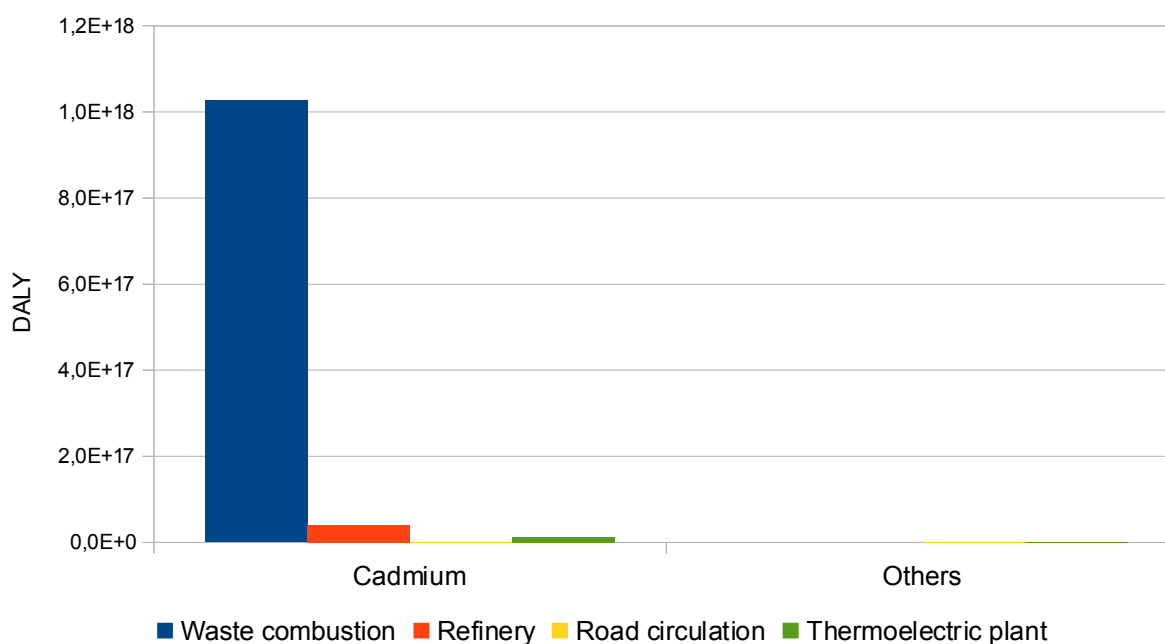

Figure 48: Damages of human carcinogenic substances according to Impact 2002+

Non-carcinogen and other toxic impacts

The non-carcinogen (Figure 49, Impact 2002+) are negligible in comparison with the carcinogen impacts (Figure 48, Impact 2002+). It is unsure if a similar comparison can be done between the carcinogen impacts (Figure 48, Impact 2002+) and the human toxic impacts (Figure 50, ReCiPe) because estimations are done by two different calculation methods and imply two different toxicities. Let us note that the ReCiPe's human toxic impacts are one (refinery, thermoelectric plant) to two (illegal waste combustion, road circulation) orders of magnitude higher than the non-carcinogen results from Impact 2002+. This is partly due to the absence of vanadium in the Impact 2002+ method, partly to the differences in the models underlying each method, and partly to the different classification of the chemical species into impacts upon human health (“non-carcinogen” vs “toxic” impacts).

Global-scale calculation

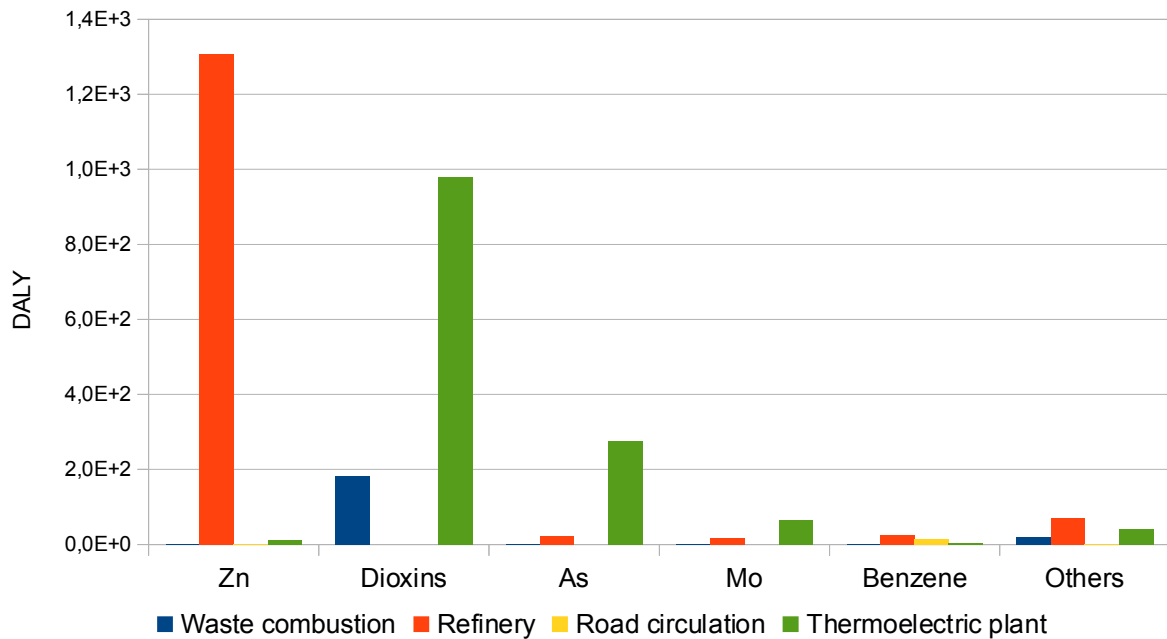

Figure 49: Toxic damages of non-carcinogenic substances according to Impact 2002+

According to the results obtained with Impact 2002+ (Figure 49), the chemical causing the most toxic, non-carcinogen impacts upon human health is zinc (43.52%), emitted by the refinery during the combustion of heavy fuels. The second most toxic chemicals are the dioxins, emitted by the thermoelectric plant and the domestic waste during combustion processes. Because dioxins are formed only during incomplete combustions, they are emitted by the activities where the combustion of fuel is not optimal, i.e. the combustion of domestic waste and the combustion processes taking place in the power-plant. Then comes arsenic (9.83%) and molybdenum (2.63%), also emitted during the combustion process of the thermoelectric plant. Benzene (1.36%) is evaporated during the distillation process of the refinery, and during incomplete combustion in vehicles' engine. The other chemicals are individually negligible (<1% of total impacts of non-carcinogen toxicity upon human health).

The impacts caused by the refinery and the thermoelectric plant are of equivalent level (47.51% share for the refinery, 45.32% share for the thermoelectric plant) but they are done by different chemicals. The illegal combustion of domestic waste also has a share of importance (6.67%) while the road circulation's share is negligible (0.50%).

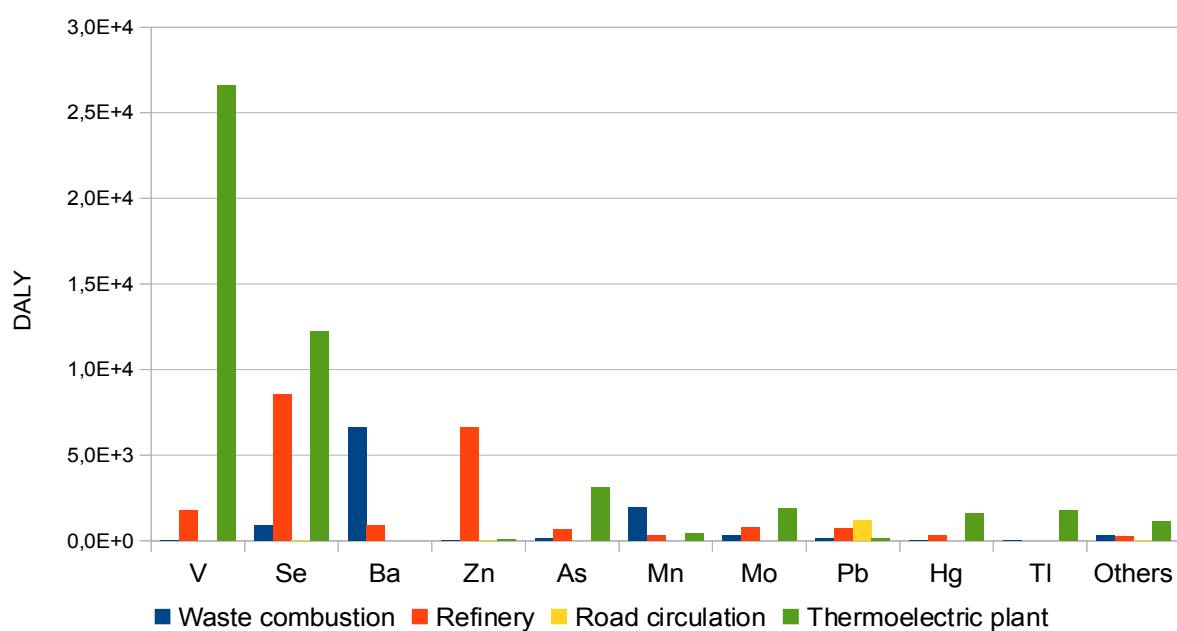

Figure 50: Human toxic damages according to ReCiPe

Many metals and metalloids contribute to human toxic impacts, according to ReCiPe (Figure 50). The two main toxic metals are the vanadium (34.72%), emitted by the thermoelectric plant's furnaces and the selenium (26.55%) emitted by both the refinery and the thermoelectric plant's furnaces. Then comes barium (9.20%) from the illegal combustion of domestic waste and zinc (8.25%) from the refinery's furnaces. Arsenic (4.83%), molybdenum (3.71%), mercury (2.39%) and thallium (2.21%) are also emitted by the thermoelectric plant's combustion process, while manganese (3.37%) comes from the illegal combustion of domestic waste and lead (2.67%) from the road traffic. Other chemicals are mainly emitted by the thermoelectric plant. While all these metals and metalloids come from diverse combustion processes, the anthropogenic activity from which they are emitted depends on the used fuels.

On the contrary to the results obtained with Impact 2002+ (Figure 49), the share is different for the thermoelectric plant and the refinery: the first has a most important share (59.93%) than the refinery (25.65%), principally because ReCiPe takes vanadium into account. The illegal combustion of domestic waste (12.97%) and the road circulation (1.46%) also have more important shares in human toxic impacts calculated with ReCiPe than calculated with Impact 2002+. This is because the models underlying the two methods are different.

Radiations

Only one anthropogenic activity causes impacts on human health through ionizing radiations: the refinery (Figure 51, Figure 52). The only chemical species responsible for these impacts is the ²²²radon emitted during the combustion of gas in the refinery's furnaces. ReCiPe and Impact 2002+ give results of the same order of magnitude, even though Impact 2002+ results are higher.

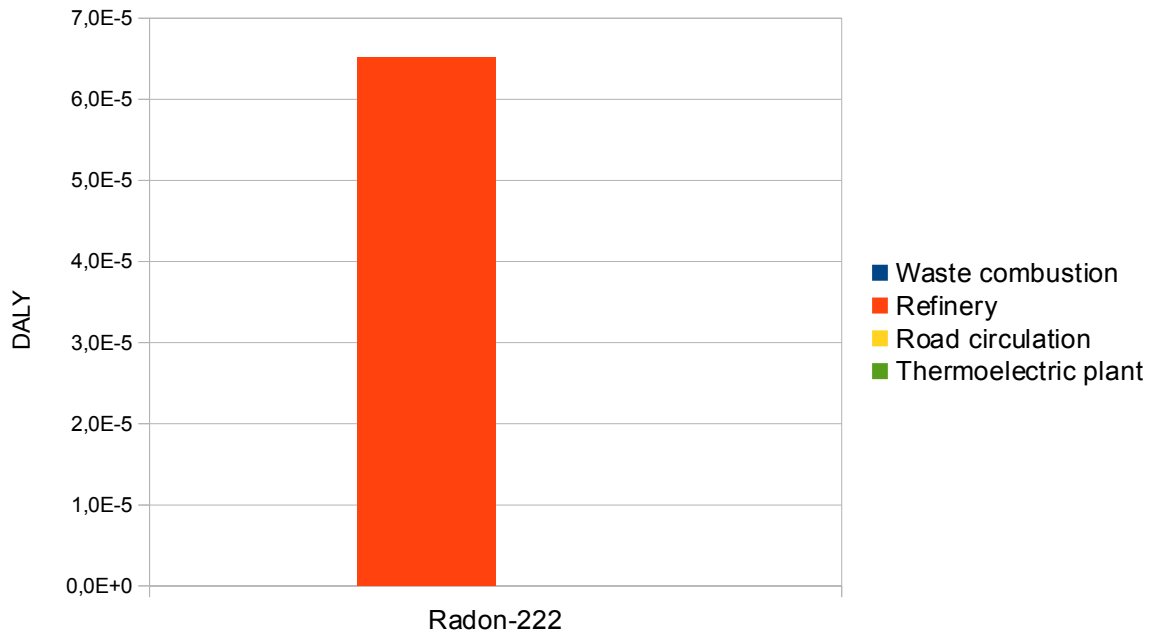

Figure 51: Damages from ionizing radiations according to Impact 2002+

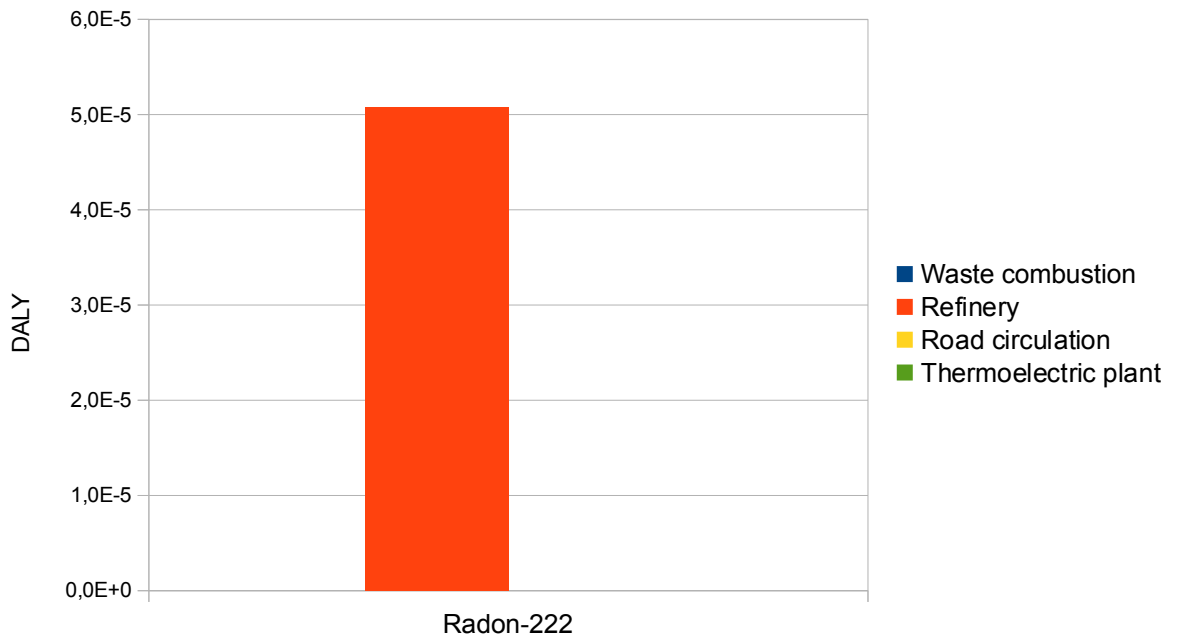

Figure 52: Damages from ionizing radiations according to ReCiPe

3.5.3 Total damages

The total damages are expressed in points, a dimensionless unit. By comparing Impact 2002+ results (Figure 53, Figure 54) with ReCiPe results (Figure 56, Figure 55, Figure 58, Figure 57), we can see that there is a difference in total results of two orders of magnitude. Both methodologies give a higher share to the global warming / climate change damages through emissions of carbon dioxide. Second and third come nitrogen oxides and sulfur dioxide, through respiratory inorganics / particulate matter formation impacts. The other impacting chemicals, and ways of impacts, are differently shared according to each calculation method.

Global-scale calculation

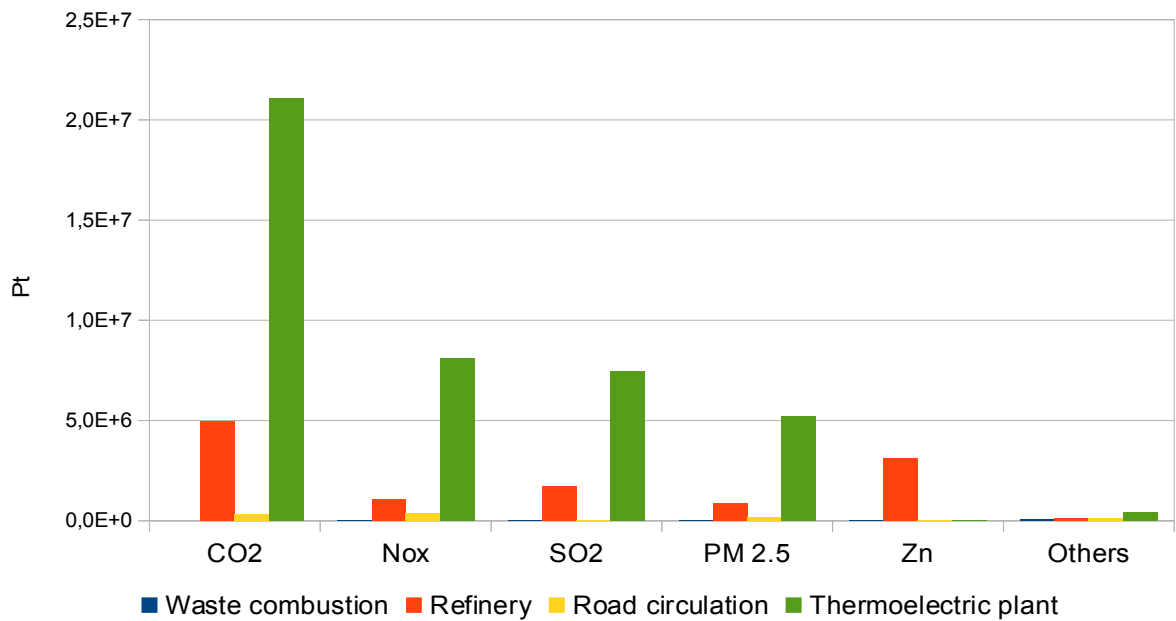

Figure 53: Single-score, per-substance damages according to Impact 2002+

According to the Impact 2002+ single-score results (Figure 53), the chemical causing the most overall impacts is the carbon dioxide (47.74% of total single-score result). Second come nitrogen oxides and sulfur dioxide with similar shares (respectively 17.30% and 16.68%). These three first species are released into the environment during the combustion processes of the thermoelectric plant. The others are the thin particulate matter (11.21%), also emitted mainly by the thermoelectric plant's furnaces, the zinc (5.71%) from the refinery's furnaces, and other chemicals (<1% per chemical).

The Life Cycle Assessment of the Milazzo Peninsula

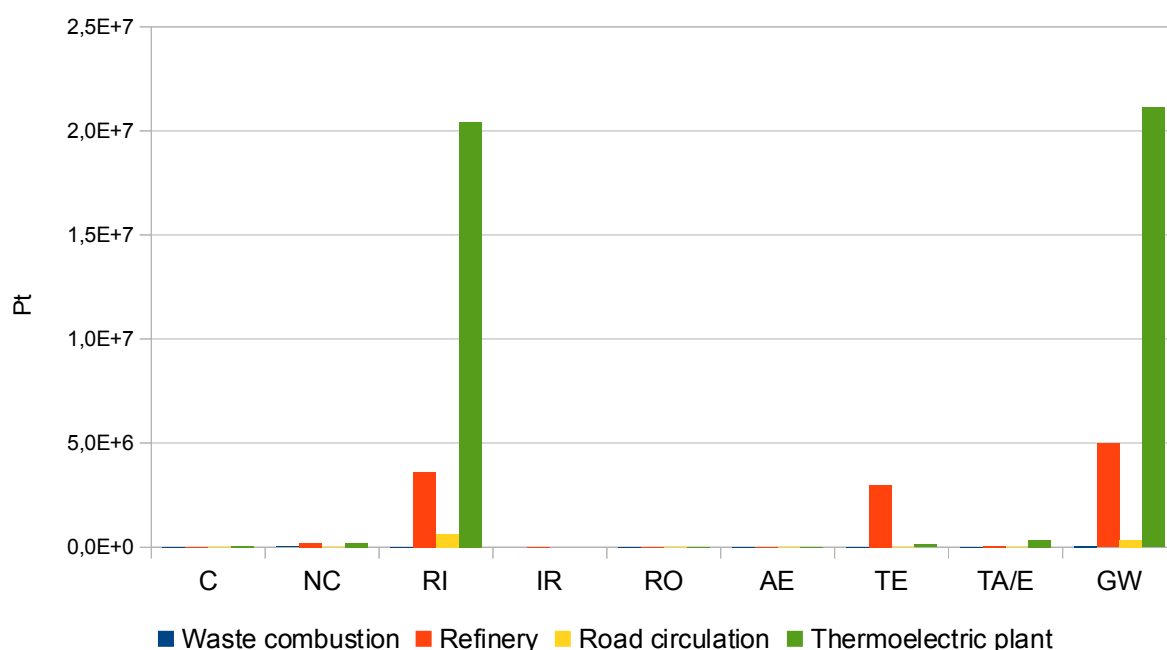

Figure 54: Single-score, per-impact damages according to Impact 2002+.

C: carcinogen

NC: non-carcinogen

RI: respiratory inorganic

IR: ironizing radiations

RO: respiratory organic

AE: aquatic ecotoxicity

TE: terrestrial ecotoxicity

TA/E: terrestrial acidification/eutrophication

GW: global warming

As for the shares of each impact category in the single-score results calculated with Impact 2002+ method (Figure 54), two categories have a similar, important share: global warming (47.96%) and respiratory inorganics (44.69%). The other categories of impacts damaging the human health have an individual share under 1%. As for the damages upon ecosystems, the main impact category is the terrestrial exotoxicity (5.63%). The impacts upon aquatic ecosystems and the acidification / eutrophication impacts are negligible in regard (<1% per impact category).

According to Impact 2002+ method (Figure 53, Figure 54), the anthropogenic activity causing the most damages is the thermoelectric plant (76.56%). The share of the refinery is small in comparison (21.48%), and so is the share of road circulation (1.80%) while the share of illegal combustion of domestic waste is negligible (0.16%).

Global-scale calculation

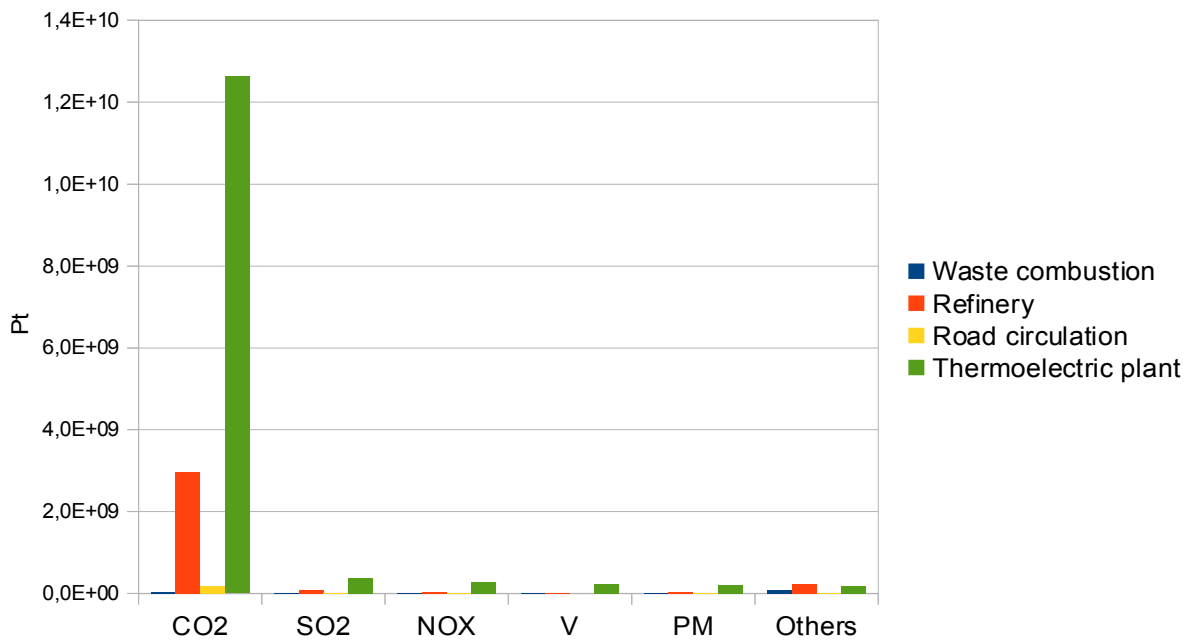

Figure 55: Single-score, per-substance damages according to ReCiPe

The results obtained with ReCiPe method (Figure 55), similarly to Impact 2002+ results (Figure 53), also give the highest share in total damages to the carbon dioxide (89.83%) but unlike Impact 2002+, the share according to ReCiPe is two times higher. Other chemicals have a similar share according to ReCiPe: sulfur dioxide (2.73%), nitrogen oxides (1.82%), vanadium (1.36%) and particulate matter, all diameters combined (1.42%). These shares are similar to those obtained with Impact 2002+ (Figure 53) save for the vanadium, which is absent in Impact 2002+ and zinc, which does not appear in the graphic according to ReCiPe. These emissions mainly come from the combustion processes of the thermoelectric plant, except for carbon dioxide, which is also released by the refinery's furnaces.

The Life Cycle Assessment of the Milazzo Peninsula

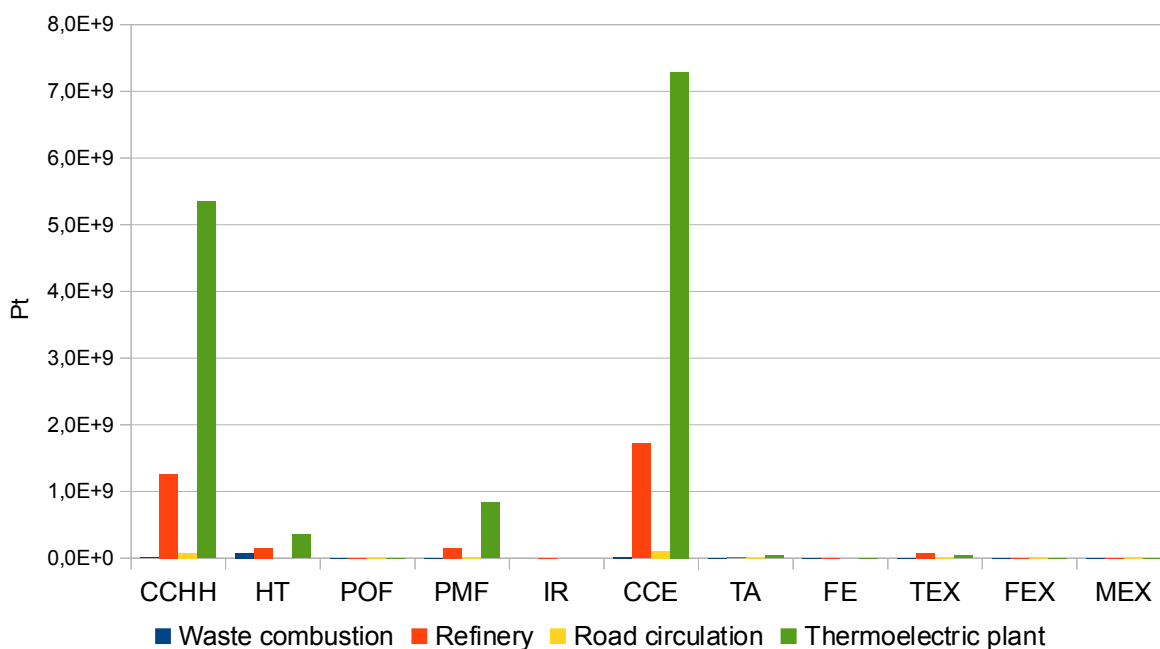

Figure 56: Single-score, per-impact damages according to ReCiPe

CCHH: climate change human health

HT: human toxicity

POF: photochemical oxidant formation

PMF: particulate matter formation

IR: ionizing radiations

CCE: climate change ecosystems

TA: terrestrial acidification

FE: freshwater eutrophication

TEX: terrestrial ecotoxicity

FEX: freshwater ecotoxicity

MEX: marine ecotoxicity

The shares of the different impact categories also share similarities between both calculation methods: both Impact 2002+ (Figure 54) and ReCiPe (Figure 56) give the highest share to the global warming/climate change (89.98% according to ReCiPe). Damages upon human health come second according to both Impact 2002+ and ReCiPe, with damages to the respiratory system for Impact 2002+, and human toxicity (3.39%) and particulate matter formation (5.72%) for ReCiPe. While terrestrial ecotoxicity had a relative important share according to Impact 2002+, it has a share under 1% according to ReCiPe, like all the other impact categories.

Even though the relative shares of the chemical species and impact categories are different between the two methodologies, the shares between the anthropogenic activities are similar. Just like Impact 2002+, ReCiPe gives the highest share to the thermolectric plant (79.01%), a smaller

Global-scale calculation

share to the refinery (19.14%), a very small share to the road circulation (1.25%) and a negligible share to the illegal combustion of domestic waste (0.06%).

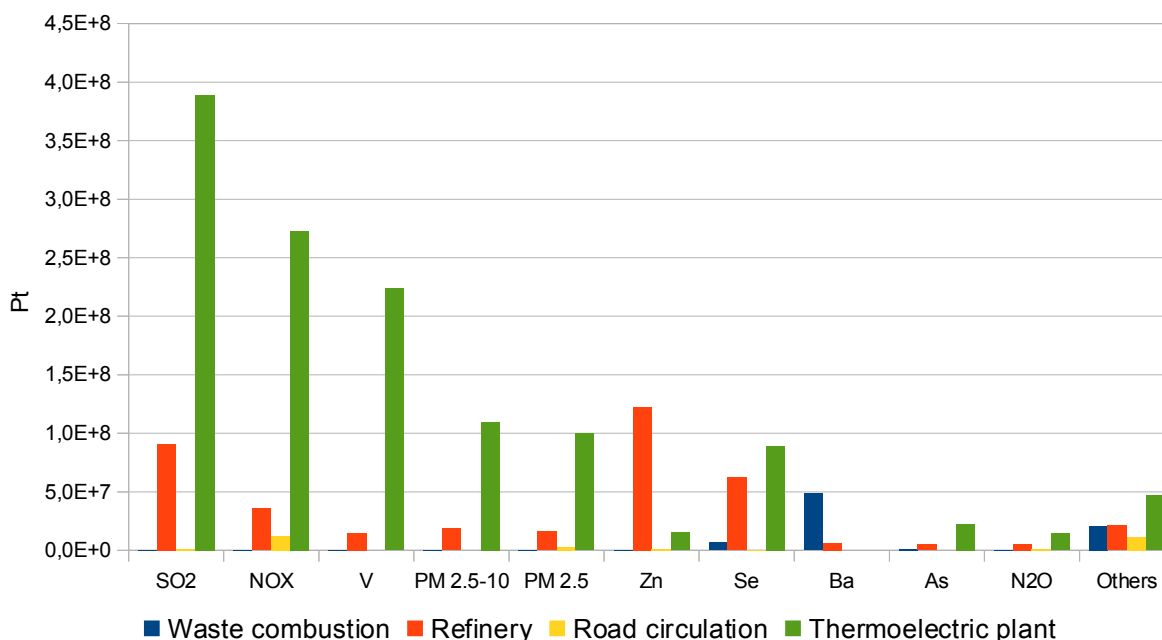

Figure 57: Single-score, per-substance damages according to ReCiPe; CO₂ not taken into account

If carbon dioxide is taken off the total single-score results, it is possible to have a better understanding of the shares of the other emissions according to ReCiPe (Figure 57). The main damaging chemicals are either inorganic (sulfur dioxide, nitrogen oxides, particulate matter) or metals and metalloids (vanadium, zinc, selenium, barium, arsenic). The individual shares of inorganic species are similar (26.85% for sulfur oxides, 17.93% for nitrogen oxides, and 13.79% for particulate matter, all diameters together).

The damages caused by trace elements are dominated by vanadium (13.34% of total damages), while selenium and zinc have similar shares (8.85% and 7.76% respectively). Barium and arsenic also have similar shares (3.07% and 1.61%).

All the inorganic chemicals are emitted in majority by the thermoelectric plant. The metals and metalloids are emitted principally by the thermoelectric plant, though zinc is emitted principally by the refinery, selenium, half by the refinery and half by the thermoelectric plant, while barium comes from the illegal combustion of domestic waste.

The Life Cycle Assessment of the Milazzo Peninsula

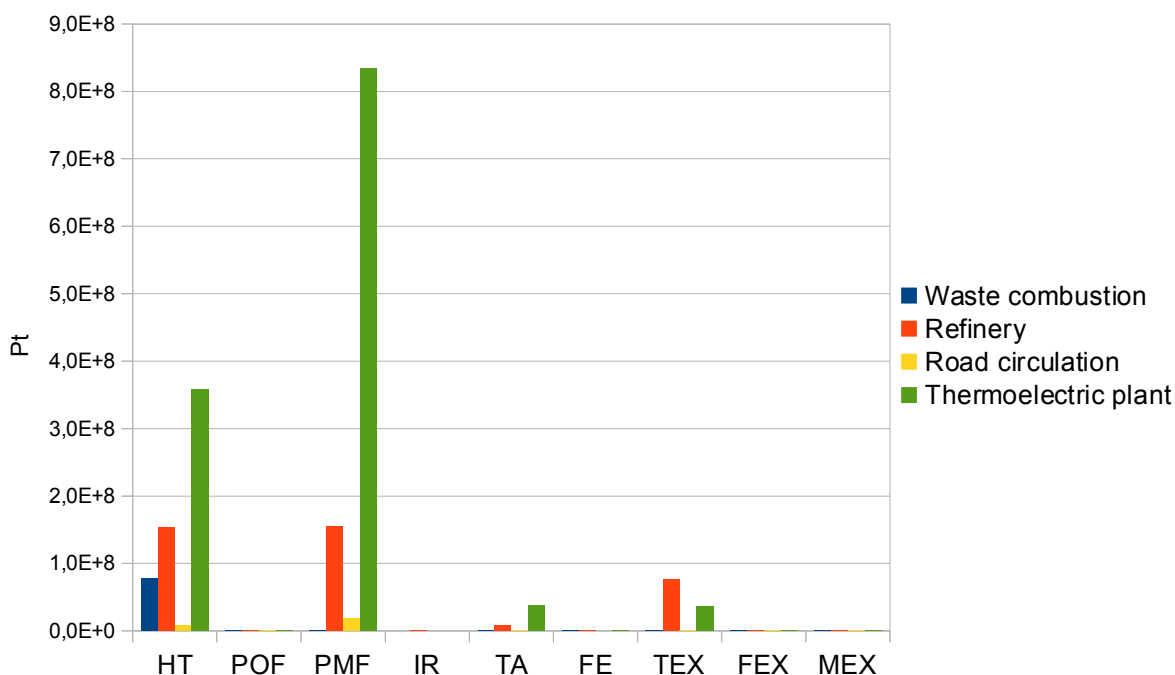

Figure 58: Single-score, per-impact damages according to ReCiPe; CO₂ not taken into account

HT: human toxicity

POF: photochemical oxidant formation

PMF: particulate matter formation

IR: ionizing radiations

TA: terrestrial acidification

FE: freshwater eutrophication

TEX: terrestrial ecotoxicity

FEX: freshwater ecotoxicity

MEX: marine ecotoxicity

Once the global warming damages are put aside, the other damages caused by the anthropogenic activities according to ReCiPe (Figure 58) show a net domination of damages to human health. These damages are done principally through particulate matter formation (57.12% of single-score damages without carbon dioxide's damages) and human toxicity (33.86%). The terrestrial (6.39%) and aquatic (2.57%) ecotoxicities are also of importance, while all the other impact categories are still negligible.

Particulate matter formation impacts are mainly done by the thermolectric plant while the refinery causes most terrestrial ecotoxic impacts. The human toxicity is shared between the thermolectric plant, the refinery and the illegal combustion of domestic waste while the aquatic ecotoxicity is caused in majority by the thermolectric plant.

Global-scale calculation

Regarding the total single-score results, the share of the different activities is still similar to all the previous results for the thermoelectric plant (71.78%) and the refinery (22.18%). But on the contrary to the previous conclusions, the share of the illegal combustion of domestic waste appears to be more important (4.40%) than the share of the road circulation (1.63%) and to be done mainly through the mean of human toxicity.

3.5.4 Conclusions

The study of the considered anthropogenic activities of the Milazzo Peninsula and their impacts and damages showed the different shares of each activity and each emission in the different impact categories. The thermoelectric plant is the most damaging activity, though none of the four studied activities can be seen as negligible in comparison.

Global warming / climate change impacts through the emission of carbon dioxide is a damage caused worldwide, and the most important of all according to the present study.

Focusing on local-range impacts and damages, we can see that the damages on human health are more important than the ecotoxic damages. The most important share of these damages is done to the respiratory system through emissions of inorganic chemicals, principally emitted by the combustion processes of the thermoelectric plant. These chemicals (sulfur dioxide, nitrogen oxides, particulate matter) cause an irritation of the lungs, a diminution of the respiratory capacity, and even cancer.

The other toxic impacts on human health are done through the emissions of vanadium by the thermoelectric plant, other metals and metalloids released by both the refinery and the thermoelectric plant, while the illegal combustion of domestic waste is responsible for cadmium emissions. Vanadium, emitted by the thermoelectric plant is highly toxic for humans, specially if absorbed orally (general inflammation and nerve cells damages). The zinc, released principally by the refinery, affects the digestive system. Selenium is emitted by both refinery and thermoelectric plant, and it is a toxic for the muscles, skin and eyes. The thermoelectric plant releases enough arsenic to cause important damages by its toxicity to the general human organism. The illegal combustion of domestic waste releases barium, which is also a general toxic.

Translation into single-score indicator left apart, the chemical being the most toxic for the human health is, many orders of magnitude above all the other chemicals (effect calculated in DALY), the cadmium, through its carcinogen effects. This metal comes from the illegal combustion of domestic waste.

Regarding the ecotoxic damages, the environmental compartment that is impacted the most is the terrestrial one. Each calculation method gives a different cause to this toxicity: according to Impact 2002+ (which does not take vanadium into account) it is because of the refinery's emissions while ReCiPe (which takes vanadium into account) gives similar shares to both the refinery and the

Global-scale calculation

thermoelectric plant. The toxic elements affecting this compartment are the zinc from the refinery, and the vanadium from the thermoelectric plant. These metals affect the environment through the diminution of the floral biodiversity, the soil activity (death of the soil microorganisms), and neurological, respiratory and reproducing failures in more complex, animal organisms.

4 Site-specific characterization

4.1 Introduction

In this part we are interested in a more regional-specific analysis. As previously explained in chapter 2.2 page 27 “Impact Assessment Methodology”, LCA results are generally estimated at a worldwide scale, and the generic characterization factors are well adapted to evaluate global impacts, such as global warming and ozone layer depletion (Rochat et al., 2006). There may be however discrepancies between the impacts calculated with global-scale characterization factors, and the on-site observed impact when assessing impact categories that are not global in nature such as acidification, eutrophication, toxicity, etc. (Potting & Hauschild, 1997a and b). Although site-dependent LCIA seems more suitable in some cases than the global approach, only few studies report on the use of site-dependent characterization factors. One can mention for example Finnveden and Nilsson who showed that country level is not the appropriate level for site-dependent characterization factors for health impacts (Finnveden & Nilsson, 2005), and Ghazi and Ghazi et al. who showed that site specific LCIA for an oil drilling mud system enables to assess terrestrial and human ecotoxicity more effectively (Ghazi, 2009; Ghazi et al., 2011).

Indeed, the local scale characterization depends a lot on the characteristics of the receiving area (target, compartment of emission). Therefore, to increase the relevance of LCIA results on a specific region, site-dependent factors were calculated for the small-scale impacts. In the following parts we will focus on 1) the terrestrial ecotoxicity, and particularly impacts on Milazzo peninsula soils, and 2) the aquatic ecotoxicity, and particularly impacts on the Milazzo peninsula costal sea water. The considered pollutant substances are heavy metals and metalloids.

The methodology for Life Cycle Impact Assessment (LCIA) at local scale is given in paragraph 2.2.3 page 35 “Site-specific evaluation methodology”. The calculation of site-dependent parameters for toxic impacts assessment on terrestrial as well as aquatic ecosystems, are made using LCIA basic equations (Ciroth et al., 2003) which are the following:

$$CI_c = \sum_n FC_n \cdot LCI_n$$

$$\text{with } FC_n = FF_n \cdot EF_n$$

where CI is the Category Indicator; (c) is a category; FC is the Factor of Characterization; LCI is the result found in the List of Classified Inventory; FF is the Fate Factor; EF is the Effect factor; (n) is a substance.

The Life Cycle Assessment of the Milazzo Peninsula

The main difference between global and local scale treatment is in the determination of characterization factors (FC) based on site specific fate factors (FF) for each considered pollutant, and effect factors (EF) specific of the local compartment characteristics.

FF calculations are based on the specific bio-available fractions (F_n^s) and residence times (θ_n^s) of the considered substances (s) in the considered compartment n (soils or sea water) and are expressed as (Jolliet et al., 2003):

$$FF_n^s = F_n^s \cdot \theta_n^s$$

where F is, for the metals and metalloids, the bioavailable fraction of substance; θ is the residence time in years; (n) is a substance; (s) is the compartment.

The residence time of a substance in a compartment is calculated as follows (Jolliet et al., 2003):

$$\theta_n^s = \frac{\Delta C_n \cdot V \cdot \Delta t}{M_n}$$

where ΔC is the change of concentration of a substance in the compartment; V is the volume of the compartment into which the substance is emitted; Δt is the time during which the change of concentration occurs; M is the mass of substance emitted during that time of observation.

Ef is expressed as (Jolliet et al., 2003):

$$EF_n = \frac{0,5}{HC50_n^s}$$

where HC50 is the the concentration of substance affecting 50% of the species. When not directly available for the soil compartment, it can be calculated after the HC50 in the water compartment using the following equation (Jolliet et al., 2003):

$$HC50_n^s = HC50_n^w (Kd_n^s \cdot \rho^s + fw)$$

where Kd is the partition coefficient of a chemical between the soil and the water; ρ is the density; fw is the fraction of water in the soil; (s) is the soil compartment; (w) is the water compartment.

4.2 Site specific geochemical data

Soil, seawater and freshwater samples have been collected in the site of study. The situation of these samples is given by Figure 59 hereafter.

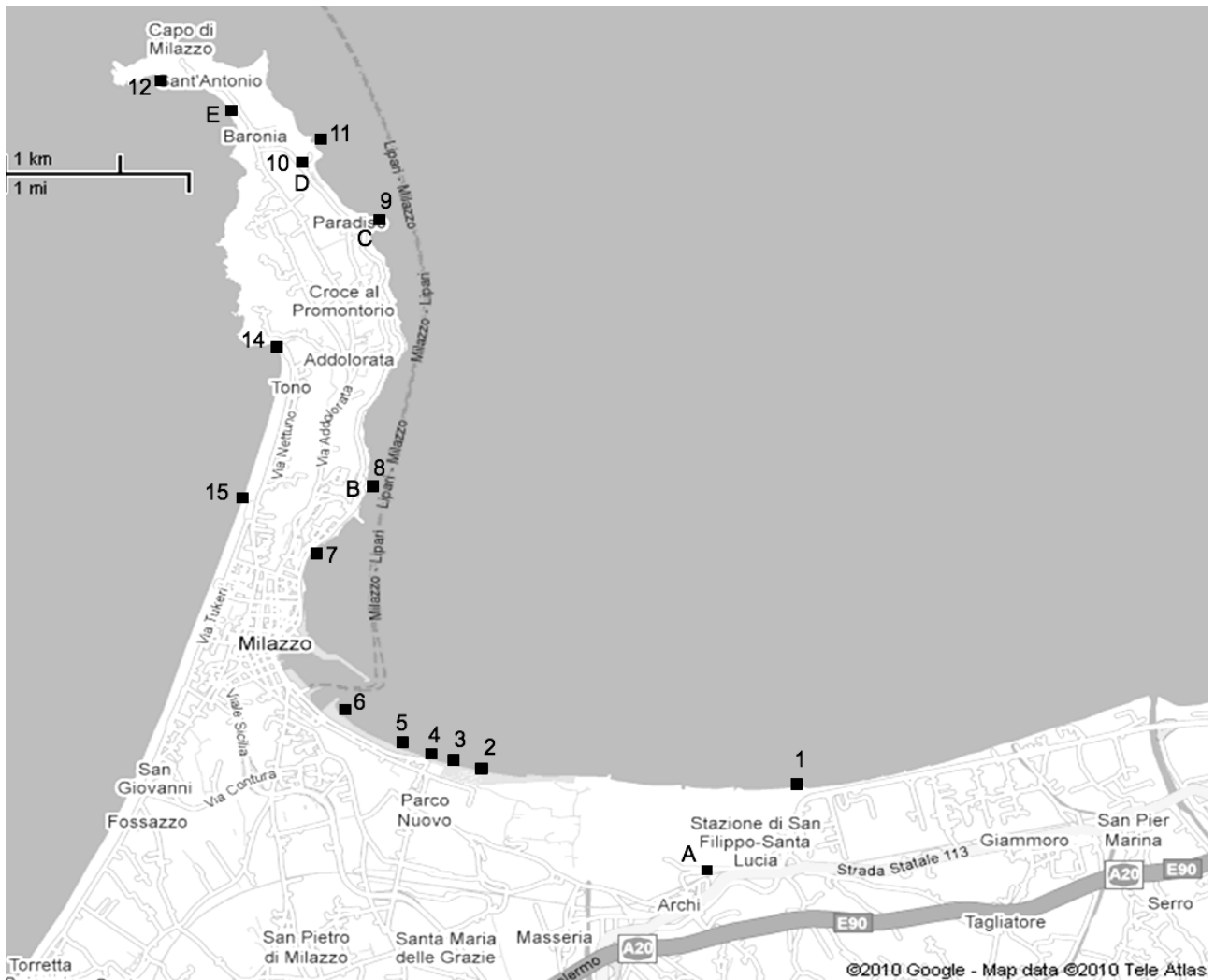

Figure 59: Map displaying the situation of the sampling points. Water samples are given numbers while soil samples are given letters.

The trace elements that were analyzed in the water and soil samples can have different origins, natural or anthropogenic, gathered in Table 21 hereafter.

The Life Cycle Assessment of the Milazzo Peninsula

Element	To the air + deposited on soil and seawater	To the seawater
As	Thermoelectric plant	Thermoelectric plant
Cd	Refinery	Boats, refinery
Co	Thermoelectric plant	Thermoelectric plant
Cr	Thermoelectric plant	Boats, thermoelectric plant, refinery
Cu	Refinery	Boats, waste combustion
Hg	Thermoelectric plant	Thermoelectric plant
Mn	Thermoelectric plant	Boats, waste combustion
Mo	Thermoelectric plant	Thermoelectric plant
Ni	Thermoelectric plant	Thermoelectric plant, waste combustion
Pb	Road traffic, refinery	Boats, waste combustion, refinery
Se	Thermoelectric plant	Thermoelectric plant, refinery
V	Thermoelectric plant	Boats, thermoelectric plant
Zn	Refinery	Boats, refinery, waste combustion
Fe	Thermoelectric plant	Thermoelectric plant, boats, refinery, waste combustion
Al	Waste combustion	Boats, refinery, waste combustion

Table 21: Main possible sources of trace elements emissions in the Milazzo area, per compartment

4.2.1 Water analyses results

In this paragraph we are interested in the results from the freshwater and the seawater analyses.

Freshwater

The concentration in trace elements of the fresh waters varies according to their provenance (Figure 60).

Site-specific calculations

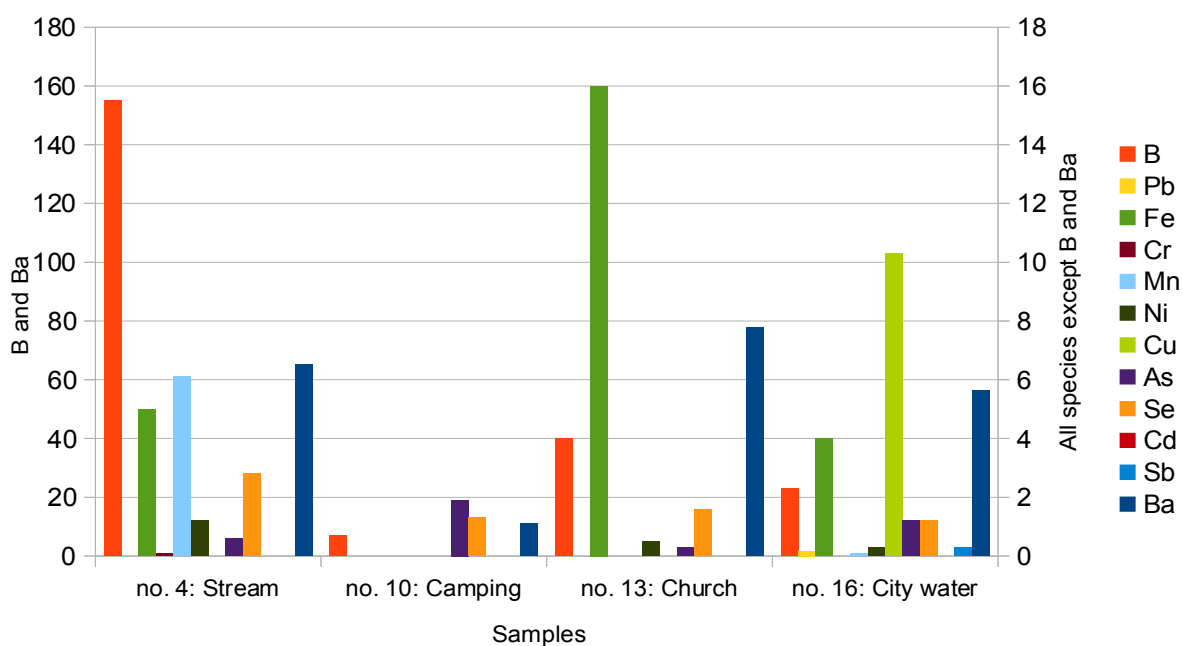

Figure 60: Chemical Analyses results for freshwater samples, June 2011, in µg/L

According to Table 22 hereafter, none of the freshwaters of the Milazzo Peninsula are polluted with the analyzed trace elements.

Element	Sample 4	Sample 10	Sample 13	Sample 16	EU guideline for drinkable water
B	155	7	40	23	1 000
Pb	<0.05	<0.05	<1	0.17	10
Fe	5	<3	16	4	200
Cr	0.08	<0.05	<0.05	<0.05	50
Mn	6.1	<0.01	<0.01	0.1	50
Ni	1.2	<0.01	0.5	0.3	20
Cu	<0.04	<0.04	<0.04	10.3	2 000
As	0.6	1.9	0.3	1.2	10
Se	2.8	1.3	1.6	1.2	10
Cd	<0.002	<0.002	<0.002	<0.002	5
Sb	<0.06	<0.06	<0.06	0.3	5
Ba	65.2	11.1	77.9	56.2	300

Table 22: Chemical analyses results in freshwater samples, in µg/L, compared to the European guidelines for drinkable water (Council Directive 98/83/CE)

The water from the fountain next to the camping area contains very low concentrations of elements, showing that it comes from an unpolluted spring.

The Life Cycle Assessment of the Milazzo Peninsula

The water from the city is loaded with copper, tracing its way through copper tubes before distribution to the inhabitants.

The iron found in the church fountain's water is probably a signature of its origins from the Peloritani Mounts (Rivaro et al., 1998), as do the barium and bore. The church fountain's water is loaded with more elements than the camping fountain's, translating a different and farthest origin.

Marine water

The Milazzo Peninsula is subject to West-East sea currents; in the gulf, the currents turn clockwise (A. Messina, personal communication). These parameters play an important role in the distribution of trace elements in Milazzo's seawaters. The sea water geochemistry may thus reflect the influence of the Eolian Islands' volcanic inputs.

Because of its higher and more intense evaporation, the Mediterranean Sea displays average concentrations in elements that is higher than in the oceanic waters. Table 23 reports the concentration for some elements in the North Atlantic Ocean and in the Mediterranean Sea and illustrates this peculiarity. Despite the important differences in chemistry between the different Mediterranean sub-basins, it can be seen that as a whole, the Mediterranean Sea can be up to twenty times more concentrated in heavy metals than oceanic water.

Element	Oceanic water	Mediterranean Sea water
Mn	0.165 µg/L	0.060-17.36 µg/L
Fe	0.140 µg/L	0.0726-43.73 µg/L
Ni	0.700 µg/L	0.10-228.90 µg/L
Cu	0.380 µg/L	0.063-6.74 µg/L
Cd	0.117-0.124 µg/L	$3.98 \cdot 10^{-5}$ -11.02 µg/L
Pb	0.036 µg/L	0.018-24 µg/L
Hg	0.002 µg/L	0.005-0.017 µg/L
Zn	0.590 µg/L	0.33359-38.22 µg/L
B	4 400-4 500 µg/L	
As	1.8 µg/L	26 µg/L
V	1.19-1.78 µg/L	Lower (no concentration found)
Se	0.18 µg/L	
Sb	0.0026-0.146 µg/L	
Cr	0.0004-0.26 µg/L	0.060 µg/L
Ba	210 µg/L	10 µg/L
Co	0.006 µg/L	0.004-0.020 µg/L

Table 23: Comparison of trace elements concentrations between oceanic water (Holmes-Farley, 2010; Wilde, 2010) and the Mediterranean Sea (Okbah & Nasr, 2006; Faragallah et al., 2009; Yoon et al., 1999; Breder, 1987; La Pera et al., 2008; Sherrel & Boyle, 1988; Bernat et al., 1972; Voutsinou-Taliadouri et al., 1997; Morley et al., 1997)

Site-specific calculations

These literature data will now be compared to the analyses results.

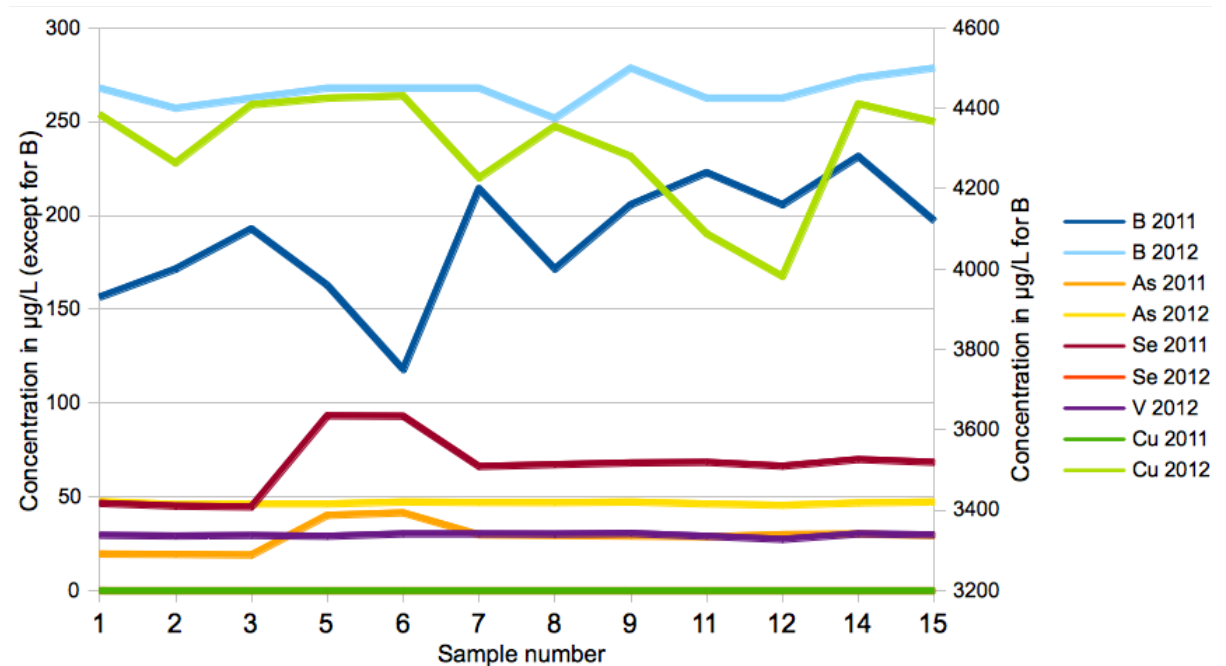

Figure 61: Results of chemical analyses in seawater for June 2011 and February 2012

As we can see in Figure 61, some of the studied trace elements (lead, iron, chromium, manganese, nickel, cadmium, antimony, barium, mercury) show concentrations in the Milazzo Peninsula seawaters too low to be detectable. The metals and metalloids that were detected are: boron, arsenic, selenium, vanadium and copper.

*Boron

Boron shows high concentrations in a range between 3750 and 4500 µg/L. These concentrations are lower in summer than in winter, with a winter concentration distribution more homogeneous all around the peninsula. The higher concentrations in winter may be explained by the higher amounts of precipitations in winter, washing down the soils and carrying into the sea the metals and metalloids adsorbed on particulate matter deposited throughout the year.

Boron's average concentration in seawater (see Table 23) ranges from 4400 µg/L (Wilde, 2010) to 4500 µg/L (Holmes-Farley, 2010). Therefore the present results do not show any pollution by boron.

***Arsenic**

As for boron, arsenic displays lower concentrations in summer than in winter, with a peak in summer at sampling points number 5 and 6. This peak corresponds to the area of sanding and blasting of the boats' paint, translating a local pollution during the period of the year most suitable to such outdoor activities.

The difference in concentrations between the two seasons may come from the washing of the soils during winter rainfall.

Usually, arsenic can be found, in the Tyrrhenian Sea, at concentrations up to 26 µg/L (La Pera et al., 2008) while our samples show a concentration twice as high in winter in the area of Milazzo. Therefore we face a seasonal pollution by arsenic in the area of Milazzo.

***Vanadium**

Vanadium was analyzed only during the winter sampling campaign. Just like arsenic during the same season, its level is the same in all sampled points, translating no local pollution but either a global-scale, homogeneous pollution of the area or the global level of vanadium in Mediterranean seawater.

This observed homogeneous concentration is one order of magnitude higher than the oceanic range of vanadium concentration, which is 1.19 µg/L to 1.78 µg/L (Holmes-Farley, 2010) while previous studies showed that vanadium is present in the Mediterranean Sea at a concentration level lower than the other oceans (Sherrel & Boyle, 1988).

Therefore, we are in the presence of a homogeneous, local pollution of the seawater by vanadium.

***Selenium**

Selenium displays a behavior similar to arsenic's in the summer while it was not detected in my winter samples.

The explanation of selenium's peak next to the sanding and blasting area as for arsenic, is the release of this metal from the boats' paint into the seawater (see Table 21). The difference between the summer and winter concentrations comes from the seasonality of the sanding and

Site-specific calculations

blasting activity, occurring in summer only, together with a short residence time in the seawater around the Milazzo Peninsula.

The average concentration of selenium in seawater is 0.18 µg/L (Holmes-Farley, 2010); this means that the Milazzo Peninsula is subject to a pollution by selenium, at least in summer which is the maintenance season for the ships.

*Copper

We can see that while the concentration of copper was too low to be detected during the summer campaign, it displayed many peaks of concentration in the samples taken during winter. According to the literature, the natural concentration of copper in Mediterranean seawater ranges from 2 µg/L to 6.74 µg/L (Faragallah et al., 2009). The high concentrations found in my samples show a local pollution by copper during the winter season.

The fact that the peaks appear next to the anthropogenic domestic settlements may be linked to the presence of humans, but not to the presence of industrial activities (no peak next to the refinery and thermoelectric plant, no peak in front of the sanding and blasting area). The distribution of copper concentration in the seawater around the Milazzo peninsula leads to thinking it comes from the discharge of domestic wastewater into the sea, because the domestic water from the city is also loaded with copper (Figure 60 page 127). But the comparison between the two different types of water shows a concentration of copper in seawater twenty times higher than compared to freshwater. Also, despite a higher concentration of people in the area during the summer (tourism activities) and a higher rate of evaporation from the waters, the concentration during summer is two orders of magnitude lower than during winter. This difference cannot be explained by the higher solubility of copper in cool water than in warm water.

In conclusion, there is no clear explanation for the huge difference in the concentration of copper between summer and winter.

*Other chemicals

The concentrations in mercury, antimony, cadmium, nickel, chromium, lead and iron recorded during the summer and winter campaigns are low (Figure 61), the average value being in the range of natural concentrations of these elements in seawater according to the literature (Table 23). It shows that there is no detectable pollution by these elements in Milazzo peninsula seawater.

Barium concentrations were under 2 µg/L in summer and under 0.3 µg/L in winter. This is completely out of the range of natural barium concentrations in seawater: from 10 µg/L in surface Mediterranean water (Bernat et al., 1972) to 210 µg/L in oceans (Holmes-Farley, 2010). For manganese as well, the recorded concentrations are very low (below 2 µg/L in winter and below 0.2 µg/L in summer) compared to literature data for Mediterranean coastal water (Table 23). These data are questionable and probably related to analytical problems.

4.2.2 Soil analyses results

For each soil sampling point, two replicas, numbered 1 and 2, were collected. These samples are split into surface samples (s) corresponding to the first 20 cm, and depth samples (p) corresponding to the 20-40 cm deep layer. Therefore, a sample named e.g. Dp2 corresponds to the sampling point D, 20-40 cm deep layer, second replica.

Collecting the deep part of the sample was not always possible, therefore, a “p” sample is not always present for each “s” sample.

Analyses results

Particle size analyses show that Milazzo peninsula soils are dominantly sandy with a percentage of sand ranging from 79% to 91%; lime and clay represent on average respectively 12% and 4% of the particle sizes. The mineralogical analyses indicate that quartz is dominant, followed by feldspars or calcite depending on the soil, and minor minerals such as amphiboles and phyllosilicates. Moreover, carbonate content obtained by volumetric calcimetry ranges between 1% and 10%.

The total concentration of trace elements was analyzed in surface and deeper soil samples. The concentrations distribution is illustrated in Figure 62.

Let us keep in mind that the soil from the sample A comes from a median strip in the road and therefore is assumed to be of exogenous origins.

Site-specific calculations

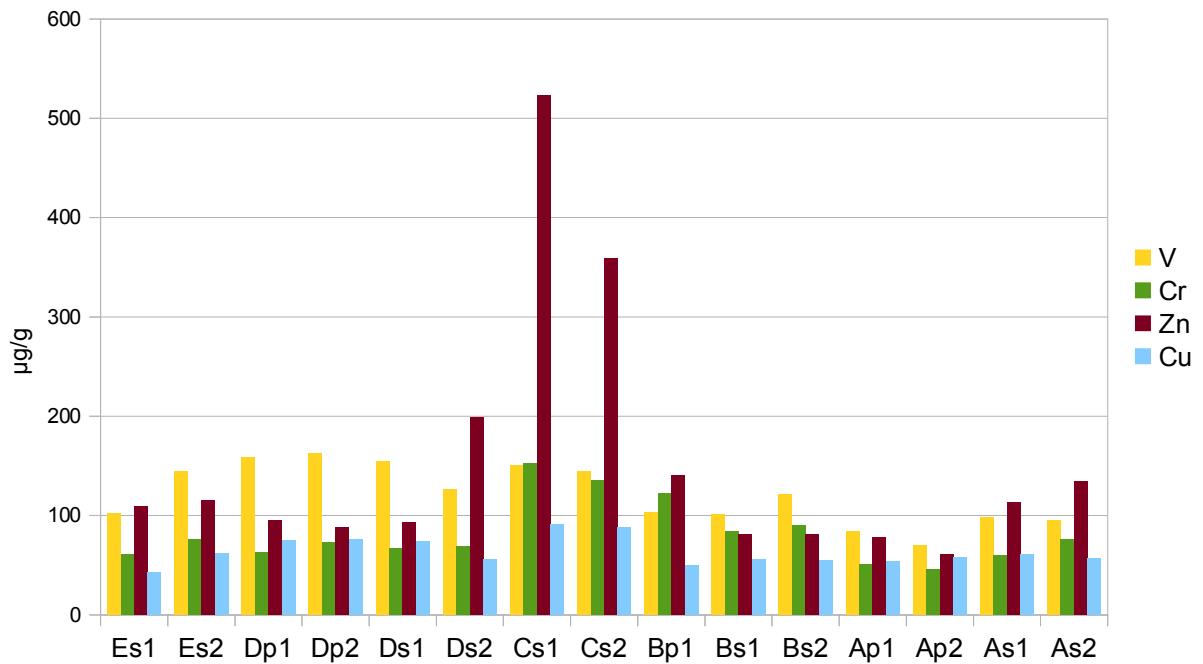

a) Concentrations of V, Cr, Zn, and Cu

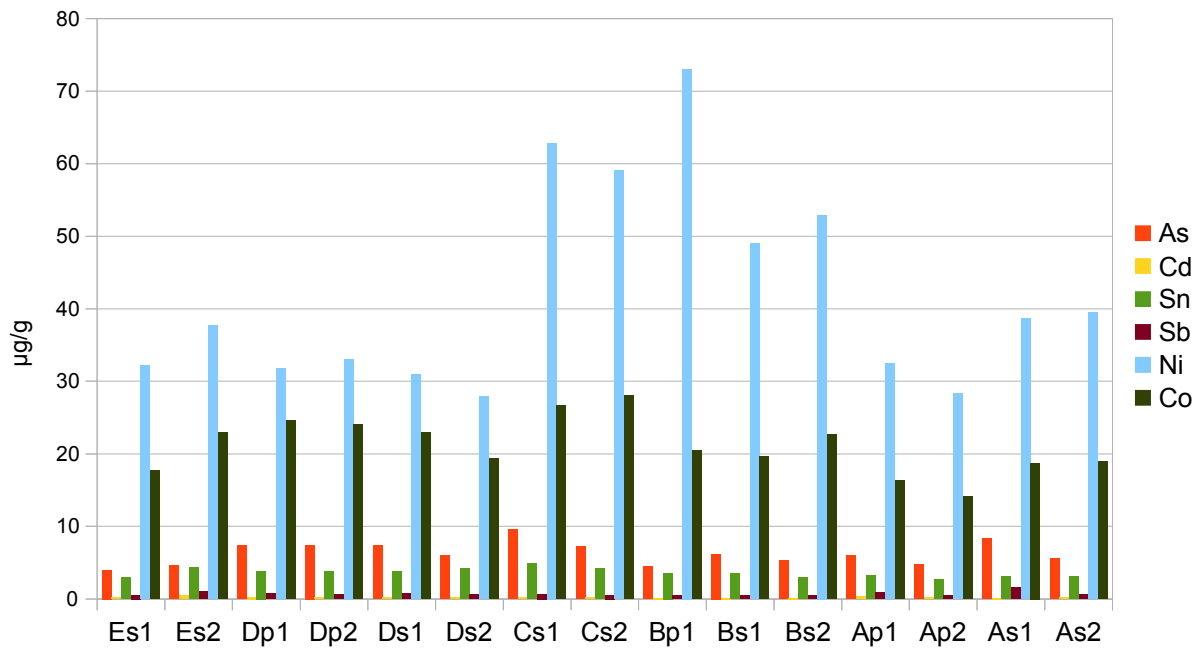

b) Concentrations of As, Cd, Sn, Sb, Ni, and Co

Figure 62: Comparison of trace elements contents (expressed in µg/g) in the different studied soils of Milazzo peninsula at surface and depth (20cm)

The Life Cycle Assessment of the Milazzo Peninsula

The decreasing order in average trace elements contents in Milazzo soils is the following: zinc, vanadium, chromium, copper, nickel, cobalt, arsenic, tin, antimony, cadmium.

From Figure 62 one can notice that the highest contents in Zn are encountered in soils from C site (near coastal road and illegal domestic waste combustion site) as well as in surface soils at D (near coastal road) and A sites (Milazzo city). On the contrary, vanadium contents show the highest values in soils far from Milazzo city. Chromium and Nickel show similar trends with the highest contents in C, B and A soils which are near or inside Milazzo industrial sites. Copper and arsenic contents are the highest in C soils followed by D and A soils. Sn shows also the highest contents in C and E sites whereas antimony content is the highest in A soils.

In order to investigate if these trace elements contents may be related to contamination it is necessary to determine the soil enrichment and calculate enrichment factors.

Enrichment factors

The calculation of enrichment factors (EF) enables to estimate trace elements enrichment or impoverishment in sediments or soils and thus to investigate the contamination levels of these media. It is based on normalisation of the element concentration in the sample to the concentration in a reference material, which is generally the average continental crust, and by considering a geochemical marker of the dominant natural mineralogical phase (Szefer et al., 1998). Furthermore, its variation coefficient must be low. Reference elements like aluminium, beryllium, brome, iron, manganese, zirconium, titanium, thorium and scandium have been considered in previous studies (Nesbitt, 1979; Middelburg et al., 1988; Hill et al., 2000; Ma et al., 2007).

The enrichment factor (EF) is calculated according to the following equation:

$$EF = \frac{\left(\frac{CX_{sample}}{CR_{sample}}\right)}{\left(\frac{CX_{ref}}{CR_{ref}}\right)}$$

where: CX is the concentration of the element of interest; CR is the conservative element; (sample) is the studied sample; (ref) is the reference material.

In this study, enrichment factors in Milazzo soils were calculated using thorium as conservative element, and three different reference materials: a global reference, the continental crust (Taylor & McLennan), rocks from the Peloritoni mounts (Frezza et al., 2004), and limestone

Site-specific calculations

under *Terra Rossa* (Palumbo et al., 2000) which constitute the local background and which were most probably contributing to the geochemistry of soils during their formation.

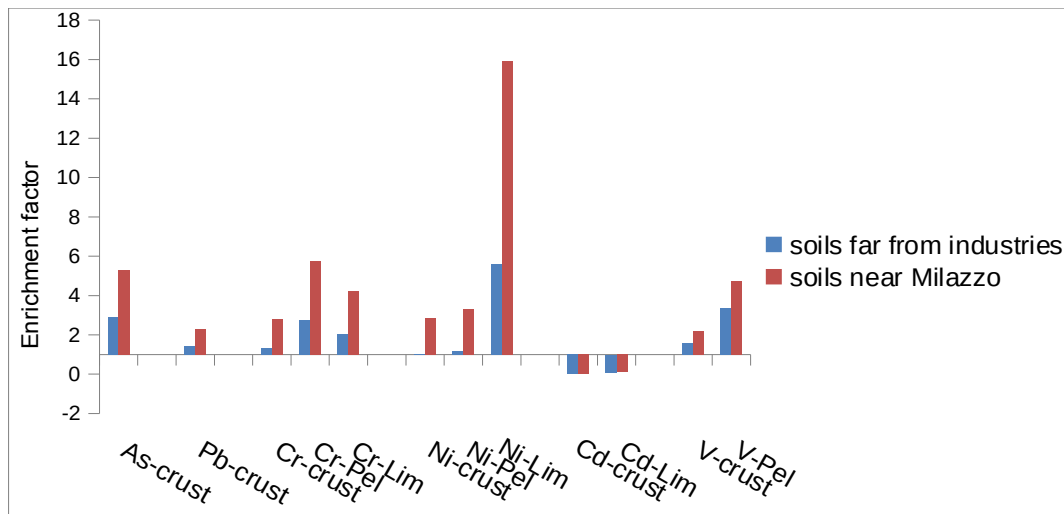

Figure 63: Average enrichment factor for Milazzo peninsula soils near industrial sites and 10 km away from them. Normalization to continental crust (crust), rocks from Peloritani Mounts (Pel) and limestone (Lim).

Figure 63 illustrates the differences in average enrichment factor for soils around Milazzo industries, and soils 10 km away from them.

The calculation results show that whatever the reference material, there is an enrichment in arsenic, nickel, chromium, vanadium and lead, and impoverishment in cadmium in both soil sites. Enrichment is noticeable even in soils at some distance from the pollutant emission sources. However, enrichment is significantly much stronger in soils near Milazzo industries than far from them. Nickel is the most enriched followed in decreasing order by chromium, vanadium, arsenic and lead.

Geochemical background used in site specific impact assessment

The total concentration of metals and metalloids in the gathered soil samples was compared to the geochemical background as found in the literature. This geochemical background was drawn from different literature sources displaying similar climate, soil texture and bedrock, for lack of unpolluted soils in the area of Milazzo. In most cases, literature geochemical data are incomplete. Therefore more than one data source was used to have a complete geochemical background data set (Table 24). For example cadmium and manganese background concentrations are taken from Bellanca et al. (1996) who analyzed *Terra Rossa* soils (NW Sicily). It is an average of concentrations recorded in the 50 cm top soil, with a sandy-clayey texture. For cobalt, chromium,

The Life Cycle Assessment of the Milazzo Peninsula

copper, nickel, lead, and zinc, background concentrations come from analyses obtained on south-western Spain sandy soils samples over a carbonated bedrock (Galán et al., 2008).

The molybdenum, selenium and vanadium background concentrations are averages over the Europe taken from from Alloway (1995).

For iron and aluminium background concentrations are averaged over the whole Italy for the soil horizons A and B (Bini et al., 1988), and for arsenic and mercury they were taken from a previous study done in the area of Milazzo (Agenda 21 Milazzo, 2009).

Elements	Geochemical background [mg/kg dry weight]	References
Arsenic	6	Agenda 21 Milazzo, 2009
Cadmium	0.09	Bellanca et al., 1996
Cobalt	15.91	Galán et al., 2008
Chromium	71.64	Galán et al., 2008
Copper	48.63	Galán et al., 2008
Mercury	0.06	Agenda 21 Milazzo, 2009
Molybdenum	1.5	Alloway, 1995
Manganese	507	Bellanca et al., 1996
Nickel	40.06	Galán et al., 2008
Lead	74.87	Galán et al., 2008
Selenium	0.02	Alloway, 1995
Vanadium	18.4	Alloway, 1995
Zinc	144.8	Galán et al., 2008
Iron	36200	Bini et al., 1988
Aluminium	55550	Bini et al., 1988

Table 24: Trace elements background contents in soils taken from the literature

4.3 Site-specific characterization of the soil ecotoxicity

Global scale analysis has shown that emissions to the air are by far the most important releases. There are no pollutant emitted directly towards the soil in the area of Milazzo. In fact, they are emitted to the air and fall down to the soil afterwards.

A part of emissions to the air consist of particulate matter which may travel several kilometers away from the emission point before settling on the ground or sea.

In order to assess the impacts of heavy metals and metalloids emitted by anthropogenic activities in Milazzo peninsula ecosystems, the first step is to determine the activities' impact area. This means to determine how far the releases may have been transported before deposition on soil or sea water.

4.3.1 Fraction of air-emitted chemicals falling down towards the soil

The fraction of air-emitted pollutants that ends in the soil depends on the direction of the wind and other climatic conditions. According to Cellura et al. the winds' speed in the Milazzo peninsula region are very low (1 m/s) which is in favor of a short transport distance of particles (Cellura et al., 2008a and b). The fraction was estimated using a soil deposition map of air-emitted particulate matter originating from the refinery and the thermoelectric plant (ENEA, 2003).

The deposition areas are approximated to simple geometric shapes and weighted according to the average yearly concentration of deposited particulates. The calculations details are displayed in Table 25. The final result is that 57.97% of the particulate matter emitted to the air by the refinery and the thermoelectric plant are soil deposited. The same fraction is assumed for the road traffic and waste combustion emissions.

Particulate deposition concentrations	Deposition surface area	
	on soil	in seawater
2.5 mg/m ²	207.64•10 ⁶ m ²	312.10•10 ⁶ m ²
7.5 mg/m ²	178.04•10 ⁶ m ²	127.27•10 ⁶ m ²
12.5 mg/m ²	76.38•10 ⁶ m ²	39.03•10 ⁶ m ²
17.5 mg/m ²	25.39•10 ⁶ m ²	14.26•10 ⁶ m ²
30 mg/m ²	5.22•10 ⁶ m ²	0.00•10 ⁶ m ²
Total deposition mass	3 410.07 kg	2 472.22 kg

Table 25: Calculation of the deposition surface areas and particulate matter mass in the zone of Milazzo (ENEA, 2003)

Moreover, on the base of the data from ENEA (2003) the considered area was defined by a circle around the refinery and thermoelectric plant, with a diameter of 35.42 km for a surface of $985.34 \cdot 10^6 \text{ m}^2$. The volume of soil affected by the emissions (V) was approximated considering an average depth of 30 cm over the total affected soil area.

4.3.2 Residence time

The residence time of elements in a soil may be found in the literature as far as the soil physicochemical characteristics and the climatic conditions are identical. In a first approximation one can choose sandy soils from the Mediterranean region if data are available. A second way is an estimation based on data from the studied site: the amount of chemical emitted (M), the difference of concentration of said chemicals in soils between present day and supposed background content (ΔC), the volume of soil into which the emissions are diluted (V); the time separating the two measurements of chemicals concentration in the soils (Δt).

The chosen time frame covers the estimated period of activity of the refinery and the thermoelectric plant. It is assumed that these two activities settled down during the economic development of the area, circa 1965, i.e. 10 years after the agricultural development of the area (Bazan, 1956).

Present concentration in the soils and chemical background

The total concentration of metals and metalloids in the gathered soil samples was compared to the chemical background as found in the literature in order to calculate the ΔC . This geochemical background was drawn from different literature sources displaying similar climate, soil texture and bedrock, for lack of unpolluted soils' data in the area of Milazzo.

The results are reported in Table 26.

Site-specific calculations

Elements	Geochemical background [mg/kg dry weight]	Average measured concentrations in soil [mg/kg dry weight]	ΔC [mg/kg dry weight]
Arsenic	6	6.26	0.26
Cadmium	0.09	0.2	0.11
Cobalt	15.91	21.14	5.23
Chromium	71.64	81.66	10.02
Copper	48.63	63.5	14.87
Mercury	0.06	2.2 (Agenda 21 Milazzo, 2009)	2.14
Molybdenum	1.5	2	0.5
Manganese	507	793.34	286.34
Nickel	40.06	41.97	1.91
Lead	74.87	370	295.13
Selenium	0.02	0.21	0.19
Vanadium	18.4	121.03	102.63
Zinc	144.8	151.25	6.45
Iron	36200	37420	1220
Aluminium	55550	59879	4329

Table 26: Baseline concentration, measured concentration and ΔC for selected metals and metalloids

Mass of chemicals emitted towards the soil during the chosen timeframe

In order to estimate the mass of chemicals that are deposited on the soil during the considered period of activity, the total amount of airborne emissions during that timeframe was estimated and multiplied by the fraction of airborne particulate matter deposited on the soil.

The total amount of airborne emissions is estimated based upon the inventory collection. The results for the chemicals of interest (see Table 26 page 140) are displayed in Table 27.

The Life Cycle Assessment of the Milazzo Peninsula

Elements	Total airborne emissions [kg]	Soil depositions [kg]
Arsenic	18 005.46	10 437.77
Cadmium	3 801.35	2 203.64
Cobalt	177 678.53	103 000.24
Chromium	129 127.06	74 854.96
Copper	78 268.73	45 372.38
Mercury	5 368.29	3 112
Manganese	53 576.20	31 058.12
Molybdenum	40 631.98	23 554.36
Nickel	577 956.44	335 041.35
Lead	129 247.33	74 924.68
Selenium	12 989.95	7 530.27
Vanadium	4 998 242.13	2 897 480.96
Zinc	173 994.45	100 864.59
Iron	490 980.69	284 621.50
Aluminium	11 747.79	6 810.19

Table 27: Total estimations of airborne emissions and soil depositions of selected trace elements

Residence time

Using the aforementioned data, the residence time of chosen metals and metalloids in the area of Milazzo was calculated according to the formula given in Jolliet et al., 2003. The results are displayed in Table 28. Because of lack of data for lead and mercury, the residence times of these two metals are drawn from the literature, in a place with similar soil texture, geochemistry and climate (Tipping et al., 2011; Erel, 1998).

Site-specific calculations

Elements	Residence time in years
Arsenic	139.01
Cadmium	281.19
Cobalt	282.43
Chromium	743.89
Copper	1 821.30
Mercury	400
Manganese	51 235.28
Molybdenum	117.97
Nickel	31.68
Lead	150
Selenium	140.22
Vanadium	196.84
Zinc	355.37
Iron	23 820.69
Aluminium	3 532 568.31

Table 28: Site-specific soil residence time for the studied chemicals

As a whole, we can see that the specificity of the Milazzo peninsula is the short residence time of most metals and metalloids, translating a weak bound to the soil and a strong leaching of these components. There are four exceptions: copper, which resides in the soils of Milazzo the average amount of time for metals (Alloway, 1995), and manganese, iron and aluminium. The latter show a very long residence time, especially for the aluminium, which means that they tend to accumulate in the area of Milazzo.

4.3.3 Effect factors

The effect factor is expressed as $0.5/HC50$ (Jolliet et al., 2003). When the soil HC50 was not available in the literature, it was estimated after the water HC50 (Payet, 2004). Therefore, the soil HC50 of cobalt, manganese, molybdenum, iron and aluminium was extrapolated after their water HC50. In order to estimate the partition coefficient of a chemical between the soil and the water (K_d) in a sandy soil, the geometric mean of this coefficient in the soil was used (van de Plassche & de Bruijn, 1992), except for the manganese, iron and aluminium, drawn from a sandy soil sample from a site-specific study (ECOMatters Inc & SGU, 2009). The density of a sandy soil

The Life Cycle Assessment of the Milazzo Peninsula

is estimated to be 1.6 g/cm³ and the average water fraction of a Mediterranean soil is estimated to be 13.6% (Fang & Moncrieff, 2001). The final results of the calculation are displayed in Table 29.

Elements	HC50w [mg/kg]	Kd soil-water	HC50s [mg/kg]
Cobalt	0.35	39.81	22.1
Manganese	7.59	3600	43 700
Molybdenum	226.44	870.96	30 900
Iron	9.84	4900	771
Aluminium	1.2	2900	5 570

Table 29: HC50 in water and as calculated in soil for the chemicals molybdenum, cobalt, manganese, iron and aluminium, with their respective Kd.

The collected (Sorvari et al., 2012) and calculated HC50 in the soil, and the calculated effect factors, are displayed hereafter in Table 30.

Elements	HC50 [mg/kg]	Calculated Effect Factor [PDF•m ² /kg]
Arsenic	56	8.93•10 ⁻³
Cadmium	12	4.17•10 ⁻²
Cobalt	22.1	2.26•10 ⁻²
Chromium	120	4.17•10 ⁻³
Copper	125	4.00•10 ⁻³
Mercury	3.7	1.35•10 ⁻¹
Manganese	43 700	1.14•10 ⁻⁵
Molybdenum	30 900	1.62•10 ⁻⁶
Nickel	2.04 (Haye et al. 2007)	2.45•10 ⁻¹
Lead	490	1.02•10 ⁻³
Selenium	1.2	4.17•10 ⁻¹
Vanadium	25	2.00•10 ⁻²
Zinc	210	2.38•10 ⁻³
Iron	771	6.48•10 ⁻⁶
Aluminium	5 570	8.98•10 ⁻⁵

Table 30: Collected HC50 in the soils for selected chemicals, and corresponding effect factors.

4.3.4 Bioavailable fraction

The bioavailable fraction was calculated based upon the EDTA extractable elements contents (see chapter 2.1.2 “Analyses methodologies” page 25). The results are gathered in Table 31.

Elements	Bioavailable fraction
Arsenic	0.0351
Cadmium	0.3
Cobalt	0.09 (Ghazi, 2009)
Chromium	0.0016
Copper	0.2882
Mercury	0.0136
Manganese	0.1472
Molybdenum	1 (worst-case assumption)
Nickel	0.0384
Lead	0.0292
Selenium	1 (Alloway, 1995)
Vanadium	0.0331
Zinc	0.0517
Iron	0.0043
Aluminium	0.36 (Ghazi, 2009)

Table 31: Bioavailable fraction of chosen metals and metalloids in the soils of Milazzo

4.3.5 Terrestrial ecotoxicity potential results and interpretation

The different elements needed to calculate the site-specific characterization factors are sorted out in Table 32, together with the impact scores of the chosen chemicals. The following equation was used for the calculation of the soil ecotoxicity potential:

$$CI_{soil\ ecotox} = \sum_n FC_n^s \cdot LCI_n^s$$

$$CI_{soil\ ecotox} = \sum_n FF_n^s \cdot EF_n^s \cdot LCI_n^s$$

$$CI_{soil\ ecotox} = \sum_n F_n^s \cdot \theta_n^s \cdot EF_n^s \cdot LCI_n^s$$

The Life Cycle Assessment of the Milazzo Peninsula

with: CI is the category indicator; (soil ecotox) is the category; (s) is the soil compartment; (n) is an element; FC is the ecotoxicity potential; LCI is the Life Cycle Inventory result; FF is the fate factor; EF is the effect factor; F is the bioavailable fraction; θ is the residence time.

This equation regroups all the different equations explained in 2.2.3: “Site-specific evaluation methodologies” page 35.

Elements	Effect factor [PAF•m ² /kg]	Bioavailable fraction	Residence time [year]	Terrestrial Ecotoxicity Potential [PAF•m ² •year/kg]	Total mass emitted towards the soil [kg]	Impact score [PAF•m ² •year]
Arsenic	8.93•10 ⁻³	0.0351	139.01	4.36•10 ⁻²	10 437	455.22
Cadmium	4.17•10 ⁻²	0.3	281.19	3.51	2 203	7 745.46
Cobalt	2.26•10 ⁻²	0.09	282.43	5.76•10 ⁻¹	103 000	59 280.52
Chromium	4.17•10 ⁻³	0.0016	743.89	4.93•10 ⁻³	74 855	369.36
Copper	4.00•10 ⁻³	0.2882	1 821.30	2.10	45 372	95 260.01
Mercury	1.35•10 ⁻¹	0.0136	400	7.37•10 ⁻¹	3 112	2 293.86
Manganese	1.14•10 ⁻⁵	0.1472	51 235.28	8.63•10 ⁻²	31 058	2 680.80
Molybdenum	1.62•10 ⁻⁶	1	117.97	1.91•10 ⁻⁴	23 554	4.49
Nickel	2.45•10 ⁻¹	0.0384	31.68	2.98•10 ⁻¹	335 041	99 789.13
Lead	1.02•10 ⁻³	0.0292	150	4.46•10 ⁻³	74 925	334.43
Selenium	4.17•10 ⁻¹	1	140.22	5.84•10 ¹	7 530	439 951.33
Vanadium	2.00•10 ⁻²	0.0331	196.84	1.30•10 ⁻¹	2 897 481	377 935.72
Zinc	2.38•10 ⁻³	0.0517	355.37	4.37•10 ⁻²	100 865	4 412.49
Iron	6.48•10 ⁻⁶	0.0043	23 820.69	6.66•10 ⁻⁴	284 621	189.69
Aluminium	8.98•10 ⁻⁵	0.36	3 532 568.31	1.14•10 ⁺²	6 810	777 696.98

Table 32: Results of the site-specific soil ecotoxicological impact assessment parameters

The aforementioned results can also be expressed per anthropogenic activity, for a better interpretation. The results for the whole timeframe are displayed in Figure 64.

According to the site-specific study, the soil ecotoxic impacts by metals and metalloids are done mainly by the thermoelectric plant (73% of total soil ecotoxic impacts). The second most important impacting activity for the soils is the illegal domestic waste combustion (22% of total soil ecotoxic impacts). Together, the refinery and the road traffic represent 5% of total ecotoxic impacts.

Site-specific calculations

The metals and metalloids causing the most important impacts to the soil of the Milazzo peninsula are the aluminium (41%) from the illegal combustion of domestic waste, the selenium (24%) and vanadium (20%) from the thermoelectric plant.

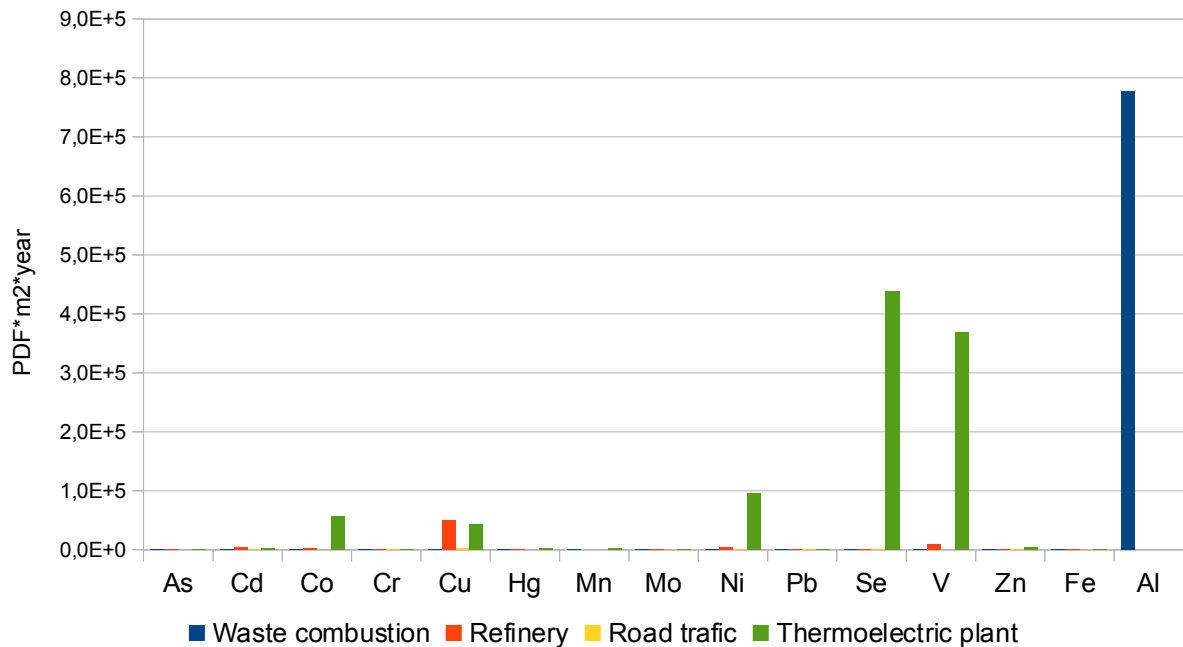

Figure 64: Site-specific soil ecotoxicity results for the anthropogenic activities in the area of Milazzo over the studied timeframe

Aluminium, selenium and vanadium have the highest ecotoxicity potentials compared to nickel, copper, cobalt. The lowest ecotoxicity potential are recorded for the other elements among them cadmium, zinc. The reasons for the different potentials are not always related to the same parameters. For example aluminium has the highest ecotoxicity potential because of its high bioavailable fraction combined with an important ecotoxicity and accumulation in the soils. The importance of the selenium emissions' impacts is caused by its high toxicity and its very high bioavailability, on the contrary to vanadium for which the high importance of emissions plays a major role. Cobalt and copper are both highly bioavailable, but it is the residence time in the soils of the Milazzo peninsula which is also important in the case of copper, contrary to cobalt which is highly toxic and strongly emitted, as is the case for nickel.

The cadmium impacts of soil ecotoxicity are low, its emissions and residence time are very low. The important emissions of zinc cause only a low ecotoxic impact on the soil, because of the low level of its toxicity, bioavailability and residence time. Mercury as well as manganese cause

The Life Cycle Assessment of the Milazzo Peninsula

low impacts because their emissions and toxicity in the soils are low. Moreover mercury has a low bioavailability,

The impacts from arsenic and chromium are very low because arsenic's residence time is low, and because chromium's bioavailability is low.

Three elements cause negligible impacts: molybdenum, iron and lead. Molybdenum and iron, because of their short residence time and very low toxicity while lead has only a short residence time.

Moreover, the presence of toxic contaminants in the soils can induce modifications in the biodiversity and in the metabolism of the microfauna, hence perturbations in the whole local ecosystem (Triolo et al, 2008).

4.4 Site-specific characterization of the seawater ecotoxicity

In a similar way than for the soil ecotoxicity, the seawater ecological impacts were modeled.

4.4.1 Residence time

Due to the specificities of the calculation of the residence time of a chemical in a compartment as vast as the Mediterranean Sea, they could not be calculated and instead were gathered from the literature. The results of this research is displayed in Table 33.

Elements	Residence time [years]	Specificities of this data
Arsenic	490	Western Atlantic (Cutter et al., 2001)
Cadmium	17	Western Mediterranean (Takayanagi et al., 1996)
Cobalt	0.19	Average in top 100m of Atlantic (Saito & Moffett, 2002)
Chromium	11	Western Mediterranean (Takayanagi et al., 1996)
Copper	16	Western Mediterranean (Takayanagi et al., 1996)
Mercury	350	Western Mediterranean (Cossa et al., 1997)
Manganese	5.12	Upper 100m of the Sargasso Sea (Jickells, 1999)
Molybdenum	800 000	Oceanic (Reitz et al., 2007)
Nickel	18	Western Mediterranean (Takayanagi et al., 1996)
Lead	5.1	Average between Western Mediterranean (Takayanagi et al., 1996) and whole Mediterranean (Guerzoni et al., 1999)
Selenium	39	North Pacific (Sherrard et al., 2004)
Vanadium	100 000	Oceanic (Shiller & Boyle, 1987)
Zinc	9	Western Mediterranean (Takayanagi et al., 1996)
Iron	0.05	Upper 100m of the Sargasso Sea (Jickells, 1999)
Aluminium	1	Western Mediterranean (Takayanagi et al., 1996)

Table 33: Gathered residence time of selected metals and metalloids in seawater

4.4.2 Effect factors

As seen earlier, the effect factors are calculated as $0.5/HC50$. The HC50 in the water is drawn from the AMI database (Payet, 2004). These values and the calculated effect factors are displayed hereafter in Table 34.

Elements	HC50 in the water [kg/m ³]	Effect factor [PAF•m ³ /kg]
Arsenic	3.94	0.13
Cadmium	4.31•10 ⁻¹	1.16
Cobalt	0.35	1.43
Chromium	2.12	0.24
Copper	1.68•10 ⁻¹	2.98
Mercury	7.72•10 ⁻²	6.48
Manganese	7.59	0.07
Molybdenum	2.22•10 ⁻²	2.25•10 ⁻³
Nickel	8.10•10 ⁻¹	0.62
Lead	1.88	0.27
Selenium	1.59	0.31
Vanadium	2.18	0.23
Zinc	1.05	0.48
Iron	9.84	0.05
Aluminium	1.2	0.42

Table 34: HC50 in water and calculated effect factors for the selected metals and metalloids

4.4.3 Fraction of air-emitted chemicals falling down towards the sea

We saw in the previous chapter that 57.97% of airborne emissions are deposited to the soil. This means that 42.03% of airborne emissions are deposited in the seawater.

Given the peculiarities of the site, with its sandy soil and its Mediterranean climate, as well as the cliffs all around the peninsula and the absence of groundwater in the peninsula, we can assume that the elements deposited on the soil are easily carried away by the intense and short rainfalls and end into the sea. Therefore it is assumed that any element with a residence time lower than five hundred years that is deposited to the soil, is carried into the sea. Therefore, all selected metals and metalloids' soil depositions, except manganese's, iron's and aluminium's, are assumed to be carried by rainfall into the sea.

4.4.4 Marine ecotoxicity potential results and interpretation

Similarly to the soils, the site-specific characterization factors are calculated for the chosen chemicals and their impact scores in seawater. They are sorted out in Table 35. The following equation was used for the calculation of the marine ecotoxicity potential:

Site-specific calculations

$$CI_{marine\ ecotox} = \sum_n FC_n^m \cdot LCI_n^m$$

$$CI_{marine\ ecotox} = \sum_n FF_n^m \cdot EF_n^m \cdot LCI_n^m$$

$$CI_{marine\ ecotox} = \sum_n F_n^m \cdot \theta_n^m \cdot EF_n^m \cdot LCI_n^m$$

with: CI is the category indicator; (marine ecotox) is the category; (m) is the marine compartment; (n) is an element; FC is the ecotoxicity potential; LCI is the Life Cycle Inventory result; FF is the fate factor; EF is the effect factor; F is the bioavailable fraction; θ is the residence time.

This equation regroups all the different equations explained in 2.2.3: “Site-specific evaluation methodologies” page 35.

Elements	Effect factor [PAF•m ² /kg]	Residence time [year]	Terrestrial Ecotoxicity Potential [PAF•m ² •year/kg]	Total mass emitted towards the soil [kg]	Impact score [PAF•m ² •year]
As	490	0.13	793 937	62.18	49 369 201
Cd	17	1.16	1 893 521	19.72	37 343 223
Co	0.19	1.43	1 729 050	0.27	462 327
Cr	11	0.24	19 988 966	2.59	51 858 168
Cu	16	2.98	16 505 448	47.62	785 973 743
Hg	350	6.48	819 895	2266.84	1 858 572 503
Mn	5.12	0.07	23 333 411	0.34	7 874 413
Mo	800 000	2.25•10 ⁻³	42 995	1801.8	77 470 012
Ni	18	0.62	115 337 908	11.11	1 281 532 321
Pb	5.1	0.27	32 596 834	1.36	44 213 792
Se	39	0.31	16 112	12.26	197 600
V	100 000	0.23	239 629 315	22907.09	5.4892•10 ⁻¹²
Zn	9	0.48	41 187 980	4.29	176 519 915
Fe	0.05	0.05	816 357 573	2.54•10 ⁻³	2 074 079
Al	1	0.42	21 492	0.42	8 955

Table 35: Results of the site-specific seawater ecotoxicological impact assessment

The aforementioned results can also be expressed per anthropogenic activity, for a better interpretation. The per-activity seawater ecotoxic impacts for the whole timeframe are displayed in Figure 65.

The Life Cycle Assessment of the Milazzo Peninsula

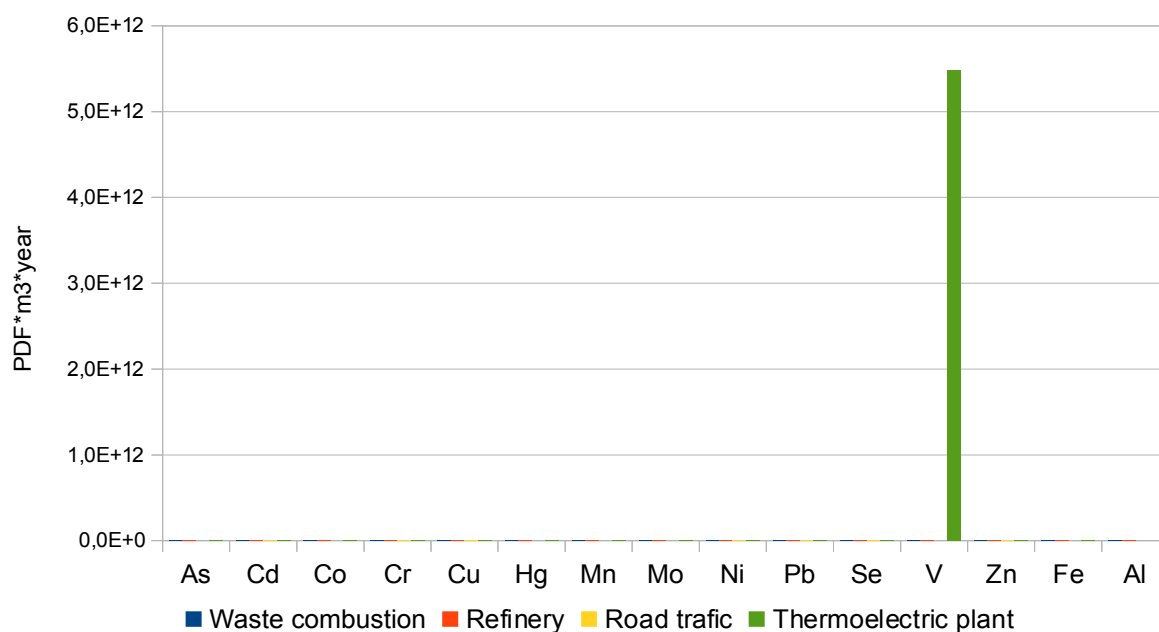

Figure 65: Site-specific seawater ecotoxic impact results for the anthropogenic activities in the area of Milazzo over the studied timeframe

As for the soil ecotoxic impacts, the thermoelectric plant is responsible for the majority (99.94%) of ecotoxicological impacts from metals and metalloids. The main toxic element is the vanadium, which represent 99.92% of total marine ecotoxic impacts. This important contrast between vanadium and the other elements comes from the amount of vanadium emitted towards the seawater, as well as its very long residence time. Even highly persistent elements like molybdenum (which has a very low ecotoxicity) and highly toxic elements like mercury (which has an average residence time and a medium amount of emissions) cause marine ecotoxic impacts that are negligible compared to those of vanadium.

4.5 Uncertainty calculation

The results of the uncertainty over the site-specific calculations are shown in Figure 66 and Figure 67. On these figures, we can notice that all the uncertainties are very low except for the uncertainties over the aluminium results for the soil ecotoxicity (Figure 66).

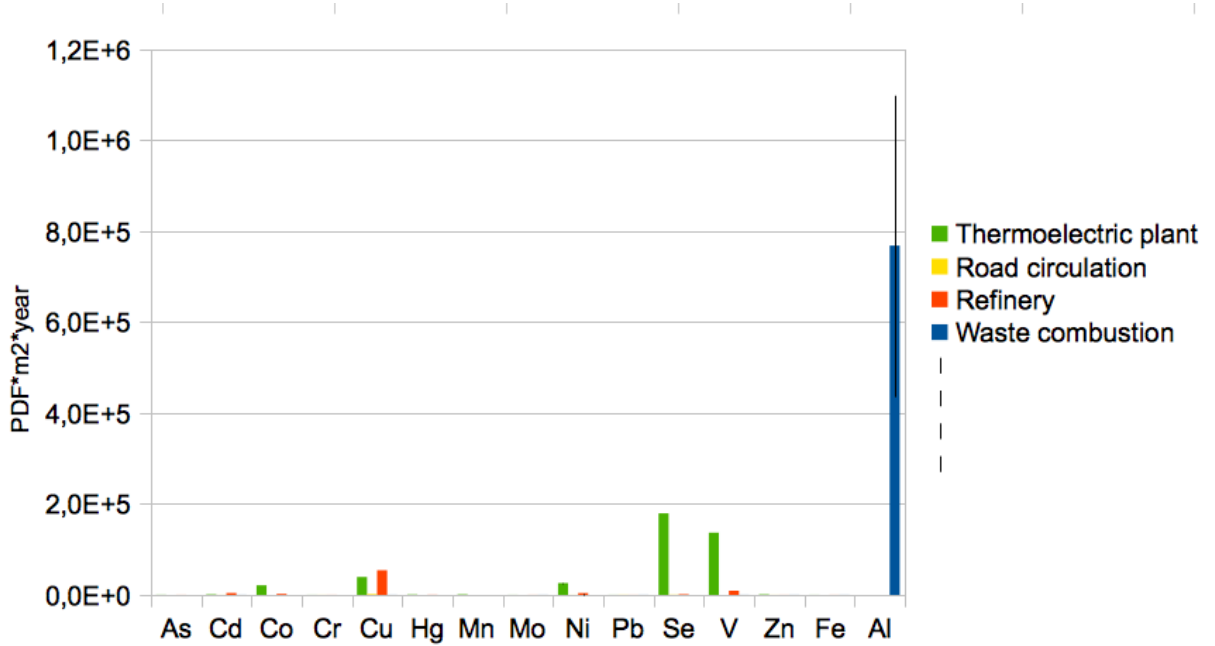

Figure 66: Uncertainties over the site-specific soil ecotoxicity

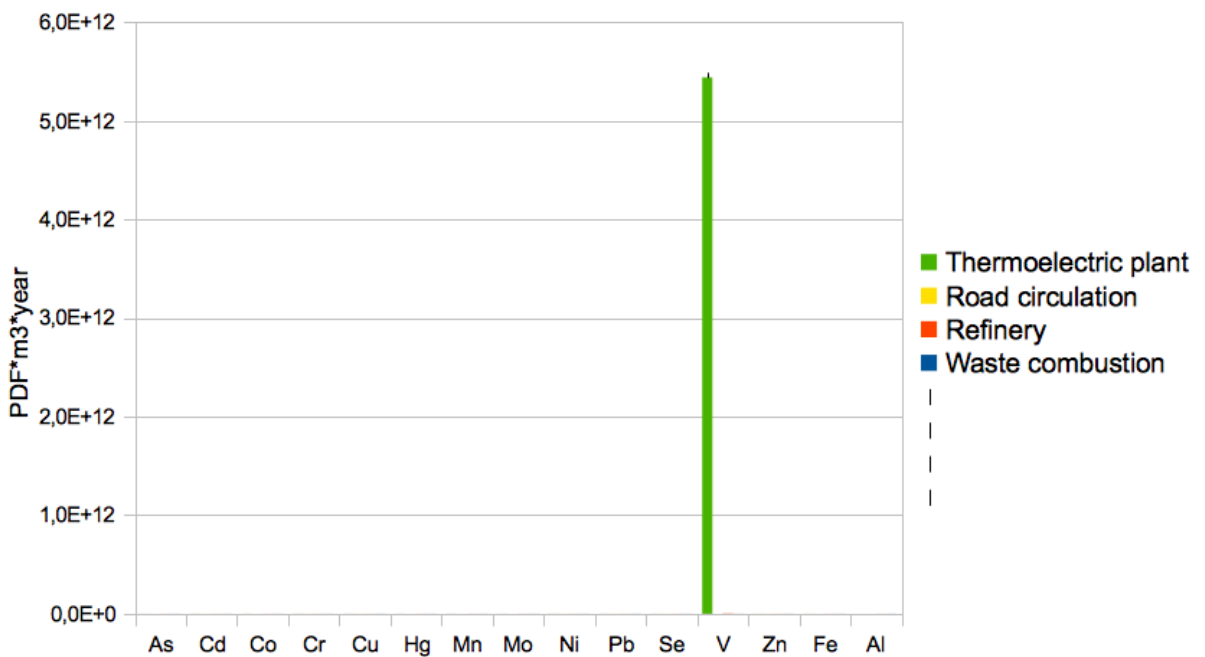

Figure 67: Uncertainties over the site-specific seawater ecotoxicity

The Life Cycle Assessment of the Milazzo Peninsula

These uncertainties appear to be very low, close to negligible, for all analyzed trace element and both selected impact categories, to an only exception: the soil ecotoxicity of aluminium. The aluminium is deposited on the soil after emission by the illegal combustion of domestic waste. The uncertainties that are reported on the Figure 66 are therefore the uncertainties from the model that was used. Indeed, more assumptions were made regarding the emissions of this anthropogenic activity compared to the other activities. What can be observed on the Figure 66 are the consequences of these numerous assumptions regarding the amount of waste that is illegally burned as well as the technological and geographical assumptions over the model of emissions (e.g. emissions from a legal incineration center in another country).

As a conclusion, the site-specific calculation results are very reliable.

5 Comparison of the site-specific characterization with the global-scale results

5.1 Soil ecotoxicity

The global-scale and site-specific results for the soil ecotoxicity of metals and metalloids, are now being compared. This is illustrated in Figure 68.

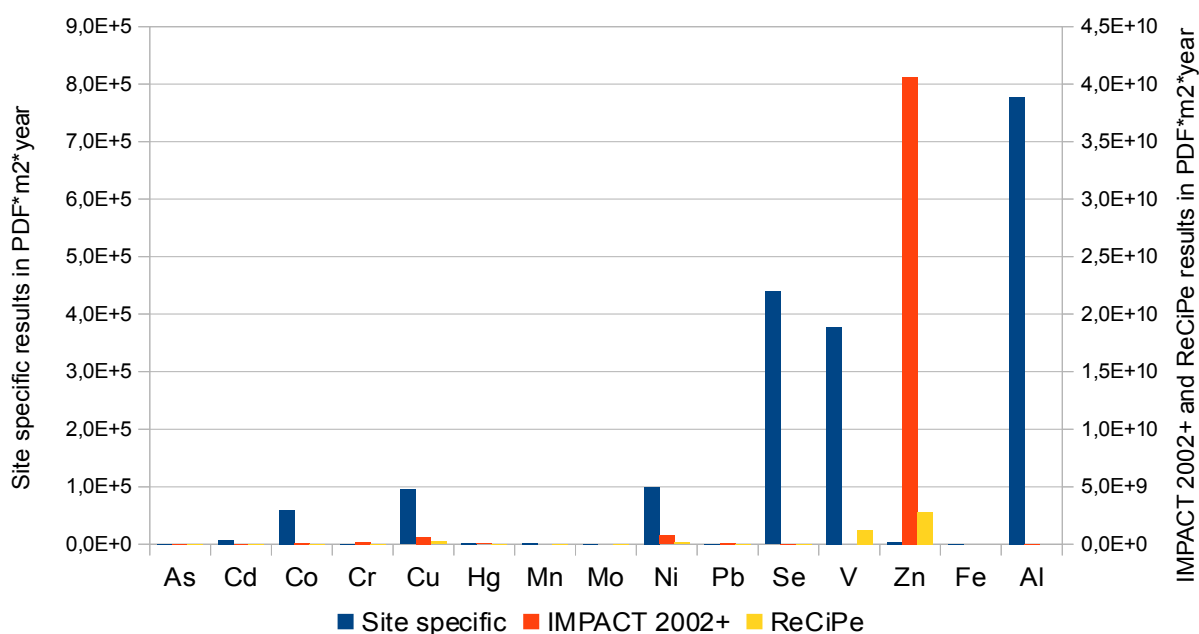

Figure 68: Comparison between the global-scale and site-specific results for the soil ecotoxicity

First, we can notice that the global-scale results are four (ReCiPe) to five (Impact 2002+) orders of magnitude higher than the local-scale results: the IMPACT 2002+ and ReCiPe models overestimate the soil ecotoxic impacts of metals and metalloids over sandy soils with a Mediterranean climate. The first part of the explanation is that the average residence time of metals and metalloids in the soils of the area of study is one order of magnitude lower than their average residence time in a more organic and clayey soil with a temperate climate (Salomons & Förstner, 1984). The second part of the explanation comes from the calculation of the effect factor, using HC50s adapted to the peculiar soil of the area of study, that are lower than the generic HC50s. Previous studies in similar soil and climate conditions lead to similar results (Ghazi, 2009).

But these are not the only differences between the two scales.

While for Impact 2002+, the main impacting chemical species are nickel and zinc and for ReCiPe it is vanadium, for the site-specific approach, they are the selenium, vanadium and aluminium. The global trend of ten over fifteen elements is different from one model to the other. Together with the difference of fate and effect of these elements between the two scales, as

Comparison global-scale vs site-specific

explained before, we can note that Impact 2002+ does not take into account the impacts from vanadium and molybdenum, and that the soil ecotoxicity of manganese and iron is assumed to be negligible in this model. ReCiPe estimates lower impacts from zinc, nickel, copper than Impact 2002+. The site-specific approach showed the importance of the inclusion of vanadium in the model, as well as the non-negligibility of the impacts from manganese emissions. But the site-specific study also confirmed the Impact 2002+'s and ReCiPe's assumption of negligible soil ecotoxic impacts from molybdenum and iron.

5.2 Marine ecotoxicity

The global-scale and site-specific results for the marine ecotoxicity of metals and metalloids, are compared and illustrated in Figure 69. Only ReCiPe appears on this figure because Impact 2002+ does not account for the marine ecotoxicity.

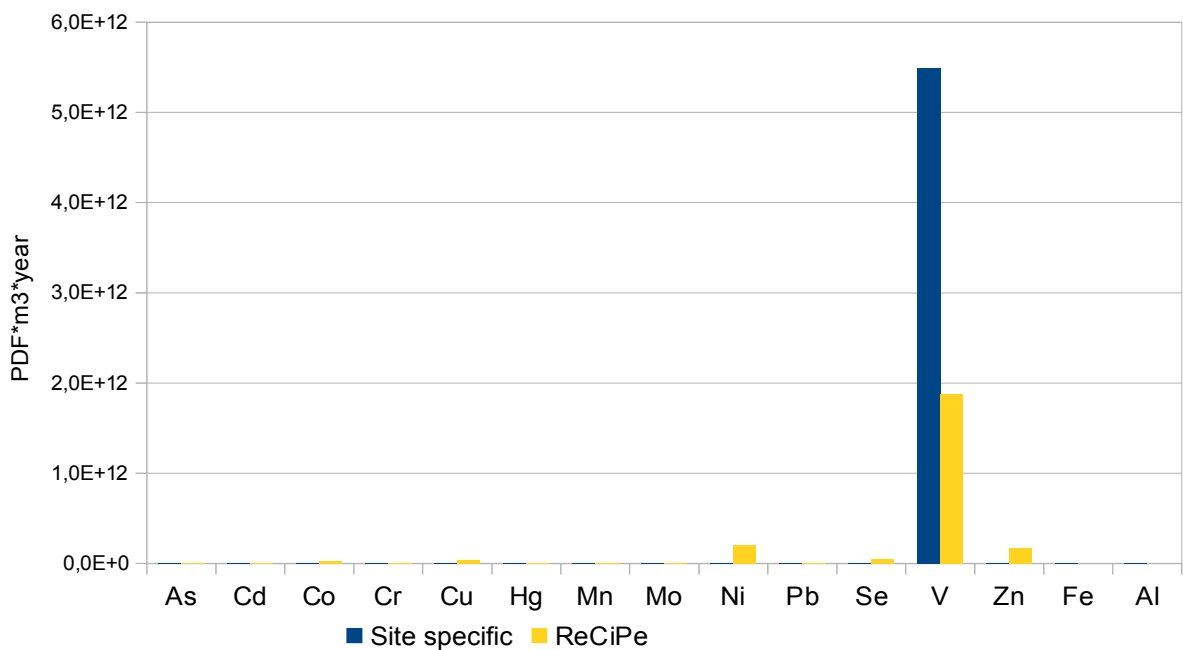

Figure 69: Comparison between the global-scale and site-specific results for the marine ecotoxicity

As we can see in Figure 69, the global-scale and site-specific results for the marine ecotoxicity are of the same order or magnitude. In both approaches, the vanadium is the element causing the highest impact score. But in the site-specific approach, the other elements cause negligible impacts while in the ReCiPe approach, zinc, nickel, selenium, copper and cobalt cause non-negligible impacts in comparison to the score for vanadium.

The relative variations of the three methods can only be explained by the different underlying models, but without knowledge of the details concerning factors calculations, it is not possible to compare the variability of the used toxicities, bioavailabilities and residence times.

5.3 Conclusion

Regarding the soil ecotoxicity, the global-scale method seems to overestimate the impacts compared to the site-specific methodology. There is a large difference in the order of magnitude of total impacts from chosen metals and metalloids as well as in the respective importance of the impacts caused by said chemicals. The range of this difference, as well as the lack of some chemicals in the global-scale method, show that the local-scale method is more appropriate in areas such as the Milazzo peninsula, with peculiar ecologic conditions (here, Mediterranean climate and sandy soil).

Regarding the marine ecotoxicity, the ReCiPe global-scale study show slightly different results compared to the site-specific model though the order of magnitude of the highest impacts are the same.

Therefore, the site-specific model is more suitable than the global-scale ones.

6 Conclusions and recommendations

The objectives of this study were to assess the impacts and damages upon human health and ecosystem and climate change/global warming caused by major anthropogenic activities' pollutant emissions in Milazzo area using the LCA standard methodology. The considered activities are: the thermoelectric plant, the refinery, the road traffic, the illegal combustion of domestic waste.

The aim was to help answering to the following questions:

1) do local anthropogenic activities contribute to the on-site observed damages on health as suspected by the inhabitants?

2) do the anthropogenic activities also cause damages on the environment and on what extend?

3) what activities and emissions are causing the most important damages?

4) what recommendations could be drawn from the previous answers in order to improve the Milazzo peninsula's environmental state?

In order to answer those questions, two approaches were used: the global-scale approach and site-specific approach. In the global-scale approach, ready-to-use characterization factors were applied to the inventory results in order to estimate the impacts and damages. The factors sets chosen for this approach were taken from Impact 2002+ and ReCiPe 2008 models. In the site-specific approach, the characterization factors were calculated based upon the specificities of the site under study.

Main results from the global-scale approach

The damages are split into three categories: climate change (also named global warming), human health, and ecosystems. As a whole, damage score normalization and weighting show that the highest damage score is obtained for the climate change/global warming category because of the CO₂ emissions of the anthropogenic activities, more specifically, from the thermoelectric plant. The second highest damage score is given for the human health, because of the emissions of inorganic chemicals leading to particulate matter formation. This damage is caused by the emissions of SO₂, NO_x and particulate matter from the thermoelectric plant. The lowest damage score is given for the ecosystems, because of the marine toxicity resulting from the vanadium emissions of the thermoelectric plant.

Normalization into damage score and weighting left apart, the damage categories can then be split into impact classes. By considering the different impact classes of the damage categories

Conclusions and recommendations

(climate change/global warming left apart), they can be hierarchized from the highest impacts to the lowest impacts.

Let us note that although the human health and ecosystems damages are not split exactly the same way in the two calculation sets, as a whole, the impacts and substances have a similar hierarchy from one calculation set to the other.

Regarding the human health, the impact categories from the highest score to the lowest are: carcinogens; non-carcinogens; respiratory inorganics leading to particulate matter formation; respiratory organics; photochemical oxidant formation; ionizing radiations.

These impacts can be related to the activities and it is pointed out that depending on the impact, the activities mainly responsible of these impacts are different. The majority of the carcinogen impacts are done through the cadmium emissions resulting from the illegal combustion of domestic waste. The non-carcinogenic impacts, according to ReCiPe are caused by vanadium from the thermoelectric plant and selenium from both thermoelectric plant and refinery; according to Impact 2002+, it is by zinc from the refinery and dioxins from the thermoelectric plant.

The respiratory impacts are done by the emission of the inorganic chemicals SO_2 , NO_x and particulate matter from the thermoelectric plant. The respiratory organics that cause the highest impacts are the NMVOC emitted by the refinery. The thermoelectric plant is responsible for the emissions of the NO_x causing the formation of photochemical oxidant substances. Last, the radiating impacts are caused by the $^{222}\text{radon}$ emissions from the refinery.

Regarding the ecosystems, the impact categories from highest score to lowest score are: marine ecotoxicity; terrestrial ecotoxicity; terrestrial acidification; aquatic (freshwater) ecotoxicity; aquatic eutrophication.

The marine ecotoxicity is calculated by ReCiPe only and these impacts are done by the vanadium emissions from the thermoelectric plant, whereas the terrestrial ecotoxicity is caused by the zinc emissions from the refinery. As for the acidification of the terrestrial ecosystems, it is done by the SO_2 and NO_x from the thermoelectric plant. The freshwater ecotoxicity comes from the vanadium emitted by the thermoelectric plant according to ReCiPe, and from the zinc emitted by the refinery according to Impact 2002+. The eutrophication of the aquatic ecosystems is done by phosphorous emitted by the refinery and thermoelectric plant, as well as the PO_4^{2-} from the illegal combustion of domestic waste.

The above results were obtained on a long time frame. But if we consider the detailed yearly inventory analysis, the impact calculation results force to mitigate these conclusions. In fact, total past impacts as exposed above does not inform about the future possible yearly evolution of the emissions (and impacts) and therefore, does not inform about the emissions that will, in the future, impact and damage the environment the most. For example, the level of activity and the total emissions of the thermoelectric plant started decreasing in the early 2000s while additional depolluting systems enabled a faster reduction of sulfur dioxide, nitrogen oxides and particulate matter emissions. As for the refinery, the yearly inventory shows an increase of SO₂ emissions during the year 1990s due to the beginning of the production of low-sulfur refined products as well as a 100% increase of this industry's level of activity. Therefore, in the future, there will be a more important share of emissions hence impacts and damages coming from the refinery, than coming from the thermoelectric plant. This needs to be taken into account while suggesting recommendations. Moreover, the inventory and yearly calculations showed an increase in the amount of domestic waste that is illegally burned in the streets of the city. The emissions resulting from this activity may too tend to keep on increasing throughout the future years.

Main results from the site-specific approach

In the site-specific approach, the study focuses on the impact classes with the highest impact scores in order to specify said impacts in both impact score calculation and hierarchization of the chemicals from the most impacting to the less impacting. The focus was not on human health (carcinogens and inorganic emissions leading to particulate matter formation) because the specific data needed for the calculation are too difficult to access. Instead, the study focused upon the environmental toxicity, especially in the soil and seawater compartments. Indeed, these two impacts were the highest, especially knowing that there is no underground water in the site of study, and that the streams are discharged into the sea after entering the zone of study.

The site-specific study consisted in re-calculating the characterization factors in order to adapt them to the specificities of the Milazzo peninsula. These specificities are: sandy soils, arid climate and situation on the Mediterranean Sea. On one hand, the sandy soils of the area are not very charged in organic matter and clay. Because it is the organic matter and clay that adsorb most of the trace elements, their residence time is low in low organic content soils. This residence time can be high in sandy soils only if there are enough inputs to cause an accumulation. Also, because of the arid climate, sandy texture and low organic and clay contents of the soils, the metallic trace

Conclusions and recommendations

elements are not very bioavailable. On the other hand, the Mediterranean Sea is a peculiar water body with low exchanges with the open ocean. This causes some trace elements such as vanadium to have a longer residence time in this water body.

In order to determine site-specific characterization factors to be introduced into LCIA calculations, soils and seawater samples were collected and analyzed. Then the site-specific characterization factors were calculated as well as the ecotoxicological impact scores.

Results show that regarding the seawater ecotoxicity potential, the vanadium emissions from the thermoelectric plant are responsible for the majority (>99,9%) of total marine ecotoxic impacts. This is because this metal is emitted in very important amounts towards the seawater and also because it has a very long residence time in the Mediterranean Sea. In comparison to vanadium, the other elements cause negligible impacts upon the seawater. The impact score for the vanadium is similar to the score obtained with the ReCiPe global-scale approach, confirming the role of the thermoelectric plant in the seawater ecotoxicity.

Regarding the terrestrial ecotoxicity, this study showed that the trace elements that are potentially the most toxic for the soils are the aluminium from the illegal combustion of domestic waste, the selenium and the vanadium from the thermoelectric plant while three elements cause negligible impacts: molybdenum, iron and lead. The reasons to these different levels of ecotoxic potentials come from different parameters. Indeed, aluminium has a high toxicity combined to a high bioavailable fraction and a tendency to accumulate in the soils of the Milazzo area. Selenium too is highly bioavailable in the area of study and very toxic. But for vanadium, it is the important released amounts of this element that are the cause of its high ecotoxicity potential. Molybdenum's and iron's ecotoxic potentials are negligible because of their short residence time and very low toxicity while lead has only a short residence time. As a whole, the terrestrial site-specific ecotoxic scores are non-negligible though they are three orders of magnitude lower than the scores obtained with a global-scale approach.

The comparison between site-specific and global-scale approaches

Those comparison showed differences that can be explained as follows.

First, regarding the seawater ecotoxicity potential, the two global-scale calculation methods give very different results from each-other and from the site-specific approach. Impact 2002+ method overestimates the seawater ecotoxic impacts of copper, nickel and zinc of two orders of magnitude while ReCiPe overestimates them of two orders of magnitude for vanadium compared

to the site-specific results. But without knowledge of the details concerning the factors calculation in the global-scale methods, it is not possible to understand the differences between them and the site-specific method.

Second, regarding the soil ecotoxicity potential, it is noticeable that the global-scale methods tend to overestimate, of four orders of magnitude in the case of Impact 2002+, the toxicity of trace elements in the sandy soil and arid climate of the area of study. On one hand, this is due to the residence time and bioavailability of trace elements, lower in arid sandy soils, higher in organic, clayey, temperate environment. On the other hand, this is because the toxicity of the elements was not estimated the same way: global-scale methods use generic soil ecotoxic results while the present study focused over the toxicity in a more sandy environment. Consequently, the elements having the highest calculated ecotoxicity are not the same from one model to the other. While for Impact 2002+, the main impacting chemical species are nickel and zinc and for ReCiPe it is vanadium, for the site-specific approach, they are the selenium, vanadium and aluminium. Also, the proportions between the scores of the different elements vary from one calculation set to the other. On one hand, Impact 2002+ does not account for the vanadium, while ReCiPe estimates lower impacts from zinc, nickel, copper than Impact 2002+. On the other hand, the site-specific approach confirms the importance of the inclusion of vanadium in the model, as well as the two other calculation methods' assumption of negligible soil ecotoxic impacts from molybdenum and iron.

As a whole, the comparison between the global-scale and site-specific approaches clearly shows the interest of the site-specific approach in the case of peculiar sites of study like the Milazzo area. Moreover, the uncertainties in the site-specific approach are quite negligible, save for the aluminium resulting from the illegal combustion of domestic waste. These uncertainties can be explained by the many assumptions used for the modeling of this anthropogenic activity regarding the amount of waste that is illegally burned as well as the technological and geographical assumptions over the model of emissions.

Recommendations

In regard to the global-scale and site-specific LCA calculations, it is possible to give advice about how to limit the future impacts and damages done by the local anthropogenic activities. First, the use of de-sulfured fuel by the thermoelectric plant needs to be carried on. This will keep its sulfur dioxide emissions at a lower level than in the past. Because both refinery and thermoelectric plant cause important impacts and damages to both human health and ecosystems

Conclusions and recommendations

through the emissions of trace elements, we suggest the combination of two successive dust removal systems: a cyclonic system and a filtration system. Because the trace elements are adsorbed on the particulate matter before being emitted, these systems will conjointly remove particulate matter and trace elements from the exhaust fumes of the two concerned activities.

The present domestic waste disposal through illegal incineration is also the cause of very important impacts and damages upon both the ecosystem and the human health. Reducing the influence of this activity upon the peninsula of Milazzo requires the whole of the inhabitants to stop illegally burning the waste in the area, as well as the amelioration by the city of the present waste disposal system (e.g. more frequent circulation of the garbage collection trucks).

As a conclusion

The global-scale LCA of the anthropogenic activities in the area of Milazzo showed the importance of trace elements emissions in the impacts towards both the ecosystems and the human health. But the comparison between the two used global-scale methods did not enable to identify precisely which elements cause the most impacts towards the environmental compartments.

Turning towards site-specific calculation factors for the trace elements, the local-scale calculations gave more precise ecotoxic potential results, correcting the generic factors applied in the global-scale approach with the specificities of the Milazzo peninsula. This site-specific characterization took into account the Mediterranean climate together with the sandy soils and the peculiar residence times in the local environmental compartments. These results are lower for the soils than the global-scale results, with a different share of each elements. The results for the seawater are also very different from those of the global-scale calculations. Moreover, the site-specific calculations proved very relevant, except for the soil deposited aluminium.

This opens potentialities for further, more complete site-specific studies of the area, including the inorganic emissions causing terrestrial acidification as well as the carcinogenic and respiratory inorganic impacts towards the human health.

7 References

AGENDA 21 MILAZZO. 2009. *Agenda21L "Horus Milae", Milazzo: Rapporto sullo Stato dell'Ambiente*. Directed by Imbesi, G. Città di Milazzo; A Misura Di Natura; Regione Siciliana, Assessorato Territorio e Ambiente.

AGENDA 21 PACE-NICETTO. 2008. *1° Rapporto sullo stato dell'ambiente: Agenda21 locale Pace- Niceto*. Directed by Simonetti, C. & Cotone, S. Comune di Pace del Mela; Comune di San Pier Niceto; Regione Siciliana Assessorato Territorio ed Ambiente; A Misura Di Natura (A.R.T.A.).

AGENZIA PER LA PROTEZIONE DELL'AMBIENTE E PER I SERVIZI TECNICI. *Registro INES [online]*. Accessible on: <www.eper.sinanet.apat.it/site/it-IT/Registro_INES/>. Date of consultation: settembre 2010.

ALLOWAY B.J. *Heavy metals in soils, second edition*. Blackie Academic & Professional, 1995, 368 p.

ALTHAUS HJ, BAUER C, DOKA G, DONES R, HISCHIER R, HELLWEG S, HUMBERT S, KÖLLNER T, LOERINCIK Y, MARGNI M, NEMECEK T. *Implementation of Life Cycle Assessment Methods. Data v.2.0 (2007). Ecoinvent report No. 3 [online]*. Accessible on: <www.ecoinvent.org/documentation/reports/>. Date of consultation: 2007.

ALTHAUS, H.-J.; BAUER, C.; DOKA, G.; DONES, R.; HISCHIER, R.; HELLWEG, S.; HUMBERT, S.; KÖLLNER, T.; LOERINCIK, Y.; MARGNI, M.; NEMECEK, T. 2007. *Implementation of Life Cycle Assessment Methods. Data v.2.0 (2007). ecoinvent report No. 3*. Directed by Frischknecht, R.. Dübendorf, ecoinvent Centre.

ARMATO, M.; MADONIA, G.; NANIA, P. RIFIUTI. In: Agenzia Regionale per la Protezione dell'Ambiente - Sicilia. *Annuario regionale dei dati ambientali 2010*. ARPA Sicilia2010, p.38.

ASKE, N. *Characterisation of Crude Oil Components, Asphaltene Aggregation and Emulsion Stability by means of Near Infrared Spectroscopy and Multivariate Analysis*. Thesis in ChemicalEngineering. Trondheim: Norwegian University of Science and Technology, 2002, 47 p.

BAGNATO, E.; AIUPPA, A.; PARELLO, F.; CALABRESE, S.; D'ALESSANDRO, W.; MATHER, T.A.; MCGONIGLE A.J.S.; PYLE, D.M.; WÄNGBERG, I. 2007. Degassing of gaseous (elemental and reactive) and particulate mercury from Mount Etna volcano (Southern Italy). *Atmospheric Environment*, vol.41, p.7377-7388.

References

- BAKKER, M.I.; CASADO, B.; KOERSELMAN, J.W.; TOLLS, J.; KOLLÖFFEL, C. 2000. Polycyclic aromatic hydrocarbons in soil and plant samples from the vicinity of an oil refinery. *The Science of the Total Environment*, vol.263, p.91-100.
- BARE, J. C.; HOFSTETTER, P.; PENNINGTON, D. W.; UDO DEHAES, H. A. 2000. Life Cycle Impact Assessment Workshop Summary. Midpoints versus Endpoints: The Sacrifices and Benefits. *International Journal of Life Cycle Assessment*, vol.5 no.6, p.319-326.
- BARE, J.C. 2010. Life cycle impact assessment research developments and needs. *Clean Techn Environ Policy*, vol.12, p.341–351.
- BAZAN C. 1956. Le développement économique de la région autonome de Sicile. *Politique étrangère*, vol.21 no.2, p.191-200.
- BECK, A.; SCHERINGER, M.; HUNGERBÜHLER, K. 2000. Fate Modelling Within LCA. The Case of Textile Chemicals. *International Journal of Life Cycle Assessment*, vol.5 no.6, p.335-344.
- BELLANCA A., HAUSER S., NERI R., PALUMBO B. 1996. Mineralogy and geochemistry of Terra Rossa soils, western Sicily: insights into heavy metal fractionation and mobility. *The Science of the Total Environment*, vol.193, p.57-67.
- BERNAT, M.; CHURCH, T.; ALLÈGRE, C. J. 1972. Barium and strontium concentrations in Pacific and Mediterranean sea water profiles by direct isotopic dilution mass spectrometry. *Earth and planetary science letters*, vol.16 no.1, p.75-80.
- BÉTHOUX, J.P.; MORIN, P.; CHAUMERY, C.; CONNAN, O.; GENTILI, B.; RUIZ-PINTO, D. 1998. Nutrients in the Mediterranean Sea, mass balance and statistical analysis of concentrations with respect to environmental change. *Marine Chemistry*, vol.63, p.155-169.
- BEVILACQUA, M.; BRAGLIA, M. 2002. Environmental efficiency analysis for ENI oil refineries. *Journal of Cleaner Production*, vol.10, p.85-92.
- BINI C., DALL'AGLIO M., FERRETTI O., GRAGNANI R. 1988. Background levels of microelements in soils of Italy. *Environmental Geochemistry and Health*, vol.10 no.2, p.63-69.
- BISWAS, G.; CLIFT, R.; DAVIS, G.; EHRENFELD, J.; FÖRSTER, R.; JOLLIET, O.; KNOEPFEL, I.; LUTERBACHER, U.; RUSSEL, D.; HUNKELER, D. 1998. Ecometrics. *International Journal of Life Cycle Assessment*, vol.3 no.4, p.184-190.
- BONARDI G., COMPAGNONI R., DEL MORO A., MESSINA A., PERRONE V. & MACAIONE E. 2008. Rb/Sr radiometric dating of the Alpine metamorphic overprint in the Aspromonte Nappe (Calabrian-Peloritanian Arc, Southern Italy). *Boll., Soc. Geol. It.*, vol.128.

References

- BONFIGLIO, L.; MANGANO, G. . In: Tignano, G. *Mylai III. Scavi e ricerche nell'area urbana (1996- 2005)*. Regione Siciliana. Messina: Assessorato dei Beni Culturali Ambientali e della Pubblica Istruzione. Dipartimento dei Beni Culturali Ambientali e dell'Educazione Permanente, 2009, p.7-9.
- BOSCO, M.L.; VARRICA, D.; DONGARRÀ, G. 2005. Case study: Inorganic pollutants associated with particulate matter from an area near a petrochemical plant. *Environmental Research*, vol.99, p.18-30.
- BREDER, R. 1987. Distribution of heavy metals in Ligurian and Tyrrhenian coastal waters. *The Science of the Total Environment*, vol.69, p.197-212.
- CAPILLI, G.; BALLARINO, G.; MORMILE, L.. 2005. *Laboratorio Mobile. Campagna di Misura Inquinamento Atmosferico. COMUNE DI SAN FILIPPO DEL MELA. Località Corriolo. 18/08/2005-16/09/2005*. Directed by Capilli, G. Agenzia Regionale per la Protezione dell'Ambiente.
- CAPILLI, G.; BALLARINO, G.; MORMILE, L.. 2005. *Laboratorio Mobile. Campagna di Misura Inquinamento Atmosferico. COMUNE DI SAN FILIPPO DEL MELA. Località Cattafi. 10/06/2005-03/08/2005*. Directed by Capilli, G. Agenzia Regionale per la Protezione dell'Ambiente.
- CAPILLI, G.; BALLARINO, G.; MORMILE, L.. 2005. *Laboratorio Mobile. Campagna di Misura Inquinamento Atmosferico. COMUNE DI PACE DEL MELA. 14/10/2005-10/11/2005*. Directed by Capilli, G. Agenzia Regionale per la Protezione dell'Ambiente.
- CAPILLI, G.; BALLARINO, G.; MORMILE, L.. 2005. *Laboratorio Mobile. Campagna di Misura Inquinamento Atmosferico. COMUNE DI MILAZZO. 24/04/2005-13/05/2005*. Directed by Capilli, G. Agenzia Regionale per la Protezione dell'Ambiente (Sicilia).
- CARBONE S., MESSINA A., LENTINI F. & MACAIONE E. 2011. *Note Illustrative della Carta Geologica d'Italia alla Scala 1:50.000. Foglio 587 Milazzo e 600 Barcellona Pozzo di Gotto*. Servizio Geologico d'Italia, ISPRA-Regione Siciliana, 1-262. S.EL.CA., Firenze
- CELLURA M, CIRRINCIONE G, MARVUGLIA A, MIRAQUI A 2008a. Wind speed spatial estimation for energy planning in Sicily: Introduction and statistical analysis. *Renewable Energy*, vol.33, p.1237-1250.
- CELLURA M, CIRRINCIONE G, MARVUGLIA A, MIRAQUI A 2008b. Wind speed spatial estimation for energy planning in Sicily: A neural kriging application. *Renewable Energy*, vol.33, p.1251-1266.
- CETIN, E.; ODABASI, M.; SEYFIOGLU, R. 2003. Ambient volatile organic compound (VOC) concentrations around a petrochemical complex and a petroleum refinery. *The Science of the Total Environment*, vol.312, p.103-112.

References

- CHEVALIER, J.; ROUSSEAU, P. 1999. Classification in LCA: Building a Coherent Family of Criteria. *International Journal of Life Cycle Assessment*, vol.4 no.6, p.352-356.
- CHIMENOS, J.M.; SEGARRA, M.; FERNÁNDEZ, M.A.; ESPIELL, F. 1999. Characterization of the bottom ash in municipal solid waste incinerator. *Journal of Hazardous Materials*, vol.A66, p.211-222.
- CIROTH, A.; FLEISCHER, G.; GERNER, K.; KUNST, H. 2003. A New Approach for a Modular Valuation of LCAs. *International Journal of Life Cycle Assessment*, vol.8 no.5, p.273-282.
- CLEAL, C.J.; THOMAS, B.A.; BEVINS, R.E.; WIMBLEDON, W.P. 1999. GEOSITES - an international geoconservation initiative. *Geology Today*, vol.2, p.64-68.
- COMPAGNIA DEI VINI. *Casa Vinicola Grasso [online]*. Accessible on: <www.compagniadivini.it/casavinicolagrasso1.htm>. Date of consultation: settembre 2010.
- COMUNE DI MILAZZO. *Città di Milazzo :: Sito Web Ufficiale [online]*. Accessible on: <www.comune.milazzo.me.it>. Date of consultation: settembre 2010.
- COMUNI-ITALIANI.IT. *Numero abitanti a Milazzo [online]*. Accessible on: <<http://www.comuni-italiani.it/083/049/statistiche/popolazione.html>>. Date of consultation: august 2012.
- CORNET Y., FITSCHY C., GOBATO O., ERPICUM M. 2005. Modélisation de la distribution spatiale des précipitations en Sicile. *Bull Soc Géogr de Liège*, vol.46, p.11-26.
- COSSA D., MARTIN J.M., TAKAYANAGI K., SANJUAN J. 1997. The distribution and cycling of mercury species in the western Mediterranean. *Deep-Sea Research II*, vol.44 no.3-4, p.721-740.
- COSTANTINI, E. A. C.; L'ABATE, G. 2009. The soil cultural heritage of Italy: Geodatabase, maps and pedodiversity evaluation. *Quaternary International*, vol.209, p.142-153.
- COUNCIL OF THE EUROPEAN UNION. *COUNCIL DIRECTIVE 98/83/EC of 3 November 1998 on the quality of water intended for human consumption [online]*. Accessible on: <<http://eur-lex.europa.eu/LexUriServ/LexUriServ.do?uri=CELEX:31998L0083:EN:HTML>>. Date of consultation: august 2012.
- CRISAFULLI, M.. *Il clima e il suolo di Capo Milazzo [online]*. Accessible on: <spazioinwind.libero.it/gastroepato/riservacapo_piante.htm>. Date of consultation: april 2012.
- CRISAFULLI, S., VICE PRES. TAT. *La raffineria di Milazzo. Grave incompatibilità della struttura nell'attuale territorio [online]*. Accessible on: <www.osservatorio-sicilia.it>. Date of consultation: july 2010.

References

CUTTER G.A., CUTTER L.S., FEATHERSTONE A.M., LOHRENZ S.E. 2001. Antimony and arsenic biogeochemistry in the western Atlantic Ocean. *Deep-Sea Research II*, vol.48, p.2895–2915.

DE GREGORIO S., ROTOLO S.G. & VILLA I.M. 2003. Geochronology of the medium to high-grade metamorphic units of the Peloritani Mts., Sicily. *Int J Earth Sci*, vol.92, p.852-872.

DET NORSKE VERITAS ITALIA S.R.L., 2004. *Environmental Management System Certificate No. CERT-817-2004-AE-CIA-SINCERT [online]*. Accessible on: <www.raffineriadimilazzo.it>. Date of consultation: july 2010.

DET NORSKE VERITAS ITALIA S.R.L., 2004. *Environmental Management System Certificate No. CERT-817-2004-AE-CIA-SINCERT [online]*. Accessible on: <www.raffineriadimilazzo.it>. Date of consultation: july 2010.

DI LENOARDO, R.; TRANCHIDA, G.; BELLANCA, A.; NERI, R.; ANGELONE, M.; MAZZOLA, S. 2006. Mercury levels in sediments of central Mediterranean Sea: A 150+ year record from box-cores recovered in the Strait of Sicily. *Chemosphere*, vol.65, p.2366-2376.

DINELLI, E.; LIMA, A.; ALBANESE, S.; BIRKE, M.; CICHELLA, D.; GIACCIO, L.; VALERA, P.; DE VIVO, B. 2012. Major and trace elements in tap water from Italy. *Journal of Geochemical Exploration*, vol.112, p.22.

DINELLI, E.; LIMA, A.; DE VIVO, B.; ALBANESE, S.; CICHELLA, D.; VALERA, P. 2010. Hydrogeochemical analysis on Italian bottled mineral waters: Effects of geology. *Journal of Geochemical Exploration*, vol.107 no. 3, p.317-335.

DISTEFANO, M.L.; INGRANDO, M.; MANDANICI, A.. RIFIUTI. In: Agenzia Regionale per la Protezione dell'Ambiente - Sicilia. *Annuario regionale dei dati ambientali 2009*. ARPA Sicilia2009, p.44.

DNV ITALIA, 2005. *Centrale di Milazzo. Dichiarazione Ambientale anno 2004 [online]*. Accessible on: <www.edipower.it>. Date of consultation: july 2010.

DONGARRÀ, G.; VARRICA, D. 1998. The presence of heavy metals in air particulate at Vulcano island (Italy). *The Science of the Total Environment*, vol.212, p.1-9.

DREYER, L. C.; NIEMANN, A. L.; HAUSCHILD, M. Z. 2003. Comparison of Three Different LCIA Methods: EDIP97, CML2001 and Eco-indicator 99. *International Journal of Life Cycle Assessment*, vol.8 no.4, p.191-200.

ECOMATTERS INC CANADA, GEOLOGICAL SURVEY OF SWEDEN (SGU) *Solid/liquid partition coefficients (Kd) for selected soils and sediments at Forsmark and Laxemar-Simpevarp*. Swedish Nuclear Fuel and Waste Management Co, 2009, 72 p.

References

EDIPOWER. *Bilancio Ambientale e Indicatori di Prestazione Ambientale. Centrale termoelettrica di San Filippo del Mela* [online]. Accessible on: <www.edipower.it>. Date of consultation: July 2010.

EDIPOWER, 2009. *Official website* [online]. Accessible on: <www.edipower.it>. Date of consultation: July 2010.

EDISON. *Termica Milazzo S.r.l.* [online]. Accessible on: <<http://www.termica-milazzo.it>>. Date of consultation: July 2010.

EKVALL, T.; WEIDEMA, B. P. 2004. System Boundaries and Input Data in Consequential Life Cycle Inventory Analysis. *International Journal of Life Cycle Assessment*, vol.9 no.3, p.161-171.

ENEA. 2003. *Artemisia 2. Uno strumento per valutare gli effetti ambientali e sanitari degli inquinanti aeriformi emessi da insediamenti produttivi e per indirizzare la scelta di nuovi siti, anche ai fini dell'applicazione della direttiva 96/61 CE sulla prevenzione e riduzione integrata dell'inquinamento (IPPC): Applicazione all'area di Milazzo*. Directed by Rubbia, C. Ente per le Nuove tecnologie, l'Energia e l'Ambiente; Ministero dell'Ambiente e della Tutela del Territorio; Regione Siciliana.

ERA CONSULT. 2002. *Ecotoxicology and other issues for the Mediterranean Sea*. Directed by Vega, M. ERA Consult.

EREL Y. . Mechanisms and Velocities of Anthropogenic Pb Migration in Mediterranean Soils. *Environmental Research, Section a*, vol.78, p.112—117.

EUROPEAN COMMISSION JOINT RESEARCH CENTRE INSTITUTE FOR ENVIRONMENT AND SUSTAINABILITY. 2010. *ILCD Handbook: Analysing of existing Environmental Impact Assessment methodologies for use in Life Cycle Assessment First edition*. Directed by Pant, R. & Bersani, R.. Joint Research Centre.

EUROPEAN COMMISSION, JOINT RESEARCH CENTRE. *ILCD Handbook: Analysing of existing Environmental Impact Assessment methodologies for use in Life Cycle Assessment - First edition* [online]. Accessible on: <ict.jrc.ec.europa.eu/assessment/projects>. Date of consultation: 2010.

EUROPEAN ENVIRONMENT AGENCY. *Search E-PTR data at facility level* [online]. Accessible on: <<http://prtr.ec.europa.eu/FacilityLevels.aspx>>. Date of consultation: 16 July 2012.

EUROPEAN REGIONAL SCIENCE ASSOCIATION (ERSA). August 23rd - 27th, 2005. *45th Congress - Land Use and Water Management in a Sustainable Network Society - PRECAUTION AND PROTECTION POLICIES OF URBAN ECOSYSTEM IN THE IBLEA NORTH EASTERN COAST OF SICILY - Paper 139*. Directed by Cirelli, C.; Mercatani, L.; Nicosia, E.D.; Porto, C.M.. Amsterdam.

References

- FANC C., MONCRIEFF J.B. 2001. The dependence of soil CO₂ flux on temperature. *Soil Biology & Biochemistry*, vol.33, p.155-165.
- FANO, V.; CERNIGLIARO, A.; SCODOTTO, S.; POLLINA ADDARIO, S.; CARUSO, S.; MIRA, A.; FORASTIERE, F.; PERUCCI, C. A.. 2008. *Stato di salute della popolazione residente nelle aree ad elevato rischio ambientale e nei siti di interesse nazionale della Sicilia : Analisi della mortalità (aa 1995-2000) e dei ricoveri ospedalieri (aa 2001-2003)*. Directed by Fano, V. Epidemiologia Sviluppo Ambientale; Assessorato Sanità Dipartimento Osservatorio Epidemiologico (Regione Siciliana); Dipartimento di Epidemiologia ASL RME.
- FARAGALLAH, H. M.; ASKAR, A. I.; OKBAH, M. A.; MOUSTAFA, H. M. 2009. Physico-chemical characteristics of the open Mediterranean sea water far about 60 km from Damietta harbor, Egypt. *Journal of Ecology and The Natural Environment*, vol.1 no.5, p.106-119.
- FERRARA, R.; MAZZOLAI, B.; LANZILLOTTA, E.; NUCARO, E.; PIRRONE, N. 2000. Volcanoes as emission sources of atmospheric mercury in the Mediterranean basin. *The Science of the Total Environment*, vol.259, p.115-121.
- FINKBEINER, M.; INABA, A.; TAN, R. B. H.; CHRISTIANSEN, K.; KLÜPPEL, H.-J. 2006. The New International Standards for Life Cycle Assessment: ISO 14040 and ISO 14044. *International Journal of Life Cycle Assessment*, vol.11 no.2, p.80-85.
- FINNVEDEN, G.; HAUSCHILD, M.Z.; EKVALL, T.; GUINÉE, J.; HEIJUNGS, R.; HELLWEG, S.; KOEHLER, A.; PENNINGTON, D.; SUH, S. . Recent developments in Life Cycle Assessment. *Journal of Environmental Management*, vol.91, p.1-21.
- FINNVEDEN, G.; HOFSTETTER, P.; BARE, J.C.; BASSON, L.; CIROTH, A.; METTIER, T.; SEPPÄLÄ, J.; JOHANSSON, J.; NORRIS, G.; VOLKWEIN, S.. Normalisation, grouping, and weighting in Life-Cycle Impact Assessment. In: Udo de Haes et al.. *Life-Cycle Impact Assessment: Striving Towards Best Practice*. 2002, p.177-208.
- FINNVEDEN, G.; NILSSON, M. 2005. Site-dependent Life-Cycle Impact Assessment in Sweden. *International Journal of Life Cycle Assessment*, vol.10 no.4, p.235-239.
- FOIS, E. 1990. Stratigraphy and palaeogeography of the Capo Milazzo area (NE Sicily, Italy): clues to the evolution of the southern margin of the Tyrrhenian Basin during the Neogene. *Palaeogeography, Palaeoclimatology, Palaeoecology*, vol.78, p.87-108.
- FREZZOTTI ML, PECCERILLO A, ZANON V, NIKOGOSIAN I 2004. Silica-rich melts in quartz xenoliths from Vulcano Island and their bearing in processes of crustal anatexis and crust-magma interaction beneath the Aeolian Arc, Southern Italy. *Journal of petrology*, vol.45 no.1, p.3-26.

References

FRISCHKNECHT R, JUNGBLUTH N, ALTHAUS HJ, DOKA G, DONES R, HECK T, HELLWEG S, HISCHIER R, NEMECEK T, REBITZER G, SPIELMANN M 2004. The ecoinvent Database: Overview and Methodological Framework. *International Journal of Life Cycle Assessment*, vol.10 no.1, p.3-9.

GALÁN E., FERNÁNDEZ-CALIANI J.C., GONZÁLEZ I., APARICIO P., ROMERO A. 2008. Influence of geological setting on geochemical baselines of trace elements in soils. Application to soils of South–West Spain. *Journal of Geochemical Exploration*, vol.98, p.89-106.

GALGANI, F.; MARTÍNEZ-GÓMEZ, C.; GIOVANARDI, F.; ROMANELLI, G.; CAIXACH, J.; CENTO, A.; SCARPATO, A.; BENBRAHIM, S.; MESSAOUDI, S.; DEUDERO, S.; BOULAHDIR, M.; BENEDICTO, J.; ANDRAL, B. 2001. Assessment of polycyclic aromatic hydrocarbon concentrations in mussels (*Mytilus gallprovincialis*) from the Western basin of the Mediterranean Sea. *Environmental Monitoring and Assessment*, vol.172 no.1-4, p.301-317.

GALLEGO, A.; RODRÍGUEZ, L.; HOSPIDO, A.; MOREIRA, M.T.; FELJOO, G. 2010. Development of regional characterization factors for aquatic eutrophication. *International Journal of Life Cycle Assessment*, vol.15, p.32-43.

GATTO, E.; MUDU, P.; SAITTA, P. *L'industria petrolchimica nella Valle del Mela: uno studio qualitativo sulla percezione del rischio e gli immaginari*. CIRSDIG – Working Paper n. 27. , 2008, 66 p.

GAZZETTA UFFICIALE SERIE GENERALE SICILIA 18 february 2005. Stagione balneare per l'anno 2005. *DECRETO 21 gennaio 2005*, vol.7, p.28.

GEYER, R.; STOMS, D.M.; LINDNER, J.P.; DAVIS, F.W.; WITTSTOCK, B 2010. Coupling GIS and LCA for biodiversity assessments of land use Part 1: Inventory modeling. *International Journal of Life Cycle Assessment*, vol.15, p.454-467.

GHAZI M, QUARANTA G, DUPLAY J, HADJAMOR R, KHODJA M, AIT AMAR H, KESSAÏSSIA Z . Life-Cycle Impact Assessment of oil drilling mud system in Algerian arid area. *Resources, Conservation and Recycling*, vol.55 no.12, p.1222-1231.

GHAZI, M. *Analyse du Cycle de Vie des boues de forage pétrolier. Caractérisation des émissions toxiques en milieu aride*. Thesis in Sciences de la Terre et de l'Univers option Géochimie de l'Environnement. Strasbourg: Université de Strasbourg - Ecole et Observatoire des Sciences de la Terre, 2009, 170 p.

GOEDKOOP M, HEIJUNGS R, HUIJBREGTS M, DE SCHRYVER A, STRUIJS J, VAN ZELM R. *ReCiPe 2008, A life cycle impact assessment method which comprises harmonised category indicators at the*

References

midpoint and the endpoint level; First edition Report I: Characterisation [online]. Accessible on: <www.lcia-recipe.net>. Date of consultation: 2009.

GOEDKOOP, M.; HEIJUNGS, R.; HUIJBREGTS, M.; DE SCHRYVER, A.; STRUIJS, J.; VAN ZELM, R. .

ReCiPe 2008A life cycle impact assessment method which comprises harmonised category indicators at the midpoint and the endpoint level First edition Report I: Characterisation. Directed by Strietman, H.. Netherlands: Ruimte en Milieu, Ministerie van Volkshuisvesting, Ruimtelijke Ordening en Milieubeheer.

GRAHL, B.; SCHMINCKE, E. 1996. Evaluation and Decision-making Processes in Life Cycle Assessment. *International Journal of Life Cycle Assessment*, vol.1 no.1, p.32-35.

GRINGERI, G.; BONFIGLIO, L.; DI GERONIMO, I.; MANGANO, G.; ANTONOLI, F. 2004. Uplifted Holocene Littoral Deposits in the Milazzo Peninsula (North Eastern Sicily, Italy). *Quaternaria nova: Storia culturale e naturale del quaternario*, vol.8, p.141-153.

GROUSSET, F.E.; QUETEL, C.R.; THOMAS, B.; DONARD, O.F.X.; LAMBERT, C.E.; GUILLARD, F.;

MONACO, A. 1995. Anthropogenic vs. lithogenic origins of trace elements (As, Cd, Pb, Rb, Sb, Sc, Sn, Zn) in water column particles: northwestern Mediterranean Sea. *Marine Chemistry*, vol.48, p.291-310.

GUERZONI S., CHESTER R., DULAC F., HERUT B., LOÏE-PILOT M.-D., MEASURES C., MIGON G, EMANUELA MOLINAROLI H, CYRIL MOULIN C, PAOLO ROSSINI A, SAYDAM C., SOUDINE A., ZIVERI P. 1999. The role of atmospheric deposition in the biogeochemistry of the Mediterranean Sea. *Progress in Oceanography*, vol.44, p.147-190.

GUINÉE, J. B.; HEIJUNGS, R.; HUPPES, G. 2004. Economic Allocation: Examples and Derived Decision Tree. *International Journal of Life Cycle Assessment*, vol.9 no.1, p.23-33.

HADJ AMOR, R. *Evaluation des Impacts anthropiques de l'Ecosystème lagunaire d'El Melah de Slimane (Tunisie) par la méthode d'Analyse du Cycle de Vie*. Thesis in Sciences de la Terre et de l'Univers option Géochimie de l'Environnement. Strasbourg: Université Louis Pasteur - Ecole et Observatoire des Sciences de la Terre, 2008, 138 p.

HAYE S., SLAVEYKOVA V.I., PAYET J. 2007. Terrestrial ecotoxicity and effect factors of metals in life cycle assessment (LCA). *Chemosphere*, vol.68, p.1489-1496.

HEDMAN, B.; NÄSLUND, M.; NILSSON, C.; MARKLUND, S. . Emissions of Polychlorinated Dibenzodioxins and Dibenzofurans and Polychlorinated Biphenyls from Uncontrolled Burning of Garden and Domestic Waste (Backyard Burning). *Environmental Science and Technology*, vol.39, p.8790-8796.

References

- HEIJUNGS, R.; SUH, S.; KLEIJN, R. 2005. Numerical Approaches to Life Cycle Interpretation. The cas of the ecoinvent'96 database. *International Journal of Life Cycle Assessment*, vol.10 no.2, p.103-112.
- HELLWEG, S.; HOFSTETTER, T. B.; HUNGERBÜHLER, K. 2003. Discounting and the Environment. Should Current Impacts be Weighted Differently than Impacts Harming Future Generations?. *Internaitonal Journal of Life Cycle Assessment*, vol.8 no.1, p.8-18.
- HERTWICH, E. G.; HAMMITT, J. K. 2001. A Decision-Analytic Framework for Impact Assessment. Part I: LCA and Decision Analysis. *International Journal of Life Cycle Assessment*, vol.6 no.1, p.5-12.
- HERTWICH, E.G.; PENNINGTON, D.W.; BARE, J.C.. Introduction. In: Udo de Haes et al.. *Life-Cycle Impact Assessment: Striving Towards Best Practice*. Society of Environmental Toxicology and Chemistry (SETAC) 2002, p.1-10.
- HILL, IG; WORDEN, RH; MEIGHAN, IG 2000. Yttrium: the immobility-mobility transition during basaltic weathering. *Geology*, vol.28 no.10, p.923-926.
- HOCHSCHORNER, E.; FINNVEDEN, G. 2003. Evaluation of Two Simplified Life Cycle Assessment Methods. *International Journal of Life Cycle Assessment*, vol.8 no.3, p.119-128.
- HOGAAS EIDE, M.; OHLSSON, T. 1998. A Comparison of Two Different Approaches to Inventory Analysis of Dairies. *International Journal of Life Cycle Assessment*, vol.3 no.4, p.209-215.
- HOLMES-FARLEY, R. . *Reef alchemy [online]*. Accessible on: <<http://reefkeeping.com/issues/2005-11/rhf/index.php>>. Date of consultation: septembre 2010.
- HORVAT, M.; KOTNIK, J.; LOGAR, M.; FAJON, V.; ZVONARIĆ, T.; PIRRONE, N. 2003. Speciation of mercury in surface and deep-seawaters in the Mediterranean Sea. *Atmospheric Environment*, vol.37 Supplement No.1, p.S93-S108.
- HOSPIDO, A.; MOREIRA, T.; MARTIN, M.; RIGOLA, M.; FEIJOO, G. 2005. Environmental Evaluation of Different Treatment Processes for Sludge from Urban Wastewater Treatments: Anaerobic Digestion versus Thermal Processes. *International Journal of Life Cycle Assessment*, vol.10 no.5, p.336-345.
- HUIJBREGTS, M.A.J.; LUNDI, S.; MCKONE, T.E.; VAN DE MEENT, D. 2003. Geographical scenario uncertainty in generic fate and exposure factors of toxic pollutants for life-cycle impact assessment. *Chemosphere*, vol.51, p.501-508.

References

HUNKELER, D.; BISWAS, G. 2000. Return on Environment. An Objective Indicator To Validate Life Cycle Assessments?. *International Journal of Life Cycle Assessment*, vol.5 no.6, p.358-362.

IL METEO. *Climat Milazzo - Medie Climatiche | IL METEO.IT [online]*. Accessible on: <www.ilmeteo.it/portale/medie-climatiche/Milazzo>. Date of consultation: april 2012.

INABA, A.; HUNKELER, D.; REBITZER, G.; FINKBEINER, M.; SIEGENTHALER, C.; SAUR, K. 2003. The Fifth International Conference on Ecobalances. Practical Tools and Thoughtful Principles for Sustainability. *International Journal of Life Cycle Assessment*, vol.8 no.1, p.1-5.

ISTITUTO IDROGRAFICO DELLA MARINA *Atlante delle correnti superficiali dei mari italiani*. , 1982, 45 p.

ISTITUTO SUPERIORE PER LA PROTEZIONE E LA RICERCA AMBIENTALE. *Disaggregazione dell'inventario nazionale 2005 :: emissioni provinciali per attività :: tutti i macrosettori [online]*. Accessible on: <www.sinanet.isprambiente.it/it/inventaria/disaggregazione_prov2005/emissioni%attivita/db_provinciale_on_line_xls.zip/view>. Date of consultation: 17 July 2012.

INTERNATIONAL ORGANISATION FOR STANDARDISATION. ISO 14044 International Standard. In: . *Environmental Management - Life Cycle Assessment - Requirements and Guidelines*. International Organisation for Standardisation, Geneva, Switzerland 2006, p.49.

INTERNATIONAL ORGANISATION FOR STANDARDISATION. ISO 14040 International Standard. In: . *Environmental Management - Life Cycle Assessment - Principles and Framework*. International Organisation for Standardisation, Geneva, Switzerland 2006, p.23.

ITSUBO, N.; SAKAGAMI M.; WASHIDA, T.; KOKUBU, K.; INBA, A. 2004. Weighting Across Safeguard Subjects for LCIA through the Application of Conjoint Analysis. *International Journal of Life Cycle Assessment*, vol.9 no.3, p.196-205.

JICKELLS T.D. 1999. The inputs of dust derived elements to the Sargasso Sea; a synthesis. *Marine Chemistry*, vol.68, p.5-14.

JOLLIET O, MARGNI M, CHARLES R, HUMBERT S, PAYET J, REBITZER G, ROSENBAUM R 2003. IMPACT 2002+: A New Life Cycle Impact Assessment Methodology. *Int J of LCA*, vol.8, p.324- 330.

JOLLIET, O. 2006. Emergence and Future of Life Cycle Impact Assessment: Good science comes from good people. *International Journal of Life Cycle Assessment*, vol.1 Special issue, p.9-10.

JOLLIET, O.; MARGNI, M.; CHARLES, R.; HUMBERT, S.; PAYET, J.; REBITZER, G.; ROSENBAUM, R. 2003. IMPACT 2002+: A New Life Cycle Impact Assessment Methodology. *International Journal of Life Cycle Assessment*, vol.8 no.6, p.324-330.

References

KOTNIK, J.; HORVAT, M.; TESSIER, E.; OGRINC, N.; MONPERRUS, M.; AMOUROUX, D.; FAJON, V.; GIBIČAR, D.; ŽIŽEC, S.; SPROVIERI, F.; PIRRONE, N. 2007. Mercury speciation in surface and deep waters of the Mediterranean Sea. *Marine Chemistry*, vol.107, p.13-30.

LA PERA, L.; DI BELLA, G.; RANDO, R.; LO TURCO, V.; DUGO, G. 2008. Speciation of inorganic arsenic in coastal seawater from Ionian and Tyrrhenian Seas (Sicily, Italy) using derivative anodic stripping chronopotentiometry. *Environ Monit Assess*, vol.145, p.119-126.

LA PERA, L.; DI BELLA, G.; RANDO, R.; LO TURCO, V.; DUGO, G. 2008. Speciation of inorganic arsenic in coastal seawater from Ionian and Tyrrhenian Seas (Sicily, Italy) using derivative anodic stripping chronopotentiometry. *Environmentla MOnitoring Assessment*, vol.145, p.119-126.

LA TRIBUNE. *Des pluies torrentielles font 14 morts en Sicile [online]*. Accessible on: <http://www.latribune.fr/depeches/reuters/des-pluies-torrentielles-font-14-morts-en-sicile.html>. Date of consultation: november 2010.

LEMIEUX, P.M.; LUTES, C.C.; ABBOTT, J.A.; ALDOUS, K.M. 2000. Emissions of Polychlorinated Dibenzo-p-dioxins and Polychlorinated Dibenzofurans from the Open Burning of Household Waste in Barrels. *Environmental Science and Technology*, vol.34 no.3, p.377-384.

LENTINI, F.; CATALANO, S.; CARBONE, S. 1999. *Carta Geologica della Provincia di Messina, Scala 1:50 000*. Provincia Regionale di Messina.

LENTINI F., CARBONE S., MESSINA A. & MACAIONE. 2011. *Foglio 587 Milazzo e 600 Barcellona Pozzo di Gotto della Carta Geologica d'Italia alla scala 1:50.000*. ISPRA - Regione Siciliana. S.EL.CA., Firenze

LUCCHESI, T. 2004. *Piano Stralcio di Bacio per l'Assetto Idrogeologico della Regione Siciliana. Relazione Generale*. Regione Siciliana; Assessorato Territorio e Ambiente; Dipartimento Territorio; Servizio Assetto del Territorio e Difesa del Suolo; Unità Operativa Piano per l'Assetto Idrogeologico.

MA, J; WEI, G; XU, Y; LONG, W; SUN, W 2007. Mobilization and re-distribution of major and trace elements during extreme weathering of basalt in Hainan Island South China. *Geochimica et Cosmochimica Acta*, vol.71, p.3223-3237.

MACAIONE E., MESSINA A., BONANNO R., CARABETTA M. T. 2010. An itinerary through Proterozoic to Holocene rocks in the North-Eastern Peloritani Mts. (Southern Italy). *Geological Field Trips, Online Journal of the Società Geologica Italiana and Servizio Geologico d'Italia*, vol. 2 No.1, p.1-98.

References

- MANDANICI, A., RIFIUTI. In: Agenzia Regionale per la Protezione dell'Ambiente - Sicilia. *Annuario regionale dei dati ambientali 2008*. ARPA Sicilia 2008, p.41.
- MANNO, E.; VARRICA, D.; DONGARRÀ, G. 2006. Metal distribution in road dust samples collected in an urban area close to a petrochemical plant at Gela, Sicily. *Atmospheric Environment*, vol.40, p.5929–5941.
- MAY, J. R.; BRENNAN, D. J. 2003. Application of Data Quality Assessment Methods to an LCA of Electricity Generation. *International Journal of Life Cycle Assessment*, vol.84, p.215-225.
- MESSINA, A.; MACAIONE, E.; CARBONE, S.; LENTINI, F. Karst Phenomena in the North-Eastern Sicily (Calabria-Peloritani Arc, Italy). In: *3rd International Symposium : Karst Evolution in the south mediterranean area*, 29/31 Maggio 2009. C.I.R.S. - Centro Ibleo di Ricerche Speleo-Idrogeologiche, 2010, 37p.
- MESSINA A., SOMMA R., LIMA A.M., MACAIONE E., CARBONE G. & CARERI G. 2004a. *The abundance of 55 elements and petrovolumetric models of the Crust in the Peloritani Mountains*. In: “The abundance of 55 elements and petrovolumetric models of the crust in 9 type areas from the crystalline basements of Italy, with some geophysical and petrophysical data”. Accad. Nazionale delle Scienze detta dei XL. F.P. Sassi Editor – Rome chapter 13, p.411-450. 32nd International Geological Congress.
- MESSINA A., SOMMA R., MACAIONE E., CARBONE G. & CARERI G. 2004b. *Peloritani Continental Crust Composition (Southern Italy): geological and petrochemical evidence*. Boll. Soc. Geol. It., vol. 123, p.405-441.
- MESSINA A., LENTINI F., MACAIONE E., CARBONE S., DOHERTY A. 2012-2013. *Tectono-stratigraphic evolution of the Southern Sector of the Calabria-Peloritani Chain: state of knowledge*. 86th National Congress of Italian Geological Society *The Mediterranean Geological archive of past and present*. Post-Congress Geological Field Trip 21-23 September 2012. Online Journal of the Società Geologica Italiana and Servizio Geologico d'Italia, p.1-167.
- MICHELETTI F., BARBEY P., FORNELLI A., PICCARRETTA G. & DELOULE E. 2007. Latest Precambrian to Early Cambrian U-Pb zircon ages of augen gneisses from Calabria (Italy), with inference to the Alboran microplate in the evolution of the peri-Gondwana terranes. *International Journal of Earth Science*, vol.96, p.843-860.
- MIDDELBURG, JJ; VAN DER WEIJDEN, CH; WOITTEZ, JRW 1988. Chemical processes affecting the mobility of major minor and trace elements during weathering of granitic rocks. *Chemical Geology*, vol.68, p.253-273.

References

MINISTERO DELL'AMBIENTE E DELLA TUTELA DEL TERRITORIO E DEL MARE. *Official website [online]*. Accessible on: <www.minambiente.it>. Date of consultation: settembre 2010.

MINISTRO DELL'AMBIENTE E DELLA TUTELA DEL TERRITORIO E DEL MARE. *DECRETO 30 marzo 2009. Secondo elenco aggiornato dei siti di importanza comunitaria per la regione biogeografia mediterranea in Italia ai sensi della direttiva 92/43/CEE [online]*. Accessible on: <www.minalbiente.it/opencms/opencms/home_it/menu.html>. Date of consultation: settembre 2010.

MORLEY, NH; BURTON, JD; TANKERE, SPC; MARTIN, JM 1997. Distribution and behaviour of some dissolved trace metals in the western Mediterranean Sea. *Deep Sea Research II*, vol.44 no.3-4, p.675-691.

MUELLER, K. G.; LAMPÉRTH, M. U.; KIMURA, F. 2004. Parametriser Inventories for Life Cycle Assessment. Systematically Relating Design Parameters to the Life Cycle Inventory. *International Journal of Life Cycle Assessment*, vol.9 no.4, p.227-235.

NADAL, M.; MARI, M.; SHUHMACHER, M.; DOMINGO, J.L. 2009. Multi-compartmental environmental surveillance of a petrochemical area: Levels of micropollutants. *Environment International*, vol.35, p.227-235.

NADAL, M.; SCHUHMACHER, M.; DOMINGO, J.L. 2007. Levels of metals, PCBs, PCNs and PAHs in soils of a highly industrialized chemical/petrochemical area: Temporal trend. *Chemosphere*, vol.66, p.267-276.

NESBITT, HW 1979. Mobility and fractionation of rare earth elements during weathering of a granodiorite. *Nature*, vol.279, p.206-210.

NET RESOURCE INTERNATIONAL. *Milazzo Refinery, Italy [online]*. Accessible on: <www.hydrocarbons-technology.com>. Date of consultation: april 2010.

NOTARNICOLA, B.; HUPPES, G.; VAN DEN BERG, N. W. 1998. Evaluating Options in LCA: The Emergence of Conflicting Paradigms for Impact Assessment and Evaluation. *International Journal of Life Cycle Assessment*, vol.3 no.5, p.289-300.

NÚÑEZ, M.; CIVIT, B.; MUÑOZ, P.; ARENA, A.P.; RIERADEVALL, J.; ANTÓN, A. 2010. Assessing potential desertification environmental impact in life cycle assessment Part 1: Methodological aspects. *International Journal of Life Cycle Assessment*, vol.15, p.67-78.

OKBAH, M. A.; NASR, S. M. 2006. Dissolved trace-metal concentrations along the Mediterranean Sea, to the north of the Nile Delta region, Egypt. *Chemistry in ecology*, vol.22 no.2, p.125-135.

References

- OKUDA, T.; IWASE, T.; UEDA, H.; SUDA, Y.; TANAKA, S.; DOKIYA, Y.; FUSHIMI, K.; HOSOE, M. 2005. The impact of volcanic gases from Miyake island on the chemical constituents in precipitation in the Tokyo metropolitan area. *Science of the Total Environment*, vol.341, p.185-197.
- OTTO, H. E.; MUELLER, K. G.; KIMURA, F. 2003. Efficient Information Visualization in LCA. Introduction and Overview. *International Journal of Life Cycle Assessment*, vol.8 no.4, p.183-189.
- OWENS, J. W. 1999. Why Life Cycle Impact Assessment is Now Described as an Indicator System. *International Journal of Life Cycle Assessment*, vol.4 no.2, p.81-86.
- PALUMBO B, ANGELONE M, BELLANCA A, DAZZI C, HAUSER S, NERI R, WILSON J 2000. Influence of inheritance and pedogenesis on heavy metal distribution in soils of Sicily, Italy. *Geoderma*, vol.95, p.247-266.
- PAYET J. *Assessing Toxic Impacts on Aquatic Ecosystems in Life Cycle Assessment (LCA)*. Thesis in sciences et ingénierie de l'environnement. Lausanne: École Polytechnique Fédérale, 2004, 204 p.
- PECORAINO, G.; SCALICI L.; AVELLONE G.; CERAULO L.; FAVARA R.; CANDELA E.G.; PROVENZANO M.C.; SCALETTA C. 2008. Distribution of volatile organic compounds in Sicilian groundwaters analysed by head space-solid phase micro extraction coupled with gas chromatography mass spectrometry (SPME/GC/MS). *Water Research*, vol.42, p.3563-3577.
- PENATI, G.. *Termica Milazzo S.r.l. Centrale di Milazzo. Dichiarazione Ambientale 2008 [online]*. Accessible on: <www.edison.it>. Date of consultation: 2008.
- PENNINGTON, D.W.; POTTING, J.; FINNVEDEN, G.; LINDEIJER, E.; JOLLIET, O.; RYDBERG, T.; REBITZER, G. 2004. Life cycle assessment Part 2: Current impact assessment practice. *Environment International*, vol.30 no.5, p.721-739.
- PEPE, F.; SCOPELLITI, G.; DI LEONARDO, R.; FERRUZZUA, G. 2010. Granulometry, mineralogy and trace elements of marine sediments from the Gulf of Milazzo (NZ Sicily): evaluation of anthropogenic impact. *Italian Journal of Geoscience*, vol.129 no.3, p.385-394.
- PIRRELLO, M.. RIFIUTI. In: Agenzia Regionale per la Protezione dell'Ambiente - Sicilia. *Annuario regionale dei dati ambientali 2005*. ARPA Sicilia2005, p.23.
- PIRRELLO, M.. RIFIUTI. In: Agenzia Regionale per la Protezione dell'Ambiente - Sicilia. *Annuario regionale dei dati ambientali 2006*. ARPA Sicilia2006, p.24.
- POTTING, J.; HAUSCHILD, M. 1997. Predicted Environmental Impact and Expected Occurrence of Actual Environmental Impact Part II: Spatial Differentiation in Life-Cycle Assessment via the

References

Site- Dependent Characterisation of Environmental Impact from Emissions. *International Journal of Life Cycle Assessment*, vol.2 no.4, p.209-216.

POTTING, J.; HAUSCHILD, M. 1997. Predicted Environmental Impact and Expected Occurrence of Actual Environmental Impact Part I: The Linear Nature of Environmental Impact from Emissions in Life-Cycle Assessment. *International Journal of Life Cycle Assessment*, vol.2 no.3, p.171-177.

RAFFINERIA DI MILAZZO S.C.P.A.. *Raffineria di Milazzo, Società Consortile per Azioni [online]*. Accessible on: <www.raffineriadimilazzo.it>. Date of consultation: july 2010.

RAFFINERIA DI MILAZZO S.C.P.A., 2007. *Politica della Società per... Sicurezza, Ambiente e Salute [online]*. Accessible on: <www.raffineriadimilazzo.it>. Date of consultation: july 2010.

RAFFINERIA DI MILAZZO S.C.P.A., 2007. *Politica della Società per... la Qualità [online]*. Accessible on: <www.raffineriadimilazzo.it>. Date of consultation: july 2010.

RAFFINERIA DI MILAZZO S.C.P.A., 2009. *Modello 231 [online]*. Accessible on: <www.raffineriadimilazzo.it>. Date of consultation: july 2010.

RAJESH, D.; SUNIL, C.; LALITA, R.; SUSHILA, S. 2009. Impact assessment of soils treated with refineries effluent. *European Journal of Soil Biology*, vol.45, p.459-465.

RAUGEI, M.; ULGIATI, S. 2009. A novel approach to the problem of geographic allocation of environmental impact in Life Cycle Assessment and Material Flow Analysis. *Ecological Indicators*, vol.9, p.1257-1264.

REAP, J.; ROMAN, F.; DUNCAN, S.; BRAS, B. 2008. A survey of unresolved problems in life cycle assessment Part 2: impact assessment and interpretation. *International Journal of Life Cycle Assessment*, vol.13, p.374–388.

REGIONE SICILIANA ASSESSORATO TERRITORIO E AMBIENTE 2002. *Piano Stralcio di Bacino per l'Assetto Idrogeologico (P.A.I.). Bacino Idrografico del Torrente Corriolo (006). Area Territoriale tra i bacini del T.Muto e del T.te Corriolo (006a). Area Territoriale tra i bacini del T.te Corriolo e del T.te Mela (006b). Carta Litologica Tav. N°02. Scala 1:50.000. .*

REGIONE SICILIANA ASSESSORATO TERRITORIO E AMBIENTE 2002. *Piano Stralcio di Bacino per l'Assetto Idrogeologico (P.A.I.). Bacino Idrographico del Torrente Mela (007) e centro abitato di Santa Lucia del Mela. Carta Litologica Tav. N°02. Scala 1:50.000. .*

REGIONE SICILIANA ASSESSORATO TERRITORIO E AMBIENTE 2002. *Piano Stralcio di Bacino per l'Assetto Idrogeologico (P.A.I.). Bacino Idrografico del Torrente Corriolo (006). Area Territoriale tra i bacini del T.Muto e del T.te Corriolo (006a). Area Territoriale tra i bacini del T.te Corriolo e del T.te Mela (006b). Carta Litologica Tav. N°02. Scala 1:50.000. .*

References

REGIONE SICILIANA ASSESSORATO TERRITORIO E AMBIENTE 2002. *Piano Stralcio di Bacino per l'Assetto Idrogeologico (P.A.I.). Bacino Idrografico del Torrente Mela (007) e centro abitato di Santa Lucia del Mela. Carta Litologica Tav. N°02. Scala 1:50.000.* .

REGIONE SICILIANA, ASSESSORATO TERRITORIO E AMBIENTE 2004. *Piano Stralcio di Bacino per l'Assetto Idrogeologico (P.A.I.). Bacino Idrografico del Torrente Mela (007) e centro abitato di Santa Lucia Del Mela. Quadro d'unione.* Regione Siciliana; Assessorato Territorio e Ambiente.

REGIONE SICILIANA, ASSESSORATO TERRITORIO E AMBIENTE 2004. *Piano Stralcio di Bacino per l'Assetto Idrogeologico (P.A.I.). Bacino idrografico del Torrente Corriolo (006). Area Territoriale tra i bacini del T.te Muto e del T.te Corriolo (006a). Area Territoriale tra i bacini del T.te Corriolo e del T.te Mela (006b). Quadro d'unione.* Regione Siciliana; Assessorato Territorio e Ambiente.

REITZ A., WILLE M., NÄGLER T.F., DE LANGE G.J. 2007. Atypical Mo isotope signatures in eastern Mediterranean sediments. *Chemical Geology*, vol.245, p.1-8.

RINA S.p.A., 2008. *Centrale termoelettrica di San Filippo del Mela. Dichiarazione Ambientale 2009 [online]*. Accessible on: <www.edipower.it>. Date of consultation: july 2010.

RIVARO, P. ; GROTTI, M. ; IANNI, C. ; MAGI, M. 1998. Heavy Metals Distribution in the Eolian Basin (South Tyrrhenian Sea). *Manne Pollution Bulh,tm,*, vol.3611, p.880-886. RIVARO, P.; GROTTI, M.; IANNI, C.; MAGI, E. 1998. Heavy Metals Distribution in the Eolian Basin (South Tyrrhenian Sea). *Manne Pollution Bulh,tm,*, vol.36 no.11, p.880-886.

ROBINSON, A. R.; LESLIE, W. G.; THEOCHARIS, A.; LASCARATOS, A. Mediterranean Sea Circulation. In: *Encyclopedia of Ocean Sciences*. Academic Press, 2001, p.1689-1706.

ROCHAT D, MARGNI M, JOLLIET O . Continent-specific Intake Fractions and Characterization Factors for Toxic Emissions: Does it make a Difference?. *International Journal of Life Cycle Assessment*, vol.11 special issue 1, p.55-63.

RUBAN, D. A. 2010. Quantification of geodiversity and its loss. *Proceedings of the Geologists' Association*, vol.121, p.326-333.

ROTTURA A., BARGOSSI G.M., CAIRONI V., DEL MORO A., MACCARRONE E., MACERA P., PAGLIONICO A., PERRINI R., PICCARRETA G. & POLI G. 1990. Petrogenesis of contrasting Hercynian granitoids from the Calabrian Arc, Southern Italy. *Lithos*, vol.24, p.97-119.

SACCÀ, C. ; SACCÀ, D. ; NUCERA, P. ; DE FAZIO, A. 2011. Composition and geochemistry of clay sediments offshore the northeastern Sicilian coast (Southeastern Tyrrhenian Sea, Italy). *Estuarine, Coastal and Shelf Science*, vol.92, p.564-572.

References

- SACCÀ, C.; SACCÀ, D.; NUCERA, P.; DE FAZIO, A. 2011. Composition and geochemistry of clay sediments offshore the northeastern Sicilian coast (Southeastern Tyrrhenian Sea, Italy). *Estuarine, Coastal and Shelf Science*, vol.92, p.564-572.
- SAITO M.A., MOFFETT J.W. 2002. Temporal and spatial variability of cobalt in the Atlantic Ocean. *Geochimica et Cosmochimica Acta*, vol.66 no.11, p.1943-1953.
- SALMONE, R.; MONDELLO, F.; LANUZZA, F.; MICALI, G. 2005. ENVIRONMENTAL ASSESSMENT An Eco-balance of a Recycling Plant for Spent Lead–Acid Batteries. *Environmental Management*, vol.35 no.2, p.206–219.
- SALOMONS W., FÖRSTNER U. *Metals in the hydrocycle*. Springer Verlag, Berlin and New York, 1984, 349 p.
- SAUR, K.; GEDIGA, J.; HESSELBACH, J.; SCHUCKERT, M.; EYERER, P. 1996. Life Cycle Assessment as an Engineering Tool in the Automotive Industry. *International Journal of Life Cycle Assessment*, vol.1 no.1, p.15-21.
- SCHENK V. & TODT W. 1989. The age of the Adriatic crust in Calabria (Southern Italy): constraints from U-Pb zircon data. In: Evolution of Metamorphic Belts (eds J.S. Daly, R.A. Cliff & B. W. D. Yardley). *Geological Society of London, Special Publication*, vol.43, p.337-342.
- SCICCHITANO, G.; SPAMPINATO, C.R.; FERRANTI, L.; ANTONIOLI, F.; MONACO, C.; CAPANO, M.; LUBRITTO, C. 2011. Uplifted Holocene shorelines at Capo Milazzo (NE Sicily, Italy): Evidence of co-seismic and steady-state deformation. *Quaternary International*, vol.232, p.201-213.
- SEUM, S. 1998. The HoVe Assessment Method: Principal Structure and Pilot Application. *International Journal of Life Cycle Assessment*, vol.3 no.4, p.191-199.
- SHERRARD J.C., HUNTER K.A., BOYD P.W. 2004. Selenium speciation in subantarctic and subtropical waters east of New Zealand: trends and temporal variations. *Deep-Sea Research Part I*, vol.51, p.491-506.
- SHERREL RM, BOYLE EA 1988. Zinc, chromium, vanadium and iron in the Mediterranean Sea. *Deep Sea Research Part A. Oceanographic Research Papers*, vol.35 no.8, p.1319-1334.
- SHIBAMOTO, T.; YASUHARA, A.; KATAMI, T. 2007. Dioxin Formation from Waste Incineration. *Reviews of Environmental Contamination & Toxicology*, vol.190, p.1-41.
- SHILLER A.M., BOYLE E.A. 1987. Western Mediterranean (Takayanagi et al., 1996). *Dissolved vanadium in rivers and estuaries*, vol.86 issue 2-4, p.214-224.
- SINGH, N.; TURNER, A. 2009. Trace metals in antifouling paint particles and their heterogeneous contamination of coastal sediments. *Marine Pollution Bulletin*, vol.58, p.559-564.

References

- SIRA - ARPAT. *Dichiarazione EPER relativa all'anno 2001* [online]. Accessible on: <<http://sira.arpato.toscana.it>>. Date of consultation: July 2010.
- SORVARI J., SCHULTZ E., HAIMI J. 2012. Assessment of Ecological Risks at Former Landfill Site Using TRIAD Procedure and Multicriteria Analysis. *Risk Analysis*, vol.in press, p..
- SRINIVASA REDDY, M.; BASHA, S.; JOSHI, H.V.; JA, B. 2005. Evaluation of the emission characteristics of trace metals from coal and fuel oil fired power plants and their fate during combustion. *Journal of Hazardous Materials*, vol.B123, p.242-249.
- SZEFER P, KUSAK A, SZEFER K 1998. Evaluation of the anthropogenic influx of metallic pollutants into Puck Bay, southern Baltic. *Applied Geochemistry*, vol.13, p.293-304.
- TAKAYANAGI K., COSSA D., MARTIN J.M. 1996. Antimony cycling in the western Mediterranean. *Marine Chemistry*, vol.54, p.303-312.
- TAYLOR SR, McLENNAN SM . The Geochemical evolution of the continental crust. *Reviews of Geophysics*, vol.33 no.2, p.241-265.
- TIPPING E., WADSWORTH R.A., NORRIS D.A., HALL J.R., ILYN I. 2011. Long-term mercury dynamics in UK soils. *Environmental Pollution*, vol.159, p.3474-3483.
- TOFFOLETTO, L.; DESCHÊNES, L.; SAMSON, R. 2005. LCA of Ex-Situ Bioremediation of Diesel-Contaminated Soil. *International Journal of Life Cycle Assessment*, vol.10 no.6, p.406-416.
- TORRE, R.; MESSINA, A.; CARABETTA, M.T.; MASSACCI, G.A.; LENTINI, F.. 2009. *The Geomorphological and Geological Heritage of the Milazzo Peninsula (North-Eastern Sicily, Italy) as a new model of environmental education and territorial management*. Directed by Torre, R. Geoitalia.
- TRIOLO, L.; BINAZZI, A.; CAGNETTI, P.; CARCONI, P.; CORRENTI, A.; DE LUCA, E.; DI BONITO, R.; GRANDONI, G.; MASTRANTONIO, M.; ROSA, S.; SCHIMBERNI, M.; UCCELLI, R.; ZAPPA, G. 2008. Air pollution impact assessment on agroecosystem and human health characterisation in the area surrounding the industrial settlement of Milazzo (Italy): a multidisciplinary approach. *Environmental Monitoring Assessment*, vol.140, p.191-209.
- TUKKER, A. 2000. Life cycle assessment as a tool in environmental impact assessment. *Environmental Impact Assessment Review*, vol.20, p.435-456.
- TURNER, A.; FITZER, S.; GLEGG, G. A. 2008. Impact of boat paint chips on the distribution and availability of copper in an English ria. *Environmental Pollution*, vol.151, p.176-181.
- TURNER, A.; RADFORD, A. 2010. Bioaccessibility of trace metals in boat paint particles. Unpublished.

References

UDO DE HAES, A.; FINNVEDEN, G.; GOEDKOOP, M.; HAUSCHILD, M.; HERTWICH, E. G.; HOFSTETTER, P.; JOLLIET, O.; KLÖPFER, W.; KREWITT, W.; LINDEIJER, E.; MÜLLER-WENK, R.; OLSEN, S.I.; PENNINGTON, D. W.; POTTING, J.; STEEN, B. *Life-Cycle Impact Assessment: Striving Towards Best Practice*. SETAC Press, 2002, 249 p.

UDO DE HAES, H. A.; JOLLIET, O. 1999. How Does ISO/DIS 14042 on Life Cycle Impact Assessment Accomodate Current Best Available Practice?. *International Journal of Life Cycle Assessment*, vol.4 no.2, p.75-80.

UDO DE HAES, H. A.; JOLLIET, O.; FINNVEDEN, G.; HAUSCHILD, M.; KREWITT, W.; MÜLLER-WENK, R. 1999. Best Available Practice Regarding Impact Categories and Category Indicators in Life Cycle Impact Assessment. *International Journal of Life Cycle Assessment*, vol.4 no.2, p.66-74.

UDO DE HAES, H.A.; HEIJUNGS,, R. 2007. Life-cycle assessment for energy analysis and management. *Applied Energy*, vol.87, p.817-827.

URBISTAT. *Comune di MILAZZO: bilancio demografico, trend popolazione, tasso di mortalità, Tasso di natalità, tasso migratorio [online]*. Accessible on: <www.urbistat.it/it/demografia/popolazione/milazzo/83049/4>. Date of consultation: april 2012.

VAN DE PLASSCHE E.J., DE BRUIJN J.H.M. *Towards integrated environmental quality objectives for surface water, ground water, sediment and soil for nine trace elements. Report no. 679101 005*. National Institute of Public Health and Environmental Protection. Bilthoven, the Netherlands, 1992, 43 p.

VESIN A *Comparison Analysis of the Existing Life-Cycle Impact Assessment Methodologies. Recommendations - Precautions*. Thesis in Environmental Engineering. Technical University of Denmark, Departement of Environmental Engineering: , 2009, 145 p.

VESIN, A. *Comparison Analysis of the Existing Life-Cycle Impact Assessment Methodologies. Recommendations - Precautions*. Thesis in Environmental Engineering. Departement of Environmental Engineering: Technical University of Denmark, 2009, 145 p.

VOUTSINOU-TALIADOURI F, VARNAVAS SP, NAKOPOULOU C, MORIKI A 1997. Dissolved trace elements in South Aegean Seawater. *Marine pollution bulletin*, vol.34 no.10, p.840-843.

WAKE, H. 2004. Oil refineries: a review of their ecological impacts on the aquatic environment. *Estruarine, Coastal and Shelf Science*, vol.62, p.131-140.

WEIDEMA BP, WESNÆS MS 1996. Data quality management for life cycle inventories-an example of using data quality indicators. *Journal of Cleaner Production*, vol.4 no.3-4, p.167-174.

References

WEIDEMA, B.P. 2006. The Integration of Economic and Social Aspects in Life Cycle Impact Assessment. *International Journal of Life Cycle Assessment*, vol.11 Special Issue 1, p.89-96.

WENZEL, H. 1998. Application Dependency of LCA Methodology: Key Variables and Their Mode of Influencing the Method. *International Journal of Life Cycle Assessment*, vol.5 no.3, p.281-288.

WILDE, P. *The periodic table with seawater additions [online]*. Accessible on: <www.marscigrp.org/ocpertbl.html>. Date of consultation: september 2010.

WIMBLEDON, W.A.P.; ISHCHENKO, A.A.; GERASIMENKO, N.P.; KARIS, L.O.; SUOMINEN, V.; JOHANSSON, C.E.; FREDEN, C.. GEOSITES - AN IUGS INITIATIVE: SCIENCE SUPPORTED BY CONSERVATION. In: D. Baretino, W.A.P. Wimbledon and E. Gallego. *Geological Heritage: its conservation and management*. 2000, p.69-94.

YAKIMOV, M.M.; DENARO, R.; GENOVESE, M.; CAPPELLO, S.; D'AURIA, G.; CHERNIKOVA, T.N.; TIMMIS, K.N.; GOLYSHIN, P.N.; GILULIANO, L. 2005. Natural microbial diversity in superficial sediments of Milazzo Harbor (Sicily) and community successions during microcosm enrichment with various hydrocarbons. *Environmental Microbiology*, vol.7 no.9, p.1426–1441.

YOON, Y.-Y.; MARTIN, J.-M.; COTTÉ, M. H. 1999. Dissolved trace metals in the Western Mediterranean Sea: total concentration and fraction isolated by C18 Sep-Pak technique. *Marine Chemistry*, vol.66, p.129-148.

8 Annexes

**Annexe 1 Letters from Tutela
Ambientale e Territorio (TAT)**

A MILAZZO MORIAMO COSÌ!!!

SCUSATECI SE SIETE IN FERIE, MA QUESTI NUMERI, SE AZZERATI, VALGONO PIÙ DI QUALSIASI 6 AL SUPERENALOTTO.

A MILAZZO MORIAMO COSÌ!!!

	ANNO					
	2003	2004	2005	2006	2007	2008
MORTALITA' PER TUMORE NELL'AREA DEL DISTRETTO ED A MILAZZO						
DISTRETTO						
TOTALE	194	143	173	180	169	203
MASCHI	112	81	94	107	100	111
FEMMINE	82	62	79	73	69	92
MILAZZO						
TOTALE	71	49	69	75	67	86
MASCHI	43	25	40	43	36	46
FEMMINE	28	24	29	32	31	40
% di decessi per cause tumorali rispetto al Distretto						
	36.6	34.3	39.9	41.7	39.6	42.4
Età media al decesso						
sul totale	75.8	77.8	78.1	77.8	79.9	77.9
solo per tumore	72.6	73.4	74.4	71.6	72.9	72.9
MASCHI	70.7	71.4	73.6	71.2	72.8	75.8
FEMMINE	75.6	75.5	75.5	72.1	73.1	69.6
Numero di decessi per cause tumorali prima dell'età media						
MASCHI	19	10	17	17	14	32
%	44.2	40.0	42.5	39.5	38.9	69.6
FEMMINE	15	8	9	16	14	17
%	53.6	33.3	31.0	50.0	45.2	42.5
TOTALE DECESSI A MILAZZO						
TOTALE	263	204	269	289	283	281
% dei decessi per cause tumorali rispetto al totale dei decessi a Milazzo						
VALORE %	27.0	24.0	25.7	26.0	23.7	30.6

Cari lettori, scusateci, avevamo dimenticato che siete in vacanza. Ma forse i dati che vi stiamo presentando vi rimarranno più impressi. Speriamo che rimangano impressi anche a chi dice che da noi non si muore per tumore. Dal 2003 al 2008, tanto per cominciare... Ogni commento è superfluo. Per ordine di riga, sono riportati i morti per tumore nei comuni del Distretto dell'ASL, quindi quelli di Milazzo, poi la percentuale dei decessi a Milazzo rispetto all'intero distretto (il valore è alto, poiché la popolazione di Milazzo è maggiore: in una successiva tabella vi forniremo il tasso di mortalità per cause tumorali in tutti i comuni...). Abbiamo messo poi l'età media al decesso, sempre a Milazzo, e quella per tumore, suddivisa per maschi e per femmine. Quindi i decessi per tumore prima di giungere all'età media alla morte che, per inciso, è di gran lunga inferiore alla media nazionale (85 per le donne, 79 per gli uomini). La penultima e l'ultima riga riportano le morti totali a Milazzo, e la percentuale dei decessi per tumore rispetto al totale dei decessi: per il valore numerico vi rimandiamo a quanto detto prima. Mentre in tutta Italia si moltiplicano i tentativi di azzeccare il sei al Superenalotto, la nostra migliore vincita sarebbe quella di ridurre drasticamente tutte quelle morti per tumore. O non la pensate come noi?

(dati raccolti ed elaborati dal dott. Salvatore Formica, statistico)

A PROPOSITO DI CHERNOBYL

NEL 1986 A CHERNOBYL, SCONOSCIUTA CITTADINA DELLA VECCHIA UNIONE SOVIETICA, SALITA ALLA RIBALTA PROPRIO PERCHÉ ACCADDE IL CASO, L'ESPLOSIONE DI UN REATTORE NUCLEARE SPRIGIONÒ UNA NUBE TOSSICA CHE PROVOCÒ VITTIME (NESSUNO SA QUANTE) E EMISE RADIAZIONI PER UN RAGGIO IMPRECISATO DI CHILOMETRI. DA OLTRE VENTI ANNI UNA GARA DI SOLIDARIETÀ CONTINUA AD UNIRE I POPOLI. ANCHE MILAZZO PARTECIPA A QUESTA MISSIONE UMANITARIA, E OGNI ANNO OSPITA I BAMBINI NATI IN QUELLO SFORTUNATO PAESE. NON SO PER QUANTI GIORNI VENGONO OSPITATI QUESTI INNOCENTI (QUALCUNO, PIÙ INFORMATO DI ME, E CHE MAGARI LI HA OSPITATI, STA DANDO LA RISPOSTA ESATTA). MA VORREI CHIEDERE UNA COSA AI NOSTRI POLITICI, ALLE FAMIGLIE CHE SI METTONO A DISPOSIZIONE, A PIPPO RUGGERI CHE PER ANNI CON LEGAMBIENTE HA COORDINATO L'OSPITALITÀ. PARLIAMO DI MILAZZO COME ZONA A RISCHIO, INQUINATA, CANCEROGENA, PER LA PRESENZA DI RAFFINERIA, EDIPOWER, TRAFFICO VEICOLARE E CHI PIÙ NE HA, PIÙ NE METTA. RAFFORZIAMO LE NOSTRE CONVINZIONI CON LE RILEVAZIONI DEL TASSO D'INQUINAMENTO DELLE CENTRALINE ARPA E DELLA PROVINCIA. A QUESTO PUNTO SORGE SPONTANEA UNA CONSIDERAZIONE: PERCHÉ OFFRIAMO OSPITALITÀ A QUESTI POVERI BAMBINI SE ANCHE NOI SIAMO

INQUINATI? LO FACCIAMO PER UMANITÀ O PERCHÉ VOGLIAMO CHE LORO CI SAPPIANO DIRE DOVE SI È PIÙ INQUINATI? NON SAREBBE MEGLIO FARE UN GESTO DI ALTRUISMO PAGANDO PER TUTTI LORO UNA VACANZA IN TRENTINO, SULLE DOLOMITI, A MADONNA DI CAMPIGLIO, E MAGARI ANDARCI PURE NOI, PER DISINTOSSICARCI?
SCUSATE, MA NON ME LO POTEVO TENERE PIÙ!

Fonte: Terminal Agosto 2008

October 16, 2008: NON CAPISCO PERCHÉ, CI OSTINIAMO A CHIAMARLA... “VALLE DEL MELA”!!!!!!

Nuova Unità Steam Reforming HUM3- RAM – Raffineria di Milazzo Scpa

Il progetto finanziato dalla società proprietaria, Raffineria di Milazzo S.C.p.A. (RAM), joint-venture paritaria fra Eni S.p.A. e Kuwait Petroleum Italia, riguarda la realizzazione, nell'area della Raffineria esistente di un nuovo impianto per la produzione di idrogeno di capacità produttiva massima di circa 25.000 Nm³/h di idrogeno puro (2.27 t/h) in affiancamento agli esistenti, nel seguito denominato **unità HMU3**.

Nella documentazione di **sintesi non tecnica** si dice ancora che “L'intervento si inquadra nell'ambito delle realizzazioni previste per attenersi alle disposizioni della Comunità Europea (Direttive 98/70/CE e CEE/CEEA/CE n° 17 del 3/03/2003), recepite nell'ordinamento nazionale con DPCM n. 434 del 23/11/2000, con DPCM 29/2002 e con Legge n. 306 del 31/10/2003, che impongono a partire dal gennaio 2009 un'ulteriore diminuzione della concentrazione di zolfo nelle benzine e nei gasoli fino a 10 ppm rispetto alla concentrazione oggi ammessa di 50 ppm.”

Nelle Motivazioni del Progetto viene detto :” L'idrogeno rappresenta a tutti gli effetti una materia prima di primaria importanza per il ciclo di raffinazione in quanto viene utilizzata come carica combinata in diversi impianti di conversione presenti in Raffineria. Nella configurazione attuale di Raffineria, la sua produzione viene realizzata dal Reformer, dall'Idrogeno 1 e dall'impianto Linde (gestito inoutsourcing)..... D'altra parte, l'Industria Petrolifera, per le caratteristiche delle riserve mondiali di greggio disponibili, per la flessibilità di mercato, sicurezza di approvvigionamenti e per ragioni di competitività, è sollecitata a lavorare greggi sempre più ricchi di zolfo, che produrrebbero ingenti quantitativi di olio combustibile e gasoli con tenore di zolfo medio/alto se non fossero oggetto di una conversione più spinta.

La realizzazione dell'impianto Steam Reformer HMU3 rappresenta quindi una tappa obbligata per soddisfare il fabbisogno di H₂ necessario agli impianti esistenti per incrementare la conversione dei residui pesanti in prodotti a più alto valore aggiunto ed a basso contenuto di zolfo, in accordo alle disposizioni in materia di antinquinamento.”

Al capitolo **Strumenti di pianificazione energetica viene precisato:**” Gli interventi di progetto si inquadrano nell'ambito di quanto previsto dai Piani nazionali, regionali e provinciali in termini di riqualificazione e tutela dell'ambiente mediante innovazione e ottimizzazione delle tecnologie produttive.

permette la lavorazione di greggi a più alto tenore di zolfo, pur elevando la qualità dei prodotti, e riduce il grado di dipendenza dalle fonti estere, in quanto permette di utilizzare materie prime maggiormente disponibili a prezzi più convenienti;

costituisce uno degli investimenti indicati dalla programmazione come necessari per elevare il livello tecnologico nella raffinazione del petrolio. Permette infatti di ottenere prodotti con minori quantità di zolfo, in linea con le direttive comunitarie in materia;

comporta la produzione di carburanti più “puliti” contribuendo al miglioramento della qualità complessiva dell'aria;

prevede l'utilizzo di gas naturale come unico combustibile per il nuovo impianto garantendo emissioni trascurabili di biossido di zolfo e Polveri.

Al Capitolo **combustibili** si legge:

La Raffineria è un impianto ad alta intensità energetica, che utilizza però principalmente combustibili prodotti internamente dai processi di raffinazione come gas combustibile (fuel gas) e combustibili liquidi (fuel oil).

Ad integrazione dei combustibili autoprodotti la Raffineria utilizza gas naturale (metano) prelevato dalla **rete Snam Rete gas**.

I combustibili vengono utilizzati per alimentare i forni di raffineria.

L'impianto viene sinteticamente così descritto:

Impianto Steam Reforming

Il nuovo impianto per la produzione di idrogeno avrà una capacità produttiva massima di circa 25.000 Nm³/h di idrogeno puro (**2.27 t/h**). Oltre all'idrogeno, l'impianto genererà vapore surriscaldato ad alta pressione (**52 bar**).

La carica all'impianto sarà costituita interamente da gas naturale proveniente dalla rete Snam Rete Gas.

L'impianto di produzione idrogeno sarà suddiviso nelle seguenti sei sezioni principali:

Sezione di desolfurazione: la funzione di questa sezione è di eliminare lo zolfo;

Sezione di steam reforming: la funzione di questa sezione è convertire l'alimentazione di idrocarburi miscelata con vapore a gas di sintesi, contenente principalmente H₂, CO e CO₂, oltre a una piccola quantità di CH₄ non reagito;

Sezione di shift: scopo di questa sezione è la conversione di CO a CO₂, dalla reazione con H₂O, generando idrogeno. La reazione è di tipo esotermico;

Raffreddamento del gas di processo;

Sezione di separazione dell'idrogeno: la funzione di questa sezione è la separazione dell'idrogeno contenuto nel gas di processo per raggiungere la purezza richiesta;

Generazione di vapore ad alta pressione (52 bar, 430 °C).

Stato attuale dell'ARTE: quasi tutto approvato

La documentazione del via ovviamente descrive un ambito industriale perfetto, le emissioni tutte sotto controllo, il nuovo impianto emetterà in forma limitata CO₂, NOx, se pensavate che non vi erano emissioni sbagliate.

I lavori dureranno 14 mesi ed avranno inizio nell'aprile 2009.

Avremo un nuovo camino,

Le emissioni relative all'impianto HMU3 saranno convogliate in un nuovo camino denominato **E30** (di altezza prevista pari a **75 m** e diametro interno di **1.4 m**). il fatto che si chiami **E30** potrebbe significare che ve ne siano altri 29 prima di questo ma non so dirvi dove.

Infine, dopo aver precisato che il traffico non subirà nessun incremento, che i rumori, pur in assenza di una zonizzazione acustica del comune di S. Filippo del Mela e di Milazzo, loro garantiscono, (non si sa come??) che tutto sarà contenuto.

Le opere di mitigazione riguardano esclusivamente aspetti di natura tecnologica:

esclusivo utilizzo nei forni del nuovo impianto di combustibili gassosi con conseguente limitazione delle emissioni di biossido di zolfo e di Polveri;

dotazione di sistemi di monitoraggio della temperatura e del contenuto di ossigeno per tutti i nuovi forni al fine di ottimizzare l'efficienza di combustione (abbattimento emissioni di monossido di carbonio);

Installazione di bruciatori di tipo LowNox nel forno del nuovo impianto HMU3 con conseguente limitazione delle emissioni di ossidi di azoto;

dotazione di sistemi di tenuta ad alta efficienza per le pompe ed i compressori dei nuovi impianti (abbattimento emissioni di composti organici volatili).

Con questa breve sintesi ho inteso dare solo la informativa, possiamo solo dire che l'area a rischio della **valle del mela** da oggi sarà più ricca di ... rischi.

Quindi propongo di cambiare nome in "la valle dei rischi", quindi Milazzo forse manterrà il suo nome mentre avremo S. Lucia del Rischio, S. Filippo del

Rischio, Pace del Rischio, mi dispiace per gli altri comuni che pur avendo il rischio non possono cambiare nome.

Mi domando se quei signori che con conferenze strettamente riservate in ambito istituzionale non sapevano???

Cosa c'è da scoprire ancora???

Che ne dite: ci mobilitiamo o ci riempiamo i polmoni di altri veleni???

Secondo il mio sommosso parere nella ex valle del mela oggi valle dei rischi vi è un ottimo impianto della dissimulazione, sempre attivo ed efficace, infatti se dovessimo rivolgere la domanda non dico ad un cittadino ma ad un politico, scegliete Voi il livello, "scusi lei sapeva dell'impianto HMU3..." la risposta sarebbe sicuramente no, o forse molto evasiva, o forse: stiamo cercando di contrastare la disoccupazione.

Già negli anni sessanta è accaduta la medesima cosa, in nome dello sviluppo si è compiuto il più grave scempio della valle del mela, oggi in forza dei fatti valle del rischio e se continuiamo così diventerà la valle della m....., non oso dire la parola immaginatela pure nella vostra mente -

Milazzo, li 16 Ottobre 2008

Il Vice Presidente TAT
Arch. Salvatore Crisafulli

June 3, 2009 : NECESSITAS NON HABET LEGEM

Sua Eccellenza il Prefetto di Messina convoca **la terza conferenza dei servizi** (art. 5 comma 10 D.lgs 59/05), escludendo il Comune di San Filippo del Mela.

Nell'ordinamento amministrativo italiano, SS.EE. il **Prefetto** è un organo monocratico dello Stato, rappresentante del governo nella provincia, preposto ad ufficio denominato prefettura-ufficio territoriale del governo.

Cosa recita l'art.5 comma 10 del Dlgs 59/05 : “10. *L'autorità competente, ai fini del rilascio dell'autorizzazione integrata ambientale, convoca apposita conferenza dei servizi ai sensi degli articoli 14, 14-ter, commi da 1 a 3 e da 6 a 9, e 14-quater della legge 7 agosto 1990, n. 241, e successive modificazioni, alla quale invita le amministrazioni competenti in materia ambientale e comunque, nel caso di impianti di competenza statale, i Ministeri dell'interno, della salute e delle attività produttive.*” Come viene specificato la conferenza viene convocata ai sensi dell'art. 14 quindi a seguito di intervenuto dissenso di uno o più soggetti coinvolti (il senso è questo).

In tal caso Il Prefetto in forza dei suoi poteri convoca **la terza conferenza dei servizi** escludendo proprio il comune che ospita la Centrale Termoelettrica, cioè San Filippo del Mela.

Un atto di forza? Sicuramente SI.

Poiché, volendo presumere, rispetto alle caratteristiche ambientali di cui si cerca la tutela, al mancato sviluppo socio economico, si vuol far prevalere la funzione strategica della Centrale Termoelettrica Edipower.

Ciò che non si riesce ad ottenere con le normali procedure lo si ottiene con procedure straordinarie almeno così pare, salvo che il Prefetto non imponga alla Edipower **GARANZIE REALI SULLA SALVAGUARDIA AMBIENTALE E SULLA TUTELA DELLA SALUTE**, e la Prefettura stessa non Garantisca il perfetto controllo delle emissioni in ambiente, la non contaminazione del suolo e sottosuolo, ed il razionale uso delle acque, in sintesi il rispetto dell'acqua, dell'aria e della terra.

SS. EE. Il Prefetto, nella sua condizione monocratica avrà cura di spiegare perché noi nella Valle del Mela dobbiamo pagare un così alto prezzo per ospitare un impianto con tanti limiti ed avverso la salute e l'Ambiente e perché dobbiamo rinunciare ad altre forme di sviluppo ?

Forse tale domanda la dobbiamo fare al **Presidente Berlusconi**, anzi chiediamo un suo

intervento, per chiarire in via definitiva perché tanti cittadini debbono rischiare la propria salute, a fronte di una produzione di energia elettrica in spregio ad ogni norma comunitaria, con forte ricaduta negativa sul territorio: **Esimio Presidente, anche noi siamo figli di Dio.**

È palese il fatto che la Centrale Edipower non rispetta i parametri sulle emissioni, malgrado ciò si soverchia il tutto con l'intervento autoritario del Prefetto, quindi si darà il via alla Centrale ed i Cittadini ingoieranno ulteriori veleni nella già precaria condizione di salute di gravi malattie respiratorie e diffuse neoplasie.

Inutile allarmismo, no caro Presidente, certo è, che Lei in una realtà con elevato degrado fisico ed ambientale non verrebbe mai a farci le sue vacanze.

In questa realtà non funzionano gli organi statali per il controllo ambientale, non ci sono adeguate strutture sanitarie per contrastare il danno alla salute, non è possibile presumere altre forme di sviluppo proprio per la presenza di strutture tecnologiche che generano il grave disastro ambientale, qui regna la logica del potere economico e dello sfruttamento.

A chi imputare il danno patrimoniale ed il danno esistenziale? Molti lo chiamano colonialismo industriale, comunque sia la presenza dello stato non si avverte.

Ci scuserà se in un momento di grave disagio abbiamo pensato a Lei, ma siamo sicuri che un suo modesto intervento possa innescare un processo diverso dallo indiscriminato sfruttamento, anche noi pensiamo che l'industria debba essere amica dell'uomo, e nella carta dei valori del Suo nuovo Partito, la efficienza economica, la giustizia sociale, da noi non si percepisce. Vorremmo che da noi, si fondessero armoniosamente le nuove forze di mercato con il nuovo dinamismo economico, piuttosto che il prevalere asimmetrico di realtà speculative.

Abbiamo creduto e vogliamo continuare a credere nel principio della sussidiarietà, nella tutela delle nostre famiglie come prezioso elemento di stabilità sociale ed economica, e fino adesso siamo stati sostenuti più dalla nostra storia che da precise azioni di Governo.

L'intervento del Prefetto di Messina, seppur apprezzabile come sforzo di mediazione, non produce effetti utili alla condizione socio-economica della Valle del Mela ne si può affermare che esso mira a tutelare un preciso Piano Industriale, ma protrae nel tempo un aspetto altamente negativo della nostra realtà, gravi errori del passato che debbono mantenersi anche con grave pregiudizio sulla salute di oltre 90.000 cittadini. Ci aspettavamo qualcosa di diverso.

Le generazioni future da noi non sono poste nelle condizioni di vivere in armonia con l'ambiente naturale, e se la politica ha il compito di sostenere la vita e l'attività delle

persone e delle famiglie, allora la supplichiamo di fare un solo gesto per non reprimere l'unico sostegno della nostra coscienza: **La Speranza**.

Seppur convinti che l'azione della conferenza dei servizi, alla fine produrrà l'autorizzazione A.I.A. alla Edipower, noi produciamo lo stesso le seguenti richieste ed osservazioni:

A - Di ritenere la Terza conferenza dei servizi incoerente con le normative comunitarie e nazionali, in quanto surroga il lavoro già svolto dalla Commissione IPPC, ed interviene ad attenuare l'impatto economico del soggetto operatore per adeguamenti impianti nel perseguimento della giusta ambientalizzazione;

In subordine:

B - L'energia prodotta deve essere garantita nel rispetto e nella tutela della qualità dell'ambiente e nella tutela della sicurezza del personale interno ed esterno all'azienda, così come dalla Soc. Edipower affermato;

C - La Edipower per la Centrale di S: Filippo del Mela, fornisca garanzie fidejussorie sufficienti a garantire il risanamento di eventuali danni ambientali, e che il Comitato Regionale contro l'Inquinamento Atmosferico (CRIA) (od il Prefetto) autorizzi all'emissione dei fumi in atmosfera dopo aver valutato la consistenza giuridica ed azionaria della società.

D - Venga affermato il principio cardine "**Chi inquina paga**", alla luce di questo principio l'operatore la cui attività ha causato un danno ambientale o è all'origine di una minaccia imminente di tale danno deve essere considerato finanziariamente responsabile e, quindi, deve sostenere il costo delle necessarie misure di prevenzione o riparazione.

E - Vengano predisposti precisi piani operativi a sostegno della salute e della riqualificazione ambientale e dello sviluppo socio economico all'insegna della sostenibilità nella Valle del Mela.

F - Che vengano definiti precisi soggetti responsabili oltre alla Soc. Edipower, per gli impegni ed obblighi assunti.

Milazzo, li 3 Giugno 2009

Il Vice Presidente T.A.T.

Arch. Salvatore Crisafulli

Agust 9, 2009 : L'INTRICATA VICENDA DELLA VALLE DEL MELA !

L'intricata vicenda della Valle Del Mela o dei..Veleni, propone analisi sociali specifici e risalendo a ritroso nel tempo, appare del tutto verosimile la questione posta nel remoto 1883 dall'allora Procuratore Generale di Trapani, il costituzionalista Avv. Pietro Calà Ulloa, che fu persino l'ultimo Presidente del Consiglio napoletano, quando sentì la necessità di spiegare il fenomeno a cui sembra collegabile l'affermarsi della Mafia: *"Non vi è impiegato in Sicilia che non si sia prostato al cenno di un prepotente e che non abbia pensato a trar profitto dal suo ufficio"*.

Da un'inchiesta giornalistica di Salvatore Cammareri Scurti (17/12/1899) *"...In questo inferno chi non vuole essere dannato deve farsi diavolo..."* e continuando si arriva ai nostri giorni, dove la Sicilia divisa od unita rimane sempre terra fragile ed impotente.

Dal Gattopardo di T. di Lampedusa: *"Sono venticinque secoli che portiamo sulle spalle il peso di magnifiche civiltà eterogenee, tutte venute da fuori, nessuna germogliata da noi stessi, nessuna a cui noi abbiamo dato il là...da duemilacinquecento anni siamo colonia."*

E poi facendo un piccolo salto pindarico nel tempo: *"Vacilla la fede nella giustizia legale, anzi non vacilla, manca addirittura."*

Quindi la nostra condizione ha radici storiche e sembra difficile sfuggire alla nostra storia, anche con un governo liberal-capitalista non si riesce a sradicare tale situazione.

La Sicilia ha la possibilità di sfuggire da questo triste retaggio storico, è necessario un vigoroso risveglio intellettuale, attraverso un processo culturale capace di sfruttare le sue risorse storiche, naturali e paesaggistiche, con attivazione di una politica di ampi confronti piuttosto che autonomista, con slanci nord-europeistici.

Forse siamo geograficamente lontani dai processi più evoluti per lo sviluppo socio economico?

Tuttavia pare necessario abbandonare la vecchia concezione assistenziale e puntare sulla sussidiarietà e sullo sviluppo sostenibile.

Occorre un grande coraggio per neutralizzare una classe politica che si esprime molto bene in campo nazionale, mentre risulta incapace nella condizione regionale. Allora il problema è il regionalismo, ove si formano i pastrocchi che inibiscono le liberalizzazioni delle risorse e formano privilegi senza le necessarie condizioni meritocratiche.

La politica in questo momento, ha dimostrato che da sola non può assolvere alle necessità di una società le cui esigenze sono variegata e molteplici, pertanto il processo di partecipazione dev'essere il più ampio possibile e la politica dovrà risultare lo strumento applicativo di attuazione, la base di ogni istanza parte proprio dagli individui, i quali esprimono aspettative che non possono essere semplificate da intricati rapporti di varie forme di governo.

Questa riflessione mi sembra opportuna in quanto in questi giorni ho visto in giro per Milazzo e dintorni più politici che turisti, ma non nei punti necessari come ad esempio al nosocomio mamertino od in tant'altre tristi realtà, che subiscono le pericolose induzioni della Raffineria, della Centrale Edipower di San Filippo del Mela ed altre strutture industriali altamente inquinanti, che accrescono oltremodo il grave degrado fisico ambientale e non solo...!!

Vetrine, show, sfilate, meeting.. forse s'approssima qualche competizione elettorale ed allora bisogna apparire a tutti i costi, per presunte visibilità politiche.

Sarebbe sufficiente che taluni, andassero per qualche ora, al Pronto Soccorso dell' Ospedale Fogliani di Milazzo e capire la caotica situazione e magari approfondire meglio le prestazioni sanitarie della struttura nel suo complesso, verificare il costo sanitario e le qualità delle prestazioni, verificando i diritti del malato, etc. etc.

Vi assicuro che, il degrado fisico della struttura ospedaliera è poca cosa rispetto al caos della stessa, soprattutto in una realtà come la nostra di crisi ambientale.

Uscire indenni (*intendo psicologicamente, almeno credo*) sarebbe già sufficiente, però abbiamo una realtà da diporto nautico con imbarcazioni anche di lusso che farebbe presumere una realtà socio-economica di buon livello.

Tale contraddizione non trova giustificazione, in una realtà che territorialmente chiamiamo Valle del Mela o dei Veleni, vi è di tutto e di più, caotica commistione tra benessere reale, virtuale, figurativo e forte disagio sociale, stupendo golfo con industrie metiliche, che versano i loro liquami ed immettono in ambiente i loro veleni, depuratori urbani con condotte sottomarine che scaricano inquinando la costa e limitano la balneazione, traffico veicolare incasinato, sistema commerciale spontaneo e senza alcuna strategica pianificazione, sviluppo industriale inesistente ovvero non legato in modo funzionale alla realtà economica locale, sviluppo urbano non controllato, feste popolari e fuochi pirotecnici quale coreografia di un folklore più artefatto che reale.

Ma qualche politico, un po' pimpante, crede che con le strategie delle interrogazioni consiliari e con operazioni politiche di intesa a cordata, si possono mitigare le cose, *...forniteci i dati certi delle forme d'inquinamento, noi interveniamo..*, così ribadiva.

Ma se i dati certi non sono disponibili, su che dati allora le industrie che hanno redatto la Valutazione di Impatto Ambientale si sono basati ?

Centraline dappertutto, in modo che il monitoraggio sia garantito, va bene, ma quando scopriamo che ci sono ripetitivi sforamenti, l'ancor rampante consigliere può garantire l'intervento adeguato, ovvero il fermo impianti ?

Il prolisso Ass.re Provinciale all'Ambiente P. Petrella fa anche lui il medesimo ragionamento, e noi siamo stanchi di sentircelo ripetere e soprattutto di ascoltarlo, stavolta, vuole mettere le centraline per i cavi Terna.!!

Il monitoraggio presuppone una forte capacità di intervento, in caso di anomalia.

Un vero impianto tecnocratico sterile e disumanizzato, arricchito da soggetti che grazie a taluni favorevoli aspetti della vita, pretendono di sincronizzare il loro futuro con le esigenze sociali e amministrative.

Mi permetto di suggerire a tali individui di non vessare e di cooperare per far valere il diritto al lavoro, alla salute alla vita, ed abbattere il grave disordine che impedisce lo sviluppo armonico del nostro sistema socio economico, e l'accorato appello che rivolgo a tutti è di diffondere il più possibile l'acquisizione della piena consapevolezza che possiamo cambiare, migliorare ed evolverci, smaterializzando le sofferenze e le angosce che ci provengono dal retaggio di tanti anni di grave subordinazione a sistemi che avversano la nostra libertà

d'essere, affinché possiamo ritornare ad essere orgogliosi protagonisti del nostro futuro.

Noi della T.A.T., non intendiamo promuovere la tutela dell'ambiente come movimento ideologico disconoscendo ogni altra fenomenica, riteniamo che lo sviluppo consapevole ed ordinato sia necessario quale garanzia di tutti gli interessi.

Ciò che avviene nella nostra ridente isola, lo vediamo anche se in qualche modo diverso in altri luoghi, scevra di una vera condivisione dei valori, ma in ogni caso pur nella diversità, si deve ricercare in modo costante l'unità di intenti e di interessi.

Quindi ai politici che si stanno promovendo e che oggi si scoprono "Ambientalisti per.caso", chiediamo anziché roboanti proclami di intenzioni, precise azioni finalizzati di governo.

Infine troviamo ridicolo che, un qualsiasi consigliere di maggioranza faccia le interrogazioni alla forma di governo a cui appartiene.

A molti non sarà sfuggito che, avremmo potuto essere molto più critici verso chi possiede forme di potere amministrativo, questo non significa che a tale possibilità vi abbiamo rinunciato, vuol dire che crediamo che in certe cose, c'è chi arriva prima e chi dopo, noi pensiamo di aspettare...ancora un po'!!



La foto di cui sopra è stata ripresa il distante 10 aprile 2001, alla fatidica ora delle 18.37 da Venetico Superiore, ed è eclatantemente esplicitiva per far

comprendere qual'era e qual'è la drammatica situazione, in cui versa la flagellata Valle del Mela.

Malgrado ciò, ricordo a me stesso che l'Edipower riuscì ad ottenere la sospirata Certificazione EMAS, forse attraverso discutibili "operazioni manageriali", piuttosto che per meriti industriali.

Oggi la Edipower vuole proseguire con l'**OCD** (*Olio Combustibile Denso*), presuppongo che tutti siamo d'accordo nel suggerire alla Edipower, che non è proprio il caso di.. insistere.!!!

Milazzo li 9 Agosto 2009

Il Vice Presidente T.A.T.

Arch. Salvatore Crisafulli

Octobre 19, 2009: Tocca alla Raffineria di Milazzo – S. Filippo del Mela !!

È in corso la procedura A.I.A. per la Raffineria Milazzo S.C.p.A., ed a nostro sommo avviso, emergono molteplici criticità;

I cittadini è giusto che sappiano qual è la struttura di analisi della procedura nella fase istruttoria e le possibili conseguenze in caso di definizione aggiustata per effetto di ripercussioni negative sull'economie locali.

Infatti queste sono le preoccupazioni, ad usare una nota frase *“piuttosto che niente, meglio piuttosto...”*, pensiamo che tale percorso sia influenzato dalle condizioni locali di mantenere una industria che comunque contribuisce a sostenere una certa quota di occupazione e visti i tempi che corrono, questa necessità può prevalere su esigenze più restrittive di tipo ambientale.

In forza di tali preoccupazioni, i politici poco lungimiranti sostengono che gli ambientalisti sono stupidi ideologi, pronti a contrastare ogni forma di sviluppo!

Ma se riflettiamo bene, è dal remoto 1961 che insiste la Raffineria e l'economia locale, sia di Milazzo che dei Comuni interessati da tale insediamento, non ha prodotto effetti significativi tali da generare uno sviluppo ordinato e coordinato dell'intero territorio, mentre è accresciuto oltremodo il degrado fisico ed ambientale ed il disagio sociale, **qualche villa in più**, al famoso capo di Milazzo e nient'altro, salvo diversa analisi e/o visione.

Il Comune di Milazzo, sempre secondo noi, ha perso molte occasioni per creare un utile sistema infrastrutturale sostenuto da risorse che sarebbero dovute pervenire sia dall'operatore R. M., ossia la Raffineria che dalle istituzioni, per attenuare l'impatto e non solo, avrebbe dovuto farsi carico di coordinare una riorganizzazione territoriale intercomunale per meglio armonizzare le esigenze della riqualificazione urbana e della tutela del patrimonio, tutte occasioni sprecate!!

Cosa pensare? I cittadini, se interrogati su questa vicenda si dividono, alcuni dicono *“siamo in Sicilia e le cose vanno così!”* altri, *“si fottunu i soddi e amara a cu mori!”*, oppure *“chi comanda non sta nel comune”*, poi ci sono gli apologisti: *“tutte stronzate, inventate da chi ha perso le elezioni, poi non ci sono dati certi ed i morti per tumore, non sono poi, così tanti!”*

Qualcuno ha anche sostenuto che l'Ass.re Provinciale P. Petrella è da tempo che si batte per attivare il monitoraggio, solo che non ha saputo precisare contro chi si batte e con quale strumenti?

Nel mezzo della discussione, emerge anche un'affermazione inquietante: *“in quella raffineria ci sono sepolte quantità rilevanti di amianto, almeno decine di vagoni di coppelle d'amianto!!”*

Non sembra facile confutare i dubbi emersi, del resto pare che non vi sia, un vero rapporto dello stato di quei luoghi.

Tutti ricordano le esalazioni emesse recentemente che hanno provocato irritazioni agli occhi ed alle vie respiratorie di decine di studenti nella città di Milazzo, le continue puzze e le proteste, i **8** deceduti nel 1995 per la violenta esplosione al “Topping 4” oltre i **20** feriti.

Nella sua storia la Raffineria di Milazzo conta molti incidenti con numerose vittime, cosa dire poi del pericoloso impianto di idroconversione dei residui, tristemente noto come **LC FINING?**

Pericolosissimo impianto che, in caso di incidente coinvolgerebbe tutto ciò che trova nel raggio di oltre 100 Km, ricordiamo a noi stessi che i pochi impianti esistenti al mondo, sono situati a 200 Km dai centri abitati, come conciliare tale stridente realtà, in un contesto fortemente antropizzato??

L'interesse industriale di tale Raffineria è evidente, ma vi sono altri interessi di cui occorre tener conto, la vita degli oltre **150.000** cittadini della Valle del Mela e dintorni, la loro condizione socio economica fortemente limitata dalla presenza di tale struttura, la loro salute e la loro sicurezza, il mancato assetto territoriale, al tavolo della Commissione

speriamo che vengano opportunamente rappresentati tutti gli interessi.

Alcune integrazioni alla domanda di autorizzazione integrata ambientale e la relativa documentazione tecnica allegata presentata nel recente 31/01/2007 e quella trasmessa *on-line* circa le modalità di monitoraggio e controllo, fanno pensare ad una costruzione piuttosto che ad una corretta rappresentazione dei fatti, magari saranno ipotesi, *ma chi si guardò si salvò!!*

Il Caso della Raffineria di Milazzo e S. Filippo del Mela è molto problematico, poiché non vi è solo il **Rischio Chimico**, ma anche quello di Impianto a rischio di incidente rilevante e non si capisce quale possa essere quello con maggiore criticità!!

A lungo si è parlato di “Piano di Risanamento”, ma sempre, con criterio che presuppone la complicità, il Piano rimasto una ipotesi mai esperita, la preoccupazione è alta, infatti è **lapalissiano** che per l'inquinamento atmosferico, alla luce di una disposizione dell'Assessorato all'industria della Regione Sicilia (*pubblicata sulla G.U.R.S. n° 20 del 9/5/2008*) concernente **annullamento di finanziamenti** a favore dei Comuni di Milazzo e San Filippo del Mela per la realizzazione del progetto denominato “*Rete di centraline per il monitoraggio dei fattori inquinanti nei Comuni di Milazzo e San Filippo del Mela*”, si deduce che nel territorio su cui insiste la Raffineria risultano scarse conoscenze sullo Stato dell'Ambiente, e scarse le prospettive di potenziare la rete pubblica di acquisizioni dati sullo stato dell'ambiente locale.

Ad aggravio di tutto ciò vi è che nessuno strumento organico previsto per normativa è stato posto in essere, Negligenza e Strategia?

Infatti: **non risultano** essere definiti **Piani d'Azione** per la gestione della qualità dell'aria previsti dall'art. 7 del d.lgs. 351/99, nel territorio del Mela;

Il Piano Territoriale Provinciale (PTP), strumento di pianificazione generale della Provincia Regionale di Messina, strumento urbanistico di area vasta, che assume il ruolo di strumento operativo, disegna la rete infrastrutturale ed individua aree per la realizzazione delle “*opere ed impianti di interesse sovracomunale*”;

Il **P.T.P. è perennemente in fase di formazione** (approvazione da parte del Consiglio Provinciale dello “*Studio Propedeutico del P.T.P. di Messina*” in data 28/6/1999).

Alla luce dell'analisi effettuata, tale Studio suddivide il territorio della Provincia Regionale in sette Unità Territoriali Produttive (U.T.P.). La Raffineria di Milazzo ricade all'interno dell'UTP n. 2 (Comuni della fascia costiera tirrenica dell'Area Metropolitana), fasce strisce e null'altro. Cosa dire poi dell'impovertimento delle acque di falda, con intrusione di acqua salmastra?

L'inquinamento della costa marittima è consistente, le analisi di sedimenti nelle acque marino costiere indicano presenza di pesticidi come alfa-esaclorocicloesano e isodrin, IPA (*antracene, fluorantene, benzo-a-pirene, ...*), metalli pesanti (Ni, V, Pb, Zn).

La integrazione della Raffineria sembra diluire il criterio di educazione di acqua di falda coinvolgendo soggetti quali diverse attività industriali significative e di attività agricole intensive che in realtà incidono in maniera poco rilevante.

Sulla qualità dell'aria è accertato che la Media Oraria di SO₂, supera il valore limite di protezione della salute umana, quelle poche centraline installate hanno registrato numerosi superamenti di NO_x e SO_x e polveri mentre il cartello elettronico visibile dalla strada, rassicura che tutta va bene.

Infatti la Raffineria ha in corso ben 6 procedimenti giudiziari, però nel procedura del V.I.A. dell'HMU3 non si hanno riscontri in merito, ci permettiamo di constatare: “ottima la regia”.

Il Clima acustico nella zona ove è ubicata la Raffineria risulta caratterizzata da un evidente rumore di fondo, ma i comuni di Milazzo e S. Filippo del Mela non risultano dotati di zonizzazione acustica. L'impatto visivo secondo la nostra visione e rispetto al contesto è altamente devastante, la Raffineria rompe un preciso schema naturale che si estende lungo la valle e caratterizza la costa, coinvolge nel processo della *skyline*; Milazzo con

forte connotazioni storiche ed i frammenti comunali che vi si accostano, tanto da consentire anche all'A.S.I. processi pericolosi di industrializzazione incrementando il degrado fisico del territorio, a discapito della struttura paesaggistica soprattutto quella di antica formazione.

La raffineria rappresenta un processo complesso di chimica sofisticata che coinvolge aria, acqua, terra, noi pensiamo che il suolo possa essere contaminato come pure il sottosuolo, ad esempio lo scarico a mare viene dichiarato ultimato solo nel 2007, e comunque v'è sempre presenza di prodotti chimici.

Dagli innumerevoli camini viene immessa una considerevole (**10.000** milioni di normali metri cubi/anno) quantità di fumi in atmosfera, circa **11.000** tonnellate anno di SO₂, **2.500** tonnellate di NO_x e **270** tonnellate di polveri, i serbatoi stoccano prodotti infiammabili per circa **3.5 milioni** di mc e consuma circa **7 milioni** di mc di acqua da pozzo ogni anno, mediamente ogni anno scarica a mare circa **6 milioni** di mc di acqua di processo, consuma circa **720 milioni** di KW di cui il **50%** la produce in proprio e l'altra probabilmente la scambia, con la vendita di prodotto (**olio combustibile BTZ?**) con la Edipower o qualche altra azienda vicinora, preoccupante è la presenza di materiali pericolosi e perniciosi, come **l'amianto, fanghi, morchie e scorie di vario tipo.**

Tale inquietante realtà, non è ubicata in una zona desertica non antropizzata, ma purtroppo è all'interno del sistema urbanizzato di Milazzo e San Filippo del Mela, e nel cuore della Valle del Mela e dintorni, ove ogni giorno circa 150.000 persone metabolizzano veleni e micropolveri emessi in ambiente, vittime negligenti ed ignare, grazie ad un apparato incosciente od ignorante, non so se si possa, in tale specie dire: "Signore perdona loro, perché non sanno quello che fanno!".

Oggi sono innanzi alla Commissione IPPC, per valutare concertare la quantità da somministrare ai Cittadini che oltre a pagare con la salute pagano in sacrifici sociali ed economici di tale magistero, si perché tutto questo avviene senza alcuna contropartita, nessun beneficio solo malefico, mentre coloro che possiedono i pacchetti azionari, vivono in ville con vista mare pulito, giardino con essenze pregiate, servitù, si alimentano con *prodotti biologici, praticano fitness, nuoto, tennis, golf etc. etc.*, per il proprio benessere fisico, e magari vanno a messa la domenica.

Questa e la stridente realtà, allora cosa auspichiamo ?

Se l'Autorizzazione Integrata Ambientale dev'essere tale da limitare il più possibile il danno sociale e il danno alla salute, che lo sia altrimenti non si capisce cosa significa il termine "**Integrata**", non solo, che il processo di monitoraggio sia efficace e non gestito, che si intraprendano iniziative utile al risveglio economico e sociale della Valle del Mela, che si formino effettive forme di garanzia e non teoriche ipotesi o promesse da marinaio, ed infine un "tocchetto" ai Signori Sindaci, agli amministratori provinciali e regionali, agite nella tutela degli interessi dei Cittadini, smettiamola di fare burocrazia, ormai tutti hanno capito: "SOLO VOI, SFUGGITE ALLA VOSTRA COSCIENZA" !!

Milazzo li 19 Ottobre 2009

Il Vice Presidente **T.A.T.**

Arch. Salvatore Crisafulli

January 28, 2010: LA CULTURA DEL TERRITORIO E LO SPOPOLAMENTO

LA CULTURA DEL TERRITORIO

A seguito dello scorporamento di funzioni, da parte delle regioni agli **Enti Locali**, le competenze dei comuni sono aumentate oltremodo. Inoltre, hanno molteplici opportunità di sviluppo ma, talvolta, si alzano barriere di tipo *culturale-economico*, che non permettono al territorio di innescare reali circuiti di sviluppo. D'altra parte i processi di trasformazioni degli ultimi decenni hanno determinato profonde differenziazioni territoriali. Il **72%** dei comuni italiani ha meno di **5000 abitanti** e rappresenta una risorsa *insediativa*, che conosce da tempi remoti **fenomeni di spopolamento**, depauperamento e relativo invecchiamento della popolazione. Ciò implica per gli Enti preposti, difficoltà sia di tipo gestionale, che in termini di servizi e **programmazione** economica e sociale. Tali fenomeni si riscontrano altresì, in molte nazioni europee, i quali hanno già avviato da tempo, politiche d'intervento per arginare i fenomeni di spopolamento dei piccoli centri. In Italia, il governo ha approvato delle leggi, con lo scopo di sostenerne le attività economiche, sociali, ambientali e culturali. Nel Sud come in Sicilia, infatti, sono state sperimentate sia **politiche esogene** (*incentivazioni finanziarie e interventi infrastrutturali*) sia **politiche endogene**. Secondo gli esperti, queste ultime sono state di due tipi: una di tipo particolaristico e clientelare, che spesso si è accompagnata alla **politica esogena**; l'altra derivante da un cambiamento della politica pubblica, che ha sostituito al modello dello sviluppo dall'alto, quello dello sviluppo locale dal basso, negoziato.

LO SPOPOLAMENTO - Per quanto riguarda la distribuzione della popolazione sul territorio, la crisi dei piccoli comuni inizia agli albori degli anni **'50**, con riferimento ai piccoli centri interni. Da quegli anni, tale crisi diventa la nota dominante delle **regioni** DEL SUD. Essa si riversa a valle, con l'utilizzo intensivo delle pianure e dei litorali: quei centri isolati adesso si toccano, ma si tratta di una contiguità solo edilizia, perché essi continuano ad essere sempre più piccoli e separati dal punto di vista economico e socio-culturale.

LA TRADIZIONE - L'intervento straordinario caratterizza la politica di sviluppo territoriale del Mezzogiorno nel dopoguerra. Si tratta di una politica settoriale, ideata da un ristretto gruppo di tecnocrati e gestita dalla famosa **CASMEZ** (Cassa per il Mezzogiorno), anche per la scarsa fiducia che si nutriva, nell'amministrazione ordinaria. La classe dirigente locale, estranea sia alla fase di **programmazione** sia a quella gestionale, diventa in quel periodo, mera mediatrice con la politica centrale, soprattutto in funzione delle risorse finanziarie da ridistribuire a livello locale, anche a scopi clientelari. La suindicata politica al sud è caratterizzata da interventi di tipo infrastrutturale e da una scarsa incentivazione dell'attività industriale. Con il "*grande cantiere*" si è voluto ridurre l'autonomia dei ceti produttivi nelle campagne, rallentare la formazione di nuove imprese ed incanalare forza lavoro, nei lavori pubblici in modo da rendere disponibile una massa fluttuante di popolazione o per il reimpiego in altri cantieri oppure ancora per l'emigrazione. Sono i centri interni che, subiscono le maggiori perdite in termini di riduzione delle attività economiche e di migrazione. In particolare, nei centri collinari s'interviene attraverso la legislazione speciale per la realizzazione d'opere di consolidamento, etc., che cercano di attenuare situazioni d'emergenza. Il debole tessuto produttivo costituito da piccole imprese artigianali del settore che lavorano per il mercato locale, in assenza di un'adeguata politica d'incentivazione, non regge all'inserimento nel mercato nazionale. Al contrario, cresce a dismisura l'attività edilizia, soprattutto alle opere pubbliche. Negli anni **'70** si attua la politica dei grossi poli industriali, proprio quando in altri territori fallisce a causa della crisi del modello "*fordista*" e da più parti si afferma la necessità di sostenere le piccole e/o medie imprese spesso integrate in "**distretti industriali**". Lo sviluppo della piccola **impresa** fa emergere l'importanza della dimensione locale: "*Il territorio come sistema particolare tra fattori economici, socio-culturali e politici che influenzano lo sviluppo*". Se si tiene conto che, la crescita di nuove iniziative e l'incremento della produzione industriale sono venuti negli ultimi anni soprattutto dall'economia della piccola **impresa**, si può logicamente presupporre che la crisi delle piccole imprese degli anni **'60** che ha colpito soprattutto i piccoli centri e la limitata crescita nel ventennio successivo, abbiano contribuito a frenarne definitivamente le possibilità di sviluppo auto-propulsivo.

L'INNOVAZIONE - Dal punto di vista della **programmazione** dello sviluppo, agli inizi degli anni **'90** segna la fine definitiva della politica dell'intervento straordinario affidato ad istituzioni speciali, con lo scioglimento della **CASMEZ**. Alla fine degli anni **'80**, si assiste ad innovazioni istituzionali ispirate al "**federalismo**", che trasferiscono poteri dal centro agli enti periferici. Ai comuni è attribuita competenza amministrativa generale

salvo che, per assicurarne un esercizio unitario, essa sia conferita a livelli istituzionali superiori, secondo un riparto dei poteri pubblici dal basso verso l'alto. Il comune, che è l'ente più vicino ai cittadini, diventa così **"II PRIMO MATTONE DELLA REPUBBLICA"**.

Per quanto riguarda la politica nazionale, gli anni '90 sono gli anni dei "Patti" e dei "Contratti d'Area", che prevedono la "concertazione" degli interventi a livello territoriale;

Nel frattempo è riformata la politica regionale europea che viene, contestualmente, dotata anche di risorse più ingenti, seppure con regole stringenti di programmazione pluriennale, di *partneriato* istituzionale e sociale, di monitoraggio e di valutazione degli interventi. Per quanto riguarda, invece, la legittimazione del *partneriato* sul territorio, la programmazione negoziata, ha visto il proliferare di diversi strumenti anche all'interno di uno stesso programma.

Così accade che all'interno di un medesimo territorio, coesistono diverse istituzioni e diversi programmi per lo sviluppo; Al contempo, si forma un *compartecipazione* diversa per ciascun programma. Non esiste, in altri termini, una continuità istituzionale nella politica di sviluppo locale. A migliore intelligenza, gli enti pubblici locali (*i comuni*) sono presenti nei consorzi a caccia di visibilità politica e di cospicui finanziamenti e particolare non trascurabile:

"non assumono impegni specifici riguardo lo sviluppo dell'area".

I PICCOLI COMUNI TRA TRADIZIONE E INNOVAZIONE - Da un primo *screening*, emerge una situazione molto composita, ma che comunque permette di formulare delle prime riflessioni sui possibili modelli di *governance* per i piccoli comuni.

E' evidente che con la riforma della Costituzione, ha preso forma un sistema a rete in cui le diverse istituzioni si integrano secondo i principi della partecipazione, della sussidiarietà e dell'efficienza. In questo nuovo quadro i comuni assumono il ruolo di "veri protagonisti" dello sviluppo dei propri territori. La programmazione negoziata ha offerto politiche di sviluppo e strumenti innovativi basati sui principi dello sviluppo dal basso, integrato e concertato. I piccoli comuni hanno partecipato all'attuazione di questi nuovi strumenti. La partecipazione ai tavoli della concertazione, ha accresciuto la loro consapevolezza di poter contribuire alla determinazione del proprio sviluppo. Spesso, però, questa consapevolezza non si è tradotta in comportamenti concreti. Al nuovo schema socio-istituzionale non si è accompagnato cioè uno SVILUPPO TERRITORIALE. Una *governance* adeguata al quadro istituzionale e di politica pubblica che abbiamo definito innovativo richiede per i piccoli comuni due condizioni necessarie: una forte capacità di coordinamento e di proposta progettuale rispetto ai diversi livelli sovra-comunali della programmazione; una reale partecipazione dei cittadini alle scelte collettive locali. Storicamente, nelle comunità montane, infatti l'insediamento si è sviluppato soprattutto in collina mentre furono rifuggite le coste, insicure per le continue incursioni barbaresche. L'ascesa verso l'alto inoltre era diretta sempre là dove la presenza di più sicuri e forti presidi, sia fisici che morali (*castelli, monasteri*), situati sempre sulle sommità dei rilievi collinari e sub-montani, offriva alle spaurite ed inermi popolazioni almeno una parvenza di maggiore sicurezza e protezione. Nell'ultimo trentennio, abbiamo assistito impotentemente, ad un INGENTE SPOSTAMENTO DELLA POPOLAZIONE DAL MONTE VERSO IL MARE, lungo le fasce costiere dell'intera penisola. **Il generale spopolamento**, non tocca di contro gli agglomerati costieri, (*i quali sono soggetti a continui incrementi demografici*).

Lo **spopolamento**, senza ombra di dubbio crea emergenza sociale, ma anche tanti disagi per chi resta, per la chiusura delle scuole, per l'assenza di servizi essenziali per la qualità della vita. I pochi negozi chiudono per l'impossibilità di reggere il ritmo dei prezzi rispetto ai grandi centri e alla distribuzione. Lo spopolamento genera PIGRIZIA, INERZIA, PARALISI, LENTA MORTE. I CERVELLI, i pochi che rimangono, finiscono per ARRUGGINIRE: sono nell'immobilità di eguali stagioni, in attesa di mutamenti chissà quali che, da sé non verranno a rifare il mondo.

Come vivono i nostri ANZIANI nei piccoli centri? Un dato su tutti, in moltissimi comuni la componente di persone anziane superiori ai sessantenni supera il 40% della popolazione residente, mentre la percentuale di individui inferiore ai 16 anni non supera il 15% DEGLI ABITANTI RESIDENTI.

L'UNITÀ e la CONCENTRAZIONE producono *forza contrattuale*; la campagna ed ancor di più la montagna sono per loro natura "*struttura debole*" alla mercè delle strutture urbane. La città è il simbolo di tutto ciò che è appetibile: il luogo del lavoro, il luogo di incontri, di scambi, di conoscenza, il luogo del sapere, il "paese", il *mondo rurale* invece è simbolo di isolamento, differenziazione, separazione, dove.. *la civiltà viene da fuori*.

"LA CITTÀ TERRITORIO"- "CITTÀ", come simbolo di UNITÀ, di IDENTITÀ, di EQUITÀ TERRITORIALE, di QUALITÀ

DEI SERVIZI, cioè l'assunzione di un concetto "urbanità" che vivifichi il ruolo delle aree marginali, da coinvolgere in un processo di crescita facendo "MASSA CRITICA" e realizzando *servizi* di natura "urbana" utilizzabili dall'intera comunità; "TERRITORIO", inteso come spazio ecologico per la vita dell'uomo e delle attività da questo promosse, come ECOSISTEMA in cui l'ambiente offre sempre più reali opportunità di sviluppo e benessere per le generazioni presenti, il TERRITORIO come NUCLEO E MOTORE DI UNO SVILUPPO da ricercare attraverso la valorizzazione delle sue valenze ambientali, culturali e produttive.

Un TERRITORIO ORGANIZZATO, con l'identificazione e la distribuzione degli ELEMENTI PORTANTI E CONCENTRATI DI UNA CITTÀ, in un'estensione fondata sui processi ambientali che la strutturano in un'ottica di rete ecologica e di una piena integrazione amministrativa fra i comuni dell'area.

Nei modi di vita, i due termini sono opposti: non lo sono nella quotidianità cittadina, ove quella rappresentazione manipolabile che abbiamo chiamato "cultura" ha sostituito entro l'immaginario collettivo, tramite tv e pubblicità ed anche tramite l'insegnamento scolastico, l'esperienza viva del territorio reale. Qualcosa di simile è avvenuto in tempi remoti, specificatamente nell'Alto Medioevo, con la memoria dell'Impero, con l'estinzione di molte varietà locali e tradizionali, e con la presenza di una specifica classe di "COLTURE IN ABBANDONO", che altri non è, che il tema dominante nella "Crisi TARDOMEDIEVALE".

Milazzo li 28 Gennaio 2010

Il Segretario Generale TAT
Antonino Cavatoì

Annexe 2 Detailed depiction of the Milazzo Peninsula's issues

The Milazzo peninsula is above all a protected area. It is a geosite and a place of history as well as a spiritual centre. All those aspects that can be threatened by pollutants will be developed through field observation and bibliography. These aspects are of importance in order to understand why the presence of pollutants in this area represent an issue.

The Milazzo Peninsula, a geosite

A geosite is a geological site having scientific, historic and cultural heritage interest Costantini & L'Abate, 2009. The classification of geological sites as geosites is an attempt to select globally important geological sites. Their importance is not only at national scale; it is also related to different frameworks Cleal et al., 1999.

The Milazzo Peninsula is a place of geological heritage worth being conserved. Among all the 21 geosite types proposed by Ruban (2010) Ruban, 2010, the Peninsula shows 7 the following ones: stratigraphical, paleontological, sedimentary, metamorphic, structural, geomorphological and geohistorical. Indeed, the geohistory of the site is very complex. It shows three metamorphic events and three volcanic ones, granting it a unique structure. The formation of the Peninsula ended with sedimentary deposits structured in precise stratigraphic layers. Numerous karstic caves where interesting and sometimes unique paleontological remains where found complete the frame. Following Ruban's equations Ruban, 2010, we can say that the Milazzo Peninsula is a geosite of importance with a Geodiversity(1) equal to 7.

The sedimentary aspect is important at local scale. The stratigraphical, structural, geomorphological and paleontological aspects are important at regional scale. The metamorphic aspect is important at national scale. The geohistorical aspect is important at world-wide scale. Therefore, following Ruban's equations Ruban, 2010, we can say that the Milazzo Peninsula is a geosite of importance with a Geodiversity(2) of 1.141 according to the logarithmic scale, and of 4.000 according to the linear scale.

Because the Milazzo Peninsula is a site reduced in size, it is not possible to calculate its Geodiversity(3). This factor can only be calculated at regional scale Ruban, 2010.

The Milazzo Peninsula, a Natura 2000 site

The Natura 2000 ecological net is a tool from the European Union to protect the biodiversity. It is composed of Special Conservation Zones ("Habitat" directive) and Special Protection Zones ("Birds" directive). But Natura 2000 do not ban human activities from protected areas; in fact, some of them are benefit for some species, such as sunken boats give shelter to

marine fauna. Maintaining traditional activities, such as non-intensive cultures, can preserve and protect endangered species Ministero dell'Ambiente e della Tutela del Territorio e del Mare, 2010.

The cliffs around the Milazzo Peninsula are registered as a Natura 2000 Site of Community Importance under the number ITA030032 since March 2009; 47 hectares are covered Ministro dell'Ambiente e della Tutela del Territorio e del Mare, décret 30/03/2009. It is one of 232 Natura 2000 sites in the Sicily region, and its area represents less than 0.08 % if the total Natura 2000 area for Sicily. The average Sicilian Natura 2000 site covers 2 452 hectares.

The Milazzo Peninsula, a place for tourism

Tourism is a very important sector, at national and international level. It has a non-negligible impact upon economical and cultural richness and is tightly linked to the natural environment. To-day, there exists only one information office for the tourists in Milazzo, the Sistema Turistico Regionale, and the city is poorly linked to the transit network. Despite these difficulties, the touristic flux towards the Milazzo Peninsula is important enough to have non-negligible impacts: positive impacts upon the economy, negative impacts on the environment. In fact, the presence of tourists in Milazzo increases the air pollution (usage of cars and boats), the noise, the water consumption and the production of waste, thus leading to higher environmental pressure. The role of tourism is to protect the cultural and natural patrimony while using it as a base and tool for economic development in a sustainable way Agenda 21 Milazzo, 2009.

Year	Number of tourists	Average stay	Admissions (= number of tourists * average stay)
1996	41 361	2.49	102 825
1997	42 410	2.48	105 145
1998	46 855	2.43	113 873
1999	52 656	2.36	124 277
2000	54 678	2.25	123 179
2001	57 615	2.31	133 323
2002	55 131	2.32	127 743
2003	49 291	2.60	128 325
2004	43 352	2.72	117 750
2005	45 334	2.42	109 720
2006	39 370	2.19	86 139
2007	41 743	2.20	91 895

*Table 36: Touristic flux and admissions upon the Milazzo territory from year 1996 to year 2007
Agenda 21 Milazzo, 2009*

As we can see in Table 36, until the end of the year 2001, the touristic fluxes were on increase : +28.3 % in the number of tourists, +23 % in the admissions. But in the following years, the decrease of the number of tourists as well as of the admissions were down to -12 %. The amount of touristic arrivals was in 2007 about the same than in 1996, with a difference of -0.91 % only. The foreign tourists represent 25 % of the admissions. The average stay was of two days and a half in 1996 and increased to close to tree days in 2004, to diminish again and drop to 2.2 days in 2007.

The tourism, in Milazzo, present different aspects. 32 % of the tourists came for the sea while 27 % were attracted by the local culture and natural landscapes. Most of the persons visiting Milazzo (60 %) wish to see the peculiar natural environment of the site, when 32 % wish to see the cultural peculiarities Agenda 21 Milazzo, 2009.

Different places can be visited in the city, including three museums, a castle, a library that used to be a palace, nine churches, three statues and monuments, numerous villas and palaces Comune di Milazzo, 2010.

*The museums

Three museums can be visited in Milazzo. The building of the Archeological museum used to be the women's prison. It shows archaeological findings made in the area of the peninsula and tells the history of the place, which started as soon as the Neolithic age Comune di Milazzo, 2010. The Wine museum is about the Grasso winehouse, dated back from 1887, and who won prestigious prizes in international contests Compagnia dei Vini, 2010. There also is a Tuna fish museum Comune di Milazzo, 2010.

*The Library

The library used to be the Palace of Marquis D'Amico, a noble family living in Milazzo. It was built in 1733 – 1735. In the frame of a “European Union Prize for Cultural Heritage 2006” the building was restored, restructured and repurposed as a multifunctionnal cultural centre. The splendid ceilings still keep their original paintings, as do some of the floors. The original kitchen is still visible Comune di Milazzo, 2010.

*The Castle

The Castel, as it is to-day, was built between 976 and 1100, and later modified by the Norman, the Swabian and the Aragonese. To-day the old walls welcome concertos and shows. It covers seven hectares, including 12 070 m² for the buildings. The first fortifications are dated back

from 4 000 B.C. Then the Greeks settled down in VIII-VII B.C. In 843 the Arabs put together the eldest part still visible, starting to give it its definitive appearance Comune di Milazzo, 2010.

*Commemorative monuments

Spread around the city, commemorative monuments can be seen. The eldest is dated back from the end of the nineteenth century; it is the Milazzo's liberty statue by Francesco Greco. The war memorial is by Nino Geraci, and is dated back from the twentieth century. The last commemorative monument is dated back from 1965; it is a bronze statue of Admiral Luigi Rizzo (World War I) by Antonio Bonfiglio Comune di Milazzo, 2010.

Annexe 3 The fauna and flora of the Milazzo Peninsula

The flora

The flora of Milazzo is very diversified because of the geomorphology of the territory. From the cliffs of the promontory to the hinterlands' beaches, the territory changes gradually. The vegetations types that can be encountered today at Milazzo are:

- ♣ high-altitude Mediterranean scrub (macchia) or forestry scrub;
- ♣ Mediterranean scrub (Mediterranean macchia);
- ♣ scrubland (gariga);
- ♣ steppe;
- ♣ lithophytic vegetation (vegetation growing on rocks);
- ♣ halophilic vegetation (vegetation adapted to salt);
- ♣ riparian forest (along the torrents);
- ♣ mesophyllous vegetation.

*The scrub (macchia)

The high-altitude scrub or forestry scrub results from the degradation of the “Mediterranean forest” which used to be present on the main part of Milazzo's territory, usually named “lecceta” because of the presence of holly oak (*Quercus ilex*, “leccio” in italian). This oak is characteristic of the 0 to 1000 m Mediterranean forest and at present time it does no longer exist in the wild in Milazzo. Another oak is more frequent in Milazzo: it is the Southern live oak (*Quercus virginiana*) that can cohabit anywhere with the field elm (*Ulmus minor*). On the Promontory it is also possible to find the manna ash (*Fraxinus ornus*) and in the plain, the european nettle tree (*Celtis australis*) Agenda 21 Milazzo, 2009.

Are also present species that are common in the scrubs, like the mirtle (*Myrtus communis*), the european wild apple (*Malus sylvestris*), the common hawthorn (*Crataegus monogyna*), the blackthorn (*Prunus spinosa*). The Mediterranean scrub of Milazzo is dominated by the mastic tree (*Pistacia lentiscus*), associated with the tree heath (*Erica arborea*), the spanish broom (*Spartium junceum*) and the Mediterranean honeysuckle (*Lonicera implexa*). The presence of *Asparagus acutifolius*, of evergreen rose (*Rosa sempervirens*) and of ivy (*Hedera helix*) made the milazzanese scrub impassable. Other species that can be observed are the black spleenwort (*Asplenium adiantum-nigrum*), the Southern polypody (*Polypodium cambricum*), the lanceolate spleenwort (*Asplenium obovatum*) and the laurestine (*Viburnum tinus*). This last one is a vulnerable species belonging to the Regional Red List of Italian Plants. In conditions of major drought, the scrub is

more or less exclusively composed of tree spurges (*Euphorbia dendroides*) which may be the most striking plant of the whole promontory during the blossoming season, lasting until the end of winter Agenda 21 Milazzo, 2009 .

*The scrubland (gariga)

The scrubland is a type of bushy vegetation growing at anyplace where the scrub is destroyed and where the fields are left uncultivated. It is found everywhere on the promontory because of the action of West North-West winds, drying the environment and keeping more mature vegetation to develop. Species typical of this gariga scrubland are the sagebrush (*Artemisia arborescens*), the spiny broom (*Calicotme villosa*), the *Asphodelus microcarpus* and the red squill (*Scilla maritima*). There also grow rare and endemic species such as the Southern tea tree (*Lycium intricatum*), the panormitanum early spring orchid (*Ophrys sphegodes* subsp. *Panormitanum*), the *Bellevalia dubia*. This last one is endemic and registered in the Inventory of species at risk Agenda 21 Milazzo, 2009.

*The steppe

The steppe represent the state of maximum degradation of the scrub (macchia), particularly when the scrubland (gariga) suffers other degradation phenomenons like fire, pasture etc. The typical plant of the steppe is the common thatching grass (*Hyparrhenia hirta*). There are also present the fennel (*Foeniculum vulgare*), the blueweed (*Echium vulgare*), the giant fennel (*Ferula communis*), the *Cachrys pungens* Jan, etc Agenda 21 Milazzo, 2009.

*The lithophytic vegetation

The lithophytic vegetation takes its name from its place of growth, the rock cliffs. This environment is rich of rare and endemic species. Among the species found on the promontory are the caper (*Capparis spinosa*), the picushion flower (*Scabiosa cretica*), the *Dianthus rupicola*, the *Erucastrum virgatum* and the rare *Echinops spinosissimus Turra*, registered both in the regional and national Red List of species risking extinction. It is now found only at Milazzo, Patti and Tindari Agenda 21 Milazzo, 2009.

*The halophilic vegetation

The halophilic vegetation lives in salty environment. Among the species characteristic of this type of vegetation, there is an endemic species growing only on the cliffs of the Milazzo cape and of the Aeolian Islands; it is named limonium of the Aeolian (*Limonium minutiflorum*) Agenda 21 Milazzo, 2009.

*The riparian forest

The milazzese riparian forest is located along the Mela and Floripotema-Corriolo torrents. It is discontinued because of the degradation of the environment. The vegetation grows to a forest mainly along the Floripotema-Corriolo torrent, where are observed species such as the black poplar (*Populus nigra*), the white willow (*Salix alba*), the tamarisks (*Tamarix*), the oleander (*Nerium oleander*) and beds of common reed (*Phragmites australis*) Agenda 21 Milazzo, 2009.

*The mesophyllous vegetation

The mesophyllous vegetation is limited to the small spring of the Promontory. On the West versant grows quite exclusively the giant cane (*Arundo donax*) while on the east can be found the blackberry (*Rubus fruticosus*), the *Pulicaria dysenterica*, the Italian orchid (*Orchis italica*), the *Serapias lingua*, the rare creeping witchgrass (*Panicum repens*) and the *Salomus valerandi*, another rare species Agenda 21 Milazzo, 2009.

The fauna

The sicilian fauna used to be characterized by species extinct by now. Among them, the brown bear, extinct in Sicily for centuries, deers and roes that were present until the nineteenth century, wolves and griffin vultures. These two last species were present until a few decades ago, when the uncontrolled hunt shot down the last individuals. The huntings of the last centuries, as well as the anthropogenication of the peninsula, destroyed the medieval forests and depleted the diversified fauna. Some species are seen only punctually now, like the fox, the dormouse, the marten Agenda 21 Milazzo, 2009.

*Mammals

Among the mammals present at Milazzo, the most numerous is the European rabbit (*Oryctolagus cuniculus*). It breeds a lot and lives on the Promontory. The least weasel (*Mustela nivalis*) is the only carnivorous species that is left of the milazzese fauna. The insectivore species are more numerous; are observed at Milazzo the European hedgehog (*Erinaceus europaeus*), the etruscan shrew (*Sunus etruscus*), the greater white-toothed shrew (*Corcidura russula*), the lesser white-toothed shrew (*Corcidura suaveolens*). The rodents present at Milazzo are the black rat (*Rattus rattus*), the brown rat (*Rattus norvegicus*), the house mouse (*Mus musculus*) and the wood mouse (*Apodemus sylvaticus*) Agenda 21 Milazzo, 2009.

*Birds

The Milazzo peninsula, constituted of very diversified environments, still present a few uncontaminated ecosystems with little degradation where numerous bird species shelter. Among those species, the peregrine falcon (*Falco peregrinus*), registered in the New Red List of birds nesting in Italy; it usually nests on the cliffs of Milazzo Promontory. Among the other day birds of prey it is possible to observe the common kestrel (*Falco tinnunculus*), occasionally the buzzard (*Buteo buteo*) and, during migration, the honey buzzard (*Pernis apivorus*). The night birds of prey are more common. Among them, the eurasian scops-owl (*Otus scops*), the little owl (*Athene noctua*), the barn owl (*Tyto alba*). Among the marine species, the black-headed gull (*Chroicocephalus ridibundus*) and the yellow-legged gull (*Larus michahellis*) can be observed. Among the occasional species there are evidences of the presence of kingfishers (suborder *Alcedines*), the european shag (*Phalacrocorax aristotelis*), the great cormorant (*Phalacrocorax carbo*), the blue rock-thrush (*Monticola solitarius*) and the rock pigeon (*Columba livia*). Some migrating aquatic species can also be observed, such as the little bittern (*Ixobrychus minutus*), the grey heron (*Ardea cinerea*), the little egret (*Egretta garzetta*). Other bird species living on this territory are the spanish sparrow (*Passer hispaniolensis*), the common blackbird (*Turdus merula*), the european robin (*Erithacus rubecula*), the hoopoe (*Upupa epops*) Agenda 21 Milazzo, 2009.

*Amphibians

The amphibians are, among the vertebrates, those who suffered the most from the anthropisation of the territory. The slow disappearance of the wetlands and the usage of pesticides are the first causes of their rarefaction. By now the most common species in the milazzese territory are the European tree frog (*Hyla arborea*) and the Mediterranean painted frog (*Discoglossus pictus*). This last one is registered as a fauna species rigorously protected. These two species are observed South of the peninsula, along the Mela torrent. Another species, more rare, is the pool frog (*Pelophylax lessonae*). The lack of evidence of the presence of the common toad (*Bufo bufo*) leads to thinking that this species has completely disappeared from the Milazzo territory Agenda 21 Milazzo, 2009.

*Reptiles

The green whip snake (*Hierophis viridiflavus*) is the most common snake of Milazzo while the grass snake (*Natrix natrix*) is rarifying because of the environmental degradation and of the disappearance of its preys (frogs). The Italian wall lizard (*Podarcis sicula*) is the most common lizard, living in wild environment as well as gardens and streets. Another lizard is present at Milazzo; it is the Western green lizard (*Lacerta bilineata*). Two species of gecko are present, the

Mediterranean house gecko (*Hemidactylus turcicus*) and the Moorish gecko (*Tarentola mauritanica*); the first is common around houses when the second fears the Man. Other species of reptiles are the gongilo (*Chalcides ocellatus*) and the three-toed skink (*Chalcides chalcides*). Of all reptiles present at Milazzo, the following are registered as rigorously protected: the green whip snake, the Italian wall lizard, the Western green lizard and the gonglio Agenda 21 Milazzo, 2009.

Annexe 4 Depiction of the anthropogenic activities

Milazzo refinery (Raffineria Mediterranea, Raffineria di Milazzo S.C.p.A.)

Extended on 212 hectares Bevilacqua & Braglia, 2002; Raffineria di Milazzo S.C.p.A., 2010 (a), the oil refinery of Milazzo is assumed to be the main possible source of pollutants in the peninsula. Half of it belongs to the AgipPetroli group (Eni S.p.A.) while the other half belongs to Kuwait Petroleum Italia S.p.A. Bevilacqua & Braglia, 2002; Raffineria di Milazzo S.C.p.A., 2010 (b); NRi, 2010. It is specialized in the production of extra-heavy crude oils from nearby Eni fields offshore of Sicily Bevilacqua & Braglia, 2002.

The refinery was certificated for ISO 14 001:2004 in 2004 for the first time, for the following products and services Raffineria di Milazzo S.C.p.A., 2010 (a); ISO 14 001 Milazzo 2004:

- ^ Refining of crude oil and intermediate products unloaded by ship, storage and handling of petroleum products including ship and truck loading;
- ^ Production of steam and electric power for internal use by multifuel boilers utilities (industrial waste water treatment, preliminary waste storage).

It is also conform to the ISO 9 001:2000 certification of Bureau Veritas Raffineria di Milazzo S.C.p.A., 2010 (a); Raffineria di Milazzo S.C.p.A., 2010 (c).

The refinery will emit pollutants to the water, because of effluents. It will emit pollutants to the air, because of smokes; the pollutants in the air will fall because of gravity and will be fund in the soil. The pollutants emitted by the refinery will be looked for in the water and soil samples.

***Capacity of the refinery**

In 2002, the Milazzo refinery had a refining capacity of 160 000 barrels a day, with a conversion equivalent of 57.7 % Bevilacqua & Braglia, 2002. By 2010, the capacity increased to 300 000 barrels a day according to NRi NRi, 2010, or twelve millions tons a year according to the Refinery's website Raffineria di Milazzo S.C.p.A., 2010 (a). It produces one million tons a year of combustible oil (heavy fraction) according to Association TAT Crisafulli et al., 2010. It can handle a wide range of crudes and can produce a wide variety of petroleum products depending on market demand. The main product, since the 1990s, is unleaded gasoline and gas oil with a low sulfur content Bevilacqua & Braglia, 2002. The gasoline represent 42 % of the production, the fuel gas represent 20 %, fuel oil is 14 % and diesel oil, 12 % Raffineria di Milazzo S.C.p.A., 2010 (a).

*Functioning of the refinery

The Raffineria di Milazzo S.p.A. is composed of different units. Among those units, the hydrodesulfurisation unit is based upon high-pressure technology. Its capacity is of 6.800 ton/day of gas oil. The crude vacuum distillation units have been specially upgraded in order to reduce sulphur content in the emissions. The liquid petroleum (LPG) gas storage plant was added in year 2000 and its safety system provides both emergency shut down and fire and gas detection NRi, 2010. After the separation of the different phases, the heavy fraction is not sold for itself, but catalyzed into a lighter fraction or converted into thermic energy to be used by the refinery itself Crisafulli et al., 2010.

A park of 127 oil tankers, for a capacity of 3 750 000 m³, transport the crude oil to the refinery Raffineria di Milazzo S.C.p.A., 2010 (a).

*Situation of the refinery

The refinery is situated in the zone of industrial development of Milazzo (Area di Sviluppo Industriale di Milazzo, ASI) and covers an area of about 212 ha Bevilacqua & Braglia, 2002; Raffineria di Milazzo S.C.p.A., 2010 (a). The coordinates of the refinery are: 38.2 of latitude North, 15.266667 of longitude East SIRA, 2007.

*Environmental implications of the refinery

According to its ethical code Raffineria di Milazzo S.C.p.A., 2010 (b), its internal policies Raffineria di Milazzo S.C.p.A., 2010 (b); Raffineria di Milazzo S.C.p.A., 2010 (d), its ISO 14 001:2004 certification Det Norske Veritas Italia S.r.l., 2004 and its website Raffineria di Milazzo S.C.p.A., 2010 (a), the Milazzo refinery is engaged in actions of sustainable development. About 33 % of the investments of the years 2007-2012 are dedicated to the reduction of the impacts towards the environment, mainly regarding the treatment of wastewater Raffineria di Milazzo S.C.p.A., 2010 (a). During the 1990s, the refinery started to produce unleaded and low-sulfured oils and gas Bevilacqua & Braglia, 2002. Its ethical code indicates that the refinery is engaged for the protection of human health, environment and biodiversity, and that this vision has a philanthropogenic motivation Raffineria di Milazzo S.C.p.A., 2010 (b).

Around the year 2006, the Refinery decided some other changes in its relationship with the environment. Among them, it decided to reduce its water and energy consumption, to protect its worker from PCB and asbestos, and to reduce its emissions to the air Raffineria di Milazzo S.C.p.A., 2010 (a).

Thermo-electric plant (Termica Milazzo S.r.l.)

Close from the oil refinery plant is situated a thermo-electric plant. They both are strongly linked in their activities: the main part of the one million barrel a year of combustible oil that is produced by the refinery is used to feed the thermo-electric plant Crisafulli et al., 2010. The Termica Milazzo S.r.l. plant is composed of Edison S.p.a. (60 %) and of ENI POWER (40 %) EMAS, 2008; EDISON, 2010. It provides the refinery with vapor (100 t/h, EMAS, 2008), while the refinery provides the thermo-electric plant with fuel EDISON, 2010. The map of the thermo-electric plant can be found in Figure 70.

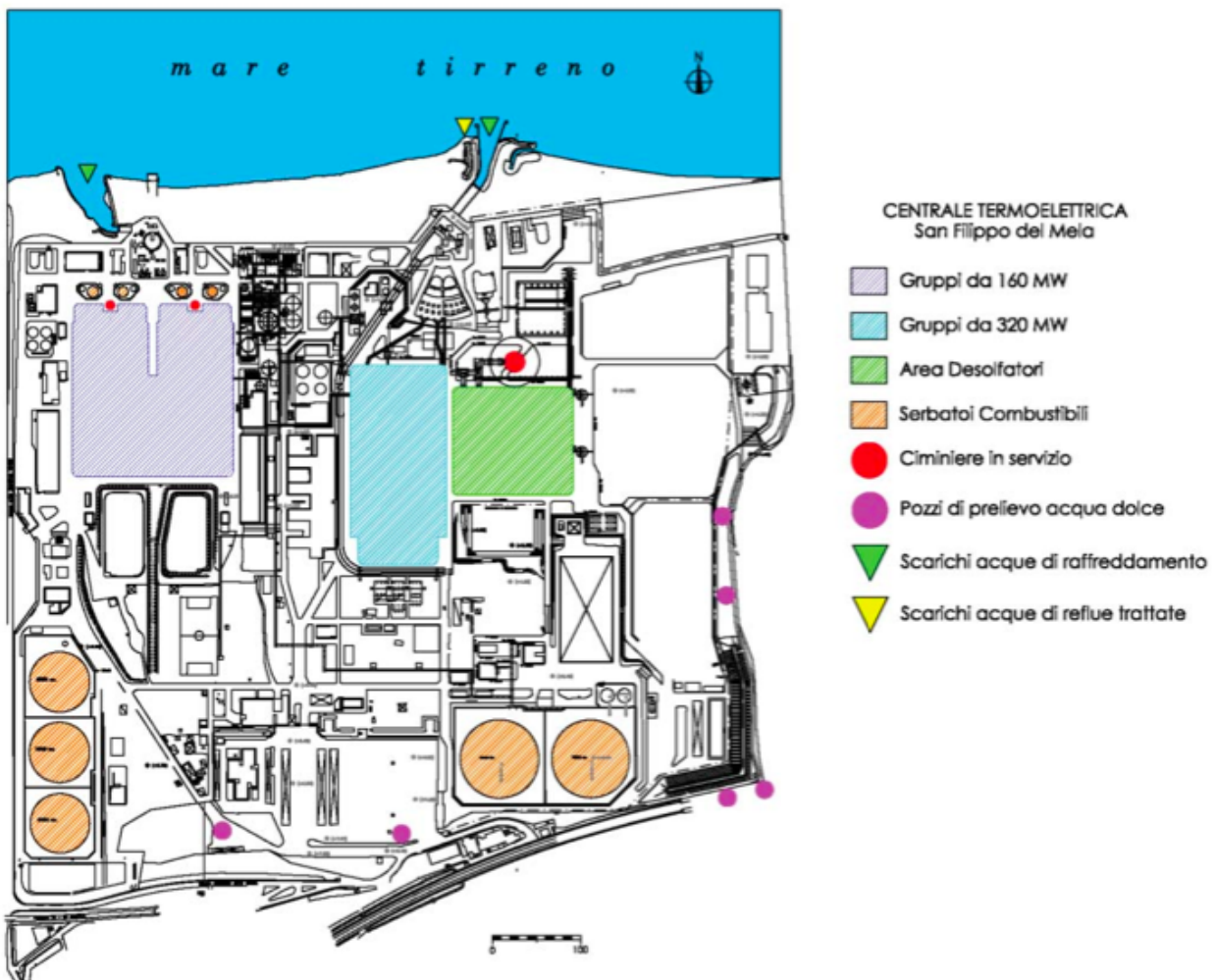

Figure 70: map of Termica Milazzo site EMAS, 2009.

*Depiction of Termica di Milazzo

Termica Milazzo S.r.l. is a thermo-electric plant authorized by the Decree Assessoriale n°434 of the 24th of april, 2001, according to the Decree of the Environment Ministry n°5275 of the 4th of august, 2000. It has a potential of 365 thermic MW EDISON, 2010 and of 160 electric MW in cogeneration EMAS, 2004; EMAS, 2008. The total potential of the six generators is 1 280 MW EMAS, 2009. The operative management of the thermo-electric plant is done by MEGS S.r.l.

(Mediterranean Electric Generating Services, a society controlled by Edison. In 2004, 88.9 % of the electricity produced by the Edison company was of thermic origin EMAS, 2004.

The combustion system uses methane and both the heat and the vapor are used to produce energy. The system is of cogeneration, working with two different cycles. The first cycle uses the mechanical energy of the methane's expansion in order to run a turbine. In the second cycle, the mechanical energy is produced by vapor and smoke resulting from the combustion.

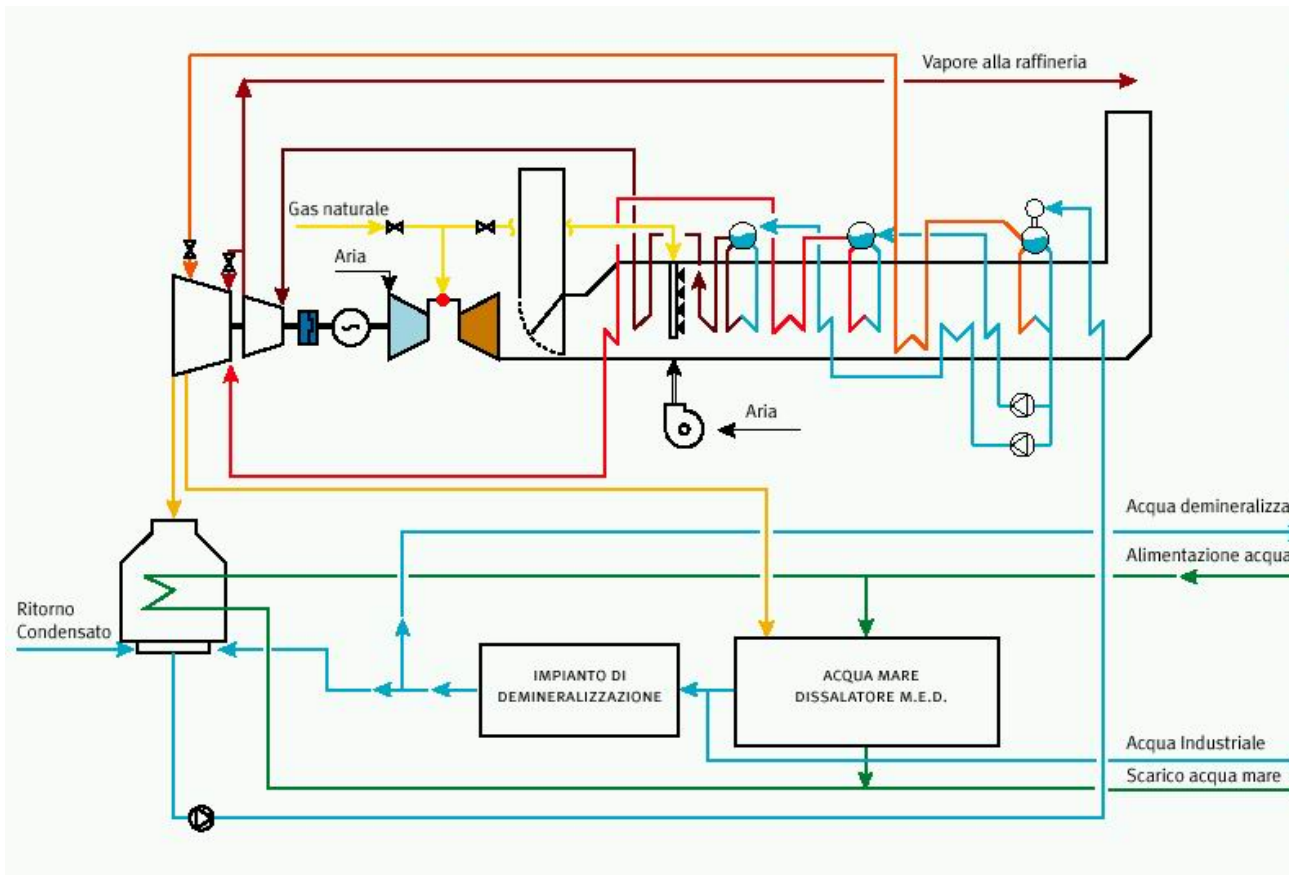

Figure 71: functioning scheme of Termica di Milazzo EDISON, 2010

The water used by the thermo-electric plant is marine water that is demineralized. The desalination of the marine water is done through an evaporation-condensation process. Eleven successive distillations are used in order to desalinize the marine water. The marine water entering the system is used to cool the vapor, therefore reducing the amount of energy needed to evaporate this water. The distillation process takes place at very low atmospheric pressure, in order to reduce the amount of energy needed to evaporate the water.

The discharge of the water is located at a depth of 7 meters, next to the mouth of the Corriolo torrent, 200 m from the coast line. The smokes are cleaned from NO_x and SO_2 before being released into the atmosphere. EMAS, 2004; EMAS, 2009; EDISON, 2010

*Situation of the thermo-electric plant

The thermo-electric plant is situated in the zone of industrial development of Milazzo (Area di Sviluppo Industriale di Milazzo, ASI), but also on the communal territory of the city Pace del Mela. The coordinates of the plant are: 38.184171 of latitude North, 15.277686 of longitude East according to SIRA SIRA, 2007; 38°11'59" N, 15°16'19" E according to the 2004 EMAS registration EMAS, 2004.

The buildings of the thermo-electric plant cover 8 000 m², with another 6 000 m² of free areas, 25 000 m² of parkings and green, and 15 000 m² of reclaimed landfill of municipal waste and some open areas according to the 2004 EMAS registration EMAS, 2004. It occupies a total of 54 000 m² belonging to Edipower according to the 2009 EMAS registration EMAS, 2009; EMAS, 2008.

*Environmental implications of the thermo-electric plant

Since 2000, the thermo-electric plant of Milazzo is certified ISO 14 001 (1996 then 2004 version) EMAS, 2008; EDISON, 2010; Edipower website, 2009. The EMAS registration is dated back from 2002 and since 2006 it is also certified OHSAS 18 001:2007 EMAS, 2004; EMAS, 2009; EMAS, 2008; EDISON, 2010. Two units clean the smoke in order to remove NO_x and SO_x EDISON, 2010; Edipower website, 2009. The future technological developments of the Edison's thermo-electric plants include tri-generation (electricity, heat and cold) units and the recuperation of divers fuels from other activities. The diminution of the consumption of water diminishes the risks of soil aridity and the penetration of salty marine water inside the phreatic water EMAS, 2004.

The Life Cycle Assessment of the Milazzo Peninsula's