



HAL
open science

Synthesis of novel iminogalactitol and epi-isofagomine derivatives as potential pharmacological chaperones for Krabbe disease

Anna Banas Biela

► **To cite this version:**

Anna Banas Biela. Synthesis of novel iminogalactitol and epi-isofagomine derivatives as potential pharmacological chaperones for Krabbe disease. Other. Université d'Orléans, 2013. English. NNT : 2013ORLE2057 . tel-01022929

HAL Id: tel-01022929

<https://theses.hal.science/tel-01022929v1>

Submitted on 11 Jul 2014

HAL is a multi-disciplinary open access archive for the deposit and dissemination of scientific research documents, whether they are published or not. The documents may come from teaching and research institutions in France or abroad, or from public or private research centers.

L'archive ouverte pluridisciplinaire **HAL**, est destinée au dépôt et à la diffusion de documents scientifiques de niveau recherche, publiés ou non, émanant des établissements d'enseignement et de recherche français ou étrangers, des laboratoires publics ou privés.



UNIVERSITÉ D'ORLÉANS



ÉCOLE DOCTORALE SCIENCES BIOLOGIQUES ET CHIMIE DU VIVANT

Institut de Chimie Organique et Analytique, UMR7311

THÈSE présentée par :

Anna BIELA

soutenue le : **9 décembre 2013**

pour obtenir le grade de : **Docteur de l'université d'Orléans**

Discipline/ Spécialité : Chimie organique

**Synthèse de nouveaux dérivés
d'iminogalactitol et d'épi-isofagomine
comme chaperons pharmacologiques
potentiels pour la maladie de Krabbe**

THÈSE dirigée par :

Olivier R. MARTIN	Professeur, Université d'Orléans - Directeur de thèse
Estelle GALLIENNE	Maître de conférences, Université d'Orléans - Co-encadrant de thèse

RAPPORTEURS :

Tanja WRODNIGG	Professeur, Technische Universität, Graz, Autriche
Joanne XIE	Professeur, Ecole Normale Supérieure de Cachan

JURY :

Richard DANIELLOU	Professeur, Université d'Orléans, Président du jury
Yves BLERIOU	Professeur, Université de Poitiers
Estelle GALLIENNE	Maître de conférences, Université d'Orléans
Olivier R. MARTIN	Professeur, Université d'Orléans
Tanja WRODNIGG	Professeur, Technische Universität, Graz, Autriche
Joanne XIE	Professeur, Ecole Normale Supérieure de Cachan

Acknowledgements

In this special moment, I would like to thank many people that have supported me the course of my PhD, and without whom this work could not be achieved.

I would like to show gratitude to my supervisor Professor Olivier Martin who three years ago took the risk and welcomed me in his group as a PhD student. He guided me and shared with his experience in sugar chemistry during my stay in his team. I thank him especially for his positive thinking and constant encouragement even when chemistry was against us.

My second supervisor, Doctor Estelle Gallienne, showed an enormous patience for all my questions, kept correcting my French and helped me to better understand the chemistry I have done. She introduced me into sugar chemistry, lab routine and was not only my superior but also a friend, for what I am really grateful to her.

This thesis could not be done without a fellowship of The Ministry of French Higher Education and Research, for which I am very grateful.

Besides my supervisors, I would like to thank Professor Tanja Wrodnigg (TU Graz, Austria), Professor Joanne XIE (ENS Cachan, France), Professeur Yves Blériot (Université de Poitiers, France) and Professor Richard Daniellou (Université d'Orléans, France) for accepting to read my manuscript, for their time and precious comments to my work.

I would like to express my thanks to Agnès Chartier, Nathalie Percina and their trainee Sakthi who performed HPLC purifications of my final products.

Thank you Marie-Madeleine and Yann for helping me understand and deal with French bureaucracy, for your smile and kindness.

During last four years Orléans and ICOA became my second home, and all Professors, Doctors and Students that I had a pleasure to meet and work with, were a part of my “new” life. I thank you all for your guidelines and positive attitude to a new Polish girl that tried a lot to speak French:) You are unique people that developed my friends.

First of all: thank you Sophie! For your irreplaceable advices concerning laboratory, children, French language... Thank you for listening to all my stories, trying to cheer me up and to find solutions to my (non)chemical problems! Thank you for sharing our morning teas, for helping me with shopping when Artur was not there, for cherries, strawberries, blackberries, a drawer full of sweets and Christophe May! Without you (and your complaining!) lab 7 would never be the same!

Thank you Ela! For being my real friend, rescuing me in almost every emergency situation, listening to my problems, sweating together on a gym and the most important: for being the best aunt for my son!

I cannot forget H el ene Blin, who changed rainy Orleans for sunny Marseille, but will always be a part of our lab. You are the most warm-hearted person I met in France. You were so kind that you welcomed me for Christmas at your home. For a long time you were the only French I could understand easily!

There were many Polish students in my lab, and all of them became my dear friends: crazy Ola who loved climbing and was one of the prettiest brides I've ever seen; Dominika who loved the order and Scandinavia; Roman who enjoyed my cheesecake and is the tallest person I know; Magda who sang and danced with me in the lab and spread her positive energy all day long; Ania and Oksana: two lovely blonds who seduced my son and both Joannas who survived my welcome dinner:)

In our team we were lucky to always have kind and gifted trainees, who made our lab full of laughter. It was nice to meet you: H el enes, Asma, Lydie and especially Nathanael, Ludovic and Norhane. I will never forget Garry and his true words about the most beautiful NMR spectrum in my career! I should also mention Julien, who does not mind (or at least not a lot) when I am making fun of him and pays me back with interest.

I would like to thank all of you for my good souvenirs from ICOA: Pascal for the rhubarb and NMR advices, Marie, who appreciated my cookies, Aziz for taking care of wearing suitable clothes, Mathieu for his "Salut Anna!", Mikael (the cute guy) for constructive comments on my French and English (hope you are going to finally get your "bronzage mythique"!). Thank you Sandrine, Audr e, Stephanie, Magalie, Romain, Nicolas, Mathieu, Katia, Aleksandra, Aurelien, Oskan, Jeremy, Cyril, Chlo e!

One of the most trilling experiences during my thesis was the stage in Portland in Doctor Magdalena Petryniak and Greg Potter team in Oregon Health and Science University. I would like to thank you for your very warm reception and guiding me in my adventure with molecular biology! Hope your nights become calm soon!

My deepest thanks go to my family: my Parents Elzbieta and Jerzy, my "little" Sister Agnieszka, my dearest husband Artur and our Son Szymon. They loved me unselfishly and constantly supported me through all my life even if it was not that easy! Thank you for your patience, comprehension and help in every discipline of my life!



Table of contents

<i>Acknowledgements</i>	1
Table of contents	5
Glossary.....	9
Abbreviations	15
Avant-propos	17
Introduction	19
I. Lysosomal storage disorders	19
I.1 Lysosome	19
I.2 Synthesis and transport of lysosomal proteins.....	20
I.3 Lysosomal storage disorders.....	21
II. Therapies for LSDs.....	27
II.1 General.....	27
II.2 Hematopoietic stem cells therapy	28
II.3 Gene therapy	30
II.4 Enzyme replacement therapy	31
II.5 Substrate reduction therapy.....	34
II.6 Pharmacological chaperone therapy	36
III. Krabbe disease.....	41
IV. Galactosidases inhibitors	47
IV.1 General.....	47
IV.2 Use of galactosidase inhibitors as PCs for galactosidase-linked LSDs	47
IV.3 Additional studies	53
Objectives	55
I. General comments on GALC-mediated hydrolysis of β -galactosides	55
II. Structures of iminosugars of interest.....	57
III. Detailed objectives	57
Results and discussion	61
I. The synthesis and biological evaluation of 1- <i>C</i> -alkyl-imino- <i>L</i> -arabinotols.....	61
I.1 Synthetic strategy.....	61
I.2 Synthesis of 2,3,4-tri- <i>O</i> -benzyl- α,β - <i>L</i> -arabinopyranose 3	62

I.3	Synthesis of protected arabinopyranosylamines 4 and 11	63
I.4	C-1 chain elongation of <i>N</i> -protected glycosylamines	63
I.5	Intramolecular S _N 2-type cyclisation	66
I.6	Functionalization of double bond and deprotection: preparation of iminosugars 8 , 9 , 19 , 20 and 22	67
I.7	Biological evaluation	71
I.8	Conclusions.....	72
II.	The synthesis of 1- <i>C</i> -alkyl-imino- <i>D</i> -galactitols.	75
II.1	Synthetic strategy.....	75
II.2	Synthesis of <i>N-Z</i> protected galactopyranosylamine 25 and C-1 chain elongation	77
II.3	Synthesis of ketones 41 and 42	79
II.4	Intramolecular reductive amination.	80
II.5	Synthesis of 1- <i>C</i> -alkyl-imino- <i>D</i> -galactitols by intramolecular S _N 2 reaction	86
II.6	Conclusions.....	88
III.	Alternative synthesis of 1- <i>C</i> -alkyl-imino- <i>D</i> -galactitols from <i>L</i> -sorbose: strategy by way of a C-6 chain elongation.....	91
III.1	Synthetic strategy.....	91
III.2	Synthesis of 1,2:4,6-di- <i>O</i> -isopropylidene- α - <i>L</i> -sorbofuranose and conversion to a <i>L</i> -tagatofuranose derivative	93
III.3	Synthesis of 1,2:4,6-di- <i>O</i> -isopropylidene- α - <i>L</i> -sorbofuranose and inversion of configuration by way of an oxidation with PCC	96
III.4	Liberation and oxidation of C-6 hydroxyl group.....	97
III.5	Condensation of aldehyde 66 with sulfinylamines	98
III.6	Addition of Grignard reagents	98
III.7	Deprotection and reductive amination of amine intermediates	101
III.8	Synthesis of azido-derivatives	103
III.9	Deprotection and reductive amination of azido-intermediates	104
III.10	Synthesis of DGJ.....	106
III.11	Conclusions	106
IV.	The synthesis of 1- <i>C</i> -alkyl-imino- <i>L</i> -altritols.	111
IV.1	Synthetic strategy.....	111
IV.2	Synthesis of protected 1- <i>C</i> -alkyl-imino- <i>L</i> -altritols.	111
IV.3	Functionalization of the double bond.	112
V.	The synthesis of <i>galacto</i> -isofagomine-like iminosugars.....	117

V.1	Synthetic strategy.....	117
V.2	Synthesis of benzyl 2,3- <i>O</i> -isopropylidene- β -L-ribofuranoside 101	119
V.3	Attempted substitution reactions to introduce a CN group.....	120
V.4	Modified synthesis of cyano-derivative.....	121
V.5	Synthesis of nitro-alcohols 112+113 and dehydration assays.....	122
V.6	Reduction of the nitro-intermediates and cyclisation by reductive amination. ...	124
V.7	Conclusions.....	128
VI.	Preliminary biological evaluation of the new <i>D-galacto</i> and <i>L-altro</i> -configured iminosugar derivatives.....	131
	Conclusion	133
	Experimental part	135
I.	General.....	135
II.	General treatment with basic ion-exchange resin after hydrogenation.....	135
III.	General procedure for purification on Dowex 50WX8 resin (H ⁺ , 50-100 mesh).....	136
IV.	General procedure for biological assays.....	136
	<i>Bibliography</i>	260

Glossary

Aglycone

The compound remaining after replacement of the glycosyl group from a glycoside by a hydrogen atom. For example, for the galactosylceramide the aglycone is a ceramide.

Allele

One member of a pair (or any of the series) of genes occupying a specific spot on a chromosome (called locus) that controls the same trait.

Apoptosis

Programmed cell death as signalled by the nuclei in normally functioning human and animal cells when age or state of cell health and condition dictates.

Astrocytic gliosis

Also known as astrogliosis or astrocytosis, is an abnormal increase in the number of astrocytes due to the destruction of nearby neurons from CNS trauma, infection, stroke, autoimmune responses, and neurodegenerative disease.

Autophagy

Also known as autophagocytosis is the basic catabolic mechanism that involves cell degradation of unnecessary or dysfunctional cellular components through the lysosomal machinery. Autophagy, if regulated, ensures the synthesis, degradation and recycling of cellular components. During this process, targeted cytoplasmic constituents are isolated from the rest of the cell within the autophagosomes, which are then fused with lysosomes and degraded or recycled.

Autosomal

Being encoded by one of the 22 non-sex determining chromosomes.

Cytosol

Also known as an intracellular fluid or cytoplasmic matrix is the liquid found inside cells. It is separated into compartments by membranes.

Cytotoxic

Toxic to cells.

Demyelination

The loss or removal of myelin sheath (e.g. from the nerve fibre).

Dysostosis

A disorder of the development of bone.

Endocytosis

A process in which cell takes in materials from the outside by engulfing and fusing them with its plasma membrane.

Endoplasmic reticulum (ER)

A membrane-bounded organelle that occurs as labyrinthine, interconnected flattened sacs or tubules that is connected to the nuclear membrane, runs through the cytoplasm, and may well extend into the cell membrane.

Endosomes

A membrane-bounded compartment inside eukaryotic cells.

ER quality control system

A quality-control system for 'proof-reading' newly synthesized proteins, so that only native conformers reach their final destinations. Non-native conformers and incompletely assembled oligomers are retained, and, if misfolded persistently, they are degraded.

Eukaryotic cell

A cell that contains a nucleus and other organelles enclosed within membranes.

ex vivo

Outside an organism. It refers to experimentation or measurements done in or on tissue in an artificial environment outside the organism with the minimum alteration of natural conditions.

Genotype

The genetic make-up of a cell, an organism, or an individual usually with reference to a specific characteristic under consideration

Hematopoietic stem cells

The blood cells that give rise to all the other blood cells.

Hypertrophic cardiomyopathy

A primary disease of the muscle of the heart in which its portion is thickened without any obvious cause.

Hypotonia

A state of low muscle tone (the amount of tension or resistance to stretch in a muscle), often involving reduced muscle strength.

in vitro

Conducted using components of an organism that have been isolated from their usual biological surroundings in order to permit a more detailed or more convenient analysis than can be done with whole organisms.

in vivo

It is experimentation using a whole, living organism.

Lymphoblasts

A different form of a naive lymphocyte that occurs when the lymphocyte is activated by an antigen (from antigen-presenting cells) and increased in volume by nucleus and cytoplasm growth as well as new mRNA and protein synthesis.

Macrophage

The cells produced by the differentiation of monocytes in tissues. Macrophages function in both non-specific defence (innate immunity) as well as help initiate specific defence mechanisms (adaptive immunity) of vertebrate animals. Their roles are to phagocytise, or engulf and then digest, cellular debris and pathogens, either as stationary or as mobile cells.

Missense mutation

A point mutation in which a single nucleotide change results in a codon that codes for a different amino acid.

Monogenic mutation

A single gene mutation.

Necrotic cell death

Also known as necrosis is a form of cell injury that results in the premature death of cells in living tissue. Necrosis is caused by factors external to the cell or tissue, such as infection, toxins, or trauma that result in the unregulated digestion of cell components.

Nonsense mutation

A point mutation in a sequence of DNA that results in a premature stop codon, or a nonsense codon in the transcribed mRNA, and in a truncated, incomplete, and usually nonfunctional protein product. It differs from a missense mutation, which is a point mutation where a single nucleotide is changed to cause substitution of a different amino acid.

Ocular system

An eye and its central visual system.

Oncogenesis

Literally: the creation of cancer. A process by which normal cells are transformed into cancer cells.

Phagocytosis

The process of engulfing a solid particle by a phagocyte or a protist to form an internal phagosome. Phagocytosis is a specific form of endocytosis involving the vesicular internalization of solids such as bacteria, and is, therefore, distinct from other forms of endocytosis such as the vesicular internalization of various liquids. Phagocytosis is involved in the acquisition of nutrients for some cells, and, in the immune system, it is a major mechanism used to remove pathogens and cell debris. Bacteria, dead tissue cells, and small mineral particles are all examples of objects that may be phagocytosed.

Phenotype

The composite of an organism's observable characteristics or traits, such as its morphology, development, biochemical or physiological properties, behaviour, and products of behaviour (such as a bird's nest). Phenotypes result from the expression of an organism's genes as well as the influence of environmental factors and the interactions between the two.

Phenylketonuria

An autosomal recessive metabolic genetic disorder characterized by a mutation in the gene for the hepatic enzyme phenylalanine hydroxylase (PAH), rendering it nonfunctional. This enzyme is necessary to metabolize the amino acid phenylalanine to the amino acid tyrosine. When PAH activity is reduced, phenylalanine accumulates and is converted into phenylpyruvate (also known as phenylketone), which can be detected in the urine.

Polysomes

A cluster of ribosomes, bound to a mRNA molecule. Many ribosomes read one mRNA simultaneously, progressing along the mRNA to synthesize the same protein. They may appear as clusters, linear polysomes, or circular rosettes on microscopy, but mainly circular *in vivo*.

Recessive

A recessive trait only becomes phenotypically apparent when two copies of a gene (two alleles) are present.

Ribosome

A molecule consisting of two subunits that fit together and work as one to build proteins according to the genetic sequence held within the messenger RNA (mRNA). Some ribosomes occur freely in the cytosol whereas others are attached to the nuclear membrane or to the endoplasmic reticulum (ER)

Rough endoplasmic reticulum (RER)

ER bearing many ribosomes on its outer surface giving it a rough appearance; hence, its name. Since RER has ribosomes attached to its surface it is therefore involved in protein synthesis and secretion. It synthesizes and secretes serum proteins (such as albumin) in the liver, and hormones (such as insulin) and other substances (such as milk) in the glands.

Splice-site mutation

A genetic mutation that inserts, deletes or changes a number of nucleotides in the specific site at which splicing of an intron takes place during the processing of precursor messenger RNA into mature messenger RNA.

Trans Golgi network (TGN)

A major secretory pathway sorting station that directs newly synthesized proteins to different subcellular destinations. The TGN also receives extracellular materials and recycled molecules from endocytic compartments.

Transgene expression

Expression of an exogenous gene introduced into the genome of another organism

Vacuole

A membrane-bound organelle which is present in all plant and fungal cells and some protist, animal and bacterial cells. Vacuoles are essentially enclosed compartments which are filled with water containing inorganic and organic molecules including enzymes in solution, though in certain cases they may contain solids which have been engulfed. Vacuoles are formed by the fusion of multiple membrane vesicles and are effectively just larger forms of these. The organelle has no basic shape or size; its structure varies according to the needs of the cell.

Vector

A DNA molecule used as a vehicle to artificially carry foreign genetic material into another cell, where it can be replicated and/or expressed. A vector containing foreign DNA is termed recombinant DNA. The four major types of vectors are plasmids, viral vectors, cosmids, and artificial chromosomes.

Abbreviations

Ac	Acetyl
Ac ₂ O	acetic anhydride
AcOH	acetic acid
Atm	atmosphere
BBB	blood brain barrier
BMT	bone-marrow transplantation
Bn	Benzyl
Bu	Butyl
CNS	central nervous system
DGJ	1-deoxygalactonojirimycin
DMF	dimethylformamide
DNJ	1-deoxynojirimycin
ECD	electronic circular dichroism
ELSD	evaporative light scattering detector
Eq	equivalent
ER	endoplasmic reticulum
ERT	enzyme replacement therapy
Et ₂ O	diethyl ether
EtOAc	ethyl acetate
GALC	Galactocerebrosidase (= galactoceramidase)
GCS	glucosylceramide synthase
HPLC	high-performance liquid chromatography
HSCT	hematopoietic stem cell therapy
IC ₅₀	half maximal inhibitory concentration
IFG	isofagomine
iPrOH	isopropanol
LSD	lysosomal storage disorder
MeOH	methanol
mM	millimolar
MU	methylumbelliferyl
NEt ₃	triethylamine
NMO	<i>N</i> -methylmorpholine- <i>N</i> -Oxide

NMR	nuclear magnetic resonance
PC	pharmacological chaperone
PCC	pyridinium chlorochromate
PCT	pharmacological chaperone therapy
PNS	peripheral nervous system
RER	rough endoplasmic reticulum
RT	room temperature
SM	starting material
SRT	substrate reduction therapy
<i>t</i> -BuOH	<i>tert</i> -butanol
TFA	trifluoroacetic acid
TGN	trans Golgi network
THF	tetrahydrofuran
TLC	thin layer chromatography
TMS	trimethylsilane (also trimethylsilyl)
TMSOTf	trimethylsilyl trifluoromethanesulfonate
TS	transition state
Z	benzyloxycarbonyl

Avant-propos

La maladie de Krabbe est une maladie rare, héréditaire et mortelle, causée par des mutations de la β -galactocérébrosidase (GALC) une glycosidase lysosomale impliquée dans l'hydrolyse de différents galactolipides. Les mutations situées en dehors du domaine catalytique empêchent la GALC d'adopter sa conformation native. L'enzyme mal repliée est ainsi détectée et éliminée de l'organisme. Son substrat non-hydrolysé s'accumule dans le système nerveux central et périphérique entraînant des symptômes mortels avant l'âge de deux ans.

La thérapie chaperon (PCT) est une nouvelle stratégie consistant à administrer, à des concentrations très faibles, une petite molécule ayant des interactions fortes avec l'enzyme. Cela l'aide à adopter une conformation correcte et à restaurer partiellement l'activité au niveau du lysosome, permettant au substrat en excès d'être hydrolysé. La plupart du temps, les chaperons les plus efficaces sont de puissants inhibiteurs de l'enzyme et les iminosucres sont connus pour inhiber fortement les glycosidases. L'efficacité de cette stratégie a été récemment démontrée pour deux maladies lysosomales: les maladies de Fabry et de Gaucher.

Dans cette optique, l'objectif de mon projet de thèse consistait à synthétiser de nouveaux iminosucres, inhibiteurs potentiels de β -galactocérébrosidase : des imino-L-arabinitols, imino-D-galactitols et des composés de type *galacto*-isofagomine (galacto-IFGs), et à évaluer leur potentiel en tant que chaperons pharmacologiques pour la maladie de Krabbe. La conception de ces iminosucres a été dictée par la structure de l'état de transition de la réaction catalysée par la GALC, les données de la littérature sur les inhibiteurs de galactosidases et l'expérience de notre groupe dans la synthèse d'iminosucres en tant que chaperons pharmacologiques pour la maladie de Gaucher.

Introduction

I. Lysosomal storage disorders

I.1 Lysosome

A human organism is a complicated machine, where the organic and inorganic molecules undergo constantly the catabolic and anabolic processes in order to obtain, accumulate and use energy. To preserve the perfect equilibrium, each cell is equipped with a variety of repair and quality control mechanisms, correcting almost every error. Nevertheless, sometimes the cell balance is disturbed and different pathologies can be observed.

Every cell of our body is composed of diverse organelles, among which the lysosome was originally discovered and described in 1955 by De Duve.^{1,2} This small, single membrane, bag-like vesicle, also called the cellular digestive machine, contains at least 7 integral membrane proteins³ and about 60 soluble hydrolytic enzymes⁴ necessary for intracellular digestion. It occurs in almost every eukaryotic cell (common in animals but rare in plants) and its specific functions include digestion of macromolecules (glycosphingolipids, glycogen, oligosaccharides, mucopolysaccharides, glycoproteins and proteins),⁵ phagocytosis, endocytosis, or autophagy (**Figure 1**)⁶ and digestion of any other waste materials. It is also responsible for apoptosis⁷ and for repair of damage to the plasma membrane by acting as a membrane patch.⁸ In white blood cells, lysosome content is carefully released into the vacuole around the bacteria and serves to kill and digest it. Lysosomal functions are dependent on lysosomes fusing with target vacuoles and liberation of digestive enzymes.⁹ Uncontrolled release of lysosome contents into the cytoplasm is also a component of necrotic cell death.¹⁰ The pH of lysosome is 4.6-5.0, which is carefully maintained by the proton-pumping ATPases.¹¹ As all enzymes in the lysosome work best at an acidic pH and as the pH of the cytosol is 7.2, the cell is protected from auto-digestion.

¹ De Duve, C.; Pressman, B. C.; Gianetto, R.; Wattiaux, R.; Appelmans, F. *Biochem J* **1955**, *60*, 604.

² De Duve, C. *Nat Cell Biol* **2005**, *7*, 847.

³ Eskelinen, E. L.; Tanaka, Y.; Saftig, P. *Trends Cell Biol* **2003**, *13*, 137.

⁴ Journet, A.; Chapel, A.; Kieffer, S.; Roux, F.; Garin, J. *Proteomics* **2002**, *2*, 1026.

⁵ Futerman, A. H.; van Meer, G. *Nat Rev Mol Cell Biol* **2004**, *5*, 554.

⁶ Luzio, J. P.; Pryor, P. R.; Bright, N. A. *Nat Rev Mol Cell Biol* **2007**, *8*, 622.

⁷ Guicciardi, M. E.; Leist, M.; Gores, G. J. *Oncogene* **2004**, *23*, 2881.

⁸ McNeil, P. L.; Kirchhausen, T. *Nat Rev Mol Cell Biol* **2005**, *6*, 499.

⁹ Hopwood, J. J.; Brooks, D. A. In *Organelle Disease*; Applegarth, D. A., Dimmick, J. E., Hall, J., Eds.; Chapman and Hall Medical: 1997, p 7.

¹⁰ Ferri, K. F.; Kroemer, G. *Nat Cell Biol* **2001**, *3*, E255.

¹¹ Mellman, I.; Fuchs, R.; Helenius, A. *Ann Rev Biochem* **1986**, *55*, 663.

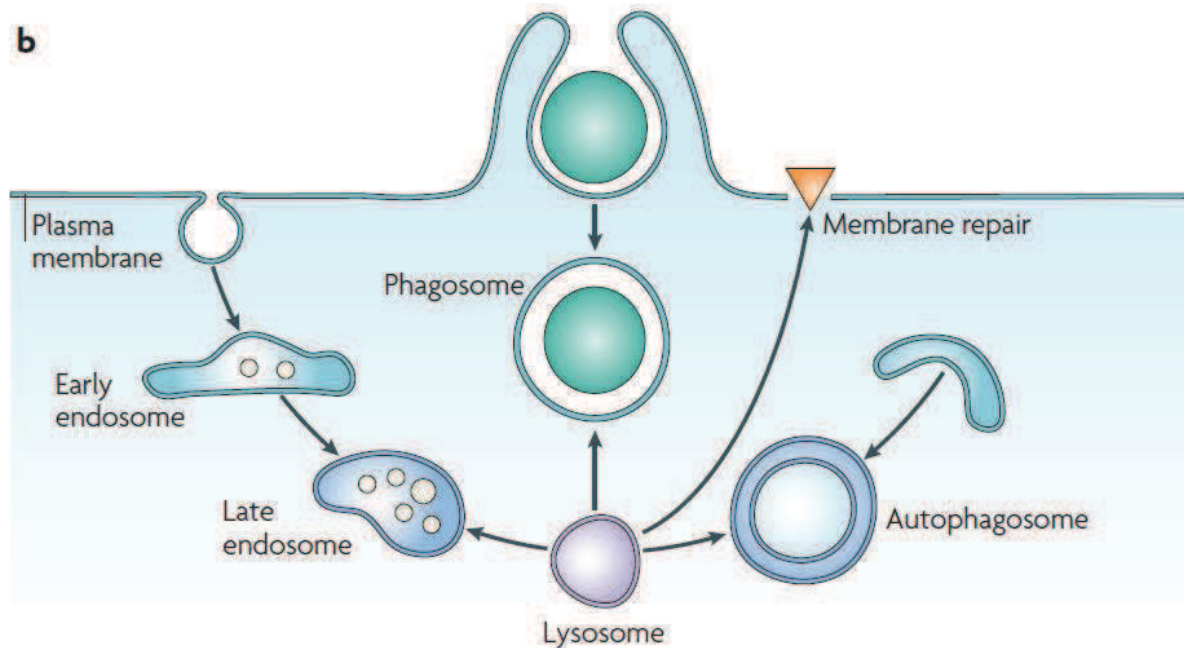

Figure 1. Specific functions of lysosome.⁶

I.2 Synthesis and transport of lysosomal proteins.

Lysosomal proteins are synthesized on membrane-bound polysomes in the rough endoplasmic reticulum (RER). The soluble lysosomal enzymes contain a hydrophobic N-terminal signal peptide, which directs the ribosome towards the endoplasmic reticulum (ER). After core glycosylation on selected asparagine residues (by transfer of a tetradecasaccharide made of 3 glucose, 9 mannose and 2 *N*-acetylglucosamine residues, followed by the elaboration of this oligosaccharide by so-called trimming glycosidases),¹² the protein is transported to the trans Golgi network (TGN). The next step is the addition of a phosphomannosyl recognition marker (M6P) that mediates enzyme translocation to the lysosomes, which is divided into two phases (**Figure 2**): the transfer of a *N*-acetylglucosamine-1-phosphate from UDP-GlcNAc (catalyzed by *N*-acetylglucosaminyl-1-phosphotransferase) to one or more mannose residues on the lysosomal protein¹³ and subsequent removal of the *N*-acetylglucosamine residue to generate a phosphoester intermediate.^{14,15} Once this active form of an enzyme is created, it forms a complex with one of the two possible receptors: cation dependent or cation independent mannose-6-phosphate receptors (CDM6P-Rc or CIM6P-Rc).¹⁶ Clathrin-coated vesicles that contain the complex

⁶ Luzio, J. P.; Pryor, P. R.; Bright, N. A. *Nat Rev Mol Cell Biol* **2007**, *8*, 622.

¹² Kornfeld, R.; Kornfeld, S. *Annu Rev Biochem* **1985**, *54*, 631.

¹³ Little, L.; Alcouloumre, M.; Drotar, A. M.; Herman, S.; Robertson, R.; Yeh, R. Y.; Miller, A. L. *Biochem J* **1987**, *248*, 151.

¹⁴ Reitman, M. L.; Kornfeld, S. *J Biol Chem* **1981**, *256*, 4275.

¹⁵ Reitman, M. L.; Kornfeld, S. *J Biol Chem* **1981**, *256*, 11977.

¹⁶ Ni, X.; Canuel, M.; Morales, C. R. *Histol Histopathol* **2006**, *21*, 899.

fuse with late endosomes, where due to the acidic pH the enzyme dissociates from the receptor. The released M6P-Rc recycles back to the TGN or move to the plasma membrane to integrate the exogenous ligands.¹⁷ Unlike soluble hydrolases, lysosomal membrane proteins do not require mediation by M6P receptors. They are transported via the plasma membrane or by a direct intracellular route.¹⁸

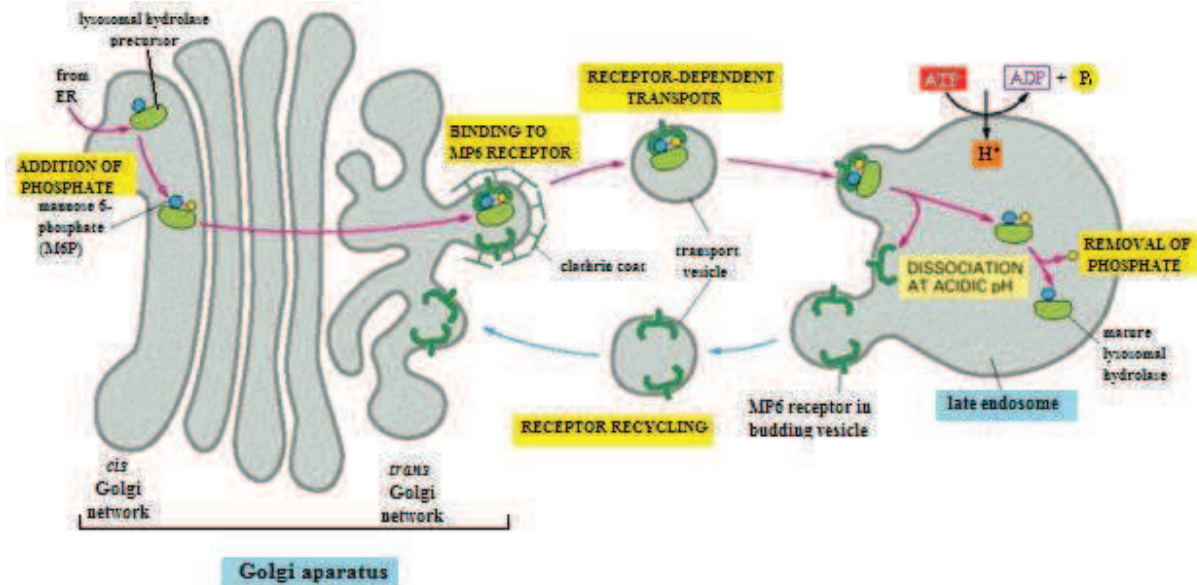

Figure 2. Transport from the Trans Golgi Network to lysosomes.¹⁹

I.3 Lysosomal storage disorders.

The lysosomal storage diseases (LSDs) are a group of genetic, inherited disorders, resulting from impaired activity of one of the lysosomal proteins. There are over 50²⁰ such diseases described so far (**Table 1**). Individually, LSDs have incidence rate of less than 1:100 000 births but overall they occur with incidence rate between 1:5 000-1:8 000 births,²¹ which makes them relatively common and represents an important health problem. Moreover, some populations show higher risk for certain LSDs. Among them we can list Ashkenazi Jewish population with greater prevalence of Gaucher,²² Tay-Sachs and Niemann-Pick diseases,²³ or the Finnish population more susceptible to aspartylglucosaminuria²⁴ and to

¹⁷ Lodish, A.; Berk, A.; Zipursky, S. *Molecular Cell Biology*. 4th edition; W. H. Freeman; New York, 2000.

¹⁸ Linder, M. E.; Deschenes, R. J. *Biochemistry* **2003**, *42*, 4311.

¹⁹ Alberts, B.; Johnson, A.; Lewis, J. In *Molecular Biology of the Cell*. 4th edition; Garland Science: New York, 2002.

²⁰ Parkinson-Lawrence, E. J.; Shandala, T.; Prodoehl, M.; Plew, R.; Borlace, G. N.; Brooks, D. A. *Physiology (Bethesda)* **2010**, *25*, 102.

²¹ Meikle, P. J.; Hopwood, J. J.; Clague, A. E.; Carey, W. F. *JAMA* **1999**, *281*, 249.

²² Beutler, E.; Grabowski, G. In *The Metabolic and Molecular Bases of Inherited Disease*. 8th ed.; McGraw-Hill: New York, 2001, p 3635.

²³ Vallance, H.; Ford, J. *Crit Rev Clin Lab Sci* **2003**, *40*, 473.

²⁴ Arvio, M.; Autio, S.; Louhiala, P. *Acta Paediatr* **1993**, *82*, 587.

infantile/juvenile neuronal ceroid lipofuscinosis (NCLs).²⁵ LSDs are generally monogenic disorders, however, for most of them different mutations have been detected in the same gene in different patients. The mutations (missense, nonsense and splice-site) lead to complete or reduced loss of activity of mutant proteins. Although some enzymes can be synthesized at a normal level, and some of them are also functionally competent, most of them are not correctly folded and as a consequence they are not properly processed and trafficked to the lysosome. Many of them are detected and discarded by the quality control system in the ER. Most of the dysfunctions observed in LSDs result from a hydrolase deficiency (and subsequent substrate accumulation), but mutations in genes coding for any of the lysosomal proteins or even proteins processing them can lead to those illnesses (**Figure 3**)⁵.

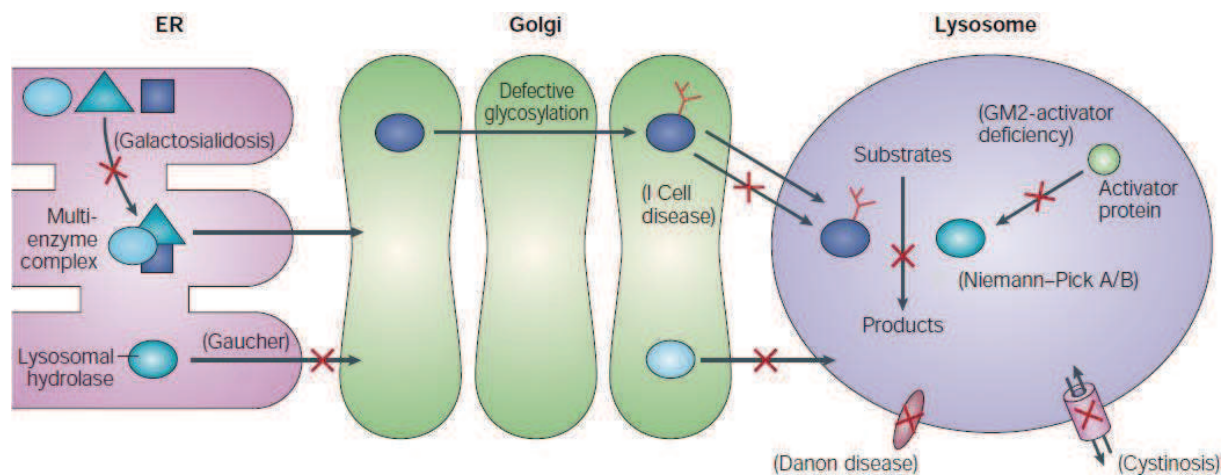

Figure 3. Different basis of LSDs⁵

For example, the deficiency of two lysosomal membrane transporter proteins: sialin and cystinosin causes sialic-acid-storage disease and cystinosis respectively.^{26,27} It is also known that Danon disease results from mutations in abundant lysosome-associated membrane protein-2 (LAMP2).²⁸ Moreover, any perturbation of lysosomal enzymes transport through TGN can lead to LSD⁵ such as I Cell or pseudo-Hurler disease, where mutations occur in genes coding for *N*-acetyl-glucosaminyl-1-phosphotransferase (see I.2). In some cases (multiple sulfatase deficiency,²⁹ galactosialidosis³⁰) the mutation affects only one enzyme, but

²⁵ Santavuori, P. *Brain Dev* **1988**, *10*, 80.

²⁶ Verheijen, F. W.; Verbeek, E.; Aula, N.; Beerens, C. E.; Havelaar, A. C.; Joosse, M.; Peltonen, L.; Aula, P.; Galjaard, H.; van der Spek, P. J.; Mancini, G. M. *Nat Genet* **1999**, *23*, 462.

²⁷ Town, M.; Jean, G.; Cherqui, S.; Attard, M.; Forestier, L.; Whitmore, S. A.; Callen, D. F.; Gribouval, O.; Broyer, M.; Bates, G. P.; van't Hoff, W.; Antignac, C. *Nat Genet* **1998**, *18*, 319.

²⁸ Nishino, I.; Fu, J.; Tanji, K.; Yamada, T.; Shimojo, S.; Koori, T.; Mora, M.; Riggs, J. E.; Oh, S. J.; Koga, Y.; Sue, C. M.; Yamamoto, A.; Murakami, N.; Shanske, S.; Byrne, E.; Bonilla, E.; Nonaka, I.; DiMauro, S.; Hirano, M. *Nature* **2000**, *406*, 906.

⁵ Futerman, A. H.; van Meer, G. *Nat Rev Mol Cell Biol* **2004**, *5*, 554.

²⁹ Schmidt, B.; Selmer, T.; Ingendoh, A.; von Figura, K. *Cell* **1995**, *82*, 271.

³⁰ Ostrowska, H.; Krukowska, K.; Kalinowska, J.; Orłowska, M.; Lengiewicz, I. *Cell Mol Biol Lett* **2003**, *8*, 19.

as it is necessary for the stability or activity of numerous proteins, the deficiency of many enzymes is observed. On the other hand, in illnesses such as NCLs or Batten Disease³¹ it was observed that defects in up to 8 distinct genes cause similar pathology by accumulation of similar substances in lysosomes. There are also mutations severe enough to be lethal in early stages of development and because of that they will never be associated with any lysosomal storage diseases.

Being aware of the complexity and the diversity of LSDs it is difficult to find an appropriate classification model. They can be grouped according to the type of material accumulated or on the basis of the deficient enzyme. **Table 1** represents all known LSDs classified according to the molecular defect and provides details on both the defective enzyme and the main substrate accumulated.³²

The severity and the type of the disorder depend not only on the enzyme implied but also on the degree to which its activity is compromised. Therefore, a complete or almost complete loss of enzymatic activity leads to the most severe pathology, with an early onset and death. Interestingly, residual enzymatic activity is often sufficient for late onset (juvenile or adult form) and milder symptoms to be observed.³³ The same enzyme defect can lead to different symptoms. In Pompe disease a severe infantile onset of the disorder is expressed by hypotonia, hypertrophic cardiomyopathy and failure to thrive, where the adult onset has no cardiac findings, but proximal muscle weakness and respiratory insufficiency.³⁴ The nature of the undegraded storage material and the location of its accumulation play also a crucial role by changing the architecture and function of cells, tissues and organs. The cells with a high turnover of enzyme's substrate are usually more concerned than other cells. For example, mucopolysaccharidose type IVA (MPS IVA), called also Morquio A syndrome, results from the impaired activity of *N*-acetyl-galactosamine-6-sulphatase. This enzyme breakdowns keratan sulfate, mostly found in the skeletal system, which thus implies severe skeletal growth problems, dysostosis and joint disease.³⁵ Alternatively, the accumulation in the central nervous system (CNS) leads to much more severe disorders than when other tissues are affected. This is the case in Krabbe disease³⁶ characterized by the deficiency of galactocerebrosidase: the enzyme degrading galactosylceramide. This sphingolipid is highly

³¹ Cooper, J. D. *Curr Opin Neurol* **2003**, *16*, 121.

³² Filocamo, M.; Morrone, A. *Hum Genomics* **2011**, *5*, 156.

³³ Boyd, R. E.; Lee, G.; Rybczynski, P.; Benjamin, E. R.; Khanna, R.; Wustman, B. A.; Valenzano, K. J. *J Med Chem* **2013**, *56*, 2705.

³⁴ Heese, B. A. *Semin Pediatr Neurol* **2008**, *15*, 119.

³⁵ Tomatsu, S.; Montano, A. M.; Oikawa, H.; Smith, M.; Barrera, L.; Chinen, Y.; Thacker, M. M.; Mackenzie, W. G.; Suzuki, Y.; Orii, T. *Curr Pharm Biotechnol* **2011**, *12*, 931.

³⁶ Sakai, N. *Brain Dev* **2009**, *31*, 485.

abundant in neurons and its buildup results in progressive neuroregression. Only in some cases (e.g. Krabbe disease) the accumulated substrate is cytotoxic itself. Usually, its accumulation activates secondary and tertiary biochemical pathways, which have not been well understood until now. Genetic defects that lay at the basis of all LSDs can change cellular processes, alternate signaling pathways and modify gene expression, which leads finally to tissue damage and death.⁵ However, even if the pathology development strongly relies on all the factors above and even if the gene mutations are well documented, prediction of illness seriousness and progression is almost never accurate.

⁵ Futerman, A. H.; van Meer, G. *Nat Rev Mol Cell Biol* **2004**, 5, 554.

DISEASE	DEFECTIVE PROTEIN	MAIN STORAGE MATERIAL	DISEASE	DEFECTIVE PROTEIN	MAIN STORAGE MATERIAL
Mucopolysaccharidoses (MPSs)			Gangliosidosis GM2, Tay-sachs	β -Hexosaminidase A	GM2 ganglioside, oligos, glycolipids
MPS I (Hurler, Scheie, Hurler/Scheie)	α -Iduronidase	Dermatan sulfate, heparan sulfate	Gangliosidosis GM2, Sandhoff	β -Hexosaminidase A+B	GM2 ganglioside, oligos
MPS II (Hunter)	Iduronate sulphatase	Dermatan sulfate, heparan sulfate	Gaucher (Types I, II, III)	Glucosylceramidase	Glucosylceramide
MPS III A (Sanfilippo A)	Heparan sulphamidase	Heparan sulfate	Krabbe	β -Galactocerebrosidase	Galactosylceramide
MPS III B (Sanfilippo B)	Acetyl α -glucosaminidase	Heparan sulfate	Metachromatic leukodystrophy	Arylsulphatase A	Sulphatides
MPS III C (Sanfilippo C)	Acetyl CoA: α -glucosaminidase	Heparan sulfate	Niemann-Pick (type A, type B)	Sphingolyelinase	Sphingomyelin
MPS III D (Sanfilippo D)	N-acetyl glucosamine-6-sulphatase	Heparan sulfate	Oligosaccharidoses (glycoproteinoses)		
MPS IV A (Morquio A)	Acetyl glucosamine-6-sulphatase	Keratan sulfate, chondroitin 6-sulfate	Aspartylglucosaminuria	Glycosylasparaginase	Aspartylglucosamine
MPS IV B (Morquio B)	β -Galactosidase	Keratan sulfate	Fucosidosis	α -Fucosidase	Glycoproteins, glycolipids, oligos
MPS VI (Morteaux-Lamy)	Acetyl galactosamine	Dermatan sulphate	α -Mannosidosis	α -Mannosidase	Mannose-rich oligos
MPS VII (Sly)	β -Glucuronidase	Dermatan sulphate, heparan sulfate, chondroitin 6-sulfate	Schindler	N-Acetylgalactosaminidase	Sialylated/asialglycopeptides, glycolipids
MPS IX (Natowicz)	Hyaluronidase	Hyluronan	β -Mannosidosis	β -Mannosidase	Man(b1-4)GlnNAc
Sphingolipidoses			Sialidosis	Neuraminidase	glycopeptides, oligos
Fabry	α -Galactosidase A	Globotriasylceramide	Glycogenoses		
Farber	Acid ceramidase	Ceramide	Wolman/CESD	Acid lipase	Cholesterol esters
Gangliosidosis GM1 (Types I, II, III)	GM1- β -galactosidase	GM1 ganglioside, keratan sulfate, oligos, glycolipids	Glycogenesis II/Pompe	α 1,4-glucosidase (acid maltase)	Glycogen

DISEASE	DEFECTIVE PROTEIN	MAIN STORAGE MATERIAL	DISEASE	DEFECTIVE PROTEIN	MAIN STORAGE MATERIAL
Non-enzymatic lysosomal protein defect			Trafficking defect in lysosomal enzymes		
Gangliosidosis GM2, activator defect	GM2 activator protein	GM2 ganglioside, oligos	Mucopolipidosis II α/β , III α/β	GlcNAc-1-P transferase	Oligos, GAGs, lipids
Metachromatic leucodystrophy, MLD	Saposin B	Sulphatides	Mucopolipidosis III γ	GlcNAc-1-P transferase	Oligos, GAGs, lipids
Krabbe	Saposin A	Galactosylceramide	Polypeptide degradation defect		
Gaucher	Saposin C	Glucosylceramide	Pycnodystosis	Cathepsin K	Bone proteins
Transporting protein defect			Neuronal ceroid lipofuscinoses (NCLs)		
Sialic acid storage disease: infantile (ISSD) adult (Salla)	Sialin	Sialic acid	NCL 1	Palmitoyl protein thioesterase (PPT1)	Saposins A and D
Cystinosis	Cystinosin	Cystine	NCL 2	Tripeptidyl peptidase I (TPPI)	Subunit c of ATP synthase
Niemann-Pick Type C1	Niemann-Pick type 1 (NPC1)	Cholesterol and sphingolipids	NCL 3	CLN3, lysosomal transmembrane protein	Subunit c of ATP synthase
Niemann-Pick Type C2	Niemann-Pick type 2 (NPC2)	Cholesterol and sphingolipids	NCL 5	CLN5, soluble lysosomal protein	Subunit c of ATP synthase
Danon	Lysosome-associated membrane protein 2	Cytoplasmatic debris and glycogen	NCL 6	CLN6, transmembrane protein of ER	Subunit c of ATP synthase
Mucopolipidosis IV	Mucopolin	Lipids	NCL 7	CLC7, lysosomal chloride channel	Subunit c of ATP synthase
Lysosomal enzyme protection defect			NCL 8	CLN8, transmembrane protein of ER	Subunit c of ATP synthase
Galactosialidosis	Protective protein cathepsin A (PPCA)	Sialyloligosaccharides	NCL 10	Cathepsin D	Saposins A and D
Post-translational processing defect					
Multiple sulphatase deficiency	Multiple sulphatase	Sulphatides, glycolipids, GAGs			

Table 1. List of lysosomal storage disorders with the deficient enzyme and main storage material.³²

³² Filocamo, M.; Morrone, A. *Hum Genomics* **2011**, *5*, 156.

II. Therapies for LSDs

II.1 General

The clinical course of LSDs is chronic, progressive, and frequently lethal in the late childhood. Although the symptoms associated with those illnesses are often neurological, they can also be multisystemic, with skeletal, CNS, cardiovascular, and ocular system involvement. As mentioned before, there is no clear correlation between the mutation and its phenotypic consequences. This is why next to genetic and molecular analysis, the preliminary (urine and serum) tests and clinical interview are indispensable. Furthermore, it was proved that earlier diagnosis and presymptomatically treatment provide the best outcome. This highlights the need of newborn screening (NBS) for LSDs. The NBS concept was originally developed and used in the early 1960s³⁷ predominantly for patients suffering from phenylketonuria. Presently, by using tandem mass spectrometry identification of enzyme reaction's products or immunologic protein assays, it is possible to screen several LSDs at once.³⁸ Although this technique still needs optimization, it gives a hope for early diagnosis and a life-saving therapy. It is already applied in the New York state where the NBS for Krabbe disease has been performed since 2006.³⁴ The newborn screening has another advantage: it can reveal an illness in parents of sick children, giving them opportunity of early treatment. However, there is also the dark side of the NBS: they are often done without parental consent, which raises psychosocial and ethical concerns.

For most of the LSDs, as soon as they are well diagnosed, immediate therapy is initiated. The vital need of developing existing and finding new therapies for LSDs is due to two facts. Firstly, for many of the lysosomal storage disorders, even if well diagnosed, no specific or definitive treatment is available. Secondly, due to the high regulatory and research costs and lack of competition on LSDs' medicines market, the therapies are very expensive (*Table 2*).³⁹

Disease	Treatment	Annual Cost (per patient)
Gaucher	ERT	\$ 145,000 - \$ 290,000
Gaucher	SRT	\$ 91,000
Fabry	ERT	\$ 156,000
MPS I	ERT	\$ 340,000
MPS IV	ERT	\$ 377,000

Table 2. Currently licensed treatments for LSDs.³⁹

³⁷ Marsden, D.; Larson, C.; Levy, H. L. *J Pediatr* **2006**, *148*, 577.

³⁸ Li, Y.; Scott, C. R.; Chamoles, N. A.; Ghavami, A.; Pinto, B. M.; Turecek, F.; Gelb, M. H. *Clin Chem* **2004**, *50*, 1785.

³⁴ Heese, B. A. *Semin Pediatr Neurol* **2008**, *15*, 119.

³⁹ Beutler, E. *Mol Genet Metab* **2006**, *88*, 208.

Classically, the treatment consists in symptomatic care of disease manifestations. The therapies applied in LSDs can be roughly divided into those that act on the symptoms and those that act on the cause (**Figure 4**).⁴⁰

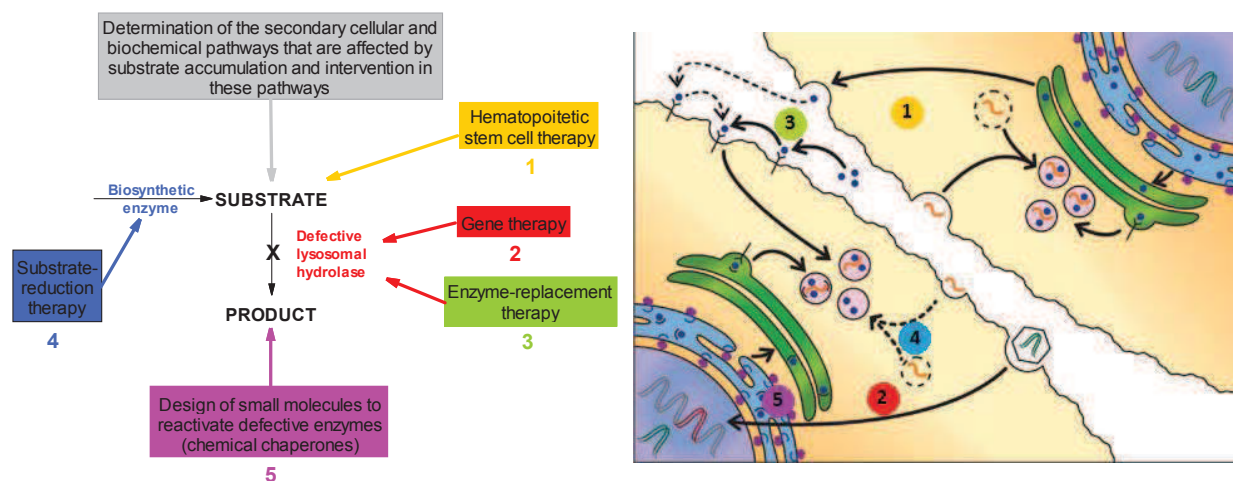

Figure 4. LSDs therapy strategies. 1- stem cell therapy, 2-gene therapy, 3-ERT, 4-SRT, 5-PCT.⁴⁰

General treatment includes bone-marrow transplantation⁴¹ (BMT) or splenectomy (partial or complete surgical removal of the spleen) applied in Gaucher disease⁴². The latter was recommended earlier only in life-saving cases and is no longer used. More important therapeutic approaches are those which can act on accumulating substrate (substrate reduction therapy SRT), on deficient enzyme (enzyme replacement therapy ERT and the novel pharmacological chaperone therapy PCT) or which use directly gene therapy.

II.2 Hematopoietic stem cells therapy

Although BMT was successful in some cases, it has two major drawbacks: the requirement of matched donors and a high mortality rate. A more recent version of this method uses hematopoietic stem cells from placental cord blood.⁴³ The objective of hematopoietic stem cells therapy (HSCT) is to engraft healthy cells into a patient without functional enzyme.⁴⁴ The donor leukocytes in the host tissue produce and secrete the enzyme, which is then taken up by enzyme-deficient host cells (**Figure 5**).⁴⁵ This principle is called cross-correlation and is a basis of ERT (II.4).

⁴⁰ van Gelder, C. M.; Vollebregt, A. A.; Plug, I.; van der Ploeg, A. T.; Reuser, A. J. *Expert Opin Pharmacother* **2012**, *13*, 2281.

⁴¹ Hoogerbrugge, P. M.; Brouwer, O. F.; Bordigoni, P.; Ringden, O.; Kapaun, P.; Ortega, J. J.; O'Meara, A.; Cornu, G.; Souillet, G.; Frappaz, D.; et al. *Lancet* **1995**, *345*, 1398.

⁴² Salky, B.; Kreel, I.; Gelernt, I.; Bauer, J.; Aufses, A. H., Jr. *Ann surg* **1979**, *190*, 592.

⁴³ Martin, P. L.; Carter, S. L.; Kernan, N. A.; Sahdev, I.; Wall, D.; Pietryga, D.; Wagner, J. E.; Kurtzberg, J. *Biol Blood Marrow Transplant* **2006**, *12*, 184.

⁴⁴ Peters, C.; Steward, C. G. *Bone Marrow Transplant* **2003**, *31*, 229.

⁴⁵ Wynn, R. *Hematology Am Soc Hematol Educ Program* **2011**, *2011*, 285.

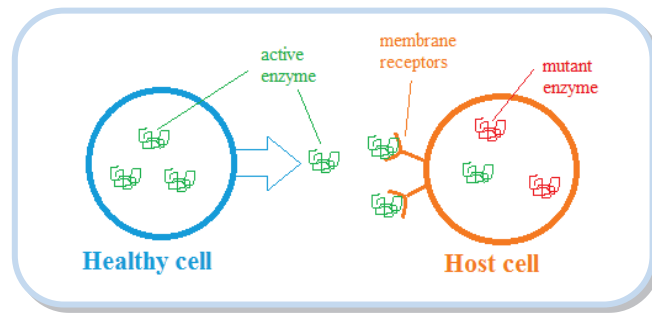

Figure 5. The concept of cross-correlation in HSCT.

Hematopoietic stem cells therapy can be applied in two ways: by transplanting donor healthy cells to a patient or by associating it with *ex-vivo* gene therapy, where after genetic modifications, the patient own cells are re-grafted to its organism (II.3).⁴⁶ The first HSCT for LSDs was performed on Hurler syndrome (MPS I) patient in 1980⁴⁷ resulting in biochemical and clinical improvements up to 13 months after. Since then over 900 HSCTs⁴⁸ were done (**Figure 6**). Most of them concern Hurler disease, metachromatic leukodystrophy (MLD) and Krabbe disease.⁴⁹

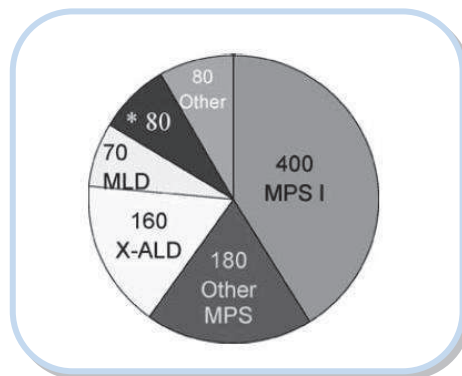

Figure 6. Estimated frequencies of HSCTs for various inborn errors in metabolism since 1980. * Other leukodystrophies/white-matter diseases.⁵⁰

Even though HSCT is a very promising option for treating LSDs at the source of the problem (it is easier to prevent the pathology than to correct it) it has serious limitations. First of all, HSCT is most successful in the neonatal and presymptomatic stage of disease, especially when CNS dysfunction is involved.⁵¹ This requires early diagnosis and transplantation in a young age. Furthermore, hematopoietic stem cells migrate only to several

⁴⁶ Priller, J.; Flugel, A.; Wehner, T.; Boentert, M.; Haas, C. A.; Prinz, M.; Fernandez-Klett, F.; Prass, K.; Bechmann, I.; de Boer, B. A.; Frotscher, M.; Kreutzberg, G. W.; Persons, D. A.; Dirnagl, U. *Nat Med* **2001**, 7, 1356.

⁴⁷ Hobbs, J. R.; Hugh-Jones, K.; Barrett, A. J.; Byrom, N.; Chambers, D.; Henry, K.; James, D. C.; Lucas, C. F.; Rogers, T. R.; Benson, P. F.; Tansley, L. R.; Patrick, A. D.; Mossman, J.; Young, E. P. *Lancet* **1981**, 2, 709.

⁴⁸ Rovelli, A. M.; Steward, C. G. *Bone Marrow Transplant* **2005**, 35 Suppl 1, S23.

⁴⁹ Boelens, J. J.; Prasad, V. K.; Tolar, J.; Wynn, R. F.; Peters, C. *Pediatr Clin North Am* **2010**, 57, 123.

⁵⁰ Boelens, J. J. *J Inherit Metab Dis* **2006**, 29, 413.

⁵¹ Escolar, M. L.; Poe, M. D.; Provenzale, J. M.; Richards, K. C.; Allison, J.; Wood, S.; Wenger, D. A.; Pietryga, D.; Wall, D.; Champagne, M.; Morse, R.; Krivit, W.; Kurtzberg, J. *N Engl J Med* **2005**, 352, 2069.

organs (shown in mice)⁵² such as bone marrow, liver, spleen, lungs and CNS, and barely reach the skeletal muscles and cartilage (shown in rats⁵³) which results in no therapeutic improvement in skeletal diseases.⁵⁴ Finally, like for BMT, the transplant-related mortality rate is about 10-25%⁴¹ and the surgery delays are too long. To limit the risk, careful selection of donor graft source is required. Moreover, the application of cord blood stem cells has reduced the time to transplantation and the danger of the graft-versus-host disease.

II.3 Gene therapy

As the majority of therapies applied to LSDs treat secondary complications of the disease, the somatic gene therapy would be the most attractive and effective approach.⁵⁵ It consists in inserting a functional gene to produce a correctly working enzyme and replace the deficient one. The LSDs are monogenic, for many of them the mutation has been identified and a relatively small amount of active lysosomal enzyme can resolve the disease, which make them perfect candidates for such type of therapy. Thanks to a phenomenon known as cross correlation phenomenon genes do not have to be transferred to all cells of the organism, which means that only a small percentage of transduced cells can have a therapeutic effect. Gene transfer can be applied *in vivo* and *ex vivo*. The first method requires a vector (based on disabled adenovirus, adeno-associated virus, lentivirus or herpes virus)⁵⁶ carrying the transgene which is injected into circulation or directly into a target tissue. The second one implies *in vitro* genetic correction of patients cells (often hematopoietic stem cells) followed by re-implantation (**Figure 7**).⁴⁰ Despite a number of animal models⁵⁷ and biochemical and clinical progress,⁵⁸ very little development has been made in applying this method to humans. Three human clinical trials of gene therapy for Gaucher disease did not show significant improvements.⁵⁹ One of the drawbacks of applying gene therapy to humans is the potential

⁵² Kennedy, D. W.; Abkowitz, J. L. *Blood* **1997**, *90*, 986.

⁵³ Odorfer, K. I.; Egerbacher, M.; Unger, N. J.; Weber, K.; Jamnig, A.; Lepperdinger, G.; Kleiter, M.; Sandgren, E. P.; Erben, R. G. *J Cell Mol Med* **2011**, *15*, 2232.

⁵⁴ Aldenhoven, M.; Boelens, J. J.; de Koning, T. J. *Biol Blood Marrow Transplant* **2008**, *14*, 485.

⁴¹ Hoogerbrugge, P. M.; Brouwer, O. F.; Bordigoni, P.; Ringden, O.; Kapaun, P.; Ortega, J. J.; O'Meara, A.; Cornu, G.; Souillet, G.; Frappaz, D.; et al. *Lancet* **1995**, *345*, 1398.

⁵⁵ Barranger, J. M.; Novelli, E. A. *Expert Opin Biol Ther* **2001**, *1*, 857.

⁵⁶ Sands, M. S.; Haskins, M. E. *Acta Paediatr Suppl* **2008**, *97*, 22.

⁴⁰ van Gelder, C. M.; Vollebregt, A. A.; Plug, I.; van der Ploeg, A. T.; Reuser, A. J. *Expert Opin Pharmacother* **2012**, *13*, 2281.

⁵⁷ Haskins, M. *ILAR J* **2009**, *50*, 112.

⁵⁸ Ioannou, Y. A.; Enriquez, A.; Benjamin, C. *Expert Opin Biol Ther* **2003**, *3*, 789.

⁵⁹ Dunbar, C. E.; Kohn, D. B.; Schiffmann, R.; Barton, N. W.; Nolte, J. A.; Esplin, J. A.; Pensiero, M.; Long, Z.; Lockett, C.; Emmons, R. V.; Csik, S.; Leitman, S.; Krebs, C. B.; Carter, C.; Brady, R. O.; Karlsson, S. *Hum Gene Ther* **1998**, *9*, 2629.

risk of oncogenesis.⁶⁰ Additionally, viral vectors can activate inflammatory and immunological responses.⁶¹ The success of gene therapy depends on the level of transgene expression, as well as on the ability of the treatment to cross the blood-brain barrier (BBB) to reach the CNS. Overall, to become a real option to treat LSDs, gene therapy still needs a great deal of optimization on the vectors and procedures safety, specificity and efficiency.

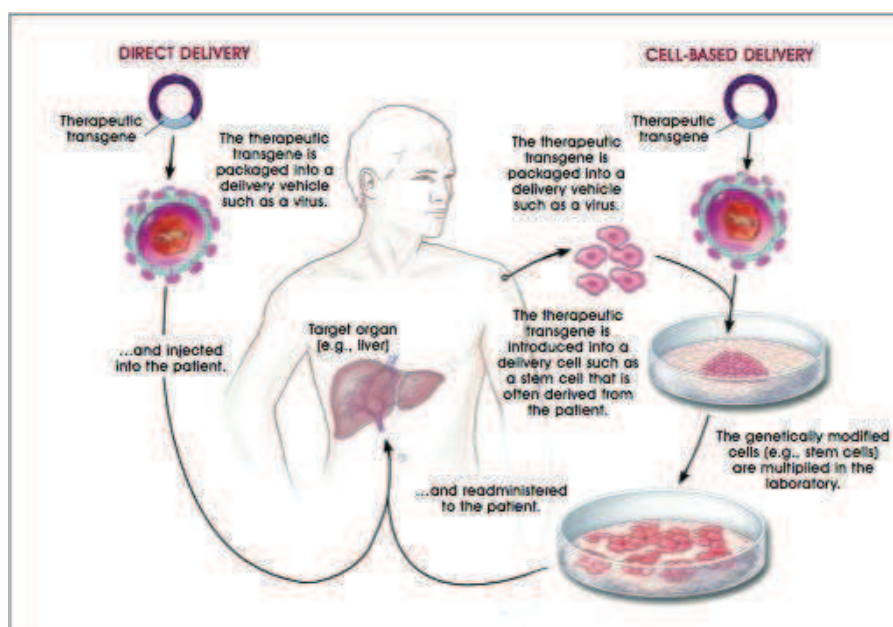

Figure 7. *In vivo* (direct) and *ex vivo* (cell-based) gene therapy.
 Extracted from <http://stemcells.nih.gov/info/2001report/pages/chapter11.aspx>

II.4 Enzyme replacement therapy

Pompe disease was discovered in 1963 by Hers,⁶² which one year later brought in the idea of treatment by replacing defective enzyme by a healthy one.⁶³ In 1968, Neufeld and coworkers discovered that culturing together cells of patients suffering from Hurler disease (α -iduronidase) and Hunter disease also called MPS II (iduronate sulphatase) leads to correcting of both enzymes' defects.⁶⁴ The earliest attempts of ERT were unsuccessful⁶⁵ (Pompe disease) owing to the low doses, short treatment duration, the lack of knowledge about receptor-mediated endocytosis and insufficient sources of highly purified enzymes with appropriate markers for targeted uptake. The first victorious ERT was achieved in 1991⁶⁶ for type I Gaucher disease, using human placental glucocerebrosidase. The enzyme was

⁶⁰ Hacein-Bey-Abina, S.; Garrigue, A.; Wang, G. P.; Soulier, J.; Lim, *et al. J Clin Invest* **2008**, *118*, 3132.

⁶¹ Cheng, S. H.; Smith, A. E. *Gene Ther* **2003**, *10*, 1275.

⁶² Hers, H. G. *Biochem J* **1963**, *86*, 11.

⁶³ De Duve, C. *Fed Proc* **1964**, *23*, 1045.

⁶⁴ Fratantoni, J. C.; Hall, C. W.; Neufeld, E. F. *Science* **1968**, *162*, 570.

⁶⁵ Valayannopoulos, V. *Handb Clin Neurol* **2013**, *113*, 1851.

⁶⁶ Barton, N. W.; Brady, R. O.; Dambrosia, J. M.; Di Bisceglie, A. M.; Doppelt, S. H.; Hill, S. C.; Mankin, H. J.; Murray, G. J.; Parker, R. I.; Argoff, C. E.; *et al. N Engl J Med* **1991**, *324*, 1464.

previously partially deglycosylated, to enhance its uptake by mannose receptor of macrophages (**Figure 8**).⁶⁷ Since then, this therapy was applied to five other³⁴ LSDs: Fabry, Hunter, Hurler, Maroteaux-Lamy (MPS VI) and Pompe diseases. ERTs for metachromatic leukodystrophy, Morquio A disease and lysosomal acid lipase deficiency are in clinical trials.⁴⁰

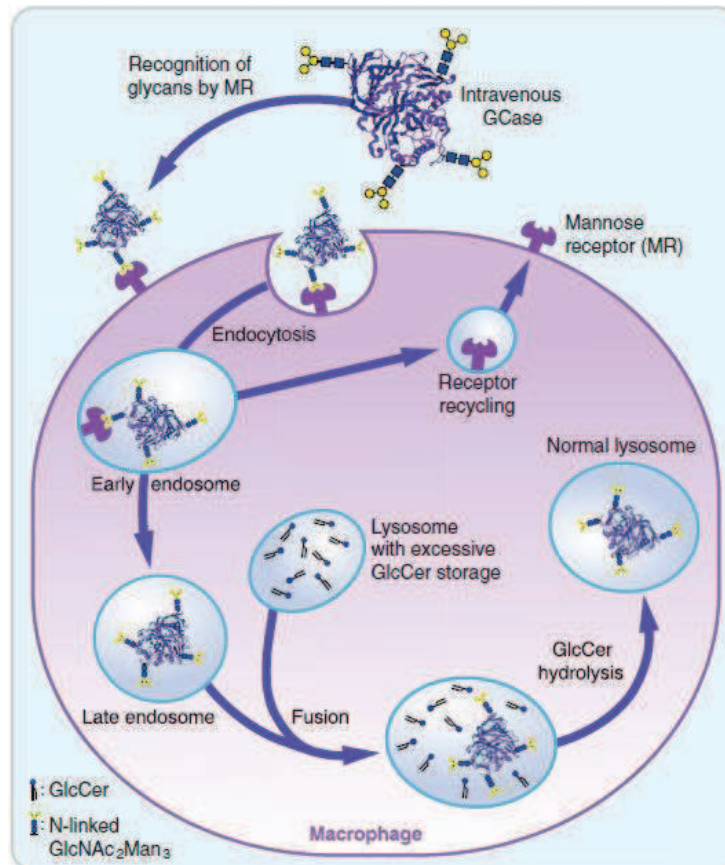

Figure 8. Macrophage uptake of intravenously administered recombinant GCCase.⁶⁷

Although studies during the last decade have demonstrated the benefits of using ERT, the overall outcome varies from disease to disease. The success of ERT strongly depends on the following factors: accessibility of affected cells,⁶⁸ molecular composition and turn-over of the tissue, antibody formation⁶⁹ against the therapeutic enzymes and finally, irreversible cell damages impairing intracellular trafficking.⁷⁰ As a consequence, ERT has little effect on the

⁶⁷ Phenix, C. P.; Rempel, B. P.; Colobong, K.; Doudet, D. J.; Adam, M. J.; Clarke, L. A.; Withers, S. G. *Proc Natl Acad Sci U S A* **2010**, *107*, 10842.

³⁴ Heese, B. A. *Semin Pediatr Neurol* **2008**, *15*, 119.

⁴⁰ van Gelder, C. M.; Vollebregt, A. A.; Plug, I.; van der Ploeg, A. T.; Reuser, A. J. *Expert Opin Pharmacother* **2012**, *13*, 2281.

⁶⁸ Brands, M. M.; Frohn-Mulder, I. M.; Hagemans, M. L.; Hop, W. C.; Oussoren, E.; Helbing, W. A.; van der Ploeg, A. T. *J Inherit Metab Dis* **2013**, *36*, 227.

⁶⁹ Brooks, D. A. *Mol Genet Metab* **1999**, *68*, 268.

⁷⁰ Fukuda, T.; Ahearn, M.; Roberts, A.; Mattaliano, R. J.; Zaal, K.; Ralston, E.; Plotz, P. H.; Raben, N. *Mol Ther* **2006**, *14*, 831.

brain (due to the BBB), skeletal tissue (slow turn-over of the bones and slow diffusion to cartilage through the matrix), and valvular heart disease in LSD. Animal studies have shown though, that some of the problems associated with cell and tissue accessibility may be overcome by increasing the doses of ERT.⁷¹ However, this approach can increase the immunological response and the therapy cost. Concerning the mild allergic reactions observed during intravenous ERT, they are neutralized with antihistamine and non-steroidal anti-inflammatory drugs.

Despite the development mentioned above, low recombinant enzyme uptake by the cells is still the biggest challenge in ERT. It can be resolved by several strategies that will improve enzyme trafficking and recognition by both cells and lysosomes. The first consist in conjugating the enzyme with synthetic oligosaccharides having M6P (see I.2). This idea was tested on a mouse model of Pompe disease (enzyme used: oxime-neo-recombinant human α -glucosidase) and has shown decrease of glycogen accumulated during illness in muscles.⁷² Another approach is so called glycosylation independent lysosomal targeting, which consist in replacing the enzyme's N-terminal peptide by an N-terminal fragment of insulin-like growth factor 2. Thanks to the high affinity of this signal peptide to M6PR, the modified enzyme is better recognized and more efficiently binds to cell and/or lysosome membrane.⁷³ Two more solutions for increased enzyme uptake are either to modulate the expression of M6PR on the target cells⁷⁴ or to inject enzyme directly to the tissue of interest (e.g. to intracerebrospinal fluid⁷⁵). However, the latter procedure remains controversial from ethical and practical point of view. Completely different problem lies in passing BBB. No receptor recognition enhancement is successful so far in this case. To overcome this problem, one of the possibilities is to bind the recombinant protein to a monoclonal antibody against an endogenous BBB receptor.⁷⁶ This strategy proved to be working in Hunter disease animal models.

Finally, regardless of how optimized and adapted ERT will be, it remains an expensive treatment (see **Table 2**) and a long-life burden to the patients.

⁷¹ Ioannou, Y. A.; Zeidner, K. M.; Gordon, R. E.; Desnick, R. J. *Am J Hum Genet* **2001**, *68*, 14.

⁷² Maga, J. A.; Zhou, J.; Kambampati, R.; Peng, S.; Wang, X.; Bohnsack, R. N.; Thomm, A.; Golata, S.; Tom, P.; Dahms, N. M.; Byrne, B. J.; LeBowitz, J. H. *J Biol Chem* **2013**, *288*, 1428.

⁷³ Koeberl, D. D.; Li, S.; Dai, J.; Thurberg, B. L.; Bali, D.; Kishnani, P. S. *Mol Genet Metab* **2012**, *105*, 221.

⁷⁴ Hemsley, K. M.; Hopwood, J. J. *Int J Clin Pharmacol Ther* **2009**, *47 Suppl 1*, S118.

⁷⁵ Pardridge, W. M.; Boado, R. J. *Methods Enzymol* **2012**, *503*, 269.

⁷⁶ Lu, J. Z.; Boado, R. J.; Hui, E. K.; Zhou, Q. H.; Pardridge, W. M. *Biotechnol Bioeng* **2011**, *108*, 1954.

II.5 Substrate reduction therapy

Substrate reduction therapy (SRT) is a drug-based treatment with the objective to diminish lysosomal storage by inhibition of the substrate biosynthesis.⁷⁷ As an applied treatment, SRT is used only for glycosphingolipidoses (see **Table 1**) so far.⁷⁸ Those disorders result from accumulation of various glycosphingolipids (GLS), which all have the same first step of biosynthesis (**Scheme 1**): the addition of a glucose unit to ceramide by ceramide-specific glucosyltransferase (also termed glucosylceramide synthase, GCS).⁷⁹

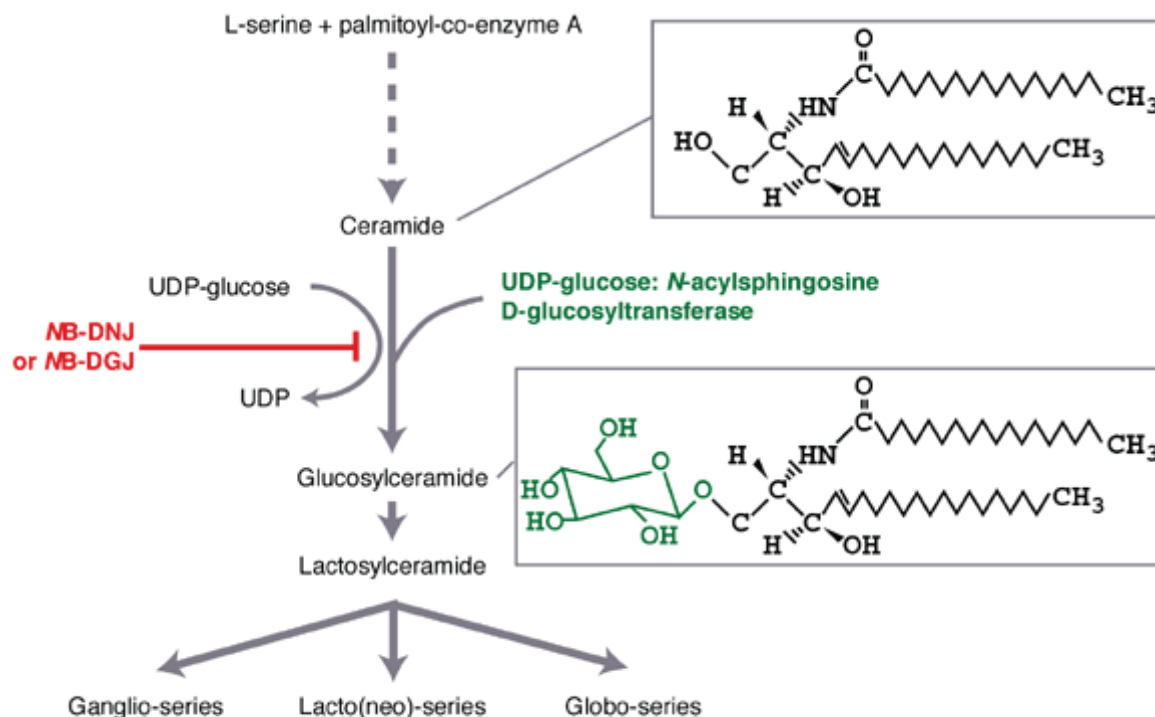

Scheme 1. Biosynthesis of glycosphingolipids in humans.⁸⁰

This approach was introduced in the 1970s by Radin⁸¹ and coworkers who identified the first type of glucosyltransferase inhibitors. PDMP (D,L-threo-1-phenyl-2-decanoylamino-3-morpholino-1-propanol) (**Figure 9**) and its analogues are powerful inhibitors of GCS, but relatively cytotoxic due to their hydrophobicity. Additionally, they provoke accumulation of free ceramide. New generations of PDMP derivatives proved to be efficient glucosylceramide synthase inhibitors,⁸² nevertheless none of them was tested on humans so far.

⁷⁷ Cox, T. M. *Acta Paediatr Suppl* **2005**, *94*, 69.

⁷⁸ Aerts, J. M.; Hollak, C. E.; Boot, R. G.; Groener, J. E.; Maas, M. *J Inherit Metab Dis* **2006**, *29*, 449.

⁷⁹ Lachmann, R. H.; Platt, F. M. *Expert Opin Investig Drugs* **2001**, *10*, 455.

⁸⁰ Platt, F. M.; Butters, T. D. *Expert Rev Mol Med* **2000**, *2*, 1.

⁸¹ Vunnam, R. R.; Radin, N. S. *Chem Phys Lipids* **1980**, *26*, 265.

⁸² Abe, A.; Wild, S. R.; Lee, W. L.; Shayman, J. A. *Curr Drug Metab* **2001**, *2*, 331.

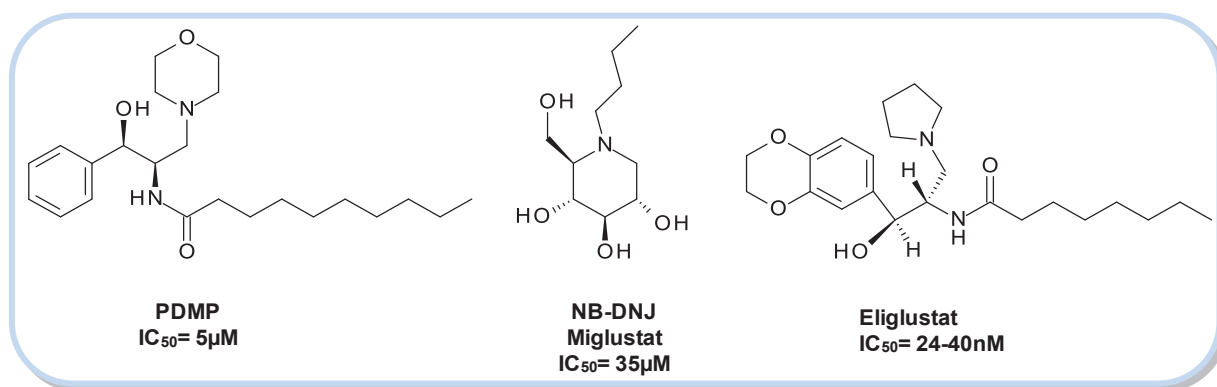

Figure 9. GCS inhibitors.^{83, 84, 85} NB-DNJ is used in SRT.

Another group of GCS inhibitors includes the *N*-alkylated iminosugars. The leading compound NB-DNJ (*N*-butyldeoxynojirimycin, miglustat) was initially designed to be an antiviral agent.⁸⁶ by being a good inhibitor of intracellular α -glucosidases I and II, this compound blocks glucosylation of viral proteins and ends virus life cycle. Unfortunately, the 6-month clinical trial⁸⁷ has shown no important efficacy of the drug. In 1994, while working on an *in vitro* model of Gaucher disease, Platt and Butters⁸⁴ found that NB-DNJ reduced significantly the endogenous glucosylceramide synthesis. Although this iminosugar is not GCS-specific (it inhibits also α -glucosidase I and II as well as digestive α -glucosidases), the therapy is more efficient than in the HIV case⁸⁰ (thanks to cytosolic orientation of ceramide-specific UDP-glucosyltransferase the enzyme is more accessible for the drug). After a series of encouraging assays on animals,⁸⁸ the first clinical test was performed on mild-to-moderate type 1 (non-neuronopathic) Gaucher patients.⁸⁹ The results of this experiment and follow-up studies lead to registration of miglustat (Zavesca[®], 2003) as a drug for Gaucher type I patients, for whom ERT cannot be applied. In 2009, NB-DNJ was also approved as a drug for Niemann-Pick disease, as it proved to stabilize one of the neurological symptoms of the disorder.⁹⁰ On the other hand, even though NB-DNJ was shown to cross BBB in some mouse

⁸³ Inokuchi, J.; Radin, N. S. *J Lipid Res* **1987**, *28*, 565.

⁸⁴ Platt, F. M.; Neises, G. R.; Dwek, R. A.; Butters, T. D. *J Biol Chem* **1994**, *269*, 8362.

⁸⁵ McEachern, K. A.; Fung, J.; Komarnitsky, S.; Siegel, C. S.; Chuang, W. L.; Hutto, E.; Shayman, J. A.; Grabowski, G. A.; Aerts, J. M.; Cheng, S. H.; Copeland, D. P.; Marshall, J. *Mol Genet Metab* **2007**, *91*, 259.

⁸⁶ Fenouillet, E.; Gluckman, J. C. *J Gen Virol* **1991**, *72 (Pt 8)*, 1919.

⁸⁷ Fischl, M. A.; Resnick, L.; Coombs, R.; Kremer, A. B.; Pottage, J. C., Jr.; Fass, R. J.; Fife, K. H.; Powderly, W. G.; Collier, A. C.; Aspinall, R. L.; et al. *J Acquir Immune Defic Syndr* **1994**, *7*, 139.

⁸⁰ Platt, F. M.; Butters, T. D. *Expert Rev Mol Med* **2000**, *2*, 1.

⁸⁸ Jeyakumar, M.; Butters, T. D.; Cortina-Borja, M.; Hunnam, V.; Proia, R. L.; Perry, V. H.; Dwek, R. A.; Platt, F. M. *Proc Natl Acad Sci U S A* **1999**, *96*, 6388.

⁸⁹ Cox, T.; Lachmann, R.; Hollak, C.; Aerts, J.; van Weely, S.; Hrebicek, M.; Platt, F.; Butters, T.; Dwek, R.; Moyses, C.; Gow, I.; Elstein, D.; Zimran, A. *Lancet* **2000**, *355*, 1481.

⁹⁰ Patterson, M. C.; Vecchio, D.; Prady, H.; Abel, L.; Wraith, J. E. *Lancet Neurol* **2007**, *6*, 765.

models, it didn't demonstrate any effect on Gaucher type III patients over a 2-year period of treatment.⁹¹

Despite its benefits to LSDs patients, miglustat has gastrointestinal side-effects⁹² and remains an expensive therapy. An alternative to this drug may be eliglustat (Phase III trial in Gaucher type I patients in progress), which due to a higher specificity for ceramide-specific UDP-glucosyltransferase shows minimal side-effects.⁹³ Other trials of SRT for LSDs are pending: e.g. for MPSs using a soybean isoflavone genistein.⁹⁴

To summarize, SRT seems to be a promising approach to treat some LSDs. The advantages include lower cost, oral administration and possibility to treat the disorders with neurological manifestations. However, further investigation is required to find novel compound with higher specificity to be used at lower dosage and to avoid side-effects.

II.6 Pharmacological chaperone therapy

In biology, a chaperone is a protein which helps in the folding of nascent polypeptide chains, refolding of denatured proteins. It also prevents aggregation of surface-exposed hydrophobic parts of the proteins that have problems with folding. Apart from that, chaperones can play an important role in signal transduction, in the maintenance of the organized state of the cytoplasm and other intracellular compartments, in the motions inside the cell, and some other vital functions of the cells.⁹⁵ Pharmacological chaperone therapy (PCT) arises from the same principle, with the difference of using low-molecular-weight molecules (PCs) instead of proteins as chaperones. As mentioned previously, LSDs are the genetic disorders resulting from deficiencies of lysosomal proteins. In some cases, the mutant enzymes retain their activity or it is slightly compromised,⁹⁶ but as they are often misfolded, they are recognized by the ER quality control system of the cell.⁹⁷ In consequence, mutants are polyubiquitinated and translocated to the cytosol, where they are degraded by proteases.⁹⁸ However, even small improvement in protein stability or conformation may prevent their

⁹¹ Tylki-Szymanska, A.; Groener, J. E.; Kaminski, M. L.; Lugowska, A.; Jurkiewicz, E.; Czartoryska, B. *Mol Genet Metab* **2011**, *104*, 627.

⁹² Reuser, A. J.; Wisselaar, H. A. *Eur J Clin Invest* **1994**, *24 Suppl 3*, 19.

⁹³ Lukina, E.; Watman, N.; Arreguin, E. A.; Dragosky, M.; Iastrebner, M.; Rosenbaum, H.; Phillips, M.; Pastores, G. M.; Kamath, R. S.; Rosenthal, D. I.; Kaper, M.; Singh, T.; Puga, A. C.; Peterschmitt, M. J. *Blood* **2010**, *116*, 4095.

⁹⁴ Piotrowska, E.; Jakóbkiewicz-Banecka, J.; Tylki-Szymanska, A.; Liberek, A.; Maryniak, A.; Malinowska, M.; Czartoryska, B.; Puk, E.; Kloska, A.; Liberek, T.; Baranska, S.; Wegrzyn, A.; Wegrzyn, G. *Current Therapeutic Research* **2008**, *69*, 166.

⁹⁵ Ellis, R. J.; Hemmingsen, S. M. *Trends Biochem Sci* **1989**, *14*, 339.

⁹⁶ Fan, J. Q. *Biol Chem* **2008**, *389*, 1.

⁹⁷ Ellgaard, L.; Helenius, A. *Curr Opin Cell Biol* **2001**, *13*, 431.

⁹⁸ Bonifacino, J. S.; Weissman, A. M. *Annu Rev Cell Dev Biol* **1998**, *14*, 19.

premature degradation and favor further transport to the lysosome. Originally, PCs were believed to enhance the stability of mutant proteins and thanks to this, to avoid their degradation in ER. PCs are designed to selectively bind and stabilize mutant proteins. The concept of this therapy is often considered to be controversial⁹⁹ as to restore the enzyme activity, one has to use its own inhibitor. In fact, by binding to the active site of the misfolded protein, the competitive enzyme inhibitor (which has a high affinity for the catalytic domain) acts as a template to re-establish the enzyme's three-dimensional structure, stabilizes it and therefore facilitates its proper trafficking through ER and to the lysosome.¹⁰⁰ As soon as reaching the lysosome, in the presence of undegraded substrate in excess, the inhibitor (in sub-inhibitory concentrations) dissociates from the enzyme and liberated protein can function normally (**Figure 10**).¹⁰¹ However, other mechanisms are possible: in 2011, Wei and coworkers¹⁰² showed that even if catalytically defective, the N370S mutant human acid β -glucosidase (GCase, most common cause for Gaucher disease) is actually more stable than the wild type enzyme! They have preceded the assays with addition of the GCase competitive inhibitor NN-DNJ, which increased 2-3 folds GCase levels in 24h. They concluded that the major mechanism of this chaperone-mediated enhancement consists in reducing the susceptibility to proteases and decreasing the degradation of the defective enzyme in the lysosome.

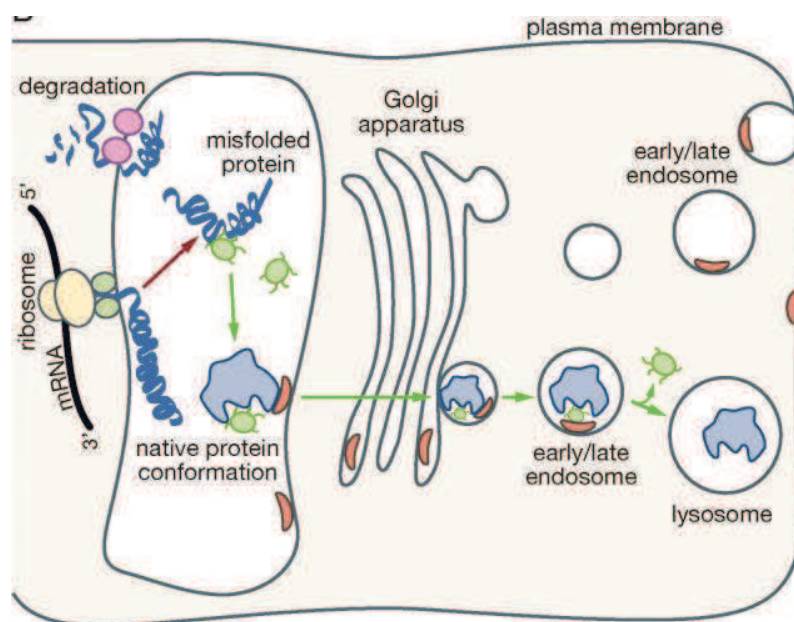

Figure 10. Principles of pharmacological chaperone therapy.¹⁰¹

⁹⁹ Fan, J. Q. *Trends Pharmacol Sci* **2003**, *24*, 355.

¹⁰⁰ Fan, J. Q. *FEBS J* **2007**, *274*, 4943.

¹⁰¹ Parenti, G. *EMBO Mol Med* **2009**, *1*, 268.

¹⁰² Wei, R. R.; Hughes, H.; Boucher, S.; Bird, J. J.; Guziewicz, N.; Van Patten, S. M.; Qiu, H.; Pan, C. Q.; Edmunds, T. *J Biol Chem* **2011**, *286*, 299.

The studies of Asano¹⁰³ on α -galactosidase A showed that, apparently a more potent enzyme inhibitor is a more efficient PC. Ideally, a compound should have weaker inhibitory effects and higher enhancing activity: recent studies have revealed compounds with moderate inhibitory activity having indeed very good activity enhancements.¹⁰⁴ Moreover, it should be noted that PCT can be successful only when mutant enzymes show residual activity. Enzymes which are truncated or carry large deletions cannot be activated by a PC. Thus only disorders resulting from mutations that involve little 3D modifications can be treated by this approach. The activity above a threshold level (10-15% of native enzyme activity) results in normal substrate turnover, which means that, if delivered to lysosome, even enzymes with small residual activity can reverse the illness.

First chaperone effect was demonstrated by Suzuki et al in 1995¹⁰⁵ on lymphoblasts from patients with Fabry disease using galactose. In their report, they showed a significant increase of α -Gal A levels in cell cultures upon addition of galactose. Moreover, for 7 among 11 tested mutants they observed enzyme activity enhancement. Subsequently, other studies were carried out to provide a proof of principle for other LSDs: Fabry disease,¹⁰⁶ Gaucher disease,^{107,108} GM1-¹⁰⁹ and GM2-gangliosidoses,^{110,111} and Pompe disease.^{112,113} Currently 1-deoxygalactonojirimycin (DGJ, migalastat, AmigalTM) is in Phase III trial for Fabry disease. Isofagomine (IFG) (**Figure 11**), which was developed by Amicus Therapeutics as a candidate (*Plicera*[®]) for the treatment of Gaucher disease, was eventually discontinued in phase II trials

¹⁰³ Asano, N.; Ishii, S.; Kizu, H.; Ikeda, K.; Yasuda, K.; Kato, A.; Martin, O. R.; Fan, J. Q. *Eur J Biochem* **2000**, *267*, 4179.

¹⁰⁴ Wang, G. N.; Reinkensmeier, G.; Zhang, S. W.; Zhou, J.; Zhang, L. R.; Zhang, L. H.; Butters, T. D.; Ye, X. *S. J Med Chem* **2009**, *52*, 3146.

¹⁰⁵ Okumiya, T.; Ishii, S.; Takenaka, T.; Kase, R.; Kamei, S.; Sakuraba, H.; Suzuki, Y. *Biochem Biophys Res Commun* **1995**, *214*, 1219.

¹⁰⁶ Fan, J. Q.; Ishii, S.; Asano, N.; Suzuki, Y. *Nat Med* **1999**, *5*, 112.

¹⁰⁷ Sawkar, A. R.; Cheng, W. C.; Beutler, E.; Wong, C. H.; Balch, W. E.; Kelly, J. W. *Proc Natl Acad Sci U S A* **2002**, *99*, 15428.

¹⁰⁸ Chang, H. H.; Asano, N.; Ishii, S.; Ichikawa, Y.; Fan, J. Q. *FEBS J* **2006**, *273*, 4082.

¹⁰⁹ Matsuda, J.; Suzuki, O.; Oshima, A.; Yamamoto, Y.; Noguchi, A.; Takimoto, K.; Itoh, M.; Matsuzaki, Y.; Yasuda, Y.; Ogawa, S.; Sakata, Y.; Nanba, E.; Higaki, K.; Ogawa, Y.; Tominaga, L.; Ohno, K.; Iwasaki, H.; Watanabe, H.; Brady, R. O.; Suzuki, Y. *Proc Natl Acad Sci U S A* **2003**, *100*, 15912.

¹¹⁰ Maegawa, G. H.; Tropak, M.; Buttner, J.; Stockley, T.; Kok, F.; Clarke, J. T.; Mahuran, D. J. *J Biol Chem* **2007**, *282*, 9150.

¹¹¹ Tropak, M. B.; Reid, S. P.; Guiral, M.; Withers, S. G.; Mahuran, D. *J Biol Chem* **2004**, *279*, 13478.

¹¹² Okumiya, T.; Kroos, M. A.; Vliet, L. V.; Takeuchi, H.; Van der Ploeg, A. T.; Reuser, A. J. *Mol Genet Metab* **2007**, *90*, 49.

¹¹³ Parenti, G.; Zuppaldi, A.; Gabriela Pittis, M.; Rosaria Tuzzi, M.; Annunziata, I.; Meroni, G.; Porto, C.; Donaudy, F.; Rossi, B.; Rossi, M.; Filocamo, M.; Donati, A.; Bembi, B.; Ballabio, A.; Andria, G. *Mol Ther* **2007**, *15*, 508.

because it failed to meet efficacy expectations. Another iminosugar 1-deoxynojirimycin (DNJ) is in Phase II trials for Pompe disease (*Figure 11, Table 3*).¹¹⁴

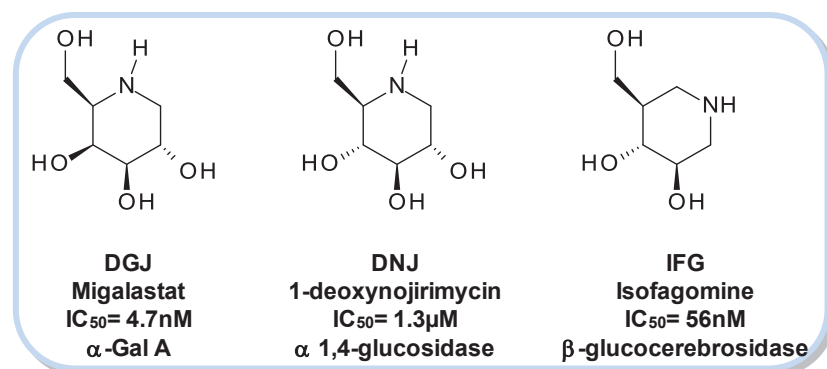

Figure 11. Currently tested iminosugars as potential PCs for LSDs.^{106, 112, 115}

The pharmacological chaperone therapy arises as a very promising treatment for lysosomal storage disorders mainly because of relatively low cost of drug production, oral administration, small doses used (limited side effects) and finally the possibility of crossing the BBB, thus providing hope for severe LSDs with CNS involvement.

Disease	PC	Status
Fabry	Galactose	Preclinical
	DGJ (AT1001, Amigal™)	Phase 3
Gaucher	Various derivatives of DNJ	Preclinical
	IFG (AT2101)	Stopped at phase 2
	2-O-alkyl iminoxylitol derivatives	Preclinical
Morquio B	NOEV	Preclinical
	DGJ, NB-DGJ	Preclinical
	Galactose	Preclinical
Pompe	DNJ (AT2220)	Phase 2
	NB-DNJ	Preclinical
Krabbe	α-lobeline	Preclinical
MPS C	Glucosamine	Preclinical

Table 3. Examples of pharmacological chaperones for LSDs¹¹⁴

¹¹⁴ Valenzano, K. J.; Khanna, R.; Powe, A. C.; Boyd, R.; Lee, G.; Flanagan, J. J.; Benjamin, E. R. *Assay Drug Dev Technol* **2011**, *9*, 213.

¹⁰⁶ Fan, J. Q.; Ishii, S.; Asano, N.; Suzuki, Y. *Nat Med* **1999**, *5*, 112.

¹¹² Okumiya, T.; Kroos, M. A.; Vliet, L. V.; Takeuchi, H.; Van der Ploeg, A. T.; Reuser, A. J. *Mol Genet Metab* **2007**, *90*, 49.

¹¹⁵ Zhu, X.; Sheth, K. A.; Li, S.; Chang, H.-H.; Fan, J.-Q. *Angew Chem Int Ed* **2005**, *44*, 7450.

III. Krabbe disease

Krabbe disease, also called globoid cell leukodystrophy, is an autosomal, recessive lysosomal disorder affecting the white matter of central and peripheral nervous system. It was described in 1916 as “a new familial, infantile form of diffusive brain sclerosis”.¹¹⁶ It is a severe, neurodegenerative disease which is characterized by a progressive demyelination. Other pathologies of this illness include axonal loss, astrocytic gliosis and infiltration of macrophages with galactosylceramide inclusions (globoid cells).¹¹⁷ Krabbe disease occurs once in 100,000 births,¹¹⁸ but its prevalence varies depending on countries. The Druze and Moslem Arab populations in Israel have an extremely high occurrence of the infantile form of this disorder: about 1 in 100-150 live births.¹¹⁹ Most of the patients with Krabbe disease suffer from rapidly progressing leuko-encephalopathy with onset between 3 to 6 months of age and death before 2 years.¹²⁰ Only 5% of Krabbe patients are those with late infancy, childhood or adulthood onset.¹¹⁸ The infantile type is characterized by spasticity, irritability and hypersensitivity to external stimuli, followed by abnormal posturing, visual failure, hypertonic fits and loss of tendon reflex.¹²¹ Feeding difficulties and aspiration problems are frequent complications.¹²² As for many other LSDs, Krabbe patients with similar or identical mutated genome can present different clinical courses.¹²⁰ This makes the diagnosis of adult forms of the disease even more challenging. Generally, the magnetic resonance imaging evidence of white matter changes, weakness, loss of skills and onset of vision loss can indicate Krabbe disease. To confirm it, the deficient enzyme activity must be measured.¹²⁰ Prenatal diagnosis is also indispensable for at-risk couples, as the affected fetuses will have 0-5% of normal enzyme activity.

The protein implied in Krabbe disease is a hydrolase: galactosylceramide- β -galactosidase (galactocerebrosidase, GALC, EC 3.2.1.46).¹²³ This enzyme is responsible for the degradation of a major component of the myelin: galactosylceramide, and other

¹¹⁶ Krabbe, K. *Brain* **1916**, 39, 74.

¹¹⁷ Kolodny, E., H In *Handbook of clinical neurology*; Moser, H. W., Ed.; Elsevier: Amsterdam, 1996; Vol. 22, p 187.

¹¹⁸ Fiumara, A.; Barone, R.; Arena, A.; Filocamo, M.; Lissens, W.; Pavone, L.; Sorge, G. *Clin Genet* **2011**, 80, 452.

¹¹⁹ Rafi, M. A.; Luzi, P.; Zlotogora, J.; Wenger, D. A. *Hum Genet* **1996**, 97, 304.

¹²⁰ Wenger, D. A.; Rafi, M. A.; Luzi, P.; Datto, J.; Costantino-Ceccarini, E. *Mol Genet Metab* **2000**, 70, 1.

¹²¹ Suzuki, K.; Suzuki, Y. In *The metabolic basis of inherited disease*; Scriver, C. R., Beaudet, A. L., Sly, W. S., Valle, D., Eds.; McGraw-Hill: New York, 1989, p 1699.

¹²² Puckett, R. L.; Orsini, J. J.; Pastores, G. M.; Wang, R. Y.; Chang, R.; Saavedra-Matiz, C. A.; Torres, P. A.; Zeng, B.; Caggana, M.; Lorey, F.; Abdenur, J. E. *Mol Genet Metab* **2012**, 105, 126.

¹²³ Suzuki, K. *J Child Neurol* **2003**, 18, 595.

sphingolipids containing terminal β -galactose such as D-galactosylsphingosine (psychosine),¹²⁴ lactosyl ceramide and monogalactosyldiglyceride (**Figure 12**).

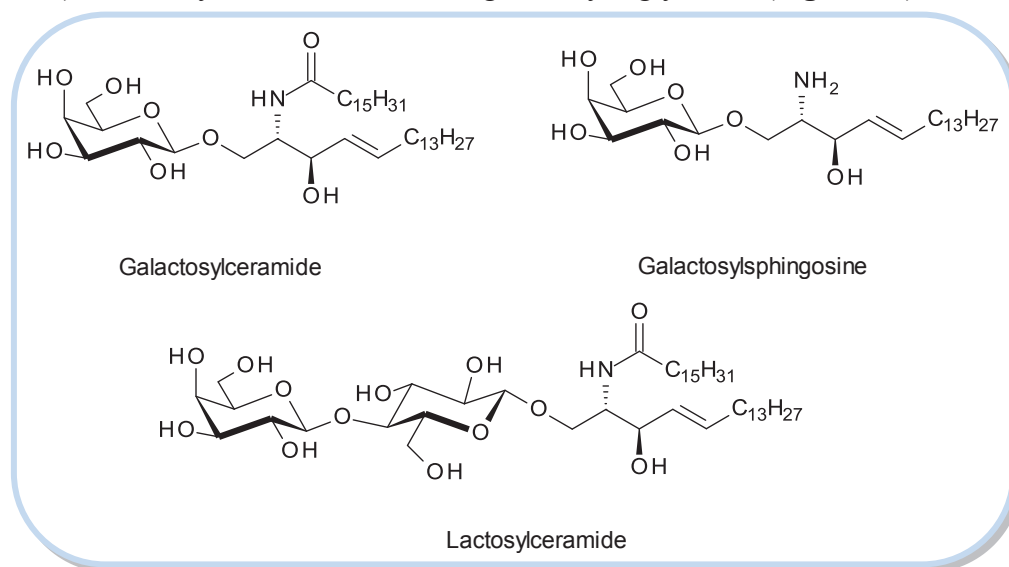

Figure 12. GALC natural substrates.

The gene coding GALC was mapped to chromosome 14q31.¹²⁵ Approximately, 80 distinct mutations have been identified in this gene.¹²⁶ The most common large deletion (IVS10del30kb) and three others mutations (1538C>T, 1652A>T, 1424delA) together account for about 60% of alleles in European patients (infantile form) and are absent in their Japanese counterparts.¹²⁷ By contrast, ~30% of Japanese GALC has either 635-646del12insCTC or 1954A>C mutation.¹²⁸ By preventing a glycosylation, promoting structure destabilization or interfering with binding to activation factors, a large portion of the missense mutations in GALC is likely to result in protein mistargeting or premature degradation.¹²⁹ However, some of those mutations¹³⁰ have been shown to retain enzyme residual activity. In 2011, Deane and coworkers¹³¹ have resolved the structure of the mouse GALC (83% homology with human GALC) alone and in complex with D-galactose. The protein is composed of 668 residues forming three domains: a triosephosphate isomerase (TIM) barrel, a β -sandwich and a lectin domain (**Figure 13**).

¹²⁴ Won, J. S.; Kim, J.; Paintlia, M. K.; Singh, I.; Singh, A. K. *Brain Res* **2013**, *1508*, 44.

¹²⁵ Cannizzaro, L. A.; Chen, Y. Q.; Rafi, M. A.; Wenger, D. A. *Cytogenet Cell Genet* **1994**, *66*, 244.

¹²⁶ Sakai, N.; Inui, K.; Fujii, N.; Fukushima, H.; Nishimoto, J.; Yanagihara, I.; Isegawa, Y.; Iwamatsu, A.; Okada, S. *Biochem Biophys Res Commun* **1994**, *198*, 485.

¹²⁷ Tappino, B.; Biancheri, R.; Mort, M.; Regis, S.; Corsolini, F.; Rossi, A.; Stroppiano, M.; Lualdi, S.; Fiumara, A.; Bembi, B.; Di Rocco, M.; Cooper, D. N.; Filocamo, M. *Hum Mutat* **2010**, *31*, E1894.

¹²⁸ Xu, C.; Sakai, N.; Taniike, M.; Inui, K.; Ozono, K. *J Hum Genet* **2006**, *51*, 548.

¹²⁹ Lee, W. C.; Kang, D.; Causevic, E.; Herdt, A. R.; Eckman, E. A.; Eckman, C. B. *J Neurosci* **2010**, *30*, 5489.

¹³⁰ Harzer, K.; Knoblich, R.; Rolfs, A.; Bauer, P.; Eggers, J. *Clin Chim Acta* **2002**, *317*, 77.

¹³¹ Deane, J. E.; Graham, S. C.; Kim, N. N.; Stein, P. E.; McNair, R.; Cachon-Gonzalez, M. B.; Cox, T. M.; Read, R. J. *Proc Natl Acad Sci U S A* **2011**, *108*, 15169.

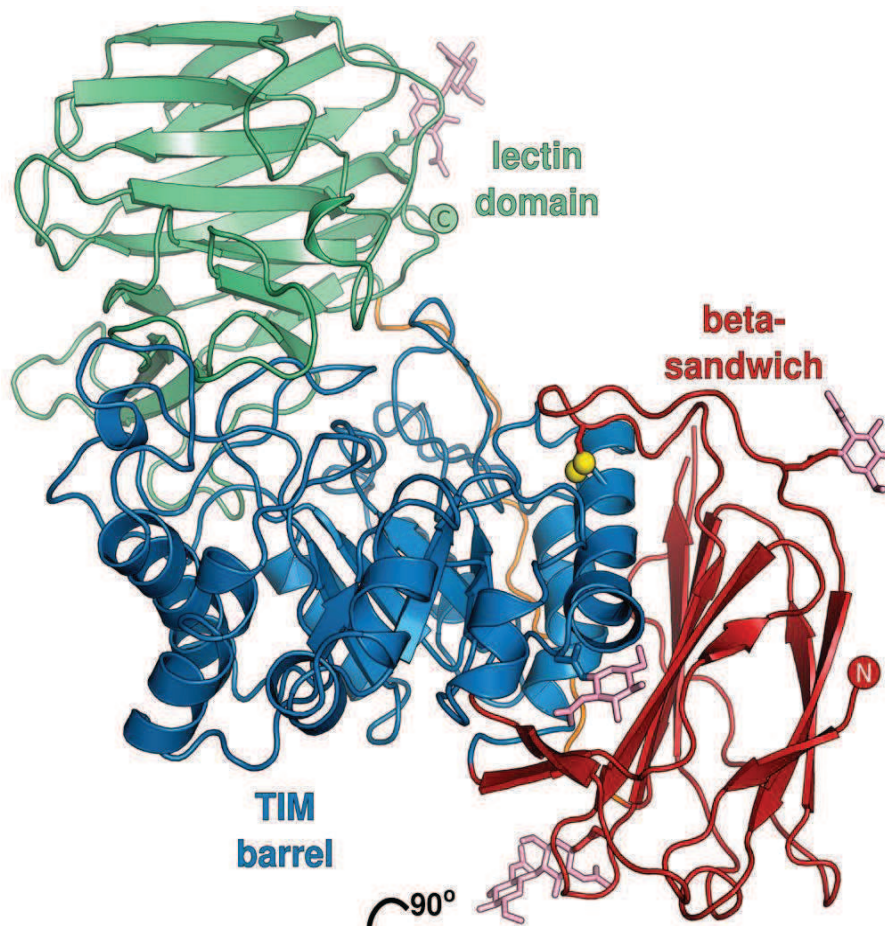

Figure 13. X-ray structure of mouse GALC¹³¹

According to their studies, the active site of the enzyme accommodates only the galactose moiety without any space for the lipid tails of sphingolipids. Compared to other lysosomal enzymes, GALC is the only one so far that possesses a lectin domain, which contributes to the formation of the enzyme-substrate cleft. Moreover, each of the three domains is involved in the substrate binding site.¹³¹

Residual GALC activity in Krabbe patients ranges from 0-22% of normal values, with leukocyte enzyme level significantly lower than in healthy controls.¹¹⁸ Interestingly, impaired activity of GALC does not result in accumulation of the primary substrate of the enzyme: galactosylceramide in the CNS, because it is also degraded by G_{M1} β -galactosidase (ganglioside β -galactosidase).¹³² This is why the excess storage of psychosine is predominantly observed.¹³³

¹³¹ Deane, J. E.; Graham, S. C.; Kim, N. N.; Stein, P. E.; McNair, R.; Cachon-Gonzalez, M. B.; Cox, T. M.; Read, R. J. *Proc Natl Acad Sci U S A* **2011**, *108*, 15169.

¹¹⁸ Fiumara, A.; Barone, R.; Arena, A.; Filocamo, M.; Lissens, W.; Pavone, L.; Sorge, G. *Clin Genet* **2011**, *80*, 452.

¹³² Kobayashi, T.; Shinnoh, N.; Goto, I.; Kuroiwa, Y. *J Biol Chem* **1985**, *260*, 14982.

¹³³ Vanier, M.; Svennerholm, L. *Adv Exp Med Biol* **1976**, *68*, 115.

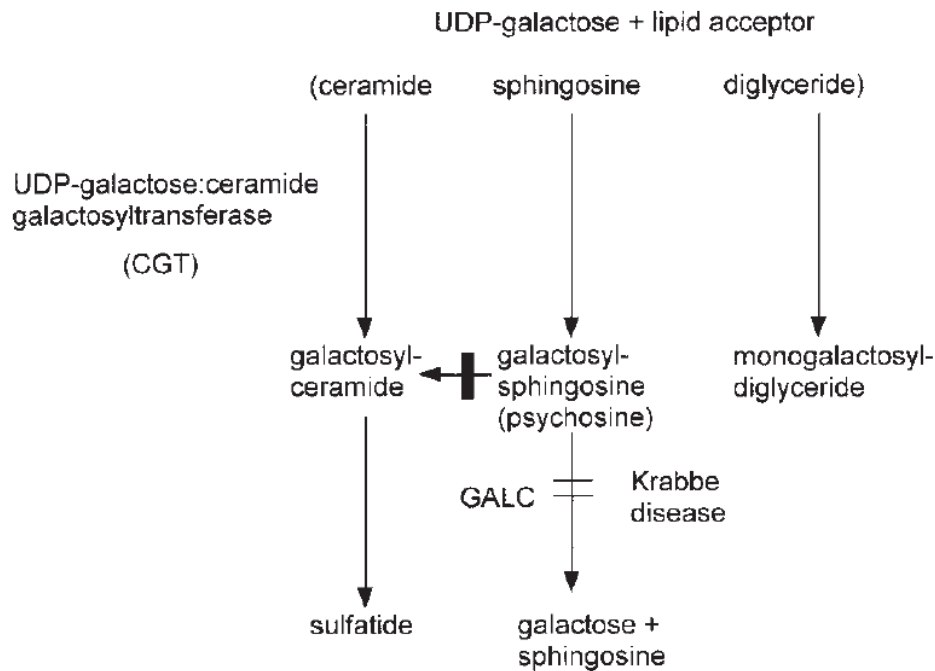

Scheme 2. Biosynthesis of the major galactolipids of myelin.¹²⁰

As shown on **Scheme 2**, both galactosylceramide from ceramide and psychosine from sphingosine are synthesized by UDP-galactose ceramide galactosyltransferase (CGT), which is primarily expressed in oligodendrocytes (OLs).¹³⁴ During OLs differentiations the CGT activity is enhanced, resulting in increased synthesis of both sphingolipids.¹³⁵ Moreover, under deficiency of GALC, galactosylceramide may be converted to psychosine by deacylation.¹³⁶ As psychosine was shown to be cytotoxic (possibly by inhibition of cytokinesis¹³⁷ and triggering apoptosis¹³⁸) especially in OLs and Schwann cells (which are responsible for myelination), its accumulation impedes OLs maturation and as a consequence causes demyelination of neurons in CNS and PNS (peripheral NS).

Studies for potential treatments of Krabbe disease were performed on an animal model of this disorder: the twitcher mouse. First BMT for Krabbe disease (1984)¹³⁹ was done on a twitcher mouse which showed prolonged survival and remyelination. More recently HSCT also proved to slow down the clinical course of the disease.¹⁴⁰ In addition some new viral

¹²⁰ Wenger, D. A.; Rafi, M. A.; Luzi, P.; Datto, J.; Costantino-Ceccarini, E. *Mol Genet Metab* **2000**, *70*, 1.

¹³⁴ Schulte, S.; Stoffel, W. *Proc Natl Acad Sci U S A* **1993**, *90*, 10265.

¹³⁵ Mitsuo, K.; Kobayashi, T.; Shinnoh, N.; Goto, I. *Neurochem Res* **1989**, *14*, 899.

¹³⁶ Svennerholm, L.; Vanier, M. T.; Mansson, J. E. *J Lipid Res* **1980**, *21*, 53.

¹³⁷ Kanazawa, T.; Nakamura, S.; Momoi, M.; Yamaji, T.; Takematsu, H.; Yano, H.; Sabe, H.; Yamamoto, A.; Kawasaki, T.; Kozutsumi, Y. *J Cell Biol* **2000**, *149*, 943.

¹³⁸ Haq, E.; Giri, S.; Singh, I.; Singh, A. K. *J Neurochem* **2003**, *86*, 1428.

¹³⁹ Yeager, A. M.; Brennan, S.; Tiffany, C.; Moser, H. W.; Santos, G. W. *Science* **1984**, *225*, 1052.

¹⁴⁰ Krivit, W.; Shapiro, E. G.; Peters, C.; Wagner, J. E.; Cornu, G.; Kurtzberg, J.; Wenger, D. A.; Kolodny, E. H.; Vanier, M. T.; Loes, D. J.; Dusenbery, K.; Lockman, L. A. *N Engl J Med* **1998**, *338*, 1119.

vectors for transferring mutant GALC are under development for gene therapy. In 2005 direct ERT was proposed by Lee¹⁴¹ which resulted in improved GALC activity in CNS and PNS as well as lowered levels of psychosine. This approach, even if efficient (peripheral injections of recombinant GALC every day significantly improved most of the early clinical animal phenotypes¹³⁵) is not practical due to the necessity of direct brain injections, which are difficult to perform and risky. As shown in **Table 3**, there is only one PC candidate for Krabbe disease.³³ α -Lobeline (**Figure 14**) was identified as a weak inhibitor of GALC. In their studies Lee et al¹²⁹ demonstrated an important increase of 52% for intracellular and 64% for extracellular D528N GALC mutant activity when the cells were treated with α -lobeline (240 μ M). Moreover, α -lobeline passes through the BBB, which is crucial for all drug-based treatment of Krabbe disease. However, despite all the efforts described above, Krabbe disease still remains an untreatable, neurodegenerative illness which is lethal at young age.

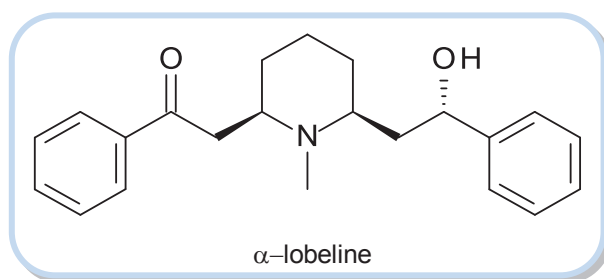

Figure 14. Structure of α -lobeline.

¹⁴¹ Lee, W. C.; Courtenay, A.; Troendle, F. J.; Stallings-Mann, M. L.; Dickey, C. A.; DeLucia, M. W.; Dickson, D. W.; Eckman, C. B. *FASEB J* **2005**, *19*, 1549.

³³ Boyd, R. E.; Lee, G.; Rybczynski, P.; Benjamin, E. R.; Khanna, R.; Wustman, B. A.; Valenzano, K. J. *J Med Chem* **2013**, *56*, 2705.

¹²⁹ Lee, W. C.; Kang, D.; Causevic, E.; Herdt, A. R.; Eckman, E. A.; Eckman, C. B. *J Neurosci* **2010**, *30*, 5489.

IV. Galactosidases inhibitors

IV.1 General

Enzyme inhibitors represent almost 47% of the drugs in clinical use today.¹⁴² The two most famous: aspirin and amoxicillin act on cyclooxygenase (to fight down the pain, fever and inflammation) and penicillin-binding proteins (to stop bacterial infection) respectively. As described previously (chapter II.5 and II.6), enzyme inhibitors are crucial to implement LSDs therapies such as SRT and PCT. Several LSDs are caused by galactosidase deficiencies (Fabry, GM1, Morquio B and Krabbe diseases) and thus potent and selective inhibitors of the corresponding enzymes are needed. A number of galactosidase inhibitors have already been reported, which can be divided into three groups: structures of fagomine/isofagomine type, DNJ type or novel structures of NOEV type which are carbocyclic.

IV.2 Use of galactosidase inhibitors as PCs for galactosidase-linked LSDs

α -Galactosidase A (α -Gal A), the enzyme implied in Fabry disease is the most thoroughly studied target for PCT. The first assays were conducted simply with D-galactose itself by Suzuki and coworkers, and led to the first evidence that the concept of pharmacological chaperone could work, albeit with high concentrations of galactose.¹⁰⁵ Further experiments¹⁴³ consisting in three months of intravenous galactose infusions to cardiac Fabry patients resulted in remarkable improvement in patients' health. After two years of treatment the patient did not require cardiac transplantation. Then, as DNJ proved to be a good inhibitor of acid α -glucosidase, a number of *galacto*-analogues such as DGJ and other epimers were tested on human α -Gal A and other galactosidases by Fan and coworkers.¹⁰³ As shown in **Table 4**, the most potent inhibitors of this enzyme are DGJ and α -galacto-homonojirimycin (α -HGJ, **Figure 15**) with IC₅₀ values equal to 0.04 μ M and 0.21 μ M respectively. DGJ was the first example of a PC for an LSD and is now in phase III clinical trials. Generally, *N*-alkylation (*e.g.* *N*-butyl-DGJ), deoxygenation at C-2 and epimerization at C-3 of DGJ lowered or abolished the inhibition of α -Gal A. Fan's group investigations highlight also the importance of the choice of the enzyme source (human, plant or

¹⁴² Copeland, R. A. *Methods Biochem Anal* **2005**, *46*, 1.

¹⁰⁵ Okumiya, T.; Ishii, S.; Takenaka, T.; Kase, R.; Kamei, S.; Sakuraba, H.; Suzuki, Y. *Biochem Biophys Res Commun* **1995**, *214*, 1219.

¹⁴³ Frustaci, A.; Chimenti, C.; Ricci, R.; Natale, L.; Russo, M. A.; Pieroni, M.; Eng, C. M.; Desnick, R. J. *N Engl J Med* **2001**, *345*, 25.

¹⁰³ Asano, N.; Ishii, S.; Kizu, H.; Ikeda, K.; Yasuda, K.; Kato, A.; Martin, O. R.; Fan, J. Q. *Eur J Biochem* **2000**, *267*, 4179.

microorganism) for the biological assays, as the inhibition properties vary very significantly between different α -galactosidases (DGJ: 270-fold higher IC₅₀ value for α -Gal A then for α -galactosidase from *E. coli*).

Inhibitor	IC ₅₀ ^a for α -galactosidases			
	Human	Coffee bean	<i>A. niger</i> ^b	<i>E. Coli</i> ^c
DNJ	830	320	NI	NI
manno-DNJ	NI ^d	420	NI	NI
allo-DNJ	NI	NI	NI	NI
galacto-DNJ (DGJ)	0.04	0.003	1.0	11
gulo-DNJ	NI	400	350	NI
2-deoxy-DGJ	250	8.0	NI	NI
α-homonojirimycin (α-HNJ)	NI	NI	NI	NI
α-manno-HNJ	464	NI	NI	NI
α-allo-HNJ	4.3	50	NI	NI
α-galacto-HNJ (α-HGJ)	0.21	0.06	5.8	32
N-methyl-DGJ	96	1.8	55	950
N-ethyl-DGJ	306	13	NI	NI
N-propyl-DGJ	301	20	NI	NI
N-butyl-DGJ	300	21	370	NI
N-hydroxyethyl-DGJ	520	32	NI	NI
β-1-C-butyl-DGJ	24	0.5	365	NI

Table 4. Inhibition of α -galactosidases by DGJ derivatives. IC₅₀ values (i.e. inhibitor concentration giving 50% inhibition) were determined by variation of inhibitor concentrations. All constants are expressed in μ M.¹⁰³ ^a K_m of α -Gal A was determined as 0.17 mM with *p*-nitrophenyl- α -D-galactopyranoside. ^b*Aspergillus niger*. ^c*Escherichia coli*. ^dNI: Inhibition <50% at 1000 μ M

As mentioned before, even such weak α -Gal A inhibitor as galactose showed a chaperone effect in Fabry disease. As DGJ is about a 120 000-fold more potent competitive inhibitor than galactose, it should be a much better PC as well. Indeed, an increase in enzyme activity was observed in Fabry patient-derived lymphoblasts cultured with 0.2-20 μ M DGJ. Moreover, this state was maintained for five days after drug removal from the medium.¹⁴⁴ Further studies on mouse model TgM/KO (which expresses a human mutant R301Q instead of the endogenous α -Gal A gene) showed a significant increase in enzyme activity in various organs: 4- and 18-fold in heart, 2- and 28-fold in kidney, 1.7- and 1.8-fold in spleen and 3.1-

¹⁴⁴ Benjamin, E. R.; Flanagan, J. J.; Schilling, A.; Chang, H. H.; Agarwal, L.; Katz, E.; Wu, X.; Pine, C.; Wustman, B.; Desnick, R. J.; Lockhart, D. J.; Valenzano, K. J. *J Inherit Metab Dis* **2009**, *32*, 424.

and 7.1-fold in liver at doses of 3 and 30 mg/kg doses respectively.¹⁴⁵ Another series of experiments performed on different transgenic mouse models demonstrated also reduction of the accumulated substrate in skin, heart and kidneys.¹⁴⁶ All this proves that oral administration of DGJ restores the α -Gal A activity and decreases accumulation of glycolipids in tissues. As mentioned previously, DGJ is currently in phase III clinical studies, after phases I and II had shown that it is generally a safe and well-tolerated drug. Three other good inhibitors (α -galacto-HNJ, α -allo-HNJ and β -1-C-butyl-DGJ) examined by Asano's group did not show chaperone properties better than DGJ, with 2- to 5-fold α -Gal A activity enhancement after a 4-day incubation at 100 μ M inhibitor concentration (in comparison with 14-fold activity enhancement for DGJ at the same concentration).

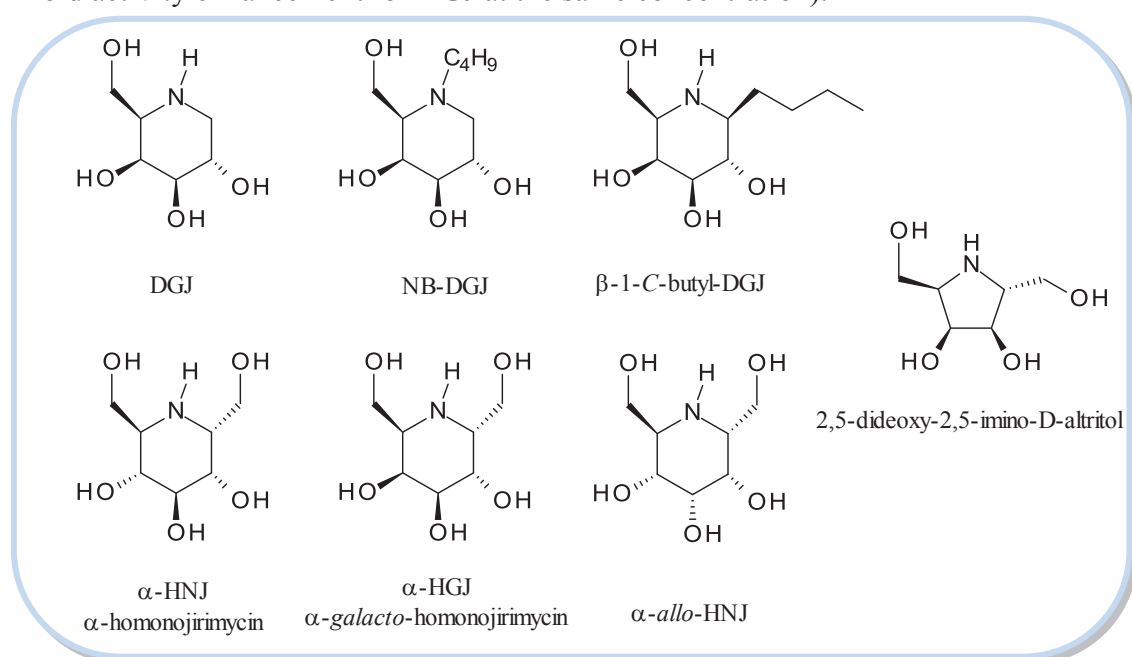

Figure 15. α -Galactosidase inhibitors and PCs

Recently, Kato et al.¹⁴⁷ isolated another series of iminosugars, among which the most interesting was 2,5-dideoxy-2,5-imino-D-altritol that binds to α -Gal A with an IC₅₀ of ~700nM and increases enzyme activity 2- to 9-fold at 50-500 μ M. However, this interesting work was not continued in further PC application.

¹⁴⁵ Ishii, S.; Yoshioka, H.; Mannen, K.; Kulkarni, A. B.; Fan, J. Q. *Biochim Biophys Acta* **2004**, *1690*, 250.

¹⁴⁶ Khanna, R.; Soska, R.; Lun, Y.; Feng, J.; Frascella, M.; Young, B.; Brignol, N.; Pellegrino, L.; Sitaraman, S. A.; Desnick, R. J.; Benjamin, E. R.; Lockhart, D. J.; Valenzano, K. J. *Mol Ther* **2010**, *18*, 23.

¹⁴⁷ Kato, A.; Yamashita, Y.; Nakagawa, S.; Koike, Y.; Adachi, I.; Hollinshead, J.; Nash, R. J.; Ikeda, K.; Asano, N. *Bioorg Med Chem* **2010**, *18*, 3790.

β -Galactosidase is the enzyme implied in two LSDs. Different mutations in this protein cause either GM1 gangliosidosis or Morquio B syndrome. This is why the molecules that can increase the activity of β -galactosidase were already widely investigated. As for all galactosidases, the first candidate as PC was galactose itself. The test on patients-derived cell-lines expressing R401H and T393A mutants showed 1.4- and 2.5 fold increase in activity respectively (at 200mM Gal concentration). However, galactose failed to boost S54N mutant activity.¹⁴⁸ Next choices for β -galactosidase inhibitors were DGJ, NB-DGJ and NN-DGJ. The first two compounds were evaluated in mouse cell lines transfected with mutant forms of human β -galactosidase. Both iminosugars promoted increase in enzyme activity: 2- to 6-fold for mutations related to GM1 disease and 1.1- to 1.8-fold for mutations responsible for Morquio B disease.¹⁴⁹ However, those results were obtained at high inhibitor concentration (500 μ M). Recently, Rigat et al¹⁵⁰ examined inhibitory properties of DGJ, NB-DGJ and NN-DGJ on human lysosomal β -galactosidase and their chaperone effect in cultures of skin-fibroblasts derived from patients suffering from either LSDs. They established IC₅₀ values of 18.4 μ M, 3.5 μ M and 0.12 μ M for the three DGJ derivatives respectively. Moreover, they compared the inhibitory activities of the three compounds on α -galactosidase and found that NB-DGJ and NN-DGJ were weak α -galactosidase inhibitors with <30% and <10% inhibition respectively (at 100 μ M). These values indicate that the addition of an N-alkyl chain significantly increases the specificity of the DGJ-derivative for β -galactosidase, and that the strength of the inhibition is further increased when the chain is lengthened from 4 to 9 carbon atoms. Further assays were conducted on NN-DGJ and they proved its good chaperone effect on various mutations responsible for GM1 or Morquio syndrome B (up to ~5-fold increase of enzyme activity that would raise the residual activity to about 15% of normal).

¹⁴⁸ Caciotti, A.; Donati, M. A.; d'Azzo, A.; Salvioli, R.; Guerrini, R.; Zammarchi, E.; Morrone, A. *Eur J Paediatr Neurol* **2009**, *13*, 160.

¹⁴⁹ Tominaga, L.; Ogawa, Y.; Taniguchi, M.; Ohno, K.; Matsuda, J.; Oshima, A.; Suzuki, Y.; Nanba, E. *Brain Dev* **2001**, *23*, 284.

¹⁵⁰ Rigat, B. A.; Tropak, M. B.; Buttner, J.; Crushell, E.; Benedict, D.; Callahan, J. W.; Martin, D. R.; Mahuran, D. J. *Mol Genet Metab* **2012**, *107*, 203.

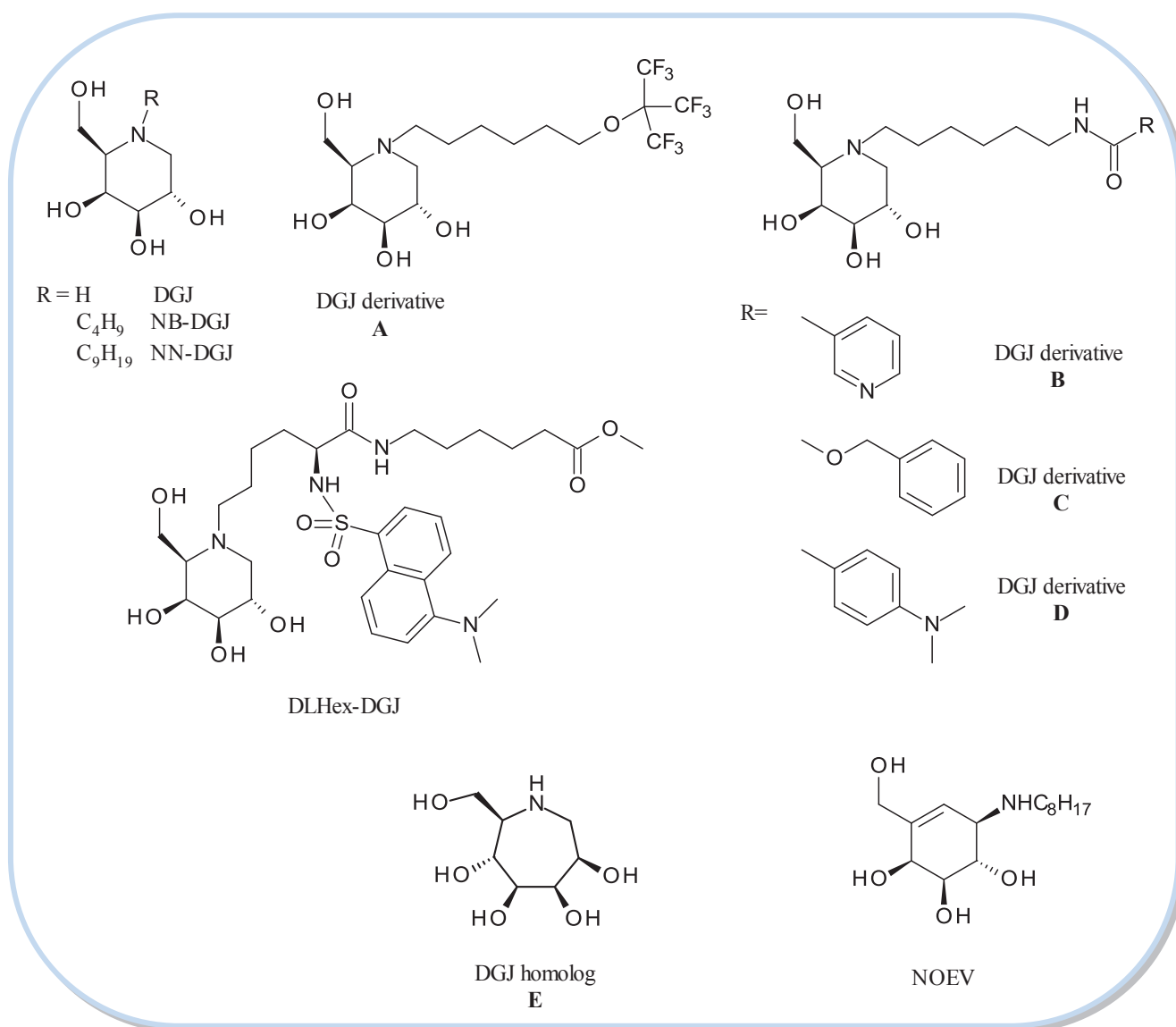

Figure 16. β -Galactosidase inhibitors and PCs

A wide series of other DGJ derivatives (**Figure 16**) was synthesized and tested by Wrodnigg and co-workers. The nonafluoro-*t*-Bu ether **A** increases β -galactosidase activity 1.6-fold at $30\mu\text{M}$ (patient-derived fibroblasts).¹⁵¹ Compounds **B** and **C** enhance 5.5-fold the mutant enzyme activity at $100\mu\text{M}$ and **D** gives a 4.8-fold improvement in activity at $2\mu\text{M}$.¹⁵² The same group synthesized and tested DL-Hex DGJ on various mutant β -galactosidases derived from GM1 and Morquio B patients.¹⁵³ They established the IC_{50} value to be $6\mu\text{M}$ and showed significant enzyme activity enhancements for 7 among 13 mutants tested (best result

¹⁵¹ Schitter, G.; Steiner, A. J.; Pototschnig, G.; Scheucher, E.; Thonhofer, M.; Tarling, C. A.; Withers, S. G.; Fantur, K.; Paschke, E.; Mahuran, D. J.; Rigat, B. A.; Tropak, M. B.; Illaszewicz, C.; Saf, R.; Stutz, A. E.; Wrodnigg, T. M. *Chembiochem* **2010**, *11*, 2026.

¹⁵² Schitter, G.; Scheucher, E.; Steiner, A. J.; Stutz, A. E.; Thonhofer, M.; Tarling, C. A.; Withers, S. G.; Wicki, J.; Fantur, K.; Paschke, E.; Mahuran, D. J.; Rigat, B. A.; Tropak, M.; Wrodnigg, T. M. *Beilstein J Org Chem* **2010**, *6*, 21.

¹⁵³ Fantur, K.; Hofer, D.; Schitter, G.; Steiner, A. J.; Pabst, B. M.; Wrodnigg, T. M.; Stutz, A. E.; Paschke, E. *Mol Genet Metab* **2010**, *100*, 262.

is ~12-fold). Further analogs of DGJ built on an azepane scaffold have been reported by Sinaÿ, Blériot and coworkers: for example, the DGJ homolog and β -galactose mimick **E** (**Figure 16**) exhibits a good activity as an inhibitor of bovine liver β -galactosidase ($K_i = 5.7 \mu\text{M}$).¹⁵⁴

The most examined inhibitor of lysosomal β -galactosidase is carbagalactosylamine NOEV (**Figure 16**). It was developed by Ogawa and Suzuki¹⁵⁵ as a chemical chaperone for Morquio B disease and GM1 gangliosidosis. Assays on 50 different cell lines expressing various mutant β -galactosidases responsible for these diseases showed >3-fold increase of activity for 17 of them, among which 10 reached >10% of normal activity (at 0.2-2 μM).¹⁵⁶ These encouraging results were confirmed on a mouse model carrying human R201C mutation responsible for GM1 gangliosidosis. Immunostaining showed reduction in accumulated storage material in various regions of the brain.¹⁰⁹

While NOEV itself shows good inhibitory activity towards lysosomal β -galactosidase from bovine liver with $\text{IC}_{50} = 0.87 \mu\text{M}$, its derivative carrying a dodecyl instead of an octyl group demonstrates even higher potency: $\text{IC}_{50} = 0.01 \mu\text{M}$.

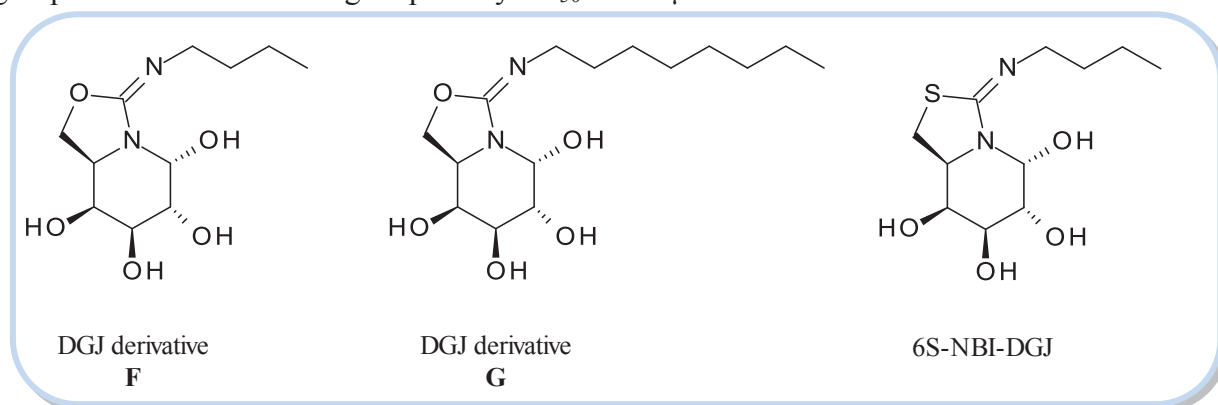

Figure 17. Examples of sp^2 iminosugars

The most recent group of interesting β -galactosidase inhibitors are so-called sp^2 -iminosugars developed by Garcia Fernandez and coworkers (**Figure 17**).¹⁵⁷ These bicyclic derivatives of galactonojirimycin or allonojirimycin were found to be potent and selective inhibitors of various glycosidases. Modifications of the aglycone by introducing heteroatoms

¹⁵⁴ Li, H.; Blériot, Y.; Chantereau, C.; Mallet, J.-M.; Sollogoub, M.; Zhang, Y.; Rodríguez-García, E.; Vogel, P.; Jiménez-Barbero, J.; Sinaÿ, P. *Org Biomol Chem* **2004**, *2*, 1492.

¹⁵⁵ Ogawa, S.; Matsunaga, Y. K.; Suzuki, Y. *Bioorg Med Chem* **2002**, *10*, 1967.

¹⁵⁶ Iwasaki, H.; Watanabe, H.; Iida, M.; Ogawa, S.; Tabe, M.; Higaki, K.; Nanba, E.; Suzuki, Y. *Brain Dev* **2006**, *28*, 482.

¹⁰⁹ Matsuda, J.; Suzuki, O.; Oshima, A.; Yamamoto, Y.; Noguchi, A.; Takimoto, K.; Itoh, M.; Matsuzaki, Y.; Yasuda, Y.; Ogawa, S.; Sakata, Y.; Nanba, E.; Higaki, K.; Ogawa, Y.; Tominaga, L.; Ohno, K.; Iwasaki, H.; Watanabe, H.; Brady, R. O.; Suzuki, Y. *Proc Natl Acad Sci U S A* **2003**, *100*, 15912.

¹⁵⁷ Aguilar-Moncayo, M.; Díaz-Pérez, P.; García Fernández, J. M.; Ortiz Mellet, C.; García-Moreno, M. I. *Tetrahedron* **2012**, *68*, 681.

(oxygen or sulphur) as well as by changing the length of the imide *N*-alkyl chain led to selective and potent inhibitors. Two of them (**F** and **G** *Figure 17*) were shown to be good inhibitors for bovine liver β -galactosidase with IC₅₀ of 0.2 μ M and 0.052 μ M. The latest experiments on another sp²-iminosugar, 6S-NBI-DGJ (*Figure 17*) confirmed its very good chaperone activity (despite higher IC₅₀ value compared to the reference compound NOEV).¹⁵⁸ This compound was tested on 88 human β -galactosidase mutants. For 24 of them, the enzyme activity was increased. Moreover, 16 of these mutations were not responding to the NOEV treatment. All of these results indicate that 6S-NBI-DGJ is a promising candidate as PC for a large number of patients suffering from GM1 gangliosidosis.

An extremely powerful β -galactosidase inhibitor is 4-epi IFG (*galacto*-IFG), with an IC₅₀ of 12 nM (enzyme from *Aspergillus oryzae*). Its *N*-butyl derivative is no longer that potent with IC₅₀ = 5 μ M.^{159,160} There are no studies of this compound and of its *N*-butyl derivative as pharmacological chaperones.

GALC is the least explored lysosomal galactosidase. Little is known about inhibitors and the best and only candidate as chaperone so far is α -lobeline (**Figure 14**), which has been mentioned before.

IV.3 Additional studies

Recently, Kato and coworkers¹⁶¹ showed that, while DGJ is a competitive nanomolar inhibitor of several α -galactosidases, its enantiomer, L-DGJ is a non-competitive, micromolar one. Moreover, it was found that iminosugars related to fagomine: 2-deoxy-DGJ (4-epi-fagomine), deoxyadenophorine (1-*C*-alkyl-2-deoxy DGJ) also showed inhibitory properties towards α -galactosidase.¹⁶² The presence of an ethyl chain at C-1 position of 2-deoxy DGJ slightly enhances the inhibitory properties towards α -galactosidase from coffee bean (IC₅₀= 6.4 μ M).

¹⁵⁸ Takai, T.; Higaki, K.; Aguilar-Moncayo, M.; Mena-Barragan, T.; Hirano, Y.; Yura, K.; Yu, L.; Ninomiya, H.; Garcia-Moreno, M. I.; Sakakibara, Y.; Ohno, K.; Nanba, E.; Ortiz Mellet, C.; Garcia Fernandez, J. M.; Suzuki, Y. *Mol Ther* **2013**, *21*, 526.

¹⁵⁹ Ichikawa, Y.; Igarashi, Y. *Tetrahedron Lett* **1995**, *36*, 4585.

¹⁶⁰ Ichikawa, Y.; Igarashi, Y.; Ichikawa, M.; Suhara, Y. *J Am Chem Soc* **1998**, *120*, 3007.

¹⁶¹ Kato, A.; Kato, N.; Kano, E.; Adachi, I.; Ikeda, K.; Yu, L.; Okamoto, T.; Banba, Y.; Ouchi, H.; Takahata, H.; Asano, N. *J Med Chem* **2005**, *48*, 2036.

¹⁶² Pearson, M. S.; Saad, R. O.; Dintinger, T.; Amri, H.; Mathe-Allainmat, M.; Lebreton, J. *Bioorg Med Chem Lett* **2006**, *16*, 3262.

Objectives

The aim of my PhD project was to synthesize three families of iminosugar derivatives as potential inhibitors of galactocerebrosidase (GALC): novel imino-L-arabinitols, imino-D-galactitols and *galacto*-isofagomines (*galacto*-IFGs) carrying a C-alkyl chain, and to evaluate them as potential chaperones for Krabbe disease.

The choice of those structures was dictated by the consideration of the transition state (TS) of β -galactocerebrosidase (**Scheme 3**), literature data on galactosidase inhibitors and previous experience of our group with iminosugars as pharmacological chaperones for Gaucher disease.

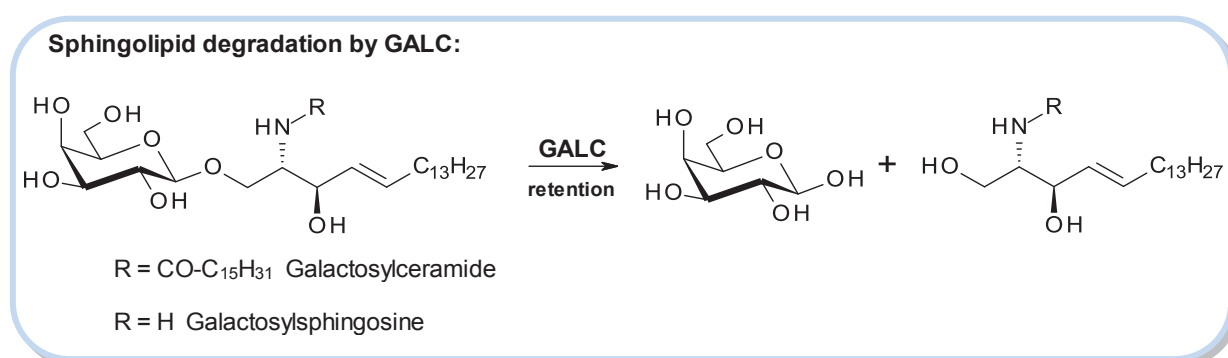

Scheme 3. Reaction of hydrolysis promoted by GALC.

I. General comments on GALC-mediated hydrolysis of β -galactosides

While cleaving glycosidic bond, glycosidases can retain or invert the configuration of the released sugar hemiacetal with respect to the substrate configuration.¹⁶³ GALC (EC 3.2.1.46) belongs to family 59 of glycoside hydrolases (GH59). As shown on **Scheme 4**, the hydrolysis performed by this group of enzymes occurs with retention of configuration. Catalytic glutamates present in GALC active site, nucleophilic E-258 and acidic E-182 were determined from mouse GALC X-Ray structure¹³¹. The distance between these two residues (5.0Å) is consistent with retaining mechanism of glycosidic bond hydrolysis.

¹⁶³ Davies, G.; Henrissat, B. *Structure* **1995**, *3*, 853.

¹³¹ Deane, J. E.; Graham, S. C.; Kim, N. N.; Stein, P. E.; McNair, R.; Cachon-Gonzalez, M. B.; Cox, T. M.; Read, R. J. *Proc Natl Acad Sci U S A* **2011**, *108*, 15169.

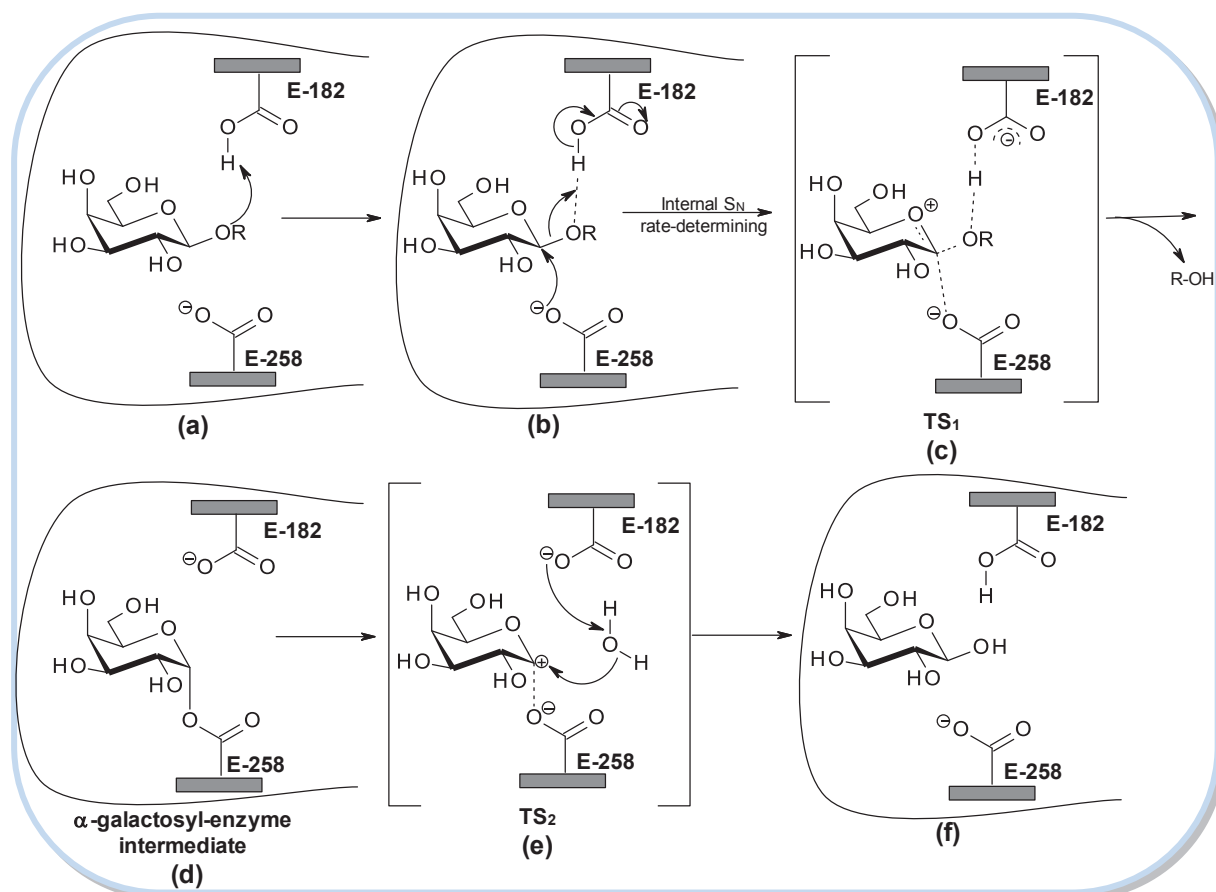

Scheme 4. Catalytic mechanism of configuration-retaining glycosidases, explained on mouse GALC.

The original mechanism for configuration-retaining glycosidases was proposed in 1953 by Koshland.¹⁶⁴ Despite several modifications it is still used now to describe this process. The first step is the protonation of the aglycone by the acidic residue of the enzyme and its activation as a leaving group (**Scheme 4, (a)**). Then, the nucleophilic enzyme residue, located on the opposite side of the sugar ring, attacks the anomeric carbon of sugar moiety (**b**) to form a glycosyl ester intermediate (rate-determining step, first transition state TS_1 , **(c)**). This transition state has significant oxocarbenium ion character, and the mechanism is borderline between S_N1 and S_N2 . Then the aglycone diffuses to form an α -galactosyl-enzyme intermediate (**(c/d)**). The molecule of water is then deprotonated by the conjugate base of the acidic enzyme residue and attacks the anomeric carbon of the sugar to cleave the newly formed glycosyl ester bond (second transition state TS_2 , **(e)**) and release β -galactose (**(f)**).¹⁶⁵

¹⁶⁴ Koshland, D. E. *Biological Reviews* **1953**, 28, 416.

¹⁶⁵ Heightman, T. D.; Vasella, A. T. *Angew Chem Int Ed* **1999**, 38, 750.

II. Structures of iminosugars of interest

Because of their ability to mimic in their protonated form the transition state of the glycoside hydrolysis reaction, iminosugars are potent glycosidase inhibitors.¹⁶⁶ In general, it has been observed that DNJ-like structures, with nitrogen replacing the ring oxygen atom, are selective and potent inhibitors for α -glycosidase, whereas IFG-like structures, where nitrogen occupies the position of the anomeric carbon, are potent β -glycosidase inhibitors.^{167,168} For galactosidases, 4-epi-IFG is indeed a very powerful β -galactosidase inhibitor, but DGJ derivatives are also good inhibitors of both α - and β -galactosidases. Nevertheless, as no inhibitors of GALC are known so far, we decided to investigate both types of structures in our search for potent and selective inhibitors of this enzyme.

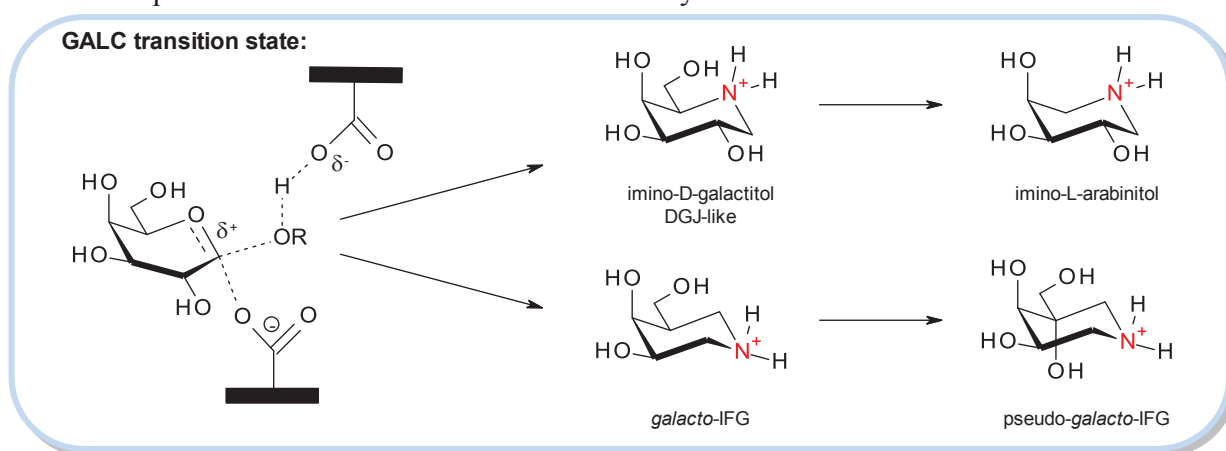

Scheme 5. GALC transition state and possible structures of inhibitors.

As shown in **Scheme 5**, the oxocarbenium ion character of the GALC transition state can be reproduced by creating structures in which the nitrogen atom is at the position of oxygen (DGJ-like) or of C-1 (*galacto*-IFG-like).

III. Detailed objectives

Our first objective, namely, the synthesis of imino-L-arabinitol derivatives as potential GALC inhibitors, was suggested by the previous work of our group on PC for GCase (glucocerebrosidase).^{169,170} Indeed, our group showed that iminosugars having an iminoxylitol core (OH configurations as in glucose, but no CH₂OH group at C-5, DIX) and carrying a

¹⁶⁶ Compain, P.; Martin, O. R. *Iminosugars: From Synthesis to Therapeutic Applications*; WILEY, 2007.

¹⁶⁷ Legler, G. In *Iminosugars as Glycosidase Inhibitors*; Wiley-VCH Verlag GmbH & Co. KGaA: 2004, p 31.

¹⁶⁸ Lundt, I.; Madsen, R. In *Iminosugars as Glycosidase Inhibitors*; Wiley-VCH Verlag GmbH & Co. KGaA: 2004, p 112.

¹⁶⁹ Compain, P.; Martin, O. R.; Boucheron, C.; Godin, G.; Yu, L.; Ikeda, K.; Asano, N. *ChemBiochem* 2006, 7, 1356.

¹⁷⁰ Yu, L.; Ikeda, K.; Kato, A.; Adachi, I.; Godin, G.; Compain, P.; Martin, O.; Asano, N. *Bioorg Med Chem* 2006, 14, 7736.

lipophilic C-linked aglycone, were even more powerful inhibitors of GCCase than the corresponding imino-D-glucitols (**Figure 18**). Moreover, Deane and co-workers showed in their X-ray structure of GALC-galactose complex that galactose orientation in the active site is similar to the one of glucose analogues in GCCase.¹³¹ This led us to the idea that compounds based on an imino-L-arabinitol structure may be also interesting as inhibitors of GALC.

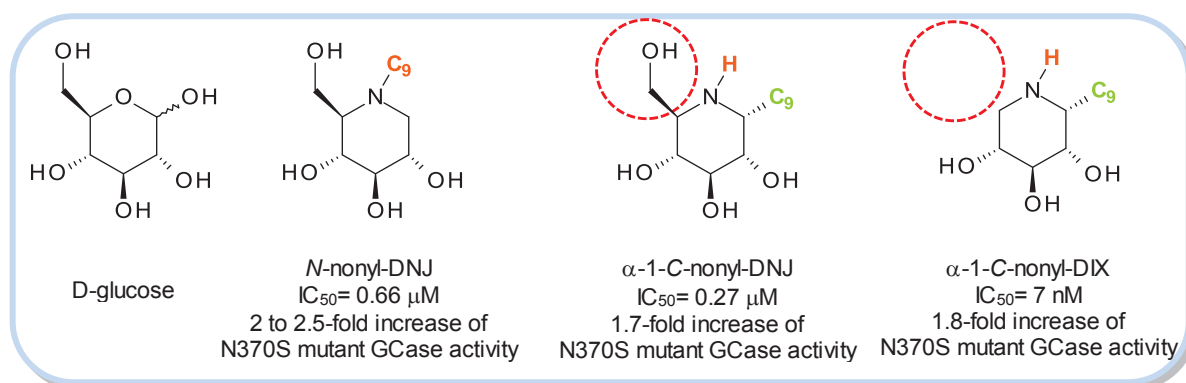

Figure 18. Potent GCCase inhibitors synthesised previously by our group.

Our synthetic strategy was based on the same principle as for the synthesis of 1-C-alkyl DIX derivatives: C-1 chain elongation by the addition of allyltrimethylsilane to an *N*-protected arabinopyranosylamine. Further elaboration by cyclization, double bond functionalization and deprotection should afford a small library of 1-C-alkyl imino-L-arabinitols (**Figure 19**). These compounds turned out to be completely devoid of activity as GALC inhibitors.

The second objective was the synthesis of imino-D-galactitols carrying a 1-C-linked lipophilic aglycone. We firstly used a strategy similar to that used for arabinitols, but in spite of intensive optimization, the desired compounds were obtained in very poor yield. However, this synthetic approach was used to obtain a related family of compounds, the C-5 epimer of the desired product namely imino-L-altritols which were functionalized and also submitted to biological tests (**Figure 19**). To reach the target imino-D-galactitols, we used another strategy, consisting of a C-6 chain elongation by way of Ellman's imine (*tert*-butanesulfinylimines) formation, followed by Grignard reagents addition. This provided us novel 1-C-alkyl-imino-D-galactitols (**Figure 19**).

The third type of structure of interest was 1-*N*-iminosugar derivatives related to D-galactose (*galacto*-IFG derivatives). As described by Ichikawa,¹⁶⁰ the parent *galacto*-IFG is a very potent inhibitor of β-galactosidases. Our goal was to synthesize various derivatives of

¹³¹ Deane, J. E.; Graham, S. C.; Kim, N. N.; Stein, P. E.; McNair, R.; Cachon-Gonzalez, M. B.; Cox, T. M.; Read, R. J. *Proc Natl Acad Sci U S A* **2011**, *108*, 15169.

¹⁶⁰ Ichikawa, Y.; Igarashi, Y.; Ichikawa, M.; Suhara, Y. *J Am Chem Soc* **1998**, *120*, 3007.

galacto-IFG carrying substituents at C-1, C-5 and at nitrogen to test them on GALC. The synthetic approach proved very challenging and required several improvements. Our studies led to two main structures: pseudo-*galacto*-IFG and 5-*C*-pentyl-pseudo-*galacto*-IFG. Although the first one was previously described by Ichikawa,¹⁷¹ our synthesis was shorter with better overall yield.

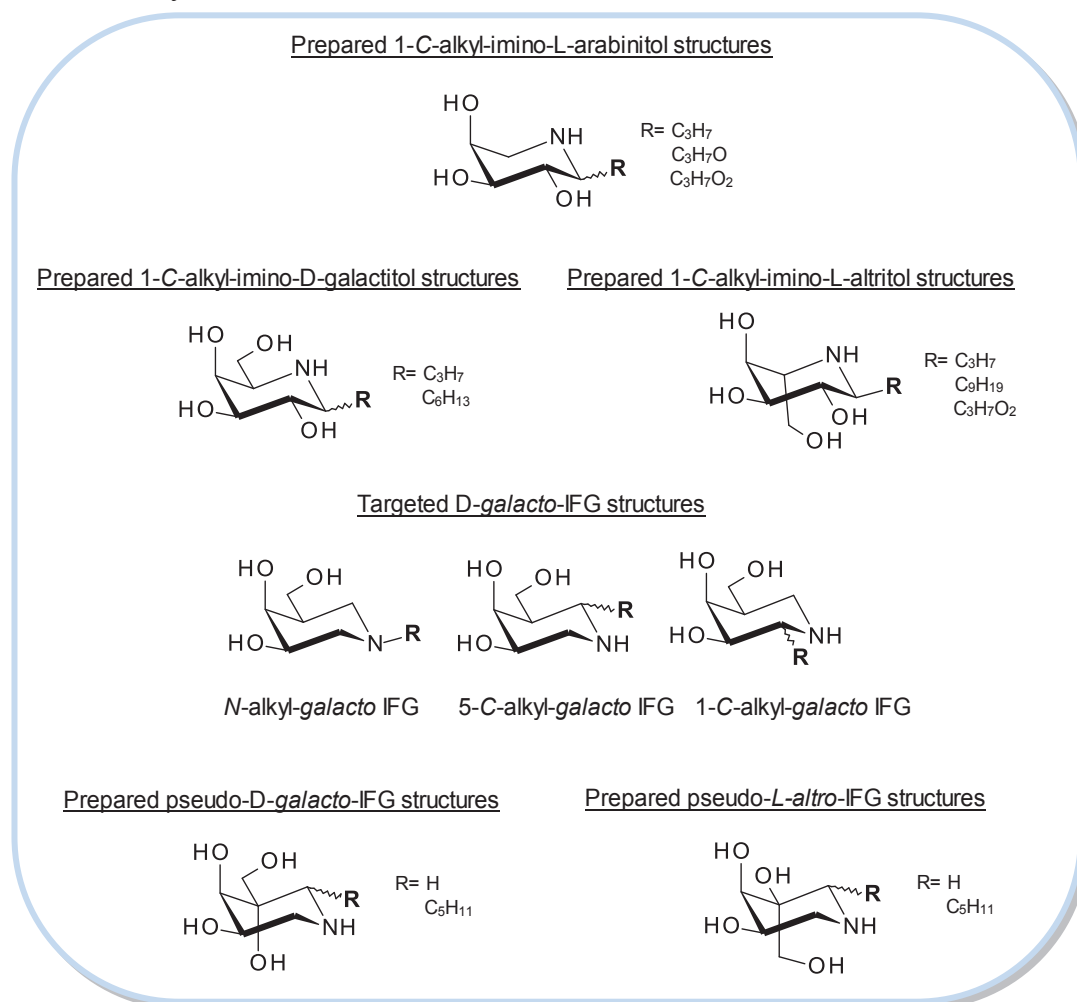

Figure 19. Target and achieved structures of potential GALC inhibitors.

The final objective of this project was to realize the biological assays of synthesized compounds. Thanks to the collaboration with Dr Asano (Hokuriku University, Japan) our compounds were tested on various galactosidases to determine their inhibitory properties and their selectivity. Experiments have also been performed on human lysosomal GALC in collaboration with Dr Wenger, (Thomas Jefferson University, USA) and further biological investigations on mutant lysosomal GALC will be conducted, in part by myself, in the research group of Dr. M. Petryniak (at the Oregon Health Science University, USA).

¹⁷¹ Ichikawa, M.; Ichikawa, Y. *Bioorg Med Chem* **1995**, 3, 161.

Results and discussion

I. The synthesis and biological evaluation of 1-C-alkyl-imino-L-arabinitols.

I.1 Synthetic strategy.

The synthesis of 1-C-alkyl-imino-D-xylitols acting as pharmacological chaperones for Gaucher disease, previously designed and performed by our group was very favorable for the following reasons:

- efficiency of synthetic route with a 26% overall yield for 10 steps¹⁷²
- possibility of obtaining a wide range of different compounds by adding one step (functionalization of the double bond or chain elongation via cross metathesis)
- excellent inhibitory and chaperone properties of the iminoxylitol derivatives towards β -glucocerebrosidase

As the deficient enzyme involved in Krabbe disease is a β -galactocerebrosidase, we decided to benefit from the experience we had with imino-D-xylitols and use at first the same synthetic strategy to prepare 1-C-alkyl-imino-L-arabinitols of well defined configuration (*Scheme 6*).

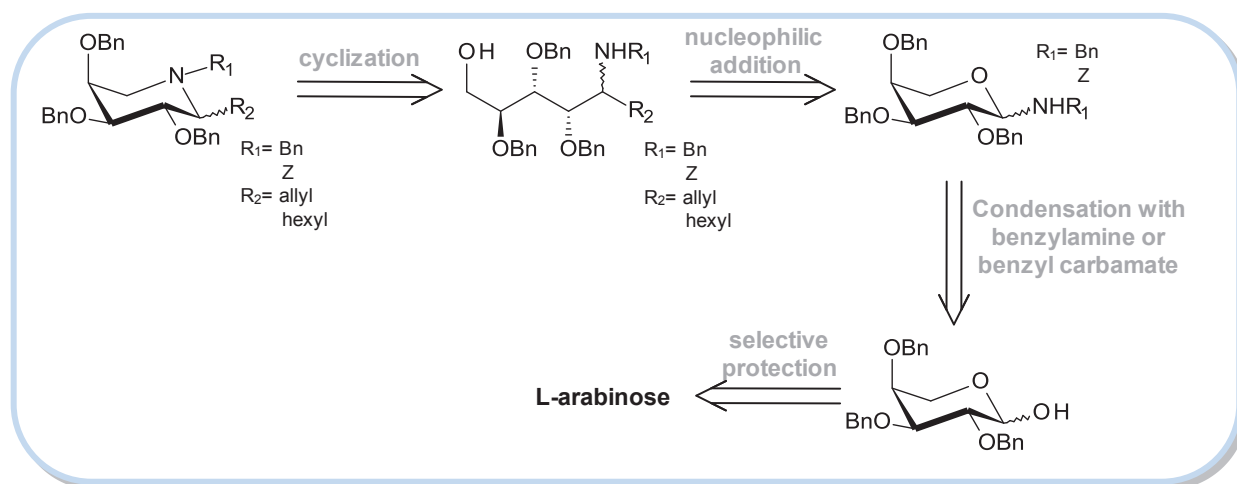

Scheme 6. Synthetic strategy towards 1-C-alkyl-imino-L-arabinitols by C-1 chain extension

This approach, originally developed by Nicotra,^{173,174} consists of four major steps:

- selective protection and deprotection of commercially available L-arabinose to form tri-O-benzyl-L-arabinopyranose
- condensation of the hemiacetal either with benzylamine or with benzyl carbamate

¹⁷² Biela, A.; Oulaïdi, F.; Gallienne, E.; Górecki, M.; Frelek, J.; Martin, O. R. *Tetrahedron* **2013**, *69*, 3348.

¹⁷³ Cipolla, P.; Castano, M.; Kirchin, M. A.; de Haen, C.; Tirone, P. *Acad Radiol* **1995**, *2*, 306.

¹⁷⁴ Cipolla, L.; Lay, L.; Nicotra, F.; Pangrazio, C.; Panza, L. *Tetrahedron* **1995**, *51*, 4679.

- iii. diastereoselective nucleophilic addition of Grignard reagents or of allyltrimethylsilane to the *N*-protected arabinopyranosylamine (C-1 chain elongation, the key step)
- iv. cyclisation by an intramolecular S_N2 reaction

Functionalization of the double bond was performed on the *N*-Z protected iminosugars, while the *N*-Bn compounds were directly deprotected to give 1-*C*-propyl-imino-L-arabinitols (**Scheme 7**).

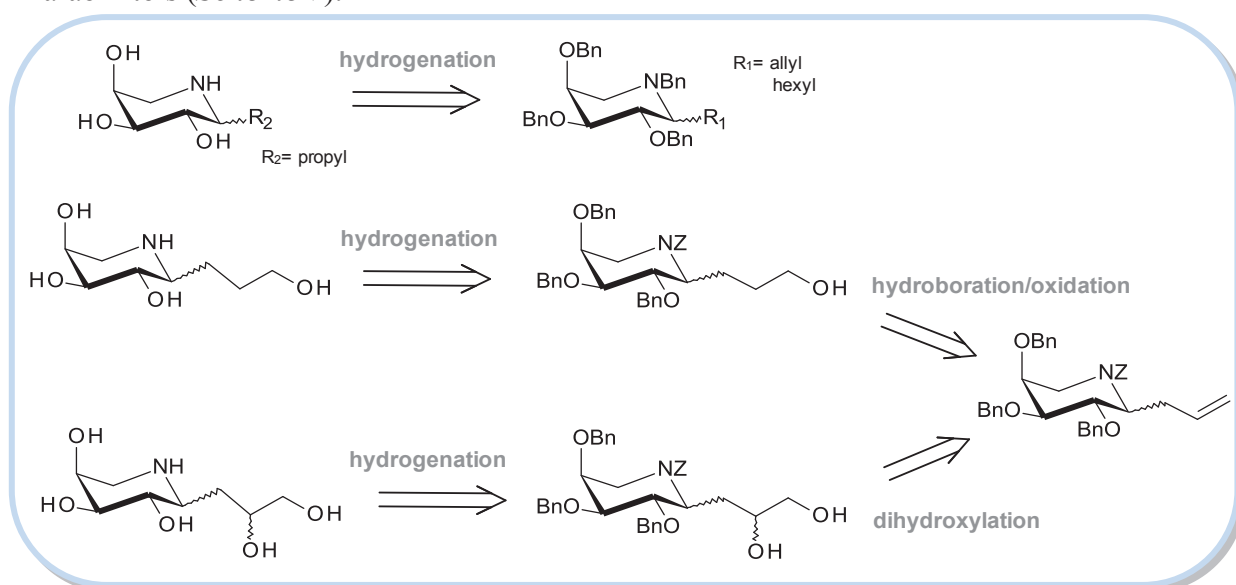

Scheme 7. Functionalization and deprotection of imino-L-arabinitol derivatives.

I.2 Synthesis of 2,3,4-tri-*O*-benzyl- α,β -L-arabinopyranose **3**

This known compound¹⁷⁵ was prepared in three steps from L-arabinose. L-arabinose was first converted into methyl L-arabinopyranoside **1** in refluxing methanolic HCl. The three hydroxyl groups of **1** were then benzylated under standard conditions to give **2** and then the methyl glycoside was hydrolyzed under strongly acidic conditions to afford **3** in moderate yield.

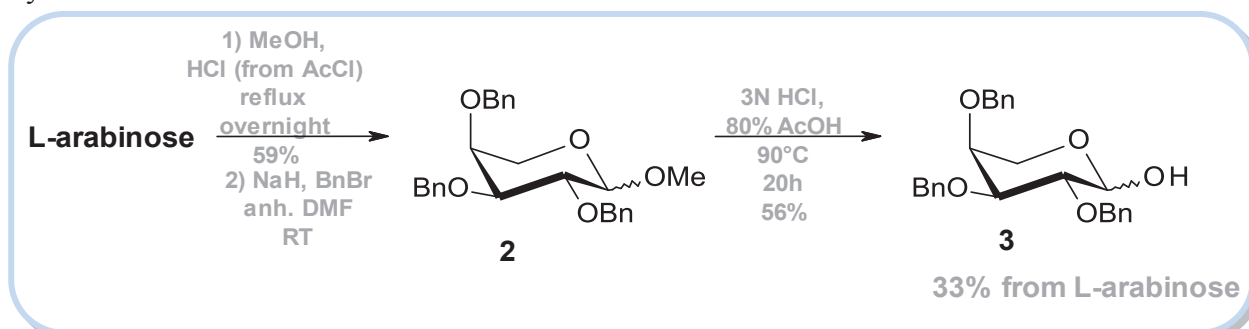

Scheme 8. Synthesis of 2,3,4-tri-*O*-benzyl- α,β -L-arabinopyranose **3**.

¹⁷⁵ Zhao, G.-L.; Yu, Z.-Y.; Li, Y.; Pang, L.-N.; Wang, J.-W. *Chin J Chem* **2008**, *26*, 158.

I.3 Synthesis of protected arabinopyranosylamines 4 and 11

For the preparation of compound **4**, 2,3,4-tri-*O*-benzyl- α,β -L-arabinopyranose **3** was directly submitted to condensation with benzylamine.¹⁷⁶ In the processing, a coevaporation with toluene was used to remove the excess of benzylamine and the crude product **4** was clean enough to be used for further reactions.

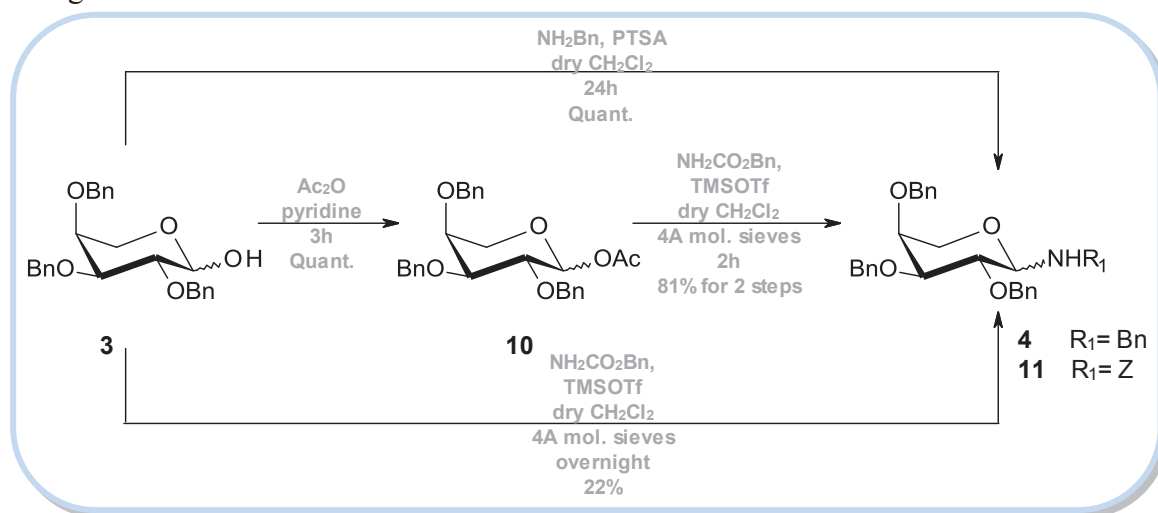

Scheme 9. Synthesis of protected arabinopyranosylamines **4** and **11**.

By contrast, the direct condensation of **3** with benzyl carbamate in the presence of trimethylsilyl trifluoromethanesulfonate resulted in a complex mixture of the desired amine **11** and by-products, with a drastically low yield (22%). To improve the synthesis of **11**, hemiacetal **3** was firstly acylated using acetic anhydride in pyridine¹⁷⁷ to give **10** which was then condensed with benzyl carbamate as described previously by our team.¹⁷⁸ This simplified the purification and increased the yield of **11** to 81% over two steps.

I.4 C-1 chain elongation of *N*-protected glycosylamines

The C-1 chain elongation could be conducted on both glycosylamines, but under different conditions: as described by Nicotra,¹⁷⁴ *N*-benzyl glycosamines are convenient substrates for chain-extension by the addition of an organometallic reagent (Grignard reagent, R-Li). However, the stereoselectivity of the addition is often modest. In our group, we have shown that *N*-COOBn glycosylamines can be submitted to chain-elongation by the reaction with a silylated nucleophile (e.g. allyltrimethylsilane) in the presence of a Lewis acid, with

¹⁷⁶ Lay, L.; Nicotra, F.; Paganini, A.; Pangrazio, C.; Panza, L. *Tetrahedron Lett* **1993**, *34*, 4555.

¹⁷⁷ Lucero, C. G.; Woerpel, K. A. *J Org Chem* **2006**, *71*, 2641.

¹⁷⁸ Liautard, V.; Pillard, C.; Desvergnès, V.; Martin, O. R. *Carbohydr Res* **2008**, *343*, 2111.

¹⁷⁴ Cipolla, L.; Lay, L.; Nicotra, F.; Pangrazio, C.; Panza, L. *Tetrahedron* **1995**, *51*, 4679.

excellent diastereoselectivity.¹⁷⁹ Both procedures were investigated from the glycosylamines **4** and **11** (*Scheme 10*).

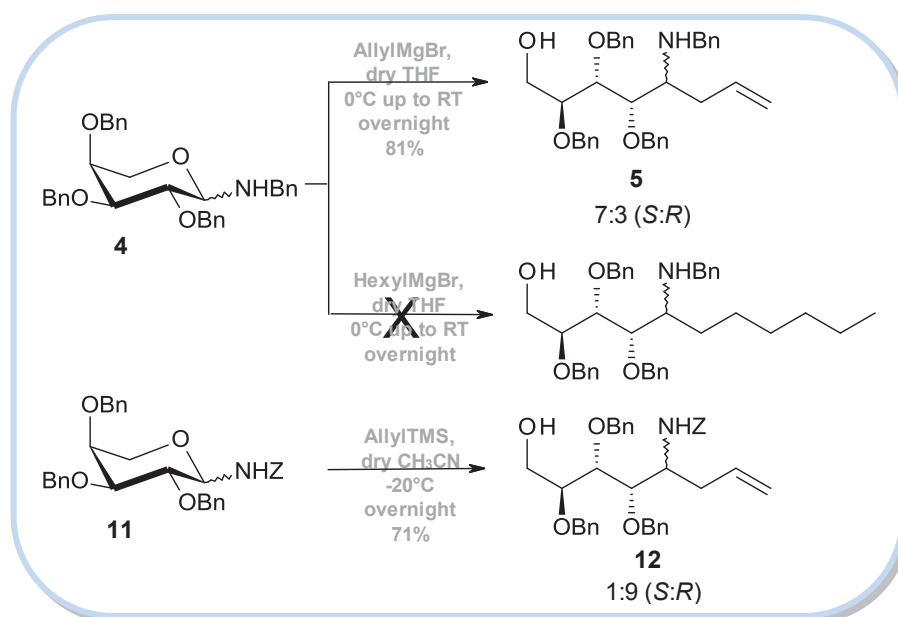

Scheme 10. C-1 chain elongation of *N*-protected glycosylamines.

Addition of allylmagnesium bromide directly onto **4** gave the open chain product **5** in 81% yield as a 7:3 mixture of diastereoisomers in favour of the *S* (*anti*) isomer. Surprisingly, the same reaction with hexylmagnesium bromide failed to give the expected 1-*C*-hexyl derivative.

The first assay of addition of allyltrimethylsilane to **11** using 0.5 eq of trimethylsilyl trifluoromethanesulfonate as an azaphilic¹⁸⁰ Lewis acid gave the desired amine **12** in 87% yield but difficult to purify. The same reaction with 1 eq of Lewis acid gave much cleaner compound in 71% yield. It is worth mentioning that the reaction did not have to be conducted at -40°C as previously done in our team,¹⁷⁹ but at -20°C. In contrast to the reaction of the *N*-benzyl glycosamine, the addition of allyltrimethylsilane to the *N*-*Z* compound gave selectively the *syn* isomer (9:1 ratio). Both mixtures of diastereoisomers were not separable at this stage. The difference in the diastereoselectivity of those two reactions comes from different mechanisms. The *N*H*Bn* group is first deprotonated which favors ring opening to an alkoxide. Then we would expect a mechanism with a chelation-controlled addition onto the imine. This model would however favour the *syn* isomer (which is generally observed in such additions to glycosylamines). The formation of the *anti* product in this case is unusual and we do not have a good explanation for its formation.

¹⁷⁹ Liautard, V.; Desvergnès, V.; Itoh, K.; Liu, H.-W.; Martin, O. R. *J. Org. Chem.* **2008**, *73*, 3103.

¹⁸⁰ Kobayashi, S.; Busujima, T.; Nagayama, S. *Chemistry* **2000**, *6*, 3491.

Kobayashi proposed the mechanism of the reaction of nucleophilic addition mediated by Lewis acid (**Scheme 11**). The first step is glycosylamine opening, where the open-chain form is stabilised by coordination of trimethylsilyl group of Lewis acid to oxygen and nitrogen charge compensation by triflate anion. Then nucleophile attacks iminium carbon, the Lewis acid catalyst is recovered and during aqueous treatment the O-TMS group is hydrolyzed to free alcohol.

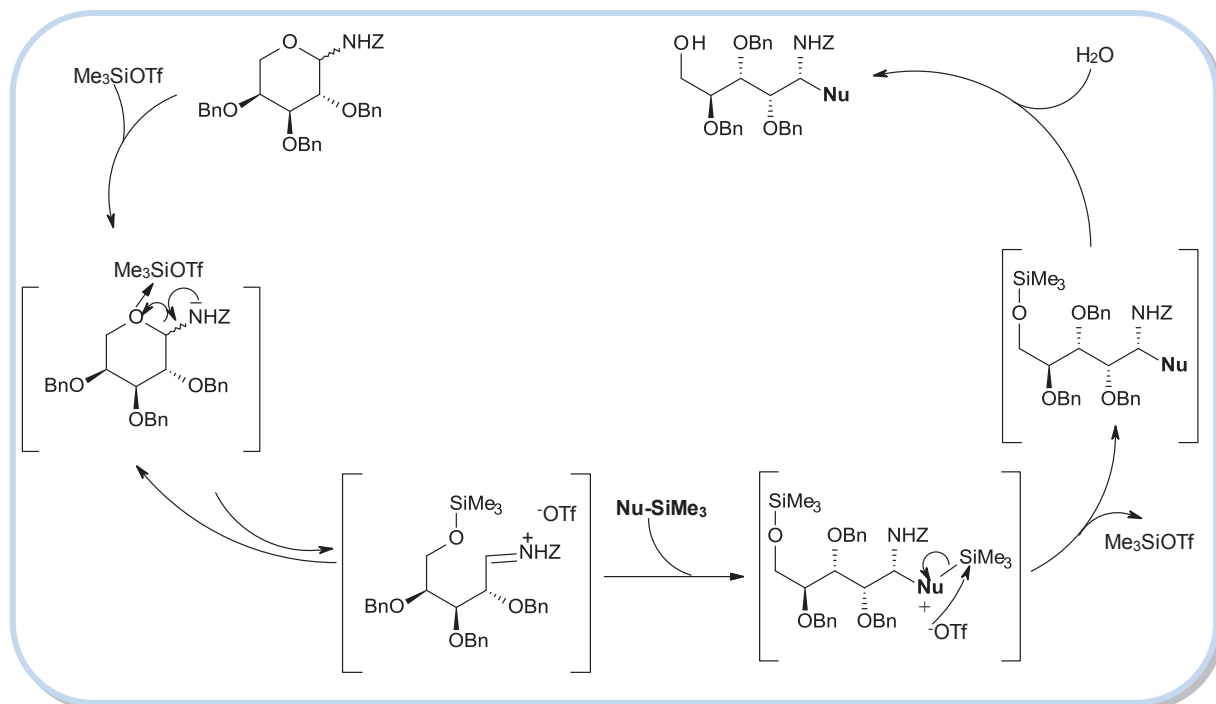

Scheme 11. Mechanism of the reaction of nucleophilic addition mediated by Lewis acid proposed by Kobayashi.

The stereochemistry of this reaction is influenced by the asymmetric environment in α of the electrophilic carbon. We can assume that the formation of a hydrogen bond between oxygen in position 2 and hydrogen of the iminium (**Scheme 12**) defines the conformation of iminium intermediate. In this case, the *Si* face is crowded and the nucleophilic attack comes from the *Re* face resulting in *syn* product.

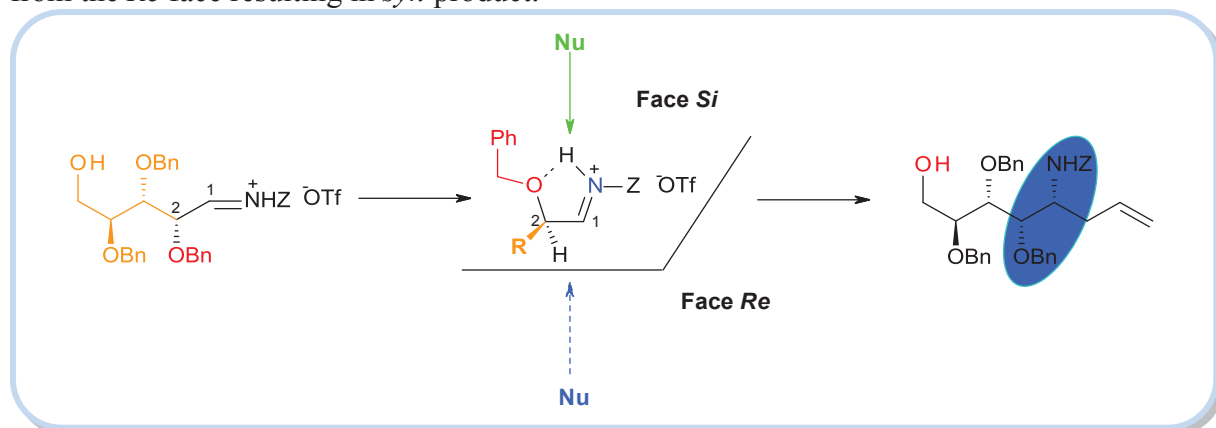

Scheme 12. Explanation for the observed diastereoselectivity.

I.5 Intramolecular S_N2-type cyclisation

For both open chain intermediates **5** and **12**, the cyclisation was performed by way of a mesylation. However, while **6** and **7** were obtained by spontaneous intramolecular S_N2 upon activation of the hydroxyl group of **5**,¹⁷⁴ the strong base *t*BuOK was needed to activate the benzyl carbamate and to cyclise **12** to **14** and **15**.

According to the NMR analysis, the major, pseudo α -(*S*)-isomer **6** is in a well defined ⁴C₁ chair conformation, while its minor epimer, the pseudo β -(*R*)-**7** exists in an equilibrium of two chair forms: ⁴C₁ and ¹C₄ (**Scheme 13**). This can be explained by the fact that each of these two conformers of **7** has two axial and two equatorial substituents, the two chair forms being thus of similar stability.

Considering the *N*-Z protected derivatives, the direct determination of the pseudo anomeric configuration in **14** and **15** was difficult as a result of the low quality of their ¹H NMR spectra due to the presence of rotamers. However, it is known that *N*-acyl protected piperidines usually favor the conformation in which the substituent α to nitrogen is in axial position.^{181,182} We assumed then that the minor, pseudo α (*S*) isomer **14** would be in ¹C₄ chair conformation with three axial substituents (**Scheme 13**) and the major, pseudo β (*R*) isomer **15** would be in ⁴C₁ chair conformation. Thus both **14** and **15** have their *C*-alkyl substituent axial. To confirm this assignment, epimers **14** and **15** were selectively *N*-deprotected by hydrogenolysis under basic conditions in order to avoid *O*-debenzylation, to obtain **16** and **17** respectively. The large coupling constants in **16** ($J_{1-2}=J_{2-3}= 9.3$ Hz) suggested that this compound adopted the ⁴C₁ conformation, while small constants for **17** ($J_{1-2}= 1.9$ Hz, $J_{2-3}=J_{3-4}= 2.8$ Hz) indicated ¹C₄ conformation. Both compounds are formed in the more stable conformation which has the propyl group equatorial, unlike **14** and **15**. This means that piperidines **14** and **15** inverted their conformations upon *N*-protecting group cleavage (from ¹C₄ of **14** to ⁴C₁ of **16** and from ⁴C₁ of **15** to ¹C₄ of **17**). The difference between the conformations of the corresponding isomers in the *N*-Bn and *N*-Z protected series is thus due to the presence of the carbonyl group in *Z* group, which forces the molecule to adopt specific orientation of the substituents α to nitrogen.

¹⁷⁴ Cipolla, L.; Lay, L.; Nicotra, F.; Pangrazio, C.; Panza, L. *Tetrahedron* **1995**, *51*, 4679.

¹⁸¹ Johnson, F. *Chem Rev* **1968**, *68*, 375.

¹⁸² Paulsen, H.; Todt, K.; Ripperger, H. *Chem Ber* **1968**, *101*, 3365.

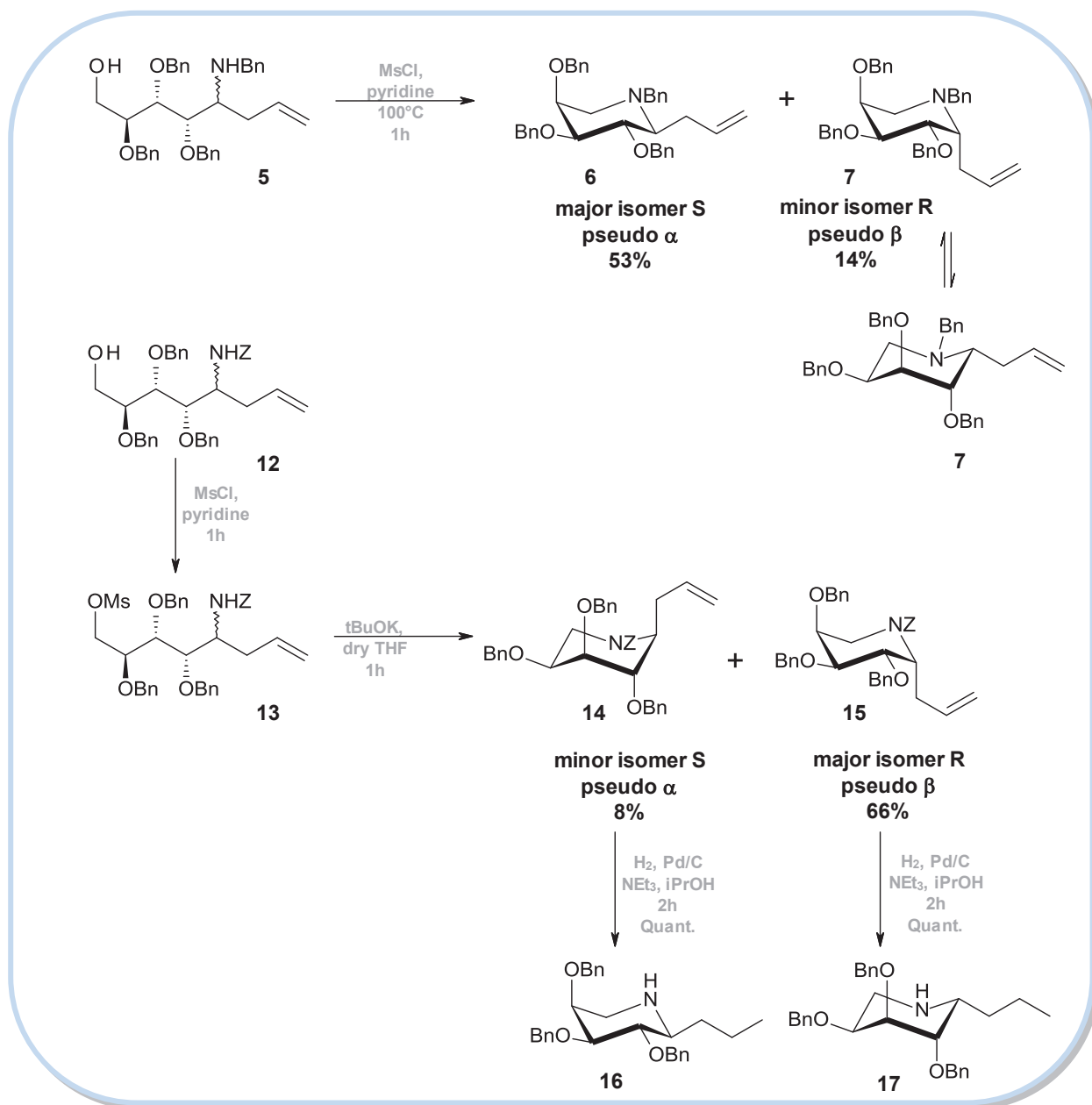

Scheme 13. Intramolecular S_N2 -type cyclisation.

I.6 Functionalization of double bond and deprotection: preparation of iminosugars 8, 9, 19, 20 and 22.

As mentioned before, the *N*-Bn protected imino-*L*-arabinitols are not compatible with oxidation reactions of the double bond: the non-deactivated nitrogen atom of the amine could be itself oxidized. The *N*-Bn glycosylamines were designed to undergo reactions with various Grignard reagents, which, except with the allyl reagent, failed. Compounds **6** and **7** were fully deprotected to prepare pseudo α -(1*S*)- and pseudo β -(1*R*)-1-*C*-propyl-1,5-dideoxy-1,5-imino-*L*-arabinitols **8** and **9** respectively (**Scheme 14**). We predicted that the first compound (**8**) would have the same 4C_1 conformation as his precursor **6**. For the other isomer **9**, the conformation should be well defined this time as a 1C_4 chair conformation with the propyl

chain in equatorial position. The first hypothesis was confirmed by the analysis of ^1H NMR spectrum, despite its low resolution. For compound **8**, both H5 have one large ($J_{5eq-5ax} = 13.75$ Hz) coupling constant, and the other much smaller ($J_{5eq-4} = 1.5$ Hz, $J_{5ax-4} = 2.75$ Hz). This indicates that H4 is equatorial, which confirms the $^4\text{C}_1$ chair conformation. Compound **9** exhibited broad signals in its ^1H NMR spectrum in $\text{MeOH-}d_4$ and we could not verify its conformation.

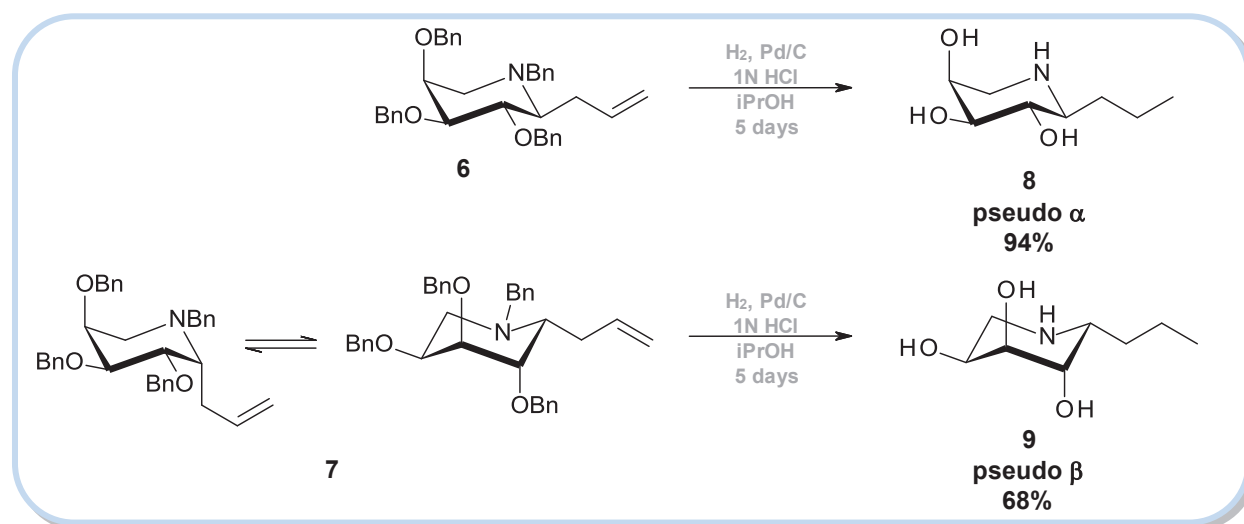

Scheme 14. Deprotection of iminosugars **6** and **7**.

N-Z Protected imino-L-arabinitols were submitted to further functionalization. We investigated two modes of functionalization designed to add polar substituents to the pseudo aglycone, to mimic more closely the natural substrates of GALC. For this the introduction of one hydroxyl group by hydroboration/oxidation and of two hydroxyl groups by dihydroxylation were envisaged. Another potential modification would be chain elongation by cross metathesis; however, we limited our investigation to the formation of more polar aglycones (**Scheme 15**).

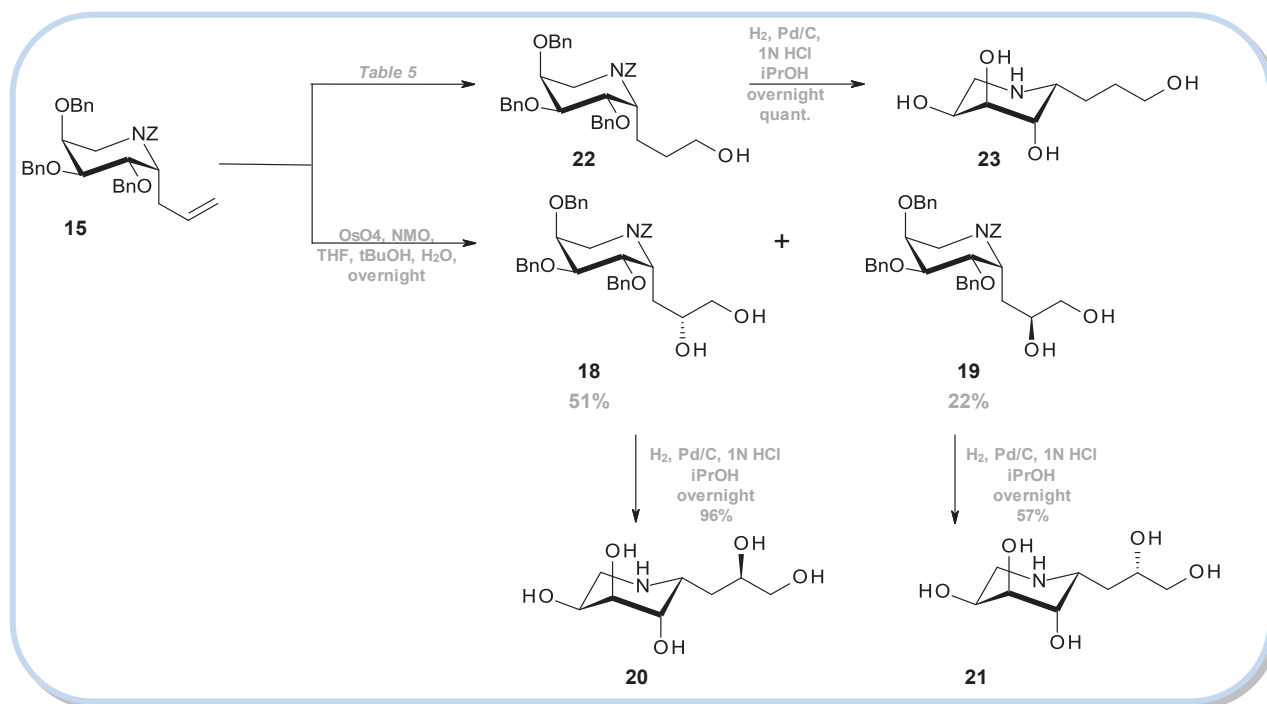

Scheme 15. Functionalization of double bond.

Hydroboration/oxidation reaction of **15** turned out to be a challenging task. Various hydroboration agents were tried, but the reaction was never complete and the yield was moderate (**Table 5**). The best result was achieved by using catecholborane in the presence of Wilkinson catalyst (**Figure 20**), which is known to improve hydroboration of alkenes with catecholborane and pinacolborane.¹⁸³ According to our experiments, this catalyst is not compatible with 9-BBN, as its addition drastically lowered the yield. The best conditions gave compound **22** in 46% yield and 14% of starting material was recovered. We were aware of the need for additional optimization, but as we obtained enough product to continue, we decided to finish the synthesis and to wait for biological evaluation results before working again on this reaction.

Reagent	Eq	Temp	Catalyst	Yield	SM recovered
Pinacolborane	6	40°C	--	--	50%
Catecholborane	2+2	40°C	--	36%	37%
Catecholborane	2	40°C	Wilkinson, (2%)	46%	14%
9BBN	2	40°C	--	28%	35%
9BBN	2	40°C	Wilkinson, (2%)	8%	30%

Table 5. Different conditions for the hydroboration of **15**. All reactions were conducted in THF.

¹⁸³ Evans, D. A.; Fu, G. C.; Hoveyda, A. H. *J Am Chem Soc* **1988**, *110*, 6917.

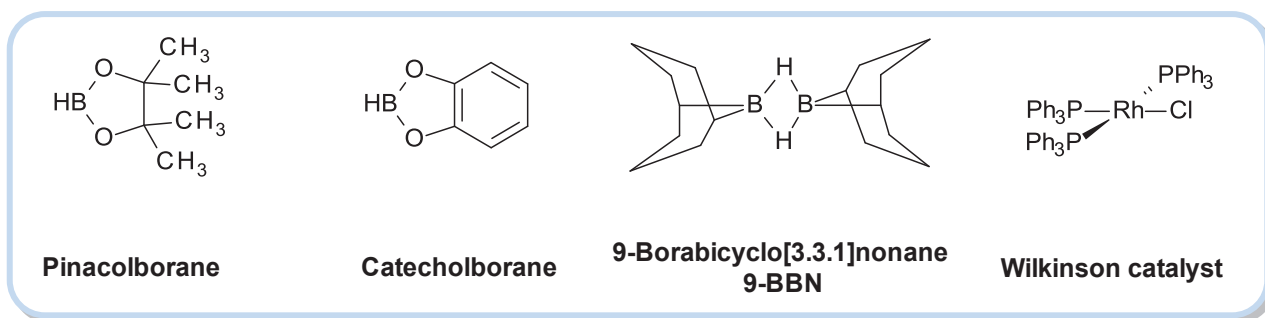

Figure 20. Reagents used for hydroboration/oxidation reaction.

Dihydroxylation of **15** was efficiently (73% overall yield) realized using the OsO₄/NMO system¹⁸⁴ leading to a separable mixture of diastereoisomers **18** and **19**. The configurations of the secondary alcohols were determined by circular dichroism analysis¹⁸⁵ with the kind help of Prof. Frelek team (Institute of Organic Chemistry of Polish Academy of Science in Warsaw, Poland). The *in situ* dimolybdenum methodology of electronic circular dichroism spectroscopy (ECD) has been applied. This straightforward, simple, and reliable approach consists of mixing a nonracemic transparent *vic*-diol with dimolybdenum tetraacetate acting as an auxiliary chromophore. The transition metal ions, when complexed to an optically active ligand, become involved in the symmetry of the ligand. Thus, the Cotton Effects (CEs) related to electronic transitions of the metal atom are obtained and they are characteristic for the absolute configuration of the compound acting as ligand (in this case 1,2-diol). In general, an application of the helicity rule relating the sign of the O-C-C-O torsional angle with the sign of the CEs arising in the 300–400 nm spectral range allows an unequivocal assignment of the stereostructure of investigated diol units. This is due to the fact that in the chiral Mo-complexes formed *in situ* the conformational mobility of diols is very much reduced due to the restricted rotations of the remaining acetate ligands still coordinated to the metal atoms. Thus, this reduction or restriction of the conformational freedom makes an absolute configurational assignment possible on the basis of the chiroptical data alone.

¹⁸⁴ Schonemann, W.; Gallienne, E.; Compain, P.; Ikeda, K.; Asano, N.; Martin, O. R. *Bioorg Med Chem* **2010**, *18*, 2645.

¹⁸⁵ Górecki, M.; Jabłońska, E.; Kruszewska, A.; Suszczyńska, A.; Urbańczyk-Lipkowska, Z.; Gerards, M.; Morzycki, J. W.; Szczepiek, W. J.; Frelek, J. *J Org Chem* **2007**, *72*, 2906.

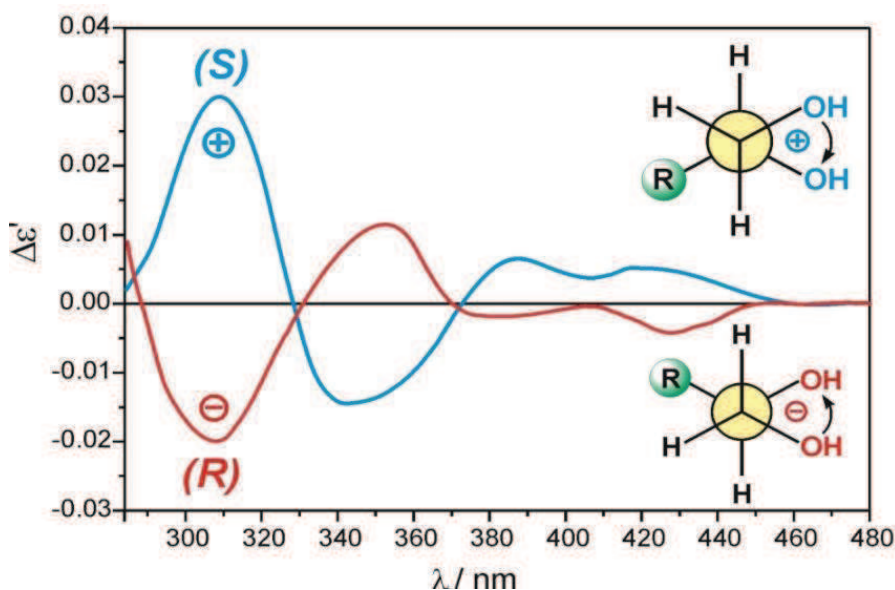

Figure 21. ECD spectra of in situ formed Mo-complexes of **18** (red line) and **19** (blue line) recorded in DMSO. The preferred conformation of the diols in the chiral Mo-complexes is shown on the right.

As can be seen in **Figure 21**, a positive helicity of the diol **18** correlates with positive CEs at 310 and 380 nm whilst the inverse correlation of helicity of the diol subunit and sign of CEs takes place for diol **19**. Thus, provided the relative configuration of *vic*-diol after ligation to the Mo₂-core to be *gauche* with preferred antiperiplanar orientation of the hydroxyl group *versus* bulky substituent, the absolute configuration of the newly formed stereogenic center in **18** is (*R*) and in **19** (*S*).

Finally, all the above compounds were deprotected by hydrogenolysis under acidic conditions to afford the *L-arabino* functionalized iminosugars **20**, **21** and **23**. The presence of the acid in those reactions was necessary to avoid the poisoning effect of the formed free amine on the catalyst.¹⁸⁶

I.7 Biological evaluation

Compounds **20**, **21** and **23** were submitted to biological assays to investigate their inhibitory activities and selectivity towards α -galactosidase, β -galactosidase and β -galactocerebrosidase. The tests on two first enzymes were conducted both in Prof. Asano and Dr Wenger laboratories, while the analysis on GALC was performed by Dr Wenger exclusively. All studied iminosugars showed no activity towards those enzymes. Preliminary work in our group allowed, using another methodology,²⁰² the synthesis of pseudo α and pseudo β 1-*C*-hexyl- and 2-*O*-hexyl-imino-*L*-arabinitols (**Figure 22**), which were also tested and found to be inactive towards these enzymes. These deceiving results were justified

¹⁸⁶ Czech, B. P.; Bartsch, R. A. *J Org Chem* **1984**, *49*, 4076.

²⁰² Oulaïdi, F.; Gallienne, E.; Compain, P.; Martin, O. R. *Tetrahedron: Asymmetry* **2011**, *22*, 609.

recently by modeling studies performed on the very recently published¹³¹ mouse GALC structure (83% homology with human GALC). They have confirmed that for β -galactocerebrosidase, the CH₂OH group is essential for binding to the active site of the enzyme.

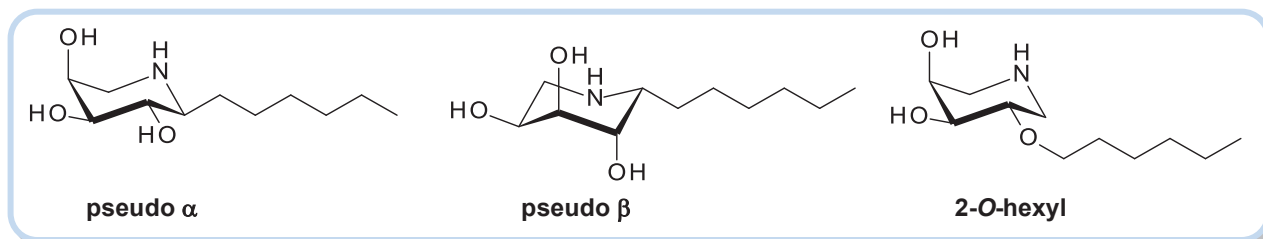

Figure 22. Structures of synthesized pseudo α and pseudo β 1-C-hexyl- and 2-O-hexyl-imino-L-arabinitols.

I.8 Conclusions

In conclusion, we have successfully applied our existing methodology to obtain 1-C-substituted imino-L-arabinitols. The key step is the diastereoselective addition of allylmagnesium bromide or allyltrimethylsilane which takes place on the open-chain form of a glycosylamine. Moreover, the diastereoselectivity is opposite for *N*-Bn and *N*-Z protected amines, which gave thus access to both pseudo anomers of the 1-C-alkyl imino-L-arabinitol derivatives. In addition, this strategy allows the direct functionalization of the allyl substituent using oxidation reactions, leading to a diversity of non-functionalized or functionalized 1-C-alkylated iminosugars.

¹³¹ Deane, J. E.; Graham, S. C.; Kim, N. N.; Stein, P. E.; McNair, R.; Cachon-Gonzalez, M. B.; Cox, T. M.; Read, R. J. *Proc Natl Acad Sci U S A* **2011**, *108*, 15169.

Résumé section I:

Synthèse et évaluation biologique des 1-C-alkyl-imino-L-arabinitols.

Sur la base des résultats très prometteurs que notre groupe a obtenus avec les 1-C-alkyl-imino-D-xylitols comme chaperons pharmacologiques pour la maladie de Gaucher, nous avons décidé de préparer de nouveaux 1-C-alkyl-imino-L-arabinitols, portant une aglycone polaire ou apolaire. Les arabinitols sont les analogues des galactitols ne possédant pas de groupement CH₂OH en position C-5. La synthèse s'est déroulée en quatre étapes principales:

- i. protection et déprotection sélective du L-arabinose commercial pour parvenir au tri-*O*-benzyl-L-arabinopyranose
- ii. condensation de l'hémiacétal soit avec la benzylamine soit avec le carbamate de benzyle
- iii. addition nucléophile diastéréosélective de réactifs de Grignard ou d'allyltriméthylsilane sur l'arabinopyranosylamine N-protégée
- iv. cyclisation par réaction de S_N2 intramoléculaire

L'étape clé de cette stratégie d'élongation de la chaîne en C-1 est une addition diastéréosélective de bromure d'allylmagnésium ou d'allyltriméthylsilane sur la forme ouverte de la glycosylamine. La diastéréosélectivité observée est différente selon que l'amine est protégée par un groupement Bn ou Z, ce qui a donné ainsi accès aux deux anomères pseudo α et β des dérivés 1-C-alkyl imino-L-arabinitols. Cette stratégie a permis à partir du dérivé *N*-Z la fonctionnalisation directe du groupement allyle en utilisant des réactions d'oxydation, conduisant à une diversité d'iminosucres 1-C-alkylés fonctionnalisés, tandis que les composés *N*-Bn ont été déprotégés directement pour donner les 1-C-propyl-imino-L-arabinitols.

Les composés obtenus ont été soumis aux essais biologiques permettant d'évaluer leurs activités inhibitrices et leur sélectivité vis-à-vis de l' α -galactosidase et de la β -galactosidase lysosomales et de la β -galactocérébrosidase. Les iminosucres étudiés n'ont montré aucune activité envers ces enzymes. Des études récentes de modélisation sur la structure de la GALC ont montré que le groupement CH₂OH est essentiel pour la liaison au site actif de l'enzyme, ce qui explique ces résultats décevants.

II. The synthesis of 1-C-alkyl-imino-D-galactitols.

II.1 Synthetic strategy

After having successfully achieved the synthesis of non-functionalized and functionalized 1-C-alkylated imino-L-arabinitols, we moved to our second objective which was the synthesis of 1-C-alkyl imino-D-galactitols. We wanted to compare these two groups of compounds to investigate structure-activity relationships, in particular the influence of the CH₂OH group. To prepare imino-D-galactitol derivatives we applied a synthetic strategy similar to that used for *arabino* and *xylo* series (**Scheme 16**) with three differences:

- we used commercially available 2,3,4,6-tetra-*O*-benzyl-D-galactopyranose as the starting material
- the synthesis was performed on *N*-Z protected amines only
- cyclisation to protected iminosugars was achieved by intramolecular reductive amination, not by an intramolecular S_N2 reaction

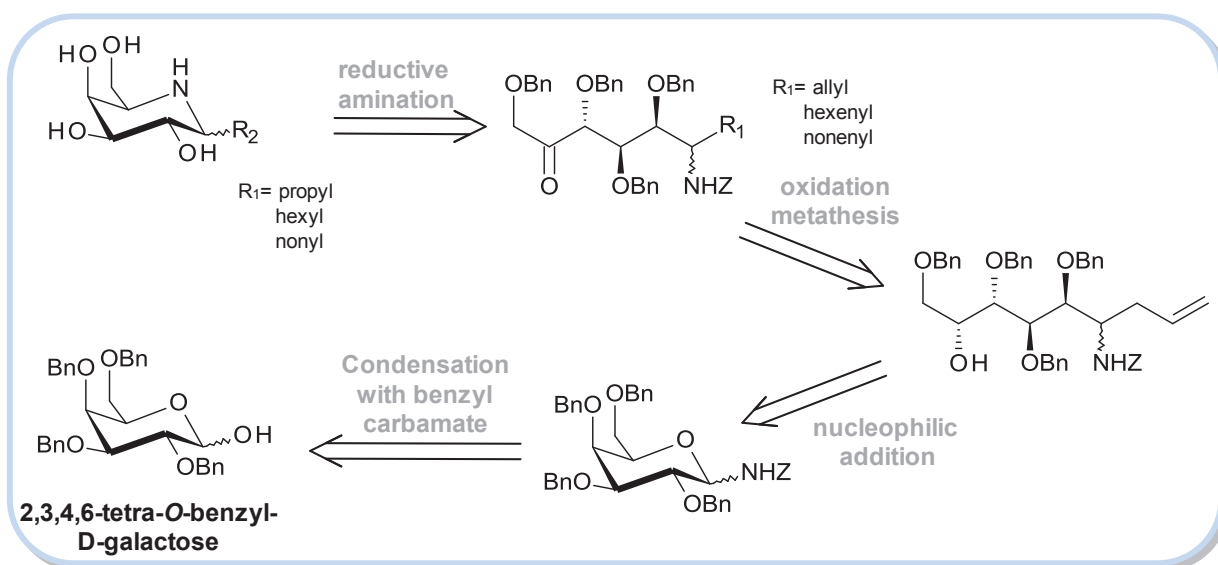

Scheme 16. Synthetic strategy towards 1-C-alkyl-imino-D-galactitols.

The final step of the synthesis could not be achieved by intramolecular S_N2 for the following reason. In the *galacto* open-chain intermediate **26**, position C-5 is a secondary alcohol, which under S_N2 conditions will undergo a Walden inversion.¹⁸⁷ As a result, by using the substitution approach, we would obtain the *L-althro* iminosugars instead of the *D-galacto* isomers (**Scheme 17**). This was actually also done and will be discussed later in this report.

¹⁸⁷ Walden, P. *Berichte der deutschen chemischen Gesellschaft* **1896**, 29, 133.

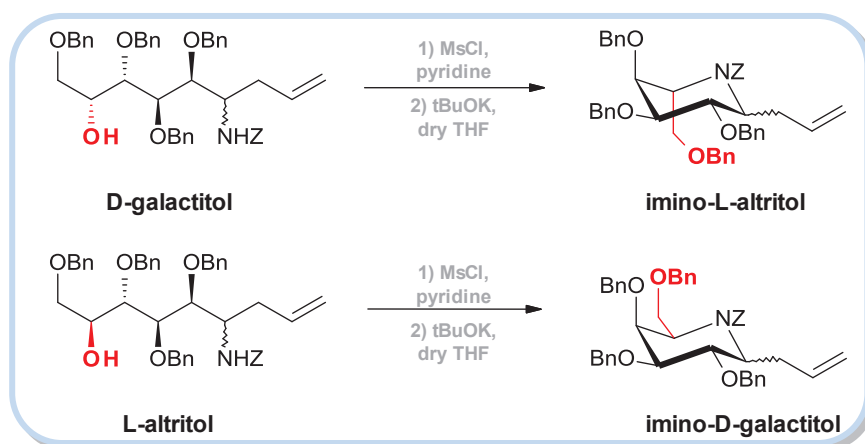

Scheme 17. Walden inversion under S_N2 conditions.

The synthesis turned out to be very challenging. The first difficulties were faced during the allyltrimethylsilane addition. This reaction gave an inseparable mixture of the desired alcohol and the starting material in low yield (**26mix**). Despite thorough optimization (time, temperature, number of equivalents of Lewis acid, Lewis acid), we did not find conditions under which the reaction could be completed. Secondly, the last step, intramolecular reductive amination, was inefficient and afforded complex mixtures of two or more deoxy iminosugars or epimers of the expected product even under the mildest conditions. To better understand the reaction mechanism, some of the mixtures were separated by HPLC and characterized by NMR analysis.

Eventually, to overcome the epimerization problems, we decided to abandon the intramolecular reductive amination approach and implement an intramolecular S_N2 type cyclisation as used previously for the *arabino* series. To achieve this, we had to invert the configuration of the hydroxyl group at C-5 in the addition product (*R* epimer gives an *L-altro* final product, while the *S* epimer gives *D-galacto*, **Scheme 17**). Again, this task was a real challenge and only a small amount of the desired alcohol was obtained which could lead eventually to 1-*C*-propyl-imino-*D*-galactitol **49**. The details of these synthetic studies are provided in the next sections.

II.2 Synthesis of *N*-Z protected galactopyranosylamine **25** and C-1 chain elongation

According to our experience from the *arabino* series, we did not try the direct condensation of 2,3,4,6-tetra-*O*-benzyl-D-galactose with benzyl carbamate but we used the acetylated derivative **24** as the starting material. The reaction with benzyl carbamate worked very well with an overall yield of 80% for two steps (1g scale).

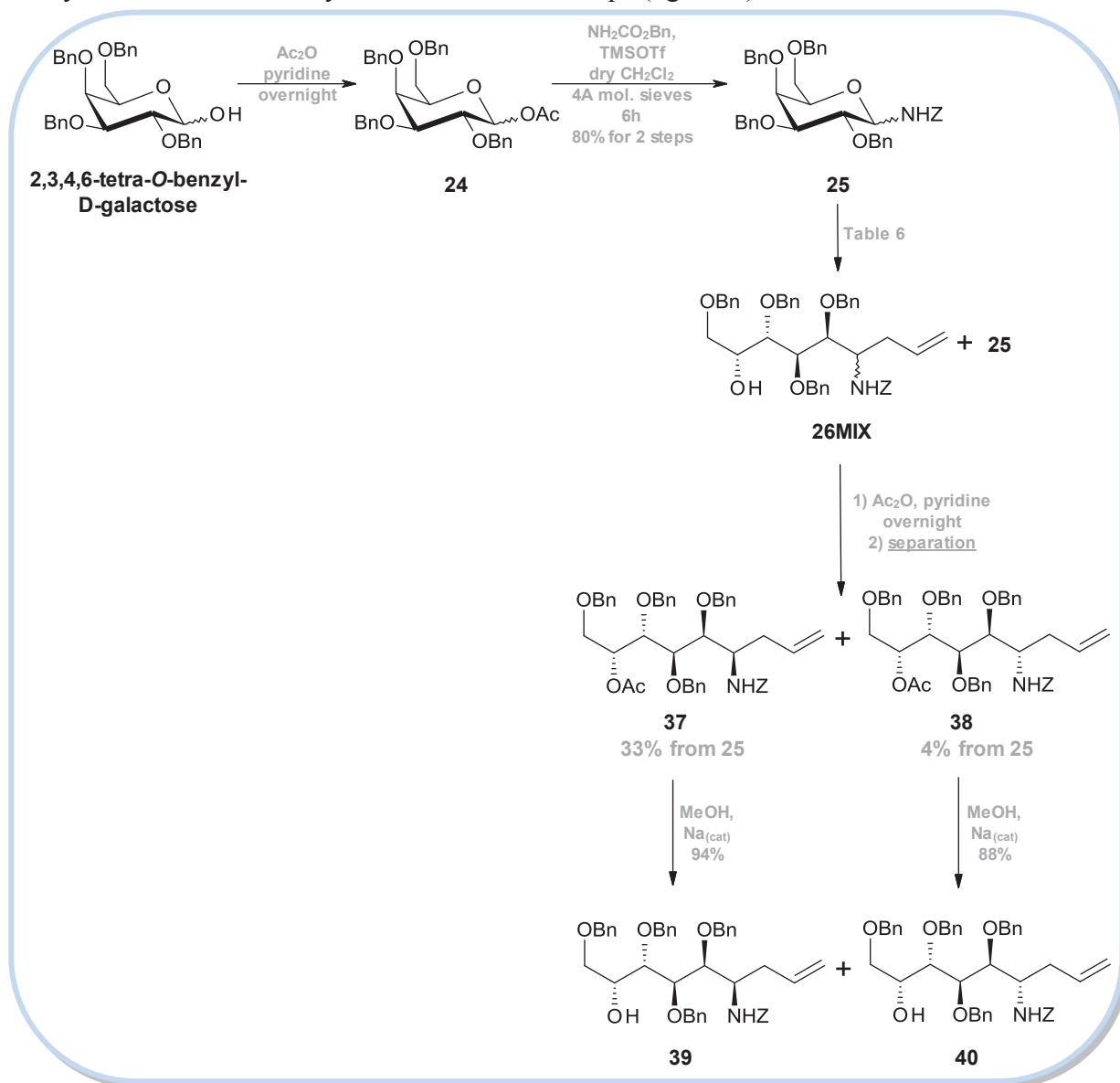

Scheme 18. Synthesis of *N*-Z protected galactopyranosylamine **25** and C-1 chain elongation.

The key chain-elongation step, the addition of allyltrimethylsilane to *N*-Z protected amine surprised us because it did not give the expected product in the first assay. Various conditions were used with different Lewis acids (**Table 6**) but the reaction was never complete and moreover, the open-chain product was inseparable from starting material **25**. As shown in **Table 6**, one equivalent of TMSOTf as the Lewis acid was not sufficient to promote

the reaction (entry 1). An excess of Lewis acid (3 eq) as well as increasing the temperature led to degradation (entry 3 and 5). This indicated clearly that the reaction was extremely sensitive to variations of the conditions and needed to be handled carefully. The reaction time did not seem to play a crucial role. Lewis acids other than trimethylsilyl trifluoromethanesulfonate did not improve the reaction turnover. On the contrary, bismuth (III) trifluoromethanesulfonate did not catalyze the reaction, and zinc trifluoromethanesulfonate caused degradation (entries 6 and 7). Triisopropylsilyl trifluoromethanesulfonate seemed to be promising (entry 8), but not as efficient as trimethylsilyl trifluoromethanesulfonate.

Entry	Lewis acid	Eq	Temp	Time	Conversion ^a (Yield ^b)	Comments
1	TMSOTf	1	-20°C	3 days	--	SM, degradation
2	TMSOTf	1	-20°C	42h	82% (27%)	Low yield
3	TMSOTf	1	0°C	42h	36%	important degradation
4	TMSOTf	2	-20°C	29h	85%	50% ^c of desired alcohol
5	TMSOTf	3	-20°C	42h	--	degradation
6	Bi(OTf) ₃	2	-20°C	42h	--	SM
7	Zn(OTf) ₂	2	-20°C	42h	--	SM, degradation
8	TIPSOTf	2	-20°C	42h	70% (10%)	--
9	TMSOTf	2	-20°C	2.5 days	85% (30%)	--
10	TMSOTf	2	-20°C	2*2.5days	90% (59%)	Chosen conditions

Table 6. Various conditions used to optimize allyltrimethylsilane addition onto **25**.

All assays performed in CH₃CN.^a reaction conversion calculated as if only expected alcohol was obtained. ^b yield calculated for pure alcohol obtained after an acetylation/separation/deacetylation sequence ^c based on the NMR spectrum of the crude mixture

Finally, we decided to carry out the reaction with two equivalents of trimethylsilyl trifluoromethanesulfonate, at -20°C for 2.5 days, then to purify the reaction mixture and repeat the procedure on the mixture, as if it would be pure starting material **25**. This approach resulted in a satisfactory yield (~60%) that allowed the continuation of the synthesis. However, the alcohol thus obtained was inseparable from the residual starting material. To overcome this inconvenience, we acetylated the mixture **26mix**, separated the acylated alcohols **37** and **38** from the *N*-Z protected amine **25** and deacetylated them to obtain pure **39** and **40** in 31% and 3.5% overall yield from **25** respectively (*Scheme 18*).

The diastereoselectivity of this reaction was fairly good, as the two epimers **37** and **38** were obtained in a ratio of ~8:1. Their configuration cannot be determined precisely at this stage, but later transformation showed that the major epimer **37** is the *syn* (1*R*) product.

II.3 Synthesis of ketones **41** and **42**

The alcohols **39** and **40** were oxidized with Dess-Martin periodinane¹⁸⁸ in good yields to give ketones **41** and **42**. However, as **42** was issued from the minor alcohol **40**, it was synthesized for characterization purposes only and was not used further in synthesis.

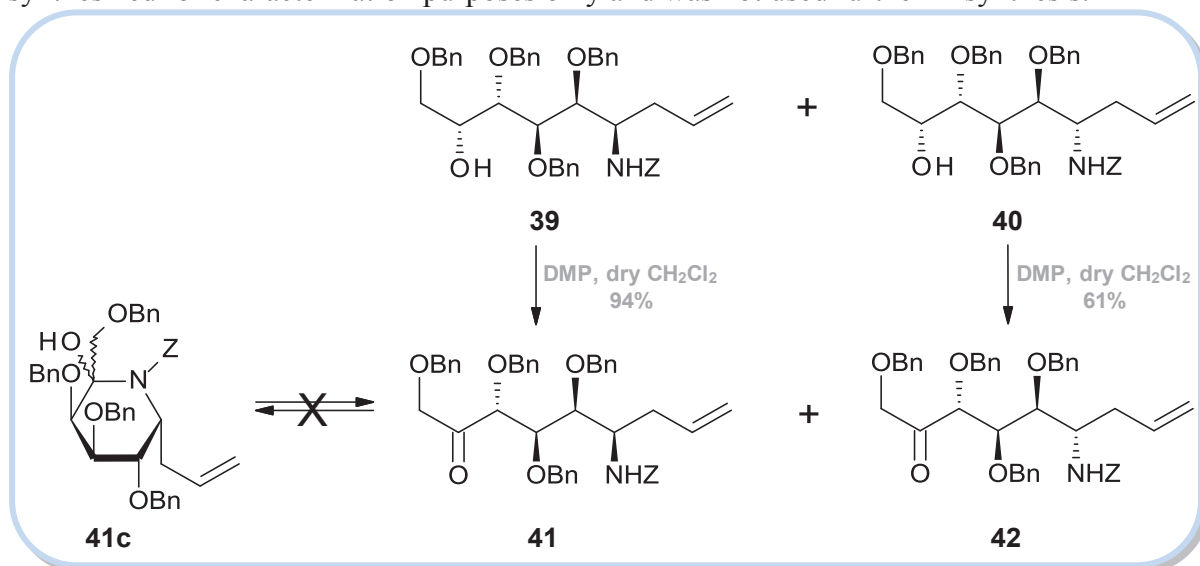

Scheme 19. Synthesis of ketones **41** and **42**.

It should be noted that these ketones exist exclusively in the open-chain form: the nucleophilic character of the NHZ group appears to be too weak to give any amount of the corresponding cyclic hemiaminal (**41c** on *Scheme 19*)

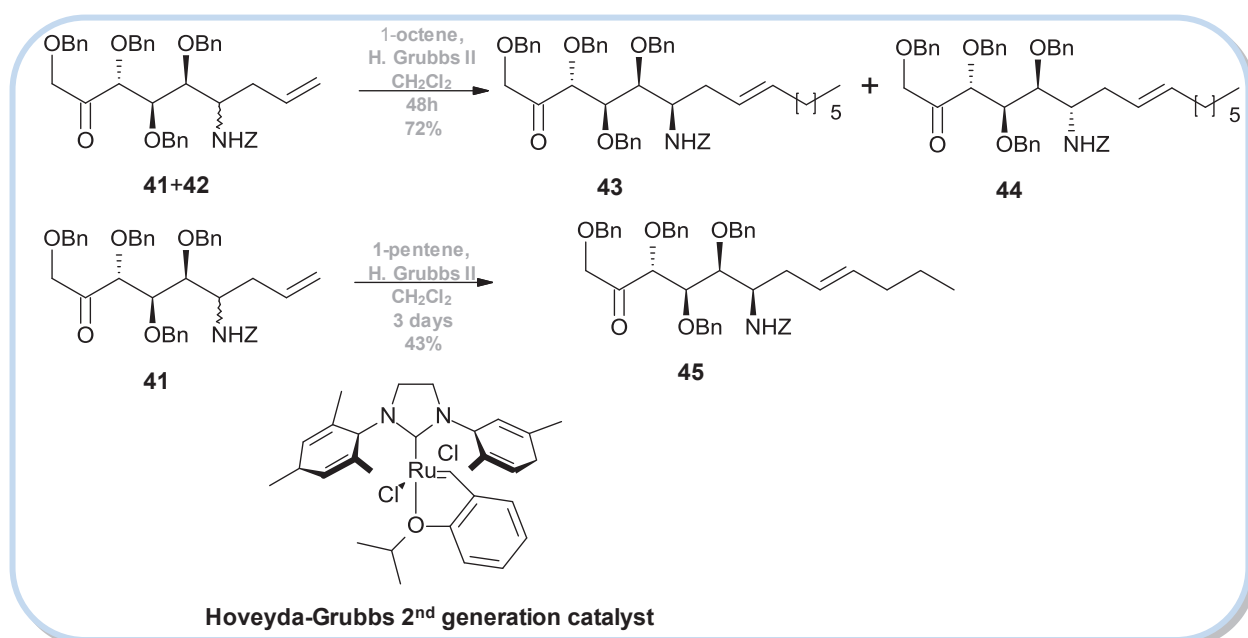

Scheme 20. Chain extension via cross metathesis.

¹⁸⁸ Dess, D. B.; Martin, J. C. *J Org Chem* **1983**, *48*, 4155.

Ketones **41** and **42** were submitted then to cross metathesis^{189,190} in order to prepare the final iminosugars with various alkyl chain lengths (**Scheme 20**). The reaction with 1-octene was conducted on a mixture of ketones **41** and **42** to give ketones **43** and **44** and the one with 1-pentene on pure **41** to afford ketone **45**. Hoveyda-Grubbs 2nd generation catalyst^{191,192} was used to improve the reaction conversion. While the derivatives with the longer chain were obtained in a good global yield of 72%, compound **45** was obtained in the much lower yield of 43%. This could be explained by the fact that 1-pentene is quite volatile and while the reaction was conducted during the summer, the light alkene could have easily evaporated during manipulation.

In both reactions, homodimers were not observed (mass analysis of the crude compound) and only the *E* isomer was obtained. The ketones were then submitted to the next step, which was intramolecular reductive amination by hydrogenolysis, to obtain cyclic *galacto* iminosugars.

II.4 Intramolecular reductive amination.

There are several ways to form C-N bonds to afford an iminosugar. As described for the *arabino* and *xylo* series, an intramolecular S_N2 reaction is one of the solutions. In the *galacto* series, due to the presence of the CH₂OH group at C-5 and the inversion of configuration at this position during cyclisation, this approach cannot be directly applied. The most popular method to achieve cyclisation is reductive amination.¹⁹³ In this reaction, the amine reacts with a carbonyl group (aldehyde or ketone) to form a hemiaminal. By losing one molecule of water an imine is created, which is subsequently reduced to an amine (**Scheme 21**). This reaction generally requires an acidic pH (~5) in order to activate the imine as an iminium salt.

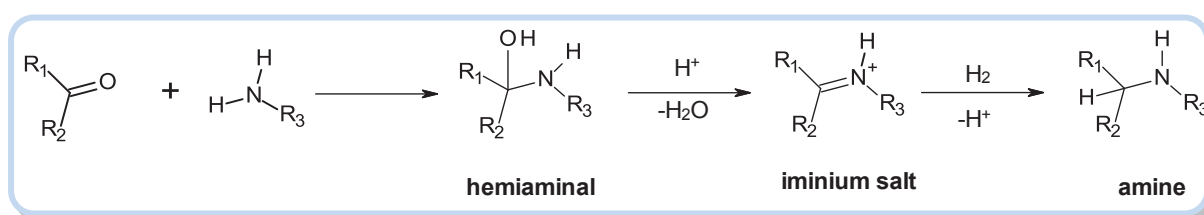

Scheme 21. Mechanism of reductive amination.

¹⁸⁹ Hérisson, J.-L.; Chauvin, Y. *Die Makromolekulare Chemie* **1971**, *141*, 161.

¹⁹⁰ Katz, T. J.; Rothchild, R. *J Am Chem Soc* **1976**, *98*, 2519.

¹⁹¹ Garber, S. B.; Kingsbury, J. S.; Gray, B. L.; Hoveyda, A. H. *J Am Chem Soc* **2000**, *122*, 8168.

¹⁹² Gessler, S.; Randl, S.; Blechert, S. *Tetrahedron Lett* **2000**, *41*, 9973.

¹⁹³ Compain, P.; Chagnault, V.; Martin, O. R. *Tetrahedron: Asymmetry* **2009**, *20*, 672.

A very common reducing agent for reductive amination is sodium cyanoborohydride. This mild hydride donor does not reduce ketones nor aldehydes.¹⁹⁴ Thanks to this method, in a single synthetic operation, a C-N bond can be stereoselectively formed to create a piperidine ring from a ketone and an amine within the same molecule (intramolecular reductive amination).¹⁹⁵ However, the amine function in **41** and related compounds is protected as a benzyl carbamate, which requires its cleavage in a first step. It is well known that hydrogenation is a very efficient and clean way to deprotect *N*- and *O*-benzyl groups.¹⁹⁶ Thus, hydrogenation is the ideal way to perform the last steps of imino-galactitols' synthesis. Reductive amination can also be performed using hydrogen as the reagent. This one-pot reaction can be divided into several stages (*Scheme 22*):

- i. reduction of the double bond
- ii. cleavage of benzyl carbamate to liberate the amine
- iii. intramolecular nucleophilic addition to generate a hemiaminal
- iv. formation of iminium ion intermediate (protonated imine)
- v. stereoselective reduction of iminium ion
- vi. deprotection of hydroxyl groups

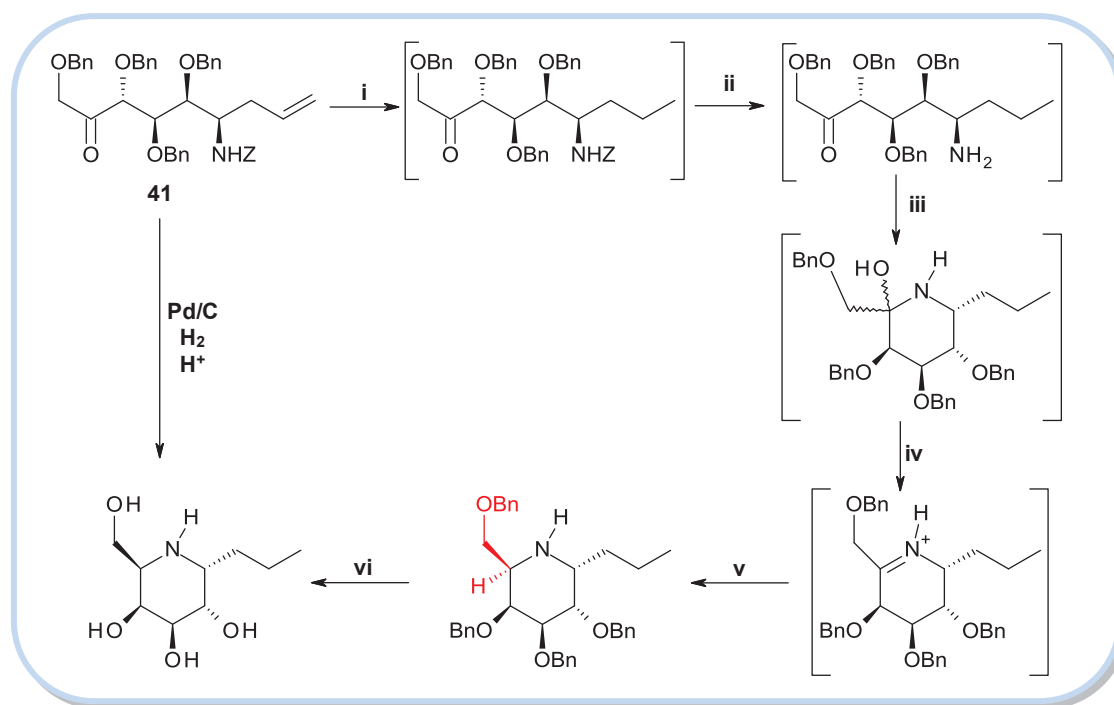

Scheme 22. Processes taking place during reductive amination.

¹⁹⁴ Baxter, E. W.; Reitz, A. B. In *Organic Reactions*; John Wiley & Sons, Inc.: 2004.

¹⁹⁵ Abe, K.; Okumura, H.; Tsugoshi, T.; Nakamura, N. *Synthesis* **1984**, 1984, 597.

¹⁹⁶ Freifelder, M. *Practical catalytic hydrogenation: techniques and applications*; Wiley-Interscience, 1971.

The hydrogenation step of the iminium ion creates a new stereogenic center (step v, *Scheme 22*). We expected from studies by Wong et al¹⁹⁷ and from our own work that the reaction should predominantly lead to the desired “D” configuration of the final product (axial orientation of hydrogen at C-5, stereodirection by the group at C-3).

While it is sure that reduction of the double bond and hydrogenolysis of *N-Z* occur first, the other reactions may take place simultaneously.

Being confident to obtain positive results in the reductive amination process, we submitted ketones **43**, **44** and **45** to hydrogenation under acidic conditions. How deceived we were to see complex, illegible mixtures instead of expected products!

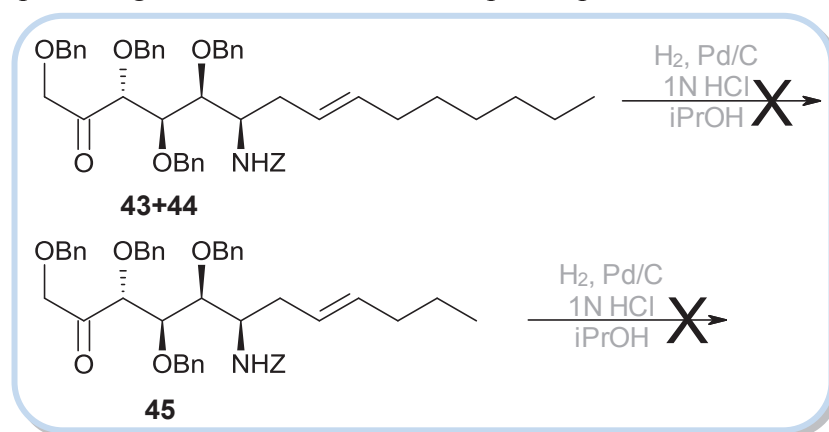

Scheme 23. Reductive amination via hydrogenation of ketones **43**, **44** and **45**.

To better understand what did not work in the cyclisation step, we decided to repeat the synthesis of ketone **41** and submit it to reductive amination under various conditions. We have performed hydrogenation in acid, neutral and basic conditions as well as classical reductive amination using sodium cyanoborohydride (*Scheme 24*).¹⁹⁸

We first tried the reaction with sodium cyanoborohydride, although this reaction was unlikely to work with the *N-Z* group (formation of cyclic hemiaminal not favourable, *Scheme 19*). The reaction failed, we recovered starting material with traces of alcohol resulting from reduction of ketone.

¹⁹⁷ Von der Osten, C. H.; Sinskey, A. J.; Barbas, C. F.; Pederson, R. L.; Wang, Y. F.; Wong, C. H. *J Am Chem Soc* **1989**, *111*, 3924.

¹⁹⁸ Hutchins, R. O.; Su, W. Y.; Sivakumar, R.; Cistone, F.; Stercho, Y. P. *J Org Chem* **1983**, *48*, 3412.

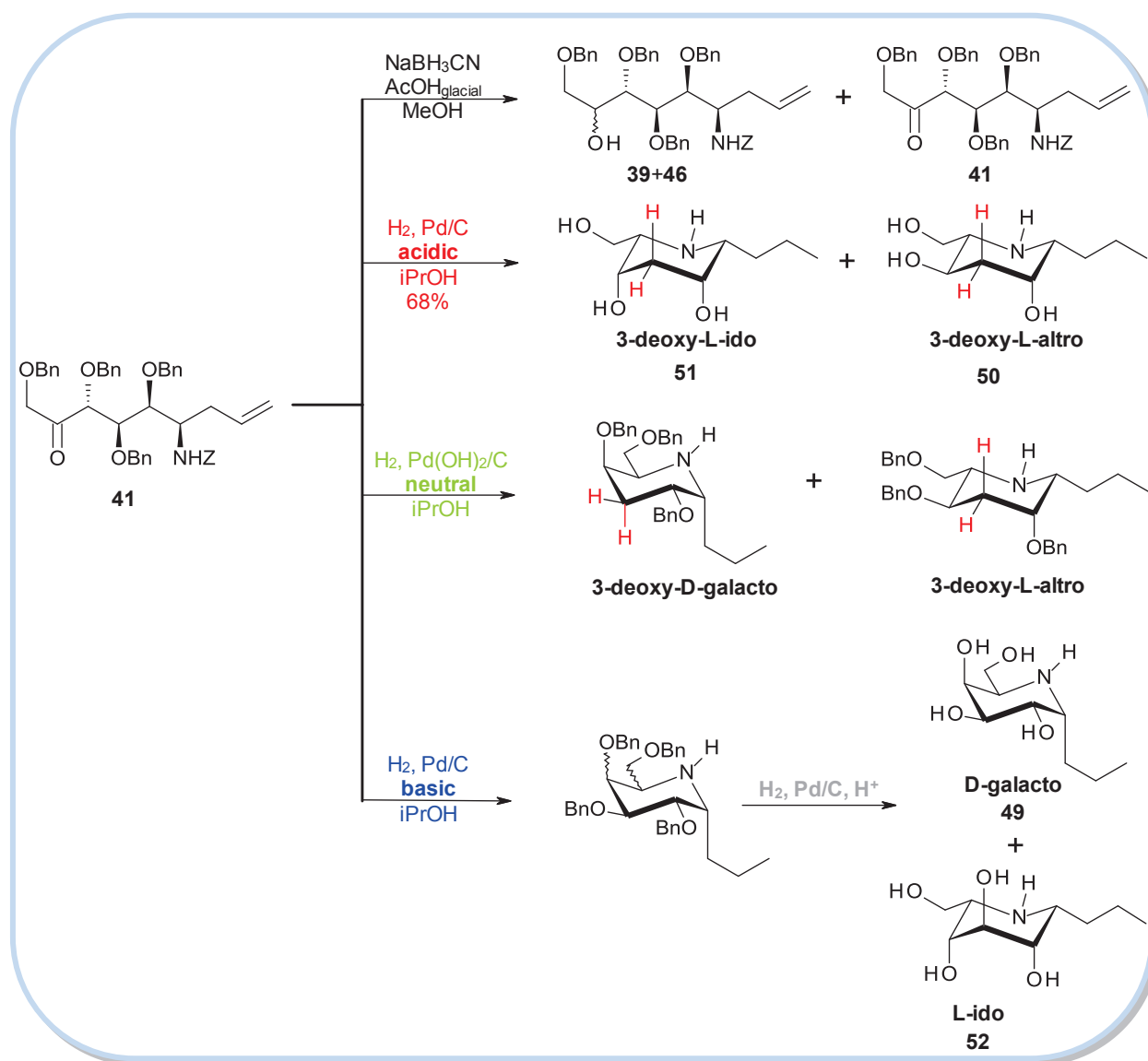

Scheme 24. Reductive amination assays.

Then we attempted hydrogenation under acidic conditions (**Scheme 24**). Surprisingly, these conditions were too vigorous, leading unexpectedly to 3-deoxy products. The reaction gave a mixture of 1-*C*-propyl iminohexitols (1:1 ratio), deoxy at position 3 and having a pseudo-*L-ido* or pseudo-*L-altro* configuration. The sample was purified by HPLC (column Hypercarb, 250mm x 10mm, H_2O /formic acid 0.1%, pressure 2.2 bars, debit 4.4mL/min, $T=30^\circ\text{C}$, ELS detection) and both isomers were separated and described thanks to NMR analysis. The presence of the 3-deoxy position provides a great deal of information on the structure of these products. Thus, for example, coupling constants for 3-deoxy-*L-altro* epimer are given in the following **Figure 23**:

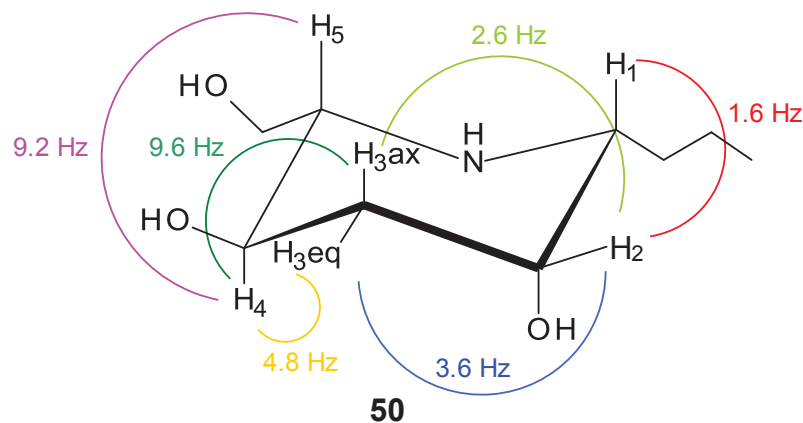

Figure 23. Coupling constants for compound **50**.

These data establish unambiguously that the imino hexitol has a pseudo *L-altro* configuration (4,5-*trans*) and that the anomeric configuration is pseudo- β (*L-series*; 1,2-*cis*). Hydrogenation of the iminium salt occurred from the “top face” (*trans* with respect to the C-1 substituent) and the “anomeric” configuration is *R*. The second product, pseudo β -*L-ido*, has undergone epimerisation at C-4, remarkably. A possible mechanism is suggested further below (**Figure 24**).

Hydrogenation under neutral conditions (**Scheme 24**) promoted also the intramolecular reductive amination, but the benzyl groups were not cleaved. Remarkably, under these milder conditions, the benzyloxy group at C-3 was also lost, leading again to 3-deoxy iminohexitols. In this case however, only the epimers at C-5 were obtained (mixture of pseudo *D-galacto* and pseudo-*L-altro* in a 1:1 ratio), without epimerisation at C-4.

Although it is unusual to perform this type of reaction under basic conditions, the treatment of ketone **41** under catalytic hydrogenation conditions in the presence of triethylamine promoted the desired, intramolecular reductive amination (i.e. reduction of allyl group, cleavage of *Z*-group and reductive amination) to afford the α -1-*C*-alkyl iminohexitol derivatives with traces only of the product of deoxygenation at C-3. Two major products were obtained, which could not be separated by flash column chromatography. The mixture was debenzylated and samples of both epimers could be isolated by HPLC (column Hypercarb, 250mm x 10mm, H₂O/formic acid 0.5%, pressure 2.2 bars, debit 4.4mL/min, T=30°C, ELS detection). NMR analysis of the two products revealed that we had finally obtained the desired α -1-*C*-propyl imino-*D-galactitol* **49**, as well as its *L-ido* epimer **52** (double epimer at C-4 and C-5) in a 1:1 ratio.

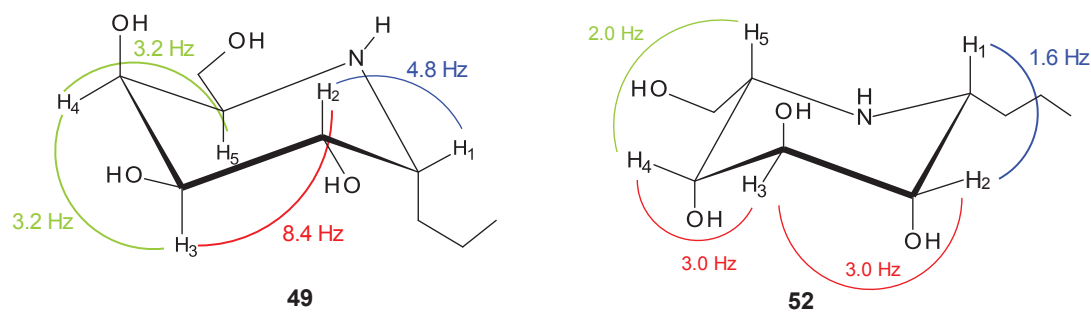

Figure 24. Coupling constants for compounds 49 and 52.

These unanticipated difficulties are undoubtedly due to the particular structure/configuration of the *galacto* substrate. Possible explanation of this particular behaviour is outlined in **Figure 25**.

A likely structure and conformation (3H_2) of the intermediate iminium cation **A** is given as a starting point. MM2 calculations of the steric energy of this conformation and of the alternate 2H_3 conformation indicate that the former one is significantly more stable. Hydrogenation of this iminium ion away from the 3-OBn group would give the desired α -D-*galacto* compound (axial orientation of H₂ addition). This is what is mainly observed under basic conditions. In the intermediate, the pseudo-axial C₄-H bond is allylic with respect to the iminium salt and therefore highly sensitive towards “enolate-like” chemistry and β -elimination. In this system enamine formation is probably highly favoured: hydrogenation at the enamine stage could provide the α -D-*galacto* product and also the observed β -L-*ido* compound (basic conditions). Under acidic conditions, elimination of the 3-OBn group as BnOH would be facilitated by the formation of an α,β -unsaturated iminium salt **B**. Hydrogenation of this intermediate could lead to the two 3-deoxy products observed, having pseudo- β -L-*ido* or pseudo- β -L-*altro* configurations. “Acidification” of the C₄-H bond in the intermediate iminium salt is clearly the factor that distinguishes the *galacto* series from the *gluco* series in which such complications are not observed.

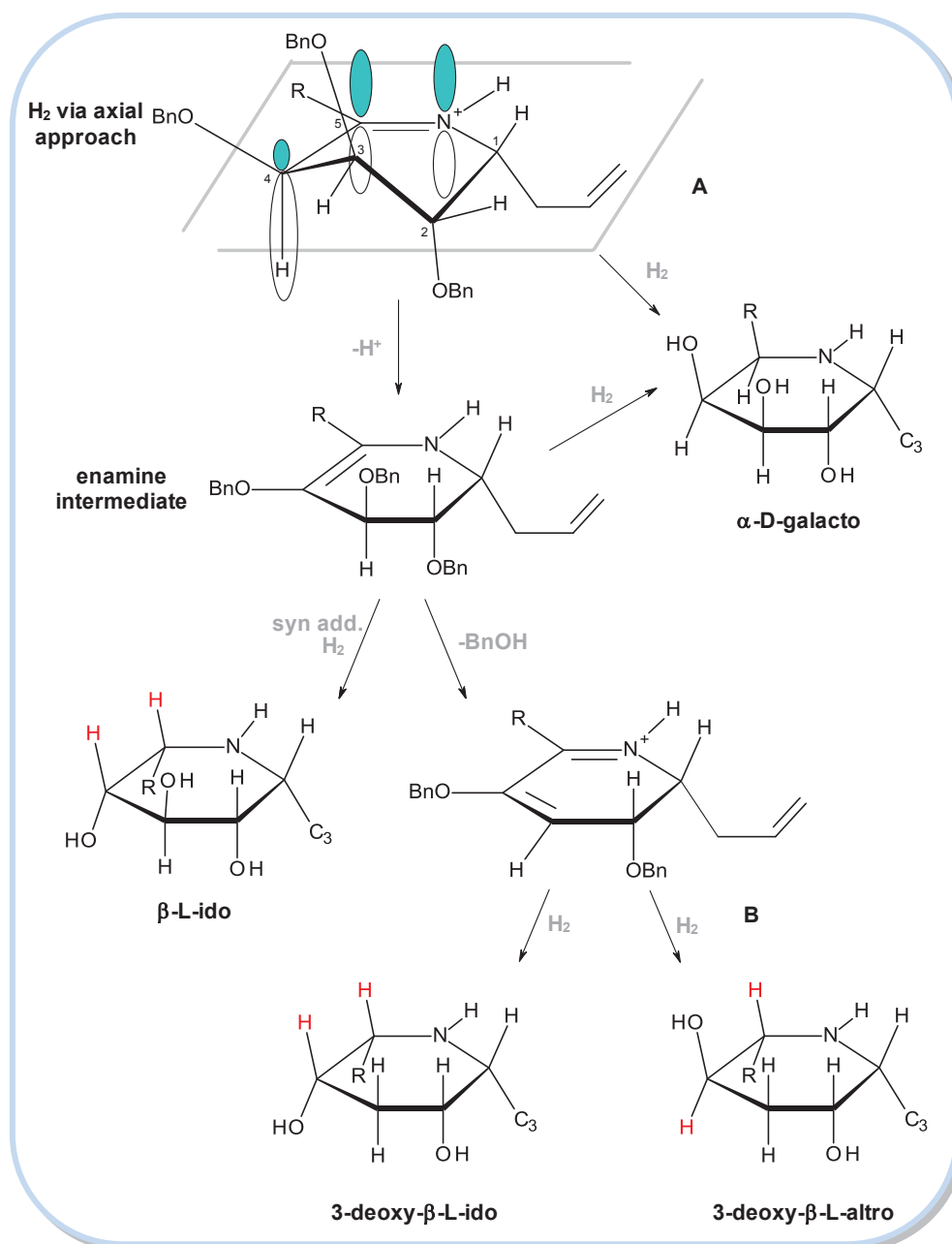

Figure 25. Proposed mechanism of epimerisation and debenzylation during catalytic hydrogenation.

II.5 Synthesis of 1-C-alkyl-imino-D-galactitols by intramolecular S_N2 reaction

In order to try to improve the synthesis of the target compounds, we decided to examine also the approach by intramolecular cyclisation via a S_N2 reaction. Since cyclisation of the original alcohol **39** would give a 1-C-propyl-imino-L-altritol, we attempted to invert its configuration at C-5. However, this turned out to be again a challenging task. The simplest way to achieve this would be to oxidize the alcohol **39** to ketone **41**, and to reduce then to the alcohol **46**, provided that the stereochemistry of the reduction would be in favor of the *L-altro* epimer. Another method would be to use the Mitsunobu reaction¹⁹⁹, wherein the alcohol **39**

¹⁹⁹ Mitsunobu, O. *Synthesis* **1981**, 1.

would be converted into an ester with an inversion of configuration. We investigated a series of hydride reducing agents (entries 1-4, **Table 7**) and attempted the Mitsunobu reaction (entry 5). The latter was unsuccessful and led to degradation: only half of the starting material was recovered. None of the investigated hydrides gave the desired *L-althro* product as the major isomer.

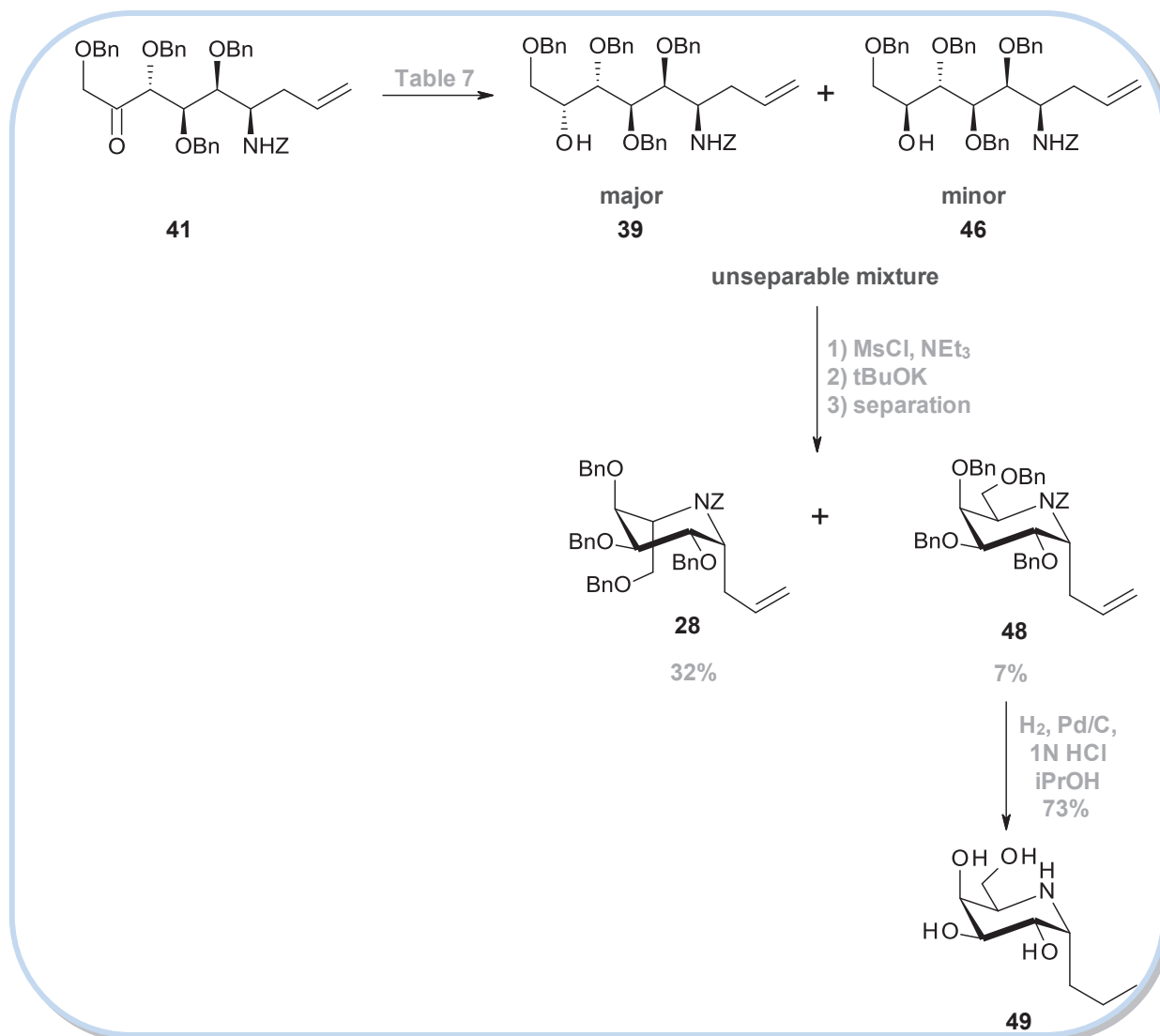

Scheme 25. Synthesis of 1-C-alkyl-imino-D-galactitols by intramolecular S_N2 reaction.

Reduction with sodium and lithium borohydrides gave an inseparable mixture of both *L-althro* **39** and *D-galacto* **46** alcohols in high yield. *L*-selectride afforded also a mixture of alcohols but with significantly lower yield and poor purity of the crude product. The reaction with sodium borohydride under Luche conditions²⁰⁰ (entry 3) also gave a mixture of the two epimeric alcohols. Each assay was conducted on a small sample of ketone **41** and none of them gave the desired results, therefore the synthesis was not continued on them. Moreover,

²⁰⁰ Luche, J. L. *J Am Chem Soc* **1978**, *100*, 2226.

as the epimeric alcohols have very similar NMR spectra, it was difficult to determine their percentage in each mixture. In any event, the highest global yield and the cleanest crude mixture of the two alcohols were obtained by the reduction with sodium borohydride (entry 1). The mixture was then mesylated. S_N2 cyclisation under basic conditions afforded a mixture of the two expected products in a 5:1 ratio which could be separated: compound **48** was isolated in 7% yield and **28** in 32% yield from the mixture of alcohols **39**+**46**. Hydrogenolysis of **48** afforded the desired 1-*C*-propyl-imino-*D*-galactitol **49** in 5% overall yield from ketone **41**.

Entry	Reagent	Eq	Time	Yield	Comments
1	NaBH ₄	2	overnight	97% (86%) ^a	mixture of two alcohols, attempt of separation
2	L-selectride	6	24h	-- (47%) ^a	complex mixture, purification needed
3	NaBH ₄ , CeCl ₃	1/1	30min	71% (39%) ^a	mixture of two alcohols, attempt of separation
4	LiBH ₄	2	2h	90% --	mixture of two alcohols, no purification
5	PH ₃ P, DEAD <i>p</i> -nitro-benzoic acid	2/2 2	5 days	54% of SM	degradation

Table 7. Conditions and yields of various attempts to inverse C-5 hydroxyl group configuration.

^aYield after purification

II.6 Conclusions

Unanticipated problems and challenges were faced in the synthesis of 1-*C*-alkyl iminogalactitol derivatives. In the first strategy we observed an unexpected behaviour of the *galacto* substrate, which led to new 3-deoxy derivatives of the target compound. However, by adjusting the conditions of catalytic hydrogenation from acidic to basic pH, we obtained the desired 1-*C*-propyl-imino-*D*-galactitol as a mixture with its *L-ido* epimer (1:1). On the other hand, the yield and diastereoselectivity of this synthesis towards the desired product is low.

The other approach, by the procedure of double inversion of hydroxyl group configuration at C-5 was not satisfactory either. None of the reduction methods of ketone **41** afforded the desired *L-altro* alcohol **46** (precursor of *D-galacto* final product) but gave back in majority the *D-galacto* intermediate **39**. However, the amount of alcohol **46** obtained allowed continuing the synthesis to achieve the first, pure sample of α -1-*C*-propyl-imino-*D*-galactitol!

Résumé section II:

Synthèse des 1-C-alkyl-imino-D-galactitols.

Après avoir réalisé avec succès la synthèse des 1-C-alkyl-imino-L-arabinitols, nous sommes passés à notre deuxième objectif : la synthèse des 1-C-alkyl-imino-D-galactitols. Nous avons voulu comparer ces deux familles de composés pour étudier les relations structure-activité, et en particulier l'influence du groupement CH₂OH. Pour préparer ces dérivés, nous avons appliqué une stratégie de synthèse similaire à celle utilisée précédemment avec trois différences principales :

- i. comme produit de départ, nous avons utilisé le 2,3,4,6-tétra-*O*-benzyl-D-galactopyranose commercial
- ii. la synthèse a été réalisée uniquement sur les iminosucres N-Z protégés
- iii. la cyclisation a été réalisée par amination réductrice intramoléculaire, et non par réaction de S_N2 intramoléculaire

En effet, il n'est pas possible dans cette série d'utiliser la S_N2 intramoléculaire. Car en série *arabino*, l'alcool en position C-5 qui subit la substitution est primaire, il n'y a donc pas de modification stéréochimique. Mais dans la série *galacto*, l'alcool en position C-5 est secondaire, et ferait donc l'objet dans les conditions d'une S_N2 d'une inversion de Walden, ce qui conduirait à l'obtention d'iminosucres de type *L-altro* et non *D-galacto*.

Malheureusement, cette voie de synthèse s'est avérée très difficile. Les premières difficultés ont été rencontrées lors de l'addition de l'allyltriméthylsilane. Cette réaction a conduit à un mélange inséparable de l'alcool désiré et du produit de départ avec un rendement faible. Malgré une optimisation complète (temps, température, nombre d'équivalents et acide de Lewis), nous n'avons pas trouvé de conditions idéales. Ensuite, lors de l'amination réductrice intramoléculaire, nous avons observé un comportement inattendu du substrat *galacto*, qui a conduit à l'obtention d'iminosucres deoxy et/ou d'épimères, même dans des conditions douces. Pour mieux comprendre le mécanisme de cette réaction, certains des mélanges ont été séparés par HPLC et caractérisés par RMN. En utilisant des conditions d'hydrogénation catalytique à pH basique, nous avons pu obtenir le 1-C-propyl-imino-D-galactitol désiré en mélange avec l'épimère *L-ido*. Mais le rendement et la diastéréosélectivité de cette synthèse restent faibles.

Finalement, pour surmonter ces problèmes de désoxygénation et d'épimérisation, nous avons décidé d'abandonner l'amination réductrice intramoléculaire et de mettre en œuvre une cyclisation de type S_N2. Pour ce faire, il nous fallait inverser la configuration du groupement

hydroxyle en position C-5 (l'épimère (*R*) donnant un produit final de configuration *L-altro*, l'épimère (*S*) un produit final de configuration *D-galacto*). Malheureusement aucune des méthodes de réduction de cétone testées n'a permis d'obtenir majoritairement l'épimère (*S*) et seulement une faible quantité de 1-*C*-propyl-imino-*D*-galactitol a pu être isolée.

III. Alternative synthesis of 1-C-alkyl-imino-D-galactitols from L-sorbose: strategy by way of a C-6 chain elongation.

III.1 Synthetic strategy

Considering the difficulties of the synthetic strategy relying on the C-1 chain elongation, we decided to find another tactic. Inspired by work of Tyler's group²⁰¹ in which they synthesised 1-deoxy-galactonojirimycin from L-sorbose, we decided to adapt their approach to the C-6 chain elongation²⁰² previously used in our team to obtain the desired compounds. Recently published work of Fleet, Kato et al²⁰³ used a similar tactic but started from expensive L-tagatose. Originally, we wanted to start from commercially available 1,2:4,6-di-*O*-isopropylidene- α -L-sorbofuranose **53**. However, the product obtained from *Carbosynth* turned out to be highly heterogenous and to contain a significant amount of L-sorbose. Therefore we decided to synthesize this compound ourselves. Although **53** has been used as a starting material for various syntheses (sugar derivatives²⁰⁴ or ligands and catalysts for asymmetric synthesis^{205, 206, 207}), its synthesis appeared to be a challenging task, due to misleading literature data. Eventually, we obtained 1,2:4,6-di-*O*-isopropylidene- α -L-sorbofuranose **53**, the improved synthesis and correct characterisation of which we described in a recent publication.²⁰⁸ The newly developed synthetic strategy to access 1-C-alkyl imino-D-galactitols consists of seven main steps (*Scheme 26*):

- i. protection of L-sorbose to get 1,2:4,6-di-*O*-isopropylidene- α -L-sorbofuranose
- ii. inversion of C-3 hydroxyl group configuration to obtain *L-tagato* intermediate
- iii. liberation (by 4,6 isopropylidene migration) of the C-6 hydroxyl group and oxidation
- iv. condensation of obtained aldehyde with Ellman's amine
- v. Grignard reagents addition
- vi. deprotection
- vii. piperidine ring formation by intramolecular reductive amination

²⁰¹ Furneaux, R. H.; Tyler, P. C.; Whitehouse, L. A. *Tetrahedron Lett* **1993**, *34*, 3609.

²⁰² Oulaïdi, F.; Gallienne, E.; Compain, P.; Martin, O. R. *Tetrahedron: Asymmetry* **2011**, *22*, 609.

²⁰³ Jenkinson, S. F.; Fleet, G. W.; Nash, R. J.; Koike, Y.; Adachi, I.; Yoshihara, A.; Morimoto, K.; Izumori, K.; Kato, A. *Org Lett* **2011**, *13*, 4064.

²⁰⁴ Wennekes, T.; Lang, B.; Leeman, M.; van der Marel, G. A.; Smits, E.; Weber, M.; Wiltenburg, J. v.; Wolberg, M.; Aerts, J. M. F. G.; Overkleeft, H. S. *Org Proc Res Dev* **2008**, *12*, 414.

²⁰⁵ Wang, Z.-X.; Tu, Y.; Frohn, M.; Zhang, J.-R.; Shi, Y. *J Am Chem Soc* **1997**, *119*, 11224.

²⁰⁶ Tu, Y.; Wang, Z.-X.; Frohn, M.; He, M.; Yu, H.; Tang, Y.; Shi, Y. *J Org Chem* **1998**, *63*, 8475.

²⁰⁷ Asaoka, S.; Horiguchi, H.; Wada, T.; Inoue, Y. *J Chem Soc Perkin 2* **2000**, 737.

²⁰⁸ Biela-Banaś, A.; Gallienne, E.; Martin, O. R. *Carbohydr Res* **2013**, *380*, 23.

The amine intermediate **A** turned out to be very unstable and degraded under isopropylidene cleavage conditions. We decided to proceed by way of an azide derivative to overcome instability and degradation difficulties (viii, *Scheme 26*).

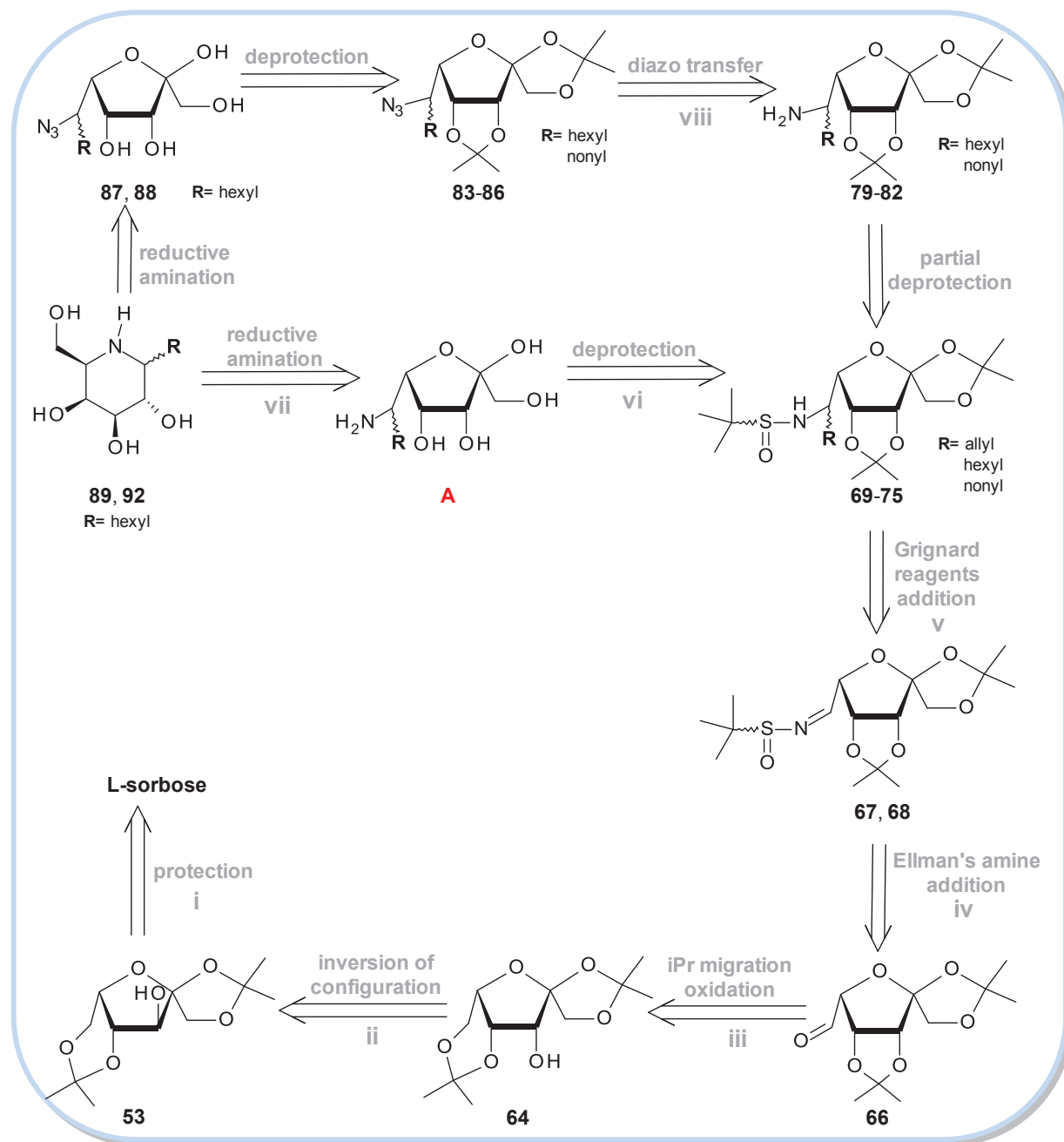

Scheme 26. Synthetic strategy towards 1-C-alkyl-imino-D-galactitols from L-sorbose.

III.2 Synthesis of 1,2:4,6-di-*O*-isopropylidene- α -L-sorbofuranose and conversion to a L-tagatofuranose derivative

The synthesis of 1,2:4,6-di-*O*-isopropylidene- α -L-sorbofuranose is a demanding task because standard isopropylideneation of L-sorbose under acidic conditions affords the other, most stable isomer: 2,3:4,6-di-*O*-isopropylidene- α -L-sorbofuranose²⁰⁹ (**Figure 26**).

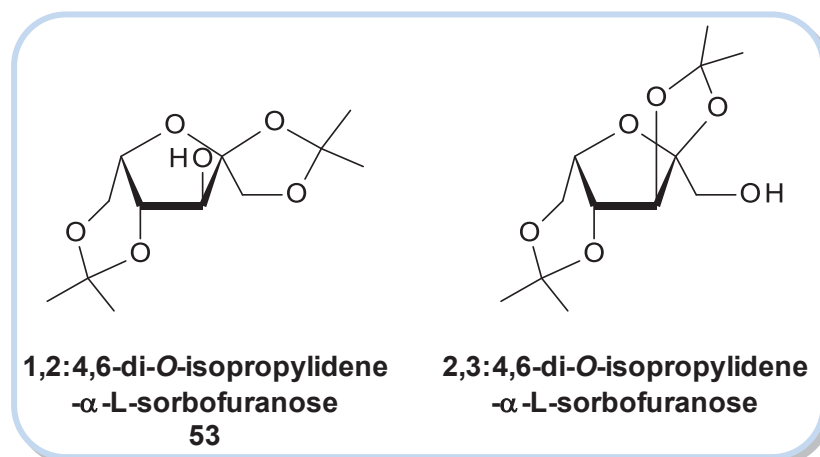
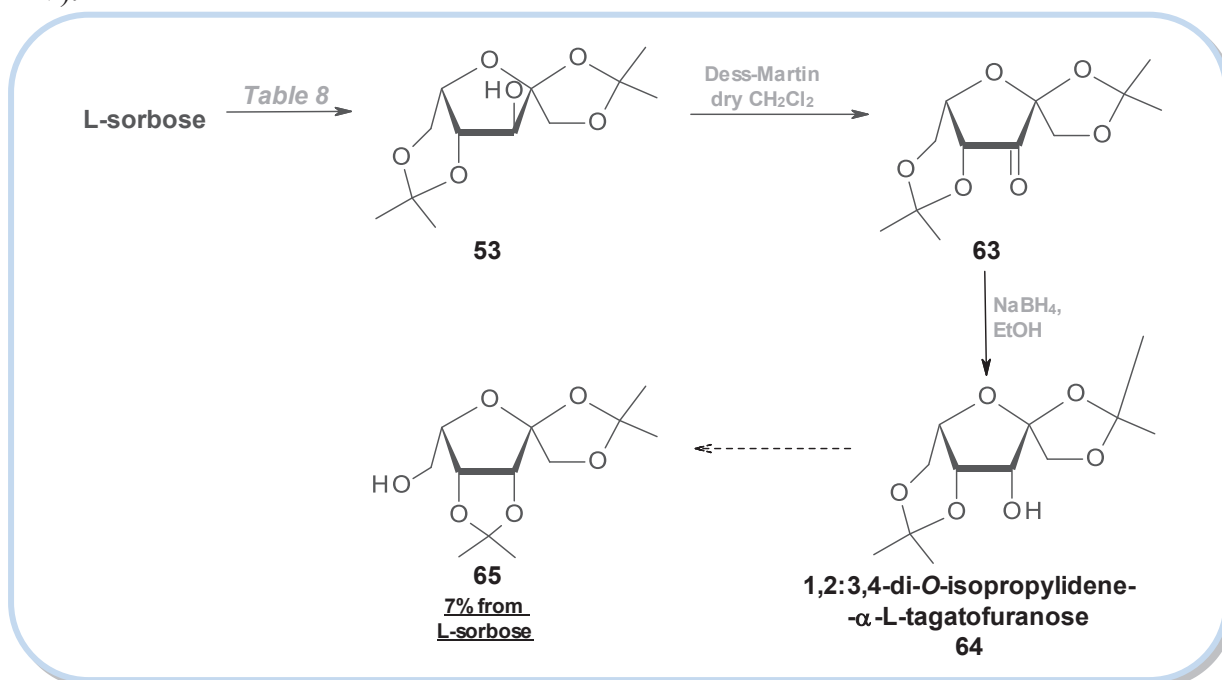

Figure 26. Two isomers of di-*O*-isopropylidene- α -L-sorbofuranose.

The first convenient method for the selective preparation of the kinetic product 1,2:4,6-di-*O*-isopropylidene- α -L-sorbofuranose **53** was described by Chen and Whistler.²¹⁰ It was favoured by the addition of catalytic amounts of tin (II) chloride as Lewis acid (**Scheme 27**).



Scheme 27. Synthesis of alcohol intermediate **65** from L-sorbose.

²⁰⁹ Reichstein, T.; Grüssner, A. *Helv Chim Acta* **1934**, *17*, 311.

²¹⁰ Chen, C.-C.; Whistler, R. L. *Carbohydr Res* **1988**, *175*, 265.

Moreover, better yields were obtained when the reaction was carried out in 2,2-dimethoxypropane as the solvent and when dimethoxyethane was used in small amount to solubilise the tin salt. Initially we have experienced difficulties with this protocol which consisted in refluxing the reaction mixture until complete disappearance of starting material (the solution becomes clear after 3-4 h on a 5 g-scale). In our hands, these conditions led to a mixture of 1,2:4,6- and 2,3:4,6-di-*O*-isopropylidene- α -L-sorbofuranose that could not be separated by crystallization. We used other conditions, but our effort was fruitless (**Table 8**, entries 1 to 3 and 7). As suggested by Zhao and Shi²¹¹ we decreased the reaction temperature to 70°C and stopped the reaction before the solution became clear (**Table 8**, entries 4 and 5). Although the reaction was not complete (66% of L-sorbose was recovered), we were able to obtain mainly the desired isomer that could be purified by recrystallization from hexane. The purity of 1,2:4,6-di-*O*-isopropylidene- α -L-sorbose **53** obtained by this procedure was sufficient to continue the synthesis (yield of 16%, 46% based on consumed L-sorbose).

Entry	Temp	Time	Reagents	Yield ^b (XX) ^c	Comments
1	106°C	5h (8g)	SnCl ₂ , <u>DME</u> ^a , <i>DMP</i>	ND ^d	Brown oil, purification not possible, Dess-Martin <u>failed</u>
2	70°C	2h (8g)	SnCl ₂ , <u>DME</u> ^a , <i>DMP</i>	ND	Brown oil, purification not possible, Dess-Martin <u>failed</u>
3	70°C	1h (1g)	SnCl ₂ in <i>DME</i> , <u>DMP</u> ^a	46%	Yellowish solid, recrystallization not efficient, purification by acetylation not efficient
4	70°C	20 min (1g)	SnCl ₂ in <i>DME</i> , <u>DMP</u> ^a	28%	Yellowish solid, purification on silica works, Dess-Martin works
5	70°C	1h (10g)	SnCl ₂ in <i>DME</i> , <u>DMP</u> ^a	16% (7%)	Yellowish solid, recrystallization works, Dess-Martin <u>works</u>
6	70°C	3h45min (7g)	SnCl ₂ in <i>DME</i> , <u>DMP</u> ^a	ND (12%)	No purification, used the crude for oxidation with PCC, works well
7	65°C	2h	Silica-H ₂ SO ₄	ND	2,3:4,6-di- <i>O</i> -isopropylidene- α -L-sorbofuranose instead of 53

Table 8. Various conditions to prepare 1,2:4,6-di-*O*-isopropylidene- α -L-sorbose **53**. ^a The solvent is underlined, while the reactive or co-solvent is in italics. ^b Yield of first step, after purification, does not mean pure **53**. ^c Yield after 4 steps (pure 65 from L-sorbose). ^d Not determined.

²¹¹ Zhao, M. X.; Shi, Y. *J Org Chem* **2006**, *71*, 5377.

We have identified a number of errors in literature reports,^{212,213} with instances of confusion between the 1,2:4,6-di-*O*-isopropylidene derivative **53** and the more common 2,3:4,6-di-*O*-isopropylidene- α -L-sorbofuranose (**Figure 26**) as well as between the corresponding mono-*O*-isopropylidene derivatives **55**, **57**, **59** and **62** (**Scheme 28**).

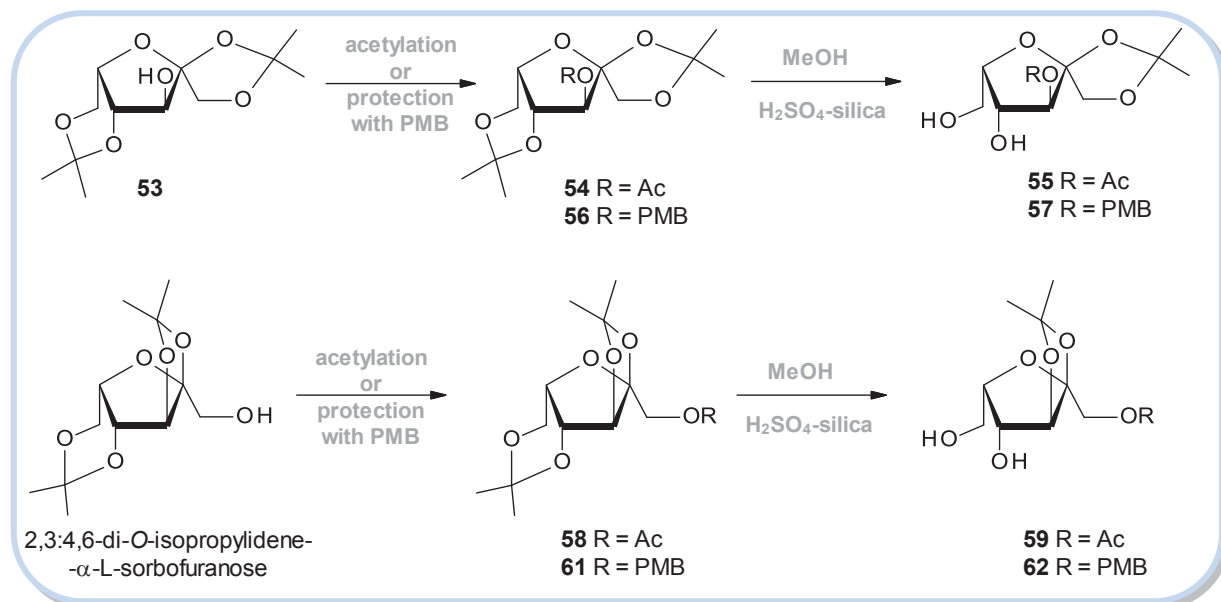

Scheme 28. Synthesis of 1,2- and 2,3:4,6-di-*O*-isopropylidene- α -L-sorbofuranose derivatives.

Thus the *O*-acetyl and *O*-*p*-methoxybenzyl derivatives of **53** and 2,3:4,6-di-*O*-isopropylidene- α -L-sorbofuranose, compounds **54**, **56**, **58** and **61**, were prepared by standard procedures and then submitted to the selective hydrolysis procedure of Mukhopadhyay et al.²¹⁴ Compounds **55**, **57**, **59** and **62** were isolated generally in good yields (21-80%) Comparison of the NMR spectra of synthesized compounds with the spectra provided in supplementary materials by Mukhopadhyay showed clearly that the compounds they have made are not the 1,2-*O*-isopropylidene derivatives, but the 2,3-*O*-isopropylidene derivatives. The fact that compound **57** is the correct isomer is further supported by the large chemical shift of the H-3 proton in the 3-*O*-acetyl derivative **55** (δ = 5.12 ppm for **55** and δ = 3.77 ppm for **57**).

The following step was the inversion of the C-3 hydroxyl group configuration by oxidation/reduction sequence. The lower face of **53** is sterically crowded and, after oxidation, the reducing agent will approach the keto group of **63** from the upper face, which will result in inversion of the configuration at C-3.²⁰¹ While having a good experience with Dess-Martin periodinane as an oxidizing agent, we decided to use it. However, it turned out that this

²¹² Rajput, V. K.; Mukhopadhyay, B. *Tetrahedron Lett* **2006**, *47*, 5939.

²¹³ Rauter, A. P.; Ramôa-Ribeiro, F.; Fernandes, A. C.; Figueiredo, J. *Tetrahedron* **1995**, *51*, 6529.

²¹⁴ Rajput, V. K.; Roy, B.; Mukhopadhyay, B. *Tetrahedron Lett* **2006**, *47*, 6987.

²⁰¹ Furneaux, R. H.; Tyler, P. C.; Whitehouse, L. A. *Tetrahedron Lett* **1993**, *34*, 3609.

reagent required a high purity of 1,2:4,6-di-*O*-isopropylidene- α -L-sorbose. The oxidation assay on the commercial **53** failed due to its degradation. The quality of crude or even purified by chromatography **53** was not sufficient as no traces of the desired ketone **63** could be obtained. On the other hand, when **53** was obtained by recrystallization, it was clean enough to be oxidized with Dess-Martin periodinane quantitatively. Subsequent reduction with an excess (2.5 eq) of sodium borohydride afforded the crude *L*-tagato-derivative **64** ready to be used in the next step. As all intermediates, except **53** were used as crude compounds, the yield was calculated after the next step, which was the migration of the isopropylidene to give alcohol **65**. The best overall yield for this 4-step sequence from L-sorbose to **65** (including two purifications) was 7%.

III.3 Synthesis of 1,2:4,6-di-*O*-isopropylidene- α -L-sorbofuranose and inversion of configuration by way of an oxidation with PCC

As the purity of the 1,2:4,6-di-*O*-isopropylidene- α -L-sorbose was crucial for oxidation with Dess-Martin periodinane, and implied a low yield procedure for the first step, we decided to try other oxidation agents. The Swern oxidation of less clean 1,2:4,6-di-*O*-isopropylidene- α -L-sorbofuranose failed also, but the same reaction with PCC gave the expected ketone **63** in 22% yield from L-sorbose (*Scheme 29*). The following reduction and isopropylidene migration afforded alcohol **65** in 12% overall yield from L-sorbose.

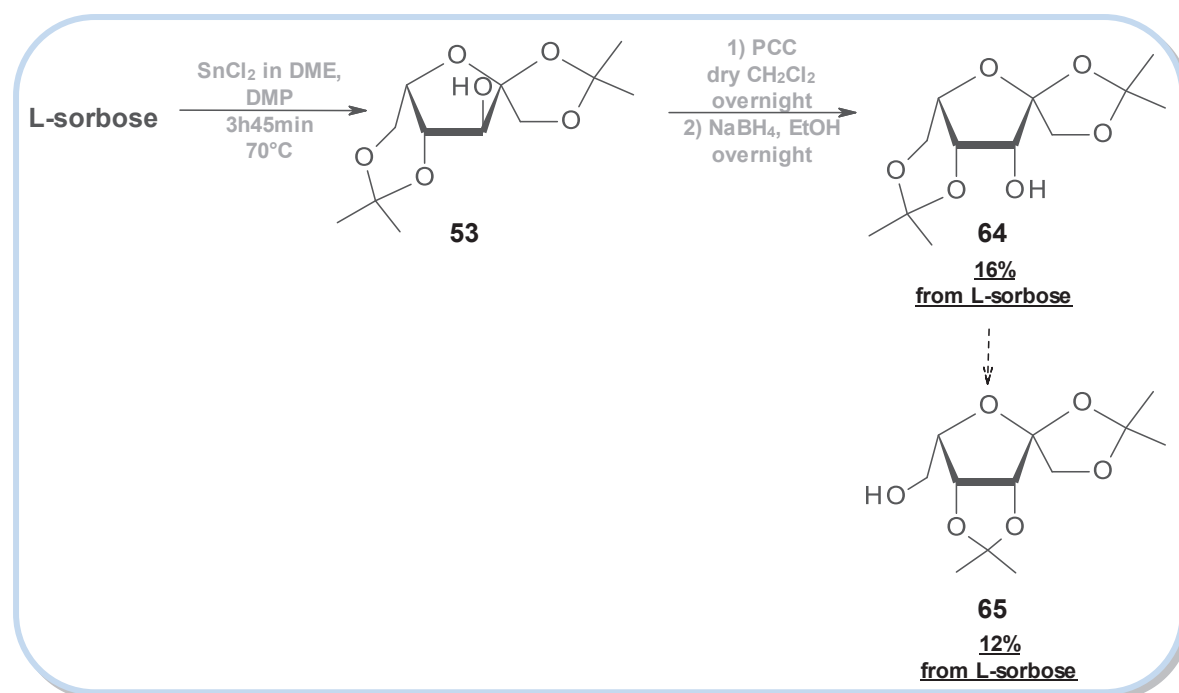

Scheme 29. Synthesis of 1,2:3,4-di-*O*-isopropylidene- α -L-tagatofuranose **65**.

Confident with those conditions, we performed the first protection step with the difference that we used a longer reaction time to obtain the maximum conversion (reaction stopped when the solution was clear, 3h 45min on 7g scale), and then we repeated the oxidation-reduction sequence on crude **53**. As the formed ketone **63** has a different R_f from **53** and its isomer, as well as from other by-products, we can oxidize the crude mixture and isolate the desired ketone **63** by flash column chromatography on silica gel. We succeeded to obtain the inverted *L*-tagato-alcohol **64** which was purified on silica gel and submitted to further reaction to prepare **65**. The best overall yield for this 4-step sequence from *L*-sorbitol to alcohol **65** is 12% (purification after reduction). This means that we almost doubled the yield of the previous procedure and avoided difficult purification by recrystallization. The disadvantage of this approach is the use of toxic PCC. However with careful handling and proper waste disposal, this method becomes efficient and safe.

III.4 Liberation and oxidation of C-6 hydroxyl group

As the principle of this synthetic strategy is to elongate the chain at C-6 position, we had to liberate it. To achieve this, we capitalized on the differences in stabilities of isopropylidene groups. The acetonide between two vicinal secondary hydroxyl groups (C-3 and C-4) is more stable than the one between primary and secondary hydroxyl groups (C-4 and C-6). In 1,2:4,6-di-*O*-isopropylidene- α -*L*-sorbitol **53** the C-3 and C-4 hydroxyl groups are in trans orientation thus an isopropylidene acetal between these secondary hydroxyl groups cannot be formed and migration of protecting group is not possible. However, in an *L*-tagatofuranose, the C-3 and C-4 hydroxyl groups are in cis orientation which favours displacement of acetonide to form a more stable one. This occurs spontaneously in acetone and is accelerated by the addition of a catalytic amount of acid (**Scheme 30**). The *L*-tagatofuranose derivative **65** was thus obtained in 73% yield (12% overall yield from *L*-sorbitol).

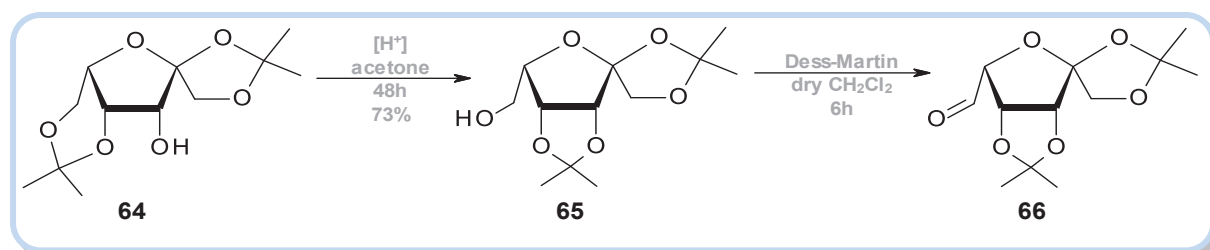

Scheme 30. Synthesis of aldehyde **66**.

Oxidation with Dess-Martin periodinane was then performed to prepare the key aldehyde intermediate **66**. This unstable aldehyde **66** was directly used in the next reaction. As the reaction is difficult to monitor by TLC, the reaction time was set up experimentally on

the basis of the yield of the subsequent reaction. We observed that leaving the reaction overnight leads to degradation of the aldehyde **66**, while 4h was not sufficient to oxidize completely the alcohol **65** (recovered after the next step): the reaction time was set up to 6h.

III.5 Condensation of aldehyde **66** with sulfinylamines

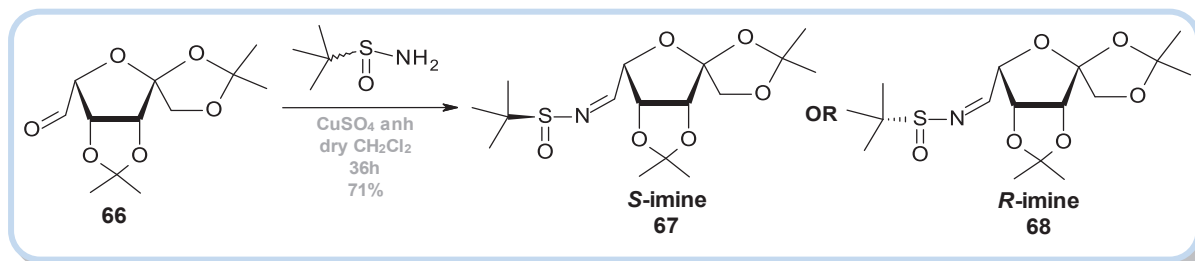

Scheme 31. Condensation of aldehyde **66** with sulfinylamines.

Sulfinylimines are known to be excellent “Michael” acceptors due to the strong electron withdrawing *N*-sulfinyl group. They react with a variety of nucleophiles in a 1,4-addition fashion, including oxygen, nitrogen, sulfur, carbon, and phosphorous nucleophiles.²¹⁵ Moreover, the sulfinyl group is easily removed under acidic conditions.²¹⁶ This is why, to introduce the nitrogen into the molecule and then to perform addition of organometallics we decided to use Ellman’s imines.²¹⁷ The condensation of aldehyde **66** with a racemic mixture of Ellman’s amines ((*S/R*)-*tert*-butanesulfinamide) in the presence of molecular sieves and dry copper sulfate afforded *tert*-butanesulfinylimine derivatives **67** and **68**. The *S* and *R* isomers were separable by silica gel chromatography. We also performed the synthesis of **67** and **68** using each enantiomer of Ellman’s amine separately in order to have stereochemically well defined intermediate and to investigate the stereochemistry of the following additions of the Grignard reagents (**Scheme 30**). Both reactions gave satisfactory yields of 71% and 79% (from alcohol **65**).

III.6 Addition of Grignard reagents

The additions of Grignard reagents were conducted in dry toluene, at 0°C or -78°C with five equivalents of allyl, hexyl or nonyl Grignard reagent used as solutions in ether or THF.²¹⁸ Each reaction was conducted on pure starting imine (**67** or **68**) and gave from one to three distinct products (**Scheme 32**).

²¹⁵ Ellman, J. A.; Owens, T. D.; Tang, T. P. *Acc. Chem. Res.* **2002**, *35*, 984.

²¹⁶ Zhou, P.; Chen, B.-C.; Davis, F. A. *Tetrahedron* **2004**, *60*, 8003.

²¹⁷ Liu, G.; Cogan, D. A.; Ellman, J. A. *J Am Chem Soc* **1997**, *119*, 9913.

²¹⁸ El Oualid, F.; van der Marel, G. A.; Overkleeft, H. S.; Overhand, M. *Org Lett* **2004**, *6*, 3167.

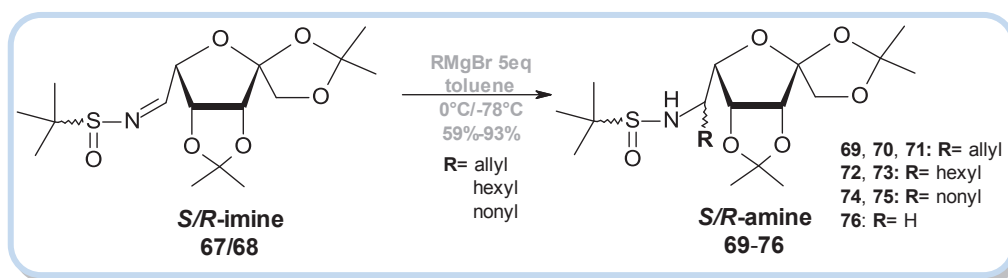

Scheme 32. Addition of Grignard reagents to Ellman's imines.

As a result of introducing Ellman's chiral auxiliary, there are two chiral fragments in the molecule that can direct the addition of Grignard reagents. In our previous experience in the *xylo* series,²⁰² only the sugar moiety was responsible for the stereochemistry of the organometallic addition, while the configuration of the imine was completely passive. However, it was reported in the literature that changes in reaction conditions can reverse the diastereoselectivity of organometallics addition to sulfinimines.²¹⁹ The results we obtained were sensitive to reagents used as well as the type of organomagnesium reagent involved (**Tables 9** and **10**).

Entry	Imine	Reagent	Temp	Yield of <i>S</i> isomer	Yield of <i>R</i> isomer
1	<i>R</i>	AllylMgBr 1N in Et ₂ O	0°C	7% (7 mg)	76% (113 mg)
2			-78°C	Traces	80% (89 mg)
3	<i>S</i>	AllylMgBr 1N in Et ₂ O	0°C	--	93% (145 mg)

Table 9. Yields and diastereoselectivity of allylmagnesium bromide addition to sulfinimines **67** and **68**.

As summarized in **Table 9** for the addition of allylmagnesium bromide, essentially only one stereoisomer is obtained from both the *R*- and *S*-imines, and therefore the reaction is almost exclusively controlled by the sugar moiety. As expected, the stereoselectivity is higher at lower temperature. We are not completely sure about the attribution of the configuration of the allyl chain, as the synthesis was not carried out from these intermediates until the final cyclic compounds and the assignment is based on NMR spectra comparisons.

In **Table 10** are listed the results for the addition of hexylmagnesium bromide and nonylmagnesium bromide. As regards the addition of a hexyl chain, the experiments were carried out at -78°C and two solutions of hexylmagnesium bromide were used: 0.8N in THF and 2N in Et₂O. For the assays with the THF solution, only one diastereoisomer was obtained

²⁰² Oulaïdi, F.; Gallienne, E.; Compain, P.; Martin, O. R. *Tetrahedron: Asymmetry* **2011**, 22, 609.

²¹⁹ Koriyama, Y.; Nozawa, A.; Hayakawa, R.; Shimizu, M. *Tetrahedron* **2002**, 58, 9621.

from both imines (entry 1 and 2). In this case it appears that it is also the sugar which controls the stereochemistry of the addition. The same reaction with an Et₂O solution of hexylmagnesium bromide afforded two different epimeric amines, with the *R* isomer highly predominant from the *R* imine and a majority of *S* isomer from the *S* imine. This means that changing the cosolvent (Et₂O instead of THF) decreased the influence of the sugar moiety on the stereochemistry of the addition in favor of that of the chiral sulfinylimine. As regards the addition of a nonyl chain, only one assay for each imine was done at 0°C using the Grignard reagent as a solution in ether. The diastereoselectivity was better for the *S* imine **67** (1:6 in favor of *S* isomer) while for the *R* imine **68**, both isomers were obtained in nearly the same yield. As the reactions in the nonyl series were performed at higher temperature, their diastereoselectivity is lower. Interestingly, the addition of nonylmagnesium bromide gave a third product: a compound without any chain **76**, which must arise from a Meerwein-Ponndorf-Verley-type reduction. Finally, the isomers were separable by silica gel chromatography, and the low diastereoselectivity of the Grignard reagent addition was not an important problem, as we need to have access to both isomers (α and β) of the final 1-*C*-alkyl-imino-*D*-galactitols.

Entry	Imine	Reagent	Temp	Yield of <i>S</i> isomer	Yield of <i>R</i> isomer	Total Yield
1	R	HexylMgBr 0.8N in THF	-78°C	65% (47 mg)	--	65%
2	S	HexylMgBr 0.8N in THF	-78°C	60% (26 mg)	traces	60%
3	R	HexylMgBr 2N in Et ₂ O	-78°C	8% (14 mg)	71% (128 mg)	79%
4	S	HexylMgBr 2N in Et ₂ O	-78°C	65% (108 mg)	27% (44 mg)	92%
5	R	NonylMgBr 1N in Et ₂ O	0°C	32% (74 mg)	29% (68 mg)	--
6	S	NonylMgBr 1N in Et ₂ O	0°C	60% (113 mg)	10% (19 mg)	70%

Table 10. Yields and diastereoselectivity of hexyl- and nonylmagnesium bromide additions to sulfinimines **67** and **68**.

III.7 Deprotection and reductive amination of amine intermediates

As the last step of this synthesis was a ring closure by reductive amination, we needed to cleave first the sulfinyl group to liberate the amine, and then to hydrolyze the isopropylidene acetals to free the anomeric position. Both processes were to be performed under acidic conditions, using HCl, HBr, TFA, AcOH or acid resin.^{216, 220, 221} After successful deprotection, we planned to achieve an intramolecular reductive amination to access the final 1-C-alkyl-imino-D-galactitols.

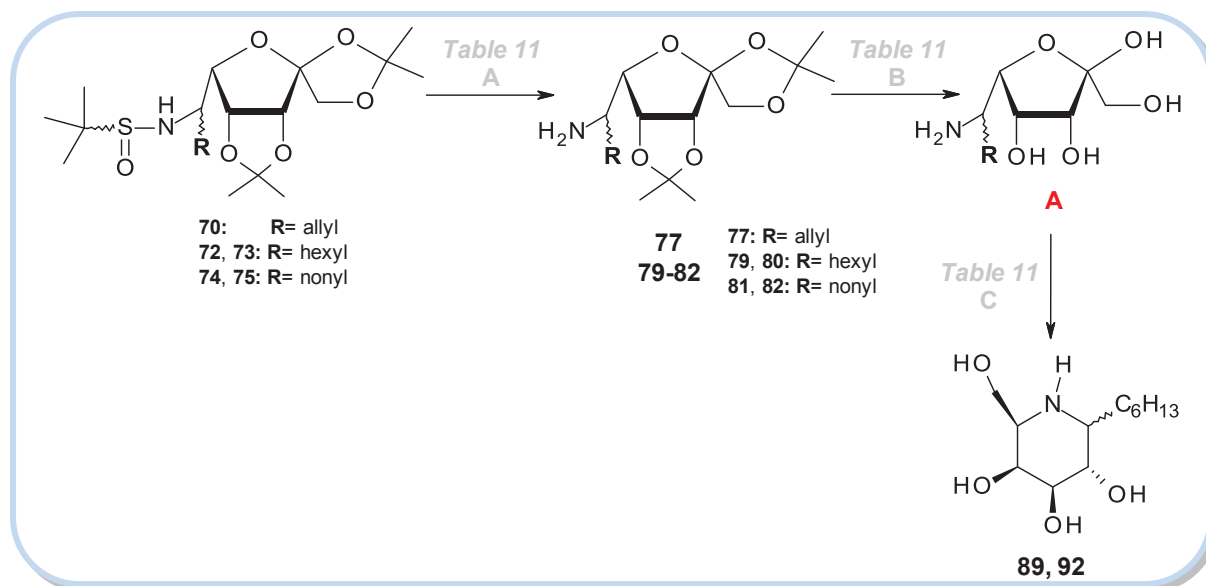

Scheme 33. Deprotection and reductive amination of amine intermediates.

At the beginning we decided to cleave the sulfinyl group and the isopropylidene acetals at the same time by using trifluoroacetic acid in water (*Table 11*, entry 1). The spectra of the crude product were very difficult to interpret, which could be due to the presence of various possible forms of expected compound **A**. The mixture was submitted to hydrogenation which resulted in a complicated combination of desired imino-galactitols, their deoxy derivatives and epimers. The NMR was again illegible and the only information we had came from mass spectroscopy analysis.

We decided to repeat the deprotection but stepwise. At first we cleaved the sulfinyl with hydrochloric acid in methanol. It turned out however, that we also removed one of the acetonides which resulted in an unstable intermediate. To remove the second isopropylidene, we used the same conditions as previously. But we realized after hydrogenation that the product must have partially been degraded during the second step and the reaction sequence

²¹⁶ Zhou, P.; Chen, B.-C.; Davis, F. A. *Tetrahedron* **2004**, *60*, 8003.

²²⁰ Clode, D. M. *Chem Rev* **1979**, *79*, 491.

²²¹ Hun Park, K.; Jin Yoon, Y.; Gyeong Lee, S. *Tetrahedron Lett* **1994**, *35*, 9737.

gave a complex mixture. As MeOH/HCl mixture was efficient enough to cleave isopropylidene also, we decided to use this method to achieve deprotection (**Table 11**, entry 3). However, this time we formed, as we could have expected, the corresponding methyl glycoside (confirmed by the mass analysis and NMR) and further reductive amination was not possible. Then we tried an acidic ion exchange resin (Dowex50WX8), but again we obtained a complex mixture and we did not achieve the isopropylidene cleavage (**Table 11**, entry 4). From those fruitless trials, we realized that the intermediate with a free primary amino group and deprotected anomeric hydroxyl group (an amino hemiketal) must be very unstable and labile. Therefore, in the next assays (**Table 11**, entries 5 and 6) we shortened the time for sulfinyl cleavage and we tried to deprotect the isopropylidene groups during hydrogenation under acidic conditions in order to promote reductive amination as soon as the labile intermediate **A** is formed. This time we reached completely deprotected compounds, but the reductive amination still did not work.

Entry	A	B	C	Comments
1	TFA:H ₂ O (3:1), 4.5h		H ₂ , Pd/C, HCl 1N, iPrOH	Low yield, desired compound in <u>an unseparable mixture with deoxy products.</u>
2	MeOH:HCl, 2h	TFA:H ₂ O (3:1), 5 h	H ₂ , Pd/C, AcOH _{gl} 10%, iPrOH	Cleavage of one of the isopropylidenes during first step, unstable product. Degradation after second step.
3	MeOH:HCl, 2h	MeOH:HCl 1 h	H ₂ , Pd/C, AcOH _{gl} 10%, iPrOH	During second step, <u>formation of methyl glycoside.</u> Traces of desired compound.
4	Resin H ⁺		--	Degradation, <u>not efficient</u> for isopropylidene cleavage.
5	MeOH:HCl, 30 min	TFA:H ₂ O (3:1 or 1:1), 6 h then H ₂ , Pd/C		Fully deprotected compound, <u>reductive amination does not work.</u> Degradation
6	MeOH:HCl, 15 min	H ₂ , Pd(OH) ₂ , HCl 1N, 3 eq, iPrOH		<u>Fully deprotected compound,</u> traces of desired compound.
7	MeOH:HCl, 20 min, then <u>resin OH⁻</u>	1) HCl 1N, 3 eq iPrOH, 2) Resin H ⁺	NaBH ₃ CN, AcOH _{gl} , MeOH	<u>Clean crude compound after first step.</u> Cleavage with HCl does not work. Reaction <u>repeated with resin H⁺ works!</u> Reductive amination gives mixture of desired compound and <u>deoxy derivatives.</u>

Table 11. Summary of conditions used for the sulfinyl group cleavage and further reductive amination.

During all these attempts, the desulfinylation with MeOH/HCl gave a compound without 1,2-*O*-isopropylidene as a by-product. To avoid further degradation during concentration, we neutralized the reaction mixture with a basic resin. As a result, we obtained a clean crude amine-intermediate quantitatively. Further successful cleavage of

isopropylidene groups with Dowex 50WX8 resin and subsequent reductive amination with sodium cyanoborohydride afforded the desired imino-D-galactitol in a mixture with their deoxy derivatives.

All of the assays above were conducted on different amines with allyl, hexyl or nonyl chain at the C-6 position. None of them was satisfactory and we had to revise the synthetic scheme. As noted by Tyler:²⁰¹ this type of aminohemiketal is particularly unstable and degrades easily upon acidic acetonide cleavage conditions. Additionally, after the isopropylidene deprotection step, we could not determine the composition of the reaction mixture and could not give a reason for the inefficacy of the chosen synthetic approach. Inspired by work of Vasella²²² and Wong²²³ we realized that the synthesis could be successful, if we temporarily “protected” the amine as an azido group and we decided to transform the amine into an azide.

III.8 Synthesis of azido-derivatives

In 1972 Cavender and Shiner²²⁴ described the first example of diazo transfer from triflyl azide to primary amines. This method was successfully applied in carbohydrate chemistry by Vasella in 1991²²² and optimised by use of copper (II) by Wong²²³. We decided to employ this method to convert the hexyl and nonyl-amino-derivatives **79-82** into the corresponding azido compounds **83-86** (*Scheme 34*).

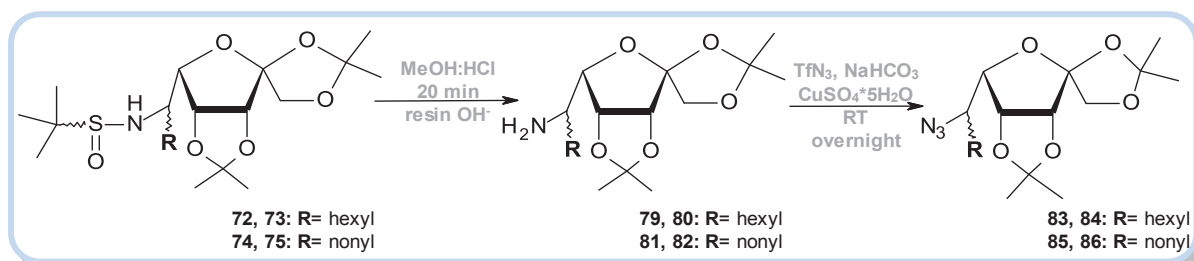

Scheme 34. Synthesis of azido-derivatives.

As triflyl azide is a hazardous reagent that can be stored in solution only, we chose to synthesise it according to the safe and convenient protocol reported by Ernst and co-workers.²²⁵ All azido-derivatives **83-86** were synthesised using the same procedure in the presence of catalytic copper (II) sulfate in good yields from 61% to 85% (for two steps). Unfortunately we did not have time to verify if this methodology could be applied to the 6-C-allyl derivatives.

²⁰¹ Furneaux, R. H.; Tyler, P. C.; Whitehouse, L. A. *Tetrahedron Lett* **1993**, *34*, 3609.

²²² Vasella, A.; Witzig, C.; Chiara, J.-L.; Martin-Lomas, M. *Helv Chim Acta* **1991**, *74*, 2073.

²²³ Alper, P. B.; Hung, S.-C.; Wong, C.-H. *Tetrahedron Lett* **1996**, *37*, 6029.

²²⁴ Cavender, C. J.; Shiner, V. J. *J Org Chem* **1972**, *37*, 3567.

²²⁵ Titz, A.; Radic, Z.; Schwardt, O.; Ernst, B. *Tetrahedron Lett* **2006**, *47*, 2383.

III.9 Deprotection and reductive amination of azido-intermediates

Having azido-intermediates **83-86** in hand, we decided to cleave the isopropylidene groups using Dowex 50WX8 (H⁺) resin as described by O'Brien and Murphy.²²⁶ This time we succeeded to obtain the desired free azido hemiketal derivatives **87** and **88**, which allowed us to complete the synthesis. Although this reaction is long and sensitive to temperature (at lower temperature the reaction is not complete and very slow, while heating over 65°C leads to elimination reactions), we found optimized conditions (*Scheme 35*) that led us to very clean samples of azido intermediates **87** and **88** in 61-78% yields. We observed also that for the *R* isomer this reaction functions better than for the *S* one. During those assays we completely consumed the nonyl derivatives and further reductive amination reactions were conducted on hexyl-intermediates only (*Scheme 35*).

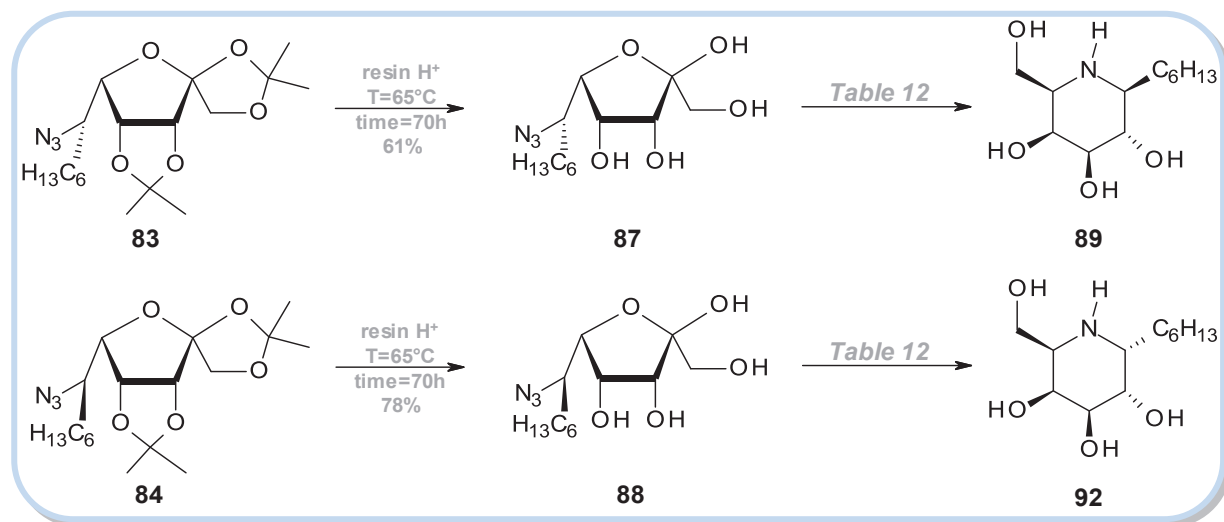

Scheme 35. Deprotection and reductive amination of azido-intermediates **83** and **84**.

The last, final step of this synthesis was the intramolecular reductive amination by hydrogenation of azido intermediates **87** and **88**. During this reaction, firstly the azide was reduced to an amine that reacted with the open chain keto form, according to the previously described mechanism (*Scheme 21*).

²²⁶ O'Brien, C.; Murphy, P. V. *J Carbohydr Chem* **2011**, *30*, 626.

Entry	Isomer	Solvent	Catalyst	Time	H ₂ pressure	Comments
1		MeOH _{anh}	Pd/C 10%	overnight	atm	68% yield, desired compound with <i>N</i> -methylated derivative
2	S	iPrOH	Pd/C 10%	overnight	atm	59% yield, 20% of <i>gluco</i> epimer
3		MeOH	Pd/C 10%	4h	10 bars	64% with 6% of <i>gluco</i> epimer only
4		iPrOH	Pd/C 5%	6h	atm	50%, illegible mixture,
5		Dioxane/ H ₂ O	Pd/C 10%	5.5h	atm	45%, mixture of epimers
5	R	MeOH _{anh}	Pd/C 10%	overnight	atm	63%, illegible mixture
6		iPrOH	Pd/C 10%	14h	atm	low yield, illegible mixture
7		MeOH	Pd/C 10%	4h	10 bars	71%, 20% of another epimer

Table 12. Various conditions of reductive amination via catalytic hydrogenation.

This time, we did obtain the desired imino-D-galactitols without any deoxy by-products! The first assay from **87** in methanol under atmospheric hydrogen pressure gave the desired product **89** in a mixture with the corresponding *N*-methyl-imino-D-galactitol **90** and another epimer in a ratio 5:2.5:2.5 (entry 1, **Table 12**). When we changed the solvent to isopropanol, we did not observe any *N*-methyl by-product, but the desired **89** was in a mixture with its *gluco* epimer **91** (4:1 ratio approx). The best results were obtained by hydrogenation under a 10 bar pressure in methanol with 10% palladium on carbon as the catalyst (entry 3, **Table 12**). This time we also observed an important difference in reactivity between the two isomers. Interestingly, less reactive in the previous reaction, the *S* isomer gave the expected β -1-*C*-hexyl-imino-D-galactitol **89** in 64% yield contaminated with a very small amount of *gluco* epimer **91** (6% only). The *R* isomer gave α -1-*C*-hexyl-imino-D-galactitol **92** in 71% yield, but the sample contains a small amount of a second product that is probably also the *gluco* epimer **93**. Nevertheless, the quality of the NMR spectrum did not allow identifying precisely this other iminosugar. Separation of epimers by HPLC to obtain very pure samples for biological assays are in progress.

III.10 Synthesis of DGJ

While working on the synthesis of 1-*C*-substituted imino-*D*-galactitols, we decided to verify if this strategy could provide an improved synthesis of DGJ. Starting from *L*-sorbitose we could reach DGJ in 8 steps (**Scheme 36**). As we already had the *L*-tagatofuranose **65** we envisaged to substitute its C-6 hydroxyl group with an azide, to cleave the isopropylidene groups and to perform the reductive amination by hydrogenation. To transform the hydroxyl group into an azide, we used the triflate intermediate **95** which was very reactive and gave the desired azide **96** in 76% yield (from alcohol **65**). Cleavage of the acetonides using Dowex 50WX8 (H⁺) worked in 61% yield. However, for the last step, we faced the same problems as during the synthesis of substituted DGJs. We tried hydrogenation under atmospheric pressure in isopropanol with palladium hydroxide, but recovered starting material. On the same sample we performed hydrogenation in dry methanol with 10% palladium on carbon, which gave an illegible mixture of epimers. In the last assay we tried to silylate the primary hydroxyl group as suggested by Tyler,²⁰¹ but the reaction did not work. During those optimizations, we ran out of the precursors **65** and **96** and we could not further investigate this synthesis.

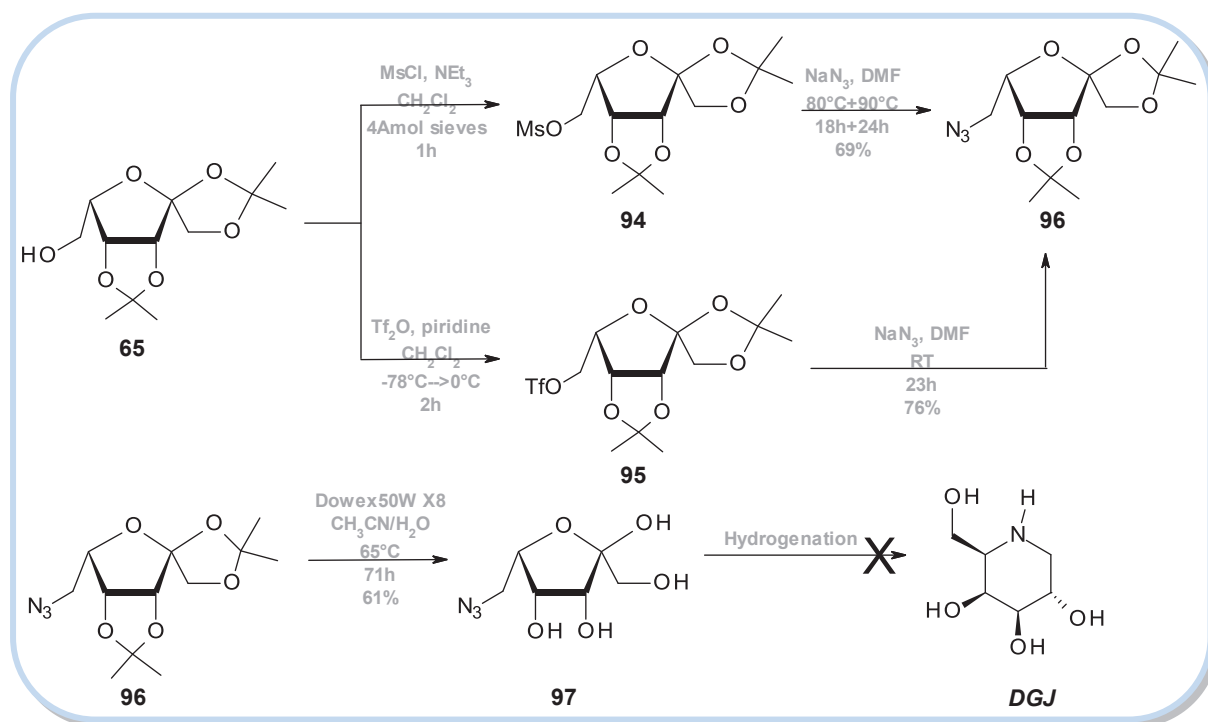

Scheme 36. Synthesis of DGJ from alcohol **65**.

III.11 Conclusions

The alternative synthetic strategy to prepare 1-*C*-alkyl-imino-*D*-galactitols from *L*-sorbitose is significantly more efficient than the previous one from *D*-galactose. We first overcame the difficulties in the synthesis of 1,2:4,6-di-*O*-isopropylidene- α -*L*-sorbitose **53** and

established correct protocols and characterizations for 1,2:4,6- and 2,3:4,6-di-*O*-isopropylidene- α -L-sorbose isomers. This is important because, for many of sorbfuranose derivatives, correct analytical data were missing in the literature. We then successfully applied our previous experience with Ellman's imines to *tagato* intermediates as precursors of 1-*C*-alkyl iminogalatitol derivatives. The deprotected amine intermediates resulting from this strategy were found to be extremely labile: the conversion of the amino group into an azido group by diazo transfer, an unusual step at the late stage of such synthesis, allowed us to solve this problem and to perform the deprotection step to a clean azido hemiketal in high yield. The final piperidine ring formation by intramolecular reductive amination upon catalytic hydrogenation led successfully to the desired final products, in appropriate yields, but contaminated by a small amount of an epimer. Some optimization of this last step is still required in order to obtain eventually the desired iminogalactitols free of traces of other epimers.

Résumé section III :

Synthèse alternative des 1-C-alkyl-imino-D-galactitols à partir du L-sorbose: stratégie par élongation de la chaîne en C-6.

Compte tenu des difficultés de la stratégie de synthèse précédente s'appuyant sur une élongation de la chaîne en C-1, nous avons décidé de développer une autre voie d'accès à ces composés. Inspirés par les travaux de Tyler sur la synthèse de la 1-déoxygalactonojirimycine (DGJ) à partir du L-sorbose, nous avons adapté leur approche à la méthodologie d'élongation de la chaîne en C-6 précédemment utilisée dans notre équipe. En raison d'une qualité insuffisante du produit de départ commercial : le 1,2:4,6-di-*O*-isopropylidene- α -L-sorbofuranose, nous avons également réexaminé sa synthèse et vérifié les données spectrales de ce composé, qui faisaient apparaître de nombreuses erreurs dans la littérature. La stratégie de synthèse ainsi mise au point pour accéder aux iminogalactitols 1-C-alkylés se décompose en sept grandes étapes :

- i. protection du L-sorbose pour obtenir le 1,2:4,6-di-*O*-isopropylidene- α -L-sorbofuranose
- ii. inversion de la configuration du groupement hydroxyle en C-3 pour obtenir l'intermédiaire en série *L-tagato*
- iii. libération (par migration de l'isopropylidène des positions 4,6 aux positions 3,4) du groupement hydroxyle en C-6 et oxydation
- iv. condensation de l'aldéhyde obtenu avec le sulfinamide d'Ellman
- v. addition de réactifs de Grignard
- vi. déprotection
- vii. formation du cycle pipéridine par amination réductrice intramoléculaire

Cependant, l'intermédiaire aminé, obtenu après l'étape de déprotection, s'est révélé très instable dans les conditions utilisées pour la coupure des isopropylidènes. Nous avons donc décidé de le transformer en un dérivé azido afin de surmonter ces difficultés. De même que précédemment, une longue optimisation a été nécessaire pour l'amination réductrice intramoléculaire, qui nous a donné les composés désirés avec des rendements satisfaisants, mais en mélange avec de petites quantités d'un autre épimère. Cette nouvelle stratégie pour synthétiser les 1-C-alkyl-imino-D-galactitols est donc significativement plus efficace que la précédente. Toutefois, d'autres travaux seront nécessaires afin d'obtenir exclusivement les iminogalactitols désirés ainsi que la DGJ.

IV. The synthesis of 1-C-alkyl-imino-L-altritol.

IV.1 Synthetic strategy

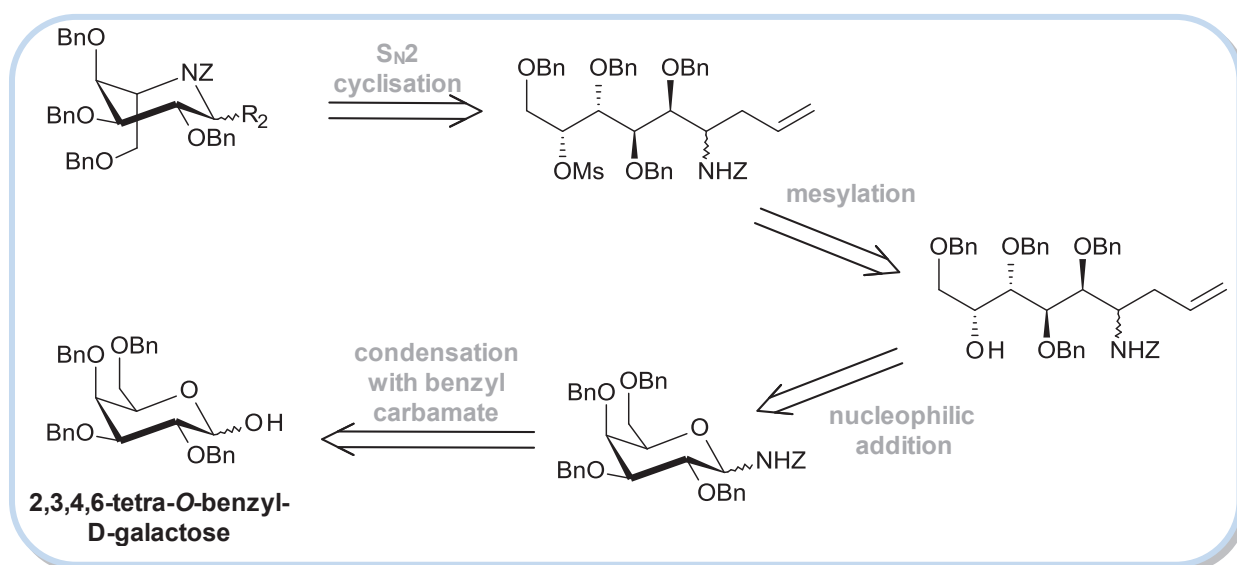

Scheme 37. Synthetic strategy to prepare 1-C-alkyl-imino-L-altritol

The synthetic strategy to prepare 1-C-alkyl-imino-L-altritol starts with the same reactions as for the *galacto* series; in the last step, instead of a reductive amination, we applied an intramolecular S_N2 cyclisation. As the starting material for this synthesis, we used the mixture of open-chain alcohols containing *N-Z* protected galactopyranosylamine (**26mix**), obtained in the first imino-D-galactitols synthesis. It turned out that after mesylation we can also separate the desired alcohol derivatives from the *N-Z* protected galactopyranosylamine. The advantage of this approach is the fact that we do not have to obtain pure alcohols: purification of the mesylated derivative provides intermediates ready to be used in the last step: cyclisation. The 1-C-alkyl-iminosugar derivatives obtained in this way can be:

- deprotected to give 1-C-propyl-imino-L-altritol
- functionalized by metathesis to give other 1-C-alkyl derivatives
- functionalized to give imino-L-altritol carrying a polar aglycone

IV.2 Synthesis of protected 1-C-alkyl-imino-L-altritol.

A sample of **26mix** was submitted to the reaction with mesyl chloride and the resulting mixture was separated to afford pure diastereoisomer **27R** in 27% yield from **25**, a mixture of both mesylated alcohols **27R** and **27S** (10%) and recovered *N-Z* protected galactopyranosylamine **25**. The minor *S* isomer could not be isolated from the mixture of epimers. The rest of the synthesis was then conducted on the major *R* isomer. Using an S_N2 reaction,

cyclisation of **27R** upon treatment with potassium *tert*-butoxide afforded protected iminosugar **28** in 47% yield.

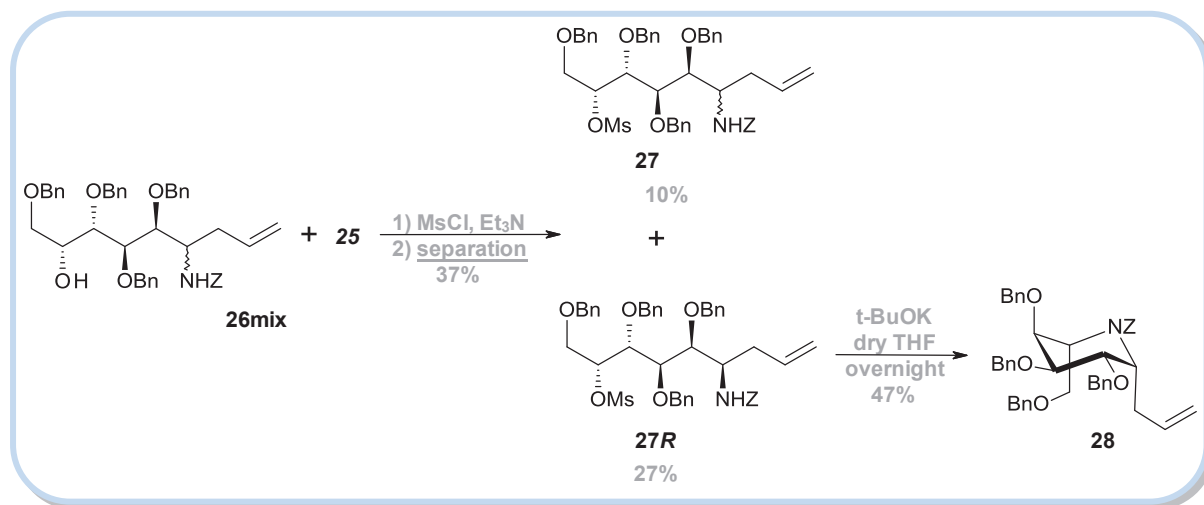

Scheme 38. Synthesis of protected 1-C-alkyl-imino-L-altritols via S_N2 cyclisation.

IV.3 Functionalization of the double bond.

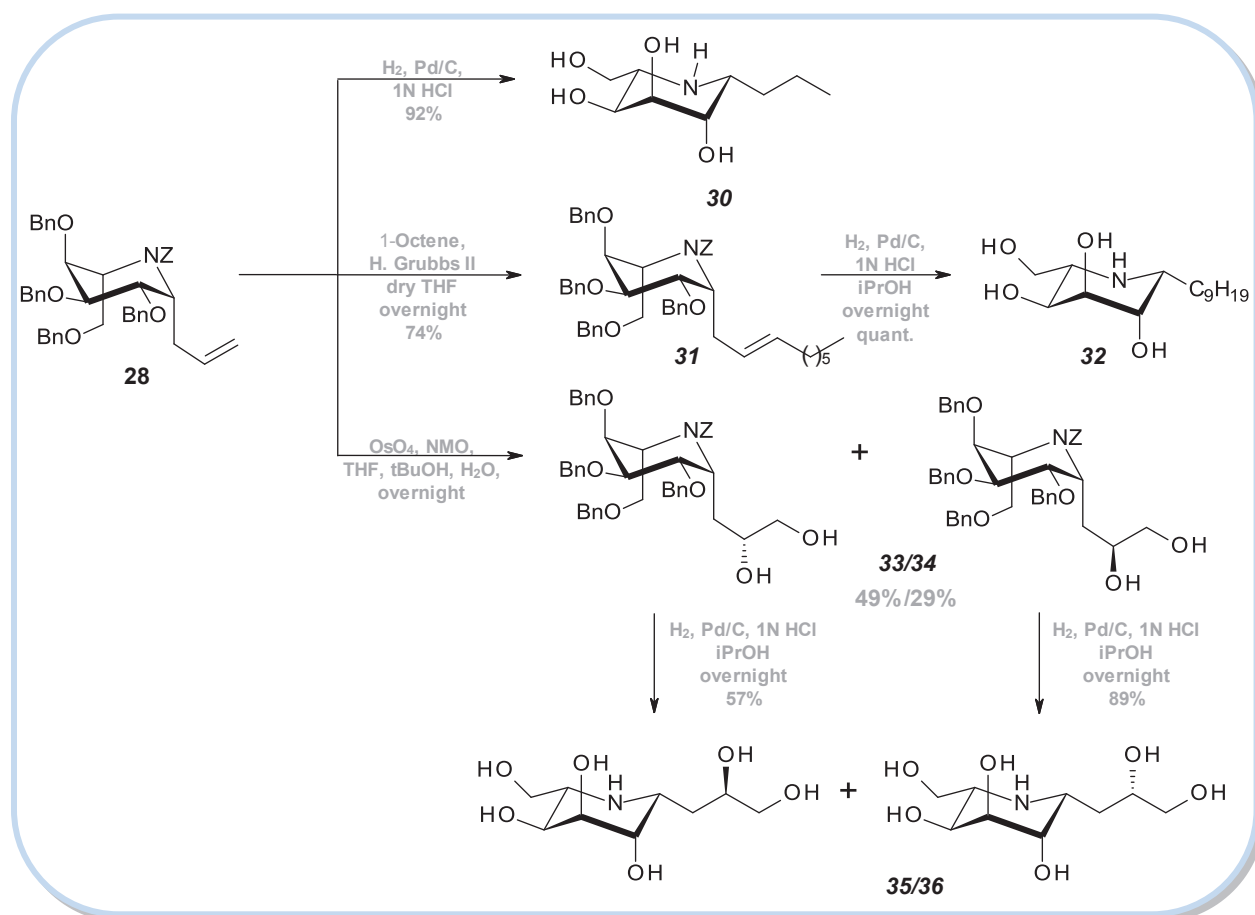

Scheme 39. Deprotection and functionalization of the double bond.

As shown on *Scheme 39*, compound **28** was submitted to three further reactions:

- deprotection by hydrogenation to give 1-*C*-propyl-imino-L-altritol **30**
- cross-metathesis with 1-octene and deprotection to give 1-*C*-nonyl-imino-L-altritol **32**
- dihydroxylation and deprotection of the resulting epimeric diols **33** and **34** to give **35** and **36**

All these compounds were obtained in satisfactory yields. As expected, dihydroxylation of the double bond in **28** was not stereoselective and afforded a mixture of diols **33** and **34**, which could be separated. Configurations of the secondary alcohols were determined by circular dichroism analysis in Prof. Frelek's laboratory. The absolute configurations of the newly formed stereogenic centers are (*R*) in **33** and (*S*) in **34**.

As regards the conformations of the compounds prepared in *L-althro* series, we observed the same phenomenon as for *D-arabino* products: the *N*-acyl protected piperidines favor the conformation in which the substituent α to nitrogen is in axial position. We assumed then, that the major pseudo β (*R*) isomer of protected imino-L-altritols **28**, **31** and **33/34** would be in 4C_1 chair conformation with three axial substituents: this is confirmed by the large $J_{2,3}$ coupling constant in **28** (*Figure 27*).

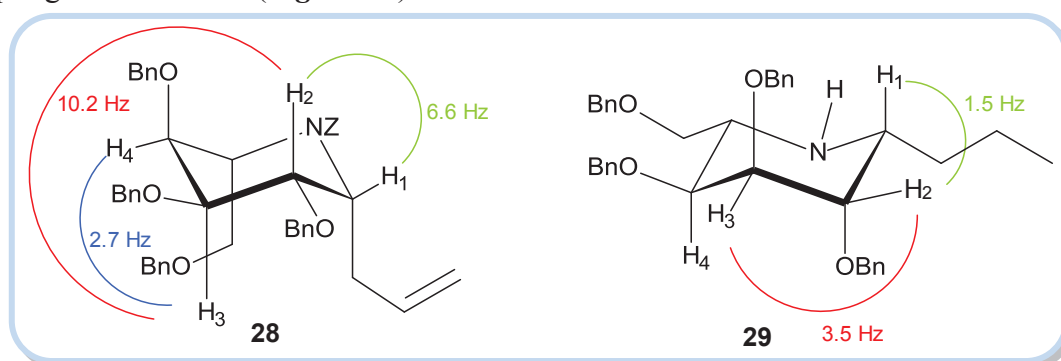

Figure 27. Coupling constants for compounds **28** and **29**.

After selective *N*-deprotection of **28**, we obtained **29** which adopted 1C_4 conformation, as indicated by the small $J_{2,3}$ coupling constants (*Figure 27*). The deprotected iminosugars **30**, **32**, **35** and **36** also adopt this 1C_4 conformation which was confirmed by NMR analysis. All the *N*-Z protected compounds inverted thus their conformations upon *N*-protecting group cleavage (from 4C_1 to 1C_4). This led to a series of new 1-*C*-alkyl imino-L-altritol derivatives, which can be submitted to biological assays.

Résumé section IV:

La synthèse des 1-C-alkyl-imino-L-altritols.

La stratégie de synthèse pour préparer les 1-C-alkyl-imino-L-altritols est similaire à la première voie de synthèse envisagée pour la série *D-galacto*, à l'exception de la dernière étape. En effet, au lieu d'une amination réductrice, nous réalisons, comme dans la série *L-arabino*, une cyclisation intramoléculaire de type S_N2 . Comme produit de départ pour cette synthèse, nous avons utilisé l'alcool obtenu par addition de l'allyltriméthylsilane sur la galactopyranosylamine *N-Z* protégée. Comme précédemment, la réaction d'addition n'est pas complète et l'alcool n'est pas séparable de l'amine de départ. Mais il s'est avéré qu'après méthylation, nous avons pu les séparer plus facilement. L'avantage de cette approche est le fait qu'il n'est pas nécessaire de purifier les alcools intermédiaires. Cette purification s'effectue sur les dérivés méthylés, qui sont ensuite cyclisés pour donner directement les imino-L-altritols 1-C-alkylés. Ces dérivés sont par la suite :

- i. déprotégés pour donner les 1-C-propyl-imino-L-altritols
- ii. fonctionnalisés par métathèse de donner d'autres dérivés 1-C-alkylés
- iii. fonctionnalisés pour donner des imino-L-altritols portant un aglycone polaire conduisant ainsi à une diversité de nouveaux imino-L-altritols 1-C-alkylés.

V. The synthesis of galacto-isofagomine-like iminosugars.

V.1 Synthetic strategy

The best inhibitor for a β -galactosidase known so far is the C-4 epimer of IFG: *galacto*-IFG (4-epi-IFG, **Scheme 40**) which has an IC₅₀ value of 12 nM for the enzyme from *Aspergillus orizae*.¹⁶⁰ For this reason, 4-epi-IFG was one of the three main target structures in this project. We decided to synthesize *galacto*-IFG itself (as a reference for biological tests on human lysosomal enzymes) and derivatives carrying an alkyl chain. The initial synthetic strategy, inspired by the work of Fan and co-workers,¹¹⁵ consisted of (**Scheme 40**):

- selective protection of D-lyxose²²⁷
- inversion of C-4 hydroxyl group configuration to obtain an *L-ribo*-derivative²²⁸
- S_N2 reaction to replace the C-4 hydroxyl by a cyano group¹¹⁵
- reductive amination by hydrogenolysis to obtain *galacto*-IFG followed by reductive alkylation²²⁹ to prepare *N*-alkylated *galacto*-IFG¹¹⁵
- further manipulations on the cyano-intermediate to prepare 5-*C*-alkyl *galacto*-IFGs

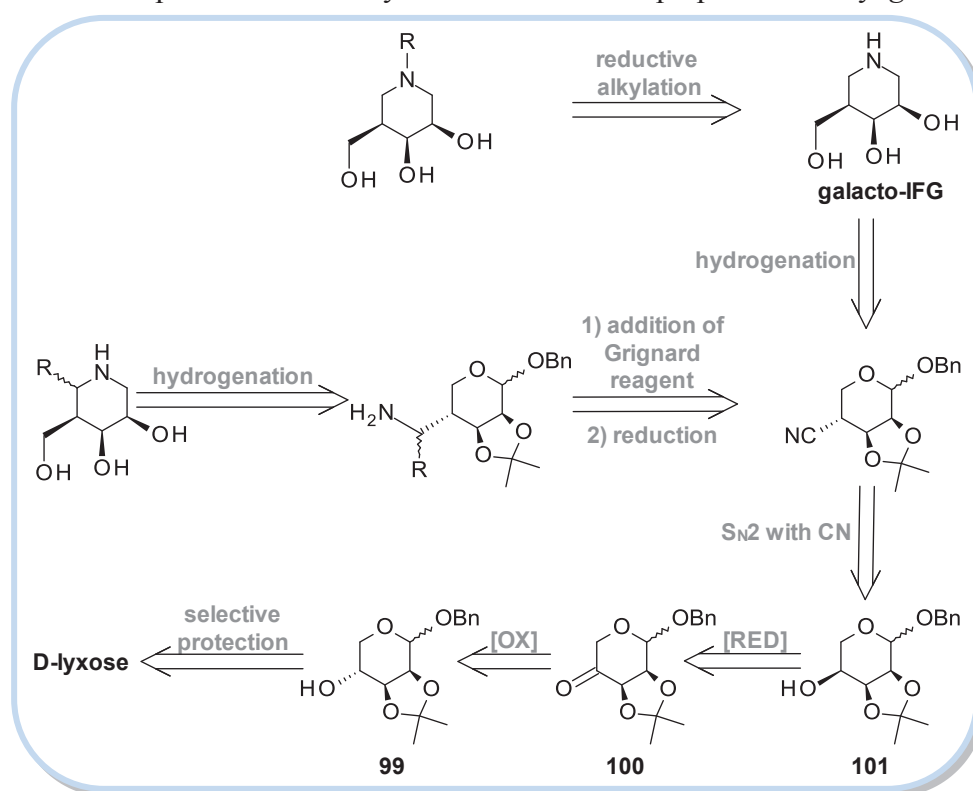

Scheme 40. Synthetic strategy to prepare *galacto*-IFG and its derivatives.

¹⁶⁰ Ichikawa, Y.; Igarashi, Y.; Ichikawa, M.; Suhara, Y. *J Am Chem Soc* **1998**, *120*, 3007.

¹¹⁵ Zhu, X.; Sheth, K. A.; Li, S.; Chang, H.-H.; Fan, J.-Q. *Angew Chem Int Ed* **2005**, *44*, 7450.

²²⁷ Keck, G. E.; Kachensky, D. F.; Enholm, E. J. *J Org Chem* **1985**, *50*, 4317.

²²⁸ Anastasi, C.; Buchet, F. F.; Crowe, M. A.; Helliwell, M.; Raftery, J.; Sutherland, J. D. *Chem Eur J* **2008**, *14*, 2375.

²²⁹ Mellor, H. R.; Nolan, J.; Pickering, L.; Platt, F. M.; Fleet, G. W.; Butters, T. D. *Biochem J* **2002**, *366*, 225.

Although this promising synthetic strategy worked beautifully for IFG itself (*gluco*-like configuration), it failed for *galacto*-IFG. This was due to the ineffectiveness of all of the assays carried out to substitute the C-4 hydroxyl with a cyano group.

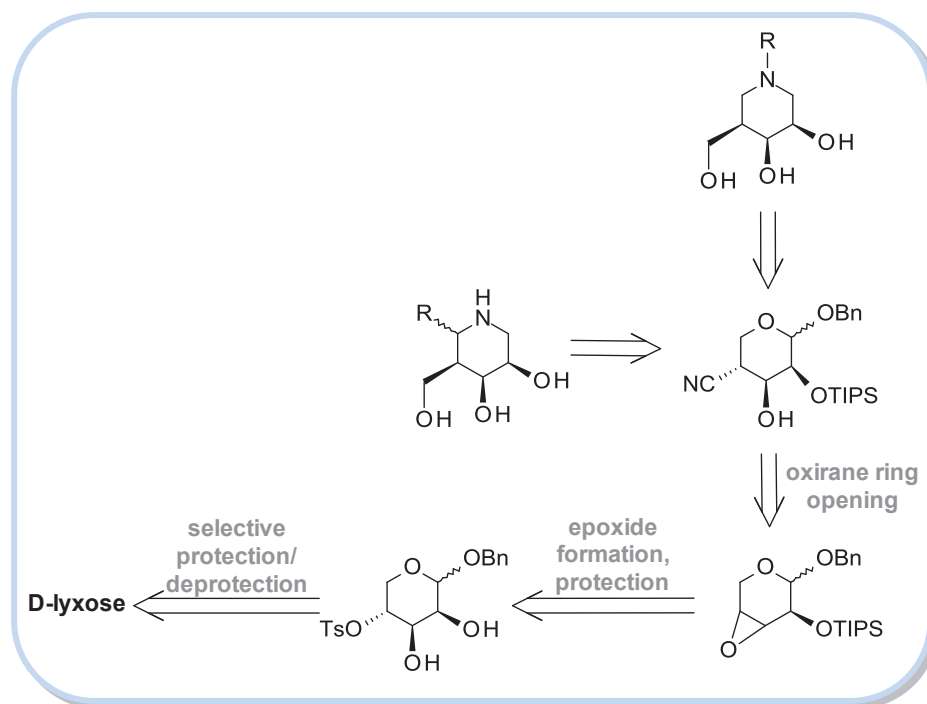

Scheme 41. Improved synthetic strategy to prepare *galacto*-IFG and its derivatives.

Thus we changed our tactic to one developed by Vasella's team,²³⁰ in which the key step was the regioselective opening of an oxirane ring with diethylaluminum cyanide to provide the 4-cyano derivative (**Scheme 41**). Improvement and further investigations on this second approach are currently undertaken by other members of our group.

This synthesis however, provided the beginning steps of another approach to pseudo-*galacto*-IFGs **117**, **118**, **125** and **126** (**Scheme 42**). Inspired by Bols' IFG synthesis,²³¹ we realized that addition of nitromethane onto the previously obtained ketone **100**, might provide an intermediate that could serve as a precursor (**112**, $R_2=H$) of *galacto*-IFG in few steps. Furthermore, use of a nitroalkane with a longer chain in this process opens a direct access to the highly desired 5-*C*-alkyl *galacto*-IFG ($R_2 \neq H$), by way of an unsaturated intermediate such as **B** ($R_2 \neq H$). This would constitute an efficient synthesis in which the R_2 -C-N fragment of the target compound is introduced in one step.

²³⁰ Mohal, N.; Bernet, B.; Vasella, A. *Helv Chim Acta* **2005**, *88*, 3232.

²³¹ Andersch, J.; Bols, M. *Chem Eur J* **2001**, *7*, 3744.

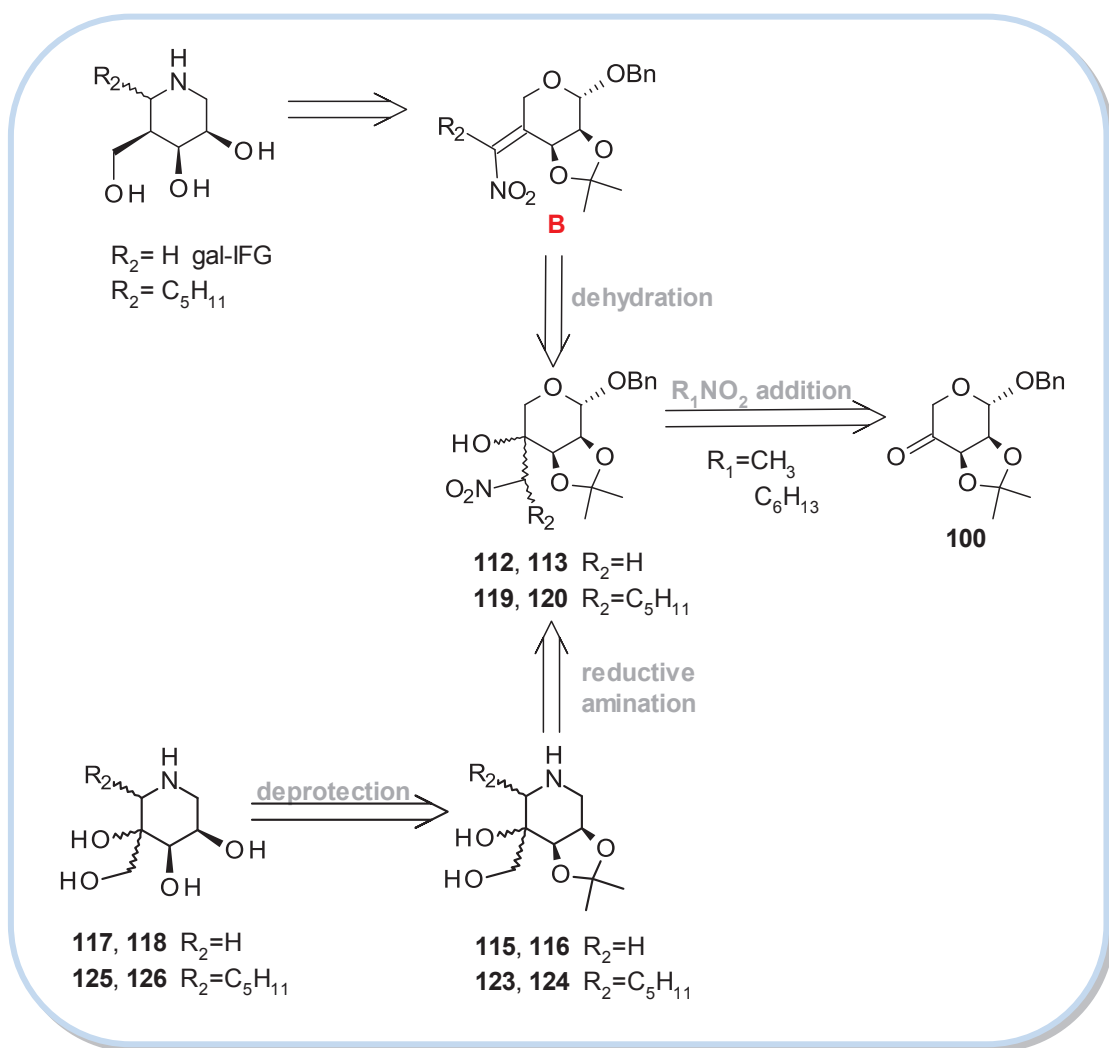

Scheme 42. Synthetic approach to pseudo-galacto-IFGs.

Difficulties with the dehydration step prevented us from implementing this scheme as planned. However, the synthesis could be continued from the 4-hydroxylated intermediate **112**, and provided the 4-hydroxyl-galacto-IFG **118** as well as the 5-*C*-alkyl derivatives of this compound, **125** and **126**.

V.2 Synthesis of benzyl 2,3-*O*-isopropylidene- β -L-ribofuranoside **101**

Benzyl 2,3-*O*-isopropylidene- β -L-ribofuranoside **101** was synthesized in four steps (*Scheme 43*). Fischer glycosylation of D-lyxose with benzyl alcohol in the presence of *p*-toluenesulfonic acid followed by several crystallizations/recrystallisations afforded white crystalline product **98** as a single α anomer in 69% yield. The two *cis*-oriented hydroxyl groups were protected with an isopropylidene acetal to afford **99**. Finally, inversion of the configuration of the C-4 hydroxyl group gave benzyl 2,3-*O*-isopropylidene- β -L-

ribofuranoside **101**. For the first step, the original conditions²²⁷ were modified (decrease of benzyl alcohol volume) to improve the crystallization yield. Inversion of configuration was achieved by a successive oxidation/reduction sequence. Initially we used Swern oxidation conditions, but the reaction was not complete. On the contrary, Dess-Martin periodinane oxidation gave the desired ketone **100** in excellent yield and the following reduction with sodium borohydride afforded the desired *ribo*-derivative **101**.

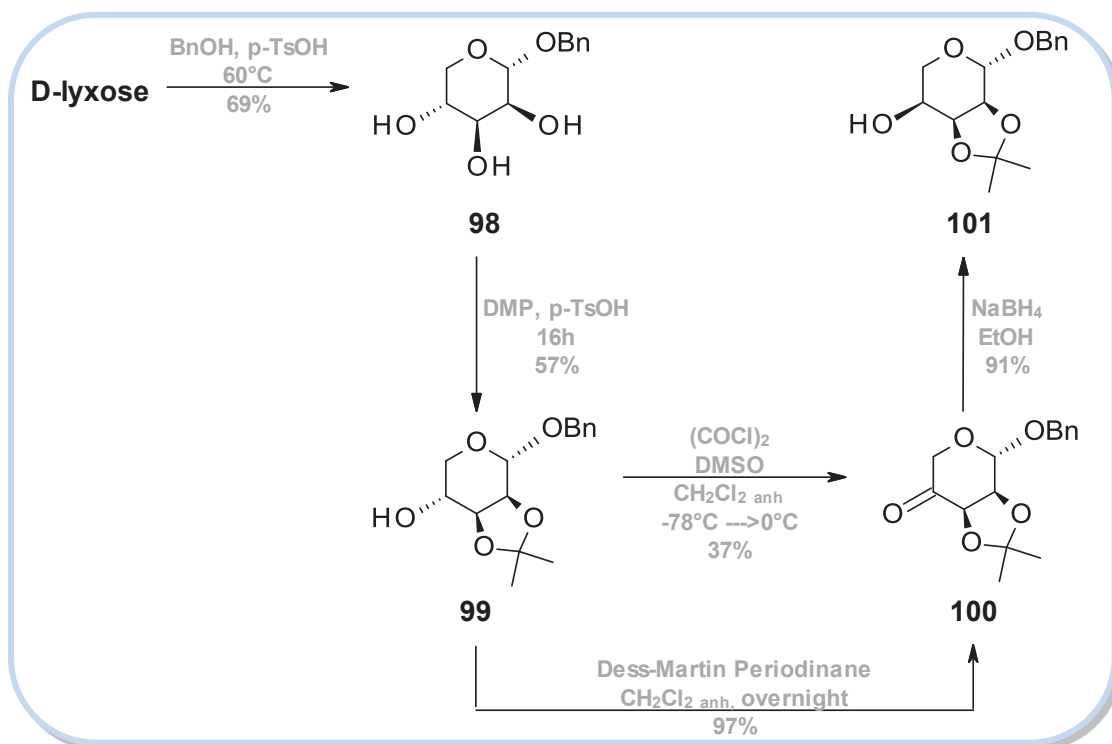

Scheme 43. Synthesis of the alcohol **101** from D-lyxose.

Although Dess-Martin periodinane is more expensive than the reagents used for Swern or PCC oxidations, it is less toxic, easier to manipulate and finally gives very clean crude products. The high stereoselectivity of the reduction of the ketone **100** is arising from its bicyclic structure, which ensures a clean addition of the hydride in the *exo* direction.

V.3 Attempted substitution reactions to introduce a CN group

As summarized in *Scheme 44*, several methods were tried to introduce the cyano group into the molecule. The first one consisted in performing an S_N2 reaction of activated alcohol **101** with potassium cyanide. Neither the triflate of **101**, nor its mesylate **103** reacted with potassium cyanide to give the desired compound. The triflate favored elimination reactions and the mesylate was unreactive. Different phase transfer agents or use of molecular sieves did not help either.

²²⁷ Keck, G. E.; Kachensky, D. F.; Enholm, E. J. *J Org Chem* **1985**, *50*, 4317.

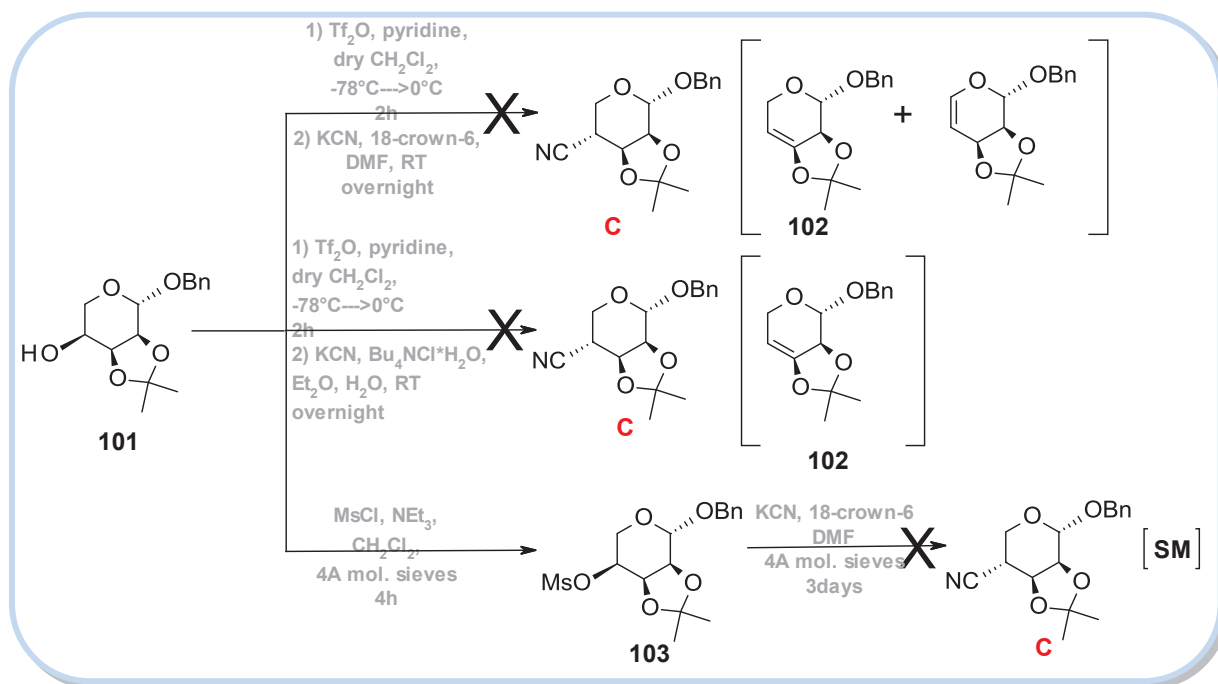

Scheme 44. Different approaches to introduce cyano group into intermediate **101**.

Another approach was to perform a double S_N2 from **99** by way of an iodo-intermediate (**Scheme 45**) which might make the elimination reaction less favorable. Since during two S_N2 reactions, the configuration of C-4 would be changed twice, we had to start from *D-lyxo* alcohol **99**. However, none of the attempted reactions to replace the 4-hydroxyl group by iodine was successful. The assay by way of a triflate gave degradation only, while the mesylate intermediate was very stable and gave only traces of the desired compound (identified by mass spectroscopy).

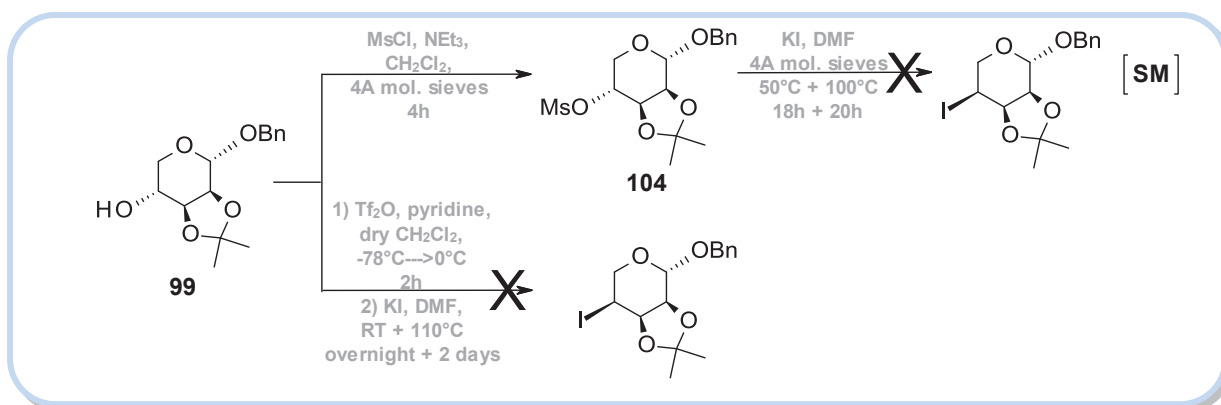

Scheme 45. Alternative approaches to introduce cyano group into intermediate **101**.

V.4 Modified synthesis of cyano-derivative

After these numerous fruitless assays, we decided to use Vasella's approach²³⁰ to prepare the cyano derivative, by way of the opening of an oxirane intermediate (**Scheme 46**).

²³⁰ Mohal, N.; Bernet, B.; Vasella, A. *Helv Chim Acta* **2005**, *88*, 3232.

Starting from protected D-lyxopyranoside **99**, we tosylated the free 4-hydroxyl group and subsequently cleaved the isopropylidene acetal under acidic conditions. The resulting diol was treated with potassium *tert*-butoxide to give the corresponding *L-ribo* epoxide. The hydroxyl group at C-2 was then protected with a bulky triisopropylsilyl group. The key step of this strategy is the regioselective oxirane ring opening with diethylaluminum cyanide to give the desired C-4 cyano intermediate, which is favoured by the presence of a large group at O-2, as shown by Vasella.²³⁰ This step was optimised by a trainee Lydie Mbele, and the cyano intermediate **109** was obtained in good yield. The synthesis was completed by Sophie Front in our group, which afforded the free *galacto*-IFG as a reference compound.

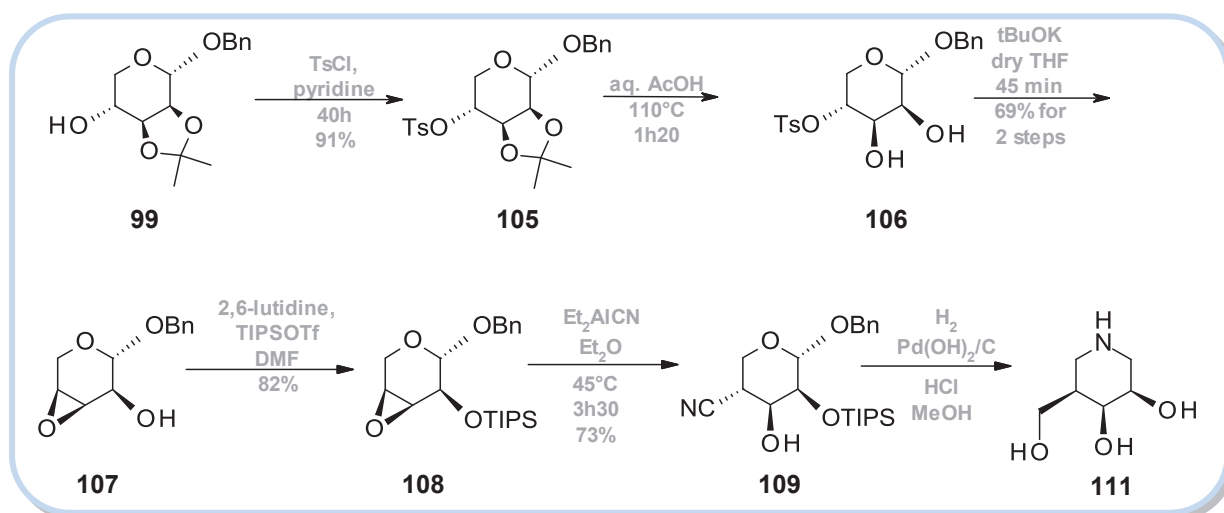

Scheme 46. Synthesis of cyano-derivative **109** using Vasella's approach.

V.5 Synthesis of nitro-alcohols **112+113** and dehydration assays

Since the initial synthetic approach to *galacto*-IFGs by way of cyano-intermediates failed, we considered using nitromethane in order to introduce the C-N fragment²³¹ by way of its addition to the keto intermediate **100** (**Scheme 47**). As indicated above, the extension of this strategy to nitroalkanes may provide a means of introducing directly a 5-*C*-alkyl substituent, and initial assays were performed with nitrohexane. The addition of nitromethane and nitrohexane to the ketone **100** was then investigated. We found that the diastereoselectivity and the yield of the addition of nitromethane depended strongly on the conditions used. When using DBU (1,8-diazabicyclo[5.4.0]undec-7-ene) as a base and acetonitrile as the solvent, the reaction was not diastereoselective and gave an unseparable mixture of 4*R* and 4*S* isomers in 1:1 proportion in low yield. This changed drastically when

²³⁰ Mohal, N.; Bernet, B.; Vasella, A. *Helv Chim Acta* **2005**, *88*, 3232.

²³¹ Andersch, J.; Bols, M. *Chem Eur J* **2001**, *7*, 3744.

the reaction was conducted in pure nitromethane with triethylamine as a base. One diastereoisomer, **112**, was highly predominant, and the yield much improved.

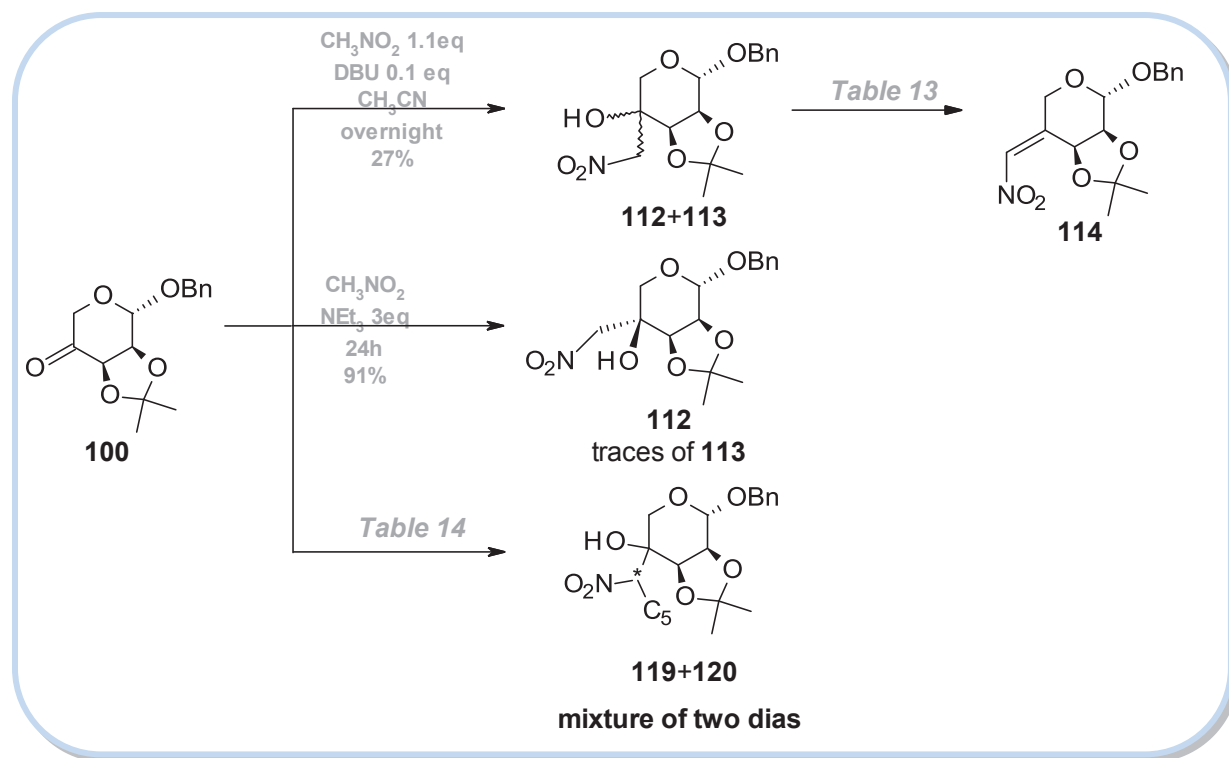

Scheme 47. Synthesis of nitro-alcohols **112**, **113**, **119** and **120** and dehydration assays.

Dehydration of the nitroaldols to the corresponding nitroalkenes can be performed under a number of conditions. We decided to investigate first the dehydration under the mild conditions reported by Moffatt et al²³² on the mixture of isomers **112**+**113** (conditions listed in *Table 13*). However these conditions did not promote the expected reaction. Among the other conditions investigated, only the last attempt with trifluoroacetic acid in DMSO gave the desired unsaturated product, however, in a mixture with an endocyclic isomer. Hydrogenation of this mixture failed and due to lack of time we did not study further this reaction.

Entry	Conditions	Yield	Comments
1	Ac ₂ O (3 eq) dry DMSO 0.3N	--	SM
2	Ac ₂ O (2.3 eq) dry DMSO 0.5N	--	SM
3	MsCl, NEt ₃ , CH ₂ Cl ₂	--	SM and ketone 100
4	TFA /DMSO 4Å mol sieves	28%	Mixture of 114 with its endocyclic isomer, SM

Table 13. Various dehydration conditions used on nitro-alcohols **112** and **113**.

²³² Albrecht, H. P.; Moffatt, J. G. *Tetrahedron Lett* **1970**, 1063.

As regards the reaction with nitrohexane, we investigated different nitrohexane concentrations, with and without co-solvent, and with triethylamine as a base only. The best results (64% yield) were obtained using a 0.28N solution of SM in neat nitrohexane during 2.5 days. Longer reaction times did not improve the yield. In each case the reaction was not complete and the starting material was recovered. The reaction with nitrohexane is more complex than that with nitromethane, as it can lead up to four diastereoisomers (two chiral carbons created C-4 and C-5). Gratefully, the reaction led to only two major isomers **119+120** in a 65:35 ratio, but their actual configurations cannot be determined at this stage.

Entry	Conditions	Time	Yield
1	nitrohexane, NEt ₃ CH ₃ CN 0.3N	overnight	23%
2	nitrohexane, NEt ₃ CH ₃ CN 0.3N	overnight	26%
3	nitrohexane 0.5N, NEt ₃	overnight	49%
4	nitrohexane 0.28N, NEt ₃	72h	64%

Table 14. Different conditions used for nitrohexane addition to ketone **100**.

V.6 Reduction of the nitro-intermediates and cyclisation by reductive amination.

The mixtures of epimers **112+113** and **119+120** were submitted to hydrogenation. During this reaction, the following processes take place:

- i. reduction of the nitro group to give an amine
- ii. cleavage of benzyl group to liberate the anomeric hydroxyl group
- iii. intramolecular reductive amination with formation of a piperidine ring

The reactions performed on the nitromethane adducts are outlined in *Scheme 48*. Catalytic hydrogenation of the mixture of epimers **112+113** provided successfully the corresponding, protected epi-IFG derivatives **115** and **116**. These compounds could be separated and deprotected using Dowex 50WX8 H⁺ resin to afford pure 4-hydroxy-L-*altro*-IFG derivative **117** and 4-hydroxy-D-*galacto*-IFG derivative **118** in good yields. Hydrogenation of **112** alone gave predominantly **116** and the minor diastereoisomer **115** present in a trace amount was lost during purification.

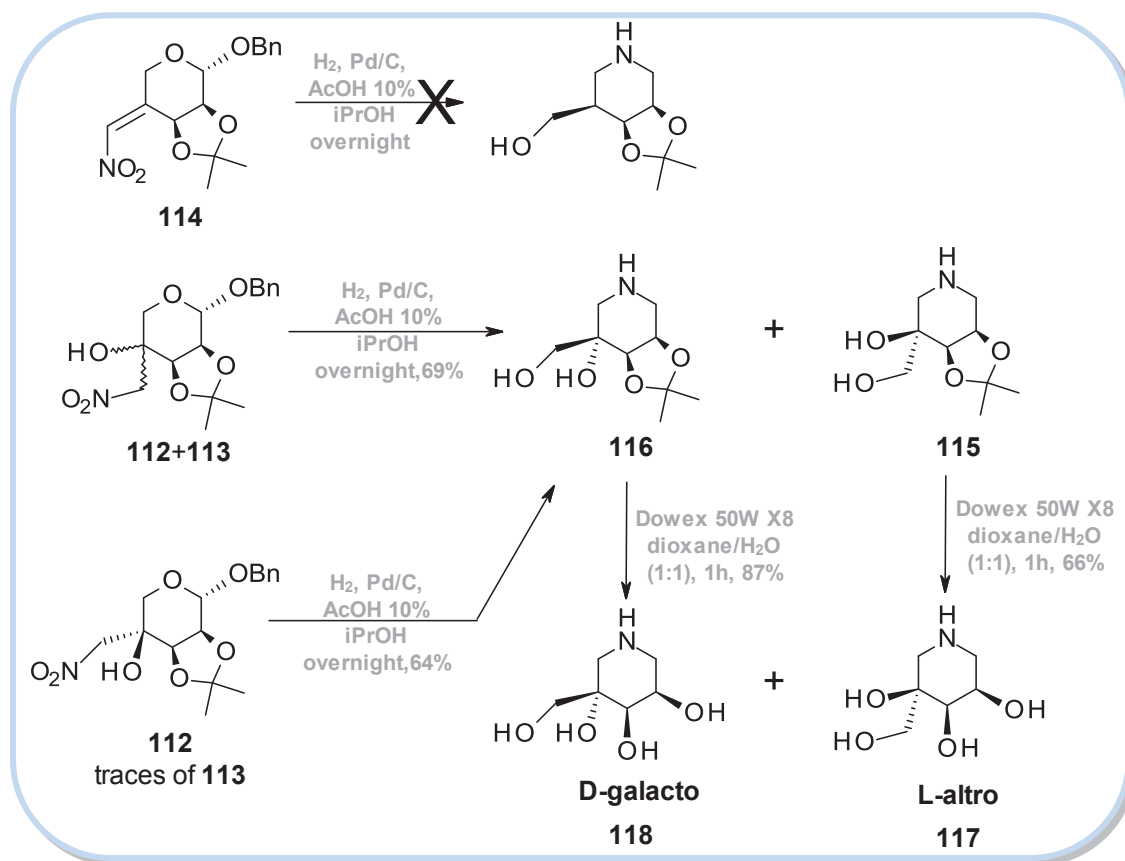

Scheme 48. Reductive amination of nitromethane adducts.

The assignment of configuration at C-4 in **115** and **116** is a difficult problem, as a result of the absence of a proton at C-4, and cannot be determined from NMR data. However, we could consider two arguments to assign a configuration. Addition of nitromethane under $\text{CH}_3\text{NO}_2/\text{NET}_3$ conditions is likely to give the thermodynamic product (weak base, excess CH_3NO_2 would give a reversible reaction). The thermodynamic product is probably the one with the CH_2NO_2 group equatorial (**Figure 28**).

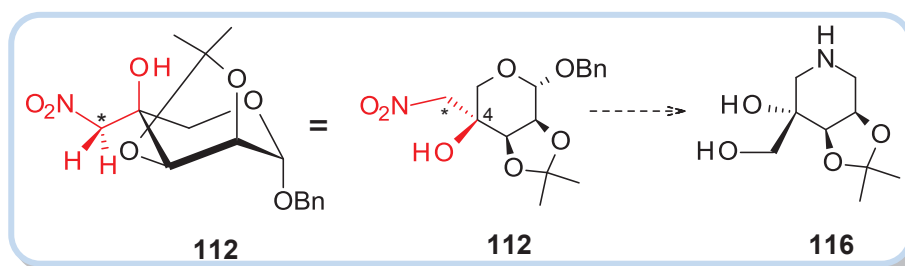

Figure 28. Chair representation of thermodynamic product of nitromethane addition.

If this is correct, the hydrogenation of **112** should give *D-galacto* isomer **116**. This hypothesis is supported by the biological assays of the deprotected products **117** and **118**: the major isomer **118** is a much better inhibitor of GALC than the minor one (see *Results and discussion* section VI). We deduce that the better inhibitor has a *D-galacto*-like, and not *L-*

altro-like configuration. This indicates that the compound **118** is most likely the pseudo-D-*galacto* epimer.

After these satisfying results with nitromethane derivatives, we applied the same strategy to nitrohexane adducts. This time, the hydrogenation using palladium on carbon or palladium hydroxide did not give the expected product. We realized that, while the benzyl group was cleaved, the reduction of the nitro group is more difficult under these conditions because it is hindered by the presence of the pentyl chain (**Table 15**).

Entry	Conditions	Time	Comments
1	H ₂ , Pd/C, AcOH 10%	2 days	--
2	H ₂ , Pd/C, HCl 1N, 1eq	5 days	isopropylidene partially hydrolyzed
3	H ₂ , Pd(OH) ₂ , AcOH 10%	3 days	--
4	H ₂ , Pd(OH) ₂ , HCl 1N, 1eq	6 days	isopropylidene partially cut off

Table 15. Various conditions used to reduce the nitro group and perform reductive amination. All reactions were done in 0.1N solution of isopropanol, at atmospheric pressure of hydrogen and room temperature.

We decided to perform this reaction in two steps: first reduce the nitro group into an amine with Raney nickel, and then deprotect the anomeric position to promote reductive amination (**Scheme 49**). Under these conditions, we obtained first a clean mixture of two aminoalkyl derivatives (**121+122**), which was purified and submitted to catalytic hydrogenation using palladium hydroxide as the catalyst in acidic isopropanol. This reaction led to the formation of the desired, 5-*C*-substituted piperidines (isomers **123+124**) which were deprotected using an acidic ion-exchange resin to provide 5-*C*-pentyl pseudo IFG isomers **125** and **126**. While this sequence of reaction led to a clean mixture of epimers, the epimers themselves could not be separated. Pure samples of **125** and **126** were isolated by HPLC (column Hypercarb, 250mm x 10mm, H₂O/isopropanol 99.5/0.5 formic acid 0.4%, pressure 3.3 bars, debit 4.4mL/min, T=30°C, ELS detection).

trans relation with respect to the 4-OH group. Further investigations on the isolated products will be performed in order to ascertain their configuration.

V.7 Conclusions

Although we were not able to remove the hydroxyl group at the branching position, we successfully achieved the synthesis of pseudo-IFG derivatives in the *L-altro* and *D-galacto* series: 4-hydroxy *L-altro*-IFG **117** and 4-hydroxy *D-galacto*-IFG **118**, as well as 5-*C*-alkylated derivatives in the *D-galacto* series: 4-hydroxy-(5*R*) and (5*S*)-5-*C*-pentyl-*D-galacto*-IFG **125** and **126**.

Résumé section V:

La synthèse d'iminosucres de type *galacto-isofagomine*.

Le meilleur inhibiteur de β -galactosidase connu à ce jour étant un épimère en position C-4 de l'isofagomine (IFG) : la *galacto*-IFG (ou 4-*epi*-IFG), cette structure a constitué une des trois cibles principales de ce projet. Nous avons décidé de synthétiser la *galacto*-IFG elle-même (comme référence pour les tests biologiques sur les galactosidases lysosomales), mais également des dérivés portant une chaîne alkyle en position C-5. La stratégie de synthèse envisagée comprend les étapes suivantes :

- i. protection sélective du D-lyxose
- ii. inversion de la configuration du groupement hydroxyle en C-4 pour obtenir un dérivé en série *L-ribo*
- iii. substitution par S_N2 de l'hydroxyle en C-4 par un groupement cyano
- iv. amination réductrice par hydrogénolyse pour obtenir la *galacto*-IFG, suivie d'une alkylation réductrice pour préparer des dérivés *N*-alkylés
- v. autres réactions sur l'intermédiaire cyano pour préparer des 5-*C*-alkyl-*galacto*-IFGs

Bien que cette stratégie de synthèse prometteuse ait bien fonctionné pour l'IFG (en série *D-gluco*), elle a échoué pour la *galacto*-IFG, en raison de la difficulté à substituer l'hydroxyle en C-4 par un groupement cyano.

Nous avons donc suivi la voie de synthèse élaborée par Vasella, dans laquelle l'étape clé est l'ouverture stéréosélective d'un époxyde avec du cyanure de diéthylaluminium permettant l'obtention du dérivé 4-cyano. L'optimisation et d'autres investigations sur cette approche sont actuellement en cours dans notre groupe.

Cette voie de synthèse nous a également permis d'envisager une autre méthodologie pour l'obtention de composés de type *galacto*-IFGs. Par analogie avec la synthèse de l'IFG effectuée par Bols, nous avons envisagé qu'une addition de nitrométhane sur la cétone précédemment obtenue à partir du D-lyxose pourrait fournir un précurseur de la *galacto*-IFG en quelques étapes. En outre, l'utilisation dans ce processus d'un nitroalcane avec une chaîne plus longue ouvre un accès direct aux très désirés 5-*C*-alkyl-*galacto*-IFGs. Bien que nous ne soyons pas parvenus à éliminer le groupement hydroxyle supplémentaire en C-4, nous avons réussi à synthétiser différents dérivés alkylés ou non de la *galacto*-IFG.

VI. Preliminary biological evaluation of the new D-galacto and L-althro-configured iminosugar derivatives

Compounds **30**, **32**, **35**, **36**, **49**, **117** and **118** (**Figure 30**) were submitted to preliminary biological assays in Dr Wenger's laboratory (Jefferson School of Medicine, Philadelphia), to investigate their inhibitory activities and selectivity towards lysosomal α -galactosidase A (substrate = 4-MU- α -galactoside) and β -galactocerebrosidase (substrate = radiolabeled ^3H -GalCer).

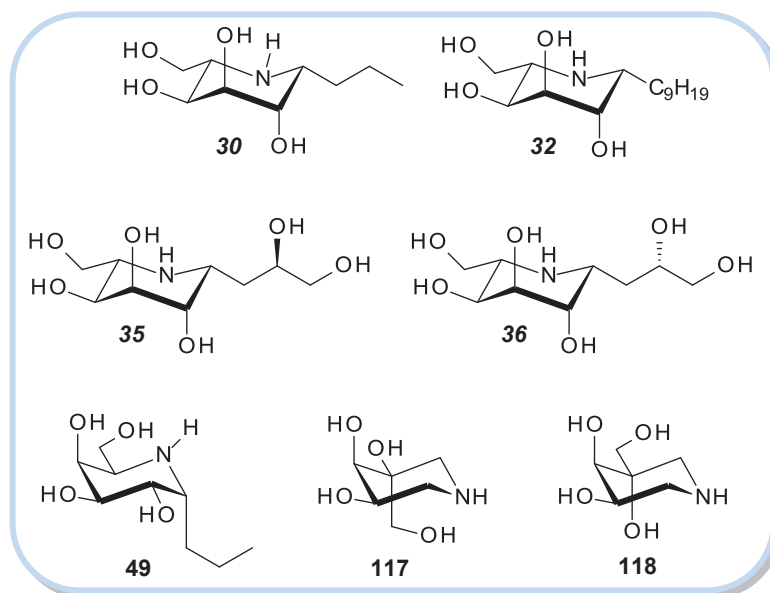

Figure 30. Structures of tested compounds.

Initial results are listed in **Table 16**:

Entry	Inhibitor	α -gal	GALC
1	30	8%	0%
2	32	59%	24%
3	35	56%	0%
4	36	69%	0%
5	49	97%	0%
6	117	13%	0%
7	118	0%	67%

Table 16. Percent inhibition at 1 mM final inhibitor concentration (or 1.2mM for **117** and **118**).

As shown above, the imino-L-altritol with apolar (**30** and **32**) or polar (**35** and **36**) aglycones do not have interesting inhibitory properties on the examined enzymes. However, we observed that longer alkyl chain increases inhibition of GALC (entry 2). Although imino-D-galactitol **49** turned out to be inactive on GALC, it inhibits strongly α -galactosidase A (97%) at 1mM concentration. The most interesting properties were observed for D-galacto IFG analogue **118**, with 67% of inhibition of GALC at 1.2 mM.

Entry	Inhibitor	Concentration [mM]	Enzyme	% inhibition	IC ₅₀ [mM]
1	118	1.2	GALC	71%	0.45
2		0.6		58%	
3		0.24		31%	
4		0.12		22%	
5		0.024		13%	
6	49	1	α -gal	99%	0.01
7		0.1		91%	
8		0.01		51%	
9		0.001		10%	

Table 17. Percent of inhibition at different concentrations for **49** and **118**.

For **49** and **118** further investigations were carried out by Dr. Wenger to estimate the IC₅₀ values (**Table 17**).

Even though these results show that none of the tested compounds are potent inhibitor of GALC, they gave us very important information about structure-activity relationships. It is clear that the imino D-galactitols are good α -galactosidase inhibitors, and apparently alkyl chain elongation enhances inhibitory properties. IFG-related compounds are much better β -galactosidase inhibitors: pseudo *galacto* IFG **118** is a promising candidate as an inhibitor of lysosomal GALC, but further structural modifications have to be done to increase both the selectivity and inhibitory properties.

Evaluation of the latest compounds as well as further investigations on **118** will be performed in the Laboratory of Dr. Petryniak at Oregon Health and Science University in October 2013.

Conclusion

During my PhD, we have effectively realized all presumed goals. We have successfully applied our existing methodology to obtain 1-*C*-substituted imino-*L*-arabinotols. These compounds turned out to be deprived from all inhibitory activity towards GALC and other galactosidases. However, these data confirmed that CH₂OH group is essential to obtain strong inhibitor-enzyme interactions.

The same synthetic strategy was applied to obtain 1-*C*-substituted imino-*D*-galactitols. Despite numerous unanticipated problems and challenges we faced during this synthesis, we finally obtained a small sample of 1-*C*-propyl-imino-*D*-galactitol. This compound did not show inhibitory activity towards GALC. However, it turned out to be a weak inhibitor of α -galactosidase with an IC₅₀ of 0.01 mM. This approach was also applied to prepare the 1-*C*-substituted imino-*L*-altritols, but they did not show interesting biological activity.

To overcome the problems faced in the first synthesis of imino-*D*-galactitols, we used an alternative synthetic strategy by a C-6 chain elongation strategy. This methodology was significantly more successful than the previous one and we obtained samples of both anomers of 1-*C*-hexyl-imino-*D*-galactitol.

As the last goal, we have developed an easy and convenient synthesis to prepare pseudo-*galacto*-IFG derivatives. Pseudo-*galacto*-IFG is our first compound showing a moderate activity towards GALC with an IC₅₀ value of 0.45 mM.

As perspectives for this work, we need to optimize the last step of the 1-*C*-hexyl-imino-*D*-galactitol's synthesis to obtain pure samples without epimerisation. It would be also interesting to complete this synthesis with the nonyl and allyl chains in order to prepare 1-*C*-substituted-imino-*D*-galactitols with a longer alkyl chain or more polar aglycone. We realized that the chemistry in the *D*-galacto series is much more difficult than we expected compared to the *D*-gluco series. Thus the synthesis of such iminosugars remains a real challenge for organic chemists and will need the development of new and innovative methodologies.

For the newly synthesized C-5-substituted pseudo-*galacto*-IFGs, we will have to determine the C-5 absolute configuration and also to confirm the suspected configuration at C-4. Our encouraging results on GALC activity with these compounds will lead us to develop other strategies for the synthesis of *galacto*-IFG derivatives, which do not bear the supplementary hydroxyl group at C-4 and to investigate their biological activities. This family represents the best objective to achieve for the discovery of potent GALC inhibitors and potential pharmacological chaperones for the treatment of Krabbe disease.

Experimental part

I. General

All reactions requiring anhydrous conditions were carried out using oven-dried glassware under an atmosphere of dry Ar. THF was distilled using Glass Technology Dry Solvent Station GTS100. CH₂Cl₂ was distilled from CaH₂. CH₃CN, DMF and pyridine were dried using activated 3Å molecular sieves. Other anhydrous solvents and all reagent-grade chemicals were obtained from commercial suppliers and were used as received. Analytical thin layer chromatography was performed using Silica Gel 60F₂₅₄ precoated plates (Merck) with visualization by ultraviolet light and phosphomolybdic acid or ceric sulfate/ammonium molybdate solutions. Flash chromatography was performed on Silica Gel 60 (230-400 mesh).

Melting points were determined in capillary tubes with a Büchi apparatus and are uncorrected. Optical rotations were measured with a Perkin-Elmer 341 polarimeter in appropriate solvent, at the indicated temperature and at 589 nm sodium line, in a 1 dm cell. Concentrations are given in g/100 mL. ¹H and ¹³C NMR spectra were recorded on Bruker Avance DPX 250 or Bruker Avance 400 spectrometers. Chemical shifts are given in ppm and are referenced to the residual solvent signal or to TMS as internal standard. Carbon multiplicities were assigned by distortionless enhancement by polarization transfer (DEPT) experiments. ¹H and ¹³C signals were attributed on the basis of H-H and H-C correlations. Low-resolution mass spectra were recorded on a Perkin-Elmer Sciex API 3000. High-resolution mass spectra were recorded on a Bruker Q-TOF MaXis spectrometer in Orléans (precision 5 or 6 digits) or on a Waters Q-TOF micro spectrometer in Clermont-Ferrand (precision 4 digits).

II. General treatment with basic ion-exchange resin after hydrogenation

The crude compound was dissolved in MeOH. Amberlite IRA400 resin (OH⁻, 16-50 mesh) was washed thoroughly with H₂O and then with MeOH before it was added to the solution. The suspension was left stirring for 30 min, the resin was filtered and washed with MeOH. Evaporation of the solvent under reduced pressure gave the desired compound as a free base.

III. General procedure for purification on Dowex 50WX8 resin (H⁺, 50-100 mesh)

Approximately 1 mL of resin per 10 mg of compound was used. The resin was first washed in a column with H₂O and then with MeOH. The product was dissolved in MeOH, the solution was loaded onto the column and washed with MeOH. Then the compound of interest was eluted with a 0.5M aqueous solution of NH₃. Evaporation of the solvent under reduced pressure gave the desired compound as a free base.

IV. General procedure for biological assays

Tests of compounds in Dr. Asano's laboratory (Hokuriku University).

α -Galactosidase A: The enzyme was prepared according to the method of Ishii¹⁴⁵. The reaction mixture consisted of 100 μ L of 0.15 M sodium phosphate-citrate buffer (pH 4.5), 50 μ L of enzyme solution, 50 μ L of inhibitor solution, and 200 μ L of H₂O. The enzyme activity was assayed with 2 mM *p*-nitrophenyl α -D-galactopyranoside as substrate. The reaction was stopped by adding 1 mL of 400 mM Na₂CO₃. The released *p*-nitrophenol was measured spectrophotometrically at 400 nm.

Tests of compounds in Dr. Wenger laboratory (Jefferson School of Medicine, Philadelphia).

Dissolve ³H-gal-cer in 6mL 2:1 chloroform-methanol (C-M). Solutions of sodium taurocholate (10mg/mL in C-M, 2:1) and of oleic acid (1mg/mL in C-M, 2:1) were prepared and then equal volumes of them were mixed together to prepare a *mixture A*. All solutions should be stored at 4°C. Into each 10x13 glass tube about 20-25 nmol ³H-gal-cer and 0.1 mL of *mixture A* were added. Solvents were evaporated with N₂ or overnight in air. 0.1 mL of citrate-phosphate buffer (0.2 M in phosphate, pH 4.2), enzyme source (usually about 50 μ g protein of leukocyte or fibroblast sonicate) and distilled water were added up to the total volume of 0.2 mL. The mixture was incubated at 37°C for 1 or 2 hours. Then, on ice, 0.1 mL of a solution of galactose (0.5 mg/mL in distilled water) and 1.5 mL of C-M (2-1) were added, vortexed and centrifuged at 1200 g for about 3 min. The lower phase was removed with pipette on syringe and saved in waste tube. 1mL of theoretical lower* was added to the assay tube, vortexed and centrifuged as above. Upper phase was carefully removed to scintillation vial, 10 mL of scintillation fluid was added and the ³H-galactose hydrolyzed from the starting ³H-gal-cer was counted. The specific activity of the enzyme was calculated as nmol/h/mg protein.

¹⁴⁵ Ishii, S.; Yoshioka, H.; Mannen, K.; Kulkarni, A. B.; Fan, J. Q. *Biochim Biophys Acta* **2004**, 1690, 250.

* Theoretical lower is made by taking 100 mL a solution of galactose (0.5 mg/ml) plus 500 mL of C-M (2:1) in a glass stoppered separatory funnel. Shake and let separate. Save lower phase for working up assays. This is a theoretical lower phase.

Methyl α,β -L-arabinopyranoside 1.

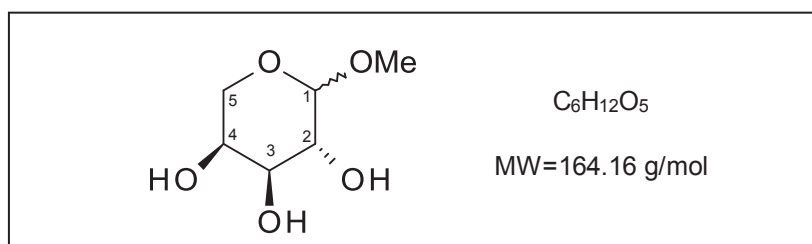

Acetyl chloride (2.4 mL, 33.6 mmol, 0.5 eq) was added to anhydrous methanol (111 mL) at 0°C. The mixture was left stirring for 20 min in an ice-bath. Then solid L-arabinose (10 g, 66.6 mmol) was added. The reaction mixture was heated under reflux overnight. The mixture was allowed to cool down gradually to RT and left in the fridge for 24 h to give crystals of the desired glycoside as a mixture of anomers (4:6 α : β). The crystals were filtered and washed with cold MeOH. After partial concentration of the filtrate the crystallization was repeated. New crystals were collected with the product previously obtained.

TLC:

- DCM/MeOH (8:2);
- $R_{fSM} = 0.1$; $R_{fI} = 0.43$

NMR

Obtained spectrum corresponds to literature data.²³³

Yield

59% (6.46 g).

²³³ Gorin, P. A. J.; Mazurek, M. *Can. J. Chem.*, **1975**, 53, 1212-1223.

Methyl 2,3,4-tri-O-benzyl- α,β -L-arabinopyranoside 2.

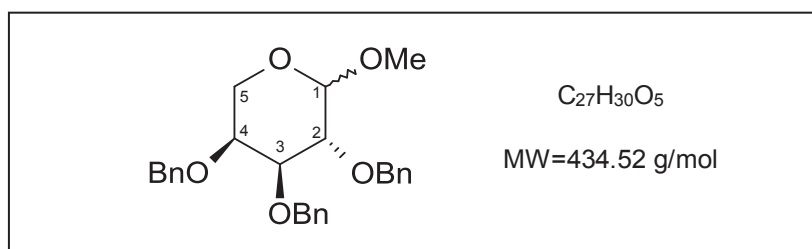

The reaction was conducted under argon. Crystalline **1** (6.46 g, 39.4 mmol) was dissolved in dry DMF (120 mL) at RT. After 15 min of stirring in an ice bath, sodium hydride (60% dispersion in oil, 9.49 g, 237 mmol, 4.7 eq) was added portionwise. When H₂ evolution ceased (30 min), benzyl bromide (22 mL, 184 mmol, 6 eq) was slowly added. The reaction mixture was left stirring overnight at RT. The reaction was then quenched with ice-water (170 mL). EtOAc (300 mL) was added. The organic phase was washed with water (3 x 150 mL), with saturated NaHCO₃ (150 mL) and then dried over MgSO₄. After concentration under vacuum the crude product was obtained as a yellow oil, which was used without purification in the next reaction.

TLC:

- PE/EtOAc (8:2);
- R_f = 0.25

NMR

Obtained spectrum corresponds to literature data.¹⁷⁵

¹⁷⁵ Zhao, G-L.; Yu, Z-Y.; Li, Y.; Pang, L-N.; Wang, J-W. *Chin. J. Chem.*, **2008**, 26, 158-164.

2,3,4-Tri-O-benzyl- α,β -L-arabinopyranose 3.

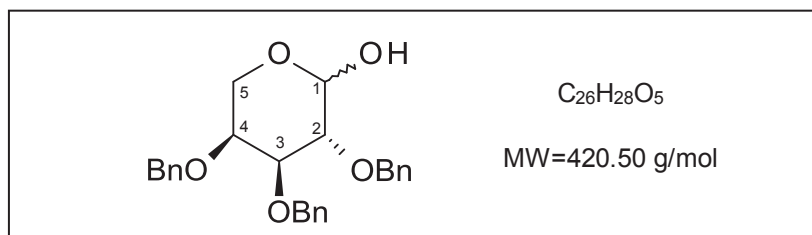

To a solution of crude **2** (39.4 mmol) in 80% aqueous AcOH (32.5 mL), 3N HCl (9.5 mL) was slowly added. The mixture was stirred at 90°C until TLC showed completion of the reaction (20 h). Most of the acetic acid was removed by evaporation under vacuum, and then water (54 mL) and EtOAc (27 mL) were added. The organic phase was separated and the aqueous phase was extracted with EtOAc (3 x 27 mL). The organic phases were combined, washed with saturated $NaHCO_3$ (60 mL) and dried over $MgSO_4$. Concentration under vacuum gave the crude product as a yellowish oil. Flash column chromatography on silica gel (PE/EtOAc 7:3) gave pure product as a white solid.

TLC:

- PE/EtOAc (7:3);
- $R_f = 0.10$

NMR

Obtained spectrum corresponds to literature data.²³⁴

Yield

56% (9.26 g).

²³⁴ Violante de Paz Banez, M.; Aznar Moreno, J. A.; Galbis, J. A. *J. Carbohydr. Chem.*, **2008**, 27, 120-140.

N-Benzyl 2,3,4-tri-*O*-benzyl- α,β -L-arabinopyranosylamine **4**.

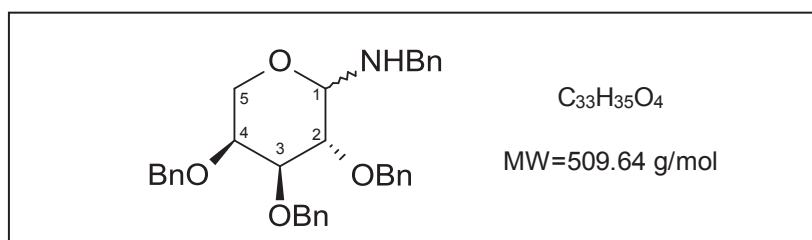

The reaction was conducted under argon at RT. To a solution of compound **3** (1.00 g, 2.38 mmol) in anhydrous CH_2Cl_2 (2.4 mL) were added *p*-toluenesulfonic acid monohydrate (0.414 g, 2.4 mmol, 1 eq) and benzylamine (0.78 mL, 7.14 mmol, 3 eq) to give a milky solution. The reaction was left stirring until TLC showed completion (24 h). The reaction mixture was diluted with CH_2Cl_2 (20 mL) then washed with saturated Na_2CO_3 (10 mL) and dried over $MgSO_4$. After concentration under vacuum and three coevaporations with toluene, the crude product was obtained as a yellow oil which was used without purification in the next reaction.

TLC:

- PE/EtOAc (6:4);
- R_f = 0.83

(1*R*,1*S*)-1-*C*-Allyl-2,3,4-tri-*O*-benzyl-1-(*N*-benzyl)amino-1-deoxy-*L*-arabinitol 5

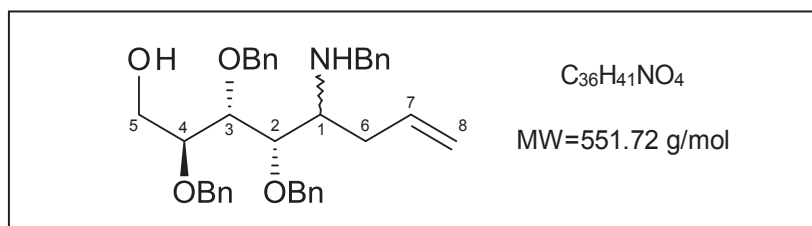

The reaction was conducted under argon. To a solution of crude **4** (655 mg, 1.19 mmol) in anhydrous THF (11.9 mL) was slowly added at 0°C a 1M solution of allylmagnesium bromide in Et₂O (5.95 mL, 5.95 mmol, 5 eq). The reaction was left stirring at RT until TLC showed completion (16 h). The reaction was quenched with saturated NH₄Cl (10 mL). Then CH₂Cl₂ (25 mL) was then added. The organic phase was separated, washed successively with a 5% aqueous solution of HCl (15 mL), saturated NaHCO₃ (15 mL), water (15 mL) and dried over MgSO₄. After concentration under vacuum the crude compound was obtained as a light yellow oil. Flash column chromatography on silica gel (PE/EtOAc 8:2) gave the desired product as a light yellow oil and as a mixture of inseparable diastereoisomers **5*S*** and **5*R*** in a 7:3 ratio.

TLC:

- PE/EtOAc (8:2);
- R_f = 0.19

¹H NMR (400MHz, CDCl₃), δ 7.37-7.19 (m, 20H, H_{aromatic}), 5.82-5.62 (m, 1H, H7), 5.11-4.99 (m, 2H, 2H8), 4.85-4.41 (m, 6H, 3CH₂Ph), 4.24 (dd, 0.3H, H3_R, *J* = 3.2 Hz, *J* = 7.3 Hz), 3.97 (t, 0.7H, H3_S, *J*_{3,2/4} = 5 Hz), 3.91-3.60 (m, 6H, 2H5, NHCH₂Ph, H2, H4), 2.86 (q, 0.7H, H1_S, *J* = 5.7 Hz), 2.77-2.72 (m, 0.3H, H1_S), 2.48-2.28 (m, 2H, 2H6).

¹³C NMR (100 MHz, CDCl₃), δ 140.37-138.25 (C^{IV}_{aromatic}), 135.94 (C7_R), 135.66 (C7_S), 128.48-127.14 (C_{aromatic}), 117.77 (C8_S), 117.65 (C8_R), 81.12 (C3_R), 80.33-79.72 (C2_R, C3_S, C4), 78.87 (C2_S), 74.90-71.69 (CH₂Ph), 61.57, 60.79 (NHCH₂Ph), 58.13 (C1_S), 57.79 (C1_R), 51.75 (C5_S), 51.22 (C5_R), 34.69 (2C6).

IR [cm⁻¹] ν 3438 (O-H), 3063, 3029 (C-H_{aromatic}), 2870 (C-H), 1639 (C=C), 1453 (C=C_{aromatic}), 1088, 1064, 1027 (C-C/C-O), 733, 695 (C-H_{aromatic}).

HRMS (ESI)

[M+H]⁺ calculated for C₃₆H₄₂NO₄ *m/z* = 552.31084; found *m/z* = 552.31171

Yield

81% (529 mg).

(1S)-1-C-Allyl-2,3,4-tri-O-benzyl-N-benzyl-1,5-dideoxy-1,5-imino-L-arabinitol 6
(1R)-1-C-Allyl-2,3,4-tri-O-benzyl-N-benzyl-1,5-dideoxy-1,5-imino-L-arabinitol 7

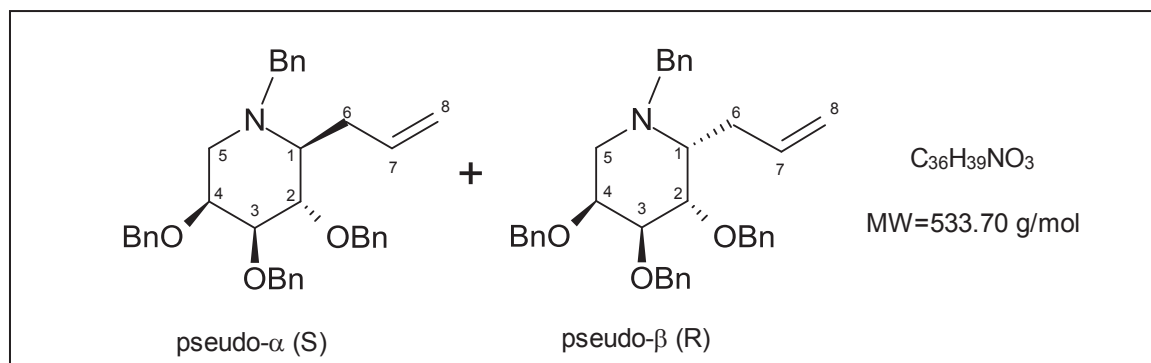

The reaction was conducted under argon. Mixture **5** (0.57 g, 1.03 mmol) was dissolved in anhydrous pyridine (10.3 mL) containing 4Å molecular sieves. After 10 min of stirring, methanesulfonyl chloride (0.2 mL, 2.58 mmol, 2.5 eq) was added. The mixture was stirred at 100°C until TLC showed completion of the reaction (1 h), then filtered over celite and the solid was washed with CH₂Cl₂. The filtrate was combined and concentrated under vacuum, EtOAc (30 mL) was added and the organic phase was washed with water (3 x 15 mL) then dried over MgSO₄. After concentration under vacuum and coevaporation with toluene, the crude product was obtained as a dark orange oil. Flash column chromatography on silica gel (PE/EtOAc 95:5) gave the two desired isomers as separated products: **6** as an orange oil (1S, isomer pseudo-α) and **7** as a light yellow oil (1R, isomer pseudo-β).

IR [cm⁻¹] ν 3063, 3029 (C-H_{aromatic}), 2865, 2794 (C-H), 1638 (C=C), 1495, 1452 (C=C_{aromatic}), 1094, 1071, 1027 (C-O/C-C), 731, 696 (C-H_{aromatic}).

LRMS (ESI)

[M+H]⁺ = 534.5

pseudo-α isomer :

TLC:

- PE/EtOAc (9:1);
- R_{fα} = 0.35

¹H NMR (400MHz, CDCl₃), δ 7.37-7.19 (m, 20H, H_{aromatic}), 6.09-5.99 (m, 1H, H7), 5.14-5.09 (m, 2H, H8), 4.93 (d, 1H, CH₂Ph, *J* = 11 Hz), 4.63 (d, 1H, CH₂Ph, *J* = 11 Hz), 4.63 (d, 1H, CH₂Ph, *J* = 12 Hz), 4.55 (d, 1H, CH₂Ph, *J* = 12 Hz), 4.53 (d, 1H, CH₂Ph, *J* = 12.5 Hz), 4.29 (d, 1H, CH₂Ph, *J* = 12.5 Hz), 4.15 (d, 1H, NCH₂Ph, *J* = 13.2 Hz), 3.90 (t, 1H, H2, *J*_{2,1/3} = 8 Hz), 3.70 (br s, 1H, H4), 3.53 (dd, 1H, H3, *J*_{3,4} = 2.8 Hz, *J*_{3,2} = 8 Hz), 3.16 (d, 1H, NCH₂Ph, *J* = 13.2 Hz), 3.01 (dd, 1H, H5_b, *J*_{5b,4} = 4.9 Hz, *J*_{5b,5a} = 12.9 Hz), 2.69-2.68 (m, 2H, H6), 2.49-2.47 (m, 1H, H1), 1.93 (d, 1H, H5_a, *J*_{5a,5b} = 12.9 Hz).

¹³C NMR (100 MHz, CDCl₃), δ 139.50-138.66 (C^{IV}_{aromatic}), 135.36 (C7), 128.25-127.01 (C_{aromatic}), 116.94 (C8), 82.26 (C3), 77.14 (C2), 74.54, 71.60, 69.92 (CH₂Ph), 71.13 (C4), 63.69 (C1), 57.03 (NCH₂Ph), 50.13 (C5), 31.62 (C6).

HRMS (ESI)

[M+H]⁺ calculated for C₃₆H₄₀NO₃ *m/z* = 534.3008; found *m/z* = 534.2988

Optical rotation

$[\alpha]_D^{20} = +60.5$ (c= 1.3; CHCl₃)

Yield

53% (0.29 g).

pseudo-β isomer :

TLC:

- PE/EtOAc (9:1);
- $R_{f\beta} = 0.27$;

¹H NMR (400MHz, CDCl₃), δ 7.34-7.21 (m, 20H, H_{aromatic}), 5.82-5.71 (m, 1H, H7), 5.04-4.98 (m, 2H, H8), 4.70 (d, 1H, CH₂Ph, $J = 12.3$ Hz), 4.56 (d, 1H, CH₂Ph, $J = 12.3$ Hz), 4.56-4.47 (m, 3H, CH₂Ph), 4.43 (d, 1H, CH₂Ph, $J = 12.3$ Hz), 3.88-3.72 (m, 5H, H4, H3, H2, NCH₂Ph), 3.03 (br s, 1H, H1), 2.78-2.68 (m, 2H, H5), 2.51-2.37 (m, 2H, H6).

¹³C NMR (100 MHz, CDCl₃), δ 139.48-138.84 (C^{IV}_{aromatic}), 137.19 (C7), 128.39-126.92 (C_{aromatic}), 116.28 (C8), 77.59 (C2 or C3), 75.00 (C3 or C2), 73.50 (C4), 72.90-71.13 (CH₂Ph), 59.29 (C1), 57.21 (NCH₂Ph), 48.36 (C5), 31.65 (C6).

HRMS (ESI)

$[M+H]^+$ calculated for C₃₆H₄₀NO₃ $m/z = 534.3008$; found $m/z = 534.3013$

Optical rotation

$[\alpha]_D^{20} = +35.6$ (c= 1.0; CHCl₃)

Yield

14% (76 mg).

(1S)-1-C-Propyl-1,5-dideoxy-1,5-imino-L-arabinitol 8.

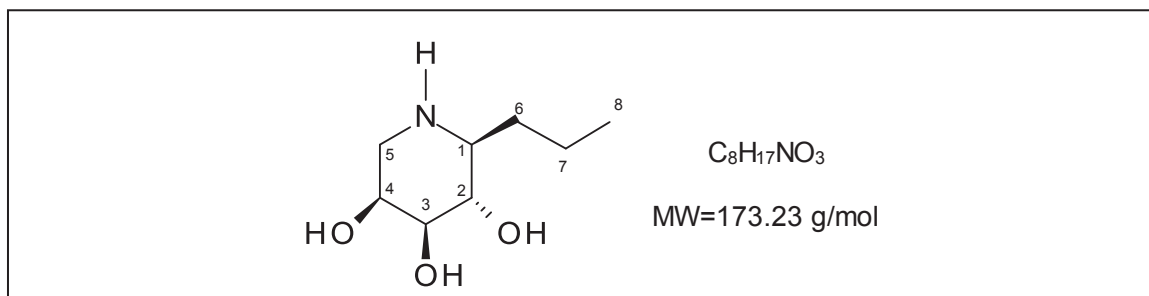

To a solution of isomer **6** (200 mg, 0.375 mmol) in isopropanol (3.7 mL) were added 1N aqueous HCl (0.74 mL, 0.74 mmol, 2 eq) and 10% Pd/C (56 mg). The reaction mixture was left stirring at RT under a hydrogen atmosphere for 5 days. It was then filtered through a membrane, the retained catalyst was washed with MeOH and the solvents were evaporated. After treatment with Amberlite IRA400 resin (OH⁻) and purification on Dowex 50WX8 resin (H⁺) the final product was obtained as brownish crystals.

¹H NMR (250 MHz, CD₃OD), δ 3.89 (br s, 1H, H4), 3.42-3.34 (m, 2H, H2, H3), 3.00 (dd, 1H, H5_{ax}, $J_{5ax,4} = 2.75$ Hz, $J_{5ax,5eq} = 13.75$ Hz), 2.71 (dd, 1H, H5_{eq}, $J_{5eq,4} = 1.5$ Hz, $J_{5eq,5ax} = 13.75$ Hz), 2.37-2.29 (m, 1H, H1), 1.90-1.80 (m, 1H, H6_{ax}), 1.66-1.57 (m, 1H, H7_{ax}), 1.46-1.35 (m, 2H, H6_{eq}, H7_{eq}), 0.98 (t, 3H, H8, $J_{8,7} = 7.0$ Hz).

¹³C NMR (62.5 MHz, CD₃OD), δ 76.62 (C3 or C2), 73.84 (C2 or C3), 70.68 (C4), 61.42 (C1), 50.71 (C5), 35.17 (C6), 19.79 (C7), 14.72 (C8).

HRMS (ESI)

[M+H]⁺ calculated for C₈H₁₈NO₃ $m/z = 176.128120$; found $m/z = 176.128236$

Optical rotation

$[\alpha]_D^{20} = +31.2$ ($c = 1.00$; MeOH)

Yield

94% (61 mg).

(1*R*)-1-*C*-Propyl-1,5-dideoxy-1,5-imino-L-arabinitol 9.

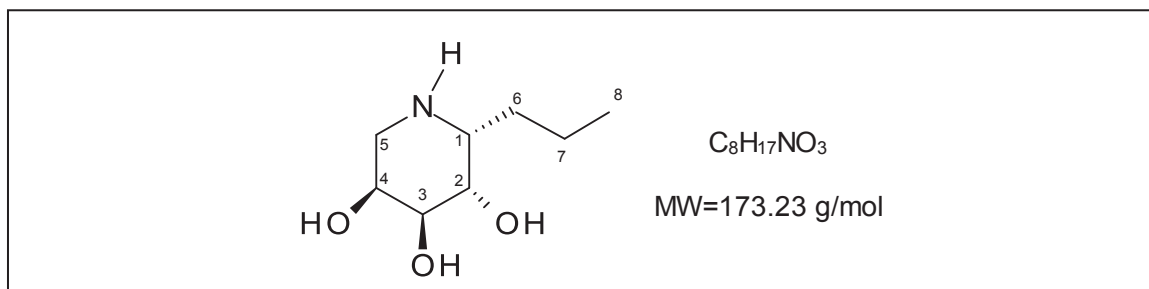

To a solution of isomer **7** (66 mg, 0.124 mmol) in isopropanol (1.2 mL) were added 1N aqueous HCl (0.24 mL, 0.24 mmol, 2 eq) and 10% Pd/C (19 mg). The reaction mixture was left stirring at RT under a hydrogen atmosphere for 5 days. Then it was filtered through a membrane, the retained catalyst was washed with MeOH and the solvents were evaporated. After treatment with Amberlite IRA400 resin (OH⁻) and purification on Dowex 50WX8 resin (H⁺) the final product was obtained as a brownish solid.

¹H NMR (400 MHz, CD₃OD), δ 3.88-3.84 (m, 2H, H3, H4), 3.70-3.68 (m, 1H, H2), 2.89-2.86 (m, 1H, H1), 2.79 (d, 2H, H5, *J*= 8.0 Hz), 1.53-1.32 (m, 4H, H6, H7), 0.95 (t, 3H, H8, *J*_{8,7}= 7.0 Hz).

¹³C NMR(100 MHz, CD₃OD), δ 72.30 (C3), 71.34 (C2), 66.80 (C4), 53.96 (C1), 46.67 (C5), 33.65 (C6), 20.37 (C7), 14.51 (C8).

HRMS (ESI)

[M+H]⁺ calculated for C₈H₁₈NO₃ *m/z*= 176.128120; found *m/z*= 176.128340

Yield

68% (14.9 mg).

1-O-Acetyl 2,3,4-tri-O-benzyl- α,β -L-arabinopyranose **10**.

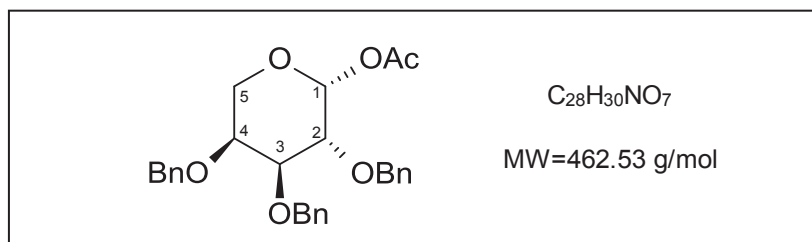

The reaction was conducted at RT. To a solution of compound **3** (1.0 g, 2.38 mmol) in pyridine (4.8 mL), Ac_2O was added (1.2 mL, 12.8 mmol, 5.4 eq). The mixture was left stirring until TLC showed completion of the reaction (3 h). CH_2Cl_2 (48 mL) was added. The mixture was washed with water (3 x 18 mL) and dried over $MgSO_4$. After concentration under vacuum and coevaporation with toluene, the crude product was obtained as a colorless oil, which was used in the next step without purification.

TLC:

- PE/EtOAc (8:2);
- $R_f = 0.28$

N-Benzyloxycarbonyl 2,3,4-tri-*O*-benzyl- α,β -L-arabinopyranosylamine **11**.

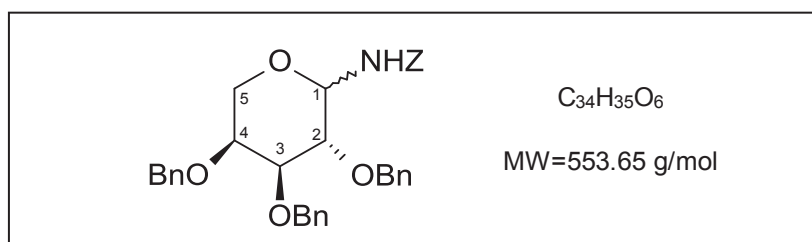

The reaction was conducted under argon at RT. Crude **10** (2.38 mmol) was dissolved in dry CH₂Cl₂ (2.4 mL) containing 4Å molecular sieves. After 5 min of stirring, benzyl carbamate (0.72 g, 4.76 mmol, 2 eq), then trimethylsilyl trifluoromethanesulfonate (0.44 mL, 2.43 mmol, 1.0 eq) were added. The mixture was left stirring until TLC showed completion of the reaction (2 h). The reaction was quenched by the addition of NEt₃ (0.33 mL, 2.37 mmol, 1 eq). The solids were filtered over celite, washed with CH₂Cl₂ and the filtrate was concentrated to give the crude product as a dark orange oil. Flash column chromatography on silica gel (toluene/acetone 95:5) gave the mixture of anomers (**11** α :**11** β 4:6) as a colourless oil.

TLC:

- PE/EtOAc (9:1);
- R_{f1}= 0.27; R_{f2}= 0.35

¹H NMR (400 MHz, CDCl₃), δ 7.31-7.21 (m, 20H, H_{aromatic}), 6.30 (d, 0.4H, NH α COOCH₂Ph, $J_{NH,I}$ = 6.7 Hz), 5.68 (d, 0.6H, NH β COOCH₂Ph, $J_{NH,I}$ = 9.4 Hz), 5.32 (d, 0.6H, H1 β , $J_{I,NH}$ = 9.4 Hz), 5.18-5.15 (m, 0.4H, H1 α), 5.15-5.03 (m, 2H, NHCOOCH₂Ph), 4.73-4.34 (m, 6H, CH₂Ph), 3.95-3.87 (m, 1H, H5_b), 3.83-3.75 (m, 2.6H, H3, H4, H5_a β), 3.59 (t, 0.4H, H2 α , J = 5.3 Hz), 3.52 (dd, 0.4H, H5 α , $J_{5,4}$ = 2.2 Hz, $J_{5a,5b}$ = 11.6 Hz), 3.47 (dd, 0.6H, H2 β , J = 1.9 Hz, J = 3.5 Hz).

¹³C NMR (100 MHz, CDCl₃), δ 155.48 (C=O), 138.16-138.11 (C^{IV}_{aromatic}), 128.59-127.56 (C_{aromatic}), 79.04 (C1 α), 77.60 (C3 α), 76.98 (C1 β), 76.58 (C2 β), 76.20 (C2 α), 73.10-72.93 (CH₂Ph), 72.29-72.22 (C3 β , C4), 71.41, 71.39 (CH₂Ph), 66.91, 66.79 (NHCOOCH₂Ph), 62.57 (C5 β), 60.69 (C5 α).

IR [cm⁻¹] ν 3320 (N-H), 3063, 3031 (C-H_{aromatic}), 2902 (C-H), 1732, 1689 (C=O), 1534 (C=C_{aromatic}), 1292, 1250, 1081, 1045 (C-C/C-O), 772, 730 (C-H_{aromatic}).

LRMS (ESI)

[M+H]⁺ = 554.5, [M+Na]⁺ = 576.5, [M+K]⁺ = 592.0

HRMS (ESI)

[M+Na]⁺ calculated for C₃₄H₃₅NNaO₆ m/z = 576.2362; found m/z = 576.2357

Yield

81% (1.07 g).

(1R,1S)-1-C-Allyl-2,3,4-tri-O-benzyl-1-(N-benzyloxycarbonyl)amino-1-deoxy-L-arabinitol
12.

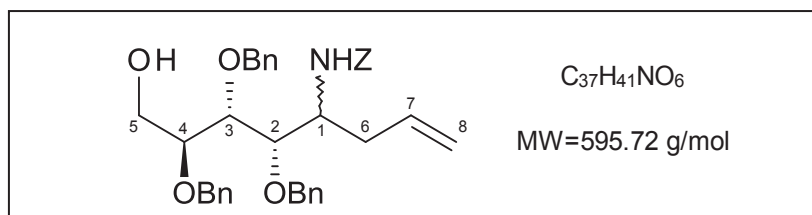

The reaction was conducted under argon at $-20^{\circ}C$. To a solution of glycosamine **11** (1.07 g, 1.92 mmol) in anhydrous acetonitrile (19 mL) was added allyltrimethylsilane (2.15 mL, 13.5 mmol, 7 eq). After 10 min of stirring, trimethylsilyl trifluoromethanesulfonate (0.36 mL, 1.98 mmol, 1 eq) was slowly added. The reaction mixture was left stirring overnight. The reaction was quenched with saturated $NaHCO_3$ (33 mL) at $0^{\circ}C$. Then EtOAc (200 mL) was added. The organic phase separated, then was washed with brine (2 x 70 mL) and dried over $MgSO_4$. Concentration under vacuum gave the crude product as a light yellow oil. Flash column chromatography on silica gel (toluene/acetone 95:5, solid loading) gave an unseparable mixture of diastereoisomers **12S** (*anti*)/ **12R** (*syn*) in a ratio of 1:9 approximately, as a colourless oil.

TLC:

- Toluene/Acetone (9:1);
- $R_f = 0.33$

1H NMR of the major *anti* isomer (400 MHz, $CDCl_3$), δ 7.32-7.23 (m, 20H, $H_{aromatic}$), 5.73-5.63 (m, 1H, H7), 5.20 (d, 1H, NH, $J_{NH,I} = 9.8$ Hz), 5.13-5.05 (m, 4H, $NHCOOCH_2Ph$, H8), 4.87-4.44 (m, 6H, CH_2Ph), 3.90-3.61 (m, 6H, H1, H2, H3, H4, H5), 2.35-2.22 (m, 3H, H6, OH).

^{13}C NMR of the major *anti* isomer (100 MHz, $CDCl_3$), δ 156.28 (C=O), 138.44-136.62 ($C_{aromatic}^{IV}$), 134.51 (C7), 128.55-127.83 ($C_{aromatic}$), 118.21 (C8), 80.81, 80.28, 79.42 (C2, C3, C4), 75.42, 75.27, 71.86 (CH_2Ph), 66.97 ($NHCOOCH_2Ph$), 61.34 (C5), 52.29 (C1), 38.21 (C6).

IR [cm^{-1}] ν 3031 ($C-H_{aromatic}$), 2875 (C-H), 1714.5 (C=O), 1498, 1454 ($C=C_{aromatic}$), 1210, 1057, 1026.5 (C-C, C-O), 734, 696 ($C-H_{aromatic}$).

LRMS (ESI)

$[M+H]^+ = 596.5$, $[M+Na]^+ = 618.0$, $[M+K]^+ = 634.5$

HRMS (ESI)

$[M+Na]^+$ calculated for $C_{37}H_{41}NNaO_6$ $m/z = 618.2832$; found $m/z = 618.2838$

Yield

71% (0.82 g).

(1*R*,1*S*)-1-*C*-Allyl-2,3,4-tri-*O*-benzyl-1-(*N*-benzyloxycarbonyl)amino-1-deoxy-5-*O*-methanesulfonyl-L-arabinitol **13**.

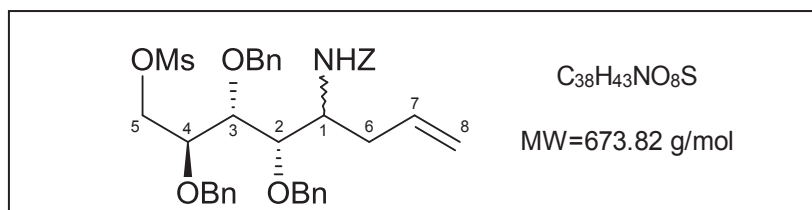

The reaction was conducted under argon at RT. To a solution of isomers **12** (0.82 g, 1.37 mmol) in dry CH_2Cl_2 (14 mL) were added NEt_3 (0.42 mL, 3.02 mmol, 2.2 eq) and 4 Å molecular sieves. Then methanesulfonyl chloride was added (0.22 mL, 2.84 mmol, 2.1 eq). The mixture was left stirring until TLC showed completion of the reaction (35 min). The solids were filtered, washed with CH_2Cl_2 (150 mL) and the filtrate was washed with saturated NH_4Cl (27 mL). The organic phase was separated, washed with brine (2 x 50 mL) and dried over $MgSO_4$. Concentration under vacuum gave the crude product as a yellow oil, which was used without purification in the next reaction.

TLC:

- Toluene/Acetone (9:1);
- $R_f = 0.53$

(1S)-1-C-Allyl-2,3,4-tri-O-benzyl-N-benzyloxycarbonyl-1,5-dideoxy-1,5-imino-L-arabinitol
14.

(1R)-1-C-Allyl-2,3,4-tri-O-benzyl-N-benzyloxycarbonyl-1,5-dideoxy-1,5-imino-L-arabinitol
15.

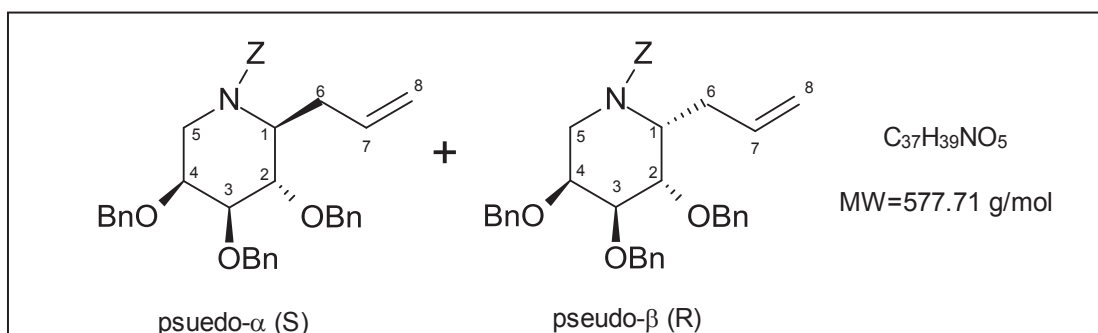

The reaction was conducted under argon at RT. To a solution of crude mesylates **13** (1.37 mmol) in dry THF (14 mL) was added potassium *tert*-butoxide (0.31 g, 2.76 mmol, 2 eq). The mixture was left stirring until TLC showed completion of the reaction (2.5h). The reaction was quenched with saturated NH₄Cl (27 mL). EtOAc (150 mL) was added. The organic phase was separated, washed with brine (150 mL), and dried over MgSO₄. Concentration under vacuum gave the crude product as a yellow oil. Flash column chromatography on silica gel (PE/EtOAc 9:1, solid loading) afforded the two pure desired products as colourless oils. Both isomers were found to exist as mixtures of rotamers (rot_a/rot_b 1:1).

IR [cm⁻¹] ν 3064, 3031 (C-H_{aromatic}), 2868 (C-H), 1695 (C=O), 1496, 1453, 1422 (C=C_{aromatic}), 1090, 1072, 1027 (C-O/C-C), 734, 695 (C-H_{aromatic}).

LRMS (ESI)

[M+H]⁺ = 578.5, [M+Na]⁺ = 600.5, [M+K]⁺ = 616.0

pseudo- α isomer :

TLC:

- PE/EtOAc (8:2);
- R_{f α} = 0.67

¹H NMR (400MHz, CDCl₃), δ 7.41-7.05 (m, 20H, H_{aromatic}), 5.79-5.69 (m, 0.5H, H7_{rot-b}), 5.69-5.58 (m, 0.5H, H7_{rot-a}), 5.17-5.08 (m, 2H, NCOOCH₂Ph), 5.08-4.91 (m, 2H, H8), 4.73-4.24 (m, 7.5H, 3CH₂Ph, H1_{rot-a+b}, H5_{b-rot-b}), 4.13-4.07 (m, 0.5H, H5_{b-rot-a}), 3.91-3.48 (m, 3H, H2_{rot-a+b}, H4_{rot-a+b}, H3_{rot-a+b}), 3.33-3.15 (m, 1H, H5_{a-rot-a+b}), 2.69-2.57 (m, 1H, H6_{b-rot-a+b}), 2.57-2.36 (m, 1H, H6_{a-rot-a+b}).

¹³C NMR (100 MHz, CDCl₃), δ 156.24, 156.00 (C=O), 138.49-135.22 (C^{IV}_{aromatic}), 135.21 (C7_{rot-a+b}), 128.44-127.54 (C_{aromatic}), 117.67, 117.44 (C8_{rot-a+b}), 75.88 (C3_{rot-a+b}), 75.36, 75.16 (C2_{rot-a+b}), 73.45 (C4_{rot-a+b}), 73.36-73.11, 71.37, 71.25 (3CH₂Ph), 67.23 (NCOOCH₂Ph), 53.65, 52.67 (C1_{rot-a+b}), 38.27, 37.77 (C5_{rot-a+b}), 34.03, 33.73 (C6_{rot-a+b}).

HRMS (ESI)

[M+H]⁺ calculated for C₃₇H₄₀NO₅ m/z = 578.29010; found m/z = 578.29032

Yield

8% (61 mg).

pseudo-β isomer :

TLC:

- PE/EtOAc (8:2);
- $R_{f\beta}$ = 0.51;

¹H NMR (400MHz, CDCl₃), δ 7.38-7.00 (m, 20H, H_{aromatic}), 5.74 (br s, 0.5H, H7_{rot-b}), 5.60 (br s, 0.5H, H7_{rot-a}), 5.14-5.07 (m, 2H, NCOOCH₂Ph), 5.03-4.91 (m, 2H, H8), 4.85-4.46 (m, 7.5H, CH₂Ph, H1, H5_{b-rot-a} or rot-b), 4.31-4.20 (m, 0.5H, H5_{a-rot-a} or rot-b), 4.12-4.07 (m, 1H, H2), 3.74-3.69 (m, 1H, H4), 3.55 (dd, 1H, H3, J_{3-2} = 10.1 Hz, J_{3-4} = 3.3 Hz), 2.71 (br s, 1H, H5_a), 2.58 (br s, 1H, H6_b), 2.22-2.13 (m, 1H, H6_a).

¹³C NMR (100 MHz, CDCl₃), δ 156.23 (C=O), 138.77-136.77 (C^{IV}_{aromatic}), 135.09 (C7), 128.41-127.57 (C_{aromatic}), 117.12 (C8), 78.26 (C3), 76.46 (C2), 73.27 (CH₂Ph), 72.57 (C4), 72.31, 70.82 (CH₂Ph), 67.45 (NCOOCH₂Ph), 53.63, 52.98 (C1), 40.03, 39.35 (C5), 29.37 (C6).

HRMS (ESI)

[M+Na]⁺ calculated for C₃₇H₃₉NNaO₅ m/z = 600.2726; found m/z = 600.2712

Yield

66% (503 mg).

(1S)-2,3,4-Tri-O-benzyl-1-C-propyl-1,5-dideoxy-1,5-imino-L-arabinitol 16.

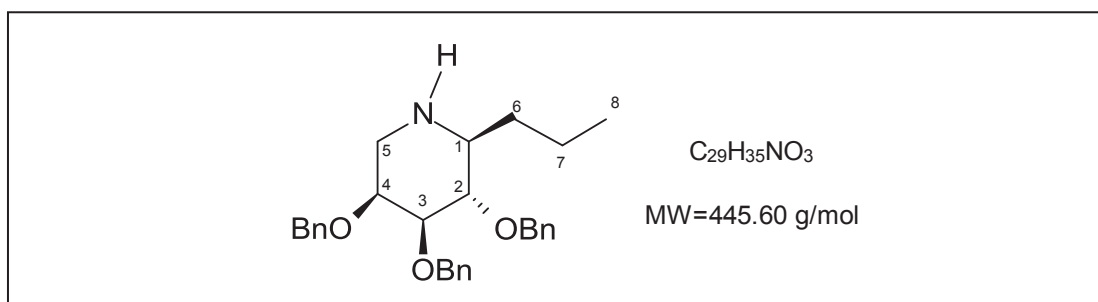

The reaction was conducted at room temperature. To a solution of compound **14** (60 mg, 0.104 mmol) in isopropanol (1.0 mL) were added NEt_3 (3.5 μ L, 0.024 mmol, 0.24 eq) and 10% Pd/C (15.6 mg). The mixture was left stirring under a hydrogen atmosphere until TLC showed completion of the reaction (2 h). Then it was filtered through a membrane, the retained catalyst was washed with CH_2Cl_2 . Concentration under vacuum gave the desired product **16** as a colorless oil.

1H NMR (400 MHz, $CDCl_3$), δ 7.40-7.26 (m, 15H, $H_{aromatic}$), 4.97 (d, 1H, CH_2Ph , $J= 10.8$ Hz), 4.70 (s, 2H, CH_2Ph), 4.64-4.57 (m, 3H, CH_2Ph), 3.77 (s, 1H, H4), 3.49-3.47 (m, 2H, H2, H3), 3.13 (dd, 1H, $H5_{ax}$, $J_{5ax,4}= 2.9$ Hz, $J_{5ax,5eq}= 14.3$ Hz), 2.48-2.44 (m, 2H, H1, $H5_{eq}$), 2.00 (br s, 1H, NH), 1.88-1.81 (m, 1H, H6), 1.58- 1.47 (m, 1H, H7), 1.36-1.23 (m, 2H, H7,H6), 0.91 (t, 3H, H8, $J_{8,7}= 7.1$ Hz).

^{13}C NMR (100 MHz, $CDCl_3$), δ 138.98, 138.73, 138.71 ($C^{IV}_{aromatic}$), 128.49-127.63 ($C_{aromatic}$), 84.36, 81.14 (C2, C3), 75.60 (CH_2Ph), 73.83 (C4), 71.81, 71.51 (CH_2Ph), 60.23 (C1), 47.06 (C5), 34.62 (C6), 19.22 (C7), 14.44 (C8).

1H NMR (400 MHz, acetone- d_6), δ 7.31-7.09 (m, 15H, $H_{aromatic}$), 4.82 (d, 1H, CH_2Ph , $J= 11.2$ Hz), 4.60-4.53 (m, 3H, CH_2Ph), 4.47 (d, 1H, CH_2Ph , $J= 11.2$ Hz), 4.46 (d, 1H, CH_2Ph , $J= 11.8$ Hz), 3.81-3.80 (m, 1H, H4), 3.43 (dd, 1H, H3, $J_{3,4}= 2.8$ Hz, $J_{2,3}= 9.3$ Hz), 3.29 (t, 1H, H2, $J_{2,3}= J_{2,1}= 9.3$ Hz), 3.01 (dd, 1H, $H5_{ax}$, $J_{5ax,4}= 2.9$ Hz, $J_{5ax,5eq}= 14.4$ Hz), 2.52 (br s, 1H, NH), 2.37 (dd, 1H, $H5_{eq}$, $J_{5eq,4}= 1.1$ Hz, $J_{5eq,5ax}= 14.4$ Hz), 2.25 (dt, 1H, H1, $J_{1,6b}= J_{1,6a}= 2.8$ Hz, $J_{1,2}= 9.3$ Hz), 1.74-1.66 (m, 1H, H6), 1.48-1.37 (m, 1H, H7), 1.28-1.05 (m, 2H, H7, H6), 0.84 (t, 2H, H8, $J_{8,7}= 7.3$ Hz).

^{13}C NMR (100 MHz, acetone- d_6), δ 140.52, 140.40, 140.20 ($C^{IV}_{aromatic}$), 129.00-127.96 ($C_{aromatic}$), 85.50 (C3), 82.03 (C2), 75.55 (CH_2Ph), 75.39 (C4), 71.95, 71.73 (CH_2Ph), 60.74 (C1), 47.61 (C5), 35.36 (C6), 19.94 (C7), 14.60 (C8).

HRMS (ESI)

$[M+H]^+$ calculated for $C_{29}H_{36}NO_3$ $m/z= 446.26897$; found $m/z= 446.26941$

Yield

Quant.

(1R)-2,3,4-Tri-O-benzyl-1-C-propyl-1,5-dideoxy-1,5-imino-L-arabinitol 17.

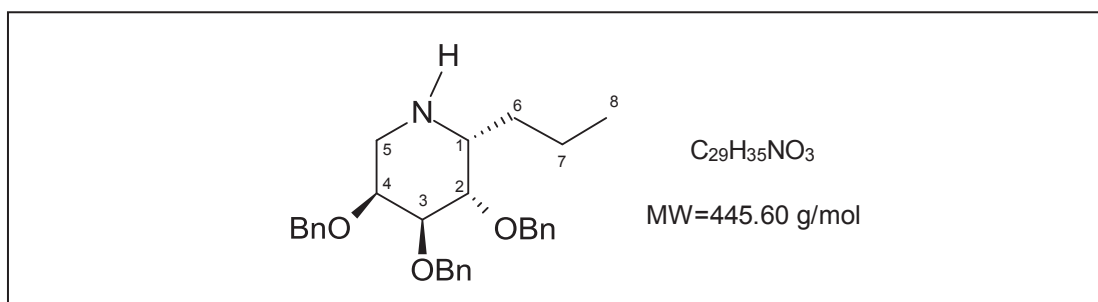

The reaction was conducted at room temperature. To a solution of **15** (60 mg, 0.104 mmol) in isopropanol (1.0 mL) were added NEt_3 (3.5 μ L, 0.024 mmol, 0.24 eq) and 10% Pd/C (15.6 mg). The mixture was left stirring under a hydrogen atmosphere until TLC showed completion of the reaction (2 h). Then it was filtered through a membrane, the retained catalyst was washed with CH_2Cl_2 . Concentration under vacuum gave product **17** as a light yellow oil.

1H NMR (400 MHz, $CDCl_3$), δ 7.36-7.17 (m, 15H, $H_{aromatic}$), 4.78 (d, 1H, CH_2Ph , $J=12.3$ Hz), 4.56 (d, 1H, CH_2Ph , $J=12.3$ Hz), 4.55 (d, 1H, CH_2Ph , $J=12.2$ Hz), 4.49 (d, 1H, CH_2Ph , $J=12.2$ Hz), 4.43 (d, 1H, CH_2Ph , $J=11.8$ Hz), 4.36 (d, 1H, CH_2Ph , $J=11.8$ Hz), 3.86 (t, 1H, H3, $J_{3,2}=J_{3,4}=2.8$ Hz), 3.71 (ddd, 1H, H4, $J_{4,3}=2.8$ Hz, $J_{4,5eq}=6.3$ Hz, $J_{4,5ax}=9.3$ Hz), 3.37 (br d, 1H, H2, $J_{2,3}=2.8$ Hz), 3.04-2.97 (m, 2H, H5), 2.93 (dt, 1H, H1, $J_{1,2}=1.9$ Hz, $J_{1,6b}=6.9$ Hz, $J_{1,6a}=6.9$ Hz), 1.98 (br s, 1H, NH), 1.43-1.26 (m, 3H, H6, H7), 1.20-1.10 (m, 1H, H7), 0.86 (t, 3H, H8, $J_{8,7}=7.3$ Hz).

^{13}C NMR (100 MHz, $CDCl_3$), δ 139.05, 138.84, 138.36 ($C^{IV}_{aromatic}$), 128.46-127.65 ($C_{aromatic}$), 77.18 (C2), 75.11 (C4), 73.49 (C3), 73.13, 72.66, 71.05 (C_{CH_2Ph}), 53.71 (C1), 44.58 (C5), 33.33 (C6), 19.71 (C7), 14.34 (C8).

IR [cm^{-1}] ν 3029 ($C-H_{aromatic}$), 2926, 2867 (C-H), 1604 (N-H), 1495, 1454 ($C=C_{aromatic}$), 1356, 1206, 1091, 1027 (C-O/C-C), 909, 816, 733, 696 ($C-H_{aromatic}$).

HRMS (ESI)

$[M+H]^+$ calculated for $C_{29}H_{36}NO_3$ $m/z=446.26897$; found $m/z=446.26937$

Yield

Quant.

(1R)-2,3,4-Tri-O-benzyl-N-benzyloxycarbonyl-1-C-((2R)-2,3-dihydroxypropyl)-1,5-dideoxy-1,5-imino-L-arabinitol **18**.

(1R)-2,3,4-Tri-O-benzyl-N-benzyloxycarbonyl-1-C-((2S)-2,3-dihydroxypropyl)-1,5-dideoxy-1,5-imino-L-arabinitol **19**.

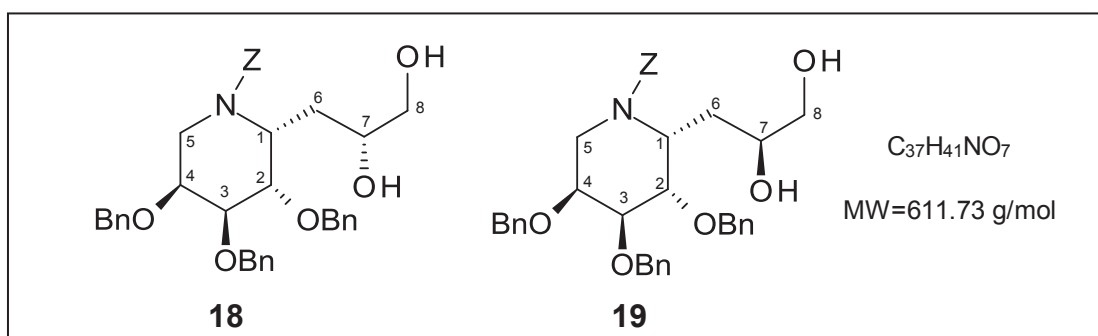

Compound **15** (465 mg, 0.805 mmol) was dissolved in a mixture of THF, *t*-BuOH, H₂O (3 mL: 9 mL: 1.6 mL). Then *N*-methylmorpholine-*N*-oxide (113 mg, 0.965 mmol, 1.2 eq) was added. After 5 min of stirring, a 2.5% solution of OsO₄ in *t*-BuOH (0.82 mL, 0.062 mmol, 0.08 eq) was slowly added. The reaction was left stirring at RT for 16 h. After the addition of a 0.1 N Na₂S₂O₅ solution (5 mL) the reaction mixture was stirred for 30 min. CH₂Cl₂ (20 mL) and H₂O (10 mL) were added and the organic phase was separated. The aqueous phase was further extracted with CH₂Cl₂ (20 mL). The combined organic phases were dried over MgSO₄. Concentration under vacuum gave the crude product as a light yellow oil. Flash column chromatography of the mixture on silica gel (CH₂Cl₂/Acetone 9:1) afforded the two pure isomers **18** and **19** as colourless oils.

1st isomer **18**:

TLC:

- CH₂Cl₂/Acetone (9:1)
- R_{f1} = 0.63

¹H NMR (400 MHz, CDCl₃), δ 7.40-7.24 (m, 20H, H_{aromatic}), 5.19 (d, 1H, NCOOCH₂Ph, *J* = 12.2 Hz), 5.09 (d, 1H, NCOOCH₂Ph, *J* = 12.2 Hz), 4.92-4.90 (m, 1H, H1), 4.73-4.55 (m, 6H, CH₂Ph), 4.27 (d, 1H, H5_b, *J*_{5b,5a} = 14.6 Hz), 4.19 (dd, 1H, H2, *J*_{2,1} = 6.5 Hz, *J*_{2,3} = 10.0 Hz), 3.97 (s, 1H, OH), 3.69 (s, 1H, H4), 3.53-3.49 (m, 4H, H3, H7, H8), 2.68 (d, 1H, H5_a, *J*_{5a,5b} = 14.6 Hz), 2.34-2.33 (m, 1H, OH), 1.89-1.82 (m, 1H, H6), 1.48 (t, 1H, H6, *J* = 13.1 Hz).

¹³C NMR (100 MHz, CDCl₃), δ 157.32 (C=O), 138.65-136.11 (C^{IV}_{aromatic}), 128.73-127.64 (C_{aromatic}), 78.40 (C3), 75.80 (C2), 73.31, 72.76 (CH₂Ph), 72.48 (C4), 71.25 (CH₂Ph), 68.28 (NCOOCH₂Ph), 68.25 (C7), 66.73 (C8), 50.41 (C1), 40.71 (C5), 27.85 (C6).

HRMS (ESI)

[M+H]⁺ calculated for C₃₇H₄₂NO₇ *m/z* = 612.29558; found *m/z* = 612.29541

[M+Na]⁺ calculated for C₃₇H₄₁NNaO₇ *m/z* = 634.27750; found *m/z* = 634.27752

Yield

51% (252 mg).

2nd isomer 19:

TLC:

- CH₂Cl₂/Acetone (9:1)
- R_{f2} = 0.53

¹H NMR (400 MHz, CDCl₃), δ 7.34-7.24 (m, 20H, H_{aromatic}), 5.16-5.06 (m, 2H, NCOOCH₂Ph), 4.80 (d, 1H, CH₂Ph, *J* = 11.4 Hz), 4.73-4.49 (m, 6H, H1, CH₂Ph), 4.28-4.25 (m, 1H, H5_b), 4.12-4.09 (m, 1H, H2), 3.76-3.64 (m, 3H, H4, H7, H8_b), 3.51-3.44 (m, 2H, H3, H8_a), 2.86 (d, 1H, H5_a, *J*_{5a,5b} = 15.0 Hz), 2.04-2.00 (m, 1H, H6), 1.60-1.52 (m, 1H, H6).

¹³C NMR (100 MHz, CDCl₃), δ 156.76 (C=O), 138.63-136.28 (C^{IV}_{aromatic}), 128.70-127.68 (C_{aromatic}), 78.42 (C3), 76.32 (C2), 73.61 (CH₂Ph), 72.64, 72.61 (C4, C7), 71.44, 71.12 (CH₂Ph), 68.02 (NCOOCH₂Ph), 66.29 (C8), 52.29 (C1), 40.79 (C5), 28.51 (C6).

HRMS (ESI)

[M+H]⁺ calculated for C₃₇H₄₂NO₇ *m/z* = 612.29558; found *m/z* = 612.29569

[M+Na]⁺ calculated for C₃₇H₄₁NNaO₇ *m/z* = 634.27750; found *m/z* = 634.27766

Yield

22% (106 mg).

Note: The configuration of the carbinol chiral center C7 of **18** and **19** was determined in Prof. Frelek laboratory (Institute of Organic chemistry, Polish Academy of Science, Warsaw) from the ECD spectrum of the preformed complex of these compounds with dimolybdenum tetracetate (see Results and Discussion, section I.6 for details). These results have already been published¹⁷². It is thus established that **18** is the 7*R* epimer and **19** the 7*S* epimer.

¹⁷² Biela, A.; Oulaïdi, F.; Gallienne, E.; Górecki, M.; Frelek, J.; Martin, O. R. *Tetrahedron* **2013**, *69*, 3348.

(1R)-1-C-((2R)-2,3-Dihydroxypropyl)-1,5-dideoxy-1,5-imino-L-arabinitol **20**.

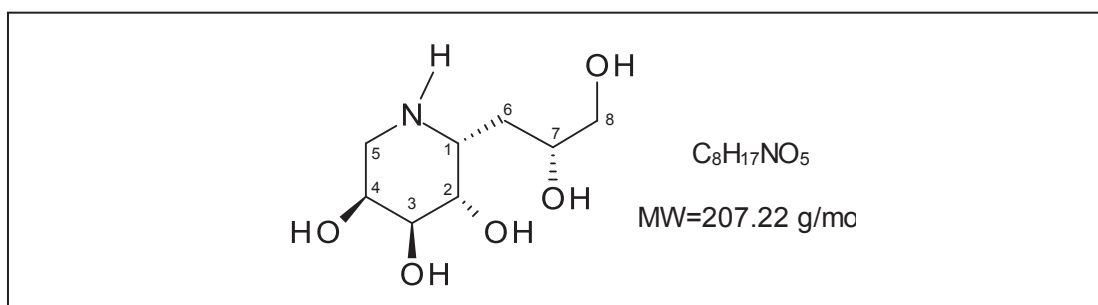

To a solution of isomer **18** (213 mg, 0.348 mmol) in isopropanol (3.5 mL) were added 1N aqueous HCl (0.7 mL, 0.7 mmol, 2 eq) and 10% Pd/C (52.5 mg). The reaction mixture was left stirring at RT under a hydrogen atmosphere overnight. Then it was filtered through a membrane, the retained catalyst was washed with MeOH and the solvents were evaporated. The procedure was repeated once to afford a fully deprotected compound. After treatment with Amberlite IRA400 resin (OH⁻), the final product was obtained as a brownish solid.

¹H NMR (400 MHz, CD₃OD), δ 3.87-3.85 (m, 1H, H3), 3.82 (dd, 1H, H4, $J_{4,3}$ = 2.9 Hz, $J_{4,5}$ = 7.9 Hz), 3.78-3.72 (m, 1H, H7), 3.66 (dd, 1H, H2, $J_{2,3}$ = 1.5 Hz, $J_{2,1}$ = 3.9 Hz), 3.50-3.43 (m, 2H, H8), 3.10-3.07 (m, 1H, H1), 2.76 (d, 2H, H5, $J_{5,4}$ = 7.9 Hz), 1.64-1.49 (m, 2H, H6).

¹³C NMR (100 MHz, CD₃OD), δ 73.67 (C2), 72.60 (C3), 71.08 (C7), 67.71 (C8), 67.19 (C4), 51.67 (C1), 46.72 (C5), 36.46 (C6).

HRMS (ESI)

[M+H]⁺ calculated for C₈H₁₈NO₅ m/z =208.11795; found m/z =208.11799

Optical rotation

$[\alpha]_D^{20}$ = +10.3 (c= 1.0; MeOH)

Yield

96% (69 mg).

(1R)-1-C-((2S)-2,3-Dihydroxypropyl)-1,5-dideoxy-1,5-imino-L-arabinitol 21.

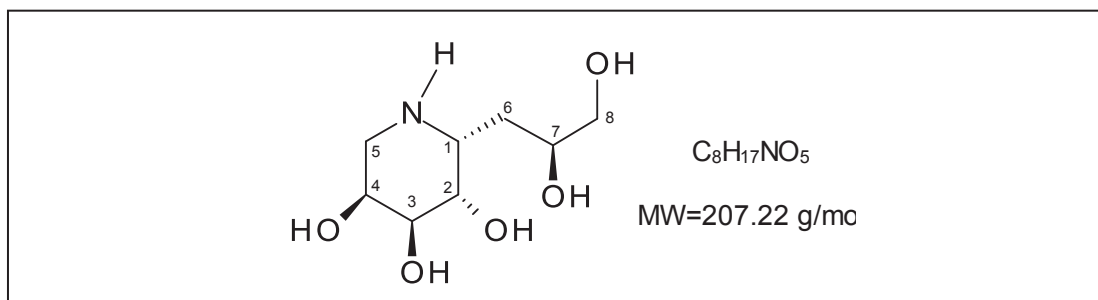

To a solution of isomer **19** (103 mg, 0.168 mmol) in isopropanol (1.7 mL) were added 1 N aqueous HCl (0.34 mL, 0.34 mmol, 2 eq) and 10% Pd/C (25.5 mg). The reaction mixture was left stirring at RT under a hydrogen atmosphere overnight. Then it was filtered through a membrane, the retained catalyst was washed with MeOH and the solvents were evaporated. The procedure was repeated twice to afford a fully deprotected compound. After treatment with Amberlite IRA400 resin (OH⁻), the final product was obtained as a light yellow oil.

¹H NMR (400 MHz, CD₃OD), δ 3.89-3.86 (m, 1H, H3), 3.84 (dd, 1H, H4, $J_{4,3}$ = 2.9 Hz, $J_{4,5}$ = 7.9 Hz), 3.81-3.75 (m, 1H, H7), 3.72-3.71 (m, 1H, H2), 3.51-3.43 (m, 2H, H8), 3.15-3.12 (m, 1H, H1), 2.79 (d, 2H, H5, $J_{4,5}$ = 7.9 Hz), 1.66 (ddd, 1H, H6_b, J =3.3 Hz, J_{6b-6a} =5.9 Hz, J =14.2 Hz), 1.53-1.46 (m, 1H, H6_a).

¹³C NMR (100 MHz, CD₃OD), δ 72.53 (C3), 72.39 (C2), 71.91 (C7), 67.54 (C8), 67.16 (C4), 52.88 (C1), 46.79 (C5), 34.85 (C6).

HRMS (ESI)

$[M+H]^+$ calculated for C₈H₁₈NO₅ m/z = 208.11795; found m/z = 208.11787

Optical rotation

$[\alpha]_D^{20}$ = -11.3 (c= 1.00; MeOH)

Yield

57% (20 mg).

(1R)-2,3,4-Tri-O-benzyl-N-benzyloxycarbonyl-1-C-(3-hydroxypropyl)-1,5-dideoxy-1,5-imino-L-arabinitol **22**.

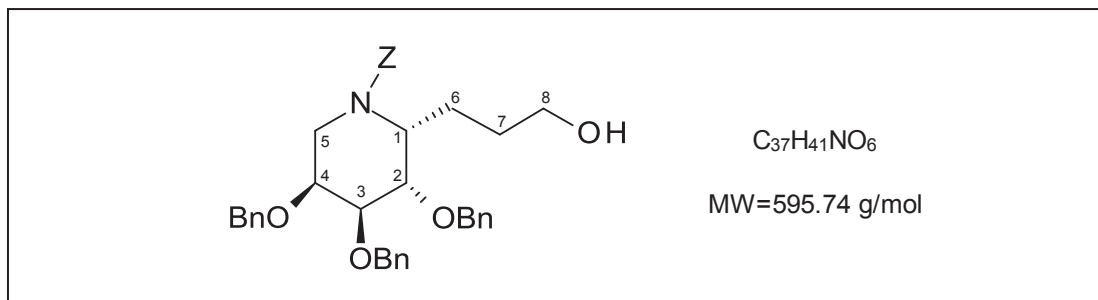

The reaction was conducted under argon. To a solution of compound **15** (208 mg, 0.360 mmol) in dry THF (0.8 mL) were added catecholborane (1 N solution in THF, 0.72 mL, 2 eq) and Wilkinson's catalyst (6.5 mg, 0.007 mmol, 0.02 eq). The reaction mixture was heated at 40°C for 4 days, then cooled down to RT and diluted with EtOH (0.72 mL). 2N Aqueous NaOH (0.72 mL) and 30% H₂O₂ (0.72 mL) were added. The reaction mixture was left stirring at RT for 2.5 days. The aqueous phase was then extracted with Et₂O (2 x 10 mL). The combined organic phases were washed successively with 0.1 N Na₂S₂O₃ (2 x 10 mL), 2 N NaOH (2 x 10 mL), H₂O (10 mL), saturated NH₄Cl (10 mL) and dried over MgSO₄. Concentration under vacuum gave the crude product as a brown oil. Flash column chromatography on silica gel (PE/AcOEt 8:2/5:5) gave pure product **22** as a colorless oil.

TLC:

- PE/EtOAc (8:2);
- R_f= 0.095

¹H NMR (400 MHz, CDCl₃), δ 7.34-7.24 (m, 20H, H_{aromatic}), 5.10 (br s, 2H, NCOOCH₂Ph), 4.79-4.24 (m, 8H, CH₂Ph, H1, H5_b), 4.09 (br s, 1H, H2), 3.73-3.53 (m, 3H, H4, H8), 3.55 (dd, 1H, H3, J_{3,4}= 2.8 Hz, J_{3,2}= 10.1 Hz), 2.76-2.73 (m, 1H, H5_a), 1.86-1.15 (m, 4H, H6, H7).

¹³C NMR (100 MHz, CDCl₃), δ 156.46 (C=O), 138.81-136.57 (C^{IV}_{aromatic}), 128.61-127.55 (C_{aromatic}), 78.30 (C3), 76.65 (C2), 73.29 (CH₂Ph), 72.62 (C4), 72.26, 70.91 (CH₂Ph), 67.70 (NCOOCH₂Ph), 62.62 (C8), 53.32 (C1), 40.00 (C5), 29.10, 20.58 (C6, C7).

HRMS (ESI)

[M+H]⁺ calculated for C₃₇H₄₂NO₆ m/z= 596.30066; found m/z= 596.30055

[M+Na]⁺ calculated for C₃₇H₄₁NNaO₆ m/z= 618.28261; found m/z= 618.28206

[M+K]⁺ calculated for C₃₇H₄₁KNO₆ m/z= 634.25655; found m/z= 634.25590

Yield

46% (98 mg).

(1R)-1-C-(3-Hydroxypropyl)-1,5-dideoxy-1,5-imino-L-arabinitol 23.

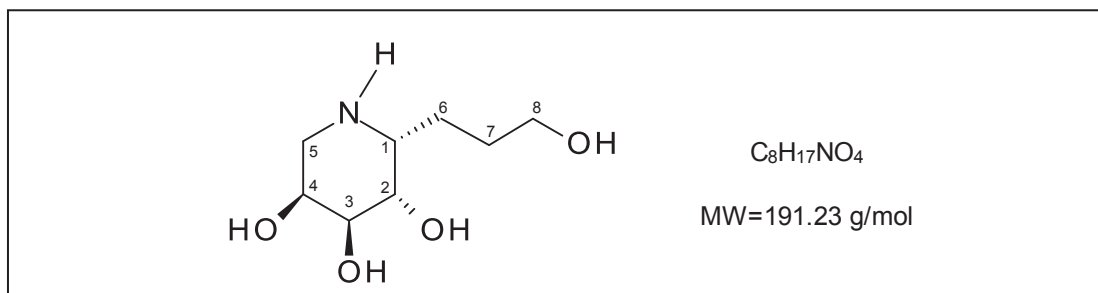

To a solution of compound **22** (135 mg, 0.227 mmol) in isopropanol (0.44 mL) were added 1N aqueous HCl (0.44 mL, 0.44 mmol, 2 eq) and 10% Pd/C (35 mg). The reaction mixture was left stirring at RT under a hydrogen atmosphere overnight. Then it was filtered through a membrane, the retained catalyst was washed with MeOH and the solvents were evaporated. The procedure was repeated once to give a fully deprotected compound. After treatment with Amberlite IRA400 resin (OH⁻) the final product was obtained as a light yellow oil.

¹H NMR (400 MHz, CD₃OD), δ 3.91-3.88 (m, 2H, H3, H4), 3.73-3.72 (m, 1H, H2), 3.58-3.56 (m, 2H, H8), 2.90 (t, 1H, H1, *J*= 6.3 Hz), 2.81 (d, 2H, H5, *J*_{5,4}= 7.8 Hz), 1.66-1.47 (m, 4H, H7, H6).

¹³C NMR (100 MHz, CD₃OD), δ 72.16 (C3/C4), 71.49 (C2), 66.53 (C3/4), 62.91 (C8), 54.43 (C1), 46.39 (C5), 30.44 (67), 28.20 (C7).

HRMS (ESI)

[M+H]⁺ calculated for C₈H₁₈NO₄ *m/z*= 192.12303; found *m/z*= 192.12315

Yield

Quant. (43 mg).

1-O-Acetyl-2,3,4,6-tetra-O-benzyl- α,β -D-galactopyranose 24.

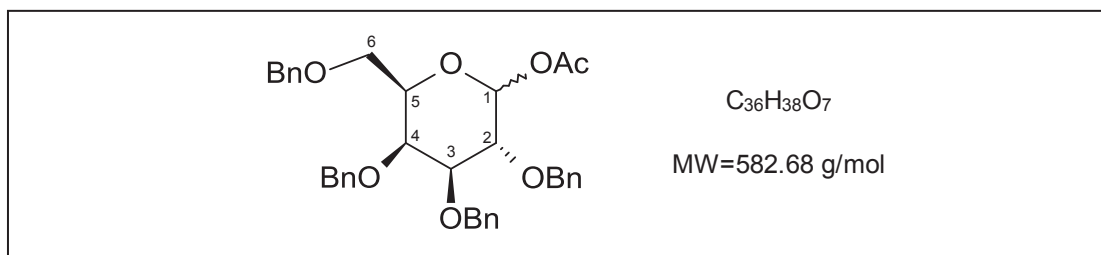

To a solution of commercial 2,3,4,6-tetra-*O*-benzyl-D-galactose (1.0 g, 1.85 mmol) in pyridine (3.7 mL), Ac₂O (0.87 mL, 9.26 mmol, 5 eq) was added. The reaction mixture was left stirring at RT overnight. Then CH₂Cl₂ (40 mL) was added. The organic phase was washed with H₂O (3 x 15 mL) and dried over MgSO₄. Concentration under vacuum and coevaporation with toluene (3 x 10 mL) gave the crude product as a light orange oil, which was used without purification in the next reaction.

TLC:

- PE/EtOAc (8:2);
- R_f = 0.4

NMR

Obtained spectrum corresponds to literature data.²³⁵

²³⁵ Austin, P. W.; Hardy, F. E.; Buchanan, J. G.; Baddiley, J. *J Chem Soc* **1964**, 2128.

N-Benzoyloxycarbonyl 2,3,4,6-tetra-O-benzyl- α,β -D-galactopyranosylamine 25.

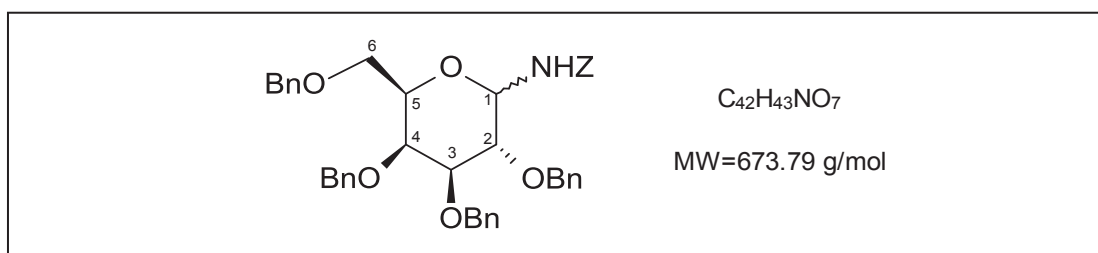

The reaction was conducted under argon at RT. Crude acetate **24** (1.85 mmol) was dissolved in dry CH_2Cl_2 (3.75 mL) containing 4Å molecular sieves. Then benzyl carbamate (560 mg, 3.7 mmol, 2 eq) and trimethylsilyl trifluoromethanesulfonate (0.34 mL, 1.85 mmol, 1 eq) were added. The reaction mixture was left stirring for 6 h. Then it was quenched by the addition of NEt_3 (0.26 mL, 1.85 mmol, 1 eq). The reaction mixture was filtered over celite and the solids were washed with CH_2Cl_2 . The filtrate was concentrated under vacuum and the residue was coevaporated with toluene to afford the crude product as a yellow oil. Flash column chromatography on silica gel (toluene/EtOAc, 95:5) gave the desired product **25** as a mixture of anomers (1:1) and as a dense, slightly yellow oil.

TLC:

- toluene/Acetone (9:1);
- $R_f = 0.44$

1H NMR (400 MHz, $CDCl_3$), δ 7.38-6.98 (m, 25H, $H_{aromatic}$), 5.70 (d, 0.5H, $NH_{\alpha}COOCH_2Ph$, $J_{NH,I} = 6.8$ Hz), 5.58-5.56 (m, 0.5H, $H1\alpha$), 5.24 (d, 0.5H, $NH_{\beta}COOCH_2Ph$, $J_{NH,I} = 9.9$ Hz), 5.16-5.00 (m, 2H, $NHCOOCH_2Ph$), 4.92-4.78 (m, 2H, $H2\beta$, CH_2Ph), 4.72-4.35 (m, 6.5H, CH_2Ph), 4.10 (dd, 0.5H, $H2\alpha$, $J = 5.0$ Hz, $J = 9.20$ Hz), 3.97 (d, 0.5H, $H4\alpha$, $J = 1.6$ Hz), 3.90 (t, 0.5H, $H4\beta$, $J_{4,3} = J_{4,5} = 5.6$ Hz), 3.71-3.53 (m, 4.5H, $H2\beta$, $H3\alpha$, $H3\beta$, $H5\alpha$, $H5\beta$, 2H6),

^{13}C NMR (100 MHz, $CDCl_3$), δ 156.10, 155.67 (C=O), 138.57-136.15 ($C^{IV}_{aromatic}$), 126.39-125.33 ($C_{aromatic}$), 83.50 (C3/C5), 82.07 (C1 β), 78.10 (C3/C5), 77.55 (C2 β), 77.07 (C1 α), 75.09 (C2 α), 74.99, 74.77, 74.41, 73.47, 72.93, 72.89, 72.62 (CH_2Ph), 74.56 (C3/C5), 74.01 (C4 α), 70.46 (C4 β), 68.01 (C6), 67.06, 66.93 ($NHCOOCH_2Ph$).

IR [cm^{-1}] ν 3322 (N-H), 3030 (C- $H_{aromatic}$), 2869 (C-H), 1730 (C=O), 1529, 1496, 1453 (C=C $_{aromatic}$), 1363, 1250, 1216, 1095, 1040, 1027 (C-O/C-C), 910, 733, 695 (C- $H_{aromatic}$).

LRMS (ESI)

673.79, $[M+H]^+ = 674.5$, $[M+Na]^+ = 696.0$, $[M+K]^+ = 712.5$

HRMS (ESI)

$[M+Na]^+$ calculated for $C_{42}H_{43}NNaO_7$ $m/z = 696.29317$; found $m/z = 696.29351$

Yield

80% (1.00 g).

Mixture **26mix** of *N*-Benzyloxycarbonyl 2,3,4,6-tetra-*O*-benzyl- α,β -D-galactopyranosylamine **25** and (1*R*,1*S*)-1-*C*-allyl-2,3,4,6-tetra-*O*-benzyl-1-(*N*-benzyloxycarbonyl) amino-1-deoxy-D-galactitol **39, 40**.

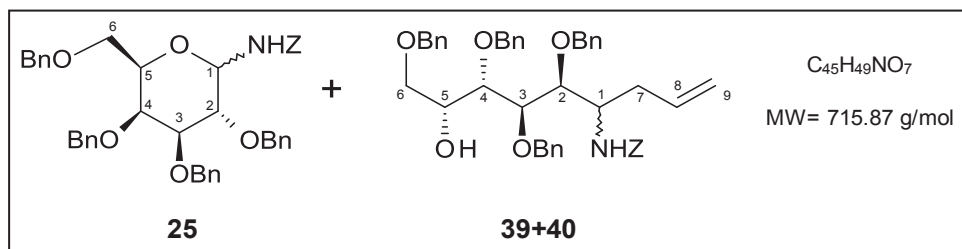

The reaction was conducted under argon. To a solution of **25** (978 mg, 1.45 mmol) in dry acetonitrile (14.5 mL) was added allyltrimethylsilane (1.61 mL, 10.16 mmol, 7 eq). After 10 min of stirring at -20°C, trimethylsilyl trifluoromethanesulfonate (0.53 mL, 2.90 mmol, 2 eq) was slowly added. The mixture was left stirring at -25°C for 48 h. The reaction was then quenched by the addition of saturated NaHCO₃ (60 mL). After extraction with EtOAc (2 x 100 mL), the organic phase was washed with saturated NaCl (2 x 70 mL) and dried over MgSO₄. Concentration under vacuum gave the crude mixture of products as a light yellow oil. Flash column chromatography on silica gel (toluene/acetone 95:5) afforded a mixture of the addition products **39, 40** and starting material **25** as a colorless oil (ratio1:1). The whole procedure was repeated using the purified mixture as a starting material. Diastereoselectivity of the reaction cannot be determined at this point; however, the excess of one of the diastereoisomers is observed. The sample **26mix** thus obtained contains approximately 60% of addition products 40% of residual starting material **25**. This mixture was used in the next step.

TLC:

- toluene/Acetone (9:1);
- R_f= 0.44

IR, HMR, CNMR

Due to the fact that the product is in mixture with the starting material, only LRMS was performed to confirm the presence of the desired addition product.

LRMS (ESI)

Products **39, 40**: [M+H]⁺= 716.5, [M+Na]⁺= 738.5

Starting material **25**: [M+H]⁺= 674.0, [M+Na]⁺= 696.0

(1*R*,1*S*)-1-*C*-Allyl-2,3,4,6-tetra-*O*-benzyl-1-(*N*-benzyloxycarbonyl)amino-1-deoxy-5-*O*-methanesulfonyl-D-galactitol **27**.

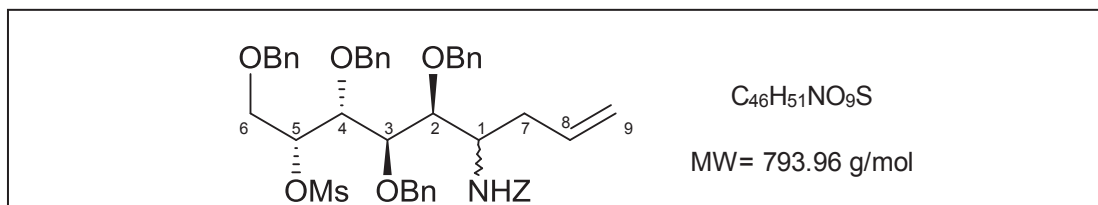

The reaction was conducted under argon at RT on the sample of **26mix** previously obtained. To a solution of **26mix** (0.8 mmol) in dry CH₂Cl₂ (7 mL) were added Et₃N (0.21 mL, 1.54 mmol) and 4Å molecular sieves. Then methanesulfonyl chloride was added (0.11 mL, 1.47 mmol). The reaction was left stirring overnight. The solids were filtered, washed with CH₂Cl₂ (100 mL) and the filtrate was washed with saturated aqueous NH₄Cl (20 mL). The organic phase was separated, washed with brine (2 x 30 mL) and dried over MgSO₄. Concentration under vacuum gave the crude product as a mixture of **27R/S** and starting material **25** in a ratio 6:4 as a yellowish oil. Flash column chromatography on silica gel (toluene/EtOAc, 95:5) afforded the first, major addition product **27R** (175 mg, 27%), the mixture of diastereoisomers **27R** and **27S** (65 mg, 10%), both as yellowish oils, and recovered **25** (221 mg, 41%). All yields are calculated for two steps from **25**.

TLC:

- toluene/acetone (9:1);
- R_{fR} = 0.51; R_{fS} = 0.56

LRMS (ESI)

[M+H]⁺ = 794.5

Yield

37% (240 mg) (27% for **27R**, 10% for mixture of diastereoisomers) and 41% (221 mg) of **25**
Corrected yield: 65%

All yields are calculated for two steps, from **25**.

(1R)-1-C-Allyl-2,3,4,6-tetra-O-benzyl-N-benzyloxycarbonyl-1,5-dideoxy-1,5-imino-L-altritol
28.

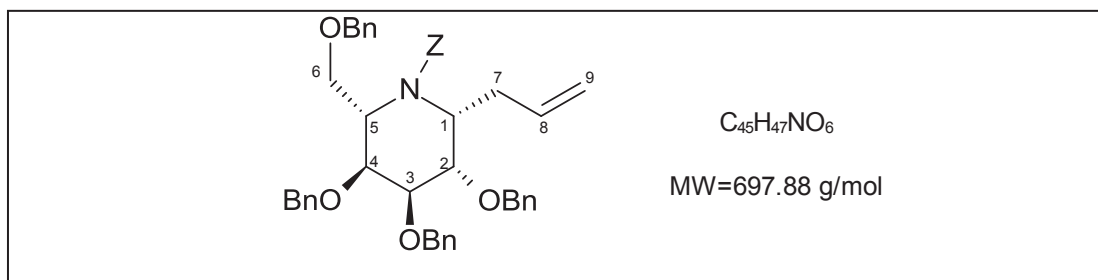

To a solution of **27R** (170 mg, 0.21 mmol) in dry THF (3 mL) was added potassium *tert*-butoxide (72 mg, 0.64 mmol, 3 eq). The reaction was left stirring for 24h. The reaction was quenched with saturated NH₄Cl (5 mL). After extraction with EtOAc (25 mL), the organic phase was washed with brine (10 mL) and dried over MgSO₄. Concentration under vacuum gave the crude product as a yellowish oil. Flash column chromatography on silica gel (toluene/EtOAc, 95:5) gave the pure product as a mixture of rotamers (1:1) and as a yellowish oil.

TLC:

- toluene/EtOAc (9:1);
- R_f = 0.5

¹H NMR (250 MHz, CDCl₃), δ 7.31-7.19 (m, 25H, H_{aromatic}), 5.95-5.48 (m, 1H, H₈), 5.17-5.05 (m, 2H, NCOOCH₂Ph), 4.91-4.34 (m, 12H, CH₂Ph, H₁, H₅, 2H₉), 4.20 (dd, 1H, H₂, J_{2,1} = 6.6 Hz, J_{2,3} = 10.2 Hz), 3.97 (br s, 1H, H₄), 3.75 (dd, 1H, H₃, J_{3,4} = 2.7 Hz, J_{3,2} = 10.2 Hz), 3.47-3.44 (m, 2H, 2H₆), 2.69-2.64 (m, 1H, H_{7b}), 2.03-1.89 (m, 1H, H_{7a}).

¹³C NMR (100 MHz, CDCl₃), δ 156.42 (C=O), 138.76-137.84 (C^{IV}_{aromatic}), 136.08 (C₈), 128.34-127.52 (C_{aromatic}), 116.78 (C₉), 75.85 (C₂), 75.17 (C₃), 74.05 (C₄), 73.35-71.85 (CH₂Ph), 69.96 (C₆), 67.61 (NCOOCH₂Ph), 54.59, 53.73 (C₁, C₅), 34.81 (C₇).

IR [cm⁻¹] ν 3063, 3030 (C-H_{aromatic}), 2864 (C-H), 1694 (C=O), 1495, 1453, 1453 (C=C_{aromatic}), 1324, 1205, 1092, 1025 (C-O/C-C), 910 (C-H_{aromatic}).

HRMS (ESI)

[M+H]⁺ calculated for C₄₅H₄₈NO₆ m/z = 698.34761; found m/z = 698.34850

Optical rotation

[α]_D²⁰ = +21.3 (c = 1.1; CHCl₃)

Yield

47% (69 mg)

(1R)-2,3,4,6-Tri-O-benzyl-1-C-propyl-1,5-dideoxy-1,5-imino-L- altritol **29**.

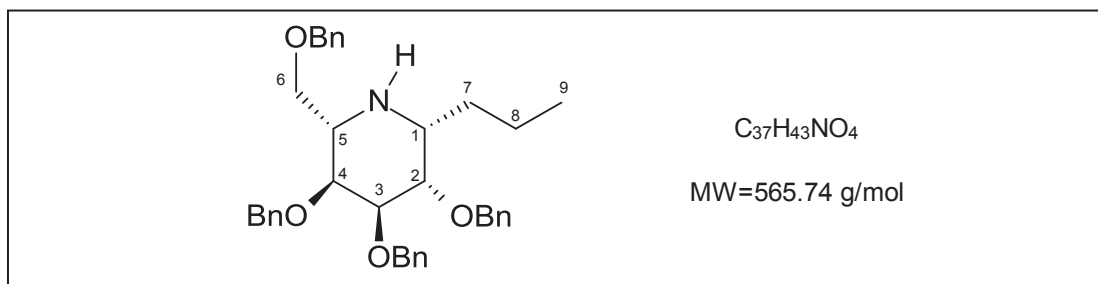

To a solution of compound **28** (69 mg, 0.099 mmol) in isopropanol (1 mL), NEt_3 (3.5 μ L, 0.025 mmol, 0.25 eq) and 10% Pd/C (15 mg) were added. The reaction was left stirring under a hydrogen atmosphere overnight. Then the mixture was filtered through a membrane, the retained catalyst was washed with MeOH and the solvents were evaporated to give compound **29** as a light yellow oil.

TLC:

- toluene/acetone (9:1);
- $R_f = 0.26$

1H NMR (250 MHz, $CDCl_3$), δ 7.31-7.16 (m, 20H, $H_{aromatic}$), 4.68 (d, 1H, \underline{CH}_2Ph , $J = 12.3$ Hz), 4.56-4.34 (m, 7H, \underline{CH}_2Ph), 3.77 (t, 1H, H3, $J_{2,3} = 3.5$ Hz), 3.73-3.68 (m, 3H, 2H6, H4), 3.33 (dd, 1H, H2, $J_{1,2} = 1.5$ Hz, $J_{2,3} = 3.5$ Hz), 3.23 (ddd, 1H, H5, $J_{5,6a} = 2.9$ Hz, $J_{5,6b} = 4.6$ Hz, $J_{5,4} = 10.2$ Hz), 3.0 (td, 1H, H1, $J_{1,2} = 1.5$ Hz, $J_{1,7a} = J_{1,7b} = 7.0$ Hz), 1.45-1.36 (m, 2H, H7), 1.28-1.23 (m, 2H, H8), 0.84 (t, 3H, H9, $J = 7.2$ Hz).

^{13}C NMR (62.5 MHz, $CDCl_3$), δ 138.88-138.51 ($C_{aromatic}^{IV}$), 128.41-127.54 ($C_{aromatic}$), 76.24 (C2), 75.30 (C4), 73.33, 72.95 (\underline{CH}_2Ph), 72.61 (C3), 72.36, 71.74 (\underline{CH}_2Ph), 70.53 (C6), 54.65 (C5), 53.38 (C1), 33.43 (C7), 19.59 (C8), 14.35 (C9).

HRMS (ESI)

$[M+H]^+$ calculated for $C_{37}H_{44}NO_4$ $m/z = 566.32649$; found $m/z = 566.32670$

Yield

Quant. (56 mg)

(1*R*)-1-*C*-Propyl-1,5-dideoxy-1,5-imino-L- altritol **30**.

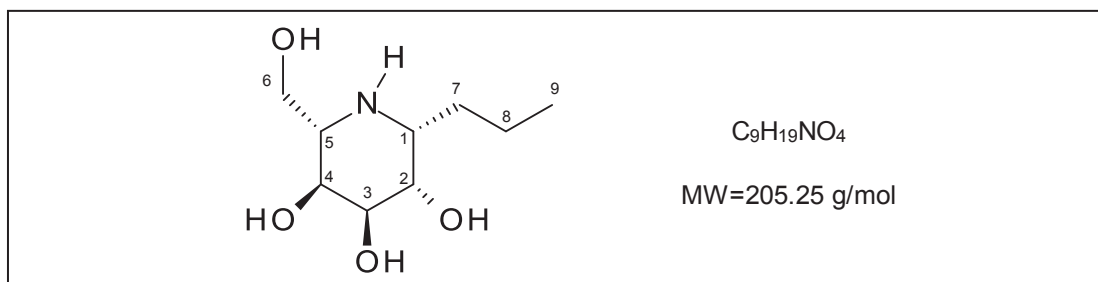

To a solution of compound **28** (132 mg, 0.19 mmol) in isopropanol (1.9 mL), 1N HCl (0.38 mL, 0.38 mmol, 2 eq) and 10% Pd/C (38 mg) were added. The mixture was left stirring under a hydrogen atmosphere until TLC showed completion of the reaction (20h). Then the mixture was filtered through a membrane, the retained catalyst was washed with MeOH and the solvents were evaporated. The procedure was repeated once to afford a fully deprotected compound. After treatment with Amberlite IRA400 resin (OH), the final product was obtained as an orange, amorphous solid.

¹H NMR (400 MHz, DMSO-*d*₆), δ 4.49-4.35 (m, 3H, 3OH), 3.14 (br s, 1H, OH), 3.67 (br s, 1H, H3), 3.47-3.46 (m, 3H, H4, 2H6), 3.38 (br s, 1H, H2), 2.75-2.73 (m, 1H, H1), 2.54-2.50 (m, 1H, H5), 1.29-1.23 (m, 4H, 2H7, 2H8), 0.85 (t, 3H, H9, *J*= 6.6 Hz).

¹³C NMR (100 MHz, DMSO-*d*₆), δ 71.98 (C3), 71.08 (C2), 66.10 (C4), 61.66 (C6), 56.61 (C5), 52.16 (C1), 33.51 (C7), 19.19 (C8), 14.29 (C9).

HRMS (ESI)

[M+H]⁺ calculated for C₉H₂₀NO₄ *m/z*= 206.13868; found *m/z*= 206.13885

Yield

92% (35 mg).

(1R)-2,3,4,6-tetra-O-benzyl-N-benzyloxycarbonyl-1-C-(E-Non-3-enyl)-1,5-dideoxy-1,5-imino-L-altritol **31**

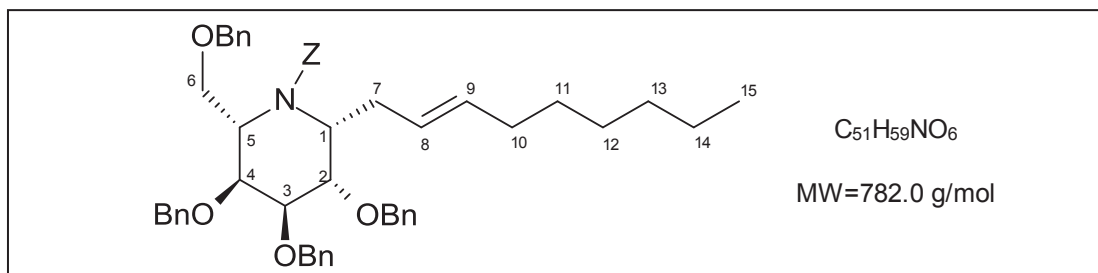

The reaction was conducted under argon at RT. To a solution of compound **28** (100 mg, 0.14 mmol) in dry CH_2Cl_2 (1 mL) were added Hoveyda-Grubs 2nd generation catalyst (9 mg, 0.014 mmol, 0.1 eq) and 1-octene (112 μ L, 0.72 mmol, 5 eq). The reaction mixture was left stirring overnight. Concentration under vacuum and purification of the crude product by flash column chromatography on silica gel (PE/EtOAc, 9:1) gave compound **31** as a colorless oil.

TLC:

- PE/EtOAc (8:2);
- $R_f=0.54$

1H NMR (400 MHz, $CDCl_3$), δ 7.66-7.00 (m, 25H, $H_{aromatic}$), 5.37-5.20 (m, 2H, H8, H9), 5.15-5.06 (m, 2H, $NCOOCH_2Ph$), 4.97-4.34 (m, 10H, H1, H5, CH_2Ph), 4.19 (br s, 1H, H2), 3.97 (br s, 1H, H4), 3.74 (dd, 1H, H3, $J_{3,4}=3.2$ Hz, $J_{3,2}=10.4$ Hz), 3.45 (br s, 2H, 2H6), 2.61-2.58 (m, 1H, H7), 1.95-1.77 (m, 3H, H7, H10), 1.41-1.15 (m, 8H, H11-H14), 0.88 (t, 3H, CH_3 , $J=6.8$ Hz).

^{13}C NMR (100 MHz, $CDCl_3$), δ 156.41 (C=O), 138.80-137.90 ($C_{aromatic}^{IV}$), 133.14 (C8), 128.55-127.51 ($C_{aromatic}$), 127.02 (C9), 75.97 (C2), 75.09 (C3), 74.09 (C4), 73.28-71.81 (CH_2Ph), 69.94 (C6), 67.57 ($NCOOCH_2Ph$), 54.26, 53.82 (C1,C5), 33.59 (C7), 32.67, 31.86, 29.59, 29.03, 22.75 (C10-C14), 14.25 (C15).

HRMS (ESI)

$[M+H]^+$ calculated for $C_{51}H_{60}NO_6$ $m/z=782.441515$; found $m/z=782.440307$

Optical rotation

$[\alpha]_D^{20}=+26.0$ (c= 1.0; $CHCl_3$)

Yield

74% (83 mg)

(1R)-1-C-nonyl-1,5-dideoxy-1,5-imino-L-altritol **32**.



To a solution of compound **31** (80 mg, 0.10 mmol) in isopropanol (1.0 mL), 1N HCl (100 μ L, 0.10 mmol, 1 eq) and 10% Pd/C (15 mg) were added. The reaction mixture was left stirring under a hydrogen atmosphere overnight. Then it was filtered through a membrane, the retained catalyst was washed with MeOH and the solvents were evaporated. The procedure was repeated once to afford a fully deprotected compound. After treatment with Amberlite IRA400 resin (OH⁻) and purification on Dowex 50WX8 resin (H⁺), the final product was obtained as a brownish, amorphous solid.

¹H NMR (400 MHz, CD₃OD), δ 3.89 (t, 1H, H3, $J_{3,2}=J_{3,4}=3.8$ Hz), 3.76-3.69 (m, 3H, 2H6, H4), 3.67 (dd, 1H, H2, $J_{2,1}=1.6$ Hz, $J_{2,3}=3.8$ Hz), 2.94-2.91 (m, 1H, H1), 2.80 (dt, 1H, H5, $J_{5,6a}=J_{5,6b}=4.0$ Hz, $J_{5,4}=10.4$ Hz), 1.58-1.20 (m, 16H, H7-H14), 0.90 (t, 3H, CH₃, $J=6.8$ Hz).

¹³C NMR (100 MHz, CD₃OD), δ 73.18 (C3), 71.73 (C2), 67.61 (C4), 63.07 (C6), 57.67 (C5), 54.02 (C1), 33.06, 31.97, 30.92, 30.73, 30.70, 30.46, 27.28, 23.72 (C7-C14), 14.43 (C15).

HRMS (ESI)

[M+H]⁺ calculated for C₁₅H₃₂NO₄ $m/z=290.232585$; found $m/z=290.232911$

Yield

Quant.

2nd isomer 34:

TLC:

- CH₂Cl₂/acetone (9:1);
- R_{f2} = 0.33

¹H NMR (400 MHz, CDCl₃), δ 7.43-7.08 (m, 25H, H_{aromatic}), 5.15 (d, 1H, NCOOCH₂Ph, *J* = 12.4 Hz), 5.09 (d, 1H, NCOOCH₂Ph, *J* = 12.4 Hz), 4.79 (d, 1H, CH₂Ph, *J* = 11.2 Hz), 4.68-4.58 (m, 6H, H1, H5, CH₂Ph), 4.53 (d, 1H, CH₂Ph, *J* = 12 Hz), 4.36 (d, 1H, CH₂Ph, *J* = 12 Hz), 4.29 (d, 1H, CH₂Ph, *J* = 12 Hz), 4.24-4.20 (m, 1H, H2), 3.90-3.87 (m, 2H, H4, OH₈), 3.78-3.68 (m, 2H, H8, H3), 3.59-3.56 (m, 1H, H6_b), 3.39-3.34 (m, 3H, H6_a, 2H9), 2.25 (br s, 1H, OH₉), 2.17-2.13 (m, 1H, H7_b), 1.35-1.22 (m, 1H, H7_a).

¹³C NMR (100 MHz, CDCl₃), δ 157.19 (C=O), 138.52-136.30 (C^{IV}_{aromatic}), 128.69-127.62 (C_{aromatic}), 75.58 (C3), 75.36 (C2), 73.96 (CH₂Ph), 73.76 (C4), 73.12-72.29 (CH₂Ph), 71.41 (C8), 69.85 (C9), 68.09 (NCOOCH₂Ph), 66.36 (C6), 55.22 (C5), 52.23 (C1), 35.55 (C7).

HRMS (ESI)

[M+H]⁺ calculated for C₄₅H₅₀NO₈ *m/z* = 732.353094; found *m/z* = 732.352445

[M+Na]⁺ calculated for C₄₅H₄₉NNaO₈ *m/z* = 754.335038; found *m/z* = 754.333740

Optical rotation

[α]_D²⁰ = +11.2 (c = 1.0; CHCl₃)

Yield

29% (36 mg)

Note: The configuration of the carbinol chiral center C7 of **33** and **34** was determined in Prf. Frelek laboratory (Institute of Organic chemistry, Polish Academy of Science, Warsaw) from the ECD spectrum of the preformed complex of these compounds with dimolybdenum tetracetate (see Results and Discussion, section I.6 for details). These results have already been published¹⁷². It is thus established that **33** is the 7*S* epimer and **34** the 7*R* epimer.

¹⁷² Biela, A.; Oulaïdi, F.; Gallienne, E.; Górecki, M.; Frelek, J.; Martin, O. R. *Tetrahedron* **2013**, *69*, 3348.

(1R)-1-C-((2R)-2,3-Dihydroxypropyl)-1,5-dideoxy-1,5-imino-L-altritol **35**.

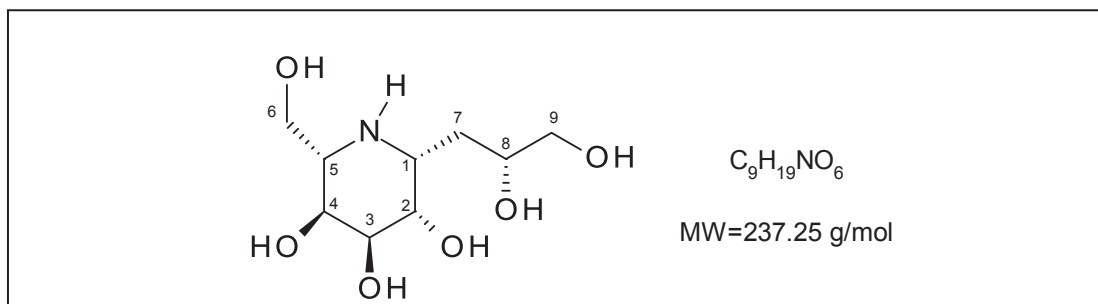

To a solution of **33** (52 mg, 0.07 mmol) in isopropanol (1.0 mL) were added 1N HCl (70 μ L, 0.070 mmol, 1 eq) and 10% Pd/C (11 mg). The reaction mixture was left stirring under a hydrogen atmosphere for 48 h. Then the mixture was filtered through a membrane, the retained catalyst was washed with MeOH and the solvents were evaporated. After treatment with Amberlite IRA400 resin (OH⁻) and purification on Dowex 50WX8 resin (H⁺), the final product **35** was obtained as a brownish, thick oil.

¹H NMR (400 MHz, CD₃OD), δ 3.90 (t, 1H, H3, $J_{3,2} = J_{3,4} = 3.6$ Hz), 3.80-3.74 (m, 1H, H8), 3.74-3.69 (m, 3H, H4, 2H6), 3.65 (dd, 1H, H2, $J_{2,1} = 1.4$ Hz, $J_{2,3} = 3.6$ Hz), 3.52-3.42 (m, 2H, 2H9), 3.19 (ddd, 1H, H1, $J_{1,2} = 1.4$ Hz, $J_{1,7b} = 4.5$ Hz, $J_{1,7a} = 9.0$ Hz), 2.81 (dt, 1H, H5, $J_{5,6a} = J_{5,6b} = 4.1$ Hz, $J_{5,4} = 10.4$ Hz), 1.71-1.53 (m, 2H, 2H7).

¹³C NMR (100 MHz, CD₃OD), δ 74.07 (C2), 73.23 (C3), 71.29 (C8), 67.36 (C9), 67.36 (C4), 63.04 (C6), 57.48 (C5), 51.58 (C1), 37.11 (C7).

HRMS (ESI)

[M+H]⁺ calculated for C₉H₂₀NO₆ $m/z = 238.128514$; found $m/z = 238.128654$

Optical rotation

$[\alpha]_D^{20} = -8.1$ (c= 1.0; MeOH)

Yield

57% (9.6 mg)

(1R)-1-C-((2S)-2,3-Dihydroxypropyl)-1,5-dideoxy-1,5-imino-L-altritol **36**.

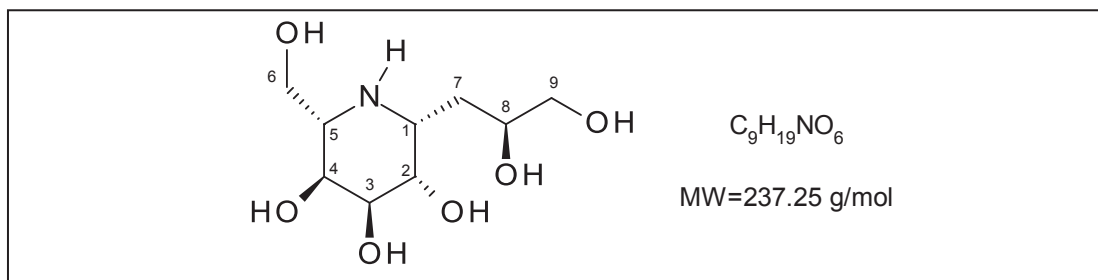

To a solution of **34** (25 mg, 0.034 mmol) in isopropanol (0.5 mL) were added 1N HCl (34 μ L, 0.034 mmol, 1 eq) and 10% Pd/C (5 mg). The reaction mixture was left stirring under a hydrogen atmosphere 48h. Then the mixture was filtered through a membrane, the retained catalyst was washed with MeOH and the solvents were evaporated. The procedure was repeated once to give a fully deprotected compound. After treatment with Amberlite IRA400 resin (OH⁻) and purification on Dowex 50WX8 resin (H⁺), the final product **36** was obtained as an orange/brown, thick oil.

¹H NMR (400 MHz, CD₃OD), δ 3.91 (t, 1H, H3, $J_{3,2} = J_{3,4} = 3.7$ Hz), 3.83-3.77 (m, 1H, H8), 3.75-3.72 (m, 3H, H4, 2H6), 3.69 (dd, 1H, H2, $J_{2,1} = 1.2$ Hz, $J_{2,3} = 3.7$ Hz), 3.47 (d, 2H, H9, $J_{9,8} = 5.2$ Hz), 3.27-3.24 (m, 1H, H1), 2.85 (dt, 1H, H5, $J_{5,6a} = J_{5,6b} = 4.0$ Hz, $J_{5,4} = 10.3$ Hz), 1.66 (ddd, 1H, H7_b, $J = 3.1$ Hz, $J = 5.5$ Hz, $J_{7b,7a} = 14.3$ Hz), 1.44 (ddd, 1H, H7_a, $J = 8.2$ Hz, $J = 9.6$ Hz, $J_{7a,7b} = 14.3$ Hz).

¹³C NMR (100 MHz, CD₃OD), δ 73.12, 73.04 (C2, C3), 72.22 (C8), 67.58 (C9), 67.21 (C4), 62.87 (C6), 57.68 (C5), 53.08 (C1), 35.40 (C7).

HRMS (ESI)

$[M+H]^+$ calculated for C₉H₂₀NO₆ $m/z = 238.128514$; found $m/z = 238.128686$

Optical rotation

$[\alpha]_D^{20} = -22.1$ (c= 0.7; MeOH)

Yield

89% (7.1 mg)

(1R)-5-O-Acetyl-1-C-allyl-2,3,4,6-tetra-O-benzyl-1-(N-benzyloxycarbonyl)amino-1-deoxy-D-galactitol **37**

(1S)-5-O-Acetyl-1-C-allyl-2,3,4,6-tetra-O-benzyl-1-(N-benzyloxycarbonyl)amino-1-deoxy-D-galactitol **38**

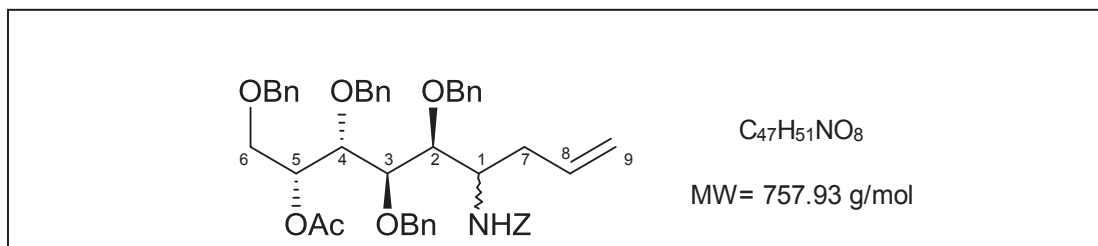

To a solution of **26mix** (1.45 mmol) in pyridine (2.0 mL) was added Ac_2O (0.47 mL, 5.03 mmol, 5 eq). The reaction was left stirring at RT until TLC showed completion of the reaction (24 h). After addition of CH_2Cl_2 (15 mL), the reaction mixture was washed with H_2O (3 x 5 mL) and the organic phase was dried over $MgSO_4$. After concentration under vacuum, the crude product mixture was obtained as a yellowish oil. Flash column chromatography on silica gel (toluene/EtOAc, 95:05) gave the two separated diastereoisomers **37** (*R*, *syn*, 358 mg, 33%) and **38** (*S*, *anti*, 44 mg, 4%), the mixture of both diastereoisomers (**37**+**38**, 80 mg, 7%), all three as yellowish oils, and recovered **25** (236 mg, 24%). All yields are calculated for two steps from **25**.

IR [cm^{-1}] ν 3422 (N-H), 3063, 3031 ($C-H_{aromatic}$), 2868 (C-H), 1718 (C=O), 1498, 1454, ($C=C_{aromatic}$), 1235, 1055, 1026 (C-O/C-C), 913, 848, 733 ($C-H_{aromatic}$).

HRMS (ESI)

$[M+H]^+$ calculated for $C_{47}H_{52}NO_8$ $m/z=758.36874$; found $m/z=758.36901$

$[M+NH_4]^+$ calculated for $C_{47}H_{55}N_2O_8$ $m/z=775.39529$; found $m/z=775.39510$

$[M+Na]^+$ calculated for $C_{47}H_{51}NNaO_8$ $m/z=780.35069$; found $m/z=780.35070$

1st isomer **37**:

TLC:

- toluene/EtOAc (9:1);
- $R_{f1}=0.41$

1H NMR (400 MHz, $CDCl_3$), δ 7.30-7.22 (m, 25H, $H_{aromatic}$), 5.65-5.55 (m, 1H, H8), 5.41 (q, 1H, H5, $J=4.9$ Hz), 5.15 (d, 1H, $NHCOOCH_2Ph$, $J=10.1$ Hz), 5.10-5.04 (m, 2H, $NHCOOCH_2Ph$), 5.00-4.92 (m, 2H, 2H9), 4.87(d, 1H, CH_2Ph , $J=11.0$ Hz), 4.68-4.41 (m, 7H, CH_2Ph), 3.91-3.89 (m, 1H, H4), 3.86-3.83 (m, 2H, H1, H3), 3.69-3.59 (m, 3H, 2H6, H2), 2.30-2.12 (m, 2H, 2H7), 1.92 (s, 3H, CH_3).

^{13}C NMR (100 MHz, $CDCl_3$), δ 170.66 (C=O OAc), 156.27 (C=O Z), 138.76-130.71 ($C^{IV}_{aromatic}$), 134.56 (C8), 128.50-127.57 ($C_{aromatic}$), 117.88 (C9), 81.00 (C3), 79.54 (C2), 78.57 (C4), 75.43-73.24 (CH_2Ph), 71.74 (C5), 68.90 (C6), 66.84 ($NHCOOCH_2Ph$), 52.43 (C1), 38.35 (C7), 21.26 (CH_3).

Yield

33% (from **25**, 358 mg). Corrected yield: 43%.

2nd isomer 38:

TLC:

- toluene/EtOAc (9:1);
- $R_{f2} = 0.35$

¹H NMR (250 MHz, CDCl₃), δ 7.34-7.21 (25H, H_{aromatic}), 5.76-5.55 (m, 1H, H8), 5.55-5.44 (m, 1H, H5), 5.32 (d, 1H, NHCOOCH₂Ph, $J = 8.8$ Hz), 5.04-4.95 (m, 4H, NHCOOCH₂Ph, 2H9), 4.66-4.46 (m, 8H, CH₂Ph), 4.12-3.99 (m, 1H, H4), 3.99-3.94 (m, 1H, H1), 3.83 (t, 1H, H3, $J_{3-2} = J_{3-4} = 5.2$ Hz), 3.71-3.59 (m, 3H, 2H6, H2), 2.35-2.11 (m, 2H, H7), 1.97 (s, 3H, CH₃)

Yield

4% (from **25**, 44 mg)

Corrected yield: 5.5 %

(1R)-1-C-Allyl-2,3,4,6-tetra-O-benzyl-1-(N-benzyloxycarbonyl)amino-1-deoxy-D-galactitol
39.

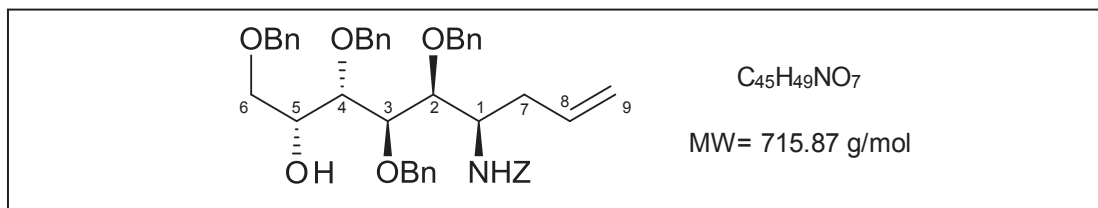

To a solution of **37** (690 mg, 0.91 mmol) in MeOH (25 mL) sodium was added until basic pH. The mixture was left stirring at RT until TLC showed completion of the reaction (22 h). The mixture was neutralized with Dowex 50WX8 resin (H^+). The resin was filtered, washed with MeOH and the filtrate was concentrated under vacuum, to give the crude product **39** as a colorless oil.

IR [cm^{-1}] ν 3434 (N-H), 3063, 3030 ($C-H_{aromatic}$), 2864 (C-H), 1716 (C=O), 1497, 1453 ($C=C_{aromatic}$), 1209, 1061, 1026 (C-C /C-O), 912 (C-H), 734 ($C-H_{aromatic}$).

TLC:

- toluene/EtOAc (9:1);
- R_f = 0.31

1H NMR (400 MHz, $CDCl_3$), δ 7.35-7.18 (m, 25H, $H_{aromatic}$), 5.67-5.56 (m, 1H, H8), 5.18 (d, 1H, $NHCOOCH_2Ph$, J = 10.0 Hz), 5.12 (d, 1H $NHCOOCH_2Ph$, J = 12.4 Hz), 5.08 (d, 1H $NHCOOCH_2Ph$, J = 12.4 Hz), 5.05-4.94 (m, 2H, 2H9), 43.89 (d, 1H, CH_2Ph , J = 11.1 Hz), 4.69 (s, 2H, CH_2Ph), 4.57-4.39 (m, 5H, CH_2Ph), 4.07-4.04 (m, 1H, H5), 3.97 (dd, 1H, H3, $J_{3,4}$ = 2.75 Hz, $J_{2,3}$ = 8.6 Hz), 3.90-3.84 (m, 1H, H1), 3.79-3.78 (m, 1H, H4), 3.65 (d, 1H, H2, $J_{2,3}$ = 8.6 Hz), 3.56 (dd, 1H, H6_b, $J_{6b,5}$ = 5.5 Hz, $J_{6b,6a}$ = 9.3 Hz), 3.50 (dd, 1H, H6_a, $J_{6a,5}$ = 6.6 Hz, $J_{6a,6b}$ = 9.3 Hz), 2.28-2.15 (m, 2H, 2H7).

^{13}C NMR (100 MHz, $CDCl_3$), δ 156.25 (C=O), 138.30-136.63 ($C^{IV}_{aromatic}$), 134.40 (C8), 128.51-127.70 ($C_{aromatic}$), 118.12 (C9), 81.99 (C3), 79.50 (C2), 77.79 (C4), 75.69-72.75 (CH_2Ph), 75.52-66.92 (CH_2Ph), 70.99 (C6), 70.49 (C5), 66.92 ($NHCOOCH_2Ph$), 52.13 (C1), 38.11 (C7).

HRMS (ESI)

$[M+H]^+$ calculated for $C_{45}H_{50}NO_7$ m/z = 716.35818; found m/z = 716.35865

$[M+Na]^+$ calculated for $C_{45}H_{49}NNaO_7$ m/z = 738.34012; found m/z = 738.34099

Optical rotation

$[\alpha]_D^{20}$ = -5.1 (c = 1.0; $CHCl_3$)

Yield

94% (613 mg).

(1S)-1-C-Allyl-2,3,4,6-tetra-O-benzyl-1-(N-benzyloxycarbonyl)amino-1-deoxy-D-galactitol
40.

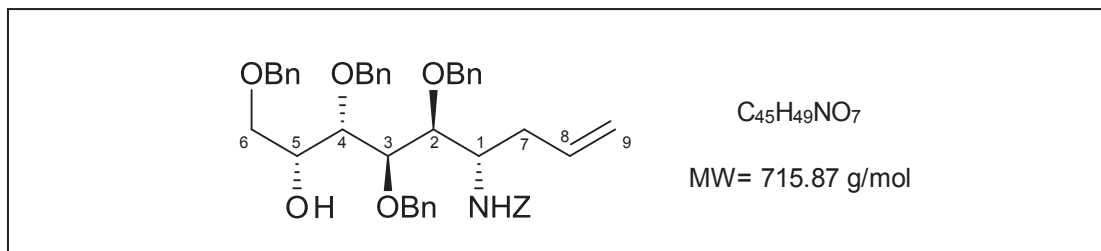

To a solution of **38** (44 mg, 0.058 mmol) in MeOH (5 mL) sodium was added until basic pH. The mixture was left stirring at RT until TLC showed completion of the reaction (48 h). The mixture was neutralized with Dowex 50WX8 resin (H^+). The resin was filtered, washed with MeOH and the filtrate was concentrated under vacuum, to give the crude product **40** as a colorless oil.

TLC:

- toluene/EtOAc (9:1);
- $R_f = 0.29$

1H NMR (400 MHz, $CDCl_3$) δ 7.36-7.18 (m, 25H, $H_{aromatic}$), 5.72-5.64 (m, 1H, H8), 5.48 (d, 1H, $NHCOOCH_2Ph$, $J = 8.4$ Hz), 5.12-4.92 (m, 4H, $NHCOOCH_2Ph$, 2H9), 4.84 (d, 1H, CH_2Ph , $J = 10.8$ Hz), 4.69 (d, 1H, CH_2Ph , $J = 10.9$ Hz), 4.61 (d, 1H, CH_2Ph , $J = 11.3$ Hz), 4.56-4.44 (m, 5H, CH_2Ph), 4.24-4.15 (m, 1H, H5), 4.15-4.03 (m, 1H, H1), 3.95-3.92 (m, 1H, H3), 3.84 (d, 1H, H4, $J = 5.9$ Hz), 3.72 (t, 1H, H2, $J = 4.4$ Hz), 3.60-3.50 (m, 2H, 2H6), 2.90 (d, 1H, OH, $J = 6.4$ Hz), 2.38-2.08 (m, 2H, 2H7).

^{13}C NMR (100 MHz, $CDCl_3$) δ 156.39 (C=O), 138.17-136.88 ($C^{IV}_{aromatic}$), 134.41 (C8), 129.03-126.95 ($C_{aromatic}$), 117.84 (C9), 79.53 (C3), 78.68 (C2), 77.49 (C4), 74.47, 73.91, 73.37, 72.62 (CH_2Ph), 71.21 (C6), 69.45 (C5), 66.51 ($NHCOOCH_2Ph$), 51.13 (C1), 35.67 (C7).

HRMS (ESI)

$[M+H]^+$ calculated for $C_{45}H_{50}NO_7$ $m/z = 716.35818$; found $m/z = 716.35843$

$[M+NH_4]^+$ calculated for $C_{45}H_{53}N_2O_7$ $m/z = 733.38473$; found $m/z = 733.38499$

$[M+Na]^+$ calculated for $C_{45}H_{49}NNaO_7$ $m/z = 738.34012$; found $m/z = 738.34048$

Optical rotation

$[\alpha]_D^{20} = -10.9$ ($c = 1.0$; $CHCl_3$)

Yield

88% (36 mg).

(6R)-6-C-Allyl-1,3,4,5-tetra-O-benzyl-6-(N-benzyloxycarbonyl)amino-keto-l-tagatose 41

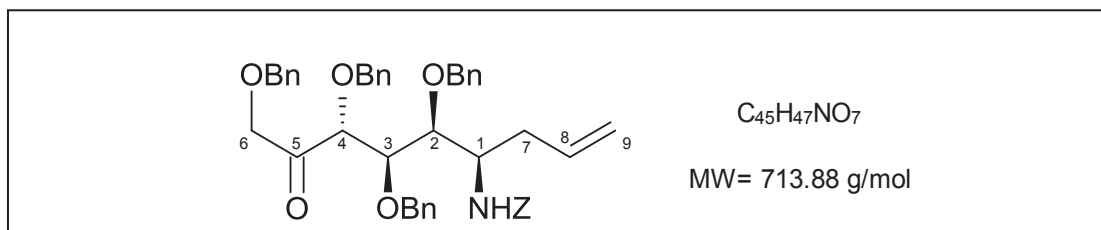

The reaction was conducted under argon at RT. To a solution of alcohol **39** (610 mg, 0.85 mmol) in dry CH₂Cl₂ (8.5 mL) was added Dess-Martin periodinane (434 mg, 1.02 mmol, 1.2 eq). The reaction mixture was left stirring overnight. After concentration under vacuum, the crude product was suspended in a small volume of Et₂O, the solids were removed by filtration through a membrane and the filtrate was concentrated under vacuum. Simple filtration through a layer of silica gel (toluene/EtOAc, 95:5) gave ketose **41** as a yellowish oil.

IR [cm⁻¹] ν 3433 (N-H), 3031 (C-H_{aromatic}), 2849, 2916 (C-H), 1716 (C=O), 1498, 1454 (C=C_{aromatic}), 1333, 1244, 1209, 1070, 1026 (C-O/C-C), 913, 821, 734 (C-H_{aromatic}).

LRMS (ESI)

[M+H]⁺ = 714.5, [M+Na]⁺ = 736.5

TLC:

- toluene/EtOAc (9:1);
- R_f = 0.31

¹H NMR (400 MHz, CDCl₃), δ 7.50-7.13 (m, 25H, H_{aromatic}), 5.84-5.74 (m, 1H, H8), 5.11-4.98 (m, 5H, NHCOOCH₂Ph, NHCOOCH₂Ph, 2H9), 4.80 (d, 1H, CH₂Ph, *J* = 11.0 Hz), 4.74 (d, 1H, CH₂Ph, *J* = 11.1 Hz), 4.67 (d, 1H, CH₂Ph, *J* = 11.0 Hz), 4.53-4.36 (m, 7H, CH₂Ph, 2H6), 4.30 (br s, 1H, H4), 4.09-4.03 (m, 1H, H1), 3.94 (d, 1H, H3, *J*_{3,2} = 8.6 Hz), 3.79 (d, 1H, H2, *J*_{2,3} = 8.6 Hz), 2.33 (t, 2H, 2H7, *J* = 6.7 Hz).

¹³C NMR (100 MHz, CDCl₃), δ 208.35 (C5), 156.29 (NHCOOCH₂Ph), 138.41-136.64 (C^{IV}_{aromatic}), 134.49 (C8), 128.64-127.68 (C_{aromatic}), 118.00 (C9), 84.80 (C4), 82.63 (C3), 79.71 (C2), 75.66-72.69 (CH₂Ph), 75.66, 74.77, 73.30, 72.69 (C6, CH₂Ph), 66.91 (NHCOOCH₂Ph), 51.94 (C1), 38.11 (C7).

HRMS (ESI)

[M+H]⁺ calculated for C₄₅H₄₈NO₇ *m/z* = 714.34253; found *m/z* = 714.34268

[M+NH₄]⁺ calculated for C₄₅H₅₁N₂O₇ *m/z* = 731.36908; found *m/z* = 731.36904

[M+Na]⁺ calculated for C₄₅H₄₇NNaO₇ *m/z* = 736.32447; found *m/z* = 736.32467

Optical rotation

[α]_D²⁰ = +32.2 (c = 1.0; CHCl₃)

Yield

94% (570 mg).

(6S)-6-C-Allyl-1,3,4,5-tetra-O-benzyl-6-(N-benzyloxycarbonyl)amino-keto-L-tagatose 42

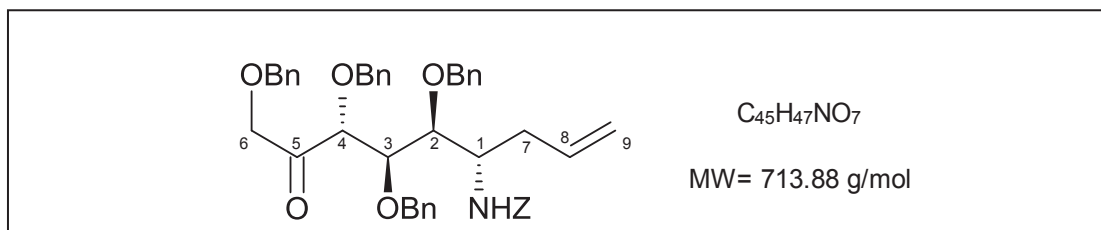

The reaction was conducted under argon at RT. To a solution of alcohol **40** (36 mg, 0.05 mmol) in dry CH₂Cl₂ (0.5 mL) was added Dess-Martin periodinane (26.5 mg, 0.62 mmol, 1.2 eq). The reaction mixture was left stirring overnight. After concentration under vacuum, the crude product was suspended in a small volume of Et₂O, filtered through a membrane and the filtrate was concentrated under vacuum. Purification by flash column chromatography on silica gel (toluene/EtOAc, 95:5) gave the desired ketose **42** as a yellowish oil.

TLC:

- toluene/EtOAc (9:1);
- R_f = 0.29

¹H NMR (400 MHz, CDCl₃), δ 7.31-7.23 (m, 25H, H_{aromatic}), 5.73-5.59 (m, 1H, H₈), 5.30 (d, 1H, NHCOOCH₂Ph, *J* = 8.6 Hz), 5.04-4.96 (m, 4H, NHCOOCH₂Ph, 2H₉), 4.59-4.23 (m, 10H, CH₂Ph, 2H₆), 4.21-4.15 (m, 1H, H₄), 4.08-4.03 (m, 1H, H₁), 3.99 (t, 1H, H₃, *J* = 4.9 Hz), 3.69 (t, 1H, H₂, *J* = 4.9 Hz), 2.33-2.11 (m, 2H, 2H₇).

¹³C NMR (100 MHz, CDCl₃), δ 207.00 (C₅), 156.30 (NHCOOCH₂Ph), 137.92-136.92 (C_{aromatic}^{IV}), 134.45 (C₈), 128.61-127.92 (C_{aromatic}), 117.84 (C₉), 82.41 (C₄), 80.69 (C₃), 79.48 (C₂), 74.63, 73.54, 73.32, 72.86 (CH₂Ph, C₆), 66.56 (NHCOOCH₂Ph), 51.18 (C₁), 35.54 (C₇).

HRMS (ESI)

[M+H]⁺ calculated for C₄₅H₄₈NO₇ *m/z* = 714.34253; found *m/z* = 714.34203

[M+NH₄]⁺ calculated for C₄₅H₅₁N₂O₇ *m/z* = 731.36908; found *m/z* = 731.36922

[M+Na]⁺ calculated for C₄₅H₄₇NNaO₇ *m/z* = 736.32447; found *m/z* = 736.32408

[M+K]⁺ calculated for C₄₅H₄₇NKO₇ *m/z* = 752.29841; found *m/z* = 752.29778

Optical rotation

[α]_D²⁰ = -11.0 (c = 1.0; CHCl₃)

Yield

61% (22 mg).

(6S) and (6R)-6-C-(Non-2-enyl)-1,3,4,5-tetra-O-benzyl-6-(N-benzyloxycarbonyl)amino-keto-L-tagatose **43** and **44**

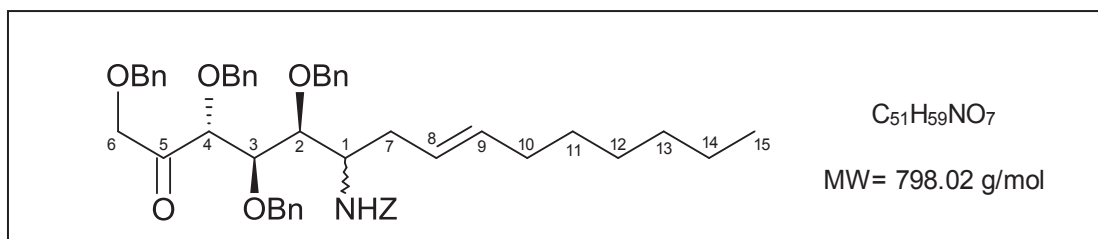

The reaction was conducted under argon at RT. To a solution of a mixture of ketoses **41** and **42** (30 mg, 0.042 mmol) in dry CH₂Cl₂ (0.21 mL) was added Hoveyda-Grubbs 2nd generation catalyst (2.6 mg, 0.0041 mmol, 0.1 eq). Then 1-octene (33 μL, 0.21 mmol, 5 eq) was added. The reaction was left stirring for 48 h. After concentration under vacuum, the crude product was obtained as a dark brown oil. Purification by flash column chromatography on silica gel (toluene/EtOAc 95:5) gave two separable diastereoisomers **43** and **44** as colorless oils.

LRMS (ESI)

[M+H]⁺ = 798.5, [M+Na]⁺ = 820.5

Yield total

72% (24.2 mg).

1st isomer **43**

TLC:

- toluene/EtOAc (95:5);
- R_{f1}=0.35

¹H NMR (400 MHz, CDCl₃), δ 7.31-7.21 (m, 25H, H_{aromatic}), 5.47-5.33 (m, 2H, H₈, H₉), 5.11-5.02 (m, 3H, NHCOOCH₂Ph, NHCOOCH₂Ph), 4.80-4.36 (m, 10H, CH₂Ph, 2H₆), 4.30 (d, 1H, H₄, J_{4,3} = 1.9 Hz), 4.02-3.97 (m, 1H, H₁), 3.94 (dd, 1H, H₃, J_{3,4} = 1.9 Hz, J_{3,2} = 8.7 Hz), 3.80 (d, 1H, H₂, J_{2,3} = 8.7 Hz), 2.27 (t, 2H, 2H₇, J = 6.4 Hz), 1.98-1.93 (m, 2H, H₁₀), 1.26 (m, 8H, H₁₁-H₁₄), 0.87 (t, 3H, CH₃, J = 6.6 Hz).

¹³C NMR (100 MHz, CDCl₃), δ 208.24 (C₅), 156.31 (NHCOOCH₂Ph), 138.51-136.72 (C_{aromatic}^{IV}), 134.40 (C₈), 128.66-127.68 (C_{aromatic}), 125.53 (C₉), 84.83 (C₄), 82.71 (C₃), 79.74 (C₂), 75.64, 75.61, 74.80, 73.31, 72.67 (CH₂Ph, C₆), 66.86 (NHCOOCH₂Ph), 52.31 (C₁), 36.94 (C₇), 32.75 (C₁₀), 31.90, 29.58, 29.06, 22.79 (C₁₁-C₁₄), 14.26 (C₁₅).

HRMS (ESI)

[M+H]⁺ calculated for C₅₁H₆₀NO₇ m/z = 798.43643; found m/z = 798.43712

[M+Na]⁺ calculated for C₅₁H₅₉NNaO₇ m/z = 820.41837; found m/z = 820.41916

[M+K]⁺ calculated for C₅₁H₅₉NKO₇ m/z = 836.39231; found m/z = 836.39338

Optical rotation

[α]_D²⁰ = +19.9 (c = 1.0; CHCl₃)

Yield

37% (12.4 mg).

2nd isomer 44

TLC:

- toluene/EtOAc (95:5);
- $R_{f2}=0.19$

¹H NMR (400 MHz, CDCl₃), δ 7.31-7.23 (m, 25H, H_{aromatic}), 5.43-5.34 (m, 1H, H9), 5.32-5.23 (m, 1H, H8), 5.08-5.04 (m, 3H, NHCOOCH₂Ph, NHCOOCH₂Ph), 4.59-4.18 (m, 11H, CH₂Ph, 2H6, H4), 4.01-3.98 (m, 2H, H1, H3), 3.71-3.69 (m, 1H, H2), 2.35-2.17 (m, 2H, H7), 1.92-1.90 (m, 2H, H10), 1.25 (br s, 8H, H11-H14), 0.89-0.86 (m, 3H, CH₃).

¹³C NMR (100 MHz, CDCl₃), δ 207.03 (C5), 156.31 (NHCOOCH₂Ph), 137.99-136.98 (C^{IV}_{aromatic}), 134.26 (C8), 128.53-127.94 (C_{aromatic}), 125.35 (C9), 82.47 (C4), 81.54 (C3), 80.71 (C1), 79.26 (C2), 75.65, 74.62, 73.32, 72.80 (CH₂Ph, C6), 66.52 (NHCOOCH₂Ph), 34.33 (C7), 32.73 (C10), 31.88, 29.51, 29.03, 22.79 (C11-C14), 14.28 (C15).

HRMS (ESI)

[M+H]⁺ calculated for C₅₁H₆₀NO₇ $m/z=798.43643$; found $m/z=798.43716$

[M+Na]⁺ calculated for C₅₁H₅₉NNaO₇ $m/z=820.41837$; found $m/z=820.41900$

[M+K]⁺ calculated for C₅₁H₅₉NKO₇ $m/z=836.39231$; found $m/z=836.39317$

Optical rotation

$[\alpha]_D^{20} = +2.8$ (c= 0.9; CHCl₃)

Yield

35% (11.8 mg).

(1R)-1-C-Allyl-2,3,4,6-tetra-O-benzyl-1-(N-benzyloxycarbonyl)amino-1-deoxy-L-altritol 46.

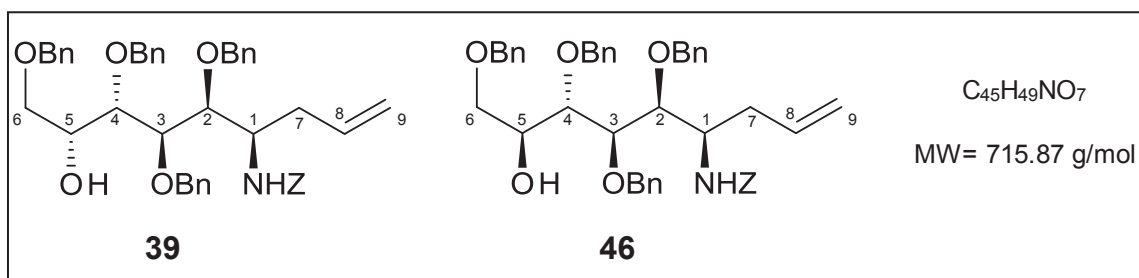

To a solution of ketose **41** (422 mg, 0.59 mmol) in EtOH (6 mL) NaBH₄ was slowly added at 0°C. The reaction mixture was left stirring at RT overnight. Then it was quenched with a 50% solution of NH₄Cl (4 mL) in an ice bath. EtOAc (10 mL) was added, the organic phase was separated and the aqueous phase was extracted with EtOAc (3 x 15 mL). The combined organic phases were washed with H₂O (15 mL), brine (15 mL) and dried over MgSO₄. Concentration under vacuum gave a colorless oil which contained the *D-galacto* and *L-althro* epimers **39** and **46** in 9:1 ratio approximately. Purification by flash column chromatography on silica gel (toluene/EtOAc 95:5) afforded an analytical sample of *L-althro* isomer **46** which is described below. However, the separation was very difficult and the rest of the synthesis was performed on the mixture of diastereoisomers **39** and **46**.

TLC:

- toluene/EtOAc (9:1);
- R_{f46} = 0.37
- R_{f39} = 0.32

¹H NMR (400 MHz, CDCl₃), δ 7.42-7.00 (m, 25H, H_{aromatic}), 5.76-5.65 (m, 1H, H₈), 5.21 (d, 1H, NHCOOCH₂Ph, *J* = 10.1 Hz), 5.10 (d, 1H, NHCOOCH₂Ph, *J* = 12.4 Hz), 5.06 (d, 1H, NHCOOCH₂Ph, *J* = 12.4 Hz), 5.02-4.97 (m, 2H, 2H₉), 4.91 (d, 1H, CH₂Ph, *J* = 11.0 Hz), 4.76 (d, 1H, CH₂Ph, *J* = 11.2 Hz), 4.69 (d, 1H, CH₂Ph, *J* = 11.2 Hz), 4.57-4.78 (m, 4H, CH₂Ph), 4.37 (d, 1H, CH₂Ph, *J* = 11.4 Hz), 4.18-4.13 (m, 1H, H₅), 4.01-3.94 (m, 3H, H₁, H₃, H₄), 3.74-3.70 (m, 2H, H₂, H_{6_b}), 3.56 (dd, 1H, H_{6_a}, *J* = 6.5 Hz, *J* = 9.6 Hz), 2.66 (d, 1H, OH, *J* = 4.4 Hz), 2.37-2.24 (m, 2H, 2H₇).

¹³C NMR (100 MHz, CDCl₃), δ 156.34 (C=O), 138.92-136.68 (C^{IV}_{aromatic}), 134.79 (C₈), 128.64-127.54 (C_{aromatic}), 117.73 (C₉), 81.88 (C₃), 80.62 (C₂), 80.07 (C₄), 75.62, 75.06, 73.47, 72.75 (CH₂Ph), 71.87 (C₆), 69.94 (C₅), 66.88 (NHCOOCH₂Ph), 52.23 (C₁), 38.38 (C₇).

LRMS (ESI)

[M+Na]⁺ = 738.5

Yield

97% (412 mg) mixture of **39** and **46** (9:1 ratio).

(1R)-1-C-Allyl-2,3,4,6-tetra-O-benzyl-1-(N-benzyloxycarbonyl)amino-1-deoxy-5-O-methanesulfonyl-D-galactitol **27R** and L-altritol **47**.

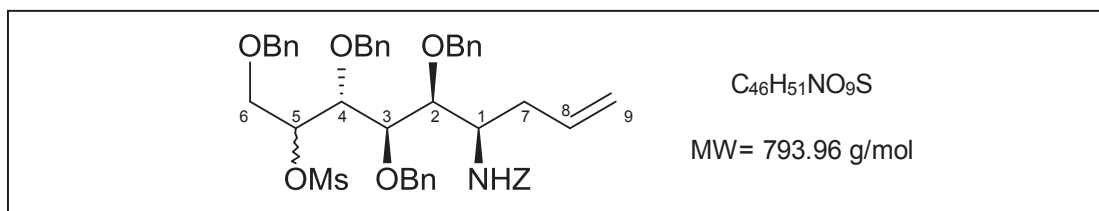

The reaction was conducted under argon at RT. To a solution of the mixture of **39** and **46** (ratio 9:1, 500 mg, 0.70 mmol) in dry CH_2Cl_2 (7 mL), were added Et_3N (0.21 mL, 1.54 mmol, 2.2 eq) and 4Å molecular sieves. Then methanesulfonyl chloride was added (0.11 mL, 1.47 mmol, 2.1 eq). The reaction was left stirring overnight. The solid was filtered, washed with CH_2Cl_2 (100 mL) and the filtrate was washed with saturated NH_4Cl (20 mL). The organic phase was separated, washed with brine (2 x 30 mL) and dried over $MgSO_4$. Concentration under vacuum gave the crude product as a mixture of **27R** and **47** and as an orange oil.

TLC:

- toluene/acetone (9:1);
- $R_f = 0.30$

(1R)-1-C-Allyl-2,3,4,6-tetra-O-benzyl-N-benzyloxycarbonyl-1,5-dideoxy-1,5-imino-D-galactitol **48**

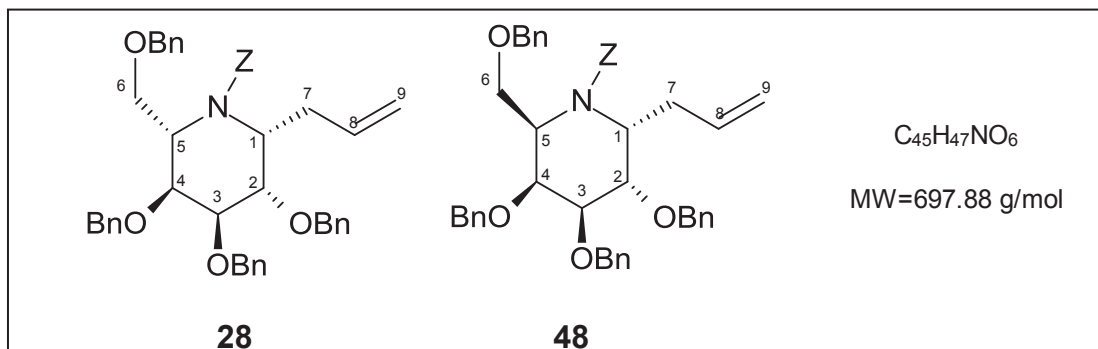

The reaction was conducted under argon at RT. To a solution of the mixture of **27R** + **47** (0.70 mmol) in dry THF (7 mL) was added potassium *tert*-butoxide (160 mg, 1.40 mmol, 2 eq). The mixture was left stirring for 24h. Reaction was quenched with saturated NH₄Cl (10 mL). EtOAc was added (50 mL). The organic phase was separated, washed with brine (20 mL), and dried over MgSO₄. After concentration under vacuum the crude product was obtained as a mixture of epimers **28** and **48** (5:1 ratio) as a yellowish oil. Flash column chromatography on silica gel (toluene/EtOAc, 98:2) gave pure **28** (36 mg, 7%), mixture of both isomers (17 mg, 3%) and pure **48** (163 mg, 33%) as yellowish oils. All yields are calculated for two steps from the mixture of alcohols **39** and **46**.

48:

TLC:

- PE/EtOAc (8:2);
- R_{f28} = 0.58
- R_{f48} = 0.64

¹H NMR (250 MHz, CDCl₃), δ 7.32-7.25 (m, 25H, H_{aromatic}), 5.72-5.61 (m, 1H, H8), 5.09-4.97 (m, 4H, 2H9, NCOOCH₂Ph), 4.81 (d, 1H, CH₂Ph, *J* = 11.75 Hz), 4.75-4.15 (m, 9H, H1, H5, CH₂Ph), 4.15-3.44 (m, 4H, H2, H4, 2H6), 3.60 (dd, 1H, H3, *J*_{3,2} = 9.0 Hz, *J*_{3,4} = 2.9 Hz), 2.69-2.22 (m, 2H, H7).

¹³C NMR (62.5 MHz, CDCl₃), δ 155.35 (C=O), 139.05-138.24 (C^{IV}_{aromatic}), 136.62 (C^{IV}_{aromatic}), 135.27 (C8) 128.50-127.42 (C_{aromatic}), 116.92 (C9), 80.20 (C3), 77.04, 74.73 (C4, C2), 74.09, 73.12, 73.06 (CH₂Ph), 68.18, 67.21 (NHCOOCH₂Ph, C6), 55.29, 54.35 (C5, C1), 29.82 (C7).

HRMS (ESI)

[M+H]⁺ calculated for C₄₅H₄₈NO₆ *m/z* = 698.347132; found *m/z* = 698.347615

[M+Na]⁺ calculated for C₄₅H₄₇NNaO₆ *m/z* = 720.328986; found *m/z* = 720.329559

Optical rotation

[α]_D²⁰ = -1.3 (c = 1.0; CHCl₃)

Yield

48 7% (36 mg) from **39** and **46**

28 32% (163) from **39** and **46**

(1*R*)-1-*C*-Propyl-1,5-dideoxy-1,5-imino-D-galactitol **49**.

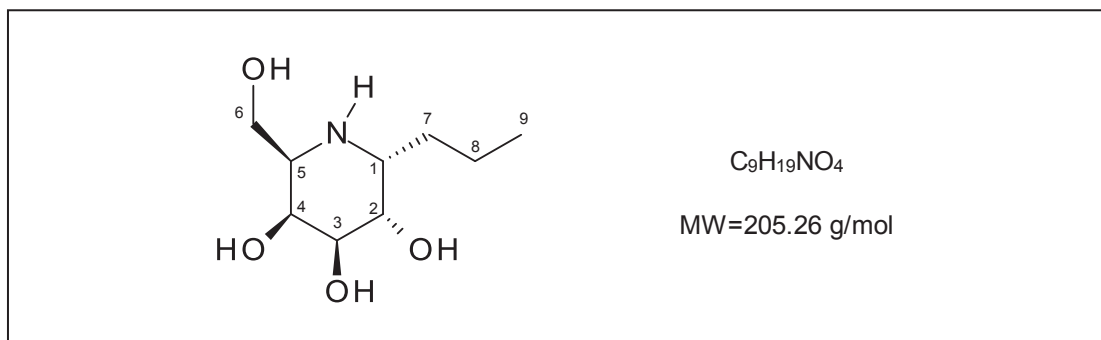

To a solution of **48** (40 mg, 0.057 mmol) in isopropanol (0.6 mL) were added 1N HCl (60 μ L, 0.06 mmol, 1 eq) and 10% Pd/C (9 mg). The reaction was left stirring under a hydrogen atmosphere for 60h. Then the mixture was filtered through a membrane, the retained catalyst was washed with MeOH and the solvents were evaporated. After treatment with Amberlite IRA400 resin (OH⁻) and purification on Dowex 50WX8 resin (H⁺), the final product **49** was obtained as a colorless solid.

¹H NMR (400 MHz, CD₃OD), δ 3.91 (t, 1H, H4, $J_{4,5}=J_{4,3}= 3.2$ Hz), 3.84 (dd, 1H, H2, $J_{2,1}= 4.8$ Hz, $J_{2,3}= 8.4$ Hz), 3.74-3.65 (m, 2H, 2H6), 3.60 (dd, 1H, H3, $J_{3,4}= 3.2$ Hz, $J_{3,2}= 8.4$ Hz), 3.09-3.04 (m, 1H, H1), 2.93-2.90 (m, 1H, H5), 1.64-1.22 (m, 4H, 2H7, 2H8), 0.96 (t, 3H, H9, $J= 8.0$ Hz).

¹³C NMR (100 MHz, CD₃OD), δ 72.82 (C3), 71.48 (C2), 70.21 (C4), 62.67 (C6), 55.87 (C5), 55.30 (C1), 28.88 (C7), 20.84 (C8), 14.49 (C9).

HRMS (ESI)

[M+H]⁺ calculated for C₉H₂₀NO₄ $m/z= 206.138685$; found $m/z= 206.138836$

Optical rotation

$[\alpha]_D^{20}= +57.3$ (c= 0.9; MeOH)

Yield

73% (8.8 mg)

(1R)-1-C-Propyl-1,3,5-trideoxy-1,5-imino-L-altritol **50**
(1R)-1-C-Propyl-1,3,5-trideoxy-1,5-imino-L-iditol **51**

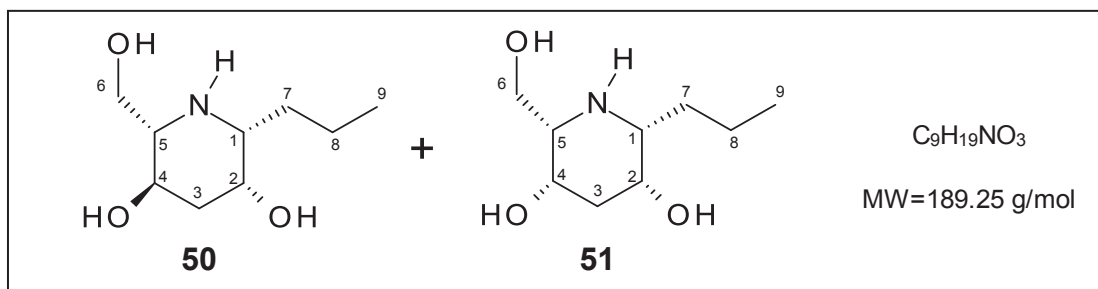

To a solution of **41** (94 mg, 0.13 mmol) in isopropanol (1.9 mL) were added glacial AcOH (15 μ L, 0.26 mmol, 2 eq) and 10% Pd/C (26 mg). The reaction was left stirring under a hydrogen atmosphere for 20h. Then the mixture was filtered through a membrane, the retained catalyst was washed with MeOH and the solvents were evaporated. The procedure was repeated twice to afford a fully deprotected compound. After treatment with Amberlite IRA400 resin (OH⁻) the final product was obtained as an inseparable mixture of **50** and **51** in a 1:1 ratio and as an orange, amorphous solid. HPLC purification (column Hypercarb, 250mm x 10mm, H₂O/formic acid 0.1%, pressure 2.2 bars, debit 4.4mL/min, T=30°C, ELS detection) gave analytical samples of both 3-deoxy compounds **50** and **51**.

Yield

68% (17 mg)

HRMS (ESI)

[M+H]⁺ calculated for C₉H₂₀NO₃ m/z = 190.143770; found m/z = 190.144172

50:

¹H NMR (400 MHz, CD₃OD), δ 3.84-3.77 (m, 2H, H2, H6_b), 3.71 (ddd, 1H, H4, $J_{4,3eq}$ = 4.8 Hz, $J_{4,3ax}$ = 9.6 Hz, $J_{4,5}$ = 9.2 Hz), 3.67 (dd, 1H, H6_a, $J_{6a,5}$ = 6.0 Hz, $J_{6a,6b}$ = 11.2 Hz), 3.66 (br s, 1H, NH), 2.59-2.53 (m, 1H, H1), 2.42 (ddd, 1H, H5, $J_{5,6b}$ = 3.6 Hz, $J_{5,6a}$ = 6.0 Hz, $J_{5,4}$ = 9.2 Hz), 2.19 (ddd, 1H, H3_{eq}, $J_{3eq,2}$ = 3.6 Hz, $J_{3eq,4}$ = 4.8 Hz, $J_{3eq,3ax}$ = 13.2 Hz), 1.50 (ddd, 1H, H3_{ax}, $J_{3ax,2}$ = 2.6 Hz, $J_{3ax,4}$ = 9.6 Hz, $J_{3ax,3eq}$ = 13.2 Hz), 1.56-1.32 (m, 4H, 2H7, 2H8), 0.95 (t, 3H, 3H9, J = 7.0 Hz).

¹³C NMR (100 MHz, CD₃OD), δ 68.27 (C2), 65.30 (C4), 64.85 (C5), 63.19 (C6), 59.94 (C1), 42.17 (C3), 34.96 (C7), 20.36 (C8), 14.58 (C9).

51:

¹H NMR (400 MHz, CD₃OD), δ 3.89-3.86 (m, 1H, H4), 3.77-3.74 (m, 1H, H2), 3.66 (dd, 1H, H6_b, $J_{6b,5}$ = 6.4 Hz, $J_{6b,6a}$ = 10.8 Hz), 3.63 (dd, 1H, H6_a, $J_{6a,5}$ = 6.4 Hz, $J_{6a,6b}$ = 10.8 Hz), 2.71 (dt, 1H, H5, $J_{5,4}$ = 1.6 Hz, $J_{5,6}$ = $J_{5,6}$ = 6.4 Hz), 2.42 (ddd, 1H, H1, $J_{1,2}$ = 1.6 Hz, $J_{1,7}$ = 5.6 Hz, $J_{1,7}$ = 8.0 Hz), 2.16 (dt, 1H, H3_{eq}, $J_{3eq,4}$ = $J_{3eq,2}$ = 3.2 Hz, $J_{3eq,3ax}$ = 14.4 Hz), 1.71 (dt, 1H, H3_{ax}, $J_{3ax,4}$ = $J_{3ax,2}$ = 3.0 Hz, $J_{3ax,3ax}$ = 14.4 Hz), 1.63-1.54 (m, 1H, H7), 1.49-1.35 (m, 3H, H7, 2H8), 0.96 (t, 3H, 3H9, J = 7.2 Hz).

¹³C NMR (100 MHz, CD₃OD), δ 67.95 (C2), 67.25 (C4), 64.14 (C6), 62.37 (C5), 60.65 (C1), 38.10 (C3), 35.38 (C7), 20.04 (C8), 14.57 (C9).

(1R)-1-C-Propyl-1,5-dideoxy-1,5-imino-L-iditol **52**.

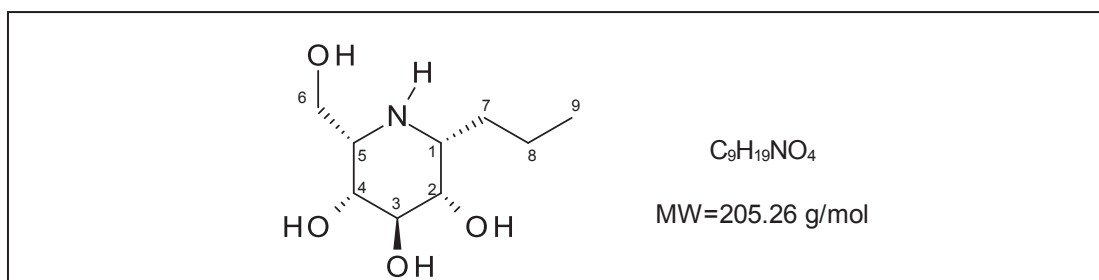

To a solution of **41** (185 mg, 0.26 mmol) in isopropanol (2.6 mL) were added NEt_3 (9 μ L, 0.065 mmol, 0.25 eq) and 10% Pd/C (39 mg). The reaction was left stirring under a hydrogen atmosphere overnight. Then the mixture was filtered through a membrane, the retained catalyst was washed with MeOH and the solvents were evaporated. Flash column chromatography on silica gel (CH_2Cl_2 /acetone, 95:5) afforded *N*-H deprotected cyclic intermediate (63 mg, 0.088 mmol) which was then submitted to further deprotection. It was dissolved in isopropanol (0.88 mL) and then were added 1N HCl (88 μ L, 0.088 mmol, 1 eq) and 10% Pd/C (13 mg). The reaction was left stirring under a hydrogen atmosphere for 48h. Then the mixture was filtered through a membrane, the retained catalyst was washed with MeOH and the solvents were evaporated. After treatment with Amberlite IRA400 resin (OH^-) and purification on Dowex 50WX8 resin (H^+), an inseparable mixture of **49** and **52** (1:1 ratio) was obtained as a colorless oil. HPLC purification (column Hypercarb, 250mm x 10mm, H_2O /formic acid 0.5%, pressure 2.2 bars, debit 4.4mL/min, $T=30^\circ C$, ELS detection) gave an analytical sample of **52**.

Yield

26% (14 mg) fort wo steps, from **41**

52:

1H NMR (400 MHz, D_2O), δ 4.05 (t, 1H, H3, $J_{3,2}=J_{3,4}= 3.0$ Hz), 3.80-3.39 (m, 1H, H4), 3.77-3.64 (m, 3H, H2, 2H6), 3.08 (dt, 1H, H5, $J= 2.0$ Hz, $J= 6.4$ Hz, $J= 6.4$ Hz), 2.99-2.94 (ddd, 1H, H1, $J_{1,2}= 1.6$ Hz, $J_{1,7}= 6.0$ Hz, $J_{1,7}= 8.0$ Hz), 1.61-1.32 (m, 4H, 2H7, 2H8), 0.94 (t, 3H, H9, $J= 7.0$ Hz).

^{13}C NMR (100 MHz, D_2O), δ 69.22, 69.16 (C2, C3), 68.34 (C4), 61.88 (C6), 55.20 (C5), 53.22 (C1), 32.64 (C7), 18.39 (C8), 13.45 (C9).

HRMS (ESI)

$[M+H]^+$ calculated for $C_9H_{20}NO_4$ $m/z= 206.138685$; found $m/z= 206.139079$

1,2:4,6-Di-*O*-isopropylidene- α -L-sorbofuranose **53**

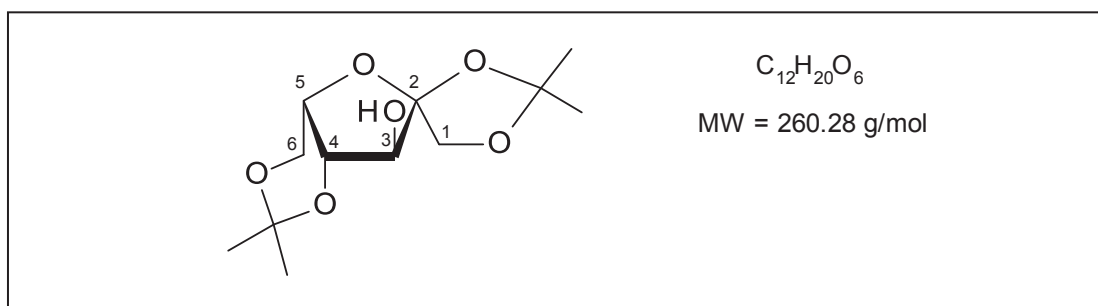

The reaction was conducted under argon. To a suspension of L-sorbose (10 g, 0.056 mol) in 2,2-dimethoxypropane (30 mL) was added $SnCl_2$ (50 mg, 0.264 mmol, 0.005 eq) in DME (1 mL). The reaction was left stirring 1 h at 70°C and then quenched with NEt_3 (0.26 mL, 1.87 mmol, 0.03 eq). The remaining sorbose was removed by filtration and the filtrate was concentrated under vacuum. The residue was dissolved in EtOAc (100 mL) and washed with H_2O (2 x 50 mL). The organic phase was dried over $MgSO_4$ and concentrated under vacuum. The crude product was obtained as a yellow oil which crystallized overnight. Recrystallization from *n*-hexane gave pure **53** as a white solid.

TLC:

- toluene/EtOAc (5:5);
- $R_f = 0.46$

1H NMR (250 MHz, $CDCl_3$), δ 4.26 (dd, 1H, H4, $J_{4,3} = 1.3$ Hz, $J_{4,5} = 2.8$ Hz), 4.17-4.14 (m, 3H, 2H1, H5), 4.00-3.95 (m, 3H, 2H6, H3), 2.85 (d, 1H, OH, $J = 2.3$ Hz), 1.54 (s, 3H, CH_3iPr), 1.46 (s, 3H, CH_3iPr), 1.42 (s, 3H, CH_3iPr), 1.36 (s, 3H, CH_3iPr).

^{13}C NMR (62.5 MHz, $CDCl_3$), δ 111.23, 110.51 ($C^{IV}iPr$), 97.42 (C2), 79.31 (C3), 74.34 (C4), 72.90 (C1), 72.43 (C5), 60.43 (C6), 28.49, 26.33, 25.42, 19.23 (CH_3iPr).

HRMS (ESI)

$[M+Na]^+$ calculated for $C_{12}H_{20}NaO_6$ $m/z = 283.115209$; found $m/z = 283.115171$

Optical rotation

$[\alpha]_D^{26} = -30.9$ (c = 1.0; acetone)

Yield

16% (2.275 g)

Corrected yield: 46%

3-O-Acetyl-1,2:4,6-di-O-isopropylidene- α -L-sorbofuranose **54**

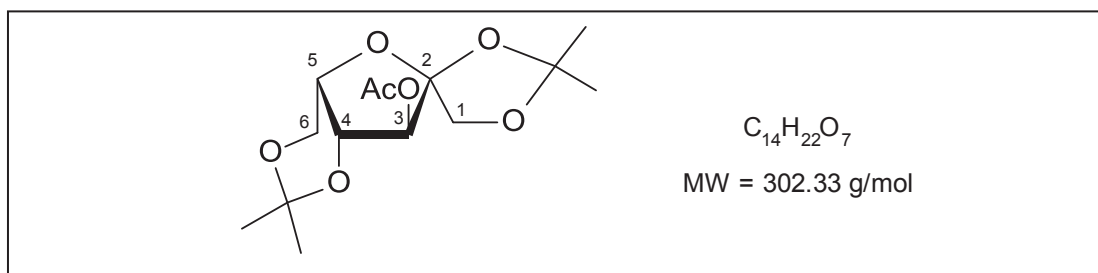

To a solution of compound **53** (150 mg, 0.58 mmol) in pyridine (3 mL) was added Ac₂O (0.27 mL, 2.88 mmol, 5 eq). The reaction was left stirring overnight at RT. CH₂Cl₂ (40 mL) was then added. The mixture was washed with 1N aqueous HCl (2 x 20 mL), then with water (20 mL) and dried over MgSO₄. After concentration under vacuum and coevaporation with toluene, the crude product **54** was obtained as a colorless oil, which was used in the next step without purification.

TLC:

- toluene/EtOAc (5:5);
- R_f = 0.55

¹H NMR (400 MHz, CDCl₃), δ 5.15 (br s, 1H, H3), 4.31 (dd, 1H, H4, $J_{4,3}$ = 1.4 Hz, $J_{4,5}$ = 2.8 Hz), 4.29 (d, 1H, H1_b, $J_{1b,1a}$ = 9.2 Hz), 4.18 (d, 1H, H1_a, $J_{1a,1b}$ = 9.2 Hz), 4.14 (q, 1H, H5, J ~ 2.8 Hz), 4.03 (dd, 1H, H6_b, $J_{5,6b}$ = 2.8 Hz, $J_{6b,6a}$ = 13.2 Hz), 3.95 (dd, 1H, H6_a, $J_{6a,5}$ = 2.8 Hz, $J_{6a,6b}$ = 13.2 Hz), 2.12 (s, 3H, OAc), 1.50 (s, 3H, CH₃iPr), 1.42 (s, 3H, CH₃iPr), 1.37 (s, 3H, CH₃iPr), 1.34 (s, 3H, CH₃iPr).

¹³C NMR (100 MHz, CDCl₃), δ 169.44 (C=O from OAc), 111.03, 110.25 (C^{IV}iPr), 97.90 (C2), 79.31 (C3), 73.59 (C1), 73.31 (C4), 72.06 (C5), 60.36 (C6), 28.47, 25.94, 25.79, 19.52 (CH₃iPr), 20.73 (CH₃CO).

HRMS (ESI)

[M+NH₄]⁺ calculated for C₁₄H₂₆NO₇ m/z = 320.170379; found m/z = 320.169904

[M+Na]⁺ calculated for C₁₄H₂₂NaO₇ m/z = 325.125774; found m/z = 325.125450

Optical rotation

$[\alpha]_D^{26}$ = -64.7 (c=1.1; CHCl₃)

Yield

99 % (173 mg).

3-O-Acetyl-1,2-O-isopropylidene- α -L-sorbofuranose **55**

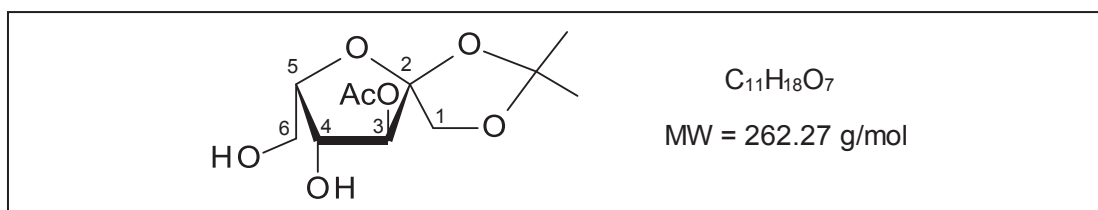

H_2SO_4 on silica was prepared according to the protocol of Mukhopadhyay and co-workers.²¹² To a solution of compound **54** (67 mg, 0.22 mmol) in MeOH (1.2 mL), silica- H_2SO_4 (22 mg) was added. The reaction was left stirring 1 h at RT. The suspension was filtered through a membrane and the filtrate was concentrated under vacuum to give crude compound. Flash column chromatography on silica gel ($CH_2Cl_2/MeOH$ 95:5) gave pure **55** as a white solid.

TLC:

- $CH_2Cl_2/MeOH$ (9:1);
- $R_f = 0.69$

1H NMR (400 MHz, CD_3OD), δ 5.12 (d, 1H, H3, $J_{3,4} = 5.2$ Hz), 4.40 (t, 1H, H4, $J \sim 5$ Hz, $J_{4,5} = 5.6$ Hz), 4.20 (d, 1H, H1_b, $J = 9.2$ Hz), 4.16 (q, 1H, H5, $J \sim 5$ Hz), 4.05 (d, 1H, H1_a, $J = 9.2$ Hz), 3.75 (dd, 1H, H6_b, $J_{6b-5} = 4.4$ Hz, $J_{6a,6b} = 12.0$ Hz), 3.71 (dd, 1H, H6_a, $J_{6a-5} = 5.2$ Hz, $J_{6a,6b} = 12.0$ Hz), 2.10 (s, 3H, OAc), 1.44 (s, 3H, CH_3iPr), 1.30 (s, 3H, CH_3iPr).

^{13}C NMR (100 MHz, CD_3OD), δ 171.90 (C=O from OAc), 112.11, 109.58 ($C^{IV}iPr$, C2), 80.48 (C5), 80.44 (C3), 74.77 (C4), 73.13 (C1), 61.79 (C6), 26.49, 26.31 (CH_3iPr), 20.67 (CH_3O).

LRMS (ESI) (ESI)

$[M+Na]^+ = 285.0$

HRMS

$[M+Na]^+$ calculated for $C_{14}H_{22}NaO$ $m/z = 285.094474$; found $m/z = 285.094838$

Optical rotation

$[\alpha]_D^{20} = -111.4$ ($c = 1.2$; MeOH)

Melting point

$T_m = 133-135^\circ C$

Yield

76 % (44 mg)

²¹² Rajput, V. K.; Roy, B.; Mukhopadhyay, B. *Tetrahedron Lett* **2006**, 47, 6987.

3-*O*-*p*-Methoxybenzyl-1,2:4,6-di-*O*-isopropylidene- α -L-sorbofuranose **56**

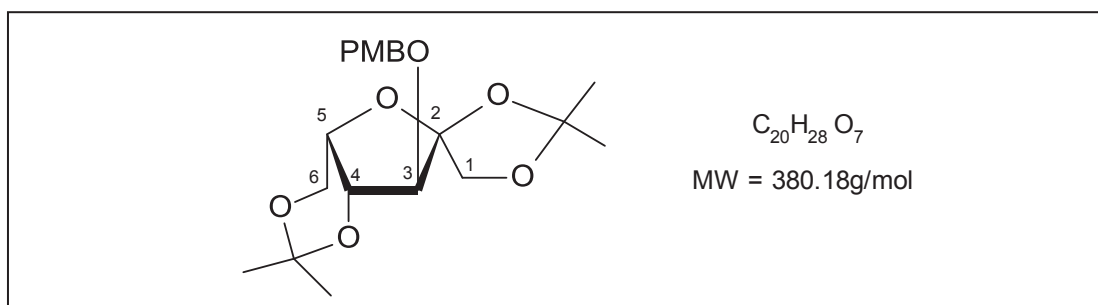

To a solution of compound **53** (100 mg, 0.38 mmol) in dry DMF (4 mL) at 0°C sodium hydride (60% dispersion in oil, 30.4 mg, 0.76 mmol, 2 eq) was added. When no H₂ evolution ceased (5 min), *p*-methoxybenzyl chloride (77 μ L, 0.57 mmol, 1.5 eq) was added dropwise. The mixture was left stirring overnight at RT. The reaction was quenched with ice water (5 mL). EtOAc (15 mL) was added. The organic phase was washed with water (2 x 7 mL), and saturated NaHCO₃ (7 mL) and then dried over MgSO₄. After concentration under vacuum, the crude product was purified by flash column chromatography on silica gel (PE/EtOAc 8:2) to afford a pure **56** as a yellowish oil.

TLC:

- PE/EtOAc (7:3);
- R_f = 0.48

¹H NMR (250 MHz, CDCl₃), δ 7.29 (d, 2H, H_{aromatic}, J = 8.5 Hz), 6.87 (d, 2H, H_{aromatic}, J = 8.75 Hz), 4.71 (d, 1H, CH₂(OPMB), J = 11.8 Hz), 4.61 (d, 1H, CH₂(OPMB), J = 11.8 Hz), 4.26 (dd, 1H, H₄, $J_{4,3}$ = 1.8 Hz, $J_{4,5}$ = 3.5 Hz), 4.19 (br q, 1H, H₅, J = 3.5 Hz), 4.14 (d, 1H, H_{1b}, J = 9.5 Hz), 4.02 (d, 1H, H_{1a}, J = 9.5 Hz), 3.96 (dd, 1H, H_{6b}, $J_{6b,5}$ = 3.5 Hz, $J_{6b,6a}$ = 12.8 Hz), 3.84 (dd, 1H, H_{6a}, $J_{6a,5}$ = 3.5 Hz, $J_{6a,6b}$ = 12.8 Hz), 3.80 (s, 4H, CH₃O, H₃), 1.54, 1.48, 1.38, 1.34 (s, 3H, CH₃iPr).

¹³C NMR (100 MHz, CDCl₃), δ 159.42, 129.84 (C^{IV}_{aromatic}), 129.61, 113.85 (C_{aromatic}), 110.94, 110.80 (C^{IV}_{iPr}), 97.96 (C₂), 84.55 (C₃), 74.01 (C₄), 73.27 (CH₂(OPMB)), 72.67 (C₁), 72.14 (C₅), 60.59 (C₆), 55.31 (CH₃O), 28.02, 26.30, 26.12, 20.28 (CH₃iPr).

LRMS (ESI)

[M+Na]⁺ = 403.0

HRMS (ESI)

[M+H]⁺ calculated for C₂₀H₂₉O₇ m/z = 381.190780; found m/z = 381.190771

[M+Na]⁺ calculated for C₂₀H₂₈NaO₇ m/z = 403.172724; found m/z = 403.172306

Optical rotation

$[\alpha]_D^{20}$ = -18.7 (c = 1.9; CHCl₃)

Melting point

T_m = 98-99°C

Yield

93% (136 mg)

3-O-*p*-Methoxybenzyl-1,2-O-isopropylidene- α -L-sorbofuranose 57

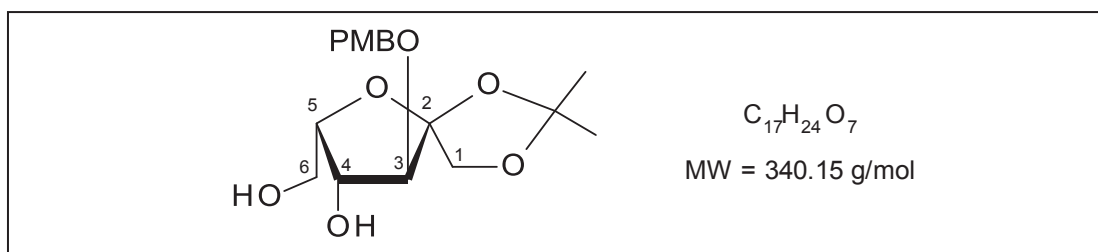

H₂SO₄ on silica was prepared according to the protocol of Mukhopadhyay and co-workers.²¹² To a solution of compound **56** (136 mg, 0.36 mmol) in MeOH (1.9 mL), silica-H₂SO₄ (36 mg) was added. The mixture was left stirring 1 h at RT. The suspension was filtered through a membrane and the filtrate was concentrated under vacuum to give crude compound. Flash column chromatography on silica gel (PE/EtOAc 3:7) afforded pure **57** as a white solid.

TLC:

- CH₂Cl₂/MeOH (9:1)
- R_f = 0.67

¹H NMR (250 MHz, CDCl₃), δ 7.30 (d, 2H, H_{aromatic}, J = 8.5 Hz), 6.89 (d, 2H, H_{aromatic}, J = 8.7 Hz), 4.74 (d, 1H, CH₂(OPMB), J = 11.8 Hz), 4.68 (d, 1H, CH₂(OPMB), J = 11.8 Hz), 4.54 (dt, 1H, H4, $J_{4,5}$ = 7.0 Hz, $J_{4,3}$ = 6.0 Hz, $J_{4,OH}$ = 7.0 Hz), 4.25 (dt, 1H, H5, $J_{5,6}$ = 3.25 Hz, $J_{5,4}$ = 7.0 Hz), 4.05 (d, 1H, H1, J = 9.25 Hz), 3.97 (d, 1H, H1, J = 9.25 Hz), 3.87 (dd, 2H, H6, $J_{6,5}$ = 3.25 Hz, $J_{6,OH}$ = 6.25 Hz), 3.81 (s, 3H, CH₃O), 3.77 (d, 1H, H3, $J_{3,4}$ = 6.0 Hz), 3.04 (d, 1H, 4-OH, J = 7.25 Hz), 2.20 (t, 1H, CH₂OH, J = 6.5 Hz), 1.51, 1.46 (s, 3H, CH₃iPr).

¹³C NMR (62.5 MHz, CDCl₃), δ 159.53, 129.99 (C^{IV}_{aromatic}), 129.64, 114.04 (C_{aromatic}), 111.70, 108.33 (C^{IV}_{iPr}, C2), 84.37 (C3), 77.13 (C4), 76.89 (C5), 72.12 (C1), 71.29 (CH₂(OPMB)), 62.07 (C6), 55.43 (CH₃O), 26.74, 26.31 (CH₃iPr).

LRMS (ESI)

[M+Na]⁺ = 363.5

HRMS

[M+NH₄]⁺ calculated for C₁₇H₂₈NO₇ m/z = 358.186029; found m/z = 358.185917

[M+Na]⁺ calculated for C₁₇H₂₄NaO₇ m/z = 363.141424; found m/z = 363.141514

Optical rotation

$[\alpha]_D^{20}$ = -57.6 (c = 0.9; MeOH)

Melting point

T_m = 119-120°C

Yield

21 % (25 mg)

²¹² Rajput, V. K.; Roy, B.; Mukhopadhyay, B. *Tetrahedron Lett* **2006**, 47, 6987.

1-O-Acetyl 2,3:4,6-di-O-isopropylidene- α -L-sorbofuranose 58

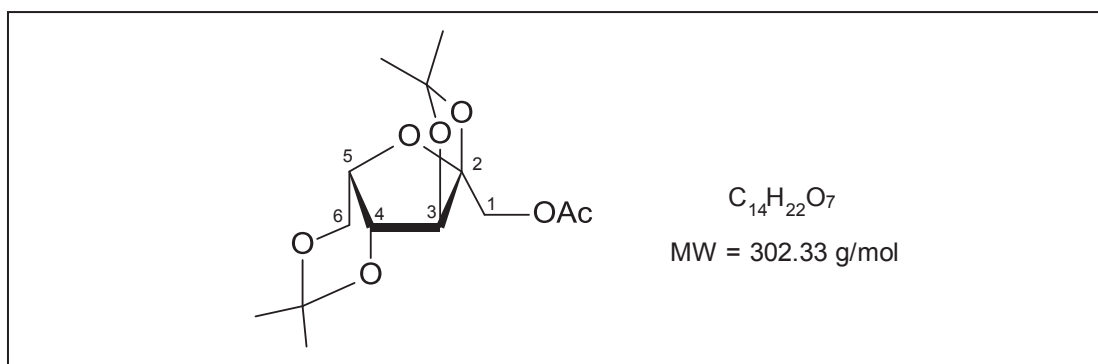

To a solution of 2,3:4,6-di-O-isopropylidene- α -L-sorbofuranose (200 mg, 0.77 mmol) in pyridine (4 mL) was added Ac₂O (0.36 mL, 3.84 mmol, 5 eq). The reaction was left stirring overnight at RT. CH₂Cl₂ (50 mL) was added. The mixture was washed with 1N aqueous HCl (2 x 20 mL), then with water (20 mL) and dried over MgSO₄. After concentration under vacuum and coevaporation with toluene, the crude product was obtained as a colorless oil, which was used in the next step without purification.

TLC:

- toluene/EtOAc (5:5);
- R_f = 0.69

¹H NMR (400 MHz, CDCl₃), δ 4.56 (d, 1H, H1_b, $J_{1b,1a}$ = 12.0 Hz), 4.43 (s, 1H, H3), 4.33 (d, 1H, H4, $J_{4,5}$ = 2.0 Hz), 4.17 (d, 1H, H1_a, $J_{1a,1b}$ = 12.0 Hz), 4.12 (q, 1H, H5, J ~ 2 Hz), 4.10-4.00 (m, 2H, 2H6), 2.11 (s, 3H, OAc), 1.51, 1.44, 1.39, 1.37 (s, 3H, CH₃iPr).

¹³C NMR (100 MHz, CDCl₃), δ 169.97 (C=O from OAc), 112.56, 112.16 (C^{IV}iPr), 97.28 (C2), 84.55 (C3), 73.11 (C4), 72.34 (C5), 63.42 (C1), 60.04 (C6), 28.82, 27.34, 26.26, 18.57 (CH₃iPr), 20.76 (CH₃CO).

HRMS (ESI)

[M+H]⁺ calculated for C₁₄H₂₃O₇ m/z = 303.143829; found m/z = 303.140610

[M+NH₄]⁺ calculated for C₁₄H₂₆NO₇ m/z = 320.170379; found m/z = 320.170543

[M+Na]⁺ calculated for C₁₄H₂₂NaO₇ m/z = 325.125774; found m/z = 325.125708

Optical rotation

$[\alpha]_D^{25}$ = -13.9 (c = 1.0; CHCl₃)

Yield

Quant. (233 mg)

1-O-Acetyl-2,3-O-isopropylidene- α -L-sorbofuranose **59** and 2,3-O-isopropylidene- α -L-sorbofuranose **60**

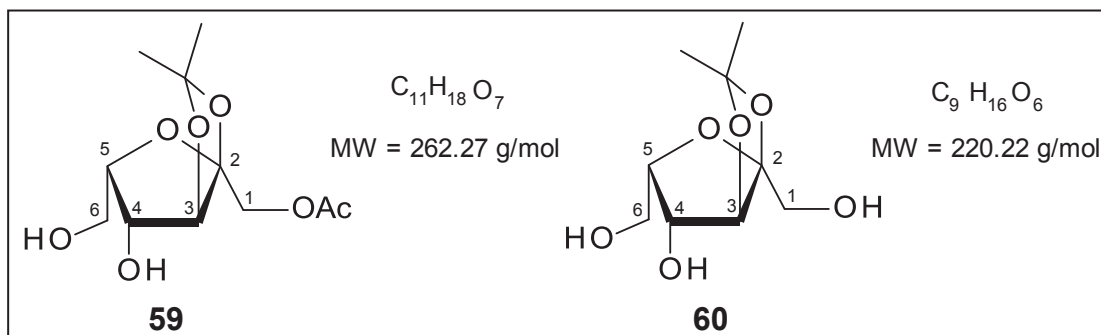

H_2SO_4 on silica was prepared according to the protocol of Mukhopadhyay and co-workers.²¹² To a solution of acetate **58** (100 mg, 0.33 mmol) in MeOH (1.7 mL), silica- H_2SO_4 (33 mg) was added. The reaction was left stirring 4 h at RT. The suspension was filtered through a membrane and the filtrate was concentrated under vacuum to give crude mixture of compound **59** and **60**. Flash column chromatography on silica gel ($CH_2Cl_2/MeOH$ 95:5) gave pure products **59** and **60** as yellow oils.

Compound **59**:

TLC:

- $CH_2Cl_2/MeOH$ (9:1);
- $R_f = 0.50$

1H NMR (250 MHz, CD_3OD), δ 4.46 (d, 1H, H_{1b} , $J_{1b,1a} = 11.8$ Hz), 4.40 (s, 1H, H_3), 4.28 (ddd 1H, H_5 , $J_{5,4} = 2.8$ Hz, $J_{5,6b} = 5.0$ Hz, $J_{5,6a} = 6.25$ Hz), 4.17 (d, 1H, H_4 , $J_{4,5} = 2.8$ Hz), 4.09 (d, 1H, H_{1a} , $J_{1a,1b} = 11.8$ Hz), 3.80 (dd, 1H, H_{6b} , $J_{6b,5} = 5.0$ Hz, $J_{6a,6b} = 11.8$ Hz), 3.74 (dd, 1H, H_{6a} , $J_{6a,5} = 6.25$ Hz, $J_{6a,6b} = 11.8$ Hz), 2.07 (s, 3H, OAc), 1.47, 1.36 (s, 3H, CH_3iPr).

^{13}C NMR (100 MHz, CD_3OD), δ 171.98 (C=O from OAc), 113.67, 113.23 ($C^{IV}iPr$, C2), 87.00 (C3), 83.41 (C5), 75.76 (C4), 64.49 (C1), 61.13 (C6), 27.72, 26.77 (CH_3iPr), 20.75 (CH_3CO).

LRMS (ESI)

$[M+Na]^+ = 285.0$

Yield

34% (30 mg)

Compound **59**:

TLC:

- $CH_2Cl_2/MeOH$ (9:1);
- $R_f = 0.31$

²¹² Rajput, V. K.; Roy, B.; Mukhopadhyay, B. *Tetrahedron Lett* **2006**, 47, 6987.

¹H NMR (250 MHz, CD₃OD), δ 4.39 (s, 1H, H3), 4.29 (ddd 1H, H5, $J_{5,4} = 2.8$ Hz, $J_{5,6b} = 5.3$ Hz, $J_{5,6a} = 6.3$ Hz), 4.13 (d, 1H, H4, $J_{4,5} = 2.8$ Hz), 3.81 (dd, 1H, H6_b, $J_{6b,5} = 5.3$ Hz, $J_{6a,6b} = 11.5$ Hz), 3.73 (dd, 1H, H6_a, $J_{6a,5} = 6.3$ Hz, $J_{6a,6b} = 11.5$ Hz), 3.68 (s, 2H, 2H1), 1.48, 1.36 (s, 3H, CH₃iPr).

¹³C NMR (62.5 MHz, CD₃OD), δ 115.54, 113.12 (C^{IV}iPr, C2), 86.79 (C3), 83.33 (C5), 75.65 (C4), 63.78 (C1), 61.13 (C6), 27.77, 26.86 (CH₃iPr).

LRMS (ESI)

[M+Na]⁺ = 243.0

Yield

53% (39 mg)

1-*O*-*p*-Methoxybenzyl-2,3:4,6-di-*O*-isopropylidene- α -L-sorbofuranose **61**

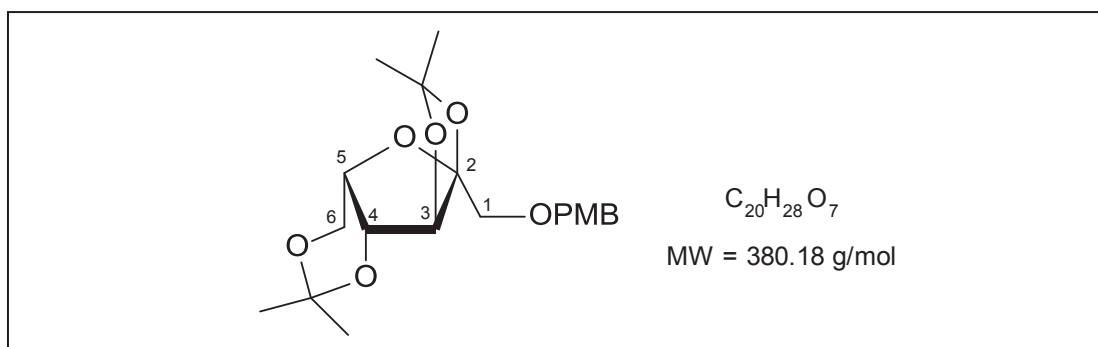

To a solution of 2,3,4,6-diisopropylidene L-sorbofuranose (100 mg, 0.38 mmol) in dry DMF (4 mL), sodium hydride (60% dispersion in oil, 30.4 mg, 0.76 mmol, 2 eq) was added. When H_2 evolution ceased (5 min), *p*-methoxybenzyl chloride (77 μ L, 0.57 mmol, 1.5 eq) was added dropwise. The mixture was left stirring overnight at RT. The reaction was quenched with ice water (5 mL). EtOAc (15 mL) was added. The organic phase was washed with water (2 x 7 mL) and saturated $NaHCO_3$ (7 mL) and then dried over $MgSO_4$. After concentration under vacuum, the crude product was purified by flash column chromatography on silica gel (PE/EtOAc 8:2) to afford pure **61** as a colourless oil.

TLC:

- PE/EtOAc (7:3);
- $R_f = 0.50$

1H NMR (400 MHz, $CDCl_3$), δ 7.27 (d, 2H, $H_{aromatic}$, $J = 8.4$ Hz), 6.86 (d, 2H, $H_{aromatic}$, $J = 8.4$ Hz), 4.65 (d, 1H, $CH_2(OPMB)$, $J = 11.6$ Hz), 4.52 (d, 1H, $CH_2(OPMB)$, $J = 11.6$ Hz), 4.48 (s, 1H, H3), 4.29 (d, 1H, H4, $J_{4,5} = 2.4$ Hz), 4.10-4.07 (m, 1H, H5), 4.04 (dd, 1H, H6_b, $J_{6b,5} = 2.2$ Hz, $J_{6b,6a} = 13.6$ Hz), 3.98 (d, 1H, H6_a, $J_{6b,6a} = 13.6$ Hz), 3.79 (s, 3H, CH_3O), 3.77 (d, 1H, H1_b, $J_{1b-1a} = 10.8$ Hz), 3.69 (d, 1H, H1_a, $J_{1a-1b} = 10.8$ Hz), 1.51, 1.41, 1.40, 1.29 (s, 3H, CH_3iPr).

^{13}C NMR (100 MHz, $CDCl_3$), δ 159.17, 130.37 ($C_{aromatic}^{IV}$), 129.30 ($C_{aromatic}$), 114.24 (C_{iPr}^{IV}), 113.76 ($C_{aromatic}$), 112.27 (C_{iPr}^{IV}), 97.30 (C2), 84.37 (C3), 73.32 (C4), 73.30 ($CH_2(OPMB)$), 72.16 (C5), 69.63 (C1), 60.40 (C6), 55.31 (CH_3O), 28.97, 27.66, 26.60, 18.69 (CH_3iPr).

LRMS (ESI)

$[M+Na]^+ = 403.0$

HRMS (ESI)

$[M+NH_4]^+$ calculated for $C_{20}H_{32}NO_7$ $m/z = 398.217329$; found $m/z = 398.217460$

$[M+Na]^+$ calculated for $C_{20}H_{28}NaO_7$ $m/z = 403.172724$; found $m/z = 403.172497$

Optical rotation

$[\alpha]_D^{20} = -4.8$ ($c = 1.0$; $CHCl_3$)

Yield

87% (127 mg)

1-*O*-*p*-Methoxybenzyl-2,3-*O*-isopropylidene- α -L-sorbofuranose **62**

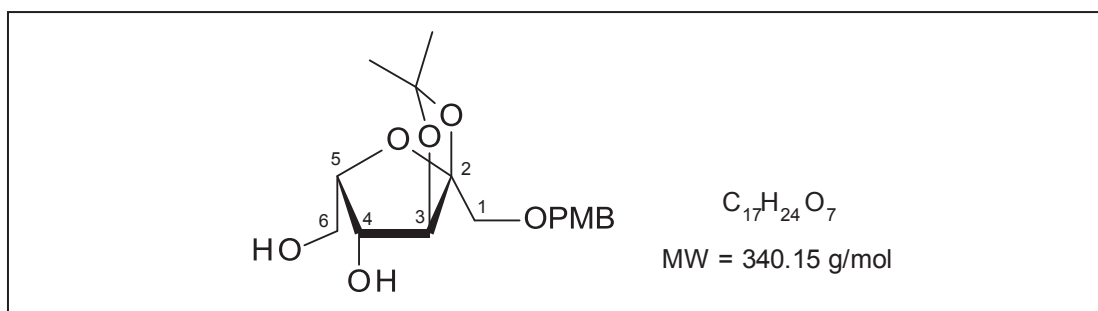

H₂SO₄ on silica was prepared according to the protocol of Mukhopadhyay and co-workers.²¹² To a solution of compound **61** (127 mg, 0.33 mmol) in MeOH (1.7 mL), silica-H₂SO₄ (33 mg) was added. The mixture was left stirring 1 h at RT. The suspension was filtered through a membrane and the filtrate was concentrated under vacuum to give crude compound. Flash column chromatography on silica gel (PE/EtOAc 3:7) afforded pure **62** as a white solid.

TLC:

- PE/EtOAc (3:7)
- R_f = 0.36

¹H NMR (400 MHz, CDCl₃), δ 7.24 (d, 2H, H_{aromatic}, J = 8.5 Hz), 6.86 (d, 2H, H_{aromatic}, J = 8.6 Hz), 4.60 (d, 1H, CH₂(OPMB), J = 11.3 Hz), 4.51 (d, 1H, CH₂(OPMB), J = 11.3 Hz), 4.40 (br s, 1H, H3), 4.33 (td, 1H, H5, $J_{4,5}$ = 2.8 Hz, $J_{5,6}$ = 5.2 Hz), 4.16 (dd, 1H, H4, $J_{4,5}$ = 2.7 Hz, $J_{4,OH}$ = 10.6 Hz), 3.89 (br t, 2H, H6, $J_{6,5}$ = $J_{6,OH}$ = 5.6 Hz), 3.84 (d, 1H, 4-OH, J = 10.6 Hz), 3.80 (d, 1H, H1_b, $J_{1b,1a}$ = 10.0 Hz), 3.79 (s, 3H, CH₃O), 3.61 (d, 1H, H1_a, $J_{1a,1b}$ = 10.0 Hz), 2.63 (t, 1H, CH₂OH, J = 6.1 Hz), 1.50, 1.30 (s, 3H, CH₃iPr).

¹³C NMR (100 MHz, CDCl₃), δ 159.63 (C^{IV}_{aromatic}), 129.66 (C_{aromatic}), 128.82 (C^{IV}_{aromatic}), 114.05 (C_{aromatic}), 112.72, 112.41 (C^{IV}iPr, C2), 86.82 (C3), 81.87 (C5), 75.31 (C4), 73.67 (CH₂(OPMB)), 71.13 (C1), 61.09 (C6), 55.29 (CH₃O), 27.23, 26.18 (CH₃iPr).

LRMS (ESI)

[M+Na]⁺ = 363.5

HRMS

[M+H]⁺ calculated for C₁₇H₂₅NO₇ m/z = 341.159480; found m/z = 341.159301

[M+Na]⁺ calculated for C₁₇H₂₄NaO₇ m/z = 363.141424; found m/z = 363.141371

Optical rotation

$[\alpha]_D^{20}$ = +4.2 (c = 1.4; MeOH)

Melting point

T_m = 60-61 °C

Yield

80% (90 mg)

²¹² Rajput, V. K.; Roy, B.; Mukhopadhyay, B. *Tetrahedron Lett* **2006**, 47, 6987.

1,2:4,6-Di-*O*-isopropylidene- α -L-tagatofuranose **64**

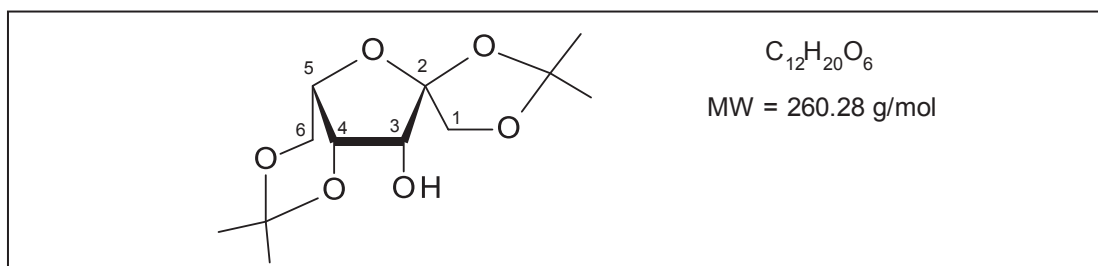

The reaction was conducted under argon. To a suspension of L-sorbose (7 g, 0.039 mol) in 2,2-dimethoxypropane (21 mL) was added $SnCl_2$ (35 mg, 0.183 mmol, 0.005 eq) in DME (0.7 mL). The reaction was left stirring 3h45 at 70°C and then quenched with NEt_3 (0.21 mL, 1.51 mmol, 0.04 eq). The remaining sorbose was removed by filtration and the filtrate was concentrated under vacuum. The residue was dissolved in EtOAc (70 mL) and washed with H_2O (2 x 350 mL). The organic phase was dried over $MgSO_4$ and concentrated under vacuum to afford the crude **53**. The reaction of oxidation was conducted under argon. To a solution of crude **53** (0.039 mol) in dry CH_2Cl_2 (78 mL) 3Å molecular sieves (12.9 g) were added. The suspension was left stirring for 5 min and then PCC (16.8 g, 0.078 mol, 2 eq) was added. The reaction was left stirring overnight, then Et_2O (390 mL) and celite were added and the suspension was stirred vigorously. The solids were filtered through celite and washed with Et_2O . The filtrate was concentrated under vacuum to give crude ketone **63** as a dense, dark brown oil, which was used in the next step without further purification. To solution of crude ketone **63** in EtOH (78 mL) and CH_2Cl_2 (10 mL, to increase the solubility of starting material mixture) $NaBH_4$ (3.69 g, 0.098 mol, 2.5 eq) was slowly added at 0°C. The mixture was left stirring overnight. Then it was quenched with a 50% solution of NH_4Cl (150 mL) at an ice bath. EtOAc (250 mL) was added, the organic phase was separated and the aqueous phase was extracted with EtOAc (3 x 100 mL). The combined organic phases were washed with H_2O (150 mL), brine (150 mL) and dried over $MgSO_4$. Concentration under vacuum gave the crude alcohol **64**, which was purified by flash column chromatography on silica gel (PE/EtOAc 8:2) affording the alcohol **64** as a colorless oil.

TLC:

- PE/EtOAc (6:4);
- $R_f = 0.29$

1H NMR (400 MHz, $CDCl_3$), δ 4.38 (dd, 1H, H3, $J_{3,4} = 4.4$ Hz, $J_{3,OH} = 8.4$ Hz), 4.34-4.32 (m, 2H, H4, H1_b), 4.06-3.97 (m, 3H, H1_a, H5, H6_b), 3.90 (dd, 1H, H6_a, $J_{6a,5} = 1.4$ Hz, $J_{6a-6b} = 13.0$ Hz), 2.95 (d, 1H, OH, $J_{OH-3} = 8.4$ Hz), 1.50, 1.45, 1.42, 1.41 (s, 3H, CH_3iPr).

^{13}C NMR (100 MHz, $CDCl_3$), δ 112.84, 110.09 ($C^{IV}iPr$), 98.00 (C2), 77.48 (C3), 70.04 (C1), 69.89 (C5), 68.85 (C4), 60.87 (C6), 28.65, 26.31, 26.06, 19.62 (CH_3iPr).

HRMS (ESI)

$[M+Na]^+$ calculated for $C_{12}H_{20}NaO_6$ $m/z = 283.115209$; found $m/z = 283.115194$

Optical rotation

$[\alpha]_D^{25} = -60.8$ (c= 1.0; $CHCl_3$)

Yield

16% (1.64 g) from L-sorbose.

1,2:3,4-Di-*O*-isopropylidene- α -L-tagatofuranose **65**

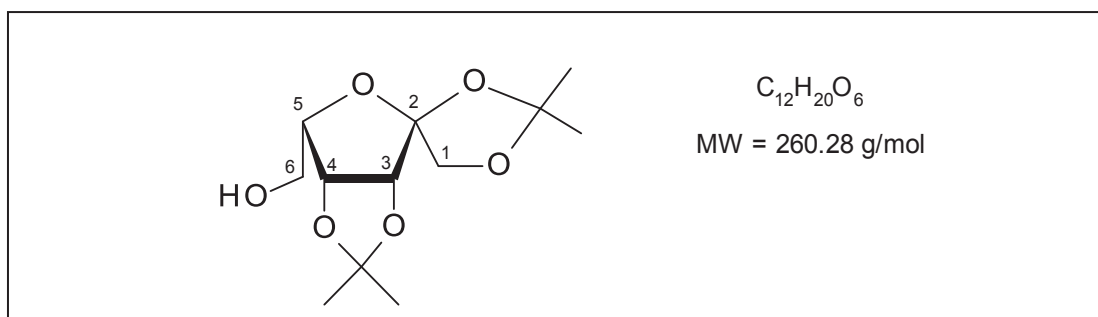

To a solution of alcohol **64** (1.64 g, 6.30 mmol) in acetone (63 mL) was added camphorsulfonic acid (144 mg, 0.63 mmol, 0.1 eq). The reaction was left stirring 72 h at RT. The reaction was stopped with NEt_3 (96 μ L, 0.69 mmol, 0.11 eq) and concentrated under vacuum. EtOAc (200 mL) was added. The mixture was washed with water (2 x 100 mL) and dried over $MgSO_4$. After concentration under vacuum the crude product was obtained as a colorless oil. Flash column chromatography on silica gel (PE/EtOAc 8:2) gave the desired alcohol **65** as a white solid.

TLC:

- PE/EtOAc (6:4);
- $R_f = 0.35$

1H NMR (400 MHz, $CDCl_3$), δ 4.84 (dd, 1H, H4, $J_{4,5} = 4.0$ Hz, $J_{4,3} = 6.0$ Hz), 4.63 (d, 1H, H3, $J_{3,4} = 6.0$ Hz), 4.27 (d, 1H, H1_b, $J_{1b,1a} = 9.6$ Hz), 4.08 (d, 1H, H1_a, $J_{1a,1b} = 9.6$ Hz), 4.07 (td, 1H, H5, $J_{4,5} = 4.0$ Hz, $J_{5,6b} = J_{5,6a} = 5.5$ Hz), 3.96-3.85 (m, 2H, 2H6), 2.29 (br s, 1H, OH), 1.47, 1.43, 1.40, 1.31 (s, 3H, CH_3iPr).

^{13}C NMR (100 MHz, $CDCl_3$), δ 113.02, 111.88, 111.82 ($C^{IV}iPr$, C2), 85.50 (C3), 80.62 (C4), 78.97 (C5), 69.31 (C1), 61.16 (C6), 26.56, 26.05, 24.79 (CH_3iPr).

HRMS (ESI)

$[M+Na]^+$ calculated for $C_{12}H_{20}NaO_6$ $m/z = 283.115209$; found $m/z = 283.115463$

Optical rotation

$[\alpha]_D^{25} = -61.4$ (c=1.1; $CHCl_3$)

Melting point

$T_m = 60-61^\circ C$

Yield

73 % (1.19 g).

12% from L-sorbose

1,2:3,4-Di-*O*-isopropylidene-6-aldehydo- α -L-tagato-furanose **66**

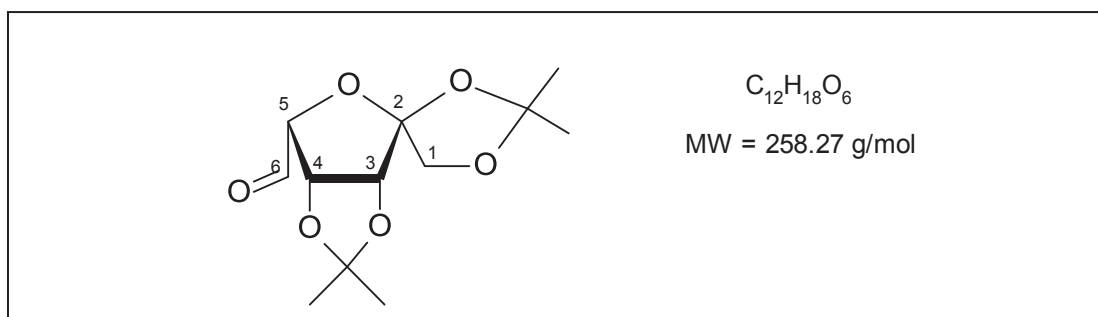

To a solution of alcohol **65** (1.0 g, 3.85 mmol) in dry CH_2Cl_2 (39 mL) was added Dess-Martin periodinane (1.96 g, 4.61 mmol, 1.2 eq). The reaction was left stirring for 6 h at RT. The mixture was concentrated under vacuum. The residue was suspended in minimum volume of cold Et_2O and filtered through a membrane. The filtrate was concentrated under vacuum to give crude aldehyde **66** as a colorless oil, which was used in the next step without purification.

1H NMR (400 MHz, $CDCl_3$), δ 9.61 (d, 1H, H6, $J_{6,5}$ = 1.6 Hz), 5.12 (dd, 1H, H4, $J_{4,5}$ = 4.0 Hz, $J_{4,3}$ = 5.6 Hz), 4.66-4.61 (m, 1H, H3), 4.35 (dd, 1H, H5, $J_{5,6}$ = 1.6 Hz, $J_{5,4}$ = 4.0 Hz), 4.35 (d, 1H, H1_b, $J_{1b,1a}$ = 10.0 Hz), 4.22 (d, 1H, H1_a, $J_{1a,1b}$ = 10.0 Hz), 1.47, 1.40, 1.29 (s, 3H, CH_3iPr).

^{13}C NMR (100 MHz, $CDCl_3$), δ 198.33 (C6), 113.80, 112.81, 112.39 ($C^{IV}iPr$, C2), 84.77 (C3), 83.35 (C5), 81.41 (C4), 69.29 (C1), 26.51, 26.41, 26.01, 24.77 (CH_3iPr).

6-(*S*)-*N*-*tert*-butanesulfinylimino-6-deoxy-1,2:3,4-Di-*O*-isopropylidene- α -L-tagatofuranose

67

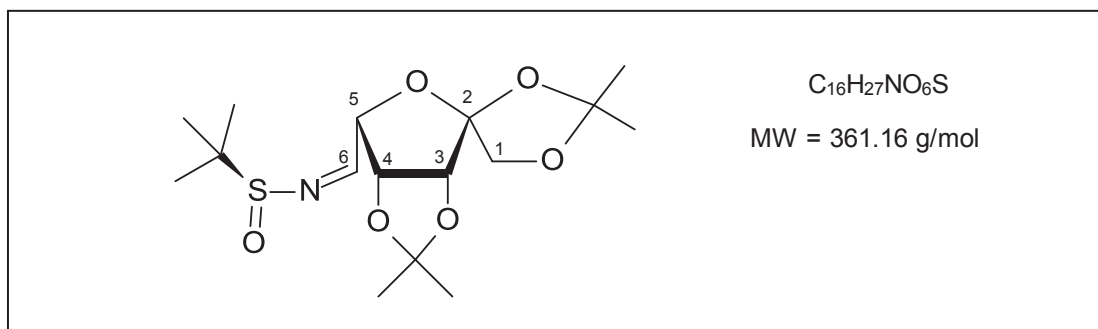

To a solution of crude aldehyde **66** (1.96 mmol) in dry CH_2Cl_2 (20 mL) were added (*S*)-*N*-*tert*-butanesulfinamide (261 mg, 2.16 mmol, 1.1 eq) and dry $CuSO_4$ (1.56 g, 9.80 mmol, 5 eq). The reaction was left stirring overnight at RT. The mixture was filtered through a membrane and the filtrate was concentrated under vacuum to give crude product as a yellowish oil. Flash column chromatography on silica gel (PE/ EtOAc 8:2) gave pure **67** as a white solid.

TLC:

- PE/EtOAc (8:2);
- R_{fS} = 0.55

1H NMR (400 MHz, $CDCl_3$), δ 8.02 (d, 1H, H6, $J_{6,5}$ = 4.2 Hz), 4.99 (dd, 1H, H4, $J_{4,5}$ = 4.2 Hz, $J_{4,3}$ = 6.0 Hz), 4.73 (t, 1H, H5, $J_{5,6}$ = $J_{5,4}$ = 4.2 Hz), 4.65 (d, 1H, H3, $J_{3,4}$ = 6.0 Hz), 4.33 (d, 1H, H1_b, $J_{1b,1a}$ = 10.0 Hz), 4.16 (d, 1H, H1_a, $J_{1a,1b}$ = 10.0 Hz), 1.47, 1.41, 1.39, 1.27 (s, 3H, CH_3iPr), 1.23 (s, 9H, CH_3tBu).

^{13}C NMR (100 MHz, $CDCl_3$), δ 166.07 (C6), 113.48, 112.52, 112.18 ($C^{IV}iPr$, C2), 85.04 (C3), 82.04 (C4), 80.88 (C5), 69.40 (C1), 57.48 ($C^{IV}tBu$), 26.57, 26.38, 26.11, 25.08 (CH_3iPr), 22.58 (CH_3tBu).

HRMS (ESI)

$[M+H]^+$ calculated for $C_{16}H_{28}NO_6S$ m/z = 362.163185; found m/z = 362.163434

$[M+Na]^+$ calculated for $C_{16}H_{27}NNaO_6S$ m/z = 384.145129; found m/z = 384.145380

Optical rotation

$[\alpha]_D^{25}$ = +227.2 (c=1.2; $CHCl_3$)

Melting point

T_m = 98-100°C

IR [cm^{-1}] ν 2986 (C-H), 1631 (N=C), 1457, 1373, 1209, (C-O/C-C), 1071, 1033 (S=O), 854.

Yield

71 % (510 mg) for two steps from **65**.

6-(*S_R*)-*N*-tert-butanesulfinylimino-6-deoxy-1,2:3,4-Di-*O*-isopropylidene- α -L-tagatofuranose

68

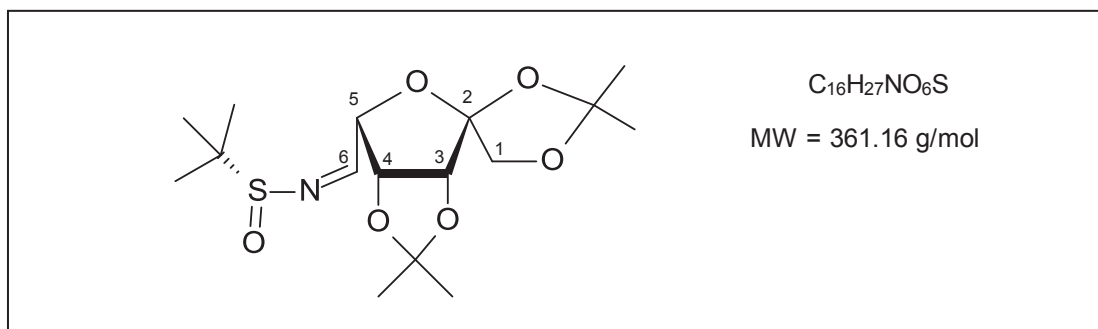

To a solution of crude aldehyde **66** (1.93 mmol) in dry CH_2Cl_2 (19 mL) were added (*R*)-*N*-tert-butanesulfinamide (257 mg, 2.12 mmol, 1.1 eq) and dry $CuSO_4$ (1.54 g, 9.63 mmol, 5 eq). The reaction was left stirring overnight at RT. The mixture was filtered through a membrane and the filtrate was concentrated under vacuum to give crude product as a yellowish oil. Flash column chromatography on silica gel (PE/ EtOAc 9:1) gave pure **68** as a colorless oil.

TLC:

- PE/EtOAc (8:2);
- $R_{fR} = 0.33$

1H NMR (400 MHz, $CDCl_3$), δ 8.04 (d, 1H, H6, $J_{6,5} = 4.0$ Hz), 5.02 (dd, 1H, H4, $J_{4,5} = 4.0$ Hz, $J_{4,3} = 5.6$ Hz), 4.74 (t, 1H, H5, $J_{5,6} = J_{5,4} = 4.0$ Hz), 4.67 (d, 1H, H3, $J_{3,4} = 5.6$ Hz), 4.33 (d, 1H, H1_b, $J_{1b,1a} = 10.0$ Hz), 4.16 (d, 1H, H1_a, $J_{1a,1b} = 10.0$ Hz), 1.48, 1.41, 1.40, 1.29 (s, 3H, CH_3iPr), 1.23 (s, 9H, CH_3tBu).

^{13}C NMR (100 MHz, $CDCl_3$), δ 164.74 (C6), 113.54, 112.53, 112.17 ($C^{IV}iPr$, C2), 85.15 (C3), 81.17 (C4), 80.56 (C5), 69.28 (C1), 57.32 ($C^{IV}tBu$), 26.49, 26.46, 26.15, 24.84 (CH_3iPr), 22.59 (CH_3tBu).

HRMS (ESI)

$[M+H]^+$ calculated for $C_{16}H_{28}NO_6S$ $m/z = 362.163185$; found $m/z = 362.163214$

$[M+Na]^+$ calculated for $C_{16}H_{27}NNaO_6S$ $m/z = 384.145129$; found $m/z = 384.144936$

Optical rotation

$[\alpha]_D^{25} = -106.9$ ($c = 1.0$; $CHCl_3$)

Yield

79 % (551 mg) for two steps from **65**.

(6*R*^{*})-6-*C*-Allyl-6-(*S*₅)-*N*-*tert*-butanesulfinylamino-6-deoxy-1,2:3,4-di-*O*-isopropylidene- α -*L*-tagatofuranose **69**

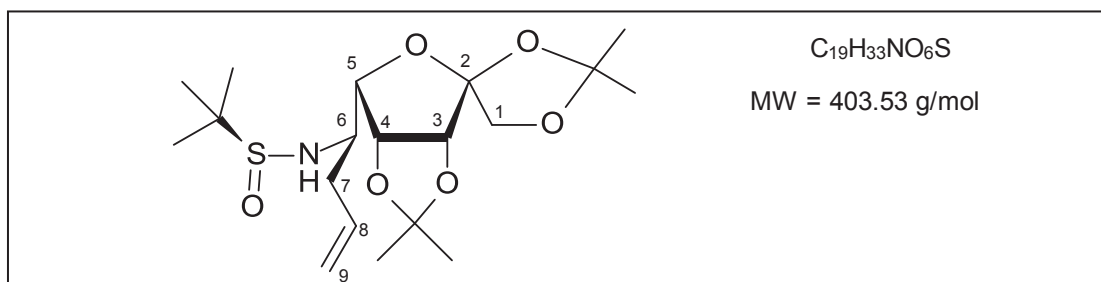

To a solution of sulfinylimine **67** (220 mg, 0.61 mmol) in dry toluene (30 mL), at 0°C a 1N solution of allylMgBr in Et₂O (3.04 mL, 3.04 mmol, 5 eq) was added dropwise. The reaction was left stirring overnight at RT. Then it was stopped at 0°C with a saturated solution of NH₄Cl (20 mL). The mixture was extracted with Et₂O (3 x 20 mL). The combined organic phases were dried over MgSO₄. After concentration under vacuum the crude product was obtained as a colorless oil with solids. Flash column chromatography on silica gel (PE/EtOAc 7:3) gave pure **69** as a single diastereoisomer and as a white solid.

TLC:

- PE/EtOAc (8:2);
- R_f = 0.08

¹H NMR (400 MHz, CDCl₃), δ 5.95-5.78 (m, 1H, H8), 5.25-5.18 (m, 2H, 2H9), 4.72 (dd, 1H, H4, $J_{4,5}$ = 3.4 Hz, $J_{4,3}$ = 5.8 Hz), 4.60 (d, 1H, H3, $J_{3,4}$ = 5.8 Hz), 4.26 (d, 1H, H1_b, $J_{1b,1a}$ = 9.6 Hz), 4.01 (d, 1H, H1_a, $J_{1a,1b}$ = 9.6 Hz), 3.84 (dd, 1H, H5, $J_{5,4}$ = 3.4 Hz, $J_{5,6}$ = 9.1 Hz), 3.73-3.62 (m, 1H, H6), 3.53 (d, 1H, NH, J = 5.8 Hz), 2.68-2.58 (m, 1H, H7_b), 2.53-2.42 (m, 1H, H7_a), 1.43, 1.42, 1.39, 1.30 (s, 3H, CH₃iPr), 1.21 (s, 9H, CH₃tBu).

¹³C NMR (100 MHz, CDCl₃), δ 133.66 (C8), 119.49 (C9), 112.87, 111.69, 111.55 (C^{IV}iPr, C2), 85.67 (C3), 81.82 (C5), 79.69 (C4), 69.40 (C1), 56.22 (C^{IV}tBu), 55.10 (C6), 36.17 (C7), 26.67, 26.31, 26.20, 25.06 (CH₃iPr), 22.74 (CH₃tBu).

HRMS (ESI)

[M+H]⁺ calculated for C₁₉H₃₄NO₆S m/z = 404.210135; found m/z = 404.210220

[M+Na]⁺ calculated for C₁₉H₃₃NNaO₆S m/z = 426.192079; found m/z = 426.192200

Optical rotation

$[\alpha]_D^{25}$ = -13.8 (c = 1.0; CHCl₃)

Melting point

T_m = 78-81°C

IR [cm⁻¹] ν 3240 (N-H), 3103 (=C-H), 2987, 2938 (C-H), 1642 (C=C), 1456, 1381, 1372, 1207, 1063, 1026 (C-O/C-C/C-N).

Yield

81 % (200 mg)

Note: *These configurations could be inverted

(6*R**)-6-C-Allyl-6-(*S_R*)-*N*-*tert*-butanesulfinylamino-6-deoxy-1,2:3,4-di-*O*-isopropylidene- α -L-tagatofuranose **70** and (6*S**)-6-C-Allyl-6-(*S_R*)-*N*-*tert*-butanesulfinylamino-6-deoxy-1,2:3,4-di-*O*-isopropylidene- α -L-tagatofuranose **71**

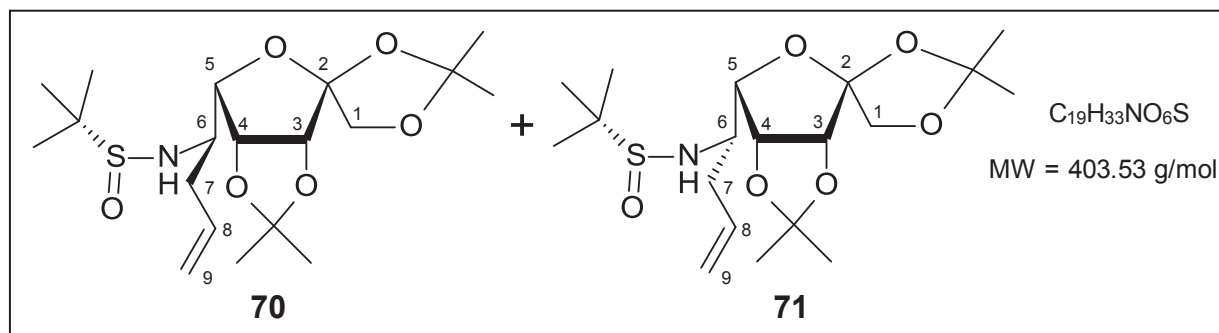

To a solution of sulfinylimine **68** (133 mg, 0.37 mmol) in dry toluene (18.5 mL) at 0°C, a 1N solution of allylMgBr in Et₂O (1.84mL, 1.84 mmol, 5 eq) was added dropwise. The reaction was left stirring overnight at RT. Then it was stopped at 0°C with a saturated solution of NH₄Cl (15 mL). The mixture was extracted with Et₂O (3 x 20 mL). The combined organic phases were dried over MgSO₄. After concentration under vacuum the crude product was obtained as a colorless oil with solids. Flash column chromatography on silica gel (PE/EtOAc 7:3) gave two diastereoisomers: the major **70** as a white solid and the minor **71** as a colorless oil.

TLC:

- PE/EtOAc (7:3);
- R_{f70} = 0.34, R_{f71} = 0.23

1st isomer **70**

¹H NMR (400 MHz, CDCl₃), δ 5.89-5.79 (m, 1H, H8), 5.22-5.14 (m, 2H, 2H9), 4.87 (dd, 1H, H4, $J_{4,5}$ = 3.6 Hz, $J_{4,3}$ = 6.0 Hz), 4.57 (d, 1H, H3, $J_{3,4}$ = 6.0 Hz), 4.23 (d, 1H, H1_b, $J_{1b,1a}$ = 9.4 Hz), 4.01 (d, 1H, H1_a, $J_{1a,1b}$ = 9.4 Hz), 3.91 (dd, 1H, H5, $J_{5,4}$ = 3.6 Hz, $J_{5,6}$ = 9.2 Hz), 3.69 (d, 1H, NH, J = 6.8 Hz), 3.67-3.58 (m, 1H, H6), 2.66-2.55 (m, 2H, 2H7), 1.45, 1.42, 1.39, 1.29 (s, 3H, CH₃iPr), 1.21 (s, 9H, CH₃tBu).

¹³C NMR (100 MHz, CDCl₃), δ 133.97 (C8), 118.99 (C9), 112.57, 111.88, 111.67 (C^{IV}iPr, C2), 85.10 (C3), 80.68 (C5), 80.09 (C4), 69.47 (C1), 56.07 (C^{IV}tBu), 54.84 (C6), 36.34 (C7), 26.61, 26.52, 26.18, 24.87 (CH₃iPr), 22.73 (CH₃tBu).

HRMS (ESI)

[M+H]⁺ calculated for C₁₉H₃₄NO₆S m/z = 404.210135; found m/z = 404.210166

[M+Na]⁺ calculated for C₁₉H₃₃NNaO₆ S m/z = 426.192079; found m/z = 426.192147

Optical rotation

$[\alpha]_D^{25}$ = -68.1 (c = 1.1; CHCl₃)

Melting point

T_m = 95-98°C

Yield

76 % (113 mg)

2nd isomer 71:

¹H NMR (400 MHz, CDCl₃), δ 5.93-5.82 (m, 1H, H8), 5.17-5.09 (m, 2H, 2H9), 4.77 (dd, 1H, H4, $J_{4,5}$ = 3.6 Hz, $J_{4,3}$ = 6.0 Hz), 4.60 (d, 1H, H3, $J_{3,4}$ = 6.0 Hz), 4.25 (d, 1H, H1_b, $J_{1b,1a}$ = 9.6 Hz), 4.04 (d, 1H, H1_a, $J_{1a,1b}$ = 9.6 Hz), 3.88 (dd, 1H, H5, $J_{5,4}$ = 3.6 Hz, $J_{5,6}$ = 8.6 Hz), 3.84-3.75 (m, 2H, H6, NH), 2.73-2.67 (m, 1H, H7_b), 2.46 (ddd, 1H, H7_a, J = 4.6 Hz, J = 8.2 Hz, J_{7a-7b} = 14.6 Hz), 1.44, 1.41, 1.40, 1.30 (s, 3H, CH₃iPr), 1.22 (s, 9H, CH₃tBu).

¹³C NMR (100 MHz, CDCl₃), δ 133.68 (C8), 118.12 (C9), 113.12, 111.78, 111.57 (C^{IV}iPr, C2), 85.71 (C3), 80.13 (C5), 79.57 (C4), 69.49 (C1), 55.76 (C^{IV}tBu), 52.46 (C6), 34.30 (C7), 26.67, 26.48, 26.23, 24.96 (CH₃iPr), 22.81 (CH₃tBu).

HRMS (ESI)

[M+H]⁺ calculated for C₁₉H₃₄NO₆S m/z = 404.210135; found m/z = 404.210344

[M+Na]⁺ calculated for C₁₉H₃₃NNaO₆S m/z = 426.192079; found m/z = 426.192104

Optical rotation

$[\alpha]_D^{25}$ = -121.8 (c = 0.8; CHCl₃)

Yield

7 % (10 mg)

Note:

* These configurations could be inverted

6-(*S*₅)-*N*-*tert*-butanesulfinylamino-6-deoxy-(6*R*)-6-*C*-Hexyl-1,2:3,4-di-*O*-isopropylidene- α -L-tagatofuranose **72R** and 6-(*S*₅)-*N*-*tert*-butanesulfinylamino-6-deoxy-(6*S*)-6-*C*-Hexyl-1,2:3,4-di-*O*-isopropylidene- α -L-tagatofuranose **72S**

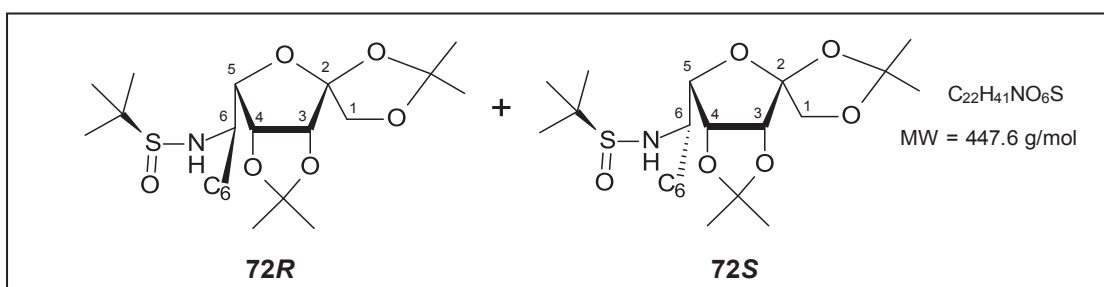

To a solution of sulfinylimine **67** (134 mg, 0.37 mmol) in dry toluene (18.5 mL) at -78°C , a 2N solution of hexylMgBr in Et₂O (0.93 mL, 1.85 mmol, 5 eq) was added dropwise. The reaction was left stirring overnight at RT. Then it was stopped at 0°C with a saturated solution of NH₄Cl (10 mL). The mixture was extracted with Et₂O (3 x 25 mL). The combined organic phases were dried over MgSO₄. After concentration under vacuum the crude product was obtained as a yellowish oil. Flash column chromatography on silica gel (PE/EtOAc 8:2/7:3) gave two diastereoisomers: the first **72R** as a white amorphous solid and the second **72S** as a colorless oil.

TLC:

- PE/EtOAc (8:2);
- $R_{fR} = 0.19$, $R_{fS} = 0.09$

IR [cm^{-1}] ν 2984, 2932, 2860 (C-H), 1457, 1372, 1208, 1068, 1029 (C-O/C-C/C-N).

1st isomer **72R**:

¹H NMR (400 MHz, CDCl₃), δ 4.70 (dd, 1H, H4, $J_{4,5} = 3.6$ Hz, $J_{4,3} = 6.0$ Hz), 4.59 (d, 1H, H3, $J_{3,4} = 6.0$ Hz), 4.25 (d, 1H, H1_b, $J_{1b,1a} = 9.6$ Hz), 4.0 (d, 1H, H1_a, $J_{1a,1b} = 9.6$ Hz), 3.89 (dd, 1H, H5, $J_{5,4} = 3.6$ Hz, $J_{5,6} = 9.2$ Hz), 3.55-3.49 (m, 1H, H6), 3.35 (d, 1H, NH, $J_{NH,6} = 5.6$ Hz), 1.82-1.70 (m, 1H, CH₂), 1.66-1.49 (m, 2H, CH₂) 1.47-1.17 (m, 28H, CH₂, CH₃iPr, CH₃tBu), 0.87-0.91 (m, 3H, CH₃-hexyl).

¹³C NMR (100 MHz, CDCl₃), δ 112.77, 111.75, 111.46 (C^{IV}iPr, C2), 85.72 (C3), 82.58 (C5), 79.96 (C4), 69.43 (C1), 56.63 (C6), 56.20 (C^{IV}tBu), 31.75, 30.81, 29.11, 25.40, 22.80 (CH₂-hexyl), 26.70, 26.45, 26.21, 25.12 (CH₃iPr), 22.83 (CH₃tBu), 14.24 (CH₃-hexyl).

HRMS (ESI)

[M+H]⁺ calculated for C₂₂H₄₂NO₆S $m/z = 448.272735$; found $m/z = 448.273053$

[M+Na]⁺ calculated for C₂₂H₄₁NNaO₆S $m/z = 470.254680$; found $m/z = 470.254609$

Optical rotation

$[\alpha]_D^{25} = -7.9$ (c = 1.1; CHCl₃)

Yield

27 % (44 mg)

2nd isomer 72S:

¹H NMR (400 MHz, CDCl₃), δ 4.89 (dd, 1H, H4, $J_{4,5}$ = 3.6 Hz, $J_{4,3}$ = 6.0 Hz), 4.59 (d, 1H, H3, $J_{3,4}$ = 6.0 Hz), 4.25 (d, 1H, H1_b, $J_{1b,1a}$ = 9.6 Hz), 4.11 (d, 1H, H1_a, $J_{1a,1b}$ = 9.6 Hz), 3.85 (dd, 1H, H5, $J_{5,4}$ = 3.6 Hz, $J_{5,6}$ = 7.6 Hz), 3.70 (d, 1H, NH, J = 8.0 Hz), 3.64-3.57 (m, 1H, H6), 1.82-1.71 (m, 1H, CH₂-hexyl), 1.66-1.59 (m, 1H, CH₂-hexyl), 1.57-1.49 (m, 1H, CH₂-hexyl), 1.48-1.13 (m, 28H, CH₂-hexyl, CH₃iPr, CH₃tBu), 0.90-0.86 (m, 3H, CH₃-hexyl).

¹³C NMR (100 MHz, CDCl₃), δ 112.97, 111.79, 111.64 (C^{IV}iPr, C2), 85.47 (C3), 80.41 (C5), 80.23 (C4), 69.42 (C1), 56.21 (C^{IV}tBu), 55.70 (C6), 32.61, 31.89, 29.35, 25.56, 22.86 (CH₂-hexyl), 26.68, 26.51, 26.13, 24.84 (CH₃iPr), 22.74 (CH₃tBu), 14.20 (CH₃-hexyl).

HRMS (ESI)

[M+H]⁺ calculated for C₂₂H₄₂NO₆S m/z = 448.272735; found m/z = 448.272959

[M+Na]⁺ calculated for C₂₂H₄₁NNaO₆S m/z = 470.254680; found m/z = 470.254616

Optical rotation

$[\alpha]_D^{25}$ = -11.0 (c = 1.2; CHCl₃)

Yield

65 % (108 mg)

Note:

* These configurations could be inverted

6-(*S_R*)-*N*-tert-butanesulfinylamino-6-deoxy-(6*S*)-6-*C*-Hexyl-1,2:3,4-di-*O*-isopropylidene- α -L-tagatofuranose **73R** and 6-(*S_R*)-*N*-tert-butanesulfinylamino-6-deoxy-(6*R*)-6-*C*-Hexyl-1,2:3,4-di-*O*-isopropylidene- α -L-tagatofuranose **73S**

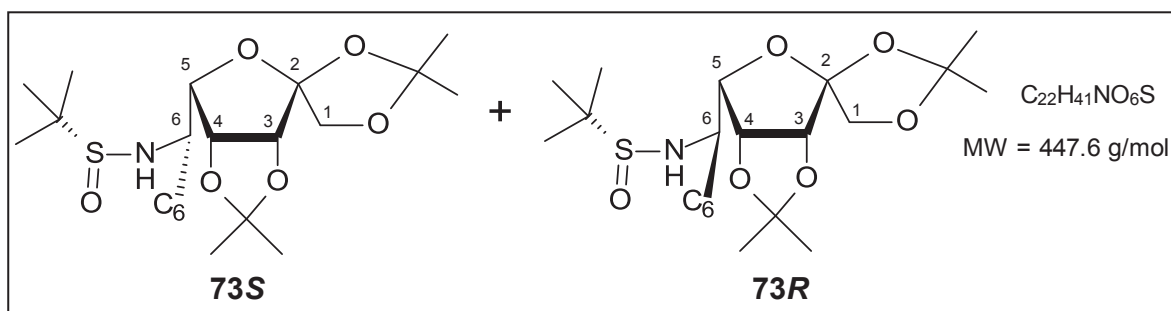

To a solution of sulfinylimine **68** (100 mg, 0.28 mmol) in dry toluene (3 mL) at -78°C , a 2N solution of hexylMgBr in Et_2O (0.7 mL, 1.4 mmol, 5 eq) was added dropwise. The reaction was left stirring overnight at RT. Then it was stopped at 0°C with a saturated solution of NH_4Cl (10 mL). The mixture was extracted with Et_2O (3 x 20 mL). The combined organic phases were dried over MgSO_4 . After concentration under vacuum the crude product was obtained as a yellowish oil. Flash column chromatography on silica gel (PE/EtOAc 8:2) gave two diastereoisomers: the first one **73S** as a white solid and the second one **73R** as a colorless oil.

TLC:

- PE/EtOAc (7:3);
- $R_{fR} = 0.38$, $R_{fS} = 0.25$,

1st isomer **73S**:

^1H NMR (400 MHz, CDCl_3), δ 4.95-4.93 (m, 1H, H4), 4.56 (d, 1H, H3, $J_{3,4} = 6.0$ Hz), 4.21 (d, 1H, H1_b, $J_{1b,1a} = 10.0$ Hz), 3.99 (d, 1H, H1_a, $J_{1a,1b} = 10.0$ Hz), 3.96 (dd, 1H, H5, $J_{5,4} = 3.2$ Hz, $J_{5,6} = 9.2$ Hz), 3.68 (d, 1H, NH, $J = 5.2$ Hz), 3.46-3.39 (m, 1H, H6), 1.88-1.67 (m, 3H, CH_2 -hexyl), 1.61-1.49 (m, 2H, CH_2 -hexyl), 1.44-1.16 (m, 26H, CH_2 -hexyl, CH_3 iPr, CH_3 tBu), 0.95-0.81 (m, 3H, CH_3 -hexyl).

^{13}C NMR (100 MHz, CDCl_3), δ 112.49, 111.91, 111.67 (C^{IV} iPr, C2), 85.11 (C3), 81.85 (C5), 80.41 (C4), 69.51 (C1), 56.08 (C6), 56.00 (C^{IV} tBu), 31.92, 31.80, 29.31, 25.74, 22.75 (CH_2 -hexyl), 26.68, 26.57, 26.22, 24.89 (CH_3 iPr), 22.80 (s, 9H, CH_3 tBu), 14.21 (CH_3 -hexyl).

HRMS (ESI)

$[\text{M}+\text{H}]^+$ calculated for $\text{C}_{22}\text{H}_{42}\text{NO}_6\text{S}$ $m/z = 448.272735$; found $m/z = 448.272655$

$[\text{M}+\text{Na}]^+$ calculated for $\text{C}_{22}\text{H}_{41}\text{NNaO}_6\text{S}$ $m/z = 470.254680$; found $m/z = 470.254400$

Optical rotation

$[\alpha]_D^{25} = -67.7$ ($c = 1.0$; CHCl_3)

Melting point

$T_m = 64-66^{\circ}\text{C}$

Yield

12 % (14.5 mg)

2nd isomer 73R:

¹H NMR (400 MHz, CDCl₃), δ 4.77 (dd, 1H, H4, $J_{4,5}$ = 3.4 Hz, $J_{4,3}$ = 5.6 Hz), 4.61 (d, 1H, H3, $J_{3,4}$ = 5.6 Hz), 4.25 (d, 1H, H1_b, $J_{1b,1a}$ = 9.8 Hz), 4.04 (d, 1H, H1_a, $J_{1a,1b}$ = 9.8 Hz), 3.92 (dd, 1H, H5, $J_{5,4}$ = 3.4 Hz, $J_{5,6}$ = 8.6 Hz), 3.77 (d, 1H, NH, J = 2.4 Hz), 3.73-3.68 (m, 1H, H6), 1.88-1.74 (m, 1H, CH₂-hexyl), 1.74-1.60 (m, 1H, CH₂-hexyl), 1.60-1.12 (m, 29H, CH₂ hexyl, CH₃iPr, CH₃tBu), 0.94-0.81 (m, 3H, CH₃-hexyl).

¹³C NMR (100 MHz, CDCl₃), δ 113.03, 111.69, 111.55 (C^{IV}iPr, C2), 85.66 (C3), 80.38 (C5), 79.96 (C4), 69.42 (C1), 55.63 (C^{IV}tBu), 53.25 (C6), 31.82, 29.95, 29.57, 24.43, 22.70 (CH₂-hexyl), 26.64, 26.44, 26.18, 24.95 (CH₃iPr), 22.77 (s, 9H, CH₃tBu), 14.18 (CH₃-hexyl).

HRMS (ESI)

[M+H]⁺ calculated for C₂₂H₄₂NO₆S m/z = 448.272735; found m/z = 448.272735

[M+Na]⁺ calculated for C₂₂H₄₁NNaO₆S m/z = 470.254680; found m/z = 470.254623

Optical rotation

$[\alpha]_D^{25}$ = -80.1 (c = 1.1; CHCl₃)

Yield

62 % (76 mg)

6-(*S*₅)-*N*-*tert*-butanesulfinylamino-6-deoxy-(6*R*)-1,2:3,4-di-*O*-isopropylidene-6-*C*-nonyl- α -L-tagatofuranose **74R** and 6-(*S*₅)-*N*-*tert*-butanesulfinylamino-6-deoxy-(6*S*)-6-1,2:3,4-di-*O*-isopropylidene-6-*C*-nonyl- α -L-tagatofuranose **74S**

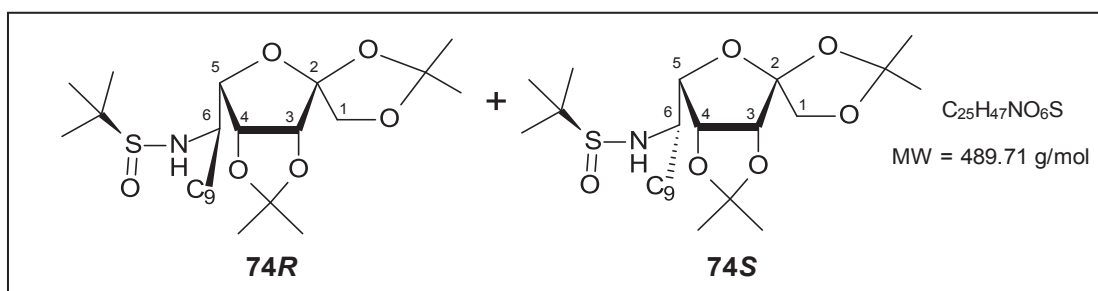

To a solution of sulfinylimine **67** (138 mg, 0.38 mmol) in dry toluene (19 mL) at 0°C, a 1N solution of nonylMgBr in Et₂O (1.91 mL, 1.91 mmol, 5 eq) was added dropwise. The reaction was left stirring overnight at RT. Then it was stopped at 0°C with a saturated solution of NH₄Cl (15 mL). The mixture was extracted with Et₂O (3 x 20 mL). The combined organic phases were dried over MgSO₄. After concentration under vacuum the crude product was obtained as a colorless oil with solids. Flash column chromatography on silica gel (PE/EtOAc 8:2) gave two diastereoisomers: the first **74R** as a white solid and the second **74S** as a colorless oil.

TLC:

- PE/EtOAc (8:2);
- R_{fR} = 0.18,
- R_{fS} = 0.06

IR [cm⁻¹] ν 2924, 2854 (C-H), 1457, 1372, 1263, 1209, 1161, 1072, 1026, 858 (C-O/C-C, C-N).

1st isomer **74R**:

¹H NMR (400 MHz, CDCl₃), δ 4.70 (dd, 1H, H4, $J_{4,5}$ = 3.6 Hz, $J_{4,3}$ = 6.0 Hz), 4.59 (d, 1H, H3, $J_{3,4}$ = 6.0 Hz), 4.25 (d, 1H, H1_b, $J_{1b,1a}$ = 9.6 Hz), 4.00 (d, 1H, H1_a, $J_{1a,1b}$ = 9.6 Hz), 3.89 (dd, 1H, H5, $J_{5,4}$ = 3.6 Hz, $J_{5,6}$ = 9.2 Hz), 3.55-3.48 (m, 1H, H6), 3.36 (d, 1H, NH, J = 5.2 Hz), 1.82-1.71 (m, 1H, CH₂ nonyl), 1.67-1.49 (m, 2H, CH₂ nonyl), 1.44-1.47 (m, 3H, CH₃iPr), 1.40, 1.38 (s, 3H, CH₃iPr), 1.35-1.20 (m, 25H, CH₃iPr, CH₂nonyl, CH₃tBu), 0.88 (t, 3H, CH₃nonyl, J = 6.6 Hz).

¹³C NMR (100 MHz, CDCl₃), δ 112.78, 111.77, 111.47 (C^{IV}iPr, C2), 85.73 (C3), 82.59 (C5), 79.97 (C4), 69.44 (C1), 56.62 (C6), 56.21 (C^{IV}tBu), 32.05, 30.78, 29.77, 29.56, 29.49, 29.46, 25.46 (CH₂ nonyl), 26.71, 26.46, 26.22, 25.12 (CH₃iPr), 22.84 (CH₃tBu), 14.26 (CH₃ nonyl).

LRMS (ESI)

[M+H]⁺ = 490.5
[M+Na]⁺ = 512.5

Optical rotation

[α]_D²⁵ = -5.4 (c = 1.0; CHCl₃)

Melting point

$T_m = 44-46^\circ\text{C}$

Yield

10 % (19 mg)

2nd isomer 74S:

¹H NMR (400 MHz, CDCl₃), δ 4.89 (dd, 1H, H4, $J_{4,5} = 3.6$ Hz, $J_{4,3} = 6.2$ Hz), 4.59 (d, 1H, H3, $J_{3,4} = 6.2$ Hz), 4.25 (d, 1H, H1_b, $J_{1b,1a} = 9.6$ Hz), 4.11 (d, 1H, H1_a, $J_{1a,1b} = 9.6$ Hz), 3.85 (dd, 1H, H5, $J_{5,4} = 3.6$ Hz, $J_{5,6} = 7.2$ Hz), 3.70 (d, 1H, NH, $J = 7.6$ Hz), 3.64-3.57 (m, 1H, H6), 1.81-1.70 (m, 1H, CH₂ nonyl), 1.69-1.56 (m, 1H, CH₂ nonyl), 1.55-1.51 (m, 2H, CH₂ nonyl), 1.46, 1.45, 1.39 (s, 3H, CH₃iPr), 1.31-1.15 (m, 25H, CH₃iPr, CH₂nonyl, CH₃tBu), 0.88 (t, 3H, CH₃nonyl, $J = 6.8$ Hz).

¹³C NMR (100 MHz, CDCl₃), δ 112.96, 111.78, 111.63 (C^{IV}iPr, C2), 85.46 (C3), 80.38 (C5), 80.23 (C4), 69.41 (C1), 56.21 (C^{IV}tBu), 55.71 (C6), 32.60, 32.02, 29.69, 29.67, 29.42, 25.58, 22.80 (CH₂ nonyl), 26.67, 26.51, 26.12, 24.83 (CH₃iPr), 22.85 (CH₃tBu), 14.24 (CH₃ nonyl).

HRMS (ESI)

[M+H]⁺ calculated for C₂₅H₄₈NO₆S $m/z = 490.319686$; found $m/z = 490.319755$

[M+Na]⁺ calculated for C₂₅H₄₇NNaO₆S $m/z = 512.301630$; found $m/z = 512.301456$

Optical rotation

$[\alpha]_D^{25} = -9.5$ ($c = 1.0$; CHCl₃)

Yield

60 % (113 mg)

6-(*S_R*)-*N*-tert-butanesulfinylamino-6-deoxy-(6*S*)-1,2:3,4-di-*O*-isopropylidene-6-*C*-nonyl- α -L-tagatofuranose **75S** and 6-(*S_R*)-*N*-tert-butanesulfinylamino-6-deoxy-(6*R*)-6-1,2:3,4-di-*O*-isopropylidene-6-*C*-nonyl- α -L-tagatofuranose **75R**

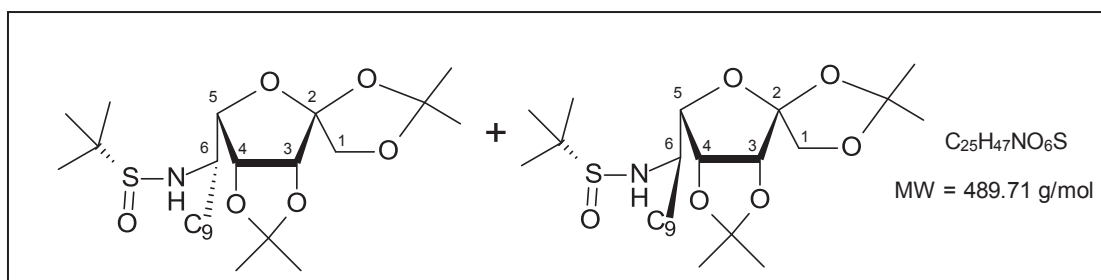

To a solution of sulfinylimine **68** (171 mg, 0.47 mmol) in dry toluene (20 mL) at 0°C, a 1N solution of nonylMgBr in Et₂O (2.40 mL, 2.40 mmol, 5.1 eq) was added dropwise. The reaction was left stirring overnight at RT. Then it was stopped at 0°C with a saturated solution of NH₄Cl (15 mL). The mixture was extracted with Et₂O (3 x 20 mL). The combined organic phases were dried over MgSO₄. After concentration under vacuum the crude product was obtained as a liquid, colorless oil with solids. Flash column chromatography on silica gel (PE/EtOAc 8:2) gave two diastereoisomers **75S** and **75R** as colorless oils and a byproduct **76** as a white solid.

TLC:

- PE/EtOAc (8:2);
- R_{fS} = 0.26,
- R_{fR} = 0.13

1st isomer **75S**:

¹H NMR (400 MHz, CDCl₃), δ 4.94 (dd, 1H, H4, $J_{4,5}$ = 3.6 Hz, $J_{4,3}$ = 5.6 Hz), 4.56 (d, 1H, H3, $J_{3,4}$ = 5.6 Hz), 4.21 (d, 1H, H1_b, $J_{1b,1a}$ = 9.6 Hz), 3.99 (d, 1H, H1_a, $J_{1a,1b}$ = 9.6 Hz), 3.96 (dd, 1H, H5, $J_{5,4}$ = 3.6 Hz, $J_{5,6}$ = 9.2 Hz), 3.68 (d, 1H, NH, J = 5.6 Hz), 3.46-3.39 (m, 1H, H6), 1.84-1.69 (m, 3H, CH₂ nonyl), 1.61-1.48 (m, 1H, CH₂ nonyl), 1.44, 1.41, 1.38 (s, 3H, CH₃iPr), 1.34-1.22 (m, 24H, CH₂ nonyl, CH₃iPr, CH₃tBu), 0.90-0.86 (m, 3H, CH₃-nonyl).

¹³C NMR (100 MHz, CDCl₃), δ 112.48, 111.91, 111.67 (C^{IV}iPr, C2), 85.11 (C3), 81.85 (C5), 80.41 (C4), 69.50 (C1), 56.07 (C6), 55.99 (C^{IV}tBu), 32.03, 31.77, 29.70, 29.63, 29.44, 25.78, 22.82 (CH₂ nonyl), 26.68, 26.57, 26.22, 24.89 (CH₃iPr), 22.80 (CH₃tBu), 14.25 (CH₃ nonyl).

HRMS (ESI)

[M+H]⁺ calculated for C₂₅H₄₈NO₆S m/z = 490.319686; found m/z = 490.319736

[M+Na]⁺ calculated for C₂₅H₄₇NNaO₆S m/z = 512.301630; found m/z = 512.301462

Optical rotation

$[\alpha]_D^{25}$ = -53.0 (c = 1.0; CHCl₃)

Yield

32 % (74 mg)

2nd isomer 75R:

¹H NMR (400 MHz, CDCl₃), δ 4.77 (dd, 1H, H4, $J_{4,5}$ = 3.2 Hz, $J_{4,3}$ = 5.6 Hz), 4.61 (d, 1H, H3, $J_{3,4}$ = 5.6 Hz), 4.25 (d, 1H, H1_b, $J_{1b,1a}$ = 9.6 Hz), 4.05 (d, 1H, H1_a, $J_{1a,1b}$ = 9.6 Hz), 3.92 (dd, 1H, H5, $J_{5,4}$ = 3.2 Hz, $J_{5,6}$ = 8.4 Hz), 3.78 (d, 1H, NH, J = 3.2 Hz), 3.72-3.67 (m, 1H, H6), 1.87-1.76 (m, 1H, CH₂ nonyl), 1.74-1.63 (m, 1H, CH₂ nonyl), 1.45, 1.41, 1.40 (s, 3H, CH₃iPr), 1.29-1.20 (m, 26H, CH₃iPr, CH₂nonyl, CH₃tBu), 0.94-0.84 (m, 3H, CH₃nonyl).

¹³C NMR (100 MHz, CDCl₃), δ 113.05, 111.71, 111.55 (C^{IV}iPr, C2), 85.66 (C3), 80.38 (C5), 79.96 (C4), 69.42 (C1), 55.67 (C^{IV}tBu), 53.30 (C6), 32.01, 29.97, 29.89, 29.65, 29.61, 29.42, 24.46, 22.79 (CH₂ nonyl), 26.64, 26.44, 26.18, 24.94 (CH₃iPr), 22.77 (CH₃tBu), 14.22 (CH₃ nonyl).

HRMS (ESI)

[M+H]⁺ calculated for C₂₅H₄₈NO₆S m/z = 490.319686; found m/z = 490.319794

[M+Na]⁺ calculated for C₂₅H₄₇NNaO₆S m/z = 512.301630; found m/z = 512.301529

Optical rotation

[α]_D²⁵ = -64.4 (c= 1.0; CHCl₃)

Yield

29 % (68 mg)

3rd product: 76

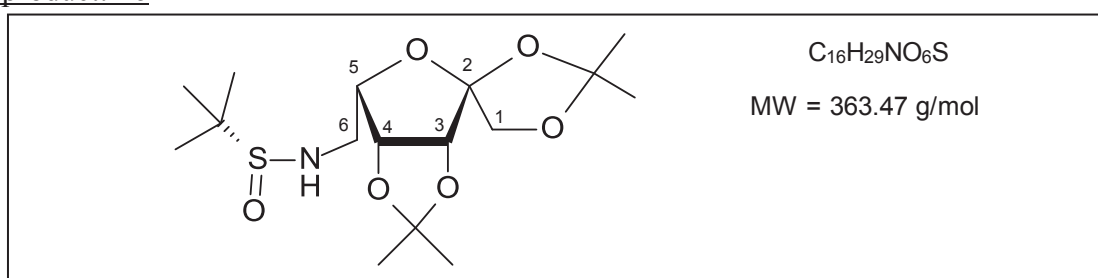

TLC:

- PE/EtOAc (8:2);
- R_f = 0.05

¹H NMR (400 MHz, CDCl₃), δ 4.80 (dd, 1H, H4, $J_{4,5}$ = 4.0 Hz, $J_{4,3}$ = 6.0 Hz), 4.60 (d, 1H, H3, $J_{3,4}$ = 6.0 Hz), 4.24 (d, 1H, H1_b, $J_{1b,1a}$ = 9.9 Hz), 4.17-4.12 (m, 1H, H5), 4.02 (d, 1H, H1_a, $J_{1a,1b}$ = 9.9 Hz), 3.55 (t, 1H, NH, J =6.4 Hz), 3.53-3.46 (m, 1H, H6_b), 3.39-3.23 (m, 1H, H6_a), 1.45, 1.41, 1.39, 1.30 (s, 3H, CH₃iPr), 1.22 (s, 9H, CH₃tBu).

¹³C NMR (100 MHz, CDCl₃), δ 112.98, 111.96, 111.79 (C^{IV}iPr, C2), 85.40 (C3), 80.19 (C4), 78.72 (C5), 69.41 (C1), 55.96 (C^{IV}tBu), 44.96 (C6), 26.78, 26.56, 26.16, 24.96 (CH₃iPr), 22.67 (CH₃tBu).

LRMS (ESI)

[M+H]⁺ = 364.5

[M+Na]⁺ = 386.0

Melting point

$T_m = 112-114^\circ\text{C}$

Yield

24% (41 mg)

(6*R**)-6-C-Allyl-6-amino-6-deoxy-1,2:3,4-di-*O*-isopropylidene- α -L-tagatofuranose **77**

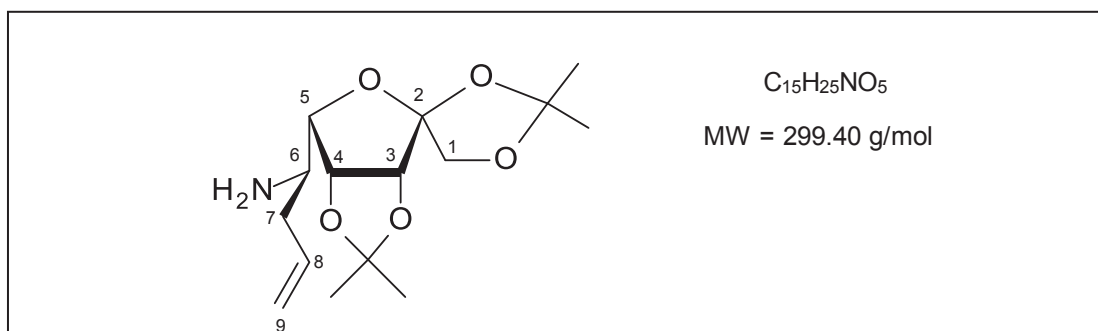

A solution of acetyl chloride (100 μ L, 1.40 mmol, 5 eq) in dry MeOH (4.3 mL) was left stirring for 30 min. Then it was added to **70** (113 mg, 0.28 mmol) and the suspension was left stirring for 20 min. The reaction was stopped with amberlite IRA400 resin (OH⁻) until basic pH. The resin was filtered, washed with MeOH and the filtrate was concentrated under vacuum to give crude **77** as a yellowish oil, which was used in the next step without purification.

TLC:

- MeOH/CH₂Cl₂ (9:1);
- R_f = 0.59.

¹H NMR (250 MHz, CD₃OD), δ 5.98-5.78 (m, 1H, H8), 5.20-5.12 (m, 2H, 2H9), 4.88 (dd, 1H, H4, $J_{4,5}$ = 3.6 Hz, $J_{4,3}$ = 5.8 Hz), 4.63 (d, 1H, H3, $J_{3,4}$ = 5.8 Hz), 4.21 (d, 1H, H1_b, $J_{1b,1a}$ = 9.5 Hz), 3.99 (d, 1H, H1_a, $J_{1a,1b}$ = 9.5 Hz), 3.72 (dd, 1H, H5, $J_{5,4}$ = 3.6 Hz, $J_{5,6}$ = 8.4 Hz), 3.15 (dt, 1H, H6, $J_{6,7}$ = 4.0 Hz, $J_{6,7}$ = 8.4 Hz, $J_{6,5}$ = 8.4 Hz), 2.58-2.44 (m, 1H, H7_b), 2.27-2.15 (m, 1H, H7_a), 1.43, 1.41, 1.37, 1.33 (s, 3H, CH₃iPr).

¹³C NMR (100 MHz, CD₃OD), δ 135.42 (C8), 118.79 (C9), 113.94, 113.04, 112.84 (C^{iV}iPr, C2), 86.56 (C3), 82.47 (C5), 81.18 (C4), 70.31 (C1), 50.74 (C6), 38.81 (C7), 26.81, 26.78, 26.27, 24.86 (CH₃iPr).

LRMS (ESI)

[M+H]⁺ = 300.0

*Note:

This configuration was determined on the basis of the NMR spectra comparison with hexyl analogues **79** and **80**, and may be inverted.

(6S)-6-Amino-6-deoxy-6-C-Hexyl-1,2:3,4-di-O-isopropylidene- α -L-tagatofuranose **79**

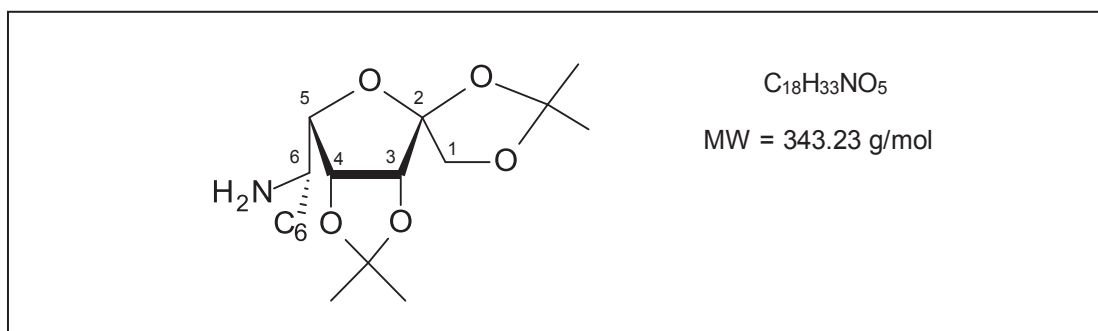

A solution of acetyl chloride (116 μ L, 1.62 mmol, 5 eq) in dry MeOH (4.9 mL) was left stirring for 30 min. Then it was added to **72S** (145 mg, 0.32 mmol) and the suspension was left stirring for 20 min. The reaction was stopped with amberlite IRA400 resin (OH⁻) until basic pH. The resin was filtered, washed with MeOH and the filtrate was concentrated under vacuum to give crude **79** as an orange oil, which was used in the next step without purification.

TLC:

- MeOH/CH₂Cl₂ (9:1);
- R_f = 0.46.

¹H NMR (400 MHz, CD₃OD), δ 5.01 (dd, 1H, H4, $J_{4,5}$ = 3.4 Hz, $J_{4,3}$ = 5.8 Hz), 4.70 (d, 1H, H3, $J_{3,4}$ = 5.8 Hz), 4.24 (d, 1H, H1_b, $J_{1b,1a}$ = 9.6 Hz), 4.12 (d, 1H, H1_a, $J_{1a,1b}$ = 9.6 Hz), 4.09 (dd, 1H, H5, $J_{5,4}$ = 3.4 Hz, $J_{5,6}$ = 5.6 Hz), 3.60-3.56 (m, 1H, H6), 1.93-1.73 (m, 2H, CH₂-hexyl), 1.60-1.20 (m, 8H, CH₂-hexyl), 1.47, 1.44, 1.39, 1.34 (s, 3H, CH₃iPr), 0.98-0.83 (m, 3H, CH₃-hexyl).

¹³C NMR (100 MHz, CD₃OD), δ 114.62, 113.40, 113.12 (C^{IV}iPr, C2), 86.44 (C3), 80.90 (C4), 77.77 (C5), 70.18 (C1), 52.34 (C6), 32.65, 30.86, 30.21, 26.50, 23.59 (CH₂-hexyl), 26.88, 26.59, 25.95, 24.20 (CH₃iPr), 14.37 (CH₃-hexyl).

HRMS (ESI)

[M+H]⁺ calculated for C₁₈H₃₄NO₅ m/z = 344.243150; found m/z = 344.243334

(6*R*)-6-Amino-6-deoxy-6-*C*-Hexyl-1,2:3,4-di-*O*-isopropylidene- α -L-tagatofuranose **80**

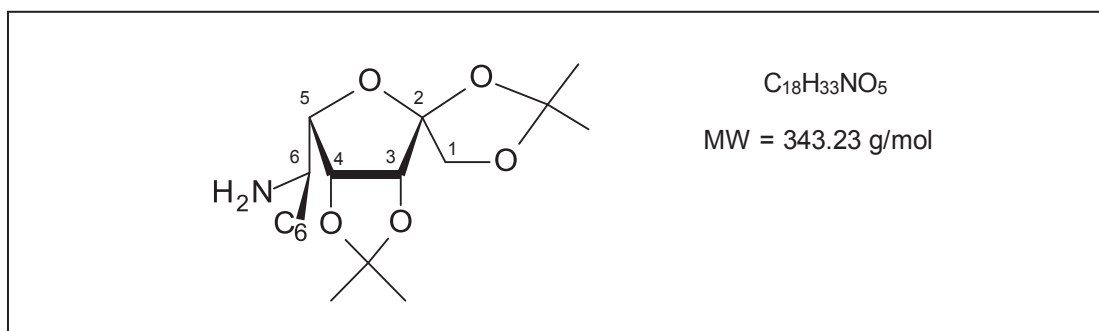

A solution of acetyl chloride (114 μ L, 1.60 mmol, 5 eq) in dry MeOH (5.3 mL) was left stirring for 30 min. Then it was added to **73R** (143 mg, 0.32 mmol) and the suspension was left stirring for 20 min. The reaction was stopped with amberlite IRA400 resin (OH⁻) until basic pH. The resin was filtered, washed with MeOH and the filtrate was concentrated under vacuum to give crude **80** as a brownish oil, which was used in the next step without purification.

TLC:

- MeOH/CH₂Cl₂ (9:1);
- R_f = 0.45.

¹H NMR (400 MHz, CD₃OD), δ 4.96 (dd, 1H, H4, $J_{4,5}$ = 3.6 Hz, $J_{4,3}$ = 5.6 Hz), 4.71 (d, 1H, H3, $J_{3,4}$ = 5.6 Hz), 4.25 (d, 1H, H1_b, $J_{1b,1a}$ = 9.8 Hz), 4.09 (d, 1H, H1_a, $J_{1a,1b}$ = 9.8 Hz), 4.00 (dd, 1H, H5, $J_{5,4}$ = 3.6 Hz, $J_{5,6}$ = 8.0 Hz), 3.50 (dt, 1H, H6, $J_{6,7}$ = 4.8 Hz, $J_{6,5}$ = 8.0 Hz), 1.86-1.61 (m, 2H, \underline{CH}_2 -hexyl), 1.60-1.24 (m, 8H, \underline{CH}_2 -hexyl), 1.47, 1.44, 1.39, 1.34 (s, 3H, \underline{CH}_3 iPr), 0.96-0.83 (m, 3H, \underline{CH}_3 -hexyl).

¹³C NMR (100 MHz, CD₃OD), δ 114.43, 113.47, 113.09 (C^{IV}iPr, C2), 86.72 (C3), 81.03 (C4), 79.22 (C5), 70.18 (C1), 52.40 (C6), 32.53, 30.80, 30.01, 25.85, 23.57 (\underline{CH}_2 -hexyl), 26.88, 26.58, 26.14, 24.61 (\underline{CH}_3 iPr), 14.37 (\underline{CH}_3 -hexyl).

HRMS (ESI)

[M+H]⁺ calculated for C₁₈H₃₄NO₅ m/z = 344.243150; found m/z = 344.243475

(6S)-6-Amino-6-deoxy-6-C-Nonyl-1,2:3,4-di-O-isopropylidene- α -L-tagatofuranose **81**

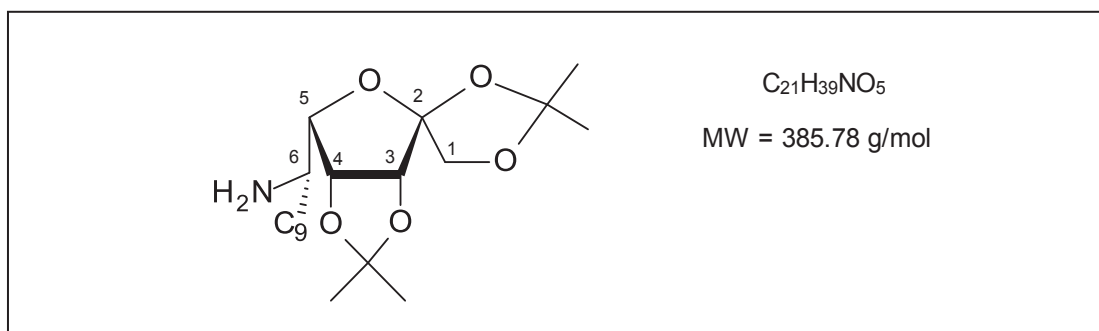

A solution of acetyl chloride (82 μ L, 1.15 mmol, 5 eq) in dry MeOH (3.5 mL) was left stirring for 30 min. Then it was added to **74S** (113 mg, 0.23 mmol) and the suspension was left stirring for 20 min. The reaction was stopped with amberlite IRA400 resin (OH⁻) until basic pH. The resin was filtered, washed with MeOH and the filtrate was concentrated under vacuum to give crude **81** as a brown solid, which was used in the next step without purification.

TLC:

- MeOH/CH₂Cl₂ (9:1);
- R_f= 0.54.

¹H NMR (250 MHz, CD₃OD), δ 4.89 (dd, 1H, H4, $J_{4,5}$ = 3.75 Hz, $J_{4,3}$ = 6.0 Hz), 4.62 (d, 1H, H3, $J_{3,4}$ = 6.0 Hz), 4.21 (d, 1H, H1_b, $J_{1b,1a}$ = 9.75 Hz), 3.99 (d, 1H, H1_a, $J_{1a,1b}$ = 9.75 Hz), 3.73 (dd, 1H, H5, $J_{5,4}$ =3.75 Hz, $J_{5,6}$ = 8.25 Hz), 3.16-3.04 (m, 1H, H6), 1.78-1.60 (m, 1H, CH₂-nonyl), 1.60-1.15 (m, 15H, CH₂-nonyl), 1.43, 1.41, 1.37, 1.33 (s, 3H, CH₃iPr), 0.90 (t, 3H, CH₃-nonyl, J = 6.5 Hz).

¹³C NMR (62.5 MHz, CD₃OD), δ 113.89, 113.02, 112.79 (C^{IV}iPr, C2), 86.51 (C3), 82.76 (C5), 81.32 (C4), 70.31 (C1), 51.38 (C6), 34.43, 33.05, 30.92, 30.68, 30.65, 30.45, 26.36, 23.74 (CH₂-nonyl), 26.85, 26.83, 26.30, 24.87 (CH₃iPr), 14.49 (CH₃-nonyl).

HRMS (ESI)

[M+H]⁺ calculated for C₂₁H₄₀NO₅ m/z = 386.290100; found m/z = 386.290223

(6R)-6-Amino-6-deoxy-6-C-Nonyl-1,2:3,4-di-O-isopropylidene- α -L-tagatofuranose **82**

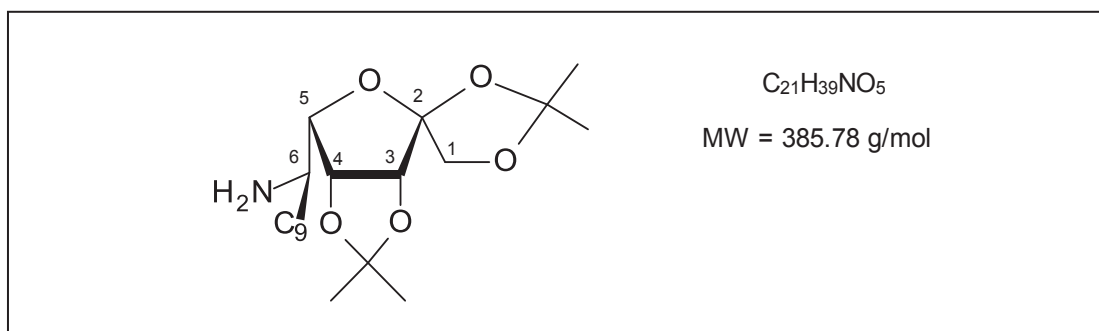

A solution of acetyl chloride (50 μ L, 0.69 mmol, 5 eq) in dry MeOH (2.1 mL) was left stirring for 30 min. Then it was added to **75R** (68 mg, 0.14 mmol), and the suspension was left stirring for 20 min. The reaction was stopped with amberlite IRA400 resin (OH⁻) until basic pH. The resin was filtered, washed with MeOH and the filtrate was concentrated under vacuum to give crude **82** as a yellow solid, which was used in the next step without purification.

TLC:

- MeOH/CH₂Cl₂ (9:1);
- R_f = 0.51.

¹H NMR (250 MHz, CD₃OD), δ 4.94 (dd, 1H, H4, $J_{4,5}$ = 3.5 Hz, $J_{4,3}$ = 5.8 Hz), 4.70 (d, 1H, H3, $J_{3,4}$ = 5.8 Hz), 4.25 (d, 1H, H1_b, $J_{1b,1a}$ = 9.8 Hz), 4.08 (d, 1H, H1_a, $J_{1a,1b}$ = 9.8 Hz), 3.96 (dd, 1H, H5, $J_{5,4}$ = 3.5 Hz, $J_{5,6}$ = 7.8 Hz), 3.50 (dt, 1H, H6, $J_{6,7}$ = 5.0 Hz, $J_{6,7} = J_{6,5} = 7.8$ Hz), 1.85-1.53 (m, 2H, CH₂-nonyl), 1.53-1.21 (m, 14H, CH₂-nonyl), 1.46, 1.43, 1.39, 1.33 (s, 3H, CH₃iPr), 0.90 (t, 3H, CH₃-nonyl, J = 6.5 Hz).

¹³C NMR (62.5 MHz, CD₃OD), δ 114.34, 113.39, 113.08 (C^{IV}iPr, C2), 86.78 (C4), 81.05 (C3), 79.77 (C5), 70.23 (C1), 52.27 (C6), 33.04, 31.08, 30.61, 30.42, 30.40, 30.36, 26.17, 23.72 (CH₂-nonyl), 26.91, 26.60, 25.96, 24.64 (CH₃iPr), 14.44 (CH₃-nonyl).

HRMS (ESI)

[M+H]⁺ calculated for C₂₁H₄₀NO₅ m/z = 386.290100; found m/z = 386.290210

(6S)-6-Azido-6-deoxy-6-C-hexyl-1,2:3,4-di-O-isopropylidene- α -L-tagatofuranose **83**

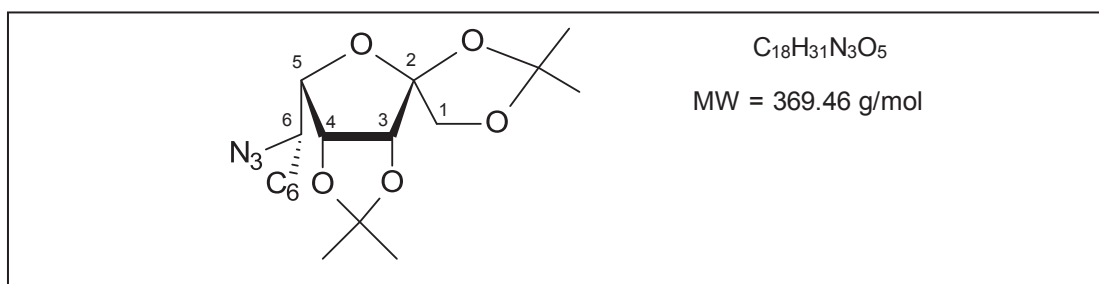

A stock solution of TfN₃ in toluene (around 0.5 M) was prepared according to Ernst protocol.²²⁵ To crude **79** (0.32 mmol), NaHCO₃ (107 mg, 1.28 mmol, 4 eq), CuSO₄·5H₂O (3.2 mg, 0.013 mmol, 0.04 eq) and 0.5 mL of water were added. Then MeOH (2.7 mL) and stock solution of TfN₃ (505 μL) were added. The reaction was left stirring overnight. After concentration under vacuum, the crude product was obtained as a brown oil with solids. Flash column chromatography on silica gel (PE/EtOAc 9:1) gave pure **83** as a colorless oil.

TLC:

- PE/EtOAc (9:1);
- R_f = 0.59.

¹H NMR (400 MHz, CDCl₃), δ 4.82 (dd, 1H, H4, *J*_{4,5} = 3.6 Hz, *J*_{4,3} = 6.0 Hz), 4.60 (d, 1H, H3, *J*_{3,4} = 6.0 Hz), 4.23 (d, 1H, H1_b, *J*_{1b,1a} = 9.8 Hz), 4.01 (d, 1H, H1_a, *J*_{1a,1b} = 9.8 Hz), 3.72 (dd, 1H, H5, *J*_{5,4} = 3.6 Hz, *J*_{5,6} = 9.2 Hz), 3.62 (dt, 1H, H6, *J*_{6,7} = 2.8 Hz, *J*_{6,5} = 9.2 Hz), 1.88-1.76 (m, 1H, CH₂-hexyl), 1.59-1.47 (m, 2H, CH₂-hexyl), 1.47-1.24 (m, 7H, CH₂-hexyl), 1.44, 1.43, 1.39, 1.33 (s, 3H, CH₃iPr), 0.89 (t, 3H, CH₃-hexyl, *J* = 6.6 Hz).

¹³C NMR (100 MHz, CDCl₃), δ 112.95, 111.95, 111.85 (C^{IV}iPr, C2), 85.10 (C3), 80.17, 80.02 (C4, C5), 69.54 (C1), 60.49 (C6), 31.89, 31.19, 29.28, 25.54, 22.69 (CH₂-hexyl), 26.63, 26.52, 26.16, 25.04 (CH₃iPr), 14.18 (CH₃-hexyl).

HRMS (ESI)

[M+Na]⁺ calculated for C₁₈H₃₁N₃NaO₅ *m/z* = 392.215592; found *m/z* = 392.215584

Yield

83% (100 mg) for two steps, from **72S**

²²⁵ Titz, A.; Radic, Z.; Schwardt, O.; Ernst, B. *Tetrahedron Lett* **2006**, 47, 2383.

(6*R*)-6-Azido-6-deoxy-6-*C*-hexyl-1,2:3,4-di-*O*-isopropylidene- α -L-tagatofuranose **84**

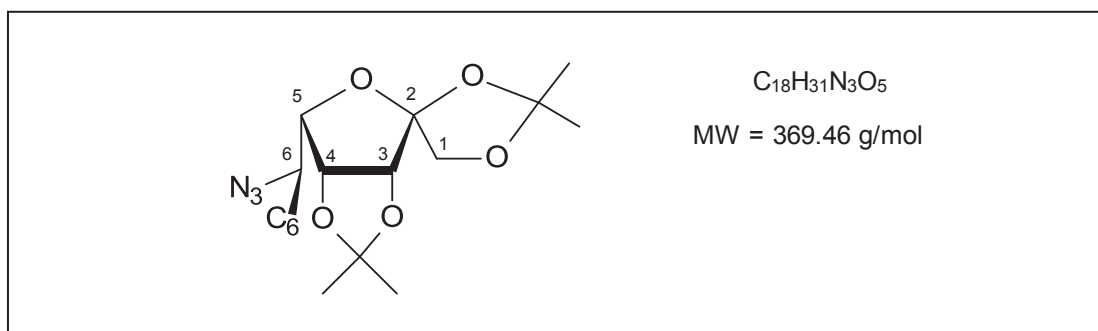

A stock solution of TfN₃ in toluene (around 0.5 M) was prepared according to Ernst protocol.²²⁵ To crude **80** (0.32 mmol) NaHCO₃ (108 mg, 1.28 mmol, 4 eq), CuSO₄·5H₂O (3.2 mg, 0.0128 mmol, 0.04 eq) and 0.5 mL of water were added. Then MeOH (2.7 mL) and a stock solution of TfN₃ (770 μ L) were added. The reaction was left stirring overnight. After concentration under vacuum, the crude product was obtained as a green oil. Flash column chromatography on silica gel (PE/EtOAc 9:1) gave pure **84** as a colorless oil.

TLC:

- PE/EtOAc (9:1);
- R_f = 0.50.

¹H NMR (400 MHz, CDCl₃), δ 4.70 (dd, 1H, H4, $J_{4,5}$ = 3.6 Hz, $J_{4,3}$ = 6.0 Hz), 4.60 (d, 1H, H3, $J_{3,4}$ = 6.0 Hz), 4.28 (d, 1H, H1_b, $J_{1b,1a}$ = 9.6 Hz), 4.07 (d, 1H, H1_a, $J_{1a,1b}$ = 9.6 Hz), 3.90 (dd, 1H, H5, $J_{5,4}$ = 3.6 Hz, $J_{5,6}$ = 9.2 Hz), 3.64-3.56 (m, 1H, H6), 1.69-1.55 (m, 1H, $\underline{\text{CH}}_2$ -hexyl), 1.55-1.21 (m, 9H, $\underline{\text{CH}}_2$ -hexyl), 1.50, 1.42, 1.41, 1.30 (s, 3H, $\underline{\text{CH}}_3$ iPr), 0.89 (t, 3H, $\underline{\text{CH}}_3$ -hexyl, J = 6.4 Hz).

¹³C NMR (100 MHz, CDCl₃), δ 112.97, 111.95, 111.72 (C^{IV}iPr, C2), 85.47 (C3), 82.14 (C5), 79.93 (C4), 69.46 (C1), 61.80 (C6), 31.75, 30.40, 29.00, 25.85, 22.71 ($\underline{\text{CH}}_2$ -hexyl), 26.76, 26.16, 25.06 ($\underline{\text{CH}}_3$ iPr), 14.19 ($\underline{\text{CH}}_3$ -hexyl).

HRMS (ESI)

[M+H]⁺ calculated for C₁₈H₃₂N₃O₅ m/z = 370.233648; found m/z = 370.233650

[M+NH₄]⁺ calculated for C₁₈H₃₅N₄O₅ m/z = 387.260197; found m/z = 387.260265

[M+Na]⁺ calculated for C₁₈H₃₁N₃NaO₅ m/z = 392.215592; found m/z = 392.215360

Optical rotation

$[\alpha]_D^{25}$ = -21.8 (c = 1.5; CHCl₃)

IR [cm⁻¹] ν 2989, 2931, 2859 (C-H), 2098 (N₃), 1381, 1372, 1263, 1209, 1075, 1029 (C-O/C-C).

Yield

85% (100 mg) for two steps, from **73R**

²²⁵ Titz, A.; Radic, Z.; Schwardt, O.; Ernst, B. *Tetrahedron Lett* **2006**, 47, 2383.

(6S)- 6-Azido-6-deoxy-6-C-nonyl-1,2:3,4-di-O-isopropylidene- α -L-tagatofuranose **85**

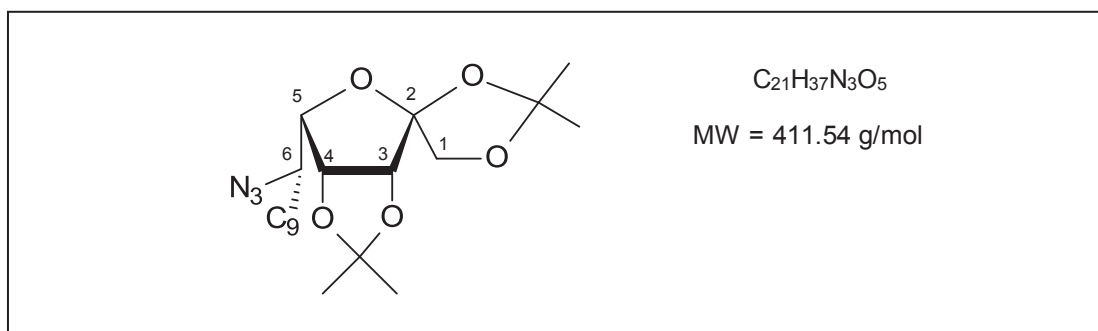

A stock solution of TfN₃ in toluene (around 0.5 M) was prepared according to Ernst protocol.²²⁵ To crude **81** (0.23 mmol) NaHCO₃ (77 mg, 0.92 mmol, 4 eq), CuSO₄·5H₂O (2.3 mg, 0.0092 mmol, 0.04 eq) and 0.5 mL of water were added. Then MeOH (1.9 mL) and A stock solution of TfN₃ (533 μ L) were added. The reaction was left stirring overnight. After concentration under vacuum the crude product was obtained as a brownish oil with solids. Flash column chromatography on silica gel (PE/EtOAc 9:1) gave pure **85** as a colorless oil.

TLC:

- PE/EtOAc (9:1);
- R_f = 0.68.

¹H NMR (250 MHz, CDCl₃), δ 4.82 (dd, 1H, H4, $J_{4,5}$ = 3.3 Hz, $J_{4,3}$ = 5.8 Hz), 4.60 (d, 1H, H3, $J_{3,4}$ = 5.8 Hz), 4.23 (d, 1H, H1_b, $J_{1b,1a}$ = 9.8 Hz), 4.01 (d, 1H, H1_a, $J_{1a,1b}$ = 9.8 Hz), 3.73 (dd, 1H, H5, $J_{5,4}$ = 3.3 Hz, $J_{5,6}$ = 9.8 Hz), 3.66-3.57 (m, 1H, H6), 1.88-1.76 (m, 1H, CH₂-nonyl), 1.64-1.10 (m, 15H, CH₂-nonyl), 1.44, 1.43, 1.39, 1.33 (s, 3H, CH₃iPr), 0.88 (t, 3H, CH₃-nonyl, J = 6.6 Hz).

¹³C NMR (62.5 MHz, CDCl₃), δ 112.96, 111.95, 111.86 (C^{IV}iPr, C2), 85.09 (C3), 80.17, 80.02 (C4, C5), 69.54 (C1), 60.49 (C6), 32.02, 31.87, 29.70, 29.65, 29.62, 29.43, 25.59, 22.82 (CH₂-nonyl), 26.64, 26.54, 26.17, 25.04 (CH₃iPr), 14.25 (CH₃-nonyl).

HRMS (ESI)

[M+Na]⁺ calculated for C₂₁H₃₇N₃NaO₅ m/z = 434.262542; found m/z = 434.262558

IR [cm⁻¹] ν 2990, 2926, 2855 (C-H), 2100 (N₃), 1457, 1381, 1372 (C-H), 1263, 1209, 1161, 1080, 1030 (C-O/C-C/C-N).

Yield

68% (64 mg) for two steps, from **74S**

²²⁵ Titz, A.; Radic, Z.; Schwardt, O.; Ernst, B. *Tetrahedron Lett* **2006**, 47, 2383.

(6R)- 6-Azido-6-deoxy-6-C-nonyl-1,2:3,4-di-O-isopropylidene- α -L-tagatofuranose **86**

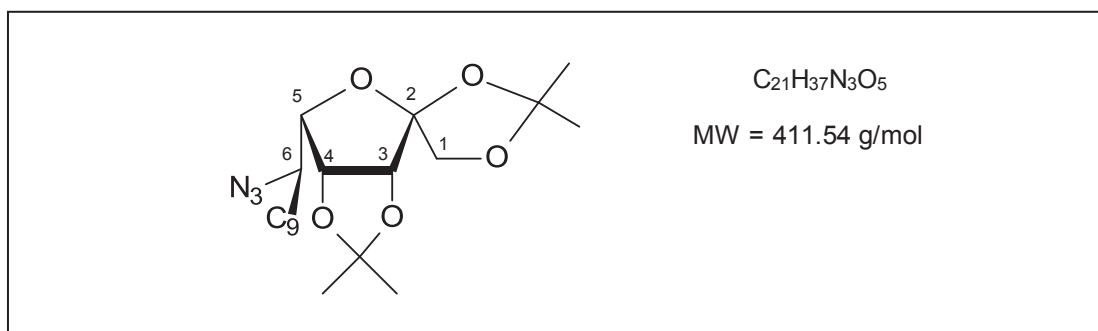

A stock solution of TfN₃ in toluene (around 0.5 M) was prepared according to Ernst protocol.²²⁵ To crude **82** (0.14 mmol) NaHCO₃ (47 mg, 0.56 mmol, 4 eq), CuSO₄·5H₂O (1.4 mg, 0.0056 mmol, 0.04 eq) and 0.5 mL of water were added. Then MeOH (1.1 mL) and a stock solution of TfN₃ (337 μ L) were added. The reaction was left stirring overnight. After concentration under vacuum, the crude product was obtained as a brownish oil with solids. Flash column chromatography on silica gel (PE/EtOAc 9:1) gave pure **86** as a white solid.

TLC:

- PE/EtOAc (9:1);
- R_f = 0.59.

¹H NMR (400 MHz, CDCl₃), δ 4.70 (dd, 1H, H4, $J_{4,5}$ = 3.6 Hz, $J_{4,3}$ = 5.6 Hz), 4.60 (d, 1H, H3, $J_{3,4}$ = 5.6 Hz), 4.28 (d, 1H, H1_b, $J_{1b,1a}$ = 9.6 Hz), 4.07 (d, 1H, H1_a, $J_{1a,1b}$ = 9.6 Hz), 3.90 (dd, 1H, H5, $J_{5,4}$ = 3.6 Hz, $J_{5,6}$ = 9.2 Hz), 3.60 (dt, 1H, H6, $J_{6,7}$ = 2.8 Hz, $J_{6,7} = J_{6,5}$ = 9.2 Hz), 1.68-1.55 (m, 1H, \underline{CH}_2 -nonyl), 1.55-1.20 (m, 15H, \underline{CH}_2 -nonyl), 1.50, 1.42, 1.41, 1.30 (s, 3H, \underline{CH}_3 iPr), 0.88 (t, 3H, \underline{CH}_3 -nonyl, J = 6.8 Hz).

¹³C NMR (100 MHz, CDCl₃), δ 112.99, 111.97, 111.73 (C^{IV}iPr, C2), 85.48 (C3), 82.15 (C5), 79.94 (C4), 69.47 (C1), 61.82 (C6), 32.03, 30.42, 29.68, 29.57, 29.46, 29.37, 25.90, 22.82, (\underline{CH}_2 -nonyl), 26.78, 26.18, 25.09 (\underline{CH}_3 iPr), 14.25 (\underline{CH}_3 -nonyl).

HRMS (ESI)

[M+NH₄]⁺ calculated for C₂₁H₄₁N₄O₅ m/z = 429.307147; found m/z = 429.307176

[M+Na]⁺ calculated for C₂₁H₃₇N₃NaO₅ m/z = 434.262542; found m/z = 434.262603

Yield

61% (35 mg) for two steps, from **75R**

²²⁵ Titz, A.; Radic, Z.; Schwardt, O.; Ernst, B. *Tetrahedron Lett* **2006**, 47, 2383.

(6S)-6-Azido-6-deoxy-6-C-hexyl- α,β -L-tagatofuranose **87**

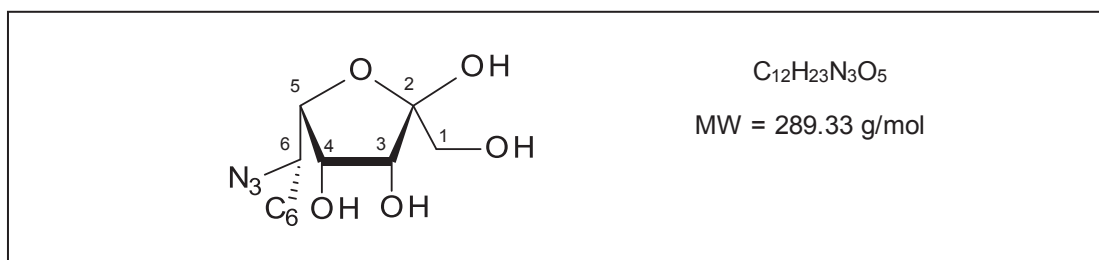

To a solution of the azide **83** (50 mg, 0.14 mmol) in a mixture of acetonitrile/water (1:1) (5.6 mL) resin Dowex 50WX8 (H^+) (750 mg) was added. The reaction was left stirring at $85^\circ C$ for 48h. The resin was filtered, washed with acetonitrile/water (1:1) and the filtrate was concentrated under vacuum to give crude product as a brownish solid. Flash column chromatography on silica gel (MeOH/ CH_2Cl_2 9:1) gave pure **87** as a colorless oil and as a mixture of anomers (7:3).

TLC:

- MeOH/ CH_2Cl_2 (9:1);
- $R_f = 0.28$.

1H NMR (400 MHz, CD_3OD), δ 4.21-4.17 (m, 1H, H_{4MAJ} , H_{3min}), 4.15-4.12 (m, 1H, H_{3MAJ} , H_{4min}), 3.81 (dd, 0.3H, H_{5min} , $J_{5,4} = 3.0$ Hz, $J_{5,6} = 9.4$ Hz), 3.76-3.68 (m, 0.7H, H_{6MAJ}), 3.68-3.62 (m, 1.3H, $H_{1b min}$, H_{5MAJ} , H_{6min}), 3.52-3.42 (m, 1.7H, $2H_{1MAJ}$, $H_{1a min}$), 1.96-1.80 (m, 1H, \underline{CH}_2 -hexyl), 1.62-1.49 (m, 1H, \underline{CH}_2 -hexyl), 1.49-1.24 (m, 8H, \underline{CH}_2 -hexyl), 0.97-0.84 (m, 3H, CH_3 -hexyl).

^{13}C NMR (100 MHz, CD_3OD), δ 106.73 (C_{2min}), 104.41(C_{2MAJ}), 82.34 (C_{5MAJ}), 81.39 (C_{5min}), 80.34 (C_{3min}), 73.39 (C_{4min}), 73.11 (C_{4MAJ}), 71.99 (C_{3MAJ}), 63.96 (C_{1min}), 63.76 (C_{1MAJ}), 63.17 (C_{6MAJ}), 62.27 (C_{6min}), 32.93, 32.63, 30.30, 30.27, 26.97, 26.82, 23.65 (\underline{CH}_2 -hexyl), 14.40 (\underline{CH}_3 -hexyl).

HRMS (ESI)

$[M+Na]^+$ calculated for $C_{12}H_{23}N_3NaO_5$ $m/z = 312.152992$; found $m/z = 312.153129$

Yield

61% (24 mg)

(6R)-6-Azido-6-deoxy-6-C-hexyl- α,β -L-tagatofuranose **88**

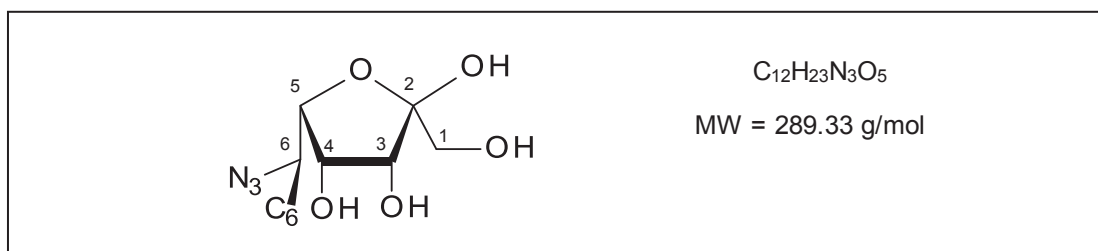

To a solution of the azide **84** (100 mg, 0.27 mmol) in a mixture of acetonitrile/water (1:1) (11 mL) resin Dowex 50WX8 (H^+) (1.94 mg) was added. The reaction was left stirring at 60°C for 4 days. The resin was filtered, washed with acetonitrile/water (1:1) and the filtrate was concentrated under vacuum to give crude product as a brownish solid. Flash column chromatography on silica gel (MeOH/ CH_2Cl_2 9:1) gave pure **88** as colorless oil and a mixture of anomers (7:3).

TLC:

- MeOH/ CH_2Cl_2 (9:1);
- R_f = 0.22.

1H NMR (400 MHz, CD_3OD), δ 4.17 (d, 0.3H, $H_{3_{min}}$, $J_{3,4}$ = 3.2 Hz), 4.16 (d, 0.7H, $H_{3_{MAJ}}$, $J_{3,4}$ = 3.2 Hz), 4.10 (t, 0.7H, $H_{4_{MAJ}}$, $J_{4,5}$ = 3.6 Hz, $J_{4,3}$ = 3.2 Hz), 4.07 (dd, 0.3H, $H_{4_{min}}$, $J_{4,5}$ = 3.6 Hz, $J_{4,3}$ = 3.2 Hz), 3.99 (dd, 0.3H, $H_{5_{min}}$, $J_{5,4}$ = 3.6 Hz, $J_{5,6}$ = 8.6 Hz), 3.80 (dd, 0.7H, $H_{5_{MAJ}}$, $J_{5,4}$ = 3.6 Hz, $J_{5,6}$ = 9.4 Hz), 3.71-3.66 (m, 1H, $H_{6_{MAJ}}$, $H_{1_{b_{min}}}$), 3.61-3.56 (m, 0.3H, $H_{6_{min}}$), 3.54 (br s, 0.3H, $H_{1_{a_{min}}}$), 3.51 (br s, 1.4H, $2H_{1_{MAJ}}$), 1.71-1.59 (m, 1H, $\underline{CH_2}$ -hexyl), 1.59-1.22 (m, 9H, $\underline{CH_2}$ -hexyl), 0.96-0.86 (m, 3H, $\underline{CH_3}$ -hexyl).

^{13}C NMR (100 MHz, CD_3OD), δ 106.56 ($C_{2_{min}}$), 104.22 ($C_{2_{MAJ}}$), 84.20 ($C_{5_{MAJ}}$), 83.19 ($C_{5_{min}}$), 80.17 ($C_{3_{min}}$), 73.30 ($C_{4_{min}}$), 73.01 ($C_{4_{MAJ}}$), 72.03 ($C_{3_{MAJ}}$), 65.76 ($C_{6_{MAJ}}$), 64.08 ($C_{6_{min}}$), 63.94 ($C_{1_{min}}$), 63.74 ($C_{1_{MAJ}}$), 32.85, 31.50, 31.26, 30.08, 27.10, 27.08, 23.63, ($\underline{CH_2}$ -hexyl), 14.39 ($\underline{CH_3}$ -hexyl).

HRMS (ESI)

$[M+Na]^+$ calculated for $C_{12}H_{23}N_3NaO_5$ m/z = 312.152992; found m/z = 312.153197

IR [cm^{-1}] ν 3362 (O-H), 2927, 2858 (C-H), 2100 (N_3), 1457, 1262, 1137, 1044 (C-O/C-C).

Yield

78% (61 mg)

(1S)-1-C-Hexyl-1,5-dideoxy-1,5-imino-D-galactitol **89**
(1S)-1-C-Hexyl-N-methyl-1,5-dideoxy-1,5-imino-D-galactitol **90**

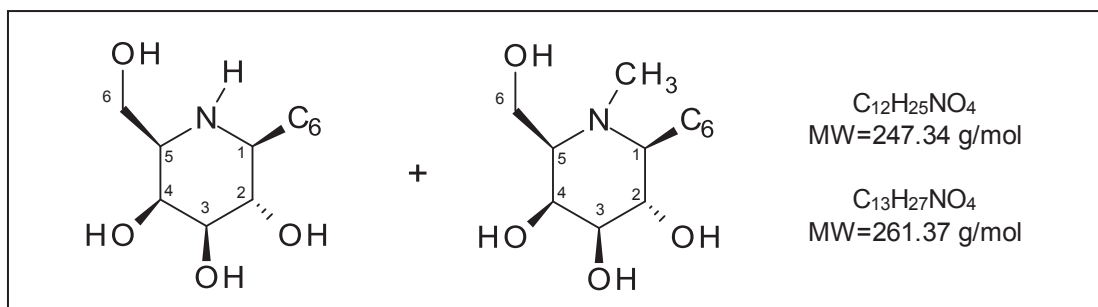

To a solution of **87** (24 mg, 0.08 mmol) in anhydrous MeOH (1.0 mL) was added 10% Pd/C (12mg). The reaction was left stirring under a hydrogen atmosphere for 3 days. Then the mixture was filtered through a membrane, the retained catalyst was washed with MeOH and the solvents were evaporated. Purification on Dowex 50WX8 resin (H^+) afforded the final product as a mixture of the desired compound **89** and the *N*-methyl by-product **90** in a 8:2 ratio and as a yellowish oil.

1H NMR (400 MHz, CD_3OD), δ 3.98-3.97 (m, 0.2H, $H_{4,N,methyl}$), 3.85 (br s, 0.8H, H4), 3.83-3.81 (m, 0.4H, $2H_{6,N,methyl}$), 3.63 (d, 1.6H, $2H_6$, $J_{6,5} = 6.5$ Hz), 3.56 (t, 0.2H, $H_{2,N,methyl}$, $J_{2,3} = 9.2$ Hz), 3.32-3.28 (m, 1.6H, H2, H3), 3.24 (dd, 0.2H, $H_{3,N,methyl}$, $J = 3.2$ Hz, $J_{3,2} = 9.2$ Hz), 2.69 (t, 0.8H, H5, $J_{5,6} = 6.5$ Hz), 2.40-2.32 (m, 0.8H, H1), 2.25 (s, 0.6H, N- CH_3), 2.23-2.19 (m, 0.2H, $H_{5,N,methyl}$), 1.95-1.77 (m, 1H, $H_{1,N,methyl}$, CH_2 -hexyl), 1.77-1.68 (m, 0.4H, CH_2 -hexyl $_{N,methyl}$), 1.57-1.45 (m, 0.8H, CH_2 -hexyl), 1.43-1.26 (m, 8H, CH_2 -hexyl, CH_2 -hexyl $_{N,methyl}$), 0.96-0.84 (m, 3H, CH_3 -hexyl, CH_3 -hexyl $_{N,methyl}$).

^{13}C NMR (100 MHz, CD_3OD), δ 77.45 (C3), 77.15 ($C_{3,N,methyl}$), 74.06 (C2), 71.92 ($C_{4,N,methyl}$), 70.99 ($C_{2,N,methyl}$), 70.79 (C4), 69.08 ($C_{1,N,methyl}$), 67.97 ($C_{5,N,methyl}$), 63.51 (C6), 63.05 ($C_{6,N,methyl}$), 61.38 (C1), 60.87 (C5), 37.43 (N- CH_3), 33.05 (CH_2 -hexyl $_{N,methyl}$), 32.99 (CH_2 -hexyl), 32.95 (CH_2 -hexyl), 30.99 (CH_2 -hexyl $_{N,methyl}$), 30.76 (CH_2 -hexyl), 29.78 (CH_2 -hexyl $_{N,methyl}$), 26.73 (CH_2 -hexyl), 25.92 (CH_2 -hexyl $_{N,methyl}$), 23.75 (CH_2 -hexyl $_{N,methyl}$), 23.69 (CH_2 -hexyl), 14.43 (CH_3 -hexyl $_{N,methyl}$), 14.42 (CH_3 -hexyl).

HRMS (ESI)

$[M+H]^+$ calculated for $C_{12}H_{26}NO_4$ $m/z = 248.185635$; found $m/z = 248.185964$

$[M+H]^+$ calculated for $C_{13}H_{28}NO_4$ $m/z = 262.201285$; found $m/z = 262.201324$

Yield

14.5 mg

Note:

H2 and H3 are under the CD_3OD signal, but they can be seen on the correlation spectra. The quality of the 1H NMR spectrum in DMSO- d_6 was not good enough to be described.

(1S)-1-C-Hexyl-1,5-dideoxy-1,5-imino-D-galactitol **89**
(1S)-1-C-Hexyl-1,5-dideoxy-1,5-imino-D-glucitol **91**

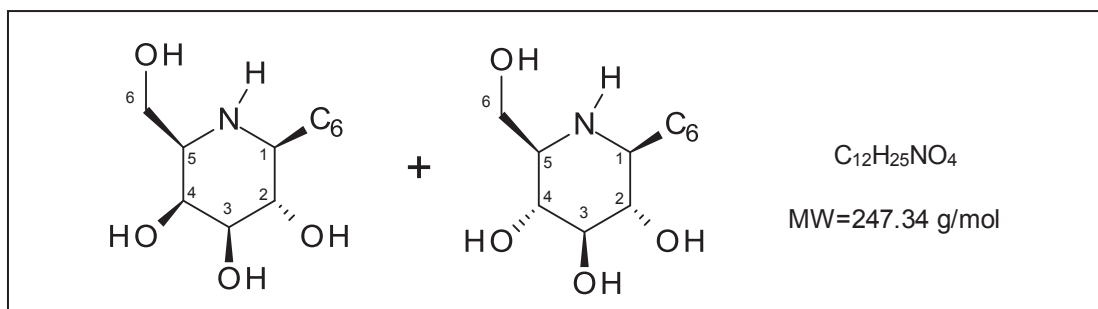

To a solution of **87** (30 mg, 0.10 mmol) in anhydrous MeOH (7.0 mL) was added 10% Pd/C (16 mg). The reaction was left stirring under a 10 bar hydrogen pressure for 4h. Then the mixture was filtered through a membrane, the retained catalyst was washed with MeOH and the solvents were evaporated. Purification on Dowex 50WX8 resin (H^+) afforded the final product as a yellowish oil. The desired *D-galacto* compound **89** was obtained as a mixture with around 6% of *D-gluco* epimer **91**.

1H NMR (400 MHz, CD_3OD), δ 3.93 (dd, 0.06H, $H_{6b,gluco}$, $J_{6b,5} = 2.8$ Hz, $J_{6b,6a} = 10.8$ Hz), 3.86 (d, 0.94H, H4, $J_{4,5} = 1.2$ Hz), 3.65 (d, 1.88H, 2H6, $J_{6,5} = 6.4$ Hz), 3.50 (dd, 0.06H, $H_{6a,gluco}$, $J_{6a,5} = 8.0$ Hz, $J_{6a,6b} = 10.8$ Hz), 3.35-3.29 (m, 1.88H, H2, H3), 3.20 (t, 0.06H, $H_{3,gluco}$, $J_{3,4} = J_{3,2} = 9.2$ Hz), 3.11 (t, 0.06H, $H_{4,gluco}$, $J_{4,3} = J_{4,5} = 9.2$ Hz), 2.99 (t, 0.06H, $H_{2,gluco}$, $J_{2,3} = J_{2,1} = 9.2$ Hz), 2.69 (dt, 0.94H, H5, $J_{5,4} = 1.2$ Hz, $J_{5,6a} = J_{5,6b} = 6.4$ Hz), 2.57-2.52 (m, 0.06H, $H_{5,gluco}$), 2.41-2.31 (m, 1H, H1, $H_{1,gluco}$), 1.92-1.80 (m, 1H, CH_2 -hexyl), 1.58-1.44 (m, 1H, CH_2 -hexyl), 1.44-1.24 (m, 8H, CH_2 -hexyl), 0.912 (t, 1H, CH_3 -hexyl, $J = 6.6$ Hz).

^{13}C NMR (100 MHz, CD_3OD), δ 80.61 ($C_{3,gluco}$), 77.45, 74.07 (C_3 , C_2), 76.65 ($C_{2,gluco}$), 73.67 ($C_{4,gluco}$), 70.80 (C_4), 63.52 (C_6), 63.67 ($C_{6,gluco}$), 62.48 ($C_{5,gluco}$), 61.37 (C_1), 60.86 (C_5), 60.75 ($C_{1,gluco}$), 32.92, 30.66, 26.78, 23.69 (CH_2 -hexyl $_{gluco}$), 32.98, 32.95, 30.75, 26.72, 23.69 (CH_2 -hexyl), 14.42 (CH_3 -hexyl $_{gluco}$), 14.44 (CH_3 -hexyl).

HRMS (ESI)

$[M+H]^+$ calculated for $C_{12}H_{26}NO_4$ $m/z = 248.185635$; found $m/z = 248.186133$

Yield

64% (16.5 mg)

(1S)-1-C-Hexyl-1,5-dideoxy-1,5-imino-D-galactitol **92**
(1S)-1-C-Hexyl-1,5-dideoxy-1,5-imino-D-glucitol **93**

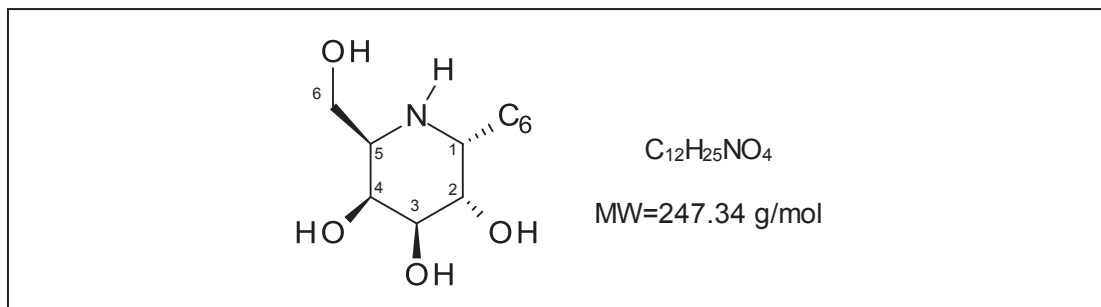

To a solution of **88** (66 mg, 0.23 mmol) in anhydrous MeOH (7.0 mL) was added 10% Pd/C (34mg). The reaction was left stirring under a 10 bar hydrogen pressure for 4h. Then the mixture was filtered through a membrane, the retained catalyst was washed with MeOH and the solvents were evaporated. Purification on Dowex 50WX8 resin (H^+) afforded the final product as a brownish solid. The desired *D-galacto* compound was obtained in a mixture with around 20% of another epimer.

1H NMR (400 MHz, CD_3OD), δ 3.90 (t, 01H, H3, $J_{3,4}$ = 3.2 Hz), 3.77-3.69 (m, 3H, 2H6, H4), 3.67 (dd, 1H, H2, $J_{2,1}$ = 1.6 Hz, $J_{2,3}$ = 4.0 Hz), 2.96-2.87 (1H, H1), 2.81 (dt, 1H, H5, J = 3.6 Hz, J = 3.6 Hz, J = 10 Hz), 1.65-1.24 (m, 10H, CH_2 -hexyl), 0.907 (t, 3H, CH_3 -hexyl, J = 6.6 Hz).

^{13}C NMR (100 MHz, CD_3OD), δ 73.12 (C3), 71.66 (C2), 67.56 (C4), 63.00 (C6), 57.65 (C5), 54.03 (C1), 32.97, 31.91, 30.58, 27.21, 23.67 (CH_2 -hexyl), 14.43 (CH_3 -hexyl).

HRMS (ESI)

$[M+H]^+$ calculated for $C_{12}H_{26}NO_4$ m/z = 248.185635; found m/z = 248.185977

Yield

71% (40 mg)

1,2:3,4-di-*O*-Isopropylidene-6-*O*-methanesulfonyl- α -L-tagatofuranose **94**

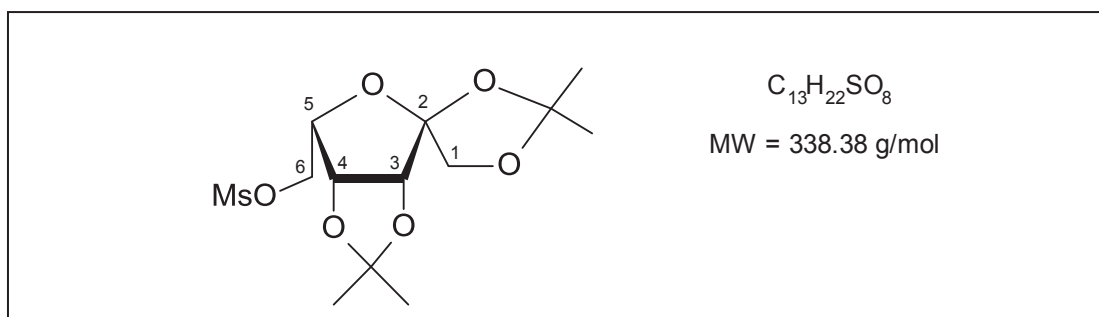

To a solution of alcohol **65** (158 mg, 0.607 mmol) in dry CH_2Cl_2 (6 mL) were added NEt_3 (186 μ L, 1.34 mmol, 2.2 eq) and 4Å molecular sieves. Then methanesulfonyl chloride (99 μ L, 1.28 mmol, 2.1 eq) was added. The reaction was left stirring 1 h at RT. Then it was stopped with a saturated solution of NH_4Cl (5 mL). The solid was filtered through a cotton and filtrate was extracted with CH_2Cl_2 (25 mL). The organic phase was washed with brine (7 mL) and dried over $MgSO_4$. After concentration under vacuum the crude **94** was obtained as a yellow solid, which was used in the next step without further purification.

TLC:

- PE/EtOAc (6:4);
- $R_f = 0.64$

1H NMR (400 MHz, $CDCl_3$), δ 4.82 (dd, 1H, H4, $J_{4,5} = 4.0$ Hz, $J_{4,3} = 5.6$ Hz), 4.62 (d, 1H, H3, $J_{3,4} = 5.6$ Hz), 4.48 (dd, 1H, H6_b, $J_{6b,5} = 4.4$ Hz, $J_{6b,6a} = 11.2$ Hz), 4.38 (dd, 1H, H6_a, $J_{6a,5} = 7.2$ Hz, $J_{6b,6a} = 11.2$ Hz), 4.27 (d, 1H, H1_b, $J_{1b,1a} = 10.0$ Hz), 4.25-4.22 (m, 1H, H5), 4.05 (d, 1H, H1_a, $J_{1a,1b} = 10.0$ Hz), 3.07 (s, 3H, CH_3 Ms), 1.46 (s, 3H, CH_3 iPr), 1.42 (s, 3H, CH_3 iPr), 1.40 (s, 3H, CH_3 iPr), 1.30 (s, 3H, CH_3 iPr).

^{13}C NMR (100 MHz, $CDCl_3$), δ 113.25, 112.11, 112.09 (C^{IV} iPr, C2), 85.07 (C3), 79.72 (C4), 76.81 (C5), 69.28 (C1), 68.09 (C6), 37.65 (CH_3 Ms), 26.48, 26.44, 26.03, 24.79 (CH_3 iPr).

LRMS (ESI)

$[M+Na]^+ = 361.0$

1,2:3,4-di-O-Isopropylidene-6-O-trifluoromethanesulfonic- α -L-tagatofuranose **95**

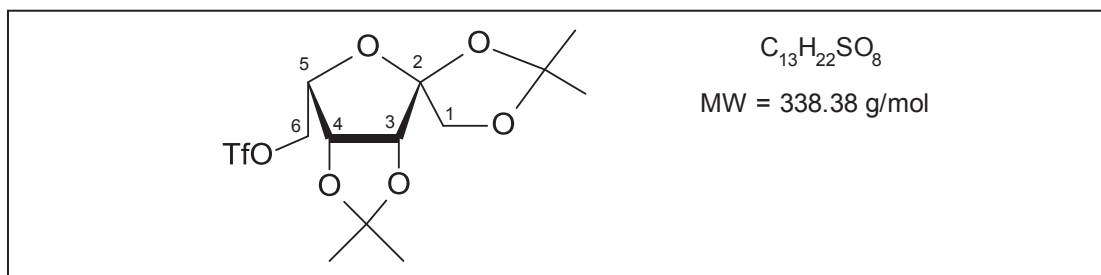

To a solution of alcohol **65** (190 mg, 0.73 mmol) in dry CH_2Cl_2 (2.2 mL) was added pyridine (195 μ L, 2.41 mmol, 3.3 eq). Then, at $-78^\circ C$ was added trifluoromethanesulfonic anhydride (164 μ L, 0.99 mmol, 1.35 mmol). The reaction was left stirring 2 h at ice-water bath temperature. The mixture was extracted with EtOAc (10 mL). The organic phase was washed with brine (5 mL), ice-water (5 mL) and dried over $MgSO_4$. After concentration under vacuum the crude **95** was obtained as a yellow oil, which was used in the next step without further purification.

TLC:

- PE/EtOAc (7:3);
- $R_f = 0.75$

6-Azido-1,2:3,4-di-O-isopropylidene- α -L-tagatofuranose **96**

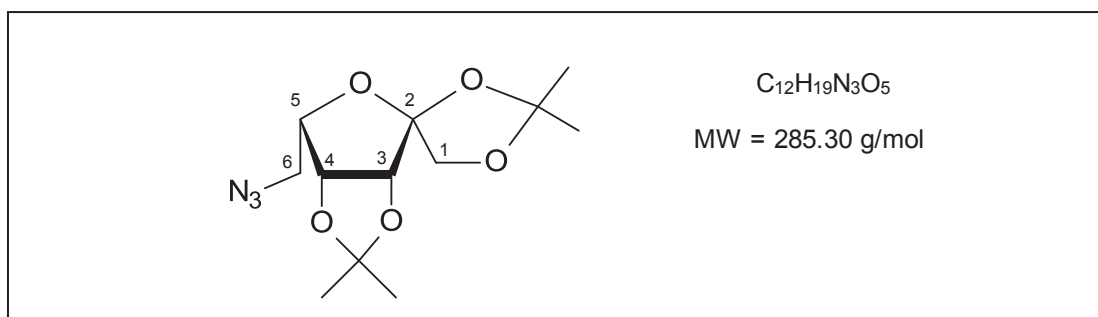

To a solution of crude **95** (0.73 mmol) in DMF (7.3 mL) was added NaN_3 (95 mg, 1.46 mmol, 2 eq). The reaction was left stirring overnight at RT. After extraction with CH_2Cl_2 (15 mL), the organic phase was washed with saturated $NaHCO_3$ (7 mL), water (2 x 7 mL) and dried over $MgSO_4$. Concentration under vacuum afforded the crude product as a yellow solid. Flash column chromatography on silica gel (PE/EtOAc 95:5) gave pure **96** as a colorless oil.

TLC:

- PE/EtOAc (9:1);
- $R_f = 0.48$

1H NMR (400 MHz, $CDCl_3$), δ 4.77 (dd, 1H, H4, $J_{4,5} = 3.6$ Hz, $J_{4,3} = 5.6$ Hz), 4.61 (d, 1H, H3, $J_{3,4} = 5.6$ Hz), 4.27 (d, 1H, H1_b, $J_{1b,1a} = 9.6$ Hz), 4.09 (dd, 1H, H5, $J_{5,4} = 3.6$ Hz, $J_{5,6a} = 5.6$ Hz, $J_{5,6b} = 7.4$ Hz), 4.05 (d, 1H, H1_a, $J_{1a,1b} = 9.6$ Hz), 3.54 (dd, 1H, H6_b, $J_{6b,5} = 7.4$ Hz, $J_{6b,6a} = 12.8$ Hz), 3.46 (dd, 1H, H6_a, $J_{6a,5} = 5.6$ Hz, $J_{6a,6b} = 12.8$ Hz), 1.48 (s, 3H, CH_3iPr), 1.42 (s, 3H, CH_3iPr), 1.40 (s, 3H, CH_3iPr), 1.30 (s, 3H, CH_3iPr).

^{13}C NMR (100 MHz, $CDCl_3$), δ 113.10, 111.98, 111.95 ($C^{IV}iPr$, C2), 85.24 (C3), 79.93 (C4), 77.81 (C5), 69.32 (C1), 49.56 (C6), 26.56, 26.34, 26.05, 24.91 (CH_3iPr).

HRMS (ESI)

$[M+Na]^+$ calculated for $C_{12}H_{19}N_3NaO_5$ $m/z = 308.121691$; found $m/z = 308.121464$

Optical rotation

$[\alpha]_D^{25} = -46.7$ ($c = 1.2$; $CHCl_3$)

Yield

76% (159 mg)

6-Azido- α -L-tagatofuranose **97**

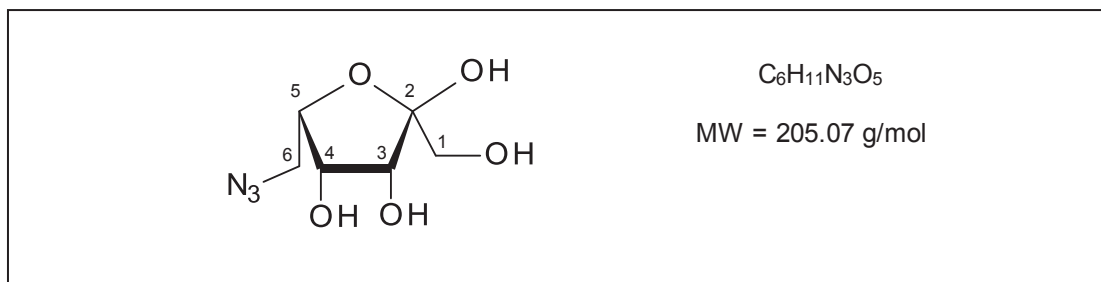

To a solution of **96** (159 mg, 0.56 mmol) in a mixture of acetonitrile/water (1:1) (22 mL), resin Dowex 50WX8 (H^+) (4.03 g) was added. The reaction was left stirring at 65°C for 70h. The resin was filtered, washed with MeOH and the filtrate was concentrated under vacuum to give crude product as a brownish solid. Flash column chromatography on silica gel (PE/EtOAc 9:1) gave pure **97** as a colorless oil and a mixture of anomers (7:3).

TLC:

- $CH_2Cl_2/MeOH$ (9:1);
- $R_f = 0.097$

1H NMR (400 MHz, CD_3OD), δ 4.27-4.21 (m, 0.6H, H_{5min} , H_{4min}), 4.20-4.15 (m, 1.4H, H_{4MAJ} , H_{3MAJ}), 4.12 (d, 0.3H, H_{3min} , $J_{3,4} = 4.8$ Hz), 4.06 (dt, 0.7H, H_{5MAJ} , $J_{5,4} = 4.0$ Hz, $J_{5,6b} = J_{5,6a} = 6.4$ Hz), 3.64 (d, 0.3H, $H_{1b,min}$, $J_{1b,1a} = 11.2$ Hz), 3.57 (d, 0.3H, $H_{1a,min}$, $J_{1a,min,1b,min} = 11.2$ Hz), 3.52 (d, 1.4H, $2H_{6MAJ}$, $J = 6.4$ Hz), 3.49-3.48 (m, 1.4H, $2H_{1MAJ}$), 3.45 (d, 0.6H, $2H_{6min}$, $J = 5.6$ Hz).

^{13}C NMR (100 MHz, CD_3OD), δ 106.71 (C_{2min}), 104.45 (C_{2MAJ}), 80.16 (C_{5MAJ}), 79.39 (C_{5min}), 79.01 (C_{3min}), 73.13 (C_{4min}), 72.84 (C_{4MAJ}), 71.96 (C_{3MAJ}), 64.13 (C_{1min}), 64.01 (C_{1MAJ}), 52.74 (C_{6MAJ}), 52.12 (C_{6min}).

Yield

61% (69 mg)

Benzyl α -D-lyxopyranoside **98**

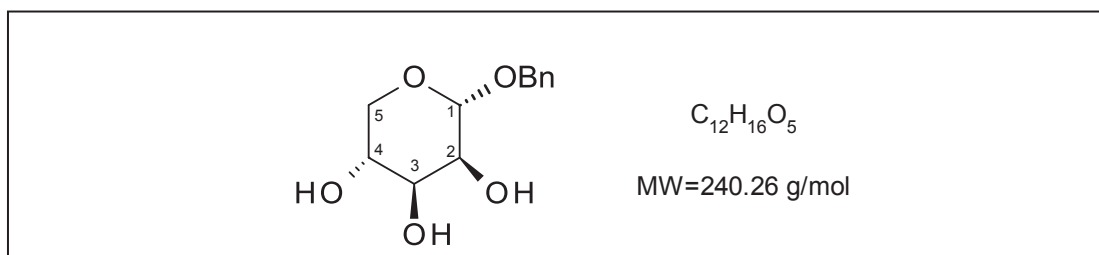

To a solution of D-lyxose (20.0 g, 0.13 mol) in benzyl alcohol (37 mL) was added *p*-toluenesulfonic acid (201 mg, 1.10 mmol, 0.008 eq). The reaction was left stirring for 78h at 60°C. Then the mixture was cooled down to RT, concentrated under vacuum and coevaporated with toluene (3 x 30 mL) to give a soft white solid. This residue was slurred in a mixture of hexane/CH₂Cl₂ (2:1) (180 mL). The solid was filtered, then stirred with cold Et₂O (25 mL), filtered again and dried under vacuum to give the desired compound **98** as a white solid. The filtrate was concentrated and the procedure was repeated three times.

TLC:

- CH₂Cl₂/MeOH (9:1)
- R_f= 0.58

NMR

The obtained spectrum corresponds to literature data²²⁷.

Yield

69% (21.6 g).

²²⁷ Keck, G. E.; Kachensky, D. F.; Enholm, E. J. *J Org Chem* **1985**, *50*, 4317.

Benzyl 2,3-*O*-isopropylidene- α,β -D-lyxopyranoside **99**

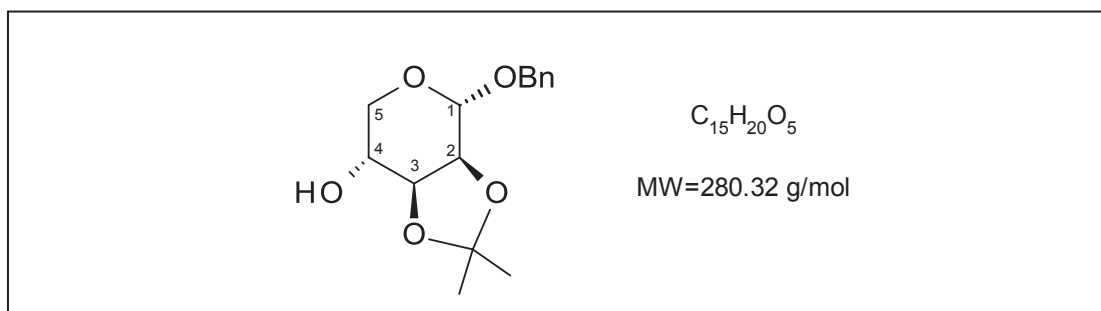

The reaction was conducted under argon. To a solution of compound **98** (9.62 g, 0.04 mol) in acetone (128 mL) were added dimethoxypropane (16.7 mL, 0.14 mol, 3.5 eq) and *p*-toluenosulfonic acid (150 mg, 0.8 mmol, 0.02 eq). The reaction was left stirring overnight at RT. The mixture was concentrated under vacuum and the residue was diluted with EtOAc (120 mL). The solution was washed with a saturated solution of NaHCO₃ (40 mL), water (2 x 40 mL) and dried over MgSO₄. Concentration under vacuum gave crude product as a colorless oil. Flash column chromatography on silica gel (PE/EtOAc 85:15/5:5) afforded compound **99** as a white solid.

TLC:

- toluene/EtOAc (8:2);
- R_f= 0.22

NMR

The obtained spectrum corresponds to literature data²²⁷

Yield

57% (6.46 g).

²²⁷ Keck, G. E.; Kachensky, D. F.; Enholm, E. J. *J Org Chem* **1985**, *50*, 4317.

Benzyl 2,3-O-isopropylidene-β-L-erythropent-4-uloside **100**

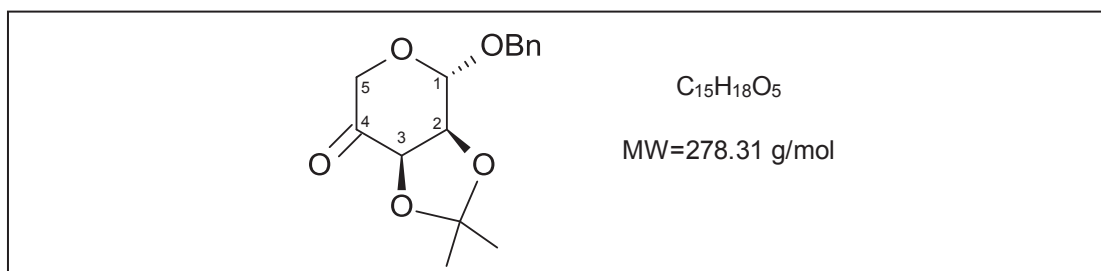

The reaction was conducted under argon. To a solution of alcohol **99** (1.0 g, 3.57 mmol) in anhydrous CH₂Cl₂ (36 mL) was added Dess-Martin periodinane (1.82 g, 4.28 mmol, 1.2 eq). The reaction was left stirring overnight. The mixture was concentrated under vacuum. The residue was suspended in the minimal volume of cold Et₂O and filtered through a membrane. The filtrate was concentrated under vacuum to give the crude product as a colorless oil with white solids. Rapid filtration on silica gel (PE/EtOAc 8:2) gave the desired ketone **100** as a colorless oil.

TLC:

- PE/EtOAc (8:2);
- R_f= 0.61

NMR

The obtained spectrum corresponds to literature data²²⁸.

LRMS (ESI)

[M+H]⁺= 279.0

Yield

97% (0.98 g)

²²⁸ Anastasi, C.; Buchet, F. F.; Crowe, M. A.; Helliwell, M.; Raftery, J.; Sutherland, J. D. *Chem. Eur. J.* **2008**, *14*, 2375.

Benzyl 2,3-*O*-isopropylidene- β -L-ribofuranoside **101**

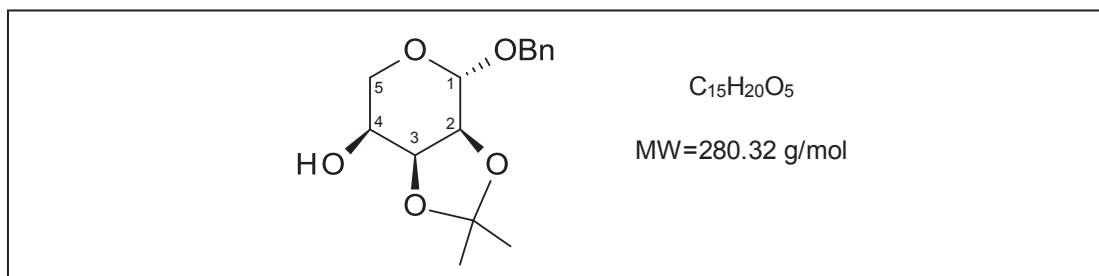

To a solution of ketone **100** (2.2 g, 7.91 mmol) in ethanol (40 mL) at 0 °C was added sodium borohydride (598 mg, 15.8 mmol, 2 eq). The reaction was left stirring at 0 °C for 1h and then at RT for 5h. Then it was stopped with 50% aqueous solution of NH_4Cl (40 mL). EtOAc was added (30 mL). The aqueous phase was separated and washed with EtOAc (3 x 50 mL). The combined organic phases were washed with water (30 mL), brine (30 mL) and dried over $MgSO_4$. After concentration under vacuum, the crude product was obtained as an amorphous, white solid. Crude compound was dissolved in hot Et_2O (6 mL), then petroleum ether was slowly added (3 mL). The solution was left at 0 °C for about 1 h. White crystals of **101** were filtered and washed with hexane. The filtrate was concentrated and the procedure was repeated once.

TLC:

- PE/EtOAc (6:4);
- $R_f = 0.44$

NMR

The obtained spectrum corresponds to literature data²²⁸.

LRMS (ESI)

$[M+H]^+ = 281.0$

$[M+Na]^+ = 303.0$

Yield

91% (2.0 g).

²²⁸ Anastasi, C.; Buchet, F. F.; Crowe, M. A.; Helliwell, M.; Raftery, J.; Sutherland, J. D. *Chem. Eur. J.* **2008**, *14*, 2375.

Unsaturated compound **102A**

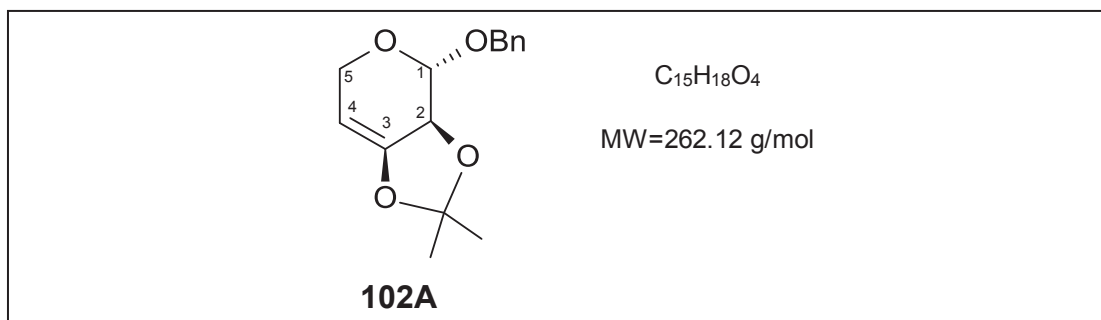

To a stirred solution of **101** (415 mg, 1.48 mmol) in CH_2Cl_2 (8 mL) was added pyridine (0.4 mL, 4.88 mmol, 3.3 eq). Then, at $-78^\circ C$ was dropwise added trifluoromethanesulfonic anhydride (0.33 mL, 2.0 mmol, 1.35 eq). The mixture was left stirring for 2h at $0^\circ C$. EtOAc was added (25 mL) and the mixture was washed with brine (7 mL) and ice-water (7 mL) and then dried over $MgSO_4$. After concentration under vacuum, the crude triflate was obtained as a yellow oil.

The mixture of crude triflate, KCN (482 mg, 7.4 mmol, 5 eq) and 18-crown-6 ether (195 mg, 0.74 mmol, 0.5 eq) were stirred in DMF (30 mL) in a presence of 4\AA molecular sieves for 16h at RT. EtOAc was added (20 mL) and the mixture was washed with brine (15 mL) and water (15 mL) and then dried over $MgSO_4$. After concentration under vacuum, the crude mixture was obtained as a brown oil. Flash column chromatography on silica gel (toluene/EtOAc 95:5) afforded elimination by-product **102A** (200 mg, 52%).

TLC:

- toluene/EtOAc (9:1);
- $R_f = 0.9$

102A

1H NMR (400 MHz, $CDCl_3$), δ 7.38-7.23 (m, 5H, $H_{aromatic}$), 4.92 (d, 1H, $\underline{CH_2}Ph$, $J = 11.6$ Hz), 4.72-4.70 (m, 1H, H4), 4.66 (d, 1H, $\underline{CH_2}Ph$, $J = 11.6$ Hz), 4.53 (d, 1H, H1, $J = 6.4$ Hz), 4.41-4.35 (m, 2H, H5_b, H2), 4.26-4.20 (m, 1H, H5_a), 1.48, 1.45 (s, 3H, $\underline{CH_3}iPr$).

^{13}C NMR (100 MHz, $CDCl_3$), δ 147.19 (C3), 137.22 ($C_{aromatic}^{IV}$), 128.38-127.77 ($C_{aromatic}$), 112.07 ($C^{IV}iPr$), 100.29 (C1), 90.14 (C4), 73.76 (C2), 70.09 ($\underline{CH_2}Ph$), 63.73 (C5), 26.65, 24.81 ($\underline{CH_3}iPr$).

LRMS (ESI)

$[M+H]^+ = 263.0$

$[M+Na]^+ = 285.0$

Benzyl 2,3-*O*-isopropylidene-4-*O*-methanesulfonyl- β -L-ribofuranoside **103**

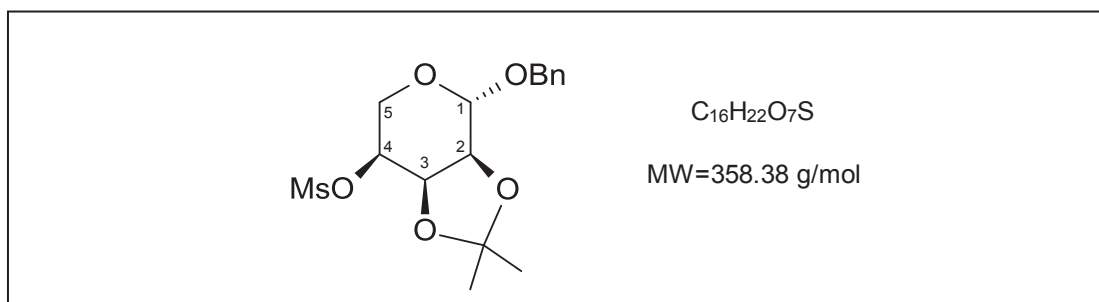

The reaction was conducted under argon. To a solution of alcohol **101** (200 mg, 0.71 mmol) in dry CH₂Cl₂ (7.1 mL) were added NEt₃ (0.22 mL, 1.57 mmol, 2.2 eq) and 4Å molecular sieves. Then methanesulfonyl chloride (0.12 mL, 1.50 mmol, 2.1 eq) was added. The reaction was left stirring for 4h. The solid was filtered and washed with CH₂Cl₂ (10 mL). The filtrate was washed with a saturated aqueous NH₄Cl solution (10 mL). The organic phase was separated, washed with brine (2 x 5 mL) and dried over MgSO₄. Concentration under vacuum gave the crude product **103**, which was used in the next step without further purification.

TLC:

- PE/EtOAc (7:3);
- R_f= 0.28

LRMS (ESI)

[M+H]⁺ = 359.0
[M+Na]⁺ = 381.0

Benzyl 2,3-O-isopropylidene-4-O-methanesulfonyl- α -D-lyxopyranoside **104**

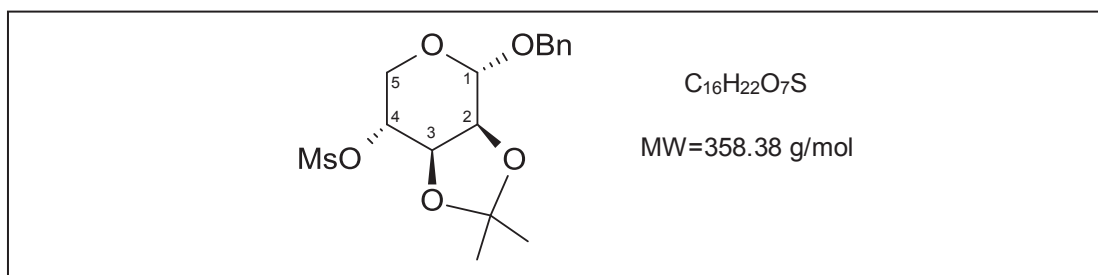

The reaction was conducted under argon. To a solution of alcohol **99** (200 mg, 0.71 mmol) in dry CH_2Cl_2 (7.1 mL) were added Et_3N (0.22 mL, 1.57 mmol, 2.2 eq) and 4Å molecular sieves. Then methanesulfonyl chloride (0.12 mL, 1.50 mmol, 2.1 eq) was added. The reaction was left stirring for 4h. The solid was filtered and washed with CH_2Cl_2 (10 mL). The filtrate was washed with a saturated aqueous NH_4Cl solution (10 mL). The organic phase was separated, washed with brine (2 x 5 mL) and dried over $MgSO_4$. Concentration under vacuum gave the crude product **104**, which was used in the next step without further purification.

TLC:

- PE/EtOAc (7:3);
- $R_f = 0.45$

1H NMR (250 MHz, $CDCl_3$), δ 7.43-7.26 (m, 5H, $H_{aromatic}$), 5.03 (s, 1H, H1), 4.72 (d, 1H, CH_2Ph , $J = 11.8$ Hz), 4.74-4.65 (m, 1H, H4), 4.52 (d, 1H, CH_2Ph , $J = 11.8$ Hz), 4.31-4.26 (m, 1H, H3), 4.21 (dd, 1H, H2, $J_{2,1} = 1.25$ Hz, $J_{2,3} = 5.5$ Hz), 3.85-3.70 (m, 2H, 2H5), 3.14 (s, 3H, $CH_3(Ms)$), 1.55, 1.36 (s, 3H, CH_3iPr).

LRMS (ESI)

$[M+H]^+ = 359.0$

$[M+Na]^+ = 381.0$

Benzyl 2,3-O-isopropylidene-4-O-(4-methylphenylsulfonyl)- α -D-lyxopyranoside **105**

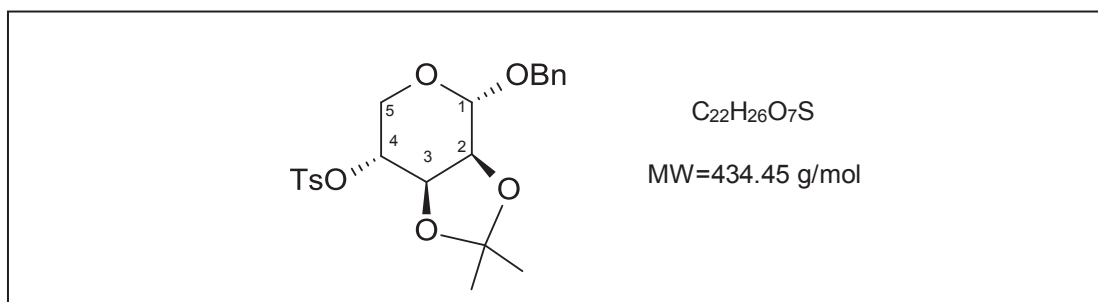

The reaction was conducted under argon. To a solution of compound **99** (5.33 g, 0.019 mol) in dry pyridine (20 mL) was added *p*-toluenesulfonyl chloride (5g, 0.026 mol, 1.38 eq). The reaction was left stirring for 40h. The mixture was diluted with Et₂O (25 mL) and was washed with 3N aqueous HCl (2 x 25 mL), water (2 x 25 mL) and brine (25 mL). Then the organic phase was dried over MgSO₄ and the solvents were evaporated under vacuum. Flash column chromatography on silica gel (PE/EtOAc 9:1) afforded the pure **105** as a white solid.

TLC:

- PE/EtOAc (8:2);
- R_f= 0.43

¹H NMR (400 MHz, CDCl₃), δ 7.85 (d, 2H, H_{aromatic}, J = 8.3 Hz), 7.39-7.27 (m, 7H, H_{aromatic}), 4.92 (d, 1H, H1, $J_{1,2}$ = 1.2 Hz), 4.72 (d, 1H, CH₂Ph, J = 11.6 Hz), 4.49 (d, 1H, CH₂Ph, J = 11.6 Hz), 4.41 (ddd, 1H, H4, $J_{4,3}$ = 6.8 Hz, $J_{4,5b}$ = 5.2 Hz, $J_{4,5a}$ = 9.6 Hz), 4.18 (dd, 1H, H3, $J_{3,4}$ = 6.8 Hz, $J_{3,2}$ = 5.2 Hz), 4.11 (dd, 1H, H2, $J_{2,1}$ = 1.2 Hz, $J_{2,3}$ = 5.2 Hz), 3.85 (dd, 1H, H5_b, $J_{5b,4}$ =5.2 Hz, J_{5b-5a} = 11.6 Hz), 3.71 (dd, 1H, H5_a, $J_{4,5a}$ = 9.6 Hz, J_{5a-5b} = 11.6 Hz), 2.44 (s, 3H, CH₃Ts), 1.24, 1.14 (s, 3H, CH₃iPr).

¹³C NMR (100 MHz, CDCl₃), δ 144.98-133.08 (C^{IV}_{aromatic}) 129.76-128.07 (C_{aromatic}), 109.65 (C^{IV}iPr), 96.34 (C1), 76.98 (C4), 75.62 (C2), 74.52 (C3), 69.36 (CH₂Ph), 58.58 (C5), 27.33-26.140 (CH₃iPr), 21.61 (CH₃Ts).

LRMS (ESI)

[M+H]⁺= 435.0

[M+Na]⁺= 457.0

Melting point

T_m= 88-90°C

Yield

91% (7.47 g)

Benzyl 4-O-(4-methylphenylsulfonyl)- α -D-lyxopyranoside **106**

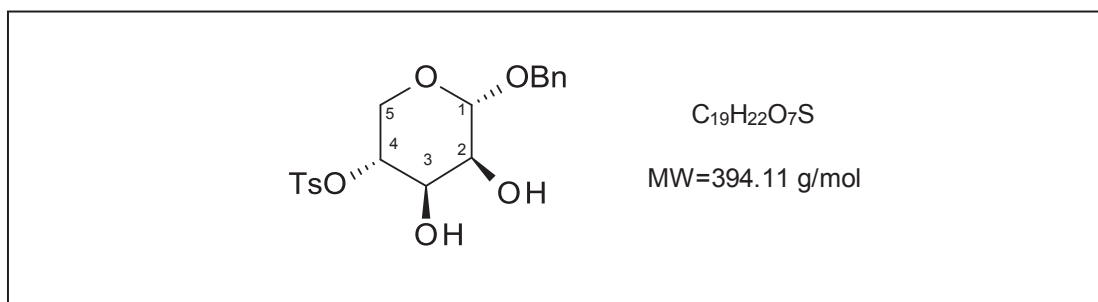

Compound **105** (7.45 g, 0.017 mol) was dissolved in glacial acetic acid (28 mL) and the solution was heated at 110°C for 5 min. Then water (7 mL) was added and the mixture was heated for an additional 80 min. The solvents were evaporated under vacuum and the residue was dissolved in diethyl ether (80 mL). The organic phase was washed with H₂O (10 mL), saturated NaHCO₃ (2 x 10 mL) and dried over MgSO₄. The solvents were evaporated under vacuum to give compound **106**, which was used in the next step without further purification.

TLC:

- PE/EtOAc (5:5);
- R_f= 0.27

¹H NMR (250 MHz, CDCl₃), δ 7.82 (d, 2H, H_{aromatic}, J = 8.3 Hz), 7.41-7.12 (m, 7H, H_{aromatic}), 4.81 (d, 1H, H1, $J_{1,2}$ = 2.8 Hz), 4.71 (d, 1H, CH₂Ph, J = 11.8 Hz), 4.63 (dt, 1H, H4, $J_{4,5}$ = $J_{4,3}$ = 8.3 Hz, $J_{4,5}$ = 4.8 Hz), 4.47 (d, 1H, CH₂Ph, J = 11.8 Hz), 4.02 (dd, 1H, H3, $J_{3,4}$ = 8.3 Hz, $J_{3,2}$ = 3.5 Hz), 3.97 (dd, 1H, H2, $J_{2,1}$ = 2.8 Hz, $J_{2,3}$ = 3.5 Hz), 3.68-3.65 (m, 2H, 2H5), 2.89 (br s, 1H, OH), 2.45 (s, 3H, CH₃Ts).

¹³C NMR (100 MHz, CDCl₃), δ 145.34-133.03 (C^{IV}_{aromatic}) 130.01-127.96 (C_{aromatic}), 98.61 (C1), 77.26 (C4), 70.51 (C2), 68.91 (C3), 69.36 (CH₂Ph), 60.02 (C5), 21.68 (CH₃Ts).

HRMS (ESI)

[M+NH₄]⁺ calculated for C₁₉H₂₆NO₇S m/z = 412.142450; found m/z = 412.142255

[M+Na]⁺ calculated for C₁₉H₂₂NaO₇S m/z = 417.097845; found m/z = 417.097405

Yield

97% (6.56 g)

Benzyl 3,4-anhydro- β -L-ribofuranoside 107

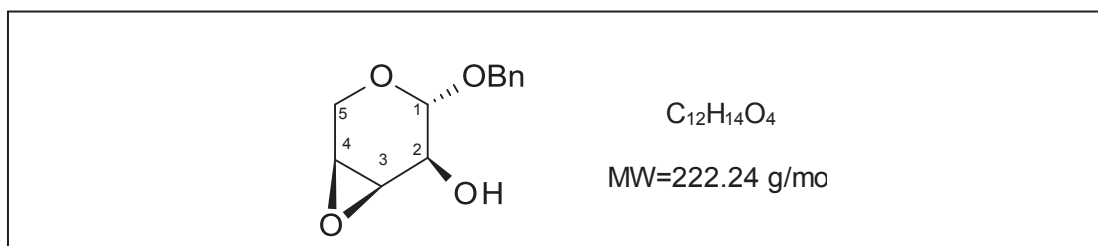

A cold solution of compound **106** (6.38 g, 16.19 mmol) in dry tetrahydrofuran (40 mL) was added at 0°C under argon to a suspension of potassium *tert*-butoxide (2.18 g, 19.40 mmol, 1.2 eq) in tetrahydrofuran (160 mL). The reaction was stirred for 45 min at RT and a saturated NH_4Cl solution (60 mL) was then added. After 30 min of stirring, the mixture was extracted with EtOAc (2 x 160 mL). The organic phase was dried over $MgSO_4$ and the solvents were evaporated under vacuum. Flash column chromatography on silica gel (PE:EtOAc 5:5) afforded the pure compound **107** as a white crystalline solid.

TLC:

- PE/EtOAc (5:5);
- $R_f = 0.41$

1H NMR (400 MHz, $CDCl_3$), δ 7.40-7.26 (m, 5H, $H_{aromatic}$), 4.72 (d, 1H, \underline{CH}_2Ph , $J = 11.6$ Hz), 4.58 (d, 1H, H1, $J_{1,2} = 2.0$ Hz), 4.50 (d, 1H, \underline{CH}_2Ph , $J = 11.6$ Hz), 4.01 (dd, 1H, H5_b, $J_{5b,4} = 1.6$ Hz, $J_{5b,5a} = 13.4$ Hz), 3.94 (d, 1H, H5_a, $J_{5a-5b} = 13.4$ Hz), 3.82 (ddd, 1H, H2, $J_{2,1} = 2.0$ Hz, $J_{2,3} = 4.4$ Hz, $J_{2,OH} = 10.0$ Hz), 3.51 (t, 1H, H3, $J_{3,2} = J_{3,4} = 4.4$ Hz), 3.34 (d, 1H, H4, $J_{4,3} = 4.4$ Hz), 2.73 (d, 1H, OH, $J_{OH,2} = 10.0$ Hz).

^{13}C NMR (100 MHz, $CDCl_3$), δ 137.00 ($C^{IV}_{aromatic}$), 128.45-127.93 ($C_{aromatic}$), 97.90 (C1), 69.62 (\underline{CH}_2Ph), 64.73 (C2), 58.00 (C5), 51.74 (C4), 51.39 (C3).

HRMS (ESI)

$[M+NH_4]^+$ calculated for $C_{12}H_{18}NO_4$ $m/z = 240.123034$; found $m/z = 240.123181$

$[M+Na]^+$ calculated for $C_{12}H_{14}NaO_4$ $m/z = 245.078430$; found $m/z = 245.078620$

Optical rotation

$[\alpha]_D^{20} = +157.0$ ($c = 1.1$; $CHCl_3$)

Melting point

$T_m = 66-67^\circ C$

Yield

71% (2.55 g)

Benzyl 3,4-anhydro-2-O-triisopropylsilyl-β-L-ribofuranoside 108

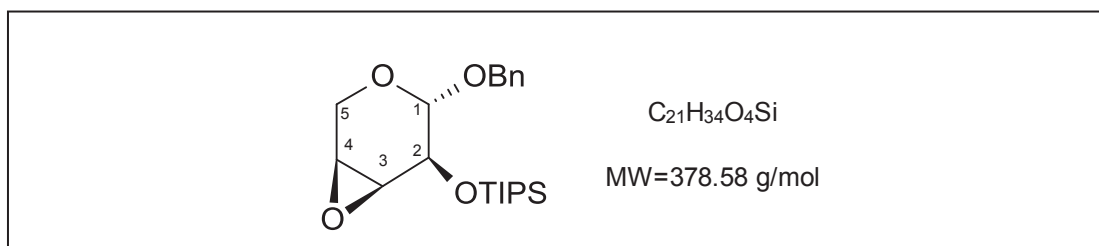

Compound **107** (1.84 g, 8.28 mmol) was dissolved under argon in dry dimethylformamide (18 mL). 2,6-Lutidine (2.2 mL, 18.88 mmol, 2.3 eq) was added, the mixture was cooled down to 0°C and triisopropylsilyltriflate (2.23 mL, 8.28 mmol, 1 eq) was added. The reaction was stirred at RT overnight and then diluted with EtOAc (60 mL). The organic phase was washed with 2N aqueous HCl (2 x 10 mL), water (10 mL), brine (10 mL) and dried over MgSO₄. Concentration under vacuum and flash column chromatography on silica gel (PE/EtOAc 95:5) afforded the pure compound **108** as a colorless oil.

TLC:

- PE/EtOAc (95:5);
- R_f= 0.14

¹H NMR (250 MHz, CDCl₃), δ 7.38-7.24 (m, 5H, H_{aromatic}), 4.75 (d, 1H, CH₂Ph, *J*= 11.7 Hz), 4.53 (d, 1H, H1, *J*_{1,2}= 3.8 Hz), 4.53 (d, 1H, CH₂Ph, *J*= 11.7 Hz), 4.08 (dd, 1H, H5_b, *J*_{5_b,4}= 2.4 Hz, *J*_{5_b,5_a}= 13.4 Hz), 4.02 (t, 1H, H2, *J*_{2,1}= *J*_{2,3}= 3.8 Hz), 3.96 (d, 1H, H5_a, *J*_{5_a-5_b}= 13.4 Hz), 3.42 (t, 1H, H3, *J*_{3,2}= *J*_{3,4}= 3.8 Hz), 3.37-3.32 (m, 1H, H4), 1.12-1.06 (m, 21H, CH₃TIPS).

¹³C NMR (100 MHz, CDCl₃), δ 137.25 (C^{IV}_{aromatic}), 128.34-127.80 (C_{aromatic}), 99.56 (C1), 70.09 (CH₂Ph), 68.58 (C2), 59.96 (C5), 53.58 (C3), 52.52 (C4), 17.97 (CH₃ TIPS), 12.35 (CH TIPS).

HRMS (ESI)

[M+H]⁺ calculated for C₂₁H₃₅O₄Si *m/z*= 379.229913; found *m/z*= 379.229719

[M+NH₄]⁺ calculated for C₂₁H₃₈NO₄Si *m/z*= 396.256462; found *m/z*= 396.256342

[M+Na]⁺ calculated for C₂₁H₃₄NaO₄Si *m/z*= 401.211857; found *m/z*= 401.211666

[M+K]⁺ calculated for C₂₁H₃₄KO₄Si *m/z*= 417.185794; found *m/z*= 417.185408

Yield

82% (2.57 g)

Benzyl 4-cyano-4-deoxy-2-O-(triisopropylsilyl)- α -D-lyxopyranoside **109**

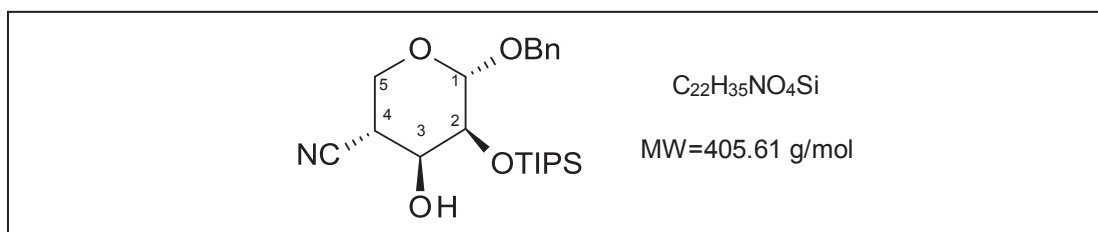

The reaction was conducted under argon. To a cold solution of compound **108** (2.54 g, 6.71 mmol) in dry diethyl ether (40 mL) was added dropwise a 1M solution of diethylaluminum cyanide in toluene (7.26 mL, 7.26 mmol, 1.1 eq). The mixture was stirred for 3h30 at 45°C then 1h at RT and then cooled to -40°C. A saturated NH_4Cl solution (14 mL) was added dropwise and the mixture was stirred for 2h at RT. The solid was filtered and washed with EtOAc (2 x 10 mL). The filtrate was evaporated under vacuum and the residue was purified by flash column chromatography on silica gel (toluene/acetone 99.5:0.5) to give the pure compound **109** as a colorless oil.

TLC:

- PE/EtOAc (95:5);
- R_f = 0.65

1H NMR (250 MHz, $CDCl_3$), δ 7.44-7.25 (m, 5H, $H_{aromatic}$), 4.77 (d, 1H, H1, $J_{1,2}$ = 2.7 Hz), 4.74 (d, 1H, $\underline{CH_2}Ph$, J = 11.8 Hz), 4.49 (d, 1H, $\underline{CH_2}Ph$, J = 11.8 Hz), 4.10 (dt, 1H, H3, $J_{3,2}$ =2.7 Hz, $J_{3,4}$ = $J_{3,OH}$ = 10.0 Hz), 3.99 (t, 1H, H2, $J_{2,1}$ = $J_{2,3}$ = 2.7 Hz), 3.92-3.81 (m, 2H, H5), 3.06 (dt, 1H, H4, $J_{4,5}$ = 5.5 Hz, $J_{4,3}$ = $J_{4,5}$ = 10.0 Hz), 2.42 (d, 1H, OH, $J_{OH,3}$ = 10.0 Hz), 1.10-1.01 (m, 21H, $\underline{CH_3}TIPS$).

^{13}C NMR (100 MHz, $CDCl_3$), δ 136.64 ($C^{IV}_{aromatic}$), 128.67-128.35 ($C_{aromatic}$), 118.43 (CN), 98.64 (C1), 70.09 (C2), 69.46 ($\underline{CH_2}Ph$), 67.77 (C3), 59.29 (C5), 32.48 (C4), 18.04-17.95 ($\underline{CH_3}TIPS$), 12.51 ($\underline{CH}TIPS$).

Yield

73% (1.95 g)

Benzyl 4-cyano-4-deoxy- α -D-lyxopyranoside **110**

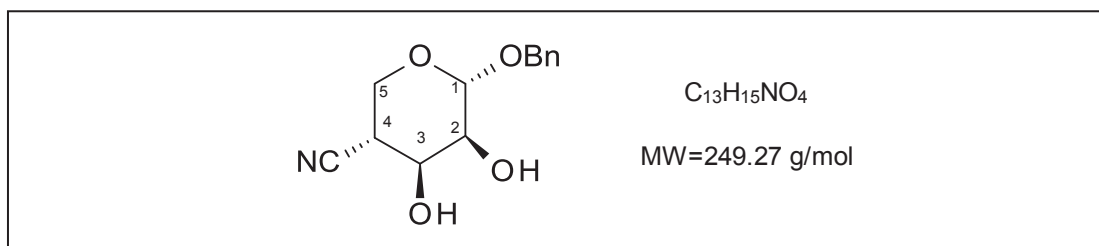

To a solution of **109** (1.585 g, 3.91 mmol) in tetrahydrofuran (50 mL) was added at 0°C a 1M solution of tetrabutylammonium fluoride in tetrahydrofuran (7.5 mL, 7.5 mmol, 1.9 eq). The mixture was stirred for 3h30 at RT and the solvent was removed under vacuum. The residue was purified by flash column chromatography on silica gel (CH_2Cl_2 /acetone 9:1) to give the pure compound **110** as a white solid.

TLC:

- CH_2Cl_2 /acetone (9:1);
- $R_f = 0.27$

1H NMR (400 MHz, CD_3OD), δ 7.26-7.46 (m, 5H, $H_{aromatic}$), 4.82 (d, 1H, H1, $J_{1,2} = 2.4$ Hz), 4.72 (d, 1H, \underline{CH}_2Ph , $J = 12.0$ Hz), 4.52 (d, 1H, \underline{CH}_2Ph , $J = 12.0$ Hz), 3.97 (dd, 1H, H3, $J_{3,2} = 2.4$ Hz, $J_{3,4} = 10.7$ Hz), 3.90 (dd, 1H, H5_b, $J_{5b,5a} = 10.7$ Hz, $J_{5b,4} = 4.8$ Hz), 3.82 (t, 1H, H5_a, $J_{5a,4} = J_{5a,5b} = 10.7$ Hz), 3.74 (t, 1H, H2, $J_{2,3} = J_{2,1} = 2.4$ Hz), 3.15 (dt, 1H, H4, $J_{4,3} = J_{4,5a} = 10.7$ Hz, $J_{4,5b} = 4.8$ Hz).

^{13}C NMR (100 MHz, CD_3OD), δ 138.65 ($C^{IV}_{aromatic}$), 128.94-129.49 ($C_{aromatic}$), 119.85 (CN), 101.02 (C1), 70.40 (\underline{CH}_2Ph), 69.84 (C2), 68.21 (C3), 60.36 (C5), 32.66 (C4).

Optical rotation

$[\alpha]_D^{20} = +72.6$ ($c = 1.1$; $CHCl_3$)

Melting point

$T_m = 144-146^\circ C$

Yield

89% (862 mg).

Galacto-isofagomine 111

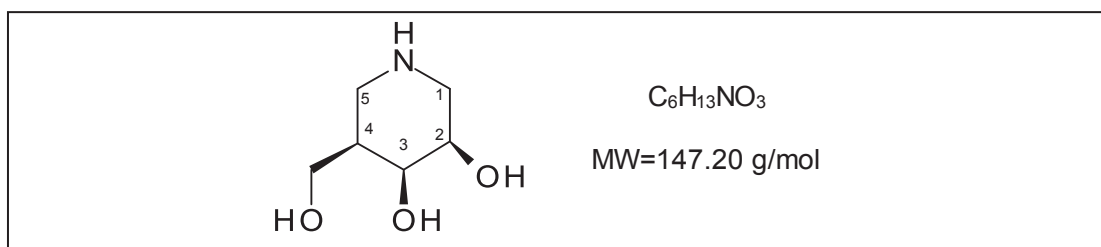

To a solution of compound **110** (134 mg, 0.54 mmol) in MeOH (9 mL) were added a 12N solution of HCl (45 μ L, 0.54 mmol, 1 eq) and 20% palladium hydroxide on carbon (117 mg). The reaction was stirred for 48h under a hydrogen atmosphere. Then the mixture was filtered through a membrane, the retained catalyst was washed with MeOH and the solvents were evaporated to give the expected galacto-isofagomine **111** (62 mg) containing 10% of *N*-methyl-galacto-isofagomine. A sample of pure galacto-isofagomine **111** could be obtained by recrystallization from EtOH.

NMR

The obtained spectrum corresponds to literature data.¹⁵⁹

HRMS (ESI)

$[M+H]^+$ calculated for $C_6H_{14}NO_3$ $m/z= 148.096820$; found $m/z= 148.096935$.

Yield

62 mg containing 10% of *N*-methyl by-product.

¹⁵⁹ Ichikawa, Y.; Igarashi, Y. *Tetrahedron Lett* **1995**, 36, 4585.

Benzyl 2,3-O-isopropylidene-4-nitromethyl-β-D-ribofuranoside **112**

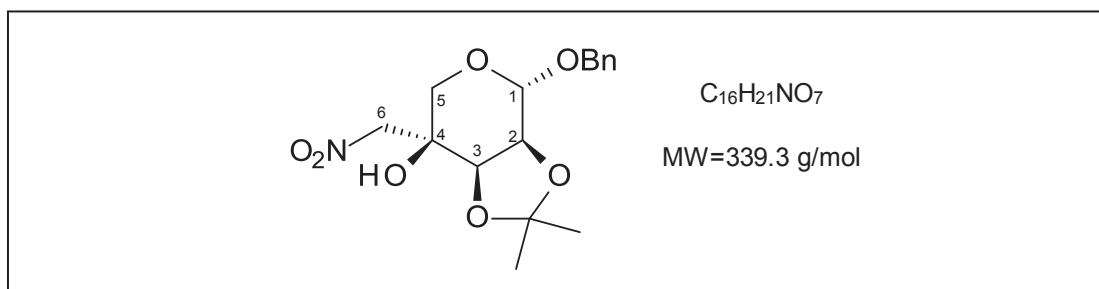

The reaction was conducted under argon. To a solution of ketone **100** (567 mg, 2.04 mmol) in nitromethane (4.1 mL) was added triethylamine (0.85 mL, 6.10 mmol, 3 eq). The reaction was left stirring for 24 h and then was quenched with a saturated solution of NH_4Cl (10 mL). The aqueous phase was separated and extracted with EtOAc (50 mL). The organic phase was washed with brine (15 mL) and dried over $MgSO_4$. Concentration under vacuum gave the crude product as a beige solid. Flash column chromatography on silica gel (PE/EtOAc, 9:1) gave **112** as a white solid, containing about 8% of the other diastereoisomer.

TLC:

- PE/EtOAc (8:2);
- $R_f = 0.21$

1H NMR (250 MHz, $CDCl_3$), δ 7.37-7.34 (m, 5H, $H_{aromatic}$), 5.02 (d, 1H, H1, $J_{1,2} = 1.75$ Hz), 4.78 (d, 1H, CH_2Ph , $J = 11.75$ Hz), 4.60 (d, 1H, CH_2NO_2 , $J = 11.25$ Hz), 4.56 (d, 1H, CH_2Ph , $J = 11.75$ Hz), 4.40 (d, 1H, CH_2NO_2 , $J = 11.25$ Hz), 4.16 (dd, 1H, H2, $J_{2,1} = 1.75$ Hz, $J_{2,3} = 6.0$ Hz), 4.12 (d, 1H, H3, $J_{2,3} = 6.0$ Hz), 3.91-3.78 (m, 2H, 2H5), 3.02 (br s, 1H, OH), 1.54, 1.37 (s, 3H, CH_3iPr).

^{13}C NMR (62.5 MHz, $CDCl_3$), δ 136.60 ($C^{IV}_{aromatic}$), 128.70-127.30 ($C_{aromatic}$), 110.57 ($C^{IV}iPr$), 97.10 (C1), 79.75 (CH_2NO_2), 74.43 (C2), 72.88 (C3), 69.56 (CH_2Ph), 65.71 (C4), 62.53 (C5), 26.36, 25.53 (CH_3iPr).

HRMS (ESI)

$[M+NH_4]^+$ calculated for $C_{16}H_{25}NO_7$ $m/z = 357.165628$; found $m/z = 357.165765$
 $[M+Na]^+$ calculated for $C_{16}H_{21}NNaO_7$ $m/z = 362.121023$; found $m/z = 362.121305$

Yield

91% (625 mg)

Benzyl 2,3-O-isopropylidene-4-nitromethyl-β-D-ribofuranoside **112** and
benzyl 2,3-O-isopropylidene-4-nitromethyl-α-L-lyxofuranoside **113**

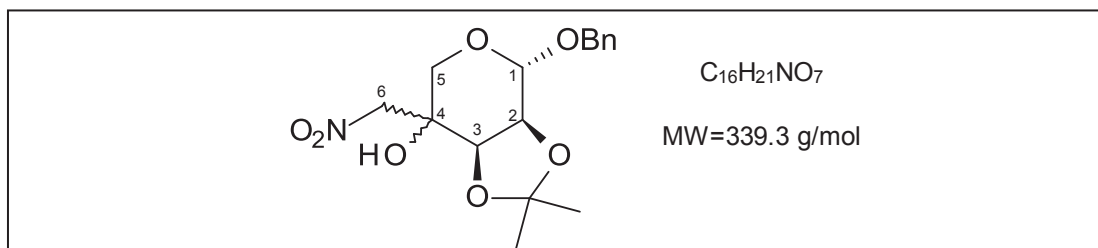

The reaction was conducted under argon. To a solution of nitromethane (34 μ L, 0.63 mmol, 1 eq) in acetonitrile (2.1 mL) was added dropwise DBU (10 μ L, 0.067 mmol, 0.1 eq). After 5 min of stirring, this solution was added to ketone **100** (176 mg, 0.63 mmol). The mixture was left stirring overnight. The reaction was quenched with a saturated solution of NH_4Cl (1 mL). The aqueous phase was separated and extracted with EtOAc (5 mL). The organic phase was washed with brine (2 mL) and dried over Na_2SO_3 . Concentration under vacuum gave the crude product as a yellow oil. Flash column chromatography on silica gel (PE/EtOAc, 9:1) afforded an inseparable mixture of the **112** and **113** (1:1 ratio) as a colorless oil.

TLC:

- PE/EtOAc (8:2);
- R_f = 0.21

Note: Signals for **112** are underlined. Signals for **113** are *in italics*.

1H NMR (250 MHz, $CDCl_3$), δ 7.40-7.25 (m, 5H, $H_{aromatic}$), 5.01 (d, 0.5H, $H1$, $J_{1,2}$ = 1.75 Hz), 4.85 (d, 0.5H, CH_2Ph , J = 12.0 Hz), 4.78 (d, 0.5H, CH_2Ph , J = 11.75 Hz), 4.68 (d, 0.5H, $H1$, $J_{1,2}$ = 3.75 Hz), 4.61 (d, 1H, CH_2NO_2 , CH_2Ph , J = 12.0 Hz), 4.59 (d, 0.5H, CH_2NO_2 , J = 11.25 Hz), 4.56 (d, 0.5H, CH_2Ph , J = 11.75 Hz), 4.49 (d, 0.5H, CH_2NO_2 , J =12.0 Hz) 4.40 (d, 0.5H, CH_2NO_2 , J = 11.25 Hz), 4.29 (dd, 0.5H, $H3$, J = 1.25 Hz, $J_{2,3}$ = 6.2 Hz), 4.24 (dd, 1H, $H2$, $J_{2,1}$ = 3.75 Hz, $J_{2,3}$ = 6.2 Hz), 4.17-4.11 (m, 1.5H, $H2$, $H3$, OH), 3.92 (dd, 0.5H, $H5_b$, J = 1.1 Hz, $J_{5b,5a}$ = 12.1 Hz), 3.84-3.79 (m, 1.5H, $H5_a$, $H5_b$, $H5_a$), 3.07 (br s, 0.5H, OH), 1.53, 1.39, 1.36, 1.33 (s, 6H, CH_3iPr).

^{13}C NMR (62.5 MHz, $CDCl_3$), δ 136.57, 136.30 ($C^{IV}_{aromatic}$), 128.64-128.24 ($C_{aromatic}$), 110.52, 110.47 (C^{IV}_{iPr}), 98.68 ($C1$), 97.11 ($C1$), 79.71 (CH_2NO_2), 78.86 (CH_2NO_2), 76.24 ($C3$), 74.48 ($C2$), 74.38 ($C3$), 72.88 ($C2$), 70.46 (CH_2Ph), 69.88 (CH_2Ph), 69.53, 68.47 ($C4$), 65.75 ($C5$), 62.50 ($C5$), 26.95, 26.31, 25.49, 25.36 (CH_3iPr).

IR [cm^{-1}] ν 3427 (O-H), 2988, 2935 (C-H), 1550 (NO_2), 1497, 1455, ($C=C_{aromatic}$), 1379 (NO_2), 1246, 1217, 1161, 1136, 1065, 1019 (C-O/C-C), 739, 699, (C-H_{aromatic}).

HRMS (ESI)

$[M+H]^+$ calculated for $C_{16}H_{22}NO_7$ m/z = 340.139078; found m/z = 340.1399429

$[M+NH_4]^+$ calculated for $C_{16}H_{25}NO_7$ m/z = 357.165628; found m/z = 357.165800

$[M+Na]^+$ calculated for $C_{16}H_{21}NNaO_7$ m/z = 362.121023; found m/z = 362.121138

$[M+K]^+$ calculated for $C_{16}H_{21}KNO_7$ m/z = 378.094960; found m/z = 378.094935

Yield

27% (56 mg)

(3*R*, 4*R*, 5*R*)-5-Hydroxymethyl-2,3-*O*-isopropylidene-piperidine-3,4,5-triol **115**
(3*R*, 4*R*, 5*S*)-5-Hydroxymethyl-2,3-*O*-isopropylidene-piperidine-3,4,5-triol **116**

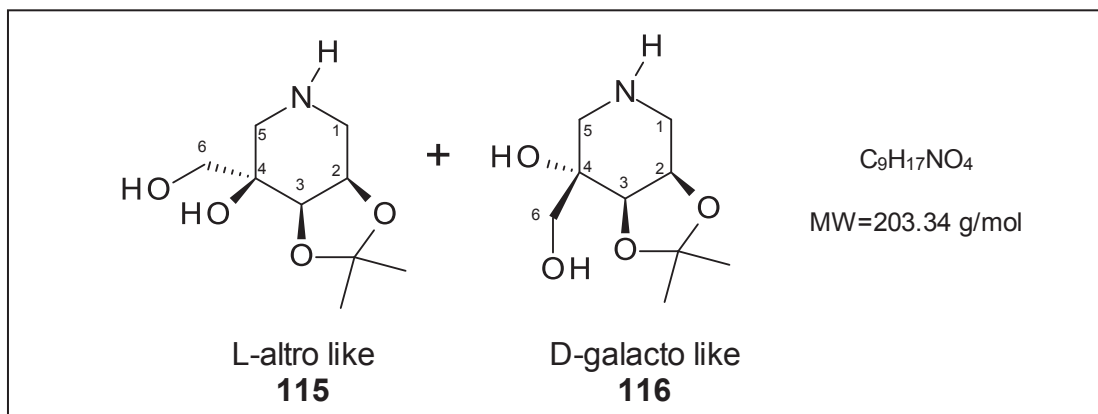

To a solution of mixture of compounds **112**+**113** (200 mg, 0.59 mmol) in isopropanol (6 mL) were added glacial acetic acid (0.59 mL, 10.3 mmol, 17 eq) and 10% Pd/C (88 mg). The mixture was left stirring under a hydrogen atmosphere for 2 days. Then it was filtered through a membrane, retained catalyst was washed with methanol and the solvents were evaporated. After treatment with Amberlite IRA400 resin (OH⁻) the crude product was obtained as a yellowish oil. Flash column chromatography on silica gel (CH₂Cl₂/MeOH 7:3) gave the two separated diastereoisomers **115** and **116** as colorless oils.

TLC:

- CH₂Cl₂/MeOH (6:4);
- R_f *altro* = 0.31, R_f *galacto* = 0.14

1st isomer **115** (L-*altro*-like)

¹H NMR (250 MHz, CD₃OD), δ 4.41-4.35 (m, 1H, H₂), 4.21 (d, 1H, H₃, $J_{2,3}$ = 6.0 Hz), 3.52 (d, 1H, H_{6b}, J = 11.0 Hz), 3.42 (d, 1H, H_{6a}, J = 11.0 Hz), 3.35-3.28 (m, 1H, H_{1eq}), 3.16 (dd, 1H, H_{1ax}, $J_{1ax,2}$ = 4.75 Hz, $J_{1ax,1eq}$ = 14.25 Hz), 3.02 (d, 1H, H_{5b}, $J_{5b,5a}$ = 13.25 Hz), 2.85 (d, 1H, H_{5a}, $J_{5a,5b}$ = 13.25 Hz), 1.55, 1.38 (s, 3H, CH₃iPr).

¹³C NMR (62.5 MHz, CD₃OD), δ 110.51 (C^{IV}iPr), 74.17 (C₃), 71.72 (C₂), 69.87 (C₄), 66.81 (C₆), 49.49 (C₅), 45.77 (C₁), 26.72, 25.76 (CH₃iPr).

HRMS (ESI)

[M+H]⁺ calculated for C₉H₁₈NO₄ m/z = 204.123034; found m/z = 204.123362

[M+Na]⁺ calculated for C₉H₁₇NNaO₄ m/z = 226.104979; found m/z = 226.105209

Yield

31% (37 mg)

2nd isomer 116 (D-galacto-like):

¹H NMR (400 MHz, CD₃OD), δ 4.34 (dt, 1H, H2, $J_{2,3} = J_{2,1b} = 5.6$ Hz, $J_{2,1a} = 7.0$ Hz), 4.11 (dd, 1H, H3, $J_{3,5} = 1.2$ Hz, $J_{3,2} = 5.6$ Hz), 3.59 (d, 1H, H6_b, $J = 11.6$ Hz), 3.48 (d, 1H, H6_a, $J = 11.6$ Hz), 3.21 (dd, 1H, H1_b, $J_{1b,2} = 5.6$ Hz, $J_{1b,1a} = 13.2$ Hz), 2.85 (d, 1H, H5_b, $J = 13.4$ Hz), 2.78 (d, 1H, H5_a, $J = 13.4$ Hz), 2.74 (dd, 1H, H1_a, $J_{1a,2} = 7.0$ Hz, $J_{1a,1b} = 13.2$ Hz), 1.48, 1.35 (s, 3H, CH₃iPr).

¹³C NMR (100 MHz, CD₃OD), δ 110.66 (C^{IV}iPr), 75.64 (C3), 71.91 (C2), 71.63 (C4), 66.33 (C6), 46.76 (C5), 45.84 (C1), 27.93, 25.67 (CH₃iPr).

HRMS (ESI)

[M+H]⁺ calculated for C₉H₁₈NO₄ $m/z = 204.123034$; found $m/z = 204.123371$

Yield

23% (28 mg)

(3*R*, 4*R*, 5*R*)-5-Hydroxymethyl-piperidine-3,4,5-triol **117**

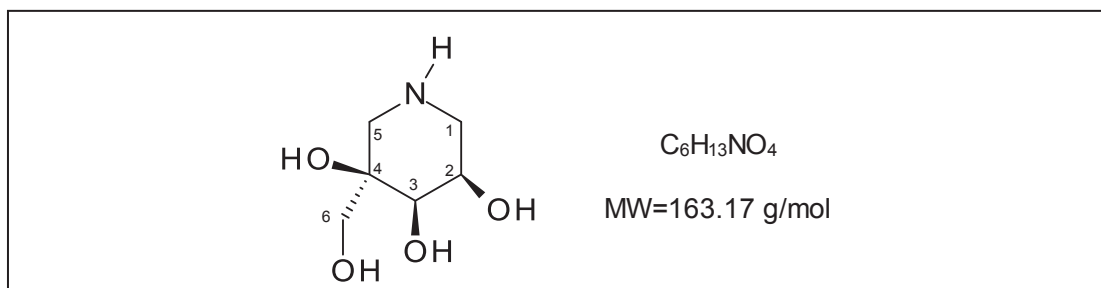

To a solution of **115** (36.8 mg, 0.18 mmol) in a mixture of dioxane/H₂O (1:1, 1.8 mL) was added Dowex 50WX8 resin (H⁺) (250 mg). The mixture was left stirring gently for 1 h. The resin was filtered and washed with MeOH. Then 0.5N aqueous solution of NH₃ was added to the filtrate and the mixture was left gently stirring for 30 min. The resin was filtered and washed with a 0.5N aqueous solution of NH₃. The filtrate was concentrated to give the crude product as a white solid. Purification on Dowex 50WX8 resin (H⁺) gave the pure **117** as a white solid.

¹H NMR (400 MHz, D₂O), δ 3.98 (br s, 1H, H₂), 3.77-3.76 (m, 1H, H₃), 3.65 (d, 1H, H_{6b}, $J=11.6$ Hz), 3.53 (d, 1H, H_{6a}, $J=11.6$ Hz), 3.07 (br d, 1H, H_{1b}, $J_{1b,1a}=13.8$ Hz), 2.95 (d, 1H, H_{5b}, $J_{5b,5a}=13.8$ Hz), 2.86 (d, 1H, H_{1a}, $J_{1a,1b}=13.8$ Hz), 2.78 (d, 1H, H_{5a}, $J_{5a,5b}=13.8$ Hz).

¹³C NMR (100 MHz, D₂O), δ 73.58 (C₄), 68.12 (C₂, C₃), 63.52 (C₆), 49.05 (C₅), 47.83 (C₁).

HRMS (ESI)

[M+H]⁺ calculated for C₆H₁₄NO₄ $m/z=164.091734$; found $m/z=164.091837$

[M+Na]⁺ calculated for C₆H₁₃NNaO₄ $m/z=186.073679$; found $m/z=186.073729$

Optical rotation

$[\alpha]_D^{20} = -21.2$ ($c=1.0$; MeOH)

Yield

66% (19.6 mg)

(3*R*, 4*R*, 5*S*)-5-Hydroxymethyl-piperidine-3,4,5-triol **118**

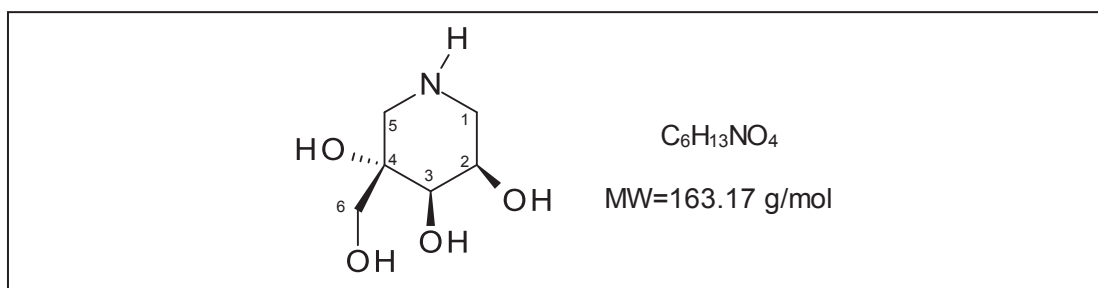

To a solution of **116** (28 mg, 0.14 mmol) in a mixture of dioxane/H₂O (1:1, 1.4 mL) was added Dowex 50WX8 resin (H⁺) (190 mg). The mixture was left stirring gently for 1 h. The resin was filtered and washed with MeOH. Then a 0.5N aqueous solution of NH₃ was added to the resin and the mixture was left gently stirring for 30 min. The resin was filtered and washed with a 0.5N aqueous solution of NH₃. The filtrate was concentrated to give the crude product as a white solid. Purification on Dowex 50WX8 resin (H⁺) gave the pure **118** as a white solid.

¹H NMR (400 MHz, D₂O), δ 4.00-3.96 (m, 1H, H2), 3.81 (br s, 1H, H3), 3.63 (d, 1H, H6, *J*=12.0 Hz), 3.52 (d, 1H, H6, *J*=12.0 Hz), 2.84 (dd, 1H, H1_b, *J*_{1b,2}= 3.6 Hz, *J*_{1b,1a}= 12.8 Hz), 2.66 (d, 1H, H5_b, *J*= 15.6 Hz), 2.61-2.56 (m, 2H, H1_a, H5_a).

¹³C NMR (100 MHz, D₂O), δ 73.75 (C4), 69.94 (C3), 66.00 (C2), 64.32 (C6), 45.44 (C5), 44.25 (C1).

HRMS (ESI)

[M+H]⁺ calculated for C₆H₁₄NO₄ *m/z*= 164.091734; found *m/z*= 164.091799

[M+Na]⁺ calculated for C₆H₁₃NNaO₄ *m/z*= 186.073679; found *m/z*= 186.073786

Optical rotation

[α]_D²⁰ = -32.2 (c= 1.0; MeOH)

Yield

87% (19.8 mg)

Benzyl 2,3-O-isopropylidene-4-C-(1-nitrohexyl)-β-L-ribofuranoside **119+120**

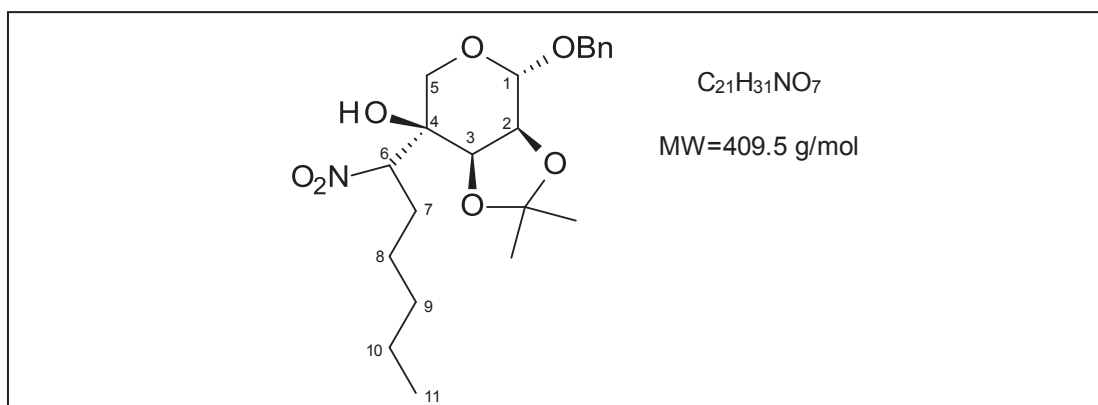

The reaction was conducted under argon. To a solution of crude ketone **100** (1.57 mmol) in nitrohexane (5.3 mL) was added triethylamine (0.61 mL, 4.38 mmol, 2.8eq). The mixture was left stirring for 24h. The reaction was quenched with a saturated solution of NH_4Cl (15 mL). The aqueous phase was separated and extracted with EtOAc (40 mL). The organic phase was washed with brine (15 mL) and dried over $MgSO_4$. Concentration under vacuum gave the crude product as a liquid oil. Flash column chromatography on silica gel (PE/EtOAc, 92:8) gave an inseparable mixture of the two diastereoisomers (7:3 ratio) **119** and **120** as a colorless oil.

TLC:

- PE/EtOAc (8:2);
- $R_f = 0.56$

1H NMR (400 MHz, $CDCl_3$), 7.47-4.28 (m, 5H, $H_{aromatic}$), 5.05 (br s, 1H, H1), 4.75 (d, 1H, CH_2Ph , $J = 11.6$ Hz), 4.60-4.51 (m, 1H, H6), 4.54 (d, 1H, CH_2Ph , $J = 11.6$ Hz), 4.26 (d, 0.7H, H_{3MAJ} , $J = 6.4$ Hz), 4.17-4.09 (m, 1.35H, H_{2MAJ} , H_{3min} , H_{2min}), 3.88 (d, 0.3H, $H_{5b min}$, $J = 12.4$ Hz), 3.81 (d, 0.7H, $H_{5b MAJ}$, $J = 12.0$ Hz), 3.73 (d, 0.7H, $H_{5a MAJ}$, $J = 12.0$ Hz), 3.58 (d, 0.3H, $H_{5a min}$, $J = 12.4$ Hz), 3.04 (s, 0.7H, OH_{MAJ}), 2.96 (s, 0.3H, OH_{min}), 2.16-1.95 (m, 1.3H, $H_{7b MAJ}$, $2H_{7min}$), 1.72-1.65 (m, 0.7H, $H_{7a MAJ}$), 1.55 (s, 0.9H, CH_3iPr_{min}), 1.54 (s, 2.1H, CH_3iPr_{MAJ}), 1.37 (s, 0.9H, CH_3iPr_{min}), 1.36 (s, 2.1H, CH_3iPr_{MAJ}), 1.30-1.29 (m, 6H, CH_2 -hexyl), 0.95-0.82 (m, 3H, CH_3 -hexyl).

^{13}C NMR (100 MHz, $CDCl_3$), δ 136.65 ($C_{aromatic}^{IV}$), 128.69-128.28 ($C_{aromatic}$), 110.24 ($C_{iPr_{MAJ}}^{IV}$), 110.15 ($C_{iPr_{min}}^{IV}$), 96.60 (C_{1MAJ}), 96.40 (C_{1min}), 92.71 (C_{6min}), 92.68 (C_{6MAJ}), 74.35 (C_{2MAJ}), 74.32 (C_{2min}), 72.52 (C_{3min}), 72.03 (C_{3MAJ}), 69.74 (CH_2Ph_{MAJ}), 69.66 (CH_2Ph_{min}), 69.49 (C_{4MAJ}), 69.05 (C_{4min}), 61.26 (C_{5min}), 60.79 (C_{5MAJ}), 31.12, 28.02, 25.99, 22.41 (CH_2 -hexyl_{MAJ}), 31.17, 27.23, 25.93, 22.45 (CH_2 -hexyl_{min}), 26.17, 25.36 (CH_3iPr_{MAJ}), 26.13, 25.36 (CH_3iPr_{min}), 14.00 (CH_3 hexyl_{min}), 13.98 (CH_3 hexyl_{MAJ}).

HRMS (ESI)

$[M+NH_4]^+$ calculated for $C_{21}H_{35}NO_7$ $m/z = 427.243878$; found $m/z = 427.243845$

$[M+Na]^+$ calculated for $C_{21}H_{31}NNaO_7$ $m/z = 432.199273$; found $m/z = 432.199176$

Yield

60% (384 mg)

Benzyl 2,3-O-isopropylidene-4-C-(1-aminohexyl)-β-L-ribofuranoside **121+122**

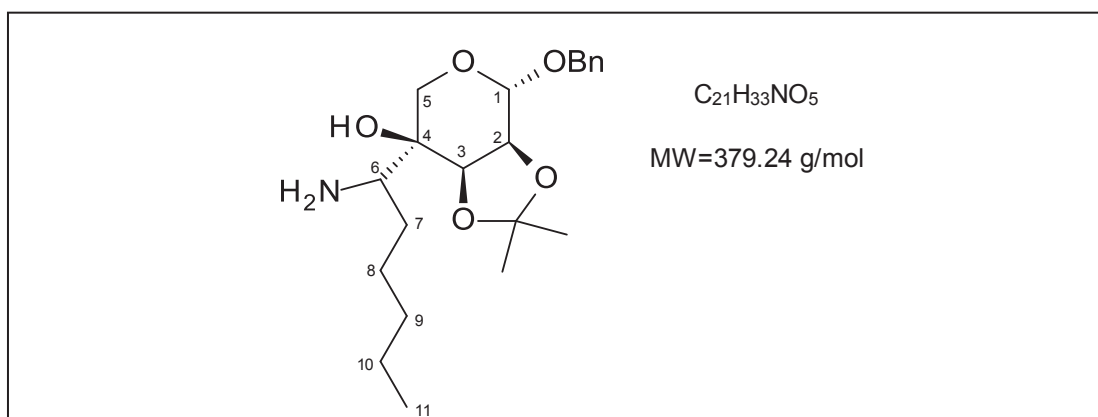

To a solution of the mixture of compounds **119+120** (289 mg, 0.71 mmol) in isopropanol (7.1 mL) were added glacial acetic acid (0.71 mL) and Raney Ni (106 mg). The mixture was left stirring under a hydrogen atmosphere for 5 days. Then the mixture was filtered through a membrane, the retained catalyst was washed with MeOH and the solvents were evaporated to give the crude product as a thick, green oil. Flash column chromatography on silica gel ($CH_2Cl_2/MeOH$ 9:1) gave an inseparable mixture of diastereoisomers **121+122** as a slightly green oil.

TLC:

- $CH_2Cl_2/MeOH$ (9:1);
- $R_f = 0.44$

1H NMR (400 MHz, CD_3OD), δ 7.43-7.28 (m, 5H, $H_{aromatic}$), 4.90 (d, 1H, H1, $J_{1,2} = 3.3$ Hz); 4.79 (d, 1H, CH_2Ph , $J = 11.90$ Hz), 4.61 (d, 1H, \underline{CH}_2Ph , $J = 11.90$ Hz), 4.36 (d, 1H, H3, $J_{3,2} = 5.8$ Hz), 4.13 (dd, 1H, H2, $J_{2,1} = 3.3$ Hz, $J_{2,3} = 5.8$ Hz), 3.78 (d, 1H, H5_b, $J_{5b,5a} = 12.0$ Hz), 3.57 (d, 1H, H5_a, $J_{5a,5b} = 12.0$ Hz), 2.96 (dd, 0.7H, H6_{MAJ}, $J = 2.4$ Hz, $J = 9.6$ Hz), 2.81-2.79 (m, 0.3H, H6_{min}), 1.69-1.26 (m, 14H, \underline{CH}_2 -hexyl, \underline{CH}_3iPr), 0.95 (t, 3H, \underline{CH}_3 -hexyl, $J = 6.6$ Hz).

^{13}C NMR (100 MHz, CD_3OD), δ 138.63 ($C^{IV}_{aromatic}$), 129.41, 129.19, 128.90 ($C_{aromatic}$), 110.96 ($C^{IV}iPr_{MAJ}$), 110.63 ($C^{IV}iPr_{min}$), 99.73 ($C1_{min}$), 99.56 ($C1_{MAJ}$), 76.33 (C2), 76.09 (C3), 71.20 (C4), 70.76 (CH_2Ph), 64.84 (C5_{min}), 63.52 (C5_{MAJ}), 58.39 (C6_{min}), 57.59 (C6_{MAJ}), 32.95, 30.66, 27.24, 23.60 (\underline{CH}_2 -hexyl_{MAJ}), 31.66, 27.48 (\underline{CH}_2 -hexyl_{min}), 26.92 ($\underline{CH}_3iPr_{min}$), 26.84, 25.96 ($\underline{CH}_3iPr_{MAJ}$), 14.39 (\underline{CH}_3 -hexyl)

HRMS (ESI)

$[M+H]^+$ calculated for $C_{21}H_{34}NO_5$ $m/z = 380.243150$; found $m/z = 380.243272$

Yield

85% (228 mg)

(3*R*, 4*R*, 5*S*, 6*R* or *S*)-5-Hydroxymethyl-2,3-*O*-isopropylidene-6-*C*-pentyl-piperidine-3,4,5-triol **123**

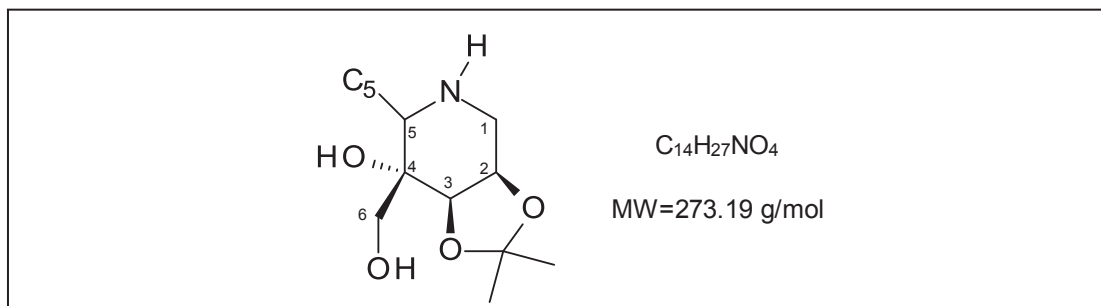

To a solution of the mixture of compounds **121** and **122** (26 mg, 0.07 mmol) in isopropanol (1 mL) were added glacial acetic acid (0.1 mL) and 20% Pd(OH)₂ (11 mg). The mixture was left stirring under a hydrogen atmosphere for 2 days. It was not completed. Then it was filtered through a membrane, retained catalyst was washed with MeOH and the solvents were evaporated to give the crude product as a yellowish oil. Flash column chromatography on silica gel (CH₂Cl₂/MeOH 9:1) gave desired **123** almost exclusively as a single diastereoisomer and as a colorless oil.

TLC:

- CH₂Cl₂/MeOH (9:1);
- R_f= 0.15

¹H NMR (400 MHz, CD₃OD), δ 4.31-4.27 (m, 1H, H2), 4.23 (d, 1H, H3, *J*= 6.0 Hz), 3.61 (s, 2H, 2H6), 3.16 (dd, 1H, H1_b, *J*_{1b,2}= 5.4 Hz, *J*_{1b,1a}= 13.2 Hz), 2.77-2.74 (m, 1H, H5), 2.71 (dd, 1H, H1_a, *J*_{1a,2}= 7.6 Hz, *J*_{1a,1b}= 13.2 Hz), 1.61-1.20 (m, 14H, CH₂-pentyl, CH₃iPr), 0.92 (t, 3H, CH₃-pentyl, *J*= 7.0 Hz).

¹³C NMR (100 MHz, CD₃OD), δ 110.36 (C^{IV}iPr), 76.95 (C3), 73.32 (C4), 72.29 (C2), 65.58 (C6), 56.60 (C5), 46.73 (C1), 33.18, 29.65, 27.48, 23.61 (CH₂-pentyl), 28.09, 25.80 (CH₃iPr), 14.40 (CH₃-pentyl).

LRMS (ESI)

[M+H]⁺ = 274.0;

Yield

38% (6.8 mg)

(3R, 4R, 5S, 6RS)-5-Hydroxymethyl-2,3-O-isopropylidene-6-C-pentyl-piperidine-3,4,5-triol

123+ 124

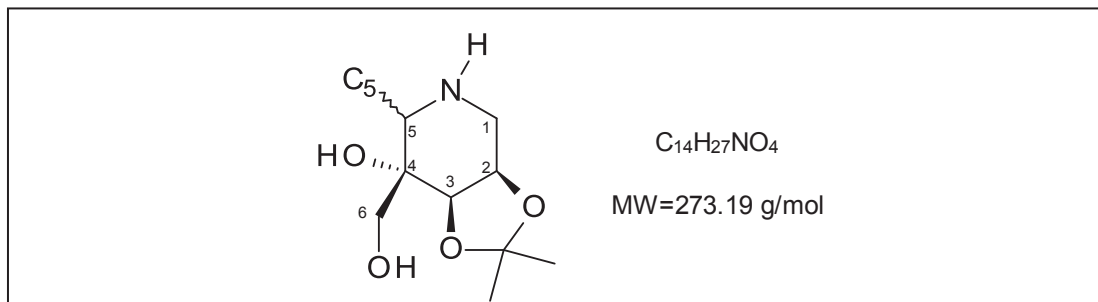

To a solution of the mixture of compounds **121** and **122** (228 mg, 0.6 mmol) in isopropanol (6 mL) were added glacial acetic acid (0.6 mL) and 20% Pd(OH)₂ (91 mg). The mixture was left stirring under a hydrogen atmosphere for 2 days. Then it was filtered through a membrane, retained catalyst was washed with MeOH and the solvents were evaporated to give the crude product as a thick, yellow oil. Flash column chromatography on silica gel (CH₂Cl₂/MeOH 9:1) gave a mixture of diastereoisomers **123+124** (7:3) as a colorless oil.

TLC:

- CH₂Cl₂/MeOH (9:1);
- R_f = 0.15

¹H NMR (600 MHz, CD₃OD), δ 4.55 (dt, 0.7H, H₂_{MAJ}, $J_{2,1b} = J_{2,1a} = 3.9$ Hz, $J_{2,3} = 7.2$ Hz), 4.49-4.46 (m, 0.3H, H₂_{min}), 4.29 (d, 0.7H, H₃_{MAJ}, $J = 7.2$ Hz), 4.21 (dd, 0.3H, H₃_{min}, $J_{3,5} = 1.2$ Hz, $J_{3,2} = 6.6$ Hz), 3.72 (d, 0.3H, H₆_{b min}, $J = 11.4$ Hz), 3.66 (d, 0.3H, H₆_{a min}, $J = 11.4$ Hz), 3.64 (d, 0.7H, H₆_{bMAJ}, $J_{6b,6a} = 11.4$ Hz), 3.61 (d, 0.7H, H₆_{aMAJ}, $J_{6a,6b} = 11.4$ Hz), 3.51 (dd, 0.7H, H₁_{b MAJ}, $J_{1,2} = 3.9$ Hz, $J_{1b,1a} = 13.5$ Hz), 3.34 (dd, 0.3H, H₁_{b min}, $J_{1,2} = 5.4$ Hz, $J_{1b,1a} = 13.2$ Hz), 3.23 (dd, 0.7H, H₅_{MAJ}, $J = 3.6$ Hz, $J = 13.2$ Hz), 3.21-3.18 (m, 0.3H, H₅_{min}), 3.18 (dd, 0.7H, H₁_{a MAJ}, $J_{1a,2} = 3.9$ Hz, $J_{1a,1b} = 13.5$ Hz), 2.92 (dd, 0.3H, H₁_{a min}, $J_{1a,2} = 6.0$ Hz, $J_{1a,1b} = 13.2$ Hz), 1.93-1.83 (m, 1H, CH₂ pentyl), 1.76-1.60 (m, 2H, CH₂ pentyl), 1.51 (s, 3H, CH₃iPr), 1.40-1.27 (m, 5H, CH₂ pentyl), 1.38 (s, 3H, CH₃iPr), 0.94 (t, 3H, CH₃-pentyl, $J = 6.6$ Hz).

¹³C NMR (62.5 MHz, CD₃OD),

MAJOR: δ 110.68 (C^{IV}iPr), 75.20 (C3), 72.74 (C4), 70.79 (C2), 64.70 (C6), 54.83 (C5), 42.43 (C1), 32.84, 28.41, 26.53, 23.45 (CH₂-pentyl), 27.08, 24.58 (CH₃iPr), 14.35 (CH₃-pentyl).

MINOR: δ 111.20 (C^{IV}iPr), 75.52 (C3), 72.82 (C4), 70.82 (C2), 65.27 (C6), 60.01 (C5), 41.61 (C1), 32.67, 28.60, 27.40 (CH₂-pentyl), 27.18, 24.86 (CH₃iPr), 14.35 (CH₃-pentyl).

HRMS (ESI)

[M+H]⁺ calculated for C₁₄H₂₈NO₄ $m/z = 274.201285$; found $m/z = 274.201459$

Yield

64% (106 mg)

(3*R*, 4*R*, 5*S*, 6*R* or *S*)-5-Hydroxymethyl-6-*C*-pentyl-piperidine-3,4,5-triol **125**

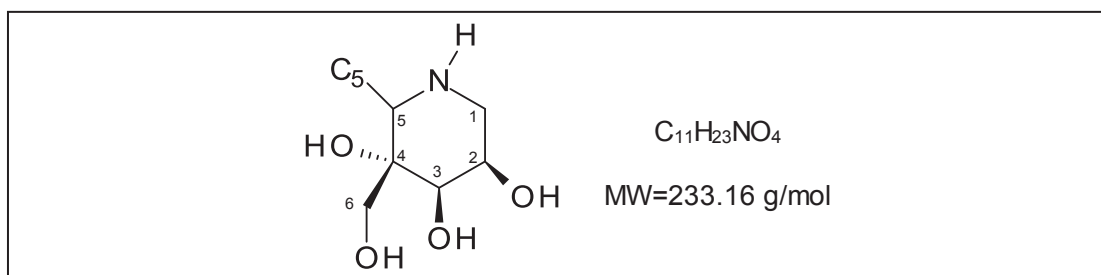

To a solution of iminosugar **123** (18.4 mg, 0.067 mmol) in a mixture of dioxane/H₂O (1:1, 1 mL) was added Dowex 50WX8 resin (H⁺) (99 mg). The mixture was left stirring gently for 1h. The resin was filtered and washed with MeOH. Then a 0.5N aqueous solution of NH₃ was added to the resin and mixture was left stirring gently for 30 min. The resin was filtered and washed with a 0.5N aqueous solution of NH₃. The filtrate was concentrated under vacuum to give **125** as a colorless oil.

¹H NMR (400 MHz, CD₃OD), δ 3.95-3.82 (m, 2H, H2, H3), 3.67 (d, 1H, H6_b, $J_{6b,6a}$ = 11.2 Hz), 3.53 (d, 1H, H6_a, $J_{6a,6b}$ = 11.2 Hz), 2.85-2.69 (m, 3H, H5, 2H1), 1.61-1.43 (m, 2H, CH₂-pentyl), 1.43-1.16 (m, 6H, CH₂-pentyl), 0.97-0.85 (m, 3H, CH₃-pentyl).

¹³C NMR (100 MHz, CD₃OD), δ 75.54 (C4), 73.11 (C3), 67.47 (C2), 66.49 (C6), 55.84 (C5), 46.61 (C1), 33.18, 29.45, 27.70, 23.62 (CH₂-pentyl), 14.42 (CH₃-pentyl).

Yield

56% (8.8 mg)

(3*R*, 4*R*, 5*S*, 6*RS*)-5-Hydroxymethyl-6-*C*-pentyl-piperidine-3,4,5-triol **125**+**126**

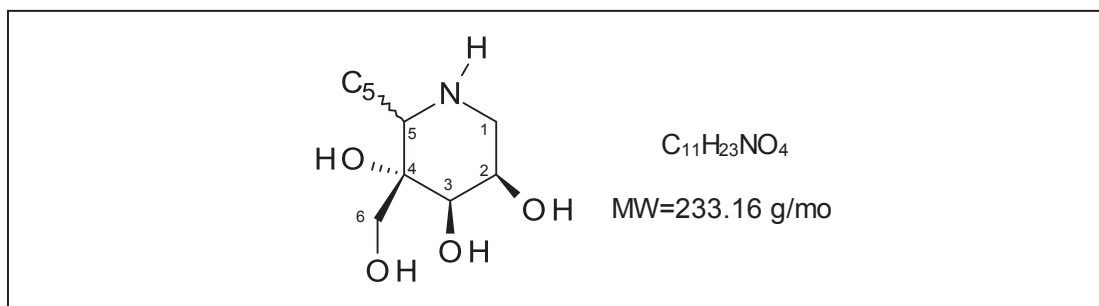

To a solution of a mixture of compounds **123**+**124** (106 mg, 0.39 mmol) in a mixture of dioxane/water (1:1, 4 mL) was added Dowex 50WX8 resin (H^+) (550 mg). The mixture was left stirring gently for 1h. The resin was filtered and washed with MeOH. Then a 0.5N aqueous solution of NH_3 was added and the mixture was left stirring gently for 30 min. The resin was filtered and washed with a 0.5N aqueous solution of NH_3 . The filtrate was concentrated under vacuum to give the crude product as a mixture of two diastereoisomers **125** and **126** (7:3) and as a colorless oil. Pure samples of **125** and **126** were isolated by HPLC (column Hypercarb, 250mm x 10mm, H_2O /isopropanol/formic acid 99.5/0.5/0.4, pressure 3.3 bars, debit 4.4mL/min, $T=30^\circ C$, ELS detection).

1H NMR (250 MHz, CD_3OD), δ 3.91-3.85 (m, 2H, H2, H3), 3.83 (d, 0.3H, $H_{6b\ min}$, $J_{6b,6a}=11.2$ Hz), 3.67 (d, 0.7H, H_{6b} , $J_{6b,6a}=11.2$ Hz), 3.64 (d, 0.3H, $H_{6a\ min}$, $J_{6a,6b}=11.2$ Hz), 3.53 (d, 0.7H, H_{6a} , $J_{6a,6b}=11.2$ Hz), 2.95 (dd, 0.3H, $H_{1b\ min}$, $J_{1b,2}=3.6$ Hz, $J_{1b,1a}=14.0$ Hz), 2.78-2.69 (m, 2.4H, H_{5MAJ} , H_{1MAJ} , $H_{1a\ min}$), 2.38 (d, 0.3H, $H_{5\ min}$, $J=10.0$ Hz), 1.86-1.74 (m, 0.3H, CH_2 -pentyl $_{\min}$), 1.68-1.41 (m, 2H, CH_2 -pentyl), 1.41-1.17 (m, 5.7H, CH_2 -pentyl), 0.91 (t, 3H, CH_3 -pentyl, $J=7.0$ Hz).

^{13}C NMR Only the major diastereoisomer **125** is fully visible on this spectrum and is very similar to the ^{13}C spectrum of compound **125**.

HRMS (ESI)

$[M+H]^+$ calculated for $C_{11}H_{24}NO_4$ $m/z=234.169985$; found $m/z=234.170167$

Yield

60% (54 mg)

Bibliography

- (1) De Duve, C.; Pressman, B. C.; Gianetto, R.; Wattiaux, R.; Appelmans, F. *Biochem J* **1955**, *60*, 604.
- (2) De Duve, C. *Nat Cell Biol* **2005**, *7*, 847.
- (3) Eskelinen, E. L.; Tanaka, Y.; Saftig, P. *Trends Cell Biol* **2003**, *13*, 137.
- (4) Journet, A.; Chapel, A.; Kieffer, S.; Roux, F.; Garin, J. *Proteomics* **2002**, *2*, 1026.
- (5) Futerman, A. H.; van Meer, G. *Nat Rev Mol Cell Biol* **2004**, *5*, 554.
- (6) Luzio, J. P.; Pryor, P. R.; Bright, N. A. *Nat Rev Mol Cell Biol* **2007**, *8*, 622.
- (7) Guicciardi, M. E.; Leist, M.; Gores, G. J. *Oncogene* **2004**, *23*, 2881.
- (8) McNeil, P. L.; Kirchhausen, T. *Nat Rev Mol Cell Biol* **2005**, *6*, 499.
- (9) Hopwood, J. J.; Brooks, D. A. In *Organelle Diseases*; Chapman and Hall Medical: 1997, p 7.
- (10) Ferri, K. F.; Kroemer, G. *Nat Cell Biol* **2001**, *3*, E255.
- (11) Mellman, I.; Fuchs, R.; Helenius, A. *Annu Rev Biochem* **1986**, *55*, 663.
- (12) Kornfeld, R.; Kornfeld, S. *Annu Rev Biochem* **1985**, *54*, 631.
- (13) Little, L.; Alcouloumre, M.; Drotar, A. M.; Herman, S.; Robertson, R.; Yeh, R. Y.; Miller, A. L. *The Biochemical journal* **1987**, *248*, 151.
- (14) Reitman, M. L.; Kornfeld, S. *J Biol Chem* **1981**, *256*, 4275.
- (15) Reitman, M. L.; Kornfeld, S. *J Biol Chem* **1981**, *256*, 11977.
- (16) Ni, X.; Canuel, M.; Morales, C. R. *Histol Histopathol* **2006**, *21*, 899.
- (17) Lodish, A.; Berk, A.; Zipursky, S.; W. H. Freeman;: New York, **2000**.
- (18) Linder, M. E.; Deschenes, R. J. *Biochemistry (Mosc)* **2003**, *42*, 4311.
- (19) Alberts, B.; Johnson, A.; Lewis, J. In *Molecular Biology of the Cell. 4th edition*; Garland Science: New York, 2002.
- (20) Parkinson-Lawrence, E. J.; Shandala, T.; Prodoehl, M.; Plew, R.; Borlace, G. N.; Brooks, D. A. *Physiology (Bethesda)* **2010**, *25*, 102.
- (21) Meikle, P. J.; Hopwood, J. J.; Clague, A. E.; Carey, W. F. *JAMA* **1999**, *281*, 249.
- (22) Beutler, E.; Grabowski, G. In *The Metabolic and Molecular Bases of Inherited Disease. 8th ed.*; McGraw-Hill: New York, 2001, p 3635.
- (23) Vallance, H.; Ford, J. *Crit Rev Clin Lab Sci* **2003**, *40*, 473.
- (24) Arvio, M.; Autio, S.; Louhiala, P. *Acta Paediatr* **1993**, *82*, 587.
- (25) Santavuori, P. *Brain Dev* **1988**, *10*, 80.
- (26) Verheijen, F. W.; Verbeek, E.; Aula, N.; Beerens, C. E.; Havelaar, A. C.; Joosse, M.; Peltonen, L.; Aula, P.; Galjaard, H.; van der Spek, P. J.; Mancini, G. M. *Nat Genet* **1999**, *23*, 462.
- (27) Town, M.; Jean, G.; Cherqui, S.; Attard, M.; Forestier, L.; Whitmore, S. A.; Callen, D. F.; Gribouval, O.; Broyer, M.; Bates, G. P.; van't Hoff, W.; Antignac, C. *Nat Genet* **1998**, *18*, 319.
- (28) Nishino, I.; Fu, J.; Tanji, K.; Yamada, T.; Shimojo, S.; Koori, T.; Mora, M.; Riggs, J. E.; Oh, S. J.; Koga, Y.; Sue, C. M.; Yamamoto, A.; Murakami, N.; Shanske, S.; Byrne, E.; Bonilla, E.; Nonaka, I.; DiMauro, S.; Hirano, M. *Nature* **2000**, *406*, 906.
- (29) Schmidt, B.; Selmer, T.; Ingendoh, A.; von Figura, K. *Cell* **1995**, *82*, 271.
- (30) Ostrowska, H.; Krukowska, K.; Kalinowska, J.; Orłowska, M.; Lengiewicz, I. *Cell Mol Biol Lett* **2003**, *8*, 19.
- (31) Cooper, J. D. *Curr Opin Neurol* **2003**, *16*, 121.
- (32) Filocamo, M.; Morrone, A. *Hum Genomics* **2011**, *5*, 156.

- (33) Boyd, R. E.; Lee, G.; Rybczynski, P.; Benjamin, E. R.; Khanna, R.; Wustman, B. A.; Valenzano, K. J. *J Med Chem* **2013**, *56*, 2705.
- (34) Heese, B. A. *Semin Pediatr Neurol* **2008**, *15*, 119.
- (35) Tomatsu, S.; Montano, A. M.; Oikawa, H.; Smith, M.; Barrera, L.; Chinen, Y.; Thacker, M. M.; Mackenzie, W. G.; Suzuki, Y.; Orii, T. *Curr Pharm Biotechnol* **2011**, *12*, 931.
- (36) Sakai, N. *Brain Dev* **2009**, *31*, 485.
- (37) Marsden, D.; Larson, C.; Levy, H. L. *J Pediatr* **2006**, *148*, 577.
- (38) Li, Y.; Scott, C. R.; Chamoles, N. A.; Ghavami, A.; Pinto, B. M.; Turecek, F.; Gelb, M. H. *Clin Chem* **2004**, *50*, 1785.
- (39) Beutler, E. *Mol Genet Metab* **2006**, *88*, 208.
- (40) van Gelder, C. M.; Vollebregt, A. A.; Plug, I.; van der Ploeg, A. T.; Reuser, A. J. *Expert Opin Pharmacother* **2012**, *13*, 2281.
- (41) Hoogerbrugge, P. M.; Brouwer, O. F.; Bordigoni, P.; Ringden, O.; Kapaun, P.; Ortega, J. J.; O'Meara, A.; Cornu, G.; Souillet, G.; Frappaz, D.; et al. *Lancet* **1995**, *345*, 1398.
- (42) Salky, B.; Kreel, I.; Gelernt, I.; Bauer, J.; Aufses, A. H., Jr. *Ann Surg* **1979**, *190*, 592.
- (43) Martin, P. L.; Carter, S. L.; Kernan, N. A.; Sahdev, I.; Wall, D.; Pietryga, D.; Wagner, J. E.; Kurtzberg, J. *Biol Blood Marrow Transplant* **2006**, *12*, 184.
- (44) Peters, C.; Steward, C. G. *Bone Marrow Transplant* **2003**, *31*, 229.
- (45) Wynn, R. *Hematology Am Soc Hematol Educ Program* **2011**, *2011*, 285.
- (46) Priller, J.; Flugel, A.; Wehner, T.; Boentert, M.; Haas, C. A.; Prinz, M.; Fernandez-Klett, F.; Prass, K.; Bechmann, I.; de Boer, B. A.; Frotscher, M.; Kreutzberg, G. W.; Persons, D. A.; Dirnagl, U. *Nat Med* **2001**, *7*, 1356.
- (47) Hobbs, J. R.; Hugh-Jones, K.; Barrett, A. J.; Byrom, N.; Chambers, D.; Henry, K.; James, D. C.; Lucas, C. F.; Rogers, T. R.; Benson, P. F.; Tansley, L. R.; Patrick, A. D.; Mossman, J.; Young, E. P. *Lancet* **1981**, *2*, 709.
- (48) Rovelli, A. M.; Steward, C. G. *Bone Marrow Transplant* **2005**, *35 Suppl 1*, S23.
- (49) Boelens, J. J.; Prasad, V. K.; Tolar, J.; Wynn, R. F.; Peters, C. *Pediatr Clin North Am* **2010**, *57*, 123.
- (50) Boelens, J. J. *J Inherit Metab Dis* **2006**, *29*, 413.
- (51) Escolar, M. L.; Poe, M. D.; Provenzale, J. M.; Richards, K. C.; Allison, J.; Wood, S.; Wenger, D. A.; Pietryga, D.; Wall, D.; Champagne, M.; Morse, R.; Krivit, W.; Kurtzberg, J. *N Engl J Med* **2005**, *352*, 2069.
- (52) Kennedy, D. W.; Abkowitz, J. L. *Blood* **1997**, *90*, 986.
- (53) Odorfer, K. I.; Egerbacher, M.; Unger, N. J.; Weber, K.; Jamnig, A.; Lepperdinger, G.; Kleiter, M.; Sandgren, E. P.; Erben, R. G. *J Cell Mol Med* **2011**, *15*, 2232.
- (54) Aldenhoven, M.; Boelens, J. J.; de Koning, T. J. *Biol Blood Marrow Transplant* **2008**, *14*, 485.
- (55) Barranger, J. M.; Novelli, E. A. *Expert Opin Biol Ther* **2001**, *1*, 857.
- (56) Sands, M. S.; Haskins, M. E. *Acta Paediatr Suppl* **2008**, *97*, 22.
- (57) Haskins, M. *ILAR J* **2009**, *50*, 112.
- (58) Ioannou, Y. A.; Enriquez, A.; Benjamin, C. *Expert Opin Biol Ther* **2003**, *3*, 789.
- (59) Dunbar, C. E.; Kohn, D. B.; Schiffmann, R.; Barton, N. W.; Nolta, J. A.; Esplin, J. A.; Pensiero, M.; Long, Z.; Lockey, C.; Emmons, R. V.; Csik, S.; Leitman, S.; Krebs, C. B.; Carter, C.; Brady, R. O.; Karlsson, S. *Hum Gene Ther* **1998**, *9*, 2629.
- (60) Hacein-Bey-Abina, S.; Garrigue, A.; Wang, G. P.; Soulier, J.; Lim, A.; Morillon, E.; Clappier, E.; Caccavelli, L.; Delabesse, E.; Beldjord, K.; Asnafi, V.; MacIntyre,

E.; Dal Cortivo, L.; Radford, I.; Brousse, N.; Sigaux, F.; Moshous, D.; Hauer, J.; Borkhardt, A.; Belohradsky, B. H.; Wintergerst, U.; Velez, M. C.; Leiva, L.; Sorensen, R.; Wulffraat, N.; Blanche, S.; Bushman, F. D.; Fischer, A.; Cavazzana-Calvo, M. *J Clin Invest* **2008**, *118*, 3132.

- (61) Cheng, S. H.; Smith, A. E. *Gene Ther* **2003**, *10*, 1275.
- (62) Hers, H. G. *Biochem J* **1963**, *86*, 11.
- (63) De Duve, C. *Fed Proc* **1964**, *23*, 1045.
- (64) Fratantoni, J. C.; Hall, C. W.; Neufeld, E. F. *Science* **1968**, *162*, 570.
- (65) Valayannopoulos, V. *Handb Clin Neurol* **2013**, *113*, 1851.
- (66) Barton, N. W.; Brady, R. O.; Dambrosia, J. M.; Di Bisceglie, A. M.; Doppelt, S. H.; Hill, S. C.; Mankin, H. J.; Murray, G. J.; Parker, R. I.; Argoff, C. E.; et al. *N Engl J Med* **1991**, *324*, 1464.
- (67) Phenix, C. P.; Rempel, B. P.; Colobong, K.; Doudet, D. J.; Adam, M. J.; Clarke, L. A.; Withers, S. G. *Proc Natl Acad Sci U S A* **2010**, *107*, 10842.
- (68) Brands, M. M.; Frohn-Mulder, I. M.; Hagemans, M. L.; Hop, W. C.; Oussoren, E.; Helbing, W. A.; van der Ploeg, A. T. *J Inherit Metab Dis* **2013**, *36*, 227.
- (69) Brooks, D. A. *Mol Genet Metab* **1999**, *68*, 268.
- (70) Fukuda, T.; Ahearn, M.; Roberts, A.; Mattaliano, R. J.; Zaal, K.; Ralston, E.; Plotz, P. H.; Raben, N. *Mol Ther* **2006**, *14*, 831.
- (71) Ioannou, Y. A.; Zeidner, K. M.; Gordon, R. E.; Desnick, R. J. *Am J Hum Genet* **2001**, *68*, 14.
- (72) Maga, J. A.; Zhou, J.; Kambampati, R.; Peng, S.; Wang, X.; Bohnsack, R. N.; Thomm, A.; Golata, S.; Tom, P.; Dahms, N. M.; Byrne, B. J.; LeBowitz, J. H. *J Biol Chem* **2013**, *288*, 1428.
- (73) Koeberl, D. D.; Li, S.; Dai, J.; Thurberg, B. L.; Bali, D.; Kishnani, P. S. *Mol Genet Metab* **2012**, *105*, 221.
- (74) Hemsley, K. M.; Hopwood, J. J. *Int J Clin Pharmacol Ther* **2009**, *47 Suppl 1*, S118.
- (75) Pardridge, W. M.; Boado, R. J. *Methods Enzymol* **2012**, *503*, 269.
- (76) Lu, J. Z.; Boado, R. J.; Hui, E. K.; Zhou, Q. H.; Pardridge, W. M. *Biotechnol Bioeng* **2011**, *108*, 1954.
- (77) Cox, T. M. *Acta Paediatr Suppl* **2005**, *94*, 69.
- (78) Aerts, J. M.; Hollak, C. E.; Boot, R. G.; Groener, J. E.; Maas, M. *J Inherit Metab Dis* **2006**, *29*, 449.
- (79) Lachmann, R. H.; Platt, F. M. *Expert Opin Investig Drugs* **2001**, *10*, 455.
- (80) Platt, F. M.; Butters, T. D. *Expert Rev Mol Med* **2000**, *2*, 1.
- (81) Vunnam, R. R.; Radin, N. S. *Chem Phys Lipids* **1980**, *26*, 265.
- (82) Abe, A.; Wild, S. R.; Lee, W. L.; Shayman, J. A. *Curr Drug Metab* **2001**, *2*, 331.
- (83) Inokuchi, J.; Radin, N. S. *J Lipid Res* **1987**, *28*, 565.
- (84) Platt, F. M.; Neises, G. R.; Dwek, R. A.; Butters, T. D. *J Biol Chem* **1994**, *269*, 8362.
- (85) McEachern, K. A.; Fung, J.; Komarnitsky, S.; Siegel, C. S.; Chuang, W. L.; Hutto, E.; Shayman, J. A.; Grabowski, G. A.; Aerts, J. M.; Cheng, S. H.; Copeland, D. P.; Marshall, J. *Mol Genet Metab* **2007**, *91*, 259.
- (86) Fenouillet, E.; Gluckman, J. C. *J Gen Virol* **1991**, *72 (Pt 8)*, 1919.
- (87) Fischl, M. A.; Resnick, L.; Coombs, R.; Kremer, A. B.; Pottage, J. C., Jr.; Fass, R. J.; Fife, K. H.; Powderly, W. G.; Collier, A. C.; Aspinall, R. L.; et al. *J Acquir Immune Defic Syndr* **1994**, *7*, 139.

- (88) Jeyakumar, M.; Butters, T. D.; Cortina-Borja, M.; Hunnam, V.; Proia, R. L.; Perry, V. H.; Dwek, R. A.; Platt, F. M. *Proc Natl Acad Sci U S A* **1999**, *96*, 6388.
- (89) Cox, T.; Lachmann, R.; Hollak, C.; Aerts, J.; van Weely, S.; Hrebicek, M.; Platt, F.; Butters, T.; Dwek, R.; Moyses, C.; Gow, I.; Elstein, D.; Zimran, A. *Lancet* **2000**, *355*, 1481.
- (90) Patterson, M. C.; Vecchio, D.; Prady, H.; Abel, L.; Wraith, J. E. *Lancet Neurol* **2007**, *6*, 765.
- (91) Tylki-Szymanska, A.; Groener, J. E.; Kaminski, M. L.; Lugowska, A.; Jurkiewicz, E.; Czartoryska, B. *Mol Genet Metab* **2011**, *104*, 627.
- (92) Reuser, A. J.; Wisselaar, H. A. *Eur J Clin Invest* **1994**, *24 Suppl 3*, 19.
- (93) Lukina, E.; Watman, N.; Arreguin, E. A.; Dragosky, M.; Iastrebner, M.; Rosenbaum, H.; Phillips, M.; Pastores, G. M.; Kamath, R. S.; Rosenthal, D. I.; Kaper, M.; Singh, T.; Puga, A. C.; Peterschmitt, M. J. *Blood* **2010**, *116*, 4095.
- (94) Piotrowska, E.; Jakóbkiewicz-Banecka, J.; Tylki-Szymanska, A.; Liberek, A.; Maryniak, A.; Malinowska, M.; Czartoryska, B.; Puk, E.; Kloska, A.; Liberek, T.; Baranska, S.; Wegrzyn, A.; Wegrzyn, G. *Current Therapeutic Research* **2008**, *69*, 166.
- (95) Ellis, R. J.; Hemmingsen, S. M. *Trends Biochem Sci* **1989**, *14*, 339.
- (96) Fan, J. Q. *Biol Chem* **2008**, *389*, 1.
- (97) Ellgaard, L.; Helenius, A. *Curr Opin Cell Biol* **2001**, *13*, 431.
- (98) Bonifacino, J. S.; Weissman, A. M. *Annu Rev Cell Dev Biol* **1998**, *14*, 19.
- (99) Fan, J. Q. *Trends Pharmacol Sci* **2003**, *24*, 355.
- (100) Fan, J. Q. *FEBS J* **2007**, *274*, 4943.
- (101) Parenti, G. *EMBO Mol Med* **2009**, *1*, 268.
- (102) Wei, R. R.; Hughes, H.; Boucher, S.; Bird, J. J.; Guziewicz, N.; Van Patten, S. M.; Qiu, H.; Pan, C. Q.; Edmunds, T. *J Biol Chem* **2011**, *286*, 299.
- (103) Asano, N.; Ishii, S.; Kizu, H.; Ikeda, K.; Yasuda, K.; Kato, A.; Martin, O. R.; Fan, J. Q. *Eur J Biochem* **2000**, *267*, 4179.
- (104) Wang, G. N.; Reinkensmeier, G.; Zhang, S. W.; Zhou, J.; Zhang, L. R.; Zhang, L. H.; Butters, T. D.; Ye, X. S. *J Med Chem* **2009**, *52*, 3146.
- (105) Okumiya, T.; Ishii, S.; Takenaka, T.; Kase, R.; Kamei, S.; Sakuraba, H.; Suzuki, Y. *Biochem Biophys Res Commun* **1995**, *214*, 1219.
- (106) Fan, J. Q.; Ishii, S.; Asano, N.; Suzuki, Y. *Nat Med* **1999**, *5*, 112.
- (107) Sawkar, A. R.; Cheng, W. C.; Beutler, E.; Wong, C. H.; Balch, W. E.; Kelly, J. W. *Proc Natl Acad Sci U S A* **2002**, *99*, 15428.
- (108) Chang, H. H.; Asano, N.; Ishii, S.; Ichikawa, Y.; Fan, J. Q. *FEBS J* **2006**, *273*, 4082.
- (109) Matsuda, J.; Suzuki, O.; Oshima, A.; Yamamoto, Y.; Noguchi, A.; Takimoto, K.; Itoh, M.; Matsuzaki, Y.; Yasuda, Y.; Ogawa, S.; Sakata, Y.; Nanba, E.; Higaki, K.; Ogawa, Y.; Tominaga, L.; Ohno, K.; Iwasaki, H.; Watanabe, H.; Brady, R. O.; Suzuki, Y. *Proc Natl Acad Sci U S A* **2003**, *100*, 15912.
- (110) Maegawa, G. H.; Tropak, M.; Buttner, J.; Stockley, T.; Kok, F.; Clarke, J. T.; Mahuran, D. J. *J Biol Chem* **2007**, *282*, 9150.
- (111) Tropak, M. B.; Reid, S. P.; Guiral, M.; Withers, S. G.; Mahuran, D. *J Biol Chem* **2004**, *279*, 13478.
- (112) Okumiya, T.; Kroos, M. A.; Vliet, L. V.; Takeuchi, H.; Van der Ploeg, A. T.; Reuser, A. J. *Mol Genet Metab* **2007**, *90*, 49.
- (113) Parenti, G.; Zuppaldi, A.; Gabriela Pittis, M.; Rosaria Tuzzi, M.; Annunziata, I.; Meroni, G.; Porto, C.; Donaudy, F.; Rossi, B.; Rossi, M.; Filocamo, M.; Donati, A.; Bembi, B.; Ballabio, A.; Andria, G. *Mol Ther* **2007**, *15*, 508.

- (114) Valenzano, K. J.; Khanna, R.; Powe, A. C.; Boyd, R.; Lee, G.; Flanagan, J. J.; Benjamin, E. R. *Assay Drug Dev Technol* **2011**, *9*, 213.
- (115) Zhu, X.; Sheth, K. A.; Li, S.; Chang, H.-H.; Fan, J.-Q. *Angew Chem Int Ed* **2005**, *44*, 7450.
- (116) Krabe, K. *Brain* **1916**, *39*, 74.
- (117) Kolodny, E., H In *Handbook of clinical neurology*; Moser, H. W., Ed.; Elsevier: Amsterdam, 1996; Vol. 22, p 187.
- (118) Fiumara, A.; Barone, R.; Arena, A.; Filocamo, M.; Lissens, W.; Pavone, L.; Sorge, G. *Clin Genet* **2011**, *80*, 452.
- (119) Rafi, M. A.; Luzi, P.; Zlotogora, J.; Wenger, D. A. *Hum Genet* **1996**, *97*, 304.
- (120) Wenger, D. A.; Rafi, M. A.; Luzi, P.; Datto, J.; Costantino-Ceccarini, E. *Mol Genet Metab* **2000**, *70*, 1.
- (121) Suzuki, K.; Suzuki, Y. In *The metabolic basis of inherited disease*; Scriver, C. R., Beaudet, A. L., Sly, W. S., Valle, D., Eds.; McGraw-Hill: New York, 1989, p 1699.
- (122) Puckett, R. L.; Orsini, J. J.; Pastores, G. M.; Wang, R. Y.; Chang, R.; Saavedra-Matiz, C. A.; Torres, P. A.; Zeng, B.; Caggana, M.; Lorey, F.; Abdenur, J. E. *Mol Genet Metab* **2012**, *105*, 126.
- (123) Suzuki, K. *J Child Neurol* **2003**, *18*, 595.
- (124) Won, J. S.; Kim, J.; Paintlia, M. K.; Singh, I.; Singh, A. K. *Brain Res* **2013**, *1508*, 44.
- (125) Cannizzaro, L. A.; Chen, Y. Q.; Rafi, M. A.; Wenger, D. A. *Cytogenet Cell Genet* **1994**, *66*, 244.
- (126) Sakai, N.; Inui, K.; Fujii, N.; Fukushima, H.; Nishimoto, J.; Yanagihara, I.; Isegawa, Y.; Iwamatsu, A.; Okada, S. *Biochem Biophys Res Commun* **1994**, *198*, 485.
- (127) Tappino, B.; Biancheri, R.; Mort, M.; Regis, S.; Corsolini, F.; Rossi, A.; Stroppiano, M.; Lualdi, S.; Fiumara, A.; Bembi, B.; Di Rocco, M.; Cooper, D. N.; Filocamo, M. *Hum Mutat* **2010**, *31*, E1894.
- (128) Xu, C.; Sakai, N.; Taniike, M.; Inui, K.; Ozono, K. *J Hum Genet* **2006**, *51*, 548.
- (129) Lee, W. C.; Kang, D.; Causevic, E.; Herdt, A. R.; Eckman, E. A.; Eckman, C. B. *J Neurosci* **2010**, *30*, 5489.
- (130) Harzer, K.; Knoblich, R.; Rolfs, A.; Bauer, P.; Eggers, J. *Clin Chim Acta* **2002**, *317*, 77.
- (131) Deane, J. E.; Graham, S. C.; Kim, N. N.; Stein, P. E.; McNair, R.; Cachon-Gonzalez, M. B.; Cox, T. M.; Read, R. J. *Proc Natl Acad Sci U S A* **2011**, *108*, 15169.
- (132) Kobayashi, T.; Shinnoh, N.; Goto, I.; Kuroiwa, Y. *J Biol Chem* **1985**, *260*, 14982.
- (133) Vanier, M.; Svennerholm, L. *Adv Exp Med Biol* **1976**, *68*, 115.
- (134) Schulte, S.; Stoffel, W. *Proc Natl Acad Sci U S A* **1993**, *90*, 10265.
- (135) Mitsuo, K.; Kobayashi, T.; Shinnoh, N.; Goto, I. *Neurochem Res* **1989**, *14*, 899.
- (136) Svennerholm, L.; Vanier, M. T.; Mansson, J. E. *J Lipid Res* **1980**, *21*, 53.
- (137) Kanazawa, T.; Nakamura, S.; Momoi, M.; Yamaji, T.; Takematsu, H.; Yano, H.; Sabe, H.; Yamamoto, A.; Kawasaki, T.; Kozutsumi, Y. *J Cell Biol* **2000**, *149*, 943.
- (138) Haq, E.; Giri, S.; Singh, I.; Singh, A. K. *J Neurochem* **2003**, *86*, 1428.
- (139) Yeager, A. M.; Brennan, S.; Tiffany, C.; Moser, H. W.; Santos, G. W. *Science* **1984**, *225*, 1052.
- (140) Krivit, W.; Shapiro, E. G.; Peters, C.; Wagner, J. E.; Cornu, G.; Kurtzberg, J.; Wenger, D. A.; Kolodny, E. H.; Vanier, M. T.; Loes, D. J.; Dusenbery, K.; Lockman, L. A. *N Engl J Med* **1998**, *338*, 1119.

- (141) Lee, W. C.; Courtenay, A.; Troendle, F. J.; Stallings-Mann, M. L.; Dickey, C. A.; DeLucia, M. W.; Dickson, D. W.; Eckman, C. B. *FASEB J* **2005**, *19*, 1549.
- (142) Copeland, R. A. *Methods Biochem Anal* **2005**, *46*, 1.
- (143) Frustaci, A.; Chimenti, C.; Ricci, R.; Natale, L.; Russo, M. A.; Pieroni, M.; Eng, C. M.; Desnick, R. J. *N Engl J Med* **2001**, *345*, 25.
- (144) Benjamin, E. R.; Flanagan, J. J.; Schilling, A.; Chang, H. H.; Agarwal, L.; Katz, E.; Wu, X.; Pine, C.; Wustman, B.; Desnick, R. J.; Lockhart, D. J.; Valenzano, K. J. *J Inherit Metab Dis* **2009**, *32*, 424.
- (145) Ishii, S.; Yoshioka, H.; Mannen, K.; Kulkarni, A. B.; Fan, J. Q. *Biochim Biophys Acta* **2004**, *1690*, 250.
- (146) Khanna, R.; Soska, R.; Lun, Y.; Feng, J.; Frascella, M.; Young, B.; Brignol, N.; Pellegrino, L.; Sitaraman, S. A.; Desnick, R. J.; Benjamin, E. R.; Lockhart, D. J.; Valenzano, K. J. *Mol Ther* **2010**, *18*, 23.
- (147) Kato, A.; Yamashita, Y.; Nakagawa, S.; Koike, Y.; Adachi, I.; Hollinshead, J.; Nash, R. J.; Ikeda, K.; Asano, N. *Bioorg Med Chem* **2010**, *18*, 3790.
- (148) Caciotti, A.; Donati, M. A.; d'Azzo, A.; Salvioli, R.; Guerrini, R.; Zammarchi, E.; Morrone, A. *Eur J Paediatr Neurol* **2009**, *13*, 160.
- (149) Tominaga, L.; Ogawa, Y.; Taniguchi, M.; Ohno, K.; Matsuda, J.; Oshima, A.; Suzuki, Y.; Nanba, E. *Brain Dev* **2001**, *23*, 284.
- (150) Rigat, B. A.; Tropak, M. B.; Buttner, J.; Crushell, E.; Benedict, D.; Callahan, J. W.; Martin, D. R.; Mahuran, D. J. *Mol Genet Metab* **2012**, *107*, 203.
- (151) Schitter, G.; Steiner, A. J.; Pototschnig, G.; Scheucher, E.; Thonhofer, M.; Tarling, C. A.; Withers, S. G.; Fantur, K.; Paschke, E.; Mahuran, D. J.; Rigat, B. A.; Tropak, M. B.; Illaszewicz, C.; Saf, R.; Stutz, A. E.; Wrodnigg, T. M. *Chembiochem* **2010**, *11*, 2026.
- (152) Schitter, G.; Scheucher, E.; Steiner, A. J.; Stutz, A. E.; Thonhofer, M.; Tarling, C. A.; Withers, S. G.; Wicki, J.; Fantur, K.; Paschke, E.; Mahuran, D. J.; Rigat, B. A.; Tropak, M.; Wrodnigg, T. M. *Beilstein J Org Chem* **2010**, *6*, 21.
- (153) Fantur, K.; Hofer, D.; Schitter, G.; Steiner, A. J.; Pabst, B. M.; Wrodnigg, T. M.; Stutz, A. E.; Paschke, E. *Mol Genet Metab* **2010**, *100*, 262.
- (154) Li, H.; Blériot, Y.; Chantereau, C.; Mallet, J.-M.; Sollogoub, M.; Zhang, Y.; Rodríguez-García, E.; Vogel, P.; Jiménez-Barbero, J.; Sinaÿ, P. *Org Biomol Chem* **2004**, *2*, 1492.
- (155) Ogawa, S.; Matsunaga, Y. K.; Suzuki, Y. *Bioorg Med Chem* **2002**, *10*, 1967.
- (156) Iwasaki, H.; Watanabe, H.; Iida, M.; Ogawa, S.; Tabe, M.; Higaki, K.; Nanba, E.; Suzuki, Y. *Brain Dev* **2006**, *28*, 482.
- (157) Aguilar-Moncayo, M.; Díaz-Pérez, P.; García Fernández, J. M.; Ortiz Mellet, C.; García-Moreno, M. I. *Tetrahedron* **2012**, *68*, 681.
- (158) Takai, T.; Higaki, K.; Aguilar-Moncayo, M.; Mena-Barragan, T.; Hirano, Y.; Yura, K.; Yu, L.; Ninomiya, H.; Garcia-Moreno, M. I.; Sakakibara, Y.; Ohno, K.; Nanba, E.; Ortiz Mellet, C.; Garcia Fernandez, J. M.; Suzuki, Y. *Mol Ther* **2013**, *21*, 526.
- (159) Ichikawa, Y.; Igarashi, Y. *Tetrahedron Lett* **1995**, *36*, 4585.
- (160) Ichikawa, Y.; Igarashi, Y.; Ichikawa, M.; Suhara, Y. *J Am Chem Soc* **1998**, *120*, 3007.
- (161) Kato, A.; Kato, N.; Kano, E.; Adachi, I.; Ikeda, K.; Yu, L.; Okamoto, T.; Banba, Y.; Ouchi, H.; Takahata, H.; Asano, N. *J Med Chem* **2005**, *48*, 2036.
- (162) Pearson, M. S.; Saad, R. O.; Dintinger, T.; Amri, H.; Mathe-Allainmat, M.; Lebreton, J. *Bioorg Med Chem Lett* **2006**, *16*, 3262.
- (163) Davies, G.; Henrissat, B. *Structure* **1995**, *3*, 853.
- (164) Koshland, D. E. *Biological Reviews* **1953**, *28*, 416.
- (165) Heightman, T. D.; Vasella, A. T. *Angew Chem Int Ed* **1999**, *38*, 750.

- (166) Compain, P.; Martin, O. R. *Iminosugars: From Synthesis to Therapeutic Applications*; WILEY, 2007.
- (167) Legler, G. In *Iminosugars as Glycosidase Inhibitors*; Wiley-VCH Verlag GmbH & Co. KGaA: 2004, p 31.
- (168) Lundt, I.; Madsen, R. In *Iminosugars as Glycosidase Inhibitors*; Wiley-VCH Verlag GmbH & Co. KGaA: 2004, p 112.
- (169) Compain, P.; Martin, O. R.; Boucheron, C.; Godin, G.; Yu, L.; Ikeda, K.; Asano, N. *Chembiochem* **2006**, *7*, 1356.
- (170) Yu, L.; Ikeda, K.; Kato, A.; Adachi, I.; Godin, G.; Compain, P.; Martin, O.; Asano, N. *Bioorg Med Chem* **2006**, *14*, 7736.
- (171) Ichikawa, M.; Ichikawa, Y. *Bioorg Med Chem* **1995**, *3*, 161.
- (172) Biela, A.; Oulaïdi, F.; Gallienne, E.; Górecki, M.; Frelek, J.; Martin, O. R. *Tetrahedron* **2013**, *69*, 3348.
- (173) Cipolla, P.; Castano, M.; Kirchin, M. A.; de Haen, C.; Tirone, P. *Acad Radiol* **1995**, *2*, 306.
- (174) Cipolla, L.; Lay, L.; Nicotra, F.; Pangrazio, C.; Panza, L. *Tetrahedron* **1995**, *51*, 4679.
- (175) Zhao, G.-L.; Yu, Z.-Y.; Li, Y.; Pang, L.-N.; Wang, J.-W. *Chin J Chem* **2008**, *26*, 158.
- (176) Lay, L.; Nicotra, F.; Paganini, A.; Pangrazio, C.; Panza, L. *Tetrahedron Lett* **1993**, *34*, 4555.
- (177) Lucero, C. G.; Woerpel, K. A. *J Org Chem* **2006**, *71*, 2641.
- (178) Liautard, V.; Pillard, C.; Desvergnès, V.; Martin, O. R. *Carbohydr Res* **2008**, *343*, 2111.
- (179) Liautard, V.; Desvergnès, V.; Itoh, K.; Liu, H.-w.; Martin, O. R. *J Org Chem* **2008**, *73*, 3103.
- (180) Kobayashi, S.; Busujima, T.; Nagayama, S. *Chemistry* **2000**, *6*, 3491.
- (181) Johnson, F. *Chem Rev* **1968**, *68*, 375.
- (182) Paulsen, H.; Todt, K.; Ripperger, H. *Chem Ber* **1968**, *101*, 3365.
- (183) Evans, D. A.; Fu, G. C.; Hoveyda, A. H. *J Am Chem Soc* **1988**, *110*, 6917.
- (184) Schonemann, W.; Gallienne, E.; Compain, P.; Ikeda, K.; Asano, N.; Martin, O. R. *Bioorg Med Chem* **2010**, *18*, 2645.
- (185) Górecki, M.; Jabłońska, E.; Kruszewska, A.; Suszczyńska, A.; Urbańczyk-Lipkowska, Z.; Gerards, M.; Morzycki, J. W.; Szczepek, W. J.; Frelek, J. *J Org Chem* **2007**, *72*, 2906.
- (186) Czech, B. P.; Bartsch, R. A. *J Org Chem* **1984**, *49*, 4076.
- (187) Walden, P. *Berichte der deutschen chemischen Gesellschaft* **1896**, *29*, 133.
- (188) Dess, D. B.; Martin, J. C. *J Org Chem* **1983**, *48*, 4155.
- (189) Hérisson, J.-L.; Chauvin, Y. *Die Makromolekulare Chemie* **1971**, *141*, 161.
- (190) Katz, T. J.; Rothchild, R. *J Am Chem Soc* **1976**, *98*, 2519.
- (191) Garber, S. B.; Kingsbury, J. S.; Gray, B. L.; Hoveyda, A. H. *J Am Chem Soc* **2000**, *122*, 8168.
- (192) Gessler, S.; Randl, S.; Blechert, S. *Tetrahedron Lett* **2000**, *41*, 9973.
- (193) Compain, P.; Chagnault, V.; Martin, O. R. *Tetrahedron: Asymmetry* **2009**, *20*, 672.
- (194) Baxter, E. W.; Reitz, A. B. In *Organic Reactions*; John Wiley & Sons, Inc.: 2004.
- (195) Abe, K.; Okumura, H.; Tsugoshi, T.; Nakamura, N. *Synthesis* **1984**, 1984, 597.
- (196) Freifelder, M. *Practical catalytic hydrogenation: techniques and applications*; Wiley-Interscience, **1971**.

- (197) Von der Osten, C. H.; Sinskey, A. J.; Barbas, C. F.; Pederson, R. L.; Wang, Y. F.; Wong, C. H. *J Am Chem Soc* **1989**, *111*, 3924.
- (198) Hutchins, R. O.; Su, W. Y.; Sivakumar, R.; Cistone, F.; Stercho, Y. P. *J Org Chem* **1983**, *48*, 3412.
- (199) Mitsunobu, O. *Synthesis* **1981**, 1981, 1.
- (200) Luche, J. L. *J Am Chem Soc* **1978**, *100*, 2226.
- (201) Furneaux, R. H.; Tyler, P. C.; Whitehouse, L. A. *Tetrahedron Lett* **1993**, *34*, 3609.
- (202) Oulaïdi, F.; Gallienne, E.; Compain, P.; Martin, O. R. *Tetrahedron: Asymmetry* **2011**, *22*, 609.
- (203) Jenkinson, S. F.; Fleet, G. W.; Nash, R. J.; Koike, Y.; Adachi, I.; Yoshihara, A.; Morimoto, K.; Izumori, K.; Kato, A. *Org Lett* **2011**, *13*, 4064.
- (204) Wennekes, T.; Lang, B.; Leeman, M.; Marel, G. A. v. d.; Smits, E.; Weber, M.; Wiltenburg, J. v.; Wolberg, M.; Aerts, J. M. F. G.; Overkleeft, H. S. *Org Proc Res Dev* **2008**, *12*, 414.
- (205) Wang, Z.-X.; Tu, Y.; Frohn, M.; Zhang, J.-R.; Shi, Y. *J Am Chem Soc* **1997**, *119*, 11224.
- (206) Tu, Y.; Wang, Z.-X.; Frohn, M.; He, M.; Yu, H.; Tang, Y.; Shi, Y. *J Org Chem* **1998**, *63*, 8475.
- (207) Asaoka, S.; Horiguchi, H.; Wada, T.; Inoue, Y. *J Chem Soc Perkin 2* **2000**, 737.
- (208) Biela-Banaś, A.; Gallienne, E.; Martin, O. R. *Carbohydr Res* **2013**, *380*, 23.
- (209) Reichstein, T.; Grüssner, A. *Helv Chim Acta* **1934**, *17*, 311.
- (210) Chen, C.-C.; Whistler, R. L. *Carbohydr Res* **1988**, *175*, 265.
- (211) Zhao, M. X.; Shi, Y. *J Org Chem* **2006**, *71*, 5377.
- (212) Rajput, V. K.; Mukhopadhyay, B. *Tetrahedron Lett* **2006**, *47*, 5939.
- (213) Rauter, A. P.; Ramôa-Ribeiro, F.; Fernandes, A. C.; Figueiredo, J. *Tetrahedron* **1995**, *51*, 6529.
- (214) Rajput, V. K.; Roy, B.; Mukhopadhyay, B. *Tetrahedron Lett* **2006**, *47*, 6987.
- (215) Ellman, J. A.; Owens, T. D.; Tang, T. P. *Acc Chem Res* **2002**, *35*, 984.
- (216) Zhou, P.; Chen, B.-C.; Davis, F. A. *Tetrahedron* **2004**, *60*, 8003.
- (217) Liu, G.; Cogan, D. A.; Ellman, J. A. *J Am Chem Soc* **1997**, *119*, 9913.
- (218) El Oualid, F.; van der Marel, G. A.; Overkleeft, H. S.; Overhand, M. *Org Lett* **2004**, *6*, 3167.
- (219) Koriyama, Y.; Nozawa, A.; Hayakawa, R.; Shimizu, M. *Tetrahedron* **2002**, *58*, 9621.
- (220) Clode, D. M. *Chem Rev* **1979**, *79*, 491.
- (221) Hun Park, K.; Jin Yoon, Y.; Gyeong Lee, S. *Tetrahedron Lett* **1994**, *35*, 9737.
- (222) Vasella, A.; Witzig, C.; Chiara, J.-L.; Martin-Lomas, M. *Helv Chim Acta* **1991**, *74*, 2073.
- (223) Alper, P. B.; Hung, S.-C.; Wong, C.-H. *Tetrahedron Lett* **1996**, *37*, 6029.
- (224) Cavender, C. J.; Shiner, V. J. *J Org Chem* **1972**, *37*, 3567.
- (225) Titz, A.; Radic, Z.; Schwardt, O.; Ernst, B. *Tetrahedron Lett* **2006**, *47*, 2383.
- (226) O'Brien, C.; Murphy, P. V. *J Carbohydr Chem* **2011**, *30*, 626.
- (227) Keck, G. E.; Kachensky, D. F.; Enholm, E. J. *J Org Chem* **1985**, *50*, 4317.
- (228) Anastasi, C.; Buchet, F. F.; Crowe, M. A.; Helliwell, M.; Raftery, J.; Sutherland, J. D. *Chem Eur J* **2008**, *14*, 2375.
- (229) Mellor, H. R.; Nolan, J.; Pickering, L.; Wormald, M. R.; Platt, F. M.; Dwek, R. A.; Fleet, G. W.; Butters, T. D. *Biochem J* **2002**, *366*, 225.
- (230) Mohal, N.; Bernet, B.; Vasella, A. *Helv Chim Acta* **2005**, *88*, 3232.

- (231) Andersch, J.; Bols, M. *Chem Eur J* **2001**, 7, 3744.
- (232) Albrecht, H. P.; Moffatt, J. G. *Tetrahedron Lett* **1970**, 1063.
- (233) Gorin, P. A. J.; Mazurek, M. *Can J Chem* **1975**, 53, 1212.
- (234) Violante de Paz Bañez, M.; Aznar Moreno, J. A.; Galbis, J. A. *J Carbohydr Chem* **2008**, 27, 120.
- (235) Austin, P. W.; Hardy, F. E.; Buchanan, J. G.; Baddiley, J. *J Chem Soc* **1964**, 2128.

Anna BIELA

Synthèse de nouveaux dérivés d'iminogalactitol et d'épi-isofagomine comme chaperons pharmacologiques potentiels pour la maladie de Krabbe

Résumé : L'objectif de mon projet de thèse était de synthétiser différentes familles d'iminosucres comme chaperons pharmacologiques potentiels de la β -galactocérébrosidase (GALC). Cette glycosidase lysosomale est responsable de la maladie de Krabbe, une maladie rare et héréditaire qui ne dispose actuellement pas de traitement. La thérapie chaperon est une nouvelle stratégie consistant à administrer, à des concentrations très faibles, une petite molécule ayant des interactions fortes avec l'enzyme. La plupart du temps, les molécules à effet chaperon les plus efficaces sont de puissants inhibiteurs de l'enzyme et les iminosucres sont connus pour inhiber fortement les glycosidases. La conception de ces iminosucres a été dictée par la structure de l'état de transition de la réaction catalysée par la GALC et l'expérience de notre groupe dans la synthèse d'iminosucres en tant que chaperons pharmacologiques pour la maladie de Gaucher.

Dans un premier temps, la synthèse d'imino-L-arabinitols a été réalisée en utilisant une méthodologie d'élongation de chaîne en C1. Puis la même stratégie a été appliquée à la synthèse d'imino-D-galactitols C-alkylés. Des difficultés rencontrées avec cette méthodologie nous ont alors conduits à développer une autre voie d'accès à ces composés, via un allongement de chaîne en C6. Enfin une dernière famille de composés de type *galacto*-isofagomine a été préparée. Ces nouveaux composés ont été testés comme inhibiteurs de deux galactosidases lysosomales, afin d'évaluer leur sélectivité et leur potentiel en tant que chaperons pharmacologiques pour la maladie de Krabbe.

Mots clés : iminosucres, β -galactocérébrosidase, maladie de Krabbe

Synthesis of novel iminogalactitol and epi-isofagomine derivatives as potential pharmacological chaperones for Krabbe disease

Abstract: The objective of my PhD was to synthesize different families of iminosugars as potential pharmacological chaperones of β -galactocerebrosidase (GALC). This lysosomal glycosidase is responsible for Krabbe disease, a rare inherited disease that currently has no treatment. Chaperone therapy is a new strategy that consists in the administration, at very low concentrations, of small molecules having strong interactions with the enzyme. Most of the time, the most effective chaperones are potent inhibitors of the enzyme and iminosugars are known to strongly inhibit glycosidases. The design of these iminosugars was dictated by the transition state structure of the reaction catalyzed by GALC and the experience of our group in the synthesis of iminosugars as pharmacological chaperones for Gaucher disease.

As a first stage, the synthesis of imino-L-arabinitols was conducted using a C1 chain extension methodology. Then the same strategy was applied to the synthesis of 1-C-alkyl-imino-D-galactitols. The difficulties encountered with this methodology led us then to develop another approach to these compounds, by way of a C6 chain extension. Finally a last family of *galacto*-isofagomine derivatives was prepared. These new compounds have been evaluated as inhibitors of two lysosomal galactosidases, to assess their selectivity and their potential as pharmacological chaperones for Krabbe disease.

Keywords: iminosugars, β -galactocerebrosidase, Krabbe disease



ICOA
Université d'Orléans
Pôle de chimie, BP 6759
rue de Chartres
45067 Orléans cedex 2

