



HAL
open science

**At the crossroad of metabolism and ageing :
mitochondrial proximal control of oxidants and ultimate
modulation of life history trade-offs**

Antoine Stier

► **To cite this version:**

Antoine Stier. At the crossroad of metabolism and ageing : mitochondrial proximal control of oxidants and ultimate modulation of life history trade-offs. Vertebrate Zoology. Université de Strasbourg, 2013. English. NNT : 2013STRAJ109 . tel-01023812

HAL Id: tel-01023812

<https://theses.hal.science/tel-01023812>

Submitted on 15 Jul 2014

HAL is a multi-disciplinary open access archive for the deposit and dissemination of scientific research documents, whether they are published or not. The documents may come from teaching and research institutions in France or abroad, or from public or private research centers.

L'archive ouverte pluridisciplinaire **HAL**, est destinée au dépôt et à la diffusion de documents scientifiques de niveau recherche, publiés ou non, émanant des établissements d'enseignement et de recherche français ou étrangers, des laboratoires publics ou privés.

ÉCOLE DOCTORALE Vie et Santé (ED414)

IPHC, Département Ecologie, Physiologie & Ethologie (UMR 7178)

Thèse présentée par :

Antoine STIER

soutenue le : **24 Octobre 2013**

pour obtenir le grade de : **Docteur de l'université de Strasbourg**

Discipline : Sciences du Vivant

Spécialité : Physiologie et Biologie des organismes et des populations

**At the crossroad of metabolism and ageing:
mitochondrial proximal control of oxidants and ultimate
modulation of life history trade-offs**

**Implications du stress oxydant et du découplage mitochondrial dans les
compromis entre traits d'histoire de vie**

THÈSE dirigée par :

Dr. CRISCUOLO François
Dr. MASSEMIN Sylvie

Chargé de Recherche CNRS, IPHC-DEPE, Strasbourg
Maître de conférence, Université de Strasbourg

RAPPORTEURS :

Pr. METCALFE Neil
Pr. VOITURON YANN

Professeur, Université de Glasgow (UK)
Professeur, Université Lyon 1

AUTRES MEMBRES DU JURY :

Pr. GAUER François
Dr. BIZE Pierre

Professeur, Université de Strasbourg
Chargé de recherche, Université d'Aberdeen (UK)

At the crossroad of metabolism and ageing: mitochondrial proximal control of oxidants and ultimate modulation of life history trade-offs

Implications du stress oxydant et du découplage mitochondrial dans les compromis entre traits d'histoire de vie

Thèse présentée pour obtenir
Le grade de docteur de l'Université de Strasbourg

Discipline: Sciences du Vivant
Spécialité: Physiologie et Biologie des organismes et des populations



Antoine Stier

Soutenance publique prévue le 24 Octobre 2013

Devant le jury composé de:

Pr. Neil Metcalfe

Professor, University of Glasgow

Rapporteur

Pr. Yann Voituron

Professeur, Université Lyon 1

Rapporteur

Pr. François Gauer

Professeur, Université de Strasbourg

Examineur interne

Dr. Pierre Bize

Senior researcher, University of Aberdeen

Membre invité

Dr. Sylvie Massemin-Challet

Maître de conférence, Université de Strasbourg

Co-directeur de thèse

Dr. François Criscuolo

Chargé de recherche, CNRS Strasbourg

Directeur de thèse

Remerciements / Acknowledgments

Je tiens tout d'abord à remercier mes parents et ma sœur, car sans leur aide, leur soutien quotidien et leur compréhension, il aurait été difficile d'envisager la poursuite des belles et longues études ayant menées in fine à ce travail de thèse.

Définir un ordre dans les remerciements est une mission aussi impossible que de réaliser un travail de thèse sans aide, et donc je vous prie d'excuser l'ordre qui risque d'être un peu brouillon.

Tout d'abord, un immense merci et une reconnaissance éternelle sont attribués à un descendant direct de Napoléon, le Dr. François Bonaparte-Criscuolo. Merci pour l'excellent encadrement de cette thèse, merci pour le soutien scientifique et personnel sans failles, merci pour les idées lumineuses, merci pour la variété des opportunités scientifiques offertes lors de ce travail de thèse, merci d'avoir su me donner l'envie au cours de ces 3 années de toujours et encore vouloir faire de la recherche, merci de représenter avec brio les (rares ?) chercheurs ayant un ego justement proportionné et des qualités humaines développées, merci pour tant de choses qu'il serait difficile de toutes les nommer.

Tous mes remerciements et ma gratitude au Dr. Massemin-petite-maison-dans-la-montagne pour son encadrement, son soutien scientifique et moral, son aide et les bons moments passés sur le terrain. Merci également de m'avoir suivi de ma première année à l'université (L1 : MTU) à ma dernière année de thèse : 2005-2013 ça fait quelques années au final, et merci d'avoir su me donner l'opportunité et l'envie d'enseigner!

Malgré mon amour pour la France, ce travail de thèse n'aurait été que l'ombre de lui-même sans l'aide précieuse et sans faille du plus fameux Dr. Suisse : Pierre Bize, alias le transformateur-fou-de-manuscrits. Merci d'avoir mis tant de couleurs, mais également de bonnes idées dans un bon nombre des articles composant cette thèse. Merci pour ta sympathie, ta réactivité et ton soutien sans failles au cours de ces 3 années, et je n'ai qu'une chose à dire : *pourvu que cela continue!*

Je souhaite adresser mes plus grands remerciements aux membres ayant accepté de faire partie de mon jury de thèse : le Professeur François Gauer (Université de Strasbourg), le Professeur Yann Voituron (Université de Lyon), Professor Neil Metcalfe (University of Glasgow) & le Dr. Pierre Bize (University of Aberdeen). Un grand merci à tous les quatre, car sans critiques et évaluations, le travail scientifique ne représenterait pas grand chose.

Le travail scientifique ne saurait également exister sans collaborations, et de ce fait je souhaite remercier du fond du cœur toutes les personnes qui ont contribué scientifiquement aux travaux présentés dans cette thèse. Un grand merci à Anne Delestrade et son équipe du CREA de Chamonix pour l'accueil, pour l'opportunité de donner un côté un peu plus 'éco' à ma thèse, pour la découverte de Vallorcine et ses environs, et pour sa sympathie et sa bonne humeur quotidienne. Un grand merci à Damien Roussel mais également à Caroline Romestaing & Karine Salin pour m'avoir fait découvrir le monde si particulier de la mitochondrie (l'isolée, la vraie !), merci pour les km de papier ruban à analyser, les journées mitochondries au doux son de la radio et des grenouilles qui chantent ! Mes plus grands remerciements à Joffrey Zoll et son équipe pour leur aide et leur

compétence sur le fonctionnement mitochondrial, merci infiniment de m'avoir ouvert les 'portes de la mitochondrie'. Un grand merci aux amis du grand sud 'nigriens' (JP et les autres) de m'avoir permis de mettre un pied dans le monde merveilleux du manchot royal, mais également de me permettre de mettre le second à Crozet cet automne. Je tiens à adresser des remerciements particuliers à Vincent Viblanc pour son aide scientifique et son soutien, aussi bien lors de ce travail de thèse qu'auparavant (et après j'espère !). Un grand merci à Sandrine Zahn de m'avoir aussi bien formé aux pratiques de laboratoires, et d'avoir mis à profit sa maîtrise de la gPCR pour ce travail de thèse. Un grand merci à Frédéric Gros pour m'avoir initié à la cytométrie en flux et avoir toujours été présent et enthousiaste pour des mesures sur des drôles d'animaux! Un grand merci à Caroline Habold pour son aide avec les souris tandis que Bonaparte était parti à la conquête de Crozet! Je tiens également à remercier les étudiants de master que j'ai pu aider/encadrer lors de ces 3 ans de thèse : Julie, Olivier, Aude, Quentin et Mathilde. Un remerciement particulier à Quentin pour le travail accompli sur les diamants mandarins, pour ses bonnes idées et son amitié, mais également à Mathilde pour sa bonne humeur, sa gentillesse et les relectures de certaines parties de ce manuscrit. Je vous souhaite à tous les deux un bel avenir scientifique et personnel! Je souhaite également remercier Joanna Lignot (Munro Language Services) pour la correction 'anglophonique' de la prose présentée dans les chapitres 1 et 5, mais également dans l'article 4.

Pour innover un peu, je remercie du fond du cœur tous les étudiants à qui j'ai pu enseigner pendant ces trois années, de la première année de Licence à la dernière année de Master. Merci pour votre patience et votre

compréhension, mais également merci pour le divertissement et certaines phrases cultes dans vos copies ('le mouton mange la souris').

Je souhaite adresser des remerciements particuliers à Stéphane Blanc, pour m'avoir accueilli pour ma première expérience de recherche au sein du DEPE. Un grand merci, car il est évident que sans la qualité de son encadrement et son soutien ma route aurait sans doute quitté le monde de la recherche. Je souhaite également remercier chaleureusement Odile Petit, directrice du département, pour son accueil, sa confiance, sa bonne humeur et son soutien sans faille aux étudiants du DEPE.

Remercier chaque membre du DEPE qui le mérite serait une tâche impossible tant il y a de personnes rentrant dans cette catégorie ! Je vous adresse donc un grand merci à tous, mais je souhaite quand même remercier quelques artistes en particulier, notamment Yan le roi de la bonne humeur, de la bonne bouffe et des bons conseils, Thierry le roi du poisson et autres mets variés pour son humour et son maillot rose de cycliste qu'on attend toujours, JP pour son côté plus que déjanté mais toujours prêt à aider, et Cédric pour sa bonne humeur naturelle et son soutien.

Un grand merci à la folle jeunesse du DEPE, spécifiquement à tous les doctorants ayant été impliqués dans l'organisation de la 9^{ème} édition du colloque « Ecology & Behaviour » ce printemps. Un grand merci pour votre soutien, pour votre amitié et pour les moments inoubliables vécus avec vous ! Des remerciements spéciaux à ceux qui sont bien plus que des collègues : à minimoy de ne jamais avoir dépassé 1,20m et d'avoir inventé le bracelet de cheville, à Anne-mat pour son calme légendaire et pour avoir été une fausse Suisse pour les arbitrages intra-bureau (toujours en ma défaveur ; oui oui, la bonne foi m'habite toujours), à Laure pour son esprit

« bien placé » et ses goûts musicaux déjantés (pan, pan, pan...). Une mention très spéciale pour Sophie, pour avoir supporté mes humeurs, ma bonne foi, mon vocabulaire limité à 500 mots, mon sens de la contradiction, mes petites blagues, ma sobriété en conférence, et tant d'autres choses!

Je souhaite remercier les fantastiques amis 'extra-labo' qui ont su être présents au cours de ces 3 années, avec une attention particulière pour mon ami de toujours Max, pour la folle équipe des horse-balleurs d'Eckbolsheim, pour tous les amis de l'écurie au sens large, mais également pour Virginie, Céline, Alex, Emma, Fred, Matichou, Remy, Carole, Julien H (dit le chauve) et bien entendu ma petite Maman / Marion.

Il faudrait trois pages pour témoigner à Flo tous les remerciements qu'elle mérite pour m'avoir supporté et soutenu tout au long de ces trois années. Un grand merci même si c'est un mot bien faible pour faire part de la gratitude que j'ai envers toi.

Je finirai par remercier celle avec qui j'ai découvert le monde de la recherche, qui a été plus que présente au cours des 5 dernières années, et à qui toute mon amitié va naturellement. Mille merci Céline pour tous les bons (et les moins bons) moments passés ensemble, ta présence a été d'une aide inestimable tout au long de ces années.



Publications

Published or in revision:

Geiger S, Le Vaillant M, Lebard T, Reichert S, **Stier A**, Le Maho Y, Criscuolo F (2011). **Catching-up but telomere loss: half-opening the black box of growth and ageing trade-off in wild king penguin chicks.** *Molecular Ecology* **21**(6): 1500-1510. **(Paper 7)**

Stier A, Reichert S, Massemin S, Bize P & Criscuolo F (2012) **Constraint and cost of oxidative stress on reproduction - correlative evidence in laboratory mice and review of the literature.** *Frontiers in Zoology* 2012 **9**: 37. **(Paper 4)**

Stier A, Bize P, Schull Q, Zoll J, Singh F, Geny B, Gros F, Royer C, Massemin S & Criscuolo F (2013) **Avian erythrocytes have functional mitochondria, opening novel perspectives for birds as animal models in the study of ageing.** *Frontiers in Zoology* 2013 **10**: 33. **(Paper 1)**

Stier A, Viblanc V, Massemin S, Handrich Y, Zahn S, Rojas E, Saraux C, Le Vaillant M, Prud'homme O, Grosbellet E, Robin JP, Bize P & Criscuolo F (2014). **Starting with a handicap: phenotypic differences between early- and late-born king penguin chicks and their survival correlates.** *Functional Ecology* doi: 10.1111/1365-2435.12204. **(Paper 8)**

Stier A, Bize P, Habolod-Oudart C, Bouillaud F, Massemin S & Criscuolo F (2014). **Mitochondrial uncoupling prevents cold-induced oxidative stress: a case study using UCP1 knockout mice.** *J. Exp. Biol.* 2014 **217**: 624-630 **(Paper 2)**

Stier A, Delestrade A, Zahn S, Criscuolo F & Massemin S (2014). **Elevation impacts the balance between growth and oxidative stress in coal tits.** *Oecologia, in press.* **(Paper 5)**

Lehto Hürlimann M, **Stier A**, Scholly O, Criscuolo F & Bize P (2014). **Short- and long-term effects of litter size manipulation in wild-derived common voles.** *Biology Letters, in press.* (non présenté dans la thèse)

Viblanc VA, Gineste B, **Stier A**, Robin JP & Groscolas R (2014). **Stress hormones in relation to breeding status and territory location in colonial king penguin: a role for social density?** *Oecologia, in press.* (non présenté dans la thèse)

Stier A, Bize P, Roussel D, Schull Q, Massemin S & Criscuolo F (*in revision for J. Exp. Biol.*). **Mitochondrial uncoupling as a regulator of life-history trajectories: an experimental study in the zebra finch.** **(Paper 3)**

Reichert S, **Stier A**, Zahn S, Bize P, Massemin S & Criscuolo F (*in revision for Frontiers in Ecology & Evolution*). **Increased Reproductive effort leads to long-term eroded telomeres. (Annexe I)**

Submitted or in preparation for 2013-2014:

Stier A, Delestrade A, Pierre Bize, Zahn S, Criscuolo F & Massemin S (submitted to *J. Evol. Biol.*). **A growth rate-telomere loss covariation in the wild? A test in coal and great tit chicks reared at different elevations. (Paper 6)**

Stier A, Massemin S, Tissier M, Zahn S, Criscuolo F (*in prep.*). **Starting with a handicap: asynchronous hatching and the growth/maintenance trade-off in free-living great tit. (Box 4)**

Stier A & Criscuolo F (*in prep.*). **Does mitochondrial uncoupling prevents from cold-induced oxidative stress? An experimental study in the zebra finch. (Box 2)**

Unpublished work:

Stier A, Bouillaud F & Criscuolo F. **Uncoupling protein 1 (UCP1) & longevity: an open question. (Box 1)**

Stier A & Criscuolo F. **Mitochondrial uncoupling and the oxidative cost of reproduction in the zebra finch (Box 3)**

Communications of PhD results

19th European Meeting of PhD Students in Evolutionary Biology, September 2013 (Exeter, UK)

Oral presentation « *Uncoupling to survive? Lessons from an experimental study in the zebra finch* »

Stier A, Bize P & Criscuolo F.

9th European Ornithologists' Union Conference August 2013 (Norwich, UK)

Poster « *Starting with a handicap: The impact of asynchronous hatching on growth and self-maintenance (oxidative stress and telomere dynamics) in great tit chicks* »

Stier A, Tissier M, Zahn S, Criscuolo F & Massemin S.

11th INTECOL Congress, August 2013 (London, UK)

Poster « *Differential impact of elevation on life-history trajectories of great and coal tit chicks: Growth rate and telomere dynamics along an elevational gradient* »

Stier A, Delestrade A, Bize P, Zahn S, Criscuolo F & Massemin S.

9th Meeting Ecology & Behaviour, April 2013 (Strasbourg, France)

Poster « Hatching asynchrony uncovers a trade-off between growth & telomere erosion rate in great tit chicks ».

Stier A, Tissier M, Zahn S, Criscuolo F & Massemin S.

Mito@Strass Meeting - December 2012 (Strasbourg, France)

Oral presentation « Uncoupling Protein 1 and ageing: *New insight from the link between non-shivering thermogenesis and oxidative stress, and from a long-term survival analysis* »

Stier A, Bize P, Habold-Oudart C, Massemin S & Criscuolo F.

ED day Meeting - December 2012 (Strasbourg, France)

Oral presentation « Mitochondria within non-mammalian erythrocytes: Presence, functionality & oxidative stress consequences ». *Awarded best oral presentation.*

Stier A, Bize P, Schull Q, Royer C, Gros F, Zoll J, Massemin S & Criscuolo F.

6th Meeting "Réseau MeetOchondrie" - September 2012 (Soustons, France)

Poster "Functional mitochondria in avian erythrocytes: Perspectives for ageing & evolutionary studies "

Stier A, Schull Q, Zoll J, Bize P, Massemin S & Criscuolo F.

Evolutionary Biology Meeting - September 2012 (Marseilles, France)

Poster + short oral presentation "Uncoupling to survive in the cold? New insight from the link between non-shivering thermogenesis and oxidative stress"

Stier A, Bize P, Habold-Oudart C, Massemin S & Criscuolo F.

8th Meeting Ecology & Behaviour - April 2012 (Chizé, France)

Poster « Oxidative stress in mice: both a reproductive cost and a reproductive constraint »

Antoine Stier, Sophie Reichert, Pierre Bize, Sylvie Massemin, François Criscuolo

Oral presentation « Does altitude shape the trade-off between growth and ageing rate? Insight from oxidative stress and telomere dynamics measurements in coal tits »

Stier A, Delestrade A, Zahn S, Arrive M, Criscuolo F & Massemin S.

2012 EGI Evolution & Ecology Conference - January 2012 (Oxford, UK)

Oral presentation « *The growth and ageing trade-off: Oxidative stress as a cost for naturally higher growth rates* »

Stier A, Delestrade A, Criscuolo F & Massemin S.

Foreword

Integrating physiological mechanisms into life-history theory has been an expanding but challenging field of research over the past 20 years. This thesis investigates the role played by two mechanisms recognised as potential determinants of the rate of ageing, namely oxidative stress and mitochondrial uncoupling, in mediating life-history trade-offs. The work presented in this manuscript has been conducted with different animal models, both in the laboratory (mouse and zebra finch) and in the wild (great tit, coal tit and king penguin), using both experimental and correlative studies.

The manuscript is divided into five main parts. The first part (**Chapter 1**) provides a general introduction to life history trade-offs, mitochondrial functioning and the integration of oxidative stress and mitochondrial uncoupling within a life-history framework. In **Chapter 2**, I briefly describe some of the experimental procedures employed in this thesis, and present a 'methodological' paper validating the presence of mitochondria within avian erythrocytes (Paper 1). **Chapter 3** evaluates the impact of high energy expenditure and mitochondrial uncoupling state on oxidative stress levels and longevity, both in a transgenic mouse model (uncoupling protein 1 deficient - Paper 2 & Box 1) and in zebra finches treated chronically with a mitochondrial uncoupler (Paper 3 & Box 2). In **Chapter 4**, I investigate the variations in oxidative stress levels during two major phases of an organism's life, namely reproduction and growth. The first part of this chapter presents a correlative study describing oxidative stress as a cost and a constraint for reproduction in the laboratory mouse (Paper 4). I also review existing literature on the subject (Paper 4), and present preliminary results about the oxidative cost of reproduction in zebra finches (Box 3). In the second part of this chapter, I investigate the impact of naturally divergent growth rates (Paper 5, Paper 6, Paper 7) and conditions experienced during the growth period (Paper 8 and Box 4) on self-maintenance parameters (oxidative stress and telomere dynamics) in wild birds. A final section (**Chapter 5**) completes the thesis with a discussion of the results, before presenting some of the perspectives that arise from this PhD work.

The work presented in this thesis has greatly benefitted from the support provided by my two supervisors (François Criscuolo and Sylvie Massemin) and my main collaborator (Pierre Bize).

Thesis contents

Remerciements / Acknowledgements	i
Publications and communications of PhD results	vi
Foreword	ix
Thesis contents	x
Chapter 1: General introduction - oxidative stress and mitochondrial uncoupling in a life history perspective	1
1. Life history trade-offs	2
1.1 General notions on life-history trade-offs	2
1.2 Principle of resource allocation and trade-offs	3
1.3 Additional levels of complexity in the expression of trade-offs	3
2. The physiology of life history trade-offs	5
2.1 Why integrate physiology to understand life history trade-offs?	5
2.2 Energy, physiology and life history	5
3. A mitochondrial dilemma: producing ATP and being a source of ROS	6
3.1 Oxidative phosphorylation by the mitochondria	6
3.2 Reactive oxygen species (ROS) production by the mitochondria	8
3.3 Oxidative stress and oxidative balance	9
3.3.1 <i>Oxidative damage</i>	9
3.3.2 <i>Antioxidant defences</i>	9

3.3.3 A clear definition of oxidative stress	10
3.3.4 Possible shifts in the oxidative balance	11
<i>Box A: Telomere length as a biomarker of chronic oxidative stress and ageing?</i>	13
4. Mitochondria, oxidative stress and ageing	14
4.1 Linking energy metabolism and ageing/longevity	15
4.2 The free radical/oxidative stress theory of ageing	15
4.3 The ‘uncoupling to survive hypothesis’	17
4.3.1 <i>Why should mitochondrial uncoupling state control ROS production?</i>	17
4.3.2 <i>Mitochondrial uncoupling and longevity</i>	18
4.3.3 <i>Mitochondrial uncoupling proteins (UCPs)</i>	18
5. Oxidative stress and mitochondrial uncoupling in an eco-evolutionary context	20
5.1 Theoretical framework of this thesis	20
5.2 Mitochondrial uncoupling state and life history trade-offs	23
5.3 What do already know about oxidative stress involvement in life history trade-offs?	24
5.3.1 <i>Reproduction and oxidative stress</i>	24
5.3.2 <i>Growth and oxidative stress</i>	25
6. Aims and scope of the thesis	26
6.1 Impact of mitochondrial functioning and energy metabolism on oxidative stress and life history trajectories (Chapter 3)	27
6.2 Oxidative stress and life history trade-offs (Chapter 4)	28

Chapter 2: Materials & Methods	30
1. Overview of biological models	31
1.1 UCP1 knock-out (KO) mouse model	31
1.2 Zebra finch and 2,4-dinitrophenol (DNP) uncoupling treatment	32
1.3 Coal and Great tits	34
1.4 King penguin chicks	37
2. Overview of oxidative stress measurements	39
2.1 Oxidative stress markers in the blood	39
2.1.1 <i>Reactive oxygen metabolites (ROMs)</i>	39
2.1.2 <i>Plasma antioxidant capacity (OXY)</i>	40
2.1.3 <i>Oxidative damage to DNA: 8-hydroxy-2'-deoxyguanosine (8-OHdG)</i>	40
2.2 Oxidative stress markers in tissues	41
2.2.1 <i>Glutathione, GSSG/GSH ratio and glutathione reductase activity</i>	41
2.2.2 <i>Lipid peroxidation (MDA levels)</i>	42
2.2.3 <i>Protein carbonyl levels</i>	43
2.3 Mitochondria within avian erythrocytes and mitochondrial ROS production	44
Paper 1: Avian erythrocytes have functional mitochondria, opening novel perspectives for birds as animal model in the study of ageing	45

Chapter 3: Impact of mitochondrial uncoupling state and energy metabolism on oxidative stress levels and life history trajectories	64
Paper 2: Increased metabolism, mitochondrial functioning and oxidative stress: UCP1-dependent thermogenesis protects from cold-induced oxidative stress	65
Box 1: Uncoupling protein 1 (UCP1) & longevity: an open question	80
Paper 3: Mitochondrial uncoupling as a regulator of life history trajectories in birds: An experimental study in the zebra finch	90
Box 2: Does mitochondrial uncoupling prevents from cold-induced oxidative stress: An experimental study in the zebra finch	117
Chapter 4: Implication of oxidative stress in specific life history trade-offs	130
<u>A) Oxidative stress & reproduction</u>	
Paper 4: Constraint and cost of oxidative stress on reproduction: correlative evidence in laboratory mice and review of the literature	131
Box 3: Mitochondrial uncoupling and the oxidative cost of reproduction in the zebra finch	149
<u>B) Oxidative stress & growth</u>	
Paper 5: Elevation impacts the balance between growth and oxidative stress in coal tits	158

Paper 6: A growth rate / telomere loss trade-off in the wild? A test in coal and great tit chicks reared at different elevations.	178
Paper 7: Catching-up but telomere loss: half-opening the black box of growth and ageing trade-off in wild king penguin chicks	192
Paper 8: Starting with a handicap: phenotypic differences between early- and late-born king penguin chicks and their survival correlates	202
Box 4: Starting with a handicap: Asynchronous hatching and the growth/maintenance trade-off in free-living great tits	223
Chapter 5: Synthesis, general discussion, limitations and prospects	243
1. Brief synthesis	244
2. Interplays between metabolism and oxidative stress	247
2.1 Mitochondrial uncoupling: a physiologically relevant means to reduce ROS production?	247
2.2 Does high-energy expenditure constitute an oxidative challenge for organisms?	249
3. Interplays between life history, oxidative stress and telomere dynamics	251
3.1 Did you say “cost of reproduction”?	251
3.2 Do growth rate or early-life conditions matter?	253
4. Did you say limitations?	254

4.1 Oxidative stress measurements	254
4.2 Concluding about oxidative stress implication in life history trade offs”?	256
4.3 Are there weaknesses in the free radical theory of ageing (FRTA)?	259
5. Research prospects	261
5.1 Experimental testing of constraining and hormetic effects	262
5.2 Do prenatal growth rate and conditions matter?	264
5.3 Are we moving toward (longitudinal) monitoring of mitochondria functioning in the wild?	266
<i>5.3.1 Mitochondria from erythrocytes: a representative target for eco-evolutionary studies?</i>	266
<i>5.3.1 Mitochondria functioning in the wild</i>	268
6. Final words	269
References	271
Appendix I: Increased reproductive effort leads to persistent eroded telomeres (Reichert, Stier <i>et al.</i>)	299
List of co-authors and affiliations	325
Résumé en français	329

' Biologists must constantly keep in mind that what they see was not designed, but rather evolved. '

Francis Crick, 1990



Chapter 1

General introduction: Oxidative stress and mitochondrial uncoupling in a life history perspective

1. Life history trade-offs

1.1 General notions on life history trade-offs

Life history is defined as the set of adaptive traits (anatomical, physiological, but also behavioural) that are displayed by an organism within its environment (Stearns 1992). Organisms cannot simultaneously maximize all their life history traits¹, otherwise natural selection would have led to the evolution of “Darwinian demons” (*i.e.* organisms that reproduced at birth and during their entire life, with no or minimum ageing). In nature, life history traits are often negatively related with each other (Stearns 1992). This suggests that even if natural selection favours a certain combination of traits providing the higher fitness² to individuals, each trait is constrained by the amount of energy invested in other traits (*e.g.* growth, reproduction and self-maintenance³). The existence of negative associations between these fitness-related traits, referred as to life history trade-offs, is a central concept in evolutionary ecology and a useful framework to understand the diversity observed in life histories both within and between species (Reznick 1985, Stearns 1989, Roff 1992, Stearns 1992).

One classical example of such trade-offs is the so-called “cost of reproduction”, which implies a negative relationship between current reproduction and the expectations of future reproduction and survival in adult organisms, also known as the residual reproductive value (Williams 1966, Reznick 1985). This cost of reproduction might result from a survival cost linked to the investment in current reproduction (*e.g.* Dijkstra *et al.* 1990), but could also be explained by a negative impact on future reproductive capacities (*i.e.* reproductive cost, Gustafsson & Pärt 1990).

¹ Life history trait: a trait directly associated with reproduction and survival (*e.g.* size at birth, growth rate, age and size at maturity, lifespan, etc. (Stearns & Hoekstra 2000).

² Contribution made to the gene pool of the next generation by an individual with a given genotype/phenotype, within a given environment. Fitness is often approximated by the relative lifetime reproductive success (LRS) of individuals (Stearns & Hoekstra 2000).

³ Self-maintenance: processes favouring an organism’s survival (*e.g.* the efficiency of the immune system) and preventing premature ageing.

1.2 Principle of resource allocation and trade-offs

An understanding of the constraints leading to life history trade-offs is central to evolutionary biology. In this context, the most intuitive way to explain trade-offs has been to consider that they result from the competition among different organismal functions for limited resources (van Noordwijk & de Jong 1986, Stearns 1992, Zera & Harshman 2001). Indeed available resources are expected to be limited in natural conditions, as well as the time available to acquire them. This concept has been illustrated using the “Y allocation tree”, as shown in figure 1 (Zera & Harshman 2001). The classical view (figure 1 A-E) is that the common pool of resources is variable (A-B: medium / C: high / D-E: low) and allocated toward competing functions (R and S) following different possibilities (A,D: $R < S$; B,E: $R > S$; C: $R = S$). For instance, resource availability could be relatively restricted in a given year (figure 1 A & B), thereby forcing individuals to share resources between their somatic maintenance (S) and their reproduction (R). Resource availability could then substantially increase the following year (figure 1 C), allowing individuals to invest more resources in both functions. Following these allocation models, it is likely that decreased availability of resources (figure 1 D-E) tends to amplify the magnitude of the trade-off between competing functions (*i.e.* A: 5 vs. 10 / D: 1 vs. 4).

1.3 Additional levels of complexity in the expression of trade-offs

However, the classical view of allocation-based trade-offs (figure 1 A-E) is often too simplistic to explain biological reality, and more complex scenarios are likely to occur. For instance, the variability allowed in the acquisition and allocation of resources could be of importance when determining the sign of the correlation between two traits involved in a potential trade-off (figure 1 F-G). Indeed, if the variability of resource availability between individuals is greater than the variability allowed in resource allocation, positive correlations between traits involved in potential trade-offs are likely to occur (figure 1F). On the contrary, if variability in resource input between individuals is lower than the variability in resource allocation, trade-offs (negative correlations) are likely to occur (figure 1G). Finally, multiple traits could be involved in trade-offs, giving rise to much more complex models of resource allocation (figure 1H). Another level of complexity in our understanding of life history trade-offs is the variety of time scales at which trade-offs could be expressed (Zera & Harshman 2001). Indeed, some trade-offs could be immediate, *e.g.* a down-regulation of the immune

system during a reproductive event (Harshman & Zera 2007) or expressed over short-term periods, *e.g.* the starvation-predation risk trade-off (Macleod *et al.* 2005), whereas others would only be expressed over long periods of time, *e.g.* deleterious impact of bad nutritional conditions early in life on adult fecundity and survival (Metcalfe & Monaghan 2001).

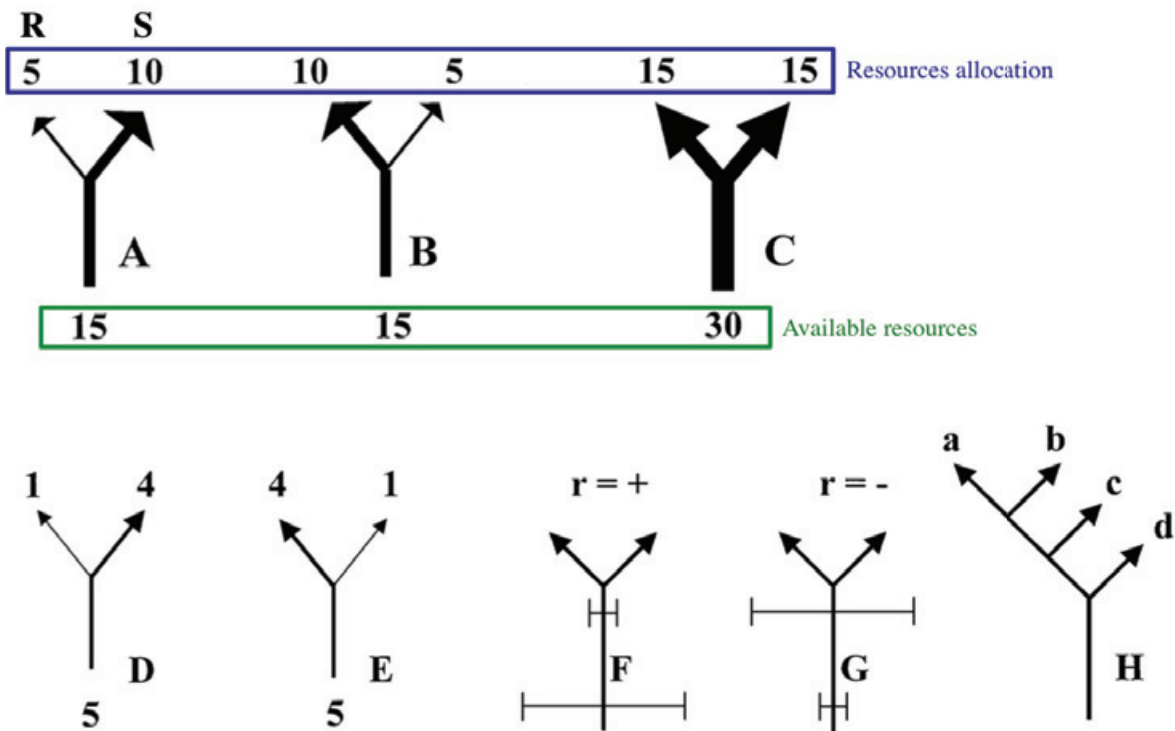

Figure 1: Diagrammatic representation of trade-offs (adapted from Zera and Harshman 2001).

The number (green) at the base of each “Y allocation tree” represents the resource input/availability for a given phenotype within a particular environment, while the numbers at the top of each Y allocation tree represent the allocation of available resources toward the competing functions R (reproduction) and S (somatic maintenance). Trees F and G illustrate the possible influence of the relative variation (length of the bar) in resource input compared to the possible variation in resource allocation on the sign of the relationship (r) between two traits. Finally, tree H illustrates the possibility of resource allocation models based on trade-offs between more than two competing functions. See text for details on each tree.

We also have to keep in mind that the environments in which organisms live are not static and as such, are not always predictable. A given combination of life history traits can be advantageous in one ecological context, but could be neutral or unfavourable in another (Stearns 1992). In response, organisms exhibit some plasticity in their phenotypes (morphological, physiological or behavioural changes in response to modifications of their environment), a phenomenon called ‘phenotypic plasticity’ (Piersma & van Gils 2011). Along

with variations in individual quality⁴, this phenotypic plasticity will no doubt complicate our understanding of life history trade-offs. To overcome such issues, the attention has turned toward the identification/integration of the proximal mechanisms underlying life-history trade-offs.

2. The physiology of life history trade-offs

2.1 Why integrate physiology to understand life history trade-offs?

In recent years, the physiological mechanisms underlying life-history trade-offs have been a particular source of interest (Zera & Harshman 2001), since it is crucial to integrate proximal causes in our approach to understand life-history evolution. Indeed, theoretical studies clearly show that the sign of a relationship between two traits does not necessarily mean that a functional trade-off has occurred. Identifying the functional (*i.e.* physiological) relationship linking two traits should therefore provide an insight into the occurrence of functional trade-offs. For example, studies on avian endocrinology have identified some functional links between life history traits, and show that corticosteroids appear to increase survival under stressful conditions but suppress reproductive and immune functions (Wingfield *et al.* 1998). Different approaches have been used to measure physiological trade-offs, from phenotypic correlation to genetic analyses and experimental manipulation of phenotypes (Zera & Harshman 2001). It is now well recognized that every approach has strengths and weaknesses and that the use of complementary approaches is necessary to fully understand the physiological causes of life history trade-offs.

2.2 Energy, physiology and life history

Energy is an essential parameter to sustain life. This simple fact is a unifying point in biology, from cells to ecosystems, from molecular to evolutionary biologists. Indeed, as underlined by Dawkins in 1976⁵, all life on earth depends on a universal common currency: Energy (see also Brown *et al.* 2004). Therefore, the most common form of “resources” aiming to be shared between life history traits (as described above) should be energy

⁴ Individual quality is defined as being an axis of among-individual heterogeneity that is positively correlated to fitness (Wilson & Nussey 2010).

⁵ In his famous book: « the selfish gene »

(Stearns 1992, Roff & Fairbain 2007), and the main purpose of physiological ecology has been to link energy acquisition and utilisation in the context of life-history trade-offs. For example, one historical interest of integrating physiology in this context was to evaluate the energetic cost of important life-history traits, such as reproduction or immune function (Zera & Harshman 2001). Such studies reveal that mounting an immune response has an energy cost equivalent to 28.8% of the resting metabolic rate (RMR) for house sparrows (*Passer domesticus*), whereas the cost of egg production was estimated at 56.2% of RMR for the same species (Martin *et al.* 2003). Since energy appears to be a central issue for organisms, a better understanding of the physiological processes mediating energy acquisition, processing and allocation is required to gain a better insight into the evolution of life history traits. In this context, most eukaryotic cells have a specialized compartment for energy processing (*i.e.* the transformation of nutrients into a chemical form to fuel cellular processes: adenosine tri phosphate, or ATP), namely the mitochondria. The role of mitochondrial functioning in evolutionary biology/ecology has gained much interest in recent years (Criscuolo *et al.* 2005). This is especially due to a “mitochondrial paradox”, namely that mitochondria not only produce the necessary ATP, but also produce potentially deleterious reactive oxygen species (ROS, Beckman & Ames 1998, Balaban *et al.* 2005).

3. A mitochondrial dilemma: producing ATP and being a source of ROS

Strictly speaking, energy cannot be produced, created or destroyed. Indeed, energy is defined as the ability to achieve work or produce changes, and could therefore only be converted from one form to another (*e.g.* muscular work: chemical (ATP) → kinetic + heat). However, the principal available form of energy usable by the cell is ATP, which is mainly produced through the process of oxidative phosphorylation by the mitochondria.

3.1 Oxidative phosphorylation by the mitochondria

For animals, nutrients such as carbohydrates, proteins and lipids are acquired from the environment. These energy-rich molecules cannot be used directly by the cell to fulfil cellular activities before they are transformed, especially into ATP molecules. To do so, different metabolic pathways (*e.g.* glycolysis followed by the Krebs cycle in aerobic conditions) will lead to the transfer of electrons from nutrients to electron carriers such as

NAD⁺ or FAD, resulting in the formation of NADH and FADH₂. These reduced molecules will be used by the mitochondria to produce ATP through a series of different steps within the mitochondrial electron transport chain (ETC), consisting of four enzymatic complexes located in the inner mitochondrial membrane (complexes I, II, III and IV - figure 2). This oxidation process will result in the gradual release of electron potential energy (Nicholls & Ferguson 2002).

Complexes I and II (NADH-Coenzyme Q oxidoreductase and succinate-Coenzyme Q oxidoreductase) are responsible for the electron transfer from NADH and FADH₂ respectively, to the lipid-soluble carrier Coenzyme Q. Electrons are subsequently passed down through complex III (Coenzyme Q - cytochrome c oxidoreductase), to cytochrome c, which is also a mobile carrier. Finally, electrons will pass down through cytochrome c oxidase (complex IV) to the final electron-acceptor (*i.e.* O₂) and result in the formation of a water molecule.

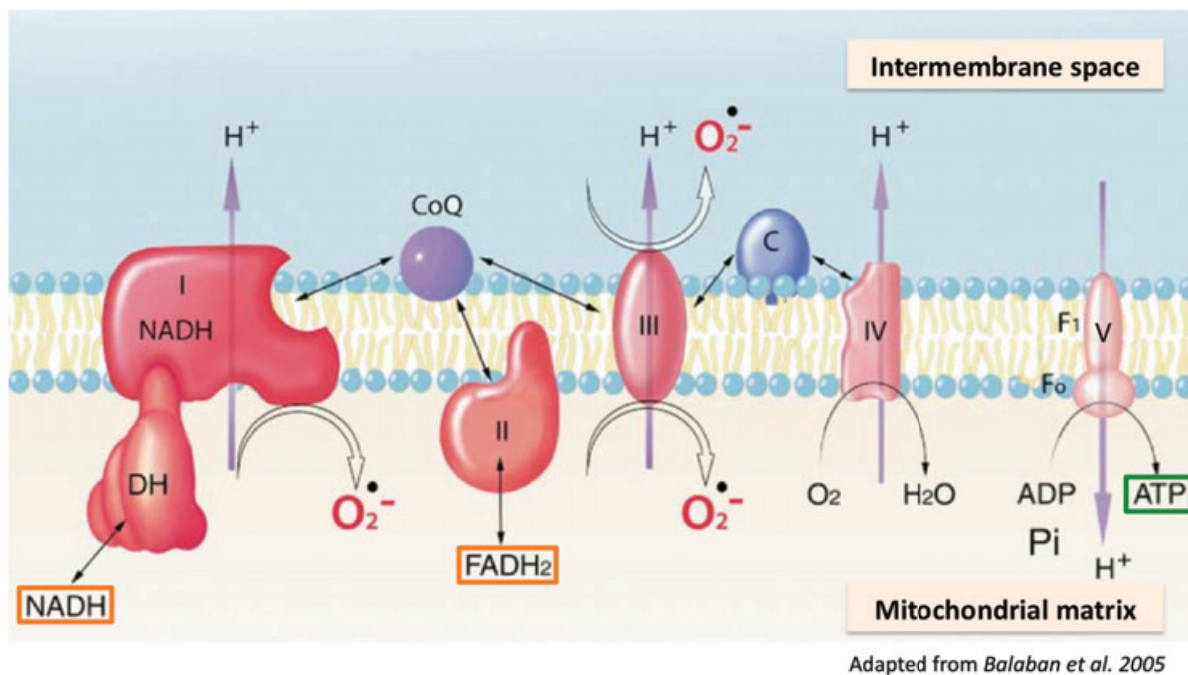

Figure 2: Mitochondrial electron transport chain (ETC) and the process of oxidative phosphorylation (adapted from Balaban 2005).

NADH or FADH₂ provide the ETC with electrons, which are then passed through the different complexes (I to IV) until the final electron acceptor (*i.e.* O₂). The ATP synthase (V) uses the proton gradient created by the ETC to synthesize ATP. Some electrons escape the normal pathway (especially in complexes I and III) and react directly with molecular oxygen, which leads to the formation of superoxide anion ($\bullet\text{O}_2^-$).

The fall in electron potential energy all along the chain is used to pump protons from the mitochondrial matrix to the intermembrane space, generating a proton-motive force. The ATP synthase (also named complex V) uses the flow of protons returning to the matrix to synthesize ATP from ADP and Pi (inorganic phosphate), a process referred to as oxidative phosphorylation (Nicholls & Ferguson 2002).

3.2 Reactive oxygen species (ROS) production by the mitochondria

Despite its vital importance for aerobic organisms (as a final electron acceptor for oxidative phosphorylation), the oxygen molecule has been known to be toxic since the 1950s (Gerschman *et al.* 1954). This toxicity was later attributed to the generation of anion radical superoxide ($\bullet\text{O}_2^-$), which is considered as the “primary-generated” ROS and leads to the formation of “secondary” ROS such as hydrogen peroxide (H_2O_2) and hydroxyl radical ($\bullet\text{OH}$). ROS are considered to be amongst the major biologically relevant oxidants (along with reactive nitrogen species). Some of these ROS are free radical species, free radicals being defined as highly reactive atoms/molecules due to unpaired electron(s) (symbolized by a \bullet) in their outer shell (Halliwell & Gutteridge 2007). However, the term ROS is also used to describe non-radical oxidants, such as hydrogen peroxide. ROS are produced in multiple cellular compartments (*e.g.* plasma membrane, peroxisomes, etc) but the majority of ROS production could be attributed to the mitochondria (\approx 90% of cellular ROS, Balaban *et al.* 2005). At several sites along the electron transport chain (figure 2), electrons may react directly with oxygen (*i.e.* slip), and generate superoxide or other free radicals. The production of ROS has been estimated to be somewhere between 0.1 and 4% of total O_2 consumption, according to *in vitro* and *in vivo* available data (Nicholls & Ferguson 2002). For a long time, complexes I and III were thought to be the two main sites of ROS production (figure 2), but recent work also indicates complex II as a significant contributor to overall ROS production (Venditti *et al.* 2013). It is important to note here that ROS are continuously generated as by-products of the normal cellular/organismal metabolism, and that mitochondria are the main source of ROS production in most tissues under physiological conditions (Lambert & Brand 2009).

3.3 Oxidative stress and oxidative balance

3.3.1 Oxidative damage

Free radicals are very reactive, as they extract electrons from any encountered molecule, which will create a new free radical. By doing so, they can trigger a rapid chain reaction that causes injuries to biomolecules, such as lipids, proteins, and nucleic acids (Beckman & Ames 1998; Halliwell & Gutteridge 2007). Such injuries are commonly named oxidative damage, the most common forms of such damage being lipid peroxides, protein carbonyl, or DNA base modifications/strand breakage. Such damage could lead to the loss of functional and structural efficiency of proteins, or to harmful DNA mutations, with possible consequences in terms of DNA replication/transcription (Halliwell & Gutteridge 2007). It is particularly important to consider oxidative damage to lipids given their role in biological membrane integrity and functionality (*e.g.* plasma and mitochondrial membranes), but also because of their secondary reactivity, which triggers complex chain reactions propagating oxidative damage to other molecules (Hulbert *et al.* 2007). Considering the continuous oxidative threat generated by ROS production, organisms have evolved complex defences against the attack of free radicals, encompassed under the general term “antioxidant defences” (Surai 2002, Constantini 2008).

3.3.2 Antioxidant defences

There is no simple definition of antioxidant defences, but Halliwell & Gutteridge (2007) proposed to define an antioxidant as “*any substance that, when present at low concentrations compared with those of an oxidizable substrate, significantly delays or prevents oxidation of that substrate*”. One primary line of defence against ROS is composed of antioxidant enzymes, which are endogenously synthesized and are present both within the cell and within the mitochondria (and in some cases can even be found in extra-cellular fluids such as plasma). First of all, metalloproteins called superoxide dismutases (SOD) can catalyze the conversion of superoxide anion into hydrogen peroxide. Although it is not a free radical, hydrogen peroxide is a powerful oxidant that could lead to the formation of hydroxyl radicals. This hydrogen peroxide is then converted to water through the action of one of the two following enzymes: the catalase (CAT) or the glutathione peroxidase (GPx).

Another important part of antioxidant defences is based on the action of non-enzymatic (low-molecular weight) compounds, either synthesized endogenously (*e.g.* glutathione (GSH) and ubiquinones) or acquired through the diet (*e.g.* vitamin E or carotenoids). These compounds are especially important to neutralize hydroxyl radical, for which there is no enzymatic neutralization. They also play a key role in neutralizing other oxidants and preventing the chain reaction of lipid peroxidation. Glutathione is probably one of the most active antioxidant in the biological system, but we have to keep in mind that the various antioxidant systems also interact with each other. Indeed, the different components of antioxidant defences do not work alone, but in recycling loops (Surai 2002, Halliwell & Gutteridge 2007), with for example oxidized vitamin E being further reduced by carotenoids.

Three other parameters could be classified as antioxidant defences, in a broader sense. First of all, any mechanisms limiting ROS production by the mitochondria could be assimilated to an antioxidant defence. The uncoupling of oxidative phosphorylation from oxygen consumption (either via uncoupling proteins or other pathways) will be discussed later in this thesis (see 4.3), but other factors such as the proportion of the different complexes within the mitochondrial ETC could play a role. For instance, a low complex I content has been associated with a low ROS production (Lambert *et al.* 2010). Secondly, it is possible for organisms to limit their vulnerability to oxidative stress, for example by having cellular components that are more resistant to oxidative attacks. This is the case for poly-unsaturated fatty acids, which are highly sensitive to lipid peroxidation. A low content of these poly-unsaturated but a high content of saturated fatty acids will help minimize oxidative damage (Hulbert *et al.* 2007). Finally, even if oxidative damage occurs, repair mechanisms could provide protection from the damaging effects of oxidant attacks (*e.g.* increased cellular permeability, defect in DNA transcription) by removing or repairing damaged molecules. For example, damaged proteins could be degraded by the proteasome (Davies 2001), and altered DNA sequences could be repaired by various mechanisms such as nucleotide excision repair (Halliwell & Gutteridge 2007).

3.3.3 A clear definition of oxidative stress

Considering the inevitable occurrence of ROS through both endogenous production (metabolism) and exogenous sources (UV, pollutants, etc), and the complex antioxidant defences that have evolved to counter oxidant attacks, the biologically relevant point in

oxidative biology appears to be the balance between pro-oxidant compounds and antioxidant defences. In healthy organisms, the **oxidative balance** is approximately equilibrated, resulting in low levels of oxidative damage (Halliwell & Gutteridge 2007). In this context, oxidative stress has been defined in 1985 by Helmut Sies, as a “*disturbance in the pro-oxidant/antioxidant balance, leading to potential damage*”. Therefore, the occurrence of oxidative stress seems closely related to the presence of oxidative damage to biomolecules. Two decades later, Sies and *al.* (2007) provided a more developed definition that considered the important functions played by ROS in cell signalling (Dröge 2002). Oxidative stress is therefore defined as “an imbalance between oxidants and antioxidants in favour of the oxidants, leading to a disruption of redox signalling⁶ and control, and/or molecular damage”.

3.3.4 Possible shifts in the oxidative balance

As underlined and illustrated (figure 3) by Monaghan et *al.* 2009, oxidative stress can occur for different reasons, so measuring only one side of the oxidative balance (ROS or antioxidants) would be inadequate to evaluate oxidative stress. Indeed, in standard healthy conditions, ROS production and antioxidants are supposed to be equilibrated and kept at a minimal level (figure 3a), thereby preventing oxidative damage. If an increase in ROS occurs (figure 2b), for example due to an acute physical exercise (Fisher-Wellman & Bloomer 2009), this ROS production could temporarily or more permanently override the antioxidant defences, leading to oxidative damage and consequently causing oxidative stress. A limited increase in ROS could be compensated by an up-regulation of antioxidant defences (figure 3c), thereby leading to a new homeostatic situation (*i.e.* no oxidative stress). Even if no oxidative stress occurs in this situation, maintaining elevated antioxidant defences may have a cost for organisms, since the resources invested in these defences will not be available for other biological functions. If the increase in ROS production is only temporary, the balance should return rapidly to a basal homeostatic situation as described in figure 3a. However, if the exposure to elevated levels is more prolonged, or repeated over time, the organism response could be to increase the baseline antioxidant defences in a more permanent manner (figure 3d). Such a response should allow a better responsiveness of the organism to

⁶ Redox signalling is defined as the involvement of free radicals and other oxidants molecules as intra-cellular messengers/regulators (Dröge 2002). For example, H₂O₂ has been shown to be an important second messenger in lymphocyte activation (Reth 2002).

oxidative attack, but come at the cost of maintaining elevated antioxidant levels on the long-term.

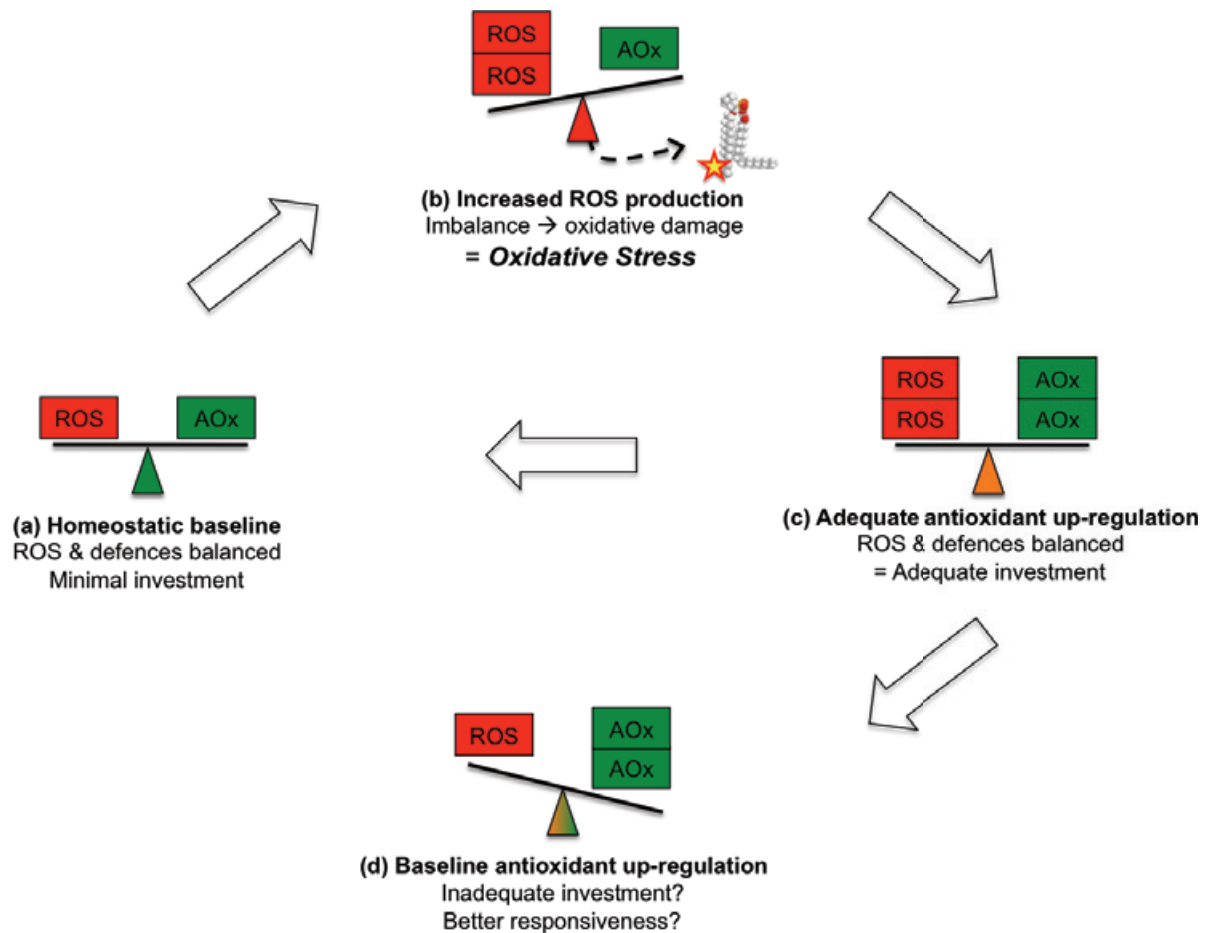

Figure 3: Simplified illustration of situations characterizing an oxidative balance or an oxidative imbalance (adapted from Monaghan 2009).

Following this simplified illustration of the relationships between antioxidant defences and ROS production, no one should conclude in terms of oxidative stress with information regarding only one side or the other of the oxidative balance (Monaghan *et al.* 2009, Constantini & Verhulst 2009). Measuring both sides of oxidative balance is therefore recommended, but given the highly unstable nature of ROS (half-life often $\approx \mu\text{s}$, Hulbert *et al.* 2007), measurements frequently focus on antioxidants and oxidative damage. As underlined by Monaghan and collaborators, the main important element at the scale of the organism is the equilibrium/disequilibrium of the oxidative balance, *i.e.* the “*level of impaired functions as a consequence of oxidative damage*”.

Despite being an incredibly complex process, ageing⁷ has been suggested by numerous theories to involve damage to macromolecules (Kirkwood 2005). In this context, mitochondria, oxidative stress and oxidative damage have been suggested as important contributors to the ageing process (Beckman & Ames 1998, Balaban *et al.* 2005).

BOX A: Telomere length as a biomarker of chronic oxidative stress and ageing?

The aim of this box is to explain that besides the focus on oxidative stress, measurements of telomere length will also be presented throughout the manuscript.

Telomeres are protective non-coding nucleoprotein structures that are located at the end of eukaryotic chromosomes. They prevent the recognition of chromosomal ends as double-strand DNA breakage, therefore protecting from end to end fusion and degradation. DNA replication is an incomplete process, since DNA polymerase cannot replicate the end of the “lagging” strand at each cell division. This is known as the “3’ end-replication problem”. Telomeres therefore protect the encoding part of the chromosome from the loss of nucleotides, but consequently shorten at each cell division (reviewed in Monaghan & Hausmann 2006, Monaghan 2010).

In addition, telomeric sequences (typically TTAGGG repeated in tandem in vertebrates) are particularly rich in guanines, which are highly sensitive to ROS-induced oxidative damage (Halliwell & Gutteridge 2007). Consequently, telomeres are prone to ROS-induced DNA strand-breaks, and this substantially accentuates their rate of shortening (reviewed in Houben *et al.* 2008). Oxidative stress thus appears to contribute more to telomere shortening than the 3’ end-replication problem (von Zglinicki 2002), leading Houben and collaborators to propose telomere length as a potential biomarker of chronic oxidative stress (Houben *et al.* 2008). However, oxidative stress is not the only factor involved in telomere length regulation, and other factors such as telomerase activity, an enzyme responsible for telomere elongation, slightly weaken the use of telomere length as an integrative marker of oxidative stress.

⁷ Ageing is defined as the inevitable and progressive physiological deterioration of an organism, leading to decreased reproductive performances and increased risks of death with increasing age (Rose 1991).

Once telomeres reach a critical minimum size, they become dysfunctional, which leads to cell death (apoptosis) and/or replicative senescence (*i.e.* the incapacity to achieve cell division, De Lange *et al.* 2006). In this context, the functional decline of telomeres has been placed as an important parameter involved in the ageing process (Sahin & Depinho 2010), and in the relationship between lifestyle and lifespan (Monaghan & Haussmann 2006, Haussmann & Marchetto 2010). Recent studies in evolutionary biology-ecology have shown that telomere length or dynamics appear as good predictors of survival in wild birds (Bize 2009, Salomon 2009) and lifespan in captive birds (Heidinger 2012).

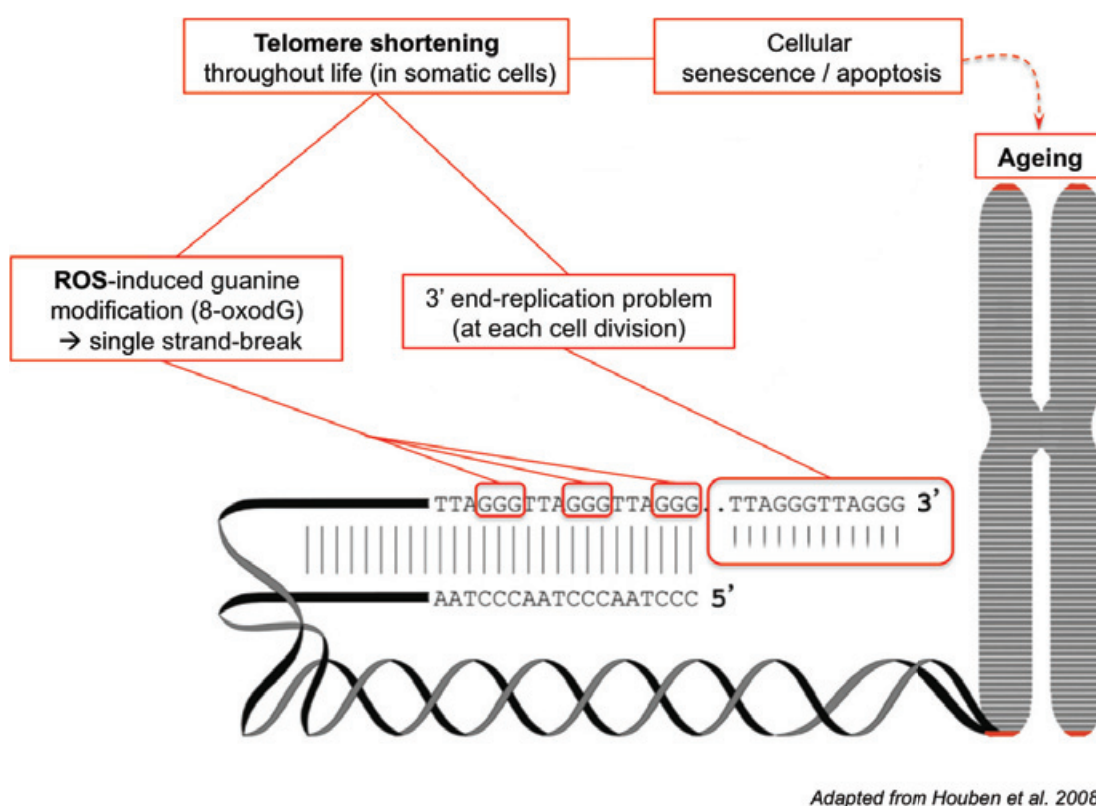

4. Mitochondria, oxidative stress and ageing

The desire to understand the differences in longevity and ageing rate, both within and between species, has a long scientific history (Speakman 2005). Energy was intuitively recognized as a central parameter for biological processes at an early stage, and scientists were already eager to link energy metabolism and ageing in the early 1900s. As described above, mitochondria are a key determinant of both energy processing and the production of

damaging free radicals. During the 20th century, this knowledge led to the enunciation of theories linking energy metabolism, mitochondria functioning and ageing rate.

4.1 Linking energy metabolism and ageing/longevity

The hypothesis that ageing should be related to energy expenditure is intuitively appealing, as illustrated by our perception that mechanical objects will present defects more quickly if we use them intensively (Speakman *et al.* 2002). Rubner was the first scientist to clearly postulate a relationship between energy expenditure and lifespan in 1908. By comparing energy expenditure and lifespan between five mammalian species, he noted that despite a strong impact of body size on both parameters, one gram of body tissue consumes approximately the same amount of energy during the animal lifespan, irrespectively of the species studied (Rubner 1908). This discovery was the first experimental link between energy metabolism and lifespan, and was the bedrock of the rate-of-living theory (ROL), which was only exposed 14 years later. This theory was originally formulated by Pearl in 1922, who exposed the idea that life duration is inversely related to the rate of energy expenditure (Pearl 1922), but did not provide any hypothetic mechanism linking the two parameters. This attractive idea that “the length of life is inversely related to the rate of living” (Pearl 1928) contributed to the emergence of other theories linking energy metabolism and ageing rate (see next paragraph), but also led to the development of a life-history concept known as “living fast and dying young” (Promislow & Harvey 1990).

4.2 The free radical/oxidative stress theory of ageing

Despite weak evidence at the time, Harman suggested in 1956 that the free radicals produced during aerobic respiration cause cumulative oxidative damage to biomolecules, which ultimately result in ageing and death (Harman 1956). His theory gained much more support in the late 60's with the discovery of the enzyme superoxide dismutase, which provided strong support for the importance of ROS generation *in vivo* (McCord & Fridovich 1969). The missing link with the rate-of-living theory was discovered only later, when it was demonstrated that the mitochondria, which is the powerhouse of aerobic eukaryotic cells, was also a primary site of endogenous oxidants generation (Chance *et al.* 1979). The *free radical theory of ageing* (FRTA) thereby provided an underlying mechanism explaining the relationship between energy metabolism and ageing rate (*i.e.* “a faster rate of respiration,

associated with a greater generation of oxygen radicals, hastens aging" - Beckman & Ames 1998).

The FRTA gained much support in the late 20th century, with extensive research being conducted essentially in a medical/physiopathological context (reviewed in Beckman & Ames 1998, but see also Finkel & Holbrook 2000 or Balaban *et al.* 2005). Intra-specific studies provided some arguments validating the accumulation of oxidative damage with increasing age (Stadtman 1992, Agarwal & Sohal 1994, Sohal *et al.* 1995), but also suggesting that oxidant generation increases with age (Sohal *et al.* 1995, Hagen *et al.* 1997). Moreover, the level of oxidative damage was demonstrated to be positively correlated to energy metabolism in humans (O₂ consumption, Loft *et al.* 1994), providing a support for the highly speculated link between metabolism, oxidative stress and ageing. In addition, interspecies comparisons provided useful insights into the validity of the FRTA, notably by explaining the inconsistency observed between longevity and metabolic rate for some phylogenetic groups such as birds (*i.e.* high metabolic rate and high longevity). Indeed, the work conducted by two independent groups (Barja and Sohal) in the 90s led to the idea that despite high rates of oxygen consumption, birds presented a low rate of oxidant production compared to mammals (Ku & Sohal 1993, Barja *et al.* 1994), therefore explaining their exceptional longevity despite their high metabolic rates. Correlative evidences supporting the validity of the FRTA were also strengthened by experimental manipulations, which have shown for example in houseflies that reduced physical activity (*i.e.* a low metabolic rate) was associated with both an increased lifespan and a decreased level of oxidative damage (Sohal *et al.* 1993, Agarwal & Sohal 1994).

Despite numerous arguments supporting the validity of the FRTA (Sohal 2002), the late 90s also marked the emergence of the first controversies. Indeed, thanks to an increasing understanding of mitochondrial functioning, it became obvious that a simple 1:1 positive relationship between energy expenditure and mitochondrial ROS production was an erroneous simplification, since an increase in metabolism is not necessarily linked to an increase in oxidant generation (reviewed by Barja 2007).

4.3 The ‘uncoupling⁸ to survive hypothesis’

4.3.1 Why should mitochondrial uncoupling state control ROS production?

Mitochondrial inner membrane potential has been recognized as a determinant of ROS production for some time now (high potential \Leftrightarrow high ROS production). Thus, any mechanism decreasing this potential should lead to lower mitochondrial ROS production (Skulachev 1996). Consequently, and contrary to the original FRTA expectations, it was shown that agents increasing respiration rate *in vitro*, such as ADP or uncouplers⁹, were also associated with a decrease in mitochondrial ROS production (Skulachev 1996, Brand 2000). Uncouplers and ATP synthesis (elicited by ADP addition) were both shown to lower mitochondrial proton-motive force by increasing the rate of electron flow along the mitochondrial transport chain, thereby lowering the global redox state of the chain. This redox state seems important in terms of $\bullet\text{O}_2^-$ generation (especially for the complex I/coenzyme Q), since reduced respiration would result in electron accumulation within the chain (*i.e.* increased redox state). This accumulation may lead to an undesired reduction of O_2 to $\bullet\text{O}_2^-$ (Barja 2007, Murphy 2009), especially through a reverse electron flow from coenzyme Q to complex I. Additionally, the production of ROS is also dependent on the partial O_2 pressure near the mitochondria (*i.e.* high $\text{pO}_2 \Leftrightarrow$ high ROS production), which is maintained at low levels by an active respiration, whether or not ATP synthesis occurs (Barja 2007). These two mechanisms lowering ROS production both contribute to a beneficial effect of a moderate/‘mild’ mitochondrial uncoupling (a high uncoupling state would be unfavourable by inhibiting ATP synthesis). In this context, it was shown that the lowering of approximately 10mV of mitochondrial membrane potential (strongly dependent upon the proton-motive force) should lead to a reduction of approximately 70% of ROS produced by complex I (Miwa *et al.* 2003).

⁸ Mitochondrial uncoupling is defined as the loss of coupling between O_2 consumption and ATP production by the mitochondria (Brand 2000). Such a phenomenon is especially linked to the proton permeability of the inner mitochondrial membrane (*i.e.* proton leak).

⁹ Uncouplers or uncoupling agents: molecules allowing the return of H^+ from the intermembrane space to the mitochondrial matrix without ATP synthesis. Such molecules “uncouple” O_2 consumption from ATP production by the mitochondria.

4.3.2 Mitochondrial uncoupling and longevity

Altogether, the relationship between mitochondrial uncoupling and ROS production leads to the ‘uncoupling to survive hypothesis’, which was originally put forward by Brand in 2000. This hypothesis is based on the FRTA by acknowledging that ageing/longevity is determined by oxidative stress and the accumulation of damage with time. However, the ‘uncoupling to survive hypothesis’ appears to be in opposition with the FRTA expectations to some extent, since this hypothesis states that an increased metabolism should lead to a decreased ROS production (and therefore a slower ageing rate) if achieved through mitochondrial uncoupling. In this context, an ‘inducible proton leak’ emerged as a possible mechanism for the adjustment of mitochondrial membrane potential (*i.e.* uncoupling state) and the associated ROS production (Brand 2000, Mailloux & Harper 2011). After the *in vitro* results leading to the original hypothesis (Skulachev 1996, Kornushov *et al.* 1997), *in vivo* experiments were conducted to validate the theory. Speakman *et al.* (2004) showed for example that within a cohort of laboratory mice, those with the highest resting metabolic rate were also those exhibiting the highest longevity (*i.e.* in accordance with the ‘uncoupling to survive hypothesis’, but not the FRTA expectations). These long-lived mice were characterized by a higher uncoupling state in muscle mitochondria, which was linked to higher mitochondrial membrane permeability to protons. An experimental validation of the hypothesis was conducted in mice by using a lifelong treatment with the artificial uncoupler 2,4-dinitrophenol (Caldeira da Silva *et al.* 2008). This pharmacological uncoupling treatment was shown to reduce oxidative stress and increase lifespan whilst increasing metabolic rate.

4.3.3 Mitochondrial uncoupling proteins (UCPs)

In endotherm vertebrates, some members of the UCP family (such as UCP 1-3 in mammals, and avUCP in birds) have been thought to play an important role in the inducible proton leak and/or in the control of ROS production (Crisuolo *et al.* 2005, Mailloux *et al.* 2011). Indeed, UCP2 was found to diminish ROS production *in vitro* (Negre-Salvayre *et al.* 1997) and accordingly, transgenic mice overexpressing UCP2 were found to produce less ROS (Teshima *et al.* 2003). However, controversies quickly emerged about the real uncoupling function of UCP2 and the effects of UCP2 on ROS production (*e.g.* see Cannon *et al.* 2006, Bouillaud 2009). Relatively similar observations were made for UCP3, with increased *in vitro* ROS production of mitochondria from UCP3 knockout mice (Vidal-Puig *et*

al. 2000, Toime & Brand 2010, but see Nabben *et al.* 2011 for controversies). UCP1 seems to be the only acknowledged “real uncoupling protein” and therefore the only UCP with a thermogenic function (see Nedergaard *et al.* 1999, Shabalina & Nedergaard 2011 for a discussion about physiological uncoupling properties of UCP1-3), a characteristic that was acquired late in the history of UCP evolution (Hughes & Criscuolo 2008). This protein is expressed in a specific thermogenic tissue of eutherian mammals, namely the brown adipose tissue (BAT). Early evidence from the knockout mouse model (UCP1^{-/-}) did not demonstrate an effect of this protein on oxidative stress levels in the BAT (Shabalina *et al.* 2006). Nevertheless, the ectopic expression of UCP1 in skeletal muscles was found to improve longevity and diminish ROS production in mice (Gates *et al.* 2007, Keipert *et al.* 2009), and recent evidence points to a beneficial effect of UCP1 in BAT mitochondria, at least in terms of ROS production *in vitro* (Oelkrug *et al.* 2010, Dlaskova *et al.* 2010). Finally, a possible role of avUCP in terms of ROS lowering (without any mitochondrial uncoupling activity) has been suggested *in vitro* (Criscuolo *et al.* 2005), and supported by some evidence *in vivo* (Rey *et al.* 2010a, 2010b). It is also worth noting that other mitochondrial carriers might be important to regulate mitochondrial proton leaks and the associated ROS production, such as the adenine nucleotide translocase (ANT, Brand 2004, 2005).

Mitochondria appear as a corner-stone factor determining both energy processing capacities and ageing rate, but the implication of mitochondrial functioning (ROS production, efficiency to produce ATP) in life-history trade-off has been largely under-explored to date. Given the inevitable and universal nature of ROS production, oxidative stress has received increasing attention in recent years, going beyond its original research fields (biomedical studies and particularly gerontology). During the first decade of the 21st century, ecologists and evolutionary biologists developed a great interest in antioxidants and the study of oxidative stress in a context of sexual selection and life-history trade-offs, giving rise to the emergence of a new research area named ‘oxidative-stress ecology’ (McGraw *et al.* 2010).

5. Oxidative stress and mitochondrial uncoupling in an eco-evolutionary context

5.1 Theoretical framework of this thesis

Oxidative stress and reactive oxygen production are two factors that ecologists were eager to integrate within life-history trade-off models, as suggested by numerous recent reviews on the subject (Constantini 2008, Monaghan *et al.* 2009, Dowling & Simmons 2009, Metcalfe & Alonso-Alvarez 2010, Isakson *et al.* 2011, Selman *et al.* 2012). Indeed, ROS production and oxidative stress are likely to influence the self-maintenance of organisms and therefore the ageing rate, but they are also closely related to energy use, energy being the primary factor suspected to shape life-history trade-offs (Stearns 1992, Roff & Fairbairn 2007). As illustrated in figure 4a, a (simplified) view of classical allocation trade-offs suggests that food and therefore resource/energy are limited in natural environments, giving rise to resource-based allocation trade-offs (see also 1.2). These trade-offs should occur between main biological functions such as growth, reproduction and self-maintenance, and the optimality of the given resource investment (within the ecological context) should determine individual fitness.

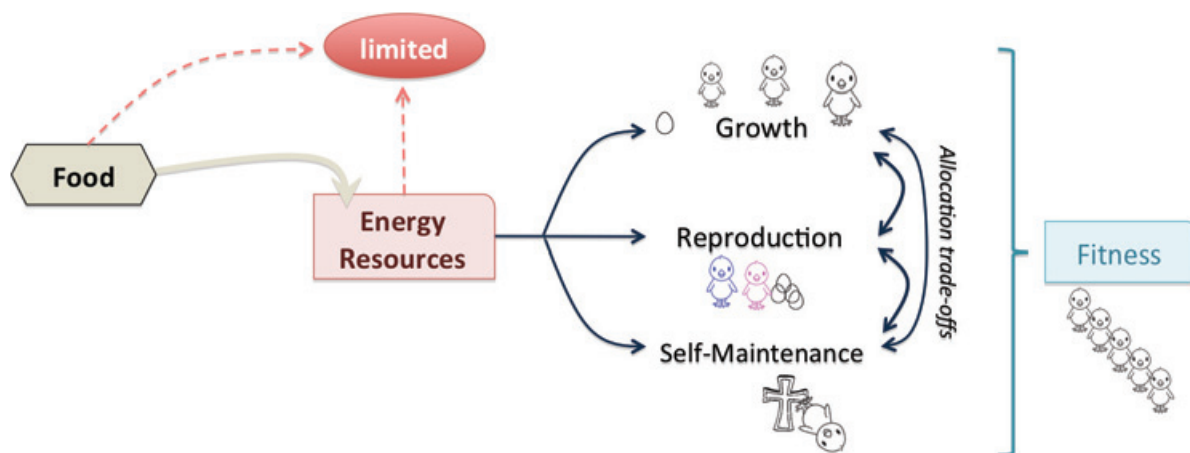

Figure 4a: Simplified illustration of the classical allocation trade-offs between growth, reproduction and self-maintenance.

Food is acquired from the environment and converted into usable resources (ATP, amino acids, etc.). However, the food is likely to be limited in natural conditions, as well as the capacity of organisms to acquire and process food (*e.g.* limited digestive efficiency). Energy and other resources are invested in different life history traits, but investment in each trait is likely to be traded-off against the investment in other traits, giving rise to allocation-based trade-offs.

Integrating oxidative stress within our approach should help to understand the physiological basis of such trade-offs. Indeed, energy use is conditioned by the ability of the mitochondria to produce ATP, but this process leads to the inevitable by-production of potentially damaging ROS (figure 4b, see also 3.2). If the antioxidant defences do not neutralise ROS production, oxidative stress and oxidative damage will occur and the self-maintenance of the organism will be negatively affected, as described by the free radical theory of ageing (see 4.2). Therefore, resource investment in one function could negatively impact the others via three non-mutually exclusive possibilities: 1) a classical resource-based trade-off, 2) a negative impact of ROS production resulting from the energy cost of the function, 3) a reallocation of resources from other functions to antioxidant defences in order to prevent ROS-induced damage.

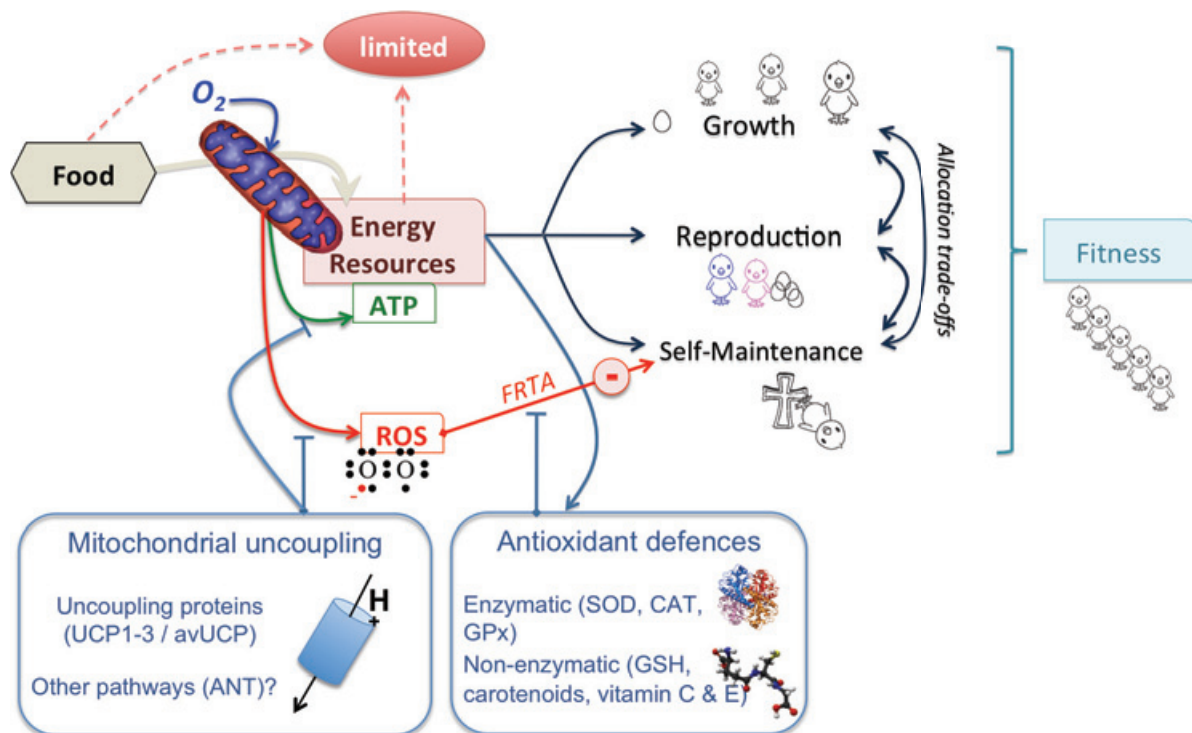

Figure 4b: Potential implications of mitochondrial functioning (ATP and ROS production) in life history trade-offs between growth, reproduction and self-maintenance.

Mitochondria are central to the transformation of acquired nutrients into usable ATP, but concomitantly produce potentially deleterious ROS. According to the free radical theory of ageing (FRTA), these ROS are likely to impair organismal self-maintenance. Mitochondrial ROS production might be lowered directly at the source by decreasing mitochondrial membrane potential (*i.e.* uncoupling), or alternatively various antioxidant defences could quench ROS before the occurrence of damaging effect. However, mitochondrial uncoupling reduces the ATP available for cellular functions, and resources investment into antioxidant defences could not be invested in other functions.

In addition and according to the ‘uncoupling to survive hypothesis’, the production of mitochondrial ROS could be reduced by an increased uncoupling state of the mitochondria (figure 4b). This process should also have consequences in term of life history trade-off, since mitochondrial uncoupling is associated with a decreased mitochondrial efficiency to transform nutrients into ATP (see also 4.3). Therefore, less energy should be available for the investment in other functions (e.g. growth or reproduction), but mitochondrial uncoupling should favour the self-maintenance of the organism, by decreasing oxidative stress.

Accordingly, and as proposed in figure 4c, an increased investment toward growth or reproduction might lead to oxidative stress and impaired self-maintenance through an increase in ROS production, a decrease in resources allocation toward antioxidant defences, or an increased mitochondrial efficiency (decreased mitochondrial uncoupling) to optimize ATP production. Therefore, an oxidative cost/constraint is likely to result from all investment in life-history traits; a cost is defined as a rise in oxidative stress/damage due to the investment in a given trait, and a constraint is defined as a decreased investment in a given trait due to high levels of oxidative stress/damage.

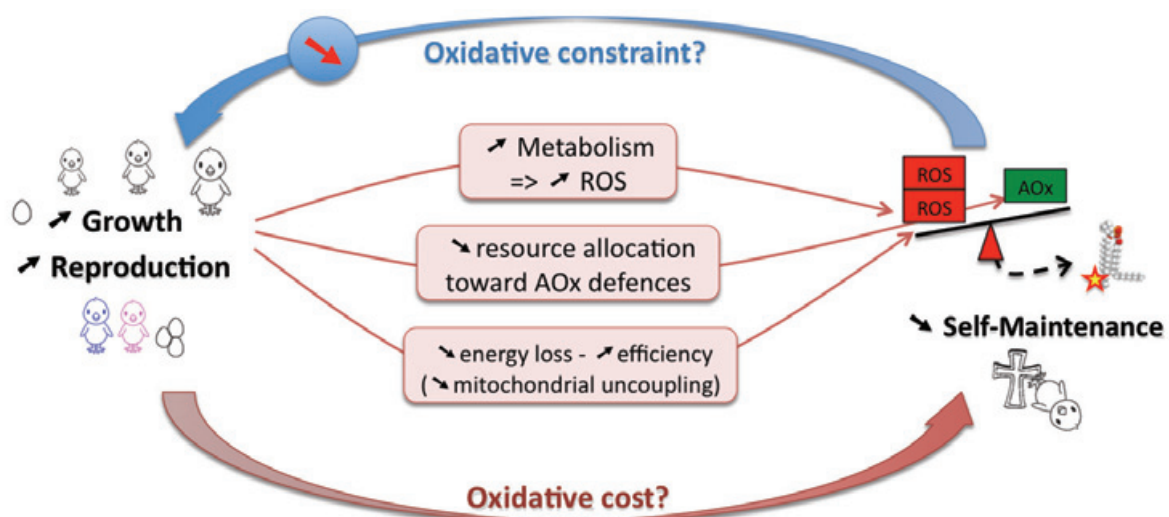

Figure 4c: Theoretical consequences of an increased investment in growth or reproduction on the oxidative balance (cost) and potential retro-control (constraint).

An increased investment in growth or reproduction may generate an oxidative imbalance through at least the three different pathways proposed here (i.e. oxidative cost). However, the reverse scenario in which oxidative imbalance limits the investment of energy in costly functions might also occur, but has been largely under-explored so far.

5.2 Mitochondrial uncoupling state and life history trade-offs

Despite the potential involvement of mitochondrial uncoupling state in both ROS generation and ATP production, it has received little attention in the context of life history studies (Salin 2012a, 2012b). According to the theoretical framework presented in 5.1, the regulation of mitochondrial efficiency could be a key means to limit oxidative stress by directly controlling the source of ROS production. However, such a mechanism is likely to impact resource investment in the different life history traits by decreasing the ATP production for a given amount of food intake. Much of the attention paid to mitochondrial efficiency in an eco-evolutionary context was linked to the involvement of mitochondrial uncoupling in adaptive non-shivering thermogenesis¹⁰. Indeed, the proton efflux characterizing mitochondrial uncoupling dissipates the energy stored in the proton gradient as heat, instead of producing ATP. This could be a useful means by which endotherms maintain their body temperature. In this context, UCP1-dependent mitochondrial uncoupling has been found to be the only mechanism capable of mediating adaptive non-shivering thermogenesis in small mammals (Golozoubova *et al.* 2001, Cannon & Nedergaard 2004), and avUCP-dependent proton conductance in birds (Talbot *et al.* 2004, but see Walter & Seebacher 2009 for controversies) has been suggested to play a role in adaptation to the cold.

In the context of life-history trade-offs, it has been suggested that UCP1 expression and BAT thermogenic capacity could be reduced during lactation in small mammals as an 'energy-saving mechanism' designed to favour energy investment in milk production (Trayhurn 1989, Li & Wang 2005). Similarly, a period of fasting has been found to decrease the level of UCP1 expression in the arctic ground squirrel (Barger *et al.* 2006) and the level of avUCP in fasting king penguin (Rey *et al.* 2008), thereby promoting metabolic efficiency and potentially increasing starvation resistance. These results suggest that energy requirements could constrain organisms to reduce their 'uncoupling state' to optimize energy utilisation. Two recent independent studies supported this evidence, showing that mitochondrial efficiency is a key element that constrains physical performances in zebra fish (Marit & Weber 2011) and laboratory rats (Schlagowski 2013). Mitochondrial efficiency was also

¹⁰ The adaptive non-shivering thermogenesis is defined as the metabolic response progressively set-up by endotherms to produce heat by another pathway than muscular shivering (Bicudo *et al.* 2001, Cannon & Nedergaard 2004).

recently shown to be a potential constraining factor for adult body size. Indeed, by comparing two neighbouring populations of frogs (*Rana temporaria*) with large differences in body size, Salin and collaborators found that a high mitochondrial efficiency to produce ATP (related to a lower proton leakage) was related to a large body size at the population level (Salin *et al.* 2012b). Although these studies make a great contribution to the research field, they do not explore the impact of mitochondrial uncoupling on life-history traits in the context of the ‘uncoupling to survive hypothesis’, neglecting a potential link between mitochondrial efficiency and oxidative stress. However, Salin and collaborators used an experimental uncoupling treatment (2,4-dinitrophenol) to investigate the consequences of altered mitochondrial efficiency on the oxidative balance and growth performances of frog tadpoles (Salin *et al.* 2012a). According to the theoretical framework presented in 5.1, this study showed that an increased mitochondrial uncoupling promoted a high metabolic rate and reduced ROS production, but resulted in lower energy investment in the rate of development (Salin *et al.* 2012a). Other informative studies about mitochondrial uncoupling and life history traits are found in biomedical-related literature, with one recent study reporting a relationship between polymorphism in the upstream enhancer region of the UCP1 gene and longevity in humans (Rose *et al.* 2011). However, little research has been conducted to investigate the relationships between mitochondrial uncoupling state, oxidative stress and life history traits.

5.3 What do we already know about oxidative stress involvement in life history trade-offs?

5.3.1 Reproduction & oxidative stress

The so-called ‘cost of reproduction’, which is defined as the negative impact of current reproduction on future reproductive potential and survival prospects, is one of the most studied trade-offs (Reznick 1985, Harshman & Zera 2007). In this context and following the theoretical framework proposed in paragraph 5.1, oxidative stress has been put forward as the mechanism responsible for the negative correlation that occurs between reproductive effort and survival prospects (Alonso-Alvarez *et al.* 2004, Harshman & Zera 2007, Constantini 2008). The first clues supporting this hypothesis were found in *Drosophila melanogaster*, where an experimental increase in egg production was found to decrease resistance to a pro-oxidant treatment (Salmon *et al.* 2001, Wang *et al.* 2001). This idea was subsequently

investigated in zebra finches by manipulating the reproductive effort (*i.e.* brood size) and then assessing activity of antioxidant enzymes (Wiersma *et al.* 2004) or the resistance of erythrocytes to an oxidative attack (KRL test, Alonso-Alvarez *et al.* 2004). The two studies demonstrated that increased reproductive effort was associated with a higher ‘susceptibility to oxidative stress’. However, these early evidences were restricted to indirect measurements of oxidative stress resistance and antioxidant defences, and are not sufficient to conclude about oxidative stress (Monaghan *et al.* 2009, Constantini & Verhulst 2009). Contradictory evidence (*i.e.* a lack of increased oxidative damage in reproducing animals) has emerged in recent years (*e.g.* Garratt *et al.* 2011, Oldakowski *et al.* 2012), thereby questioning the existence of an oxidative cost of reproduction (reviewed in Metcalfe & Monaghan 2013).

Despite being considered as a potential cost of reproduction, oxidative stress could also be seen as a potential constraint for reproductive investment (Metcalfe & Alonso-Alvarez 2010), as illustrated in figure 4c. For example, experimental treatment inducing oxidative stress in laboratory conditions was shown to be responsible for decreased male fecundity (Kaur *et al.* 2006). Following the same idea, Heiss & Schoech recently demonstrated that the pre-breeding levels of oxidative damage were negatively correlated with reproductive effort in the male Florida scrub-jay *Aphelocoma coerulescens* (Heiss & Schoech 2012). This constraining effect of oxidative stress has also been suggested to occur for immune response (Mougeot *et al.* 2011, Tobler *et al.* 2011).

5.3.2 Growth & oxidative stress

Growth is usually seen to occur at a sub-maximal rate despite the obvious immediate advantages of fast growth, such as a shortened juvenile (= vulnerable) period or the higher competitive capacities of bigger individuals (Arendt 1997, Dmitriew 2011). The natural occurrence of this sub-maximal growth pattern has been associated with the potential occurrence of costs linked to rapid/accelerated growth rate, such as a lower resistance to starvation (Gotthard *et al.* 1994) or impaired locomotor performances (Billerbeck *et al.* 2001). The costs of accelerated or compensatory¹¹ growth rate may also be expressed over a longer time-scale, with effects such as a negative impact on lifespan (Rollo 2002, Metcalfe &

¹¹ Compensatory (or catch-up) growth is defined as a phase of growth acceleration following an initial deficit (*e.g.* due to nutritional restriction in early life, Dmitriew 2011).

Monaghan 2003, Lee *et al.* 2013). In this context (and in accordance with the theoretical framework presented in 5.1), oxidative stress has been predicted to be one of the underlying mechanisms explaining the negative impact of fast growth on ageing rate and longevity (Rollo 2002, Mangel & Munch 2005). The hypothesis suggesting oxidative stress as a cost of accelerated somatic growth has been (partially) tested by an experimental manipulation of growth rate in the zebra finch via brood size manipulation (Alonso-Alvarez *et al.* 2007). This study revealed that individuals exhibiting the higher growth rates were also those whose red blood cells showed weaker resistance to an oxidative challenge. Unfortunately, the authors did not measure oxidative damage, making it impossible to conclude that accelerated somatic growth rate leads to oxidative stress. Nevertheless, one correlative study in wild conditions supports this hypothesis by reporting a link between growth rate and oxidative damage levels (Nussey *et al.* 2009). In this context, it is also worth noting that an accelerated growth rate may lead to an increased resting metabolic rate at adulthood (Crisuolo *et al.* 2008), which could hypothetically be detrimental in terms of oxidative stress and starvation resistance.

Hall and collaborators also provided important indirect evidence linking growth rate and oxidative stress. Indeed, they prove that supplementing diet with antioxidants during the juvenile period increased growth rate without affecting oxidative damage levels in red-winged blackbird (Hall *et al.* 2010). This result suggests that oxidative stress could be a potential constraint that limits growth rate. This study also raises additional questions about the importance of adverse conditions experienced during early life (independently of growth rate) in the equilibrium of the oxidative balance. Data on this topic are very scarce, but a recent study manipulating prenatal stress levels underlined its potential and its under-evaluated importance, since prenatal exposure to elevated corticosterone levels was shown to induce oxidative stress and accelerate telomere erosion (Hausmann *et al.* 2012).

6. Aims and scope of the thesis

This thesis investigates several aspects of the relationships existing between energy metabolism, oxidative stress and life history traits with the use of complementary approaches (correlative and experimental) on both captive and wild vertebrates. It aims to improve our knowledge about the physiological basis of life history trade-offs, with a specific

focus on the importance of mitochondrial uncoupling and oxidative stress as potential shapers of life histories.

The work presented in this thesis was conducted on various biological models and aimed to provide answers to two main questions:

→ Does mitochondrial functioning / 'uncoupling state' act as an important modulator of oxidative stress levels and life history trajectories?

→ Are life history parameters - such as the investment in reproduction or the conditions experienced during early life - related to the equilibrium of the oxidative balance?

6.1 Impact of mitochondrial functioning and energy metabolism on oxidative stress and life history trajectories (Chapter 3)

In the first part of this thesis, our aim was to clarify the relationships between mitochondrial 'uncoupling state', energy expenditure and oxidative stress. To do so, a first experiment (**Paper 2**) used the transgenic mouse model (*Mus musculus*) lacking UCP1 (UCP1 KO) to investigate the oxidative stress response to an experimental increase in metabolic rate (*i.e.* exposure to the cold), achieved either by a 'coupled' or an 'uncoupled' mechanism. This experiment aimed to test the importance of mitochondrial 'uncoupling state' on the equilibrium of the oxidative balance during a period of high-energy demand. This first part provides the opportunity to investigate the impact of UCP1 activity on oxidative stress levels in a physiologically relevant context (thermogenesis), which remains largely underexplored to date. Considering the potential impact of UCP1 on oxidative stress levels but also the recent findings linking UCP1 promoter to longevity in humans (Rose *et al.* 2011), we also investigate the possible impact of UCP1 ablation on longevity in mice (**Box 1**).

The second aim of **Chapter 3** was to investigate the impact of mitochondrial uncoupling state on oxidative stress levels in birds, a taxonomic group that remains to be explored in this regard (**Paper 3**). Given the specificity of birds in terms of metabolism and longevity (*i.e.* high metabolism / low ROS production / high longevity, Holmes *et al.* 2001), investigating the 'uncoupling to survive' hypothesis in this taxonomic group may provide new insights into the ageing process. To do so, we used an experimental uncoupling treatment (2,4-dinitrophenol) in captive zebra finches (*Taeniopygia guttata*) over an extended time period (more than two years). Our aim was also to investigate the potential

effect of such an uncoupling state/increased metabolism on life history trajectories of individuals (longevity, reproductive investment, growth performances and immune response). In accordance with the findings of Paper 2 on mice, we also addressed the impact of mitochondrial uncoupling state on oxidative stress response to a metabolic challenge achieved through exposure to the cold (**Box 2**).

6.2 Oxidative stress and life history trade-offs (Chapter 4)

Chapter 4 of this thesis aims to investigate if the equilibrium of the oxidative balance could be related to the investment in reproduction or to the conditions experienced during early life (*i.e.* growth) by individuals. Until now, oxidative stress has mainly been considered as the result (*i.e.* cost) of an increased investment in growth or reproduction, but a reverse effect (*i.e.* constraint) might explain why an apparent cost might sometimes be hidden. Considering the contrasting results obtained by studies investigating an oxidative cost of reproduction during the last decade, we present correlative evidence arguing for a dual role (*i.e.* constraint & cost) of oxidative stress in the reproduction of laboratory mice, and we used this opportunity to review the existing evidence concerning this topic (**Paper 4**). We also used the experimental design presented in Paper 3 to investigate a potential oxidative cost of reproduction in zebra finches, and evaluate whether such a cost could be modulated by the mitochondrial uncoupling state of individuals (**Box 3**).

In addition, we investigated the potential impact of growth rate and early life conditions on self-maintenance parameters (*i.e.* oxidative stress and telomere dynamics) in wild birds. To do so, we examined the consequences of natural contexts that are likely to modulate the benefits of a fast growth. Growing in high-elevation habitats might be a constraint for the growth-maintenance trade-off, since the favourable period of time available for growth is likely to be reduced with increasing elevation. **Paper 5** therefore aims to evaluate the covariation pattern observed between growth, metabolic rate and oxidative stress parameters in coal tit chicks (*Parus ater*) reared at different elevations. We also investigated the inter- and intra-population relationships between growth rate and telomere erosion rate in response to elevation in two bird species, coal and great tits (*Parus major*), that were likely to differ in their response to elevation (**Paper 6**). I also contributed to a study investigating the relationships between growth rate and oxidative stress/telomere

dynamics in king penguin (*Aptenodytes patagonicus*) chicks (**Paper 7**). The growth pattern of this species is characterized by two phases of growth (pre- & post-winter) interrupted by a phase of growth arrest during the winter. The aim of this study was to investigate if chicks that were small at the end of winter would exhibit catch-up growth in the post-winter period, and if such a response would be associated with impaired body maintenance.

To complement this approach, we used situations where a handicap occurs naturally during the early life of individuals, to investigate the consequences of early life conditions in terms of body maintenance. According to this idea and based on the results presented in Paper 7, we characterised phenotypic characteristics close to the hatching (body mass, oxidative stress, telomere length and corticosterone) of king penguin chicks exhibiting highly different early environment/survival probabilities (*i.e.* chicks coming from early- vs. late-breeders). These physiological markers were subsequently tested as potential predictors of chick survival (**Paper 8**). It is well known that asynchronous hatching occurs in many altricial birds, thereby creating a competitive hierarchy within a brood. Consequently, asynchronous hatching offers a good opportunity to test the impact of contrasted early-life conditions on self-maintenance parameters (**Box 4**). This study might also be useful to test for a trade-off between growth and self-maintenance processes, since resource availability and resource allocation are likely to differ between ‘first-hatched’ and ‘last-hatched’ chicks. We investigated the consequences of hatching asynchrony in terms of growth performances and self-maintenance parameters (resting metabolism, oxidative balance and telomere dynamics) by comparing first-hatched vs. last-hatched chicks in the great tit.



Chapter 2

Materials & Methods

1. Overview of biological models

This section aimed to describe briefly the different biological models used within this thesis, but further details are available in the *material & methods* sections of each paper or box. Animal models are presented following their order of appearance within the chapters 3 and 4.

1.1 UCP1 knock-out (KO) mouse model

To investigate the implication of mitochondrial uncoupling state on life-history traits, and more specifically the implication of UCP1 for oxidative stress and longevity, we used a transgenic mouse model (knock-out) developed in the laboratory of Dr. L. P. Kozak (Enerbäck *et al.* 1997). Briefly, the UCP1 gene was inactivated in embryonic stem cells using a targeting vector that replaced the *BamHI/BglIII* fragment carrying exon 2 and part of exon 3 with the *neo^r* gene (figure 5a). This manipulation leads to the deletion of an essential membrane-spanning domain, conducting to the transcription of a shortened messenger RNA (figure 5b) and the absence of UCP1 protein expression (Enerbäck *et al.* 1997). The founder mice (C57BL/6 J) UCP1 knock out for establishing our colony were originally provided by the CNRS (UPR-9078) and were backcrossed and genotyped according to The Jackson Laboratory protocol.

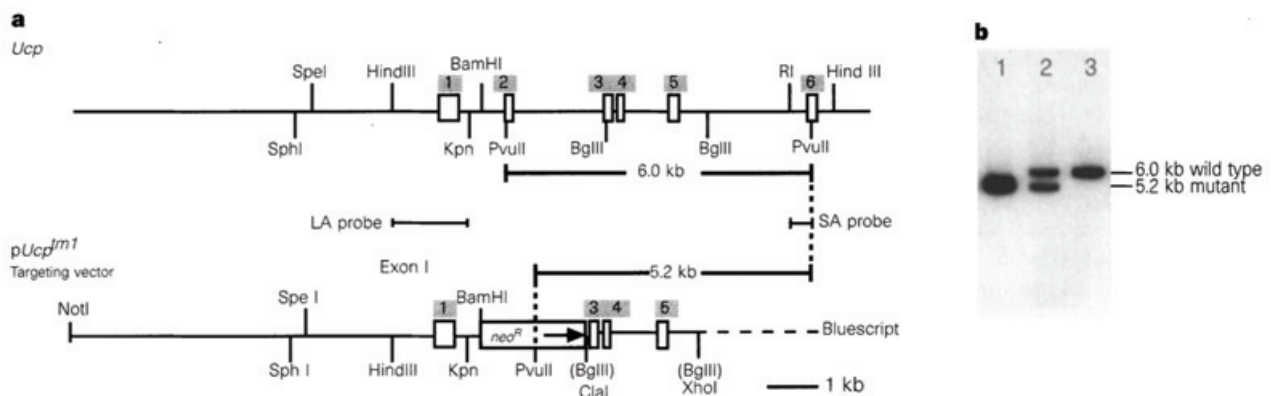

Figure 5: Illustration of the targeted disruption of the UCP1 gene leading to UCP1 KO mouse (reprinted from Enerbäck 1997).

- (a) Restriction enzyme map and localisation of the replacement with the *neo^r* gene
(b) Typical southern blot analysis showing from the left to the right: an UCP1 KO homozygous mouse ($UCP1^{-/-}$), a heterozygous mouse ($UCP1^{+/-}$) and a wild-type mouse ($UCP1^{+/+}$).

It was originally shown that UCP1 knock-out mice are cold-sensitive (*i.e.* their body temperature drop following an acute cold exposure), but not obese (Enerbäck *et al.* 1997). However, the cold-sensitivity of UCP1 KO mice might be reversed by an appropriate acclimation to mild-cold (18°C) before being exposed to cold temperatures (4°C), and UCP1 KO mice could subsequently be maintained for weeks at 4°C (Golozoubova *et al.* 2001). The sensitivity of UCP1 KO mice to obesity has been highly debated since their first description. For instance, it was suggested that UCP1 KO mice might become more sensitive to diet-induced obesity (*i.e.* high-fat diet) with age than WT mice, whereas such an effect was absent under a standard diet (Kontani *et al.* 2005). In addition, it was shown that the rearing temperature might be important to consider, since UCP1 KO mice become obese under standard diet when maintained at thermoneutrality (Feldmann *et al.* 2009). Other information on this mouse model could be found in Paper 2 and Box 1, especially about the role of UCP1 in oxidative homeostasis and longevity.

1.2 Zebra finch and 2,4-dinitrophenol (DNP) uncoupling treatment

The zebra finch (figure 6) is a common passerine bird native of central Australia, which has been domesticated and widely used as a cage bird in Europe, at least since the 1870's (Zann 1996). The zebra finch has become an increasingly common model in a wide range of biological disciplines (behaviour, genetics, physiology or neurosciences), especially since the 1970's (Zann 1996).



Figure 6: Captive zebra finches (one male and 4 fledglings) coming from our own husbandry.

The zebra finch is a small granivorous bird (12-20g), which breeds easily and during the entire year in captive conditions. The potential lifespan of captive zebra finches maintained under optimal breeding conditions is approximately 5 to 7 years (Burley 1985), and this avian model has recently been suggested as a candidate bird species for use in ageing research (Austad 2011).

The main experiment involving zebra finches (Paper 3, Box 2 & Box 3) started with 60 adult zebra finches (30 ♂ / 30 ♀) of 6 months old. After a period of baseline measurements (2 months), half of the birds (15 ♂ / 15 ♀) was kept under control conditions (*i.e.* water ad libitum), while the other half received a lifelong uncoupling treatment with 2,4-dinitrophenol (DNP, figure 7) diluted in drinking water. We choose to use DNP and not another uncoupling agent (*e.g.* FCCP: Carbonyl cyanide-*p*-trifluoromethoxyphenylhydrazone) since this molecule was previously (and successfully) used *in vivo* to induce an uncoupling state in biological models such as drosophila, mouse or frog tadpole (Padalko 2005, Caldeira da Silva et al. 2008, Salin et al 2012a).

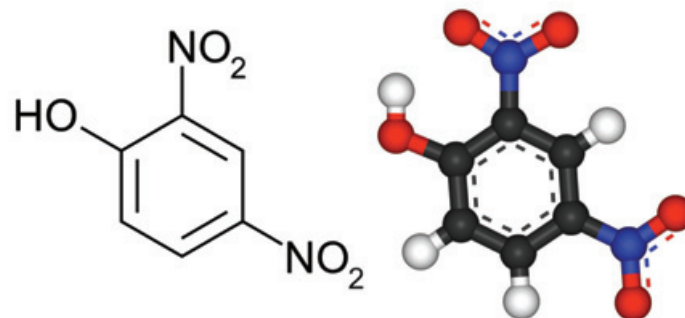

Figure 7: Chemical structure of the uncoupling agent 2,4-dinitrophenol (DNP)

DNP acts as a proton ionophore (*i.e.* protonophore) in living cells, thereby promoting the mobility of protons across biological membranes. DNP action collapses the mitochondrial proton motive force, which limits the rate of ATP synthesis through oxidative phosphorylation.

Previous studies have shown that DNP has a half-life of approximately 500 days when diluted in water. This chemical compound is efficiently absorbed by organisms (through skin or by ingestion) and eliminated by the body after a few days (Harris & Cocoran 1995). DNP was used in the 1930's in diet pills due to its extraordinary ability to increase metabolic rate, but such use has been fatal in many cases due to hyperthermia (Harris & Cocoran 1995). We conducted a preliminary experiment on 15 birds to determine the concentration at which

the long-term DNP treatment should be conducted. We tested three doses: 5, 20 and 50 mg.L⁻¹ of drinking water, which correspond approximately to 1, 4 and 10 mg.kg⁻¹.day⁻¹ for a standard bird weighing 15 g and drinking approximately 3 mL per day. We recorded water consumption, body temperature and metabolic rate for the 15 birds (5 birds/dose) during two weeks of treatment. We choose the intermediate dose (20 mg.L⁻¹), because the lower dose failed to increase noticeably metabolic rate, and the higher dose was associated with transient hyperthermia and decreased water ingestion. The impact of the intermediate dose (chosen for the long-term experiment) on metabolic rate is presented in Paper 3 and Box 2.

1.3 Coal and Great tits

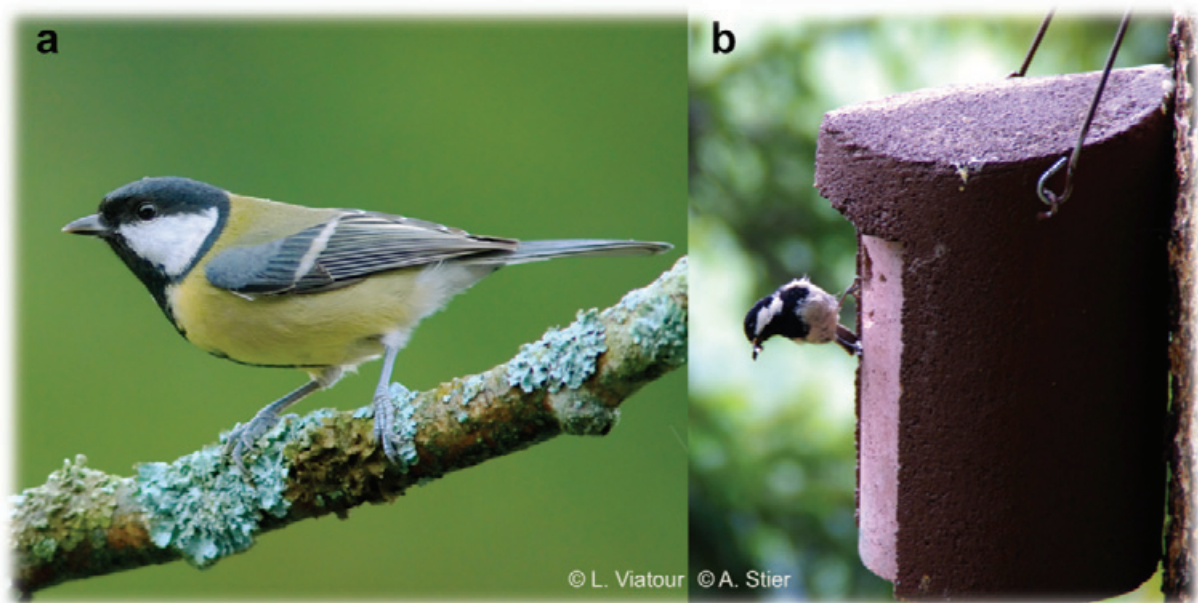

Figure 8: Adult great tit *Parus major* (a) and coal tit *Periparus ater* (b)

We investigated the relationships between early-life environment (different elevation / position within the hatching rank), growth rate and self-maintenance parameters in two common tit species, namely the great tit (*Parus major*, figure 8a) and the coal tit (*Periparus ater*, figure 8b). The two species are widely distributed in Europe and used as study models (especially great tit) considering their ability to breed in artificial nestboxes (see figure 8b).

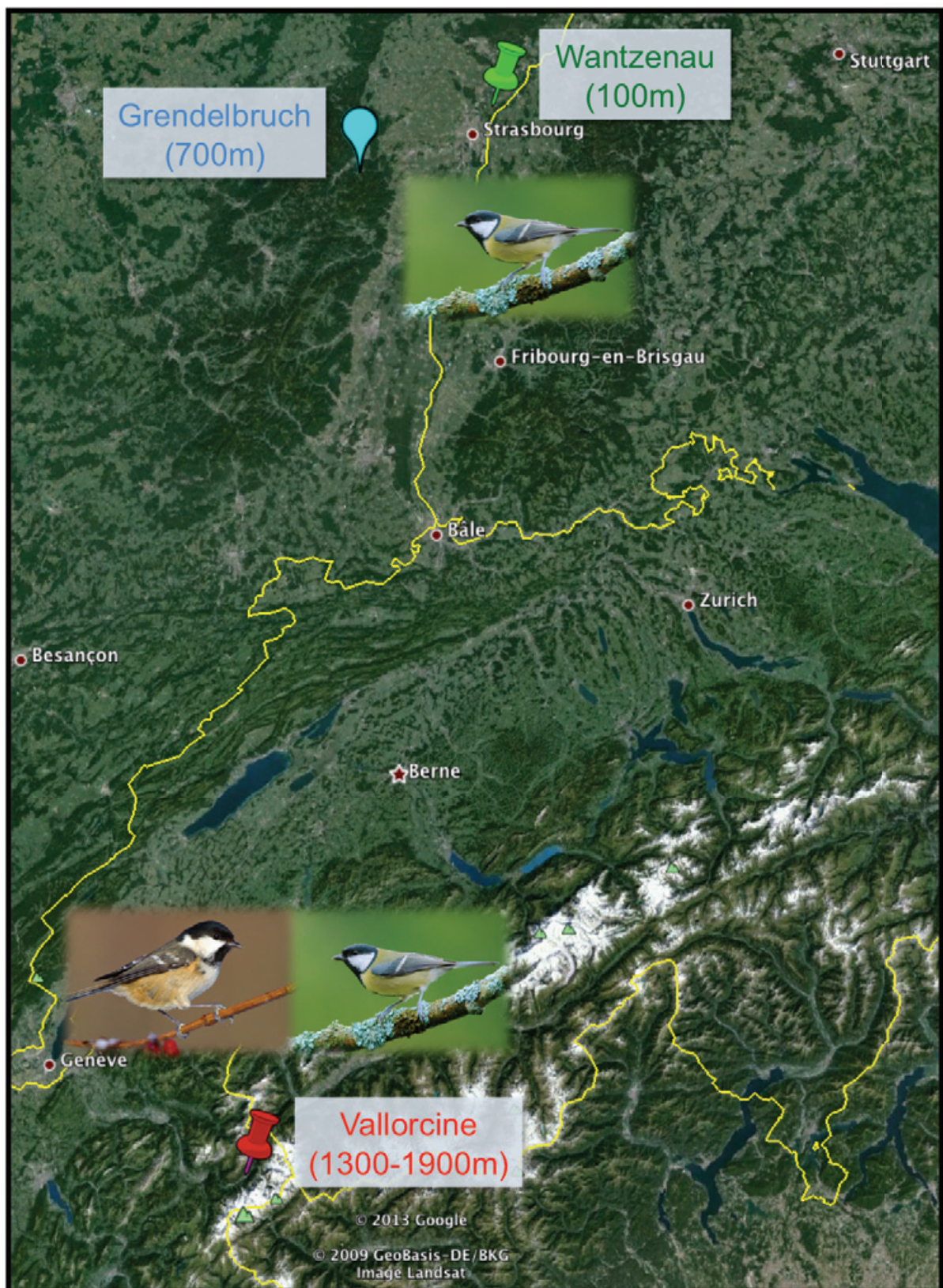

Figure 9: Field sites for the study of great and coal tits, and their respective elevation.

Great tits were present in the three field sites (but restricted at 1300m within Vallorcine area), while coal tits were only present in Vallorcine. We used nestboxes owned by the SRPO (Société Régionale de Protection des Oiseaux) in the Wantzenau study site, and the access to nestboxes in Vallorcine was allowed by our collaboration with the CREA (Centre de Recherche sur les Ecosystèmes d'Altitude). The nestboxes installed in Grendelbruch were in turn owned by our laboratory (DEPE).

Great tits use preferentially deciduous rather than coniferous forests (Gibb 1957), which is coherent with the higher density of great tits breeding in low elevation habitats (Zang 1980). In contrast, coal tits are accustomed to coniferous tree species (Gibb 1957) and are preferentially found in elevated habitats under our latitudes (Zang 1980). We monitored breeding and growth of birds in three different field sites (figure 9) during the 2011 season, namely the Wantzenau forest (near Strasbourg - elevation = 100m, which was also monitored in 2012), Grendelbruch (in the Vosges - elevation = 700m) and Vallorcine (in the French Alps - elevation = 1300-1900m). Great tits were found in the three sites, but were restricted to the lower elevation (1300m) at Vallorcine, while coal tits were only found in Vallorcine (1300 & 1900m).



Figure 10: Blood sampling in a great tit chick of approximately 16 days

We monitored the growth rate of chicks by measuring morphological parameters (body mass, head size, tarsometatarsus and wing lengths) every two days from hatching to fledging. We took two small blood samples ($\approx 30 \mu\text{L}$) during the growth phase, respectively at day 7 (the closest to hatching that could be done for ethical/practical reasons) and day 16 (short before fledging, which typically occurs at 17-20 days). Blood samples were collected from the brachial vein using a heparinized glass capillary after a venipuncture (figure 10). In addition (for coal tits in 2011 and great tits in 2012 (Wantzenau)), we measured the resting metabolic rate (RMR) of chicks approximately 12 days after hatching, using a field open-circuit respirometry system (figure 11a, FOXBOX, Sable System, USA). We monitored the O_2

consumption of chicks in the dark to reduce chick's stress and movements, within a closed metabolic chamber (0.5L). We recorded each chick during a period of 30 minutes, and we used the lowest consecutive two minutes as the resting value (figure 11b). Data were analysed using LabAnalyst X (Warthog - University of California).

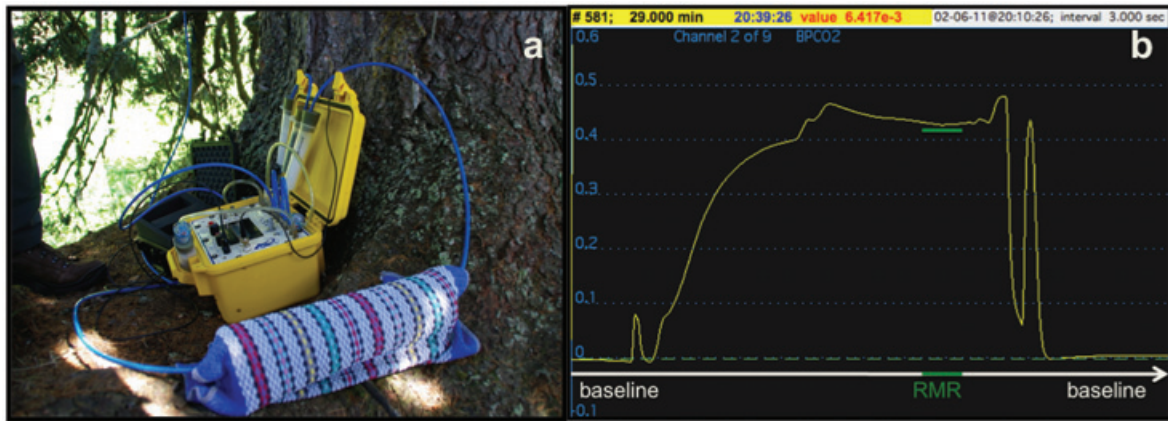

Figure 11: Field respirometry system (a) and typical recording of O₂ consumption (b)

1.4 King penguin chicks

We investigated the relationships between the conditions experienced early in life, growth rate and self-maintenance parameters (*i.e.* oxidative stress and telomere dynamics) in king penguin chicks (*Aptenodytes patagonicus*, figure 12). The studies were conducted in the colony of 'La Grande Manchotière' (*ca.* 24 000 breeding pairs) located on Possession island within the Crozet archipelago (Terres Australes Antarctiques Françaises).



Figure 12: Adult king penguin feeding its chick (*Aptenodytes patagonicus*)

The breeding cycle of this species is very particular, and extends for over a year to be successfully completed (Stonehouse 1960, Weimerskirch *et al.* 1992). The growth trajectory exhibited by young king penguins is quite uncommon (figure 13) and particularly long (*ca.* 11 months), with two phases of growth (1st and 2nd summer) interrupted by the Austral winter. The winter phase is characterized by a progressive body mass loss, since the chicks are left fasting in the colony over prolonged periods (Cherel *et al.* 1987, Descamps *et al.* 2002). Because of the time required to successfully fledge a chick, breeding occurs asynchronously in this species. Indeed, successful breeders in one-year might only start to breed 'late' in the subsequent year (Olsson 1996). Therefore, there is a marked distinction between early and late breeders, with the latter suffering from extremely poor chances of breeding success (Weimerskirch *et al.* 1992).

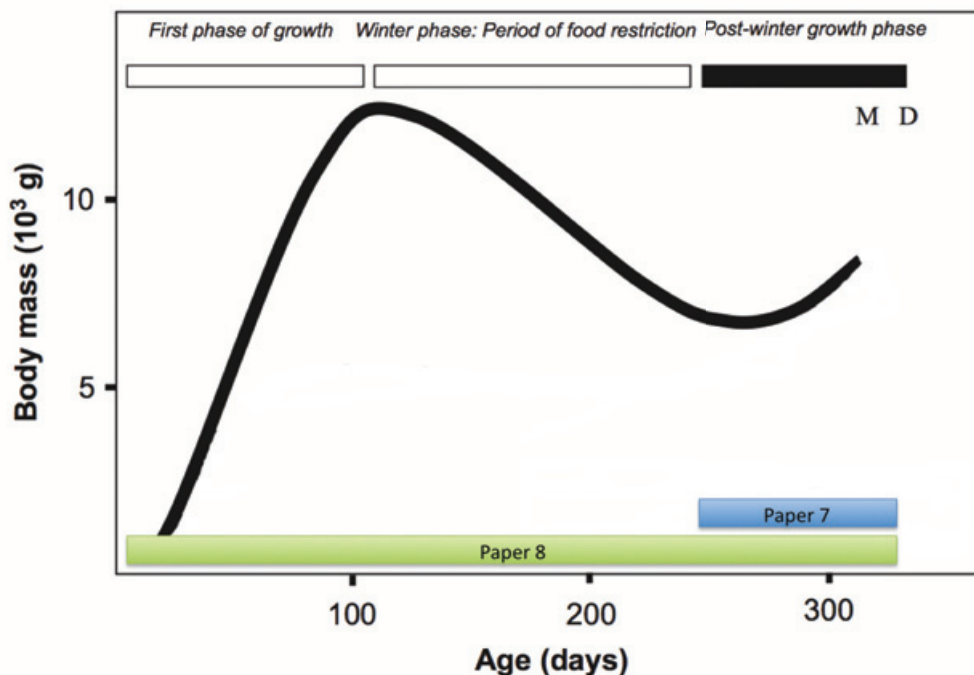

Figure 13: Typical body mass dynamics of king penguin chicks during the growth period (adapted from Geiger *et al.* 2012).

M and D represent the moult and the departure at sea respectively.

In a first study (Paper 7), we investigated the relationship between post-winter growth trajectories and self-maintenance parameters of small vs. large chicks. In a second one, we focused on the phenotypic characteristics at hatching between early and late-born chicks and their correlates with the survival all along the growth period (Paper 8).

2. Overview of oxidative stress measurements

I used several markers of oxidative stress all along my PhD work, and this section aimed to describe briefly the different markers presented in the thesis. There is no acknowledged perfect marker to determine the occurrence of oxidative stress, but we tried to measure at least one indicator of oxidative damage and one marker of antioxidant defences (see Monaghan *et al.* 2009), to gain insight on both sides of the oxidative balance (see also introduction 3.3.4).

One drawback of working with wild animals or performing longitudinal experiments in the lab is the limitation in samples being available for analysis. Indeed, we cannot kill animals, and therefore we are mostly restricted to blood samples. However, it is important to point out that oxidative stress levels are likely to differ between tissues, and therefore measurements realized in the blood may not necessarily reflect the whole-body response (Costantini 2008). In addition, oxidative stress markers are considered to vary more quickly in the plasma than in tissues because of the high turnover rate of plasma components, thereby implying that plasma oxidative stress might only reflect current oxidative state. The limited blood volume available for small animals (zebra finches, tits or mice) is an additional constraint, which preclude for measuring numerous oxidative stress markers, or markers requiring large amounts of samples. We also measured oxidative stress levels in tissues for captive mice and zebra finches, whenever it was possible according to our experimental designs (Paper 2, Box 1 and Paper 3).

2.1 Oxidative stress markers in the blood

2.1.1 Reactive oxygen metabolites (ROMs)

Considering the highly unstable nature of ROS, some assays measured their metabolites (*i.e.* more stables) - also known as reactive oxygen metabolites (ROMs) - as an indicator of early oxidative damage. We refer to 'early' oxidative damage, because such products are part of an 'oxidative cascade' leading to oxidative damage that may still be prevented by antioxidant compounds. In this context, we used the D-ROM test (Diacron international, see Constantini *et al.* 2006 for a detailed description) to measure the concentration of ROMs in plasma samples (Papers 1/2/3/4/7/8 and Boxes 2-4). This test allows the quantification of hydroperoxides (R-OOH) using an acidic buffer to catalyze the conversion of R-OOH to radical species (R-O• & R-OO•) by ferrous/ferric ions (Fe^{2+} and Fe^{3+}).

Such radical species then catalyze the oxidation of a chromogenic reagent (colourless → pink), which gives a coloration being proportional to the amount of hydroperoxides in biological samples (measured with a spectrophotometer at 510nm).

2.1.2 Plasma antioxidant capacity (OXY)

Considering the low amounts of plasma generally available for our study species, we decided to measure an integrative marker of antioxidant defences (*i.e.* measuring the antioxidant activity of several molecules at one time), rather than one or a few specific markers (*e.g.* vitamin E, carotenoids, etc.). Therefore, we measured the plasma total antioxidant capacity using the OXY test (Diacron international, see Constantini *et al.* 2006 for a detailed description) in various studies (Papers 1/2/3/4/5/7/8 and Boxes 2/4). This assay has been recognized as a method to measure plasma antioxidant capacity being unaffected by uric acid concentration (contrary to other assays: see Constantini 2010 for a discussion). The OXY test quantitatively evaluates the ability of plasma antioxidant compounds to buffer a massive *in vitro* oxidant attack by hypochlorous acid (HClO). Thereby, by measuring the residual HClO (*i.e.* not neutralized by antioxidant compounds) with a chromogenic reagent, we could evaluate plasma antioxidant capacity, which is inversely proportional to the coloration (measured with a spectrophotometer at 510nm).

2.1.3 Oxidative damage to DNA: 8-hydroxy-2'-deoxyguanosine (8-OHdG)

We evaluate the levels of oxidative damage to DNA (8-OHdG) in the blood for three studies (Papers 5/8 and Box 2). Given their chemical structure, purine nucleotides such as guanines are especially sensitive to ROS-induced modifications, and a typical oxidative damage to DNA is the hydroxylation of guanine leading to the formation of 8-OHdG (Halliwell & Gutteridge 2007, figure 14).

For Paper 8 and Box 2, we quantified 8-OHdG levels in plasma, which reflect the global level of excretion of this oxidized nucleoside. Indeed, altered guanines could not be repaired and must be excised, conveyed by the plasma and excreted into urine (Halliwell 2007). Therefore, plasma or urinary levels of these markers are integrative markers of the whole body DNA damage (Halliwell & Gutteridge 2007). For Paper 5 (coal tit chicks), we did not have enough blood to run this assay on plasma, but we had DNA extracted from blood cells for other purposes (telomeres measurement and sexing). Therefore, we evaluated the

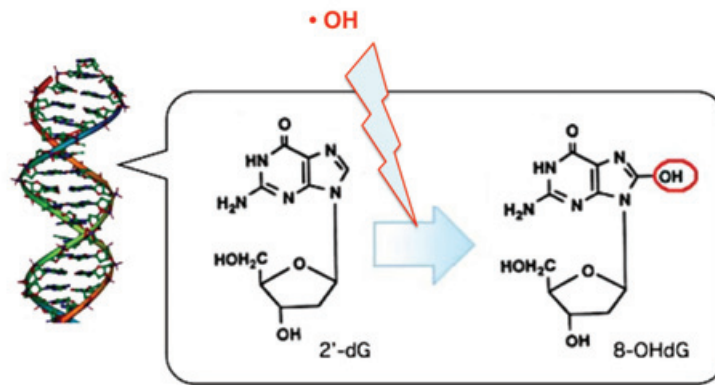

Figure 14: ROS-induced modification of guanine leading to 8-hydroxy-2'-deoxyguanosine formation

levels of 8-OHdG incorporated in cellular DNA, after an integral digestion leading to the separation of single nucleosides (Quinlivan *et al.* 2008). In both cases (plasma or cellular 8-OHdG), the amount of 8-OHdG was quantified using a competitive ELISA test (enzyme-linked immunosorbent assay).

2.2 Oxidative stress markers in tissues

2.2.1 Glutathione, GSSG/GSH ratio and glutathione reductase activity

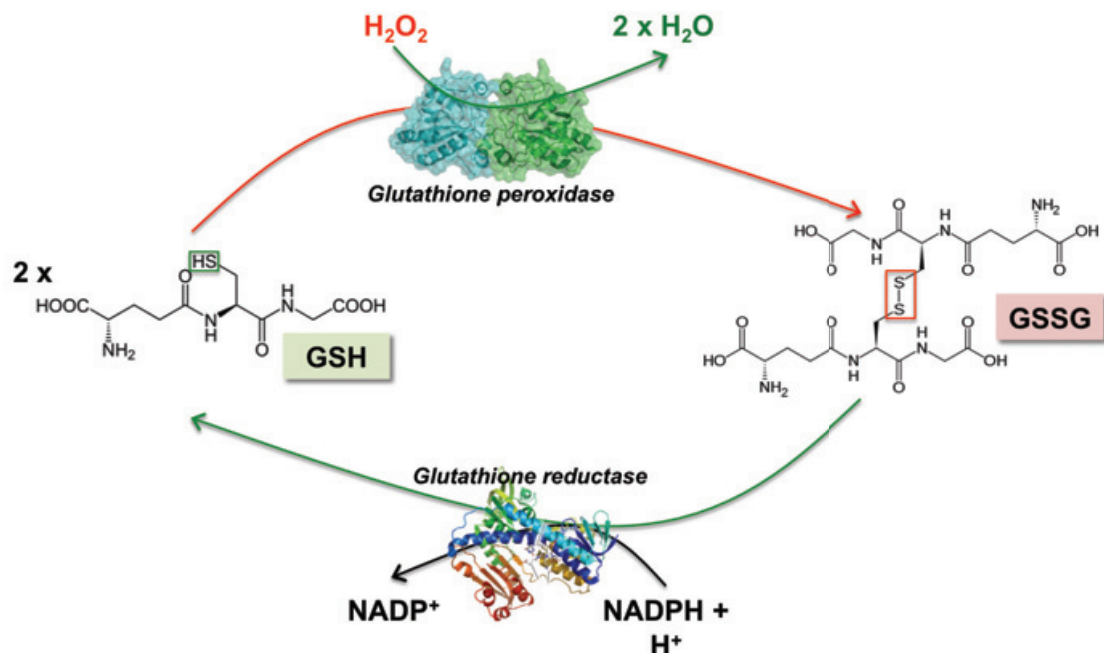

Figure 15: Antioxidant activity of the glutathione system, which detoxifies hydrogen peroxide into water

Reduced glutathione (2 x GSH) is converted to its oxidized form (GSSG, glutathione disulfide) by the glutathione peroxidase enzyme (GPx), which enables the detoxification of one H_2O_2 into two H_2O molecules. Then, GSSG can be reduced back into 2 x GSH by the glutathione reductase enzyme (GR), using NADPH as an electron donor.

Glutathione is highly abundant within the cells (*e.g.* up to 5mM in the liver, Halliwell & Gutteridge 2007), and probably one of the most active cellular antioxidant. Glutathione is a tripeptide possessing a thiol group (SH, figure 15), which serves as a reducing agent in many biological functions including antioxidant defences. Glutathione (GSH) allows the detoxification of H₂O₂ into water, thank to the action of the glutathione peroxidase enzyme (GPx). The oxidized form of glutathione (GSSG) can be restored into free GSH thank to the glutathione reductase activity (GR, figure 15). We measured free GSH and total GSH (free GSH + GSSG) in tissue homogenate of mice (Paper 2) and zebra finches (Paper 3), using a probe that bind covalently to the free thiol group to yield a highly-fluorescent product (DetectX[®] Glutathione fluorescent detection kit, Arbor Assays, USA). First, we evaluated the concentration of free GSH, and then we evaluated the concentration of total GSH after converting GSSG into GSH, allowing us to calculate the concentration of GSSG (difference between free and total GSH). The concentration of total GSH was used as an indicator of antioxidant defences, and the proportion of glutathione oxidized (GSSG/total GSH ratio) as an indicator of the oxidative challenge/stress experienced by individuals (*i.e.* the pro-oxidant power buffered by the glutathione system). In healthy organisms, approximately 90% of the glutathione is found into its reduced form (GSH), while only 10% is oxidized (Halliwell & Gutteridge 2007). In addition, we evaluated the enzymatic activity of the glutathione reductase enzyme by measuring the conversion of exogenous GSSG into free GSH, using a probe that bind covalently to the free thiol group to yield a highly-fluorescent product (DetectX[®] Glutathione Reductase fluorescent activity kit, Arbor Assays, USA).

2.2.2 Lipid peroxidation (MDA levels)

Lipid peroxidation refers to the process leading to free-radical induced damage on lipids (figure 16). Polyunsaturated fatty acids are especially prone to lipid peroxidation because of their double bonds containing highly reactive hydrogen's (Halliwell & Gutteridge 2007). In response to the oxidative attack of a radical hydroxyl (\bullet OH), fatty acid will give a hydrogen atom thereby conducting to the formation of a lipid radical (figure 16). This radical can combine with one molecule of O₂ leading to the formation of a peroxy radical, which would ultimately conduct to lipid peroxide formation. However, lipid peroxides are unstable and decompose to form a complex series of compounds, including malondialdehyde (MDA).

This latter compound is often used as an indicator of lipid peroxidation in biological samples (Halliwell & Gutteridge 2007).

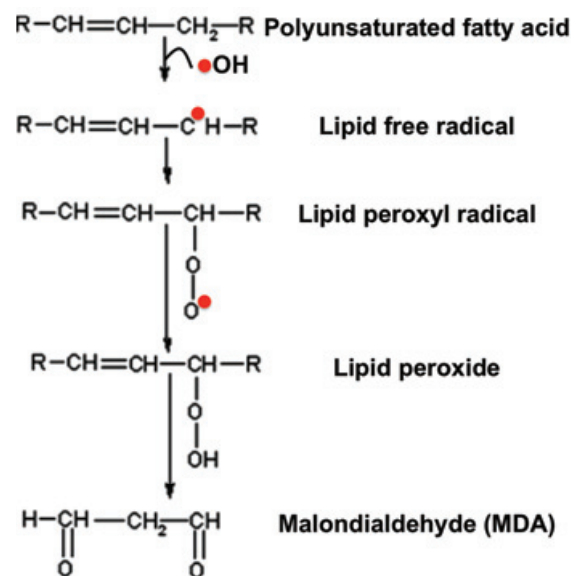

Figure 16: Oxidative cascade leading to the formation of lipid peroxides and MDA

MDA levels were assessed in tissue homogenate (treated with an antioxidant compound to avoid further oxidation during the assay) of mice (Box 1) and zebra finches (Paper 3), as an indicator of tissue oxidative damage. We used an assay based on the reaction of a chromogenic reagent (N-methyl-2-phenylindole) with MDA, giving a stable chromophore with maximal absorbance at 586nm (lipid peroxidation microplate assay kit, Oxford Biomedical Research, USA).

2.2.3 Protein carbonyl levels

Carbonylation of proteins is an irreversible oxidative damage, which generally leads to a loss of protein function and is widely used as a marker of severe oxidative damage (Halliwell & Gutteridge 2007). In healthy cells/organisms, carbonylated proteins are degraded by the proteasomal system. However in severe cases damaged proteins may form high-molecular weight aggregates, which are resistant to proteasomal degradation and accumulate within the cells (Halliwell & Gutteridge 2007). We evaluated the levels of carbonylated proteins for mice in Paper 2, using a spectrophotometric assay (OxiSelect™ Protein Carbonyl Spectrophotometric Assay, Cell Biolabs Inc., USA). Briefly, protein carbonyls were first derivatized using dinitrophenylhydrazine (DNPH) and then precipitated with

trichloroacetic acid (TCA). After washing the excess of DNPH, protein pellet was dissolved into guanidium chloride and the absorbance of protein-hydrozone was measured at 375nm.

2.3 Mitochondria within avian erythrocytes and mitochondrial ROS production (Paper 1)

Despite being implicitly acknowledged by some authors (*e.g.* Zhang et *al.* 2011 or Montgomery et *al.* 2012a), the presence of functional mitochondria within avian erythrocytes has never been properly demonstrated. Considering the importance of mitochondria for oxidative stress levels, our objective was to demonstrate the presence and the functionality of mitochondria within avian erythrocyte, to allow/validate the measurement of mitochondrial ROS production in these cells (such method being used in Paper 3). The results of this study (along with a discussion about the role of mitochondrial ROS production for the evolution of erythrocytes in vertebrates) are presented in **Paper 1**.

Paper 1 - Avian erythrocytes have functional mitochondria, opening novel perspectives for birds as animal models in the study of ageing

Antoine Stier, Pierre Bize, Quentin Schull, Joffrey Zoll, François Singh, Bernard Geny, Frédéric

Gros, Cathy Royer, Sylvie Massemin & François Criscuolo

Frontiers in Zoology 2013, **10**:33

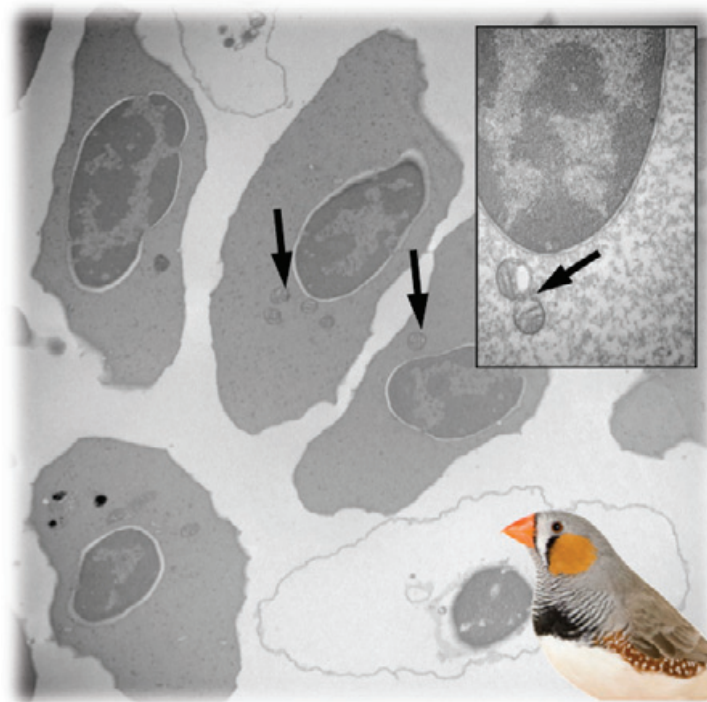

Abstract

Background

In contrast to mammalian erythrocytes, which have lost their nucleus and mitochondria during maturation, the erythrocytes of almost all other vertebrate species are nucleated throughout their lifespan. Little research has been done however to test for the presence and functionality of mitochondria in these cells, especially for birds. Here, we investigated those two points in erythrocytes of one common avian model: the zebra finch (*Taeniopygia guttata*).

Results

Transmission electron microscopy showed the presence of mitochondria in erythrocytes of this small passerine bird, especially after removal of haemoglobin interferences. High-resolution respirometry revealed increased or decreased rates of oxygen consumption by erythrocytes in response to the addition of respiratory chain substrates or inhibitors, respectively. Fluorometric assays confirmed the production of mitochondrial superoxide by avian erythrocytes. Interestingly, measurements of plasmatic oxidative markers indicated lower oxidative stress in blood of the zebra finch compared to a size-matched mammalian model, the mouse.

Conclusions

Altogether, those findings demonstrate that avian erythrocytes possess functional mitochondria in terms of respiratory activities and reactive oxygen species (ROS) production. Interestingly, since blood oxidative stress was lower for our avian model compared to a size-matched mammalian, our results also challenge the idea that mitochondrial ROS production could have been one actor leading to this loss during the course of evolution. Opportunities to assess mitochondrial functioning in avian erythrocytes open new perspectives in the use of birds as models for longitudinal studies of ageing via lifelong blood sampling of the same subjects.

Keywords

Red blood cell, ageing, mitochondria, ROS, oxidative stress, electron transport chain

Introduction

Mitochondria are the crossroads of cell life-and-death processes. First, they are essential to fuel life-sustaining metabolic processes via the production of energy as adenosine triphosphate (ATP) during respiration and oxidative phosphorylation (OXPHOS). Second, mitochondria play a key-role in the cell ageing process, with progressive mitochondrial dysfunctions accumulating with age (Lee & Wei 2012). Among these alterations, increased mitochondrial production of reactive oxygen species (ROS) appear to be important. Mitochondria are a primary source of ROS, which are molecules having crucial physiological functions, like cell signalling and redox state regulation (Dröge 2002). However, the production of ROS is also thought to have a pro-ageing effect (Finkel & Holbrook 2000; Barja 2004). Indeed, when ROS production is exceeding the antioxidant defences and the repairing cell machinery (a situation defined as oxidative stress), oxidative damage accumulate in all cell components (Finkel & Holbrook 2000; Barja 2004). Accordingly, oxidative stress is involved in many cellular defects, which in turn can lead to impairment of tissue functioning and organismal death.

Mitochondria are present in most eukaryotic cell types with few remarkable exceptions, such as mammalian erythrocytes which lose their nucleus and mitochondria during erythroblast maturation (Moritz *et al.* 1997). Two non-mutually exclusive reasons have been proposed to explain the loss of mitochondria in mature erythrocytes. First, because the main function of erythrocytes is to carry oxygen but mitochondria are oxygen consumers, the loss of mitochondria during maturation should improve oxygen transport. Note that, although mammalian erythrocytes do not produce ATP through OXPHOS, they can rely on glycolysis to fuel their own energy demanding processes (O'Neill & Reddy 2011; Zhang *et al.* 2011). Second, the loss of mitochondria might lessen the exposure of mammalian erythrocytes to the potentially deleterious production of mitochondrial ROS (Zhang *et al.* 2011), with the theoretical benefit of maximizing their lifespan. The potential implication of mitochondrial ROS production in the loss of mitochondria and nucleus throughout evolution for mammals is referred to hereafter as *the mitochondrial stress hypothesis*. Considering oxygen consumption and ROS production as two factors disfavoured the presence of mitochondria within erythrocytes, it would be expected that

similar evolutionary pressures would select for the absence of mitochondria in the erythrocytes of all vertebrate species.

Mature erythrocytes of almost all fish, amphibian, reptile and bird species keep their nucleus during maturation (see (Villolobos *et al.* 1988) for exception in some salamander species), but little is known about the presence and functionality of mitochondria in these cells, except for fish. Indeed, fish erythrocytes have been demonstrated to possess the complete cellular machinery with functional ribosomes (Lane & Tharp 1980) and mitochondria (Ferguson & Boutilier 1989; Phillips *et al.* 2000; Pica *et al.* 2001; Moyes *et al.* 2002), thus allowing protein synthesis and full cellular activity (Currie *et al.* 1999). In amphibians, mature erythrocytes retain occasionally a few mitochondria, which are often of aberrant morphology (Tooze & Davies 1967) even if there is some functional evidence of their presence (Bratosin *et al.* 2004). In reptiles, there is no clear microscopic evidences to suggest mitochondrial presence in erythrocytes but there seems to be some functional arguments supporting such occurrence (Ogo *et al.* 1993; Olsson *et al.* 2008). Studies examining the presence of mitochondria in bird erythrocytes have reached contradictory conclusions, with some reporting these to be present (Harris & Brown 1971; Beam *et al.* 1979; Leighton 1985; Maxwell *et al.* 1992), while others report these to disappear during cell maturation (Zentgraf *et al.* 1971; Brasch *et al.* 1974; Watts & Wheeler 1978). Interestingly, a recent study has reported the production of mitochondrial superoxide production within mature avian erythrocytes (Montgomery *et al.* 2012), but more expanded experimental investigation of the presence of functional mitochondria in avian erythrocytes is still lacking.

In the present study, we investigated the presence and functionality of mitochondria in erythrocytes of the zebra finch (*Taeniopygia guttata*). We used transmission electron microscopy (TEM) to demonstrate the presence of mitochondria in avian erythrocytes. We then tested whether those mitochondria were functional by analysing their respiratory activity using high-resolution respirometry, in response to diverse mitochondrial substrates and inhibitors. In addition, we checked their production of ROS using fluorometric assays. Throughout these different steps, we carried out measures on whole blood cells of birds, and we ran in parallel the same analyses of whole blood cells of mice as a negative control since mice erythrocytes lack mitochondria (see methods for details). Finally, to explore whether the presence of mitochondria in erythrocytes leads to higher oxidative stress as

stated by the *mitochondrial stress hypothesis*, we compared oxidative stress markers in the plasma of adult zebra finch and a size-matched mammalian model, the mouse.

Our study shows that zebra finches erythrocytes possess functional mitochondria, in terms of respiratory activity and ROS production. However, contrary to the expectations of the *mitochondrial stress hypothesis*, we found no evidence that the presence of functional mitochondria within erythrocytes leads to elevated levels of oxidative stress in the blood of zebra finches (compared to mice).

Materials and methods

Experimental procedure

Experiments were realized on adult zebra finches and mice (C57BL/6) coming from our main captive populations. Birds were placed as unisex pair in cages (0.57 x 0.31 x 0.39 m) and provided with food (a commercial mix of seeds for exotic birds enriched with vitamins and eggs) and water *ad libitum*. Birds were housed at 23°C on a 13 L : 11 D light cycle. Mice were placed in small unisex groups (2 to 5) in plastic cages (40 x 25 x 15 cm) with *ad libitum* access to food (SAFE A03) and water. Mice were housed at 25°C on a 12 L : 12 D light cycle. Blood samples (30 to 100 µL depending on the experiment conducted) were collected in heparinised glass capillaries from the brachial vein for the zebra finches and from the submandibular vein for mice. Considering the difficulties to appropriately separate nucleated erythrocytes from white blood cells considering their similar density (personal observation), we choose to use total blood cells of zebra finch, and to add a size-matched mammalian negative control. Indeed, white blood cells represent only a small fraction of whole blood compared to erythrocytes (around 1 white blood cell for 800 red blood cells (Vinkler et al. 2010)). Moreover, mammals and birds possess a similar small fraction of white cells in whole blood (total white blood cells counts for: BALBc mice $\approx 10.10^3/\mu\text{L}$ (Nemzek et al. 2001) and Scarlet Rosefinch $\approx 8.10^3/\mu\text{L}$ (Vinkler et al. 2010)). Hence, we use the term 'erythrocytes' rather than 'total blood cells' throughout the text when describing and discussing our results.

Transmission electron microscopy (TEM)

A 10 μ L aliquot of a fresh blood sample was diluted in 390 μ L of phosphate buffered saline (PBS) before centrifugation (300·g for 5·min) to pellet the cells. Cells were subsequently fixed or treated with saponin (200 μ g/ml for 15 min at 4°C followed by a centrifugation at 8000·g for 10·min) before fixation to remove/limit haemoglobin interferences. The cells were fixed with 2.5% glutaraldehyde (Fluka Analytical, Sigma) in 0.1 M phosphate buffer for 24 hours. Cells were post-fixed with 0.1% osmium tetroxyde (EMS) in water for one hour, and dehydrated through a series of ethanol baths before being embedded in araldite M (Fluka Analytical, Sigma). Thin sections were observed under Hitachi H7500.

Mitochondrial respiration

Fresh blood samples (80 μ L) were diluted immediately after collection in 1 mL PBS and kept on ice until analysis. Respiration measurements were made within four hours after blood collection. Before analysis, blood was centrifuged (300·g for 5·min) to pellet cells and discard the plasma fraction. Cell pellet was then diluted in 2mL of respiration buffer (CaK2EGTA 2.77 mM, K2EGTA 7.23 mM, MgCl₂ 6.56 mM, imidazole 20 mM, taurine 20 mM, dithiothreitol 0,5 mM, K-sulfonate methane 50mM; glutamate 5mM, malate 2mM, phosphate 3mM; 2 mg/ml fatty acid free bovine serum albumin (BSA) and 125 μ g/mL saponin, pH 7), and placed into respirometry chamber. Each time one mouse sample (negative control) was run in parallel of one zebra finch sample. Oxygraph-2k system (O2k, OROBOROS INSTRUMENTS, Innsbruck, Austria) contain two respirometry chambers at 37 °C, 750 rpm stirrer speed, and two point calibrations of the OROBO-POS polarographic oxygen sensors. For this experiment, 7 mice and 7 zebra finches were blood sampled, and each blood sample was measured three times consecutively. A first time for the baseline respiration ($VO_{2\text{glu-mal}}$) on glutamate-malate, a second time after amytal addition (2mM; $VO_{2\text{amytal}}$), which is an inhibitor of the complex I, and a third time after succinate addition (15mM; $VO_{2\text{succinate}}$), which is a substrate of the complex II. Mitochondrial respiration rates were normalized by protein content of the cell suspension, measured after cell lysis by Pierce BCA protein assay (THERMO scientific). Respiration rates (VO_2) are expressed in pmol O₂ consumed·s⁻¹·mg protein⁻¹.

Mitochondrial ROS production

For each individual, two 10 μL aliquots of fresh blood were diluted in 390 μL of PBS and stored on ice prior to analyses, which were completed within 3-hours of sampling. Prior to staining, diluted blood was centrifuged (300·g for 5-min) to pellet cells and discard the plasma fraction. MitoSOX Red (Molecular Probes, Life Sciences) was then added at a final concentration of 5 μM in each sample. Each individual was measured two times, the first time to determine basal superoxide production, and the second time to assess a potential increase in superoxide production in response to a specific mitochondrial inhibitor. In these latter samples, Antimycin A (a complex III inhibitor, known to increase mitochondrial superoxide production) was added at a final concentration of 100 μM . Cells were subsequently incubated for 25-min (at 37°C for mice and 40°C for zebra finches), then washed with PBS by centrifugation as described above and held on ice until analysis by flow cytometry. All flow cytometry measurements were performed using a FACScalibur cytometer (BD Bioscience, San Jose, CA) with blue laser-excitation at 488 nm. Emitted fluorescence was collected on the FL2 channel detector (575 \pm 13-nm bandpass filters). A T_0 acquisition was done for each sample and after 30 min of incubation (37 or 40°C), a second acquisition (T_{30}) was made to evaluate the increase in mitochondrial superoxide. Data were acquired and analysed using CellQuest Pro v5.1.1 software (Becton Dickinson). Analyses were performed by gating on live cells to exclude debris and dead cells. Gating was defined according to morphological indications provided by forward and side scatter detectors. For each sample, 20·000 events were acquired. Analyses allowed defining the geometric mean of fluorescence (which limits the influence of extreme values). We expressed superoxide production as the increase in relative red fluorescence per minute (RF/min). For this experiment, superoxide production was determined for 7 mice and 7 zebra finches. Preliminary analyses show that flow cytometry measurements of duplicate samples from the same individuals were highly intercorrelated ($r=0.92$, $p<0.001$, $N=14$) and intra-individual variation was low (CV = 6.43%).

Plasmatic Reactive Oxygen Metabolites & Antioxidant defences

The antioxidant capacity and the concentration of Reactive Oxygen Metabolites (ROMs) were measured using the OXY-Adsorbent (5 μL of 1:100 diluted plasma) and d-ROMs tests (5 μL of plasma, DIACRON INTERNATIONAL, s.r.l, Italy) following the manufacturer protocol (for detailed description of these tests, see (Costantini et al. 2006)). OXY adsorbent

test allows quantifying the ability of the plasma antioxidant capacity to buffer massive oxidation through hypochlorous acid while the d-ROMs test measures mostly hydroperoxydes, as a marker of oxidative damage (principally on lipids). Antioxidant capacity is expressed as mM of HClO neutralised and d-ROMs as mg of H₂O₂ equivalent/dL. For this experiment, 60 mice and 60 zebra finches were blood sampled, and all measurements were run in duplicates. Intra-individual variation in both species based on duplicates was low (respectively CV = 2.36 ± 0.38 % for the OXY test and CV = 3.06 ± 0.76 % for the d-ROMs test) as well as inter-plate variation based on a standard sample repeated over plates (CV = 4.21% for OXY and 4.79% for d-ROMs test).

Statistics

Considering our limited sample size and our repeated design, we investigated treatment and species effect on mitochondrial respiration and superoxide production by running Generalized Estimated Equations (GEE (Zuur et al. 2009)) with individual identity as subject, treatment as within-subject factor, species as a fixed factor and the interaction between those two parameters (species*treatment). We tested differences between interaction groups using Bonferroni post-hoc procedures for GEE. We tested whether levels of respiration and superoxide production were different from zero by running one-sample t-tests, independently for each species. We investigated differences in on OXY and ROMs levels between zebra finches and mice using General Linear Models (GLM). GEE and GLMs were fitted with a normal error distribution (SPSS 18.0), and data were tested for normality and homoscedasticity. All tests were two-tailed tests and p values of less than 0.05 were considered significant. Means are quoted ± S.E.

Results

Transmission electron microscopy (TEM)

For mouse, standard TEM preparation (fig. 1a) and haemoglobin-depleted TEM preparation (fig. 1b) did not reveal any cytoplasmic organelles within erythrocytes. In contrast, standard preparation of zebra finch erythrocytes revealed some occasional mitochondria (fig. 1c), while haemoglobin-depleted preparation provided clear evidence of mitochondria in almost every cell (fig. 1d).

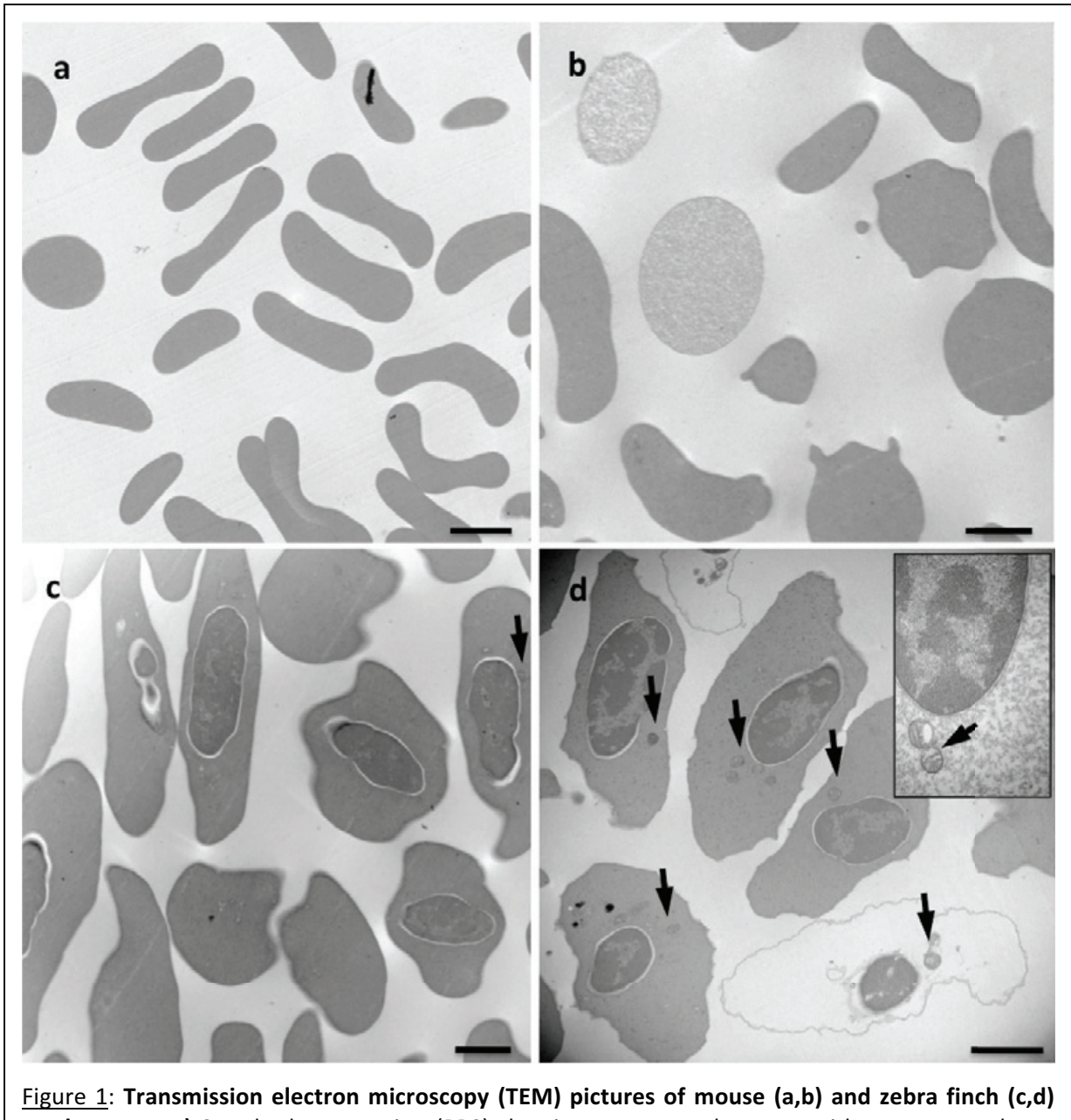

Figure 1: Transmission electron microscopy (TEM) pictures of mouse (a,b) and zebra finch (c,d) erythrocytes. a) Standard preparation (PBS) showing mouse erythrocytes with empty cytoplasm. **b)** Saponin treated mouse erythrocytes with empty cytoplasm. Note here that saponin treatment does not seem to deplete completely every cell from haemoglobin content, but alter the cell shape. **c)** Standard preparation showing zebra finch erythrocytes with apparent nucleus and occasional mitochondria (arrow). **d)** Saponin treated zebra finch erythrocytes, with apparent nucleus and numerous apparent mitochondria (arrows). Black bars represent 2 μm .

Mitochondrial respiration

Basal rates of oxygen consumption ($\text{VO}_{2_{\text{glu-mal}}}$) from avian erythrocytes were almost forty fold higher than $\text{VO}_{2_{\text{glu-mal}}}$ of mammalian erythrocytes ($p < 0.001$, Table 1, fig 2). Basal rates of oxygen consumption were significantly different from 0 in zebra finches (one sample t-test, $t = 24.10$, $df = 6$, $p < 0.001$), but not so in mice ($t = 1.80$, $df = 6$, $p = 0.122$).

Table 1: GEE model testing species (mouse or zebra finch) and treatment (Glu-mal, amytaI or succinate) effects on mitochondrial respiration rate (VO₂). Significant terms are indicated in bold characters.

<i>Mitochondrial VO₂</i>	Wald X ²	df	p-value
(Intercept)	297.1	1	< 0.001
Species	261.6	1	< 0.001
Treatment	548.8	2	< 0.001
Species x Treatment	503.9	2	< 0.001

In addition, oxygen consumption was affected by amytaI and succinate addition only for avian erythrocytes, as indicated by the significant interaction between species and treatment ($p < 0.001$, Table 1, fig. 2). Oxygen consumption of mice erythrocytes remains insensitive to the chemical treatments (post-hoc tests: all p-values > 0.5), while in the zebra finch, erythrocytes oxygen consumption decreased following amytaI treatment (post-hoc test of $VO_{2\text{glu-mal}}$ vs. $VO_{2\text{amytaI}}$: $p < 0.001$), and this inhibition was reversed by succinate addition (post-hoc test of $VO_{2\text{amytaI}}$ vs. $VO_{2\text{succinate}}$: $p < 0.001$).

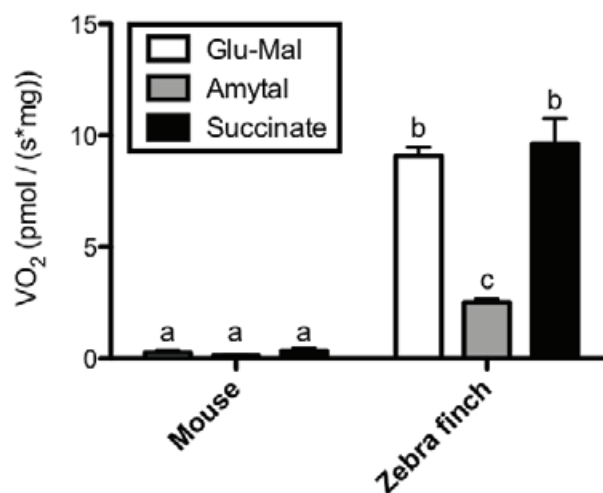

Figure 2: Mitochondrial respiration rate (VO₂) of mouse and zebra finch erythrocytes normalized by the protein content of the cell suspension. White bars represent baseline respiration rate (on glutamate-malate). Grey bars represent respiration rate after the inhibition of complex I (amytaI), which is reversed by the addition of succinate (black bars) in zebra finch. Letters indicate significant differences between groups according to GEE Bonferroni post-hoc ($N = 7$ per species for each treatment).

Mitochondrial ROS production

Table 2: GEE model testing species (mouse or zebra finch) and treatment (baseline or antimycin A) effects on mitochondrial superoxide production. Significant terms are indicated in bold characters.

<i>Superoxide production</i>	Wald X ²	df	p-value
(Intercept)	1151.3	1	< 0.001
Species	1129.4	1	< 0.001
Treatment	550.6	1	< 0.001
Species x Treatment	568.5	1	< 0.001

Mitochondrial superoxide production was clearly higher in zebra finch than mice erythrocytes ($p < 0.001$; Table 2, fig 3). Within-species analyses showed that measures of basal superoxide production were not significantly different from zero in mouse erythrocytes (one sample t-test: $t = 2.39$, $df = 6$, $p = 0.054$), but significantly greater than zero in zebra finch erythrocytes ($t = 10.16$, $df = 6$, $p < 0.001$). Mitochondrial superoxide production was significantly increased by antimycin A treatment in erythrocytes of zebra finches only (post-hoc test: $p < 0.001$), as indicated by the significant interaction between species and treatment ($p < 0.001$, Table 2) and illustrated in the figure 3. Mice superoxide production did not significantly differ between control and treated samples (post-hoc test: $p = 0.28$).

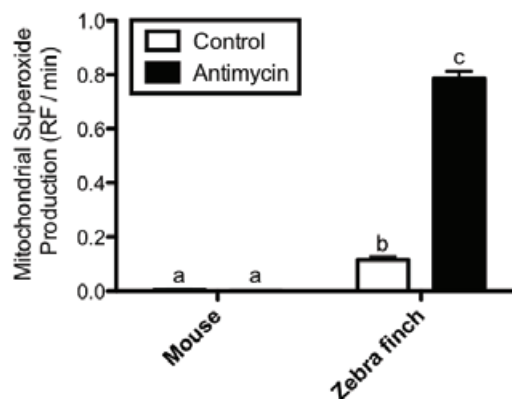
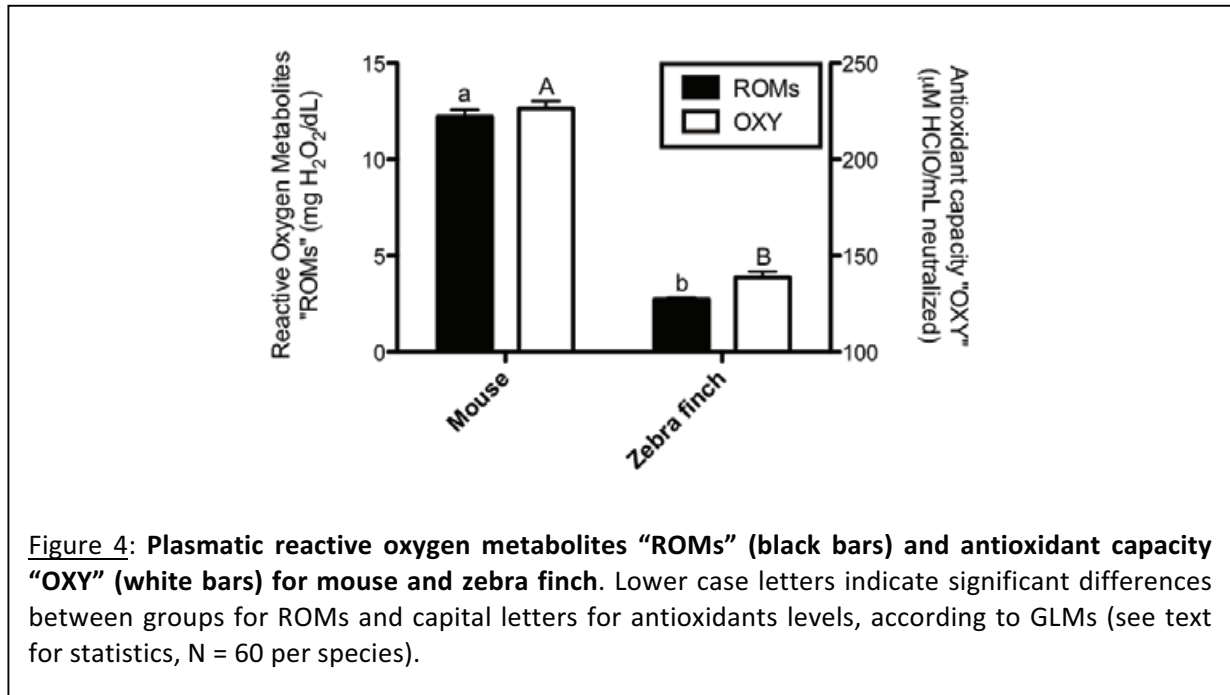

Figure 3: Mitochondrial superoxide production from mouse and zebra finch erythrocytes, expressed as change in mitosox red® relative fluorescence (RF) per minute. White bars represent baseline superoxide production and black bars represent superoxide production stimulated by the addition of an inhibitor of complex III (antimycin A). Letters indicate significant differences between groups according to GEE Bonferroni post-hoc ($N = 7$ per species for each treatment).

Plasmatic Reactive Oxygen Metabolites & Antioxidant defences

Reactive oxygen metabolites levels (ROMs) and antioxidant levels (OXY) were higher in plasma of mice compared to zebra finches (ROMs: $F = 638.9$, $df = 1$, $p < 0.001$; OXY: $F = 339.3$, $df = 1$, $p < 0.001$; fig. 4).



Discussion

The present study shows that mature erythrocytes in the zebra finch retain mitochondria in their cytoplasm. These mitochondria remain functional in terms of respiration, since their rates of oxygen consumption respond to the addition of mitochondrial fuel substrates and respiratory chain inhibitors.

We used transmission electronic microscopy (TEM) to confirm the presence of mitochondria in avian erythrocytes after haemoglobin removal (fig. 1). Some earlier microscopy studies in birds suggested that mitochondria disappear during erythrocyte maturation (Zentgraf *et al.* 1971; Brasch *et al.* 1974; Watts & Wheeler 1978), whereas others that removed haemoglobin report mitochondria persistence (Harris & Brown 1971). Because haemoglobin strongly interferes with light transmission in TEM and because its intra-cellular concentration increases during erythrocyte maturation (Kobari *et al.* 2012), it is likely that methodological issues account for these discrepancies between TEM studies. Indeed,

standard TEM preparations are probably not adapted to detect mitochondria without haemoglobin removal.

We experimentally exposed erythrocytes to inhibitors and substrates known to modulate the activity of the mitochondrial respiratory chain in order to characterize the responsiveness of mitochondrial respiration within zebra finch erythrocytes. Our results show that basal respiration rates of avian erythrocytes were not anecdotal, since oxygen consumption values were similar to those obtained in mouse hippocampal neurons (Yao *et al.* 2009). Overall, our results are in accordance with previous work on fish, indicating that erythrocyte mitochondria are functional in terms of respiratory activities (Moyes *et al.* 2002). Together, this challenges a previous conclusion that avian erythrocyte rely only on glycolysis and pentose phosphate pathway (Kalomenopoulou & Beis 1990).

What are the physiological benefits and the associated costs for birds to retain functional mitochondria in their erythrocytes, especially in terms of oxidative stress? Insights on this point should help to understand why mammalian erythrocytes have lost their mitochondria or, alternatively, why birds (and probably other non-mammalian vertebrates (Ogo *et al.* 1993; Pica *et al.* 2001; Bratosin *et al.* 2004)) have retained functional mitochondria within their erythrocytes.

What physiological role for mitochondria within erythrocytes?

Mitochondrial biogenesis is under the control of nuclear genes (Passos *et al.* 2007). Hence, mammalian erythrocytes might lose their mitochondria due to nucleus extrusion rather than due to selection against the presence of functional mitochondria. A cost of keeping respiration is that to sustain cellular oxygen consumption (fig. 2), avian erythrocytes have to synthesize the electron transport chain proteins. In contrast, containment of greater functional energetic capacity in these cells might allow various cellular activities based on high rate of ATP production through OXPHOS, as demonstrated earlier for fish (Phillips *et al.* 2000). Among other things, those activities might include the constant synthesis of various proteins such as haemoglobin or heat shock proteins (HSP). Constant turnover of haemoglobin throughout erythrocyte lifespan might allow the optimization of oxygen binding and transport (Phillips *et al.* 2000), and HSP protein synthesis might allow stress resistance of erythrocyte metabolism ((Currie & Tufts 1997), and see (Currie *et al.* 1999) for HSP implication in stress metabolism in fish erythrocytes). Moreover, functional energetic

machinery in these cells could permit other energy-requiring functions such as immune responses (Morera & MacKenzie 2011), as suggested for instance by natural and experimental phagocytosis by erythrocytes in amphibians (Prunesco 1971). All this relies on the assumption that avian erythrocytes are able to sustain protein synthesis, an idea which is not completely supported by earlier studies on transcriptional capacities of avian erythrocytes nuclei (reviewed by (Sinclair & Brasch 1975)). More work is needed to clarify protein synthesis capacities of avian erythrocytes and their potential cellular effects. Indeed, it is not excluded that the persistence of functional mitochondria within avian erythrocytes is associated with net negative rather than positive effects. First, for selection to favour the silencing of mitochondrial biogenesis within avian erythrocytes, those mechanisms should be available for selection to act upon, which still needs to be demonstrated. Furthermore, even if pathways favouring the silencing of mitochondrial biogenesis do exist in avian erythrocytes, those pathways might not be selected if they have antagonistic pleiotropic effects, being advantageous during cell maturation but detrimental later in the cell life.

Of note, besides supporting energetically demanding cellular processes, the synthesis of ATP (achieved by OXPHOS but also potentially by glycolysis) might modulate oxygen transport by haemoglobin. Accordingly, the intra-cellular ratio ADP/ATP could be an important modulator of Hb-O₂ affinity, since the addition of ATP has been found to increase haemoglobin affinity to oxygen in reptile erythrocytes (Ogo *et al.* 1993). Our pilot experiments on birds support the potential importance of the ADP/ATP ratio in oxygen transport regulation, since ADP addition during respiration measurements of avian erythrocytes causes a strong release of O₂ (Supplementary S1). This phenomenon could be interpreted as a decrease of Hb-O₂ affinity, and should encourage future work on the regulation of Hb-O₂ affinity by ADP/ATP ratio and mitochondrial activity.

The mitochondrial stress hypothesis

The unavoidable by-product of OXPHOS is the generation of potentially deleterious ROS (Finkel & Holbrook 2000). Hence, the *mitochondrial stress hypothesis* argues that mammalian erythrocytes have lost their mitochondria in order to down-regulate cell oxidative stress (Zhang *et al.* 2011). Zhang and collaborators (2011) have previously demonstrated that ROS production in mammalian erythrocytes remain stable under metabolic circumstances known to induce oxidative stress (i.e. hyperglycaemia, ischaemia),

whereas ROS production in avian erythrocytes is dramatically increased under the same conditions. These authors concluded that nuclear and mitochondrial extrusion may help mammal erythrocytes to lower ROS production under metabolic stress, which is in line with the suggested longer lifetime of mammalian erythrocytes compared to birds (Holmes et al. 2001). Several lines of evidence call into questions the importance of oxidative stress as one major driver of mitochondria loss by mammalian erythrocytes.

Mice exhibited higher plasmatic oxidative stress. Hence, it suggests that even if mice erythrocytes are lacking mitochondria, their immediate environment (*i.e.* plasma) suffers from greater oxidative damage despite a higher plasma antioxidant capacity than zebra finches (fig. 4). This challenges the *mitochondrial stress hypothesis* proposed by (Zhang et al. 2011), and suggests that the presence of functional mitochondria within avian erythrocytes does not necessarily compromise blood oxidative state. Still, our data do not rule out the possibility that an oxidative imbalance may occur at the scale of the erythrocyte but a complete comparative study is needed to resolve this point. If erythrocytes of birds accumulate oxidative damage at a higher rate because of their mitochondria, we might expect avian erythrocytes to have a shortened lifespan. Mouse erythrocytes turnover seems however to be faster than in chicken, pigeon or duck (Rodnan et al. 1957), which is contradictory with (Holmes et al. 2001) assumptions. Because numerous (confounding) parameters might affect erythrocyte lifespan, such as body size/weight (Vácha & Znojil 1981), further investigations at the inter-specific level are required before firmly concluding on this point. Research focusing at inter-individual variation in cell mitochondrial abundance and oxidative stress should also be encouraged. Here, it is worth mentioning that a few salamander species from five different genera of the subfamily *Bolitoglossinae* show relatively high amounts (> 80 %) of enucleated erythrocytes (Villalobos et al. 1988). Using such species could provide new insights on the evolutionary loss of nucleus and mitochondria also observed for mammalian erythrocytes.

Finally, it is well-known that ROS can trigger cell senescence *via* mitochondrial driven apoptosis and the opening of the mitochondrial permeability transition pore (Crompton 1999; Orrenius & Gogvadze 2007). However, previous studies have shown that chicken erythrocyte cell death does not rely on such a caspases' apoptotic pathway (Weil et al. 1998). Therefore, as stated by (Moyes et al. 2002), "mitochondria are probably a minor contributor to oxidative stress in erythrocytes", and hence mitochondria loss in mammals

has probably no or only a minor relationship with a reduction of oxidative stress. Indeed, even if the presence of mitochondria within avian erythrocytes was associated with ROS production (fig 3), the oxidative imbalance observed in the blood was lower for zebra finch than for mice (fig 4). Therefore, the presence of mitochondria within erythrocyte does not necessarily seem to be associated with increased levels of oxidative stress, perhaps due to efficient intra-cellular antioxidant defences. This point is further supported by a pilot experimental approach where we tested whether mitochondrial ROS production of avian erythrocytes is increased under hyperglycaemic conditions, as suggested by (Zhang *et al.* 2011). In this experiment, mitochondrial superoxide production was not affected by hyperglycaemic conditions (30mM Glucose, supplementary material S2).

Perspectives

The fact that avian erythrocytes possess functional mitochondria presents research potential both for evolutionary and ageing studies. In the recent past, numerous studies have addressed the implication of oxidative balance in the set-up and evolution of life history trade-offs (Dowling & Simmons 2009; Monaghan *et al.* 2009; Metcalfe & Alonso Alvarez 2010). However, due to practical and ethical constraints, most studies on vertebrates focused on plasmatic parameters to assess “organismal” oxidative stress. The presence of functional mitochondria in non-mammalian (fish, birds) erythrocytes provides a good opportunity to investigate both sides of the oxidative balance (mitochondrial ROS production and antioxidant defences), using only blood samples. Moreover, while mitochondrial research in mammals requires animal culling to collect tissues and extract mitochondria for functional studies, we can now use lifelong blood sampling of the same birds to investigate mitochondria functioning with a longitudinal experimental design. Hence, the use of erythrocytes in non-mammalian vertebrates as a source of mitochondria should be beneficial for ageing studies by providing a more powerful tool than classical cross-sectional studies to investigate mitochondrial role and modifications associated with ageing process and life history traits (such as the uncoupling state of mitochondria (Harper *et al.* 2004; Criscuolo *et al.* 2005)). It should also help to investigate the implication of mitochondria in ageing rate variability of wild and non-model animals, which are often submitted to restricted ethical rules.

Conclusions

Our findings demonstrate that avian erythrocytes possess functional mitochondria in terms of respiratory activities and ROS production. Therefore, our results combined with available literature on other vertebrates suggest that mammals are almost unique in having an evolutionary loss of mitochondria by mature erythrocytes. Since mitochondria within avian erythrocytes does not appear to result in plasma-level oxidative stress, our results challenge the idea that mitochondrial ROS production was a major factor leading to this loss during the course of evolution. Finally, the presence of functional mitochondria within avian erythrocytes open new perspectives in the use of birds as models for longitudinal studies of ageing via lifelong blood sampling of the same subjects.

Competing interests

The authors declare that they have no competing interests.

Authors' contributions

AS designed the study. AS, PB and FC wrote the paper. AS and QS collected and analyzed the data. CR realized TEM preparations and observations. JZ, FS and BG provided support with respirometry measurements, and FG provided support with FACS measurements. SM, JZ, PB and FC took part in data analyses and interpretations. All authors have read and approved the final version of the manuscript.

Acknowledgments

The study complied with the 'Principles of Animal Care' publication no.86-23, revised 1985 of the National Institute of Health, and with current legislation (L87-848) on animal experimentation in France. We are grateful to S. Blanc & F. Rudwill for fruitful discussions on a previous draft, and to the CNRS (PICS) and the French Ministry of Research for funding. P.B. is funded by the Swiss National Research Foundation (grant n° 31003A_124988).

Supplementary materials

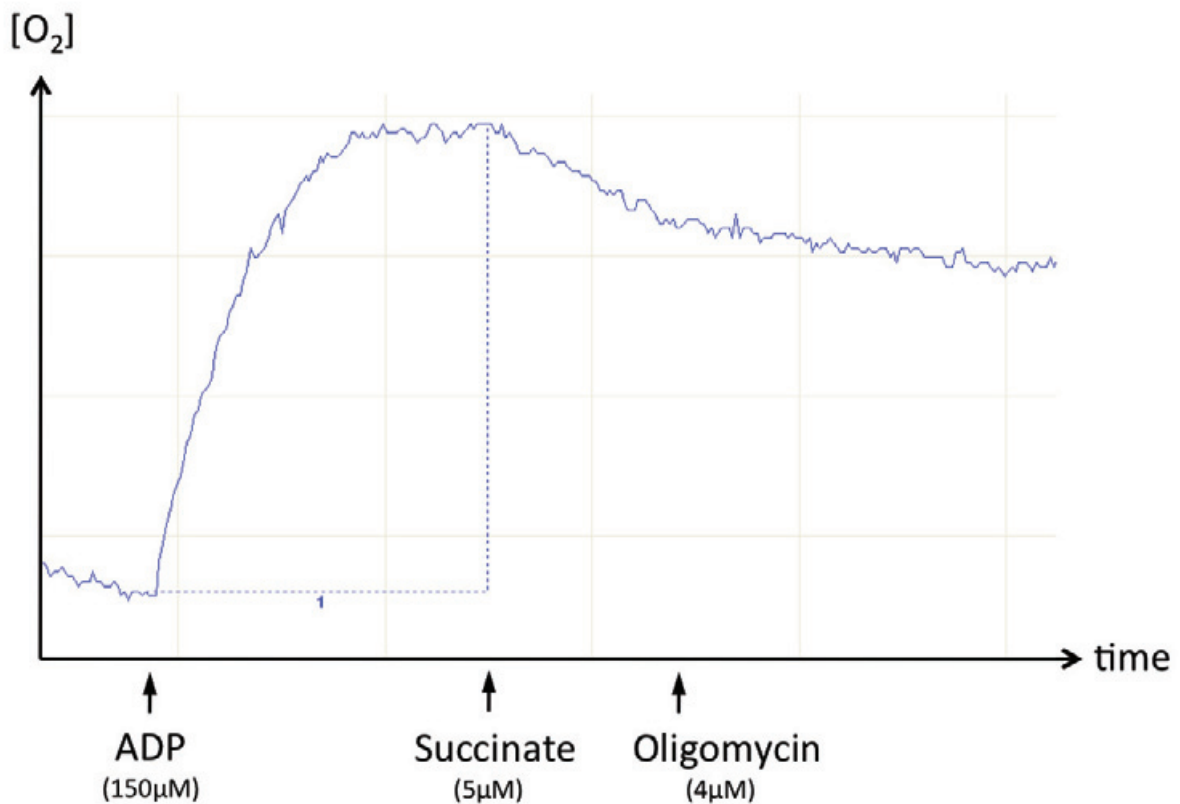

Figure S1. Typical polarographic trace of respiratory activity of avian erythrocytes in response to ADP (150 μ M) addition. One sample t-test reveals a significant change in O_2 dynamics following ADP addition (N = 5, mean = + 4.53 nmol O_2 /min/mL; $t = 3.20$, $df = 4$, $p = 0.033$). ADP addition induces a strong release of oxygen, suggesting a role of ADP in the modulation of the affinity between oxygen and haemoglobin in avian erythrocytes. The methodology used is similar to the one explained in the manuscript.

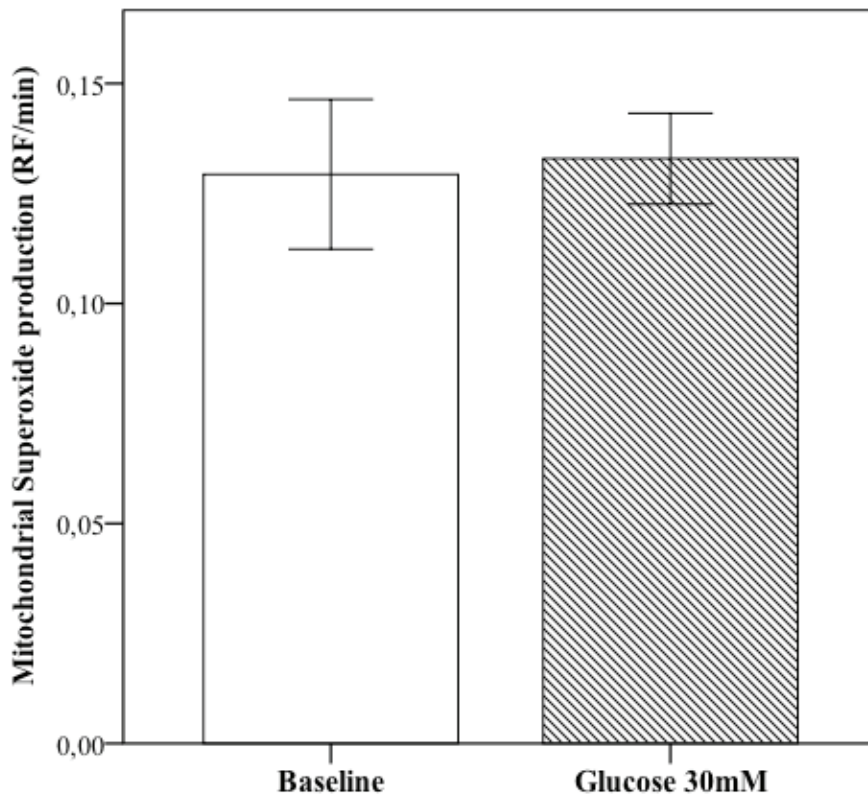

Figure S2. Mitochondrial Superoxide production in birds under normal and hyperglycaemic conditions expressed as change in mitosox red® relative fluorescence (RF) per minute. White bar represents baseline superoxide production and dashed bar represents superoxide production in hyperglycaemic conditions (incubation with 30mM Glucose). Paired t-test does not reveal significant difference between treatments (N = 9; $t_{\text{paired}} = -0.29$, $df = 8$, $p = 0.78$). The methodology used is similar to the one explained in the manuscript.



Chapter 3

Impact of mitochondrial uncoupling state and energy metabolism on oxidative stress levels and life history trajectories

Paper 2 - Mitochondrial uncoupling prevents cold-induced oxidative stress: a case study using UCP1 knockout mice

Antoine Stier, Pierre Bize, Caroline Hbold, Frederic Bouillaud, Sylvie Massemin
& François Criscuolo

Published in a revised version:

The Journal of Experimental Biology (2014) **217**: 624-630

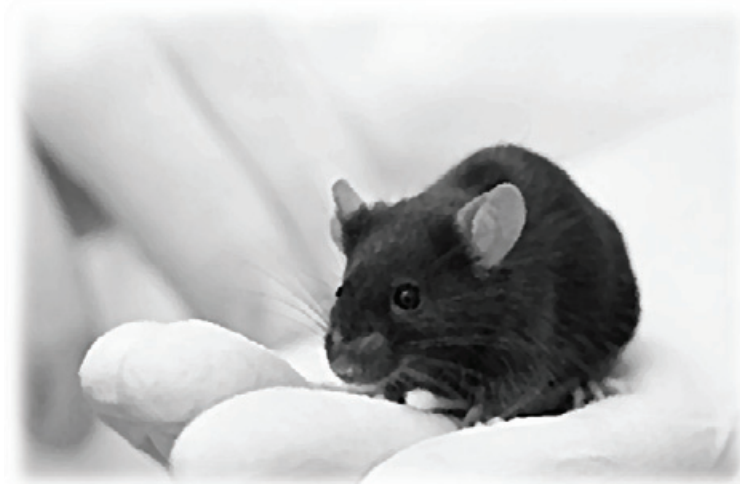

Abstract

Background

The relationship between metabolism and reactive oxygen species (ROS) production by the mitochondria has been often (wrongly) viewed as straightforward, with increased metabolism leading to higher pro-oxidants generation. Insights on mitochondrial functioning show that oxygen consumption is either coupled with energy conversion as ATP or as heat, depending on whether the ATP-synthase or the mitochondrial uncoupling protein 1 (UCP1) is driving respiration. However, those two processes might greatly differ in terms of oxidative costs. We used a cold challenge to investigate the oxidative stress consequences of an increased metabolism achieved either by the activation of an uncoupled mechanism (i.e. UCP1 activity) in the brown adipose tissue (BAT) of wild-type mice, or by ATP-dependent muscular shivering thermogenesis in mice deficient for UCP1.

Results

Although both mouse strains increased by more than twofold their metabolism when acclimatised for 4 weeks to mild cold (12°C), only mice deficient for UCP1 suffered from elevated levels of oxidative stress. When exposed to cold, mice deficient for UCP1 showed an increase of 20.2% in plasmatic reactive oxygen metabolites, 81.8% in muscular oxidized glutathione and 47.1% in muscular protein carbonyls. In contrast, there was no evidence of elevated levels of oxidative stress in the plasma, muscles or BAT of wild-type mice exposed to cold despite a drastic increase in BAT activity.

Conclusions

Our study demonstrates differing oxidative costs linked to the functioning of two highly metabolically active organs during thermogenesis. It urges for careful considerations of mitochondrial functioning when studying/considering the links between metabolism and oxidative stress.

Keywords

Uncoupling protein, free radical theory of ageing, oxidative stress, reactive oxygen species, cold, non shivering thermogenesis

Introduction

The idea of a negative impact of metabolic rate on longevity was first formulated almost a century ago by Raymond Pearl (Pearl 1928) in his *rate of living theory*, but without giving any precise mechanism on how high oxygen consumption may lead to shortened lifespan. The best explanation so far comes from Denham Harman who speculated in 1956 in his *free radical theory of ageing* (Harman 1956) that aerobic respiration leads to the inevitable by-production of damaging reactive oxygen species (ROS), or free radicals, in the mitochondria. Ageing could then result of the accumulation of oxidative damage, caused by the imbalance between free radical production and antioxidant defences (i.e. oxidative stress), with the rate of free radical production being potentially coupled to whole organism oxygen consumption and, in turn, metabolic rate (Beckman & Ames 1998). This hypothesis gained strong support when it was shown that mitochondrial ROS production follows lifespan variability among species, the lower production rate being associated with the longer lifespan ((Ku *et al.* 1993; Barja *et al.* 1994; Lambert *et al.* 2007) but see (Speakman & Selman 2011; Montgomery *et al.* 2012)). Because this production of mitochondrial ROS is sometimes assumed to be a fixed percentage of total oxygen consumption, somewhere between 0.1 and 4% according to available data (Golden & Melov 2001; Nicholls *et al.* 2002), one common prediction of the *free radical theory of ageing* is that an increase in metabolic rate (i.e. oxygen consumption) should lead to an increase in mitochondrial ROS production and concomitant rate of ageing (Beckman & Ames 1998).

However, recent evidence, mostly coming from our more accurate understanding of mitochondrial functioning, are arguing against a trivial, monotonic, relationship between oxygen consumption and ROS production (reviewed in ((Murphy 2009; Speakman & Selman 2011)). During mitochondrial respiration, electrons harvested from oxidizable substrates are passed through the different complexes (I-IV) of the respiratory chain to reduce molecular oxygen to water. Yet, some of those electrons can escape the electron transport chain during respiration and react with molecular oxygen to form ROS. The energy associated with the electron flow through the respiratory chain is used by the complexes I, II and IV to pump protons against their electrochemical gradient across the mitochondrial inner-membrane, and the backflow of protons through the Fo/F1 ATP synthase (or complex V) is responsible for the production of cellular energy as ATP. Hence, mitochondria couple respiration to ATP

synthesis through an electrochemical proton gradient (Divakaruni & Brand 2011). A growing number of studies show that electron loss from the respiratory chain and concomitant ROS production is highly sensitive to changes in mitochondrial innermembrane potential, ROS production being sharply declined at low membrane potential (Barja 2007; Murphy 2009; Mookerjee *et al.* 2010). Although the backflow of protons across the Fo/F1 ATP synthase has for consequence to reduce membrane potential, and in so ROS production (Lambert & Brand 2009; Murphy 2009), membrane potential can also be controlled by other proton leak pathways such as through the constitutive adenine nucleotide translocase (Skulachev 1999; Talbot *et al.* 2004) or the inducible uncoupling proteins (UCP1 to 3, reviewed in (Ricquier & Bouillaud 2000); but see also (Divakaruni & Brand 2011)). The leakage of protons, which can account for approximately 20% of mitochondrial oxygen consumption (Rolfe & Brown 1997), uncouples respiration from ATP production, energy being released as heat. The occurrence of such a mitochondrial uncoupling can then increase oxygen consumption while lowering ROS production, which might lead to a negative association between metabolism, ROS production and rate of ageing, as stated by the *uncoupling to survive hypothesis* (Brand 2000).

The relationship between mitochondrial uncoupling and the molecular mechanisms responsible of it, in one hand, and the generation of ROS and their impact on lifespan in the other hand, has attracted the particular attention of several research teams. The experimental increase of the uncoupling state of mitochondria, either obtained through a pharmacological uncoupling treatment (2,4-dinitrophenol (Caldeira da Silva *et al.* 2008)) or through the ectopic (i.e. muscular) expression of the uncoupling protein UCP1 (Gates *et al.* 2007) in mice has been shown to extend lifespan, Nevertheless, the relevance of mitochondrial uncoupling in the control of ROS production under normal physiological conditions remains unclear and controversial (Shabalina 2011). Some of these controversies could be attributable to the fact that the impact of UCP1 on ROS production in situations where UCP1 expression / activity is naturally triggered (e.g. chronic cold exposure) has not been evaluated, despite the fact that UCP1 is the only acknowledged UCP with a physiologically relevant uncoupling activity (Shabalina 2011).

In the present study, we used an experimental design where metabolism was increased with or without the triggering of an uncoupled mitochondrial state. To do so, we compared the metabolic rate and oxidative stress markers of wild type (WT) mice and of

mice deficient for the uncoupling protein 1 (UCP1 KO) housed at 26°C or after a four-week exposure to mild cold (12°C). Cold exposure is known to trigger adaptive non-shivering thermogenesis (NST) achieved through mitochondrial uncoupling by UCP1 in the brown adipose tissue (BAT) (Klingenberg 1990; Golozoubova *et al.* 2001). This response cannot be set-up by UCP1 KO mice (Golozoubova *et al.* 2001), which instead have to rely mostly on muscular shivering thermogenesis and on an efficient production of ATP (i.e. coupled respiration) to fuel muscle activity. This two-by-two experimental design (genotype: WT vs. UCP1 KO and temperature: 12°C vs. 26°C) allowed us to determine oxidative damage, oxidative challenge (GSSG/GSH ratio, see methods for details) and antioxidant capacities across four groups of mice, both at the plasmatic level and in the two main thermogenic tissues (i.e. skeletal muscles and BAT). We predicted that a cold-induced rise in metabolism should be associated with higher oxidative damage in UCP1 KO mice, whereas no such relationship should be observed in WT mice relying on UCP1-dependent thermogenesis. These two alternative predictions predict strong genotype by temperature interactions on markers of oxidative stress.

Materials and methods

Animal treatment

The study complied with the 'Principles of Animal Care' publication no.86-23, revised 1985 of the National Institute of Health, and with current legislation (L87-848) on animal experimentation in France. The experiment started with 40 non-reproductive male and female mice C57 black 6 from our animal husbandry unit (temperature = 26 ± 1 °C). Half of the animals were wild type (WT) mice and the other half were UCP1 knockout mice (UCP1 KO). The founder mice (C57BL/6 J) UCP1 knock out for establishing our colony were originally provided by the CNRS (UPR-9078) and were backcrossed and genotyped according to The Jackson Laboratory protocol. During five weeks, 10 mice per genotype were maintained at 26°C (groups WT26 and KO26), and 10 mice per genotype were exposed at 12°C (groups WT12 and KO12) during four weeks, after one week of progressive cooling (2°C per day). Animals from our four experimental groups did not differ in terms of mass (GLM, $p = 0.97$) and age (GLM, $p = 0.49$) at the beginning of the experiment. Animals were

maintained on a 12 L : 12 D light cycle, and food (SAFE A03) and water were provided *ad libitum*.

At the end of the experimental period, animals were culled (between 1:00pm and 4:00pm to restrict circadian bias in oxidative stress parameters) by cervical dislocation followed by decapitation in order to collect blood in heparinised micro tubes, as well as to collect the BAT and skeletal muscles (i.e. a mix of thigh and abdominal muscles). Immediately after collection, blood samples were centrifuged to separate plasma from cells, and tissues samples were snap frozen in liquid nitrogen. Samples were subsequently stored at -80°C until laboratory analyses.

Oxygen consumption measurements

Oxygen consumption (VO_2 expressed in mL O_2 consumed per minute) was determined twice for eight animals of the WT12 and KO12 groups. The first measurement was conducted before the experimental period close to thermoneutrality (26°C), and the second one-week before the end of the experiment during the moderate (12°C) cold exposure. We recorded O_2 consumption (open-circuit indirect calorimetry system, Sable System, USA) during 5 hours after one-night of acclimation (without food but with water *ad libitum*). We used the average of these 5 hours to obtain the mean VO_2 .

Plasmatic oxidative stress measurements

The antioxidant barrier and the concentration of Reactive Oxygen Metabolites (ROMs) were measured using the OXY-Adsorbent (5 μ L of 1:100 diluted plasma) and d-ROMs tests (5 μ L of plasma, DIACRON INTERNATIONAL, Italy) following the manufacturer protocol. OXY adsorbent test allows quantifying the ability of the plasma antioxidant barrier to buffer massive oxidation through hypochlorous acid, while the d-ROMs test measures mostly hydroperoxydes, as a marker of global early oxidative damages (see (Stier *et al.* 2012) for a review of the literature of previous experiments using those two markers of oxidative stress). Antioxidant barrier is expressed as mM of HClO neutralised and d-ROMs as mg of H_2O_2 equivalent/dL. Mean \pm SE intra-individual coefficient of variation based on duplicates was $2.23 \pm 0.30\%$ for the OXY test and $1.90 \pm 0.26\%$ for the d-ROMs test. Inter-plate coefficient of variation based on a standard sample repeated over plates was 4.16% for the OXY test and 2.75% for the d-ROMs test.

Tissue oxidative stress measurements

Glutathione content and proportion of oxidized glutathione in BAT and muscle was determined using DetectX® Glutathione fluorescent detection kit (Arbor Assays, USA), following manufacturer instructions. Glutathione (GSH) plays a key role in many biological processes including the protection of cells against oxidation. GSH is used as a reductant by the enzyme glutathione peroxidase to scavenge deleterious hydrogen peroxide. The oxidized form of glutathione (GSSG) can be restored into GSH by the action of the enzyme glutathione reductase. We evaluated the total glutathione content as an indicator of antioxidant protection and the ratio GSSG/total glutathione (which represent the proportion of oxidized glutathione) as an indicator of the oxidative challenge (i.e. the pro-oxidant power buffered by the glutathione system). Values are respectively expressed as nmol total glutathione/mg protein, and as a ratio of oxidized glutathione / total glutathione (0 meaning that all glutathione is free GSH, and 1 meaning that all glutathione is oxidized (GSSG)). Mean \pm SE intra-individual coefficient of variation based on duplicates was $4.13 \pm 0.42\%$.

To assess oxidative damage on protein in BAT and skeletal muscle, we determined protein carbonylation using Oxiselect™ protein carbonyl spectrophotometric assay kit (Cell Biolabs Inc., USA) following manufacturer instructions. This method allows quantifying carbonyl content, which is a common form of ROS-induced protein oxidation. All samples were measured on the same plate. Values are expressed as nmol protein carbonyl/mg protein. Mean \pm SE intra-individual coefficient variation based on duplicates was $5.13 \pm 0.78\%$. Total protein content of tissues homogenates was determined in duplicates using a Pierce™ BCA protein assay (Thermo Scientific, USA).

Statistical analysis

We investigated genotype and temperature effect on metabolic rate (VO_2) by running a repeated ANOVA. We used individual as subject, temperature as within-subject factor, genotype and the interaction between genotype and temperature as fixed factors, and mass as a covariate.

We investigated the effects of genotype (WT vs. KO), temperature (26°C vs. 12°C), and the interaction between genotype and temperature on oxidative stress parameters with GLMs (General Linear Models), after testing residuals of each model for normality and homoscedasticity. When a significant interaction between genotype and temperature was

revealed, we ran a post-hoc analysis to determine statistical differences between our four experimental groups.

Age and sex were initially included in statistical models but were not significant; they were removed in order to clarify statistical models. Repeated ANOVA and GLMs were fitted with a normal error distribution (SPSS 18.0). Analyses were two-tailed tests and p values ≤ 0.05 . Means are quoted \pm S.E.

Results

Metabolism

Exposure to mild cold ambient temperature increased mean oxygen consumption (VO_2) by more than twofold (Fig. 1, *Temperature*: $F = 1509.8$, $p < 0.001$), but independently of mouse genotype (*Genotype*: $F = 0.23$, $p = 0.64$; *Interaction*: $F = 1.43$, $p = 0.24$). Body mass was entered as a covariate in the model to control for the increase in VO_2 with body mass (*Body mass*: $F = 15.03$, $p = 0.001$).

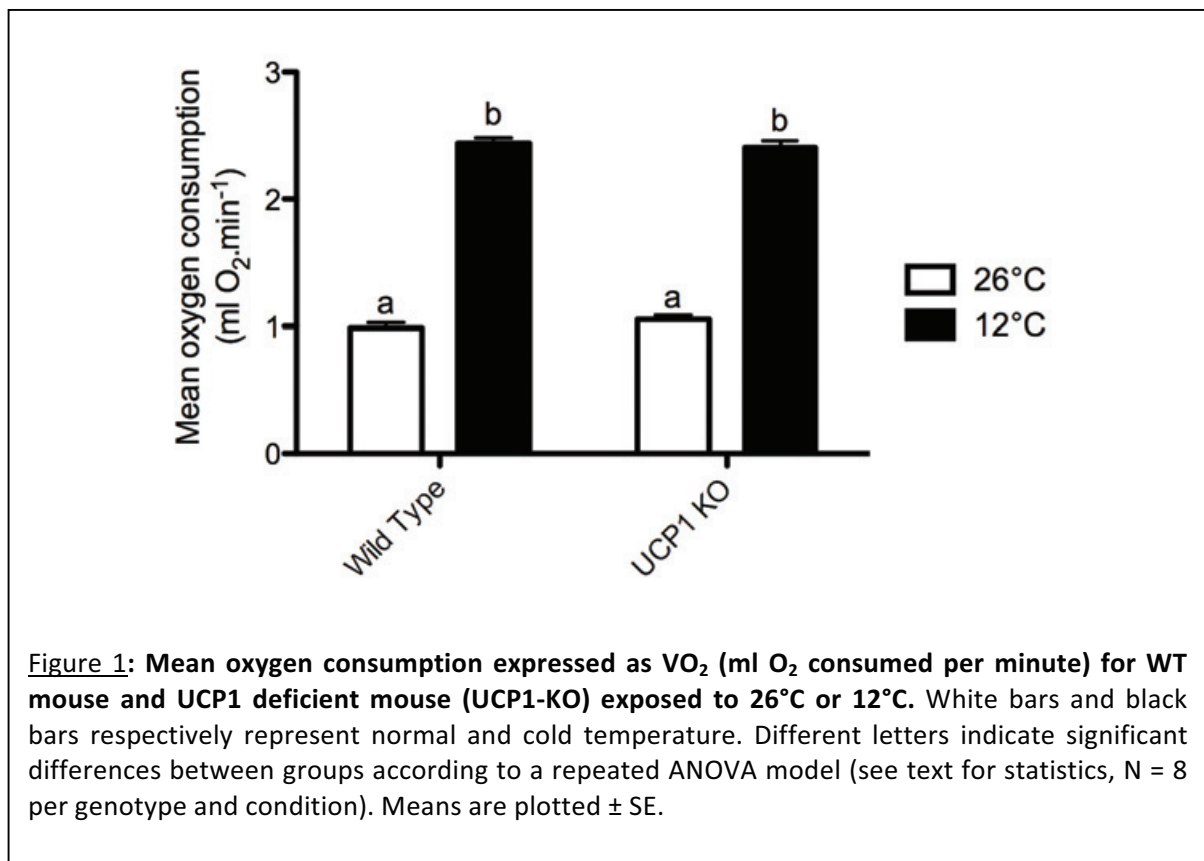

Figure 1: Mean oxygen consumption expressed as VO_2 (ml O₂ consumed per minute) for WT mouse and UCP1 deficient mouse (UCP1-KO) exposed to 26°C or 12°C. White bars and black bars respectively represent normal and cold temperature. Different letters indicate significant differences between groups according to a repeated ANOVA model (see text for statistics, $N = 8$ per genotype and condition). Means are plotted \pm SE.

Oxidative stress

Table 1: Results of GLMs (General Linear Models) testing the effects of genotype (WT vs. UCP1 KO), temperature (26 vs. 12°C) and the interaction between genotype and temperature on oxidative stress parameters. Results are presented for a general marker (plasma) and for the two main thermogenic organs (brown adipose tissue and skeletal muscle). Significant effects are reported in bold characters (N = 40, 10 mice per genotype and temperature).

Oxidative stress markers		Genotype		Temperature		Genotype x Temperature	
Plasma	<i>d-ROMs (damage)</i>	F = 7.44	p = 0.010	F = 3.26	p = 0.079	F = 8.27	p = 0.007
	<i>OXY (antioxidants)</i>	F = 3.39	p = 0.074	F = 0.64	p = 0.430	F = 0.08	p = 0.784
BAT	<i>Total glutathione</i>	F = 3.82	p = 0.058	F = 0.01	p = 0.906	F < 0.01	p = 0.974
	<i>Proportion of glutathione oxidized</i>	F < 0.01	p = 0.990	F < 0.01	p = 0.933	F = 0.04	p = 0.842
	<i>Protein carbonyl content</i>	F = 2.39	p = 0.130	F < 0.01	p = 0.934	F = 1.39	p = 0.246
Muscle	<i>Total glutathione</i>	F = 2.52	p = 0.121	F = 0.24	p = 0.623	F = 0.37	p = 0.546
	<i>Proportion of glutathione oxidized</i>	F = 14.63	p = 0.001	F = 41.22	p < 0.001	F = 8.41	p = 0.006
	<i>Protein carbonyl content</i>	F = 9.23	p = 0.004	F = 9.86	p = 0.003	F = 17.39	p < 0.001

Our experimental exposure to mild cold of WT mice and mice deficient for UCP1 revealed strongly significant genotype by temperature interactions (p -values ≤ 0.007) on markers of oxidative stress measured in the plasma (i.e. d-ROMs) and the skeletal muscles (i.e. proportion of glutathione oxidized and protein carbonyl content) but no in the BAT (Table 1, Figs 2-4). These interactions were explained by the increase in the aforementioned markers of oxidative stress in response to mild cold exposure for UCP1 KO mice (Figs 2a, 4b, 4c). In contrast, WT mice showed no or only moderate cold-induced increase in oxidative stress restricted to the proportion of glutathione oxidized in skeletal muscles (Fig. 4b). Plasma and tissue antioxidant defences did not significantly differ according to mouse genotype or temperature (Table 1, Figs 2b, 3a, 4a).

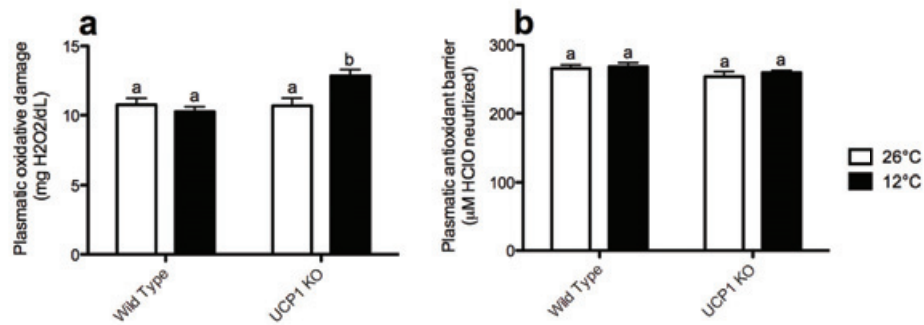

Figure 2: Plasmatic oxidative stress markers for WT and UCP1 deficient mouse exposed to 26°C or 12°C for 4 weeks. (a) Plasmatic oxidative damage (Reactive Oxygen Metabolites) (b) Plasmatic antioxidant barrier (total capacity). White bars and black bars respectively represent normal and cold temperature. Different letters indicate significant differences ($p \leq 0.05$) between groups according to GLMs models and associated post-hoc tests ($N = 10$ per genotype and temperature). Means are plotted \pm SE.

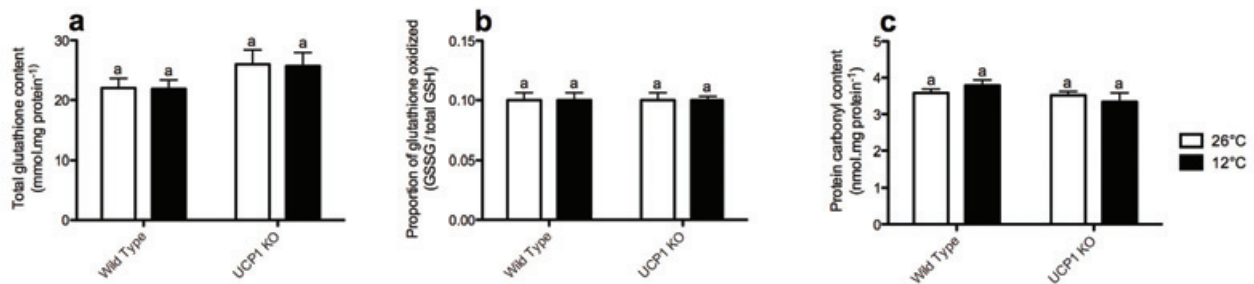

Figure 3: Brown Adipose Tissue (BAT) oxidative stress markers for WT and UCP1 deficient mouse exposed to 26°C or 12°C for 4 weeks. (a) Total glutathione content; (b) Proportion of glutathione oxidized; (c) Protein carbonylation level. White bars and black bars respectively represent normal and cold temperature. Different letters indicate significant differences ($p \leq 0.05$) between groups according to GLMs models and associated post-hoc tests ($N = 10$ per genotype and temperature). Means are plotted \pm SE.

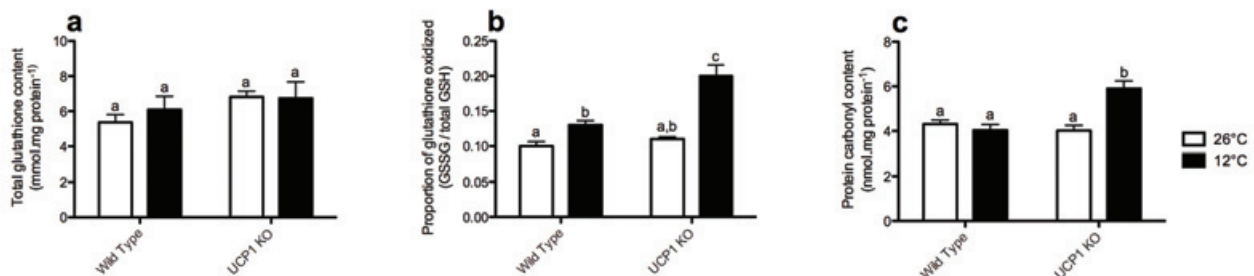

Figure 4: Muscle oxidative stress markers for WT and UCP1 deficient mouse exposed to 26°C or 12°C for 4 weeks. (a) Total glutathione content; (b) Proportion of glutathione oxidized; (c) Protein carbonylation level. White bars and black bars respectively represent normal and cold temperature. Different letters indicate significant differences ($p \leq 0.05$) between groups according to GLMs models and associated post-hoc tests ($N = 10$ per genotype and temperature). Means are plotted \pm SE.

Discussion

Cold exposure has been previously used to assess how an increased metabolism may impact ageing in rodents (*e.g.* Selman *et al.*, 2008; Vaanholt *et al.*, 2009). Several studies found significant short- to mid-term effects (from 10 hours to 3 weeks) of cold challenge on oxidative stress markers, with for example increased oxidative damage (Selman *et al.* 2002; Kaushik & Kaur 2003) or tissue-specific modifications of antioxidant defences, which globally reflect a situation of oxidative stress (Kaushik & Kaur 2003). However, while always inducing a rise in metabolism, mid to long-term cold challenge experiments are producing contrasting results. Despite higher metabolic rate in the cold, oxidative stress markers and ultimately individual survival were not markedly affected by long-term (*i.e.* throughout adult life) cold exposure in small rodents (Holloszy & Smith 1986; Selman *et al.* 2008; Vaanholt *et al.* 2009). Thermoregulatory mechanisms implicated in the cold response may be, at least partially, responsible for those discrepancies. An underestimated phenomenon is that thermogenesis is primarily achieved through muscles shivering in the hours to days of exposure to cold, but progressively replaced by the adaptive non-shivering thermogenesis (Janský 1973; Klingenspor 2003; Ouellet *et al.* 2012). This latter process is achieved through mitochondrial uncoupling *via* UCP1 in the brown adipose tissue (BAT; extensively reviewed by (Cannon & Nedergaard 2004)). Interestingly, longevity is shortened in UCP1 KO mice during prolonged cold exposure, with a median survival of *ca.* 13 weeks compared to more than 24 weeks for WT mice (Golozoubova *et al.* 2001). Following a period of acclimation at 18°C, mice lacking UCP1 could maintain body temperature and resist cold temperatures through continuous shivering but apparently at a cost for longevity. We confirmed here that a moderate cold exposure (26°C to 12°C) increases approximately twice the metabolic rate, but independently of the mice genotype as previously demonstrated (Golozoubova *et al.* 2001; Meyer *et al.* 2010). The longevity effect observed in (Golozoubova *et al.* 2001) is consequently not mediated by differences in metabolism, yet our results shed in light that cold-induced oxidative stress occurs for mice lacking UCP1, which may contribute to explain the reduced longevity of these mice in the cold.

Because cold-induced increase in metabolism at the whole organism level is related to the higher activity of few, specific, tissues (*i.e.* muscular shivering thermogenesis and/or BAT non-shivering thermogenesis), the impact of cold-induced high metabolism on the

oxidative balance is likely to be tissue-dependent (Kaushik & Kaur 2003). Accordingly, following cold exposure UCP1 KO mice showed greater levels of oxidative stress in the blood and in skeletal muscles, but not in BAT, compared to WT mice. In the absence of a cold challenge, WT and UCP1 KO mice had similar levels of BAT/muscles antioxidant defences (total glutathione content), oxidative challenge (proportion of glutathione oxidized) or oxidative damage on proteins. Hence, our results suggest first that, in the absence of a cold challenge and concomitant over-expression of UCP1, BAT has no major influence on oxidative stress (as previously suggested by (Shabalina *et al.* 2006)). Furthermore, once UCP1 expression is triggered, we found that BAT metabolism activation during NST has no local (i.e. on BAT) but also no systemic pro-oxidant deleterious effect (i.e. on the muscles and plasma). This is remarkable given that BAT metabolism is dramatically increased during cold exposure (Cannon & Nedergaard 2004) and that brown adipocytes contain numerous mitochondria and then have a high oxidative capacity (Ricquier & Bouillaud 2000). Therefore, even if UCP1 over-expression does not directly reduce oxidative stress following cold exposure, it might likely reduce the proportion of ROS generated per unit of oxygen consumed. The induced uncoupling mitochondrial state due to UCP1 activity could be one of these processes, and contributes to maintain redox homeostasis in the BAT during thermogenesis. Such UCP1 secondary effect (i.e. in addition to its thermogenic effect) in brown adipocytes is supported by *in vitro* experiments (Dlasková *et al.* 2010; Oelkrug *et al.* 2010) showing that UCP1 expression reduces ROS production by isolated mitochondria. Our results are also in line with a recent report of beneficial health effects of over expression of the tumour suppressor *Pten* in transgenic mice, those health effects being associated with striking hyperactivity of BAT and increased levels of UCP1, which in turn were leading to high energy expenditure but low levels of oxidative damage and lifespan extension (Ortega-Molina *et al.* 2012).

NST and muscular shivering thermogenesis led to similar cold-induced increase in metabolic rate. The protective effect of NST in terms of oxidative stress could be indirect, by limiting the thermal dependency of animals upon the shivering process during prolonged cold exposure. Indeed, muscle shivering thermogenesis relies on muscle contractile activity, which itself relies on strong ATP production to fuel this activity. Contractile activity was previously reported to be positively related to ROS production and to a transient decrease in thiols content, followed by increased levels of various antioxidant enzymes (McArdle *et al.*

2001). Our results show that both WT and UCP1 deficient mice exhibited an increased proportion of oxidized glutathione after cold exposure, in a significantly higher extent in UCP1-KO mice. Given that muscle glutathione reductase activity reached the same level in both groups in cold conditions (see SI) and that total glutathione did not significantly differ between groups, it implies that ROS production of muscle mitochondria was increased in the cold. This increased ROS production seems to have a different final impact (i.e. oxidative damage) depending on mice genotype. The slight rise of ROS production in WT mice, which could be attributed to a low or transient shivering activity or to a switch in pro-oxidant metabolic substrate (i.e. lipid mobilization (St-Pierre *et al.* 2002)), had no impact on protein carbonyl levels. On the contrary, UCP1 KO mice exposed to 12°C showed a larger oxidative imbalance and a higher protein carbonyl content in skeletal muscle. The idea that NST can indirectly protect the muscle from an overloading ROS production is in agreement with previous studies reporting that muscle antioxidant enzymes activities decreased over time in WT mice exposed to cold (Petrovic *et al.* 2008) and that life long exposure to cold caused no significant muscle oxidative damage in wild derived rodents (Selman *et al.* 2008). Interestingly, it has been recently demonstrated that physical activity can induce the production by the muscle of irisin, and that this hormone stimulates UCP1 expression and a brown-fat-like development of white adipose cells (Boström *et al.* 2012). Hence, such a system may act as a negative feedback to mitigate the deleterious impact of prolonged muscle shivering, such as oxidative stress (present study) or defective calcium handling (Aydin *et al.* 2008).

Conclusions

Insights on mitochondrial functioning have shown that oxygen consumption is either coupled with energy conversion as ATP or as heat, depending on whether the ATP synthase or the mitochondrial UCP1 is driving respiration. There is however growing evidence that those two processes might lead to differing oxidative costs (Brand 2000). According to one common expectation of the *free radical theory of ageing*, our results show that the high metabolism of UCP1 KO mice acclimated to cold, which was coupled to high ATP-dependent muscular shivering thermogenesis, was associated with increased levels of oxidative stress/damage in the muscles and in the blood. Alternatively and in agreement with

expectations of the *uncoupling to survive hypothesis*, we found that the cold-induced activation of UCP1 in the BAT (i.e. NST) allowed WT mice to increase their metabolism to generate heat while preventing them from oxidative damage. Therefore, we suggest that determining the accurate nature of the mitochondrial mechanisms implicated in the control of metabolism in a given environmental condition (present study), but also in the determination of life-history trajectories (Salin *al.* 2012a; 2012b), are important milestones in our understanding of the determinants of longevity.

Acknowledgments

We are grateful to the CNRS (PICS, grant n° 5296), the French Ministry of Research and the University of Strasbourg for funding. P.B. is funded by the Swiss National Research Foundation (grant n° 31003A_124988).

Authors' contributions

AS designed the study. AS, PB and FC wrote the paper. AS & CH collected the data. AS, FC, PB, SM and FB took part in data analyses and interpretations. All authors have read and approved the final version of the manuscript.

Supplementary materials

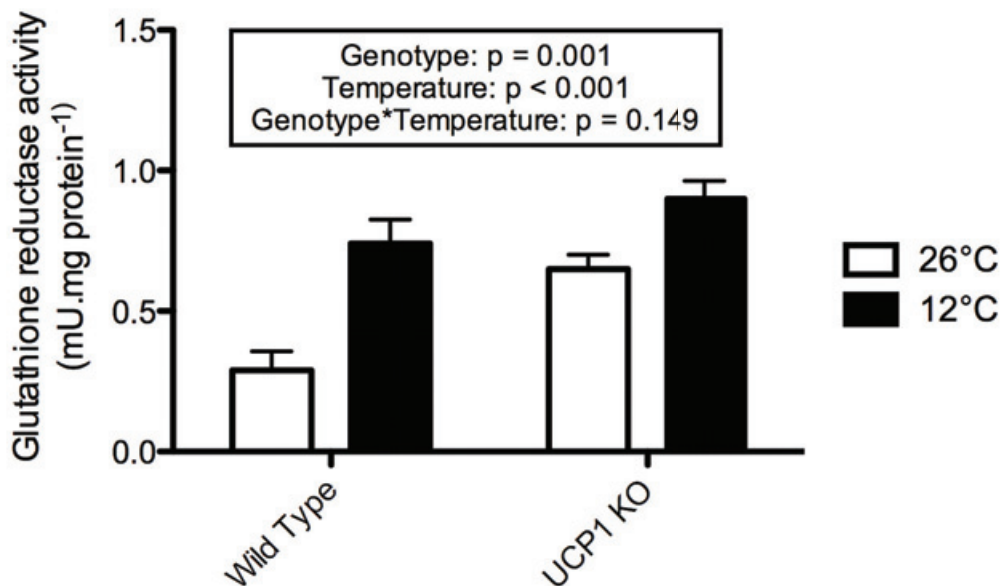

Muscle glutathione reductase activity for WT and UCP1 deficient mice exposed to 26°C or 12°C for 4 weeks. White bars and grey bars respectively represent normal and cold temperature. N = 10 per genotype and condition, and means are plotted \pm SE.

Method: The enzymatic activity of glutathione reductase (GR) was determined using DetectX[®] Glutathione Reductase fluorescent kit (Arbor Assays, USA), following manufacturer instructions. GR plays an indirect but essential role in the prevention of oxidative damage within the cell by helping to maintain appropriate levels of intracellular free glutathione (GSH). Enzymatic activity is expressed as mU/mg protein. Intra-individual variation based on duplicates was low (CV = $2.87 \pm 0.28\%$).

Results: Glutathione Reductase (GR) enzymatic activity was significantly affected both by genotype (F = 14.35, p = 0.001) and temperature (F = 26.94, p < 0.001), but not by the interaction between these two factors (F = 2.18, p = 0.149). Indeed, UCP1 deficient mice presented higher GR activity than WT mice, and for both genotypes the enzymatic activity was higher in the cold.

Box 1 - Uncoupling protein 1 (UCP1) & longevity: an open question.

Antoine Stier & François Criscuolo

Unpublished work



Abstract

Background

The 'uncoupling to survive hypothesis' state that mitochondrial uncoupling could be a mechanism selected to limit reactive oxygen species (ROS) production and to promote extended lifespan. Despite the fact that UCP1 (uncoupling protein 1) is the only acknowledged UCP with a physiological uncoupling activity, few data are available about the effect of UCP1 on oxidative balance and longevity.

Results

The aim of this study was to test the impact of UCP1 on longevity by analysing long-term survival data of UCP1 knock-out (UCP1 KO) mice, and by measuring physiological markers known to impact/reflect the health state of individuals (oxidative damage, alanine transaminase (ALT) activity and circulating triglycerides levels). UCP1 deficient mice presented an overall impaired survival compared to wild-type (WT) mice. However, oxidative damage did not significantly differ between UCP1 KO and WT mice when measured in the brown adipose tissue, skeletal muscles or in the kidneys. Yet, UCP1 KO mice presented elevated levels of oxidative damage in the liver, but we did not find significant differences in ALT levels (*i.e.* a marker of liver injury/dysfunction). Finally, UCP1 ablation significantly decreased the circulating levels of triglycerides.

Conclusions

Our findings shed some light on UCP1 as a determinant of longevity in mice, even when individuals are raised at a temperature close to thermoneutrality (*i.e.* 26°C). However, we were unable to precisely determine the mechanisms linking UCP1 to longevity, even if an alteration of lipid metabolism appears as a potential candidate.

Keywords

Uncoupling protein, UCP1, lifespan, mitochondrial efficiency, oxidative stress, lipids, non-alcoholic fatty liver disease, NAFLD

Introduction

The brown adipose tissue (BAT) and the uncoupling protein 1 (UCP1) have received much attention in regards to their thermogenic role (Cannon & Nedergaard 2004), and their potential anti-obesigenic function (Kozak *et al.* 2008; Feldman *et al.* 2009; but see Kozak 2010 for controversies). Indeed, UCP1 is required to mediate the adaptive non-shivering thermogenesis, necessary to adequately cope with prolonged periods of cold exposure in mammals (Golozoubova *et al.* 2001, but see also Paper 2 for details). The metabolic inefficiency promoted by UCP1 has however been rarely investigated in the context of oxidative stress and ageing, potentially because of its restricted expression into a unique and small tissue (BAT), and its dwindling at adulthood in humans (but see Virtanen *et al.* 2009). However, mitochondrial uncoupling/inefficiency has also been suggested to be a mechanism reducing mitochondrial reactive oxygen species (ROS) production, and thereby has been seen as a potential target to lower the rate of ageing (*i.e.* the 'uncoupling to survive hypothesis', Brand 2000, see also the recent increasing interest about UCP1/BAT and their beneficial impact on health in mice, Ortega-Molina *et al.* 2012). Since UCP1 is the only uncoupling protein acknowledged to really uncouple mitochondria under physiological conditions (Shabalina 2011), we investigated the potential role of this protein for mice longevity. Determining the effect of UCP1 on oxidative stress levels and lifespan appears as a crucial step to gain insight about the validity of the 'uncoupling to survive hypothesis'.

Early results suggested that UCP1 has no role in lifespan determination in the mouse, since UCP1 knock-out mice (UCP1 KO) did not present a reduced longevity compared to wild-type (WT) mice, when maintained on a standard diet at 23°C (Kontani *et al.* 2005). Moreover, early results about the role of UCP1 in mitigating ROS production and oxidative stress have led to the conclusion that UCP1 is probably not implicated in oxidative homeostasis (Shabalina *et al.* 2006). Yet, recent results have shown that UCP1 promoter polymorphism is probably related to longevity in human (Rose *et al.* 2011), which henceforth stimulates scientific research linking UCP1 to the ageing process. Recent *in vitro* experiments have demonstrated a beneficial effect of UCP1 expression in terms of ROS production in isolated mitochondria (Oelkrug *et al.* 2010, Dlaskova 2010 *et al.*, Clarke & Porter 2013, but see Schönfeld *et al.* 2012 for controversies).

In this context, our goal was to investigate the role of UCP1 in lifespan determination by comparing WT and UCP1 deficient mice under standard conditions (standard chow diet and 26°C, which is close but slightly under the thermoneutral zone). We also aimed to gain insight on UCP1 effects on oxidative homeostasis in various organs (BAT, skeletal muscles, kidney and liver), and on other physiological markers potentially related to health state.

Materials and methods

Animals and experimental design

The longevity monitoring was conducted between 2008 and 2012 on 78 mice C57 black 6 (males and females) from our animal husbandry unit (temperature = 26 ± 1 °C). A little less than half of the animals were wild type (WT, N = 30) mice and the others were UCP1 knockout mice (UCP1 KO, N = 48, see Enerbäck *et al.* 1997). The founder mice (C57BL/6 J) UCP1 knock out for establishing our colony were originally provided by the CNRS (UPR-9078) and were backcrossed and genotyped according to The Jackson Laboratory protocol. Animals were maintained on a 12 L : 12 D light cycle, and food (standard chow diet: SAFE A03, France) and water were provided *ad libitum*. Cages were inspected three times a week to determine the time of death for each individual. Fifty-two individuals from another experiment (N = 26 per genotype) were used to investigate changes in body mass dynamics of mice, from 1 to 12 months old.

To investigate differences in physiological parameters between WT and UCP1 KO mice, ten mice of each genotype (age: 10.2 ± 0.5 months) were culled by cervical dislocation followed by decapitation in order to collect blood in heparinised microtubes. We also collected the BAT, skeletal muscles (*i.e.* a mix of thigh and abdominal muscles), the kidneys and the liver. Immediately after collection, blood samples were centrifuged to separate plasma from cells, while tissues samples were snap frozen in liquid nitrogen. Samples were subsequently stored at -80°C until laboratory analyses.

Oxidative stress measurements

We determined oxidative damage on lipids (lipid peroxidation) by measuring the levels of malondialdehyde (MDA, a decomposition product of lipid peroxides) in tissues, using a colorimetric assay adapted for microplate analysis (lipid peroxidation microplate

assay kit, Oxford Biomedical Research). Lipid peroxidation is a well-established mechanism of cellular injury and has been widely used as an indicator of oxidative stress (Halliwell & Gutteridge, 2007). MDA levels are expressed as nmol/mg protein. Intra-individual variation based on duplicates was low ($CV = 7.94 \pm 2.09\%$).

Alanine transaminase and plasma triglycerides levels

We determined the enzymatic activity of the alanine transaminase (ALT) using a plate-based colorimetric assay (Maxdiscovery™ Alanine Transaminase Enzymatic Assay Kit, BIOO Scientific). ALT level is widely used as an indicator of liver injury/dysfunction. ALT is an enzyme expressed primarily in the liver, and damage to the liver are known to provoke the release of this enzyme into the blood. Each sample was analysed in duplicates and intra-individual variation was low ($4.30 \pm 0.93\%$).

We determined plasma triglycerides levels using a commercially available colorimetric assay kit (enzymatic triglycerides PAP150, Biomérieux). Each sample was analysed in duplicates and intra-individual variation was low ($4.21 \pm 0.52\%$).

Statistics

We analysed survival data using a Cox regression analysis with genotype (WT vs. UCP1 KO) and sex included as fixed factors. The interaction between the genotype and the sex (genotype x sex) has been removed from the final model due to its lack of explanatory power.

We analysed body mass dynamics using a repeated general linear model, with the age of individuals as the repeated factor, and the genotype and the sex as fixed factors. All the interactions were included in initial models, but for clarity purpose we decided to present simplified statistical models.

We analysed physiological parameters (oxidative damage, ALT and triglycerides) using general linear models (GLMs) with genotype and sex being included as fixed factors. Body mass was included as a covariate in initial models, but was removed from final models due to its systematic lack of significance.

General linear models were fitted with a normal error distribution (SPSS 20.0), and data were tested for normality and homoscedasticity. All tests were two-tailed tests and p values ≤ 0.05 were considered significant. Means are always quoted \pm S.E.

Results

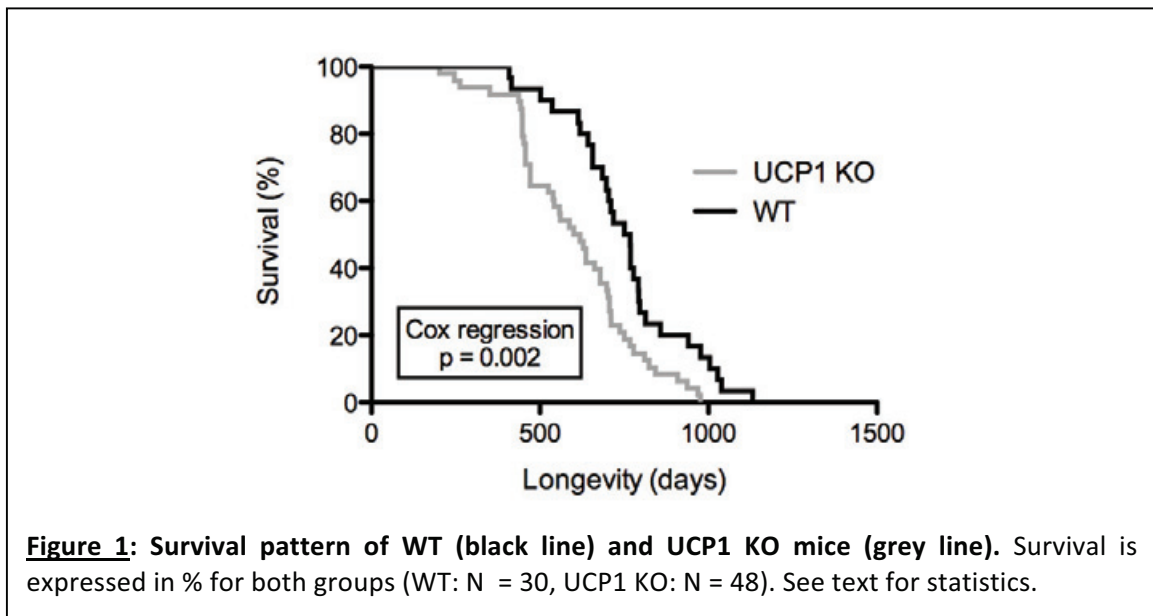

The Cox regression analysis revealed a significant effect of the genotype on mice survival pattern (fig 1), with UCP1 KO mice presenting a reduced longevity compared to WT mice (Wald $\chi^2 = 9.60$ and $p = 0.002$). The effect of the sex was not statistically significant (Wald $\chi^2 = 3.38$ and $p = 0.066$), even if females tended to live longer than males (mean longevity: males = 599.5 ± 34.6 days vs. females: 698.7 ± 27.1 days).

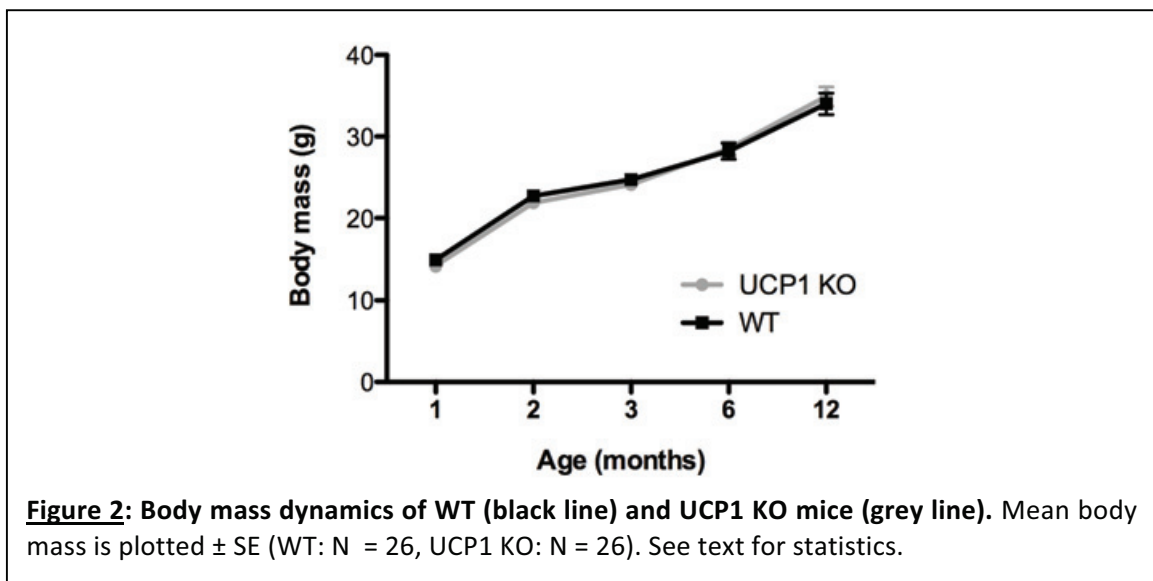

Body mass was significantly influenced both by the age ($p < 0.001$) and the sex ($p < 0.001$) of individuals, with mice being heavier with increasing age (fig 2), and males being heavier than females (mean mass: males = 27.4 ± 0.7 g vs. females = 22.2 ± 0.5 g). However, body mass did not significantly differ according to the genotype ($p = 0.61$) or the interaction between the age and the genotype ($p = 0.69$).

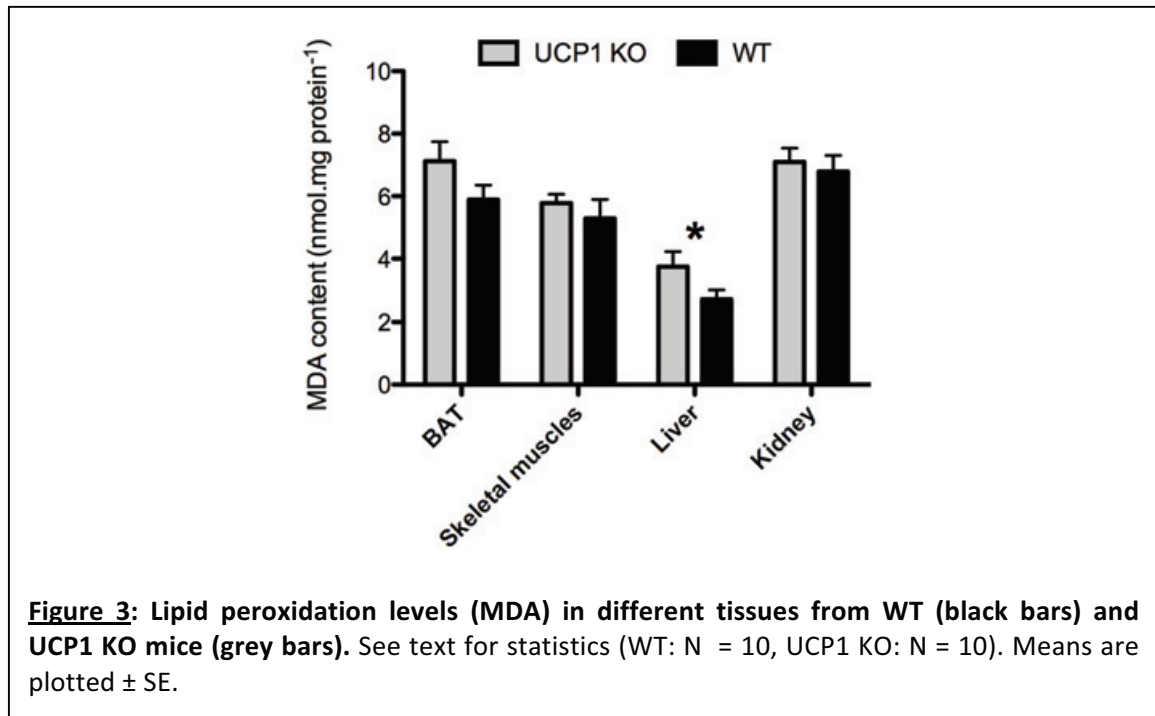

The lipid peroxidation levels were not affected by the genotype or the sex in the BAT (fig 3, $p = 0.16$ and $p = 0.70$ respectively). Similarly, MDA content in skeletal muscles and kidneys was not significantly affected by the genotype ($p = 0.54$ and $p = 0.67$) or the sex ($p = 0.40$ and $p = 0.93$). In contrast, MDA content in the liver was significantly affected both by the genotype ($p = 0.001$) and the sex ($p < 0.001$), with UCP1 KO mice and females presenting higher levels of lipid peroxidation.

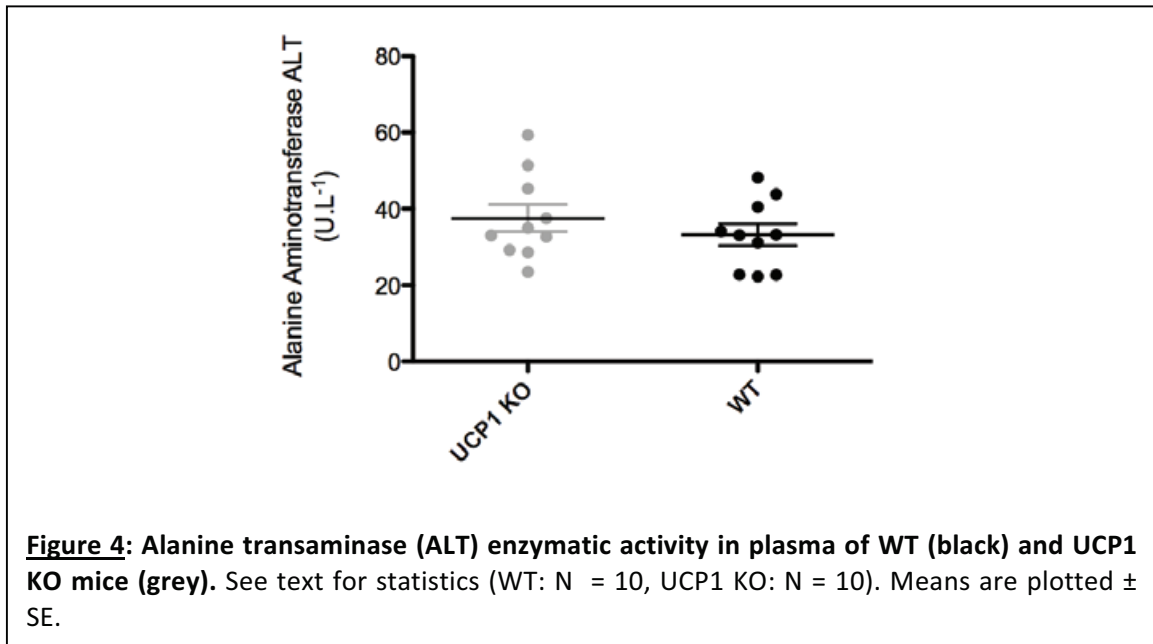

ALT enzymatic activity did not significantly differ between WT and UCP1 KO mice (fig 4, $p = 0.42$), and was not significantly affected by the sex of the mice ($p = 0.89$)

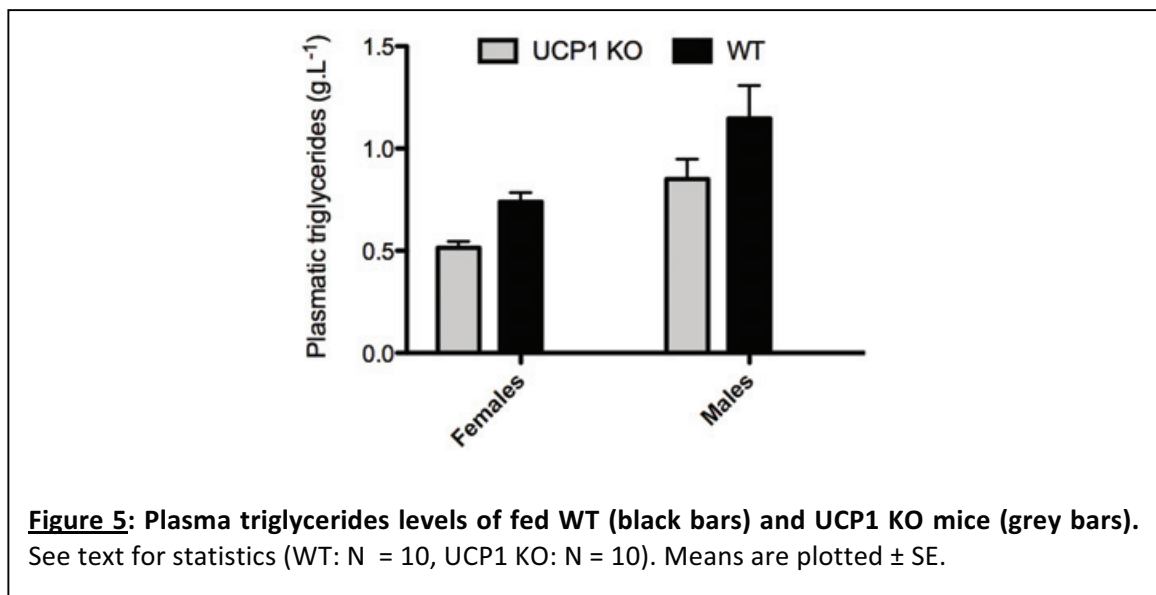

Plasma triglycerides levels were significantly affected both by the genotype (fig 5, $p = 0.024$) and the sex ($p = 0.003$), with UCP1 KO mice and females presenting the lower levels of circulating triglycerides.

Discussion

We found a significant effect of UCP1 ablation on lifespan, with UCP1 KO mice presenting a reduced survival over time (fig 1). These results are in opposition with the only available data (to our knowledge) already published on the same topic (Kontani *et al.* 2005), despite relatively similar experimental conditions. Indeed, Kontani *et al.* did not find a significant effect of UCP1 ablation on longevity, while mice were reared at 23°C (against 26°C in our study) under a similar diet (Kontani 2005: 3.5 kcal.g⁻¹ moisture 9%, proteins 25%, lipids 5%, carbohydrates 51%, fibers 4%, and mineral ash 7% vs. this study: 3.2kcal.g⁻¹, moisture 12%, proteins 21%, lipids 5%, carbohydrates 52%, fibers 4%, and mineral ash 6%). The deleterious impact of UCP1 ablation on longevity should not be attributable to differences in body mass dynamics (*i.e.* an obesigenic effect of UCP1 ablation (Feldman 2009)). Indeed, we found no effect of the genotype on body mass dynamics of mice coming from a comparable cohort (fig 2), as previously demonstrated by Kontani *et al.* (2005) for mice maintained on a similar standard chow diet.

As previously demonstrated in Paper 2, we did not find significant differences between WT and UCP1 deficient mice in terms of oxidative stress marker in the BAT and in skeletal muscles when animals were maintained at 26°C. In addition, we did not find an effect of UCP1 ablation in terms of oxidative stress in the kidneys (fig 3). These results are in accordance with the lack of UCP1 effect on oxidative stress levels previously suggested by Shabalina *et al.* 2006, at least for mice maintained close to thermoneutrality (see Paper 2 for a protective effect of UCP1 activity during cold exposure). Therefore, differences in lifespan seemed unlikely to be related to an effect of UCP1 on the oxidative balance.

However, UCP1 KO mice demonstrated higher levels of lipid peroxidation in the liver. Considering the role of BAT and UCP1 for lipid metabolism (Cannon & Nedergaard 2004), we thought that an indirect effect of UCP1 ablation could be to increase/modify the workload of the liver, which is also a major actor of lipid metabolism. For example, it has been shown that the relative importance of liver and BAT for fatty-acid synthesis are inversely related (Trayhurn 1981), with a decreasing importance of the liver at low ambient temperature (*i.e.* when the BAT and UCP1 activity are triggered). In this context, it has recently been shown that the presence of functional BAT in adult humans is associated with a decreased risk of non-alcoholic fatty liver disease (NAFLD, Yilmaz *et al.* 2011), suggesting that BAT implication

in lipid metabolism could prevent from liver alterations. Such a metabolic alteration is suggested by the decreased circulating levels of triglycerides in UCP1 deficient mice. In accordance, a previous study has also suggested that lipid utilization could be modified by UCP1 ablation, since UCP1 KO mice exhibited low free fatty acid levels but elevated levels of β -hydroxybutyrate (a marker of lipid mobilization) in the blood (Liu *et al.* 2003). Yet, low concentrations of circulating triglycerides or free fatty acids are more often viewed as indicators of an improved health status (*e.g.* Tirosh *et al.* 2008 or Khawaja *et al.* 2012), which does not actually fit with the survival pattern of UCP1 KO mice observed in our study. Glucose tolerance might also be a parameter influenced by UCP1 ablation and related to longevity, but previous studies have demonstrated that UCP1 KO mice did not present altered glucose homeostasis under standard diet (Liu *et al.* 2003, Kontani *et al.* 2005).

Murine models characterized by NAFLD presented increased levels of lipid peroxidation in the liver (Sahai *et al.* 2004), a result in accordance with our own observations in UCP1 KO mice. ALT level is used as a marker of liver dysfunction/injury and have been previously associated with the occurrence of NAFLD in humans (Sheth *et al.* 1997, but see Mofrad *et al.* 2003 for a study in which ALT levels are not systematically elevated in patients exhibiting a fatty liver) and mice (Sahai *et al.* 2004, Liu *et al.* 2009). Contrary to our expectations, we did not find a significant effect of UCP1 ablation on serum ALT levels, which does not support the occurrence of NAFLD in UCP1 KO mice. In the lack of additional measurements in our study (such as the relative liver weight and triglyceride content), we are not able to firmly conclude about the absence of NAFLD in UCP1 KO mice.

To conclude, we demonstrated that UCP1 ablation in a mouse model could be detrimental in terms of lifespan. Yet, the mechanisms linking UCP1 ablation and longevity in mice remain enigmatic, since UCP1 ablation did not modify oxidative stress levels (except in the liver) and did not seem to be related to NAFLD occurrence. Therefore, we recommend that such an effect of UCP1 for longevity should be replicated in a near future to be fully validated. Nevertheless, these results are interesting in a broader context, since UCP1 promoter polymorphism is suspected to be a determinant of human longevity (Rose *et al.* 2011). Given that oxidative damage levels in the liver and levels of lipid metabolites in the blood were affected in UCP1 KO mice, lipid metabolism could be one key factor explaining the negative effect of UCP1 ablation on lifespan.

**Paper 3 - Mitochondrial uncoupling as a regulator of life history trajectories
in birds: An experimental study in the zebra finch**

Antoine Stier, Pierre Bize, Damien Roussel, Quentin Schull, Sylvie Massemin
& François Criscuolo

In revision for the Journal of Experimental Biology



Abstract

Background

Mitochondria have a fundamental role in the transduction of energy from food into ATP. The coupling between food oxidation and ATP production is however never perfect but may be nevertheless of evolutionary significance. The ‘uncoupling to survive’ hypothesis suggests that ‘mild’ mitochondrial uncoupling evolved as a protective mechanism against the excessive production of damaging reactive oxygen species (ROS). Because resource allocation and ROS production are thought to shape animal life histories, alternative life history trajectories might be driven by individual variation in the degree of mitochondrial uncoupling.

Results

We tested this hypothesis in a small bird species, the zebra finch (*Taeniopygia guttata*), by treating captive adults with the artificial mitochondrial uncoupler 2,4-dinitrophenol (DNP) over a 32 months period. In agreement with our expectations, the uncoupling treatment increased metabolic rate. However, we found no evidence that treated birds enjoyed lower oxidative stress levels or greater survival rates, in contrast to previous results on other taxa. *In vitro* experiment revealed lower sensitivity of ROS production to DNP in mitochondria isolated from skeletal muscles of zebra finch than mouse. In addition, we found significant reductions in the number of eggs laid and in the immune response against phytohaemagglutinin in treated birds.

Conclusions

Altogether, our data suggest that the ‘uncoupling to survive’ hypothesis may not be applicable for zebra finches, presumably due to lower effects of mitochondrial uncoupling on ROS production in birds than mammals. Mitochondrial uncoupling appeared nevertheless as a potential life-history regulator of traits such as fecundity and immunity at adulthood, even with food supplied *ad libitum*.

Keywords

Uncoupling protein, free radical theory of ageing, oxidative stress, reactive oxygen species, life-history trade-off, mitochondrial efficiency

Introduction

One central tenet of evolutionary biology is that life history traits (*e.g.* growth rate, size and age at maturity) do not evolve independently from each other but are interrelated in a matrix of correlations (Stearns 1992). Life history theory explain the absence of organisms being able to maximize simultaneously all life history traits (*i.e.* “Darwinian demons” with infinite growth and reproduction throughout life) by the existence of constraints on energy acquisition and/or processing, which in turn generate trade-offs in the allocation of finite resources among traits requiring the same resources (Williams 1966; Stearns 1992). Although there is nowadays good evidences that energy acquisition, either through environmental constraints (Helle *et al.* 2011) or through internal constraints (Speakman *et al.* 2001; Speakman & Krol 2010), has a strong influence on animal life histories, the importance of energy processing has received little attention so far in a life history perspective (but see (Brand 2000; 2005; Salin *et al.* 2012a; 2012b)).

For most animals, the main site of energy transduction (*i.e.* the conversion of acquired nutrients from the organism into usable adenosine triphosphate (ATP) by their cells) is undoubtedly the mitochondria (Nicholls & Ferguson 2002). Briefly, mitochondria use electrons harvested from oxidizable substrates and O₂ as a final electron acceptor to build up a proton motive force by pumping protons from the mitochondrial matrix into the intermembrane space. The subsequent backflow of protons to the matrix across the protein complex ‘ATP synthase’ of the inner membrane drives the synthesis of ATP. This whole process is referred to as the oxidative phosphorylation (Nicholls & Ferguson 2002). Hence, one main function of mitochondria is to couple respiration (*i.e.* O₂ consumption) and nutrient oxidation to ATP synthesis, but interestingly this coupling (also defined as mitochondrial efficiency) demonstrates a certain degree of plasticity (Brand 2000; Divakaruni & Brand 2011).

According to the idea that usable resources can constrain individual investment toward competing life history traits, one could suggest that natural selection should have favour a tight coupling between O₂ consumption and ATP synthesis (*i.e.* a high mitochondrial efficiency), so that organisms can maximize their investments into life history traits and ultimately fitness. Nevertheless, not all the protons pumped during respiration are flowing back to the matrix via the ATP synthase. The leak of protons across the inner membrane has

for inevitable consequence a reduction in mitochondrial efficiency to produce ATP (Divakaruni & Brand 2011). Proton leakage can be substantial as it accounts for approximately 20% of the total respiration in various tissues from different organisms (reviewed in (Brand 2005)). Therefore, the persistence throughout evolution of high levels of mitochondrial uncoupling (*i.e.* the loss of coupling between O₂ consumption and ATP production) suggests that despite reducing the efficiency to produce ATP, mitochondrial uncoupling should provide some fitness-related advantages to organisms. One first advantage of diminishing mitochondrial efficiency to produce ATP by increasing proton leak is associated with the dissipation of the proton motive force as heat. This futile mitochondrial proton cycle is a thermogenic process and is used by endotherms to defend their body temperature against prolonged cold ambient temperatures (Cannon & Nedergaard 2004; Talbot *et al.* 2004). Yet, the basal proton leak occurs in endotherms as well as ectotherms (Brand 2005), suggesting that thermogenesis is probably not the primary function of mitochondrial uncoupling (Brand 2000; Criscuolo *et al.* 2005).

Another explanation for the evolutionary persistence of proton leakage comes from the strong impact of the proton gradient on the production of reactive oxygen species (ROS) by the mitochondria (Boveris & Chance 1973; Skulachev 1996; Korshunov *et al.* 1997). ROS are inevitable by-products of aerobic metabolism that are generated when electrons escape the mitochondrial electron transport chain during oxidative phosphorylation and react directly with molecular oxygen (Beckman & Ames 1998; Halliwell & Gutteridge 2007). Electron loss from the respiratory chain and concomitant ROS production are sharply declined at low mitochondrial membrane potential, which can be achieved either through high rates of oxidative phosphorylation or high rates of proton leakage (Brand 2000; Lambert & Brand 2004; Barja 2007; Murphy 2009; Mookerjee *et al.* 2010). When ROS production exceeds the antioxidant defences, it leads to a situation of 'oxidative stress' characterized by the occurrence of oxidative damage to diverse biomolecules such as nucleic acids, lipids and proteins (Sies 1985). Oxidative stress is thought to impair organism functioning and contribute to the ageing process according to the 'free radical theory of ageing' (Harman 1956; Beckman & Ames 1998; Balaban *et al.* 2005), and the persistence of high levels of mitochondrial proton leak might have evolved as a protection against oxidative stress and ageing, as proposed by the 'uncoupling to survive' hypothesis (Brand 2000). Furthermore, because of their universal nature and their intimate connection with energy

utilization, oxidative stress and ROS production have recently been suggested to be potential physiological mechanisms underlying life history trade-offs (Costantini 2008; Dowling & Simmons 2009; Monaghan *et al.* 2009; Metcalfe & Alonso Alvarez 2010).

Because mitochondrial coupling state is a key regulator of ATP and ROS production and because both the amounts of ATP and ROS produced are likely to influence life histories (Brand 2005; Salin *et al.* 2012a; 2012b), one hypothesis is that inter-individual variation in mitochondrial coupling state might account for the variations in life history trajectories frequently observed between individuals. In particular, individuals with a highly uncoupled metabolism are expected to produce fewer ROS and ATP molecules, which in turn could select for greater longevity but also lower amount of energy to invest into growth or reproduction. Few studies have addressed the importance of mitochondria functioning/efficiency in shaping animal life histories, and most of those studies were motivated by the ‘uncoupling to survive’ hypothesis, and therefore mostly focused on oxidative stress and longevity. Experiments in which individuals were treated with a mitochondrial uncoupler (*i.e.* the artificial protonophore 2,4-dinitrophenol, hereafter abbreviated DNP) demonstrated that mild mitochondrial uncoupling has for consequence to increase oxygen consumption rates in drosophila (Padalko 2005), *Rana temporaria* tadpoles (Salin *et al.* 2012a) and laboratory mice (Caldeira da Silva *et al.* 2008), but also to lower oxidative stress (mice and tadpoles) and to extend lifespan (drosophila and mice). Interestingly, DNP treatment was found to delay the development of tadpoles and lower the body mass gain of mice (Caldeira da Silva *et al.* 2008; Salin *et al.* 2012a). However, no studies have addressed so far the influence of such an uncoupling treatment on other life-history traits such as reproductive performances or immune responsiveness.

Here, we investigated the impact of a long-term experimental exposure to the mitochondrial uncoupler DNP on the life history trajectories of a small passerine bird: the zebra finch (*Taeniopygia guttata*). Avian models are known for their atypical combination of high metabolic rate and low ROS production (Holmes *et al.* 2001), which provides interesting ground to test the importance of the ‘uncoupling to survive hypothesis’. We hypothesised that increased mitochondrial uncoupling should lead to elevated metabolic rate and decreased oxidative stress levels, but at the expense of the investment toward other life history traits such as growth, reproduction, flight performances and immunity. We treated chronically adult birds with DNP for more than two years. We evaluated parameters related

to metabolism (body mass dynamics, food consumption, metabolic rate), oxidative stress markers (ROS production, antioxidant defences and oxidative damage), and a full set of life history traits (survival, reproductive performances, flight performances and immune competence). Complementary, we investigated the effects of our treatment on the metabolic rate and growth of chicks treated at the same time as their parents. Finally, we also tested the effects of DNP on mitochondrial functioning *in vitro*, in order to compare the effects of DNP on mitochondria isolated from skeletal muscles between the zebra finch and a size-matched mammalian model, the mouse. Indeed, preliminary *in vivo* analyses pointed contrasted findings between what we were observing in birds (this study; P. B., unpublished results in Japanese quails *Coturnix japonica*) and results previously reported for mice (Caldeira da Silva *et al.* 2008), asking thereby for insights on the effects of DNP at the mitochondrial level.

Materials and methods

Animals and experimental design

The study complied with the 'Principles of Animal Care' publication no.86-23, revised 1985 of the National Institute of Health, and with current legislation (L87-848) on animal experimentation in France. The experiment was performed on 60 primiparous adult zebra finches (30 females and 30 males) of approximately 6-month-old coming from our own husbandry. Birds were housed at 24°C on a 13 L : 11 D light cycle and provided with food *ad libitum* (commercial mix of seeds for exotic birds enriched with vitamins and eggs).

We divided our experiment in four steps. The first step of the experiment (2 months) served to measure baseline values for body mass, metabolic rate, flight performances and plasma oxidative balance before the beginning of the DNP treatment.

In the second step (6 months), half of the birds were kept with water *ad libitum*, whereas the other half was switched to the DNP treatment (20mg.L⁻¹ of 2,4-dinitrophenol diluted in drinking water). This second step was conducted to assess effects of our treatment on body mass (after 1, 3 and 6 months of treatment), food consumption, metabolic rate, immune competence, flight performances and oxidative stress markers.

In the third step (8 months), the treatment remained unchanged but birds were allowed to reproduce. Birds were kept as unisex pairs in cages of 0.57 x 0.31 x 0.39 m during the steps 1 and 2, whereas they were kept as breeding pairs in step 3. We randomly formed breeding pairs within each experimental group, provided them with a nestbox and nesting material, and allowed animals to freely breed repeatedly. Chicks were weaned 35 days after hatching, and they were subsequently kept on water or DNP solution, depending of the experimental group of their parents (*i.e.* chicks were then continuously maintained under control or DNP treatment from embryonic stage onwards). We also conducted measurements on chicks coming from this experiment to determine metabolic rate, growth rate and oxidative stress markers (at 10, 30 and 120 days).

In the last step, we reconstituted unisex pairs and follow birds over a period up to 18 months to assess their survival. Treatment remained unchanged, with birds being either fed with water or DNP according to their treatment attributed in step 2.

The DNP dose ($\approx 4\text{mg}\cdot\text{kg}^{-1}\cdot\text{day}^{-1}$ for an average bird weighing 15.0g and drinking 3.0mL of water per day (Calder 1964)) was chosen after a pilot experimentation on 15 birds demonstrating that a lower dose ($5\text{mg}\cdot\text{L}^{-1}$) was insufficient to affect noticeably the metabolic rate, whereas the chosen one ($20\text{mg}\cdot\text{L}^{-1}$) increased moderately the metabolic rate of birds ($\approx 20\%$) without apparent deleterious effect. We excluded the use of a higher dose ($50\text{mg}\cdot\text{L}^{-1}$), since it was associated with potentially deleterious effects (*i.e.* moderate hyperthermia and decreased water consumption). Drinking water was replaced twice a week, and the DNP solution was freshly prepared each time.

Food consumption

We measured food consumption two weeks after the beginning of the treatment (step 2). We monitored food consumption for each bird during a period of ten days during which the birds were kept in individual cages. We weighted bird feeders every two days at 10:00 am to determine the amount of seeds consumed by each bird, and we used the average food consumption of these five measurements to determine the daily food consumption ($\text{g}\cdot\text{day}^{-1}$).

Metabolism

For adult birds (N = 60), oxygen consumption (VO_2 expressed in mL O_2 consumed per minute) was determined both one month before and one month after the beginning of the treatment (*i.e.* in steps 1 and 2), at thermoneutrality (30°C). We recorded O_2 consumption

with an open flow respirometry system (Sable System, USA) during 4 hours (8:00 to 12:00am) after one-night of acclimation (without food, but with water or DNP solution *ad libitum*). We paid attention to equilibrate our experimental groups between the four metabolic chambers of the respirometry system, and each bird was measured in the same metabolic chamber both before and after the start of the treatment. We included the metabolic chamber as a co-factor in statistical analysis to take into account variations between our four metabolic chambers. We analysed both the average of these 4 hours (mean VO_2) and the average of the three lower values (resting VO_2), which is a better indicator of resting metabolism. Birds were weighed at the start and at the end of the metabolic measurement, and we included the average body mass as a covariate in statistical model to control for body mass effect on metabolism.

We also determined the resting metabolism (30°C) for a sub-sample of chicks 12 days after hatching (Control: N = 14 / DNP: N = 20). We recorded O_2 consumption (in the dark to reduce chick's movements and stress) during 30 minutes with a portable open flow respirometry system (FOXBOX, Sable System, USA). We defined the resting VO_2 as the lowest consecutive two minutes within the 30 minutes recording.

Oxidative stress measurements

The production of superoxide by the mitochondria of blood cells was determined for adult birds (N = 60) following the protocol fully described in Stier et al. (2013), 6 to 8 weeks after the beginning of the treatment (*i.e.* in step 2 but not in step 1). Briefly, we used the specific fluorescent probe MitoSOX Red (Molecular Probes, Life Sciences) to assess the production of mitochondrial superoxide, which was detected using a flow cytometer (FACScalibur, BD Bioscience). A T_0 acquisition was done for each sample and after 30 min of incubation at 40°C, and a second acquisition (T_{30}) was made to evaluate the change in mitochondrial superoxide levels. We expressed superoxide production as the increase in red fluorescence per minute ($RF \cdot \text{min}^{-1}$).

The plasma antioxidant capacity and the concentration of Reactive Oxygen Metabolites (ROMs) were measured using the OXY-Adsorbent (5 μL of 1:100 diluted plasma) and d-ROMs tests (5 μL of plasma, Diacron International, s.r.l, Italy) following the manufacturer protocols. We measured these two parameters on adult birds (N = 60) both before (step 1) and approximately three months after the beginning of the treatment (step 2), and on chicks at day 10 (Control: N = 30 / DNP: N = 29), day 30 (Control: N = 22 / DNP: N =

21) and day 120 (Control: N = 9 / DNP: N = 13). OXY adsorbent test allows quantifying the ability of the plasma antioxidant barrier to buffer massive oxidation through hypochlorous acid, while the d-ROMs test measures hydroperoxydes, as a marker of global early oxidative damage. Antioxidant barrier is expressed as μM of HClO neutralised per mL, and ROMs as mg of H_2O_2 equivalent.dL⁻¹. Intra-individual variation based on duplicates was low (respectively CV = $4.21 \pm 0.60\%$ for the OXY test and CV = $3.90 \pm 0.56\%$ for the d-ROMs test) as well as inter-plate variation based on a standard sample repeated over plates (CV = 8.46% for OXY and 6.95% for d-ROMs test).

We also measured different parameters of oxidative stress in tissues (pectoral muscle and heart) on a sub-sample of chicks at day 120 (Control: N = 12 / DNP: N = 12). Birds were culled by cervical dislocation, and tissues were immediately collected and flash frozen in liquid nitrogen. Glutathione content and the proportion of oxidized glutathione were determined using DetectX[®] Glutathione fluorescent detection kit (Arbor Assays), following manufacturer instructions. Glutathione (GSH) plays a key role in many biological processes including the protection of cells against oxidation. GSH is used as a reductant by the enzyme glutathione peroxidase to scavenge deleterious hydrogen peroxide. The oxidized form of glutathione (GSSG) can be restored into GSH by the action of the enzyme glutathione reductase (GR). We evaluated the total glutathione content as an indicator of antioxidant protection and the ratio GSSG/total glutathione (which represent the proportion of oxidized glutathione) as an indicator of the oxidative challenge (*i.e.* the pro-oxidant power buffered by the glutathione system). Values are respectively expressed as nmol total glutathione.mg⁻¹ protein, and as a ratio of oxidized glutathione/total glutathione (0 meaning that all glutathione is free GSH, and 1 meaning that all glutathione is oxidized (GSSG)). Intra-individual variation based on duplicates was of: CV = $1.76 \pm 0.43\%$. We also determined the enzymatic activity of the glutathione reductase (GR) using DetectX[®] Glutathione Reductase fluorescent kit (Arbor Assays), following manufacturer instructions. GR plays an indirect but essential role in the prevention of oxidative damage within the cell by helping to maintain appropriate levels of intracellular free glutathione (GSH). Enzymatic activity is expressed as mU.mg⁻¹ protein. Intra-individual variation based on duplicates was low (CV = $5.86 \pm 1.61\%$). Finally, we determined oxidative damage on lipids (lipid peroxidation) by measuring the levels of malondialdehyde (MDA), using a protocol adapted for microplate analysis (lipid

peroxidation microplate assay kit, Oxford Biomedical Research). MDA levels are expressed as nmol.mg⁻¹ protein. Intra-individual variation based on duplicates was of: CV = 8.87 ± 2.28%.

Flight performances

Vertical flight performances were measured on a sub-sample of adult birds (Control: N = 20 / DNP: N = 20) both 1-2 months before the start of the treatment and 1-2 months after the beginning of the treatment (*i.e.* in steps 1 and 2). Vertical flight speed was measured using vertical take-off when alarmed. To test flight ability we used a set-up adapted from the one used by Criscuolo *et al.* (2011). Measurements were made in a vertical plastic tube, and birds were trained two times, 2 to 5 days before the experimental trials. Each bird was released on a perch situated at 20 cm from the ground, at the base of a transparent vertical plastic tube. At the top of the flight tube (120 cm from the first perch), there was a perch where the bird could be collected after each flight. For the training trials as well as for the experimental trials, birds were released five times in the tube and were allowed to rest for 60 seconds between each flight. During the experimental trials, all flights were video recorded with a high-speed video camera (Casio high-speed EX-FH100, 420 frame.s⁻¹). To determine flight speed (m.s⁻¹), we analysed the videos and calculated the time taken by the birds to cover a distance of 40 cm (one frame covering 0.0024s - videos were analysed using Avidemux 2.5[®]). We analysed both the mean and the maximum flight speed, the second being considered as a better indicator of the bird's escape flight ability.

Immune parameters

We subjected a sub-sample (males, Control: N = 15 / DNP: N = 15) to a phytohaemagglutinin (PHA) skin-swelling test, five months after the beginning of the treatment (*i.e.* during step 2). This test assays the pro-inflammatory response to a foreign plant protein, which is mainly linked to the accumulation of small lymphocytes and the infiltration of macrophages (Smits *et al.* 1999; Vinkler *et al.* 2010). To conduct the PHA test, we measured the right wing web of each bird three times with a digital micrometer (±0.02mm; Mitutoyo, Japan) to obtain an average pre-swelling measurement and then injected this area with 100µg of PHA-P (Sigma Chemical Co., St. Louis, MO) diluted in 20 µl of phosphate-buffered saline (PBS). The birds were measured a second time 24 h after the injection, and we present the results as the difference between mean post-injection swelling and mean pre-injection-swelling (*i.e.* wing web swelling index).

We also evaluated the constitutive innate humoral immunity for the same sub-sample of birds, using a hemolysis-hemagglutination assay described extensively by Matson *et al.* (2005). Briefly, such a test allows determining two elements of the innate immunity, namely the NAbs (natural antibodies) and the complement, using the ability of plasma samples to provoke lysis / agglutination of rabbit erythrocytes *in vitro*. We evaluated lysis and agglutination scores according to Matson *et al.* (2005). Lysis score reflects the interaction of complement and NAbs, whereas agglutination score reflects NAbs only.

Growth analysis

Body mass of chicks was recorded every morning from hatching to day 30, using an electronic balance (0.1g precision). Body mass growth was fitted for chicks surviving up to 30 days (control group: N = 22, DNP group: N= 21), with the following logistic equation:

$$Y(x) = \frac{A}{[1 + \exp(-K * x - B)]}$$

$Y(x)$ represents the body mass of a chick at age x (g), A is the

asymptotic-final mass, K is the growth rate constant (an increase in K value implies an increase in the rate at which mass increases from initial value to asymptotic value) and B is a constant linked to the initial mass. Growth fitting was performed with the nonlinear regression procedure in SPSS (SPSS 20.0 © 1989-2011 SPSS Inc., USA) for each chick, and the minimum R^2 for model fitting was 0.96 across all chicks.

***In vitro* mitochondrial respiration and ROS production in adult zebra finches versus laboratory mice**

We conducted *in vitro* experiments to investigate the effects of an artificial uncoupling on ROS production by zebra finch mitochondria, compared to a size-matched mammalian model, the mouse. To do so, we compared the results obtained on mitochondria isolated from zebra finch skeletal muscles with mitochondria isolated from mouse muscles. Nine individuals of each species (males, 3 months old C57BL/6 mice and 8 months old zebra finches) were killed by cervical dislocation, and skeletal muscles (hind feet for mice and a mix of hind feet and pectoral muscle for zebra finches) were immediately collected and rinsed in ice-cold isolation medium (100mM sucrose, 50mM KCl, 5mM EDTA, 50mM Tris-base and pH 7.4). All the following steps were carried out at 4°C. Briefly, muscles were cut up finely, diluted 1:10 (w/vol) in ice-cold isolation medium and homogenized with a potter Elvehjem. Samples were subsequently treated with protease (1mg.g⁻¹ muscle wet mass) for 5 min, then diluted 1:2 in isolation medium and homogenized a second time. The mixture

was centrifuged (10 min at 1000g) and the resulting supernatant containing muscle mitochondria was filtered through cheesecloth and centrifuged two times at 8700g for 10min. We determined the protein concentration of mitochondrial suspensions in duplicates using a Biuret method with bovine serum albumin (BSA) as standard.

Oxygen consumption was recorded with a Clark oxygen electrode (Rank Brothers Ltd, UK) in 1mL of respiration buffer (120mM KCl, 5mM KH_2PO_4 , 1mM EGTA, 2mM MgCl_2 , 0.3% BSA, 3mM Hepes and pH 7.4). Muscle mitochondria ($0.25 \text{ mg protein.mL}^{-1}$) were incubated either with 5mM succinate or 5mM pyruvate-2.5 mM malate as substrate. We used these two different substrates because mitochondrial ROS production is likely to differ in magnitude (succinate > pyruvate-malate), in origin (mainly reverse electron transport with succinate) and in response to uncoupling (higher response with succinate) according to the type of substrate used (Votyakova 2001). We added increasing concentrations of DNP to induce a progressive uncoupled state (i.e. 4, 20, 40, 60, $100\mu\text{M}$), in order to compare the response of zebra finch and mice mitochondria to this chemical uncoupling. Classical mitochondrial respiration measurements (state 2, 3 and 4) were conducted in order to ensure that mitochondrial preparations were of sufficient quality (data not shown).

In addition, we determined ROS production by isolated mitochondria using an H_2O_2 -based detection, in the exact same conditions than those used for mitochondrial respiration measurements. Briefly, the respiratory medium (1mL) was supplemented with 1U.mL^{-1} horseradish peroxidase and $10\mu\text{M}$ Amplex[®] red reagent (Invitrogen, USA). Amplex[®] red fluorescence was quantified using a fluorescence spectrophotometer (Xenius, Safas, Monaco) at excitation and emission wavelength of 563 and 587nm respectively. The fluorescent signal was converted into H_2O_2 equivalents ($\text{pmol.min}^{-1}.\text{mg}^{-1}$) using a standard curve prepared with H_2O_2 .

Statistics

We tested the effect of the DNP treatment on the variables collected on adult birds using either general linear models (for parameters measured only one time) or repeated general linear models (for parameters measured repeatedly over time). The treatment was included as a fixed factor, and we included bird's ID as the repeated factor (when needed) and sex as a co-factor.

We specifically analyzed data on reproduction (*i.e.* number of reproductive events, clutch size and brood size) using generalized linear models following a Poisson distribution,

with the nest as the statistical unit. We also analyzed scores coming from the hemolysis-hemagglutination assay (*i.e.* also count data) using similar statistical models.

We analysed data on chicks using linear mixed models, with the treatment as a fixed factor and the nest as a random factor to take into account that chicks coming from one nest are not independent statistical units.

We analysed data of the *in vitro* comparison between mouse and zebra finch mitochondrial respiration rate and H₂O₂ production using repeated general linear models. The species was included as a fixed factor and the concentration of DNP (0, 4, 20, 40, 60, 100 µM) was included as the repeated factor. When a significant interaction “Species x DNP” was detected, we subsequently analysed each species separately.

General linear and linear mixed models were fitted with a normal error distribution (SPSS 20.0), and data were tested for normality and homoscedasticity. All tests were two-tailed tests and p values ≤ 0.05 were considered significant. Means are always quoted ± S.E.

Results

1] Phenotypic parameters

Body mass & food consumption

Body mass was neither significantly affected by the treatment (control = 14.9 ± 0.2 g vs. DNP = 14.7 ± 0.1 g, p = 0.32) nor the time period (p = 0.23). Females were significantly heavier than males (males = 14.5 ± 0.2 g < females = 15.1 ± 0.1 g, p = 0.002) (table 1a). DNP-treated birds had significantly higher food consumption than control birds (control = 3.93 ± 0.10 g.day⁻¹ < DNP = 4.47 ± 0.10 g.day⁻¹, p < 0.001; table 1b). Daily food consumption was higher for males and positively correlated with body mass (respectively p = 0.040 and p = 0.009, table 1b).

Table 1: Results of general linear models testing differences between control and DNP treated zebra finches in terms of body mass dynamics (a) and daily food consumption (b). Body mass was measured both before and several times after the beginning of the treatment. Estimates for fixed factors are given for the following levels: Treatment = control; Sex = female; Time = 6 months (see methods for details).

(a) Body mass (g)		Estimate	SE	F	p-value
Repeated effect	ID	2.55	0.24		
Fixed effects & covariates	Constant	14.00	0.25	20565.18	< 0.001
	Treatment	0.20	0.21	0.99	0.320
	Sex	0.65	0.21	9.98	0.002
	Time	0.52	0.29	1.44	0.230
(b) Daily food consumption (g.day⁻¹)					
Fixed effects & covariates	Constant	3.01	0.58	19.58	< 0.001
	Treatment	-0.54	0.13	17.78	< 0.001
	Sex	-0.27	0.13	4.42	0.040
	Body mass	0.11	0.04	7.43	0.009

Metabolism

DNP-treated adult birds presented overall elevated metabolic rates, either in terms of mean VO_2 (table 2a) or resting VO_2 (table 2b), but only after the beginning of the treatment as revealed by the significant Time x Treatment interactions (respectively $p = 0.045$ and $p = 0.004$, table 2, fig. 1). Body mass was a significant predictor of mean (table 2a: $p < 0.001$) and resting VO_2 (table 2b: $p = 0.005$). Of note, the metabolic chamber in which the bird was measured affected our absolute measurements of VO_2 , and thus we controlled for this effect in our analyses (table 2a: $p < 0.001$, table 2b: $p < 0.001$) and in our experimental design (see *Materials & Methods*).

The resting metabolism of chicks measured at day 12 post-hatching was affected by the treatment of their parents, with chicks presenting higher resting VO_2 in DNP than control treatment (treatment effect: $F = 9.90$ and $p = 0.021$, mass effect: $F = 10.34$ and $p = 0.008$, fig. 1).

Table 2: Results of general linear models testing differences between control and DNP treated zebra finches in terms of mean (a) and resting (b) metabolic rate (VO₂). Measurements metabolic rates were conducted both before and after the beginning of the treatment (Time). Estimates for fixed factors are given for the following levels: Treatment = control; Time = after treatment; Time*Treatment = after treatment*control; Chamber = Chamber n°1 (see methods for details).

(a) Mean VO ₂ (mL.min ⁻¹)		Estimate	SE	F	p-value	
Repeated effect		ID	0.036	0.005		
Fixed effects & covariates		Constant	0.73	0.16	23.81	< 0.001
	Treatment	-0.02	0.05	6.25	0.014	
	Sex				ns	
	Time	0.24	0.05	22.28	< 0.001	
	Time*Treatment	-0.14	0.07	4.11	0.045	
	Chamber	0.32	0.05	51.25	< 0.001	
	Body mass	0.04	0.01	13.21	< 0.001	
(b) Resting VO ₂ (mL.min ⁻¹)		Estimate	SE	F	p-value	
Repeated effect		ID	0.036	0.004		
Fixed effects & covariates		Constant	0.72	0.16	23.09	< 0.001
	Treatment	-0.02	0.05	10.71	0.001	
	Sex				ns	
	Time	0.25	0.05	16.70	< 0.001	
	Time*Treatment	-0.21	0.07	8.71	0.004	
	Chamber	0.30	0.01	46.66	< 0.001	
	Body mass	0.03	0.01	8.13	0.005	

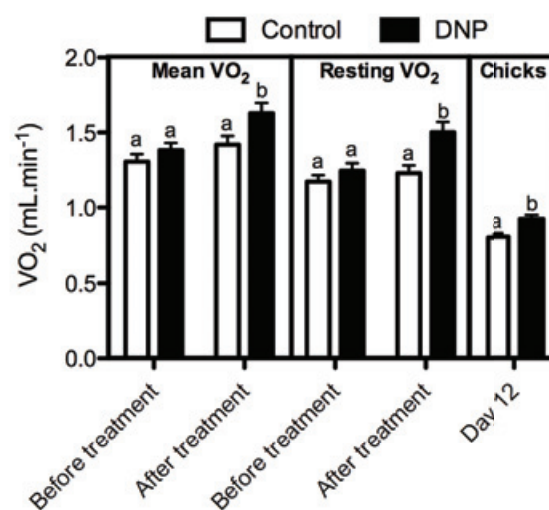
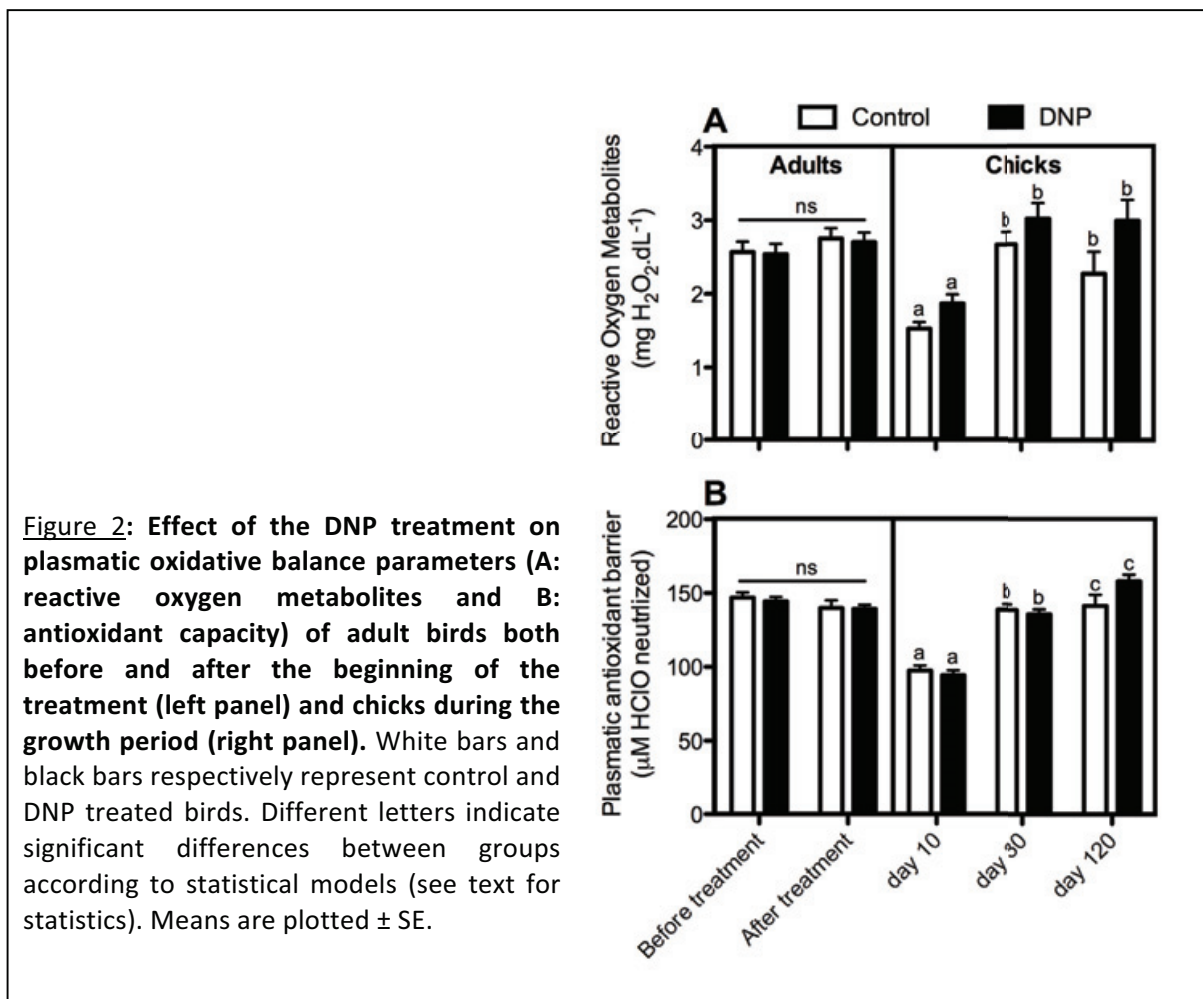

Figure 1: Effect of the DNP treatment on metabolic rate of adult birds (mean and resting VO₂, respectively left and central panel) and 12 days old chick's (right panel). White bars and black bars respectively represent control and DNP treated birds. Different letters indicate significant differences between groups according to statistical models (see table 2 and text for statistics). Means are plotted ± SE.

Oxidative balance

Mitochondrial superoxide production of adult birds was not significantly affected by the treatment (control = $0.130 \pm 0.040 \text{ RF}\cdot\text{min}^{-1}$ vs. DNP = $0.139 \pm 0.047 \text{ RF}\cdot\text{min}^{-1}$, $F = 0.60$ and $p = 0.44$) or the sex ($F = 1.50$ and $p = 0.23$). Similarly, the plasma concentration of ROMs was not significantly affected by the experimental treatment ($F = 0.07$ and $p = 0.79$, fig. 2A), the sex ($F = 0.17$ and $p = 0.68$) or the time period ($F = 1.55$ and $p = 0.22$). We found similar results for chicks, since we did not find a significant effect of the treatment ($F = 2.67$ and $p = 0.13$, fig. 2A) despite a significant effect of age ($F = 32.18$ and $p < 0.001$). The plasma antioxidant capacity of adult birds was not significantly affected by treatment ($F = 0.15$ and $p = 0.70$, fig. 2B), sex ($F = 1.31$ and $p = 0.25$) or time period ($F = 2.68$ and $p = 0.10$), nor was the antioxidant capacity of chicks (treatment effect: $F = 0.11$ and $p = 0.74$, fig 2B) despite, here again, a significant effect of age ($F = 148.49$ and $p < 0.001$).



We did not find any significant changes in chick oxidative stress markers measured in the pectoral muscle and in the heart following the DNP treatment. Indeed, the total glutathione content did not significantly differ between groups, neither in the pectoral muscle ($F = 0.13$ and $p = 0.72$) nor in the heart ($F = 0.70$ and $p = 0.41$, fig. 3A). Accordingly, the proportion of oxidized glutathione (GSSG/GSH) was not significantly affected by the DNP treatment, neither in the pectoral muscle ($F = 1.14$ and $p = 0.30$) nor in the heart ($F = 0.02$ and $p = 0.88$, fig. 3B). The enzymatic activity of the glutathione reductase (respectively $F = 2.30$ and $p = 0.14$ in the pectoral muscle; and $F = 0.23$ $p = 0.64$ in the heart, fig. 3C) and the level of lipid peroxidation ($F = 0.43$ and $p = 0.52$ in the pectoral muscle; $F = 0.81$ and $p = 0.38$ in the heart, fig. 3D) were not significantly affected by the DNP treatment.

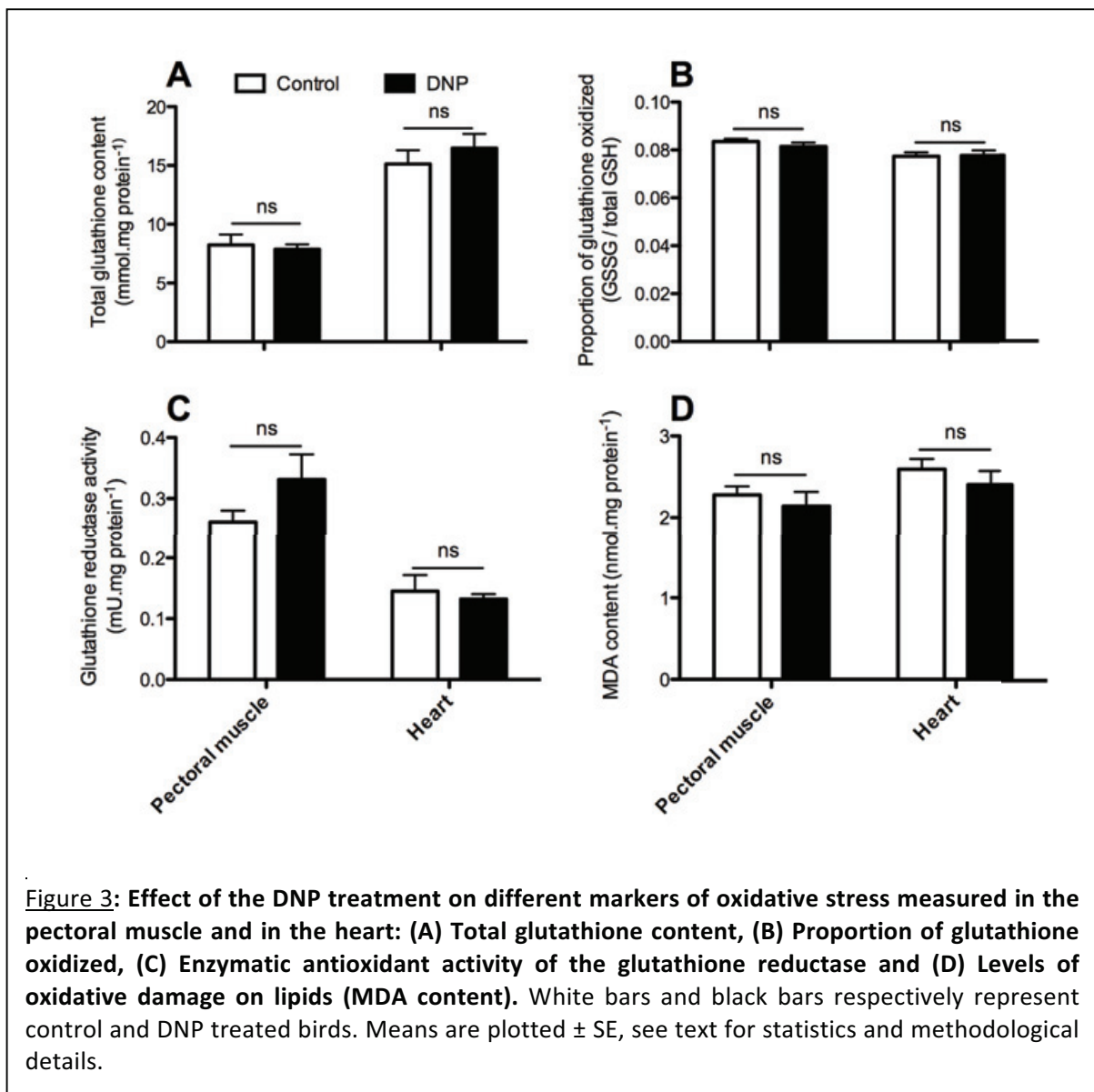

II] Life-history parameters

Survival

About 30% of adult birds (17 of 60) died naturally during our experimental study, yet at a non-significantly different rate between DNP-treated and control birds (Kaplan-Meier survival analysis: $\chi^2 = 0.69$ and $p = 0.41$, fig. 4).

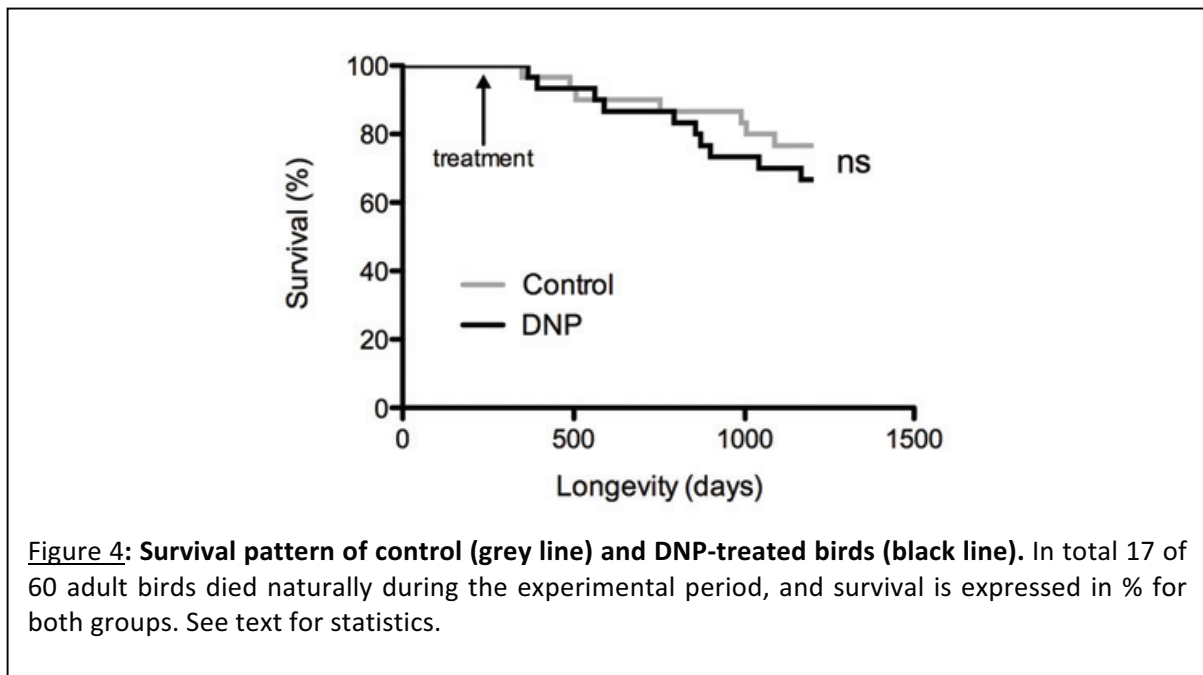

Reproduction

The experimental uncoupling treatment did not significantly affect the number of reproductive events initiated by the breeding pairs during the 8 months period (Wald $\chi^2 = 2.05$ and $p = 0.15$, fig. 5). However, the total number of eggs produced during this period was significantly lower for the DNP breeding pairs (Wald $\chi^2 = 4.05$ and $p = 0.044$, fig. 5), yet the number of fledged chicks remained unchanged between experimental groups (Wald $\chi^2 = 0.02$ and $p = 0.88$, fig. 5).

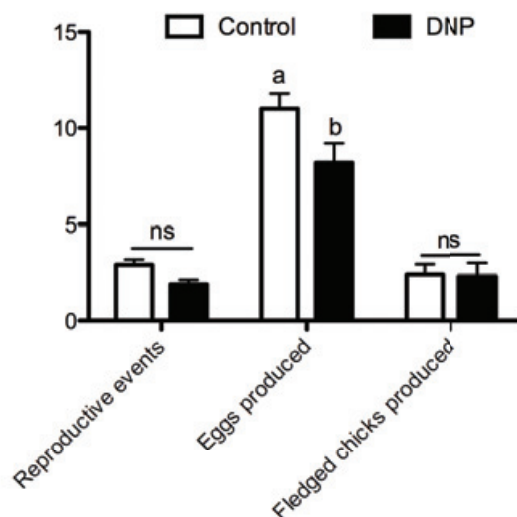

Figure 5: Reproductive performances: number of reproductive events initiated, number of eggs produced and number of chicks that fledged successfully; of control (white bars) and DNP-treated breeding pairs (black bars). Breeding pairs were randomly constituted and birds were allowed to reproduce freely during a period of 8 months. Different letters indicate significant differences between groups according to statistical models (see text for statistics). Means are plotted \pm SE.

Flight performances

DNP treatment did not significantly affect mean and maximum flight speeds ($F = 0.30$, $p = 0.58$; and $F = 0.11$, $p = 0.73$, respectively, fig. 6). Flight speeds increased with training ($F = 10.58$, $p = 0.02$; and $F = 5.99$, $p = 0.017$, respectively for mean and maximum flight speed, fig. 6) but did not differ between sexes ($F = 0.86$, $p = 0.36$; and $F = 0.03$, $p = 0.86$, respectively).

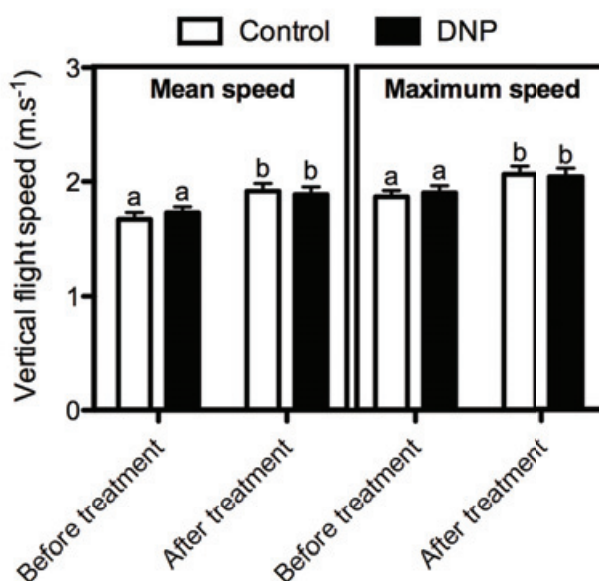
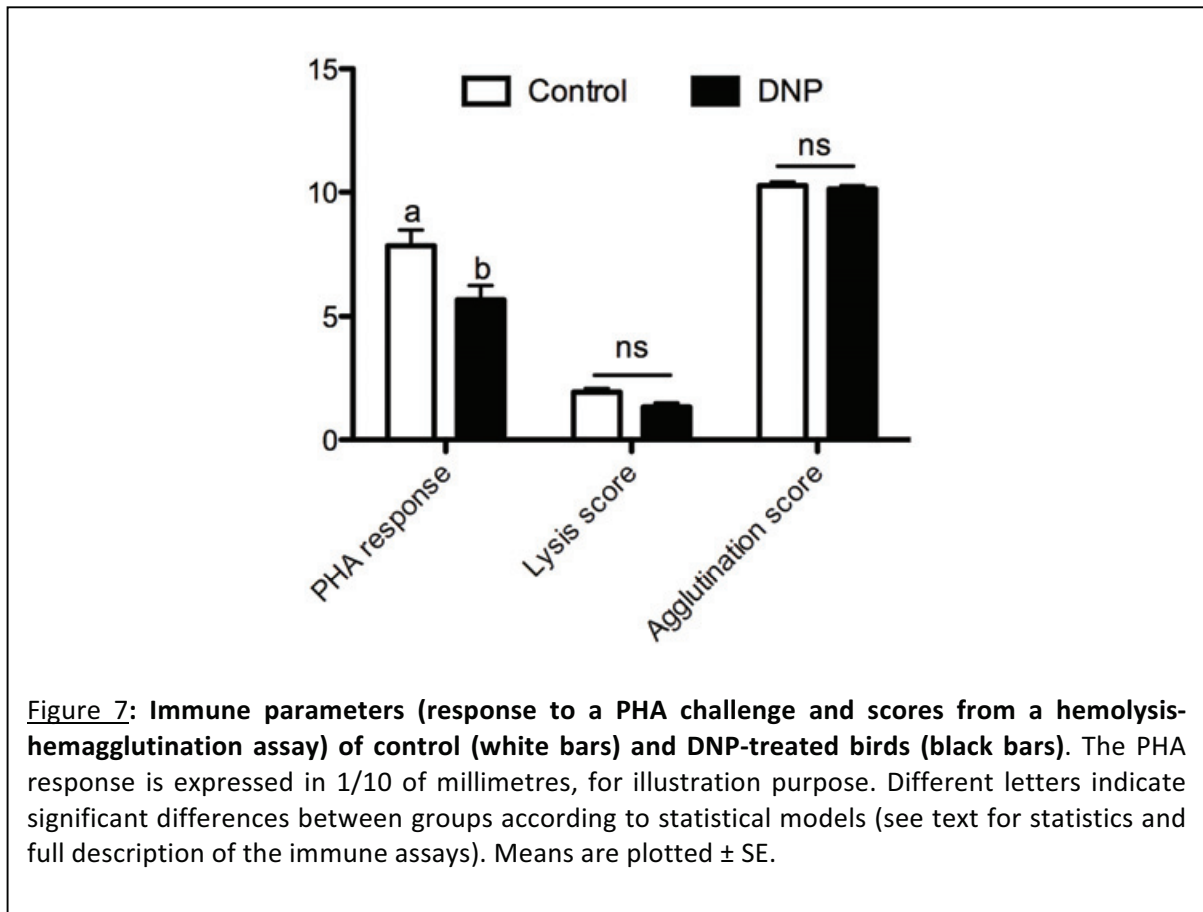

Figure 6: Flight performances (left panel: mean flight speed / right panel: maximum flight speed) of control (white bars) and DNP-treated birds (black bars), measured both before and after the beginning of the treatment. Different letters indicate significant differences between groups according to statistical models (see text for statistics). Means are plotted \pm SE.

Immunity

DNP treatment significantly reduced the response to a PHA immune challenge ($F = 6.35$ and $p = 0.018$; fig. 7). We did not find any significant effect of the treatment on parameters measured by the hemolysis-hemagglutination assay (lysis score: Wald $\chi^2 = 1.63$ and $p = 0.20$, agglutination score: Wald $\chi^2 = 0.01$ and $p = 0.91$, fig. 7).



Growth

We did not find significant effects of the DNP treatment on chick growth trajectories measured by their logistic growth rate (K : control = 0.426 ± 0.014 vs. DNP = 0.423 ± 0.019 , $F = 0.05$ and $p = 0.83$) and their asymptotic mass (A : control = 11.98 ± 0.26 g vs. DNP = 11.98 ± 0.25 g, $F = 0.00$ and $p = 1.00$).

III] Impact of DNP on mitochondria functioning measured *in vitro* between zebra finch and mouse

Mitochondrial respiration rate fuelled with pyruvate-malate (fig. 8A) was significantly affected by the species (mouse > zebra finch, $F = 4.70$, $p = 0.045$) and the concentration of DNP ($F = 18.67$, $p < 0.001$), but not by the interaction between these two parameters (Species x DNP: $F = 1.49$, $p = 0.22$). An opposite trend on mitochondrial respiration rate between the two species was found using succinate as substrate (mouse < zebra finch, $F = 9.27$, $p = 0.008$, fig. 8B). Succinate-fuelled respiration was significantly influenced by the interaction between these two parameters (Species x DNP: $F = 2.78$, $p = 0.032$). Separate analyses for each species revealed that the addition of increasing concentrations of DNP increased respiration rate until a dose of $20\mu\text{M}$ in the mouse and $40\mu\text{M}$ in the zebra finch (DNP effect: $F = 33.90$, $p < 0.001$ and $F = 21.23$, $p < 0.001$ for mouse and zebra finch respectively), while higher doses were inhibitory in both species (fig. 8B).

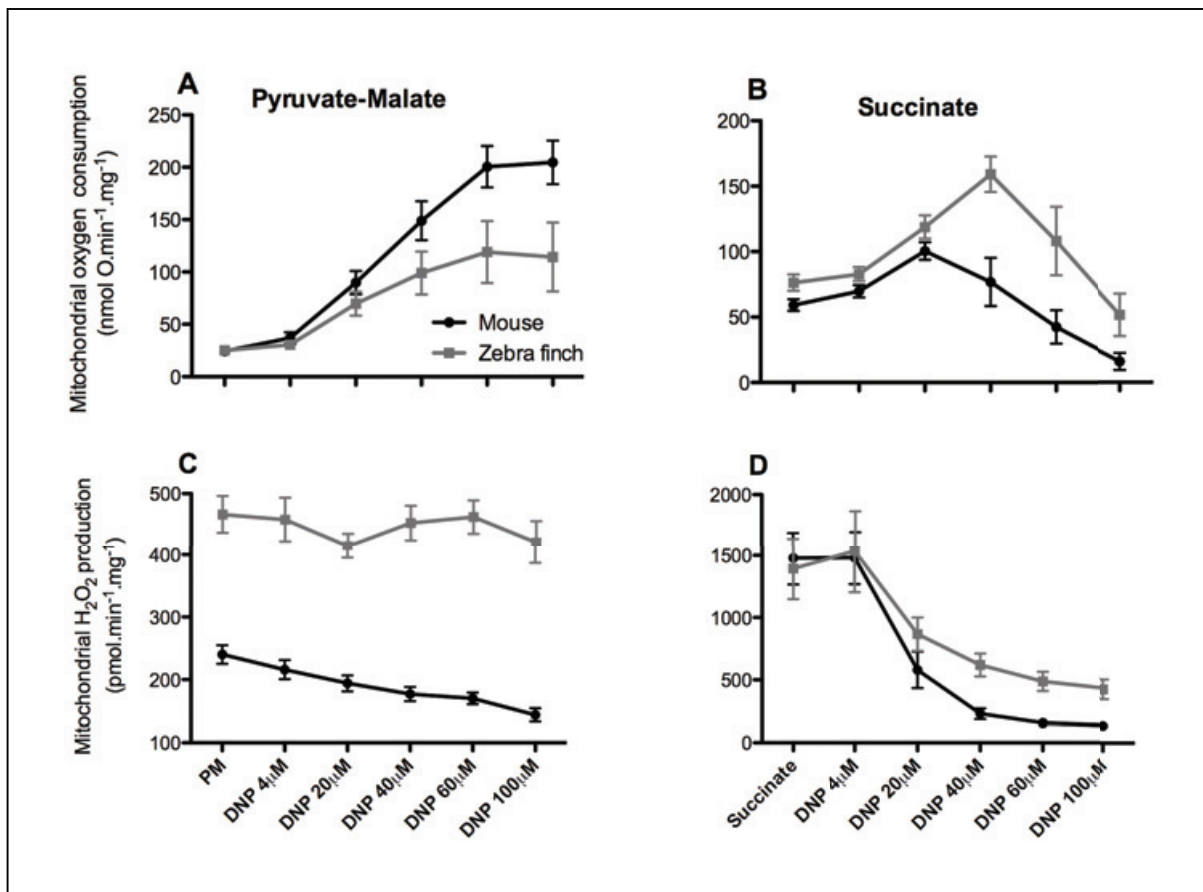

Figure 8: *In vitro* responses to a progressive artificial uncoupling (increasing concentrations of 2,4-dinitrophenol) of mitochondria isolated from zebra finches (grey) and mice (black) skeletal muscles, in terms of mitochondrial oxygen consumption (A-B) and ROS production (C-D). The measurements represented on the left panel (A-C) were conducted using 2.5mM of pyruvate-malate as substrate, while the measurements on the right panel (B-D) were obtained using 5mM of succinate as substrate (see text for statistics). Means are plotted \pm SE.

When using pyruvate-malate as substrate, mitochondrial H₂O₂ production was significantly different between the two species (mouse < zebra finch, $F = 93.83$, $p < 0.001$, fig 8C), H₂O₂ production being also modulated by DNP concentrations ($F = 6.48$, $p = 0.001$), but differently according to the species considered (Species x DNP: $F = 3.87$, $p = 0.010$). The addition of increasing concentrations of DNP decreased significantly H₂O₂ production for mice ($F = 34.18$, $p < 0.001$), but not for zebra finches ($F = 1.87$, $p = 0.16$, fig. 8C). Mitochondrial H₂O₂ production using succinate as substrate (fig. 8D) was also significantly affected by the concentration of DNP ($F = 16.70$, $p < 0.001$) and by the interaction between the species and the dose of DNP (Species x DNP: $F = 5.62$, $p = 0.001$), but not significantly by the species alone ($F = 1.22$, $p = 0.29$). For both species the addition of increasing concentrations of DNP decreased significantly H₂O₂ production (mouse: $F = 20.58$, $p < 0.001$; zebra finch: $F = 13.87$, $p < 0.001$), but apparently to a greater extent in the mouse (fig. 8D).

Discussion

In the present study, by treating over up to 32 months captive zebra finches with the mitochondrial uncoupler DNP we aimed testing the importance of mitochondrial coupling state (*i.e.* efficiency) in determining bird life history trajectories. As previously reported in the mouse (Caldeira da Silva *et al.* 2008) and *Rana temporaria* tadpoles (Salin *et al.* 2012a) and in agreement with the expected pharmacological effects of DNP (see Harris & Cocoran 1995 for a review), treated birds exhibited significantly higher energy expenditure than control ones. However, we found no evidence that long-term exposure to the uncoupler DNP can help nestling or adult birds to mitigate their exposure to oxidative stress (for positive findings, see (Caldeira da Silva *et al.* 2008; Salin *et al.* 2012a)) and live longer (for positive findings, see (Padalko 2005; Caldeira da Silva *et al.* 2008)). Interestingly, our results demonstrate moderate but nonetheless significant effects of elevated mitochondrial uncoupling on life history trajectories of adult zebra finches, as measured by a reduction in their immune responsiveness to a PHA test and in the total number of eggs produced by females. Additional *in vitro* experiments on isolated mitochondria from adult zebra finches and mice (*i.e.* a size-matched mammalian species) highlight that ROS production might be less sensitive to mitochondrial uncoupling in birds than mammals. This lower *in vitro*

sensitivity to DNP might at least partially explain the discrepancies at the whole organism level between our results and previous ones in mammals (Caldeira da Silva *et al.* 2008).

Mitochondrial uncoupling and whole organism body mass and metabolism

The long-term administration of DNP had no significant effects on body mass dynamics of treated adult birds and chicks compared to control ones. This contrasts with previous findings in mice (Caldeira da Silva *et al.* 2008) showing a clear reduction in body mass/mass gain of individuals treated with the same molecule. As previously reported in birds (Gleeson 1986; Dominguez 1993) and many other animals (see (Harris & Cocoran 1995) for a review), our chronic uncoupling treatment with DNP led to a moderate but consistent increase in metabolic rates of adult birds and chicks (+22.7% and +20.7% for mean and resting metabolic rate in adults and +14.6% in chicks), and we found a similar effect for a sub-group of birds measured a second time (below the thermoneutral zone) 20 months after the beginning of the treatment (25°C: +18.3% in terms of resting VO₂, data not shown). Because DNP treated birds increased by 13.7% their food consumption compared to control ones, one hypothesis is that greater energy intake allowed DNP treated birds maintaining a similar body mass as control birds. There was no evidence for feeding compensatory mechanisms in studies on mice (Caldeira da Silva *et al.* 2008) and frog tadpoles (Salin *et al.* 2012a). Of note, an increase in mitochondrial biogenesis can also be invoked to compensate the loss of efficiency linked to the DNP treatment, as it has been shown for laboratory rats treated for 28 days with 30mg.kg⁻¹.day⁻¹ of DNP (Schlagowski *et al.*, *pers. com.*).

Mitochondrial uncoupling and whole organism oxidative balance and survival

The 'uncoupling to survive' hypothesis stipulates that mild mitochondrial uncoupling can reduce the production of ROS, and in so doing prevent the accumulation of oxidative damage and allow organisms to live longer (Brand 2000). Accordingly, laboratory mice with high natural levels of mitochondrial uncoupling were observed to live longer (Speakman *et al.* 2004), and experimental treatment of laboratory mice with the mitochondrial uncoupler DNP reduced their exposure to oxidative stress and increased their lifespan ((Caldeira da Silva *et al.* 2008); see also (Salin *et al.* 2012a) for similar findings on oxidative markers in tadpoles, and (Padalko 2005) for similar findings on longevity in drosophila). Unexpectedly, our uncoupling treatment did not modify significantly the oxidative stress parameters measured in zebra finches, neither in term of ROS production, nor in term of oxidative

damage and antioxidant defences. At least three different hypotheses can be proposed. First, the DNP dose given to zebra finches could be irrelevant to reduce ROS production (too low or too high). This hypothesis seems however unlikely since the effect of DNP on energy metabolism was significant but moderate and comparable in magnitude to the effects reported for mice and frog tadpoles (Caldeira da Silva *et al.* 2008; Salin *et al.* 2012a). Secondly, mitochondrial uncoupling has been suggested to be physiologically irrelevant to lower ROS production *in vivo* (see (Shabalina 2011) for an extensive review on this topic). In this context, the beneficial effect of the DNP treatment on oxidative stress levels in mice (Caldeira da Silva *et al.* 2008) could be mediated by the decrease of weight gain (*i.e.* protection against obesity) rather than a direct uncoupling effect on mitochondrial ROS production. Moreover, the improved oxidative state observed in DNP-treated frog tadpoles (Salin *et al.* 2012a) may be linked to the decreased developmental rate rather than a direct effect of the uncoupling state of individuals on mitochondrial ROS production. Since body mass dynamics was not modified by the DNP treatment in zebra finches, our results on oxidative stress parameters are unlikely to be biased by confounding effects linked to body mass. Finally, avian mitochondria could be less sensitive than other taxa to mitochondrial uncoupling in terms of ROS production (present study & P.B. unpublished results in Japanese quails). Avian mitochondria are known to differ from mammalian ones in some characteristics, such as ROS production (Ku & Sohal 1993; Lambert *et al.* 2010 but see (Montgomery *et al.* 2011) or mitochondrial membrane fatty acid composition (Pamplona *et al.* 1999; Montgomery *et al.* 2011). According to this idea, our *in vitro* results suggest that ROS production of zebra finch mitochondria is less sensitive to mitochondrial uncoupling than ROS production of mouse mitochondria (fig. 8C-D), both on respiration fuelled with pyruvate-malate or succinate. Yet, the results obtained with succinate have to be interpreted cautiously since high doses of DNP inhibited mitochondrial respiration in both species (over 20-40 μM , fig. 8B). Therefore, conditions of respiration under pyruvate-malate as substrate may be of more biological sense in our case. Still, our data are in accordance with previous findings relating a less sensitive H_2O_2 production by heart mitochondria to changes in ΔpH for pigeon than for rat (Lambert *et al.* 2010). Our results also suggest that mitochondrial uncoupling is an effective way to reduce *in vitro* ROS production in mice with complex I substrate, contrary to previous conclusions ((Shabalina 2011), but see (Starkov & Fiskum 2003; Clarke & Porter 2013)). The lower *in vitro* sensitivity of zebra finch

mitochondria could be linked to different factors, but the non-linearity of the relationship between mitochondrial membrane potential and ROS production could be a key element in our understanding of this phenomenon (Korshunov *et al.* 1997). If we consider the hypothetical case where zebra finches have intrinsically ‘mild’ uncoupled mitochondria (*i.e.* in accordance with their high metabolic rate/body temperature compared to other taxa (Holmes *et al.* 2001)), an artificial uncoupling treatment will probably be ineffective to further reduce ROS production *in vivo*. Data coming from the comparison between rat and pigeon kinetics of proton leak could be in agreement with this idea (Brand *et al.* 2003). Proper comparative studies on proton leak and mitochondrial membrane potential remain nonetheless to be done for our study models as well as to be extended to a larger set of bird/mammal species comparisons. In this context, determining the exact mechanisms explaining the differential impact of mitochondrial uncoupling on ROS production between mammals and birds will be an essential step toward a better understanding and generalisation of the ‘uncoupling to survive hypothesis’.

Mitochondrial uncoupling and whole organism reproduction and immunity

Despite the increased metabolic rate induced by the DNP treatment, few life-history traits were significantly affected in zebra finches. First, growth performances were not affected by the DNP treatment contrary to the observations made on frog tadpoles (Salin *et al.* 2012a). As mentioned earlier, the fact that DNP-treated birds showed increased food consumption could be the main explanation for the limited impact of the treatment found on life-history traits. That is, DNP treated birds might have not only increase their own feeding but also the food provisioning to their offspring; unfortunately, we did not measure this parameter in our study. Moreover, by increasing their nutrients supply, the treated-birds were probably able to compensate the decreased mitochondrial efficiency in most cases. Accordingly, we did not find a negative impact of mitochondrial uncoupling on physical performances, contrary to results obtained both on zebrafish (Marit & Weber 2011) and rat (Schlagowski *et al.*, *pers. com.*). Secondly, we did not find a significant effect of the DNP treatment on survival pattern, which is however in accordance with the lack of effect observed on oxidative stress markers. A consequent part of birds being still alive at the moment, we may have to check whether survival rate is going to differ later in life. Thirdly, the reproductive capacity of birds was slightly reduced by the uncoupling treatment,

although this result was significant only for the total number of eggs produced. The compensation of mitochondrial inefficiency by an increased food intake could be insufficient in periods of high-energy demand such as egg production (+22% of RMR in female zebra finch (Vezina 2005)). Finally, concerning the immune competence, the down-regulation of the immune response to a PHA test exhibited by DNP-treated birds may have at least two distinct causes. First of all, treated animals could be unable to allocate enough energy toward immune defences (as mentioned above for reproduction), due to their increased resting metabolic rate. According to this idea, the immune response has been shown to be energetically costly (+28.8% of RMR in *Passer domesticus* submitted to a PHA test (Martin *et al.* 2003)). However, following this hypothesis, we should have observed a similar effect of DNP on parameters evaluated *via* the hemolysis-hemagglutination assay (*i.e.* NABs and complement). Therefore, we propose an alternative hypothesis to explain this result, which is based on the fact that mitochondrial coupling state might be important to determine the inflammatory responsiveness of individuals (Emre & Nübel 2010). It has been shown that mice deficient for the uncoupling protein 2 (UCP2) have a more effective immune response against *Toxoplasma gondii*, thanks to higher ROS production by macrophages (Arsenijevic *et al.* 2000). In wild-type mice, UCP2 content in macrophages is down-regulated consecutively to an immune challenge with lipopolysaccharide (LPS), to allow the build-up of an oxidative burst used to neutralize pathogens (Kizaki *et al.* 2002). This suggests that, if UCP2 is involved in ROS production, the disappearance of any uncoupling activity in mitochondria might be a prerequisite to the triggering of the immune response. In this case, the lower inflammatory response toward the PHA injection might then be explained by the lower capacity of DNP-treated birds to build-up an adequate oxidative burst, because of their loosely coupled mitochondria.

Conclusions

Altogether, our results suggest that birds (at least zebra finches) might behave differently than other taxa in response to an experimental uncoupling treatment. Indeed, one major point of this study is that a moderate mitochondrial uncoupling has no significant beneficial impact on various oxidative stress markers, contrary to results observed both in

mammals (Caldeira da Silva *et al.* 2008) and amphibians (Salin *et al.* 2012a). According to this idea, we have shown here that zebra finch mitochondria behave differently than mouse mitochondria in terms of ROS response to an artificial uncoupling. More work is now required to understand the origins of such differences, and to test the possible generalization of this pattern to other bird/mammal pairs (*e.g.* rat/pigeon). According to our study, the impact of mitochondrial inefficiency on life-history trajectories seems limited when food is provided *ad libitum* to animals. Therefore, a logical extension of this study should be to test the impact of mitochondrial uncoupling on life-history trajectories with limited food supply, or in conditions increasing the effort required to obtain food (Koetsier & Verhulst 2011). Finally, important insight on the role of mitochondrial efficiency in life-history evolution should also arise from field studies (*e.g.* (Salin *et al.* 2012b)), even if there are obvious difficulties in implementing mitochondria measurements in field conditions/wild animals (but see (Stier *et al.* 2013) for a possibility to measure mitochondria functioning based on blood samples in birds).

Acknowledgments

We are grateful to the CNRS (PICS, grant n° 5296), the French Ministry of Research and the University of Strasbourg for funding. P.B. is funded by the Swiss National Research Foundation (grant n° 31003A_124988). We are grateful to C. Romestaing for the help provided with *in vitro* measurements on isolated mitochondria and A. Hranitzky for support with bird maintenance.

Authors' contributions

FC & AS designed the study. AS & QS collected the data. AS, FC, PB and SM took part in data analyses and interpretations. DR and AS managed the measurements on isolated mitochondria. AS, PB and FC wrote the paper. All authors have read and approved the final version of the manuscript.

Box 2 - Does mitochondrial uncoupling prevents from cold-induced oxidative stress? An experimental study in the zebra finch

Antoine Stier & François Criscuolo

In prep.



Abstract

Background

An experimental mitochondrial uncoupling has been shown to be ineffective to reduce oxidative stress levels in captive zebra finches (Paper 2). However, birds and mammals are known to use mitochondrial uncoupling to sustain non-shivering thermogenesis during prolonged cold exposure. Therefore, mitochondrial uncoupling might become relevant in mitigating ROS production only during periods of high-energy demand linked to thermogenesis (see Paper 2 for details). We compared metabolic and oxidative responses of zebra finches chronically treated or not with a chemical uncoupler (2,4-dinitrophenol: DNP), undergoing an acute (24 hours) and a chronic (4 weeks) cold exposure (12°C). We predicted that control birds should present at least short-term elevated levels of oxidative stress in response to cold exposure, whereas DNP-treated birds should present an attenuated rise in oxidative stress following cold exposure, due to their higher basal uncoupling state.

Results

Despite a similar increase in metabolism, control birds presented elevated levels of DNA oxidative damage in response to an acute (but not chronic) cold exposure, while DNP-treated birds did not. Unexpectedly, plasma antioxidant capacity decreased in response to chronic cold exposure, both for treated and control birds.

Conclusions

We conclude that acute cold exposure might increase oxidative stress but that compensatory mechanisms are progressively set-up. Our results support the assertion that mitochondrial uncoupling might prevent from cold-induced oxidative rise in birds, which might be one evolutionary advantage of the non-shivering thermogenesis.

Keywords

Mitochondrial uncoupling, oxidative stress, cold, thermogenesis, mitochondrial efficiency.

Introduction

Identifying the determinants of ageing rate and longevity has always been a prime challenge for scientists, from Aristotle to modern gerontologists. In this context, oxidative stress (*i.e.* the imbalance arising when pro-oxidant generation exceeds the capacity of antioxidant defences and repair mechanisms) has been proposed to contribute to the ageing process, as stated by the ‘free radical theory of ageing’ (Harman 1956; Beckman & Ames 1998; Hekimi & Lapointe 2011; but see Speakman & Selman 2011). Mitochondria are considered as the major source of pro-oxidant compounds (Balaban *et al.* 2005), since reactive oxygen species (ROS) are continuously produced during normal energy processing (*i.e.* oxidative phosphorylation). These ROS have the ability to generate oxidative damage to macromolecules, such damage being a characteristic of oxidative stress occurrence (Sies 1985). Since mitochondria is simultaneously the powerhouse of the organism and the prime ROS producer, mitochondria functioning and energy metabolism have been proposed as a corner-stone part of the ageing process (Shigenaga *et al.* 1994; Balaban *et al.* 2005).

In this context, identifying the determinants of oxidative stress levels is an important challenge for evolutionary ecologists too, since variations in oxidative damage and antioxidant defences may affect various life history traits and underlie life history trade-offs (Monaghan *et al.* 2009; Metcalfe & Alonso Alvarez 2010). To date, reproductive performances (Bize *et al.* 2008; Stier *et al.* 2012), growth rate (Alonso-Alvarez *et al.* 2007; Geiger *et al.* 2012) or survival (Bize *et al.* 2008; Saino *et al.* 2011) have all been associated with variations in oxidative stress levels. Evolutionary ecologist’s arguments to tie oxidative stress and life history traits are often based on the (controversial but central) assumption that ROS production is correlated to energy expenditure (Beckman & Ames 1998). Yet, the relationships between energy metabolism, ROS production and ageing rate are less straightforward than previously thought, since a high metabolism could be associated with a decreased in pro-oxidant generation and an increased longevity, at least in laboratory mice (Speakman *et al.* 2004; Caldeira da Silva *et al.* 2008). Indeed, it has been shown that despite enhancing oxygen consumption, an increased mitochondrial proton leak should concomitantly decrease ROS production, by lowering the inner mitochondrial membrane potential and the intra-mitochondrial concentration of O₂ (Skulachev 1996; Brand 2000; Barja 2007). Such a phenomenon is referred as “mitochondrial uncoupling”, since it leads to

an uncoupling between mitochondrial O₂ consumption and adenosine triphosphate (ATP) synthesis (Brand 2000).

To test the impact of elevated energy expenditure on oxidative stress levels, scientists have often used short- to long-term exposure of small mammals to cold (Topp *et al.* 2000; Selman *et al.* 2002; Kaushik & Kaur 2003; Venditti *et al.* 2004; Selman *et al.* 2008). However, these studies have underestimated a crucial point, which is that muscular shivering thermogenesis is progressively replaced by non-shivering thermogenesis achieved through uncoupling protein 1 (UCP1) activity in the brown adipose tissue (BAT, Janský 1973; Cannon & Nedergaard 2004)). This may have blurred our understanding of the relationship between metabolic rate and ROS production/oxidative stress. Indeed, heat production is due to UCP1 uncoupling activity (Cannon & Nedergaard 2004), which catalyzes the dissipation of the mitochondrial membrane potential (*i.e.* by enabling the backflow of H⁺ toward mitochondrial matrix). Therefore, and according to the results presented in Paper 2, we might expect differences in terms of oxidative stress response between short- to mid-term (*i.e.* where shivering thermogenesis should lead to increased ROS production) and mid- to long-term cold exposure (*i.e.* during which non-shivering thermogenesis is likely to better control ROS production). In accordance, short- to mid-term cold exposure experiments of small mammals (10 hours to 10 days) have reported increased oxidative damage levels (Topp *et al.* 2000; Selman *et al.* 2002; Venditti *et al.* 2004), whereas mid- to long-term cold exposure (4-5 weeks to entire life) had no or only minor impact on oxidative damage levels (Selman *et al.* 2008; Paper 2; but see Kaushik & Kaur 2003) or lifespan (Vaanholt *et al.* 2009).

Birds are lacking BAT and UCP1 as those found in mammals. Yet, non-shivering thermogenesis has been described in some bird species (Barré *et al.* 1986; Duchamp *et al.* 1989; Bicudo *et al.* 2001), despite being clearly less understood in a mechanistically point of view than in mammals. The main organ implicated in non-shivering thermogenesis in birds is probably the skeletal muscle (Duchamp & Barre 1993). However, while some studies report that non-shivering thermogenesis is linked to mitochondrial uncoupling through avUCP (avian UCP) and/or ANT (adenine nucleotide translocase) activities (Toyomizu *et al.* 2002; Talbot *et al.* 2004; Ueda *et al.* 2005; Walter & Seebacher 2009), a recent study indicates that despite the up-regulation of avUCP, non-shivering thermogenesis is not linked to an increased basal proton leak or an altered mitochondrial efficiency (Teulier *et al.* 2010). Experimental studies linking oxidative stress and cold exposure are quite rare and somewhat

more ambiguous in birds than in mammals. For instance, it was shown that plasmatic oxidative damage increased in broiler chickens exposed to chronic cold (7 days to 49 days, Pan *et al.* 2005), while a recent study reported no changes in plasmatic oxidative stress markers in zebra finches facing an acute cold exposure (Beamonte-Barrientos & Verhulst 2013). In addition, it was recently shown that oxidative damage levels were first increased during acute (1 to 24 hours) and chronic (10 days) cold exposure, but that this rise was attenuated after 20 days of cold acclimation (Zhang *et al.* 2011).

We showed in a previous study (Paper 3) that an experimental mitochondrial uncoupling with 2,4-dinitrophenol (DNP) has no significant impact on oxidative stress levels of zebra finches maintained at a common rearing temperature (24°C). Yet, considering the potential implication of mitochondrial uncoupling in non-shivering thermogenesis for birds (see above), we could expect that a protective effect of DNP-induced mitochondrial uncoupling might only be revealed under cold conditions. The aim of this study was then to investigate metabolic and oxidative consequences of acute (24 hours) and chronic (4 weeks) cold exposure (12°C) for control and DNP-treated zebra finches. First of all, we predicted that the effect of DNP on metabolic rate should be attenuated or absent during cold exposure, since the heat production linked to mitochondrial uncoupling would probably be used to maintain body temperature. Then, we predicted at least a short-term increase in oxidative stress levels of control birds in response to cold exposure, while DNP-treated birds may exhibit no or only a moderate increase in oxidative stress levels.

Materials & Methods

Animals and experimental design

The experiment started with 20 adult zebra finches (10 females and 10 males) of approximately 28 months old, coming from our own husbandry. Birds were placed as unisex groups in cages (0.57 x 0.31 x 0.80 m) and provided with food (a commercial mix of seeds for exotic birds enriched with vitamins and eggs) *ad libitum*. Birds were housed at 24°C on a 13 L : 11 D light cycle, prior to the experimental cold exposure (hereafter referred as the baseline period). Half of the birds was kept with water *ad libitum*, whereas the other half was provided with the DNP uncoupling treatment (20mg.L⁻¹ of 2,4-dinitrophenol diluted in drinking water) starting 20 months before the cold experiment. The dose ($\approx 4\text{mg}\cdot\text{kg}^{-1}\cdot\text{day}^{-1}$

for an average bird weighing 15.0g and drinking 3.0mL of water per day (Calder 1964)) was chosen according to a preliminary experiment (see Paper 3 for details). Drinking water (for the control group) and DNP solution were replaced twice a week (with a freshly prepared DNP dilution for the DNP treated group).

Birds were exposed to a quick but progressive decrease in ambient temperature (-4°C/hour, for 3 hours), and were subsequently kept one month at 12°C. This temperature remains within the thermal range encountered by zebra finches in their natural habitat. Indeed, despite being naturally distributed in tropical and subtropical areas (*i.e.* continental Australia and eastern Indonesia), zebra finches encounter, and are tolerant to, relatively low temperatures in the wild (mean minimum temperature in winter \approx 4-12°C (Zann 1996)).

A first blood sample (\approx 80 μ L) was taken one month prior to cold exposure, as the baseline measurement. A second blood sample was taken 24 hours after the switch in ambient temperature (*i.e.* acute cold exposure) and a third blood sample was taken after 4 weeks of cold exposure (*i.e.* chronic cold exposure). Blood was collected with a heparinised glass capillary tube from the brachial vein. Plasma was recovered following centrifugation for 10 min at 3000g and 4°C, and subsequently stored at -80°C up to three months before analysis, according to manufacturer instructions.

Metabolism

Oxygen consumption (VO_2 expressed in mL O_2 consumed per minute) was determined both ten days before (at 25°C) and ten days after the beginning of cold exposure (12°C). We recorded O_2 consumption with an open flow respirometry system (Sable System, USA) during 4 hours (8:00 to 12:00am), without food, but with water or DNP solution *ad libitum*. We analysed both the average of these 4 hours (mean VO_2) and the average of the three lower values (resting VO_2), which is a better indicator of resting metabolism. Birds were weighted before and after the experiment, and we included the average body mass as a covariate in statistical model to control for body mass effect on metabolism.

Oxidative stress measurements

The antioxidant defences of the plasma were evaluated using the OXY test (5 μ L of 1/100e diluted plasma, Diacron International, Italy). OXY adsorbent test allows quantifying the ability of plasma antioxidant components to buffer a massive oxidation through

hypochlorous acid. Antioxidant capacity is expressed as μM of HClO neutralised/mL, and intra-individual variation based on duplicates was low (respectively $\text{CV} = 3.22 \pm 0.42 \%$) as well as inter-plate variation based on a standard sample repeated over plates ($\text{CV} = 4.55 \%$). Plasma concentration of reactive oxygen metabolites (ROMs) was measured using the D-ROM test (5 μL of plasma, Diacron International, Italy) following the manufacturer protocol. The D-ROM test – based on the Fenton reaction – measures mostly hydroperoxides and results are expressed as mg of H_2O_2 equivalent/dL. Thus, ROMs levels indicate potential levels of oxidative stress. Intra-individual variation based on duplicates was low ($\text{CV} = 3.47 \pm 0.48 \%$) as well as inter-plate variation based on a standard sample repeated over plates ($\text{CV} = 4.37 \%$). In addition, we measured an indicator of oxidative damage on DNA. We quantified the plasmatic concentration of 8-hydroxy-2'-deoxyguanosine (8-OHdG) using a competitive immunoassay (plasma diluted 1/10e, Assay Designs DNA damage ELISA Kit - Enzo Life Sciences, USA). 8-OHdG is one of the predominant forms of free radical-induced oxidative lesion on DNA, and has been widely used as a marker of oxidative damage (Halliwell & Gutteridge 2007). Intra-assay variation based on seven duplicates (we could not run duplicates for every individuals due to plasma quantity limitations) was low $6.85 \pm 2.03 \%$.

Statistics

Considering our limited sample size and our repeated design, we investigated treatment (control vs. DNP) and cold exposure (baseline, acute cold or chronic cold) effects on body mass, metabolic rate and oxidative stress markers by running Generalized Estimated Equations models (GEE, Zuur *et al.* 2009). We used individual identity as subject, cold exposure as the repeated factor and treatment as a fixed factor. Metabolism was only measured twice (before and after cold exposure), while oxidative stress markers have been measured three times (baseline, acute cold and chronic cold). We also included the sex as a co-factor and the body mass as a covariate. All interactions between factors were included in initial models, but were removed when being non-significant (except the interaction “treatment x cold exposure” considering its hypothetic importance), in order to clarify statistical models.

GEE models were fitted with a normal error distribution (SPSS 20.0), and data were tested for normality. All tests were two-tailed and p values ≤ 0.05 were considered significant. Means are always quoted \pm S.E.

Results

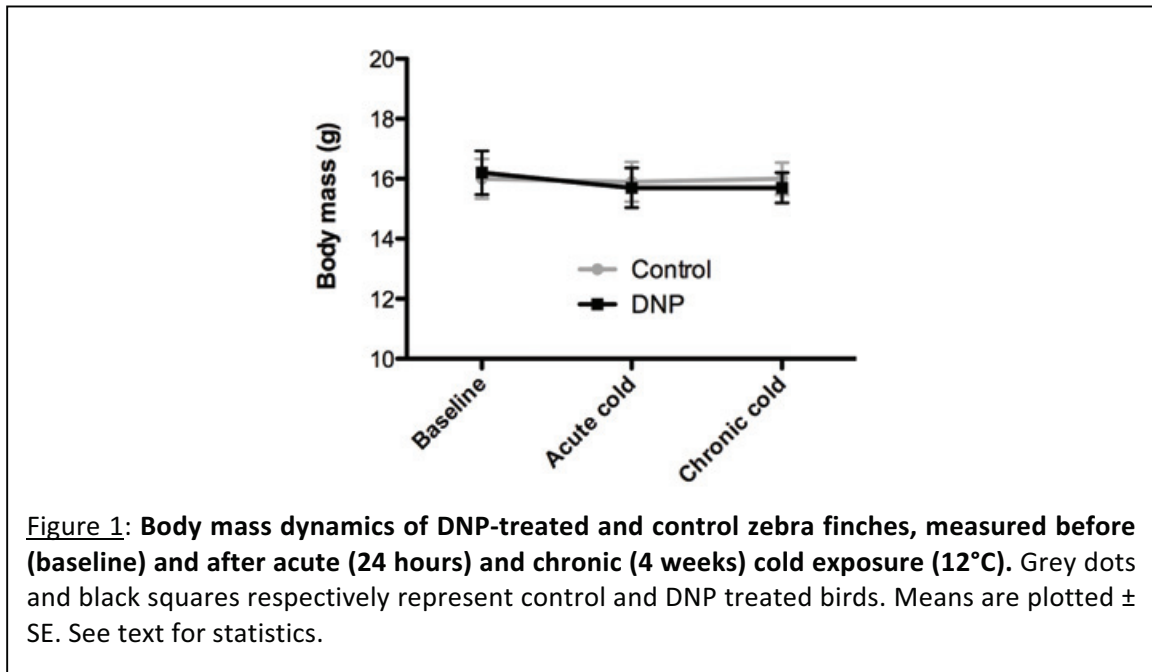

Zebra finches' body mass (Fig. 1) was not significantly affected by cold exposure ($\chi^2 = 3.56$, $p = 0.17$), DNP treatment ($\chi^2 = 0.01$, $p = 0.91$) or the sex of the individuals ($\chi^2 = 0.29$, $p = 0.59$). Similarly, body mass was not significantly influenced by the interaction between cold exposure and DNP treatment (cold exposure x treatment: $\chi^2 = 1.86$, $p = 0.39$).

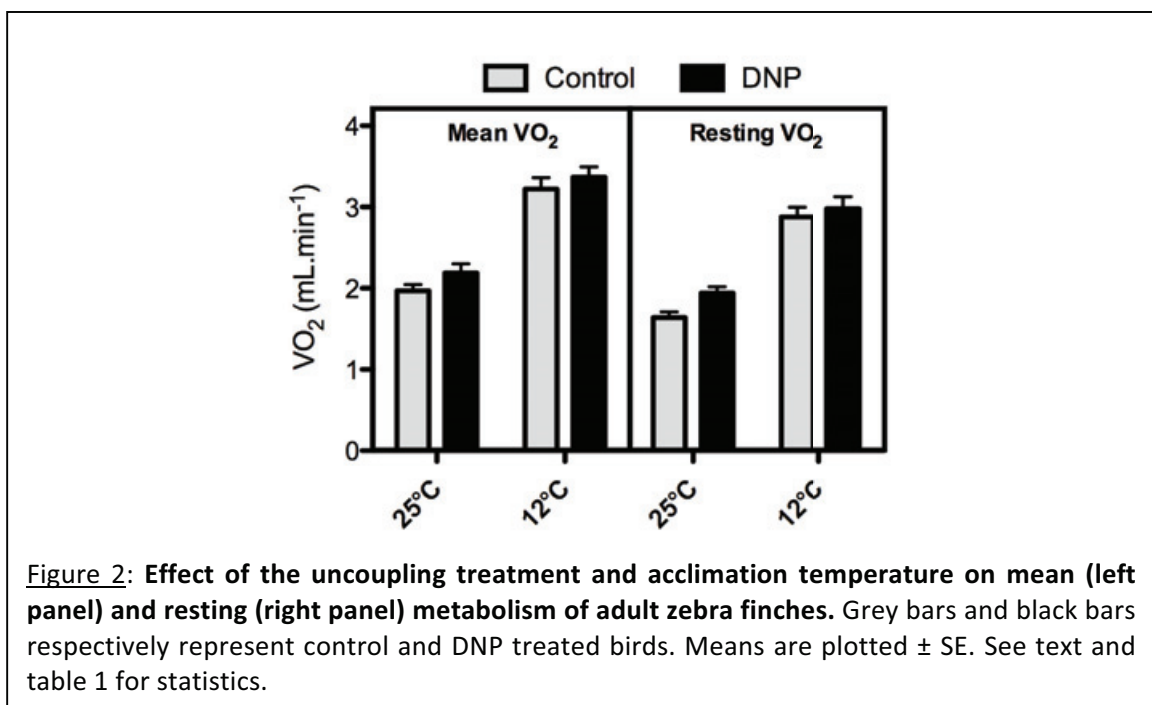

Mean and resting metabolic rates were significantly affected by the cold exposure and the DNP treatment, with elevated oxygen consumption both for DNP-treated birds and for the lower temperature (Table 1, Fig. 2). Mean and resting VO₂ were significantly influenced by body mass, but not significantly by the sex (Table 1). Despite close values between control and DNP-treated birds at the lower temperature (Fig. 2), the interaction between the temperature and the treatment did not reach statistical significance, neither for mean VO₂ (Table 1A) nor for resting VO₂ (Table 1B).

Table 1: Results of GEE models testing differences between control and DNP-treated zebra finches in terms of mean (A) and resting (B) metabolism at two ambient temperatures (25 and 12°C). Estimates for fixed factors are given for the following levels: Temperature = 25°C, Treatment = control and Sex = female.

A. Mean VO₂	Estimate	SE	Wald χ^2	p-value
Constant	1.39	0.22	12.27	< 0.001
Temperature	-1.13	0.09	244.07	< 0.001
Treatment	-0.20	0.13	10.38	0.001
Sex	-0.02	0.08	0.06	0.81
Temperature x Treatment	-0.08	0.15	0.29	0.59
Body mass	0.13	0.01	121.30	< 0.001
B. Resting VO₂	Estimate	SE	Wald χ^2	p-value
Constant	1.45	0.26	13.71	< 0.001
Temperature	-1.00	0.13	192.41	< 0.001
Treatment	-0.13	0.09	8.95	0.003
Sex	0.03	0.08	0.10	0.75
Temperature x Treatment	-0.21	0.16	1.74	0.19
Body mass	0.10	0.01	48.86	< 0.001

Plasma antioxidant capacity was significantly affected by cold exposure (Fig. 3A, $\chi^2 = 16.86$, $p = 0.001$), with birds presenting lower antioxidant capacity after a chronic cold exposure only (baseline vs. chronic cold: $p = 0.001$, acute cold vs. chronic cold: $p = 0.004$, baseline vs. acute cold: $p = 0.84$). We did not find a significant effect of DNP treatment ($\chi^2 =$

0.08, $p = 0.77$), the sex ($\chi^2 = 0.96$, $p = 0.33$) or the interaction between treatment and cold exposure ($\chi^2 = 2.73$, $p = 0.26$), but antioxidant capacity was significantly and positively influenced by individuals' body mass ($\chi^2 = 4.61$, $p = 0.032$).

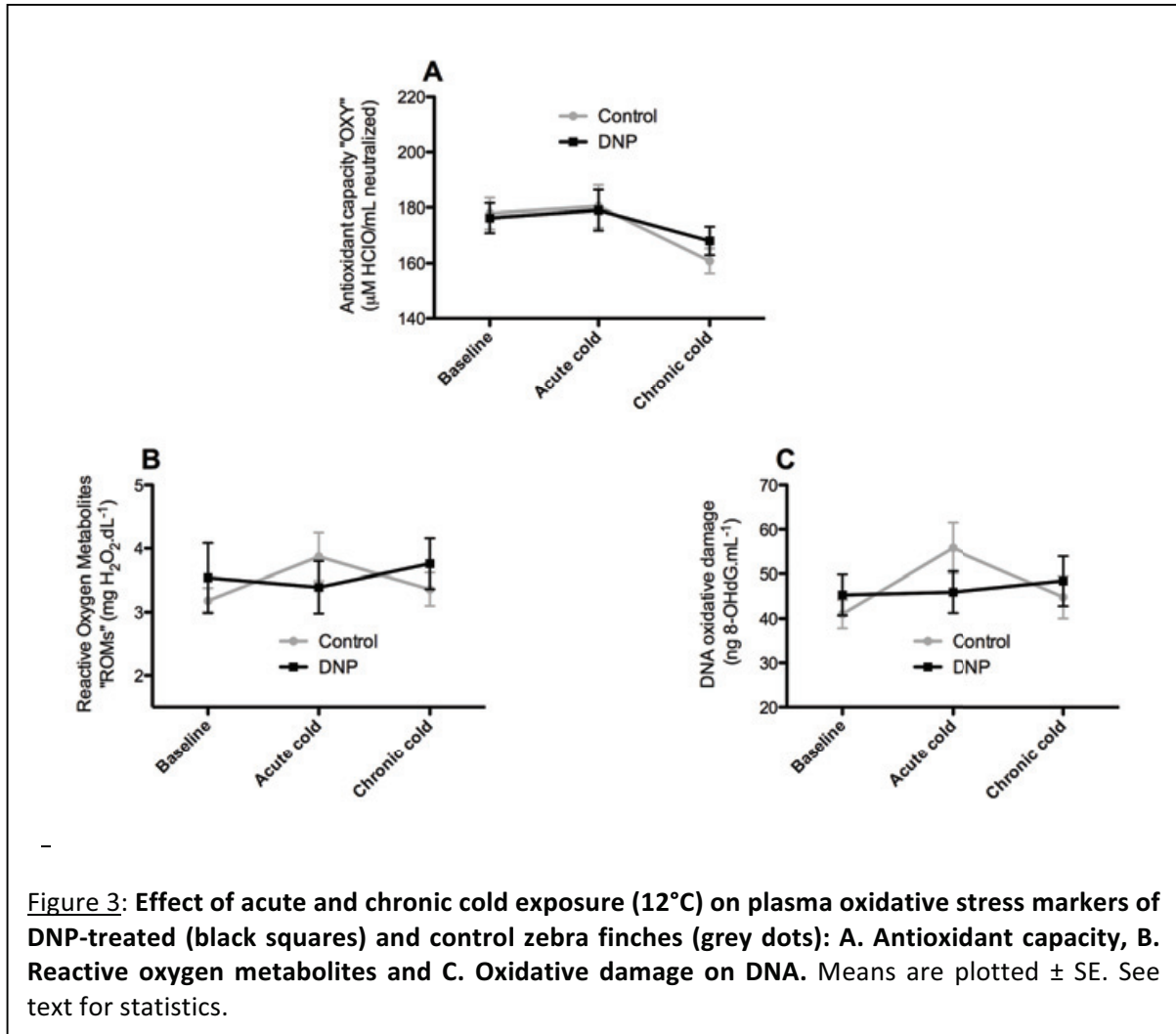

ROMs levels (Fig. 3B) were not significantly affected by cold exposure ($\chi^2 = 2.05$, $p = 0.36$), DNP treatment ($\chi^2 = 0.05$, $p = 0.82$), sex ($\chi^2 = 3.08$, $p = 0.08$) or the interaction between cold exposure and treatment ($\chi^2 = 2.55$, $p = 0.28$).

We did not find a significant effect of the DNP treatment ($\chi^2 = 0.01$, $p = 0.90$) or the sex ($\chi^2 = 0.94$, $p = 0.33$) on DNA oxidative damage (Fig. 3C). However, DNA oxidative damage levels were significantly affected by cold exposure ($\chi^2 = 10.52$, $p = 0.005$) and by the interaction between DNP treatment and cold exposure ($\chi^2 = 6.76$, $p = 0.032$), suggesting that DNA damage levels are elevated only for control birds after an acute cold exposure (Fig. 3C).

Discussion

According to our expectations, this experiment revealed that a high mitochondrial uncoupling state could attenuate oxidative stress resulting from acute cold exposure. Body mass dynamics was not altered by cold exposure or our uncoupling treatment, which prevents from confounding effects of body mass on metabolic rate and oxidative stress markers. Concerning the metabolic response to DNP treatment, the results obtained here at 25°C confirmed previous results obtained within the thermoneutral zone of zebra finches (30°C, Paper 3), namely that our DNP treatment increased moderately but significantly the metabolic rate of individuals (resting VO_2 : 30°C = +20.7% vs. 25°C = +18.3%). Contrary to our expectations, the metabolic rate of DNP-treated birds remained overall higher than the one of control birds during cold exposure (*i.e.* no significant Temperature x Treatment effect). Our sample size is however probably undersized to detect such an effect. Accordingly, a separate statistical analysis for the lower temperature (12°C) did not reveal a significant effect of the DNP treatment on mean ($\chi^2 = 0.72$, $p = 0.40$) and resting VO_2 ($\chi^2 = 0.32$, $p = 0.57$).

According to previous results on zebra finches (Beamonte-Barrientos & Verhulst 2013), we did not find elevated oxidative stress levels following an acute cold exposure based on plasma antioxidant capacity and ROMs levels. However, as underlined by a recent review (Selman *et al.* 2012), measuring more than one marker is necessary to have a broader view of the occurrence of oxidative stress. Indeed, we found that control birds exhibited significantly higher levels of DNA oxidative damage in response to an acute cold exposure. This result highlights that an increased metabolic rate in response to an acute cold might lead to oxidative stress in a passerine bird, contrary to previous conclusions (Beamonte-Barrientos & Verhulst 2013). The discrepancies between the two markers (*i.e.* ROMs vs. DNA damage) could have different origins. First of all, this could be attributable to a lack of precision of the D-ROM test (see (Harma *et al.* 2006) for bias attributable to this assay). Second, while the D-ROM test measures only potential oxidative damage in plasma, the 8-OHdG quantification revealed potentially the whole-body oxidative damage to DNA, since plasma 8-OHdG comes from damaged cellular DNA of any cell type, passes through the blood and is excreted in urine (Halliwell & Gutteridge 2007). Thus, since oxidative damage related to cold exposure could be restricted to some tissues rather than being widespread

(Selman *et al.* 2002), 8-OHdG should be a more accurate marker of cold-induced oxidative stress than ROMs levels. Since muscular shivering is the primary thermogenic response in birds (Saarela & Heldmaier 1987; Bicudo *et al.* 2001), increased DNA oxidative damage following acute cold exposure might be attributable to an increased ROS production linked to muscular contractile activity (McArdle *et al.* 2001; Oelkrug 2013).

Unlike control birds, DNP-treated birds did not exhibit elevated levels of DNA damage in response to a 24 hours cold exposure. Prevention of acute cold-induced oxidative stress may be attributable to the experimentally increased mitochondrial uncoupling state. This finding is in accordance with previous results on mice (Paper 2), demonstrating that UCP1-mediated non-shivering thermogenesis prevents from cold-induced oxidative stress. Yet, we obviously cannot state that mitochondrial uncoupling reduces ROS production in absolute term (as stated by the 'uncoupling to survive hypothesis'), but that in our specific experimental conditions, DNP-induced mitochondrial uncoupling allows increasing metabolic rate without a concomitant increase in ROS production. Prolonged shivering has been shown to have detrimental effects on longevity (Golozoubova *et al.* 2001), calcium handling (Aydin *et al.* 2008), muscular ROS production (Oelkrug 2013) or oxidative stress levels (Paper 2) for laboratory mice. The observed difference between groups in terms of DNA damage following an acute cold exposure might then be linked to a lower shivering activity of DNP-treated birds.

Interestingly, oxidative damage levels after a chronic cold exposure (4 weeks) were not significantly different from baseline levels (both for control and DNP-treated birds), thereby suggesting that compensatory mechanisms have been progressively set-up (Blagojevic *et al.* 2011). In both control and DNP-treated birds, plasma antioxidant capacity decreased following chronic cold exposure, suggesting that compensation does not take place within the oxidative balance. Still, our antioxidant measurement is mostly limited to non-enzymatic antioxidant compounds (see Sies 2007 for the limitations of total antioxidant assays in plasma), and we suggest that additional antioxidant components (*i.e.* enzymatic) should be measured before drawing clear conclusions on this point. Nevertheless, these results (*i.e.* stable levels of damage vs. decreased antioxidant defences) might indicate that ROS production is reduced following a chronic cold exposure. This idea would be in accordance with a progressive switch from shivering toward uncoupling-mediated non-shivering thermogenesis throughout time, even if we have few data to ascertain such an

idea in birds (Barré *et al.* 1986; Duchamp *et al.* 1989; but see Marjoniemi & Hohtola 2000; Teulier *et al.* 2010). In addition, the occurrence of non-shivering thermogenesis in passerine birds remains unclear (to our knowledge), even if there is evidence showing that cold-acclimated greenfinches shiver in a lesser extent than warm-acclimated ones in response to cold exposure (Saarela *et al.* 1995). An alternative compensatory mechanism could be mediated by a change in muscle fibre type, as it was observed in chickens acclimated to cold temperature for ten days (change from fibres IIB to fibres IIA, Ueda *et al.* 2005). Indeed, it has been shown that the muscular fibre type is an important modulator of ROS production, since fibres I and IIA exhibit a lower free radical leak than fibres IIB (Anderson 2005). Finally, even though the exact role of avUCP still needs to be clarified (Emre *et al.* 2007), this protein might play a role in mitigating ROS production linked to thermogenesis, even without any uncoupling activity (Crisuolo *et al.* 2005; Teulier *et al.* 2010). Indeed, avUCP is up-regulated after 48h of cold exposure (Ueda *et al.* 2005), and there is supportive evidence that avUCP mitigates free radical production (Crisuolo *et al.* 2005; Rey *et al.* 2010). Thereby, disentangling between the different mechanisms allowing birds to maintain low levels of oxidative stress during chronic cold exposure (*i.e.* enzymatic antioxidant response, uncoupling-mediated non-shivering thermogenesis, switch in muscular fibre type or protective role of avUCP) requires further investigations.

Conclusions

To conclude, we showed in this study that acute cold exposure induced a short-term oxidative stress in a passerine bird, whereas chronic cold exposure did not. In addition, we showed that mitochondrial uncoupling might be an effective way to reduce the cold-induced oxidative rise during acute cold exposure. The results of this study combined with those presented in Paper 2 are suggesting that non-shivering thermogenesis through mitochondrial uncoupling may have been favoured throughout evolution to maintain oxidative homeostasis during prolonged cold exposure.



© B. Gineste

Chapter 4

Implication of oxidative stress in specific life history trade-offs

Paper 4 - Constraint and cost of oxidative stress on reproduction: correlative evidence in laboratory mice and review of the literature

Antoine Stier, Sophie Reichert, Sylvie Massemin, Pierre Bize[†] & François Criscuolo[†]

Frontiers in Zoology 2012, **9**:37



[†] Equal contributors

Abstract

Background

One central concept in evolutionary ecology is that current and residual reproductive values are negatively linked by the so-called cost of reproduction. Previous studies examining the nature of this cost suggested a possible involvement of oxidative stress resulting from the imbalance between pro- and anti-oxidant processes. Still, data remain conflictory probably because, although oxidative damage increases during reproduction, high systemic levels of oxidative stress might also constrain parental investment in reproduction. Here, we investigated variation in oxidative balance (*i.e.* oxidative damage and antioxidant defences) over the course of reproduction by comparing female laboratory mice rearing or not pups.

Results

A significant increase in oxidative damage over time was only observed in females caring for offspring, whereas antioxidant defences increased over time regardless of reproductive status. Interestingly, oxidative damage measured prior to reproduction was negatively associated with litter size at birth (constraint), whereas damage measured after reproduction was positively related to litter size at weaning (cost).

Conclusions

Globally, our correlative results and the review of literature describing the links between reproduction and oxidative stress underline the importance of timing/dynamics when studying and interpreting oxidative balance in relation to reproduction. Our study highlights the duality (constraint and cost) of oxidative stress in life-history trade-offs, thus supporting the theory that oxidative stress plays a key role in life-history evolution.

Keywords

Life-history trade-offs, Reactive Oxygen Species, Antioxidant, Ageing, Literature Review

Introduction

A central concept in evolutionary ecology is that fitness-related traits, which allow organisms to produce many offspring over many reproductive attempts (i.e. fecundity and survival), are traded-off amongst themselves due to a ubiquitous constraint: a limited available pool of resources to share between all biological functions (Stearns 1992). Hence, current parental investment in reproduction is expected to result in decreased survival and future reproductive value known as the so-called cost of reproduction (Williams 1966, Stearns 1992). It has been established for some time that life-history trade-offs are the bedrock of evolutionary biology, and in recent years attention has turned towards examining the nature of the mechanisms underlying trade-offs. In this context, the production of reactive oxygen species (ROS), by-products of oxidative metabolism, appears to be a corner-stone factor both by its universal and inevitable nature (Metcalf & Alonso-Alvarez 2010).

Oxidative stress is defined as an imbalanced situation where deleterious production of ROS (mainly by the mitochondria during normal energy processing) exceeds the capacity of the various anti-oxidant systems to deal with them (Halliwell and Gutteridge 2007). The balance between pro-and anti-oxidative processes determines the level of oxidative stress: the higher the production of ROS and/or the lower the antioxidant defences are, the higher the oxidative stress will be. This oxidative imbalance is known to cause damage to all types of biomolecules, and the accumulation of damage over time is thought to contribute to ageing (Finkel & Holbrook 2000, Halliwell & Gutteridge 2007). Thus, if we postulate that the cost of reproduction is mediated by mechanisms having antagonistic effects on fecundity and survival (Rose & Bradley 1998), measuring the variation of a pro-ageing mechanism such as oxidative stress might provide important mechanistic insights into the cost of reproduction.

Following this idea, two innovative studies performed in captive zebra finches (*Taeniopygia guttata*) indicate oxidative stress as a proximate mechanism for the cost of reproduction (Alonso-Alvarez et al. 2004, Wiersma et al. 2004). Indeed, parents forced to rear extra offspring were seen to down-regulate important antioxidant enzymes (SOD, GPx,

Wiersma et al. 2004) and were less capable of dealing with oxidative stress, measured as a decline in the resistance of red blood cell membranes to an oxidative burst (Alonso-Alvarez et al. 2004). Because oxidative damage can impede biological function, including reproduction, previous studies have also proposed that oxidative stress can act as a constraint, limiting parental investment in reproduction (Bize et al. 2008, Dowling & Simmons 2009). This idea is also supported by toxicological studies showing that pollution or experimental contamination are often associated with higher levels of oxidative stress and impaired reproductive capacities (reviewed by Metcalfe & Alonso-Alvarez 2010, see also Agarwal et al. 2012 for evidence from biomedical research on fertility). Such a constraining effect of oxidative stress was recently illustrated by a cross fostering experiment in a wild population of Alpine swifts, where egg hatching success was positively related to the resistance of red blood cell membranes to oxidative burst in their biological rather than their foster mothers (Bize et al. 2008). However, as adult females in this study were blood sampled after egg laying, the impact of pre-reproductive oxidative stress levels on current adult reproduction output on one hand (i.e. constraint), and the level of oxidative stress induced as a result of current reproduction (i.e. cost) on the other remains to be tested within a single longitudinal study. Finally, the three aforementioned studies (Alonso-Alvarez et al. 2004, Wiersma et al. 2004, Bize et al. 2008) were based on measurements of antioxidant status or cell resistance to oxidative burst, but for a full understanding, studies on oxidative stress should ideally include at least two sides of the oxidative balance (i.e. ROS production, defences or the resulting damage, Monaghan et al. 2009). These discrepancies in measurements are important and join the contrasted recent results on the oxidative cost of reproduction, showing either weak (Bergeron et al. 2011) or inconclusive effects of reproduction on the oxidative balance (Nussey et al. 2009, Garratt et al. 2011, Oldakowski et al. 2012). All these studies point to the importance of the timing (pre- versus post-reproduction) and the choice of the markers (defence versus damage) in the investigation of the links between oxidative stress and reproduction. Indeed, while oxidative damage can worsen during reproduction, high oxidative stress levels in pre-reproductive adults might also act as a constraint (Dowling & Simmons 2009), limiting individual investment in reproduction. Hence, cost and constraint on reproduction may finally explain why oxidative stress and reproduction are sometimes positively or negatively linked together.

Our aim was to address this issue by investigating the possible dual role of oxidative stress as both a constraint and a cost of reproduction. To this end, we measured both sides of the oxidative balance (*i.e.* oxidative damage and antioxidant defences) before and after reproduction of female laboratory mice, and investigated how litter size at birth and at weaning related to measurements of the oxidative balance before and after reproduction, respectively. We predicted that if oxidative stress acts as a constraint on reproduction, measurements of oxidative balance before reproduction should be negatively related to the reproductive output. Furthermore, if reproduction induces oxidative stress, we expected positive relations between the reproductive output and measurements of oxidative balance after reproduction.

Materials and methods

General procedure

The study started with 23 primiparous adult female mice (C57 black 6) aged between 5 and 7 months from our animal husbandry unit. Females were housed in individual cages (40 x 25 x 15 cm) maintained at 25°C, on a 12 L : 12 D light cycle, and food (SAFE A03) and water were provided *ad libitum*. For mating purposes, one male was assigned randomly to each female and placed in the female's cage for 7 days before being removed. Eighteen of the twenty-three mated females gave birth (thereafter named 'successful females'). Five 'unsuccessful females', which did not show signs of pregnancy and did not produce pups, were used thereafter to assess changes in oxidative stress parameters independently of pups rearing over the time course of the study. Successful and unsuccessful females were of similar age (mean \pm SE = 6.06 \pm 0.21 vs. 5.80 \pm 0.37; t-test, = -0.58, ddl = 21, p = 0.57) and mass (22.9 \pm 0.57 vs. 24.2 \pm 0.89; t-test, = -1.09, ddl = 21, p = 0.29). Although it is common for mice, and other rodents, that females are not all giving birth when mated, we cannot exclude that some of our unsuccessful females were infertile (*i.e.* low-quality individuals). Nonetheless those unsuccessful females provide a valuable opportunity to investigate time-related change in oxidative markers in females involved in mating but not rearing pups. A week before pair formation, an initial blood sample (60 μ L) was taken from all females (hereafter referred to as *before reproduction*). A second blood sample was taken 40 days

after pair formation for both successful and unsuccessful females, which corresponded to the end of the lactation phase (i.e. 7 days before weaning) for successful females (hereafter referred as *after reproduction*). Blood was collected with a heparinised glass capillary tube from the submandibular vein. Plasma was recovered following centrifugation for 10 min at 3000 *g* and 4°C, and subsequently stored at -20°C up to three month before analysis according to manufacturer instructions.

Oxidative stress measurements

The antioxidant barrier and the concentration of Reactive Oxygen Metabolites (ROMs) were measured using the OXY-Adsorbent (2 μ L of plasma) and d-ROMs tests (5 μ L of plasma, DIACRON INTERNATIONAL, s.r.l, Italy) following the manufacturer's protocol (for detailed description of these tests, see Constantini et al. 2006). The OXY adsorbent test was used to quantify the ability of the plasma antioxidant barrier to buffer massive oxidation through hypochlorous acid, while the d-ROMs test mostly measures hydroperoxydes as a marker of global early oxidative damages (principally on lipids and proteins). Antioxidant barrier is expressed as mM of HClO neutralised and d-ROMs as mg of H₂O₂ equivalent/dL. All measurements were run in duplicates and intra-individual variation was low (respectively $1.96 \pm 0.34\%$ for the OXY test and $2.76 \pm 0.86\%$ for the d-ROMs test). Measurements for the same individual before and after reproduction were run within the same laboratory session, and measurements of all the samples were divided in three laboratory sessions. Inter-session variations in the measurement (based on one sample repeated in all the session) were 4.52% for the OXY test and 5.31% for the d-ROMs test. Repeatability, i.e. the proportion of variability explained by the individual, was calculated following (Lessels & Boag 1987). Both d-ROMs (ANOVA, $F_{1, 35} = 26.41$, $p < 0.001$, $r = 0.585$) and Oxy-Adsorbent (ANOVA, $F_{1, 35} = 4.90$, $p < 0.034$, $r = 0.178$) tests were shown to be repeatable over the study.

Statistics

Changes in oxidative damages and antioxidant defences measured in the same individuals before and after reproduction were tested with generalized linear mixed-models (GLMM) where the reproductive status (reproductive success or not) and the reproductive period (before and after reproduction) were entered as two fixed factors and individual

identity was used as a random factor. Post-hoc effects of reproductive status on oxidative balance were tested with paired t-tests. Constraint / cost of oxidative stress on reproduction was investigated by running ANCOVAs with litter size at weaning / at birth as dependent variables and OXY and d-ROMs measurements at weaning / prior to reproduction as co-variables, respectively. GLMM and ANCOVAs were fitted with a normal error distribution (SPSS 18.0). Analyses were two-tailed tests and p values ≤ 0.05 . Means obtained from Mixed Models are Estimated Marginal Means and all means are quoted \pm S.E.

Results

Variation of oxidative balance over the course of reproduction

Table 1: Results of mixed model showing the effect of reproductive status (successful vs. unsuccessful) and reproductive period (before or during reproduction) on plasmatic oxidative damage (d-ROMs) and plasmatic antioxidant defences (OXY) levels in female mice. Significant terms are reported in boldface. Non-significant interactions were backward dropped from the model. Residuals of the models follow a normal distribution, all Kolmogorov-Smirnov tests, $P > 0.79$.

d-ROMs	Random Effects	Estimate	SE		
	Constant	2.24	0.93		
	Individual	1.37	0.42		
	Fixed Effects	Estimate	SE	F_{1,21}	P value
	Intercept	9.97	0.48		
	Reproductive status	-1.48	0.96	0.10	0.753
	Reproductive period	-2.72	0.39	13.17	0.002
	Status x Period	2.4	0.84	8.25	0.009
OXY	Random Effects	Estimate	SE		
	Constant	187.9	124.5		
	Individual	351	108.3		
	Fixed Effects	Estimate	SE	F_{1,21}	P value
	Intercept	226	5.47		
	Reproductive status	-0.49	11.74	0.14	0.716
	Reproductive period	-17.94	6.25	4.31	0.050
	Status x Period	8.08	13.4	0.36	0.553

Changes over time in the plasmatic oxidative damage of successful and unsuccessful females were significantly explained by the interaction between reproductive status and

reproductive period ($p = 0.009$; Table 1). Indeed, the comparison of d-ROM levels before and after a successful reproduction revealed a significant increase (37.5%) in oxidative damage (Figure 1a; paired t-test, $t_{\text{paired}} = -6.53$, $df = 17$, $p < 0.001$), whilst these levels were not observed to differ from each other in females without offspring's (Figure 1a; $t = -0.68$, $df = 4$, $p = 0.54$). Variation in plasmatic antioxidant defences showed a moderate but significant increase over time of 6.6% (reproductive period: $p = 0.05$; Table 1, Figure 1b). However, this increase in antioxidant defences was not influenced by reproductive status alone ($p = 0.72$), or by the interaction between reproductive period and reproductive status ($p = 0.55$; Table 1, Figure 1b). Successful and unsuccessful females did not significantly differ in oxidative balance parameters before reproduction. Indeed, d-ROM levels (7.25 ± 0.33 vs. 8.17 ± 1.42 ; t-test, $t = 0.98$, $df = 21$, $p = 0.34$) and OXY levels (208.1 ± 6.3 vs. 215.6 ± 7.8 ; t-test, $t = 0.59$, $df = 21$, $p = 0.56$) were not statistically different between those two groups.

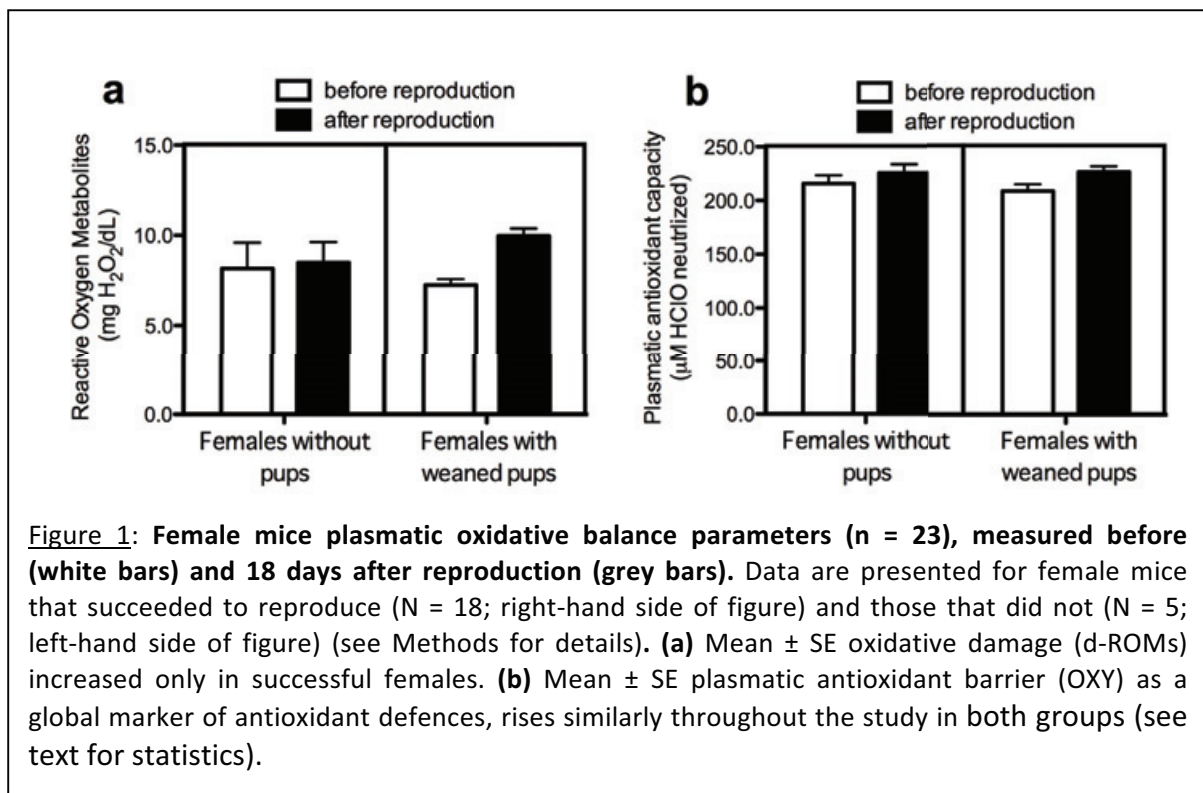

Correlations between reproductive and oxidative parameters

Before reproduction, oxidative damage (but not antioxidant defences) was negatively related to litter size at birth (Table 2a). Less offspring were born to successful females in which relatively high oxidative damage levels had been seen initially (Figure 2a).

Table 2: Analyses of covariance on relationships between pre (1) and post-reproductive (2) d-ROMs and OXY plasma levels and litter size at birth and at weaning in female mice. Significant terms are reported in boldface. Residuals of each model follow a normal distribution, all Kolmogorov-Smirnov tests, $P > 0.62$.

Litter size at birth	Pre-reproductive values	df	Estimate	SE	Khi2	P-value
	Intercept		8.08	2.21		
	d-ROMs (1)	1,17	-0.37	0.17	4.25	0.039
	OXY (1)	1,17	0.01	0.01	0.65	0.419
	Post-reproductive values					
	Intercept		6.04	3.62		
	d-ROMs (2)	1,17	-0.08	0.16	-0.51	0.621
	OXY (2)	1,17	0.01	0.01	0.55	0.588
Litter size at weaning	Pre-reproductive values					
	Intercept		6.27	4.36		
	d-ROMs (1)	1,17	0.05	0.33	0.14	0.893
	OXY (1)	1,17	-0.01	0.02	-0.40	0.694
	Post-reproductive values					
	Intercept		0.60	4.30		
	d-ROMs (2)	1,17	0.59	0.19	7.44	0.006
	OXY (2)	1,17	-0.01	0.02	0.13	0.716

After reproduction, the relation between d-ROMs levels and litter size was inverted, with larger litter sizes at weaning being associated with higher oxidative damage in post-weaning females (Table 2b, Figure 2b). Again, antioxidant defence levels were not related to litter size at weaning (Table 2b). Models testing litter size 1) at weaning in relation to d-ROMs or OXY levels before reproduction and 2) at birth in relation to d-ROMs or OXY levels after reproduction, showed no significant effects (Table 2c, d).

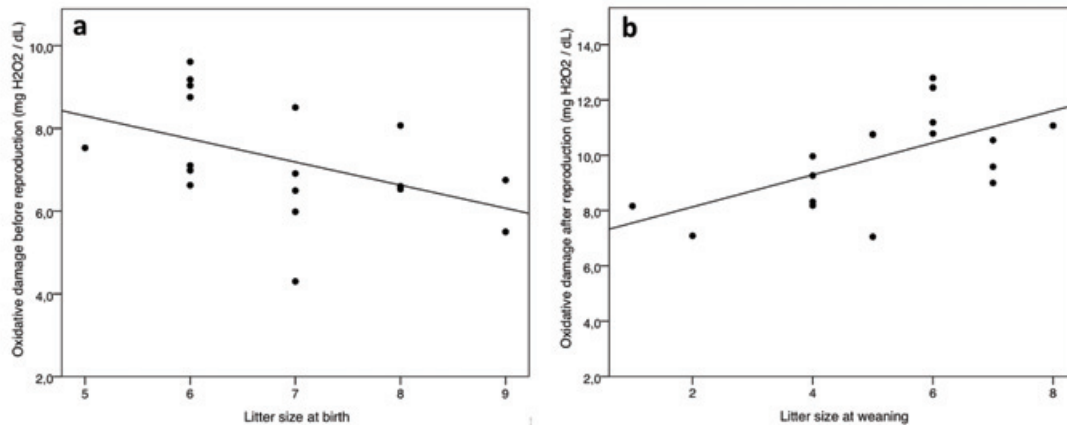

Figure 2: Relationships between litter size and oxidative damage (n = 18 in both cases). (a) Pre-reproductive oxidative damage (d-ROMs) in relation to litter size at birth ($p = 0.039$), (b) Post-reproductive oxidative damage (d-ROMs) in relation to litter size at weaning ($p = 0.006$). Unsuccessful females are not represented here because they either did not reproduce or they may have failed early in reproduction for other reasons than initial elevated oxidative stress levels. Notice that overlapping values are reducing to 16 the number of readily apparent points.

Finally, models testing whether intra-individual changes in oxidative damage and antioxidant defences over the course of reproduction were related to reproductive output evidenced that females producing the greatest number of pups at weaning were also those suffering the higher increase in oxidative damage (Figure 3, ANCOVA, $F = 19.81$, $df = 1$, $p < 0.001$). No such relationship was found with plasmatic changes of antioxidant defences (ANCOVA, $F = 0.22$, $df = 1$, $p = 0.65$).

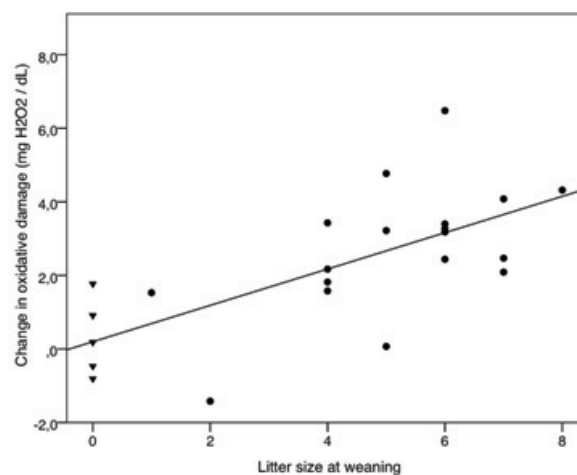

Figure 3: Female reproductive output and changes in oxidative damage during reproduction (n = 23). Change in plasmatic oxidative damage (d-ROMs) during reproduction is positively related to litter size recorded at weaning (ANCOVA, $F = 19.81$, $ddl = 1$, $p < 0.001$). Successful females (black dots) and unsuccessful females (black triangle) are shown but the relationship remains significant without unsuccessful females (ANCOVA, $F = 7.24$, $ddl = 1$, $p = 0.016$)

Discussion

In the present study, we show that pre-reproductive oxidative damage levels in female laboratory mice were negatively related to litter size at birth, whereas post-reproductive damage levels were positively related to litter size at weaning. Before mating, there was no difference in terms of age, mass and oxidative stress levels between females that then produced successfully or not a litter. However, oxidative damage levels increased strongly (+35%) over time in successfully reproducing females and remained stable in unsuccessful ones during the same time window. It suggests that reproduction (gestation and/or lactation) can lead to oxidative damage in female mice.

Oxidative stress as a cost of reproduction

Oxidative stress is due to an imbalance between ROS production and the antioxidant system (Halliwell & Gutteridge 2007). Hence, an oxidative reproductive cost can occur if reproduction is associated with an increase of the production of ROS, a down-regulation of the antioxidant defences, or a combination of those two processes (Monaghan *et al.* 2009). In the present study, plasmatic antioxidant levels do not seem to be affected by reproduction: there was no difference in antioxidant defences between female mice that reproduced and those that did not, and changes in antioxidant defences during reproduction did not correlate with the number of offspring weaned. Hence, one hypothesis is that the observed increase in plasmatic oxidative damage associated to reproduction in female mice is most probably linked to an increase in ROS production. This oxidative cost of reproduction seemed to vary with reproductive investment, as suggested by the positive relationship between litter size at weaning and oxidative damage after reproduction and the increase in intra-individual damage with litter size at weaning. Although the increase in metabolic demands with reproduction has already been acknowledged (Nilsson 2002, Speakman 2008), the link between metabolic rate and ROS production is still controversial (Barja 2007). More work is therefore required to firmly establish a chain of causation between reproduction, metabolic demands, ROS production and ultimately oxidative damage. A second hypothesis previously suggested by Wiersma *et al.* (2004) is that parents 'sacrifice oxidative protection for reproduction', thereby leading to oxidative stress even in

the absence of any increase in metabolic demands and ROS production. Although we found no significant support for this hypothesis in terms of plasmatic antioxidant defences (but our limited sample size does not allow firm conclusions on this point), studies covering additional components of the antioxidant system are necessary before ruling this possibility out.

Oxidative stress as a constraint for reproduction

A constraining role of oxidative stress on life-history evolution has recently been proposed by (Dowling & Simmons 2009). This idea was illustrated for the immune system by (Tobler et al. 2011) reporting that high pre-challenge systemic production of ROS is negatively related to the strength of subsequent cellular immune responses in male dragon lizards (*Ctenophorus pictus*). Our dataset was collected on a small mammal and supports the theory that oxidative stress plays a conserved constraining role on a closely fitness-related trait, reproduction. Indeed, we found that female mice with low pre-reproductive oxidative damage produced larger litters at birth compared to females with high pre-reproductive oxidative damage. The theory that oxidative stress has a constraining role on reproduction is also supported by data on clutch size and egg hatchability in a wild bird, the Alpine swift (*Apus melba*, Bize et al. 2008). Female swifts showing higher red cell membrane resistance to oxidative stress (measured shortly after egg laying) produce larger clutches, and eggs produced by these females were more likely to hatch (Bize et al. 2008). Using a cross-fostering experiment where clutches were swapped between nests, the authors also showed that hatching failure was related to the production of low quality eggs by females with low resistance to oxidative stress rather than to inadequate parental care during incubation (Bize et al. 2008). Our study suggests that oxidative stress has a constraining effect on only one part of the reproductive event: pre-reproductive oxidative damage was significantly related to litter size at birth but not to litter size at weaning. Our results imply that oxidative stress constrained the early investment in reproduction (i.e. conception and gestation) in female laboratory mice but did not constrain reproductive effort associated with rearing (i.e. lactation). Still, studies linking pre-reproductive oxidative balance to subsequent investment or success in reproduction are scarce, and the nature of the underlying mechanisms remains under investigated (see Agarwal et al. 2012 for results from

the medical literature, e.g. reduced sperm motility due to ROS). Hence, one suggestion is that early reproduction is probably affected more by the constraining effect of oxidative stress, whilst rearing is more likely to explain the oxidative cost of reproduction. Here, it is worth pointing that delayed costs of reproduction may further complicate the picture if past reproduction costs are constraining future reproductive success (Gustafson & Sutherland 1988, Bize et al. 2004). Experiments involving the manipulation of pre-reproductive oxidative stress are now required to validate the hypothesis of oxidative stress as a constraint for reproduction.

Disentangling constraint and cost of oxidative stress on reproduction

Present knowledge on the relationships between reproduction and oxidative stress are complex and often contradictory, as summarized in Table 3 which lists studies reporting links between reproduction and four common markers of the oxidative balance: plasmatic antioxidant defences measured by the OXY test, plasmatic oxidative damage measured by the d-ROMs test, lipid peroxidation measured by MDA or TBARS tests, and resistance of red blood cell membranes to an oxidative burst (KRL test). Here, we argue that some of these contradictions could be resolved by considering the dual role (constraint and/or cost) of oxidative stress in the biology of reproduction. Indeed, a constraining role of oxidative stress on reproduction will be expressed through negative relationships between systemic (i.e. pre-reproductive) oxidative stress and reproduction, whereas the oxidative cost of reproduction will be revealed by post-reproductive increase in oxidative stress. It follows therefore that the relationships between reproduction and oxidative stress can be blurred by one prime factor, namely the timing chosen to sample animals because both the direction and the strength of these relationships are expected to vary over the course of reproduction. In agreement with this hypothesis, Table 3 shows that modifications of oxidative parameters in relation to reproduction seem to rely on whether animals were sampled before, during or after reproduction. Few studies report associations between reproduction and measures of the oxidative balance before or early in the reproductive phase (Bize et al. 2008, Costantini et al. 2010, Isaksson et al. 2011, Marko et al. 2010), yet this is a pre-requisite to address the constraining role of oxidative stress. Interestingly, the association between reproduction and a given marker of oxidative stress in these studies

often goes in the opposite direction to those described in studies where sampling occurred later in the reproductive phase (Table 3; present results). Table 3 also supports the idea that reproduction can incur oxidative costs and that costs are likely to increase with reproductive effort, indicating that sampling animals during reproduction (i.e. at the peak of metabolic demands, Sainz et al. 2000, Upreti et al. 2002, Christe et al. 2012) provides more proof of the effects of reproduction on the oxidative balance (10 of 14 studies, Table 3) than through sampling at the end or after reproduction (0 of 2 studies, Table 3). It suggests that the oxidative imbalance induced by reproduction may be transient (Losdat et al. 2011) and could easily be missed if the sampling is wrongly timed. In this context, longitudinal design studies where animals are sampled before and during the course of reproduction (Alonso-Alvarez et al. 2004, van de Crommenacker et al. 2011, Bertrand et al. 2006, present study, but see also Alonso-Alvarez et al. 2006 for repeated measurement throughout life and long term oxidative consequences of reproduction) might provide a more powerful approach to detect an oxidative cost of reproduction than cross-sectional studies, as well as providing the opportunity to explore the constraining role of oxidative stress on reproduction (present study). Hence, studies on oxidative costs of reproduction should, ideally, control for the initial (pre-breeding) oxidative stress values by adding those values as covariate in the statistical models or by analysing changes in oxidative stress values. Finally, it is worth noting that experimental studies on costs of reproduction are generally based either on manipulation of reproductive status (i.e. comparisons between reproducing and non-reproducing individuals) or of reproductive effort (i.e. comparison between reduced and enlarged litter sizes). Those two experimental approaches however do not address the same reproductive costs *stricto sensu*. Manipulation of reproductive status allows testing for costs induced with decisions to reproduce or not, with reproducing individuals showing optimal investment into reproduction. In contrast, litter size manipulation is testing for costs induced by a deviation from optimal investment into reproduction. Because little is known on the relative importance of those different forms of reproductive costs, caution is needed in interpreting and comparing results of experiments of reproductive status *versus* effort.

MDA or TBARS | Oxidative damage

Study type	Study design	Sampling time	Sample Type	Sex	Relationship with reproduction	Reproduction trait	Reference
Sprague-Dawley rat	EXP _{RS}	During	Lung	F	+	RS	[26]
Sprague-Dawley rat	EXP _{RS}	During	Uterus	F	+	RS	[26]
Sprague-Dawley rat	EXP _{RS}	During	Kidney	F	+	RS	[26]
Sprague-Dawley rat	EXP _{RS}	During	Thymus	F	0	RS	[26]
Holtzman rat	EXP _{RS}	During	Kidney	F	+	RS	[27]
Holtzman rat	EXP _{RS}	During	Liver	F	+	RS	[27]
Red-legged partridge	COR	During	Erythrocyte	F / M	+ / 0	HS	[41]
Eastern chipmunks	COR	During	Plasma	F	+	BS	[13]
House mouse	EXP _{RS}	During / End	Liver	F	-	RS	[15]
Bank vole	EXP _{RS}	During / End	Liver	F	0	RS	[16]
Bank vole	EXP _{RS}	During / End	Kidney	F	0	RS	[16]
Bank vole	EXP _{RS}	During / End	Heart	F	0	RS	[16]
Bank vole	EXP _{RS}	During / End	Muscle	F	-	RS	[16]
Soay sheep	COR	End	Plasma	F	0	RS	[14]

dROM | Oxidative damage

C57-Black6 mouse	COR	Before	Plasma	F	-	BS	Present study
Great tit	COR	Early	Plasma	F	0	CS	[23]
Common starling	COR	Early	Plasma	F	-	CS	[23]
Tasmanian spotted snow skink	COR	Early	Plasma	F	0	BS	[24]
Collared Flycatcher	COR	Early	Plasma	F	0	CS	[25]
Adélie penguins	EXP _{RE}	During	Plasma	F / M	0 / 0	RE	[33]
Eurasian kestrel	COR	During	Plasma	F / M	0 / +	RS	[34]
Seychelles warbler	COR	△(During-Before)	Plasma	F / M	0 in malaria infected birds	RS	[30]
Seychelles warbler	COR	△(During-Before)	Plasma	F / M	- in malaria infected birds	RS	[30]
C57-Black6 mouse	COR	△(During-Before)	Plasma	F	+	RS	Present study
C57-Black6 mouse	COR	During / End	Plasma	F	+	BS	Present study

OXY | Antioxidant defences

C57-Black6 mouse	COR	Before	Plasma	F	0	BS	Present study
Great tit	COR	Early	Plasma	F	-	CS	[23]
Common starling	COR	Early	Plasma	F	+	CS	[23]
Tasmanian spotted snow skink	COR	Early	Plasma	F	0	BS	[24]
Collared Flycatcher	COR	Early	Plasma	F	0	CS	[25]
Adélie penguins	EXP _{RE}	During	Plasma	F / M	+ / +	RE	[33]
Eurasian kestrel	COR	During	Plasma	F / M	+ / 0	RS	[34]
Seychelles warbler	COR	△(During-Before)	Plasma	F / M	-	RS	[30]
C57-Black6 mouse	COR	△(During-Before)	Plasma	F	0	RS	Present study
C57-Black6 mouse	COR	During / End	Plasma	F	0	BS	Present study

KRL© | Resistance of red blood cell membranes to an oxidative burst

Alpine swift	COR	Early	Erythrocyte	F / M	+ / 0	HS	[9]
Alpine swift	COR	Early	Erythrocyte	F / M	+ / 0	CS	[9]
Great tit	EXP _{RE}	During	Erythrocyte	M	-	RE	[29]
Great tit	EXP _{RE}	During	Erythrocyte	F / M	-	RE	[28]
Zebra finch	EXP _{RE}	△(After-Before)	Erythrocyte	F / M	- / -	RE	[7]
Zebra finch	COR	△(After-Before)	Erythrocyte	F / M	- / -	CS	[31]
Great tit	EXP _{RE}	End	Erythrocyte	M	0	RE	[29]

Table 3: Review of existing literature on the relationships between reproduction and oxidative stress

To examine the importance of sampling time in relation to reproduction, we restricted our review to four markers of oxidative stress with existing measurements at different times during the reproduction. Within each marker, studies are ordered by sampling time in relation to reproduction. *Study type* refers to Captive (C), Laboratory (L) and Wild (W) conditions. *Study design* refers to correlative (COR) versus experimental studies that either manipulated individual Reproductive Status (EXP_{RS}) or Reproductive Effort (EXP_{RE}). *Reproduction trait* refers to Clutch Size (CS), Hatchling Success (HS), Brood Size (BS), experimental manipulation of Reproductive Effort (RE), and comparison of Reproduction Status (RS; namely, comparing reproducing to non-reproducing animals or intra-individual variation during the course of reproduction). If separate measurements were reported for females and males (i.e. F / M), relationships with reproduction for each sex are separated by a /.

References: [7]: Alonso-Alvarez et al. 2004; [9]: Bize et al. 2008; [13]: Bergeron et al. 2011; [14]: Nussey et al. 2009; [15]: Garratt et al. 2011; [16]: Oldakowski et al. 2012; [23]: Costantini et al. 2010; [24]: Isaksson et al. 2011; [25]: Marko et al. 2010; [26]: Sainz et al. 2000; [27]: Upreti et al. 2002; [28]: Christe et al. 2012; [29]: Losdat et al. 2011; [30]: van de Crommenacker et al. 2011; [31]: Bertrand et al. 2006; [33]: Beaulieu et al. 2011; [34] Casagrande et al. 2011, [41]: Alonso-Alvarez et al. 2010.

The choice of oxidative marker can also be a crucial element. Indeed, if we had based our interpretations on antioxidant defences alone, we would not have found correlative evidence for a constraining role of oxidative stress on reproduction or for an oxidative cost of reproduction. Although numerous methodological arguments could explain this lack of results, including the weak repeatability/accuracy of our antioxidant marker, small sample sizes and *ad libitum* access to a high-quality laboratory diet, our study backs up previous recommendations for the measurements of at least two components of the oxidative balance (Monaghan et al. 2009). Yet, it is not always possible to assess more than one part of the oxidative balance, and in these circumstances we suggest that researchers should give priority to measuring oxidative damage. Indeed, oxidative damage is expected to be deleterious for the organism (Finkel & Holbrook 2000), whilst a decrease in antioxidant defences will only be costly if the production of ROS remains constant or increases during the same period. In other words, cost and constraint of oxidative stress on reproduction are more likely to be revealed by measurements of oxidative damage.

Finally, optimization of the oxidative balance (ROS production vs. antioxidant defences, and thereby damage) is likely to differ among species and between males and females within the same species. For example, long-lived species are expected to optimize survival at the expense of reproduction (Stearns 1992), which might be achieved via the up-regulation of antioxidant defences in order to prevent the accumulation of debilitating oxidative damage. This scenario is supported by data in Adélie penguins (*Pygoscelis adeliae* (Beaulieu et al. 2011) and female Eurasian kestrels (*Falco tinnunculus* (Casagrande et al. 2011)) where reproduction is associated with an increase in plasmatic antioxidants but not with changes in oxidative damage. The latter also shows that male kestrels did not up-regulate their antioxidant defences in response to reproduction, and in turn suffered from oxidative damage (Casagrande et al. 2011). This is in conformity with Bateman's principle, which describes greater selection on female than male survival.

Conclusions

Early evolutionary biologists considered that animal responses were always optimal because adaptation inevitably results from the selection process. However, since the publishing of the corner-stone paper written by Gould and Lewontin (1979), the key role of evolutionary constraints has emerged as “biases on the production of variant phenotypes or limitations on phenotypic variability”, either due to structural or historical factors (Maynard Smith et al. 1985). Our study highlights the constraining role of oxidative stress on reproduction (Dowling & Simmons 2009), as previously outlined for other systems such as hormonal control (Ketterson & Nolan 1999). This conclusion is further supported by recent findings in adult Florida scrub-jays (*Aphelocoma coerulescens*) where high levels of pre-breeding oxidative damage were associated with a decreased reproductive effort in males only (Heiss & Schoech 2012). Oxidative state is probably tightly linked to mitochondrial functioning, itself closely related to metabolic demands during reproduction, thereby giving a mechanistic basis for this relationship. It is worth noting that reproduction in mammals covers two very different phases, gestation and lactation, and we still know very little about how far these two phases contribute to shaping the oxidative cost of reproduction. Finally, looking for other possible oxidative constraints on any fitness-related trait, especially in

free-living species, may help us to conclude how far oxidative stress plays an evolutionary role in shaping life-history trade-offs.

Competing interests

The authors declare that they have no competing interests.

Authors' contributions

AS and FC designed the study, AS and SR collected and analyzed the data. AS, PB and FC wrote the paper. SM, PB and FC took part in data interpretations. FC and PB share the seniorship of this article. All authors have read and approved the final version of the manuscript.

Acknowledgments

The study complied with the 'Principles of Animal Care' publication no.86-23, revised 1985 of the National Institute of Health, and with current legislation (L87-848) on animal experimentation in France. We are grateful to C. Alonso-Alvarez, V. Viblanc and M. Beaulieu for their helpful comments, and to the CNRS (PICS) and the French Ministry of Research for funding. P.B. is funded by the Swiss National Research Foundation (grant n° 31003A_124988). This manuscript was edited by a native-English speaker with scientific expertise (Munro Language Services).

Box 3 - Mitochondrial uncoupling and the oxidative cost of reproduction in the zebra finch.

Antoine Stier & François Criscuolo

Unpublished work



Abstract

Background

An experimental mitochondrial uncoupling has been shown to be ineffective in reducing oxidative stress levels in captive zebra finches (Paper 2). However, one could suggest that such a mechanism could only be effective during situations in which ROS production and oxidative stress are enhanced, and not in optimal/standard conditions associated to a low stress level. Reproduction has been shown to impair the oxidative balance in a wide range of species. Therefore, our aim was to investigate if an experimental uncoupling in the zebra finch could prevent the oxidative rise potentially associated with reproduction.

Results

To do so, we compared plasmatic reactive oxygen metabolites and antioxidant capacity between reproducing and non-reproducing pairs, chronically treated or not with a chemical uncoupler (2,4-dinitrophenol). We found that oxidative stress was increased in reproducing pairs (higher levels of ROMs and higher antioxidant capacity), but contrary to our prediction, this oxidative rise was not significantly affected by the uncoupling treatment.

Conclusions

We conclude that an oxidative cost of reproduction is likely to occur in zebra finch, but that mitochondrial uncoupling does not reduce ROS production, neither in standard conditions nor during a period of high-energy demand/high oxidative stress such as reproduction.

Keywords

Mitochondrial uncoupling, oxidative stress, antioxidant, cost of reproduction, mitochondrial efficiency, 2,4-dinitrophenol, DNP.

Introduction

The most studied example of life-history trade-off is undoubtedly the so-called “cost of reproduction”, defined as the negative relationship occurring between current reproduction and expectations of future reproduction and survival in adult organisms (Williams 1966, Reznick 1985, Harshman & Zera 2007). Life-history trade-offs are recognized as the bedrock of evolutionary biology, and in the past 10 years, special attention has turned towards examining the nature of the physiological mechanisms underlying such trade-offs (Zera & Harshman 2001). In this context, oxidative stress has been suggested to be involved in the cost of reproduction (see paper 3 for a review on this subject), even if this assumption remains so far an open question (see Metcalfe & Monaghan 2013).

As fully described in Paper 3, mitochondrial functioning has received little attention in a life history perspective, despite the fundamental role played by mitochondrial coupling state in determining the amount of energy allocable to life history traits on one hand (*i.e.* ATP synthesised), and the amount of reactive oxygen species (ROS) produced on the other hand (Brand 2000, Salin *et al.* 2012a, 2012b, but see Shabalina & Nedergaard 2011 for some controversies). Treating adult zebra finches with an uncoupling agent (2,4-dinitrophenol, hereafter abbreviated DNP) has been shown to be ineffective in reducing ROS production and oxidative damage (Paper 3), contrary to observations made on mice (Caldeira da Silva *et al.* 2008) or frog tadpoles (Salin *et al.* 2012a). Mitochondrial uncoupling may be irrelevant to reduce oxidative stress in standard conditions for zebra finches (*i.e.* under low energy demand), yet we cannot exclude that it could be an important factor to limit oxidative rise in “stressful” conditions (*i.e.* when energy demand increases). In this context, our objective was to investigate if an uncoupling treatment could be effective to protect against oxidative stress during a period of high metabolic demand, namely the reproduction (Speakman 2008).

To do so, we investigated the variations of oxidative stress markers (reactive oxygen metabolites and total antioxidant capacity) in reproducing and non-reproducing zebra finches chronically treated or not with a dose of DNP previously determined to increase their metabolic rate (Paper 3). We predicted that an interaction between the reproductive state (RS) and the DNP treatment should be apparent (RS x treatment) if mitochondrial uncoupling has a role in ROS mitigation when oxidative constraint is high.

Materials & Methods

Animals and experimental design

The experiment started with 56 primiparous adult zebra finches (28 females and 28 males) of 12 months old, coming from our own husbandry. Birds were randomly placed as breeding pairs in cages (0.57 x 0.31 x 0.39 m) and provided with food (a commercial mix of seeds for exotic birds enriched with vitamins and eggs) *ad libitum*. Birds were housed at 24°C on a 13 L : 11 D light cycle. All breeding pairs were provided with a nestbox and nesting material during the breeding period.

Half of the breeding pairs was kept with clear water *ad libitum*, whereas the other half was provided with the DNP treatment (20mg.L⁻¹ of 2,4-dinitrophenol diluted in drinking water) starting six months before the breeding experiment. The dose ($\approx 4\text{mg}\cdot\text{kg}^{-1}\cdot\text{day}^{-1}$ for an average bird weighing 15.0g and drinking 3.0mL of water per day (Calder 1964)) was chosen according to a preliminary experiment (see Paper 2 for details). Drinking water was replaced twice a week, and the DNP solution was freshly prepared each time to avoid the disintegration of the molecule.

A first blood sample ($\approx 80\mu\text{L}$) was taken from the brachial vein just prior to breeding pair formation. During the 30 days following pairing, 17 of the 28 couples engaged in reproduction (control: N = 9; DNP: N = 8) and were defined as “reproducing birds”, while 11 pairs did not start to reproduce during this experimental period (but succeed later in life) and were defined as “non-reproducing pairs” (control: N = 5; DNP: N = 6). A second blood sample was taken from “reproducing” pairs 10 days after the first egg hatched (*i.e.* the peak period of energy requirements for chicks (Deerenberg & Overkamp 1996)), and from “non-reproducing” birds approximately at the same period (*i.e.* 40.4 ± 4.5 days after pairing). Blood was collected with a heparinised glass capillary tube from the brachial vein and kept in ice until centrifugation. Plasma was recovered following centrifugation for 10 min at 3000g and 4°C, and subsequently stored at -80°C up to six months before analysis, according to manufacturer instructions.

Control and DNP treated birds did not statistically differ in terms of reproductive output during this first reproductive attempt. Indeed, the number of eggs produced (control:

4.2 ± 0.4 vs. DNP: 4.6 ± 0.3, Wilcoxon test: p = 0.31) and the number of chicks at fledging (control: 1.9 ± 0.4 vs. DNP: 1.6 ± 0.4, p = 0.58) did not differ according to the treatment.

Oxidative stress measurements

Plasma concentration of reactive oxygen metabolites (ROMs) was measured using the d-ROM test (5 µL of plasma, Diacron International, Italy) following manufacturer protocol. The d-ROM test is based on the Fenton reaction and measures mostly hydroperoxides, results being expressed as mg of H₂O₂ equivalent/dL. Thus, ROMs levels indicate potential exposure to oxidative stress. Intra-individual variation based on duplicates was low (CV = 5.17 ± 0.66 %) as well as inter-plate variation based on a standard sample repeated over plates (CV = 6.18 %).

The antioxidant defences of the plasma were evaluated using the Oxiselect™ Total Antioxidant Capacity (TAC) assay kit (Cell Biolabs, inc., USA) following manufacturer instructions. The TAC assay measures the total antioxidant power of biomolecules from the plasma via a single electron transfer mechanism, and results are expressed as mM UAE (Uric Acid Equivalent). Intra-individual variation based on duplicates was low (CV = 2.03 ± 0.34 %), as well as inter-plate variation based on a standard sample repeated over plates (CV = 2.85 %).

Statistics

We investigated the impact of Reproductive State (RS: reproducing vs. non-reproducing), Sex, Treatment (control vs. DNP) and the interaction between reproductive state and treatment (RS x Treatment) on oxidative stress parameters using a linear mixed model with the Nest as a random factor. We included baseline level (*i.e.* before reproduction) of each oxidative stress marker as a covariate to take into account the initial inter-individual variability in oxidative status. Initial models with all the possible interactions (Treatment x Sex, RS x Sex and Treatment x RS x Sex) were initially tested, but we decided to present simplified models given the lack of significance of these interactions.

Linear mixed models were fitted with a normal error distribution (SPSS 20.0), and data were tested for normality and homoscedasticity. All tests were two-tailed tests and p values ≤ 0.05 were considered significant. Means are always quoted ± S.E.

Results

Total antioxidant capacity during reproduction was strongly related to its baseline level (table 1a, $p = 0.002$). Antioxidant capacity has been increased in reproducing birds compared to non-reproducing ones ($p = 0.031$, table 1a, fig 1A), but was not significantly affected by the treatment or the interaction between the reproductive state and the treatment (table 1a). Similarly, antioxidant capacity was not significantly affected by the sex of the birds (table 1a).

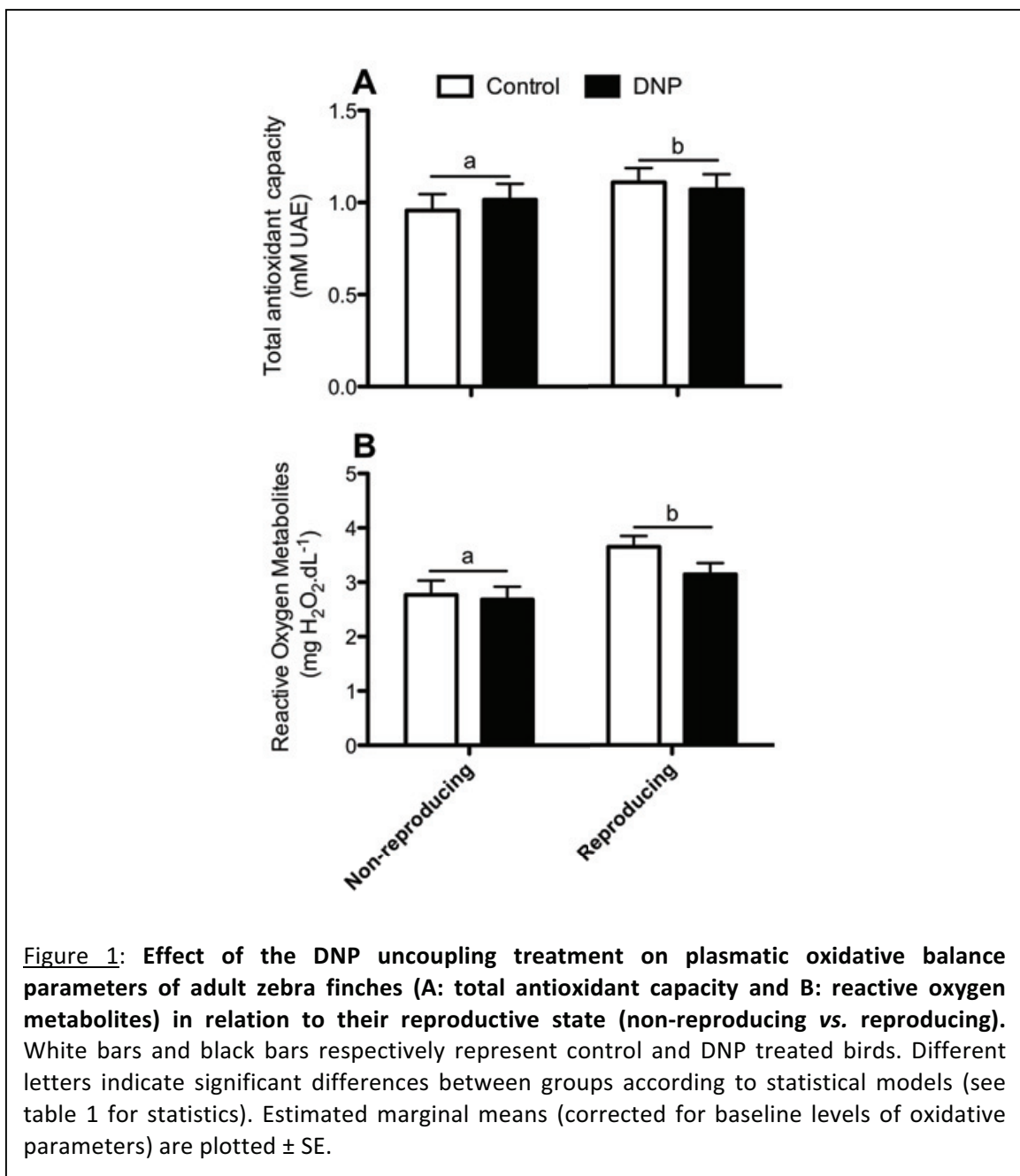

Figure 1: Effect of the DNP uncoupling treatment on plasmatic oxidative balance parameters of adult zebra finches (A: total antioxidant capacity and B: reactive oxygen metabolites) in relation to their reproductive state (non-reproducing vs. reproducing). White bars and black bars respectively represent control and DNP treated birds. Different letters indicate significant differences between groups according to statistical models (see table 1 for statistics). Estimated marginal means (corrected for baseline levels of oxidative parameters) are plotted \pm SE.

Plasma ROMs levels during reproduction were strongly related to their baseline levels (table 1b, $p < 0.001$). ROMs concentration was significantly higher for reproducing birds than for non-reproducing ones ($p = 0.005$, table 1b, fig 1B). However, we found no significant effect of the DNP treatment, the RS x treatment interaction or the sex of the birds on ROMs levels (table 1b).

Table 1: Results of linear mixed models testing differences between control and DNP treated zebra finches in terms of plasmatic antioxidant capacity (a) and reactive oxygen metabolites (b) in relation to reproduction. Estimates for fixed factors are given for the following levels: Reproductive State (RS) = non-reproducing, Treatment = control and Sex = female.

(a) Total antioxidant capacity		Estimate	SE	F	p-value
Random effect	Nest	0.005	0.004		
Fixed effects & covariates	Constant	0.68	0.15	20.69	< 0.001
	Reproductive State (RS)	-0.10	0.04	5.25	0.031
	Treatment	0.04	0.06	0.05	0.82
	Treatment*RS	-0.10	0.09	1.21	0.28
	Sex	-0.03	0.03	0.64	0.43
	Baseline level	0.40	0.12	11.18	0.002
(b) Reactive oxygen metabolites		Estimate	SE	F	p-value
Random effect	Nest	0.062	0.241		
Fixed effects & covariates	Constant	1.34	0.39	15.0	0.12
	Reproductive State (RS)	-0.67	0.22	9.62	0.005
	Treatment	0.51	0.28	1.84	0.19
	Treatment*RS	-0.42	0.44	0.91	0.35
	Sex	0.05	0.21	0.05	0.83
	Baseline level	0.62	0.11	34.56	< 0.001

Discussion

According to our expectations, reproducing birds presented higher levels of oxidative stress than non-reproducing birds, suggesting that an oxidative cost of reproduction effectively occurs in captive zebra finch. Indeed, ROMs levels were increased in reproducing birds, suggesting that plasma oxidative stress rise during reproduction. It is worth noting that the sampling time may be crucial to detect oxidative stress as a cost of reproduction (as underlined in Paper 3), since an oxidative stress does not seem obvious in zebra finches parents sampled 35 days after hatching (Reichert *et al.*, Appendix I). The elevated levels of plasma antioxidant capacity measured in reproducing birds might reflect a compensatory response to their enhanced ROS production. However, this increase in antioxidant defences was not sufficient to restore homeostasis, since ROMs levels (*i.e.* oxidative damage) were increased. Alternatively, the increase in plasma antioxidant capacity could be an indirect consequence of an increased food intake (which contains antioxidants), which is likely to occur considering the workload required for mating, egg production, incubation and finally chicks rearing (Lemon 1993).

As previously demonstrated in Paper 3, we did not find a significant effect of the uncoupling treatment on oxidative stress levels. In addition, we did not find significant interactions between the reproductive state and the DNP treatment, which indicates that even during a period of increased oxidative stress (as indicated by our plasma oxidative stress markers), the experimental treatment with a mitochondrial uncoupler did not significantly mitigate oxidative stress. These results are consistent with the results presented in Paper 3, and reinforce the idea that mitochondrial uncoupling could be irrelevant to mitigate ROS production in zebra finch (but see Box 2 for a protective effect during thermogenesis).

Even though DNP treatment significantly reduces egg production during an extensive period of reproduction (Paper 3), the results observed in this specific experiment are unlikely to be biased by a decreased reproductive investment of DNP-treated birds. Indeed, the number of eggs produced and the number of chicks at fledging did not statistically differ between control and DNP breeding pairs for their first reproduction (see methods). It is worth noting that the increase in oxidative stress levels observed in this study is quite limited (*i.e.* approximately +22% in ROMs levels and +12% in antioxidant capacity). Then, a

better approach to investigate such an oxidative cost of reproduction and its potential modulation by mitochondrial uncoupling would probably have been to manipulate/increase the reproductive effort of birds (see Metcalfe & Monaghan 2013). Unfortunately, the sample size available in our study precluded from multiplying experimental groups, which would have been necessary to manipulate the reproductive effort through a brood size manipulation experiment.

Conclusion

To conclude, a chronic uncoupling treatment with DNP has been shown to be irrelevant to reduce oxidative stress levels in zebra finch under standard conditions (Paper 3) or during a period of increased oxidative stress linked to reproduction (this study). Yet, a protective effect of mitochondrial uncoupling might be limited to specific contexts, such as the increase energy expenditure required to maintain body temperature in cold environments (Paper 2, Box 2). Nevertheless, it is interesting to note that oxidative stress markers are affected by reproduction in zebra finches, as previously suggested by studies using an experimental manipulation of the reproductive effort (Alonso-Alvarez *et al.* 2004, Wiersma *et al.* 2004).

**Paper 5 - Elevation impacts the balance between growth and
oxidative stress in coal tits**

Antoine Stier, Anne Delestrade, Sandrine Zahn, Mathilde Arrivé, François Criscuolo[†]
& Sylvie Massemin-Challet[†]

*Published in a revised version:
Oecologia 2014, in press*



[†] Equal contributors

Abstract

Background

The short favourable period of time available for the growth in seasonal environments could constrain the resources allocation between growth and other life-history traits, and the short-term fitness benefits of increased growth rate may prevail over other functions. Accelerated growth rates have been associated with long-term deleterious consequences (*e.g.* decreased lifespan), and recently oxidative stress (the imbalance between pro-oxidants generation and antioxidant defences) has been suggested as a mediator of these effects. Here, we examined the impact of elevation on growth rate and self-maintenance parameters (resting metabolism, oxidative damage and antioxidant defences) of coal tit chicks (*Parus ater*). We predicted that the shorter favourable season at the higher elevation site should lead to a reallocation of resources toward growth at the expense of self-maintenance processes.

Results

We found that high elevation chicks grew significantly faster in terms of body mass and body size. Chicks from the high elevation site presented higher resting metabolism, higher oxidative damage level, but similar antioxidant defences, compared to low elevation chicks. Interestingly, chicks that grew faster were also those with the highest levels of oxidative damage on DNA prior to fledging, although this relationship was significant only for the high elevation site.

Conclusions

Our study supports the idea that increasing elevation leads to higher growth rates in coal tit chicks, possibly in response to a shorter favourable season. In accordance with life-history theory, a bigger investment in growth was done at the expense of body maintenance, at least in terms of oxidative stress.

Key-words

Altitude, growth, oxidative stress, metabolism, life-history trade-off, ageing

Introduction

The most commonly studied trade-off is the so-called cost of reproduction (Williams 1966), explaining why investment in current reproduction limits adult future reproduction and survival prospects (Dijkstra *et al.* 1990; Reznick *et al.* 2000). Another important trade-off modulating the fitness of the future adult is the cost of growth (Metcalf & Monaghan 2001; Munch & Conover 2004). Actually, early development is a key period conditioning the organism's life history for at least two types of reasons: (i) adult size is often related to fitness (Richner 1989; Reeve *et al.* 2000) and (ii) organisms are more vulnerable during growth (Calow 1982; Arendt 1997), developmental time being inversely related to future fitness (Roff 1980). Consequently, growing as fast as possible should be a general rule when in fact most organisms are capable of growth rates superior to those observed under "normal" conditions (Calow 1982). Ecological and physiological costs of rapid growth rates (reviewed in Metcalfe & Monaghan 2001) effectively suggest that resources allocation toward growth could be done at the expense of other life-history components. Then, an individual's growth rate is usually optimal rather than maximal (even with *ad libitum* access to a high quality food), and growth rates are flexible and regulated (Metcalf & Monaghan 2001; Dmitriew 2011). In particular, the resource part invested in growth seems to be balanced against allocation toward longevity (Lee *et al.* 2013), probably through a decrease investment in body maintenance.

In recent years, more attention has been given to the specific nature of the mechanisms that underlie the global idea of trade-offs (Zera & Harshman 2001), and oxidative stress frequently appears to be involved (Dowling & Simmons 2009; Monaghan *et al.* 2009; Metcalfe & Alonso Alvarez 2010). Oxidative stress is defined as an unbalanced situation between ROS (reactive oxygen species) production - which are mainly produce by the mitochondria during normal energy processing - and the capacity of the various anti-oxidant systems to deal with them (Halliwell & Gutteridge 2007). Such an unbalanced situation will cause oxidative damage to various biomolecules, and the accumulation of damage with time is thought to be one potential cause of ageing (Finkel & Holbrook 2000). In this context, accelerated

growth was found to increase oxidative stress (as predicted by Mangel & Munch 2005), either by increasing ROS production (Rosa *et al.* 2008), decreasing resistance to an oxidative challenge (Alonso-Alvarez *et al.* 2007a; Kim *et al.* 2011) or by increasing oxidative damage (Nussey *et al.* 2009; Geiger *et al.* 2012). Interestingly, higher growth rate was also associated with increased metabolism (Careau *et al.* 2013), either measured by resting metabolic rate (RMR) or daily energy expenditure (DEE). Energy cost of higher growth rate was often used as a proximate factor to explain an increase in oxidative stress levels (*i.e.* higher growth rate leading to higher O₂ consumption, which could lead to higher ROS production), but relationships between ROS production and metabolism are still under debate (*e.g.* see Barja 2007, but see also Fletcher *et al.* 2013).

Environmental conditions are important constraints on life-history traits evolution (Stearns 1992; Naef-Daenzer *et al.* 2012). Accordingly, it was suggested that in seasonal environments, the duration of the favourable period of time available for the growth might affect its fitness consequences (Abrams *et al.* 1996; Gotthard 2008). Elevation (see McVicar & Körner 2012 for distinction between altitude and elevation) is known to impact phenology, with shorter favourable season at higher elevation (Dittmar & Elling 2005; Pellerin *et al.* 2012). Elevation has been suggested to be a major ecological constraint for birds, partly due to the restrained time-window of food abundance that coincides with breeding time at high-elevation areas (Lack 1968). Therefore, elevation could also be a constraint for the growth period, with potential consequences in terms of resources allocation in other life-history components. However, there has been no data examining the impact of such environmental conditions on the trade-off between growth and self-maintenance processes (*i.e.* processes allowing an organism's survival and preventing from premature ageing).

The timing of reproduction for tits (*Parus* sp.) is crucial since breeders have to match the quick seasonal changes in food availability (known as the "caterpillar peak" Betts 1955; Naef Daenzer & Keller 1999). Indeed, they have to supply enough food to their chicks to ensure proper growth and body condition, which are important factors determining fledging survival (Naef Daenzer *et al.* 2001). Coal tit chicks have a limited period of growth within the nest before fledging (around 17-20

days, personal observation) and their survival seems markedly affected by fledging date (Naef Daenzer *et al.* 2001). Therefore, one hypothesis is that coal tit chicks could grow faster at higher elevation, in order to take full advantage of the shorter favourable season, and fledge as soon as possible since an earlier fledging date is associated with higher survival (Naef Daenzer *et al.* 2001). However, such an accelerated growth could have a negative impact on body self-maintenance (Geiger *et al.* 2012).

To test this hypothesis, we follow environmental conditions (*i.e.* air temperature) and the breeding activity of coal tits along an elevational gradient (1300m and 1900m a.s.l.) in 2011. Body size and body mass growth of chicks were recorded and self-maintenance parameters (resting metabolism, oxidative damage and antioxidant defences) were evaluated during the growth period.

Materials and methods

Field work and birds sampling

We monitored the breeding activity and chick's growth of coal tits (*Parus ater*) in the French Alps (Vallorcine, France) during the 2011 season (April - June). Artificial nest boxes (Schwegler 1B, Germany, N = 34 per site) were placed following two transects (see *Electronic Supplementary Material* fig. S1), the first around 1300m (mean \pm SE: 1329.7 \pm 2.1m a.s.l.) of elevation and the second around 1900m (1907.3 \pm 2.7m a.s.l.). During the early season, nests were checked regularly before hatching to determine hatching date, clutch size, clutch mass and estimated incubation time (assuming that incubation started just after clutch completion). In 2011, 8 nest boxes were occupied at the lower site, and 6 at the higher site.

We selected 5 chicks per nest (and we avoid including late-hatched chicks) for which body mass and body size (wing length, tarsometatarsus length, head size) were recorded every two days following hatching (hatching = day 1) using an electronic balance (0.1g precision) and a digital calliper rule (0.1mm precision). Chicks were followed until approximately 16 days, which is close to fledging (\approx 17-20 days, personal observation). We avoided returning to the nest after day 17, in order to avoid compromising fledging success. One small blood sample (\approx 30 μ L) was taken

from the brachial vein with a heparinised glass capillary at day 7 (mean \pm SE: 6.94 \pm 0.12 days) and day 16 (15.75 \pm 0.08 days). Blood was kept on ice until the plasma was separated from blood cells by centrifugation (10 min, 1500g) and samples were subsequently stored at -80°C before analysis. We paid attention to have similar time duration before centrifugation for both sites. Only one 1300m “monitored” chick died during the study, which gave a final sample size of 69 chicks (39 at 1300m and 30 at 1900m).

Sex determination was done on DNA extracted from red blood cells following an adapted method from (Griffiths *et al.* 1998).

Temperature monitoring

One meteorological station (developed for the “Phénoclim project” of the CREA) was implanted at each site (1300m and 1900m). Those stations recorded air temperature at standard height (2m) every 15 minutes during the entire 2011 year, and transferred data via GSM network (for full description, see Pellerin *et al.* 2012). We used daily mean temperature for further statistical analysis.

Growth analysis

As an estimate of the overall body size, we used the first principal axis (PC1) resulting from a principal component analysis (PCA) of the measurements of wing, tarsometatarsus and head, which explained 96.3% of the total variance of body size (Freeman & Jackson 1990). Therefore body size is expressed in arbitrary units (AU). Body mass growth and body size (PC1) growth were fitted with the following logistic equation: $Y(x) = A/[1 + \exp(-K*x - B)]$ similarly to (Hall *et al.* 2010), which was the best fitting model based on R^2 . $Y(x)$ represents the size or mass of a chick at age x (in AU or g), “ A ” is the asymptotic mass or size (*i.e.* mass or size at fledging), “ K ” is the growth rate constant (an increase in “ K ” value implies an increase in the rate at which mass or size increases from initial value to asymptotic value) and “ B ” is a constant determining the initial mass. Growth fitting was performed with the nonlinear regression procedure in SPSS (SPSS 20.0 © 1989-2011 SPSS Inc., USA) for each chick. Equation obtained for each chick allows reconstructing the entire growth curve, estimating mass and size at each time point. We checked that growth fitting

was not significantly different between our two sites for body mass (mean $R^2 \pm SE$: 1300m = 0.995 ± 0.005 , 1900m = 0.992 ± 0.005 ; linear mixed model: $df = 1$, $F = 1.02$, $p = 0.33$) and body size (mean $R^2 \pm SE$: 1300m = 0.996 ± 0.001 , 1900m = 0.995 ± 0.001 ; linear mixed model: $df = 1$, $F = 2.53$, $p = 0.12$).

Resting metabolism

Resting oxygen consumption (VO_2 expressed in mL O_2 consumed per minute) was determined in the dark to reduce chick's movements and stress. We recorded O_2 consumption during 30 minutes with a field open-circuit indirect calorimetry system (FOXBOX, Sable System, USA), at day 11 or 12 for 46 chicks (1300m: $N = 23$ and 1900m: $N = 23$). We choose to define the resting VO_2 as the lowest consecutive two minutes within the 30 minutes recording, and we included mean value of body mass (measured both before and after the respirometry measurement) as a covariate in statistical model to control for body mass effect on metabolism. Ambient air temperature was also simultaneously recorded to control for a potential temperature effect.

DNA oxidative damage

Oxidative damage was determined on DNA extracted (Nucleospin[®] Blood QuickPure, Macherey-Nagel, Düren Germany) from blood cells (at 7 days and 16 days) using the 8-hydroxy-2-deoxy Guanosine (8-OHdG) EIA kit (StressMarq Biosciences Inc., Victoria, BC Canada), after enzymatic digestion as described by Quinlivan & Gregory (2008). 8-OHdG is produced by the oxidative damage of DNA by reactive oxygen species (ROS), and increased levels of this marker have been associated with the ageing process. Blood DNA damage is expressed as pg/mL and intra-individual variation based on duplicates was low (respectively $CV = 1.95 \pm 0.26$ %) as well as inter-plate variation based on a standard sample repeated over plates ($CV = 5.13$ %).

Antioxidant defences

The antioxidant capacity was measured using the OXY-Adsorbent (5 μ L of 1:100 diluted plasma - Diacron International, s.r.l, Italy) following the manufacturer protocol (for detailed description of this test, see (Costantini *et al.* 2006)). OXY

adsorbent test allows quantifying the ability of the plasma antioxidant capacity to buffer massive oxidation through hypochlorous acid. Antioxidant capacity is expressed as mM of HClO neutralised and intra-individual variation based on duplicates was low (respectively $CV = 6.17 \pm 0.54 \%$) as well as inter-plate variation based on a standard sample repeated over plates ($CV = 10.03 \%$).

Statistics

We tested temperature differences among sites by the use of a general additive model (GAM), because it allows capturing the shape of a relationship between y and x without prejudging the issue by choosing a particular parametric form (Wood 2006). Daily mean temperature was the response variable against day of year as smooth term and site (1300m vs. 1900m) as fixed factor. GAM model was fitted using the software R (version 2.15; R Development Core Team 2010).

We tested elevation effect on parameters measured two times (*i.e.* DNA damage and antioxidant defences) by the use of repeated linear mixed models (rLMMs), with chick's age (7 or 16 days) as the repeated effect, the nest as a random effect (since the five chicks within one nest are not independent statistical units), elevation as a fixed effect and the interaction between elevation and age.

Elevation effect on parameters measured only one time ("A", "K", resting O_2 consumption and the relation between pre-fledging DNA damage (16 days) and growth) was done using linear mixed models (LMMs), with the nest as random effect and elevation as fixed effect. Sex and other covariates (*e.g.* mass or size at hatching) were also included in initial statistical models.

We choose to present the most parsimonious final models, where parameters presenting $p > 0.05$ were sequentially removed (starting by the interactions between parameters). Linear mixed models were fitted with a normal error distribution (SPSS 20.0), and data were tested for normality and homoscedasticity. All tests were two-tailed tests and p values ≤ 0.05 were considered significant. Means are quoted \pm S.E.

Results

Annual pattern of air temperature

Both sites followed the same temperature pattern all along the year (GAM: $\beta = 7.82 \pm 0.18$, $df = 8.66$, $p < 0.001$, Adjusted $R^2=0.71$, fig. 1). Nevertheless, the 1300m site was 2.33 ± 0.26 °C warmer all along the year than the 1900m site (GAM: $p < 0.001$, fig. 1).

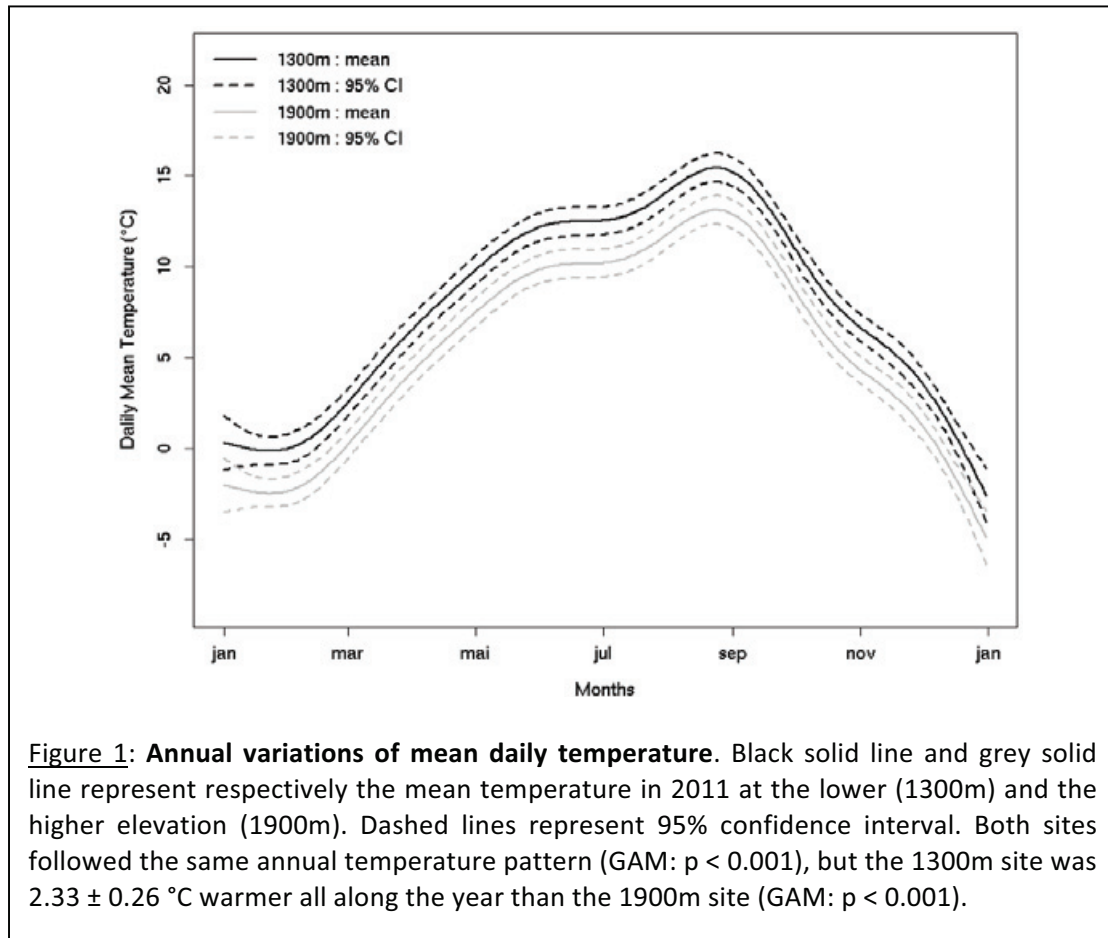

Nests parameters

As illustrated in *ESM* table S2, few nest parameters were significantly different among sites. Indeed, clutch size, clutch mass, mean egg mass, brood size at hatching and fledging, hatching success and fledging success were not statistically different between the 1300m and the 1900m sites. However, hatching date was significantly earlier for the lowest elevation site (Mann-Whitney test: $Z = - 2.52$, $p = 0.012$), with a mean hatching date being approximately 1 week earlier than for the

1900m site. Moreover, estimated incubation time appeared to be significantly longer for the 1900m site ($\approx + 1.6$ days, Mann-Whitney test: $Z = - 2.33$, $p = 0.020$).

Growth parameters

Estimated mean growth curves for both elevations are shown in fig. 2a for body mass and in fig. 2b for body size. Chicks from the two sites did not significantly differ at hatching (day 1) in terms of body mass (mean \pm SE: 1300m = 0.89 ± 0.22 vs. 1900m = 1.04 ± 0.22 g; LMM for elevation effect: $df = 1$, $F = 1.68$, $p = 0.22$) and body size (1300m = 0.25 ± 0.07 vs. 1900m = 0.28 ± 0.07 AU; LMM for elevation effect: $df = 1$, $F = 0.64$, $p = 0.44$). Similarly, we were unable to find significant differences at fledging (asymptotic value “A”), neither for body mass (1300m = 10.11 ± 0.47 g, 1900m = 9.85 ± 0.48 g; LMM for elevation effect: $df = 1$, $F = 0.97$, $p = 0.34$) nor for body size (1300m = 3.10 ± 0.11 AU, 1900m = 3.10 ± 0.11 AU; LMM for elevation effect: $df = 1$, $F = 0.007$, $p = 0.93$).

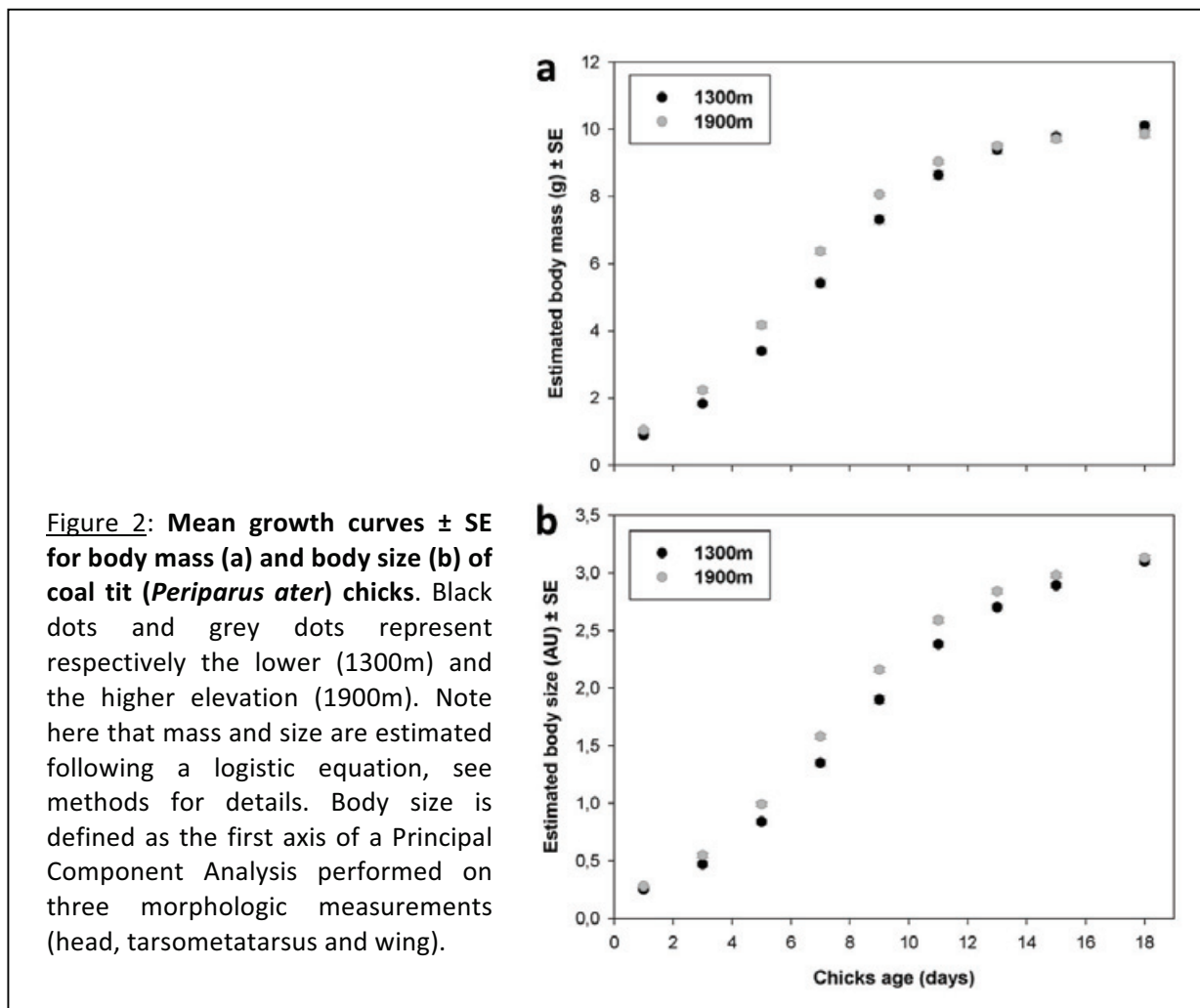

The growth rates (“K”) in terms of body mass (1300m = 0.419 ± 0.006 vs. 1900m = 0.465 ± 0.009 ; table 1a) and body size (1300m = 0.370 ± 0.006 vs. 1900m = 0.409 ± 0.009 ; table 1b) were significantly higher for chicks at 1900m than at 1300m (fig. 2). In addition, body size growth rate was negatively affected by the size at hatching (table 1b).

Table 1: Results of mixed models testing differences between 1300m and 1900m in terms of growth constant “K” for mass (a) and body size (b). See methods for detailed description of growth constant determination and for body size estimation. Estimates for fixed factors are given for the following levels: Elevation = 1300m.

(a) Mass growth constant (“K”)		Estimate	SE	F	p-value
Random effect	Nest	0.0013	0.0006		
Fixed effects & covariates	Constant	0.46	0.04	135.86	< 0.001
	Elevation	-0.05	0.02	4.72	0.050
	Mass at hatching				ns
	Sex				ns
(b) Size growth constant (“K”)		Estimate	SE	F	p-value
Random effect	Nest	0.0002	< 0.0001		
Fixed effects & covariates	Constant	0.49	0.02	582.78	< 0.001
	Elevation	-0.05	0.01	25.18	< 0.001
	Size at hatching	-0.30	0.04	63.67	< 0.001
	Sex				ns

Resting metabolism

Elevation significantly affected the resting O₂ consumption, with chicks coming from the higher elevation being those with the higher resting metabolism (mean ± SE: 1300m = 0.83 ± 0.08 vs. 1900m = 0.97 ± 0.09 mL O₂/min; table 2). Resting O₂ consumption also increased according to body mass and body mass growth rate, and decreased with increasing ambient temperature (table 2). Finally, resting metabolism was also affected by chick’s age (older chicks consuming more O₂), and by the interaction between body mass and elevation.

Table 2: Results of a linear mixed model testing differences between 1300m and 1900m in terms of resting O₂ consumption. Estimates for fixed factors are given for the following levels: Elevation = 1300m and Age = 11 days.

VO ₂ (mL/min)		Estimate	SE	F	p-value
Random effect	Nest	0.005	0.004		
Fixed effects & covariates	Constant	- 0.72	0.48	20.21	< 0.001
	Elevation	- 1.36	0.45	8.96	0.005
	Sex				ns
	Age	- 0.24	0.06	17.29	0.004
	Mass	0.10	0.04	44.20	< 0.001
	Temperature	- 0.02	0.01	6.88	0.017
	"K" growth mass	1.19	0.56	4.57	0.042
	Elevation*Mass	0.14	0.05	7.57	0.009

Oxidative stress parameters

DNA damage levels were significantly higher for chicks growing at the higher elevation (mean ± SE: 1300m = 549.8 ± 68.0 vs. 1900m = 643.0 ± 69.3 pg/mL, table 3a), but were not significantly affected by chick's age or sex.

Table 3: Results of a mixed model testing differences between 1300m and 1900m in terms of DNA damage in the blood (a) and plasmatic antioxidant defences (b) at 7 and 16 days. Estimates for fixed factors are given for the following levels: Elevation = 1300m, Age = 7 days and Sex = female.

(a) Blood DNA damage (8OH-dG)		Estimate	SE	F	p-value
Random effect	Nest	4005.54	2002.6		
Repeated effect	Age	8573.51	1093.43		
Fixed effects & covariates	Constant	643.02	69.41	81.55	< 0.001
	Elevation	-93.18	37.74	6.09	0.030
	Age				ns
	Sex				ns
(b) Antioxidant Barrier (OXY)		Estimate	SE	F	p-value
Random effect	Nest	188.69	91.71		
Repeated effect	Age	380.03	51.01		
Fixed effects & covariates	Constant	188.28	14.73	145.55	< 0.001
	Elevation				ns
	Age	- 25.52	5.26	20.12	< 0.001
	Sex	- 14.91	5.20	1.77	0.186
	Age*Sex	19.36	7.00	7.66	0.007

Plasma antioxidant capacity was not significantly affected by the elevation (mean \pm SE: 1300m = 168.9 ± 15.3 vs. 1900m = 177.8 ± 15.6 μ M HClO neutralised, table 3b), or the sex, but was significantly affected by chick's age and by the interaction between sex and age. Indeed, as revealed by a separate analysis for each sex, antioxidant defences increased significantly with age but only for males (males: 7 days = 163.2 ± 13.6 vs. 16 days = 189.0 ± 13.6 μ M HClO neutralised; LMM for age effect: df = 1, F = 25.46, p < 0.001; females: 7 days = 166.2 ± 14.3 vs. 16 days = 172.5 ± 14.3 μ M HClO neutralised, LMM for age effect: df = 1, F = 1.76, p = 0.19).

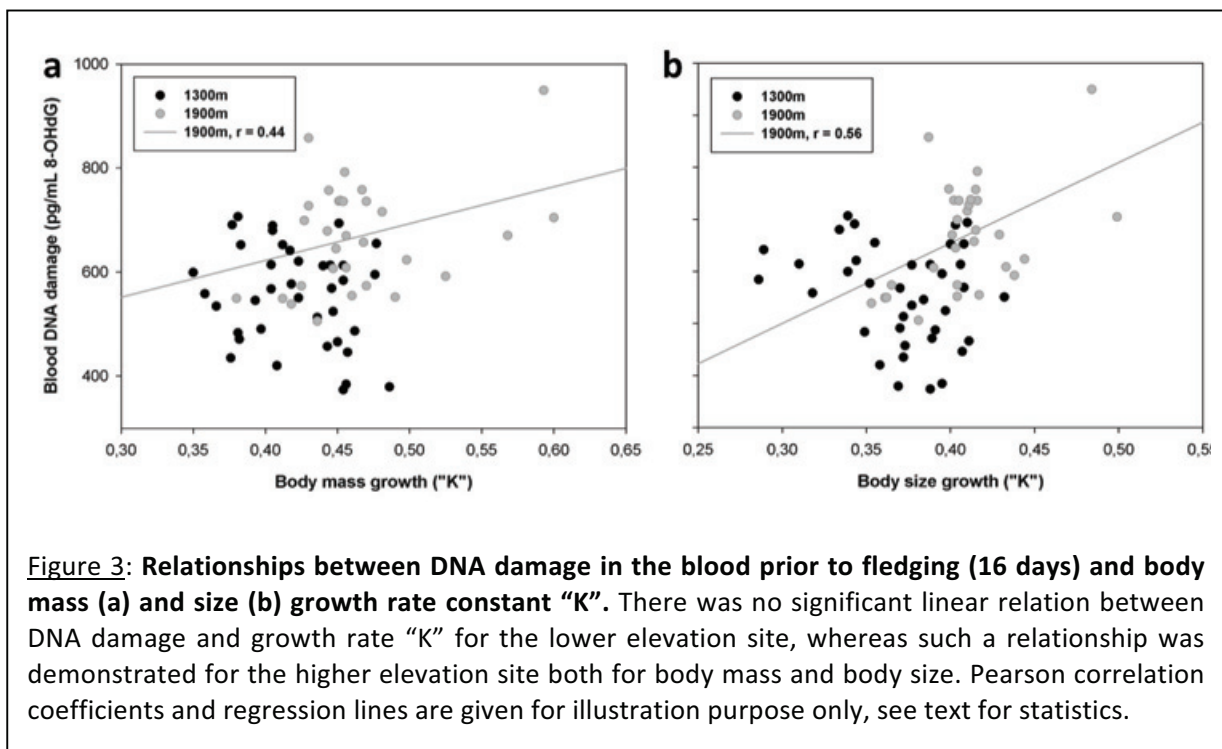

Interestingly, growth rate in terms of body mass and body size was a significant predictor of oxidative damage on DNA prior to fledging (day 16), but only for the highest elevation as revealed by the significant interaction between elevation and "K" (fig. 3a & 3b; tables 4a & 4b).

Table 4: Results of mixed models testing effects of body mass (a) and body size (b) growth rate (“K”) and elevation on DNA damage in the blood just before fledging (16 days). Estimates for fixed factors are given for the following levels: Elevation = 1300m.

(a) DNA damage at 16 days (8-OHdG)		Estimate	SE	F	p-value
Random effect	Nest	3046.26	1889.31		
Fixed effects & covariates	Constant	172.00	223.48	10.39	0.003
	Elevation	677.85	297.11	5.20	0.028
	Growth (“K” mass)	1043.94	462.58	0.28	0.60
	Elevation * Growth (“K” mass)	- 1735.87	666.20	6.79	0.013

(b) DNA damage at 16 days (8-OHdG)		Estimate	SE	F	p-value
Random effect	Nest	2144.43	1575.47		
Fixed effects & covariates	Constant	- 140.50	279.45	2.28	0.14
	Elevation	812.05	339.53	5.72	0.024
	Growth (“K” size)	1947.72	670.73	3.69	0.065
	Elevation * Growth (“K” size)	- 2252.73	854.78	6.95	0.014

Discussion

To sum up, our study shows that coal tit chicks grew faster at higher elevation. This higher allocation in growth was done at the expense of body maintenance, as stressed by the elevated levels of oxidative damage on DNA of chicks growing at the higher elevation site.

Elevation, environmental conditions and growth rates

As expected, even a moderate increase in elevation ($\approx 600\text{m}$ between our two sites) significantly modified air temperature in terms of absolute value ($- 2.33 \pm 0.26^\circ\text{C}$ for the 1900m site compared to the lower site), but not in terms of annual pattern. Therefore, if we theoretically consider that a favourable period is defined by a number of days above a certain temperature threshold, the favourable season will automatically be shorter at our higher elevation. Concomitantly to this change in environmental conditions, chicks growing at the higher elevation site grew approximately 11% faster, despite similar mass and size at hatching and just before fledging and similar brood size. This actually suggests that chicks were able to fledge

earlier, even if we cannot check this assumption because the exact fledging date was not recorded. The optimal window for growth (and the optimal fledging date) is determined according to diverse factors depending on the species (food availability, predation, social interaction), but our data confirmed that, under natural conditions, as the window shortens, growth rate increases when conditions are favourable (Bize *et al.* 2006; Geiger *et al.* 2012). Still, it is possible that growth rate could be increased at higher elevation only during favourable years.

As illustrated for body size by (Tsuchiya *et al.* 2012), the effect of elevation on growth rate could be either genetically driven, or reflect phenotypic plasticity. Considering the proximity between the two sites in our study (see *ESM* fig. S1), a genetic isolation/difference between the two sub-populations seems unlikely to occur. Therefore, we rather suggest that the higher growth rate observed for the high-elevation site is due to resources re-allocation (*i.e.* developmental flexibility), especially from self-maintenance processes toward growth (Dmitriew 2011). However, increased growth rate may also be linked to increased parental feeding (*i.e.* parental phenotypic flexibility). For instance, it was suggested by a large comparative study, that birds breeding in high elevation habitat demonstrated increased parental effort (Badyaev & Ghalambor 2001). Following this idea, parents breeding in high altitude may pay an additional reproductive cost that will be informative to follow in the future. So, a multiannual monitoring is required to fully understand the relationships between elevation, environmental conditions, parental investment and growth.

In contrast to the higher post-natal growth rate measured in this study, estimated incubation time seems to be longer for the higher elevation site (as suggested by (Badyaev & Ghalambor 2001), which could reflect a slower pre-natal development. This effect could be linked to ambient temperature differences, even if relationships between ambient temperature, incubation temperature and incubation duration are far from being simple (Conway & Martin 2000). The accelerated post-natal growth at higher elevation could then also be viewed as a compensatory response to a slower embryonic growth rate, as it was shown for young rats facing an intrauterine protein restriction (Tarry-Adkins *et al.* 2009).

Elevation and self-maintenance processes

Interestingly, chicks growing at the higher elevation site presented a higher resting O₂ consumption. This higher metabolism could be explained by a higher metabolic activity to sustain fast growth (Careau *et al.* 2013) and we found partial support for this hypothesis, since we demonstrate a significant correlation between growth rate and resting O₂ consumption. However, since elevation effect remains significant even after accounting for differences in growth rate (table 2), an additive effect of elevation *per se* seems conceivable (see (Hayes 1989) for a similar effect on deer mice and (Weathers *et al.* 2002) for contradictory results on adult bird). This elevation effect could be linked to higher thermogenic capacities developed by high-altitude chicks, since they have to face overall colder temperatures during the growth period (data not shown) than low-elevation chicks.

In any case, assigned high resting metabolism as a “good or bad thing” in terms of self-maintenance is difficult *per se*, since high metabolic rate should theoretically induce high ROS production (Beckman & Ames 1998), but high metabolism could also decrease ROS production if achieved through mitochondrial uncoupling (Salin *et al.* 2012a). Nevertheless, we found that levels of oxidative damage on DNA were higher for chicks growing at the higher elevation both at 7 and 16 days, while plasmatic antioxidant levels were not significantly affected by the elevation. This result suggests that higher oxidative stress occurs more probably because of higher ROS production rather than defect in antioxidant protection, which may be explained by a positive association between high energy expenditure and ROS production as suggested by Fletcher *et al.* (2013). Elevated levels of oxidative damage might be linked to the accelerated growth observed at higher elevation, as suggested by experimental studies demonstrating a causal relationship between accelerated somatic growth and susceptibility to oxidative stress (Alonso-Alvarez 2007a; Tarry-Adkins *et al.* 2008). Accordingly, we demonstrated in this study a significant correlation between growth rate and pre-fledging oxidative damage, although it was only the case for the high elevation site. This result could suggest that chicks growing at the lower elevation might stay above a deleterious threshold of growth rate (in terms of oxidative stress), whereas chicks growing at the higher elevation might exceed such a threshold. Such a mechanism could be consistent with

a possible constraining role of ROS production for life-history traits evolution (Dowling & Simmons 2009, but see also Stier *et al.* 2012), and could contribute to explain the weakness of the (nevertheless significant) relationships observed between growth rate and oxidative stress markers by some studies in natural conditions (Nussey *et al.* 2009; Kim *et al.* 2011). However, we cannot completely exclude that oxidative stress occurs for other reasons related to elevation, such as O₂ availability or UV exposure (Jefferson *et al.* 2004), differences in food quality (Costantini 2008) or in thermogenic capacities.

One interesting candidate to explain the accelerated growth / impaired self-maintenance pattern observed in our study could be a “testosterone-mediated maternal effect”, since females are capable of influencing/optimizing their young’s phenotype by modifying egg composition (Schwabl 1993; Grootuis *et al.* 2005). Indeed, we could hypothesize that high elevation females would increase their testosterone allocation within the eggs, which could contribute to accelerate chick’s growth (Schwabl 1996). However, high testosterone levels have previously been associated with impaired self-maintenance processes, such as increased oxidative stress (Alonso-Alvarez *et al.* 2007b). If such a hypothesis appears attractive considering our results on coal tit chicks, it remains to be properly tested.

One important point to keep in mind is that our study is restricted to short-term costs, and delayed costs of accelerated growth on fitness related-traits could also occur (see Criscuolo *et al.* 2008; 2011 for delayed costs of rapid growth rate in terms of resting metabolism and flight performances). Since oxidative stress could accelerate telomere erosion (Zglinicki 2002), chicks growing at higher elevation could also be more susceptible to a higher telomere erosion rate (see Zhong *et al.* 2011 for a link between elevation and telomere length in humans) with ultimate deleterious impacts on survival / lifespan (Bize *et al.* 2009; Heidinger *et al.* 2012).

Conclusion

The present study highlights the well-known idea that environmental conditions are primary shapers of life-history trade-offs. Indeed, elevation appears as a key factor modulating on one side the growth pattern of coal tit chicks, and on the other side the variations of markers related to the ageing process. Since oxidative stress has been recently shown to impair fitness related traits, such as recruitment (Noguera *et al.* 2012) or reproductive performances (Bize *et al.* 2008; Stier *et al.* 2012), our results highlight potential fitness costs of accelerated growth pattern in the wild. If experimental studies where elevation will be manipulated (or with cross-fostering between low and high elevation sites (Tsuchiya *et al.* 2012)) are now required to determine causal relationships between elevation, growth rate and oxidative stress/ageing rate, our study encourages future research to integrate environmental conditions to better understand physiological mechanisms underlying life-history trade-offs.

Acknowledgements

We are grateful to Guillaume Chagneau & Olivier Scholly for help with fieldwork, to Antoine Duparc for assistance with the statistical analysis of temperature data, and to the CNRS, the University of Strasbourg and the CREA for funding.

Authors' contributions

FC, AD, SM & AS designed the study. AS collected the data. AS, AD, FC and SM took part in data analyses and interpretations. MA and AS managed oxidative stress measurements and SZ performed the molecular sexing. AS, SM and FC wrote the paper.

Electronic Supplementary Material (ESM)

Stier *et al. Oecologia* (2014): Elevation impacts the balance between growth and oxidative stress in coal tits

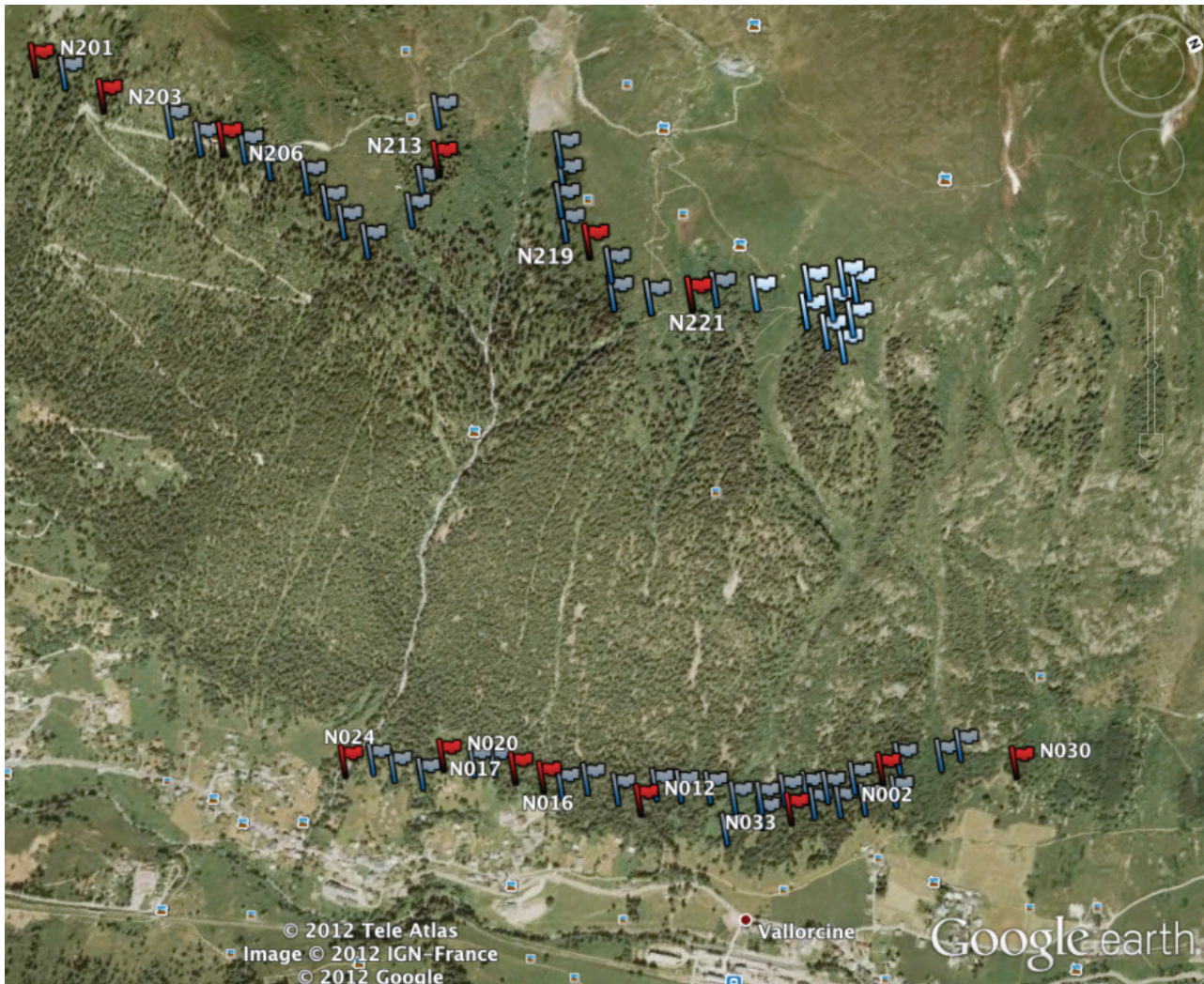

Figure S1: Vallorcine (French Alps) study site and location of coal tits nest boxes for the two transects: 1300m (N001 to N034) and 1900m (N201 to N234).

Nest boxes are represented with a flag, and occupied nest boxes for the 2011 breeding season are flagged in red (1300m: N = 8; 1900m: N = 6). © Google Earth

Table S2: Nest parameters for the two study sites (1300m: N = 8; 1900m: N = 6).

Means are quoted \pm SE and statistical differences between the two altitudes were tested using a non-parametric Mann-Whitney test. Hatching date was expressed as number of days since the 1st January 2011. Incubation time was estimated based on the assumption that incubation started just after clutch completion.

Nest variables	1300m	1900m	Z	p-value
Elevation	1343.3 \pm 11.4	1905.0 \pm 6.2	-3.11	0.002
Eggs				
Clutch size	9.0 \pm 0.3	8.3 \pm 0.4	-0.90	0.365
Clutch mass (g)	9.52 \pm 0.31	9.27 \pm 0.84	-0.19	0.846
Mean egg mass (g)	1.06 \pm 0.01	1.11 \pm 0.07	-0.712	0.477
Hatching date (days)	126.6 \pm 1.7	133.7 \pm 1.1	-2.52	0.012
Estimated incubation time (days)	13.4 \pm 0.3	15 \pm 0.5	-2.33	0.020
Chicks				
Brood size at hatching	8.5 \pm 0.4	7.8 \pm 0.3	-1.49	0.137
Hatching success (%)	94.4 \pm 3.2%	94.0 \pm 2.5%	-0.43	0.664
Brood size at fledging	7.9 \pm 0.4	7.7 \pm 0.3	-0.60	0.545
Fledging success (%)	87.7 \pm 4.4%	92.8 \pm 2.5%	-1.25	0.212

Paper 6 - A growth rate / telomere loss trade-off in the wild?
A test in coal and great tit chicks reared at different elevations

Antoine Stier, Anne Delestrade, Pierre Bize, Sandrine Zahn, François Criscuolo[†]
& Sylvie Massemin-Challet[†]

Submitted in a revised version to the Journal of Evolutionary Biology



[†] Equal contributors

Abstract

Background

Telomeres – protective DNA sequences located at the end of chromosomes – are mainly eroded during early growth, when cell division rate and metabolism are elevated. Telomere shortening during growth has been related to growth rate, while the length of telomere in early life appears to be a good predictor of adult survival prospects. Since telomere length at the end of growth seems to be such a fitness-related trait, populations naturally growing at different rates should exhibit specific patterns of telomere dynamics.

Results

We studied this hypothesis in two species of tits (*Parus major* and *Parus ater*) rearing their chicks at different elevations, by looking both at the inter- and intra-population relationships between growth rate and telomere loss. Great tit chicks grew slowly and ended growth with shorter telomeres at higher elevation, while coal tit chicks grew faster, started with longer telomeres but ended growth with similar telomere length at higher elevation. The latter inter-population comparison suggests that longer telomeres in early life may be a potential mechanism of resilience to rapid growth. However, we found no evidence of a direct link between telomere erosion and growth rate at the intra-population level, which raises questions about the causality of such a relationship in wild birds. Interestingly, chicks growing at the higher altitude were those suffering the higher telomere loss during the growth period in both species, thereby suggesting that elevation might be an important constraint for body self-maintenance in young chicks.

Conclusions

Considering the links between telomere length or loss and survival, this study highlights that environmental conditions experienced in early life might impact subsequent life history trajectories through ageing-related processes.

Keywords

Elevation, altitude, growth, ageing, telomere, wild birds

Introduction

Evolutionary theory assumes that the variation in life-history traits among individuals or populations can be explained by trade-offs among competing functions or activities. Such trade-offs are likely to reflect adaptations to local environmental conditions at the population level. Even though this concept has been largely studied using the current / future reproduction investment to assess the so-called “cost of reproduction” (Reznick 1985; Harshman & Zera 2007), variation in growth rate and the factors that regulate it are also of prime interest. In fact, body size in adulthood is a determinant of individual fitness through its correlations with longevity, fecundity or sexual competition (Clutton-Brock 1988). Although large adult size probably evolved with faster growth rates or longer growth periods (Kingslover & Pfenning 2004), physiological costs of delayed or fast growth (Metcalf & Monaghan 2001; Lee *et al.* 2013) have ultimately conducted to an evolutionary optimum of submaximal growth rates (Roff 2002). Still, ecological constraints such as a shortened favourable period under higher latitudes or elevations, may force organisms to grow “faster than normal” despite inevitable costs (Abrams *et al.* 1996).

Among others, telomeres erosion may provide one molecular mechanism of the longevity costs of fast growth (Metcalf & Monaghan 2001; Monaghan & Hausmann 2006). Telomeres are DNA non-coding sequences located at the end of eukaryote chromosomes, informing the cell about the health state of its own pool of genes (De Lange *et al.* 2006). Telomeres shorten during cell divisions and organisms ageing, enabling evolutionary ecologists to assess the biological age (*i.e.* the quality) of individuals (Monaghan & Hausmann 2006; Bauch *et al.* 2013). Telomeres are lost at a high rate during early growth (Monaghan & Hausmann 2006) and it has been previously suggested that high variability in telomere length among aged-match individuals may results from contrasted growth conditions (Hall *et al.* 2004). Since telomere length at the end of growth seems to correlate with long-term survival of individuals (Heidinger *et al.* 2012), this suggests that telomere dynamics during growth may play a major role in underpinning the growth-longevity relationship, and consequently could be an evolutionary target for adaptation to fast growth in adverse environments.

We studied this hypothesis in two species of tits, great tit (*Parus major*) and coal tit (*Periparus ater*), by following body mass growth patterns and concomitant telomere

dynamics of chicks raised by pairs breeding at different elevations, and therefore facing reproductive seasons of contrasted durations. We expected that growing in a less favourable environment in terms of available developmental time (*i.e.* higher elevation) would enhance growth rate but at a potential cost for telomere maintenance. We used these two species of tits considering their potential differences in terms of elevation preferences (Zang 1980). Great tit is well known to breed in a wide variety of habitats, particularly when adequate nesting sites are available. Yet, this species is preferentially restricted to deciduous forests rather than to coniferous ones (Gibb 1957), which is consistent with the higher density of great tits breeding in low elevation habitats (Zang 1980). In contrast, coal tits are accustomed to coniferous forests (Gibb 1957) and preferentially found in elevated habitats (Zang 1980), and are as such expected to be less sensitive to changes associated with an increase in elevation (Zang 1980).

Materials and methods

Study sites and animals

Breeding activity of both species was monitored using artificial nest boxes in three different sites from April to June 2011: in the French Alps at 1300m and 1900m elevations (Vallorcine), in the Vosges (Grendelbruch) at 700m elevation, and near Strasbourg at 100m elevation. Both 100m and 700m sites were characterized by a prevalence of deciduous trees species (personal observation). In contrast, both 1300m and 1900m sites were characterized by a mixed composition of coniferous and deciduous species, dominated by conifers and without marked differences between these two sites (A. Delestrade, personal communication). A total of 33 nests of great tits (21 nests at 100 m, 8 nests at 700 m, 4 nests at 1300 m) and 14 nests of coal tits (8 nests at 1300 m, 6 nests at 1900 m) were monitored, totalising 95 great (100 m, n = 53; 700 m, n = 22; 1300 m, n = 20) and 69 coal tit chicks (1300 m, n = 39; 1900 m, n = 30). Nests were visited all along the season to determine breeding parameters (incubation time, hatching date, clutch mass, clutch & brood size and number of fledglings).

Growth measurements

Three to five chicks per nest were selected (avoiding late-hatched chicks) to record their body mass (± 0.1 g) every two days during the first 16 days of growth (fledging taking place at day 17-20, personal observation). Body mass growth was fitted with the following

logistic equation: $Y(x) = \frac{A}{[1 + \exp(-K * x - B)]}$. $Y(x)$ represents the body mass of a chick at

age x (g), A is the asymptotic-final mass, K is the growth rate constant (an increase in K value implies an increase in the rate at which mass increases from initial value to asymptotic value) and B is a constant linked to the initial mass. Growth fitting was performed with the nonlinear regression procedure in SPSS (SPSS 20.0 © 1989-2011 SPSS Inc., USA) for each chick.

Telomere length assay

Chicks were blood sampled twice ($\approx 30 \mu\text{L}$) from the brachial vein, at day 7 and day 16. Blood was taken using a capillary tube and kept on ice until centrifugation (10 min, 1500 g), samples being subsequently stored at -80°C . Telomere length was measured using extracted DNA from blood cells, following the qPCR protocol adapted for birds by (Crisuolo et al. 2009). qPCR measurements were conducted separately for each species, and normalized by a different 'golden sample' (one per species). Therefore, relative telomere length should not be directly compared between species.

As a single control gene (or defined as a gene non variable in copy number within our population, thereafter non-VCN, (Smith *et al.* 2011)), we used the chicken zinc finger protein, with primer sequences defined by Primer 3 software as: (ZENK1: 5'-TACATGTGCCATGGTTTTGC-3'; ZENK2: 5'-AAGTGCTGCTCCCAAAGAAG-3'). Primer concentrations in the final mix were 100 nM for telomere length determination and 500 nM for the control gene. Telomere and control gene PCR conditions were 2min at 95°C followed by 40 cycles of 15s at 95°C , 30s at 56°C , 30s at 72°C and 60s at 95°C . We used 2.5ng DNA per reaction and the Power SYBR[®] Green PCR Master Mix fluorescent probe (Applied Biosystems, USA).

For great tits, mean amplification efficiency of the qPCR runs for telomere and non-VCN genes were respectively (in %): 99.86 ± 0.22 and 100.16 ± 0.31 . Intra-plate mean coefficients of variation for Ct values were of 1.74 ± 0.08 % for the telomere assay and $0.81 \pm$

0.03 % for non-VCN assay. Samples were run on five different plates and inter-plate coefficients of variation based on five repeated samples were $2.15 \pm 0.11\%$ for the telomere assay and $1.04 \pm 0.12\%$ for non-VCN assay (Ct values again).

For coal tits, mean amplification efficiency of the qPCR runs for telomere and non-VCN genes were respectively (in %): 111.60 ± 0.34 and 90.10 ± 0.35 . Intra-plate mean coefficients of variation for Ct values were $1.21 \pm 0.08\%$ for the telomere assay and $2.67 \pm 0.13\%$ for non-VCN assay. Samples were run on three different plates (mixed samples from different altitudes for each plate) and inter-plate coefficients of variation based on six repeated samples were of $1.68 \pm 0.81\%$ for the telomere assay and $0.83 \pm 0.24\%$ for non-VCN assay (Ct values again).

Final calculation of telomere length (T/non-VCN ratio) was done using the telomere and non-VCN accurate efficiencies of each plate (Pfaffl 2001).

Statistical procedures

Elevation effect on telomere length was assessed using repeated linear mixed models, with time (7 or 16 days) as the repeated effect, nest as a random effect (since the five chicks within one nest are not independent), elevation and the interaction between elevation and time as fixed effects. We also tested the effect of sex (cofactor). When a significant interaction Elevation x Time was revealed, we subsequently analysed each Time point (day 7 and day 16) independently using linear mixed models.

We tested elevation effect on growth parameters (A, K) by the use of linear mixed models, with the nest as random effect and elevation as fixed effect, with chick sex included as a fixed cofactor. Simplified models are presented, where parameters with $p > 0.05$ were sequentially removed (starting by the interactions between parameters). Linear mixed models were fitted with a normal error distribution (SPSS 20.0), and data were tested for normality and homoscedasticity.

We followed van de Pol and Wright method to test for inter- versus intra-population significance in the relationship between growth and telomere erosion rate (*i.e.* telomeres length at 16 days minus telomere length at 7 days) within each species (van de Pol & Wright 2009). We calculated the mean growth rate value for each population (*i.e.* elevation) of great and coal tits (population mean value, \bar{a}) and then used the $(a - \bar{a})$ centred growth rate for each individual (centred growth rate). We finally used mixed models (with the population

and the nest as random factors) to check how the population (\bar{a}) and the individual centred growth rate ($a - \bar{a}$) may explain the observed variation in the dependent variable, *i.e.* telomere erosion rate between day 7 and 16.

All tests were two-tailed tests and p values ≤ 0.05 were considered significant. Means are quoted \pm S.E.

Results

Breeding parameters

In both species, elevation had a significant impact on the duration of incubation, which increases with elevation (great tit $p < 0.001$; coal tit $p = 0.020$), and on hatching date, with a delay at the highest elevations (great tit $p < 0.001$; coal tit $p = 0.012$, Fig. 1a, 1b). However, there was no significant difference in variables characterizing the breeding effort among great tit pairs breeding at different elevations, *i.e.* in clutch size ($p = 0.39$), clutch mass ($p = 0.22$), brood size ($p = 0.13$) or in the number of chicks at fledging ($p = 0.29$). These variables neither differed between the two elevations for coal tits (clutch size $p = 0.37$; clutch mass $p = 0.85$; brood size $p = 0.14$; number of fledgling $p = 0.55$).

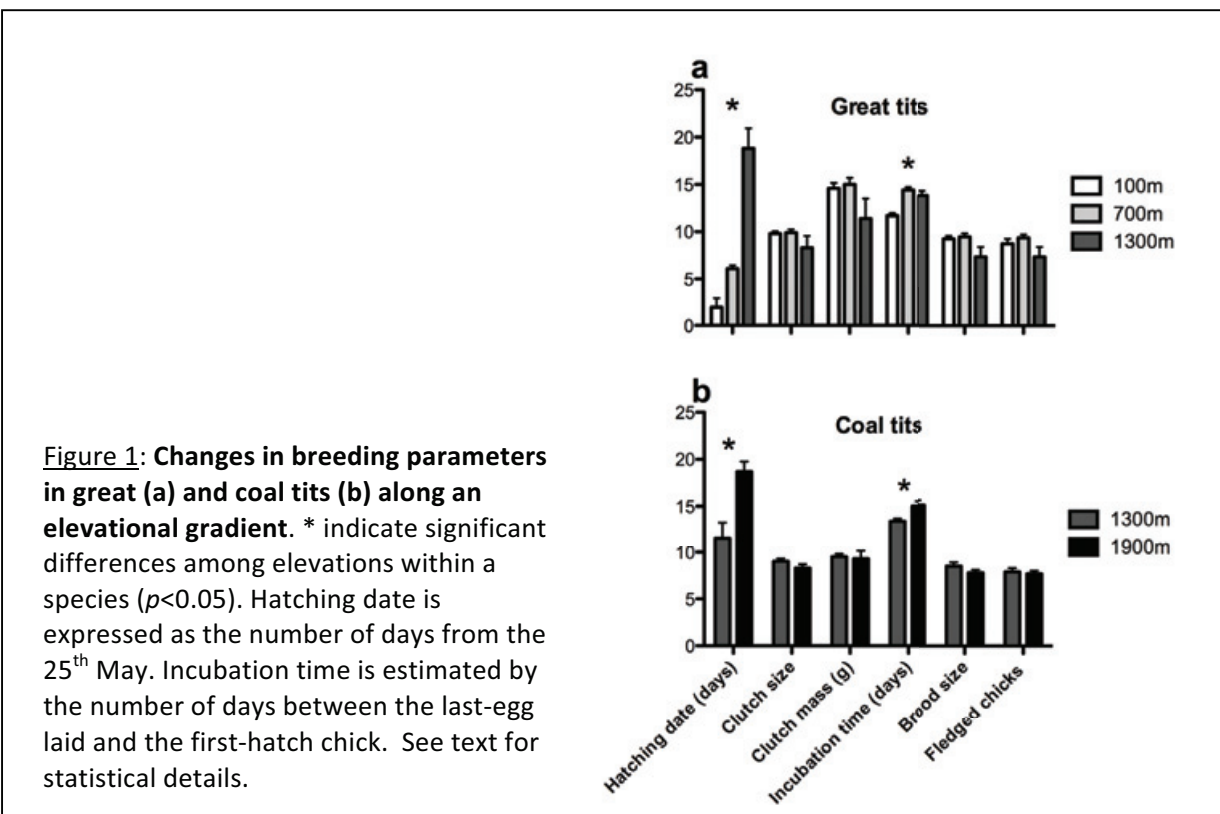

Growth parameters

Elevation did modified growth rate in both species but in opposite directions (Table 1a, figure 2a). The K growth constant was significantly decreased at 1300m in great tit chicks compared to 100m ($p=0.010$; 100m vs. 700m, $p=0.088$; 700m vs. 1300m, $p=0.235$; figure 2a, left panel). In contrast, coal tit chicks were growing at a faster rate at the highest elevation (Table 1b, figure 2a, right panel). However, body mass at fledging (asymptotic mass) was not significantly different among elevations in both species (Table 1b). There was however a sex effect on asymptotic body mass (Table 1b), with males being heavier than females at fledging, both for great tit (males = 17.94 ± 0.21 g vs. females = 17.47 ± 0.17 g) and coal tit chicks (males = 10.17 ± 0.13 g vs. females = 9.87 ± 0.09 g).

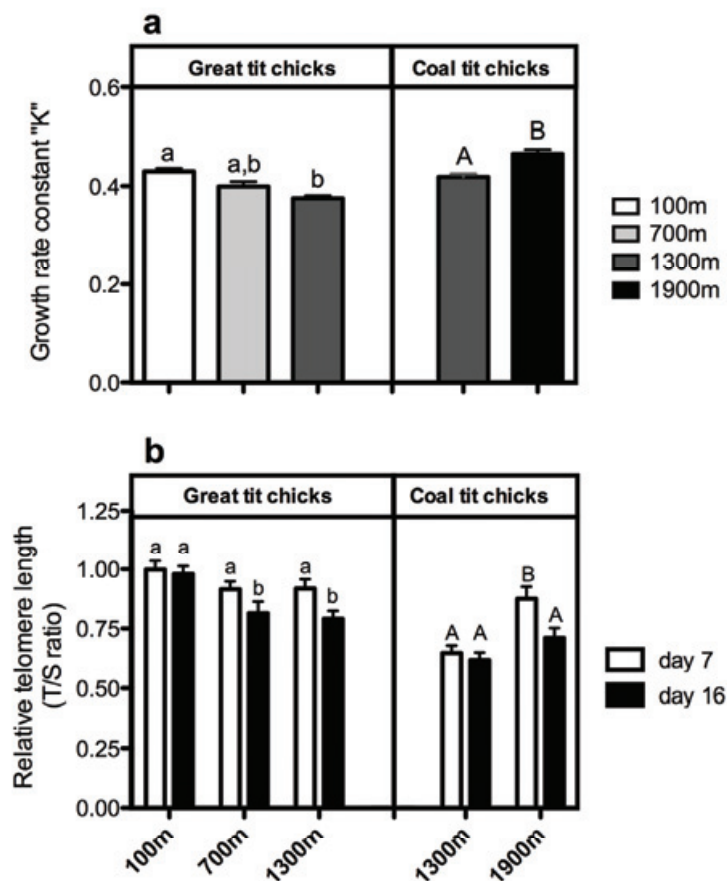

Figure 2: Differences in body mass growth rate (a) and telomere length dynamics (b) among great (left panels) and coal tit chicks (right panels) reared at different elevations (mean \pm SE). Letters indicate significant differences according to table 1 and separated analyses at each age (see results for details). Note that that relative telomere length *per se* should not be compared between species (see methods for details).

Telomere dynamics

For great tits, telomere length was not significantly affected by the sex of chicks, but there was a significant effect of the Elevation x Time interaction (table 1c, figure 2b left panel). We therefore analysed separately the differences in telomere length at day 7 and day 16 among elevations. Telomere length at day 7 was not significantly different among elevations ($F = 0.60$, $p = 0.54$), while a significant effect was revealed at day 16 ($F = 6.3$, $p = 0.011$), with longer telomeres at 100m compared to 700m ($p = 0.009$) and to 1300m ($p = 0.017$, figure 2b left panel).

In coal tit chicks, telomere length was not significantly affected by sex, but the Elevation x Time interaction was again significant (table 1c, figure 2b right panel). Separated analyses by time revealed that telomere length at day 7 was significantly affected by elevation ($F = 5.20$, $p = 0.042$), while no significant effect was found for telomere length at day 16 ($F = 2.90$, $p = 0.11$, figure 2b right panel).

Table 1: Summary of the most parsimonious linear mixed models explaining the variability in body mass growth rate “K” (a), asymptotic body mass “A” (b), and telomere length (c), for great and coal tit chicks. Estimates are also reported for random (Nest) and repeated (Time) effects.

(a) Growth rate constant K	Random effects		Estimates ± SE	F	p
Great tits	0.0011 ± 0.0003				
Intercept			0.40 ± 0.04	140.2	<0.001
Elevation			-0.03 ± 0.02	4.5	0.020
Sex					ns
Coal tits	0.0013 ± 0.0006				
Intercept			0.46 ± 0.04	135.9	0.002
Elevation			-0.05 ± 0.02	4.7	0.050
Sex					ns
(b) Asymptotic mass	Random effects		Estimates ± SE	F	p
Great tits	1.25 ± 0.33				
Intercept			17.98 ± 1.14	239.9	<0.001
Elevation					ns
Sex			-0.68 ± 0.13	14.0	<0.001
Coal tits	0.18 ± 0.09				
Intercept			10.16 ± 0.46	497.6	<0.001
Elevation					ns
Sex			-0.28 ± 0.13	4.7	0.034
(c) Telomere length	Random effects	Repeated effects	Estimates ± SE	F	p
Great tits	0.024 ± 0.009	0.026 ± 0.005			
Intercept			0.94 ± 0.07	31.7	<0.001
Elevation			-0.02 ± 0.11	1.4	0.27
Time			-0.12 ± 0.04	25.5	<0.001
Sex					ns
Elevation x Time			0.09 ± 0.04	3.5	0.034
Coal tits	0.022 ± 0.011	0.026 ± 0.005			
Intercept			0.87 ± 0.07	20.4	0.002
Elevation			-0.22 ± 0.09	2.6	0.131
Time			-0.17 ± 0.03	30.3	<0.001
Sex					ns
Elevation x Time			0.14 ± 0.04	15.3	<0.001

Inter- and intra-population relationships between growth rate and telomere loss

Mixed model analysis for great tits indicated that telomere erosion rate was not related to body mass growth rate (figure 3a), neither at the inter-population level ($F = 2.83$, $p = 0.10$) nor at the intra-population level ($F = 0.02$, $p = 0.89$).

The same analysis in coal tits showed that at the inter-population level, a positive link between growth rate and telomere loss was significant (figure 3b, $F = 15.99$, $p < 0.001$). However, this relationship was, again, not significant at the intra-population level ($F = 1.09$, $p = 0.30$).

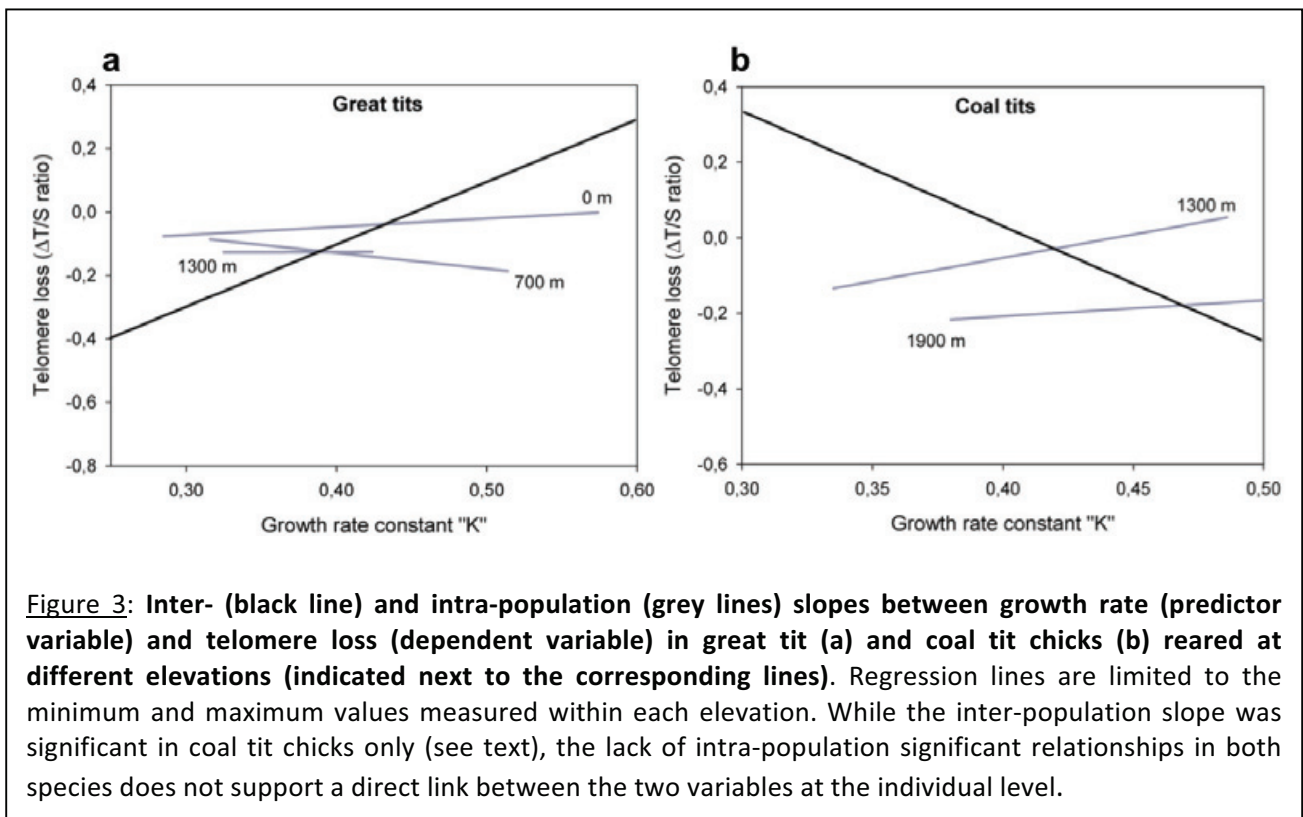

Discussion

To sum up, growing at higher elevation seems detrimental in terms of telomere loss for both species. This constraint seems to be at least partially buffered by coal tits, which may be better adapted to elevation as suggested by our results on growth rate, and previous findings on clutch size (Zang 1980). Indeed, despite presenting higher growth rate and higher telomeres erosion rate with increasing elevation, telomere length at fledging remained unaffected by elevation in coal tit chicks, thanks to longer initial telomere length. Since

telomere length at the end of growth has been found to predict lifespan in captivity (Heidinger *et al.* 2012), our results suggest that specific telomere dynamics may be part of the response that species have set-up following early life environmental challenges. However, we were not able to find a direct relationship between growth rate and telomere erosion for both species at the intra-population level (*i.e.* for individuals growing at the same elevation). This is actually raising questions about the occurrence of a causal relationship between post-hatching growth rate and telomeres erosion in wild conditions (see (Foote *et al.* 2011) for similar results in a long-lived seabird).

In both species, chicks exposed to the highest elevation presented a modification of their rate of body mass growth, but with an opposite trend between species (*i.e.* decreased growth rate for great tits vs. increased growth rate for coal tits), suggesting that coal tits may be better adapted to elevation than great tits. Great tit chicks at high elevations may have suffered from bad nutritional conditions during growth (*i.e.* explaining their lower body mass gain), as food supply may be reduced in high elevation (Lu 2004). Early bad nutritional conditions during growth may affect body maintenance processes through a sub-optimal resource trade-off between cell division / organ development and protective mechanisms (Metcalf & Monaghan 2001), explaining thereby the increased telomere loss. Among others, oxidative stress derives from the unbalanced between the inevitable production of reactive oxygen species (ROS) from mitochondria and protective mechanisms that include resistance (*e.g.* membrane composition) and antioxidant defences (Halliwell & Gutteridge 2007). Both of these components are partially defined by the diet composition (Halliwell & Gutteridge 2007; Costantini 2008), and any variability in diet richness may be responsible of an unregulated oxidative imbalance during growth with ultimately negative impacts on DNA maintenance (Jennings *et al.* 2000; Halliwell & Gutteridge 2007). Therefore, independently of a direct link with growth rate, which is not supported by our data for great tits (neither at the inter- nor at the intra-population level, figure 3b), variations in food quality/quantity may underpin the deleterious impact of elevation on telomere loss. Alternatively, living at higher elevation may increase thermoregulatory demands, thereby increasing potentially metabolic rate and its deleterious effects on body components (*e.g.* through oxidative stress), or limiting resources availability for development. In both cases, such a phenomenon should make growth at high elevation a more costly (in terms of telomeres loss) and slowly process than at lower elevation. Either of these environmental constraints (or an

accumulation of both) would have led to faster telomere erosion in 'high-elevation' great tit chicks, independently of growth rate variations.

For coal tits, faster growth at 1900 m than at 1300 m was concomitant with a faster rate of telomere erosion, at least at the inter-population level. This higher telomere loss was probably linked to the same factors that the ones described above for great tits, except for food quantity, since high-elevation chicks grew faster than the low-elevation ones. However, we could not completely exclude that an additive effect of fast growth also occurs, even if we did not find intra-population relationship between telomere erosion and growth rate to support this hypothesis (Figure 3a). We still have to keep in mind that experimental manipulations of growth rate have been shown to increase telomere erosion in laboratory rats (Jennings *et al.* 1999; Tarry-Adkins *et al.* 2008), although our results are consistent with previous findings on wild birds (Foote *et al.* 2011). Interestingly, the higher erosion rate at high elevation did not result in shorter telomeres at fledging, thanks to a longer starting telomeres length (at day 7). This result suggests that an adaptation to high elevation (and/or fast growth) may imply cellular ageing-preventing mechanisms. The extended incubation time observed at high elevation and the associated theoretical slower rate of embryo development may have induced beneficial effects on early telomere loss, as it was shown for post-natal growth retardation in rat (Jennings *et al.* 1999). This would be in accordance with the suggested importance of embryo developmental rate as a determinant of hatching telomere length in birds (Foote *et al.* 2011). However, since delayed incubation time was also found in great tit, other mechanisms like modulation of (i) embryo development through maternal effects or (ii) telomeres maintenance processes (*e.g.* telomerase activity), may explain why early telomere length is longer in 'high-elevation' coal tits. Alternatively, parental care in coal tits may be specifically increased when breeding at higher elevation, thereby buffering negative environmental impact on chick's development (Badyaev & Ghalambor 2001).

Long starting telomeres found in high elevation coal tits may be interpreted as a mean to support fast growth in a less favourable environment, given the lower ambient temperature and the shorter optimal growth window at 1900 m (data not shown). It should then allow coal tit chicks to grow faster but end with a similar fledging telomere length than those growing at lower elevation, a potentially key fitness related-variable (Heidinger *et al.* 2012). Such phenotypic covariation between growth rate and telomere loss between

populations (*i.e.* here elevations) may be interpreted as a specific adaptation to elevation, a hypothesis that would be reinforced if the same correlation exists at the individual level, *i.e.* within populations. A direct co-evolution of traits under specific environmental selection pressure may be driven by genetic changes (evolution convergence (Christin *et al.* 2010)) inducing a direct link between traits, or generating trade-offs. Such a selection process leads to phenotypic integration defined as a pattern of functional correlations among different traits in a given organism (Pigliucci 2003). Alternatively, co-variation of traits may be due to phenotypic plasticity in response to environmental demands, traits being then potentially independent from each other in the way they can be adjusted, which probably relieves individual from strong constraining effects of closely related traits (Buehler *et al.* 2012). In fact, based on the lack of evident relationship within a given population, our data rather support that there is no phenotypic integration within individuals of the growth/telomere link observed between populations. This may be explained by the fact that there is no strict separation between populations of coal tits, and/or that individuals are able to adaptively respond to high growth rate through compensatory mechanisms / trade-offs (see (Buehler *et al.* 2012) for an example of traits independence in red knot, *Calidris sp.*), with the beneficial consequence to avoid the deleterious impact of fast growth on telomere erosion (Tarry-Adkins *et al.* 2008; Geiger *et al.* 2012). It is interesting to note that we were not able to associate fast growth and rapid telomere erosion in great tit chicks either, thereby questioning whether growth *per se* or growth conditions (*i.e.* environmental stress) are the main factors acting on telomere loss (Jennings *et al.* 1999; Foote *et al.* 2011; Geiger *et al.* 2012). Local environmental quality (including parental quality) may be of major importance in driving the observed inter-population pattern of growth-telomere loss relationship.

Conclusions

In conclusion, growing in elevated habitats seems to be a major constraint for telomere maintenance during early growth in two tit species. Because telomere length at the end of growth has been found to predict lifespan in captivity (Heidinger *et al.* 2012), the fact that coal tit chicks exhibit longer initial telomere length at high-elevation suggests that specific telomere dynamics may be part of the response populations have set-up to answer early life environmental challenges. However, growth rate *per se* did not appear to be a

major determinant of telomere erosion rate in wild birds, at least at the intra-population level. Still, the phenotype of an organism is a system composed of interacting parts and the exact mechanisms underlying the growth rate / telomere erosion covariation pattern observed between coal tits populations remain to be fully elucidated.

Acknowledgments

This work was supported by a CNRS funding. We thank G. Chagneau, O. Scholly, A. Gross and the SRPO association for their contributions in the field. We thank M. Tissier & S. Reichert for helpful comments on a previous draft.

Authors' contributions

FC, AD, SM & AS designed the study. AS, FC, AD & SM collected the data. AS, FC and PB took part in data analyses and interpretations. SZ and AS managed the measurements of telomeres length. AS, PB and FC wrote the paper. All authors have read and approved the final version of the manuscript.

**Paper 7 - Catching-up but telomere loss: half-opening the black box of growth
and ageing trade-off in wild king penguin chicks**

Sylvie Geiger, Maryline Le Vaillant, Thomas Lebard, Sophie Reichert, **Antoine Stier**, Yvon Le
Maho & Francois Criscuolo

Molecular Ecology 2012, **21**:1500-1510



Catching-up but telomere loss: half-opening the black box of growth and ageing trade-off in wild king penguin chicks

SYLVIE GEIGER, MARYLINE LE VAILLANT, THOMAS LEBARD, SOPHIE REICHERT, ANTOINE STIER, YVON LE MAHO and FRANCOIS CRISCUOLO

Institut Pluridisciplinaire Hubert Curien, Département Ecologie, Physiologie et Ethologie, CNRS-UDS, UMR 7178, 23 rue Becquerel, 67087 Strasbourg Cedex 2, France

Abstract

One of the reasons for animals not to grow as fast as they potentially could is that fast growth has been shown to be associated with reduced lifespan. However, we are still lacking a clear description of the reality of growth-dependent modulation of ageing mechanisms in wild animals. Using the particular growth trajectory of small king penguin chicks naturally exhibiting higher-than-normal growth rate to compensate for the winter break, we tested whether oxidative stress and telomere shortening are related to growth trajectories. Plasma antioxidant defences, oxidative damage levels and telomere length were measured at the beginning and at the end of the post-winter growth period in three groups of chicks (small chicks, which either passed away or survived the growth period, and large chicks). Small chicks that died early during the growth period had the highest level of oxidative damage and the shortest telomere lengths prior to death. Here, we show that small chicks that grew faster did it at the detriment of body maintenance mechanisms as shown by (i) higher oxidative damage and (ii) accelerated telomere loss. Our study provides the first evidence for a mechanistic link between growth and ageing rates under natural conditions.

Keywords: ageing, bird, growth compensation, oxidative stress, telomere

Received 21 December 2010; revision received 2 September 2011; accepted 14 September 2011

Introduction

The incredible size variability among organisms has attracted much attention of many studies in the context of life history theory (Arendt 1997). Of particular interest to ecological studies is the display of intra-specific size variability and its fitness consequences (Altmann & Alberts 2005; Gagliano & McCormick 2007). The way that size impacts upon fitness is not simply a question of 'eating when big or getting eaten when small' but also depends on how optimal size is reached for a given life stage. Intuitively, one would expect large size to be achieved quickly through fast growth, and thus organisms would always grow as fast as possible. However, it is now well-known that growth rates are slower

than the maximum potential, one of the reasons (other than insufficient food availability or physiological constraints, such as changes in developmental maturity of tissues, Ricklefs 1969) being that high growth rates carry fitness costs: in addition to the higher risk of predation associated to increased foraging activities, physiological costs of rapid growth have been largely documented (see Munch & Conover 2003). Therefore, whether it became evident that a trade-off with growth must exist, understanding the mechanisms through which rapid growth may induce a suboptimal adult phenotype (for a given genotype), remains a central focus in evolutionary ecology and medicine (Lindstrom 1999; Metcalfe & Monaghan 2001; Gluckman & Hanson 2004); for example, given the strong relationship between size and fitness (Richner 1989), growth compensation is expected once feeding conditions turn adequate again for individuals that have had to face a bad

Correspondence: Francois Criscuolo, Fax: +33 (0)3 88 10 69 06; E-mail: francois.criscuolo@iphc.cnrs.fr

nutritional period. Growth compensation can be reached either through delaying age at maturity and extending the growth period (De Block *et al.* 2008) or by displaying accelerated growth rates over the normal period of time growth usually occurs (Metcalf & Monaghan 2001). Despite its short-term benefit (i.e. reaching an adequate size at fledgling), catch-up growth carries several physiologically associated costs (Crisuolo *et al.* 2008; Auer *et al.* 2010), among which one important long-term drawback is an associated reduction of longevity (Ozanne & Hales 2004). However, this suggestion is mainly based on experiments conducted under controlled environmental conditions, and, despite the fact that compensatory growth is known to occur in wild conditions (Bjorndal *et al.* 2003; Johnsson & Bohlin 2005; Bize *et al.* 2006), only scarce evidence of reduced longevity as a cost of accelerated growth has been described in free-living species (Johnsson & Bohlin 2010).

The proximal mechanisms underlying the growth-ageing relationship remain to be defined (Metcalf & Monaghan 2003). Among the potential candidates, oxidative stress has been suggested to play an important role (Alonzo-Alvarez *et al.* 2007; De Block & Stoks 2008). Oxidative stress is one of the main factors implicated in ageing theories (Beckman & Ames 1998) and may trigger quicker ageing notably via accelerated telomere erosion (von Zglinicki 2002; Tarry-Adkins *et al.* 2009). Indeed, telomeres form the termini of chromosomes and their reduction with age is one of the main mechanisms explaining cell senescence (Monaghan & Haussmann 2006). Until now, however, there has been no data examining whether oxidative stress and telomere erosion may be observed in young individuals that had to catch-up from a bad start in wild conditions.

The king penguin (*Aptenodytes patagonicus*) is the only seabird species in which the chick has to face the sub-antarctic winter period alone, while its parents are foraging at sea. During this time, roughly half of the chicks are never fed by their parents and then suffer from a high mortality (Weimerskirch *et al.* 1992). Therefore, complete growth spreads out over 11 months (one of the longest growing period in birds), mainly because parental feeding and consequently growth is interrupted during winter. Interestingly, if chicks differ in body mass and size at the beginning of the last phase of growth (when the winter fast ends), they, nevertheless, all seem to reach similar values at fledging (3 months later, Verrier 2003), suggesting that different growth rates may be exhibited by chicks during the post-winter growth phase. It is likely that these chicks must reach a threshold in either size or body condition (body lipid and protein content) before moulting and

departure at sea. These natural variability and evolutionary constraints acting on king penguin growth trajectories are unique opportunities to test the hypothesis that compensatory growth actually occurs in that species and induces an oxidative stress, which ultimately results in higher telomere shortening rates over the growth period.

Methods

Our study was conducted in the colony of 'La Grande Manchotière' (approximately 24 000 breeding pairs), Possession island, Crozet archipelago (Terres Australes Antarctiques Françaises) located 46°25'S; 51°52'E. The study began at the end of the austral winter and ended the next summer when chicks started moulting (end of the main second growth period).

The growth period in king penguin

Briefly, the growth period of king penguin chicks can be divided into three phases (Fig. 1). Following hatching, a first rapid growth phase (roughly 2.5 months) occurs, which is interrupted by the arrival of the winter period (i.e. a winter break phase of approximately 4.5 months). Indeed, following a sharp drop in marine resources in the sub-Antarctic area in early May, parents are required to rejoin the marginal sea ice (some 1800 km south off their colonies) to forage at sea (Bost *et al.* 2004). Winter is then the most sensitive period for king penguin chicks that are left fasting in the colony

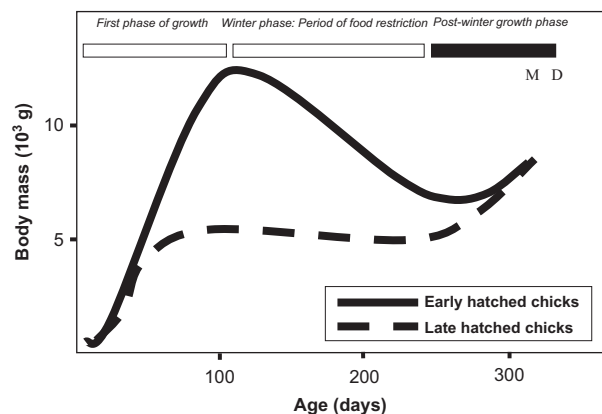

Fig. 1 Representation of body mass dynamics of king penguin chicks followed over their three successive phases of growth. Both early hatched chicks (January–early February) and late-hatched chicks (late February to early March) are represented. The whole period of development lasts around 11 months. In the present study, we focused on the last part of development (black bar) preceding the moult (M) and departure at sea (D). Adapted from Stonehouse 1960 and Verrier 2003.

over prolonged periods of time (Cherel *et al.* 1987; Descamps *et al.* 2002). A second growth period occurs in the subsequent austral summer, leading to complete maturation of the chicks (roughly 3 months, Stonehouse 1960; Descamps *et al.* 2002).

Bird sampling

To obtain a broad range of post-winter growth trajectories, we visually chose large chicks ($n = 14$; BM between 6.1 and 10.35 kg) in September, while small chicks ($n = 44$; BM between 2.6 and 5.4 kg) were banded until October 2008 to compensate for the high mortality rate of this group. Indeed, while no large chicks actually died from September until fledging, 30 chicks of the small group were victims of predation and starvation. We have no data concerning the hatching date of these birds, but small chicks were expected to grow faster, as offspring have a comparable size when leaving the colony for their first trip to sea, independently of their hatching date (Verrier 2003). Chicks were identified with a plastic band on the flipper. We ended the study with 28 birds at fledging, of which 14 were initially small chicks. After the beginning of November, no death was recorded. Whereas only values from the surviving small chicks were taken into account for analysis of changes in oxidative stress and telomere length in relation to growth rate, we, nonetheless, checked whether the small birds that died early in the study presented differences in initial values of these variables (only on 16 small chicks that died for logistic problems).

Growth measurements

Chicks were captured using a hooked pole (2 m long) and were immediately immobilized by hand. Upon capture, chicks were hooded to reduce handling stress. They were carried to a facility close to the colony where a blood sample was taken and where body size and mass were measured. No manipulation exceeded 20 min in total, and the chicks were released at the place of capture. From the beginning of September, the chicks were weighed (± 4 g) every 15 days using a platform balance (Kern IT60K2LIP) and morphometric measurements were taken: the fully extended flipper length was taken from the ventral side of the humeral head to the tip of the flipper. Initial and final body conditions of chicks were calculated using the residuals of the linear regression between body mass and flipper length. Plastic flipper bands were removed after the beginning of the moult. All chicks departed to sea on average 15 days (range 7–30 days) after the last manipulation. To evaluate the post-winter growth rate in body mass and flipper length,

we used the slope of the linear regression fitting for body mass or flipper length in relation to time for each individual. A linear relationship was the best-fitting model for our growth data, given that we were only working on a part of the growth period (mass growth, mean r value = 0.896 ± 0.023 ; flipper growth, mean r value = 0.942 ± 0.011 , $n = 28$).

Oxidative stress and telomere measurements

Blood samples from the flipper vein were taken both at the end of the winter (August–September), i.e. during the first morphometric measurement, and when the plastic flipper band was removed (during moult, last capture, November–January). Samples were centrifuged, plasma and red blood cells separated and frozen at -80 °C until analysis was carried out at the laboratory (Department of Ecology, Physiology and Ethology, Strasbourg, France). Plasma concentrations of reactive oxygen metabolites (d-ROMs) and of the antioxidant capacity (OXY-ADSORBENT) were measured using Diacron tests (Diacron International, Italy) as previously described in penguins (Beaulieu *et al.* 2010; Costantini *et al.* 2006 for a detailed description of the methodology). Mean coefficient of intra-individual variation was of $6.91 \pm 1.95\%$ and $3.94 \pm 1.33\%$, while mean interplate variation was of $9.73 \pm 1.31\%$ and of $10.29 \pm 2.06\%$, for OXY-ADSORBENT and d-ROMs tests, respectively.

Telomere length was determined using DNA extracted from red blood cells following the quantitative real-time amplification (qPCR) protocol adapted for birds and described by Criscuolo *et al.* 2009;. Primer sequences for telomere amplification were similar to previous studies (Bize *et al.* 2009; Criscuolo *et al.* 2009), and as a single control gene, we used the *Aptenodytes patagonicus* zinc finger protein (NCBI accession number AF490194), with primer sequences defined by Primer 3 software as: (Royal1: 5'-TACATGTGCCATGGTTTTGC-3'; Royal2: 5'-AAGTGCTGCTCCCAAAGAAG-3'). Primer concentrations in the final mix were 200 mM for telomere length (T) determination and 300 mM for the control gene (S). Final telomere values are expressed as the ratio between telomere and the single control gene number of amplification cycles (T/S ratio, Criscuolo *et al.* 2009). Telomere and control gene PCR conditions were 10 min at 95 °C followed by 30 cycles of 30 s at 56 °C, 30 s at 72 °C and 60 s at 95 °C. Standard electrophoresis on a 1.5% agarose gel run in standard TBE buffer (90 V for 10 min and 130 V thereafter for 30 min, ethidium bromide staining) was used to determine qPCR amplicon sizes of the control gene (170 bp) and of the telomere amplification product (darker band

between 50 and 100 bp). All samples were measured on one plate for telomere amplification and another plate for the control gene amplification. Amplification efficiencies of the qPCR run were 104% and 100% (telomere and ZENK, respectively). Mean intra-individual variation was $1.56 \pm 0.20\%$ for the telomere assay and $1.47 \pm 0.17\%$ for ZENK assay. Because of either lack of volume of plasma or of poor DNA quality, only 16 birds were used in the analysis of oxidative status (d-ROMs and OXY-ADSORBENT) and telomere dynamics, respectively. Sex determination was performed on DNA extracted from red blood cells following a method adapted from Griffiths *et al.* 1998.

Data analyses

Differences in initial values of growth, oxidative stress and telomere length (recorded at the beginning of the post-winter growth) among small chicks that resumed growth, small chicks that died early in the study and big chicks were tested using a linear model with group as a fixed factor. Post hoc comparisons were carried out using Tukey's tests. Linear mixed models (SPSS V. 18) were used to examine the dynamics of changes in body mass, wing length, d-ROM and OXY-ADSORBENT, and telomere length experienced by the chicks over the study period. To analyse our data set, random effect of individual identity (both intercept and slope) was accounted for to control for nonindependence of repeated measurements on the same individual. Group and sex were used as fixed factors, and the duration of the post-winter growth period was included as a covariate to control for the fact that large birds took a shorter time to resume their post-winter growth (on average 50 days) than did small chicks (100 days). Normality was tested afterwards, using the residuals of the model

(Kolmogorov–Smirnov test, all $P > 0.05$). A regression analysis was finally used to explicitly test the links between oxidative damage levels, growth rate, body condition and telomere loss. All tests were two-tailed, and $P < 0.05$ was considered significant. Values are given as means \pm SE.

Results

Initial characteristics of small chicks that died early in the study

Table 1 describes the initial state of the chicks followed during the study (small chicks that died and survived until fledging and big chicks). Chicks differed not only in body mass, as a result of our experimental design, but also in body size: small chicks (of both subgroups) were lighter and smaller than big ones. Interestingly, those small chicks that did not survive the growth period exhibited lower plasma antioxidant capacities, higher plasma levels of oxidative damages and lower initial telomere lengths than other surviving small chicks and big chicks. However, telomere length and oxidative damage were comparable among the two surviving groups of big and small chicks at the beginning of the experiment. Males and females presented similar initial body masses (6.1 ± 0.5 vs. 5.9 ± 0.3 kg, $F_{1,27} = 0.11$, $P = 0.746$), structural sizes (284.8 ± 4.9 vs. 283.5 ± 2.7 mm, $F_{1,27} = 0.11$, $P = 0.826$), antioxidant capacities (262.6 ± 13.8 vs. 295.9 ± 18.6 $\mu\text{mol HClO neutralized/mL}$, $F_{1,15} = 1.71$, $P = 0.208$) and oxidative damage levels (62.2 ± 26.5 vs. 73.6 ± 19.6 mg $\text{H}_2\text{O}_2/\text{dL}$, $F_{1,15} = 0.10$, $P = 0.756$). Body condition was significantly different between small chicks that naturally died and big chicks, but did not differ between sexes (0.05 ± 0.52 vs. -0.18 ± 0.29 , $F_{1,27} = 0.01$, $P = 0.908$).

Table 1 Mean (\pm SD) body mass, flipper length, body condition, oxidative balance indices and telomere length of king penguin chicks at the beginning of the post-winter growth. Values are indicated for the three experimental groups of birds, large chicks ($n = 14$), small chicks that died before ($n = 16$) or survived until fledging ($n = 14$). Duration of this post-winter growth period is also indicated for both groups of birds

Variable	Large chicks	Small chicks that died	Small chicks that survived	<i>F</i>	<i>P</i>
Body mass (10^3 g)	8.1 ± 1.1^a	3.2 ± 0.4^b	3.9 ± 0.8^b	133.4	<0.001
Wing length (mm)	307.9 ± 5.9^a	259.8 ± 4.0^b	260.4 ± 4.0^b	48.3	<0.001
Body condition (residuals mass/size)	0.3 ± 0.4^a	-0.6 ± 0.3^b	-0.3 ± 0.4^b	4.7	0.015
Antioxidant capacity ($\mu\text{mol HClO neutralized/mL}$)	309.5 ± 14.8^a	167.1 ± 8.8^b	257.1 ± 13.4^c	52.0	<0.001
Oxidative damage (mg $\text{H}_2\text{O}_2/\text{dL}$)	36.5 ± 15.8^a	132.6 ± 16.2^b	81.1 ± 13.5^a	4.0	0.029
Telomere length (T/S ratio)	1.31 ± 0.2^a	0.54 ± 0.1^b	1.48 ± 0.2^a	23.6	<0.001
Recorded post-winter growth period (days)	57.3 ± 23.4^a	10.5 ± 4.0^b	100.1 ± 15.5^c	129.2	<0.001

Differences among groups were tested using a linear model. Normality was verified in all cases using Kolmogorov–Smirnov tests (all $P > 0.16$). Columns with different letters indicate a significant difference among chick groups (using Tukey's test).

Post-winter growth rates

The growth period was longer in small than in large birds (Table 1), pointing out that those small birds took longer to resume their growth and to reach the adequate body condition or size for their departure at sea. There was an overall significant effect of chick group (i.e. initial body size) on body mass growth, small chicks accumulating body mass at a higher rate than large chicks (slope values, small chicks: 0.078 ± 0.004 , mean coefficient of variation 6.7%; large chicks: 0.049 ± 0.007 g/day, mean coefficient of variation 24.2%, Fig. 2, Table 2a). The same effect was found in flipper length growth (small chicks: 0.504 ± 0.036 mm/day, mean coefficient of variation 8.0%; large chicks: 0.212 ± 0.040 mm/day, mean coefficient of variation 29.9%, Table 2b), thereby indicating growth rate differences reflected both changes in body reserves and body size. The higher growth rate exhibited by small chicks resulted in a body mass comparable with large chick when all birds left the colony (10.51 ± 0.32 (small) vs. 11.38 ± 0.33 kg (large chicks), $F_{1,27} = 3.607$, $P = 0.164$), although small chicks still had smaller flippers (303.4 ± 1.8 vs. 320.9 ± 1.8 mm, $F_{1,27} = 47.7$, $P < 0.001$). Therefore, small chicks were initially smaller in mass and size, but grew more rapidly after the winter and did compensate totally in body mass and partially in size for their initial bad start. There was no effect of sex on final mass (males, 11.74 ± 0.47 vs.

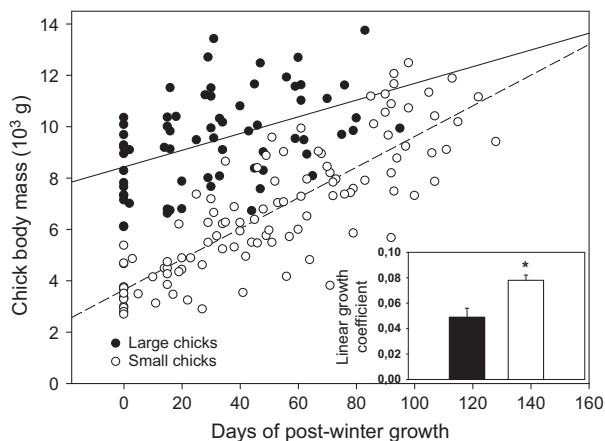

Fig. 2 Body mass growth trajectories of two groups of small (open circles) and large (filled circles) king penguin chicks measured during the post-winter growth period (between September and December). Linear regression values: small chicks, $r^2 = 0.69$, $F_{1,108} = 241.0$, $P < 0.001$; large chicks, $r^2 = 0.21$, $F_{1,67} = 17.9$, $P < 0.001$. Inset: mean linear growth coefficients differ significantly between the two groups, small chicks growing at a higher rate than large chicks during the post-winter growth period ($P < 0.001$, see Table 2 for statistics). Bars represent mean \pm SE.

Table 2 Results of separate linear mixed models analysing the differences between our two experimental groups (large and small king penguin chicks at the end of the winter) on changes over time of: (a) body mass, (b) flipper length, (c) plasma antioxidant capacity, (d) plasma levels of oxidative damages and (e) telomere loss

Variable and explanatory factors or covariates	D	F	P
<i>a. Body mass growth</i>			
Group	1, 32.1	62.92	<0.001
Post-winter growth period (days)	1, 150.4	303.98	<0.001
Group \times Post-winter growth period (days)	1, 150.4	7.83	0.006
Sex	2, 22.3	0.42	0.66
<i>b. Flipper length growth</i>			
Group	1, 28.8	116.39	<0.001
Post-winter growth period (days)	1, 146.6	353.73	<0.001
Group \times Post-winter growth period (days)	1, 146.6	52.40	<0.001
Sex	2, 24.1	0.15	0.86
<i>c. Modification of the antioxidant capacity</i>			
Group	1, 31.7	8.97	0.005
Post-winter growth period (days)	1, 20.0	2.70	0.116
Group \times Post-winter growth period (days)	1, 20.1	5.56	0.029
Sex	2, 18.5	0.33	0.57
<i>d. Modification of the oxidative damage level</i>			
Group	1, 30	0.78	0.385
Post-winter growth period (days)	1, 30	6.09	0.021
Group \times Post-winter growth period (days)	1, 30	4.88	0.037
Sex	2, 30	0.07	0.80
Body mass growth	1, 30	4.21	0.044
<i>e. Total telomere loss</i>			
Group	1, 35.9	1.13	0.30
Post-winter growth period (days)	1, 18.8	4.12	0.057
Group \times Post-winter growth period (days)	1, 18.8	5.41	0.031
Sex	2, 23.2	0.72	0.41

In each case, chick gender was used as a fixed factor and post-winter growth duration (time) as a covariate to correct for the difference in the total length of the growth period observed between the two groups of chicks. Significant terms are reported in bold, and nonsignificant terms were dropped sequentially from the model.

females, 10.68 ± 0.26 kg, $F_{1,27} = 3.66$, $P = 0.067$) or body size (males, 313.8 ± 2.7 vs. females, 311.6 ± 1.5 mm, $F_{1,27} = 0.45$, $P = 0.509$).

Post-winter oxidative stress

The dynamic in change of plasma antioxidant capacity was also different among the two groups (small, $+1.5 \pm 18.7$ vs. large, -36.5 ± 21.6 $\mu\text{mol HClO}$ neutralized/mL, Fig. 3, Table 2c), small chicks starting with lower antioxidant levels but ending with comparable

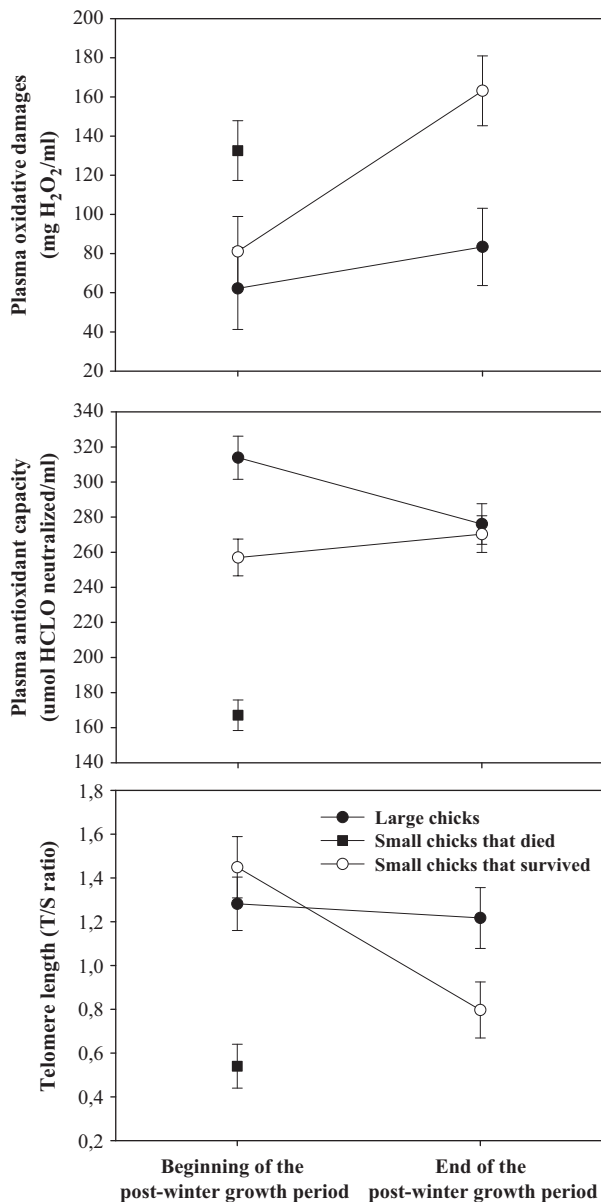

Fig. 3 Mean (\pm SE) plasma oxidative damage levels (upper panel), plasma antioxidant capacity (middle panel) and telomere length (lower panel) in king penguin chicks are indicated both at the beginning and the end of the post-winter growth period. Chicks were separated into three groups at the end of the winter in relation to their size [big chicks ($n = 14$) and two groups of small chicks that either passed away naturally at the early beginning of the longitudinal following ($n = 16$) or that resumed growth successfully ($n = 14$)]. Letters indicate significant differences, see tables for detailed statistics.

final antioxidant capacities (small, 270.3 ± 10.5 vs. large, 276.1 ± 11.6 $\mu\text{mol HClO neutralized/mL}$, Fig. 3, Table 2c). On average, small chicks presented a lower mean antioxidant capacity of the plasma over the study than large chicks (Table 2c). Small chicks also exhibited a greater increase in their oxidative damage plasma

levels over growth than large birds ($+74.7 \pm 20.6$ vs. $+27.2 \pm 23.9$ $\text{mg H}_2\text{O}_2/\text{mL}$, Fig. 3, Table 2d). Chicks that were initially small exhibited overall higher levels of oxidative damage than large chicks at the end of growth (163.1 ± 17.8 vs. 83.4 ± 19.7 $\text{mg H}_2\text{O}_2/\text{mL}$, Fig. 3, Table 2d). There was a positive regression between the final oxidative damage levels and the rates of body mass growth (residual oxidative stress, $r^2 = 0.41$, $F_{1,15} = 7.57$, $P = 0.019$). Again, there was no sex effect on these parameters ($P > 0.05$).

Post-winter telomere shortening

At the end of the winter, both small and large chicks started their growth period with a similar telomere length (Table 1), with no sex differences (males, 1.4 ± 0.2 vs. females, 1.4 ± 0.1 T/S, $F_{1,15} = 0.03$, $P = 0.875$). On average, telomere length was shortened during the post-winter growth (from 1.4 ± 0.1 to 1.1 ± 0.1 T/S, Table 2e). Males and females presented a comparable decrease in their telomere length, and there was no impact of growth period duration on telomere loss (Table 2e). However, the total telomere loss was higher in small than in large chicks (-0.6 ± 0.2 vs. -0.01 ± 0.2 T/S ratio, Table 2e, Fig. 3), the duration of the growth period being nonsignificant (Table 2e). Small chicks ended with a mean telomere length of 0.8 ± 0.1 T/S ratio and large birds with 1.2 ± 0.1 T/S ratio, telomere length being comparable between sexes at that stage (males, 1.3 ± 0.2 vs. females, 1.2 ± 0.1 T/S, $F_{1,22.9} = 0.65$, $P = 0.43$).

Interestingly, there was a regression between the absolute values of total telomere loss and of plasmatic levels of final oxidative damage, i.e. the higher the damages, the

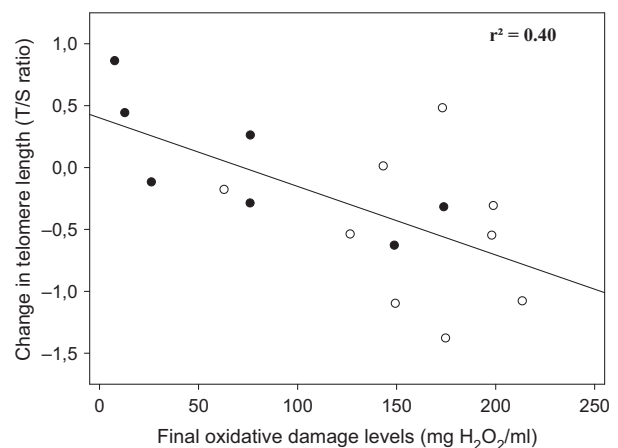

Fig. 4 Significant linear relationship between telomere loss and oxidative damage levels at the end of the growth period of king penguin chicks, which were either small (open circles) or large (filled circles) at the beginning of the post-winter growth period. See text for details.

larger the telomere loss throughout the post-winter growth period (regression, $y = -0.006x + 0.402$, $r^2 = 0.56$, $F_{1,15} = 9.13$, $P = 0.009$, Fig. 4, the impact of antioxidant capacity being non significant, $F_{1,15} = 1.21$, $P = 0.29$). Additionally, those birds that resumed their growth with a better body condition were also those having lost more telomere sequences, independently of their sex ($F_{1,15} = 4.84$, $y = -0.238x + 0.007$, $r^2 = 0.27$, $P = 0.047$, sex effect, $F_{1,15} = 4.18$, $P = 0.062$).

Discussion

To sum up, chicks from the small group were growing faster and displayed higher final oxidative damages than chicks from the large group. In addition to their implications in ageing theories (Nemoto & Finkel 2004; Monaghan & Haussmann 2006), oxidative stress and telomere loss have been recently negatively linked to both reproductive success and survival rates in several free-ranging bird species (Bize *et al.* 2008, 2009; Salomons *et al.* 2009). Therefore, our results highlight that in natural conditions, oxidative stress and telomere loss are likely to link growth to ageing. The present work gives, to our knowledge, one of the first proximal explanations about how growth can modulate ageing rate in a wild species.

Impact of fast growth on oxidative stress

Fast growth has been previously reported to have adverse effects on longevity (Ozanne & Hales 2004; but see Johnsson & Bohlin 2005). Chronic production of harmful molecules by aerobic metabolism is inevitable in the form of reactive oxygen species (ROS), and one simple (but not always obvious) assertion is that fast growth implies higher metabolic/oxygen consumption rates and exposition to ROS, leading, if organism defences are inadequately low, to a premature accumulation of important cell damages (Beckman & Ames 1998; Mangel & Munch 2005). Even if the core of this hypothesis can be discussed (Crisuolo *et al.* 2008), two previous studies have pointed out that decreased antioxidant defences may result from fast growth and suggested, despite presenting no data on oxidative damages, that oxidative stress may be part of the link between growth and lifespan (Alonzo-Alvarez *et al.* 2007; De Block & Stoks 2008).

Impact of fast growth on telomere loss

Long-term impairment of antioxidant functions has been found 12 months after a growth acceleration in rats (Tarry-Adkins *et al.* 2008), and chronic oxidative stress is known to be at the origin of many age-related

diseases (Valko *et al.* 2007). In parallel, correlation between oxidative stress and telomere shortening is well-known from *in vitro* studies, because of the extreme frailty of telomeric DNA to ROS (von Zglinicki 2002). Association between growth rate and oxidative stress or between growth rate and telomere loss has previously been described *in vivo* (see Monaghan & Haussmann 2006; Monaghan *et al.* 2009 for review), but this is the first characterization of a potential relationship between growth rate, oxidative stress and telomere loss in a wild species. The impact of fast growth in king penguin chicks on telomere loss is in accordance with the previous work conducted on laboratory rats (Tarry-Adkins *et al.* 2009). Still, other factors may be responsible for the higher telomere loss encountered by small chicks. It is well-known, for example, that telomere dynamics are related to physiological and social stress (Epel 2004; Kotrschal *et al.* 2007; Haussmann & Marchetto 2010) that are regulated primarily by endocrine networks such as the hypothalamic–pituitary–adrenal axis. Given the particular role of corticosterone in fasting physiology (i.e. increases when body reserves are low) and its impact on growth rate (delayed growth), small chicks may have experienced higher chronic corticosterone levels. High corticosterone induces a decrease in antioxidant capacities (Stier *et al.* 2009), which may be ultimately responsible for a sharper decrease in telomere length. One direct impact of stress on telomere length is mediated via the reduction of specific enzyme activities such as the telomerase (Haussmann *et al.* 2007; but see Tarry-Adkins *et al.* 2009), which is also known to be decreased by cortisol in humans (Choi *et al.* 2008). As telomerase activity is maintained throughout life in long-lived birds (Haussmann *et al.* 2007), irreversible ability of triggering telomerase because of bad early life programming could also lead to accelerated telomere loss after the growth period ceased, amplifying the early-growth modulation of ageing.

Fast growth in king penguin chicks

King penguins are set apart from other bird's life histories by the exceptionally long chick growth pattern, which is interrupted by a winter break (Stonehouse 1960; Fig. 1). Parental feeding events are irregular throughout the winter, leading to a large variety of body mass dynamics, which ranges from mass stability to important loss and sometimes even death by starvation (Stonehouse 1960; Cherel *et al.* 1987; Weimerskirch *et al.* 1992; Verrier 2003). Our data confirmed that body mass and body size can be extremely different among chicks at the end of the winter phase. But, importantly, we also show that small chicks are able to grow faster

than large chicks during the 2 months prior to fledging, thereby catching-up for their initial delay. The fact that individuals with the lowest body mass exhibited the fastest growth rate when good conditions are restored is consistent with the previous studies in the field (Johnsson & Bohlin 2005) and the laboratory (Jobling & Johansen 1994).

Compensatory growth has previously been described in wild animals (Suttie *et al.* 1983; Bjørndal *et al.* 2003; Johnsson & Bohlin 2010), and our study raised some intriguing questions: why and how might an altricial chick actually exhibit compensatory growth? The former question relates to developmental constraints such as a body condition threshold or the time schedule necessary to resume growth (Carrier & Auriemma 1992), which penguin chicks may be subject to. This is likely to be the case not only before the winter period starts (to reach a sufficient size and mass to successfully survive the winter food shortage), but also after the post-winter growth when chicks have to accumulate enough energy (i.e. proteins) stores to resume complete feather development, a prerequisite for departure at sea (Corbel *et al.* 2009).

The second question concerns the nature of the mechanisms enabling small chicks to show a higher growth rate than large ones. If compensatory growth is likely to involve hyperphagia (Niecieza & Metcalfe 1997), we did not determine how frequently small chicks were fed by parents. This is likely to be a key point, as parental feeding of king penguin chicks during the third phase of growth can be assumed either by both parents or only by one of them (for 65% of the chicks during the last month before moult, Corbel 2008). In addition, alloparental feeding has been previously observed in this species, and it may allow small chicks to be fed at a higher rate once the big chicks have started to quit the colony. However, alloparental feeding is more frequent during the winter period (Lecomte *et al.* 2006), and parents have little to gain by feeding unrelated chicks. Hyperphagia is not the unique parameter enabling full growth catch-up, and adaptations of other components of the energetic balance (e.g. energy expenditure) obviously appear as important modulators of growth rate.

In the king penguin, an entire year is needed to successfully fledge a chick with the consequence that adults can only attempt to breed on time every second year (Olsson 1996). Therefore, breeding late in the season is likely to produce small chicks (both at the entrance and at the end of the winter). In our study, we did not determine the hatching date of our chicks, and we cannot rule out the possibility that large and small chicks are rather early and late chicks. In that case, their growth trajectories may differ, because these chicks are not sampled at the same point of the growth trajectory,

and instead of growth compensation, we are measuring absolute growth rates, more or less high depending on growth stages. However, a previous study outlined that early and late chicks strongly differed in their prewinter growth rates, suggesting that chicks must reach the same degree of organism maturation when the winter fast begin (VanHeezik *et al.* 1993). We indeed observed in a recent field work that the first-fledging chick of a 2009 cohort was a late-hatching chick. In this particular species, with a unique growth pattern, the winter growth break may also synchronize all chicks before entering their last maturation phase before fledging.

Oxidative stress and telomere loss as a constraint on growth

In our bird model, it is likely that the growth fast induced a higher and unbalanced ROS production, with the consequence that it is hardly possible for penguin chicks to sustain both rapid development and adequate investment in body maintenance. Few data are available about how ROS production may be modified by growth rates. Rapid growth of transgenic mice showed enhanced lipid peroxidation or ROS production (Rollo *et al.* 1996). On the other hand, poor early nutritional conditions are known to impair long-term functioning of antioxidant network (Blount *et al.* 2003). We cannot exclude that our observations result from a bad start (during the first phase of growth) of the post-winter small chicks (e.g. dead small chicks suffered higher initial oxidative stress) rather than catch-up per se. Therefore, without more detailed data on the ontogeny of mitochondrial and antioxidant mechanisms during chick development, we are yet in the expectative concerning the exact nature of the growth/oxidative stress relationship. We also pointed out that, independently of the growth trajectory, ending with a good body condition was also associated with a higher loss of telomere sequences. This further suggests that fat accumulation (which can reach more than 20% in pre-moulting chicks, Cherel *et al.* 1993) is balanced against telomere maintenance mechanisms in penguins. Pathological fat accumulation through obesity has been previously found to be associated with higher levels of oxidative stress (Keaney *et al.* 2003; Furukawa *et al.* 2004) or shorter telomere length in humans (Valdes *et al.* 2005; Zannolli *et al.* 2008). Knowing that juvenile survival rates are positively related to body condition at departure in king penguin chicks (Saraux *et al.* 2011), the question of the potential long-term detrimental long-term effects (physiological/fitness) of ample fat accumulation evolved by penguins merit further consideration.

Small chicks that died early in the experiment were those presenting the shortest telomere length, highest

oxidative damage and least antioxidant capacity. This supports the view that telomere length may be a good predictor of future survival rate (Hausmann *et al.* 2005; Bize *et al.* 2009). Even if it deserves future experimental confirmation and long-term longitudinal studies to assess the ultimate consequences of increased telomere loss during early life in penguins (e.g. shortened lifespan), our study supports the view that telomere loss represents one proximal explanation of the growth-ageing trade-off (Metcalf & Monaghan 2003). This contributes to explain why, in general, growth rates are constrained by selection to a submaximal level.

Acknowledgements

We are grateful to P. Gabriel, O. Prud'Homme and G. Le Glaunec for help on the field and to K. Griffiths, C. Sarau, V. Viblan and to the editors and the anonymous reviewers who provided helpful comments on a previous draft, H. Gachot for sex determination, and the French Polar institute (IPEV) for providing financial support for this study. All procedures were approved by an independent ethics committee commissioned by the French Polar Institute. Entering the colony, handling chicks and sampling was allowed by a permit (no. 2008-71) obtained from the Prefet of and the Terres Australes et Antarctiques Françaises (TAAF).

- Gluckman PD, Hanson MA (2004) Living with the past: evolution, development, and patterns of disease. *Science*, **305**, 1733–1736.
- Griffiths R, Double MC, Orr K, Dawson RJG (1998) A DNA test to sex most birds. *Molecular Ecology*, **7**, 1071–1075.
- Hausmann M, Marchetto NM (2010) Telomeres: linking stress and survival, ecology and evolution. *Current Zoology*, **56**, 714–727.
- Hausmann MF, Winkler DW, Vleck CM (2005) Longer telomeres associated with higher survival in birds. *Biology Letters*, **1**, 212–214.
- Hausmann MF, Winkler DW, Huntington CE, Nisbet ICT, Vleck CM (2007) Telomerase activity is maintained throughout the lifespan of long-lived birds. *Experimental Gerontology*, **42**, 610–618.
- Jobling M, Johansen SJS (1994) The lipostat, hyperphagia and catch-up growth. *Aquaculture Research*, **30**, 473–478.
- Johnsson JI, Bohlin T (2005) Compensatory growth for free? A field experiment on brown trout, *Salmo trutta*. *Oikos*, **111**, 31–38.
- Johnsson JI, Bohlin T (2010) The cost of catching up: increased winter mortality following structural growth compensation in the wild. *Proceedings of the Royal Society of London. Series B, Biological Sciences*, **273**, 1281–1286.
- Keaney JF, Larson MG, Vasan RS *et al.* (2003) Obesity and systemic oxidative stress: clinical correlates of oxidative stress in the Framingham study. *Arteriosclerosis, Thrombosis, and Vascular Biology*, **23**, 434–439.
- Kotrschal A, Ilmonen P, Penn DJ (2007) Stress impacts telomere dynamics. *Biology Letters*, **3**, 128–130.
- Lecomte N, Kuntz G, Lambert N *et al.* (2006) Alloparental feeding in the king penguin. *Animal Behaviour*, **71**, 457–462.
- Lindstrom J (1999) Early development and fitness in birds and mammals. *Trends in Ecology & Evolution*, **14**, 343–348.
- Mangel M, Munch SB (2005) A life-history perspective on short- and long-term consequences of compensatory growth. *The American Naturalist*, **166**, E155–E176.
- Metcalfe NB, Monaghan P (2001) Compensation for a bad start: grow now, pay later? *Trends in Ecology and Evolution*, **16**, 254–260.
- Metcalfe NB, Monaghan P (2003) Growth versus lifespan: perspectives from evolutionary ecology. *Experimental Gerontology*, **38**, 935–940.
- Monaghan P, Hausmann MF (2006) Do telomere dynamics link lifestyle and lifespan? *Trends in Ecology & Evolution*, **21**, 47–53.
- Monaghan P, Metcalfe N, Torres R (2009) Oxidative stress as a mediator of life history trade-offs: mechanisms, measurements and interpretation. *Ecology Letters*, **12**, 75–92.
- Munch SB, Conover DO (2003) Rapid growth results in increased susceptibility to predation in *Menidia menidia*. *Evolution*, **57**, 2119–2127.
- Nemoto S, Finkel T (2004) Ageing and the mystery at Arles. *Nature*, **429**, 149–152.
- Nicieza AG, Metcalfe NB (1997) Growth compensation in juvenile Atlantic salmon: responses to depressed temperature and food availability. *Ecology*, **78**, 2385–2400.
- Olsson O (1996) Seasonal effects of timing and reproduction in the King Penguin: a unique breeding cycle. *Journal of Avian Biology*, **27**, 7–14.
- Ozanne SE, Hales N (2004) Catch-up growth and obesity in male mice. *Nature*, **427**, 411–412.
- Richner H (1989) Habitat-specific growth and fitness in carrion crows (*Corvus corone corone*). *Journal of Animal Ecology*, **58**, 427–440.
- Ricklefs RE (1969) Preliminary models for growth rates in altricial birds. *Ecology*, **50**, 1031–1039.
- Rollo CD, Carlson J, Sawada M (1996) Accelerated aging of giant transgenic mice is associated with elevated free radical processes. *Canadian Journal of Zoology*, **74**, 606–620.
- Salomons HM, Mulder GA, van de Zande L, Hausmann MF, Linksens MHK, Verhulst S (2009) Telomere shortening and survival in free-living corvids. *Proceedings of the Royal Society of London. Series B, Biological Sciences*, **276**, 3157–3165.
- Saraux C, Viblanc VA, Hanuise N, Le Maho Y, Le Bohec C (2011) Effects of individual pre-fledging traits and environmental conditions on return patterns in juvenile king penguins. *PLoS ONE*, **6**, e20407.
- Stier KS, Almasi B, Gasparini J, Piault R, Roulin A, Jenni L (2009) Effects of corticosterone on innate and humoral immune functions and oxidative stress in barn owl nestlings. *Journal of Experimental Biology*, **212**, 2085–2091.
- Stonehouse B (1960) The king penguin *Aptenodytes patagonica* of South Georgia. I. Breeding behaviour and development. *Scientific Report of the Falkland Islands Dependencies Survey*, **23**, 1–81.
- Suttie JM, Goodall ED, Pennie K, Kay RNB (1983) Winter food restriction and summer compensation in red deer stags (*Cervus elaphus*). *British Journal of Nutrition*, **50**, 737–747.
- Tarry-Adkins JL, Martin-Gronert MS, Chen JH, Cripps RL, Ozanne SE (2008) Maternal diet influences DNA damage, aortic telomere length, oxidative stress, and antioxidant defense capacity in rats. *The FASEB Journal*, **22**, 2037–2044.
- Tarry-Adkins JL, Chen JH, Smith NS, Jones RH, Cherif H, Ozanne SE (2009) Poor maternal nutrition followed by accelerated postnatal growth leads to telomere shortening and increased markers of cell senescence in rat islets. *The FASEB Journal*, **23**, 1521–1528.
- Valdes AM, Andrew T, Gardner JP *et al.* (2005) Obesity, cigarette smoking, and telomere length in women. *The Lancet*, **366**, 662–664.
- Valko M, Leibfritz D, Moncol J, Cronin MTD, Mazur M, Telser J (2007) Free radicals and antioxidants in normal physiological functions and human disease. *The International Journal of Biochemistry and Cell Biology*, **39**, 44–84.
- VanHeezik YM, Seddon PJ, Du Plessis CJ, Adams NJ (1993) Differential growth of king penguin chicks in relation to date of hatching. *Colonial Waterbirds*, **16**, 71–76.
- Verrier D (2003) Croissance et mue chez le poussin de manchot royal (*Aptenodytes patagonicus*): aspects écophysiologiques. Thesis, Université Claude Bernard, Lyon I, France.
- Weimerskirch H, Stahl JC, Jouventin P (1992) The breeding biology and population dynamics of king penguins *Aptenodytes patagonica* on the Crozet Islands. *Ibis*, **134**, 107–117.
- Zannoli R, Mohn A, Buoni S *et al.* (2008) Telomere length and obesity. *Acta Paediatrica*, **97**, 952–954.

von Zglinicki T (2002) Oxidative stress shortens telomeres. *Trends in Biochemical Sciences*, **27**, 339–344.

S.G. and M.L.V. resumed a PhD on fasting physiology in 2010 and on foraging performances of king penguins in 2011. S.R. and A.S. are currently working on a PhD program on telomere and oxidative stress as fitness indicators in birds, respectively. Y.L.M. is an ecophysiologicalist, specialist of penguin biology and F.C. is an evolutionary biologist working on ageing mechanisms and mitochondrial biology.

Data accessibility

Data deposited in the Dryad repository: doi: 10.5061/dryad.jh174st3.

Paper 8 - Starting with a handicap: phenotypic differences between early- and late-born king penguin chicks and their survival correlates

Antoine Stier, Vincent A. Viblanc, Sylvie Massemin-Challet, Yves Handrich, Sandrine Zahn, Emilio R. Rojas, Claire Saraux, Maryline Le Vaillant, Onésime Prud'homme, Edith Grosbellet, Jean-Patrice Robin, Pierre Bize & Francois Criscuolo

Published in a revised version:

Functional Ecology (2014) doi: 10.1111/1365-2435.12204



Abstract

Background

The exceptionally long (*ca.* 11 months) growth period of king penguin chicks (*Aptenodytes patagonicus*) is interrupted by the Austral winter. As a consequence, penguin chicks born late in the breeding season have little time to build-up their energy reserves before the drastic energy bottleneck they experience during winter, and face greater risks of mortality than early-born chicks. Whereas it is well known that breeding adults alternate between early and late breeding attempts, little is known on the phenotype of early and late-chicks, and on the potential existence of specific adaptive phenotypic responses in late-born individuals.

Results

We investigated phenotypic differences between early- and late-chicks and tested their survival correlates both before the winter and at fledgling. Chicks were sampled 10 days after hatching to measure body mass, plasma corticosterone levels, oxidative stress parameters, and telomere length. Late-chicks were heavier than early-chicks at day 10. Late-chicks also had higher corticosterone and oxidative stress levels, shorter telomere lengths, and suffered from higher mortality rates than early-chicks. For both early- and late-chicks, high body mass close to hatching was a strong predictor of survival up to, and over, the winter period. In late but not early-chicks, high corticosterone levels and long telomeres were significant predictors of survival up to winter and fledging, respectively.

Conclusions

Our study provides evidence that late- and early- king penguin chicks showed marked phenotypic differences 10 days after hatching. We provide an integrative discussion on whether these differences may be adaptive or not, and to what extent they may be driven by active maternal effects, indirectly induced by environmental effects, or stem from individual differences in parental quality.

Keywords

Growth, oxidative stress, telomere, corticosterone, early life conditions, individual quality, reproductive timing, phenotypic plasticity

Introduction

In seasonal environments, breeding timing is key to the reproductive success of most animals. Food resources often decline as the breeding season advances, which conflicts with the good nutritional conditions required by offspring to reach a body condition that promotes their survival over the growth period and after independence (Roff 1980). As a consequence, the offspring of late breeders typically suffer from higher mortality rates than those of early breeders (Perrins 1970; Daan *et al.* 1988; Verhulst & Tinbergen 1991; Olsson 1996), and sometimes appear to differ in phenotype (Brinkhof 1997). However, sources of variation in offspring phenotype may be highly diverse, and their consequences on offspring survival may differ greatly depending on environmental context (Monaghan 2008). The processes accounting for differences in early-life phenotypes of early- vs. late-born individuals, and the extent to which those differences reflect constraints or adaptations to a seasonal environment remain to be adequately defined.

Conventionally, it is assumed that an individual's phenotype is determined both by the genes it inherits and by the environment in which those genes are expressed (Nylin & Gotthard 1998). Among environmentally-driven modulations of gene expression, early-environment and/or maternal effects may be important factors affecting offspring phenotypes (Wolf & Wade 2009). Further, by influencing offspring phenotypes and their possible resilience to environmental change, perturbations during early development (*e.g.* food shortage, social stress, maternal hormones) are likely to drive the survival and fecundity prospects of entire cohorts of juveniles (Lindström 1999; Forchhammer *et al.* 2001; Metcalfe & Monaghan 2001; Saraux *et al.* 2011). In order to adaptively increase reproductive success and enhance individual fitness, the modulation of offspring phenotypes should follow environmental cues, such as changes in food availability (Muller & Groothuis 2013). For example, one possible strategy for late-born offspring to compensate for the short remaining favourable season is to exhibit higher-than-normal growth rates (Abrams *et al.* 1996). Such specific growth responses are enabled by developmental plasticity (Bize *et al.* 2006) and may be adaptive if they improve individual fitness (Arendt 1997).

Adaptive phenotypic changes, however, should be discriminated from developmental constraints (Dmitriew 2011). Indeed, poor environmental conditions during early development (*e.g.* as early as the hatchling stage or shortly after) may also preclude

the development and maturation of essential (but costly) protections or reserves, and may lead to the production of damaged or pathological phenotypes (Dmitriew 2011). For instance, by enhancing oxidative stress, poor developmental conditions have been suggested to accelerate telomere loss, a tell-tale sign of accelerated ageing in young organisms (Tarry-Adkins *et al.* 2008; 2013). Telomeres are non-coding nucleoproteins structures located at the end of eukaryotic chromosomes that protect the integrity of DNA. Yet, when organisms are in a state of oxidative stress, the unbalance between pro-oxidants (mainly generated by the mitochondria during normal energy processing) and antioxidant defences may lead to oxidative damage on various biomolecules, including DNA (Halliwell & Gutteridge 2007). This process contributes to increasing telomere erosion rates, ultimately leading to cell death or replicative senescence (Monaghan & Hausmann 2006). Poor nutritional conditions during early growth may also increase circulating levels of stress hormones such as corticosterone or cortisol (Honarmand *et al.* 2010). Although elevated concentrations of stress hormones help organisms mobilize resources over short-term periods, they are also known to have deleterious effects over extended periods (Kitaysky *et al.* 2003; Wingfield *et al.* 2008). In addition, it has recently been shown that early exposure to corticosterone may induce oxidative stress and telomere erosion (Hausmann *et al.* 2012). Thus, the putative links between growth conditions, stress hormones, oxidative stress and telomere erosion may contribute to explain differences in mortality rates between early- and late-born offspring.

Another, non-mutually exclusive, hypothesis for explaining differences in the phenotypes of early- and late-born offspring, is that those phenotypes may be related to adult quality, and not the mere consequence of timing constraints. For instance, early breeders are often more experienced or higher quality parents (Forslund & Pärt 1995), and the higher survival prospects of early-born offspring may be partly due to intrinsically higher parental phenotypic quality (Daunt *et al.* 1999). Phenotypic heterogeneity between early- and late-born offspring, and within each offspring group, may then reflect both intrinsic variability in the experience/quality of parents (individual quality hypothesis), and extrinsic deterioration in the environment as the breeding season progresses (timing of breeding hypothesis). Thus, by scrutinizing phenotype differences between offspring produced early and late in the breeding season, and investigating potential links with survival, it should

become possible to disentangle adaptive from non-adaptive phenotypic responses to a stressful late environment (Kitaysky *et al.* 2003).



Figure 1: Adult king penguin (*Aptenodytes patagonicus*) feeding its chick (Copyright permitted by G. Lemonnier).

Due to their particular reproductive cycle, king penguins (*Aptenodytes patagonicus*, Fig. 1) provide a unique opportunity to test whether chicks raised in markedly contrasted breeding environments differ in their early-life phenotypes and survival rates. King penguins are pelagic marine birds with a complex “annual” cycle of *ca.* 13 months (Weimerskirch *et al.* 1992; Heezik *et al.* 1994). Chick-development (from hatching to fledging) occurs over *ca.* 11 months and includes an energy-constraining winter period (October-April) during which chicks are seldom fed (Weimerskirch *et al.* 1992) and generally lose substantial body mass (Cherel *et al.* 1987; Descamps *et al.* 2002; see Fig. 2 for an example of body mass growth curve). Following chick fledging, parents are compelled to forage in order to restore their lost energy reserves and moult, which can take up to 2 additional months before they are able to breed again (Weimerskirch *et al.* 1992). It follows that successful breeders in one year may only attempt reproduction as late breeders in the next. As late-born chicks tend to accumulate smaller reserves than early-chicks before their winter fast (Heezik *et al.* 1994), king penguin parents that reproduce late have drastically reduced chances of breeding success (Cherel *et al.* 1987); with even zero success some years (Olsson 1996). To date

however, no study has investigated phenotypic heterogeneity within and between chicks born early or late in the breeding season, to address whether such heterogeneity (if it exists) could reflect adaptive phenotypic responses to environmental deterioration during the season.

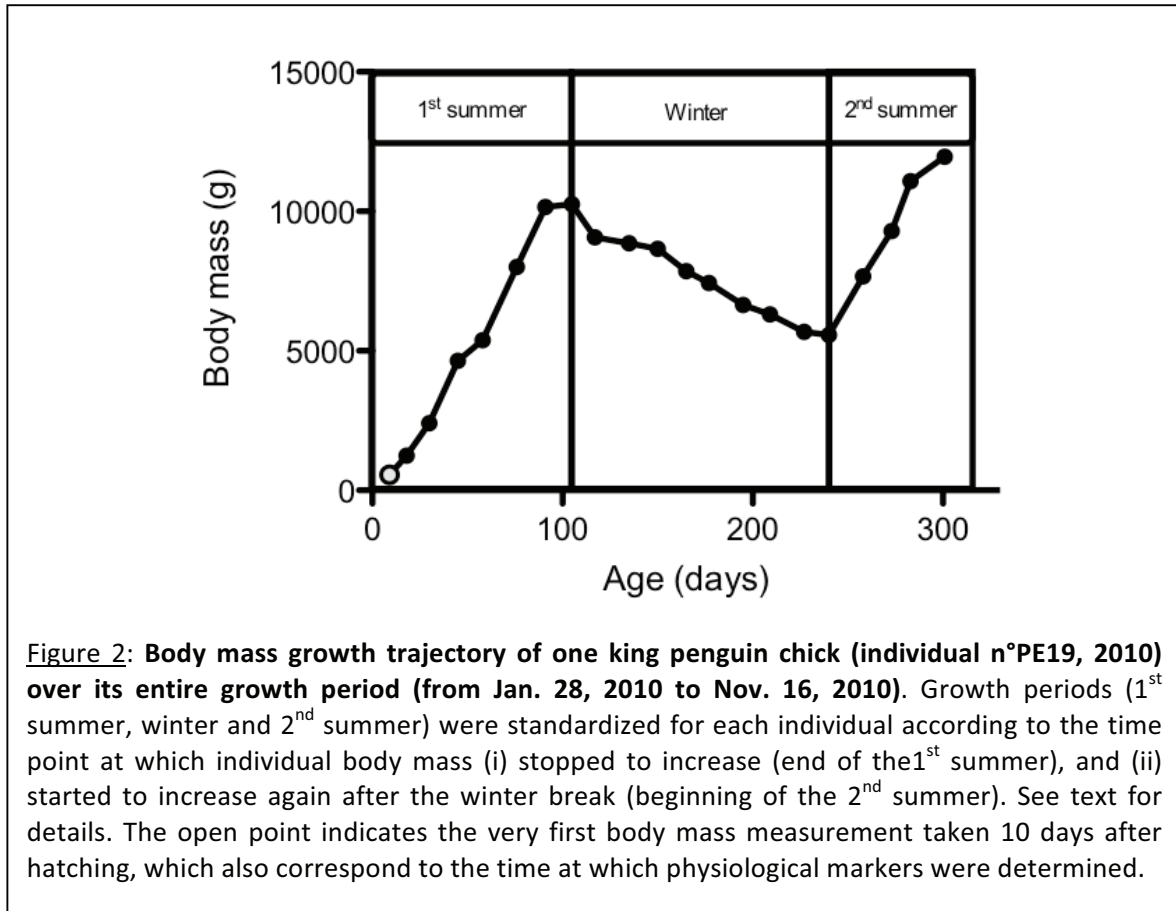

Here, we compared the phenotypes and associated survival probabilities of early and late-hatched chicks in colonial king penguins. Specifically, we (i) investigated phenotypic differences between early- and late-chicks in terms of body mass, stress hormones (corticosterone), antioxidant defences, oxidative stress/damage markers and telomere length; and (ii) investigated whether specific phenotypes (early vs. late) were associated with higher survival probabilities both before and after the critical winter period.

Material and Methods

General procedure

This study took place on Possession Island in the Crozet Archipelago (46° 25'S; 51° 52'E). Data was collected during the 2009 and 2010 breeding seasons in the king penguin colony of "La Grande Manchotière" (ca. 24,000 breeding pairs). In order to precisely determine hatching date (at ± 1 day) and start monitoring chicks shortly after, pairs of breeding adults were marked during courtship using a non-permanent animal dye (Porcimarck, Kruuse, Langeskov, Denmark). They were subsequently monitored daily throughout incubation. Breeding pairs were selected in the same area of the colony. We monitored pairs of both early (mean hatching date \pm SE = 20 January \pm 0.9 days) and late (25 February \pm 0.7 days) breeders.

Chick monitoring

In total, 39 early-hatched chicks (19 in 2009 and 20 in 2010) and 45 late hatched-chicks (16 in 2009 and 29 in 2010) were monitored (hereafter referred to as early or late-chicks). Chicks were followed from hatching to the beginning of their final (pre-fledging) moult the subsequent year. Within three days of hatching, chicks were individually identified using coloured-coded fish tags (Floy Tag and MFG, Inc. Seattle, WA) attached subcutaneously to their upper-back.

At 10 days, chicks were captured for blood sampling and morphometric measurements. To avoid disturbing breeders during these procedures, chicks were carried to a quiet laboratory facility on the outskirts of the colony (< 5 min walking distance). Blood was sampled from the chick's marginal flipper-vein generally within 10 min of capture. Body mass was measured using a platform balance (Kern IT60K2LIP, \pm 4g), and the fully extended flipper length (\pm 1 mm) using a ruler. Chicks were returned to the parent's brood-pouch as soon as measurements were completed. During chick handling, the parent was provided with a dummy-egg and its head was covered with a hood to keep it calm. One observer remained close to the adult during that time. This procedure never resulted in chick abandonment or breeding failure. When collected, blood samples were stored on ice for less than 10 min before being centrifuged for 5 min at 2000 G. Plasma and red blood cells were

separated and immediately transferred to a -20°C freezer. Samples were then transferred to a -80°C freezer for long-term storage by the end of the day.

Subsequently, chicks were captured for similar morphometric measurements every 15 days over their yearly growth period (from January until their departure at sea one year later). Measurements were carried out as above, and during procedures the chick's head was always covered with a hood to reduce handling stress.

Growth analysis

During the winter period, food resources are drastically reduced and parental food-provisioning naturally varies between chicks (Cherel & Le Maho 1985). Therefore, we standardized chick-growth trajectories by defining the “winter period” as the period when chicks face their winter fast and lose substantial body mass (± 2 weeks, Fig. 2). Growth periods were accurately determined for each individual chick according to its body mass dynamics over the pre- to post-winter periods. The first summer growth period was defined as the period of time between hatching and the date at which chick body mass gain ceased. The winter phase corresponded to the time duration during which body mass was stabilized or decreased. Finally, the 2nd summer of growth was the time duration from the date at which body mass started to increase over two successive body mass measures (*i.e.* 30 days) and the time from which the first signs of moult were detected (Corbel *et al.* 2009). Each period was defined by analysing chick growth curves individually and chick survival was monitored until fledging (*i.e.* departure at sea).

Oxidative stress

Plasma concentration of Reactive Oxygen Metabolites (ROMs) in king penguin chicks was measured using the D-ROM test (5 μ L of plasma, Diacron International, Italy) following the manufacturer protocol, as previously described in penguins by Beaulieu *et al.* (Beaulieu *et al.* 2011). The D-ROM test is based on the Fenton reaction and measures primarily hydroperoxides, the results being expressed as mg of H₂O₂ equivalent/dL. Thus, D-ROM indicates potential exposure to oxidative stress. Intra-individual variation based on duplicates was low (CV = 4.67 ± 0.57 %) as well as inter-plate variation based on a standard sample repeated over plates (CV = 5.59 %). In addition, we measured an indicator of oxidative damage on DNA. We quantified the plasmatic concentration of 8-hydroxy-2'-

deoxyguanosine (8-OHdG) using a competitive immunoassay (Assay Designs DNA damage ELISA Kit, Enzo Life Sciences, USA). 8-OHdG is one of the predominant forms of free radical-induced oxidative lesion on DNA, and has been widely used as a marker of oxidative stress (Halliwell & Gutteridge 2007). For this assay, 8-OHdG levels were determined only for 58 of 84 chicks due to plasma quantity limitations. Intra-assay variation based on seven duplicates (due to limited available plasma) was low 4.16 ± 1.24 %.

Antioxidant defences in chick plasma were evaluated using the Oxiselect™ Total Antioxidant Capacity (TAC) assay kit (Cell Biolabs, Inc., USA) following manufacturer instructions. The TAC assay measures the antioxidant power of biomolecules from the plasma via a single electron transfer mechanism, and results are expressed as mM UAE (Uric Acid Equivalent). This assay measures non-enzymatic antioxidants only, which are mostly derived from the diet (for a discussion on the limitations of the TAC assay, see (Sies 2007)). Intra-individual variation based on duplicates was low (CV = 1.81 ± 0.27 %), as was inter-plate variation based on a standard sample repeated over the plates (CV = 2.37 %).

Telomeres measurements and sex determination

Chick telomere length was determined following DNA extraction from blood cells (Nucleospin® Blood QuickPure, Macherey-Nagel, Germany), using quantitative real-time amplification (qPCR) previously adapted for birds (Crisuolo *et al.* 2009) and successfully used in king penguins (Geiger *et al.* 2012). Primer sequences for telomere amplification were similar to those used by Criscuolo and colleagues (Crisuolo *et al.* 2009). For a single control gene, defined as a gene non-variable in copy numbers within our population (hereafter non-VCN; (Smith *et al.* 2011)), we used the *Aptenodytes patagonicus* zinc finger protein, with primer sequences defined by Primer 3 software as: (Royal1: 5'-TACATGTGCCATGGTTTTGC-3'; Royal2: 5'-AAGTGCTGCTCCCAAAGAAG-3'). Primer concentrations in the final mix were 200 nM for telomere length determination and 300 nM for the control gene. Telomere and control gene PCR conditions were: 2min at 95°C followed by 40 cycles of 15s at 95°C, 30s at 56°C, 30s at 72°C and 60s at 95°C. We used 2.5ng DNA per reaction and the BRYT Green® fluorescent probe (GoTaq®qPCR Master Mix, Promega, France). DNA samples were analysed on different plates (or runs), telomere and non-VCN amplification of each sample being done on the same plate. Each plate was also composed of a mix of 2009-2010 and early-late breeder samples to avoid any undesired plate effect to interfere with the final calculations.

Mean amplification efficiency of the qPCR runs were comprised between 100.9 and 103.1 for telomere, and between 100.6 and 102.9 for the non-VCN gene. Intra-plate mean coefficients of variation for Ct values were 1.35 ± 0.06 % for the telomere assay, and 0.79 ± 0.04 % for non-VCN assay. Inter-plate coefficients of variation based on repeated samples were low: 1.56% for the telomere assay and 1.35% for non-VCN assay (Ct values again). Final calculation of telomere length (T/non-VCN ratio) was done following (Pfaffl 2001) using the telomere and non-VCN specific efficiencies of each plate.

Sex determination was also performed on DNA extracted from blood cells following a method adapted from (Griffiths *et al.* 1998).

Corticosterone assays

Circulating corticosterone levels were determined at 10 days from blood samples taken within 10 min of capture. Thus, the levels presented here are likely not basal values. Plasma CORT levels were determined by immunoassay according to guidelines provided by the manufacturer (Corticosterone EIA Kit, Enzo Life Sciences, USA). For this assay, CORT levels were determined only for 71 of 84 chicks due to plasma quantity limitations. Intra-assay variation based on five duplicates (due to limited available plasma) was low 5.92 ± 0.87 %. The detection limit provided by the manufacturer is 26.99pg/mL.

Data analysis and statistics

Data was analysed in two steps. First, we analysed changes in chicks' body mass from 10 days post-hatching to fledging. Second, we investigated post-hatching phenotypic differences between early- and late-chicks and their relationship with survival.

To investigate whether growth period durations and growth trajectories over the 1-year growth period of king penguin chicks differed between early- and late-chicks, we used a Linear Mixed Model (LMM) with chick identity specified as a random factor and the different growth phases (*i.e.* 10 days, end of the first summer, end of the winter and end of the 2nd summer) as a repeated factor. Year, sex, chick group, and all interactions were initially included as fixed factors. To anticipate the fact that the duration of growth phases were likely to differ between early- and late-chicks (late-chicks necessarily having a shorter first summer), the duration of each growth periods was initially used as a covariate in the model. However, as it turned out to be non-significant, it was not included in the final model. Non-

significant terms were dropped (starting with interactions) in a stepwise procedure to obtain the model with the best AIC value. Multiple post-hoc comparisons were done using Bonferroni correction.

At 10 days post-hatching, we tested for differences among blood parameters (corticosterone, telomere length, oxidative stress (D-ROM), DNA damage and plasmatic antioxidant capacity) between chick groups (early vs. late) using ANOVA with year, sex and chick groups as fixed factors, as well as all interactions. Determinants of chick survival between groups (early vs. late) were evaluated using a Generalized Linear Modelling procedure (GzLM) with a logistic binary distribution of the dependent variables. Pre-winter and long-term survival were analysed by running two different models where the binary dependent variable was either (i) chick survival/death (0/1) before the winter period; or (ii) chick survival/death (0/1) at the time of departure at sea (survival at fledging). Year, sex and chick groups (early vs. late-born chicks), as well as starting values of blood parameters (corticosterone, telomere length, D-ROM, DNA damage and plasmatic antioxidant levels at 10 days) were used respectively as fixed factors and covariates in the analysis. All interactions between starting values of blood parameters and chick groups were tested to determine whether our physiological markers recorded after hatching predicted differently the survival rate of chicks in each group. Again, non-significant terms (starting with interactions) were sequentially dropped to produce minimum adequate models with lowest AIC value. All analyses were run on SPSS v. 18.0. Tests were two-tailed and P values < 0.05 were considered significant. Means are given \pm SE.

Results

Chick growth duration and body mass changes

Although the duration of growth phases did not vary significantly between sex and years (Table 1A), the interaction *growth phase x chick group* was significant (Table 1A). A LMM analysis split by phases indicated that late-chicks experienced a significantly shorter winter period (87.50 ± 6.66 days) than early-chicks (126.05 ± 2.89) (Winter, $F = 26.90$, $P < 0.001$), other comparisons being non-significant: day 10, 10.31 ± 0.67 vs. 10.65 ± 0.67 days; 1st summer, 93.35 ± 2.30 vs. 87.23 ± 4.98 days; 2nd summer, 84.33 ± 3.12 vs. 89.17 ± 7.68 days).

Table 1: Results of Linear Mixed Model analyses describing the variability in A) growth phase durations and B) body mass changes occurring over the 1 year-growth period of king penguin (*Aptenodytes patagonicus*) chicks. Growth phase duration and body mass were analysed in relation to year, date of hatching in the breeding season ('*Chick group*' factor; early and late-chicks), chick sex, and Growth phase ('*Growth phase*' factor; hatching, first summer, winter and second summer). The significant interaction '*Chick group x Growth Phase*' indicates that early and late-chicks differed in their growth phase duration and body mass growth trajectories. Chick identity was used as random factor and random factor estimates are indicated in italics. Estimates of fixed effects were calculated using 2010 (*year*), late chicks (*Chick group*), males (*chick sex*), fledging (*Growth phase*) and late-chicks during the winter (interaction for growth phase duration) or at 10 days (interaction for body mass) as reference values. The model is based on 83 individuals and 180 body mass values.

A- Growth period duration		Estimate	SE	df	F	p-value
Random effect	<i>Identity</i>	135.45	14.65			
Fixed effects & covariates	Year	1.41	0.41	1, 77.5	0.06	0.80
	Chick group (A)	-7.96	8.93	1, 79.6	26.46	< 0.001
	Chick sex	0.05	0.39	1, 77.4	9.520.04	0.84
	Growth phase (B)	-81.5	8.30	3, 51.0	1408.13	< 0.001
	A x B	49.82	12.0	3, 51.0	20.94	< 0.001
B- Body mass		Estimate	SE	df	F	p-value
Random effect	<i>Identity</i>	1.78	5.77			
Fixed effects & covariates	Year	-258.0	147.0	1, 72.2	3.08	0.08
	Chick group (A)	-1138.9	509.1	1, 80.9	1.91	0.17
	Chick sex	-453.1	143.2	1, 70.7	10.01	0.002
	Growth phase (B)	-12444.9	493.6	3, 154.3	865.15	< 0.001
	A x B	2954.0	636.2	3, 154.2	8.68	< 0.001

Over the entire growth period (Fig. 2-3, Table 1B), chicks' body mass first increased from 10 days post-hatching (583.5 ± 104.3 g) to the end of the first summer period (7988.4 ± 195.6 g), then subsequently decreased during the winter fast to reach an average of 5094.5 ± 228.8 g by the end of the first growth period. Finally chicks resumed their growth to reach an average of 12473.4 ± 253.2 g at the end of the 2nd summer. Chicks' body mass was neither influenced by year or group factors (Table 1B), but was significantly influenced by sex, males being on average heavier than females over the entire growth period (6761.5 ± 127.7 g vs. 6308.4 ± 124.2 g). The interaction *Group x Stage* was significant, indicating that early- and late-chicks experienced different growth trajectories (Table 1B, Fig. 3). Thus, we

ran separate LMMs (with chick group, sex and year as fixed factors) to compare the body mass of early- and late-chicks at each growth phase. Although late-chicks were significantly heavier than early-chicks at 10 days post-hatching ($F = 5.84$, $P = 0.018$), the reverse was observed by the end of the 1st summer ($F = 12.82$, $P = 0.001$, Fig. 3.). This difference remained significant, even when only late-chicks that survived until winter were kept in the analysis (statistics not shown). During the winter period and subsequent summer, body mass did not differ significantly between the two groups of chicks (Fig. 3, all $P > 0.38$).

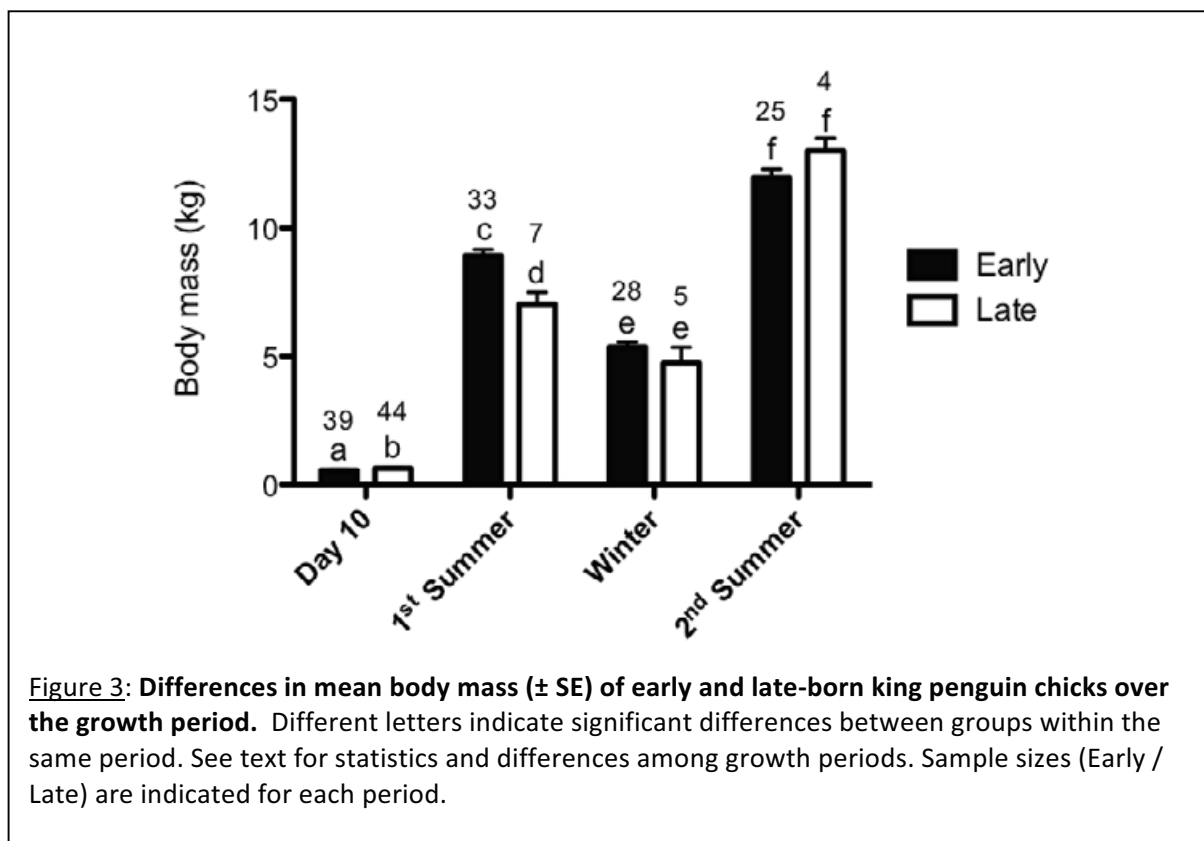

Starting values of physiological markers (day 10)

Values for the blood parameters measured 10 days after hatching for early- and late-chicks are presented in Table 2. Plasmatic concentrations of corticosterone were significantly higher in late than in early-chicks. Corticosterone levels were also significantly higher in 2009 than in 2010 (10.59 ± 0.85 vs. 7.55 ± 0.68 ng/mL), but did not differ significantly between the sexes (see Table 2). Late-chicks presented higher levels of oxidative stress (D-ROM) and DNA damage than early-chicks at 10 days (see Table 2). These levels, however, were neither significantly influenced by year or sex (Table 2). In contrast, the antioxidant capacity of the chick's plasma did not appear to significantly differ between early- and late-chicks (see Table

2). Similarly, TAC was neither affected by year or sex (Table 2). Telomeres length measured 10 days after hatching did not differ between the sexes (see Table 2). However, telomeres were longer in 2009 than in 2010 (1.43 ± 0.11 T/S ratio vs. 1.14 ± 0.08 T/S ratio, Table 2) and they were significantly shorter in late- than early-chicks (see Table 2).

Table 2: Blood parameters of early and late king penguin chicks (corticosterone, oxidative stress (D-ROM), DNA damage, total antioxidant capacity (TAC) and relative telomeres length) measured 10 days after hatching. Mean \pm SE are reported both for early and late-chicks, and results of statistical models (ANOVAs) reporting the effects of group (early vs. late), sex and year (2009 vs. 2010) are indicated, with significant terms appearing in bold.

Blood variables At 10 days post-hatching	Early-born chicks	Late-born chicks	Group	Sex	Year
Corticosterone (ng/mL)	7.91 \pm 0.63	9.59 \pm 0.88	F = 4.34 P = 0.041	F = 0.01 P = 0.931	F = 7.72 P = 0.007
Oxidative stress (D-ROM) (mg H ₂ O ₂ /dL)	1.60 \pm 0.13	2.09 \pm 0.14	F = 6.51 P = 0.013	F = 0.54 P = 0.464	F = 0.55 P = 0.463
DNA damage (8-OHdG) (ng/mL)	57.9 \pm 6.6	97.4 \pm 9.0	F = 12.45 P = 0.001	F = 2.60 P = 0.113	F = 0.46 P = 0.500
Total antioxidant capacity (mM UAE)	0.98 \pm 0.05	1.07 \pm 0.06	F = 1.63 P = 0.206	F = 2.04 P = 0.157	F = 0.34 P = 0.562
Relative telomere length (T/S ratio)	1.44 \pm 0.10	1.11 \pm 0.09	F = 17.90 P < 0.001	F = 0.01 P = 0.924	F = 4.70 P = 0.033

Phenotype at hatching and chick survival

There was no significant year effect on chick survival rate ($\phi^2 = 2.26$, $P = 0.133$). Interestingly, we found that chick survival rates recorded before winter or before fledging differed between early and late-chick groups (Fig. 4, Table 3). While early-chick survival to the beginning of winter was high (85%), only few late-chicks (16%) made it that far (Fig. 4). Similarly, whereas survival rate over the entire growth period reached 65% in early-born chicks, only \approx 10% of the late-born chicks made it to fledging (Fig. 4). This shows that early / late difference in survival rates principally occurred during the first summer, during which 86% of late chicks died.

Table 3: Separated analyses of survival rates (1=death) of king penguin (*Aptenodytes patagonicus*) chicks until the winter period (a) or until chick departure at sea (b) (Generalized Linear Models following a binary distribution). Chick groups include early and late-chicks. The presented model was obtained after backwards deletion of least significant terms and presented the lowest AIC (see text for details on model selection).

A- Survival rate until winter	df	Wald ϕ^2	p-value
Chick group (A)	1	5.55	0.001
Mass	1	10.53	0.008
Corticosterone (B)	1	7.02	0.72
A x B	1	4.07	0.044
B- Survival rate until departure	df	Wald ϕ^2	p-value
Chick group (A)	1	9.77	0.002
Mass	1	7.50	0.006
Telomere length (C)	1	0.99	0.32
A x C	1	4.09	0.043

Starting values of body mass and blood parameters measured at the age of 10 days were tested as predictors for survival of individuals both before winter and at the end of the growth period (respectively Table 4A and 4B, Fig. 5). While D-ROM, DNA damage, plasmatic antioxidant defences and telomere lengths were not related to survival rate of chicks until winter, body mass was a strong predictor of survival, in both chick groups (Table 3A, Fig. 5A). The significant interaction *Chick group x Corticosterone* indicates that a higher corticosterone plasma concentration in late-chicks was significantly related to higher survival rates before winter, while no relationship was apparent in early-chicks (Table 3A, Fig. 5C). Concerning chick survival to fledging (Table 3B), body mass of 10 days-old chicks was also a strong predictor of survival in both groups (Fig. 5B). Interestingly, the interaction *Chick group x Telomere length* pointed out that late-chicks with longer telomeres at 10 days were more likely to survive until their final moult and departure at sea (Table 3B, Fig. 5D).

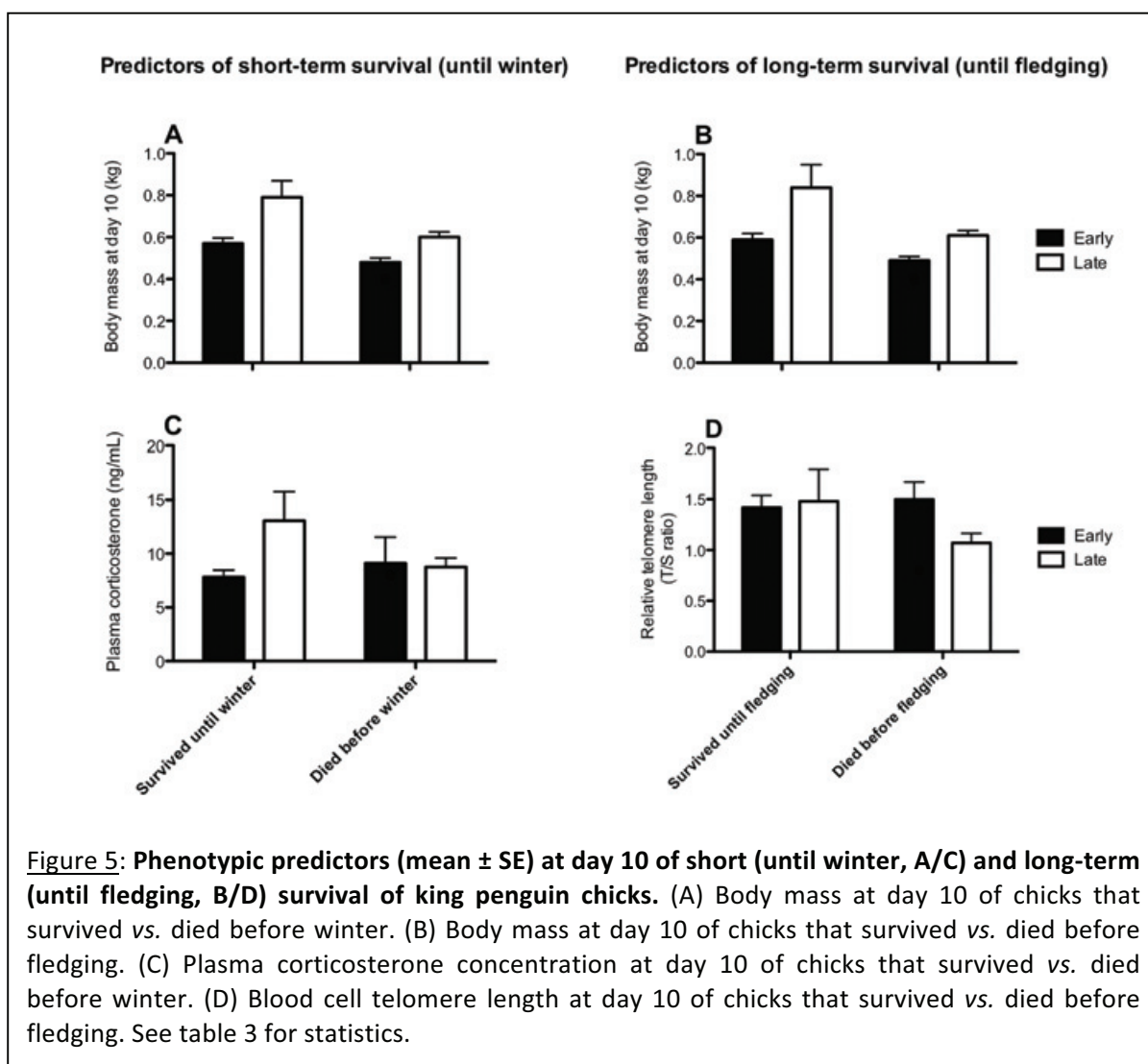

Discussion

This study reveals marked differences in the phenotypes of king penguin chicks born either early or late during the breeding season. Phenotypic differences were apparent from the early stages of life (as close as 10 days after hatching) and were tightly related to offspring survival prospects. Importantly, correlates between chick phenotype and survival appeared context-dependent. Although late-chicks were heavier at 10 days, they presented higher plasma levels of corticosterone and oxidative stress, as well as shorter blood cell telomeres. Late-chicks suffered from a higher mortality than early-chicks, mostly during the first weeks of their life. Interestingly, in late – but not early – chicks, plasma corticosterone levels significantly predicted short-term (pre-winter) survival, and telomere length at 10 days significantly predicted survival to fledging. Such strong phenotypic differences between

early- and late-born king penguin chicks shortly after hatching may reflect adaptive or pathological responses, that could either be driven by active maternal effects, induced indirectly by environmental effects, or stem from differences in parental qualities.

Chick body mass and survival

As frequently reported, our results show that offspring body mass strongly affected offspring survival, both in early- and late-chicks. The positive effect of body mass on chick survival was detectable as early as 10 days after hatching. Surprisingly, however, late-chicks were heavier than early ones at day 10, which contrasts with results from other species that typically exhibit a decline in the body condition of offspring born late in the season (Brinkhof 1997). Interestingly, and consistently with our previous findings (Geiger *et al.* 2012), we found that small (rather than late) chicks were those that grew faster during the 2nd summer, independently of their hatching date (data not shown). Remarkably, late-chicks also faced a shorter winter period (corresponding to the time during which parents rarely fed their chicks (Weimerskirch *et al.* 1992), supporting the idea that parental investment was high for late chicks that survived up to (and past) winter. Survival rate of young penguins during their first years at sea is up to 0.75, independently of whether they were born early or late in the season (Saraux *et al.* 2011). Hence, because of the strong (and widely reported) positive links between body mass and survival, it is likely that this phenotypic response is adaptive. However, the proximate factors causing late-chicks to be heavier than early-chicks close to hatching, and the potential costs of this phenomenon, remain open questions to which several hypotheses can be formulated.

Environmental effects on chick phenotype

Late-chicks may have benefited from transient favourable nutritional conditions just after hatching. Indeed, in the Southern ocean, productivity is high until the end of the summer (March) and the hatching date of late chicks may coincide with prime nutritional conditions. Accordingly, previous findings have shown that late-breeding adult king penguin return from their foraging trip close to hatching with higher food energy content stored in their stomach than early breeders (Gauthier-Clerc *et al.* 2002). Nevertheless, this greater energy content was also associated with longer foraging trips, thus resulting in much lower

energetic output per day foraging at sea. In turn, this suggests greater foraging difficulties in late than early breeders (Gauthier-Clerc *et al.* 2002).

Potential maternal effects on chick phenotype and survival

Besides altering foraging behaviour at sea (with direct effects on chick body mass) females may also indirectly modulate their offspring's growth trajectories by transferring hormones or nutrients to the egg. Maternal effects and the transfer of environmental cues to the embryo and are key parameters guiding an embryo's development (Mousseau & Fox 1998; Wingfield *et al.* 2008). In birds, the transfer of maternal corticosterone into the egg yolk during laying (Hayward & Wingfield 2004) is for instance known to affect embryo's development and to shape chick phenotype even long after hatching (Groothuis *et al.* 2005), potentially through higher corticosterone plasma levels or stress responses at the chick stage (Spencer *et al.* 2009; Haussmann *et al.* 2012).

Accordingly, we found higher corticosterone levels at day 10 after hatching in late- than early-born-chicks. Although the HPA-axis activity and corticosterone responses to acute stressors are not known for chicks this young in king penguins, Corbel *et al.* (2010) have previously reported baseline levels for king penguin chicks at the onset of their fledging moult to be 7.2 ± 0.5 ng/mL. Those values are remarkably close to the values observed for early chicks in the present study, suggesting that our corticosterone measures may not be too far from basal even though it generally took us over 5 minutes to sample the chicks. Because corticosterone can provide short-term benefits but may incur long-term costs (Hayward & Wingfield 2004; Bonier *et al.* 2009; Haussmann *et al.* 2012), cautious is needed when interpreting the adaptive value, or not, of such hormonal differences. High levels of corticosterone in late-chicks could merely reflect environmental stressful conditions experienced by mothers (*i.e.* exogenous transfer of corticosterone via the egg yolk) and/or by chick themselves (*i.e.* endogenous production of corticosterone). Early modulation of chick corticosterone plasma levels could for instance be due to differences in the colonial environment in which they were raised. Differences in colony density for instance might affect stress levels in adults king penguins (Viblanco 2011) and trigger differential corticosterone deposition in the egg of early vs. late-breeders, with higher concentrations in the latter. Still, the fact that late-chicks were in better condition and that higher levels of corticosterone early in life were associated with higher survival rate during the first weeks or

so of growth pleads toward an adaptive value rather than an environmentally driven cost of higher corticosterone levels for late-chicks (for another example of positive impact of corticosterone on survival, see (Cote *et al.* 2006)). Positive effects of elevated corticosterone levels in growing birds may for instance be linked to increased begging and aggressive behaviour, allowing chicks to solicit more food from their parents (Wingfield *et al.* 1998; Kitaysky *et al.* 2001; 2003). High corticosterone levels of late-chicks might thus account for the greater foraging effort of late king penguin parents (Gauthier-Clerc *et al.* 2002), and in turn the higher body mass of late-chicks close after hatching. Experiments are required to examine the impact of high corticosterone levels on king penguin chick behaviours, and whether those changes affect parental foraging strategies. In addition, accurate measures of basal and stress-induced levels of corticosterone in chicks, of egg hormonal content or embryo ageing parameters, are needed to fully appreciate the origin and nature of the phenotypic heterogeneity observed amongst early and late king penguin chicks.

Oxidative stress, telomere length and survival

The higher levels of oxidative stress and the shorter telomeres of late-chicks might have been induced by high exposure to corticosterone (Hausmann *et al.* 2012) and/or by the alteration of early growth trajectories (Alonso-Alvarez *et al.* 2007; Tarry-Adkins *et al.* 2009). Indeed, an experimental manipulation of yolk corticosterone levels has been shown to lead to greater oxidative stress levels in chickens (*i.e.* D-ROM levels), but also to shorter telomeres (Hausmann *et al.* 2012). Interestingly, our results also point towards greater levels of D-ROM and shorter telomeres in late king penguins chicks (*i.e.* with higher corticosterone levels). The early growth trajectory of late-chicks (the increased growth rate between hatching and day 10, leading to the higher body mass at day 10) may also account for part of the differences observed in terms of oxidative stress and telomere length between early and late-chicks. Indeed, the growth of late-chicks could be accelerated during their first 10 days of life as an attempt to catching up with early-chicks (see (Benowitz Fredericks & Kitaysky 2005) for such an example in *Uria aalge* chicks). However, catch-up or accelerated growth has been associated with a variety of ecological and physiological costs (Metcalf & Monaghan 2001), among which increased oxidative stress levels and accelerated telomeres erosion have been suggested in recent years (Alonso-Alvarez *et al.* 2007; Tarry-Adkins *et al.* 2009; Geiger *et al.* 2012).

Oxidative stress levels may be associated with differences in individual survival probability or reproductive success (Bize *et al.* 2008; Stier *et al.* 2012), and thus early differences in oxidative stress levels during offspring development may have substantial impacts on the future fitness prospects of late-born king penguins chicks. As such, oxidative stress may cause accelerated telomere erosion (in particular early in life) which has been negatively associated with long-term adult survival both in captivity and in the wild (Bize *et al.* 2009; Salomons *et al.* 2009; Heidinger *et al.* 2012). In the present study, telomere length also predicted survival up to fledging in late-chicks. However, given the limits of our oxidative stress measurements (Sies 2007), additional specific antioxidants (*i.e.* enzymatic) should be measured in the future to better understand how oxidative stress might be modulating survival in this species.

Parental quality and breeding experience

Phenotypic variations between early- and late-chicks can also be associated with variability in breeder experience and parental (care) quality due to a mixed composition of experienced and inexperienced birds in the late breeder population. In king penguins, young inexperienced adults typically moult late in the season (Stonehouse 1960), with the consequence of delaying their onset date of reproduction, which then coincides with that of experienced late breeders (Stonehouse 1960; Weimerskirch *et al.* 1992). Such differences in parental experience during late-breeding might then account for the lower quality observed in late-chick phenotype. For instance, lower breeding skills might explain shorter telomere lengths due to sub-optimal incubation and embryo developmental conditions (see (Tarry-Adkins *et al.* 2009) for examples of links between early growth and telomere loss). In addition, the high rate of chick death during the first weeks of brooding could be attributed to reduced parental care ability in inexperienced adults (Descamps *et al.* 2005). Several studies considering age-related breeding performances have indeed supported the idea that first-time breeders may be constrained by their lower foraging/reproductive skills (Olsson 1997; Angelier *et al.* 2007; Lecomte *et al.* 2010), intra-pair coordination or even lower ability to feed chicks with digested food (discussed in (Daunt *et al.* 1999)). Even more important is that brood care (*e.g.* feeding) ability in the very first period has been previously shown to be of tremendous importance for chick survival (Brinkhof & Cavé 1997). By contrast, experienced late-breeders may be able to buffer constraining environmental conditions

(increased predation, social stress) and, as a consequence, may represent a large proportion of the couples that successfully raised their chicks. In line with this idea, manipulation of reproductive timing showed that old (experienced) shags (*Phalacrocorax aristotelis*) forced to breed in the same late environmental conditions than young (inexperienced) breeders maintain a higher reproductive success (Daunt *et al.* 1999). In addition, if early king penguins breeders and successful late-breeders are parents of higher quality, this may be reflected in adults having longer telomeres (Bauch *et al.* 2013). Given that telomere length is a heritable trait (Horn *et al.* 2011; Voillemot *et al.* 2012), inheritance of longer telomeres may explain the early- / late-born chicks telomere difference at 10 days, as well as the link between telomere length and survival among late-born chicks. Longitudinal studies conducted over the first 3-5 years of a fledgling's life are anticipated to shed new results on the actual fitness differences arising between early- and late-born phenotypes. Finally, late breeding, even when unsuccessful, may nonetheless be of functional importance for young king penguin adults (4 to 8 years old), enabling them to acquire breeding experience and knowledge on the best breeding sites (Saraux *et al.* 2011).

Acknowledgements

Financial support for this study was provided by the French Polar Institut (IPEV) and the CNRS-INEE. We are grateful to Y. Le Maho and C. Le Bohec for facilitating exchanges between IPEV scientific programs 119 and 137. Special thanks are owed to all field assistants (including M. Kauffmann, M. Ripoché, L. Kernaleguen, B. Gineste & the logistic teams of the Alfred Faure base) for their great efforts during fieldwork, and to G. Lemonnier for providing the king penguin photograph on Figure 1. We are especially grateful to 2 anonymous reviewers for providing interesting and constructive comments on a previous draft of the paper, and to G. Earle for editing the English. All procedures were approved by an independent ethics committee commissioned by the French Polar Institute. Working in the colony, handling chicks and sampling was authorized by Terres Australes et Antarctiques Françaises (TAAF). The experiments comply with the current laws of France. AS was supported by a Doctoral Fellowship from the French Ministry of Education, Research and Technology. During the time of writing VAV was supported by a post-doctoral grant from the AXA Research Fund.

**Box 4 - Starting with a handicap: Asynchronous hatching
and the growth/maintenance trade-off in free-living great tit.**

Antoine Stier, Sylvie Massemin, Mathilde Tissier, Sandrine Zahn & François Criscuolo

In prep.



Abstract

Background

Hatching asynchrony creates a sibling competitive hierarchy within the brood, with first-hatched ('core') chicks enjoying substantial advantages compared to last-hatched ('marginal') chicks. We used this opportunity to test for a trade-off between growth and self-maintenance processes (resting metabolic rate, oxidative stress, telomere dynamics) in great tit chicks, since resources availability and allocation are likely to differ between 'core' and 'marginal' nestlings. We predicted that 'marginal' chicks should either preferentially allocate resources to self-maintenance and grow slowly (*constraint hypothesis*) or exhibit a similar/faster growth rate to catch-up with 'marginal' chicks, but at the expense of body self-maintenance (*cost hypothesis*).

Results

We found that despite their initial handicap, 'marginal' great tit chicks exhibited growth rates and mass/size at fledging similar to 'core' chicks. However, 'marginal' nestlings presented higher resting metabolic rate, and suffered more in terms of oxidative stress and telomere erosion than 'core' chicks. Among 'marginal' chicks, those exhibiting the faster body size growth were also those with the higher telomere loss. We also found elevated levels of plasma testosterone in 'marginal' chicks, but only during the early growth period (day 7).

Conclusions

We conclude that 'marginal' chicks are likely to favour investment toward growth to overcome their starting handicap, despite negative consequences for the body self-maintenance (*i.e. cost hypothesis*). Elevated levels of testosterone might mediate these effects by providing a competitive advantage to 'marginal' chicks but exposing them to higher oxidative stress levels and to their ageing consequences at the same time.

Keywords

Hatching asynchrony, growth, oxidative stress, antioxidant, telomere, testosterone

Introduction

Early development is a key period conditioning an organism's life, since a bad start could have profound impact on individual's life-history trajectories (Metcalfe & Monaghan 2001; Monaghan 2008; Criscuolo *et al.* 2008; 2011). Indeed, even if individuals could compensate for an early deficit by accelerating growth rate once good conditions are restored (*i.e.* compensatory growth), this accelerated growth might be associated with both ecological (*e.g.* predation risk, Gotthard 2001) and physiological costs (as a delayed sexual maturation (Morgan & Metcalfe 2001) or a reduced lifespan (Lee *et al.* 2013)). The phenomenon of compensatory growth (Mortensen & Damsgård 1993) strongly suggests that an individual's growth rate is usually optimal rather than maximal, and therefore that growth rates are flexible and regulated in response to environmental factors (Metcalfe & Monaghan 2001; Dmitriew 2011).

The most favoured explanation for growth rate flexibility is based on the central concept of trade-offs in allocation of the limited pool of resources among the key life-history traits (Stearns 1992). This approach based on energy limitation explains why traits may be negatively associated, such as reproduction and longevity (Stearns 1992). In more recent years, more attention has been given to the specific nature of the mechanisms that underlie the global idea of trade-offs (Zera & Harshman 2001). By providing such a proximate approach, evolutionary ecologists have been able to provide non-energetic alternative explanations of trade-offs, for example by including hormonal pleiotropic effects (Ketterson & Nolan 1999). For instance, increased testosterone (T) levels might enhance growth rate (Muller *et al.* 2007) at the expense of self-maintenance processes (*e.g.* oxidative stress or immune response (Alonso-Alvarez *et al.* 2007b)). As an additional/complementary possibility, the deleterious impact of one trait on another might be mediated through oxidative stress (Costantini 2008; Dowling & Simmons 2009; Monaghan *et al.* 2009; Metcalfe & Alonso Alvarez 2010). Oxidative stress is defined as the breakdown in the equilibrium between the generation of pro-oxidants (mainly by the mitochondria during normal energy processing) and the antioxidant defences, which leads to oxidative damage to biomolecules and potentially to ageing (Finkel & Holbrook 2000; Balaban *et al.* 2005;

Halliwell & Gutteridge 2007). Oxidative stress contribute to accelerate telomeres erosion (*i.e.* protective non-coding nucleoproteins structures located at the end of eukaryotic chromosomes), which ultimately leads to cell death or replicative senescence (Zglinicki 2002; Monaghan & Haussmann 2006). Therefore, oxidative stress and telomeres erosion during growth have been two factors predicted to underlie the negative impact of fast growth on other life-history traits, with a special focus on longevity (Mangel & Munch 2005; Monaghan & Haussmann 2006).

In this context, compensatory or fast growth was found to increase oxidative stress, either measured as a decreased resistance to an oxidative challenge (Alonso-Alvarez 2007a; Kim *et al.* 2011) or as an increase in oxidative damage levels (Tarry-Adkins *et al.* 2008; Nussey *et al.* 2009, see also Paper 7). Similarly, compensatory or accelerated growth rate has been associated to short telomeres or increased telomere loss, both in laboratory (Jennings *et al.* 1999; Tarry-Adkins *et al.* 2008; 2009; 2013) and wild conditions (Paper 7, but see Foote *et al.* 2011b and Paper 6 for controversies). Higher growth rate has also been associated with increased metabolic rate (Careau *et al.* 2013), and this energy cost has often been used as a proximate factor to explain the oxidative cost of a fast growth, even if the relationships between ROS production and metabolic rate are far from being straightforward (Barja 2007). Still, the occurrence of a trade-off between growth and self-maintenance parameters, such as oxidative stress and telomere maintenance, remains largely unknown in natural contexts influencing growth trajectories (but see Paper 7).

In many altricial birds, hatching occurs asynchronously, which creates a sibling competitive hierarchy within the brood (Magrath 1990; Ketterson & Nolan 1999). Indeed, first-hatched ('core') chicks are enjoying substantial advantages compared to last-hatched ('marginal') chicks. For instance, it has been shown that 'core' chicks might benefit from an increased food intake despite a reduced begging rate (Cotton *et al.* 1999). Therefore, asynchronous hatching offers a good opportunity to test for a trade-off between growth and self-maintenance processes within a natural context, since resources availability and allocation are likely to differ between 'core' and 'marginal' chicks (Nilsson & Svensson 1996; Nilsson & Gårdmark 2001). It was shown in many cases that 'marginal' chicks might suffer from reduced

growth rate or lower mass/size at fledging (e.g. Rubolini *et al.* 2006; Kilgas *et al.* 2010). However, such a pattern is not always found (e.g. (Clotfelter *et al.* 2000; Hall *et al.* 2010)), might be sex specific and/or year-dependent (Tilgar & Mänd 2006), or might also vary according to the morphological trait measured (Nilsson & Svensson 1996; Nilsson & Gårdmark 2001; Mainwaring *et al.* 2010; Kilgas *et al.* 2010). Moreover, there are some indications that ‘marginal’ chicks are able to catch-up with ‘core’ chicks during the growth period (Clotfelter *et al.* 2000), which raises the question of the physiological costs that could be paid by ‘marginal’ nestlings to overcome their starting handicap.

Few studies have examined the impact of hatching asynchrony on oxidative balance to date, but it was shown that ‘marginal’ chicks might exhibit lower plasma antioxidant capacity (Rubolini *et al.* 2006, but see Kilgas *et al.* 2010; Saino *et al.* 2011) or higher oxidative damage (Hall *et al.* 2010 in control nests, but see Saino *et al.* 2011). Still, we are lacking data describing how natural variation in growth rate impacts oxidative stress and ultimately ageing through telomere erosion. To fill this gap, we extended the study of naturally asynchronous hatching in a passerine bird, the great tit (*Parus major*), and more particularly of its impact on the following variables: (i) growth rate and plasma testosterone (T) levels, (ii) physiological parameters reflecting the self-maintenance of the organism (*i.e.* resting metabolic rate, oxidative stress and telomere dynamics), and (iii) the relationships between growth and self-maintenance parameters. We predicted that ‘marginal’ chicks should either preferentially allocate resources to self-maintenance at the expense of growth rate (*oxidative constraint hypothesis*) or exhibit a similar-to-faster growth rate than ‘marginal’ chicks, but with an incurred cost for self-maintenance (*oxidative cost hypothesis*).

Materials and methods

Field work and birds sampling

We monitored breeding activity and chick growth of great tits (*Parus major*) in artificial nest boxes, within the “Forêt de la Wantzenau” (Strasbourg, France) during the 2012 season (April - May). During the early season, nests were checked regularly before hatching to determine hatching date, clutch size and clutch mass. In 2012, 22 nest boxes were successfully occupied by great tits pairs.

We selected 4 chicks per nest (*i.e.* 88 chicks in total): the two first-hatched (*i.e.* ‘core’ chicks) and the two last-hatched chicks (‘marginal’ chicks), based on body mass and body size close to hatching. Chicks were individually marked with a waterproof marker on their rump. Overall mortality was very low (7.7%), but five ‘marginal’ chicks and two ‘core’ chicks died before the first blood sampling (day 2 to day 5) and were subsequently replaced by the closest chick in regard to the hatching rank. We did not observe mortality after day 5. ‘Marginal’ chicks hatched on average 1.38 ± 0.09 days later than ‘core’ chicks (range: 1-3 days). Body mass and body size (wing length, tarsometatarsus length, head size) were recorded every two days following hatching (hatching = day 1) using an electronic balance (0.1g precision) and a digital calliper rule (0.1mm precision). Chicks were followed until fledging (mean \pm SE = 17.55 ± 0.13 days). One small blood sample ($\approx 50 \mu\text{L}$) was taken from the brachial vein with a heparinised glass capillary at day 7 (mean \pm SE: 7.46 ± 0.08 days) and day 16 (16.35 ± 0.08 days). Blood was kept on ice until return to the laboratory. Plasma was separated from blood cells by centrifugation (10 min, 3000g) and samples were subsequently stored at -80°C before analysis.

Growth analysis

As an estimate of body size, we used the first principal axis (PC1) resulting from a principal component analysis (PCA) of wing, tarsometatarsus and head measurements, which explained 96.4 % of the total variance of body size. Therefore body size is expressed in arbitrary units (AU).

Body mass and body size (PC1) growth were fitted with the following logistic equation: $Y(x) = A/[1 + \exp(-K*x - B)]$, which was the best fitting model based on R^2 . $Y(x)$ represents the size or mass of a chick at age x (in AU or g), “A” is the asymptotic mass or size (*i.e.* mass or size at fledging), “K” is the growth rate constant (an increase in “K” value implies an increase in the rate at which mass or size increases from initial value to asymptotic value) and B is a constant determining the initial mass. Growth fitting was performed with the nonlinear regression procedure in SPSS (SPSS 20.0 © 1989-2011 SPSS Inc., USA) for each chick.

Resting metabolism

Resting oxygen consumption (VO_2 expressed in mL O_2 consumed per minute) was determined within a closed space (*i.e.* a car) and in the dark to reduce chick’s movements and stress. We recorded O_2 consumption during 30 minutes with a field open-circuit indirect calorimetry system (FOXBOX, Sable System, USA), at day 13 (mean \pm SE: 12.60 ± 0.13) for 30 chicks (‘core’: $N = 15$ and ‘marginal’: $N = 15$). We choose to define the resting VO_2 as the lowest two consecutive minutes of VO_2 reading within the 30 minutes recording. Body mass was included as a covariate in statistical model to control for body mass effect on metabolism. Ambient air temperature was also simultaneously recorded to control for a potential temperature effect.

Plasma oxidative stress markers

The antioxidant capacity and the concentration of reactive oxygen metabolites (ROMs) in the plasma were measured using the OXY-Adsorbent (5 μ L of 1:100 diluted plasma) and d-ROM tests (5 μ L of plasma, Diacron International, s.r.l, Italy) following the manufacturer instructions. OXY adsorbent test allows quantifying the ability of the plasma antioxidant compounds to buffer a massive oxidation through hypochlorous acid, while the d-ROM test measures mostly hydroperoxydes, as a marker of potential oxidative damage. Antioxidant capacity is expressed as mM of HClO neutralised/mL and ROMs as mg of H_2O_2 equivalent/dL. Intra-individual variation based on duplicates was low (respectively $CV = 4.25 \pm 0.43\%$ for the OXY test and $CV = 5.37 \pm 0.78\%$ for the d-ROMs test) as well as inter-plate variation based

on a standard sample repeated over plates (CV = 6.02% for OXY and 5.60% for d-ROM test).

Telomere length

Telomere length was determined with DNA extracted from blood cells using a quantitative real-time amplification (qPCR) protocol adapted for birds (Criscuolo *et al.* 2009). Primer sequences for telomere amplification were similar to those used by Criscuolo *et al.* (2009). As a single control gene (or defined as a non-variable copy number gene within our population, thereafter non-VCN, (Smith *et al.* 2011)), we used the chicken zinc finger protein, with primer sequences defined by Primer 3 software as: (ZENK1: 5'-TACATGTGCCATGGTTTTGC-3'; ZENK2: 5'-AAGTGCTGCTCCCAAAGAAG-3'). Primer concentrations in the final mix were 100 nM for telomere length determination and 500 nM for the control gene. Telomere and control gene PCR conditions were 2min at 95°C followed by 40 cycles of 15s at 95°C, 30s at 56°C, 30s at 72°C and 60s at 95°C. We used 2.5ng DNA per reaction and the Power SYBR[®] Green PCR Master Mix fluorescent probe (Applied Biosystems, USA). Mean amplification efficiency of the qPCR runs for telomere and non-VCN genes were respectively in %: 99.86 ± 0.22 and 100.16 ± 0.31 . Intra-plate mean coefficients of variation for Ct values were 1.74 ± 0.08 % for the telomere assay and 0.81 ± 0.03 % for non-VCN assay. Samples were run on five different plates and inter-plate coefficients of variation based on five repeated samples were $2.15 \pm 0.11\%$ for the telomere assay and $1.04 \pm 0.12\%$ for non-VCN assay (Ct values again). Final calculation of telomere length (T/non-VCN ratio) was done following (Pfaffl 2001) using the telomere and non-VCN accurate efficiencies of each plate. Sex determination was also done on DNA extracted from blood cells, following an adapted method from (Griffiths *et al.* 1998).

Testosterone assays

Circulating testosterone (T) levels were determined at day 7 and day 16. Plasma T levels were determined by immunoassay according to guidelines provided by the manufacturer (Enzo[®] Life Sciences, Testosterone EIA Kit, ADI-901-065, NY, USA). Intra-assay variation based on five duplicates per plate was low (7.11 ± 0.97

%), as well as inter-assay variation based on one repeated sample over plates (12.19 %). The detection limit provided by the manufacturer is 5.67 pg/mL. We could not run measurements in duplicates for each individual due to plasma quantity limitations, and the sample size for the measurement at day 16 was reduced to 80 individuals for the same reason.

Statistics

We tested the effect of hatching rank ('core' vs. 'marginal' chicks) on parameters measured only one time (asymptotic mass and size "A", body mass and body size growth rates "K", resting O₂ consumption and the relationship between telomere erosion rate and growth) using linear mixed models, with the nest as random effect (since the four chicks within one nest are not independent statistical units), hatching rank, sex and interactions between parameters as fixed effects.

We tested the effect of hatching rank on parameters measured two times (*i.e.* testosterone, ROMs, antioxidant capacity and telomere length) using repeated linear mixed models, with age (7 or 16 days) as the repeated effect, nest as a random effect, hatching rank ('core' vs. 'marginal') and sex as fixed effect, and interactions between fixed effects.

We choose to present the most parsimonious models, where parameters presenting $p > 0.05$ were sequentially removed (starting by the interactions between parameters). Linear mixed models were fitted with a normal error distribution (SPSS 20.0), and data were tested for normality and homoscedasticity. All tests were two-tailed tests and p values ≤ 0.05 were considered significant. Means are quoted \pm S.E.

Results

Growth

Table 1: Summary of the most parsimonious linear mixed models explaining the variability in body mass (a) and body size (b) at fledging ("A"), as well as body mass (c) and body size (d) growth rates ("K"). Estimates are also reported for the random effect (Nest). P-values and estimates are only reported for the parameters included in the most parsimonious models.

(a) Mass at fledging ("A")		Estimate	SE	F	p-value
Random effect	Nest	0.68	0.25		
Fixed effects & covariates	Constant	16.61	0.55	915.01	< 0.001
	Hatching rank				ns
	Sex	-0.53	0.17	9.52	0.003
	Mass at hatching	0.80	0.33	6.04	0.016
(b) Size at fledging ("A")		Estimate	SE	F	p-value
Random effect	Nest	0.005	0.002		
Fixed effects & covariates	Constant	3.11	0.07	2079.29	< 0.001
	Hatching rank				ns
	Sex	-0.07	0.02	16.05	< 0.001
	Size at hatching	0.67	0.18	14.18	< 0.001
(c) Body mass growth rate ("K")		Estimate	SE	F	p-value
Random effect	Nest	0.0015	0.0005		
Fixed effects & covariates	Constant	0.514	0.019		< 0.001
	Hatching rank				ns
	Sex				ns
	Mass at hatching	-0.07	0.01	42.43	< 0.001
(d) Body size growth rate ("K")		Estimate	SE	F	p-value
Random effect	Nest	0.0004	0.0001		
Fixed effects & covariates	Constant	0.38	0.01	705.82	< 0.001
	Hatching rank				ns
	Sex				ns
	Size at hatching	-0,18	0,04	24,09	< 0.001

Body mass at fledging was positively related to the mass at hatching and significantly influenced by the sex (table 1a), with males being significantly heavier than females (17.9 ± 0.2 vs. 17.3 ± 0.2 g). However, we did not find a significant difference between ‘core’ and ‘marginal’ chicks (table 1a, 17.5 ± 0.2 vs. 17.7 ± 0.2 g). Similarly, the size at fledging was positively related to the size at hatching and significantly influenced by the sex (table 1b), with males being bigger than females (3.37 ± 0.02 vs. 3.28 ± 0.01 AU). Again, no significant difference between ‘core’ and ‘marginal’ chicks was found (table 1b, 3.32 ± 0.02 vs. 3.33 ± 0.02 AU).

Body mass and body size growth rates (“K”) were significantly and negatively affected by body mass and body size at hatching respectively (table 1c and 1d). However, these two parameters were not significantly affected by the sex (mass: females = 0.40 ± 0.01 vs. males = 0.40 ± 0.01 ; size: females = 0.31 ± 0.01 vs. males = 0.31 ± 0.01) or the hatching rank of chicks (mass: ‘core’ = 0.41 ± 0.01 vs. ‘marginal’ = 0.39 ± 0.01 ; size: ‘core’ = 0.31 ± 0.01 vs. ‘marginal’ = 0.31 ± 0.01 ; table 1c and 1d).

Resting metabolic rate

Resting oxygen consumption was significantly affected by the hatching rank (table 2), with ‘marginal’ chicks exhibiting higher resting metabolic rate than ‘core’ chicks (1.61 ± 0.08 vs. 1.42 ± 0.05 mL O₂.min⁻¹). Resting metabolism was significantly related to body mass (positive effect) and affected by ambient temperature (negative effect), but not significantly so by sex (table 2).

Table 2: Summary of the most parsimonious linear mixed model explaining the variability in resting metabolic rate of great tit chicks, expressed as VO₂ (mL.min⁻¹). Estimates are also reported for the random effect (Nest). P-values and estimates are reported only for the parameters included in the most parsimonious model.

Resting VO₂		Estimate	SE	F	p-value
Random effect	Nest	0.009	0.009		
Fixed effects & covariates	Constant	0.42	0.50	0.46	0.504
	Hatching rank	-0.16	0.06	8.17	0.012
	Sex				ns
	Body mass	0.11	0.02	22.83	< 0.001
	Temperature	-0.03	0.01	4.39	0.050

Self-maintenance parameters

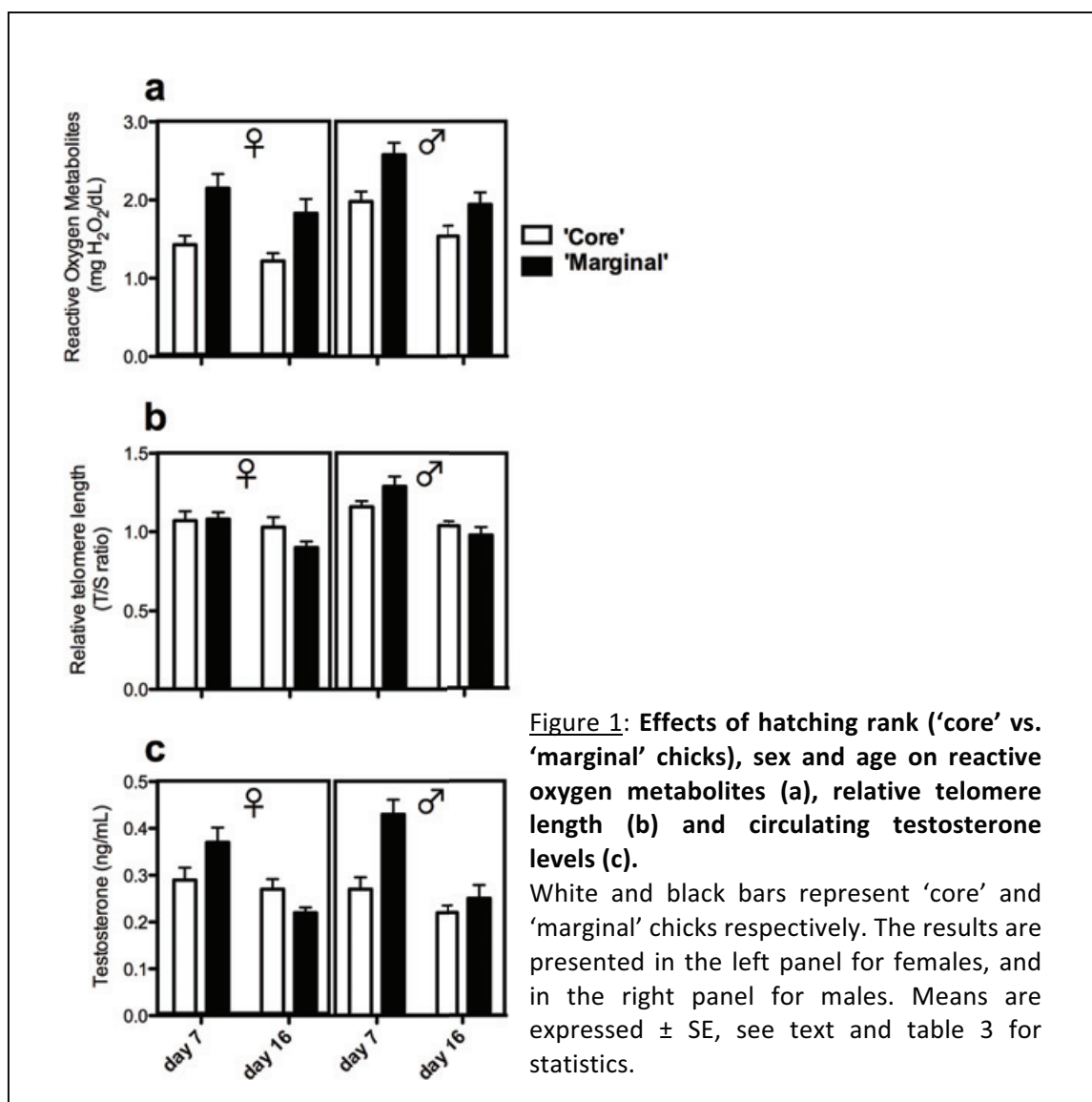

The plasma antioxidant capacity was significantly influenced by the age (table 3a), with chicks exhibiting higher antioxidant capacity at fledging than at 7 days old (7 days = 153.1 ± 2.4 vs. 16 days = 164.9 ± 1.9 mM of HClO neutralised/mL). However, antioxidant capacity was not significantly affected by the hatching rank or the sex of the chicks (table 3a).

ROMs levels were significantly influenced by the hatching rank (table 3b), with 'marginal chicks' exhibiting higher levels than 'core' chicks (figure 1a). Males exhibited significantly higher ROMs levels than females, and a significant effect of age was also apparent, with ROMs levels being lower at fledging than at 7 days old (figure 1a).

Table 3: Summary of the most parsimonious linear mixed models explaining the variability in plasma antioxidant capacity (a), reactive oxygen metabolites (b), relative telomere length (c) and circulating testosterone (d). Estimates are also reported for the random (Nest) and the repeated (Time) effects. P-values and estimates are only reported for the parameters included in the most parsimonious model.

(a) Antioxidant capacity		Estimate	SE	F	p-value
Random effect	Nest	130.88	51.29		
Repeated effect	Time	278.45	31.83		
Fixed effects & covariates	Constant	153.13	11.83	182.68	< 0.001
	Hatching rank				ns
	Age	11.78	2.51	21.92	< 0.001
	Sex				ns
(b) Reactive oxygen metabolites		Estimate	SE	F	p-value
Random effect	Nest	0.11	0.05		
Repeated effect	Time	0.37	0.04		
Fixed effects & covariates	Constant	2.54	0.35	28.81	< 0.001
	Hatching rank	-0.56	0.09	20.09	< 0.001
	Age	-0.41	0.09	37.94	< 0.001
	Sex	-0.43	0.10	17.72	< 0.001
(c) Relative telomere length		Estimate	SE	F	p-value
Random effect	Nest	0.012	0.005		
Repeated effect	Time	0.043	0.005		
Fixed effects & covariates	Constant	1.24	0.12	87.02	< 0.001
	Hatching rank	-0.07	0.04	0.16	< 0.001
	Age	-0.25	0.04	28.65	0.686
	Sex	-0.11	0.03	10.52	0.001
	Hatching rank * Age	0.16	0.06	6.80	0.010
(d) Testosterone		Estimate	SE	F	p-value
Random effect	Nest	0.00016	0.00062		
Repeated effect	Time	0.014	0.002		
Fixed effects & covariates	Constant	0.40	0.02	335.05	0.293
	Hatching rank	-0.12	0.02	8.75	0.004
	Age	-0.16	0.02	29.01	< 0.001
	Sex				ns
	Hatching rank * Age	0.13	0.04	12.46	0.001

Relative telomere length was significantly affected by the sex of individuals (table 3c), with males having on average longer telomeres than females (figure 1b). Telomere length was also significantly influenced by the interaction between hatching rank and the age of chicks (table 3c), suggesting that telomere dynamics differed between ‘core’ and ‘marginal’ chicks. A separate analysis for each age revealed that telomere length was not significantly affected by hatching rank at 7 days (figure 1b, $F = 2.05$, $p = 0.16$), while ‘marginal’ chicks exhibited shorter telomeres at 16 days-old than ‘core’ chicks (figure 1b, $F = 4.71$, $p = 0.034$). A separate analysis for each hatching rank revealed that telomeres significantly shorten with age for both groups (figure 1b, ‘core’: $F = 4.36$ and $p = 0.041$, ‘marginal’: $F = 27.64$ and $p < 0.001$).

Plasma testosterone (T) concentration was not significantly influenced by the sex of chicks (table 3d, figure 1c). However, circulating T levels were significantly affected by the interaction between age and hatching rank (table 3d). Indeed, a separate analysis for each age revealed that ‘marginal’ chicks presented higher T levels at 7 days (figure 1c, $F = 16.33$ and $p < 0.001$), while no significant difference was detected at 16 days ($F = 0.27$ and $p = 0.60$).

A growth rate - telomere loss trade-off?

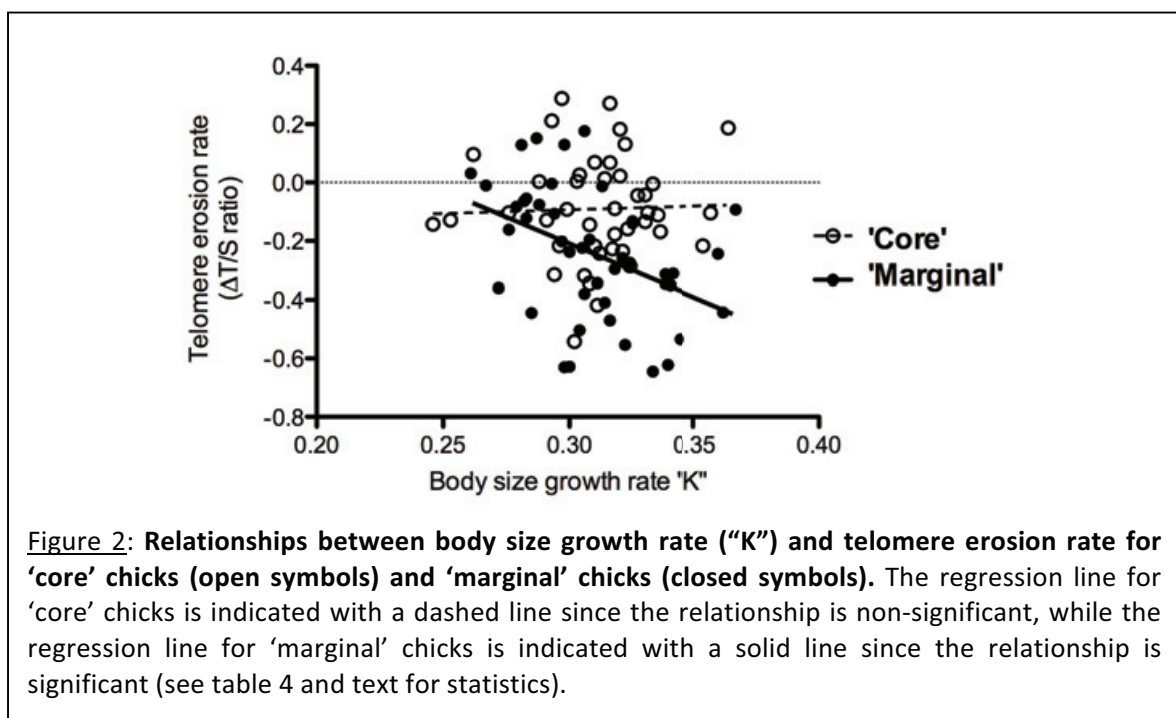

Telomere loss was significantly influenced by the sex of chicks (table 4), with males suffering a higher erosion rate than females (-0.22 ± 0.03 vs. -0.11 ± 0.03 $\Delta T/S$ ratio). In addition, telomere loss was significantly influenced by the interaction between hatching rank and body size growth rate (table 4, figure 2). A separate analysis for each hatching rank revealed that telomere loss was negatively related to body size growth rate for ‘marginal’ chicks ($F = 11.21$, $p = 0.002$), while such a relationship was not significant for ‘marginal’ chicks ($F = 0.19$, $p = 0.66$).

Table 4: Summary of the most parsimonious linear mixed model explaining the variability in telomere loss, expressed as $\Delta T/S$ ratio. Estimates are also reported for the random effect (Nest).

Telomere erosion		Estimate	SE	F	p-value
Random effect	Nest	0.002	0.004		
Fixed effects & covariates	Constant	0.80	0.36	1.78	0.192
	Hatching rank	-0.95	0.50	3.57	0.063
	Sex	0.10	0.04	5.81	0.018
	Body size growth rate	-3.52	1.14	3.91	0.055
	Hatching rank * Body size growth rate	3.59	1.62	4.90	0.030

We tested a similar relationship with body mass growth rate as explanatory variable, but telomere loss was not significantly influenced by the interaction between body mass growth rate and the hatching rank ($F = 1.10$, $p = 0.30$).

Discussion

Hatching asynchrony might be an important constraint for the investment between growth and self-maintenance in great tit chicks. Indeed, despite their starting handicap, 'marginal' chicks were able to grow as fast as 'core' chicks, but presented several signs of an altered body self-maintenance (*i.e.* higher ROMs levels and increased telomere erosion). Therefore our results support more the occurrence of an *oxidative cost* related to growth in adverse conditions, rather than the occurrence of an *oxidative constraint* limiting chicks in their rate of development.

'Marginal' chicks may have benefitted from good environmental conditions, allowing them to grow as quickly as 'core' chicks. We did not measure food availability, but the extremely low mortality of 'marginal' chicks observed in our population (5 of 44 chicks: 11.4%) compared to other studies on the same species (55.8% (Tilgar & Mänd 2006) and 63.4% (Kilgas *et al.* 2010)) suggests that environmental conditions might have been particularly good in our study area during the 2012 field season. It is also worth noting that the two above-mentioned studies reported negative effects of the hatching rank in terms of growth rate or in terms of mass/size before fledging. Consequently, the influence of hatching asynchrony on growth parameters is likely to be strongly influenced by local environmental conditions.

Despite the hypothetical high food availability, 'marginal' chicks may have been more competitive than 'core' chicks to obtain an equal amount of resources (*i.e.* equal growth rate). For instance, 'marginal' chicks may have increased their begging rate or duration (Rydén & Bengtsson 1980; Smiseth & Amundsen 2002; Gilby *et al.* 2012), even if this pattern is not always found (Hall *et al.* 2010). Interestingly, begging behaviour has been shown to be under the control of circulating testosterone levels in nestling birds (Goodship & Buchanan 2007). Since 'marginal' chicks in our study were also characterized by higher T levels at 7 days, it seems conceivable that their growth rates have been supported by a higher begging activity than 'core' chicks. A direct impact of nestling T levels on growth rate remains quite ambiguous (*e.g.* negative effect Ros 1999 or positive effect Muller *et al.* 2007), but an increased competitive ability of 'marginal' chicks may explain their elevated

resting metabolic rate. Growing as fast as 'core' chicks despite elevated resting metabolic rate would even suggest that 'marginal' chicks have obtained more food than 'core' ones, otherwise a negative impact of high resting metabolism on growth rate would have occur. Yet, the energy cost of begging *per se* has been suggested to be relatively low (Leech & Leonard 1996; McCarty 1996). Then, measurements of begging and feeding rates are required to fully understand the mechanisms allowing 'marginal' chicks to grow as fast as 'core' chicks despite their initial handicap.

Besides hypothetic high food availability and higher competitive abilities of 'marginal' nestlings, the unaltered growth rate of these chicks despite their starting handicap might also be linked to resources re-allocation from functions such as self-maintenance toward growth (Dmitriew 2011). In this context, decreased levels of antioxidant defences would have been expected in 'marginal' chicks (see Hall *et al.* 2010 for a beneficial effect of antioxidant supplementation for growth rate), but our results on plasma antioxidant capacity (*i.e.* no influence of hatching rank) did not support this idea. However, following the re-allocation hypothesis, endogenously synthesized antioxidants (*e.g.* enzymes such as superoxide dismutase or catalase) are more likely to be affected than the ones derived from the diet. Yet, our antioxidant assay is mostly limited to non-enzymatic antioxidant compounds acquired from food (see Sies 2007 for criticism about plasma total antioxidant capacity assays). Consequently, we cannot draw clear conclusions about this point without complementary measurements of antioxidant enzymes. Nevertheless, 'marginal' chicks exhibited elevated levels of ROMs and a higher rate of telomere erosion, thereby suggesting that oxidative balance and body-self-maintenance have been altered. Consequently, our hypothesis is that 'marginal' chicks effectively re-allocate resources from self-maintenance toward growth, for example by decreasing resources allocation in antioxidant defences, repair mechanisms (Halliwell & Gutteridge 2007), or other more specific DNA protective pathways (*e.g.* telomerase activity or shelterin proteins De Lange *et al.* 2006).

Besides being linked to resources re-allocation, the high oxidative stress levels and telomere erosion observed for 'marginal' chicks may have other origins. Indeed, it has been shown that elevated levels of circulating testosterone may carry costs (see Wingfield *et al.* 2001 for an overview), and recent studies on birds have

shown that an “oxidative cost of testosterone” is likely to occur (Alonso-Alvarez *et al.* 2007b; Mougeot *et al.* 2009). In this context, the impaired self-maintenance of ‘marginal’ chicks might be linked to their elevated T levels at 7 days. We observed that T levels were elevated only transiently in ‘marginal’ chicks (day 7 but not day 16), which might hypothetically occur to limit the physiological costs associated with high levels of this hormone. It is also worth noting that the elevated oxidative stress experienced by ‘marginal’ chicks might also be linked to a higher begging activity. Indeed, an intense begging activity has been associated to elevated levels of oxidative damage (Moreno-Rueda *et al.* 2012), and it was shown that antioxidant supplementation enhance begging displays in growing chicks (Noguera *et al.* 2010). Finally, the high metabolic rate exhibited by ‘marginal’ chicks may have also contributed to enhance oxidative stress, even if the relationships between metabolic rate and ROS production are far from being straightforward (but see Paper 2 for a discussion on this topic).

The idea of a trade-off between resources investment toward growth and body self-maintenance is further supported by the negative link found for ‘marginal’ chicks between body size growth and telomere erosion rate. Yet, the lack of significant relationship between growth rate and telomere erosion in ‘core’ chicks is in accordance with previous results on great and coal tits (Paper 6) and on lesser black-backed gulls (*Larus Fuscus*, (Foote *et al.* 2011b)). Therefore, evidences for a trade-off between growth and telomere maintenance might be easily detected when animals face particularly limited access to resources, such as ‘marginal’ great tit chicks in this study or king penguin chicks (*Aptenodytes patagonicus*) being small at the end of winter (Geiger *et al.* 2012). It is also worth noting that the relationship between telomere erosion and growth rate was significant for body size but not for body mass, despite a strong correlation between body size and body mass growth rates ($r = 0.71$, $p < 0.001$). Consequently, body size growth might be more costly than mass gain *per se*, or might alternatively represent a better indicator of overall growth rate.

Testosterone might be one key link between competitive ability, growth performances and self-maintenance in our study. However, one unanswered question remains the origin of the high T levels observed for ‘marginal’ chicks during

the early growth phase (*i.e.* day 7). Females are known to deposit more testosterone in last-laid eggs to increase the competitiveness of last-hatched chicks (Schwabl 1993; 1996; Muller & Groothuis 2013), making maternal effects an obvious candidate. Accordingly, it has been shown that yolk testosterone content increased with laying order in free-living great tits (Podlas *et al.* 2013), and that increased yolk testosterone might be associated with higher T levels at the nestling stage (Muller *et al.* 2007). In addition, increased yolk testosterone has been associated with high resting metabolic rate at the nestling stage in zebra finch (Tobler *et al.* 2007), a pattern in accordance with the elevated resting metabolism found for 'marginal' chicks in our study. Yet, we cannot completely exclude that the transient high T levels observed for 'marginal' chicks could be due to other factors, and for instance further studies are required to disentangle between maternal and environmental effects.

Another interesting point raised by this study is the sex effect observed both for ROMs levels and telomere dynamics, with male nestlings 'suffering' overall more than females. Such a sex effect has previously been reported for ROMs levels in adult great tits (Isaksson 2013), and was putatively linked to higher T levels in males than females (see Alonso-Alvarez *et al.* 2007b for an oxidative cost of T levels). In our study, we did not find a significant effect of nestling sex on T levels, neither at 7 days nor at 16 days (see (Silverin & Sharp 1996) for similar results), suggesting that differences in T levels are unlikely to explain the sex effect in our case. However, it has been shown that male great tit nestlings exhibit higher T levels than females close to hatching (day 1-2, (Silverin & Sharp 1996)), and a delayed effect of post-hatching T levels on oxidative stress might contribute to our sex-biased oxidative stress. Differences in terms of telomere length or erosion rate between sexes are rare in birds (Barrett & Richardson 2011, but see Foote *et al.* 2011a), but the effect observed in our study (*i.e.* higher telomere erosion for males) is consistent with the elevated levels of oxidative stress exhibited by male nestlings. Yet, sexual dimorphism (males being heavier/larger than females) might also be one key element leading to differences in terms of self-maintenance parameters between the sexes. Nevertheless, such sex differences are likely to be species-dependent

and/or environment-dependent, since we did not find a significant effect of sex for telomere dynamics in coal and great tit chicks sampled in 2011 (Paper 6).

Conclusion

To conclude, this study highlights that hatching asynchrony might be an important constraint for the balance between growth and self-maintenance processes, and that an endocrine factor (*i.e.* testosterone) might be one key determinant in this balance. Our study is unfortunately restricted to short-term costs of hatching asynchrony, but considering the potential impact of oxidative stress and telomere length/erosion on fitness related traits (*e.g.* survival or recruitment (Bize *et al.* 2008; 2009; Noguera *et al.* 2012), lifespan (Heidinger *et al.* 2012) or reproductive performances (Paper 4)), it will be of paramount importance to investigate the long-term consequences of hatching asynchrony in great tit.

Acknowledgments

This work was supported by a CNRS funding. We thank A. Gross and the SRPO association for their contributions in the field.

Authors' contributions

AS designed the study. AS & SM collected the data. AS, MT & FC took part in data analyses and interpretations. SZ and MT managed the measurements of telomeres length. AS & FC wrote the paper.



© A. Trepte

Chapter 5

Synthesis, general discussion, limitations and prospects

The specific points of discussion have already been addressed within each paper/box. This section aims to synthesize the main results, put the different studies into perspective, consider the limitations of my work and explore possible research prospects arising from this PhD.

1. Brief synthesis

In the first part of Chapter 3, I showed that the oxidative consequences of increased energy expenditure are likely to be modulated by the mitochondrial coupling state of individuals (Paper 2, but see also Box 2). Indeed, mice relying on an ‘uncoupled’ thermogenesis pathway (*i.e.* UCP1 mediated non-shivering thermogenesis) did not suffer from increased levels of oxidative stress following an experimental metabolic challenge (*i.e.* cold exposure). On the other hand, mice relying on a ‘coupled’ thermogenic mechanism suffered from elevated oxidative damage (*i.e.* UCP1 KO mice using mostly muscular shivering thermogenesis, Paper 2). However, UCP1 ablation did not significantly alter oxidative balance when mice were maintained close to thermoneutrality (Paper 2, Box 1), even if it surprisingly impacted longevity in mice (Box 1). Further investigations should enable us to specifically determine the mechanism linking UCP1 to longevity, especially by investigating the impact of UCP1 on lipid metabolism. In accordance with the findings of Paper 2, we demonstrated that an experimental uncoupling treatment (DNP) was efficient in protecting zebra finches from the increased oxidative stress caused by acute exposure to the cold (Box 2). Since control birds demonstrated a short-term increase in oxidative stress levels, our results suggest again that an increased metabolism achieved through a ‘coupled’ metabolic pathway (thermogenesis being primarily achieved through muscular shivering) might expose individuals to an oxidative cost.

However, our long-term experimental study in zebra finches shows that a mitochondrial uncoupling treatment does not have evident positive effects on oxidative balance and survival (Paper 3, Box 3), despite previous studies reporting beneficial effects in insects, mammals and amphibians (Padalko 2005, Caldeira da Silva *et al.*, 2008, Salin 2012a *et al.*). However, complementary *in vitro* investigations suggested that ROS production by zebra finch mitochondria might be less sensitive to mitochondrial uncoupling than those of a control mammalian model (the mouse). This specific point might help to explain such unexpected results. Nevertheless, Paper 3 illustrates that an increased mitochondrial

uncoupling state negatively impacted the reproductive investment and the inflammatory immune response of adult zebra finches, suggesting that even with food provided *ad libitum*, an increased mitochondrial proton leak might limit the quantity of energy that can be allocated to different life history traits.

In Chapter 4, I started by presenting correlative evidence (Paper 4) arguing for a dual role (constraint and cost) of oxidative stress for reproduction in laboratory mouse. Indeed, high pre-breeding oxidative stress was associated with smaller litter size (*i.e.* constraint), while post-breeding oxidative stress increases proportionally to litter size at weaning (*i.e.* cost). I also used this opportunity to review the contrasting evidence published so far about the existence of an oxidative cost of reproduction, and paid specific attention to point out the potential determinants of the heterogeneity observed between studies (*e.g.* wild vs. laboratory, timing of sampling, experimental design, etc.). I also presented unpublished preliminary results (Box 3) reporting a potential oxidative cost of reproduction in captive zebra finches. Yet this cost was not prevented by a higher basal mitochondrial uncoupling state, since breeding pairs treated with a mitochondrial uncoupler still exhibited an increase in oxidative stress levels. This suggests that an uncoupled mitochondrial state alone is not sufficient to stabilize the oxidative balance, whether the individuals are in a non-reproductive (Paper 3) or reproductive state (Box 3).

In the second part of Chapter 4, I provided evidence suggesting that environmental conditions might affect the balance between growth and self-maintenance parameters in free-living birds (Papers 5-8, Box 4). Indeed, coal tits growing at a higher elevation grew faster, presented higher resting metabolic rate and suffered from higher oxidative stress levels than those growing at low elevations (Paper 5). Interestingly, fast growth was only associated with higher levels of oxidative damage at the intra-population level for high-elevation chicks, suggesting that a growth/maintenance trade-off is more likely to be revealed under harsh environmental conditions. As a complement, we found that great tit and coal tit chicks have opposite growth trajectories according to elevation, and higher telomere loss was observed in chicks reared at higher elevations for both species (Paper 6). However, considering the lack of intra-population relationship between growth rate and telomere loss in this study, it seems likely that conditions experienced during the early-growth phase (*i.e.* elevation) might be at least as important as growth rate *per se* (if not more) in determining the rate of telomere erosion. I also contributed to a study (Paper 7)

demonstrating that catch-up growth exhibited by king penguins chicks that are small at the beginning of the post-winter phase might be detrimental in terms of body self-maintenance. Indeed, small chicks showed accelerated post-winter growth, but suffered from higher oxidative stress levels and telomere loss than large chicks. Interestingly, although final oxidative damage levels were related to body mass growth rate, once again this type of relationship was not found for telomere loss or length.

In the last part of this PhD, I investigated the impact of a starting handicap for subsequent growth trajectories and self-maintenance parameters. As a complement to Paper 7, we investigated the impact of the starting handicap experienced by king penguin chicks born late in the reproductive season (Paper 8). Indeed, there is a marked difference between early- and late-born chicks in this species, with the latter suffering massive mortality during the growth period. We demonstrated in this study that despite being heavier than early-born chicks shortly after hatching, late-born nestlings already presented a damaged phenotype, with increased oxidative stress levels, elevated corticosterone levels and shorter telomeres. The few late-born individuals that survived until fledging presented a growth trajectory that was relatively similar to early-born chicks, but interestingly they also showed a particular phenotype shortly after hatching. Indeed, although initial body mass was (intuitively) a strong predictor of short- and long-term survival for both early- and late-born chicks, high corticosterone levels and long telomeres were significant predictors of short- and long-term survival respectively in late-born individuals. In the same context of proximal explanation of the growth trade-offs, I also investigated the impact of the starting handicap dictated by hatching asynchrony for great tit chicks (Box 4). Indeed, as 'marginal' chicks are born 1 to 3 days later than 'core' chicks, they start their growth with a competitive disadvantage. I showed in this study that 'marginal' chicks were not only able to grow as fast as 'core' chicks, but could also attain the same mass/size at fledging. However, 'marginal' chicks exhibit higher levels of oxidative stress and increased telomere erosion, suggesting that they suffer from the compensation of their starting handicap. Interestingly, a significant negative relationship between growth rate and telomere erosion was found in 'marginal' chicks, thereby suggesting that such a link might only be revealed under specific conditions. This study also shed light on the potential role of endocrine factors such as testosterone as important modulators of the trade-off between growth/competitive abilities and body self-maintenance. Further studies integrating endocrinology and ageing-related parameters

(oxidative stress and telomere dynamics) within a common framework should help us to better understand the physiology of life history trade-offs.

2. Interplay between metabolism and oxidative stress

Physiologists have been aware of the complex relationships between energy metabolism and oxidative stress since the beginning of this century, especially considering the links between mitochondrial coupling state and ROS production (Barja 2007). However, with the integration of oxidative stress in evolutionary ecology in the 2000's, the intuitive assumption that (mitochondrial) ROS production might be linked to metabolic rate has once again become quite attractive. Here, I will discuss the pertinence of considering mitochondrial uncoupling as a means to reduce ROS production, and re-evaluate the impact of high-energy expenditure on oxidative stress levels.

2.1 Mitochondrial uncoupling: a physiologically relevant means to reduce ROS production?

Despite the experimental evidence supporting the 'uncoupling to survive hypothesis' (e.g. Kornushov *et al.* 1997, Speakman *et al.* 2004, Padalko 2005, Caldeira da Silva *et al.* 2008), the physiological relevance of mitochondrial uncoupling to reduce ROS production has been strongly criticized in recent years (Shabalina & Nedergaard 2011). Indeed, these authors suggest that the dependence of ROS production on mitochondrial coupling state might be a unique feature of succinate-fuelled respiration and reverse electron flow *in vitro* (from complex II to complex I). This contrasts with our results (Paper 3), which suggest that a beneficial effect of (DNP-mediated) uncoupling might also occur *in vitro* with complex I substrate (*i.e.* pyruvate-malate), at least for state 4 respiration (without ATP synthesis) in mouse muscle mitochondria. Yet the relevance/occurrence of state 4 mitochondrial respiration *in vivo* remains quite controversial (Shabalina & Nedergaard 2011).

Moreover, the beneficial effects of *in vivo* uncoupling treatments on oxidative stress levels (Caldeira da Silva *et al.* 2008, Salin *et al.* 2012a) might have been only indirect. Indeed, by preventing obesity in mice (Caldeira da Silva *et al.* 2008) and delaying development in frog tadpoles (Salin *et al.* 2012a), uncoupling treatments might have only *indirectly* reduced ROS production and oxidative stress, since both obesity and fast growth have already been associated with perturbations of the oxidative balance (Furukawa *et al.* 2004, Alonso-Alvarez *et al.* 2007). The lack of beneficial effect in zebra finches treated with a mitochondrial

uncoupler might be in accordance with this point (Paper 3, Box 3), since DNP-treatment did not impact the body weight or the growth rate of our birds. In addition, results of uncoupling treatments (DNP or FCCP) in cellular systems also raised serious doubts about the beneficial effect of mitochondrial uncoupling state on ROS production. Indeed, four previous studies have described negative or/neutral impact of uncouplers (Johnson-Cadwell *et al.* 2007, Stöckl *et al.* 2007, Tretter *et al.* 2007, Han *et al.* 2008), while only one found a beneficial effect (Mráček *et al.* 2006). A **direct** impact of mitochondrial uncoupling state on ROS production *in vivo* therefore remains to be clearly demonstrated. Since short-term *in vivo* uncoupling treatment is unlikely to alter body composition and mass gain (*e.g.* 24h in laboratory mice), it could be a potential means to test for a direct impact of mitochondrial uncoupling state on ROS production.

Nevertheless, the physiological role of mitochondrial uncoupling might be to increase metabolic rate without a concomitant rise in ROS production, especially for thermogenic purposes (Paper 2, Box 2). Consequently, it might be more relevant to evaluate the beneficial role of mitochondrial uncoupling state in terms of ROS production per unit of O₂ consumed, rather than in absolute ROS production. Indeed, we have shown that uncoupling protein 1 activity is required to maintain overall low levels of oxidative stress during thermogenesis in mice (Paper 2). UCP1 activity *per se* was unlikely to decrease ROS production (*i.e.* no impact on BAT oxidative stress levels), but certainly leads to an overall reduction of the ROS generated per unit of O₂ consumed at the organism level (since O₂ consumption doubled during exposure to the cold, and oxidative stress markers remained stable). Similarly, DNP-treated birds did not exhibit high oxidative damage levels when facing acute cold exposure, whereas control birds did (Box 2). This suggests that DNP-treated birds should exhibit a lower ROS/O₂ ratio than control birds in response to an acute cold challenge. One important - and probably recently evolved (Hughes & Criscuolo 2008) - function of mitochondrial uncoupling might therefore be to enable a rise in metabolic rate for thermogenesis without concomitantly increasing oxidative stress levels, particularly for resisting cold environments. This is clearly in accordance with the selection of mitochondrial uncoupling throughout evolution to sustain prolonged thermogenesis in eutherian mammals (Cannon & Nedergaard 2004, Oelkrug 2013) and potentially in birds (Talbot *et al.* 2004, Walter & Seebacher 2009).

2.2 Does high-energy expenditure constitute an oxidative challenge for organisms?

Increasing evidence suggests that the link between ROS production (and oxidative stress) and metabolic rate is not simple (Barja 2007, and see above). Yet it remains to be determined whether an increased metabolic rate can be an oxidative challenge for organisms if it is not achieved through mitochondrial uncoupling activity. Indeed, evolutionary ecologists have often assumed that potential oxidative rise associated to reproduction or growth reflects an energy cost of such functions (*e.g.* Alonso-Alvarez *et al.* 2004, 2007a). Evidence exposed in 2.1 clearly argues against a monotonic relationship between metabolic rate and ROS/oxidative stress when a mitochondrial uncoupling activity is involved. However, we have found abundant evidence indicating that an increased metabolic rate might be an oxidative challenge for organisms (Papers 2 & 5, Boxes 2 & 4). The increased oxidative stress experienced by UCP1 KO mice during prolonged cold exposure (Paper 2) and the high levels of oxidative damage experienced by control birds following an acute cold exposure (Box 2) support this assumption. In both cases, an increased metabolic rate achieved through a 'coupled' mechanism (*i.e.* muscular shivering activity) had a negative impact in terms of oxidative stress. Recent findings on muscular ROS production by UCP1 KO mice acclimated to cold conditions also reinforce this idea (figure 17, Oelkrug 2013). Indeed, mice relying on persistent muscular shivering (UCP1 KO) demonstrated an elevated mitochondrial ROS production compared to WT mice relying on UCP1-mediated non-shivering thermogenesis.

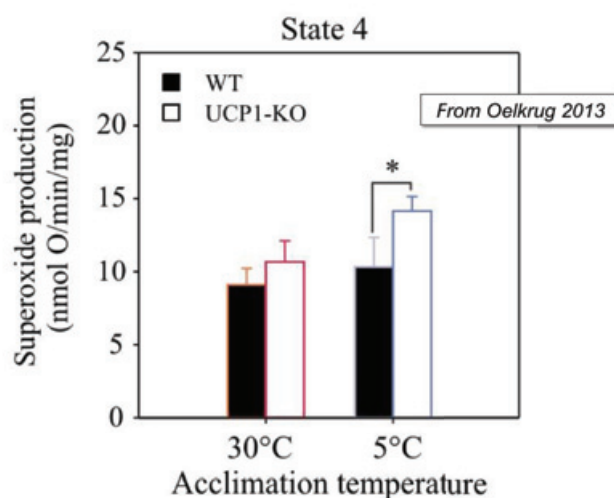

Figure 17: Superoxide production rate by skeletal muscle mitochondria of WT and UCP1 KO mice acclimated either to thermoneutral (30°C) or cold temperature (5°C). Reprinted from the PhD thesis of R. Oelkrug (Philipps-Universität Marburg, 2013).

It is however likely that in ‘standard conditions’, compensatory mechanisms are rapidly set-up to either reduce ROS production (*e.g.* inducible mitochondrial uncoupling or change in muscle fibre type) or limit their deleterious effects (*e.g.* antioxidant defences or repair mechanisms). Such compensatory mechanisms are likely to protect organisms during periods of increased metabolism linked to thermogenesis, thereby explaining the steady oxidative stress levels observed for WT mice and birds during prolonged cold exposure (Paper 2, Box 2, see also Selman *et al.* 2008).

Following the same idea, the consequences of physical exercise (*i.e.* increased metabolism) have been intensively studied in a biomedical context. These studies revealed that intensive physical exercise is associated with increased generation of pro-oxidant and higher oxidative damage levels (*e.g.* Davies *et al.* 1982, Bejma & Ji 1999). Nevertheless, chronic sub-maximal exercise has been shown to improve the oxidative homeostasis of individuals by eliciting antioxidant defences/repair mechanisms and decreasing oxidative damage levels (Ji 1999, Radak *et al.* 2013). Again, an increased metabolic rate appears to be an oxidative challenge, but compensatory mechanisms exist and are rapidly set up by healthy individuals.

Interestingly, we found that elevated resting metabolic rates were associated with elevated levels of oxidative damage in coal tit (Paper 5) and great tit chicks (Box 4). Indeed, both high-elevation and ‘marginal’ chicks presented higher resting metabolism and higher levels of oxidative damage compared to low-elevation and ‘core’ chicks, respectively. Even if metabolic rate and oxidative damage levels were only indirectly related, this suggests that an increased metabolic rate might constitute an oxidative challenge in free-living growing chicks. This effect could be attributed to the incomplete antioxidant machinery typical of young chicks (Blount *et al.* 2003, but see also the increase in antioxidant capacity with age in Paper 3, Paper 5 and Box 4). If a link between metabolic rate and ROS production/oxidative stress does exist, it is worth noting that daily energy expenditure (DEE) should be a more appropriate indicator than resting or basal metabolic rate (RMR/BMR). In accordance, Speakman *et al.* (2002) suggested that a high resting metabolic rate might be beneficial (*e.g.* linked to mitochondrial uncoupling, protective mechanisms, etc.), while an increased in total energy expenditure could be more detrimental for organisms (*e.g.* proportional to ROS production). This is exemplified by the beneficial impact of high RMR for lifespan in mice

(figure 18a, Speakman 2004) and the deleterious impact of high DEE for oxidative damage in breeding American red squirrels (*Tamiasciurus hudsonicus*, figure 18b, Fletcher 2013).

To sum up, elevated energy expenditure in many cases (cold exposure, physical exercise, reproduction, etc.) seems to constitute an oxidative challenge for organisms, but adaptive responses exist and are rapidly set up, making it difficult to reveal this phenomenon. However, studying the relationships between metabolic rate and oxidative stress in conditions limiting compensatory mechanisms (low resource/antioxidant availability) might shed more light on the validity of the relationship between high energy expenditure and oxidative stress.

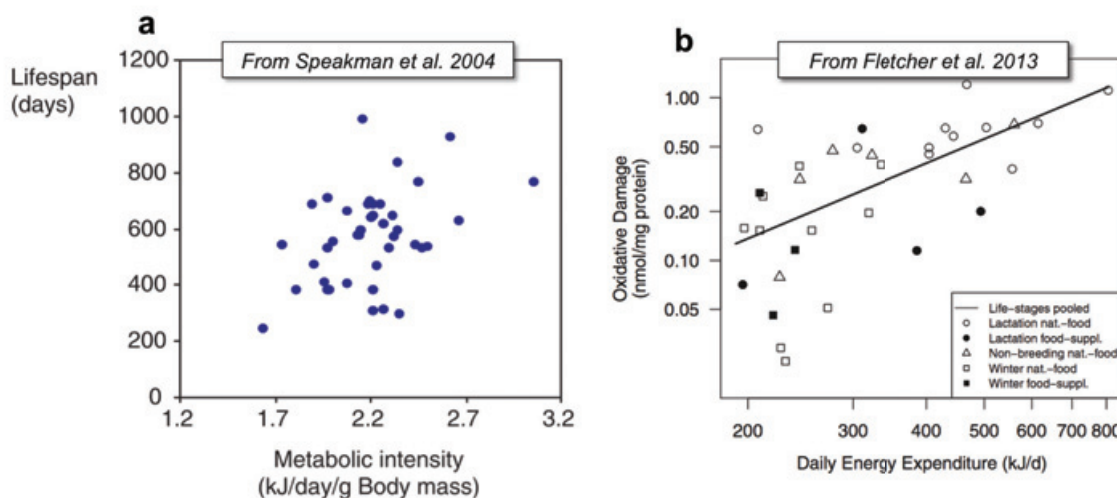

Figure 18: Positive impact of high resting metabolic rate (RMR) on mouse lifespan (a) and negative impact of high daily energy expenditure (DEE) on oxidative damage levels in American red squirrels (b)

3. Interplay between life history, oxidative stress and telomere dynamics

Our work emphasizes that individual variations in reproduction or growth might impact oxidative stress and/or telomere dynamics, but more work is obviously needed to demonstrate the importance of these two parameters as underlying mechanisms of life history trade-offs.

3.1 Did you say “cost of reproduction”?

We investigated the occurrence of an oxidative cost of reproduction in laboratory mice (Paper 4) and zebra finches (Box 3). Our data suggested a moderate but significant rise of oxidative damage (ROMs) during reproduction in both cases (+ 37.5% and + 22%

respectively), suggesting that an oxidative cost of reproduction does occur. Individuals from these two species have been selected by humans for high reproductive capacities for decades. This may explain why the increased levels of oxidative damage found in our studies (see also Sainz *et al.* 2000, Upreti *et al.* 2002), were absent in studies on wild-derived captive mammals (Garatt *et al.* 2011, Oldakowski *et al.* 2012). Such results indicate that although reproduction might incur an oxidative cost, 'unselected' individuals could be able to adjust their reproductive investment to avoid such costs (*i.e.* an oxidative constraint; see Paper 4 for a discussion on this topic). In order to test if reproduction effectively causes oxidative stress, appropriate protocol should therefore involve the manipulation of reproductive effort, for instance by manipulating litter/brood size (Metcalf & Monaghan 2013).

In this context, I contributed to a study in which the breeding effort of zebra finch pairs was manipulated (Reichert, Stier *et al.*, *in revision* for *Frontiers in Ecology & Evolution, Appendix I*) in order to investigate the consequences in terms of telomere loss and oxidative stress. This study demonstrated that an increased breeding effort (*i.e.* enlarged brood size) was associated with a higher rate of telomere erosion, but not with elevated oxidative damage levels. However, the blood sampling used to evaluate oxidative stress was carried out at the end of the reproductive period (*i.e.* 35 days after hatching), which is a long time after the peak energy demand (10 days after hatching, Deerenberg & Overkamp 1996). It is therefore difficult to use these data to conclude in terms of oxidative stress, because the oxidative damage levels might only be transiently elevated in the blood, due to rapid plasma and blood cell turnover. Nevertheless, the results for telomere dynamics (which should be a better indicator of damage accumulation over time than ROMs or 8-OHdG) could indicate that an oxidative cost of reproduction does occur, but only for birds forced to raised an enlarged brood. This shows that under control/optimal conditions (*i.e.* high quality food *ad libitum*), birds might be able to manage their reproductive investment to avoid/limit such costs. However, we still lack conclusive evidence that reproduction causes oxidative stress in 'unselected' animals. Future studies should not only manipulate breeding effort, but also work with wild-derived or free-living animals (*i.e.* 'unselected'), choosing an appropriate sampling time (*i.e.* peak energy demand) and examining different tissues (*e.g.* specific organs may hypothetically be more sensitive to an oxidative rise than blood).

The availability of resources is another important point to consider when studying the implication of oxidative stress in life history trade-off, notably for the cost of

reproduction (Fletcher *et al.* 2013, Metcalfe & Monaghan 2013). Indeed, if individuals have easy access to high-quality food *ad libitum*, we might expect an increase in resource intake to preclude from reduced investment in body maintenance during critical periods such as growth or reproduction. However, this scenario is unlikely to occur in the wild and is not therefore particularly informative for evolutionary ecologists. Fletcher *et al.* (2013) illustrated this when they demonstrated that American red squirrel females exhibit high oxidative damage levels during lactation (compared to winter), but that the former can be prevented by food supplementation. This is in accordance with the basic principles of life history theory (*i.e.* trade-offs are more likely to occur when resources are scarce, see introduction 1.2), but is unfortunately often neglected in laboratory studies (including our own). Resources might be limited either in absolute quantity (*e.g.* energy content), or in terms of specific macro- and micro-nutrients (see Isaksson *et al.* 2011).

3.2 Do growth rate or early-life conditions matter?

Our studies about the impact of growth conditions and growth rate on self-maintenance parameters were conducted using free-living birds (Paper 5-8, Box 4). This means that resources are likely to be limited, and trade-offs might be more easily revealed than under optimal laboratory conditions. Interestingly, studies suggesting that compensatory or fast growth induces a rise in oxidative stress are quite limited and sometimes questionable. For instance, the original paper of Alonso-Alvarez *et al.* (2007) is restricted to an indirect indicator of oxidative stress (KRL test) and does not include a control group in the brood size manipulation. More importantly, this study did not find significant differences between experimental groups, but only a global correlative link between the resistance of red blood cells to a free radicals attack and mass gain between day 20 and 40. It is important to note that mass gain between day 20 and 40 might reflect fat accumulation rather than structural growth *per se*. Although a thorough review of evidence for and against an oxidative cost of fast/compensatory growth is clearly out of the scope of this discussion, it is planned as part of my post-doc project.

Our studies in wild birds do however support the argument for a positive relationship between growth rate and oxidative stress levels (Paper 5 for high-elevation coal tit chicks, Paper 7 for king penguin chicks). We also showed that a negative relationship might occur between growth rate and telomere erosion rate in specific conditions (Box 4, 'marginal'

chicks). However, our results highlight that conditions experienced during the early-growth period might be important in determining oxidative stress levels and telomere length, independently of growth rate. For instance, ‘marginal’ great tit chicks suffered higher oxidative damage and higher telomere loss than ‘core’ chicks, despite similar growth rates (Box 4). Similarly, chicks growing at higher elevations suffered from higher telomere loss in great and coal tits, independently of growth rate, and this despite an inverse growth response to elevation between the two species (Paper 6). This could indicate that conditions experienced early in life (*e.g.* food availability, temperature, competitive hierarchy, stress levels, etc.) are at least as important (if not more so) as growth rate *per se* in determining oxidative stress levels and telomere dynamics. In this context, it is also noteworthy that the significant relationships between oxidative stress/telomere loss and growth rate were essentially found under harsh environmental conditions (*i.e.* high-elevation coal tit chicks and ‘marginal’ great tit chicks). Besides the importance of postnatal environmental conditions, it is likely that prenatal conditions might also influence oxidative balance (see below 5.2). Exposure to maternal hormones within the egg has been shown to reduce (testosterone, Noguera *et al.* 2011) or enhance (corticosterone, Haussmann *et al.* 2012) postnatal oxidative stress levels in birds. In this context, a recent study investigates the effects of maternally-derived hormones (corticosterone and estradiol) on growth and self-maintenance parameters of zebra finch chicks (Tissier *et al.*, *in revision for Plos One*). This experiment suggests that maternal hormones deposited in the egg yolk may have either an antioxidant/anti-ageing action (estradiol) or a pro-oxidant/pro-ageing effect (corticosterone), depending on the nature of the hormone concerned. In conclusion, more work is needed to disentangle the effects of growth rate and conditions experienced early in life, since these two factors are intrinsically interrelated.

4. Did you say limitations?

The work presented in this thesis is obviously not perfect, and suffers from a number of limitations. Some of the broadest limitations are outlined below.

4.1 Oxidative stress measurements

Although we tried to assess at least two parameters of the oxidative balance (generally oxidative damage and antioxidant defences) for each study, our assays of

oxidative stress were often too limited, with only one marker within a single 'tissue' (blood). Considering potential variations between tissues but also between oxidative stress markers (Sepp *et al.* 2012), there are now strong recommendations to use multiple oxidative stress assays in various tissues before concluding about the occurrence of oxidative stress (Selman *et al.* 2012). In this context, we measured ROMs as well as 8-OHdG levels in the two studies that provided sufficient biological material to measure both markers (Paper 8, Box 2). Interestingly, in one case the two markers gave concordant results (Paper 8), while in the other we found an effect of our experimental treatment for only one marker (8-OHdG, Box 2). Such results clearly suggest that it is important to perform multiple laboratory assays before concluding about the occurrence or absence of oxidative stress. However, biological material and research funding are often too limited to consider performing multiple assays.

The relevance of plasma (*i.e.* extra-cellular) oxidative stress markers can also be questioned (Isaksson 2013). Indeed, circulating levels of antioxidants may have little biological relevance, since it may only reflect diet-acquired compounds (see Sies 2007 for a comprehensive review about the biological irrelevance of plasma total antioxidant capacity assays). Although the measurement of cellular enzymatic antioxidant (*e.g.* SOD, CAT) and/or the glutathione system (see methods 2.2.1) is obviously biologically more relevant, it ideally requires tissue samples. Similarly, the origin of oxidative damage on plasma components (lipids and proteins) is quite unclear, since these molecules may already be damaged and result from the diet, or alternatively could be damaged afterwards due to oxidative stress within the body.

In this context, the use of plasma or urinary levels of 8-OHdG as an oxidative stress marker might be interesting. Indeed, very low amounts of DNA can be found within the plasma ($\approx 30\mu\text{g}\cdot\text{L}^{-1}$ compared to $60\text{g}\cdot\text{L}^{-1}$ of proteins in healthy humans, Stroun *et al.* 2000), limiting the influence of diet-derived components on this marker. Moreover, since circulating 8-OHdG comes from damaged DNA of any cellular type within the body, it potentially provides an integrative picture of oxidative stress throughout the body. Indeed, while damaged proteins or lipids are generally metabolised within the cells, 8-OHdG integrated into cellular DNA has to be removed by base or nucleotide excision repair mechanisms (BER or NER, Halliwell & Gutteridge 2007) before being conveyed in the plasma and eliminated in urine. This marker might however reflect the ability of repair mechanisms

more than the actual level of damage experienced by organisms (Halliwell & Gutteridge 2007).

Measuring oxidative stress markers in blood cells (essentially erythrocytes) may also be a good way to evaluate cellular oxidative stress when only blood samples are available (Costantini *et al.* 2012, Isaksson 2013). This is especially true in birds, since avian erythrocytes are quite similar to other cell types (*i.e.* possess nucleus and more importantly mitochondria, Paper 1). For instance, we could measure antioxidant enzymes (*e.g.* glutathione peroxidase activity, Costantini *et al.* 2012), cellular antioxidant capacity (OXY, Costantini *et al.* 2012), total and oxidized glutathione (Isaksson 2013), cellular DNA damage (Paper 5), or even mitochondrial ROS production (Paper 1). However, we clearly lack information about the representativeness of this measurement at the scale of the organism (but see below, 5.3.1).

Finally, although my vision of oxidative stress during this PhD has been mainly turned toward mitochondria as the only/principal ROS producer, other sources may be important to consider, especially because recent evidence suggests that mitochondria are not always the main source of ROS production (Brown & Borutaite 2012). For instance, ROS production linked to physical exercise could be linked to xanthine oxidase activity (-XO being an enzyme generating $\bullet\text{O}_2^-$ during the oxidation of hypoxanthine to xanthine, or the oxidation of xanthine to uric acid-) rather than to the mitochondrial electron transport chain (Ji 1999). It will be useful in future studies to examine the relative contribution of mitochondrial and non-mitochondrial ROS production in order to have a better understanding of the mechanisms leading to oxidative stress.

4.2 Concluding about oxidative stress implication in life history trade-offs?

One major limitation of this PhD work has been to consider short-term oxidative stress (or telomere loss) as **the** “biological cost”, since it is quite possible that oxidative stress levels or telomere loss measured in our studies might have been only transient and/or without major consequences for organisms. Indeed, even if reproduction or fast growth might increase oxidative damage levels, it is insufficient to conclude with certainty about consequences on life history trade-offs without having information about fitness (*e.g.* lifespan, but ideally lifetime reproductive success). Given the findings of available literature (especially biomedical studies, but see also Bize *et al.* 2008, 2009), we can of course

hypothesize that high oxidative stress levels/telomere loss are deleterious for organisms, but we cannot completely rule out the possibility that short-term oxidative stress could be harmless or even beneficial for individuals. Indeed, besides the crucial role of ROS in cell signalling (Dröge 2002), an emerging concept in recent years has been to consider stressful event(s) of low amplitude as potentially beneficial in the long term for organisms (*i.e.* hormesis, Ristow & Zarse 2010, Ristow & Schmeisser 2011, Costantini *et al.* 2010, Costantini 2013). Hormesis is defined as the beneficial effects of low intensity stressors in improving further stress response and potentially fitness (figure 19). For instance, the beneficial effects of moderate physical exercise have been attributed to hormetic response, since physical activity enhances ROS production but reduces oxidative stress and promotes lifespan in the long term (Radak *et al.* 2008, Ristow *et al.* 2011). Therefore, we cannot exclude the hypothesis that increased oxidative stress levels observed in our studies (*e.g.* during reproduction / growth at high elevation) may ultimately be more beneficial than detrimental for animals in the long term. We have no information about such 'oxidative hormetic response' in wild conditions, however, and the relevance/occurrence of such response when resources are limited could be questioned, since resources are required for the mediators of a hormetic response (*e.g.* antioxidants and repair mechanisms).

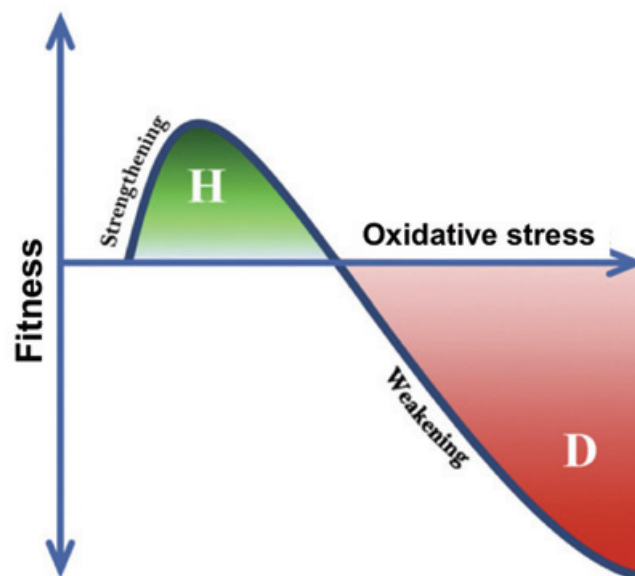

Figure 19: Oxidative stress & potential hormetic response (adapted from Demirovic & Rattan 2013).

Limited levels of oxidative stress (resulting for example from moderate physical exercise) may potentially induce the strengthening of organisms (H: hormetic response), while high levels are likely to induce damaging effects (D).

Measurements were carried out over a short timescale for most of the results presented in this PhD thesis, and this was a major limitation to my work. Most of this research was based on short-term measurements (except Paper 3 and Box 1), and consequently we do not have information about factors such as the long-term oxidative consequences of reproduction/elevation/fast growth/hatching rank/etc. However, short-term and long-term consequences may greatly differ in amplitude, but also in direction (see above for the hormetic effect of physical exercise). For example, zebra finches exhibiting catch-up growth did not present an altered metabolic rate at the end of the growth period, while they had elevated metabolic rate at adulthood (Criscuolo *et al.* 2008). This illustrates that delayed effects/costs may occur in the long term, while no short-term impact is detected (Metcalf & Monaghan 2001, Criscuolo *et al.* 2008). To further illustrate this idea, it has been shown that zebra finches that are experimentally manipulated to exhibit catch-up growth presented steady levels of oxidative stress in early life (< 100 days), but elevated levels at older ages (≥ 100 days, figure 20, Criscuolo *et al. in prep*). This shows that we must show caution in our interpretations, and consider the possible occurrence of delayed costs, even when immediate effects are lacking (see also Mougeot *et al.* 2011 for a delayed effect of oxidative stress early in life for immunity at adulthood).

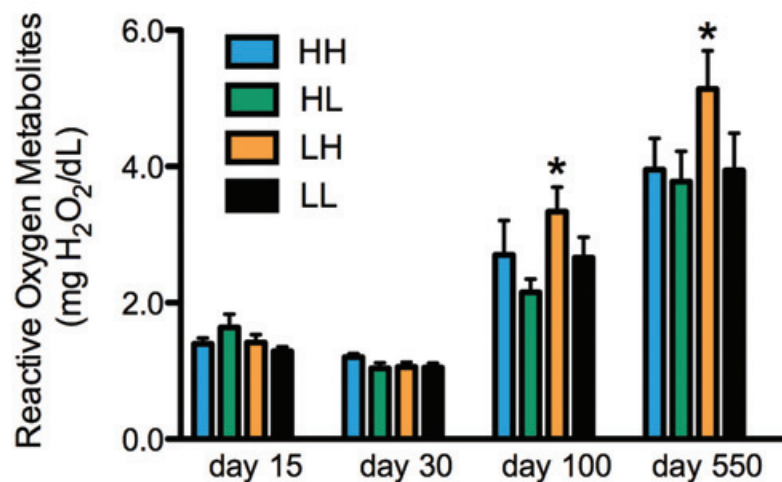

Figure 20: Short and long term impact of compensatory growth (LH group - orange) on oxidative damage levels in zebra finches (F. Criscuolo, N.B. Metcalfe, A. Stier & P. Monaghan, *in prep*)

Birds were assigned to different diets (H: high-protein / L: low-protein) during their first 15 days of growth (first letter), then half of the birds were switched from one diet to the other (L→H = LH / H→L = HL) for the next fifteen days. After 30 days, all birds were fed with the same diet. The LH group (orange) exhibited typical 'catch-up growth' (see Criscuolo *et al.* 2008 for details). It was the only group suffering from elevated levels of oxidative stress, appearing only at old age.

It is therefore important to complete this PhD work by measuring long-term oxidative stress and survival in free-living coal and great tits, and also in king penguins. It will also be important to evaluate the impact of long-term cold exposure on oxidative stress levels and survival, with comparisons between WT and UCP1 KO mice, but also between control and DNP-treated birds.

4.3 Are there weaknesses in the free radical theory of ageing (FRTA)?

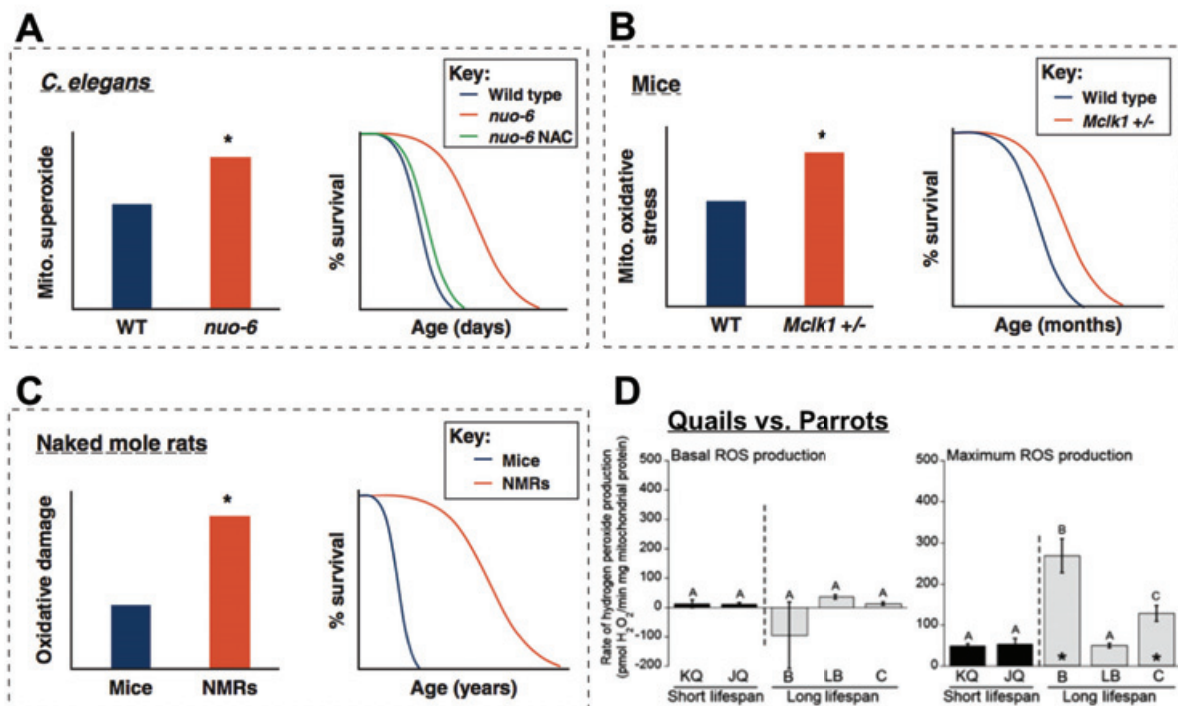

Figure 21: Illustrative examples of results arguing against the validity of the free radical theory of ageing (reprinted from Hekimi 2011 & Montgomery 2012a)

A: The *nuo-6* mutant strain of *C. elegans* produces significantly higher amounts of mitochondrial superoxide, but lives significantly longer. This effect has been shown to be causal since an antioxidant treatment (NAC) abolishes the beneficial effect on lifespan, while a ‘mild’ pro-oxidant treatment mimics it (Yang & Hekimi 2010).

B: The *Mclk1*^{+/-} mice (*Mclk1* is a mitochondrial enzyme implicated in ubiquinone biosynthesis) sustain higher mitochondrial oxidative stress, but demonstrate a significant increased lifespan (Liu 2005, Lapointe & Hekimi 2008).

C: The naked mole rat demonstrates elevated levels of various oxidative damage markers compared to ‘standard’ mice, but exhibits a substantially longer lifespan (≈ 10 times the longevity of mice) despite quite similar body size/body mass (Andziak *et al.* 2006).

D: Basal and maximal ROS production of five species of birds with different maximum lifespan MLSP (two short-lived quails (MLSP = 5-6 years) = KQ & JQ and three long-lived parrots (MLSP = 21-35 years) = B, LB & C, see Montgomery *et al.* 2012a for details). Despite considerable differences in lifespan, long-lived parrots exhibit similar basal ROS production to short-lived quails, and even showed elevated maximum ROS production in two species.

Most of my work is based on the free radical theory of ageing, which state that ageing results from the accumulation of damage caused by free radicals over time (Beckman & Ames 1998, Balaban *et al.* 2005). However, several lines of evidence are now calling this theory into question, and the relationship between ROS production, oxidative damage and ageing seems to be less straightforward than previously thought (Hekimi & Lapointe 2011, Speakman & Selman 2011). For instance, recent data coming from ‘unconventional models’, namely the naked mole rat *Heterocephalus glaber* (Andziak *et al.* 2006) and various birds species (Montgomery *et al.* 2012a & 2012b), as well as transgenic models such as *Caenorhabditis elegans* (Yang & Hekimi 2010) and mice (Liu 2005), suggest that high mitochondrial ROS production or oxidative damage might be unrelated to longevity or even able to prolong lifespan (Hekimi & Lapointe 2011, see figure 21 for details).

Moreover, some other arguments underpinning the FRTA have also been recently questioned, such as the difference between birds and mammals in terms of ROS production and oxidative damage (Montgomery *et al.* 2011). Indeed, by revisiting the classical rat/pigeon comparison, Montgomery and collaborators have shown that the differences originally found between the two species in ROS production and oxidative damage (Barja *et al.* 1994, Lambert *et al.* 2007, Lambert *et al.* 2010) were limited to a single tissue (heart) with a single mitochondrial substrate (succinate, Montgomery *et al.* 2011). Our own results comparing mitochondrial ROS production of skeletal muscles between mouse and zebra finch are in accordance with this idea, since ROS production did not differ between species with succinate as substrate, and was even higher for the zebra finch, with pyruvate-malate as substrate (Paper 3). Similarly, a comparison of mitochondrial functioning between skeletal muscles in the rat and house sparrow (*Passer domesticus*) revealed no significant differences between the two species in terms of ROS production (Kuzmiak *et al.* 2012). Therefore, the classical explanation for the high longevity of birds compared to size-matched mammals (*i.e.* a lower ROS production, Barja *et al.* 1994) appears to be challenged, adding new doubts about the validity of the FRTA.

Another outstanding species in regard to longevity is the small aquatic salamander *Proteus anguinus*, which lives on average 68.5 years and could have a maximum lifespan of over 100 years (Voituron *et al.* 2011). This species has developed an extraordinarily long lifespan given its body weight (15-20 g). However, *Proteus anguinus* seems to have levels of oxidative damage quite similar to those shown by a shorter-lived salamander (*Calotriton*

asper, 20-26 years), despite a higher capacity to resist to anoxia/reoxygenation-induced oxidative stress (Issartel *et al.* 2009). Further studies on this outstanding species are required to unravel the mechanisms underlying its incredible longevity.

Despite these controversies, the effects of oxidative stress on the fitness of organisms may be non-linear (see above, figure 19), with beneficial hormetic effects at low doses (therefore explaining the beneficial effects of oxidative stress presented in figure 21, A & B), and producing detrimental effects at higher doses. In addition, the differences in lifespan between the pigeon and the rat may still be related to oxidative stress, since the two species differ in the fatty acid composition of their membranes, with pigeon membranes being clearly less susceptible to damage induced by ROS (Montgomery *et al.* 2011). The longevity of naked mole rats has also been recently related to protein stability and higher capacities of resistance against oxidative stress (Pérez *et al.* 2009). Globally, this argues in favour of a role of oxidative stress in the ageing process, even if a simple and direct causal link between ROS production, oxidative damage and lifespan now clearly appears to be unlikely (Speakman & Selman 2011).

It is also worth noting that the link between oxidative damage and lifespan may potentially differ according to the nature/location of oxidative damage. Indeed, oxidative damage to the mitochondria could generate a vicious cycle of ROS production, and may therefore be a factor worth considering (Balaban *et al.* 2005, Orrenius *et al.* 2007). Indeed, whilst mitochondria are the primary ROS producers, they are also a sensitive 'target' of these ROS, and it has been shown that mitochondrial oxidative damage leads to further increase of ROS production (Balaban *et al.* 2005, Orrenius *et al.* 2007). Oxidative damage to mitochondrial DNA has been shown to be inversely related to maximum lifespan at the inter-specific level, while nuclear DNA damage was not (Barja & Herrero 2000). Therefore, measuring oxidative damage within the mitochondria might be an early and/or a better indicator of the damaging impact of oxidative stress for the fitness of organisms (Lane 2005).

5. Research prospects

Since a PhD is inevitably constrained by the time and resources available for experimental/field work and analysis, many of the points that I wished to study remain without answers to date. I have already raised some of these points within the different studies constituting this PhD thesis, and also describe them within the previous points of this

fifth chapter. I will now develop in greater detail three points that I consider to deserve further scientific interest.

5.1 Experimental testing of constraining and hormetic effects

In the theoretical framework of this thesis (see Chapter 1, 5.1), I suggested that oxidative stress might act as a constraint for the evolution of life history traits. In this context, we provided correlational results suggesting that high pre-breeding oxidative stress is associated with small litter size in laboratory mice (Paper 4), which adds support to the few studies suggesting that oxidative stress acts as a constraint for reproduction (Kaur *et al.* 2006, Bize *et al.* 2008, Heiss & Schoech 2012). Yet it was also suggested that the hormetic effects of moderately elevated ROS production might be beneficial for longevity (see above, 4.2 / 4.3). However, there is no clear experimental demonstration of constraining or hormetic effects of oxidative stress. In this context, I propose to experimentally modulate the generation of pro-oxidant molecules *in vivo* over an extended time-period and at different intensities in order to investigate potential constraining and hormetic effects.

This modulation could be done through an experimental treatment with diquat or paraquat (*i.e.* herbicides). These compounds have been used successfully in the past to manipulate *in vivo* oxidative stress levels by generating superoxide in various models like *C. elegans* (Yang & Hekimi 2010), *Drosophila melanogaster* (Rzezniczak *et al.* 2011), mice (Chen *et al.* 2010) or birds (Alonso-Alvarez *et al.* 2011). I therefore propose to use four experimental groups (control, low, medium and high doses of paraquat) in two species, *D. melanogaster* and the zebra finch. With this experimental design (summarized in figure 22), we should be able to investigate the possible occurrence of constraining and hormetic effects of oxidative stress. The four doses will be used to investigate not only hypothetical beneficial hormetic effects (*i.e.* low dose), but also potential constraining and damaging effects (*i.e.* medium-high doses). The two biological models will be complementary because *D. melanogaster* makes it possible to investigate effects on longevity/fecundity/lifetime reproductive success (*i.e.* individual fitness) in large sample sizes along with large-scale analysis of gene expression using DNA microarrays, while the zebra finch is a good model to study not only numerous life history traits (see Paper 3, reproduction, growth, immunity, physical performances and sexual signalling) but also mitochondria functioning in longitudinal experiments (see Paper 1). An important point (often neglected with this kind of

treatment) will be to assess both short- and long-term impact of our treatment on the oxidative balance and mitochondria functioning in order to assess the possible set-up of compensatory mechanisms and determine their nature (*i.e.* hormetic effects). For instance, antioxidant defences or repair mechanisms might be up-regulated in response to the pro-oxidant treatment, or alternatively endogenous ROS production might be reduced by increasing the uncoupling state of mitochondria. In both cases, investigating such mechanisms should help to determine the pathways leading to potential hormetic responses or deleterious effects.

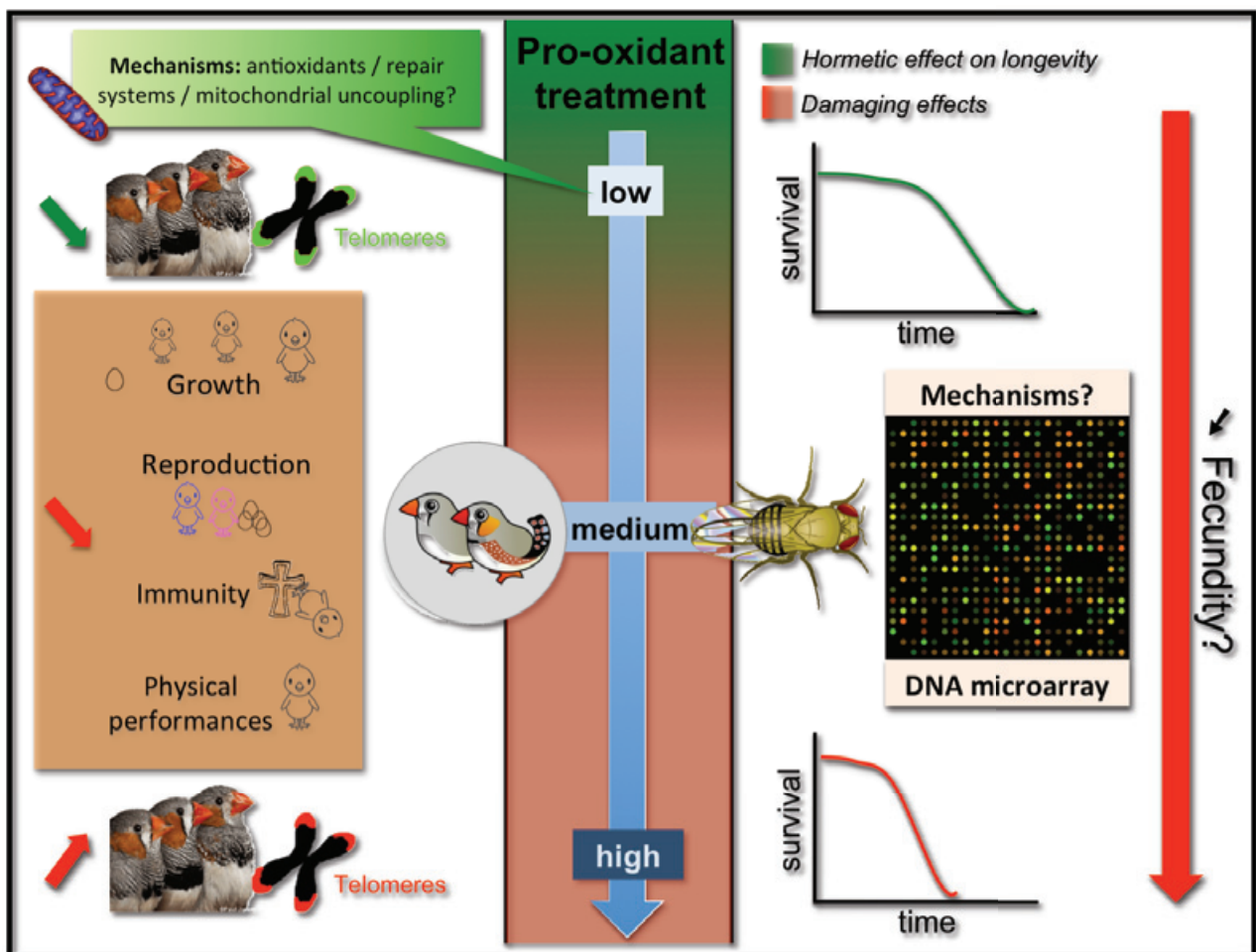

Figure 22: Experimental design to test hormetic and constraining effects of oxidative stress using two complementary biological models: the zebra finch (left panel) and drosophila (right panel). See text for details.

A comparable experimental design could also be used to test two important points concerning hormetic effects. First of all, if a hormetic effect actually occurs with the protocol described briefly above, we should repeat the experiment by implementing the additional

constraint of resource limitations. Indeed, hormetic responses are likely to require significant amounts of resources (*e.g.* for up-regulating antioxidant defences), and we might hypothesize that a hormetic response could only be set-up when resources are highly abundant, as under standard laboratory conditions. Finally, we should also test if punctual exposure to oxidative stress early in life (within the egg for the zebra finch / at the larval stage for drosophila) can influence/program the subsequent development of individuals in order to promote resistance to oxidative stress later in life.

5.2 Do prenatal growth rate and conditions matter?

It has been shown that both growth rate and conditions experienced during the growth period might be important determinants of oxidative balance and telomere erosion rate. Indeed, fast or compensatory growth has been associated with increased oxidative stress levels and/or telomere loss (Alonso-Alvarez *et al.* 2007, Nussey *et al.* 2009, Kim *et al.* 2011, Criscuolo *et al. in prep* (see figure 20), Paper 5, Paper 7, Box 4). In addition, adverse/harsh conditions experienced early in life have also been associated with similar markers of impaired self-maintenance (Papers 5-8, Box 4). While the effects of postnatal growth on subsequent health and performances are now increasingly studied, we have little information about the impact of prenatal (embryo) developmental rate and conditions (Hallows *et al.* 2012). Yet embryo development is a key period during the life of an organism, and the sooner a perturbation affects an individual, the greater the consequences will be. Accordingly, numerous human pathologies occurring during growth or at adulthood have been suggested to result from poor conditions experienced during early development. For instance, intra-uterine growth restriction has been associated with hypertension, type 2 diabetes or coronary artery diseases at adulthood in human (Brodsky 2004).

One major challenge for the years ahead would therefore be to determine the underlying mechanisms linking poor prenatal conditions and subsequent impaired health. This may open new research avenues for therapies to prevent the deleterious delayed effects of adverse prenatal development. Given the relationship observed between postnatal growth rate and ageing-related parameters (oxidative stress and telomere erosion), we might expect poor developmental conditions to affect subsequent health state due to the oxidative stress and telomere erosion that results from impaired mitochondrial functioning. While comparative studies (Ricklefs 2006, 2010) suggest that embryo

development is an important parameter influencing ageing rates in both mammals and birds, intra-specific experimental studies remain scarce, mostly due to the difficulty involved in manipulating embryo development without altering the mother's condition or causing the mother to compensate for any manipulation. However, birds are a great experimental opportunity to uncouple maternal and embryonic conditions, since embryo development takes place outside the mother's body and can easily be manipulated through modifications of incubation temperature (Durant *et al.* 2010).

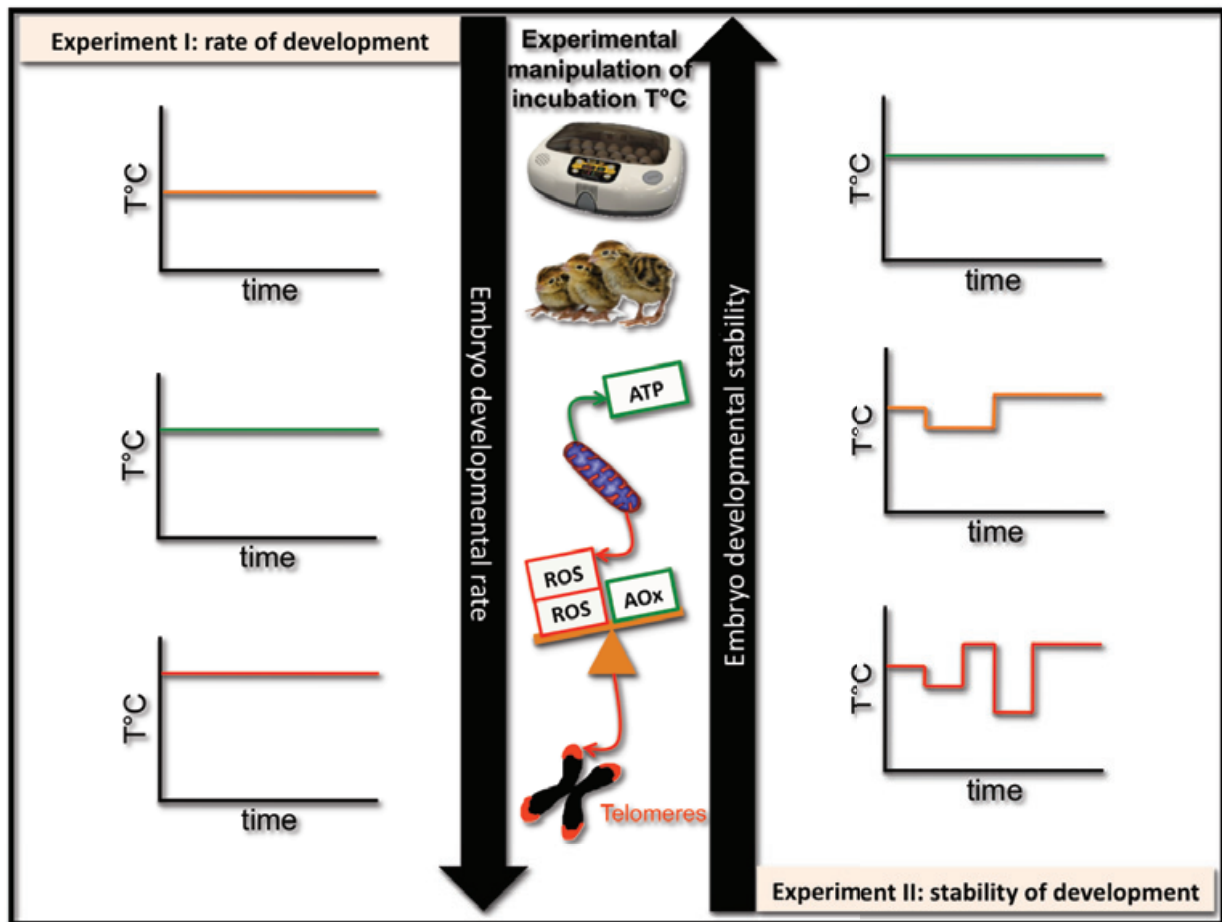

Figure 23: Experimental design to test the impact of prenatal growth rate and stability on body self-maintenance parameters, using the manipulation of incubation temperature with artificial incubators.

I therefore propose to use precocial birds (*i.e.* quails: *Coturnix japonica*) as model to investigate the consequences of two different early perturbations, namely modifications (reduction and acceleration) of embryonic growth rate (figure 23, experiment I) and alterations of developmental stability (figure 23, experiment II). The consequences of embryonic growth rate/stability should be determined for specific key determinants of

organism health and rate of ageing, such as mitochondrial functioning, oxidative stress and telomere dynamics. This would be a highly innovative experimental approach to investigate the consequences of prenatal period for future rates of ageing, a topic that is not readily amenable to scientific investigation using mammals.

These experiments will provide a robust test for a causal relationship between developmental conditions and ageing-related processes, and pinpoint an underlying mechanism explaining the numerous observations of a link between suboptimal prenatal conditions and pathologies observed at adulthood (Brodsky 2004, Hallows *et al.* 2012).

5.3 Are we moving towards the (longitudinal) monitoring of mitochondria functioning in the wild?

We demonstrated in Paper 1 that avian erythrocytes possess functional mitochondria, at least in terms of respiration and ROS production. As proposed by this study, the presence/functionality of these organelles might make it possible to study mitochondrial functioning in longitudinal experiments and non-model animals, since a simple blood sample would be required. This should provide the opportunity to not only investigate mitochondrial efficiency (estimated by the quantity of ATP produced per molecule of O₂ consumed: ATP/O ratio (*e.g.* see Salin *et al.* 2012a, 2012b)) and ROS production, but also evaluate specific oxidative damage to the mitochondria (see 4.3 and Lane 2005) in order to answer a wide range of eco-evolutionary questions. However, we currently lack information about the representativeness of these mitochondria at the organism level, so methodological validations are urgently required before we can carry out further studies.

5.3.1 Mitochondria from erythrocytes: a representative target for eco-evolutionary studies?

In order to use mitochondria from avian erythrocytes for functional studies, we should evaluate the potential representativeness (step I, figure 24) of such mitochondria compared to the tissues classically used as sources of mitochondria by physiologists (*i.e.* skeletal muscles and liver). A first approach would be to determine if the respiration rate/ROS production of mitochondria extracted from erythrocytes correlates with those of other tissues (step I.a figure 24, see Daniali *et al.* 2013 for a similar approach validating leukocyte telomere length as a good proxy of telomere length in humans). I propose to investigate this point for two avian models (captive zebra finch and free-living king penguin

chick) in order to validate this method in both laboratory and field conditions. Indeed, the zebra finch is a common laboratory model and we already have information about mitochondria functioning in this species (Paper 3), while the natural high-mortality of young king penguin chick makes 'ethical' tissue sampling possible in a wild species (*i.e.* on freshly predated chicks). Ideally, respiration rate and ROS production should be evaluated using three different mitochondrial substrates, namely pyruvate-malate (complex I substrate), succinate (complex II substrate) and palmitoyl-carnitine (fatty acid-derived substrate), since the response of mitochondria might vary according to the substrate used (*e.g.* see paper 3 or Kuzmiak *et al.* 2012).

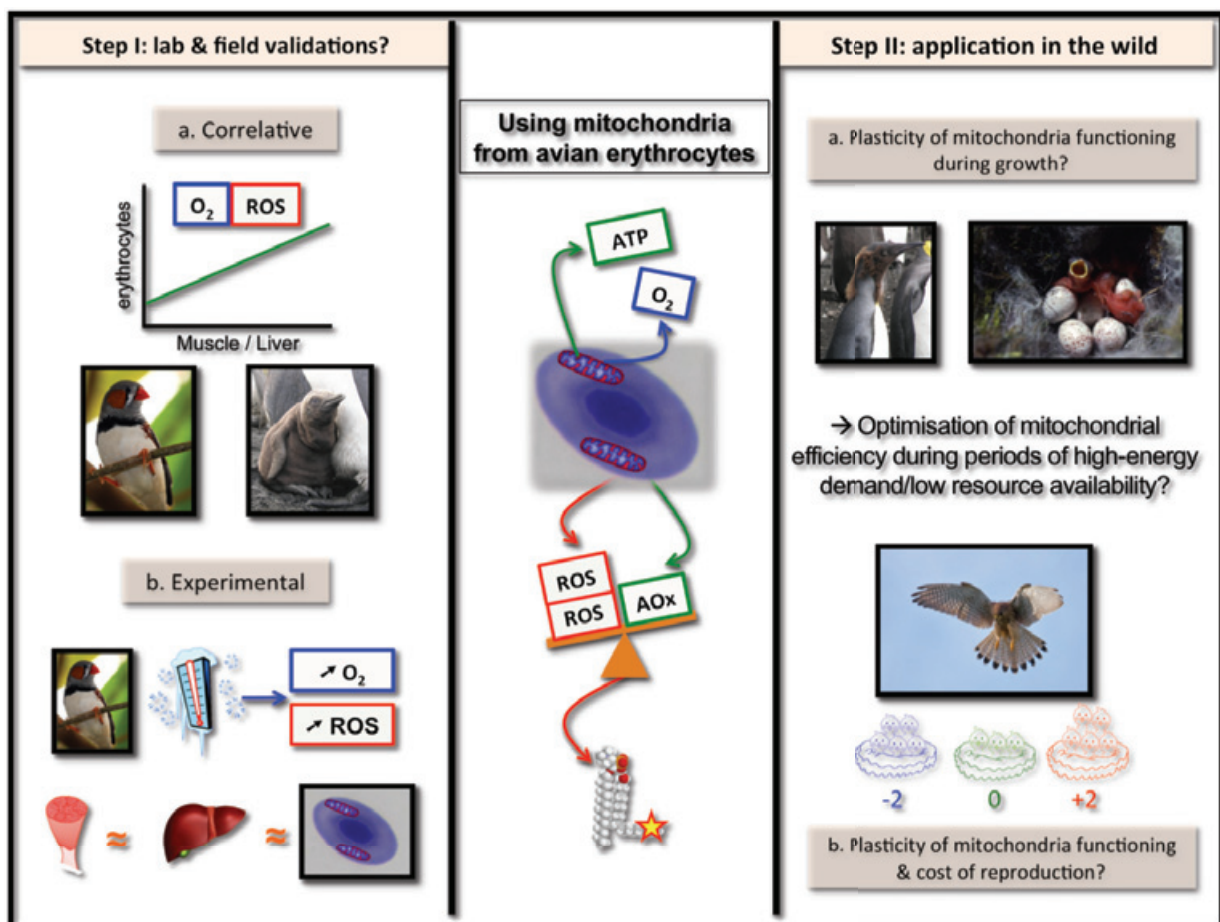

Figure X8: Experimental design to validate the utilisation of mitochondria extracted from avian erythrocytes (step I), and potential application for studying the plasticity of mitochondria functioning in wild animals during different life history phases (step II).

We should also investigate experimentally if mitochondria coming from erythrocytes respond in a similar way than other tissues in physiological conditions known to influence mitochondria functioning (step I.b, figure 24). In this context, we might use prolonged cold

exposure in captive birds, since it has been demonstrated that mitochondria respiration rate increased in both the skeletal muscles and the liver of cold-acclimated ducklings (*Cairina moschata*, Goglia *et al.* 1993). Therefore, if mitochondria taken from erythrocytes respond in the same way as other tissues (*i.e.* increased their oxidative capacity in response to cold acclimation), we could be confident about the representativeness of our measurements. This experiment might also be a good opportunity to evaluate the impact of exposure to the cold on ROS production in different tissues, since this information is lacking, especially in birds (but see Box 2 & Rey 2010a).

5.3.2 Mitochondrial functioning in the wild

To date, very few studies have investigated mitochondrial functioning in wild animals, essentially due to ethical constraints (but see Talbot *et al.* 2004, Rey *et al.* 2008 or Salin *et al.* 2012a, 2012b). If mitochondria extracted from avian erythrocytes prove to be representative of other tissues, new research prospects will arise for ecologists interested in the physiological mechanisms shaping adaptations of organisms to their environments and life history trade-offs. In this context, one important point will be to determine if plasticity in mitochondrial functioning allows organisms to adjust mitochondria efficiency to resource availability or energy demand (figure 24, step II). Indeed, we might hypothesize that increasing mitochondrial efficiency (*i.e.* diminishing mitochondrial uncoupling state) when resources are scarce would be advantageous for survival, but that such efficiency might come with an inevitable oxidative cost linked to mitochondrial ROS production.

We could consider three scenarios related to this thesis in which determining mitochondrial functioning and efficiency to produce ATP would be interesting research prospects. First of all, determining both mitochondrial efficiency to produce ATP and ROS production and evaluating cellular oxidative stress during the entire growth period of king penguin chicks might cast light on several points: i) the potential plasticity in mitochondrial efficiency according to resource availability (*i.e.* high during the 1st and 2nd summers, low-null during the winter), ii) the implication of mitochondrial efficiency in post-winter catch-up growth exhibited by small chicks (see Paper 7 for details) and the associated oxidative cost and iii) potential adjustments of mitochondrial efficiency during a period of high-energy demand: the moult (Cherel *et al.* 1994). We can also investigate if plasticity in mitochondrial functioning and efficiency could underpin the strategy exhibited by 'marginal' chicks to

survive in asynchronous broods of great tits (Box 4). Indeed, we could hypothesize that such disadvantaged chicks should exhibit more 'coupled' mitochondria in order to catch up with their older siblings (*i.e.* maximising resource allocation toward growth) despite a concurrent cost in terms of oxidative stress.

Finally, we should integrate the analysis of mitochondrial functioning and efficiency in a broader experiment designed to test whether or not reproduction causes oxidative stress. Indeed, reproduction constitutes an energetically costly life history phase (Speakman 2008), and we might expect a tight mitochondrial coupling state to be favoured in such conditions. According to the arguments presented in Paper 4 and in the discussion of this thesis (see 3.1), I suggest using brood size manipulation as a means to manipulate the reproductive effort of parents (see *Appendix I* for a similar experimental design in laboratory conditions). Such manipulation should be carried out in free-living birds, in order to be certain that resources are limited (figure 24 step IIb). Both parents should be captured and blood sampling carried out during the peak period of energy demand, and mitochondrial efficiency to produce ATP, ROS production, various plasma and cellular oxidative stress markers and telomere length should be determined. In order to have enough biological samples to conduct a comprehensive study, I suggest using relatively large birds, such as the common kestrel (*Falco tinnunculus*). Brood size manipulation has been successfully used in the past for this species, thereby making it an ideal model to study the oxidative cost of reproduction. Indeed, well-known previous studies have demonstrated that an enlarged brood size simultaneously increases parental effort and daily energy expenditure whilst survival rate decreases (Dijkstra *et al.* 1990, Deerenberg *et al.* 1995, Daan *et al.* 1996).

6. Final words

The work presented in this PhD investigates the implication of mitochondrial uncoupling and oxidative stress as potential shapers of life histories. By encompassing animal physiology and evolutionary biology research fields, this work provides arguments strengthening the idea that mitochondrial functioning and oxidative stress could be important mediators of life history trade-offs. Our work suggests that mitochondrial uncoupling state might be a key parameter for managing oxidative stress in cold environments, but raises doubts about the relevance of mitochondrial uncoupling as a mechanism reducing ROS production *per se*, especially in birds. Our results do however

suggest that mitochondrial coupling state might be a key determinant of life-history trajectories by determining the total amount of resources allocable to biological functions such as reproduction or immunity. Our work also suggests that reproductive investment, growth rate and also adverse conditions experienced early in life are key determinants of oxidative stress levels. Considering the relationships between oxidative stress and fitness-related traits such as fledging success (Losdat *et al.* 2013), recruitment (Noguera *et al.* 2012) or reproductive success / annual survival (Bize *et al.* 2008), our data suggest that oxidative stress might be a common factor determining the occurrence of life history trade-offs, and especially those observed between reproduction/growth and longevity. Nevertheless, integrative studies investigating both mitochondrial functioning and oxidative stress levels in relation to lifetime reproductive success are necessary to fully ascertain this hypothesis.

References

A

- Abrams P, Leimar O, Nylin S, Wiklund C (1996) The effect of flexible growth rates on optimal sizes and development times in a seasonal environment. *American Naturalist*, **147**, 381–395.
- Agarwal A, Aponte-Mellado A, Premkumar BJ, Shaman A, Gupta S (2012) The effects of oxidative stress on female reproduction: a review. *Reproductive Biology and Endocrinology*, **10**, 49.
- Agarwal S, Sohal RS (1994) DNA oxidative damage and life expectancy in houseflies. *Proceedings of the National Academy of Sciences*, **91**, 12332–12335.
- Alonso-Alvarez C, Galván I (2011) Free Radical Exposure Creates Paler Carotenoid-Based Ornaments: A Possible Interaction in the Expression of Black and Red Traits (Z Barta, Ed.). *PLoS ONE*, **6**, e19403.
- Alonso-Alvarez C, Bertrand S, Devevey G *et al.* (2004) Increased susceptibility to oxidative stress as a proximate cost of reproduction. *Ecology Letters*, **7**, 363–368.
- Alonso-Alvarez C, Bertrand S, Devevey G *et al.* (2006) An experimental manipulation of life-history trajectories and resistance to oxidative stress. *Evolution*, **60**, 1913–1924.
- Alonso-Alvarez C, Bertrand S, Faivre B, Sorci G (2007a) Increased susceptibility to oxidative damage as a cost of accelerated somatic growth in zebra finches. *Functional Ecology*, **21**, 873–879.
- Alonso-Alvarez C, Bertrand S, Faivre B, Chastel O, Sorci G (2007b) Testosterone and oxidative stress: the oxidation handicap hypothesis. *Proceedings of the Royal Society B*, **274**, 819.
- Alonso-Alvarez C, Perez-Rodriguez L, Garcia JT, Vinuela J, Mateo R (2010) Age and Breeding Effort as Sources of Individual Variability in Oxidative Stress Markers in a Bird Species. *Physiological And Biochemical Zoology*, **83**, 110–118.
- Altmann J, Alberts SC (2004) Growth rates in a wild primate population: ecological influences and maternal effects. *Behavioral Ecology and Sociobiology*, **57**, 490–501.
- Anderson EJ (2005) Type II skeletal myofibers possess unique properties that potentiate mitochondrial H₂O₂ generation. *AJP: Cell Physiology*, **290**, C844–C851.
- Andziak B, O'Connor TP, Qi W *et al.* (2006) High oxidative damage levels in the longest-living rodent, the naked mole-rat. *Aging Cell*, **5**, 463–471.
- Angelier F, Weimerskirch H, Dano S, Chastel O (2007) Age, experience and reproductive performance in a long-lived bird: a hormonal perspective. *Behavioral Ecology and Sociobiology*, **61**, 611–621.
- Arendt JD (1997) Adaptive intrinsic growth rates: an integration across taxa. *Quarterly Review of Biology*, **72**, 149–177.
- Arsenijevic D, Onuma H, Pecqueur C *et al.* (2000) Disruption of the uncoupling protein-2 gene in mice reveals a role in immunity and reactive oxygen species production. *Nature genetics*, **26**, 435–439.
- Auer SK, Arendt JD, Chandramouli R, Reznick DN (2010) Juvenile compensatory growth has negative consequences for reproduction in Trinidadian guppies (*Poecilia reticulata*). *Ecology Letters*, **13**, 998–1007.
- Austad SN (2011) Candidate bird species for use in aging research. *ILAR journal / National Research Council, Institute of Laboratory Animal Resources*, **52**, 89–96.

Aydin J, Shabalina IG, Place N *et al.* (2008) Nonshivering thermogenesis protects against defective calcium handling in muscle. *The FASEB Journal*, **22**, 3919–3924.

B

Badyaev AV, Ghalambor CK (2001) Evolution of life histories along elevational gradients: trade-off between parental care and fecundity. *Ecology*, **82**, 2948–2960.

Balaban RS, Nemoto S, Finkel T (2005) Mitochondria, Oxidants, and Aging. *Cell*, **120**, 483–495.

Barger JL, Barnes BM, Boyer BB (2006) Regulation of UCP1 and UCP3 in arctic ground squirrels and relation with mitochondrial proton leak. *Journal of Applied Physiology*, **101**, 339–347.

Barja G (2004) Free radicals and aging. *TRENDS in Neurosciences*, **27**, 595–600.

Barja G (2007) Mitochondrial oxygen consumption and reactive oxygen species production are independently modulated: Implications for aging studies. *Rejuvenation Research*, **10**, 215–223.

Barja G, Herrero A (2000) Oxidative damage to mitochondrial DNA is inversely related to maximum life span in the heart and brain of mammals. *The FASEB Journal*, **14**, 312–318.

Barja G, Cadenas S, Rojas C (1994) Low mitochondrial free radical production per unit O₂ consumption can explain the simultaneous presence of high longevity and high aerobic metabolic rate in birds. *Free radical research*, **21**, 317–327.

Barrett ELB, Richardson DS (2011) Sex differences in telomeres and lifespan. *Aging Cell*, **10**, 913–921.

Barré HH, Cohen-Adad FF, Duchamp CC, Rouanet JL (1986) Multilocular adipocytes from muscovy ducklings differentiated in response to cold acclimation. *The Journal of Physiology*, **375**, 27–38.

Bauch C, Becker PH, Verhulst S (2013) Telomere length reflects phenotypic quality and costs of reproduction in a long-lived seabird. *Proceedings of the Royal Society of London. Series B: Biological Sciences*, **280**.

Beam K, Alper S, Palade G, Greengard P (1979) Hormonally regulated phosphoprotein of turkey erythrocytes: localization to plasma membrane. *The Journal of cell biology*, **83**, 1–15.

Beamonte-Barrientos R, Verhulst S (2013) Plasma reactive oxygen metabolites and non-enzymatic antioxidant capacity are not affected by an acute increase of metabolic rate in zebra finches. *Journal Of Comparative Physiology B-Biochemical Systemic And Environmental Physiology*, **183**, 675–683.

Beaulieu M, Reichert S, LE Maho Y, Ancel A, Criscuolo F (2011) Oxidative status and telomere length in a long-lived bird facing a costly reproductive event. *Functional Ecology*, **25**, 577–585.

Beaulieu M, Ropert-Coudert Y, Le Maho Y, Ancel A, Criscuolo F (2010) Foraging in an oxidative environment: relationship between ¹³C values and oxidative status in Adelie penguins. *Proceedings of the Royal Society B: Biological Sciences*, **277**, 1087–1092.

Beckman K, Ames B (1998) The free radical theory of aging matures. *Physiological Reviews*, **78**, 547–581.

Bejma J, Ji LL (1999) Aging and acute exercise enhance free radical generation in rat skeletal muscle. *Journal of Applied Physiology*, **87**, 465–470.

Benowitz Fredericks ZM, Kitaysky AS (2005) Benefits and costs of rapid growth in common murre chicks *Uria aalge*. *Journal of Avian Biology*, **36**, 287–294.

Bergeron P, Careau V, Humphries MM *et al.* (2011) The energetic and oxidative costs of reproduction in a free-ranging rodent. *Functional Ecology*, **25**, 1063–1071.

Bertrand S, Alonso-Alvarez C, Devevey G *et al.* (2006) Carotenoids modulate the trade-off between

- egg production and resistance to oxidative stress in zebra finches. *Oecologia*, **147**, 576–584.
- Betts MM (1955) The food of titmice in oak woodland. *The Journal of Animal Ecology*, **24**, 282–323.
- Bicudo J, Vianna C, Chaui-Berlinck J (2001) Thermogenesis in birds. *Bioscience reports*, **21**, 181–188.
- Billerbeck JM, Lankford TE, Conover DO (2001) Evolution of intrinsic growth and energy acquisition rates. I. trade-offs with swimming performance in menidia menidia. *Evolution*, **55**, 1863–1872.
- Bize P, Criscuolo F, Metcalfe N, Nasir L, Monaghan P (2009) Telomere dynamics rather than age predict life expectancy in the wild. *Proceedings of the Royal Society B: Biological Sciences*, **276**, 1679–1683.
- Bize P, Devevey G, Monaghan P, Doligez B, Christe P (2008) Fecundity and survival in relation to resistance to oxidative stress in a free-living bird. *Ecology*, **89**, 2584–2593.
- Bize P, Metcalfe NB, Roulin A (2006) Catch-up growth strategies differ between body structures: interactions between age and structure-specific growth in wild nestling Alpine Swifts. *Functional Ecology*, **20**, 857–864.
- Bize P, Roulin A, Tella JL, Bersier L-F, Richner H (2004) Additive Effects of Ectoparasites over Reproductive Attempts in the Long-Lived Alpine Swift. *The Journal of Animal Ecology*, **73**, 1080–1088.
- Bjorndal KA, Bolten AB, Dellinger T, Delgado C, Martins HR (2003) Compensatory growth in oceanic loggerhead sea turtles: response to a stochastic environment. *Ecology*, **84**, 1237–1249.
- Blagojevic DP, Grubor-Lajsic GN, Spasic MB (2011) Cold defence responses: the role of oxidative stress. *Frontiers in bioscience (Scholar edition)*, **3**, 416.
- Blount JD, Metcalfe NB, Arnold KE *et al.* (2003) Neonatal nutrition, adult antioxidant defences and sexual attractiveness in the zebra finch. *Proceedings of the Royal Society B: Biological Sciences*, **270**, 1691–1696.
- Bonier F, Martin PR, Moore IT, Wingfield JC (2009) Do baseline glucocorticoids predict fitness? *Trends in Ecology & Evolution*, **24**, 634–642.
- Bost CA, Charrassin JB, Clerquin Y, Ropert-Coudert Y, Le Maho Y (2004) Exploitation of distant marginal ice zones by king penguins during winter. *Marine Ecology Progress Series*, **283**, 293–297.
- Boström P, Wu J, Jedrychowski MP *et al.* (2012) A PGC1- α -dependent myokine that drives brown-fat-like development of white fat and thermogenesis. *Nature*, **481**, 463–468.
- Bouillaud F (2009) UCP2, not a physiologically relevant uncoupler but a glucose sparing switch impacting ROS production and glucose sensing. *BBA - Bioenergetics*, **1787**, 377–383.
- Boveris A, Chance B (1973) The mitochondrial generation of hydrogen peroxide. General properties and effect of hyperbaric oxygen. *The Biochemical journal*, **134**, 707–716.
- Brand M (2000) Uncoupling to survive? The role of mitochondrial inefficiency in ageing. *Experimental Gerontology*, **35**, 811–820.
- Brand MD (2005) The efficiency and plasticity of mitochondrial energy transduction. *Biochemical Society Transactions*, **33**, 897–904.
- Brand MD, Affourtit C, Esteves TC *et al.* (2004) Mitochondrial superoxide: production, biological effects, and activation of uncoupling proteins. *Free Radical Biology and Medicine*, **37**, 755–767.
- Brand MD, Pakay JL, Ocloo A *et al.* (2005) The basal proton conductance of mitochondria depends on adenine nucleotide translocase content. *Biochemical Journal*, **392**, 353–362.
- Brand M, Turner N, Ocloo A, Else P, Hulbert A (2003) Proton conductance and fatty acyl composition

of liver mitochondria correlates with body mass in birds. *Biochemical Journal*, **376**, 741-748.

- Brasch K, Adams G, Neelin J (1974) Evidence for erythrocyte-specific histone modification and structural changes in chromatin during goose erythrocyte maturation. *Journal of cell science*, **15**, 659-677.
- Bratosin D, Estaquier J, Slomianny C *et al.* (2004) On the evolution of erythrocyte programmed cell death: apoptosis of *Rana esculenta* nucleated red blood cells involves cysteine proteinase activation and mitochondrion permeabilization. *Biochimie*, **86**, 183-192.
- Brinkhof MW (1997) Seasonal decline in body size of Coot chicks. *Journal of Avian Biology*, **28**, 117-131.
- Brinkhof MW, Cavé AJ (1997) Food supply and seasonal variation in breeding success: an experiment in the European coot. *Proceedings of the Royal Society of London. Series B: Biological Sciences*, **264**, 291-296.
- Brodsky D (2004) Current Concepts in Intrauterine Growth Restriction. *Journal of Intensive Care Medicine*, **19**, 307-319.
- Brown GC, Borutaite V (2012) There is no evidence that mitochondria are the main source of reactive oxygen species in mammalian cells. *Mitochondrion*, **12**, 1-4.
- Brown JH, Gillooly JF, Allen AP, Savage VM, West GB (2004) Toward a metabolic theory of ecology. *Ecology*, **85**, 1771-1789.
- Buehler DM, Vezina F, Goymann W *et al.* (2012) Independence among physiological traits suggests flexibility in the face of ecological demands on phenotypes. *Journal of Evolutionary Biology*, **25**, 1600-1613.
- Burley N (1985) Leg-band color and mortality patterns in captive breeding populations of zebra finches. *The Auk*, **102**, 647-651.

C

- Caldeira da Silva CC, Cerqueira FM, Barbosa LF, Medeiros MHG, Kowaltowski AJ (2008) Mild mitochondrial uncoupling in mice affects energy metabolism, redox balance and longevity. *Aging Cell*, **7**, 552-560.
- Calder WA (1964) Gaseous metabolism and water relations of the zebra finch, *Taeniopygia castanotis*. *Physiological Zoology*, **37**, 400-413.
- Calow P (1982) Homeostasis and fitness. *The American Naturalist*, **120**, 416-419.
- Cannon B, Nedergaard J (2004) Brown adipose tissue: Function and physiological significance. *Physiological Reviews*, **84**, 277-359.
- Cannon B, Shabalina I, Kramarova T, Petrovic N, Nedergaard J (2006) Uncoupling proteins: a role in protection against reactive oxygen species--or not? *Biochimica et Biophysica Acta (BBA)-Bioenergetics*, **1757**, 449-458.
- Careau V, Bergeron P, Garant D *et al.* (2013) The energetic and survival costs of growth in free-ranging chipmunks. *Oecologia*, **171**, 11-23.
- Carrier DR, Auriemma J (1992) A developmental constraint on the fledging time of birds. *Biological Journal of the Linnean Society*, **47**, 61-77.
- Casagrande S, Dell'Omo G, Costantini D, Tagliavini J, Groothuis T (2011) Variation of a carotenoid-based trait in relation to oxidative stress and endocrine status during the breeding season in the Eurasian kestrel: A multi-factorial study. *Comparative Biochemistry and Physiology Part A: Molecular & Integrative Physiology*, **160**, 16-26.

- Chance B, Sies H, Boveris A (1979) Hydroperoxide metabolism in mammalian organs. *Physiological Reviews*, **59**, 527–605.
- Chen Q, Niu Y, Zhang R *et al.* (2010) The toxic influence of paraquat on hippocampus of mice: Involvement of oxidative stress. *NeuroToxicology*, **31**, 310–316.
- Cherel Y, LE Maho Y (1985) Five months of fasting in king penguin chicks: body mass loss and fuel metabolism. *American Journal of Physiology-Regulatory, Integrative and Comparative Physiology*, **249**, R387–R392.
- Cherel Y, Charrassin JB, Challet E (1994) Energy and protein requirements for molt in the king penguin *Aptenodytes patagonicus*. *American Journal of Physiology-Regulatory, Integrative and Comparative Physiology*, **266**, R1182–R1188.
- Cherel Y, Charrassin JB, Handrich Y (1993) Comparison of body reserve buildup in prefasting chicks and adults of king penguins (*Aptenodytes patagonicus*). *Physiological Zoology*, **66**, 750–770.
- Cherel Y, Stahl J-C, LE Maho Y (1987) Ecology and physiology of fasting in king penguin chicks. *The Auk*, **104**, 254–262.
- Choi J, Fauce SR, Effros RB (2008) Reduced telomerase activity in human T lymphocytes exposed to cortisol. *Brain, Behavior, and Immunity*, **22**, 600–605.
- Christe P, Glaizot O, Strepparava N, Devevey G, Fumagalli L (2012) Twofold cost of reproduction: an increase in parental effort leads to higher malarial parasitaemia and to a decrease in resistance to oxidative stress. *Proceedings of the Royal Society B: Biological Sciences*, **279**, 1142–1149.
- Christin P-A, Weinreich DM, Besnard G (2010) Causes and evolutionary significance of genetic convergence. *Trends in Genetics*, **26**, 400–405.
- Clarke KJ, Porter RK (2013) Uncoupling protein 1 dependent reactive oxygen species production by thymus mitochondria. *The International Journal of Biochemistry & Cell Biology*, **45**, 81–89.
- Clotfelter ED, Whittingham LA, Dunn PO (2000) Laying order, hatching asynchrony and nestling body mass in Tree Swallows *Tachycineta bicolor*. *Journal of Avian Biology*, **31**, 329–334.
- Clutton Brock TH (1988) Reproductive success: studies of individual variation in contrasting breeding systems. *University of Chicago Press*.
- Conway C, Martin T (2000) Effects of ambient temperature on avian incubation behavior. *Behavioral Ecology*, **11**, 178–188.
- Corbel H (2008) Envol chez le poussin d'oiseau: Rôle de l'investissement parental et mécanismes proximaux. *PhD thesis*.
- Corbel H, Geiger S, Groscolas R (2010) Preparing to fledge: the adrenocortical and metabolic responses to stress in king penguin chicks. *Functional Ecology*, **24**, 82–92.
- Corbel H, Morlon F, Geiger S, Groscolas R (2009) State-dependent decisions during the fledging process of king penguin chicks. *Animal Behaviour*, **78**, 829–838.
- Costantini D (2008) Oxidative stress in ecology and evolution: lessons from avian studies. *Ecology Letters*, **11**, 1238–1251.
- Costantini D (2013) Oxidative Stress and Hormetic Responses in the Early Life of Birds. In: pp. 257–273. Springer New York, New York, NY.
- Costantini D, Verhulst S (2009) Does high antioxidant capacity indicate low oxidative stress? *Functional Ecology*, **23**, 506–509.
- Costantini D, Carello L, Fanfani A (2010a) Relationships among oxidative status, breeding conditions and life-history traits in free-living Great Tits *Parus major* and Common Starlings *Sturnus*

vulgaris. *Ibis*, **152**, 793–802.

- Costantini D, Casagrande S, de Filippis S *et al.* (2006) Correlates of oxidative stress in wild kestrel nestlings (*Falco tinnunculus*). *Journal Of Comparative Physiology B-Biochemical Systemic And Environmental Physiology*, **176**, 329–337.
- Costantini D, Metcalfe NB, Monaghan P (2010b) Ecological processes in a hormetic framework. *Ecology Letters*, **13**, 1435–1447.
- Costantini D, Monaghan P, Metcalfe NB (2012) Early life experience primes resistance to oxidative stress. *Journal Of Experimental Biology*, **215**, 2820–2826.
- Cote J, Clobert J, Meylan S, Fitze PS (2006) Experimental enhancement of corticosterone levels positively affects subsequent male survival. *Hormones And Behavior*, **49**, 320–327.
- Cotton PA, Wright J, Kacelnik A (1999) Chick begging strategies in relation to brood hierarchies and hatching asynchrony. *The American Naturalist*, **153**, 412–420.
- Criscuolo F, Bize P, Nasir L *et al.* (2009) Real-time quantitative PCR assay for measurement of avian telomeres. *Journal of Avian Biology*, **40**, 342–347.
- Criscuolo F, Gonzalez-Barroso M, Bouillaud F *et al.* (2005a) Mitochondrial uncoupling proteins - new perspectives for evolutionary ecologists. *The American Naturalist*, **116**, 686–699.
- Criscuolo F, Gonzalez-Barroso M, Maho Y, Ricquier D, Bouillaud F (2005b) Avian uncoupling protein expressed in yeast mitochondria prevents endogenous free radical damage. *Proceedings of the Royal Society B: Biological Sciences*, **272**, 803–810.
- Criscuolo F, Monaghan P, Nasir L, Metcalfe NB (2008) Early nutrition and phenotypic development: “catch-up” growth leads to elevated metabolic rate in adulthood. *Proceedings of the Royal Society B: Biological Sciences*, **275**, 1565–1570.
- Criscuolo F, Monaghan P, Proust A *et al.* (2011) Costs of compensation: effect of early life conditions and reproduction on flight performance in zebra finches. *Oecologia*, **167**, 315–323.
- Crompton M (1999) The mitochondrial permeability transition pore and its role in cell death. *Biochemical Journal*, **341**, 233–249.
- Currie S, Tufts B (1997) Synthesis of stress protein 70 (Hsp70) in rainbow trout (*Oncorhynchus mykiss*) red blood cells. *Journal Of Experimental Biology*, **200**, 607–614.
- Currie S, Tufts BL, Moyes CD (1999) Influence of bioenergetic stress on heat shock protein gene expression in nucleated red blood cells of fish. *American Journal of Physiology-Regulatory, Integrative and Comparative Physiology*, **276**, R990–R996.

D

- Daan S, Deerenberg C, Dijkstra C (1996) Increased daily work precipitates natural death in the kestrel. *The Journal of Animal Ecology*, 539–544.
- Daan S, Dijkstra C, Drent R, Meijer T (1988) Food supply and the annual timing of avian reproduction. *Proceedings XIXth Ornithological Congress, Ottawa 1986*, 392–407.
- Daniali L, Benetos A, Susser E *et al.* (2013) Telomeres shorten at equivalent rates in somatic tissues of adults. *Nature communications*, **4**, 1597.
- Daunt F, Wanless S, Harris MP, Monaghan P (1999) Experimental evidence that age-specific reproductive success is independent of environmental effects. *Proceedings of the Royal Society of London. Series B: Biological Sciences*, **266**, 1489–1493.
- Davies KJA (2001) Degradation of oxidized proteins by the 20S proteasome. *Biochimie*, **83**, 301–310.

- Davies KJ, Quintanilha AT, Brooks GA, Packer L (1982) Free radicals and tissue damage produced by exercise. *Biochemical and biophysical research communications*, **107**, 1198–1205.
- Dawkins R (1976) *The selfish gene*. Oxford: Oxford University Press.
- De Block M, Stoks R (2008) Compensatory growth and oxidative stress in a damselfly. *Proceedings of the Royal Society B: Biological Sciences*, **275**, 781–785.
- De Block M, McPeck MA, Stoks R (2008) Stronger compensatory growth in a permanent-pond Lestes damselfly relative to temporary-pond Lestes. *Oikos*, **117**, 245–254.
- De Lange T, Lundblad V, Blackburn EH (2006) *Telomeres*. Cold Spring Harbor Laboratory Press, New York.
- Deerenberg C, Overkamp GJ (1996) Parental effort and costs of reproduction of zebra finches. *PhD thesis, University of Groningen*.
- Deerenberg C, Pen I, Dijkstra C *et al.* (1995) Parental energy expenditure in relation to manipulated brood size in the European kestrel. *Zool Ana Compl Syst*, **99**, 38–47.
- Descamps S, Gauthier-Clerc M, Gendner J-P, LE Maho Y (2002) The annual breeding cycle of unbanded king penguins *Aptenodytes patagonicus* on Possession Island (Crozet). *Avian Science*, **2**, 87–98.
- Descamps S, Gauthier-Clerc M, Le Bohec C, Gendner J-P, LE Maho Y (2005) Impact of predation on king penguin *Aptenodytes patagonicus* in Crozet Archipelago. *Polar Biology*, **28**, 303–310.
- Dijkstra C, Bult A, Bijlsma S *et al.* (1990) Brood size manipulations in the kestrel (*Falco tinnunculus*): effects on offspring and parent survival. *The Journal of Animal Ecology*, **59**, 269–285.
- Dittmar C, Elling W (2005) Phenological phases of common beech (*Fagus sylvatica* L.) and their dependence on region and altitude in Southern Germany. *European Journal of Forest Research*, **125**, 181–188.
- Divakaruni AS, Brand MD (2011) The Regulation and Physiology of Mitochondrial Proton Leak. *Physiology*, **26**, 192–205.
- Dlasková A, Clarke KJ, Porter RK (2010) The role of UCP 1 in production of reactive oxygen species by mitochondria isolated from brown adipose tissue. *BBA - Bioenergetics*, **1797**, 1470–1476.
- Dmitriew CM (2011) The evolution of growth trajectories: what limits growth rate? *Biological Reviews*, **86**, 97–116.
- Dominguez S (1993) The Effect of 2,4-Dinitrophenol on the Metabolic Rate of Bobwhite Quail. *Toxicology and Applied Pharmacology*, **123**, 226–233.
- Dowling D, Simmons L (2009) Reactive oxygen species as universal constraints in life-history evolution. *Proceedings of the Royal Society B: Biological Sciences*, **276**, 1737–1745.
- Dröge W (2002) Free radicals in the physiological control of cell function. *Physiological Reviews*, **82**, 47–95.
- Duchamp C, Barre H (1993) Skeletal muscle as the major site of nonshivering thermogenesis in cold-acclimated ducklings. *American Journal of Physiology-Regulatory, Integrative and Comparative Physiology*, **265**, R1076–R1083.
- Duchamp C, Barre H, Delage D *et al.* (1989) Nonshivering thermogenesis and adaptation to fasting in king penguin chicks. *American Journal of Physiology-Regulatory, Integrative and Comparative Physiology*, **257**, R744–R751.
- DuRant S, Hepp G, Moore I, Hopkins B, Hopkins W (2010) Slight differences in incubation temperature affect early growth and stress endocrinology of wood duck (*Aix sponsa*) ducklings.

The Journal of Experimental Biology, **213**, 45–51.

E

Emre Y, Nübel T (2010) Uncoupling protein UCP2: when mitochondrial activity meets immunity. *FEBS Letters*, **584**, 1437–1442.

Emre Y, Hurtaud C, Ricquier D *et al.* (2007) Avian UCP: The Killjoy in the Evolution of the Mitochondrial Uncoupling Proteins. *Journal of Molecular Evolution*, **65**, 392–402.

Enerbäck S, Jacobsson A, Simpson E *et al.* (1997) Mice lacking mitochondrial uncoupling protein are cold-sensitive but not obese. *Nature*, **387**, 90–94.

Epel E, Blackburn E, Lin J *et al.* (2004) Accelerated telomere shortening in response to life stress. *Proceedings of the National Academy of Sciences*, **101**, 17312–17315.

F

Feldmann HM, Golozoubova V, Cannon B, Nedergaard J (2009) UCP1 Ablation Induces Obesity and Abolishes Diet-Induced Thermogenesis in Mice Exempt from Thermal Stress by Living at Thermoneutrality. *Cell Metabolism*, **9**, 203–209.

Ferguson RA, Boutilier RG (1989) Metabolic-membrane coupling in red blood cells of trout: the effects of anoxia and adrenergic stimulation. **143**, 149–164.

Finkel T, Holbrook N (2000) Oxidants, oxidative stress and the biology of ageing. *Nature*, **408**, 239–247.

Fletcher QE, Selman C, Boutin S *et al.* (2013) Oxidative damage increases with reproductive energy expenditure and is reduced by food-supplementation. *Evolution*, **67**, 1527–1536.

Footo CG, Gault EA, Nasir L, Monaghan P (2011a) Telomere dynamics in relation to early growth conditions in the wild in the lesser black-backed gull. *Journal of Zoology*, **283**, 203–209.

Footo CG, Daunt F, Gonzalez-Solis J *et al.* (2011b) Individual state and survival prospects: age, sex, and telomere length in a long-lived seabird. *Behavioral Ecology*, **22**, 156–161.

Forchhammer MC, Clutton Brock TH, Lindström J, Albon SD (2001) Climate and population density induce long-term cohort variation in a northern ungulate. *Journal of Animal Ecology*, **70**, 721–729.

Forslund P, Pärt T (1995) Age and reproduction in birds—hypotheses and tests. *Trends in Ecology & Evolution*, **10**, 374–378.

Freeman S, Jackson WM (1990) Univariante metrics are not adequate to measure avian body size. *The Auk*, **107**, 69–74.

Furukawa S, Fujita T, Shimabukuro M *et al.* (2004) Increased oxidative stress in obesity and its impact on metabolic syndrome. *Journal of Clinical Investigation*, **114**, 1752–1761.

G

Gagliano M, McCormick MI (2007) Compensating in the wild: is flexible growth the key to early juvenile survival? *Oikos*, **116**, 111–120.

Garratt M, Vasilaki A, Stockley P *et al.* (2011) Is oxidative stress a physiological cost of reproduction? An experimental test in house mice. *Proceedings of the Royal Society B: Biological Sciences*, **278**, 1098–1106.

Gates A, Bernal-Mizrachi C, Chinault S *et al.* (2007) Respiratory uncoupling in skeletal muscle delays death and diminishes age-related disease. *Cell Metabolism*, **6**, 497–505.

- Gauthier-Clerc M, LE Maho Y, Clerquin Y, Bost C-A, Handrich Y (2002) Seabird reproduction in an unpredictable environment: how king penguins provide their young chicks with food. *Marine Ecology Progress Series*, **237**, 291–300.
- Geiger S, Le Vaillant M, Lebard T *et al.* (2012) Catching-up but telomere loss: half-opening the black box of growth and ageing trade-off in wild king penguin chicks. *Molecular Ecology*, **21**, 1500–1510.
- Gerschman R, Gilbert DL, Nye SW, Dwyer P, Fenn DO (1954) Oxygen Poisoning and X-irradiation: A Mechanism in Common. *Science*, **119**, 623–626.
- Gibb J (1957) Food Requirements and other Observations on Captive Tits. *Bird Study*, **4**, 207–215.
- Gilby AJ, Sorato E, Griffith SC (2012) Maternal effects on begging behaviour: an experimental demonstration of the effects of laying sequence, hatch order, nestling sex and brood size. *Behavioral Ecology and Sociobiology*, **66**, 1519–1529.
- Gleeson M (1986) Respiratory Adjustments of the Unanesthetized Chicken, *Gallus-Domesticus*, to Elevated Metabolism Elicited by 2,4-Dinitrophenol or Cold-Exposure. *Comparative Biochemistry and Physiology, Part A*, **83**, 283–289.
- Gluckman PD, Hanson MA (2004) Living with the Past: Evolution, Development, and Patterns of Disease. *Science*, **305**, 1733–1736.
- Goglia F, Lanni A, Duchamp C, Rouanet J-L, Barre H (1993) Effect of cold acclimation on oxidative capacity and respiratory properties of liver and muscle mitochondria in ducklings, *Cairina moschata*. *Comparative Biochemistry and Physiology Part B: Comparative Biochemistry*, **106**, 95–101.
- Golden TR, Melov S (2001) Mitochondrial DNA mutations, oxidative stress, and aging. *Mech Age Dev*, **122**, 1577–1589.
- Golozoubova V, Hohtola E, Matthias A *et al.* (2001) Only UCP1 can mediate adaptive nonshivering thermogenesis in the cold. *The FASEB Journal*, **15**, 2048–2050.
- Goodship N, Buchanan K (2007) Nestling testosterone controls begging behaviour in the pied flycatcher, *Ficedula hypoleuca*. *Hormones And Behavior*, **52**, 454–460.
- Gotthard K (2001) Increased risk of predation as a cost of high growth rate: an experimental test in a butterfly. *Journal of Animal Ecology*, **69**, 896–902.
- Gotthard K (2008) Adaptive growth decisions in butterflies. *Bioscience*, **58**, 222–230.
- Gotthard K, Nylin SR, Wiklund C (1994) Adaptive variation in growth rate: life history costs and consequences in the speckled wood butterfly, *Pararge aegeria*. *Oecologia*, **99**, 281–289.
- Gould SJ, Lewontin RC (1979) The spandrels of San Marco and the Panglossian paradigm: a critique of the adaptationist programme. *Proceedings of the Royal Society of London. Series B: Biological Sciences*, **205**, 581–598.
- Griffiths R, Double MC, Orr K, Dawson R (1998) A DNA test to sex most birds. *Molecular Ecology*, **7**, 1071–1075.
- Groothuis TGG, Müller W, Engelhardt von N, Carere C, Eising C (2005) Maternal hormones as a tool to adjust offspring phenotype in avian species. *Neuroscience & Biobehavioral Reviews*, **29**, 329–352.
- Gustafsson L, Pärt T (1990) Acceleration of senescence in the collared flycatcher *Ficedula albicollis* by reproductive costs. *Nature*, **347**, 279–281.
- Gustafsson L, Sutherland WJ (1988) The costs of reproduction in the collared flycatcher *Ficedula albicollis*. *Nature*, **335**, 813–815.

H

- Hagen TM, Yowe DL, Bartholomew JC *et al.* (1997) Mitochondrial decay in hepatocytes from old rats: Membrane potential declines, heterogeneity and oxidants increase. *Proceedings of the National Academy of Sciences*, **94**, 3064–3069.
- Hall ME, Blount JD, Forbes S, Royle NJ (2010) Does oxidative stress mediate the trade-off between growth and self-maintenance in structured families? *Functional Ecology*, **24**, 365–373.
- Hall ME, Nasir L, Daunt F *et al.* (2004) Telomere loss in relation to age and early environment in long-lived birds. *Proceedings of the Royal Society B: Biological Sciences*, **271**, 1571–1576.
- Halliwell B, Gutteridge J (2007) *Free Radicals in Biology and Medicine*. Oxford: Oxford University Press.
- Hallows SE, Regnault TRH, Betts DH (2012) The Long and Short of It: The Role of Telomeres in Fetal Origins of Adult Disease. *Journal of Pregnancy*, **2012**, 1–8.
- Han YH, Kim SW, Kim SH, Kim SZ, Park WH (2008) 2, 4-Dinitrophenol induces G1 phase arrest and apoptosis in human pulmonary adenocarcinoma Calu-6 cells. *Toxicology in Vitro*, **22**, 659–670.
- Harma MI, Harma M, Erel O (2006) d-ROMs test detects ceruloplasmin, not oxidative stress. *CHEST Journal*, **130**, 1276–1277.
- Harman D (1956) Aging: A Theory Based on Free Radical and Radiation Chemistry. *Journal of Gerontology*, **11**, 298–300.
- Harper M, Bevilacqua L, Hagopian K, Weindruch R, Ramsey J (2004) Ageing, oxidative stress, and mitochondrial uncoupling. *Acta Physiologica Scandinavica*, **182**, 321–331.
- Harris J, Brown J (1971) Fractionation of the avian erythrocyte: an ultrastructural study. *Journal of Ultrastructure Research*, **36**, 8–23.
- Harris MO, Cocoran JJ (1995) Toxicological profile for dinitrophenols. *Agency for Toxic Substances and Disease Registry*.
- Harshman LG, Zera AJ (2007) The cost of reproduction: the devil in the details. *Trends in Ecology & Evolution*, **22**, 80–86.
- Hausmann MF, Marchetto NM (2010) Telomeres: linking stress and survival, ecology and evolution. *Current Zoology*, **56**, 714–727.
- Hausmann MF, Longenecker AS, Marchetto NM, Juliano SA, Bowden RM (2012) Embryonic exposure to corticosterone modifies the juvenile stress response, oxidative stress and telomere length. *Proceedings of the Royal Society B: Biological Sciences*, **279**, 1447–1456.
- Hausmann MF, Winkler DW, Vleck CM (2005) Longer telomeres associated with higher survival in birds. *Biology Letters*, **1**, 212–214.
- Hausmann MF, Winkler DW, Huntington CE, Nisbet ICT, Vleck CM (2007) Telomerase activity is maintained throughout the lifespan of long-lived birds. *Experimental Gerontology*, **42**, 610–618.
- Hayes JP (1989) Altitudinal and seasonal effects on aerobic metabolism of deer mice. *Journal Of Comparative Physiology B-Biochemical Systemic And Environmental Physiology*, **159**, 453–459.
- Hayward LS, Wingfield JC (2004) Maternal corticosterone is transferred to avian yolk and may alter offspring growth and adult phenotype. *General and comparative endocrinology*, **135**, 365–371.
- Heezik YV, Seddon PJ, Cooper J, Plös AL (1994) Interrelationships between breeding frequency, timing and outcome in King Penguins *Aptenodytes patagonicus*: are King Penguins biennial breeders? *Ibis*, **136**, 279–284.

- Heidinger BJ, Blount JD, Boner W *et al.* (2012) Telomere length in early life predicts lifespan. *Proceedings of the National Academy of Sciences*, **109**, 1743–1748.
- Heiss R, Schoech S (2012) Oxidative Cost of Reproduction Is Sex Specific and Correlated with Reproductive Effort in a Cooperatively Breeding Bird, the Florida Scrub Jay. *Physiological And Biochemical Zoology*, **85**, 499–503.
- Hekimi S, Lapointe J (2011) Taking a “good” look at free radicals in the aging process. *Trends in Cell Biology*, **21**, 569–576.
- Helle H, Koskela E, Mappes T (2011) Life in varying environments: experimental evidence for delayed effects of juvenile environment on adult life history. *Journal of Animal Ecology*, **81**, 573–582.
- Holloszy JO, Smith EK (1986) Longevity of cold-exposed rats: a reevaluation of the “rate-of-living theory.” **61**, 1656–1660.
- Holmes D, Flückiger R, Austad S (2001) Comparative biology of aging in birds: an update. *Experimental Gerontology*, **36**, 869–883.
- Honarmand M, Goymann W, Naguib M (2010) Stressful Dieting: Nutritional Conditions but Not Compensatory Growth Elevate Corticosterone Levels in Zebra Finch Nestlings and Fledglings (C Kullberg, Ed.). *PLoS ONE*, **5**, e12930.
- Horn T, Robertson BC, Will M *et al.* (2011) Inheritance of telomere length in a bird. *PLoS ONE*, **6**, e17199.
- Houben MJM, Moonen HJJ, van Schooten FJ, Hageman GJ (2008) Telomere length assessment: Biomarker of chronic oxidative stress? *Free Radical Biology and Medicine*, **44**, 235–246.
- Hughes J, Criscuolo F (2008) Evolutionary history of the UCP gene family: gene duplication and selection. *BMC Evolutionary Biology*, **8**, 306.
- Hulbert AJ, Pamplona R, Buffenstein R, Buttemer WA (2007) Life and Death: Metabolic Rate, Membrane Composition, and Life Span of Animals. *Physiological Reviews*, **87**, 1175–1213.
- I**
- Isaksson C (2013) Opposing effects on glutathione and reactive oxygen metabolites of sex, habitat, and spring date, but no effect of increased breeding density in great tits (*Parus major*). *Ecology and Evolution*.
- Isaksson C, Sheldon BC, Uller T (2011a) The Challenges of Integrating Oxidative Stress into Life-history Biology. *Bioscience*, **61**, 194–202.
- Isaksson C, While GM, Olsson M, Komdeur J, Wapstra E (2011b) Oxidative stress physiology in relation to life history traits of a free-living vertebrate: the spotted snow skink, *Niveoscincus ocellatus*. *Integrative Zoology*, **6**, 140–149.
- Issartel J, Hervant F, Fraipont M, Clobert J, Voituron Y (2009) High anoxia tolerance in the subterranean salamander *Proteus anguinus* without oxidative stress nor activation of antioxidant defenses during reoxygenation. *Journal Of Comparative Physiology B-Biochemical Systemic And Environmental Physiology*, **179**, 543–551.
- J**
- Janský L (1973) Non-shivering thermogenesis and its thermoregulatory significance. *Biological Reviews*, **48**, 85–132.
- Jefferson JA, Simoni J, Escudero E *et al.* (2004) Increased Oxidative Stress Following Acute and Chronic High Altitude Exposure. *High Altitude Medicine & Biology*, **5**, 61–69.

- Jennings BJ, Ozanne SE, Hales CN (2000) Nutrition, Oxidative Damage, Telomere Shortening, and Cellular Senescence: Individual or Connected Agents of Aging? *Molecular Genetics and Metabolism*, **71**, 32–42.
- Jennings B, Ozanne S, Dorling M, Hales C (1999) Early growth determines longevity in male rats and may be related to telomere shortening in the kidney. *FEBS Letters*, **448**, 4–8.
- Ji LL (1999) Antioxidants and oxidative stress in exercise. *Proceedings of the Society for Experimental Biology and Medicine. Society for Experimental Biology and Medicine (New York, N.Y.)*, **222**, 283–292.
- Jobling M, Johansen SJS (1999) The lipostat, hyperphagia and catch-up growth. *Aquaculture Research*, **30**, 473–478.
- Johnson Cadwell LI, Jekabsons MB, Wang A, Polster BM, Nicholls DG (2007) “Mild Uncoupling” does not decrease mitochondrial superoxide levels in cultured cerebellar granule neurons but decreases spare respiratory capacity and increases toxicity to glutamate and oxidative stress. *Journal of Neurochemistry*, **101**, 1619–1631.
- Johnsson JI, Bohlin T (2005) Compensatory growth for free? A field experiment on brown trout, *Salmo trutta*. *Oikos*, **111**, 31–38.
- ## K
- Kalomenopoulou M, Beis I (1990) Studies on the pigeon red blood cell metabolism. *Comparative Biochemistry and Physiology Part B: Comparative Biochemistry*, **95**, 677–684.
- Kaur P, Kalia S, Bansal M (2006) Effect of diethyl maleate induced oxidative stress on male reproductive activity in mice: Redox active enzymes and transcription factors expression. *Molecular and cellular biochemistry*, **291**, 55–61.
- Kaushik S, Kaur J (2003) Chronic cold exposure affects the antioxidant defense system in various rat tissues. *Clinica Chimica Acta*, **333**, 69–77.
- Keaney JF, Larson MG, Vasan RS *et al.* (2003) Obesity and systemic oxidative stress clinical correlates of oxidative stress in the Framingham Study. *Arteriosclerosis, Thrombosis and Vascular Biology*, **23**, 434–439.
- Keipert S, Klaus S, Heldmaier G, Jastroch M (2010) UCP1 ectopically expressed in murine muscle displays native function and mitigates mitochondrial superoxide production. *Biochimica et Biophysica Acta (BBA)-Bioenergetics*, **1797**, 324–330.
- Ketterson ED, Nolan V Jr (1999) Adaptation, exaptation, and constraint: a hormonal perspective. *The American Naturalist*, **154**, S4–S25.
- Khawaja O, Bartz TM, Ix JH *et al.* (2012) Plasma Free Fatty Acids and Risk of Atrial Fibrillation (from the Cardiovascular Health Study). *The American Journal of Cardiology*, **110**, 212–216.
- Kilgas P, Tilgar V, Külavee R *et al.* (2010) Antioxidant protection, immune function and growth of nestling great tits *Parus major* in relation to within-brood hierarchy. *Comparative Biochemistry and Physiology, Part B*, **157**, 288–293.
- Kim S-Y, Noguera JC, Morales J, Velando A (2011) Quantitative genetic evidence for trade-off between growth and resistance to oxidative stress in a wild bird. *Evolutionary Ecology*, **25**, 461–472.
- Kingslover JG, Pfenning DW (2004) Individual-level selection as a cause of Cope's rule of phyletic size increase. *Evolution*, **58**, 1608–1612.
- Kirkwood TBL (2005) Understanding the Odd Science of Aging. *Cell*, **120**, 437–447.

- Kitaysky AS, Wingfield JC, Piatt JF (2001) Corticosterone facilitates begging and affects resource allocation in the black-legged kittiwake. *Behavioral Ecology*, **12**, 619–625.
- Kitaysky A, Kitaiskaia E, Piatt J, Wingfield J (2003) Benefits and costs of increased levels of corticosterone in seabird chicks. *Hormones And Behavior*, **43**, 140–149.
- Kizaki T, Suzuki K, Hitomi Y *et al.* (2002) Uncoupling protein 2 plays an important role in nitric oxide production of lipopolysaccharide-stimulated macrophages. *Proceedings Of The National Academy Of Sciences Of The United States Of America*, **99**, 9392–9397.
- Klingenberg M (1990) Mechanism and evolution of the uncoupling protein of brown adipose tissue. *Trends in Biochemical Sciences*, **15**, 108–112.
- Klingenspor M (2003) Cold-induced recruitment of brown adipose tissue thermogenesis. *Experimental Physiology*, **88**, 141–148.
- Kobari L, Yates F, Oudrhiri N *et al.* (2012) Human induced pluripotent stem cells can reach complete terminal maturation: in vivo and in vitro evidence in the erythropoietic differentiation model. *Haematologica*, **97**, 1795–1803.
- Koetsier E, Verhulst S (2011) A simple technique to manipulate foraging costs in seed-eating birds. *Journal Of Experimental Biology*, **214**, 1225–1229.
- Kontani Y, Wang Y, Kimura K *et al.* (2005) UCP1 deficiency increases susceptibility to diet-induced obesity with age. *Aging Cell*, **4**, 147–155.
- Korshunov S, Skulachev V, Starkov A (1997) High protonic potential actuates a mechanism of production of reactive oxygen species in mitochondria. *FEBS Letters*, **416**, 15–18.
- Kotrschal A, Ilmonen P, Penn DJ (2007) Stress impacts telomere dynamics. *Biology Letters*, **3**, 128–130.
- Kozak LP (2010) Brown Fat and the Myth of Diet-Induced Thermogenesis. *Cell Metabolism*, **11**, 263–267.
- Kozak LP, Anunciado-Koza R (2008) UCP1: its involvement and utility in obesity. *International Journal of Obesity*, **32**, S32–S38.
- Ku H-H, Sohal RS (1993) Comparison of mitochondrial pro-oxidant generation and anti-oxidant defenses between rat and pigeon: possible basis of variation in longevity and metabolic potential. *Mechanisms Of Ageing And Development*, **72**, 67–76.
- Ku H-H, Brunk UT, Sohal RS (1993) Relationship between mitochondrial superoxide and hydrogen peroxide production and longevity of mammalian species. *Free Radical Biology and Medicine*, **15**, 621–627.
- Kuzmiak S, Glancy B, Sweazea KL, Willis WT (2012) Mitochondrial function in sparrow pectoralis muscle. *Journal Of Experimental Biology*, **215**, 2039–2050.

L

- Lack D (1968) Ecological adaptations for breeding in birds. Methuen: London.
- Lambert A, Brand M (2009) Reactive oxygen species production by mitochondria. *Methods Mol Biol*, **554**, 165–181.
- Lambert AJ, Brand MD (2004) Superoxide production by NADH: ubiquinone oxidoreductase (complex I) depends on the pH gradient across the mitochondrial inner membrane. *Biochemical Journal*, **382**, 511–517.
- Lambert AJ, Boysen HM, Buckingham JA *et al.* (2007) Low rates of hydrogen peroxide production by isolated heart mitochondria associate with long maximum lifespan in vertebrate homeotherms.

- Aging Cell*, **6**, 607–618.
- Lambert AJ, Buckingham JA, Boysen HM, Brand MD (2010) Low complex I content explains the low hydrogen peroxide production rate of heart mitochondria from the long-lived pigeon, *Columba livia*. *Aging Cell*, **9**, 78–91.
- Lane HC, Tharp TP (1980) Changes in the population of polyribosomal containing red cells of peripheral blood of rainbow trout, *Salmo gairdneri* Richardson, following starvation and bleeding. *Journal of Fish Biology*, **17**, 75–81.
- Lane N (2005) Power, sex, suicide: mitochondria and the meaning of life. *Oxford: Oxford University Press*.
- Lapointe J, Hekimi S (2008) Early Mitochondrial Dysfunction in Long-lived Mcl1+/- Mice. *Journal of Biological Chemistry*, **283**, 26217–26227.
- Lecomte N, Kuntz G, Lambert N *et al.* (2006) Alloparental feeding in the king penguin. *Animal Behaviour*, **71**, 457–462.
- Lecomte VJ, Sorci G, Cornet S *et al.* (2010) Patterns of aging in the long-lived wandering albatross. *Proceedings Of The National Academy Of Sciences Of The United States Of America*, **107**, 6370–6375.
- Lee H-C, Wei Y-H (2012) Mitochondria and aging. *Advances in experimental medicine and biology*, **942**, 311–327.
- Lee W-S, Monaghan P, Metcalfe NB (2013) Experimental demonstration of the growth rate–lifespan trade-off. *Proceedings of the Royal Society of London. Series B: Biological Sciences*, **280**.
- Leech SM, Leonard ML (1996) Is there an energetic cost to begging in nestling tree swallows (*Tachycineta bicolor*)? *Proceedings of the Royal Society of London. Series B: Biological Sciences*, **263**, 983–987.
- Leighton F (1985) Morphological lesions in red blood cells from herring gulls and Atlantic puffins ingesting Prudhoe Bay Crude Oil. *Veterinary Pathology*, **22**, 393–402.
- Lemon WC (1993) The energetics of lifetime reproductive success in the zebra finch *Taeniopygia guttata*. *Physiological Zoology*, **66**, 946–963.
- Lessells CM, Boag PT (1987) Unrepeatable repeatabilities: a common mistake. *The Auk*, **104**, 116–121.
- Li X, Wang D (2005) Suppression of thermogenic capacity during reproduction in primiparous brandt's voles (*Microtus brandtii*). *Journal of Thermal Biology*, **30**, 431–436.
- Lindström J (1999) Early development and fitness in birds and mammals. *Trends in Ecology & Evolution*, **14**, 343–348.
- Liu R, Pan X, Whittington PF (2009) Increased hepatic expression is a major determinant of serum alanine aminotransferase elevation in mice with nonalcoholic steatohepatitis. *Liver International*, **29**, 337–343.
- Liu X (2005) Evolutionary conservation of the clk-1-dependent mechanism of longevity: loss of mcl1 increases cellular fitness and lifespan in mice. *Genes & development*, **19**, 2424–2434.
- Liu X, Rossmeisl M, McClaine J, Kozak LP (2003) Paradoxical resistance to diet-induced obesity in UCP1-deficient mice. *Journal of Clinical Investigation*, **111**, 399–407.
- Loft S, Astrup A, Buemann B, Poulsen HE (1994) Oxidative DNA damage correlates with oxygen consumption in humans. *The FASEB Journal*, **8**, 534–537.
- Losdat S, Helfenstein F, Blount JD *et al.* (2013) Nestling erythrocyte resistance to oxidative stress

predicts fledging success but not local recruitment in a wild bird. *Biology Letters*, **9**.

Losdat S, Helfenstein F, Gaude B, Richner H (2011) Reproductive effort transiently reduces antioxidant capacity in a wild bird. *Behavioral Ecology*, **22**, 1218–1226.

Lu X (2004) Reproductive ecology of blackbirds (*Turdus merula maximus*) in a high-altitude location, Tibet. *Journal of Ornithology*, **146**, 172–178.

M

Macleod R, Barnett P, Clark JA, Cresswell W (2005) Body mass change strategies in blackbirds *Turdus merula*: the starvation–predation risk trade-off. *Journal of Animal Ecology*, **74**, 292–302.

Magrath RD (1990) Hatching asynchrony in altricial birds. *Biological Reviews*, **65**, 587–622.

Mailloux RJ, Harper M-E (2011) Uncoupling proteins and the control of mitochondrial reactive oxygen species production. *Free Radical Biology and Medicine*, **51**, 1106–1115.

Mainwaring MC, Dickens M, Hartley IR (2010) Environmental and not maternal effects determine variation in offspring phenotypes in a passerine bird. *Journal of Evolutionary Biology*, **23**, 1302–1311.

Mangel M, Munch S (2005) A life-history perspective on short-and long-term consequences of compensatory growth. *The American Naturalist*, **166**, E155–E176.

Marit JS, Weber LP (2011) Acute exposure to 2,4-dinitrophenol alters zebrafish swimming performance and whole body triglyceride levels. *Comparative Biochemistry and Physiology, Part C*, **154**, 14–18.

Marjoniemi KK, Hohtola EE (2000) Does cold acclimation induce nonshivering thermogenesis in juvenile birds? Experiments with Pekin ducklings and Japanese quail chicks. *Journal of Comparative Physiology B*, **170**, 537–543.

Markó G, Costantini D, Michl G, Török J (2011) Oxidative damage and plasma antioxidant capacity in relation to body size, age, male sexual traits and female reproductive performance in the collared flycatcher (*Ficedula albicollis*). *Journal of Comparative Physiology B*, **181**, 73–81.

Martin LB, Scheuerlein A, Wikelski M (2003) Immune activity elevates energy expenditure of house sparrows: a link between direct and indirect costs? *Proceedings of the Royal Society B: Biological Sciences*, **270**, 153–158.

Matson K, Ricklefs R, Klasing K (2005) A hemolysis-hemagglutination assay for characterizing constitutive innate humoral immunity in wild and domestic birds. *Developmental And Comparative Immunology*, **29**, 275–286.

Maxwell MH, Robertson B, Mitchell B, Carlisle AJ (1992) The fine-structure of broiler chicken blood-cells, with particular reference to basophils, after severe heat-stress. *Comparative Haematology International*, **2**, 190–200.

McArdle A, Pattwell D, Vasilaki A, Griffiths R, Jackson M (2001) Contractile activity-induced oxidative stress: cellular origin and adaptive responses. *American Journal of Physiology-Cell Physiology*, **280**, 621–627.

McCarty JP (1996) The energetic cost of begging in nestling passerines. *The Auk*, 178–188.

McCord JM, Fridovich I (1969) Superoxide dismutase an enzymic function for erythrocyte hemocuprein (hemocuprein). *Journal of Biological Chemistry*, **244**, 6049–6055.

McGraw K, Cohen A, Costantini D, Hõrak P (2010) The ecological significance of antioxidants and oxidative stress: a marriage between mechanistic and functional perspectives. *Functional Ecology*, **24**, 947–949.

- McVicar TR, Körner C (2012) On the use of elevation, altitude, and height in the ecological and climatological literature. *Oecologia*, **171**, 335–337.
- Metcalfe N, Alonso Alvarez C (2010) Oxidative stress as a life-history constraint: the role of reactive oxygen species in shaping phenotypes from conception to death. *Functional Ecology*, **24**, 984–996.
- Metcalfe N, Monaghan P (2001) Compensation for a bad start: grow now, pay later? *Trends in Ecology & Evolution*, **16**, 254–260.
- Metcalfe N, Monaghan P (2003) Growth versus lifespan: perspectives from evolutionary ecology. *Experimental Gerontology*, **38**, 935–940.
- Metcalfe NB, Monaghan P (2013) Does reproduction cause oxidative stress? An open question. *Trends in Ecology & Evolution*, **28**, 347–350.
- Meyer CW, Willershauser M, Jastroch M *et al.* (2010) Adaptive thermogenesis and thermal conductance in wild-type and UCP1-KO mice. *AJP: Regulatory, Integrative and Comparative Physiology*, **299**, R1396–R1406.
- Miwa S, Brand MD (2003) Mitochondrial matrix reactive oxygen species production is very sensitive to mild uncoupling. *Biochemical Society Transactions*, **31**, 1300–1301.
- Mofrad P (2003) Clinical and histologic spectrum of nonalcoholic fatty liver disease associated with normal ALT values. *Hepatology*, **37**, 1286–1292.
- Monaghan P (2008) Early growth conditions, phenotypic development and environmental change. *Philosophical Transactions of the Royal Society B: Biological Sciences*, **363**, 1635–1645.
- Monaghan P (2010) Telomeres and life histories: the long and the short of it. *Annals of the New York Academy of Sciences*, **1206**, 130–142.
- Monaghan P, Haussmann M (2006) Do telomere dynamics link lifestyle and lifespan? *Trends in Ecology & Evolution*, **21**, 47–53.
- Monaghan P, Metcalfe NB, Torres R (2009) Oxidative stress as a mediator of life history trade-offs: mechanisms, measurements and interpretation. *Ecology Letters*, **12**, 75–92.
- Montgomery MK, Hulbert AJ, Buttemer WA (2011) The long life of birds: the rat-pigeon comparison revisited. *PLoS ONE*, **6**, e24138.
- Montgomery MK, Hulbert AJ, Buttemer WA (2012a) Does the oxidative stress theory of aging explain longevity differences in birds? I. Mitochondrial ROS production. *EXG*, **47**, 203–210.
- Mookerjee SA, Divakaruni AS, Jastroch M, Brand MD (2010) Mitochondrial uncoupling and lifespan. *Mechanisms Of Ageing And Development*, **131**, 463–472.
- Moreno-Rueda G, Redondo T, Trenzado CE, Sanz A, Zúñiga JM (2012) Oxidative Stress Mediates Physiological Costs of Begging in Magpie (*Pica pica*) Nestlings (ML Leonard, Ed.). *PLoS ONE*, **7**, e40367.
- Morera D, MacKenzie S (2011) Is there a direct role for erythrocytes in the immune response? *Veterinary Research*, **42**, 1–8.
- Morgan IJ, Metcalfe NB (2001) Deferred costs of compensatory growth after autumnal food shortage in juvenile salmon. *Proceedings of the Royal Society B: Biological Sciences*, **268**, 295–301.
- Moritz KM, Lim GB, Wintour EM (1997) Developmental regulation of erythropoietin and erythropoiesis. *American Journal of Physiology-Regulatory, Integrative and Comparative Physiology*, **273**, R1829–R1844.
- Mortensen A, Damsgård B (1993) Compensatory growth and weight segregation following light and

- temperature manipulation of juvenile Atlantic salmon (*Salmo salar* L.) and Arctic charr (*Salvelinus alpinus* L.). *Aquaculture*, **114**, 261–272.
- Mougeot F, Galván I, Alonso-Alvarez C (2011) Contrasted effects of an oxidative challenge and α -melanocyte-stimulating hormone on cellular immune responsiveness: an experiment with red-legged partridges *Alectoris rufa*. *Oecologia*, **169**, 385–394.
- Mougeot F, Martinez-Padilla J, Webster LMI *et al.* (2009) Honest sexual signalling mediated by parasite and testosterone effects on oxidative balance. *Proceedings of the Royal Society B: Biological Sciences*, **276**, 1093–1100.
- Mousseau TA, Fox CW (1998) The adaptive significance of maternal effects. *Trends in Ecology & Evolution*, **13**, 403–407.
- Moyes C, Sharma M, Lyons C *et al.* (2002) Origins and consequences of mitochondrial decline in nucleated erythrocytes. *Biochimica Et Biophysica Acta-Molecular Cell Research*, **1591**, 11–20.
- Mráček T, Pecina P, Vojtíšková A *et al.* (2006) Two components in pathogenic mechanism of mitochondrial ATPase deficiency: energy deprivation and ROS production. *Experimental Gerontology*, **41**, 683–687.
- Muller M, Groothuis TG (2013) Within-clutch variation in yolk testosterone as an adaptive maternal effect to modulate avian sibling competition: evidence from a comparative study. *The American Naturalist*, **181**, 125–136.
- Muller W, Deptuch K, Lopez-Rull I, Gil D (2007) Elevated yolk androgen levels benefit offspring development in a between-clutch context. *Behavioral Ecology*, **18**, 929–936.
- Munch S, Conover D (2004) Nonlinear growth cost in *Menidia menidia*: theory and empirical evidence. *Evolution*, **58**, 661–664.
- Munch SB, Conover DO (2003) Rapid growth results in increased susceptibility to predation in *Menidia menidia*. *Evolution*, **57**, 2119–2127.
- Murphy MP (2009) How mitochondria produce reactive oxygen species. *Biochemical Journal*, **417**, 1–13.
- ## N
- Nabben M, Shabalina IG, Moonen-Kornips E *et al.* (2011) Uncoupled respiration, ROS production, acute lipotoxicity and oxidative damage in isolated skeletal muscle mitochondria from UCP3-ablated mice. *BBA - Bioenergetics*, **1807**, 1095–1105.
- Naef Daenzer B, Keller LF (1999) The foraging performance of great and blue tits (*Parus major* and *P. caeruleus*) in relation to caterpillar development, and its consequences for nestling growth and fledging weight. *Journal of Animal Ecology*, **68**, 708–718.
- Naef Daenzer B, Widmer F, Nuber M (2001) Differential post-fledging survival of great and coal tits in relation to their condition and fledging date. *Journal of Animal Ecology*, **70**, 730–738.
- Naef-Daenzer B, Luterbacher J, Nuber M, Rutishauser T, Winkel W (2012) Cascading climate effects and related ecological consequences during past centuries. *Climate of the Past*, **8**, 1527–1540.
- Nedergaard J, Matthias A, Golozoubova V, Jacobsson A, Cannon B (1999) UCP1: the original uncoupling protein--and perhaps the only one? New perspectives on UCP1, UCP2, and UCP3 in the light of the bioenergetics of the UCP1-ablated mice. *Journal of Bioenergetics and Biomembranes*, **31**, 475–491.
- Negre-Salvayre A, Hirtz C, Carrera G *et al.* (1997) A role for uncoupling protein-2 as a regulator of mitochondrial hydrogen peroxide generation. *The FASEB Journal*, **11**, 809.

- Nemoto S, Finkel T (2004) Ageing and the mystery at Arles. *Nature*, **429**, 149–152.
- Nemzek J, Bolgos G, Williams B, Remick D (2001) Differences in normal values for murine white blood cell counts and other hematological parameters based on sampling site. *Inflammation Research*, **50**, 523–527.
- Nicholls DG, Ferguson SJ (2002) Bioenergetics. *Academic press*.
- Nicieza AG, Metcalfe NB (1997) Growth compensation in juvenile atlantic salmon: responses to depressed temperature and food availability. *Ecology*, **78**, 2385–2400.
- Nilsson J (2002) Metabolic consequences of hard work. *Proceedings of the Royal Society of London. Series B: Biological Sciences*, **269**, 1735–1739.
- Nilsson J-A, Gårdmark A (2001) Sibling competition affects individual growth strategies in marsh tit, *Parus palustris*, nestlings. *Animal Behaviour*, **61**, 357–365.
- Nilsson J-A, Svensson M (1996) Sibling competition affects nestling growth strategies in marsh tits. *Journal of Animal Ecology*, **65**, 825–836.
- Noguera JC, Alonso-Alvarez C, Kim S-Y, Morales J, Velando A (2011) Yolk testosterone reduces oxidative damages during postnatal development. *Biology Letters*, **7**, 93–95.
- Noguera JC, Kim S-Y, Velando A (2012) Pre-fledgling oxidative damage predicts recruitment in a long-lived bird. *Biology Letters*, **8**, 61–63.
- Noguera JC, Morales J, Perez C, Velando A (2010) On the oxidative cost of begging: antioxidants enhance vocalizations in gull chicks. *Behavioral Ecology*, **21**, 479–484.
- Nussey DH, Pemberton JM, Pilkington JG, Blount JD (2009) Life history correlates of oxidative damage in a free-living mammal population. *Functional Ecology*, **23**, 809–817.
- Nylin S, Gotthard K (1998) Plasticity in life-history traits. *Annual review of entomology*, **43**, 63–83.

O

- Oelkrug R (2013) New perspectives on the significance of brown adipose tissue in mammals. *PhD thesis*.
- Oelkrug R, Kutschke M, Meyer CW, Heldmaier G, Jastroch M (2010) Uncoupling Protein 1 Decreases Superoxide Production in Brown Adipose Tissue Mitochondria. *Journal of Biological Chemistry*, **285**, 21961–21968.
- Ogo S, Bernardes C, Glass M, Torsoni M, Vercesi A (1993) Functional mitochondria in snake *Bothrops alternatus* erythrocytes and modulation of HbO₂ affinity by mitochondrial ATP. *Journal Of Comparative Physiology B-Biochemical Systemic And Environmental Physiology*, **163**, 614–619.
- Oldakowski L, Piotrowska Z, Chrzascik KM *et al.* (2012) Is reproduction costly? No increase of oxidative damage in breeding bank voles. *Journal Of Experimental Biology*, **215**, 1799–1805.
- Olsson M, Wilson M, Uller T *et al.* (2008) Free radicals run in lizard families. *Biology Letters*, **4**, 186.
- Olsson O (1996) Seasonal effects of timing and reproduction in the king penguin: a unique breeding cycle. *Journal of Avian Biology*, **27**, 7–14.
- Olsson O (1997) Clutch abandonment: a state-dependent decision in king penguins. *Journal of Avian Biology*, **28**, 264–267.
- Orrenius S, Gogvadze V, Zhivotovsky B (2007) Mitochondrial Oxidative Stress: Implications for Cell Death. *Annual Review of Pharmacology and Toxicology*, **47**, 143–183.
- Ortega-Molina A, Efeyan A, Lopez-Guadamillas E *et al.* (2012) Pten Positively Regulates Brown Adipose Function, Energy Expenditure, and Longevity. *Cell Metabolism*, **15**, 382–394.

Ouellet V, Labbé SM, Blondin DP *et al.* (2012) Brown adipose tissue oxidative metabolism contributes to energy expenditure during acute cold exposure in humans. *Journal of Clinical Investigation*, **122**, 545–552.

Ozanne SE, Hales CN (2004) Lifespan: Catch-up growth and obesity in male mice. *Nature*, **427**, 411–412.

O'Neill JS, Reddy AB (2011) Circadian clocks in human red blood cells. *Nature*, **469**, 498–503.

P

Padalko V (2005) Uncoupler of oxidative phosphorylation prolongs the lifespan of *Drosophila*. *Biochemistry (Moscow)*, **70**, 986–989.

Pamplona R, Portero-Otin *et al.* (1999) Heart fatty acid unsaturation and lipid peroxidation, and aging rate, are lower in the canary and the parakeet than in the mouse. *Aging (Milan, Italy)*, **11**, 44–49.

Pan JQ, Tan X, Li JC, Sun WD, Wang XL (2005) Effects of early feed restriction and cold temperature on lipid peroxidation, pulmonary vascular remodelling and ascites morbidity in broilers under normal and cold temperature. *British Poultry Science*, **46**, 374–381.

Passos J, Zglinicki von T, Kirkwood T (2007) Mitochondria and ageing: winning and losing in the numbers game. *BioEssays*, **29**, 908–917.

Pearl R (1922) *The biology of death*. Arno Press: New York.

Pearl R (1928) *The rate of living*. University of London: London.

Pellerin M, Delestrade A, Mathieu G, Rigault O, Yoccoz NG (2012) Spring tree phenology in the Alps: effects of air temperature, altitude and local topography. *European Journal of Forest Research*, **131**, 1957–1965.

Pérez VI, Buffenstein R, Masamsetti V *et al.* (2009) Protein stability and resistance to oxidative stress are determinants of longevity in the longest-living rodent, the naked mole-rat. *Proceedings of the National Academy of Sciences*, **106**, 3059–3064.

Perrins CM (1970) The timing of birds' breeding seasons. *Ibis*, **112**, 242–255.

Petrovic V, Buzadzic B, Korac A *et al.* (2008) Antioxidative defence alterations in skeletal muscle during prolonged acclimation to cold: role of L-arginine/NO-producing pathway. *Journal Of Experimental Biology*, **211**, 114–120.

Pfaffl MW (2001) A new mathematical model for relative quantification in real-time RT-PCR. *Nucleic acids research*, **29**, 2002–2007.

Phillips M, Moyes C, Tufts B (2000) The effects of cell ageing on metabolism in rainbow trout (*Oncorhynchus mykiss*) red blood cells. *Journal Of Experimental Biology*, **203**, 1039–1045.

Pica A, Scacco S, Papa F, de Nitto E, Papa S (2001) Morphological and biochemical characterization of mitochondria in Torpedo red blood cells. *Comparative Biochemistry And Physiology B-Biochemistry & Molecular Biology*, **128**, 213–219.

Piersma T, Van Gils JA (2011) *The flexible phenotype: a body-centred integration of ecology, physiology, and behaviour*. Oxford: Oxford University Press.

Pigliucci M (2003) Phenotypic integration: studying the ecology and evolution of complex phenotypes. *Ecology Letters*, **6**, 265–272.

Podlas K, Helfenstein F, Richner H (2013) Brood Reduction via Intra-clutch Variation in Testosterone - An Experimental Test in the Great Tit (G Sorci, Ed.). *PLoS ONE*, **8**, e56672.

Promislow DEL, Harvey PH (1990) Living fast and dying young: A comparative analysis of life-history

variation among mammals. *Journal of Zoology*, **220**, 417–437.

Prunesco P (1971) Natural and Experimental Phagocytosis by Erythrocytes in Amphibians. *Nature*, **231**, 143–144.

Q

Quinlivan EP, Gregory JF III (2008) DNA digestion to deoxyribonucleoside: A simplified one-step procedure. *Analytical biochemistry*, **373**, 383–385.

R

Radak Z, Chung HY, Koltai E, Taylor AW, Goto S (2008) Exercise, oxidative stress and hormesis. *Ageing Research Reviews*, **7**, 34–42.

Radak Z, Zhao Z, Koltai E, Ohno H, Atalay M (2013) Oxygen consumption and usage during physical exercise: the balance between oxidative stress and ROS-dependent adaptive signaling. *Antioxidants & redox signaling*, **18**, 1208–1246.

Reeve, Fowler, Partridge (2000) Increased body size confers greater fitness at lower experimental temperature in male *Drosophila melanogaster*. *Journal of Evolutionary Biology*, **13**, 836–844.

Reth M (2002) Hydrogen peroxide as second messenger in lymphocyte activation. *Nature Immunology*, **3**, 1129–1134.

Rey B, Halsey LG, Dolmazon V *et al.* (2008) Long-term fasting decreases mitochondrial avian UCP-mediated oxygen consumption in hypometabolic king penguins. *AJP: Regulatory, Integrative and Comparative Physiology*, **295**, R92–R100.

Rey B, Roussel D, Romestaing C *et al.* (2010a) Up-regulation of avian uncoupling protein in cold-acclimated and hyperthyroid ducklings prevents reactive oxygen species production by skeletal muscle mitochondria. *BMC physiology*, **10**, 5.

Rey B, Spée M, Belouze M *et al.* (2010b) Oxygen recovery up-regulates avian UCP and ANT in newly hatched ducklings. *Journal Of Comparative Physiology B-Biochemical Systemic And Environmental Physiology*, **180**, 239–246.

Reznick D (1985) Costs of reproduction: an evaluation of the empirical evidence. *Oikos*, **44**, 257–267.

Reznick D, Nunney L, Tessier A (2000) Big houses, big cars, superfleas and the costs of reproduction. *Trends in Ecology & Evolution*, **15**, 421–425.

Richner H (1989) Habitat-specific growth and fitness in carrion crows (*Corvus corone corone*). *The Journal of Animal Ecology*, **58**, 427–440.

Ricklefs R (2006) Embryo development and ageing in birds and mammals. *Proceedings of the Royal Society B: Biological Sciences*, **273**, 2077–2082.

Ricklefs RE (1969) Preliminary models for growth rates in altricial birds. *Ecology*, **50**, 1031–1039.

Ricklefs RE (2010) Life-history connections to rates of aging in terrestrial vertebrates. *Proceedings of the National Academy of Sciences*, **107**, 10314–10319.

Ricquier D, Bouillaud F (2000) The uncoupling protein homologues: UCP1, UCP2, UCP3, StUCP and AtUCP. *Biochemical Journal*, **345**, 161.

Ristow M, Schmeisser S (2011) Extending life span by increasing oxidative stress. *Free Radical Biology and Medicine*, **51**, 327–336.

Ristow M, Zarse K (2010) How increased oxidative stress promotes longevity and metabolic health: The concept of mitochondrial hormesis (mitohormesis). *Experimental Gerontology*, **45**, 410–418.

- Rodnan GP, Ebaugh JR FG, Fox M, Chambers DM (1957) The life span of the red blood cell and the red blood cell volume in the chicken, pigeon and duck as estimated by the use of Na₂Cr⁵¹O₄: with observations on red cell turnover rate in the mammal, bird and reptile. *Blood*, **12**, 355–366.
- Roff D (1980) Optimizing development time in a seasonal environment: the “ups and downs” of clinal variation. *Oecologia*, **45**, 202–208.
- Roff D, Fairbain DJ (2007) The evolution of trade-offs: where are we? *Journal of Evolutionary Biology*, **20**, 433–447.
- Roff DA (1992) Evolution of life histories: theory and analysis. *Springer New York*.
- Roff DA (2002) Life history evolution. *Sinauer associates, inc. Publishers Sunderland, Massachusetts U.S.A.*, **7**.
- Rolfe DF, Brown GC (1997) Cellular energy utilization and molecular origin of standard metabolic rate in mammals. *Physiological Reviews*, **77**, 731–758.
- Rollo C (2002) Growth negatively impacts the life span of mammals. *Evolution & Development*, **4**, 55–61.
- Rollo C, Carlson J, Sawada M (1996) Accelerated aging of giant transgenic mice is associated with elevated free radical processes. *Canadian Journal of Zoology*, **74**, 606–620.
- Ros AFH (1999) Effects of testosterone on growth, plumage pigmentation, and mortality in Black-headed Gull chicks. *Ibis*, **141**, 451–459.
- Rosa CE, Figueiredo MA, Lanes CFC *et al.* (2008) Metabolic rate and reactive oxygen species production in different genotypes of GH-transgenic zebrafish. *Comparative Biochemistry And Physiology B-Biochemistry & Molecular Biology*, **149**, 209–214.
- Rose G, Crocco P, D'aquila P *et al.* (2011) Two variants located in the upstream enhancer region of human UCP1 gene affect gene expression and are correlated with human longevity. *Experimental Gerontology*, **46**, 897–904.
- Rose MR (1991) Evolutionary biology of aging. *Oxford: Oxford University Press*.
- Rose MR, Bradley TJ (1998) Evolutionary physiology of the cost of reproduction. *Oikos*, **83**, 443–451.
- Rubner M (1908) Das problem der Lebensdauer und seine Beziehungen zu Wachstum und Ernährung. *R. Oldenbourg - München, Germany*.
- Rubolini D, Romano M, Bonisoli AA, Saino N (2006) Early maternal, genetic and environmental components of antioxidant protection, morphology and immunity of yellow-legged gull (*Larus michahellis*) chicks. *Journal of Evolutionary Biology*, **19**, 1571–1584.
- Rydén O, Bengtsson H (1980) Differential begging and locomotory behaviour by early and late hatched nestlings affecting the distribution of food in asynchronously hatched broods of altricial birds. *Zeitschrift für Tierpsychologie*, **53**, 209–224.
- Rzezniczak TZ, Douglas LA, Watterson JH, Merritt TJS (2011) Paraquat administration in *Drosophila* for use in metabolic studies of oxidative stress. *Analytical biochemistry*, **419**, 345–347.

S

- Saarela S, Heldmaier G (1987) Effect of photoperiod and melatonin on cold resistance, thermoregulation and shivering/nonshivering thermogenesis in Japanese quail. *Journal of Comparative Physiology B*, **157**, 625–633.
- Saarela S, Klapper B, Heldmaier G (1995) Daily rhythm of oxygen consumption and thermoregulatory responses in some European winter-or summer-acclimatized finches at different ambient temperatures. *Journal of Comparative Physiology B*, **165**, 366–376.

- Sahai A, Malladi P, Melin-Aldana H, Green RM, Whittington PF (2004) Upregulation of osteopontin expression is involved in the development of nonalcoholic steatohepatitis in a dietary murine model. *American journal of physiology. Gastrointestinal and liver physiology*, **287**, G264–73.
- Sahin E, Depinho RA (2010) Linking functional decline of telomeres, mitochondria and stem cells during ageing. *Nature*, **464**, 520–528.
- Saino N, Caprioli M, Romano M *et al.* (2011a) Antioxidant Defenses Predict Long-Term Survival in a Passerine Bird (S Helle, Ed.). *PLoS ONE*, **6**, e19593.
- Saino N, Romano M, Caprioli M, Rubolini D, Ambrosini R (2011b) Yolk carotenoids have sex-dependent effects on redox status and influence the resolution of growth trade-offs in yellow-legged gull chicks. *Behavioral Ecology*, **22**, 411–421.
- Sainz R, Reiter R, Mayo J *et al.* (2000) Changes in lipid peroxidation during pregnancy and after delivery in rats: effect of pinealectomy. *Journal of reproduction and fertility*, **119**, 143–149.
- Salin K, Luquet E, Rey B, Roussel D, Voituron Y (2012a) Alteration of mitochondrial efficiency affects oxidative balance, development and growth in frog (*Rana temporaria*) tadpoles. *Journal Of Experimental Biology*, **215**, 863–869.
- Salin K, Roussel D, Rey B, Voituron Y (2012b) David and Goliath: A Mitochondrial Coupling Problem? *Journal of Experimental Zoology Part A: Ecological Genetics and Physiology*, **317**, 283–293.
- Salmon AB, Marx DB, Harshman LG (2001) A cost of reproduction in *Drosophila melanogaster*: stress susceptibility. *Evolution*, **55**, 1600–1608.
- Salomons HM, Mulder GA, van de Zande L *et al.* (2009) Telomere shortening and survival in free-living corvids. *Proceedings of the Royal Society B: Biological Sciences*, **276**, 3157–3165.
- Saraux C, Viblanc VA, Hanuise N, LE Maho Y, Le Bohec C (2011) Effects of Individual Pre-Fledging Traits and Environmental Conditions on Return Patterns in Juvenile King Penguins (S Thrush, Ed.). *PLoS ONE*, **6**, e20407.
- Schlagowski AI, Singh F, Charles AL *et al.* (2013) Efficiency of skeletal muscle mitochondrial coupling is a critical factor for maximal exercise capacity and oxygen uptake in rats. *Fundamental & Clinical Pharmacology*, **27**, 33–33.
- Schönfeld P, Wojtczak L (2012) Brown adipose tissue mitochondria oxidizing fatty acids generate high levels of reactive oxygen species irrespective of the uncoupling protein-1 activity state. *Biochimica et Biophysica Acta (BBA)-Bioenergetics*, **1817**, 410–418.
- Schwabl H (1993) Yolk is a source of maternal testosterone for developing birds. *Proceedings of the National Academy of Sciences*, **90**, 11446–11450.
- Schwabl H (1996) Maternal testosterone in the avian egg enhances postnatal growth. *Comparative Biochemistry And Physiology A-Physiology*, **114**, 271–276.
- Selman C, Blount JD, Nussey DH, Speakman JR (2012) Oxidative damage, ageing, and life-history evolution: where now? *Trends in Ecology & Evolution*, **27**, 570–577.
- Selman C, Grune T, Stolzing A *et al.* (2002) The consequences of acute cold exposure on protein oxidation and proteasome activity in short-tailed field voles, *Microtus agrestis*. *Free Radical Biology and Medicine*, **33**, 259–265.
- Selman C, McLaren J, Collins A, Duthie G, Speakman J (2008) The impact of experimentally elevated energy expenditure on oxidative stress and lifespan in the short-tailed field vole *Microtus agrestis*. *Proceedings of the Royal Society B: Biological Sciences*, **275**, 1907–1916.
- Sepp T, Sild E, Blount JD *et al.* (2012) Individual consistency and covariation of measures of oxidative status in greenfinches. *Physiological And Biochemical Zoology*, **85**, 299–307.

- Shabalina I, Nedergaard J (2011) Mitochondrial (“mild”) uncoupling and ROS production: physiologically relevant or not? *Biochem Soc Trans*, **39**, 1305–1309.
- Shabalina I, Petrovic N, Kramarova T *et al.* (2006) UCP1 and Defense against Oxidative Stress. *Journal of Biological Chemistry*, **281**, 13882–13893.
- Sheth SG, Gordon FD, Chopra S (1997) Nonalcoholic steatohepatitis. *Annals of internal medicine*, **126**, 137–145.
- Shigenaga MK, Hagen TM, Ames BN (1994) Oxidative damage and mitochondrial decay in aging. *Proceedings Of The National Academy Of Sciences Of The United States Of America*, **91**, 10771–10778.
- Sies H (1985) Oxidative stress. *Academic Press Inc., Orlando, FL*.
- Sies H (2007) Total antioxidant capacity: appraisal of a concept. *The Journal of nutrition*, **137**, 1493–1495.
- Sies H, Jones D (2007) Oxidative stress. *Encyclopedia of stress. San Diego: Elsevier*.
- Silverin B, Sharp P (1996) The development of the hypothalamic-pituitary-gonadal axis in juvenile great tits. *General and comparative endocrinology*, **103**, 150–166.
- Sinclair GD, Brasch K (1975) Nucleated erythrocyte - model of cell-differentiation. *Revue Canadienne De Biologie*, **34**, 287–303.
- Skulachev VP (1996) Role of uncoupled and non-coupled oxidations in maintenance of safely low levels of oxygen and its one-electron reductants. *Quarterly Reviews of Biophysics*, **29**, 169–202.
- Skulachev VP (1999) Anion carriers in fatty acid-mediated physiological uncoupling. *Journal of Bioenergetics and Biomembranes*, **31**, 431–445.
- Smiseth PT, Amundsen T (2002) Senior and junior nestlings in asynchronous bluethroat broods differ in their effectiveness of begging. *Evolutionary Ecology Research*, **4**, 1177–1189.
- Smith JM, Burian R, Kauffman S *et al.* (1985) Developmental constraints and evolution: a perspective from the Mountain Lake conference on development and evolution. *Quarterly Review of Biology*, **60**, 265–287.
- Smith S, Turbill C, Penn DJ (2011) Chasing telomeres, not red herrings, in evolutionary ecology. *Heredity*, **107**, 372–373.
- Smits JE, Bortolotti GR, Tella JL (1999) Simplifying the phytohaemagglutinin skin-testing technique in studies of avian immunocompetence. *Functional Ecology*, **13**, 567–572.
- Sohal RS, Agarwal S, Dubey A, Orr WC (1993) Protein oxidative damage is associated with life expectancy of houseflies. *Proceedings of the National Academy of Sciences*, **90**, 7255–7259.
- Sohal RS, Sohal BH, Orr WC (1995) Mitochondrial superoxide and hydrogen peroxide generation, protein oxidative damage, and longevity in different species of flies. *Free Radical Biology and Medicine*, **19**, 499–504.
- Speakman J (2008) The physiological costs of reproduction in small mammals. *Philosophical Transactions of the Royal Society B: Biological Sciences*, **363**, 375–378.
- Speakman JR (2005) Body size, energy metabolism and lifespan. *Journal Of Experimental Biology*, **208**, 1717–1730.
- Speakman JR, Krol E (2010) Limits to sustained energy intake. XIII. Recent progress and future perspectives. *Journal Of Experimental Biology*, **214**, 230–241.
- Speakman JR, Selman C (2011) The free-radical damage theory: Accumulating evidence against a simple link of oxidative stress to ageing and lifespan. *BioEssays*, **33**, 255–259.

- Speakman JR, Gidney A, Bett J, Mitchell IP, Johnson MS (2001) Limits to sustained energy intake. IV. Effect of variation in food quality on lactating mice *Mus musculus*. *The Journal of Experimental Biology*, **204**, 1957–1965.
- Speakman J, Selman C, McLaren J, Harper E (2002) Living fast, dying when? The link between aging and energetics. *The Journal of nutrition*, **132**, 1583S–1597S.
- Speakman J, Talbot D, Selman C *et al.* (2004) Uncoupled and surviving: individual mice with high metabolism have greater mitochondrial uncoupling and live longer. *Aging Cell*, **3**, 87–95.
- Spencer KA, Evans NP, Monaghan P (2009) Postnatal stress in birds: a novel model of glucocorticoid programming of the hypothalamic-pituitary-adrenal axis. *Endocrinology*, **150**, 1931–1934.
- St-Pierre J, Buckingham JA, Roebuck SJ (2002) Topology of superoxide production from different sites in the mitochondrial electron transport chain. *Journal of Biological Chemistry*, **277**, 44784–44790.
- Stadtman E (1992) Protein oxidation and aging. *Science*, **257**, 1220–1224.
- Starkov AA, Fiskum G (2003) Regulation of brain mitochondrial H₂O₂ production by membrane potential and NAD(P)H redox state. *Journal of Neurochemistry*, **86**, 1101–1107.
- Stearns SC (1989) Trade-offs in life-history evolution. *Functional Ecology*, **3**, 259–268.
- Stearns SC (1992) The evolution of life histories. *Oxford: Oxford University Press*.
- Stearns SC, Hoekstra RF (2000) Evolution: an introduction. *Oxford: Oxford University Press*.
- Stier A, Bize P, Schull Q *et al.* (2013) Avian erythrocytes have functional mitochondria, opening novel perspectives for birds as animal models in the study of ageing. *Frontiers in zoology*, **10**, 33.
- Stier A, Reichert S, Massemin S, Bize P, Criscuolo F (2012) Constraint and cost of oxidative stress on reproduction: correlative evidence in laboratory mice and review of the literature. *Frontiers in zoology*, **9**, 37.
- Stier KS, Almasi B, Gasparini J *et al.* (2009) Effects of corticosterone on innate and humoral immune functions and oxidative stress in barn owl nestlings. *Journal Of Experimental Biology*, **212**, 2085–2091.
- Stonehouse B (1960) The King Penguin: *Aptenodytes Patagonica*, of South Georgia. *Scientific Report of the Falkland Islands Dependencies Survey*, 1–81.
- Stöckl P, Zankl C, Hütter E *et al.* (2007) Partial uncoupling of oxidative phosphorylation induces premature senescence in human fibroblasts and yeast mother cells. *Free Radical Biology and Medicine*, **43**, 947–958.
- Stroun M, Maurice P, Vasioukhin V *et al.* (2000) The origin and mechanism of circulating DNA. *Annals of the New York Academy of Sciences*, **906**, 161–168.
- Surai PF (2002) Natural antioxidants in avian nutrition and reproduction. *Nottingham University Press: Nottingham*.
- Suttie JM, Goodall ED, Pennie K, Kay RNB (1983) Winter food restriction and summer compensation in red deer stags (*Cervus elaphus*). *British Journal of Nutrition*, **50**, 737–747.

T

- Talbot DA, Duchamp C, REY B *et al.* (2004) Uncoupling protein and ATP/ADP carrier increase mitochondrial proton conductance after cold adaptation of king penguins. *The Journal of Physiology*, **558**, 123–135.
- Tarry-Adkins JL, Chen JH, Smith NS *et al.* (2009) Poor maternal nutrition followed by accelerated

- postnatal growth leads to telomere shortening and increased markers of cell senescence in rat islets. *The FASEB Journal*, **23**, 1521–1528.
- Tarry-Adkins JL, Martin-Gronert MS, Chen JH, Cripps RL, Ozanne SE (2008) Maternal diet influences DNA damage, aortic telomere length, oxidative stress, and antioxidant defense capacity in rats. *The FASEB Journal*, **22**, 2037–2044.
- Tarry-Adkins JL, Martin-Gronert MS, Fernandez-Twinn DS *et al.* (2013) Poor maternal nutrition followed by accelerated postnatal growth leads to alterations in DNA damage and repair, oxidative and nitrosative stress, and oxidative defense capacity in rat heart. *The FASEB Journal*, **27**, 379–390.
- Teshima Y, Akao M, Jones SP, Marbán E (2003) Uncoupling protein-2 overexpression inhibits mitochondrial death pathway in cardiomyocytes. *Circulation research*, **93**, 192–200.
- Teulier L, Rouanet J-L, Letexier D *et al.* (2010) Cold-acclimation-induced non-shivering thermogenesis in birds is associated with upregulation of avian UCP but not with innate uncoupling or altered ATP efficiency. *Journal Of Experimental Biology*, **213**, 2476–2482.
- Tilgar V, Mänd R (2006) Sibling Growth Patterns in Great tits: Does Increased Selection on Last-hatched Chicks Favour an Asynchronous Hatching Strategy? *Evolutionary Ecology*, **20**, 217–234.
- Tirosh A, Shai I, Bitzur R *et al.* (2008) Changes in Triglyceride Levels Over Time and Risk of Type 2 Diabetes in Young Men. *Diabetes Care*, **31**, 2032–2037.
- Tobler M, Healey M, Wilson M, Olsson M (2011) Basal superoxide as a sex-specific immune constraint. *Biology Letters*, **7**, 906–908.
- Tobler M, Nilsson J-A, Nilsson JF (2007) Costly steroids: egg testosterone modulates nestling metabolic rate in the zebra finch. *Biology Letters*, **3**, 408–410.
- Toime LJ, Brand MD (2010) Uncoupling protein-3 lowers reactive oxygen species production in isolated mitochondria. *Free Radical Biology and Medicine*, **49**, 606–611.
- Tooze J, Davies H (1967) Light-and electron-microscope studies on the spleen of the newt *Triturus cristatus*: the fine structure of erythropoietic cells. *Journal of cell science*, **2**, 617–640.
- Topp H, Lengger C, Schöch G, Werner J, Mietzsch E (2000) Renal Excretion of 8-Oxo-7,8-dihydro-2'-deoxyguanosine in Wistar Rats with Increased O₂ Consumption Due to Cold Stress. *Archives of Biochemistry and Biophysics*, **376**, 328–332.
- Toyomizu M, Ueda M, Sato S *et al.* (2002) Cold-induced mitochondrial uncoupling and expression of chicken UCP and ANT mRNA in chicken skeletal muscle. *FEBS Letters*, **529**, 313–318.
- Trayhurn P (1981) Fatty acid synthesis in mouse brown adipose tissue the influence of environmental temperature on the proportion of whole-body fatty acid synthesis in brown adipose tissue and the liver. *Biochimica et Biophysica Acta (BBA) - Lipids and Lipid Metabolism*, **664**, 549–560.
- Trayhurn P (1989) Thermogenesis and the energetics of pregnancy and lactation. *Canadian journal of physiology and pharmacology*, **67**, 370–375.
- Tretter L, Adam-Vizi V (2007) Uncoupling is without an effect on the production of reactive oxygen species by in situ synaptic mitochondria. *Journal of Neurochemistry*, **103**, 1864–1871.
- Tsuchiya Y, Takami Y, Okuzaki Y, Sota T (2012) Genetic differences and phenotypic plasticity in body size between high- and low-altitude populations of the ground beetle *Carabus tosanus*. *Journal of Evolutionary Biology*, **25**, 1835–1842.

U

Ueda M, Watanabe K, Sato K, Akiba Y, Toyomizu M (2005) Possible role for avPGC-1 α in the control of expression of fiber type, along with avUCP and avANT mRNAs in the skeletal muscles of cold-exposed chickens. *FEBS Letters*, **579**, 11–17.

Upreti K, Chaki S, Misro M (2002) Evaluation of peroxidative stress and enzymatic antioxidant activity in liver and kidney during pregnancy and lactation in rats. *Health Popul. Issues Perspect*, **25**, 177–185.

V

Vaanholt LM, Daan S, Schubert KA, Visser GH (2009) Metabolism and Aging: Effects of Cold Exposure on Metabolic Rate, Body Composition, and Longevity in Mice. *Physiological And Biochemical Zoology*, **82**, 314–324.

Valdes AM, Andrew T, Gardner JP *et al.* (2005) Obesity, cigarette smoking, and telomere length in women. *The Lancet*, **366**, 662–664.

Valko M, Leibfritz D, Moncol J *et al.* (2007) Free radicals and antioxidants in normal physiological functions and human disease. *The International Journal of Biochemistry & Cell Biology*, **39**, 44–84.

van de Crommenacker J, Richardson DS, Koltz AM, Hutchings K, Komdeur J (2012) Parasitic infection and oxidative status are associated and vary with breeding activity in the Seychelles warbler. *Proceedings of the Royal Society B: Biological Sciences*, **279**, 1466–1476.

van de Pol M, Wright J (2009) A simple method for distinguishing within- versus between-subject effects using mixed models. *Animal Behaviour*, **77**, 753–758.

Van Noordwijk AJ, de Jong G (1986) Acquisition and allocation of resources: their influence on variation in life history tactics. *The American Naturalist*, **128**, 137–142.

VanHeezik YM, Seddon PJ, Plessis Du CJ, Adams NJ (1993) Differential growth of king penguin chicks in relation to date of hatching. *Colonial waterbirds*, **16**, 71–76.

Vácha J, Znojil V (1981) The allometric dependence of the life span of erythrocytes on body weight in mammals. *Comparative Biochemistry and Physiology Part A: Physiology*, **69**, 357–362.

Venditti P, Di Stefano L, Di Meo S (2013) Mitochondrial metabolism of reactive oxygen species. *Mitochondrion*, **13**, 71–82.

Venditti P, Rosa RD, Portero-Otín M, Pamplona R, Meo SD (2004) Cold-induced hyperthyroidism produces oxidative damage in rat tissues and increases susceptibility to oxidants. *The International Journal of Biochemistry & Cell Biology*, **36**, 1319–1331.

Verhulst S, Tinbergen JM (1991) Experimental evidence for a causal relationship between timing and success of reproduction in the great tit *Parus m. major*. *The Journal of Animal Ecology*, **60**, 269–282.

Verrier D (2003) Croissance et mue chez le poussin de manchot royal (*Aptenodytes patagonicus*): aspects ecophysiologiques. *PhD thesis*.

Vezina F (2005) The metabolic cost of egg production is repeatable. *Journal Of Experimental Biology*, **208**, 2533–2538.

Viblanc VAV (2011) Coping with Energy Limitation, Social Constraints and Stress in a Colonial Breeder, the King Penguin (*Aptenodytes Patagonicus*). *PhD thesis*.

Vidal-Puig AJ (2000) Energy Metabolism in Uncoupling Protein 3 Gene Knockout Mice. *Journal of Biological Chemistry*, **275**, 16258–16266.

- Villolobos M, León P, Sessions SK, Kezer J (1988) Enucleated Erythrocytes in Plethodontid Salamanders. *Herpetologica*, **44**, 243–250.
- Vinkler M, Bainová H, Albrecht T (2010a) Functional analysis of the skin-swelling response to phytohaemagglutinin. *Functional Ecology*, **24**, 1081–1086.
- Vinkler M, Schnitzer J, Munclinger P, Votýpka J, Albrecht T (2010b) Haematological health assessment in a passerine with extremely high proportion of basophils in peripheral blood. *Journal of Ornithology*, **151**, 841–849.
- Virtanen K, Lidell M, Orava J *et al.* (2009) Functional brown adipose tissue in healthy adults. *New England Journal Of Medicine*, **360**, 1518–1525.
- Voillemot M, Hine K, Zahn S *et al.* (2012) Effects of brood size manipulation and common origin on phenotype and telomere length in nestling collared flycatchers. *BMC ecology*, **12**, 17.
- Voituron Y, de Fraipont M, Issartel J, Guillaume O, Clobert J (2011) Extreme lifespan of the human fish (*Proteus anguinus*): a challenge for ageing mechanisms. *Biology Letters*, **7**, 105–107.

W

- Walter I, Seebacher F (2009) Endothermy in birds: underlying molecular mechanisms. *Journal Of Experimental Biology*, **212**, 2328–2336.
- Wang Y, Salmon AB, Harshman LG (2001) A cost of reproduction: oxidative stress susceptibility is associated with increased egg production in *Drosophila melanogaster*. *Experimental Gerontology*, **36**, 1349–1359.
- Watts C, Wheeler K (1978) Protein and lipid components of the pigeon erythrocyte membrane. *Biochemical Journal*, **173**, 899–907.
- Weathers W, Davidson C, Olson C *et al.* (2002) Altitudinal variation in parental energy expenditure by white-crowned sparrows. *Journal Of Experimental Biology*, **205**, 2915–2924.
- Weil M, Jacobson M, Raff M (1998) Are caspases involved in the death of cells with a transcriptionally inactive nucleus? Sperm and chicken erythrocytes. *Journal of cell science*, **111**, 2707–2715.
- Weimerskirch H, Stahl JC, Jouventin P (1992) The breeding biology and population dynamics of king penguins *Aptenodytes patagonica* on the Crozet Islands. *Ibis*, **134**, 107–117.
- Wiersma P, Selman C, Speakman JR, Verhulst S (2004) Birds sacrifice oxidative protection for reproduction. *Proceedings of the Royal Society B: Biological Sciences*, **271**, S360–S363.
- Williams G (1966) Natural selection, the costs of reproduction, and a refinement of Lack's principle. *American Naturalist*, **100**, 687–690.
- Wingfield JC, Lynn S, Soma KK (2001) Avoiding the “costs” of testosterone: ecological bases of hormone-behavior interactions. *Brain, Behavior and Evolution*, **57**, 239–251.
- Wingfield JC, Maney DL, Breuner CW *et al.* (1998) Ecological Bases of Hormone—Behavior Interactions: The “Emergency Life History Stage.” *Integrative and Comparative Biology*, **38**, 191–206.
- Wingfield JC, Williams TD, Visser ME (2008) Introduction. Integration of ecology and endocrinology in avian reproduction: a new synthesis. *Philosophical Transactions of the Royal Society B: Biological Sciences*, **363**, 1581–1588.
- Wolf JB, Wade MJ (2009) What are maternal effects (and what are they not)? *Philosophical Transactions of the Royal Society B: Biological Sciences*, **364**, 1107–1115.
- Wood SN (2006) *Generalized Additive Models: An Introduction with R*. CRC press

Y

Yang W, Hekimi S (2010) A Mitochondrial Superoxide Signal Triggers Increased Longevity in *Caenorhabditis elegans* (HA Tissenbaum, Ed.). *PLoS Biology*, **8**, e1000556.

Yao J, Irwin R, Zhao L *et al.* (2009) Mitochondrial bioenergetic deficit precedes Alzheimer's pathology in female mouse model of Alzheimer's disease. *Proceedings of the National Academy of Sciences*, **106**, 14670–14675.

Yilmaz Y, Ones T, Purnak T *et al.* (2011) Association between the presence of brown adipose tissue and non-alcoholic fatty liver disease in adult humans. *Alimentary Pharmacology & Therapeutics*, **34**, 318–323.

Z

Zang H (1980) The altitudinal influence on the population density and on the breeding biology of *Ficedula hypoleuca*, *Parus palustris*, *P. caeruleus*, *P. major* and *P. ater* in the Harz Mountains. *Journal für Ornithologie*, **121**, 371–386.

Zann RA (1996) The zebra finch: a synthesis of field and laboratory studies. *Oxford: Oxford University Press*.

Zannolli R, Mohn A, Buoni S *et al.* (2008) Telomere length and obesity. *Acta Paediatrica*, **97**, 952–954.

Zentgraf H, Deumling B, Jarasch E, Franke W (1971) Nuclear membranes and plasma membranes from hen erythrocytes. *Journal of Biological Chemistry*, **246**, 2986–2995.

Zera A, Harshman L (2001) The physiology of life history trade-offs in animals. *Annual Review of Ecology and Systematics*, **32**, 95–126.

Zglinicki von T (2002) Oxidative stress shortens telomeres. *Trends in Biochemical Sciences*, **27**, 339–344.

Zhang Z-W, Cheng J, Xu F *et al.* (2011a) Red Blood Cell Extrudes Nucleus and Mitochondria Against Oxidative Stress. *Iubmb Life*, **63**, 560–565.

Zhang ZW, Lv ZH, Li JL *et al.* (2011b) Effects of cold stress on nitric oxide in duodenum of chicks. *Poultry science*, **90**, 1555–1561.

Zhong YC, Luo P, Jin G *et al.* (2011) The dynamic changing profiles of peripheral white blood cell telomere length in populations of different ages living at different altitude areas (Zhong 2008). *Zhonghua Yu Fang Yi Xue Za Zhi*, **42**, 502–505.

Zuur AF, Ieno EN, Walker N, Saveliev AA, Smith GM (2009) Mixed Effects Models and Extensions in Ecology With R. *Springer New York*.

Appendix I - Increased reproductive effort leads to persistent eroded telomeres

Sophie Reichert, **Antoine Stier**, Sandrine Zahn, Mathilde Arrivé, Pierre Bize, Sylvie Massemin[†], François Criscuolo[†]

In revision for Frontiers in Ecology & Evolution



[†] Equal contributors

Abstract

Background

Costs of reproduction can be divided in mandatory costs coming from physiological, metabolic and anatomical changes required to sustain reproduction itself, and in investment-dependent costs that are likely to become apparent when reproductive efforts are exceeding what organisms were prepared to sustain. Interestingly, recent data showed that entering reproduction enhanced breeders' telomere loss, but no data explored so far the impact of reproductive investment. Telomeres protect the ends of eukaryote chromosomes. Shortened telomeres were associated with shorter lifespan, telomere erosion being then proposed to powerfully quantify life's insults.

Results

Here, we experimentally manipulated reproductive effort of adult zebra finches (*Taeniopygia guttata*) below or beyond their (optimal) starting investment and tested the consequences of our treatment on parents' telomere dynamics. We show that an increased workload led to a reduction in telomere lengths in both parents compared to control and to parents raising a reduced brood. This greater telomere erosion in parents forced to work harder than initially planned were detected immediately after the reproductive event and persisted up to one year later. However, we did not detect effects of reproductive effort on annual survival of parents kept under laboratory conditions, and telomere lengths at the end of reproduction were not associated with annual survival.

Conclusions

Altogether, although our findings highlight that fast telomere erosion can come at a cost of increased reproductive investment, they provide mixed correlative support to the emerging hypothesis that telomere erosion could account for the links between high reproductive investment and longevity.

Key-words

Ageing, cost of reproduction, telomere, oxidative stress, bird, zebra finch

Introduction

A central tenet of life history theory is that reproduction can come at a cost of longevity. Accordingly, numerous empirical studies demonstrated that individuals prevented from reproduction live longer than those allowed to reproduce (SMITH 1958; Partridge & Farquhar 1981) and that an increase in parental reproductive effort can ‘precipitate death’ (Daan, Deerenberg & Dijkstra 1996; Santos & Nakagawa 2012). The underlying mechanisms accounting for costs of reproduction on longevity remain however little understood and are the current topic of intense investigations (Harshman & Zera 2007; Speakman 2008; Monaghan, Metcalfe & Torres 2009).

Costs of reproduction can be divided in two complementary components. Firstly, reproduction itself is associated with numerous, mandatory, changes that stem chiefly from changes in sex hormone levels and of their pleiotropic effects on traits as diverse as immunity, metabolism and behaviours (Brown-Borg 2007). Experimental manipulation of sex hormone profiles, for instance using castration in males and progesterone implants in females, are supporting the existence of mandatory costs of engagement in reproduction on longevity (Tavecchia *et al.* 2005; Brown-Borg 2007; Min, Lee & Park 2012). Secondly, once reproduction has started, parents of species that display post-fertilization care to their offspring are expected to optimise their reproductive investment according to their own condition (or quality) and to environmental conditions encountered during reproduction (Stearns 1992; Santos & Nakagawa 2012). This optimization problem is commonly studied in birds by manipulating clutch size or brood size, and in so doing parental effort (Santos & Nakagawa 2012). Accumulating evidence demonstrates that post-fertilization costs of reproduction on longevity are “investment-dependent”, becoming apparent only when reproductive efforts are exceeding what parents were prepared to sustain (Santos & Nakagawa 2012).

Interestingly, although there is little doubt nowadays that reproduction can shorten lifespan through combinations of mandatory and investment-dependent costs (originating on whether one considers reproduction status, i.e. entering or not in reproduction, or levels of reproductive effort, respectively), one emerging hypothesis is that reproduction impacts adult survival and/or longevity through a shared, endpoint, ageing mechanism: telomere erosion (Allsopp *et al.* 1992).

Telomeres are highly conserved non coding repetitive DNA sequences located at the end of linear chromosomes which hide the chromosome ends as being recognised as double stranded breaks (Blackburn 1991). Because of the inability of telomeres to be completely replicated by DNA polymerase, progressive telomere shortening occurs over cell divisions. Once reaching a lower critical size, telomere signalisation pathway induces cell division arrest and/or cell senescence (Harley, Futcher & Greider 1990; Blackburn 1991). Furthermore, the rate at which telomeres are lost is dependent on the balancing of pro- and anti-erosion factors. Oxidative stress comes from the imbalance between the production of reactive oxygen species and the antioxidant capacity (Finkel & Holbrook 2000), and increased investment into reproduction has been demonstrated to increase oxidative stress (Alonso-Alvarez *et al.* 2004). Oxidative stress accelerates telomere loss (Hausmann *et al.* 2011; Blackburn & Epel 2012) while telomerase activity (mainly active in germinal and stem cells) and shelterin protein complex stability favour telomere maintenance (Blackburn 2000; De Lange 2009). Therefore, telomeres are not just cell division counters but their rate of erosion is actually largely modulated by environmental stressors thereby explaining the age-matched individual variability observed in telomere length (Hausmann *et al.* 2003; Hall *et al.* 2004; Monaghan & Hausmann 2006). This telomere ability to “powerfully quantify life’s insults” (Blackburn & Epel 2012) makes them a potential proxy of future individual fitness, which starts now to be confirmed by the accumulation of an increasing number of studies, from humans to birds (Cawthon *et al.* 2003; Hausmann, Winkler & Vleck 2005; Bize *et al.* 2009; Salomons *et al.* 2009; Heidinger *et al.* 2012).

“Engaging in reproduction accelerated telomere shortening” was one the main results of Heidinger *et al.* (2012). However, this effect was not related to the number of reproductive events undertaken during this time period, and reproductive birds did not exhibit shorter telomeres than non-reproducers after two years. This is a rather surprising result in the light of the expected trade-off between reproduction and adult lifespan (see (Kotrschal, Ilmonen & Penn 2007) for a suggested link between reproduction and telomere loss). One important point was that birds were only allowed to lay eggs and not to raise chicks during each reproductive attempt (Heidinger *et al.* 2012), therefore largely reducing reproductive costs due to brooding and chick feeding. Hence, one explanation may be that entering in the reproductive life induces sexual maturation costs, but that subsequent

reproductive efforts are optimised in relation to adult somatic maintenance ability. If this hypothesis is right, finding a correlation between reproduction investment and telomere erosion in non-manipulated breeders, moreover under *ad libitum* feeding conditions will prove to be difficult. Adult reproductive investment and its impact on telomeres has been previously tested in two wild bird species. In the Adélie penguin (*Pygoscelis adeliae*), experimental increased reproductive effort (breeding workload being modulated through an increase of the adult foraging costs) was found to be associated with enhanced antioxidant defences and unchanged telomere length but also survival (Beaulieu *et al.* 2011). Alternatively, observations in the common tern (*Sterna hirundo*) showed that parents providing care to their brood beyond the 10th nestling day experienced greater telomere loss compared to parents that failed in their reproduction (Bauch *et al.* 2013). Thus, evidence of costs of reproduction on telomere dynamics remains scarce and controversial.

To fully understand how telomere erosion is implicated in the trade-off between reproduction and longevity, we need to investigate how the level of reproductive effort during a single breeding event is affecting adult telomere loss and over which time window. To address this question, we experimentally manipulate zebra finches (*Taeniopygia guttata*) reproductive effort by increasing brood size and by determining the short- (end of reproduction) and mid-terms (one year) impact on adult telomere loss. If investment in reproduction is done at the expense of longevity, we expect that pro-ageing markers (oxidative damage and telomere loss) to be increased in adult zebra finches that raised enlarged broods. To assess the effects of reproductive effort on ageing markers, we measured telomere length by relative qPCR, as well as plasmatic oxidative stress with the d-ROMs and the OXY-ADSORBENT tests (Diacron International, Grosseto, Italy). If increased reproductive investment has persistent effects on telomere length (even more under *ad libitum* feeding conditions), this may suggest that telomere loss during an unexpectedly costly breeding attempt would potentially have fitness consequences for the individual. We also tested whether oxidative stress is involved in the potential reproduction - telomere loss relationship. Actually, increased reproductive effort has been previously associated with decreased protection against oxidative stress (Wiersma *et al.* 2004) or with altered cell resistance to an oxidative burst (Alonso-Alvarez *et al.* 2004). Since telomere loss is further exacerbated by exposure to oxidative stress, at least *in vitro* (Von Zglinicki 2002), this is making

oxidative balance a good candidate to mediate the relationship between telomere dynamics and the reproduction-ageing investment trade-offs.

Materials & Methods

General procedures

The study was conducted on captive zebra finches. We experimentally modified breeding effort using a combined partial cross-fostering and brood size manipulation protocol. Twenty-five randomly formed pairs were placed in breeding cages (0.57 x 0.31 x 0.39 m) with food (a commercial mix of seeds for exotic birds enriched with vitamins and eggs) and water *ad libitum*. Nest boxes and straw were provided for breeding. The cages were put in a room with a constant temperature of 24°C ($\pm 1^\circ\text{C}$) and light conditions were 13L : 11 D. The brood size was manipulated in order to create three groups: 9 enlarged pairs, 9 reduced pairs, and 7 control pairs. Mean age in years of the parents was similar for the three groups (enlarged: 2.3 ± 0.8 , reduced: 2.1 ± 0.8 , control: 1.7 ± 0.9 ; total range for the three groups, 1 to 3 years). Chicks from 1 to 3 days old were randomly cross-fostered to form 9 enlarged (2 chicks added, mean clutch size $4.8, \pm 0.75$), 9 reduced (2 chicks removed, 1.8 ± 0.64) and 7 control pairs (number of chicks unchanged, 2.8 ± 0.64). Brood size was constant in each of the treatments during the experiment. Small blood samples (50 μL) were collected from the brachial vein of the parents at the beginning of the reproductive period (when the breeding pairs were formed) and at the end of the reproductive period (when the chicks were 35 days old, which corresponds to the moment when they were separated from the parents). After reproduction, birds were put back on different aviaries in the same room, males and females being separated.

In order to evaluate the long term effects of a manipulated reproductive effort on the breeding adults, we monitored the survival rate and collected a blood sample (50 μL) on the birds that were still alive a year after (10 individuals in the enlarged group, 6 individuals in the control group, 11 individuals in the reduced group) a year after the end of the breeding period. There are fewer individuals in the three experimental groups a year after the experiment because some of them died of undetermined natural causes (mean age of the birds which died: $2.8 \text{ years} \pm 0.5$).

All blood samples were centrifuged (2000g, 10 min at 4°C), and red blood cells and plasma once separated were immediately stored at -80°C until analyses.

Telomere measurements

Telomere length measurements were done before, after reproduction, and a year after the experiment. Telomere length was measured on DNA extracted from red blood cells (stored at – 20°C until analysis), which are nucleated in birds, using DNeasy Blood and Tissue kit (Qiagen). Telomere length was assessed by the quantitative real-time amplification (qPCR) procedure (Cawthon 2002) adapted to birds and described by (Criscuolo *et al.* 2009). Relative telomere length is expressed as the ratio (T/S) of telomere repeat copy number (T) to a control single gene copy number (S). We used glyceraldehyde-3-phosphate dehydrogenase (GAPDH) as a single control gene. Forward and reverse primers for the GAPDH gene were 5'-AACCAGCCAAGTACGATGACAT-3' and 5'-CCATCAGCAGCAGCCTTCA-3' respectively. Telomere primers were: Tel1b (5'-CGTTTTGTTTGGGTTTGGGTTTGGGTTTGGGTTTGGGTT-3') and Tel2b (5'-GGCTTGCCTTACCCTTACCCTTACCCTTACCCTTACCCT-3'). qPCR for both telomere and GAPDH were performed using 5 ng of DNA with sets of primers Tel1b/Tel2b (or GAPDH-F/GAPDH-R), each used at a concentration of 200 nM/200 nM, in a final volume of 10 µl containing 5 µl of Power SYBR Green PCR Master Mix (Applied biosystems). Telomere and GAPDH real time amplification were performed on two different plates. qPCR conditions for telomeres were 10 min at 95°C followed by 30 cycles of 1 min at 56°C and 1 min at 95°C. PCR conditions for the GAPDH were 10 min at 95°C followed by 40 cycles of 1 min at 60°C and 1 min at 95°C. Each plate (telomere and GAPDH) included serial dilutions (10 ng, 5 ng, 2.5 ng, 1.25 ng) of DNA of the same reference bird. This was used to generate a reference curve to control for the amplifying efficiency of the qPCR (efficiencies for GAPDH and telomere plates were between 95 % and 105 %). Samples were run in duplicate on each plate. Samples were run on a total of 4 plates. To take into account the slight variation of efficiencies between telomere and GAPDH amplifications, we calculate relative telomere length using the method suggested by (Pfaffl 2001). The mean values were used to calculate the relative T/S ratios using the formula: $((1 + E_{\text{telomere}})^{\Delta Ct_{\text{telomere}}(\text{control} - \text{sample})} / (1 + E_{\text{GAPDH}})^{\Delta Ct_{\text{GAPDH}}(\text{control} - \text{sample})})$.

Mean intra-plate coefficient of variation was 1.1% for the Ct values of the GAPDH assays and 3.0% for the Ct values of the telomere assays, and inter-plate coefficient of variation was calculated on four samples repeated on the different plates and was of 1.6% for the Ct values the GAPDH assays, 2.9% for the Ct values of the telomere assays and 8.5 % for the relative T/S ratios.

Oxidative stress measurements

Oxidative stress measurements were done before, after reproduction, and a year after the experiment. We investigated oxidative stress in plasma samples (stored at – 20°C until analysis), with the d-ROMs and the OXY-ADSORBENT tests (Diacron International, Grosseto, Italy) as previously described in birds (Costantini, Cardinale & Carere 2007; Costantini, Dell'Araccia & Lipp 2008; Beaulieu *et al.* 2010; Beaulieu *et al.* 2011) and mammals (Stier *et al.* 2012). The OXY-ADSORBENT test measures the total antioxidant capacity of the plasma using a colorimetric determination to quantify the ability of the antioxidant barrier to cope with the oxidant action of hypochlorous acid (HOCl). This assay measures non-enzymatic antioxidants only, which are mostly derived from diet (see (Sies 2007) for a discussion of limitations of the TAC assay). Measurements are expressed as mmol-1 HOCl neutralised. For the OXY-ADSORBENT assay mean intra-plate coefficient of variation was of 2.2% and mean inter-plate coefficient of variation was of 7%. The d-ROMs test measures the early exposure to oxidative stress by evaluating the concentration of hydroperoxide (ROOH) which is a reactive oxygen metabolite (ROM) resulting from the attack of ROS on macromolecules (lipids, protein, DNA). The concentration of hydroperoxyde was then calculated by comparison with a standard solution whose oxidative activity on the chromogen is equivalent to the activity of H₂O₂ (0.08 mg dl⁻¹). Measurements were expressed as mg dl⁻¹ H₂O₂ equivalents. Mean intra-plate coefficient of variation was of 1.3% and mean inter-plate coefficient of variation was of 2%. Procedures for both tests were performed according to manufacturer instructions.

We also investigated DNA oxidative damage through measurements of 8-hydroxy-2-deoxy Guanosine (8-OHdG), using the 8-OHdG EIA kit (StressMarq Biosciences Inc., Victoria, BC Canada). 8-OHdG is the by-product of oxidative damage on DNA due to reactive oxygen species (ROS) and increased levels of this marker have been associated with the ageing

process (Shen et al. 2007 - Cancer). DNA was first extracted from blood cells with (DNeasy Blood and Tissue kit Qiagen) and then genomic DNA was totally digested following the instructions described in Quinlivan (2008). DNA damage measurements are expressed in pg/mL. Mean coefficient of variation was of 12%.

Statistical analysis

All statistical analyses were performed using SPSS v. 18.0. Generalized linear mixed models (GLMM) with sex and breeding effort as fixed factors and individual identity as a random factor were used to analyse body mass, telomere length, antioxidant levels, and oxidative damage levels before the reproductive period, and show no significant differences between treatments or sex (all P-values > 0.1).

Short and long term effects of brood manipulation on body mass, telomere length and oxidative stress

Body mass, telomere length, antioxidant levels, and oxidative damage levels (plasmatic and DNA) were measured at the three different periods (before, at the end, and a year after the breeding period). To compare the short and long term effects of breeding effort on telomere length, we used GLMMs with time period (beginning, end, a year after the reproductive period) as a repeated variable, individual identity as a random factor, and sex, breeding effort, as well as the interaction between the breeding effort and the time period as factors in the model. For telomere length analysis, oxidative damage levels (plasmatic and DNA), antioxidant levels and body mass were added as covariates. For plasmatic and DNA oxidative damage levels analysis, antioxidant levels and body mass were added as covariates. For antioxidant levels analysis, body mass was added as a covariate. To identify differences between the breeding groups and the time periods we used LSD post-hoc tests.

Effects on survival

We used a binomial GLMM to analyse survival a year after the breeding period where the experimental group, the sex, the age and telomere length at the end of the breeding period were entered as explanatory variables.

Results

Short and long term effects of brood manipulation on body mass, telomere length and oxidative stress

There was no effect of brood size manipulation, nor of the interaction between brood size manipulation and the time period on adult body mass (Table 1, $p=0.652$ and $p=0.122$).

Variables	Statistical models			
Body mass	<i>Random effect</i>	<i>Var comp</i>	<i>SE</i>	
	Individual	5,398	1,246	
	<i>Fixed effects</i>	<i>D.F</i>	<i>F</i>	<i>P</i>
	Reproductive status	2	0,431	0,652
	Sex	1	2,101	0,154
	Time	2	6,860	0,002
	Reproductive status*Time	4	1,889	0,122
Telomere length	<i>Random effect</i>	<i>Var comp</i>	<i>SE</i>	
	Individual	0,096	0,031	
	<i>Fixed effects</i>	<i>D.F</i>	<i>F</i>	<i>P</i>
	Reproductive status	2	2,956	0,062
	Sex	1	1,853	0,180
	Time	2	16,662	0,000
	Reproductive status*Time	4	5,520	0,001
	Plasmatic oxidative damage levels	1	0,019	0,889
	DNA oxidative damage levels	1	0,075	0,785
	Antioxidant levels	1	1,542	0,219
Body mass	1	0,963	0,330	
Plasmatic oxidative damage levels	<i>Random effect</i>	<i>Var comp</i>	<i>SE</i>	
	Individual	186,200	696,537	

		<i>D.F</i>	<i>F</i>	<i>P</i>
<i>Fixed effects</i>				
	Reproductive status	2	0,722	0,494
	Sex	1	12,162	0,001
	Time	2	10,230	0,000
	Reproductive status*Time	4	0,172	0,952
	Sex*Time	2	7,761	0,001
	Antioxidant levels	1	0,607	0,438
	Body mass	1	1,267	0,269
DNA				
oxidative damage levels	<i>Random effect</i>	<i>Var comp</i>	<i>SE</i>	
	Individual	0,000	0,000	
<i>Fixed effects</i>		<i>D.F</i>	<i>F</i>	<i>P</i>
	Reproductive status	2	1,466	0,236
	Sex	1	0,311	0,578
	Time	2	1,125	0,329
	Reproductive status*Time	4	0,394	0,812
	Sex*Time	2	0,621	0,540
	Antioxidant levels	1	0,033	0,857
	Body mass	1	4,138	0,045
Antioxidant levels				
	<i>Random effect</i>	<i>Var comp</i>	<i>SE</i>	
	Individual	0,000	0,000	
<i>Fixed effects</i>		<i>D.F</i>	<i>F</i>	<i>P</i>
	Reproductive status	2	1,106	0,334
	Sex	1	0,737	0,393
	Time	2	11,974	0,000
	Reproductive status*Time	4	0,947	0,440
	Body mass	1	0,290	0,591

Table 1: Results of linear mixed model on body mass, telomere length, oxidative damage levels (plasmatic measured as mg dl-1 H2O2 equivalents and DNA measured as 8-OHdG pg/ml), and antioxidant levels (measured as mmol-1 HOCl neutralised).

However, the time period affected body mass (Table 1 and 2A, $p=0.002$), individuals being lighter during the breeding event compared to a year after the experiment (LSD post hoc comparisons, respectively $p=0.008$ and $p<0.001$).

The effect of brood manipulation had strong consequences on nestling development. Nestlings from enlarged broods stayed longer in the nest compared to those from control and reduced broods (mean age in days at fledging: enlarged broods: 21.3 ± 0.4 , reduced broods: 17.0 ± 0.6 , control broods: 18.4 ± 0.7 ; LSD post hoc comparisons after a general linear model, $p=0.001$ and $p=0.000$ respectively). At the end of the growth period (35 days), nestlings from enlarged broods were lighter than those from control and reduced broods (mean body mass in grams: enlarged broods: 12.1 ± 0.3 , reduced broods: 13.6 ± 0.5 , control broods: 13.8 ± 0.6 ; LSD post hoc comparisons after a general linear model, $p=0.013$ and $p=0.015$ respectively).

Reproductive effort had short and long term effects on telomere length (Table 1 and 2B). Brood manipulation, the time period (i.e. before vs. at the end vs. a year after the breeding event), as well as the interaction between brood manipulation and the time period had significant effects on telomere lengths and telomere loss (Table 1 and 2B). Parents forced to raise two additional chicks had reduced telomere lengths at the end of the reproductive period compared to parents raising a control brood or a reduced brood (LSD post hoc comparisons, $p=0.002$ and $p<0.001$, Fig 1).

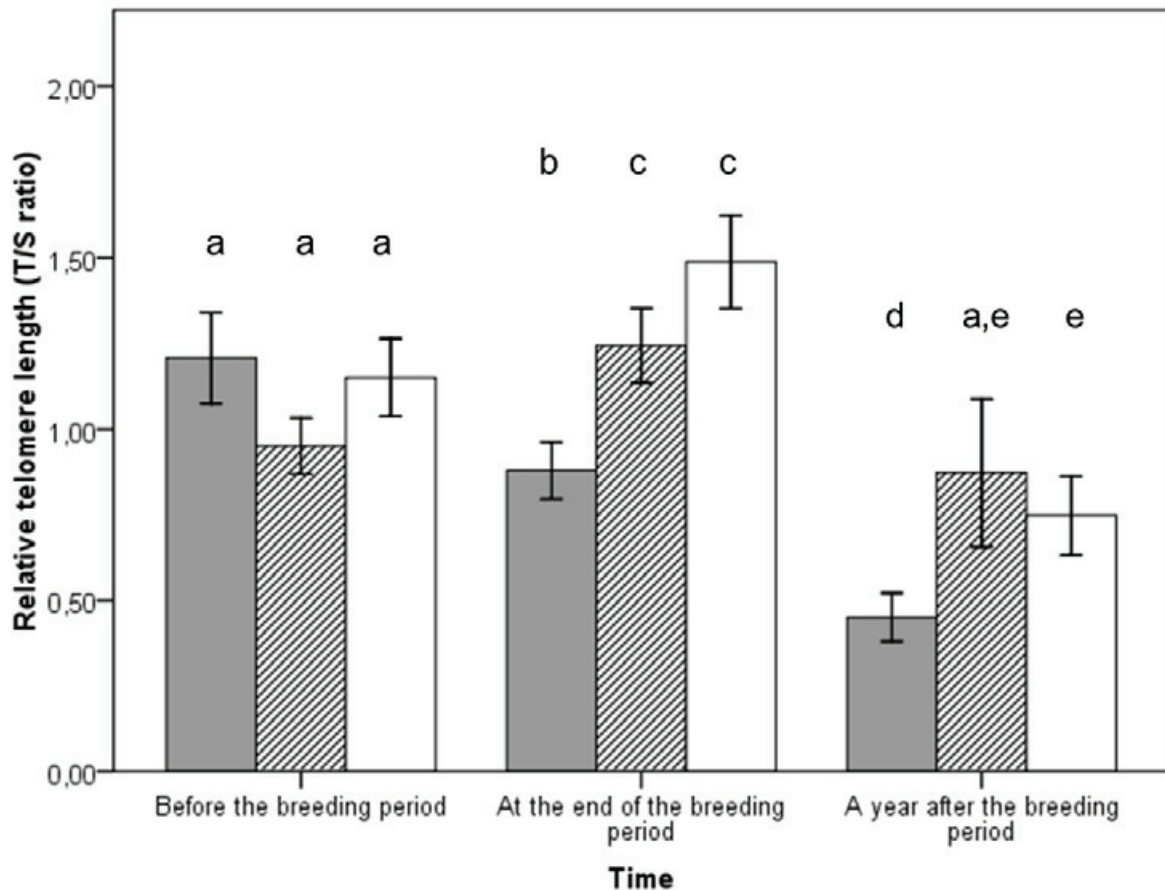

Figure 1: *Telomere lengths for both parents in the three different reproductive statuses at different time periods: before the breeding event (enhanced group n=18, control group n=18, reduced group n=14), at the end of the breeding event (enhanced group n=18, control group n=18, reduced group n=14), a year after the breeding event (enhanced group n=10, control group n=6, reduced group n=11). Bars represent \pm SE. Enhanced in grey, control in hatched, reduced in white.*

There was no significant difference of telomere length between the control and the reduced group (LSD post hoc comparisons, $p=0.184$). The same pattern was observed a year after the experiment. Parents subjected to increased brood size were the ones that suffered the most in terms of telomere loss. Indeed, the detrimental effect of brood enlargement on telomere length was amplified with time and the enlarged group displayed the shortest telomeres a year after compared to the control and reduced groups (LSD post hoc comparisons, $p=0.040$ and $p=0.017$ respectively, Fig 1). Conversely, a year after, parents from the control and reduced groups displayed similar telomere lengths (LSD post hoc comparisons, $p=0.601$, Fig 1). There was no relationship between telomere length and

plasmatic antioxidant levels (OXY; $p=0.219$) or exposure to oxidative stress (d-ROM; $p=0.889$, nor was there any link between telomere length and DNA oxidative damage (8-oxo-dG; $p=0.785$) or between telomere length and body mass ($p=0.330$) (Table 1).

All groups exhibited similar plasmatic and DNA oxidative stress levels (d-ROM: $p=0.494$; 8-oxo-dG: $p=0.236$) (Table 1). However, the time period (i.e. before vs. at the end vs. a year after the breeding event), sex, as well as the interaction between sex and the time period had significant effects on plasmatic oxidative stress (Table 1 and 2C). Indeed, at the end of the breeding period and a year after the experiment, females exhibited higher plasmatic levels of oxidative stress than males (LSD post hoc comparisons, respectively $p<0.001$ and $p=0.033$) (Table 1) (Fig 2).

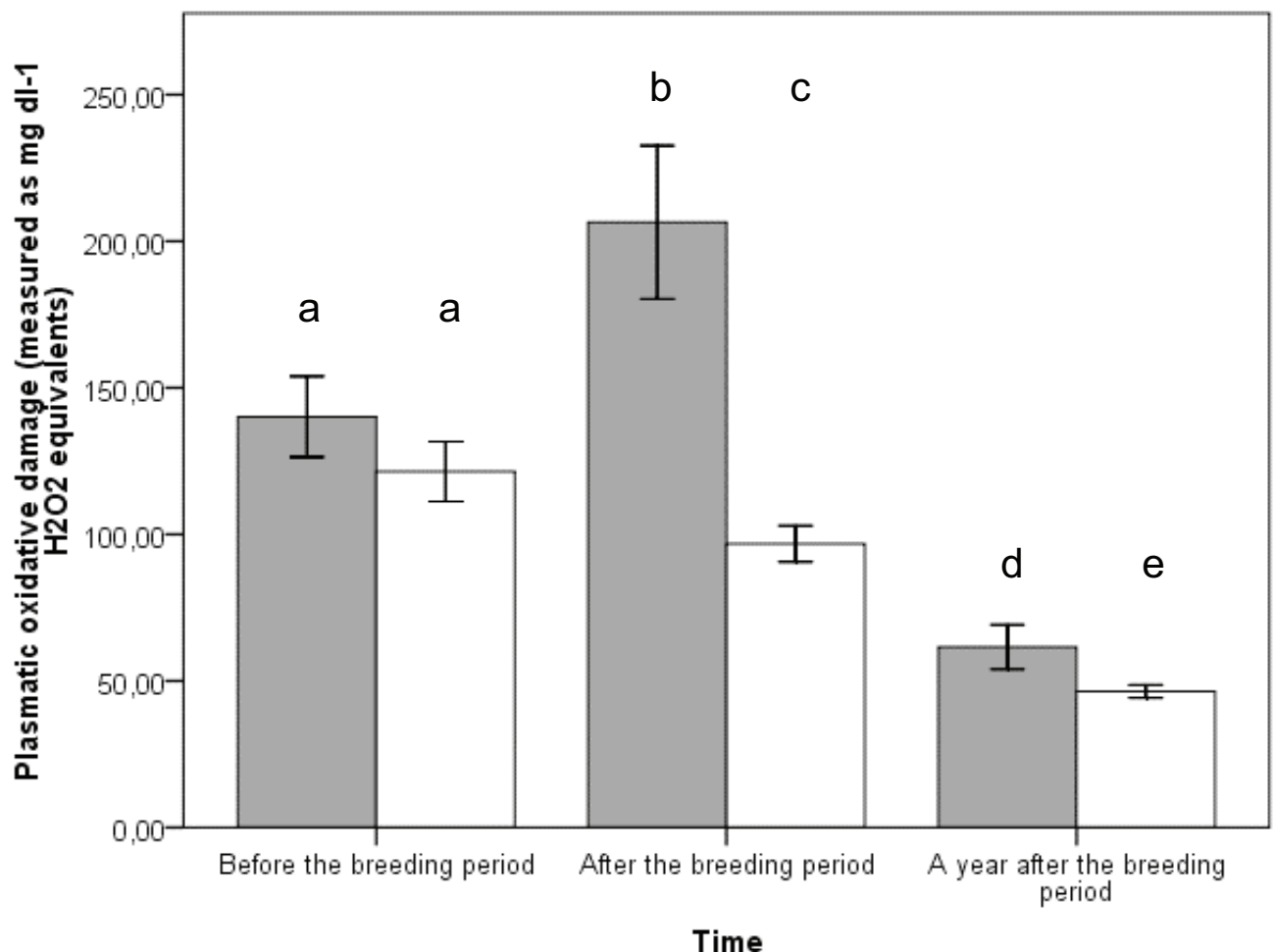

Figure 2: *Plasmatic oxidative stress at different time periods: before the breeding event (females $n=25$, males $n=25$), at the end of the breeding (females $n=25$, males $n=25$), a year after the breeding event (females $n=10$, males $n=17$). Bars represent \pm SE. Females in grey and males in white.*

All groups exhibited similar plasmatic antioxidant levels ($p=0.334$) (Table 1). Nonetheless, individuals exhibited higher antioxidant levels a year after the experiment compared to the breeding period (Table 1 and 2D, time effect $p<0.001$, LSD post hoc comparisons both $p<0.001$) (Fig 3).

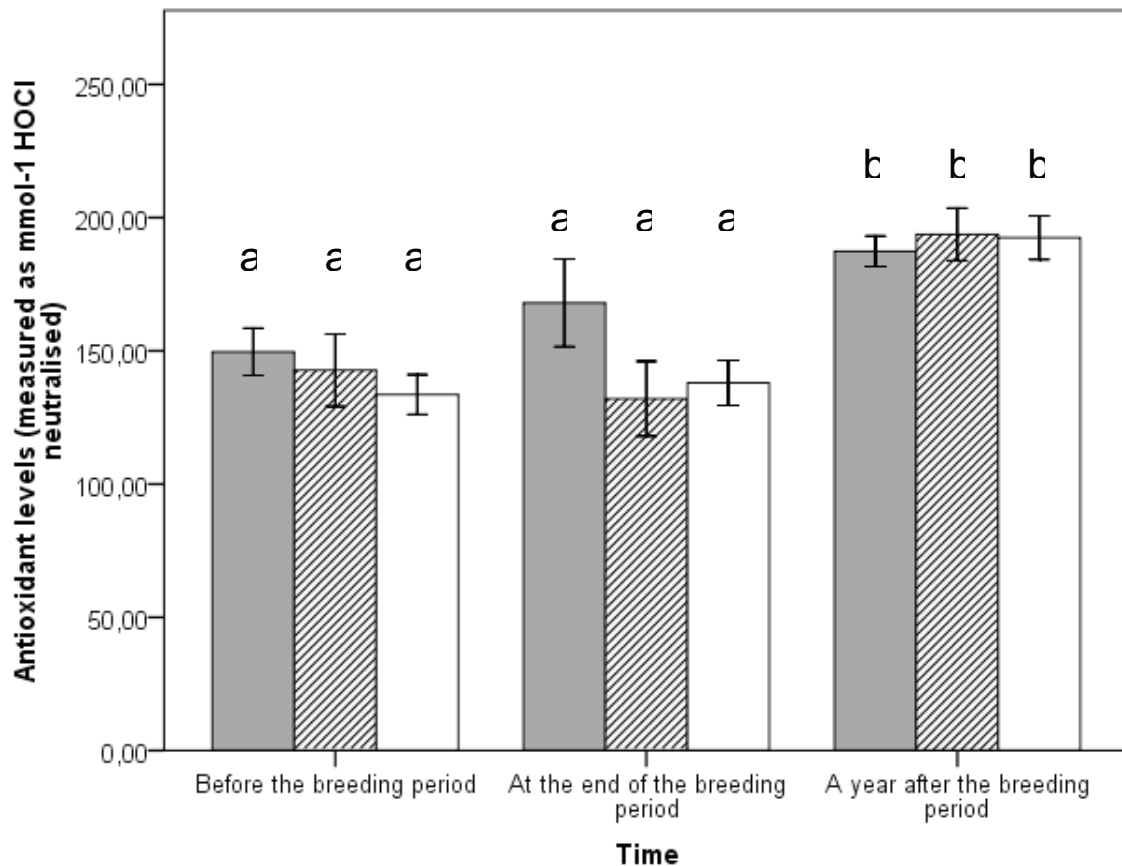

Figure 3: *Plasmatic antioxidant levels for both parents in the three different reproductive statuses at different time periods: before the breeding event (enhanced group $n=18$, control group $n=18$, reduced group $n=14$), at the end of the breeding event (enhanced group $n=18$, control group $n=18$, reduced group $n=14$), a year after the breeding event (enhanced group $n=10$, control group $n=6$, reduced group $n=11$). Bars represent \pm SE. Enhanced in grey, control in hatched, reduced in white.*

	Before the breeding period			After the breeding period			A year after the breeding period		
	Enhanced (n=18)	Control (n=18)	Reduced (n=14)	Enhanced (n=18)	Control (n=18)	Reduced (n=14)	Enhanced (n=10)	Control (n=6)	Reduced (n=11)
Body mass	15,40 (2,40)	16,74 (2,43)	15,30 (2,40)	15,12 (2,40)	15,84 (2,43)	15,57 (2,40)	16,23 (2,42)	16,61 (2,47)	17,17 (2,42)

Table 2A: Mean body mass values (SE) before, after and a year after the breeding period for the three experimental groups (enlarged pairs, reduced pairs, and control pairs).

	Before the breeding period			After the breeding period			A year after the breeding period		
	Enhanced (n=18)	Control (n=18)	Reduced (n=14)	Enhanced (n=18)	Control (n=18)	Reduced (n=14)	Enhanced (n=10)	Control (n=6)	Reduced (n=11)
Telomere length	1,15 (0,33)	1,00 (0,33)	1,11 (0,33)	0,86 (0,33)	1,27 (0,33)	1,50 (0,33)	0,43 (0,34)	0,79 (0,35)	0,74 (0,33)

Table 2B: Mean telomere length values (SE) before, after and a year after the breeding period for the three experimental groups (enlarged pairs, reduced pairs, and control pairs).

	Before the breeding period		After the breeding period		A year after the breeding period	
	Females (n=25)	Males (n=25)	Females (n=25)	Males (n=25)	Females (n=10)	Males (n=17)
Plasmatic oxidative damage levels	125,79 (20,18)	117,23 (19,91)	204,73 (19,59)	91,54 (19,60)	75,87 (27,48)	50,26 (22,67)

Table 2C: Mean plasmatic oxidative stress values (SE) before, after and a year after the breeding period for females and males.

	Before the breeding period			After the breeding period			A year after the breeding period		
	Enhanced (n=18)	Control (n=18)	Reduced (n=14)	Enhanced (n=18)	Control (n=18)	Reduced (n=14)	Enhanced (n=10)	Control (n=6)	Reduced (n=11)
Antioxidant levels	149,43 (11,17)	142,92 (12,47)	133,16 (10,21)	167,40 (10,23)	132,34 (11,98)	137,80 (10,18)	188,66 (13,74)	195,10 (17,81)	195,07 (13,34)

Table 2D: Mean plasmatic antioxidant values (SE) before, after and a year after the breeding period for the three experimental groups (enlarged pairs, reduced pairs, and control pairs).

Effects on survival

Survival rate a year after was the same in all experimental groups (Table 3, $p=0.222$), but females had lower survival rates a year after than males (Table 3, $p=0.048$). Telomere length after the breeding period was not predictive of survival a year after (Table 3, $p=0.591$).

Variable		D.F	Khi2	P
Survival	<i>Effects</i>			
	Reproductive status	2	3,007	,222
	Sex	1	3,922	,048
	Age	2	4,305	,116
	Telomere length (end of the breeding period)	1	,289	,591

Table 3: Results of the binomial GLMM on survival a year after the breeding event with the experimental group, the sex, the age and telomere length at the end of the breeding period were entered as explanatory variables.

Discussion

Daan, Deerenberg and Dijkstra (1996) were the first to uncover that increased parental effort can have persistent effect on adult future fitness, even when feeding conditions were not restricted, therefore suggesting non-energetic trade-offs. In direct line with this suggestion, our study shows that a single costly reproductive event shortens adult telomeres in a way that telomeres are not restored one year after despite the fact that, in between, birds were maintained as non-breeders under optimal environmental and feeding conditions.

Did the experimental treatment increase adult investment in reproduction?

One result gave support to the idea that our experimental treatment has effectively increased parental investment in chick care for parents caring for enlarged broods. Nestlings from the enlarged broods were lighter and as they fledged later, and thus their period of dependency on the parents was longer than for the control and the reduced group. These results are similar to what was found by Daan, Deerenberg and Dijkstra (1996) showing that brood size manipulation affects current reproduction. However, contrary to previous studies (Daan, Deerenberg and Dijkstra 1996; Alonso-Alvarez *et al.* 2004; Wiersma *et al.* 2004), increased reproductive effort did not induce a cost in terms of adult body mass loss in our study. These results indicate that in the case of the enlarged broods, parents might not have

been able to go beyond their physiological limits to care for their young. Indeed, parent and offspring are expected to disagree over how long the period of parental investment should last and over the amount of parental investment that should be given (Trivers, 1974; Stearns, 1992). Therefore, parents from the enlarged group might have invested less in their young to compensate the costs of increased reproductive effort in order to preserve their body maintenance, at least in terms of body mass.

Moreover, breeding effort induced short and mid term rise in oxidative stress, as previously described (Alonso-Alvarez *et al.* 2004), but only in females and independently of the experimental treatment in our case. To confirm this result, we checked the effect of the experimental treatment on a DNA oxidative damage marker. As for plasmatic markers of oxidative stress, the level of reproductive effort had neither short nor mid terms repercussions on DNA oxidative damage. Despite the rise in antioxidant levels a year after the experiment, females still displayed higher plasmatic levels of oxidative stress, suggesting that females may pay a higher and long term cost in terms of oxidative stress compared to males.

Therefore, our experimental design probably led to an increased reproductive effort (chick data) but with none of the adverse effects previously described on adults (Alonso-Alvarez *et al.* 2004; Wiersma *et al.* 2004). This lack of impact of our clutch size manipulation may be attributed to the bleeding timing. The second blood sample and body mass measurements were taken when the chicks were independent (i.e. around 35 days). No blood sample was taken during reproduction in order to avoid disturbing parents' blood volume during their reproduction and to avoid potential chick abandonment. At the time of the second blood sample, the offspring were probably feeding alone since the age of 20 days, enabling the parents to partially recover from any previous deleterious effect of high investment. In the two studies cited above, the second blood sampling was done at 20 and 14 days, when the work load for the parents is likely to be at its highest level. Still, we followed oxidative stress levels in the same individuals before and after the entire reproductive event, as well as a year after the breeding event, which proved to be a powerful design to detect changes in oxidative balance during reproduction (Alonso-Alvarez *et al.* 2004; Stier *et al.* 2012). This enabled us to show that females still displayed higher plasmatic levels of oxidative stress than males when their chicks were 35 days old and that even though the level of plasmatic oxidative stress decreased a year after, it was still higher

in females. In zebra finches, parental care is performed by both sexes; however, females take a greater part of the burden than males (Zann 1996), which could explain the sex differences in oxidative stress we observed. Consequently, this exposure to oxidative stress could be the cause of the lower survival rates that females exhibit a year after the reproductive event (see below).

Reproductive investment and telomere loss

Our study also suggests short- and mid-term effects of reproductive effort on telomere length. Parents engaged in increased breeding effort displayed shorter telomeres both at the end of the reproductive event (35 days) and one year after reproduction.

Surprisingly, we were unable to clearly establish a link between high levels of plasmatic oxidative stress or of DNA oxidative damage and a higher rate of telomere shortening. Firstly, even though females of all groups displayed immediate higher plasmatic oxidative stress, their telomere loss was not exacerbated and we did not find any correlation between telomere loss and oxidative stress at the end of the reproductive event or a year after the reproductive event. In addition, if we focus particularly on females of the enlarged group, the acceleration of telomere erosion concomitant to the increased reproductive work load might not be attributed solely to a deleterious impact of a higher oxidative stress, since this was not the case for females of the other groups despite comparable high levels of oxidative damage. These findings support the idea that the link between oxidative stress and telomere erosion is unsettled at present *in vivo* (Chen *et al.* 2001). However, beside the fact that we may have failed to detect an oxidative unbalance in adults caring for enlarged broods (see above), the lack of apparent relationship between oxidative stress and telomere loss may also be explained by other factors. Telomere loss results not only from the deleterious effect of oxidant attacks on DNA, but is balanced by repairing systems such as telomerase activity (Greider & Blackburn 1985). In fact, our higher telomere loss in “enlarged breeders” may rather reflect the inability of birds, which were forced to invest more into reproduction, to insure adequate telomere maintenance. This may be mediated by a reduced telomerase activity in red blood stem cells (Greider & Blackburn 1985), but other regulatory telomere length pathways may also be implicated such as telomere recombination (Dunham *et al.* 2000) or, more importantly, pattern of expression of protecting shelterin proteins (De Lange

2005). However, more experimental work is needed to understand accurately how telomere maintenance mechanisms might be involved into reproductive costs.

The stimulating action of oestrogen, a primary female sex hormone, on telomerase activity (Calado *et al.* 2009) may explain this absence of link between oxidative stress and telomere loss in females by a direct compensatory action on telomere length recovery. However, because there is rarely a sex-biased difference in telomere length in birds (Barrett & Richardson 2011) and because oestrogen also have a suppressing effect on oxidative stress (Razmara *et al.* 2007), the exact role of sex hormones in the modulation of cost of reproduction needs further consideration.

Another noteworthy point is that the effects of breeding effort found on telomeres at the end of the reproductive period persist a year after the experiment. Indeed, parents subjected to increased breeding constraints had the shortest telomeres even a year after the costly breeding effort. These results enrich the recent finding of long-term telomere changes over the entire reproductive life of zebra finches, showing erosion of telomeres takes place independently of the number of reproductive events (Heidinger *et al.* 2012). This latter study actually suggested that entering the reproductive life is associated to a reduction of telomere length, as a consequence of the triggering of processes leading to sexual maturity. It will be interesting to test in future experiment the impact of the progressive rise in sexual steroids on telomere dynamics. However, in Heidinger *et al.* (2012) study, the breeding pairs were only allowed to produce and incubate the eggs, and not to raise any chick. Therefore, we think that both components of the reproductive costs (reproductive maturity and investment) are modulating adult telomere loss, and that chick brooding and feeding activities may have an important impact on adult cell senescence pathways (Bauch *et al.* 2013).

After the breeding attempt, parents of the control and the reduced groups did not incur any cost in terms of telomere loss. In fact, telomere length increased slightly. This result indicates that in optimal conditions individuals probably adjust their reproductive effort in order to avoid any cost such as accelerated ageing rate, potentially through activation of telomere maintenance mechanisms such as telomerase. This is supported by Hausmann study (2007) which showed that telomerase activity is maintained throughout

lifespan in different somatic tissues (including bone marrow) in birds. Therefore telomerase activity in the hematopoietic cells of the bone marrow (Broccoli *et al.* 1995) might have maintained telomere length in the control and the reduced groups. In addition, when parents see their initial investment reduced (as it is the case in the reduced group), there is no apparent positive impact on telomere loss, reinforcing the idea of a fine tuned parental effort related to individual physiological state.

Our data suggest that the level of the total reproductive effort that the parents put in during a single breeding event can have short and long terms effects on telomere dynamics. This is likely to have different implications at the fitness level, particularly if those results apply in natural conditions (see Daan, Deerenberg and Dijkstra (1996) for correlative support in the wild). Several studies indicate that telomere length being a good predictor of survival and lifespan in wild species (Hausmann, Winkler & Vleck 2005; Bize *et al.* 2009; Salomons *et al.* 2009; Heidinger *et al.* 2012), short telomeres after a costly breeding event might compromise future survival. In this context, telomere dynamics could still be a good candidate to explain the mechanistic link between reproduction and survival, but we still lack a definitive demonstration of this ultimate consequence. In fact, as it was the case in the study of (Heidinger *et al.* 2012), we found that the level of breeding effort did not influence survival even for the parents that had the shortest telomeres. A possible explanation for that would be that the study was conducted in captivity and in *ad libitum* feeding conditions, thus creating favourable conditions which might have preserved individuals. Moreover, following survival rate of adult zebra finches over a year is probably not long enough to conclude. However, an interesting observation was the relationship between female higher oxidative damage and lower survival rates one year later, suggesting more rapid fitness consequences of an acute unexpected oxidative disorder. Such an observation between oxidative stress and annual survival rate were previously observed in free-living barn swallows (*Hirundo rustica*) (Saino *et al.* 2011) and male alpine swifts (*Apus melba*; (Bize *et al.* 2008), suggesting as well an important role of this process in immediate individual fitness.

Conclusions

In conclusion, our study extends our understanding of the proximate mechanisms involved in the cost of reproduction. It highlights that increased reproductive effort can come at a cost of reproduction via long term eroded telomeres. In the future, particular attention should be given to experimental brood manipulation and their repercussions on telomere maintenance mechanisms in order to understand how they may be involved into reproductive costs and if they may mediate the effects of reproductive investment on telomere dynamics.

Finally, as telomeres have previously been associated to lifespan, our study suggests that telomere dynamics might be one of the proximate mechanistic link underlying the trade-off between reproduction and longevity, a hypothesis that needs to be tested on the long-term in zebra finches.

Acknowledgments

We thank Dr Etienne Challet, Dr Stéphane Blanc and AM Thierry for helpful discussions on the manuscript. This work was supported by the CNRS and the Conseil Régional of Alsace. The study complied with the 'Principles of Animal Care' publication no.86-23, revised 1985 of the National Institute of Health, and with current legislation (L87-848) on animal experimentation in France. This work was entirely supported by a CNRS funding and a PhD grant from the Region Alsace. We thank Hranitsky Aurélie for her help with the bird husbandry.

Authors' contribution

Conception and design of the experiment was done by SR, SM, FC and PB. Data was acquired by SR, SM, FC, AS and SZ while analysis and interpretation of the data was done by SR, SM, FC, PB and AS.

References

- Allsopp, R.C., Vaziri, H., Patterson, C., Goldstein, S., Younglai, E.V., Futcher, A.B., Greider, C.W. & Harley, C.B. (1992) Telomere length predicts replicative capacity of human fibroblasts. *Proceedings of the National Academy of Sciences of the United States of America*, **89**, 10114-10118.
- Alonso-Alvarez, C., Bertrand, S., Devevey, G., Prost, J., Faivre, B. & Sorci, G. (2004) Increased susceptibility to oxidative stress as a proximate cost of reproduction. *Ecology Letters*, **7**, 363-368.
- Barrett, E.L.B. & Richardson, D.S. (2011) Sex differences in telomeres and lifespan. *Aging Cell*, **10**, 913-921.
- Beaulieu, M., Reichert, S., Le Maho, Y., Ancel, A. & Criscuolo, F. (2011) Oxidative status and telomere length in a long-lived bird facing a costly reproductive event. *Functional Ecology*, **25**, 577-585.
- Beaulieu, M., Ropert-Coudert, Y., Le Maho, Y., Ancel, A. & Criscuolo, F. (2010) Foraging in an oxidative environment: Relationship between $\delta^{13}\text{C}$ values and oxidative status in Adélie penguins. *Proceedings of the Royal Society B: Biological Sciences*, **277**, 1087-1092.
- Bize, P., Criscuolo, F., Metcalfe, N.B., Nasir, L. & Monaghan, P. (2009) Telomere dynamics rather than age predict life expectancy in the wild. *Proceedings of the Royal Society B: Biological Sciences*, **276**, 1679-1683.
- Bize, P., Devevey, G., Monaghan, P., Doligez, B. & Christie, P. (2008) Fecundity and survival in relation to resistance to oxidative stress in a free-living bird. *Ecology*, **89**, 2584-2593.
- Blackburn, E.H. (1991) Structure and function of telomeres. *Nature*, **350**, 569-573.
- Blackburn, E.H. (2000) Telomere states and cell fates. *Nature*, **408**, 53-56.
- Blackburn, E.H. & Epel, E.S. (2012) Too toxic to ignore. *Nature*, **490**, 169-171.
- Brown-Borg, H.M. (2007) Hormonal regulation of longevity in mammals. *Ageing Research Reviews*, **6**, 28-45.
- Calado, R.T., Yewdell, W.T., Wilkerson, K.L., Regal, J.A., Kajigaya, S., Stratakis, C.A. & Young, N.S. (2009) Sex hormones, acting on the TERT gene, increase telomerase activity in human primary hematopoietic cells. *Blood*, **114**, 2236-2243.
- Cawthon, R., Smith, K., O'Brien, E., Sivatchenko, A. & Kerber, R. (2003) Association between telomere length in blood and mortality in people aged 60 years or older. *The Lancet*, **361**, 393-395.
- Cawthon, R.M. (2002) Telomere measurement by quantitative PCR. *Nucleic Acids Research*, **30**.
- Chen, Q.M., Prowse, K.R., Tu, V.C., Purdom, S. & Linskens, M.H.K. (2001) Uncoupling the Senescent Phenotype from Telomere Shortening in Hydrogen Peroxide-Treated Fibroblasts. *Experimental Cell Research*, **265**, 294-303.

- Costantini, D., Cardinale, M. & Carere, C. (2007) Oxidative damage and anti-oxidant capacity in two migratory bird species at a stop-over site. *Comparative Biochemistry and Physiology - C Toxicology and Pharmacology*, **144**, 363-371.
- Costantini, D., Dell'Araccia, G. & Lipp, H.P. (2008) Long flights and age affect oxidative status of homing pigeons (*Columba livia*). *Journal of Experimental Biology*, **211**, 377-381.
- Criscuolo, F., Bize, P., Nasir, L., Metcalfe, N.B., Foote, C.G., Griffiths, K., Gault, E.A. & Monaghan, P. (2009) Real-time quantitative PCR assay for measurement of avian telomeres. *Journal of Avian Biology*, **40**, 342-347.
- Daan, S., Deerenberg, C. & Dijkstra, C. (1996) Increased daily work precipitates natural death in the kestrel. *Journal of Animal Ecology*, **65**, 539-544.
- De Lange, T. (2005) Shelterin: The protein complex that shapes and safeguards human telomeres. *Genes and Development*, **19**, 2100-2110.
- De Lange, T. (2009) How telomeres solve the end-protection problem. *Science*, **326**, 948-952.
- Dunham, M.A., Neumann, A.A., Fasching, C.L. & Reddel, R.R. (2000) Telomere maintenance by recombination in human cells. *Nature Genetics*, **26**, 447-450.
- Finkel, T. & Holbrook, N.J. (2000) Oxidants, oxidative stress and the biology of ageing. *Nature*, **408**, 239-247.
- Greider, C.W. & Blackburn, E.H. (1985) Identification of a specific telomere terminal transferase activity in tetrahymena extracts. *Cell*, **43**, 405-413.
- Hall, M.E., Nasir, L., Daunt, F., Gault, E.A., Croxall, J.P., Wanless, S. & Monaghan, P. (2004) Telomere loss in relation to age and early environment in long-lived birds. *Proceedings of the Royal Society B: Biological Sciences*, **271**, 1571-1576.
- Harley, C.B., Futcher, A.B. & Greider, C.W. (1990) Telomeres shorten during ageing of human fibroblasts. *Nature*, **345**, 458-460.
- Harshman, L.G. & Zera, A.J. (2007) The cost of reproduction: the devil in the details. *Trends in Ecology and Evolution*, **22**, 80-86.
- Hausmann, M.F., Longenecker, A.S., Marchetto, N.M., Juliano, S.A. & Bowden, R.M. (2011) Embryonic exposure to corticosterone modifies the juvenile stress response, oxidative stress and telomere length. *Proceedings of the Royal Society B: Biological Sciences*, **279**, 1447-1456.
- Hausmann, M.F., Winkler, D.W., O'Reilly, K.M., Huntington, C.E., Nisbet, I.C.T. & Vleck, C.M. (2003) Telomeres shorten more slowly in long-lived birds and mammals than in short-lived ones. *Proceedings of the Royal Society B: Biological Sciences*, **270**, 1387-1392.
- Hausmann, M.F., Winkler, D.W. & Vleck, C.M. (2005) Longer telomeres associated with higher survival in birds. *Biology Letters*, **1**, 212-214.
- Heidinger, B.J., Blount, J.D., Boner, W., Griffiths, K., Metcalfe, N.B. & Monaghan, P. (2012) Telomere length in early life predicts lifespan. *Proceedings of the National Academy of Sciences of the United States of America*, **109**, 1743-1748.
- Kotschal, A., Ilmonen, P. & Penn, D.J. (2007) Stress impacts telomere dynamics. *Biology Letters*, **3**, 128-130.

- Min, K.J., Lee, C.K. & Park, H.N. (2012) The lifespan of Korean eunuchs. *Current Biology*, **22**, R792-R793.
- Monaghan, P. & Haussmann, M.F. (2006) Do telomere dynamics link lifestyle and lifespan? *Trends in Ecology and Evolution*, **21**, 47-53.
- Monaghan, P., Metcalfe, N.B. & Torres, R. (2009) Oxidative stress as a mediator of life history trade-offs: Mechanisms, measurements and interpretation. *Ecology Letters*, **12**, 75-92.
- Partridge, L. & Farquhar, M. (1981) Sexual activity reduces lifespan of male fruitflies. *Nature*, **294**, 580-582.
- Pfaffl, M.W. (2001) A new mathematical model for relative quantification in real-time RT-PCR. *Nucleic Acids Research*, **29**.
- Razmara, A., Duckles, S.P., Krause, D.N. & Procaccio, V. (2007) Estrogen suppresses brain mitochondrial oxidative stress in female and male rats. *Brain Research*, **1176**, 71-81.
- Saino, N., Caprioli, M., Romano, M., Boncoraglio, G., Rubolini, D., Ambrosini, R., Bonisoli-Alquati, A. & Romano, A. (2011) Antioxidant defenses predict long-term survival in a passerine bird. *PLoS ONE*, **6**.
- Salomons, H.M., Mulder, G.A., Van De Zande, L., Haussmann, M.F., Linskens, M.H.K. & Verhulst, S. (2009) Telomere shortening and survival in free-living corvids. *Proceedings of the Royal Society B: Biological Sciences*, **276**, 3157-3165.
- Santos, E.S.A. & Nakagawa, S. (2012) The costs of parental care: A meta-analysis of the trade-off between parental effort and survival in birds. *Journal of Evolutionary Biology*, **25**, 1911-1917.
- Sies, H. (2007) Total antioxidant capacity: Appraisal of a concept. *Journal of Nutrition*, **137**, 1493-1495.
- SMITH, J.M. (1958) The Effects of Temperature and of Egg-Laying on the Longevity of *Drosophila Subobscura*. *Journal of Experimental Biology*, **35**, 832-842.
- Speakman, J.R. (2008) The physiological costs of reproduction in small mammals. *Philosophical Transactions of the Royal Society B: Biological Sciences*, **363**, 375-398.
- Stier, A., Reichert, S., Massemin, S., Bize, P. & Criscuolo, F. (2012) Constraint and cost of oxidative stress on reproduction: Correlative evidence in laboratory mice and review of the literature. *Frontiers in Zoology*, **37**.
- Tavecchia, G., Coulson, T., Morgan, B.J.T., Pemberton, J.M., Pilkington, J.C., Gulland, F.M.D. & Clutton-Brock, T.H. (2005) Predictors of reproductive cost in female Soay sheep. *Journal of Animal Ecology*, **74**, 201-213.
- Von Zglinicki, T. (2002) Oxidative stress shortens telomeres. *Trends in Biochemical Sciences*, **27**, 339-344.
- Wiersma, P., Selman, C., Speakman, J.R. & Verhulst, S. (2004) Birds sacrifice oxidative protection for reproduction. *Proceedings of the Royal Society B: Biological Sciences*, **271**, S360-S363.

List of co-authors and affiliations

Arrivé, Mathilde

University of Strasbourg, Institut Pluridisciplinaire Hubert Curien, Strasbourg, France
Département d'Ecologie, Physiologie et Ethologie (DEPE), CNRS UMR7178, 23 rue
Becquerel, 67087 Strasbourg Cedex 2, France

Bize, Pierre

Department of Ecology and Evolution, University of Lausanne, Biophore 1015 Lausanne-
Dorigny, Switzerland.

Present address: Institute of Biological and Environmental Sciences, University of Aberdeen,
Aberdeen AB24 2TZ, UK

Bouillaud, Frédéric

Institut Cochin, Inserm UMRS 1016, CNRS UMR 8104, Université Paris Descartes, 75014
Paris, France

Criscuolo, François

University of Strasbourg, Institut Pluridisciplinaire Hubert Curien, Strasbourg, France
Département d'Ecologie, Physiologie et Ethologie (DEPE), CNRS UMR7178, 23 rue
Becquerel, 67087 Strasbourg Cedex 2, France

Delestrade, Anne

Centre de Recherche sur les Ecosystèmes d'Altitude (CREA), Observatoire du Mont-Blanc, 67
lacets du Belvédère, 74400 Chamonix, France

Laboratoire d'Ecologie Alpine, Université de Savoie (UMR 5553), 73376 Le Bourget du Lac,
France

Geiger, Sylvie

University of Strasbourg, Institut Pluridisciplinaire Hubert Curien, Strasbourg, France
Département d'Ecologie, Physiologie et Ethologie (DEPE), CNRS UMR7178, 23 rue
Becquerel, 67087 Strasbourg Cedex 2, France

Geny, Bernard

University of Strasbourg, Faculty of medicine, EA 3072, France

CHRU of Strasbourg, Physiology and Functional Explorations Department, New Civil Hospital,
BP 426, 67091, Strasbourg, France

Gros, Frédéric

Immunologie et Chimie Thérapeutiques UPR 9021, Institut de Biologie Moléculaire et
Cellulaire du CNRS, Université de Strasbourg, Strasbourg, France

Grosbellet, Edith

Institut des Neurosciences Cellulaires et Intégratives, CNRS UPR 3212, 5 rue Blaise Pascal,
67084 Strasbourg, France.

Habold, Caroline

University of Strasbourg, Institut Pluridisciplinaire Hubert Curien, Strasbourg, France

Département d'Ecologie, Physiologie et Ethologie (DEPE), CNRS UMR7178, 23 rue
Becquerel, 67087 Strasbourg Cedex 2, France

Handrich, Yves

University of Strasbourg, Institut Pluridisciplinaire Hubert Curien, Strasbourg, France

Département d'Ecologie, Physiologie et Ethologie (DEPE), CNRS UMR7178, 23 rue
Becquerel, 67087 Strasbourg Cedex 2, France

Le Maho, Yvon

University of Strasbourg, Institut Pluridisciplinaire Hubert Curien, Strasbourg, France

Département d'Ecologie, Physiologie et Ethologie (DEPE), CNRS UMR7178, 23 rue
Becquerel, 67087 Strasbourg Cedex 2, France

Le Vaillant, Maryline

Stockholm University, Department of Zoology, SE-10691 Stockholm, Sweden

Lebard, Thomas

University of Strasbourg, Institut Pluridisciplinaire Hubert Curien, Strasbourg, France

Département d'Ecologie, Physiologie et Ethologie (DEPE), CNRS UMR7178, 23 rue
Becquerel, 67087 Strasbourg Cedex 2, France

Massemin, Sylvie

University of Strasbourg, Institut Pluridisciplinaire Hubert Curien, Strasbourg, France
Département d'Ecologie, Physiologie et Ethologie (DEPE), CNRS UMR7178, 23 rue
Becquerel, 67087 Strasbourg Cedex 2, France

Prud'homme, Onésime

University of Strasbourg, Institut Pluridisciplinaire Hubert Curien, Strasbourg, France
Département d'Ecologie, Physiologie et Ethologie (DEPE), CNRS UMR7178, 23 rue
Becquerel, 67087 Strasbourg Cedex 2, France

Robin, Jean-Patrice

University of Strasbourg, Institut Pluridisciplinaire Hubert Curien, Strasbourg, France
Département d'Ecologie, Physiologie et Ethologie (DEPE), CNRS UMR7178, 23 rue
Becquerel, 67087 Strasbourg Cedex 2, France

Rojas, Emilio R.

University of Strasbourg, Institut Pluridisciplinaire Hubert Curien, Strasbourg, France
Département d'Ecologie, Physiologie et Ethologie (DEPE), CNRS UMR7178, 23 rue
Becquerel, 67087 Strasbourg Cedex 2, France

Roussel, Damien

Laboratoire d'Ecologie des Hydrosystèmes Naturels et Anthropisés, CNRS UMR 5023,
Université de Lyon.

Royer, Cathy

Plateforme Imagerie in vitro, IFR 37 CNRS, 67084 Strasbourg, France

Saroux, Claire

Laboratoire des Ressources halieutiques, IFREMER, Av. Jean Monnet, BP 171, 34203 Sète
Cedex, France.

Schull, Quentin

University of Strasbourg, Institut Pluridisciplinaire Hubert Curien, Strasbourg, France

Département d'Ecologie, Physiologie et Ethologie (DEPE), CNRS UMR7178, 23 rue Becquerel, 67087 Strasbourg Cedex 2, France

Singh, François

University of Strasbourg, Faculty of medicine, EA 3072, France

CHRU of Strasbourg, Physiology and Functional Explorations Department, New Civil Hospital, BP 426, 67091, Strasbourg, France

Tissier, Mathilde

University of Strasbourg, Institut Pluridisciplinaire Hubert Curien, Strasbourg, France

Département d'Ecologie, Physiologie et Ethologie (DEPE), CNRS UMR7178, 23 rue Becquerel, 67087 Strasbourg Cedex 2, France

Viblanç, Vincent A.

Centre d'Ecologie Fonctionnelle et Evolutive, CNRS-UM2, UMR 5175, 1919 route de Mende, 34293 Montpellier cedex 5, France.

Zahn, Sandrine

University of Strasbourg, Institut Pluridisciplinaire Hubert Curien, Strasbourg, France

Département d'Ecologie, Physiologie et Ethologie (DEPE), CNRS UMR7178, 23 rue Becquerel, 67087 Strasbourg Cedex 2, France

Zoll, Joffrey

University of Strasbourg, Faculty of medicine, EA 3072, France

CHRU of Strasbourg, Physiology and Functional Explorations Department, New Civil Hospital, BP 426, 67091, Strasbourg, France

Résumé de la thèse :

Mots clés : compromis évolutifs, stress oxydant, découplage mitochondrial, métabolisme

Une des théories fondatrices de l'écologie évolutive, la théorie des traits d'histoire de vie, stipule que les individus sont limités dans leurs grandes fonctions biologiques (croissance / maintenance / reproduction) par la quantité de ressources/d'énergie dont ils disposent. De ce fait, l'allocation des ressources disponibles entre les différentes grandes fonctions biologiques devrait suivre des relations de compromis. Par exemple, les organismes présentant une activité de reproduction intense et précoce auront classiquement tendance à présenter un taux de survie ou une longévité réduite. Durant la dernière décennie, l'attention scientifique s'est plus particulièrement portée sur les mécanismes physiologiques sous-jacents à ces compromis évolutifs.

Dans ce cadre, la production d'espèces réactives de l'oxygène (ROS) par les mitochondries lors du processus de phosphorylation oxydative (production aérobie d'ATP) a été suggérée comme une contrainte majeure pour l'évolution des traits d'histoire de vie. En effet, l'utilisation d'énergie par la cellule (et donc l'organisme) est intimement liée à la capacité de la mitochondrie à produire de l'ATP, mais cette production d'ATP s'accompagne inexorablement de la production de ROS qui peuvent être dommageables pour la cellule/l'organisme, et la mitochondrie elle-même. Les ROS ($\bullet\text{O}_2^-$, $\bullet\text{OH}$, H_2O_2) sont en effet des espèces chimiques très réactives, qui peuvent causer des dommages oxydatifs sur différentes molécules, telles que l'ADN, les protéines et les lipides. Cependant, les organismes ont développé des mécanismes pour lutter contre ces agressions oxydantes, qui sont globalement dénommés « défenses antioxydantes ». Ces défenses comprennent des acteurs synthétisés de manière endogène, avec notamment des enzymes antioxydantes (superoxyde dismutases, catalase) et des composés de faible poids moléculaire tel que le glutathion ; mais également des éléments acquis au travers de l'alimentation (vitamine E, caroténoïdes, etc.). Si la production de ROS vient à dépasser le niveau des défenses, l'organisme fait alors face à une situation dite de **stress oxydant**, dont la résultante est la production et l'accumulation (en cas de défaillance chronique) de dégâts oxydatifs. Ces dégâts vont nuire au bon fonctionnement de la cellule (problèmes de réplication/transcription du génome, perte d'activité des protéines, modifications de la fonctionnalité/perméabilité des membranes lipidiques, etc.), et sont suspectés d'être un

acteur majeur du processus de vieillissement ('Théorie radicalaire du vieillissement' - Harman 1956).

Initialement, la production de ROS a été suspectée de suivre positivement l'activité respiratoire mitochondriale, et donc la dépense énergétique des individus, donnant un cadre théorique intéressant pour expliquer les compromis entre les traits d'histoire de vie. Un exemple de ce lien métabolisme / ROS / traits d'histoire de vie est donné par l'impact d'un investissement accru dans la reproduction, qui à travers l'augmentation du métabolisme et donc de la production de ROS, engendrerait une accumulation de dégâts oxydatifs et une réduction de la survie. Cependant, les avancées récentes en terme de bioénergétique mitochondriale ont démontré qu'une respiration mitochondriale élevée pouvait être associée à une production de ROS faible, notamment si l'efficacité à produire de l'ATP est réduite par une perméabilité mitochondriale élevée (fuite de proton). Ce mécanisme, dénommé découplage mitochondrial (car on découple la consommation d'oxygène de la production d'ATP), pourrait réduire le stress oxydant et ainsi limiter la vitesse de vieillissement ('uncoupling to survive hypothesis' - Brand 2000), mais aux dépens cependant de l'efficacité énergétique (production d'ATP).

Suivant ce cadre théorique, cette thèse se propose de tester l'implication du stress oxydant et du découplage mitochondrial dans les compromis évolutifs. Pour ce faire, une première partie du travail de thèse (**Chapitre 3**) a consisté à tester les liens entre dépense énergétique, découplage mitochondrial et stress oxydant, en utilisant un modèle de souris (*Mus musculus*) transgénique 'knock-out' (KO, dépourvu) pour la protéine découplante UCP1, et un modèle aviaire (diamant mandarin, *Taeniopygia guttata*) traité au long terme avec un agent découplant artificiel (2,4-dinitrophénol, DNP). Nous nous sommes également intéressés dans cette première partie à l'impact du découplage mitochondrial sur les traits d'histoire de vie des individus, c'est à dire sur leur longévité/survie, mais également sur leurs performances de reproduction ou leur immunocompétence. La seconde partie de cette thèse (**Chapitre 4**) a eu pour objectif de tester l'influence de deux périodes cruciales que sont la reproduction et la croissance sur l'homéostasie oxydative des individus. Dans ce cadre, nous avons étudié les effets de la reproduction chez deux modèles en laboratoire (souris et diamants mandarins), tandis que nous avons étudié l'impact du taux de croissance mais également des conditions environnementales subies pendant la croissance chez trois

espèces d'oiseaux sauvages (mésange noire (*Periparus ater*), mésange charbonnière (*Parus major*) et manchot royal (*Aptenodytes patagonicus*)).

La première partie de ce travail de thèse nous a permis de démontrer que suite à un challenge métabolique (exposition au froid), la présence de la protéine découplante UCP1 chez la souris permet d'augmenter la dépense énergétique drastiquement dans le cadre de la thermogénèse sans frisson, sans pour autant avoir de conséquences néfastes en terme de stress oxydant (**Article 2**). Au contraire, une augmentation du métabolisme par un mécanisme couplé à la production d'ATP (frisson musculaire utilisé par les souris UCP1 KO) s'est révélée délétère pour la balance oxydative lors d'une exposition au froid prolongée. Malgré le manque d'effet d'UCP1 sur les niveaux de stress oxydant à des températures proches de la thermoneutralité, nous avons démontré que l'absence de cette protéine provoque une diminution de l'espérance de vie chez la souris (**Encadré 1**). Nous n'avons cependant pas pu identifier les mécanismes précis responsables de cet effet, même si il est probable qu'une dérégulation du métabolisme lipidique en soit au moins en partie à l'origine. En accord avec les résultats présentés dans l'article 2, nous avons démontré qu'un traitement chronique avec un découplant mitochondrial (DNP) pouvait protéger d'une augmentation des niveaux de stress oxydant lors d'une exposition aigue au froid chez le diamant mandarin (**Encadré 2**). Cependant, comme les oiseaux non traités présentent une élévation des dégâts oxydatifs en réponse à un tel challenge métabolique, nos résultats démontrent à nouveau qu'une augmentation du métabolisme par un mécanisme couplé à la production d'ATP (frisson musculaire) peut conduire à une situation de stress oxydant.

Nous avons démontré chez le diamant mandarin que malgré un impact sur le métabolisme énergétique (augmentation d'environ 20%), un traitement découplant chronique au DNP ne permet pas pour autant de diminuer la production de ROS ou le stress oxydant, ni d'améliorer le taux de survie (**Article 3**). Cette augmentation du métabolisme a été compensée, au moins en partie, par une augmentation de la prise alimentaire, permettant ainsi aux individus de limiter les effets délétères sur des traits d'histoire de vie tels que la croissance ou les performances de vol. Cependant, cette compensation ne semble pas avoir été totale puisque les individus traités au DNP ont présenté des performances reproductives et immunitaires diminuées. Suite à des expérimentations *in vitro* sur mitochondries isolées, nous avons démontré que le fonctionnement mitochondrial aviaire,

bien que sensible à un découplage artificiel en terme de consommation d'O₂, semble en revanche peu sensible au découplage en terme de production de ROS, contrairement à ce que nous avons pu observer chez la souris (et ce qui est classiquement décrit pour les mammifères, **Article 3**).

Ainsi, nos données suggèrent que le découplage mitochondrial est un mécanisme important pour réguler les niveaux de stress oxydant lors du processus de thermogénèse. En revanche, un découplage mitochondrial pharmacologique chronique chez l'oiseau semble rester sans effet majeur sur la survie et le stress oxydant. Un tel résultat pourrait être lié à un mode de fonctionnement mitochondrial basal différent entre oiseau et mammifère. Cela suggère qu'un approfondissement de notre connaissance de la bioénergétique mitochondriale chez l'oiseau pourrait être bénéfique afin de déterminer les mécanismes clés de la longévité aviaire.

La seconde partie de ce travail de thèse nous a quant à elle permis de suggérer que le stress oxydant semble agir comme un coût mais également comme une contrainte pour la reproduction chez la souris de laboratoire (**Article 4**). Basé sur une synthèse bibliographique de l'état d'avancement des travaux scientifiques dans ce domaine, notre travail suggère des facteurs potentiels pouvant être à l'origine des contradictions observées par les études publiées à ce jour sur le sujet. Des résultats préliminaires suggérant que la reproduction peut engendrer une augmentation des dégâts oxydatifs, mais également des défenses antioxydantes chez le diamant mandarin, sont également présentés (**Encadré 3**). Ce travail montre cependant que le découplage mitochondrial induit par un traitement chronique au DNP est inefficace dans la prévention d'une telle augmentation du stress oxydant.

De plus, nous avons démontré qu'en conditions naturelles, les niveaux de stress oxydant, mais également la vitesse d'érosion des télomères (structures non codantes protégeant l'extrémité des chromosomes), semblent être intimement liés aux conditions de vie précoce expérimentées par les individus. Dans une première approche, nous nous sommes intéressés aux effets de l'altitude sur le compromis croissance/maintenance, puisque la fenêtre temporelle de conditions favorables est réduite en altitude, ce qui pourrait hypothétiquement accentuer les bénéfices d'une croissance rapide. Dans ce cadre, l'altitude semble pouvoir être une contrainte pour l'équilibre entre vitesse de croissance et stress oxydant pour les poussins de mésanges noires. En effet, les poussins grandissant à une

altitude plus élevée présentent une vitesse de croissance supérieure mais également des niveaux de dégâts oxydatifs plus importants (**Article 5**). En complément, nous avons également montré que la vitesse d'érosion des télomères pendant la croissance est accentuée par l'altitude, et ce aussi bien pour la mésange charbonnière que pour la mésange noire (**Article 6**). Cependant cet effet semble être indépendant de la vitesse de croissance des poussins, au moins au niveau intra-populationnel. Dans une seconde approche, nous avons étudié le même compromis chez une espèce dont la phase de croissance est contrainte par la date de ponte et par une pause hivernale (manchot royal). Nous avons montré que la croissance compensatoire (c'est à dire accélérée) post-hivernale mise en place par les poussins de manchots royaux ayant un retard initial de croissance, est associée à des niveaux de dégâts oxydatifs élevés et à une érosion des télomères accentuée (**Article 7**). En complément, nous avons tenté de caractériser des stratégies adaptatives de croissance induites par le handicap initial des poussins de manchots royaux issus de parents étant reproducteurs tardifs (**Article 8**). Cette étude a démontré qu'en plus d'avoir des chances de survie réduites au cours de la croissance, les poussins tardifs présentent un phénotype altéré déjà 10 jours après l'éclosion, avec des niveaux de dégâts oxydatifs élevés, des télomères courts et des niveaux circulants de corticostérone élevés, malgré une masse corporelle plus importante. En plus d'un impact bénéfique de la masse pour la survie des poussins, cette étude a montré que des niveaux élevés de corticostérone ou de longs télomères peuvent également être des prédicteurs significatifs des chances de survie à court et moyen terme respectivement, et ce uniquement pour les poussins tardifs. Dans la même optique, une troisième approche en conditions naturelles a cherché à évaluer l'impact du handicap initial subi par les poussins de mésanges charbonnières asynchrones (nés 1 à 3 jours après les premiers éclos) sur l'équilibre entre croissance et maintenance de l'organisme (**Encadré 4**). Cette étude nous a permis de montrer que malgré leur handicap initial, les poussins asynchrones grandissent aussi vite et atteignent la même masse/taille à l'envol que les premiers éclos. Cependant, le fait de surmonter ce handicap initial semble associé à une maintenance corporelle réduite, puisque les poussins asynchrones ont souffert de niveaux de stress oxydant élevés et d'une érosion accrue des télomères.

Ainsi, cette partie de mon travail suggère que la vitesse et les conditions de croissance semblent être des déterminants importants du stress oxydant subi par les individus en début de vie. La modulation du stress oxydant et d'autres mécanismes

impliqués dans le vieillissement (télomères) pourrait donc être un élément important dans l'ajustement des compromis entre les différents traits d'histoire de vie.

De plus amples études prenant à la fois en compte de multiples paramètres du fonctionnement mitochondrial, des mesures de stress oxydant et de physiologie comparée, le tout couplé à des indicateurs pertinents de la fitness (survie, fécondité ou succès reproducteur total), sont cependant requises pour permettre de tester en détails les hypothèses émanant de ce travail de thèse. La poursuite de l'étude de la bioénergétique mitochondriale semble en tout cas être une voie prometteuse pour mieux comprendre les bases de l'ajustement des traits d'histoire de vie qui ont permis l'adaptation et la diversification des formes de vie.

Abstract

Because resources are limited, life history theory predicts a trade-off in terms of resource allocation between the main biological functions: growth, reproduction and body self-maintenance. In recent years, attention has turned towards the nature of the mechanisms underlying such trade-offs. Amongst these mechanisms, the production of reactive oxygen species (ROS) appears to be a key factor due both to its universal and inevitable nature. ROS are by-products of energy processing by the mitochondria (*i.e.* oxidative phosphorylation). If ROS production exceeds the capacity of the various antioxidant systems, oxidative stress will occur, and the accumulation of oxidative damage over time is thought to be a potential cause of ageing. Since mitochondria are not only the powerhouse of animal cells but also the main producer of ROS, this PhD thesis aimed to clarify the relationships between mitochondrial uncoupling state (*i.e.* efficiency to produce ATP), energy metabolism and oxidative stress. I investigated the impact of energy-demanding activities such as thermogenesis, reproduction and growth on oxidative homeostasis, and provided new insights into the potential implication of mitochondrial uncoupling state and oxidative stress as candidate mechanisms underlying life history trade-offs. I particularly aimed to highlight that mechanisms controlling energy processing might be part of the proximate processes shaping life histories.

First, I evaluated the impact of high-energy expenditure and mitochondrial uncoupling state on oxidative stress levels and longevity in two different models, namely a transgenic mouse model (uncoupling protein 1 deficient) and zebra finches treated chronically with a mitochondrial uncoupler. This work suggests that mitochondrial uncoupling state might be one of the key parameters for managing oxidative stress in cold environments. For instance, an increased metabolic rate in response to the cold that is achieved without mitochondrial uncoupling seems to be an oxidative challenge for organisms, even if compensatory mechanisms exist and are quickly set-up to avoid/limit oxidative stress occurrence. However, my work raises doubts about the relevance of mitochondrial uncoupling as a mechanism reducing ROS production *per se*, especially in birds. Mitochondrial uncoupling state might however play a key role in life-history trajectories by determining the total amount of energy available to individuals for investment in different traits. Secondly, my thesis supports the argument for a dual role of oxidative stress (*i.e.* constraint and cost) in reproduction in the laboratory mouse, whilst the work carried out on wild birds (coal and great tits, but also king penguin chicks) strengthens the idea that growth rate and conditions experienced during the growth period are both important determinants of oxidative stress levels. To conclude, this thesis highlights the importance of mitochondrial functioning and oxidative stress as potential mechanisms in the shaping of life histories.

Keywords: life history trade-offs, oxidative stress, mitochondrial uncoupling, metabolism

Antoine STIER



At the crossroad of metabolism and ageing: mitochondrial proximal control of oxidants and ultimate modulation of life history trade-offs



Implications du stress oxydant et du découplage mitochondrial dans les compromis entre traits d'histoire de vie

Résumé

L'attention scientifique s'est récemment portée sur l'identification des mécanismes proximaux sous-tendant les compromis évolutifs ; tels que les compromis existant entre croissance/reproduction et longévité. La production d'espèces réactives de l'oxygène (ROS) a été suggérée comme un candidat potentiel, de par sa liaison étroite au métabolisme énergétique (sous-produits du fonctionnement mitochondrial) et son caractère inévitable. Si la production de ROS excède le niveau des défenses antioxydantes, une situation de stress oxydant va en résulter et a été associée au vieillissement. Puisque la mitochondrie n'est pas uniquement la centrale énergétique de la cellule mais aussi le principal producteur de ROS, cette thèse s'est attachée à clarifier les relations entre métabolisme énergétique, fonctionnement mitochondrial et stress oxydant ; avec des études concernant l'impact d'activités coûteuses en énergie (croissance, reproduction, thermogénèse) sur l'équilibre de la balance oxydative.

Résumé en anglais

In recent years, scientific attention has turned towards the identification of the mechanisms underlying the trade-offs occurring between growth rate/reproductive investment and longevity. Amongst these mechanisms, the production of reactive oxygen species (ROS) appears to be a key factor due both to its universal and inevitable nature. ROS are by-products of energy processing by the mitochondria. If ROS production exceeds the capacity of the various antioxidant systems, oxidative stress will occur, and the accumulation of oxidative damage over time is thought to be a potential cause of ageing. Since mitochondria are not only the powerhouse of animal cells but also the main producer of ROS, this PhD thesis aimed to clarify the relationships between mitochondrial uncoupling state (*i.e.* efficiency to produce ATP), energy metabolism and oxidative stress. I investigated the impact of energy-demanding activities such as thermogenesis, reproduction and growth on oxidative homeostasis.