



HAL
open science

Operational research on an urban planning tool: application in the urban development of Strasbourg 1982

Mohammad Hadi Kaboli

► To cite this version:

Mohammad Hadi Kaboli. Operational research on an urban planning tool: application in the urban development of Strasbourg 1982. Architecture, space management. Université de Strasbourg, 2013. English. NNT : 2013STRAG006 . tel-01057695

HAL Id: tel-01057695

<https://theses.hal.science/tel-01057695>

Submitted on 25 Aug 2014

HAL is a multi-disciplinary open access archive for the deposit and dissemination of scientific research documents, whether they are published or not. The documents may come from teaching and research institutions in France or abroad, or from public or private research centers.

L'archive ouverte pluridisciplinaire **HAL**, est destinée au dépôt et à la diffusion de documents scientifiques de niveau recherche, publiés ou non, émanant des établissements d'enseignement et de recherche français ou étrangers, des laboratoires publics ou privés.

ÉCOLE DOCTORALE SCIENCES HUMAINES ET SOCIALES

Laboratoire SAGE (UMR 7363)

THÈSE présentée par :

Mohammad Hadi KABOLI

soutenue le : **28 juin 2013**

pour obtenir le grade de : **Docteur de l'université de Strasbourg**

Discipline/ Spécialité : Aménagement et Urbanisme

**Approche empirique de la
restructuration urbaine : application
d'un Système Multi Agent (SAM), à
Strasbourg 1982.**

THÈSE dirigée par :

M. BLANC Maurice

Professeur, université de Strasbourg

RAPPORTEURS :

M. FRANKHAUSER Pierre

M. FREYTAG Tim

Professeur, Université de Franche-Comté

Professeur, Université de Fribourg en Brisgau

AUTRES MEMBRES DU JURY :

M. MERCIER Jean-Luc

Professeur (président du jury), université de Strasbourg

Mohammad Hadi KABOLI
Approche empirique de la
restructuration urbaine :

Application d'un Système Multi
Agent (SMA) à Strasbourg 1982.

Résumé

L'Impact des caractéristiques spatiales sur les dynamiques de développement urbain est d'un grand intérêt dans les études urbaines.

L'interaction entre les résidents et les caractéristiques spatiales est d'un intérêt particulier dans le contexte des modèles urbains car de nombreux modèles urbains sont fondés sur le processus d'installation des individus dans des parties spécifiques des villes.

Il s'agit d'une étude sur la dynamique de développement urbain avec des Automates Cellulaires et un Système Multi-Agent. Le développement urbain de cette étude recouvre le « urban renewal » et la mobilité résidentielle. Il correspond à la mobilité résidentielle des ménages qui sont attirés par le confort résidentiel et le confort de centralité ; ces comforts sont localisés dans quelques quartiers de Strasbourg. La diversité et la qualité de ces comforts deviennent des critères pour les choix résidentiels de telle façon que chaque ménage recherche la proximité de ces comforts.

Dans cette étude l'Automate Cellulaire modélise les caractéristiques techniques des unités spatiales, celles-ci sont identifiées par des attributs inhérents qui sont égaux aux comforts dans les résidences et dans les zones urbaines. Dans le Système Multi-Agent la population de la ville de Strasbourg interagit entre elle et avec la ville. Les agents représentent les classes socio-professionnelles des ménages. Pendant un changement spatio-temporel, l'aspiration des ménages forme le développement socio-spatio-temporelle de la ville.

Mots-clés : *Système Multi Agent, Automates Cellulaires, Mobilité résidentielle, Ségrégation, Analyse en Composante Principale, Gentrification, Rénovation Urbaine, Netlogo.*

Résumé en anglais

The impact of spatial characteristics on the dynamics of urban development is a topic of great interest in urban studies. The interaction between the residents and the spatial characteristics is of particular interest in the context of urban models where some of the most famous urban models have been based on the process of individual settlements in some specific parts of cities.

This research investigates the dynamism of urban development modeled by Cellular Automata and Multi-Agent System. The urban development, in this study embraces urban renewal and residential mobility. It corresponds to the residential mobility of households, attracted by residential and centrality comfort; these comforts are crystallized in some areas and residences of Strasbourg. The diversity and quality of these comforts become criteria for residential choice in a way that the households seek for proximity to these comforts.

The Cellular Automata in this study, models the spatial characteristics of urban spatial units and they are identified by some inherent attributes that are equal to the comfort in residences and urban areas. The Multi-Agent System represent a system in which the population of the city interact between them and between them and the city; the agents delegate the socio-professional classes of households. During the spatiotemporal change, the aspiration of households forms the socio-spatio-temporal development of the city.

Keywords: *Multi Agent System, Cellular Automata, Residential mobility, Segregation, Principal Component Analysis, Gentrification, Urban renewal, Netlogo.*

Ouverture

La ville est la résultante des occurrences dans l'environnement et au cours du temps ; c'est le plus grand œuvre généré au cours du temps par l'homme ; la ville a transformé l'espace. Des excavations dans les montagnes qui abritent toujours des hommes, comme *Kandavan* en Iran, aux 100 villes mondiales comme New-York, Paris et Shanghai, une trajectoire est observable qui est l'interaction entre l'homme et la ville.

Le fonctionnement d'une ville minute par minute, jour par jour ou année par année dépend beaucoup de la manière dont elle est organisée dans l'espace et le temps et cela dépend aussi de sa position dans un système global. Outre la nature et les événements anthropiques qui peuvent perturber la vie ordinaire de la ville, au cours du temps, la ville elle-même est dans un échange entre les citoyens et les espaces. La ville pourvoit des structures et des réseaux pour les activités sociales d'une part et d'autre part, les activités individuelles mobilisent les moyens pour former un nouvel espace. Dans le domaine de l'action humaine, la planification d'un côté, et les actions des résidents de l'autre côté déterminent les caractéristiques spatiales de la ville. Les deux actions mentionnées portent sur les motivations des groupes ou celles des individus ; ils ou elles peuvent transférer les caractéristiques de certaines parties d'une ville dans une mesure sensible ou ils peuvent transformer les espaces au fur et à mesure, mais à travers le temps ; des changements minuscules peuvent aboutir à des changements remarquables.

Comme un exemple, le processus de renouvellement est décidé principalement par les autorités ou leurs représentants et il a un impact sur la vie des résidents. Mais de l'autre côté les gens qui utilisent les espaces ont un impact sur la survie de ces espaces. Le premier a lieu *a priori* via le changement et nous pouvons en observer la conséquence sur la vie des résidents, mais le suivant influence l'image générale d'un quartier et peut soit absorber soit repousser l'activité de valorisation dans le quartier.

Le procès multivalent de renouvellement englobe certain ensemble des désires, des activités et des résultats qui met en avant les discussions à propos des causes et des conséquences de ces désires, activités et résultats. La nécessité de rénovation, le désir pour l'accroissement de l'investissement dans la ville combiné avec le désir pour prévenir la ségrégation des différentes communautés ou classes sociales appelle pour une approche synergétique qui peut inspecter plusieurs dimensions simultanément.

Il semble que cette demande soit répondue par le système complexe. La science de complexité est 'l'étude de comportement des collections macroscopiques à partir des actions des unités de base qui sont dotées par les potentiels de s'évoluer dans le temps. A part les transitions naturelles, les décisions sont à la base de la genèse et l'organisation de la ville. Les décisions peuvent être de la société ou du groupe ou des individus ou de petites unités sociales, mais les deux proviennent de l'état actuel et induisent une vision d'avenir. Lors de la décision, les options sont nombreuses mais comme le physicien Archibald Wheeler le note, par le rapport de 'it from bit' même à l'échelle des atomes, il y a deux options : prendre une décision ou non.

C'est ce que nous cherchons pour créer un modèle du développement urbain avec une approche ascendante. Le résultat de décisions entre un très grand nombre de possibilités qu'un atome ou un électron aurait pu choisir aboutit à un état actuel. Alors que poursuivre les changements des atomes dans chaque instant n'est pas possible, mais le résultat permet d'accéder aux décisions et aux choix retenus.

Une chaîne des événements a lieu dans la genèse des espaces et structures urbaines: les individus ou les groupes ont des myriades d'options dans différentes situations et ces options augmentent exponentiellement lorsqu'une seconde décision est censée être prise.

Profitant de la tendance qui existe dans la constitution du modèle, on essaie de transférer le mécanisme dominant d'un système au mécanisme d'un autre système, et on se donne que les options infinies qui sont attribuables aux décisions des atomes et celles des humains sont comparables. Les deux entités sont confrontés aux nombreuses options, mais lors de la décision, ils choisissent ou ne choisissent pas quelque option et si on regarde la chaîne des décisions on observe que le nombre des décisions prises sont énormément moins que les décisions qu'aurait pu être prises.

Dans les modèles urbains, il y a eu un mouvement depuis parcimonie dans le nombre des procès et variables envers les structures qui bénéficient des interactions entre les individus, comme le cas des modèles basés sur les agents et l'Automate Cellulaire. Ici, le système est mise à jour par rapport aux interactions entre les agents et celles entre les agents et les attributs spatiaux.

On tente de compter sur le comportement des individus en tant que les constituants de la société. Alors qu'il y a imprévisibilité dans le comportement des individus, on essaiera de mettre en avant la décision des individus dans une sorte d'algorithme via lequel les individus sont censés décider par rapport à des options reconnaissables. L'action des individus, ou par rapport à notre recherche, l'action des agents par rapport aux caractéristiques de l'espace forment notre modèle du développement de Strasbourg.

De nombreux modèles sont proposés pour démontrer le fonctionnement d'une ville. Des plans schématiques aux modèles d'étalement urbain, la quintessence des efforts a été d'abord de montrer la composition actuelle de la ville et deuxièmement aider aux meilleures décisions à la base de l'information que le modèle pourvoit. L'information qu'une carte peut fournir, montre la localisation des composants saillants de la ville qui sont principalement les corps physiques et l'infrastructure de la ville. Plus récemment, les entités de la ville sont représentées par les données de SIG. Quant aux informations qualitatives, nous pouvons les obtenir par les media comme : romans, infos, films etc.

Des approches variées dans les modélisations ont essayé de suggérer les plans appropriés à la base de la rétrospection des phénomènes dans la ville.

Ce qui est accompli dans l'approche statistique est majoritairement les tentations d'attribuer de réalité à la ville, et sur cela de décider comment la ville enclin à être dans le futur. D'autres sortes de modèles sont plus abstraits et tentent de générer le système dans lequel les ingrédients ont des relations les uns avec les autres et le changement dans les ingrédients ou le résultat des interactions entre eux peut aboutir au changement de système de la ville.

Ainsi, le décalage augmente entre l'approche statistique et l'approche générative ; dans les modèles génératifs, les informations qui sont agrégées dans les modèles ne produisent pas seulement les vestiges depuis le passé vers le futur, mais également assurent les scénarios via lesquels les planificateurs peuvent comparer plusieurs résultats et choisir celui qui 'peut être autrement'. Le concept de 'que faire au cas où c'était autrement' a été appliqué dans les romans, films et les arts dramatiques et surtout dans ceux de science-fiction.

John Collings Squire et Winston Churchill présentent dans leur livre 'que faire au cas où c'était autrement' les histoires des grands événements qui pouvaient être autrement si les personnes effectives dans les aventures avaient su quelques réalités ou avait agi autrement; de cette façon, les histoires pouvaient être considérées

comme les histoires alternatives ou les histoires contrefactuelles. Par exemple 'si Napoléon avait gagné la bataille de Waterloo' La Grande Bretagne serait devenue une dictature réactionnaire qui courrait à la ruine par l'instabilité politique au début du XIXème siècle faisant face au trauma de la défaite et de la réparation, causant l'augmentation de critiques au romantisme anglais. La France gouvernerait une grande partie de l'Europe, et Napoléon décédait de vieillesse.

De même, on peut adresser certains scénarios qui sont formés à la base d'hypothèses initiales dont le processus de leur cristallisation est observable dans un modèle génératif. Dans le contexte de décisions et d'actions urbaines avec les données que les planificateurs se peuvent disposer, s'ils peuvent observer les processus d'interactions entre les constituants de la ville, dans le temps de la décision ils peuvent avoir une vision plus étendue. Dans le processus de décision et d'accomplissement, le modèle peut toujours être complété et peut pourvoir un scénario et par conséquent, les options pour des décisions sont ouvertes aux changements.

Projet

Ce projet est basé sur le travail de Philippe Gerber (2000) sur Strasbourg. La ville de Strasbourg est un bon exemple d'une ville ancienne qui avec la préservation et la conservation de ces identités héritées a expérimenté plusieurs constructions à grande échelle. Située sur la frontière orientale de la France et attachée aux bords du Rhin, la ville a expérimenté l'urbanisme et l'architecture français et allemand. L'unicité de la ville n'est pas seulement définie par la Cathédrale vieille de huit siècles, mais aussi le parlement de l'Europe et la Cour des droits de l'homme ont contribué à générer une identité internationale à la ville; en tant que quatrième plus grande université de France, l'université de Strasbourg avec ses 53129 étudiants (dont environ 20% étrangers) a défini un nouveau mode de vie dans la ville. De cohabitation de la jeune génération d'étudiants à côté de générations plus âgées, la ville est le siège d'événements scientifiques et diplomatiques. Comme les autres villes de France, Strasbourg a été un laboratoire de développement, de rénovation, et de réhabilitation et cela nous a induit à choisir ce cas d'étude pour bénéficier des études et des données qui ont déjà été acquises dans des études similaires comme celle de Gerber (2000). Dans sa dissertation, Gerber a cherché les corrélations entre le confort et la gentrification.

A la base des données qui reflètent trois sortes de comforts, il a appliqué l'Analyse Factorielle pour montrer la corrélation entre le changement dans les variables du confort et le changement dans la concentration des classes de population dans la ville de Strasbourg à trois moments du temps 1967, 1982 et 1990. Avec les nouvelles définitions de centralité, de gentrification et de confort, il enquête s'il y a des corrélations significatives entre les comforts et la localisation des classes de population dans différents quartiers de la ville.

La cartographie de la répartition des comforts a été utilisée dans cette recherche avec une approche différente, on a bénéficié de la capacité des modèles génératifs dans cette recherche; en comparaison avec l'approche statistique exploratoire, qui a été utilisée dans la thèse de Gerber, les modèles génératifs peuvent générer des modèles *in silico* qui imitent le monde *in vivo*. Si dans la construction du modèle génératif, on peut balayer les facteurs plus prédominants qui sont signifiants dans la transition de la ville, on peut générer la ville dans une future section du temps ou peut prévoir des sorties variées. C'est un autre atout qui n'est pas généralement à la portée de l'approche statistique.

Dans ce projet, on génère le développement de la ville de Strasbourg à la base des constituants basiques de la ville : les résidents et les résidences. Cela a besoin d'une étude urbaine socio-spatiale qui embrasse deux aspects de la ville: l'espace et la société. On explorera la relation entre les résidents et les résidences par la combinaison

de deux outils de modélisation, les Automates Cellulaires et les Systèmes Multi Agent, pour représenter les changements interdépendants dans la ville. Le résultat sera un modèle qui est un outil pour explorer les relations entre les micro-actions et les macro-comportements dans la ville; la relation existe entre les activités des agents et le dynamisme de la ville.

Cette approche nous permet d'explorer les impacts des attributs spatiaux sur les décisions des individus et cela est l'axe essentiel de ce projet. Lorsque les décisions dans l'échelle de planification ou les activités individuelles sont pratiquées dans le monde avec beaucoup de données, la disposition des données est un privilège ou une obligation dans les deux sortes de décisions et même dans certains modèles en temps réel comme les modèles de trafic, il y a des efforts pour organiser le système par rapport à des changements instantanés de l'information.

Donc ce modèle fournit les données aux individus et en tant que résultat, les activités des individus fournissent le nouvel état au planificateur. La différence substantielle entre l'approche actuelle en tant que modèle génératif et celle de Gerber en tant qu'approche statistique exploratoire est le choix de la section par laquelle les événements sont démontrés. Les sections du temps 1967, 1982 et 1990 sont des fenêtres à travers desquelles il a observé le phénomène de gentrification.

D'après lui, le procès qui résulte à un phénomène ne constitue pas l'axe principal de sa recherche, mais dans ce projet, le procès lui-même est le centre d'attention et nous essayons de montrer le processus.

Pour modéliser le processus on profitera des informations qui existent dans les sections du temps pour définir les règles.

Dans ce projet, on a choisi seulement une section du temps, 1982, pour construire le modèle et pour vérifier les résultats la même année. Le choix d'une seule section du temps est associé à des difficultés à utiliser et maîtriser plusieurs logiciels. Ecrire les scripts dans Netlogo, Matlab, Excel, R project a consommé beaucoup de temps et le problème est devenu compliqué quand quelques parties du travail ont été exécutées et vérifiées plusieurs fois. Choix de l'algorithme approprié pour définir les règles avait besoins d'études, de discussions, de révisions d'une manière cyclique et récursive. Le modèle est construit avec Netlogo ; le logiciel donne la possibilité de lancer l'Automate Cellulaire et le Système Multi Agent en même temps. Les Automates Cellulaires sont les systèmes formels qui peuvent représenter la carte avec une grille de cellules ; chaque cellule a un état actuel et elle peut se transformer en un nouvel état par ses relations avec des cellules du voisinage. L'Automate Cellulaire peut présenter les dynamiques urbaines et les processus de changement dans la ville. Ils étaient appliqués largement pour modélisation des phénomènes urbains et les procès comme : étalement des espaces urbains, changement d'utilisation du sol, dynamiques des piétons, mobilité résidentielle, ségrégation socio-spatiale, circulation des véhicules, gentrification et etc.

L'Automate Cellulaire est un grille des figures qui chacun entre eux changent leurs états à travers de pas du temps; la situation des voisins est décisive pour une cellule donnée pour déterminer qu'est-ce que sera la situation d'avenir; Par rapport aux règles de transition qui dominant l'automate, l'état d'une cellule se conformera à ce qui se passe dans le voisinage.

D'après Torrens, l'application de l'Automate Cellulaire seulement, satisfait le besoin de représenter les caractéristiques spatiaux comme ceux de paysages et structures mais ils sont impropres pour démonstration les agents mobiles parce que les automates ne sont pas libre de se déplacer.

Un des privilèges d'utilisation ce modèle est qu'on peut le construire simplement et il montre efficacement la relation entre les changements locaux et globaux. Généralement, les grilles de l'Automate Cellulaire sont les résultats d'un traitement de l'image de la ville et les cellules représentent les unités spatiales de la ville, mais quelque fois on doit fournir les strates de données à chaque ou à quelque partie des cellules pour que les cellules agissent par rapport à des informations inhérentes et aussi avec les informations que les cellules du voisinage pourvoient.

Le Système Multi Agent est composé de multiples agents qui interagissent dans un environnement. Le Système Multi Agent représente le comportement des agents qui ont généralement des informations inhérentes et à la base des informations inhérentes et locales et par rapport aux règles, ils montrent des comportements. Ils peuvent interagir avec l'espace du programme ou juste avec les autres agents. Les systèmes Multi-Agent sont les modèles basés sur les agents qui tirent ses origines de l'Intelligence Artificiel et étudient le comportement individuel et comment il affecte le système. Les deux ingrédients des SAM sont les agents et l'environnement. Les agents sont intelligents et autonomes et l'environnement a certaines caractéristiques qui dans une interaction avec les agents, un de ou les deux côtés peu(ven)t se changer. Les agents dans le système Multi Agent sont adeptes pour représentation des agents mobiles mais les règles pour les agents ne sont pas suffisantes pour démontrer les caractéristiques des infrastructures. Donc dans cette étude, un système hybride de deux systèmes mentionnés est utilisé pour déléguer les caractéristiques spatiaux et les agents humains.

Le comportement des agents est discipliné par rapport aux caractéristiques spatiales ; à cause de l'interaction entre les agents et les unités spatiales et aussi à cause des deux formes d'informations qu'un agent peut disposer, information locale et information personnelle, l'Automate Cellulaire et le Système Multi Agent sont couplés.

En outre, les comportements des agents sont déterminés dans l'Automate Cellulaire et par rapport au comportement du système d'Automate; par exemple un agent peut choisir une action par rapport aux attributs d'une cellule et aussi par rapport aux caractéristiques des cellules voisines. Les deux facteurs importants dans le modèle qui peuvent permettre aux agents de se mouvoir sont la recherche pour le confort et le départ à cause de la ségrégation. Car le premier a besoin d'informations à propos du monde, le Système Multi Agent répond mieux à ce besoin ; le deuxième est majoritairement attribué à une situation dans laquelle un individu est entouré par des voisins similaires et dissimilaires et par rapport à cela, l'individu décide de rester ou de sortir de sa place par rapport à la similitude ou dissimilitude des voisins. Dans ce but, l'Automate Cellulaire semble d'être un bon outil.

Profil de thèse en détail

Ce projet se compose de deux parties et chaque partie se compose de trois chapitres. Dans la première partie, on considère la ville en tant qu'un système complexe. Pour étudier les deux constituants de gentrification qui sont renouvellement urbain et remplacements des résidents, on discute le renouvellement urbain et son approche et la position que chacun des deux a pris envers les résidents. Mobilité en général et mobilité résidentielle en particulier sont présentés dans ce chapitre.

Dans le second chapitre, le renouvellement urbain est présenté et les approches qui ont été appliquées envers l'étude des attributs spatiaux via l'hébergement viennent en suivant. L'ordre des chapitres et la distinction entre modèles urbains et les systèmes complexes sont arbitraires et c'est parce qu'on pourvoit un ensemble de deux approches complémentaires qui éclaircissent mieux le contexte de la ville. Dans le second chapitre, les agents

sont majoritairement sous l'impact des espaces et leurs décisions et actions sont sous l'impact de caractéristiques spatiales comme la distance, l'espace de travail, l'espace de vie, etc. Dans le troisième chapitre, on essaie de présenter des systèmes dans lesquels les agents influencent et sont influencés par l'espace.

Dans la deuxième partie, les modèles complexes de mobilités résidentielles, gentrification et la ségrégation sont introduits dans le quatrième chapitre et par rapport aux modèles existants, notre modèle est généré dans un modèle hybride d'Automate Cellulaire et Système Multi Agent. Dans le cinquième chapitre, on applique le modèle à la ville de Strasbourg, donc cette partie se compose d'introduction de la ville et les interventions qui sont pratiquées dans le processus de renouvellement et après on lance le modèle et on récupère les résultats. Dans le dernier chapitre on discute les résultats et l'avenir de ce type de recherche.

Le premier chapitre considère le renouvellement urbain. On discute ici les buts et la réalité des actions dans le renouvellement urbain en tant qu'un contexte qui peut mettre en avant la gentrification et la mobilité résidentielle. Différentes approches qui sont poursuivies dans la définition et la réalisation des termes seront discutées ici. Trois approches principales sont introduites par rapport auxquelles le degré de conservation et rénovation et aussi le degré de maintenance et protection des résidents varient d'une approche à l'autre. Les différentes sortes de mobilités seront discutées pour localiser les connotations de mobilité résidentielle. Le chapitre se termine par une considération de ce qui pousse les planificateurs et les décideurs politiques à manipuler la texture de la population ou la qualité d'un quartier.

Le chapitre deux est un aperçu des modèles urbains et une introduction au choix d'un outil pour déterminer les règles, configurer les paramètres et enfin calibrer le modèle et valider sa précision. La classification des modèles est présentée par rapport aux paramètres appropriés pour le modèle.

Le chapitre trois, il s'agit de systèmes complexes et leurs applications dans les modèles urbains. Certains d'entre eux comme le système cybernétique suggèrent la modélisation dynamique de la ville dans une manière temps réel. Certains proposent des outils qui peuvent représenter l'aspect spatial, mobile ou social de la ville comme l'Automate Cellulaire pour l'application spatiale et les Systèmes Multi Agents pour l'aspect social et les entités mobiles. Et certains comme les Réseaux neuronaux et les Algorithmes Génétiques aident à construire les modèles plus précisément. Certains comme la logique floue étendent les spectres de décisions et sont appliqués en tant que complément à côté des autres outils de modélisation.

Le chapitre quatre, il s'agit de l'introduction des modèles qui sont construits avec outils similaires au nôtre, ou avec une problématique similaire à la nôtre ou ceux qui ont été les pionniers d'application systèmes complexes dans les études urbaines et sociales. Dans le prolongement de ces modèles, on propose l'algorithme, les formules et les probabilités qui sont appliqués dans le modèle.

Le chapitre 5 explique le modèle à la base de renouvellement qui est pratiqué à Strasbourg en 1982 et ce qui est simulé en tant que choix résidentiel des habitants potentiels dans l'année. On bénéficie des études de Philippe Gerber (2000) sur Strasbourg. La collection des données et les paramètres pour calculer le confort sont discutés ici. En tant que préambule à la gentrification, on construit le modèle dans lequel les résidents de Strasbourg se meuvent pour choisir des résidences pour y habiter.

Ici, l'accent est mis sur les effets du confort sur la mobilité résidentielle et en particulier sur les différentes manières dont la dispersion des populations peut être conceptualisée. Le modèle est lancé et les résultats du modèle sont validés par comparaison avec la situation réelle. Les résultats sont sous l'impact des décisions des

agents (quatre classes socioprofessionnelles) et les caractéristiques spécifiques des 17 quartiers de Strasbourg ; donc les résultats sont discutés pour chaque classe de population et pour chaque quartier de la ville de Strasbourg. En outre on appliquera « l'analyse en composantes principales » pour explorer la corrélation qui peut exister entre les caractéristiques des quartiers de Strasbourg et la dispersion des résidents dans chaque quartier.

Dans le chapitre 6, on présente la conclusion et l'avenir de la recherche. On revoit les bases théoriques et comment celles-ci sont concrétisées dans le modèle. Les techniques qui aident à répondre aux problèmes complexes viendront à la fin. Alors que le modèle reste abstrait, la praticabilité et l'utilité du modèle, en tant que véhicule pour développer l'intuition et poser des questions sont les buts du modèle actuel.

Théorie et discussion

Le projet implique le développement de la ville en général et l'application des systèmes complexes dans la modélisation des interactions entre les résidents et la ville. En outre, la tentative de créer un modèle de la ville, en tant que système qui se transforme en une nouvelle situation par un processus de feed-back et feed-forward, a été l'axe de l'étude actuelle. L'interaction entre la ville et ses habitants et la transformation est poursuivie dans le cadre du renouvellement urbain. Deux aspects de notre modèle ont été composés de caractéristiques spatiales de la ville et l'aspect social du renouvellement urbain que dans notre projet la gentrification, ségrégation et mobilité résidentielle sont majoritairement discutées. La Mobilité résidentielle et la ségrégation sont modélisés en tant que deux constituants de la gentrification et le modèle se déroule lorsque les résidents s'installent dans ou sortent des résidences ; les agents choisissent une résidence par rapport au niveau du confort ou sortent à cause de la ségrégation dans leur voisinage ou pour chercher les meilleures localisations.

On a appliqué le modèle hybride d'Automate Cellulaire et Système Multi Agent pour comprendre deux aspects de la ville tels que résidences et résidents. Les cellules dans l'Automate Cellulaire contiennent des strates des données qui reflètent les facteurs du confort des résidences, et les agents dans le Système Multi Agent délèguent les résidents potentiels qui sont censés choisir des cellules en tant que leurs résidences. Le modèle hybride permet d'affecter un agent donné à des cellules voisines ; dans ce travail on a représenté la ségrégation par l'impact des voisins.

Selon notre scénario, les agents se meuvent dans la ville et choisissent certaines cellules en tant que leurs résidences. Pour choisir une cellule, ils évaluent son facteur de confort par rapport aux données qui sont dans les cellules. Trois types du confort qui peuvent être cristallisés dans un procès de valorisation d'un quartier constituent les aspects attractifs des résidences de cette recherche. Confort résidentiel adresse au confort dans une résidence et est composé de confort technique et confort spacieux ; le confort de centralité remonte à la proximité aux services finaux. Le confort technique embrasse le développement dans les aménités techniques comme l'eau, l'électricité, etc et le confort résidentiel spacieux il s'agit de nombre des pièces, taille, etc de logement lorsque le confort de centralité se trouve dans l'accessibilité aux quartiers qui ont la capacité de répondre aux besoins des ménages ; certains besoins banals (nutrition, maintenance, hygiénique, ...) certain occasionnel comme (vêtement, loisir, service privé/public, culture, santé, ...) et certain rare comme (des produits de luxe , des biens et des services durables, ...)

Ils choisissent les cellules en tant que leurs résidences et s'y installent. Deux facteurs peuvent pousser un agent à s'installer ou à se mouvoir et chercher encore ; la ségrégation et l'existence d'une meilleur situation. Le premier

est une force répulsive et le deuxième motive les résidents de chercher pour une meilleure résidence. On se donne qu'un individu se peut choisir de s'installer dans une accessibilité proximale au confort de centralité dans une résidence qui est dotée du confort technique ou ils se peuvent choisir de s'installer dans une accessibilité distale au confort dans une résidence qui est spacieuse. Le premier est généralement fourni dans les quartiers centraux de la ville et le dernier se trouve dans certaine distance aux centres.

Pour réaliser le modèle on a introduit les modèles qui généralement ont passé à travers d'une histoire de simplification et réduction aux systèmes plus complexes ; les modèles ont tendance d'appliquer les modèles ascendants résultant du comportement des éléments basiques d'un système plutôt qu'une approche descendante qui poursuit les résultats des planifications de haut niveau. La recherche sur le comportement du système et ses ingrédients est la manière de le construire, le calibrer et le valider a fabriqué l'histoire du premier chapitre jusqu'au chapitre 5 et la recherche sur la manière de faire fonctionner plus précisément le modèle et comment le transférer à d'autres situations et enfin les intérêts et les limites du modèle sont présentées dans le dernier chapitre.

Pour lancer le modèle, on a choisi Strasbourg en tant qu'une ville qui a expérimenté différentes sortes de renouvellement urbain. Le renouvellement urbain est pratiqué pour améliorer la cadre de vie par rapport à situation des bâtiments et de structure ; cependant les approches et les résultats ont été différents dans différentes sections du temps et dans différents contextes. Pour expliquer la connotation du renouvellement urbain on a choisi d'élucider le terme en général dans le premier chapitre et en usage local dans le cinquième chapitre.

En ce qui concerne les politiques et les situations réelles, on a essayé de faire le modèle dans une manière qu'il peut pourvoir plusieurs scénarios qui peuvent décrire la situation actuelle de la ville. Le modèle fonctionne à la base des règles qui sont inférées des études sur le renouvellement urbain et les mécanismes qui ont induit le développement concernant le comportement humain.

Principaux points du modèle et résultats

Dans le cinquième chapitre, la répartition spatiale des confort a été appliquée pour définir les attributs des cellules dans l'Automate Cellulaire et les agents délèguent les populations de Strasbourg qui sont en quête de choisir une résidence. La cellule à qui est attribuée un grand degré du confort agit comme un aimant qui attire les agents.

La population se répartit dans 17 quartiers de Strasbourg et en errant, elle parvient aux cellules spatiales de la ville.

Après la première installation, le programme signale à tout le monde que certaines cellules sont vides. La qualité de ces cellules peut motiver les agents de partir leurs cellules initiales. On se donne qu'il y a deux facteurs enjeux ; d'abord la préférence de chacun des agents et deuxième facteur est le poids que chacun des confort dispose.

La première génération des agents s'installe par rapport aux facteurs qui satisfont leurs désirs; par rapport à la mise à jour du programme, la génération suivante décide de quitter leur résidence initiale par rapport à la ségrégation qui peut exister dans les cellules du voisinage ; ils peuvent être tolérants envers la ségrégation. La

tolérance envers la ségrégation est ajustable par les curseurs du programme. Par rapport aux voisins une cellule donnée peut avoir le modèle de voisinage de Moore (8 voisins), la tolérance est ajustable entre 1 et 8.

Le planificateur peut tester différentes configurations des curseurs pour observer les résultats et selon les observations il peut décider, discuter ou répercuter certaines nouvelles configurations par rapport aux politiques prospectives. On a configuré le programme avec des réglages moyens pour la tolérance envers la ségrégation, l'importance des facteurs du confort et la préférence des agents envers chacun des facteurs du confort. Avec ces configurations, on a lancé le modèle pour 10000 pas de temps et on l'a répété 50 fois.

Outre l'observation des résultats du programme, on a testé les sorties du programme. La dispersion de population en tant que le résultat du modèle et sa comparaison avec la dispersion réelle de population ont validé les résultats. Car il n'y a pas des règles strictes pour les agents comme les règles des modèles déterministes, la dispersion de la population résultant de simulations et celle dans l'état réel semble proche dans certains quartiers. On a validé les résultats de deux manières: d'abord par comparaison entre la dispersion de la population en simulation dans chaque quartier et la dispersion réelle de population via graphes et deuxièmement en groupant les résultats de simulation d'un côté et de l'autre côté via l'Analyse en Composantes Principales.

La comparaison de dispersion de population dans les deux situations montre que les meilleurs résultats ont été vérifiés pour les ouvriers, employés, classes intermédiaire, et la classes supérieure. Ce que l'Analyse en Composantes Principales a confirmé été que le résultat de simulation (moyenne de 50 runs pour chaque classe dans chaque quartier) a été proche de la réalité de la dispersion de la population dans le même ordre que celle des graphes ; mais les résultats acceptables n'étaient pas répartis de la même manière dans chacun des runs du programme. Les résultats les plus convergents de 50 runs du programme ont été respectivement ceux des classes intermédiaires, les cadres supérieurs, ouvriers et finalement les employés.

Les résultats des runs des employés ont été remarquablement plus divergents en comparaison avec les résultats des autres groupes. Le premier facteur dans la comparaison des runs a été le confort. Le résultat le plus intéressant a été une concordance de ségrégation avec le second facteur. Ça signifie que les résultats pour un quartier donné peuvent être corrélés avec le confort en facteur F1 ou corrélé avec la ségrégation de ce quartier en facteur F2. Car on a comparé la dispersion de population dans le cas réel et la simulation, la population a montré la tendance de choisir sa résidence par rapport au confort plutôt que par la ségrégation.

Ils ont présenté une corrélation étroite avec le facteur F1 ou le facteur de confort est indépendant du facteur F2 ou le facteur de ségrégation. Un des résultats intéressants a été la corrélation intense entre la ségrégation de classe supérieure et celle de classe intermédiaire avec la ségrégation totale des quartiers. Donc pour la nouvelle configuration des règles, on doit considérer ce fait. Alors qu'on n'avait pas d'intention *a priori*, la ségrégation dans cette étape a été corrélée intensivement avec la ségrégation des classes supérieures ; C'est ce qu'on peut observer dans l'entrée des classes supérieures après la rénovation ou la réhabilitation. Depuis qu'on avait choisi la sixième étape de cycle de la gentrification d'après Lidia Diappi, le résultat ne se conforme pas à la concomitance de la ségrégation et la provision des résidences confortables. **Par rapport à la ségrégation totale et la ségrégation de chaque classe, un autre résultat est pris comme ci-dessous : L'impact plus fort sur la ségrégation a été de ségrégation des managers et intermédiaires. C'est intéressant que la ségrégation se tienne plutôt Independent de ségrégation des ouvriers et le résultat plus étonnant est l'opposition de ségrégation des ouvriers et les employés. Les deux classes les plus proches ont montré les comportements**

le plus opposés envers la ségrégation ; cela signifie que presque n'importe où qu'il peut exister la ségrégation des ouvriers, on n'observe pas la ségrégation des employés.

La reconceptualisation de problème

La modélisation des phénomènes et processus sont prédominants dans les domaines variés de la science, et le procès commun dans la modélisation est le transfert de certains concepts et règles depuis un domaine de la science envers autre domaine et l'observation des procès par rapport aux règles. La tentation initiale de l'approche ascendant dans les modélisations urbaines est de présenter un alternatif aux modèles descendants. Dans l'étude actuelle, certaine place est prévu pour ce que le procès de planification fait en tant qu'une réalité descendante. Quand on développe son compréhension de système urbain, on peut percevoir intuitivement que les politiques publiques peuvent anticiper l'impacte de, par exemple, le renouvellement sur la valeur d'un quartier en cherchant des soutiens financiers, les décideurs politiques se peuvent chercher à remplacer certains états existants par certains états prospectifs ; pour chercher ce but, d'après O'Sullivan, on ressent une tentation conscient d'accélérer le développement des quartiers urbains complexes a une direction désirable.

Le modèle a la capacité de combiner les procès ascendants et descendants pour décrire ce qui a lieu dan le niveau des agents et ce qui a lieu dans le niveau des planificateurs. A côté du rôle qui joue un planificateur dans la décision par rapport à l'observation et les résultats de program, fournir les nouvelles données au program est l'autre rôle de planificateur. La nouvelle donnée peut être le résultat de décision, action et réalisation des projets. Les projets peuvent embrasser les activités de peuplement ou renouvellement des quartiers de la ville ; ceci est proche à l'approche descendante.

Le système qu'on a utilisé dans ce projet a dépeint les liens entre les événements locaux et globaux. L'application d'Automate Cellulaire et Système Multi Agent, outre la capacité qu'il donne au modeleur pour modeler les événements spatiaux, fait le modeleur capable de modeler les événements locaux et globaux par exploiter les agents mobiles et immobiles. Les attributs des cellules dans l'Automate Cellulaire sont locaux, les décisions des agents et leurs interaction dans une cellule données est locale lorsque leurs impacts sur la mis à jour du programme et le nouvel état du programme sont globaux et la mis à jour globale de système encore se reflète dans les décisions locales des agents.

Le procès de renouvellement peut avoir lieu dans le niveau des bâtiments individuels, mais peut affecter le quartier totalement. Certaines parties des impacts mutuels et récursifs sont exécutées par le programme. Ce paquet de programme a la capacité d'être ajusté et montrer les différents résultats par rapport aux différentes configurations. D'après notre assomption initiale, il y a de corrélation entre le confort et la démographie de gens qui habitent dans un quartier.

Les résultats de 'analyse en composantes principales' a vérifié à quelque degré ce fait par démonstration la corrélation qui existe entre la dispersion réelle de population et la population qui est dispersée par rapport des règles ; les règles ont été définit dans une manière que les individus ont tenté d'atteindre aux certaines résidences en haute-qualité. Selon le renouvellement, la classe de population peut devenir l'objet de changement. Les classes de population peuvent choisir une nouvelle résidence ou rester dans la résidence actuelle par rapport aux comforts que nous avons présenté dans cette recherche ou par rapport aux autres aspirations; les comforts ou les

aspirations se peuvent être satisfaites pour certaine partie de population ou pas pour certaine autre. L'augmentation du confort peut être contrôlée à certain degré par les politiques protectives qui peuvent exténer ou atténuer l'influence cyclique entre renouvellement et la population.

Ce qui a lieu dans la réalité de dispersion de population montre la corrélation entre les facteurs concrets du confort et la dispersion de population; cela peut être appliqué pour calibrer les comportements des agents par rapport aux taux de corrélation dans chaque quartier. L'autre côté qui remonte au confort discret peut être poursuivi par les interviews ou questionnaires avec les résidents et ceux-ci peuvent être appliqués pour présenter d'autre facteurs signifiants au modèle et en proportion de signifiante des corrélations, les poids pour les deux côtés peuvent être déterminés ; celui pour les résidences et celui pour les préférences des résidents.

Dans cette recherche, l'impact d'un côté qui implique les espaces urbaines sur les classes sociales est montré, mais l'impact des habitants sur le changement des facteurs du confort n'est pas étudié. On peut appliquer les répercussions qui sont émises par la concentration des groupes sociales dans un quartier et progresser dans une approche systémique dans laquelle les ingrédients du système peuvent changer le comportement du système.

On dispose un système qui nous permet d'observer les occurrences prédominantes et décider par rapport aux situations actuelles et la situation désirées. Profitant des études qui attribuent de corrélations comme celle entre la dispersion de population et la condition du confort dans un quartier donné, d'abord on peut évaluer la situation actuelle, et après en poursuivant plusieurs scénarios, choisir et discuter à la base de celui qui semble répondre aux situations désirées.

For Leila, with love

Acknowledgements

It is never possible to thank all the people involved in a dissertation. But a brief list includes Professor Maurice BLANC and Professor Jean-Luc MERCIER who are primarily responsible for my instruction in urban study and complex system.

I want to express my sincere gratitude to my advisor, Professor Maurice BLANC, who throughout my doctoral studies has contributed with excellent scientific support and encouragement to commence and achieve this work. I have furthermore to thank to my co-advisor, Professor Jean-Luc MERCIER who supported me with excellent scientific help, particularly in the domain of complex systems and programming. I would like to thank to Professor Pierre FRANKHAUSER and Professor Tim FREYTAG for their valuable comments and opinions in judging this dissertation. I wish also express my deepest gratitude to Professor Jean-Luc PIERMAY for his valuable ideas and fruitful discussions. His supports have been a major reason for me to connect to great scientific links. I am deeply indebted to Professor Colette CAUVIN who has let me have the databases of Strasbourg and also to Doctor Philippe GERBER who has helped me to have some documents of Strasbourg.

I am also grateful to the *CRESS* (Centre de Recherches des Sciences Sociales) and *Faculté de Géographie* and *Images et Villes* for the excellent technical supports.

I am heartily thankful to my greatest source of inspiration, my family, who has always been there for me, understanding and unconditionally supportive of my endeavors as I pursued this goal.

I want to express my gratitude to my best Iranian friends in Strasbourg, Professor Hossein BEYKBAGHBAN, Doctor Mahmoud TAHERI and Professor Hamid Alebuye who have been causes to better perceive the great residence in Strasbourg.

Special thanks are reserved for Mr. Majid BANIASADI who helped me in image processing and scientific works, Akbar GHAZAVIZADEH who has been a reliable scholar, Bohayra MORTAZAVI, Maximilliano SOTO, Elodie PIQUETTE, Guillaume CHRISTEN, Sara MULLER, Béatrice BADER, an and all my friends and colleagues from *CRESS*, *Sage* and *Faculté de Géographie* for helping me to follow my researches.

Finally great appreciation must be expressed to my wife, Leila, and daughter, Yasmine, for their constant love and support.

Table of contents

General introduction.....	1
Overview	1
Overture.....	1
Project.....	2
Detailed outline of the dissertation	4
First part: A planning tool on urban renewal and mobility.....	4
Second part: Implementation in Strasbourg (1982).....	5
The advantages and limits of the model.....	5

Part I

Introduction of part I.....	8
1 First chapter: Urban renewal and residential mobility	10
1.1 General problem discussion	10
1.2 Urban renewal.....	10
1.2.1 Definition.....	10
1.2.2 Brief History of Renewal.....	12
1.3 Main approaches to renewal.....	16
1.3.1 Redevelopment.....	16
1.3.2 Rehabilitation	18
1.3.3 Integration.....	19
1.4 Gentrification.....	20
1.5 Mobility.....	21
1.5.1 Residential mobility.....	22
1.6 Population and urban renewal	23
1.6.1 Populating the areas	24
2 Second chapter: Urban models.....	26
2.1 Urban modeling.....	26
2.1.1 Why apply Model?	26
2.1.2 Properties of Model	27
2.1.3 Types of Models	27
2.1.4 Process of building the model.....	29
2.2 Theoretical approaches of urban development modeling.....	30
3 Third chapter: Complex systems.....	33
3.1 The complex system of city	33
3.2 Complex system definition	34
3.3 Cybernetics.....	36
3.4 Artificial intelligence.....	38
3.4.1 Neural Networks	40
3.4.2 Agent-Based Modeling.....	41
3.4.3 Cellular Automaton	42

Table of contents

3.4.4	Genetic Algorithm	43
3.4.5	Multi-Agent System.....	43
3.4.6	Fuzzy logic	44
	Conclusion of part I.....	46
Part II		
4	Fourth chapter: Determination of variables via a review of similar researches	50
4.1	Literature review	50
4.1.1	Introduction	50
4.1.2	Schelling	51
4.1.3	Portugali	51
4.1.4	Atkinson	52
4.1.5	Lidia Diappi.....	53
4.1.6	Atsushi Nara and Paul M. Torrens.....	54
4.1.7	Giddens	56
4.1.8	Conclusion of literature review	59
4.2	Toward making the model.....	60
4.2.1	Agent Type	60
4.2.2	Simulation Process	61
4.2.3	Simulation Assumptions.....	64
4.2.4	Simulation Results.....	65
4.3	Conclusion	65
5	Fifth chapter: Multi Agent model of urban renewal in Strasbourg 1982.....	66
5.1	Introduction.....	66
5.1.1	The preferences of present model to the study of Gerber	67
5.2	Hypothesis	68
5.3	Cherotaxic and Functional space.....	69
5.4	Multi Agent and Cellular Automata.....	69
5.4.1	Cellular Automata	70
5.4.2	Neighborhood important factors	70
5.5	Strasbourg	72
5.5.1	Development of Strasbourg	73
5.6	Centrality	74
5.6.1	Distal and Proximal accessibility	76
5.7	Gentrification of Strasbourg	76
5.8	Model	78
5.8.1	Data collection	79
5.8.2	Defining comfort	79
5.8.3	Defining segregation	85
5.9	Description of model	87
5.9.1	The simulation in Cellular Automata.....	87

Table of contents

5.9.2	The Scenario	88
5.9.3	The interface of program	89
5.9.4	How the model works	91
5.10	Results	91
5.10.1	Validation	91
5.10.2	Interpretation of the outputs	95
5.11	The results of each area	99
5.12	A principal Component Analysis	102
5.12.1	Workers	103
5.12.2	Employees.....	106
5.12.3	Intermediates.....	109
5.12.4	Managers	112
5.12.5	Real and simulation-result population.....	115
5.12.6	Comfort and population dispersion	117
5.12.7	Segregation and population dispersion	119
5.12.8	Comfort and Segregation in population dispersion.....	124
6	General conclusion and future works	126
6.1	Theory review and discussion.....	126
6.2	Main points of model and results.....	127
6.3	Interests, limits and optimization of model.....	128
6.3.1	A possible improvement of the model.....	129
6.3.2	Reconceptualization of problem	130
6.3.3	Future concepts.....	131
6.4	Reapplicability of the model.....	132
	Bibliography	133
	Appendix	140
	Graphs	140
	Interface of the program.....	165
	Script	190
	Recapitulation of urban renewal in France.....	195
	Cellular Automata neighborhood	196

i General introduction

« *If It Had Happened Otherwise* »

(A book by John Collins Squire, Winston Churchill)

i.1 Overview

i.1.1 Overture

City is the vestige of occurrences in the environment through the history; the largest continuous man-made work that has been generated through the time and it has manipulated drastically the space. From excavations in mountains that are still doing their task of sheltering habitants in some cities like *Kandavan* in Iran to the hundred ‘world cities’ like *New-York*, *Paris*, *Shanghai* and etc, a common trend is observable that is the interaction between human and the city.

‘How a city functions minute-to-minute, day-to-day and year-to-year depends as much on how it is organized in space and time, as on its position in the global system.’ Apart from the natural or artificial events that may refract the routine life of city, city itself is in a reciprocal change between citizens and spaces through the time. City provides structure or framework for social activities from one side and from other side the individual activities mobilize the mediums to form a new space.

In the realm of human authority, planning from one side and actions of residents of city from other side determine the spatial characteristics of a city. The two mentioned actions refer to the motivation of groups or individuals; they may transfer the characteristics of some parts of a city to a noticeable extent or they may transition the spaces piecemeal, but through the time, the minute changes finally end to noticeable changes. As an example, the renewal process that is mostly decided by authorities or their representants has impacts on the life of residents. But from other side the people that use the spaces have impact on how these spaces are going to survive. The former one takes place initially via a noticeable change and we can observe the consequent changes on the life of residents, however the latter one influence the general image of an area and may cause to absorb or to repulse the valorization activities in the area.

Apart from natural transitions, decisions are the quintessence of forming and organizing the city. Decisions can be of a society or group or of individuals or little social units, but the two arise from the present state and lead to a prospect state. At the moment of decision, the options are many but as the physicist John Archibald Wheeler posits, according to ‘it from bit’ even in the scale of atoms, you have two options for decision: take some given decision or not¹ (Ford & Wheeler, 2010). This is what we look for in modeling the urban development process in a bottom-up approach. The result of the decision between huge numbers of possibility that an atom or electron could have chosen ends to a present state that is some form of material; although pursuing the atoms at every moment has not been possible, but the result can address to a retrospect of decisions and choices that it has taken. A similar story occurs in forming urban spaces or structures; the single individuals or groups have a myriad of options in different situations and these options exponentially increase while the second decision is supposed to be taken with regard to initial decisions and actions. But again the present situation is the result of not many choices and alternatives. Profiting from the tendency that exists in modeling, in which we attempt to transfer the dominant mechanism in one system to mechanism of other system under study, we assume that the

¹ *it is not unreasonable to imagine that information sits at the core of physics, just as it sits at the core of a computer. It from bit. Otherwise put, every 'it'—every particle, every field of force, even the space-time continuum itself—derives its function, its meaning, its very existence entirely—even if in some contexts indirectly—from the apparatus-elicited answers to yes-or-no questions, binary choices, bits.*

infinite options that are ascribable to decision of atoms and humans are comparable. The two entities confront to numerous options, but at the time of decision, they choose or do not choose some option. We try to rely on the behavior of individuals as the constituents of society. Despite the fact that there exists unpredictability in the behavior of individuals, we will try to broach the decision of individuals in some sort of algorithms upon which individuals are supposed to decide according to some discernible options. The action of individuals or according to our research, the action of agents according to the characteristics of space forms our model on the development of Strasbourg.

Multitude models are proposed for demonstrating how a city works. From the pictorial schematic plans to the growth model of a city, the quintessence of the attempts have been firstly showing the actual composition of city and secondly helping to better decisions based on the information that the models provide. The information that a map can provide, shows the localization of the bold ingredients of the city that are mostly the physical body and the infrastructure of the city. More recently, the entities of the city are represented by the data as what exist in GIS data. As the matter of information that we can obtain from a city, media like novels, News, films and etc can provide us these information as well.

Varied approaches in modeling tried to suggest appropriate prospect plans on the basis of a retrospect of the phenomena in the city. What is mostly accomplished in statistical approaches, is mostly attempts to predicate a reality to the city, and upon this to decide what the city incline to be in future. The other sort of models that are more abstractive try to generate some system in which the ingredients of the system have relations with each other and the change in the ingredients or the result of the interaction between them can end to the change of the city system.

The offshoot here grows between the statistical approach and the generative approach; in generative models, the information which are aggregated in models do not only make the vestiges from the past onto the future, but assures scenarios via which the planner can compare several results and choose the one that 'it can be otherwise'. The concept of 'what if it had been otherwise' has been applied many in novels, films and dramatic arts and especially in science-fiction ones. John Collings Squire and Winston Churchill presented in their book '*If It Had Happened Otherwise*' some stories of great events that could have been otherwise if the effective persons in the adventures had known some facts or had acted otherwise; in this way the stories could be considered alternate history or counterfactual history. For example "If Napoleon Had Won the Battle of Waterloo", Great Britain becomes a reactionary dictatorship wracked with political instability in the early nineteenth century, dealing with the trauma of defeat and reparations, resulting in the censorship of much of English Romanticism. France governs much of Europe, and Napoleon eventually dies of old age. In the same way, we can refer to some scenarios that are formed on the basis of initial assumptions and the process of their crystallization is observable in a generative model. In the context of urban decisions and actions, along with the data that the planners may dispose, if they can observe the process of some interactions between the constituents of city they may have a wider vista at the time of decision. In the process of decision and accomplishment, the model still can be completed and provide scenario for discussion and as the consequence, the options for decision are open to changes.

i.1.2 Project

The present project is based on the findings of Philippe Gerber (2000) in Strasbourg. The city of Strasbourg is a good example of an ancient city that along with the preservation and conservation of its archaic identity has experienced several large scale constructions. Located at the eastern frontier of France and attached to the borders of Germany, the city has experienced the German and French architecture and urbanism. The uniqueness of the city is not defined just by the eight-century-old Cathedral and the Parliament of Europe and the court of human right has endowed an international identity to the city; as the fourth largest university of France, the University of Strasbourg with its 43890 students (20% foreign students) has defined a new life style in the city. From cohabitation of young generation of students with aged people in the most luxurious parts of the city, to the occasional diplomatic seating, the city is introduced as a siege for scientific and diplomatic events. Like other cities of France, Strasbourg has been the laboratory of development, renovation and rehabilitation and this has led us to choose this case by benefitting from the studies and data that are already provided in similar studies like that of Gerber. In his dissertation, Gerber has sought for some correlations between comfort and gentrification.

On the basis of databases that reflected three forms of comfort, he has applied Factor Analysis for showing the correlation between the change in some comfort factor and the change in concentration of classes of population in the city of Strasbourg in three time sections 1967, 1982 and 1990. With some new definitions of centrality, gentrification and comfort, he inquires if there are some significant correlations between the comforts and the concentration of classes of population in different areas of the city.

The cartography of repartition of comforts has been used in this research and in a different approach we have benefitted from the capabilities of generative models in the present research; in comparison with exploratory statistical approach that has been used in the research of Gerber, generative models can generate *in silico* model that mimics the *in vivo* world. If in constructing the generative model, we can sweep the most prevailing factors that matter in transition of the city, we can generate the city in a future time section or provide some varied outcomes which are resulted by varied extents of factors. This is some trump that generally is not in the scope of steadfast statistical approaches.

In this project, we generate the development of the city of Strasbourg on the basis of basic constituents of the city: residents and residences. This needs a socio-spatial urban study which embraces two aspects of space and society. We will explore the relation between the residents and the residences by combining the two modeling tools, Cellular Automata and Multi-Agent System, to represent the interrelated changes in city. The resulting model is a proper vehicle for probing the relation between the micro-actions and macro-behavior in city; the relation exists between the agents' activities and dynamism of city. This approach enables us to explore the impacts of spatial attribute on the individuals' decisions and this will be the major focus of the present project. Since the decisions in the scale of planning or individual activities are practiced in world with rich data, the provision of data is a privilege or a must in the two forms of decisions and even in some real-time models like traffic models, there are some attempts to organize the system according to the instantaneous changes of information. Therefore the present model feeds data to individuals, and as the result, individuals' activities feed the new state to planners. The substantial difference between the present approach as a generative model one and that of Gerber as exploratory statistical approach is the choice of section by which some event is demonstrated. Time sections 1967, 1982 and 1990 have provided a monitor through which he has scoped out the phenomenon of gentrification. To him, the process that has resulted in some phenomenon in a given time section is not probed in form of media for depicting the process that has ended to the situation and maybe in the interpretation, some part of discussion put forward the process that has ended to some event; but in our study, the process itself is the center of attention and we try to monitor the process. For modeling the process we profit from the information that exist in time section for defining rules.

In the present dissertation, we have chosen only one time section of 1982 for constructing the model and testing the results for the same year. The choice of one time section is as to the limits of time and oppressiveness of mastering several softwares; writing the scripts in Netlogo, Matlab, Excel, R project has been a time-consuming task and the problem has been intensified when some part of the job had been implemented and revised several times. Choosing a proper algorithm for defining the rules has required studies, discussions, revisions in a cyclical and recursive manner. The model is constructed in Netlogo; the software supports the Cellular Automata and Multi Agent System.

Cellular Automata are formal systems that can represent a map (generally) in form of grids of cells; each cell has some present state and it can transform to a new state according to the state of neighboring cells. Cellular Automata can present urban dynamics and the processes of change. It has been widely applied for showing the growth of urban areas. One of the privileges of using this model is that we can simply construct it and it efficiently shows the relationship between local and global changes. Generally the Cellular Automata grid is the result of some image processing and the cells represent the spatial units of city, but sometimes we should feed some layers of data to each or some of cells in order that the cell act according to the inherent information along with the information that the neighbor cells provide.

Multi-Agent System is composed of multiple interacting agents within an environment. Multi-Agent System represents the behaviors of agents that generally have some inherent information and on the basis of the inherent and local information and according to the rules, they show some behaviors. They can interact with the space of programs or just with other agents. The behavior of agents is disciplined according to some spatial characteristics; because of the interaction between the agents and spatial units and also because of the two forms of information that an agent can dispose, local information and personal ones, the Cellular Automata and Multi-Agent System are coupled. Besides, some behaviors of agents are determined in a Cellular Automata field and

with respect to the Automata's system behavior; for example an agent can choose an action according to the attributes of a cell and also according to the characteristics of the cells' neighbors. The two important factors in the model that provoke the agents to move are the seeking for comfort and leaving because of segregation. Since the first one needs some information about the world of the model, Multi Agent System respond to this need better; the latter one is mostly ascribed to a situation that some individual is surrounded by some similar and dissimilar neighbors and according to that the individual decides to rest in or leave its place. So for this one, Cellular Automata seems to be a suitable tool.

i.2 Detailed outline of the dissertation

The present project is consisted of two parts and each part is consisted of three chapters.

In the first part, we consider the city as a complex system. For studying the two constituents of gentrification which are urban renewal and replacements of the residents, we discuss the urban renewal and its approaches and the position that has been taken against residents via each approach. Movement in general and residential mobility in specific sense will be presented in this chapter. In the second chapter the urban model is introduced and the approaches that have been applied toward studying the spatial attributes via residents' settlements will come in following. In the third chapter, the complex system and its applications in urban models are introduced. The order of the chapters and the distinction between urban models and complex systems are arbitrary and this is done in order to provide a package of two complementary approaches that clarify the context of city better. In the second chapter, the agents are mostly under the impact of space and their decisions and actions are under the impact of spatial characteristics like distance, working space, living area, etc and in the third chapter, we try to introduce some systems in which the agents are influenced and influence the space.

In the second part, the complex models of residential mobility, gentrification and segregation are introduced in the fourth chapter and according to existing models, our model will be formed in a hybrid model of Cellular Automata and Multi-Agent System. In the fifth chapter, we apply the model for the city of Strasbourg; so this part is consisted of the introduction of the city and the interventions which are practiced in renewal process and then we will launch the model and take the results. In the last chapter we will discuss the results and the future of the present research.

i.2.1 First part: A planning tool on urban renewal and mobility

The first part is consisted of three chapters in which we introduce bases of our model; it includes the discussions about urban renewal, model and complex system.

The first chapter, *urban renewal and residential mobility*, considers the urban renewal. Here we discuss about the aims and the reality of actions in urban renewal as a context that may bring up gentrification and residential mobility. Different approaches that are pursued in defining the terms and realizing them will be discussed here. Three main approaches are introduced according to which the extent of conservation and renovation and also the extent of maintenance and protection of the residents vary from approach to approach. The different kinds of movements will be discussed for better localizing the connotation of residential mobility. The chapter finishes with a consideration of what pushes the planners and policy-makers to manipulate in the texture of population or in the quality of a neighborhood.

Chapter 2, *urban models*, is an overview of urban models and an introduction to how to choose a proper model, to determine the rules and to configure the parameters and finally to calibrate the model and to validate its preciseness. The classification of models will be presented by different aspects in order to choose the most suitable parameters for the model.

Chapter 3, *complex systems*, reviews the complex systems and their applications in urban models. Some of them, like the cybernetic system, suggest dynamic modeling of the city in a real-time mood. Some propose tools that can represent the spatial, mobile or social aspect of city like the Cellular Automata for spatial purpose and the agent-based modeling for social aspect and mobile entities. And some, like Neural Network and Genetic Algorithm helps to make the models more precise and to find solutions for model problems. And some, like the fuzzy logic widens the spectra of decisions and is applied as a complement of other modeling tools.

i.2.2 Second part: Implementation in Strasbourg (1982)

The second part is consisted of three chapters; here, we review some similar researches, launch model in the city of Strasbourg and discuss the results and present the future of the research.

The fourth chapter, *determination of variables via a review of similar researches*, in this part includes the introduction of models that are made with similar tools to ours, or with similar problem to ours or those who have been the pioneers of applying complex systems in urban or social studies. In the extension of these models we propose the algorithm, the formulas and the probabilities which are applied in model.

Building on the material in the previous parts, chapter 5, Multi Agent model of urban renewal in Strasbourg 1982, describes the model on the basis of the renewal that is practiced in Strasbourg in 1982 and what is simulated as residential choice of potential habitants in the same year. We will benefit from the studies of Philippe Gerber (2000) on Strasbourg. The gathering of data and the parameters for calculating comfort will be discussed here. As a preamble to gentrification, here we construct the model in which the residents of Strasbourg move for choosing some residence for living. The focus here is on the effects of comfort on residential mobility and in particular on the different ways in which the dispersion of population might be conceptualized. The model is launched and the results of the model are validated by comparing with the real situation. The results are under the impact of the decisions of the agents (four socio-professional classes delegate them) and the special characteristics of the 17 areas of Strasbourg; so the results are discussed for each class of population and for each area of the city of Strasbourg. Besides, we will apply Principal Component Analysis for probing the correlations that may exist between the characteristics of areas of Strasbourg and the dispersion of residents in each area.

In chapter 6, *general conclusion and future works*, we present the conclusion and the future of the research. We review the theoretical bases of the model and how they are concretized in the model. The capability of the model in responding to the urban renewal and the future completion of the model will be presented in this chapter. The techniques that help to respond to complex problems will come at the end. Although the model remains an abstract one, the practicability and usefulness as a vehicle for developing intuition and raising question will be one the targets of present model.

i.2.3 The advantages and limits of the model

In this project we will attempt to model urban development via rules and factors that transit the present state of the city to a prospect state. The planner or decision-maker may use the model for testing various planning options and finding the answer to ‘what if’ questions. We will launch and test the model for the city of Strasbourg; the new data and configuration of other cities can be fed to the present model however, and according to new data and configurations we can firstly describe the context and secondly observe and interpret the results for the new context.

The first advantage of this model is its capability in depicting the relations between variables or factors in a generative process. The most important changes in the variables are monitored in the interface of the program as live changes. Apart from the observable changes in the state of program in different times, the inputs and outputs of the program is compared to a real situation as another part of our modeling process.

The second advantage of using this model will be benefitting from the competence to proceed in an empirical or heuristic method. The modeler or user may desire to test the result of some general events like segregation in the model. So he or she can observe the results with different configurations. In a more active role, the user or modeler may desire to add or change some of pre-assumed relationships between the variables by changing the weights that exist in the script of the program.

There are some limits in using complex models or Multi Agent Systems in which the program may function well according to multi-aspect changes in program, but the user or observer may not be able to decide which part of the changes may respond to the planning problem better; so although the program is friendly-user, the user should be able to choose the variables or factors that are mostly pertinent.

The second limit of our model goes back to the lack of data. We have used the population dispersion as real data for comparing the results with the real situation. The data related to residents of a given residence in a period of time could have helped to optimizing the rules and parameters, but we could not find this kind of data. The

classification of population in different censuses makes the other part of our limit. The classes of population that we have for France are different with those of, for example, the US or Iran, so we need to choose the classes that are more relevant.

And finally, the simultaneous advantage and limit of this project is seeking for the state-of-the-art methods and tools. Optimism about technology and computer science may welcome methods that hasten the accomplishment of a repeated action and at the same time someone may stand in pessimist position as to the power that may be at the hand of a planner or decider for manipulating an event. In this project we try to present a package that assemble some variable that are at stake in urban renewal with the possibility to launch the program and visualize the process of events resulted by variables and probably decide upon what the depiction provides us with information. The discussion on each part of the program may end to changing the parameters, rules, factors, etc. The planner is present in the modeling as someone that can configure the present program via 13 settings (someone can adjust the settings by changing the sliders on the interface of the program) or can change, omit or add some other variables and factors to the present program and if the program applies in other context, he or she can feed new data or information according to the new context.

Part I

A planning tool on urban renewal and
residential mobility

Introduction of part I

City and its physical parts, such as buildings and structures, provide living environment inscribed in the natural environment. The lifecycle of the physical part of the city, and the life time of living entity like man are assessed in different measures. From one point, somebody may experience a variety of spaces in his or her life and at the same time all of urban spaces continue their life and become old; the other point is that spaces continue to experience varied generations that use or live in them. The cohabitation between the spaces and their users cannot be studied by considering just one side. One should develop the field of study to other related fields for approaching the model in a more holistic way. The different aspects of a city and the fields of science that involve in studying them make the urban studies interdisciplinary ones.

Because of the life time for people and lifecycle of cities, there are some critical points in their life history that before and after these points, the behavior of urban and human system may be subject to some changes. One of these points in the city life is the renewal era.

The physical part of the city is in interchange with human decisions and can be organically shaped in a long time or can transit to a new position hastily in a process of decision making. The first one is for example crystallized in some organic shaping of medieval cities according to some cores like castle, cathedral, mosques, etc. The second one is especially realized in modern era by comprehensive plans or renovation programs. The interventions in the physical parts can end to some shifts in the present population as well. The projects like enhancing the living areas via urban development are often multivalent projects that beside the palpable changes in urban spaces, they have some impacts on residents and sometimes a special class of individuals may be more susceptible to changes.

For example along with changes in the quality or quantity of buildings or their amenities, some changes in the population will be inevitable or some planners or developers may seek for settling a specific class of population for guarantying the development or maybe they desire to settle some classes to help them benefit the facilities that already exist in a given area. The desire to settle some class of population according to existing amenities and the desire to valorize some area according to the settled population may be pursued in one project; the valorization of an area can be realized in enhancing the physical parts and infrastructure and at the same time it can be practiced by absorbing higher classes and dispersing lower classes to and from a given area. We will discuss that there exists some discrepancies between the aims of this valorization and the reality that some lower classes are obliged to leave their residences either as to the increase in quality of life and consequently the increase in life cost, or as to the lack of affordable houses for the lower classes. The development may differ from location to location and from time to time and the context of the development may influence the policies and the thriving of the projects' but what occurs in varied situations is the inevitable aging of the buildings and the dilapidation of the physical facilities. When the downgrades are concomitant with the settlement of lower socio-economic class of population in the areas, the intervention in the areas cannot be accomplished merely by considering the urban structures or housing projects (Alterman & Kirschenbaum, 1970).

In this part we will present the process of making a complex model of urban development in three chapters. We will discuss the urban renewal and its relation with the residential mobility in the first chapter, the urban models and its different approaches will be presented in the second chapter and the complex models will be discussed in the third chapter.

The first chapter will get into the discussion of two important sides of gentrification: the urban renewal and the residential mobility. From the experiences obtained from the large scale constructions and reconstructions, we will proceed from those urban actions like renovations that did not consider enough the future of residents in the period of renovation, to actions like rehabilitation that try to keep into account the state of neighborhoods and that of the residents together.

In the second chapter, the change, or to some extent, the evolution of models is introduced. The main approaches in modeling has been urban ecological approach, social physical approach, neoclassical approach, behavioral approach, systems approach and the model of this project has benefitted from some aspects of these models. The distinctions between inductive and deductive models, predictive or descriptive models are described here.

In the third chapter, different approaches for modeling complex systems are introduced. Like all the urban models that we introduce in the second chapter, the city is comprised of its residents and the spaces that accommodate them. Some actions in the development of the city can influence the residents. Here, residents mean some intelligent agents or humans that can have interactions between them and between them and the city. So in a process, we will study the influence of urban development on the residents in a complex system.

1 First chapter: Urban renewal and residential mobility

1.1 General problem discussion

The debates around the urban renewal involved some disciplines from which we have followed the discussions mostly in social, spatial, economical and architectural point of view. Generally, the synchronization of renovation with changes in the standards of living of residences and the promotion of neighborhood ends to the shift of residents of the neighborhood. The mobility and departure of some population like lower class is related to the increase in the life cost when it goes beyond their solvency. From other side, the segregation of this class in a neighborhood may seem not to provide guaranties for realizing the projects that can maintain the favorable situation of the neighborhood. We can track the cause of departure of lower class according to some aims of development plans. Dormois et al (2005) mention a trend in European cities in which at the same time that the cities are declining socially, economically and physically, the planners put some programs of development in their political agenda. The programs convey some long shots making the cities attractive for high-income firms and households. In this context, the urban renewal aims to re-image the cities in a competitive urban system. Since the program seems to rely on the external resources to a great deal, some parts of the debates are dedicated to how to attract the high and middle classes and also how to build accommodation for these classes (Dormois, Pinson, & Reignier, 2005). There exists a tendency to prevent the segregation of lower classes as well. As we will mention later, the segregation of upper classes does not put forward problems in the same kind as the segregation of popular class, except that it may bring about the discussions like 'social diversity' for letting all social classes profit the facilities in the same or in a balanced mood. So the focal point in an integration attempt can be the elimination of poverty concentration with its side effects and let the popular class benefit the facilities that can help them to exit the poverty culture (Gerard, 2011).

The necessity of renovation, the desire for increasing in investments in the city combined with the desire to prevent the segregation of different communities or social classes, call for a synergetic approach that can launch several dimensions simultaneously. This approach provides the means for analyzing the complex system of city on the basis of simple elements that make the whole system. The simple elements can be structured and on the basis of the behavior of these simple systems, the whole system can be directed to a latent result that is inferred from the real and valid variables. For this, we can focus on simple elements with the simple rules that change the elements, and study the system that is the result of these elements and rules. For example, in the city system, instead of focusing on the elements that have noticeable impacts (they themselves can be complex systems), we assume the individuals as the elements of the system, and their decisions as the rules that form and change the system.

1.2 Urban renewal

1.2.1 Definition

Urban renewal is not easily defined because of the complexity that exists in its components and procedure. Besides, the words are not passive and application of some words may have different results. Terms like *urban regeneration*, *urban revitalization*, *gentrification*, *neighborhood renewal*, *rehabilitation*, and *renovation* are used sometimes without clear definitions (Palen & London, 1984).

By looking up the expression in Collins dictionary, we find ‘the process of redeveloping dilapidated or no longer functional urban areas’ (W. Collins, 2009). ‘Government-sponsored destruction of slum housing with a view to the construction of new housing’ is suggested by American Heritage (The American Heritage, 2005). Encyclopedia of Britannica suggests ‘comprehensive scheme to redress a complex of urban problems, including unsanitary, deficient, or obsolete housing; inadequate transportation, sanitation, and other services and facilities; haphazard land use; traffic congestion; and the sociological correlates of urban decay, such as crime. Early efforts usually focused on housing reform and sanitary and public-health measures, followed by growing emphasis on slum clearance and the relocation of population and industry from congested areas to less-crowded sites, as in the garden-city and new-towns movements in Great Britain. Late 20th-century criticisms of urban sprawl prompted new interest in the efficiencies of urban centralization’ (Encyclopedia Britannica, 2008) and finally the Dictionary reference suggests ‘the process of redeveloping dilapidated or no longer functional urban areas’ or ‘the rehabilitation of city areas by renovating or replacing dilapidated buildings with new housing, public buildings, parks, roadways, industrial areas, etc., often in accordance with comprehensive plans’ (Dictionary.reference).

Speaking of urban renewal in most contexts brings to mind a public intervention in the process of urban change in a great scale in which the objectives of the state are pursued in policies and their accomplishments. The process is ramified in several fields and put forward the studies and debates in the very policies and in how they are going to be accomplished or on the results which are close or far away from the ambitions (Alterman & Kirschenbaum, 1970). The most involved fields of study seem to be in social, spatial and economical matters.

According to Hill and Schechter (1970), the urban renewal can give a direction to the process of urban change. The changes that occur in an isolated site or in a greater scales parts of the city can plan the quality, location, quantity and the direction of urban change (Hill, 1970). This can be repeated in the history of a city and the urban areas can go under revitalization for responding to urban living and working issues (Miller, 1959). So revitalizing some parts or all parts of urban structure can fulfill the functions that the city has been supposed to undertake (Miller, 1959). Hence in areas of moderate to high density urban land use, urban renewal is involved in programs of land redevelopment. Urban renewal generally applies to inner-city areas, centrally located in historical districts including non-residential as well as residential land uses (Grebler, 1964).

Urban renewal may involve relocation of businesses, the demolition of structures, the relocation of people, and the use of *eminent domain*¹ as a legal instrument to take private property for city-initiated development projects.

It will inevitably bring about the social, economic and physical interventions (Verhage, 2005), and carries on different functions, forms, or facets. The process has major impacts on many urban landscapes, history and demography of city. It may enhance existing communities, and in some cases result in the demolition of neighborhoods (Broudehoux, 1994). I prefer to borrow the definition that François Delarue has proposed in the ambitions of a rehabilitation as the transformation of the city and its habitants, offering to each one a better building condition in which the soul of the neighborhood and the memory of the loci is preserved² (Foret & Porchet, 2001) (translation by H. Kaboli).

In this text, urban renewal is referred as the general process of transforming the urban environment. Its fundamental objective is the revitalization of any or all portions of the urban structure which are not fulfilling the functions for which they were designed. It embraces the intervention in the physical part of areas and also the population texture. From one side the conscious attempt to valorize an area endow some higher standards to living area and from other side, some wanted or unwanted shift in the population texture will be some consequence of the attempt. As we mean to model the interchange between the added values as to the mentioned

¹ ‘The right of a government to appropriate private property for public use, usually with compensation to the owner’ (Heritage, 2009)

² ‘transformer la ville avec ses habitants, offrir à chacun de meilleures conditions de logement tout en préservant l’âme des quartiers et la mémoire des lieux.’

attempts and residential mobility as two facts in renewal, some third fact seems to be at stake in renewal; gentrification, as the third fact will be mentioned in this research as the meeting point of interventions in physical parts of an area and residential mobility according to the intervention. The general concept reaches to some options that according to the history and the experiences of countries, there has been a tendency from the revitalization of the central business district and gentrification of residential neighborhoods into a policy based on less destruction and more renovation and investment.

1.2.2 Brief History of Renewal

Urban renewal has been in form of constant regeneration (Harris & Conzen, 1986), or in the late nineteenth century and the twentieth century, an attempt by local government or reform groups for impeding the decline of physical image of the city (Holcomb & Beauregard, 1981).

The first large scale project in urban renewal was that of Baron Haussmann in Paris, (1852-1870), but the large scale renewal in twentieth century in the United States was triggered in 1949 (Grebler, 1964) some 10 years earlier than that of France in 1958 in which the state got involved in the renewal as the national program. So, the comparison between the two programs can help to observe the path that each of the two countries, as the pioneers of great scale renovation, have run through. As we will mention later the term renewal is recently added to the French urban lexicography.

According to Henri Coing (1966), two ideas were born simultaneously toward the causes for renovation in France: The one that is known as Hausmannian approach which concerns the urban planning, prestige seeking and political tactics and the other one that concerns the undesirable state of buildings. The latter one rose from the conscience that the family lived in defected buildings and this deflection could influence negatively the health of residents ; hence a social urgency provoked the destruction of these buildings (Coing, 1966).

Urban renewal extends to areas that, according to Verhage (2005), do not function well and phenomena like marginalization, exclusion, degradation, devaluation, or abandonment is widespread (Verhage, 2005).

The preponderant targets of interventions are housing, public space, facilities, social measures and fiscal measures and the interventions are mostly accomplished in refurbishing, demolishing, reconstructing, etc of houses, or in rearranging, the roads, parks, play spaces, etc, or in enhancing the facilities like public transport, cultural and educational facilities, or in social activities, support, supervision, etc, or in reducing the taxes for new settlers, transactions in the area, etc (Verhage, 2005).

According to the institutional, economic, social, cultural and geographical context, the urban renewal projects can have varied start points and hence the projects can be defined differently (Verhage, 2005). The urban renewal in each country will be unique by this sense, because the influence of choices made at earlier moment in time contributes to uniqueness and differentiation of usage of the term in different national contexts. But there exists the possibility to transfer the experiences that are resulted by different definition of the term and the different approaches that are taken for confronting the problematic. As an example, in the US, the set of urban renewal programs spanned the operation between 1949 and 1974 and helped cities clear areas of existing buildings for redevelopment, rehabilitation of deteriorating structures, completing comprehensive city plans, and establishing and enforcing building codes (W. J. Collins & Shester, October 2009) whilst in France, it has been used mostly in the framework of *the urban policy (Politique de la ville)* which concerns to a great deal to high-rise social buildings in *fringes (banlieues)* and Bonneville tries to show some exceptions to this trend (Verhage, 2005).

1.2.2.1 Urban Renewal in the United States

In 19th century, as a response to the impacts of industrialization and urbanization on environment, two movements in the United States emerged: The park movement and the City Beautiful movement. They insisted on changing the centers of cities by constructing parks and public buildings. With a little deviation from the former program, in 1930's, the attempts were made in clearing the slum parts of city and replacing them with new multistoried buildings for popular people (Broudehox, 1994; Holcomb & Beauregard, 1981; Nelson, 1988).

According to Colborn (1963), the Housing Act of 1949 formally involved the federal government in Renewal Program. He defined urban renewal of that stage as:

'the diversified efforts by localities, with the assistance of the Federal Government, for the elimination and prevention of slums and blight, whether residential or non-residential, and the removal of the factors that create slums and blighting conditions' (Colborn, 1963).

The main targets of this program was **slum prevention** by conserving the neighborhood and strictly controlling the building codes; **the rehabilitation of structures and neighborhoods** and **the clearance and the redevelopment of structures and neighborhoods** (Broudehox, 1994; Colborn, 1963). Since reaching to the two first targets required an investment that was not going to be lucrative in short term, the one that was more easily attainable was clearance and redevelopment of slum areas.

This approach did not rest in the layer of buildings and by demolishing the inhabitable houses and displacing the small businesses, the popular classes were mostly affected; because the investment were absorbed to central districts and not to the neighborhood under development (Holcomb & Beauregard, 1981). This approach was then known as 'bulldozer approach', because along with re-structuring economy and city, it carried out demolishing blighted areas and building luxurious houses (Blanc, 2011; Santiago, 1975).

According to the program of 1949, the turn-over in a neighborhood took place in a process that many low-rent buildings were destroyed in order that some high-rent buildings replace them; besides the number of demolished building were more than the constructed ones like in the case of Lincoln Center in New York in which 7000 apartments were destroyed for constructing 4400 ones from which 4000 were luxurious apartments (Anderson, 1964).

In 1954, the Housing Act of 1949 was amended in a way that the slum areas around central business districts were cleared to make new land uses. New class of people settled in this area and private sectors had more motivation to invest in these areas (Holcomb & Beauregard, 1981). It was a step forward paying attention to rehabilitation rather than demolition and reconstruction (Nelson, 1988).

Fairbanks (2012) points to a tendency that the Housing Act of 1954 has been a shift from a focus on slum areas and their habitants to a prominence of saving the downtown and allowing the city to better compete the suburbs. This alteration conveys a shift from social focus on slum clearance to an economic stress on making the city more attractive (Fairbanks, 2012).

In 1960s, improving urban conditions required actions more than mere physical renewal (Nelson, 1988). The rehabilitation-oriented program was realized in 1966, when in The Model Cities program, social renewal was taken to account beside the housing programs. The need for supporting the low-income residents to economically and socially rehabilitate their own neighborhoods, caused that revitalization become the main tendency in urban renewal in 1970s. By preserving the neighborhood and rehabilitating the houses, former residents did not need to move like before (Broudehox, 1994; Holcomb & Beauregard, 1981).

1.2.2.2 Urban Renewal in France

Europe had been familiar with **conservation and rehabilitation as parts of urban renewal programs** before the United States. That was to some extent because after World War II, a special attention was attributed to conservation and rehabilitation of historical cities in a reflection to losses of the war and to maintenance of the historic continuum of urban scenes which were inherited from the past (Grebler, 1964).

By the end of the 1960s, Europeans mostly implemented rehabilitation and area improvement as renewal policies (Couch, 1990). According to Daniel Pinson (2001), the urban renewal or 'renouvellement urbain' takes the famous motto 'reconstructing the city on city' and means recovering the most abandoned, obsolete but well infrastructurally situated parts by developing it in a way that it can respond to the present needs of the city.

France, in 19th century had experienced the great problem of housing and sanitary problems after the industrial revolution and that of migration of people from villages to cities. At the time of Hausmann (1852-1870) a large scale intervention in Paris was practiced by demolishing the slum areas and making big avenues (Cottureau, 1978). The modern houses were provided for rich people in this process, but there were not something planned for lower class. So the popular class was obliged to live in crowded inner-city or to move to peripheries (Blanc, 2011).

After the world war two, the houses were not in a good situation and averagely 80% of buildings were more than 100 years old. There was a great need for new houses and according to the shortage in credits, the constructions did not start instantly after the war and it became concomitant with the demolition of the unhealthy buildings and continuing the hygienic process that had started after the French revolution and was seriously followed in the 19th century. The land saving necessity caused the new urban composition to become denser and to substitute the old central areas (Foret & Porchet, 2001).

In 1958, President de Gaulle confronted the housing problems in two fields:

- The central parts that demanded the renewal in working class neighborhood
- And the suburbs that accommodated the affordable social buildings.

The state used its authority to expropriate the lands and then demolished the existing buildings and constructed new ones. Around 300 operations would be done in the coming years and 120000 buildings would be demolished for constructing 190000 new ones. The modest families left the centers of the city, because of tense increase in prices and the state pursued the accommodation of popular classes by constructing social buildings (Foret & Porchet, 2001).

The recycling in industrial and military brownfields and in derelict residential sectors in or around the city centers has been practiced after 1958. The activity that involved the state to a great deal in subsidizing the deficits had prioritized the recycling of urban lands and according to Bonneville (2005) the involvement of state in the renovation of 1960s and 1970s has been the antecedents of the urban renewal nowadays (Bonneville, 2005).

The urban renovation was succeeded by the process of the *joint development zone (ZAC - Zone d'Aménagement Concerté)* in 1967 in the *frame law (loi d'orientation foncière)* that beside the laws of decentralization of 1982-1985 assigns the responsibility of the urban renewal to the municipalities; to some degree, because of the demanded autonomy in supplying the charges of required public facilities, the logic of balancing the costs and incomes tended to select the sectors that needed renovation with regarding to their 'market potentials' (Bonneville, 2005).

The high-rise social buildings of 1960s and 1970s accommodated the lower and middle class, but ever since 1970s, a new trend toward these buildings emerged; these buildings were reckoned as the samples of exclusion and inconvenient life. The leaving of the middle class, accompanied by the logic of social lessors that rented the social buildings to anyone for preventing the vacancy of the buildings, and the pauperization of social buildings rendered the buildings as the accommodation of modest, precarious, socially aided workers and especially the immigrants (Gerard, 2011; Paquot, 2002).

The new situation of these areas attracted the attentions to *fringes (banlieues)* in which the degradation of the buildings and the neighborhood demanded an eminent urban renewal supported by the state. The demolishing of these areas began in the framework of urban renewal after 2003. *The urban policy (Politique de la ville)* prioritized the sites that needed massive renovation or renewal in the *Town contracts (contrats de ville)* (2000-2006) (Bonneville, 2005).

The *solidarity and urban renewal law*³ (*SRU - Solidarité et Renouvellement Urbains*) (2000) helped to extend the field of activity beyond the high-rise buildings of 1960s and 1970s and hence the state involved in the renewal of the sites that wasn't attractive to the market but needed interventions. Some peri-central sites like the ones in Roubaix and Saint-Etienne that were in the *Major City Project (GPV - Grand Projet de Ville)* or *Urban renewal operation (ORU - Operation de Renouvellement Urbain)* which were in a declining situation could go under renewal (Bonneville, 2005).

The urban renewal, according to Bonneville, is added to the French vocabulary of urban policies tardily. He mentions that the urban renewal is a break in the formerly public-led approaches to urban regeneration and it has introduced a new way of framing the relations between private and public actors (Bonneville, 2005; Dormois, et al., 2005).

According to him, the term was imported in the *solidarity and urban renewal law (SRU - Solidarité et Renouvellement Urbains)* of December 13th, 2000. Before this, the terms like renovation, reconstruction, recycling or refurbishing were used in similar circumstances. Since the prevalence of the usage of the term in France in 2000, two mainstreams are followed under the connotation of the term: one that is mostly seen in the social urban development and concerns the *sensitive neighbourhoods (quartiers sensibles)* and it benefits the central state subsidies. The other one is realized in regeneration of derelict and run-down areas of the city which benefits the market (Bonneville, 2005).

Bonneville discerns between the interpretation of the states and that one of the *solidarity and urban renewal law (SRU - Solidarité et Renouvellement Urbains)* (2000) from the urban renewal connotation.

First, because the *Town Planning and Urban Renewal (programmation pour la ville et la renovation urbaine (Loi Borloo))* of August 2003 has not used the term urban renewal, as to him, it reflected the refusal of the heritage of the word and the tendency to follow the renovation trend. Besides, in more concrete aspect, the *Town Planning and Urban Renewal (programmation pour la ville et la renovation urbaine (Loi Borloo))* concerned utterly the large high-rise housing in the *fringes (banlieues)* that were in *Major City Project (GPV - Grand Projet de Ville)* and *Urban renewal operation (ORU- Operation de Renouvellement Urbain)* and the housing estates were the subjects of activity in the scale of sites and not in a greater context of agglomeration, and also the housing estate, not the diversified uses, were of main concerns of the *Town Planning and Urban Renewal (programmation pour la ville et la renovation urbaine (Loi Borloo))*. So the center of attention of *Town Planning and Urban Renewal (programmation pour la ville et la renovation urbaine (Loi Borloo))* was the *sensitive neighbourhoods (quartiers sensibles)* with the approach of demolishing and reconstructing social buildings.

³ the *solidarity and urban renewal law (SRU - Solidarité et Renouvellement Urbains)* (2000) *The program for strengthening the solidarity among citizens. The law has had a profound impact on urbanism and housing of France. One of its controversial items was the obligation of municipalities to dedicate more than 20% of housing stock in each commune to social housing.*

Second, attributing the term for initial project showed that there was not only the type of operation that demanded the labeling, but also the process that was followed in realizing the project mattered as well. Hence, in the recent texts of *Department of infrastructures (Ministère de l'équipement)*, the classical interventions of urban recycling, even when are supported by state and aimed to reinsert an area into the real estate market are not considered as urban renewal (Bonneville, 2005).

The program for strengthening the solidarity among citizens known as *the solidarity and urban renewal law (SRU - Solidarité et Renouveau Urbains) (2000)* and the *National Agency for Urban Renewal (ANRU- l'Agence Nationale de Renovation Urbaine) (2003)* focused on urban renewal by taking to account the residents of these areas. For the *National Agency for Urban Renewal (ANRU- l'Agence Nationale de Renovation Urbaine)*, a task of demolishing the dilapidated and stigmatized buildings was defined and it was supposed to build new developments outside the estates (Blanc, 2011).

Verhage (2005) mentions the property-led type of urban renewal after the *solidarity and urban renewal law (SRU - Solidarité et Renouveau Urbains) (2000)* in which a shift in trends is recognized; a shift from the socio-cultural and socio-economic objectives as the cores of urban renewal to the physical-economic one. With the prevalent discourses around the attraction of private investments into urban renewal areas, the attempt is toward solving the problems of the areas of *the urban policy (Politique de la ville)* that couldn't get to a result despite the financial efforts already done (Verhage, 2005).

1.3 Main approaches to renewal

Two extreme actions in confronting an existing city context are demolishing and preserving, and between these two, there come other approaches. One can divide these actions as **redevelopment**, **rehabilitation** and **integration** as Claude H. Boistière has done (Broudehoux, 1994). In this approach **redevelopment** takes place when some land becomes free by demolishing the blighted area and new constructions replace the older ones; **rehabilitation** is when the main structures are preserved and the equipments upgrade and the **integration** is the combination of the two. In all of them, the residents may be kept in their present neighborhood or they may go to other places. The three different approaches are presented here in more details.

1.3.1 Redevelopment

According to Miller (1959), when there are seriously deteriorated buildings in a neighborhood, or when the arrangement of buildings are not satisfactory and they are not worth saving, dilapidated buildings will be demolished and new projects will replace them (Miller, 1959)(Fig1.2).

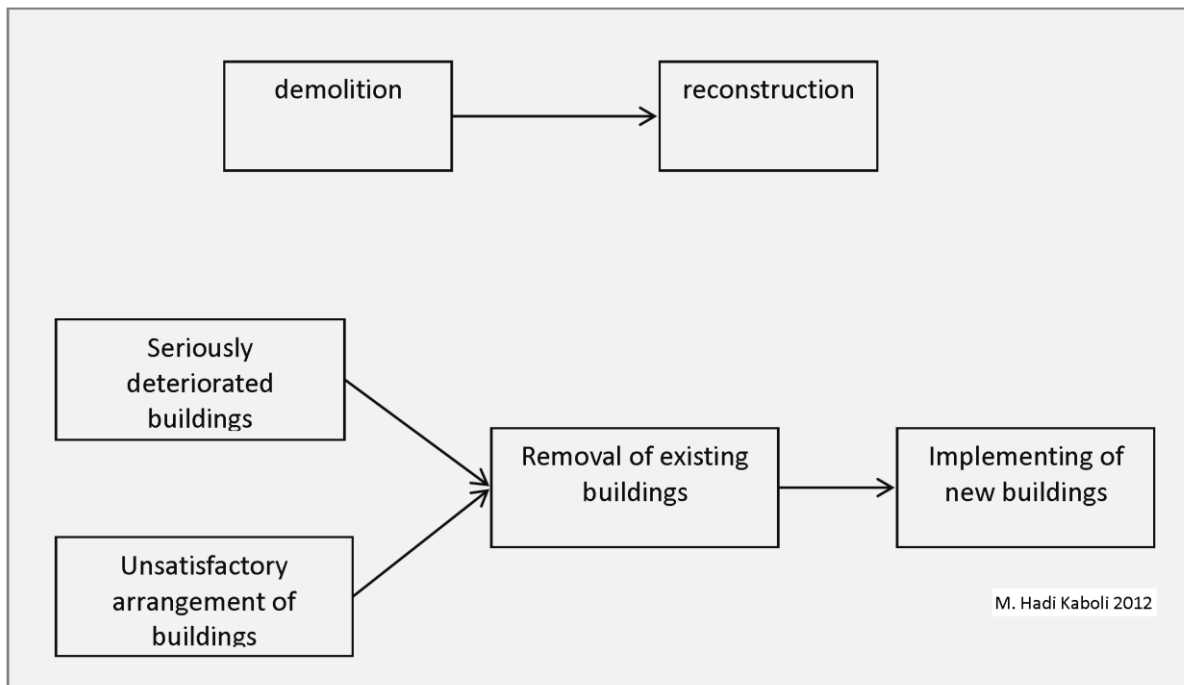

Fig 1.1. Redevelopment process

In this approach, there will be some incentives for developers to invest in these areas because of a great profit they can earn from selling the new buildings. Generally, the density of population and buildings in this redevelopment increases and it is the same about the population with high incomes. The last can be a motivation for policy-makers to absorb these classes to the neighborhood for enhancing the image of a neighborhood (Broudehoux, 1994; Zhuyuan, 1989).

The changes in population to some extent will be because of the emigration of lower classes and to some extent in entrance of new population that will affect the former social relations. This can damage the community cultural heritage, as Frieden (1964) mentions, or bring about psycho problems to new community (Frieden, 1964). The place attachment that helps to social participation and identity constitution will be vulnerable to damages in replacement or displacement. The participation and emotional connections are mostly overlooked in urban operations. According to Pretty et al (2006), social epidemiologists have demonstrated how community connections, belonging, networks, cohesion, and social capital play a significant role in the health, well-being, and mental health outcomes of populations and sub-groups (Manzo & Perkins, 2006; Pretty, Bishop, Fisher, & Sonn, 2006).

The intervention in Paris, as one of the first large scale redevelopment has been the topic of many debates. According to Castells (1975), the renovation in Paris, slowly started in 1956 and widely accomplished in the years between 1964 and 1970 and gradually it was assigned to private sectors by support of public administrative. The renovation movement was undertaken under the title of the *winning back Paris (la Reconquête urbain de Paris)*. The aim of this public program was eliminating slum areas, but it showed some contradictions; the areas that were utterly dilapidated, mostly in the worker and immigrant areas that needed renovation were overlooked, but the operations were mostly seen in areas that had luxurious and administrative buildings because they were more lucrative. New facilities were installed for new residents that had replaced the former ones and not for the people who lived there. Manuel Castells believed that the result of the program was an emblem of an operation that introduced Paris as a directional city to those who were intensely thirsty of modernity. The project has conveyed 'renovation-deportation' (Castells, 1975).

According to Friedrich Engels (1887) the decrepit neighborhoods and impoverished population will not get better, but will relocate to other parts of city (Blanc & Bidou-Zachariasen, 2010).

1.3.2 Rehabilitation

In a situation that the structure and the buildings in a neighborhood are sound but are not enough maintained, the natural and man-made environment can be preserved, repaired or restored (Miller, 1959) (Fig1.3).

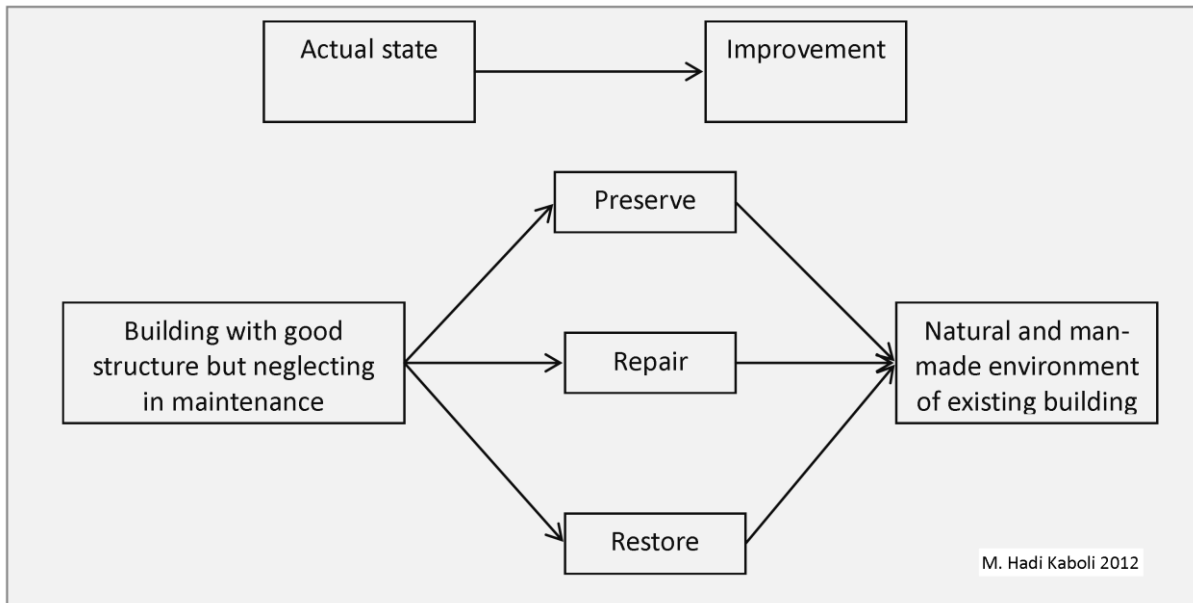

Fig 1.2. Rehabilitation process

The population is the inseparable part of the neighborhood and in different stages of development, it can be affected or affect the urban actions. They can participate in the rehabilitation process and beside the technical and financial assistance, they can encourage other habitants to participate in a process of rehabilitating their buildings (Holcomb & Beauregard, 1981). As Laquian (1984) notes, security of tenure and homeownership can be a guaranty for participation of habitants.

Gentrification and incumbent upgrading are two approaches that according to Clay (1979) can upgrade a neighborhood (Clay, 1979). The first one involves in upgrading the neighborhood by turn-over of population, but in the second, the residents spend their time, money and energy to repair their houses (Broudehoux, 1994; Varady, 1986).

The long time of rehabilitation is the subject of criticism especially from the side of developers who look for greater profits in short term (Holcomb & Beauregard, 1981). Also the present situation of some buildings does not seem worthy to maintain and maybe some more actions are needed for enhancing the structures.

In France, according to the reports of S. Nora (1975) the state has replaced the renovation with rehabilitation in policies and it has commissioned the communes to pursue the rehabilitation plans (Merlin, 1995). Rehabilitation included the activities by which the norms of comfort and habitability are inserted to buildings and a great part of efforts were dedicated to conserving the façades and stair boxes of buildings. We will talk more about the comfort and the standards that the INSEE had defined for comfort in part three.

The rehabilitation was followed especially in central parts of the city and also in villages with *protection, improvement, conservation and conversion of habitats; regional association for restructuring of real estate (PACT-ARIM -Protection, Amélioration, Conservation et Transformation de l'habitat ; Association régionale pour la Restructuration IMmobilière)* and the *urban development fund (FAU- Fonds d'Aménagement Urbain)* programs; the first consulted the residents and recommended the local collectivity in accordance with the activity of the *programmed operation for the improvement of the housing environment (OPAH- Opération Programmée*

d'Amélioration de l'Habitat), and the second one had collected a practical package from the juridical procedures to new methods of intervention in old parts (Gerber, 2000).

Although the tendency to the development of service sectors was not set aside and it could end to some changes in the buildings and population, the attempt by *Malraux law* (1962) and *urban development fund (FAU- Fonds d'Aménagement Urbain)* was to protect the dilapidated buildings and the habitants by revitalizing the areas (instead of renovating) and elevating the level of comforts of buildings and consequently the comfort for habitants. Even the municipality interfered in the use of dilapidated buildings and limited the access to the buildings that lacked the basic comforts (Gerber, 2000).

The rehabilitation has been accomplished by the institutions that provided the technical, financial and administrative supports and the State supervised the rehabilitation activities with the institutions like *National Agency for Improvement of the Habitat (ANAH- l'Agence Nationale pour l'Amélioration de l'Habitat)* and the *urban social fund (FSU- Fonds Social Urbain)*; by them the buildings were controlled to be equipped with modern norms of habitability like central heating and shower rooms, or protecting the owners whose habitats were under rehabilitation by the *National Agency for Improvement of the Habitat (ANAH- l'Agence Nationale pour l'Amélioration de l'Habitat)* aids that half of what was spent for the *programmed operation for the improvement of the housing environment (OPAH- Opération Programmée d'Amélioration de l'Habitat)* activities to be refunded and in the period of rehabilitation they could use the social buildings, and the last was the *personalised housing allowance (APL- Aide Personnalisée au Logement)* for the tenants that might have experienced increase in rents (Levy, 1987).

1.3.3 Integration

Redevelopment and rehabilitation as two sides of urban action can be integrated in a third approach that profits from the positive points of the two sides. In this approach the target is preserving the buildings that are worth saving and reconstructing those ones that are not (Qingkang, 1988) (Fig1.4).

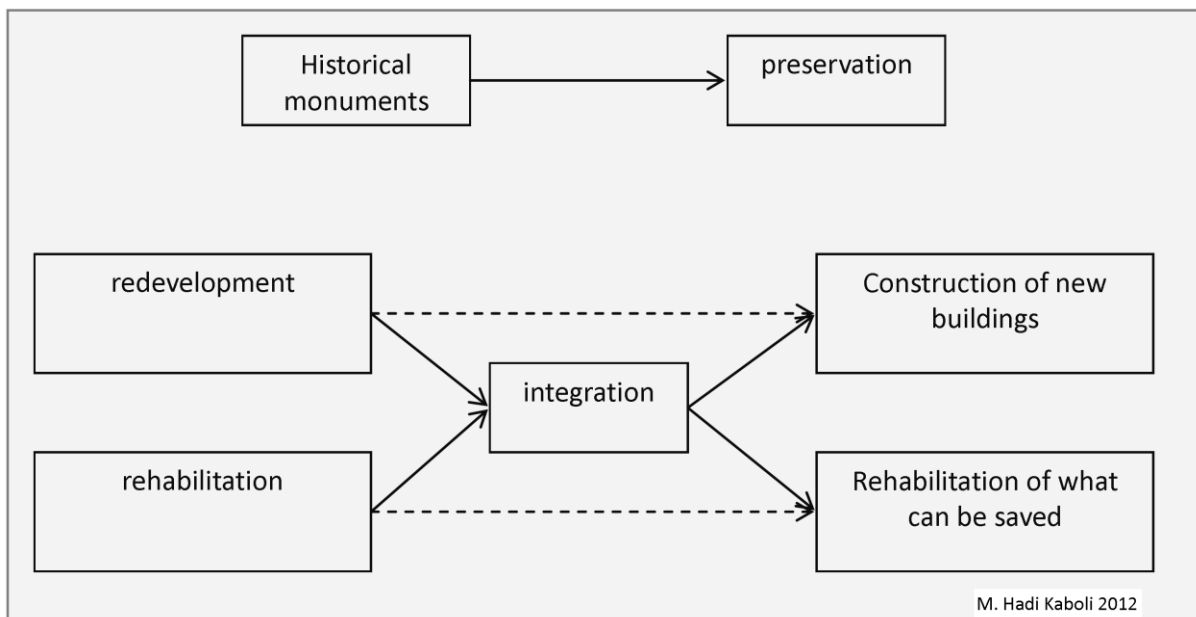

Fig 1.3. Integration process

In this process, the community and the historical heritage are saved to a great extent and if necessary, the new buildings and structures are added to the neighborhood or the density of the neighborhood can be subject to changes. Some new architecture can modernize the image of the neighborhood while the overall identity of the neighborhood can be preserved; but again the works do not progress as fast as those one in redevelopment.

The role of comfort in the definition of urban intervention in France is adaptable to the integration approach. As it can be inferred from the housing research 1984, the French people do not do with the dilapidated buildings as much as they did in 1978 and between 1975-1995 the new construction has given its place to a great extent to *aménagement* (the intervention in land, path, or public space in an urban environment of a neighborhood in order to enhance their state and appearance) and new jobs relating to renovation, development, enhancement, embellishing appear in these years. This helps to enhancing the comfort and welfare (Seze, 1994).

As the matter of social buildings, they are generally reconstructed and that implies the demolition of some degraded ones and reconstruction of some new ones; according to the new trend, the number of constructed buildings are less than the demolished ones and some part of the reinserted lands may accommodate the private buildings. The demolished social houses are not compensated exactly like before and that can be the effect of two causes: First goes back the typology of the new constructed ones that offers less modest ones like before. Second, the rents of the new housings are generally more than the former ones and the part of the income that each tenant should pay frighten the tenants and this is reflected to the project managers (Gerard, 2011).

The diversity in supply of houses, as part of the urban renovation, aims to demolish the social houses and to reconstruct them partly on the former site and to construct the houses by the private sector on the rest. The combination of two actions depends to three factors: the demand of *National Agency for Urban Renewal (ANRU* ⁴ - *l'Agence Nationale de Renovation Urbaine*) (2003), the local political decision and the availability of land; the land can already exist or become free by usage change (Gerard, 2011).

According to Foret, we recapitulate the history of urban renewal as it comes in the appendix (Foret & Porchet, 2001).

Our research is on renewal interventions and it embraces the interventions in space, the residential mobility and as we will mention, the gentrification as the meeting point of spatial interventions and the residential mobility.

1.4 Gentrification

'Gentrification' as a process or cycle of turn-over in population in favor of middle class and as the consequence of renovation in the city was first coined by Ruth Glass in the city of London in 1964.

Conventional definitions of gentrification tend to introduce gentrification as the coincidence of renovation, or especially rehabilitation and turn-over of population as the result of high standards and high costs that emerge after renovation. The new demography can be one of the desires in gentrifying process of an area however. The samples of renovated areas can verify this coincidence and maybe they can push us to believe in causal relationship between them.

The demand side of gentrification focuses on the entrance of middle class, the new costs and prices and new situations for popular class. It insists that it can be the start of eviction of popular class or at least it can bring a new hard situation for the resting popular class (Vigdor, 2002).

The supply side that will be discussed more in next part reveals the intention of planners and developers to profit from a segregated area with dilapidated buildings for profiting from the gap between low prices in time of buying the properties and high prices after renovations. In this situation again, the eviction or hard situation for the popular population can seem inevitable (Smith, 1987).

But we focus on six steps of gentrification that Lidia Diappi based her model on, and via this she studies the Rent Gap Theory of Smith (We will show it in the next part). The first stage of gentrification cycle according to her is the depreciation of the buildings, the second stage is the departure of middle or high class from the

⁴ The ANRU law states that for each demolished house, some house should be replaced but partly as the social buildings on the site and partly out of the site (Gerard, 2011).

neighborhood and some properties may be left vacant, the third stage is when the prices of properties decrease because of vacant properties and the segregation of popular class and the actual state of buildings, the fourth stage is the decrease in the land prices or rents due to the negative situations, the fifth stage is when there is the best time for developers to buy the properties and realize their projects of redevelopment or rehabilitate the existing buildings, the sixth stage is the increases in the prices and rents and maybe the cost of living in the neighborhood. In this stage the popular class experience new situation and eventually leave the neighborhood (Diappi & Bolchi, 2008).

Our focus is on the last stage; with all the differences that may exist in the studied zone of Smith and Diappi and our study zone, we can find the common points respectively depreciation, renewal and new situation.

We can consider gentrification as the meeting point of urban renewal and residential mobility. In another word an area can be considered as gentrified when two conditions hold: Firstly when middle or higher classes invade a neighborhood and make the working or lower class leave the neighborhood. Secondly when most of the buildings in the neighborhood get rehabilitated in a combination of modern and traditional designs.

According to protective policies for former residents such as owners or tenants, the new situation that is a modernized neighborhood may or may not be with the entrance of middle or high classes or the eviction of lower classes. The middle or lower classes may settle in these areas proportionate to their solvency or they may desire to live in a neighborhood that is located in central parts but in smaller residences equipped with technical comfort such as WC, Shower room and central heating, or may live in bigger houses that may not be in central parts but they are more spacious and near to the centralities that offer a good infrastructure or final services. This can be considered as the 'embourgeoisement' of the residents of a neighborhood; so with regard to the connotation of gentrification, since in the context of our research we may renovate or rehabilitate the areas, we may be closer to the application of embourgeoisement. The embourgeoisement is more general and it embraces the renovation and rehabilitation or building new buildings in a poor area whilst the gentrification is consisted of rehabilitation of old buildings in a poor area that benefits the upper classes.

The shift in the population as a form of mobility and in the context of populating the areas will come in next titles.

1.5 Mobility

According to Brunet (1993), the mobility is the set of events related to movement of social realities (human, material and immaterial objects) in the space (Brunet, Ferras, & Théry, 1993). The definition can cover movements like displacements, migrations, transports etc. The mobility has been discussed in the sciences related to the city like urbanism, sociology, geography, housing studies, etc.

According to Pumain et al (2006) in the *Dictionnaire de la ville et l'urbanisme* the mobility can refer to social one as the social mobility and they discuss that it can be eased via the diversity of urban society. They exemplify a young person who is pursuing his or her education or an immigrant seeking for a job as preliminary activities to social mobility; the chance for education and work may not be found enough in secluded areas (Pumain, Paquot, & Kleinschmager, 2006).

In geography, some part of issues can refer to the information about the movements in a space and structuring these movements in transportation or infrastructures will be the other part.

In the field of urban mobility, some aspect of the event goes back to urban territory and some other refers to individuals. The city may provide urban spaces and system of transportation while the one in the center of attention will be the human; so urban mobility settles in the common field of urban and social practice. For example, in studying the frequentation a place, the distance between a given place and a residential area or the population and its texture can be at issue. Vincent Kaufmann distinguishes four types of mobility of individuals in the space: the daily mobility, the travel, the migration and the residential mobility. The daily mobility is the cyclic recursive frequenting an activity area. There is a limit for this kind of mobility that is defined by the farthest place from where the individuals frequent an activity area. The travels happen in an interregional or

international scale with the intention to return to the starting point. One of its differences with the daily mobility is in its time scale; generally for a daily mobility, the time is considered as less than a day, but the travels often last more than one day. Migration is going out of the residential area and it takes place in a linear movement with or without returning to the start point. It mostly engages the space rather than the time. Residential mobility addresses the change of residence and can occur because of the change in the situation of the family, the children's education, the working space or as the matter of our project, because of some interventions in the living area. That is non-cyclical linear mobility (Epstein, 2007; Kaufmann, 2000).

1.5.1 Residential mobility

The mobility of population as to renovation is one of the most important concerns of urban renewal. The turnover of population can be one of the targets of planners and developers but it is not explicitly mentioned (Kleinhans, 2004). According to Fischer (2000), three forms of mobility can be differentiated in residential mobility: The mobility of *communities* and those for *individuals*, the *voluntary* and *forced* moves and finally, the *local* and *distant* moves.

1.5.1.1 Individual or collective mobility

Individuals can be some members of family that because of a change in the situation of life, work or etc can move individually, but some mobility will be for families or some groups of people. The individual mobility can be for one given individual like a parent, child, etc as to the change in the family status, work and study and so on and collective mobility can occur in some groups like different classes, races, types of households, etc as a result of disasters, housing issues, etc. Here according to the status of a given person, the move can be as one's own decision or as following someone else's decision; that brings about the *voluntary* or *forced* movement and depending on whether the move is in the commune or out of that it put forward the *local* or *distant* mobility.

1.5.1.2 Voluntary or forced mobility

Also the moves can be voluntarily in cases like finding a better residence or better community and it can be forced as the consequence of some cases like the cost elevations or the stigmatization of a neighborhood. Enhancing of life can be practiced in finding better job, better house, better social network, etc but on the other side the moves can be involuntarily practices like in the case of victims of natural or man-made disasters, the poor who cannot meet housing costs, dependent wives who must follow their husbands' job changes or residential preferences, spouses who experience divorce unwillingly, and children who follow the decision of parents for choosing a residence. Apart from the situation that may be unfavorable for all, the members of family do not have the same authority in choosing the kind of mobility and it addresses the residence, its location and its specificities.

1.5.1.3 Local and Distant mobility

The moves can be in a near distance like the one in the same commune and that can be to out of a given commune or even out of the province. The reasons and measurements of local and distal mobilities are varied. That depends to some factors like life cycle, family status, level of education, kind of tenure and etc. In our model, the class of population which moves is the socio-professional class, but this is not the group or class that moves, but the individuals that are counted in the census do. The movements are voluntary ones and even the program alerts all the individuals about the status of other residences and maybe some individuals decide to seek for better residences in the city. All the mobilities in the present program are local none of the residents are not assumed to exit the study zone; this matters by two aspects:

First, the number of individuals that move while the program churns are constant and only at the end of the program, those who are not in the world of the program are not counted,

Second, the system of the program is assumed as endogenous and there is no externality like immigration or emigration taken to account at this step of program.

1.6 Population and urban renewal

According to Coing (1966) the high-income and young generations welcome the renovations more than other groups of population and as his study shows, the new rents in 13th arrondissement of Paris became five times more than before and the families had to crucially re-organize their budgets for affording the new costs of life (Coing, 1966).

From one side, the investments in renovation can be refunded when the quality of the neighborhood and the people who can pay for occupying new-state buildings enhances and from other side the popular residents that cannot afford this increase in costs confront a new difficult situation.

The attempt to enhance the situation of popular class along with the attempt to attract the middle class has been pursued in France via *Town Planning and Urban Renewal (programmation pour la ville et la renovation urbaine (Loi Borloo))* (DIV, 2005). Parallel to or compensating *the solidarity and urban renewal law (SRU - Solidarité et Renouvellement Urbains) (2000)* plan, the attempt of the two programs is going toward *social diversity*.

For enhancing the social diversity, ever since 1990, two courses of actions were followed in France. *The frame law (LOV- Loi d'orientation pour la ville*⁵ of 13 January 1991 was pursued in the scale of agglomeration and aimed at balancing the social buildings in the whole country and *the solidarity and urban renewal law (SRU - Solidarité et Renouvellement Urbains) of 13 December 2000)* aimed at realizing the social diversity in the neighborhoods that already were satiated with social buildings: Diminishing the number of poor population and dispersing them in the urban spaces and keeping the solvent households in their spot and adding new installations for the new affluent classes (Bacqué, 2003; Gerard, 2011). Hence, there is supposed to practice two strategies about populating the social buildings: the diversity in the status of the houses and the change of the image of social buildings (Gerard, 2011).

Prof. Blanc (2010) reviews the paradoxes that exist in the subjectivity and objectivity of *social diversity (la mixité sociale)* especially when it is supposed to be realized by a concrete plan that until 2020, 20% of housings of each commune should be of social buildings (Blanc & Bidou-Zachariassen, 2010). In these programs, the concern for maintaining the middle and upper classes are not as much as that one for lower classes; in segregation, as the opposite point of social diversity, the middle or upper classes have used their solvency and liberty to leave or stay in a given neighborhood; but in the case that the neighborhood or buildings are not in a favorable state, the lower class may reveal a problem. Their segregated areas alert the planners about some kind of slum area or ghetto. So beside the attempt to protect this class in times of renovations, the departure of other classes may help to the segregation of these areas.

One of the obstacles in the way of implanting the social buildings in the areas liable to the *solidarity and urban renewal law (SRU - Solidarité et Renouvellement Urbains) (2000)* is that it is very difficult to insert this project in an area that there is not already any social building like in the case of areas of Strasbourg without *low rent housing (HLM- Habitations à Loyer Modéré)* (Gerard, 2011). Strasbourg had already dedicated 25% of its housing stock to social housing but it was repartitioned in the areas unequally, so some of areas did not have already social buildings and inserting new social buildings has not been easy.

Besides, there exists a contradiction in relocating some people for balancing the population texture with the liberty to choose one's residence and as Prof. Blanc quotes 'enforced desegregation is no better than segregation' (Blanc & Bidou-Zachariassen, 2010; Edgar, Doherty, & Meert, 2004).

⁵Loi n° 91-662 du 13 juillet 1991 d'orientation pour la ville

The law seeks for a life condition that assure social cohesion and preventing or disappearing the segregation. It demanded that each area of the city assure the coexistence of diverse social classes in each development that it may exercise.

According to our model which tries to simulate an urban phenomenon, the agents in four socio-professional classes choose their neighborhood and they will demonstrate the tendency to choose to 'cohabit with ones who are similar'. Although some people deny the fact that they tend to live with people of their class or with people who have some similarity to them, even a spare tendency of this kind can end to segregation. Schelling (1971) has depicted in an empirical model that even when people show high tolerance in living beside dissimilar ones, the result of the program shows a noticeable segregation of people. We have applied this fact in the model and the segregation is represented in a range between 0 and 8; the more the variable increase, the more the people are sensitive to the number of dissimilar ones beside them and if it passes their tolerance, they will leave their present residence.

1.6.1 Populating the areas

The population texture in an area may push the planners to have a preview of what is going on in the mixture of different classes or maybe they desire to manipulate it.

The change in the texture of population is desired by the *Town Planning and Urban Renewal (programmation pour la ville et la renovation urbaine (Loi Borloo) (2003))*. As mentioned before, there is a willing to disperse the poor population in other spots of the city and to keep in place the middle class and to absorb the affluent classes via the social diversity program. According to Bacqué (2007), the elimination of pocket of poverty takes place in order to prevent the danger that it has for the cohesion of the society and for the security of the citizens; besides the social diversity can be aimed for fighting against the exclusion process and let the individuals exit the culture of poverty by benefitting from a good neighborhood. Two sides of the policy of *social diversity* is: firstly diminishing the concentration of the poor population for sheltering them against the 'neighborhood effect' such as school scores, access to job or deviant behaviors and secondly the hope that the spatial proximity will end to social proximity via the integration model and the useful networks for inserting them in social integrity (Bacqué, 2003).

Populating the areas (dispersion of different classes in areas) can be in two forms; it can reflect the present dispersion or can be an intervention in the settlement of the classes in areas.

In our study, according to what the present state of areas can propose as the comfort items (we will discuss more in third part) the population disperses in the whole city and chooses some neighborhood as its area of residence. Prof. Blanc (2010) mentions that the segregation of social class is stronger than that of ethnic groups (Blanc, 2010); hence the classes that represent the population are chosen in socio-professional classification.

As the matter of decision, two items are defined for the prospective residents for settlement; one is the comfort factors that may be an item for which the residents compete and this is embedded in the cartography that shows the repartition of three comfort factors and the other one is the segregation that may cause the classes to choose their neighbors like themselves. The final combination can be close to or far from the actual state in the given time section and this can enable us to identify the result of the behaviors of different population classes that exhibit different distributional behavior around the zones that benefit from comfort factors.

The two sides of this project are the population and the city or in more precise sense the agents and the space of the city of Strasbourg. We will discuss city as a complex system and as the target of this project is modeling the city, we need to present the complex systems and models.

As it is shown in the Figure 1.1, the interaction between the members of a social group according to their aspiration make some internal rules that determine their behavior; the behavior that they show ends to some new situations where something is put in common and two members should decide how to act. These common situations end to some interaction between different social groups in spatial confinement; the interactions can result in transition of urban situation. At each stage, it is possible for a planner to set objectives and by following some plans and implementing them give a new direction to the system.

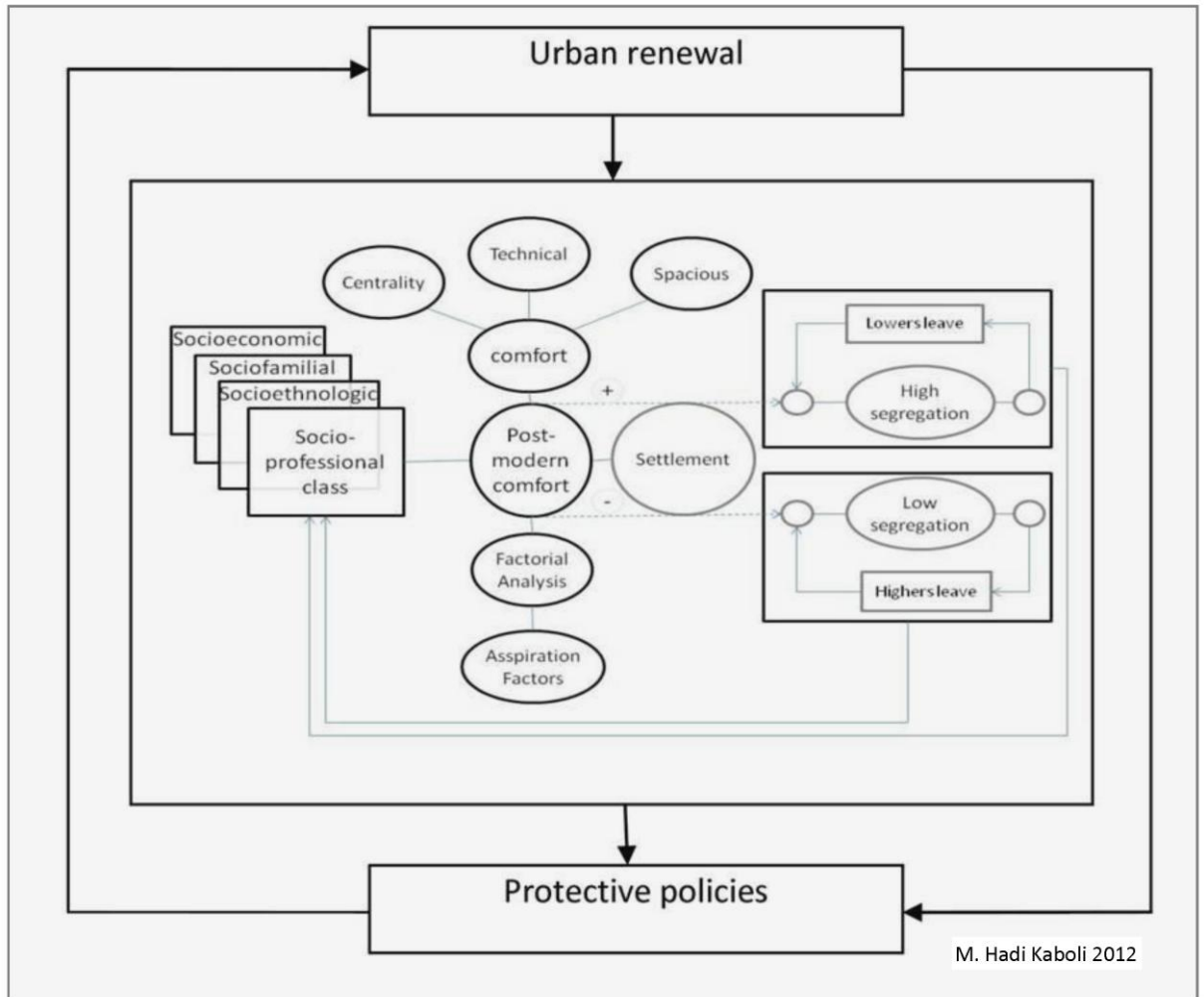

Fig 1.4. The mutual impact of population shift and urban interventions.

In the next chapter we will discuss model and modeling and in the third chapter we will introduce complex systems and those applied in urban modeling.

2 Second chapter: Urban models

2.1 Urban modeling

Urban models and urban modeling prevail in great part of urban studies. The two terms refer to the application of computer programs for generating or testing a theory against data. In the *'International Encyclopedia of Human Geography'* Michael Batty introduces Urban Models as 'representations of functions and processes which generate urban spatial structure in terms of land use, population, employment and transportation, usually embodied in computer programs that enable location theories to be tested against data and predictions of future locational patterns to be generated', and Urban Modeling as 'the process of identifying appropriate theory, translating this into a mathematical or formal model, developing relevant computer programs and then confronting the model with data so that it might be calibrated, validated and verified prior to its use in prediction' (Thrift & Kitchin, 2009).

Models are anterior to computerization; we will mention in this chapter that different approaches in modeling the city have pursued some theory and according to the data that can have proved or refuted the initial theory, the models have been applied by others in different situations or they may have been subject to some changes or amendments. For urban modeling we benefit the computer-based simulations and via these, we test theories about spatial location and the interaction between land uses and related activities. Also we can observe the physical changes of city as to the physical planning policies. With the evolution in software and the change in approaches from top-down to bottom-up ones, the urban models have changed from theories and structures that articulate land use and movement in aggregate static terms to more dynamic models that the behavior of individuals form the spatial structures.

Modeling in general is defined as visualizing difficult concepts or complex phenomena or intricate theories (Gilbert, 2011). It helps to show the relations that exist between the parts of the subject of the study.

Chorley & Kennedy (1971) define model as 'representation of an event, object, process or system that is used for prediction or control.' They differentiate between the models that describe something and those who show causal relationships (Chorley & Kennedy, 1971). According to Batty in the past 50 years the models have been more descriptive (Batty, 2007) and our model will be one of them.

2.1.1 Why apply Model?

The use of models let us discuss a problem and its context, and if necessary, like in our model, define some rules and demonstrate the process; sometimes with the initial rules, we can change the parameters and give importance to some factors and observe different situation. That means we observe different results according to different inputs; in our model the inputs are the initial state of program with initial calibration of interrelation between the factors. In this way we simplify the topic by modeling it and try to understand the subject better by controlling and manipulating the process (Liu, 2009).

According to Paul Meadows (1957) models have become general because we tend to think like systems and to some extent because the systems are by themselves models, so when we talk about systems we are already mentioning models. The other reason is that the history of science is a succession of models that has been introduced and discussed (Apostel, 1960; Meadows, 1957). The extent to which abstract models are applied in analytic and predictive discussions can show how much the theories are advanced in a given science (Kilbridge, O'Block, Teplitz, & Research, 1970).

The use of models, as do in descriptive models, provides media that conveys the items of scientific discussion and at the same time it gives the possibility to test the presumptions and theories. And also the model can take part in deduction or induction according to the position that it has toward the theory (Liu, 2009). The first step of our program will conclude a macrostructure from the micro-actions between some agents; so it is inductive, but like other models, if the general theory can change the rules that is between the agents it can feedback the

macrostructure to the micro-actions and that can be deductive. By inserting our model in a proper context, and by properly calibrating the relation between the factors of our model with those of expanded ones, the model can be applied for describing the development of the city of Strasbourg and after testing and validating the results in three time sections 1967, 1982 and 1990, we can apply the model for predicting the development of the city in future based on the interaction that is current in the model.

2.1.2 Properties of Model

In making the model, the significant factors and their relations are chosen and we do not apply all the elements and relations; so the model will be highly *selective* toward choosing the information that we consider as important and this is done because the noises should be omitted, but in this process many important data and relations will be subject to omission as well (Chorley & Haggett, 1967). So even for the same context, the parameters should be changed for two different time sections and for a new context both the factors and the parameters should be defined again. So as Liu (2009) proposes we can call it an *approximation* of reality that can suggest a tool upon which the planners can decide (Liu, 2009).

Another point in models is that they should be *suggestive* of how they are supposed to be extended or generalized (Hesse 1953). So like what the *predictive* models do in showing what the world will be as the result of the model or what *descriptive* models do in revealing the structure of real world, the modeler should provide his or her evidence for showing why some group of things in the model affect other things (Liu, 2009; Lowry & Corporation, 1965). Of course two main obstacles will restrain the re-applicability of models that are mostly caused by the theoretical problems and the technical problems. As mentioned before, even if we have the access to all the existing data in an urban model, we do not know exactly which parts influence which part and to what extent.

The human factor in forming and changing the city can practice its effect in macro scale by the planning and in micro scale by the tendency of people; So according to Giddens (1987) in addition that the different methodology of research and validations are inadequate, the causal conditions that exist in social behaviors are not stable and so they cannot be generalized (Giddens, 1987). So does it stand in opposition to the attempt to describe or predict a situation? We see in the next title that the different approaches in urban studies have put forward the models that were not clear beforehand but in the process of collecting the data, suggesting the models and validating them, firstly some descriptions were proposed for the development of the city and secondly based on what were proposed, the validation of the models could assert their potentiality to predict or what could help to their generalization.

2.1.3 Types of Models

Models can be categorized in different ways. Liu (2009) suggests that they can be divided into three groups as their extent of abstraction increases. By this classification the most non-abstract models are of *scale* that consists the iconic models that copy the reality in a miniature mode; we can see this example in architectural plans, or geographical maps. More abstract models are the *conceptual models* that depict the relationships between different components of reality; the von Thünen model of agricultural location is one of these models. He proposed in his model a land-use pattern that was resulted from the maximization of rent at every site in Mecklenburg, Germany (Liu, 2009; Thunen, 1966). The most abstract model are *mathematical models* which describe a system by using mathematical concepts and language; we can see the examples in locating residential areas or industrial activities by representing the flows of persons or trips among the zones, and the whole forms the urban areas (Cirinà, 1978; Liu, 2009) (Fig2.1).

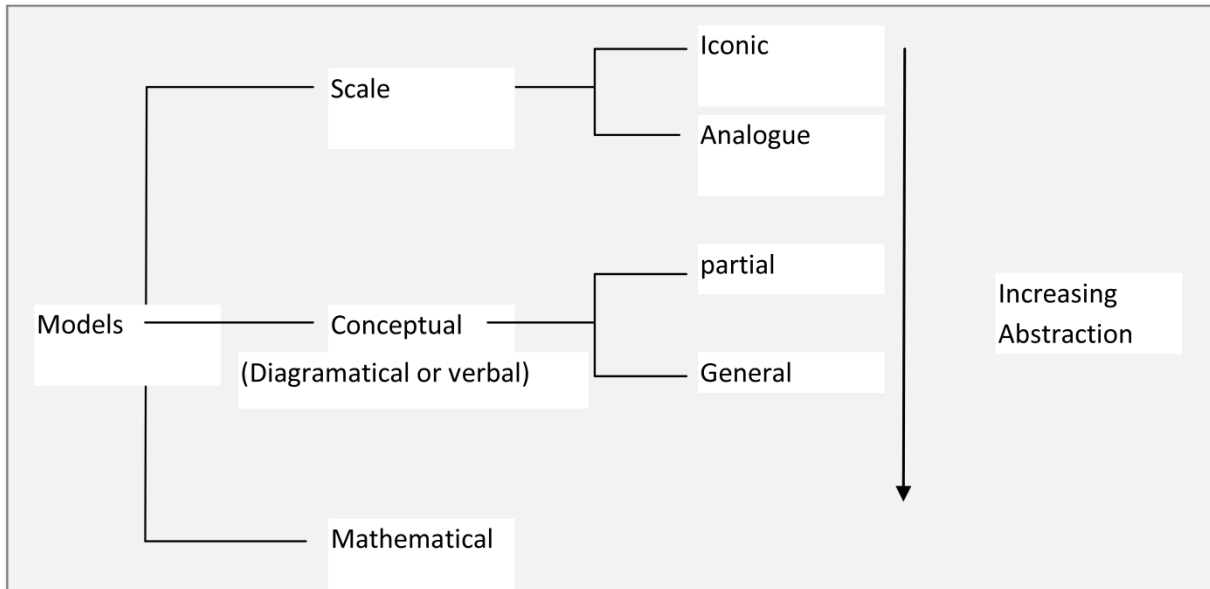

Fig2.1. Classification of models. Y. LIU, *Modelling urban development with geographical information systems and cellular automata* (Liu, 2009, p.4).

Fig2.2 shows the classifications of frequently used models in urban modeling (Batty, 1976; Chorley & Haggett, 1967; Kilbridge, et al., 1970; Robinson, 1998).

In mathematical modeling there is some movement from differential and statistical models into generative non-linear models from which we have used the agent-based model and Cellular Automata; the two of them generate a world that is not predictable. In agent-based and Cellular automata models, the program proceeds according to the rules defined by If-Then's and according to the classification that Liu (2009) has presented in her book *Modelling urban development with geographical information systems and cellular automata*, as a matter of theoretical base, our model is a theory-laden model that takes the moving agents as the moving residents of the city and from the point of substantive issue, it is a general model because it involves in modeling two main subsystems of urban development which is the fixed one which define the cells and the moving one which refers to agents. The substantial characteristic of the model is that, although the city is reduced to two mobile and immobile entities that interact, the sub-system is not simplified to just one sub-system with one rule like what happens in its counterpart in economic model; if the economy is modeled just by a two-sided relation like demand and supply, that will be a partial model, but when it considers other factors like stagnations, security and so on, that will be general model (Fig2.3).

Different classification of models		
Classification criteria	Type of models	Explanation of classification criteria
Theoretical base of models	Theory-based models	Models are derived directly from a theory as a symbolic statement of the theory.
	Theory-laden models	The real world with only a part of the system being modeled or a subsystem of the reality
Substantive issues being modeled	Partial models	Models deal with only a part of the system being modeled or a subsystem of the reality.
	General models	Models attempting to deal with two or more subsystems of the reality being modeled.
Descriptive or normative features of models	Descriptive models	Descriptive models deal with some stylistic description of reality.
	Normative models	Normative models deal with what might be expected to occur under stated conditions.
The way models deal with time	Static models	Models concentrating on the equilibrium structural features.
	Dynamic models	Models concentrating on processes and functions through time.
The predictive nature of models	Deterministic models	Models are based on the notion of exact prediction which is produced by natural and physical laws.
	Stochastic models	These are also called probabilistic models which involve the use of probabilities and they produce a range of possible outcomes rather than a single prediction.
The solution procedure of models	Analytic models	Analytic solution procedures are direct and do not involve any form of iteration.
	Simulation models	Solutions in these models are gradually reached in stages.

Fig2.2. classification of models, Y. LIU, *Modeling urban development with geographical information systems and cellular automata* (Liu, 2009, p.5).

2.1.4 Process of building the model

The process in which we have made the model, is according to the stages that Liu (2009) has presented upon the flowchart of Caldwell and Ram (Caldwell & Ram, 1999; Liu, 2009) (Fig2.3).

First stage will be defining the problem and objectives and knowing better the context of the problem. In this stage the acquaintance with the problem and the studies that have been done on the similar problems is necessary to well locate the problem in the real world. The mutual impact of city development and citizens define the problem of our project.

The second stage is introducing the theory of work and if not, instead of the theory, some hypothesis that can be proved or rejected should be proposed. Selection of important factors will be in this stage. In our work, the two constituents of city which is the spaces with their characteristics and the people with their preferences are chosen as the element of the model and we assume that the three comfort factors can help to the settling of the residents in areas and residences that are provided by these factors.

The third stage is formulating the problem and defining the parameters or as in our work defining the weights of factors in the interactions.

The fourth stage is the implementation of the program and here the empirical variables should be fed to the program; our work has some statistical data about the city (the population of socio-economic classes and the cartography of residence comfort) and some changeable values (the arbitrary adjustable values such as the

threshold of segregation, the weight of residential comforts and the weight of residents' preferences for each of comforts) that may determine the best configuration of the parameters.

The last stage is validating the results and eventually calibrating the program again. In our study the two real and simulated situations exist and that helps to compare the two situations.

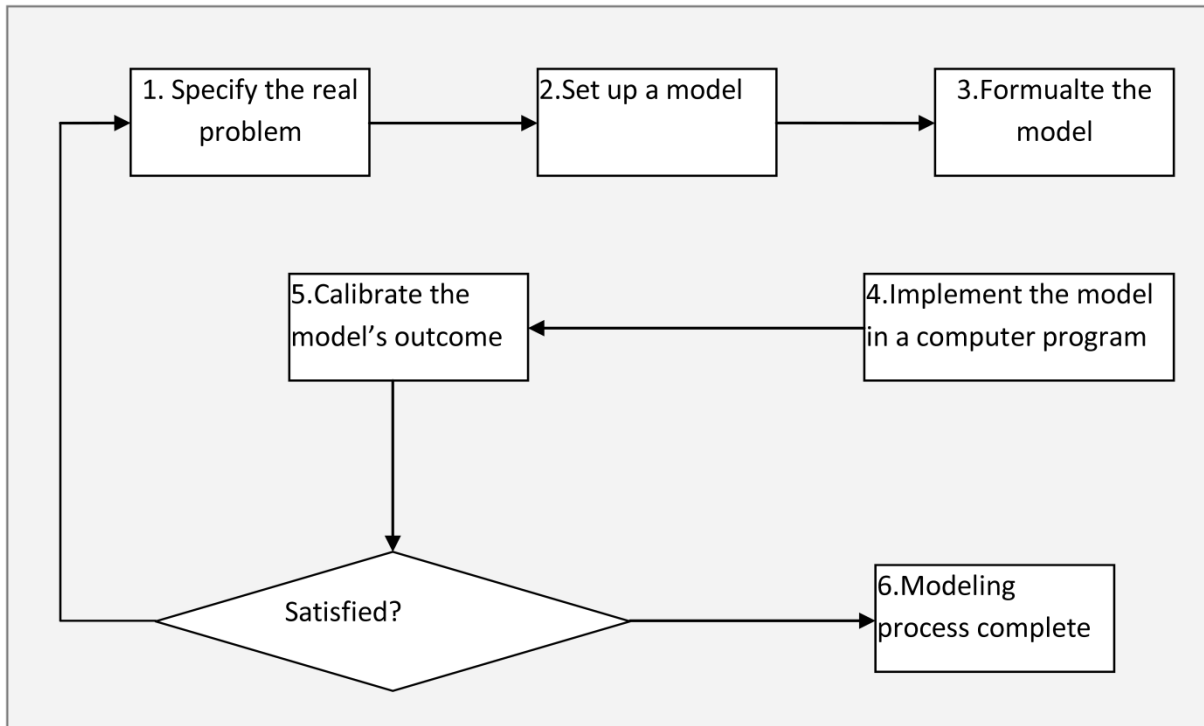

Fig2.3. A flow chart showing the various stages of a modelling process, Y. LIU, *Modelling urban development with geographical information systems and cellular automata* (Liu, 2009, p.6).

2.2 Theoretical approaches of urban development modeling

Urban models as testing some theories about the city development goes back to von Thünen; different approaches emerged in this field and all of them were based on the study of patterns of urban development and in all of them the decision and action of people, when confronted to some constraints in a social process, could be the main factor that developed the city (Hall, 1998). Liu (2009) classifies the main approaches as urban ecological approach, social physical approach, neoclassical approach, behavioral approach and system approach (Liu, 2009). Our model conforms in some aspects to the approaches that come here:

In the **urban ecological approach**, human behavior is assumed to follow the ecological principles including competition, selection, succession and dominance. The result will be the dominance of stronger people.

Burgess (1925) shows this in the growth of central parts of city; central parts accommodate the competition between social groups; the physical result of this competition was the growth of city toward peripheries in shape of concentric rings (Carter, 1995).

Hoyt (1939) reached to a wedge shape instead of rings, because of considering transportation routes, topography and the line of travels in the direction of an existing nucleus of buildings. The topography of high lands along the waterfronts absorbed the high-rate areas and extended to the location of community leaders (Liu, 2009).

Harris and Ullman (1945) discovered the multi nuclei model; they accepted the ecological principles that Burgess had applied and they added that some activities attract and some repel each other. Because of the high rents of good sites, some of them scatter not around the central district but around some nuclei. The multiple nuclei repelled and attracted newcomers in broadened areas and each o areas was formed in consideration of multiple adjoining areas (Carter, 1995; Liu, 2009).

Shevky and Williams (1949) suggested *social area analysis* by using multivariate statistical analysis. They based their studies on three features of *economic status*, *family status* and *ethnic classification* and distinguished the

urban areas as *social areas*. The progress of computer technology and sufficient data helped to the development of factorial analysis (Liu, 2009). Factorial analysis is used in classification of data used in this study; the newcomers that enter to the city are the social groups that make the core of interaction between them and the city.

In the **social physical approach**, city follows the physical rule in human interaction in space. In this approach, resembling the Newton's gravity law, the intensity of movements as the result of residential or employment change is proportionate to the mass of activity in origin and destination and inversely proportionate to the cost that should be paid for traveling between them (Liu, 2009).

The thermodynamic laws were applied by Wilson (1970) for studying the social behavior, like the particles in gas, with respect to their origin and destination (Liu, 2009). The aggregate behaviors were the center of these studies.

In the **neoclassical approach**, the urban development is crucially an economic phenomenon in which according to the general principle of maximum profit with the least cost, the spatial patterns of transport cost and land rent determine the urban structure.

For example in Wingo's (1961) model, rent and residential density decline from center to peripheries because the time and money costs increase as the distance between residential area and working area increases, and the money that depends to the distance and number of trips substitutes the location cost. (Liu, 2009)

In Alonso's (1964) model, the land development process was the result of the decisions of households or firms to minimize the rent and the transportation cost and to maximize the occupied area. According to his rent curve, for two given households with similar tastes, the one who is less solvent prefers to live in high density near the city but the solvent one prefers to go to a low density area in peripheries.

Lowry's (1964) model had two assumptions that first, the dispersion of residences are more dense around employment centers and second, the location and level of employment is under the impact of accessibility to local customers and as the residents live farther, the impact of accessibility reduces. Hence the basic employments were allocated to some locations; after that, the population that was supposed to be proportionate to these employments were calculated and allocated to these areas. Then the employments were allocated proportionate to the population and the recursive process continued till reaching to equilibrium (Johnson, 1972; Liu, 2009).

In the **behavioral approach**, the focus is on the motivation of individual behavior in the city. The decision that is taken by each household ends to some pattern of city development. The four key items that are discussed in the process of behavioral approach are the *value system* upon which human actions are realized, the *behavior pattern* that is the function of people's value, the *urban development* that is the end result of human actions and the *control process* that tries to make the urban development reach to a desired goal by affecting the behavior pattern. In urban strategies and planning, the control item is applied for structuring the urban development; then the individual decisions of great number of households, business and government are taken according to the first key decisions (Chapin, 1962b; Liu, 2009).

The **systems approach** is based on the General Systems Theory in which according to Bertalanffy (1968), everything is an element of a system and these elements are themselves systems that have interaction with other elements and the whole system. For example in a city, the population, land, employment, services and transport are in interaction with each other in economic, social and spatial mechanism and also in interaction with the environment (Liu, 2009).

The system in this way develops as the result of the mechanism that exists in the system; so for systematical analysis, first we should define a particular system for the subject of the study and then define the structure and behavior of the system (Liu, 2009).

According to Chorley and Kennedy (1971), we can distinguish four types of systems according to the interrelations that exist between its elements; in *morphological systems*, there are static relationships between elements, in *cascading systems*, beside the relationship between the elements, the energy transfer from one element to other, in *process-respond systems*, the two aforementioned systems are combined and in searching for the process of the system, the causal relations dominates links, and in *control systems* that are known as some type of process-respond systems, some elements play the role of valves that regulate the system and in another word control it (Chorley & Kennedy, 1971).

The systems may be considered as closed to the external changes or as it is more accepted today they can be open to the external changes (Liu, 2009).

The development of city in this project is not considered as sprawling but mostly urban renewal. So according to the mobility of people as a result of residential choice, the development of city refers to the state of buildings and neighborhood and what it can do in accommodating the classes of people.

There is no application of steadfast dominance as the result of competition of people, but what can differentiate the different classes in reaching to their convenient residences is assumed to be the quality of the building and of the neighborhood, the solvency of the residents, their preferences and the extent to which they keep living next to dissimilar neighbors.

The more a place benefits the comfort properties, the more it is assumed to attract the people who are looking for a proper choice. That can be resembled to some magnetic fields that attract the ones that are looking for these kinds of sources. The attracting sources are defined according to the repartition of comforts that Philippe Gerber (2000) has provided in his study. He distinguishes three kinds of comfort that two of them refer to the buildings and one refers to the neighborhood. The comforts of buildings take to account the area and the facilities of the building and the one of neighborhood takes to account the centrality that will be discussed more in the fifth chapter.

As the matter of system models, our system will be morphological one and the interactions are between the elements and they do not transfer energy to other element and do not control the whole system (The usage of morphology should not be mistaken with the morphology as the study of forms). It is assumed closed to the influences of events that occur beyond the frontiers of the city, and the mobilities are limited to the traditional central parts of the city and its developments in a time section; that will be discussed in the fifth chapter.

3 Third chapter: Complex systems

3.1 The complex system of city

The events in a city occur in a complex context; at the time of occurrence of a given event, as Jane Jacobs says, myriads of other events are happening. Always there is the risk that when some planner implements a project A to reach to point B, he or she reaches to point C, because the factors that are in middle of A and B are many and mostly unknown.

In urban modeling, there has been a shift from parsimony in number of processes and variables to structures that benefit from more interactions like the agent-based and cellular automata models.

Also in dynamic models, there are discontinuities in the growth of urban systems that demand for simplicity in articulating the structures of the cities and also embracing the complexities that confront our understandings and interventions in these systems (Thrift & Kitchin, 2009).

In our model, we attempt to generate a two-sided process that embraces the behavior of agents from one side, and the spatial characteristics of the city from other side. Here, the system does not proceed in an equational manner and the system churns as the result of the interaction between the agents and the one between them and the spatial attributes. Of course here, the agents do not have the same impact on the space as much as the one that the spaces have on the agents. In the reality, the spaces are not transitioned as fast as what the individuals can be limited by the space instantaneously.

Although Jane Jacobs believes that the city is an organized complexity according to quantities that vary simultaneously and in an interconnected way (Jacobs, 1961), the quantities themselves may be dynamic and when it comes to decision, maybe some of these quantities go under the impact of a planning decision, or the decision of many people that live in the city become the subject of planning and that will become more complex.

According to Batty (2007), Jacobs was inspired by the work of Warren Weaver (1948). He believed that the systems could be in disorganized or organized complexity and if the properties of the elements of the systems were given, the degree of difficulty in predicting the properties of the system could define the complexity of it (Batty, 2007). In disorganized complexity, like that of the molecules in gas, many particles are in interaction and the system is more random and by probability and statistics, one can understand the behavior of the system better. But in organized complexity like that one in a city neighborhood, there exist some correlated variables and interactive parts such as a city neighborhood as a living mechanism, with the neighborhood people among the system's parts (Batty, 2007).

As the city develops two kinds of interactions from the agents' decision process in micro and macro scale. One is the interaction and the decision made by inhabitants that occurs in micro-scale and second is the planning which controls the system and can change the system in macro-scale. The decision of a society can differ with that of the individuals. Societies like the city authorities or the planning offices may play a role that result in something different with the intentions and activities of individual agents.

People participate in decisions through democratization and decentralization in various levels, and new technologies and globalization increase their interrelations; growing individualism help to the diversity of people and their minds. Hence in a system that is more similar to far-from-equilibrium, the emergent event is not predictable beforehand (Batty, 2007). The unpredictable results of bottom-up systems and the large scale of urban development demands methods that can measure and test the validity of urban models.

In this chapter, we discuss the complexity that is applied in models. A set of systems that are chronologically developed according to Castellani's diagram will be introduced. The evolution of models has been more recognizable especially after the application of statistics and computer technology in urban studies.

3.2 Complex system definition

Complexity science is ‘the study of the behavior of macroscopic collections of basic units that are endowed with the potential to evolve in time’ (Coveney & Highfield, 1996). Peter Coveney and Roger Highfield explore complexity in mathematics, physics, biology, chemistry, and the social sciences and changing the assumptions in conventional science. Complexity studies the interaction between units like those in atoms, bits within a computer, ants in a colony, or the neurons firing in the human brain. It is a move from reductionism to complexity. Here, the modern technology in computer, the application of fuzzy logic and the quantum mechanics play an important role in deepening our understanding of the complexity (Coveney & Highfield, 1996). According to Edgar Morin (1990), complexity carries confusion, uncertainty and disorder in it and it is a way to confront the phenomena with regard to their contexts. Every phenomenon is caused by some series of events and at the same time it causes some other series of events (Morin, 1990). We cannot substitute complexity for simplicity in a straightforward manner and what we look for in complex thinking, is to integrate order, clarity, distinction and preciseness in whole; something that is observed in opposite manner by simplicity. In simplicity, the attempt is to disintegrate the complexity from the reality. Although in complex thinking we pursue the integration of simple thoughts, but we avoid mutilation, reduction, unidimensionality and simplification in reflecting the reality and what we seek for is integrating the simplicity and complexity (Morin, 1990).

The interaction between the ingredients of a complex system and that one between the ingredients and the system cannot be understood just at the level of the components (Cilliers, 1998). The non-linear interactions between the elements and the non-additive properties cause that the system be irreducible and the ‘scaling up’ of local behaviors to global ones not to be straightforward or in another word ‘the whole is more than the sum of its parts’ (Anderson, 1972). The behavior of the system cannot be predicted from the behavior of the parts and so instead of describing each step as the result of the preceding step, we can study the given situation of the system as the product of the whole history. A schematic chronology of complex systems is proposed by Brian Castellani. The model defines the situation of complex systems mostly used in social sciences (Fig3.1).

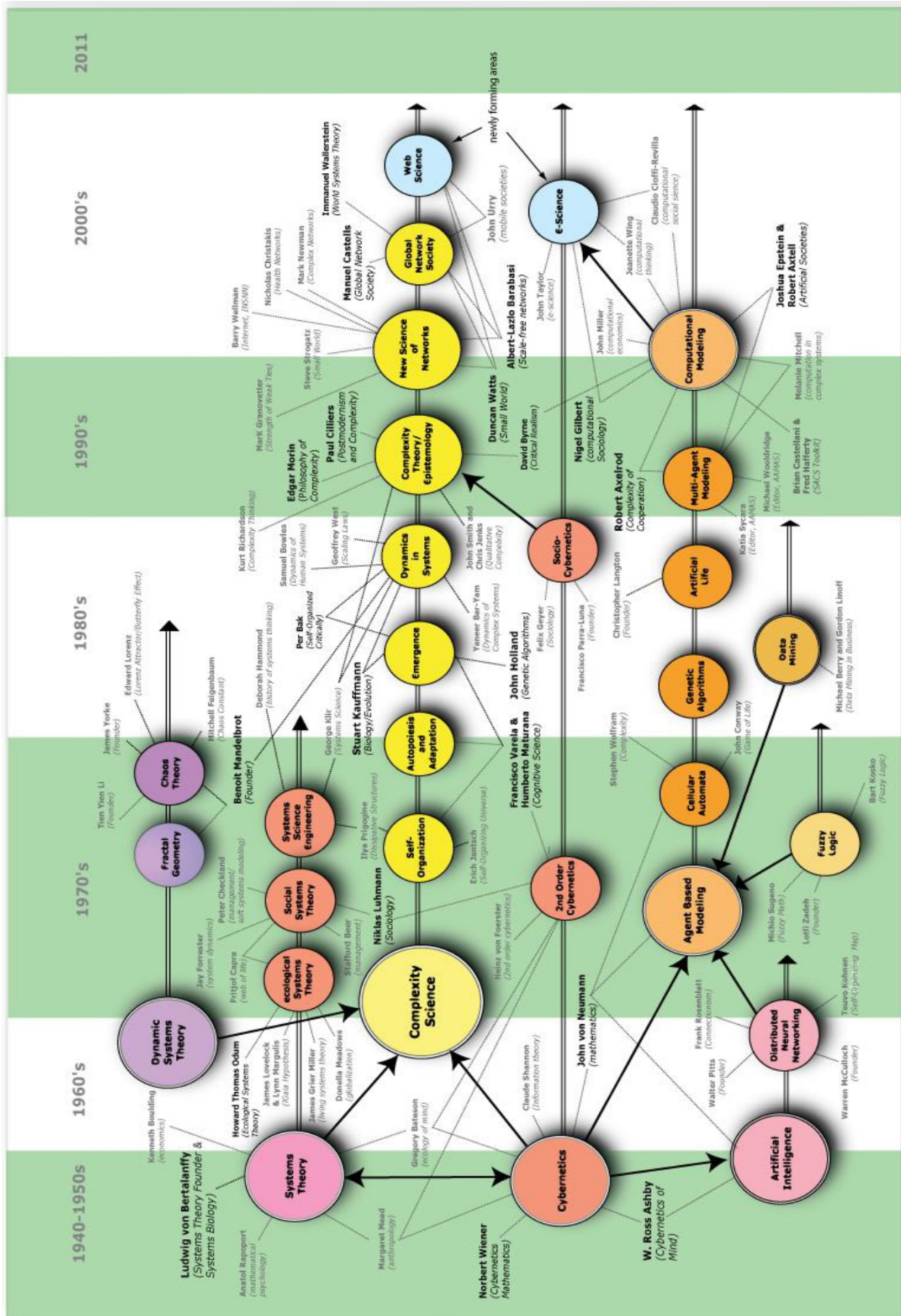

Fig 3.1. chronology of complex systems is proposed by Brian Castellani, 2012.

According to the diagram, agent-based models are the results of two approaches that began in late 1950s: the Cybernetics and Artificial Intelligence; so a short introduction of the Agent-Based Models can situate the method used in this thesis better:

3.3 Cybernetics

‘Cybernetics is the study of systems and processes that interact with themselves and produce themselves from themselves’ (Kauffman, 2007). This definition can best define the process and the target of cybernetics proposed by Louis Kauffman, President of the American Society for Cybernetics. Cybernetics studies the structure of regulatory systems. It is close to information theory, control theory and systems theory and as mentioned before (second chapter 2.5), in systems model approach, the feedback of transition in the system regulates the system again. It is applicable in physical and social systems because they are language-based systems and most of the program is implemented in software rather than hardware. In another saying, the problematic that can be responded by this system rely mostly on the programs rather than the tools and machines; so especially in social systems that we dispose great amount of data, most of our system will need programming and organizing data. ‘Cybernetics is applicable when a system being analyzed is involved in a closed signaling loop; that is, where action by the system generates some change in its environment and that change is reflected in that system in some manner (feedback) that triggers a system change, originally referred to as a *circular causal* relationship’ (Mühlh, Tange, & Kultermann, 1978).

Generally, the design and function of any system can be studied in cybernetics, including management, social systems and urban systems. The use of cybernetics in urbanism has been logical because large quantity of data exists in a city and they change continuously due to its dynamic nature. An Urban Cybernetic Project normally seeks clear answers to certain questions in a dynamic city in which a large quantity of data exists and changes, but the answer should not transfer all irrelevant data.

In the study by Kristian Kloeckl of MIT SENSEable city lab, he notes that city as cybernetic system is something that *is sensed, is conditioned and is actuated*. The sensing involves detecting spatio-temporal changes via sensing technology or by agents like people equipped with sensors. The conditioning involves in organization of data and how they should be used for changing the environment. The actuating makes a new situation in the environment by using embedded systems or information delivery platforms. In this way, the citizens access to real-time information and act based on well-informed decisions and change behavior positively (Kloeckl, 2011). Providing the data can be user-generated (Fig3.2).



Fig 3.2. The data are collaboratively generated on user-generated content sharing platforms to make sense of the spatial dynamics (MIT SENSEable city lab,2011).

Complex systems

37

The cities in this approach can be *ephemeral, capable of transformation, interactive and non-substantial* rather than the former properties like being *durable, solid, fix, non-responsive to changes and substantial* (Kloeckl, 2011).

There is thus one sense in which the reactive environment is a controller and another in which it is controlled by its inhabitants. So in short expression, the structures is in an interaction with the data and vice versa (Fig3.3). The two layers of an urban or architectural space are the physical and digital ones; each one has some class of interaction with individuals and the combination of these layers cause a new kind of interaction between the space and individuals.

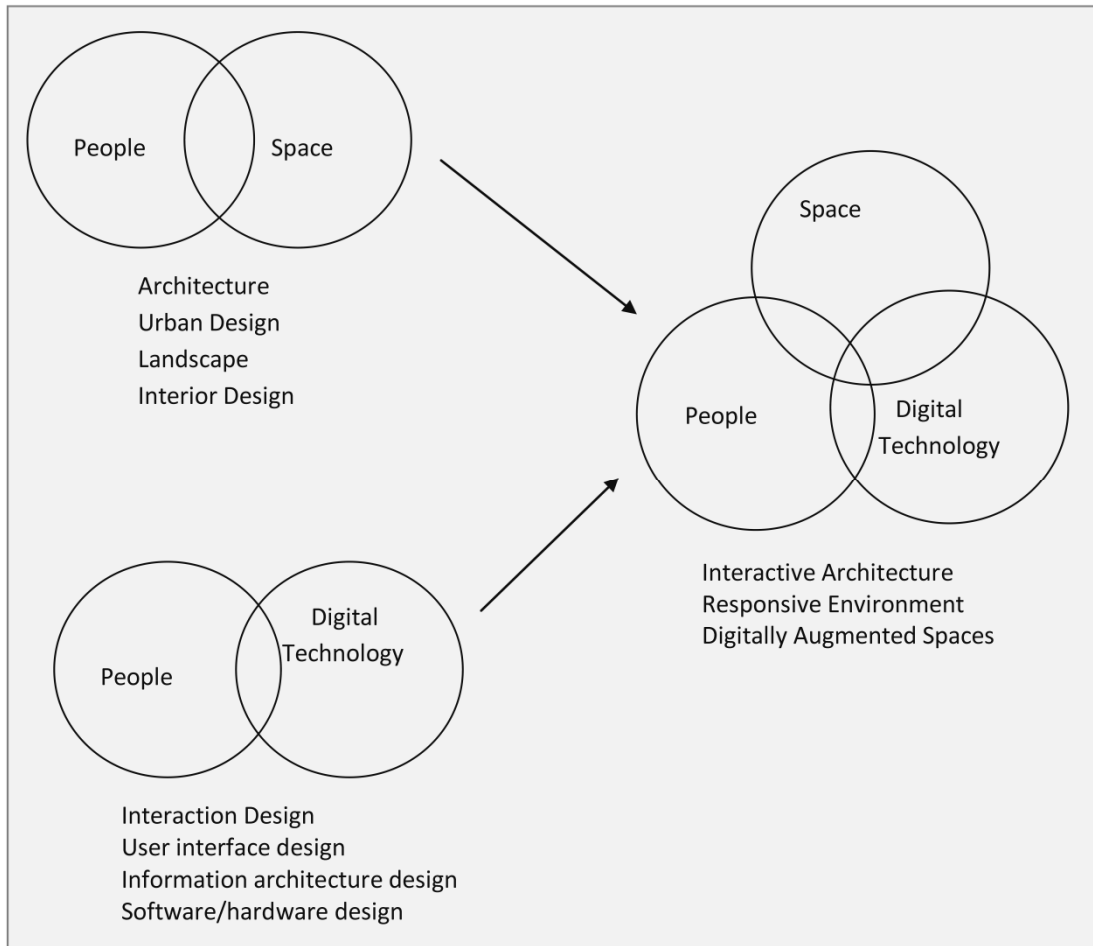

Fig 3.3. The interaction of people and space according to space and digital technology (MIT SENSEable city lab,2011).

The urban space after this technology will be the multilayer of data. Hence according to the present physical situation, another layer is in interchange with it which is the digital data (Fig3.4). Each of the layers of the space assert an identifiable approach in feeding the information to planners, deciders or users; but their combination ends to a new approach that is distinguishable by its simultaneity and although this is not practiced in this step of our study, that is one of the principle long shots of the approach of this study.

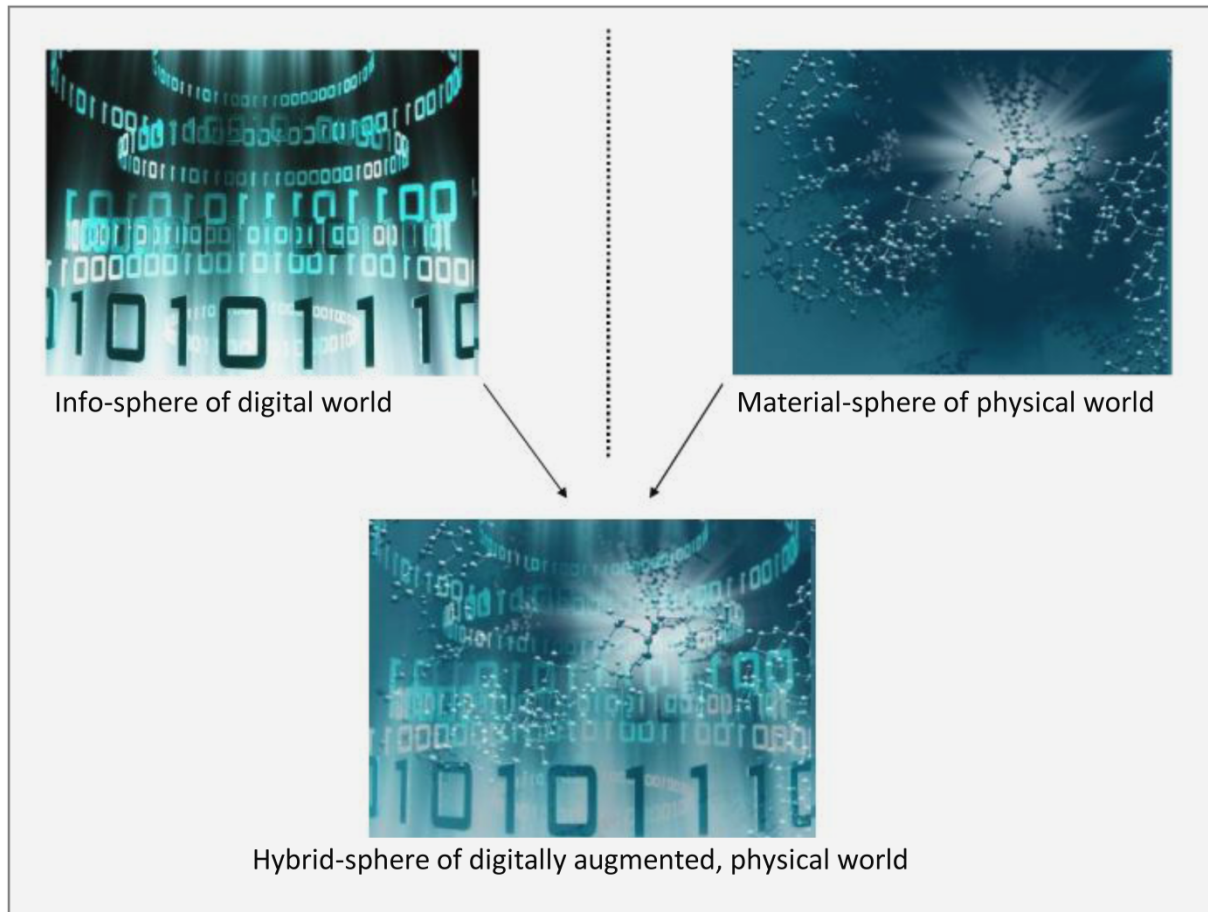

Fig 3.4. The hybrid nature of cybernetic city: digital side and physical side (MIT SENSEable city lab, 2011).

The real-time city is not in the scope of this project, but the bottom-up approach of this system that applies the data that agents collect has some common realm with Agent-Based Models used in this project. According to Prof. Freytag (2010), one of the applications of modern information and communication technologies will be in tourist stay via the use of real-time. The real-time technologies are being tested for mass tourism and for participatory tourism in less touristy areas. The use of mobile phone and GPS can be a proper tool for spatial orientation and for developing tours or games that let the tourist explore neighborhood interactively under the guide of someone's mobile phone (Freytag, 2010).

There is a distinction between the cybernetic system and agent-based system that in Agent-Based Models the decisions are taken locally by the agents but the rules are defined by programmer although they are open to changes resulted from feedback of the environment. But in cybernetic city the role of programmer is mostly seen in conditioning stage in which he or she filters or organizes the data and the agents have less inherent rules imposed by the programmer.

3.4 Artificial intelligence

Artificial intelligence (AI) is 'the study and design of intelligent agents' (Nilsson, 1998; Poole, Mackworth, & Goebel, 1998; Russell & Norvig, 2003, 2010). By this definition we expect that the agents perceive the environment and decide in a manner that increases their chance to succeed (Luger & Stubblefield, 1993; Nilsson, 1998; Poole, et al., 1998). The AI was the result of a claim that intelligence could be described and simulated in a machine; naturally it was a bit different with what was formerly known about the substance of intelligence. Beside the ethical and philosophical debates around the topic, there is not a compromise of what an artificial

Complex systems

intelligent action is going to do. Is it some action that is rational or an action like what an intelligent entity like human does, or is it a machine that does an action or is it supposed to reason or think? Russell and Norvig (2010) suggest four situations in which Artificial Intelligence Modern Approach (AIMA) is applied (Fig3.5).

	Human-Based	Ideal (logical) Rationality
Reasoning-Based	Systems that think like humans.	Systems that think rationally.
Behavior-Based	Systems that act like humans.	Systems that act rationally.

Fig 3.5. Four possible purposes of applying Artificial Intelligence (AIMA) (Russell and Norvig, 2010).

AI has been applied mostly in representation and reasoning and especially in the computer domain and there is a hope that they can do some actions like executing a plan. We can summarize the process of AI as taking tuples of percepts from external environment and producing behavior (Russell & Norvig, 2010), See Figure3.6.

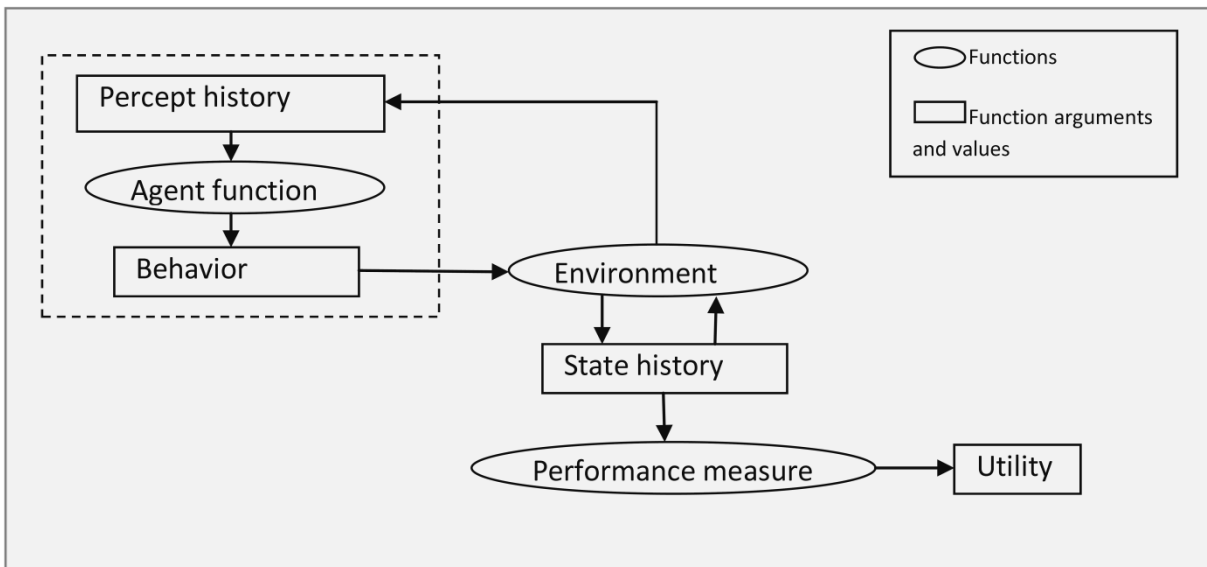

Fig 3.6. The basic picture of Russel’s account of intelligence/rationality (Russell and Norvig, 2010).

In urban studies, AI is more known from its sub-systems; Wu and Silva (2010) differentiate four groups of application that AI offers: first is *Artificial Life* which includes Cellular Automata, Agent-based and SWARM Intelligence, second is *Intelligent stochastic optimization process* with Genetic algorithm and simulated Annealing, third is *Evolution computing and spatial DNA* with Artificial Neural Network and spatial DNA and fourth is *Knowledge-based intelligent systems* which include Fuzzy logic, Express system, heuristic search and reasoning system. Also they divide the AI into two groups of applications; one in micro-simulation that mostly applies Artificial Life and second in operational applications that covers the rest of three other sub-systems mentioned above (Ning Wu & Silva, 2010).

According to the concerns of cybernetic city that senses the environment partially with its agents, and the goal of studies by artificial life in societies that study the emergent properties of societies of agents, we make our model as a tool that with simulating the behavior of the agents, some aspects of the city that influence their behavior become known in order that in the future of development, the data of agents can represent the present situation of the city and help to feedback for better decisions of planners and citizens. The agent-based models, Cellular automata and Multi-Agent Systems will be discussed in future items but according to chronological order according to the model of Castellani (Fig3.1), now we talk about Neural Network.

3.4.1 Neural Networks

Artificial Neural Network is the process of solving a specific problem in information processing like what is done in nervous system. It was first made by a neurophysiologist called McCulloch in 1943. Like the nervous system of human brain, Neural Network system can learn in a process by adjusting the synoptic connections between neurons. It can be used for recognizing a pattern or classifying data. The Neural Network (NN) is consisted of three layers of neurons that are interconnected by weighted links; the input layer, output layer and hidden layer that can itself be consisted of several layers. The weights of connection are adjustable. See Figure 3.7.

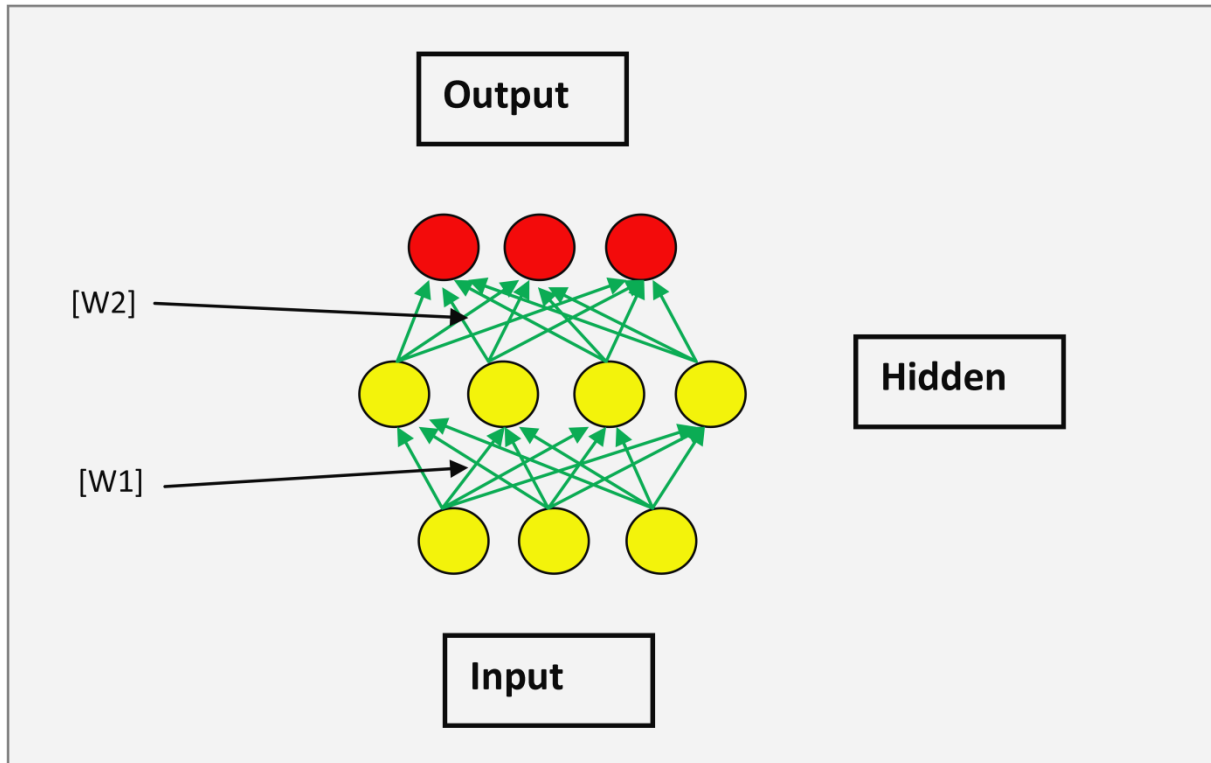

Fig 3.7. An artificial neural network (Kaboli, 2013).

NN learns by example and this is the need for training the system. It learns via the algorithms that make the system determine weighting parameters that match the input and output data of a function. The capability of this system is more distinguishable when we have a great amount of data that extracting a pattern out of them will be impossible for human.

The process of NN is obtaining the input data and generating the first outputs; according to the input and output data, the program adjusts the weights within the network. Again it takes the next inputs and outputs in a correlation with the weights that were determined in the first step. The program adjusts again the weights and this procedure iterates till the program reaches to a good fit of data. A flowchart summarizing this iterative process is shown in Figure 3.8.

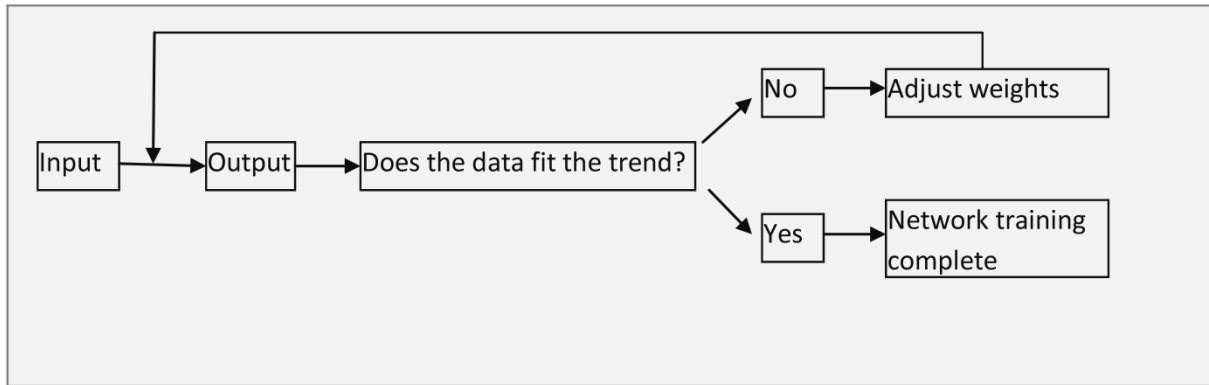

Fig 3.8. Flowchart for training a network (Kaboli, 2013).

NN has been used in urban studies especially in classifying land cover and distinguishing land patterns (Ning Wu & Silva, 2010). In our first stage of project that will be presented in this thesis, the dispersion of population can be parameterized according to the input as the population that already exists in the study zones, and the output as the simulated dispersion; the system can learn to adjust the weights. For the future of the work, the interchanging of population and cells can be considered as the quantities according to which the system adjusts the weights.

3.4.2 Agent-Based Modeling

The Agent-Based Models (ABM) are models that study the actions and interactions between autonomous agents and the evaluation of their impact on the whole system (Niazi & Hussain, 2011). In social science, it is important to study the behavior of individuals while they interact, and the results that can be more than the sum of its parts. This kind of study are mostly applied when the result of aggregation behavior is not traceable to individual actions and the agents may experience new things and behave differently that is out of reach of mathematical models' capability. Axelrod and Tesfatsion (2006) suggest that beside deduction and induction, the ABM is the third way of doing science:

'In addition to deduction and induction, simulation in general and ABM in particular is a third way of doing science. Scientists use deduction to derive theorems from assumptions, and induction to find patterns in empirical data. Simulation, like deduction, starts with a set of explicit assumptions. But unlike deduction, simulation does not prove theorems with generality. Instead, simulation generates suitable data for analysis by induction. Nevertheless, unlike typical induction, the simulated data come from a rigorously specified set of assumptions regarding an actual or proposed system of interest rather than direct measurements of the real world. Consequently, simulation differs from standard deduction and induction in both its implementation and its goals. Simulation permits increased understanding of systems through controlled computational experiments' (Axelrod, 2006).

As the third way of science, the simulation is a tool which can be very varied but can reach to a result by an empirical way and not on the base of theorem. According to them, ABM is applied in four forms: empirical, normative, heuristic, and methodological.

In **empirical understanding**, the existing regularities, like what happens in a standing ovation despite the fact that there is no control from top, push the researcher to 'causal explanations grounded in the repeated interactions of agents operating in specified environments'. In another way of saying, the researchers asks if a given observed global regularity can be generated from the interaction of individual agents.

In **normative understanding**, the ABM is applied for testing if a good design will result in desirable system performance or time. They resemble it like **'filling a bucket with water to determine if it leaks.'** In studying like what is done in voting rules, the system is constructed on the basis of important aspects of social system and then a population that is assumed to be motivated to learn and experience is added to this world. By considering that each individual agent will decide for its benefits through strategic behaviors, the proceeding of the system can show if that is efficient, fair and orderly.

In **heuristic approach**, we look for greater social insights from causal mechanism that may be based on simple rules. Like what Schelling has done in studying segregation, the large-scale effect was surprising despite the simple rules and the tolerance that was assumed for agents toward segregation. In his model, two groups of agents decide to cohabit with their neighbors or leave their initial locations according to the number of similar and dissimilar neighbor cells. Although the tolerance was assumed high and the agents left their location when more than half of the neighbors became dissimilar, but the final structure of the cellular world asserted a noticeable segregation.

In **methodological advancement**, we discuss about how ABM can be better applied by researcher for rigorous social systems. Careful consideration of methodological principles and efficient programming and choosing visual tools can be of these concerns. According to the two sides of these systems that is the computer science and the domain in which the social model is being studied, we should pay attention to two points:

‘(1) the rigorous testing, refinement, and extension of existing theories that have proved to be difficult to formulate and evaluate using standard statistical and mathematical tools; and

(2) a deeper understanding of fundamental causal mechanisms in Multi-Agent Systems whose study is currently separated by artificial disciplinary boundaries’ (Axelrod, 2006).

The method that we have used in this project is heuristic based on the actions of and interactions between the agents that end to a large-scale effect. When the agents mass and they randomly enter to the world of program and then leave it, they are said to act a-spatially, but when they move according to the Euclidian space or they behave as the attributes of the cellular space, the agents have spatial characteristics (Macal & North, 2009).

The agents in our model move randomly in a 2-dimensioned space and act according the intrinsic rules confronting the cellular attributes in a given space.

The agents in our model delegate the socio-professional classes of residents of Strasbourg. As we will explain more in next chapter, the agents practice some actions that arise from their decisions. After the accomplishment of the decisions, the action is put between the actor and other agents that may have acted according to their decisions. Here, in the spatial world of the program, or in another word, the city of Strasbourg, the characteristics of the space of the program and the interaction between the agents lead the agents to take decision according to their aspirations and according to the reality that exists between them and other agents and between them and the spatial characteristic of the program; spatial characteristics is assigned to the Cells of Automata.

3.4.3 Cellular Automaton

Cellular automata is a lattice of specified colored shapes that each shape changes its state in time step; the situation of the neighbors is decisive for a given cell (shape) to determine what the future situation of the cell will be; According to the transition rules that dominate the automata, the state of a cell will conform to what is current in the neighborhood. Von Newman is known as one of the first people who have considered Cellular Automata in 1950s (Wolfram, 2002).

Cellular Automata come in a variety of shapes and arrangements; from one-dimensional to two- and three-dimensional and in shapes of triangle, square and hexagonal ones. The shapes generally juxtapose in a Cartesian order. The simplest and most general coloring of the shapes is black and white, but it can also reflect the non-binary like that of fuzzy setting by using a gray spectrum or colors other than black and white.

Since the role of neighbors in influencing the state of a given cell is crucial, maybe only the contiguous neighbors or the neighbors in a determined radius affect the cell. There are some studies on kinds of neighborhood or the radius of influence from which two neighborhoods are very famous; the one that includes the square neighborhood known as Moore neighborhood and the other one that include the diamond-shaped neighborhood known as the von Neumann neighborhood. We use the Moore model that includes the given cell in center and eight cells around it (Appendix, Cellular Automata neighborhood). CA are applied in numerous works related to urban studies especially because of their nature that can generate complex spatial combination based on simple rules (Ning Wu & Silva, 2010). More discussion about Cellular Automata and their application in urban models will come in the fifth chapter.

3.4.4 Genetic Algorithm

A Genetic algorithm (GA) is an iterative procedure of optimization the problem solution in which a constant number of individuals can be generated by random or heuristically; the individuals are presented each by a string of symbols, called genome, that encodes a possible solution in a given problem space. At each evolutionary step, the individuals are decoded and evaluated in order to show whether they conform to the predefined quality criteria or not. Those who conform, or what is called *fitness*, survive to other evolution time step, known as *generation*. Those who are in a good fitness *reproduced* and the others die.

GA is used efficiently in urban applications and according to its famous application, the Traveling Salesperson Problem (TSP), it is vastly used in domains that involve in the shortest paths such as in traffic studies. TSP refers to a given list of cities and their pairwise distances upon which the passenger or salesperson should find the shortest possible route that visits each city exactly once and returns to the origin city.

Due to its ability of dealing with nonlinear optimization problems, it has been applied in urban growth and sprawl, urban planning and decision making, urban transportation infrastructure planning and urban spatial optimization (Ning Wu & Silva, 2010). In the future of the study along with the Neural Network that can optimize our project in introducing the destination cells to agents, the GA can be applied for renewing the program in timesteps (generations) with new agents and cells that help the two sides to reach sooner and more precisely.

3.4.5 Multi-Agent System

Multi-Agent Systems are Agent-Based Models originated in Artificial Intelligence (Gilbert & Troitzsch, 2005) that study the individual behavior and how it affects the system. The two ingredients of MAS are the agents and the environment. The agents are intelligent and autonomous and the environment has some characteristics that in the interaction of agents with each other or with the environment, one of or both sides can be changed (Campo, 2003). The agents and the environment have some characteristics that the ones for environment differentiate the models.

The system can be defined with respect to:

accessibility that determines whether it is possible to gather the information of all the environment; in our case that is accessible and the agents can know about the changes after the updates of the program,

determinism that tells us if the actions cause some definite effects; that is so in our case,

dynamics says about the number of entities that influence the environment at the moment,

discreteness that defines if the number of possible actions in the environment is finite; in our case it is finite,

episodicity is about whether agent actions in certain time periods influence other periods; in our case it affects other periods so we can say that it is episodic,

dimensionality tells about the role of spatial characteristics if the agent considers space in its decision making; in our model they have basic roles in decision of our agents.

Synchronicity that tells if the changes are at the same time of action or it is after some timesteps; in our case that is synchronous for the events resulted by the interactions between agents and asynchronous in updating the environment of the program.

The agents have some important characteristics:

Autonomy that says that the agents are at least partially autonomous

Local views means that no agent has a full global view of the system, or the system is too complex for an agent to make practical use of such knowledge; in our model the agents can know about the whole environment but they do not know about the result of other decisions in order that they can decide as to the decisions of other agents.

Decentralization declares that there is no designated controlling agent (Panait & Luke, 2005).

More discussion about Multi Agent Systems and their application in urban systems will come in the fifth chapter.

3.4.6 Fuzzy logic

Fuzzy logic is a form of many-valued logic; In contrast to crispy binary choices that something can be true or false, in Fuzzy logic it can be some percent true or for example 20% wrong (Novák, Perfilieva, & Močkoř, 1999).

Fuzzy logic began with the 1965 proposal of fuzzy set theory by Lotfi Zadeh (Zadeh, 1965) and has been applied to many fields, from control theory to artificial intelligence. It has helped to a more supple classification in which, the elements can belong to a set or not belong or partly belong. So in contrary to binary division that the membership of an element which belongs to the set is shown by “0” and the one which does not belong by “1”, some memberships can belong to the range in between, something like “0.4” membership.

It can process incomplete data and find an approximate solution for a problem (O'Brien & Marakas, 2008). Application of some locutions like “renovated”, “semi- renovated” and “non- renovated” in comparison with those like “renovated” and “non- renovated” follows the trend of fuzzifying the crispy division.

For applying fuzzy logic we will have three main stages: Fuzzification, defining rules and Defuzzification;

- First, in Fuzzification, a crisp set of input data are gathered and converted to a fuzzy set using fuzzy linguistic variables, fuzzy linguistic terms and membership functions. We introduce some thresholds for delimiting the memberships; for example if a threshold is introduced for some part of a city to be “renovated”, the parts that satisfy this condition, or in another word the parts that have numerical attributes more than the threshold number will be renovated. The other threshold may be the “non-renovated” and we can locate those parts that have the numbers less than this threshold in this group and we can interpose the rests in the third group which we can name it as the “semi- renovated”. According to the number of thresholds that we introduce, we can have several ranges that each one is described by some fuzzy terms like “very renovated”, ”renovated”, “scarcely renovated”, “non-renovated” and so on.
- Second, we define the rules according to the membership percent and the fuzzy system will act according to the rules that are defined for each situation.
- Third, in Defuzzification, the resulting fuzzy output is mapped to a crisp output using the membership functions (Fig3.9).

Since the classification in the program may differ with what is applied in standard terms, we change the fuzzy data to crispy data. Hence forth, the elements of the program can have varied behaviors according to the fuzzification and the outputs can be legible according to the existing classification.

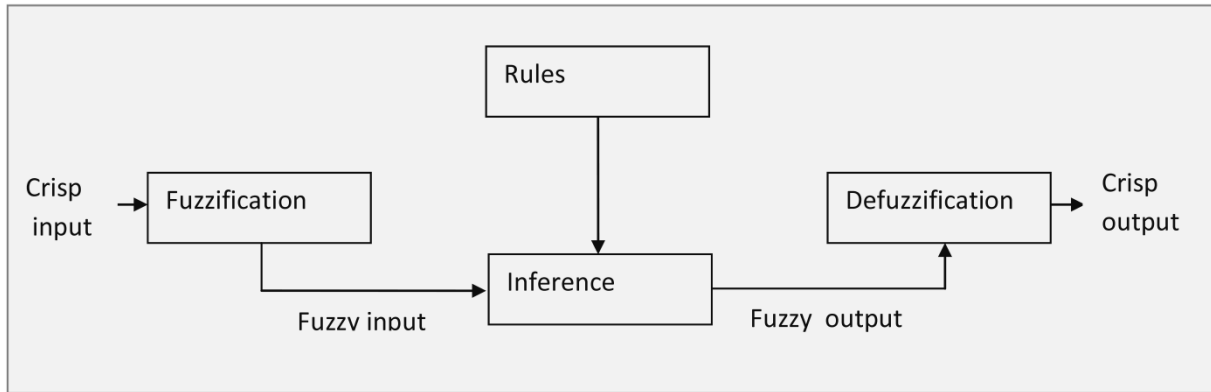

Fig 3.9. application of fuzzy logic, *fuzzification* and *deffuzzification* (Kaboli, 2013).

In urban models, Fuzzy logic is generally used in combination with other Artificial Intelligence approaches and is used for studying land covers, traffic urban sprawl and other applications. The famous application of terms like: urban, semi-urban no-urban define a wider range for spatial units which are the result of using fuzzy logic approach. In a hybrid Cellular Automata and ABM, beside the internal rules that determine the behavior of agents, the wider range of options that the spatial units suggest can multiply the agents' options for decisions.

Conclusion of part I

The models generally have passed through a history of simplification and reduction to more complex systems and also there has been a tendency to apply the bottom-up models that rise from the behavior of basic elements of a system rather than the top-down approach.

The model has been based on the spatial world of Strasbourg. The city has experienced some series of interventions according to the urban renewal. We have discussed the three forms of renewal including the redevelopment, rehabilitation and integral approaches; the redevelopment covers the activities of destruction of dilapidated buildings and replacing them with new constructions. The rehabilitation consists of preserving or conserving the old buildings and enhancing it by adding new facilities or repairing the decrepit parts and structure. The integration covers the two mentioned approaches and resort to reconstruction when the arrangement or decrepitude of the buildings and the structure are in an excessive unfavorable state and to rehabilitation when by enhancing the present situation of the building and the structure we can preserve the present buildings, structure and other important element like the population that is living in the area. We have discussed that in France, the three methods are followed but the critics mostly targeted the approach that resort to vast destruction and the obligation of residents to leave their former residences.

We will focus on some aspect of urban renewal that goes back to interventions in physical part of the city, the gentrification that can be resulted by renovation and rehabilitation and the residential mobility according to the interventions that has resulted in enhancing the comfort in living areas. For constituting the model, we need to know the models, their approaches, their results and measuring the facts that are at stake in urban activities. We make our models on the basis of rules that are inferred from the studies of urban development and the mechanisms that have led the development with respect to human behavior. We have reviewed the most known urban models that have tried to describe the process of forming the present state of city or to predict the future states on the basis of what the information of the present state feeds the modeler.

In the urban ecological approach, the model is based on the human behavior and the assumption is the **dominance of some groups of people** in a competition, selection and succession and dominance of choosing the residence. In the social physical approach, the behavior of people is followed in an attempt to resembling the bases of their actions to the **rules of physics**. In the neoclassical approach, the economic rules are assumed to have formed urban development and the localization of activities and residences are assumed to be according to the **distances between the places** that accommodate them. In the behavioral approach, the **individual motivations** make the households to take decision upon which some pattern of city development is formed. The value system, behavioral pattern, urban development and control process are the mechanisms of this system. And the system approach reckon each entity as a system which has some **elements that are by themselves some systems** and the elements are interacting with other elements and with the whole system. For a city, the elements or in another word the systems are the population, land, employment, services and transport that interact between them and in some economic, social and spatial mechanisms.

According to the five mentioned urban modeling approaches, we have benefitted from some aspects of ecological approach, neoclassical approach and the system approach. Although we have not assumed that the people compete for winning the best opportunity in the city, but the more solvent people are assumed to leave their initial residence if some other residence exists that concord more to their criteria. So in the fourth and fifth chapter, we will discuss how this is parameterized in the model. The social physical approach is not directly used in this research; however, the centrality comfort that is mostly attainable according the distance between the places, is indirectly under the impact of physical laws. The more a given place accommodates activities, the more it can be known as an activity center or as what we will address it as final service sectors. The distance between the places that can be related to the costs of voyages, is assumed to attract our individuals to be closer to centralities; what is addressed mostly by neoclassical approach. We have not benefitted from the behavioral approach according to its overstating the individual values and patterns that would be out of the scope of this research. We have profited the system approach in which the elements of the system are themselves some

systems. The interaction between the individuals is in a structure and in our system, no energy is transferred from one individual to another. For illustrating the structure and the behavior of the system, we need to be familiar with some complex systems. City is studied as a complex system and for modeling this system, we have introduced some approaches in complex systems according to the model of Castellani. In his model, the chronological order of evolution of complex systems is introduced (Fig3.10).

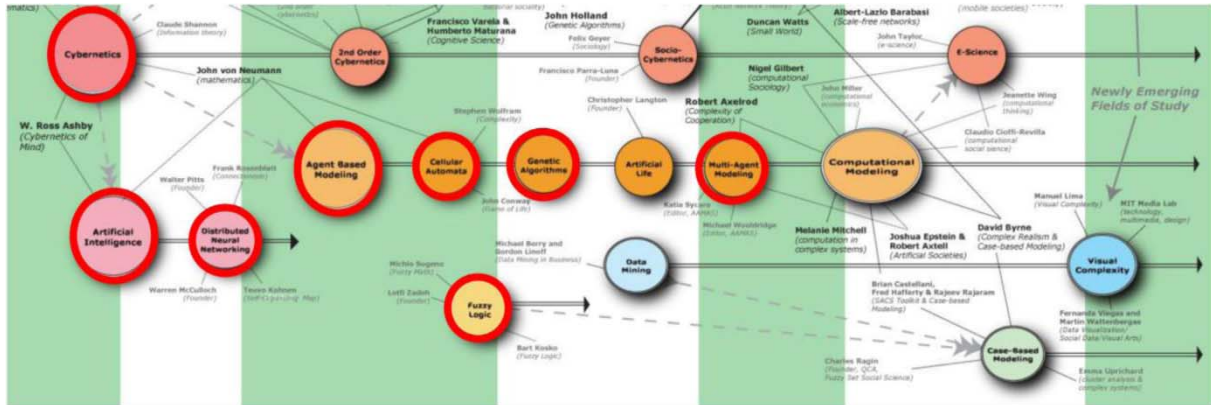

Fig3.10. Complex systems in social science (Castellani, 2012).

The cybernetics acts as a system that renews according to the data that is provided to the system by actors and these data and the activity of the actors make some new system and new data upon which the actors act in the updated system.

The Artificial Intelligence put forward an approach in which the agents are supposed to act like intelligent entities and for that they may act or think rationally or like human. According to the diagram of Castellani, we have introduced Neural Network, Genetic Algorithm, Agent-based models, Fuzzy logic, Cellular Automata and Multi Agent System under the title of Artificial Intelligence.

The Neural Network and Genetic Algorithm are introduced as some methods for making the stochastic models more precise.

The Agent-Based model and its sub-set Multi-Agent Model is supposed to proceed on the basis of the actions of the agents in the system.

The fuzzy logic is discussed as a solution for problems that do not apply the binary situations and as an example an urban region can be 100% urban and 0% non-urban or in a spectrum between the two extremes it can be urban to some percent, for example 80%, and in some extent non-urban, for example 20%.

The Cellular Automata is introduced as a system that model the spatial characteristics; the system updates according to the change of cells and each cell can be updated according to the characteristics of neighboring cells or as in our model beside the characteristics of neighbors they can change according to the characteristics of the agents that reach to the given cell.

We will use the Cellular Automata and the Multi-Agent System for modeling the socio-spatio-temporal process of urban development according to urban renewal and residential mobility. Neural Network, Genetic Algorithm and Fuzzy can help to enhancing our model and we will discuss them in the sixth chapter under the title of future studies. Cybernetic system introduces some approach that will encourage the modelers to model some real-time interactive systems in the city. Although it is one of the long shots of this project, but the lack of sufficient data, the need to study the mechanism of our model and that one of the city and the need to actuating the program close to reality cause that the latter system remain as a motivation for future development of the model. In the next chapter, we review some studies in order to have some samples for defining the rules.

Part II

Implementation in Strasbourg (1982)

4 Fourth chapter: Determination of variables via a review of similar researches

4.1 Literature review

4.1.1 Introduction

Human behavior in gentrification is discussed in this chapter. From the first modeling in social science that has considered the segregation as the tendency of people to live with similar ones, to different modeling of gentrification in Multi Agent Systems have been the sources of the model introduced in this project.

In the model, we have profited from the capability of Automaton in which simple cells transform by following simple rules of transition and interaction which are based on the inherent attributes of the cells. The spatial and social data will determine two of the five principle constituents of Cellular Automata such as: cells and states, and the configuration of spatial units and their relation will determine the three others: lattice, neighborhoods and transition rules.

For inserting the other part of program that are moving agents, we have used the specificity of Multi Agent Systems that permits us to move our agents in a spatial world and to define rules for each agent in order that it can take decisions according to the attributes of the space where it is located, and according to other agents that have their rules and are in interaction with the given agent.

According to Torrens (2003), Cellular Automata can design something with considering the details, conform to their process by decentralized spatial forms, show dynamic behavior, act in multi-scale, and apply raster data while Multi Agent Systems can represent mobile entities like households (Torrens 2003), follow internal and external rules according to different spatial situations and change elements beyond their very adjacent elements.

Since the system of city, according to Batty (2001), is consisted of its immobile entities like infrastructures and mobile ones like the human, we apply the hybrid model that can respond to the need that the mobile and immobile parts can affect each other (Batty & Torrens, 2001).

Some application of Multi Agent System in modeling the residential mobility and segregation that are used in this study, and also the agents, their decisions and the context of their actions will be introduced in the works of:

Schelling who has used Cellular Automata in urban studies; He studied segregation and the tendency of people of a special class to choose their residents according to the similarity to their neighbors,

Portugali who has systemized the theory of Schelling in a heuristic auto-organizing model via studying the probabilities for each agent in the city to choose its residents according to its neighbors,

Atkinson who has studied the gentrification in London by taking to account the segregation of socio-professional classes in specialized areas of the city,

Diappi who has modeled Rent Gap Theory in Multi Agent System; She studied the amount of investment in a depreciating area as a factor that can end to gentrification. Her initial theory is based on the supply side of gentrification proposed by Smith.

Atsushi Nara and Torrens who have studied the mobility of people as a result of decisions in micro-scale that can affect the macro-scale,

Giddens who discusses the agents, their decisions and interactions with other agents and introduces the structuration as some kind of system that affects and is affected by the agents.

Finally we will determine the variables and probabilities of the model by profiting from the similar researches.

4.1.2 Schelling

In 1971, Schelling tested a model of two groups of agents which moved in a space and reacted to what was going on in their vicinities. For a given agent, if the number of its dissimilar neighbors exceeded some assumed amount of 33%, it changed its place and if not, it rested in its position. The process ended to segregation and the model has been referred to very much as one of the first application of complex systems in social studies. More over it modeled a micro-motive interaction that ended to a macro-behavior that could not be guessed from start; the individuals did not prefer segregation but their behavior resulted in this phenomenon. (Pancs & Vriend, 2007). The process involves in models in which the agents coordinate the action of some other agents. This includes two processes in segregation: one is the exodus tip that when some similar agent leaves, another agent of that kind may reach to a threshold that he or she should leave as well. The other process is the genesis tip in which when some similar agents enter, they can encourage other similar ones to enter. One may observe tipping point in the model; tipping point refers to some critical point in the model when the behavior of the model changes noticeably before and after this point; Gladwell (2006) quotes the meaning of tipping point from Dederrer as 'The Tipping Point is that magic moment when an idea, trend, or social behavior crosses a threshold, tips, and spreads like wildfire'. Examples like the spread of viruses, crime waves, fashion trends, when proliferate noticeably after some critical point are examples of contagious behavior that have reached tipping points (Gladwell, 2006).

The study of Schelling on segregation has been one of the first usages of Cellular Automata in social study but it has remained as an empirical study that has just considered the agents as the Automata and did not apply moving agents.

We have applied Schelling's study by combining Multi Agent and Cellular Automata. In this way the number of agents and also the number of layers of data increased and our Agent-based model function according to the attributes of cells that are fixed in their place and according to the agents that are moving. How much the agents are neutral against segregation and how much they try for integration? In our model, the agents are active in reaction to segregation but passive to integration; it means they do not look for integration but if it comes they accept it.

The segregation repulsive force is defined in a range between 1 and 8; we can say the most intolerant agent is the one who changes its position when just one dissimilar agent settle beside it, and in a Moore neighboring model, the most tolerant one accepts all dissimilar neighbors to that point that all the eight neighbors are dissimilar and at this time it leaves its place. Regarding the fact that in a range of four socio-professional class, the classes that are close like the managers and intermediates may cohabit simpler than the extreme classes like the managers and workers, we use the average of the neighbors' class index as the difference factor. As it is depicted in Fig4.6, the cells determine the attributes of the cells to some extent, and the rest of attributes of neighboring cells is assigned to settling agents. So an agent does not decide to rest or leave just according to the attributes of neighboring cells, but it considers the neighboring agents as well.

4.1.3 Portugali

Portugali et al. (2000) modeled the mobility of people in multi agent system according to two criteria: residential and cultural situation. The city is represented in two layers; Immobile elements that consists of urban infrastructure, and moving agents that are free to change their location (Benenson, 1998; Portugali, 2000).

In his book, *Self-organization and the City*, Portugali attempts to explore the conjunction between a city and self-organization in relation to issues of social-spatial urban segregation of national, ethnic and other socio-cultural groups.

He considers the city as a grid of cells that represent the spatial units. In each time step, the residents of the forming city enter to the world of program in three stages; first leaving the city, second occupying by local residents and third occupying by external residents. The first stage has three sub-stages that according to the neighbors, a given cell may decide to leave or stay in a probability, then the internal cells try to settle in an empty cell and finally the external cells try to settle in an empty cell. They enter in two groups of greens and blues in a constant proportion.

In the process of settling, each group determines the state of cells and according to its blue or green state, a given cell decides to move or stay according to the desire to be surrounded by similar colors and the repugnance to be with dissimilars. When the city is formed, the empty cells are provided for the immigrant cells that enter the world of the program. Like before, the cells change according to the state of neighbors. The cells that cannot decide to settle exit the program and finally a mixture of internal and external cells continue to form the city.

In his model, the agents do not decide what to do and they are the cells that decide to be in which state, because the aim of the program is the auto-organization of the city on the basis of the interaction between the cells by considering segregation.

In his model, he focuses on: first, applying Cellular automata in an auto-organizing city by taking to account the socio-cultural phenomenon, second, highlighting the local regions of stability and instability according to socio-spatial segregation, third, considering the actual location and movement of individuals in space, fourth, differentiating between the motivations and wants of individuals and what can be concretized in reality, and finally showing how the wants and preferences of individuals is affected by actual behaviors and socio-spatial properties of the city (Portugali, 2000).

Like Schelling, Portugali has just studied the development of city according to segregation. Although his model is more complete than that of Schelling, but he has not applied other factors that are at stake for agents to rest or move a cell. The cells of his program have just one layer of data in comparison to the cells of our model that have several layers of local data. He does not validate his model in comparison to any concrete sample.

Our model has applied some assumptions of Portugali's model. As a hybrid Multi-agent and Cellular automata model, the preferences of the agents leads them to choose what can thrive them, but in the reality which is the collision between the preferences of one given agent and that of other agents, a new situation may emerge that is not predictable from before. The socio-spatial properties are effective in two aspects; the spatial properties of the cells are defined in the initial world of the program, and the social properties come to stage when the agents study their neighbors to find if there are similar ones (the decision upon the state of neighbors is discussed in Schelling part) and when two agents arrive to a common cell.

It is different with Portugali's model in some aspects like: It is not a growing of Cellular Automata, and our city development does not show growth. Besides we have allocated the decisions to agents in accordance with what takes place spatially and socially.

4.1.4 Atkinson

Atkinson studies the gentrification in four boroughs of London and looks for the change in the concentration of social groups that are generally assumed to be susceptible to renovation.

He mentions the belief of Smith and LeFaivre (1984) that capitalism desires to move popular class when it is profitable, and despite the compromise that the displacement is harmful (Hartman, 1979 ; Marcuse, 1986; Smith & Lefaivre, 1984; Sumka, 1979), many have attempted to measure it; of course measuring displacements needs to track them and that needs studies in other domains for knowing how to approach it.

Professionalization in London was the first symptom to him that could end to gentrification or according to what he looked for, the evacuation of popular classes from these areas could verify it.

According to him the gentrifications tends to show two side of an event; one side implies that the desirable areas are renovated practically for those who can pay more and the other side seems to have resolved the problem of an area as to the changes in the space and the population after renovation; this seems like to evacuate the social problem. However he believes that the solution of the problem implies diversity and not the homogeneity of the

poor and rich population in an area. (Atkinson & Kintrea, 1998; Page & Boughton, 1997). These two sides that are both demonstrating the good side of gentrification bring about the 'managing gentrification' used by Freeman (2006) for being able to reach to an equitable and just society via gentrification (Atkinson, 2000; Freeman, 2006)

In this way the win-win approach according to him can be accompanied with absorbing the investments for enhancing the neighborhood and the population that are not very different with former residents of the neighborhood for preventing the influx of invaders. Via this, he looks for what Elorza (2007) mentions as dispersing the poor population in order to prevent their concentration in one area and to Elorza this process can be a meeting point of liberal and conservative thinking that in the first, the poor people can develop their attitudes and expectations and participate in the mainstream of society and in the second, the poor learn not to rely on public supports and provide themselves (Atkinson, 2000).

For studying the movements, he traced the displacement of last residents with the reality that the census intervals for these data were 10 years and the condition for including the displacements was that they were obligatory movements resulted by the changes in immediate surroundings; because according to McCarthy (1974), the renovations were not useful for the original residents and the three quarter of former residents of which 80% were tenants were obliged to leave their residence prior to renovations.

Further, it is exceedingly hard to distinguish between gentrification as a form of neighborhood replacement or displacement (McCarthy, 1974).

Querying the gentrification by statistical comparison between the concentration of socio-professional classes has been the source of studying the residential mobility as some part of gentrification; however the statistical approach, like that of Atkinson does not have the capability to generate the process of some phenomenon.

In our study we have not tracked the movements because of gentrification, but the initial movements of the population seeking for new conditions has constituted the core of our study; the generative characteristic of our model make us capable of observing the genesis of residential mobility as the preliminary step to genesis of gentrification. The other thing that is configured by inspiring from the work of Atkinson is introducing the classification of movements due to Marcuse (1986) that will be presented in the next part.

4.1.5 Lidia Diappi

Lidia Diappi (2008) has made her spatial model of gentrification based on Rent Gap Theory of Smith and via this model she studied the housing market. She used Multi-agent and Cellular Automata for showing the interaction between homeowners, landlords, tenants, developers and property units (Diappi & Bolchi, 2008). In her model the agents interact and influence some cells and the neighbor cells change because of their neighbor new state.

Based on Smith rent Gap theory, her model reckons the gentrification as a bottom-up self-organizing system. In a decay-revitalization cycle, the real estate market forms as the result of relationship within the local markets. Her spatial units are buildings that have *capitalized rent* and *potential rent* and in their life cycle, their prices decrease each year because of aging and if they get restored they find a new price close to the average rent of the neighborhood.

She defines the *capital rent* as local determinants like land use and socio-economic characteristics of the neighborhood, and the *potential rent* as neo-classical rent theory that believes the rent is upper in areas near the centers and lower in a distance to centers.

She considers two situations that in one situation, a good building is located in a decrepit neighborhood and in the other situation, a dilapidated building is located in a gentrifying area. The first building cannot have a price more than the average price of other buildings, but the second one can be a good investment according to other restored buildings.

According to the relationships between buildings, four groups of agents will take decisions: the *owner occupiers*, *landlords*, *tenants* and *developers*. The *owners* seek for investment in their property and in a depreciating area, they may sell or rent their property and go to other parts of the city. The *landlords* may invest in their properties to maintain or renovate it, but that will depend on the prices and qualities of the neighborhood and if the property

cannot find any added value they may not spend for maintenance and the building continues to decay. The *tenants* act according to their income; so if the rents increase or the quality of buildings is in a bad situation they leave.

The three mentioned agents act as their local view, but the last one has also a market view:

The *developers* seek to invest where they can have a great profit and the best profits is in a situation that the prices of buildings have reached to their lowest threshold and by investing and renovating these properties, they can obtain the profit they sought as the result of the gap between the two prices.

By running the model, she concludes that a large scale investment and renovation in the neighborhood may encourage the owners and landlords to renovate their properties, but before this action, they cannot make a big change in the neighborhood. Also in her dynamic system, the great investments may cause a large scale renovation and a noticeable social mix, but the little investments may advance slowly and keep the market in a dull situation (Diappi & Bolchi, 2008). She assumed that there are no intervention of authorities like protective policies and etc.

In her research, she applies the Rent Gap of Smith as the dominant factor in gentrification. She just considers the aging of the buildings as the depreciating factor of area and buildings and does not pay attention to the social aspect; the social aspect is reflected in our work as the classes of population and the segregation of these classes that may influence the decision of other agents for choosing or leaving some residence.

In our model, the cycle of six stages of gentrification is taken from this study and as mentioned before in the first chapter, we focus on the sixth stage and enlarge it in a time section. The Multi Agent and Cellular automata are used like this study and in the process of running the model, any external control or manipulation is not applied. The state of our cells, unlike this model, does not change and the agents act locally but they know about the state of unoccupied cells and they can compare it to the situation of their occupied cells.

4.1.6 Atsushi Nara and Paul M. Torrens

The dynamical process of gentrification was modeled by Atsushi Nara and Paul M. Torrens. They studied the mobility and residents' decision-making processes in a hybrid model of Cellular automata and Multi Agent System. They focused on individual activities and the interaction between the individuals as the human part of residential mobility (Nara, 2005).

In his thesis, Atsushi Nara studies the Gateway district in Salt Lake City and makes his model in several scenarios of gentrification. He considers the immobile agents as the cells in Cellular Automata, and the mobile agents in Multi Agent system. The cells represent the properties in the city and the mobile agents represent the human.

The fixed agents are comprised of four groups such as: *market, sub-area, property and fixed land*. The immobile agents act in two meso- and micro-scale. The *market* that is in macro-scale updates as the variables of its sub-market in micro-scale change. *Market* updates according to another factor which is the *sub-area*; the *sub-area* is itself comprised of *property* and *fixed-land* and that is between meso- and micro-scale. The *property* units are active automata that their variables change and that covers *property type, property value, and vacancy status* and finally the *fixed-land* is a fixed automaton and its state variables are fixed and can affect the transition of other cells. *Fixed-lands* are comprised of roads and access points and access points include the *points, downtown, highway entrance/exit, shopping mall, and grocery*.

The mobile agents or humans have some characteristics like economic status, ethnicity, preferences for housing choice, and sense of their neighborhood's environment.

He follows the demand side of gentrification and according to Ley, believes that gentrifiers have different characteristics and behavior that can have different roles in the process of gentrification and according to Hammett some factors should aggregate to realize gentrification: first there should be suitable area for gentrification, second the potential gentrifiers should exist, third attractive central part of an inner-city is necessary and finally the central parts should benefit cultural preferences for residence and some sectors of service class (Hammett, 1991).

His program begins with the initial definitions of the spatial attributes and the agents' variables. Then the variables for market and sub-area are determined. The program proceeds as the residents decide to move; they choose a house and finally the program updates. Figure 4.2 shows his flowchart of the program.

He calculates some decision thresholds beyond which the residents take decisions. The first threshold is applied when the actual residents decide to move, so if the probability of their decision passes the threshold, they will move. The second threshold is when they decide to choose a market in meso-scale and choose the house in micro-scale in a hierarchical process (Fig 4.3); if the probability of their decision to choose the market and the house in this market exceeds the threshold, they will settle there.

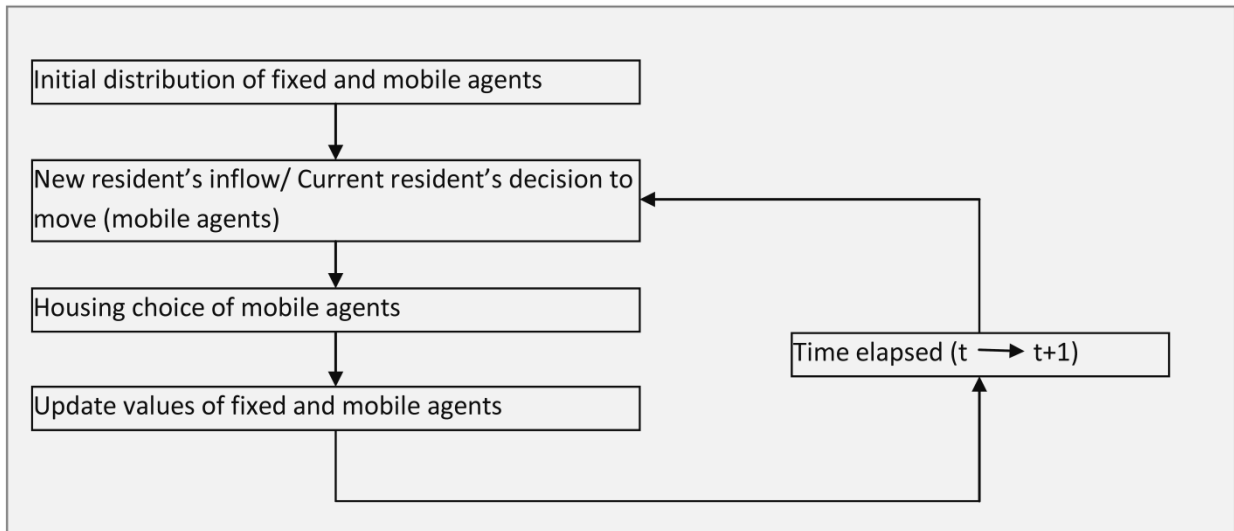

Fig 4.2. flowchart of the fundamental simulation process by Atsushi Nara (2005).

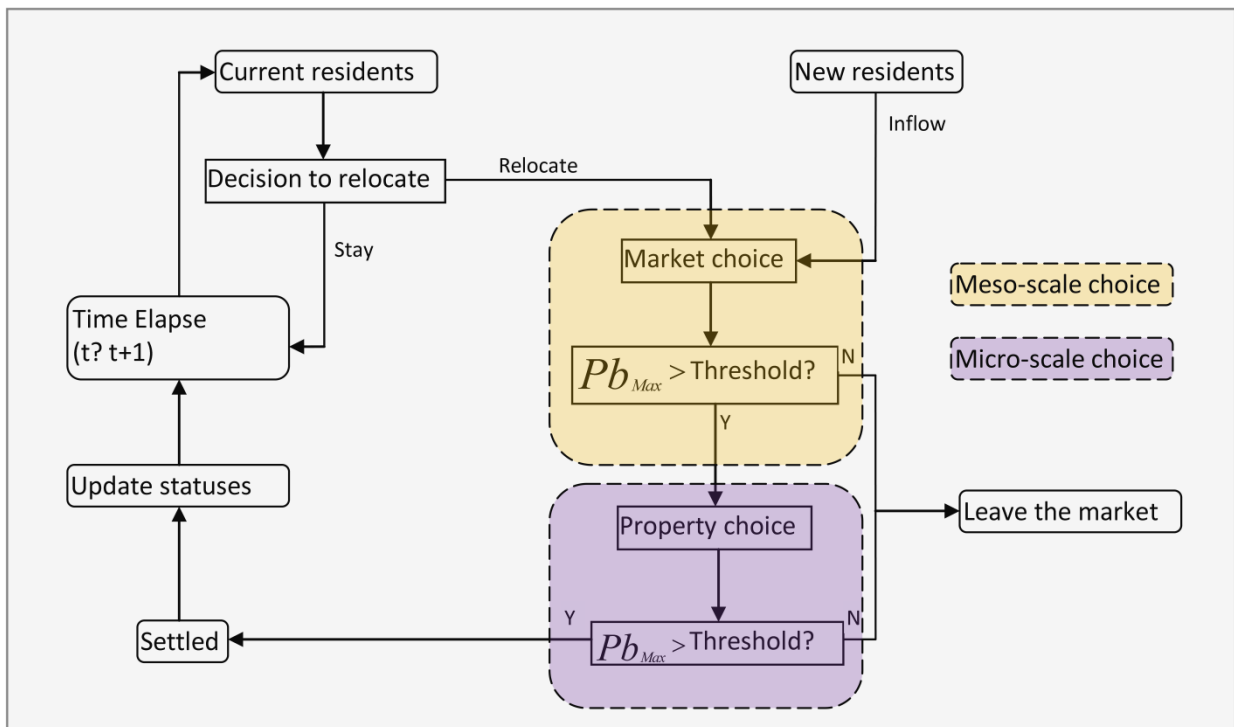

Fig 4.2. Diagram of residential housing choice process by Atsushi Nara (2005).

According to his model, the factors that are important for a resident to choose a house are in two groups; the neighborhood attributes such as neighborhood's economic state and ethnicity and the house attributes such as property value suitability, house type preference, house size preference, and accessibility preference.

The new values of properties are under the impact of vacancy rate of property, and as the program proceeds these values update. He uses the findings of UrbanSim Beta Version (University of Washington 1998) for formulation of these impacts.

He does not apply the land use transitions or residential properties expansions, he just takes to account the owner-occupied properties and they include the single house units and condominium units, he takes only the Latino as ethnicities and finally the choices of residents is based on the maximum utility and except the last one, the other limitations are the lack of data and model simplification and the last one is because of the assumption of the project. He examines these requirements by running the gentrification model in different scenarios.

As said before the gentrification depends on gentrifiers and gentrifiables; hence he bases his scenarios on this distinction and because some side plays the demander and the other side plays the supplier role, he finally takes to account the two sides in the last scenario. According to these, he runs his model in these scenarios, first he makes the base simulation, second he introduces the potential gentrifiers, third he introduces the potential gentrifiable properties and finally he applies the two sides in the model. For introducing the potential gentrifiers, he increases the economic status of new residents for showing the inflow of higher class population and for showing the gentrifiable properties, he introduces the gentrifiable properties in two markets.

He runs his model ten times for each scenario and sets the timestep equal to 500 by assuming that each time step is equal to one month and the total time of the program is about forty years. He observes the property value, economic status and the residential displacement process. He obtains the market average values of total household, property value, economic status, original resident profile, and Non-Latino ethnicity as the outputs.

In his research, he applies the market as economic factor, ethnicity as social one and gentrification as socio-economic factor and he runs his model in several scenarios. He also divides two scales of action for the agents as micro- and meso-scale in which for example the market is chosen first and the residence is chosen next. However choosing the area of action in micro- and meso- has been concomitant with lack of data for micro-scale and the model has been run theoretically according to the scenarios and the results were not compared to any real situation. The other downside of the model is that he has not determined any place for top-down actions or decisions.

We use his procedure in formulizing the probabilities for the residents' choice and make our model. After constructing the model we will validate the results by comparing the simulation results with the real ones. We dispose the repartition of databases in micro-scale and according to that we can launch micro-action and observe the resulted macro-behavior of the system. Besides in our model the top-down decisions or actions can be reflected in defining new area of action for the agents. The present area is made of the repartition of comforts in different areas of the city, but a central decision like urban planning or local strategies can make a new area in which the agents act.

4.1.7 Giddens

According to our program, there exist some interactions between the individuals or agents and the space of the city. For knowing more about the agents, their motivations, decisions and actions we have use the discussion of Anthony Giddens. Giddens (1984) discusses in his book, *the constitution of society*, the structure, its forming, its role and its interaction with the agents; he proposes the theory of structuration as a social theory of creation and reproduction of social systems. The structuration is based on the analysis of both structure and agents without giving primacy to either.

For functionalists, structure is developing or existing of a pattern of social relations or social phenomena. The structure is naively likened to the skeleton of a body or the timbers of a building. These concepts are close to the dualism in the subjectivity of the individuals and the objectivity of the social. The structure seems to be exterior of

the human action and seems it constrains the free initiative of the subject that is constituted independently of it (Giddens, 1987).

Giddens queried the abstract characteristics of social relations. According to him, the human become experienced in space and time. Neither the individuals' experiences and nor some form of societal totality could not establish his social theory and the social practices that become ordered across space and time could help to forming of a more exhaustive theory.

Social systems have some patterns of social relations that are liable to changes as the time passes; so the change of space and time changes the social relations and consequently the social structure. In one side, the positivists believe that the social structures are beyond the realm of human control and the interpretivists know it as the result of actions. So Giddens try to change the question instead as how the social orders are created by the duality of structure.

He cautiously avoids the position of the objectivists that detach the structure from the human elements and the one of subjectivists that pays utmost attention to the individual and group agencies without considering the role of socio-structural context.

He brings about the aids of other disciplines to the notion of time and space in social theory; to him, the geography, history and philosophy help to this notion. Some disciplines make some cells, places or ranks and they make some complex spaces by them: at the same time they are architectural, functional, and hierarchical. These are the spaces that assure the fixation and permit the circulation; they make individual segments and establish the operational relations; they mark the places and indicate the values; they guarantee obedience of individuals but also the best economy of time and movement (Giddens, 1987).

He keeps distance from the structuralism and does not consider the reproduction of social system as a mechanical outcome but as an active constituting process in which active subjects accomplish the reproduction of social system and the agents are not the bearers of the structure but they actively make it.

According to Giddens, there exist three forms of constraints in a social system:

The first one is the *material* constraints which refers to the nature of material world and the physical quality of the bodies,

The second one is the *sanctions* that refers to the punitive responses of other bodies,

And the third is the *structural* constraints that refer to the contextual character of the action or the spatio-temporal situation of the actors (Giddens, 1987).

'Structure' and 'system' are the core of structuration theory. But he distinguishes between structure and system. According to him, the structure concerns the reciprocity of the action with two individual face to face but the system concerns the relation that the persons or the collective have with those who are absent in time or the space (Giddens, 1987).

Giddens observed that the structure was referred to 'rules and resources' and to 'structure properties' and they allowed the binding the time and space in social systems. Similar social practices could exist at the same time and space and take a systemic form. Agents use these structures as a source for performing social actions through embedded memory or the *memory trace*. The social actions are conveyed in the memory trace and since the social practices result in structures, Giddens proposes the *duality of structure*. According to the duality of structure, the structural properties of social systems are at the same time the medium and the results of the practices that they organize recursively. The structural is not out of the impact of agents; the structure is not only the constraints and it is both constraining and habilitating. It does not prevent that the social system extend in time and space completely beyond the control of the each actor. The actors can construct and reconstruct the systems (Giddens, 1987).

All the individuals have competence in making a social life. So he is careful not to commit the error of the structuralists and functionalists who ignore the reason or rationalization of the agents and they allocate their studies to explain the activities of these agents by the phenomena and ignore the reasons; And also not to commit the error of the opposite group who apply the hermeneutic approach that see the society as the plastic creation of human subjects. The two groups form a reductionism that is not sufficient to embrace the structural duality. He pays attention that at the time of production of an action, the new context is being reproduced (Giddens, 1987).

The agents and the structure, in a feedback-feedforward process, enact a social system that functions in a social cycle; in this cycle, the social system becomes a part of duality of structure. In this system, the *structure* is translated to *interaction* via *modality*.

The interaction is the agents' activities within the social system, space and time. It can be routinized occurrence of encounters that dissolve in time and space or it can be reconstituted within different times and spaces. *Rules* can affect the activities by constituting and regulating them and by defining them as activities that can be subject to some *sanctions*. A set of rules form a *framework* by which a given agent can feel safe by trusting that the daily actions have some degree of predictability and someone can make sense of what he or she is doing.

The rationalization of the action notes that the actors have a 'theoretical comprehension' of the bases of what they do in routine. Of course this comprehension is not in a discursive reasoning and there is not an expectation that the agents can provide reasons for their behavior in a discursive manner. In this way, an agent expects that the other agents can express what they are doing at any time that they are asked. The agents practice their actions by applying a reflexive control (Fig 2.1) (Giddens, 1987) .

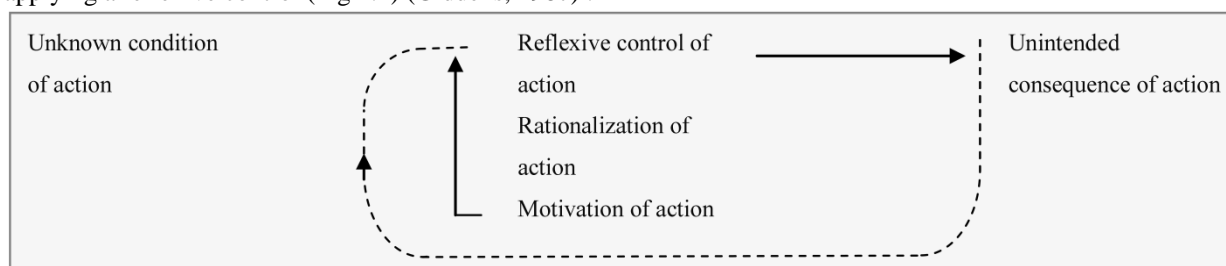

Fig 4.1. The layers of action motivation for an agent (Giddens, 1987).

The reflexive control is a characteristic of all actions; it bears on the behavior of one who carries on this control and on the behavior of other actors. So the agents do not only follow their own activities and expect the others to do the same; they also control routinely the social and physical dimension of the context in which they act.

The context of the agents' activities including the rational decisions and the interaction between the agents and between the agents and the social system shows that the social systems are complex systems and beside the attempt to generalize some tendencies of a society, the interactions between the agents does not stand as the extension of societal tendencies. We continue the discussion of modeling by focusing on the complexity that exists in urban context.

As the matter of social activities, Anthony Giddens (1984) mentions that there are some intended and unintended results of a given action (Giddens, 1987).

We should distinguish between the actions of the agents and the action itself. For example the decision or actions of a government is an action but only the individuals and those who have corporal existence can be agents and not the group.

In another word we say that the 'individuals' decide to 'collectively' take a decision and maybe someone disagree with the taken decision (Giddens, 1987).

There may be three situations that a decision is made:

When a definite decision should be taken,

When it is possible to assert the precise consequences of different possibilities at stake and

When the decisions are taken in a separated way by a set of persons who are not in communication with each other (Giddens, 1987).

The actors have some motivation and some rationalizations for their actions. There will be some consequences that are not wanted. The competence of the human actors is limited and they produce unwanted results by their actions and also they produce the results unintentionally that can help to make a new context for the ulterior actions (Giddens, 1987). When the actions of individuals oppose and contradict with others, according to Elster two forms of contradictions generate: the 'contre-finalité' and the 'sub-optimalité'. The first one is when all the actors want to do the same action in a group; maybe no one or many do not reach to their targets (the contre-finalité is when the

results are not exactly as the one expected and there are some negative results are produced as the consequence of actions) like when all the audience stand in a hall for seeing better a celebrity.

In the second one when some action is practiced, maybe the others may lose their chances and they prevent each other to do the same action like when someone makes a cartel, he or she can benefit more and limit the profit of others, so the others prevent him from making the cartel (the sub-optimality is reaching to a result in a game theory that is less than what is expected initially and the result would be optimal if the actors acted differently, but there are not the negative consequences produced as the consequence of the actions) (Busino, Valade, Honorez, Jacquemet, & Miéville, 1998).

So in the contre-finalité and sub-optimality the common event is the production of unintended consequences that in the first one, some part of the results can go back to the negative results and the second one can be the results that are deviated from the targeted results but just in the sense that is less than the expectation.

In the game theory, it is assumed that the solution of a game is anticipated by all the actors. The difference should be sought in the structure of the accessible information in each situation. In the game, each actor has a perfect knowledge of what other actors will obtain and the other actors dispose the same information that the given actor dispose. The situation that generates sub-optimality, lacks at least one of these conditions (Busino, et al., 1998).

The result of individual decisions in urban life is not crystallized in the context of game theory; in another word the agents are not aware of what the others are doing and taking a profit by someone may not be in contradiction with the profit of others. So the decisions by actors are subject to some unintended results other than the rules of a game theory.

In a logical plan, the action is involved in power as a transforming capacity. The power is defined as the intention and volition like the capacity to reach to the desired results. Power can be something that can help the actor to reach to the desired result or the capability to mobilize the means which are inherent in the institution (Giddens, 1987).

Concretizing a social or spatial project in the context of the city has some internal and external opportunity and importunity. Like what we have mentioned before about constrains and habilitation of a social system, the characteristic of the present situation of life space is the result of history of actions that are practiced by agents. In the present context, the attempt to reach to the intended results or mobilizing the tendencies of some part of society for reaching to a favorable target brings about the power and in the present project, the agents are assumed to have the volition to reach to a desired result and for this they need to obey some rules that may constrain them or give them some capability.

Giddens can help to the constitution of our model in two ways:

First, he combines the interdependence and autonomy of agents. At the same time that they are constrained by rules and structure, they can generate new structure by their actions; this concept is close to what we have referred to system approach of modeling and to cybernetic systems. In the two latter ones, the system is the cause and effect of the decisions and actions of elements of the system.

Second, although the city is not presented in his theory conspicuously, the stress on space and time can be inspiring for our project. We have provided the space of the city with its characteristics as the field of action for the agents. The time sections in which we validate our models can be considered as milestones according to which we generate the inter-census periods. Time can be applied for the memory that the agents make for future actions; this one is not used in this stage of our program but in the future it can be applied for training the agents.

4.1.8 Conclusion of literature review

We have presented the scientific works that contribute to the constitution of our theoretical base. Except for Giddens who has helped to the concept of society and its constitution, the others have helped to modelization.

The first study of Schelling on segregation and the development and formulation of Portugali is used for defining the probabilities that an agent may behave under the impact of segregation. This makes the Cellular Automata system of our research. After the first dispersion in the world of our program, the agents choose some residence. Apart from the criteria of comfort, they choose to rest in the present residence or decide to leave according to the tolerance that they may perform against their dissimilar neighbors.

Atkinson puts forward the discussions on the reasons and results of gentrification and the approaches that have accepted the gentrification as a phenomenon that has negative consequences on the displaced population but look for measuring it. He tracks the gentrification in specialized areas of London and to him, the criteria for emersion of gentrification is the difference in the population of lower classes in a period of ten years between 1971 and 1981 and this difference for the population of upper classes in this period. As the first step to modeling gentrification, we have used the concentration of population in areas as a hint for inquiring if we have gentrification in some given area. In this step of our program we disperse the agents in the areas of the city according to the rules of the program and use the population as a tool for validating our program. The other use of Atkinson model is the introduction of classification that Marcuse has done on different forms of movements; as we will talk more in the fifth chapter, we have applied the chain movements of residents according to residential mobility.

The rent gap theory proposed by Smith was well formulated by Lidia Diappi. The sixth stage of gentrification and modeling it with Cellular Automata and Multi Agent System is a source of inspiration for considering the supply side of gentrification; this is what a neighborhood can suggest to prospective residents and can tempt them to choose a neighborhood for living. The six-step cycle of gentrification that Lidia Diappi has presented for introducing the Rent Gap Theory of Smith has been the source of our model. In this stage, we expand the sixth step of the theory in which according to the investments in a decrepit area, the quality of living area enhances and the life cost may be liable to increase, some new upper classes may enter to the area and some lower classes may leave.

The model has benefitted the Torrens and Atsushi Nara with respect to their configuration of the weights for each factor. Also the combination of Cellular Automata and Multi Agent System is done according to their application of these two models. In our model the Cellular Automata is applied for the impact of segregation on the decision of agents, and the Multi Agent System for moving the agents in the world of the program.

The structuration and system, proposed by Giddens, is used to situate the agents in a social context. Agents can decide according to their rationalities and motivations, but when some action is practiced by a given agent, there may be some change in the context for the decision of other agents. The interaction between the agents and that one between agents and the system may bring about results that might not have been anticipated by the agents. Especially when there are some clashes between the action of one agent and those of others, there may be some constrains for the action of agents. We do not apply the rules of Game theory because it does not seem that the profits of someone in a city are necessarily in contrast with the profits of others. However we cannot forget that reaching to a desirable occasion does not solely go back to the decision and action of a given individual. So we design the model according to potential aspirations of individuals and for reaching to the targets, we take to account the power of each individual for reaching to the target.

4.2 Toward making the model

4.2.1 Agent Type

Our model will apply the hybrid Multi Agent and Cellular Automata in which the spatial units of the city of Strasbourg are represented in the cells of Cellular Automata and each cell will have the inherent characteristics that we name it wholly the comfort, and the mobile agents as the residents of Strasbourg are represented by the agents of Multi Agent System. Of course there exists an existential contradiction between the term 'resident' and 'mobility' and the combination of 'residential mobility' is an exception and not a routine. So the initial assumption is that the individuals choose a residence and they remain residents unless some attracting or repulsive force propels them to move and choose another residence.

The lattice of our Cells will be the square cells that each one is 100m ×100m. The cell size is as big as some isles of several buildings.

In this model, three layers of fixed agents and one mobile agent are assumed to represent the spaces and humans of the city. The three layers of comfort that are determined for the cells are spacious residence comfort, residence technical comfort and the centrality and the humans or residents are in four socio-professional classes of Senior

executives and company managers, intermediates, employees and workers. The state variables of residents include their preferences for housing choice, and the state of their neighborhood according to segregation.

4.2.2 Simulation Process

The fundamental simulation process is shown in Figure 4.4. First of all, the program begins with making the world of program according to the initial information for cells and mobile agents and the agents disperse randomly. After the initial distribution, the residents roam to find a good residence according to the internal information of the cells that the agents can be aware of. The counterpart of information that exists in cells can be the information that someone can obtain from a residence directly or some kind of on-site information. The other sort of information that is supposed to be accessible to all agents is what exists in ads, News or virtual world. However the rate of awareness according to information and News is not equal for all, even when the information is accessible for all.

At each time step, there are four main processes, residents' moving and seeking for settlement, choosing a residence, moving because of segregation and moving for finding better residents. After some time steps, the system updates for counting the empty cells and evaluating their values and announcing it to all agents.

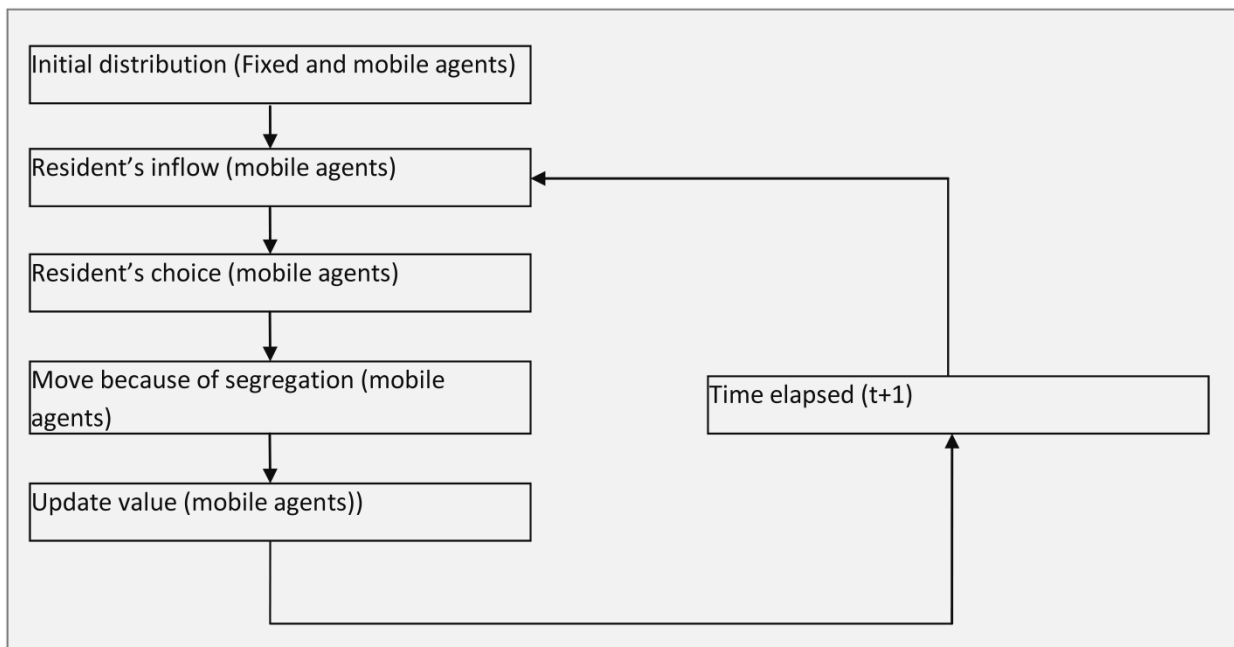

Fig 4.4. The fundamental simulation process.

A resident selects a cell among available cells in the selected neighborhood and may move in this process (Fig4.4):

The first step begins with roaming the agents in the city.

At the second step, they reach to the cells and ask about the properties of the occupied cell. If the three comfort factors of TC_j , as the technical comfort of a given cell, SC_j , as the spacious comfort of a given cell and $Cent_j$, as the centrality of a given cell are in high scores, they choose to settle there and if not, they continue to roam.

At the third step, current residents will calculate the probability for leaving their property because of low quality of neighborhood resulted by low centrality, low spacious comfort, low technical comfort, segregation of lower class separately or some of them together. If the probability of resident i leaving his property j is greater than the threshold, the resident will decide to leave.

After some steps, the system updates and new process begins in fourth step.

At the fourth step, the updated program announces all residents that there are some unoccupied cells in the city and let them know the Bet_j as better situation. The residents may choose to search again if there is some residence better than their initial residence.

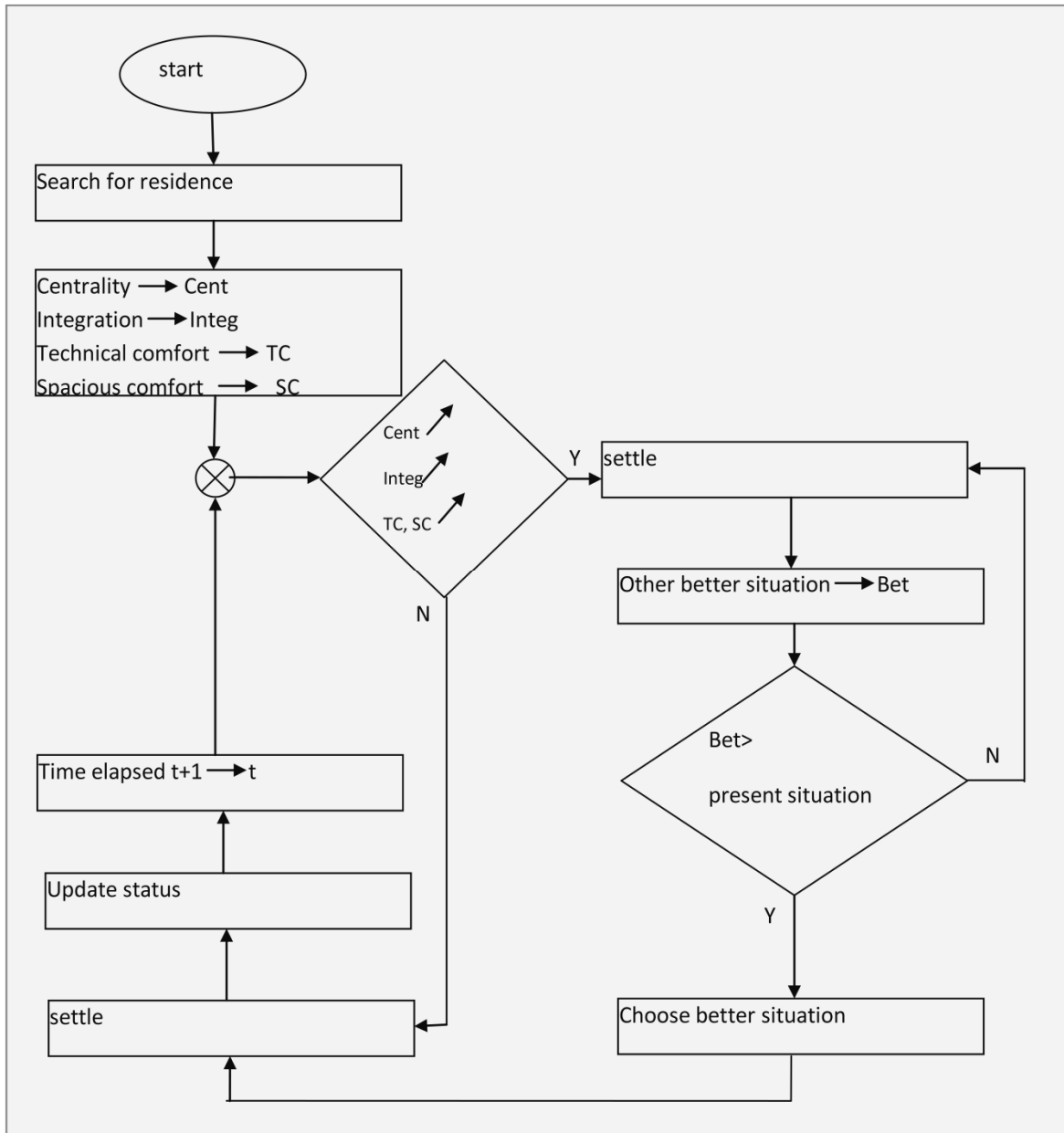

Fig 4.5. Residential choice diagram.

In a mathematical language, the probability that an agent choose a cell is as below:

$$Pb_{C_{ij}} = \sum (b_1.Cent_{C_j}) + \sum (b_2.TC_{C_j}) + \sum (b_3.SC_{C_j})$$

Where:

$Cent_j$ = the centrality of a given cell,

TC_j = the technical comfort of a given cell,

SC_j = the spacious comfort of a given cell,

b_1 = the importance of centrality in a given cell,

b_2 = the importance of technical comfort in a given cell,

b_3 = the importance of spacious comfort in a given.

$\sum_1^3 b_i$ is assumed to be equal to 1; this is what the program will adjust if the sum is more or less than 1.

From other side, a given agent may take into account the weight of properties proportionate to its desires or solvency; hence the preference of agents is calculated as the sigmoid sum of each preference multiplied by the property of each cell. The preference of the agent is as below:

$$\sum (SP_{s_i} \cdot R_{PSP_{s_i}}) = R_{PCent_j} \cdot Cent_j + R_{PTC_j} \cdot TC_j + R_{PSC_j} \cdot SC_j$$

where

SP_{s_i} = the socio-professional situation of a given agent,

$R_{PSP_{s_i}}$ = agent's preference for choosing a cell,

R_{PCent_j} = agent's preference for centrality,

R_{PTC_j} = agent's preference for technical comfort,

R_{PSC_j} = agent's preference for spacious comfort.

The probability that an agent leaves the initial cell is assumed to be dependent to the existence of some better situation in the city and also the segregation situation. In another word an agent may start to search again if it sees there are better residences in the city or if the neighbors are not similar. The probability to leave the initial cell is as below:

$$Pb_{L_{ij}} = \sum (R_{PInteg_i} \cdot Integ_j) + \sum (R_{PBet_j} \cdot Bet_j)$$

where

R_{PInteg_i} = agent's preference for integration,

$Integ_j$ = the segregation in adjacent cells in the Moore neighborhood model,

R_{PBet_j} = agent's preference for benefitting of a better occasion in the city,

Bet_j = better situation.

The better situation is assumed to be the average of three properties of unoccupied cells minus the average of these properties that exists for the occupied cell of a given agent. The better situation is as below:

$$Bet_i = \frac{\sum (Cent_j + TC_j + SC_j)}{n_{E_c}} - \frac{Cent_i + TC_i + SC_i}{3}$$

where

n_{E_c} = number of unoccupied cells.

(i refers to a number of resident's identity and j refers to cells.)

The segregation in the neighboring cells is defined as the average of classes of population who are settled around a given cell. If the classes that surround the given cell are very different and the comfort of the neighborhood is in a large contrast with solvency of the given cell, it will leave and search again. In the figure 4.6, the agents who are surrounded by different classes may leave the cells, especially when the comfort of the cells around them does not make motivation for them to stay.

	E	W	W				
	E	I	M	W			
	W	W	W	E			
			W			M	
				I	M	M	
				M	W	I	
				M	I	M	

Fig 4.6. segregation and comfort of areas; W stands for workers, E for employees, I for intermediates and M for managers. Light colors stand for lower comforts and dark color for higher comforts.

4.2.3 Simulation Assumptions

The simulation applied to the study area is based on some underlying assumptions as follows.

1. Only the status of residences and centrality affect the residents' decisions and the residents do not affect the quality of the residences and the neighborhood.
2. Only two factors affect the potential residents to settle in cells: residential comfort and centrality; other factors like cultural factors, investment policies and etc, are not taken to account.
3. The study area is endogenous and the migrations are not applied in this study.

These are due to data limitations and model simplification in this step of the project.

The one-way influence of space on the decision of agents cause that we cannot echo the decisions and actions of residence to the space and in this step of program we do not expect that the space transitions. This will be applied in the future to model the interaction between the agents and the space.

Besides along with comforts, other factors that lie in the package of aspiration can be queried by further researches such as questionnaires and etc.

We have excluded the movements to endogenous situation and that will cause that the impact of migrations get overlooked. The present model will be a substructure for further developments and the package will provide the basic tool that according to each initial part some complementary parts can help to optimization of the model.

4.2.4 Simulation Results

The result of the model will be the repartition of four classes (Senior executives and company managers, intermediate occupations, employees, and workers) in spatial units. The result of census in 1982 by districts will be compared with that one produced by model. For this comparison, the standard deviation of two repartitions can be a good tool. On the basis of the comparison between the real dispersion of population and the simulated one, we can infer if there are correlations between the factors that are assumed as important ones and the settlement of population in each area. Of course because of the non-deterministical characteristic of our model, these inferential conclusions will be practice in the domain of *in silico*, but in the case that there are some correspondence between the *in silico* and *in vivo* results, we can expect some interesting results.

4.3 Conclusion

The application of Cellular Automat and Multi Agent System, in addition to the capability that it gives to modeler to model the spatial event by exploiting the immobile and mobile agents, makes possible to model the local and global events. The properties of the cells are local and the decisions of the cells and their interaction in a given cell is local whereas their impact on updating the program and the new state of the program is global and the updated system again is reflected in the local decisions of the agents.

As mentioned in modeling section, the rules are determined by selection of most generalizable tendencies of population. The rules that can exist for the behavior of agents are not easily defined and even if it is possible to define rules for all agents, the interaction between the agents and the one with the social system will end to a complex set that is not traceable and that will not provide the possibility of making a model. In making the model, we use the apple law that was mentioned by Giddens. He believes that the organisms are active and they do something and set aside some others. For picking an apple between several ones, there is no necessity to omit the apples that we do not want to pick and we just pick the one that we want. But for designing a mechanism that how we choose an apple and which one we will choose, we should not include the sorting of the apples that should not be cut in the mechanism (Giddens, 1987).

We have chosen the most important factor according to the researches that we have introduced in the first part of this chapter. The segregation with its parameterization is done according to Schilling and Portugali. The concentration of population in the areas that are prone to be gentrified is chosen as another factor according to Atkinson. According to his presentation, the chain residential movement is chosen according to Marcuse. The six-step cycle of gentrification is chosen according to Lidia Diappi. Defining the probabilities is practiced according to Torrens and Nara. And the enriching discussion of Giddens helped to introduce the agents, their motivations, their decisions and actions better.

We will launch the model, validate the results and discuss and conclude from the results in the next chapter.

5 Fifth chapter: Multi Agent model of urban renewal in Strasbourg 1982

5.1 Introduction

In this chapter, the model is implemented for developing the city of Strasbourg with respect to decisions that prospective habitants may take for choosing their habitats. For explaining the context of this study, some main approaches in modeling the city is presented in the first chapter and according to the attention that they have paid to people and their decisions as the organizers of city development, some aspects of the mentioned approaches are reflected in our project.

As we have discussed in the first chapter, urban renewal can be concomitant with the entrance or leaving of some classes of population. If the renewal takes place in some central part and it embraces the rehabilitation of some decrepit parts of the city, this can predicate gentrification to the given area. So as a first step to modeling the whole mentioned events, we model the settlement and displacement of classes of population in areas that have experience urban renewal.

Settlements and displacements will occur on the basis of people's decision. The rationality of the system is better understood, if we assume that a given person is making a choice when he or she encounters a situation; he or she should choose between not many options, some of them close to the tendency of people, and some, far from a logical or conventional decision. As the experience of rehabilitation in central parts of cities has shown, there are demands for accessing to some central parts as to the proximity to the services that exist in these areas and also according to the enhancement of buildings and structures after renewal, the general quality of the neighborhood promotes; this triggers some filtration of population as the result of increase in prices and other factors like segregation. We discern the forces that may attract or repulse a resident to choose a given residence to live in. Some like the valorized residences and areas are assumed to attract the prospective residents and some like segregation are assumed to repulse the dissimilar population from a given residence.

For knowing the city of Strasbourg and its renewal activities, we have profited from the researches of Philippe Gerber. So first we compare our model with the approach that he has taken for his research.

Then we will posit our hypotheses according to efficiency of the present model and the correlation of comfort and segregation with residential choice.

Under the next title, the Multi Agent modeling and its comparison to Cellular Automata are analyzed and they are expanded by pointing out its constituents.

Strasbourg, its patrimonial programs, parallel to the definition of its core and its development is what has attributed the next item to itself. As the space and context of this project, the local definitions of global concepts are subjects to some inflections, including some important elements of our study like centrality, accessibility, and gentrification.

The next part goes to the more concrete causes of why some parts of the city are assumed to be more favorable than other parts, and also what make the aspirations of someone. This part of study is relying on the findings of Philippe Gerber's thesis (2000).

We will discuss the rationality of residents for choosing their residence under the next title.

Due to the data and three categories that provide some range of credits for the spatial units, the targets are defined for absorbing the prospective habitants and on the other side, the probabilities according to which each person may choose its desired neighborhood are introduced.

Under the next title, the simulation results are compared with the real situation or in another word the dispersion of socio-professional classes in the spatial zones of Strasbourg is compared in the real and simulated situation.

5.1.1 The preferences of present model to the study of Gerber

Gerber has studied the gentrification in Strasbourg according to the post-modern comfort. First, he has presented his definition of comfort and how it can be incarnated in urban events. As a concrete aspect of comfort, he has reviewed the activities which are practiced for promoting the comfortability of living environment; some part in residence and some part in living area. He collects the necessary data for defining two types of comfort that a residence can provide and he calls them the technical comfort and spacious comfort; the first one goes back to the facilities like central heating, bathroom and tap water that the buildings did not have formerly and the latter one takes the surface area of buildings as other comfort variable. The centrality, to him covers the need for equipment that a household can dispose in his or her house or what he or she can easily have access to it.

He applies several statistical techniques for harmonizing of data that are mostly provided by INSEE¹ and SIRENE² and finally introduces the correlations between the comforts and the population of classes of people who live in Strasbourg. He benefits from the efficient method of factor analysis.

In statistical approach such as factor analysis, the data are collected in order that the correlations between the variables are discovered. The significant correlations may be in the same directions or in another word, the increase in one variable will be accompanied with a increasing change in other variable that is positively correlated with, or they may be in opposite directions or what can be said as negatively correlated ones in which the increase in one variable is accompanied with the decrease in other correlated variable. The correlation can be between the two mentioned states and the direction of the vectors that depict the changes in variables of one group can be in some angle with the vector of the variables of other group; that means that the variables are not significantly correlated.

On the basis of the correlations between the spatial and human factors, we will use our model as an apparatus for depicting what will be the result of manipulation of some variables on the whole system. For example if there is need to change the state of an area with respect to the renovation or rehabilitation, we can see the results on the population change or alternatively, if we have observed a correlation between the population and some urban activities, by shifting the population, we can observe the change in the side of urban activities. So as a complement to statistic approach, the generative model supplies a media for observing the changes in urban system. On the other step of the program that the feedback of population change may influence the pace of renewal, a good advice can be the one that can represent to what extent the change can influence the renewal.

As the Figure 5.1 shows, at the top, in a given time section, some variables exist that overlap to some extent on other variables; this is describing the correlation between variables by statistical approach like Factor Analysis. The process that is resulted or ends to the existing situation of time sections is in the black box. In an attempt to open the black box, at the middle of below diagram, the process is reckoned as the basis of generating the model. The bottom of diagram depicts the situation in the process that ends to or resulted by the situation in the time sections. The colored part shows the scope of our research in the present dissertation and the gray part will be probed in later researches.

¹ National Institute for Statistics and Economic Studies

² The Sirene® base de données (databases) are managed by INSEE. It provides the databases of companies and their assessments and they update daily.

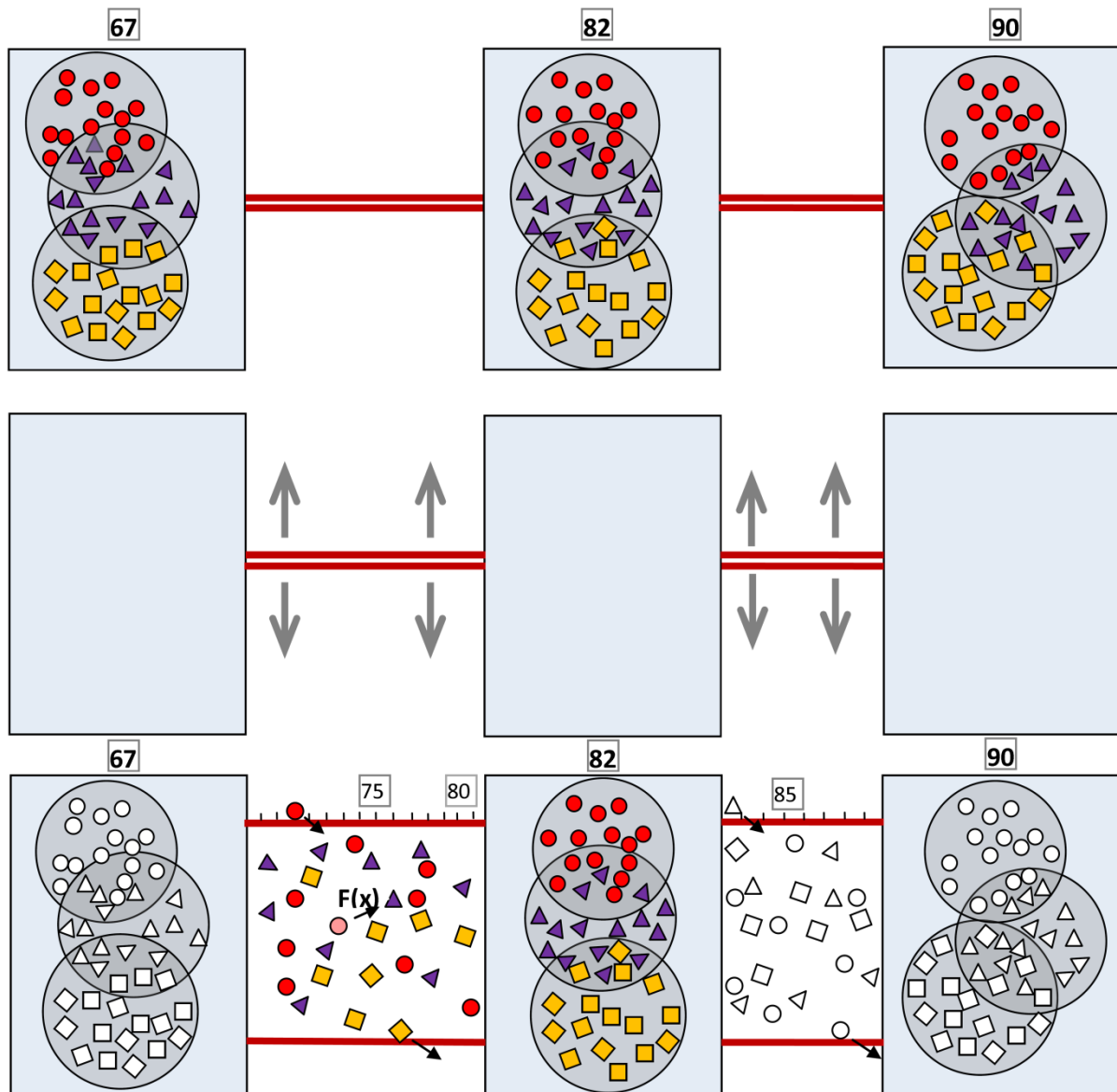

Fig 5.1. the evolution of the present model; at the *top*, the correlation between variables are queried by Gerber in three time sections 1967, 1982 and 1990. At the *middle*, the attempt to model the process between the time sections is depicted. At the *bottom*, on the basis of three censuses of the aforementioned time sections, the process between the time sections is generated (Kaboli, 2013).

The trump of using this model is that we can follow several strategies and see the resulted situation and in accordance to the most favorable situation, we can target best situation. In another word we benefit the descriptive nature of the program for discussing each case in its decisional context. In our model and the approach that Gerber has chosen for probing the subject, three main aspects of the problematic are the individuals, space and time. We will base our hypotheses as below:

5.2 Hypothesis

By constructing our model we query some bases for proving or rejecting our hypothesis as below:

H1: The present model can be a proper tool for describing urban renewal and proposing scenarios that are based on reliable rules and configurations?

H2: Introducing comforts as absorbing variables will drive the population to an acceptable concordance between simulate population dispersion and real population dispersion.

H3: Introducing segregation as a force can be a decisive factor for residents to choose their residence.

H4: Efficient Policies can rely on some manipulations in segregation or comforts as important factors for renewal, desegregation and valorization of areas.

5.3 Chorotaxic and Functional space

The interaction between individuals and the system is discussed in previous chapters and we have introduced them mostly in System approach in the second chapter, cybernetic systems in the third chapter and the structuration in the fourth chapter. Here we introduce a definition of space that discern between the space and individuals and it can be of interest of urban activities.

Prof. Colette Cauvin and Prof. Henri Reymond (1984) differentiate between 'chorotaxic space' and 'functional space' in which they discuss about the role of people in defining a space and also the functional relationship. The definitions decompose the space as:

Chorotaxic space is a range that is consisted of human and its surroundings and it is determined by the links and the arrangements between places with specific attributes; it is universally measurable, but recognized by the function of particular motivations of one or several persons. It can be represented on a plan under a map of localization.

Functional spaces are the spaces that are derived from the chorotaxic spaces. These are the spaces that can be affected by the movements and the displacements which are caused by the function of a given target (Cauvin & Reymond, 1984; Gerber, 2000).

According to this classification, in our chorotaxic space the individuals are under the impact of the space and its organization and in this stage of the program, the spaces will not be affected by the activities of the individuals.

5.4 Multi Agent and Cellular Automata

Two of the best tools for modeling the dynamism of the cities have been Cellular Automata and Multi Agent Systems that have been repeatedly applied by urban modelers. The use of space and time in these programs make them work as generative models that can describe some iterative events or grow an event from simple interactions to an emergent phenomenon.

According to White and Engelen (2000), the Cellular Automata is a favorite tool because of its inherent characteristics like ability to define a spatial world, to proceed in a non-linear and dynamic manner, to be configured and adaptable to different local situations, to implement the rules in the proper situations, and despite its simplicity the ability to exhibit rich behaviors on the basis of simple rules and actions.

The Multi Agent Systems are interesting because of their capability in joining the spatial characteristics with the behavior of individuals. The number of individuals or the complexity of the behaviors may get the interactions complex. They can classify the groups of individuals and some characteristics can be inherited from one class to others. Also, we can expect that they represent some aspect of natural and human systems by modeling the interactions between the elements. According to Prof. Jean-Luc Mercier (1975), by knowing the input and output of the system, we can calculate some states of the system (Mercier, 1980). The input and output of our program will be the population of the city in four classes; by knowing these data we have the media for monitoring the different states of the system on the basis of interactions between the agents and the parameters upon which the state of the program transitions.

The two systems are applied together in many studies and the tasks are divided in the way that the individuals move according to the definitions of Multi Agent System and the space is defined by and act according to the Cellular Automata (Benenson & Torrens, 2004; White & Engelen, 2000).

Multi Agent System, in this research, is applied for modeling the mobility of residents in Strasbourg. Some factors make them settle or stay in their residences and some make them move into other parts of the city.

5.4.1 Cellular Automata

According to Liu (2009), the Cellular Automata have five basic elements: the cells, the state, the neighborhood, the transition rule, and the resolution time.

The **cells** are the basic spatial units that are arranged in spatial tessellation. The most general tessellation is a square lattice which is used in modeling urban growth and land use changes. The two-dimensional models are mostly used, but the one-dimensional one can be applied for example in a model of highway traffic and the three-dimensional can be used in the buildings by taking to account the building's stories.

The **state** refers to the possible conditions that a cell can be in. According to the set of states, the whole system can have a state in a time step. At each time step, a given cell can have only one state and this is not in contradiction with the several layers of data that a cell can convey.

The **neighborhood** includes a given cell with the cells around it. There are some known neighborhoods like the von Neumann and Moore neighborhood that are often used in two and three dimension. Von Neumann neighborhood is consisted of the cell and its contingent cells in left and right and up and down, and Moore neighborhood is the von Neumann plus the cells in the corners of the given cell. Here, we use the Moore Neighborhood for modeling the impact of (class of) neighbors on the decision that a given agent may take. The preference of this neighborhood to other ones, especially in comparison with the von Neumann neighborhood is its smooth edges and the better inscribing the central cell.

The **transition rules** are the guidelines for the cells for how to behave in a situation that the neighbors are in a given state and according to them they should take a special state. The rules are typically the same for all the cells and they do not change in the steps of the program.

The **time** in Cellular Automata allows the model to be refreshed simultaneously in its iterations, so each time step can be a counterpart of real world timing. Generally the time factor is equal for all the cells but as Liu (2009) notes, Uljee and Engelen and White (1996) have applied the different time length for changing two different lands; the low-lying lands change monthly but the uplands change yearly (Liu, 2009; Uljee, 1996).

In this step of our model, the time steps are not considered as the real world timing; in another word, each iteration time of the program does not have a counterpart like week, month or year and the timescale is chosen in a way that the stochastic changes of the program reaches to a convergent state in ≈ 10000 iterations. For some configurations of the program, mostly when the number of population is low, the model reaches to an equilibrium soon, but in other cases the model continues to update but the changes that are observed in the last iterations are not as much as those in the first iterations.

5.4.2 Neighborhood important factors

According to Liu (2009), some factors can affect the behavior of the Cellular automata. Since the essence of the transitions in Cellular Automata are a cell surrounded by neighbor cells, the number of surrounding cells, the size of neighborhood and the type of neighborhood can be important factors according to which the behavior and the sensitivity of the system can find different inclinations. For example White and Engelen (1993) have proposed their neighborhood type not with four or eight surrounding cells but with 113 surrounding cells in a circular arrangement within a circle of a six-cell radius and Wu (1996) has proposed it with 120 cell in a square arrangement of a 5×5 cell surrounding the cell in question (Liu, 2009; White & Engelen, 1993; Wu, 1996)(Fig5.2).

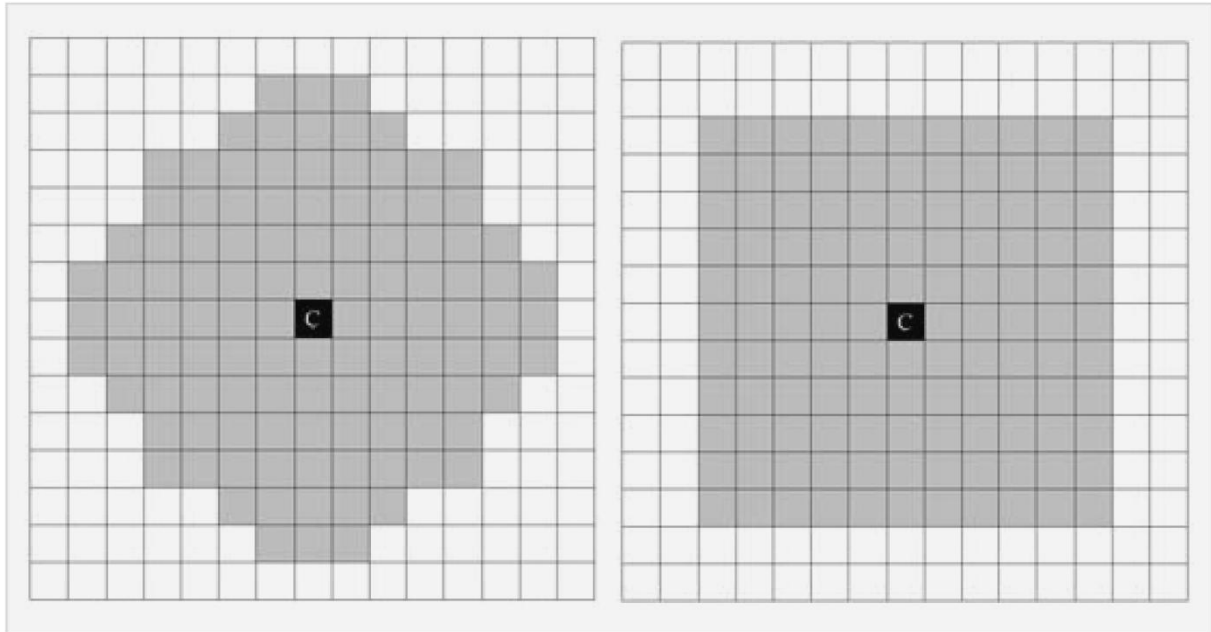

Fig 5.2. (left) White and Engelen (1993) neighborhood type, (right) Wu (1996) neighborhood type. (From the book of *Modeling urban development with geographical information systems and cellular Automata* by Liu 2009, p.42).

The size of the neighborhood can be an issue in behavior of the cells. The important thing here is the distance-decay; according to White and Engelen (1993) if the neighborhood size is very large, the most impacts will be of the closer neighbor cells rather than the one in a distance (White & Engelen, 1993). This means that in a neighborhood that a cell have some very neighbors and some non-contiguous neighbors, the given cell have the most impact on the closest neighbors and with the increase in the distance, the impact decreases.

According to the definition of the state of the cells, a given cell can have some varied actions in its life cycle. The actions depend upon how they are converted and for this we define their locations and time of their establishment. The probability that an activity become in its initial state declines as time passes in an exponential decay function.

The transition in activities, according to Batty et al (1999), can be the result of distance functions: they can be the result of inverse linear function, negative exponential, inverse power or a gamma-like function of distance; the gamma-like function combines the exponential and power functions (Batty, Xie, & Sun, 1999; Xie, 1994, 1996).

We apply the Moore neighborhood with the very adjacent cells in order to consider the segregation in a local scale of neighborhood. Although in rectangular neighborhoods, we observe a circular distortion as is shown in Fig5.3, but the small number of neighbors does not permit the distortion and decay to be a great deal.

We can define a Cellular Automata as an **autonomous spatial unit** linked, in a preferred way, to surroundings. Conveying the data according to comfort and according to the agent that settles in a given cell determine the behavior of the settling agent (this is described in the fourth chapter).

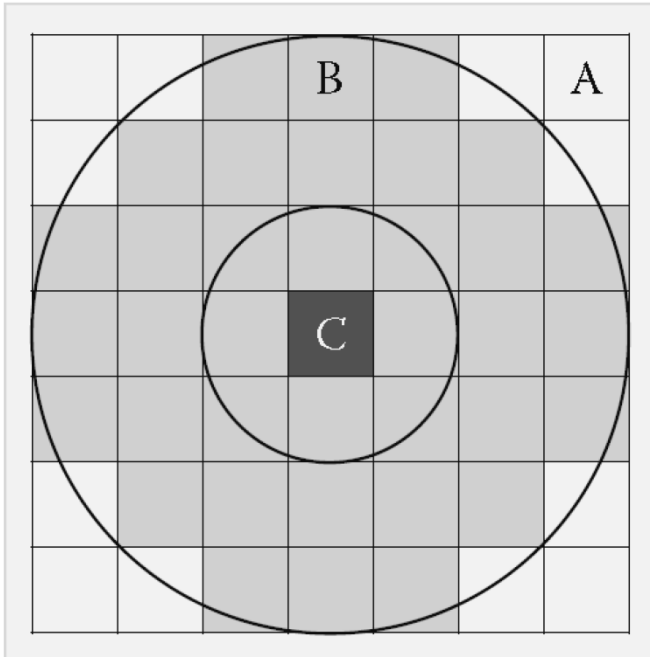

Fig 5.3. 'Distortion produced by a rectangular neighbourhood. (C (dark colour) is the processing cell. For a rectangular neighbourhood of 7×7 cells, the effect of cell A (one of the white-coloured cells) on the processing cell (C) differs from that of cell B (one of the greycoloured cells), although both A and B are in the same row of the neighbourhood. This is because the distances from the centres of A or B to the processing cell C are different' (Liu, 2009, p.43).

5.5 Strasbourg

From *Argentorate* (The eminent element of the Ill) in 12 B.C, to *Strateburgum*, (the powerful city of the road) in 498 A.D and the actual name, the evolution of Strasbourg has been the subject of rigorous land contests. As the capital of Alsace, the city now plays a new role on the frontier of Germany and France. After the unification of Europe, it has found its role as the capital of Europe; the Institution of European Union that is mostly located at the peripheries of the city verifies the internationalization of its power and economy (Gerber, 2000).

Since we have used the results of Gerber's thesis, our site of study is the same that he has defined in his project. The city of Strasbourg in our study will cover the first core of the city and its development that make it bigger than a neighborhood and smaller than the whole city. Hence it includes the medieval and modern parts of the city (Gerber, 2000). Our spatial units conform to that of his study as well and they are different with the definitions of INSEE. From the point of view of population and building, the spatial units of INSEE are heterogeneous, so the blocks and areas have been the base of this study (Gerber, 2000; Mansuy & Marpsat, 1994). According to ecological approach, the city is considered as the central parts and its peripheries but in our study, the residential mobility is limited to the ancient center and its development.

Finally, there is not any compromise for defining a city; it can be defined with cognitive, economic and functional to historical morphological tendencies. So the limits of city are chosen according to the most general and inclusive spaces that define the centers of city.

In the 1970s, the state and municipalities involved in renovating the unhealthy housing areas which were mostly in center of the city and near to the train station (Gare); they initiated some activities for enhancing the urban landscape and Strasbourg was one the cities that accommodated these activities.

The activities were mostly practiced with the concern of:

- Requirement of circulation
- overpopulation of places that were deprived of technical comfort and had experienced the escape of middle classes

- Brutal renovation without respect to the history.
- Extravagance of certain architectural styles
- The difficulty in manipulation of decrepit housing stock

These are some criteria that reflect a negative image of ancient center and these cause that some residents start to leave the neighborhood. M. Castells (1973) names it the “renovation-deportation”. This defines all the activities of private (or public) developers that do not consider the patrimony and just bold the profit that comes out of new constructions (Blanc, 2011; Castells, 1973; Gerber, 2000).

In 1980, CUS (Communauté Urbaine de Strasbourg) targets the ancient parts of Strasbourg for promoting its image and the level of life.

According to C. Lobstein, the adjunct general secretary (1980), the objectives of these operations were:

- Ensuring the preservation of old Strasbourg by restoration of old buildings.
- Enhancing the value of edifices by imposing curettage
- Providing the new hygienic and comfort condition for buildings
- For conserving the old streets, traces and the proportion of old Parcels, the circulation comes to second plan.

In some parts like ‘Petite France’ according to the standards of INSEE, some standards were promoted. Since many houses didn’t have the necessary standards, after these promotions, the rent prices elevated and many aged people and laborers couldn’t afford the rent so they had to give their place to new more eased people. In this process, some of owners regain 40% of what was spent for renovating their houses and neighborhood in some sort of subventions.

Some great scale operation begins during the next years: this stage is related to operations that were developed through an analysis of modern comfort and its qualitative reorganization which made the foundation of gentrification. Hence, rehabilitation succeeds the partial renovation. This was realized in ‘Petite France’ in 1982 and it extends till 1985 with the *housing rehabilitation program in a city neighborhood* (OPAH). This sector is in a decrepit situation and with a great proportion of immigrant and aged people: after the inquiry of 1981, 20% of buildings (218 counted) evidenced a technical comfort by the norms of INSEE while the others deteriorate slowly; 55% of these buildings did not have sanitary. Different actors like the State, the P.A.C.T.-A.R.I.M. (Protection, Amélioration, Conservation et Transformation de l’habitat; Association Régionale pour la Restructuration IMmobilière), OPAH and the city of Strasbourg intermediated for opposing this decrepitude. The enhancement of private houses reaches to 338 buildings (47% more than the predicted number) and 130 for the social residences. The aim of intervention of the city was helping this population to rest in their places; despite that, the problem for the tenants was greater than that of lessors. ‘The restoration cause an increase in rents that mostly strikes the occupants, aged people, immigrant workers, and generally absorbs eased population.’ (Gerber, 2000).

5.5.1 Development of Strasbourg

Kleinschmager (1997) differentiates three distinctive parts in Alsatian cities: Hypercentre that are more patrimonial, and commercial peripheries that are location of controversial activities to habitation like banks and public services, and finally the suburbs (Fig5.4).

He also names two essential arrangements in the city; first Neustadt at the time of Reichsland and the second, Esplanade under the rein of Pierre Pfimlin in 1960. These developments were in order to expand the central functions in a rather homogeneous and coherent framework.(Gerber, 2000; Kleinschmager, 1997)

J. P. Levy (1987) differentiates between two essential parts: the historical medieval core and the suburbs; he considers the peripheries as some transition between the two principal parts (Levy, 1987).

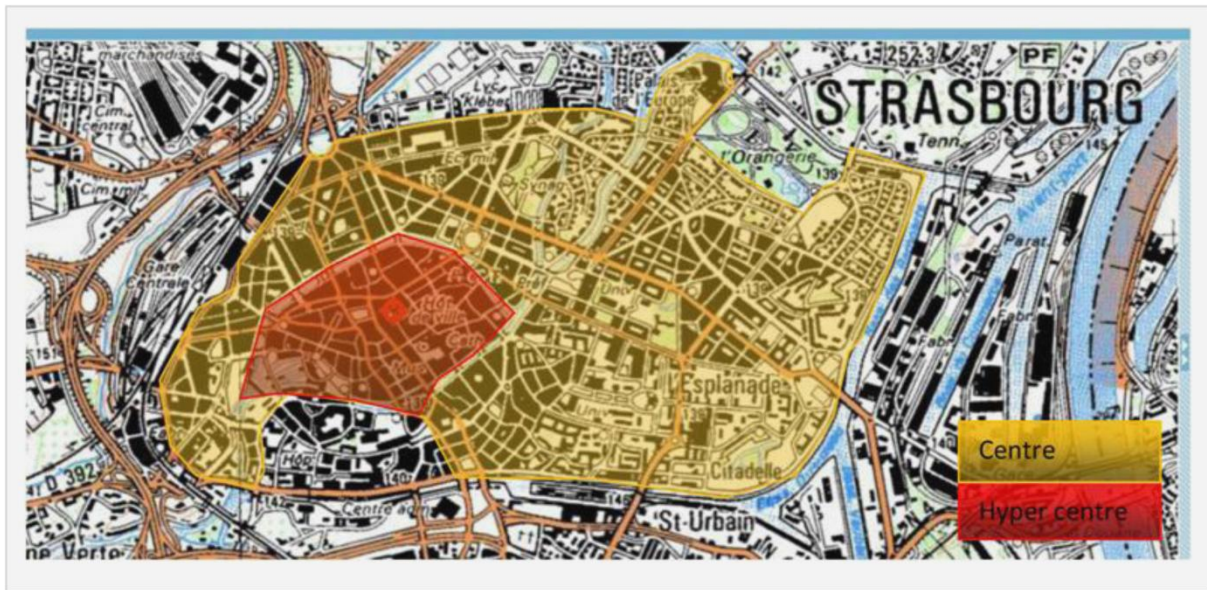

Fig 5.4. The center of Strasbourg; the Hypercentre and the development.

The other division is between physical and representative spatial categories (Gerber, 2000). For delimiting the center of Strasbourg, the representative limit, and not the physical one, is chosen. In this limit, the representatives of cathedral, library, prefecture and other symbolic parts of center are included.

A regular rectangle cuts some streets, superposes on the old city, includes the Halles in the north, the station in the west, the department hall and the medicine faculty in the southwest, the administrative Cité in the south, the national library and the university and also the prefect's office in the northeast. Neither the University of the Esplanade Campus, nor the buildings of Europe Palace is included in this perimeter, but most of the edifices that point out the administrative, functional, cultural and symbolic centrality, like the Cathedral, the town hall, the cinemas and the principle commerce are located in this zone.

The exact limit of referred center of the city is defined by surrounding streets: The limit extends to the communal border of 1870 in the south, by moving from the station, it goes along the boulevards (Metz, Nancy, and Lyon) and the queue (Pasteur, De Coulanges, Gal Koenig, the Alpes, the Belges), and also parallel to the canals. In continuing to the west, it avoids the Orangerie Park by the boulevard de l'Orangerie and by getting through the Robertsau Avenue. This omits the Europe Palace and the parliament and approaches the Spach Avenue and goes through the Lauth Street and cross the Bordeaux square and continues until J. Kablé street and finally reaches to Haguenau square. The ramparts of the northern 1870 border are not taken, including the very decentered areas, because the habitation is rare there (Gerber, 2000).

According to Dr. Czerkauer & Prof. Frankhauser (2010), the accessibility and centrality as some constituents of space are determined by their spatial organization. High accessibility, connectivity and centrality are the musts for a sustainable transportation (Czerkauer & Frankhauser, 2010). Here we discuss the centrality and accessibility as two items that may influence the residents' options in selecting their residence.

5.6 Centrality

The first definitions of gentrification were intertwined with the unique center of city. With the growing of decentralization, polycentricity and etc., the center of city is proliferated and hence forth the spatial context of gentrification is changed. M. Castells pinpoints that it is now admitted that the urban center does not have anything in common with the geographic centrality in an urban domain, and also this central position, when exists, is the result of functional process (Castells, 1973; Gerber, 2000). According to Hoyler, Freytag and Mager (2008), the notion of polycentricity is mostly sought in the context of spatial forms, while the function is a great

issue for defining this phenomenon. They suggest a scale-dependent polycentricity which is based on gathering various business service networks of different organizational architecture and scalar reach (Hoyler, Freytag, & Mager, 2008). So the centrality can be somewhere other than the center of the city. In an agglomeration, several centers are dispersed in center of the city and also in the peripheries. So this centrality is a material 'set of objects and equipment for an activity' and 'set of elements that are submitted for processing'(Gerber, 2000).

Beside the role that the centers played in exchange and coordination of material goods and services, Castells have added some 'symbolic and integrator' and 'sublimation of urban atmosphere' role to the tasks of centers; the centers crystallize some kind of micro-cosmos of social relations and cultural values in conjunction with exterior thanks to their attractions. According to him, the centrality can be subdivided into four categories:

Economic

Politico- institutional

Ideological/symbolic

Social connections

Economic level is related to goods, services and their production, consuming and exchanging; their flow can be material (changing a business for example) or immaterial (information, decision). For the eligibility of economic centrality, we mean here just the material structure in a moment t and we define the movements (flow) between time t and $t+1$. According to the complexity that exists in evolution of goods and services, taking just the material into account seems enough.

The second level, *politico-institutional*, is related to the hierarchy that dominates the city in a given space. For example a county town does not have the same attributes of the prefecture of a region, the same institutional power and consequently the same number of habitants. The polarization of these administrative and political centers creates an attraction for new economic centrality like new commerce and services. This institutional level is realized by the delimited spatial imprints like the municipalities, the prefectures and other department halls.

The *ideological/symbolic* level is generally the urban social representations. In fact, the urban symbolism combines multiple values of centrality. In a reductionist definition, in a central area, the more the symbolism collects and produces the values in number, the less space size is allocated to these symbols. These values are represented by images, symbols and icons through all central spaces. This can be the vitrines, monuments, crowd, games, spectacles and etc. This symbolic value is found to be reinforced by the historical aspects, especially in Europe and it can provoke the emergence of other resources like tourism, restoration of historical monuments, multiplication of museums, and ensuring the return of economic and even institutional centrality.

The *social relations level* benefits simultaneously myth and reality, formal and informal, active and passive interpersonal relations. The places for these relations are suitable for meetings in solitude and anonymity, or for material and immaterial links. The centrality would become social in this sense and due to the fight against distance, it does not involve only physical concentration of function or symbols, but it involves a social concentration according to the existence of place, by its content and container concept: 'the centrality is not anymore expressed in terms of geometric spaces, but in social potentiality of action, wherever the geographic place of the acting person or group would be. Hence a new centrality takes place: the fact of tensions or internal will of all the society for displaying an appearance in facing others and oneself. That is 'the immaterial victory of social on spatial' (Gerber, 2000).

By this classification, the center of the city is not necessarily the first core of the city and according to the geographical zone of this study, it embraces the historical parts plus the developments, and at the same time it covers the spaces that correspond to the aforementioned definitions. In addition, as the space that accommodates urban activities, the centrality is ascribable to geographical spots that best fulfill the needs for access. Here we discern two kinds of accessibility: proximal and distal accessibility.

5.6.1 Distal and Proximal accessibility

The new modes of transportation develop a new kind of socio-spatial mobility. The replacement of deindustrialization with service sectors accelerates this process. The evolution of jobs reinforces the concentration and specialization. With redevelopment of central urban functions and the diversification of the activities of service sectors, two spatial forms are deployed:

The first is a central form –centralization- with a new trade and commercial center, hotel complexes, offices, and supermarkets. The “Halles” [market] of Strasbourg and that one of Paris, located in the very central parts of city are some examples that form the functional and material centralities and they reinforce the concentration role in central areas.

The second one is characterized by the peripheral spatial forms, installed in the proximity of main axes of transport: supermarkets and other large surfaces specialized in different domains (gardening, entertainments, tools and machinery, cars, etc.) The centrality is not limited to the central parts in this sense and it is deployed in the peri-urban zones. They respond to growing demands of habitants in a competition between the commerce and services (Gerber, 2000).

As the matter of accessibility, there will be two different personal preferences. Human should –or want to- move for its needs, desires or aspirations. So as the matter of residence, two options exist for rationalization of a solvent household settlement choice:

The *proximal* choice consists of the least time for moving, so it ends to settling in a place that has the most opportunity of accessing to the supplier- house, work, entertainment and culture. A central area is the most favorable place for responding to these needs, despite the need to pay more for the rent.

The *distal* choice supposes that the household accepts to move farther for responding to its needs. The needs can be fulfilled in peripheral parts of city. The advantage of this choice is the existence of greenery, more spacious house, and of course the drastic centrality development that was general in 1970s for peripheral areas.

According to the distance between house and companies, the cost of frequenting increases; however for people who have car, the vast parking are provided in peripheries. The influx of these vehicles is found to be canalized and hence, that helps to fast and effective shopping (Gerber, 2000). The two kinds of centrality are mostly dependent to responding to the needs that the city can provide; we will formulize the centrality according to services that the city can provide in 5.8.2. Defining comfort.

Dr. Czerkauer & Prof. Frankhauser (2010) discuss that beside the importance of cost of transportation and the importance of accessibility, the spatial amenities matter in residence choice as well (Czerkauer & Frankhauser, 2010).

5.7 Gentrification of Strasbourg

The terms like gentrification become subject to some changes in connotation and application in different places and different times. One of these terms is gentrification; we have presented the general definitions of the term in the first chapter and here, we try to localize the term in Strasbourg.

R. Brunet (1993) describes gentrification as the replacement of popular class by eased one in central parts of a city as the result of renovation and rehabilitation. Gerber challenges this definition of gentrification that makes one feel social, economic and residential inequality (Brunet, Ferras, & Théry, 1993; Gerber, 2000). He believes that after the thirty gold years, a change in demography, culture and economy took place and the consequences of the crisis after that, the actions for readjusting it and some housing policies which influenced the housing market brought some new factors that didn't exist before. These changes were reflected in residence level (Gerber, 2000).

Some contradictions to the conventional definition of gentrification are observed in Strasbourg by Philippe Gerber (2000):

first, center of Strasbourg has had several distinct stages of construction: the villas or particular hotels dated XVIII and XIX century and big residential buildings were constructed in 1920s and after second world war.

Second, the people who had option to go to a poor house in the center of city or a comfortable house in some distance to the centers didn't necessarily choose center of city. Maybe a cheap new apartment would be preferred to a poor non-renovated house in the Hypercentre which did not provide any comfort.

Third, the emerging of comfortable housing was not necessarily related to bourgeois class and they had already accumulated the technical and spatial comfort in their residences. But the employees invested on some new houses that did not have enough comfort (Gerber, 2000).

Gentrification is mostly described as the result of enhancing the quality of living area in some concrete aspect of life such as the buildings and their quality. The rising quality of buildings and urban surroundings result in social shift, attracting classes who are affluent enough to pay continually increasing prices (Diappi & Bolchi, 2008).

The classes that enter to or leave the neighborhood vary in different studies. In the study on London, Atkinson studies the socio-familial and socio-economic classes and shows the increase or decrease in concentration of upper classes and that of lower classes, and if it exceeds a given threshold of 5% of normal urban population growth, he has taken it as gentrification (Atkinson, 2000).

The kind of displacement should be considered too.

In a study by Marcuse (1986) four types of displacements are classified:

- (1) economic/physical (where residents are priced out of a dwelling through rent increases or by physical means);
- (2) last-resident displacement (only the last resident is counted as displaced);
- (3) chain displacement (counting includes the number of residents over time who have been displaced from a property); and
- (4) exclusionary displacement (a figure which includes those who have been unable to access property because it has been gentrified) (Atkinson, 2000; Marcuse, Smith, & Williams, 1986).

In this study, the chain of settling and leaving is used and as we will describe later, they will displace because of segregation or in search for other occasions.

According to the studies by Philippe Gerber, the seven classes of managers, intermediates, employees and workers (four socio-professional classes of this study) and the foreigners, retired and artisans dispersed in two distinct zones:

- (1) The one that mostly is consisted of unemployed and foreigners disperse in central neighborhoods like Esplanade, Citadelle, République, Ecole Militaire and five sectors of Hypercentre.
- (2) The second classes that are consisted of retired and managers and higher classes or in another word the affluent people disperse in four neighborhoods: Université, Orangerie, Contades and Quartier des XV.

Peripheries of old central parts of the city are divided into two sectors: Orangerie and Quartier des XV represent the big houses occupied by owners and the Halles, Ecole Militaire, Sainte Aurélie, Cité Rotterdam and Citadelle are occupied by employees and the residences are equipped with residence technical comfort.

In 1960, there is not still gentrification in Strasbourg and just there is some emigration from the Hyper center to newly constructed zones, especially Esplanade. After 1960, the dichotomy between Hypercentre/Neustadt changes to the one between social and public buildings and the private ones; the workers and employees live in the first one, like the HLM, and the higher classes live in the latter one. Knowing that the spacious buildings

belong to higher classes, the technical comfort disperses in the whole city. The spacious comfort completes the technical comfort and can arouse the gentrification.

Although in 1968, the workers and employees settle mostly in Hypercentre, this tendency has changed in 1982 and the majority of population of this area that is consisted of middle and worker class goes to peripheries that have the social buildings: the neighborhoods like Esplanade, Cité Rotterdam and Gare. This evolution takes place slowly. The early 1980 is accompanied with a demand wait-and-see period related to the economy crisis rather than the hesitation to settle in Hypercentre. This passage defines the infiltration which is applied in gentrification.

As there are some forces in the centrality that may absorb people, these centers are assumed to be the nodes that are subject to competition. But there is no certainty that if some centers are in a high rank of accessibility and other standards, they are necessarily subject to become a good choice for resident. So, a combination of three variables defines a high standard location. The three variables are residence technical comfort, spacious residence comfort and centrality.

5.8 Model

For modeling the system in a bottom-up approach, we need to determine some rules according to which the ingredients of the system can work. We have attempted to choose some rules that may conform to the tendency of people. Despite the oppressiveness of determining the rules that guide the agents in the interaction between them and that one between them and the system, we have tried to study the social aspect of agents' actions and also to determine rules that do not seem to be far away from the general tendencies of human. We have attempted to model these interactions in a simple way.

There exist a substantive limit in complex system that goes back to the non-linear behavior of the system; the inherent unpredictability of the system in opposition to the traditional scientific sense do not permit that the prediction be straightforward and that may cause the system to seem difficult to attach to any sort of confidence. In searching predictable global behavior resulted from unpredictable local behavior, we have problems in two principal sections; first in quantifying the behavior of the agents that delegate the human and second in the interactions that may occur between the agents.

For the first problem, it was necessary to discuss the actions by the agents and how it could be disciplined as to rules; For the second problem, we have used the ecological and system models that were applied for modeling urban development.

According to the numerous actions that a given agent may practice solely and the exponentially numerous interactions that he or she may practice in confronting another agent, we have tried to act as the 'apple law' that Giddens has introduces; according to this rule, at the time of defining the rules in picking some apple, we should not resort to a mechanism that first omits all the apples that we will not choose and then go to apples that we may choose (Giddens, 1987). This rule is reflected in reducing the myriad number of decisions that may be taken by an individual while confronting to residence options. The action of settlement or departure takes place as the consequence of some decision; at the time of decision, individuals decide on the basis of motivation that they have and for the motivation they have some rationality. They are sure that the others have some rationality for their decisions if they are asked at the time of action. This reduces the many numbers of actions that are possible for others and the individual feels safe that maybe the decisions will be in some numbered options.

This can respond to the problem that one agent desires an apple from several ones. But the other form of problem arises when several agents want to choose something that lies in common. In this situation the solution of choosing apple does not work. We can follow the clue in common resource problem that has been the field of research of Elinor Ostrom³.

³ Elinor Ostrom (August 7, 1933 – June 12, 2012) was an American political economist who was awarded the Nobel Prize Of 2009 in Economic Sciences; she shared with Oliver E. Williamson, for "her analysis of economic governance, especially the commons".

According to Ostrom (2009), there is no panacea⁴ for solving the problem of common resources; she has followed some supposition that is basic in game theory; everyone looks for some benefits and a given individual will not relinquish his or her benefits although it can end to the benefits of the society; the reason is that the miss of benefit is simultaneous and individual, but the collective benefit is in a long-term and is divided by the population of the group, so less than that of what could be for an individual (Ostrom, 2009), but the incentives and sanctions can compensate the lacking motivation. We try to define the rules according to the motivations of an individual for reaching to a high standard situation, or in another word to some benefits; the benefits are assumed to be the settling in a residence that is granted with high comfort. Although, there may exist some traps like the fallacies or biases in determining the rules, we have tried to choose rules that seem to be close to what occurs in real world. What is assumed to be attractive for the agents is a residence with high standards that seems to provide the personal benefits, but in an atmosphere that the opportunities are put in common, there may occur some filtration in reality. According to Ostrom and Giddens, what may push the agents to give in some part of their benefits to group is the sanction. Ostrom changes some rules of game theory; although the agents are supposed to be unaware of the decisions and actions of other agents, she assumes that in some common resource problems, the agents can know about the incentives or sanctions that are executed for the society and via this they may choose to act according to some criteria other than just personal benefits.

According to the clashes that may occur between two agents that arrive to the same cell, we figure out some rules that may determine which one of the individuals will probably have the chance to obtain that cell as its residence. In a situation that the opportunities in other parts of city are announced to all, we assume that the ones who are more solvent, seek for the better situations in stronger probability. Although we have assumed that the opportunities in city are not concordant to game theory, and thriving of some agent is not necessarily threat for other ones, but the problem of common resources arises from the deprivation of some individuals in case that the opportunities are already taken. We have applied the mentioned rationalities for determining the rules for the agents. In this stage of the model we have not exerted any sanctions and the problem of opportunities in a city are not of the kind that we look for exerting sanction for someone who has more power to access to opportunities in comparison with someone else that may have it less. But since there exist some protective policies in city management, we can expect some balance in accessing to opportunities like a residence with high standards. The deviation in rules of Game theory and announcing the sanctions or incentives to all can be applied in completion of the model in the way that the people who can obtain some chance that is out of the reach of others pay some sort of taxes; this one exists as taxes that the more solvent people pay to municipality or to the state. The incentives and sanctions can be parameterized and announced to other actors; on the other side, the protection in form of subventions may be endowed to less solvent ones.

5.8.1 Data collection

Socio-geographic data was necessary for modeling the centrality and residential comfort that affected a neighborhood and made it ready for residential mobility. The comfort variables function as absorbing ones for residents. The other variable that can repulse the residents from a residence is segregation. We present here the formulas upon which we have calculated comfort and segregation.

The data for centrality and residential comfort were collected and modeled in cartographic maps (Gerber, 2000). The five basic elements of Cellular Automata were specified with reference to the geographical data. The various parameters associated with the transition rules are calibrated via the data that are extracted from comfort definition, centrality, socio-professional class population and the probability of choosing a cell. We have presented the formulation in chapter four.

5.8.2 Defining comfort

There is a measurable comfort in intra-urban scale according to eco-socio-spatial logic in gentrification. The definitions like residential comfort, equipment comfort, life level, life style, etc. that are mostly immeasurable, are inferred from a qualitative explanatory method.

⁴ The Oxford English Dictionary defines panacea as 'a remedy, cure, or medicine reputed to heal all diseases; a universal remedy'.

In this study, the comforts are important for deciding to stay or move. This comfort is measurable standard variables that enhance the residence and neighborhood; they are some facilities like centrality or in another word having easy access to urban equipments.

The results of statistical outputs in Strasbourg in 1982 define the variables that incarnate the comfort of habitants. All of the variables enhance the quality of life in a neighborhood, however at the same time they elevate the cost of living in these areas.

The equipment comfort is evaluated by the function of **quantitatively measurable centrality** from one side (the assesment of companies with final activities that are directly frequented by users) and by the function of **qualitatively evaluated centrality** from other side. The latter one takes to account the psychological or comfort services, the relation of quality-price, assortment, etc. and that is reflected in the evaluation of equipment quality.

The domination of qualitative evaluation essentially gives benefit to the solvent population who are the first who can/wish to benefit from this qualitative equipment comfort. This phenomenon reinforces the gentrification by the perspective of being near to these goods and services of quality. Now in this study knowing that all the promotions at the level of life make it more costly, all the variables are brought in modeling to see their role in mobility of residents from some neighborhood in/to the/other neighborhood. As it is shown in flowchart Fig 5.5, the modern and discreet comfort makes the post-modern comfort. The modern comfort, as the subject of this project, is divided into two types of comfort: the equipment comfort and residential comfort. The residential comfort is also divided into two types: The residence technical comfort and the spacious residence comfort.

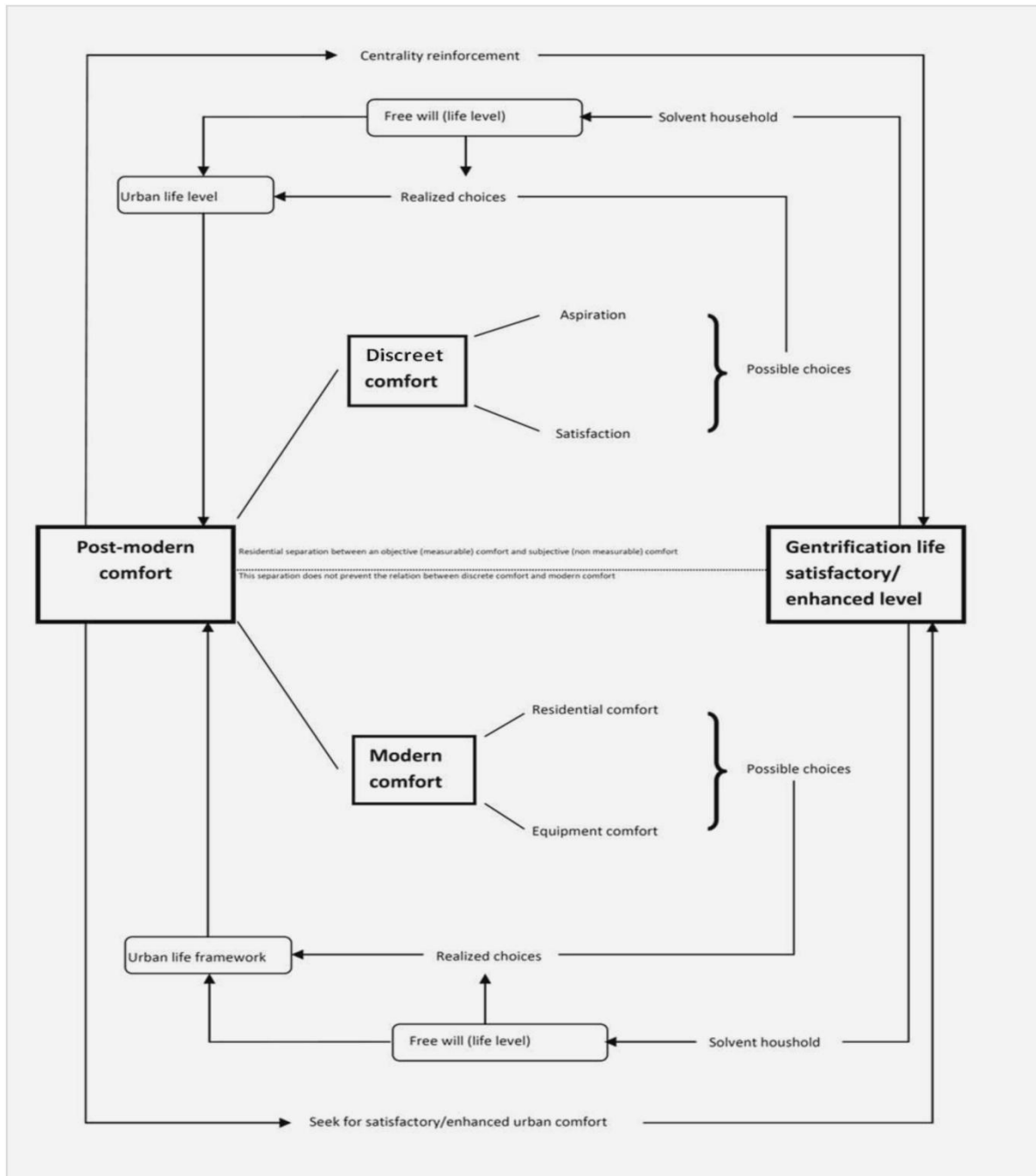

Fig 5.5. The post modern comfort consisting of Modern and discreet comfort (Philippe Gerber,2000, p.98).

Two kinds of comfort are:

- 1- residential comfort which embraces the building (number of pieces, size, ...), the improvement in technical facilities (water, electricity,...),
- 2- equipment comfort which is portable equipment use in house (refrigerator, washing machine,...) and variation of facilities found in accessibility like (proximity, accessibility,...) and capability to answer to the needs of household some daily needs like (nutrition, maintaining, hygienic, ...) some occasional

like (clothing, entertainment private/ public services, culture, health,...) and rare like (shopping sustainable goods, luxuries, ...)(Gerber, 2000).

Centrality is one of the interfaces that possibly interpret the complex phenomenon of gentrification; to a great extent, the modern comfort considers the materialistic needs. Of course this does not cover all the aspects of the evolution in residential occupation of city center. Cultural factors are best answered in the behavior of middle classes that look for this centrality. The material needs, accompanied with the physiologic needs, are satisfied in the centrality (Gerber, 2000).

Gentrification involves another kind of comfort which involves in an individual with his behaviors that make the 'discreet comfort' that is not in the scope of this step of the program (Gerber, 2000). There have been some renovations in residences that are mainly in the central parts of city. Equipping the old building with WCs, baths and central heating are taken as the examples of renovation; for the residences a little far from central parts, the other form of residential comfort emerges and that is the spacious residence comfort.

According to the repartitioning of facilities and equipments in the city, the centrality of parts of the city is calculated as below:

$$d_{ij} = \frac{f_j}{\sum f_j} = \frac{f_j}{s_j} \quad (1)$$

Which d_{ij} is the Scarcity Index, f is the number of specific institutions in different neighborhoods, and s_j is the sum of those institutions in all neighborhoods; so for example if we have f barbershops in a given area i , we obtain the index by dividing the sum of barbershops in the area \sum_{ij} to the sum of the barbershops in the study zone \sum_j .

$$\text{Centrality index} = c_i = \sum_i d_j \quad (2)$$

The centrality index is obtained by calculating the sum of scarcity index in an area and the Bennison Index introduces the rate of centrality of a given location.

$$\text{Bennison Index}(i,j) = \frac{\frac{c_i}{\sum c_i}}{\frac{pop_i}{\sum pop_i}} \quad (3)$$

In which c_i is the centrality of i , $\sum c_i$ the sum of centralities, pop_i the population of i and $\sum pop_i$ is the sum of population in the zone of study (Reymond, Cauvin, & Kleinschmager, 1998).

As it can be seen in Fig 5.6, for calculating the centrality, the scarcity of 67 institutes in 65 spatial units is investigated and the variables are depicted in Fig 5.7.

The technical comfort is determined by the standard facilities that make a residence more comfortable and these are resulted by the statistics issued by INSEE.

$$RC = \frac{\sum \text{residence with WC} + \sum \text{residence with shower} + \sum \text{residence with central heating}}{\sum \text{residence}} \quad (4)$$

RC (Residential Comfort) ranges between 0, 1 and its repartition is shown in Fig 5.8.

And the comfort found in a spacious residence is based on the number of people living in each unit. Person per piece= [0, 4.6] according to INSEE (Gerber, 2000).

The repartition of spacious residence comfort is mapped in Fig 5.9.

<p>1. Big suppliers Supermarkets (400 to 2500 m²) Popular stores (400 to 2500 m²) Hypermarkets (> 2500 m²)</p> <p>2. Little food suppliers Bakeries Confectionaries Independent food stores Small independent supermarkets Food stores (central dependent several stores) Small supermarkets (central dependent several stores) Food cooperatives Fruit-vegetables retail commerce Diaries retail commerce Meat retail commerce Fish retail commerce Drinking wines retail commerce Sweetshops retail commerce</p> <p>3. Cafes, hotels, restaurants Restaurant café-restaurant without hosting Canteen Delicatessen Bar (without spectacle) Café-smoking store (without tobaccos) Bar (with spectacles) Café associated with other activities Hotels</p> <p>4. Services and appliances for person Clothes retail commerce Shoes commerce Travel leather shop Watch-jewel commerce Shoes repair Watch-jewel repair</p> <p>5. Health services Pharmacy Medicine analysis laboratory Medical practice Dentist's practice Medical auxiliary practice</p> <p>6. Person maintenance services Medical article commerce, beauty product Laundry, dry cleaner Barbershop Body aesthetics</p>	<p>7. Entertainment services Stationary commerce Floor commerce Art sport commerce Smoke shop commerce</p> <p>8. Diverse services Real-state agencies Driving school Funeral services Photography studios Diverse services (banks, ...)</p> <p>9. Home appliances House textile commerce Furniture commerce House hardware commerce Building materials commerce Electrical materials commerce Other house materials commerce Repairing household appliances</p> <p>10. Transport facilities Commerce and repairing (moto)cycles Commerce appliance + fuel autos Sell + repairing autos</p> <p>11. Social action Nursery Child protection institutes Needy adults institutes Elderly persons institute</p> <p>12. Education Primary, secondary teaching (private) Other education and higher education (private) Secondary school High school</p>
--	--

Fig 5.6. Final activities dispersed in center of Strasbourg (Philippe Gerber,2000, p.319).

In the scale of the CUS, the interaction between gentrification and residential comfort are analyzed for three censuses in 1968, 1982 and 1990 by Philippe Gerber (2000).The map of these years is adapted to the census. The

physiognomy rest in according with the three dates. So the direct statistic and geographic comparison is not possible and factorial structure varies statistically and spatially in time (Gerber, 2000). In this study, the result of the data harmonization for 1982 is used for modeling. The repartitions of the comforts are as below:

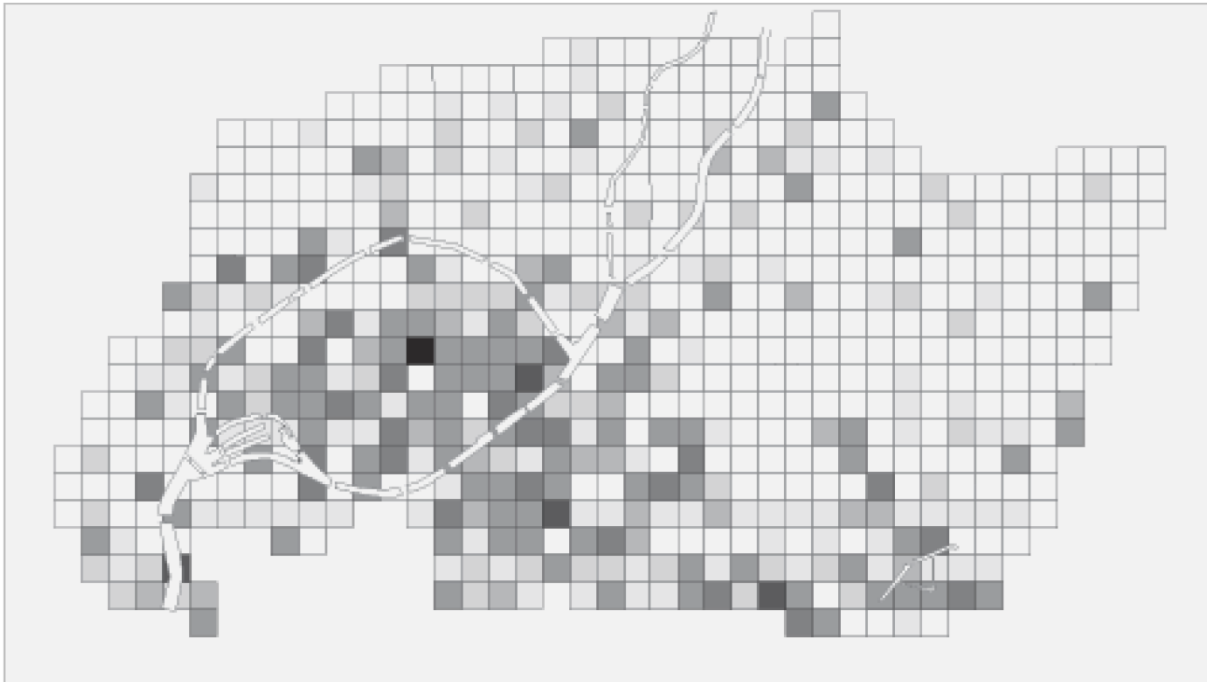

Fig 5.7. The centralities figured by repartition of urban equipment (Philippe Gerber,2000, p.366).

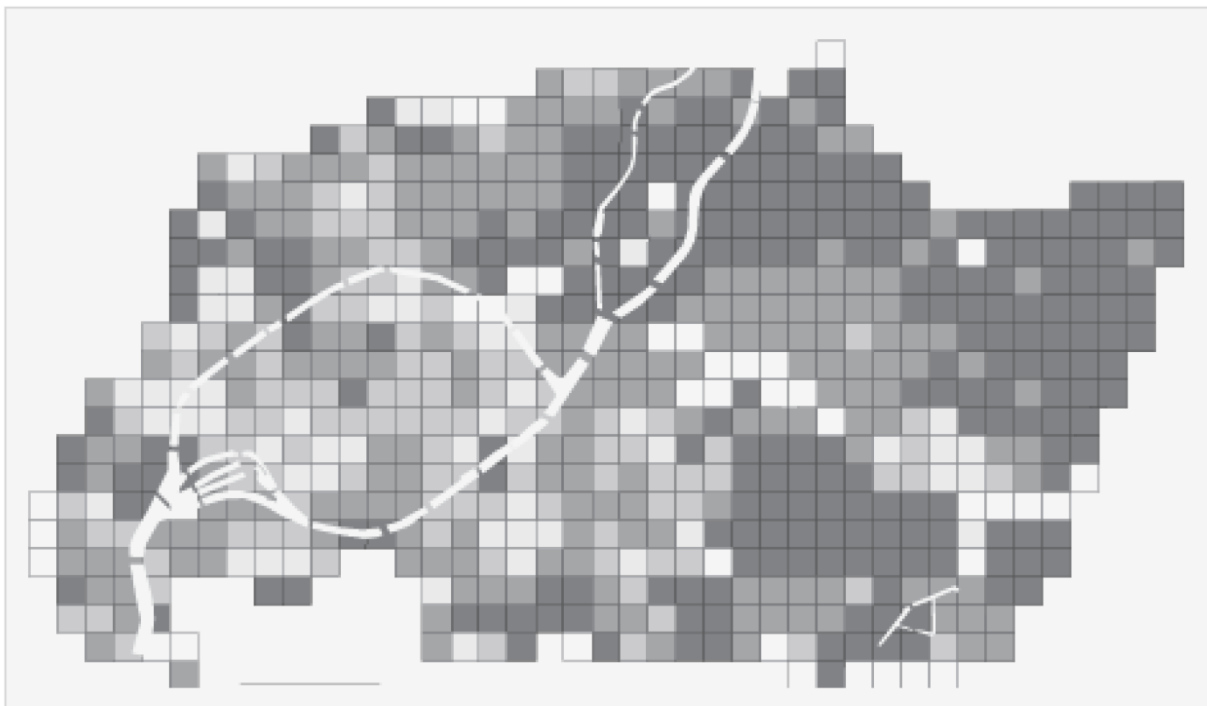

Fig 5.8. The repartition of technical comfort in residences (Philippe Gerber,2000, p.370).

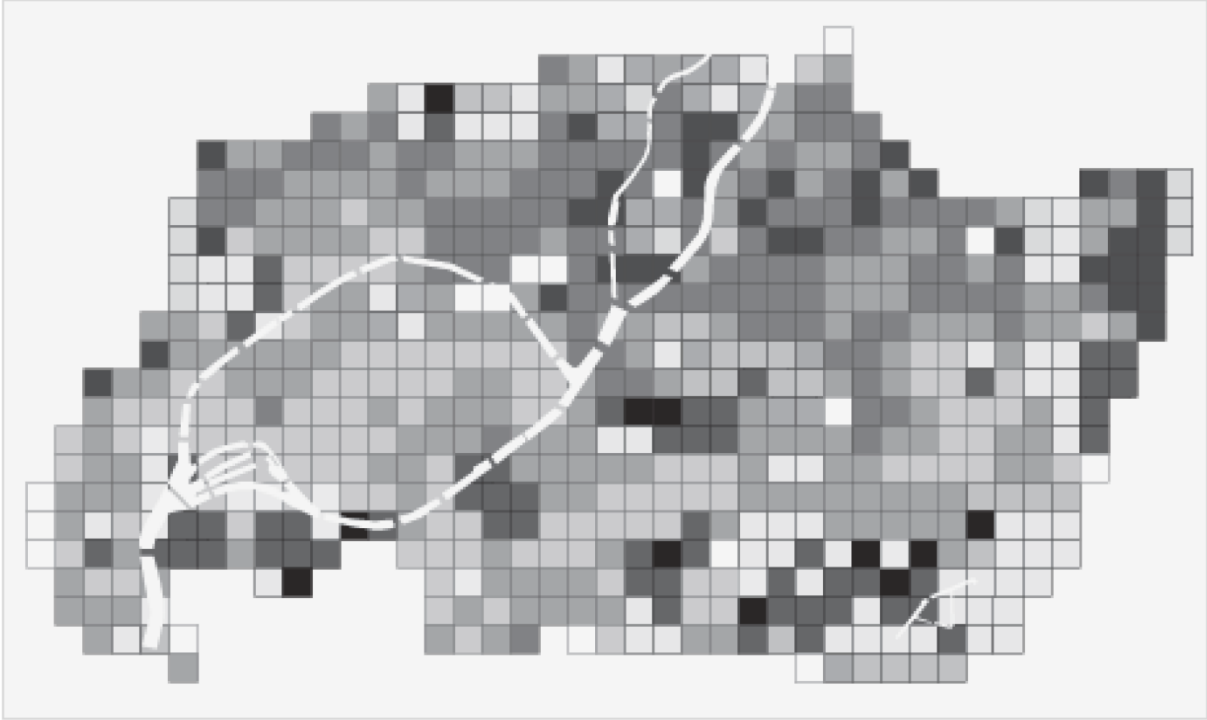

Fig 5.9. The repartition of spacious comfort in residences (Philippe Gerber, 2000, p.369).

5.8.3 Defining segregation

To exemplify the segregation, we begin by a theoretical example, according to E. Page (2012), the segregation of an area can be calculated on the basis of the gap between integral combination of different groups and what really exists as non-integral combination. For example if we have just two groups of population in equal numbers, dispersed in two given areas, the segregation close to 0% is verified when half of each group disperse in each area; that means each area is consisted of 50% of each group of population. The segregation close to 100% will hold when one of the two areas accommodate just one of these groups. The rates vary between 0% and 100% according to different combination of population; the closer it is to 0% the more integrated is and the closer it is to 100% the more segregated is the area. The segregation of the whole area will be the average of the segregation of each single area (Page, 2012).

We extend the formulae for more than two groups and for more than two areas and we will calculate the segregation of each area according to each group and the segregation of a given area according the combination of four groups that delegate our four socio-professional classes of population.

First we calculate the whole population (of four classes) of each area and that of 17 areas, i stands for each class and j for each area.

$$P_j = \sum_{i=1}^4 p_i \quad (5)$$

In which P_j is the total population of each area, p_i stands for the population of workers, employees, intermediates and managers of that area.

Then we calculate the population of the whole 17 areas.

$$\sum_{i=1, j=1}^{i=4, j=17} P_{ij} = p_{i1} + p_{i2} + \dots + p_{i17} \quad (6)$$

In which $\sum_{i=1, j=1}^{i=4, j=17} P_{ij}$ is the total population of four classes in 17 areas and $p_{i1} \dots p_{i17}$ are the total population of four classes of each area.

Then we calculate the average population of each class by assuming that they are supposed to be dispersed equally in each area.

$$\bar{p}_{ij} = \frac{\sum_{j=1}^{j=17} P_{ij}}{17} \quad (7)$$

In which \bar{p}_{ij} is the average of population of each class, and p_{ij} is the population of each class in each one of 17 areas. Since the total population of four classes are not dispersed equally, so we multiply the average of each class of population by a coefficient; the coefficient is calculated as below:

$$\phi_j = \frac{P_j}{\sum_{i=1, j=1}^{i=4, j=17} P_{ij}} \quad (8)$$

In which ϕ_j is the coefficient of inequality of total population dispersion in each area, P_j the total population of four classes in each area and $\sum_{i=1, j=1}^{i=4, j=17} P_{ij}$ is the total population of 17 areas.

So now we can calculate the segregation formula as below:

$$seg_{ij} = |p_i - \phi \bar{p}_{ij}| \times 100 \quad (9)$$

In which seg_{ij} is the segregation of a given class in a given area, ϕ is the coefficient of inequality of total population dispersion in each area and \bar{p}_{ij} is the average of population of each class. For calculating the segregation of each area, we calculate the average of segregation of each class as below:

$$seg_j = \frac{\sum_{i=1}^{i=4} seg_{ij}}{i} \quad (10)$$

In which seg_j is the segregation of a given area, seg_{ij} is the segregation of a single class in the given area and i is the number of classes that are the subject of study (here $i=4$). Thus the segregation of an area can be calculated on the basis of the gap between integral combination of different groups and what really exists as non-integral combination. The segregation of each area according to each class of population and the total segregation of each area is as below:

	Segregation in %				Whole segreaiton
	Workers	Employees	Intermediates	Managers	
Sainte Aurélie	31	33	18	61	36
Citadelle	48	100	14	3	41
cité Rotterdam	31	20	5	14	18
Contades	30	34	16	57	34
Ecole militaire	2	48	4	12	17
Esplanade	18	47	21	26	28
Gare	28	18	18	57	30
Halles	27	44	3	23	24
Hôpital	52	0	19	2	19
Hypercentre	8	98	4	5	29
Orangerie	43	29	12	57	35
Quartier des XV	41	2	10	8	15
République	13	7	22	54	24
Sainte Madeleine	1	12	8	16	9
Saint Guillaume	1	23	18	38	20
Université	26	16	9	38	22
Wacken	60	30	10	25	31

5.9 Description of model

5.9.1 The simulation in Cellular Automata

In the algorithm shown in figure 5.10, the sectors that benefit more from residence technical comfort, spacious residence comfort and centrality absorb people, and these people decide to settle in or to leave the residences. The decision is based on closeness to the centralities; either in small residence with technical comfort or in residence with spacious comfort. The algorithm shows a decision process for an agent that enters the world of the program. It reaches to a cell and sees if it has a favorite centrality; in this case it chooses to settle there with the assumption that being close to the centralities can be a criteria for choosing a residence.

If the motivations for staying in the residence holds for a time step, the agent will not move till the program refreshes and if the agent is not satisfied it looks for a residence that is close to the centrality and has the technical comfort to some extent; if it is so, it will choose to settle and again if it keeps staying there, the time step goes to an end, the resident stays and the program refreshes. If the residence is not satisfactory, the agent chooses a residence that is somehow privileged with centrality and sees if the spacious residence comfort is in a good state; if it is so, it chooses to stay and the program goes to refresh, and if not, it continues to move and choose a new residence.

Four classes of population of central parts of Strasbourg disperse in the neighborhoods. The managers, intermediates, employees and workers are the mentioned classes which according to their characteristics obey some rules and choose some cells.

The real proportion of population is used as the reference for generating the initial population of the program. This population is named as the agents in the program. The total population in four classes that is counted in 1982 is 37216 persons that 9700 are of manager class, 19864 of intermediate class, 724 of employee class and 6928 of worker class.

The agents roam in the world of program in 10000 iterations and choose a cell that best fulfills comfort aspirations or as mentioned before: residence technical comfort, spacious residence comfort and the centrality. The comfort variables have been attributed to each cell and in this way every cell has several layers of characteristics.

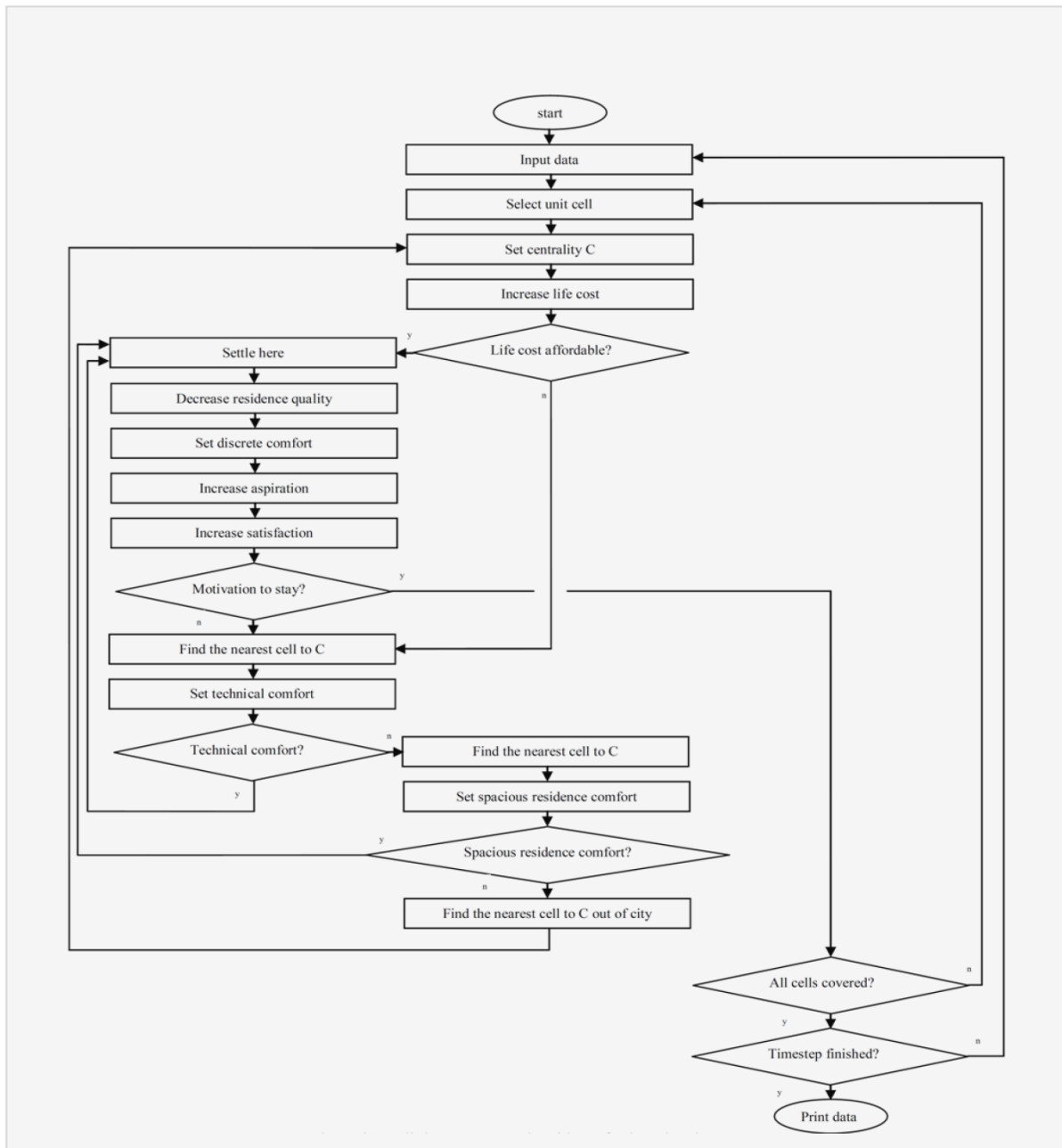

Fig 5.10. The Cellular automata algorithm of urban development.

5.9.2 The Scenario

In Netlogo world, there are fixed cells that are named patches, and moving cells, called turtles (Wilensky, 1999) (We called them agents). The patches in this model have some inherent characteristics like the centrality index, inner or outer state (that limits the patches to those who are in the study zone), index of residence technical comfort and index of spacious residence comfort.

The agents (turtles) have the class index. The number of agents can vary in a constant proportion: 26% senior executives and company managers, 54% intermediate occupations, 2% employees, and 18% workers according to the real population dispersion. The total number of agents affects the number of collisions between agents and also the impact of neighborhood, so this number is adjustable in a constant ratio by one of the sliders in the interface of program. The ratio of population of studied areas to that one in the model ranges between 51.71 (employees) and 54.98 (workers). This matters in two stages; firstly in transforming the real population to the population of agents. Here we need to round the number and this make the representant population a little bit

different with the real population; secondly in transforming the output population of agents to a comparable population with the real population. Here again we have a little deviation from the real number.

When the model is launched, the people disperse in the world and they walk randomly till they reach to a cell that has some given properties. For a given resident, he or she may choose to settle in a cell. A given agent, beside other demanders, looks for residence which has the privileges like closeness to the centrality to the detriment of space of the house, or goes to some distance from the center and near to the centralities and benefits from more spacious buildings; if none of these situation can provide a favorable choice, the resident will choose to settle in some residence that has none of the aforementioned qualities.

The second step is the impact of neighbors and the assumption is that if the number of similar neighbors increases, the neighbor that is not similar to the rests, leaves and searches again;

IF the number of neighbors that are in the same high class increases and the standard is high

THEN the turtle that is different enough leaves;

IF the number of neighbors that are in the same low class increases and the standard is low

THEN the turtle that is different enough leaves.

There is no acceptance of more than two agents in a cell at the same time and the number of agents is chosen in a proportion close to the number of cells.

5.9.3 The interface of program

As it is shown in Fig 5.11, some tabs, numerators, sliders, world view and graph are used in the interface of Netlogo and they are used for controlling or showing the present situation of the program.

The first slider controls the number of agents that are created in the first run of the program. They are created in a constant proportion but in varied total numbers. This is because when the agents are few, there won't be many collisions between the agents. So maybe the agents choose some cells that are not necessarily privileged with high standards.

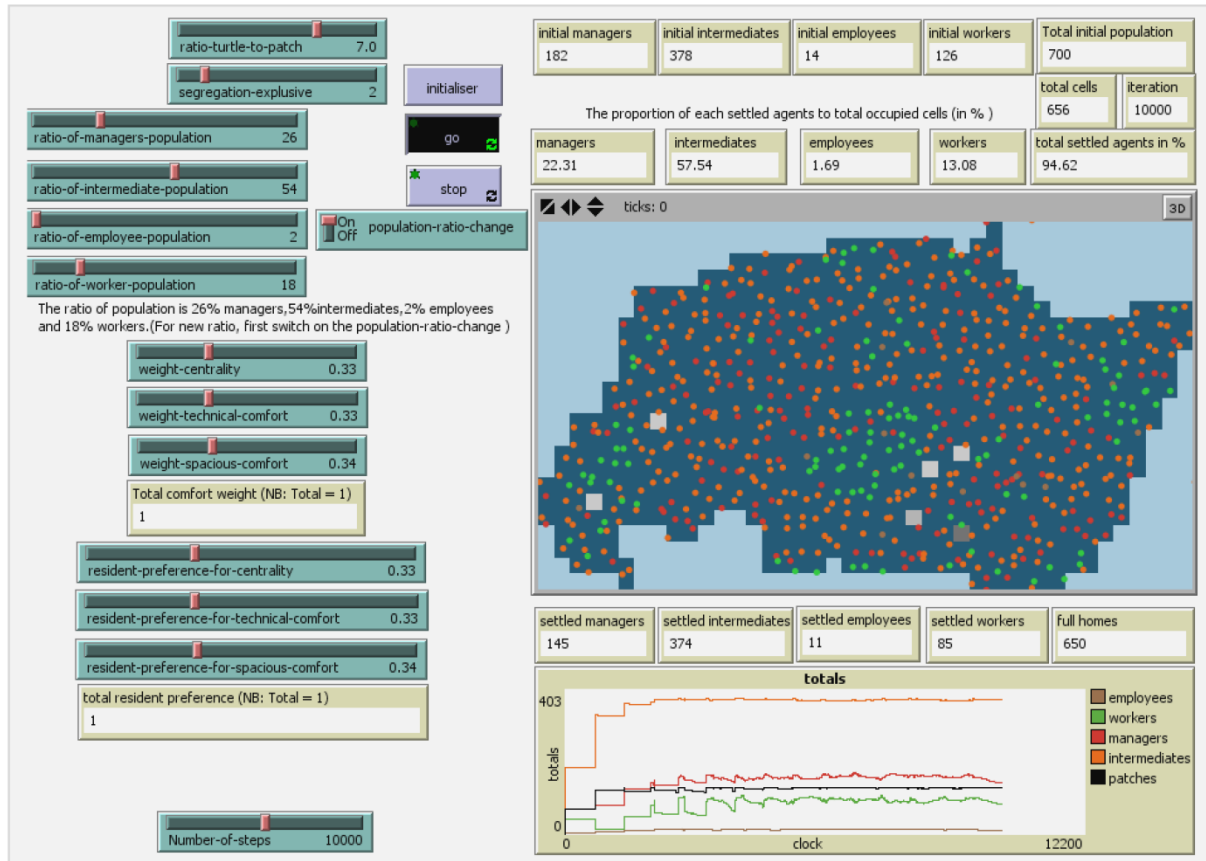

Fig 5.11. The interface of program.

On the other side, if the number of turtles is very more than the cells, some agents that are supposed to leave their cells because of the high concentration of other classes (segregation) or because of the great difference between the quality of the neighborhood and the class of the given agents may roam forever.

The second slider adjusts the segregation repulsive force. This means the higher the expulsive force is, the less is the tolerance of an agent, or in another word, the agent will leave its cell if the average of dissimilar agents is more than some amount.

The third group that consists of four sliders adjusts the population of each class in a constant ratio. The sum of these variables is 100%.

The fourth group that is composed of three sliders defines the weight or importance of each property of a cell. The sum of these variables is equal to 1.

The fifth group that consists of three sliders adjusts the preferences of agents for each property of the cells. The sum of these three sliders is equal to 1.

The last slider is the number of iterations that program updates itself.

The configuration of the present model has been as below:

Configuration items	Number	Unit
Ratio of population to cells	7	Multiplied by 100 (700 agents)
Segregation threshold	2	Similar agents
Managers	26	% of total population
Intermediates	54	% of total population
Employees	2	% of total population
Workers	18	% of total population
The importance of centrality	33	% of total importance
The importance of residence technical comfort	33	% of total importance
The importance of spacious residence comfort	34	% of total importance
The preference of agents for choosing centrality	33	% of total preference by each class
The preference of agents for choosing residence technical comfort	33	% of total preference by each class
The preference of agents for choosing spacious residence comfort	34	% of total preference by each class
iterations	10000	times

5.9.4 How the model works

When the model runs, we begin in 1982 on the basis of the population dispersion that is extracted from Gerber's thesis. But in a generative model, we use Gerber's data for reaching to new population dispersion; we finish in 1982 but with a new spatial distribution. In this way, the model is a tool for populating the city in accordance with the spatial and human factors that we choose for the system. Populating the areas according to residential mobility will be the first step for modeling gentrification.

5.10 Results

5.10.1 Validation

For verifying if a model performs satisfactorily, the simulation is validated (Balci, 1997). The degree to which the real world and the simulation correspond can define the performance of the program (Ligtenberg, van Lammeren, Bregt, & Beulens, 2010).

The repartition of all classes are shown in Fig5.12, and for each class, the figures Fig5.13 through Fig5.16 show the repartitions.

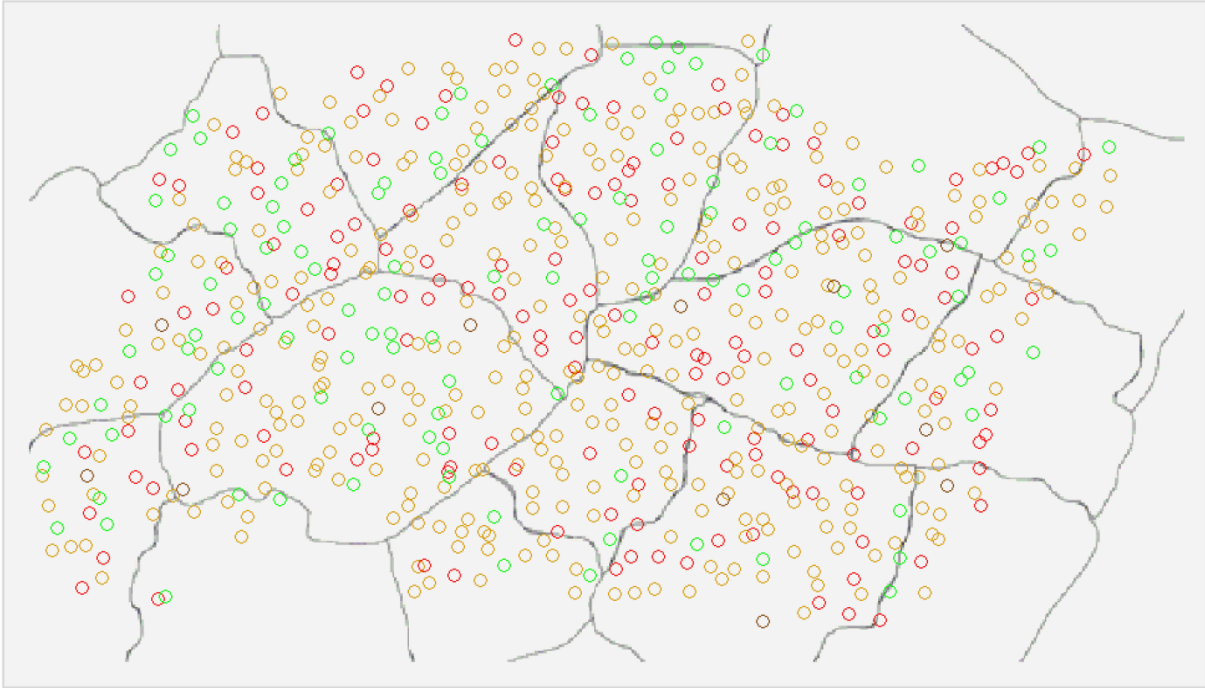

Fig 5.12. the repartition of all classes. The reds are the managers, oranges are the intermediates, browns are the employees and the greens are the workers.

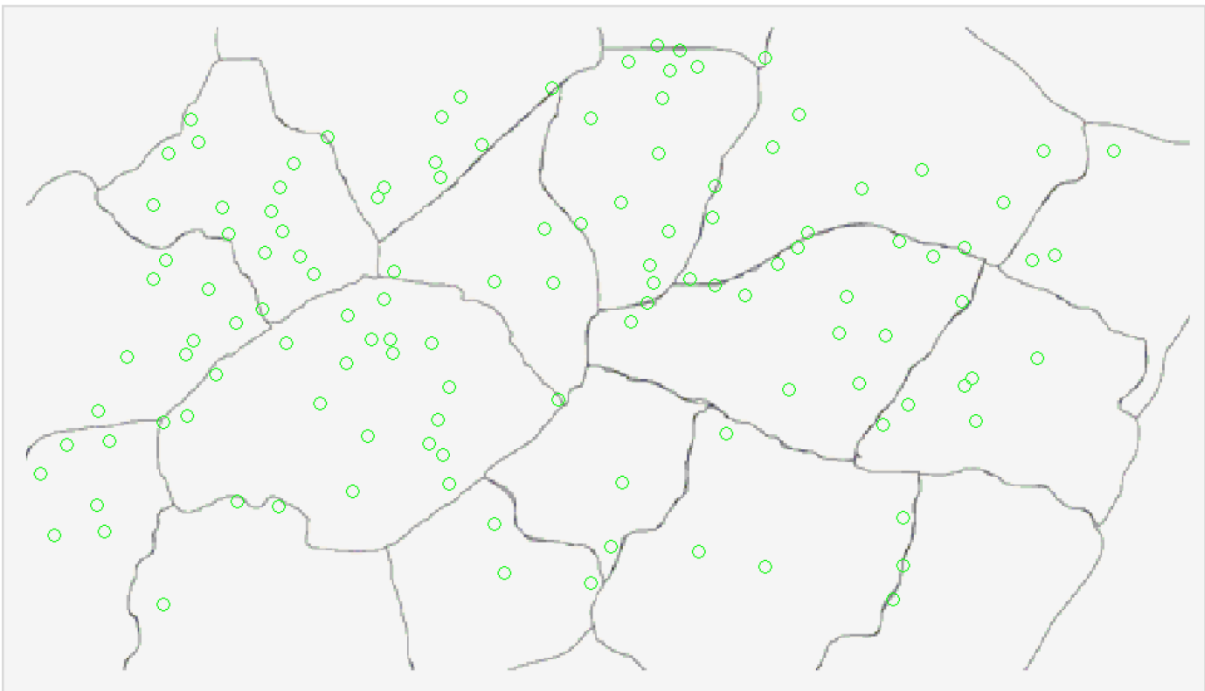

Fig 5.13. the repartition of worker class.

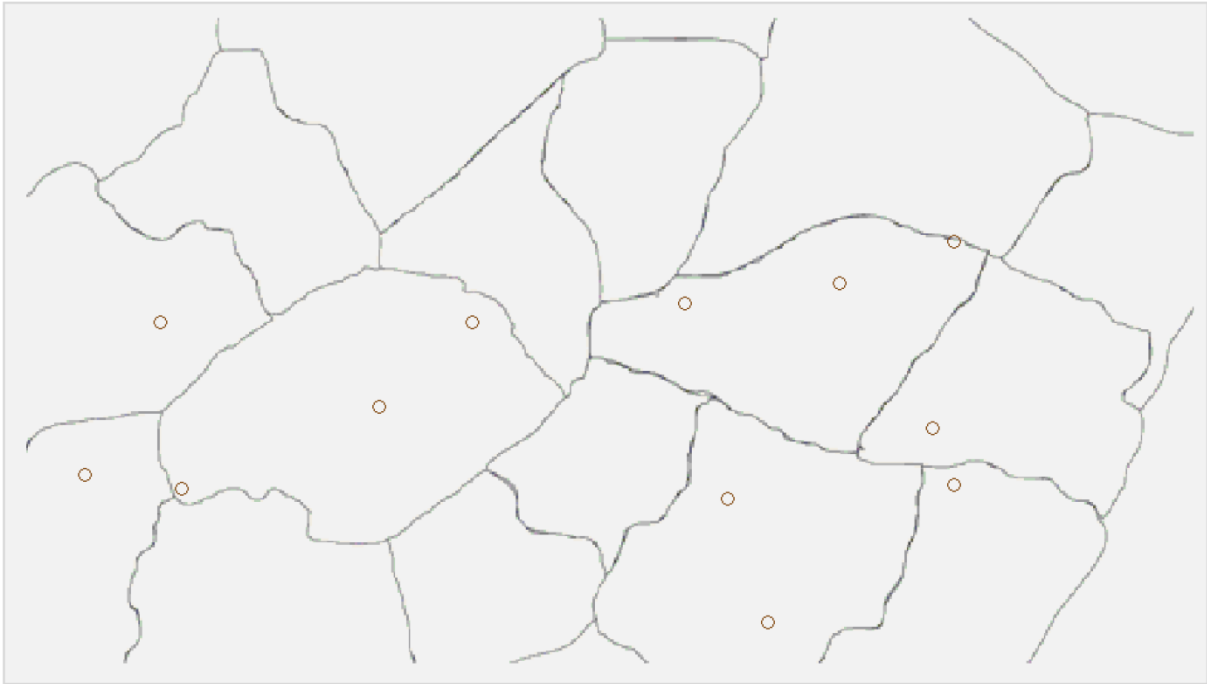

Fig 5.14. the repartition of employee class.

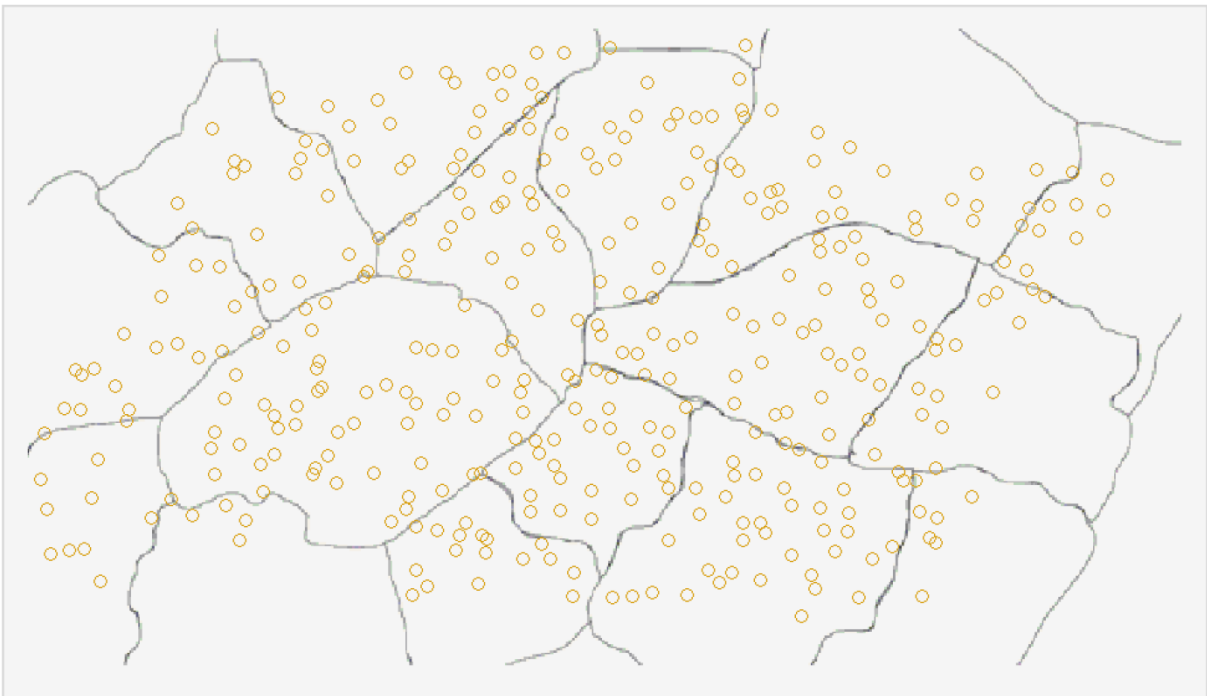

Fig 5.15. the repartition of intermediate class.

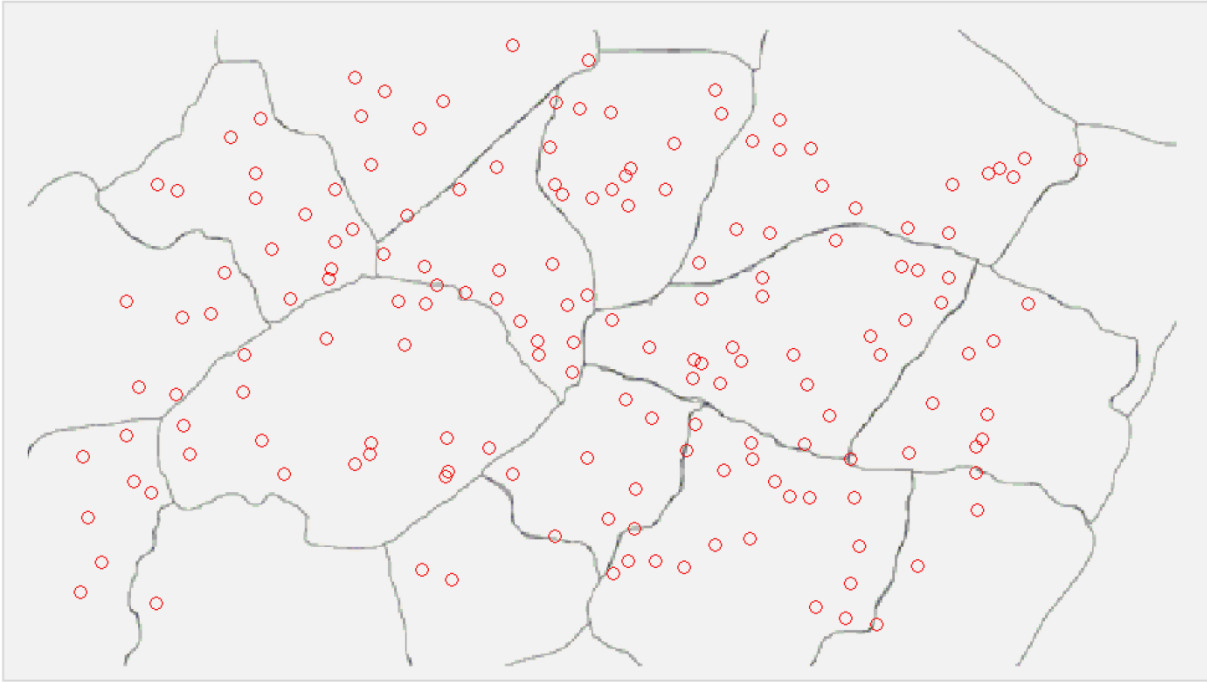

Fig 5.16. the repartition of senior executive and company manager class.

For showing the final results, the number of population that is located in each neighborhood is compared to that one which really exists in the same neighborhoods. As the graphs show (in the appendix), the results of 50 runs are very similar and this shows that the program works in a convergent manner. The mean of population of each class in each neighborhood in 50 runs is calculated in order that we can compare them with the actual situation. In addition to the mean of population, the deviation of results is reflected by the standard deviation. The standard deviation increases the range of mean population for comparing in a more flexible manner; In another word, if the real situation is near to the mean population or it is in the range between the upper or lower limit of the mean value plus or minus one standard deviation, it can be said that the result is satisfactory and if that is out of the range, we can infer that the error is large. As the Gaussian distribution verifies being in this range means that the result of each neighborhood approximates the real situation in a probability of 68.2%.

In all class groups, we can expect that the resulted population to be less than that of the real situation; to some extent because the agents roam in the world of program that consists two zones: the study zone and the out-of-zone areas; at the end of each run, the agents die if they are not in the study zone, so generally they should be less than the initial population.

5.10.2 Interpretation of the outputs

The scattering of classes in the areas are as below:

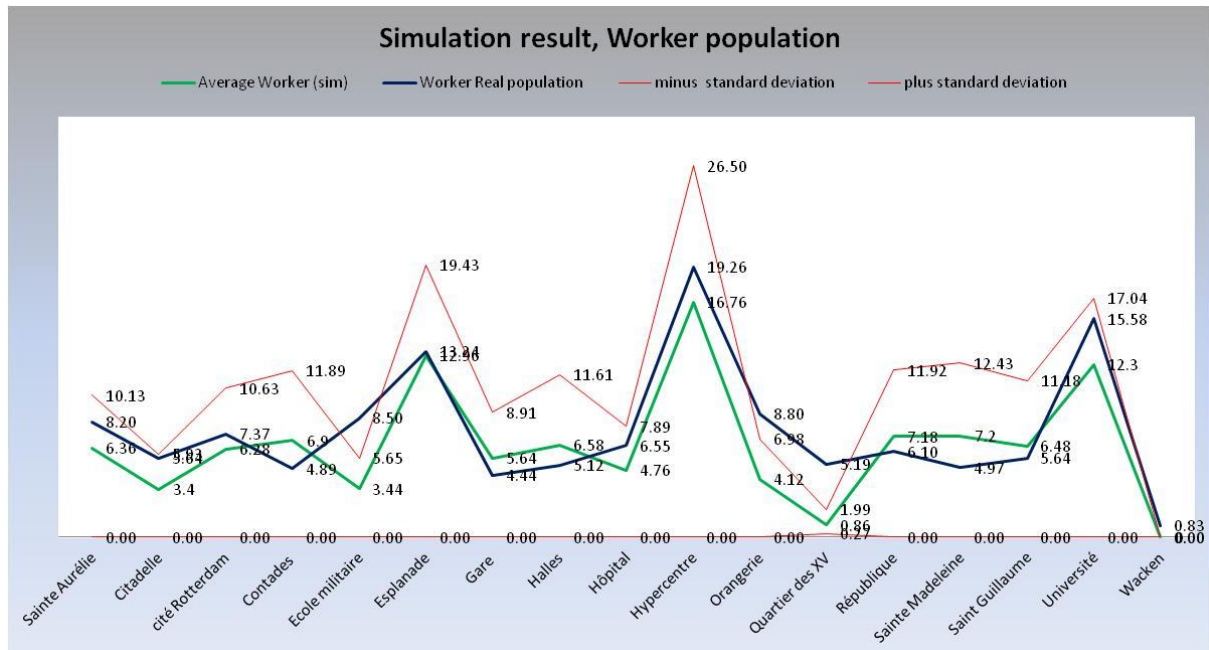

Fig 5.17. The comparison of real worker population and the population resulted by the simulation.

The diagram of the worker class (Fig5.17) shows that there is similitude between the simulation results and the real situation in Sainte Aurélie, Citadelle, Cité Rotterdam, Contades, Esplanade, Gare, Halles, Hopitale, Hypercentre, République, Sainte Madeleine, Saint Guillaume, Université and Wacken and except for Sainte Aurélie, Citadelle, Cite Rotterdam, Université and Wacken, all the real situation that are in the range of upper and lower limits of standard deviation in simulation are very close to the simulation result.

The gaps are noticeable in Ecole Militaire, Orangerie and Quartier des quinze. The simulated population is less than that of the real one except for Gare, Halles, République, Sainte Madeleine and Sanit Guillaume that has attracted the population more than what was expected.

As the scattering maps show (eg. Fig5.12), the population did not show the tendency to go to the frontier areas. The Citadelle and Quartier des Quinze that are in frontiers have not attracted this class enough. The cluster of population has been seen mostly in central parts of the world of the program. So in this case, Contades has attracted the population more than it should have; this can be because the attraction in this area is in a favorable level and also because the central position of this area can have helped to attract this population more than enough.

We can expect this problem in other frontier areas for other classes of population as well.

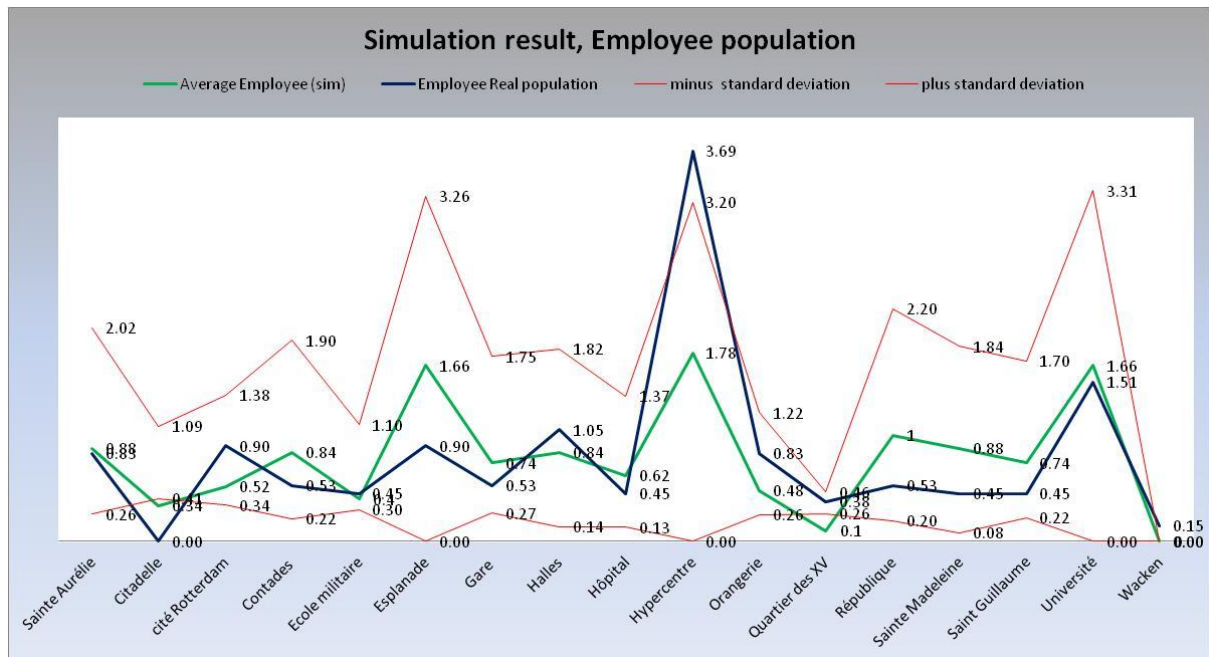

Fig 5.18. The comparison of real employee population and the population resulted by the simulation.

According to Fig5.18, the similitude between the simulation results and the real situation shows that there is some close results in all neighborhoods except for Citadelle and Hypercentre, and exact corresponding in Sainte Aurélie and Ecole Militaire.

We can observe that the population is attracted more than expected in Citadelle, Contades, Esplanade, Quartier des Quinze, République and Saint Guillaume and Sainte Madeleine.

The biggest gaps are in Citadelle and Hypercentre.

The initial population of this class is very lower than that of others, so it can be expected that the number of collisions between the agents of this class and those of other classes not to be as many as other collisions.

Also by assuming segregation, the difference between this class and other classes that could expulse one of the two, is not great and this difference only exists with the manager class. Because in the program, just the classes that are very different repulse each other and those who are similar or in two classes that are not very different can cohabit.

As the sample scattering map in Fig5.13 shows, we have very few population in all the world of program and also very few in each area. The very few number of this population could have shown great deviations, because by adding or removing some few agents it could have shown a big gap but they did not. That can have been because the little number of this class has been located in the very first steps of the program and they did not have any expulsive forces like segregation to move, and they can have moved just for finding better situations.

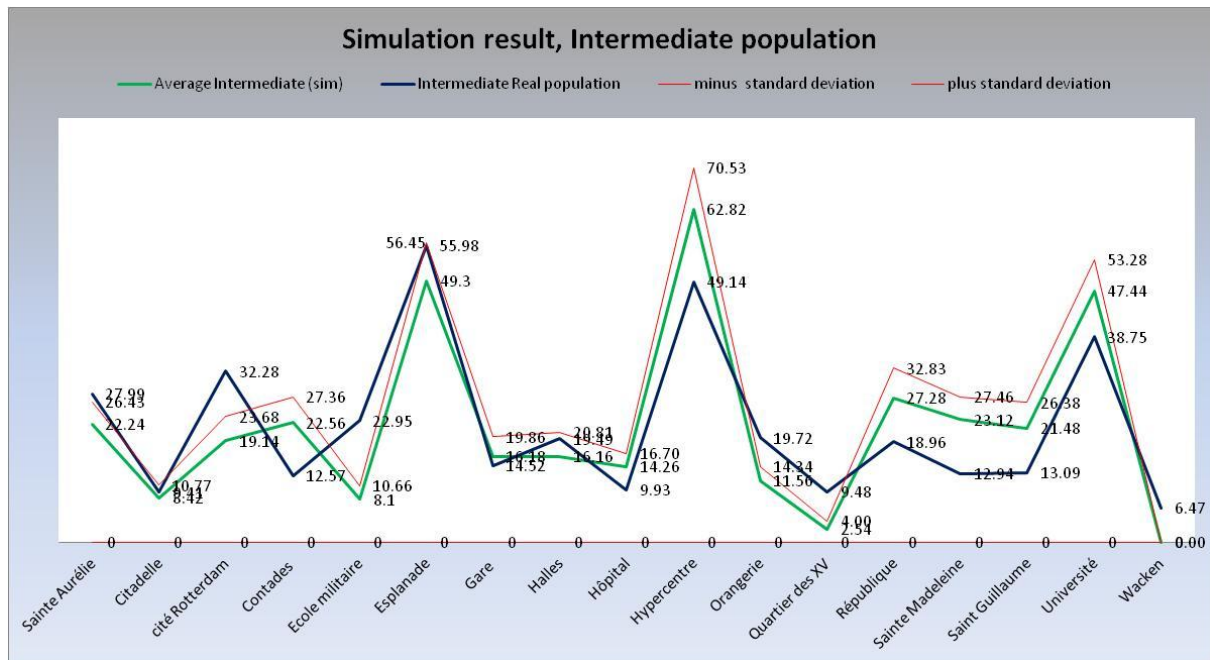

Fig5.19. The comparison of real intermediate population and the population resulted by the simulation.

The results for the intermediate class (Fig5.19) show that except for exact corresponding in Citadelle and Halles, and close results in Gare and the result of Contades, Halles, Hôpital, République, Sainte Madeleine, Saint Guillaume and Université that is in the range of standard deviation, the rest of neighborhoods show some gap between the resulted and the initial population.

The biggest gaps are in Sainte Aurélie, Cité Rotterdam, Ecole Militaire, Esplanade, Orangerie and Quartier des Quinze.

In Contades, Hôpital, Hypercentre, République, Sainte Madeleine, Saint Guillaume and Université, the neighborhoods have succeeded to attract more population than what was expected.

As the largest population, the intermediate class can show large deviations as well. Unlike the employees, that some little change in the number of scattered population could end to a great deviation, for this class overpopulation or underpopulation is not resulted by little changes, but if we expect acceptable results in 17 areas, a greater amount of agents should have acted according to the rules and that is not seen very noticeably for this class.

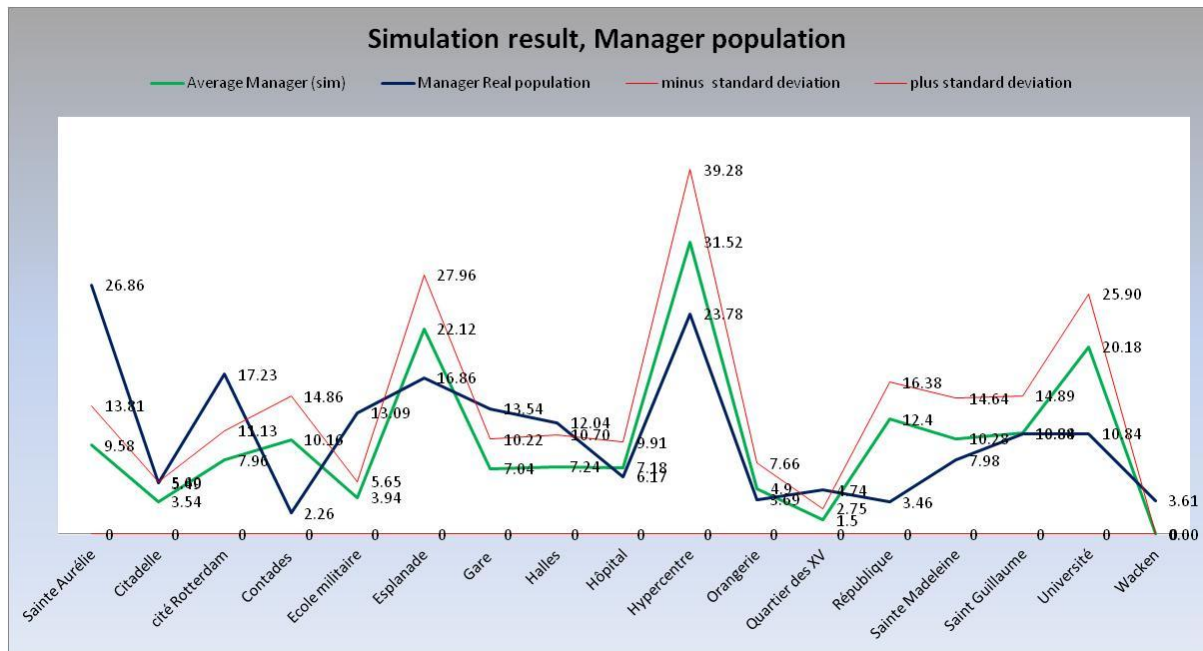

Fig 5.20. The comparison of real manager population and the population resulted by the simulation.

The result (Fig5.20) shows an exact corresponding in Orangerie and Saint Guillaume and close results in Hôpital. The simulation results in Ciadelle, Contades, Esplanade, Hypercentre, République, Sainte Madeleine, Université and Wacken are in the acceptable range.

For manager class, the results show some gaps between the two situations.

Contades, Esplanade, Hypercentre, République, Sainte Madeleine and Université have attracted more agents than what was expected by the initial population.

In other neighborhoods, the resulted population is generally less than the initial population.

As the second populous group and the highest one, it can be expected that the number of collisions to be many. As the consequence we can expect two big challenges:

First in catching better situations and consequently leaving the cells that have less opportunities; this is because the agents look for best situations and after selecting one unoccupied cell and after updating of the program, they compare their situation with unoccupied cells. If the unoccupied cells are in a quality more than their solvency, they do not move and keep their initial place, and if it is close to their solvency, they start again to search.

This makes difference between two classes; the time that one agent gives up is proportionate to its solvency, or in another word the less solvent one agent is, the sooner it gives up for searching more. The one who is more solvent may leave its initial place and search again and in this period its former cell can be occupied by others.

This may cause that the solvent people move more than the popular classes and hence, those who have settled sooner can keep their residences as long as other expulsive forces like segregation have not make them leave. If that continues till the end of the program, the moving agents are not taken to account as the settled ones and as the result shows the two lower classes showed better results; to some extent because of their little population and to some extent because they have not moved for finding better situations as much as the two upper classes.

Second in segregation; because when some agent resides in one cell, it looks around for evaluating its neighbors, if they are very different with respect to class difference, or if the number of dissimilar classes exceeds some given threshold, the different one decides to leave.

Again here, the little population of lower classes could not make the area as segregated as what the upper classes could have, but the power of upper classes to make the areas segregated of upper classes has not been to a great extent and what is seen in most populous areas of upper classes like the Hypercentre, Université and Esplanade verifies this. In these areas we can expect that the increase in population of upper classes not to leave enough room for the lower classes but as it is seen for the lower classes, we have close results or not with a noticeable decrease in population; this can be because the number of residences are close to that of population, for more population maybe we could observe more impacts of segregation.

5.11 The results of each area

Now for each area, we compare the areas as reality according to Philippe Gerber (2000), and what they have attained in attracting the population in a way that the population chooses them as their residence area.

In **Sainte-Aurélie**, the repartition of workers and employees is noticeable. The technical comfort is general in this neighborhood.

Result: As the results of the program show, it has attracted all the classes less than it should have, except for precise result for employees. So according to its local situation, its proximity to Hypercentre of the city was not helpful for absorbing the population.

In **Citadelle**, the social houses have accommodated the families with children and the population of 24-35 years and the unemployed and foreigners are dispersed in this area.

Result: Except for employees, it could not attract the other classes.

The families in **Cite Rotterdam** are mostly employees or workers that live in houses with comfort. They are mostly aged families or families without children. The houses are mostly spacious ones in big buildings like HLM.

Result: It was not successful to absorb people close to the present number or more than that. Its location on eastern borders of the city can have helped to this failure.

Ecole Militaire is occupied to a great extent by employees and the residences are equipped with technical comfort. This area is mostly consisted of administrative building and shows the concentration of neither aged nor active people.

We can see the presence of workers and/or employees around Ecole Militaire and Contades park. This neighborhood collects the companies and individual houses. It profits of the supermarket and other commercial centers that in this year is not limited to central parts.

Result: It was not successful to absorb any classes more than what it should but it has attracted the employees precisely.

Esplanade was a 112 hectare military land between the limits of the city, the Citadelle and the Vauban which was built in 1681. It had a change in 1954 because of the actions of National Defense. The municipality under the aegis of the Mayor Pfirmiln takes to account the importance of this terrain that was near to the core of city. Its reserves of lands could support a new complex of institutes and faculties.

Finally Strasbourg could implement the projects in 16 hectares out of 74 hectares that was initially planned because of the lack of credits. But in 1958 it was compensated and it went under construction of 4000 housing projects, park (that one of Citadelle 7 hectares), commercial and scholar centers. The housing covered a range between the luxurious HLM especially in General de Gaulle to little studio flats four couples and students.

In this neighborhood, there is some increase in number of families with children and that is at the same time that this kind of family has left the Hypercentre.

After 1968 the attraction of middle and high class to this neighborhood has increased. The employees also live in a noticeable saturation.

The percentage of one-room apartments in Esplanade is 36.2% while this is 8.12% for other areas. A noticeable number of unemployed people live in this area.

In this area, the lower class can profit from 3 or 4 units in their house because of HLMs. Most of the buildings in this area are new buildings and most of renovated or rehabilitated buildings are in other areas of the city. Some of centralities have not grown in this area, and that can be because it is very close to the center of the city. Because of the high density of population in Esplanade, the urban equipment in this area is low. The technical comfort is high in this area because the buildings are rather new.

Result: It shows that workers can choose this area according to reality, but the employees and managers are attracted more. It has not been very attractive for intermediate class.

Gare has experienced two main renovations: one in 1883 by a belt that connects to Vauban and the second was in 1913 where the 22 November Street has connected Place Kleber to Gare.

The wide streets made some perspective of line of houses that were little but have accommodated little bourgeois. Here the squares are vast and under the dominance of pedestrian and bicyclists.

The repartition of workers and foreigners is rather high in this area. Most of the buildings are administrative. The young employees are dispersed in this area. The owners are not seen many.

In 1970-80 the area profited from multi-polarization of centrality and the centrality in this area grew in parallel to the center of the city. The technical comfort emerges in 1982.

The population of this area shows some rejuvenation.

There is a dispersion of buildings built before 1915. The dispersion of urban equipment is found to be proportionate to the population density.

Result: Gare has attracted very precisely, except for the manager class that have not found the area attractive enough.

The **Halles** is the intersection of commercial areas of Strasbourg. The Halles is constructed on the old station and now plays a directional role in commerce of Strasbourg.

The employees that live in residences with technical comfort, the intermediate class and the young between 24-35 years old are noticeable in this area.

Here has one of the most centrality of the city.

Two popular classes of foreigners and unemployed are also dispersed in this area.

Result: Except for managers all other classes have chosen the area logically and close to the population that it should have absorbed, but the managers have not liked it enough.

The urban functions are spatially centralized in **Hypercentre**. The buildings that are located in this zone cover 232 hectares. All the displacements were in the borders of this zone according to the census 1886; 782 habitants lived out of the city at that time. In the zone, the streets are narrow and sinuous; they accommodate the artisans, commerce, banks, nobles and bourgeois. One unique concentration is characterized in the central core due to the essential functions like commercial, cultural administrative activities.

The population of this area is mostly middle classes. The population of this part of city (the first core of Strasbourg) has shown decreases after 1890, stability between 1921 and 1931 and again decreases after these years. It was not necessarily because of gentrification, but mostly depopulation without renewing it. The administrative areas around the core of the city absorbed these populations.

In 1968 the concentration of aged people in this area is seen. In 1982 the artisans and foreigners with middle salaries and also unemployed are seen in this area.

The residential comfort is less than the average of the CUS. The comfort in this area and other areas (except for Université, Orangerie, Contades and Quartier des XV) are the technical comfort.

After 1970 the repartition of rehabilitated houses in this area is noticeable.

After 1980 it misses some of its worker and employees and they go to neighbor areas.

The centrality index in this area is high.

Result: The workers have entered to this part of city in a balance with reality. On the contrary to employees, the intermediates and manager were interested more.

The next area is **Orangerie**. After 1871, the limits of Strasbourg that has been unchanged for 400 years changed and it extended to Contades and Orangerie park and after this development, the surface of Strasbourg has increased from 362,5 to 827,9 hectares.

The high class have settled in this area mostly in private buildings. The Palais de l'Europe, Conseil de l'Europe and Palais des Droits de l'Homme are built next to the prestigious area of Orangerie and the densification of small buildings changed to high densification of 1300 offices of these large buildings.

The technical comfort is upper than the average in Strasbourg. The aged population is dispersed in this area.

Result: The area has shown the capacity to attract the managers according to reality, but it was not attractive for other classes especially for workers and intermediates.

Quartier des XV is consisted of large pavilions surrounded by gardens. The technical comfort is high in the area. The people of higher class live in this area. The foreigners that mostly work in Parliament of Europe live there as well.

Result: All these realitiess has not been attractive for any class and except for employees, the other classes seem to have ignored this area at all.

République was the result of the German government decision who wanted to complete the historic center of the city. The new administrative buildings around Place République like collegiate bibliothèque, two ministries with secretariat of the state and Imperial Palace -terminated in 1888- represent the architectural ensemble of the era. It is connected to center of the city via Hotel de Ville and Place Broglie. It splits the politic and symbolic centrality.

The higher classes and young families live in the area and some unemployed and foreigners are dispersed in this area as well. The technical comfort is high in this area. Spacious houses are many in the area.

Result: The workers have chosen to live in this area near to reality, but other classes have shown interest to enter into the area.

Sainte Madeleine has been formed to some extent after the war. After the bombardment of the World War two in 1943-44 by allied air force, 7 481 house units became inhabitable or totally destructed, 2 606 buildings damaged or demolished. Since the destruction had left the urban structure usable, the architects and urbanists implemented a 'mild modernization' and an 'identical reconstruction'. The tendency to build some open spaces ended to some squares like Place Sainte Madeleine. The popular class and young population have dispersed in this area.

Result: All classes have shown interest to enter into the area, but the workers entered it as many as enough.

Saint Guillaume shows a noticeable dispersion of the immigrants and young population and workers.

Result: The employees and intermediates are interested in it, but workers and managers have been realistic in their immigration.

Université was a remarkable decentered area out of the old central parts that canalized the movement population. It was the link between Neudorf and Krutenau and at the time of rehabilitation of Krutenau, it continued its construction and played its role as public and administrative spaces. The middle class are dispersed in the area. 3 or 4 unit houses are dispersed here.

Result: The workers have not entered enough, but the employees entered close to reality. The intermediates and managers were attracted more.

Wacken is the place for open spaces for exhibitions. The families with children and even those who have several children and the employees are dispersed in the area.

Because of proximity to European area, some higher classes live here. Many people are owners.

Result: It has not been attractive for any class and that can be caused by the location of the site in the periphery of the world of the program.

5.12 A principal Component Analysis

Beside the comparison between the actual population in 1982 and resulted population as to simulation, we have tried to find the classes that have behaved in similar or opposite manner according to the areas, and on the other side, the areas that have responded in similar or opposite manner for absorbing population. For reaching to this target, we have run a Principal Component Analysis (PCA) to describe and summarize the datasets. PCA answers to three questions:

1. Individuals' study: two areas will be close to each other if their results to the population dispersion are close. We want to see the variability between the individual runs.
2. Variables' study: We want to read the intensity of linear relationships between variables.
3. Link between these two studies: can we characterize groups of individuals by variables? The two objectives are to summarize the correlation matrix and to look for synthetic variables: can we resume the dispersion of population by smaller number of synthetic variables?

We do our analysis for two objectives: first for finding the correlations that exist between the classes of population and between the areas in 50 runs separately and second for finding the correlations that exists between the areas and the classes of population in real and simulated dispersion. The first output of our analysis will show the areas and the classes of population that show close results. The data for this set is the outputs of population dispersion resulted by 50 runs for each class separately. We have used the 'R project' software for Principal Component Analysis that includes individual factors, variable factors, hierarchical clustering and hierarchical clustering on map.

5.12.1 Workers

The data for the population dispersion of worker class are organized in a $W(i,j)$ matrix where $i=1,17$ stands for each areas of the city of Strasbourg and $j=1,50$ stands for the population of worker class as to 50 runs of the program. The individual factor map below shows the scattering of 17 areas of the city according to two synthetic factors.

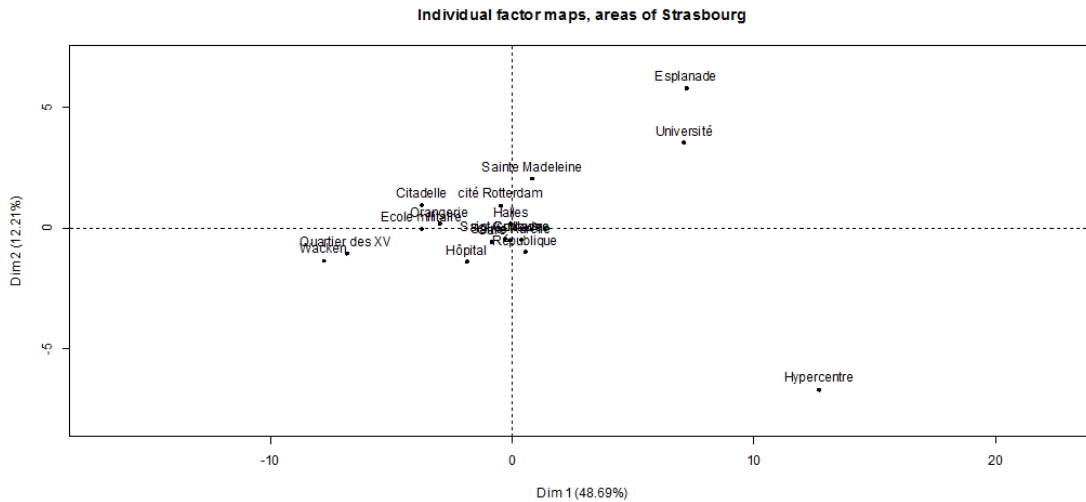

Fig 5.21. F1-F2 factor map of areas (workers).

The first factor describes 48% of the variance while the second one does it in 12.5%; so the map F1F2 describes 60% of the variance of the data and 40% of the variance is not described by these factors. The areas that are in the center of the map do not have a noticeable weight on the factors. The areas like Esplanade, Université, Hypercentre influence the F1 and F2 whilst the areas like Wacken and Quartier des XV just behave in an opposite manner according to the F1 factor.

In a distance to the important factor F1, three areas of Esplanade, Université and Hypercentre are between the first and second factor. Esplanade and Université have the most contribution to the first factor and they organized positively to the second factor as well. Hypercentre has the greatest contribution to the first factor but responds negatively to the second factor. Areas like Sainte Madeleine and Cité Rotterdam behave mostly according to the second factor. Wacken and Quartier des XV behave opposite to the first factor.

F2(-) represents the opposition of the old Hypercentre to the modernity F2(+) of University and Esplanade. F1(-) is very precise, it's the peaceful local "Bourgeoisie" with few workers, opposed to the F1(+) youth, modernity, commerce and the workers population.

Variable factor map, population dispersion

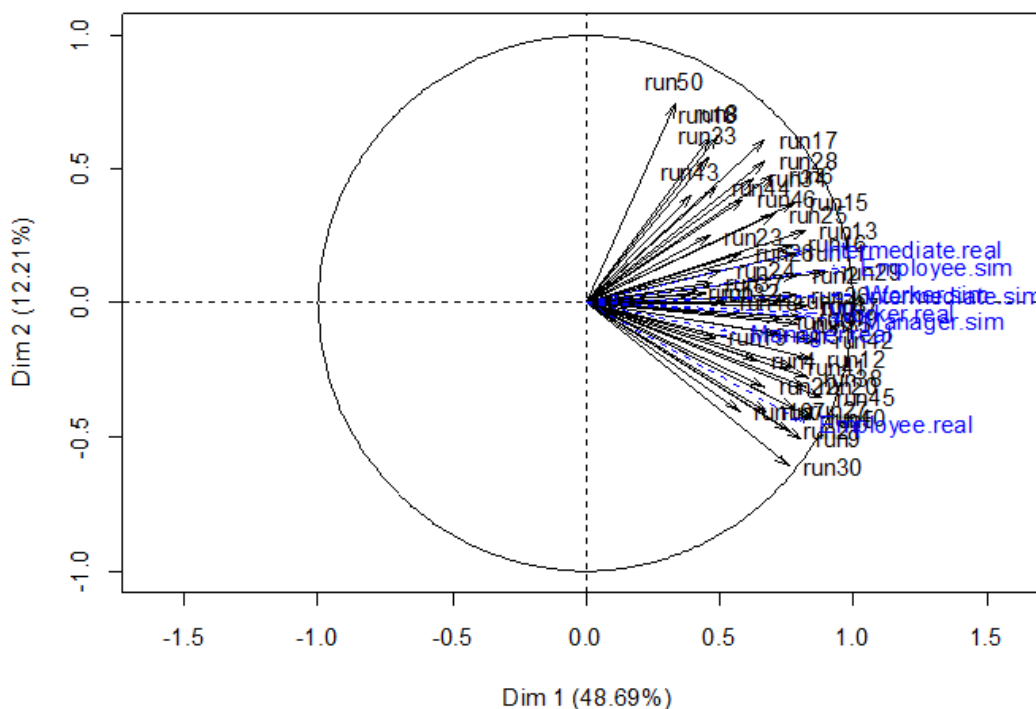

Fig 5.22. Variable factor map of runs (workers).

The arrows length indicates the importance of the variables in each run of the program. The angle between arrows and F1 means the correlation between the factor and variable and the angle between the runs, like between run30 and run50 shows that there is hardly correlation between these two runs as to the cosines of the angle between the two arrows; these two runs are almost perpendicular to each other.

The F1 factor is mostly close to the result of the runs 14, 36 and 47. For the runs that have shown positive result to the first factor and negative result to the second factor, like the ones in run 9, 21, 30, the maximum are in noticeable difference with others. The most population in these runs is attracted to Hypercentre. In the individual factor map, the Hypercentre is in a noticeable distance to other areas.

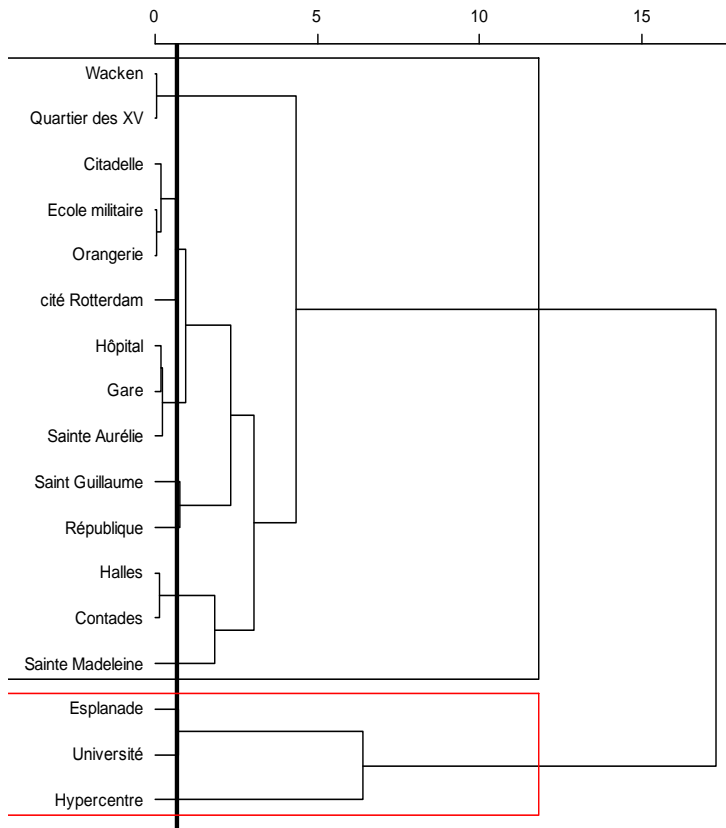

Fig 5.23. Hierarchical clustering of areas (workers).

The Y-axis separates the areas that have the least variance in the group and the most variance between the groups; in another saying the groups of variables are intra-homogeneous and extra-heterogeneous. X-axis shows the relation between the areas.

Except for Ecole Militaire, the areas in the left of the X-axis are the north-western old and bourgeois areas and Université and Esplanade are at the right of this axis. Hôpital, Gare and Sainte Aurélie that are grouped in the middle of axis are located in western part of the city.

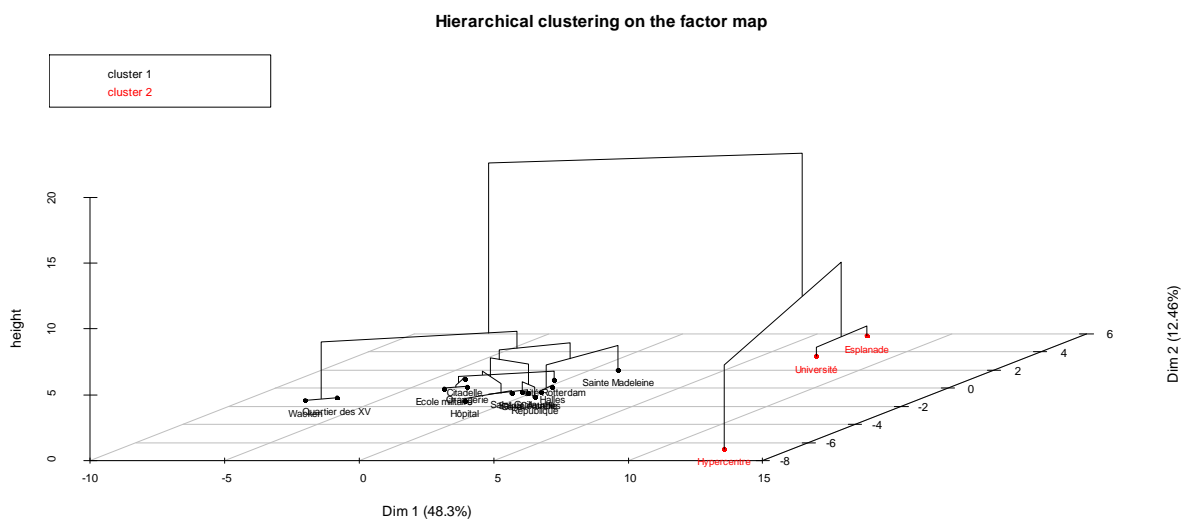

Fig 5.24. Hierarchical clustering on the factor map of areas (workers).

The hierarchical clustering on the factor map is the synthesis of PCA and classification. It presents a better view of grouping the variables according to their correlations and the position of these groups in relation to the factors.

The first two dimensions resume 60% of the total inertia and as the total variance of datasets, they cover a great part of databases. The runs show some close results and for example the results of run 30 and run 50 shows no close result but we do not see any opposite runs for this class of population. The clustering of the areas are in two principal groups; the first one is comprised of Hypercentre, Esplanade and Université and the other 14 areas grouped in the second cluster.

5.12.2 Employees

The data for the population dispersion of employee class are organized in a $E(i,j)$ matrix where $i = 1,17$ stands for each areas of the city of Strasbourg and $j = 1,50$ stands for the population of employee class as to 50 runs of the program.

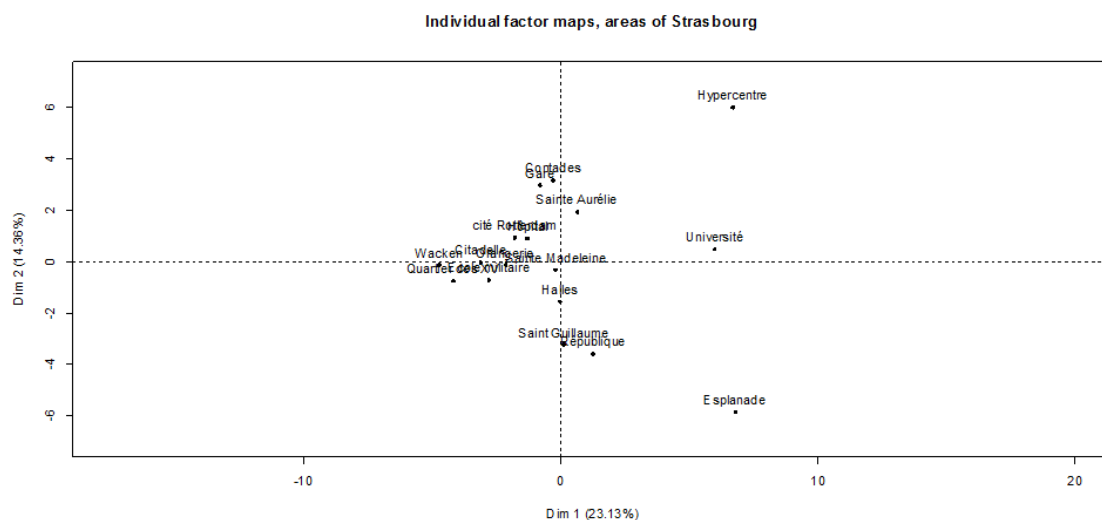

Fig 5.25. F1-F2 factor map of areas (employees).

The first factor describes 23% of the variance while the second one does it in 14.3%; so the map F1F2 only describes 37% of the variance of the data and 63% of the variance is not described by these factors. The areas like Sainte Madeleine do not have a noticeable weight on the factors while the areas like Esplanade, Université, Hypercentre influence the F1 and F2 and especially Esplanade contributes to the F2(-) and Hypercentre does to F2(+). Areas like Wacken and Quartier des XV behave in an opposite manner according to the first factor.

In a distance to the important factor F1, three areas of Esplanade, Université and Hypercentre are between the first and second factor. Esplanade and Université have the most contribution to the first factor and they respond positively to the second factor as well. Hypercentre has the greatest contribution to the first factor but responds negatively to the second factor. Areas like Contades and Gare behave mostly according to the second factor. Saint Guillaume and République behave opposite to the first factor.

Here again F1(-) is with few employees in the clam bourgeoise areas of quartier des XV and Wacken, opposed to the F1(+) youth, modernity, commerce and the employees population. The first factor is not very exhaustive and in comparing to other classes of population, the second factor has less inertia for covering more data.

Variable factor map, population dispersion

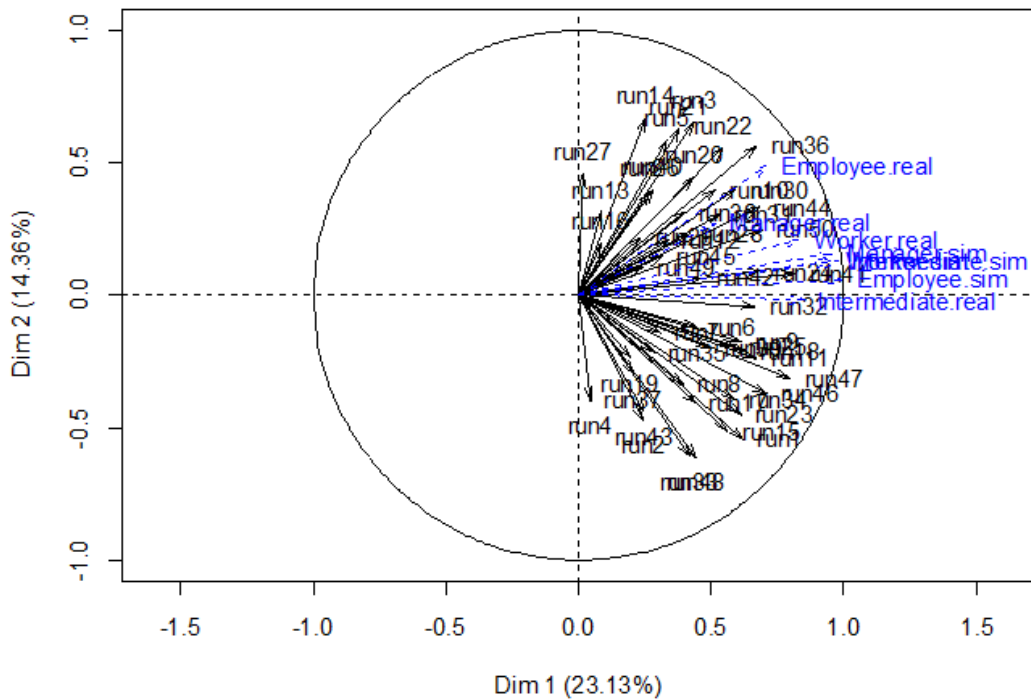

Fig 5.26. Variable factor map of runs (employees).

The correlation between the F1 factor and run 41 and 32 is high and the angle between the runs 4 and 27 shows that there is an opposite correlation between these two variables; these two runs; they almost show a $r \approx -1$ correlation. The most population in these runs is attracted to Hypercentre. In the individual factor map, the Hypercentre is in a noticeable distance to other areas.

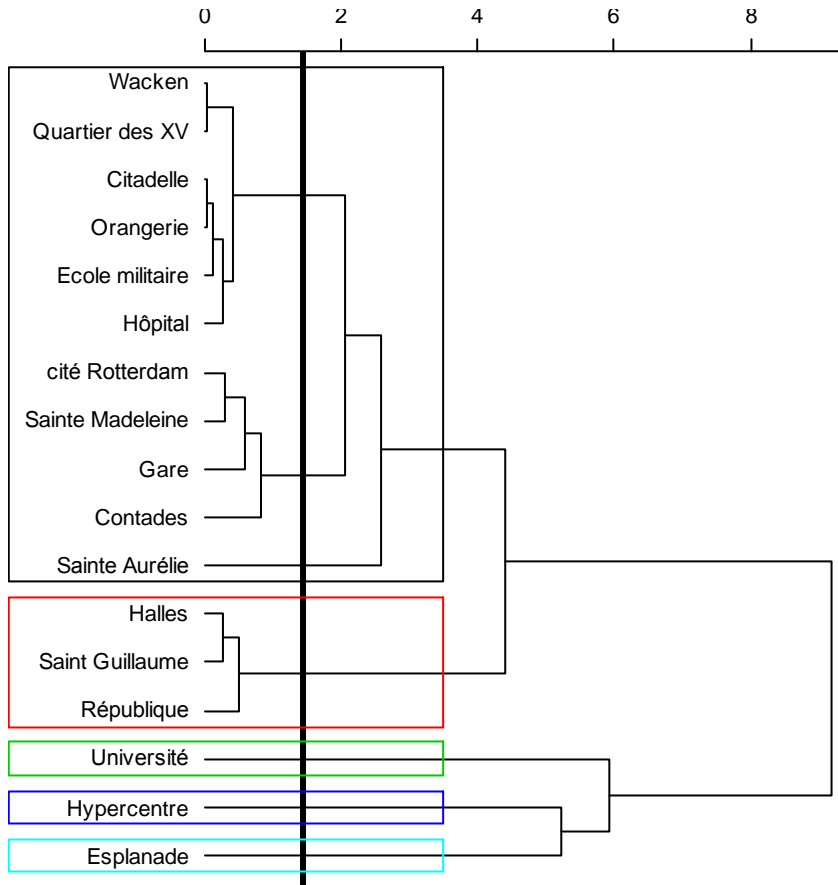

Fig 5.27. Hierarchical clustering of areas (employees).

Clustering of the areas that have the most correlation is practiced here in five distinct groups. Esplanade, Hypercentre and Esplanade behave according to the first but in three different ways according to the second factor. The Halles, Saint Guillaume and République do not respond to the first factor neither positively nor negatively but respond to the second factor negatively.

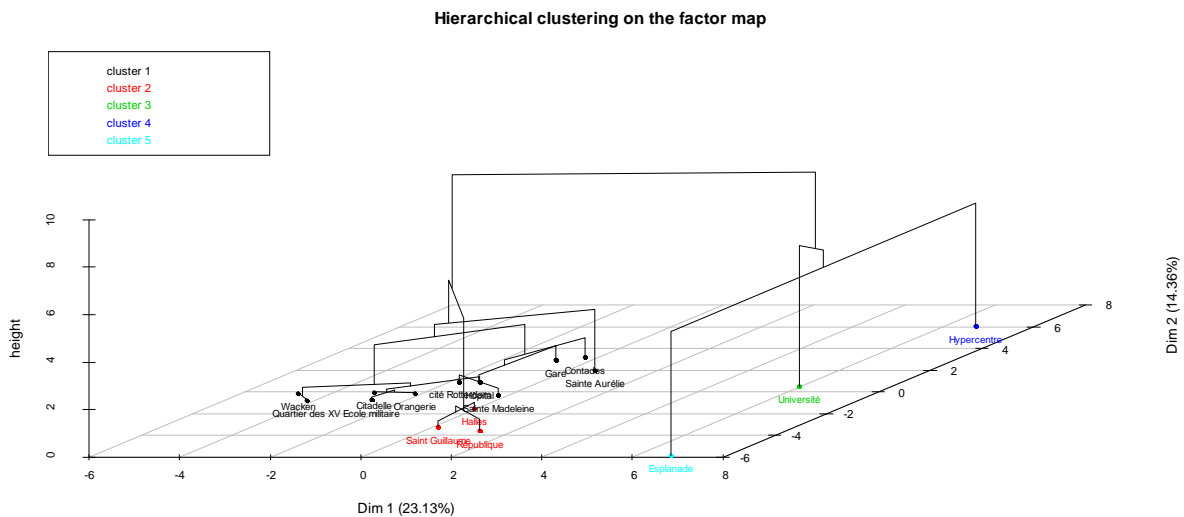

Fig 5.28. Hierarchical clustering on the factor map of areas (employees).

The first two dimensions resume 37% of the total inertia and, the total variance of dataset does not cover a great part of databases. This group shows the most miscellaneous results; for example the results of run 27 and run 4 shows some opposite results and we see several results that are not close at all. The clustering of the areas are in five groups; Hypercentre, Esplanade and Université, each one has dedicated one group to itself separately, Halles, Saint Guillaume and République have gathered in one group and the other 11 areas are grouped in the fifth cluster. The most contrasting results are of Hypercentre and Quartier des XV and the one of Esplanade and Cité Rotterdam.

5.12.3 Intermediates

The data for the population dispersion of intermediate class are organized in a $I(i,j)$ matrix where $i = 1,17$ stands for each areas of the city of Strasbourg and $j = 1,50$ stands for the population of intermediate class as to 50 runs of the program.

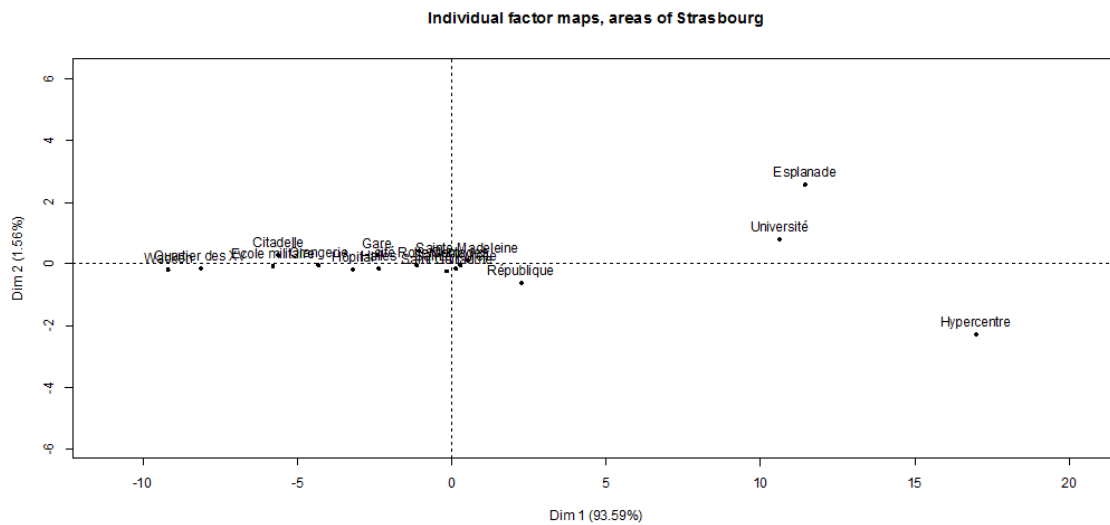

Fig 5.29. F1-F2 factor map of areas (intermediates).

The first factor covers the data to a great extent (93.59%). The most positive respond to this factor is again on the part of Esplanade, Université and Hypercentre. Université mostly applies this factor, but Esplanade has some tendency to the second factor and the Hypercentre acts negatively against the second factor. Here again the areas like Wacken and Quartier des XV stand in opposition to Esplanade, Université and Hypercentre.

Variable factor map, population dispersion

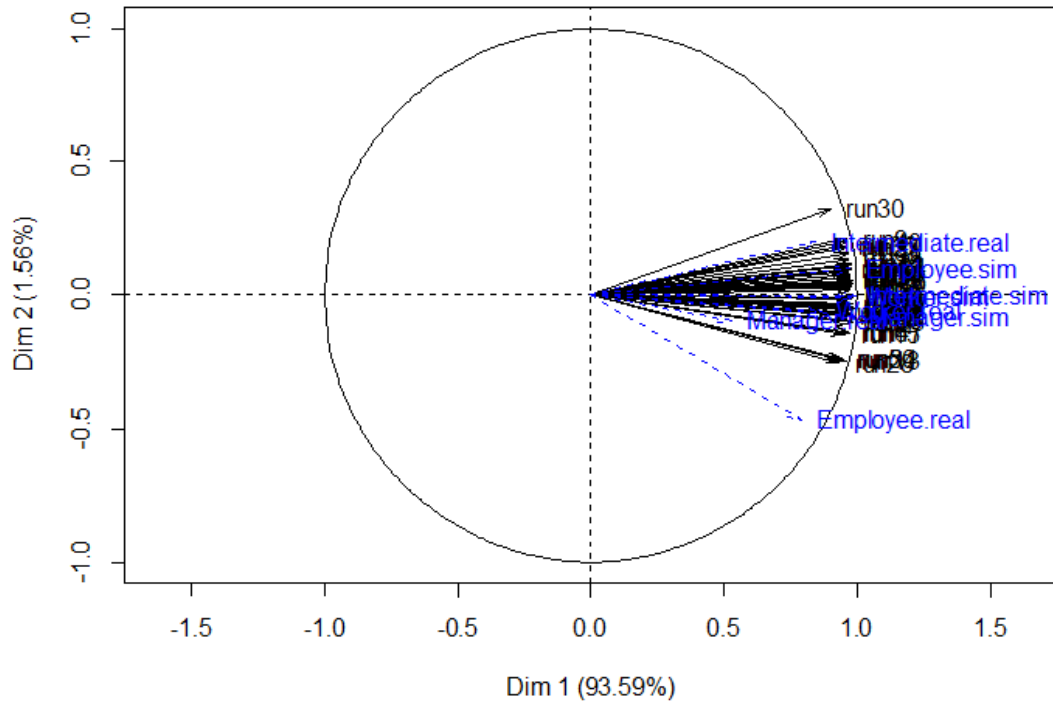

Fig 5.30. Variable factor map of runs (intermediates).

All the runs are close to the first exhaustive factor and the most opposition is between the run 26 and 30 that is not a great issue. The result of runs of this class is very close to the real population dispersion.

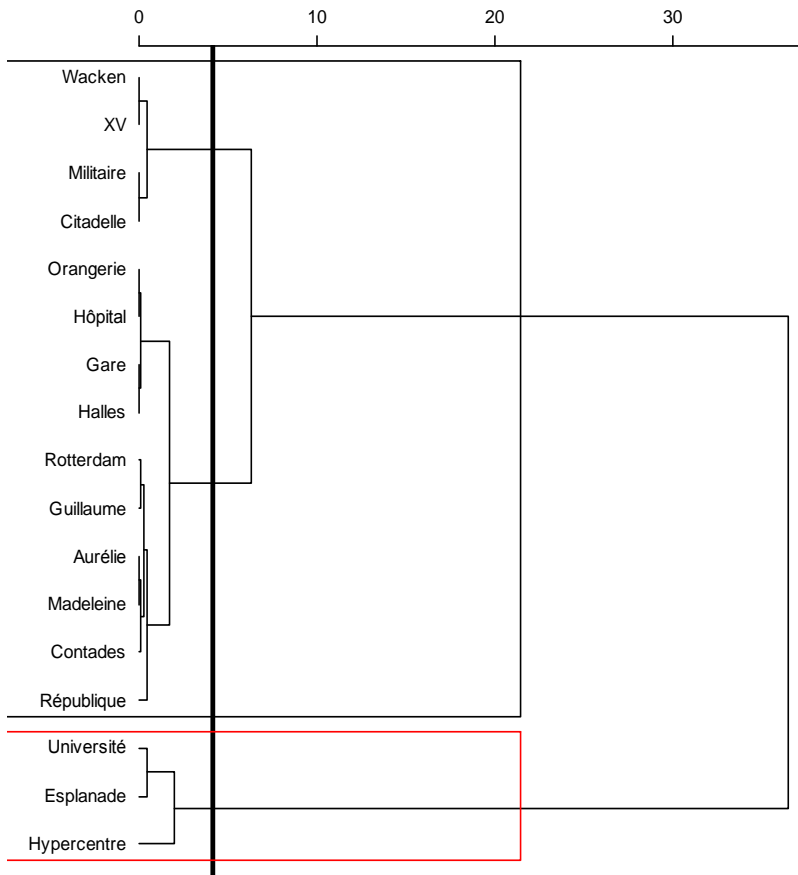

Fig 5.31. Hierarchical clustering of areas (intermediates).

Here again we have two clusters of areas from which one is consisted of Université, Esplanade and Hypercentre and the other 14 areas are in other group; the farthest areas to the first cluster are Wacken and Quartier des XV.

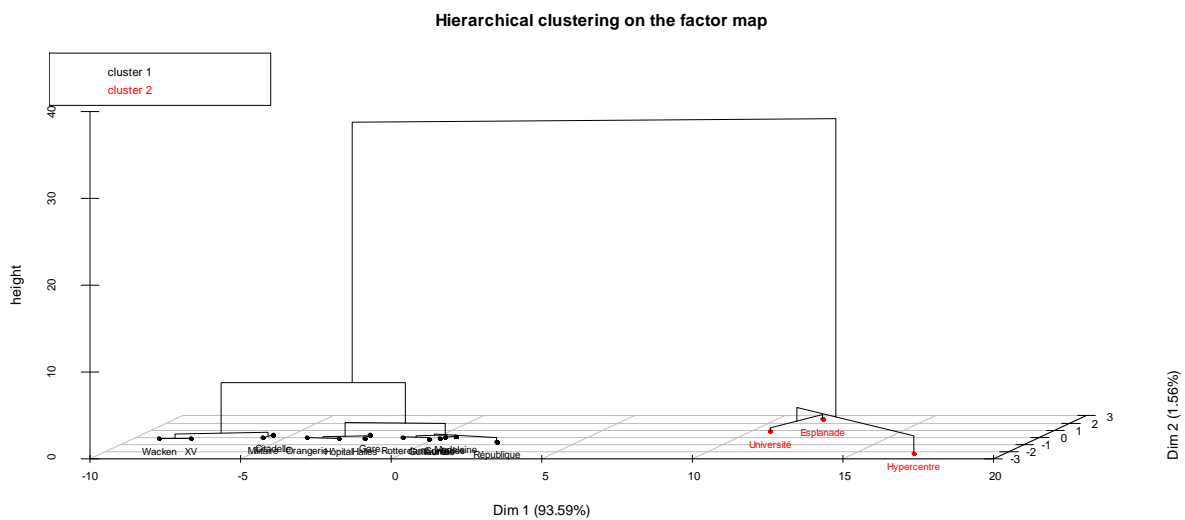

Fig 5.32. Hierarchical clustering on the factor map of areas (intermediates).

The intermediate class has shown the most convergent results and both the inertia shows that the databases are covered in a very high extent of 94% and the result of runs show that they have shown some close results. Even

the real population is very close to the first factor and that shows that the runs that are near to the F1 factor have behave very near to the reality.

5.12.4 Managers

The data for the population dispersion of manager class are organized in a $M(i,j)$ matrix where $i = 1,17$ stands for each areas of the city of Strasbourg and $j = 1,50$ stands for the population of manager class as to 50 runs of the program.

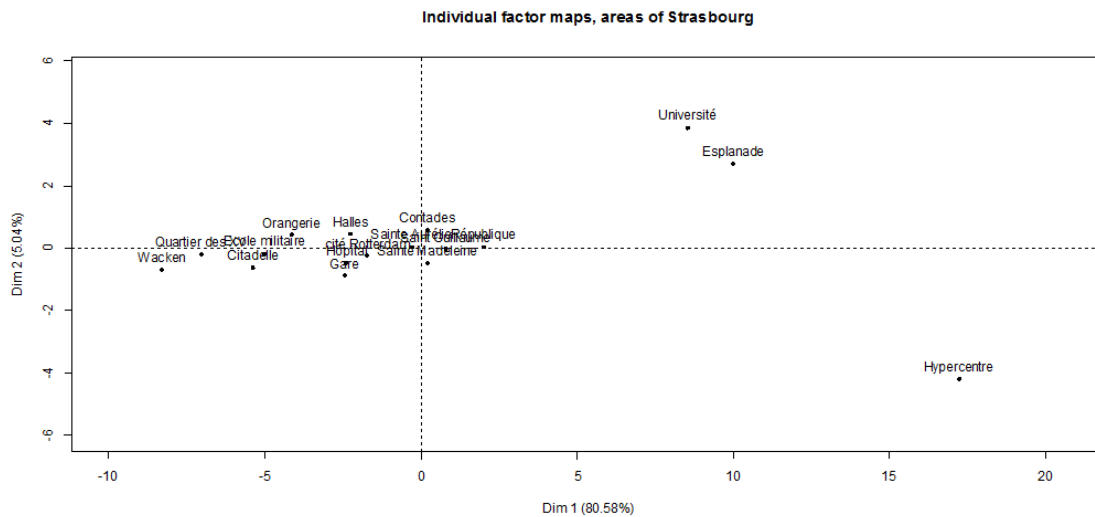

Fig 5.33. F1-F2 factor map of areas (managers).

This class of population has responded positively the most to F1 factor in Hypercentre and in a less extent but enough different with other areas in Esplanade and Université. Hypercentre has shown the most negative respond to the F2 factor but Université and Esplanade has responded positively to that factor.

Variable factor map, population dispersion

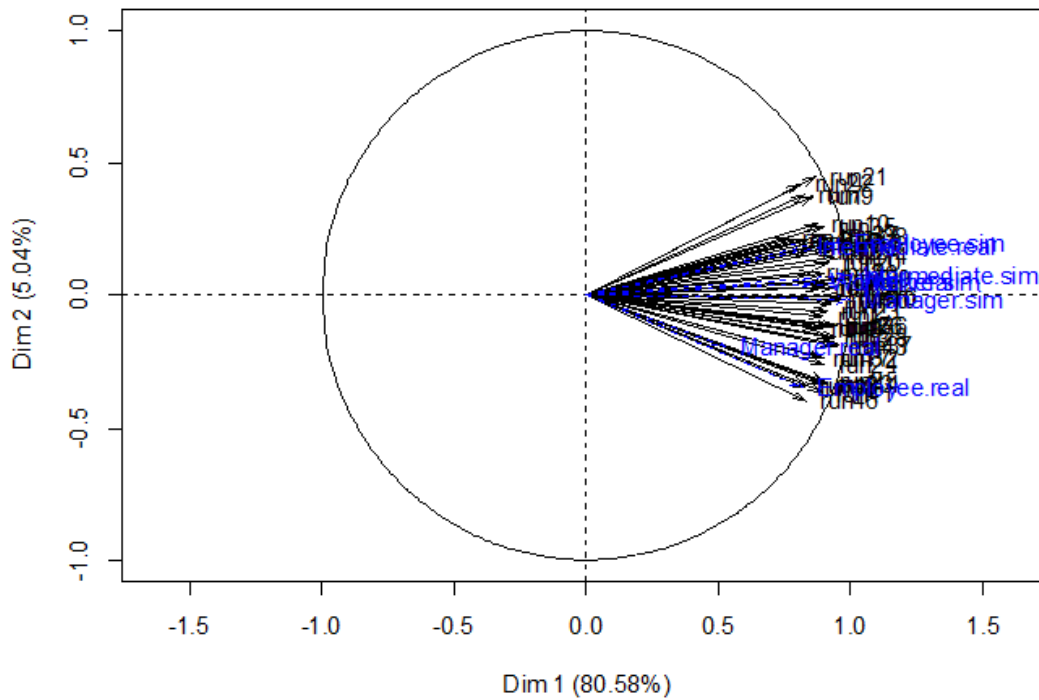

Fig 5.34. Variable factor map of runs (managers).

Like the intermediates, this class has convergent results and the most different results are of run 21 and 46. Here again, like the results for intermediates, the real population is very close to the F1 and this shows that all the runs that are close to F1 (most of the 50 runs) have acted very close to the reality.

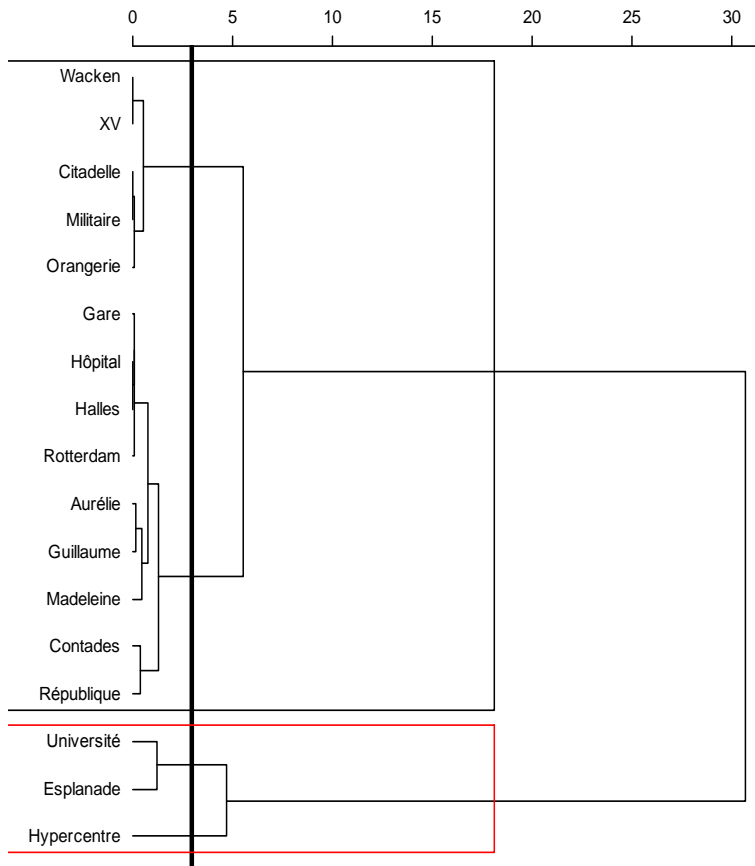

Fig 5.35. Hierarchical clustering of areas (managers).

The cluster of areas is very similar to intermediates; two main clusters including Université, Esplanade and Hypercentre in one group and the other 14 areas in the second group. Like intermediates, the areas of Wacken, Quartier des XV, Citadelle, Ecole Militaire and Orangerie are in opposition to Université, Esplanade and Hypercentre.

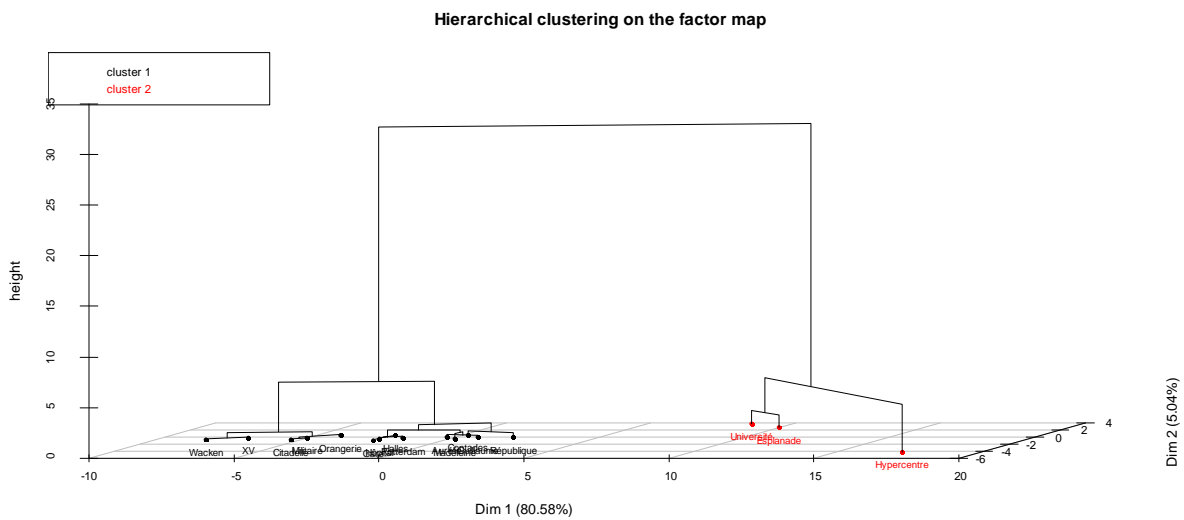

Fig 5.36. Hierarchical clustering on the factor map of areas (managers).

The manager class, like the intermediate one has shown very close results and the variance of 85%.

5.12.5 Real and simulation-result population

The second output will show the areas and also the classes of population that show close results. The data for this set are the average of population dispersion as the result of 50 runs and also the real population dispersion. The data for the population dispersion in real and simulation for all classes are organized in a $M(i,j)$ matrix where $i = 1,17$ stands for each areas of the city of Strasbourg and $j = 1,8$ stands for the average of population of each class in each area as to 50 runs of the program (four columns) and real population of each class in each area (four columns).

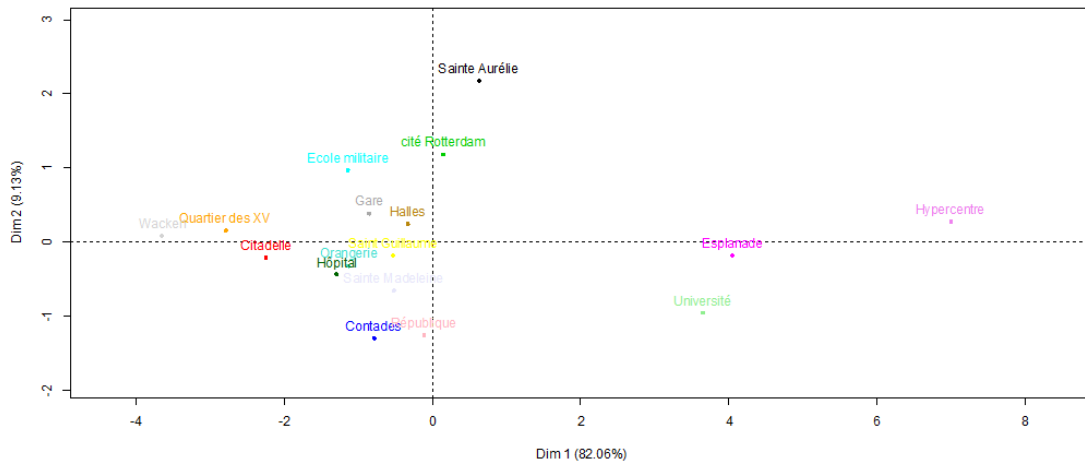

Fig 5.37. F1-F2 factor map of areas.

The first factor describes 82% of the variance while the second one does it in 9.1%; so the map F1F2 describes 91% of the variance of the data and only 9% of the variance is not described by these factors. The areas like Sainte Madeleine, Saint Guillaume and Halles do not have a noticeable weight on the factors while the areas like Esplanade, Université, Hypercentre influence the F1 and Esplanade contributes the most to the F1 factor and Wacken, Quartier des XV and Citadelle behave noticeably in opposition to Esplanade, Université, Hypercentre and they behave according to $F1(-)$. Citadelle and République contribute to the F2 factor and opposed to them, Contades and République behave as $F2(-)$ factor.

In a distance to the important factor F1, two areas of Université and Hypercentre are between the first and second factor. Hypercentre has the most contribution to the first factor and it respond positively to the second factor as well. Université has a high contribution to the first factor but responds negatively to the second factor. Areas like Cite Rotterdam and République behave mostly according to the second factor.

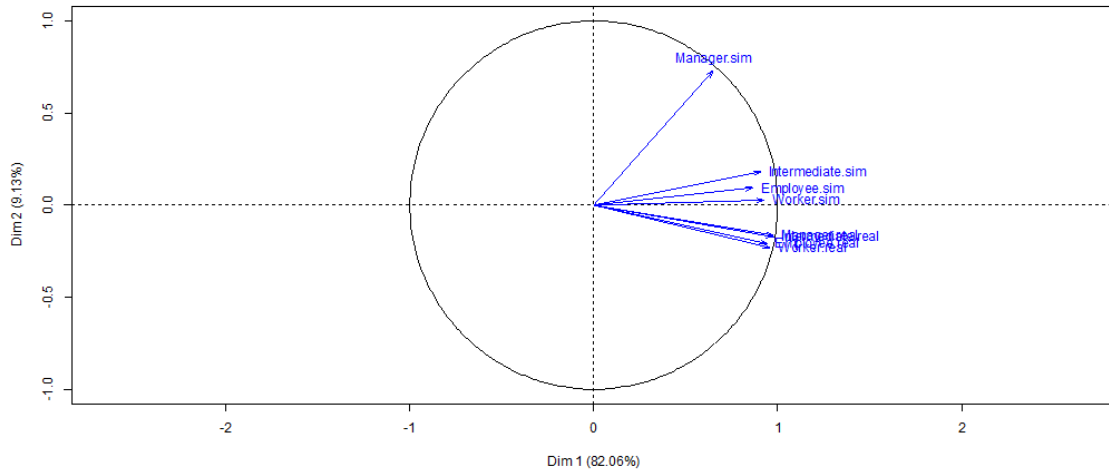

Fig 5.38. Variable factor map of runs.

The results of simulations are close to the F1 factor and the most contribution is of worker class simulation results. Close to this is the result of employees and then the intermediate class; the most uncorrelated results is of actual workers and managers. The interesting result here is the order of classes that have the most correlated results. The workers and employees are much correlated and then the intermediates and then with a noticeable angle the managers. The managers show a total independence to the real population dispersion. Since the correlation between the real population is very high, we can say that the dispersion of the four classes in the areas of the city are in a constant rate from one area to the other but this is not so for the results of simulation.

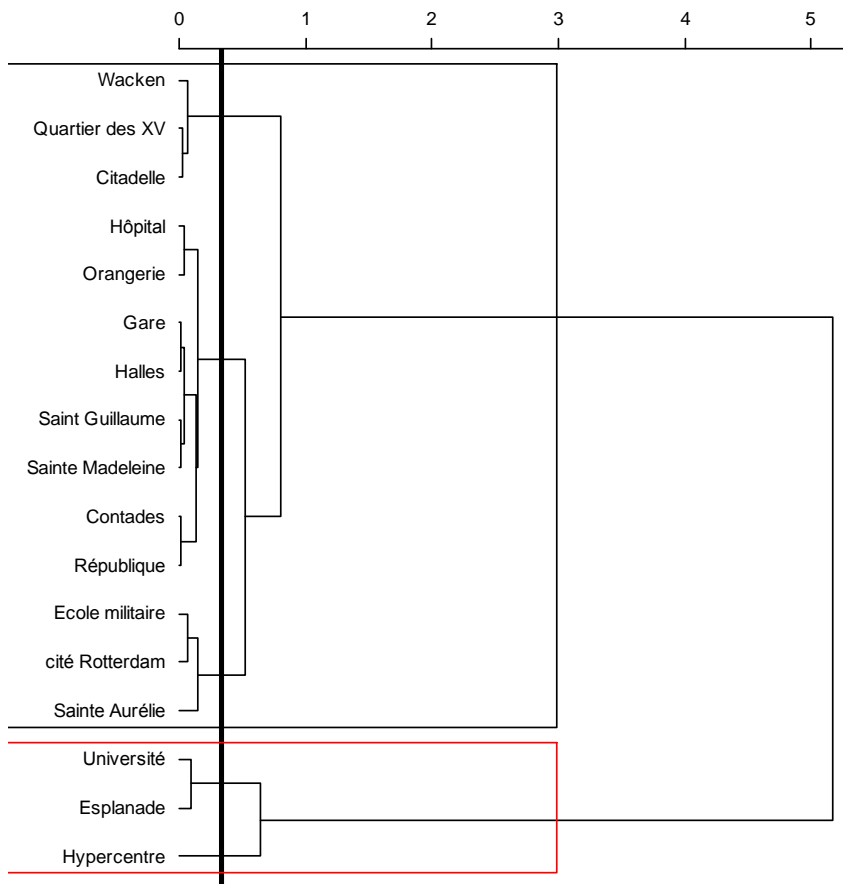

Fig 5.39. Hierarchical clustering of areas.

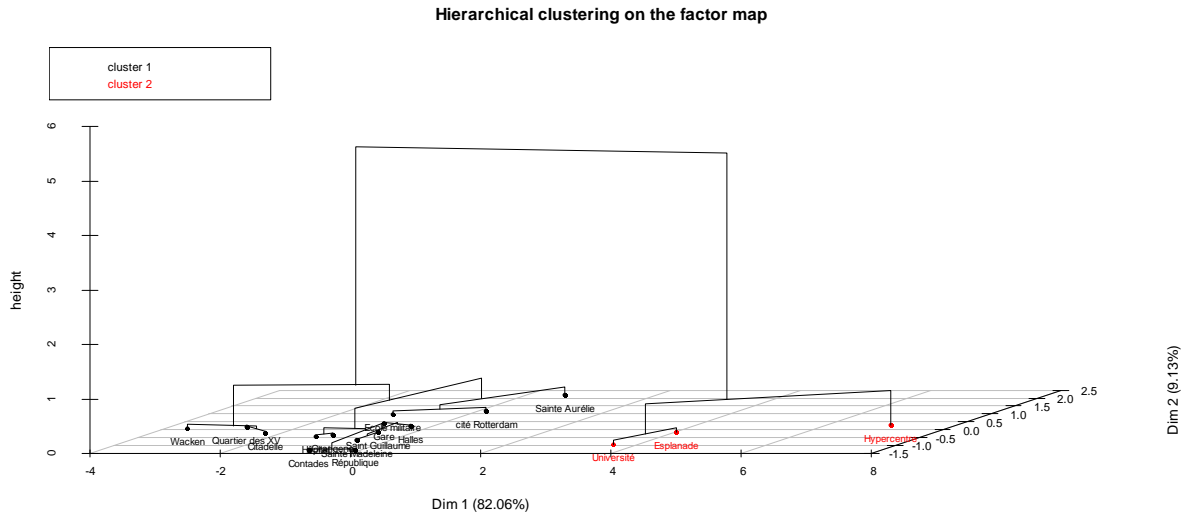

Fig 5.40. Hierarchical clustering on the factor map of areas.

The most interesting result shows that the clustering of the areas is the same as what we have observed for four classes separately: Hypercentre, Esplanade and Université in one group and the other 14 areas in the second groups. The comparison between the two groups of analyses shows that except for the employees, the clustering of areas are the same; two groups of areas that we have Université, Esplanade and Hypercentre in one, and the rest of 14 areas in the other group. Université and Ecole Militaire have shown the opposite results and Contades and Sainte Aurélie have shown the other opposite results.

Besides, the result of dispersions shows that except for the manager class, the dispersion resulted by simulation have had the variations close to the dispersion of real population. As we mentioned before the different behavior of the managers can be because they may have moved more than other classes as the result of segregation repugnance and comfort attraction. This tendency causes that this class be moving more than others. With a less intensity, this is true for the intermediate class as well; but since the population of this class is more in comparison with the one of other classes, they may have already settled in some residences and do not move as fast as managers according to segregation from one side and comfort from other side. The population of employees was very thin; so they may have chosen some residences that were not very different with what could encourage them to give in their initial place to someone else. Finally the graphs (6th chapter, Appendix) show that the workers have moved much; they can have settled in some residences that except for the cause of segregation, no other motivation have been so attractive to leave their initial place. However the population dispersion of this class as to simulation has been the closest that one in real situation.

5.12.6 Comfort and population dispersion

We test the results according to comfort factors. Since we have assumed in the program that each agent evaluate a given cell by its comfort index, we calculate the comfort of each area as the number of cells that convey the comfort data multiplied by the index number of that comfort. For example, for centrality comfort, if we have 30 cells with the index 1 and 15 cells with the index 2 in a given area, the total centrality comfort of this area will be 60 and since we have multiply the number of each comfort by the number of its index, we divide the result by the sigmoid sum of the indices, so the mentioned comfort will be 60 divided by three or 20. The extension of the formula is as below:

$$comfort = \frac{\sum n_i \times i}{\sum i} \quad (11)$$

In which comfort is defined as the total comfort (one of the three comforts of this study) of a given area, n_i is the number of cells conveying a given comfort by a special index (this can refer to one of the three comforts of this research) and i is the index of the mentioned comfort. Here the indices of the centrality and spacious comforts range between [1,8] and the one of technical comfort ranges between [1,7].

The comforts of each area are as below:

	Centrality	Spacious	Technical
"Sainte Aurélie"	5.94	6.03	6.46
"Citadelle"	2.97	3.47	3.21
"cité Rotterdam"	7.08	7.08	7.86
"Contades"	9.50	7.92	10.43
"Ecole militaire"	7.81	7.25	9.00
"Esplanade"	11.72	11.69	13.07
"Gare"	6.81	6.28	8.18
"Halles"	7.42	7.25	8.71
"Hôpital"	2.67	2.39	3.36
"Hypercentre"	14.56	17.06	19.54
"Orangerie"	11.08	8.75	12.04
"Quartier des XV"	2.58	1.86	2.75
"République"	7.89	6.19	8.86
"Sainte Madeleine"	4.31	5.06	5.54
"Saint Guillaume"	6.53	6.50	8.18
"Université"	15.22	11.81	14.54
"Wacken"	0.19	0.19	0.14

The PCA results according to comfort are as below:

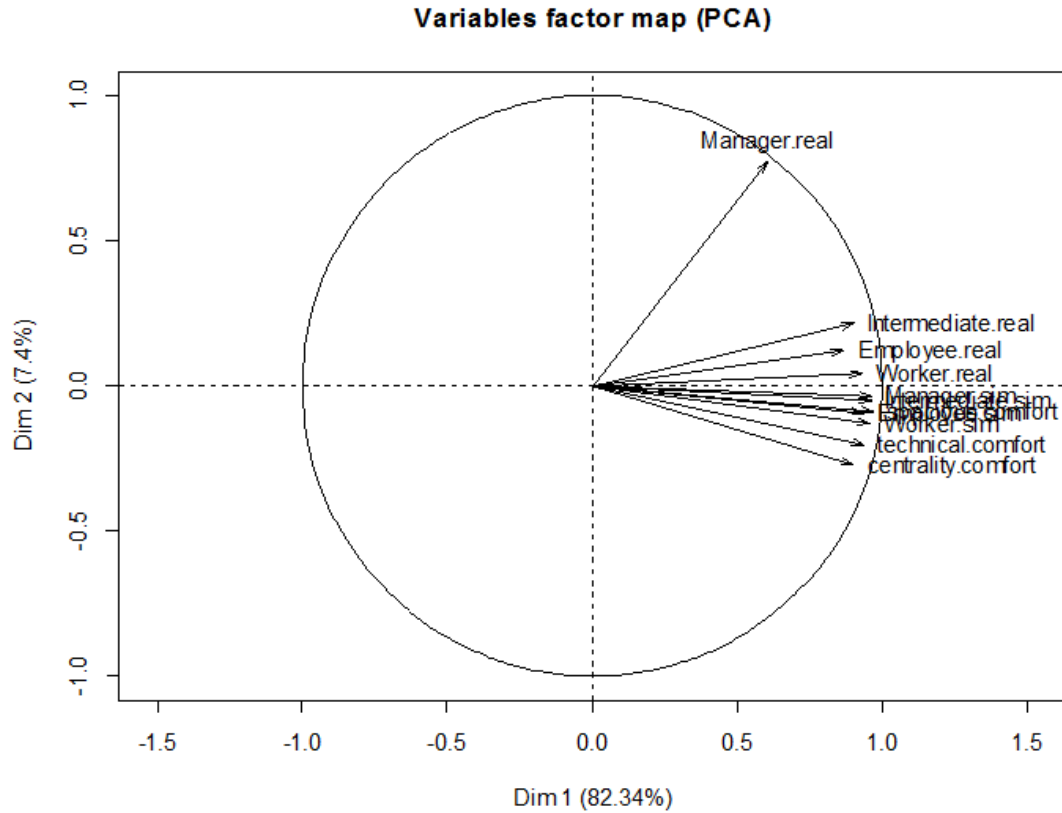

Fig 5.41. F1-F2 Variable factor map of comforts and population dispersion.

As we can see, the two factors cover 89% of variance and the comfort factors are correlated with each other and with the F1 factor, and the spacious comfort is intensely correlated to the F1 factor. So we can say that the first factor describes comfort very much. In a glance at the total comfort of Hypercentre, Université and Esplande, we can now understand why these areas have been clustered differently rather than other 14 areas. The comfort variables in these areas are distinctively more than those of other areas.

5.12.7 Segregation and population dispersion

According to the formula that we have extended for segregation, we have tested the results according to segregation. The outputs are as below:

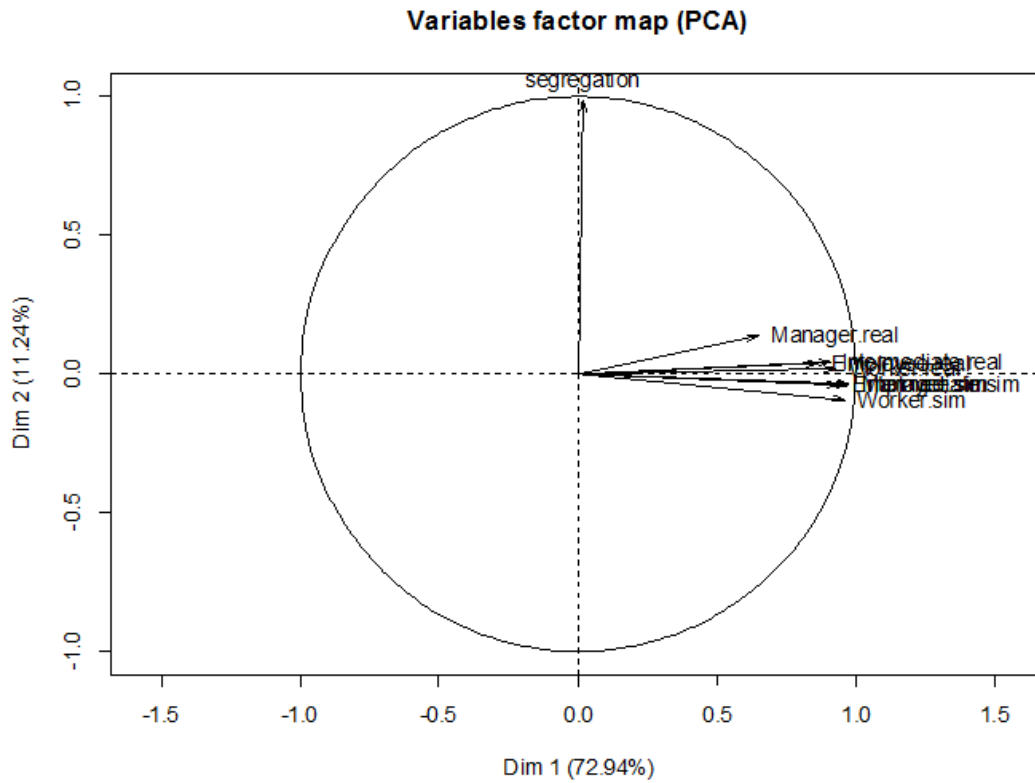

Fig 5.42. Variable factor map of segregation and population dispersion.

What is amazing here is the high concordance between the segregation and the F2 factor. As the F1 factor mostly describes the variation of population in reality and as to simulation, the F2 factor stands in a high distinctive independence according to F1. There is a ‘homogeneity’ in the city and the calculated segregation has no meanings with this part of Strasbourg population.

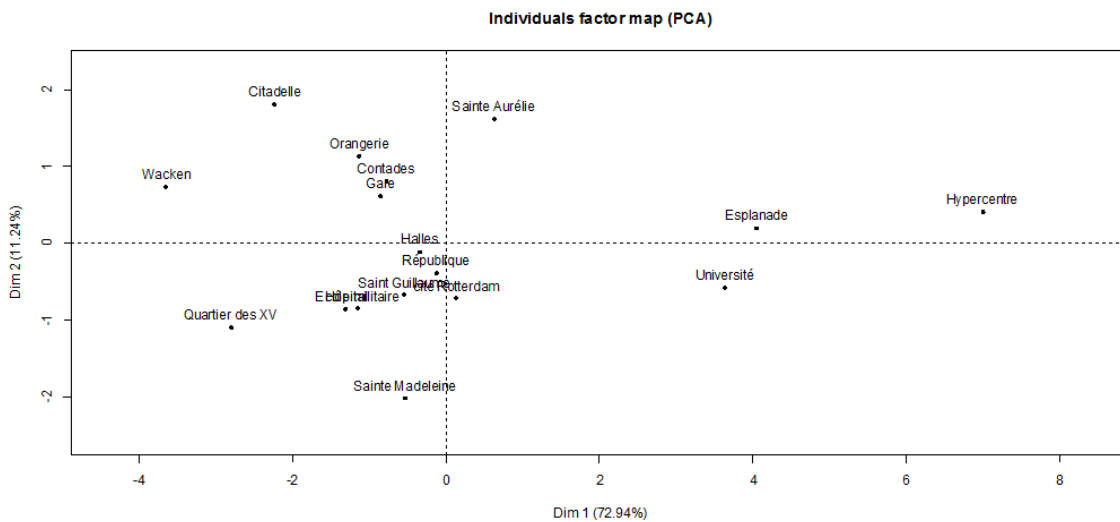

Fig 5.43. F1-F2 factor map of areas according to segregation and population dispersion.

The area like Sainte Aurélie seems to have behaved just according to this factor and Sainte Madeleine in opposite manner according to F2 factor. Citadelle , Orangerie, Contades and Gare have behaved positively according to segregation and negatively to the divergent population dispersion.

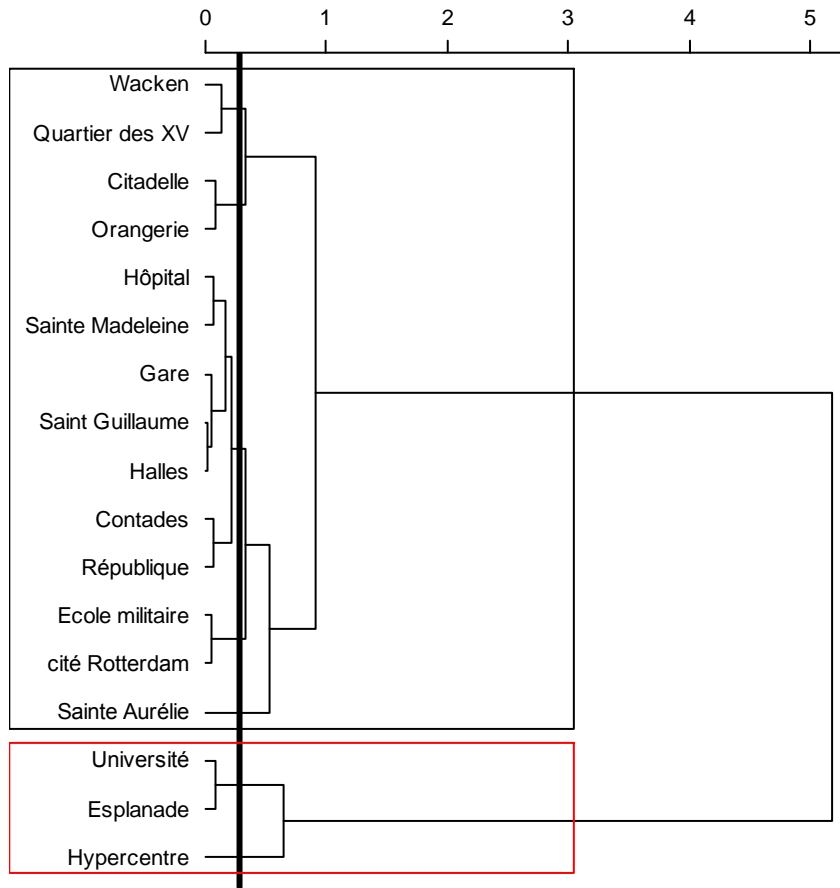

Fig 5.44. Hierarchical clustering of areas.

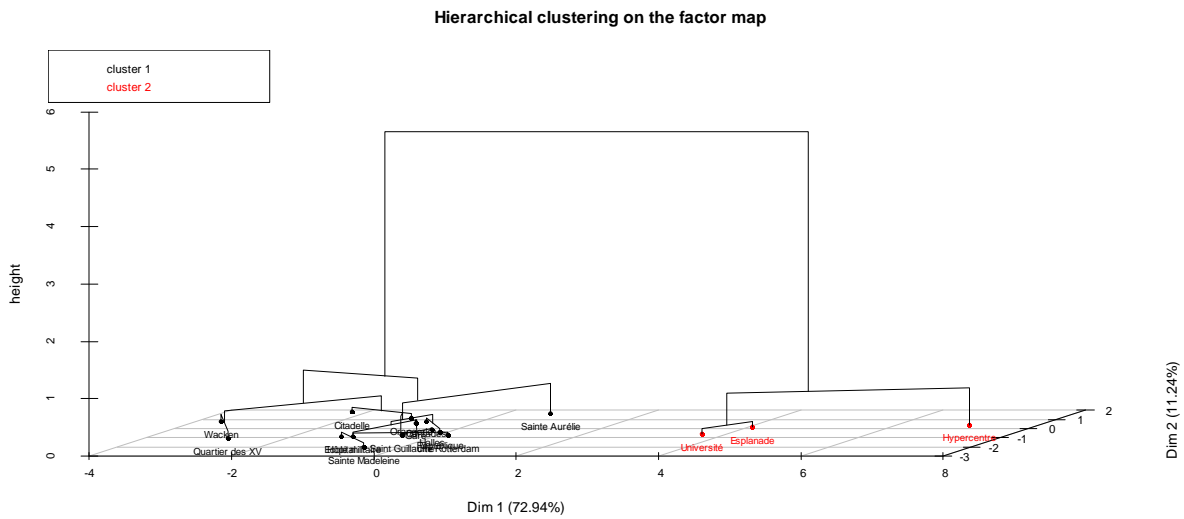

Fig 5.45. Hierarchical clustering on the factor map of areas.

The clustering keeps out three areas (Université, Esplanade and Hypercentre) in a distinction to others like Wacken and Quartier des XV.

We take another output according to the total segregation and the segregation of each class as below:

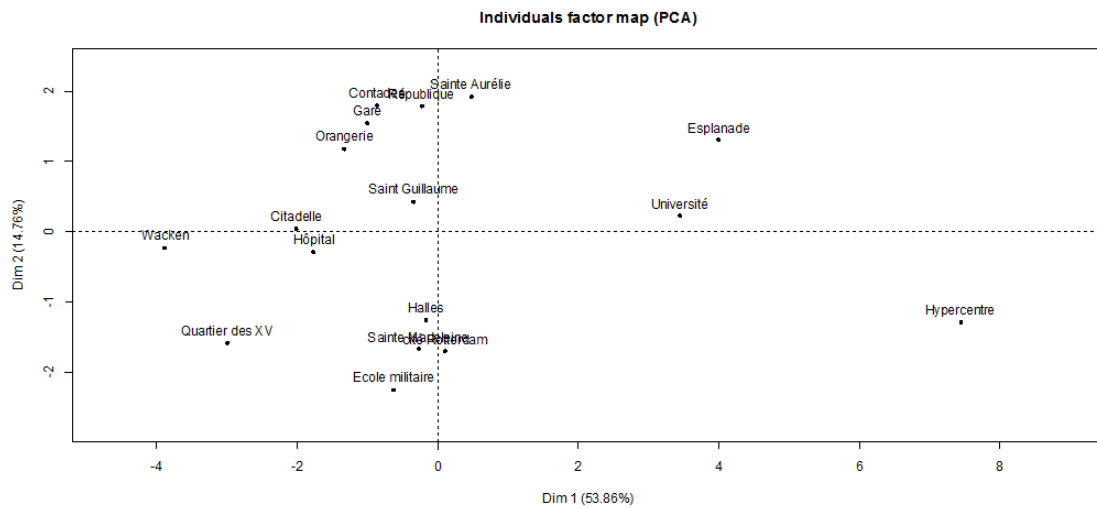

Fig 5.46. F1-F2 factor map of areas according to segregation and population dispersion.

Here the scattering of the areas according the F2 factor has become more distinctive. Sainte Aurélie, Contades, République, Contades, Gare and Orangerie have shown positive signal to segregation and Ecole Militaire, Saint Guillaume, Cité Rotterdam and Ecole Militaire did it negatively. Since the F1 and F2 factors covers almost 67% of variables, we take the third factor as well. The F1-F2, F1-F3 and F2-F3 variable factor maps are as below:

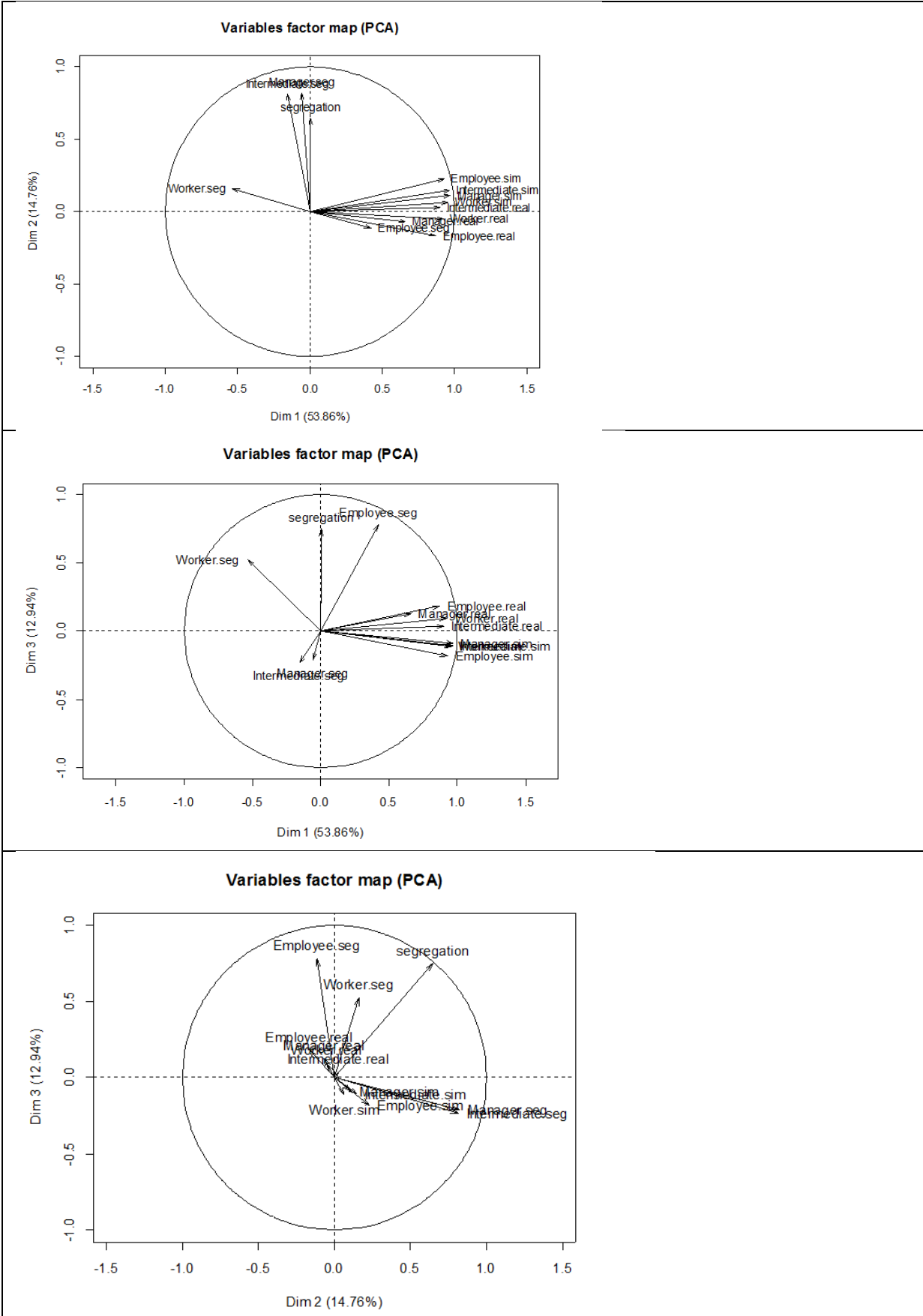

Fig 5.47. F1-F2 Variable factor map of segregation and population dispersion.
 Fig 5.48. F1-F3 Variable factor map of segregation and population dispersion.
 Fig 5.49. F2-F3 Variable factor map of segregation and population dispersion.

The result is very interesting. According to F1-F2 map,

1) **The most impact on the segregation seems to be of the segregation of managers and intermediates despite the fact that the managers have not been the most populous.**

2) **It is interesting that the segregation stands almost independent of segregation of workers and**

3) **more surprising result is the opposition of the segregation of worker class and employee class. The two closest classes in terms of wages have shown the most opposite behavior in segregation; this means almost anywhere that we may observe the segregation of worker class, we will not observe that of employees. If there is a "seclusion" of workers, the employees are widely dispersed and on the other side, a segregation of employees stands opposite to the ocean of workers! A possible interpretation is to say that employees feel to be a different population and they escape the workers.**

Since the contribution of employees' segregation to the F1-F2 factor map is weak, we test the F1-F3 and F2-F3 factor maps in order to see whether the projection of this variable on other factors is more or not. As it is shown in the F1-F3 factor map, the segregation has a very strong contribution to the F3(+) factor as well and its contribution to this factor seems to be almost the same as the contribution to F2(+) factor. This means segregation is not only independent from F1 but belongs to other sociological factors. Here we see that the segregation of workers and employees which were opposed on the F1-F2 factors are now merely independent. Here the managers and intermediates stand in opposite side of segregation of employees and also in opposite to the segregation factor; however their contribution to the F1(-)-F3(-) map is not very high. Although the employees had a tendency to be in a contrasted segregation than that of the workers, the managers and intermediates show some opposition in segregation of employees.

In a glance at the F2-F3 factor map, we get that the total segregation settle between the F2(+) and F3(+) factor. The runs of the program and especially the segregation of the two upper classes and the actual population have contributed the most to the F2 factor and the intense segregation of the two lower classes have contributed to the F3 factor. We can say that the F2 factor stands for the segregation of upper classes that has relation to the population dispersion as to simulation while the F3 factor stands for the segregation of lower classes that show a behavior that is close to the behavior of actual population dispersion. So the upper classes show a tendency to be segregated in simulation and the lower ones tend to be segregated in reality.

In a glance at the two factors, we can perceive that the first factor has covered mostly the results of areas and results of the program that have variegated population dispersion like that of Hypercentre, Université and Esplanade. The second and third factor describes the segregation. This is apparent that the more an area is segregated the less it will be variegated; but some interesting distinction is asserted between the segregation of higher classes and that one of lower classes. The higher classes have more tendencies to aggregate in an "**absolute segregation**" and this is not an issue for the lower ones. Another interesting point is the opposition of segregation of two closest lower classes. It is stated that these two classes have shown opposite tendencies against segregation. The employees running after their social ascent want to be separated from the workers. The workers suffer a "**relative segregation**" by selective mobility of employees.

In the next factor map we test the most important factors of our model together: the segregation and comforts.

5.12.8 Comfort and Segregation in population dispersion

Finally we take the PCA results that monitor the relation between comfort, segregation and population dispersion. The result is as below:

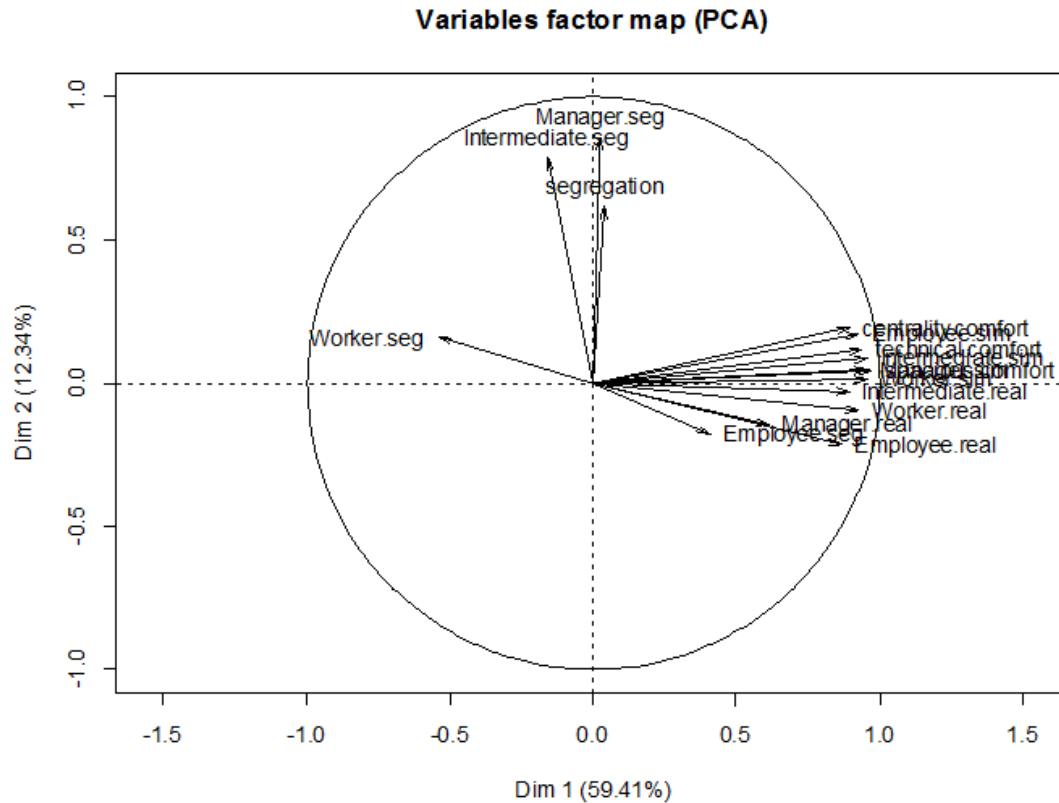

Fig 5.50. F1-F2 Variable factor map of comforts, segregation and population dispersion.

Here, the comfort factor is highly correlated to the F1 factor and the segregation has kept its intense correlation with the F2 factor. Both the real and simulated population dispersion are highly correlated to the F1 factor and we can say that in reality the population have acted a little according to F2(-) factor and in simulation to some extent according to F2(+) factor.

The test of our initial hypotheses verifies that:

H1: The results show that the model has acted close to the variation that exists in the population dispersion. The comparison between the population in real and simulation dispersion can help to observe the behavior of classes of population and that can be evidenced for the spatial areas of Strasbourg.

H2: The population dispersion has followed, to a great extent, the comfort factors as the criteria for choosing residences.

H3: Although we have not defined special segregation rules in the model, the segregation appears in the results and it shows independent behavior according to the choice of residence.

H4: The renewal, valorization and desegregation of a given area can be realized by elevating the comfort levels, and the segregation of an area cannot be a great issue *a priori*.

6 General conclusion and future works

6.1 Theory review and discussion

Here we try to outline the research reported in the previous chapters of the project. The project implies the development of the city in general, and the application of complex system in modeling the interaction of city and its residents in particular. Moreover, the attempt to model the city as a system that transforms to a new situation in a process of feed-back and feed-forward has been the axis of the present study. The interaction between the city and its habitant and the feed-back and feed-forward transformation is pursued in the framework of urban renewal. Two sides of our model have been consisted of spatial characteristics of city and social aspect of urban renewal which in our project gentrification, segregation and residential mobility were mostly discussed. Residential mobility and segregation are modeled as two constituents of gentrification and the model proceeded as the residents settled in or left some residences; they choose some residence according to its level of comfort or leave because of segregation in their neighborhood or because of looking for better occasions.

We have applied the hybrid model of Cellular Automata and Multi Agent System for embracing two aspects of city such as residences and residents. The cells in Cellular Automata convey layers of data which reflect the comfort factors of residences and the agents in Multi Agent System delegate the potential residences who are supposed to choose some cells as their residence. The hybrid model supports the affectability of a given agent from its neighboring cells; in this dissertation we have reflected the impact of segregation as the impact of neighbors.

According to our scenario, the agents move in the city and choose some cell as their residence. For choosing a cell, they assess its comfort factors according to the data that lie in the cell. They choose the cell as their residence and settle there. Two factors may provoke a settled agent to move and search again; segregation and existence of better situations. The first one is a repulsive force and the latter one motivates the resident to seek for some better residence.

For realizing the model we have introduced models that generally have passed through a history of simplification and reduction to more complex systems and also the models have tended to apply the bottom-up models that arise from the behavior of basic elements of a system rather than the top-down approach that pursues the results of some early and high level planning. The Research on the behavior of the system and its ingredients and the process of making, calibrating and validating the model has made the storyline from the first chapter till the fifth one, and the research on how to make the model work more precisely and how to make it re-applicable in some other situations along with the interests and limits of applying this model will be presented in this final chapter.

For launching the model we have chosen Strasbourg as a city that has experienced different sorts of urban renewal. Urban renewal has been used as an attempt to enhance the living area according to the situation of the buildings and structures; however the approaches and the results have been different in different time sections and different contexts. For explaining the connotation of urban renewal, we have chosen to elucidate the term in general in the first chapter and in local usage in the fifth chapter.

With respect to the policies and the real situations, we have tried to make our model in a way that it can provide us with several scenarios that can describe the present situation of the city. The model functions on the basis of rules that are inferred from the studies of urban development and the mechanisms that have led the development with respect to human behavior.

6.2 Main points of model and results

In the last chapter, the spatial repartition of the comfort has been applied for defining the attributes of the cells in Cellular Automata and the agents delegate the population of Strasbourg that seek for choosing a residence.

According to the guidelines for defining the rules like the 'apple law' or 'parsimony principle' the cells that are granted with high degree of comfort act like the magnets that attract the roaming agents. The population disperses in 17 areas of Strasbourg and in a random walk they reach to cells which delegate spatial units of the city. The individuals are granted with different rates of power according to their social class; so it is assumed that if there is some better occasion that is declared to all individuals or if the occasion of the present neighborhood is not in a favorite situation, those who are encouraged to leave their initial residence will be mostly of upper classes and also it is assumed that beside the solvency that is necessary for someone to reach to a favorite situation, the individuals have different preferences in choosing their residence; so if some occasion may nudge some individual of some class to possess that residence, that preference may not be the same for individuals of some other class. We have suggested two sides of configuration according to the extent to which comfort matters: the first one gives weight to each comfort factor and is under the control of programmer and launcher of the model in three sliders that are adjustable on the interface of the program. The second one is the preference of agents for choosing the comfort factors. This one is configurable by three sliders as well. The two sides, comfort weights and comfort preferences, are formulized as probabilities in which the sum of probabilities of each group is 1.

The first generation of cells settle according to the factors that fulfill their desires; according to the update of the program, the next generations decide to look for some comfort-privileged cells proportionate to their preference and to the weight of comforts, or decide to leave their initial residence according to the segregation that may exist in their neighboring cells; they can be tolerant or intolerant against the segregation. The tolerance against segregation is adjustable by the sliders of the program as well. According to the most adjacent neighbors that a given cell may have in a Moore neighborhood (8 neighbors), the tolerance is adjustable between 1 and 8. The planner can test different configuration of the mentioned sliders to observe the results and according to the observation decide upon, discuss on or feed-forward some new configuration according to prospective policies.

We have configured the program as the middle tolerance against segregation, middle importance of comfort factors and middle preference of agents against each one of comfort factors. With these configurations, we launched the model for 10000 time steps of the program and we repeated this for 50 times. Apart from the observation of churning of program and testing different configurations, we have attempted to test the outputs of the program.

The population dispersion as the result of the model and comparing it with the real population dispersion has validated the results. Since there has not been restrict rules for agents like the rules of deterministic models, the dispersion of population as the result of simulation and that one in reality seem close in some areas. We have validated the results in two ways: first by comparing the simulated population dispersion in each area with the real population dispersion via line graphs (appendix, graphs) and second by clustering the results of simulation from one side and the areas from other side via Principal Component Analysis. The comparison of the population dispersion in the two situations shows that the best results have been respectively for the workers, employees, intermediates and the managers. What has Principal Component Analysis confirmed was that the result of simulation (average of 50 runs for each class in each area) was close to reality of population dispersion in the same order as the line graphs; but the acceptable results were not in the same mode in each run of the program. The most convergent results of 50 runs of the program were respectively those of intermediate, of managers, workers and finally that of employees. The results of runs of employees were distinctively more divergent in comparison to the results of other groups. The first factor in comparing the runs has been the comfort. The most interesting result was the intensive concordance of segregation to the second factor. This means that the results for a given area can be correlated to comfort as F1 factor or correlated to segregation of that area as F2 factor. Since we have compared the population dispersion in real and simulation, the population have shown tendency to choose their residents according to comfort rather than segregation. They have acted in

a high correlation to the F1 factor or the comfort factor and almost independent to the F2 factor or the segregation factor. One of the interesting result was the intense correlation between segregation of managers and intermediates to the total segregation of a given area and the independence of segregation of workers and employees with the total segregation of areas. So for new configuration of rules, we should consider this fact. Although it was not targeted initially, the segregation in this step has been intensely correlated to the segregation of upper classes; what is observed in entrance of higher classes after renovation or rehabilitation. Since we had chosen the sixth step of the cycle of gentrification according to Lidia Diappi, the result does not conform to the concomitance of segregation and provision of comfortable residences.

6.3 Interests, limits and optimization of model

Our model functions as an analytical tool to examine and evaluate the impact of rules or factors that provide the bases of urban development. Since the transition rules are flexible, planners or decision-makers are able to test various planning options in order to answer to 'what if' questions. The model provides an operative tool that at the same time that helps to understanding the process, it makes possible to control urban development in a generative process. As described in construction, launching and validation the results of the model, the model has shown the capability to depict the relations between the factors in a generative process. According to the most correlated factors, we can change the configuration of the model or change the equation that is assumed between the variables. In a proper parameterization of the variables, we will be able to observe the results according to different configurations or compare the final results with some verified data. The changing variables are tractable via the monitors of the program and the results will be extractable via the export command of the program.

Another advantage of the program is the competence that it gives to the modeler to proceed in an empirical or heuristic method. Like the case of our program, the initial assumption for the segregation of classes of population has appeared different with what the results of Principal Component Analysis has asserted. (We had assumed that the provision of comfort will be in intense correlation with segregation of some special class in the neighborhood, but the model showed that it has been confirmed that it had been independent to segregation and the population dispersion has behaved according the comfort factor and not according to the segregation one.) So, apart from the entry that it can put forward for further queries on the basis of observations, the configuration of the model and the most relevant factors can get subject to changes.

There may be some mistakes in observing the events in the way that in some cases that the events are just coincident, maybe one interfere that they are in a causal relations. The correlations may be causal or just coincidence of events, but the positive point of the model will be its capability to change the correlated events in an interchangeable manner; for example if in the reality there is some relation between the demography of a neighborhood and the urban actions there will be the possibility to observe the changing of one side by changing the other side, what is rarely possible in a tough statistical approach.

The limits of the model go back firstly to the substance of complex models or Multi Agent Systems. Although the attempt of these approaches is to generate a process rather than just relying on cross-section depiction of events, the myriad of interactions between the elements or ingredients of system generates a black box that is not demonstrable in whole details. Of course the monitors of the program let us track the changes that we desire to follow, but if the number of monitors augment excessively, finding the relation between the monitored variables generate a new kind of complexity that stands in contradiction to the aim of usage of descriptive models. So finding the most relevant variables and factors can help to overcome this problem. This can be attained to some extent by experience and to some extent, according to Prof. Mercier (1975), by choosing the best inputs and outputs for calculating an actual state of the system (Mercier, 1975).

The second limit of our program is that since the tendency of people may differ in different time sections, different ages or different spaces, the rules are not determined the exact imitation of residents' behavior and even Torrens (2004) calls his Multi Agent simulation as a hedonistic method of generating gentrification. Here, the transitions apply uniformly to all cells and agents over the whole area. The categorization of process and change

of local and global factors underpinning urban renewal can help to make the model proper for describing a reality despite the non-deterministic characteristic of the model.

The third limit is the lack of data. Surmounting this one demands that the data for former, present and future residence be provided on the basis of classes of population. If it exists, we could not reach to this type of data, besides reflecting the class of population, ethno groups, etc in censuses is an issue according to different countries. For example in the US, 67 racial classes were counted in the census according to *Federal directive Race and Ethnic Standard for Federal Statistics and Administration Reporting –1977* but there exist some limits for taking to account the social groups as ethnic groups in France. The different classification of population should be considered in feeding the data to the model. Here, we have used four socio-economic classes of population because as we have discussed in the first chapter, the segregation between the socio-economic classes is more intense than that of for example ethnic ones. So in a different context, if the observations show some other tendencies in cohabitation of different classes of population, we should take it into account.

The fourth limit is that we have tested our model just for one time section, so we have not reached to one of the targets of this approach which is the capability to predict the future development. By testing the model for the three time sections, 1967, 1982, 1990 (and if there exists more recent data according to census) that we have the data, we can test the model and reduce its deviations and make it prepared for predicting the future.

The fifth limit of the present model goes back to test of concrete comfort according to the accessible data. The other part of comfort that roots in the aspirations of individuals is not applied in this research; those aspiration that are incarnated in enhancing the comfort in a residence without obligation to move, and those who may go back to the characteristics of the living area that may keep someone attached to his or her initial residence. Again here the census can help to estimate the number of people who are looking for new living area or new residences and those who may prefer or obliged to rest.

We are testing the model and at the same time try to develop and to enhance it. The experience of different approaches or different models can enrich our knowledge of upsides and downsides of the present model and can help to reduce or increase the number of relevant factors.

6.3.1 A possible improvement of the model

The attempt is at the same time that we keep our distance from a deterministic model, we try to make the results closer to reality in order to be able to benefit from the capability of model in predicting the future. In this project, we have studied two forces that matter in residential mobility; absorbing comforts and repulsive segregation. Apart from the reforms in defining the rules, the validation of the model in three time sections that we have their data can help to make the model more precise.

One of the targets of modeling in complex system is to model an unpredictable phenomenon in a non-deterministic manner. As a matter of fact we have a few alternative rules instead of hundred questions and there is no possibility that we can model the reality, but there are some attempts to correspond the simulated models to a realistic image of real situations. In the future, our model will go under some precision in the last part in order that it becomes more reliable by making the two situations close to each other. For making our model more realistic, we will try to make the time steps of the program and that of real word correspond to each other.

As time passes, the first item that may be prone to be changed will be the demography. The formulations that exist for calculation of population consider the important factors like migrations, births, deaths and etc. In this research, the population is assumed to be constant and there has not been any migration to or from outside of the area of research.

The second items that may change while time passes are the spatial attributes. They can be reflected in new situation of urban spaces according to development of the city. As we have discussed, the development of city is a two-sided process. From one side the bottom-up interactions of individuals of the city can lead the city to a specific direction and from other side the top-down decisions by planners can help to this orientation. At this step, just the existing situation of the city has been the subject of the research and at the time of churning the program we have not exerted any development in the spatial attributes.

The timescale and spatial units can be chosen as the representatives of the time and space of real world. In this study the spatial units are chosen, according to the research of Gerber, close to blocks of the city. However the time is not chosen as the counterpart of real world time because the program has still been under preliminary tests. In the future, with the same spatial units as the present ones, we can develop the model through three time sections, 1967, 1982 and 1990, which we have their databases, in order to benefit from the prediction capability of model for next years.

We have presented some approaches in the third chapter that help to solving the complex problems; they can be applied independently or as a complement to some programs. The main purpose is to make the model train itself in order that at the same time that it is non-deterministic, it can make the agents and targets reach each other more precisely.

6.3.2 Reconceptualization of problem

Modeling the phenomena and processes are prevailing in varied fields of science and the common procedure in models is transferring some concepts and rules from one field of science to other fields and observing the proceeding process according to the rules. The initial attempt of the bottom-up approach in urban modeling is to present an alternative to the top-down model. In the present study, some place is anticipated for what a planning procedure does as a top-down reality. When we develop our understanding of urban system, we may perceive intuitively that the public policies may anticipate the impact of, for example, the renewal on the value of a neighborhood and looking for financial supports, the policy-makers may seek to replace some existing state with some prospective state; for reaching to this aim, according to O'Sullivan (2000), we feel a conscious attempt to accelerate the development of complex city neighborhoods in a desirable direction (O'Sullivan, 2000). The model has the potentiality to combine the bottom-up and top-down processes in order to describe what occurs at the level of agents and the one that occurs at the level of planners. Beside the role that a planner plays in decision according to observation and results of program, feeding new data to the program is the other role of planner. The new data can be the result of decision, action and realization of projects. The projects can embrace the activities in populating or renewal of areas of the city; this is close to top-down approach.

The systems that we have used in this project have depicted the links between the local and global events. The application of Cellular Automat and Multi Agent System, in addition to the capability that it gives to modeler to model the spatial event, makes the modeler able to model the local and global events by exploiting the immobile and mobile agents. The properties of the cells in Cellular Automata are local, the decisions of the cells and their interaction in a given cell is local whereas their impact on updating the program and the new state of the program is global and the global updated system again is reflected in the local decisions of the agents.

The process of renewal can occur at the level of individual buildings, but affects the whole neighborhood. Some of the mutual and recursive impacts are implemented by the program. This package of program has the capability to be adjusted and show the different results according to different configurations. According to our initial assumption, there is some correlation between the comfort and the demography of people who live in a neighborhood. The results of Principle Component Analysis has verified to some extent the fact by showing the correlation that exists between the real population dispersion and the population that has been dispersed according to the rules; the rules were defined in a way that the individuals tried to reach to some high-quality residences. According to renewal, the classes of population may become subject to change. The classes of

population may choose a new residence or rest in their present residence according to the comforts that we have presented in this research or according to some other aspirations; The comforts or aspirations may be fulfilled for some part of population or not for some other part. The increase in comfort can be controlled to some degree by protective policies that may extenuate or attenuate the cyclical influence between renewal and population.

What has occurred in reality of population dispersion shows the correlation between the concrete comfort factors and the population dispersion; that can be applied for calibrating the behaviors of agents according to the rate of correlation in each area. The other side that goes back to the discreet comfort can be followed by the interviews or questionnaires with the residents and those can be applied for introducing other significant factors to the model and in proportion with the significance of the correlations, the weights for the two sides can be determined; the one for the residences and the one for residents' preferences.

In this study, the impact of one side that includes the urban space on social groups is shown, but the impact of inhabitants on changing the comfort factors is not studied. We can apply the feedbacks emitted by the concentration of social groups in a neighborhood and proceed in a system approach in which the ingredients of the system can change the behavior of the system.

Here we dispose a system that let us observe prevailing occurrences and decide upon the actual and targeted situation. Profiting from studies that ascribe some correlations like the one between population dispersion and the condition of comfort in a given area, first we can assess the actual situation and then by pursuing several scenarios, choose and discuss on the one that seems mostly respond to the targeted situation.

6.3.3 Future concepts

The correlation between comfort and the number of residences that go under renovation and the emergence of gentrification can be studied in future. The depreciating buildings that accommodate population of lower classes can trigger the first stage of gentrification. The emergence of higher classes after renovation may trigger the price augmentations. But the number of these two populations may not be the same as one can expect that after reaching to a given threshold, gentrification take place. Here in this study, we have perceived that the correlation between the segregation of upper classes and the total segregation of areas was much more intense than the one between the segregation of lower classes and the total segregation. In the same way, the starting point of depreciation or gentrification of an area can be queried by measuring some events at these times. Some correlated procedures that show the symptom of stigmatization of neighborhood like: the unfavorable state of buildings, deprivation, vandalism, escaping the investments or on the other side, the procedures that show the symptom of gentrification like: renovation, luxury shops, augmentation in rents can evidence some clues for studying the tipping point in emergence of gentrification.

On the basis of correlations we can optimize our model, but before this we need to make our model more precise. Our model is non-deterministic one but in such models, we can reduce the loss of energy that the roaming agents consume for reaching to haphazard targets. In another word we can introduce the targets more precisely to the agents and this does not make our model deterministic. Application of some methods like Bayesian method, Neural Network, Genetic Algorithm or fuzzy setting can eventually enhance the model efficiency and this preliminary promotion can prepare the model for two-sided effects. We will show how our model can be better by applying Neural Network, and Fuzzy settings.

First we can apply **Neural Network**:

As it is introduced in the first chapter, Neural Network tries to work like human nervous system in which they can learn and decide on the basis of incomplete, noisy and fuzzy information and recognize a pattern or classify the data by which it can be a good tool for spatial problems (Abrahart & See, 2000).

The Neural Network gets some input data and some output data and according to the deviations in these data, the system trains itself by defining the weights in hidden layers (Almeida & Gleriani, 2005). In this stage of that project that we have modeled the dispersion of the population, the output of the program that is close to the real

population can be considered as 1 and the overpopulated or underpopulated areas as 0. So the program will define the weights according to this correspondence. Several neurons can take the inputs and outputs and hence can process several classes of data. So in the future of the work that the urban spaces are going to be affected by the social groups, the correspondence of social and spatial agents between two time sections can be expected from our program which functions according to Neural Network method.

Then we can use **Fuzzy** sets for setting the model in a way that it can have different behaviors in different parts of the city and in different time steps. This method will be one of the best answers to the need of a heterogeneous system or in our work, the city.

Cells' states are defined as memberships in fuzzy sets while transitions are determined by a fuzzy system that is built according to the transition rules. Since the application of Fuzzy sets is accompanied with the compound conditional phrases, in some situations that the correlation between the factors are high, we can use the operator 'AND' and in situations that the factors are not very correlated we can use operator 'OR'.

Through the integration of Cellular Automata and Multi Agent System with the fuzzy set theory and fuzzy logic controls, the transition rules will be implemented using a number of linguistic variables, such as "choose definitely," "choose more probably" "choose less probably" and so forth. The application of natural language statements makes the modeling process more realistic and transparent.

In our project the agents choose the high qualified cells in stages; as said before to some extent because the program could rest in a state that all agents search for the best occasions and many agents could roam forever, the program introduced each group of high qualified cells in some time steps and then in other time steps it introduced the lower qualified ones. By applying fuzzy settings, the agents can have the capability to decide differently when they confront a unique situation; for example if they reach to a cell that has one high factor, they choose it and do not wait that the program announces new occasions.

6.4 Reapplicability of the model

The hybrid model of Cellular Automata and Multi Agent System that we have presented in this dissertation is constructed, applied and validated for Strasbourg. Future application of this model in other cities will call for feeding the data in form of spatial and social characteristics of the new context, amending the rules on the basis of new correlations, and choosing the proper criteria for comparing the results.

Further application of Multi Agent Systems will contribute to application of agent-based models in urban development and also will provide a media for describing and understanding urban renewal.

Bibliography

- Abrahart, R. J., & See, L. (2000). Comparing neural network and autoregressive moving average techniques for the provision of continuous river flow forecasts in two contrasting catchments. *Hydrological Processes*, 14, 2157-2172.
- Almeida, C. M. D., & Gleriani, J. M. (2005). Cellular Automata and Neural Networks as a modeling framework for the simulation of urban land use change. *Anais XII Simpósio Brasileiro de Sensoriamento Remoto* pp. 3697-3705). Goiânia, Brasil.
- Alterman, R., & Kirschenbaum, A. (1970). *Urban renewal planning in Israel: symposium 1970*: Center for Urban and Regional Studies, Technion Institute for Research & Development.
- Anderson, M. (1964). *The Federal bulldozer: a critical analysis of urban renewal, 1949-1962*: M.I.T. Press.
- Anderson, P. W. (1972). More is different: Broken symmetry and the nature of the hierarchical structure of science. *Science*, 177, 393–396.
- Apostel, L. (1960). Towards the formal study of models in the non-formal sciences. *Synthese*, 12, 125-161.
- Atkinson, R. (2000). Measuring Gentrification and Displacement in Greater London. *Urban Studies*, 37, 149-165.
- Atkinson, R., & Kintrea, K. (1998). Reconstructing excluded communities: the neighbourhood impacts of owner occupation. Edinburgh: Scottish Homes.
- Axelrod, R., & Tesfatsion, Leigh (2006). A guide for newcomers to agent-based modeling in the social sciences. In I. L. T. K. L. J. (Eds.) (Ed.).
- Bacqué, M. H. (2003). Mixité sociale. In J. B. M. Ségaud, J. C. Driant (Ed.), *Dictionnaire de l'habitat et du logement* pp. 297-298). Paris: Colin,.
- Balci, O. (1997). Verification validation and accreditation of simulation models. *Proceedings of the 29th conference on Winter simulation* pp. 135-141). Atlanta, Georgia, United States: IEEE Computer Society.
- Batty, M. (1976). *Urban modelling: algorithms calibrations, predictions*: Cambridge University Press.
- Batty, M. (2007). *Cities and complexity: understanding cities with cellular automata, agent-based models, and fractals*: MIT.
- Batty, M., & Torrens, P. M. (2001). Modeling Complexity : The Limits to Prediction *Cybergeo : European Journal of Geography*. St-Valery-en-Caux.
- Batty, M., Xie, Y., & Sun, Z. (1999). Modeling urban dynamics through GIS-based cellular automata. *Computers, Environment and Urban Systems*, 23, 205-233.
- Benenson, I. (1998). Multi-agent simulations of residential dynamics in the city. *Computers, Environment and Urban Systems*, 22, 25-42.
- Benenson, I., & Torrens, P. M. (2004). *Geosimulation: automata-based modeling of urban phenomena*: John Wiley & Sons.
- Blanc, M. (2010). The Impact of Social Mix Policies in France. *Housing Studies*, 25, 257-272.
- Blanc, M. (2011). Urban Renewal, Demolition and Social Mix in France: Aims & Results. *Enhr Conference Toulouse*.

- Blanc, M., & Bidou-Zachariassen, C. (2010). PARADOXES DE LA MIXITÉ SOCIALE. *Espaces et Sociétés, La gentrification urbaine*, 140-141, 7-20.
- Bonneville, M. (2005). The ambiguity of urban renewal in France: Between continuity and rupture. *Journal of Housing and the Built Environment*, 20, 229-242.
- Broudehoux, A.-M. (1994). *Neighborhood Regeneration in Beijing: An Overview Of Projects Implemented in the Inner City Since 1990*. McGill University
- Minimum Cost Housing Group (<http://www.mcgill.ca/mchg>).
- Brunet, R., Ferras, R., & Théry, H. (1993). *Les mots de la géographie: dictionnaire critique*: RECLUS.
- Busino, G., Valade, B., Honorez, I., Jacquemet, N., & Miéville, A. (1998). *La valeur de la sociologie: les travaux de Raymond Boudon*: Librairie Droz.
- Caldwell, J., & Ram, Y. M. (1999). *Mathematical modelling: concepts and case studies*: Kluwer Academic.
- Campo, P. C. (2003). *MULTI-AGENT SYSTEMS MODELING INTEGRATING GEOGRAPHIC INFORMATION SYSTEMS AND REMOTE SENSING*. College of Engineering University of the Philippines.
- Carter, H. (1995). *The study of urban geography*. Edward Arnold.
- Castells, M. (1973). *Luttes urbaines*: François Maspéro.
- Castells, M. (1975). *Luttes urbaines et pouvoir politique*: F. Maspero.
- Cauvin, C., & Reymond, H. (1984). *Espaces cognitifs et transformations graphiques. Les conditions de la comparaison des espaces cognitifs : de la carte aux configurations. Exemples de l'espace urbain strasbourgeois*. Strasbourg.
- Chapin, F. S. a. W., S. F. (1962b). Land development patterns and growth alternatives. In Eds. F. S. Chapin and S. F. Weiss (Ed.), *Urban growth dynamics in a regional cluster of cities* pp. 425–458). New York: John Wiley.
- Chorley, R. J., & Haggett, P. (1967). *Models in geography*. Methuen; distributed in the U.S.A. by Barnes & Noble.
- Chorley, R. J., & Kennedy, B. A. (1971). *Physical geography: a systems approach*: Prentice-Hall.
- Cilliers, P. (1998). *Complexity and postmodernism: understanding complex systems*: Routledge.
- Cirinà, M. (1978). Calibration of a Mathematical Model for Urban Planning. *The Journal of the Operational Research Society*, 29, 565-575.
- Clay, P. L. (1979). *Neighborhood renewal: middle-class resettlement and incumbent upgrading in American neighborhoods*: Lexington Books.
- Coing, H. (1966). *Rénovation urbaine et changement social*. Paris Les Éditions ouvrières.
- Colborn, F. M. (1963). *The neighborhood and urban renewal*. National Federation of Settlements and Neighborhood Centers: New York.
- Collins, W. (2009). Collins English Dictionary - Complete & Unabridged 10th Edition. In HarperCollins & Publishers (Eds.).
- Collins, W. J., & Shester, K. L. (October 2009). Slum Clearance and Urban Renewal in the United States, 1949–1974 *Economic History Workshop*. Cambridge, MA.

- Cottureau, A. (1978). La tuberculose à Paris, 1882-1914 : maladie urbaine ou maladie de l'usure au travail ? . *Sociologie du travail*, 192-225.
- Couch, C. (1990). *Urban renewal: theory and practice*: Macmillan Education.
- Coveney, P., & Highfield, R. (1996). *Frontiers of complexity: the search for order in a chaotic world*: Random House Publishing Group.
- Czerkauer, C., & Frankhauser, P. (2010). A Multi-Scale (Multi-Fractal) Approach for a Systemic Planning Strategy from a Regional to an Architectural Scale., *REAL CORP 2010*. Vienne : Autriche
- Diappi, L., & Bolchi, P. (2008). Smith's rent gap theory and local real estate dynamics: A multi-agent model. *Computers, Environment and Urban Systems*, 32, 6-18.
- Dictionary.reference.
- DIV (2005). La mobilité résidentielle des habitants des ZUS entre 1990 et 1999. pp. 116-153). l'Observatoire national des zones urbaines sensibles (ONZUS).
- Dormois, R., Pinson, G., & Reignier, H. (2005). Path-dependency in public-private partnership in French urban renewal. *Journal of Housing and the Built Environment*, 20, 243-256.
- Edgar, B., Doherty, J., & Meert, H. (2004). *Immigration And Homelessness In Europe*: Policy Press.
- Encyclopedia Britannica (2008). Encyclopedia Britannica Online.
- Epstein, D. (2007). *Mobilité quotidienne et localisation résidentielle: quelles pratiques de déplacement? L'exemple de l'agglomération Strasbourgeoise*. Université Louis Pasteur Strasbourg.
- Fairbanks, R. B. (2012). The Housing Act of 1954 and the war against slums in the southeastern United States. *15th International Planning History Society Conference*.
- Ford, K., & Wheeler, J. A. (2010). *Geons, Black Holes, and Quantum Foam: A Life in Physics*: W. W. Norton.
- Foret, C., & Porchet, F. (2001). *La réhabilitation urbaine: Dossier documentaire*: La Documentation Française.
- Freeman, L. (2006). *There Goes the Hood: Views of Gentrification from the Ground Up*: Temple University Press.
- Freytag, T. (2010). Déjà-vu: tourist practices of repeat visitors in the city of Paris. *Soc. Geogr.*, 5, 49-58.
- Frieden, B. J. (1964). *The Future of Old Neighborhoods*.
- Gerard, B. (2011). The evolution of social diversity, the challenges of urban renewal of housing estates in the strasbourg agglomeration. *Géographie, Économie, Société*, 13, 69-92.
- Gerber, P. (2000). *Gentrification et confort postmoderne elements émergents de nouvelle centralité* Université de Strasbourg, Strasbourg.
- Giddens, A. (1987). *La constitution de la société: éléments de la théorie de la structuration*: Presses Universitaires de France.
- Gilbert, J. K. (2011). Models and Modeling:Cognitive Tools for Scientific Enquiry. *International Journal of Science Education*, 6.
- Gilbert, N., & Troitzsch, K. G. (2005). *Simulation for the Social Scientist*: McGraw-Hill.

- Gladwell, M. (2006). *The Tipping Point: How Little Things Can Make a Big Difference*: Little, Brown.
- Grebler, L. (1964). *Urban renewal in European countries: its emergence and potentials*: University of Pennsylvania Press.
- Hall, T. (1998). Urban geography. In Routledge (Ed.), *Contemporary Human Geography Series*. London: Routledge.
- Hamnett, C. (1991). The blind men and the elephant: the explanation of gentrification. pp. 173–189). *Transactions of the Institute of British Geographers*.
- Harris, C. D., & Conzen, M. P. (1986). *World patterns of modern urban change: essays in honor of Chauncy D. Harris*: University of Chicago, Dept. of Geography.
- Hartman, C. (1979). Displacement: a not so new problem. *Social Policy*.
- Heritage, T. A. (2009). *Dictionary of the English Language*. Houghton Mifflin Company.
- Hill, M. S., Mordechai (1970). The use of quantitative models in urban renewal planning. In R. Alterman & A. Kirschenbaum (Eds.), *Urban renewal planning in Israel: symposium 1970*. Center for Urban and Regional Studies, Technion Institute for Research & Development.
- Holcomb, H. B., & Beauregard, R. A. (1981). *Revitalizing cities*: Association of American Geographers.
- Hoyler, M., Freytag, T., & Mager, C. (2008). Connecting Rhine-Main: The Production of Multi-Scalar Polycentricities through Knowledge-Intensive Business Services. *Regional Studies*, 42, 1095-1111.
- Jacobs, J. (1961). *The death and life of great American cities*: Vintage Books.
- Johnson, J. H. (1972). *Urban geography: an introductory analysis*: Pergamon Press.
- Kauffman, L. (2007). discussion group 18. *CYBCON* (p. 15).
- Kaufmann, V. (2000). *Mobilité quotidienne et dynamiques urbaines: la question du report modal*: Presses Polytechniques et Universitaires Romandes.
- Kilbridge, M. D., O'Block, R. P., Teplitz, P. V., & Research, H. U. G. S. o. B. A. D. o. (1970). *Urban analysis*: Division of Research, Graduate School of Business Administration, Harvard University.
- Kleinhans, R. (2004). Social implications of housing diversification in urban renewal: A review of recent literature. *Journal of Housing and the Built Environment*, 19, 367-390.
- Kleinschmager, R. (1997). *Strasbourg: une ambition européenne*: Diffusion, Economica.
- Kloeckl, K. (2011). Real-time cities: an introduction to urban cybernetics. (p. 84). MIT SENSEable city lab.
- Levy, J.-P. (1987). *Centres villes en mutation*. CNRS.
- Ligtenberg, A., van Lammeren, R. J. A., Bregt, A. K., & Beulens, A. J. M. (2010). Validation of an agent-based model for spatial planning: A role-playing approach. *Computers, Environment and Urban Systems*, 34, 424-434.
- Liu, Y. (2009). *Modelling urban development with geographical information systems and cellular automata*: CRC Press.
- Lowry, I. S., & Corporation, R. (1965). *A short course in model design*: Rand Corp.
- Luger, G. F., & Stubblefield, W. A. (1993). *Artificial intelligence: structures and strategies for complex problem solving*: The Benjamin/Cummings.

- Macal, C. M., & North, M. J. (2009). Agent-based modeling and simulation. *Simulation Conference (WSC), Proceedings of the 2009 Winter* pp. 86-98).
- Mansuy, M., & Marpsat, M. (1994). In C. R. J. BRUN (Ed.), *La ségrégation dans la ville. Éd. , 258 p.* (p. 196). L'Harmattan.
- Manzo, L. C., & Perkins, D. D. (2006). Finding Common Ground: The Importance of Place Attachment to Community Participation and Planning. *Journal of Planning Literature, 20*, 335-350.
- Marcuse, P. (1986). Abandonment, gentrification and displacement: the linkages in New York City In N. S. a. P. WILLIAMS (Ed.), *Gentrification of the City* pp. 153-177). London: Unwin Hyman.
- Marcuse, P., Smith, N., & Williams, P. (1986). *Abandonment, gentrification, and displacement: the linkages in New York City.*
- McCarthy, J. (1974). Some social implications of improvement policy in London Social Research Division, Directorate of Development, Department of the Environment.
- Meadows, P. (1957). Models, system and science. *American Sociological Review, 22*, 3-9.
- Mercier, J.-L. (1975). Équilibre, sensibilité, complexité du milieu naturel : définition et méthode de calcul en région méditerranéenne. In CEGERM (Ed.), *Colloque "Versants en région méditerranéenne"* pp. 183 - 187). Aix en Provence.
- Mercier, J.-L. (1980). Statistiques, Systèmes et modèles en géomorphologie (quantitative techniques in geomorphology). In J. C. Wieber (Ed.), *Journées Géographiques*. Tours: Bull. Assoc. Géogr. Franç., Paris, .
- Merlin, P. (1995). Les techniques de l'urbanisme. *Que sais-je* (p. 127). P.U.F.
- Miller, J. M. (1959). *New life for cities around the world: international handbook on urban renewal:* Books International.
- Morin, E. (1990). *Introduction à la pensée complexe:* ESF.
- Mühll, H. R., Tange, K., & Kultermann, U. (1978). *Kenzo Tange*. Zürich: Verlag für Architektur Artemis.
- Nara, A. (2005). *Simulating inner city gentrification using hybrid models of Cellular Automata and Multi-Agent Systems:* Dept. of Geography, University of Utah.
- Nelson, K. P. (1988). *Gentrification and distressed cities: an assessment of trends in intrametropolitan migration:* University of Wisconsin Press.
- Niazi, M., & Hussain, A. (2011). Agent-based computing from multi-agent systems to agent-based models: a visual survey. *Scientometrics, 89*, 479-499.
- Nilsson, N. J. (1998). *Artificial Intelligence: a new synthesis:* Morgan Kaufmann Publishers.
- Ning Wu, & Silva, E. A. (2010). Artificial Intelligence Solutions for Urban Land Dynamics: A Review. *Journal of Planning Literature, 24*, 246-265.
- Novák, V., Perfilieva, I., & Močkoř, J. (1999). *Mathematical principles of fuzzy logic:* Kluwer Academic.
- O'Brien, J. A., & Marakas, G. M. (2008). *Management information systems:* McGraw-Hill/Irwin.
- O'Sullivan, D. B. (2000). *Graph-based Cellular Automaton Models of Urban Spatial Processes:* University of London.
- Ostrom, E. (2009). A Polycentric Approach for Coping with Climate Change. *SSRN eLibrary*.
- Page, D., & Boughton, R. (1997). *Mixed Tenure Housing Estates* London: Notting Hill Housing Association.

- Page, E. (2012). Model thinking. In T. U. o. Michigan (Ed.). Coursera.
- Palen, J. J., & London, B. (1984). *Gentrification, Displacement, and Neighborhood Revitalization*: State University of New York Press.
- Panait, L., & Luke, S. (2005). Cooperative Multi-Agent Learning: The State of the Art. *Autonomous Agents and Multi-Agent Systems*, 11, 387-434.
- Pancs, R., & Vriend, N. J. (2007). *Journal of Public Economics*, 91, 1–24.
- Paquot, T. (2002). Le Grand ensemble, histoire et devenir. *Revue Urbanisme*, 322-335.
- Poole, D. L., Mackworth, A. K., & Goebel, R. (1998). *Computational intelligence: a logical approach*: Oxford University Press.
- Portugali, J. (2000). *Self-organization and the city*: Springer.
- Pretty, G., Bishop, B., Fisher, A., & Sonn, C. (2006). Psychological sense of community and its relevance to well-being and everyday life in Australia. The Australian Psychological Society Ltd.
- Pumain, D., Paquot, T., & Kleinschmager, R. (2006). *Dictionnaire La ville et l'urbain*: Economica.
- Qinggang, Y. (1988). Integration of Old and New in China's Historical Cities. *Building in China*, 8-15.
- Reymond, H., Cauvin, C., & Kleinschmager, R. (1998). *L'espace géographique des villes: pour une synergie multistrates*: Anthropos.
- Robinson, G. M. (1998). *Methods and techniques in human geography*: J. Wiley.
- Russell, S. J., & Norvig, P. (2003). *Artificial intelligence: a modern approach*: Prentice Hall.
- Russell, S. J., & Norvig, P. (2010). *Artificial Intelligence: A Modern Approach*: Prentice Hall.
- Santiago, A. M. (1975). *Residential rehabilitation--with special reference to Montreal*.
- Seze, C. (1994). Confort moderne. Une nouvelle culture du bien-être. *Série Sciences en société*, 10, 216
- Smith, N. (1987). Gentrification and the rent gap. *Annals of the Association of American Geographers* pp. 462–465).
- Smith, N., & Lefavre, M. (1984). A class analysis of gentrification. In B. L. a. J. Palen (Ed.), *Gentrification, Displacement and Neighbourhood Revitalization* pp. 43-64). Albany, NY: State University of New York Press.
- Sumka, H. J. (1979). Neighborhood Revitalization and Displacement A Review of the Evidence. *Journal of the American Planning Association*, 45, 480-487.
- The American Heritage, N. D. o. C. L. (2005). In H. M. Company (Ed.). Published by Houghton Mifflin Company.
- Thrift, N., & Kitchin, R. (2009). *International Encyclopedia of Human Geography*. Elsevier Science.
- Thunen, J. H. v. (1966). *Isolated state : an English edition of Der isolierte Staat / Translated by Carla M. Wartenberg ; Edited with an introd. by Peter Hall*. Oxford, New York :: Pergamon Press.
- Tyler, T. Cellular Automata.
- Uljee, I., Engelen, G. and White, R. (1996). Ramco Demo Guide. *Workdocument CZM-C 96.08*. Coastal Zone Management Centre, National Institute for Coastal and Marine Management.
- Varady, D. P. (1986). *Neighborhood upgrading: a realistic assessment*. State University of New York Press.

- Verhage, R. (2005). Renewing urban renewal in France, the UK and the Netherlands: Introduction. *Journal of Housing and the Built Environment*, 20, 215-227.
- Vigdor, J. L. (2002). Does Gentrification Harm the Poor? *Brookings-Wharton Papers on Urban Affairs*.
- White, R., & Engelen, G. (1993). Cellular automata and fractal urban form: a cellular modelling approach to the evolution of urban land-use patterns. *Environment and Planning A*, 25, 1175-1199.
- White, R., & Engelen, G. (2000). High-resolution integrated modelling of the spatial dynamics of urban and regional systems. *Computers, Environment and Urban Systems*, 24, 383-400.
- Wilensky, U. (1999). NetLogo, <http://ccl.northwestern.edu/netlogo/>, Center for Connected Learning and Computer-Based Modeling. Evanston, IL.: Northwestern University.
- Wolfram, S. (2002). *A new kind of science*: Wolfram Media.
- Wu, F. (1996). A linguistic cellular automata simulation approach for sustainable land development in a fast growing region. *Computers, Environment and Urban Systems*, 20, 367-387.
- Xie, Y. (1994). *Analytical Models and Algorithms for Cellular Urban Dynamics*: State University of New York at Buffalo.
- Xie, Y. (1996). A Generalized Model for Cellular Urban Dynamics. *Geographical Analysis*, 28, 350-373.
- Zadeh, L. A. (1965). Fuzzy sets. *Information and Control*, 8, 338-353.
- Zhuyuan, L. (1989). A Study of the Structure and Functions of the Local Residents Organization in China's Urban Society. *China City Planning Review*, 39-45.

Appendix

Graphs

The X axis in the graphs depicts 17 studied areas in Strasbourg. The Y axis represents the output of agents dispersion in the areas and the real population dispersion in the areas. The real total population is 53.16 times bigger than the population in the model or the number of agents (37216 to 700).

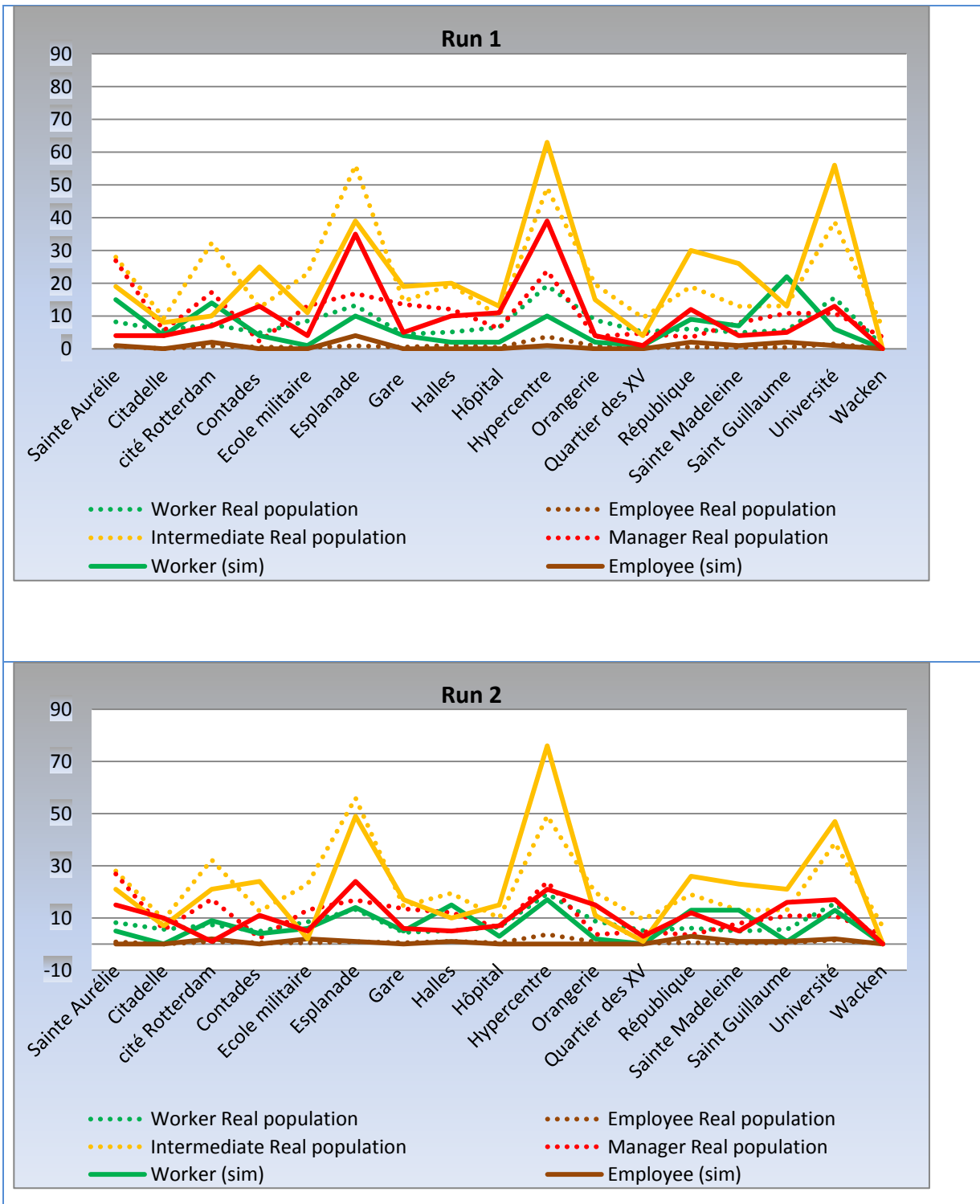

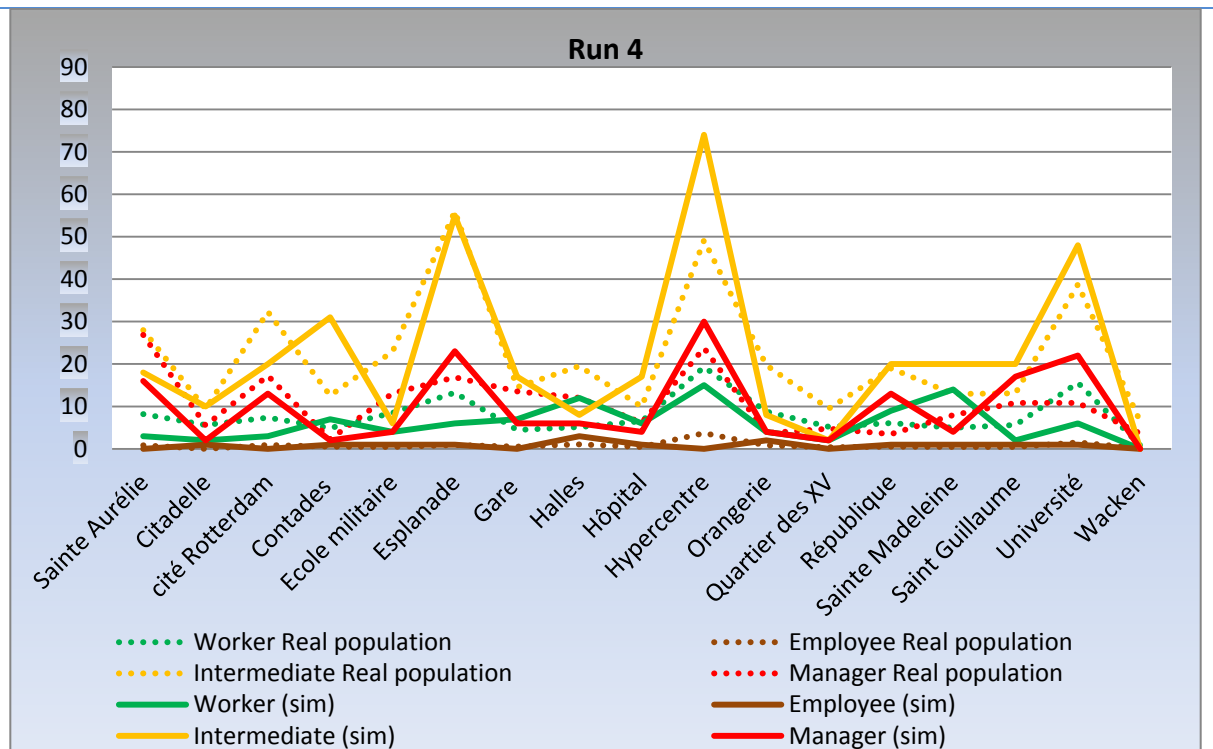
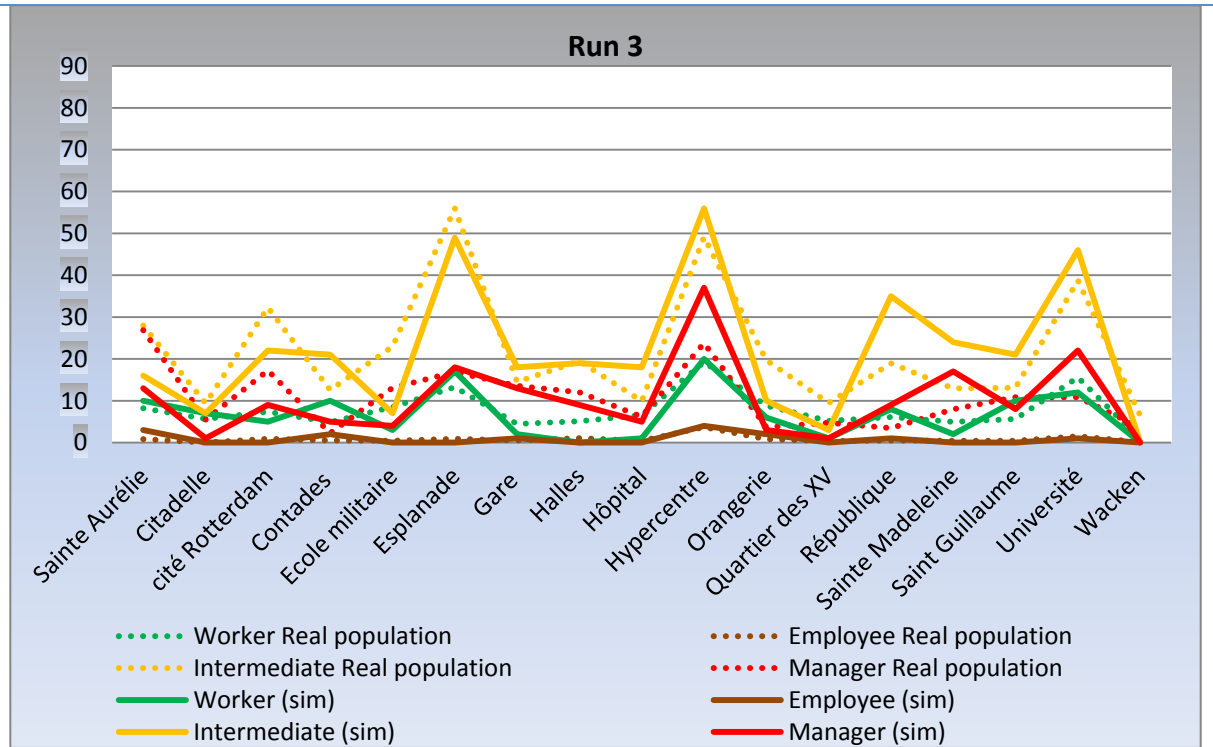

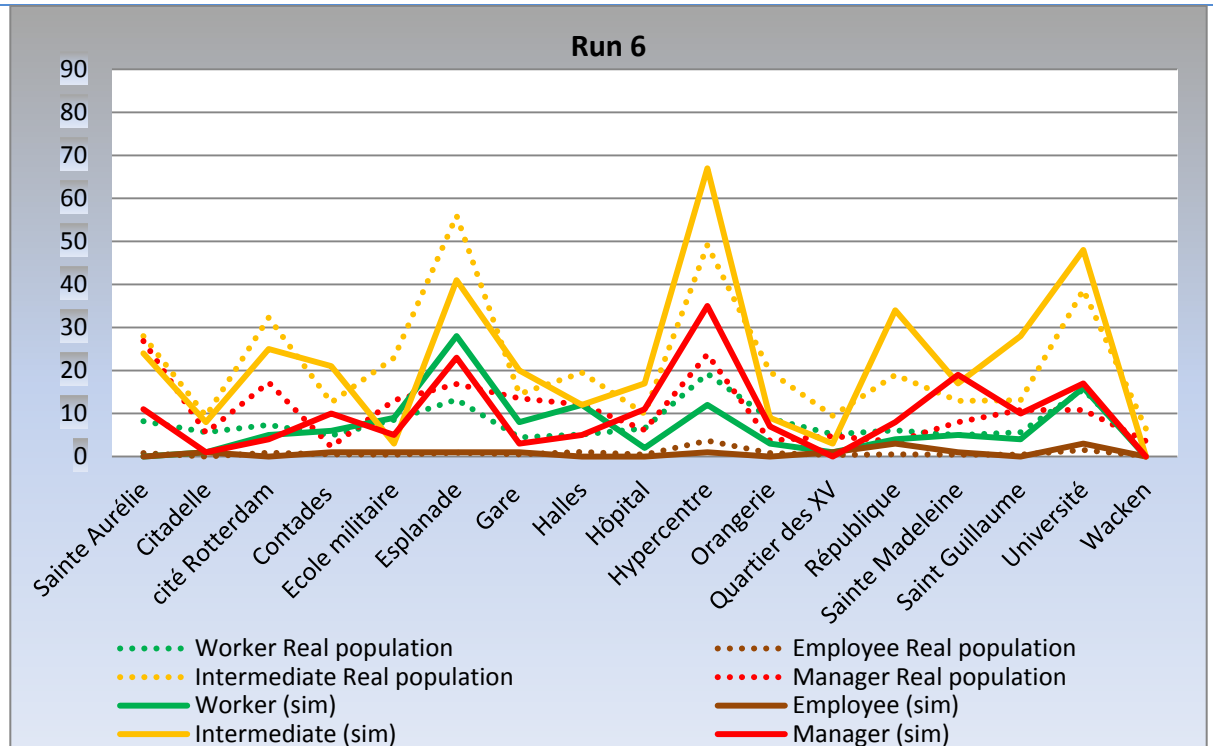
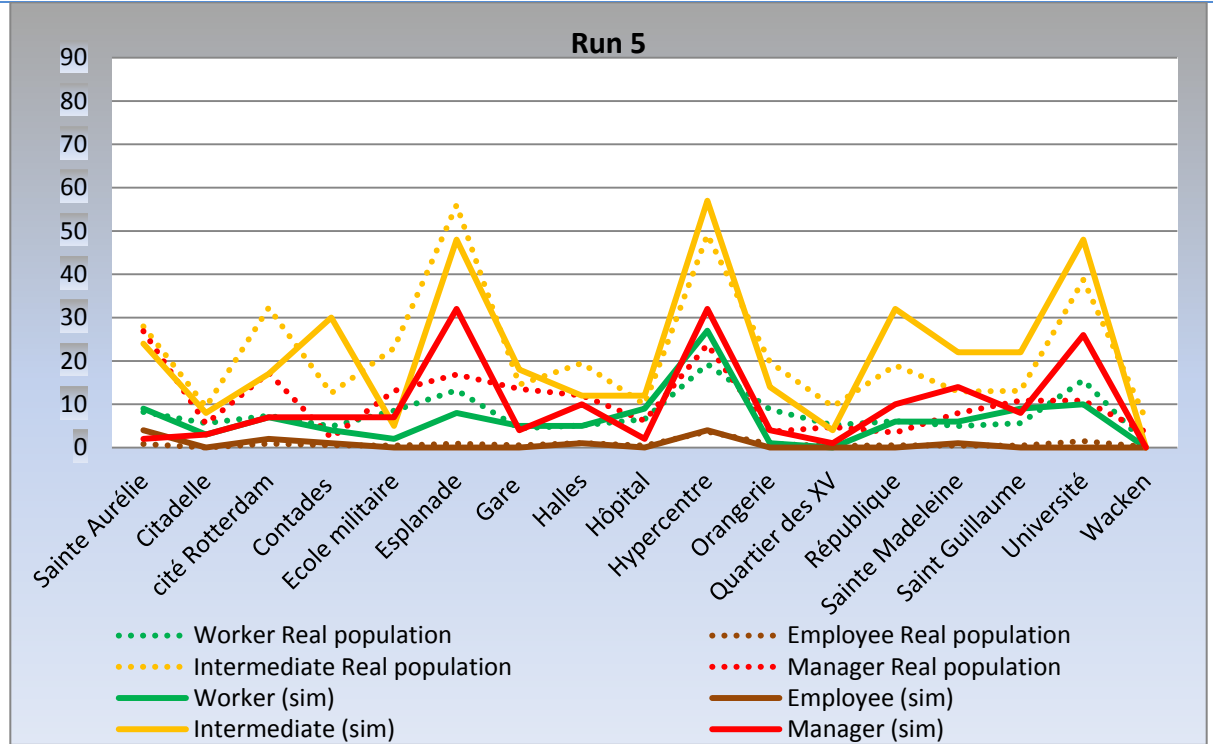

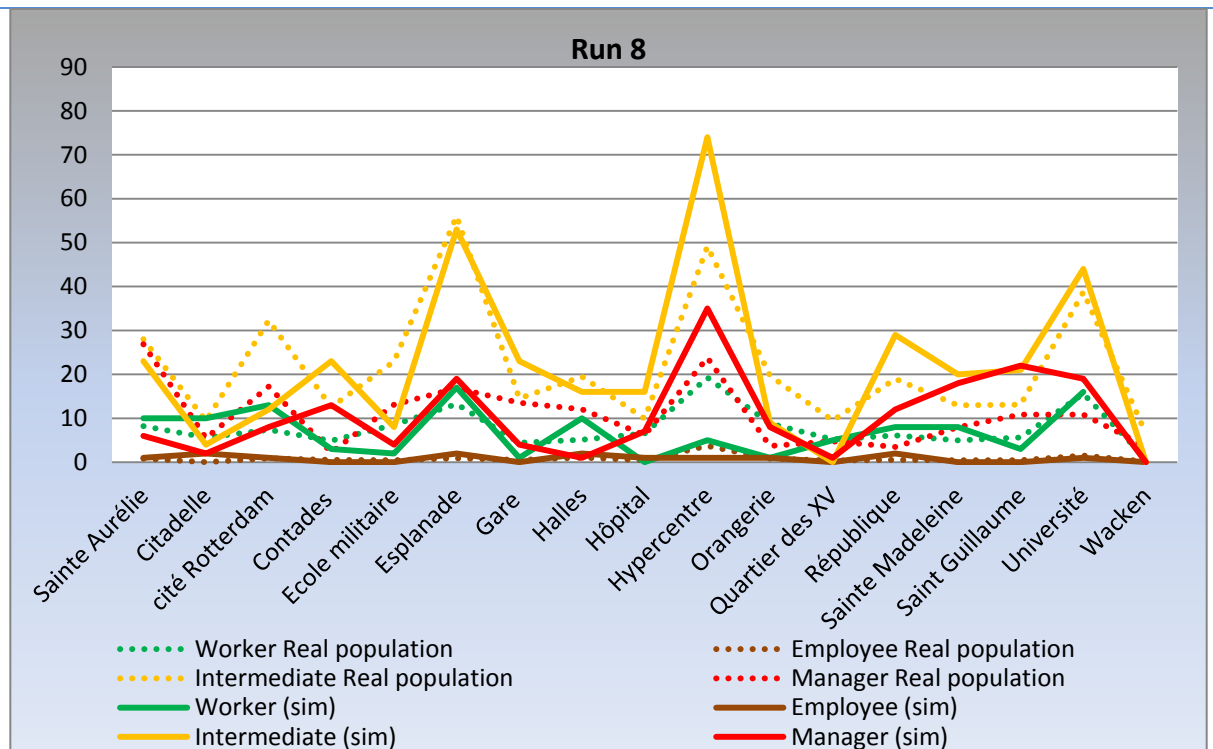
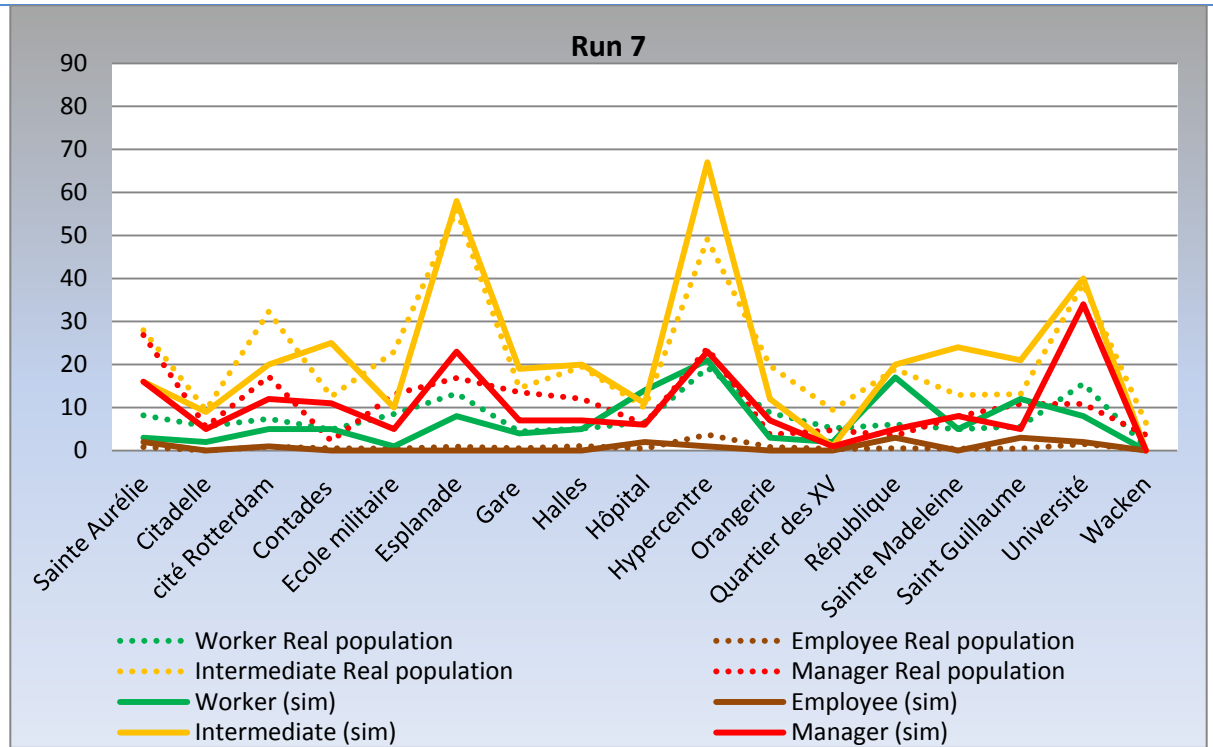

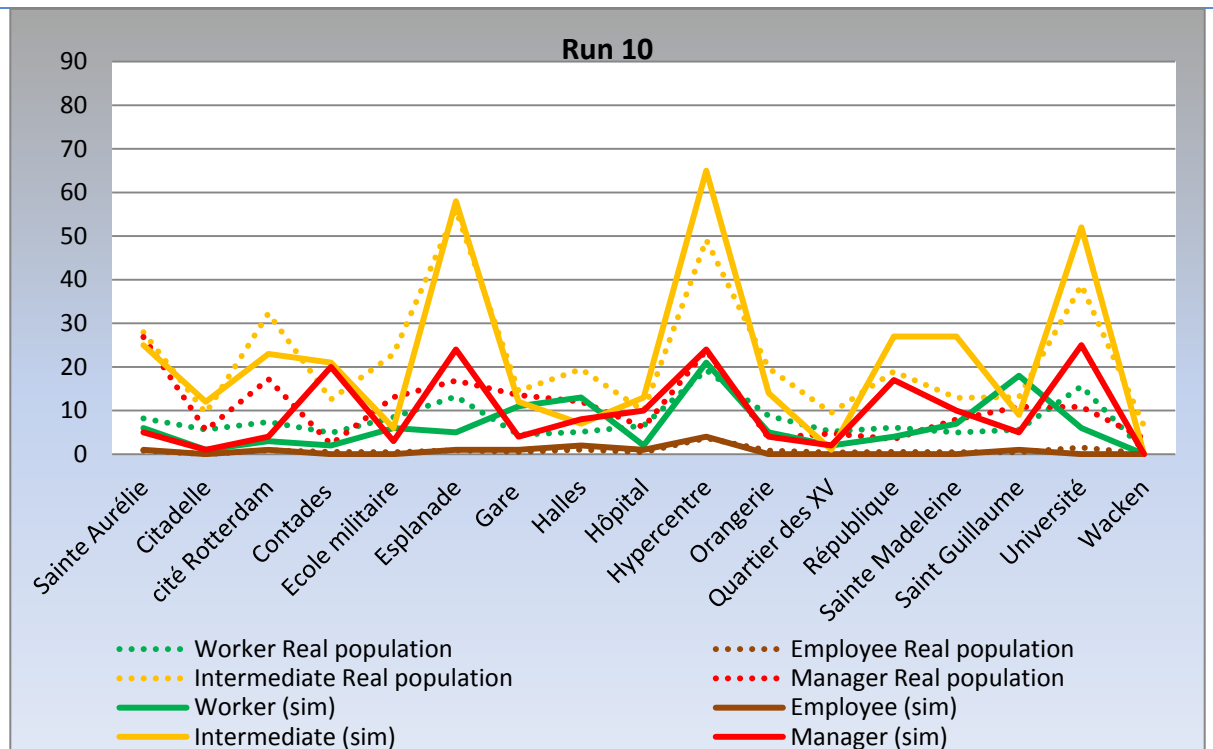
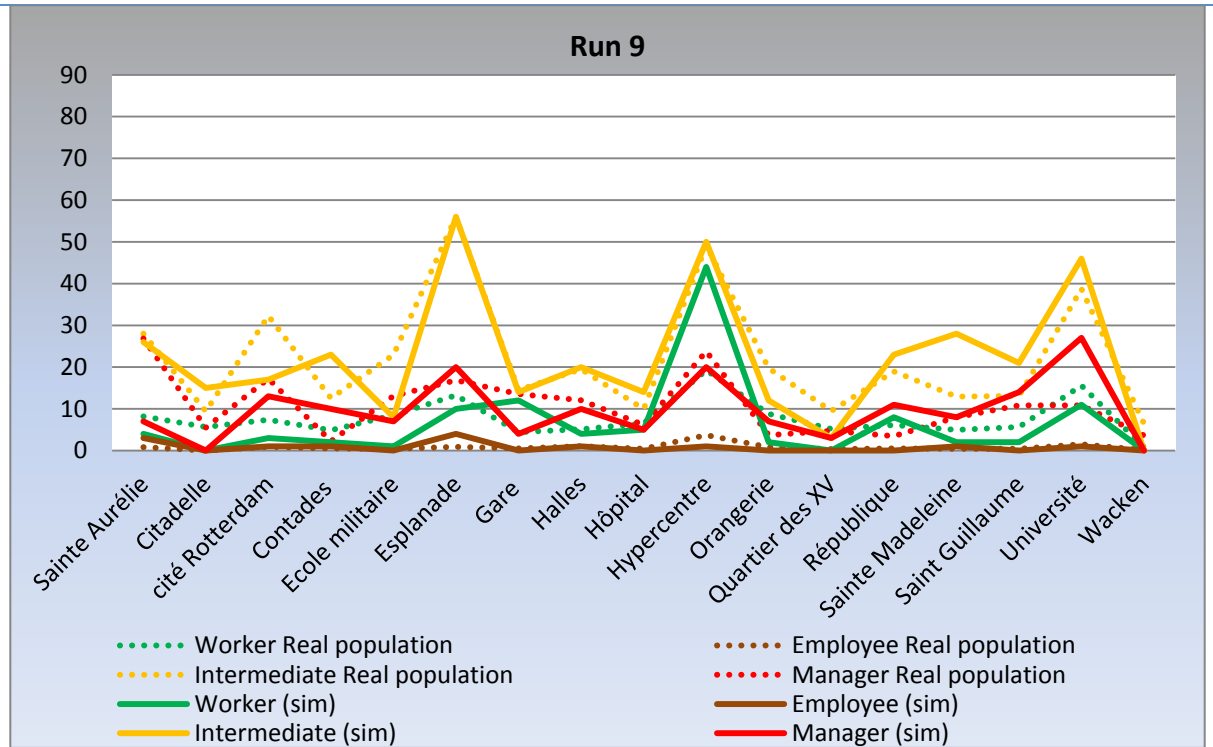

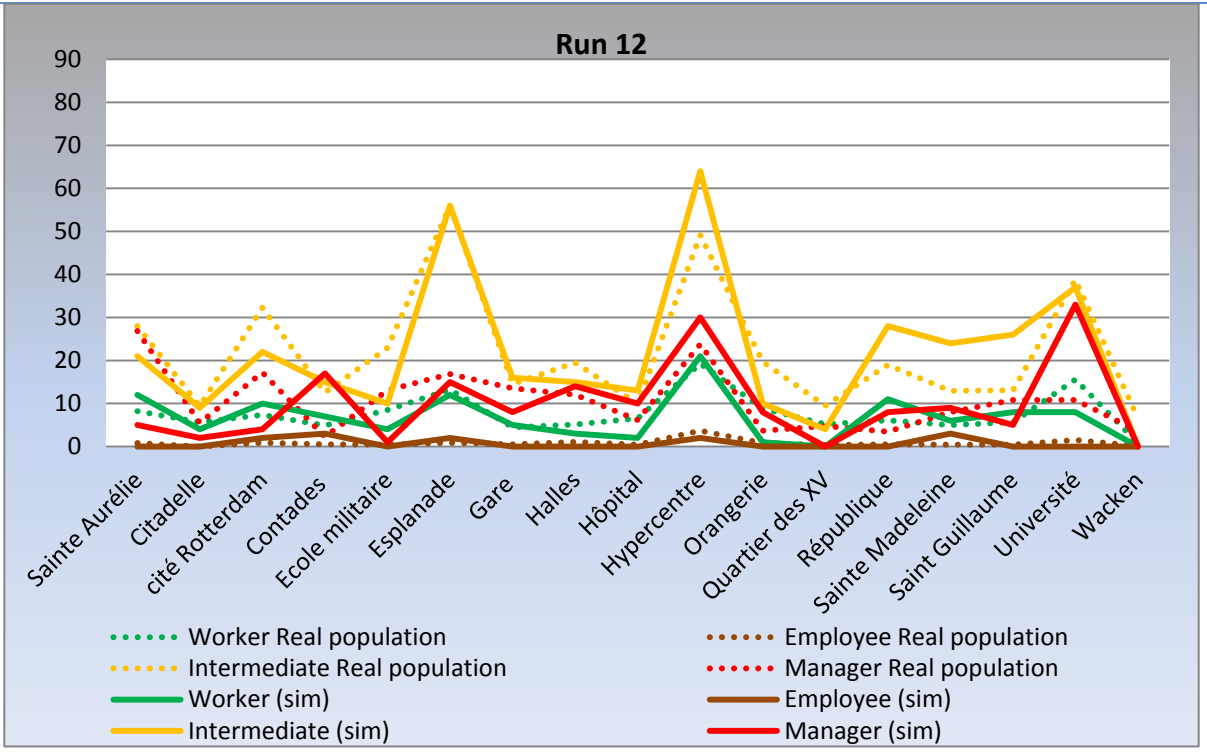
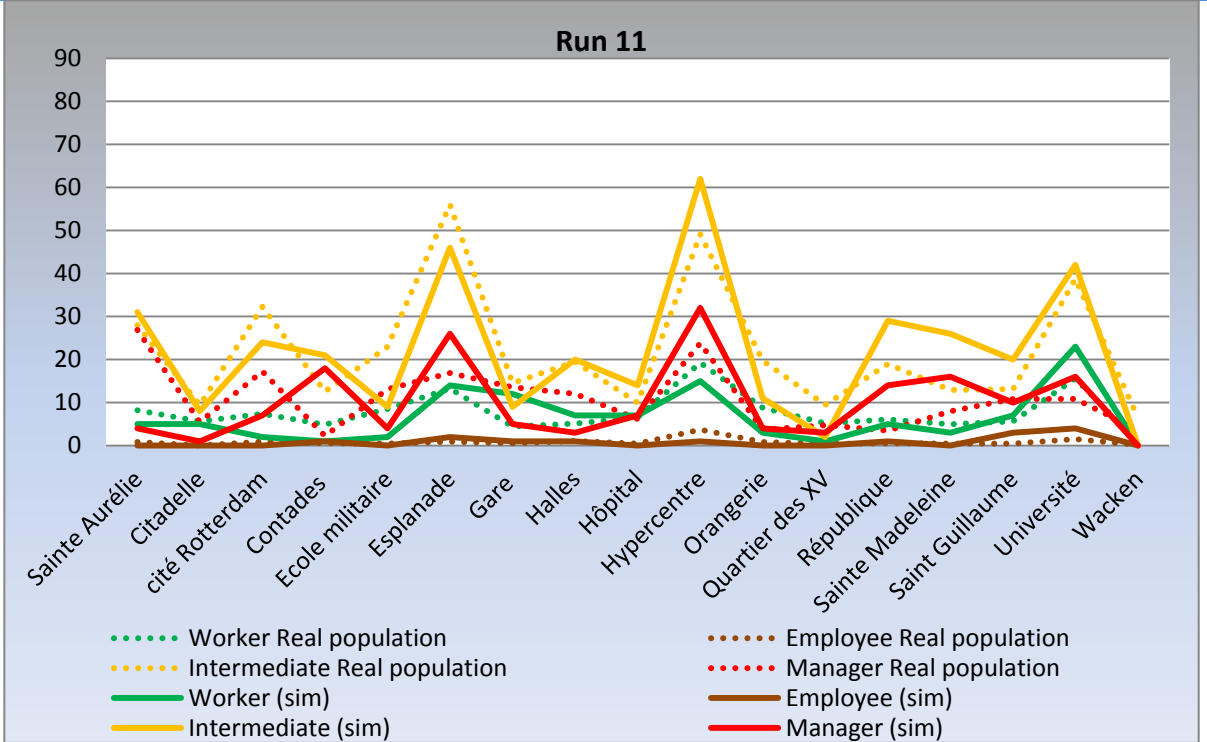

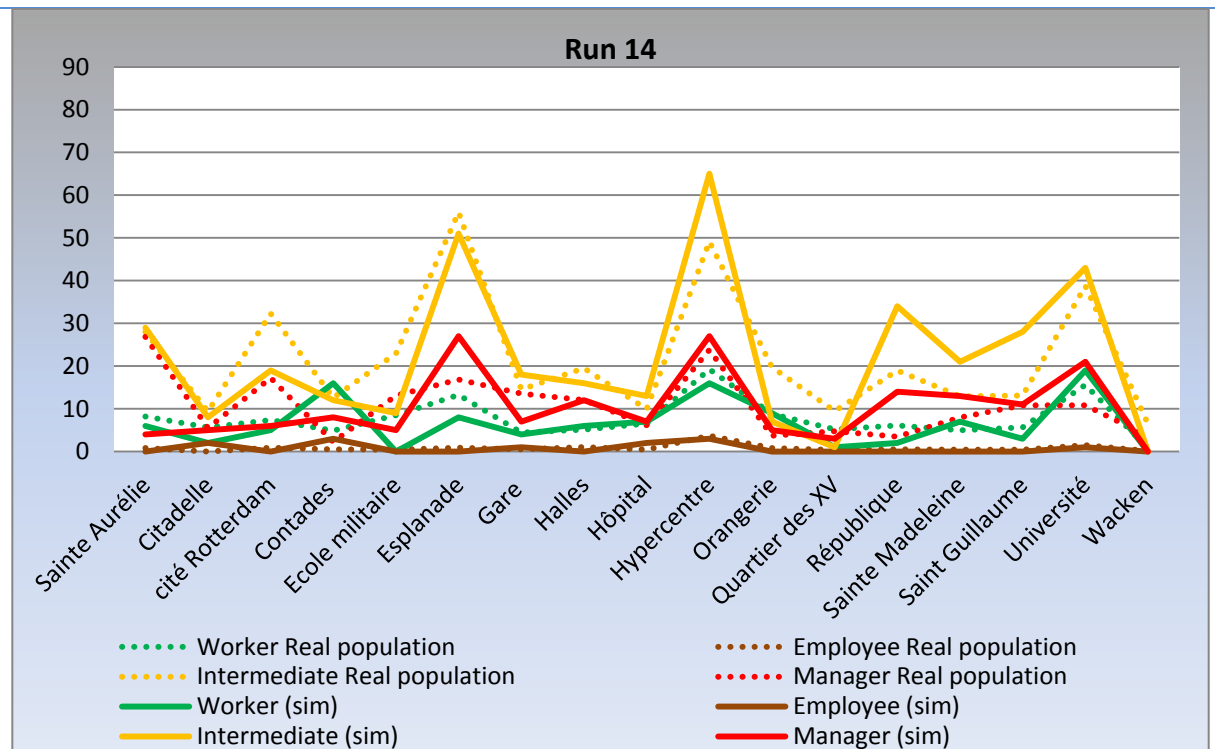
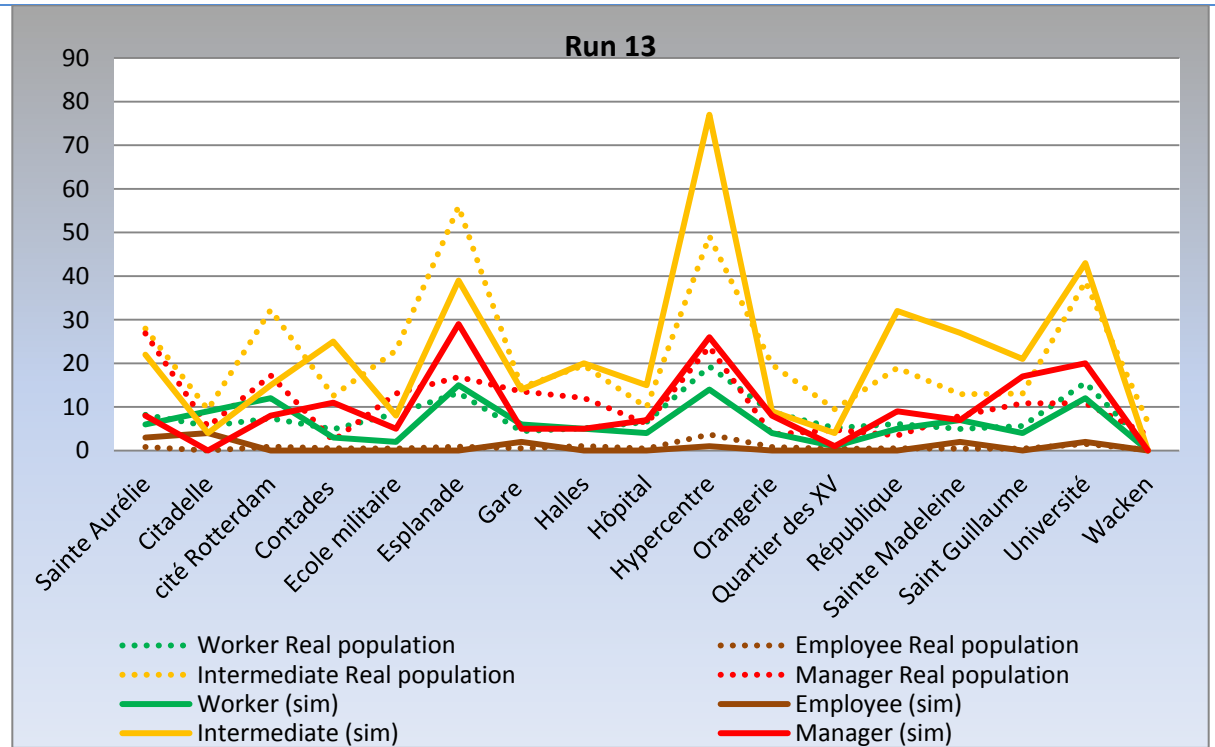

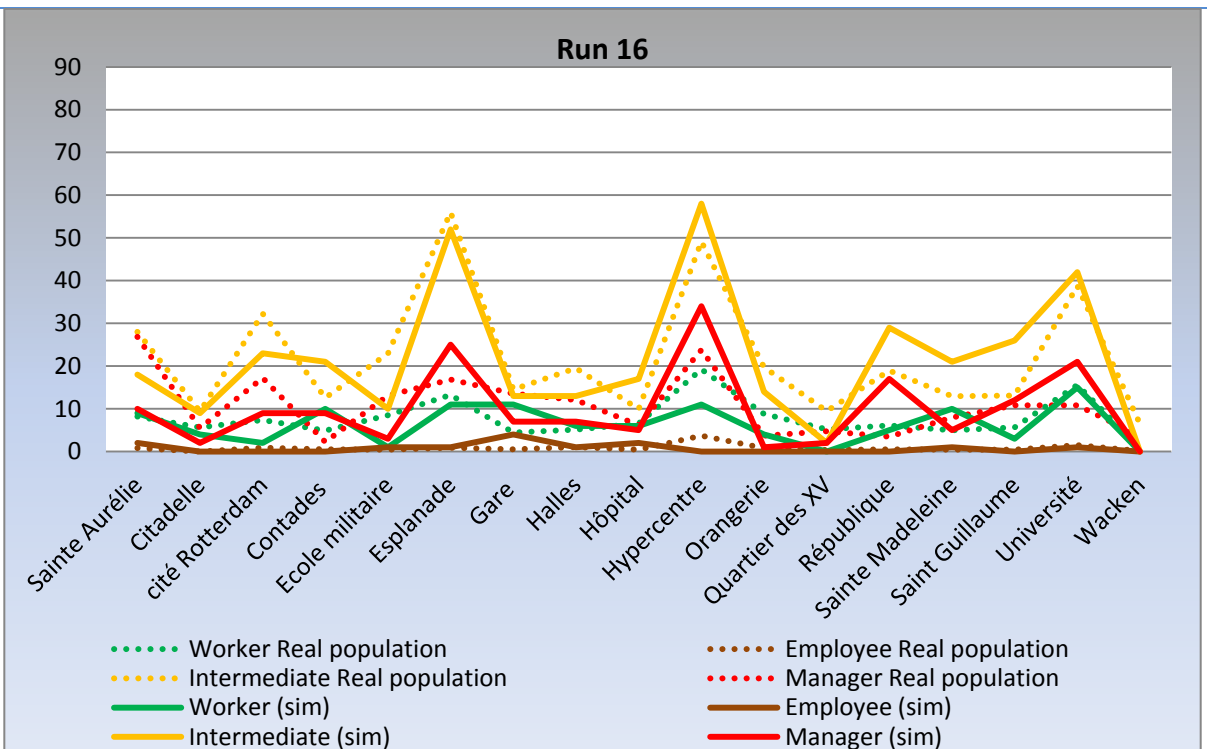
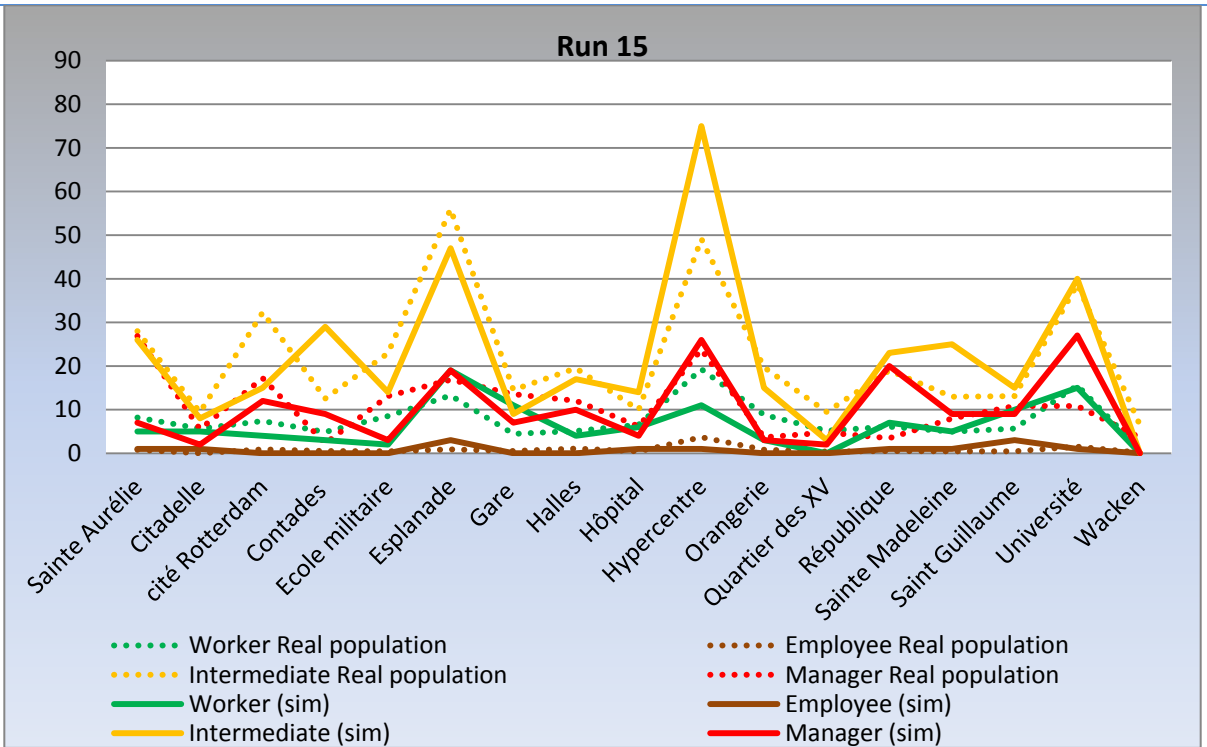

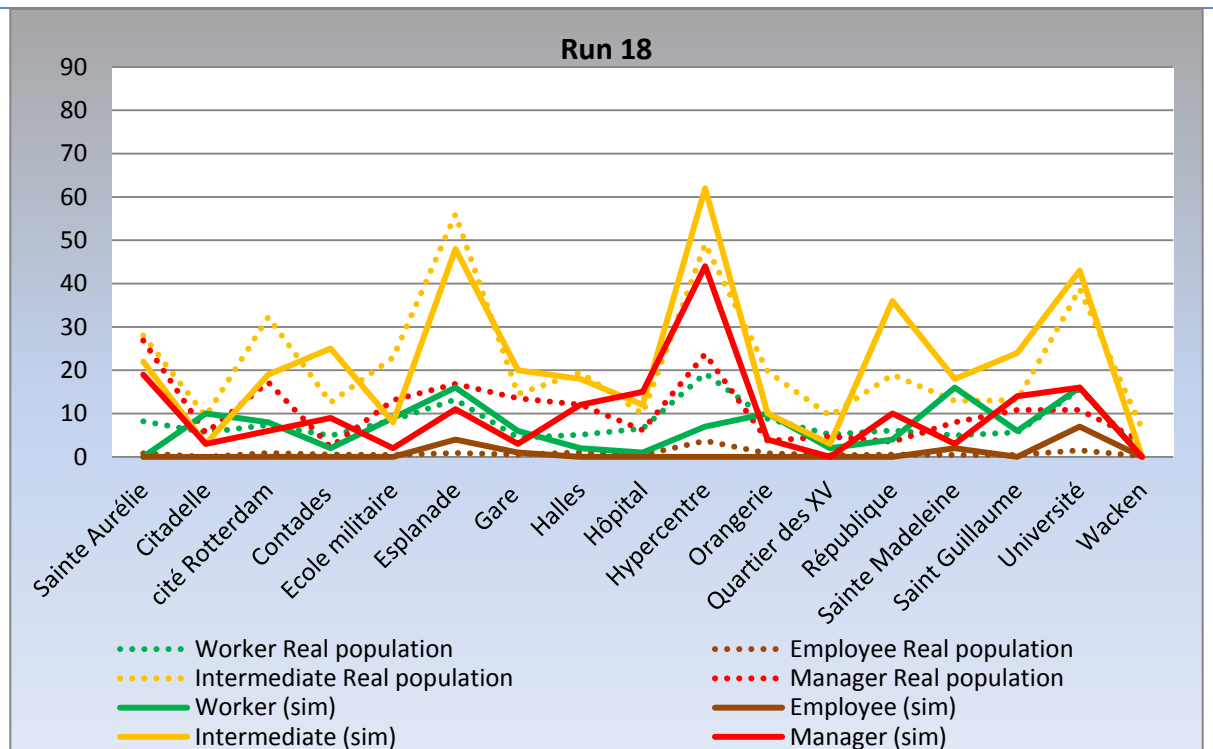
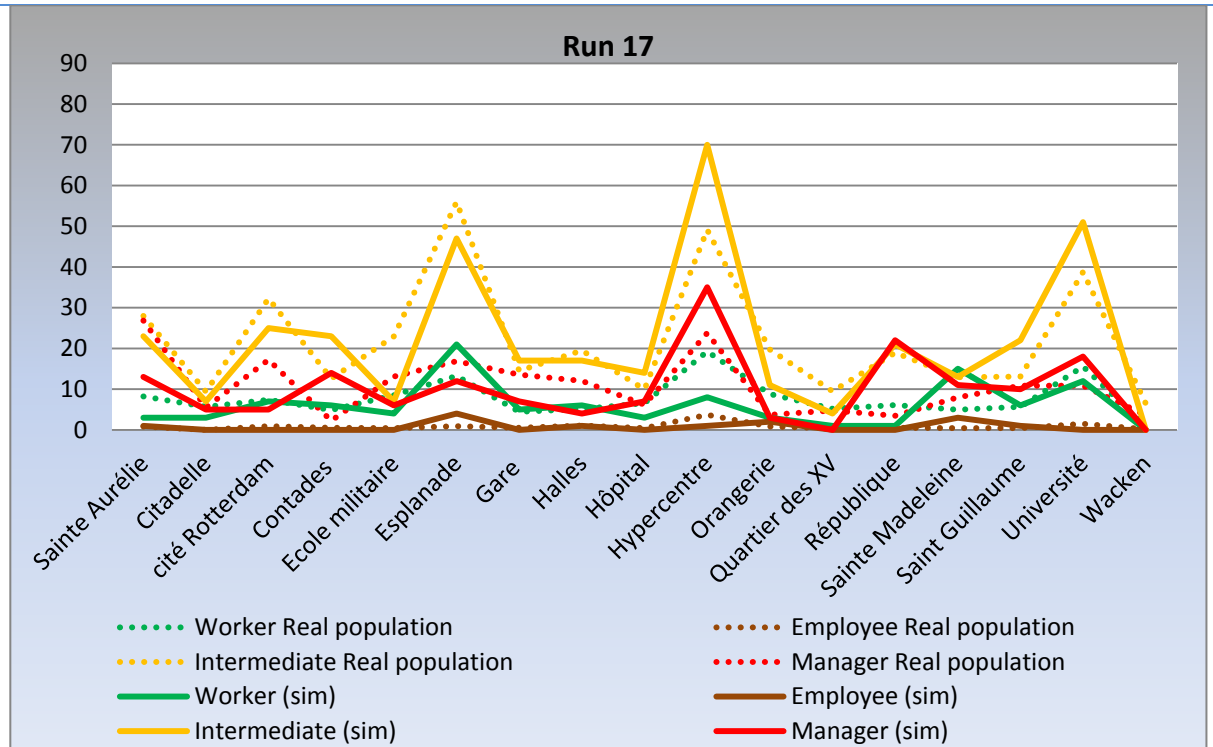

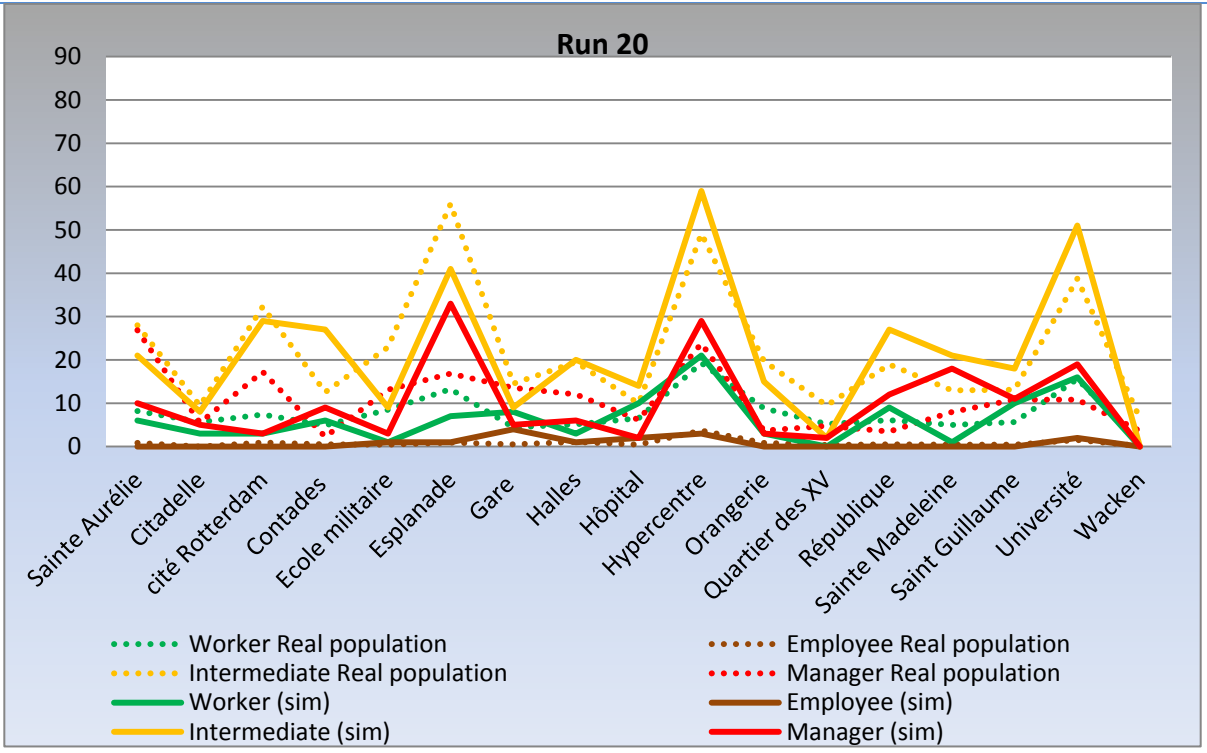
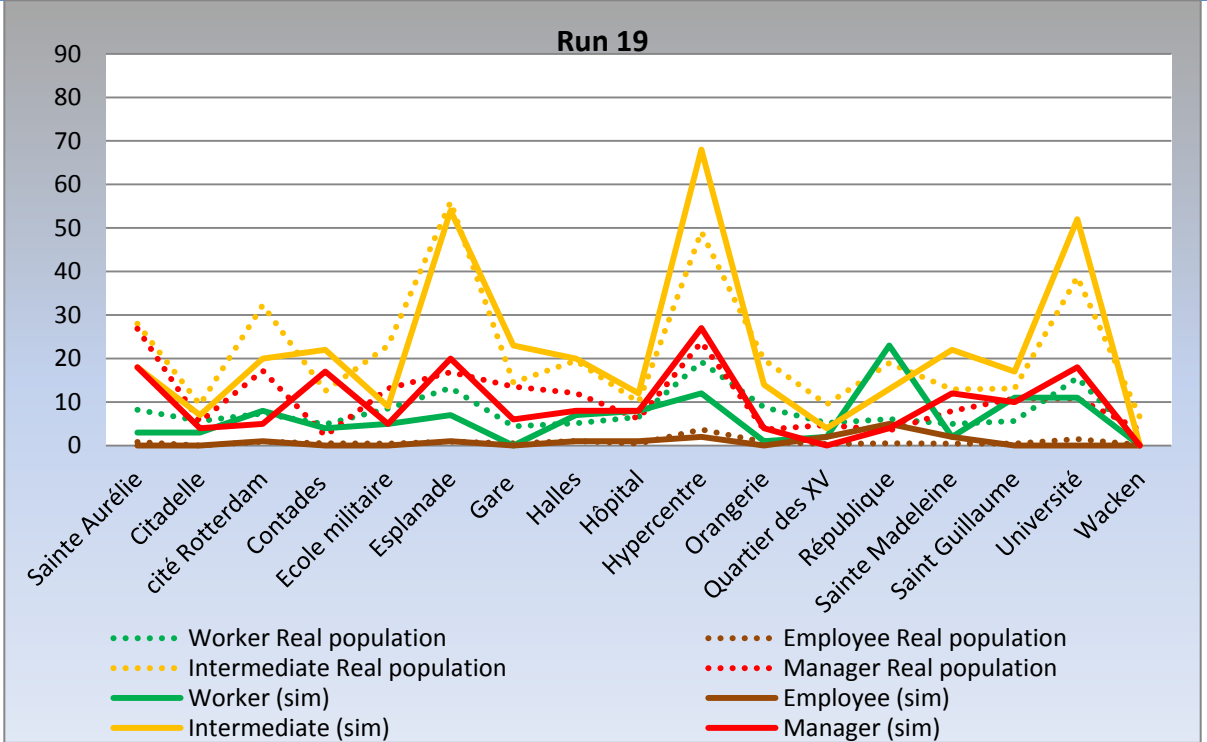

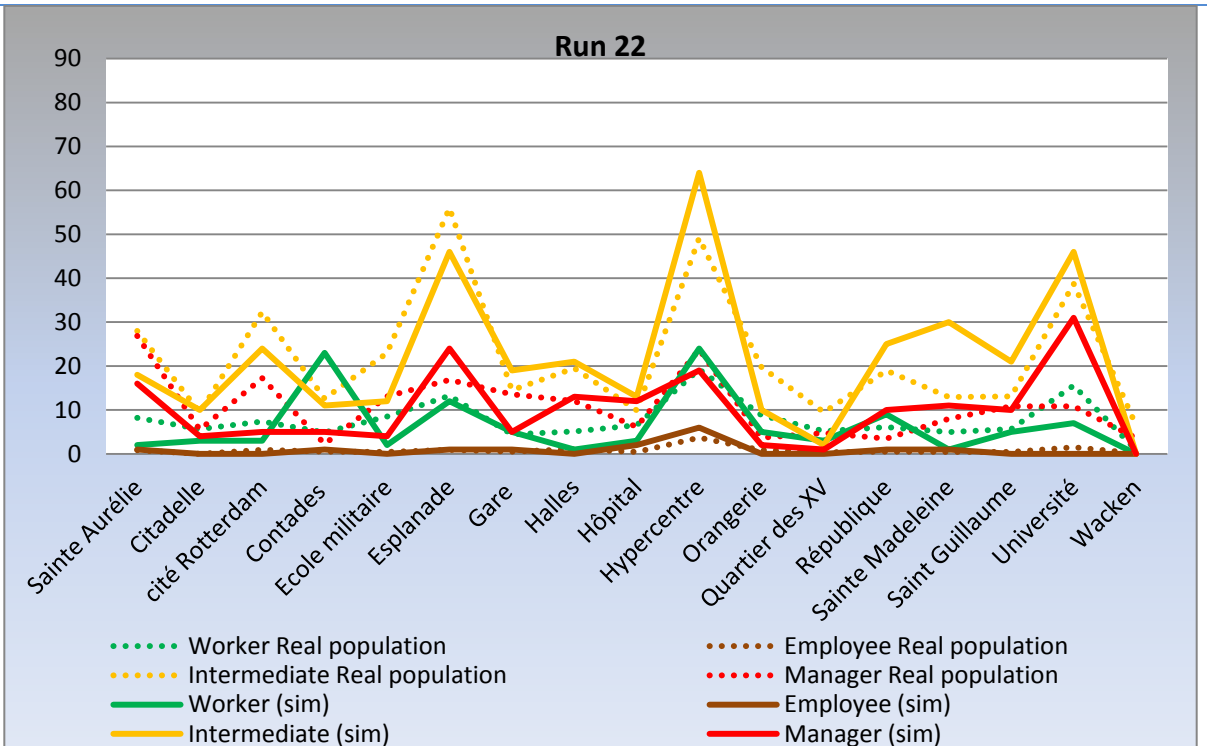
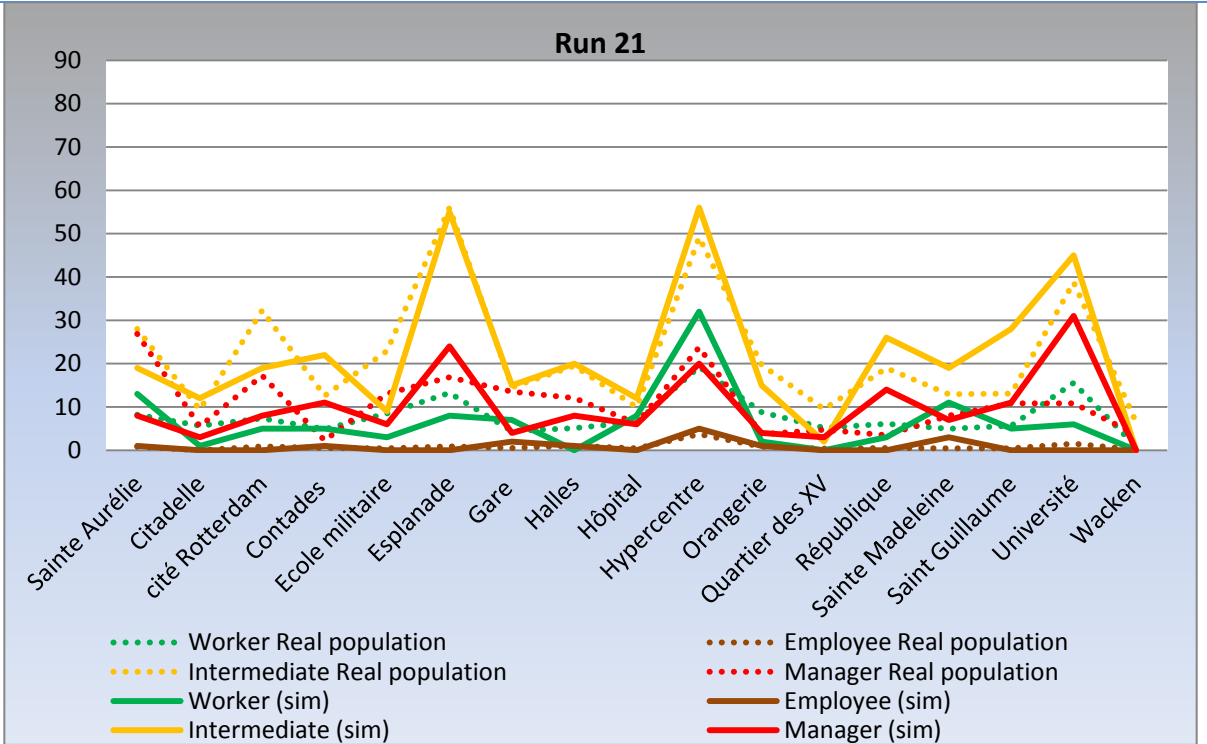

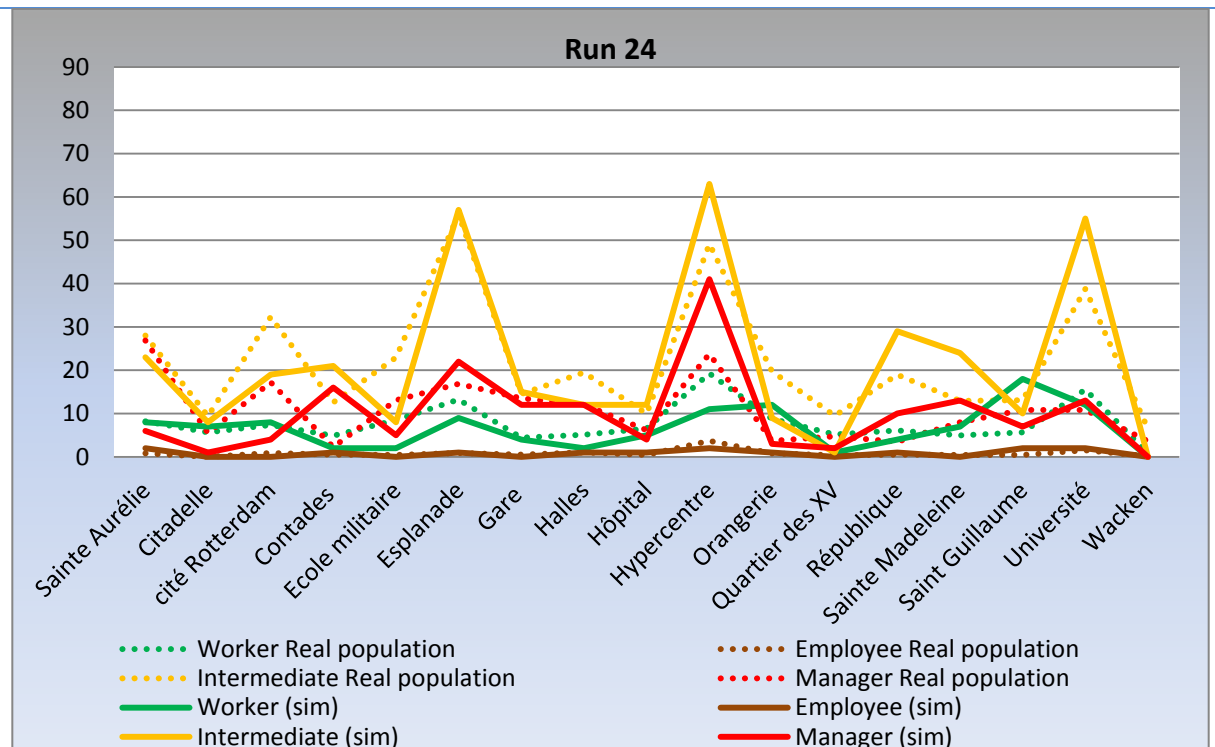
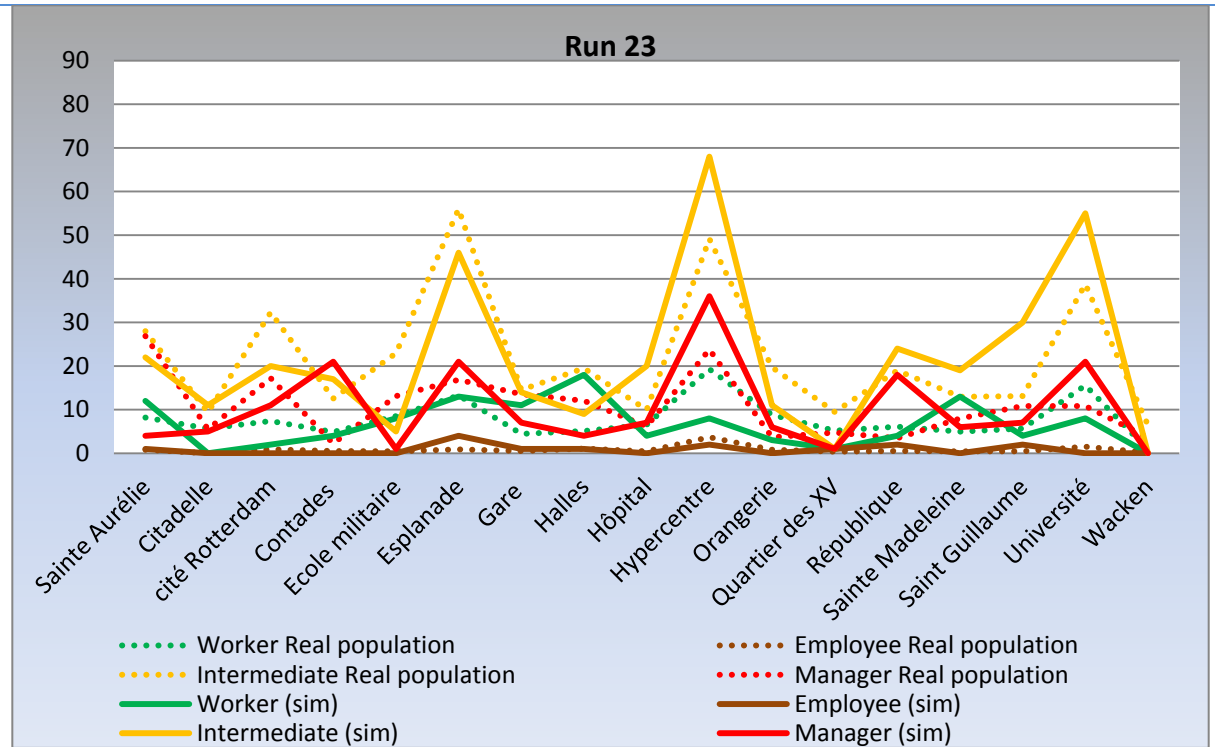

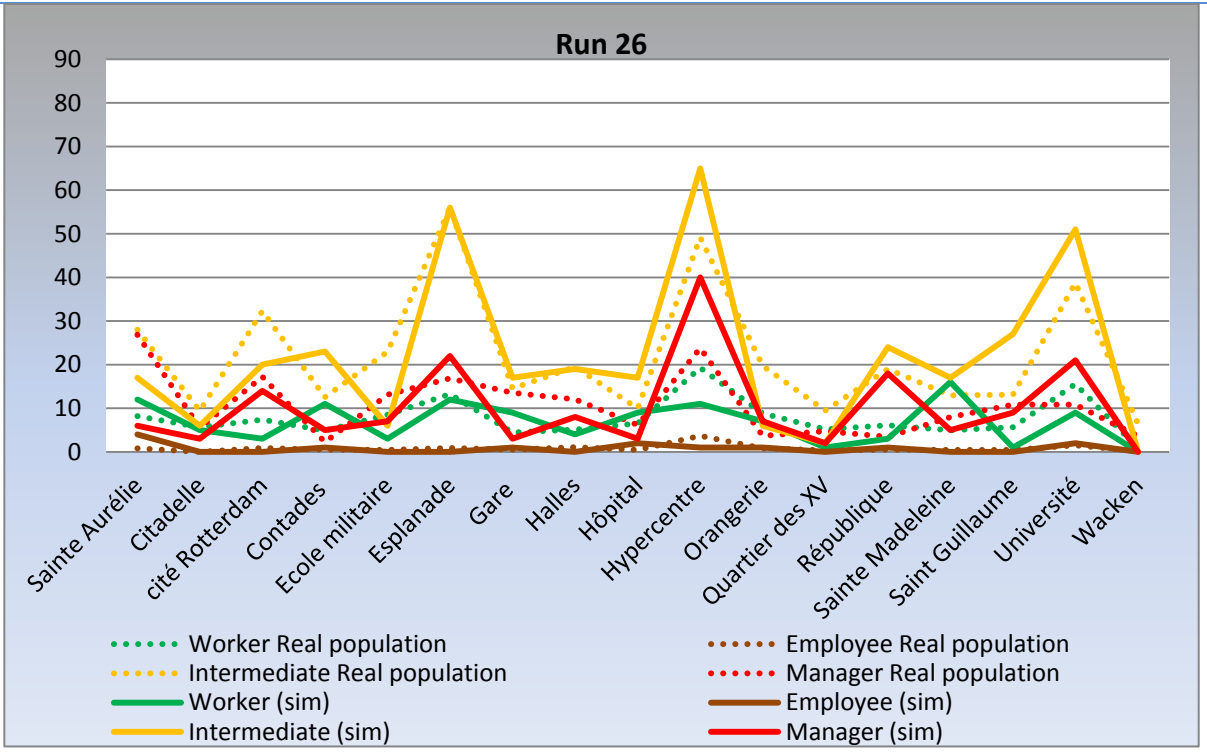
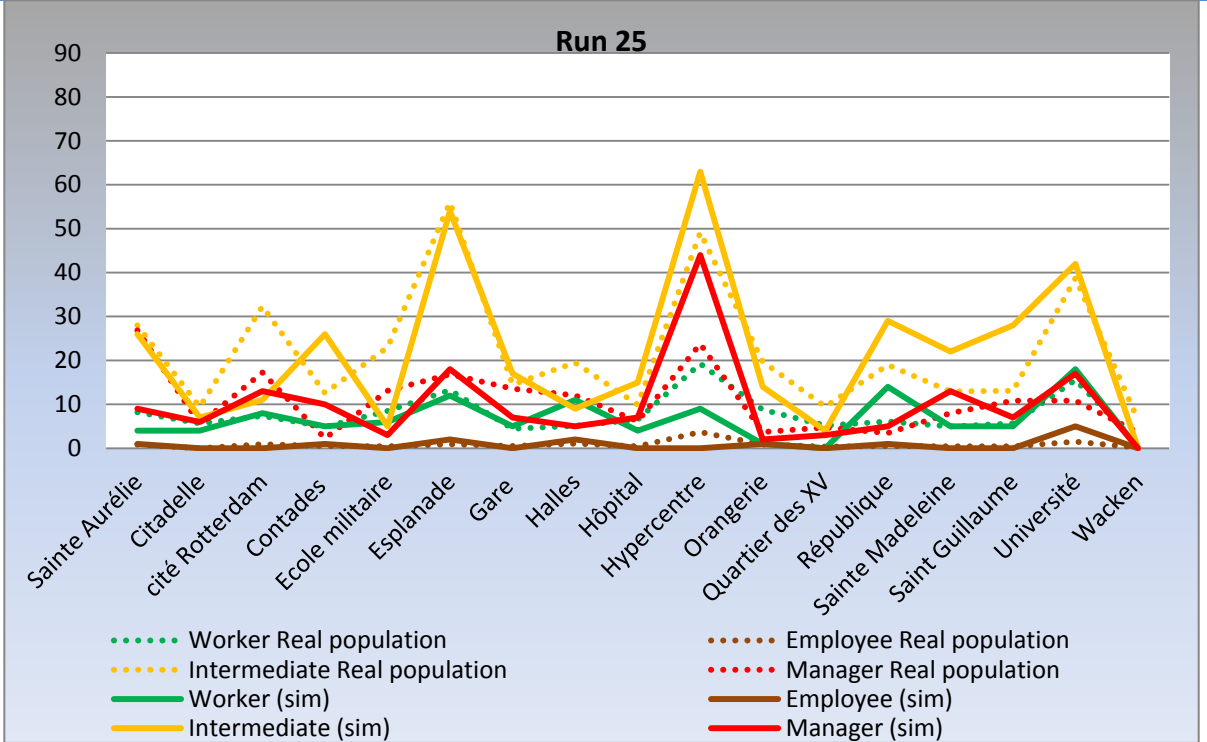

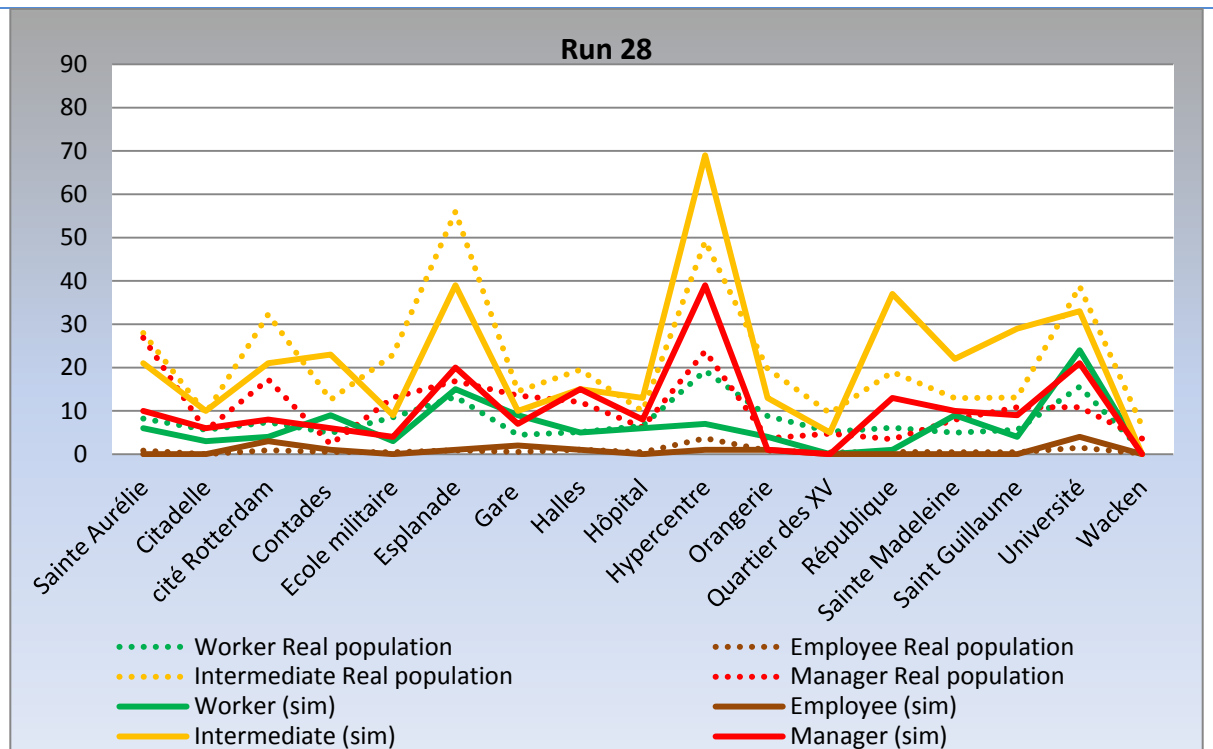
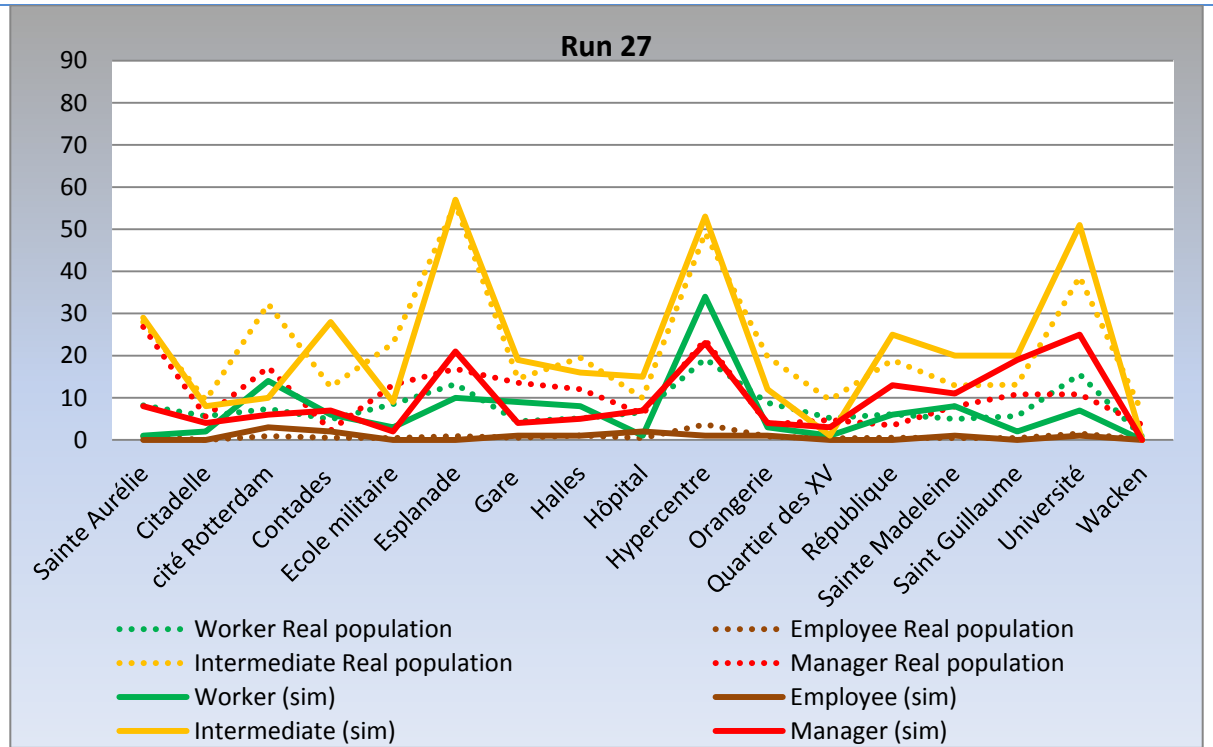

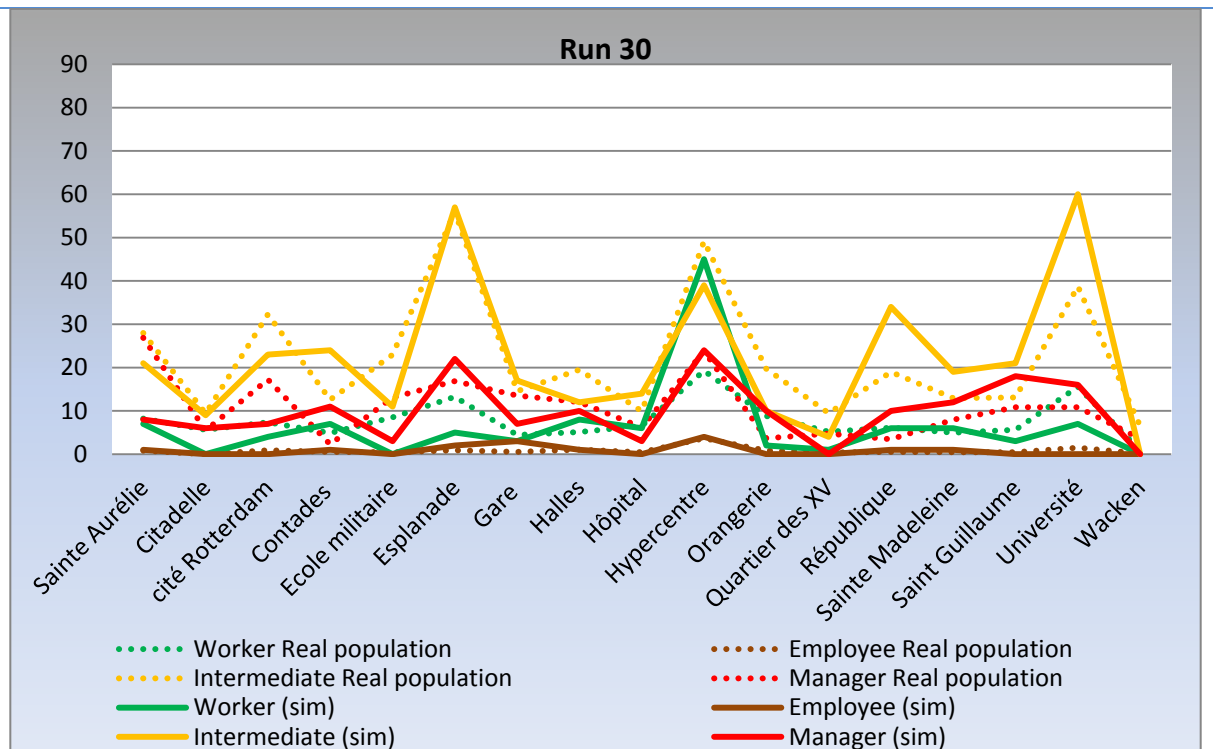
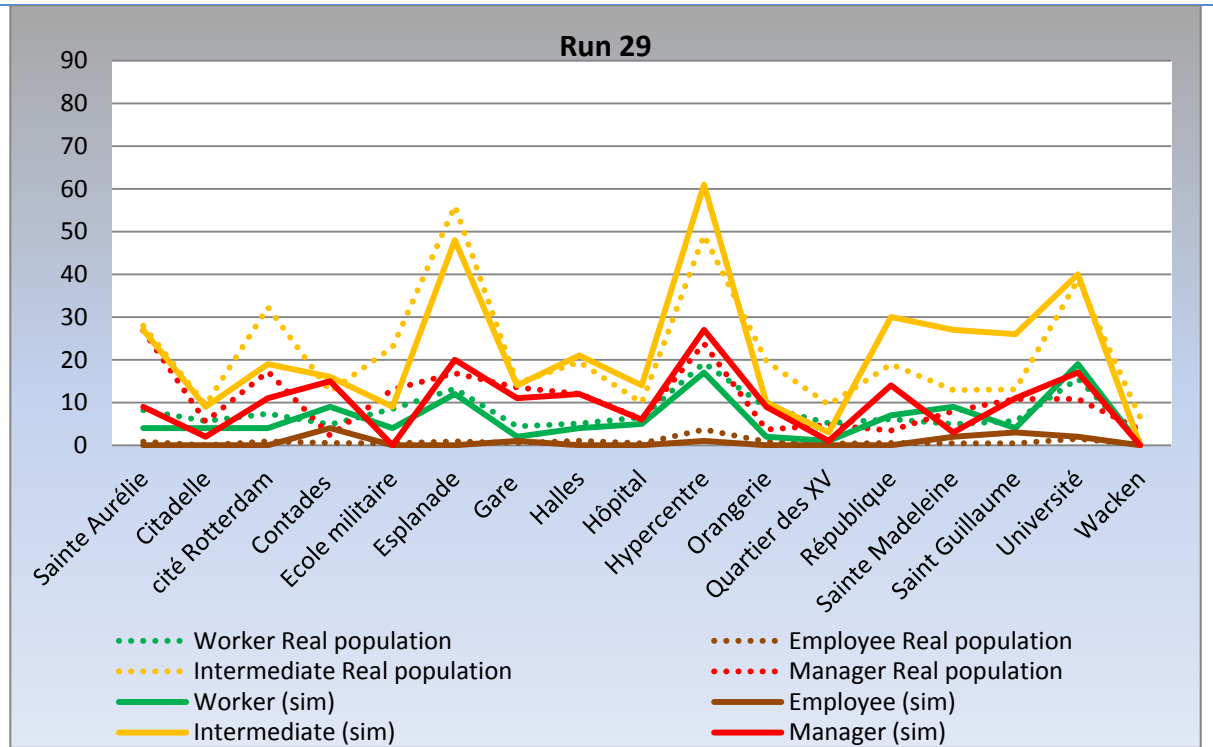

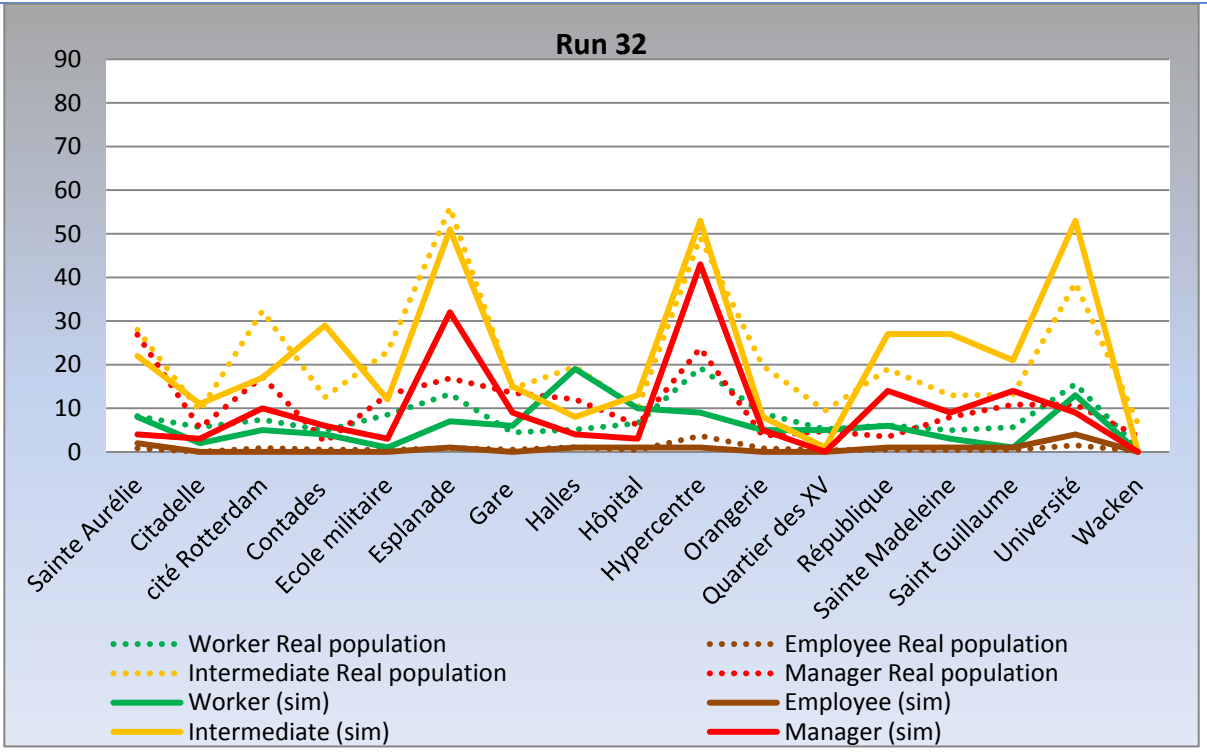
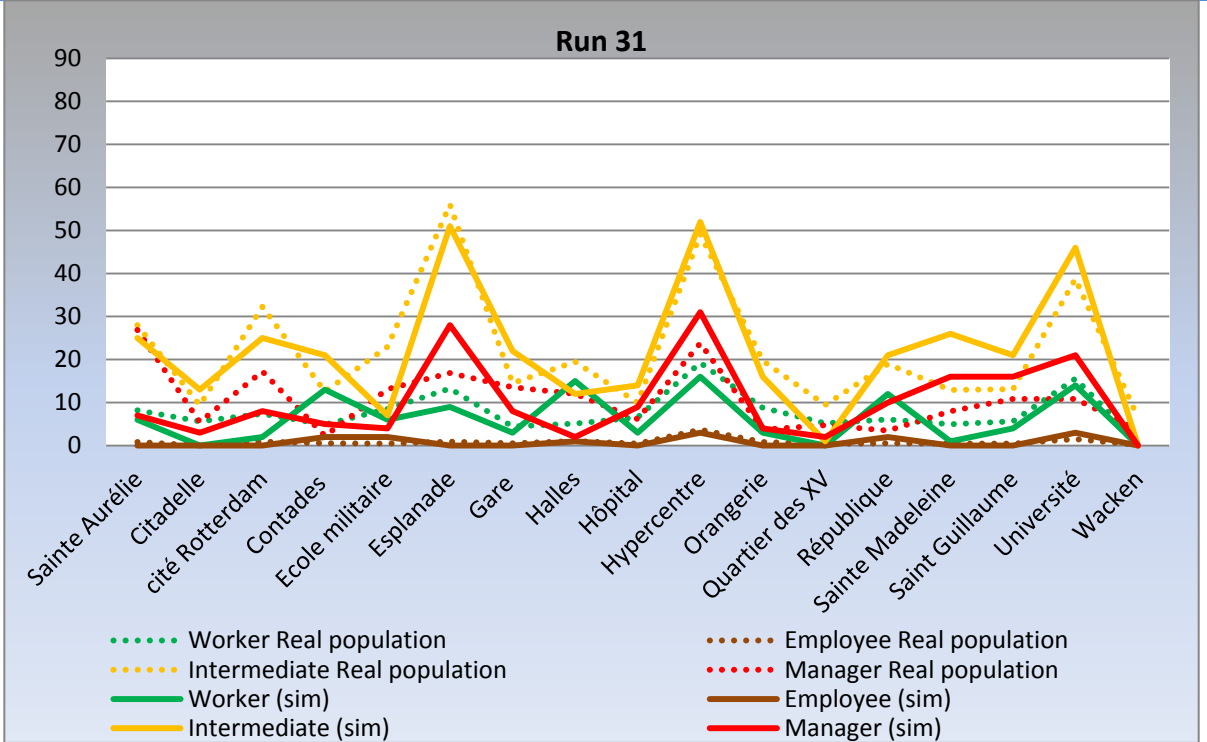

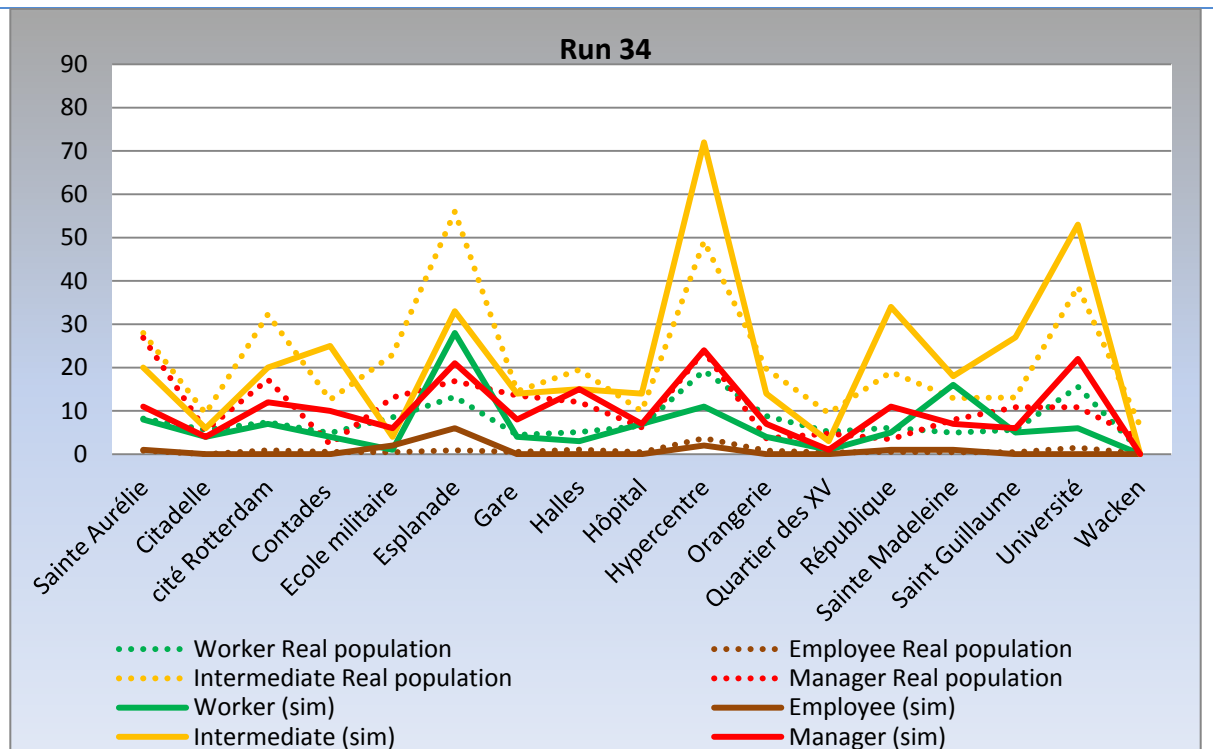
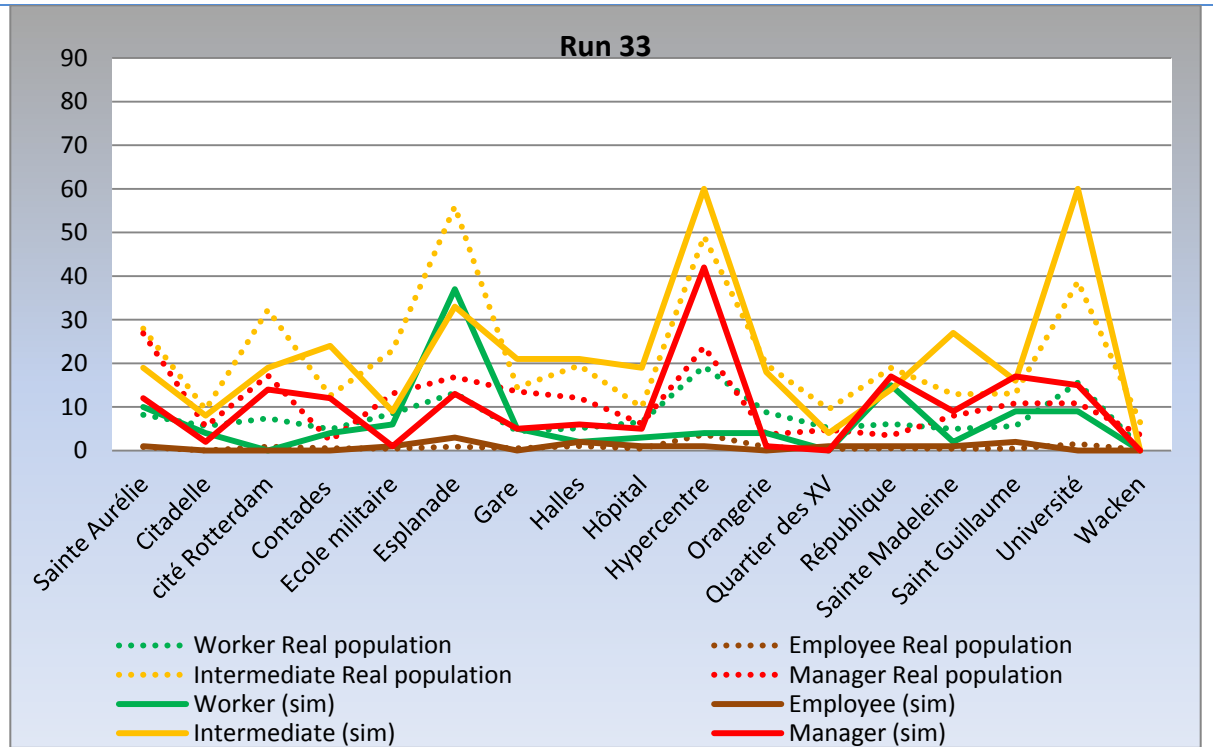

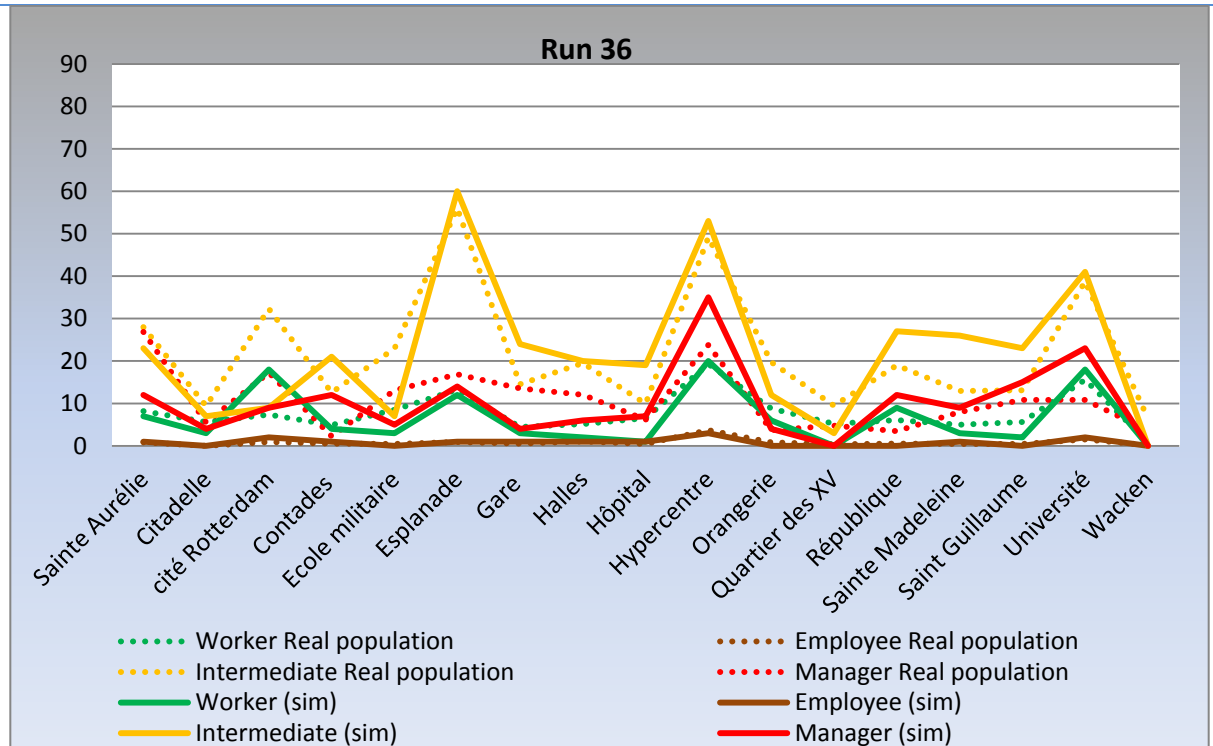
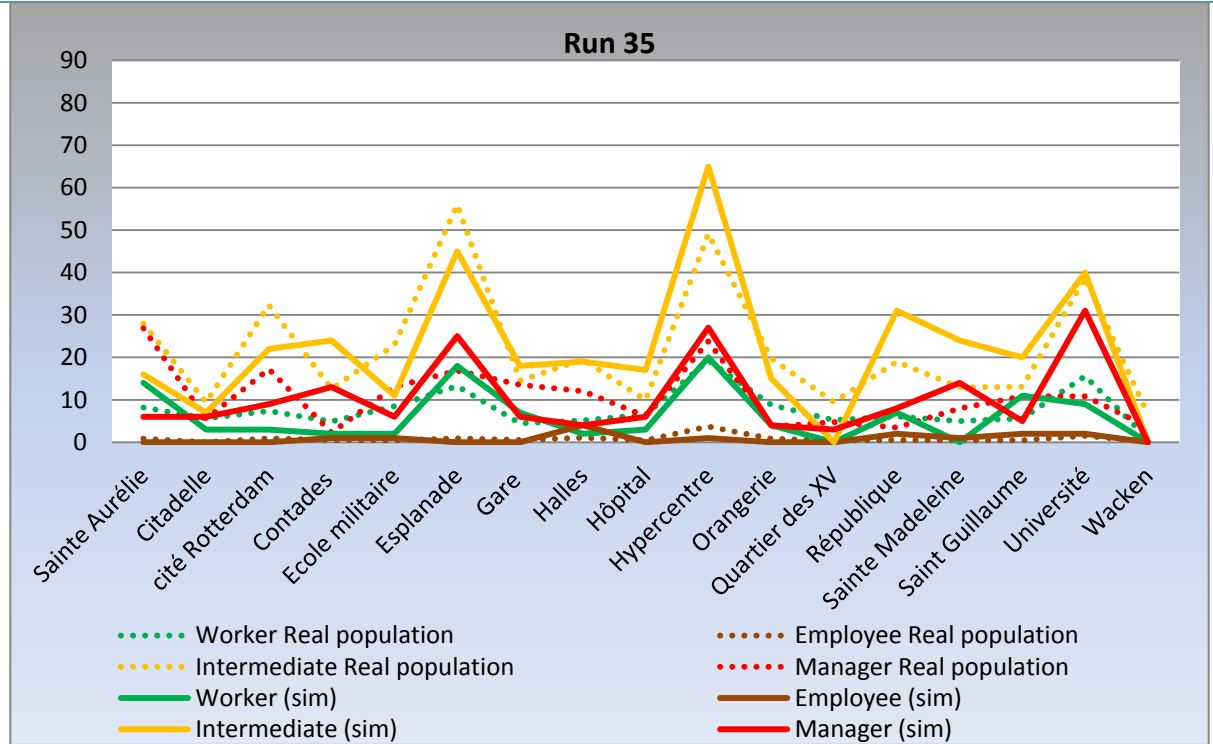

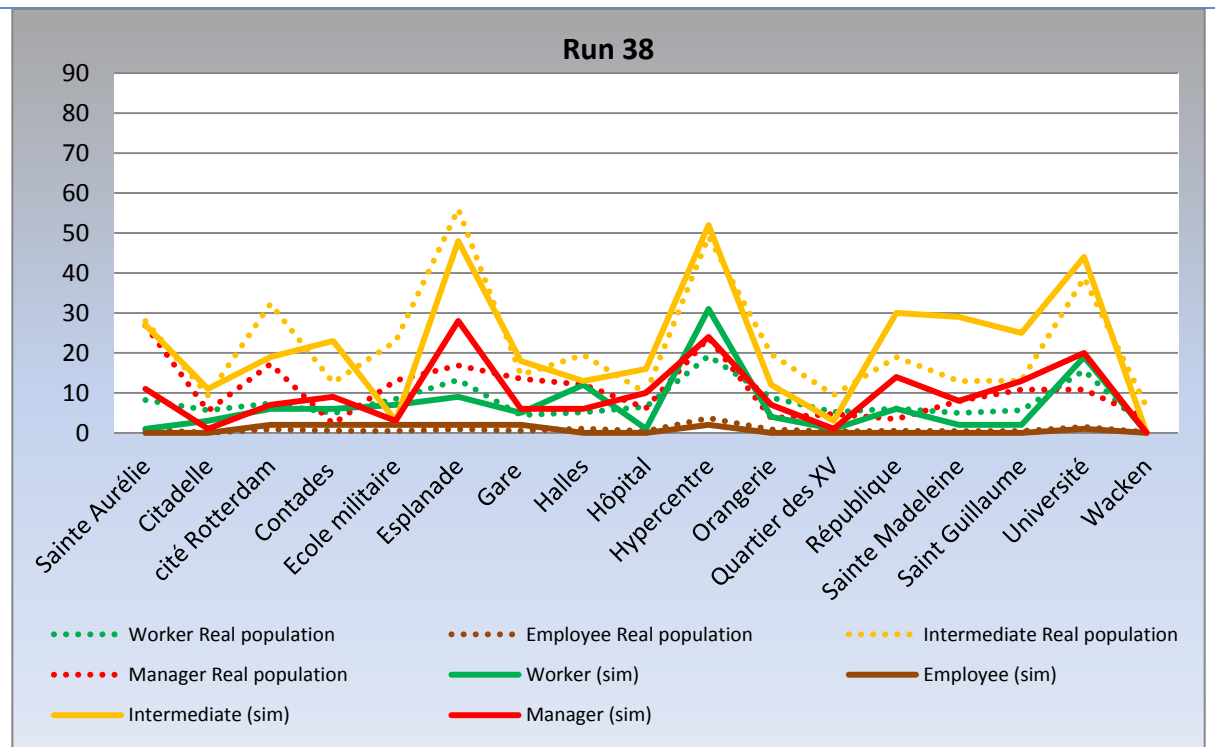
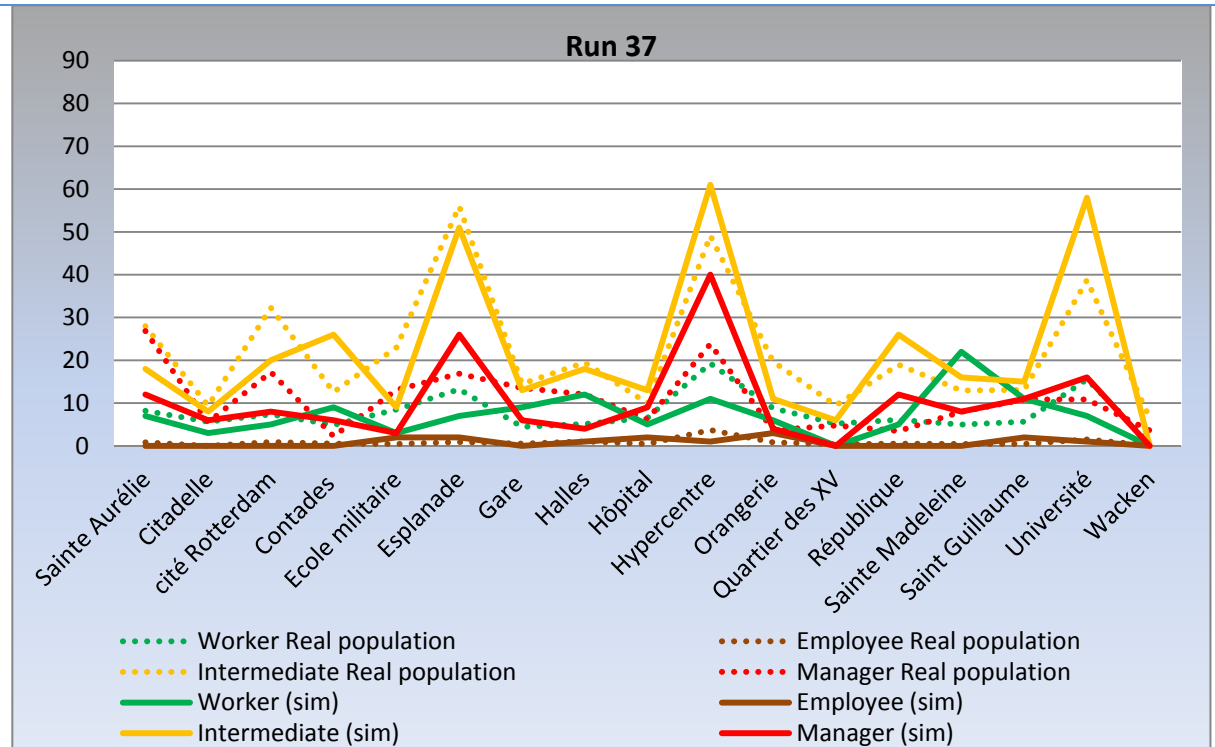

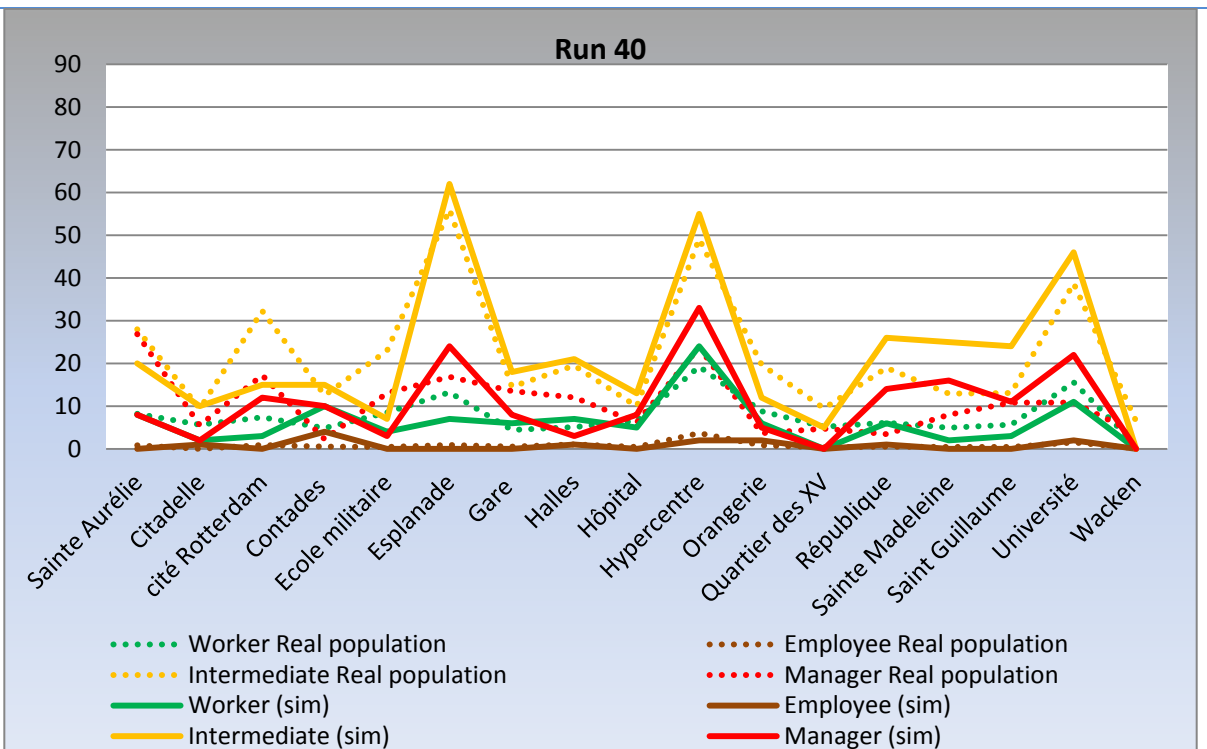
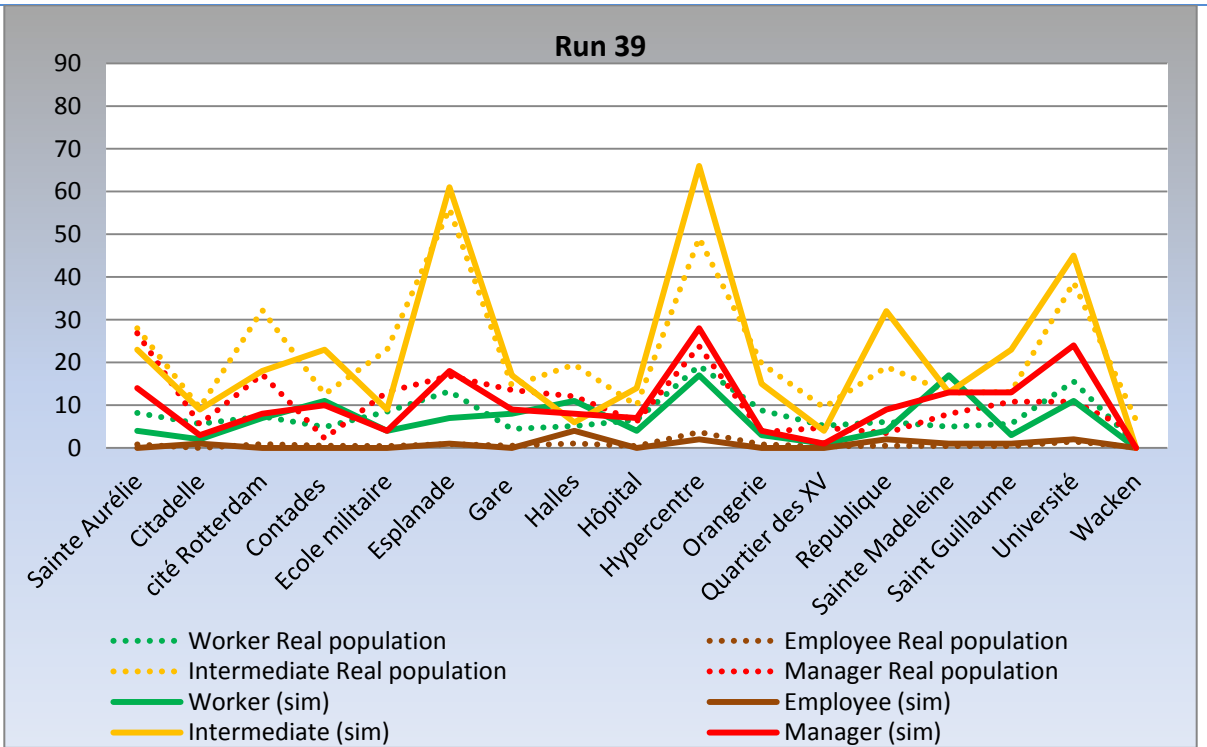

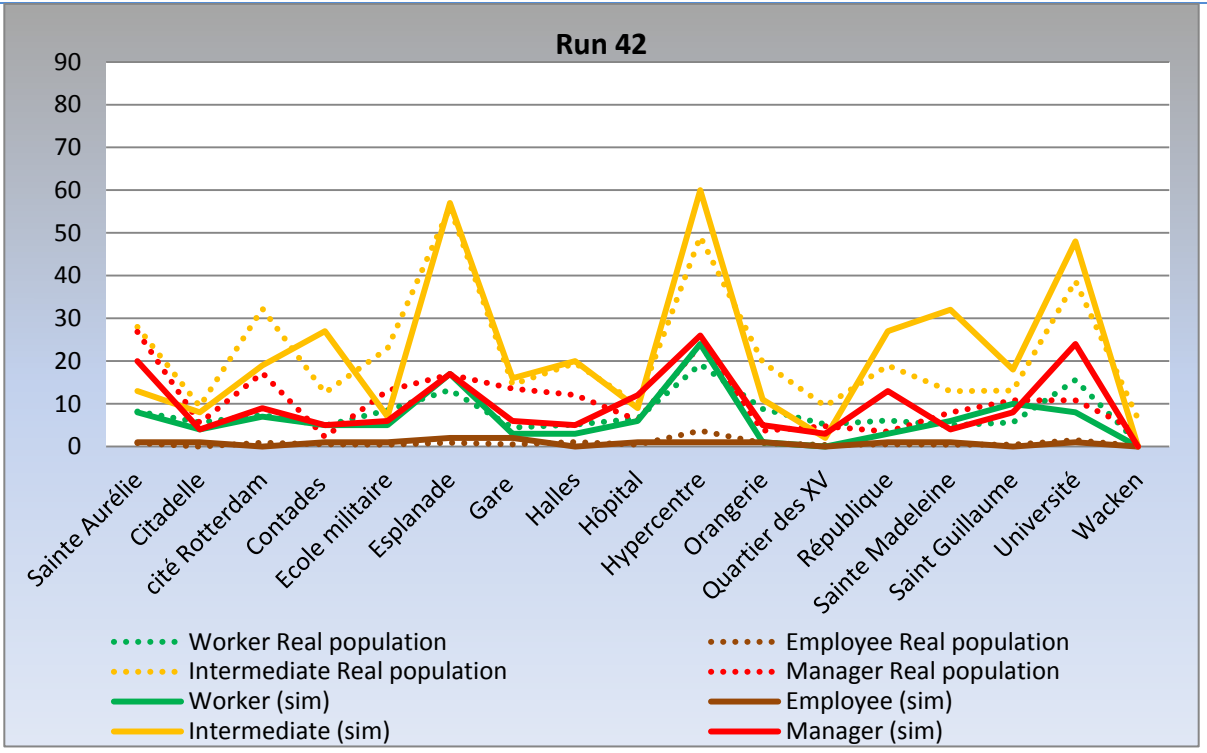
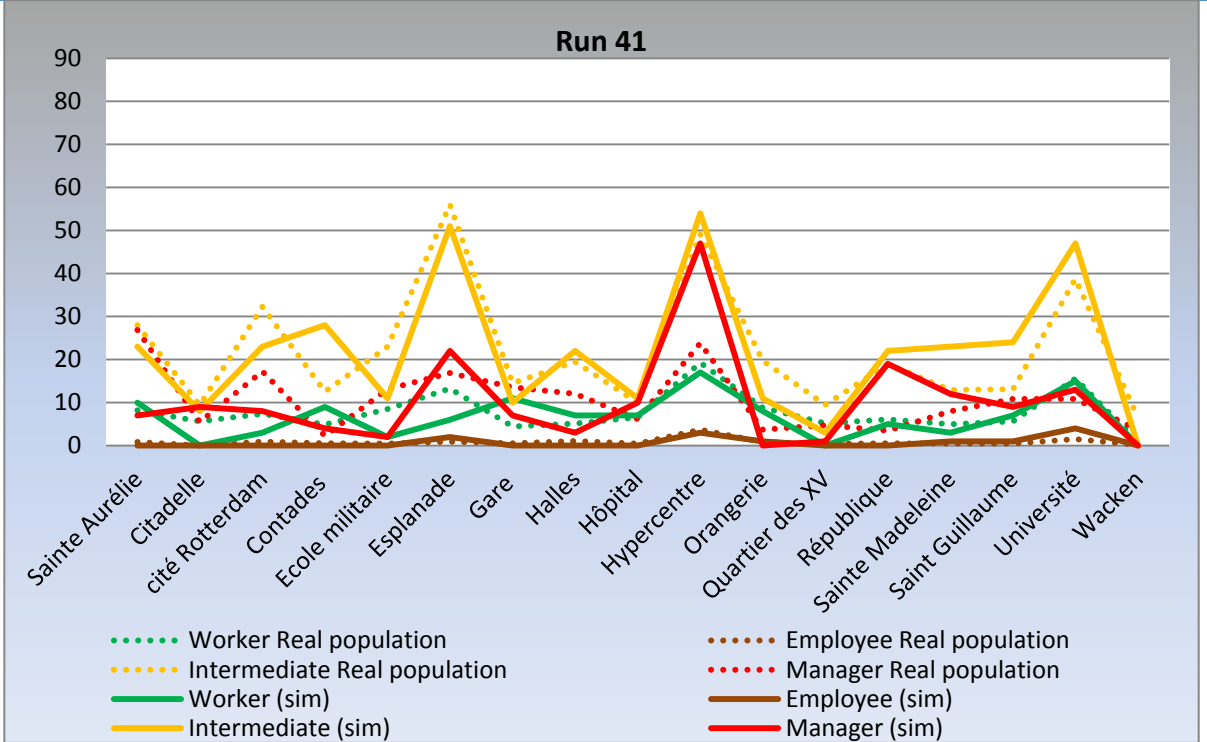

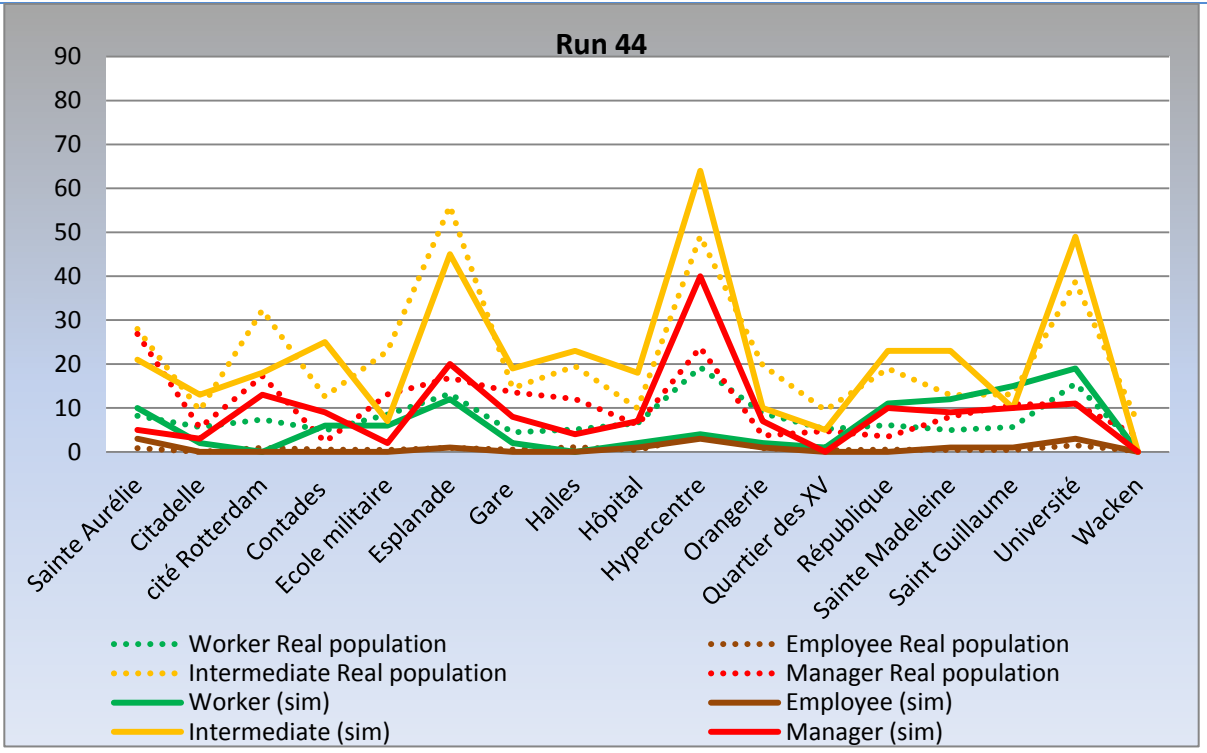
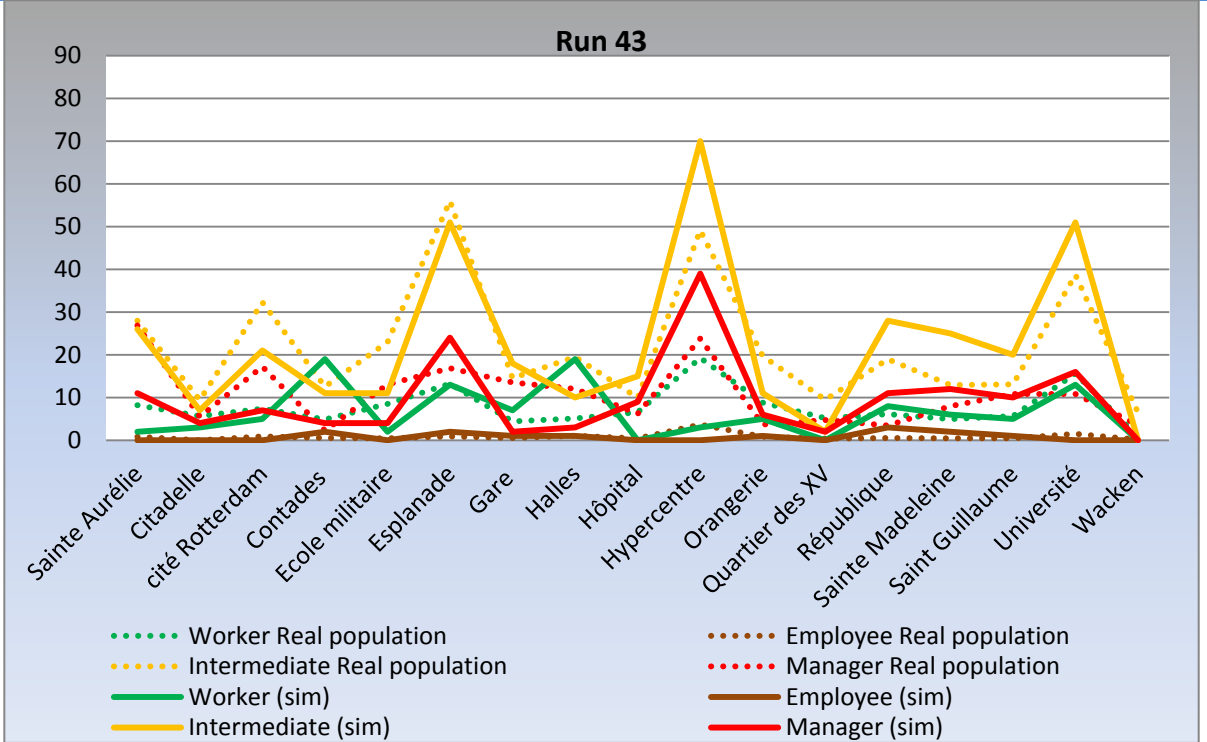

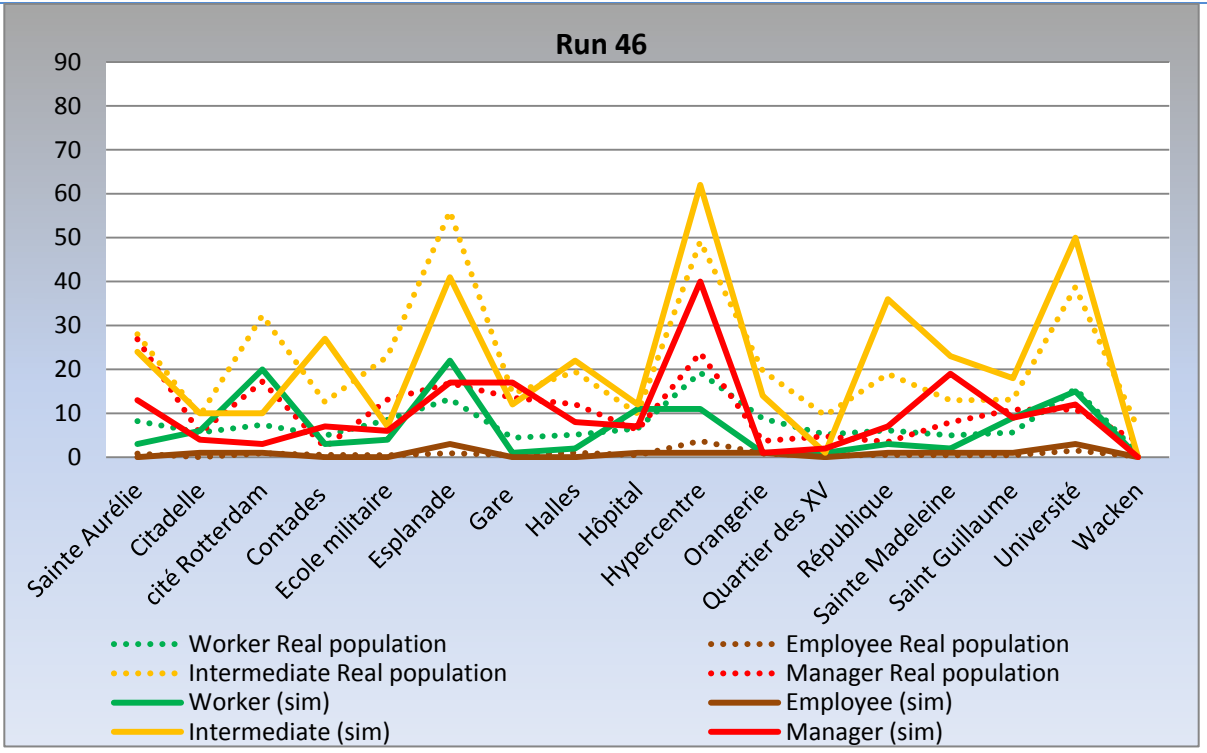
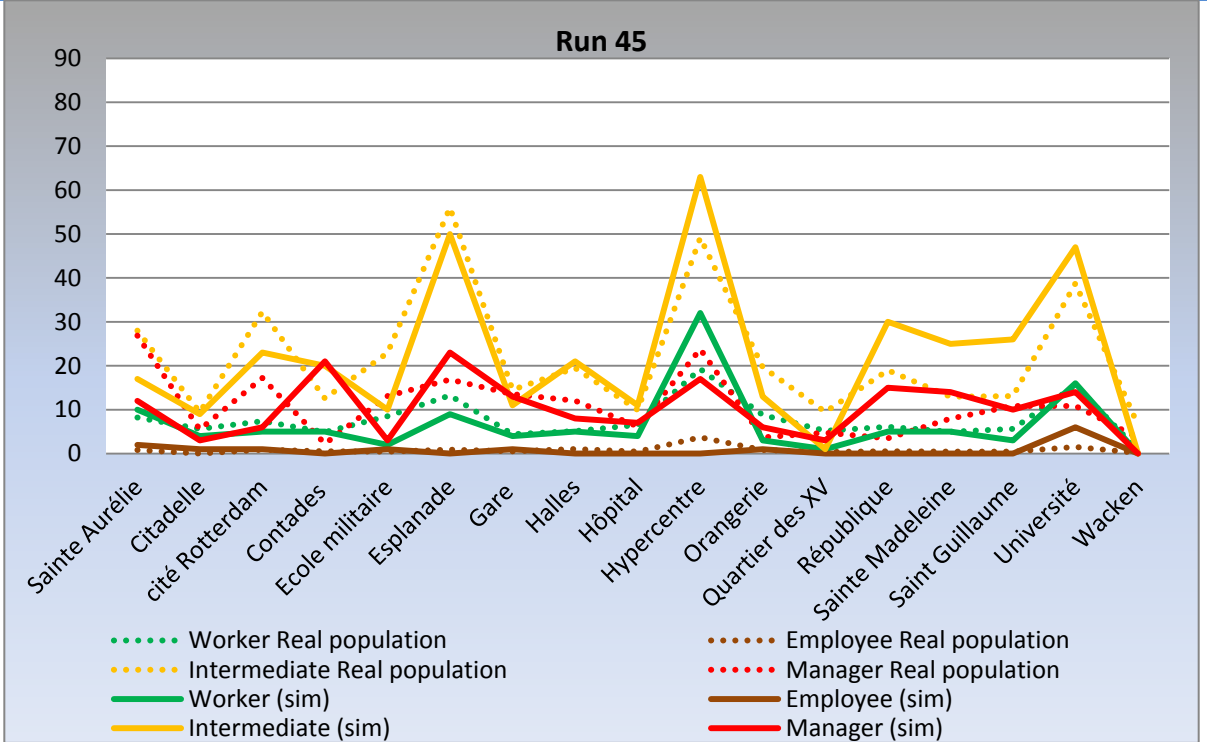

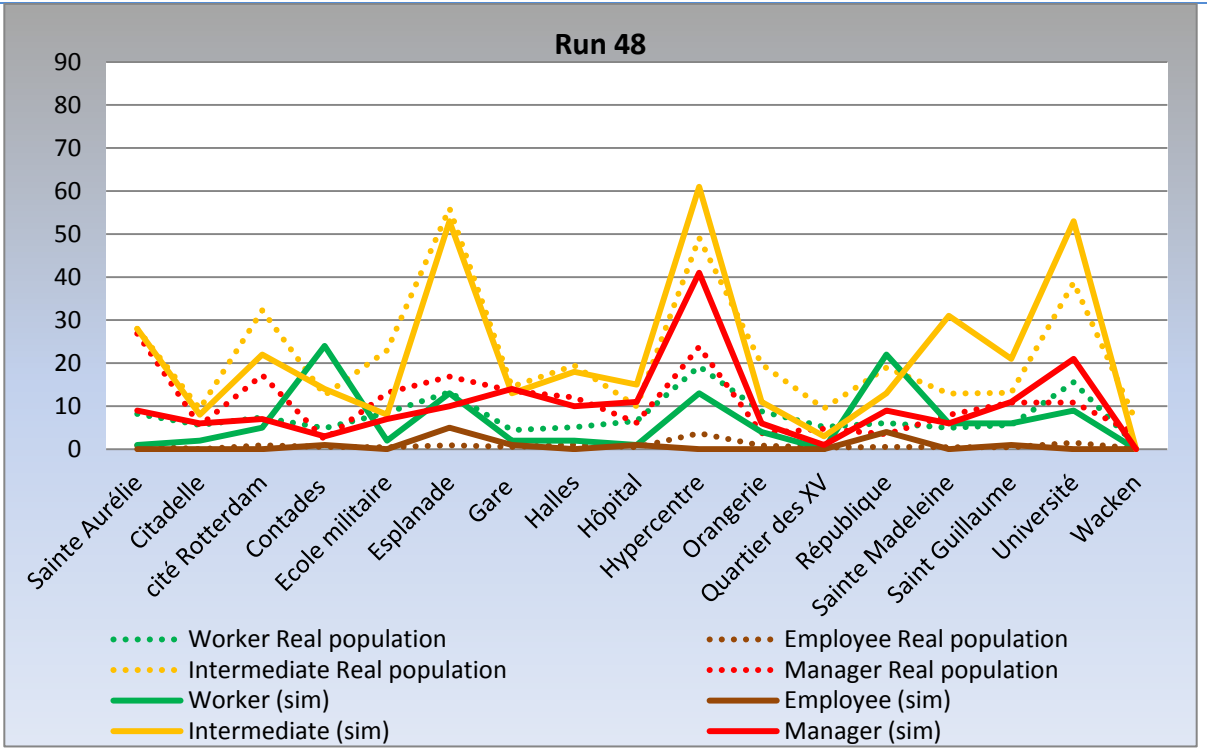
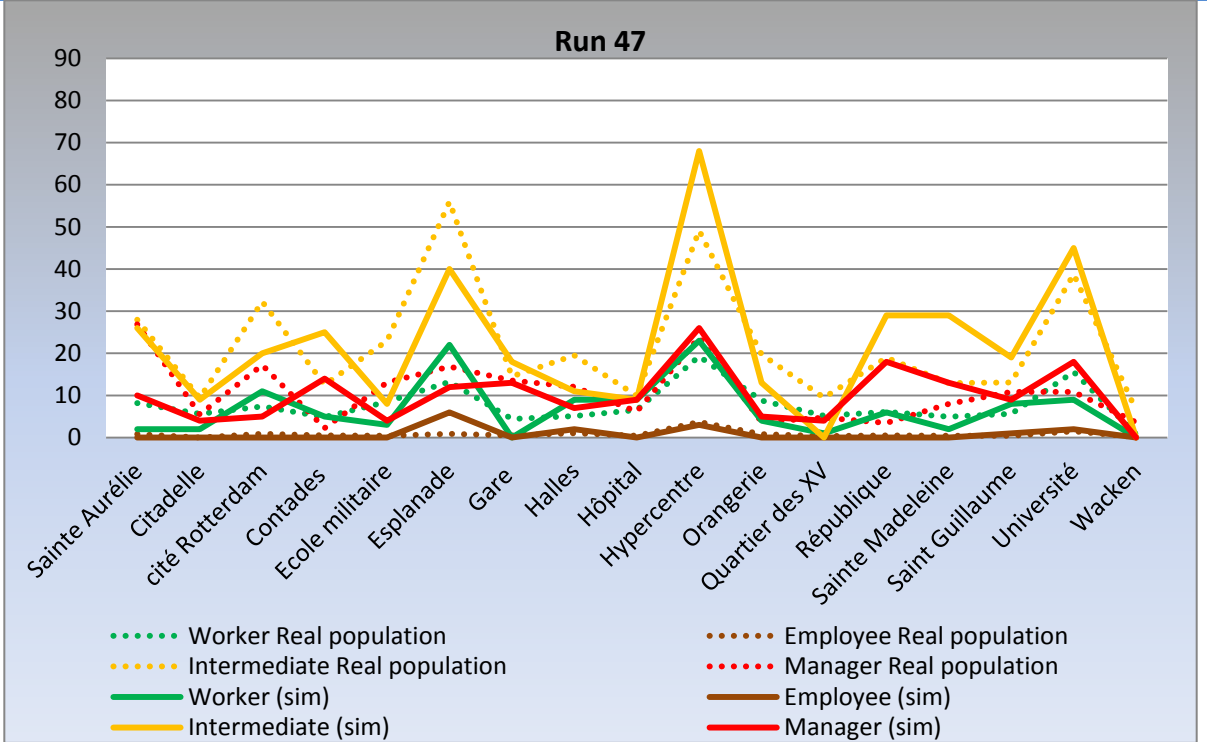

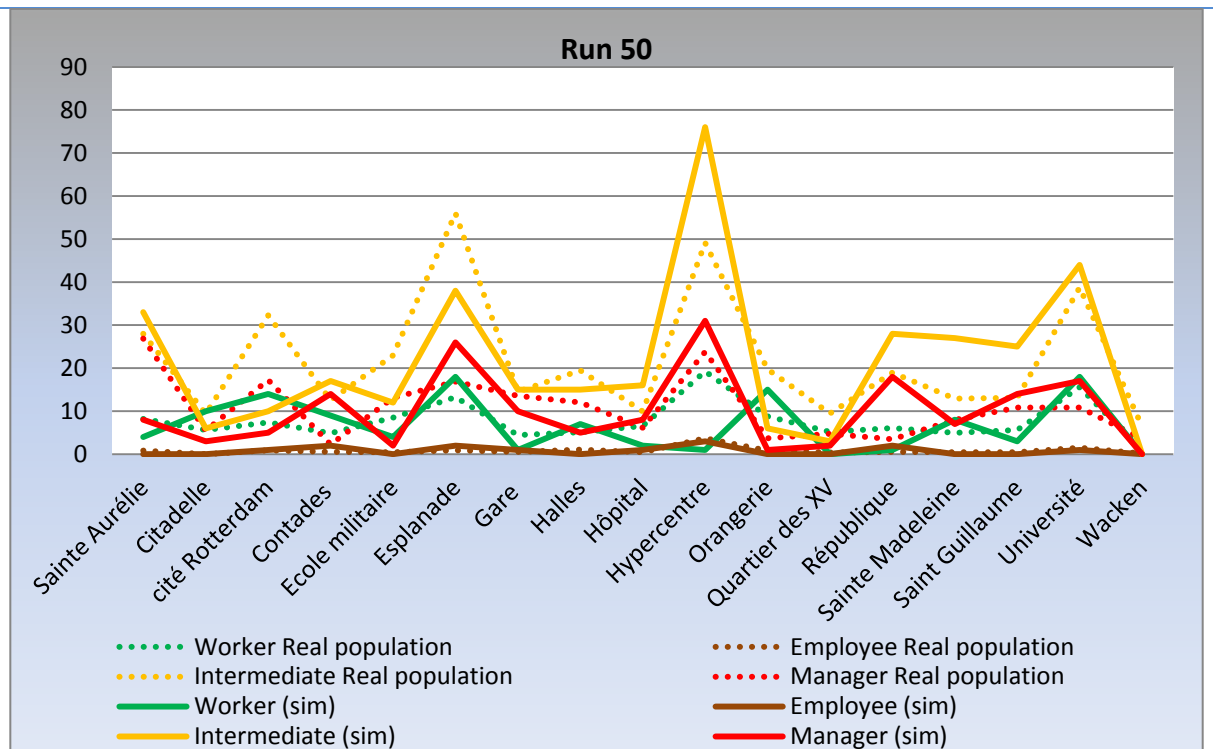
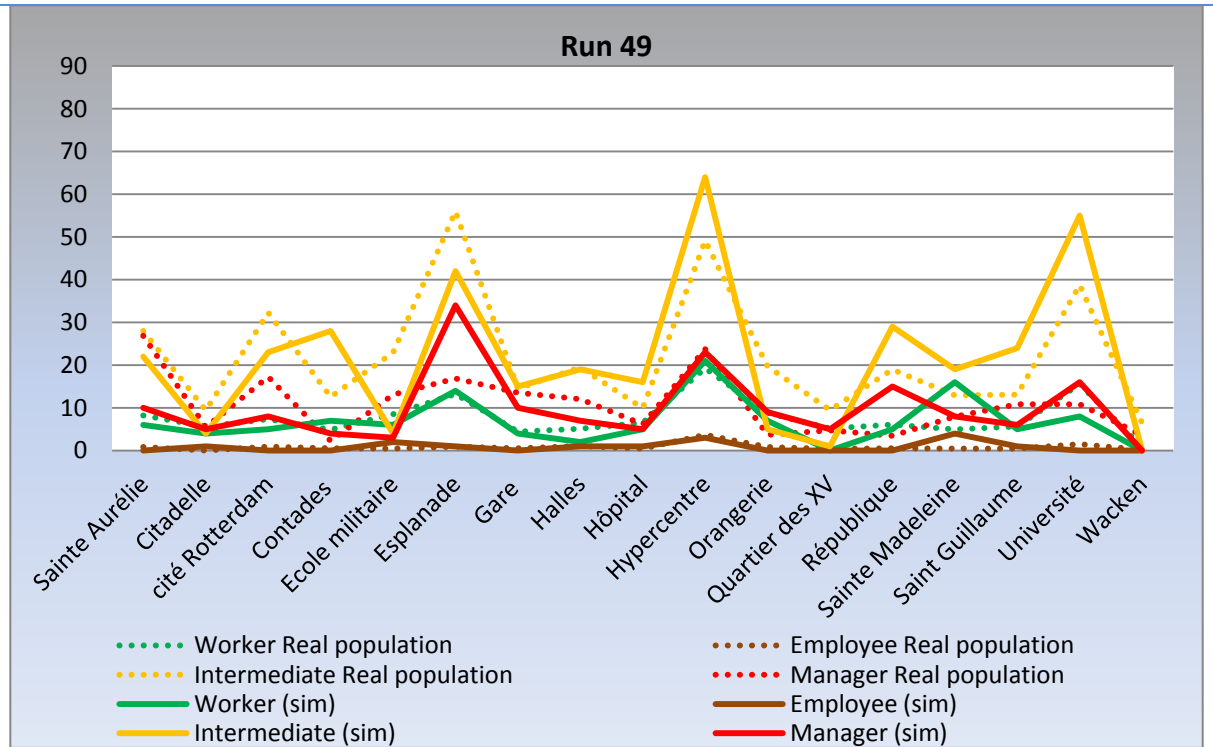

Interface of the program

The interface for 'run 1' includes the following data:

initial managers	initial intermediates	initial employees	initial workers	Total initial population
182	378	14	126	700

The proportion of each settled agents to total occupied cells (in %)				total cells	iteration
managers	intermediates	employees	workers	656	10000
22.31	57.54	1.69	13.08	total settled agents in %	
				94.62	

settled managers	settled intermediates	settled employees	settled workers	full homes
145	374	11	85	650

total resident preference (NB: Total = 1): 1

Number-of-steps: 10000

ticks: 0

clock: 0 to 12200

run 1

The interface for 'run 2' includes the following data:

initial managers	initial intermediates	initial employees	initial workers	Total initial population
182	378	14	126	700

The proportion of each settled agents to total occupied cells (in %)				total cells	iteration
managers	intermediates	employees	workers	656	10000
22.93	58.19	1.87	12.64	total settled agents in %	
				95.63	

settled managers	settled intermediates	settled employees	settled workers	full homes
147	373	12	81	641

total resident preference (NB: Total = 1): 1

Number-of-steps: 10000

ticks: 0

clock: 0 to 12200

run 2

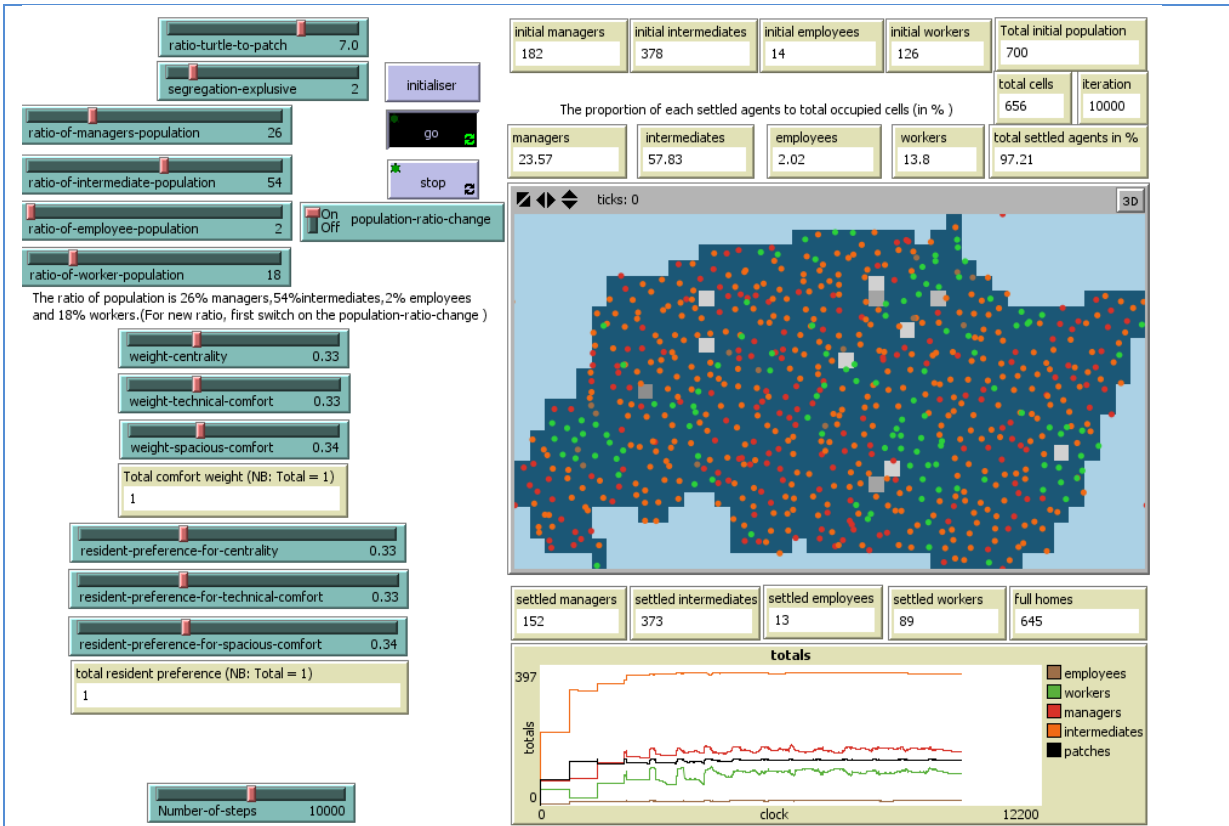

run 3

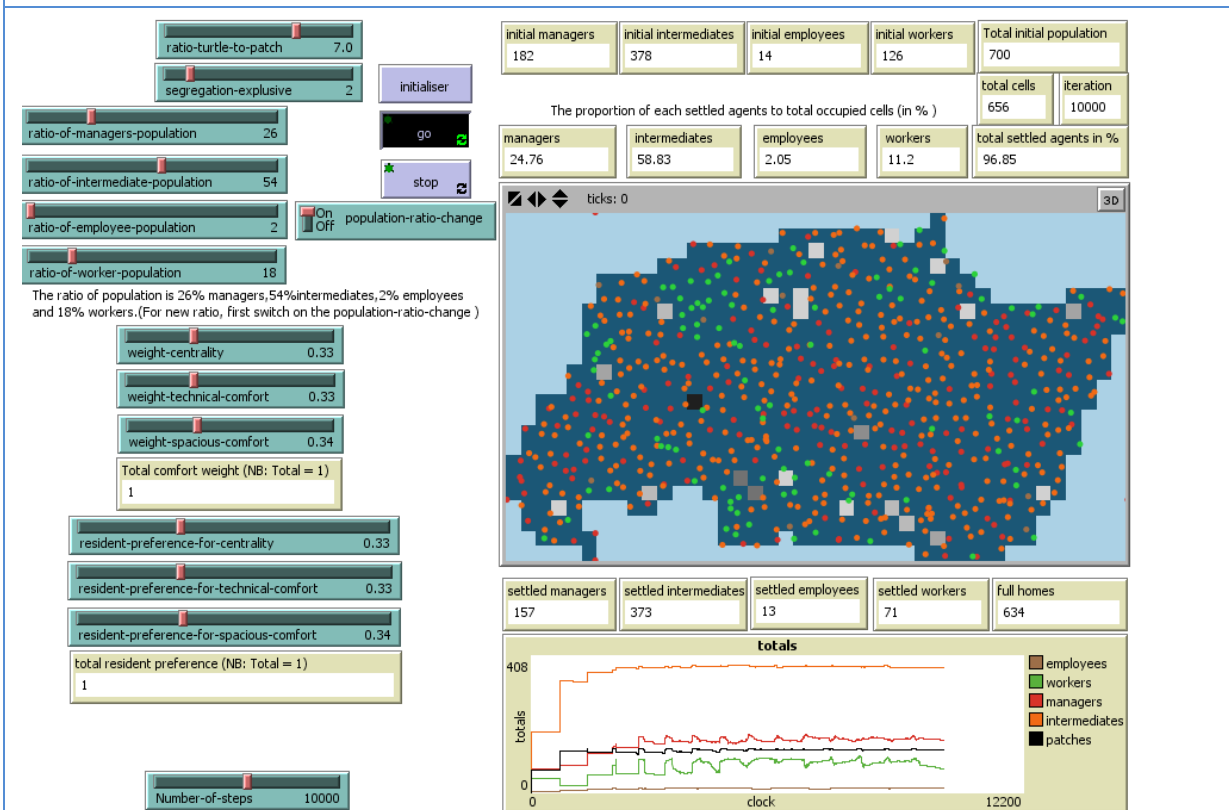

run 4

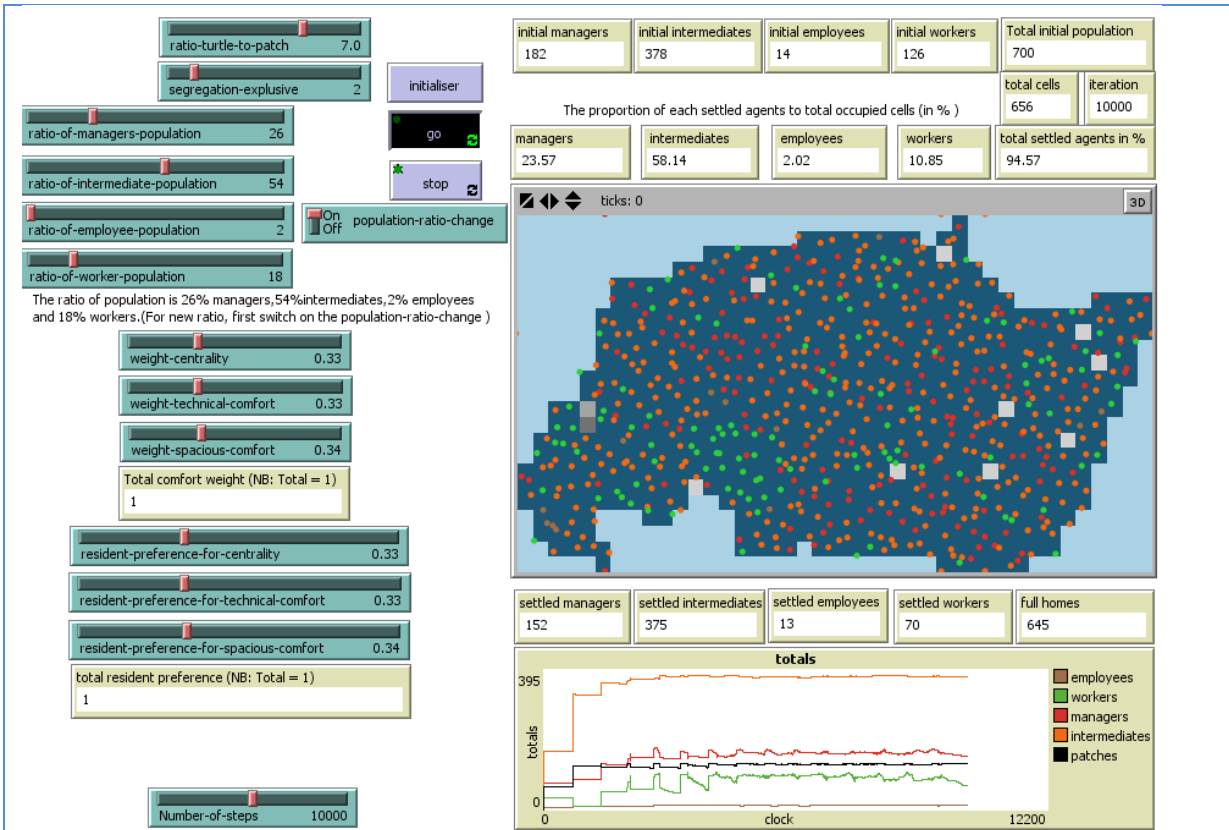

run 5

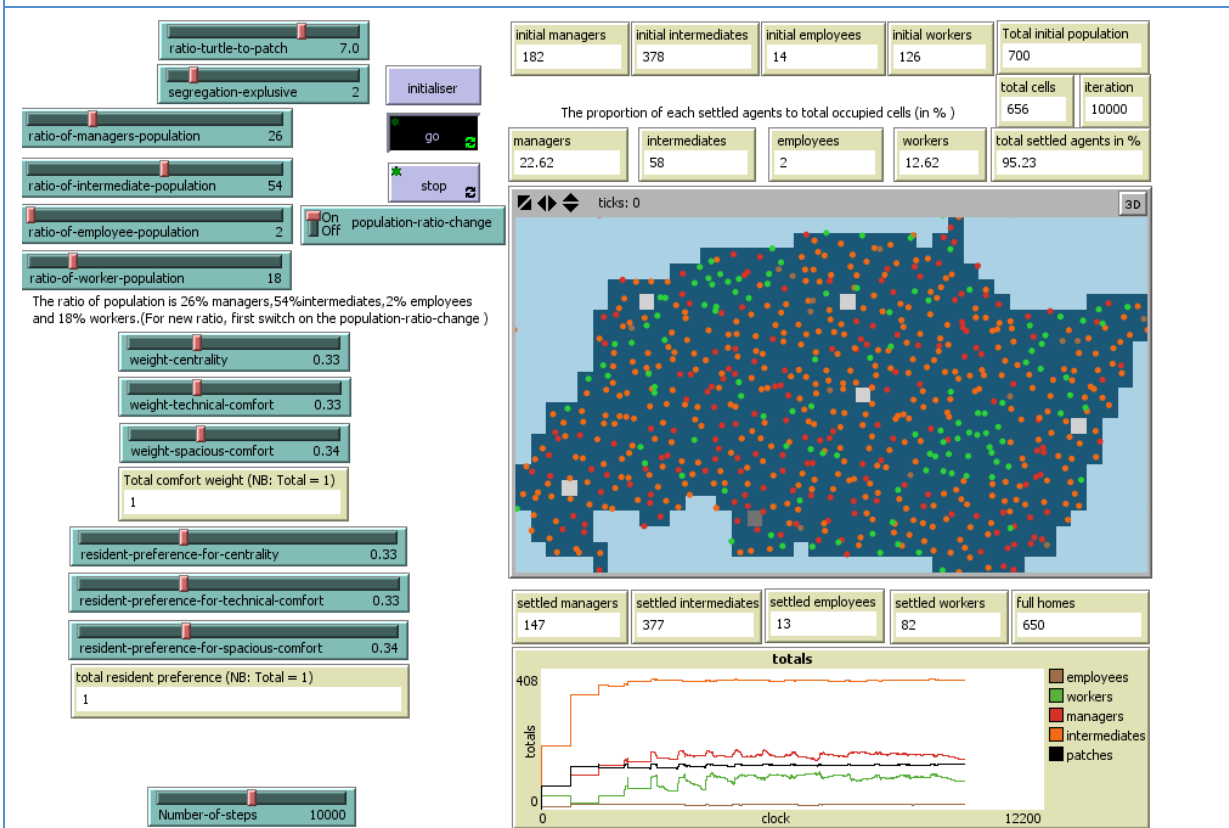

run 6

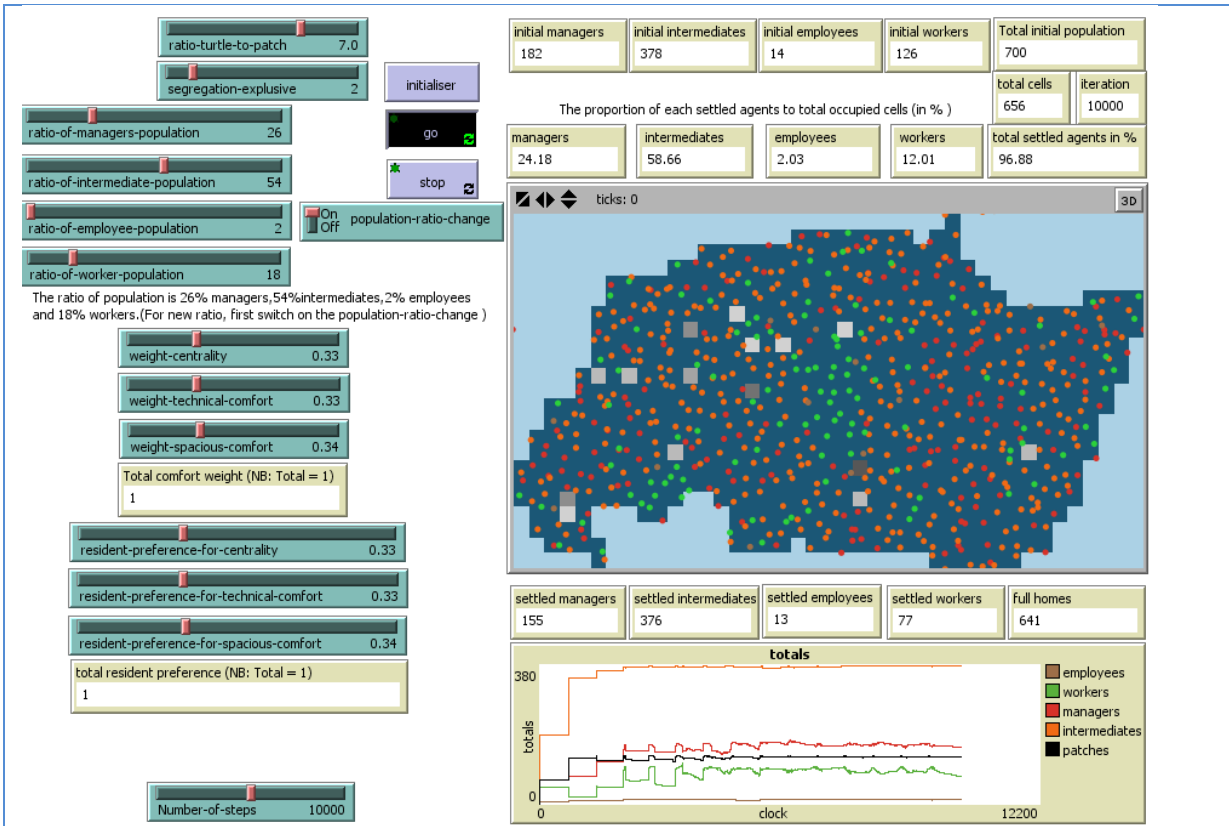

run 7

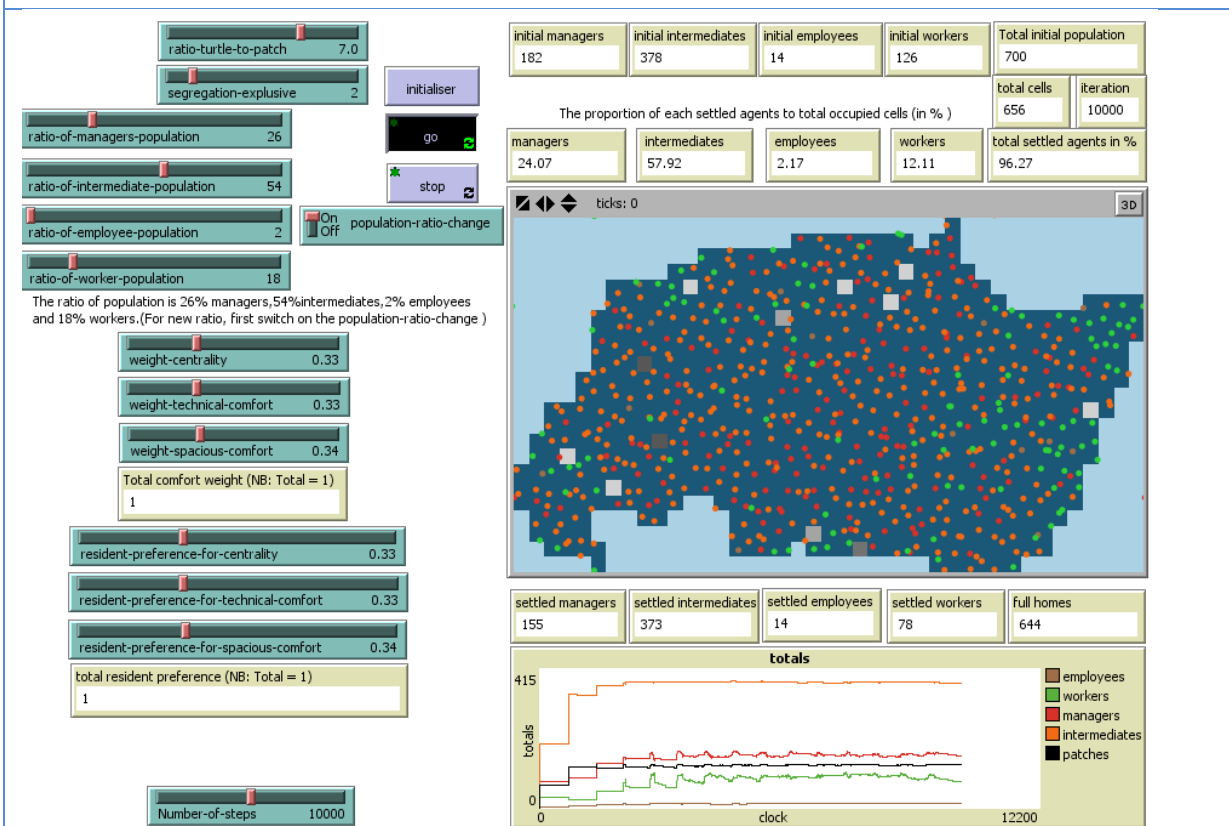

run 8

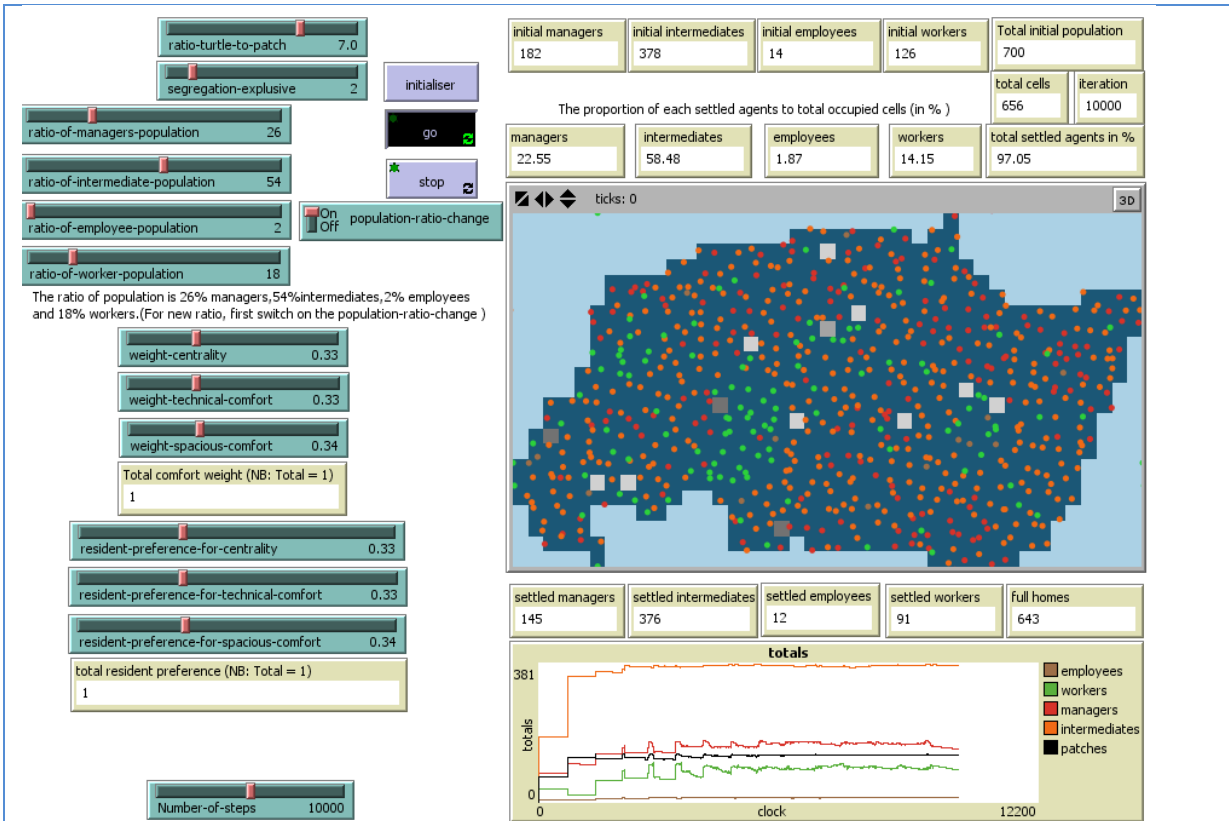

run 9

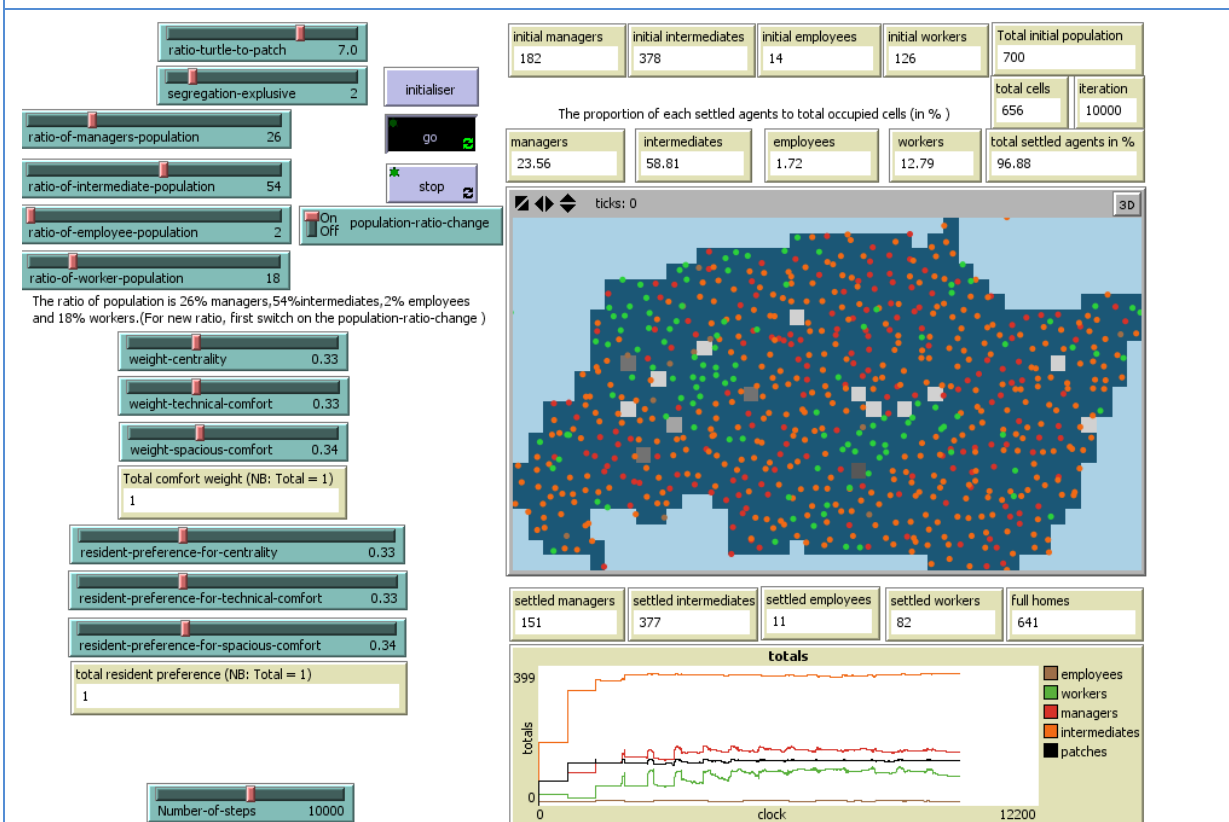

run 10

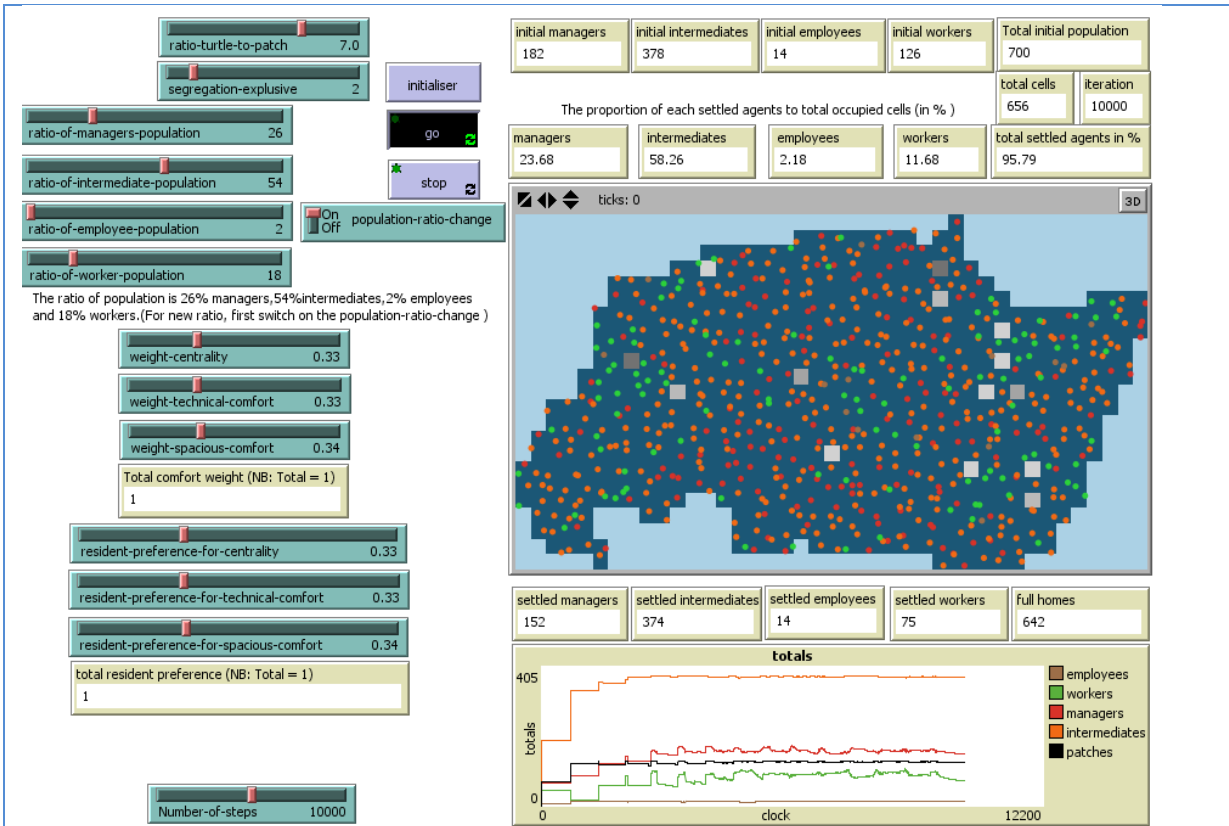

run 11

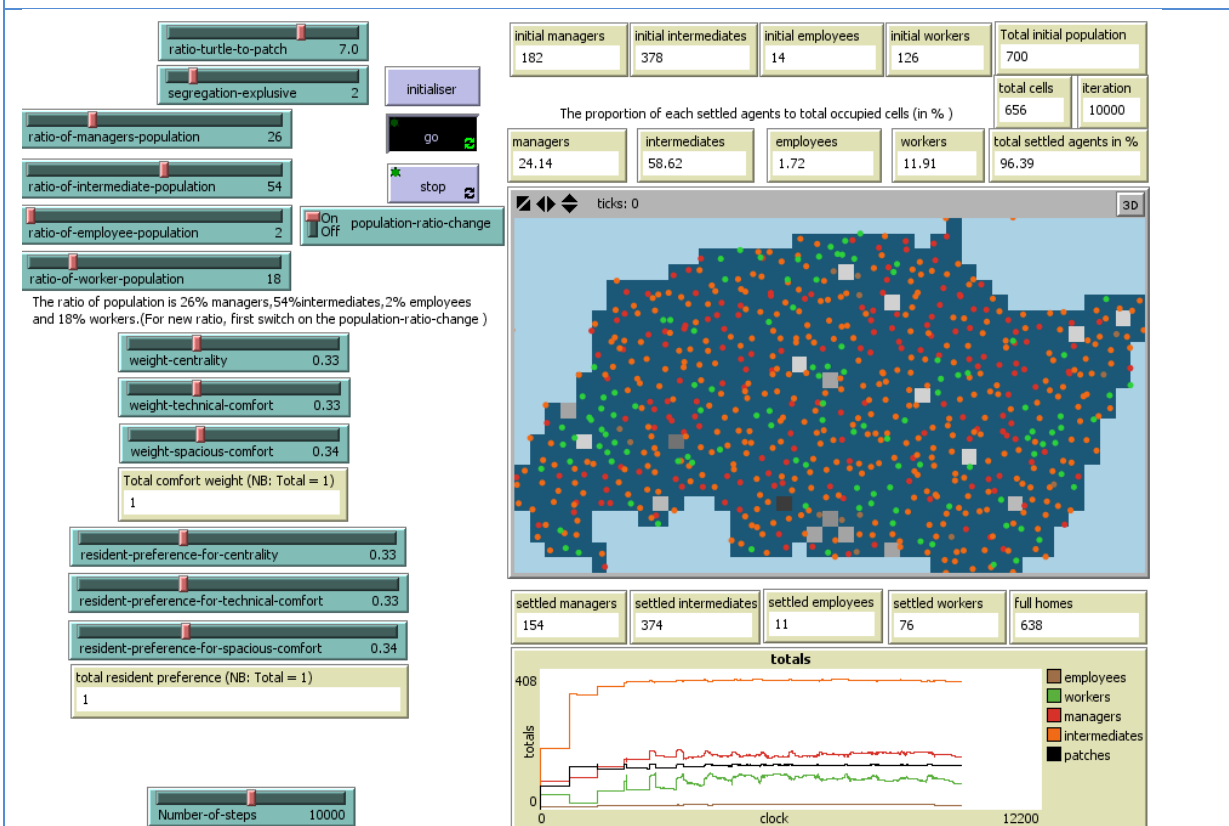

run 12

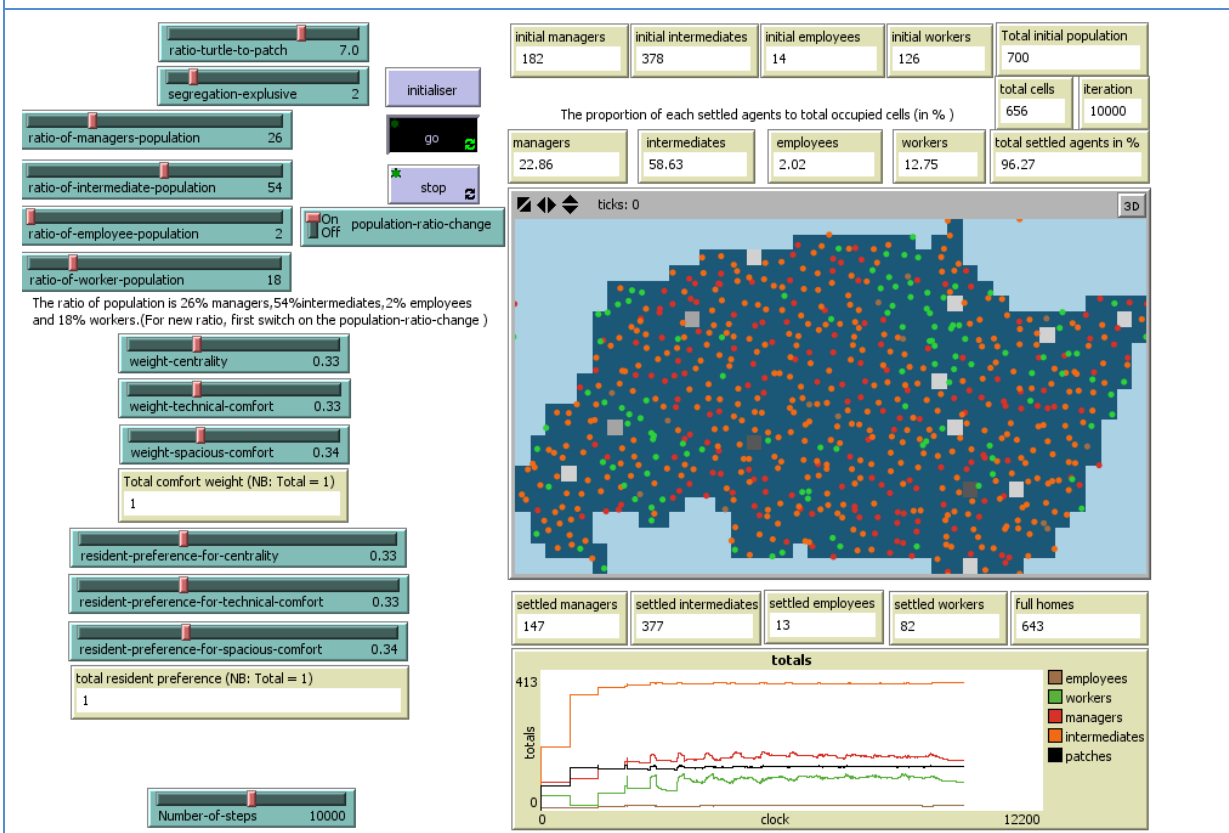
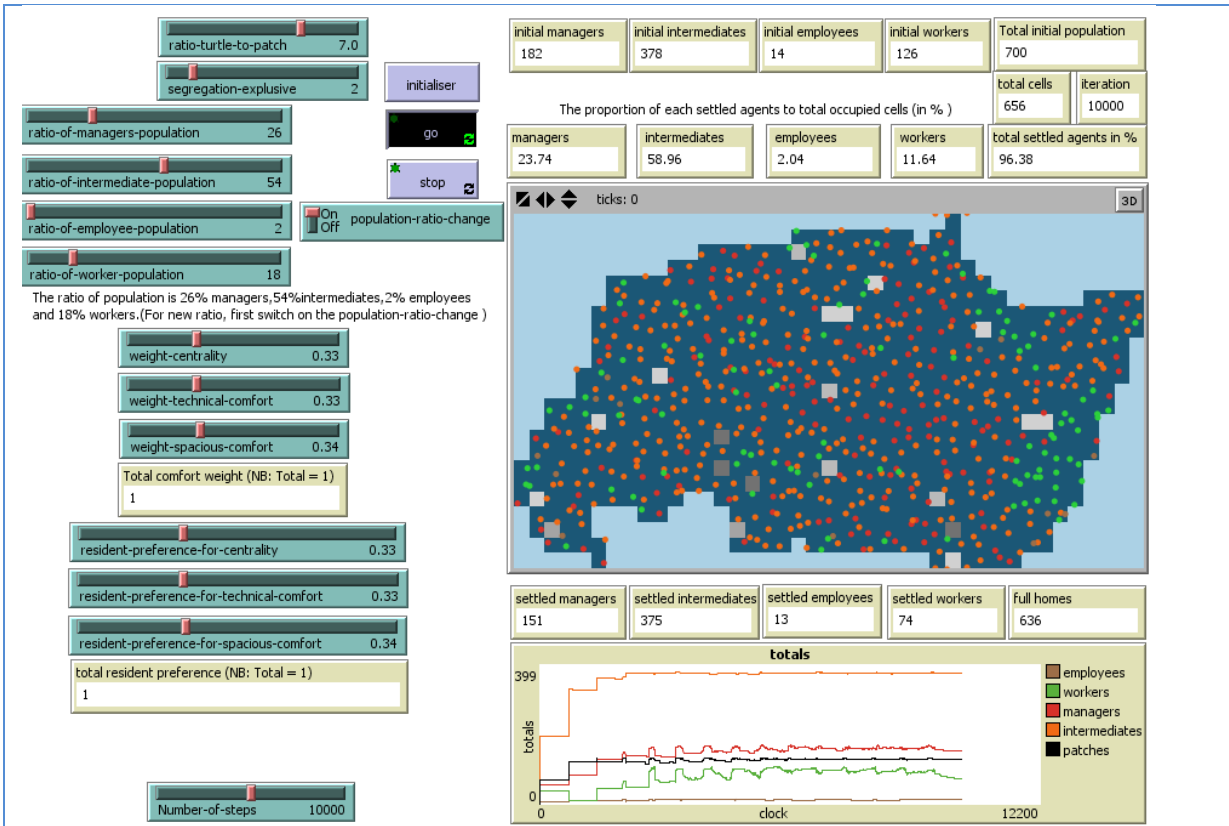

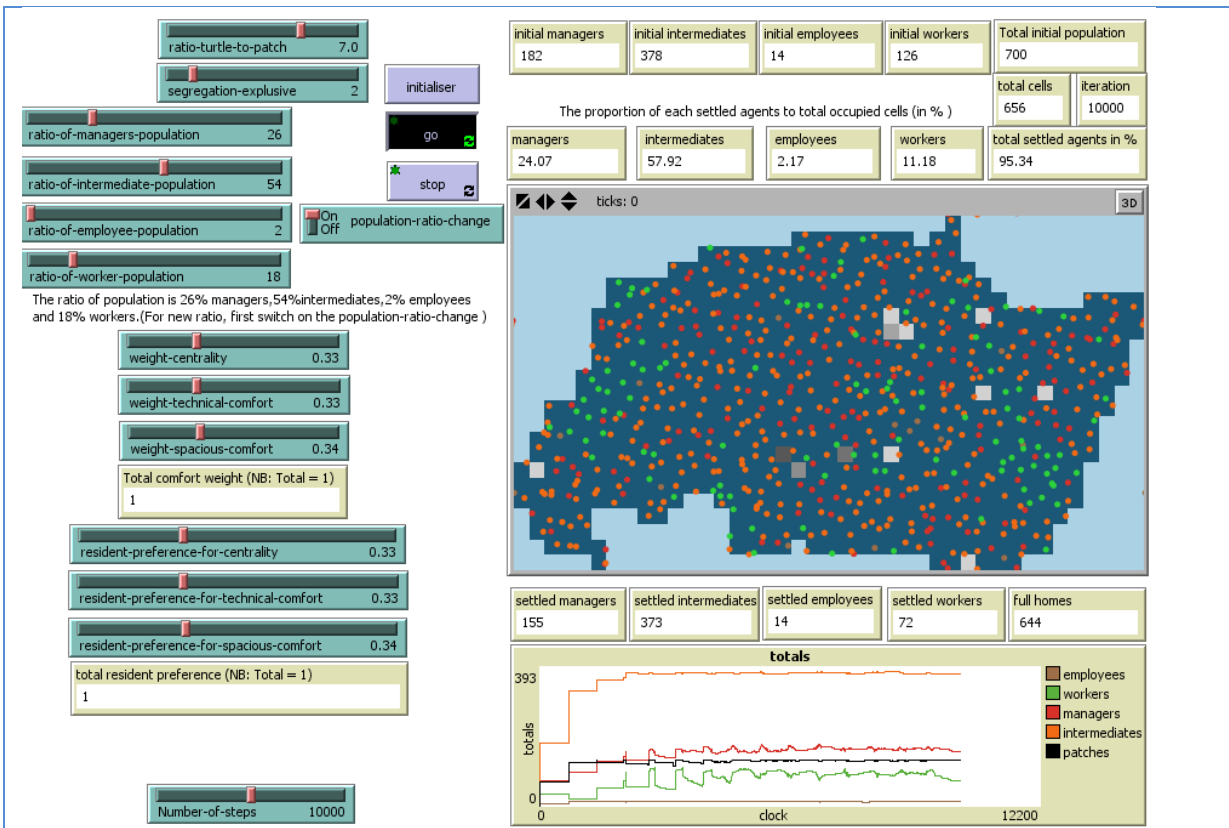

run 15

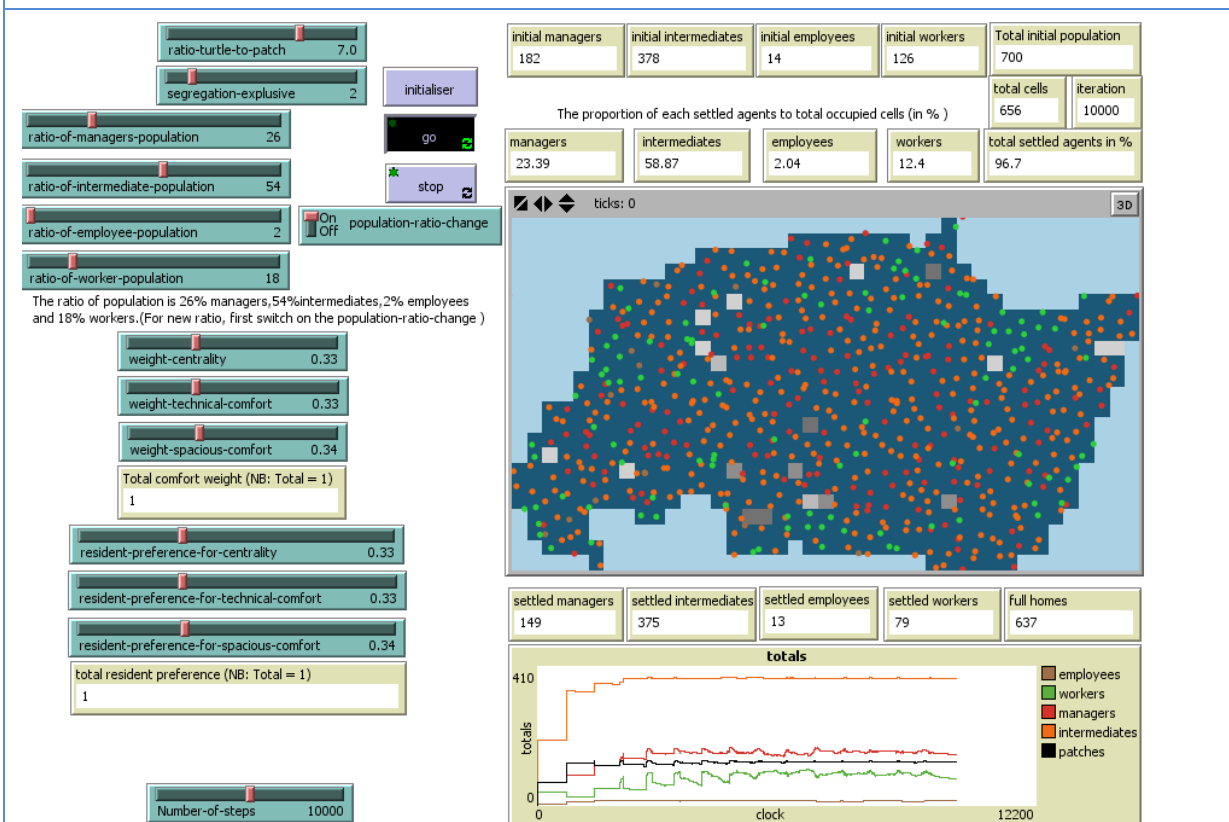

run 16

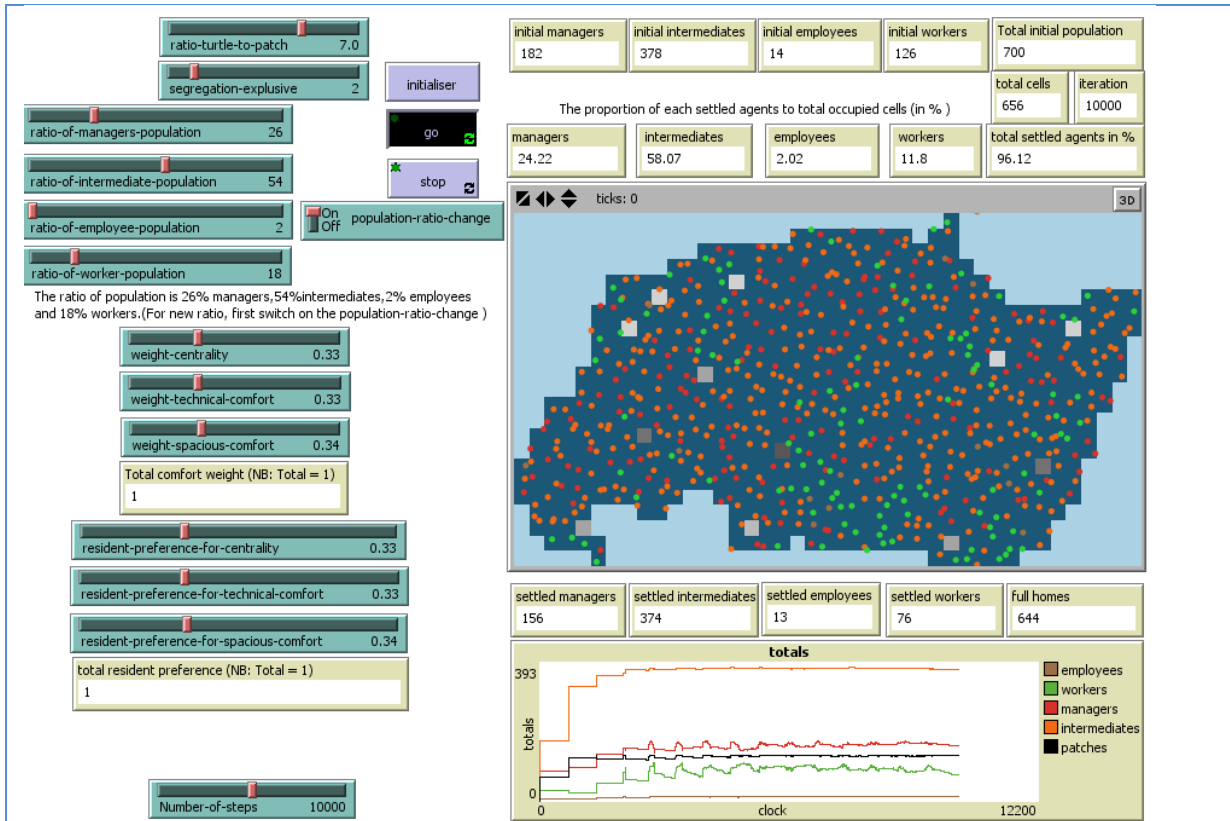

run 17

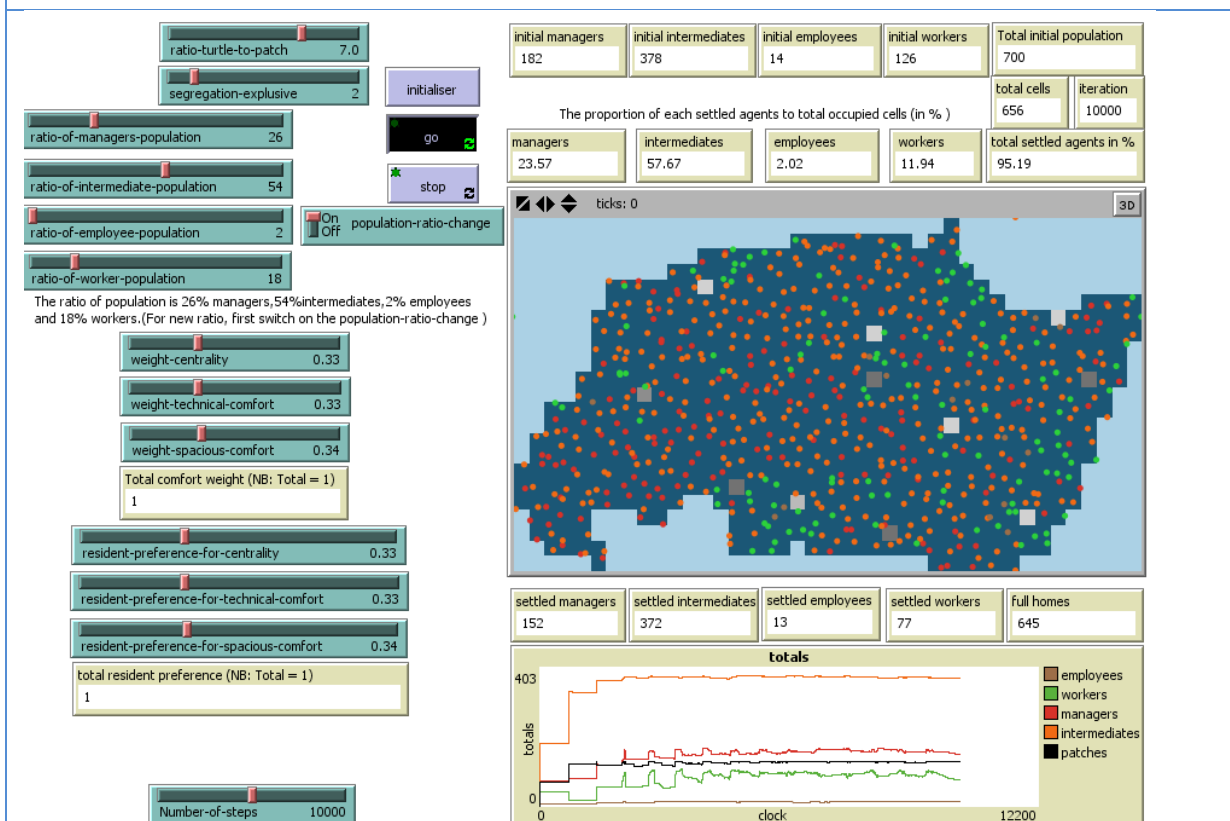

run 18

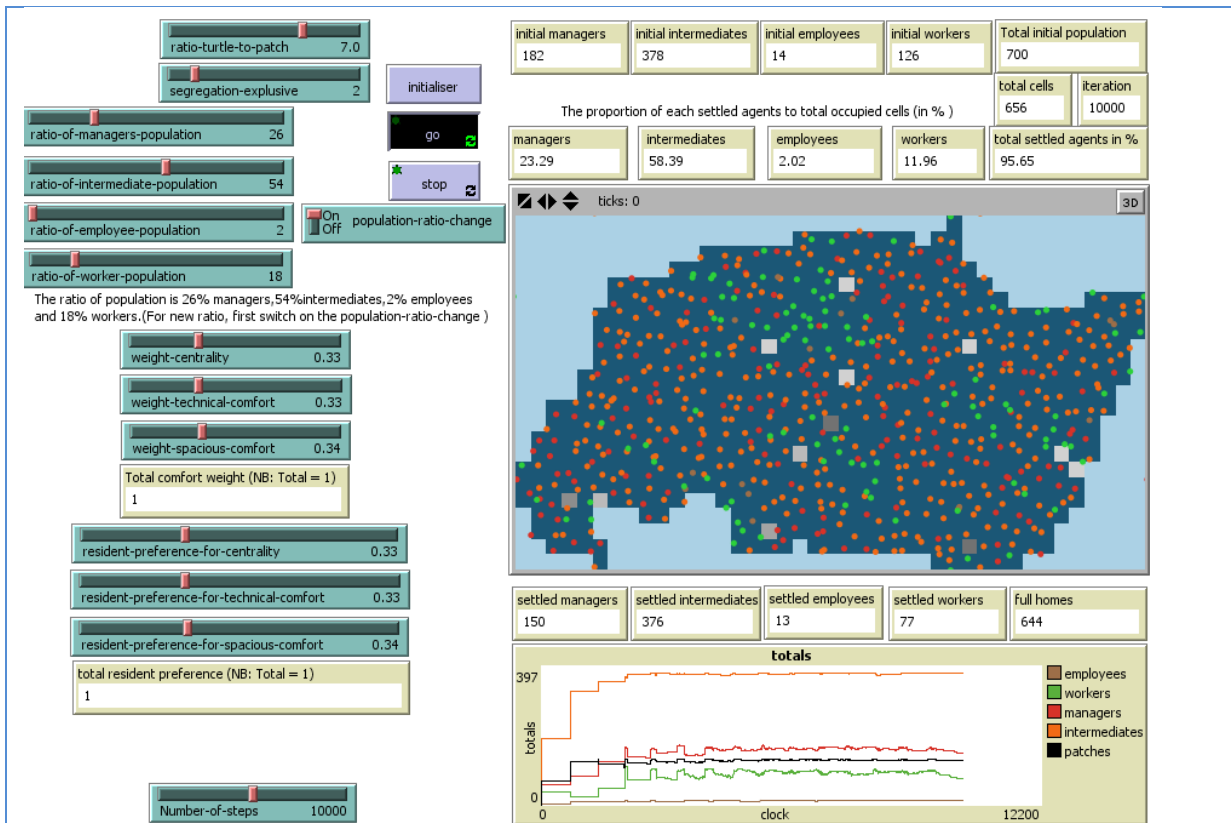

run 19

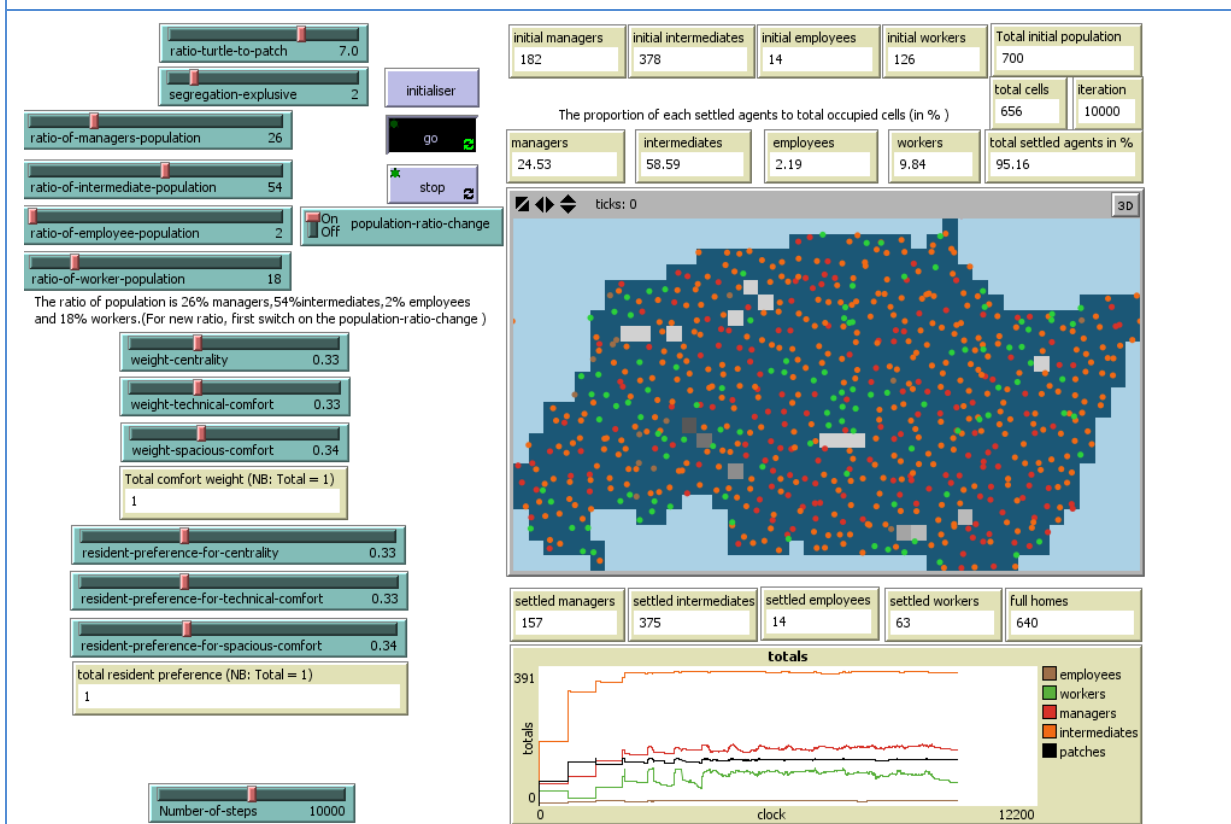

run 20

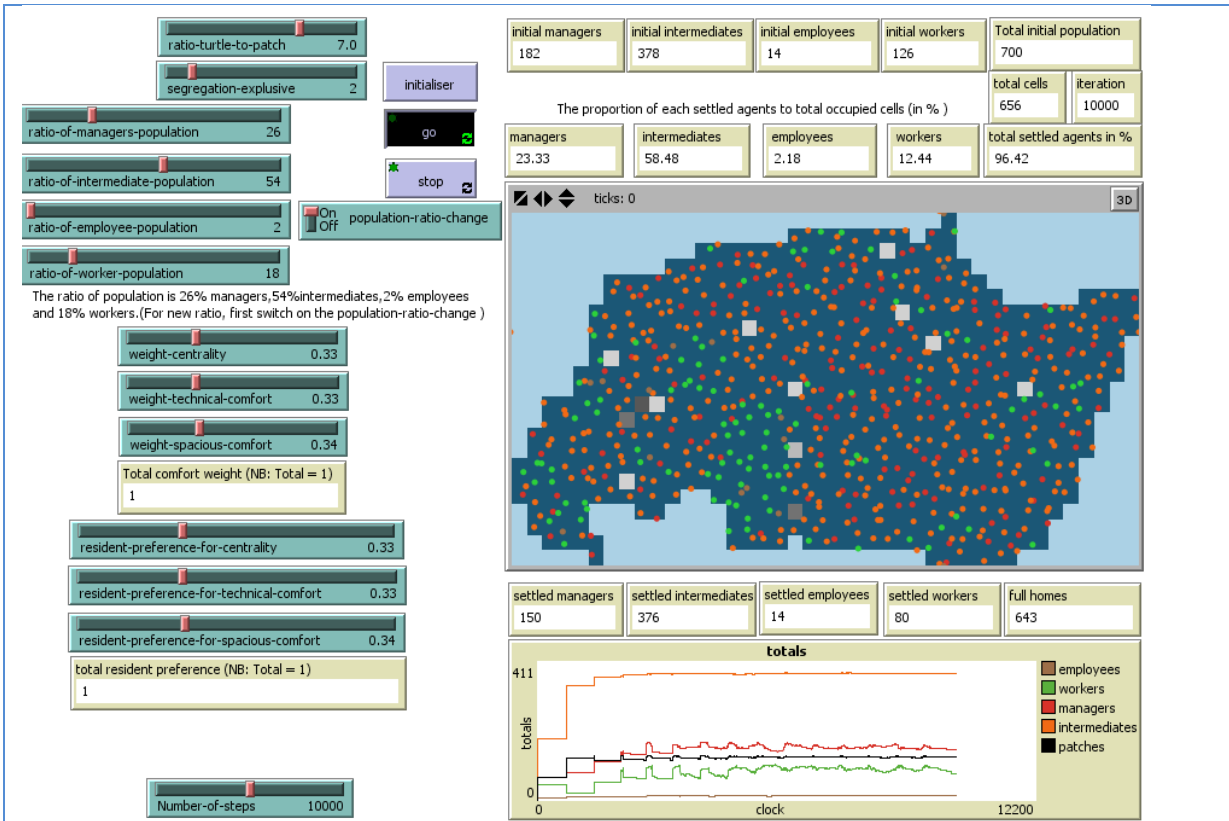

run 21

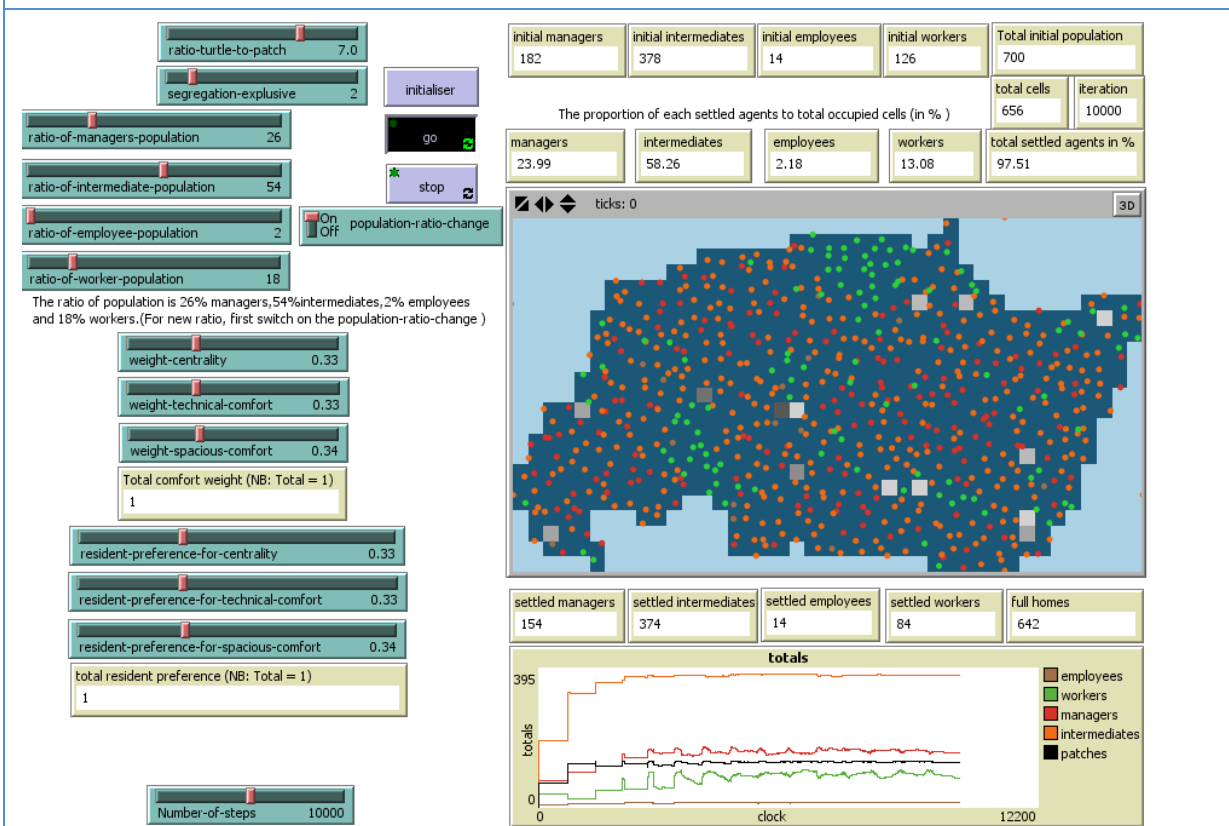

run 22

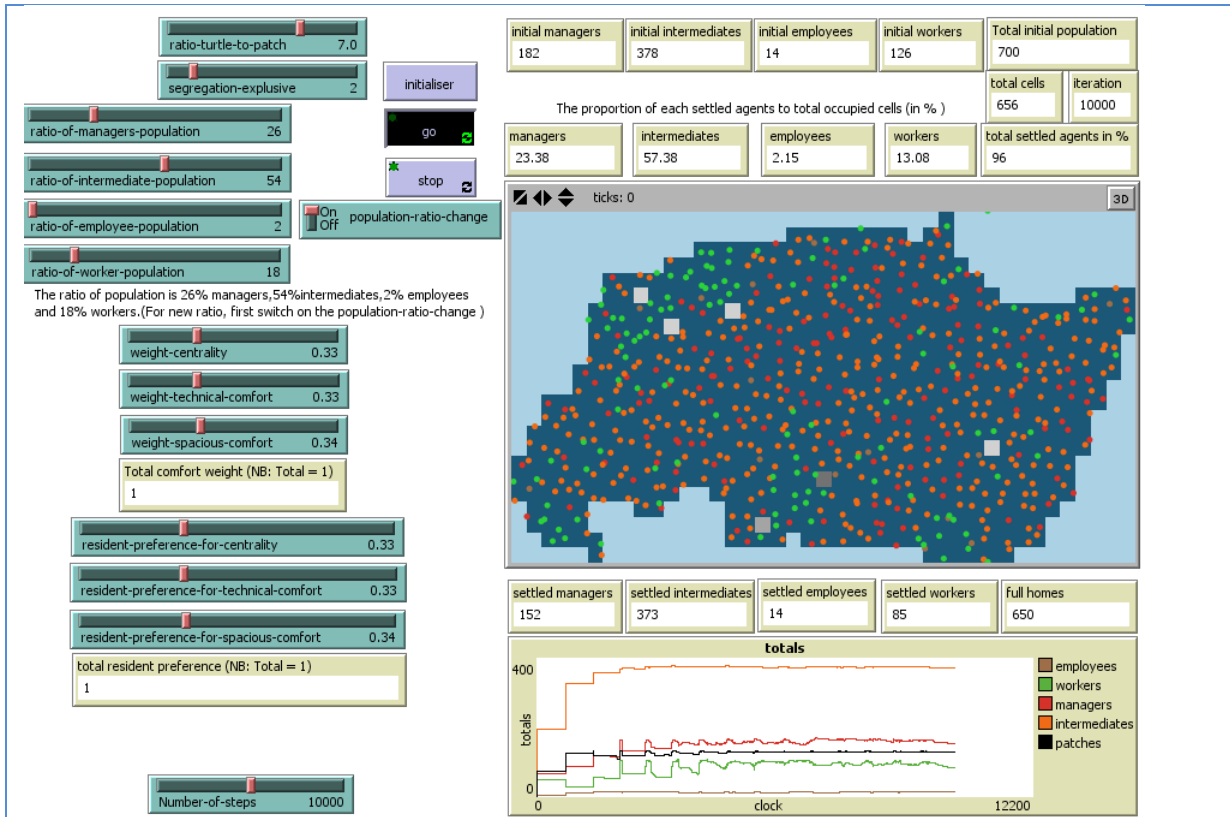

run 23

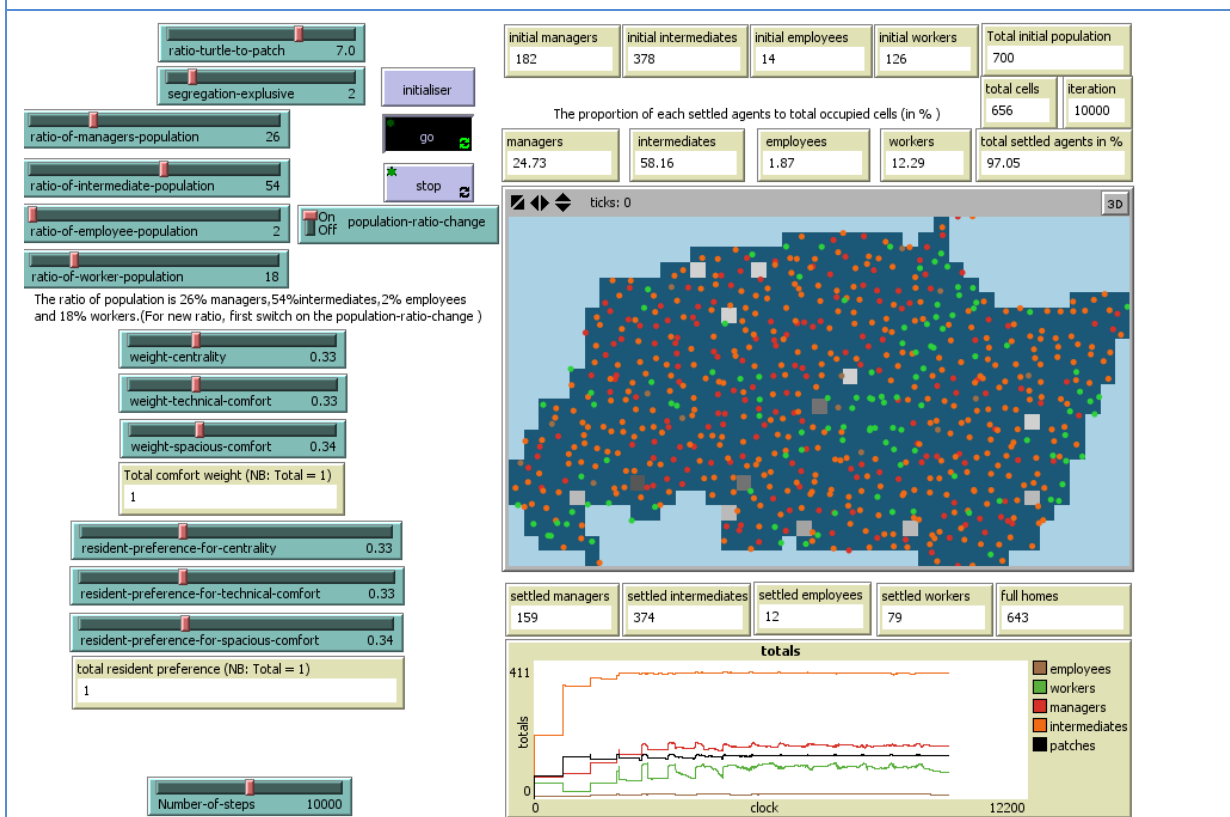

run 24

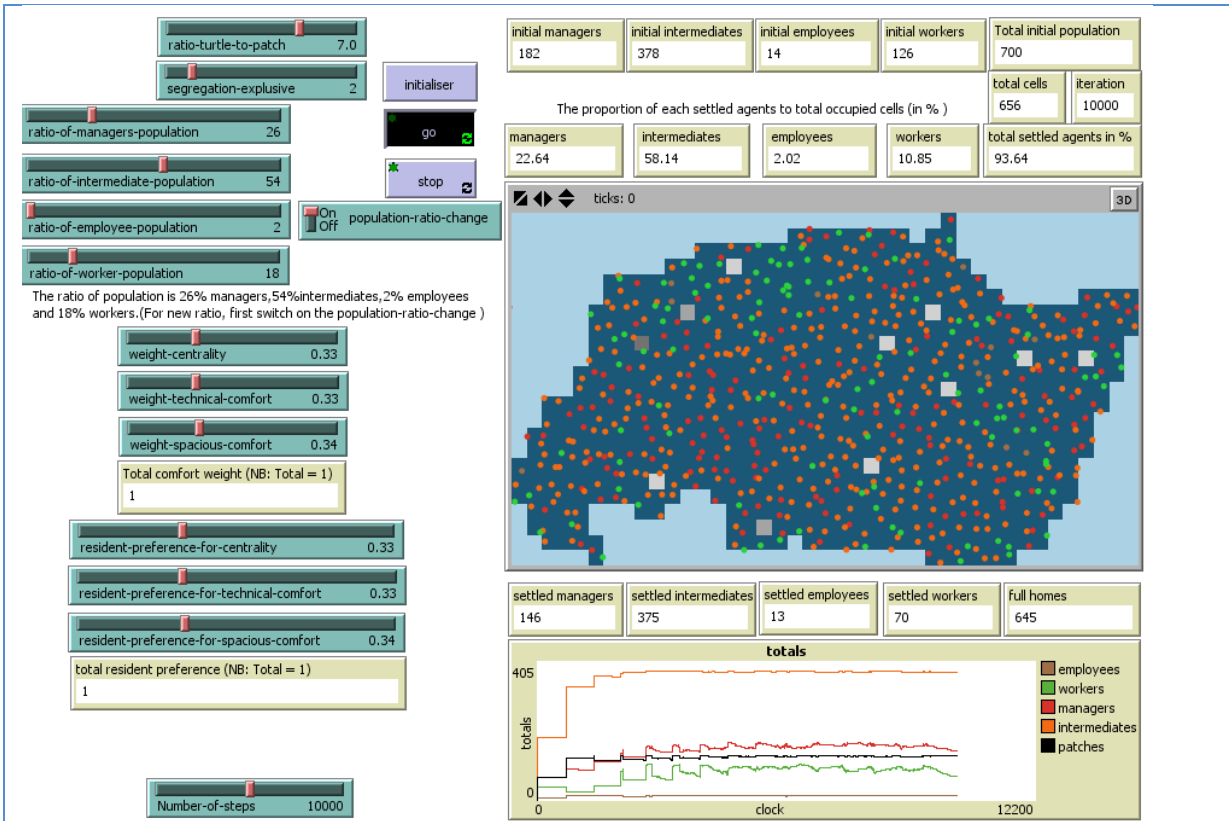

run 25

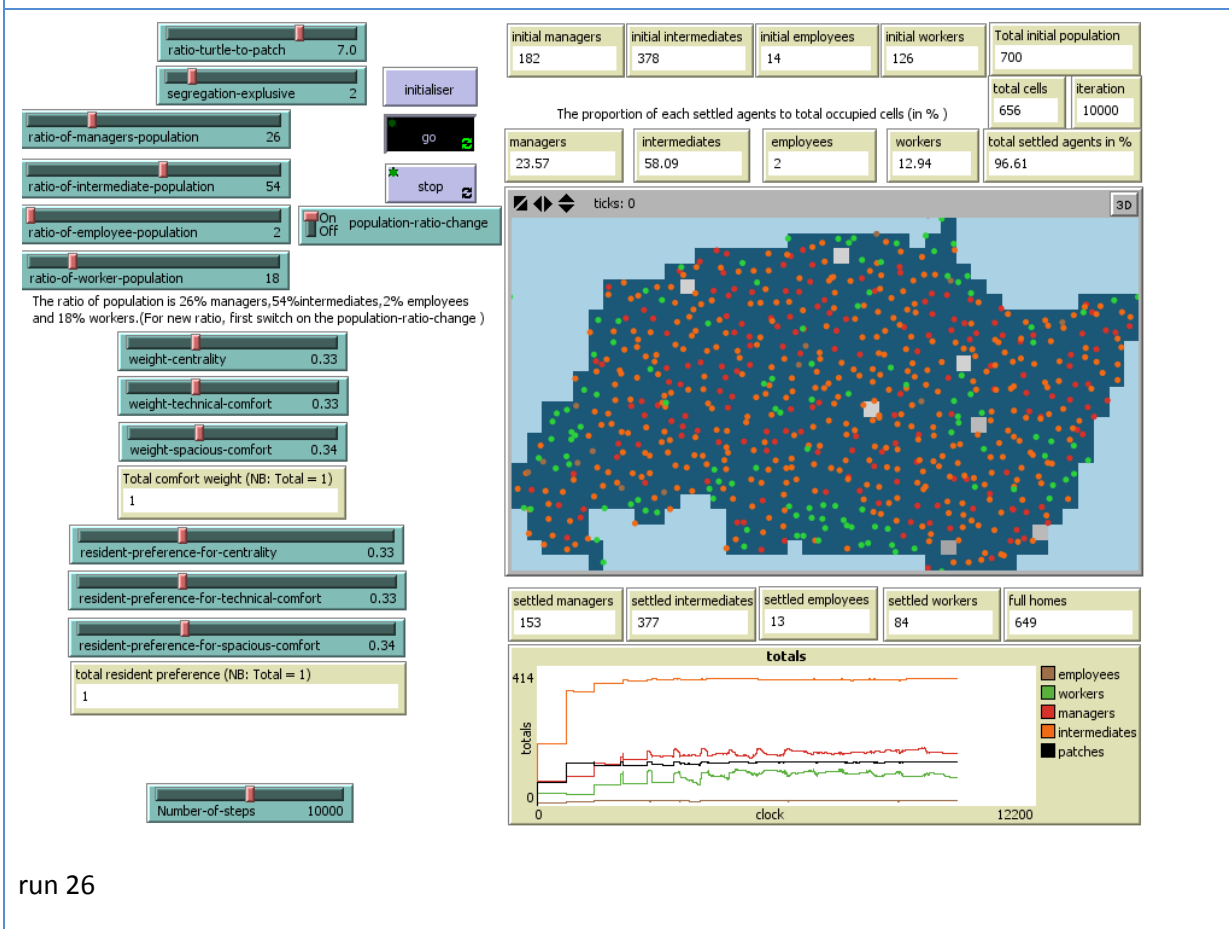

run 26

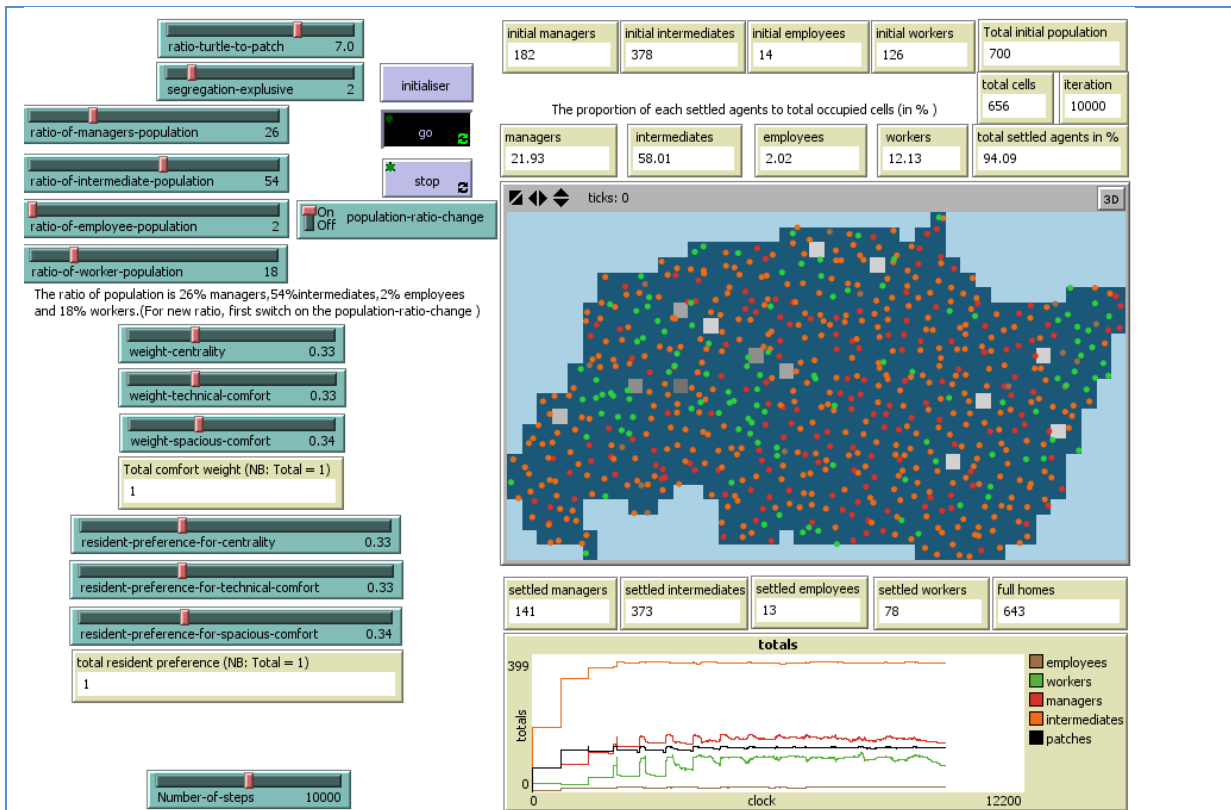

run 27

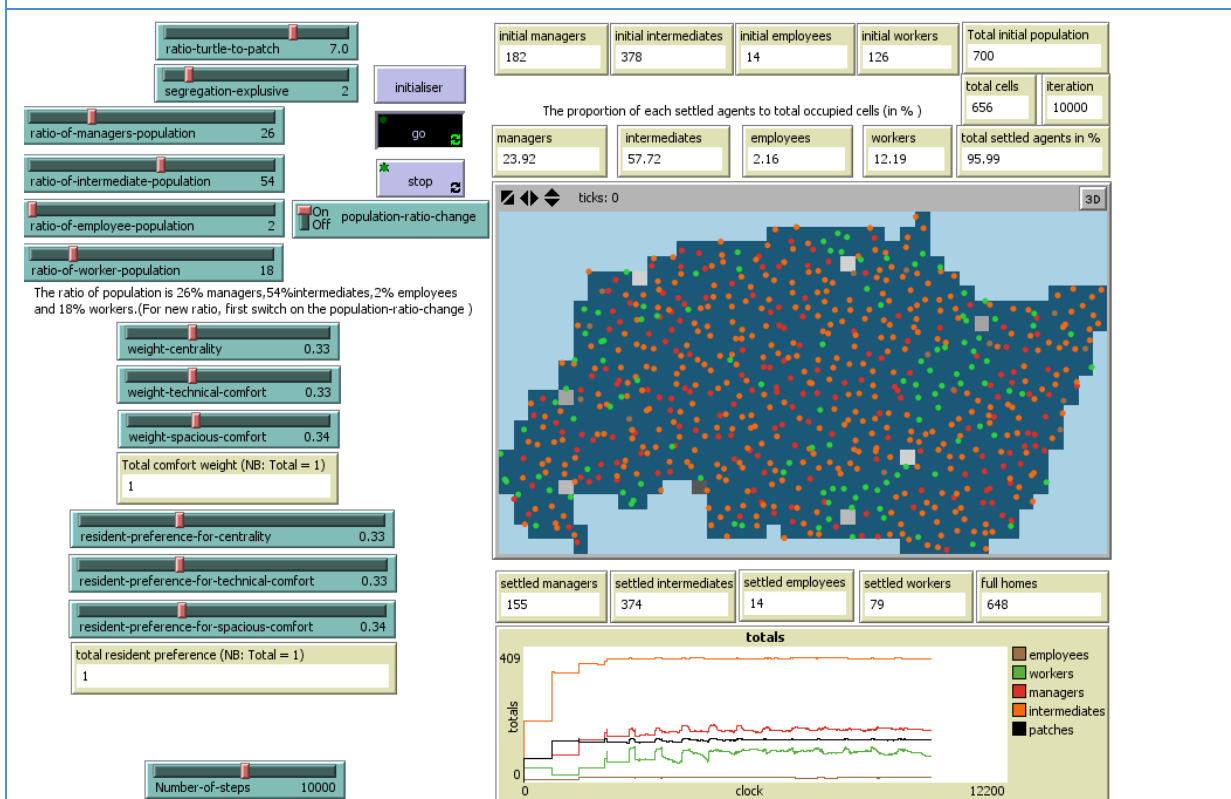

run 28

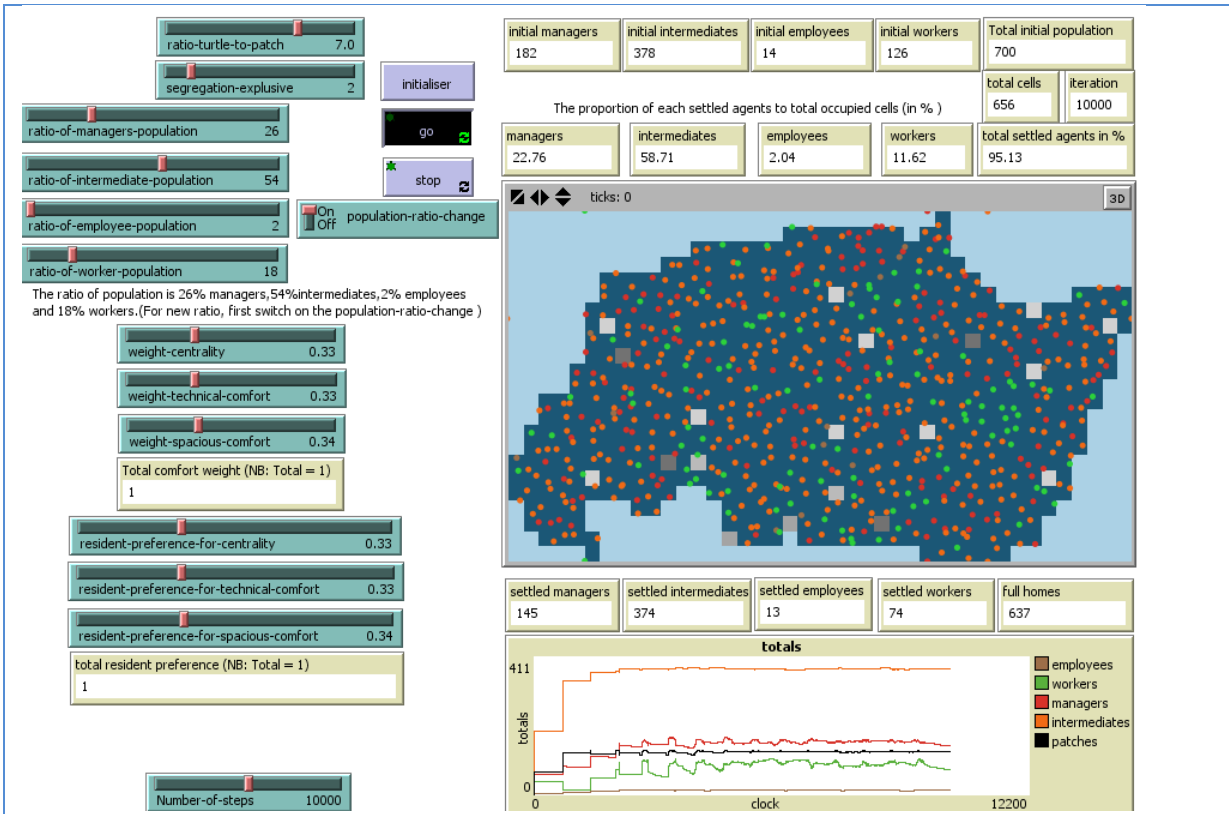

run 29

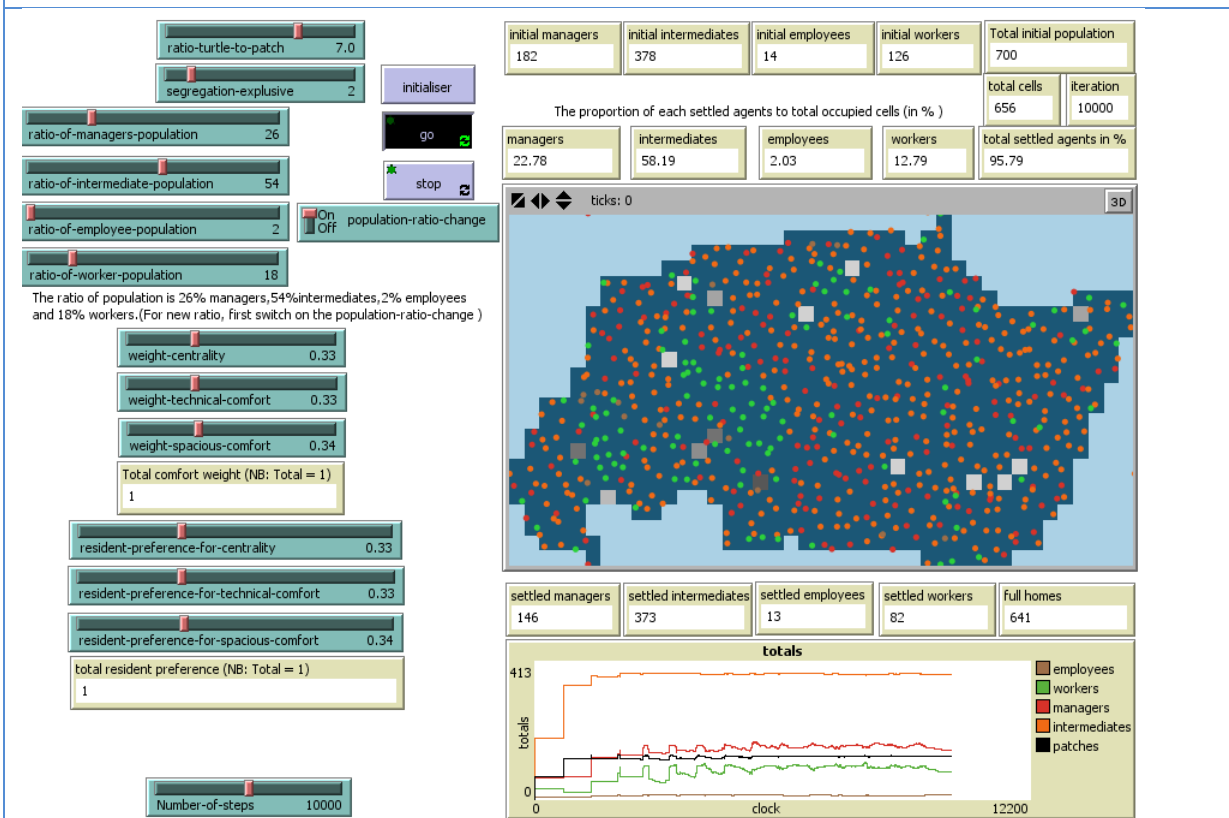

run 30

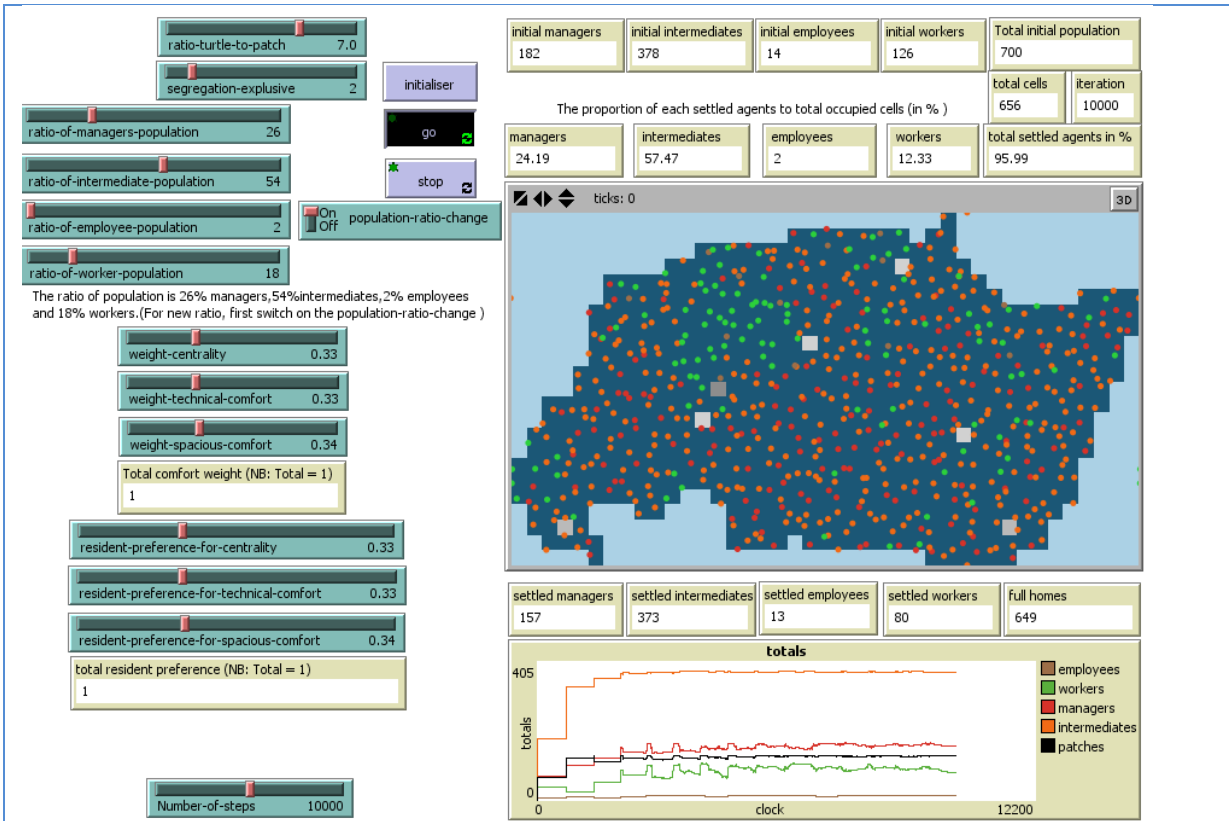

run 31

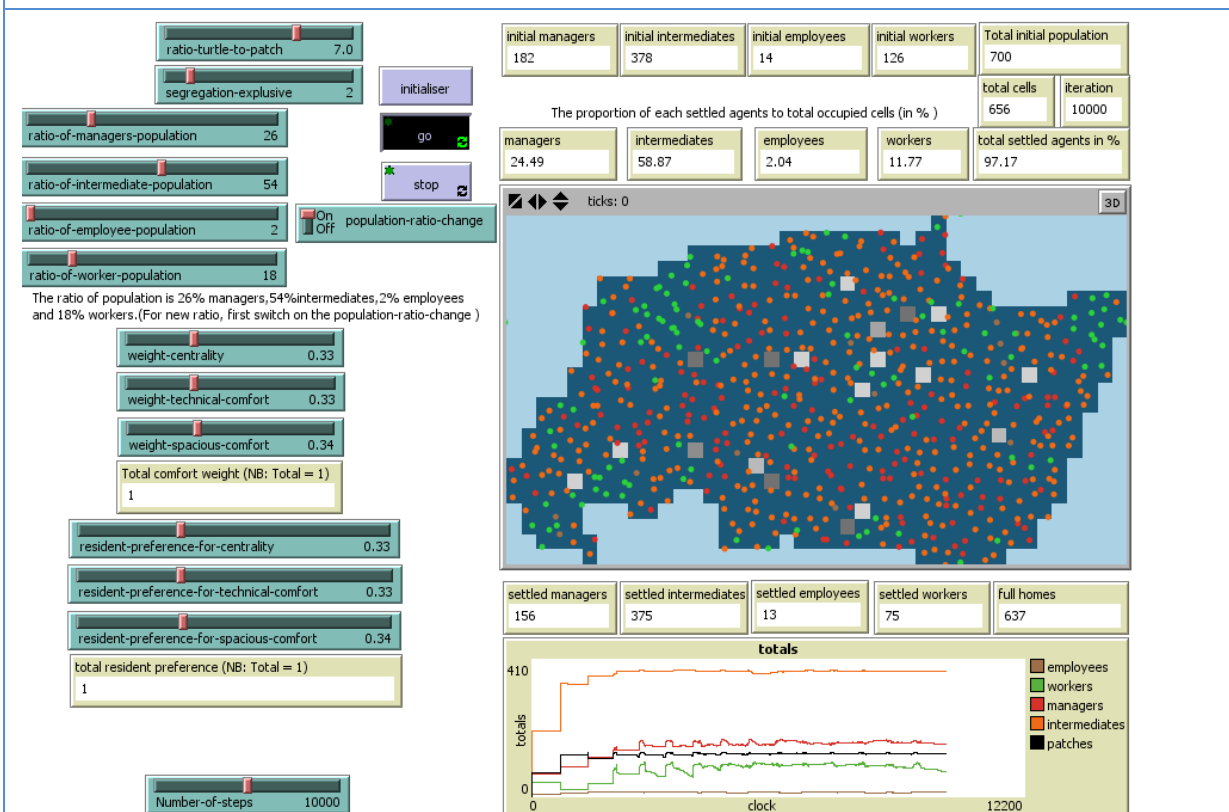

run 32

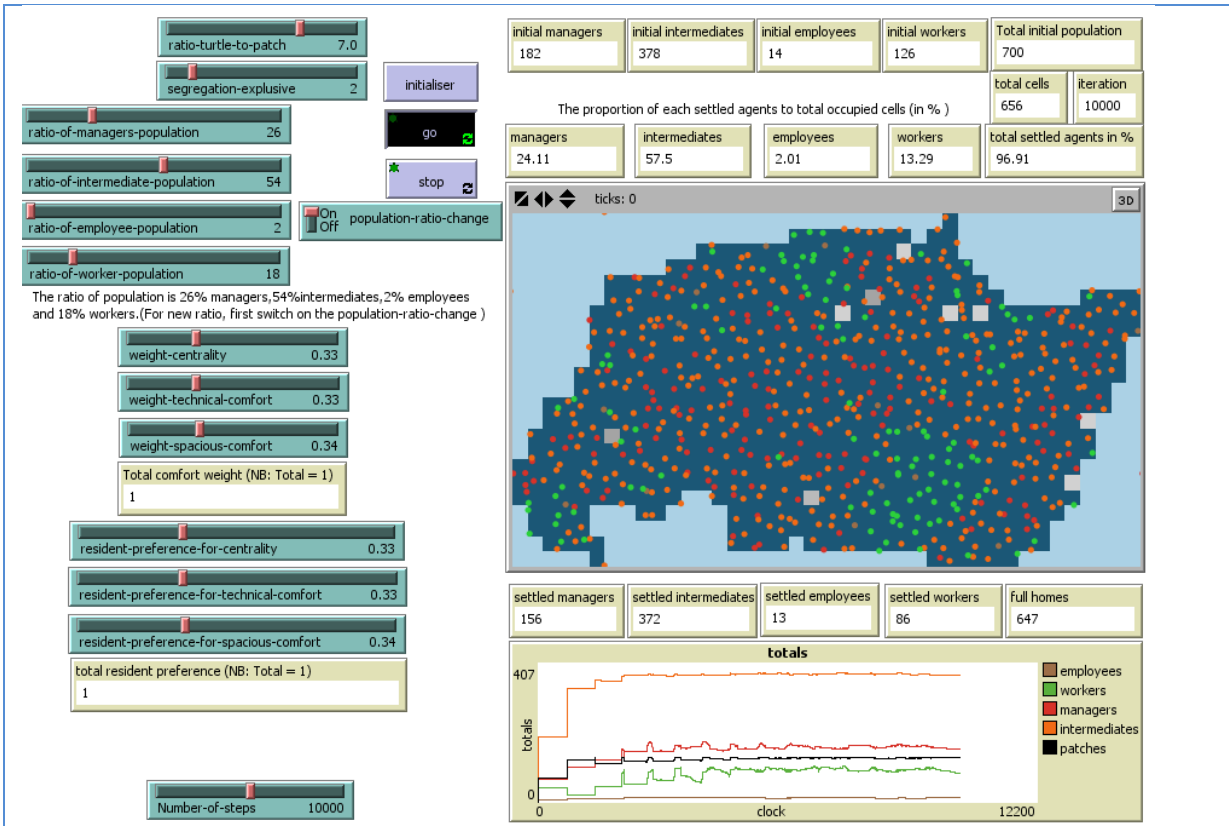

run 33

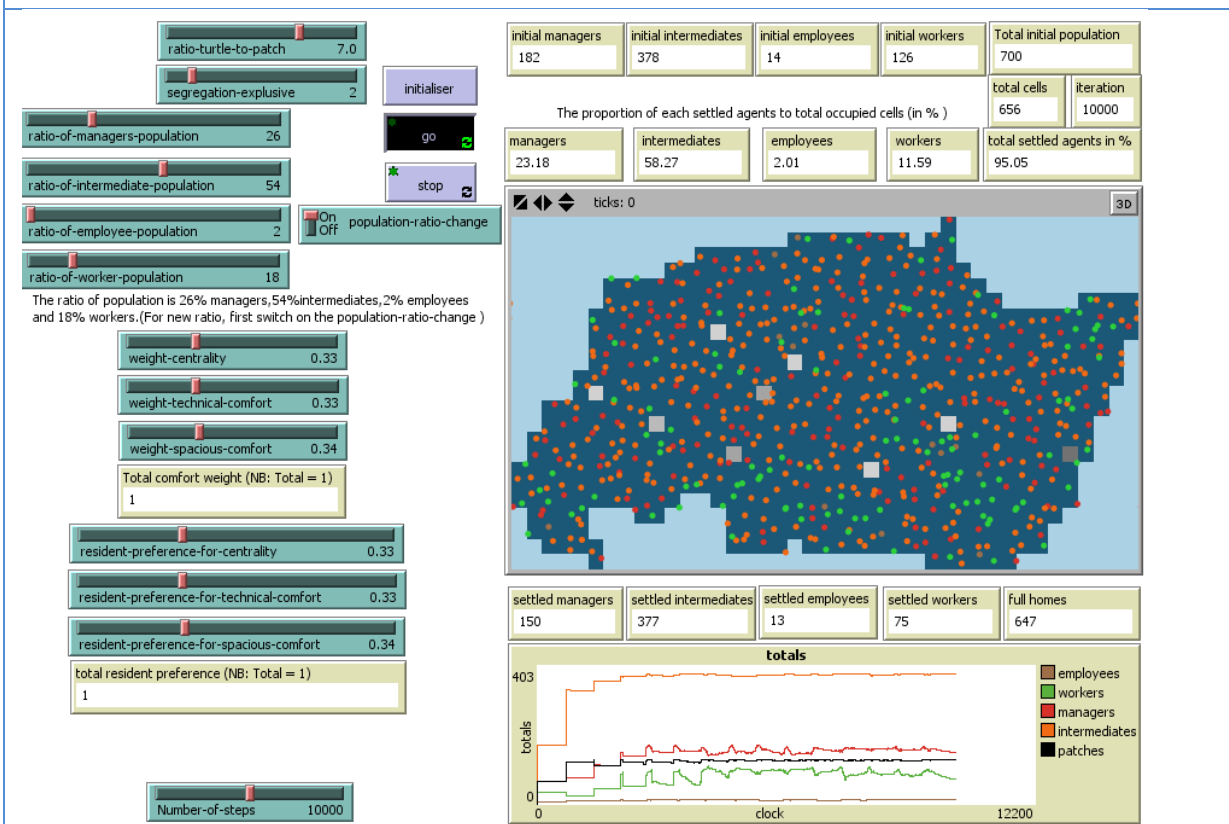

run 34

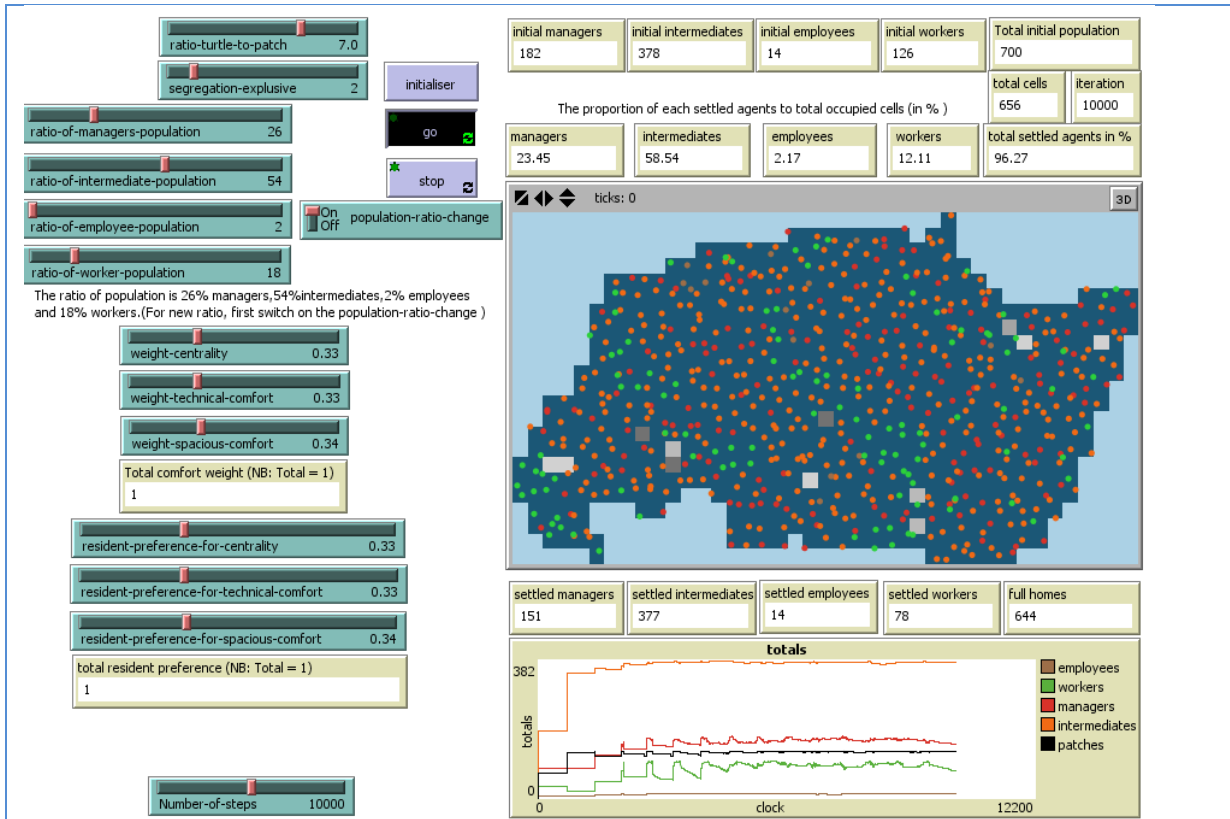

run 35

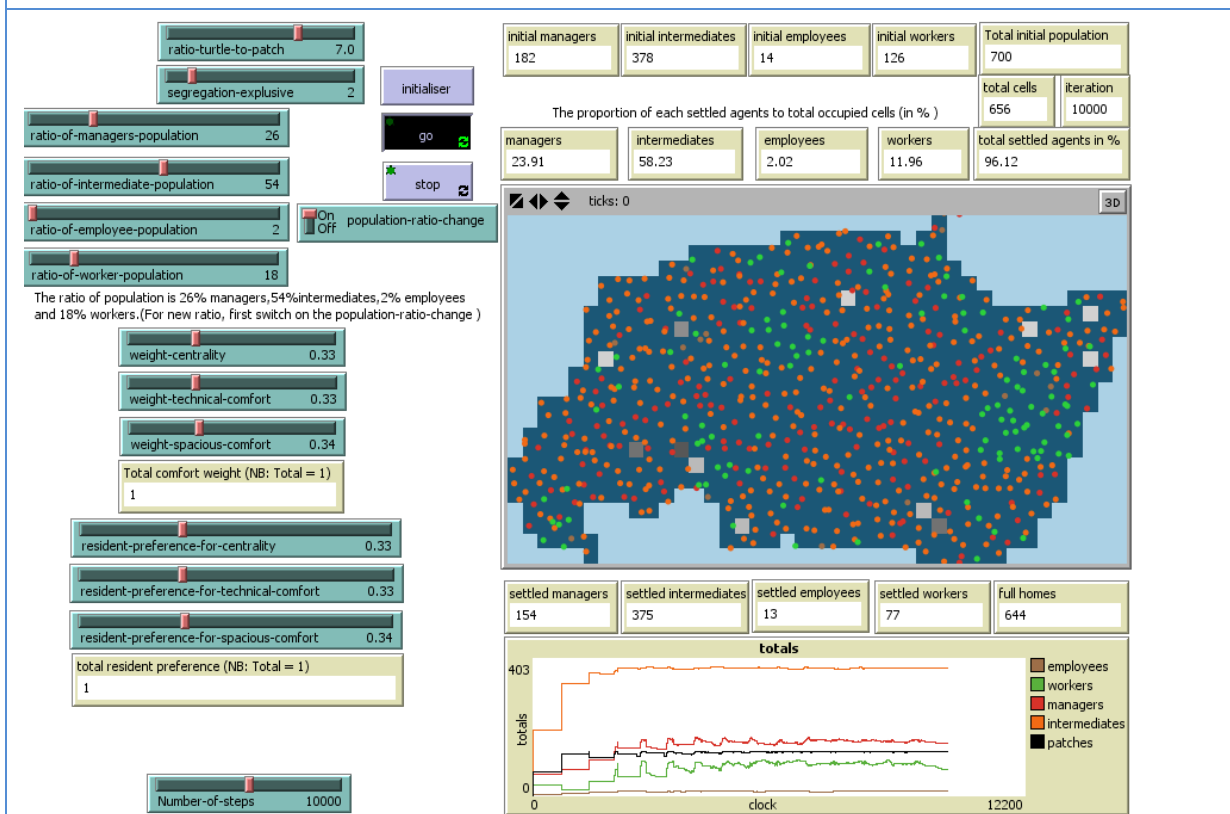

run 36

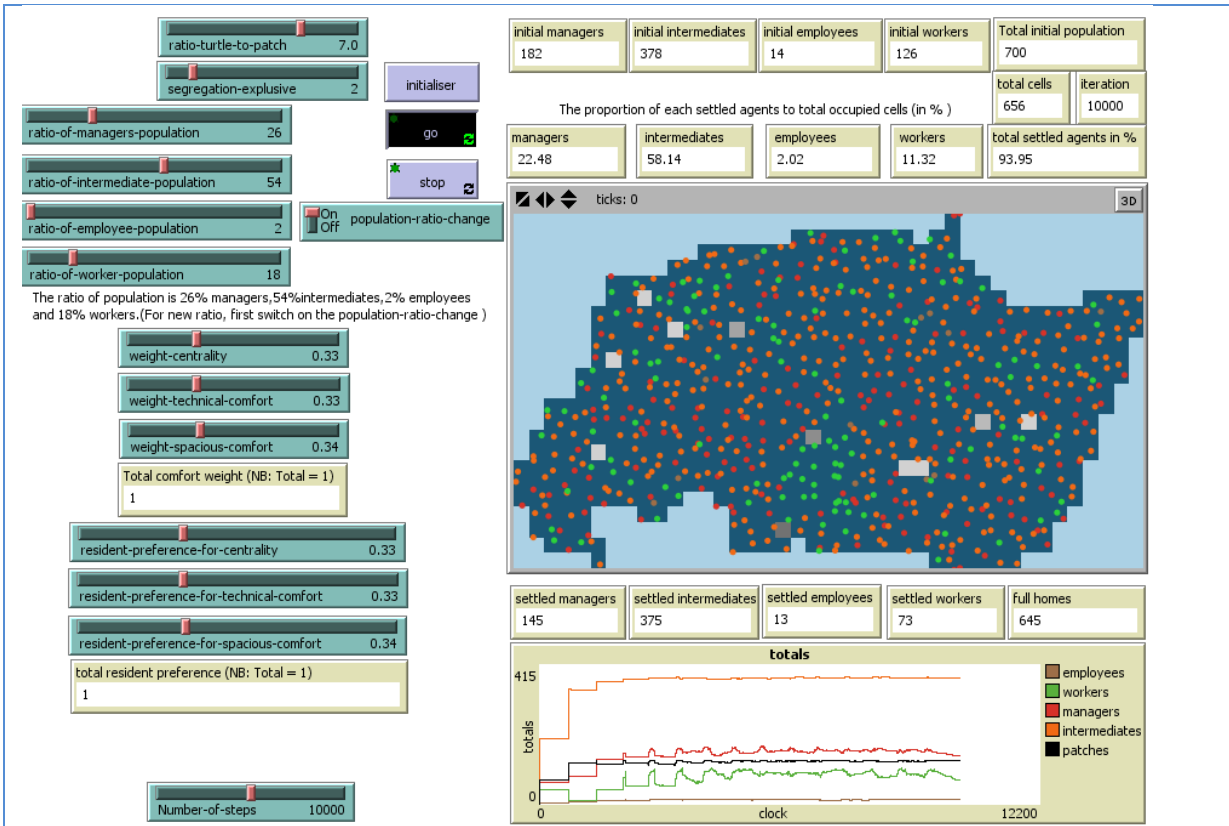

run 37

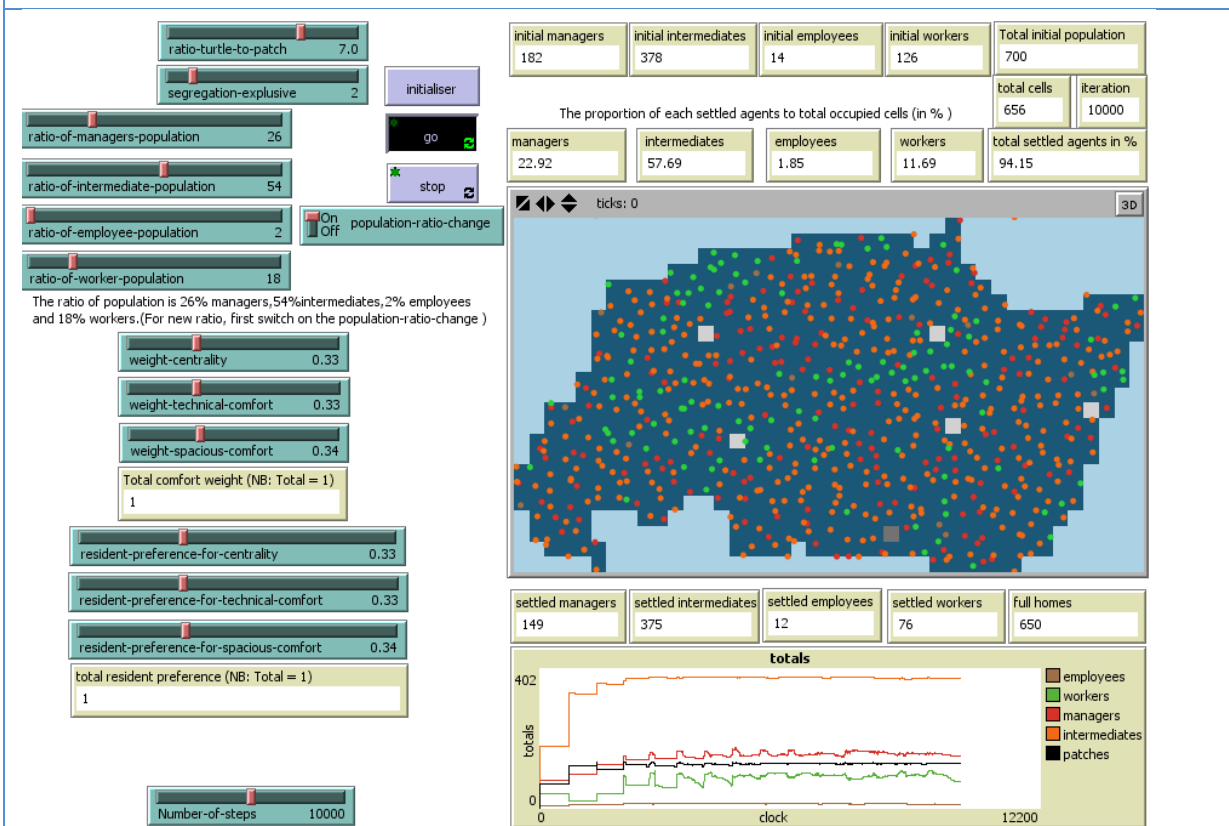

run 38

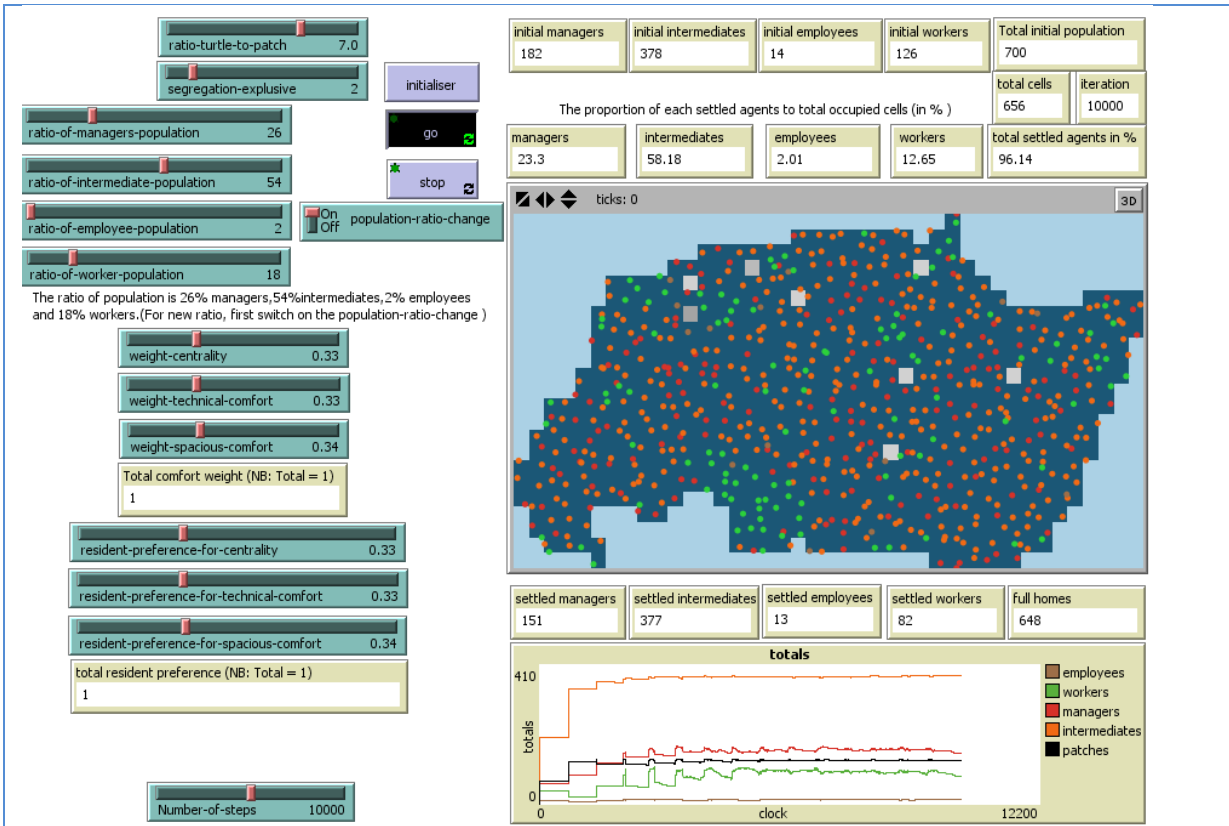

run 39

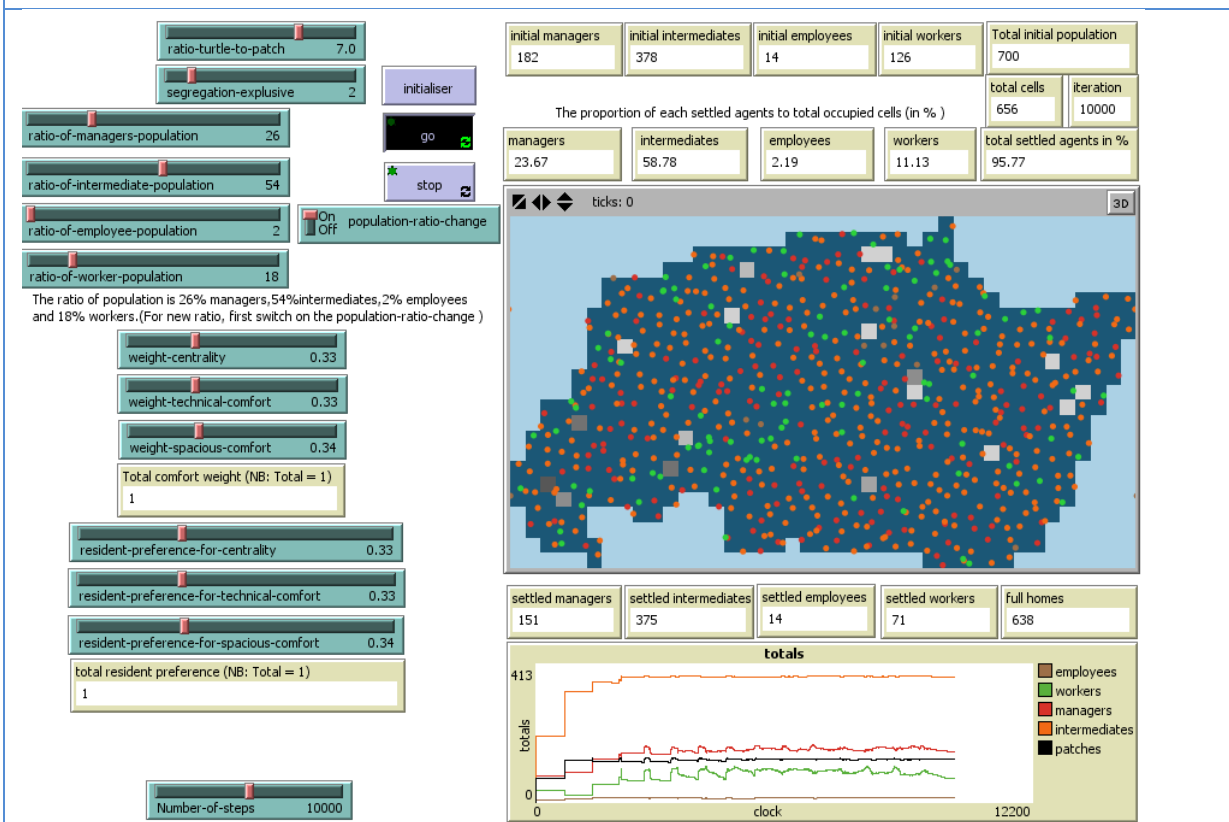

run 40

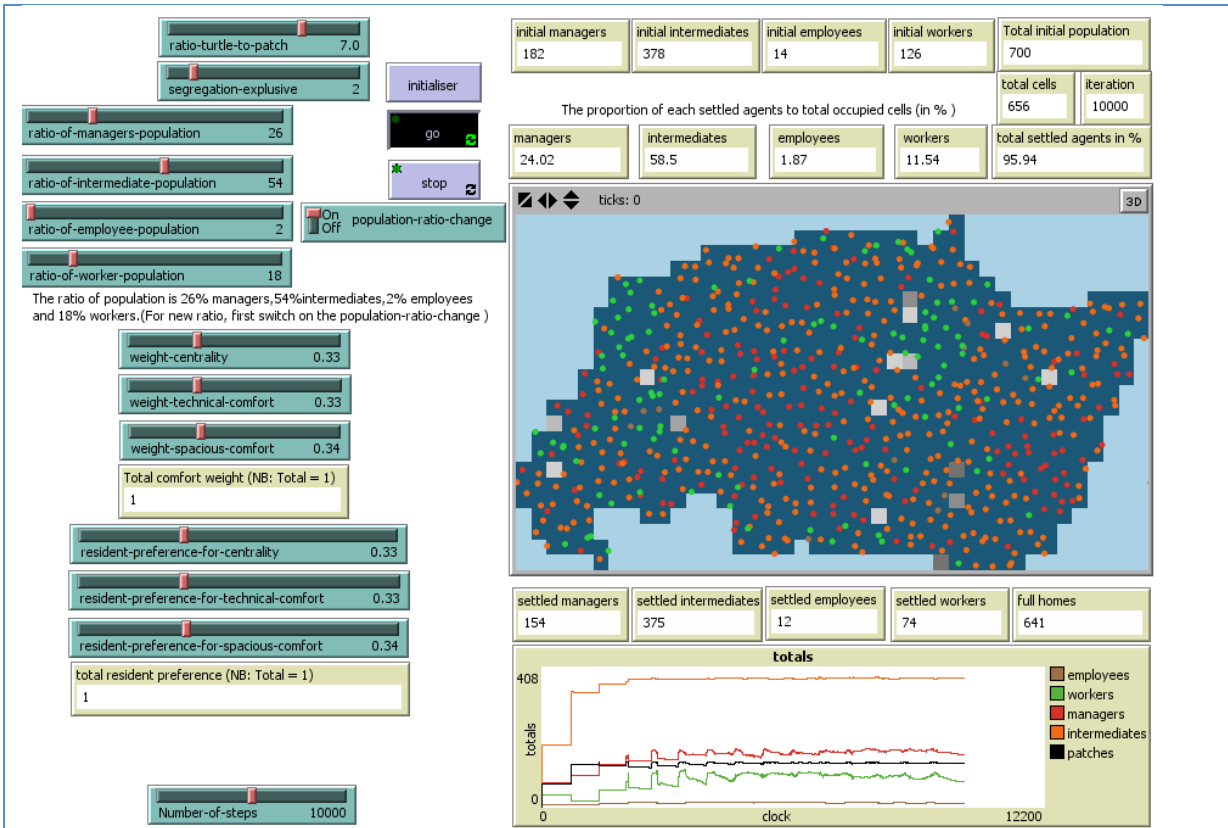

run 41

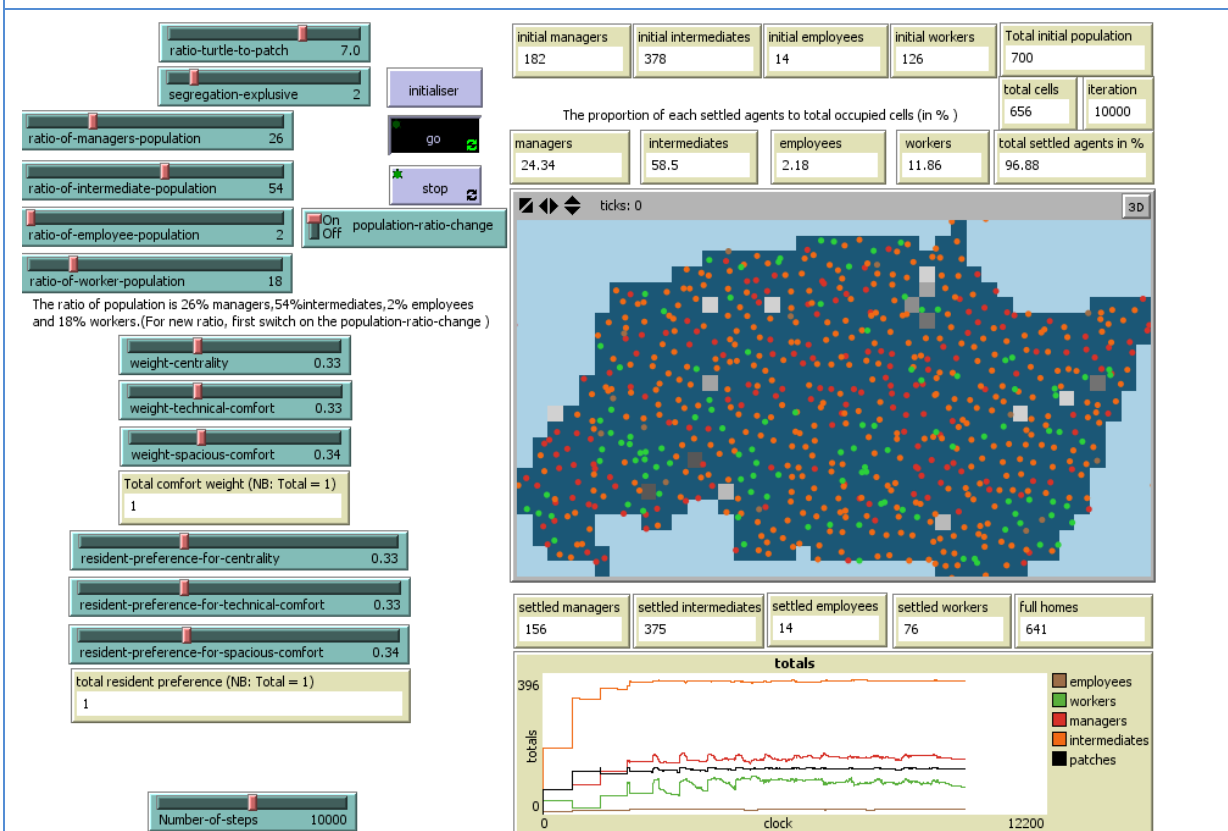

run 42

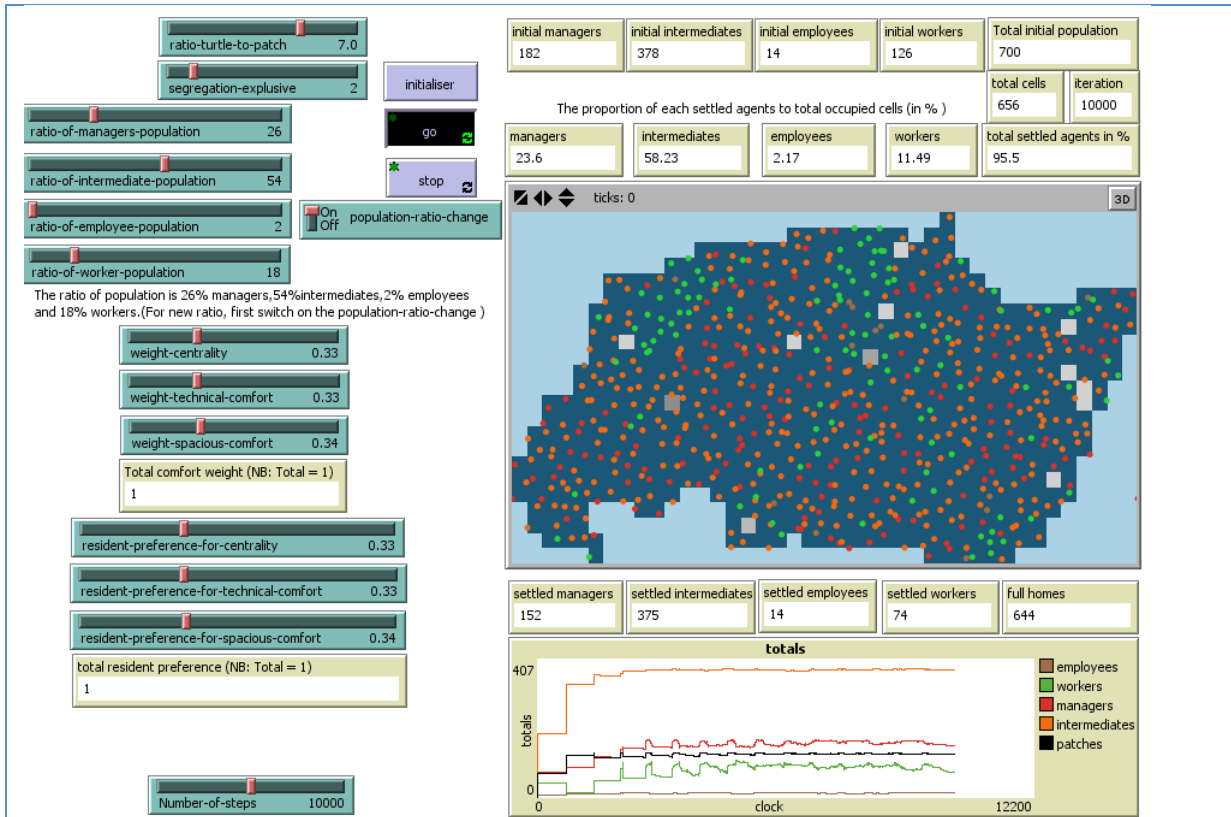

run 43

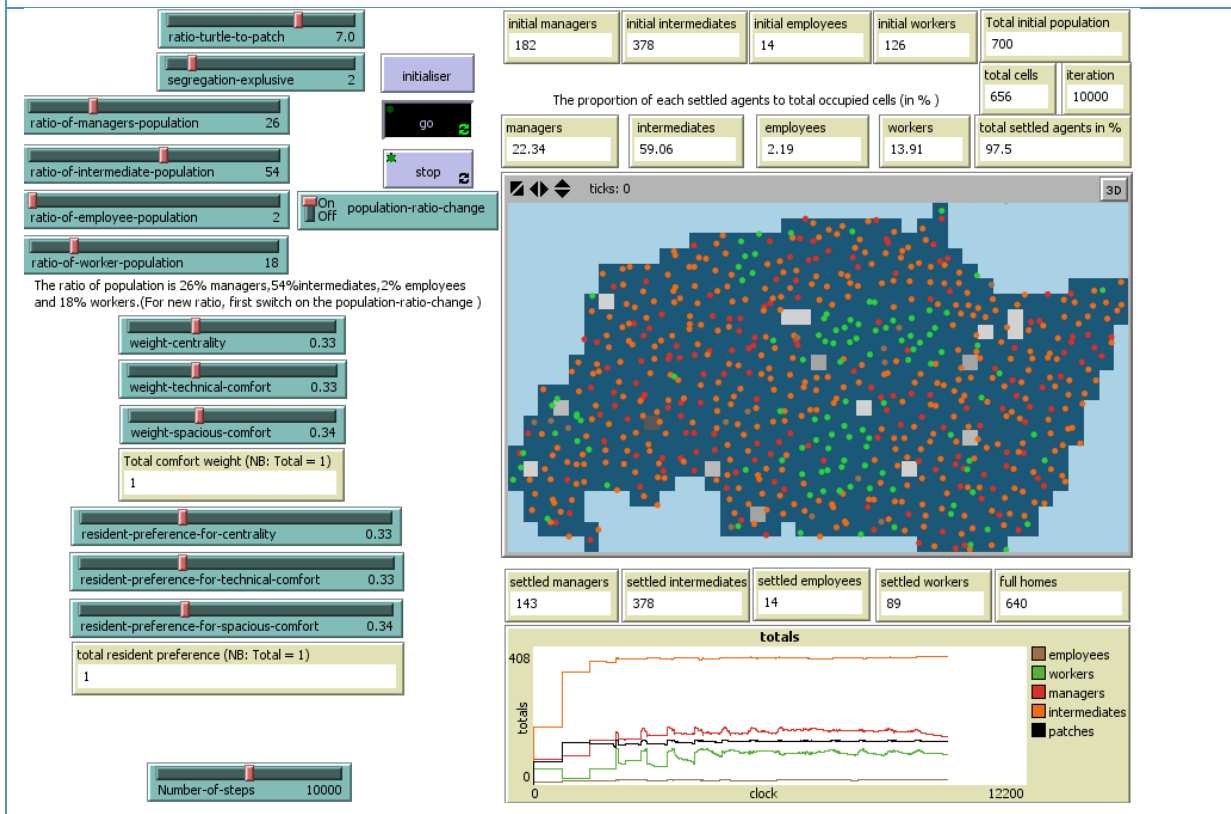

run 44

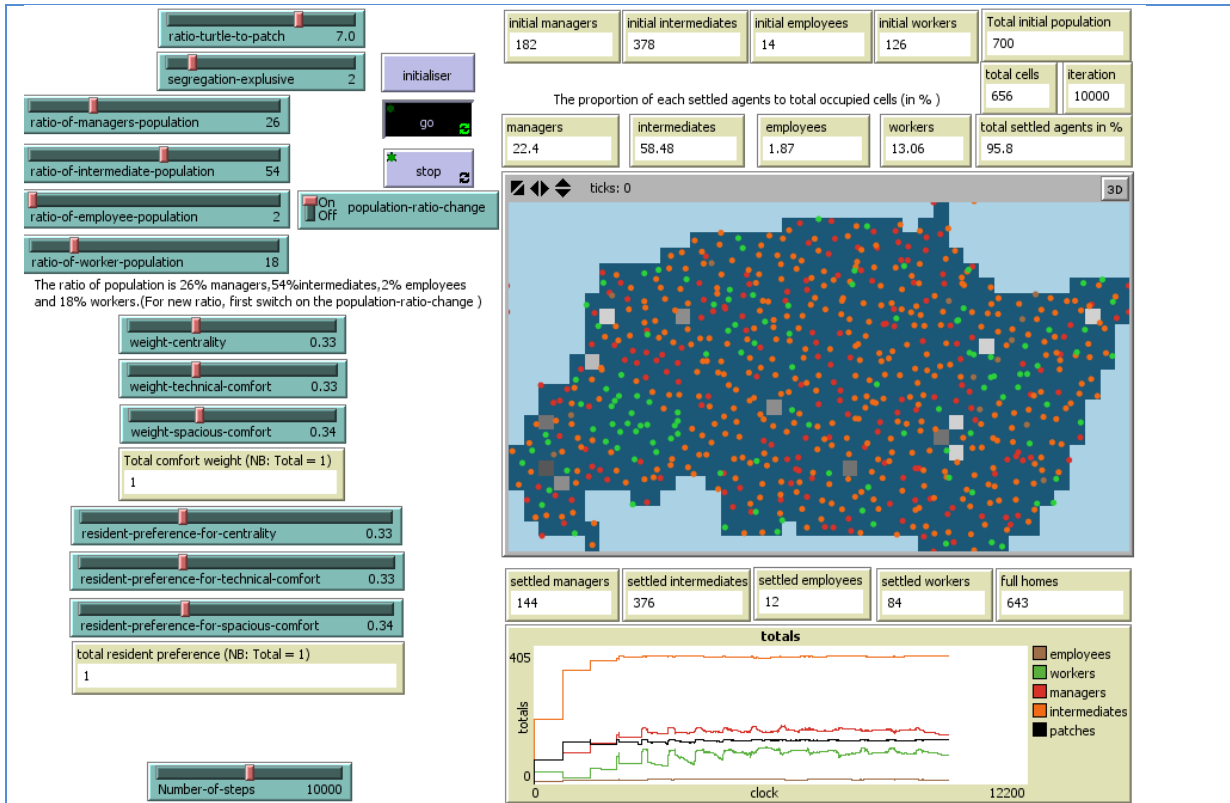

run 45

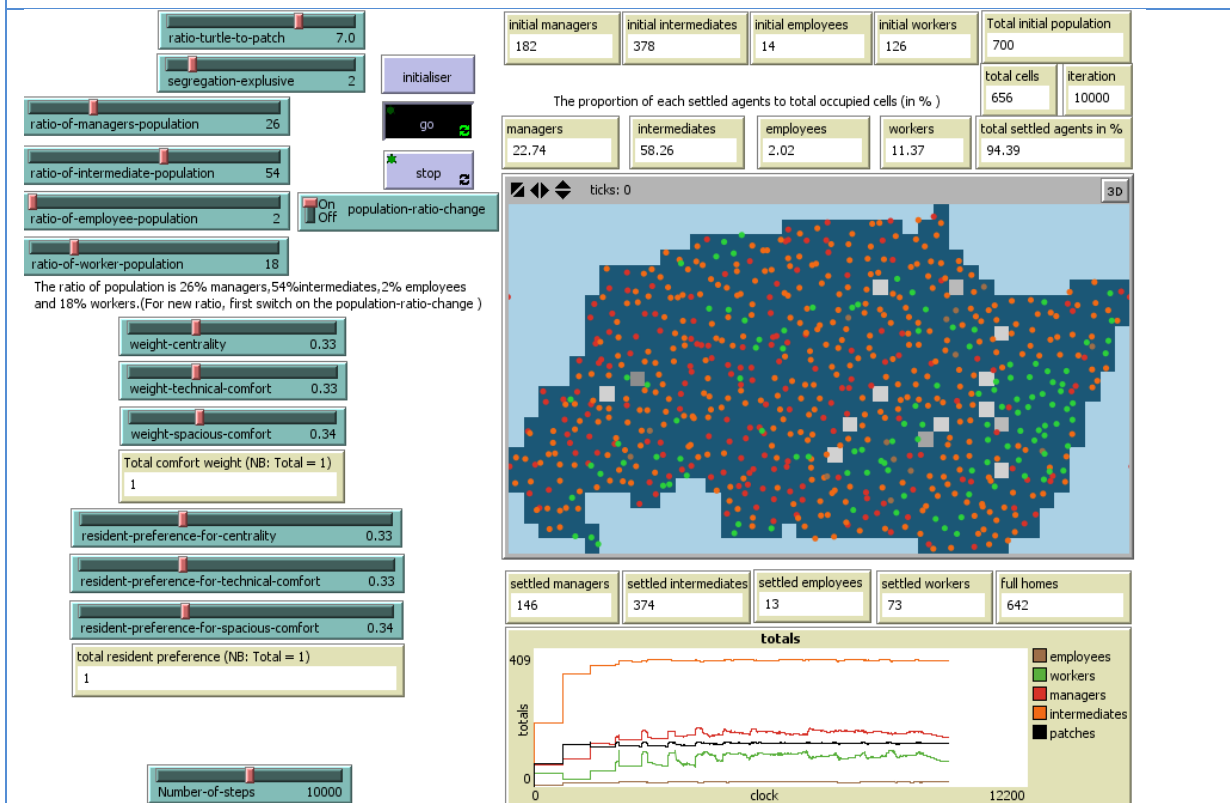

run 46

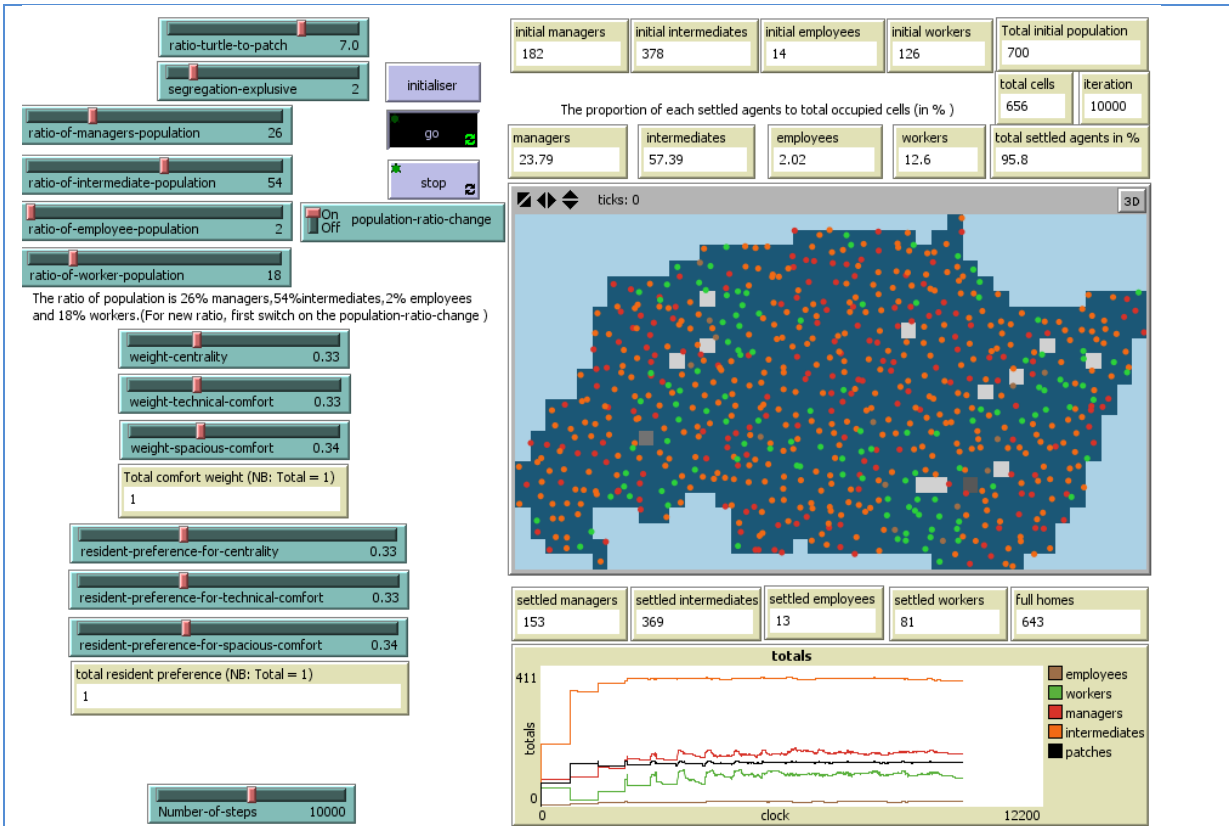

run 47

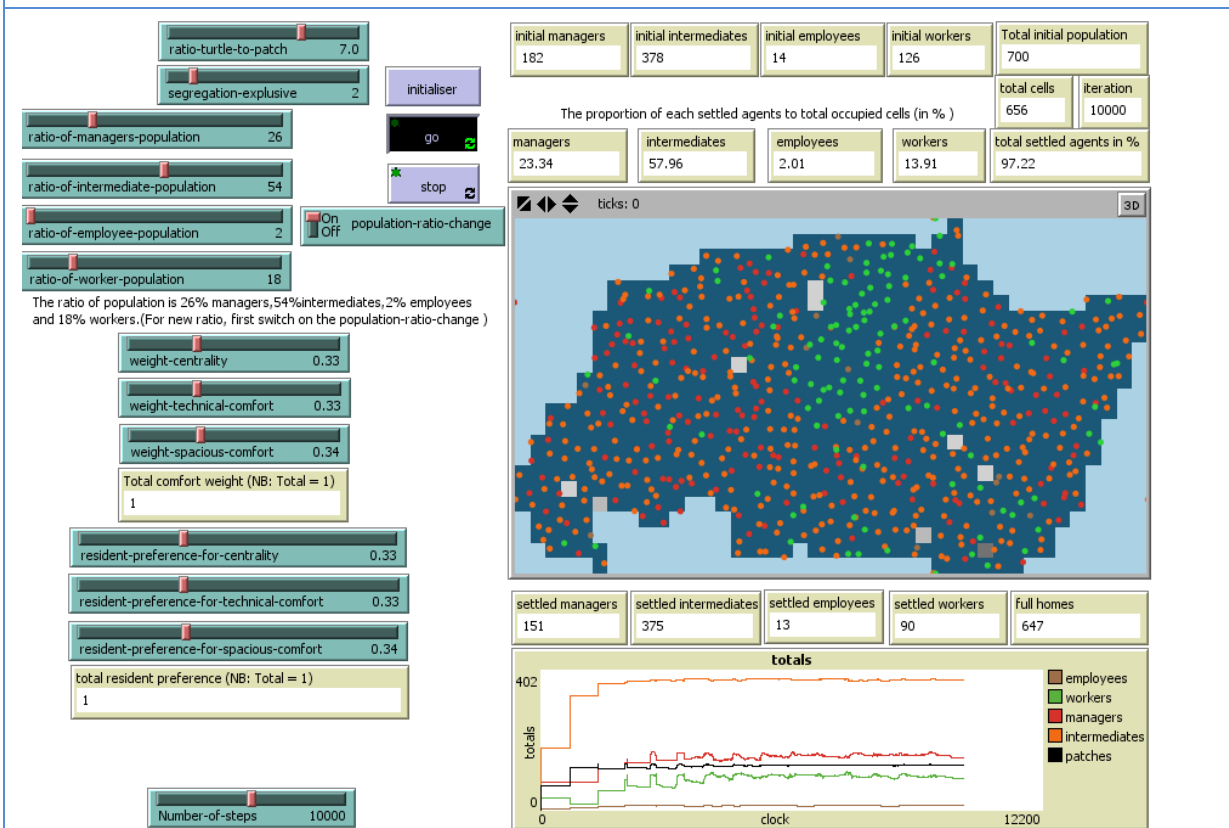

run 48

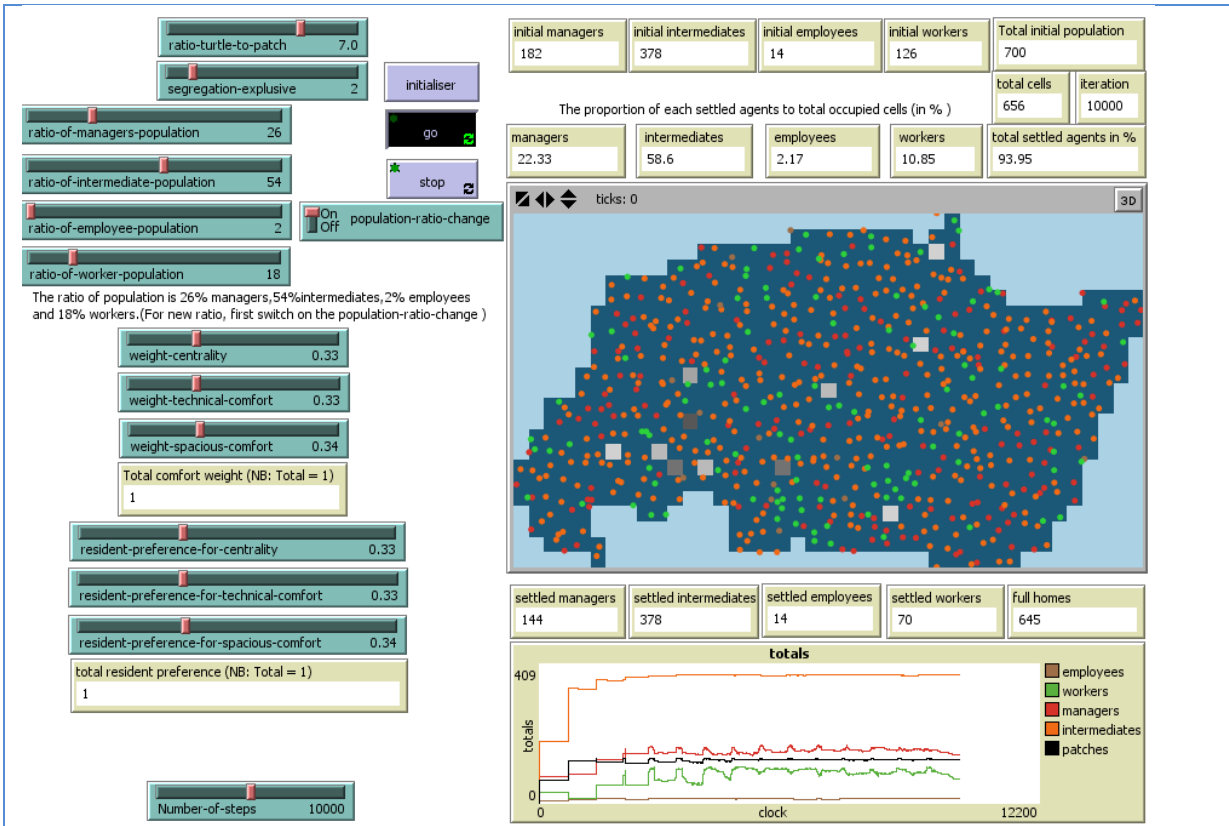

run 49

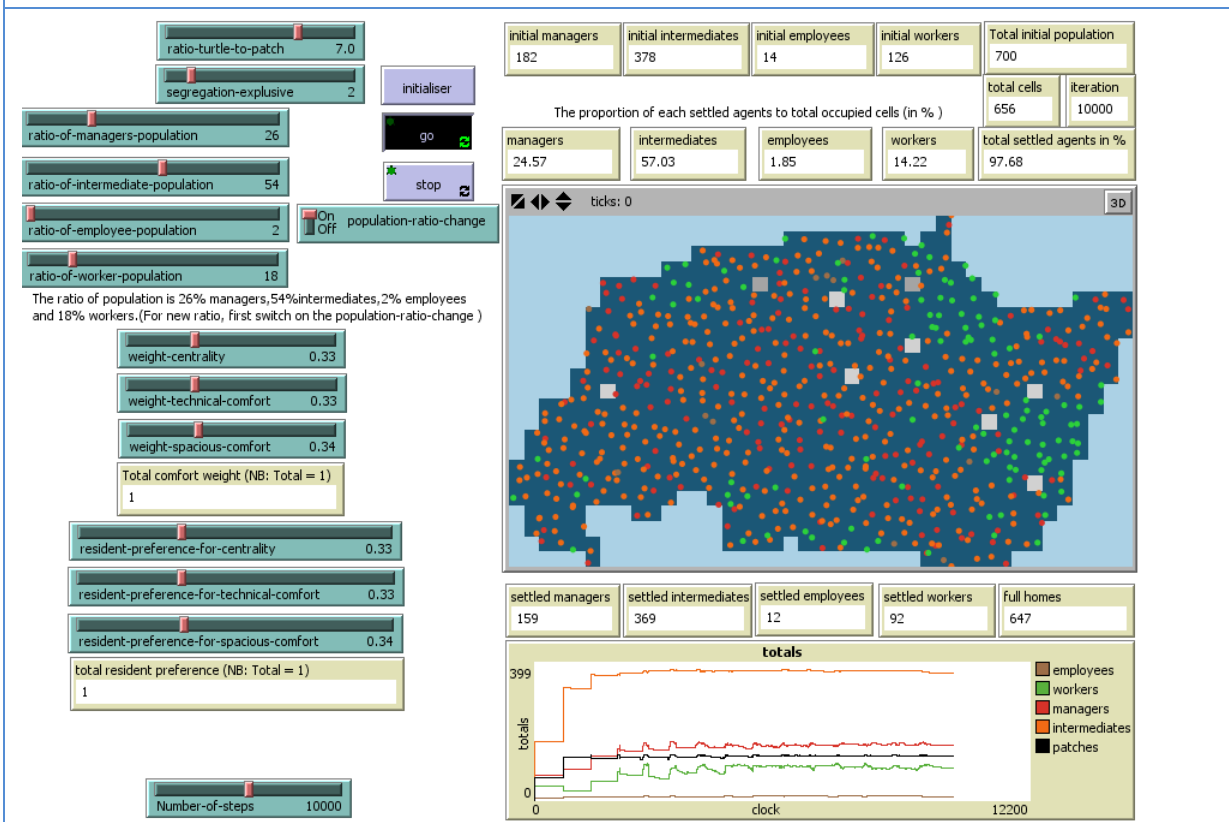

run 50

Script

The script of the program is presented here with this notion that the cells' attribution is not wholly given for succinctness.

```

patches-own [clr cons ful in crts crs seg qlty total-cells ]
turtles-own [mov cls ]
Globals [ clock click j k l bet-tick other-oppurtunities total-comfort total-resident-preference switch-a switch-b
]
to initialiser ; Observer
    ca
    set j 8 set k 7 set l 7
    set clock 0
set other-oppurtunities 0
    init-patches
    setup
weigh
adjust-the-quality-weight-slider
adjust-the-preference-weight-slider
    do-plots
end
to init-patches ; Observer

ask patch 42 23 [set clr 4 set ful 0 set crts 4 set crs 4 set seg 4 ]
..... 1032 lignes semblables
ask patch 42 23 [set clr 0 set ful 0 set crts 0 set crs 0 set seg 0 ]

;to color ; contexte turtle/patch
    ask patches with [ clr = 0 ] [set pcolor 98 set in 0 ] ; centrality 0
    ask patches with [ clr = 1 ] [set pcolor 8 set in 1 ] ; centrality 1
    ask patches with [ clr = 2 ] [set pcolor 7 set in 1 ] ; centrality 2
    ask patches with [ clr = 3 ] [set pcolor 6 set in 1 ] ; centrality 3
    ask patches with [ clr = 4 ] [set pcolor 5 set in 1 ] ; centrality 4
    ask patches with [ clr = 5 ] [set pcolor 4 set in 1 ] ; centrality 5
    ask patches with [ clr = 6 ] [set pcolor 3 set in 1 ] ; centrality 6
    ask patches with [ clr = 7 ] [set pcolor 2 set in 1 ] ; centrality 7
    ask patches with [ clr = 8 ] [set pcolor 1 set in 1 ] ; centrality 8
end

; breed-social-group
    breed [managers manager]
    breed [intermediates intermediate]
    breed [employees employeee]
    breed [workers worker]

to setup
ifelse populattio-ratio-change
[
create-managers ratio-of-managers-population * ratio-turtle-to-patch
create-intermediates ratio-of-intermediate-population * ratio-turtle-to-patch
create-employees ratio-of-employee-population * ratio-turtle-to-patch
create-workers ratio-of-worker-population * ratio-turtle-to-patch
]
[
create-managers ratio-of-managers-population * ratio-turtle-to-patch
set ratio-of-managers-population 56

```

```

;ask managers [ set color 15 set mov 1 set cls 4 ]
create-intermediates ratio-of-intermediate-population * ratio-turtle-to-patch
set ratio-of-intermediate-population 2
;ask intermediates [ set color 25 set mov 1 set cls 3 ]
create-employees ratio-of-employee-population * ratio-turtle-to-patch
set ratio-of-employee-population 4
;ask employees [ set color 35 set mov 1 set cls 2 ]
create-workers ratio-of-worker-population * ratio-turtle-to-patch
set ratio-of-worker-population 38
;ask workers [ set color 65 set mov 1 set cls 1 ]
]
ask managers [ set color 15 set mov 1 set cls 4 ]
ask intermediates [ set color 25 set mov 1 set cls 3 ]
ask employees [ set color 35 set mov 1 set cls 2 ]
ask workers [ set color 65 set mov 1 set cls 1 ]

ask turtles [setxy random-xcor random-ycor ]
ask turtles [ set shape "dot" ]
end

```

to weigh ; for giving each patch some characteristic that is the integral of the three factors (centrality, technical comfort, spacious comfort

```

ask patches
[
  set qlty

  ( weight-centrality * [ clr ] of self ) + ( weight-spacious-comfort * [ crs ] of self ) + ( weight-technical-comfort
* [ crts ] of self )
  set total-comfort ( weight-centrality + weight-spacious-comfort + weight-technical-comfort )
  set total-resident-preference ( resident-preference-for-centrality + resident-preference-for-technical-comfort
+ resident-preference-for-spacious-comfort )
  ;set weight-centrality ( 1 - ( weight-spacious-comfort + weight-technical-comfort ))
  ;set weight-spacious-comfort ( 1 - ( weight-centrality + weight-technical-comfort ))
  ;set weight-technical-comfort ( 1 - ( weight-centrality + weight-spacious-comfort ))
]
end

```

to adjust-the-quality-weight-slider

```

if ( weight-centrality + weight-spacious-comfort + weight-technical-comfort ) != 1
[
  type " you should choose the sum of three quality factors equal to 1, "
]
end

```

to adjust-the-preference-weight-slider

```

if ( resident-preference-for-centrality + resident-preference-for-technical-comfort + resident-preference-for-
spacious-comfort ) != 1

```

```

[
  type " you should choose the sum of three preference factors equal to 1 "
]
end

```

to switch [switch-c]

```

if switch-c != switch-a

```

```

[
  set switch-a switch-b
  set switch-b switch-c
]
end

```

```

to go
simulate
choose-to-settle
;replace
neighbor
better-situation
not-stay-out-of-zone
color-empty-house
not-more-than-one-resident
Numerate
do-plots
die-out-of-zone
  output
;export
end

to simulate ; turtles
ask turtles with [mov = 1]
  [ rt random-float 30 - random-float 30
    fd 1
  ]
end

  to choose-to-settle
ask turtles with [mov = 1]
[
if pcolor != 98 and ful = 0 and qlty > 0 ;and count turtles-here = 0
[
ask self [ set mov 0 ]
ask patch-here [ set ful 1 ]
ask patch-here [ set pcolor 93 ]
]
]
end

;to replace ; turtle
;if any? other turtles-here with [cls <= [cls] of myself]
;[
; ask other turtles-here [set mov 1]
; ]
;end

to neighbor
let turtles-nearby count (turtles-on neighbors)
if (turtles-nearby != 0 and [mov] of self = 0 and turtles-nearby > ( 8 - segregation-expulsive ) ) and ( (mean [cls]
of turtles-on neighbors - 1 > [ cls ] of self )
or (mean [cls] of turtles-on neighbors + 1 < [ cls ] of self ) )
[
ask self [ set mov 1 ]
]
end

to better-situation
let resident-preference ( ( resident-preference-for-centrality * clr ) + ( resident-preference-for-technical-
comfort * crts )
+ ( resident-preference-for-spacious-comfort * crs ))
set total-resident-preference ( resident-preference-for-centrality +
resident-preference-for-technical-comfort + resident-preference-for-spacious-comfort )

```

```

;let power-to-choose ( resident-preference * [ cls ] of self )
;set resident-preference-for-centrality ( 1 - ( resident-preference-for-technical-comfort + resident-preference-
for-spacious-comfort ) )
;set resident-preference-for-technical-comfort ( 1 - ( resident-preference-for-centrality + resident-preference-
for-spacious-comfort ) )
;set resident-preference-for-spacious-comfort ( 1 - ( resident-preference-for-centrality + resident-preference-
for-technical-comfort ) )
if int bet-tick / 100 >= 1

[ set bet-tick bet-tick - 99
  set other-oppurtunities mean [ qlty ] of patches with [not any? turtles-here]
]
if other-oppurtunities > [ resident-preference ] of self ;[ power-to-choose ] of self
[ set mov 1 ]
end

to not-stay-out-of-zone
if in = 0 [
ask turtles-here
[set mov 1 ]
]
end

to color-empty-house
ask patches with [not any? turtles-here]
[
  set ful 0
if clr = 0 [set pcolor 98 ]
if clr = 1 [set pcolor 8 ]
if clr = 2 [set pcolor 7 ]
if clr = 3 [set pcolor 6 ]
if clr = 4 [set pcolor 5 ]
if clr = 5 [set pcolor 4 ]
if clr = 6 [set pcolor 3 ]
if clr = 7 [set pcolor 2 ]
if clr = 8 [set pcolor 1 ]

]
end

to not-more-than-one-resident
ask patches with
[ count turtles-here > 1 ]
[ if int bet-tick / 100 >= 1
  [
    ask turtles-here
    [ set mov 1
  ]
  set bet-tick bet-tick - 99
]
]
end

to Numerate
if clock < Number-of-steps
[
set clock clock + 1

```



```
;set click int (clock / (quality-change * 500))
set bet-tick bet-tick + 1
]
end

to do-plots
  set-current-plot "totals"
  set-current-plot-pen "managers"
  plot count managers with [mov = 0]
  set-current-plot-pen "intermediates"
  plot count intermediates with [mov = 0]
  set-current-plot-pen "employees"
  plot count employees with [mov = 0]
  set-current-plot-pen "workers"
  plot count workers with [mov = 0]
  set-current-plot-pen "patches"
  plot count patches with [ful = 1] / 5
end

to die-out-of-zone
  ask turtles with [ mov = 1 ]
  [
  if in = 0 and clock > ( Number-of-steps - 20 )
  [ die ]
  ]
end

to output
  if clock = ( Number-of-steps - 10 )
  [
  export-world ( word "gent " output-number " .csv" )
  export-interface ( word "gent " output-number " .png" )
  ]
End
```

Recapitulation of urban renewal in France

Urban rehabilitation in France. The landmarks

1945: End of world war two.

1948: controlling law on the rents in old houses.

1951: Creation of the movement *propaganda and action against the slum* (PACT- *Propagande et Action contre les Taudis*)

1958: Starting the operation of urban renovation: a total 120000 buildings will be demolished and 190000 will be reconstructed in this process ;it concerns 300 sites in France.

1962: The Malraux law constitutes the protected sectors in the neighborhoods which are in high historical value (20 sectors are of concern)

1967: the housing development law: it defines the minimal norms of habitability and make the relation between the owner and the tenant clear.

1970: Law on the reduction of unhealthy houses (RHI- *Résorption de l'Habitat Insalubre*) that reforms the precedent law on the "shantytown". It is applied as the successor of the urban renovation with the same hygienic aspects and similar social problems.

1971: Creation of the *National Agency for Improvement of the Habitat* (ANAH- *l'Agence Nationale pour l'Amélioration de l'Habitat*): aid to owner-lessors who set the comfort in their houses

1974: First petroleum shock.

1976: Nora report. This report criticizes the actions that are done by the state up to the moment. He proposes to give a place to old houses in housing policy and encourage the less intensive rehabilitation. Three objectives: preserve the heritage, saving the center of the city, helping to the most disadvantaged ones. The same year, the urban renovation is stopped and the *urban development fund* (FAU- *Fonds d'Aménagement Urbain*) is constituted.

1977: Reform of the housing finance. The law of 2 January constitutes the *personalized housing allowance* (APL- *Aide Personnalisée au Logement*). The same year: *dwelling units and social life* (HVS- *Habitat et Vie Sociale*)

1981-83: Decentralization law that reinforce the decision-makers and the financial means of the local authorities in urban issues. It does not stay in the state's proficiency, except in historical heritage, the houses, and the most social aspect of interventions.

1981: Creation of the *National commission of social development of areas* (CNDSQ- *Commission Nationale de Développement Social des Quartiers*). Signing the first *social development of neighbourhoods* (DSQ- *Développement Social des Quartiers*) convention between the state, the cities and the regions. (148 areas).

1983: Creation of the *fringe 89* (*Banlieues 89*) mission (116 projects finance and ended in 1989).

1984: Creation of the *urban social fund* (FSU- *Fonds Social Urbain*) which substitutes the *urban development fund available* (FAU- *Fonds d'Aménagement Urbain*).

1988: Moving from the rehabilitation of the areas to a more global approach of urban rehabilitation, under denomination national council of the cities (CNV- *Conseil National des Villes*), consultative sample composed of the elected and qualified personalities, moderated by the prime minister; the *interministerial committee of the cities* (CIV- *Comité Interministériel des Villes*), deliberative sample in charge of defining and coordinating the actions of the state, the communication and training.

1989: start of 13 experimental *city contracts* (*Contrats de Ville*).

1990: nomination of a minister of state in charge of *city policy* (*Politique de la Ville*).

1991: the frame law for the city (LOV- *Loi d'Orientation pour la Ville*). Objectives: implementing the « city right » by assuring all the residents the conditions of equitable livings. The same year, designation of 14 *major urban projects* (GPU- *Grands Projets Urbains*): exceptional effort of the state for requalifying the particular disadvantaged sectors.

1994: Signing 214 city contracts (*Contrats de Ville*) between the state and the local collectivities.

1996: *treaty of revival for the city* (*Pacte de Relance pour la Ville*), urgent plans for the fringes that stress on the economic development of the job.

2000: *the solidarity and urban renewal law* (SRU - *Solidarité et Renouvellement Urbains*). Objectives: renewing the urban policy by mixing the urbanism, habitat and displacements questions, in the scale of agglomeration. Guarantying a better respect to social diversity and involving the urban renewal of the areas which needs to be in the services of a sustainable development and territory solidarity.

2000-2006: In the framework of the twelfth plan, new generation of *city contracts* (*Contrats de Ville*) (1300 areas) and *major city projects* (*Grands Projets de Ville*) (50 sites).

Cellular Automata neighborhood

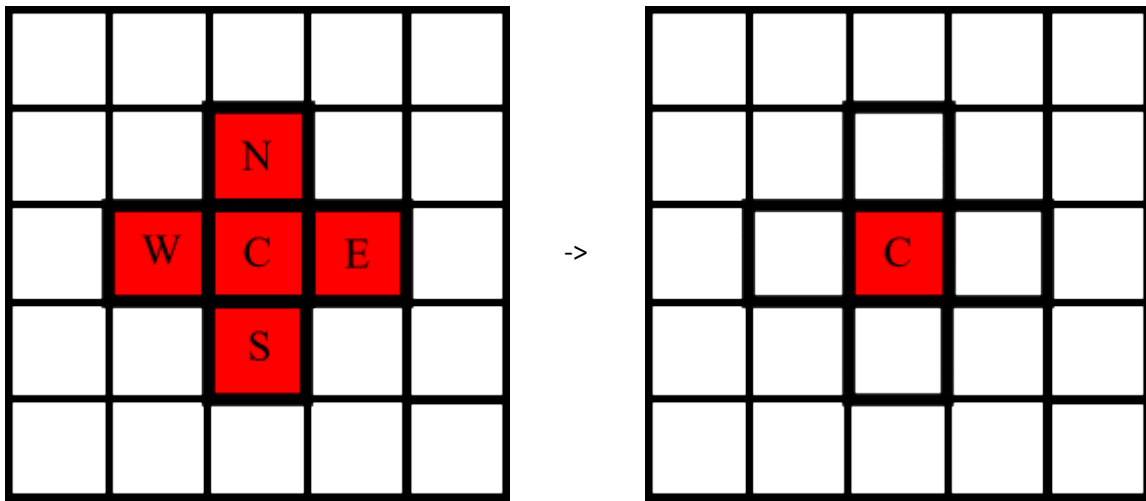

Fig.i-1. The von Neumann neighborhood. The Von Neumann neighborhood is a common and popular neighborhood. The neighborhood takes its name from John Von Neumann.

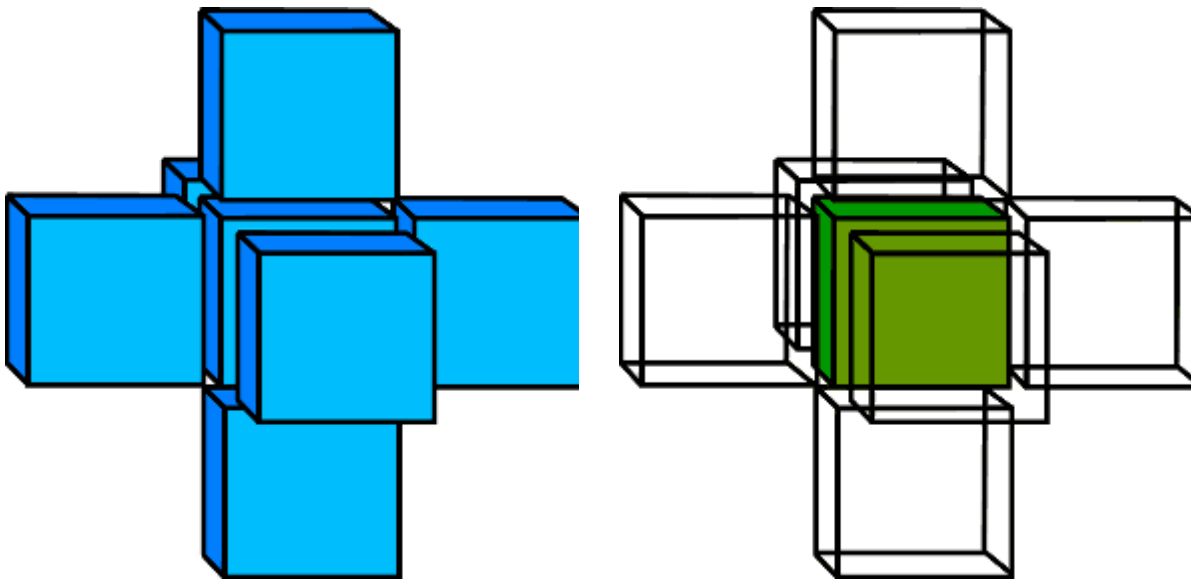

Fig.i-2. 3D von Neumann neighborhood. This is one of the simpler and more commonly-used cubic neighborhoods.

The first reference to the term "3D von Neumann neighborhood" comes from a 1992 paper by Philippe-Michel Binder and Vladimir Privman.

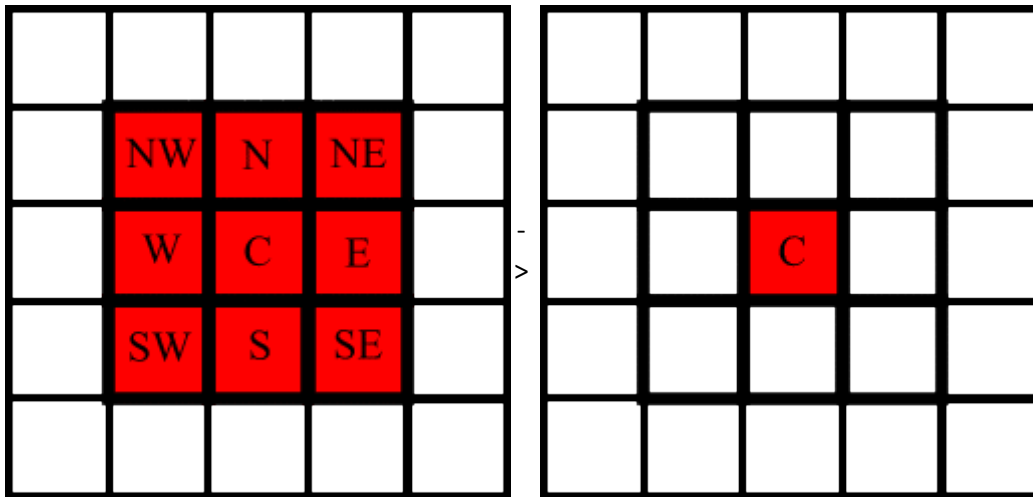

Fig.i-3. The Moore neighborhood

The Moore neighborhood is a common and popular neighborhood. It is the neighborhood used by John Conway's "Game of Life". The neighborhood takes its name from the pioneer, Edward F. Moore.

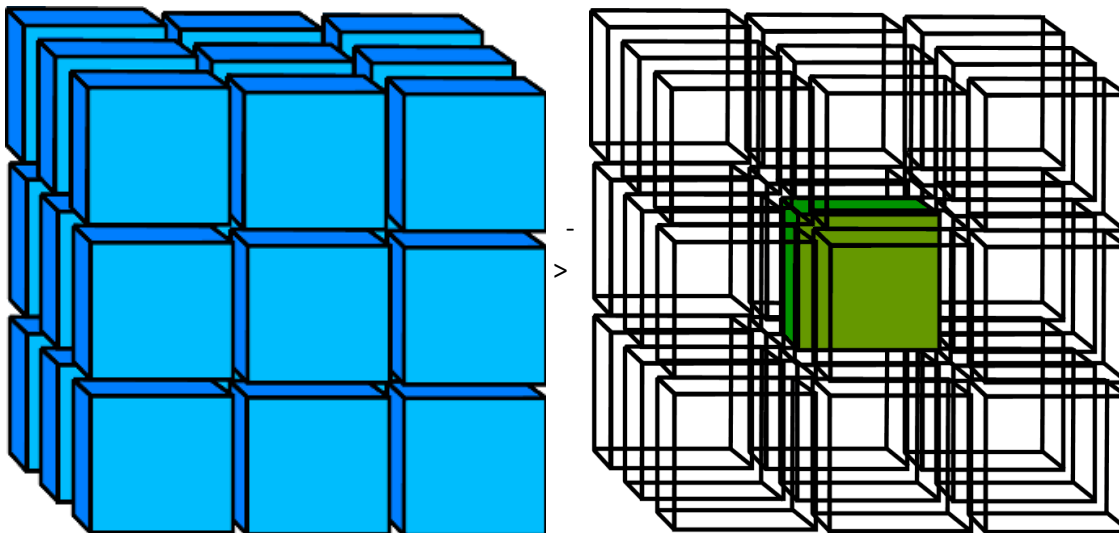

Fig.i-4. 3D Moore neighborhood. This is the neighborhood most commonly used by 3D versions of Conway's game of life.

There has been some other types that are not as conventional as Moore and Von Neuman neighborhood models. We can list them as below:

*For 2D neighborhoods we can refer to: Triumphant, Q*Bert, Margolus, Star of David, Triangle-6, Square-4, Hexagon-Triangle, Morita and Ueno's 8-state triangular scheme, Flipping Triangle, Stellated Hexagon-Triangle, Isometric von Neumann, Isometric Moore, Central Isometric Octagonal, X, Y, Distant Sector, and for 3D neighborhoods: Isometric Gold, Isometric 3D von Neumann, 3D X, Necker.*

(Tyler)

<http://cell-auto.com/neighbourhood/>