



HAL
open science

Planification visuelle et interactive d'interventions dans des environnements d'accélérateur de particules émettant des rayonnements ionisants

Thomas Fabry

► **To cite this version:**

Thomas Fabry. Planification visuelle et interactive d'interventions dans des environnements d'accélérateur de particules émettant des rayonnements ionisants. Sciences de l'ingénieur [physics]. Université de Grenoble, 2014. Français. NNT : 2014GRENA013 . tel-01060156

HAL Id: tel-01060156

<https://theses.hal.science/tel-01060156>

Submitted on 3 Sep 2014

HAL is a multi-disciplinary open access archive for the deposit and dissemination of scientific research documents, whether they are published or not. The documents may come from teaching and research institutions in France or abroad, or from public or private research centers.

L'archive ouverte pluridisciplinaire **HAL**, est destinée au dépôt et à la diffusion de documents scientifiques de niveau recherche, publiés ou non, émanant des établissements d'enseignement et de recherche français ou étrangers, des laboratoires publics ou privés.

THÈSE

Pour obtenir le grade de

DOCTEUR DE L'UNIVERSITÉ DE GRENOBLE

Spécialité : **sciences pour l'ingénieur**

Arrêté ministériel : 7 août 2006

Présentée par

Thomas FABRY

Thèse dirigée par **Laurent TABOUROT**

préparée au sein du **Laboratoire SYstèmes et Matériaux pour la MÉcatronique (SYMME)**
dans l'**École Doctorale Sciences et Ingénierie des Systèmes, de l'Environnement et des Organisations (SISEO)**

et du **CERN**, Organisation Européenne pour la Recherche Nucléaire, Laboratoire Européen de Physique des Particules, Genève

Planification visuelle et interactive d'interventions dans des environnements d'accélérateur de particules émettant des rayonnements ionisants

Thèse soutenue publiquement le **30 mai 2014**,
devant le jury composé de :

Bruno FERAL

Ingénieur, CERN, Examinateur

Daniel MESTRE

Professeur des Universités, Université de la Méditerranée, Examinateur

Frédéric NOËL

Professeur des Universités, Grenoble INP, Président

Samir OTMANE

Professeur des Universités, Université d'Evry, Rapporteur

Laurent TABOUROT

Professeur des Universités, Directeur de thèse

Helmut VINCKE

Dipl.-Ing. Dr.techn. Priv.-Doz., Technische Universität Graz, Rapporteur



Interactive visual intervention planning in particle accelerator environments with ionizing radiation

Thomas Fabry

May 2014

Preamble

Radiation is omnipresent. It has many extremely interesting applications: in medicine, where it enables physicians to cure and diagnose patients; in communication, where all modern communication systems use forms of electromagnetic radiation; and in science, where researchers make use of it to discover the structure of materials; to name a few.

Physically, radiation is a process in which particles or waves travel through any kind of material, usually air. Radiation can be very energetic, in which case it can break the atoms of ordinary matter (ionization). If this is the case, radiation is called ionizing. Often, the word “radiation” is used to refer to ionizing radiation.

Both ionizing and non-ionizing radiation can be harmful to human beings and to nature in general. It is thought, however, that ionizing radiation is far more harmful to living beings than non-ionizing radiation. This does not imply that non-ionizing radiation is always completely harmless (just think of sunburn, which is caused by non-ionizing radiation from the sun).

In this dissertation, we are concerned with ionizing radiation. Naturally occurring ionizing radiation in the form of radioactivity is a most natural phenomenon. Almost everything is radioactive: there is radiation emerging from the soil, it is in the air, and the whole planet is constantly undergoing streams of energetic cosmic radiation. Since the beginning of the twentieth century, we are also able to artificially create radioactive matter. This has opened a lot of interesting technological opportunities, but has also given a tremendous responsibility to humanity, as the nuclear accidents in Chernobyl and Fukushima, and various accidents in the medical world have made clear.

This has led to the elaboration of a radiological protection system. This system is of great importance, not in the least because of the fact that radiation cannot be “seen”, nor “felt”.

Radiological protection or radiation protection is the science, the technology and its implementation with the goal of protecting human beings from the damaging biological effects of ionizing radiation.

The framework of radiation protection is defined by national legal limits. These legal limits mostly originate from recommendations of international expert commissions. In turn, these recommendations are based upon the current scientific knowledge in radiation biology. Because the effects of ionizing radiation at low levels are not yet fully understood, the radiological protection systems relies on conservative assumptions.

In practice, the radiological protection systems is mostly implemented using a methodology that is indicated with the acronym ALARP or ALARA: As Low As Reasonably Possible or Achievable. This methodology consists of justifying, optimizing and limiting the radiation dose received. This methodology is applied in conjunction with the legal limits (only ALARA would not always be sufficient because optimizing radiation exposure in the spirit of ALARA cannot always be pushed to the point that the legal limits are met). The word “reasonably” means that the optimization of radiation exposure has to be seen in context. The optimization is constrained by the fact that the positive effects of an operation might surpass the negative effects caused by the radiation. ALARA is thus a kind or constrained optimization procedure.

Several industrial and scientific procedures give rise to facilities with ionizing radiation. Most technical and scientific facilities also need maintenance operations, which can mostly only be performed by human technicians. This means that the need exists, in several scientific and industrial facilities, to perform maintenance activities in facilities with ionizing radiation.

In the spirit of ALARA, these interventions need to be optimized in terms of the exposure of the maintenance workers to ionizing radiation. This optimization cannot be automated since the practical feasibility of the intervention tasks requires human assessment. The intervention planning could however be facilitated by technical-scientific means, e.g. software tools. The development of these tools is a complex undertaking for three reasons. Firstly, it needs a visualization of the infrastructure, the (expected) radiation levels in the facility and the intervention. Secondly, this visualization has to be intuitive to work with for all stakeholders involved (intervention planners, scientists, maintenance workers, safety officers,...) and useful in different scenarios (visual training of operators, three-dimensional visualizations to support the decisions of the ALARA committee,...). Thirdly, the software is about the safety of humans, and is therefore not allowed to have any kind of ambiguity.

In the context sketched above, **this thesis provides technical-scientific considerations and the development of technical-scientific methodologies and software tools for the implementation of radiation protection.** More specifically, it treats the data science needed in the processing of simulation data for applications in radiation protection.

In particular, this thesis addresses the need for an interactive visual intervention planning tool in the context of high energy particle accelerator facilities: how can today's state-of-the-art visualization techniques be applied or adapted to optimize the human interventions in infrastructures emitting ionizing radiation?

High Energy Physics (HEP), or particle physics, is a branch of modern physics studying the smallest known constituents of matter. Essential tools of particle physics are particle accelerators and detectors, which are very large and complex scientific instruments. Over time, the needs of particle physics have progressed towards ever higher energies (hence the term High Energy Physics), leading to ever larger and more complex machines. These large and complex machines consist of a huge amount of complex sub-systems, which in turn leads to the inevitable need for maintenance and handling interventions. Apart from the benefits the accelerators and detectors bring to frontier research in fundamental physics, the circulation and collisions of high energy beams in these accelerators and detectors also have an undesirable consequence: the radiological activation of some of the components of accelerator facilities. This activation leads to the presence of ionizing radiation in HEP facilities.

This thesis was made in the context of CERN, the largest laboratory for particle physics worldwide, within the context of the PURESAFE project, a European project aiming to research solutions to protect humans from radiation and to increase scientific machine experimental time at scientific facilities. Although the methodology and tools developed and presented in this work are general, certain design choices are inevitably made with the specific context of CERN in mind.

Contents

Preamble	i
Contents	v
List of Figures	xi
List of Tables	xv
1 Introduction	1
1.1 Context	1
1.1.1 PURESAFE	1
1.1.2 The general context	2
1.1.3 CERN	3
1.2 Radiation protection	3
1.2.1 Radiation protection in general	3
1.2.2 Radiation protection in practice	4
1.3 Technical-scientific considerations for the implementation of radiation protection	5
1.3.1 Current situation	5
1.3.2 Motivation and goals	6
1.4 Outline of the text	7

2	Radiation protection	9
2.1	The radiological protection system	9
2.1.1	Legal context	9
2.1.2	Justification, optimization and limitation	11
2.1.3	ALARA	13
2.1.4	Critics	14
2.2	Work and dose planning	14
2.2.1	Introduction	14
2.2.2	Current situation: work and dose planning at CERN	15
2.3	Scientific-mathematical bases of dose evaluation	18
2.3.1	Introduction	18
2.3.2	Absorbed dose	18
2.3.3	Dose equivalent	19
2.3.4	Effective dose	20
2.3.5	Collective effective dose	22
2.4	Simulations for dose evaluation	23
2.5	Conclusion	25
3	Intervention planning in environments with ionizing radiation	27
3.1	Intervention planning concepts	28
3.2	Intervention planning integrated with radiation protection	30
3.3	Elaboration of the radiation protection integration	31
3.4	Assessment of the radiation protection integration	34
3.5	Further theoretical elaboration of the radiation protection integration	35
3.6	The intervention planning process	39
3.7	Conclusion	41
4	A systems engineering perspective	43

- 4.1 Introduction 44
 - 4.1.1 Life cycles in systems engineering 44
 - 4.1.2 The development process of an interactive intervention planner 45
- 4.2 The systems engineering life cycle of the development process of an interactive intervention planner 48
 - 4.2.1 Needs analysis & specification explication 48
 - 4.2.2 Conceptual mathematical modelling 51
 - 4.2.3 Iterative implementation & design and prototype testing 53
 - 4.2.4 Usability testing 54
- 4.3 The resulting application 56
- 4.4 A possible future direction: robotics integration 57
- 4.5 Conclusion 58

- 5 A technical-scientific perspective 61**
 - 5.1 State of the art and related work 62
 - 5.1.1 Technical-scientific tools for three-dimensional radiation mapping 62
 - 5.1.2 Three-dimensional visualization software packages 64
 - 5.1.3 Three-dimensional visualization software libraries 66
 - 5.2 The intervention planning process 67
 - 5.2.1 Assessment of the conditions in the facility where the intervention will be performed 67
 - 5.2.2 Preparing the trajectory of the intervention 72
 - 5.3 Calculation of the equivalent dose 73
 - 5.4 Reporting 76
 - 5.5 Software 78
 - 5.5.1 A software tool for computer-aided intervention planning 78
 - 5.5.2 Software Architecture 78
 - 5.6 Conclusion 84

6	Validation	89
6.1	Qualitative validation: user testing	90
6.1.1	Material and methods	90
6.1.2	Results	93
6.1.3	Discussion and conclusion	93
6.2	Quantitative validation	95
6.2.1	The context of the use case	95
6.2.2	Visual interactive intervention planning as part of the design process of a new accelerator facility	97
6.2.3	Discussion and conclusion	103
6.3	Accuracy of the dose planning	104
6.4	Conclusion	107
7	Conclusion	109
7.1	Summary	109
7.2	Contributions	111
7.3	Future work	112
7.3.1	Visualization science	112
7.3.2	Scientific data analysis	114
7.3.3	Radiation protection	114
7.3.4	Computer science	115
	Appendices	119
A	Use cases	119
A.1	Visualise FLUKA simulation data	119
A.2	Visualise FLUKA geometry data	120
A.3	Plan intervention	122
A.4	Save session	125

- A.5 Generate report 126
- B Needs analysis & Specification explicitation 129**
 - B.1 Current situation 129
 - B.1.1 Radiation level simulations 129
 - B.1.2 Measurements 130
 - B.1.3 Conclusion 131
 - B.2 User needs 131
 - B.2.1 User needs gathering: actions taken 135
- Résumé en français 137**
- Acknowledgements 153**
- Bibliography 155**
- List of publications 169**

List of Figures

1.1	A typical FLAIR visualization of radiation levels [153].	6
2.1	An aerial view of the CERN accelerator complex. The facilities of CERN stretch over France's and Switzerland's mutual border. . . .	12
2.2	Screenshots of the work and dose planning file of an intervention at CERN.	17
2.3	Facilitated FLUKA input.	26
3.1	Schema of the mathematical model for intervention planning. . . .	29
4.1	Life cycles in systems engineering and project management.	46
4.2	The systems engineering life cycle for the development of an interactive intervention planner.	49
4.3	The use case context diagram. This diagram shows how the different stakeholders (depicted as named stick figures) and external systems (depicted as named boxes) are expected to interact with the software system, here indicated as 'RADIJS'.	50
4.4	The user interface of the visual intervention planner.	57
5.1	An example of a visualization of a high energy physics facility [141].	68
5.2	The principle of volume rendering. Image from [9].	69
5.3	Colour and alpha mapping.	70
5.4	Examples of volume rendering.	71

5.5	An illustration of volume rendering as implemented in this research project. The data visualized are radiation doses in a tunnel facility at CERN.	72
5.6	Examples of a trajectory, as implemented in the software supporting this research.	74
5.7	Two possible trajectories for a maintenance intervention in a tunnel facility at CERN. The equivalent dose contracted during the trajectory depicted in (a) proves to be 25% higher than the dose contracted during the trajectory depicted in (b).	75
5.8	The software tool for computer-aided intervention planning developed in the context of this thesis.	79
5.9	Proposed package diagram.	81
5.10	Current package diagram.	82
5.11	Class diagram sketches. For reasons of readability, this sketch has been digitized and can be found in figure 5.12.	85
5.12	Class diagram sketches, digitized from figure 5.11.	87
5.13	Current class diagram.	88
6.1	The interface shown to the user performing the user test. The begin and end points and the control point marked “Maintenance Activity” are fixed. The user can alter the given trajectory by displacing the remaining control points, as well as any additional control points that he can add.	92
6.2	Boxplot of the measured variables: 6.2(a) the computed expected integrated equivalent dose (normalized), 6.2(b) the length of the constructed trajectory (normalized) and 6.2(c) the number of control points used in the trajectory. On the left the results of the user test, the data visualized using the continuous diverging colour map, for the data on the right the rainbow colour map was used.	94
6.3	The number of control points plotted against the normalized computed expected integrated equivalent dose per user test instance.	95
6.4	Areas where workers will be situated during a beam dump core replacement intervention in the LHC [155].	96
6.5	Fluka geometry of the Linac4 civil engineering (top) and the beam dump shielding (side view (bottom left) and front view (bottom right)) [39, 41].	98

6.6	Ambient dose equivalent rate after one month of irradiation with 160 MeV proton beam (2.84 kW beam power) for different cooling times [39, 41].	99
6.7	Intervention planning of the Linac4 beam dump replacement. . . .	100
6.8	Intervention planning of the Linac4 beam dump replacement. . . .	102
7.1	An example of artificially created volume data with the same behaviour as ionizing radiation, including hotspots, with different parameter sets for user evaluation.	113
B.1	FLUKA simulation visualised using FLAIR (figure from the FLUKA website [22]).	130
B.2	Manual measurements of radiation levels.	131
B.3	Schéma du modèle mathématique pour la planification des interventions.	144
B.4	Le cycle de vie pour le développement d'un logiciel de planification d'interventions interactive.	145
B.5	Le logiciel de planification d'interventions.	147
B.6	Planification de l'intervention pour le remplacement du <i>beam dump</i> de Linac4.	149

List of Tables

2.1	Radiation weighting factors w_R as defined in ICRP103.	20
2.2	Tissue weighting factors w_T as defined in ICPR103.	21
4.1	Needs table and importance mapping.	53
6.1	Preparation of the beam dump equipment for remote opening if a failure occurs during the reliability run.	101
B.1	Customer needs table.	134
B.2	Customer needs table: importance mapping.	135

Chapter 1

Introduction

In this dissertation, we aim at providing technical-scientific considerations for the implementation of radiation protection in the context of scientific facilities, in a way that can lead to the development of software tools for the implementation of radiation protection in the context of these facilities.

In this introductory chapter, we first introduce the context of this dissertation on three levels. Subsequently, we touch upon the meaning of radiation protection, after which the motivation and goals of this thesis are discussed. As a conclusion of this chapter, an outline of the text is given.

1.1 Context

1.1.1 PURES SAFE

The broad context of this work is the context of the PURES SAFE¹ project. PURES SAFE is an acronym for Preventing hUMAN intervention for incrREased SAfety in inFrastructures Emitting ionizing radiation. The scientific objective of this project is the development of models, methods and tools, with the aim to enhance radiation protection in scientific facilities emitting ionizing radiation, in particular high energy physics accelerator facilities.

The PURES SAFE project is a multi-disciplinary project, which can be seen from the fact that it has been broken down into five work packages (WPs), of which three are directly related to actual research projects. WP1 is the work package that

1. PURES SAFE is a Marie Curie project in the framework of the European Community's Seventh Framework Programme.

addresses processes and modelling. WP2 is related to robotics hardware platforms for remote handling. WP3 is about (remote handling) software platforms. The research project of which this dissertation is one of the outcomes is part of WP3. It has to be noted that another research package is performing research on an Augmented Reality (AR) based maintenance tool for hazardous places, while this work is about Augmented Virtuality (AV)², and most notably the models, methods and tools that can lead to the implementation of such an AV tool for interactive visual intervention planning. In the future, these two research axes might converge.

1.1.2 The general context

The main application field of the PURES SAFE research project is high energy physics accelerator facilities. High Energy Physics (HEP), or particle physics, is a branch of modern physics studying the smallest known constituents of matter. Essential tools of particle physics are particle accelerators and detectors, which are very large and complex scientific instruments [106, 166]. Over time, the needs of particle physics have progressed towards ever higher energies (hence the term High Energy Physics), leading to ever larger and more complex machines. These large and complex machines consist of a huge amount of complex sub-systems, which in turn leads to the inevitable need for maintenance and handling interventions.

Apart from the benefits the accelerators and detectors bring to frontier research in fundamental physics, the circulation and collisions of high energy beams in these accelerators and detectors also have an undesirable consequence: the radiological activation of some of the components of accelerator facilities [151]. This activation leads to the presence of ionizing radiation in HEP facilities.

The presence of ionizing radiation makes certain parts of HEP infrastructure an undesirable working environment. Strategies to mitigate the risk of irradiation, i.e. the dose contracted during maintenance and handling activities by the workers, include, amongst others, optimization of the design of the equipment for easier maintenance and handling, implementation of telerobotics solutions, and the implementation of tools for better planning of the interventions.

The specific case of a high energy physics accelerator scientific facility that is often referred to in this dissertation is the situation at CERN. However, the content described in this thesis is valid for high energy physics accelerator facilities in general, and per extension to many facilities with ionizing radiation. Examples are the

2. In the virtuality continuum, as proposed by Milgram and Kishino in [101], Augmented Virtuality (AV) refers to a merging of a complete virtual world with some real objects. This can for instance be the body of a gamer displayed in the otherwise completely virtual gaming universe. The real object will in our case be a radiation dose field obtained from simulations or measurements, which can be considered as physically real, although not in general visible to the human eye in real life.

Joint European Torus (JET) [119], the International Thermonuclear Experimental Reactor (ITER) [36], the GSI Helmholtz centre for heavy ion research (GSI) [137] and the Facility for Antiproton and Ion Research (FAIR) [124]. Practically, the thesis was developed in the context of CERN. This implies that certain design choices have been made with this specific context in mind. This does not restrict the usability of the developed methodologies, methods and tools to this specific context, but assures that the methodologies have been validated in this context.

1.1.3 CERN

CERN, the European Laboratory for Particle Physics, was founded in 1954 in Geneva (Switzerland) as a joint European project to provide a major scientific facility for nuclear physicists [4, 19]³. Over the years nuclear physics gave birth to particle physics, which is now the main interest of CERN. For this purpose, CERN operates an accelerator chain, going from two linear injectors at low energy (50 MeV for protons, 4.2 MeV/u for heavy ions) to the Large Hadron Collider (LHC) [47, 48], a machine of ca. 27 kilometre in circumference, designed to accelerate two counter-rotating beams of protons to an energy of 7 TeV, or fully stripped lead ions (Pb^{82+}) to 2.76 TeV per nucleon. The accelerator complex at CERN hosts a large number of experiments, of which the four biggest reside on the LHC.

In this gigantic accelerator complex, activation is present, as explained. It is in this context that we research tools for the optimization of intervention planning.

CERN's contribution to the PURES SAFE project is not only as a host institution for research, but also as a provider of use cases for the research performed within the framework of PURES SAFE.

1.2 Radiation protection

1.2.1 Radiation protection in general

Radiation protection [166, 62, 139], sometimes also called *radiological protection* or *health physics* [136], is the science, the technology and its implementation with the goal of protecting human beings and the environment from the damaging biological effects of ionizing radiation [163].

The framework of radiation protection is defined by national legal limits. These legal limits mostly originate from recommendations of international expert commissions

3. "CERN" originally was an acronym for "Conseil Européen pour la Recherche Nucléaire", the council that led to the establishment of the research laboratory.

such as the International Commission on Radiological Protection (ICRP) [25]. In turn, these recommendations are based upon the current scientific knowledge in radiation biology. The interactions of ionizing particles with the structures of the human body create a cascade of reactions, which radio-biologic effects are not yet fully understood [105]. Radiation protection is thus an evolving field: at high radiation doses, where deterministic effects are to be seen, the understanding of the reactions is well established [11]. The effects at lower levels, are however not yet fully understood, and thus the models have to cope with uncertainty. For this reason, conservative assumptions are usually applied to ensure protection of humans (both professionals and the general population) against ionizing radiation, while allowing technologies involving ionizing radiation to be developed and used.

1.2.2 Radiation protection in practice

The complexity of certain industrial installations and scientific apparatus such as particle accelerators and detectors leads to the frequent necessity of maintenance operations. To protect maintenance personnel from ionizing radiation during interventions in its particle accelerators and detectors, the so-called ALARP or ALARA approach (As Low As Reasonably Possible or Achievable) [5, 82] is mostly used, which consists of justifying, optimizing and limiting the dose received by all those who need to work on, or near, activated components. Because of this, a core issue during the planning of a maintenance intervention in a facility with ionizing radiation is the minimization of the dose contracted by the maintenance workers.

This optimization cannot be automated since the practical feasibility of the intervention tasks requires human assessment. The intervention planning could however be facilitated by using an Augmented Virtuality (AV) software tool with three-dimensional visualization capabilities. The development of this tool is a complex undertaking for three reasons. Firstly, the visualization has to cover the infrastructure, the (expected) radiation levels in the facility and the intervention. Secondly, this visualization has to be intuitive to work with for all stakeholders involved (intervention planners, scientists, maintenance workers, safety officers, . . .) and useful in different scenarios (visual training of operators, three-dimensional visualizations to support the decisions of the ALARA committee, . . .). Thirdly, the application is about the safety of humans, and is therefore not allowed to have any kind of ambiguity.

The complexity that these aspects imply can be perceived even better by referring to a case study, which is treated in section 6.2. Here, a replacement operation of a key mechanical part of a beam dump is treated, which is a part of an accelerator that risks to become very radioactive. The complex operation involves moveable shielding, multiple workers from multiple groups, remote operation and time constraints, among others. Given this complex setting, the visual conditions in

which the intervention planner can perform the optimization are important, and the several layers of data involved in the planning process, i.e. the facility geometry, the radiation levels and the intervention trajectory, therefore need to be appropriately visualized.

This context of the development of the scientific considerations and methods, and accompanying software tools in this thesis is discussed in the next section.

1.3 Technical-scientific considerations for the implementation of radiation protection

1.3.1 Current situation

The context at CERN can be considered representative for the situation at scientific facilities. The work described in this dissertation was performed at, and in the first instance for the context of CERN, although not exclusively. The developed methodologies, methods and tools surpass this context and are valid in general for high energy physics facilities, and beyond.

Currently at CERN, interventions in environments with ionizing radiation are planned based on two-dimensional plots of simulation results of the ambient radiation, and on the results of manual measurements of the radiation. For the simulations of radiation levels and other radiological quantities after operation of accelerator and detector infrastructure, the FLUKA package is used. “FLUKA is a fully integrated particle physics Monte Carlo simulation package. It has many applications in high energy experimental physics and engineering, shielding, detector and telescope design, cosmic ray studies, dosimetry, medical physics and radio-biology” [22, 38, 76]. The results of these simulations are most often visualized using the FLUKA Advanced Interface (FLAIR) [152]. Figure 1.1 shows an example of a FLAIR visualization of radiation levels. Typically, this type of visualization is used for communication between Radiation Protection experts and other persons involved in specific accelerator or detector projects [153]. Other software programs have been developed to allow visualization of FLUKA simulation results, such as SimpleGeo [141, 143]. SimpleGeo is an interactive solid modeller, which is made for implementing geometries for particle transport problems based on Constructive Solid Geometry (CSG). Together with the DaVis3D plugin [142], SimpleGeo allows interactive visualization of two-dimensional cuts of FLUKA voxel geometries.

While FLAIR and SimpleGeo are useful tools, they do not give answers to the questions we have. Our intention is to enhance intervention planning in environments with ionizing radiation by means of a software program usable by both maintenance workers and intervention planners, in *three dimensions*, using

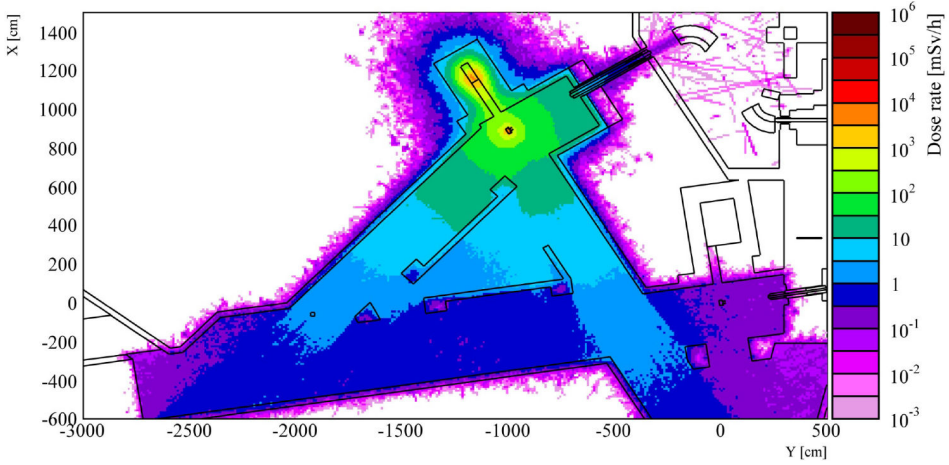

Figure 1.1 – A typical FLAIR visualization of radiation levels [153].

existing 3D CAD models of the facilities and FLUKA simulation data. The software requires the possibility to perform *interactive visual inspection* of the radiation levels and *trajectory planning*. In addition, the software should be able to numerically *calculate the resulting radiation dose* contracted during a planned intervention.

1.3.2 Motivation and goals

The scholarly treatment of the topics in this thesis are a specialized analysis of the possibilities for implementation of scientific processes and technical applications of radiation protection. This includes addressing the need for an interactive visual intervention planning tool in the context of high energy particle accelerator facilities: how can today's state-of-the-art visualization techniques be applied or adapted to optimize the human interventions in infrastructures emitting ionizing radiation?

The main top-level research questions that will be treated are the following:

- How can we improve safety in scientific facilities through the use of science and technology?
- How can we let scientific and mathematical knowledge, combined with technical innovation, act for the benefit of radiation protection in scientific environments with ionizing?
- The validation of the developed technical-scientific methodologies and software tools for the implementation of radiation protection in the context of high energy physics facilities. This includes the question of how this

technical-scientific software tool can be made useful in the collaborative scientific environment of CERN and other high energy physics facilities?

1.4 Outline of the text

The text starts in **Chapter 2** with an introduction to radiation protection. This topic is assessed from three angles. First the radiological protection system is illuminated, sketching the international principles that govern radiation protection. Second, work and dose planning is discussed in the framework of the legal requirements, and in the framework of the specific context of CERN. Third, the scientific-mathematical bases of radiation protection are covered.

In **Chapter 3**, we lay down the concepts of planning an intervention in an environment with ionizing radiation. These concepts form the basis of the intervention planning methodology. They allow for a rigorous treatment of the intervention planning challenge and are the facilitator of the translation from the science-based technical radiation protection system to the digital world.

Chapter 4 discusses the development of a software tool for interactive visual intervention planning in particle accelerator environments with ionizing radiation from a systems engineering point of view. The full systems engineering life cycle of the development process of an interactive intervention planner is addressed.

Next, in **Chapter 5**, the computational and computer-technical aspects of the development of a software tool for interactive visual intervention planning in particle accelerator environments with ionizing radiation are discussed. The advantages, challenges and limitations of a software tool in this context are analyzed.

Chapter 6 demonstrates the added value and the usefulness of the software tool. First the use of the tool is explored through controlled user/usability studies. Next, the new software tool is tested in the technical-scientific context of CERN. The case studies covered, is the elaboration of intervention scenarios for the main dump of the new Linac4 injector.

We end in **Chapter 7** with a summary of the contributions of this thesis, and suggestions and directions for future research.

Chapter 2

Radiation protection

The purpose of this chapter is to provide an introduction to radiation protection and the radiological protection system. Furthermore, the system of work and dose planning that emerges from radiation protection standards is discussed. In particular, the scientific-mathematical bases of radiation protection that are applied in the rest of the thesis are presented.

We begin, in section 2.1, by introducing the radiological protection system from a legal point of view. We go further by describing the principles of justification, optimization and limitation, and the ALARA system that can be considered an implementation of these principles.

In section 2.2, we go on by explaining the procedure of work and dose planning, taking CERN as an example. After this, we discuss in section 2.3 the scientific-mathematical bases of radiation protection, introducing the concepts of absorbed dose, dose equivalent, effective dose and collective effective dose. In section 2.4, we discuss numerical simulations for radiation protection, after which we conclude this chapter in section 2.5.

2.1 The radiological protection system

2.1.1 Legal context

Radiation protection [166, 62, 139, 82, 12], also referred to as *radiological protection* or *health physics* [136], is the science of how ionizing¹ radiation interacts with living

1. Ionizing radiation is radiation composed of particles that individually carry enough kinetic energy to liberate an electron from an atom or molecule, hereby ionizing it [130]. Although

tissue, and the technology and its implementation associated with this science, with the goal of protecting human beings from the damaging biological effects of ionizing radiation [163].

Radiation protection, and more in particular occupational radiation protection, is a field of work where many international organizations are involved in, notably the International Atomic Energy Agency (IAEA), the International Labour Organization (ILO), the European Commission (EC), the World Health Organization (WHO), the organization for Economic Co-operation and Development's Nuclear Energy Agency (OECD/NEA), the United Nations Scientific Committee on the Effects of Atomic Radiation (UNSCEAR), the International Commission on Radiological Protection (ICRP) and the International Commission on Radiation Units and Measurements (ICRU). For an enlightening clarification of the interlocking responsibilities, we refer to the proceedings of the Proceedings of the 2002 International Conference on Occupational Radiation Protection [85]. This conference was organized by the International Atomic Energy Agency, convened jointly with the International Labour organization and co-sponsored by the European Commission in co-operation with the OECD Nuclear Energy Agency and the World Health organization, and is as such a first-hand source of information. We here discuss the origin and legal roots of radiation protection, which are conferred by the ICRP and the ICRU.

Most important in the context of this work are indeed the ICRP and the ICRU. The ICRP is a non-governmental organization (NGO) whose recommendations have been the basis for all standards issued by the organizations mentioned earlier, and together with the ICRU, it has developed definitions of quantities and units for basic and operational measurements. The relevant recommendations in this context are *The 1990 Recommendations of the International Commission on Radiological Protection* [6], commonly referred to as "ICRP 60", and *The 2007 Recommendations of the International Commission on Radiological Protection* [11], commonly referred to as "ICRP 103". The 1990 ICRP recommendations were adapted by the European Union as European Council Directive 96/29/EURATOM [8] and have as such been integrated into the European Union member states' national radiation protection legislation. The relevant French legal texts can be found on [20]. The Swiss legislation also implements ICRP 60 in the Swiss Law of 22 March 1991 on Radiation Protection (LRaP) [2] and the Ordinance of 22 June 1994 on Radiation Protection (ORaP) [7].

In 2007, the ICRP issued an update of the recommendations, commonly referred to as "ICRP 103" [11], which will most probably be the basis for updates of the relevant legal context. There is, however, more continuity than change in the 2007 recommendations, meaning that the legal text will only have to be given minor

non-ionizing radiation can also be harmful to humans, think for instance of sunburn or cancer induced by exposure to ultraviolet radiation, the term *radiation protection* is usually used to only refer to protection against ionizing radiation.

updates. The most notable change is that there was a decrease in the estimates of the hereditary risk estimates for ionizing radiation, which are however not reflected in the dose limits. The dose limits are thus essentially the same in ICRP 103 and ICRP 60 [60].

The above describes the worldwide legal context of radiation protection, focuses on the European Union and gives the example of the legal texts in Switzerland and France. For an overview of other jurisdictions, we refer to [82, Chapter 6].

In what follows we focus on the specific legal context at CERN. The CERN context is specific because CERN is an international organization. The methodologies developed further in this thesis are however not only relevant for CERN, but can be applied in any jurisdiction where the ICRP model is implemented, i.e. in almost all jurisdictions worldwide.

CERN is an international organization and has as such the authority and control over the whole of its site with competence to establish its own safety policy and regulations for its staff and property, independently of the host states [129]. CERN is hosted by two of its member states, France and Switzerland, as its facilities stretch over France's and Switzerland's mutual border (see Figure 2.1). However, as a general rule, CERN must ensure a level of safety which may not fall below the standard of the most advanced regulations of the host states. In case CERN regulations are lacking or incomplete, the regulations of the host state concerned are applicable on its territory [51].

Furthermore, CERN and the French and Swiss governments have signed a tripartite agreement [13] in which is implied that the rules established by CERN should provide guarantees in matters of protection against ionizing radiation and safety that are equivalent to those which would result from the application of the respective national regulations. The agreement also stipulates that for all new facilities recognised or approved by CERN, CERN has to provide a number of documents relative to radiation protection, including an impact study, safety file and rules associated with the operation of the facility.

2.1.2 Justification, optimization and limitation

In the “ICRP 60” and “ICRP 103” recommendations, the International Commission on Radiological Protection recommends that radiological protection should be based on three principles: *justification*, *optimization* and *limitation*.

Justification involves showing that a practice produces sufficient benefit to individuals or society to offset the radiation detriment it causes. In the Swiss “Ordonnance sur la Radioprotection” [7], for instance, it is clarified that a practice is justified when the advantages clearly outweigh the disadvantages and that no alternative solution exists which would not involve radiation exposure. In the CERN

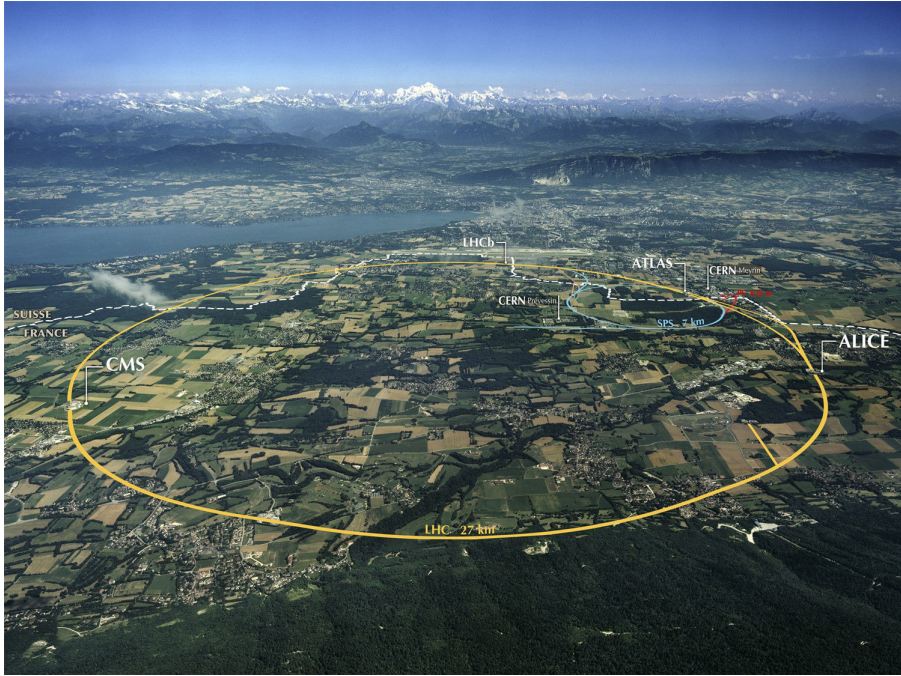

Figure 2.1 – An aerial view of the CERN accelerator complex. The facilities of CERN stretch over France’s and Switzerland’s mutual border.

radiation protection rules, a similar clarification is given [10]: “The justification principle in radiation protection requires that any practice involving exposure to radiations should produce sufficient benefit to the exposed individuals or to society to offset the radiation detriment it causes.” In case of CERN, it is clear that there is no way to go ahead with the various nuclear and particle physics experiments conducted at CERN without implying some radiation exposure, and the mission of CERN [4] is deemed to justify this. With regard to small exposures, both the Swiss “Ordonnance sur la Radioprotection” [7] and the CERN radiation protection rules [10] state that any professional activity which gives rise to an effective dose of less than $10 \mu\text{Sv}$ per year can automatically be considered optimized.

Optimization is the balancing of constraints on individual doses, risks, number of persons involved, cost of protection measures, . . . The Swiss “Ordonnance sur la Radioprotection” [7], for instance, defines that radiation protection is optimized when:

- the various appropriate options have been assessed and compared in terms of radiological protection;

- it is possible to trace the steps in the decision-making process leading to the solution adopted; and
- the possibility of abnormal occurrences and the disposal of radiation sources have been taken into account.

The same ordonnance also states that the principle of optimization is deemed to be satisfied where activities do not lead in any case to an exposure of more than 100 μSv per year for occupationally exposed persons and more than 10 μSv per year for non-occupationally exposed persons.

Limitation is the keeping of actual exposures below specified limits. These annual dose limits, expressed in effective dose received by a person, are derived from the national legislations that (in Europe) rely on the recommendations of the ICRP [6]. In the case of occupational exposure, which is the relevant case in the context of this thesis, the dose received by individually monitored² personnel during any consecutive 12-month period must not exceed 20 mSv. However, further special restrictions apply to women of child-bearing age. In the case of CERN, these limits are to be found in [10].

It is furthermore worth noting that the optimization of doses which could be received by personnel starts already during the design phase of a new installation. In this case legal limits should not be applied due to possible uncertainties in the estimations, but one is working with *design limits*. Obviously, the design limits must stay below the legal limits. For the LHC, for instance, it has been decided to plan maintenance operations with a design limit in order not to exceed the annual dose of 5 mSv [51].

2.1.3 ALARA

The prevalent method for implementing the justification, optimization and limitation above is the so-called ALARP or ALARA approach (As Low As Reasonably Practicable or Achievable [5, 82]). What is “Reasonably Practicable” or “Reasonably Achievable” is not stated explicitly in any official document. In the proceedings of the IAEA’s 2002 conference on occupational radiation protection [85], ALARA is explained as follows: “ALARA is an acronym for the ICRP recommendation on the optimization of radiation protection, namely, that radiation doses be kept ‘as low as reasonably achievable’, social and economic considerations being taken into account.”

Also at CERN, the ALARA principle is adopted [10].

2. The effective dose received by persons who are not individually monitored shall not exceed 1 mSv per year. [10]

2.1.4 Critics

Although many stakeholders in radiation protection (in particular the regulators) seem to agree that the standards developed at the international level now in place are “generally satisfactory as a framework for the control of occupational exposures in developed and developing countries” [85], this view is not unanimously endorsed by all scientists [34]. In particular the Linear No-Threshold (LNT) relationship, on which the ALARA principle is based, is often criticized and seems to be inconsistent with radiation biologic and experimental data [145, 146, 117, 127]. The LNT model is a model used in radiological protection that assumes that biological damage caused by ionizing radiation is directly proportional to the received dose.

It has to be noted that the radiation protection system conceived by the ICRP is meant to be a conservative system. This means that, even considering the critics, the current radiological protection system is perceived to be safe, because it reasons from the point of view of the most disadvantageous assumption for human safety.

The intervention planning model developed in chapter 3 can accommodate possible future changes in the radiation protection system, because it makes no presumptions on the input that can consider in the current radiological protection system or can eventually be made with a future system in mind. On top of this, the parameters that are included in the model are also without presumptions and allow for future accommodations.

2.2 Work and dose planning

2.2.1 Introduction

One essential part of the optimization principle is work and dose planning [53]. According to [51], effective and realistic work planning should comprise the following aspects – depending on collective dose and special risks (e.g., contamination):

1. specification of radiological training and monitoring requirements,
2. establishment of intervention plans, procedures or work packages (preparatory meeting, etc.),
3. prior estimation of individual and collective dose,
4. evaluation of contamination risks,
5. consideration of the use of work processes and special tooling to reduce the time spent in the work area (e.g., staging and preparation of necessary materials and special tools; prefabrication and work shop preparation outside the active areas),
6. the use of mock-ups for complex tasks,

7. the use of “dry-runs” for the activities using applicable procedures,
8. engineering, design and use of temporary shielding,
9. provision for waste minimization and disposal,
10. a review of emergency procedures and plans,
11. establishment of success or completion criteria, with contingency plans to anticipate difficulties,
12. in case the total accumulated dose exceeds the established estimate by 25% or more, a periodical review regarding work methods becomes necessary.

During the work, the operational dosimetry system is used to control the doses received by the persons involved. The measured values must be regularly compared to the estimated ones, thus enabling an early warning of dose over-runs and a possible correction in the work methods applied. At the end of a job, a post-intervention analysis has to be performed, comparing planned and actual conditions and doses, in order to improve future interventions by profiting from the experience of the past.

Most relevant for this thesis are aspects number 2 and 3, although also aspects 8, 10, and 5 can benefit from the methods and tools developed in this thesis.

In the remainder of this section, we concentrate on the work and dose planning in a more restricted meaning, i.e. the establishment of the intervention plans by prior estimation of individual and collective dose. We will use *intervention planning* as a synonym for work and dose planning in this sense.

2.2.2 Current situation: work and dose planning at CERN

Work and dose planning at CERN can be considered representative for the situation in high energy physics facilities. The work in this dissertation was developed in the specific context of CERN, but can be trivially transposed to other high energy physics facilities.

For what concerns ‘traditional’³ intervention planning at CERN, we can discern two main scenarios. One is intervention planning as part of the study of a new (accelerator) facility, for estimating the individual and collective doses due to a maintenance or handling activity that is foreseen to be undertaken, or might be needed, in the future. The second is work dose planning as part of the preparation of an intervention that is, or will be, scheduled. The first form of intervention planning can be used as part of the design process of a new facility, to optimize future interventions in terms of work dose, by optimizing the design of the facility.

3. By traditional, we understand the way in which work and dose planning is currently practised at CERN, not (yet) using the tools that are developed in this thesis.

Both scenarios differ in a number of ways: e.g. the stakeholders involved, the design parameters that can be changed in the course of the optimization of the intervention, and the time that is available for the planning.

In both of these cases, the start of the intervention planning exercise is the explicitation of the maintenance plan and listing of the different steps associated with the maintenance activity, and their attributes. These attributes are mainly the location of the workers during the different steps of the intervention, and the duration of each activity in the intervention. To come to collective dose, also the number of workers involved should be stated.

In a next step, these attributes of the intervention planning are then combined with radiation data. This data can either be measured data or simulated data, and has to allow to find out the dose the worker will receive at each stage of the intervention, most notably while performing the different steps of the intervention.

This two-step explicitation of the maintenance plan is a rather encumbered process, in which many collaborators (radiation protection experts, work planners, equipment owners, maintenance personnel, ...) are involved. The tools used for this process are mostly 2D maps of a facility, on which locations are approximately indicated (for an example, see figure 6.4), and large Excel tables to perform the (mostly manual) dose calculations (for an example, see Figure 2.2).

The scientific methodology and resulting proof-of-concept software tool we developed as part of the work described in this thesis can enhance this intervention planning process and turn the current work dose planning into software-supported interactive visual intervention planning: the different steps associated with the intervention that can be seen in Figure 2.2(a) can be in-putted in a software tool and can be visually and interactively be positioned in 3D in the facility, with immediate visual feedback of the radiation doses, and can be associated with staying times. From this input, the software can then immediately construct a report, including a dose table and visualisations of the dose rates, for example.

Work and dose planning - Graissage des tax en TCC2

Graissage des 3 tables tax T2 - T4 - T6 en TCC2

Prior intervention To be completed and checked by work coordinator(s) and experts				Prior intervention To be checked and completed by RP				Calculations				
No.	Work description (Task)	Responsible person	Day/Grp (executing)	Work Team	Location (check table 'DoseRates')	Persons (No.)	Exposure time (min)	Dose rate (µSv/h)	Estimated dose (µSv)	Estimated total dose (µSv)	Real time (min)	Real dose (µSv)
Preparation												
1.01	Verification de materiel	Florian	EN/CV		TAB01	1	45	2	2	2		0
Grassage												
2.01	Temps de trajet T6 aval	Florian	EN/CV		Trajet T6 aval	1	2	25	1	1		0
2.02	Connection/deconnection XTAX T6 aval	Florian	EN/CV		XTAX T6 aval 1	1	1	400	7	7		0
2.03	Pompage graisse XTAX T6 aval	Florian	EN/CV		XTAX T6 aval 2	1	3	100	5	5		0
2.04	Temps de trajet T2 aval	Florian	EN/CV		Trajet T2 aval	1	2	20	1	1		0
2.05	Connection/deconnection XTAX T2 aval	Florian	EN/CV		XTAX T2 aval 1	1	1	400	7	7		0
2.06	Pompage graisse XTAX T2 aval	Florian	EN/CV		XTAX T2 aval 2	1	3	200	13	13		0
2.07	Temps de trajet T4 aval	Florian	EN/CV		Trajet T4 aval	1	2	40	1	1		0
2.08	Connection/deconnection XTAX T4 aval	Florian	EN/CV		XTAX T4 aval 1	1	1	250	4	4		0
2.09	Pompage graisse XTAX T4 aval	Florian	EN/CV		XTAX T4 aval 2	1	3	1150	58	58		0
2.10	Temps de trajet T2 amont	Florian	EN/CV		Trajet T2 amont	1	2	30	1	1		0
2.11	Connection/deconnection XTAX T2 amont	Florian	EN/CV		XTAX T2 amont 1	1	1	260	4	4		0

(a) Screenshot of the work and dose planning file of an intervention at CERN – the actual intervention planning.

Prior intervention To be completed and checked by work coordinator(s) and experts		Prior intervention To be checked and completed by RP		Calculations	
Working positions (refer to drawing on tab 'DoseMap')	Description	Dose rate (µSv/h)	Reduction factor	New dose rate (µSv/h)	
TAB01	Zone de repli	2		0	0
5	Trajet T6 aval	25		0	0
6	XTAX T6 aval 1	400		0	0
7	XTAX T6 aval 2	T6 aval graissage		0	0
8	Trajet T2 aval	20		0	0
9	XTAX T2 aval 1	T2 aval connection/deconnection		0	0
10	XTAX T2 aval 2	T2 aval graissage		0	0
11	Trajet T4 aval	40		0	0
12	XTAX T4 aval 1	T4 aval connection/deconnection		0	0
13	XTAX T4 aval 2	T4 aval graissage		0	0
14	Trajet T2 amont	30		0	0
15	XTAX T2 amont 1	T2 amont connection/deconnection		0	0
16	XTAX T2 amont 2	T2 amont graissage		0	0
17	Trajet T4 amont	50		0	0
18	XTAX T4 amont 1	T4 amont connection/deconnection		0	0
19	XTAX T4 amont 2	T4 amont graissage		0	0
20	Trajet T6 amont	350		0	0
21	XTAX T6 amont 1	T6 amont connection/deconnection		0	0
22	XTAX T6 amont 2	T6 amont graissage		0	0

(b) Screenshot of the work and dose planning file of an intervention at CERN – dose rates.

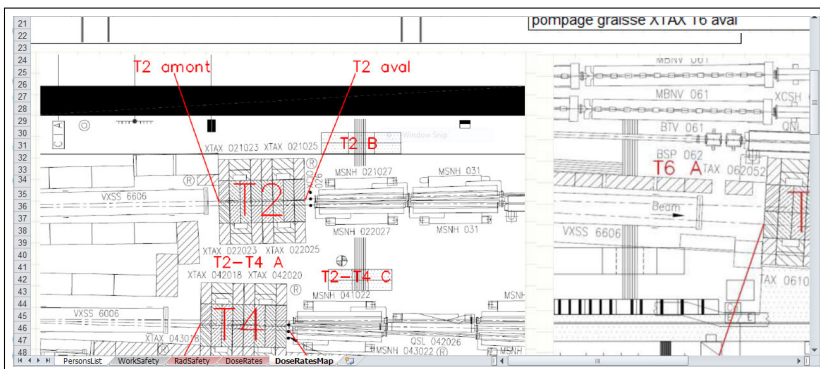

(c) Screenshot of the work and dose planning file of an intervention at CERN – dose rate maps.

Figure 2.2 – Screenshots of the work and dose planning file of an intervention at CERN.

2.3 Scientific-mathematical bases of dose evaluation

2.3.1 Introduction

In Section 2.1, we have mentioned the existence of the International Commission on Radiation Units and Measurements (ICRU) as one of the international organizations involved in radiation protection, and particularly relevant for the work in this thesis. Indeed, with the objective to “develop concepts, definitions and recommendations for the use of quantities and their units for ionizing radiation and its interaction with matter, in particular with respect to the biological effects induced by radiation” [85], the work of the ICRU is very pertinent *in casu*. The work of the ICRU has as such laid the scientific-mathematical bases of radiation protection, and has developed special *dosimetric quantities* for the assessment of doses from radiation exposures. These quantities have also been included in the before-mentioned recommendations of the ICRP, which deal not only with these quantities, but broaden the scientific-mathematical bases of radiation protection. This is the subject of this section, and as such the following is heavily based on [11].

The fundamental *protection quantities* adopted by the ICRP are based on measures of the energy deposited in organs and tissues of the human body. In order to relate the radiation dose to radiation risk (detriment), variations in the “biological effectiveness” of radiation types of different quality as well as the varying sensitivity of organs and tissues to ionizing radiation are taken into account.

The procedure for the assessment of effective dose adopted by the ICRP [11] is to use *absorbed dose* as the fundamental physical quantity, to average it over specified organs and tissues, to apply suitably chosen weighting factors to take account of differences in biological effectiveness of different radiation types to give the quantity equivalent dose, and to consider differences in sensitivities of organs and tissues to stochastic health effects. Values of the equivalent dose to organs and tissues weighted for the radiosensitivity of these organs and tissues are then summed to give the effective dose. This quantity is based on the exposure to radiation from external radiation fields and from incorporated radionuclides as well as on the primary physical interactions in human tissues and on judgements about the biological reactions resulting in stochastic health effects. All of these aspects of dose radiation protection quantities will be discussed in the subsequent sections.

2.3.2 Absorbed dose

Absorbed dose, or *energy dose*, is the fundamental physical quantity that is used as the basis for all subsequent *protection quantities* that are used in radiation protection. In ICRP 103, it is specifically stated that “the definition of absorbed dose has the scientific rigour required for a basic physical quantity”, highlighting

the difference between the *physical quantity* of absorbed dose, versus the subsequent protection quantities.

The *absorbed dose*, or *energy dose*, abbreviated as D , is the amount of energy locally deposited at a given location in matter. It is defined as the deposited energy (ΔE) per unit of mass of material (Δm)⁴:

$$D = \frac{\Delta E}{\Delta m} \quad [\text{J} \cdot \text{kg}^{-1} = \text{Gy}]. \quad (2.2)$$

The unit of absorbed dose is the *gray*⁵.

The absorbed dose depends on the incident radiation, but also on the absorbing material.

To use the absorbed dose in practical radiation protection applications, doses have to be averaged over tissue volumes (i.e. organs). According ICRP 103 [11], the mean absorbed dose in the region of an organ or tissue T is defined by:

$$\bar{D}_T = D_T = \frac{\int_T D(x, y, z) \rho(x, y, z) dV}{\int_T \rho(x, y, z) dV} \quad [\text{Gy}], \quad (2.5)$$

with:

- V the volume of the tissue region T ,
- D the absorbed dose at point (x, y, z) and
- ρ the mass density at this point.

2.3.3 Dose equivalent

Different types of ionizing radiation cause different amounts of damage to living tissue. In radiation protection, a concept related to the absorbed dose, but taking this effect into account is defined as the *equivalent dose* or *dose equivalent*, abbreviated as H .

4. The notation used in ICRP 103 [11] is:

$$D = \frac{d\bar{\epsilon}}{dm} \quad [\text{J} \cdot \text{kg}^{-1} = \text{Gy}]. \quad (2.1)$$

This indicates more clearly that the absorbed dose is a mean value of the stochastic quantity of energy imparted, ϵ , and is obtained as an average over a mass element dm .

5. Old units, which are still used in parts of the world are the *rad* and the *rep*.

$$1 \text{ rad} = 0.01 \text{ Gy} \quad (2.3)$$

$$1 \text{ rep} = 8.3 \text{ or } 9.3 \text{ mGy} \quad (2.4)$$

The type of radiation is therefore qualified by a radiation weighting factor w_R . These radiation weighting factors are defined by the International Commission on Radiation Protection. The most recent values are to be found in the publication ICRP 103 [11], although the values that are most commonly used in law are the old values that can be found in the publication ICPR 60 [6]. The values defined in ICRP 103 [11] are reproduced in Table 2.1.

Using these radiation weighting factors, the *equivalent dose* is then defined as:

$$H = \sum_R w_R D_R \quad [Sv]. \quad (2.6)$$

The *equivalent dose* in an organ or tissue T is defined as:

$$H_T = \sum_R w_R D_{T,R} \quad [Sv]. \quad (2.7)$$

The unit of equivalent dose is $J \text{ kg}^{-1}$, and has the special name *sievert* (Sv). In the above formulas, R stands for the radiation type (see Table 2.1).

The values of w_R are defined largely on the basis of the Relative Biological Effectiveness (RBE) of the different radiations. The RBE is defined as the ratio of a reference radiation to a dose of the radiation considered that gives an identical biological effect, and have been inferred from cellular and biophysical data [148].

2.3.4 Effective dose

Different types of human tissue are more or less sensitive to ionizing radiation: the same equivalent dose does more harm to one organ than to another one. To

Radiation type	Radiation weighting factor, w_R
Photons	1
Electrons and muons	1
Protons and charged pi- ons	2
Alpha particles, fission fragments, heavy ions	20
Neutrons	$\begin{cases} 2.5 + 18.2 \cdot e^{-(\ln(E_n))^2/6} & E_n < 1 \text{ MeV} \\ 5.0 + 17.0 \cdot e^{-(\ln(2E_n))^2/6} & 1 \text{ MeV} \leq E_n \leq 50 \text{ MeV} \\ 2.5 + 3.25 \cdot e^{-(\ln(2E_n))^2/6} & E_n > 50 \text{ MeV} \end{cases}$

Table 2.1 – Radiation weighting factors w_R as defined in ICRP103.

quantify this, another concept derived from equivalent dose, but taking this effect into account is defined as the *effective dose*, abbreviated as E or H_{eff} .

The equivalent dose is therefore weighted by tissue weighting factor w_T , depending on the tissue or organ the radiation is incident on. Also these tissue weighting factors are defined by the International Commission on Radiation Protection in the publication ICRP 103 [11]. The values for the tissue weighting factors, as defined in ICRP 103 [11] can be found in table 2.2. These values are average values, defined using reference adult male and female (computational) phantoms.

Using these tissue weighting factors, the *effective dose* is then defined as:

$$H_{\text{eff}} = E = \sum_T w_T H_T \tag{2.8}$$

$$= \sum_T w_T \sum_R w_R D_{T,R} \quad [\text{Sv}], \tag{2.9}$$

with:

- w_T the tissue weighting factor for tissue T and
- $\sum w_T = 1$.

The unit of effective dose is J kg^{-1} , and has the special name *sievert* (Sv). This is the same unit as for equivalent dose, so that care must be taken to ensure that the quantity being used is clearly stated.

The effective dose is the main quantity that is used in radiation protection, and also the main quantity that we will use in our work. To explain the use of this protection quantity, we cite from the 2007 recommendations of the International Commission on Radiological Protection [11]:

Tissue	w_T	$\sum w_T$
Bone-marrow (red), Colon, Lung, Stomach, Breast, Remainder tissues ¹	0.12	0.72
Gonads	0.08	0.08
Bladder, Oesophagus, Liver, Thyroid	0.04	0.16
Bone surface, Brain, Salivary glands, Skin	0.01	0.04
Total	1	1

¹ Remainder tissues: Adrenals, Extrathoracic (ET) region, Gall Bladder, Heart, Kidneys, Lymphatic nodes, Muscle, Oral mucosa, Pancreas, Prostate (σ), Small intestine, Spleen, Thymus, Uterus/cervix (φ)

Table 2.2 – Tissue weighting factors w_T as defined in ICPR103.

The main and primary uses of effective dose in radiological protection for both occupational workers and the general public are:

- prospective dose assessment for planning and optimization of protection; and
- retrospective dose assessment for demonstrating compliance with dose limits, or for comparing with dose constraints or reference levels.

In this sense, effective dose is used for regulatory purposes worldwide. In practical radiological protection applications, effective dose is used for managing the risks of stochastic effects in workers and the public.

Other units for effective dose exist, but are mostly deprecated units that are still used in some parts of the world. One alternative unit however deserves a mention: the DARI. DARI is an French acronym for “Dose Annuelle due aux Radiations Internes” – annual dose from internal radioactivity. Essentially, this unit is established as a unit of radiation dose that is equal to that provided annually to a human being by the naturally occurring radioactivity of human tissue. It was conceived to be more user-friendly and as such give the wider public a clearer understanding of the health effects of radioactive material originating from the nuclear industry [58].

2.3.5 Collective effective dose

The *collective effective dose*, or *energy dose*, abbreviated as S , is calculated as the sum of all individual doses during an operation or time period ΔT :

$$S = \sum_{\text{operation}} E \quad [\text{man Sv}] \quad (2.10)$$

∨

$$S = \sum_{\Delta T} E \quad [\text{man Sv}]. \quad (2.11)$$

The special name used for quantifying this measure is the *man sievert* (man Sv). Collective effective dose is only to be used as an instrument for optimization, comparing radiological technologies and protection procedures.

ICRP103 [11] also defines the collective effective dose due to individual effective dose values between E_1 and E_2 as:

$$S(E_1, E_2, \Delta T) = \int_{E_1}^{E_2} E \left(\frac{dN}{dE} \right)_{\Delta T} dE \quad (2.12)$$

with $\left(\frac{dN}{dE} \right)_{\Delta T} dE$ the number of individuals exposed to an effective dose between E and $E + dE$ within time period ΔT .

2.4 Simulations for dose evaluation

Given the radiological protection system, as elaborated in the previous sections, it seems natural to expect simulations of the various radiation dose rates in facilities with ionizing radiation, in order to plan interventions. These simulations have been the topic of many PhD dissertation (e.g. [51, 169, 99]), but are not the focus of the current dissertation. The topic of this thesis is the data science for the post-processing of simulation data, data fusion and intervention planning using these simulations. Therefore, this section gives a short and germane overview of the use of simulation for dose evaluation, focused at applications for high energy physics experimental facilities with ionizing radiation.

In the context of simulations for radiation protection, one needs to remember that ionizing radiation is radiation that has the power to liberate an electron from an atom or molecule, thus producing ions (atoms or molecules with an electric charge). Because ions are chemically reactive, they can cause biological damage when produced in living tissue. Sources of ionizing radiation are ubiquitous, such as cosmic rays and naturally occurring radioactive materials, but ionizing radiation can also be created, e.g. with particle accelerators that can also produce artificially created radioisotopes.

Ionizing radiation exists in various forms. The particles of which ionizing radiation consists must have a sufficiently high energy and interact with the atoms of a target. These particles can be photons (electromagnetic radiation), electrons, positrons, muons, protons, alpha particles, heavy atomic nuclei or neutrons.

Simulation for radiation protection thus comes down to particle interaction and transport simulations. Given the complexity of the particle interactions and transport, deterministic codes are infeasible for this particular problem. Consequently, Monte Carlo simulations are the computational technique of choice.

A large number of radiation transport codes exist, such as EGS [107], GEANT4 [32, 33], MARS [103], MCNP [167], PENELOPE [126], PHITS [109],... Each of these code specializes in and covers certain energy ranges and particle types. For example, PENELOPE covers photons, electrons and positrons. MCNP is

a multiple-particle code with an emphasis on neutrons (and thus much-used for reactor physics). FLUKA is a multiple-particle code, and currently the only one covering primary energies up to very high in the TeV range.

For the implementation of the model developed here, which specific radiation transport code is used is of no importance. We here describe the code that is most used at CERN, but anywhere this code is mentioned further in this thesis, it could be substituted by any other relevant code for use in the model and methodologies developed in this thesis.

The simulation package mainly used for radiation protection simulations at CERN is FLUKA [38, 75]. Most of the before-mentioned codes differ from FLUKA by being essentially built as specialized codes or assemblies of specialized codes, making them mostly only useful in specific radiation protection contexts [51]. FLUKA has been extensively benchmarked for radiation protection purposes [154, 54, 65, 55, 52, 37], and has been proven to be sufficient for this purpose. It can also be considered the most appropriate choice for radiation protection studies, as it has its roots in this field. In [52], it is confirmed that “FLUKA is the most suitable particle interaction and transport code for calculating induced radioactivity at high energy hadron accelerators”, and mentions that FLUKA “reproduces measured specific activities to within 20 – 30% for most isotopes”. It can, as a consequence be used to compute radiation protection quantities.

The principle of FLUKA simulation for radiation protection simulations, e.g. for radiation protection studies for the Large Hadron Collider [37], is the following: given as input the geometry of a facility and the physics parameters of the particle beams used in the facility, the FLUKA Monte Carlo code computes the various radiological protection quantities at a specified time in the life time of the facility, with respect to the physics experiments conducted. This output, referred to as the “scored quantity”, is then outputted as values per three-dimensional bin. Here, every bin is a three-dimensional sub-volume of a larger three-dimensional volume. Usually, these bins are arranged into a three-dimensional Cartesian grid, although FLUKA also provides cylindrical grids. The three-dimensional bin structure in the output of FLUKA is equivalent to the voxel (volume element) concepts that are found in three-dimensional medical imaging and scientific data processing.

Remark that the geometry given as input to FLUKA cannot be in a format that can easily be extracted from regular Computer Aided Design (CAD) tools, but has to be established in a format that is specific to FLUKA. This is due to the fact that FLUKA geometries are based on a different paradigm (Computational Solid Geometry (CSG)) than the one used in CAD tools, which is also the reason why conversion is not trivial. As a consequence, the geometry has to be coded manually or with one of the very few tools that facilitate this encoding, e.g. FLAIR [152, 21] (see figures 2.3(a) and 2.3(b)) and SimpleGeo [143, 141] (see figure 2.3(c)). Also the physics parameters that are used as input have to be established in code, in a

format specific to FLUKA. For the output data, there is up to now no tool that leverages the output fully in three dimensions, as will be discussed in chapter 5.

For the purpose of intervention planning at CERN, it must be clear that access to the facilities where the machines (particle accelerators and experiments) are located is prohibited during operation, except in some very specific location such as the counting rooms⁶ of the experiments. Because of this, for the purpose of radiation studies, the calculation of induced radioactivity and accompanying residual dose rates are the simulations of interest.

2.5 Conclusion

In this chapter, we have provided an introduction to radiation protection and the radiological protection system. This included the legal context of radiation protection, and the principles of justification, optimization and limitation with their implementation in the form of the ALARA principle.

Furthermore, the system of work and dose planning that emerges from radiation protection standards was discussed, including the current practices at CERN.

In particular, the scientific-mathematical bases of dose evaluation that are applied in the rest of the thesis were presented.

6. The counting rooms are the physical locations where the data acquisition is performed on large computing clusters.

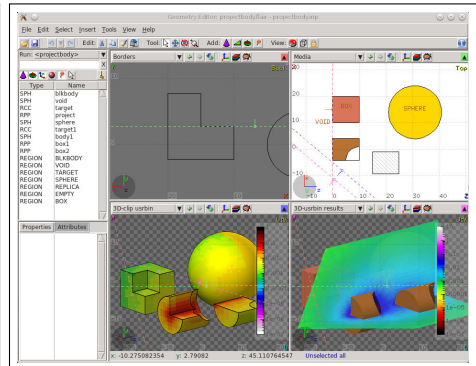
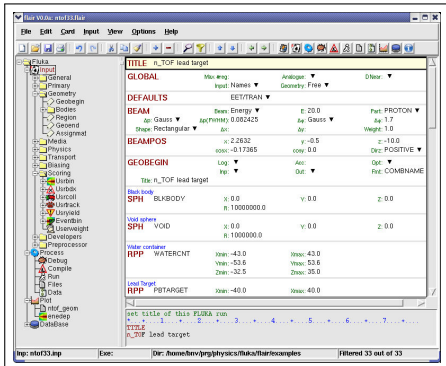

(a) Facilitated editing of the FLUKA input using FLAIR [21].

(b) Facilitated editing of the FLUKA geometry using FLAIR [21].

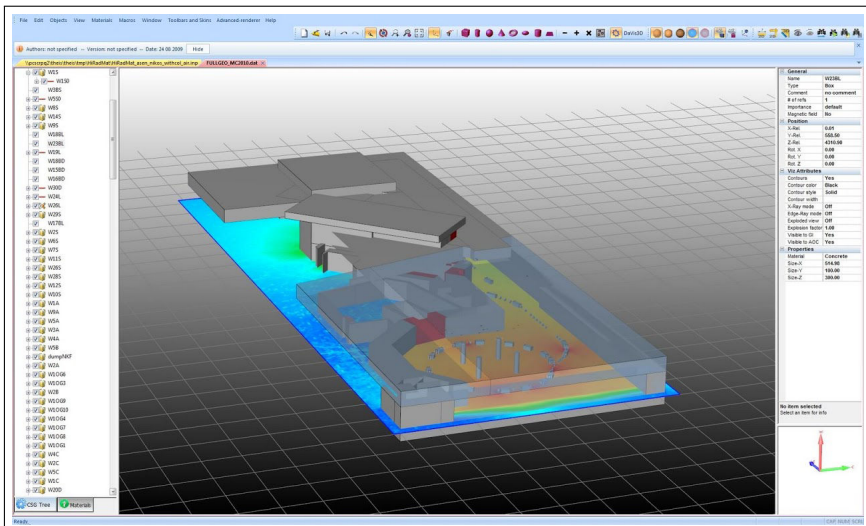

(c) Facilitated editing of the FLUKA geometry and visualisation of FLUKA output using SimpleGeo [141].

Figure 2.3 – Facilitated FLUKA input.

Chapter 3

Intervention planning in environments with ionizing radiation

In this chapter, we discuss intervention planning in particle accelerator environments with ionizing radiation. Every treated subject is looked at in the context of computer-assisted intervention planning.

We start, in section 3.1 with defining the concepts of intervention planning, leading to a sound, powerful but accessible mathematical model of intervention planning. We explain in sections 3.2 and 3.3 how this model seamlessly ties in with the technical-scientific radiation protection concepts defined by the ICRP and explained in the previous chapter. Next, in section 3.4 we make a taxonomy of the intervention planning process, tie this in with the optimization of a trajectory and as such lay the bases for a software implementation of intervention planning in particle accelerator environments with ionizing radiation. We then give a further theoretical elaboration of the integration of the model and the radiation protection concepts in section 3.5. Finally, we elaborate on the optimization process in the intervention planning in section 3.6, and conclude the chapter in section 3.7.

The main contribution of this chapter is the development of a novel powerful mathematical model for intervention planning in environments with ionizing radiation that lends itself to be implemented in software. It is sound but simple and serves as the basis of the answers to the research questions: how can today's state-of-the-art interactive visualization techniques be applied or adapted to optimize human interventions in radioactive environments at a particle accelerator?

3.1 Intervention planning concepts

In the light of the research questions that are treated in this thesis, as outlined in section 1.3.2, a sound, powerful but accessible mathematical model of intervention planning is defined. This is a step towards the goals of the thesis, that can in part be summarized as: how can today's state-of-the-art interactive visualization techniques be applied or adapted to optimize human interventions in radioactive environments at a particle accelerator? An additional important condition for the mathematical model has been that the model has to lend itself to implementation into a software tool for interactive visual intervention planning in particle accelerator environments with ionizing radiation.

An **intervention** \mathcal{I} is a set of **tasks** T_k that need to be completed by the maintenance worker, each with a specific description and an estimated duration τ_k :

$$\mathcal{I} = \{T_k; \quad k = 0, 1, \dots, K\}. \quad (3.1)$$

Task T_0 corresponds to the entrance of the facility by the worker; task T_K corresponds to the exit of the facility. Tasks T_k can be any task that has to be performed during the intervention, e.g. unscrewing a bolt, or cutting a weld line.

A **trajectory** \mathcal{T} consists of a series of **locations** m_i , with $i = 0, 1, \dots, N$. At each location m_i , a maintenance worker will spend an amount of time denoted by t_i .

The **path** between two consecutive locations m_i and m_{i+1} is denoted by S_i , with $i = 0, 1, \dots, N - 1$. Each path S_i is taken by the maintenance worker at a velocity v_i .

The planner of an intervention will decide on a trajectory \mathcal{T} with an intervention \mathcal{I} in mind, thus constructing a map between \mathcal{I} and \mathcal{T} . As a result:

$$\forall T_k \in \mathcal{I} : \quad T_k \text{ is assigned to a location } m_i \text{ and } t_i = \tau_k, \quad (3.2)$$

$$\forall m_i \in \mathcal{T} \text{ and } \nexists T_k \text{ assigned to location } m_i : \quad t_i = 0, \quad (3.3)$$

with $K \leq N$.

This model is schematically represented in Figure 3.1.

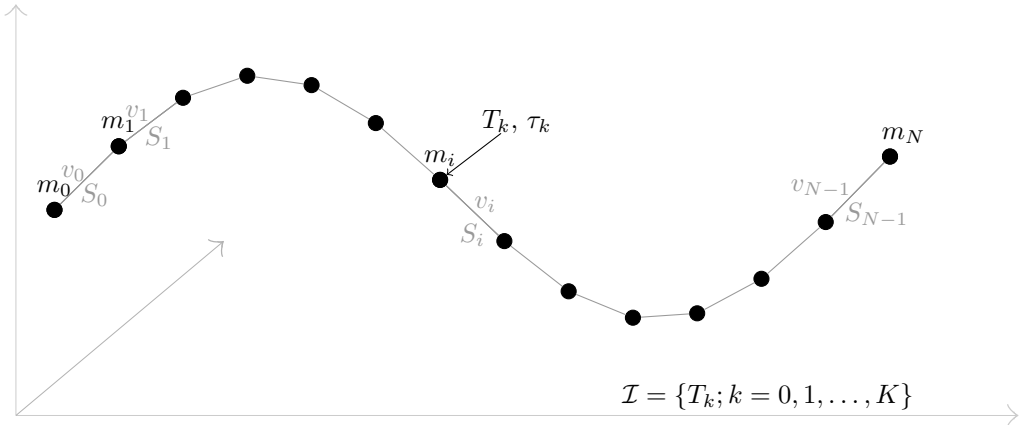

Figure 3.1 – Schema of the mathematical model for intervention planning.

3.2 Intervention planning integrated with radiation protection

From a radiation protection point of view, workers that perform maintenance in an environment with ionizing radiation contract an **absorbed dose** D ($[\text{Gy} = \frac{\text{J}}{\text{kg}}]$), leading to an **equivalent dose** H ($[\text{Sv}]$), as explained in Chapter 2.

The equivalent dose H contracted by the maintenance worker performing an intervention \mathcal{I} mapped on a trajectory \mathcal{T} , modelled using the formulations introduced above, is calculated as the sum of the equivalent doses received at the locations m_i and the radiation received over the paths S_i between the locations:

$$H(\mathcal{I}, \mathcal{T}) = \sum_{i=0}^N t_i \dot{H}(m_i) + \sum_{i=0}^{N-1} \int_{m_i}^{m_{i+1}} v_i^{-1} \dot{H}(s) ds, \quad (3.4)$$

where s is a point on the path S_i . The equivalent dose rates \dot{H} are available from simulations of the activation of the facility equipment, or could eventually be obtained from manual or automated measurements performed in the irradiated facility. Currently only simulation data is readily available at CERN; i.e. the simulation data is available in a format suitable for extensive data analysis.

Although not readily available in a format that is suitable for further processing, dose rates are also measured in facilities with ionizing radiation at CERN. While automatic radiation data gathering at CERN is performed through a state-of-the-art radiation monitoring and alarming system (RAMSES) [102], the data is too sparse for allowing three-dimensional processing in the fine-grained way that is needed to implement our model. Of course, more detailed measurements are made in a facility like CERN. These are often done manually by radiation protection technicians. If they are stored into a computer system, they are often not readily usable for automated three-dimensional processing: localization in an automated way is often not possible due to a lack of positioning system. It is indeed close to impossible to implement a GPS-like system in a large scientific facility consisting of tens of kilometres of underground tunnel areas¹. Radiation data are thus often stored using relative positioning data, such as “at x cm of device y ”. While these data suffice for many radiation protection purposes, they are not adequate to be integrated into the model that we are using.

Similar equations hold for the many other related concepts in radiation protection, such as the **effective dose equivalent** H_{eff} ($[\text{Sv}]$) (see chapter 2):

$$H_{\text{eff}}(\mathcal{I}, \mathcal{T}) = \sum_{i=0}^N t_i \dot{H}_{\text{eff}}(m_i) + \sum_{i=0}^{N-1} \int_{m_i}^{m_{i+1}} v_i^{-1} \dot{H}_{\text{eff}}(s) ds. \quad (3.5)$$

1. GSM-based systems for this purpose are currently being investigated [114, 115, 116].

3.3 Elaboration of the radiation protection integration

In most cases, and also mostly in situations involving intervention planning in particle accelerator environments with ionizing radiation, the ionizing radiation is originating from natural radioactivity or from induced radioactivity, also called activation.

Radioactivity is a dynamic phenomenon: radioactivity, more accurately described as radioactive decay is a stochastic process by which nuclei of unstable atoms lose energy by emitting particles of ionizing radiation. The chance that a given atom will decay is constant over time, which makes that, aggregated over a large number of atoms in a piece of material, the number of decays per second will go down as time evolves. A corollary of this is that also the equivalent dose rates near a radioactive piece of material are time-dependent. The gradient is usually rather small over the time period of an intervention, but this depends on the isotopic composition of the activated material. If the ionizing radiation in the facility where the intervention is planned is thus only originating from natural or induced radioactivity, then equation 3.4 can be more accurately stated as:

$$H(\mathcal{I}, \mathcal{T}) = \sum_{i=0}^N \int_{t_{s_i}}^{t_{e_i}} \dot{H}(m_i, t) dt + \sum_{i=0}^{N-1} \int_{m_i}^{m_{i+1}} \|S_i\|^{-1} \int_{t_{s_j}}^{t_{e_j}} \dot{H}(s, t) dt ds, \quad (3.6)$$

with:

- N the number of locations m_i ,
- $t_i = [t_{s_i}, t_{e_i}]$ the estimated time spent at location m , which may correspond to a task duration τ_k , in case a task is to be executed at m , with start time t_{s_i} and end time t_{e_i} ,
- $t_j = [t_{s_j}, t_{e_j}]$ the estimated time spent at location s on the path S_i between m_i and m_{i+1} , with start time t_{s_j} and end time t_{e_j} ,
- $\|S_i\|$ the path length of path S_i ,
- $t_{e_j} = t_{s_j} + \|S_i\|v_i^{-1}$,
- $\dot{H}(p, t)$ the dose rate at point p in three-dimensional space, at time t ,
- v_i the speed of the maintenance worker, and
- v_i constant on (m_i, m_{i+1}) .

Maintenance operations are always to be performed when the accelerator is switched off. Given this fact, radioactivity from activated materials, giving raise to the radioactive decay and ionizing radiation as described above, is the most probable kind of ionizing radiation to be expected during maintenance operations

in accelerator facilities. Ionizing radiation from other sources can of course also be included in the time-dependent variable \dot{H} in formula (3.6) above.

Again, similar equations hold for the many other related concepts in radiation protection, such as the **effective dose equivalent** H_{eff} ([Sv]), in which case equation (3.6) becomes:

$$\begin{aligned}
 H_{\text{eff}}(\mathcal{I}, \mathcal{T}) &= \sum_{i=0}^N \int_{t_{s_i}}^{t_{e_i}} \dot{H}_{\text{eff}}(m_i, t) dt \\
 &+ \sum_{i=0}^{N-1} \int_{m_i}^{m_{i+1}} \|S_i\|^{-1} \int_{t_{s_j}}^{t_{e_j}} \dot{H}_{\text{eff}}(s, t) dt ds, \quad (3.7)
 \end{aligned}$$

with:

- N the number of locations m_i ,
- $t_i = [t_{s_i}, t_{e_i}]$ the estimated time spent at location m , which may correspond to a task duration τ_k , in case a task is to be executed at m , with start time t_{s_i} and end time t_{e_i} ,
- $t_j = [t_{s_j}, t_{e_j}]$ the estimated time spent at location s on the path S_i between m_i and m_{i+1} , with start time t_{s_j} and end time t_{e_j} ,
- $\|S_i\|$ the path length of path S_i ,
- $t_{e_j} = t_{s_j} + \|S_i\|v_i^{-1}$,
- $\dot{H}(p, t)$ the dose rate at point p in three-dimensional space, at time t ,
- v_i the speed of the maintenance worker, and
- v_i constant on (m_i, m_{i+1}) .

Using equation (2.8), which states the relation between the equivalent dose and the effective dose, via the mechanism of tissue weighting factors, this formula becomes:

$$\begin{aligned}
 H_{\text{eff}}(\mathcal{I}, \mathcal{T}) &= \sum_{i=0}^N \int_{t_{s_i}}^{t_{e_i}} \sum_T w_T \dot{H}_T(m_i, t) dt \\
 &+ \sum_{i=0}^{N-1} \int_{m_i}^{m_{i+1}} \|S_i\|^{-1} \int_{t_{s_j}}^{t_{e_j}} \sum_T w_T \dot{H}_T(s, t) dt ds, \quad (3.8)
 \end{aligned}$$

with:

- N the number of locations m_i ,
- $t_i = [t_{s_i}, t_{e_i}]$ the estimated time spent at location m , which may correspond to a task duration τ_k , in case a task is to be executed at m , with start time t_{s_i} and end time t_{e_i} ,

- $t_j = [t_{s_j}, t_{e_j}]$ the estimated time spent at location s on the path S_i between m_i and m_{i+1} , with start time t_{s_j} and end time t_{e_j} ,
- $\|S_i\|$ the path length of path S_i ,
- $t_{e_j} = t_{s_j} + \|S_i\|v_i^{-1}$,
- $\dot{H}(p, t)$ the dose rate at point p in three-dimensional space, at time t ,
- v_i the speed of the maintenance worker, and
- v_i constant on (m_i, m_{i+1}) .

Inclusion of the radiation weighting factors (see equation (2.7)), which account for the conversion between the absorbed and the equivalent dose, leads to the following formula:

$$\begin{aligned}
 H_{\text{eff}}(\mathcal{I}, \mathcal{T}) &= \sum_{i=0}^N \int_{t_{s_i}}^{t_{e_i}} \sum_R \sum_T w_R w_T \dot{D}_{T,R}(m_i, t) dt \\
 &+ \sum_{i=0}^{N-1} \int_{m_i}^{m_{i+1}} \|S_i\|^{-1} \int_{t_{s_j}}^{t_{e_j}} \sum_R \sum_T w_R w_T \dot{D}_{T,R}(s, t) dt ds,
 \end{aligned} \tag{3.9}$$

with:

- N the number of locations m_i ,
- $t_i = [t_{s_i}, t_{e_i}]$ the estimated time spent at location m , which may correspond to a task duration τ_k , in case a task is to be executed at m , with start time t_{s_i} and end time t_{e_i} ,
- $t_j = [t_{s_j}, t_{e_j}]$ the estimated time spent at location s on the path S_i between m_i and m_{i+1} , with start time t_{s_j} and end time t_{e_j} ,
- $\|S_i\|$ the path length of path S_i ,
- $t_{e_j} = t_{s_j} + \|S_i\|v_i^{-1}$,
- $\dot{H}(p, t)$ the dose rate at point p in three-dimensional space, at time t ,
- v_i the speed of the maintenance worker, and
- v_i constant on (m_i, m_{i+1}) .

The model described so far is novel in the sense that it combines intervention planning knowledge with radiation protection concepts, and does this in a sound scientific-mathematical form. Additionally, and most important to be able to be used in technical-scientific data analysis is that the mathematical model lends itself to be implemented in software. It is sound but simple and serves as the basis of the answers to the research questions: how can today's state-of-the-art interactive visualization techniques be applied or adapted to optimize human interventions in radioactive environments at a particle accelerator?

3.4 Assessment of the radiation protection integration

We now assess the model for use in computer-assisted intervention planning.

The last formulation of the model (equation (3.9)) would be a most accurate implementation of the ICRP model for radiation protection, outlined in chapter 2, using the mathematical model introduced in section 3.1. For the purpose of the software tool developed further, it is however the implementation outlined in section 3.2 that is retained.

The major reason for not implementing the computation of the effective dose starting from the absorbed dose, as introduced in equation (3.9), is that the computation of the equivalent dose (i.e. the aggregation of the different radiation types) is done as part of the simulation that will be used as the input to the software tool. Implementing equation (3.9) would thus mean that the software tool would request another kind of input data than the one generally produced, i.e. effective dose instead of ambient dose equivalent. On top of this, the variable that is measured is normally also not the effective dose, but rather the ambient dose equivalent.

This last fact is also one of the reasons why the computation of the effective dose from the aggregation of the tissue-specific equivalent doses is not retained for implementation in the software tool. The relevant radiation protection quantities are practically always measured at one point in the three-dimensional space, reducing the human body to this one point for the purpose of the radiation protection calculations. This inhibits the computation of the effective dose from the aggregation of the tissue-specific equivalent. It makes it also highly appropriate to implement the processing of simulated data in the same way, in order to ease comparisons and validations of the planned intervention. Implementing the computation of the effective dose from the aggregation of the tissue-specific equivalent doses would also mean a *de facto* decomposition of the trajectory used for the planning into multiple trajectories, one for each of the organs that are used in the computation of the equivalent dose. This not only adds to the computational and implementational complexity of the software tool, but would also add an additional burden to the use of the software tool. The user would indeed not only have to plan one trajectory, the trajectory of the worker performing the maintenance operation, but would also have to control the movements of the maintenance worker, which would have to be foreseen to be in-putted into the software. This kind of fine-grained body-movement input is not standard. Most video games, for instance, only allow for a very coarse movement (running in any direction, moving an object, ...). The field is however rapidly evolving. An approximative body posing solution is for instance implemented with the Microsoft Kinect [134]. The evolution of these technologies could be very interesting for our application.

The last complexity reduction that has been made to the model by not using equations (3.6) and (3.7) but rather (3.4) and (3.5), is not taking into account the time dynamic nature of ionizing radiation, i.e. the radioactive decay. The main reasons here are again that the input data does not provide time evolutions. The input data will generally be obtained from Monte Carlo simulations (e.g. [37, 121, 40, 41, 42, 39, 54, 155]). As Monte Carlo simulations are a class of computational algorithms that are generally very computationally intensive, the radiation protection data that is simulated and used as an input for our software tool is usually only computed at certain points in time and not as a function of time. Also if the input data to our software would consist of measured data, it would generally only be known on certain points in time, as the measurements most often have to be done by the use of portable equipment.

On top of the issues sketched above, care should be taken to acknowledge that the accuracy of the computations performed using the implementation of our proposed intervention planning model in the end always relies on the accuracy of the underlying simulations. The inherent uncertainty of the Monte Carlo simulations in particular has to be taken into account. Monte Carlo algorithms rely on repeated random sampling to obtain numerical results. They are a great tool when it is not feasible to apply a deterministic algorithm, as is the case in the simulations that are of interest here, but as they are a statistical approximation to physical results, there is an inherent limit to their accuracy: perfect accuracy would require an unlimited computing time and/or unlimited memory. The limit in accuracy is furthermore also influenced by the accuracy in mimicking the real world of the Monte Carlo algorithm itself.

As mentioned before, the simulation package mainly used for radiation protection simulations at CERN is FLUKA [38, 75]. FLUKA has been extensively benchmarked for radiation protection purposes [154, 54, 65, 55, 52, 37], and has been proven to be sufficient for this purpose. Moreover, FLUKA has been found to be the most appropriate simulation code for use at high energy accelerators [52], attaining an accuracy to within 20 – 30% for most isotopes². This result also contributed to the choice for the first implementation of the model for intervention planning.

3.5 Further theoretical elaboration of the radiation protection integration

The further theoretical elaboration of the radiation protection integration, tackled in this section, has multiple goals:

2. Measurement uncertainties of detectors for radiation protection are often larger than this, and can – for some measurement devices – amount to 100% and even more [82].

- It illustrates the power of the model, showing that the integration of the mathematical model and the radiological protection system can be taken to heights that go beyond the current state of the art in work and dose planning;
- it exhibits the flexibility of the model;
- and makes clear that possible further development of radio-biological knowledge can be integrated in the model.

The elaboration in this section can be expected to become more relevant with the advancement of radio-biology, radiation simulations, the evolution of the radiological protection system, etc. Indeed, while the relative coarseness of the current knowledge in radio-biology, etc., makes it very difficult to take advantage of the more sophisticated nature of the following elaboration, it can be expected that future advances in the state of radiological protection knowledge will accommodate for this.

While the implementation of the model as detailed above (equations (3.4) to (3.9)) is a full implementation of the ICRP radiation protection recommendations, it can be used to implement more accurate radiation exposure models of humans in environments with ionizing radiation. We can herefore use the *dose-equivalent rate per kg²* $\dot{\mathcal{H}}$, measured in watt per kilogram squared. This gives rise to the following formulation:

$$\begin{aligned}
 H_{\text{eff}} = & \sum_{i=0}^N \int_{t_{s_i}}^{t_{e_i}} \sum_T \rho_T \left(\iiint_{V_T(t)} \dot{\mathcal{H}}(V, t) dV \right) dt \\
 & + \sum_{i=0}^{N-1} \int_{s=m_i}^{m_{i+1}} \|S_i\|^{-1} \int_{t=t_{s_j}}^{t_{e_j}} \sum_T \rho_T \left(\iiint_{V_T(t)} \dot{\mathcal{H}}(V, t) dV \right) dt ds \quad (3.10)
 \end{aligned}$$

with:

- N the number of locations m_i ,
- $t_i = [t_{s_i}, t_{e_i}]$ the estimated time spent at location m , which may correspond to a task duration τ_k , in case a task is to be executed at m , with start time t_{s_i} and end time t_{e_i} ,
- $t_j = [t_{s_j}, t_{e_j}]$ the estimated time spent at location s on the path S_i between m_i and m_{i+1} , with start time t_{s_j} and end time t_{e_j} ,
- $\|S_i\|$ the path length of path S_i ,
- $t_{e_j} = t_{s_j} + \|S_i\|v_i^{-1}$,
- v_i the speed of the maintenance worker,

- T the tissue type, here to be interpreted as the different organs of the person performing the intervention,
- $V_T(t)$ the volume of organ T , which is time-dependent because of the movements of the maintenance worker,
- ρ_T the density of organ T of the subject,
- $\dot{\mathcal{H}}(V, t)$ the dose-equivalent rate per kg inside volume V in three-dimensional space, at time t .

The implementation of this elaboration of the intervention planning model in software is very involved. It means incorporating a full volumetric anatomical model of a radiation protection phantom including all relevant organ models with their relevant organ density together with a physical movement of human movement, including the internal movement of the organs. Several three-dimensional volumetric phantoms for use in radiation protection exist, including time deformable models of certain organs [168]. To the best of our knowledge, no volumetric phantom exists that provides a full physical model for any human movement and can be readily implemented in interactive technical-scientific visualisation and computation software.

Even more detail can be added to this formulation (equation (3.10)) by considering that the organ density is not necessary uniform, and can be a function of time. This last consideration is due to organ deformation because of movement of the subject, but also because of functional deformation, e.g. the beating of the heart or the respiratory movement of lungs. Formulation (3.10) then becomes:

$$\begin{aligned}
 H_{\text{eff}} &= \sum_{i=0}^N \int_{t_{s_i}}^{t_{e_i}} \sum_T \left(\iiint_{V_T(t)} \rho_T(V(t)) \dot{\mathcal{H}}(V(t)) dV \right) dt \\
 &+ \sum_{i=0}^{N-1} \int_{s=m_i}^{m_{i+1}} \|S_i\|^{-1} \int_{t=t_{s_j}}^{t_{e_j}} \sum_T \left(\iiint_{V_T(t)} \rho_T(V(t)) \dot{\mathcal{H}}(V(t)) dV \right) dt ds,
 \end{aligned}
 \tag{3.11}$$

or, stated in Cartesian coordinates:

$$\begin{aligned}
 E &= \sum_{i=0}^N \int_{t_{s_i}}^{t_{e_i}} \sum_T \left(\iiint_{V_p(t)} \rho_p(x, y, z, t) \dot{\mathcal{H}}(x, y, z, t) dx dy dz \right) dt \\
 &+ \sum_{i=0}^{N-1} \int_{s=m_i}^{m_{i+1}} \|S_i\|^{-1} \int_{t=t_{s_j}}^{t_{e_j}} \sum_T \left(\iiint_{V_T(t)} \rho_p(x, y, z, t) \dot{\mathcal{H}}(x, y, z, t) dx dy dz \right) dt ds
 \end{aligned} \tag{3.12}$$

with:

- N the number of locations m_i ,
- $t_i = [t_{s_i}, t_{e_i}]$ the estimated time spent at location m , which may correspond to a task duration τ_k , in case a task is to be executed at m , with start time t_{s_i} and end time t_{e_i} ,
- $t_j = [t_{s_j}, t_{e_j}]$ the estimated time spent at location s on the path S_i between m_i and m_{i+1} , with start time t_{s_j} and end time t_{e_j} ,
- $\|S_i\|$ the path length of path S_i ,
- $t_{e_j} = t_{s_j} + \|S_i\|v_i^{-1}$,
- v_i the speed of the maintenance worker,
- T the tissue type, here to be interpreted as the different organs of the person performing the intervention,
- $V_T(t)$ the volume of organ T , which is time-dependent as elaborated above,
- $\rho_p(x, y, z, t)$ the density of organ p of the subject, which is time-dependent as elaborated above,
- $\dot{\mathcal{H}}(x, y, z, t)$ the dose-equivalent rate per kg at point (x, y, z) in three-dimensional space, at time t .

The novel, in the sense of mathematical modelling, fine-grainedness of the modelling and integration of scientific-mathematical model that is the subject of this chapter is able to be used in technical-scientific data analysis that goes beyond the analysis that is currently commonly performed. We have hereby expanded mathematical model beyond the ICRP model, while keeping its sound and simple but powerful essence. As such, it still lends itself for implementation in software.

This section has given an illustration of the power of the flexible model, making clear that the model is extendible with possible future radio-biological knowledge and/or evolutions of the radiological protection system.

3.6 The intervention planning process

Now that we have defined a mathematical model for intervention planning in environments with ionizing radiation, we have a closer look at the intervention planning process itself.

The intervention planning process itself has two main aims, that are closely intertwined:

1. Assessment of the conditions in the facility where the intervention will be performed, and
2. preparing the trajectory of the intervention.

Several types, or layers, of information are required to be able to reach these aims: the geometry of the facility, the radiation environment in the facility, and a description of the intervention, including all its subtasks with their duration. In the initial assessment of the conditions in the facility this information can then be used to assert the accessibility of the facility in terms of physical opportunities of where to go, and in terms of accessibility with regard to radiation safety. On top of these information layers that are to be expected to be integrated in a computer-assisted intervention planning tool, a lot of information has to be taken into account that cannot be integrated into a software tool. These are: such as changes in the facility geometry that were not yet implemented in the software geometry, safety passages that have to be avoided, other interventions taking place at the same facilities, amongst others.

After the first assessment of the conditions in the facility, one proceeds to planning the intervention. Convenient is to start with a rough estimate, that is easily assessable by all of the stakeholders of the intervention. One of the expected benefits of the software-assisted intervention planning tool is precisely to be able to easily make an initial estimate of the intervention, which can then be iteratively optimized

The next and final phase in the planning is the optimization of the intervention. This usually is an iterative process, given the many parameters that are to be taken into account, and the many stakeholders that are usually involved in the intervention. Our intention being the optimization of the intervention from a radiation protection point of view, this must consist of two parts: the optimization of the work conditions during the execution of each task, and the optimization of the path followed between the tasks. Both of these optimizations have to simultaneously consider two aspects: the location and the radiation dose.

In the case of the optimization of the work conditions during the execution of the tasks, the first of these two aspects, the location, means to improve the accessibility of the equipment and thus the comfort of the maintenance worker. Additionally, this

optimization is expected to, because of the improved accessibility of the equipment, reduce the time the tasks will take to perform. This time reduction will in turn also lead to a diminishing in radiation dose.

The radiation dose itself is the second of the two aspects that needs to be optimized. In the case of the optimization of the work conditions during the execution of the tasks this means to optimize the position the task is performed with the aim to perform the task from a position with a lower dose rate.

In the case of the optimization of the paths followed between the tasks, the first of the two aspects, the location, has to take into account that the maintenance worker may carry equipment, and has to take into account possible obstacles on the path.

The radiation dose can be optimized by constructing a path through areas with less ionizing radiation.

In summary, given an intervention \mathcal{I} consisting of a set of tasks that have to be executed, each with their own practical limitations, the planning of an intervention consists of three main parts:

1. Assessment of the conditions in the facility, based on the geometry of the facility and of the radiation levels present.
2. preparation of a first trajectory of locations and a map of the tasks onto the trajectory.
3. Optimization of the intervention:
 - (a) optimization of the work conditions during the execution of each task:
 - location: improve accessibility of the equipment and thus the comfort of the maintenance worker
 - radiation dose: perform the task from a less irradiated position
 - (b) optimization of the paths followed between tasks:
 - location: take into account that the maintenance worker may carry equipment, take obstacles into account
 - radiation dose: construct a path through less irradiated areas

This taxonomy of the intervention planning process will give us the opportunity to validate the use of the developed software tool for computer-assisted intervention planning to the intervention planning process, defined without any specific information technology tools in mind.

As the part of the taxonomy defined before that is the most relevant to the developed methodology and software in this thesis is the optimization of a trajectory, we have a closer look at this subtask in this section. In essence, what follows is a re-formulation of the optimization part of the justification, optimization and limitation principle as defined by the radiological protection system discussed in chapter 2.

For this re-formulation, we rely on the concepts defined in section 3.1:

- an **intervention** \mathcal{I} consisting of **tasks** T_k , $k = 0, 1, \dots, K$, each with a specific description and an estimated duration τ_k ;
- a **trajectory** \mathcal{T} defined as a series of **locations** m_i , $i = 0, 1, \dots, N$, with a working time t_i associated with each of the locations;
- a **path** between two consecutive locations m_i and m_{i+1} , denoted by S_i , $i = 0, 1, \dots, N - 1$, each with an associated velocity v_i ;

With a mapping between \mathcal{I} and \mathcal{T} :

$$\forall T_k \in \mathcal{I} : T_k \text{ is assigned to a location } m_i \text{ and } t_i = \tau_k, \quad (3.13)$$

$$\forall m_i \in \mathcal{T} \text{ and } \nexists T_k \text{ assigned to location } m_i : t_i = 0, \quad (3.14)$$

with $K \leq N$.

A trajectory is optimal when the equivalent dose H or effective dose H_{eff} is minimal, respecting the constraints that all tasks require a minimal execution time and that the velocities v_i have to stay within the abilities of the maintenance worker.

The variables in the intervention planning are the locations m_i that the maintenance worker will pass during his trajectory through the irradiated facility. Other possible variables are the time τ_k to complete a task, which may depend on the location from which the task is executed, or the velocity v_i with which a path is taken.

Some aspects of the trajectory optimization could be automated: the locations m_i can be placed such that the total amount of received radiation is minimized. However, other aspects require human assessment based on experience, such as practical considerations on the location from where a task is executed, or the velocity with which a specific part of the trajectory can be taken.

Important remark

A trajectory is only valid if the equivalent dose H divided by the total duration of the intervention does not exceed a certain threshold value, which is subject to legal regulations. If it is not possible to complete a planned list of tasks with a dose that stays below the threshold value, an intervention should be split into two or, if necessary, more interventions.

3.7 Conclusion

To conclude this chapter, we list the implications of the topics discussed in this chapter on the development of a technical-scientific computer-assisted intervention

planning tool. While the development of the software requires a user needs study, discussed in chapter 4, the discussion in this chapter outlines the technical necessities for the software.

Interactive visualization & Data fusion In order to make a good assessment of the conditions in the facility, both the geometry of the facility and the radiation levels have to be clearly represented. The visualization of these two levels of information has to be such that the intervention planner has a good insight into what level of radiation is present at a specific location. It is very important to provide a clear overall view of the working conditions in the facilities in order to quickly assess which are the places that have to be avoided during maintenance interventions. Interactive visualization of the conditions in the facility, which allows zooming or panning to have a better view, is therefore a practical and indispensable tool. In addition, tools to interactively probe the input data at a specific point are in order.

Visual interactivity The preparation of a first trajectory and a map of the tasks requires that the software has the possibility to let the intervention planner add locations m_i next to the existing geometries in the facility, and attribute tasks T_k with an execution time $t_i = \tau_k$ to these locations. Appropriate visualization of the trajectory information is necessary to be able to make a good map. In order to perform the optimization of the intervention, the software needs to provide tools to add more locations m_i to the trajectory followed between tasks, and tools to move existing locations m_i to optimize work conditions during the execution of a task as well as the trajectories between the task locations.

Three-dimensional data processing The core of the computer-assisted intervention planner will be the calculation of the equivalent dose H received by a worker over a user-defined trajectory \mathcal{T} through the simulation volume. This will involve three-dimensional data processing, including probing of the simulation volume at many well-defined three-dimensional locations.

Chapter 4

A systems engineering perspective

One of the aspects of the research project in the framework of which the work described in this thesis was developed is the integration of systems engineering in the research methodology. The systems engineering life cycle, adapted to meet the properties of the research carried out in this thesis, is as such an integral part of the research itself.

In this chapter, we discuss how the research on interactive visual intervention planning can be integrated with the development of a proof-of-concept software tool for interactive visual intervention planning in particle accelerator environments with ionizing radiation, implementing the methods and methodologies developed in this thesis. This whole process is here treated from a systems engineering point of view. The full systems engineering life cycle of the development process of an interactive intervention planner is addressed. This chapter is written with the software development process in the centre of the research effort, while at the same time not overlooking the technical-scientific aspects of the work discussed in this thesis.

We start in section 4.1 by introducing our work from a systems engineering point of view, and position our work with respect to systems engineering and project management literature. We then go further discussing the systems engineering life cycle developed in this chapter and examine its various phases in section 4.2. After this, in section 4.3, we shortly discuss the software tool resulting from the process implemented in the life cycle as an outcome of this methodology, and discuss a possible future direction for the development of the systems engineering life cycle in section 4.4. We conclude this chapter in section 4.5.

This chapter is intended to be self-contained, and as such repeats some information that was introduced before. Most of the content of this chapter has been published in [74].

4.1 Introduction

Systems engineering and project management are sometimes considered to be fields of scientific research *per se*. For this reason, it is important to state that we do not claim to intrinsically contribute to these fields. One of the aspects of the research project in the framework of which the work described in this thesis was developed is however the integration of systems engineering in the research methodology. The systems engineering life cycle, adapted to meet the properties of the research carried out in this thesis, is as such an integral part of the research itself.

The need for the development a systems engineering life cycle in this particular research is validated by the ascertainment that small to medium size research projects are usually not explicitly implemented using any systems engineering approach. One of the reasons for this fact certainly is the perceived heaviness of systems engineering and project management methodologies in this regard. We want to solve this issue by showing the feasibility of adapting a relaxed systems engineering approach in a small-size complex multi-disciplinary research project. The work described here can as such be considered a case study for further concretisation of the integration of systems engineering in academic research.

4.1.1 Life cycles in systems engineering

In [113], a life cycle is defined as an application of the systems approach for the purpose of understanding and implementing processes. Here, the systems approach refers to seeing things as an organized or complex whole. While these definitions might seem heavy, it has to be clear that life cycles are a very important aspect in the accomplishment of a particular objective according to plan.

Many generic and specific life cycles exist in systems engineering and project management. One example project life cycle is the so-called innovation funnel. In the innovation funnel life cycle, a project starts with a broad range of inputs or ideas, after which these are gradually refined and selected, leading to only one or a handful of formal projects that can be pushed to rapid completion and introduction (see figure 4.1(a)) [159].

The axiomatic design model complements the innovation funnel in looking at the conceptualisation-design process from an engineering point of view. It is argued that developing a technical object requires going through four domains that can

be understood as phases. The customer domain-phase is aiming at gathering user needs. The functional domain-phase is aiming at transforming these needs into requirements. At that point, the end-object exists as a set of functionalities it will offer. The physical domain-phase is aiming at transforming the requirements into design parameters, and finally the process domain-phase is dedicated to the processes that will be used to transform the designed concepts into physical objects [138] (see figure 4.1(b)) .

The V-model is a life cycle model that originates from systems engineering itself, while the before-mentioned life cycles are more related to project management. According to the V-model, a project consists of six phases: conception of operations; requirements and architecture; detailed design; implementation; integration, test and verification; and systems verification and validation, possibly followed by the operation and maintenance phase (see figure 4.1(c)) [125]. This breakdown corresponds to those promoted in the systems engineering, new product development or IT project management literature [43].

This representative selection of the most relevant generic life cycle concepts share a relative heaviness in their definition and elaboration, leading to the fact that research projects are usually not explicitly implemented using any systems engineering approach. In what follows, we show a lightweight implementation of adapting a relaxed systems engineering approach in a small-size complex multi-disciplinary research project. It has to be noted however, that the life cycle we will describe further is to a great extent compatible with many general life cycles, and most in particular the V-model.

4.1.2 The development process of an interactive intervention planner

The work in this thesis is primarily closely entangled with particle physics experimental areas. In particle physics, scientists study the nature of particles are the elementary building blocks that make up matter in the world we live in. For this study, scientists need large and complex scientific instruments: particle accelerators and detectors [106, 166], in which they let beams of particles circulate and collide. This circulation and these collisions of high energy beams of particles in these large scientific instruments that are particle accelerators and detectors are performed to take measurements of the behaviour of particles in extreme conditions. They however also have an unwanted effect, namely the radiological activation of some of the components of accelerator facilities [151, 169].

Modern particle accelerators and detectors are highly complex machines, which provoke a frequent necessity of maintenance operations. Imperative is thus that maintenance personnel is protected from ionizing radiation during these operations particle accelerators and detectors. For this purpose, the so-called ALARP or

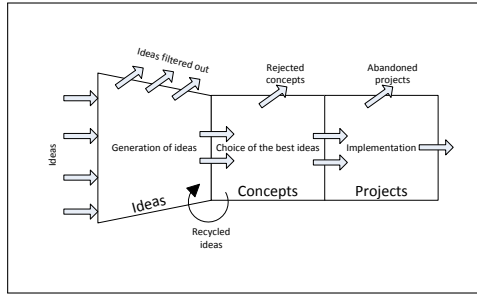

(a) The innovation funnel.

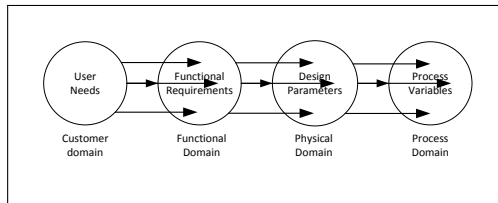

(b) The axiomatic design model.

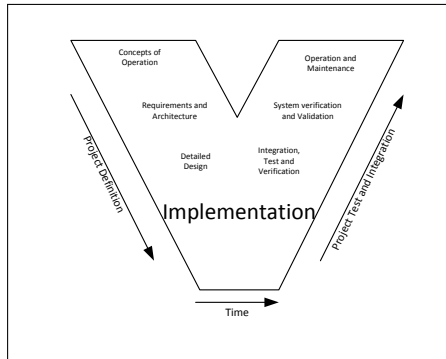

(c) The V-model.

Figure 4.1 – Life cycles in systems engineering and project management.

ALARA approach (As Low As Reasonably Possible or Achievable) [5, 82] is commonly used. This approach amounts to justifying, optimizing and limiting the dose received by all those who need to work on activated components. Because of this, an essential point in question in the planning of a maintenance intervention in a facility with ionizing radiation is the minimization of the dose contracted by the maintenance workers. Automation of this optimization is not possible since the practical feasibility of the intervention tasks is requiring an assessment by a human expert. However, the planning of an intervention could greatly benefit from the availability of a computerized tool providing three-dimensional visualization capabilities.

In the context of systems engineering, it is of major importance to re-iterate that the research and development with as an aim the development of such a tool is an intricate venture. This fact has three main reasons. We can firstly mention the multiple forms that the data to be visualized has: the visualization has to cover the infrastructure, the (expected) radiation levels in the facility and the intervention trajectory. Secondly, this visualization has to be manageable intuitively, and this for all stakeholders involved (intervention planners, scientists, maintenance workers, safety officers, . . .). It also has to be appropriate for multiple scenarios (visual training of operators, three-dimensional visualizations to support the decisions of the ALARA committee, . . .). Thirdly, the tool of interest will be a key actor in the assurance of the safety of human workers. Therefore, there is absolutely no question about having any kind of ambiguity. These three points lead to the necessity of a good systems engineering¹ approach.

This chapter deals with the development process of a technical-scientific methodology and software tool providing interactive visualization for intervention planning in particle accelerator environments with ionizing radiation from a systems engineering point of view. In section 4.2 we discuss the various phases of the systems engineering life cycle: needs analysis & specification explicitation (section 4.2.1), conceptual mathematical modelling (section 4.2.2), iterative implementation (section 4.2.3) and usability testing (section 4.2.4). Section 4.3 shortly discusses the resulting application, developed following this systems engineering approach. More details on the application will be discussed in the chapter 5. Section 4.4 discusses a possible future direction for the development and the systems engineering life cycle. Section 4.5, finally, gives the conclusions for this chapter.

1. Systems Engineering is defined as “the management technology that controls a total system life-cycle process, which involves and which results in the definition, development, and deployment of a system that is of high quality, trustworthy, and cost effective in meeting user needs” [125].

4.2 The systems engineering life cycle of the development process of an interactive intervention planner

Systems engineering life cycles are a very important aspect in the accomplishment of a particular objective according to plan [113]. The systems engineering life cycle of the development process of an interactive intervention planner, the analysis and synthesis of the problem parts in the development of the interactive intervention planning application, is shown in Figure 4.2. The structure of the systems engineering life cycle also allows for clear documentation: every block of the life cycle does also include a documentation phase. The different phases of this research, development, test and evaluation (RDT&E) life cycle are discussed in the following sections.

4.2.1 Needs analysis & specification explicitation

In every project, be it an Information Technology (IT), construction, industrial, organisational change or new service development project, identifying user needs is of key importance for the successful termination of the project [147]. Although this project is a research project and therefore a relaxed systems engineering approach might have to be adapted, it is no exception in that the needs are important to start with. But, identifying user needs is also “the most difficult, most critical, most error prone and most communication-intensive aspect of software development” [160]. Furthermore, the needs will typically be more easily changed during a research project than during any other project.

In addition to this, at the start point of our life cycle, the needs analysis or user needs study is particularly important because of the set-up of this project: the user needs are not centred around one user group. They are distributed around many stakeholders: the intervention planner, the maintenance worker, the radiation protection experts, and almost all persons involved in a particular particle science experiment or equipment.

Because this work is a research project and because of the scattering of the user needs, we decided to go for a low-profile way of needs gathering. We did not organize formal *customer panels*, but attended various meetings and discussed in an informal, non-intrusive way about the potential applications of software for visualization of radiation levels with people that are concerned with this type of problem. It became clear that in the current situation, powerful three-dimensional visualization techniques are not consistently used for the visualization of radiation levels. However, both simulated and measured data from manual measurements

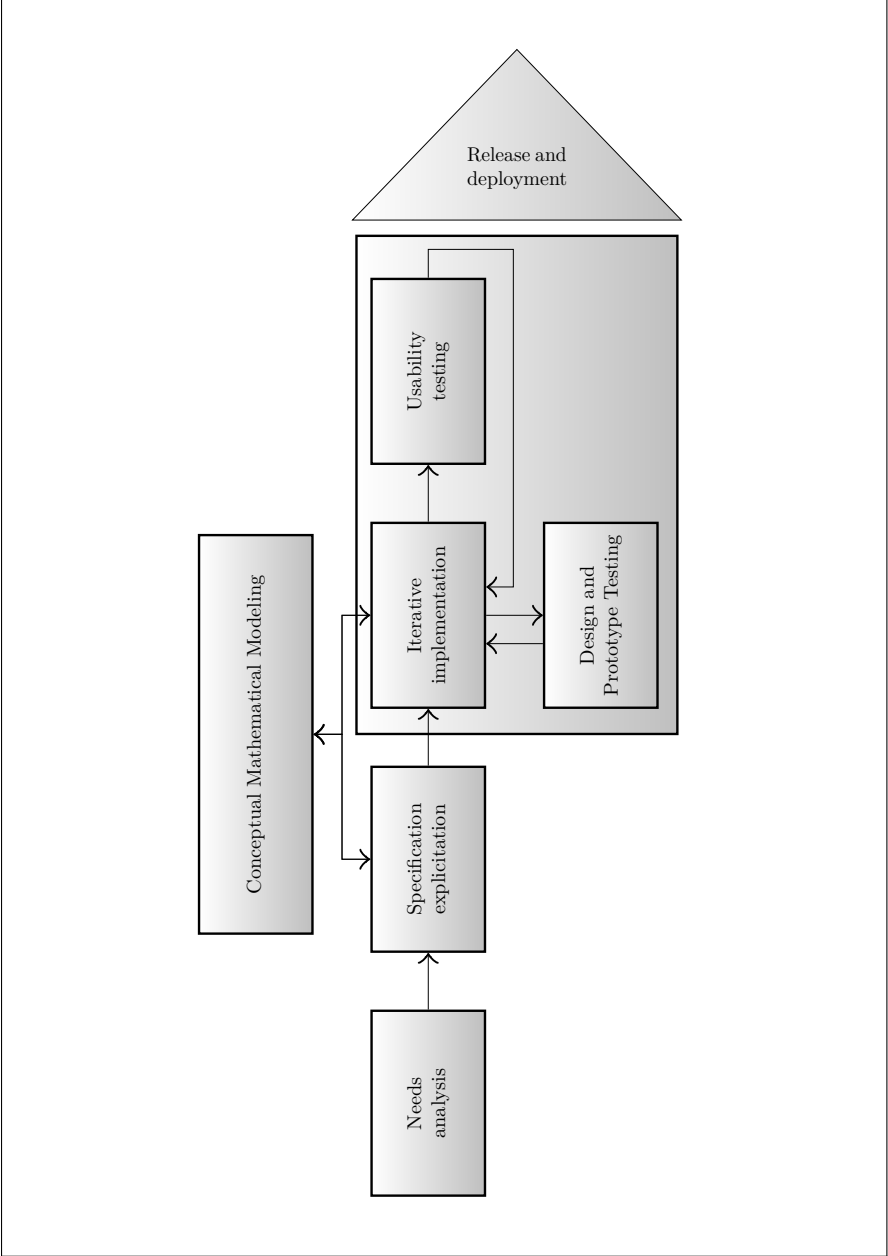

Figure 4.2 – The systems engineering life cycle for the development of an interactive intervention planner.

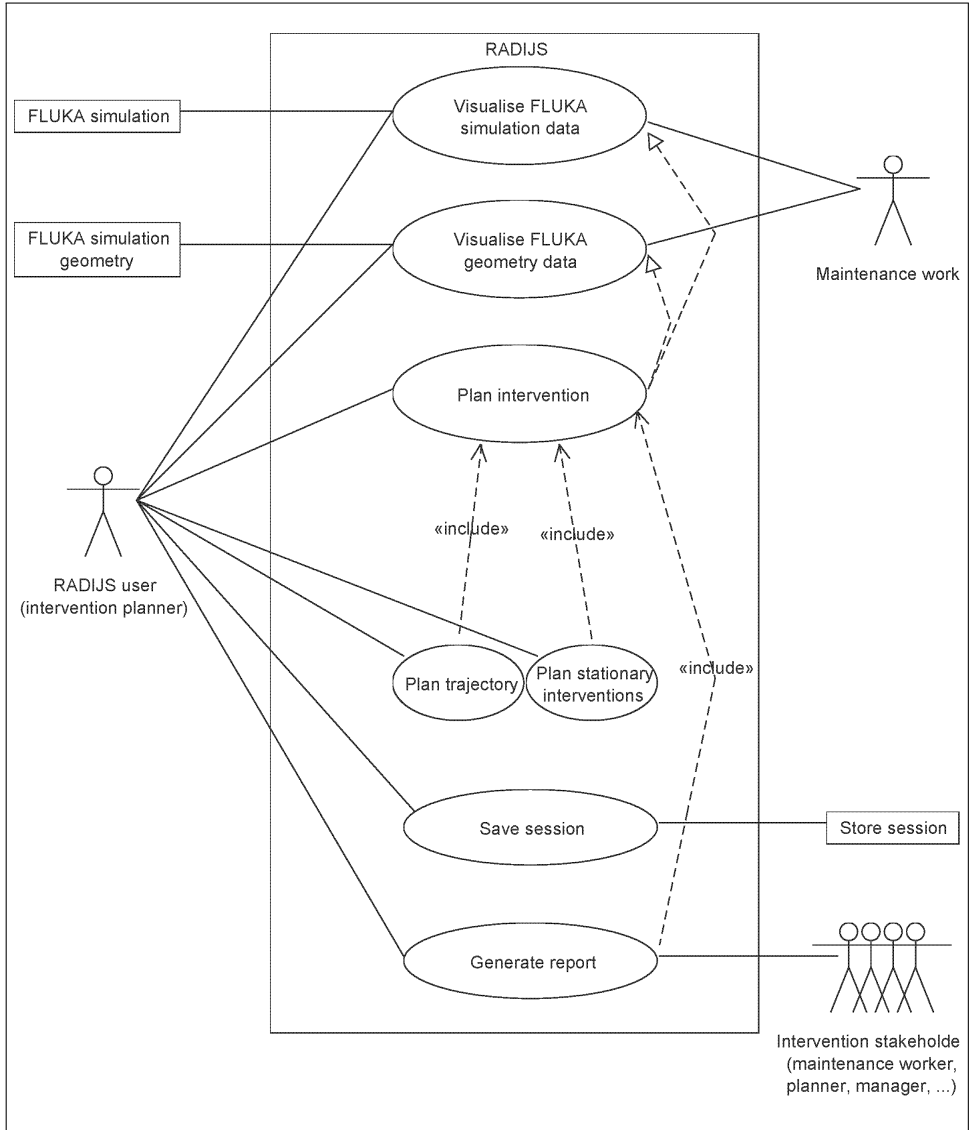

Figure 4.3 – The use case context diagram. This diagram shows how the different stakeholders (depicted as named stick figures) and external systems (depicted as named boxes) are expected to interact with the software system, here indicated as ‘RADIJS’.

and from a fixed survey system are typically used. In the future, also data measured by mobile robots might become available [98, 61, 112].

Also because of reasons of user needs scattering and the research nature of the project, it is utterly important to explicitate the software specification in a way that is as simple and straightforward as possible, while keeping the information content high. This is why was opted for use cases [90] to communicate the specifications. The use cases are based on the gathered user needs that are mapped in table 4.1, together with their estimated importance. This table also shows the nature of the input data of the software, which is an important outcome of the needs analysis. The full use cases can be found in appendix A.

The use case context diagram [90] for the developed use cases can be seen in figure 4.3. We have explicitized the functional specifications in this way as the use case context diagram is widely recognised as the simplest graphical representation of the interaction of the user with the to-be-developed software. It portrays different types of user–software interactions in a very intuitive way, namely, it shows how the different stakeholders (depicted as named stick figures) and external systems (depicted as named boxes) are expected to interact with the software system, indicated in the figure as ‘RADIJS’.

An important outcome of the needs analysis and specification explicitation phase is the starting point of the data flow of our application, i.e. the radiation simulations and three-dimensional geometry. At CERN, the FLUKA Monte Carlo simulation package [38, 76] is used for radiation protection studies, as FLUKA has its roots in this field and is thus the most appropriate choice for these studies [51]. It will thus be necessary for our application to be able to deal with the data that is the output of a FLUKA simulation, and with the geometry data that is given as input to FLUKA. This is reflected the two uppermost of the use cases in figure 4.3.

Data from manual measurements and/or robotic measurements are to be considered in a further phase of the development. These data will not have the dense nature that the simulation data has, and will thus need interpolation. This interpolation is however far from trivial [73], and much research will be needed to make this feasible. Augmenting the simulated data with measured data, to assess the quality of the simulated data, is more promising (see section 4.4).

More information on the needs analysis and specification explicitation can be found in appendix B.

4.2.2 Conceptual mathematical modelling

As the intervention planning software will be used in a scientific environment and, more importantly, will be used to assess the safety of maintenance workers, a rigorous mathematical model of the intervention planning is necessary. This model

was discussed thoroughly in chapter 3. It is synthesized here to show how it fits into the systems engineering life cycle.

The modelling includes various planning concepts, such as the intervention \mathcal{I} , a trajectory \mathcal{T} , and the contracted radiation dose H .

An intervention \mathcal{I} consists of a set of tasks T_k :

$$\mathcal{I} = \{T_k; \quad k = 0, 1, \dots, K\}. \quad (4.1)$$

Each and every task T_k , has as attributes a description of the task to be performed, and duration associated with it. The tasks are the parts of the intervention that has to be performed, starting with the entrance of the facility by the worker (T_0), and ending with the worker exiting the facility (T_K).

A trajectory \mathcal{T} is composed of a series of locations m_i . These locations are joint by paths S_i , with $i = 0, \dots, N$. Each location and each path can be associated with certain radiological properties, that can be deduced from the radiation dose rates that are available from the FLUKA simulations. The equivalent dose H contracted by the maintenance worker performing an intervention \mathcal{I} , which is mapped on a trajectory \mathcal{T} , is then calculated as the sum of the radiation received at the specified locations m_i and the radiation received over the paths S_i between the locations, which the maintenance worker travels along with a velocity v_i :

$$H(\mathcal{I}, \mathcal{T}) = \sum_{i=0}^N t_i \dot{H}(m_i) + \sum_{i=0}^{N-1} \int_{m_i}^{m_{i+1}} v_i^{-1} \dot{H}(s) ds, \quad (4.2)$$

where s is a point on the path S_i . The radiation rates \dot{H} are available from simulations of the activation of facility equipment, or could be available from manual measurements performed in the irradiated facility. For more information on the mathematical model, we refer to chapter 3.

The model described above is able to deal with manual measurements as well as measurements collected by a robot, as long as the measurements can be associated with the locations m_i or the paths S_i . While the interactive intervention planner is intended for planning interventions where the work cannot be done by a remotely operated vehicle, it is imaginable that it is possible for a robot to perform a pre-inspection task, of which a validation of the simulation used for the intervention planning can be an outcome. Efforts on such mobile robotic devices are under way in this context [98, 61, 112].

To make this model as useful as possible in the systems engineering life cycle, the conceptual mathematical modelling effort is developed in parallel with the specification explicitation and iterative implementation phases, as is clear from Figure 4.2, and has been published to be checked by the wider scientific community [73]. The mathematical modelling is compliant with the intervention planning needs at stake, with radiation protection theory [82], and sound to be implemented.

	User need	Estimated importance
1.	Intuitive visualization	***
1.1.	CAD-like visualization of geometry	***
2.	“Easy-to-read” visualization	***
2.1.	3D visualization	***
2.2.	Interactive visualization	***
3.	Easy-to-use software	***
3.1.	Intuitive interaction possibilities	***
3.2.	Intuitive GUI	***
3.3.	Usable on normal PC hardware	**
3.4.	Easily installable	**
3.5.	Cross-platform	*
4.	3D interaction possibilities	***
4.1.	3D on/off interaction possibilities	**
4.2.	3D camera interaction possibilities	***
4.2.1.	Free movements of camera	***
4.2.2.	Camera zoom	***
4.3.	3D labels	*
5.	Possibility to save program status/scenarios	*
6.	Possibility to export 2D images	*
7.	Possibility to import simulation data	***
7.1.	Possibility to import from FLUKA	***
8.	Possibility to import geometry	***
8.1.	Possibility to import a 3D file format	***
9.	Possibility to import measured data	*
10.	Possibility to input various scenarios	***
10.1.	Possibility to input trajectories	***
10.2.	Possibility to input trajectory properties, such as moving speed	***
10.3.	Radiological calculations	***

Table 4.1 – Needs table and importance mapping.

4.2.3 Iterative implementation & design and prototype testing

Iterative software development methods are used by many organizations to reduce development risks and to deliver the software projects on time [140, 91]. Design and prototype testing are integral parts of the iterative implementation strategy. Also this software development project makes use of an iterative implementation method.

To be able to do fast development, we opted to develop in Python [27, 97]. Important are also the choices of the visualization library and the graphical user interface (GUI) library. More information on the actual implementation can be found in chapter 5.

During this phase of the software development, many implementation iterations are run through. Each time, a prototype version of the software is tested by several users. The resulting prototype test results are used as an input for a new iteration of implementation. This phase of prototype testing distinguishes itself from the phase of usability testing described in the next section, in that intermediate prototype versions of the software were tested for practical reasons, i.e. the correct functioning of the software, such as successfully loading data and the utility of interaction tools, whereas usability testing tests whether the final software meets the intended result.

4.2.4 Usability testing

The central idea of the usability testing (top right in Figure 4.2) is to test whether the software meets the intended result, and to determine the optimal settings for newly developed software to be user-friendly for as many of the stakeholders as possible. The needs table that was developed during the needs analysis and the specification elicitation phase, as discussed in section 4.2.1 and more specifically table 4.1 is the guide the this usability testing.

Secondarily, in this particular case, since the use of a interactive and three-dimensional visualization tool for the planning of interventions in facilities emitting ionizing radiation is not implemented yet in the facilities it is designed for, usability tests are needed to prove that the application of these techniques is indeed useful to intervention planners.

The usability tests are split into two phases. The main goals of the first phase are, firstly, to qualitatively prove the usefulness of the three-dimensional visualization for the user, and secondly, to make way for larger usability tests using more quantitative variables in order to discover the optimal settings for the three-dimensional visualization. More information on these first-phase tests can be found in [72]. In a second phase, more extensive tests are pursued to make way for the release and deployment of the application.

For this second phase, we propose to develop a test where a large number of users each go through the intervention planning process of a real-life situation, for different well-known, existing visualization methods. The test users will originate from all stakeholders involved in intervention planning. The results of the intervention planning, such as the simulated contracted radiation dose, will be studied to obtain visualization parameters that are optimal for the application. Furthermore, the subjective feelings of the user with respect to the visualization will be inquired. At

the same time, the user will be questioned on the planning experience to assess whether the needs listed in Table 4.1 have been met.

This recording of the subjective feelings of the test subjects will be done in an informal way, by having an informal chat with the test subject after the usability test. In this way, a very coarse retrospective analysis of the performance of the software tool's visualizations is envisaged. No formal think-aloud protocol (having the subjects taking part in the usability test participants think aloud as they perform the tests) will however be implemented. A concurrent think-aloud protocol would make the timings that will be recorded less reliable, as is proven in [149], while a retrospective think-aloud protocol would make the usability testing infeasible due to time constraints. In addition to this, the methodological foundations of think-aloud usability testing are still questioned for their scientific value [45].

The most particular part of the usability testing, i.e. the study for the optimal volume rendering parameters, consists of a thorough investigation of the influence of the values of the volume rendering parameters that we presuppose to be important for the acceptance, the usability and the usefulness of the software in the context of CERN operations. To our knowledge, similar previous studies were always limited to:

- academic examples [56, 94, 128],
- very well-defined visualisation or interpretation subtasks of visual data analysis [93, 94],
- static images [93, 56, 94, 128] and
- specific, very specialized rendering methods or environments [93, 56, 89, 94, 128].

We propose to develop an interactive user study of a real-life situation, using well-known, existing rendering methods. The planned second phase usability tests will therefore be more extensive and their results will be compared to the more specific studies of literature. We thus aim to demonstrate the usefulness of volume rendering techniques and visual data analysis to the empirical science of radiation protection.

That even small changes in the volume rendering technique can have significant effect, and what kind of effect they lead to in the visualisation can for instance be appreciated from the figures in [93].

In the spirit of systems engineering, usability tests are an important step in the project, and can lead to valuable insights in the iterative development process.

4.3 The resulting application

This section summarizes the technical-scientific proof-of-concept application that has resulted from the application of the systems engineering life cycle developed in this chapter. More details will be given in chapter 5.

The core of the resulting application is the visualisation capacity for FLUKA simulation results and the geometry that comes with it. Due to the nature of FLUKA simulation data and the requirement of a clear visualization of the working conditions, volume rendering is the natural choice to visualize the radiation levels augmented on the facility geometry. As we want to be able not only to see the radiation levels on certain positions in the three-dimensional space of the facility, but also inside the volume that makes up the facility, volume rendering is the only feasible choice. We consider volume rendering to be a very intuitive volume visualization technique, compared to e.g. volume slicing (the visualisation, in two dimensions, of extracted two-dimensional slices of a three-dimensional volume). Volume rendering has been around for many years [92, 66]. Recently, the development and improvement of of-the-shelf GPUs has led to the proposition of several interactive advanced volumetric illumination models [120].

Architecturally, the application consists of two main packages, and a number of supporting modules. It makes use of a number of well-known design patterns, such as the Facade, Observer and Iterator patterns [77]. The two main packages are a framework package for the processing of the facility geometry and radiation (simulation) data, and a GUI (Graphical User Interface) package. In the context of this chapter, the architecture will not be fully discussed, but it suffices to point out that using an iterative development methodology, embedded in a rigorous systems engineering life cycle, an elegant design can be obtained.

Arguably one of the most important aspects of the software, certainly in the context of this particular software project and as outlined before, is the interface the software proposed to the users. A screenshot of this interface, the GUI of the resulting application, can be seen in figure 4.4.

The application is made so that it is intuitively possible for every stakeholder in the intervention planning process (intervention planners, scientists, maintenance workers, . . .) to assess the important features of the intervention. This means that for every possible user of the software, with his own personal background and interest in e.g. radiation protection, practical implication of certain technical interventions, transport requirements, . . ., it has to be possible to *see* the variables he is interested in visualized by the software. It is thus possible to make a good *assessment of the conditions in the facility*, by investigation of both the geometry of the facility and the volume-rendered (simulated) radiation levels. The visualization is interactive and allows zooming or panning to have a better view. In addition, there are tools have a closer look into the radiation levels at specific points.

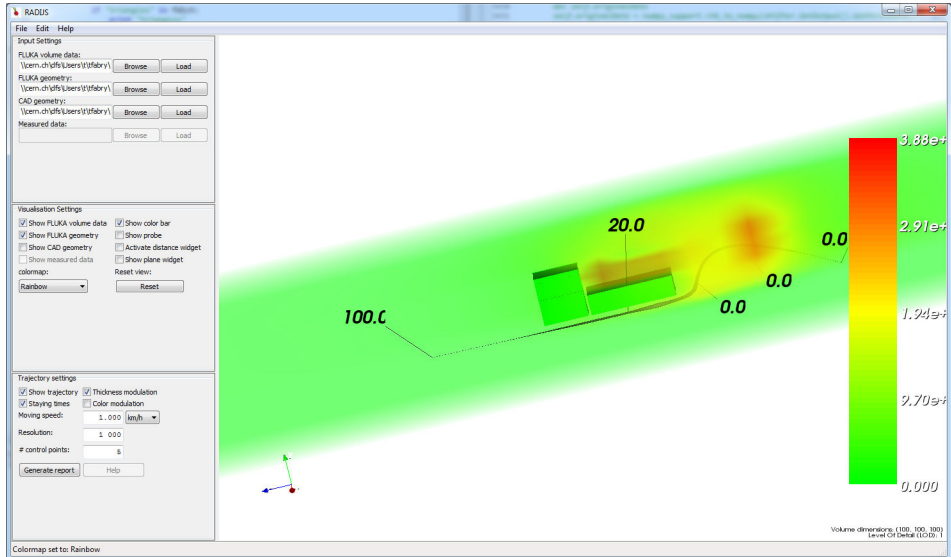

Figure 4.4 – The user interface of the visual intervention planner.

Next, it is possible to *prepare a trajectory* in the facility, and map the tasks to specific locations part of the trajectory. To allow for *optimization of the intervention*, the software provides tools to add locations to the trajectory, refine and edit the trajectory, move existing locations. . . At any time, it is possible to generate a *report* with the radiological impact the intervention will have on the persons implied in the intervention.

The GUI is very simple in conception. The application interface is divided in two regions: a region for the interactive visualization and a region for the various settings. This latter region is divided into three boxes for, respectively, input settings, visualization settings and trajectory settings. The settings are preset to values that have empirically proven to be meaningful for the cases that we have been provided with as test cases (see chapter 6).

4.4 A possible future direction: robotics integration

This section gives an example of a future extension of the systems engineering life cycle, hereby demonstrating the power of the systems engineering approach in a research setting.

So far, we have described a systems engineering life cycle for the development of an interactive intervention planner with human and computer actors. In the future, there may however also be a need to include robotic actors. Indeed, work on obtaining measured data by using mobile robots is underway [98, 61, 112, 110, 111]. In this context, we discuss a particular use case that could be part of an extended systems engineering life cycle for the development of the intervention planning methodology in general, namely the validation of the latter methodology using programmable mobile radiation-measuring robots.

Until now, the software relies on FLUKA simulation data for its operation. This is justified because FLUKA was extensively validated for use in radiation protection around high energy accelerators [154, 54, 65, 55, 52]. By integrating the software with a mobile robot equipped for radiation measurement, which is under development [98, 61, 112], the validation of individual intervention scenarios constructed with the software tool will become feasible.

With the availability of a radiation-detecting mobile robot, a use case can be envisaged where the trajectory generated with the intervention planning software is used as the input for the programming of a trajectory of the robotic device. The robot shall therefore be equipped with a suitable radiation sensor, so that it can measure radiation levels while covering the trajectory. With the results of the measurements taken by the robot, both the FLUKA simulation data and the interactive intervention planner can be validated in a fine-grained way, taking into account all (possibly hidden) variables that come into play when planning the intervention. This will further strengthen the validation of the simulations or, alternatively, provide new input data for strengthening the simulation code. If robotic devices become more powerful and – for some interventions – suitable to replace human maintenance workers, similar use cases can be imagined to plan robotic interventions.

4.5 Conclusion

In this chapter, we outlined the systems engineering life cycle of the development of a software tool for interactive planning of interventions in environments with ionizing radiation. This development is a complex problem with many aspects that requires a dedicated structured approach. The different steps of the systems engineering life cycle were discussed, including a needs analysis, specification explicitation, conceptual mathematical modelling, iterative implementation, design and prototype testing and usability testing. The result of this rigorous approach is a well-documented and purposeful software tool with demonstrated potential.

This work contributes to the important question of the feasibility of adapting a (relaxed) systems engineering approach in complex multi-disciplinary research projects.

Chapter 5

A technical-scientific perspective

In this chapter, we discuss the core technical-scientific aspects of interactive visual intervention planning in environments with ionizing radiation.

The starting point, discussed in section 5.1, is the state of the art and related work, which accentuates the scientific rationale for the necessity to implement the work developed in this thesis. Next to an overview of the technical-scientific tools for three-dimensional radiation mapping, we also mention the most relevant three-dimensional visualization software packages and libraries in this context.

Following this study, we discuss in section 5.2 interactive visualization of the facility geometry of facilities with ionizing radiation, together with the radiation levels, and interactive visualization of trajectory information in the context of the mathematical model developed in chapter 3.

This is followed, in sections 5.3 and 5.4, by a discussion of the processing of the planning: the numerical mathematical calculation of the equivalent dose of the planned interventions, and the subsequent reporting.

All these technical-scientific aspects of interactive visual intervention planning are important for the implementation of the developed methodology and model in software. As such, the discussion of every one of these aspects include hints to software-specific considerations in the text. Following these considerations, the software that has been developed to support the methodology developed in this dissertation, and in particular the software architecture of the developed software tool is discussed in section 5.5, after which this chapter is concluded in section 5.6.

Parts of this chapter have been published in [73].

5.1 State of the art and related work

Discussing the state of the art of research related to interactive visual intervention planning in (particle accelerator) environments with ionizing radiation is not straightforward. This is so firstly because of the distinct interdisciplinary nature of the research, and secondly because of the fact that relatively few prior work exists. These are also the reasons why this discussion is inserted here, and was not treated earlier in this text.

Next to an overview of the technical-scientific tools for three-dimensional radiation mapping, which is an overview of related work, we in this section subsequently also mention the most relevant three-dimensional visualization software packages and libraries in this context.

5.1.1 Technical-scientific tools for three-dimensional radiation mapping

In chapter 2, we have described the state of the art for three-dimensional radiation mapping, using the situation at CERN as a representative case. The situation at CERN is exemplary for the situation in high energy accelerator facilities and per extension for scientific facilities in general. The fact that the following analysis is based on a case study does not mean that we restrict our work to this specific case, but is on the contrary meant to position this work with respect to the state of the art in the whole high energy physics community. On top of this, we also mention the state of the art in nuclear facilities and explain the considerations that make the methods and tools utilized there less suitable in the context of certain scientific facilities.

We remind the reader that interventions in environments with ionizing radiation at CERN are currently planned based on two-dimensional plots of simulation results, making use of the FLUKA simulation package, and on the results of manual measurements. Intervention planning based on simulations is always followed by an additional manual measurement step, before authorization (or suspension) of maintenance operations. With regard to these measurements, only numbers are communicated, e.g. the expected radiation levels at x cm of a specific part of the installation.

This description of the current situation at CERN (see section 2.2.2) leads us to the conclusion that the intervention planning process thus makes use of state-of-the

art tools, but the potential of three-dimensional simulations and other radiation data, and of the benefits of computerised tools is not fully leveraged.

The intention of this research is to enhance intervention planning in environments with ionizing radiation by means of technical-scientific considerations and methodologies, implemented in a software program usable by both maintenance workers and intervention planners, in *three dimensions*, using existing three-dimensional models of the facilities and FLUKA simulation data. This requires the possibility to perform *interactive visual inspection* of the radiation levels and *trajectory planning*. In addition, there should be the possibility for numerically *calculating the resulting radiation dose* contracted during a planned intervention.

To the best of our knowledge, there are two efforts comparable to ours. The first one is a software package that implements most of the requirements gathered by us, namely Narveos [144], which is a software tool made by Euriware [15]. Euriware is a subsidiary of the AREVA group [14, 161], dealing with consulting and IT services in the energy and industry sectors. AREVA is a French public multinational industrial conglomerate, mainly known for nuclear power. The Narveos software allows to virtually visit a nuclear facility, and to compute different quantities used in radiation protection for residual dose rates. The Narveos tool thus allows the planning of interventions in radioactive environments. The second software package is Visiplan [150], a software tool made by SCK-CEN, the Belgian Nuclear Research Centre [17]. Visiplan is a dose assessment program developed to assist the ALARA analyst in pre-job studies. The Visiplan tools assist both in the calculation and the communication in ALARA evaluations [18].

However, these solutions have several drawbacks for use in high energy accelerator facilities. Narveos and Visiplan are tailored for application in nuclear power plants and as such provide point-kernel methods to calculate gamma dose rates based on source terms encountered typically in such facilities. The user has to provide the information in terms of radionuclide composition as well as spatial distribution.

While this approach is fast, it cannot be applied directly to radiation environments encountered at high energy accelerators. As described in [151], the composition of the prompt radiation field and as a consequence also the source term of the produced radionuclides is to a certain extent different. In addition, the spatial distribution of the residual radiation source term cannot be left to the user due to the complexity of the beam interaction with the accelerator infrastructure. A beam loss in a high energy accelerator triggers the evolution of secondary particle showers which in turn induce the production of radioisotopes. These showers depend on a multitude of parameters like material composition, the actual geometry of the accelerator infrastructure, particle types and energies. As a consequence they can only be described with the help of explicit Monte Carlo particle transport simulations.

It is thus necessary to split the task of planning an intervention at high energy

proton accelerators in two steps. In the first step the nuclide inventory and the associated residual radiation field has to be calculated by using a Monte Carlo code such as FLUKA which includes dedicated high energy nuclear models and is capable of treating the full build-up and decay chain of the radionuclide production based on a user-defined irradiation pattern and customizable material compositions. In contrast to the simulations conducted with a software package such as Narveos, these calculations are based solely on the beam loss of the primary beam, followed by an explicit treatment of all subsequent particle showers leading to the production and spatial distribution of the radioisotopes and the resulting residual radiation fields, which include not only gamma radiation but also electrons and positrons. In a second step these results can be used to plan and optimize interventions.

Furthermore, Narveos and Visiplan are commercial, closed-source program, a software paradigm that sometimes conflicts with the philosophy of non-for-profit research. In addition to this, Narveos depends on the commercial VIRTTOOLS player [16]. Finally, Narveos and Visiplan are not customizable. This also makes it of less use for implementing the methodologies developed in this work because the methodologies and their implementations developed here have to be dealt with in a scientific way. This means experimentation with different visualization methods, trajectory planners, user feedback, reporting means and other aspects of intervention planning in radiated environments.

The previous work in the context of interactive visual intervention planning in particle accelerator environments with ionizing radiation thus shows the need for an innovative approach and implementation, as developed in this thesis.

5.1.2 Three-dimensional visualization software packages

In the implementation of the technical-scientific considerations and the development of technical-scientific methodologies and software tools for the implementation of radiation protection, visualization is playing an important role. This fact has been discussed before in this text, and will be elaborated from a technical-scientific viewpoint in section 5.2.1. We here first discuss related work, and more in particular three-dimensional visualization software packages.

Three-dimensional visualization is an active field of research since many years [108, 123, 83, 86]. This research has already led to several scientific visualization tools that are used in a wide range of scientific activities. This leads to the question: can these software packages be used for interactive visual intervention planning in environments with ionizing radiation, using the mathematical model that has been elaborated in chapter 3?

We have identified several interesting scientific visualization packages that come close to being able to fulfil this goal. The three scientific visualization packages

that we have identified as possibly relevant in the context of the work in this thesis are mentioned here. We have specifically looked at scientific visualization packages capable of visualizing large data volumes.

VolView [29] is an end-user application for volume visualization designed for the exploration of three-dimensional medical or scientific volume data sets on multiple platforms. It offers an interface for custom made image processing plug-ins. VolView is based on the Visualization ToolKit (VTK) (see section 5.1.3).

ParaView [26] is a scientific visualization tool, capable of using a variety of data representations. It has been developed to analyze extremely large datasets using distributed memory computing resources. Like VolView, ParaView is based on the Visualization ToolKit (VTK) (see section 5.1.3) as the data processing and rendering engine.

VisIt [28] is an interactive parallel visualization and graphical analysis tool for viewing scientific data on multiple platforms, designed to handle very large data set sizes.

While these three packages seem to be a good choice for the scientific visualization of three-dimensional radiation protection simulation volumes, they do not fulfil the necessary requirements to be used for implementing the interactive visual intervention planning methodologies presented in this thesis. In particular:

- It is not trivial to combine the different data types that are to be visualized for interactive visual intervention planning. We have to deal with at least three different data types: geometry data representing the facility itself, volume data representing the radiological quantities and trajectory data representing the intervention.
- The user interface of these software tools is complex, due to the generic approach of these packages. It is therefore not fit for the purpose of interactive visual intervention planning, where many stakeholders are involved with varying competences.
- It is not possible to integrate the mathematical model developed in chapter 3 into the software tools, as they are intended solely for visual inspection of scientific data.
- There are no tools to deal with the specificities of radiation data in these software packages. We can hereby think of tools accommodating the use of the different units, specific scaling tools, etc.
- There are no possibilities to export textual reports of the data processing (in this particular case the intervention planning). These reports are needed in the context of the integration of the computer-aided intervention planning into the radiological protection system implementation, e.g. in the course of an ALARA procedure (see section 2.1.3).

In summary: to the best of our knowledge, there is no three-dimensional visualization software package that can be used for interactive visual intervention planning in environments with ionizing radiation. The study of available three-dimensional visualization packages has however shown that, for scientific research, there exists a very relevant visualization software library that will be discussed in the next section.

5.1.3 Three-dimensional visualization software libraries

Research of the state of the art in visualization for radiation protection, and related disciplines, as described above, has shown that a custom software tool had to be developed. The interdisciplinary research performed in this thesis is focused on the development of technical-scientific methodologies for the implementation of radiation protection. The implementation of this goal in software can best be reached making use of a scientific visualization library.

Before starting the implementation of the developed mathematical model into software, several alternatives for visualization of the relevant data were studied. A description of this selection process can be found in [68]. This had led to the selection of the Visualization ToolKit (VTK).

The Visualization ToolKit (VTK) [30, 133, 131, 132, 88, 79] is an open source, cross-platform visualization library, written in C++. The object-oriented Visualization ToolKit (VTK) has been the standard for scientific visualization tool kits since many years. It is a class library that contains a large number of functions for the presentation of scientific data. VTK uses a pipeline mechanism for rendering. Data is passed through various pipeline objects (e.g. filters and mappers) to obtain geometry that can be displayed by the renderer.

To the best of our knowledge, VTK is the only visualization library capable to combine the multiple visualization methods needed for this work (see section 5.2.1). Other notable facts about VTK are:

- VTK is the de facto standard for scientific visualization, and has been developed in a scientific context. It has a wide range of capabilities.
- VTK is open source and has a large community of users/developers.
- VTK has multi-platform support.
- VTK has interfaces with Python, Java and Tcl (by automated wrapping of the C++ core).

After this overview of the state of the art related to our work, including technical-scientific tools for three-dimensional radiation mapping, the most relevant three-dimensional visualization software packages and software libraries in this context,

we can now discuss further technical-scientific considerations of interactive visual intervention planning.

5.2 The intervention planning process

The intervention planning process was discussed conceptually in section 3.6, linked to the elaboration of the mathematical model for radiation protection developed in the framework of this thesis. In this section, the two aims of the intervention planning process are revisited and discussed in an interdisciplinary technical-scientific way, linking intervention planning and radiation protection to visualization science.

5.2.1 Assessment of the conditions in the facility where the intervention will be performed

The first aim of the intervention planning process is the assessment of the conditions in the facility where the intervention will be performed. When implemented into software, this comes down to interactive visualization of the facility geometry and the radiation levels. The interactivity hereby means that several relevant visualization parameters need to be adjustable, and that it is possible to visualize the facility and radiation level data from every possible viewpoint.

Interactive visualization of facility geometries is what is called “surface rendering”. Visualization algorithms that are capable of producing and rendering polygonal data for surface visualization are mainstream, for instance in computer aided design packages. An example of a visualization of a high energy physics facility can be found in figure 5.1. Remark that only part of the facility geometry is visible, because some surfaces are hidden by objects in front of them.

Because of the volumetric nature of radiation protection simulations, the interactive visualization of the radiation levels in the facility is more involved. We namely search for a visual technique that gives full three-dimensional insight. While the radiation data could be visualized using surface data, for instance by visualizing slices of the volumetric data, or showing iso-surfaces of the radiation data, volume rendering is a more sophisticated visualization technique that can be used to visualize the structure of three-dimensional volumes [100]. Volume rendering visualizes volume data without reducing the three-dimensional data to two-dimensional data structures, as is the case with the aforementioned slicing or iso-surfacing¹. It

1. Iso-surfacing is the process of constructing an iso-surface. An iso-surface is the three-dimensional equivalent of an iso-line: a surface on which the value of a three-dimensional function (in our case the radiation data) is of constant value.

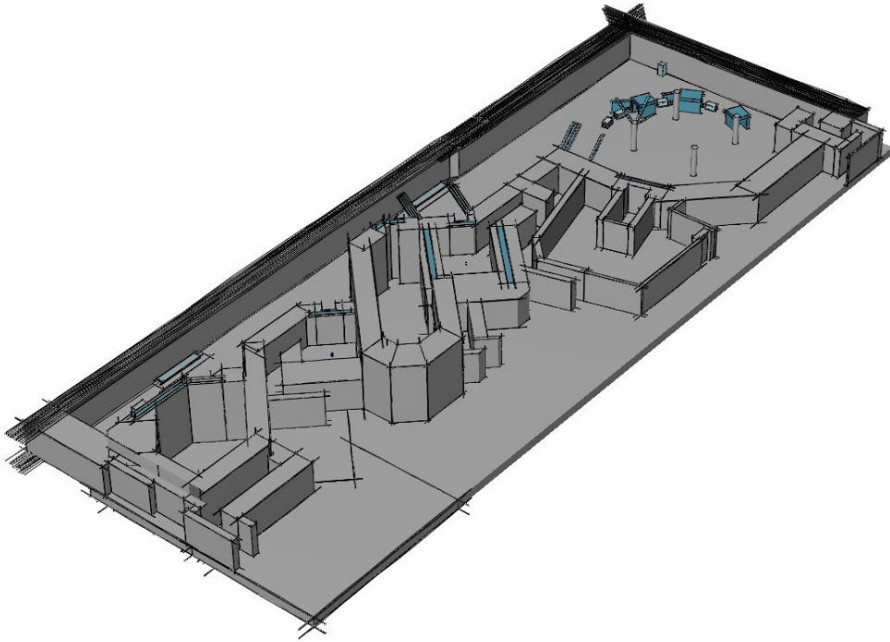

Figure 5.1 – An example of a visualization of a high energy physics facility [141].

therefore does not suffer from, for instance, hidden surfaces, and allows to see “inside” the data.

As a remark, we mention that while iso-surfacing is not the methodology of choice for the purpose of intervention planning in facilities with ionizing radiation, it can have its applications in radiation protection. For instance when delimiting a limited-stay area, iso-surfacing can be a purposeful tool. In this regard, we mention the most widespread algorithm for iso-surfacing three-dimensional volumes, namely the marching cubes algorithm [96].

A volume is a three-dimensional arrangement of voxels, in the same way as an image is a two-dimensional arrangement of pixels. The most well-known use of three-dimensional voxelized volumes are images produced by medical imaging devices such as CT or MRI scanners. This type of three-dimensional volumes can also be produced by mathematical simulations, e.g. by radiation level simulations, the case of interest for this work.

Multiple algorithms exist to perform volume rendering. The ray casting algorithm

is a direct implementation of the principle of volume rendering, which is why it is explained here. In ray casting, for every pixel of the two-dimensional screen on which a three-dimensional volume is to be displayed, a ray is cast through that volume. The ray intersects a line of voxels. While intersecting the subsequent voxels, as depicted in figure 5.2, the colour of the pixel is constructed accumulating the values the voxels' colour and transparency. These colours and transparencies are defined using the techniques of colour mapping and alpha mapping.

The technique of colour mapping is often used in conventional graphing. In graphs using colour mapping, a numerical range of values is mapped to a colour scale (see figure 5.3(a)). To allow for seeing “through” or “into” a three-dimensional volume, the voxels of the visualized three-dimensional volume must be to a certain degree transparent. This transparency mapping is performed in a way similar to conventional colour mapping (see figure 5.3(b)), and is commonly referred to as *alpha mapping*. The α value thereby stands for the *opacity*, a number between 0 and 1, and relates to the transparency T as $T = 1 - \alpha$.

Given a colour value c_i and an alpha value α_i associated with every voxel i , and given that the voxels are run through back-to-front, the colour of a pixel p can be determined using the following formula:

$$c_p = \sum_{i_r=\text{front}}^{\text{back}} \alpha_{i_r} \cdot c_{i_r} \prod_{j=\text{front}}^{i_r-1} T_{i_r}, \quad (5.1)$$

with the transparency $T_i = 1 - \alpha_i$. In this formula, the voxels i_r that are run through are the voxels that the cast ray crosses, from the front to the back of the

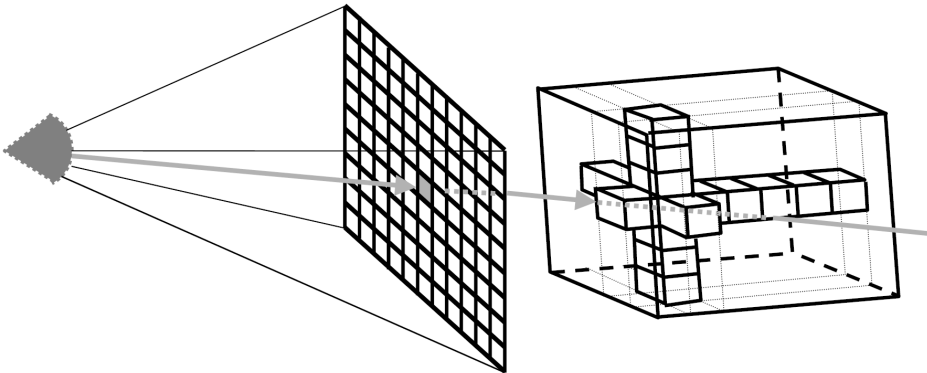
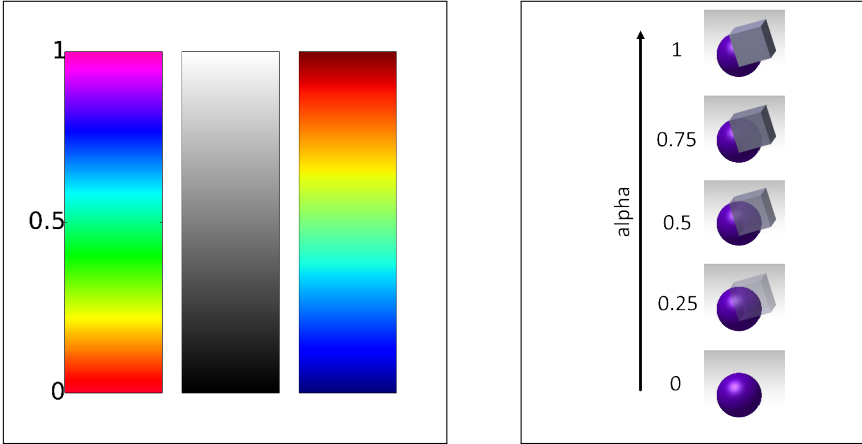

Figure 5.2 – The principle of volume rendering. Image from [9].



(a) Colour mapping. Every numerical value in the interval $[0, 1]$ is mapped to a particular colour. Here, three much-used example colour maps are shown. The displayed colour maps are commonly referred to as the *rainbow*, *black-and-white*, and *jet* colour maps.

(b) Alpha mapping. Every numerical value in the $[0, 1]$ is mapped to an alpha value associated with the grey cube in the image on the right. 0 stands for perfect transparency, while 1 stands for perfect opacity.

Figure 5.3 – Colour and alpha mapping.

volume that is visualized.

Examples of volume rendering can be found in figure 5.4.

The technique above is a technique of *direct volume mapping*, sometimes also referred to as *integral mapping*, where every numerical voxel value is mapped to opacity and a colour. As opposed to this, there exists a technique called *maximum intensity projection* [157]. This technique only projects and visualizes the numerical voxel values with maximum intensity that is to be found on the rays that are cast similarly as explained above. Among the advantages of this technique, we can mention the fact that it is computationally faster than direct volume rendering. However, the results of this technique do not provide a good sense of depth of the original data, in general, and in the specific context we are dealing with, a hotspot in the data can be completely invisible if another, slightly more pronounced hotspot is located behind it from the viewer's perspective. Given the considerations regarding human safety, discussions between ourselves, radiation protection experts and computer graphics experts have lead to the consensus that this technique is not the methodology of choice for the typical user, although it might have advantages for the advanced user.

A complete overview of volume rendering techniques can be found in [87].

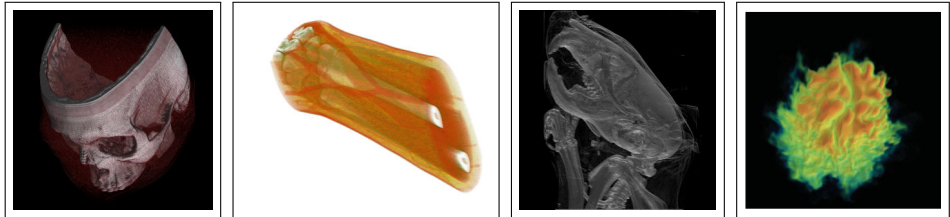

(a) A volume rendered cadaver head [165]. (b) A volume rendered CT scan of a forearm [165]. (c) A volume rendered mouse skull [165]. (d) A volume rendered combustion simulation result [84].

Figure 5.4 – Examples of volume rendering.

Due to the volumetric nature of radiation protection simulations, and the requirement of a clear visualization of the working conditions during the intervention planning, volume rendering is a natural choice to visualize the facility geometry and the radiation levels. Volume rendering can be considered to be a very intuitive volume visualization technique, compared to e.g. volume slicing. Volume rendering is a technique that was first proposed in the early eighties of the twentieth centuries [92, 66]. In the early days, it was a technique difficult to put into practice because of its heavy computational requirements. Recently, the ascent of General-Purpose computing on Graphics Processing Units (GPU) and the advancement of off-the-shelf Graphics Processing Units (GPUs) has led to the presentation of a number of interactive advanced volumetric illumination models [120], meaning that volume rendering of big volumes becomes more and more feasible on consumer hardware.

In order to perform volume rendering, we will use the fixed-point volume ray cast mapper that is built-in in VTK. Figure 5.5 shows an illustration of volume rendering implemented using this method. The visualized data are radiation doses in the TNC tunnel facility at CERN.

Practically, the volume rendering is to be integrated in the intervention planning software package, offering an interface for the user where he can select and import the geometry of a facility as well as the applicable radiation level simulation. To get good insight into the radiological (work) conditions in the facility, several tools should be available to interact with the geometries and to assess the radiation levels at specific points.

After the assessment of the conditions in the facility where the intervention will be performed, in which interactive visualization of facility geometries and radiation levels is the key component, the next step in the intervention planning process that has to be re-iterated here is the preparation of the trajectory of the intervention. This is discussed in the next section.

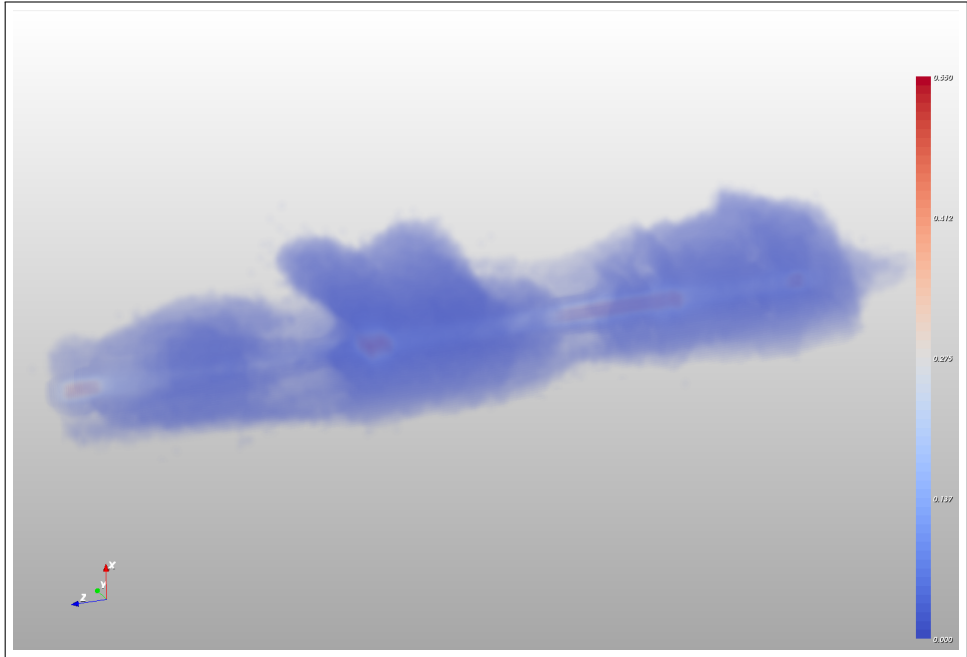

Figure 5.5 – An illustration of volume rendering as implemented in this research project. The data visualized are radiation doses in a tunnel facility at CERN.

5.2.2 Preparing the trajectory of the intervention

The first aim of the intervention planning process has been discussed in the previous section. The second aim of the intervention planning process is the preparation of the trajectory of the intervention. When implemented into software, this comes down to interactive visualization of the trajectory information. In this context, ‘interactive’ means that the trajectory can be constructed from scratch, and that all parameters of the trajectory that are possibly relevant for the intervention can be tweaked. This is different from the interactivity in the visualization of the facility geometry and radiation levels, where the interactivity refers to options to adjust several relevant visualization parameters and the possibility to visualize the *immutable* facility and radiation level data from every possible viewpoint.

For implementation in software, the trajectory is represented by a three-dimensional cardinal spline. Splines are an ideal mathematical representation of the trajectory, since they are piece-wise defined and possess a high degree of smoothness at the points where their polynomial pieces connect, i.e. at the locations m_i as defined in the mathematical model that was introduced in chapter 3. In addition, splines are very intuitive to work with and allow to design and control complex curves.

Each of the control points of the spline is considered a location where a task can be executed. This does not restrict the number of control points to be equal to the number of tasks in the meaning of the tasks as defined in chapter 3, as it is possible to define locations with no task assigned to, as foreseen in the mathematical model. In each of these control points, the task duration (if any) can be in-putted, as well as a task name. It is possible to define the locations of the control points / locations in a visual interactive way, as well as numerically, through the manual input of three-dimensional coordinates. Examples of an in-putted trajectory, as implemented in software, can be found in figure 5.6.

The number of locations is easily adjustable, and the locations can be displaced interactively to shape the spline into the trajectory that the maintenance worker will follow during the intervention.

To illustrate the importance of (manual) trajectory optimization, figure 5.7 shows two possible trajectories through a tunnel facility with ionizing radiation. The dose contracted during the trajectory visualized in figure 5.7(a) proves to be 25% higher than the dose contracted when following the trajectory in figure 5.7(b). These hypothetical trajectories are an illustration of the principle but indicate that small changes in an intervention can lead to much smaller exposure: in this case passing at the right side of an activated piece of equipment instead of at the left side leads to a considerable reduction in dose. The volume rendered data is coming from a realistic simulation of the dose levels in an existing facility.

The two main parts of the intervention planning process have now been re-iterated, after they were conceptually discussed in section 3.6, in an interdisciplinary technical-scientific way, linking intervention planning and radiation protection with visualization science. These two parts of the intervention planning both serve to optimize the intervention in terms of radiation protection. For this, the most important feature of the model is the calculation of the equivalent dose, which is discussed in the next section.

5.3 Calculation of the equivalent dose

Interactive visual intervention planning in particle accelerator environments with ionizing radiation is done with the aim to optimize interventions in the spirit of ALARA: the aim is to reduce radiation doses to maintenance personnel as much as possible, within the constraints of what is “reasonably achievable”. The core of the interactive visual intervention planning, as discussed in this dissertation, can thus be considered to be the calculation of the equivalent dose H received by a worker over a user-defined trajectory \mathcal{T} through the simulation volume, as defined in chapter 3.

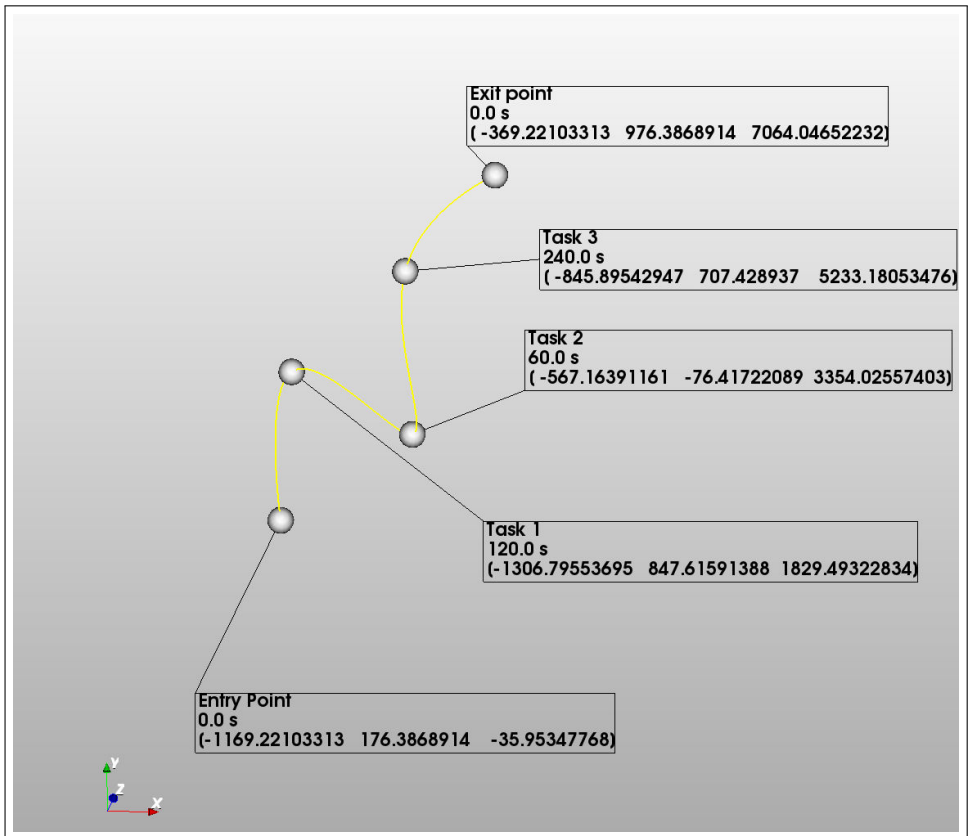

(a)

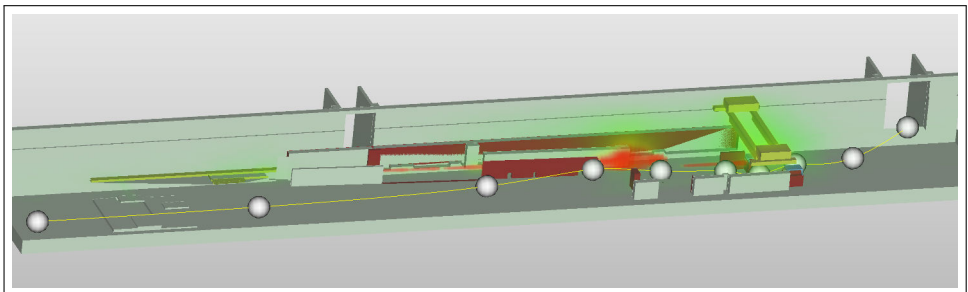

(b)

Figure 5.6 – Examples of a trajectory, as implemented in the software supporting this research.

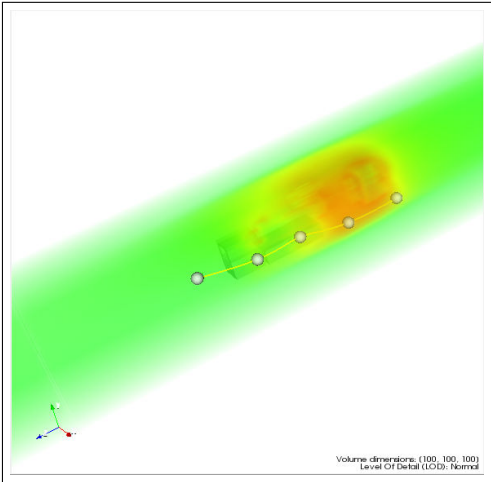

(a)

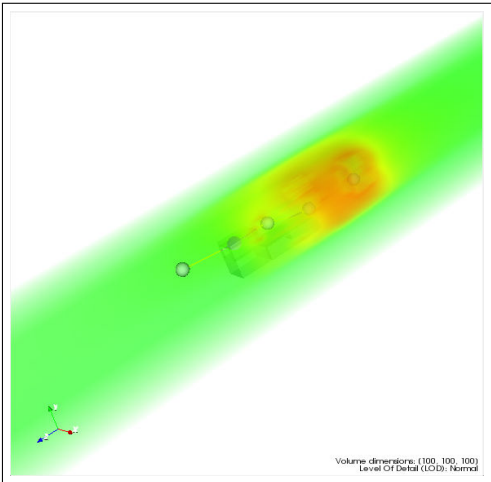

(b)

Figure 5.7 – Two possible trajectories for a maintenance intervention in a tunnel facility at CERN. The equivalent dose contracted during the trajectory depicted in (a) proves to be 25% higher than the dose contracted during the trajectory depicted in (b).

To calculate the equivalent dose H , the trajectory spline, as introduced in section 5.2.2, is discretized into q segments, creating a series of consecutive points s_j on the spline, with $l = 0, 1, \dots, q$. The number of discretization steps can be set to a value that is suitable with regard to the resolution of the discretizations in the radiation protection simulations; for instance, a default value of $q = 1000$ could be proposed, which can be empirically validated.

Using the trapezoidal rule, equation (3.4) can now be calculated as:

$$\hat{H} = \sum_{i=0}^N t_i \dot{H}(m_i) + \frac{1}{v} \sum_{l=0}^q \frac{\dot{H}(s_l) + \dot{H}(s_{l+1})}{2} \|s_l s_{l+1}\|, \quad (5.2)$$

with:

- \hat{H} the approximation of the equivalent dose H .
- N the number of locations m_i , as defined in chapter 3. For the calculation, the locations m_i are equivalent to the control points of the trajectory spline.
- $t_i = [t_{s_i}, t_{e_i}]$ the estimated time spent at location m_i , which may correspond to a task duration τ_k , in case a task is to be executed at m_i , with start time t_{s_i} and end time t_{e_i} .
- $\dot{H}(p)$ the dose rate at point p in three-dimensional space.
- v the speed of the maintenance worker.
- q the number of discretization steps.

Here, the assumption has been made that the speed of the maintenance worker is constant over the whole trajectory.

Increasing the value of q theoretically has a positive influence on the accuracy of \hat{H} . However, one should keep in mind that the overall accuracy of equation (5.2) also depends on the accuracy of the radiation dose rates \dot{H} , which are obtained from simulations or from (sparse) manual measurements, both with limited accuracy. A profound accuracy analysis will be given in section 6.3.

Once the intervention planning has been performed and subsequent calculations have been made, the intervention planning can be outputted in a format suitable for further analysis and in line with the requirements for intervention planning in environments with ionizing radiation. This is discussed in the following section.

5.4 Reporting

As has been stated, the work in this thesis is done with the aim to be able to optimize interventions in the spirit of ALARA: to be able to reduce radiation

doses to maintenance personnel as much as possible, within the constraints of what is “reasonably achievable”. This can be done using a software tool, that is an implementation of the considerations in this chapter. This optimization is as such made a computer-aided process. The outcome of this process should consequently be transferred to the real world. It is along these lines very important that the computer-aided optimization leads to a report that can be used in further processes, and can be used administratively by the ALARA committee, for instance.

In general, the reporting fulfils the need to be able to communicate planned and optimized interventions with all parameters and computed parameters, i.e. from the intervention planners to the other stakeholders. This reporting can be used to inform the maintenance workers about the parameters of the intervention they are going to perform; to inform the management about the planned intervention in order to get approval; to communicate during the conception of a new facility with ionizing radiation; to communicate between the designers and the radiation protection personnel; etc.

Once the interactive visual intervention planning is completed, a paper, or electronic equivalent, report should thus be generated. This report should contain, amongst others:

- the sources of information: the names of the input files containing the geometry of the facility and the radiation levels, the applicable units, normalization factors for the input simulation data, . . .
- the trajectory information: locations, discretization information, velocities of the maintenance worker, . . .
- the results of the trajectory planning: the total length of the constructed trajectory, the computed received dose to be expected during the intervention, the dose received while working and while moving, the maximum dose received while working and moving, radiation data per location, . . .
- graphs of the computed quantities.
- supporting figures.
- various meta-information, such as the date of the report generation, and version information of the intervention planner.

An example report can be found in figure 6.8(b).

All technical-scientific considerations that have been discussed so far can lead to an implementation of the developed models and methodologies software. This is the content of the next section.

5.5 Software

Developing software has sometimes been considered a side issue in research. More and more, however, it is acknowledged that software should be considered a key issue in a world where research is performed more and more *in silico*. Some examples of the growing importance of computer science in the core of science are, for instance, the 2013 Nobel prize in chemistry, “for the development of multi-scale models for complex chemical systems” [3], or the awarding of the Human Brain Project, a project aiming for the development of a complete virtual human brain, as one of two funded European FET Flagship projects [31].

5.5.1 A software tool for computer-aided intervention planning

In the context of this research, a proof-of-concept tool implementing the technical-scientific models and methodologies developed here was implemented. This tool is briefly discussed in this section.

We opted to develop the intervention planning software in Python [27, 97]. Python is a general-purpose, high-level programming language whose design philosophy emphasizes code readability. This is a very important quality in the collaborative context at high energy physics facilities. Moreover, Python interpreters are available for many operation systems. Python supports the object-oriented programming paradigm, which naturally allows future extensions of the intervention planning software. Finally, using third-party tools, Python code can be packaged into stand-alone executable programs.

For the visualization aspects of the intervention planning, we decided to use the Visualization Toolkit (VTK) [30], which has been described above.

For the development of the graphical user interface (GUI), we chose to make use of wxPython [118]. Because major attention has to be paid to the requirement of an intuitive graphical user interface allowing fast and flexible visualization, trajectory creation, and reporting, the user interface (UI) is as much as possible decoupled from the back-end of the software.

A screen shot of the software thus developed can be found in figure 5.8.

5.5.2 Software Architecture

A critical part of any software project is the software architecture. The criticality of software architecture has been described very pertinently by Amy Brown and Greg Wilson in their book *The Architecture of Open Source Applications* [49, 50]:

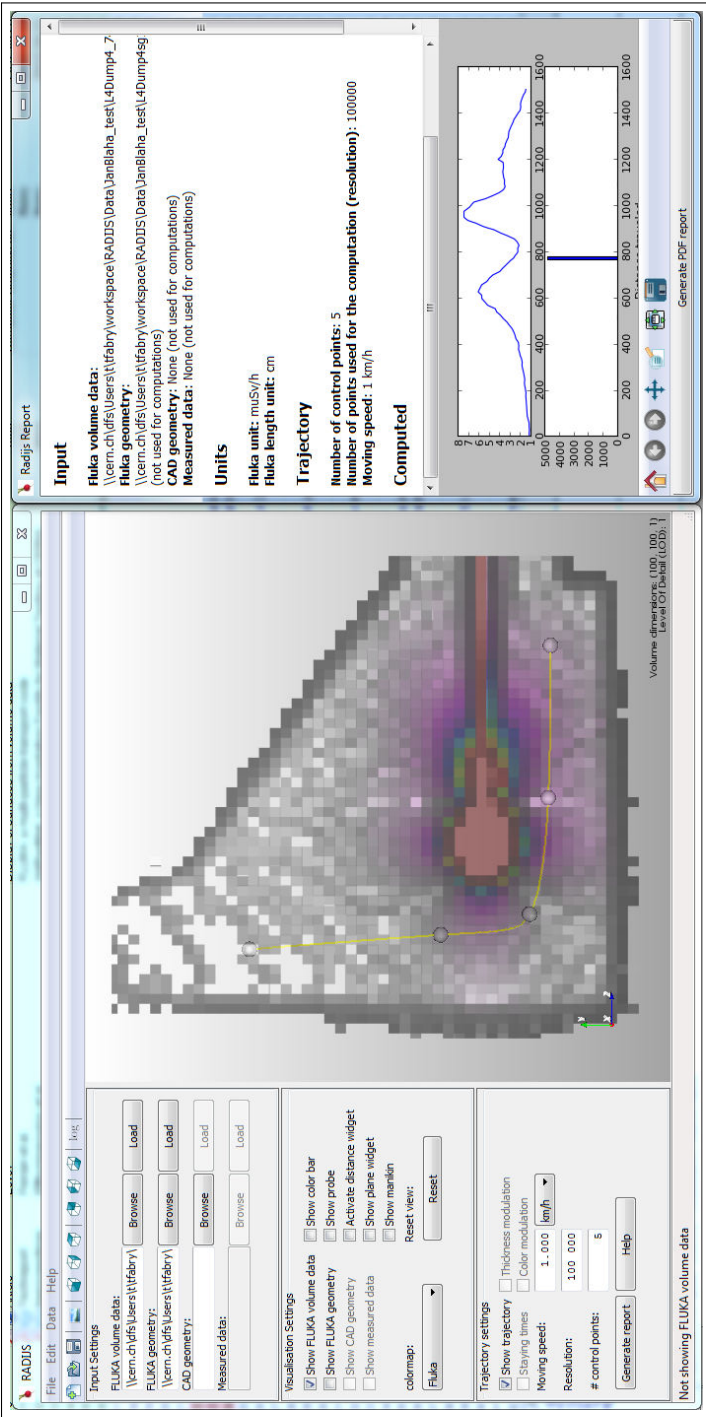

Figure 5.8 – The software tool for computer-aided intervention planning developed in the context of this thesis.

“Programming is (...) an exacting craft, and people can spend their entire lives learning how to do it well. But programming is not software architecture. Many programmers spend years thinking about (or wrestling with) larger design issues: Should this application be extensible? If so, should that be done by providing a scripting interface, through some sort of plugin mechanism, or in some other way entirely? What should be done by the client, what should be left to the server, and is “client-server” even a useful way to think about this application? These are not programming questions, any more than where to put the stairs is a question of carpentry.”

This dissertation cannot give a complete elaboration on the software architecture aspects of the software project related to the interactive visual intervention planning in particle accelerator environments with ionizing radiation. Because of the importance of this aspect, an overview of the software architecture choices is however given.

Software architecture is indeed a very important and difficult aspect of software development, and it would be unrealistic to pretend to have come up with the perfect, adequate and definitive architecture. Rather, we here describe the most important global design decisions made up to today and propose an architecture that is in line with the research project software aims. For more information, we refer to the architectural design report [69] and the detailed design report [70], published as deliverables of the PURES SAFE project.

Global Package Diagram

“The logical architecture is the large scale organization of the software classes into packages (or name spaces), subsystems and layers.” [90]

Figure 5.9 shows the proposed (desired) logical architecture for the relevant software, drawn using the UML package diagram notation. Here, and in the remainder of this section, the software is referred to with its working title “RADIJS”.

The current package diagram can be seen in Figure 5.10². It can be seen that this package diagram is essentially the same as the proposed package diagram, with some addition of sub-packages, packages for testing, error handling, ...

The RadijsTools package is a utilities package with various help functions/classes/... and does as such not need to be well structured.

The RadijsTest and RadijsUserTestPhase2 are packages that allow for user test capabilities. The package RadijsFramwork_UT is an extension to the “normal”

2. This package diagram has been made with PyReverse, part of the PyLint package [95].

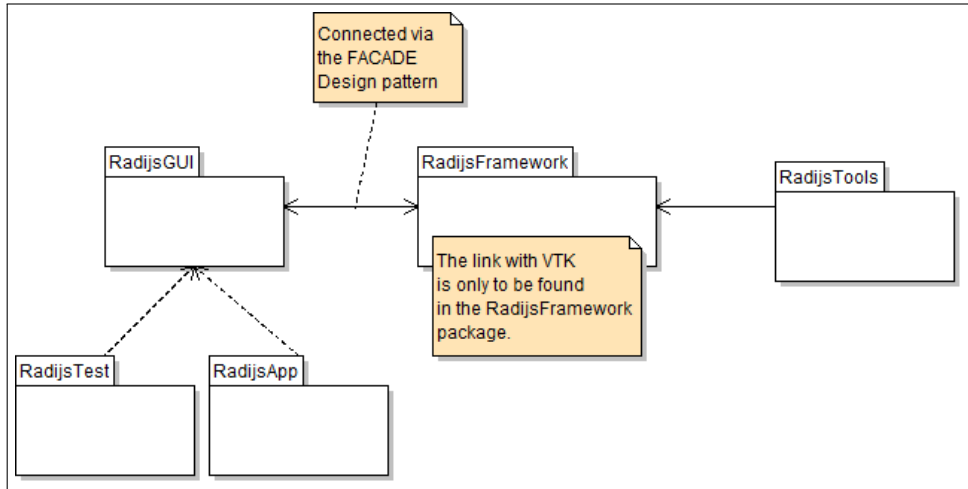

Figure 5.9 – Proposed package diagram.

RadijsFramework package, giving more possibilities to construct user tests. The architectural design of these packages is less critical as they are not intended to be shipped with the release versions of the program. As such, these test packages are changing in form and also architectural changes are to be expected. The test packages can be used to prove the usefulness of the software in the final acceptance test phase of this research project, and for the scientific validation of the developed methods and methodologies.

The RadijsApp package is a package with the functionality for launching the application, and doing some tests during launch.

The only function of the RadijsVersion packages is provisioning the other packages/classes with the current software version number.

The package RadijsGUI is responsible for the Graphical User Interface of the software.

The Framework of the application is implemented in the package RadijsFramework. It is meant to be the core of the application and includes:

- Import capabilities. These capabilities are partly provided by VTK, and partly to be found in the classes Radijs*Importer* (currently RadijsFlukaImporter2 and Radijs3DXMLImporter).
- Visualisation capabilities. These capabilities are provided by VTK, and are to be found in the class RadijsVisualisationPipeline. This class is responsible for building, maintaining and piloting the VTK visualisation pipeline, and is thus much influenced by the VTK architecture [79].

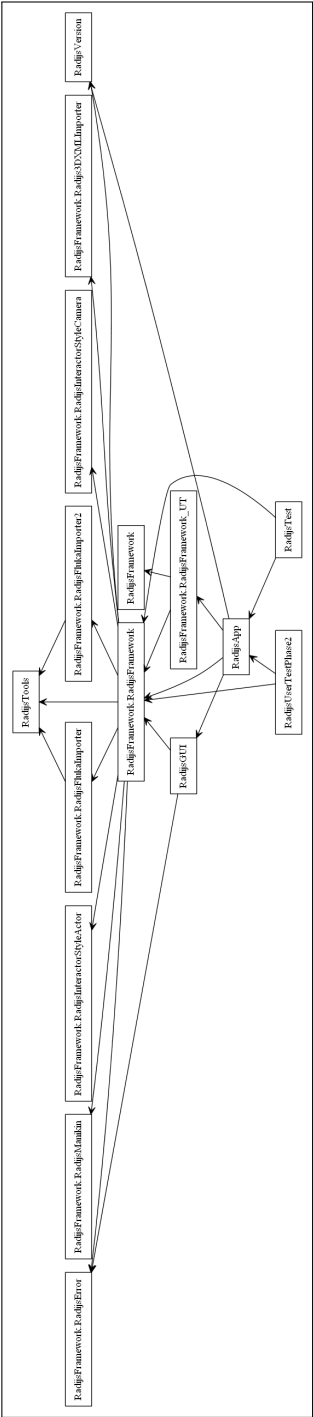

Figure 5.10 – Current package diagram.

- Trajectory manipulation capabilities. These capabilities are implemented in the `RadijsTrajectory` class. They include the internal data structure of the trajectory, certain computing capabilities related to the trajectory and link to a VTK widget (`vtkSplineWidget`). This class and the `RadijsVisualisationPipeline` are the only two classes that have a link with the VTK toolbox.
- Reporting capabilities. These capabilities are implemented in the `RadijsReport` class. This class makes use of the PDF exporting capabilities of `ReportLab`.
- A class for preserving the current state of the application (`RadijsSettings`).
- The facade for interacting with the GUI (`RadijsFacade`).
- Error Classes.

Global Class Diagram

In line with the current agile development methods that are promoted in efficient object-oriented software design [80], the UML class diagram of the application developed in the context of RP13 is elaborated in an iterative way, i.e., through a repeated cycle of analysis, design, and implementation. Often issues that affect the design arise during implementation. Changes made to implementation code need to be reversed back into the analysis model so that iterative design can continue [1].

Two important architectural design decisions, with a big impact on the class diagram, are specified in the coloured notes on Figure 5.9:

- The `RadijsGUI` (Graphical User Interface) and `RadijsFramework` are connected via a facade pattern³. The facade pattern is an object that provides a simplified interface to the `RadijsFramework`, so that [77]:
 - It makes the `RadijsFramework` package easier to re-use, understand and test.
 - It makes the GUI-module easily replaceable.
- The link with the VTK library is only to be found in the `RadijsFramework` package.
 - This makes it easier to deal with possible future changes in the VTK used.

3. “In software engineering, a design pattern is a general reusable solution to a commonly occurring problem within a given context in software design. A design pattern is not a finished design that can be transformed directly into source or machine code. It is a description or template for how to solve a problem that can be used in many different situations. Patterns are formalized best practices that the programmers must implement themselves in the application.” [164]

- This allows for easier interchange of the visualisation library.
- This makes the remainder of the code base more easily understandable, as only understanding the code in this package, some knowledge of the VTK structure and architecture is needed.

A sketch of the class diagram⁴ (domain model), drawn during the third design iteration (version 0.3 of the software), is displayed in Figure 5.11. The overall structure and principles of the class diagram have not changed since.

The current class diagram can be seen in Figure 5.13⁵. This class diagram is essentially the same as the proposed class diagram, but, because of lazy initialisation⁶ and other performance-tweaking and code optimization techniques and the difficulties PyReverse has to deal with these, this class diagram looks less transparent than the diagram in Figure 5.11.

We conclude the discussion of the software architecture here, and as mentioned before refer the interested reader to the architectural design report [69] and the detailed design report [70], published as deliverables of the PURES SAFE project, for more information.

In this section, we have given a concise overview of the software architecture choices in the implementation of the developed mathematical models and scientific methodologies into software. As such, this is an evidence that the developed models and methodologies are sound for implementation in software, and do not only have a scientific and theoretical value but can also be applied.

5.6 Conclusion

In this chapter, we have discussed the technical-scientific aspects of interactive visual intervention planning in particle accelerator environments with ionizing radiation. The starting point has been the state of the art and related work, which accentuates the scientific rationale for the necessity of the work developed in this thesis.

The intervention planning process, as conceptually discussed in section 3.6, has been revisited and discussed in an interdisciplinary technical-scientific way, linking intervention planning and radiation protection with visualization science and interactive scientific data processing and analysis.

4. Why software developers use sketches [59].

5. This class diagram has been made with PyReverse, part of the PyLint package [95], and has been edited with GIMP [23].

6. “In computer programming, lazy initialization is the tactic of delaying the creation of an object, the calculation of a value, or some other expensive process until the first time it is needed.” [162]

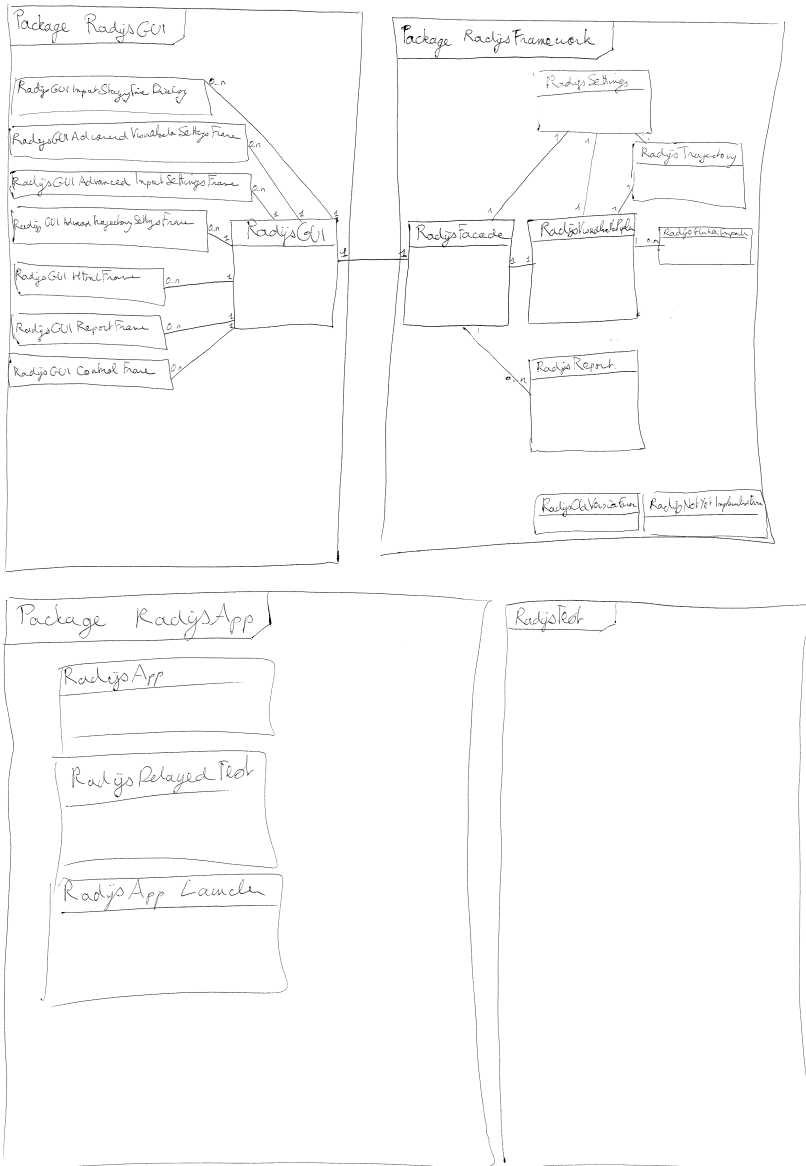

Figure 5.11 – Class diagram sketches. For reasons of readability, this sketch has been digitized and can be found in figure 5.12.

It has furthermore been proven that the developed methodologies and models are implementable in software, and a prototype software application has been presented.

At this stage, the evaluation of doses during an intervention has been introduced from all angles relevant for this work and a conceptual mathematical model for the planning of interventions in environments with ionizing radiation has been developed. The work has been enlightened from a systems engineering point of view, followed by a technical-scientific treatment of the developed methodologies and models.

The following chapter will demonstrate the added value and the usefulness of the developed methodologies and models and validate the use of the models and the developed prototype software.

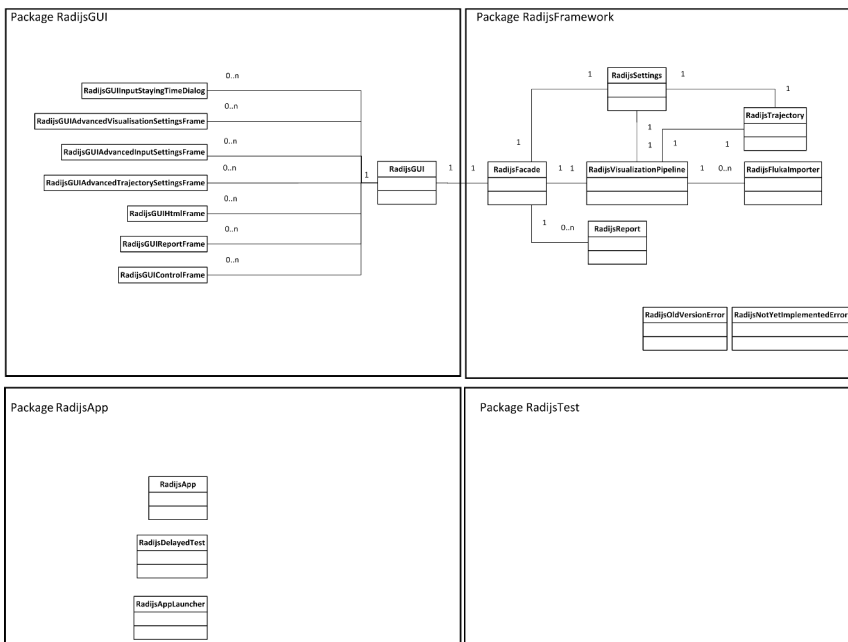

Figure 5.12 – Class diagram sketches, digitized from figure 5.11.

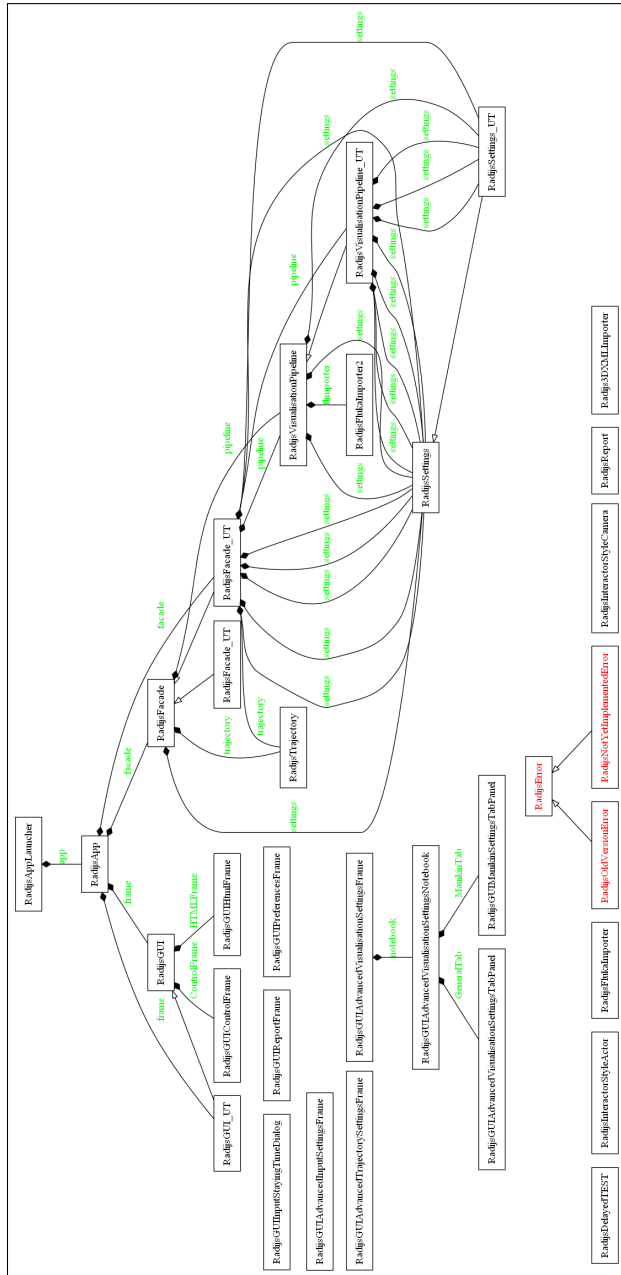

Figure 5.13 – Current class diagram.

Chapter 6

Validation

In this chapter, we validate the scientific methods and methodologies for interactive visual intervention planning in environments with ionizing radiation that were developed in the framework of this thesis. This is done through using the proof-of-concept software that was developed as an implementation of these methods and methodologies.

First, in section 6.1, we qualitatively prove the usefulness of the interactive visual intervention planning through a user test. From the results of the test, we conclude that the implementation of the work developed in this thesis is well-suited for the intended purpose. This work has been published in [72].

Next, in section 6.2, the practical use of the interactive visualisation and planning tool for intervention planning in particle accelerator environments with ionizing radiation is explored. This is done through a case study: visual interactive intervention planning as part of the design process of a new accelerator facility. The proof-of-concept software that was implemented is as such situated and given a place into the current intervention and dose planning procedures, supported with a case study involving the replacement of the beam dump core of a new linear accelerator that is being constructed at CERN. The software is also benchmarked against an existing dose planning. This work has been published in [71].

Finally, in section 6.3, we discuss and illustrate how the accuracy of the trajectory and intervention planning in the software is influenced by a variety of parameters and circumstances. This work has been published in [71].

6.1 Qualitative validation: user testing

Since the use of a three-dimensional visualization tool for the planning of interventions in facilities emitting ionizing radiation is, to the best of our knowledge, not implemented yet in any scientific facility, a user test is needed to prove that the application is useful to the stakeholders of the intervention planning. The main goal of the user test we are proposing is to qualitatively prove the usefulness of the three-dimensional visualization for the user. It can also make way for a larger user test, using more quantitative variables, in order to discover the optimal settings for the three-dimensional visualization. We also set a secondary goal, namely the quantitative comparison of two different colour maps for the volume rendering visualization of the radiation level simulations. We evaluate this using the quantitative measures that are subject of the optimization during the planning of the maintenance operations.

The appropriate use of colour visualization is seen as a very important, and one of the most fundamental subjects in visualization [135]. We thus, as a secondary goal of this user test, want to test whether the choice of the colour map has indeed an important effect on the user experience, and if it has an effect on the optimization process that the user is performing in this application.

In scientific visualization literature, many publications of user tests and user test designs can be found. However, these user tests deal almost exclusively with the effectiveness of one visualization method on the user perception, without incorporating the context of a concrete application. For instance, many user studies can be found on the influence of different illumination models on three-dimensional visualization on user perception of static computer-generated images [158, 81, 122, 93, 156]. In contrast to this, our user test design is conceived to take the interactive context of the trajectory planning application into account. Furthermore, the user test will also contribute to abate the relative scarceness of volume rendering applications user studies. Indeed, perceptual studies are scarcer in volume rendering applications than in surface rendering applications [93].

6.1.1 Material and methods

As the user test is mainly a feasibility test for the developed concepts that were implemented in software, the most important variable that was recorded was the qualitative appreciation of the user on the usability of the tool. This was done by asking for comments after the user test instance was performed. The other recorded variables were:

- H_{rec} : the computed expected integrated equivalent dose received by the worker in the environment with ionizing radiation when he would walk this trajectory at a constant speed,

- l_{rec} : the length of the trajectory that was constructed by the user, and
- n_{rec} : the number of control points the user used to construct the trajectory.

In addition to this, the full session information is recorded: all of the variables that are needed to reproduce the view the user had at the end of his session, including visualization, camera and interaction parameters.

These parameters are recorded as the result of the user test: a controlled possible real-life scenario of a planning of an intervention. The user was shown real-life simulation of example radiation dose rates in the TNC tunnel at CERN. The TNC tunnel is part of the infrastructure where the HiRadMat facility is located [67]. The HiRadMat facility will be used to investigate the impact of high energy particle beams on different materials.

The residual radiation dose rates originate from a FLUKA simulation of beam impact on beam equipment for the Large Hadron Collider (LHC) [57]. The radiation doses were shown using the GPU ray casting volume rendering algorithm as implemented in VTK [132, 88]. This volume rendering was overlayed on a transparent visualization of the geometry of the tunnel, as conceived and used for the FLUKA simulation (see figure 6.1).

For the secondary goal of the user test, two colour maps were consecutively shown to the user: the standard, much-used and much-contested *rainbow* colour map [46] and a continuous diverging colour map claimed to be well-suited for scientific visualization [104]. The order of the colour maps in the user tests was randomized to mitigate the effect of familiarity the user might get the second time he performs the manual trajectory optimization. The quality of the colour map is measured according to the three recorded variables discussed above.

The scenario of the test is a scheme where a maintenance worker has to enter the facility through a given entrance location, go to a given location to perform a maintenance operation on a particular piece of equipment, and leave the facility through a given exit location. To let the user simulate this, the locations of the entrance, maintenance and exit points were given as fixed points on a dummy trajectory. This dummy trajectory had a number of control points that the user can move in order to alter the trajectory. In addition, the user is given the possibility to suppress or add control points in order to be able to make a more detailed trajectory (see figure 6.1). In every user session, the user had to perform these actions twice, using a visualization with different colour maps.

In this context, the user was asked to construct a trajectory that he thinks is optimal, in terms of radiation the maintenance worker would undergo, given the constraints and the visualization of the simulated radiation dose rates. In order for the test to be as controlled as possible, most of the software user controlled settings/features were disabled. The user was given no real-time feedback in terms

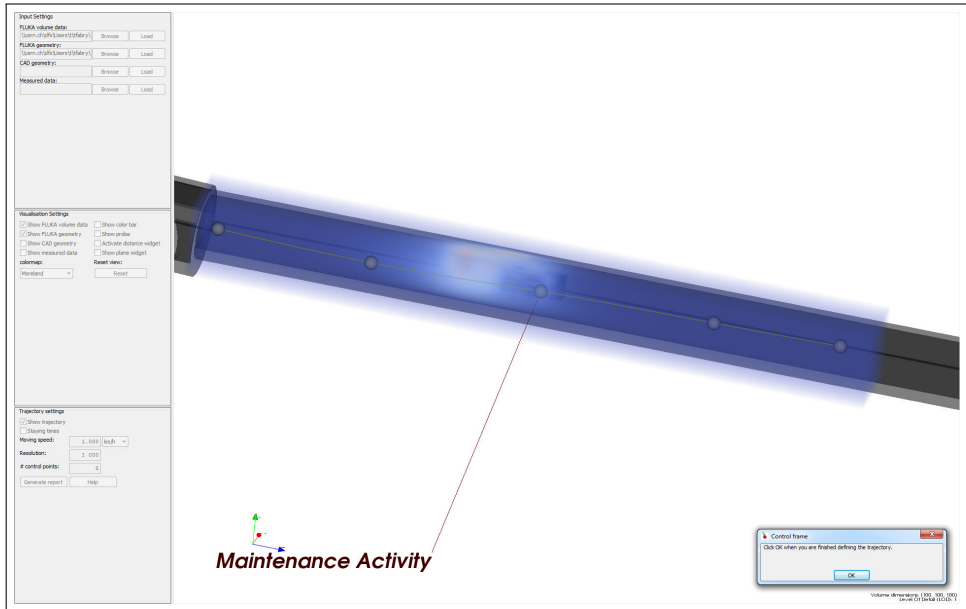

Figure 6.1 – The interface shown to the user performing the user test. The begin and end points and the control point marked “Maintenance Activity” are fixed. The user can alter the given trajectory by displacing the remaining control points, as well as any additional control points that he can add.

of resulting dose of the planned trajectory.

The user test was performed 10 times, by 7 different subjects. All of the subjects were more or less familiar with the type of facilities that our research is being done for, but only one of them was familiar with the particular facility used for the user test. Three subjects performed the user test twice. The interval between two tests performed by the same user was always more than 2 weeks, so that all test instances can be considered independent.

None of the subjects is professionally involved in maintenance planning, which gives us the possibility to assess if it will be feasible to use this tool not only in the intervention planning but also to give the maintenance workers an idea of the tasks they will have to perform and the relation of these tasks to the relative radiation levels they lead to. Furthermore, the fact that the user test subjects are not professionally involved in maintenance planning allows us to have stronger indications on the user-friendliness of the software.

6.1.2 Results

As for the qualitative feasibility test, all of the subjects were convinced of the potential of the given tool. None of them had comments on the visualization. There were some comments on the controls of the three-dimensional navigation. These comments were very interesting and were dealt with in the iterative development process of the software. They are however not directly relevant to the results of qualitative validation.

As for the quantitative discriminatory test between the two colour maps, box plots of the measured variables, per colour map, can be found in figure 6.2. We performed paired two-tailed t-tests on the three measured variables. The results found are:

- a t-value of $p(9) = 0.821$, $p = 0.43$ for the computed expected integrated equivalent radiation dose received by the radiation worker when he would run this trajectory at a constant speed, meaning that the computed expected integrated equivalent radiation doses are not significantly different for the trajectory plannings with the different colour maps;
- a t-value of $p(9) = 0.609$, $p = 0.56$ for the length of the trajectory that was constructed by the user, meaning that the trajectory lengths are not significantly different for the trajectory plannings with the different colour maps and
- a t-value of $p(9) = 0.137$, $p = 0.89$ for the number of control points the user used to construct the trajectory, meaning that the number of control points the user preferred to make the trajectory are not significantly different for the different colour maps.

6.1.3 Discussion and conclusion

From the results of the user tests, we cannot conclude that there is a significant difference between the two colour maps. We can thus conclude that for this particular test, the colour map is not of large importance for obtaining good results in operation planning in facilities emitting ionizing radiation. The result is however of limited strength, because of the relatively small sample of users and the very small number of scenarios. While we could have obtained more conclusive results with more users, we think that the main improvement in the user test can be made with letting the user optimize operations in more different facilities and scenarios.

The Student t-test for the number of control points is however leading to a p -value of 0.89, so that we can almost, with a significance level of $\alpha = 0.1$, exclude that the user prefers more or less control points with one or the other colour map. This

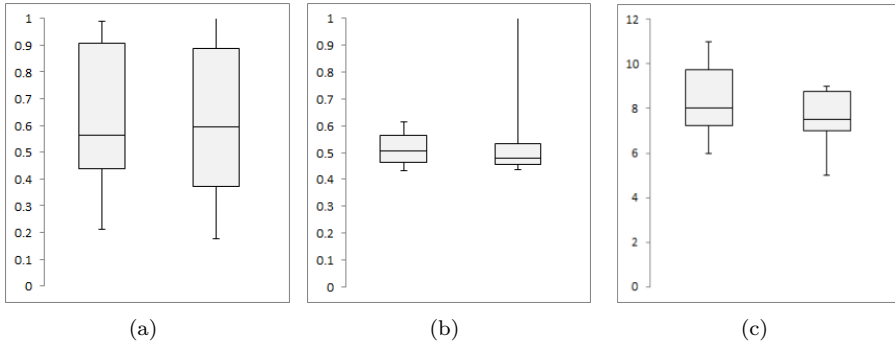

Figure 6.2 – Boxplot of the measured variables: 6.2(a) the computed expected integrated equivalent dose (normalized), 6.2(b) the length of the constructed trajectory (normalized) and 6.2(c) the number of control points used in the trajectory. On the left the results of the user test, the data visualized using the continuous diverging colour map, for the data on the right the rainbow colour map was used.

could have been a sign that the user is better able to minimize the radiation dose over the trajectory with one colour map. This means that we can almost reject the hypothesis that the user uses more control points to specify the trajectory in the case of the continuous diverging colour map, because he considers to be better able to construct a detailed trajectory in this case. This conclusion is however also not evident when we plot the normalized computed expected integrated equivalent dose against the number of control points used per user test instance (see figure 6.3). More user tests are needed to confirm this hypothesis.

For the colour map part of the user test, we cannot conclude that the continuous diverging colour map is outperforming the rainbow colour map, which was expected before the test. This can be caused by the relatively small number of user tests performed, or it can mean that the colour map is not a critical factor in this application. Both outcomes are potentially interesting, but will have to be confirmed in a future, more extensive, test.

In general, relying on the qualitative results of the user test, we can conclude from this test that the developed tool is well-suited for the intended purpose. The user comments are very positive and make the way for an extensive user test. Every user acknowledged the possibility to better plan maintenance interventions using this tool.

In this section, we have as such given a qualitative validation of the usefulness of the interactive visual intervention planning developed in this thesis.

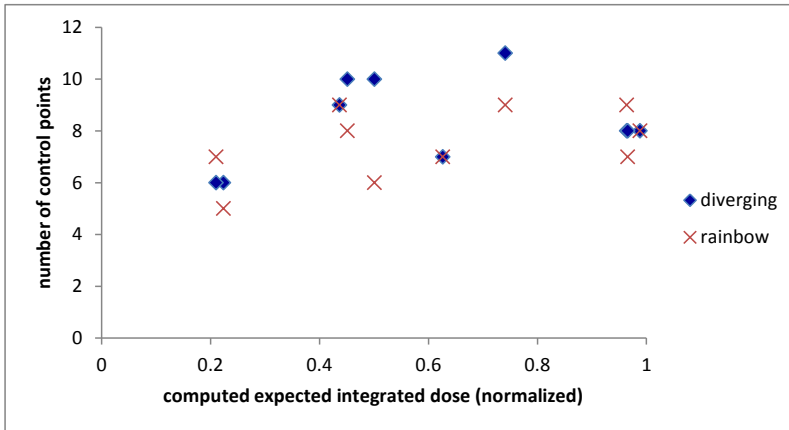

Figure 6.3 – The number of control points plotted against the normalized computed expected integrated equivalent dose per user test instance.

6.2 Quantitative validation

After the qualitative validation, we now move on to the validation of the practical use of the interactive visualisation and planning tool for intervention planning in particle accelerator environments with ionizing radiation is explored. For this, we use intervention planning as part of the design process of a new accelerator facility. Using this case, the proof-of-concept software implemented in the context of this thesis is situated with respect to conventional work and dose planning, and benchmarked against an existing dose planning.

6.2.1 The context of the use case

In this section, we contextualize the use case that is the subject of the quantitative validation. We summarize and remind the reader of the context of work and dose planning as described in section 2.2, while focussing on the aspects that are important for this case study.

For what concerns traditional intervention planning, we can discern two main scenarios: intervention planning as part of the study of a new (accelerator) facility, for estimating the individual and collective doses due to a maintenance or handling activity that is foreseen to be undertaken, or might be needed, in the future; and work dose planning as part of the preparation of an intervention that is scheduled. The first form of intervention planning can be used as part of the design process of a new facility, to optimize future interventions in terms of work dose, by optimizing

the design of the facility. This form of intervention planning will be treated in this case study.

In both of these cases, the start of the intervention planning exercise is the explicitation of the maintenance scenario and listing of the different steps associated with the maintenance activity, and their attributes. These attributes are mainly the location of the workers during the different steps of the intervention, and the duration of each activity in the intervention.

This explicitation of the maintenance scenario is a rather encumbered process, in which many collaborators (radiation protection experts, work planners, equipment owners, maintenance personnel, . . .) are involved. The tools used for this process are mostly two-dimensional maps of a facility, on which locations are approximately indicated (for an example, see figure 6.4 and figure 2.2), and large Excel tables to perform the (mostly manual) dose calculations. A more elaborated explanation of this process was given in section 2.2.

The methods and methodologies we developed can enhance this intervention planning process and turn the work dose planning into software-supported interactive visual intervention planning: the different steps associated with the maintenance can be in-putted in the developed proof-of-concept software program

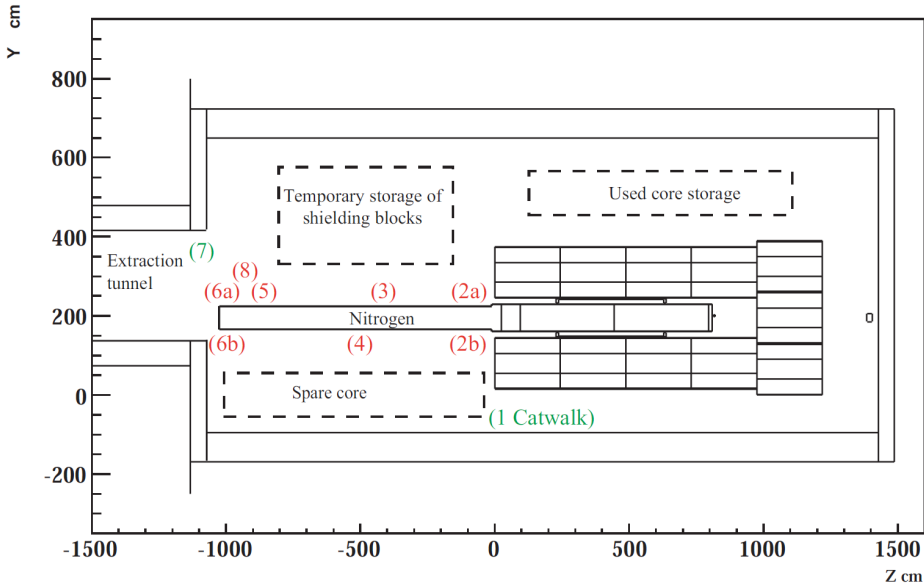

Figure 6.4 – Areas where workers will be situated during a beam dump core replacement intervention in the LHC [155].

and can be visually and interactively be positioned in three dimensions in the facility, with immediate visual feedback of the radiation doses, and can be associated with staying times. From this input, the software can then immediately construct a report, including a dose table and visualisations of the dose rates, for example, potentially making it possible to perform the intervention planning in a more rigorous way.

6.2.2 Visual interactive intervention planning as part of the design process of a new accelerator facility

Linac4 [35] is a new linear accelerator at CERN, designed to provide a pulsed 160 MeV H^- beam. Linac4 will replace the present 50 MeV proton accelerator Linac2 as injector to the CERN accelerator chain [78]. Linac4 will as such become an essential component of the whole CERN accelerator complex, especially considering the future increase of the LHC luminosity [24]. A transfer line will connect Linac4 to the rest of the accelerator complex, as illustrated in figure 6.5(a).

Linac4 is terminated by a dump collecting the beam during the accelerator commissioning phase, during the measurements, and in case of degraded situations of the beam. The material of the beam dump can as such become highly activated. Therefore, an effective shielding surrounding the dump was established in order to limit activation of the structures placed in dump proximity and to protect personnel accessing the machine, for instance during maintenance operations of, or near this beam dump.

As part of the design effort of the beam dump, a detailed Monte Carlo calculation, using the FLUKA particle physics simulation package [38, 75], has been performed in order to optimize the choice of shielding material and its design in accordance with the ALARA principle (see figure 6.5) [39, 41], and to prepare for possible future maintenance operations. Estimations of individual and collective doses for the Linac4 dump replacement and decommissioning are thus used to optimize the design of the dump. Figure 6.6 shows dose rate maps resulting of this study, in their conventional visualisation. A result of this optimization exercise is the report [42].

Preprocessing of the FLUKA data

One way of preprocessing the FLUKA [38, 76] output data for use in intervention planning is to integrate the scored values over a vertical interval of 60 cm, representing the torso of a human being. This way, residual dose rate is converted to effective dose rate. Because full-body irradiation is presupposed, there is no difference between equivalent and effective dose in this case.

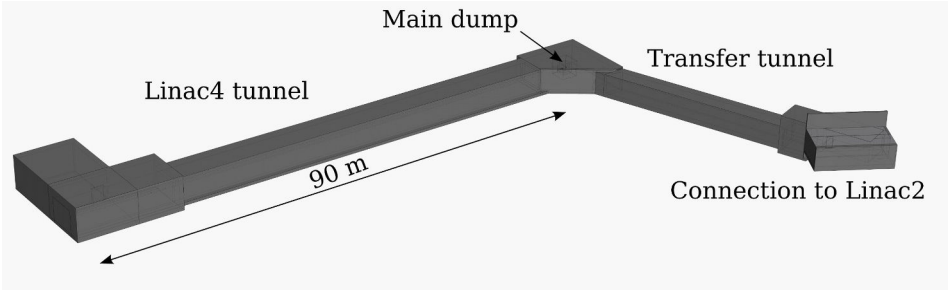

(a)

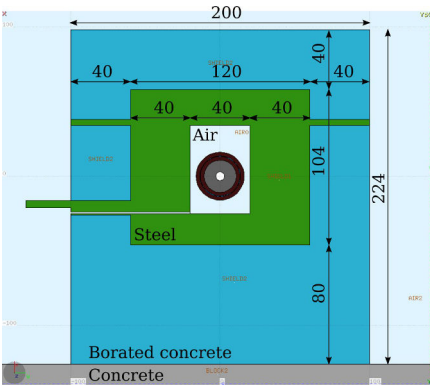

(b)

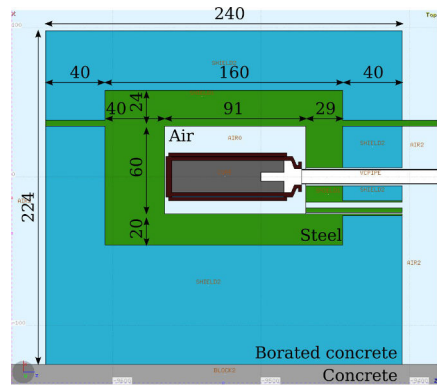

(c)

Figure 6.5 – Fluka geometry of the Linac4 civil engineering (top) and the beam dump shielding (side view (bottom left) and front view (bottom right)) [39, 41].

This preprocessing operation leads to a reduction in dimensionality: in the vertical direction, only one bin/voxel of 60 cm high is retained. This makes the data easier to handle with the traditional work dose planning approach. It however also makes that our software tool’s abilities are not fully leveraged: instead of a fully three-dimensional tool, the tool is factually used as a two-dimensional planning tool, although the visualisation is still three-dimensional and it stays possible to navigate through the facility in three dimensions.

Although with this kind of data it is not possible to fully leverage all features of our software tool, this case study is performed with this data, because this is the data currently available and it also allows us to benchmark the performance of our data processing. It has become clear that also in this scenario, the software tool can be useful.

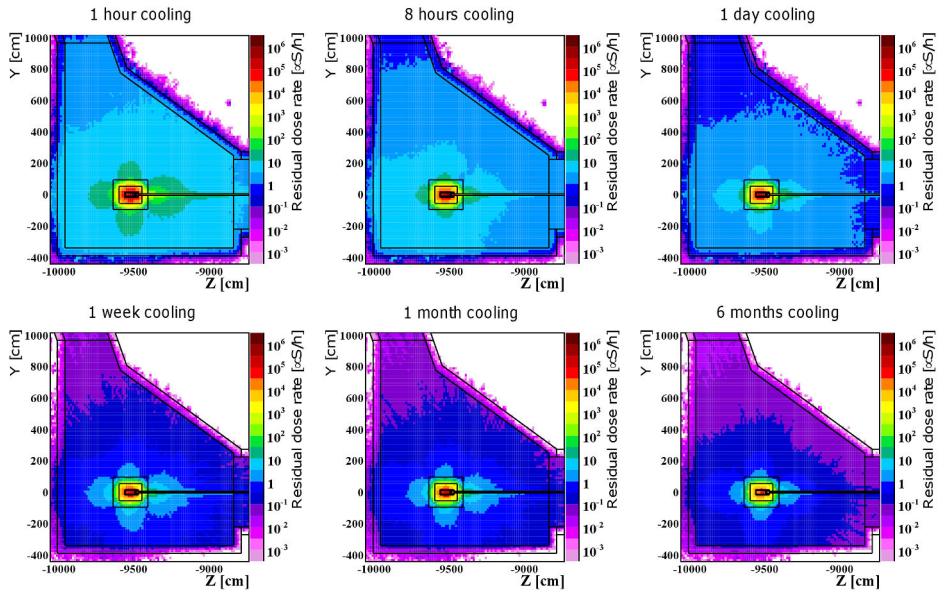

Figure 6.6 – Ambient dose equivalent rate after one month of irradiation with 160 MeV proton beam (2.84 kW beam power) for different cooling times [39, 41].

Trajectory planning around the Linac4 beam dump

Figure B.6(a) shows a volume rendered visualisation of a FLUKA simulation of the Linac4 beam dump area. Other than in the traditional case, radiation data can be visualized together with the facility geometry, and the simulation can be probed. In this way, the position of the worker for a certain activity can be optimised interactively and visually, allowing all stakeholders involvement at once.

Figure B.6(b) shows a volume rendered visualisation of a FLUKA simulation of the Linac4 beam dump area, together with an interactively positioned trajectory that a maintenance worker could be following. The trajectory can also be easily updated by just grabbing and moving the control point location interactively. Trajectory points can also interactively be added or deleted. In figure B.6(c), the trajectory path’s thickness and colour is also modulated according to the underlying simulation data, so that the user of the software can easily spot where on the trajectory the maintenance worker will receive the most dose.

Once this is done, or even in during the making of the trajectory, also staying times can be attached to the various activity locations. This can be seen in figure B.6(c), where three attributes of every control point are shown: a name that can be associated with every control point, the in-putted staying time, and the three-

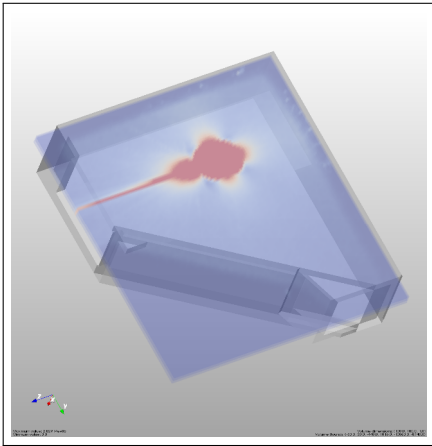

(a) The geometry of the Linac4 beam dump facility, transparently overlaid on the volume rendered simulation data.

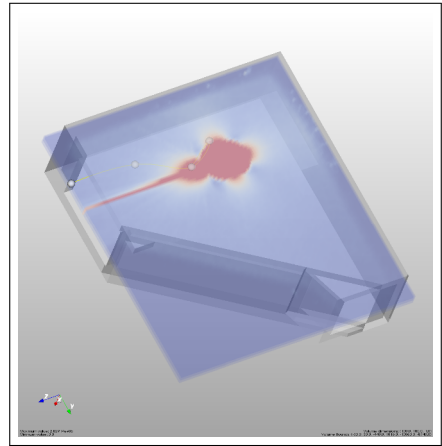

(b) The geometry, volume rendered simulation data and the interactively planned trajectory.

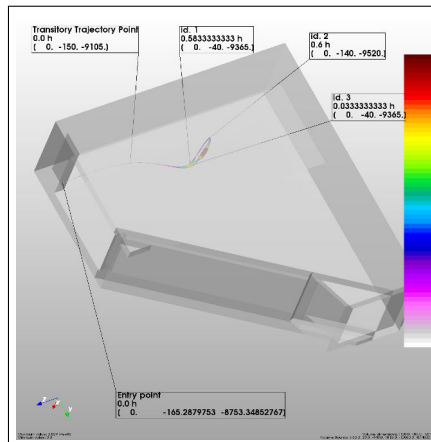

(c) The planned trajectory, with staying times and other control point attributes. The trajectory thickness and colour are modulated according to the dose the maintenance worker will get while passing.

Figure 6.7 – Intervention planning of the Linac4 beam dump replacement.

dimensional coordinates of the control point. These three-dimensional coordinates can be changed by interactively moving the control point, as described before, but can also be in-putted as numbers.

Benchmarking of the trajectory planning around the Linac4 beam dump

For benchmarking and quantitative testing of the software tool, we reproduced part of one of the scenarios that are discussed in [42]. This scenario concerns the preparation of the beam dump equipment for remote opening, following a failure during the reliability run leading to the need for replacement. The steps for this operation are summarized in table 6.2.2. The opening of the beam dump is the first step in the beam dump core replacement.

This operation has been implemented in the tool, as visualized in figure 6.8(a), for a simulation with a cooling time of 1 h¹. The control point annotations indicated in figure 6.8(a) map the control points to the identification numbers in table 6.2.2.

In figure 6.8(b), an impression of the first page of the report that is automatically generated by the software, in PDF format, is visualized. In the current implementation, this report shows the relevant input values of the software (input files and normalization values) and relevant dose planning quantities, as there are the total trajectory length, the total time and total dose, the maximum dose received while working and moving respectively, and the maximum dose received while moving with the relevant trajectory sector. While these quantities have been defined in co-operation with many stakeholders, most notably radiation protection experts, the format of this report is not fixed and will evolve over time until the

1. For real situations, because of practical consideration, 1 h is a very short cooling time, and generally it is recommended to wait longer so that short-lived radionuclides that might be present can decay. For the purpose of this study, we use 1 h as a test case because planning for this data set better illustrates the power of our tool.

id.	Action	Position	Time (min.)
1	Disconnect water, jackets, vacuum chamber	2	15
	Mounting the engine on Shielding	2	10
2	Hang the hoist, lifter	1	15
	Set-up the movable carriage	1	10
	Place the shielded trolley	1	10
	Fix the carriage to shielding	1	1
3	Unlock the movable shielding	2	2

Table 6.1 – Preparation of the beam dump equipment for remote opening if a failure occurs during the reliability run.

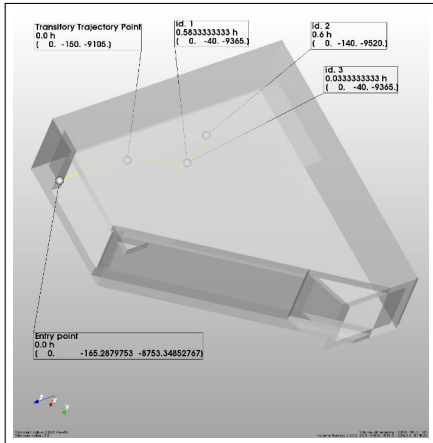

(a) The trajectory for the preparation of the beam dump equipment for remote opening if a failure occurs during the reliability run.

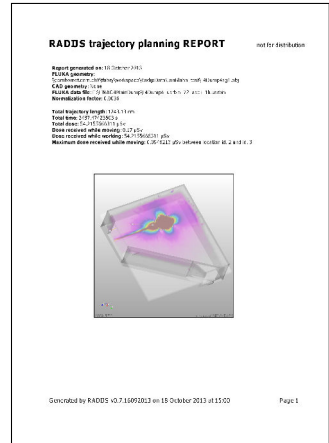

(b) The resulting report, following the software-assisted trajectory planning of the preparation of the beam dump equipment for remote opening if a failure occurs during the reliability run.

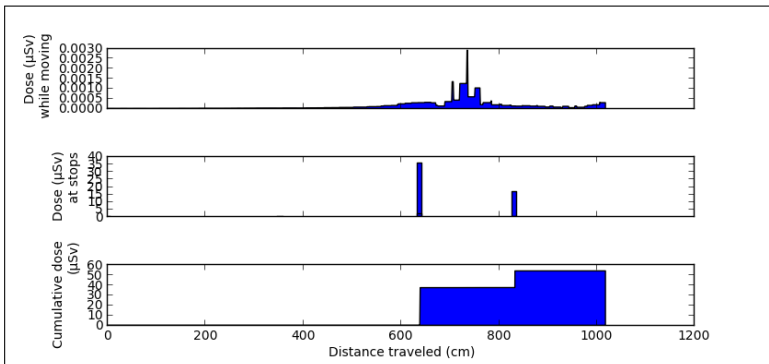

(c) Graphs of the resulting doses, following the software-assisted trajectory planning of the preparation of the beam dump equipment for remote opening if a failure occurs during the reliability run. These graphs are also part of the resulting report.

Figure 6.8 – Intervention planning of the Linac4 beam dump replacement.

final acceptance of the software. Furthermore, the reports include an overview image of the planned trajectory, a table with the various control points that were interactively indicated, with their staying times and resulting dose, and various graphs mapping the dose over the trajectory (see figure 6.8(c)).

The values of the doses are exactly the values that were computed “manually” and written down in [42]. We can see that the time for the worker to be able to move between the different work locations accounts for a dose that makes up ca. 0.3 % of the total received dose, as illustrated in figure 6.8(c). This portion of the total dose is neglected in the traditional dose planning procedure. Whereas in this particular case study this seems indeed justifiable, there are certainly situations in which our software can, by not neglecting the *dose while moving*, add to the radiological safety of the worker. Cases where this is potentially the case are being identified and will form further test cases for our software.

6.2.3 Discussion and conclusion

The software tool for the support of planning interventions in environments with ionizing radiation, that has been developed as an implementation of the work in this dissertation, has been proven relevant using the case study of the replacement of the beam dump core of a new linear accelerator. This case study, which has also been used for benchmarking, has led to the following insights into the technical-scientific benefits that the developed methods and methodologies, implemented in a software tool, may lead to. It has also allowed us to identify some challenges the software will have to face.

Benefits

From the text above, it may be clear that the developed methods and methodologies and prototype software has many benefits, of which we list the most important here:

- The trajectory and work dose planning becomes more approachable. This not only has benefits for the usual planning personnel, but also unlocks the trajectory and dose planning results to a wider range of stakeholders in the intervention.
- The trajectory and work dose planning becomes more apt to be used in a collaborative fashion, uniting multiple stakeholders with different requirements, better suited for the current HEP big science project organisation.
- The proposed software exploits the simulation data that is already available in a more visual, accessible way.

- Accuracy is potentially gained in the intervention planning process, because also dose during movement is taken into account, and because of the visually interactive features of the software that permit more accuracy than a manual planning. This point will be discussed further in section 6.3.

Challenges

In its current form, the developed software can only deal with mono-simulation scenarios, meaning only situations where the activated equipment (or other sources of radiation) is static. In the case of the Linac4 beam dump replacement and decommissioning scenarios that were described before, this means that the trajectory planning has to be done in multiple steps, according to the number of simulations that have to be used. It is currently under consideration to implement support for multiple simulation scenarios, where care will have to be taken not to diminish the user-friendliness of the application by adding the necessary extra features for this update.

The interactiveness of the software is a big asset, but at the same time it can also be a burden to process a big number of datasets. While it is entirely possible to use a maintenance planning session, and keep all the (visually and interactively) in-putted arguments of the planning while changing the underlying simulation data, it can still be is still tiresome to do this with a large number of simulations (for instance for different cool-down times). It is currently under investigation if a 'batch mode' can be integrated in the software while not loosing out of sight the original idea of a collaborative, easy-to-use visual and interactive intervention planner.

6.3 Accuracy of the dose planning

In consonance with the qualitative and quantitative validation of interactive visual intervention planning, it is very instrumental to look at the accuracy of the dose planning. In this section, we in consequence discuss and illustrate how the accuracy of the trajectory and intervention planning in the software implementation of the scientific method developed in this dissertation is influenced by a variety of parameters and circumstances.

In line with the previously proposed mathematical model for planning of interventions in an environment with ionizing radiation [72], the software computes

the equivalent dose H contracted by the maintenance worker as:

$$\hat{H} = \underbrace{\sum_{i=0}^N t_i \dot{H}(m_i)}_{\text{stationary dose}} + \underbrace{\frac{1}{v} \sum_{l=0}^q \frac{\dot{H}(s_l) + \dot{H}(s_{l+1})}{2} \|s_l s_{l+1}\|}_{\text{dose while moving}}, \tag{6.1}$$

with:

- \hat{H} the approximation of the equivalent dose H ,
- N the number of locations m_i ,
- $t_i = [t_{s_i}, t_{e_i}]$ the estimated time spent at location m_i , which may correspond to a task duration τ_k , in case a task is to be executed at m_i , with start time t_{s_i} and end time t_{e_i} ,
- $\dot{H}(p)$ the dose rate at point p in three-dimensional space,
- v the speed of the maintenance worker, and
- q the number of discretization steps,

which is a discretization of the equation (3.4) for a maintenance worker performing an intervention \mathcal{I} mapped on a trajectory \mathcal{T} , as defined in chapter 3.

Compared to the traditional work dose planning procedure, accuracy is gained in at least three ways:

- In traditional work dose planning, only “stationary dose” term in equation (6.1) is taken into account. The second term, which stands for the dose received during movement, is considered negligible. While this can be justified in many intervention scenarios, sometimes it cannot be justified. An example of the latter is the preparation of a maintenance activity in a highly-radioactive area, where a person first goes on a ‘scouting’ mission to take pictures of the state of the equipment, for planning of the intervention.
- The visually interactive features of the software permit a more accurate positioning of the points of interest in the facility.
- The easiness with which one can add control points of the spline and as such activity locations as part of the trajectory planning will allow for a more fine-grained planning, which will lead to a gain in accuracy.

The effect of the discretization can be considered negligible, as the discretization steps are typically much smaller than the simulation resolution, i.e. the voxel/bin size. To allow maximum flexibility, the software tool currently implements a setting so that the user can very easily choose a value for the discretization size for the trajectory. This number is by default set to a value that has empirically been shown to be more than sufficient, so that no user-friendliness is lost because the user typically does not need to care about this setting.

The accuracy of the results of the software tool for intervention and dose planning that we developed can also be influenced negatively by at least three issues. These issues are not specific to the software-supported trajectory planning, but are also present in the traditional trajectory/work dose planning procedure.

The first source of possible inaccuracies is the inherent uncertainty of the Monte Carlo simulations. Monte Carlo algorithms rely on repeated random sampling to obtain numerical results. They are a great tool when it is not feasible to apply a deterministic algorithm, as is the case in the simulations that are of interest here, but as they are a statistical approximation to the physical results, there is an inherent limit to their accuracy. This limit is also influenced by the accuracy in mimicking the real world of the Monte Carlo algorithm itself.

For this, it is relevant to mention again that FLUKA has been extensively benchmarked for radiation protection purposes [154, 54, 65, 55, 52], and has been proven to be sufficient for this purpose.

The second and third source of inaccuracy lies in the fact that equation 3.4 is in fact a simplification of [11]:

$$\begin{aligned}
 E &= \sum_{i=0}^N \int_{t_{s_i}}^{t_{e_i}} \sum_T \left(\iiint_{V_p(t)} \rho_p(x, y, z, t) \dot{\mathcal{H}}(x, y, z, t) dx dy dz \right) dt \\
 &+ \sum_{i=0}^{N-1} \int_{s=m_i}^{m_{i+1}} \|S_i\|^{-1} \int_{t=t_{s_j}}^{t_{e_j}} \sum_T \left(\iiint_{V_T(t)} \rho_p(x, y, z, t) \dot{\mathcal{H}}(x, y, z, t) dx dy dz \right) dt ds
 \end{aligned} \tag{6.2}$$

with:

- N the number of locations m_i ,
- $t_i = [t_{s_i}, t_{e_i}]$ the estimated time spent at location m , which may correspond to a task duration τ_k , in case a task is to be executed at m , with start time t_{s_i} and end time t_{e_i} ,
- $t_j = [t_{s_j}, t_{e_j}]$ the estimated time spent at location s on the path S_i between m_i and m_{i+1} , with start time t_{s_j} and end time t_{e_j} ,
- $\|S_i\|$ the path length of path S_i ,
- $t_{e_j} = t_{s_j} + \|S_i\|v_i^{-1}$,
- v_i the speed of the maintenance worker,
- T the tissue type, here to be interpreted as the different organs of the person performing the intervention,

- $V_T(t)$ the volume of organ T , which is time-dependent as elaborated above,
- $\rho_p(x, y, z, t)$ the density of organ p of the subject, which is time-dependent as elaborated above,
- $\dot{\mathcal{H}}(x, y, z, t)$ the dose-equivalent rate at point (x, y, z) in three-dimensional space, at time t .

The difference between equation (6.2) and equation (6.1) lies in two separate approximations that have been made. The first one is the time-dependency of the radiation field that has been neglected. Indeed, as we currently work with one set of FLUKA simulation data per trajectory planning instance, the radioactive decay over the time of the intervention is not accounted for. As the simulation for an intervention that is used is always one at a time point at the start of the intervention, this can only leads to an overestimate of the resulting dose, thus not negatively impacting the radiological safety. Because of the particularity of the radiation field around high energy accelerators, the time dependence of the radiation field should be calculated with a Monte Carlo simulation such as FLUKA, which would result in a large number of three-dimensional simulation results which should then be appropriately processed by the proposed software. Technically, this is certainly possible, as the toolbox that is used for the visualisation is capable of handling time-dependent volumetric data [132, 88, 30]. Computing the time dependence would however make the FLUKA simulations even more computationally and time intensive.

The second approximation that is visible when comparing equations (6.2) and (6.1) lies in the fact that the human phantom used in equations (6.1) is reduced to one single three-dimensional location. Given the fact that the dose are in real-life also measured at one point in three-dimensional space using a personal dosimeter, this is a natural approximation. If it would be possible to make very detailed Monte Carlo simulations, leading to very low uncertainties with regard to all of the aforementioned aspects, it might become instrumental to have detailed human phantom be implemented in software. It would take a considerable research and development effort to integrate an existing human phantom into any visualisation software [168]. Another open question is how to decouple the human phantom from the simulations, if possible at all, with a satisfactory accuracy, in order to be able to load the simulation data and the phantom independently into the planning software.

6.4 Conclusion

To conclude this chapter, we summarize its content. We have validated the work that is the subject of this thesis: scientific methods and methodologies for interactive visual intervention planning in particle accelerator environments with ionizing

radiation through the use of the proof-of-concept software that was developed as an implementation of these methods and methodologies.

First, we have performed a qualitative validation of the interactive visual intervention planning through a user test. From the results of the test, we were able to conclude that the implementation of the work developed in this thesis is well-suited for the intended purpose.

Next, we performed a practical, quantitative validation of the interactive visualisation and planning tool for intervention planning in particle accelerator environments with ionizing radiation. This was done using a case study: visual interactive intervention planning as part of the design process of a new accelerator facility. Through this case study, the proof-of-concept software that was implemented has been situated and given a place into the current intervention and dose planning procedures. The software has also been benchmarked against an existing dose planning.

Finally, we discussed and illustrated how the accuracy of the trajectory and intervention planning in the software is influenced by a variety of parameters and circumstances.

Chapter 7

Conclusion

This thesis has discussed how radiation protection can be implemented in facilities emitting ionizing radiation, from a technical-scientific point of view, and has included the conception of related methodologies and software tools.

More in particular, this thesis has addressed the need for an interactive visual intervention planning tool in the context of high energy particle accelerator facilities.

In this final chapter, the main topics of this dissertation are summarized in section 7.1. The original contributions of this work are highlighted in section 7.2. Possible avenues for future research are outlined in section 7.3.

7.1 Summary

In **chapter 2**, the concepts of the radiation protection were introduced. We introduced the radiological protection system, starting with the legal context and its scientific roots. The radiological protection system notably includes the principle of *justification, optimization and limitation*, and the *ALARA* principle, which stands for “As Low As Reasonably Achievable”. Also the system of work and dose planning were introduced, and explained with the current situation at CERN as an example. Finally, the scientific-mathematical bases of radiation protection were described. They serve as the basis for the next chapter.

In **chapter 3**, intervention planning in environments with ionizing radiation was discussed from a scientific-mathematical point of view. Intervention planning was first formalized into a scientific-mathematical model. This model was then integrated with radiation protection, leaning on the scientific-mathematical bases

of dose evaluation and the radiological protection system as described in the previous chapter. The model was worked up from the simplest workable model, and elaborated using more detailed radiological protection concepts into a model perfectly suitable to the purpose of intervention planning in environments with ionizing radiation. The model was then assessed for use in computer-aided intervention planning. A further theoretical elaboration was thereafter given illustrating the power of the model – showing that it can go beyond the current state-of-the-art in work and dose planning – and exhibiting its flexibility, including in the light of possible future development of radio-biological knowledge. The intervention planning itself was given a closer look in the light of the novel model, and its implications on the development of technical-scientific computer-assisted planning tools were discussed.

In **chapter 4**, we took a step back and looked at the research problem in this dissertation from a systems engineering point of view. We in particular discussed how the research on intervention planning in environments with ionizing radiation can be integrated with the development of a proof-of-concept software tool for interactive visual intervention planning, and treated this from a systems engineering perspective. We thus contributed to the important question of adapting a relaxed systems engineering approach in complex multi-disciplinary research projects.

In **chapter 5**, the technical-scientific aspects of interactive visual intervention planning in particle accelerator environments with ionizing radiation were discussed. The starting point for this has been the state of the art and related work, which accentuates the scientific rationale for the necessity of the work developed in this thesis. An overview of the technical-scientific tools for three-dimensional radiation mapping, and an investigation of the most relevant three-dimensional visualization software packages and libraries in this context were also given. Following this study, interactive visualization of the facility geometry of facilities with ionizing radiation, together with the radiation levels, and interactive visualization of trajectory information in the context of the mathematical model developed in **chapter 3** were discussed. This was followed by a discussion about the processing of the planning: the numerical mathematical calculation of the equivalent dose of the planned interventions, and the following reporting. As more and more, the importance of software and good software practices in research are acknowledged, we also discussed the software that has been developed to support the methodology developed in this dissertation, and in particular the software architecture of the developed software tool.

Chapter 6 presented a validation of the developed scientific methods and methodologies for interactive visual intervention planning in particle accelerator environments with ionizing radiation, through studies involving the use of the proof-of-concept software that was developed as an implementation of these methods and methodologies. We qualitatively proved the usefulness of the interactive visual intervention planning through a user test. From the results of the test, we

concluded that the implementation of the work developed in this thesis is well-suited for the intended purpose. The practical use of the interactive visualisation and planning tool was explored supported by a case study: visual interactive intervention planning as part of the design process of a new accelerator facility. The proof-of-concept software that was implemented was in this way situated and given a place into the current intervention and dose planning procedures. The software has also been benchmarked against an existing dose planning exercise. Finally, we have discussed how the accuracy of the trajectory and intervention planning in the software is influenced by a variety of parameters and circumstances.

7.2 Contributions

Throughout this work we have aimed to perform quality research with the intention of providing a scientific-mathematical framework and a proof of concept implementation of a technical-scientific software tool for interactive visual intervention planning in particle accelerator environments with ionizing radiation. We believe that it is time to unite scientific computing, mathematical modelling in radiation protection and operational radiation protection at high energy particle accelerators, and we hope that this dissertation may serve as a foundation and an inspiration for future work, both in applied scientific computing and visualization and its applications in radiation protection.

The main contributions of this thesis are:

- The development of a novel model for intervention planning in environments with ionizing radiation. The model is novel in the sense that it combines intervention planning knowledge with radiation protection concepts, and does this in a sound scientific-mathematical form.
- A theoretical elaboration of the integration of this model with radiation protection, illustrating the power, flexibility and future-proofness of the model.
- The development of a relaxed systems engineering approach for complex multi-disciplinary research projects, tackling the important question of the feasibility of adapting a relaxed systems engineering approach in research projects.
- A profound treatment of the core technical-scientific aspects of interactive visual intervention planning in particle accelerator environments with ionizing radiation, leading to a proof-of-concept tool for computer-aided interactive visual intervention planning.
- Bringing three-dimensional visualization and treatment of simulation data to radiation protection, where radiation protection applications used to only make use of two-dimensional visualizations.

- A qualitative and quantitative validation of the newly developed scientific methods and methodologies for interactive visual intervention planning developed, including a study of the accuracy hereof.

7.3 Future work

There are different possible directions for future research, in any of the four sciences on the crossroad of which this thesis was developed: visualization science, scientific data analysis, radiation protection and computer science.

7.3.1 Visualization science

In chapter 6, the developed software and the used visualization techniques have been validated qualitatively. The qualitative study can give way for a larger, more quantitative user test, giving insight in the interplay of the various parameters of the visualization and the aptness of the visualization for the intended purpose.

In a user test that has been partially pursued, but has not been described in this thesis because of the non-representativeness of the population that have been contacted as subjects, several parameters of volume rendering have been tested using several test scenarios. The parameters that have been tested in first instance were: the presence of shading, different colour maps, the nature of the three-dimensional projection method (perspective or parallel projection) and different standard volume rendering technique. The test scenarios that were proposed were:

- Hotspot localization in artificially created volumes with data with the same behaviour as ionizing radiation. For this scenario, statistical evaluation of the outcome is possible based on the distance between the divined hotspot location and the real hotspot location, both in the three dimensions separately as combined into one Cartesian distance. An example of this kind of artificially created volume data with different parameter sets is displayed in figure 7.1.
- Controlled trajectory planning where the begin and end point of the trajectory and the maintenance activity location are predefined and fixed. The user has to strive to minimal radiation doses for the intervention. Statistical evaluation of the outcome can here be based on computed dose as a result of the user-generated trajectory, the length of the user-generated trajectory, and the number of control points the user preferred in his trajectory planning, among others.
- Uncontrolled trajectory planning, similar to the former case, but without fixed trajectory points. The equipment on which the maintenance activity

has to be performed has to be indicated in the scenery. Statistical evaluation of the outcome can be done similarly as the former case.

On top of the statistical evaluation proposed above, also qualitative evaluation by user comments can be very instrumental.

When planning to perform a similar test, care has been taken to not under-estimate the time needed for the test, the large implication that is asked from the test subjects, notably in time investment, the fact that advanced statistical methods have to be used for the evaluation of the user tests and the fact that the parameter space for this kind of user tests explodes very quickly.

These user tests can also lead to new developments in visualization techniques and to the development of new visualization techniques intended for the visualization of radiation levels in large facilities. Furthermore, possibilities lie in the implementation of even more advanced visualization methods. One interesting

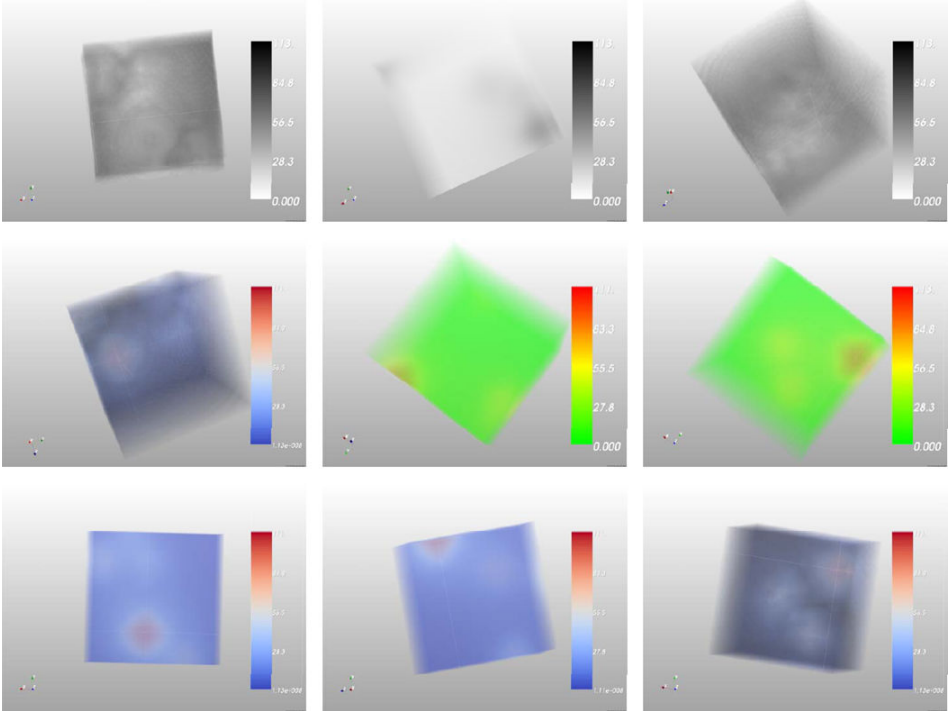

Figure 7.1 – An example of artificially created volume data with the same behaviour as ionizing radiation, including hotspots, with different parameter sets for user evaluation.

direction for future research is the visualization of uncertainties in the radiation levels, be it on the full volumetric data or on the simulated trajectory. Another interesting direction for future research could lie in the development of special shaders for volume renderers of the specific data of concern here, to improve intuitive visualization of dose levels.

Another axis of research is to add Augmented Reality (AR) to the developed software, in a way that the intervention planning can also be used to train the maintenance workers for the upcoming intervention, giving them real-time feedback on radiation levels. The training could also be implemented using Virtual Reality (VR). In this case, it would be possible to stage the intervention on a digital mock-up of the facility of interest, having the system track the intervening person while he is moving around. This way, it would be possible to get dose values which really reflect the operational steps instead of a somewhat simplified path. In addition, the user could be provided on-the-fly with dose feedback, intervention instructions, etcetera. This digital mock-up could be a physical mock-up equipped with relevant sensors and displays, but could also be implemented as a CAVE-like system [64, 63]. It is expected that it will be possible to largely re-use the Augmented Virtuality (AV) code base that was developed in the framework of this dissertation.

7.3.2 Scientific data analysis

In terms of scientific computing, one direction of future research is how to make manual measurements usable for volumetric visualization. The interpolation of measured radiation levels is a very complex task, because of the plethora of unknowns in both the spacial, temporal and functional domains: unknown can be the spacial distribution of the sources of radiation (the activated material), the exact distribution of radioactive isotopes which give rise to different temporal decay functions, and the exact material composition of the surrounding material. One interesting possibility for the development of a relevant interpolation method would be the maximum-likelihood estimation, using the measured data as observed data and simulations data as a prior.

7.3.3 Radiation protection

The integration of more radiological protection scenarios present a challenging direction for future work. One example would be to use the developed methodology and software not only for pre-intervention planning, but also for post-intervention analysis. This would involve the development of an advanced personal dosimeter with in-facility localization, which could be feeded back into the developed model and software.

7.3.4 Computer science

Throughout the whole work of the development of technical-scientific methodologies and software tools for the implementation of radiation protection, we have kept the context of the multiple stakeholders in mind. This has amongst others lead to the relaxed systems engineering approach discussed in chapter 4, and the fact that the mathematical model has been kept as simple as possible, while not giving up any flexibility or rigorousness. These contributions could be established further into design and architecture guidelines for the development of such software.

On top of these more scientific suggestions for future work, there is a lot to do implementation-wise:

- Integration of the developed software with the current work and dose planning via the import and export of different file formats, e.g. Excel tables.
- The implementation of a batch function, as suggested in chapter 6.
- Implementation of the possibility to import multiple input simulations in order to test multiple radiological scenarios.
- etc.

Appendices

Appendix A

Use cases

This appendix presents use cases (functional requirements) for a technical-scientific software tool for visual and interactive intervention planning in infrastructures emitting ionizing radiation.

A.1 Visualise FLUKA simulation data

Scope RADIJS application

Level User goal

Primary actor RADIJS user (intervention planner)

Stakeholders and Interests

- RADIJS user: Wants to visualise the FLUKA simulation data to have a better view on the radiation levels in the context and to be able to plan the intervention.
- Maintenance worker: Wants to have a visual idea of the radiation levels in the context to be able to prepare the maintenance work.
- FLUKA simulation performer: has to supply the data.

Basic Flow

1. User supplies the file with the FLUKA simulation data to load.
2. User clicks "Load".
 - (a) System loads data.
3. User selects the checkbox "show FLUKA data".
 - (a) System shows data.
4. User can interactively change the visualisation parameters (camera, colour map, ...)

Alternate Flows

- * User can alter the FLUKA data loading parameters.
 - If this is done before 2. then the loading is performed with these parameters.
 - Otherwise the data is reloaded.
- * User can alter the data visualisation parameters.

Special Requirements None

Technology and Data Variations List FLUKA simulation data input formats:

- Cartesian USRBIN
- XYZ (rebinned with SimpleGeo)
- (cylindrical USRBIN)
- (radial USRBIN)

Frequency of Occurrence High (for every maintenance planning)

Open Issues

- What input formats should we support and to what level?
- How do we get hold of information not contained in the FLUKA usrbn format, such as kind of simulation, units, ...?

A.2 Visualise FLUKA geometry data

Scope RADIJS application

Level User goal

Primary actor RADIJS user (intervention planner)

Stakeholders and Interests

- RADIJS user: Wants to visualise the FLUKA geometry together with the FLUKA simulation data to have a better view on the radiation levels in the context and to be able to plan the intervention.
- Maintenance worker: Wants to have a visual idea of the radiation levels in the context to be able to prepare the maintenance work. The FLUKA geometry helps in interpreting these radiation levels.
- FLUKA simulation performer: has to supply the data.

Basic Flow

1. User supplies the file with the FLUKA simulation geometry to load.
2. User clicks "Load".
 - (a) System loads data.
3. User selects the checkbox "show FLUKA geometry".
 - (a) System shows data.
4. User can interactively change the visualisation parameters (camera, colourmap, ...)

Alternate Flows

- * User can alter the geometry visualisation parameters.

Special Requirements None

Technology and Data Variations List FLUKA simulation data input formats:

- Wavefront OBJ format (from SimpleGeo)

- STL format (from SimpleGeo)
- (VRML format)
- (FLUKA geometry input cards)

Frequency of Occurrence High (for every maintenance planning)

Open Issues

- What input formats should we support and to what level?
- Should we implement the possibility to directly load FLUKA geometry input cards?

A.3 Plan intervention

Scope RADIJS application

Level User goal

Primary actor RADIJS user (intervention planner)

Stakeholders and Interests

- RADIJS user: Wants to be able to plan the intervention on beforehand, in a visual and interactive way, based on FLUKA simulations.

Basic Flow

1. Trajectory planning (see use case [A.3](#)).
2. Stationary intervention planning (see use case [A.3](#)).

Alternate Flows The sub use cases can be repeated many times as needed and re-ordered in any possible way.

Special Requirements None

Technology and Data Variations List None

Frequency of Occurrence High (for every maintenance planning)

Open Issues See sub use cases [A.3](#) and [A.3](#).

Plan trajectory

Scope RADIJS application

Level subfunction

Primary actor RADIJS user (intervention planner)

Stakeholders and Interests

- RADIJS user: Wants to be able to plan the intervention trajectory on beforehand, in a visual and interactive way, based on FLUKA simulations.

Basic Flow

1. User selects checkbox "Show trajectory".
2. User manipulates trajectory.
 - User moves the control points of the trajectory.
 - User can delete control points.
 - User can add control points.

Alternate Flows

2. Items can be repeated many times as needed and re-ordered in any possible way.
- * User can change the resolution of the trajectory, to be used in the report generation (see use case [A.5](#)).

Special Requirements None

Technology and Data Variations List None

Frequency of Occurrence High (for every maintenance planning)

Open Issues

- What is the best suited mathematical trajectory description (spline)?

Plan stationary interventions

Scope RADIJS application

Level subfunction

Primary actor RADIJS user (intervention planner)

Stakeholders and Interests

- RADIJS user: Wants to be able to plan the stationary interventions on beforehand, in a visual and interactive way, based on FLUKA simulations.

Basic Flow

1. User selects checkbox "Show staying times" while the checkbox "Show trajectory" is checked.
2. User indicates a staying time per control point in the trajectory.
 - If the user does not specify a staying time, a default value of 0 is displayed and recorded.
 - User can add control points.
 - User can delete control points.

Alternate Flows

2. At any time, any staying time can be altered.

Special Requirements None

Technology and Data Variations List None

Frequency of Occurrence High (for every maintenance planning)

Open Issues

- What is the best way to handle the staying time units?

A.4 Save session

Scope RADIJS application

Level User goal

Primary actor RADIJS user (intervention planner)

Stakeholders and Interests

- RADIJS user: Wants to be able to temporarily suspend the intervention planning and resume later.

Basic Flow

1. User selects menu action "File > Save Session".
2. User indicates path and file name.
3. System saves session/file.

Alternate Flows

1. User selects menu action "File > Load Session".

2. User indicates path and file name.
3. System loads session/file.

Special Requirements None

Technology and Data Variations List

- Save session by Python pickling of a settings class.

Frequency of Occurrence Occasionally

Open Issues

- Which settings to save?
- Is pickling the best way to save the session.
- Include the FLUKA geometry and simulation data in the session file?

A.5 Generate report

Scope RADIJS application

Level User goal

Primary actor RADIJS user (intervention planner)

Stakeholders and Interests

- RADIJS user: Wants to be able to communicate the planned intervention with all its parameters and computed parameters.
- Maintenance worker: Has to be informed about the intervention he will be performing.
- Manager: Has to approve the intervention based on the generated report.
- Other stakeholders: Have similar interests.

Basic Flow

1. After the user has made the trajectory, user presses the button "Generate Report"
2. The system generates the report.
3. The system displays a pop-up window with the report.

Alternate Flows

4. The user presses the button "Generate PDF" in the report pop-up window.
5. The user indicates path and file name.
6. The system generates and saves a PDF of the report of the planned intervention.

Special Requirements None

Technology and Data Variations List

- PDF generator

Frequency of Occurrence High (for every maintenance planning)

Open Issues

- Other output formats that PDF needed?
- PDF layout?

Appendix B

Needs analysis & Specification explicitation

B.1 Current situation

At CERN, the Radiation Protection Group (RP), part of the HSE Unit (Occupational Health & Safety and Environmental Protection Unit) ensures that personnel on the CERN sites and the public are protected from potentially harmful effects of ionizing radiation linked to CERN activities. The RP Group fulfils its mandate in collaboration with the CERN departments owning or operating sources of ionizing radiation and having the responsibility for Radiation Safety of these sources. The RP Group thus assesses the hazards of ionizing radiation and radioactivity from existing and future CERN installations and their associated risks for personnel and members of the public. Two modalities that the RP group uses herefore and that are of interest for us, are

1. simulations of radiation levels and other radiological quantities after operation of CERN infrastructure (accelerators and experiments), and
2. manual measurements (surveys) of these quantities.

B.1.1 Radiation level simulations

For simulating radiation levels and other radiological quantities after operation of CERN infrastructure (accelerators and experiments), the RP group mainly uses FLUKA. “FLUKA is a fully integrated particle physics Monte Carlo simulation package. It has many applications in high energy experimental physics and

engineering, shielding, detector and telescope design, cosmic ray studies, dosimetry, medical physics and radio-biology” [22, 38, 76]. The results of these simulations are most often visualised using the FLUKA Advanced Interface (FLAIR). For an example of this kind of visualisations, see figure B.1. Typically, these are the kind of visualisations used for the communication between RP and the other people involved in the specific accelerator/experiment projects. See for example [153].

B.1.2 Measurements

Before the RP group authorizes (or suspends) maintenance operations in areas where ionizing radiation is (possibly) present, the RP group performs manual measurements of the radioactivity level in the concerned areas, see figure B.2. The measurements are then used for assessment of the hazards of ionizing radiation and radioactivity in CERN installations and their associated risks for personnel and members of the public, but are not visualised or communicated in a visual manner. Only numbers are communicated, e.g. the to-be-expected radiation levels at x cm of a collimator.

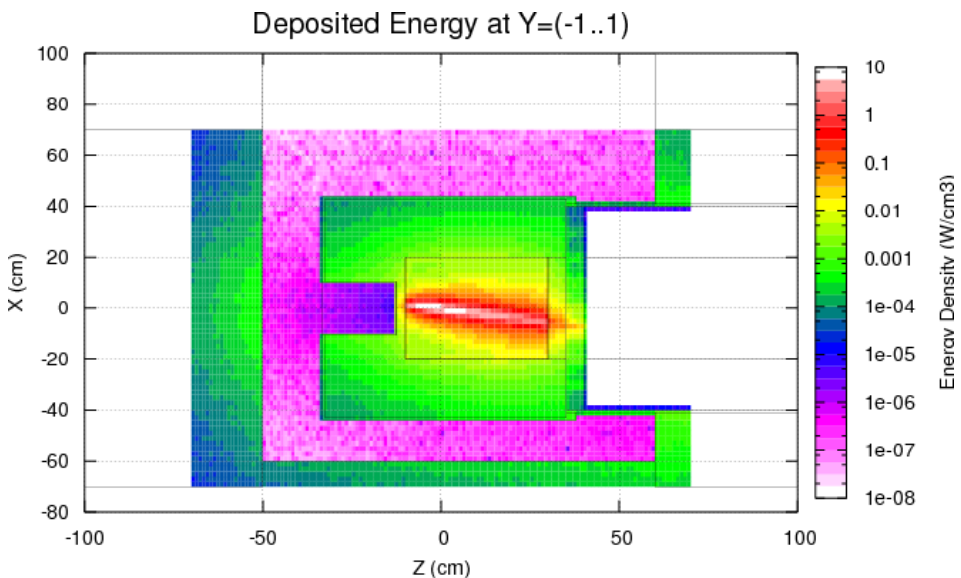

Figure B.1 – FLUKA simulation visualised using FLAIR (figure from the FLUKA website [22]).

B.1.3 Conclusion

From the discussion of the current situation, it is clear that powerful 3D visualisation techniques are not yet consequently used for the visualisation of radiation levels at CERN. It will therefore be very interesting to assess the possibilities of this kind of visualisation techniques.

B.2 User needs

In every project, be it an Information Technology (IT), construction, industrial, organisational change or new service development project, identifying customer needs is of key importance for the successful termination of the project [147].



Figure B.2 – Manual measurements of radiation levels.

Although this project is a research project, it is no exception in that the needs are important to start with. But, identifying needs is also “the most difficult, most critical, most error prone and most communication-intensive aspect of software development” [160]. In addition, the needs will typically be more easily changed during a research project than during any other project.

We commenced our project by gathering raw data from potential users of our end product. Because this is a research project, we decided to go for a low-profile way of needs gathering, trying to capture “What, Not How”. We did not organise formal *customer panels*, but attended various meetings and spoke in an informal, non-intrusive way about the potential applications of software for visualisation of radiation levels with people that are concerned with this type of problem.

Section B.2.1 lists the needs gathering actions we undertook so far. This way, we avoided that preliminary discussion of needs resulted in the future user of the software telling us what he thinks he wants rather than what he really needs. It should be noted that for research projects, the potential users or customers of the end product are less specifically defined than is the case for many other projects. The caveat of gathering design details (e.g. “I want the button to be orange if this condition is true”) instead of the real requirements (e.g. “I need a way of letting the user of the software know that this condition is active”) is in this case thus much more pronounced than in other projects. Therefore, we tried to keep the number of gathered and interpreted needs as low as possible. The list of appendix B.2.1 is growing, and as the project moves ahead, more specific actions will be taken.

The output of this study is written down in table B.1, where the needs are organised as a hierarchy [44]. The table has been kept compact to keep room for innovative solutions, research problems and not to fix design details too early. Table B.2 shows the relative importance of the interpreted needs. This summary could be the basis for a more extensive document on design requirements.

As a closing remark for this section, we quote Steve Jobs: “You can’t just ask customers what they want and then try to give it to them. By the time you get it built, they’ll want something else”. Although the needs study is thus very important, it is also important to not give too much importance to each and every one of the needs, and to always be knowledgeable about what will be feasible with the future state of technology and within the time and other constraints of the project.

Potential user statement	Interpreted need
“I do not understand the current visualisations issued by the RP group”	1. Intuitive visualisation 1.1. CAD-like visualisation of geometry
“It is not easy to interpret the 2D plots that are provided by the RP group to us now.”	2. “Easy-to-read” visualisation

	2.1. 3D visualisation
	2.2. Interactive visualisation
“The software has to be usable by me and my colleague.”	3. Easy-to-use software
	3.1. Intuitive interaction possibilities
	3.2. Intuitive GUI
“I want to be able to install the software on my laptop.”	3.3. Usable on normal PC hardware
“It would be nice to have an app on my smartphone.”; “I have an Apple computer. Will it work on my computer as well?”	3.4. Easily installable
	3.5. Cross-platform
“I want to be able to compare the results of different simulations in a clear way, e.g. I want to see the radiation levels with and without an additional concrete wall.”; “I want to be able to select objects and hide them, to get a clearer view of other objects.”	4. 3D interaction possibilities
	4.1. 3D on/off interaction possibilities
“I want to be able to see the radiation measurements from different viewpoints”	4.2. 3D camera interaction possibilities
“ I want to be able to zoom in on areas that are of special interest to me.”	4.2.1. Free movements of camera
“Even though I prefer three-dimensional views to two-dimensional views, I sometimes get lost in the three-dimensional representations. It would be good to have an option where I can see labels of objects, or labels of zones, or maybe the beam direction.”	4.2.2. Camera zoom
	4.3. 3D labels
“I want to be able to save my “user session”.”	5. Possibility to save program status/scenarios
“I want to be able to export a two-dimensional image to use in my presentations.”	6. Possibility to export 2D images
	7. Possibility to import simulation data
	7.1. Possibility to import from FLUKA

	8.	Possibility to import geometry
	8.1.	Possibility to import a 3D file format
	9.	Possibility to import measured data
"I want the program to be able to compute radiation doses when I input a maintenance scenario"	10.	Possibility to input various scenarios
	10.1.	Possibility to input trajectories
	10.2.	Possibility to input trajectory properties, such as moving speed
	10.3.	Radiological calculations

Table B.1: Customer needs table.

	Interpreted need	Estimated importance
1.	Intuitive visualisation	***
1.1.	CAD-like visualisation of geometry	***
2.	"Easy-to-read" visualisation	***
2.1.	3D visualisation	***
2.2.	Interactive visualisation	***
3.	Easy-to-use software	***
3.1.	Intuitive interaction possibilities	***
3.2.	Intuitive GUI	***
3.3.	Usable on normal PC hardware	**
3.4.	Easily installable	**
3.5.	Cross-platform	*
4.	3D interaction possibilities	***
4.1.	3D on/off interaction possibilities	**
4.2.	3D camera interaction possibilities	***
4.2.1.	Free movements of camera	***
4.2.2.	Camera zoom	***
4.3.	3D labels	*
5.	Possibility to save program status/scenarios	*
6.	Possibility to export 2D images	*
7.	Possibility to import simulation data	***
7.1.	Possibility to import from FLUKA	***
8.	Possibility to import geometry	***
8.1.	Possibility to import a 3D file format	***

9.	Possibility to import measured data	★
10.	Possibility to input various scenarios	★★★
10.1.	Possibility to input trajectories	★★★
10.2.	Possibility to input trajectory properties, such as moving speed	★★★
10.3.	Radiological calculations	★★★

Table B.2: Customer needs table: importance mapping.

B.2.1 User needs gathering: actions taken

This list documents the interactions we had with potential users of our to-be-developed 3D radiation mapping software tool:

- Informal discussions with Handling Engineering personnel.
- Brainstorming with the Handling Technologies section leader.
- Informal discussions with the other PURES SAFE fellows.
- Discussions with Radiological Protection personnel.
- Attending meeting about TAX interventions.
- Discussions during the Radiation Protection Course.
- Informal discussions with CERN colleagues.

The information gathered in this way is completed with:

- Study of CERN documentation (edms.cern.ch).
- Literature study.
- Study of available solutions.

**Planification visuelle et
interactive d'interventions dans
des environnements
d'accélérateur de particules
émettant des rayonnements
ionisants**

Résumé en français

Les radiations sont omniprésentes dans notre environnement. Elles ont de nombreuses applications dans des domaines variés : en médecine, elles permettent de réaliser des diagnostics et de guérir des patients ; en communication, tous les systèmes modernes utilisent des formes de rayonnements électromagnétiques et en science, les chercheurs les utilisent pour découvrir la composition et la structure des matériaux, pour n'en nommer que quelques-unes.

Concrètement, la radiation est un processus au cours duquel des particules ou des ondes voyagent à travers différents types de matériaux. Une radiation peut être très énergétique, et aller jusqu'à casser les atomes au sein de la matière. Dans ce cas, on parlera de radiation ionisante. Le plus souvent, le mot radiation est utilisé en référence à la radiation ionisante.

Il est communément admis que les rayonnements ionisants peuvent être bien plus nocifs pour les êtres vivants que les radiations non ionisantes. Il ne faut pas en déduire pour autant qu'un rayonnement non ionisant est toujours dépourvu d'effets.

Dans ce rapport, nous traiterons de la radiation ionisante. La radioactivité est le processus d'émission des radiations ionisantes. Elle existe sous forme naturelle, et est présente dans les sols, dans l'air et notre planète entière est bombardée en permanence de rayonnements cosmiques énergétiques. Depuis le début du XX^e siècle, les chercheurs sont capables de créer artificiellement de la matière radioactive. Cette découverte a permis de multiples avancées technologiques, mais a eu également de lourdes conséquences pour l'humanité comme l'ont démontré les événements de Tchernobyl et de Fukushima, ainsi que d'autres accidents dans le monde médical.

Cette dangerosité a conduit à l'élaboration d'un système de radioprotection. Il est d'une importance capitale notamment parce que la radiation n'est pas un phénomène perceptible et visible pour l'homme.

En pratique, la radioprotection est principalement mise en œuvre en utilisant la méthode ALARA ou ALARP. Cette méthode consiste à justifier, optimiser et limiter les doses reçues. Elle est utilisée conjointement avec des limites législatives. Le principe ALARA permet de caractériser la dose reçue dans un contexte donné. Le facteur d'optimisation est contraint par le fait que l'exposition volontaire d'un travailleur aux radiations lors d'une opération doit être plus bénéfique que si aucune intervention humaine n'était conduite dans une situation donnée.

Dans le monde industriel et scientifique, il existe des infrastructures qui émettent des rayonnements ionisants. La plupart d'entre elles nécessitent des opérations de maintenance qui devront être dans la majorité des cas conduites par des techniciens qui seront exposés à des radiations ionisantes.

Dans l'esprit du principe ALARA, ces interventions doivent être optimisées pour réduire l'exposition des travailleurs aux rayonnements ionisants. Cette optimisation ne peut pas être réalisée de manière automatique car la faisabilité des interventions nécessite dans tous les cas une évaluation humaine. La planification des interventions peut cependant être facilitée par des moyens techniques et scientifiques comme par exemple un outil informatique. Le développement d'un tel outil est un processus complexe pour trois raisons : premièrement cela requiert de pouvoir combiner la visualisation de l'infrastructure, les niveaux de rayonnements à l'intérieur de l'infrastructure ainsi que la nature et le déroulement des interventions elles-mêmes. Deuxièmement, la visualisation doit être intuitive pour pouvoir être utilisée par tous les intervenants impliqués et être exploitable dans différents scénarios. Troisièmement, le programme concerne la sécurité des personnes et de ce fait ne doit laisser aucune prise aux ambiguïtés.

Dans le contexte décrit ci-dessus, cette thèse regroupe des considérations techniques et scientifiques, et présente la méthode utilisée pour développer des outils logiciels pour la mise en œuvre de la radioprotection

En particulier, cette thèse traite de la nécessité de développer un outil interactif de planification visuelle utilisable dans les infrastructures disposant d'accélérateurs de particules à hautes énergies, notamment en se demandant comment les techniques de visualisation actuelles peuvent être appliquées ou adaptées afin d'optimiser les interventions humaines dans de telles infrastructures.

1. Introduction

Dans ce chapitre, nous présentons d'abord le contexte de cette thèse, sur trois niveaux. Par la suite, nous introduisons le domaine de la radioprotection, après quoi la motivation et les objectifs de cette thèse sont discutés.

Context

Le contexte général de ce travail est le contexte du projet PURESAFE¹. PURESAFE est un acronyme pour "Preventing hUman intervention for incrREased SAfety in inFrastructures Emitting ionizing radiation", soit en français "prévention d'interventions humaines pour une sécurité accrue au sein d'infrastructures émettant des rayonnements ionisants". L'objectif scientifique de ce projet est le développement des modèles, méthodes et outils, avec pour but d'améliorer la radioprotection au sein des laboratoires scientifiques émettant des rayonnements ionisants, en particulier

1. PURESAFE est un projet européen financé par les actions Marie Curie du septième programme-cadre de la Commission Européenne.

des installations d'accélérateurs de particules. Le projet de PURES SAFE est un projet multi-disciplinaire, dans lequel le projet de recherche de cette thèse s'inscrit.

Le principal champ d'application du projet PURES SAFE est l'environnement des accélérateurs de particules ou les laboratoires de physique des hautes énergies. La physique des hautes énergies ou physique des particules, est une branche de la physique moderne étudiant les plus petits constituants connus de la matière. Les outils essentiels de la physique des particules sont des accélérateurs et détecteurs de particules, qui sont des instruments scientifiques très vastes et complexes [106, 166]. Au fil du temps, les besoins de la physique des particules ont progressé vers des énergies toujours plus élevées (d'où le terme de physique des hautes énergies), conduisant à des machines de plus en plus grandes et complexes. Celles-ci se composent d'un nombre important de sous-systèmes eux-mêmes complexes, ce qui impose d'inévitablement d'interventions d'entretien et de maintenance.

Outre les avantages qu'apportent les accélérateurs et les détecteurs à la recherche exploratoire en physique fondamentale, la circulation et les collisions de faisceaux de haute énergie dans ces accélérateurs ont aussi une conséquence indésirable : l'activation radiologique de certains des composants de l'accélérateur [151]. Cette activation conduit à la présence de rayonnements ionisants, rendant certaines parties des laboratoires de physique des particules des environnements de travail hostiles. Les stratégies visant à atténuer le risque d'irradiation comprennent, entre autres, l'optimisation de la conception de l'équipement pour faciliter la maintenance et la manipulation, la mise en œuvre de solutions de télérobotique, et la mise en œuvre d'outils pour une meilleure planification des interventions.

Le cas spécifique d'un laboratoire scientifique pour la physique des hautes énergies qui est souvent cité dans cette thèse est la situation au CERN. L'Organisation Européenne pour la Recherche Nucléaire (CERN), est l'un des plus grands laboratoires scientifiques au monde, avec pour vocation de fournir et d'opérer les outils nécessaires à la recherche en physique fondamentale. Toutefois, le contenu de cette thèse est valable pour les installations d'accélérateurs de particules en général, et par extension pour de nombreuses installations présentant des rayonnements ionisants, par exemple le Joint European Torus (JET) [119], le réacteur thermonucléaire expérimental international (ITER) [36] et le centre de recherche sur les ions lourds (GSI) [137]. Le fait que la thèse ait été développée au CERN implique que certains choix de conception ont été faits en ayant ce contexte spécifique à l'esprit, mais ne limite pas la mise en œuvre des méthodologies développées dans des autres contextes.

Radioprotection

La *radioprotection* [166, 62, 139, 136] est un terme qui englobe la radiophysique, les technologies associées et leur implémentation pour la protection des êtres humains

et de l'environnement contre les effets biologiques nocifs des rayonnements ionisants.

La radioprotection est définie par des limites juridiques nationales, qui proviennent principalement des recommandations de commissions d'experts internationaux telles que la Commission Internationale de Protection Radiologique (CIPR, en anglais International Commission on Radiological Protection ou ICRP) [25]. Ces recommandations sont fondées sur les connaissances scientifiques actuelles en radiobiologie. La radioprotection est un domaine en pleine évolution, et dont les lacunes sont actuellement comblées par l'application du principe de précaution.

Pour protéger le personnel d'entretien des rayonnements ionisants lors d'interventions dans, par exemple, des accélérateurs et détecteurs de particules ou dans certaines installations industrielles avec rayonnements ionisants, il est fait appel à l'approche dite ALARA [5, 82]. ALARA est l'acronyme de l'expression anglophone "As Low As Reasonably Achievable" (aussi bas que raisonnablement possible). Cette approche consiste en la justification, l'optimisation et la limitation de la dose reçue par tous ceux qui ont besoin de travailler sur ou à proximité de composants activés. Pour cette raison, une question centrale lors de la planification d'une intervention d'entretien dans des environnements avec des rayonnements ionisants est l'optimisation de la dose reçue par les travailleurs.

Cette optimisation ne peut pas être automatisée. La planification d'interventions pourrait cependant être facilitée par l'utilisation d'un outil logiciel aux capacités de visualisation en trois dimensions. Le développement d'un tel outil est une entreprise complexe pour au moins trois raisons. Tout d'abord, la visualisation doit inclure l'infrastructure, les niveaux de radiation et les paramètres d'intervention. Deuxièmement, la visualisation doit être intuitive pour toutes les parties prenantes du processus de planification d'interventions et utilisable dans différents scénarios. Troisièmement, la planification d'interventions concerne la sécurité humaine, et il n'est donc pas permis d'avoir d'ambiguïté quelconque.

La mise en œuvre de la radioprotection

Le contexte au CERN peut être considéré comme représentatif de la situation au sein des établissements scientifiques possédant des infrastructures émettant des rayonnement ionisants. Le travail décrit dans cette thèse a été réalisé au CERN, et en premier lieu pour le CERN, mais a bien entendu une utilité dépassant ce contexte. Les méthodes et les outils développés peuvent en être extraits et sont valables en général pour les laboratoires de physique des hautes énergies, et au-delà.

Une investigation détaillée de la situation actuelle au CERN concernant la mise en œuvre de la radioprotection nous conduit à la conclusion que le processus de planification d'interventions intègre des outils de simulation conformément avec

l'état de l'art actuel, mais le potentiel des simulations en trois dimensions ainsi que des autres données collectées n'est pas pleinement exploité.

Le traitement scientifique des sujets dans cette thèse inclut une analyse des possibilités de mise en œuvre des processus scientifiques et des applications techniques pour la radioprotection. Ceci inclut une réponse au besoin d'un outil de planification visuelle et interactive d'interventions dans des environnements d'accélérateur de particules émettant des rayonnements ionisants, en traitant la question : comment l'état de l'art en matière de techniques de visualisations modernes peut-il être appliqué ou adapté pour optimiser des interventions humaines dans des infrastructures avec rayonnements ionisants ?

Les principales questions de recherche sont :

- Comment peut-on améliorer la sécurité dans des installations scientifiques à travers l'application de la science et de la technologie ?
- Comment peut-on exploiter la connaissance scientifique et mathématique, combinée à l'innovation technique, pour agir dans l'intérêt de la radioprotection dans les installations scientifiques émettant des rayonnements ionisants ?
- Comment valider les méthodes techniques et scientifiques développées et les outils pour la mise en œuvre de la radioprotection ? Ceci inclut une investigation qui démontre comment un logiciel technico-scientifique peut être utile dans des environnements de collaboration scientifique comme le CERN.

2. Radioprotection

Le but de ce chapitre est de fournir une introduction sur la radioprotection et les bases et principes du système de radioprotection. Le système de travail et de planification de la dose provenant de normes de radioprotection est aussi discuté. En particulier, les bases scientifiques et mathématiques de la radioprotection qui sont appliquées dans le reste de la thèse sont présentées.

La radioprotection est d'abord traitée d'un point de vue légal. Le document le plus important dans le contexte professionnel actuel est une série de recommandations de la Commission Internationale de Protection Radiologique (CIPR) de 2007 (CIPR 103) [11], qui servira de base pour les futures législations nationales. Ensuite, les trois principes sur lesquels la radioprotection s'appuie sont décrits : le principe de justification, le principe de limitation et le principe d'optimisation. Nous traitons également de la méthode ALARA, qui peut être considérée comme une implémentation pratique de ces principes. Tout cela est ensuite illustré par une explication de la procédure de *work and dose planning*, en utilisant le CERN comme cas d'étude.

Suivant ce traitement général de la radioprotection, nous étudions les bases scientifiques et mathématiques de la radioprotection. Ici sont présentées les principales quantités propres à la radioprotection.

S'appuyant sur la dose absorbée (D), l'énergie déposée par unité de masse par un rayonnement ionisant, la radioprotection définit des quantités de protection, qui ne sont pas des quantités physiques *sensu stricto*. La dose équivalente (H) est une grandeur physique mesurant l'impact sur les tissus biologiques d'une exposition à des rayonnements ionisants. Elle se définit comme la dose absorbée corrigée d'un facteur de pondération du rayonnement qui prend en compte la "dangerosité" relative du rayonnement considéré. La dose efficace ($H_{\text{eff}} = E$) est une grandeur de radioprotection mesurant l'impact sur des tissus biologiques spécifiques d'une exposition à des rayonnements ionisants. Elle se définit comme la dose absorbée corrigée de facteurs sans dimension prenant en compte d'une part la dangerosité relative du ou des rayonnements considérés et d'autre part la sensibilité du tissu irradié. La dose collective (S) est également mentionnée, et est une grandeur exprimant les effets des rayonnements non pour un individu, mais pour une population. Pour finir, des simulations numériques pour la radioprotection sont discutées.

3. Planification d'interventions dans des environnements radioactifs

Dans ce chapitre, la planification d'interventions dans des environnements d'accélérateur de particules émettant des rayonnements ionisants est discutée. Chaque sujet traité est examiné dans le contexte de la planification d'interventions assistée par ordinateur.

Dans cette optique, un modèle mathématique de la planification d'interventions puissant mais accessible est défini.

Une **intervention** \mathcal{I} est un ensemble de **tâches** T_k qui doivent être accomplies par le personnel de maintenance, chacune avec une description précise et une durée estimée τ_k :

$$\mathcal{I} = \{T_k; \quad k = 0, 1, \dots, K\}. \quad (\text{B.1})$$

La tâche T_0 correspond à l'entrée de l'installation par le travailleur ; la tâche T_K correspond à la sortie de l'installation. Les tâches T_k sont les tâches qui doivent être effectuées au cours de l'intervention.

Un **trajectoire** \mathcal{T} se compose d'une série d'**emplacements** m_i , avec $i = 0, 1, \dots, N$. A chaque emplacement m_i , le travailleur passera un temps t_i .

Le **chemin** entre deux emplacements consécutifs m_i et m_{i+1} est noté S_i , avec $i = 0, 1, \dots, N-1$. Chaque chemin S_i est parcouru par le travailleur de maintenance à une vitesse v_i .

Le planificateur de l'intervention construira la trajectoire \mathcal{T} avec une intervention \mathcal{I} à l'esprit, construisant ainsi le lien entre \mathcal{I} et \mathcal{T} . Par conséquence :

$$\forall T_k \in \mathcal{I} : T_k \text{ est affecté à } m_i \text{ and } t_i = \tau_k, \quad (\text{B.2})$$

$$\forall m_i \in \mathcal{T} \text{ et } \nexists T_k \text{ est affecté à } m_i : t_i = 0, \quad (\text{B.3})$$

avec $K \leq N$.

Pour une représentation schématique de ce modèle, voir figure B.3.

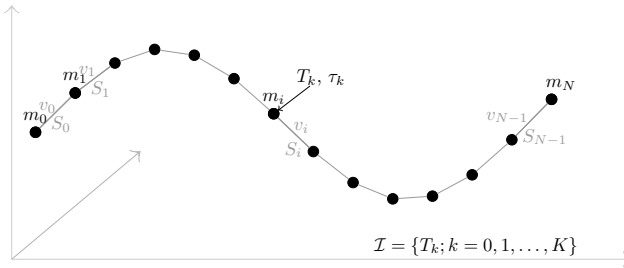

FIGURE B.3 – Schéma du modèle mathématique pour la planification des interventions.

Les concepts de la planification d'interventions ainsi définis peuvent être intégrés parfaitement avec les concepts techniques et scientifiques de la radioprotection, comme définis par la CIPR et traités dans le chapitre précédent. Ceci est fait sur trois niveaux dans ce chapitre. D'abord, l'intégration du modèle avec les concepts existants de la radioprotection est discutée du point de vue des pratiques actuelles. Ensuite, cette intégration est élaborée au-delà de ces pratiques en intégrant tous les concepts définis par le CIPR, suivi par une évaluation critique de cette intégration. Une élaboration plus étendue, purement théorique, est enfin donnée. Enfin, sur base de tout ceci, nous élaborons le processus d'optimisation au sein de la planification des interventions.

4. Une approche d'ingénierie des systèmes

L'un des aspects du projet PURES SAFE, dans lequel les travaux décrits dans cette thèse s'inscrivent, est l'intégration d'une approche d'ingénierie des systèmes dans la méthodologie de recherche. De ce fait, le cycle de vie de l'ingénierie des systèmes,

adapté aux particularités des travaux de recherche menés dans cette thèse, est une partie intégrante de la recherche elle-même.

Dans ce chapitre, nous expliquons comment la recherche sur la planification visuelle et interactive d'interventions peut être intégrée avec le développement d'un logiciel de démonstration de faisabilité pour la planification visuelle et interactive d'interventions dans des environnements d'accélérateur de particules émettant des rayonnements ionisants, tout en implémentant les méthodes et les méthodologies développées dans le cadre de cette thèse. Ce processus est intégralement décrit dans ce chapitre, d'un point de vue de l'ingénierie des système.

Y est discuté le cycle de vie complet du processus de développement d'un logiciel interactif de planification d'interventions. Dans ce chapitre, le processus de développement de logiciels est considéré comme le point focal de l'effort de recherche, sans pour autant négliger les aspects techniques et scientifiques des réalisations discutées.

Le chapitre commence en introduisant notre travail et en le positionnant vis à vis de l'ingénierie des systèmes en général et ainsi que de la littérature de gestion de projet. Ensuite, le cycle de vie de l'ingénierie des systèmes spécifique tel qu'il a été développé dans le cadre de ce projet est discuté, en examinant ses différentes phases. Une visualisation de ce cycle de vie est présentée dans la figure B.4.

Ensuite, le logiciel résultant de ce processus intégré dans le cycle de vie est discuté, en tant que résultat de la mise en œuvre de cette méthodologie. Finalement, une discussion d'une éventuelle perspective pour la poursuite du développement du

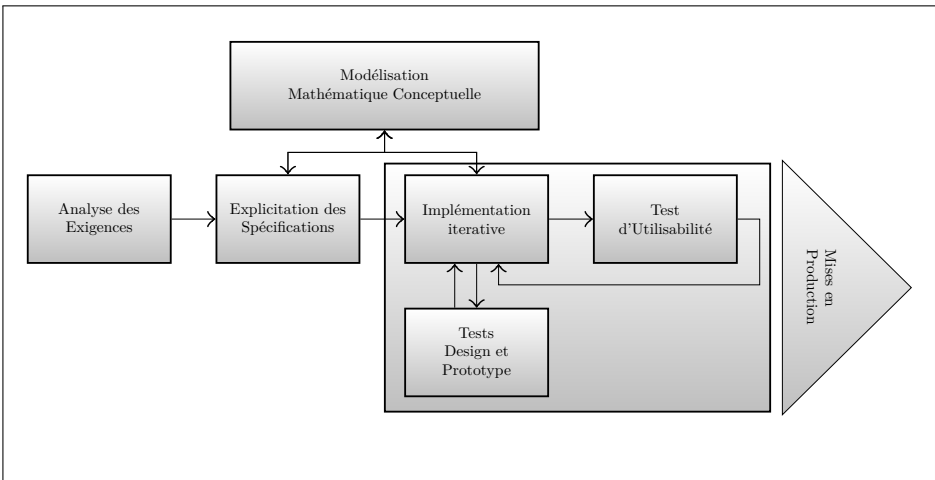

FIGURE B.4 – Le cycle de vie pour le développement d'un logiciel de planification d'interventions interactive.

cycle de vie d'ingénierie des systèmes est menée.

Ce chapitre est conçu comme une unité autonome. L'essentiel de son contenu a été publié dans [74].

5. Une approche technico-scientifique

Dans ce chapitre, le sujet traité est relatif aux aspects techniques et scientifiques fondamentaux de la planification interactive et visuelle d'interventions dans des environnements émettant des rayonnements ionisants.

Le point de départ est l'état de l'art et les travaux connexes, afin d'accentuer la justification scientifique et la nécessité de la recherche développée dans cette thèse ainsi que la mise en œuvre de ses résultats. Après un aperçu des outils techniques et scientifiques de cartographie de rayonnement tridimensionnel, on discute également les paquetages et bibliothèques logicielles les plus pertinents pour la visualisation tridimensionnelle.

Suite à cette étude est traitée la visualisation interactive de géométries d'environnements radioactifs, ainsi que des niveaux de rayonnement, et la visualisation interactive des informations de trajectoire. Tout ceci est discuté dans le contexte du modèle mathématique développé antérieurement.

Ceci est suivi d'une discussion sur le traitement des données concernant la planification des interventions : le calcul de la dose équivalente des interventions prévues, et les rapports subséquents.

Tous ces aspects techniques et scientifiques de la planification interactive et visuelle d'interventions sont importants pour la mise en œuvre de la méthodologie et du modèle développé dans le logiciel. La discussion sur chacun de ces aspects comprend donc des indices pour le développement du logiciel. Suite à ces considérations, le logiciel qui a été développé pour soutenir la méthodologie développée dans cette thèse est décrit, notamment en ce qui concerne son architecture.

Un aperçu de l'interface du logiciel en question est donné par figure B.5.

Certaines parties de ce chapitre ont été publiées dans [73].

6. Validation

Dans ce chapitre sont validées les méthodes et méthodologies scientifiques de planification interactive et visuelle des interventions dans des environnements émettant des rayonnements ionisants développées dans le cadre de cette thèse. Cette

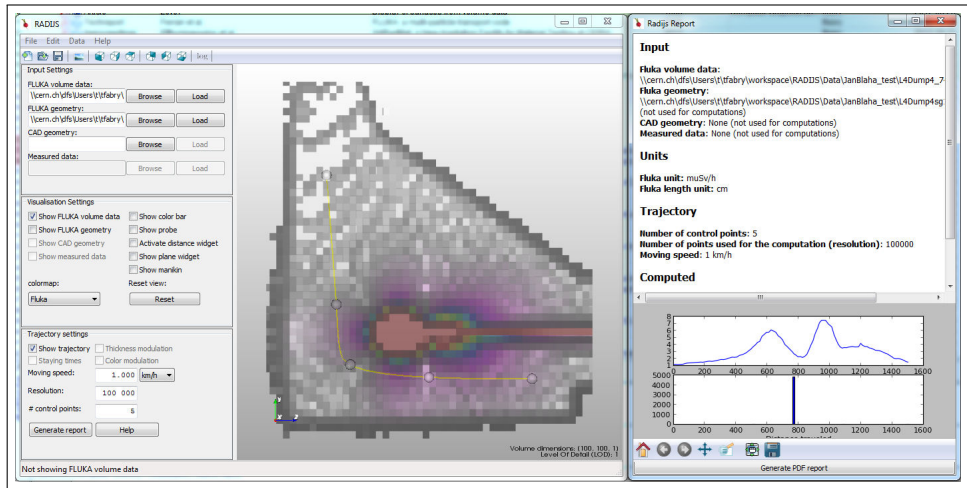

FIGURE B.5 – Le logiciel de planification d'interventions.

validation est effectuée en exploitant le logiciel prototype développé implémentant ces méthodes et méthodologies sur des cas d'études réel tiré du contexte du CERN.

D'abord, une expérience de faisabilité qualitative du planificateur d'interventions interactif et visuel est effectuée, en faisant appel à un test utilisateur. En se basant sur les résultats de ce test, on peut conclure que l'implémentation du travail établi dans le cadre de cette thèse est adapté à l'usage prévu. Cette expérience a été publiée dans [72].

Ensuite, une expérimentation a été effectuée à l'aide d'un prototype de logiciel, afin de démontrer la valeur ajoutée apportée par l'utilisation de la planification visuelle interactive à la planification d'interventions dans des installations d'accélérateurs de particules émettant des rayonnements ionisants. Cette expérience est réalisée à travers un cas d'étude réel : la planification interactive et visuelle dans le cadre d'une procédure de conception et optimisation de design d'un nouvel accélérateur de particules linéaire, des procédures de manutention de ce nouvel accélérateur et de la nouvelle installation qui l'accueille. Ainsi, le nouveau logiciel prototype est testé sur des procédures de planification concrètes, en s'appuyant sur une situation réelle : le remplacement du noyau du *beam dump* de cet accélérateur de particules linéaire qui est en phase d'installation au CERN. En même temps, une analyse comparative du nouveau logiciel et des procédures de planification de des activités avec prise en compte des paramètres radiologiques est menée. Ce travail a été publié dans [71].

La figure B.6 présente des différents aspects de cette expérience. La figure B.6(a) présente un rendu volumique d'une simulation radiologique de l'environnement du

beam dump en question. Cette figure montre, entre autres, que, contrairement aux visualisations traditionnelles, les données radiologiques peuvent dans le cas de notre logiciel être visualisées ensembles avec la géométrie des environnements (bâtiments, équipements, ...). La simulation peut également être sondée interactivement et numériquement en utilisant les outils qui font partie intégrante du logiciel prototype. De cette façon, les positions de la personne concernée par la simulation peuvent être optimisées pour chaque activité concernée, et ceci interactivement et visuellement. Cette façon de faire permet également à toutes les parties prenantes d'être impliquées ensembles dans toutes les phases d'optimisation et de conception de l'intervention.

La figure B.6(b) présente également un rendu volumique de la même simulation radiologique de l'environnement du *beam dump* en question, combiné cette fois-ci avec une trajectoire. Cette trajectoire est créée de façon interactive en entrant dans le programme les positions successives de la personne concernée durant l'intervention. Elle peut facilement être mise à jour : il suffit de déplacer l'emplacement des points de contrôle, et ceci toujours de manière interactive. Il est également possible de supprimer ou ajouter des points de contrôle.

La figure B.6(c) présente la même trajectoire, cette fois-ci visualisée en modulant son épaisseur et sa couleur suivant des données radiologiques. De cette manière, l'utilisateur du logiciel peut très facilement se faire une idée des endroits de sa trajectoire qui vont être les plus critiques en termes de dose de radiations. La figure B.6(c) montre également la possibilité donnée à l'utilisateur du logiciel d'associer des durées de séjour aux emplacements où le personnel va effectuer certaines activités en lien avec l'intervention modélisée. Il est visible sur la figure que l'utilisateur du logiciel peut associer trois paramètres à tout point de contrôle : un nom, un temps de séjour et des coordonnées tridimensionnelles. Typiquement, ces dernières coordonnées sont entrées de manière interactive, comme décrit précédemment. Elles peuvent cependant également être spécifiées de manière numérique.

Pour terminer le chapitre, une analyse de précision est menée, et la fidélité de la planification de l'intervention, y compris celle de la trajectoire, est examinée. Nous discutons comment des paramètres et conditions diverses et variés peuvent influencer le fonctionnement de la planification d'intervention assistée par ordinateur. Ce travail a été publié dans [71].

7. Conclusion

Bilan des contributions réalisées

Au cours de ce travail de thèse, l'objectif a été de faire de la recherche de qualité dans le but de fournir un cadre scientifique et de développer un logiciel prototype

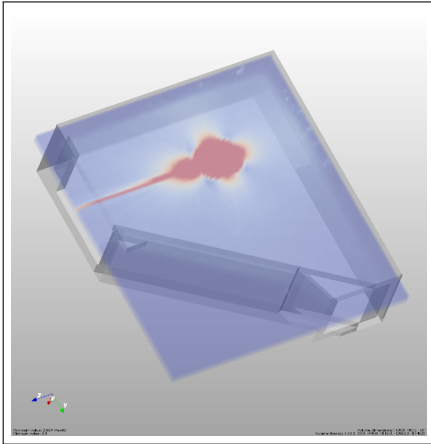

(a) La géométrie de l'installation du *beam dump* de Linac4. La géométrie des bâtiments et visualisée en transparence et superposée sur un rendu volumique des données de simulation radiologique.

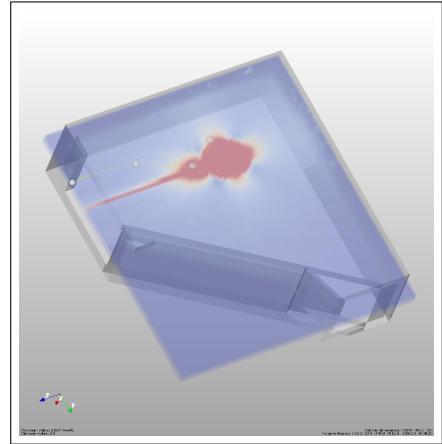

(b) La géométrie, le rendu volumique de la simulation radiologique, et la trajectoire, éditée de manière interactive.

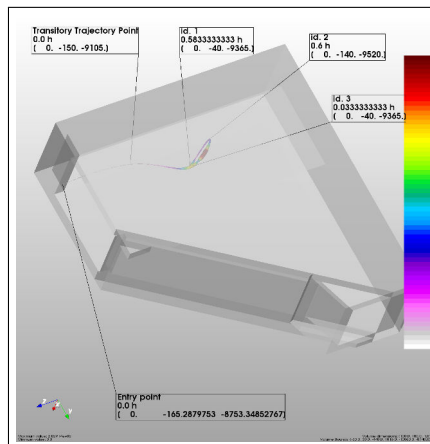

(c) La trajectoire planifiée, avec temps de séjour et les autres attributs des points de contrôle. L'épaisseur et la couleur de la trajectoire sont modulées suivant la magnitude des données radiologiques sous-jacentes.

FIGURE B.6 – Planification de l'intervention pour le remplacement du *beam dump* de Linac4.

de planification visuelle et interactive d'interventions dans des installations d'accélération de particules émettant des rayonnements ionisants, afin de mettre en application le cadre scientifique développé au dans nos recherches. Cela montre que l'unification des disciplines de calcul scientifique, modélisation mathématique, radioprotection et radioprotection opérationnelle peuvent non seulement contribuer à améliorer des aspects opérationnels de la physique des particules, mais aussi mener à des défis scientifiques très intéressants, dans les domaines de calcul scientifique et de la visualisation numérique, ainsi que leurs applications dans le domaine de la radioprotection. On peut donc espérer que ce travail va servir de base pour ces nouveaux domaines de la science.

Les contributions principales du travail décrit dans cette thèse sont :

- Le développement d'un modèle original pour la planification d'intervention dans des environnements émettant des rayonnements ionisants. Le modèle est original dans le sens où il combine le savoir-faire de la planification des interventions avec les concepts scientifiques de la radioprotection, et ceci d'une façon scientifiquement et mathématiquement judicieuse.
- Une élaboration théorique de l'intégration de ce modèle avec la radioprotection, illustrant la puissance, la flexibilité et les possibilités futures du modèle.
- Le développement d'une approche d'ingénierie des systèmes *relaxée*, ciblant des projets de recherche complexes et multidisciplinaires, traitant ainsi des possibilités de l'adaptation de l'approche d'ingénierie des systèmes aux spécificités des projets de recherche.
- Un traitement en profondeur des bases techniques et scientifiques de la planification d'intervention visuelle et interactive dans des environnements d'accélérateur de particules émettant des rayonnements ionisants, conduisant à un outil prototype pour la planification des interventions assistée par ordinateur.
- L'association de la visualisation en trois dimensions et du traitement des données de simulations radiologiques. Auparavant, la radioprotection ne faisait appel que à des visualisations en deux dimensions.
- La validation qualitative et quantitative des méthodes et des méthodologies scientifiques nouvellement établies, comprenant notamment une étude de précision.

Perspectives

Les résultats du travail mené dans cette thèse ouvrent la voie à de multiples perspectives de recherches scientifiques ainsi que de développement de nouvelles méthodes pratiques. Elles se situent à l'interface des disciplines techniques reliées à

la problématique traitée dans la thèse : la science de la visualisation, l'analyse de données scientifiques, la radioprotection et l'informatique.

Visualisation

Dans le chapitre 6, le logiciel développé et les techniques de visualisation mises en œuvre ont été validées qualitativement. Cette étude qualitative peut donner lieu à un test utilisateur plus poussé et plus quantitatif, avec pour but de donner un aperçu de l'interaction entre les différents paramètres de visualisation ainsi que de leur pertinence pour la visualisation, dans le cadre de la planification pour la radioprotection. Ce test aura le potentiel de conduire à de nouveaux développements dans le domaine des techniques de visualisation scientifiques destinés à la visualisation des niveaux de rayonnement dans les grandes installations.

De plus, des opportunités sont à prévoir dans le domaine de la mise en œuvre où des méthodes de visualisation plus avancées peuvent être développées, comme par exemple la visualisation des incertitudes des niveaux de rayonnements, que ce soit pour les données volumétriques complets ou pour les trajectoires simulées.

D'autres perspectives de recherche et développement se trouvent dans l'ajout de la réalité augmentée au logiciel, de façon à ce que le plan d'intervention puisse être utilisé pour former les travailleurs d'entretien pour l'intervention à venir, en leur fournissant des informations sur les niveaux de radiation en temps réel.

Analyse des données

Dans le domaine du calcul scientifique, une perspective de recherche est le traitement des mesures manuelles afin de les rendre utilisables pour la visualisation volumétrique. L'interpolation des niveaux de rayonnement mesurés est une tâche très complexe, en raison de la pléthore d'inconnues dans les domaines spatial, temporel et fonctionnel : ces inconnues peuvent être la distribution spatiale des sources de rayonnements (la matière activée), la répartition exacte des isotopes radioactifs qui donnent lieu à de différentes fonctions de décroissance temporelle, et la composition exacte des matériaux environnants. Une piste de recherche prometteuse pour le développement d'une méthode d'interpolation est la méthode de l'estimation du maximum de vraisemblance, en traitant les données mesurées comme données observées et les données de simulations de type *a priori* (souvent utilisées sous le terme anglais *prior*).

Radioprotection

L'intégration de plusieurs scénarios radiologiques au sein de la méthode de recherche présente un défi intéressant. Un exemple d'une telle intégration consiste à utiliser la méthode et le logiciel développés non seulement pour la planification pré-intervention, mais aussi pour l'analyse post-intervention et le retour d'expérience. Ceci impliquerait le développement d'une dosimétrie personnelle de pointe avec localisation automatique. Les données ainsi recueillies pourraient être fournies au modèle avec pour but de combiner les données de la planification avec les données réelles et de pouvoir ainsi les comparer.

Informatique

Tout au long de l'ensemble des travaux d'élaboration de méthodes techniques et scientifiques et des outils de mise en œuvre de la radioprotection, nous avons gardé à l'esprit le contexte multi-acteurs spécifique à la problématique concernée. Cela a, entre autres, conduit à une approche d'ingénierie des systèmes relaxée, décrite dans le chapitre 4, et à un modèle mathématique qui est gardé aussi simple que possible, tout en ne pas renonçant à une flexibilité et une rigueur extrême. Ces contributions pourraient être établies comme lignes directrices pour le design et l'architecture de tels logiciels dans le futur.

Remerciements

Ces travaux ont pu être menés à bien grâce à un projet financé par les actions Marie Curie du septième programme-cadre de la Commission Européenne, sous numéro de contrat (PITN-GA-2010-264336-PURESAFE).

Acknowledgements

This research project has been supported by a Marie Curie Fellowship of the European Community's Seventh Framework Programme under contract number (PITN-GA-2010-264336-PURESAFE).

Bibliography

- [1] IBM Rational System Architect Help. <http://publib.boulder.ibm.com/infocenter/rsysarch/v11/index.jsp>. 83
- [2] Loi sur la radioprotection (LRaP) du 22 mars 1991, 1991. Etat le 1er janvier 2007. 10
- [3] Scientific background on the Nobel Prize in Chemistry 2013: Development of multiscale models for complex chemical systems, 2013. The Royal Swedish Academy of Sciences. 78
- [4] Convention for the establishment of a European organization for nuclear research, July 1953. As amended, 1971. 3, 12
- [5] UK Health and Safety at Work etc. Act, 1974. 4, 13, 47, 141
- [6] *1990 recommendations of the International Commission on Radiological Protection*. No. ICRP Publication 60 in Annals of the ICRP. Pergamon, Oxford, 1991. 10, 13, 20
- [7] Ordonnance sur la radioprotection (ORaP) du 22 juin 1994, 1994. 10, 11, 12
- [8] Council Directive 96/29/EURATOM of 13 May 1996 laying down basic safety standards for the protection of the health of workers and the general public against the dangers arising from ionizing radiation, 1996. 10
- [9] Visualization. http://graphics.ethz.ch/teaching/former/scivis_07/Notes/stuff/StuttgartCourse, 2003. Slides of the lecture “Visualization” held in the summer term 2003 at the University of Stuttgart. xi, 69
- [10] CERN Safety Code F/Rev. on Radiation Protection, November 2006. 12, 13
- [11] *2007 recommendations of the International Commission on Radiological Protection*. No. ICRP Publication 103 in Annals of the ICRP. Elsevier, February 2008. 4, 10, 18, 19, 20, 21, 23, 106, 142
- [12] *Training course for radiation protection officers*. Institut de radiophysique, Rue du Grand-Pré, CH-1007 Lausanne, 2009. 9
- [13] Accord entre le gouvernement de la république française, le conseil fédéral suisse et l’organisation européenne pour la recherche nucléaire relatif à la

- protection contre les rayonnements ionisants et à la sûreté des installations de l'organisation européenne pour la recherche nucléaire (ensemble deux annexes), 2010. 11
- [14] Areva Official website, 2011. 63
- [15] EURIWARE : Conseil, intégration, infogérance - Groupe AREVA. <http://euraware.aveva.com/>, January 2011. 63
- [16] 3DVIA Virtools - Dassault Systèmes. <http://www.virttools.com/>, April 2012. 64
- [17] SCK-CEN Official website. <http://www.sck-cen.be>, June 2012. 63
- [18] Visiplan Official website. <http://www.visiplan.be>, June 2012. 63
- [19] About CERN — CERN. <http://home.web.cern.ch/about>, 2013. 3
- [20] Autorité de sûreté nucléaire – la réglementation – cadre législatif. <http://www.asn.fr/index.php/Les-actions-de-l-ASN/La-reglementation/Cadre-legislatif>, 2013. 10
- [21] FLAIR Official Website. <http://www.fluka.org/flair>, 2013. 24, 26
- [22] FLUKA Official Website. <http://www.fluka.org>, 2013. xiii, 5, 130
- [23] GIMP – The GNU Image Manipulation Program. <http://www.gimp.org>, 2013. 84
- [24] HL-LHC: High Luminosity Large Hadron Collider. <http://hilumilhc.web.cern.ch>, 2013. 97
- [25] International Commission on Radiological Protection. <http://www.icrp.org>, 2013. 4, 141
- [26] ParaView – Open Source Scientific Visualization. <http://www.paraview.org>, 2013. 65
- [27] Python Programming Language – Official Website. <http://www.python.org>, 2013. 54, 78
- [28] VisIt Visualization Tool. <https://wci.llnl.gov/codes/visit/>, 2013. 65
- [29] VolView. <http://www.volview.com>, 2013. 65
- [30] VTK – The Visualization Toolkit. <http://www.vtk.org>, 2013. 66, 78, 107
- [31] The Blue Brain Project. <http://bluebrain.epfl.ch/>, 2014. 78
- [32] AGOSTINELLI, S., ALLISON, J., AMAKO, K., APOSTOLAKIS, J., ARAUJO, H., ARCE, P., ASAI, M., AXEN, D., BANERJEE, S., BARRAND, G., AND ET AL. Geant4 – a simulation toolkit. *Nuclear Instruments and Methods in Physics Research Section A: Accelerators, Spectrometers, Detectors and Associated Equipment* 506, 3 (July 2003), 250–303. 23
- [33] ALLISON, J., AMAKO, K., APOSTOLAKIS, J., ARAUJO, H., ARCE DUBOIS, P., ASAI, M., BARRAND, G., CAPRA, R., CHAUVIE, S., CHYTRACEK, R., AND ET AL. Geant4 developments and applications. *IEEE Transactions on Nuclear Science* 53, 1 (Feb 2006), 270–278. 23

- [34] ALLISON, W. *Radiation and Reason*. Royal Octavo, October 2009. [14](#)
- [35] ARNAUDON, L., BAUDRENGHIEN, P., BAYLAC, M., BELLODI, G., BODY, Y., BORBURGH, J., BOURQUIN, P., BROERE, J., BRUNNER, O., BRUNO, L., CARLI, C., CASPERS, F., COUSINEAU, S. M., CUVET, Y., DE ALMEIDA MARTINS, C., DOBERS, T., FOWLER, T., GAROBY, R., GERIGK, F., GODDARD, B., HANKE, K., HORI, M., JONES, M., KAHLE, K., KALBREIER, W., KROYER, T., KÄJCHLER, D., LOMBARDI, A. M., LĂȘPEZ-HERNANDEZ, L. A., MAGISTRIS, M., MARTINI, M., MAURY, S., PAGE, E., PAOLUZZI, M., PASINI, M., RAICH, U., ROSSI, C., ROYER, J. P., SARGSYAN, E., SERRANO, J., SCRIVENS, R., SILARI, M., TIMMINS, M., VENTURINI-DELSOLARO, W., VRETENAR, M., WEGNER, R., WETERINGS, W., AND ZICKLER, T. Linac4 Technical Design Report. Tech. Rep. CERN-AB-2006-084. CARE-Note-2006-022-HIPPI, CERN, Geneva, December 2006. revised version submitted on 2006-12-14 09:00:40. [97](#)
- [36] AYMAR, R., BARABASCHI, P., AND SHIMOMURA, Y. The ITER design. *Plasma Physics and Controlled Fusion* *44*, 5 (May 2002), 519–565. [3](#), [140](#)
- [37] BATTISTONI, G., BROGGI, F., BRUGGER, M., CAMPANELLA, M., CARBONI, M., EMPL, A., FASSÒ, A., GADIOLI, E., CERUTTI, F., FERRARI, A., FERRARI, A., GARZELLI, M. V., LANTZ, M., MARIANI, A., MARGIOTTI, M., MORONE, C., MURARO, S., PARODI, K., PATERA, V., PELLICIONI, M., PINSKY, L., RANFT, J., ROESLER, S., ROLLET, S., SALA, P. R., SANTANA, M., SARCHIAPONE, L., SIOLI, M., SMIRNOV, G., SOMMERER, F., THEIS, C., TROVATI, S., VILLARI, R., VINCKE, H., VINCKE, H., VLACHOUDIS, V., VOLLAIRE, J., AND ZAPP, N. The Application of the Monte Carlo Code FLUKA in Radiation Protection Studies for the Large Hadron Collider. *Progress in NUCLEAR SCIENCE and TECHNOLOGY*, *2* (2011), 358–364. [24](#), [35](#)
- [38] BATTISTONI, G., CERUTTI, F., FASSÒ, A., FERRARI, A., MURARO, S., RANFT, J., ROESLER, S., AND SALA, P. R. The FLUKA code: description and benchmarking. *AIP Conference Proceedings* *896*, 1 (2007), 31–49. [5](#), [24](#), [35](#), [51](#), [97](#), [130](#)
- [39] BLAHA, J., TORRE, F. P. L., SILARI, M., AND VOLLAIRE, J. Long-term residual radioactivity in intermediate-energy proton linac. *Nuclear Instruments and Methods in Physics Research Section A: Accelerators, Spectrometers, Detectors and Associated Equipment* (2013). Submitted. [xii](#), [xiii](#), [35](#), [97](#), [98](#), [99](#)
- [40] BLAHA, J., AND VOLLAIRE, J. Monte Carlo Calculation for the LINAC4 Beam Dump Shielding. In *Joint International Conference on Supercomputing in Nuclear Applications and Monte Carlo 2013* (October 2013). [35](#)
- [41] BLAHA, J., AND VOLLAIRE, J. Radiation Protection Study for the Shielding Design of the LINAC4 Beam Dump. In *Proceedings of the fourth International Particle Accelerator Conference, IPAC13* (2013). [xii](#), [xiii](#), [35](#), [97](#), [98](#), [99](#)

- [42] BLAHA, J., AND VOLLAIRE, J. Radiation Protection Study for the Shielding Design of the LINAC4 Beam Dump. Technical Note CERN-DGS-2013-001-RP-TN, CERN, CH-1211 Geneva 23, Switzerland, 2013. In work. [35](#), [97](#), [101](#), [103](#)
- [43] BOEHM, B. W. A spiral model of software development and enhancement. *Computer* 21, 5 (May 1988), 61–72. [45](#)
- [44] BONNAL, P. Project Management workshop, 2011. [132](#)
- [45] BOREN, T., AND RAMEY, J. Thinking aloud: reconciling theory and practice. *IEEE Transactions on Professional Communication* 43, 3 (2000), 261–278. [55](#)
- [46] BORLAND, D., AND TAYLOR II, R. M. Rainbow Color Map (Still) Considered Harmful. *IEEE Computer Graphics and Applications* 27 (2007), 14–17. [91](#)
- [47] BRESKIN, A., AND VOSS, R., Eds. *The CERN Large Hadron Collider: Accelerator and Experiments*, vol. 1: LHC Machine, Alice, and Atlas. CERN, 2008. [3](#)
- [48] BRESKIN, A., AND VOSS, R., Eds. *The CERN Large Hadron Collider: Accelerator and Experiments*, vol. 2: CMS, LHCb, LHCf, and Totem. CERN, 2008. [3](#)
- [49] BROWN, A., AND WILSON, G., Eds. *The Architecture of Open Source Applications*, vol. I: Elegance, Evolution, and a Few Fearless Hacks. lulu.com, March 2012. [78](#)
- [50] BROWN, A., AND WILSON, G., Eds. *The Architecture of Open Source Applications*, vol. II: Structure, Scale, and a Few More Fearless Hacks. lulu.com, May 2012. [78](#)
- [51] BRUGGER, M. *The Radiological Situation in the Beam-Cleaning Sections of the CERN Large Hadron Collider (LHC)*. PhD thesis, Technischen Universität Graz, Graz, November 2003. [11](#), [13](#), [14](#), [23](#), [24](#), [51](#)
- [52] BRUGGER, M., FERRARI, A., ROESLER, S., AND ULRICI, L. Validation of the FLUKA Monte Carlo code for predicting induced radioactivity at high-energy accelerators. *Nuclear Instruments and Methods in Physics Research Section A: Accelerators, Spectrometers, Detectors and Associated Equipment* 562, 2 (2006), 814 – 818. Proceedings of the 7th International Conference on Accelerator Applications AccApp05. [24](#), [35](#), [58](#), [106](#)
- [53] BRUGGER, M., FORKEL-WIRTH, D., ROESLER, S., AND STEVENSON, G. R. Constraints from induced radioactivity on design and maintenance. In *Proceedings of the Workshop on LHC Performance - Chamonix XII* (March 2003), CERN. [14](#)
- [54] BRUGGER, M., FORKEL-WIRTH, D., ROESLER, S., AND VOLLAIRE, J. Studies of induced radioactivity and residual dose rates around beam absorbers of different materials. In *Proceedings of HB2010* (Morschach, Switzerland, 2010). [24](#), [35](#), [58](#), [106](#)

- [55] BRUGGER, M., KHATER, H., MAYER, S., PRINZ, A., ROESLER, S., ULRICI, L., AND VINCKE, H. Benchmark studies of induced radioactivity produced in LHC materials, part I: specific activities. *Radiation Protection Dosimetry* 116, 1-4 (December 2005), 6–11. [24](#), [35](#), [58](#), [106](#)
- [56] CABAN, J., RHEINGANS, P., AND YOO, T. An Evaluation of Visualization Techniques to Illustrate Statistical Deformation Models. *Computer Graphics Forum* 30, 3 (2011), 821–830. [55](#)
- [57] CHARITONIDIS, N., EFTHYMIPOULOS, I., THEIS, C., AND VINCKE, H. Prompt, activation and background radiation studies for the HiRadMat facility of CERN/SPS. CERN technical Note CERN-DGS-2011-039-RP-TN, CERN, 2011. [91](#)
- [58] CHARPAK, G., AND GARWIN, R. L. The DARI. *Europhysics News* 22, 1 (January/February 2002), 14–16. [22](#)
- [59] CHERUBINI, M., VENOLIA, G., DELINE, R., AND KO, A. J. Let’s go to the whiteboard. In *Proceedings of the SIGCHI conference on Human factors in computing systems - CHI '07* (2007), ACM Press. [84](#)
- [60] CLARKE, R. H., AND BINES, W. Evolution of ICRP Recommendations – 1977, 1990 and 2007. Changes in Underlying Science and Protection Policy and Case Study of their Impact on European and UK Domestic Regulation. Tech. Rep. 6920, Organisation for Economic Co-operation and Development / Nuclear Energy Agency (OECD/NEA), February 2011. [11](#)
- [61] CORTEZ, R., PAPAGEORGIOU, X., TANNER, H., KLIMENKO, A., BOROZDIN, K., AND PRIEDHORSKY, W. Experimental implementation of robotic sequential nuclear search. In *Mediterranean Conference on Control Automation, MED '07*. (June 2007), pp. 1 –6. [51](#), [52](#), [58](#)
- [62] COSSAIRT, J. Radiation Physics for Personnel and Environmental Protection. Tech. Rep. FERMILAB-TM-1834 Revision 4, Fermi National Accelerator Laboratory, Batavia, IL (US), 1999. [3](#), [9](#), [140](#)
- [63] CRUZ-NEIRA, C., SANDIN, D. J., AND DEFANTI, T. A. Surround-screen projection-based virtual reality. In *Proceedings of the 20th annual conference on Computer graphics and interactive techniques SIGGRAPH '93* (1993), ACM Press. [114](#)
- [64] CRUZ-NEIRA, C., SANDIN, D. J., DEFANTI, T. A., KENYON, R. V., AND HART, J. C. The CAVE: audio visual experience automatic virtual environment. *Communications of the ACM* 35, 6 (Jun 1992), 64–72. [114](#)
- [65] DISSERTORI, G., LECOMTE, P., LUCKEY, D., NESSI-TEDALDI, F., PAUSS, F., OTTO, T., ROESLER, S., AND URSCHELER, C. A study of high-energy proton induced damage in cerium fluoride in comparison with measurements in lead tungstate calorimeter crystals. *Nuclear Instruments and Methods in Physics Research Section A: Accelerators, Spectrometers, Detectors and Associated Equipment* 622, 1 (2010), 41 – 48. [24](#), [35](#), [58](#), [106](#)

- [66] DREBIN, R. A., CARPENTER, L., AND HANRAHAN, P. Volume rendering. *SIGGRAPH Comput. Graph.* 22 (June 1988), 65–74. [56](#), [71](#)
- [67] EFTHYMIPOULOS, I., HESSLER, C., GAILLARD, H., GRENIER, D., MEDDAHI, M., TRILHE, P., PARDONS, A., THEIS, C., CHARITONIDIS, N., EVRARD, S., VINCKE, H., AND LAZZARONI, M. HiRadMat: A New Irradiation Facility for Material Testing at CERN. In *Proceedings of IPAC2011* (San Sebastián, Spain, November 2011). [91](#)
- [68] FABRY, T. User needs study and study of available technology for a data fusion for 3D radiation mapping software tool. Tech. Rep. EDMS 1195619, CERN, 2011. [66](#)
- [69] FABRY, T. RP13 Architectural Design Document. Tech. Rep. D3.4, PURESAFE, 2012. [80](#), [84](#)
- [70] FABRY, T. RP13 Detailed Design Description Document. Tech. Rep. D3.5, PURESAFE, 2013. [80](#), [84](#)
- [71] FABRY, T., BLAHA, J., VANHERPE, L., BRAESCH, C., TABOUROT, L., AND FERAL, B. The practical use of an interactive visualisation and planning tool for intervention planning in particle accelerator environments with ionizing radiation. *Nuclear Instruments and Methods in Physics Research Section A: Accelerators, Spectrometers, Detectors and Associated Equipment* (2014). [89](#), [147](#), [148](#)
- [72] FABRY, T., BRAESCH, C., AND FERAL, B. Interactive Visual Intervention Planning – Interactive visualization for intervention planning in particle accelerator environments with ionizing radiation. In *Proceedings of the 8th International Conference on Information Visualization Theory and Applications (IVAPP)* (2013). [54](#), [89](#), [104](#), [147](#)
- [73] FABRY, T., VANHERPE, L., BAUDIN, M., THEIS, C., BRAESCH, C., AND FERAL, B. Interactive intervention planning in particle accelerator environments with ionizing radiation. *Nuclear Instruments and Methods in Physics Research Section A: Accelerators, Spectrometers, Detectors and Associated Equipment* 708 (April 2013), 32–38. [51](#), [52](#), [62](#), [146](#)
- [74] FABRY, T., VANHERPE, L., FERAL, B., AND BRAESCH, C. Developing an interactive intervention planner – A systems engineering perspective. *International Journal of Advanced Robotic Systems* 10 (2013), 1 – 8. Accepted. [44](#), [146](#)
- [75] FASSÓ, A., FERRARI, A., ROESLER, S., SALA, P., BATTISTONI, G., CERUTTI, F., GADIOLI, E., GARZELLI, M., BALLARINI, F., OTTOLENGHI, A., EMPL, A., AND RANFT, J. The physics models of FLUKA: status and recent developments. In *Computing in High Energy and Nuclear Physics 2003 Conference (CHEP2003)* (La Jolla, CA, USA, March 2003). (paper MOMT005) eConf C0303241 (2003), arXiv:hep-ph/0306267. [24](#), [35](#), [97](#)

- [76] FERRARI, A., SALA, P. R., FASSÒ, A., AND RANFT, J. FLUKA: a multi-particle transport code. Tech. Rep. CERN-2005-10, INFN/TC_05/11, SLAC-R-773, CERN, INFN, SLAC, 2005. [5](#), [51](#), [97](#), [130](#)
- [77] GAMMA, E., HELM, R., JOHNSON, R., AND VLISSIDES, J. *Design Patterns*. Addison-Wesley Professional Computing Series. Addison-Wesley, 1995. [56](#), [83](#)
- [78] GAROBY, R., DAMERAU, H., GILARDONI, S., GODDARD, B., HANKE, K., LOMBARDI, A., MANGLUNKI, D., MEDDAHL, M., MIKULEC, B., PONCE, L., SHAPOSHNIKOVA, E., STEERENBERG, R., AND VRETENAR, M. Status and Plans for the Upgrade of the LHC Injectors. In *Proceedings of the fourth International Particle Accelerator Conference, IPAC'13* (2013). [97](#)
- [79] GEVECI, B., AND SCHROEDER, W. VTK. In *The Architecture of Open Source Applications*, A. Brown and G. Wilson, Eds., vol. 1. lulu.com, 2012, ch. 24, pp. 387 – 402. [66](#), [81](#)
- [80] GREER, D., AND HAMON, Y. Agile Software Development. *Software: Practice and Experience* *41*, 9 (Aug 2011), 943–944. [83](#)
- [81] GRIBBLE, C. P., AND PARKER, S. G. An experimental design for determining the effects of illumination models in particle visualization. In *Proc. 2nd symposium on Applied perception in graphics and visualization* (New York, NY, USA, 2005), ACM, pp. 175–175. [90](#)
- [82] GRUPEN, C. *Introduction to Radiation Protection – Practical Knowledge for Handling Radioactive Sources*. Graduate Texts in Physics. Springer-Verlag Berlin Heidelberg, 2010. [4](#), [9](#), [11](#), [13](#), [35](#), [47](#), [52](#), [141](#)
- [83] HANSEN, C. D., AND JOHNSON, C. R., Eds. *The Visualization Handbook*. Elsevier, 2005. [64](#)
- [84] HOWISON, M., BETHEL, E. W., AND CHILDS, H. Hybrid Parallelism for Volume Rendering on Large-, Multi-, and Many-Core Systems. *IEEE Transactions on Visualization and Computer Graphics* *18*, 1 (Jan 2012), 17–29. [71](#)
- [85] INTERNATIONAL ATOMIC ENERGY AGENCY. *Occupational Radiation Protection: Protecting Workers against Exposure to Ionizing Radiation* (2003), International Atomic Energy Agency, Vienna. Held in Geneva, 26–30 August 2002. [10](#), [13](#), [14](#), [18](#)
- [86] JOHNSON, C. Top scientific visualization research problems. *Computer Graphics and Applications, IEEE* *24*, 4 (2004), 13–17. [64](#)
- [87] KAUFMAN, A., AND MUELLER, K. *An Overview of Volume Rendering*. Elsevier, 2005, ch. 7, pp. 127–174. [70](#)
- [88] KITWARE, INC. *The VTK User's Guide*, 11 ed., 2010. [66](#), [91](#), [107](#)
- [89] LAHA, B., SENSARMA, K., SCHIFFBAUER, J. D., AND BOWMAN, D. A. Effects of Immersion on Visual Analysis of Volume Data. *IEEE Transactions on Visualization and Computer Graphics* *18*, 4 (April 2012), 597–606. [55](#)

- [90] LARMAN, C. *Applying UML and Patterns - An Introduction to Object-Oriented Analysis and Design and Iterative Development*, third edition ed. Pearson Education, Inc., 2005. 51, 80
- [91] LARMAN, C., AND BASILI, V. R. Iterative and Incremental Development: A Brief History. *Computer* 36, 6 (june 2003), 47–56. 53
- [92] LEVOY, M. Display of surfaces from volume data. *Computer Graphics and Applications, IEEE* 8, 3 (may 1988), 29–37. 56, 71
- [93] LINDEMANN, F., AND ROPINSKI, T. About the Influence of Illumination Models on Image Comprehension in Direct Volume Rendering. *IEEE Transactions on Visualization and Computer Graphics* 17, 12 (December 2011), 1922–1931. 55, 90
- [94] LIU, Z., CAI, S., SWAN II, J. E., MOORHEAD II, R. J., MARTIN, J. P., AND JANKUN-KELLY, T. J. A 2D Flow Visualization User Study Using Explicit Flow Synthesis and Implicit Task Design. *IEEE Transactions on Visualization and Computer Graphics* 18, 5 (May 2012), 783–796. 55
- [95] LOGILAB. PyLint – code analysis for Python. <http://www.pylint.org>, 2013. 80, 84
- [96] LORENSEN, W. E., AND CLINE, H. E. Marching cubes: A high resolution 3D surface construction algorithm. *Proceedings of the 14th annual conference on Computer graphics and interactive techniques - SIGGRAPH '87* (1987). 68
- [97] LUTZ, M. *Programming Python*, 4 ed. O'Reilly, 2010. 54, 78
- [98] MARSZALEK, M., EDER, M., TROPSCHUG, A., KNOLL, A., AND HOEFER, H. Mobile robots for the simultaneous exploration and 2D determination of radioactivity. In *Proceedings of the 8th WSEAS International Conference on Circuits, Systems, Electronics, Control & Signal Processing (CSECS '09)* (December 2009), World Scientific and Engineering Academy and Society, WSEAS. 51, 52, 58
- [99] MAURO, E. *Radiation protection studies for CERN linac4/SPL accelerator complex*. PhD thesis, Ecole Polytechnique Federale de Lausanne, September 2009. 23
- [100] MEISSNER, M., PFISTER, H., WESTERMANN, R., AND WITTENBRINK, C. Volume Visualization and Volume Rendering Techniques. Eurographics Tutorial, 2000. 67
- [101] MILGRAM, P., AND KISHINO, F. A Taxonomy of Mixed Reality Visual Displays. *IEICE TRANSACTIONS on Information and Systems E77-D*, 12 (1994), 1321–1329. 2
- [102] MILLAN, G. S., PERRIN, D., AND SCIBILE, L. RAMSES: The LHC radiation monitoring system for the environment and safety. In *10th ICALEPCS International Conference on Accelerator & Large Experimental Physics Control Systems* (2005). 30

- [103] MOKHOV, N. V. *Physics Models in the MARS15 Code for Accelerator and Space Applications*. American Institute of Physics, 2005, pp. 1618–1623. 23
- [104] MORELAND, K. Diverging Color Maps for Scientific Visualization. In *Proceedings of the 5th International Symposium on Visual Computing* (December 2009). 91
- [105] MORGAN, W. F., AND BAIR, W. J. Issues in Low Dose Radiation Biology: The Controversy Continues. A Perspective. *Radiation Research* 179, 5 (May 2013), 501–510. 4
- [106] MYERS, S. The engineering needed for particle physics. *Philosophical Transactions of the Royal Society A: Mathematical, Physical and Engineering Sciences* 370, 1973 (2012), 3887–3923. 2, 45, 140
- [107] NELSON, W. R., HIRAYAMA, H., AND ROGERS, D. W. The EGS4 Code System. Tech. Rep. SLAC-265, Stanford Linear Accelerator Center, December 1985. 23
- [108] NIELSEN, G. M., AND SHRIVER, B., Eds. *Visualization in Scientific Computing*. IEEE Computer Society Press, 1990. 64
- [109] NIITA, K., SATO, T., IWASE, H., NOSE, H., NAKASHIMA, H., AND SIHVER, L. PHITS – a particle and heavy ion transport code system. *Radiation Measurements* 41, 9-10 (October 2006), 1080–1090. 23
- [110] PARASURAMAN, R., FABRY, T., KERSHAW, K., AND FERRE, M. Spatial sampling methods for improved communication for wireless relay robots. In *International Conference on Connected Vehicles* (December 2013). 58
- [111] PARASURAMAN, R., KERSHAW, K., AND FERRE, M. Experimental Investigation of Radio Signal Propagation in Scientific Facilities for Telerobotic Applications. *International Journal of Advanced Robotic Systems* (2013), 1. 58
- [112] PARASURAMAN, R., PAGALA, P., KERSHAW, K., AND FERRE, M. Energy Management Module for Mobile Robots in Hostile Environments. In *Advances in Autonomous Robotics* (2012), G. Herrmann, M. Studley, M. Pearson, A. Conn, C. Melhuish, M. Witkowski, J.-H. Kim, and P. Vadakkepat, Eds., vol. 7429 of *Lecture Notes in Computer Science*, Springer Berlin / Heidelberg, pp. 430–431. 51, 52, 58
- [113] PATTERSON JR., F. G. *Systems Engineering Life Cycles: Life Cycles for Research, Development, Test, and Evaluation; Acquisition; and Planning and Marketing*. John Wiley & Sons, 2009, ch. 1, pp. 65–115. 44, 48
- [114] PEREIRA, F., THEIS, C., MOREIRA, A., AND RICARDO, M. Evaluating location fingerprinting methods for underground GSM networks deployed over Leaky Feeder. In *2011 International Conference on Indoor Positioning and Indoor Navigation* (Sep 2011), Institute of Electrical and Electronics Engineers, pp. 1–6. 30

- [115] PEREIRA, F., THEIS, C., MOREIRA, A., AND RICARDO, M. Multi-technology RF fingerprinting with leaky-feeder in underground tunnels. In *2012 International Conference on Indoor Positioning and Indoor Navigation (IPIN)* (Nov 2012), Institute of Electrical and Electronics Engineers, pp. 1–9. [30](#)
- [116] PEREIRA, F., THEIS, C., MOREIRA, A., AND RICARDO, M. Performance and limits of KNN-based positioning methods for GSM networks over leaky feeder in underground tunnels. *Journal of Location Based Services* 6, 2 (Jun 2012), 117–133. [30](#)
- [117] POLLYCOVE, M., AND FEINENDEGEN, L. E. Low-dose radioimmuno-therapy of cancer. *Human & Experimental Toxicology* 27, 2 (February 2008), 169–175. [14](#)
- [118] RAPPIN, N., AND DUNN, R. *wxPython in Action*. Manning Publications Co., March 2006. [78](#)
- [119] REBUT, P., BICKERTON, R., AND KEEN, B. The Joint European Torus: installation, first results and prospects. *Nuclear Fusion* 25, 9 (Sep 1985), 1011–1022. [3](#), [140](#)
- [120] RITSCHEL, T. Fast GPU-based Visibility Computation for Natural Illumination of Volume Data Sets. In *Eurographics* (2007), pp. 57–60. [56](#), [71](#)
- [121] ROMANETS, Y., BERNARDES, A. P., DORSIVAL, A., GONÇALVES, I. F., KADI, Y., DI MARIA, S., VAZ, P., VLACHOUDIS, V., AND VOLLAIRE, J. Radiation protection, radiation safety and radiation shielding assesment of HIE-Isolde. *Radiation Protection Dosimetry* 155, 3 (2013), 351–363. Advance Access. [35](#)
- [122] ROPINSKI, T., DÖRING, C., AND REZK-SALAMA, C. Interactive Volumetric Lighting Simulating Scattering and Shadowing. In *Proc. IEEE Pacific Visualization Symposium* (mar 2010), pp. 169–176. [90](#)
- [123] ROSENBLUM, L. J., EARNSHAW, R., AO, J. L. E., HAGEN, H., KAUFMAN, A. E., KLIMENKO, S. V., POST, G. M. N. M. N., AND THALMANN, D., Eds. *Scientific Visualization Advances and Challenges*. Academic Press Limited, 1994. [64](#)
- [124] ROSNER, G. Future Facility: FAIR at GSI. *Nuclear Physics B - Proceedings Supplements* 167 (May 2007), 77–81. [3](#)
- [125] SAGE, A. P., AND ET AL., W. B. R. *Handbook of Systems Engineering and Management*. Wiley Series in Systems Engineering and Management. John Wiley & Sons, 2009. [45](#), [47](#)
- [126] SALVAT, F., FERNÁNDEZ-VAREA, J. M., AND SEMPAY, J. *PENELOPE, a code system for Monte Carlo simulation of electron and photon transport*. Facultat de Física (ECM), Universitat de Barcelona, Diagonal 647, E-08028 Barcelona, Spain, 2011. [23](#)

- [127] SANDERS, C. L. *Radiation Hormesis and the Linear-No-Threshold Assumption*. Springer, 2010. 14
- [128] SANYAL, J., ZHANG, S., BHATTACHARYA, G., AMBURN, P., AND MOORHEAD, R. A User Study to Compare Four Uncertainty Visualization Methods for 1D and 2D Datasets. *IEEE Transactions on Visualization and Computer Graphics* 15, 6 (Nov. 2009), 1209–1218. 55
- [129] SAPOCO42. Safety Policy at CERN. Tech. rep., CERN, 2006. 11
- [130] SATAKE, M., TAGUCHI, S., MIDO, Y., AND IQBAL, S. *Environmental Toxicology*. Discovery Publishing Pvt.Ltd, 1997. 9
- [131] SCHROEDER, W., AVILA, L., AND HOFFMAN, W. Visualizing with VTK: a tutorial. *Computer Graphics and Applications, IEEE* 20, 5 (September 2000), 20–27. 66
- [132] SCHROEDER, W., MARTIN, K., AND LORENSEN, B. *The Visualization Toolkit. An Object-Oriented Approach To 3D Graphics*, 4 ed. Kitware, December 2006. 66, 91, 107
- [133] SCHROEDER, W. J., MARTIN, K. M., AND LORENSEN, W. E. The design and implementation of an object-oriented toolkit for 3D graphics and visualization. In *Proceedings of the 7th conference on Visualization '96* (Los Alamitos, CA, USA, 1996), VIS '96, IEEE Computer Society Press, pp. 93–100. 66
- [134] SHOTTON, J., FITZGIBBON, A., COOK, M., SHARP, T., FINOCCHIO, M., MOORE, R., KIPMAN, A., AND BLAKE, A. Real-time human pose recognition in parts from single depth images. In *IEEE Computer Vision and Pattern Recognition (CVPR)* (2011). 34
- [135] SILVA, S., MADEIRA, J., AND SANTOS, B. There is More to Color Scales than Meets the Eye: A Review on the Use of Color in Visualization. In *Proc. Int. Conf. Information Visualization* (July 2007), pp. 943–950. 90
- [136] STABIN, M. G. *Radiation Protection and Dosimetry*. Springer, 2008. 3, 9, 140
- [137] STÖHLKER, T., BACKE, H., BEYER, H., BOSCH, F., BRÄUNING-DEMIAN, A., HAGMANN, S., IONESCU, D., JUNGSMANN, K., KLUGE, H.-J., KOZHUHAROV, C., KÜHL, T., LIESEN, D., MANN, R., MOKLER, P., AND QUINT, W. Status and perspectives of atomic physics research at GSI: The new GSI accelerator project. *Nuclear Instruments and Methods in Physics Research Section B: Beam Interactions with Materials and Atoms* 205 (May 2003), 156–161. 3, 140
- [138] SUH, N. P. *The Principles of Design*. Oxford Series on Advanced Manufacturing. Oxford University Press, April 1990. 45
- [139] SULLIVAN, A. H. *A guide to radiation and radioactivity levels near high energy particle accelerators*. Nuclear Technology Publishing, 1992. 3, 9, 140

- [140] TAN, T., LI, Q., BOEHM, B., YANG, Y., HE, M., AND MOAZENI, R. Productivity trends in incremental and iterative software development. In *Empirical Software Engineering and Measurement, 2009. ESEM 2009. 3rd International Symposium on* (oct. 2009), pp. 1–10. **53**
- [141] THEIS, C. SimpleGeo: solid modeling for particle transport Monte Carlo simulations. <http://theis.web.cern.ch/theis/simplegeo/>. **xi, 5, 24, 26, 68**
- [142] THEIS, C. Visualization of FLUKA voxel geometries with DaVis3D. <http://theis.web.cern.ch/theis/simplegeo/voxels.htm>. **5**
- [143] THEIS, C., BUCHEGGER, K., BRUGGER, M., FORKEL-WIRTH, D., ROESLER, S., AND VINCKE, H. Interactive three-dimensional visualization and creation of geometries for Monte Carlo calculations. *Nuclear Instruments and Methods in Physics Research Section A: Accelerators, Spectrometers, Detectors and Associated Equipment* **562**, 2 (2006), 827–829. Proceedings of the 7th International Conference on Accelerator Applications. **5, 24**
- [144] THEVENON, J.-B., LOPEZ, L., CHABAL, C., MAHE, C., IDASIAK, J.-M., CHODORGE, L., DESBATS, P., AND GRAVEZ, P. Using simulation for intervention design in radiating environment: first evaluation of NARVEOS. In *Proceedings of the GLOBAL 2009 congress – The Nuclear Fuel Cycle: Sustainable Options and Industrial Perspectives* (5 rue des Morillons, 75015 Paris (France), June 2009), Societe Francaise d’Energie Nucleaire - SFEN. **63**
- [145] TUBIANA, M., AND AURENGO, A. La relation dose-effet et l’estimation des effets cancérogènes des faibles doses de rayonnements ionisants. Tech. rep., Académie nationale de médecine and Académie des sciences, 2005. **14**
- [146] TUBIANA, M., FEINENDEGEN, L. E., YANG, C., AND KAMINSKI, J. M. The Linear No-Threshold Relationship Is Inconsistent with Radiation Biologic and Experimental Data1. *Radiology* **251**, 1 (March 2009), 13–22. **14**
- [147] ULRICH, K., AND EPPINGER, S. *Product Design and Development*. McGraw-Hill/Irwin, May 2011. **48, 131**
- [148] VALENTIN, J. Relative biological effectiveness (RBE), quality factor (Q), and radiation weighting factor (wR). *Annals of the ICRP* **33**, 4 (December 2003), 1–121. **20**
- [149] VAN DEN HAAK, M., DE JONG, M., AND JAN SCHELLENS, P. Retrospective vs. concurrent think-aloud protocols: Testing the usability of an online library catalogue. *Behaviour & Information Technology* **22**, 5 (2003), 339–351. **55**
- [150] VERMEERSCH, F., AND VAN BOSSTRAETEN, C. Development of the VISIPLAN ALARA planning tool. In *Proceeding of the International Conference on Topical issues in Nuclear Radiation and Radioactive Waste Safety* (1998). **63**
- [151] VINCKE, H., THEIS, C., AND ROESLER, S. Induced radioactivity in and around high-energy particle accelerators. *Radiation Protection Dosimetry* **146**, 4 (2011), 434–439. **2, 45, 63, 140**

- [152] VLACHOUDIS, V. FLAIR: A Powerful But User Friendly Graphical Interface For FLUKA. In *Proc. Int. Conf. on Mathematics, Computational Methods & Reactor Physics, (M and C 2009), Saratoga Springs, New York* (2009). 5, 24
- [153] VOLLAIRE, J. Calculation of the residual dose rate from targets used in the ISOLDE facility. In *4th High Power Targetry Workshop* (2011). xi, 5, 6, 130
- [154] VOLLAIRE, J., BRUGGER, M., FORKEL-WIRTH, D., ROESLER, S., AND VOJTYLA, P. Calculation of water activation for the LHC. *Nuclear Instruments and Methods in Physics Research Section A: Accelerators, Spectrometers, Detectors and Associated Equipment* 562, 2 (2006), 976 – 980. Proceedings of the 7th International Conference on Accelerator Applications AccApp05. 24, 35, 58, 106
- [155] VOLLAIRE, J., FORKEL-WIRTH, D., AND ROESLER, S. Estimation of the individual and collective dose due to the replacement and transport of one of the LHC beam dump cores. Tech. Rep. CERN-SC-2007-060-RP-TN, CERN, September 2007. EDMS Document Number: 866062. xii, 35, 96
- [156] ŠOLTÉSZOVÁ, V., PATEL, D., AND VIOLA, I. Chromatic Shadows for Improved Perception. In *Proc. Non-photorealistic Animation and Rendering (NPAR 2011)* (2011), pp. 105–115. 90
- [157] WALLIS, J., MILLER, T., LERNER, C., AND KLEERUP, E. Three-dimensional display in nuclear medicine. *IEEE Trans. Med. Imaging* 8, 4 (1989), 297–230. 70
- [158] WANGER, L. The effect of shadow quality on the perception of spatial relationships in computer generated imagery. In *Proc. symp. on Interactive 3D graphics* (New York, NY, USA, 1992), ACM, pp. 39–42. 90
- [159] WHEELWRIGHT, S. C., AND CLARK, K. B. *Revolutionizing Product Development*. The Free Press, 1992. 44
- [160] WIEGERS, K. *Software Requirements*, 2 ed. Microsoft Press, March 2003. 48, 132
- [161] WIKIPEDIA. Areva — Wikipedia, The Free Encyclopedia, 2013. [Online; accessed 6-December-2013]. 63
- [162] WIKIPEDIA. Lazy initialization — Wikipedia, The Free Encyclopedia, 2013. [Online; accessed 7-May-2013]. 84
- [163] WIKIPEDIA. Radiation protection — Wikipedia, The Free Encyclopedia, 2013. [Online; accessed 4-September-2013]. 3, 10
- [164] WIKIPEDIA. Software design pattern — Wikipedia, The Free Encyclopedia, 2013. [Online; accessed 30-April-2013]. 83
- [165] WIKIPEDIA. Volume rendering — Wikipedia, The Free Encyclopedia, 2014. [Online; accessed 17-January-2014]. 71
- [166] WILLE, K. *The Physics of Particle Accelerators: An Introduction*. Oxford University Press, 2001. 2, 3, 9, 45, 140

- [167] X-5 MONTE CARLO TEAM. “MCNP - A General N-Particle Transport Code, Version 5” Volume I: Overview and Theory. Tech. Rep. LA-UR-03-1987, Los Alamos National Laboratory, 2003. 23
- [168] XU, X. G., AND ECKERMAN, K. F., Eds. *Handbook of anatomical models for radiation dosimetry*. Taylor and Francis Group LLC, Boca Raton, FL, USA, 2010. 37, 107
- [169] ZAJACOVÁ, Z. *Assessment of radiological risks at the ATLAS experiment*. PhD thesis, Slovak University of Technology in Bratislava, July 2009. 23, 45

List of Publications

This is a list of all scientific publications of Thomas Fabry. This list also includes publications not discussed in this dissertation.

Articles in internationally reviewed academic journals

- Héctor Martínez, Thomas Fabry, Seppo Laukkanen, Jouni Mattila and Laurent Tabourot. *Augmented reality aiding collimator exchange at the LHC*, Nuclear Instruments and Methods in Physics Research Section A: Accelerators, Spectrometers, Detectors and Associated Equipment, Volume 762, pages 354-363, ISSN 0168-9002, 2014.
<http://dx.doi.org/10.1016/j.nima.2014.06.037>
- Thomas Fabry, Jan Blaha, Liesbeth Vanherpe, Christian Braesch, Laurent Tabourot and Bruno Feral. *The practical use of an interactive visualisation and planning tool for intervention planning in particle accelerator environments with ionizing radiation*, Nuclear Instruments and Methods in Physics Research Section A: Accelerators, Spectrometers, Detectors and Associated Equipment, Volume 743, pages 14-21, ISSN 0168-9002, 2014.
<http://dx.doi.org/10.1016/j.nima.2013.12.051>
- Thomas Fabry, Liesbeth Vanherpe, Bruno Feral and Christian Braesch. *Developing an Interactive Intervention Planner - A Systems Engineering Perspective*. International Journal of Advanced Robotic Systems, 10:335, 2013.
<http://dx.doi.org/10.5772/56846>
- Thomas Fabry, Liesbeth Vanherpe, Mathieu Baudin, Chris Theis, Christian Braesch and Bruno Feral. *Interactive intervention planning in particle accelerator environments with ionizing radiation*, Nuclear Instruments and Methods in Physics Research Section A: Accelerators, Spectrometers, Detectors and Associated Equipment, Volume 708, Pages 32-38, ISSN 0168-9002, 2013.
<http://dx.doi.org/10.1016/j.nima.2013.01.010>

Articles in academic books, internationally recognised scientific publisher

- Thomas Fabry, Dirk Smeets and Dirk Vandermeulen. *Surface representations for 3D face recognition*. In: Oravec M. (Eds.), *Face recognition*, INTECH publishing, 273-294, 2010.
<http://dx.doi.org/10.5772/8951>

Papers at international scientific conferences and symposia, published in full in proceedings

- Thomas Fabry, Mathieu Baudin, Bruno Feral, Liesbeth Vanherpe and Laurent Tabourot. *Intervention Modelling at High-energy Particle Accelerators*, 5th International Particle Accelerator Conference - IPAC, Dresden, Germany, 2014. *Abstract accepted for presentation*.
- Ramviyas Parasuraman, Thomas Fabry, Keith Kershaw and Manuel Ferre. *Spatial sampling methods for improved communication for wireless relay robots*, International Conference on Connected Vehicles - ICCVE, 2013.
<http://dx.doi.org/10.1109/ICCVE.2013.6799919>
- Thomas Fabry, Christian Braesch and Bruno Feral. *Interactive Visual Intervention Planning – Interactive visualization for intervention planning in particle accelerator environments with ionizing radiation*, International Conference on Information Visualization Theory and Applications - IVAPP, 2013.
<http://dx.doi.org/10.5220/0004212505850592>
- Zhouhui Lian, Afzal Godil, Thomas Fabry, Takahiko Furuya, Jeroen Hermans, Ryutarou Ohbuchi, Chang Shu, Dirk Smeets, Paul Suetens, Dirk Vandermeulen and Stefanie Wuhler. *SHREC'10 track: non-rigid 3D shape retrieval*, Eurographics workshop on 3D object retrieval - 3DOR, 2010.
- Dirk Smeets, Thomas Fabry, Jeroen Hermans, Dirk Vandermeulen and Paul Suetens. *Inelastic deformation invariant modal representation for non-rigid 3D object recognition*, Lecture Notes in Computer Science: Vol. 6169, pp. 162-171, Conference on articulated motion and deformable objects - AMDO, 2010.
http://dx.doi.org/10.1007/978-3-642-14061-7_16
- Dirk Smeets, Thomas Fabry, Jeroen Hermans, Dirk Vandermeulen and Paul Suetens. *Fusion of an isometric deformation modeling approach using spectral decomposition and a region-based approach using ICP for expression-invariant 3D face recognition*, International conference on pattern recognition - ICPR, 2010.
<http://dx.doi.org/10.1109/ICPR.2010.293>

- Chris Maes, Thomas Fabry, Johannes Keustermans, Dirk Smeets, Paul Suetens and Dirk Vandermeulen. *Feature detection on 3D face surfaces for pose normalisation and recognition*, International conference on biometrics : theory, applications and systems - BTAS, 2010.
<http://dx.doi.org/10.1109/BTAS.2010.5634543>
- Thomas Fabry, Dirk Smeets, Dirk Vandermeulen and Paul Suetens. *3D non-rigid point cloud based surface registration based on mean shift*, Proceedings 18th international conference on computer graphics, visualization and computer vision - WSCG, 2010.
- Dirk Smeets², Thomas Fabry², Jeroen Hermans, Dirk Vandermeulen and Paul Suetens. *Isometric deformation modelling for object recognition*, Lecture Notes in Computer Science: Vol. 5702, pp. 757-765, 13th international conference on computer analysis of images and patterns - CAIP, 2009.
http://dx.doi.org/10.1007/978-3-642-03767-2_92
- Dirk Smeets, Thomas Fabry, Jeroen Hermans, Dirk Vandermeulen and Paul Suetens. *Isometric deformation modeling using singular value decomposition for 3D expression-invariant face recognition*³, IEEE international conference on biometrics : theory, applications and systems - BTAS, 2009.
<http://dx.doi.org/10.1109/BTAS.2009.5339015>
- Thomas Fabry, Dirk Vandermeulen and Paul Suetens. *3D face recognition using point cloud kernel correlation*, IEEE international conference on biometrics : theory, applications and systems - BTAS, 2008.
<http://dx.doi.org/10.1109/BTAS.2008.4699359>

Meeting abstracts, presented at international conferences and symposia

- Thomas Fabry, Liesbeth Vanherpe, Chris Theis, Jan Blaha and Bruno Feral. *Computer-aided intervention planning for high-energy particle accelerator facilities*, 14th International Congress of the International Radiation Protection Association, 2014. *Abstract accepted for presentation.*
- Thomas Fabry, *Visualisation tool for optimisation of radiation area interventions*, Remote manipulations / diagnostics in radioactive areas and handling of radioactive material Workshop, CERN, Geneva, Switzerland, 2013.
- Thomas Fabry and Bruno Feral. *Interactive intervention planning in particle accelerator environments with ionizing radiation – A systems engineering approach*, 1st International Workshop on Telerobotics and Systems Engineering for Scientific Facilities, Madrid, Spain, 2013.

2. Joint first author

3. Poster Paper Award

Meeting abstracts, presented at other scientific conferences and symposia

- Dirk Vandermeulen, Thomas Fabry, Dirk Smeets, Jeroen Hermans and Paul Suetens. *3D/2D gezichtsherkenning en poseberekening*, Workshop over gezichtsvergelijking door mensen en machines, The Hague, The Netherlands, 5 November 2009.
- Thomas Fabry, Dirk Smeets, Dirk Vandermeulen and Paul Suetens. *3D expression-invariant face recognition*, Workshop over gezichtsvergelijking door mensen en machines, The Hague, The Netherlands, 26 November 2008.

Internal reports

- Thomas Fabry, Jeroen Hermans, Dirk Smeets, Paul Suetens and Dirk Vandermeulen. *Entropy maximized weight-adaptive kernel density estimates for point cloud processing*. Internal report KUL/ESAT/PSI/1002, K.U.Leuven, ESAT, Leuven, Belgium, 2010.
- Dirk Smeets, Thomas Fabry, Dirk Vandermeulen and Paul Suetens. *Meshfree mathematical surface representations and their use in biometrics*. Internal report KUL/ESAT/PSI/0901, K.U.Leuven, ESAT, Leuven, Belgium, 2009.

PLANIFICATION VISUELLE ET INTERACTIVE D'INTERVENTIONS DANS DES ENVIRONNEMENTS D'ACCÉLÉRATEUR DE PARTICULES ÉMETTANT DES RAYONNEMENTS IONISANTS

Les radiations sont omniprésentes. Elles ont de nombreuses applications dans des domaines variés: en médecine, elles permettent de réaliser des diagnostics et de guérir des patients; en communication, tous les systèmes modernes utilisent des formes de rayonnements électromagnétiques; et en science, les chercheurs les utilisent pour découvrir la composition et la structure des matériaux, pour n'en nommer que quelques-unes.

Concrètement, la radiation est un processus au cours duquel des particules ou des ondes voyagent à travers différents types de matériaux. La radiation peut être très énergétique, et aller jusqu'à casser les atomes de la matière ordinaire. Dans ce cas, on parlera de radiation ionisante. Il est communément admis que la radiation ionisante peut être bien plus nocif pour les êtres vivants que la radiation non ionisante.

Dans cette dissertation, nous traiterons de la radiation ionisante. La radioactivité est le processus d'émission des radiations ionisantes. Elle existe sous forme naturelle, et est présente dans les sols, dans l'air et notre planète entière est bombardée en permanence de rayonnements cosmiques énergétiques. Depuis le début du XXe siècle, les chercheurs sont capables de créer artificiellement de la matière radioactive. Cette découverte a offert de multiples avancées technologiques, mais a eu également de lourdes conséquences pour l'humanité comme l'ont démontrés les événements de Tchernobyl et de Fukushima ou d'autres accidents dans le monde médical.

Cette dangerosité a conduit à l'élaboration d'un système de radioprotection. Dans la pratique, la radioprotection est principalement mise en œuvre en utilisant la méthode ALARA. Cette méthodologie consiste à justifier, optimiser et limiter les doses reçues. Elle est utilisée conjointement avec les limites légales. Le facteur d'optimisation est contraint par le fait que l'exposition volontaire d'un travailleur aux radiations lors d'une opération doit être plus bénéfique que si aucune intervention humaine n'était conduite dans une situation donnée.

Dans le monde industriel et scientifique, il existe des infrastructures qui émettent des rayonnements ionisants. La plupart d'entre elles nécessitent des opérations de maintenance. Dans l'esprit du principe ALARA, ces interventions doivent être optimisées pour réduire l'exposition des travailleurs aux rayonnements ionisants. Cette optimisation ne peut pas être réalisée de manière automatique car la faisabilité des interventions nécessite dans tous les cas une évaluation humaine. La planification des interventions peut cependant être facilitée par des moyens techniques et scientifiques comme par exemple un outil informatique.

Dans le contexte décrit ci-dessus, cette thèse regroupe des considérations techniques et scientifiques, et présente la méthodologie utilisée pour développer des outils logiciels pour la mise en œuvre de la radioprotection.

Mots-clés: Visualisation 3D; Fusion des données; Radioprotection; Planification des interventions

INTERACTIVE VISUAL INTERVENTION PLANNING IN PARTICLE ACCELERATOR ENVIRONMENTS WITH IONIZING RADIATION

Radiation is omnipresent. It has many interesting applications: in medicine, where it allows curing and diagnosing patients; in communication, where modern communication systems make use of electromagnetic radiation; and in science, where it is used to discover the structure of materials; to name a few.

Physically, radiation is a process in which particles or waves travel through any kind of material, usually air. Radiation can be very energetic, in which case it can break the atoms of ordinary matter (ionization). If this is the case, radiation is called ionizing. It is known that ionizing radiation can be far more harmful to living beings than non-ionizing radiation.

In this dissertation, we are concerned with ionizing radiation. Naturally occurring ionizing radiation in the form of radioactivity is a most natural phenomenon. Almost everything is radioactive: there is radiation emerging from the soil, it is in the air, and the whole planet is constantly undergoing streams of energetic cosmic radiation. Since the beginning of the twentieth century, we are also able to artificially create radio-active matter. This has opened a lot of interesting technological opportunities, but has also given a tremendous responsibility to humanity, as the nuclear accidents in Chernobyl and Fukushima, and various accidents in the medical world have made clear.

This has led to the elaboration of a radiological protection system. In practice, the radiological protection system is mostly implemented using a methodology that is indicated with the acronym ALARA: As Low As Reasonably Achievable. This methodology consists of justifying, optimizing and limiting the radiation dose received. This methodology is applied in conjunction with the legal limits. The word "reasonably" means that the optimization of radiation exposure has to be seen in context. The optimization is constrained by the fact that the positive effects of an operation might surpass the negative effects caused by the radiation.

Several industrial and scientific procedures give rise to facilities with ionizing radiation. Most technical and scientific facilities also need maintenance operations. In the spirit of ALARA, these interventions need to be optimized in terms of the exposure of the maintenance workers to ionizing radiation. This optimization cannot be automated since the feasibility of the intervention tasks requires human assessment. The intervention planning could however be facilitated by technical-scientific means, e.g. software tools.

In the context sketched above, this thesis provides technical-scientific considerations and the development of technical-scientific methodologies and software tools for the implementation of radiation protection. In particular, this thesis addresses the need for an interactive visual intervention planning tool in the context of high energy particle accelerator facilities.

Keywords: 3D visualisation; Data Fusion; Radiological protection; Intervention Planning