



HAL
open science

Planarity and locality in percolation theory

Vincent Tassion

► **To cite this version:**

Vincent Tassion. Planarity and locality in percolation theory. General Mathematics [math.GM]. Ecole normale supérieure de lyon - ENS LYON, 2014. English. NNT : 2014ENSL0910 . tel-01061007

HAL Id: tel-01061007

<https://theses.hal.science/tel-01061007>

Submitted on 4 Sep 2014

HAL is a multi-disciplinary open access archive for the deposit and dissemination of scientific research documents, whether they are published or not. The documents may come from teaching and research institutions in France or abroad, or from public or private research centers.

L'archive ouverte pluridisciplinaire **HAL**, est destinée au dépôt et à la diffusion de documents scientifiques de niveau recherche, publiés ou non, émanant des établissements d'enseignement et de recherche français ou étrangers, des laboratoires publics ou privés.

THÈSE

en vue d'obtenir le grade de
Docteur de l'Université de Lyon, délivré par l'École Normale Supérieure de
Lyon

Discipline : Mathématiques
Unité de Mathématiques Pures et Appliquées - UMR 5669
École Doctorale Informatique et Mathématiques de Lyon

présentée et soutenue publiquement le 30 juin 2014 par

Vincent Tassion

PLANARITÉ ET LOCALITÉ EN PERCOLATION

Directeur de thèse :

Vincent BEFFARA

Après avis de :

Raphaël CERF
Gady KOZMA
Geoffrey GRIMMETT

Devant la commission d'examen formée de :

Vincent BEFFARA	<i>Directeur</i>
Itai BENJAMINI	<i>Membre</i>
Jacob VAN DEN BERG	<i>Membre</i>
Raphaël CERF	<i>Rapporteur</i>
Christophe GARBAN	<i>Membre</i>
Senya SHLOSMAN	<i>Membre</i>

“Quite apart from the fact that percolation had its origin in an honest applied problem (...), it is a source of fascinating problems of the best kind a mathematician can wish for: problems which are easy to state with a minimum of preparation, but whose solutions are (apparently) difficult and require new methods.”

H. Kesten, *Percolation theory for Mathematicians*

RÉSUMÉ

Cette thèse s'inscrit dans l'étude mathématique de la percolation, qui regroupe une famille de modèles présentant une transition de phase. Ce domaine a connu de nombreuses avancées au cours de ces trente-cinq dernières années. Certains des plus grands succès remontent aux années 2000, avec notamment l'invention du SLE, et la preuve de l'invariance conforme de la percolation de Bernoulli critique sur le réseau triangulaire. Ces avancées majeures, nous permettent aujourd'hui d'avoir une image très complète de la percolation de Bernoulli sur le réseau triangulaire. Heureusement, il reste encore de nombreuses questions en suspens, dont certaines sont maintenant célèbres. Ces questions ont guidé et motivé le travail de cette thèse.

La première d'entre elle est l'universalité de la percolation plane, qui affirme que les propriétés macroscopiques de la percolation plane critique ne devraient pas dépendre du réseau sous-jacent à sa définition. Par exemple, vue de très loin, la percolation critique sur le réseau carré devrait avoir le même comportement que celui de la percolation critique sur le réseau triangulaire. Ce phénomène d'universalité est analogue à celui bien connu du mouvement brownien : lorsqu'on regarde de très loin une marche aléatoire symétrique sur un réseau, on observe un mouvement brownien, indépendamment du réseau qui définit la marche. Nous montrons dans le cadre de la percolation Divide and Color, un résultat qui va dans le sens de cette universalité et identifions dans ce contexte des phénomènes macroscopiques indépendants du réseau microscopique. Une version plus faible d'universalité est donnée par la théorie de Russo-Seymour-Welsh (RSW), dont la validité est connue pour la percolation de Bernoulli (sans dépendance) sur les réseaux plans suffisamment symétriques. Nous étudions de nouveaux arguments de type RSW pour des modèles de percolation avec dépendance.

La deuxième question que nous avons abordée est celle de l'existence d'une composante connexe ouverte infinie au point critique. Cette question fondamentale du point de vue physique, est aussi très naturelle, puisque le point critique en percolation est défini comme étant le paramètre marquant la transition entre la phase où toutes les composantes ouvertes sont finies et la phase où existe une composante connexe ouverte infinie. Lorsqu'il n'y a pas de composante connexe ouverte infinie au point critique, on dit que la transition de phase est continue. Dans deux travaux en collaboration avec Hugo Duminil-Copin et Vladas Sidoravicius, nous montrons que la transition de phase est con-

tinue pour la percolation de Bernoulli sur le graphe $\mathbb{Z}^2 \times \{0, \dots, k\}$, et pour la percolation FK avec paramètre $q \leq 4$.

Enfin, la dernière question qui nous a guidée est la localité du point critique : est-ce que la donnée des boules de grands rayons d'un graphe suffit à identifier avec une bonne précision la valeur du point critique? Dans un travail en collaboration avec Sébastien Martineau, nous répondons de manière affirmative à cette question dans le cadre des graphes de Cayley de groupe abéliens. Dans ce travail nous étendons à un cadre non symétrique des techniques de renormalisation dynamique développées dans le cadre de la percolation sur \mathbb{Z}^d .

ORGANIZATION OF THE THESIS

This manuscript begins with a general introduction: it presents an overview of the questions studied and the results obtained during this thesis, but mainly focuses on the percolation techniques that inspired this PhD work. In order to introduce the study of planar percolation, we start this introduction with a full proof of Kesten's result which states that the critical point for Bernoulli percolation on the square lattice equals $1/2$. This proof, which follows the same steps as Kesten's, allows us to present various tools which have now become standard. We also drive the interested reader to the last part of the proof, obtained jointly with Vincent Beffara, which presents a shorter version of Kesten's argument showing the sharp threshold phenomenon. In this introduction, we also discuss two general arguments which have been used in various contexts through this thesis. The first one, the RSW-theory, is one of the most fundamental tools in the study of planar percolation. The second one, the finite-criterion approach, is a very powerful and beautiful tool which has been used since the first steps of Percolation to tackle a great variety of questions.

The rest of the manuscript is organized into three parts and seven chapters. Each chapter corresponds to a paper (or a paper in progress) and can be read independently of the others:

- Chapters 1 and 2 are published in ALEA;
- Chapters 4 and 7 are submitted;
- Chapters 3, 5 and 6 are in preparation.

Chapter 3 presents the most recent work, and may later be split into two different papers. Chapters 1 and 2 are written jointly with András Bálint and Vincent Beffara, chapters 4 and 5 with Hugo Duminil-Copin and Vladas Sidoravicius, and chapter 7 with Sébastien Martineau.

Part 1. Planar Divide and Color percolation. The first part is divided into three chapters, and mainly focuses on Divide and Color (DaC) percolation on the square lattice. In the **first chapter**, we present a rigorous method based on a finite criterion for planar DaC model that provides a confidence interval for the critical value function in this model. We present simulation results that confirm previous predictions, but also rise new questions. The **second chapter** establishes continuity properties of the critical value for DaC percola-

tion on the square lattice. We investigate a monotonicity question on general graphs and identify some difficulties by giving some counter-examples. The **third chapter** presents our most interesting result on the subject. We prove a conjecture formulated by Beffara and Camia, related to one of the most fundamental question in the study of percolation, namely the universality of almost-critical and critical planar percolation.

Part 2. Critical planar percolation with dependencies. In the **fourth chapter**, we present a new RSW-result that can be applied to a large class of planar percolation models. In particular, our approach does not use a “conditioning on a lowest path” argument, and can be applied to models with local dependencies (the process tends to evolve independently in two different regions, when they are taken to be sufficiently far away from each other). We develop the RSW-result for Voronoi percolation, which is a good example of a planar percolation model with local dependencies. As a consequence we prove that the box-crossing property holds for critical Voronoi percolation. This result is new and, as far as we know, does not follow from the previously known RSW-techniques.

In the **fifth chapter**, we prove that the phase transition of the random-cluster model is continuous when the cluster-weight q is smaller than or equal to 4, and obtain a strong box-crossing property at criticality for such q : there exists an open circuit in the annulus with inner radius n and outer radius $2n$, with probability larger than some positive constant $c > 0$. This constant depends neither on n , nor on the boundary conditions. The proof uses two ingredients. The first one is a new result providing the equivalence of the following properties at criticality: absence of infinite cluster for the wired measure, uniqueness of the infinite-volume measure, sub-exponential decay of the two-point function for the free measure, the strong box-crossing property mentioned above. This equivalence relies on the self-duality of the critical model, and holds for any cluster-weight $q \geq 1$. The second ingredient is a recent result of Hugo Duminil-Copin, proving sub-exponential decay of the two-point function for the free measure.

Part 3. Locality for Bernoulli percolation. The last two chapters study Bernoulli percolation on non-planar graphs. The results proved in these chapters deal with Bernoulli percolation and are concerned with a similar question: how can we characterize locally the existence of an infinite cluster? In other words, is the existence of an infinite cluster equivalent to the occurrence of a certain event in a finite box?

In the **sixth chapter**, we prove the absence of infinite cluster at criticality for Bernoulli percolation on the graph $\mathbb{Z}^2 \times \{0, \dots, k\}$.

In the **seventh chapter**, we study Bernoulli bond percolation on Cayley graphs of abelian groups, and we prove the locality of the critical point in this setting. Consider G and G_1, G_2, \dots a sequence of Cayley graphs of abelian groups with rank larger than or equal to 2. If G_n and G have the same ball of radius n for every n , then $p_c(G_n)$ converges to $p_c(G)$ when n tends to $+\infty$. This result can be seen as a continuity statement on

the Benjamini-Schramm space, and treats a particular case of a conjecture due to Oded Schramm.

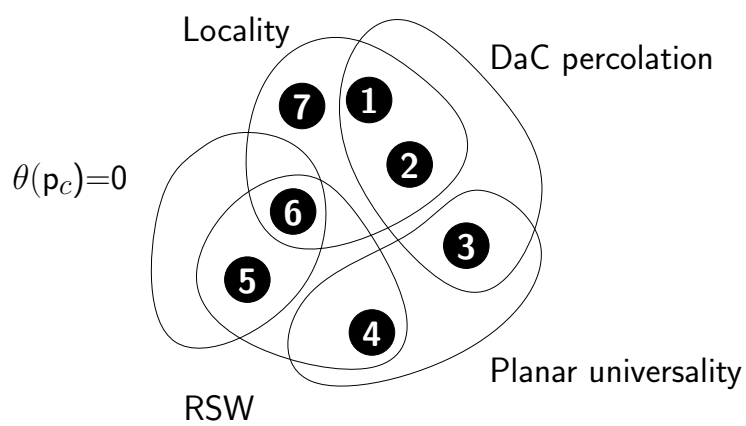

CONTENTS

General introduction	1
1 What is percolation?	1
1.1 General definitions	1
1.2 Standard techniques	2
2 Percolation on the square lattice	3
2.1 Definitions for planar percolation	3
2.2 The box-crossing property at $p=1/2$	4
2.3 Static renormalization	6
2.4 The critical point is at least $1/2$	9
2.5 The critical point is at most $1/2$	9
3 Overview of the results	13
3.1 Divide and Color percolation (Chapter 1-2-3)	13
3.2 The random cluster model (Chapter 5)	16
3.3 Bernoulli percolation: the critical behavior (Chapter 6)	19
3.4 Bernoulli percolation: the locality conjecture (Chapter 7)	20
4 Rectangle, Square, Which one can be crossed?	22
4.1 Overview	22
4.2 RSW-theory in this thesis	22
4.3 An RSW-result	23
5 Locality: the finite criterion approach	28
5.1 An example of finite criterion	28
5.2 Application 1: bounding the critical value	29
5.3 Application 2: critical behavior	29
1 Confidence intervals for the critical value in the divide and color model	33
1 Introduction	33
2 Finite size criteria	36
2.1 An upper bound for $r_c(p)$	36
2.2 Duality	38
2.3 A lower bound for $r_c(p)$	39
3 The confidence interval	39

4	Results of the simulations	42
2	On the critical value function in the divide and color model	47
1	Definitions and notation	50
2	Stochastic domination and continuity at $p = 0$	51
3	Continuity of $r_c^{\mathbb{Z}^2}(p)$ on the interval $[0, 1/2)$	53
4	The critical value functions of tree-like graphs	55
5	Counterexamples	57
5.1	Non-monotonicity	57
5.2	Graphs with discontinuous critical value functions	59
3	A universal behavior for planar DaC percolation	61
1	Definitions and notation	62
2	Preliminaries	64
2.1	The bond percolation event \mathcal{C}_L	64
2.2	The crossing probability and its derivatives	65
2.3	Previous results	66
3	Proof of Theorem 0.2	66
3.1	Proof of Proposition 3.1	68
3.2	Proof of Proposition 3.2	71
4	Behavior at $p = p_c$	73
4.1	Additional definitions	74
4.2	Proof of Lemma 3.5	76
4.3	The swapping Lemma	79
4	Crossing probabilities for Voronoi percolation	87
1	Voronoi percolation	89
1.1	Definitions and notation	89
1.2	External ingredients	90
1.3	Organization of the proof	91
2	Gluing at good scales	92
3	All the scales are good	94
5	Continuity of the phase transition for planar Potts models with $1 \leq q \leq 4$	97
1	Introduction	98
1.1	Motivation	98
1.2	Definition of the models and main statements	99
1.3	Applications to the study of the critical phase for $1 \leq q \leq 4$	106
2	Preliminaries	111
2.1	Background on the random-cluster model	112
3	Proof of Theorem 1.3	114
3.1	A preliminary result	114

3.2	Proof of Theorem 1.3: easy implications	116
3.3	Proof of Theorem 1.3: P4 implies P5	118
4	Proof of Theorem 1.6	136
4.1	An input coming from the theory of parafermionic observables . .	136
4.2	Proof of Theorem 1.6	139
4.3	Ordering for $q > 4$	144
5	Proofs of other theorems	145
5.1	Proof of Theorem 1.7	145
5.2	Proof of Theorem 1.11	147
5.3	Proof of Theorem 1.13	151
5.4	proof of Theorem 1.14	156
6	Absence of infinite cluster for critical Bernoulli percolation on slabs	157
1	Proof	160
1.1	The finite-size criterion	160
1.2	The renormalization step	164
1.3	The proof of Lemma 1.3 (the gluing Lemma)	165
1.4	The proof of Proposition 0.9	168
7	Locality of percolation for abelian Cayley graphs	171
0.5	Statement of Schramm’s conjecture	172
0.6	The Grimmett-Marstrand theorem	173
0.7	Main result	173
0.8	Questions	174
0.9	Organization of the paper	175
1	Marked abelian groups and locality	175
1.1	The space of marked abelian groups	175
1.2	Percolation on marked abelian groups	177
1.3	A first continuity result	178
1.4	Proof of Theorem 1.3	179
2	Proof of Lemma 1.8	180
2.1	Between continuous and discrete	180
2.2	Percolation toolbox	182
2.3	Geometric constructions	183
2.4	Construction of Good Blocks	189
2.5	Construction of a finite-size criterion	191
3	Proof of Lemma 1.9	192
3.1	Hypotheses and notation	192
3.2	Sketch of proof	193
3.3	Geometric setting: boxes and corridors	193
3.4	Probabilistic setting	195

Publications and pre-publications presented for the PhD thesis	201
Bibliography	203

INTRODUCTION

1 What is percolation?

1.1 General definitions

Graph definitions. We consider a simple non-oriented connected graph, given by a pair $G = (V, E)$: V denotes the vertex set, and the edge set E is a set of pairs of vertices $\{v, w\}$, $v, w \in V$. A path in G is a sequence of vertices x_0, x_1, \dots , finite or infinite, such that for every $i \geq 0$, $\{x_i, x_{i+1}\} \in E$. This path is said to be **self-avoiding** if all its vertices are distinct.

Bond percolation configurations. We consider the space $\Omega = \{0, 1\}^E$, equipped with the product sigma-algebra. An element $\omega \in \Omega$ is called a **bond percolation configuration** and we use the following definitions. An edge $e \in E$ is said to be **open** if $\omega(e) = 1$ and **closed** if $\omega(e) = 0$. A path of G is said to be **open** when all its edges are open. We consider the graph obtained from G by removing all the closed edges, and call **bond-cluster**, or simply **cluster** a maximal connected set of this graph.

Bernoulli bond percolation. In Bernoulli percolation we construct a random configuration in Ω by declaring each edge open with probability p and closed otherwise, independently for different edges. We denote by P_p the resulting probability measure on Ω .

Phase transition. Fix a vertex $\mathbf{0} \in V$, we write $\mathbf{0} \leftrightarrow \infty$ the event that there exists an infinite open self-avoiding path starting from $\mathbf{0}$, and define

$$\theta(p) = P_p[\mathbf{0} \leftrightarrow \infty].$$

The function θ is nondecreasing, and there exists a (unique) parameter $p_c = p_c(G) \in [0, 1]$, called **critical parameter** or **critical point** of G , such that

$$\theta(p) \begin{cases} = 0 & \text{if } p < p_c \\ > 0 & \text{if } p > p_c. \end{cases}$$

1.2 Standard techniques

The FKG inequality. The set $\Omega = \{0, 1\}^E$ has a natural partial ordering \leq defined by

$$\omega_1 \leq \omega_2 \iff \omega_1(e) \leq \omega_2(e) \text{ for all } e \in E.$$

An event $\mathcal{A} \subset \Omega$ is said to be increasing if

$$(\omega_1 \leq \omega_2, \omega_1 \in \mathcal{A}) \Rightarrow \omega_2 \in \mathcal{A}.$$

An event is decreasing if its complement is increasing. The following theorem, due to Harris [Har60], shows that increasing events are positively correlated.

Theorem 1.1. *If \mathcal{A}, \mathcal{B} are increasing events, then*

$$P_p[\mathcal{A} \cap \mathcal{B}] \geq P_p[\mathcal{A}] P_p[\mathcal{B}].$$

The inequality above is often called FKG inequality, in reference to Fortuin, Kasteleyn and Ginibre who proved it in a more general setting than Bernoulli percolation. We will also call FKG inequalities the following straightforward consequences of Theorem 1.1:

If \mathcal{A} and \mathcal{B} are decreasing events, then

$$P_p[\mathcal{A} \cap \mathcal{B}] \geq P_p[\mathcal{A}] P_p[\mathcal{B}].$$

If \mathcal{A} is increasing and \mathcal{B} is decreasing, then

$$P_p[\mathcal{A} \cap \mathcal{B}] \leq P_p[\mathcal{A}] P_p[\mathcal{B}].$$

Russo's formula. Let $\omega \in \Omega, e \in E$. We define the configurations ω_e and ω^e by

$$\omega_e(f) = \begin{cases} \omega(f) & \text{if } f \neq e \\ 0 & \text{if } f = e \end{cases} \quad \text{and} \quad \omega^e(f) = \begin{cases} \omega(f) & \text{if } f \neq e \\ 1 & \text{if } f = e \end{cases}$$

Let \mathcal{A} be an increasing event defined in terms of the state of finitely many edges. The event “ e is pivotal for \mathcal{A} ” is defined by all the configurations ω such that $\omega_e \notin \mathcal{A}$ and $\omega^e \in \mathcal{A}$. The following theorem, named after Russo who proved it in [Rus81], allows one to estimate the rate of change of $P_p[\mathcal{A}]$ when p varies.

Theorem 1.2 (Russo's formula). *Let \mathcal{A} be an increasing event defined in terms of the state of the edges in a finite set $E_0 \subset E$. Then*

$$\frac{d}{dp} P_p[\mathcal{A}] = \sum_{e \in E_0} P_p[e \text{ is pivotal for } \mathcal{A}]$$

2 Percolation on the square lattice

In this section, we study the percolation on the square lattice and give a full proof of Kesten's result that $p_c = 1/2$ for percolation on this graph. We choose to present this proof here because it introduces some fundamental tools of percolation, such as the Russo-Seymour-Welsh theory, the finite criterion approach, or the geometric interpretation of Russo's formula. These tools are very general and will be used and studied in various contexts all along the thesis.

2.1 Definitions for planar percolation

We consider the square lattice $G = (V, E)$ drawn in the plane, defined by setting $V = \mathbb{Z}^2$, and E the set of pairs $\{v, w\} \subset V$ at Euclidean distance $|v - w| = 1$. Its dual graph $G^* = (V^*, E^*)$ is defined by setting $V^* := (1/2, 1/2) + \mathbb{Z}^2$ (there is a vertex in the middle of each face of G), and E^* the set of pairs $\{v, w\} \subset V^*$ with $|v - w| = 1$ (two vertices are neighbours if they correspond to two adjacent faces of G). Note that the graph G^* is isomorphic to G , we call this specificity of the square lattice the self-duality property. The elements of E^* are sometimes called dual edges.

In the study of percolation on the square lattice, we see a path in G (or in G^*) as a planar curve obtained by joining its vertices x_0, x_1, \dots by segments of length 1. Note that when the path is self-avoiding the corresponding planar curve is a Jordan arc. Let $R = [a, b] \times [c, d]$ be a rectangle in the plane. We call horizontal crossing of R a self-avoiding path (of G or G^*) in R with *exactly* one point on $\{b\} \times [c, d]$ and one point on $\{a\} \times [c, d]$. Note that these two points are necessarily the two end-vertices of the path. We define similarly a vertical crossing in R .

To each edge $e \in E$ corresponds a unique dual edge $e^* \in E^*$ that crosses e (see Fig. 1). Given a bond percolation configuration, we say that the dual-edge e^* is dual-open if the edge e is closed. A path in G^* is said to be dual-open if all its edges are dual-open.

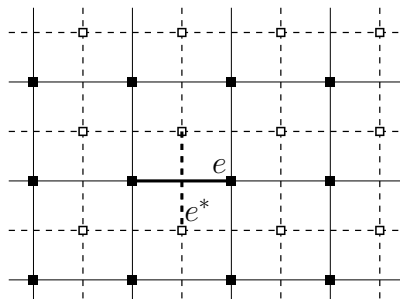

Figure 1: A portion of the square lattice G (solid lines) and its dual graph G^* (dashed lines). Each edge e of G crosses a unique dual-edge e^* of G^* .

2.2 The box-crossing property at $p=1/2$

Let $R = [a, b] \times [c, d]$ be a rectangle such that $a, b, c, d \in \mathbb{Z}^2$. We define $\mathcal{H}(R)$, resp. $\mathcal{V}(R)$, to be the event that there exists an open horizontal, resp. vertical, crossing in R . We also define $\mathcal{V}^*(R)$ to be the event that there exists a dual-open vertical crossing in the rectangle $[a + 1/2, b - 1/2] \times [c - 1/2, d + 1/2]$. The following result was first obtained by Russo[Rus81] and Seymour and Welsh[SW78]. The proof we give here is due to Bollobás and Riordan[BR06b]; as the original proofs of Russo, Seymour and Welsh, it involves a “conditioning on the lowest path argument”.

Theorem 2.1. Box-crossing property. *For any $\rho > 0$, there exist two constant $c(\rho) > 0$ and $N(\rho) \geq 1$ such that for every $n \geq N(\rho)$,*

$$1 - c(\rho) \geq P_{1/2} [\mathcal{H}([0, [2\rho n]] \times [-n, n])] \geq c(\rho)$$

The constant $N(\rho)$ appearing above is needed only to avoid the event $\mathcal{H}([0, [\rho n]] \times [-n, n])$ to be empty, in particular, we can take $N(\rho) = 1$ for every $\rho \geq 1$.

Proof. In order to emphasize the different arguments used, we decompose the proof into three steps.

Step 1: consequences of the self-duality. Given a rectangle R , one can prove that the event $\mathcal{H}(R)$ holds if and only if $\mathcal{V}^*(R)$ does not hold, and we have

$$P_{1/2} [\mathcal{H}(R)] + P_{1/2} [\mathcal{V}^*(R)] = 1.$$

When $p = 1/2$, one can easily check that $P_{1/2} [\mathcal{V}^*(R)] \leq P_{1/2} [\mathcal{V}(R)]$, and we obtain

$$P_{1/2} [\mathcal{H}(R)] + P_{1/2} [\mathcal{V}(R)] \geq 1.$$

Setting $R = [0, n]^2$, and using the invariance under $\pi/2$ rotation, we find

$$P_{1/2} [\mathcal{H}([0, n]^2)] \geq \frac{1}{2}. \tag{1}$$

From similar considerations involving the self-duality property, one can also see that it is sufficient to show that

$$P_{1/2} [\mathcal{H}([0, [2\rho n]] \times [-n, n])] \geq c(\rho) \tag{2}$$

holds for $\rho \geq 1$, in order to prove Theorem 2.1. Equation (1) concludes the case $\rho = 1$. It now remains to show that Equation (2) holds for every $\rho > 1$.

Step 2: conditioning on the lowest path. Consider the squares $S = [-n, 0] \times [0, n]$ and $S_+ = [-n, n] \times [0, 2n]$. Define the event \mathcal{E}_+ that there exists in S an open horizontal

crossing γ , and in S_+ an open path connecting γ to the top of S_+ (see Fig. 2). We will prove that

$$P_{1/2}[\mathcal{E}_+] \geq \frac{1}{8}.$$

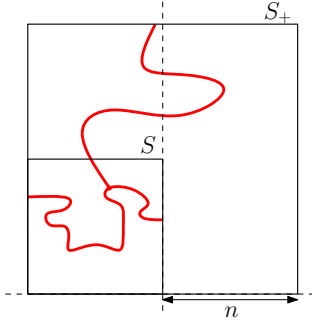

Figure 2: The event \mathcal{E}_+

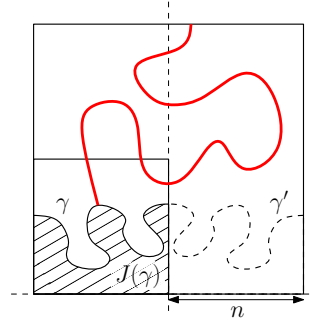

Figure 3: The event \mathcal{V}_γ

Let γ be a (deterministic) crossing in S . It separates the square S into two disjoint regions, and we write $J(\gamma)$ the union of the region below γ together with the points on the path γ . Let γ' be the path obtained by reflecting γ in the vertical line $\{0\} \times \mathbb{R}$. Define \mathcal{V}_γ to be the event that there exists an open path from γ to the top of the square S_+ in the region of S_+ above the union of γ with γ' . Note that this event is independent of the configuration in $J(\gamma)$. Any open vertical crossing in S_+ must intersect $\gamma \cup \gamma'$, and by symmetry we find

$$P_{1/2}[\mathcal{V}_\gamma] \geq \frac{1}{4}.$$

When the event $\mathcal{H}(S)$ holds, one can define the lowest open path Γ from left to right in S . Note that the event $\{\Gamma = \gamma\}$ is measurable with respect to the configuration in $J(\gamma)$ and is thus independent of \mathcal{V}_γ . Conditioning on Γ , we obtain

$$\begin{aligned} P_{1/2}[\mathcal{E}_+] &\geq \sum_{\gamma} P_{1/2}[\mathcal{V}_\gamma] P_{1/2}[\Gamma = \gamma] \\ &\geq \frac{1}{4} P_{1/2}[\mathcal{H}(S)] \\ &\geq \frac{1}{8}. \end{aligned}$$

Step 3: gluing paths with FKG inequality. Consider the square $S_- = [-n, n]^2$ and define the event \mathcal{E}_- that there exists in S an open horizontal crossing γ , and in S_- an open path connecting γ to the bottom of S_- . When \mathcal{E}_- , \mathcal{E}_+ and $\mathcal{V}(S)$ hold, it implies the existence of an open vertical crossing in the rectangle $[-n, n] \times [-n, 2n]$ (see Fig. 4). By FKG inequality, we obtain

$$\begin{aligned} P_{1/2}[\mathcal{V}([-n, n] \times [-n, 2n])] &\geq P_{1/2}[\mathcal{E}_-, \mathcal{E}_+, \mathcal{V}(S)] \\ &\geq \frac{1}{128}. \end{aligned} \tag{3}$$

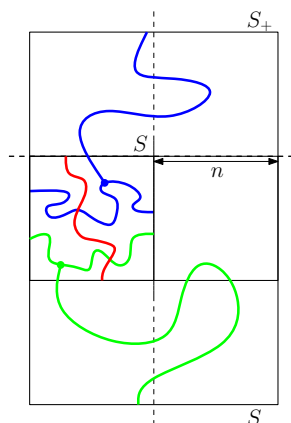
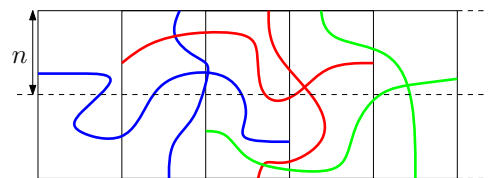
 Figure 4: The occurrence of $\mathcal{E}_-, \mathcal{E}_+, \mathcal{V}(S)$

 Figure 5: The events $\mathcal{E}_1, \mathcal{E}_2, \mathcal{E}_3, \dots$

For every $i \geq 0$, define the event \mathcal{E}_i that there exist an open horizontal crossing in $[in, (i+3)n] \times [-n, n]$ and an open vertical crossing in $[(i+1)n, (i+3)n] \times [-n, n]$. By equation (3) above, the horizontal crossing exists with probability larger than $1/128$, and by equation (1) the vertical crossing exists with probability larger than $1/2$. By FKG inequality, we find for every i

$$P_{1/2}[\mathcal{E}_i] \geq \frac{1}{256}$$

Let $k \geq 3$ and assume that \mathcal{E}_i holds for every $0 \leq i \leq k-3$, then there exists an open horizontal crossing in $[0, kn] \times [-n, n]$ (see Fig. 5). By FKG inequality, we obtain

$$\begin{aligned} P_{1/2}[\mathcal{V}([0, kn] \times [-n, n])] &\geq P_{1/2}[\mathcal{E}_0, \mathcal{E}_1, \dots, \mathcal{E}_{k-3}] \\ &\geq \left(\frac{1}{256}\right)^{k-2}, \end{aligned}$$

which concludes the proof of equation (2). □

2.3 Static renormalization

We define for every $n \geq 1$ and $0 \leq p \leq 1$, $\pi_n(p) := P_p[\mathcal{H}([0, 5n] \times [-n, n])]$.

Theorem 2.2. *If for some $n \geq 1$*

$$\pi_n(p) > \frac{2\sqrt{2}}{3},$$

then $P_p[0 \leftrightarrow \infty] > 0$.

The numerical value $2\sqrt{2}/3$ is irrelevant and could be replaced by any constant $\delta < 1$. Theorem 2.2 was proved initially by Russo [Rus81] with $2\sqrt{2}/3$ replaced by another constant. It can be proved in various ways. The proof we give here is very similar to Russo's proof. We use a coupling with a 1-dependent percolation measure. A measure \mathbf{P} on Ω is said to be 1-dependent if the events $\{e_1 \text{ is open}\}, \dots, \{e_n \text{ is open}\}$ are independent as soon as e_1, \dots, e_n are vertex-disjoint edges, meaning that e_i and e_j have no common end-vertex for all $i \neq j$.

Lemma 2.3. *Let \mathbf{P} be a 1-dependent measure on Ω_E , such that*

$$\forall e \in E, \quad \mathbf{P}[e \text{ is open}] > \frac{8}{9}.$$

Then there exists an infinite open cluster in G with positive probability.

Lemma 2.3 is proved using a Peierl's argument, named after Peierl who discovered it in the context of Ising model, see [Pei36].

Proof. If $[-n, n]^2$ does not intersect an infinite cluster, then it must be surrounded by a dual-open circuit in G^* . Such a circuit must intersect the half-axis $[n, \infty) \times \{-1/2\}$ at a point $(\ell + 1/2, -1/2)$ for some $\ell \geq n$ and contain a dual-open self-avoiding path of length ℓ starting from $(\ell + 1/2, -1/2)$ (see Fig. 6). Note that ℓ is not necessarily unique.

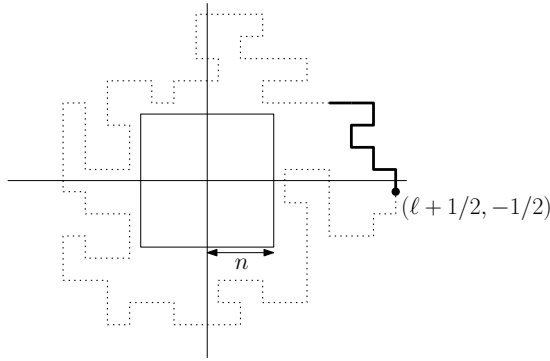

Figure 6: A dual-open circuit (in dotted line) around the box $[-n, n]^2$: it must contain a self-avoiding path (solid line) of length ℓ starting from a point $(\ell + 1/2, -1/2)$.

Let us denote SAW_ℓ the set of self-avoiding paths of length ℓ starting from $(\ell + 1/2, -1/2)$, the union bound gives

$$\mathbf{P} \left[[-n, n]^2 \text{ does not intersect an infinite cluster} \right] \leq \sum_{\ell \geq n} \sum_{\gamma \in \text{SAW}_\ell} \mathbf{P}[\gamma \text{ is dual-open}].$$

The number of paths in SAW_ℓ is smaller than $4 \cdot 3^\ell$, and a given path in SAW_ℓ , containing $\lfloor \ell + 1/2 \rfloor$ vertex-disjoint edges, is dual-open with probability smaller than $(1 - p)^{\ell/2}$. We obtain

$$\mathbf{P} \left[[-n, n]^2 \text{ does not intersect an infinite cluster} \right] \leq 4 \sum_{\ell \geq n} (3\sqrt{1-p})^\ell. \quad (4)$$

If $p > 8/9$, then by equation (4) above, one can pick n large enough so that $[-n, n]^2$ intersects an infinite cluster with positive probability. \square

Proof of Theorem 2.2. Let $0 \leq p \leq 1$, and assume that $\pi_n(p) > 2\sqrt{2}/3$. Let G_n be the graph with vertex set $3n\mathbb{Z}^2$ and edge set given by the pairs $\{x, x'\}$ such that the Euclidean distance between x and x' is exactly $3n$. Note that G_n is isomorphic (as a graph) to the square lattice. We associate to each edge e of G_n an event \mathcal{E}_e , defined as follows. If e is of the form $\{z, z + (3n, 0)\}$, we define \mathcal{E}_e to be the event that there exists an open horizontal crossing in the rectangle $z + [-n, 4n] \times [-n, n]$, and an open vertical crossing in the square $z + [-n, n]^2$ (see Fig. 7). If e is of the form $\{z, z + (0, 3n)\}$, we define \mathcal{E}_e to be the event that there exists an open vertical crossing in the rectangle $z + [-n, n] \times [-n, 4n]$ and an open horizontal crossing in the square $z + [-n, n]^2$.

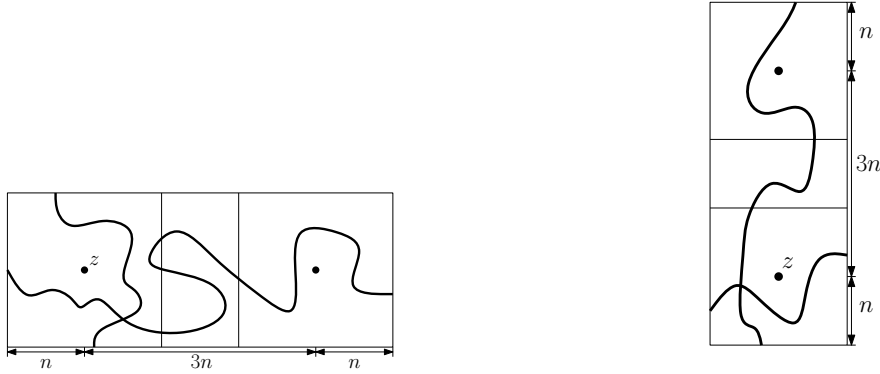

Figure 7: On the left, the event \mathcal{E}_e for $e = \{z, z + (3n, 0)\}$, and on the right for $e = \{z, z + (0, 3n)\}$

Note that the events $\mathcal{E}_{e_1}, \dots, \mathcal{E}_{e_k}$ are independent, when e_1, \dots, e_k are any vertex-disjoint edges of G_n . By the FKG inequality we have for every edge e of G_n ,

$$\begin{aligned} \mathbb{P}_p[\mathcal{E}_e] &\geq \mathbb{P}_p[\mathcal{H}([-n, 4n] \times [-n, n])] \mathbb{P}_p[\mathcal{V}([-n, n]^2)] \\ &\geq \pi_n(p)^2 \\ &> \frac{8}{9}. \end{aligned}$$

Let Y be the random variable defined by $Y(e) = 1$ if \mathcal{E}_e holds and $Y(e) = 0$ otherwise. The independence properties above imply that the law of Y is a 1-dependent percolation measure on the graph G_n . Since $Y(e) = 1$ with probability larger than $8/9$, Lemma 2.3 ensures that there exists with positive probability an infinite self-avoiding path $0 = z_0, z_1, \dots$ in G_n such that $Y(\{z_i, z_{i+1}\}) = 1$ for every $i \geq 0$. When such a path exists in G_n , it implies in G that the box $[-n, n]^2$ intersects an infinite cluster. \square

2.4 The critical point is at least 1/2

The following theorem is due to Harris[Har60] and implies that $p_c \geq 1/2$.

Theorem 2.4. *For Bernoulli bond percolation on the square lattice, we have*

$$\theta(1/2) = 0.$$

Proof. Consider the event \mathcal{A}_n that there exists in the annulus $[-3n, 3n]^2 \setminus [-n, n]^2$ a dual-open circuit surrounding the origin. It follows from Theorem 2.1 that there exists a constant $c_0 > 0$ such that for every n

$$P_{1/2}[\mathcal{A}_n] > c_0. \tag{5}$$

To see this, consider the following four rectangles $R_1 = [-3n + \frac{1}{2}, 3n - \frac{1}{2}] \times [n + \frac{1}{2}, 3n - \frac{1}{2}]$, $R_2 = [n + \frac{1}{2}, 3n - \frac{1}{2}] \times [-3n + \frac{1}{2}, 3n - \frac{1}{2}]$, $R_3 = [-3n + \frac{1}{2}, 3n - \frac{1}{2}] \times [-3n + \frac{1}{2}, -n - \frac{1}{2}]$, $R_4 = [-3n + \frac{1}{2}, -n - \frac{1}{2}] \times [-3n + \frac{1}{2}, 3n - \frac{1}{2}]$. If there exist dual-open horizontal crossings in R_1 and R_3 , and dual-open vertical crossings in R_2 and R_4 , then the event \mathcal{A}_n occurs (see Fig. 8). We obtain then the uniform bound (5) by applying FKG inequality.

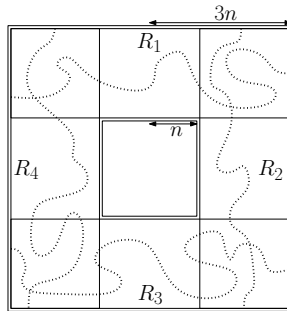

Figure 8: Dual-crossings in R_1, R_2, R_3, R_4 .

Finally consider the sequence of events $(\mathcal{A}_{3^i})_{i \geq 1}$. They are independent and by the Borel-Cantelli lemma, the origin is almost surely surrounded by a dual-open circuit, which concludes the proof. □

2.5 The critical point is at most 1/2

We prove the following theorem, which implies directly that $p_c \leq 1/2$.

Theorem 2.5. *For every $p > 1/2$, we have $\theta(p) > 0$.*

The proof of Theorem 2.5 presented here is very similar to Kesten's one. The general idea is to show that the box-crossing property cannot hold on a whole range of parameters (p_0, p_1) , $p_0 < p_1$. This sharp-threshold phenomenon can be obtained via Russo's formula by showing that there are many pivotal points when the crossing probabilities

are uniformly bounded away from 0 and 1. To show this, Kesten uses a circuit argument. Here we present a slightly shorter argument, obtained jointly with Vincent Beffara, and using a comparison between the four-arm event and the five-arm event.

Define $\theta_n(p)$ to be the probability that there exists an open path from the origin $\mathbf{0}$ to the boundary of the box $[-n, n]^2$. Consider the rectangle $R_n := [0, 6n] \times [0, 2n]$.

Lemma 2.6. *There exists a constant $c_1 > 0$ such that the following holds. For every $n \geq 1$ and every $p \geq 1/2$, we have*

$$\frac{d}{dp} \mathbb{P}_p [\mathcal{H}(R_n)] \geq c_1 \frac{1 - \pi_n(p)}{\theta_n(p)}.$$

Proof. Consider the rectangle $R_- = [0, 6n] \times [0, n]$. Let γ be a (deterministic) path from left to right in R_- , we write $J(\gamma)$ the region above γ . Note that the path γ is disjoint from $J(\gamma)$, nevertheless we consider by abuse that the edges with one end-vertex in γ and one in $J(\gamma)$ lie in $J(\gamma)$. For every edge e on the path γ , we define the events $\mathcal{A}(e, \gamma)$ that there exists an open path from an end-vertex of e to the top of R_n in the region $J(\gamma)$, and $\mathcal{A}^*(e^*, \gamma)$ that there exists a dual-open path from an end-vertex of e^* to the top of R_n in the region $J(\gamma)$. Consider the event illustrated on Fig. 9 that there exist

- (i) an open path in the region $J(\gamma) \cap ([0, n] \times [0, 2n])$, starting from γ and ending at the top of R_n ,
- (ii) a dual-open path in the region $J(\gamma) \cap ([n, 6n] \times [0, 2n])$, starting at distance $1/2$ from γ and ending on $[n, 6n] \times \{2n + 1/2\}$.

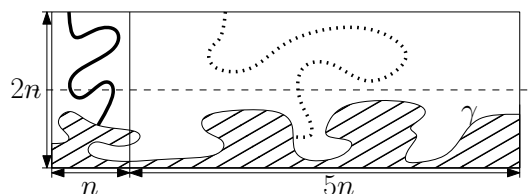

Figure 9: An event implying the occurrence of $\mathcal{A}(e, \gamma)$ and $\mathcal{A}^*(e^*, \gamma)$ for the same edge e in γ .

The first path exists with probability larger than some constant $c_2 > 0$ (by the box crossing property, see Theorem 2.1, and monotonicity), the second one with probability larger than $1 - \pi_n(p)$, by duality. When the event depicted above holds, one can consider the boundary of a cluster containing an open path of type (i) and show that there exists an edge e on γ such that both $\mathcal{A}(e, \gamma)$ and $\mathcal{A}^*(e^*, \gamma)$ hold. We find

$$\sum_{e \in \gamma} \mathbb{P}_p [\mathcal{A}(e, \gamma) \cap \mathcal{A}^*(e^*, \gamma)] \geq c_2 (1 - \pi_n(p)). \quad (6)$$

The event $\mathcal{A}(e, \gamma)$ is increasing and $\mathcal{A}^*(e^*, \gamma)$ is decreasing, and one can apply the FKG inequality to each term in the sum of equation (6). Using then the bound $\mathbb{P}_p [\mathcal{A}(e, \gamma)] \leq$

$\theta_n(p)$, we obtain

$$\sum_{e \in \gamma} P_p [\mathcal{A}^*(e^*, \gamma)] \geq c_2 \frac{1 - \pi_n(p)}{\theta_n(p)}.$$

When the event $\mathcal{H}(R_-)$ holds, we can define the lowest open horizontal crossing Γ in R_- . Let γ be a deterministic path, and assume that Γ is well defined and equal to γ . Under this assumption, one can verify that an edge e is pivotal if and only if the edge e is on the path γ and the event $\mathcal{A}^*(e^*, \gamma)$ holds. We obtain

$$P_p [e \text{ is pivotal}, \Gamma = \gamma] = \begin{cases} P_p [\Gamma = \gamma, \mathcal{A}^*(e^*, \gamma)] & \text{if } e \in \gamma \\ 0 & \text{otherwise.} \end{cases} \quad (7)$$

Using first Russo's formula, and then equation (7) above, we find

$$\begin{aligned} \frac{d}{dp} P_p [\mathcal{H}(R_n)] &= \sum_{e \in R_n} P_p [e \text{ is pivotal}] \\ &\geq \sum_{e \in R_n} P_p [e \text{ is pivotal}, \mathcal{H}(R_-)] \\ &= \sum_{\gamma} \sum_{e \in R_n} P_p [e \text{ is pivotal}, \Gamma = \gamma] \\ &= \sum_{\gamma} \sum_{e \in \gamma} P_p [\mathcal{A}^*(e^*, \gamma), \Gamma = \gamma] \end{aligned}$$

For a fixed γ , the event $\{\Gamma = \gamma\}$ is measurable with respect to the state of the edges below and on γ . It is in particular independent of the event $\mathcal{A}^*(e^*, \gamma)$, and we obtain from the computation above

$$\frac{d}{dp} P_p [\mathcal{H}(R_n)] \geq \sum_{\gamma} \left(\sum_{e \in \gamma} P_p [\mathcal{A}^*(e^*, \gamma)] \right) P_p [\Gamma = \gamma].$$

Using equation (7), we finally obtain

$$\frac{d}{dp} P_p [\mathcal{H}(R_n)] \geq c_2 P_p [\mathcal{H}(R_-)] \frac{1 - \pi_n(p)}{\theta_n(p)}.$$

We conclude the proof using the box crossing property (see Theorem 2.1) which implies by monotonicity that $P_p [\mathcal{H}(R_-)]$ is larger than some constant $c_3 > 0$ independent of n and $p \geq 1/2$. \square

Proof of Theorem 2.5. Assume for contradiction that there exists $p_0 > 1/2$ such that $\theta(p_0) = 0$. By Theorem 2.2 and monotonicity, we have for $n \geq 1$ and $1/2 \leq p \leq p_0$,

$$\pi_n(p) \leq \frac{2\sqrt{2}}{3} \quad \text{and} \quad \theta_n(p) \leq \theta_n(p_0)$$

By Lemma 2.6 we obtain, for $1/2 \leq p \leq p_0$,

$$\frac{d}{dp} P_p [\mathcal{H}(R_n)] \geq c_4 \frac{1}{\theta_n(p_0)}.$$

Integrating the equation above for p between $1/2$ and p_0 , we find

$$P_{p_0}[\mathcal{H}(R_n)] - P_{1/2}[\mathcal{H}(R_n)] \geq c_4 \frac{p_0 - 1/2}{\theta_n(p_0)}.$$

The left hand side is always smaller than 1, while the right hand side tends to infinity when n tends to infinity, which provides us a contradiction. \square

3 Overview of the results

3.1 Divide and Color percolation (Chapter 1-2-3)

Divide and Color (DaC) percolation was introduced in 2001 by Häggström [Hä01]. This is a stochastic model that was originally motivated by physical considerations (see [Hä01, CLM07]), but it has since then been used for biological modelling in [GPG07] as well and has inspired several generalizations (see e.g. [HH08, BCM09, GG06]).

Definition. Given a graph $G = (V, E)$ and two parameters $0 \leq p, r \leq 1$, DaC percolation is defined by the following two step procedure.

Step 1: Bernoulli bond percolation Consider a realization of Bernoulli bond percolation with parameter p . We focus on the resulting bond-clusters, which form a random partition of vertices of G .

Step 2: Coloring the clusters For each bond-cluster, choose one color, black or white, and assign this color to all its vertices. The chosen color is black with probability r , white otherwise, and the chosen colors are independent for different bond clusters.

These two steps yield a random configuration $X \in \{0, 1\}^V$ by defining, for each $v \in V$, $X(v) = 1$ if v is black and $X(v) = 0$ if v is white. We denote by $\mu_{p,r}^G$ the probability measure given by the law of X . Note that the process has long range dependencies: when $0 < p < 1$ two given vertices have always a positive probability to be on the same bond-cluster in the first step, and their colors are thus non-trivially correlated. In general, statistical mechanics models with non trivial correlations are not easy to define in infinite volume and are obtained by taking limits of measures in finite boxes. Here, the measure is defined only in terms of i.i.d. sequences, and can be directly defined in infinite volume.

Phase transition. Fix an origin $\mathbf{0} \in V$. We consider the event, denoted by $\mathbf{0} \xrightarrow{\text{black}} \infty$, that there exists an infinite path of G , starting from $\mathbf{0}$, all the vertices of which are colored black. For every fixed $p \in [0, 1]$, the probability $\mu_{p,r}[\mathbf{0} \xrightarrow{\text{black}} \infty]$ is a nondecreasing function of r (by a standard coupling argument), and one can define a critical value $r_c(p) \in [0, 1]$ such that the following holds:

$$\mu_{p,r}[\mathbf{0} \xrightarrow{\text{black}} \infty] \begin{cases} = 0 & \text{if } r < r_c(p) \\ > 0 & \text{if } r > r_c(p). \end{cases}$$

One can already observe that $r_c(p) = 0$ when p is larger than the critical point p_c for Bernoulli bond percolation on G . Indeed, when $p > p_c$, the origin lies in an infinite bond cluster with positive probability after the first step. As soon as $r > 0$, this cluster is colored black in the second step with positive probability, which realizes the event $\mathbf{0} \xrightarrow{\text{black}} \infty$. When G is the d -dimensional hypercubic lattice \mathbb{Z}^d , $d \geq 2$, Häggström [Hä01]

proved that the phase transition occurs at a nontrivial $r_c(p) \in (0, 1)$, for all subcritical $p < p_c$. The behavior when $p = p_c$ depends on the graph G : Häggström proved that $r_c(p_c) = 0$ when G is a sufficiently branching tree, and $r_c(p_c) = 1$ when $G = \mathbb{Z}^2$.

The function r_c is completely determined when G is the standard triangular lattice in the plane by the work of Bálint, Camia and Meester [BCM09]. On this graph, r_c is constant and equals $1/2$ on the interval $[0, p_c)$, it jumps to 1 at p_c , and is equal to 0 for $p > p_c$.

DaC percolation in the plane. We studied DaC percolation on planar lattices. We present here the results we obtained on the square lattice, but most of them extend to other planar lattices. From now on, the underlying graph is always assumed to be the square lattice (except in Theorem 3.1). In particular we have $p_c = 1/2$ but we prefer to keep the notation p_c to avoid possible confusions with other $1/2$'s. In [VT1], we adapt to DaC percolation a technique developed by Riordan and Walters [RW07] and obtain confidence intervals for the critical value function r_c . Figure 10 below shows the results of our simulations for r_c on the interval $[0, p_c)$. On the right we draw the complete expected picture, using Häggström's results mentioned above concerning the behavior on $[p_c, 1]$.

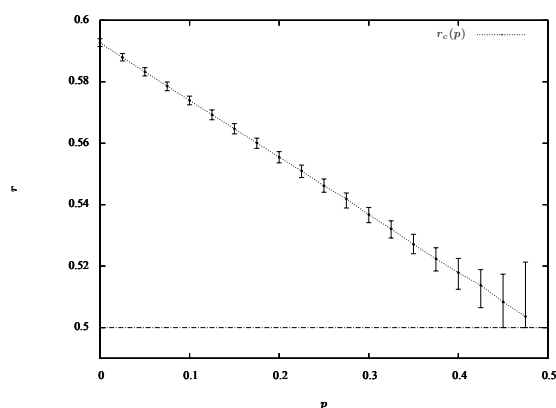

Figure 10: Simulation results for different values of $p < p_c^L$. The dashed line was obtained via a non-rigorous correction method.

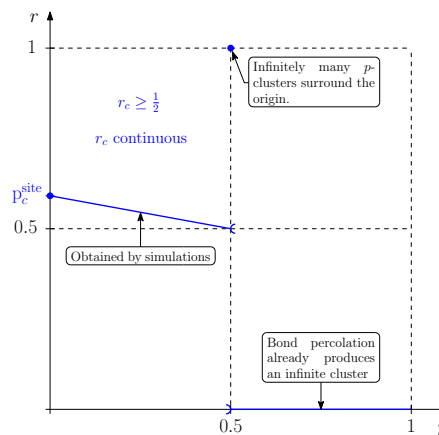

Figure 11: Expected behavior for r_c on the square lattice.

The inequality $r_c(p) \geq 1/2$ was established by Bálint, Camia and Meester, using duality arguments. The simulations strongly suggest that on the interval $[0, p_c)$, the function r_c is continuous, decreasing, and converges to $1/2$ when p tends to p_c . We studied all these features.

Monotonicity? When p increases, the underlying bond clusters become larger and one may expect that it becomes easier to have an infinite black path from the origin. This heuristic reasoning is wrong. Simply consider $r \in (r_c(0), 1)$. We have $\mu_{0,r}[\mathbf{0} \xrightarrow{\text{black}}$

$\infty] > 0$ while $\mu_{p_c, r}[0 \xleftrightarrow{\text{black}} \infty] = 0$. What happens here is that the bond clusters get larger and create “barriers” around the origin. This shows that there is a priori no easy coupling that could prove the monotonicity. In order to identify some difficulties arising with this question, we investigate the monotonicity question on general graphs and prove the following.

Theorem 3.1 (with Vincent Beffara and András Bálint). *There exists a quasi-transitive¹ graph G with a critical r_c which is not monotonic (neither nonincreasing nor nondecreasing) on $[0, p_c)$.*

Continuity. Based on the previous work of Bálint, Camia, and Meester, we could prove that r_c is continuous on the interval $[0, p_c)$. Our proof uses a finite criterion approach.

Theorem 3.2 (with Vincent Beffara and András Bálint). *The function r_c is continuous on the interval $[0, p_c)$.*

Convergence to 1/2? The fact that $r_c(p)$ should converge to $1/2$ when p tends to p_c was conjectured by Beffara and Camia, based on the following heuristic reasoning. One can see DaC percolation as a site percolation process on the random graph G_p determined by the bond-clusters: the vertices of G_p correspond to the bond-clusters, and there is an edge between two vertices if the corresponding bond-clusters are adjacent in \mathbb{Z}^2 . The value $r_c(p)$ can be interpreted as the critical parameter for site percolation on the random graph G_p . Near $p = p_c$, the large bond-clusters should be arranged as a graph which is close to a triangulation, and, from a site percolation point of view, a triangulation is self-dual and is expected to have a critical value equal to $1/2$. Thus when p is close to p_c , the value $r_c(p)$ should be close to $1/2$, being the critical parameter of a graph which looks like a triangulation.

Actually the structure of G_p is given by the geometry of “near-critical percolation clusters,” which is expected to be universal for 2-dimensional planar graphs. This suggests that the critical r for p close to its critical value should not depend much on the original underlying lattice, and we expect the convergence of $r_c(p)$ to $1/2$ to be universal and hold in the case of any 2-dimensional lattice.

Our main result on DaC percolation was to prove Beffara and Camia’s conjecture for the square lattice.

Theorem 3.3. *For DaC percolation on the square lattice, we have*

$$\lim_{\substack{p \rightarrow p_c \\ p < p_c}} r_c(p) = 1/2.$$

¹A graph is said to be quasi-transitive if the action of its group of automorphisms has finitely many orbits

Linearity? Surprisingly, the critical value function r_c seems to be linear on the interval $[0, p_c)$. We used also simulations to estimate $r_c(p)$ on the interval $[0, p_c)$ for the hexagonal lattice (see Fig. 12). In this second case the function is clearly not linear. Thus, if it holds, linearity must be a specific property of the square lattice, but we do not have any argument or heuristic reasoning to explain this fact.

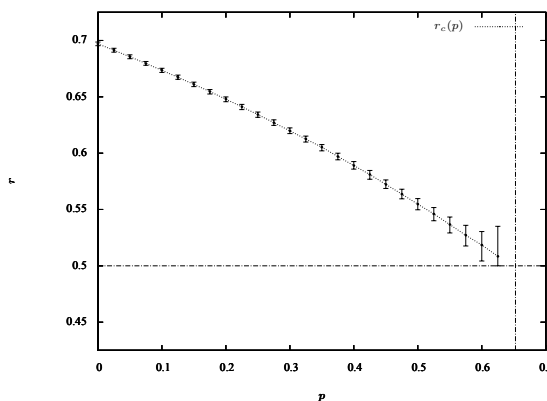

Figure 12: Estimations for the critical value function $r_c(p)$ on the hexagonal lattice.

3.2 The random cluster model (Chapter 5)

The free and wired measures. We consider the square lattice $G = (\mathbb{Z}^2, E)$. We denote by Λ_n the subgraph of \mathbb{Z}^2 illustrated on Fig. 13 and defined as follows: its vertex set is given by all the vertices of \mathbb{Z}^2 in $[-n, n]^2$ except the four corners of $[-n, n]^2$, and its edge set, denoted by E_n , is given by all the edges of the square lattice with both end-vertices $[-n, n]^2$ except those included on the boundary of $[-n, n]^2$. We write $\partial\Lambda_n$ the set of vertices of Λ_n with less than four neighbours in Λ_n . Given a bond percolation configuration $\omega \in \{0, 1\}^{E_n}$, we write $o(\omega)$ and $c(\omega)$ for the number of open and closed edges in ω . We also write $k_0(\omega)$ the number of clusters in the configuration ω . The configuration ω can also be seen as a bond percolation configuration on the graph $\widetilde{\Lambda}_n$ obtained from Λ_n by contracting into one point all the vertices of $\partial\Lambda_n$. Write then $k_1(\omega)$ the number of clusters for ω in the graph $\widetilde{\Lambda}_n$. As illustrated on Fig. 14, $k_1(\omega)$ can also be seen as the number of clusters when all the points of $\partial\Lambda_n$ are wired altogether.

Let $p \in [0, 1], q \in [1, \infty)$. Define the random-cluster measure in Λ_n with edge density p , cluster weight q , and free boundary conditions by the formula

$$\phi_{\Lambda_n, p, q}^0[\{\omega\}] := \frac{p^{o(\omega)}(1-p)^{c(\omega)}q^{k_0(\omega)}}{Z_{G, p, q}^0},$$

and the random-cluster measure in Λ_n with wired boundary conditions by

$$\phi_{\Lambda_n, p, q}^1[\{\omega\}] := \frac{p^{o(\omega)}(1-p)^{c(\omega)}q^{k_1(\omega)}}{Z_{G, p, q}^1}.$$

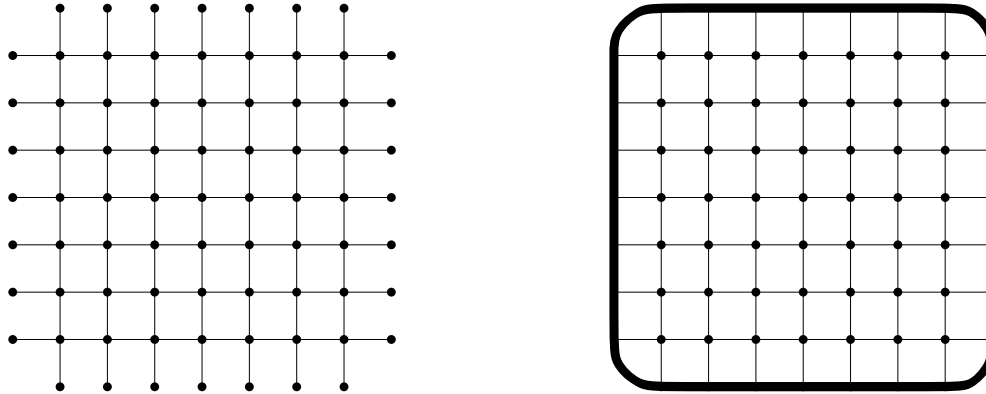

Figure 13: The graphs Λ_n (left) and $\tilde{\Lambda}_n$ (right). On the right, the thickened boundary represents a single vertex.

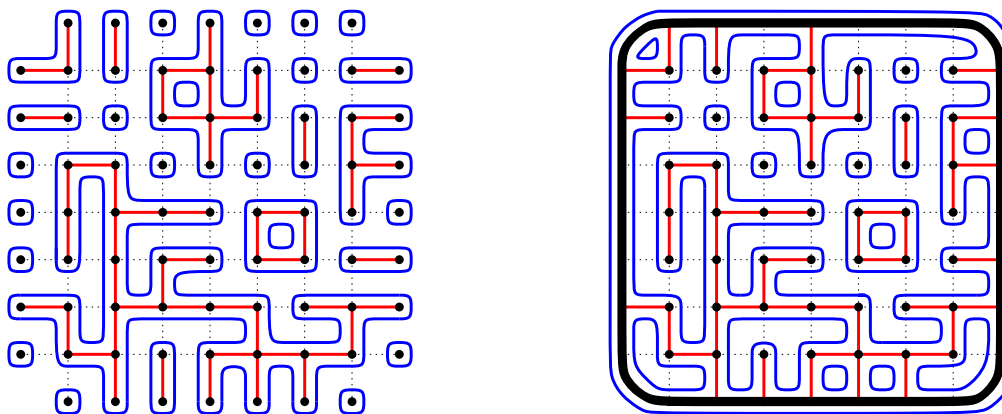

Figure 14: The bond-clusters defined by the configuration on Λ_n (left) and $\tilde{\Lambda}_n$ (right). There are $k_0(\omega)$ bond-clusters on the left, $k_1(\omega)$ on the right.

The constants $Z_{\Lambda_n, p, q}^0$ and $Z_{\Lambda_n, p, q}^1$ are called the partition functions, and are defined in such a way that the sum of the weights over all possible configurations equals 1.

Infinite-volume measures can be defined on \mathbb{Z}^2 by taking limits of finite-volume measures for graphs tending to \mathbb{Z}^2 . In particular, the infinite-volume random-cluster measure with free (resp. wired) boundary conditions $\phi_{\mathbb{Z}^2, p, q}^0$ (resp. $\phi_{\mathbb{Z}^2, p, q}^1$) can be defined as the limit of the sequence of measures $\phi_{\Lambda_n, p, q}^0$ (resp. $\phi_{\Lambda_n, p, q}^1$) for $\Lambda_n \nearrow \mathbb{Z}^2$. We refer the reader to [Gri06] for more details on this construction.

Phase transition. For fixed $q \geq 1$, the random-cluster model undergoes a phase transition in infinite volume. Define $\theta^1(p, q) = \phi_{\mathbb{Z}^2, p, q}^1[0 \leftrightarrow \infty]$, there exists a critical parameter $p_c(q) \in (0, 1)$ such that the following holds:

$$\theta^1(p, q) \begin{cases} = 0 & \text{if } p < p_c(q) \\ > 0 & \text{if } p > p_c(q). \end{cases}$$

The value of $p_c(q)$ was recently proved to be equal to $\sqrt{q}/(1 + \sqrt{q})$ for any $q \geq 1$ in [BDC12a]. The result was previously proved in [Kes80] for Bernoulli percolation ($q = 1$), in [Ons44] for $q = 2$ using the connection with the Ising model and in [LMMS⁺91] for $q \geq 25.72$.

The phase transition is said to be continuous if $\theta^1(p_c(q), q) = 0$, and discontinuous if $\theta^1(p_c(q), q) > 0$. Our main result in this context is the following theorem.

Theorem 3.4 (with Hugo Duminil-Copin and Vladas Sidoravicius). *For every $q \leq 4$, the phase transition in random cluster model is continuous.*

This theorem was already proved in the case $q = 1$ (which corresponds to Bernoulli percolation) by combining results of Harris [Har60] and Kesten [Kes80] and in the case $q = 2$ from the work of Onsager on Ising model [Ons44].

The theorem above confirms the physical predictions of Baxter [Bax71, Bax73, Bax89]. Based on exact (but non-rigorous) computations, he was able to predict the critical behavior of Potts model. Via the Edwards and Sokal coupling [ES88] which establishes a correspondence between the Potts model and the random cluster model and using Baxter's work, one can predict that the phase transition in the random cluster model should be continuous for $1 \leq q \leq 4$ and discontinuous for $q > 4$. Our theorem covers thus the whole range of values for which the phase transition is expected to be continuous. Note that Edwards and Sokal coupling allowed us to derive from Theorem 3.4 a continuity result for the Potts model, and confirm a part of Baxter's prediction on this model.

For $q > 4$, we prove a result strongly suggesting a discontinuous phase transition. Stating this result here would require additional definitions but we drive the interested reader to chapter 5 Proposition 5.4.3. Let us finally mention that the phase transition is already known to be discontinuous for every $q \geq 25.72$ (see [LMMS⁺91]).

An alternative for the behavior of critical random-cluster models. Most of our work on the random cluster consisted in proving the following theorem, which provides a great understanding of the critical behavior of the critical random-cluster, and shows that only two very different behaviors are possible. This result is valid for every $q \geq 1$ and its proof relies on a self duality property enjoyed by the model on the square lattice.

Theorem 3.5 (with Hugo Duminil-Copin and Vladas Sidoravicius). *Let $q \geq 1$. The following assertions are equivalent :*

P1 (Absence of infinite cluster at criticality) $\phi_{\mathbb{Z}^2, p_c, q}^1 [0 \longleftrightarrow \infty] = 0$;

P2 (Uniqueness of the infinite-volume measure) $\phi_{\mathbb{Z}^2, p_c, q}^0 = \phi_{\mathbb{Z}^2, p_c, q}^1$;

P3 (Infinite susceptibility) $\chi^0(p_c, q) := \sum_{x \in \mathbb{Z}^2} \phi_{\mathbb{Z}^2, p_c, q}^0 [0 \longleftrightarrow x] = \infty$;

P4 (Sub-exponential decay for free boundary conditions)

$$\lim_{n \rightarrow \infty} \frac{1}{n} \log \phi_{\mathbb{Z}^2, p_c, q}^0 [0 \longleftrightarrow \partial \Lambda_n] = 0;$$

P5 (RSW) For any $\rho \geq 1$, there exists $c = c(\rho) > 0$ such that for all $n \geq 1$,

$$\phi_{\Lambda_{2\rho n}, p_c, q}^0 [\mathcal{H}([- \rho n, \rho n] \times [-n, n])] \geq c.$$

Recently, Hugo Duminil-Copin developed new ingenious techniques based on Smirnov's parafermionic observable (see his recent book [DC13] for an overview) and obtained numerous new rigorous results in various planar models of statistical physics. In particular, for the random cluster model with $q \leq 4$, he managed to prove that the probability $\phi_{\mathbb{Z}^2, p_c, q}^0 [0 \longleftrightarrow \partial \Lambda_n]$ decays at most polynomially fast (meaning $\geq \frac{1}{n^c}$ for some constant $c > 0$) when n tends to infinity (see [DC12]). This is enough information to identify the critical behavior, since it implies that Property **P4** above holds, and Theorem 3.5 provides then a complete picture when $q \leq 4$. The strongest property is **P5**, it extends the RSW-Theorem of Bernoulli percolation, and allows to identify similarities between the critical behavior of the random cluster models with $1 \leq q \leq 4$ and the well-known critical behavior of Bernoulli percolation.

3.3 Bernoulli percolation: the critical behavior (Chapter 6)

The critical value p_c separates two different behaviors for the Bernoulli percolation process on a graph G :

- when $p < p_c$, there is almost surely no infinite cluster, we say that the process does not percolate in G .
- when $p > p_c$, there exists almost surely at least one infinite cluster: the process percolates.

A natural question to ask is whether the process percolates or not at criticality, which is equivalent to ask whether $\theta(p_c) > 0$ or $\theta(p_c) = 0$. When $\theta(p_c) = 0$ on a graph G , we say that the phase transition is **continuous** for Bernoulli percolation. A continuous phase transition has been proved to hold

- for the square lattice $G = \mathbb{Z}^2$ by combining results of Harris [Har60] and Kesten [Kes80].
- for the d -dimensional hypercubic lattice \mathbb{Z}^d , $d \geq 19$, by Harra and Slade [HS94], using a lace-expansion technique.
- for the half-spaces $\mathbb{Z}^{d-1} \times \mathbb{N}$, $d \geq 1$, by Barsky, Grimmett and Newman [BGN91b], using a dynamical renormalization argument.
- for any unimodular non-amenable transitive graph by Benjamini, Lyons, Peres and Schramm [BLPS99], using a mass-transport principle. (For definitions, see [BLPS99].)

The case of \mathbb{Z}^d for d between 3 and 18 is still open. The continuity of the phase transition for \mathbb{Z}^3 is one of the most famous open questions in Bernoulli percolation.

With an eye on this open problem, Benjamini asked the question for the slabs \mathbb{S}_k , which are expected to have the same percolation properties as \mathbb{Z}^3 when k is large. We managed to answer positively to this question.

Theorem 3.6 (with Hugo Duminil-Copin and Vladas Sidoravicius). *For every $k \geq 0$, the phase transition is continuous for Bernoulli percolation on the slab \mathbb{S}_k .*

3.4 Bernoulli percolation: the locality conjecture (Chapter 7)

Bernoulli percolation defines for each graph G a critical value $p_c(G)$. Which properties of the graph determine the value of p_c ? The **locality conjecture**, formulated in [BNP11] and attributed to Oded Schramm, states that the value of $p_c(G)$ is only sensitive to the local structure of the graph. Informally, when two graphs have the same balls of radius n for a large n , they have close critical values for Bernoulli percolation. Let us give a first example illustrating this behavior. Consider the subgraph of \mathbb{Z}^3 , called **slab**, generated by the vertices in $\mathbb{Z}^2 \times \{-k, \dots, k\}$. We denote this graph by \mathbb{S}_k . When k is large, the structure of the graph \mathbb{S}_k in a neighborhood of the origin is the same as the structure of \mathbb{Z}^3 around $\mathbf{0}$, and a fundamental result of Grimmett and Marstrand [GM90] states that $p_c(\mathbb{S}_k)$ converges to $p_c(\mathbb{Z}^3)$ when k tends to infinity. In order to generalize and formalize this phenomenon, we would like to see p_c as function defined on a set of graphs, equipped with a suitable topology, and study its continuity properties. In the next paragraph we present the space of transitive graphs, introduced by Benjamini and Schramm, which offers a natural framework to state the locality conjecture.

The space of transitive graphs. A graph G is said to be (vertex-)transitive if for every two vertices v, w there exists a graph automorphism of G mapping v to w . Let \mathcal{G} denote

the set of (locally finite, non-empty, connected) transitive graphs considered up to isomorphism. Take $G \in \mathcal{G}$ and o any vertex of G . Then consider the ball of radius k (for the graph distance) centered at o , equipped with its graph structure and rooted at o . Up to isomorphism of rooted graphs, it is independent of the choice of o , and we denote it by $B_G(k)$. Let G and H be two transitive graphs. We consider the supremum of the integers k such that balls of radius k in G and H are isomorphic,

$$n = \sup\{k : B_G(k) \simeq B_H(k)\} \in \mathbb{N} \cup \{\infty\},$$

and then define $d_{\text{loc}}(G, H) = 2^{-n}$, where $2^{-\infty} := 0$. One can verify that d_{loc} is a distance on \mathcal{G} , called the local distance. It was introduced by Benjamini and Schramm [BS01], see also [Ben13a] for more details.

The locality conjecture. With the notation above, one can state Schramm's conjecture as follows. Consider a sequence of transitive graphs (G_n) that converges locally to a transitive graph G , which means that $\lim_{n \rightarrow \infty} d_{\text{loc}}(G_n, G) = 0$. If $\sup p_c(G_n) < 1$, then the following convergence holds,

$$\lim_{n \rightarrow \infty} p_c(G_n) = p_c(G). \quad (8)$$

The restriction to graphs with p_c uniformly bounded away from 1 allows one to discard in particular the case of sequences of finite graphs converging locally toward an infinite graph with a non-trivial critical point, a situation where the convergence (8) is clearly wrong.

Benjamini, Nachmias and Peres [BNP11] prove some particular cases of the conjecture. They obtained for example the convergence (8) for particular sequences of graphs converging to a tree. Grimmett and Marstrand's theorem given at the beginning of the section does not fit directly in the framework of Schramm's conjecture, since slabs are not transitive graphs. Nevertheless, it is possible to deduce from Grimmett and Marstrand's theorem that the following convergence holds. For $n \geq 1$, write \mathbb{Z}_n the cyclic graph with vertex set $\mathbb{Z}/n\mathbb{Z}$, we have $\lim_{n \rightarrow \infty} p_c(\mathbb{Z}^2 \times \mathbb{Z}_n) = p_c(G)$.

Extending Grimmett and Marstrand's techniques to the more general setting of abelian groups, we managed to obtain the following locality result.

Theorem 3.7 (with Sébastien Martineau). *Consider a sequence (G_n) of Cayley graphs of abelian groups satisfying $p_c(G_n) < 1$ for all n . If the sequence converges to the Cayley Graph G of an abelian group, then*

$$p_c(G_n) \xrightarrow[n \rightarrow \infty]{} p_c(G).$$

4 Rectangle, Square, Which one can be crossed?

4.1 Overview

In the study of planar percolation, the Russo-Seymour-Welsh (RSW) theory has become one of the most important tools. We have already presented a proof of a RSW-result in section 2.2 for Bernoulli percolation on the square lattice, but such results can be studied for general planar percolation models: a RSW-result generally refers to an inequality providing bounds on the crossing probability for long rectangles, knowing bounds on the crossing probability for squares. Heuristically, this inequality is obtained by “gluing” together square-crossings in order to obtain a crossing in a long rectangle.

Such results have first been obtained for Bernoulli percolation on a lattice with a symmetry assumption [Rus78, SW78, Rus81, Kes82]. For continuum percolation in the plane, a RSW-result is proved in [Roy90] for open crossings and in [Ale96] for closed crossings. A RSW-theory has been recently developed for FK-percolation, see e.g. [BDC12b, DCHN11]. Some weaker versions of the standard RSW have been developed in [BR06a], [BR10] and [vdBBV08],

At criticality, RSW-theory generally implies the **box-crossing property**: the crossing probability for any rectangle remains bounded between c and $1 - c$, where $c > 0$ is a constant depending only the aspect ratio of the considered rectangle (in particular it is independent of the scale). The box-crossing property has numerous consequences and provides a great understanding of the critical and near-critical regime of percolation. For example, it is one of the key ingredients in the foundational work of Kesten [Kes87] on scaling relations. The box-crossing property is also used to study the scaling limit of percolation, providing tightness arguments (see e.g. [Smi01, SSG11, GPS13b]). In the recent work of Grimmett and Manolescu [GM13], the box-crossing property is established for critical percolation on isoradial graphs, and used in order to prove a universality result on the so-called arm exponents.

4.2 RSW-theory in this thesis

RSW-results are mainly studied in Chapter 4 and 5 of this thesis, and new results are developed in contexts where standard arguments do not apply. We prove RSW results

- in Chapter 4 for Voronoi percolation, where the “conditioning on the lowest path” argument does not apply, due to local dependencies.
- in Chapter 5 for the random-cluster model, where we have to deal with boundary conditions, due to global dependencies.

Since the difficulties are not the same, the methods developed in chapters 4 and 5 are very different. Nevertheless, one can notice that in both cases, a renormalization scheme is involved: contrarily to the proof presented in section 2.2, where two square crossings are “glued” at some scale in order to create a rectangle at the same scale, the proofs in

Chapter 4 and 5 examine how the crossing probabilities are related from one scale to another.

In Chapters 6 and 7 some RSW-type reasonings are also investigated in non-planar context: for slabs and for d -dimensional graphs. In these contexts, we can no longer use tools from planar topology and the gluing procedure is more complicated. In chapter 6, we develop a new method relying on a lexicographic ordering on the paths, and in chapter 7, we use a method known to some as “sprinkling” (see [Gri99b]).

In Chapters 1, 2 and 3, we do not work directly with RSW-results. Nevertheless, we use results of Bálint, Camia and Meester such as the duality relation $r_c(p) + r_c^*(p) = 1$ or the finite criterion of Lemma 2.10 in [BCM09], and these results rely on the RSW theorem of van den Berg, Brouwer and Vágvölgyi [vdBBV08].

4.3 An RSW-result

For Bernoulli percolation, the original proof of the Russo-Seymour-Welsh theorem uses an argument relying on the spatial Markov property of the model: knowing that a left-right crossing exists in a square, it is always possible to condition on the lowest one, which leaves an unexplored region where the configuration can be sampled independently of the explored region (below the lowest path). This argument was presented in section 2.2 for Bernoulli percolation and cannot be applied directly when the model has spatial dependencies. In this thesis, we developed a new RSW-argument without exploration, allowing to prove RSW-results for a broader class of models than Bernoulli percolation. We present this argument here for particular percolation measures on the square lattice, but it can be applied in other contexts, in particular when the “conditioning on the lowest crossing” argument cannot be used. In Chapter 4, we will refine the argument presented here together with a renormalization procedure in order to establish the box-crossing property for critical Voronoi percolation. In Chapter 6, we also use similar argument in the context of Bernoulli percolation on slabs.

What will we prove here? Let $G = (V, E)$ be the square lattice. We use the same definitions as in section 3.1. We consider a measure P on the space of bond percolation configurations $\Omega = \{0, 1\}^E$. We assume that P is positively associated, meaning that the inequality

$$P[\mathcal{A} \cap \mathcal{B}] \geq P[\mathcal{A}]P[\mathcal{B}]$$

holds for every increasing events \mathcal{A} and \mathcal{B} . We also assume that P is invariant under the translations, reflections and $\pi/2$ -rotations preserving \mathbb{Z}^2 . We will use the following elementary consequence of positive association, called the square root trick (following [CD88]). For every increasing events \mathcal{A} and \mathcal{B} , such that $P[\mathcal{A}] \geq P[\mathcal{B}]$, we have

$$P[\mathcal{A}] \geq 1 - \sqrt{P[\mathcal{A} \cup \mathcal{B}]}.$$

Define, for $\rho \geq 1$,

$$f_n(\rho) := \mathbb{P}[\mathcal{H}([0, 2\rho n] \times [-n, n])].$$

We will prove the following result.

Theorem 4.1. *Let $\eta > 0$. Assume that $\liminf_{n \rightarrow \infty} f_n(1) > 1 - \eta$, then*

$$\limsup_{n \rightarrow \infty} f_n(4/3) > (1 - \eta^{1/4})^7$$

The conclusion of the theorem above bounds the crossing probability of the rectangle $[0, 8/3n] \times [-n, n]$ only along a subsequence, and for this reason, we call it a weak RSW-result. Weak RSW-results are sufficient for many applications. For example, Bollobás and Riordan [BR06a] used a similar result for Voronoi percolation in the plane in order to prove that the critical point is $1/2$. Later, Van den Berg, Brouwer and Vágvölgyi [vdBBV08] refined Bollobás and Riordan’s result and obtained continuity properties of the self-destructive percolation model. A weak-RSW result is also obtained in [BR10] for percolation processes without any symmetry.

As in the third step of the proof of Theorem 2.1, one can use the bounds on the crossing probability $f_n(4/3)$ to obtain bounds on the crossing probabilities $f_n(\rho)$ for any ρ , and the following result is a straightforward consequence of theorem 4.1.

Corollary 4.2. *For every $\rho > 0$, there exists a continuous function $\phi_\rho : (0, 1] \rightarrow (0, 1]$ satisfying $\phi_\rho(1) = 1$, such that*

$$\limsup_{n \rightarrow \infty} f_n(\rho) \geq \phi_\rho(\liminf_{n \rightarrow \infty} f_n(1)).$$

Our strategy is inspired by Bollobás and Riordan’s. We introduce at each scale n a parameter $0 \leq \alpha_n \leq n$. At scale n , if $\alpha_{3n/2} \leq 2\alpha_n$, a geometric construction allows one to “glue” square crossings in order to create a rectangle crossing at scale $3n/2$ and bound below the crossing probability $f_{3n/2}(4/3)$ by some explicit function of the crossing probabilities $f_n(1)$ and $f_{3n/2}(1)$. We sketch the proof in the next paragraph.

Sketch of proof of Theorem 4.1. Let $\eta > 0$ and $n_0 \geq 1$. We assume that for every $n \geq n_0$,

$$f_n(1) > 1 - \eta.$$

We consider for $-n \leq \alpha \leq \beta \leq n$ the event $\mathcal{H}_n(\alpha, \beta)$ that there exists an open horizontal crossing in $[-n, n]^2$ from $\{-n\} \times [-n, n]$ to $\{n\} \times [\alpha, \beta]$. Note that

$$\mathbb{P}[\mathcal{H}_n(-n, 0) \cup \mathcal{H}_n(0, n)] \geq 1 - \eta,$$

and, by reflection invariance $P[\mathcal{H}_n(-n, 0)] = P[\mathcal{H}_n(0, n)]$. We can apply the square root trick to obtain

$$P[\mathcal{H}_n(0, n)] > 1 - \eta^{1/2}.$$

We would like to repeat this square root trick argument, but we can no longer use symmetries to “split” $\mathcal{H}_n(0, n)$ into two events with equal probabilities. Nevertheless, one can define $\alpha(n)$ such that the two events $\mathcal{H}_n(0, \alpha(n))$ and $\mathcal{H}_n(\alpha(n), n)$ illustrated below have close probabilities.

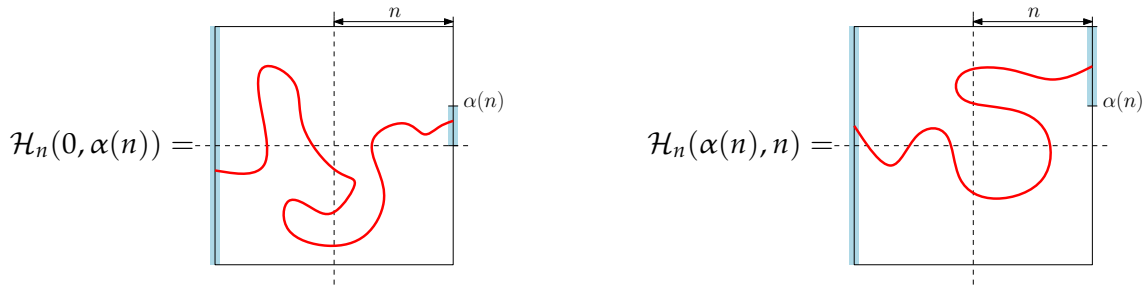

A suitable choice of $\alpha(n)$ allows one to prove by the square root trick that

$$P[\mathcal{H}_n(0, \alpha(n))] \geq 1 - \eta^{1/4} \quad \text{and} \quad P[\mathcal{H}_n(\alpha(n), n)] \geq 1 - \eta^{1/4}.$$

Then consider the event \mathcal{X}_n defined by the following picture:

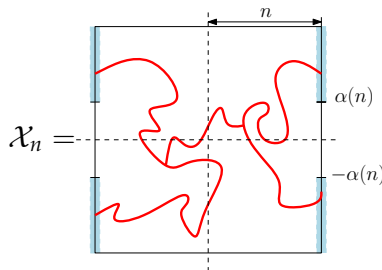

One can obtain the event \mathcal{X}_n by intersecting four symmetric versions of $\mathcal{H}_n(\alpha(n), n)$ together with the event $\mathcal{V}([-n, n]^2)$. By positive association and using the invariance properties of P , we find

$$\begin{aligned} P[\mathcal{X}_n] &\geq P[\mathcal{H}_n(\alpha(n), n)]^4 P[\mathcal{V}([-n, n]^2)] \\ &\geq (1 - \eta^{1/4})^4 (1 - \eta) \\ &\geq (1 - \eta^{1/4})^5. \end{aligned}$$

When $\alpha(3n/2) \leq 2\alpha(n)$, one can use the construction illustrated on Fig. 15 page 26 to show that the rectangle $[0, 4n] \times [0, 3n]$ contains an open horizontal crossing with probability larger than

$$P[\mathcal{X}_n] P[\mathcal{H}_{3n/2}(0, \alpha(3n/2))]^2,$$

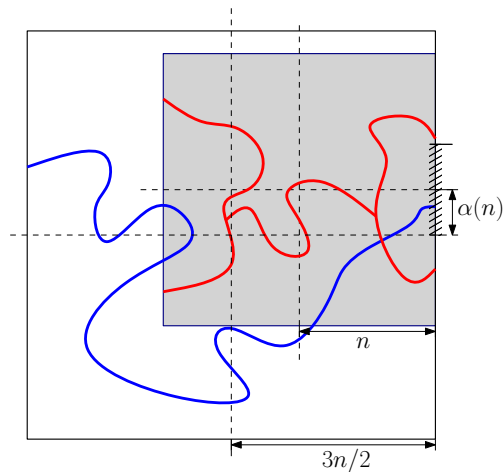

Step 1: gluing a crossing of a square of size $3n/2$ with a crossing of a square of size n . Since $\alpha(3n/2) \leq 2\alpha(n)$ the blue path exists with probability larger than $\mathbb{P} \left[\mathcal{H}_{3n/2}(0, \alpha(3n/2)) \right]$ and the event illustrated on the picture above occurs with probability larger than $\mathbb{P} \left[\mathcal{X}_n \right] \mathbb{P} \left[\mathcal{H}_{3n/2}(0, \alpha(3n/2)) \right]$.

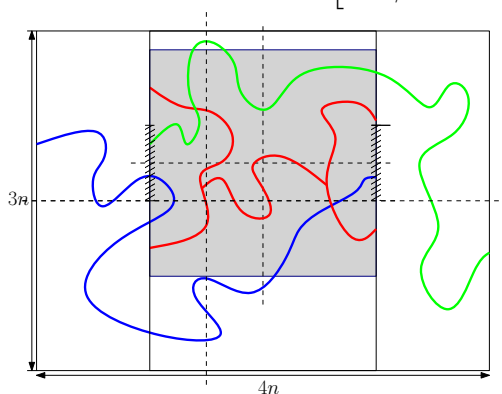

Step 2: reflection argument. The additional green path exists also with probability larger than $\mathbb{P} \left[\mathcal{H}_{3n/2}(0, \alpha(3n/2)) \right]$ and the event illustrated on the picture above occurs with probability larger than $\mathbb{P} \left[\mathcal{X}_n \right] \mathbb{P} \left[\mathcal{H}_{3n/2}(0, \alpha(3n/2)) \right]^2$.

Figure 15: Construction of an open horizontal crossing in $[0, 4n] \times [0, 3n]$ when $\alpha(3n/2) \leq 2\alpha(n)$.

Note that the construction of Fig. 15 requires the square of size n to be included in the square of size $3n/2$, which is not possible if $\alpha(n) \geq n/2$. But in this case, we can use a simpler construction to bound the probability of $\mathcal{H}([0, 4n] \times [0, 3n])$. Finally, we obtain the following implication for every $n \geq n_0$:

$$\alpha(3n/2) \leq 2\alpha(n) \Rightarrow f_n(4/3) \geq (1 - \eta^{1/4})^7 \quad (9)$$

By the implication (9) above, we only need to show that for every $n_1 \geq n_0$ there exists $n_2 \geq n_1$ such that $\alpha(3n_2/2) \leq 2\alpha(n_2)$ in order to conclude the proof of Theorem 4.1.

One can assume that $\alpha(n_1) \geq 1$. Otherwise, we have $P[\mathcal{H}(0,0)] \geq 1 - \eta^{1/4}$ and we can use the event \mathcal{E} illustrated below to conclude directly that $f_{n_1}(2) \geq (1 - \eta^{1/4})^2$.

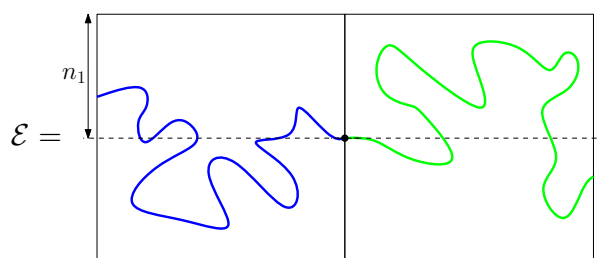

If for every $n \geq n_1$, $\alpha(3n/2) > 2\alpha(n)$, then we would have for every $k \geq 0$

$$\begin{aligned} \alpha\left(\left(\frac{3}{2}\right)^k n_1\right) &\geq 2^k \alpha(n_1) \\ &\geq 2^k, \end{aligned}$$

which would contradict the bound $\alpha(n) \leq n$. Thus, there must exist $n_2 \geq n_1$ such that $\alpha(3n_2/2) \leq 2\alpha(n_2)$.

5 Locality: the finite criterion approach

In statistical mechanics, an infinite system is generally defined by taking a limit of finite systems. On the infinite system arise questions proper to the infinite volume: for example in percolation, one can ask whether there exists an infinite cluster, whether the size of the cluster of the origin is integrable,... We would like to understand how such questions can be understood by studying the finite systems. In this section we will use finite criteria (standing for finite-size criterion). Roughly, given an event in infinite volume \mathcal{A} , a finite criterion says that the occurrence of \mathcal{A} is equivalent to the occurrence with high probability (or with low probability) of some particular finite-size events. For example, the existence of an infinite cluster should imply that big boxes are well connected, and reciprocally if we put strongly connected regions together, we should be able to construct an infinite cluster. Seeing the infinite volume event \mathcal{A} as a wall, one can see the finite size event as a brick: the wall requires bricks, and putting bricks together, one can build a wall.

Being able to translate an infinite volume question into a finite size question has many applications, and we use finite criteria at various places in this thesis:

- in Chapter 1 to obtain bounds on the critical value $r_c(p)$ in DaC percolation;
- in Chapter 2 to prove that $r_c(p)$ is a continuous function in p ;
- in Chapter 3 to prove that $r_c(p)$ is close to $1/2$ when p is close to p_c ;
- in Chapter 6 to prove absence of percolation at criticality on slabs;
- in Chapter 7 to obtain the continuity of $p_c(G)$ as a function of the graph G , when restricted to some particular class of graphs.

These applications can seem different, and our goal in this section is to explain why finite criteria approaches are natural in the enumeration above.

Rather than giving a formal definition, we will provide in the next section a simple example of a finite criterion and its consequences. More precisely we will explicit a finite criterion that witnesses in finite volume (locally) when the size of the cluster of the origin has a finite expectation. We will then illustrate how it can be a powerful tool to bound critical values, study the critical behavior of percolation, or tackle Schramm's locality conjecture. We chose to present this example here because it provides us a very simple and illustrative applications of the finite criterion approach.

5.1 An example of finite criterion

Let G be an infinite transitive graph, with a fixed vertex $\mathbf{0}$. Recall that $p_c(G)$ denotes the critical value for Bernoulli bond percolation on G . Given a bond percolation configuration, we denote by C_0 the cluster of the origin $\mathbf{0}$. Its expected size $E_p[|C_0|]$ allows to

identify the phase transition in the following sense:

$$E_p[|C_0|] \begin{cases} < +\infty & \text{when } p < p_c(G) \\ = +\infty & \text{when } p > p_c(G). \end{cases}$$

The finite expectation when $p < p_c(G)$ was obtained in this generality in [AV08], extending method of Aizenman and Barsky[AB87].

We now explicit a finite criterion that witnesses locally when the expected size of C_0 is finite. Let us denote $B^G(\mathbf{0}, n)$ the ball of radius n , centered at $\mathbf{0}$. We consider the random set X_n^G of vertices at graph distance exactly n from $\mathbf{0}$, that are connected to $\mathbf{0}$ by an open path *included in* the ball $B^G(\mathbf{0}, n)$.

Lemma 5.1 (Finite criterion for the finite expectation of the origin cluster size).

For every $p \in [0, 1]$, we have

$$E_p[|C_0|] < \infty \iff (\exists n \in \mathbb{N}, E_p[|X_n^G|] < 1). \quad (\mathbf{FC})$$

The left-to-right implication follows from the trivial inequality:

$$\sum_n E_p[|X_n^G|] \leq E_p[|C_0|].$$

The reciprocal implication was first proved by Hammersley [Ham57], who used it to obtain lower bounds on the critical value $p_c(G)$. Hammersley's proof involves an exploration argument, but a short proof can be obtained using BK inequality, see e.g. [KN11, Lemma 3.1.].

5.2 Application 1: bounding the critical value

For small value of n , one can try to compute explicitly the quantity $E_p[|X_n^G|]$. For example, we have

$$E_p[|X_1^G|] = p \cdot d_G, \quad (10)$$

where d_G denotes the degree of the graph G . From the computation (10) and the finite criterion (FC), we obtain that the expected size of C_0 is finite whenever $p \cdot d_G < 1$. We derive the lower bound

$$p_c(G) \geq \frac{1}{d_G}.$$

If one can estimate $E_p[|X_n^G|]$ for large n , which can be achieved by Monte-Carlo simulations on a computer, one can obtain good lower bounds on $p_c(G)$. This is the strategy we used in Chapter 1, but we used a different finite criterion.

5.3 Application 2: critical behavior

We illustrate here how finite criteria can be used to prove results concerning the critical behavior of percolation. We will use the finite criterion (FC) to prove the following well-known result.

Theorem 5.2. *Let G be an infinite transitive graph such that $p_c(G) < 1$. Then the expected size of the cluster of the origin at criticality is infinite: we have*

$$E_p[|C_0|] = +\infty \quad \text{when } p = p_c(G).$$

For the hypercubic lattice, Theorem 5.2 was obtained in [AN84] (see also [Gri99b]). Here, we will prove it using a finite criterion approach.

Proof of Theorem 5.2. Let us consider the set of parameters

$$S := \{p \in [0, 1] : E_p[|C_0|] < \infty\}.$$

Using the finite criterion of Lemma 5.1, we can rewrite this set as

$$S = \bigcup_{n \geq 1} \{p \in [0, 1] : E_p[|X_n^G|] < 1\}.$$

Since $E_p[|X_n^G|]$ is continuous in p (it is polynomial in p), we find that S is an open subset of $[0, 1]$. Thus, $p_c(G)$ is not an element of S , because S is a subset of $[0, p_c(G)]$ and $p_c(G) < 1$. \square

More generally, and roughly stated, if a percolation property occurring only in one phase of the process can be “witnessed” by a finite criterion, then this property cannot hold at criticality.

In Chapter 6, using a similar strategy, we proved that there is no infinite cluster at criticality for percolation on a 2-dimensional slab. Our proof involves a finite criterion that witnesses locally when $\theta(p) > 0$. Finding such a finite criterion for general graph is a natural approach in order to try to prove absence of percolation at criticality, and is thus very challenging.

Application 3: locality of the critical point

The finite criterion (FC) allows to see in a finite box for which p the expectation of C_0 is finite. Otherwise saying, it allows to identify locally which values of p are below $p_c(G)$, and it is naturally related to Schramm’s locality conjecture.

Recall that we equipped in section 3.4 the set of transitive graph \mathcal{G} with the local distance d_{BS} . Schramm’s conjecture can be seen as a continuity statement on the function $G \mapsto p_c(G)$. Thanks to the finite criterion (FC), we can obtain easily one semi-continuity, and we will prove the following.

Theorem 5.3. *The function $p_c : \mathcal{G} \rightarrow [0, 1]$ is lower semi-continuous. Otherwise saying, for any sequence (G_n) of transitive graphs such that the convergence $\lim_{n \rightarrow \infty} G_n = G$ holds in \mathcal{G} , we have*

$$\liminf_{n \rightarrow \infty} p_c(G_n) \geq p_c(G). \tag{11}$$

Some remarks:

1. Contrarily to Schramm's conjecture in section 3.4, we do not need to restrict to graphs with a critical value bounded away from 1. In particular, Equation (11) is not contradictory when $G_n = (\mathbb{Z}/n\mathbb{Z})^2$ and $G = \mathbb{Z}^2$.
2. This theorem shows that the hard part in Schramm's conjecture is the upper semi-continuity. This upper semi-continuity would follow from a finite criterion witnessing locally when $\theta(p) > 0$. Unfortunately, as we already mentioned in the previous section, finding such a finite criterion is very hard in general.
3. The remark 2 above shows that Schramm's conjecture deals with the same difficulty as trying to prove absence of percolation at criticality. Though, for Schramm's conjecture, we are authorized to move slightly the value of p and use the "sprinkling" technique. This gives rise to weaker versions (allowing "sprinkling") of finite criterion, which are sufficient to prove the desired upper semi-continuity of p_c . This is the approach developed in Chapter 7, where we use such a weaker finite criterion in the context of Cayley graphs of abelian groups, allowing us to prove a particular case of Schramm's conjecture.

Proof of Theorem 5.3. We need to show that, for every fixed $q < 1$, the set

$$\mathcal{G}_q := \{G \in \mathcal{G} : p_c(G) > q\}$$

is open in \mathcal{G} . Using first Theorem 5.2 and then the finite criterion (FC), we can rewrite this set as

$$\begin{aligned} \mathcal{G}_q &= \{G \in \mathcal{G} : E_q[C_0] < \infty\} \\ &= \bigcup_{n \geq 1} \{G \in \mathcal{G} : E_q[X_n^G] < 1\}. \end{aligned} \tag{12}$$

The mapping $G \mapsto E_q[X_n^G]$ from \mathcal{G} to $[0, +\infty)$ is continuous. This observation, together with equation (12) concludes that \mathcal{G}_q is an open subset of \mathcal{G} . \square

CONFIDENCE INTERVALS FOR THE CRITICAL VALUE IN THE DIVIDE AND COLOR MODEL

1

This chapter corresponds to the published article [VT1] with the same title, written in collaboration with András Bálint and Vincent Beffara.

We obtain confidence intervals for the location of the percolation phase transition in Häggström's divide and color model on the square lattice \mathbb{Z}^2 and the hexagonal lattice \mathbb{H} . The resulting probabilistic bounds are much tighter than the best deterministic bounds up to date; they give a clear picture of the behavior of the DaC models on \mathbb{Z}^2 and \mathbb{H} and enable a comparison with the triangular lattice \mathbb{T} . In particular, our numerical results suggest similarities between DaC model on these three lattices that are in line with universality considerations, but with a remarkable difference: while the critical value function $r_c(p)$ is known to be constant in the parameter p for $p < p_c$ on \mathbb{T} and appears to be linear on \mathbb{Z}^2 , it is almost certainly non-linear on \mathbb{H} .

1 Introduction

Our object of study in this paper is the critical value function in Häggström's divide and color (DaC) model [Hä01]. This is a stochastic model that was originally motivated by physical considerations (see [Hä01, CLM07]), but it has since then been used for biological modelling in [GPG07] as well and inspired several generalizations (see, e.g., [HH08, BCM09, GG06]). Our results concerning the location of the phase transition give a clear picture of the behavior of the DaC model on two important lattices and lead to intriguing open questions.

Our analysis will be based on the same principles as [RW07], where confidence intervals were obtained for the critical value of Bernoulli bond and site percolation on the 11 Archimedean lattices by a modification of the approach of [BBW05]. The main idea in [BBW05, RW07] is truly multidisciplinary and attractive, namely to reduce a problem which has its roots in theoretical physics by deep mathematical theorems to a situation in which a form of statistical testing by numerical methods becomes possible. Our other main goal with this paper is to demonstrate the strength of this strategy by applying it

to a system which is essentially different from those in its previous applications. In particular, in the DaC model, as opposed to the short-range dependencies in [BBW05] and the i.i.d. situation in [RW07], one has to deal with correlations between sites at arbitrary distances from each other. We believe that the method of [BBW05, RW07] has a high potential to be used in a number of further models and deserves higher publicity than it enjoys at the moment.

Given a graph G with vertex set V and edge set E and parameters $p, r \in [0, 1]$, the DaC model on G is defined in two steps: first, Bernoulli bond percolation with density p is performed on G , and then the resulting open clusters are independently colored black (with probability r) or white (a more detailed definition will follow in the next paragraph). Note that this definition resembles the so-called random-cluster (or FK) representation of the ferromagnetic Ising model, with two important differences: a product measure is used in the DaC model in the first step instead of a random-cluster measure with cluster weight 2 and the second step is more general here in that all $r \in [0, 1]$ are considered instead of only $1/2$.

Now we set the terminology that is used throughout, starting with an alternative (equivalent) definition of the DaC model which goes as follows. First, an **edge configuration** $\eta \in \{0, 1\}^E$ is drawn according to the Bernoulli percolation measure $\nu_p^E := \text{Bernoulli}(p)^{\otimes E}$. In the second step, a **coloring** $\xi \in \{0, 1\}^V$ is chosen by independently assigning state 1 with probability r or otherwise 0 to each vertex, conditioning on the event that there exists no edge $e = \langle v, w \rangle \in E$ such that $\eta(e) = 1$ and $\xi(v) \neq \xi(w)$. We denote the probability measure on $\{0, 1\}^V \times \{0, 1\}^E$ associated to this procedure by $\mathbb{P}_{p,r}^G$. An edge e (a vertex v) is said to be **open** or **closed** (**black** or **white**) if and only if it is in state 1 or 0, respectively. We will call the maximal subsets of V connected by open edges **bond clusters**, and the maximal monochromatic connected (via the edge set of E , not only the open edges!) subsets of V **black** or **white clusters**. We write $C_v(\eta)$ for the bond cluster of a vertex v in the edge configuration η and use Ω_S to denote $\{0, 1\}^S$ for arbitrary sets S .

Note that the measure $\mathbb{P}_{p,r}^G$ is concentrated on the set of pairs (η, ξ) such that for all edges $e = \langle v, w \rangle \in E$, $\xi(v) = \xi(w)$ whenever $\eta(e) = 1$. When this compatibility condition is satisfied, we write $\eta \sim \xi$.

For infinite graphs G , there are two types of phase transitions present in the DaC model in terms of the appearance of infinite clusters; first, there exists $p_c = p_c^G \in [0, 1]$ such that $\mathbb{P}_{p,r}^G$ (there exists an infinite bond cluster) is 0 for $p < p_c$ and 1 for $p > p_c$. Second, for each fixed p , there exists $r_c = r_c^G(p)$ such that $\mathbb{P}_{p,r}^G$ (there exists an infinite black cluster) is 0 for $r < r_c$ and positive for $r > r_c$. For more on the different character of these two types of phase transitions, see [VT2]. A key feature of the DaC model (as noted in [Hä01]) is that while it is close in spirit to the Ising model, its simulation is straightforward from the definition and does not require sophisticated MCMC algorithms. In this paper, we will exploit this feature in order to learn about the values and various features of the critical value function $r_c^G(p)$.

Monotonicity and continuity properties of the function $r_c^{\mathbb{G}}(p)$ for general graphs have been studied in [VT2]. Here we will focus on two specific graphs, namely the square lattice \mathbb{Z}^2 and the hexagonal lattice \mathbb{H} (see Figure 1.1), for which $p_c^{\mathbb{Z}^2} = 1/2$ and $p_c^{\mathbb{H}} = 1 - 2 \sin(\pi/18) \approx 0.6527$ (see [Kes82]). Our reason for this restriction is twofold: first, these two are the most commonly considered planar lattices (apart from the triangular lattice \mathbb{T} , for which the critical value function $r_c^{\mathbb{T}}$ has been completely characterized in [BCM09]), whence results about these cases are of the greatest interest. On the other hand, the DaC model on these lattices enjoys a form of duality (described in Section 2.2) which is a key ingredient for the analysis we perform in this paper.

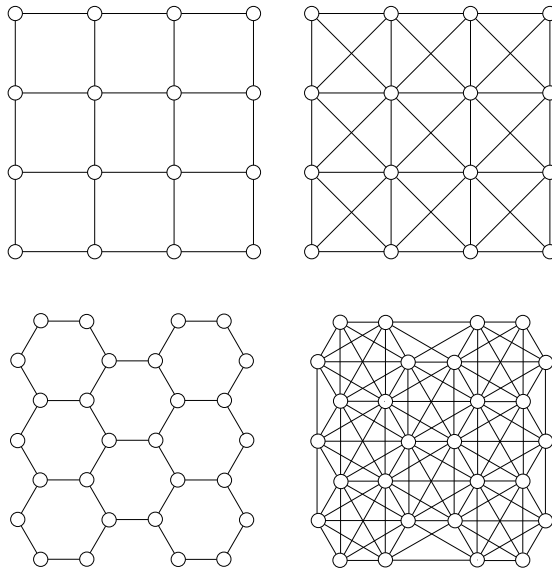

Figure 1.1: A finite sublattice of the square lattice \mathbb{Z}^2 (above left) and the hexagonal lattice \mathbb{H} (below left) and their respective matching lattices (right).

Fixing $\mathbb{L} \in \{\mathbb{Z}^2, \mathbb{H}\}$, it is trivial that $r_c^{\mathbb{L}}(p) = 0$ for all $p > p_c^{\mathbb{L}}$, and it easily follows from classical results on Bernoulli bond percolation that $r_c^{\mathbb{L}}(p_c^{\mathbb{L}}) = 1$ (see [BCM09] for the case $\mathbb{L} = \mathbb{Z}^2$). However, there are only very loose theoretical bounds for the critical value when $p < p_c^{\mathbb{L}}$: the duality relation (1.1) in Section 2.2 below and renormalization arguments as in the proof of Theorem 2.6 in [Hä01] give that $1/2 \leq r_c^{\mathbb{L}}(p) < 1$ for all such p , and Proposition 1 in [VT2] gives just a slight improvement of these bounds for very small values of p . Therefore, our ultimate goal here is to get good estimates for $r_c^{\mathbb{L}}(p)$ with $p < p_c^{\mathbb{L}}$.

We end this section with an outline of the paper. Section 2 contains a crucial reduction of the infinite-volume models to a finite situation by a criterion that is stated in terms of a finite sublattice but nonetheless implies the existence of an infinite cluster. This method, often called static renormalisation in percolation, is a particular instance of coarse graining. We then describe in Section 3 how the occurrence of this finite size criterion can be tested in an efficient way and obtain confidence intervals for $r_c^{\mathbb{L}}(p)$ as functions of

uniform random variables (Proposition 3.1). Finally, we implement this method using a (pseudo)random number generator, and present and discuss the numerical results in Section 4.

2 Finite size criteria

2.1 An upper bound for $r_c(p)$

In this section, we will show how to obtain an upper bound for $r_c^{\mathbb{L}}(p)$ by deducing a finite size criterion for percolation in the DaC model (Proposition 2.3). This criterion, which is a quantitative form of Lemma 2.10 in [BCM09], will play a key role in Sections 3–4. To enhance readability, we will henceforth focus on the case $\mathbb{L} = \mathbb{Z}^2$ and mention $\mathbb{L} = \mathbb{H}$ only when the analogy is not straightforward. Accordingly, we will write $\mathbb{P}_{p,r}$ and $r_c(p)$ for $\mathbb{P}_{p,r}^{\mathbb{Z}^2}$ and $r_c^{\mathbb{Z}^2}(p)$ respectively, and denote the edge set of \mathbb{Z}^2 by E^2 . Let us first recall a classical result (Lemma 2.2 below) concerning 1-dependent percolation.

Definition 2.1. *Given a graph $G = (V, E)$, a probability measure ν on $\{0, 1\}^E$ is called 1-dependent if, whenever $S \subset E$ and $T \subset E$ are vertex-disjoint edge sets, the state of edges in S is independent of that of edges in T under ν .*

It follows from standard arguments or from a general theorem of Liggett, Schonmann and Stacey [LSS97] that if each edge is open with a sufficiently high probability in a 1-dependent bond percolation on \mathbb{Z}^2 , then the origin is with positive probability in an infinite bond cluster. Currently the best bound is given by Balister, Bollobás and Walters [BBW05]:

Lemma 2.2. *([BBW05]) Let ν be any 1-dependent bond percolation measure on \mathbb{Z}^2 in which each edge is open with probability at least 0.8639. Then the probability under ν that the origin lies in an infinite bond cluster is positive.*

Now, suppose that the lattice \mathbb{Z}^2 is embedded in the plane the natural way (so that $v = (i, j) \in \mathbb{Z}^2$ has coordinates i and j). We consider the following partition of \mathbb{R}^2 (see Figure 1.2): given parameters $s \in \mathbb{N} = \{1, 2, \dots\}$ and $\ell \in \mathbb{N}$, we take $k = s + 2\ell$ and define, for all $i, j \in \mathbb{Z}$, the $s \times s$ squares

$$S_{i,j} = [ik + \ell, ik + \ell + s] \times [jk + \ell, jk + \ell + s],$$

the $s \times 2\ell$ rectangles

$$H_{i,j} = [ik + \ell, ik + \ell + s] \times [jk - \ell, jk + \ell],$$

the $2\ell \times s$ rectangles

$$V_{i,j} = [ik - \ell, ik + \ell] \times [jk + \ell, jk + \ell + s],$$

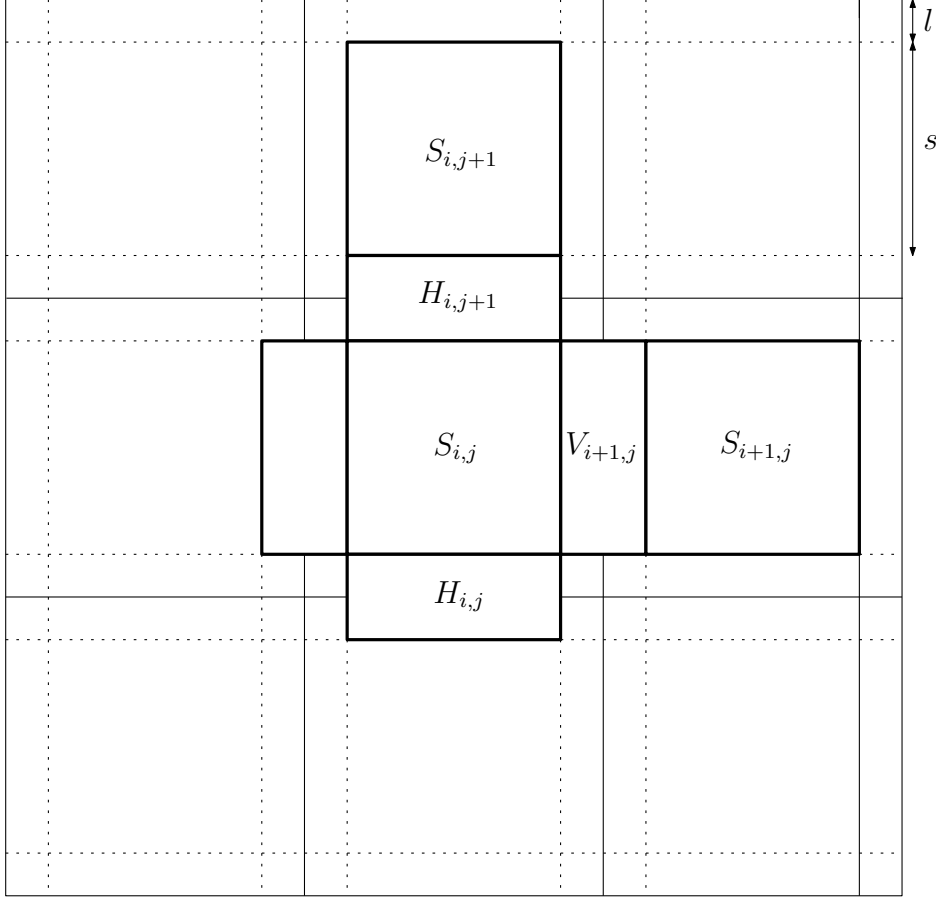
 Figure 1.2: A partition of \mathbb{R}^2 .

and what remains are the $2\ell \times 2\ell$ squares $[ik - \ell, ik + \ell] \times [jk - \ell, jk + \ell]$.

We will couple $\mathbb{P}_{p,r}$ to a 1-dependent bond percolation measure. Define $f : \Omega_{E^2} \times \Omega_{\mathbb{Z}^2} \rightarrow \Omega_{E^2}$, as follows. To each horizontal edge $e = \langle (i, j), (i + 1, j) \rangle \in E^2$, we associate a $(2\ell + 2s) \times s$ rectangle $R_e = S_{i,j} \cup V_{i+1,j} \cup S_{i+1,j}$ and the event E_e that there exists a left-right black crossing in R_e (i.e., a connected path of vertices all of which are black which links the left side of R_e to its right side) and an up-down black crossing in $S_{i,j}$ (see Figure 1.3). Here and below, a vertex in the corner of a rectangle is understood to link the corresponding sides in itself. For each vertical edge $e = \langle (i, j), (i, j + 1) \rangle \in E^2$, we define the $s \times (2\ell + 2s)$ rectangle $R_e = S_{i,j} \cup H_{i,j+1} \cup S_{i,j+1}$ and the event $E_e = \{\text{up-down black crossing in } R_e \text{ and left-right black crossing in } S_{i,j}\} \subset \Omega_{E^2} \times \Omega_{\mathbb{Z}^2}$. For each edge $e \in E^2$, we also consider the event $F_e = \{\text{there exists a bond cluster which contains a vertex in } R_e \text{ and a vertex at graph distance at least } \ell \text{ from } R_e\} \subset \Omega_{E^2} \times \Omega_{\mathbb{Z}^2}$, and define $\tilde{E}_e = E_e \cap F_e^c$. Now for each configuration $\omega = (\eta, \xi) \in \Omega_{E^2} \times \Omega_{\mathbb{Z}^2}$, we determine a corresponding bond configuration $f(\omega) = \gamma \in \Omega_{E^2}$ as follows: for all $e \in E^2$, we declare e open if and only if \tilde{E}_e holds (i.e., we define $\gamma(e) = 1$ if and only if $\omega \in \tilde{E}_e$). Finally, we define the probability measure $\nu = f_* \mathbb{P}_{p,r}$ on Ω_{E^2} .

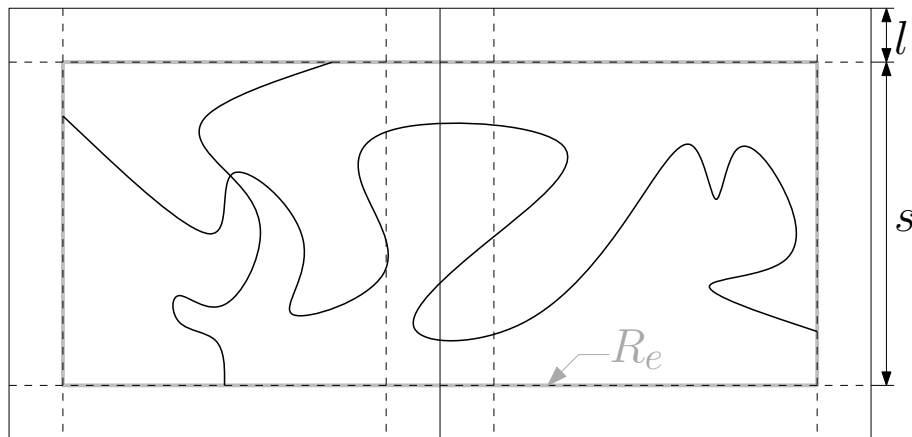

Figure 1.3: A black component in R_e witnesses the occurrence of E_e .

It is not difficult to check that ν is a 1-dependent bond percolation measure. Indeed, if e and e' are two vertex-disjoint edges in E^2 , then the corresponding rectangles R_e and $R_{e'}$ are at graph distance at least 2ℓ from one another, hence F_e^c and $F_{e'}^c$ are independent. Given that F_e and $F_{e'}$ do not hold, the bond clusters in R_e and $R_{e'}$ are colored independently of each other. Keeping this in mind, a short computation proves the independence of \tilde{E}_e and $\tilde{E}_{e'}$ under $\mathbb{P}_{p,r}$, which implies the 1-dependence of ν .

Note also that the function f was chosen in such a way that if $\gamma = f(\omega) \in \Omega_{E^2}$ contains an infinite open bond cluster, then ω contains an infinite black cluster. Such configurations have zero $\mathbb{P}_{p,r}$ -measure for $r < r_c(p)$. Finally, note that $\mathbb{P}_{p,r}(\tilde{E}_e)$ is the same for all edges $e \in E^2$. These observations combined with Lemma 2.2 imply that, denoting $\langle (0,0), (0,1) \rangle \in E^2$ by e_1 , we have the following result.

Proposition 2.3. *Given any values of the parameters $s, \ell \in \mathbb{N}$, if p and r are such that*

$$\mathbb{P}_{p,r}(\tilde{E}_{e_1}) \geq 0.8639,$$

then $r_c(p) \leq r$.

Note that Proposition 2.3 is indeed a finite size criterion since the event \tilde{E}_{e_1} depends on the state of a finite number of edges and the color of a finite number of vertices. A similar criterion, which will imply a lower bound for $r_c(p)$, will be given in Section 2.3.

2.2 Duality

A concept that is essential in understanding site percolation models on $\mathbb{L} \in \{\mathbb{Z}^2, \mathbb{H}\}$ is that of the matching lattice \mathbb{L}^* which is a graph with the same vertex set, V , as \mathbb{L} but more edges: the edge set E^* of \mathbb{L}^* consists of all the edges in E plus the diagonals of all the faces of \mathbb{L} (see Figure 1.1). The finiteness of a monochromatic cluster in \mathbb{L} can be rephrased in terms of circuits of the opposite color in \mathbb{L}^* and vice versa; see [Kes82] for further details.

We say that $B \subset V$ is a **black *-component** in a color configuration $\xi \in \Omega_V$ if it is a black component in terms of the lattice \mathbb{L}^* (i.e., $\xi(v) = 1$ for all $v \in B$ and B is connected via E^*).

Accordingly, there is yet another phase transition in the DaC model on \mathbb{L} at the point where an infinite black *-component appears; formally, for each fixed $p \in [0, 1]$, one can define $r_c^*(p, \mathbb{L})$ as the value such that $\mathbb{P}_{p,r}^{\mathbb{L}}$ (there exists an infinite black *-component) is 0 for $r < r_c^*(p, \mathbb{L})$ and positive for $r > r_c^*(p, \mathbb{L})$. It was proved in [BCM09] that there is an intimate connection between all the critical values in the DaC model that we mentioned so far; namely, for all $p < p_c^{\mathbb{L}}$,

$$r_c^{\mathbb{L}}(p) + r_c^*(p, \mathbb{L}) = 1. \quad (1.1)$$

Actually, this relation was proved only for $\mathbb{L} = \mathbb{Z}^2$, but essentially the same proof gives the result for $\mathbb{L} = \mathbb{H}$ as well. The importance of this result here is that due to the duality relation (1.1), a lower bound for $r_c^{\mathbb{L}}(p)$ may be obtained by giving an upper bound for $r_c^*(p, \mathbb{L})$.

2.3 A lower bound for $r_c(p)$

As in Section 2.1, we will focus on $\mathbb{L} = \mathbb{Z}^2$ since the case $\mathbb{L} = \mathbb{H}$ is analogous; we denote $r_c^*(p, \mathbb{Z}^2)$ here and in the next section by $r_c^*(p)$. Obviously $r_c(p)$ itself is an upper bound for $r_c^*(p)$. However, a better bound may be obtained by a slight modification of the approach given in Section 2.1. For each $e \in E^2$, let R_e and F_e be as in Section 2.1, define E_e^* by substituting black *-component for black component in the definition of E_e , and take $\tilde{E}_e^* = E_e^* \cap F_e^c$. Then, by similar arguments as those before Proposition 2.3 and using (1.1), we get the following:

Proposition 2.4. *Given any values of the parameters $s, \ell \in \mathbb{N}$, if p and r are such that*

$$\mathbb{P}_{p,r}(\tilde{E}_{e_1}^*) \geq 0.8639,$$

then $r_c^(p) \leq r$, and hence $r_c(p) \geq 1 - r$.*

3 The confidence interval

The main idea in [BBW05, RW07] is to reduce a stochastic model to a new model in finite volume by criteria similar in spirit to those in Section 2 and do repeated (computer) simulations of the new model to test whether the corresponding criteria hold. The point is that after a sufficiently large number of simulations, one can see with an arbitrarily high level of confidence whether or not the probability of an event exceeds a certain threshold. By the special nature of the events in question, statistical inferences regarding the original, infinite-volume model may be made from the simulation results.

To be able to follow this strategy, we will have to refine Propositions 2.3–2.4 as those are concerned with the state of finitely many objects, but still in the infinite-volume

model. The adjusted criteria that truly are of finite size are given below, see (1.2) and (1.3). Finding an efficient way of performing the simulation step involves further obstacles. The main problem is that it would be unfeasible to run a large number of separate simulations for different values of r to find, for a fixed p , the lowest value of r such that both (1.2) and (1.3) seem sufficiently likely to hold. We will tackle this difficulty with a stochastic coupling, which is the simultaneous construction of several stochastic models on the same probability space. Such a construction will enable us to deal with all values of $r \in [0, 1]$ at the same time and is very related to the model of invasion percolation.

After the description of the coupling, a “theoretical” confidence interval (meaning a confidence interval as a function of i.i.d. random variables) for $r_c(p)$ is given in Proposition 3.1. The numerical confidence intervals obtained by this method using computer simulations will be presented in Section 4. Note also that the inequalities (1.2) and (1.3) implicitly involve the parameters s and ℓ whose choices may influence the width of the confidence intervals obtained; this issue is addressed before the proof of Proposition 3.1. Our methods in this section work for a general $p \in [0, p_c^{\mathbb{L}})$; we note that substantial simplifications are possible in the case $p = 0$ (i.e., in the absence of correlations), see [RW07].

Fix $p \in [0, 1/2)$ and $s, \ell \in \mathbb{N}$, and define the rectangle $\tilde{R}_{e_1} = [0, 2s + 4\ell] \times [0, s + 2\ell]$. Note that for a configuration $\omega \in \Omega_{E^2} \times \Omega_{\mathbb{Z}^2}$, one can decide whether $\omega \in \tilde{E}_{e_1}$ (respectively $\omega \in \tilde{E}_{e_1}^*$) holds by checking the restriction of ω to \tilde{R}_{e_1} . In fact, defining $\tilde{G} = (\tilde{V}, \tilde{E})$ as the minimal subgraph of \mathbb{Z}^2 which contains \tilde{R}_{e_1} and considering the DaC model on \tilde{G} , it is easy to see that for any $r \in [0, 1]$, $\mathbb{P}_{p,r}^{\tilde{G}}(\tilde{E}_{e_1}) = \mathbb{P}_{p,r}(\tilde{E}_{e_1})$ and $\mathbb{P}_{p,r}^{\tilde{G}}(\tilde{E}_{e_1}^*) = \mathbb{P}_{p,r}(\tilde{E}_{e_1}^*)$. (These equalities hold despite the fact that $\mathbb{P}_{p,r}^{\tilde{G}}$ is not the same distribution as the projection of $\mathbb{P}_{p,r}$ on \tilde{G} .) Therefore, by Propositions 2.3 and 2.4,

$$\mathbb{P}_{p,r}^{\tilde{G}}(\tilde{E}_{e_1}) \geq 0.8639 \quad (1.2)$$

would imply that $r_c(p) \leq r$, and

$$\mathbb{P}_{p,r}^{\tilde{G}}(\tilde{E}_{e_1}^*) \geq 0.8639 \quad (1.3)$$

would imply that $r_c(p) \geq 1 - r$. Below we shall describe a method which tests whether (1.2) or (1.3) holds, simultaneously for all values of $r \in [0, 1]$.

We construct the DaC model on \tilde{G} with parameters p and an arbitrary $r \in [0, 1]$ as follows. Fix an arbitrary deterministic enumeration $v_1, v_2, \dots, v_{|\tilde{V}|}$ of the vertex set \tilde{V} , and for $V \subset \tilde{V}$, let $\min(V)$ denote the vertex in V of the smallest index. For all $r \in [0, 1]$, we define the function

$$\begin{aligned} \Psi_r : \quad \Omega_{\tilde{E}} \times [0, 1]^{\tilde{V}} &\rightarrow \Omega_{\tilde{E}} \times \Omega_{\tilde{V}}, \\ (\eta, U) &\mapsto (\eta, \xi_r), \end{aligned}$$

where

$$\xi_r(v) = \begin{cases} 1 & \text{if } U(\min(C_v(\eta))) < r, \\ 0 & \text{if } U(\min(C_v(\eta))) \geq r. \end{cases}$$

Now, if \mathbb{U} denotes uniform distribution on the interval $[0, 1]$ and $(\eta, U) \in \Omega_E \times [0, 1]^{\tilde{V}}$ is a random configuration with distribution $\nu_p^{\tilde{E}} \otimes \mathbb{U}^{\tilde{V}}$, then it is not difficult to see that $(\eta, \xi_r) = \Psi_r((\eta, U))$ is a random configuration with distribution $\mathbb{P}_{p,r}^{\tilde{G}}$.

We are interested in the following question: for what values of r does $(\eta, \xi_r) \in \tilde{E}_{e_1}$ (respectively, $(\eta, \xi_r) \in \tilde{E}_{e_1}^*$) hold? The first step is to look at the edges in η in $\tilde{R}_{e_1} \setminus R_{e_1}$ to see if there is a bond cluster which connects R_{e_1} and the boundary of \tilde{R}_{e_1} . If no such connection is found, it is easy to see that there exists a *threshold value* $r_1 = r_1(\eta, U) \in [0, 1]$ such that for all $r \in [0, r_1)$, $(\eta, \xi_r) \notin \tilde{E}_{e_1}$, and for all $r \in (r_1, 1]$, we have that $(\eta, \xi_r) \in \tilde{E}_{e_1}$. Indeed, the color configurations are coupled in such a way that if $r' \geq r$ and $(\eta, \xi_r) \in \tilde{E}_{e_1}$ then $(\eta, \xi_{r'}) \in \tilde{E}_{e_1}$, since all vertices that are black in ξ_r are black in $\xi_{r'}$ as well. A similar argument shows that in case of $\eta \notin F_{e_1}$, there exists $r_1^* = r_1^*(\eta, U) \in [0, 1]$ such that $(\eta, \xi_r) \notin \tilde{E}_{e_1}^*$ for all $r \in [0, r_1^*)$, whereas $(\eta, \xi_r) \in \tilde{E}_{e_1}^*$ for all $r \in (r_1^*, 1]$. Otherwise, i.e., if there is a connection in η between R_{e_1} and the boundary of \tilde{R}_{e_1} , we know that neither of \tilde{E}_{e_1} or $\tilde{E}_{e_1}^*$ has occurred. Hence, in that case, we define $r_1 = r_1^* = 1$, which preserves the above “threshold value” properties as $(r_1, 1] = (r_1^*, 1] = \emptyset$.

Now, if we want a confidence interval with confidence level $1 - \varepsilon$ where $\varepsilon > 0$ is fixed, we choose positive integers m and n in such a way that the probability of having at least m successes among n Bernoulli experiments with success probability 0.8639 each is smaller than (but close to) $\varepsilon/2$. For instance, for a 99.9999% confidence interval, we can choose $n = 400$ and $m = 373$. By repeating the above experiment n times, each time with random variables that are independent of all the previously used ones, we obtain threshold values r_1, r_2, \dots, r_n and $r_1^*, r_2^*, \dots, r_n^*$. Then we sort them so that $\tilde{r}_1 \leq \tilde{r}_2 \leq \dots \leq \tilde{r}_n$, and $\tilde{r}_1^* \leq \tilde{r}_2^* \leq \dots \leq \tilde{r}_n^*$.

Proposition 3.1. *Each of the inequalities $r_c(p) \leq \tilde{r}_m$ and $1 - \tilde{r}_m^* \leq r_c(p)$ occurs with probability at least $1 - \varepsilon/2$, hence $[1 - \tilde{r}_m^*, \tilde{r}_m]$ is a confidence interval for $r_c(p)$ of confidence level $1 - \varepsilon$.*

Before turning to the proof, we remark that the above confidence interval does not necessarily provide meaningful information. In fact, with very small ($< \varepsilon$) probability, $\tilde{r}_m < 1 - \tilde{r}_m^*$ can occur. Otherwise, for unreasonable choices of s and ℓ , taking a too small ℓ in particular, it could happen that there is a connection in the bond configuration between R_{e_1} and the boundary of \tilde{R}_{e_1} in at least $n - m + 1$ experiments out of the n , in which case $[1 - \tilde{r}_m^*, \tilde{r}_m] = [0, 1]$ indeed contains $r_c(p)$ but gives no new information.

However, the real difficulty is that although a confidence interval with an arbitrarily high confidence level may be obtained with the above algorithm, we do not know in advance how **wide** the confidence interval is. The width of the interval depends on s and ℓ , and it is a difficult problem to find good parameter values. A way to make the confidence interval narrower is to decrease the value of m , but that comes at the price of having a lower confidence level.

The choices we made for the parameters s and ℓ in our simulations, together with some intuitive reasoning advocating these choices, are given in the Appendix.

Proof of Proposition 3.1. Let \mathbb{S} be the probability measure on the sample space $[0, 1]^{2n}$ which corresponds to the above experiment, where a realization $(\tilde{r}_1, \tilde{r}_1^*, \tilde{r}_2, \tilde{r}_2^*, \dots, \tilde{r}_n, \tilde{r}_n^*)$ contains the (already ordered) threshold values. Let $\mathbb{B}_{0.8639}$ denote the binomial distribution with parameters n and 0.8639 , and $\mathbb{B}_{a(r)}$ the binomial distribution with parameters n and $a(r) = \mathbb{P}_{p,r}^{\tilde{G}}(\tilde{E}_{e_1})$.

For $r \in [0, 1]$, let N_r denote the number of trials among the n such that \tilde{E}_{e_1} occurs at level r . Note that N_r has distribution $\mathbb{B}_{a(r)}$. Since $a(r) \geq 0.8639$ implies $r \geq r_c(p)$ (see inequality (1.2)), we have that $r < r_c(p)$ implies $a(r) < 0.8639$. Therefore, for all $r < r_c(p)$, $\mathbb{B}_{a(r)}$ is stochastically dominated by $\mathbb{B}_{0.8639}$. This implies that for all $r < r_c(p)$, we have that

$$\begin{aligned} \mathbb{S}(\tilde{r}_m < r) &\leq \mathbb{S}(N_r \geq m) \\ &= \mathbb{B}_{a(r)}(\{m, m+1, \dots, n\}) \\ &\leq \mathbb{B}_{0.8639}(\{m, m+1, \dots, n\}) \\ &\leq \varepsilon/2, \end{aligned}$$

by the definition of m and n .

Hence, for all $\delta > 0$, we have that $\mathbb{S}(\tilde{r}_m < r_c(p) - \delta) \leq \varepsilon/2$, which easily implies that $\mathbb{S}(\tilde{r}_m < r_c(p)) \leq \varepsilon/2$. We also have $\mathbb{S}(\tilde{r}_m^* < r_c^*(p)) \leq \varepsilon/2$ by a completely analogous computation, which implies by equation (1.1) that $\mathbb{S}(1 - \tilde{r}_m^* > r_c(p)) \leq \varepsilon/2$. Therefore,

$$\mathbb{S}(1 - \tilde{r}_m^* \leq r_c(p) \leq \tilde{r}_m) \geq 1 - \varepsilon,$$

which is exactly what we wanted to prove. \square

4 Results of the simulations

We implemented the method described in the previous section in a computer program, and the results for parameter values $\varepsilon = 10^{-6}$, $n = 400$, $m = 373$ are given below.¹ We stress again that although the method in Section 3 that determines a confidence interval for $r_c^{\mathbb{L}}(p)$ is mathematically rigorous, the results below are obtained by using the random number generator [Mer], therefore their correctness depends on “how random” the generated numbers are. The simulations ran on the computers of the ENS-Lyon, and yielded the confidence intervals represented in Figure 1.4.

Having looked at Figure 1.4, we conjecture the following concerning the behavior of $r_c^{\mathbb{L}}(p)$ as a function of p :

Conjecture 4.1. For $\mathbb{L} \in \{\mathbb{Z}^2, \mathbb{H}\}$, in the interval $p \in [0, p_c^{\mathbb{L}})$, $r_c^{\mathbb{L}}(p)$ is a strictly decreasing function of p and

$$\lim_{p \rightarrow p_c^{\mathbb{L}-} } r_c^{\mathbb{L}}(p) = \frac{1}{2}.$$

¹These results — without the description of the method — have been included in [VT2] as well.

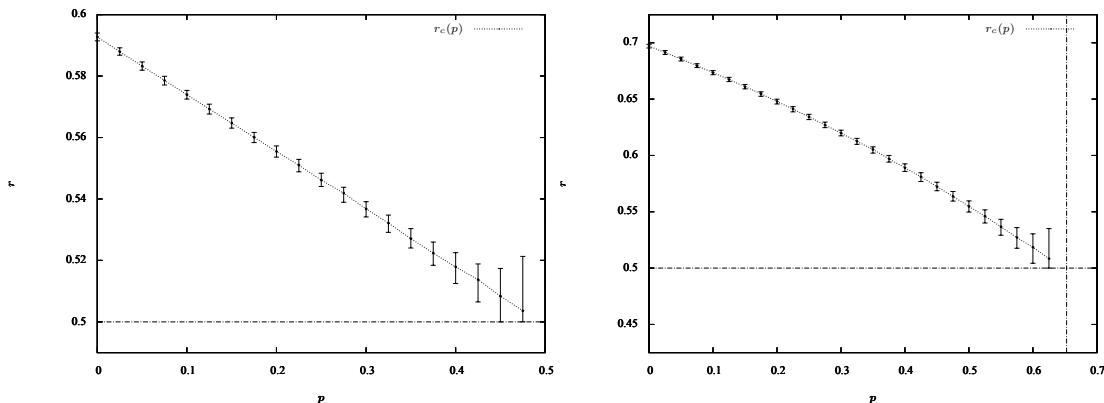

Figure 1.4: Simulation results for different values of $p < p_c^{\mathbb{L}}$ (left: on the square lattice; right: on the hexagonal lattice). The dashed line was obtained via a non-rigorous correction method.

Since it is rigorously known that $r_c^{\mathbb{L}}(0) > 1/2$ and $r_c^{\mathbb{L}}(p) \geq 1/2$ for all $p \in [0, p_c^{\mathbb{L}})$, Conjecture 4.1 would imply that $r_c^{\mathbb{L}}(p) > 1/2$ for all $p < p_c^{\mathbb{L}}$. This suggests that the DaC model on \mathbb{Z}^2 or \mathbb{H} is qualitatively different from the DaC model on the triangular lattice, where the critical value of r is $1/2$ for all subcritical p (see Theorem 1.6 in [BCM09]). However, $\lim_{p \rightarrow p_c^{\mathbb{L}}} r_c^{\mathbb{L}}(p) = 1/2$ would mean that the difference disappears as p converges to $p_c^{\mathbb{L}}$.

The fact that the difference should disappear was conjectured by one of the authors (VB) and Federico Camia, based on the following heuristic reasoning. Near $p = p_c^{\mathbb{L}}$, the structure of the random graph determined by the bond configuration (whose vertices correspond to the bond clusters, and there is an edge between two vertices if the corresponding bond clusters are adjacent in \mathbb{L}) is given by the geometry of “near-critical percolation clusters,” which is expected to be universal for 2-dimensional planar graphs. This suggests that the critical r for p close to its critical value should not depend much on the original underlying lattice, and we expect the convergence of $r_c^{\mathbb{L}}(p)$ to $1/2$ to be universal and hold in the case of any 2-dimensional lattice.

There is an additional, strange feature appearing in the case of the square lattice: $r_c(p)$ seems to be close to being an affine function of p on the interval $[0, 1/2)$. This is not at all the same on the hexagonal lattice, and we have not found any interpretation of this observation, or of the special role \mathbb{Z}^2 seems to play here.

Open question 4.2. *Is $r_c^{\mathbb{Z}^2}(p)$ an affine function of p for $p < 1/2$?*

Appendix

The algorithm in Section 3 is described for general values of s and ℓ , and the concrete

values of these parameters will not affect the correctness of the simulation results. However, a reasonable choice is important for the tightness of the bounds obtained and the efficiency of the algorithm, i.e., the running time of the program. The heuristic arguments given here are somewhat arbitrary, and it is quite possible that there exist other choices that would give at least as good results as ours.

Applying the method described in Section 3 requires to simulate a realization of the DaC model on the graph \tilde{G} , which is a $2L \times L$ rectangular subset of the square lattice where

$$L = s + 2\ell. \tag{1.4}$$

We will keep this value fixed while we let ℓ and s depend on p . Since we want to estimate the critical value for a phase transition, it is natural to take the largest L possible. After having performed various trials of our program, we chose $L = 8000$, which was estimated to be the largest value giving a reasonable time of computation.

Having fixed the size of the graph, we want to choose the parameters so that the probability of \tilde{E}_{e_1} is as high as possible. We need to find a balanced value for ℓ as small values favor E_{e_1} , but a large ℓ might be required to prevent F_{e_1} from happening. The exponential decay theorem in [AB87, Men86] for subcritical Bernoulli bond percolation ensures the existence of an appropriate ℓ of moderate size. In our context, we decided that a good $\ell = \ell(p)$ would be one that ensures

$$\mathbb{P}_{p,r}^{\tilde{G}}(F_{e_1}) \approx 0.001. \tag{1.5}$$

We did simulations in order to find an ℓ such that (1.5) holds, then chose s according to equation (1.4). The values we used in our simulations are summed up in Figure 1.5.

p	Z^2		H	
	s	ℓ	s	ℓ
0	7998	1	7998	1
0.025	7986	7	7986	7
0.05	7986	8	7984	8
0.075	7982	9	7982	9
0.1	7980	10	7980	10
0.125	7978	11	7978	11
0.15	7976	12	7976	12
0.175	7974	13	7974	13
0.2	7970	15	7970	15
0.225	7964	18	7968	16
0.25	7962	19	7964	18
0.275	7956	22	7962	19
0.3	7948	26	7954	23
0.325	7938	31	7952	24
0.35	7926	37	7946	27
0.375	7904	48	7940	30
0.4	7876	62	7932	34
0.425	7822	89	7924	38
0.45	7704	148	7908	46
0.475	7260	370	7896	52
0.5			7876	62
0.525			7844	78
0.55			7790	105
0.575			7710	145
0.6			7538	231
0.625			7002	499

Figure 1.5: Parameters chosen

ON THE CRITICAL VALUE FUNCTION IN THE DIVIDE AND COLOR MODEL

2

This chapter corresponds to the published article [VT2] with the same title, written in collaboration with András Bálint and Vincent Beffara.

We mainly study the continuity properties of the function r_c^G , which is an instance of the question of locality for percolation. Our main result is the fact that in the case $G = \mathbb{Z}^2$, r_c^G is continuous on the interval $[0, 1/2)$; we also prove continuity at $p = 0$ for the more general class of graphs with bounded degree. We then investigate the sharpness of the bounded degree condition and the monotonicity of $r_c^G(p)$ as a function of p .

Introduction

The divide and color (DaC) model is a natural dependent site percolation model introduced by Häggström in [Hä01]. It has been studied directly in [Hä01, Gar01, BCM09], and as a member of a more general family of models in [KW07, Bá10, GG06]. This model is defined on a multigraph $G = (V, E)$, where E is a multiset (i.e., it may contain an element more than once), thus allowing parallel edges between pairs of vertices. For simplicity, we will imprecisely call G a graph and E the edge set, even if G contains self-loops or multiple edges. The DaC model with parameters $p, r \in [0, 1]$, on a general (finite or infinite) graph G with vertex set V and edge set E , is defined by the following two-step procedure:

- First step: Bernoulli bond percolation. We independently declare each edge in E to be open with probability p , and closed with probability $1 - p$. We can identify a bond percolation configuration with an element $\eta \in \{0, 1\}^E$: for each $e \in E$, we define $\eta(e) = 1$ if e is open, and $\eta(e) = 0$ if e is closed.
- Second step: Bernoulli site percolation on the resulting cluster set. Given $\eta \in \{0, 1\}^E$, we call p -clusters or bond clusters the connected components in the graph with vertex set V and edge set $\{e \in E : \eta(e) = 1\}$. The set of p -clusters of η gives a partition of V . For each p -cluster \mathcal{C} , we assign the same color to all the vertices in \mathcal{C} .

The chosen color is black with probability r and white with probability $1 - r$, and this choice is independent for different p -clusters.

These two steps yield a site percolation configuration $\xi \in \{0, 1\}^V$ by defining, for each $v \in V$, $\xi(v) = 1$ if v is black, and $\xi(v) = 0$ if v is white. The connected components (via the edge set E) in ξ of the same color are called (black or white) r -clusters. The resulting measure on $\{0, 1\}^V$ is denoted by $\mu_{p,r}^G$.

Let $E_\infty^b \subset \{0, 1\}^V$ denote the event that there exists an infinite black r -cluster. By standard arguments (see Proposition 2.5 in [Hä01]), for each $p \in [0, 1]$, there exists a critical coloring value $r_c^G(p) \in [0, 1]$ such that

$$\mu_{p,r}^G(E_\infty^b) \begin{cases} = 0 & \text{if } r < r_c^G(p), \\ > 0 & \text{if } r > r_c^G(p). \end{cases}$$

The critical edge parameter $p_c^G \in [0, 1]$ is defined as follows: the probability that there exists an infinite bond cluster is 0 for all $p < p_c^G$, and positive for all $p > p_c^G$. The latter probability is in fact 1 for all $p > p_c^G$, whence $r_c^G(p) = 0$ for all such p . Kolmogorov's 0 – 1 law shows that in the case when all the bond clusters are finite, $\mu_{p,r}^G(E_\infty^b) \in \{0, 1\}$; nevertheless it is possible that $\mu_{p,r}^G(E_\infty^b) \in (0, 1)$ for some $r > r_c^G(p)$ (e.g. on the square lattice, as soon as $p > p_c = 1/2$, one has $\mu_{p,r}^G(E_\infty^b) = r$).

Statement of the results

Our main goal in this paper is to understand how the critical coloring parameter r_c^G depends on the edge parameter p . Since the addition or removal of self-loops obviously does not affect the value of $r_c^G(p)$, we will assume that all the graphs G that we consider are without self-loops. On the other hand, G is allowed to contain multiple edges.

Our first result, based on a stochastic domination argument, gives bounds on $r_c^G(p)$ in terms of $r_c^G(0)$, which is simply the critical value for Bernoulli site percolation on G . By the degree of a vertex v , we mean the number of edges incident on v (counted with multiplicity).

Proposition 0.3. *For any graph G with maximal degree Δ , for all $p \in [0, 1]$,*

$$1 - \frac{1 - r_c^G(0)}{(1 - p)^\Delta} \leq r_c^G(p) \leq \frac{r_c^G(0)}{(1 - p)^\Delta}.$$

As a direct consequence, we get continuity at $p = 0$ of the critical value function:

Proposition 0.4. *For any graph G with bounded degree, $r_c^G(p)$ is continuous in p at 0.*

One could think of an alternative approach to the question, as follows: the DaC model can be seen as Bernoulli site percolation of the random graph $G_p = (V_p, E_p)$ where V_p is the set of bond clusters and two bond clusters are connected by a bond of E_p if and only

if they are adjacent in the original graph. The study of how $r_c^G(p)$ depends on p is then a particular case of a more general question known as the **locality problem**: is it true in general that the critical points of site percolation on a graph and a small perturbation of it are always close? Here, for small p , the graphs G and G_p are somehow very similar, and their critical points are indeed close.

Dropping the bounded-degree assumption allows for the easy construction of graphs for which continuity does not hold at $p = 0$:

Proposition 0.5. *There exists a graph G with $p_c^G > 0$ such that r_c^G is discontinuous at 0.*

In general, when $p > 0$, the graph G_p does not have bounded degree, even if G does; this simple remark can be exploited to construct bounded degree graphs for which r_c^G has discontinuities below the critical point of bond percolation (though of course not at 0):

Theorem 0.6. *There exists a graph G of bounded degree satisfying $p_c^G > 1/2$ and such that $r_c^G(p)$ is discontinuous at $1/2$.*

Remark 0.7. The value $1/2$ in the statement above is not special: in fact, for every $p_0 \in (0, 1)$, it is possible to generalize our argument to construct a graph with a critical bond parameter above p_0 and for which the discontinuity of r_c occurs at p_0 .

Our main results concerns the case $G = \mathbb{Z}^2$, for which the above does not occur:

Theorem 0.8. *The critical coloring value $r_c^{\mathbb{Z}^2}(p)$ is a continuous function of p on the whole interval $[0, 1/2)$.*

The other, perhaps more anecdotal question we investigate here is whether r_c^G is monotonic below p_c . This is the case on the triangular lattice (because it is constant equal to $1/2$), and appears to hold on \mathbb{Z}^2 in simulations.

In the general case, the question seems to be rather delicate. Intuitively the presence of open edges would seem to make percolation easier, leading to the intuition that the function $p \mapsto r_c(p)$ should be non-increasing. Theorem 2.9 in [Hä01] gives a counterexample to this intuition. It is even possible to construct quasi-transitive graphs on which any monotonicity fails:

Proposition 0.9. *There exists a quasi-transitive graph G such that r_c^G is not monotone on the interval $[0, p_c^G)$.*

A brief outline of the paper is as follows. We set the notation and collect a few results from the literature in Section 1. In Section 2, we stochastically compare $\mu_{p,r}^G$ with Bernoulli site percolation (Theorem 2.1), and show how this result implies Proposition 0.3. We then turn to the proof of Theorem 0.8 in Section 3, based on a finite-size argument and the continuity of the probability of cylindrical events.

In Section 4, we determine the critical value function for a class of tree-like graphs, and in the following section we apply this to construct most of the examples of graphs we mentioned above.

1 Definitions and notation

We start by explicitly constructing the model, in a way which will be more technically convenient than the intuitive one given in the introduction.

Let G be a connected graph (V, E) where the set of vertices $V = \{v_0, v_1, v_2, \dots\}$ is countable. We define a total order “ $<$ ” on V by saying that $v_i < v_j$ if and only if $i < j$. In this way, for any subset $V \subset V$, we can uniquely define $\min(V) \in V$ as the minimal vertex in V with respect to the relation “ $<$ ”. For a set S , we denote $\{0, 1\}^S$ by Ω_S . We call the elements of Ω_E *bond configurations*, and the elements of Ω_V *site configurations*. As defined in the Introduction, in a bond configuration η , an edge $e \in E$ is called **open** if $\eta(e) = 1$, and **closed** otherwise; in a site configuration ξ , a vertex $v \in V$ is called **black** if $\xi(v) = 1$, and **white** otherwise. Finally, for $\eta \in \Omega_E$ and $v \in V$, we define the **bond cluster** $\mathcal{C}_v(\eta)$ of v as the maximal connected induced subgraph containing v of the graph with vertex set V and edge set $\{e \in E : \eta(e) = 1\}$, and denote the vertex set of $\mathcal{C}_v(\eta)$ by $C_v(\eta)$.

For $a \in [0, 1]$ and a set S , we define ν_a^S as the probability measure on Ω_S that assigns to each $s \in S$ value 1 with probability a and 0 with probability $1 - a$, independently for different elements of S . We define a function

$$\begin{aligned} \Phi : \Omega_E \times \Omega_V &\rightarrow \Omega_E \times \Omega_V, \\ (\eta, \kappa) &\mapsto (\eta, \xi), \end{aligned}$$

where $\xi(v) = \kappa(\min(C_v(\eta)))$. For $p, r \in [0, 1]$, we define $\mathbb{P}_{p,r}^G$ to be the image measure of $\nu_p^E \otimes \nu_r^V$ by the function Φ , and denote by $\mu_{p,r}^G$ the marginal of $\mathbb{P}_{p,r}^G$ on Ω_V . Note that this definition of $\mu_{p,r}^G$ is consistent with the one in the Introduction.

Finally, we give a few definitions and results that are necessary for the analysis of the DaC model on the square lattice, that is the graph with vertex set \mathbb{Z}^2 and edge set $\mathbb{E}^2 = \{\langle v, w \rangle : v = (v_1, v_2), w = (w_1, w_2) \in \mathbb{Z}^2, |v_1 - w_1| + |v_2 - w_2| = 1\}$. The **matching graph** \mathbb{Z}_*^2 of the square lattice is the graph with vertex set \mathbb{Z}^2 and edge set $\mathbb{E}_*^2 = \{\langle v, w \rangle : v = (v_1, v_2), w = (w_1, w_2) \in \mathbb{Z}^2, \max(|v_1 - w_1|, |v_2 - w_2|) = 1\}$. In the same manner as in the Introduction, we define, for a color configuration $\xi \in \{0, 1\}^{\mathbb{Z}^2}$, (black or white) ***-clusters** as connected components (via the edge set \mathbb{E}_*^2) in ξ of the same color. We denote by $\Theta^*(p, r)$ the $\mathbb{P}_{p,r}^{\mathbb{Z}^2}$ -probability that the origin is contained in an infinite black *-cluster, and define

$$r_c^*(p) = \sup\{r : \Theta^*(p, r) = 0\}$$

for all $p \in [0, 1]$ — note that this value may differ from $r_c^{\mathbb{Z}_*^2}(p)$. The main result in [BCM09] is that for all $p \in [0, 1/2)$, the critical values $r_c^{\mathbb{Z}^2}(p)$ and $r_c^*(p)$ satisfy the duality relation

$$r_c^{\mathbb{Z}^2}(p) + r_c^*(p) = 1. \tag{2.1}$$

We will also use exponential decay result for subcritical Bernoulli bond percolation on \mathbb{Z}^2 . Let $\mathbf{0}$ denote the origin in \mathbb{Z}^2 , and for each $n \in \mathbb{N} = \{1, 2, \dots\}$, let us define $S_n = \{v \in \mathbb{Z}^2 : \text{dist}(v, \mathbf{0}) = n\}$ (where *dist* denotes graph distance), and the event

$M_n = \{\eta \in \Omega_{\mathbb{E}^2} : \text{there is a path of open edges in } \eta \text{ from } \mathbf{0} \text{ to } S_n\}$. Then we have the following result:

Theorem 1.1 ([Kes80]). *For $p < 1/2$, there exists $\psi(p) > 0$ such that for all $n \in \mathbb{N}$, we have that*

$$\nu_p^{\mathbb{E}^2}(M_n) < e^{-n\psi(p)}.$$

2 Stochastic domination and continuity at $p = 0$

In this section, we prove Proposition 0.3 via a stochastic comparison between the DaC measure and Bernoulli site percolation. Before stating the corresponding result, however, let us recall the concept of stochastic domination.

We define a natural partial order on Ω_V by saying that $\xi' \geq \xi$ for $\xi, \xi' \in \Omega_V$ if, for all $v \in V$, $\xi'(v) \geq \xi(v)$. A random variable $f : \Omega_V \rightarrow \mathbb{R}$ is called **increasing** if $\xi' \geq \xi$ implies that $f(\xi') \geq f(\xi)$, and an event $E \subset \Omega_V$ is increasing if its indicator random variable is increasing. For probability measures μ, μ' on Ω_V , we say that μ' is **stochastically larger** than μ (or, equivalently, that μ is **stochastically smaller** than μ' , denoted by $\mu \leq_{st} \mu'$) if, for all bounded increasing random variables $f : \Omega_V \rightarrow \mathbb{R}$, we have that

$$\int_{\Omega_V} f(\xi) d\mu'(\xi) \geq \int_{\Omega_V} f(\xi) d\mu(\xi).$$

By Strassen's theorem [Str65], this is equivalent to the existence of an appropriate coupling of the measures μ' and μ ; that is, the existence of a probability measure \mathbb{Q} on $\Omega_V \times \Omega_V$ such that the marginals of \mathbb{Q} on the first and second coordinates are μ' and μ respectively, and $\mathbb{Q}(\{(\xi', \xi) \in \Omega_V \times \Omega_V : \xi' \geq \xi\}) = 1$.

Theorem 2.1. *For any graph $G = (V, E)$ whose maximal degree is Δ , at arbitrary values of the parameters $p, r \in [0, 1]$,*

$$\nu_{r(1-p)^\Delta}^V \leq_{st} \mu_{p,r}^G \leq_{st} \nu_{1-(1-r)(1-p)^\Delta}^V.$$

Before turning to the proof, we show how Theorem 2.1 implies Proposition 0.3.

Proof of Proposition 0.3. It follows from Theorem 2.1 and the definition of stochastic domination that for the increasing event E_∞^b (which was defined in the Introduction), we have $\mu_{p,r}^G(E_\infty^b) > 0$ whenever $r(1-p)^\Delta > r_c^G(0)$, which implies that $r_c^G(p) \leq r_c^G(0)/(1-p)^\Delta$. The derivation of the lower bound for $r_c^G(p)$ is analogous. \square

Now we give the proof of Theorem 2.1, which bears some resemblance with the proof of Theorem 2.3 in [Hä01].

Proof of Theorem 2.1. Fix $G = (V, E)$ with maximal degree Δ , and parameter values $p, r \in [0, 1]$. We will use the relation “ $<$ ” and the minimum of a vertex set with respect to this relation as defined in Section 1. In what follows, we will define several random variables; we will denote the joint distribution of all these variables by \mathbb{P} .

First, we define a collection $(\eta_{x,y}^e : x, y \in V, e = \langle x, y \rangle \in E)$ of i.i.d. Bernoulli(p) random variables (i.e., they take value 1 with probability p , and 0 otherwise); one may imagine having each edge $e \in E$ replaced by two directed edges, and the random variables represent which of these edges are open. We define also a set $(\kappa_x : x \in V)$ of Bernoulli(r) random variables. Given a realization of $(\eta_{x,y}^e : x, y \in V, e = \langle x, y \rangle \in E)$ and $(\kappa_x : x \in V)$, we will define an $\Omega_V \times \Omega_E$ -valued random configuration (η, ξ) with distribution $\mathbb{P}_{p,r}^G$ by the following algorithm.

1. Let $v = \min\{x \in V : \text{no } \xi\text{-value has been assigned yet to } x \text{ by this algorithm}\}$. (Note that v and V, v_i, H_i ($i \in \mathbb{N}$), defined below, are running variables, i.e., their values will be redefined in the course of the algorithm.)
2. We explore the “directed open cluster” V of v iteratively, as follows. Define $v_0 = v$. Given v_0, v_1, \dots, v_i for some integer $i \geq 0$, set $\eta(e) = \eta_{v_i, w}^e$ for every edge $e = \langle v_i, w \rangle \in E$ incident to v_i such that no η -value has been assigned yet to e by the algorithm, and write $H_{i+1} = \{w \in V \setminus \{v_0, v_1, \dots, v_i\} : w \text{ can be reached from any of } v_0, v_1, \dots, v_i \text{ by using only those edges } e \in E \text{ such that } \eta(e) = 1 \text{ has been assigned to } e \text{ by this algorithm}\}$. If $H_{i+1} \neq \emptyset$, then we define $v_{i+1} = \min(H_{i+1})$, and continue exploring the directed open cluster of v ; otherwise, we define $V = \{v_0, v_1, \dots, v_i\}$, and move to step 3.
3. Define $\xi(w) = \kappa_v$ for all $w \in V$, and return to step 1.

It is immediately clear that the above algorithm eventually assigns a ξ -value to each vertex. Note also that a vertex v can receive a ξ -value only after all edges incident to v have already been assigned an η -value, which shows that the algorithm eventually determines the full edge configuration as well. It is easy to convince oneself that (η, ξ) obtained this way indeed has the desired distribution.

Now, for each $v \in V$, we define $Z(v) = 1$ if $\kappa_v = 1$ and $\eta_{w,v}^e = 0$ for all edges $e = \langle v, w \rangle \in E$ incident on v (i.e., all directed edges towards v are closed), and $Z(v) = 0$ otherwise. Note that every vertex with $Z(v) = 1$ has $\xi(v) = 1$ as well, whence the distribution of ξ (i.e., $\mu_{p,r}^G$) stochastically dominates the distribution of Z (as witnessed by the coupling \mathbb{P}).

Notice that $Z(v)$ depends only on the states of the edges pointing to v and on the value of κ_v ; in particular the distribution of Z is a product measure on Ω_V with parameter $r(1-p)^{d(v)}$ at v , where $d(v) \leq \Delta$ is the degree of v , whence $\mu_{p,r}^G$ stochastically dominates the product measure on Ω_V with parameter $r(1-p)^\Delta$, which gives the desired stochastic lower bound. The upper bound can be proved analogously; alternatively, it follows from the lower bound by exchanging the roles of black and white. \square

3 Continuity of $r_c^{\mathbb{Z}^2}(p)$ on the interval $[0, 1/2)$

In this section, we will prove Theorem 0.8. Our first task is to prove a technical result valid on more general graphs stating that the probability of any event A whose occurrence depends on a finite set of ξ -variables is a continuous function of p for $p < p_c^G$. The proof relies on the fact that although the color of a vertex v may be influenced by edges arbitrarily far away, if $p < p_c^G$, the corresponding influence decreases to 0 in the limit as we move away from v . Therefore, the occurrence of the event A depends essentially on a finite number of η - and κ -variables, whence its probability can be approximated up to an arbitrarily small error by a polynomial in p and r .

Once we have proved Proposition 3.1 below, which is valid on general graphs, we will apply it on \mathbb{Z}^2 to certain “box-crossing events,” and appeal to results in [BCM09] to deduce the continuity of $r_c^{\mathbb{Z}^2}(p)$.

Proposition 3.1. *For every site percolation event $A \subset \{0, 1\}^V$ depending on the color of finitely many vertices, $\mu_{p,r}^G(A)$ is a continuous function of (p, r) on the set $[0, p_c^G) \times [0, 1]$.*

Proof. In this proof, when μ is a measure on a set S , X is a random variable with law μ and $F : S \rightarrow \mathbb{R}$ is a bounded measurable function, we write abusively $\mu[F(X)]$ for the expectation of $F(X)$. We show a slightly more general result: for any $k \geq 1$, $x = (x_1, \dots, x_k) \in V^k$ and $f : \{0, 1\}^k \rightarrow \mathbb{R}$ bounded and measurable, $\mu_{p,r}^G[f(\xi(x_1), \dots, \xi(x_k))]$ is continuous in (p, r) on the product $[0, p_c^G) \times [0, 1]$. Proposition 3.1 will follow by choosing an appropriate family $\{x_1, \dots, x_k\}$ such that the states of the x_i suffices to determine whether A occurs, and take f to be the indicator function of A .

To show the previous affirmation, we condition on the vector

$$\mathbf{m}_x(\eta) = (\min C_{x_1}(\eta), \dots, \min C_{x_k}(\eta))$$

which takes values in the finite set $\mathbf{V} = \{(v_1, \dots, v_k) \in V^k : \forall i v_i \leq \max\{x_1, \dots, x_k\}\}$, and we use the definition of $\mathbb{P}_{p,r}^G$ as an image measure. By definition,

$$\begin{aligned} & \mu_{p,r}^G[f(\xi(x_1), \dots, \xi(x_k))] \\ &= \sum_{\mathbf{v} \in \mathbf{V}} \mathbb{P}_{p,r}^G[f(\xi(x_1), \dots, \xi(x_k)) | \{\mathbf{m}_x = \mathbf{v}\}] \mathbb{P}_{p,r}^G[\{\mathbf{m}_x = \mathbf{v}\}] \\ &= \sum_{\mathbf{v} \in \mathbf{V}} \nu_p^E \otimes \nu_r^V[f(\kappa(v_1), \dots, \kappa(v_k)) | \{\mathbf{m}_x = \mathbf{v}\}] \nu_p^E[\{\mathbf{m}_x = \mathbf{v}\}] \\ &= \sum_{\mathbf{v} \in \mathbf{V}} \nu_r^V[f(\kappa(v_1), \dots, \kappa(v_k))] \nu_p^E[\{\mathbf{m}_x = \mathbf{v}\}]. \end{aligned}$$

Note that $\nu_r^V[f(\kappa(v_1), \dots, \kappa(v_k))]$ is a polynomial in r , so to conclude the proof we only need to prove that for any fixed x and \mathbf{v} , $\nu_p^E(\{\mathbf{m}(x) = \mathbf{v}\})$ depends continuously on p on the interval $[0, p_c^G)$.

For $n \geq 1$, write $F_n = \{|C_{x_1}| \leq n, \dots, |C_{x_k}| \leq n\}$. It is easy to verify that the event $\{\mathbf{m}_x = \mathbf{v}\} \cap F_n$ depends on the state of finitely many edges. Hence, $\nu_p^E[\{\mathbf{m}_x = \mathbf{v}\} \cap F_n]$ is a polynomial function of p .

Fix $p_0 < p_c^G$. For all $p \leq p_0$,

$$\begin{aligned} 0 \leq \nu_p^E [\{\mathbf{m}(\mathbf{x}) = \mathbf{v}\}] - \nu_p^E [\{\mathbf{m}_x = \mathbf{v}\} \cap F_n] &\leq \nu_p^E [F_n^c] \\ &\leq \nu_{p_0}^E [F_n^c] \end{aligned}$$

where $\lim_{n \rightarrow \infty} \nu_{p_0}^E [F_n^c] = 0$, since $p_0 < p_c^G$. So, $\nu_p^E [\mathbf{m}(\mathbf{x}) = \mathbf{v}]$ is a uniform limit of polynomials on any interval $[0, p_0]$, $p_0 < p_c^G$, which implies the desired continuity. \square

Remark 3.2. In the proof we can see that, for fixed $p < p_c^G$, $\mu_{p,r}^G(A)$ is a polynomial in r .

Remark 3.3. If G is a graph with uniqueness of the infinite bond cluster in the supercritical regime, then it is possible to verify that $\nu_p^E [\{\mathbf{m}(\mathbf{x}) = \mathbf{v}\}]$ is continuous in p on the whole interval $[0, 1]$. In this case, the continuity given by the Proposition 3.1 can be extended to the whole square $[0, 1]^2$.

Proof of Theorem 0.8. In order to simplify our notations, we write $\mathbb{P}_{p,r}$, ν_p , $r_c(p)$, for $\mathbb{P}_{p,r}^{\mathbb{Z}^2}$, $\nu_p^{\mathbb{E}^2}$ and $r_c^{\mathbb{Z}^2}(p)$ respectively. Fix $p_0 \in (0, 1/2)$ and $\varepsilon > 0$ arbitrarily. We will show that there exists $\delta = \delta(p_0, \varepsilon) > 0$ such that for all $p \in (p_0 - \delta, p_0 + \delta)$,

$$r_c(p) \geq r_c(p_0) - \varepsilon, \quad (2.2)$$

and

$$r_c(p) \leq r_c(p_0) + \varepsilon. \quad (2.3)$$

Note that by equation (2.1), for all small enough choices of $\delta > 0$ (such that $0 \leq p_0 \pm \delta < 1/2$), (2.2) is equivalent to

$$r_c^*(p) \leq r_c^*(p_0) + \varepsilon. \quad (2.4)$$

Below we will show how to find $\delta_1 > 0$ such that we have (2.3) for all $p \in (p_0 - \delta_1, p_0 + \delta_1)$. One may then completely analogously find $\delta_2 > 0$ such that (2.4) holds for all $p \in (p_0 - \delta_2, p_0 + \delta_2)$, and take $\delta = \min(\delta_1, \delta_2)$.

Fix $r = r_c(p_0) + \varepsilon$, and define the event $V_n = \{(\xi, \eta) \in \Omega_{\mathbb{Z}^2} \times \Omega_{\mathbb{E}^2} : \text{there exists a vertical crossing of } [0, n] \times [0, 3n] \text{ that is black in } \xi\}$. By ‘‘vertical crossing,’’ we mean a self-avoiding path of vertices in $[0, n] \times [0, 3n]$ with one endpoint in $[0, n] \times \{0\}$, and one in $[0, n] \times \{3n\}$. Recall also the definition of M_n in Theorem 1.1. By Lemma 2.10 in [BCM09], there exists a constant $\gamma > 0$ such that the following implication holds for any $p, a \in [0, 1]$ and $L \in \mathbb{N}$:

$$\left. \begin{aligned} (3L+1)(L+1)\nu_a(M_{\lfloor L/3 \rfloor}) &\leq \gamma, \\ \text{and } \mathbb{P}_{p,a}(V_L) &\geq 1 - \gamma \end{aligned} \right\} \Rightarrow a \geq r_c(p).$$

As usual, $\lfloor x \rfloor$ for $x > 0$ denotes the largest integer m such that $m \leq x$. Fix such a γ .

By Theorem 1.1, there exists $N \in \mathbb{N}$ such that

$$(3n+1)(n+1)\nu_{p_0}(M_{\lfloor n/3 \rfloor}) < \gamma$$

for all $n \geq N$. On the other hand, since $r > r_c(p_0)$, it follows from Lemma 2.11 in [BCM09] that there exists $L \geq N$ such that

$$\mathbb{P}_{p_0, r}(V_L) > 1 - \gamma.$$

Note that both $(3L + 1)(L + 1)\nu_p(M_{\lfloor L/3 \rfloor})$ and $\mathbb{P}_{p, r}(V_L)$ are continuous in p at p_0 . Indeed, the former is simply a polynomial in p , while the continuity of the latter follows from Proposition 3.1. Therefore, there exists $\delta_1 > 0$ such that for all $p \in (p_0 - \delta_1, p_0 + \delta_1)$,

$$\begin{aligned} (3L + 1)(L + 1)\nu_p(M_{\lfloor L/3 \rfloor}) &\leq \gamma, \\ \text{and } \mathbb{P}_{p, r}(V_L) &\geq 1 - \gamma. \end{aligned}$$

By the choice of γ , this implies that $r \geq r_c(p)$ for all such p , which is precisely what we wanted to prove.

Finding $\delta_2 > 0$ such that (2.4) holds for all $p \in (p_0 - \delta_2, p_0 + \delta_2)$ is analogous: one only needs to substitute $r_c(p_0)$ by $r_c^*(p_0)$ and “crossing” by “*-crossing,” and the exact same argument as above works. It follows that $\delta = \min(\delta_1, \delta_2) > 0$ is a constant such that both (2.3) and (2.4) hold for all $p \in (p_0 - \delta, p_0 + \delta)$, completing the proof of continuity on $(0, 1/2)$. Right-continuity at 0 may be proved analogously; alternatively, it follows from Proposition 0.4. \square

Remark 3.4. It follows from Theorem 0.8 and equation (2.1) that $r_c^*(p)$ is also continuous in p on $[0, 1/2)$.

4 The critical value functions of tree-like graphs

In this section, we will study the critical value functions of graphs that are constructed by replacing edges of an infinite tree by a sequence of finite graphs. We will then use several such constructions in the proofs of our main results in Section 5.

Let us fix an arbitrary sequence $D_n = (V_n, E_n)$ of finite connected graphs and, for every $n \in \mathbb{N}$, two distinct vertices $a_n, b_n \in V_n$. Let $\mathbb{T}_3 = (V_3, E_3)$ denote the (infinite) regular tree of degree 3, and fix an arbitrary vertex $\rho \in V_3$. Then, for each edge $e \in E_3$, we denote the end-vertex of e which is closer to ρ by $f(e)$, and the other end-vertex by $s(e)$. Let $\Gamma_D = (\tilde{V}, \tilde{E})$ be the graph obtained by replacing every edge e of Γ_3 between levels $n - 1$ and n (i.e., such that $\text{dist}(s(e), \rho) = n$) by a copy D_e of D_n , with a_n and b_n replacing respectively $f(e)$ and $s(e)$. Each vertex $v \in V_3$ is replaced by a new vertex in \tilde{V} , which we denote by \tilde{v} . It is well known that $p_c^{\Gamma_3} = r_c^{\Gamma_3}(0) = 1/2$. Using this fact and the tree-like structure of Γ_D , we will be able to determine bounds for $p_c^{\Gamma_D}$ and $r_c^{\Gamma_D}(p)$.

First, we define $h^{D_n}(p) = \nu_p^{E_n}(a_n \text{ and } b_n \text{ are in the same bond cluster})$, and prove the following, intuitively clear, lemma.

Lemma 4.1. *For any $p \in [0, 1]$, the following implications hold:*

- a) *if $\limsup_{n \rightarrow \infty} h^{D_n}(p) < 1/2$, then $p \leq p_c^{\Gamma_D}$;*
- b) *if $\liminf_{n \rightarrow \infty} h^{D_n}(p) > 1/2$, then $p \geq p_c^{\Gamma_D}$.*

Proof. We couple Bernoulli bond percolation with parameter p on Γ_D with inhomogeneous Bernoulli bond percolation with parameters $h^{D_n}(p)$ on \mathbb{T}_3 , as follows. Let η be a random variable with law $\nu_p^{\tilde{E}}$, and define, for each edge $e \in E_3$, $W(e) = 1$ if $f(\tilde{e})$ and $s(\tilde{e})$ are connected by a path consisting of edges that are open in η , and $W(e) = 0$ otherwise. The tree-like structure of Γ_D implies that $W(e)$ depends only on the state of the edges in D_e , and it is clear that if $\text{dist}(s(e), \rho) = n$, then $W(e) = 1$ with probability $h^{D_n}(p)$.

It is easy to verify that there exists an infinite open self-avoiding path on Γ_D from $\tilde{\rho}$ in the configuration η if and only if there exists an infinite open self-avoiding path on \mathbb{T}_3 from ρ in the configuration W . Now, if we assume $\limsup_{n \rightarrow \infty} h^{D_n}(p) < 1/2$, then there exists $t < 1/2$ and $N \in \mathbb{N}$ such that for all $n \geq N$, $h^{D_n}(p) \leq t$. Therefore, the distribution of the restriction of W on $L = \{e \in E_3 : \text{dist}(s(e), \rho) \geq N\}$ is stochastically dominated by the projection of $\nu_t^{E_3}$ on L . This implies that, a.s., there exists no infinite self-avoiding path in W , whence $p \leq p_c^{\Gamma_D}$ by the observation at the beginning of this paragraph. The proof of b) is analogous. \square

We now turn to the DaC model on Γ_D . Recall that for a vertex v , C_v denotes the vertex set of the bond cluster of v . Let $E_{a_n, b_n} \subset \Omega_{E_n} \times \Omega_{V_n}$ denote the event that a_n and b_n are in the same bond cluster, or a_n and b_n lie in two different bond clusters, but there exists a vertex v at distance 1 from C_{a_n} which is connected to b_n by a black path (which also includes that $\xi(v) = \xi(b_n) = 1$). This is the same as saying that C_{a_n} is pivotal for the event that there is a black path between a_n and b_n , i.e., that such a path exists if and only if C_{a_n} is black. It is important to note that E_{a_n, b_n} is independent of the color of a_n . Define $f^{D_n}(p, r) = \mathbb{P}_{p, r}^{D_n}(E_{a_n, b_n})$, and note also that, for $r > 0$, $f^{D_n}(p, r) = \mathbb{P}_{p, r}^{D_n}(\text{there is a black path from } a_n \text{ to } b_n \mid \xi(a_n) = 1)$.

Lemma 4.2. *For any $p, r \in [0, 1]$, we have the following:*

- a) *if $\limsup_{n \rightarrow \infty} f^{D_n}(p, r) < 1/2$, then $r \leq r_c^{\Gamma_D}(p)$;*
- b) *if $\liminf_{n \rightarrow \infty} f^{D_n}(p, r) > 1/2$, then $r \geq r_c^{\Gamma_D}(p)$.*

Proof. We couple here the DaC model on Γ_D with inhomogeneous Bernoulli site percolation on \mathbb{T}_3 . For each $v \in V_3 \setminus \{\rho\}$, there is a unique edge $e \in E_3$ such that $v = s(e)$. Here we denote D_e (i.e., the subgraph of Γ_D replacing the edge e) by $D_{\tilde{v}}$, and the analogous event of E_{a_n, b_n} for the graph $D_{\tilde{v}}$ by $E_{\tilde{v}}$. Let (η, ξ) with values in $\Omega_{\tilde{E}} \times \Omega_{\tilde{V}}$ be a random variable with law $\mathbb{P}_{p, r}^{\Gamma_D}$. We define a random variable X with values in Ω_{V_3} , as follows:

$$X(v) = \begin{cases} \xi(\tilde{\rho}) & \text{if } v = \rho, \\ 1 & \text{if the event } E_{\tilde{v}} \text{ is realized by the restriction of } (\eta, \xi) \text{ to } D_{\tilde{v}}, \\ 0 & \text{otherwise.} \end{cases}$$

As noted after the proof of Lemma 4.1, if $u = f(\langle u, v \rangle)$, the event $E_{\tilde{v}}$ is independent of the color of \tilde{u} , whence $(E_{\tilde{v}})_{v \in V_3 \setminus \{\rho\}}$ are independent. Therefore, as $X(\rho) = 1$ with probability r , and $X(v) = 1$ is realized with probability $f^{D_n}(p, r)$ for $v \in V_3$ with $\text{dist}(v, \rho) = n$ for some $n \in \mathbb{N}$, X is inhomogeneous Bernoulli site percolation on \mathbb{T}_3 .

Our reason for defining X is the following property: it holds for all $v \in V_3 \setminus \{\rho\}$ that

$$\tilde{\rho} \overset{\xi}{\leftrightarrow} \tilde{v} \quad \text{if and only if} \quad \rho \overset{X}{\leftrightarrow} v, \quad (2.5)$$

where $x \overset{Z}{\leftrightarrow} y$ denotes that x and y are in the same black cluster in the configuration Z . Indeed, assuming $\tilde{\rho} \overset{\xi}{\leftrightarrow} \tilde{v}$, there exists a path $\rho = x_0, x_1, \dots, x_k = v$ in Γ_3 such that, for all $0 \leq i < k$, $\tilde{x}_i \overset{\xi}{\leftrightarrow} \tilde{x}_{i+1}$ holds. This implies that $\xi(\tilde{\rho}) = 1$ and that all the events $(E_{\tilde{x}_i})_{0 \leq i \leq k}$ occur, whence $X(x_i) = 1$ for $i = 0, \dots, k$, so $\rho \overset{X}{\leftrightarrow} v$ is realized. The proof of the other implication is similar. It follows in particular from (2.5) that $\tilde{\rho}$ lies in an infinite black cluster in the configuration ξ if and only if ρ lies in an infinite black cluster in the configuration X .

Lemma 4.2 presents two scenarios when it is easy to determine (via a stochastic comparison) whether the latter event has positive probability. For example, if we assume that $\liminf_{n \rightarrow \infty} f^{D_n}(p, r) > 1/2$, then there exists $t > 1/2$ and $N \in \mathbb{N}$ such that for all $n \geq N$, $f^{D_n}(p, r) \geq t$. In this case, the distribution of the restriction of X on $K = \{v \in V_3 : \text{dist}(v, \rho) \geq N\}$ is stochastically larger than the projection of $\nu_t^{E_3}$ on K . Let us further assume that $r > 0$. In that case, $X(\rho) = 1$ with positive probability, and $f^{D_n}(p, r) > 0$ for every $n \in \mathbb{N}$. Therefore, under the assumptions $\liminf_{n \rightarrow \infty} f^{D_n}(p, r) > 1/2$ and $r > 0$, ρ is in an infinite black cluster in X (and, hence, $\tilde{\rho}$ is in an infinite black cluster in ξ) with positive probability, which can only happen if $r \geq r_c^{\Gamma_D}(p)$. On the other hand, if $\liminf_{n \rightarrow \infty} f^{D_n}(p, 0) > 1/2$, then it is clear that $\liminf_{n \rightarrow \infty} f^{D_n}(p, r) > 1/2$ (whence $r \geq r_c^{\Gamma_D}(p)$) for all $r > 0$, which implies that $r_c^{\Gamma_D}(p) = 0$. The proof of part a) is similar. \square

5 Counterexamples

In this section, we study two particular graph families and obtain examples of non-monotonicity and non-continuity of the critical value function.

5.1 Non-monotonicity

The results in Section 4 enable us to prove that (a small modification of) the construction considered by Häggström in the proof of Theorem 2.9 in [Hä01] is a graph whose critical coloring value is non-monotone in the subcritical phase.

Proof of Proposition 0.9. Define for $k \in \mathbb{N}$, D^k to be the complete bipartite graph with the vertex set partitioned into $\{z_1, z_2\}$ and $\{a, b, v_1, v_2, \dots, v_k\}$ (see Figure 2.1). We call e_1, e'_1 and e_2, e'_2 the edges incident to a and b respectively, and for $i = 1, \dots, k$, f_i, f'_i the edges incident to v_i . Consider Γ_k the quasi-transitive graph obtained by replacing each edge of the tree \mathbb{T}_3 by a copy of D_k . Γ_k can be seen as the tree-like graph resulting from the construction described at beginning of the section, when we start with the constant sequence $(D_n, a_n, b_n) = (D^k, a, b)$.

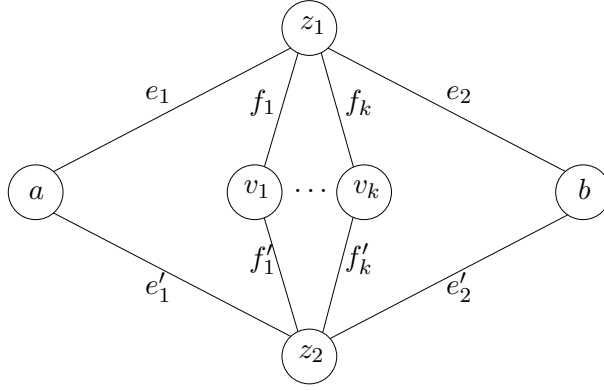
 Figure 2.1: The graph D^k .

We will show below that it holds for all $k \in \mathbb{N}$ that

$$p_c^{\Gamma_k} > 1/3, \quad (2.6)$$

$$r_c^{\Gamma_k}(0) < 2/3, \quad \text{and} \quad (2.7)$$

$$r_c^{\Gamma_k}(1/3) < 2/3. \quad (2.8)$$

Furthermore, there exists $k \in \mathbb{N}$ and $p_0 \in (0, 1/3)$ such that

$$r_c^{\Gamma_k}(p_0) > 2/3. \quad (2.9)$$

Proving (2.6)–(2.9) will finish the proof of Proposition 0.9 since these inequalities imply that the quasi-transitive graph Γ_k has a non-monotone critical value function in the sub-critical regime.

Throughout this proof, we will omit superscripts in the notation when no confusion is possible. For the proof of (2.6), recall that h^{D^k} is strictly increasing in p , and $h^{D^k}(p_{D^k}) = 1/2$. Since $1 - h^{D^k}(p)$ is the ν_p -probability of a and b being in two different bond clusters, we have that

$$1 - h^{D^k}(1/3) \geq \nu_{1/3}(\{e_1 \text{ and } e'_1 \text{ are closed}\} \cup \{e_2 \text{ and } e'_2 \text{ are closed}\}).$$

From this, we get that $h^{D^k}(1/3) \leq 25/81$, which proves (2.6).

To get (2.7), we need to remember that for fixed $p < p_{D^k}$, $f^{D^k}(p, r)$ is strictly increasing in r , and $f^{D^k}(p, r_{D^k}(p)) = 1/2$. One then easily computes that $f(0, 2/3) = 16/27 > 1/2$, whence (2.7) follows from Lemma 4.2.

Now, define A to be the event that at least one edge out of e_1, e'_1, e_2 and e'_2 is open. Then

$$\begin{aligned} f^{D^k}(1/3, 2/3) &\geq \mathbb{P}_{1/3, 2/3}(E_{a,b} \mid A) \mathbb{P}_{1/3, 2/3}(A) \\ &\geq \mathbb{P}_{1/3, 2/3}(C_b \text{ black} \mid A) \cdot 65/81, \end{aligned}$$

which gives that $f^{D^k}(1/3, 2/3) \geq 130/243 > 1/2$, and implies (2.8) by 4.2.

To prove (2.9), we consider B_k to be the event that e_1, e'_1, e_2 and e'_2 are all closed and that there exists i such that f_i and f'_i are both open. One can easily compute that

$$\mathbb{P}_{p,r}(B_k) = (1-p)^4 \left(1 - (1-p^2)^k\right),$$

which implies that we can choose $p_0 \in (0, 1/3)$ (small) and $k \in \mathbb{N}$ (large) such that $\mathbb{P}_{p_0,r}(B_k) > 17/18$. Then,

$$\begin{aligned} f^{D^k}(p_0, 2/3) &= \mathbb{P}_{p_0,r}(E_{a,b} \mid B_k) \mathbb{P}_{p_0,r}(B_k) + \mathbb{P}_{p_0,r}(E_{a,b} \mid B_k^c) (1 - \mathbb{P}_{p_0,r}(B_k)) \\ &< (2/3)^2 \cdot 1 + 1 \cdot 1/18 (= 1/2), \end{aligned}$$

whence inequality (2.9) follows with these choices from Lemma 4.2, completing the proof. \square

5.2 Graphs with discontinuous critical value functions

Proof of Proposition 0.5. For $n \in \mathbb{N}$, let D_n be the graph depicted in Figure 2.2, and let G be Γ_D constructed with this sequence of graphs as described at the beginning of Section 4.

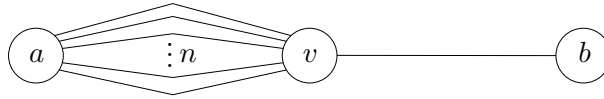

Figure 2.2: The graph D_n .

It is elementary that $\lim_{n \rightarrow \infty} h^{D_n}(p) = p$, whence $p_c^G = 1/2$ follows from Lemma 4.1, thus $p = 0$ is subcritical. Since $\lim_{n \rightarrow \infty} f^{D_n}(0, r) = r^2$, Lemma 4.2 gives that $r_c^G(0) = 1/\sqrt{2}$. On the other hand, $\lim_{n \rightarrow \infty} f^{D_n}(p, r) = p + (1-p)r$ for all $p > 0$, which implies by Lemma 4.2 that for $p \leq 1/2$,

$$r_c^G(p) = \frac{1/2 - p}{1 - p} \rightarrow 1/2$$

as $p \rightarrow 0$, so r_c^G is indeed discontinuous at $0 < p_c^G$. \square

In the rest of this section, for vertices v and w , we will write $v \leftrightarrow w$ to denote that there exists a path of open edges between v and w . Our proof of Theorem 0.6 will be based on the Lemma 2.1 in [PSS09], that we rewrite here:

Lemma 5.1. *There exists a sequence $G_n = (V^n, E^n)$ of graphs and $x_n, y_n \in V^n$ of vertices ($n \in \mathbb{N}$) such that*

1. $\nu_{1/2}^{E^n}(x_n \leftrightarrow y_n) > \frac{2}{3}$ for all n ;
2. $\lim_{n \rightarrow \infty} \nu_p^{E^n}(x_n \leftrightarrow y_n) = 0$ for all $p < 1/2$, and
3. there exists $\Delta < \infty$ such that, for all n , G_n has degree at most Δ .

Lemma 5.1 provides a sequence of bounded degree graphs that exhibit sharp threshold-type behavior at $1/2$. We will use such a sequence as a building block to obtain discontinuity at $1/2$ in the critical value function in the DaC model.

Proof of Theorem 0.6. We first prove the theorem in the case $p_0 = 1/2$. Consider the graph $G_n = (V^n, E^n), x_n, y_n$ ($n \in \mathbb{N}$) as in Lemma 5.1. We construct D_n from G_n by adding to it one extra vertex a_n and one edge $\{a_n, x_n\}$. More precisely D_n has vertex set $V^n \cup \{a_n\}$ and edge set $E^n \cup \{a_n, x_n\}$. Set $b_n = y_n$ and let G be the graph Γ_D defined with the sequence (D_n, a_n, b_n) as in Section 4.

We will show below that there exists $r_0 > r_1$ such that the graph G verify the following three properties:

- (i) $1/2 < p_c^G$
- (ii) $r_c^G(p) \geq r_0$ for all $p < 1/2$.
- (iii) $r_c^G(1/2) \leq r_1$.

It implies a discontinuity of r_c^G at $1/2 < p_c^G$, finishing the proof.

One can easily compute $h^{D_n}(p) = p v_p^{E^n}(x_n \leftrightarrow y_n)$. Since the graph G_n has degree at most Δ and the two vertices x_n, y_n are disjoint, the probability $v_p^{E^n}(x_n \leftrightarrow y_n)$ cannot exceed $1 - (1 - p)^\Delta$. This bound guarantees the existence of $p_0 > 1/2$ independent of n such that $h^{D_n}(p_0) < 1/2$ for all n , whence Lemma 4.1 implies that $1/2 < p_0 \leq p_c^G$.

For all $p \in [0, 1]$, we have

$$f^{D_n}(p, r) \leq (p + r(1 - p)) \left(v_p^{E^n}(x_n \leftrightarrow y_n) + r(1 - v_p^{E^n}(x_n \leftrightarrow y_n)) \right).$$

which gives that $\lim_{n \rightarrow \infty} f^{D_n}(p, r) < \left(\frac{r+1}{2}\right) \cdot r$. Writing r_0 the positive solution of $r(1 + r) = 1$, we get that $\lim_{n \rightarrow \infty} f^{D_n}(p, r_0) < 1/2$ for all $p < 1/2$, which implies by Lemma 4.2 that $r_c^G(p) \geq r_0$.

On the other hand, $f^{D_n}(1/2, r) \geq v_p^{E^n}(x_n \leftrightarrow y_n) \left(\frac{1+r}{2}\right)$, which gives by Lemma 5.1 that $\lim_{n \rightarrow \infty} f^{D_n}(1/2, r) > \frac{2}{3} \cdot \frac{1+r}{2}$. Writing r_1 such that $\frac{2}{3}(1 + r_1) = 1$, it is elementary to check that $r_1 < r_0$ and that $\lim_{n \rightarrow \infty} f^{D_n}(1/2, r_1) > 1/2$. Then, using Lemma 4.2, we conclude that $r_c(1/2) \leq r_1$. \square

A UNIVERSAL BEHAVIOR FOR PLANAR DAC PERCOLATION

3

This chapter corresponds to the work in progress [VT3].

Introduction

In this chapter, we study DaC percolation on the square lattice $G = (\mathbb{Z}^2, \mathbb{E}^2)$. Recall that the critical parameter for bond percolation on this graph is $p_c = 1/2$. We write $r_c(p)$ the critical value function for the DaC model, as defined in Chapter 2. In [Hä01], it was proved that $1/2 \leq r_c(p) < 1$ for all $p < p_c$. In the previous chapter we studied the behavior of $r_c(p)$ when p is small and proved in particular that $r_c(p) > 1/2$ for all p small enough. In the present chapter, we study the behavior of r_c when p is close to p_c , and we prove the following result.

Theorem 0.2. *For DaC percolation on the square lattice, we have*

$$\lim_{\substack{p \rightarrow p_c \\ p < p_c}} r_c(p) = \frac{1}{2}. \quad (3.1)$$

The theorem above should not be restricted to the square lattice, and we expect it to hold for any general periodic planar graph. In our approach, one argument (the “shift argument” developed in section 5.3) uses the following property of critical bond percolation on \mathbb{Z}^2 : one can couple two critical bond percolation processes such that the following holds (see section 1 for the definitions). To any open path $v_1, v_2, \dots, v_n \in \mathbb{Z}^2$ in the first configuration corresponds dual-open dual-path $w_1, w_2, \dots, w_n \in (1/2, 1/2) + \mathbb{Z}^2$ such that $|v_i - w_i| \leq \sqrt{2}/2$. The constant $\sqrt{2}/2$ does not play any role here, any constant would be sufficient. This property is not specific to the square lattice, and such coupling can be obtained for example on the hexagonal lattice using the star-triangle transformation. For any periodic planar graph with the coupling property above, one can use the proof presented here, with small modifications, and prove that the convergence (3.1) holds. In particular Theorem 1 holds also for the hexagonal lattice. Apart from the “shift argument”, the proof is very general, and we believe the general strategy is a good approach in order to tackle the convergence (3.1) on general periodic planar graph.

1 Definitions and notation

Plane notation. We write $|z|$ the standard Euclidean norm of a point $z \in \mathbb{R}^2$. We define the following subsets of the plane, for $0 \leq m \leq n$:

- the square $B_n := [-n, n]^2$,
- the annulus $A_{m,n} := B_n \setminus B_m$.

Graph notation. We will mainly work on graphs with vertex set \mathbb{Z}^2 , that will be constructed from the following sets of edges.

- $\mathbb{E}^2 := \{\{v, w\} : v, w \in \mathbb{Z}^2, |v - w| = 1\}$,
- $\mathbb{D}^+ := \{\{v, v + (1, 1)\} : v \in \mathbb{Z}^2\}$,
- $\mathbb{D}^- := \{\{v, v + (1, -1)\} : v \in \mathbb{Z}^2\}$.

For S a subset of \mathbb{R}^2 , we write $\mathbb{E}^2(S)$ (resp. $\mathbb{D}^+(S)$, $\mathbb{D}^-(S)$) the set of edges in \mathbb{E}^2 (resp. \mathbb{D}^+ , \mathbb{D}^-) with both ends in S . We also consider the dual graph of the square lattice, its vertex set is $\mathbb{Z}_{\text{dual}}^2 := (1/2, 1/2) + \mathbb{Z}^2$, and its edge set $\mathbb{E}_{\text{dual}}^2$ is given by the pairs $\{v, w\}$ of elements of $\mathbb{Z}_{\text{dual}}^2$ such that $|w - v| = 1$. We will sometimes call **dual vertices** the elements of $\mathbb{Z}_{\text{dual}}^2$ and **dual edges** the elements of $\mathbb{E}_{\text{dual}}^2$. To each edge $e = \{v, w\} \in \mathbb{E}^2$ corresponds a unique dual edge denoted $e^* = \{v', w'\}$ such that the two segments $[v, w]$ and $[v', w']$ intersect exactly at their middle.

The space of configurations. In this chapter, we consider the probability space $\Omega = \{0, 1\}^{\mathbb{E}^2} \times \{0, 1\}^{\mathbb{Z}^2} \times \{0, 1\}^{\mathbb{D}^+}$, equipped with the product sigma-algebra. A configuration is given by a triple $\omega = (\eta, \xi, \delta)$, and we use the following definitions.

- We call η the bond percolation configuration. An edge $e \in \mathbb{E}^2$ is said to be **open** if $\eta(e) = 1$, and **closed** otherwise. A dual edge e^* is said to be **dual-open** if its corresponding edge in \mathbb{E}^2 is closed. If S is a subset of the plane, we call **S -bond-cluster**, or simply **bond-cluster** when $S = \mathbb{R}^2$, a connected component of the graph with vertex set $\mathbb{Z}^2 \cap S$, and with edge set given by the open edges $\{v, w\}$ such that $v, w \in S$.
- We call ξ the coloring configuration. A vertex $v \in \mathbb{Z}^2$ is said to be **black** if $\xi(v) = 1$ and **white** if $\xi(v) = 0$. More generally a subset of \mathbb{Z}^2 is said to be **black**, resp. **white**, if all its elements are black, resp. white.
- We call δ the diagonal configuration. An edge $e \in \mathbb{D}^+$ is said to be **added** if $\delta(e) = 1$.

The probability measures. We construct a random configuration in Ω , by the following 3 steps procedure. Let $n \geq 1$ and $0 \leq p, r, s \leq 1$.

Step 1: Bernoulli bond percolation. Declare independently each edge of \mathbb{E}^2 open with probability p and closed otherwise.

Step 2: Bernoulli site percolation on the set of bond-clusters. Examine independently each bond-cluster obtained after the first step, and assign the same color to all its vertices. The chosen color is black with probability r and white otherwise.

Step 3: adding diagonal edges in the set B_n . Independently of the others, and of the two steps above, declare each edge in $\mathbb{D}^+(B_n)$ added with probability s . In the complement of B_n , no edge is added.

We define the probability measure $P_{p,r,s}^n$ on Ω to be the law of the random configuration obtained after the three steps above.

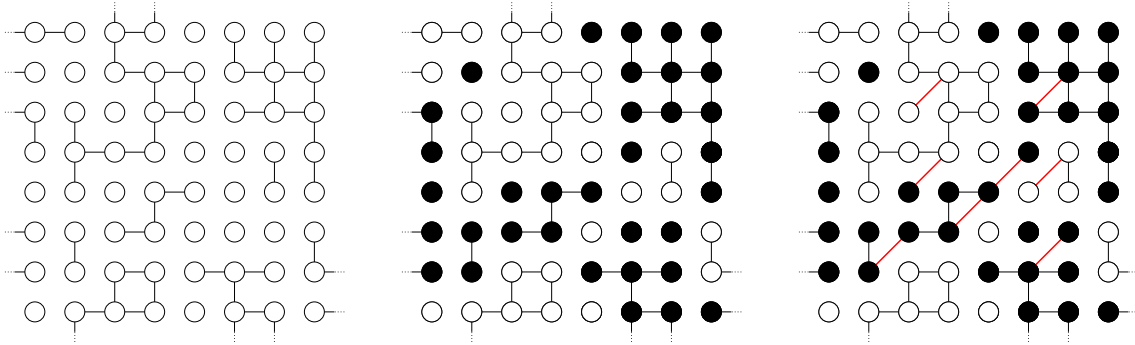

Step 1: Bernoulli bond percolation.

Step 2: Bernoulli site percolation on the set of bond-clusters.

Step 3: adding diagonal edges in the set B_n .

Figure 3.1: Construction of a random configuration ($n = 3$)

We also write ν_p the standard Bernoulli percolation measure on $\{0, 1\}^{\mathbb{E}^2}$ with parameter $p, 0 \leq p \leq 1$.

Primal/dual paths. In general we call path in a graph (V, E) , ($V = \mathbb{Z}^2$ or $V = \mathbb{Z}_{\text{dual}}^2$), a finite sequence $\gamma = (\gamma(1), \dots, \gamma(\ell))$ of elements of V , such that $\{\gamma(i), \gamma(i+1)\} \in E$. γ is said to be **self-avoiding** if all the $\gamma(i)$'s are distinct. One can identify a path γ with the compact connected subset of the plane given by the union of the segments $[\gamma(i), \gamma(i+1)]$, $1 \leq i \leq \ell - 1$. For example, given a set S in the plane, when we say that γ lies in S it means that all the segments $[\gamma(i), \gamma(i+1)]$ are subset of S .

A path in $(\mathbb{Z}^2, \mathbb{E}^2)$, is called a **primal path**. When all its edges are open, we call it a **primal-open path**. Similarly, a path in $(\mathbb{Z}_{\text{dual}}^2, \mathbb{E}_{\text{dual}}^2)$, is called a **dual path**. When all its edges are dual-open, we call it a **dual-open path**.

G-paths/G*-paths. Consider a configuration $\omega = (\eta, \xi, \delta)$. Let $G = G(\delta)$ be the random graph obtained by adding to the square lattice $(\mathbb{Z}^2, \mathbb{E}^2)$ all the diagonal edges $e \in \mathbb{D}^+$ with $\delta(e) = 1$. This graph is planar, and we can define its matching graph G^* . Its vertex set is \mathbb{Z}^2 and its edge set is given by

- the edges in $\mathbb{E}^2 \cup \mathbb{D}^+$;
- the edges $\{z + (1, 0), z + (0, 1)\}$ in \mathbb{D}^- such that $\delta(\{z, z + (1, 1)\}) = 0$.

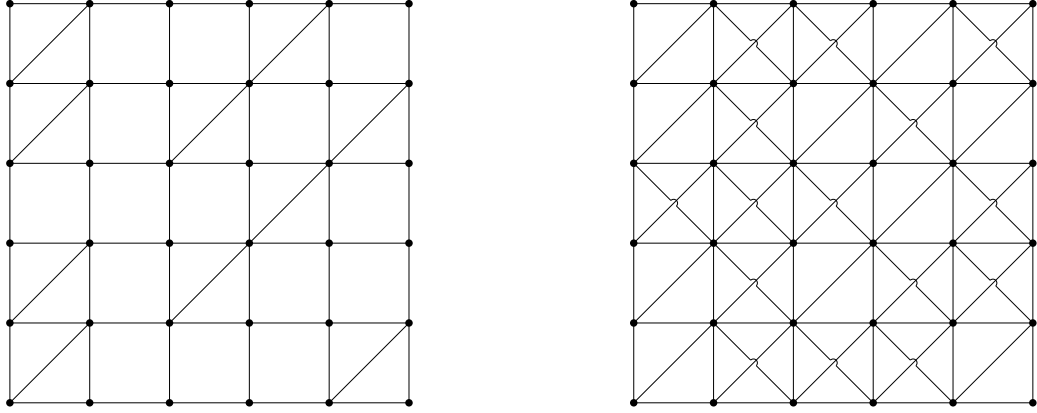

Figure 3.2: On the left, a piece of a possible graph G . On the right, the corresponding piece of its matching graph G^*

We call G -path a path in G , and G^* -path a path in G^* . In our study we will be mostly interested in black G -paths, and white G^* -paths.

Events/ bond percolation events. In general, the events will be defined on the whole probability space Ω . We will sometimes work on the smaller probability space $(\{0, 1\}^{\mathbb{E}^2}, \nu_p)$, and we call bond percolation event a measurable set in this space.

2 Preliminaries

2.1 The bond percolation event \mathcal{C}_L

For $L \geq 2$, we denote by \mathcal{C}_L the bond percolation event that there exist $L < L_1 < L_2 < 2L$ and

- a dual-open circuit in the annulus A_{L,L_1} ,
- an open circuit in the annulus A_{L_1,L_2} ,
- a dual-open circuit in the annulus $A_{L_2,2L}$,

where each of the circuits contains the origin 0 in its interior. This event illustrated on Fig. 3.3 implies that there exists a bond-cluster surrounding B_L and included in the annulus $A_{L,2L}$. We will need the following result, which follows from standard RSW-theory for critical percolation, and the continuity in p of $\nu_p[\mathcal{C}_L]$ for fixed L . There exist an absolute constant $c_0 > 0$ such that the following holds. For every $L \geq 2$, there exists $p_0 < p_c$ such that

$$\nu_p[\mathcal{C}_L] > c_0 \tag{3.2}$$

for every $p_0 \leq p \leq p_c$.

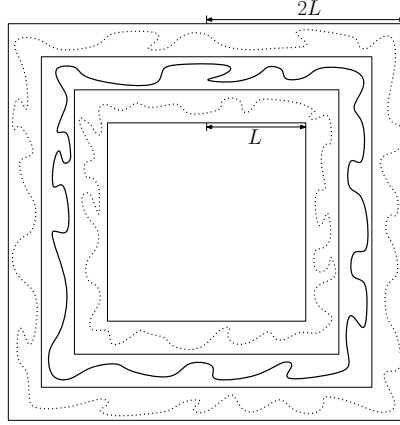

Figure 3.3: The event \mathcal{C}_L , the dotted circuits represent the dual-open circuits, and the solid circuit represents the open circuit.

2.2 The crossing probability and its derivatives

Definition of the crossing probability. Let $R = [a, b] \times [c, d]$ be a rectangle in the plane. We write $\mathcal{H}(R)$ the event that there exists a black G -path from the $\{a\} \times [c, d]$ to $\{b\} \times [c, d]$.

Let $n, L \geq 0$. We define for all $0 \leq p, r, s \leq 1$

$$f_{n,L}(p, r, s) := \mathbb{P}_{p,r,s}^n[\mathcal{H}(B_{n+4L})]. \quad (3.3)$$

Notice that in the definition (3.3) above, we consider a crossing of the square B_{n+4L} , but we take its probability under $\mathbb{P}_{p,r,s}^n$, meaning that the diagonal edges are added with density s in the square B_n , and none is added in the annulus $A_{n,n+4L}$. This choice will avoid boundary effects when we will study the derivative in s of $f_{n,L}(p, r, s)$.

The derivative in s . Consider a configuration (η, ξ, δ) . Let δ_e and δ^e be the two diagonal configurations defined by $\delta_e(e) = 0$, $\delta^e(e) = 1$, and $\delta_e(f) = \delta^e(f) = \delta(f)$ for every $f \neq e$. We call an edge $e \in \mathbb{D}^+$ **pivotal** (for the event $\mathcal{H}(B_{n+4L})$) if $\mathcal{H}(B_{n+4L})$ occurs in the configuration (η, ξ, δ^e) but not in (η, ξ, δ_e) . The derivative in s of $f_{n,L}$ can be computed by the following formula

$$\frac{\partial}{\partial s} f_{n,L}(p, r, s) = \sum_{e \in \mathbb{D}^+(B_n)} \mathbb{P}_{p,r,s}^n [e \text{ is pivotal}]. \quad (3.4)$$

The derivative in r . Let C be a bond-cluster, the coloring configurations ξ_C and ξ^C are obtained from ξ by coloring respectively white and black all the vertices in C , and keeping the other colors unchanged. A bond-cluster C is said to be **pivotal** if $\mathcal{H}(B_{n+4L})$ occurs in the configuration (η, ξ^C, δ) but not in (η, ξ_C, δ) . Let N_{piv} be the number of pivotal clusters, the derivative in r can be expressed as follows.

$$\frac{\partial}{\partial r} f_{n,L}(p, r, s) = \mathbb{P}_{p,r,s}^n [N_{\text{piv}}]. \quad (3.5)$$

We do not prove the formulas (3.4) and (3.5) above. They can be obtained exactly the same way as Russo's formula for Bernoulli percolation (see [Gri99b] for Bernoulli percolation and [BCM09], Theorem 2.8 for DaC-percolation).

2.3 Previous results

Sharp threshold. The sharp-threshold result proved in [BCM09] for standard DaC-percolation (no diagonal edge is added) implies the following result with our notation.

Theorem 2.1. *Let $p < p_c$, $L \in \mathbb{N}$, be fixed. The following convergence holds.*

$$\lim_{n \rightarrow \infty} f_{n,L}(p, r, 0) = \begin{cases} 0 & \text{if } r < r_c(p) \\ 1 & \text{if } r > r_c(p) \end{cases}$$

Duality. In his initial paper introducing DaC-percolation [Hä01], Häggström proved that there is no infinite black path on the square lattice when $p < p_c$ and $r = 1/2$. This result based on duality considerations implies the following.

Theorem 2.2. *For all $p < p_c$, the critical value $r_c(p)$ satisfies*

$$r_c(p) \geq \frac{1}{2}.$$

3 Proof of Theorem 0.2

This section presents the proof of Theorem 0.2. In order to achieve this proof we need two propositions, the proofs of which are given in the next sections. We first state and comment on these two propositions and then show how they imply Theorem 0.2.

The first proposition exploits the fact that the model becomes self-dual when $r = 1/2$ and all the diagonal edges of \mathbb{D}^+ are added. More precisely, under $\mathbb{P}_{p,1/2,1}^{B_n}$, the probability that there exists a black G -path from left to right in B_n is equal to the probability of a white G^* -path from top to bottom. This implies that both probabilities are equal to $1/2$. Then, for fixed L

Proposition 3.1. *There exists an absolute constant $c_1 > 0$ such that the following holds. For any $L \geq 0$ there exists $p_0 < p_c$ such that, for all $p_0 \leq p \leq p_c$ and $r \geq 1/2$*

$$\liminf_{n \rightarrow \infty} f_{n,L}(p, r, 1) \geq c_1$$

The second proposition is really the heart of the proof. Heuristically, it says that when p is close enough to p_c , adding diagonal edges becomes useless in order to create a left-right black crossing. This will allow us to show that the model with $s = 0$ (critical at $r = r_c(p)$) is close to the model with $s = 1$ (self-dual at $r = 1/2$), implying that $r_c(p)$ is close to $1/2$.

Proposition 3.2 (Differential inequality for $f_{n,L}$). *For all $(p, r, s) \in [0, p_c] \times (0, 1) \times [0, 1]$ and all $n, L \in \mathbb{N}$, we have*

$$\frac{\partial}{\partial s} f_{n,L}(p, r, s) \leq g_L(p, r) \frac{\partial}{\partial r} f_{n,L}(p, r, s),$$

where the function g_L satisfies the following two properties for every fixed $r_0 \in (1/2, 1)$.

1. For L fixed, g_L is continuous on $[0, p_c] \times [1/2, r_0]$;
2. $\lim_{L \rightarrow \infty} \max_{1/2 \leq r \leq r_0} g_L(p_c, r) = 0$.

Proof of Theorem 0.2. First, by Theorem 2.2, we already know that, for all $p < p_c$,

$$r_c(p) \geq \frac{1}{2}.$$

Fix $\varepsilon > 0$ and $1 > r_0 > 1/2 + \varepsilon$. There exists L large enough, and $p_0 < p_c$ close enough to p_c such that the following holds. For all $(p, r) \in [p_0, p_c] \times [1/2, r_0]$, we have

$$g_L(p, r) < c_1 \varepsilon, \tag{3.6}$$

$$\liminf_{n \rightarrow \infty} f_{n,L}(p, r, 1) \geq c_1. \tag{3.7}$$

(Recall that the constant c_1 was defined by Proposition 3.1.) To see this, use first Properties 1 and 2 of g_L in Proposition 3.2 to say that equation (3.6) holds for some L , and for all p close enough to p_c . Then, apply Proposition 3.1 with such an L to conclude.

Let us fix $L \geq 1$ and p_0 as above. By Proposition 3.2, we obtain the following differential inequality, valid for all $(p, r, s) \in [p_0, p_c] \times [1/2, r_0] \times [0, 1]$.

$$\frac{\partial}{\partial s} f_{n,L}(p, r, s) \leq c_1 \varepsilon \frac{\partial}{\partial r} f_{n,L}(p, r, s).$$

For fixed $p \in [p_0, p_c]$, integrate the equation above for $(r, s) \in [1/2, \min(r_0, r_c(p))] \times [0, 1]$, and use Fubini's Theorem to deduce

$$\int_{1/2}^{\min(r_0, r_c(p))} f_{n,L}(p, r, 1) - f_{n,L}(p, r, 0) \, dr \leq c_1 \varepsilon. \tag{3.8}$$

By Theorem 2.1, and Equation (3.7), we have for all $1/2 \leq r < \min(r_0, r_c(p))$,

$$\liminf_{n \rightarrow \infty} f_{n,L}(p, r, 1) - f_{n,L}(p, r, 0) \geq c_1.$$

Fatou's Lemma applied to the left term in Equation (3.8) gives $\min(r_0, r_c(p)) - 1/2 \leq \varepsilon$, and we can conclude that, for all $p \in [p_0, p_c]$,

$$0 \leq r_c(p) - 1/2 \leq \varepsilon,$$

since $r_0 > \varepsilon + 1/2$.

□

3.1 Proof of Proposition 3.1

In this section, we study the DaC-percolation under the measure $\mathbb{P}_{p,r,1}^{B_n}$. In this setting the diagonal configuration is deterministic, all the diagonal edges in $\mathbb{D}^+(B_n)$ are added, but none outside B_n . In order to prove Proposition 3.1, we will need two lemmas. In the first one, we use a standard self-duality argument to show that the square B_n is crossed by a black G -path with probability equal to $1/2$ when $r = 1/2$. In the second one, we consider the larger square B_{n+4L} , and we show that a black G -path from left to right in B_n can be “extended” into a black G -path from left to right in B_{n+4L} by paying a price of order $\nu_p[\mathcal{C}_{4L}]^2$.

Lemma 3.3. *For all $0 \leq p \leq 1$ and $r \geq 1/2$, we have*

$$f_{n,0}(p, r, 1) \geq 1/2.$$

Proof. First, recall that there exists a black G -path from left to right in B_n if and only if there is no white G^* -path from top to bottom. (This follows from Proposition 2.2 in [Kes82], which relies on Jordan curve theorem.) Here all the diagonal edges of $\mathbb{D}^+(B_n)$ are added and the notions of G -path and G^* -path coincide within the box B_n . In particular, the probability that there exists a white G^* -path from top to bottom in B_n is given by $f_{n,0}(p, 1-r, 1)$, and the topological observation recalled above implies the identity

$$f_{n,0}(p, 1-r, 1) + f_{n,0}(p, r, 1) = 1.$$

When $r \geq 1/2$, we have by monotonicity $f_{n,0}(p, r, 1) \geq f_{n,0}(p, 1-r, 1)$, and we finally obtain

$$f_{n,0}(p, r, 1) \geq \frac{1}{2}.$$

□

Lemma 3.4. *Let $0 \leq p \leq 1$ and $r \geq 1/2$. For all $n > 4L$, we have*

$$f_{n,L}(p, r, 1) \geq f_{n,0}(p, r, 1) \left(\frac{1}{4} \nu_p[\mathcal{C}_{4L}] \right)^2.$$

Proof. In this proof, p, r, n , and L are fixed, and we simply write \mathbb{P} for the probability measure $\mathbb{P}_{p,r,1}^n$. We consider the square $S = (-2L, 2L) + B_{n+2L}$ and the half plane $H = [-n, +\infty) \times \mathbb{R}$. We will show that

$$\mathbb{P}[\mathcal{H}(S)] \geq \frac{1}{2} r^2 \nu_p[\mathcal{C}_{4L}] \mathbb{P}[\mathcal{H}(B_n)], \quad (3.9)$$

and

$$\mathbb{P}[\mathcal{H}(B_{n+4L})] \geq \frac{1}{2} r^2 \nu_p[\mathcal{C}_{4L}] \mathbb{P}[\mathcal{H}(S)]. \quad (3.10)$$

Combining the two inequalities above provides the desired result. We will only prove Equation (3.9), Equation (3.10) can be obtained in the same way.

We will now apply a “lowest-crossing” argument, similar to the one used in Bernoulli percolation (see [Rus81]). The main difficulty comes from the dependencies in the coloring, and we will have to condition on the lowest “sequence” of black bond-clusters, as in the proof of theorem 3.2 in [BCM09]. Let \mathcal{G} be the set of all G -path from left to right in B_n , and let $\gamma \in \mathcal{G}$ be one such path. We consider the sequence of H -bond-clusters (C_0, C_1, \dots, C_k) visited by γ , ordered by the time of visit, meaning that C_0 is the first visited, then C_1 , and so on...Notice that C_0 must intersect the boundary of H , and that sequence depends only on the configuration in H (since we only looked at the H -bond-clusters). We say that γ is an **almost-crossing** of R if C_1, \dots, C_k are colored black, and none of them intersects the left side of H .

For every $\gamma \in \mathcal{G}$, let $J(\gamma)$ be the set of points in S below γ , formally defined as the set of z such that any path in S from z to the top of S must contain at least one point of γ . In particular, we have $\gamma \subset J(\gamma)$. We also define $\overline{J(\gamma)}$ as the union of all the H -bond-clusters intersecting $J(\gamma)$.

When an almost-crossing exists, we can consider the lowest one Γ defined by

- Γ is an almost-crossing of S ,
- for every almost-crossing γ' of S , we have $J(\Gamma) \subset J(\gamma')$.

(The existence of Γ can be proved rigorously, using the Jordan curve theorem, as in Proposition 2.3 of [Kes82].)

Consider the event \mathcal{E} that there exists an almost-crossing in B_n . On this event Γ is well defined and we have

$$\begin{aligned} \mathbb{P}[\mathcal{E}] &\geq \mathbb{P}[\mathcal{H}(B_n)], \text{ and} \\ \mathbb{P}[\mathcal{H}(S)] &\geq \mathbb{E} \left[\mathbb{1}_{\mathcal{E}} \mathbb{P} \left[\mathcal{H}(S) \mid \mathcal{E}, \Gamma, \overline{J(\Gamma)} \right] \right] \end{aligned}$$

In order to conclude the proof, we only need to show that

$$\mathbb{P} \left[\mathcal{H}(S) \mid \mathcal{E}, \Gamma, \overline{J(\Gamma)} \right] \geq r^2 \nu_p[\mathcal{C}_{4L}] \tag{3.11}$$

holds almost surely. The proof of Equation (3.11) relies on the observation that Γ is measurable with respect to the bond configuration in $\overline{J(\Gamma)}$, and the coloring of the clusters in $\overline{J(\Gamma)}$ that do not intersect the boundary of H . This allows us to build a configuration in \mathcal{E} by the following two-step exploration.

1. Find the lowest almost-crossing Γ of B_n by exploring the bond configuration in $\overline{J(\Gamma)}$, and then color the bond-clusters in $\overline{J(\Gamma)}$ that do not intersect the boundary of H .
2. Explore the the remaining bond configuration, and then color the bond-clusters that have not been colored in the first step.

Observe that, in the second step, we find a black G -path from left to right in S if the following holds.

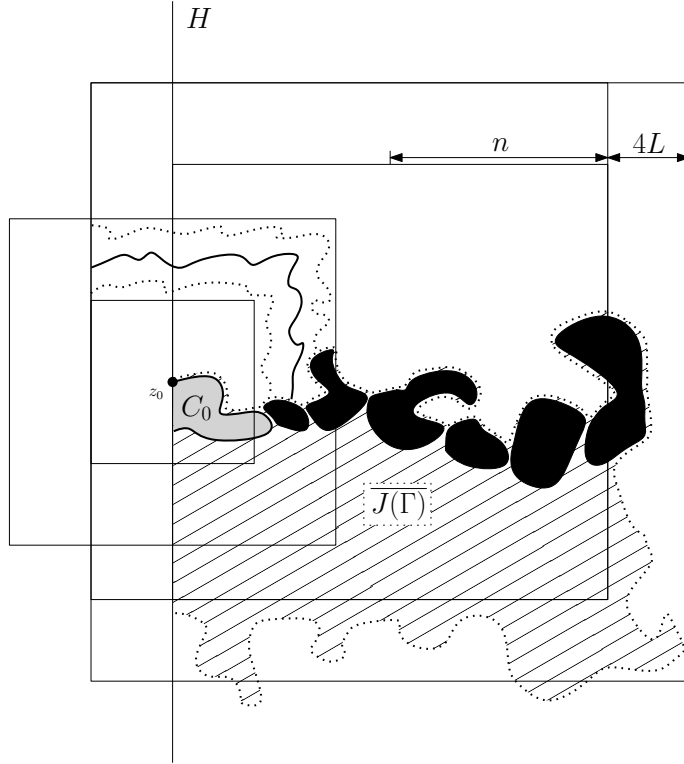

Figure 3.4: An event ensuring the existence of a bond-cluster C from the left side of S to $\overline{J(\Gamma)}$. The H -bond-cluster in grey is the first one visited by Γ and is uncolored after the first step of exploration

- (i) there exists a bond-cluster C , included in the unexplored region $\mathbb{R}^2 \setminus \overline{J(\Gamma)}$ intersecting the left side of S , and such that the distance between $\overline{J(\Gamma)}$ and C is exactly one;
- (ii) both C and the first bond-cluster visited by Γ are colored black.

The cluster C exists with probability larger than $\nu_p[\mathcal{C}_{4L}]$. To see this, one can define z_0 to be the high point of the left side of B_n lying in $\overline{J(\Gamma)}$, and consider the event illustrated on Fig. 3.4 that there exists two dual paths and one primal path from the left side of S to $\overline{J(\Gamma)}$ in the annulus $z_0 + A_{4L,8L}$. We find that, independently of Γ , $\overline{J(\Gamma)}$, ((i)) and ((ii)) occur in the second step with probability larger than

$$r^2 \nu_p[\mathcal{C}_{4L}],$$

which proves equation (3.11). □

Proposition 3.1 easily follows from the two lemmas above. First consider c_0 and p_0 such that equation (3.2) page 64 holds. By Lemma 3.4, we obtain for all $L \geq 1$, $p_0 \leq p \leq p_c$,

$$f_{n,L}(p, r, 1) \geq f_{n,0}(p, r, 1) (c_0/4)^2.$$

Using Lemma 3.3, we finally obtain the statement of Proposition 3.1 with $c_1 = c_0^2/32$.

3.2 Proof of Proposition 3.2

Let us consider the following covering of B_n by “mesoscopic boxes” of size L :

$$B_n \subset \bigcup_{z \in 2L\mathbb{Z}^2 \cap B_n} z + B_L.$$

In in the derivation formula (3.4) we decompose the sum with respect to the covering above.

$$\frac{\partial}{\partial} f_{n,L}(p, r, s) = \sum_{z \in 2L\mathbb{Z}^2 \cap B_n} \sum_{e \in \mathcal{D}^+(z + B_L)} \mathbb{P}_{p,r,s}^n [e \text{ is pivotal}]$$

We say that a subset S of B_{n+4L} is **pivotal** if coloring black all the vertices in S implies that $\mathcal{H}(B_{n+4L})$ occurs, and coloring all them white implies that $\mathcal{H}(B_{n+4L})$ does not occur. It is **almost-pivotal** if there exist four disjoint S^c -bond-clusters C_i with $d(C_i, S) = 1$, $1 \leq i \leq 4$, and such that coloring them respectively black, white, black and white implies that S is pivotal.

When a diagonal edge $e = \{v, v + (1, 1)\}$ in $z + B_n$ is pivotal, the following two events occur.

- There exist four B_{2L} -bond-clusters C_1, C_2, C_3 and C_4 intersecting ∂B_{2L} , and four paths in B_{2L} that come respectively at distance 1 from C_1, C_2, C_3 and C_4 , without using any vertex in a bond-cluster intersecting $z + \partial B_{2L}$:
 - a black G -path from v ,
 - a white G^* -path from $v + (0, 1)$,
 - a black G -path from $v + (1, 1)$,
 - a white G^* -path from $v + (1, 0)$.
- $z + B_{2L}$ is almost-pivotal.

We write $\tilde{\mathcal{A}}_4(e, z + \partial B_{2L})$ the first event. One can verify that the two events above are independent.

- $\tilde{\mathcal{A}}_4(e, z + \partial B_{2L})$ is measurable with respect to the bond percolation configuration in the box $z + B_{2L}$, and the coloring of the bond-cluster in $z + B_{2L}$ which do not intersect the boundary $z + \partial B_{2L}$.
- the event that $z + B_{2L}$ is almost-pivotal is measurable with respect to the bond percolation configuration outside $z + B_{2L}$, and the coloring of the clusters that do not intersect $z + B_{2L}$.

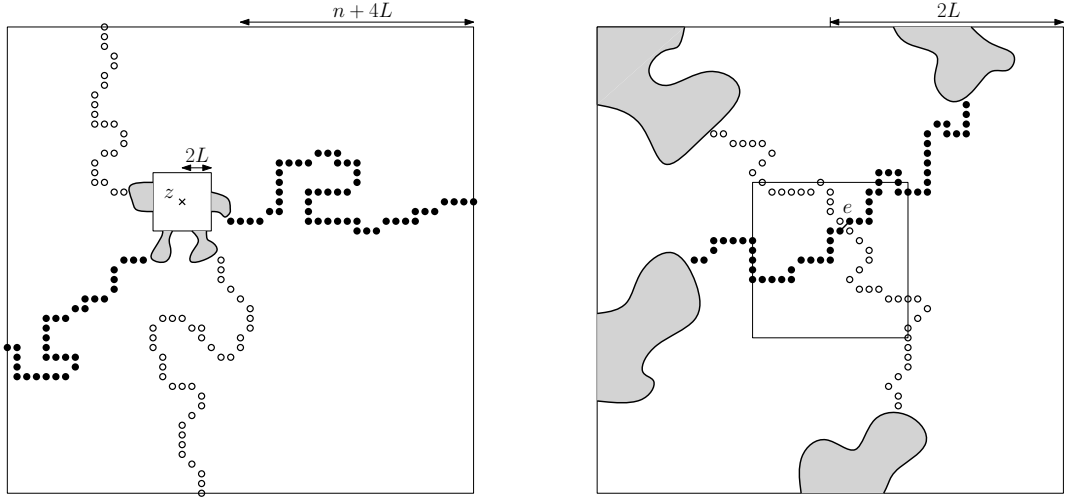

Figure 3.5: Left: the event “ $z + B_{2L}$ is almost pivotal”. Right: the event $\tilde{\mathcal{A}}_4(e, z + \partial B_{2L})$. Black G -paths are represented by black dots, and white G^* -paths by white dots

Using this independence property we find

$$\begin{aligned} \sum_{e \in \mathbb{D}^+(z+B_L)} \mathbb{P}_{p,r,s}^n [e \text{ is pivotal}] \\ \leq \underbrace{\sum_{e \in \mathbb{D}^+(z+B_L)} \mathbb{P}_{p,r,s}^n [\tilde{\mathcal{A}}_4(e, z + \partial B_{2L})]}_{(\star)} \mathbb{P}_{p,r,s}^n [z + B_{2L} \text{ almost-pivotal}] \end{aligned}$$

We want to bound the quantity (\star) independently of z . For $D \subset \mathbb{D}^+(B_{2L})$, we write \mathcal{E}_D the event that the set of added edges in the box B_{2L} is D . Let us define

$$h_L(p, r) = \max_{D \subset \mathbb{D}^+(B_{2L})} \left(\sum_{e \in \mathbb{D}^+(B_L)} \mathbb{P}_{p,r,1/2} [\tilde{\mathcal{A}}_4(e, \partial B_{2L}) | \mathcal{E}_D] \right). \quad (3.12)$$

one can easily verify that $(\star) \leq h_L(p, r)$, and we obtain for all $z \in 2L\mathbb{Z}^2 \cap B_n$,

$$\sum_{e \in \mathbb{D}^+(z+B_L)} \mathbb{P}_{p,r,s}^n [e \text{ is pivotal}] \leq h_L(p, r) \mathbb{P}_{p,r,s}^n [z + B_{2L} \text{ almost-pivotal}].$$

Summing over all z , we find

$$\frac{\partial}{\partial s} f_{n,L}(p, r, s) \leq h_L(p, r) \sum_{z \in 2L\mathbb{Z}^2 \cap \Lambda_n} \mathbb{P}_{p,r,s}^n [z + B_{2L} \text{ almost pivotal}]. \quad (3.13)$$

In order to obtain the differential inequality of Proposition 3.2, we need to compare the sum above to the derivative in r of $f_{n,L}(p, r, s)$. For $z \in \mathbb{Z}^2$, let us define the event that there exists a bond-cluster included in the annulus $z + A_{2L,4L}$ and containing an open bond-circuit with B_{2L} in its interior. (This event occurs with probability $\nu_p[\mathcal{C}_{2L}]$ by translation invariance.) Assume that such a bond-cluster C exists. We can explore C from the

inside, leaving unexplored all the configuration in the unbounded connected component of C^c . Then explore all the bond-configuration and all the colors of the clusters that do not touch C . Since C surrounds $z + B_{2L}$, we find in this second step that C is almost-pivotal with probability larger than $P_{p,r,s}^n [z + B_{2L} \text{ almost-pivotal}]$. Finally we explore the colors of the bound-clusters touching C . When C is almost-pivotal, we know that there exists at least 4 of these “touching” clusters that make C pivotal when they are colored black/white/black/white. Thus, in this last step of exploration, C is made pivotal with probability larger than $r^2(1-r)^2$. We finally obtain

$$\nu_p[\mathcal{C}_{2L}] P_{p,r,s}^n [z + \Lambda_{2L} \text{ almost pivotal}] r^2(1-r)^2 \leq P_{p,r,s}^n [\mathcal{O}_{\text{piv}}(z, L)]. \quad (3.14)$$

where $\mathcal{O}_{\text{piv}}(z, L)$ is the event that there exists a pivotal bond-cluster included in $B_{4L} \setminus B_{2L}$ and surrounding Λ_L .

Let z, z' be two different points in $2L\mathbb{Z}^2 \cap B_n$, and assume that both $\mathcal{O}_{\text{piv}}(z, L)$ and $\mathcal{O}_{\text{piv}}(z', L)$ occur. Then any pair of bond-clusters witnessing these two events are necessarily disjoint. This observation provides the following inequality,

$$\sum_{z \in 2L\mathbb{Z}^2 \cap \Lambda_n} P_{p,r,s}^n [\mathcal{O}_{\text{piv}}(z, L)] \leq \frac{\partial}{\partial r} f_{n,L}(p, r, s),$$

Together with equation (3.13) and (3.14), it finally gives

$$\frac{\partial}{\partial s} f_{n,L}(p, r, s) \leq g_L(p, r) \frac{\partial}{\partial r} f_{n,L}(p, r, s),$$

where

$$g_L(p, r) = \frac{1}{r^2(1-r)^2 \nu_p[\mathcal{C}_{2L}]} h_{n,L}(p, r).$$

It remains to verify that g_L verifies points 1 and 2 of Proposition 3.2. Point 1 is easy since all the events considered are cylindrical, and their probabilities are thus polynomial functions of (p, r) . Point 2 is the hard part of the Proposition, it follows directly from Lemma 3.5 below, that we will show in the next section.

Lemma 3.5. *There exist some absolute constants $c_3, C_3 > 0$ such that, for all $r \geq 1/2$, and all $L \geq 2$*

$$h_L(p_c, r) \leq C_3 \frac{1}{(1-r)^2} L^{-c_3(1-r)}.$$

4 Behavior at $p = p_c$

This section present a proof of Lemma 3.5 and is rather independent of the rest of the chapter. We focus here on the particular behavior at the point $p = p_c$.

4.1 Additional definitions

Through the entire section, we fix $L \geq 1$ and consider the DaC-percolation in the box B_{2L} , as defined below. The bond percolation parameter is $p = p_c$. We also fix the density of black clusters $1/2 \leq r < 1$, and a diagonal configuration $D \in \mathbb{D}^+(B_{2L})$. The absolute constants appearing in the proofs will not depend on the choice of the parameters above.

DaC-percolation in a subset of the plane. We introduce here a DaC-measure in a finite subset $S \subset B_{2L}$. It is defined similarly to the full-plane measure of section 1, except that we color the S -bond-clusters in the second step of construction, and take the diagonal configuration to be deterministic in the third step. For completeness, we provide below the 3-step procedure building this new measure. We consider the probability space $\Omega_S = \{0, 1\}^{\mathbb{E}(S)} \times \{0, 1\}^{S \cap \mathbb{Z}^2} \times \{0, 1\}^{\mathbb{D}^+(S)}$, and the terminology introduced at the beginning of this chapter for Ω (open edge, bond-cluster, black vertex, G -path...) can be adapted in a natural way. Note that, as before, the bond-clusters are defined using only the open edges of \mathbb{Z}^2 . We construct a random configuration in Ω_S , by the following 3 step procedure.

Step 1: Bernoulli bond percolation. Declare independently each edge of $\mathbb{E}^2(S)$ open with probability $p = p_c$ and closed otherwise.

Step 2: Bernoulli site percolation on the set of S -bond-clusters. Examine independently each S -bond-cluster obtained after the first step, and assign the same color to all its vertices. The chosen color is black with probability r and white otherwise.

Step 3: Add deterministically all the diagonal edges in D .

The law of the random configuration obtained after the three steps above is denoted by \mathbf{Q}^S . When the measure is constructed from the set $S = B_{2L}$, we simply write \mathbf{Q} instead of $\mathbf{Q}^{B_{2L}}$.

Arms. The arm events appear naturally the study of the geometric properties in standard Bernoulli percolation : informally speaking, one open arm corresponds to a point being on a large cluster, four arm correspond to a point at the interface of two large open clusters,... In Bernoulli percolation, there are two types of arms considered, the open arms and the closed arms. In DaC-percolation, the picture is richer and we introduce four types of arms. We call:

- primal arm a self-avoiding primal-path in B_{2L} from a vertex $v \in B_L$ to a vertex $w \in \partial B_{2L}$, with no edge in ∂B_{2L} (meaning that w is the end-vertex of the path and is the unique visited vertex of ∂B_{2L}). When all its edges are open we call it a primal-open arm.
- dual arm a self-avoiding dual-path in $B_{2L+1/2}$ from a dual vertex $v^* \in B_L$ to a self-avoiding dual vertex $w^* \in \partial B_{2L+1/2}$, with no dual edge in $\partial B_{2L+1/2}$. When all its edges are open we call it a dual-open arm.

- black arm a self-avoiding black G -path in B_{2L} from a vertex $v \in B_L$ to a vertex $w \in \partial B_{2L}$, with no edge in ∂B_{2L} .
- white arm a white G^* -path in B_{2L} from a vertex $v \in B_L$ to a vertex $w \in \partial B_{2L}$, with no edge in ∂B_{2L} .

As for the paths, the arms can be seen as piecewise linear continuous paths in the plane. This is the point of view used when we say that an arm lies in a planar subset S .

The four-arm event. Let $e = \{v, v + (1, 1)\} \in \mathbb{D}^+(B_L)$, we define the event $\mathcal{A}_4(e)$ that there exist

- two black arms starting respectively from v and $v + (1, 1)$;
- two white arms starting respectively from $v + (1, 0)$ and $v + (0, 1)$.

Notice that these four arms are necessarily disjoint, and they must be separated by four dual-open arms, as illustrated on Fig. 3.6.

The mixed-arm event. Let $e = \{v, v + (1, 1)\} \in \mathbb{D}^+(B_L)$, we define the event $\mathcal{A}_{\text{mixed}}(e)$ that the following holds.

- The bond-cluster C of $v + (1, 1)$ contains a primal-open arm (which means that C intersect the boundary B_{2L}).
- In the region $B_{2L} \setminus C$, there exist a black arm starting from v , and a white arm starting from $v + (1, 0)$.

As for the four-arm event, the three arms appearing in the definition above must be disjoint and separated by three dual-open arms, as illustrated on Fig. 3.7.

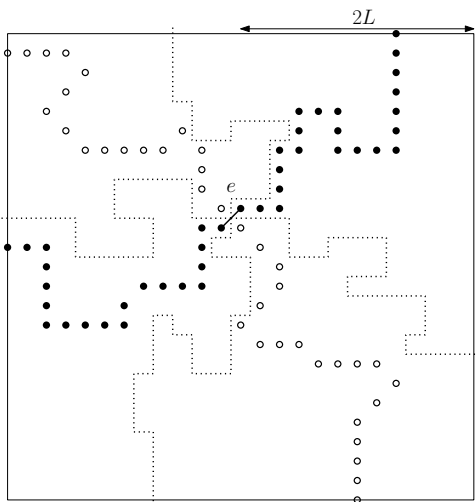

Figure 3.6: The event $\mathcal{A}_4(e)$

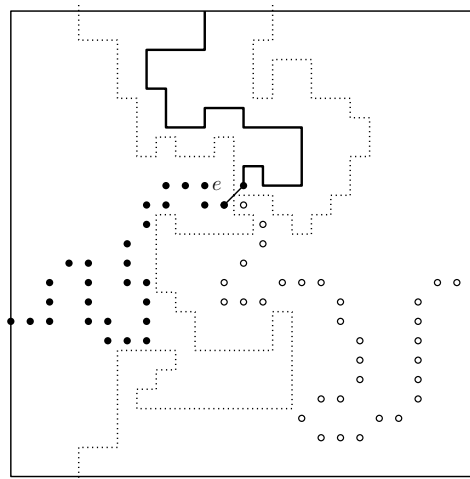

Figure 3.7: The event $\mathcal{A}_{\text{mixed}}(e)$

The black arms are represented by black dots, white arms by white dots, primal-open arms by solid lines, dual-open arms by dotted lines

4.2 Proof of Lemma 3.5

What do we need to prove? We introduced quite a lot of notation, let us restate the content of Lemma 3.5 in this new framework. We want to find two absolute constants c_3, C_3 such that $h_L(p_c, r) \leq C_3 L^{-c_3(1-r)}$. By definition (see Equation (3.12)), this is equivalent to proving that

$$\sum_{e \in \mathbb{D}^+(B_L)} \mathbf{P}_{p_c, r, 1/2} [\tilde{\mathcal{A}}_4(e, \partial B_{2L}) | \mathcal{E}_D] \leq C_3 \frac{1}{(1-r)^2} L^{-c_3(1-r)},$$

independently of the choice of $r \geq 1/2$, $L \geq 2$, and $D \subset \mathbb{D}^+(B_{2L})$ at the beginning of the section.

Let e be a diagonal edge in B_L . The event $\tilde{\mathcal{A}}_4(e, \partial B_{2L})$ can be seen as an event on the probability space $\Omega_{B_{2L}}$, and when it holds, there exist four B_{2L} -bond-clusters intersecting the boundary ∂B_{2L} such that coloring them black/white/black/white makes the event $\mathcal{A}_4(e)$ occur. Thus, we have for every $e \in \mathbb{D}^+(B_L)$,

$$\mathbf{P}_{p_c, r, s} [\tilde{\mathcal{A}}_4(e, \partial B_{2L}) | \mathcal{E}_D] r^2 (1-r)^2 \leq \mathbf{Q}[\mathcal{A}_4(e)]. \quad (3.15)$$

By equation (3.15) above, in order to prove Lemma 3.5, we only need to find two absolute constants $c_3, C_3 > 0$ such that

$$\sum_{e \in \mathbb{D}^+(B_L)} \mathbf{Q}[\mathcal{A}_4(e)] \leq C_3 L^{-c_3(1-r)}. \quad (3.16)$$

We prove the above in two steps. First, we show that

$$\mathbf{Q}[\mathcal{A}_4(e)] \leq L^{-c_3(1-r)} \mathbf{Q}[\mathcal{A}_{\text{mixed}}(e)], \quad (3.17)$$

for every diagonal edge $e \subset B_{2L}$. Equation (3.17) is proved below by conditioning on the lowest black and white arms, and using a technical ‘‘swapping’’ Lemma.

Then, we use a RSW-argument to show that the number of diagonal edges $e \subset B_L$ such that $\mathcal{A}_{\text{mixed}}(e)$ holds has a bounded expectation:

$$\sum_{e \in \mathbb{D}^+(B_L)} \mathbf{Q}[\mathcal{A}_{\text{mixed}}(e)] \leq C_3, \quad (3.18)$$

which, together with equation (3.17), implies (3.16).

Proof of (3.17). Let us fix a diagonal edge $e = \{v, v + (1, 1)\} \subset B_L$, write $v_\star = v + (1/2, 1/2)$ (v_\star is a dual vertex). We call **admissible**, a pair (γ_ℓ, γ_r) of two (deterministic) dual arms, from v_\star , such that γ_ℓ and γ_r use disjoint sets of vertices, and start respectively from the dual edges $\{v_\star, v_\star - (1, 0)\}$ and $\{v_\star, v_\star + (1, 0)\}$. Let J_0 be the region (strictly) above these two paths in $B_{2L+1/2}$, formally defined as the connected component of $v + (1, 1)$ in $B_{2L} \setminus (\gamma_\ell \cup \gamma_r)$. (Here, the connected component is defined with respect to the

plane topology, and the paths γ_ℓ and γ_r are seen as piecewise linear Jordan arc obtained by joining their vertices by segment of length 1). Finally, we define

$$J(\gamma_\ell, \gamma_r) := J_0 \cup \left(\mathbb{Z}_{\text{dual}}^2 \cap \gamma_\ell \right) \cup \left(\mathbb{Z}_{\text{dual}}^2 \cap \gamma_r \right), \text{ and}$$

$$I(\gamma_\ell, \gamma_r) := B_{2L} \setminus J_0.$$

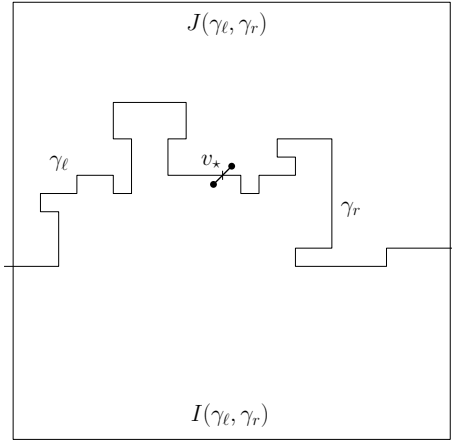

Figure 3.8: An admissible pair (γ_ℓ, γ_r) and the regions $I(\gamma_\ell, \gamma_r)$, $J(\gamma_\ell, \gamma_r)$

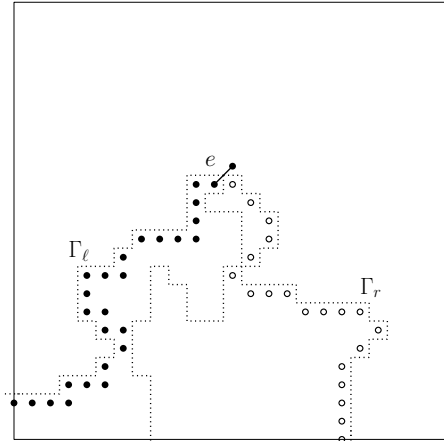

Figure 3.9: Definition of (Γ_ℓ, Γ_r)

Examine a DaC-configuration in B_{2L} . Consider the event that there exists an admissible pair (γ_ℓ, γ_r) such that

- (i) γ_ℓ and γ_r are both dual-open;
- (ii) in the region $I(\gamma_\ell, \gamma_r)$, there exist a black arm from v and a white arm from $v + (0, 1)$.

On this event we can define (Γ_ℓ, Γ_r) to be the unique¹ admissible pair such that $I(\Gamma_\ell, \Gamma_r)$ is minimal (for the inclusion ordering) among the admissible pairs satisfying ((i) and ((ii) above. An alternative and more natural way to define (Γ_ℓ, Γ_r) would be to define an exploration process in order to find the “interface” between the black arm starting from v and the white arm starting from $v + (1, 0)$. In order to find this interface, we need to explore the sequence of black bond-clusters containing the black part of the interface, and the sequence of white bond-clusters containing the white part of the interface. The paths Γ_ℓ and Γ_r are then obtained by considering the left and right boundaries of the explored region.

Given an admissible pair (γ_ℓ, γ_r) , the event $\{(\Gamma_\ell, \Gamma_r) = (\gamma_\ell, \gamma_r)\}$ is measurable with respect to the configuration in $I(\gamma_\ell, \gamma_r)$, and is independent of the configuration in $J(\gamma_\ell, \gamma_r)$.

¹ Similarly to the proof of the the existence of a lowest square crossing in Bernoulli percolation, the proof of the existence of (Γ_ℓ, Γ_r) is not obvious and would involve planar topology arguments.

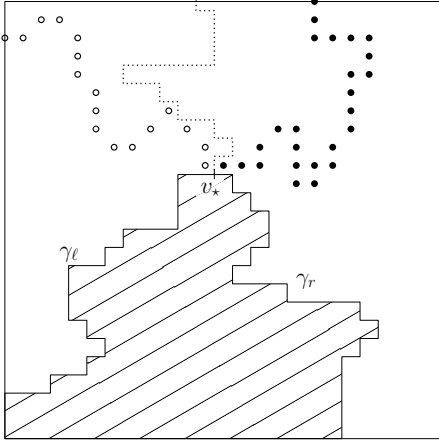
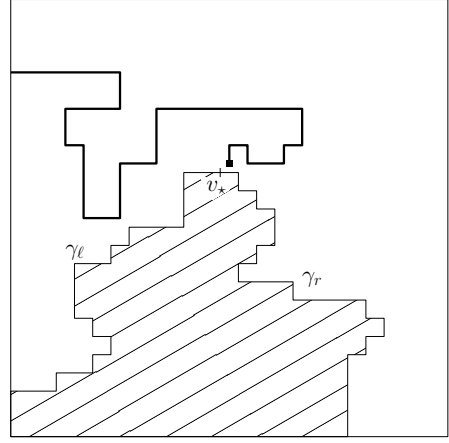
 Figure 3.10: The event $\mathcal{A}_{w,b}(\gamma_\ell, \gamma_r)$

 Figure 3.11: The event $\mathcal{A}_1(\gamma_\ell, \gamma_r)$

By conditioning on (Γ_ℓ, Γ_r) , one can compute the probability of the two event $\mathcal{A}_4(e)$ and $\mathcal{A}_{\text{mixed}}(e)$ as follows. Define $\mathcal{A}_{w,b}(\gamma_\ell, \gamma_r)$ to be the event that there exist a white arm from $v + (0, 1)$, and a black arm from $v + (1, 1)$, both lying in the region $J(\gamma_\ell, \gamma_r)$. We have

$$\mathbf{Q}[\mathcal{A}_4(e)] = \sum_{\gamma_\ell, \gamma_r} \mathbf{Q}^{J(\gamma_\ell, \gamma_r)}[\mathcal{A}_{w,b}(\gamma_\ell, \gamma_r)] \mathbf{Q}[(\Gamma_\ell, \Gamma_r) = (\gamma_\ell, \gamma_r)],$$

where the sum is taken over all the admissible pairs (γ_ℓ, γ_r) . Similarly define the event $\mathcal{A}_1(\gamma_\ell, \gamma_r)$ that there exists a primal-open arm in $J(\gamma_\ell, \gamma_r)$ from $v + (1, 1)$. We can compute the probability of $\mathcal{A}_{\text{mixed}}(e)$ with the same conditioning:

$$\mathbf{Q}[\mathcal{A}_{\text{mixed}}(e)] = \sum_{\gamma_\ell, \gamma_r} \circ p_c[\mathcal{A}_1(\gamma_\ell, \gamma_r)] \mathbf{Q}[(\Gamma_\ell, \Gamma_r) = (\gamma_\ell, \gamma_r)],$$

Equation (3.17) will follows from the two decompositions above and the following Lemma, the rigorous proof of which is postponed to section 4.3.

Lemma 4.1 (Dual to primal swapping). *There exists an absolute constant $c_3 > 0$ such that the following holds. For every admissible pair (γ_ℓ, γ_r) ,*

$$\mathbf{Q}^{J(\gamma_\ell, \gamma_r)}[\mathcal{A}_{w,b}(\gamma_\ell, \gamma_r)] \leq L^{-c_3(1-r)} \circ p_c[\mathcal{A}_1(\gamma_\ell, \gamma_r)]. \quad (3.19)$$

The proof of the lemma above relies on the following heuristic reasoning. When $\mathcal{A}_{w,b}(\gamma_\ell, \gamma_r)$ occurs, the black and white arms cannot cross, and they must lie on two disjoint sequences of bond-clusters. In particular, in the underlying bond percolation configuration, there must exist a dual-open path γ from v_* to ∂B_{2L} , that separates these two black/white paths. We will be able to “swap” this dual-open arm into a primal-open arm, showing that γ exists with a probability comparable $\mathbf{Q}[\mathcal{A}_1(R)]$. Knowing that such γ exists, one can then use a “conditioning on the left-most path” argument, leaving an unexplored region where there must exist a black path. In this unexplored region, using

a RSW-argument one can easily find $\simeq \log L$ bond-clusters that must be colored black. This shows that the black path exists with probability smaller than $\simeq r^{c' \log L}$.

Proof of (3.18). For every $e = \{v, v + (1, 1)\}$ in B_L such that $\mathcal{A}_{\text{mixed}}(e)$ holds, we write C_e the B_{2L} -bond-cluster containing the primal-open arm starting from $v + (1, 1)$, and consider a dual-open arm γ_e starting from $v_\star := v + (1/2, 1/2)$ and lying between the black arm starting from v , and the white arm starting from $v + (1, 0)$. If we fix a B_{2L} -bond-cluster C crossing the annulus $A_{L,2L}$, we can consider the set of edges e such that $\mathcal{A}_{\text{mixed}}(e)$ holds and $C_e = C$. One can verify that the set of dual-open paths γ_e corresponding to these edges are all disjoint (see Fig. 3.7).

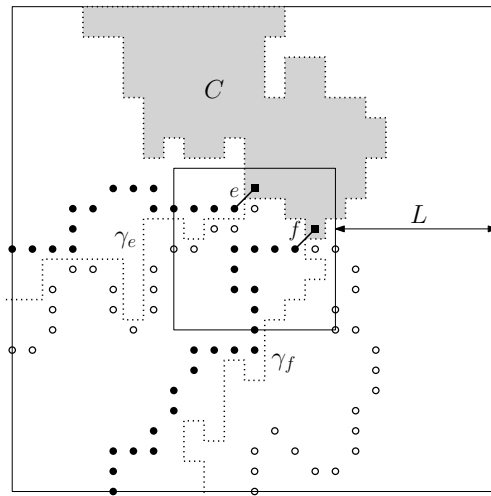

Figure 3.12: The events $\mathcal{A}_{\text{mixed}}(e)$ and $\mathcal{A}_{\text{mixed}}(f)$ realized with $C_e = C_f = C$. It implies two disjoint dual-open arms crossing the annulus $A_{L,2L}$.

Writing N^* the maximal number of disjoint dual-open paths crossing the annulus $A_{L,2L}$, and N_{clust} the number of disjoint bond-clusters crossing the annulus $A_{L,2L}$, we obtain

$$\begin{aligned} \sum_{e \in B_L} \mathbf{Q}[\mathcal{A}_{\text{mixed}}(e, \partial B_{2L})] &\leq \nu_{p_c}[N_{\text{clust}} N^*] \\ &\leq \frac{1}{2} \nu_{p_c}[N_{\text{clust}}^2] + \frac{1}{2} \nu_{p_c}[N^*^2]. \end{aligned}$$

A RSW-argument and the BK inequality show that both $\nu_{p_c}[N_{\text{clust}}^2]$ and $\nu_{p_c}[N^*^2]$ are smaller than some absolute constant $0 < C_3 < \infty$.

4.3 The swapping Lemma

In this section, we prove Lemma 4.1. We fix a diagonal edge $e = \{v, v + (1, 1)\}$ in B_L and an admissible pair (γ_ℓ, γ_r) of dual arms. Let γ_t be a dual-open arm from $v_\star :=$

$v + (1/2, 1/2)$ in $J(\gamma_\ell, \gamma_r)$. We say that a dual vertex z is bad (for γ_t) if

- $z - (1, 0), z, z - (0, 1)$ lie in γ_t ;
- $z + (1, 0), z, z + (0, 1)$ lie in $\gamma_\ell \cup \gamma_r$.

Write τ the translation by vector $(1/2, 1/2)$, and $\tau\gamma_t$ the self-avoiding primal-path obtained by translating γ_t by vector $(1/2, 1/2)$. The only vertices of γ_t mapped outside $J(\gamma_\ell, \gamma_r)$ are the end-vertices of γ_t and the bad vertices defined above, and we have following straightforward property.

Lemma 4.2. *Let γ_t be a dual arm from v_* in $J(\gamma_\ell, \gamma_r)$. If γ_t has no bad vertex, then the primal path $\tau\gamma_t$ contains a primal-arm from $v + (1, 1)$ in $J(\gamma_\ell, \gamma_r)$.*

Assume that $\mathcal{A}_{w,b}(\gamma_\ell, \gamma_r)$ holds and consider a dual-open arm γ_t from v_* , between the white arm and the black arm. Since the black arm does not use any diagonal edges of the type $\{w, w + (1, -1)\}$, the path γ_t cannot have any bad vertex on γ_r . Contrarily to the black arm, the white arm does not guarantee that there is no bad vertex on γ_ℓ , and a “surgery” step will be needed.

Organization of the proof. We drop the dependence in $J(\gamma_\ell, \gamma_r)$ in the two events appearing in equation (3.19), and we write simply \mathcal{A}_1 and $\mathcal{A}_{w,b}$ instead of $\mathcal{A}_{w,b}(J(\gamma_\ell, \gamma_r))$ and $\mathcal{A}_1(J(\gamma_\ell, \gamma_r))$. We define two other arm events. Let \mathcal{A}_w be the event that there exists

- a dual-open arm γ_t in $J(\gamma_\ell, \gamma_r)$ from v_* with no bad vertex on γ_r ,
- a white arm from $v + (0, 1)$ in the region $J(\gamma_\ell, \gamma_t)$ delimited by the two paths γ_ℓ and γ_t .

Let \mathcal{A}_0 to be the bond percolation event that there exists a dual-open arm in $J(\gamma_\ell, \gamma_r)$ from v_* without bad vertex. The proof of Lemma 4.1 is divided in 3 steps. First, we use a conditioning on the left-most dual arm, and define an absolute constant $c > 0$ such that the following inequality holds.

$$\mathbf{Q}^{J(\gamma_\ell, \gamma_r)}[\mathcal{A}_{w,b}] \leq L^{-c(1-r)} \mathbf{Q}^{J(\gamma_\ell, \gamma_r)}[\mathcal{A}_w]. \quad (\text{I1})$$

The second step is the most technical part of the proof. We perform a “surgery” on a dual-path in $J(\gamma_\ell, \gamma_r)$ in order to prove the following inequality

$$\mathbf{Q}^{J(\gamma_\ell, \gamma_r)}[\mathcal{A}_w] \leq \circ_{p_c}[\mathcal{A}_0]. \quad (\text{I2})$$

Finally, we apply Lemma 4.2 above to show that

$$\circ_{p_c}[\mathcal{A}_0] \leq \circ_{p_c}[\mathcal{A}_1]. \quad (\text{I3})$$

We conclude the proof of Lemma 4.1 by combining the three inequalities (I1)(I2) and (I3).

Proof of (I1): using the price of the black coloring. When \mathcal{A}_w holds, we define Γ_t to be the left-most dual-open arm in $J(\gamma_\ell, \gamma_r)$ such that there exists on its left, a white

arm from $v + (0, 1)$. The arm Γ_t can be seen as the right boundary of the left-most sequence of clusters containing a white arm from $v + (0, 1)$.

For a fixed dual path γ_t , the event $\{\Gamma_t = \gamma_t\}$ is measurable with respect to the configuration on its left $\gamma_t \cup J(\gamma_\ell, \gamma_t)$, and the configuration on its right is independent of it. Let $\mathcal{A}_b(\gamma_t)$ be the event that there exists a black arm in $J(\gamma_t, \gamma_r)$ from $v + (1, 1)$. Conditioning on Γ_t , we find

$$\mathbf{Q}^{J(\gamma_\ell, \gamma_r)}[\mathcal{A}_{w,b}] = \sum_{\gamma_t} \mathbf{Q}^{J(\gamma_t, \gamma_r)}[\mathcal{A}_b(\gamma_t)] \mathbf{Q}^{J(\gamma_\ell, \gamma_r)}[\Gamma_t = \gamma_t]. \quad (3.20)$$

Assume for a moment that one can find an absolute constant $c_3 > 0$, such that, for all γ_t ,

$$\mathbf{Q}^{J(\gamma_t, \gamma_r)}[\mathcal{A}_b(\gamma_t)] \leq L^{-c_3(1-r)}. \quad (3.21)$$

Together with equation (3.20), it gives

$$\mathbf{Q}[\mathcal{A}_{w,b}] \leq L^{-c_3(1-r)} \sum_{\gamma_t} \mathbf{Q}[\Gamma_t = \gamma_t].$$

The sum on the right is exactly the probability of \mathcal{A}_w , and we obtain the desired inequality (I1). It remains to show equation (3.21). Let us fix a possible value γ_t for the random arm Γ_t . Let \mathcal{B}_i be the bond percolation event that there exist in $A(2^i, 2^{i+1}) \cap J(\gamma_t, \gamma_r)$ two dual-open paths that comes at distance $1/2$ from both γ_t and γ_r , and one primal-open lying between those two paths (see Fig. 3.13). The event \mathcal{B}_i occurs with probability larger than $\circ_{p_c}[\mathcal{C}_{2^i}]$ and, by Equation (3.2), we obtain

$$\circ_{p_c}[\mathcal{B}_i] > c_0.$$

(The constant c_0 does not depend on any parameter.)

For each i such that \mathcal{B}_i occurs, there is one ‘‘blocking’’ $J(\gamma_t, \gamma_\ell)$ -bond-cluster in the region $A(2^i, 2^{i+1}) \cap J(\gamma_t, \gamma_r)$ that must be colored black. By independence, we obtain

$$\begin{aligned} \mathbf{Q}^{J(\gamma_t, \gamma_r)}[\mathcal{A}_b] &\leq \prod_{i \leq \log_2 L} \mathbf{E}_{p_c} \left[r^{\mathbb{1}_{\mathcal{B}_i}} \right] \\ &\leq (c_0 r + 1 - c_0)^{\log_2 L} \\ &\leq L^{-c_3(1-r)}. \end{aligned}$$

Proof of (I2): surgery on the dual path. Let us begin with some definitions. Since γ_ℓ is self-avoiding, any dual vertex z on γ_ℓ that is not an end has exactly two adjacent edges that lie on γ_ℓ . When these two adjacent edges are $\{z, z + (0, 1)\}$ and $\{z, z + (1, 0)\}$, we call the dual vertex z **exposed**, and the set $z - [0, 1]^2$ an **exposed box**. Let η a bond percolation realization in $J(\gamma_\ell, \gamma_r)$, define η_1 to be the configuration restricted to the edges in $J(\gamma_\ell, \gamma_r)$ that do not intersect any exposed box, and η_2 the

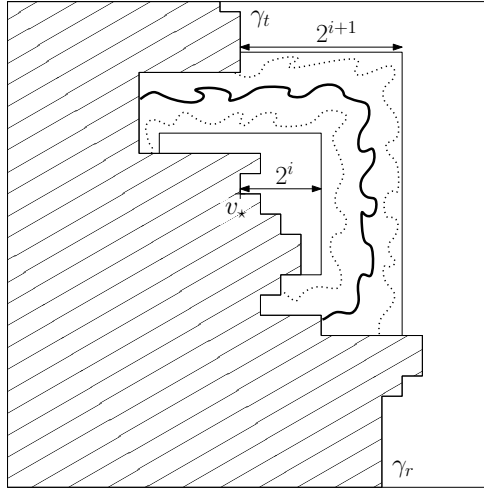

Figure 3.13: The event \mathcal{B}_i . It implies the existence of a $J(\gamma_t, \gamma_\ell)$ -bond-cluster in the annulus $A(2^i, 2^{i+1})$, from γ_t to γ_ℓ .

configuration restricted to the edges intersecting the exposed boxes. Let \mathcal{E} be the bond percolation event defined by all configurations η such that the configuration $(\eta_1, 0)$ is in the event \mathcal{A}_0 . (The configuration $(\eta_1, 0)$ is obtained from η by closing all the primal-edges intersecting exposed boxes, which corresponds to opening all the dual edges intersecting the exposed boxes.)

Computation of $\circ_{p_c} [\mathcal{A}_0]$. Assume that \mathcal{A}_0 occurs.

- First, examine the configuration η_1 . In the configuration $(\eta_1, 0)$, there must exist a dual-open arm from v_* lying in the region $J(\gamma_\ell, \gamma_r)$. One can consider the right-most such arm Γ_0 . Define then Z_1 as the set of exposed points z_1 such that the two dual edges $\{z_1 - (1, 0), z_1 - (1, 1)\}$ and $\{z_1 - (1, 1), z_1 - (0, 1)\}$ lie on Γ_0 , and Z_2 the set of exposed points z_2 such that exactly one of the two dual edges $\{z_2 - (1, 0), z_2 - (1, 1)\}$ and $\{z_2 - (1, 1), z_2 - (0, 1)\}$ lies on Γ_0 (see Fig. 3.15).
- Then, examine the configuration η_2 . For each $z_1 \in Z_1$, the two dual edges $\{z_1 - (1, 1), z_1 - (1, 0)\}$ and $\{z_1 - (1, 1), z_1 - (0, 1)\}$ must be dual-open, otherwise the dual-open arm cannot exist or the point z would be a bad point. In the same way, for each $z_2 \in Z_2$, the unique dual edge of $z - [0, 1]^2$ visited by Γ_0 in the first step must be dual-open.

The probability that the first step occurs with $|Z_1| = k_1$ and $|Z_2| = k_2$ is equal to $\circ_{p_c} [\mathcal{E}, |Z_1| = k_1, |Z_2| = k_2]$. In this case, the second step occurs with prob-

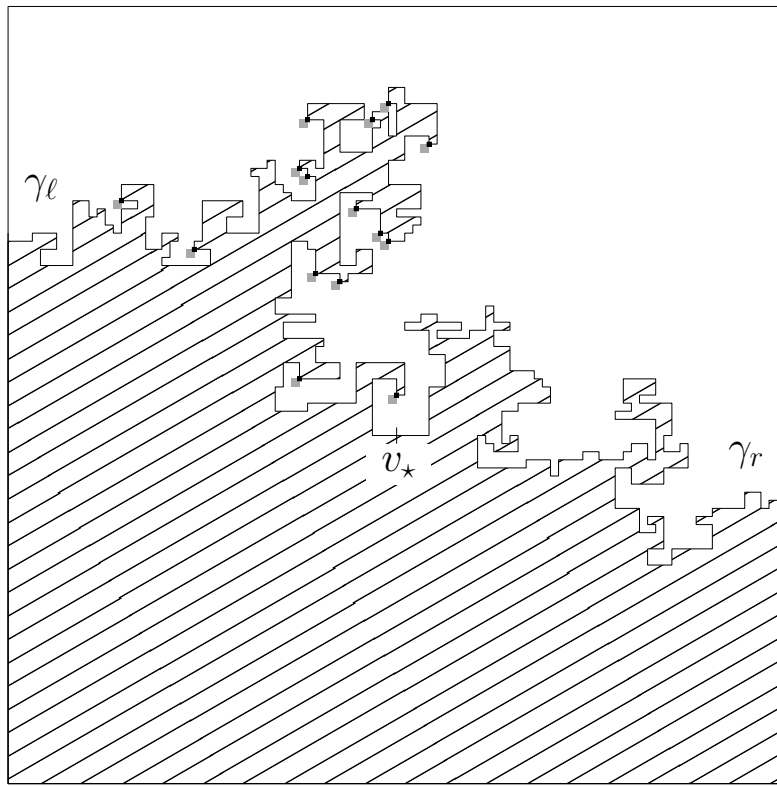

Figure 3.14: The set of exposed points (represented by black squared dots) and their associated exposed boxes (grey squares).

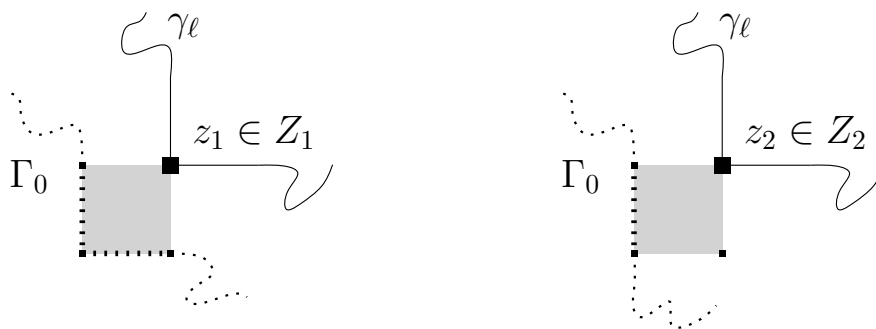

Figure 3.15: Exposed boxes visited by the path Γ_0 . On the left, the two dual-edges $\{z_1 - (1, 0), z_1 - (1, 1)\}$ and $\{z_1 - (1, 1), z_1 - (0, 1)\}$ are visited. On the right, only one is visited

ability $(1/4)^{k_1}(1/2)^{k_2}$, and we obtain

$$\begin{aligned} \circ_{p_c} [\mathcal{A}_0] &= \sum_{k \geq 0} \left(\frac{1}{4}\right)^{k_1} \left(\frac{1}{2}\right)^{k_2} \circ_{p_c} [\mathcal{E}, |Z_1| = k_1, |Z_2| = k_2] \\ &= \circ_{p_c} \left[\mathbb{1}_{\mathcal{E}} \left(\frac{1}{4}\right)^{|Z_1|} \left(\frac{1}{2}\right)^{|Z_2|} \right] \end{aligned} \quad (3.22)$$

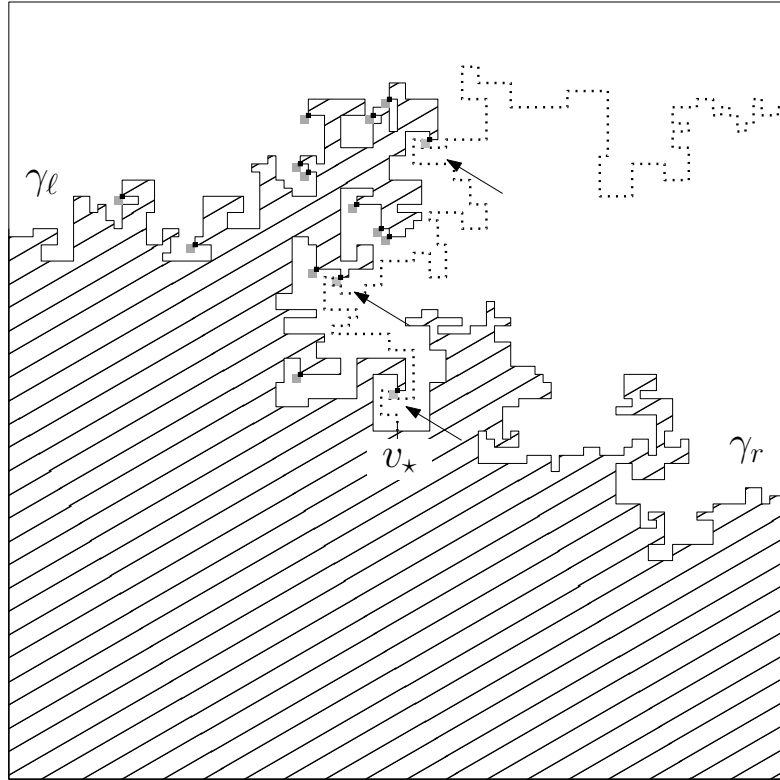

Figure 3.16: The dotted line represent the right most dual open arm, the arrows point toward the elements in the set Z .

Computation of $\mathbf{Q}[\mathcal{A}_w]$ Assume that \mathcal{A}_w occurs.

- First, examine the configuration η_1 . In the configuration $(\eta_1, 0)$, there must exist a dual-open arm from v_\star in the region $J(\gamma_\ell, \gamma_r)$. As above, we can define Z_1 as the set of exposed points z_1 such that the edges $\{z_1 - (1, 0), z_1 - (1, 1)\}$ and $\{z_1 - (1, 1), z_1 - (0, 1)\}$ are visited by the rightmost dual-open arm Γ_0 from v_\star , and Z_2 the set of exposed points z_2 such that exactly one of the two dual edges $\{z_2 - (1, 0), z_2 - (1, 1)\}$ and $\{z_2 - (1, 1), z_2 - (0, 1)\}$ is visited by Γ_0 .

- Then, examine the configuration η_2 .
 - For each $z_1 \in Z_1$, the two dual vertices $z_1 - (1, 0)$ and $z_1 - (0, 1)$ must be connected by two dual-open edges in the box $z_1 - [0, 1]^2$. We say that the connection is **separating** if in addition, at least one of the dual edge adjacent to z_1 is dual-open. Notice that, among the seven possible dual-configurations in the box $z_1 - [0, 1]^2$ that realize the dual connection between $z_1 - (1, 0)$ and $z_1 - (0, 1)$, six are separating, and one is not separating (see Fig. 3.17). Denote by Z_1^s the set of dual vertices $z_1 \in Z_1$ where a separating connection holds.
 - For each $z_2 \in Z_2$, the two end-vertices of the unique edge e in the box $z_2 - [0, 1]^2$ visited by Γ_0 must be connected by a dual path in the box $z_2 - [0, 1]^2$. We say that the connection is **separating** if in addition, one end-vertex of e is connected to z_2 by an open path in the box $z_2 - [0, 1]^2$. Notice that, among the nine possible dual-configurations in the box $z_2 - [0, 1]^2$ that realize a dual connection between the two end-vertices of e , six are separating, and three are not separating (see Fig. 3.18). Denote by Z_2^s the set of dual vertices $z_1 \in Z_2$ where a separating connection holds.
- Finally, examine the coloring configuration ξ . Consider the right most dual-open arm Γ in the whole bond configuration $\eta = (\eta_1, \eta_2)$. In the region $J(\gamma_\ell, \Gamma)$, there must exist a white arm.

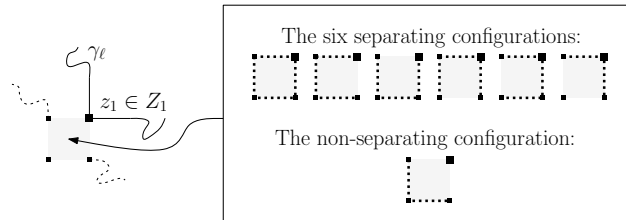

Figure 3.17: The seven possible configurations in the box $z_1 - [0, 1]^2$, $z_1 \in Z_1$, realizing the connexion between $z_1 - (1, 0)$ and $z_1 - (0, 1)$: six are separating, one is not.

As before, the probability that the first step occurs with $|Z_1| = k_1$ is $\circ_{p_c} [\mathcal{E}, |Z_1| = k_1, |Z_2| = k_2]$. The probability that the second step occurs with $|Z_1^s| = l_1$, and $|Z_2^s| = l_2$ is given by

$$\binom{k_1}{l_1} \left(\frac{6}{16}\right)^{l_1} \left(\frac{1}{16}\right)^{k_1-l_1} \cdot \binom{k_2}{l_2} \left(\frac{6}{16}\right)^{l_2} \left(\frac{3}{16}\right)^{k_2-l_2}.$$

Finally, the third step occurs with probability smaller than

$$(1 - r)^{|Z_1^s| + |Z_2^s|}.$$

To see this, one can associate to each $z \in Z_1^s \cup Z_2^s$ a $J(\gamma_\ell, \Gamma)$ -bond-cluster C_z ,

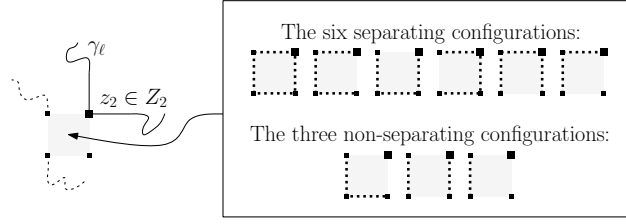

Figure 3.18: The nine possible configurations in the box $z_2 - [0, 1]^2$, $z_2 \in Z_2$ realizing the connexion between the two extremity of the dual-edge e : six are separating, three are not.

in such a way that the C_z 's are all disjoint. For a white arm to exist in the region $J(\gamma_\ell, \Gamma)$, all the C_z 's must be colored white, providing the estimate above. Putting everything together, we finally obtain

$$\begin{aligned}
 & \mathbf{Q}^{J(\gamma_\ell, \gamma_r)}[\mathcal{A}_w] \\
 & \leq \sum_{0 \leq l \leq k} (1-r)^{l_1+l_2} \circ_{p_c} [\mathcal{E}, (|Z_1|, |Z_2|, |Z_1^s|, |Z_2^s|) = (k_1, k_2, l_1, l_2)] \\
 & = \sum_{\substack{0 \leq l_1 \leq k_1 \\ 0 \leq l_2 \leq k_2}} (1-r)^{l_1+l_2} \binom{k_1}{l_1} \left(\frac{6}{16}\right)^{l_1} \left(\frac{1}{16}\right)^{k_1-l_1} \cdot \binom{k_2}{l_2} \left(\frac{6}{16}\right)^{l_2} \left(\frac{3}{16}\right)^{k_2-l_2} \\
 & \quad \circ_{p_c} [\mathcal{E}, (|Z_1|, |Z_2|) = (k_1, k_2)] \\
 & = \mathbb{E}_{p_c} \left[\mathbf{1}_{\mathcal{E}} \left(\frac{1+6(1-r)}{16} \right)^{|Z_1|} \left(\frac{3+6(1-r)}{16} \right)^{|Z_2|} \right] \tag{3.23}
 \end{aligned}$$

Since $r \geq 1/2$, we obtain inequality **(I2)** from the two computations (3.22) and (3.23) above.

Computation of (I3): The shift argument. Let $\eta \in \{0, 1\}^{\mathbb{E}^2}$. We define the configuration ${}^\tau\eta$ by

$${}^\tau\eta(e) := 1 - \eta^*(\tau^{-1}e), \quad e \in \mathbb{E}^2.$$

Otherwise saying, an edge e is open for ${}^\tau\eta$ if and only if the dual edge $\tau^{-1}e$ is dual-open for η .

Let $X \in \{0, 1\}^{\mathbb{E}}$ be a random variable with law ν_{p_c} . Since $p_c = 1/2$, the law of the random variable ${}^\tau X$ is also ν_{p_c} . By Lemma 4.2, we have

$$\mathbb{P}[X \in \mathcal{A}_0] \leq \mathbb{P}[{}^\tau X \in \mathcal{A}_1],$$

which implies inequality **(I3)**.

CROSSING PROBABILITIES FOR VORONOI PERCOLATION

4

This chapter corresponds to the work in progress [VT4].

We prove that the standard Russo-Seymour-Welsh theory is valid for Voronoi percolation. At criticality it implies that the crossing probabilities for a rectangle are bounded by constants depending only on its aspect ratio. This result has many consequences, such as the polynomial decay of the one-arm event at criticality.

Introduction

In the study of planar percolation, the Russo-Seymour-Welsh (RSW) theory has become one of the most important tools. A RSW-result generally refers to an inequality providing bounds on the probability to cross rectangles in the long direction, knowing bounds on the probability to cross squares (or a rectangles in the easy direction). Heuristically, this inequality is obtained by “gluing” together square-crossings in order to obtain a crossing in a long rectangle.

Such results have been first obtained for Bernoulli percolation on a lattice with a symmetry assumption [Rus78], [SW78], [Rus81], [Kes82]. For continuum percolation in the plane, a RSW-result is proved in [Roy90] for the open crossings, and in [Ale96] for the closed crossings. A RSW-theory has been recently developed in for FK-percolation, see e.g. [BDC12b, DCHN11] [VT5]. For Bernoulli percolation on a lattice without symmetry, or for Voronoi percolation, some weaker version of the standard RSW has been proved in [BR10] and [BR06a] respectively.

At criticality, RSW-results imply the following statement, called the **box-crossing property**: the crossing probability for any rectangle remains bounded between c and $1 - c$, where $c > 0$ is a constant depending only the aspect ratio of the considered rectangle (in particular it is independent of the scale). For the terminology, we follow [GM13] where the box-crossing is established, for Bernoulli percolation on isoradial graphs.

For Bernoulli percolation, the original proof of the Russo-Seymour-Welsh theorem uses an argument relying on the spatial Markov property of the model: knowing that a

left-right crossing exists in a square, it is always possible to condition on the lowest one, which leaves an unexplored region where the configuration can be sampled independently of the explored region (below the lowest path). This argument cannot be applied directly when the model has spatial dependencies. In this paper, we provide a new RSW-argument without exploration, allowing to prove RSW-results for a larger class of models than Bernoulli percolation. We present this argument for Voronoi percolation, since it is a good example of a model with local dependencies where the “lowest path” argument does not apply.

First introduced in the context of first passage percolation [VAW93], planar Voronoi percolation has been an active area of research, see for example [BR06a, BS98, Aiz98, BBQ05]. It can be defined by the following two-step procedure. (A more detailed definition will be given in section 1.) First, construct the Voronoi tiling associated to a Poisson point process in \mathbb{R}^2 with intensity 1. Then, color independently each tile black with probability p and white with probability $1 - p$. The self-duality of the model for $p = 1/2$ suggests that the critical value is $p_c = 1/2$. This result was proved in [BR06a] and one of the main difficulties they had to overcome was precisely that none of the known RSW-results applied in this context. An important step of their proof was to obtain the following weaker version of the standard RSW-theorem. For $\rho \geq 1$ and $s \geq 1$, let $f_s(\rho)$ the probability that there exists a left-right black crossing in the rectangle $[0, \rho s] \times [0, s]$. For fixed $0 < p < 1$, they proved that $\inf_{s>0} f_s(1) > 0$ implies that $\limsup_{s \rightarrow \infty} f_s(\rho) > 0$ for all $\rho \geq 1$. Otherwise saying, a RSW-result has been obtained for arbitrarily large scale, but not for all scales. This result was strengthened in [vdBBV08], relaxing the square crossing condition to a rectangle crossing condition, but keeping the same conclusion.

Our main result is to prove a standard RSW for Voronoi percolation.

Theorem 0.3. *Let $0 < p < 1$ fixed. If $\inf_{s \geq 1} f_s(1) > 0$, then for all $\rho \geq 1$, $\inf_{s \geq 1} f_s(\rho) > 0$.*

At criticality (when $p = 1/2$), it is known that $f_s(1) = 1/2$ for all s , and Theorem 0.3 above implies the following new results.

Theorem 0.4. *Consider Voronoi percolation at $p = 1/2$. Then the following holds.*

1. [Box crossing property] *For all $\rho > 0$, there exists $c(\rho) > 0$ such that*

$$c(\rho) < f_s(\rho) < 1 - c(\rho), \quad \text{for all } s \geq 1.$$

2. [Polynomial decay of the 1-arm event] *Let $\pi_1(s, t)$ be the probability that there exists a black path from $[-s, s]^2$ to the boundary of $[-t, t]^2$. There exists $\eta > 0$, such that, for every $1 \leq s < t$,*

$$\pi(s, t) \leq \left(\frac{s}{t}\right)^\eta.$$

Our proof is not restricted to Voronoi percolation, and Theorem 0.3 extends to a large class of planar percolation models. In order to help the reader interested in applying the technique of the present paper in a different context, we isolate in the context of Voronoi percolation, the sufficient properties that we use (see section 1 for the main definitions).

Positive association If \mathcal{A}, \mathcal{B} are two (black-)increasing events, $\mathbf{P}[\mathcal{A} \cap \mathcal{B}] \geq \mathbf{P}[\mathcal{A}] \mathbf{P}[\mathcal{B}]$.

Invariance properties The measure is invariant under translation, $\pi/2$ -rotation and horizontal reflection.

Quasi-independence We have

$$\lim_{s \rightarrow \infty} \sup_{\substack{\mathcal{A} \in \sigma(A_{2s,4s}) \\ \mathcal{B} \in \sigma(\mathbb{R}^2 \setminus A_{s,5s})}} |\mathbf{P}[\mathcal{A} \cap \mathcal{B}] - \mathbf{P}[\mathcal{A}] \mathbf{P}[\mathcal{B}]| = 0,$$

where we write $A_{s,t} = [-t, t]^2 \setminus [-s, s]^2$, $0 \leq s \leq t < \infty$, and $\sigma(S)$ the sigma-algebra defined by the events measurable with respect to the coloring in S , $S \subset \mathbb{R}^2$.

1 Voronoi percolation

1.1 Definitions and notation

General notation. The Lebesgue measure of a measurable set $A \subset \mathbb{R}^2$ is denoted by $\text{vol}(A)$. The cardinality of a set S is denoted by $|S|$ (with $|S| = +\infty$ if S is infinite). We write $d(u, v)$ the Euclidean distance between two points $u, v \in \mathbb{R}^2$. Finally, for $0 \leq s \leq t < \infty$, we consider the square $B_s = [-s, s]^2$ and the annulus $A_{s,t} = B_t \setminus B_s$.

Voronoi tilings. Let Ω be the set of all subsets ω of \mathbb{R}^2 such that the intersection of ω with any bounded set is finite. Equip Ω with the sigma-algebra generated by the functions $\omega \mapsto |\omega \cap A|$, $A \subset \mathbb{R}^2$. To each $\omega \in \Omega$ corresponds a Voronoi tiling, defined as follows. For every $z \in \omega$, let V_z be the Voronoi cell of z , defined as the set of all points $v \in \mathbb{R}^2$ such that $d(v, z) \leq d(v, z')$ for all $z' \in \omega$. The family $(V_z)_{z \in \omega}$ of all the cells forms a tiling of the plane.

Voronoi percolation. Given a parameter $p \in [0, 1]$, one defines the Voronoi percolation process as follows. Let X be a Poisson point process in \mathbb{R}^2 with density 1, it is a random variable in Ω characterized by the following two properties. For every measurable set A (with finite measure), $X \cap A$ contains exactly k points with probability

$$\frac{\text{vol}(A)^k}{k!} \exp(-\text{vol}(A)),$$

and the random variables $|X \cap A_1|, \dots, |X \cap A_n|$ are independent, when A_1, \dots, A_n are any disjoint measurable sets. Declare each point $z \in X$ open with probability p , and closed with probability $1 - p$, independently of each other and of the variable X . Define then X_o and X_c to be respectively the set of open and closed points in X . Notice that we could have equivalently defined X_o and X_c as two independent Poisson processes with density p and $1 - p$, and then formed $X = X_o \cup X_c$. Through this paper we write \mathbf{P} the measure defining the random variable (X_o, X_c) in the space Ω^2 . The definition of the

model strongly depends on the value of p . Nevertheless, in all the proofs, the value of p will be fixed, and we do not mention the dependence in the underlying p in our notation.

In Voronoi percolation, we consider the Voronoi tiling $(V_z)_{z \in X}$ associated to X , and we are interested in the random coloring of the plane obtained by coloring **black** the points in the cells to open points, and **white** the points in the cells corresponding to closed points. Otherwise saying, the set of black points is the union of the cells $V_z, z \in X_o$, and the set of white points is the union of the cells $V_z, z \in X_c$. points are de(The points at the boundary between two cells of different colors are both black and white.)

Crossing events. In our study, events will be simpler to define in terms of the colors of the points in \mathbb{R}^2 . Let us introduce some notation that allows to do so. Given some set $U \subset \mathbb{R}^2$, write \mathcal{E}_U for the event that all the points in U are black, one can verify that it is measurable. For $S \subset \mathbb{R}^2$, we say that an event is S -measurable if it lies in the sigma-algebra generated by the events $(\mathcal{E}_U)_{U \subset S}$. For a fixed subset V of S , one can verify that the event that all the points in V are white is S -measurable. Roughly, an event is S -measurable if it is defined in terms of the colors in S .

Let A, B and S be three subsets of \mathbb{R}^2 such that $A, B \subset S$. We call **black path** from A to B in S an injective continuous map $\gamma : [0, 1] \rightarrow S$ such that $\gamma(0) \in A, \gamma(1) \in B$, and all the points in the Jordan arc $\gamma([0, 1])$ are black. For A, B and S , one can verify that the existence of a path from A to B in S is an S -measurable event. (Up to some negligible set, it is equivalent to look only at γ obtained by connecting linearly a finite number of rational points.) In the same way, we define a **black circuit** in the annulus $A_{s,t}, s < t$ as a Jordan curve included in $A_{s,t}$ such that the origin 0 is in its interior, and all its point are black. **White paths** and **white circuits** are defined analogously.

We write \mathcal{A}_s the event that there exists a black circuit in the annulus $A_{s,2s}$, and $f_s(\rho)$ the probability that there exists a black path from $\{0\} \times [0, s]$ to $\{\rho s\} \times [0, s]$ in the rectangle $[0, \rho s] \times [0, s], \rho > 0, s > 0$.

1.2 External ingredients

Independence properties. One main difficulty in Voronoi percolation is the spatial dependency between the colors of the points: given two fixed points in the plane, there is a positive probability for them to lie on the same tile, thus (for $0 < p < 1$) the probability that they are both black is larger than p^2 . Nevertheless, the spatial dependencies are only local and the color of a given point is determined with high probability by the process restricted to a neighbourhood of it. More precisely, Lemma 3.2. in [BR06a] states that the color of the points in the box B_s are determined with high probability by the process (X_o, X_c) restricted to $B_{s+2\sqrt{\log s}}$. In our approach, this property is stronger than what we really need, and the following lemma is sufficient. Let \mathcal{F}_s be the event that for every $z \in A_{2s,4s}$, there exists some point $x \in X$ at distance $d(z, x) < s$.

Lemma 1.1. *We have $\lim_{s \rightarrow \infty} \mathbf{P}[\mathcal{F}_s] = 1$ and, for any $A_{2s,4s}$ -measurable event \mathcal{E} , the event $\mathcal{E} \cap \mathcal{F}_s$ is measurable with respect to the restriction of (X_o, X_c) to $\mathcal{A}_{s,5s}$.*

Proof. Let us consider an absolute constant $C > 0$ such that, for every $s \geq 1$, there exists a covering of $A_{2s,4s}$ by C Euclidean balls of diameter s . Fix $s \geq 1$ and a covering of $A_{2s,4s}$ by C Euclidean balls of diameter s . Consider the event that each of these balls contains at least one point of the Poisson process X . Using that it is a sub-event of \mathcal{F}_s , we obtain

$$\mathbf{P}[\mathcal{F}_s] \geq 1 - Ce^{-s^2}.$$

For the second part of the lemma, observe that the color of a point in $A_{2s,4s}$ is determined by the color of its closest point of the process X , the latter lies in $\mathcal{A}_{s,5s}$ when \mathcal{F}_s holds. Thus, for any $U \subset A_{2s,4s}$, the event \mathcal{E}_U is measurable with respect to $(X_o \cap \mathcal{A}_{s,5s}, X_c \cap \mathcal{A}_{s,5s})$. \square

FKG inequality. The FKG inequality is an important tool allowing to “glue” black paths. Its proof can be found in [BR10]. Before stating it, we need to define increasing events in the context of Voronoi percolation. An event \mathcal{E} is black-increasing if for any configurations $\omega = (\omega_o, \omega_c)$ and $\omega' = (\omega'_o, \omega'_c)$, we have

$$\left. \begin{array}{l} \omega \in \mathcal{E} \\ \omega_o \subset \omega'_o \text{ and } \omega_c \supset \omega'_c \end{array} \right\} \Rightarrow \omega' \in \mathcal{E}.$$

Theorem 1.2 (FKG inequality). *Let \mathcal{E}, \mathcal{F} two black-increasing events, then*

$$\mathbf{P}[\mathcal{E} \cap \mathcal{F}] \geq \mathbf{P}[\mathcal{E}] \mathbf{P}[\mathcal{F}].$$

The following standard inequalities can be easily derived from Theorem 1.2.

Corollary 1.3. *Let $s \geq 1$.*

1. $f_s(1 + i\kappa) \geq f_s(1 + \kappa)^i f_s(1)^{i-1}$ for any $\kappa > 0$ and any $i \geq 1$,
2. $\mathbf{P}[\mathcal{A}_s] \geq f_s(3)^4$,
3. $f_s(2) \geq \mathbf{P}[\mathcal{A}_s]^2$.

1.3 Organization of the proof

We fix $0 < p < 1$ and assume that there exists a constant $c_0 > 0$ such that, for all $s \geq 1$,

$$f_s(1) \geq c_0. \tag{4.1}$$

Our goal is to prove that $\inf_{s \geq 1} \mathbf{P}[\mathcal{A}_s] > 0$. Rather than studying only the sequence $(\mathbf{P}[\mathcal{A}_s])$, we introduce at each scale s a value $\alpha_s \in [0, s/4]$ (defined at the beginning of section 2) and study the couple $(\mathbf{P}[\mathcal{A}_s], \alpha_s)$ altogether.

- In section 2, a geometric construction valid only when $\alpha_{3s/2} \leq 2\alpha_s$ provides a RSW-result at scale $3s/2$. We will refer to such scale as a “good scale”.
- In section 3, we use the independence properties of the model to show that the good scales are close to each other. More precisely, we construct an infinite sequence $s(1), s(2), \dots$ of good scales such that $2s(i) \leq s(i+1) \leq Cs(i)$.

In the proof, many constants will be introduced, they will not depend on any parameter of the model, and in particular they never depend on the scale parameter s . By convention, the constants will generally be denoted by c_0, c_1, c_2, \dots or C_0, C_1, C_2, \dots (depending on whether they have to be thought small or large), and they are all assumed to be in $(0, \infty)$.

2 Gluing at good scales

Definition of α_s . Let $s \geq 1, 0 \leq \alpha \leq \beta \leq s$. Define $\mathcal{H}_s(\alpha, \beta)$ to be the event that there exists a black path in the square $B_{s/2}$, from the left side to $\{s/2\} \times [\alpha, \beta]$. Define also $\mathcal{X}_s(\alpha)$ to be the event that there exists in $B_{s/2}$

- a black path γ_{-1} from $\{-s/2\} \times [-s/2, -\alpha]$ to $\{-s/2\} \times [\alpha, s/2]$,
- a black path γ_1 from $\{s/2\} \times [-s/2, -\alpha]$ to $\{s/2\} \times [\alpha, s/2]$,
- a black path from γ_{-1} to γ_1 .

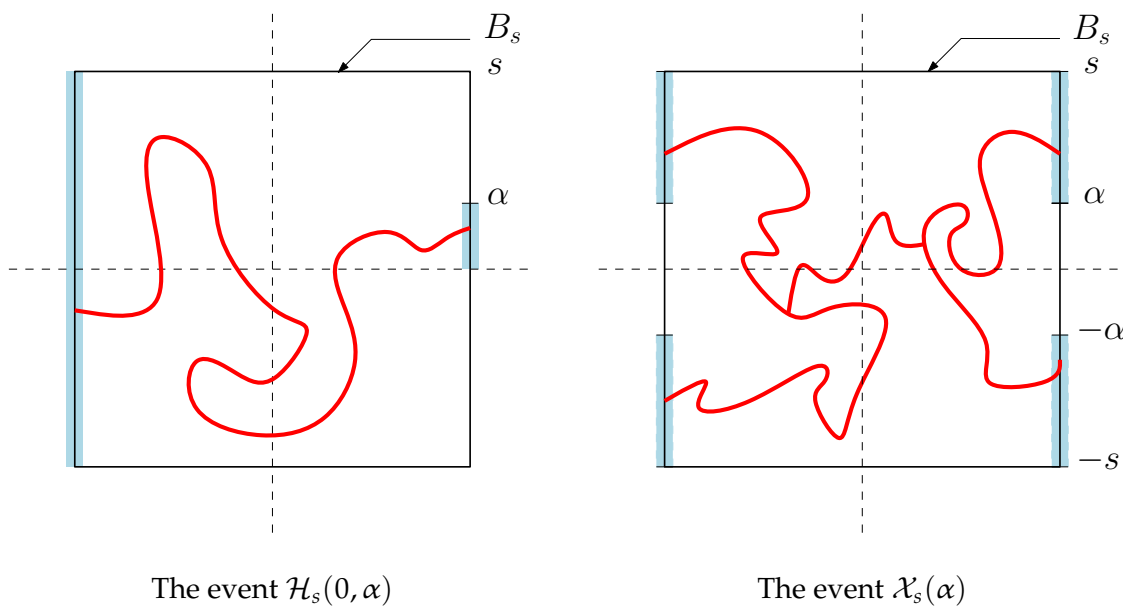

Lemma-definition 2.1. For every $s \geq 1$, there exists $\alpha_s \in [0, s/4]$ such that the following two properties hold.

(P1) For all $\alpha \leq \alpha_s$, $\mathbf{P}[\mathcal{X}_s(\alpha)] \geq c_1$.

(P2) If $\alpha_s < s/4$, then for all $\alpha \geq \alpha_s$, $\mathbf{P}[\mathcal{H}_s(0, \alpha)] \geq c_0/4 + \mathbf{P}[\mathcal{H}_s(\alpha, s/2)]$.

In the rest of the paper, we fix for every $s \geq 1$ a real number $\alpha_s \in [0, s/4]$ satisfying **(P1)** and **(P2)** above.

Proof. Define for $\alpha \in [0, s]$

$$\phi_s(\alpha) = \mathbf{P}[\mathcal{H}_s(0, \alpha)] - \mathbf{P}[\mathcal{H}_s(\alpha, s/2)].$$

For fixed s , one can verify that ϕ_s is continuous increasing, and $\phi_s(0) \leq 0$. If $\phi_s(s/4) > c_0/4$, we define α_s as the unique $\alpha \in (0, s/4)$ such that $\phi_s(\alpha) = c_0/4$. Otherwise, let $\alpha_s = s/4$.

With this definition of α_s , the property **(P2)** is clearly verified, we need to show that it also provides the property **(P1)**. Let $\alpha \leq \alpha_s$, our hypothesis (4.1) and symmetries imply that

$$\begin{aligned} c_0 &\leq 2\mathbf{P}[\mathcal{H}_s(0, s/2)] \\ &\leq 2\mathbf{P}[\mathcal{H}_s(0, \alpha)] + 2\mathbf{P}[\mathcal{H}_s(\alpha, s/2)] \\ &\leq 4\mathbf{P}[\mathcal{H}_s(\alpha, s/2)] + 2\phi_s(\alpha) \\ &\leq 4\mathbf{P}[\mathcal{H}_s(\alpha, s/2)] + c_0/2. \end{aligned}$$

We obtain, for every $\alpha \leq \alpha_s$,

$$\mathbf{P}[\mathcal{H}(\alpha_s, s/2)] \geq c_0/8.$$

A sub-event of $\mathcal{X}_s(\alpha)$ can be obtained by intersecting four symmetric versions of $\mathcal{H}_s(\alpha, s/2)$ with the event that there exists a top-down crossing in $B_{s/2}$. The FKG inequality implies then

$$\mathbf{P}[\mathcal{X}_s(\alpha)] \geq c_0(c_0/8)^4.$$

This concludes the first part of the lemma with $c_1 = c_0(c_0/8)^4$. The second part follows from the definition of α_s . \square

Lemma 2.2. *There exists $c_2 > 0$ such that, for all $s \geq 2$,*

$$\alpha_s \leq 2\alpha_{2s/3} \Rightarrow \mathbf{P}[\mathcal{A}_s] \geq c_2.$$

Proof. We first treat the case $\alpha_s = s/4$. By Lemma 2.1, we have $\mathbf{P}[\mathcal{X}_s(s/4)] \geq c_1$, and it is easy to create a black crossing in a long rectangle. For example, consider for $i = 0, \dots, 4$ the event \mathcal{E}_i that there exists a black path from $\{0\} \times [(i-1)s/2, is/2]$ to $\{0\} \times [(i+1)s/2, (i+2)s/2]$ in the strip $[0, s] \times \mathbb{R}$. For every i , the event \mathcal{E}_i has probability larger than $\mathbf{P}[\mathcal{X}_s(s/4)]$, and when all of them occur, it implies a vertical black crossing in the rectangle $[0, s] \times [0, 2s]$. We conclude using FKG inequality that

$$f_s(2) \geq c_1^5.$$

Now, let s be such that $\alpha_s \leq 2\alpha_{2s/3}$ and $\alpha_s < s/4$. We use the event $\mathcal{X}_{2s/3}$ to connect at scale $2s/3$ two crossings at scale s . Consider the two squares $R = (-s/6, -\alpha_{2s/3}) + B_s$ and

$R' = (s/6, -\alpha_{2s/3}) + B_s$. Notice that $B_{s/3} \subset R$ and $B_{s/3} \subset R'$ since $\alpha_{2s/3} \leq s/6$. Let \mathcal{E} be the event that there exists a black path from left to $\{s/3\} \times [-\alpha_{2s/3}, \alpha_{2s/3}]$ in R . Similarly, define \mathcal{E}' as the event that there exists a black path from $\{-s/3\} \times [-\alpha_{2s/3}, \alpha_{2s/3}]$ to right in R' . Since $\alpha_s \leq 2\alpha_{2s/3}$, **(P2)** in Lemma 2.1 ensures that both event \mathcal{E} and \mathcal{E}' occur with probabilities larger than $c_0/4$.

When $\mathcal{X}_{2s/3}$, \mathcal{E} and \mathcal{E}' occur, a black path must exist from left to right in the rectangle $R \cup R'$ (see fig. 4.1). The rectangle $R \cup R'$ has aspect ratio $4/3$, and we can conclude by FKG inequality that

$$\begin{aligned} f_s(4/3) &\geq \mathbf{P} \left[\mathcal{X}_{2s/3} \cap \mathcal{E} \cap \mathcal{E}' \right] \\ &\geq c_1 \left(\frac{c_0}{4} \right)^2. \end{aligned}$$

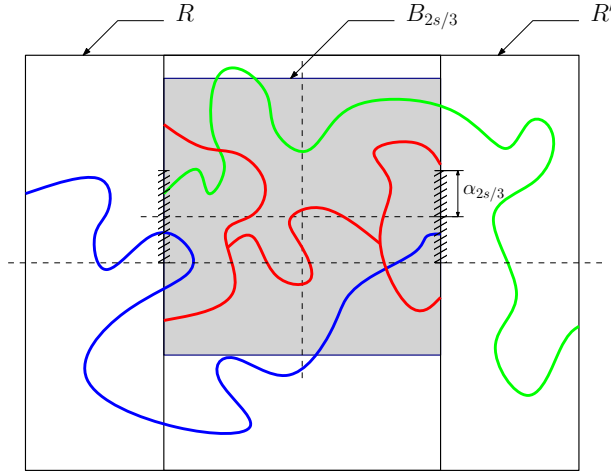

Figure 4.1: The occurrence of $\mathcal{X}_{2s/3}$, \mathcal{E} and \mathcal{E}' implies the existence of a horizontal crossing in $R \cup R'$.

□

3 All the scales are good

Lemma 3.1. *There exists $c_3 > 0$ such that the following holds. Consider a scale $s \geq 1$ such that $\mathbf{P}[\mathcal{A}_s] \geq c_2$. Then, for all $t \geq 3s$ with $\alpha_t \leq s$, we have*

$$\mathbf{P}[\mathcal{A}_t] \geq c_3.$$

Proof. Consider the event that there exist:

- a black path from left to $\{0\} \times [0, s]$ in the square $[-2t, 0] \times [-t, t]$,
- a black path from $\{0\} \times [0, s]$ to right in the square $[-2t, 0] \times [-t, t]$,
- and a black circuit in the annulus $A_{s, 2s}$.

Since $\alpha_t \leq s$, Lemma 2.1 implies that each of the first two paths exists with probability larger than $c_0/4$. When the event depicted above occurs, it implies the existence of an horizontal black crossing in the rectangle $[-2t, 2t] \times [-t, t]$. Using the FKG inequality, we obtain

$$f_t(2) \geq \left(\frac{c_0}{4}\right)^2 c_2.$$

The standard inequalities in Corollary 1.3 allow to conclude that

$$\mathbf{P}[\mathcal{A}_t] \geq c_3,$$

for some constant c_3 . □

In order to apply a ‘‘circuit argument’’, we define s_0 such that $\mathbf{P}[\mathcal{F}_s] \geq 1 - c_3/2$ for all $s \geq s_0$. (The existence of s_0 is guaranteed by Lemma 1.1.)

Lemma 3.2. *Define a constant $C_1 \geq 3$ large enough, so that*

$$(1 - c_3/2)^{\log_5(C_1)} < c_0/2.$$

Let $s \geq s_0$ such that $\mathbf{P}[\mathcal{A}_s] \geq c_2$. Then there exists $s' \in [3s, C_1s]$ with $\alpha_{s'} \geq s$.

Proof. Fix $s \geq s_0$. Assume for contradiction that

$$\alpha_t \leq s \text{ for all } 3s \leq t \leq C_1s.$$

Consider for $i = 1, 2, \dots$ the event $\mathcal{E}_i = \mathcal{F}_{5^i s} \cap \mathcal{A}_{5^i s}$. By Lemma 1.1, these events are independent, and by lemma 3.1, the probability of \mathcal{E}_i is larger than $c_3/2$ for all $i \leq \log_5 C_1$. Since $\alpha_{C_1 s} \leq s$, **(P2)** in Lemma 2.1 gives

$$\begin{aligned} c_0/2 &\leq \mathbf{P}[\mathcal{H}(0, s) \setminus \mathcal{H}(s, C_1s)] \\ &\leq \mathbf{P}\left[\bigcap_{i \leq \lfloor \log_5(C_1) \rfloor} \mathcal{E}_i^c\right] \\ &\leq (1 - c_3/2)^{\log_5 C_1}, \end{aligned}$$

which contradicts the definition of C_1 . □

Lemma 3.3. *There exists a constant $C_3 \geq 3$ and an infinite sequence $s_1, s_2 \dots$ of scales such that, for all $i \geq 1$*

- $3s_i \leq s_{i+1} \leq C_3s_i$,
- $\mathbf{P}[\mathcal{A}_{s_i}] > c_2$.

Proof. Since $\alpha_s \leq s$, the sequence α_s cannot grow super-linearly, and there must exist $s_1 \geq s_0$ such that $\alpha_{s_1} \leq 2\alpha_{2s_1/3}$.

Since $\mathbf{P}[\mathcal{A}_{s_1}] > c_2$, Lemma 3.2 implies the existence of $s'_1 \in [3s_1, C_1s_1]$ such that

$$\alpha_{s'_1} \geq s'_1/C_1.$$

Then, there must exist $s_2 \in [s'_1, C_1^{\log_{4/3}(3/2)} s'_1]$ such that $\alpha_{s_2} \leq 2\alpha_{2s_2/3}$, otherwise the bound $\alpha_s \leq s$ would be contradicted. Defining $C_3 = C_1^{1+\log_{4/3}(3/2)}$, we find from Lemma 2.2 that

$$s_2 \in [3s_1, C_3s_1], \text{ and}$$

$$\mathbf{P}[\mathcal{A}_{s_2}] \geq c_2.$$

The constant C_3 is independent of the scale, we can thus iterate the construction above, and find by induction s_3, s_4, \dots concluding the proof. \square

Theorem 1 follows easily from Lemma 3.3 and the standard inequalities of Corollary 1.3.

CONTINUITY OF THE PHASE TRANSITION FOR PLANAR POTTS MODELS WITH $1 \leq q \leq 4$

5

This chapter corresponds to the article [VT5] in preparation with the same title, written in collaboration with Hugo Duminil-Copin and Vladas Sidoravicius.

This chapter studies the planar Potts model and its random-cluster representation. We show that the phase transition of the nearest-neighbor ferromagnetic q -state Potts model on \mathbb{Z}^2 is continuous for $q \in \{2, 3, 4\}$, in the sense that there exists a unique Gibbs state, or equivalently that there is no ordering for the critical Gibbs states with monochromatic boundary conditions.

The proof uses the random-cluster representation and is based on two ingredients:

- Studying parafermionic observables on a discrete Riemann surface, it is shown that the two-point function for the free state decays sub-exponentially fast for cluster-weights $1 \leq q \leq 4$.
- A new result proving the equivalence of several properties of critical random-cluster models:
 - the absence of infinite-cluster for wired boundary conditions,
 - the uniqueness of infinite-volume measures,
 - the sub-exponential decay of the two-point function for free boundary conditions,
 - a Russo-Seymour-Welsh type result on crossing probabilities in rectangles with *arbitrary boundary conditions*.

The result leads to a number of consequences concerning the scaling limit of the model. It shows that the family of interfaces (for instance for Dobrushin boundary conditions) are tight when taking the scaling limit and that any sub-sequential limit can be parametrized by a Loewner chain. We also study the effect of boundary conditions on these sub-sequential limits. Let us mention that the result should be instrumental in the study of critical exponents as well.

1 Introduction

1.1 Motivation

The Potts model is a model of random coloring of \mathbb{Z}^2 introduced as a generalization of the Ising model to more-than-two components spin systems. In this model, each vertex of \mathbb{Z}^2 receives a spin among q possible colors. The energy of a configuration is proportional to the number of frustrated edges, meaning edges whose endpoints have different spins. Since its introduction by Potts [Pot52] (the model was suggested to him by his adviser Domb), it has been a laboratory for testing new ideas and developing far-reaching tools. In two dimensions, it exhibits a rich panel of possible critical behaviors depending on the number of colors, and despite the fact that the model is exactly solvable (yet not rigorously for $q \neq 2$), the mathematical understanding of its phase transition remains restricted to a few cases (namely $q = 2$ and q large). We refer to [Wu82] for a review on this model.

The question of deciding whether a phase transition is continuous or discontinuous constitutes one of the most fundamental questions in physics, and an extensive physics literature has been devoted to this subject in the case of the Potts model. In the planar case, Baxter [Bax71, Bax73, Bax89] used a mapping between the Potts model and solid-on-solid ice-models to compute the spontaneous magnetization at criticality for $q \geq 4$. He was able to predict that the phase transition was discontinuous for $q \geq 5$. While this computation gives a good insight on the behavior of the model, it relies on unproved assumptions which, forty years after their formulation, seem still very difficult to justify rigorously (and are related to the nature of the phase transition itself). Furthermore, Baxter outlined another heuristic predicting that the phase transition is continuous for $q \leq 4$, but according to the author, the justification is not as solid for this case. Among other results, the present article proves that the phase transition is continuous for $q \in \{2, 3, 4\}$ without any reference to unproved assumptions.

Most of our article will be devoted to the study of the so-called random-cluster model. This model is a probability measure on edge configurations (each edge is declared open or closed) such that the probability of a configuration is proportional to $p^{\#\text{open edges}}(1 - p)^{\#\text{closed edges}}q^{\#\text{clusters}}$, where clusters are maximal connected subgraphs, and $(p, q) \in [0, 1] \times \mathbb{R}_+$. For $q = 1$, the model is simply Bernoulli percolation.

Since its introduction by Fortuin and Kasteleyn [FK72], the random-cluster model has become an important tool in the study of phase transitions. The spin correlations of Potts models are rephrased as cluster connectivity properties of their random-cluster representations. As a byproduct, properties of the random-cluster model can be transferred to the Potts model, and vice-versa.

While the critical understanding of Bernoulli percolation is now fairly well understood, the case of the random-cluster model remains mysterious. The long range dependency makes the model challenging to study probabilistically, and some of its most basic

properties were not proved until recently. In this article, we derive several properties of the critical model, including a suitable generalization of the celebrated *Russo-Seymour-Welsh* theory available for Bernoulli percolation. This powerful tool enables us to prove several new results on the critical phase.

This article fits in the more general context of the study of conformally invariant planar lattice models. In the early eighties, physicists Belavin, Polyakov and Zamolodchikov postulated conformal invariance of critical planar statistical models [BPZ84b, BPZ84a]. This prediction enabled physicists to harness Conformal Field Theory in order to formulate many conjectures on these models. From a mathematical perspective, proving rigorously the conformal invariance of a model (and properties following from it) constitutes a formidable challenge.

In recent years, the connection between discrete holomorphicity and planar statistical physics led to spectacular progress in this direction. Kenyon [Ken00, Ken01], Smirnov [Smi10] and Chelkak and Smirnov [CS12] exhibited discrete holomorphic observables in the dimer and Ising models and proved their convergence to conformal maps in the scaling limit. These results paved the way to the rigorous proof of conformal invariance for these two models. Other discrete observables have been proposed for a number of critical models, including self-avoiding walks and Potts models. While these observables are *not exactly discrete holomorphic*, their discrete contour integrals vanish, a property shared by discrete holomorphic functions. It is a priori unclear whether this property is of any relevance for the models. Nevertheless, in the case of the self-avoiding walk, it was proved to be sufficient to compute the connective constant of the hexagonal lattice [DCS12]. One can consider that this article is part of a program initiated informally in [DCS12] and devoted to the study of the possible applications of the property mentioned above. In our case, we will use parafermionic observables (more precisely, we will use a corollary which may be deduced from the study of such observables) introduced independently in [FK80, RC06, Smi10] to prove our main theorem as well as several corollaries. Since such observables have been found in a large class of planar critical models, we believe that similar applications can be obtained in these models as well, and that the tools developed in this article should be instrumental there. Last but not least, the techniques developed in this article improve the understanding of the scaling limit of these models. We think that they will be useful for proving conformal invariance of these scaling limits.

1.2 Definition of the models and main statements

Definition of Potts models and statement of the main theorem

Consider an integer $q \geq 2$ and a subgraph $G = (V_G, E_G)$ of the square lattice \mathbb{Z}^2 . Here and below, V_G is the set of *vertices* of G and $E_G \subset V_G^2$ is the set of *edges*. For simplicity, the square lattice will be identified with its set of vertices, namely \mathbb{Z}^2 . For two vertices $x, y \in V_G$, $x \sim y$ denotes the fact that $(x, y) \in E_G$.

Let $\tau \in \{1, \dots, q\}^{\mathbb{Z}^2}$. The q -state Potts model on G with boundary conditions τ is defined as follows. The space of configurations is $\Omega = \{1, \dots, q\}^{\mathbb{Z}^2}$. For a configuration $\sigma = (\sigma_x : x \in \mathbb{Z}^2) \in \Omega$, the quantity σ_x is called the *spin* at x (it is sometimes interpreted as being a color). The *energy* of a configuration $\sigma \in \Omega$ is given by the Hamiltonian

$$H_G^\tau(\sigma) := \begin{cases} - \sum_{\substack{x \sim y \\ \{x,y\} \cap G \neq \emptyset}} \delta_{\sigma_x, \sigma_y} & \text{if } \sigma_x = \tau_x \text{ for } x \notin V_G, \\ \infty & \text{otherwise.} \end{cases}$$

Above, $\delta_{a,b}$ denotes the Kronecker symbol equal to 1 if $a = b$ and 0 otherwise. The spin-configuration is sampled proportionally to its Boltzmann weight: at an inverse-temperature β , the probability $\mu_{G,\beta}^\tau$ of a configuration σ is defined by

$$\mu_{G,\beta}^\tau[\sigma] := \frac{e^{-\beta H_G^\tau(\sigma)}}{Z_{G,\beta}^\tau} \quad \text{where} \quad Z_{G,\beta}^\tau := \sum_{\sigma \in \Omega} e^{-\beta H_G^\tau(\sigma)}$$

is the so-called *partition function* defined in such a way that the sum of the weights over all possible configurations equals 1. By construction, configurations that do not coincide with τ outside of G have probability 0.

Infinite-volume Gibbs measures can be defined by taking limits, as G tends to \mathbb{Z}^2 , of finite-volume measures $\mu_{G,\beta}^\tau$. In particular, if $(i) := \tau$ denotes the constant configuration equal to $i \in \{1, \dots, q\}$, the sequence of measures $\mu_{G,\beta}^{(i)}$ converges, as G tends to infinity, to a Gibbs measure denoted by $\mu_{\mathbb{Z}^2,\beta}^{(i)}$. This measure is called the *infinite-volume Gibbs measure with monochromatic boundary conditions* i .

The Potts models undergo a phase transition in infinite volume at a certain *critical inverse-temperature* $\beta_c(q) \in (0, \infty)$ in the following sense

$$\mu_{\mathbb{Z}^2,\beta}^{(i)}[\sigma_0 = i] = \begin{cases} \frac{1}{q} & \text{if } \beta < \beta_c(q), \\ \frac{1}{q} + m_\beta > \frac{1}{q} & \text{if } \beta > \beta_c(q). \end{cases}$$

The value $\beta_c(q)$ is computed in [BDC12a] and is equal to $\log(1 + \sqrt{q})$ for any integer q (this value was previously known for $q = 2$ [Ons44] and $q \geq 26$ [LMR86]).

This article is devoted to the study of the phase transition at $\beta = \beta_c(q)$. The phase transition is said to be *continuous* if $\mu_{\mathbb{Z}^2,\beta_c(q)}^{(i)}[\sigma_0 = i] = \frac{1}{q}$ and *discontinuous* otherwise. The main result is the following.

Theorem 1.1 (Continuity of the phase transition for 2, 3 or 4 colors). *Let $q \in \{2, 3, 4\}$. Then for any $i \in \{1, \dots, q\}$, we have*

$$\mu_{\mathbb{Z}^2,\beta_c(q)}^{(i)}[\sigma_0 = i] = \frac{1}{q}.$$

This result was known in the $q = 2$ case. For two colors, the model is simply the Ising model. Onsager computed the free energy in [Ons44] and Yang obtained a formula for the magnetization in [Yan52]. In particular, this formula implies that the magnetization

is zero at criticality. This results has been reproved in a number of papers since then. Let us mention a recent proof [Wer09] not harnessing any exact integrability.

For q equal to 3 or 4, the result appears to be new. As mentioned in the previous section, exact (yet non rigorous) computations performed by Baxter strongly suggest that the phase transition is continuous for $q \leq 4$, and discontinuous for $q > 4$. This result therefore tackles the whole range of q for which the phase transition is continuous. Let us mention that the technology developed here is not restricted to the study of Potts models for $q \leq 4$: a property of Potts models with $q \geq 5$ colors witnessing ordering at criticality is also derived, see Proposition 4.5. Unfortunately, we were unable to show rigorously that the phase transition is discontinuous in the sense defined above.

In dimension $d \geq 3$, the phase transition is expected to be continuous if and only if $q = 2$. The best results in this direction are the following. On the one hand, the fact that the phase transition is continuous for the Ising model ($q = 2$) is known for any $d \geq 3$ [ADCS13] (in fact, the critical exponents are known to be taking their mean-field value for $d \geq 4$ [AF86]). On the other hand, mean-field considerations together with Reflection Positivity enabled [BCC06] to prove that for any $q \geq 3$, the q -state Potts model undergoes a discontinuous phase transition above some dimension $d_c(q)$. Finally, Reflection Positivity can be harnessed to prove that for any $d \geq 2$, the phase transition is discontinuous provided q is large enough [KS82].

The random-cluster model

The proof of Theorem 1.1 is based on the study of a graphical representation of the Potts model, called the *random-cluster model*. Let us define it properly. Consider $p \in [0, 1]$, $q > 0$ and a subgraph $G = (V_G, E_G)$ of the square lattice. A configuration ω is an element of $\Omega' = \{0, 1\}^{E_G}$. An edge e with $\omega(e) = 1$ is said to be *open*, while an edge with $\omega(e) = 0$ is said to be *closed*. Two vertices x and y in V_G are said to be *connected* (this event is denoted by $x \longleftrightarrow y$) if there exists a sequence of vertices $x = v_1, v_2, \dots, v_{r-1}, v_r = y$ such that (v_i, v_{i+1}) is an open edge for every $i < r$. A *connected component* of ω is a maximal connected subgraph of ω . Let $o(\omega)$ and $c(\omega)$ be respectively the number of open and closed edges in ω .

The *random-cluster measure* on E_G with edge-weight p , cluster-weight q , and **free** boundary conditions is defined by the formula

$$\phi_{G,p,q}^0[\omega] = \frac{p^{o(\omega)}(1-p)^{c(\omega)}q^{k_0(\omega)}}{Z_{G,p,q}^0},$$

where $k_0(\omega)$ is the number of connected components of the graph ω , and $Z_{G,p,q}^0$ is defined in such a way that the sum of the weights over all possible configurations equals 1. We also define the *random-cluster measure* on E_G with edge-weight p , cluster-weight q , and **wired**

boundary conditions by the formula

$$\phi_{G,p,q}^1[\omega] = \frac{p^{o(\omega)}(1-p)^{c(\omega)}q^{k_1(\omega)}}{Z_{G,p,q}^1},$$

where $k_1(\omega)$ is the number of connected components of the graph ω , except that all the connected components of vertices in the vertex boundary ∂G , i.e. the set of vertices in V_G with less than four neighbors in G , are counted as being part of the same connected component. Again, $Z_{G,p,q}^1$ is defined in such a way that the sum of the weights over all possible configurations equals 1.

For $q \geq 1$, infinite-volume measures can be defined on \mathbb{Z}^2 by taking limits of finite-volume measures for graphs tending to \mathbb{Z}^2 . In particular, the *infinite-volume random-cluster measure with free (resp. wired) boundary conditions* $\phi_{\mathbb{Z}^2,p,q}^0$ (resp. $\phi_{\mathbb{Z}^2,p,q}^1$) can be defined as the limit of the sequence of measures $\phi_{G,p,q}^0$ (resp. $\phi_{G,p,q}^1$) for $G \nearrow \mathbb{Z}^2$. We refer the reader to [Gri06] for more details on this construction.

The random-cluster model with $q \geq 1$ undergoes a phase transition in infinite volume in the following sense. There exists $p_c(q) \in (0, 1)$ such that

$$\phi_{\mathbb{Z}^2,p,q}^1[0 \longleftrightarrow \infty] = \begin{cases} 0 & \text{if } p < p_c(q), \\ \theta^1(p, q) > 0 & \text{if } p > p_c(q), \end{cases}$$

where $\{0 \longleftrightarrow \infty\}$ denotes the event that 0 belongs to an infinite connected component. The value of $p_c(q)$ was recently proved to be equal to $\sqrt{q}/(1 + \sqrt{q})$ for any $q \geq 1$ in [BDC12a]. The result was previously proved in [Kes80] for Bernoulli percolation ($q = 1$), in [Ons44] for $q = 2$ using the connection with the Ising model and in [LMMS⁺91] for $q \geq 25.72$.

Similarly to the Potts model case, a notion of continuous/discontinuous phase transition can be defined: the phase transition is said to be *continuous* if $\phi_{\mathbb{Z}^2,p_c(q),q}^1[0 \longleftrightarrow \infty] = 0$ and discontinuous otherwise. The following theorem is the *alter ego* of Theorem 1.1.

Theorem 1.2 (Continuous phase transition for cluster-weight $1 \leq q \leq 4$). *Let $q \in [1, 4]$, then $\phi_{\mathbb{Z}^2,p_c(q),q}^1[0 \longleftrightarrow \infty] = 0$.*

Let us now describe briefly the coupling between Potts models and their random-cluster representation as well. Fix $q \geq 2$ integer. From a random-cluster configuration sampled according to $\phi_{G,p,q}^1$, color each component (meaning all the vertices in it) with one color chosen uniformly in $\{1, \dots, q\}$, except for the connected component containing the vertices in ∂G which receive color i . The law of the random coloring thus obtained is $\mu_{G,\beta}^{(i)}$, where $\beta = -\log(1-p)$. This coupling between the random-cluster model with integer cluster-weight and the Potts models enables us to deduce Theorem 1.1 from Theorem 1.2 immediately. For this reason, we now focus on Theorem 1.2.

An alternative for the behavior of critical random-cluster models

Proving Theorem 1.2 requires a much better understanding of the critical phase than the one available until now. Indeed, except for the $q = 1$, $q = 2$ and $q \geq 25.72$ cases, very little was known on critical random-cluster models. The following theorem provides new insight on the possible critical behavior of these models.

For an integer n , let Λ_n denote the box $[-n, n]^2$ of size n . An open path is a path of adjacent open edges (we refer to the next section for a formal definition). Let $0 \longleftrightarrow \partial\Lambda_n$ be the event that there exists an open path from the origin to the boundary of Λ_n . For a rectangle $R = [a, b] \times [c, d]$, let $\mathcal{C}_h(R)$ be the event that there exists an open path in R from $\{a\} \times [c, d]$ to $\{b\} \times [c, d]$.

Theorem 1.3. *Let $q \geq 1$. The following assertions are equivalent :*

P1 (Absence of infinite cluster at criticality) $\phi_{\mathbb{Z}^2, p_c, q}^1 [0 \longleftrightarrow \infty] = 0$.

P2 $\phi_{\mathbb{Z}^2, p_c, q}^0 = \phi_{\mathbb{Z}^2, p_c, q}^1$.

P3 (Infinite susceptibility) $\chi^0(p_c, q) := \sum_{x \in \mathbb{Z}^2} \phi_{\mathbb{Z}^2, p_c, q}^0 [0 \longleftrightarrow x] = \infty$.

P4 (Sub-exponential decay for free boundary conditions)

$$\lim_{n \rightarrow \infty} \frac{1}{n} \log \phi_{\mathbb{Z}^2, p_c, q}^0 [0 \longleftrightarrow \partial\Lambda_n] = 0.$$

P5 (RSW) For any $\alpha > 0$, there exists $c = c(\alpha) > 0$ such that for all $n \geq 1$,

$$\phi_{[-n, (\alpha+1)n] \times [-n, 2n], p_c, q}^0 [\mathcal{C}_h([0, \alpha n] \times [0, n])] \geq c.$$

The previous theorem does not show that these conditions are all satisfied, but that they are equivalent. In fact, whether the conditions are satisfied or not will depend on the value of q , see Section 1.2 for a more detailed discussion.

The previous result was previously known in a few cases:

- *Bernoulli percolation (random-cluster model with $q = 1$).* In such case **P2** is obviously satisfied. Furthermore, Russo [Rus78] proved that **P1**, **P3** and **P4** are all true (and therefore equivalent). Finally, **P5** was proved by Russo [Rus78] and Seymour-Welsh [SW78].
- *Random-cluster model with $q = 2$.* This model is directly related to the Ising via the Edwards-Sokal coupling. Therefore, all of these properties can be proved to be true using the following results on the Ising model: Onsager proved that the critical Ising measure is unique and that the phase transition is continuous in [Ons44]. Properties **P3** and **P4** follow from Simon's correlation inequality for the Ising model [Sim80]. Property **P5** was proved in [DCHN11] using a proof specific to the Ising model. Interestingly, in the Ising case each property is derived independently and no direct equivalence was known previously.

- *Random-cluster model with $q \geq 25.72$.* In this case, none of the above properties are satisfied, as proved by using the Pirogov-Sinai technology [LMMS⁺91].

Except for these special cases, no general result was known, and Theorem 1.3 represents, to the best of our knowledge, the first formal proof of the equivalence between these conditions for a relatively large class of dependent percolation models. We expect that a similar result can be stated for a large class of models, and that some of the tools developed in this article may be extended to these models.

Remark 1.4. **P4** \Rightarrow **P1** implies that whenever there is an infinite-cluster for the wired boundary conditions, correlations decay exponentially fast at criticality for free boundary conditions.

Before proceeding further, let us discuss alternative conditions which could replace the conditions **P1**–**P5**. Once again, q is assumed to be larger or equal to 1.

The condition **P1** has the following interpretation: it is equivalent to

$$\mathbf{P1}' \text{ (Continuous phase transition)} \lim_{p \nearrow p_c} \phi_{\mathbb{Z}^2, p, q}^1 [0 \longleftrightarrow \infty] = 0$$

(simply use [Gri06, (4.35)]). Note that the (almost sure) absence of an infinite-cluster for $\phi_{\mathbb{Z}^2, p_c, q}^0$ follows from Zhang's argument [Gri06, Theorem (6.17)(a)] and is true for any $q \geq 1$. Nevertheless, it does not imply the (almost sure) absence of an infinite-cluster for $\phi_{\mathbb{Z}^2, p_c, q}^1$ nor the continuity of the phase transition.

The property **P2** can be reinterpreted in terms of infinite-volume measures (see [Gri06] for a formal definition). Then, **P2** is equivalent to (see [Gri06, Theorem (4.34)])

P2' The infinite-volume measure on \mathbb{Z}^2 at p_c and q is unique.

Let us now turn to **P4** which can be understood in terms of the so-called *correlation length* defined for $p < p_c(q)$ by the formula

$$\xi(p, q) = \left(- \lim_{n \rightarrow \infty} \frac{1}{n} \log \phi_{\mathbb{Z}^2, p, q}^0 [(0, 0) \longleftrightarrow (n, 0)] \right)^{-1}.$$

Now, **P4** is equivalent to

P4' (vanishing mass-gap) $\xi(p, q)$ tends to $+\infty$ as $p \nearrow p_c(q)$.

Condition **P1** together with **P3** have an interesting consequence in terms of the order of the phase transition for the Potts model. We do not enter in the details here but let us briefly mention that properties **P1** and **P3** are respectively equivalent to the continuity and the non-differentiability with respect to the magnetic field h of the free energy at $(\beta = \beta_c, h = 0)$. Therefore, these properties mean that the phase transition of the corresponding Potts model is of *second order*. The properties **P1**–**P4** (and their equivalent formulations) are classical definitions describing continuous phase transitions and are believed to be equivalent for many natural models, even though it is a priori unclear how this can be proved in a robust way.

Now that we have an interpretation for properties **P1–P4**, let us explain why **P5** is of particular interest: it provides an equivalent to the RSW theorem proved in [BDC12a] which is *uniform in boundary conditions* (see Proposition 3.1 below). This uniformity with respect to boundary conditions is crucial for applications, especially when trying to decouple events, see e.g. Section 1.3. Let us also emphasize that the fact that **P5** can be derived from the other properties requires the development of a Russo-Seymour-Welsh theory for dependent percolation models. As mentioned above, such a theory existed for Bernoulli percolation [SW78, Rus78], and for $q = 2$ [DCHN11], but in the latter case the proof was based on discrete holomorphicity, hence hiding the close connection between **P5** and the other properties. This Russo-Seymour-Welsh theory is expected to apply to a large class of planar models, and we insist on the fact that uniformity on boundary conditions is crucial.

Remark 1.5. The restriction on boundary conditions being at distance n from the rectangle can be relaxed in the following way: if **P5** holds, then for any $\alpha > 0$ and $\varepsilon > 0$, there exists $c = c(\alpha, \varepsilon) > 0$ such that for every $n \geq 1$,

$$\phi_{[-\varepsilon n, (\alpha + \varepsilon)n] \times [-\varepsilon n, (1 + \varepsilon)n], p_c, q}^\xi [C_h([0, \alpha n] \times [0, n])] \geq c.$$

It is natural to ask why boundary conditions are fixed at distance εn of the rectangle $[0, \alpha n] \times [0, n]$ and not simply on the boundary. The reason is the latter property is not equivalent to **P1–P5**. Indeed, it may in fact be the case that **P5** holds but that crossing probabilities of rectangles $[0, \alpha n] \times [0, n]$ with free boundary conditions on their boundary converge to zero as n tends to infinity. Such phenomenon does not occur for $1 \leq q < 4$ as shown in Theorem 1.13 but is expected to occur for $q = 4$. In conclusion, we will always work with boundary conditions at “macroscopic distance” from the boundary.

Random-cluster model with cluster weight $q \in [1, 4]$

The previous alternative provides us with a powerful tool to prove Theorem 1.2. Namely, it is sufficient to prove one of the properties **P2–P5** when $1 \leq q \leq 4$ to derive our result. We will therefore focus on property **P4**, which is the easiest to check.

In order to prove **P4**, we will use estimate on the probability of being connected by an open path which can be deduced from the fact that discrete contour integrals of the so-called (*edge*) *parafermionic observable* vanish. This observable was introduced in [Smi10] for $q \in (0, 4)$ and then generalized to $q > 4$ in [BDCS12] (the $q = 4$ case also requires the introduction of a slightly different observable). They satisfy local relations that can be understood as discretizations of the Cauchy-Riemann equations when the model is critical. These relations imply that discrete contour integrals vanish. We do not recall the definition of the parafermionic observable nor do we describe its principal properties, and simply mention an important corollary (see Theorem 4.3). For more details on the parafermionic observable, we refer to [DC13, Chapter 6].

In any case, the parafermionic observable can be used to show the following theorem dealing with random-cluster models with $1 \leq q \leq 4$.

Theorem 1.6 ([DC12]). *Let $1 \leq q \leq 4$, then $\lim_{n \rightarrow \infty} \frac{1}{n} \log \phi_{\mathbb{Z}^2, p_c(q), q}^0 [0 \longleftrightarrow \partial \Lambda_n] = 0$.*

Theorem 1.6 together with Theorem 1.3 implies that **P1–P5** are satisfied for $1 \leq q \leq 4$. In particular, these two theorems imply Theorem 1.2.

As mentioned above, the proof harnesses the fact that the discrete contour integrals of parafermionic observables vanish. The intrinsic difficulty of this theorem relies on the fact that, for our proof to work, the random-cluster model needs to be considered on the universal cover of \mathbb{Z}^2 minus a face; see Section 2.1 for more details. Bootstrapping the information from the universal cover to the plane is not straightforward.

Investigating more general lattice models on this universal cover seems an interesting direction of research. Indeed, lattice models on Riemann surfaces have been studied extensively. Nevertheless, the theory mostly deals with surfaces of higher genus, while in our case we are facing (a discretization of) a simply connected planar Riemann surface with a logarithmic singularity at the origin.

The proof of Theorem 1.6 can be found in [DC12]. Nevertheless, other applications of parafermionic observables which are based on the same principle will be derived in this article, and most of the tools required for the proof of Theorem 1.6 will be harnessed in other places as well. In addition, some of the ideas of the proof of Theorem 1.3 allows one to simplify drastically the proof exposed in [DC12]. We therefore chose to include a streamlined version of the proof here (still, the details on parafermionic observables are omitted).

In order to conclude this section, let us mention that because the discrete contour integrals vanish, the parafermionic observable is therefore a discretization of a divergence-free differential form. For $q = 2$ (which corresponds to the Ising model), further information can be extracted from local integrability and the observable satisfies a strong notion of discrete holomorphicity, called *s-holomorphicity*. In this case, the observable can be used to understand many properties on the model, including conformal invariance of the observable [CS12, Smi10] and loops [DDCH⁺14, HK13], correlations [CI13, Hon10, HS11] and crossing probabilities [BDCH12, DCHN11, CDCH12]. It can also be extended away from criticality [DCGP14]. We do not discuss special features of the $q = 2$ case and we refer to the extensive literature for further information.

1.3 Applications to the study of the critical phase for $1 \leq q \leq 4$

The previous theorems have a large number of consequences regarding the understanding of the critical phase. We list some of them now.

Mixing properties at criticality

The bound **P5** on crossing probabilities enables us to study the spatial mixing properties at criticality. One may decouple events which are depending on edges in different areas of the space, and therefore compensate for the lack of independence. The next theorem illustrates this fact. It will be used in many occasions in the reminder of this book.

Theorem 1.7 (Polynomial ratio weak mixing under condition **P5**). *Fix $q \geq 1$ such that Property **P5** of Theorem 1.3 is satisfied. There exists $\alpha > 0$ such that for any $2k \leq n$ and for any event A depending only on edges in Λ_k ,*

$$|\phi_{\Lambda_n, p_c, q}^\xi [A] - \phi_{\Lambda_n, p_c, q}^\psi [A]| \leq \left(\frac{k}{n}\right)^\alpha \phi_{\Lambda_n, p_c, q}^\xi [A]$$

uniformly in boundary conditions ξ and ψ .

Together with the Domain Markov property, this result implies the following inequality for $2k \leq m \leq n$ (with n possibly infinite),

$$|\phi_{\Lambda_n, p_c, q}^\xi [A \cap B] - \phi_{p_c, q, \Lambda_n}^\xi [A] \phi_{\Lambda_n, p_c, q}^\xi [B]| \leq \left(\frac{k}{m}\right)^\alpha \phi_{\Lambda_n, p_c, q}^\xi [A] \phi_{\Lambda_n, p_c, q}^\xi [B],$$

where the boundary conditions ξ are arbitrary, A is an event depending on edges of Λ_k only, and B is an event depending on edges of $\Lambda_n \setminus \Lambda_m$.

Remark 1.8. For $p \neq p_c(q)$, estimates of this type (with an exponential speed of convergence instead of polynomial) can be established by using the rate of spatial decay for the influence of a single vertex [Ale98]. At criticality, the correlation between distant events does not boil down to correlations between points and a finer argument must be harnessed. Crossing-probability estimates which are uniform in boundary conditions are the key in order to prove such results.

Remark 1.9. We will see several specific applications of this theorem in the next chapters. The most striking consequence is the fact that the dependence on boundary conditions can be forgotten as long as the boundary conditions are sufficiently distant from the set of edges determining whether the events under consideration occur or not. For instance, it allows us to state several theorems in infinite volume, keeping in mind that most of these results possess natural counterparts in finite volume by using the fact that

$$c\phi_{p_c, q}^\xi [A] \leq \phi_{p_c, q, \Lambda_{2n}}^\xi [A] \leq C\phi_{p_c, q}^\xi [A]$$

for any event A depending on edges in Λ_n only, and any boundary conditions ξ (the constants c and C are universal).

Consequences for the scaling limit

The phase transition being continuous, the scaling limit of the model is expected to be conformally invariant. This work opens new perspectives in the study of this scaling

limit and we now mention several possible directions of research. We refer the reader to Section 4 for the definition of Dobrushin domains and the exploration path.

Conjecture 1.10 (Schramm, [Sch07]). *Let $0 \leq q \leq 4$ and $p = p_c(q)$. Let (Ω, a, b) be a simply connected domain with two points a and b . Let $(\Omega_\delta, a_\delta, b_\delta)$ be a sequence of Dobrushin domains converging in the Carathéodory sense towards (Ω, a, b) . The law of the exploration path (γ_δ) for critical random-cluster model with cluster-weight q and Dobrushin boundary conditions in $(\Omega_\delta, a_\delta, b_\delta)$ converges, as the mesh size δ tends to zero, to the Schramm-Loewner Evolution between a and b in Ω with parameter $\kappa = \frac{4\pi}{\arccos(-\sqrt{q}/2)}$.*

Schramm-Loewner Evolution are very-well studied objects; see e.g. [Law05]. This convergence would therefore lead to a deep understanding of the critical phase of the random-cluster models. For the $q = 0$ case corresponding to the perimeter curve of the uniform spanning tree, the conjecture was proved by Lawler, Schramm and Werner [LSW04]. The $q = 2$ case was formally proved in [DDCH⁺14] even though the fundamental contribution leading to this result was achieved in [Smi10]. Conjecture 1.10 is open for any other values of q (even for the $q = 1$ case corresponding to Bernoulli percolation).

Lawler, Schramm and Werner proposed a global strategy for proving Conjecture 1.10, which can be summarized as follows:

1. Prove compactness of the family of exploration paths $(\gamma_\delta)_{\delta>0}$ and show that any sub-sequential limits can be parametrized as a Loewner chain (with a continuous driving process denoted by W).
2. Prove the convergence of some discrete observables of the model.
3. Extract from the limit of these observables enough information to evaluate the conditional expectation and quadratic variation of W_t and use Lévy's theorem to prove that W_t is equal to $\sqrt{\kappa}B_t$, where B_t is the standard Brownian motion. As a consequence, any sub-sequential limits must be the Schramm-Loewner Evolution of parameter κ .

Step 1 of this program is provided by Theorem 1.11 below. We refer to [Law05] for details on Loewner chains.

Let X be the set of continuous parametrized curves and d be the distance on X defined by

$$d(\gamma_1, \gamma_2) = \min_{\varphi_1: [0,1] \rightarrow I, \varphi_2: [0,1] \rightarrow J \text{ increasing}} \sup_{t \in I} |\gamma_1(\varphi_1(t)) - \gamma_2(\varphi_2(t))|,$$

where $\gamma_1 : I \rightarrow \mathbb{C}$ and $\gamma_2 : J \rightarrow \mathbb{C}$. Note that I and J can be equal to $\mathbb{R}_+ \cup \{\infty\}$.

Theorem 1.11. *Fix $1 \leq q \leq 4$, $p = p_c(q)$ and a simply connected domain Ω with two marked points on its boundary a and b . Let $(\Omega_\delta, a_\delta, b_\delta)$ be a sequence of Dobrushin domains converging in the Carathéodory sense towards (Ω, a, b) . Define γ_δ to be the exploration path in $(\Omega_\delta, a_\delta, b_\delta)$ with Dobrushin boundary conditions. Then, the family (γ_δ) is tight and any sub-sequential limit γ satisfies the following properties:*

- R1 γ is almost surely a continuous non-intersecting curve from a to b staying in Ω .
- R2 For any parametrization $\gamma : [0, 1] \rightarrow \infty$, b is a simple point, in the sense that $\gamma(t) = b$ implies $t = 1$. Furthermore, almost surely $\gamma(t)$ is on the boundary of $\Omega \setminus \gamma[0, t]$ for any $t \in [0, 1]$.
- R3 Let Φ be a conformal map from Ω to the upper half-plane \mathbb{H} sending a to 0 and b to ∞ . For any parametrization $\gamma : [0, 1] \rightarrow \mathbb{R}_+$, the h -capacity of the hull \widehat{K}_s of $\Phi(\gamma[0, s])$ tends to ∞ when s approaches 1. Furthermore, if $(\widehat{K}_t)_{t \geq 0}$ denotes $(\widehat{K}_s)_{s \in [0, 1]}$ parametrized by h -capacity, then $(\widehat{K}_t)_{t \geq 0}$ is a Loewner chain with a driving process $(W_t)_{t \geq 0}$ which is α -Hölder for any $\alpha < 1/2$ almost surely. Furthermore, there exists $\varepsilon > 0$ such that for any $t > 0$, $\mathbb{E}[\exp(\varepsilon W_t / \sqrt{t})] < \infty$.
- R4 There exists $\alpha > 0$ such that γ has Hausdorff dimension between $1 + \alpha$ and $2 - \alpha$ almost surely.

Tightness criteria for random planar curves were first introduced in [AB99]. They were used as a key step in the proof of convergence of interfaces to the Schramm-Loewner Evolution for Bernoulli site percolation on the triangular lattice [CN07]. These criteria were improved in [KS12] to treat the case of random non-self-crossing planar curves parametrized as Loewner chains.

Step 2 represents the main challenge in the program outlined above (Step 3 is easy once Steps 1 and 2 have been achieved, see e.g. [DC13, Section 13.2]). Smirnov succeeded to perform Step 2 for $q = 2$ using the fermionic observable [Smi10]. He also proposed to consider the parafermionic observables introduced in [Smi06] as a potential candidate for Step 2 in the case of general cluster-weights $q < 4$ (let us mention that the choice of the observables in Step 2 are not determined uniquely). For completeness, let us mention a conjecture which, together with the results of this paper, would imply Conjecture 1.10.

Conjecture 1.12 (Smirnov). *Let $0 < q < 4$, $p = p_c(q)$ and (Ω, a, b) be a simply connected domain with two points on its boundary. For every $z \in \Omega$,*

$$\frac{1}{(2\delta)^\sigma} F_\delta(z) \rightarrow \phi'(z)^\sigma \quad \text{when } \delta \rightarrow 0$$

where

- for $\delta > 0$, F_δ is the vertex parafermionic observable of [Smi06] at $p_c(q)$ in $(\Omega_\delta, a_\delta, b_\delta)$.
- $\sigma = 1 - \frac{2}{\pi} \arccos(\sqrt{q}/2)$,
- ϕ is any conformal map from Ω to $\mathbb{R} \times (0, 1)$ sending a to $-\infty$ and b to ∞ .

Let us mention that even though we are currently unable to prove Conjecture 1.12 (and therefore Conjecture 1.10), we are still able to obtain nice results on the scaling limit. Indeed, the geometry of the random curve γ can be easily related to the geometry of clusters boundaries at a discrete level. Keeping in mind that we are not able to prove that the scaling limit of cluster boundaries is well-defined, we may still extract sub-sequential limits and ask simple properties about these objects. For instance, property **R4** of the

previous theorem implies that any sub-sequential scaling limit of cluster boundaries of random-cluster models with $1 \leq q \leq 4$ is a random fractal. The next theorem corresponds to another property of these sub-sequential scaling limits: it shows that macroscopic clusters touch the boundary of a smooth domain, for instance a rectangle, with free boundary conditions.

Theorem 1.13. *Fix $1 \leq q < 4$ and $\alpha > 0$. There exists $c_1 > 0$ such that for any $n \geq 1$,*

$$\Phi_{[0, \alpha n] \times [0, n], p_c(q), q}^0[\mathcal{C}_h([0, \alpha n] \times [0, n])] \geq c_1.$$

In the previous theorem, the free boundary conditions are directly on the boundary of the rectangle $[0, \alpha n] \times [0, n]$. This corresponds to the most naive generalization of the Russo-Seymour-Welsh theorem.

Consequences for critical exponents

Theorem 1.6 has several implications which are postponed to a future paper for so-called arm-events. Let us quickly mention that one can prove a priori bounds on the probability of arm-events, the so-called quasi-multiplicativity and extendability of these probabilities, as well as universal exponents. These tools are crucial in order to compute critical exponents via the understanding of the scaling limit. Let us also mention that universal bounds can be deduced between different critical exponents.

Theorem 1.6 is also instrumental in the understanding of the near-critical regime, and in particular to derive the scaling relations between critical exponents (see [DC13, Section 13.2.3]).

In another direction, Theorem 1.3 provides the relevant criteria in order to prove that the critical exponents of random-cluster models are universal on isoradial graphs (see [GM13, CS12] for the case of percolation and Ising). This should be the object of a future work.

Consequences for Potts

The Edwards-Sokal coupling enables one to transfer properties from the random-cluster model to the Potts model. In order to illustrate this fact, let us state the following theorem (many other results could be proved, but this would make this article substantially longer) which is a direct consequence of the previous theorems.

Theorem 1.14. *For $q \in \{2, 3, 4\}$, there exists a unique Gibbs measure $\mu_{\mathbb{Z}^2, \beta_c(q), q}$ for the critical q -state Potts model. Furthermore, there exist $\eta_1, \eta_2 > 0$ such that for any $x \in \mathbb{Z}^2 \setminus \{0\}$,*

$$\frac{1}{|x|^{\eta_1}} \leq \mu_{\mathbb{Z}^2, \beta_c(q), q}[\sigma_x = \sigma_0] - \frac{1}{q} \leq \frac{1}{|x|^{\eta_2}}.$$

The main result should also have consequences for the Glauber dynamics of the Potts model. Recently, Lubetzky and Sly [LS12] used spatial mixing properties of the Ising

model in order to derive an important conjecture on the mixing time of the Glauber dynamics of the Ising model at criticality. As a key step, they harness the equivalent of **P5** together with tools from the analysis of Markov chains, to provide polynomial upper bounds on the inverse spectral gap of the Glauber dynamics (and also on the total variation mixing time). We plan to prove similar results for 3 and 4 states Potts models in a subsequent paper.

2 Preliminaries

The norm $|\cdot|$ will denote the Euclidean norm.

Primal and dual graphs. The *square lattice* $(\mathbb{Z}^2, \mathbb{E})$ is the graph with vertex set $\mathbb{Z}^2 = \{(n, m) : n, m \in \mathbb{Z}\}$ and edge set \mathbb{E} given by edges between nearest neighbors. The square lattice will be identified with the set of vertices, i.e. \mathbb{Z}^2 . The dual square lattice $(\mathbb{Z}^2)^*$ is the dual graph of \mathbb{Z}^2 . The vertex set is $(\frac{1}{2}, \frac{1}{2}) + \mathbb{Z}^2$ and the edges are given by nearest neighbors. The vertices and edges of $(\mathbb{Z}^2)^*$ are called *dual-vertices* and *dual-edges*. In particular, every edge of \mathbb{Z}^2 is naturally associated to a dual-edge, denoted by e^* , that it crosses in its center.

Except otherwise specified, we will only consider subgraphs of $\mathbb{Z}^2, (\mathbb{Z}^2)^*$, and use the following notations. For a graph G , we denote by V_G its vertex set and by E_G its edge set. Two vertices x and y are *neighbors (in G)* if $(x, y) \in E_G$. In such case, we write $x \sim y$. Furthermore, if x is an end-point of e , we say that e is *incident* to x . Finally, the *boundary* of G , denoted by ∂G , is the set of vertices of G with strictly fewer than four incident edges in E_G .

For a graph $G \subset \mathbb{Z}^2$, we define G^* to be the subgraph of $(\mathbb{Z}^2)^*$ with edge-set $E_{G^*} = \{e^* : e \in E_G\}$ and vertex set given by the end-points of these dual-edges.

Let Λ_n be the subgraph of \mathbb{Z}^2 induced by the vertex set $[-n, n]^2$.

Connectivity properties in graphs. A path in \mathbb{Z}^2 is a sequence of vertices v_0, \dots, v_n in \mathbb{Z}^2 such that $v_i \sim v_{i+1}$ for any $0 \leq i < n$. The path will often be identified with the set of edges $(v_0, v_1), (v_1, v_2), \dots, (v_{n-1}, v_n)$. The path is said *to start at x and to end at y* if $v_0 = x$ and $v_n = y$. If $x = y$, the path is called a *circuit*.

Two vertices x and y of G are *connected* if there exists a path of edges in E_G from x to y . A graph is said to be *connected* if any two vertices of G are connected. The *connected components* of G will be the maximal connected subgraphs of G . For three sets $X, Y \subset V_G$ and $F \subset E_G$, we say that X is connected to Y in F (we denote this fact by $X \xleftrightarrow{F} Y$) if there exist two vertices $x \in X$ and $y \in Y$ and a path of edges in F starting at x and ending at y .

2.1 Background on the random-cluster model

This section is devoted to a very brief description of the tools we will use during the proofs of the next sections. The reader may consult [Gri06] or [DC13] for more details, proofs and original references.

Random-cluster model and critical point. Let $G = (V, E)$ be a finite subgraph of \mathbb{Z}^2 or \mathbb{U} . A configuration on G is an element $\omega = \{\omega(e) : e \in E\} \in \{0, 1\}^E$. An edge e is said to be *open* if $\omega(e) = 1$, and *closed* otherwise. A configuration ω can be seen as a subgraph of G , whose vertex set is V and edge set is the set of open edges $\{e \in E : \omega(e) = 1\}$. A path (resp. circuit) in ω will be called an *open path* (resp. *open circuit*). Two sets X and Y are *connected* in ω if there exists an open path from X to Y . The connected components of ω will be called *clusters*.

The boundary conditions on G are given by a partition $\xi = P_1 \sqcup \dots \sqcup P_k$ of ∂G . From a configuration ω , define ω^ξ to be the graph with vertex set V and edge set given by edges of ω together with edges of the form (x, y) , where x and y belong to the same P_i . In such case, the vertices x and y are sometimes said to be *wired* together.

Definition 2.1. The *random-cluster measure on G with edge-weight p , cluster-weight q , and boundary conditions ξ* is defined by the formula

$$\phi_{G,p,q}^\xi[\omega] = \frac{p^{o(\omega)}(1-p)^{c(\omega)}q^{k(\omega^\xi)}}{Z_{G,p,q}^\xi},$$

where $k(\omega^\xi)$ is the number of connected components of the graph ω^ξ . As usual, $Z_{G,p,q}^\xi$ is defined in such a way that the sum of the weights over all possible configurations equals 1.

The following boundary conditions play a special role in this article. The partition ξ composed of singletons only is called the *free boundary conditions* and is denoted by $\xi = 0$. It corresponds to no additional connections. The partition $\xi = \{\partial G\}$ is called the *wired boundary conditions* and is denoted by $\xi = 1$. It corresponds to the fact that all the boundary vertices are connected by boundary conditions.

Infinite-volume measures and critical point. We do not aim for a complete description, or even a formal definition of random-cluster measures on \mathbb{Z}^2 and we refer to [DC13, Chapter 4] for details. When $q \geq 1$, infinite-volume random-cluster measures can be defined by taking the limit of finite-volume measures. In particular, the sequence of measures $\phi_{\Lambda_n,p,q}^1$ (resp. $\phi_{\Lambda_n,p,q}^0$) converges to the *infinite-volume measure with wired (resp. free) boundary conditions* $\phi_{\mathbb{Z}^2,p,q}^1$ (resp. $\phi_{\mathbb{Z}^2,p,q}^0$). Furthermore, there exists $p_c = p_c(q) \in (0, 1)$ such that for $p \neq p_c(q)$, the infinite-volume measure $\phi_{\mathbb{Z}^2,p,q}$ is unique and satisfies

$$\phi_{\mathbb{Z}^2,p,q}[0 \leftrightarrow \infty] = \begin{cases} 0 & \text{if } p < p_c(q), \\ \theta(p, q) > 0 & \text{if } p > p_c(q). \end{cases}$$

The critical parameter $p_c(q)$ was proved to be equal to $\sqrt{q}/(1 + \sqrt{q})$ in [BDC12a].

Positive association when $q \geq 1$. Denote the product ordering on $\{0, 1\}^E$ by \leq . An event \mathcal{A} depending on edges in E only is *increasing* if for any $\omega' \geq \omega$, $\omega \in \mathcal{A}$ imply $\omega' \in \mathcal{A}$.

For $q \geq 1$, the random-cluster model satisfies important properties regarding increasing events. The first such property is the FKG inequality [Gri06, Theorem 3.8]: for any boundary conditions ξ and for any increasing events \mathcal{A} and \mathcal{B} ,

$$\phi_{G,p,q}^\xi[\mathcal{A} \cap \mathcal{B}] \geq \phi_{G,p,q}^\xi[\mathcal{A}] \phi_{G,p,q}^\xi[\mathcal{B}].$$

The second important property is the comparison between boundary conditions [Gri06, Lemma 4.56]: for any increasing event \mathcal{A} and for any $\xi \geq \psi$,

$$\phi_{G,p,q}^\xi[\mathcal{A}] \geq \phi_{G,p,q}^\psi[\mathcal{A}]. \quad (5.2)$$

Here, $\xi \geq \psi$ if the partition ψ is finer than the partition ξ (any wired vertices in ψ are wired in ξ). In such case, ξ is said to *dominate* ψ or equivalently ψ is said to be *dominated by* ξ . The free (resp. wired) boundary conditions is dominated by (resp. dominates) any other boundary conditions.

Domain Markov property and insertion tolerance. Consider a subgraph G' of G . The following proposition describes how the influence of the configuration outside G' on the measure within G' can be encoded using appropriate boundary conditions ξ .

Proposition 2.2 (Domain Markov Property). *Let $p \in [0, 1]$, $q > 0$ and ξ some boundary conditions. Fix $G' \subset G$. Let X be a random variable measurable which is measurable with respect to edges in $E_{G'}$. Then,*

$$\phi_{G,p,q}^\xi \left[X | \omega|_{E_G \setminus E_{G'}} = \psi \right] = \phi_{G',p,q}^{\psi^\xi} [X],$$

for any $\psi \in \{0, 1\}^{E_G \setminus E_{G'}}$. Above, ψ^ξ is the partition on $\partial G'$ obtained as follows: two vertices $x, y \in \partial G'$ are in the same element of the partition if they are connected in ψ^ξ .

The previous proposition has the following corollary, called insertion tolerance. For $p, q > 0$, there exists $c_\pi > 0$ such that for any $\omega \in \{0, 1\}^{E_G}$, any finite graph G , and any boundary conditions ξ , $\phi_{G,p,q}^\xi[\omega] \geq c_\pi^{|G|}$.

Dual representation. A configuration ω on G can be uniquely associated to a *dual configuration* ω^* on the dual graph G^* defined as follows: set $\omega^*(e^*) = 1$ if $\omega(e) = 0$ and $\omega^*(e^*) = 0$ if $\omega(e) = 1$. A dual-edge e^* is said to be *dual-open* if $\omega^*(e^*) = 1$, it is *dual-closed* otherwise. A *dual-cluster* is a connected component of ω^* . We extend the notion of *dual-open path* in a trivial way. For two sets $X, Y \subset V_{G^*}$, we set $X \overset{*}{\leftrightarrow} Y$ if there exists a dual-open path from X to Y .

If ω is distributed according to $\phi_{G,p,q}^\xi$, then ω^* is distributed according to $\phi_{G^*,p^*,q^*}^{\xi^*}$ with $q^* = q$ and $\frac{pp^*}{(1-p)(1-p^*)} = q$. In particular, for $p = p_c(q)$ we find $p^* = p = p_c(q)$. The boundary conditions ξ^* can be deduced from ξ in a case by case manner. We will mostly be interested in the case of $\xi = 0$ or 1 , for which $\xi^* = 1$ and 0 respectively.

Russo-Seymour-Welsh with wired boundary conditions. For a rectangle $R = [a, b] \times [c, d]$, let $\mathcal{C}_h(R)$ be the event that there exists an open path in R from $\{a\} \times [c, d]$ to $\{b\} \times [c, d] \subset \mathbb{Z}^2$. Such a crossing is called an *horizontal crossing* of R . Similarly, one defines $\mathcal{C}_v(R)$ to be the event that there exists an open path in R from $[a, b] \times \{c\}$ to $[a, b] \times \{d\}$ (such a path is called a *vertical crossing*). For a rectangle $R^* = [s, t] \times [u, v] \subset (\mathbb{Z}^2)^*$ (note that s, t, u, v are half-integers), let $\mathcal{C}_h^*(R^*)$ be the event that there exists a dual-open dual-path in R^* from $\{s\} \times [u, v]$ to $\{t\} \times [u, v]$ (such a path is called an *horizontal dual-crossing*), and similarly $\mathcal{C}_v^*(R^*)$ is the event that there exists a dual-open dual-path in R^* from $[s, t] \times \{u\}$ to $[s, t] \times \{v\}$ (such a path is called a *vertical dual-crossing*).

The following result will be important in the proof. Let us restate it here.

Theorem 2.3 ([BDC12a, Corollary 9]). *For $\alpha > 1$ and $q \geq 1$, there exists $c_{\text{RSW}} > 0$ such that for every $0 < m < \alpha n$,*

$$\phi_{\mathbb{Z}^2, p_c, q}^1 [\mathcal{C}_h([0, m] \times [0, n])] \geq c_{\text{RSW}}.$$

Let us mention a particularly interesting case of non wired boundary conditions. We refer the interested reader to [BDC12a] for more details. Consider the random-cluster measure on Λ_n with wired boundary conditions on top and bottom, and free elsewhere (we call these boundary conditions mixed). Then

$$\phi_{\Lambda_n, p_c, q}^{\text{mixed}} [\mathcal{C}_h(\Lambda_n)] \geq \frac{1}{1 + q^2}. \quad (5.3)$$

From now on, we fix $q \geq 1$ and $p = p_c(q)$. In order to lighten the notation, we drop the reference to p and q and simply write ϕ_G^ξ instead of $\phi_{G, p_c(q), q}^\xi$.

3 Proof of Theorem 1.3

3.1 A preliminary result

Before diving into the proof, let us mention three useful equivalent formulations of **P5**. For $z \in \mathbb{R}^2$, define $\mathcal{A}_n(z)$ to be the event that there exists an open circuit in the annulus $z + (\Lambda_{2n} \setminus \Lambda_n)$ surrounding z . Also define $\mathcal{A}_n = \mathcal{A}_n(0)$.

Proposition 3.1. *The following propositions are equivalent;*

P5 For any $\alpha > 0$, there exists $c_1 = c_1(\alpha) > 0$ such that for all $n \geq 1$, we have

$$\phi_{p_c, q, [-n, (\alpha+1)n] \times [-n, 2n]}^0 [\mathcal{C}_h([0, \alpha n] \times [0, n])] \geq c_1.$$

P5a There exists $c_2 > 0$ such that for all $n \geq 1$,

$$\phi_{p_c, q, \Lambda_{2n} \setminus \Lambda_{n+1}}^0 [\mathcal{A}_n] \geq c_2.$$

P5b For any $R \geq 2$, there exists $c_3 = c_3(R) > 0$ such that for all $n \geq 1$,

$$\phi_{p_c, q, \Lambda_{Rn}}^0 [\mathcal{A}_n] \geq c_3.$$

P5c For any $\alpha > 0$, there exists $c_4 = c_4(\alpha) > 0$ such that for all $n \geq 1$ and for all boundary conditions ξ on the boundary of $[-n, (\alpha+1)n] \times [-n, 2n]$, we have

$$c_4 \leq \phi_{p_c, q, [-n, (\alpha+1)n] \times [-n, 2n]}^\xi [\mathcal{C}_h([0, \alpha n] \times [0, n])] \leq 1 - c_4.$$

The last condition justifies the fact that the result is uniform with respect to boundary conditions.

Proof. The proof of **P5a** \Rightarrow **P5b** and **P5c** \Rightarrow **P5** are obvious by comparison between boundary conditions. In order to prove **P5** \Rightarrow **P5a**, consider the four rectangles

$$\begin{aligned} R_1 &:= [4n/3, 5n/3] \times [-5n/3, 5n/3], \\ R_2 &:= [-5n/3, -4n/3] \times [-5n/3, 5n/3], \\ R_3 &:= [-5n/3, 5n/3] \times [4n/3, 5n/3], \\ R_4 &:= [-5n/3, 5n/3] \times [-5n/3, -4n/3]. \end{aligned}$$

If the intersection of $\mathcal{C}_v(R_1)$, $\mathcal{C}_v(R_2)$, $\mathcal{C}_h(R_3)$ and $\mathcal{C}_h(R_4)$ occurs, then \mathcal{A}_n occurs. In particular, the FKG inequality and the comparison between boundary conditions implies that c_2 can be chosen to be equal to $c_1(10)^4$.

Let us now turn to the proof of **P5b** \Rightarrow **P5**. We start by the lower bound. Fix some $R \geq 2$ as in **P5b** and the corresponding $c_3 > 0$. Let $\alpha > 0$. For $n \geq 4R$, the intersection of the events $\mathcal{A}_{n/(2R)}[(j \lfloor \frac{n}{R} \rfloor, \frac{n}{2})]$ for $j = 0, \dots, \lceil R\alpha \rceil$ is included in $\mathcal{C}_h([0, \alpha n] \times [0, n])$. The FKG inequality implies

$$\phi_{p_c, q, [-n, (\alpha+1)n] \times [-n, 2n]}^0 [\mathcal{C}_h([0, \alpha n] \times [0, n])] \geq c_3^{1+R\lceil \alpha \rceil}.$$

By comparison between boundary conditions, we obtain the lower bound for every ξ .

The upper bound may be obtained from this lower bound as follows. By comparison between boundary conditions once again, it is sufficient to prove the bound for the wired boundary condition. In such case, the complement of $\mathcal{C}_h([0, \alpha n] \times [0, n])$ is $\mathcal{C}_v^*([\frac{1}{2}, \alpha n - \frac{1}{2}] \times [-\frac{1}{2}, n + \frac{1}{2}])$. Since the dual of the wired boundary conditions are the free ones, the boundary conditions for the dual measure are free. We can now harness **P5b** for the dual model to construct a dual path from top to bottom with probability bounded away from 0. This finishes the proof.

It only remains to prove that **P5** implies **P5c** to conclude. Define

$$\begin{aligned} R &:= [0, \alpha n] \times [0, n], \\ \bar{R} &:= [-n, (\alpha + 1)n] \times [-n, 2n], \\ R^* &:= [\tfrac{1}{2}, \alpha n - \tfrac{1}{2}] \times [-\tfrac{1}{2}, n + \tfrac{1}{2}]. \end{aligned}$$

First, (5.2) implies that

$$c_1 \leq \phi_{\bar{R}}^0[\mathcal{C}_h(R)] \leq \phi_{\bar{R}}^\xi[\mathcal{C}_h(R)],$$

where the first inequality is due to **P5**. Now, we wish to prove the upper bound. Let us assume without loss of generality that $\alpha < 1$. As mentioned above, the complement of the event $\mathcal{C}_h(R)$ is the event $\mathcal{C}_v^*(R^*)$. We find that

$$\phi_{\bar{R}}^1[\mathcal{C}_h(R)] \leq \phi_{\bar{R}}^1[\mathcal{C}_h(R)] = 1 - \phi_{\bar{R}}^1[\mathcal{C}_v^*(R^*)] \leq 1 - c_1(1/\alpha).$$

In the last inequality, we used the lower bound proved previously for $\alpha' = 1/\alpha$ and $n' = \alpha n$. To justify that we can do so, observe that the dual of wired boundary conditions are the free ones, and that since $\alpha < 1$, the dual graph of \bar{R} contains a rotated version of $[\frac{1}{2} - \alpha n, \alpha n - \frac{1}{2} + \alpha n] \times [-\frac{1}{2} - \alpha n, n + \frac{1}{2} + \alpha n]$. \square

3.2 Proof of Theorem 1.3: easy implications

In order to isolate the hard part of the proof, let us start by checking the four “simple” implications **P1** \Rightarrow **P2**, **P2** \Rightarrow **P3**, **P3** \Rightarrow **P4** and **P5** \Rightarrow **P1**.

Property P1 implies P2: This implication is classical, see e.g. [DC13, Corollary 4.23].

Property P2 implies P3: If **P2** holds,

$$\begin{aligned} (2n + 1) \phi_{\mathbb{Z}^2}^0[0 \leftrightarrow \partial\Lambda_n] &= (2n + 1) \phi_{\mathbb{Z}^2}^1[0 \leftrightarrow \partial\Lambda_n] \geq \sum_{x \in \{0\} \times [-n, n]} \phi_{\mathbb{Z}^2}^1[x \leftrightarrow (x + \partial\Lambda_n)] \\ &\geq \phi_{\mathbb{Z}^2}^1[\mathcal{C}_v([-n, n] \times [0, n])] \geq c, \end{aligned}$$

where $c > 0$ is a constant independent of n . The first equality is due to the uniqueness of the infinite-volume measure given by **P2** and the second inequality by Theorem 2.3. This leads to

$$\sum_{x \in \partial\Lambda_n} \phi_{\mathbb{Z}^2}^0[0 \leftrightarrow x] \geq \phi_{\mathbb{Z}^2}^0[0 \leftrightarrow \partial\Lambda_n] \geq \frac{c}{2n + 1}.$$

As a consequence, $\sum_{x \in \mathbb{Z}^2} \phi_{\mathbb{Z}^2}^0[0 \leftrightarrow x] = \infty$ and **P3** holds true.

Property P3 implies P4: Assume that **P4** does not hold. In such case, the fact that

$$\begin{aligned} \phi_{\mathbb{Z}^2}^0[0 \longleftrightarrow (n + m)x] &\geq \phi_{\mathbb{Z}^2}^0[0 \longleftrightarrow nx] \phi_{\mathbb{Z}^2}^0[nx \longleftrightarrow (n + m)x] \\ &= \phi_{\mathbb{Z}^2}^0[0 \longleftrightarrow nx] \phi_{\mathbb{Z}^2}^0[0 \longleftrightarrow mx] \end{aligned}$$

(this follows from the FKG inequality) implies the existence of $M > 0$ such that for every $x = (x_1, x_2) \in \mathbb{Z}^2$,

$$\phi_{\mathbb{Z}^2}^0 [0 \longleftrightarrow x] \leq e^{-|x|/M}.$$

Summing over every $x \in \mathbb{Z}^2$ gives

$$\sum_{x \in \mathbb{Z}^2} \phi_{\mathbb{Z}^2}^0 [0 \leftrightarrow x] < \infty$$

and thus **P3** does not hold.

Property **P5** implies **P1**: Recall that **P5** implies **P5a**. We now prove a slightly stronger result which obviously implies **P1** and will be useful later in the proof.

Lemma 3.2. *Property **P5a** implies that there exists $\varepsilon > 0$ such that for any $n \geq 1$,*

$$\phi_{\mathbb{Z}^2}^1 [0 \leftrightarrow \partial\Lambda_n] \leq n^{-\varepsilon}.$$

Proof. Let k be such that $2^k \leq n < 2^{k+1}$. Also define the annuli $A_j = \Lambda_{2^j} \setminus \Lambda_{2^{j-1}}$ for $j \geq 1$. We have

$$\begin{aligned} \phi_{\mathbb{Z}^2}^1 [0 \longleftrightarrow \partial\Lambda_n] &\leq \prod_{j=1}^k \phi_{\mathbb{Z}^2}^1 \left[\Lambda_{2^{j-1}} \xleftrightarrow{A_j} \partial\Lambda_{2^j} \left| \bigcap_{i>j} \{ \Lambda_{2^{i-1}} \xleftrightarrow{A_i} \partial\Lambda_{2^i} \} \right. \right] \\ &\leq \prod_{j=1}^k \phi_{A_j}^1 \left[\Lambda_{2^{j-1}} \xleftrightarrow{A_j} \partial\Lambda_{2^j} \right]. \end{aligned}$$

In the second line, we used the fact that the event upon which we condition depends only on edges outside of Λ_{2^j} or on $\partial\Lambda_{2^j}$ together with the comparison between boundary conditions.

Now, the complement of $\Lambda_{2^{j-1}} \xleftrightarrow{A_j} \partial\Lambda_{2^j}$ is the event that there exists a dual-open circuit in A_j^* surrounding the origin. Property **P5a** implies that this dual-open circuit exists with probability larger than or equal to $c > 0$ independently of $n \geq 1$. This implies that

$$\phi_{\mathbb{Z}^2}^1 [0 \longleftrightarrow \partial\Lambda_n] \leq \prod_{j=1}^k (1 - c) = (1 - c)^k \leq (1 - c)^{\log n / \log 2}.$$

The proof follows by setting $\varepsilon = -\frac{\log(1-c)}{\log 2}$. □

Remark 3.3. The proof of the previous lemma illustrates the need for *bounds which are uniform with respect to boundary conditions*. Indeed, it could be the case that the ϕ^1 -probability of an open path from the inner to the outer sides of A_j is bounded away from 1, but conditioning on the existence of paths in each annulus A_i (for $i < j$) could favor open edges drastically, and imply that the probability of the event under consideration is close to 1.

3.3 Proof of Theorem 1.3: P4 implies P5

Recall from Proposition 3.1 that **P5** is equivalent to **P5b** and we therefore choose to prove that **P4** implies **P5b** when $R = 8$. The proof follows two steps. First, we prove that either **P5b** holds or $\phi^0(0 \leftrightarrow \partial\Lambda_n)$ tends to 0 stretched-exponentially fast. We then prove that in the second case, the speed of convergence is actually exponential.

Proposition 3.4. *Exactly one of these two cases occurs :*

1. $\inf_{n \geq 1} \phi_{\Lambda_{8n}}^0[\mathcal{A}_n] > 0$.
2. *There exists $\alpha > 0$ such that for any $n \geq 1$,*

$$\phi_{\mathbb{Z}^2}^0[0 \longleftrightarrow \partial\Lambda_n] \leq \exp(-n^\alpha).$$

First, consider the strip $\mathbb{S} = \mathbb{Z} \times [-n, 3n]$, and the boundary conditions ξ defined to be wired on $\mathbb{Z} \times \{3n\}$, and free on $\mathbb{Z} \times \{-n\}$. Recall that boundary conditions at infinity are not relevant since the strip is essentially one dimensional.

Lemma 3.5. *For all $k \geq 1$, there exists a constant $c = c(k) > 0$ such that, for all $n \geq 1$,*

$$\phi_{\mathbb{S}}^{1/0}[\mathcal{C}_h([-kn, kn] \times [0, 2n])] \geq c. \quad (5.4)$$

Proof. Fix $n, k \geq 1$. We will assume that n is divisible by 9 (one may adapt the argument for general values of n). By duality, the complement of $\mathcal{C}_h([-kn, kn] \times [0, 2n])$ is $\mathcal{C}_v^*([-kn + \frac{1}{2}, kn - \frac{1}{2}] \times [-\frac{1}{2}, 2n + \frac{1}{2}])$. Therefore, either (5.4) is true for $c = 1/2$, or

$$\phi_{\mathbb{S}}^{1/0}[\mathcal{C}_v^*([-kn + \frac{1}{2}, kn - \frac{1}{2}] \times [-\frac{1}{2}, 2n + \frac{1}{2}])] \geq 1/2.$$

We assume that we are in this second situation for the rest of the proof.

The dual of the measure on the strip with free boundary conditions on the bottom and wired on the top is the measure on the strip with free boundary conditions on the top and wired on the bottom. This measure is the image of ϕ_{strip} under the orthogonal reflection with respect to the horizontal line $\mathbb{R} \times \{n - \frac{1}{4}\}$ composed with a translation by the vector $(\frac{1}{2}, 0)$. We thus obtain that

$$\begin{aligned} \phi_{\mathbb{S}}^{1/0}[\mathcal{C}_v([-kn, kn] \times [0, 2n])] &\geq \phi_{\mathbb{S}}^{1/0}[\mathcal{C}_v([-kn, kn - 1] \times [-1, 2n])] \\ &= \phi_{\mathbb{S}}^{1/0}[\mathcal{C}_v^*([-kn + \frac{1}{2}, kn - \frac{1}{2}] \times [-\frac{1}{2}, 2n + \frac{1}{2}])] \\ &\geq 1/2. \end{aligned}$$

Partitioning the segment $[-kn, kn] \times \{0\}$ into the union of $18k$ segments of length $\lambda := n/9$ (note that λ is an integer), the union bound gives us

$$\phi_{\mathbb{S}}^{1/0}[I \leftrightarrow \mathbb{Z} \times \{2n\}] \geq \frac{1}{36k} =: c_1, \quad (5.5)$$

where $I = [4\lambda, 5\lambda] \times \{0\}$. For future reference, let us also introduce the segment $J = [6\lambda, 7\lambda] \times \{0\}$.

Define the rectangle $R = [0, 9\lambda] \times [0, 2n]$. When the event estimated in equation (5.5) is realized, there exists an open path in R connecting I to the union of the top, left and right boundaries of R . Using the reflection with respect to the vertical line $\{\frac{n}{2}\} \times \mathbb{R}$, we find that at least one of the two following inequalities occurs:

$$\text{Case 1: } \phi_S^{1/0} \left[I \xleftrightarrow{R} [0, n] \times \{2n\} \right] \geq c_1/3.$$

$$\text{Case 2: } \phi_S^{1/0} \left[I \xleftrightarrow{R} \{0\} \times [0, 2n] \right] \geq c_1/3.$$



Figure 5.1: The construction in Case 1 with the two paths Γ_1 and Γ_2 and the domain Ω between the two paths. On the right, a combination of paths creating a long path from left to right.

Proof of (5.4) in Case 1: Consider the event that there exist

- (i) an open path from I to the top of $[0, 2n]^2$ contained in $[0, 2n]^2$,
- (ii) an open path from J to the top of $[0, 2n]^2$ contained in $[0, 2n]^2$,
- (iii) an open path connecting these two paths in $[0, 2n]^2$.

Each path in (i) and (ii) exists with probability larger than $c_1/3$ (since R and $(2\lambda, 0) + R$ are included in $[0, 2n]^2$). Furthermore, let Γ_1 be the left-most path satisfying (i) and Γ_2 the right-most path satisfying (ii); see Fig. 5.1. The subgraph of $[0, 2n]^2$ between Γ_1 and Γ_2 is denoted by Ω . Conditioning on Γ_1 and Γ_2 , the boundary conditions on Ω are wired on Γ_1 and Γ_2 , and dominate the free boundary conditions on the rest of $\partial\Omega$. We deduce that boundary conditions on Ω dominate boundary conditions inherited by wired boundary conditions on the left and right sides of the box $[0, 2n]^2$, and free on the top and bottom

sides. As a consequence of (5.3), conditionally on Γ_1 and Γ_2 , there exists an open path in Ω connecting Γ_1 to Γ_2 with probability larger than $1/(1+q^2)$. In conclusion,

$$\phi_S^{1/0} \left[I \xleftrightarrow{[0,2n]^2} J \right] \geq \phi_S^{1/0} [\text{(i), (ii) and (iii) occur}] \geq \left(\frac{c_1}{3} \right)^2 \times \frac{1}{(1+q^2)}. \quad (5.6)$$

For $x = j\lambda$, where $j \in \{-9k-5, \dots, 9k-6\}$, define the translate of the event considered in (5.6):

$$A_x := (x+I) \xleftrightarrow{x+[0,2n]^2} (x+J).$$

If A_x occurs for every such x , we obtain an open crossing from left to right in $[-kn, kn] \times [0, 2n]$. The FKG inequality implies that this happens with probability larger than $\left(\frac{c_1^2}{9(1+q^2)} \right)^{20k}$.

Proof of (5.4) in Case 2: Define the rectangle $R' = [4\lambda, 9\lambda] \times [0, 2n]$. Note that in Case 2, J is connected to one side of $[2\lambda, 11\lambda] \times [0, 2n]$ with probability bounded from below by $c_1/3$, hence the same is true for R' (since $[2\lambda, 11\lambda] \times [0, 2n]$ is wider than R'). Consider the event that there exist

- (i) an open path from I to the right side of R contained in R ,
- (ii) an open path from J to the left side of R' contained in R' ,
- (iii) an open path connecting these two paths in $[0, 2n]^2$.

The first path occurs with probability larger than $c_1/3$, and the second one with probability larger than $c_1/6$ (there exists a path to one of the sides with probability at least $c_1/3$, and therefore by symmetry in R' to the left side with probability larger than $c_1/6$). By the FKG inequality, the event that both (i) and (ii) occur has probability larger than $c_1^2/18$. We now wish to prove that conditionally on (i) and (ii) occurring, the event (iii) occurs with good probability.

Define the segments $K(y, z) = \{4\lambda\} \times [y, z]$ for $y \leq z \leq \infty$. They are all subsegments of the vertical line of first coordinate equal to 4λ .

Consider the right-most open path Γ_1 satisfying (ii). It intersects the segment $K(0, 2n)$ at a unique point with second coordinate denoted by y . Also consider the left-most open path $\tilde{\Gamma}_2$ satisfying (i). Either Γ_1 and $\tilde{\Gamma}_2$ intersect, or they do not. In the first case, we are already done since (iii) automatically occurs. In the second, we consider the subpath Γ_2 of $\tilde{\Gamma}_2$ from I to the first intersection with $K(y, 2n)$ (this intersection must exist since $\tilde{\Gamma}_2$ goes to the right side of R'). Let us now show that Γ_1 and Γ_2 are connected with good probability. Note the similarity with the construction in [BDC12a] with symmetric domains, except that the lattice is not rotated here. The proof is therefore slightly more technical and we choose to isolate it from the rest of the argument.

Claim: There exists $c_2 > 0$ such that for any possible realizations γ_1 and γ_2 of Γ_1 and Γ_2 ,

$$\phi_S^{1/0} \left[\gamma_1 \xleftrightarrow{R} \gamma_2 \mid \Gamma_1 = \gamma_1, \Gamma_2 = \gamma_2 \right] \geq c_2. \quad (5.7)$$

Proof. Fig. 5.2 should be very helpful in order to follow this proof. Construct the subgraph Ω "between γ_1 and γ_2 " formally delimited by:

- the arc γ_2 ,
- the segment $[0, n] \times \{0\}$,
- the arc γ_1 ,
- the segment $K(y + 1, 2n)$ *excluded* (the vertices on this segment are not part of the domain).

We wish to compare Ω (left of Fig. 5.2) to a reference domain D (center of Fig. 5.2) defined as the upper half-plane minus the edges intersecting $\{4\lambda - \frac{1}{2}\} \times (y, \infty)$ and define the boundary conditions *mix* on D by:

- wired boundary conditions on $K(y, \infty)$ and $A := (-\infty, 4\lambda] \times \{0\}$;
- wired boundary conditions at infinity (by this we mean that we take the limit of measures on $D \cap \Lambda_n$, with wired boundary conditions on $\partial\Lambda_n$);
- free boundary conditions elsewhere.

The boundary conditions on Ω inherited by the conditioning $\Gamma_1 = \gamma_1$ and $\Gamma_2 = \gamma_2$ dominate wired on γ_1 and γ_2 , and free elsewhere. Thus, we deduce that

$$\phi_S^{1/0} \left[\gamma_1 \xleftrightarrow{\Omega} \gamma_2 \mid \Gamma_1 = \gamma_1, \Gamma_2 = \gamma_2 \right] \geq \phi_D^{\text{mix}} \left[K(y, \infty) \xleftrightarrow{D} A \right]. \quad (5.8)$$

As mentioned above, the domain D is not exactly a symmetric domain but it is still very close to be one. Consider the domain \tilde{D} (see on the right of Fig. 5.2) obtained from D by the reflection with respect to the vertical line $d = \{(4\lambda - \frac{1}{4}, y) : y \in \mathbb{R}\}$ and a translation by $(\frac{1}{2}, \frac{1}{2})$. Let $B = (-\infty, 4\lambda - 1] \times \{0\}$. Define the boundary conditions *mix* on \tilde{D} as

- wired boundary conditions on $K(y + 1, \infty) \cup B$ (it is very important that the two arcs are wired together);
- free boundary conditions at infinity;
- free boundary conditions elsewhere.

Using duality, we find that

$$\phi_D^{\text{mix}} \left[K(y, \infty) \xleftrightarrow{D} A \right] = \phi_{\tilde{D}}^{\text{mix}} \left[K(y + 1, \infty) \xleftrightarrow{\tilde{D}} B \right]$$

and thus

$$\phi_D^{\text{mix}} \left[K(y, \infty) \xleftrightarrow{D} A \right] + \phi_{\tilde{D}}^{\text{mix}} \left[K(y + 1, \infty) \xleftrightarrow{\tilde{D}} B \right] = 1. \quad (5.9)$$

Define the *mix'* boundary conditions on D as wired boundary conditions on $K(y + 1, \infty) \cup B := (-\infty, 4\lambda - 1] \times \{0\}$ (the two arcs are once again wired together) and free elsewhere (they correspond to the boundary conditions *mix* on \tilde{D}). Since $\tilde{D} \subset D$,

$$\phi_{\tilde{D}}^{\text{mix}} \left[K(y + 1, \infty) \xleftrightarrow{\tilde{D}} B \right] \leq \phi_D^{\text{mix}'} \left[K(y, \infty) \xleftrightarrow{D} A \right].$$

The boundary conditions for the term on the right can be compared to the boundary conditions *mix*. First, one may wire the vertices $(4\lambda, y)$ and $(4\lambda, y + 1)$ together, and the vertices $(4\lambda - 1, 0)$ and $(4\lambda, 0)$ together, which increases the probability of an open path

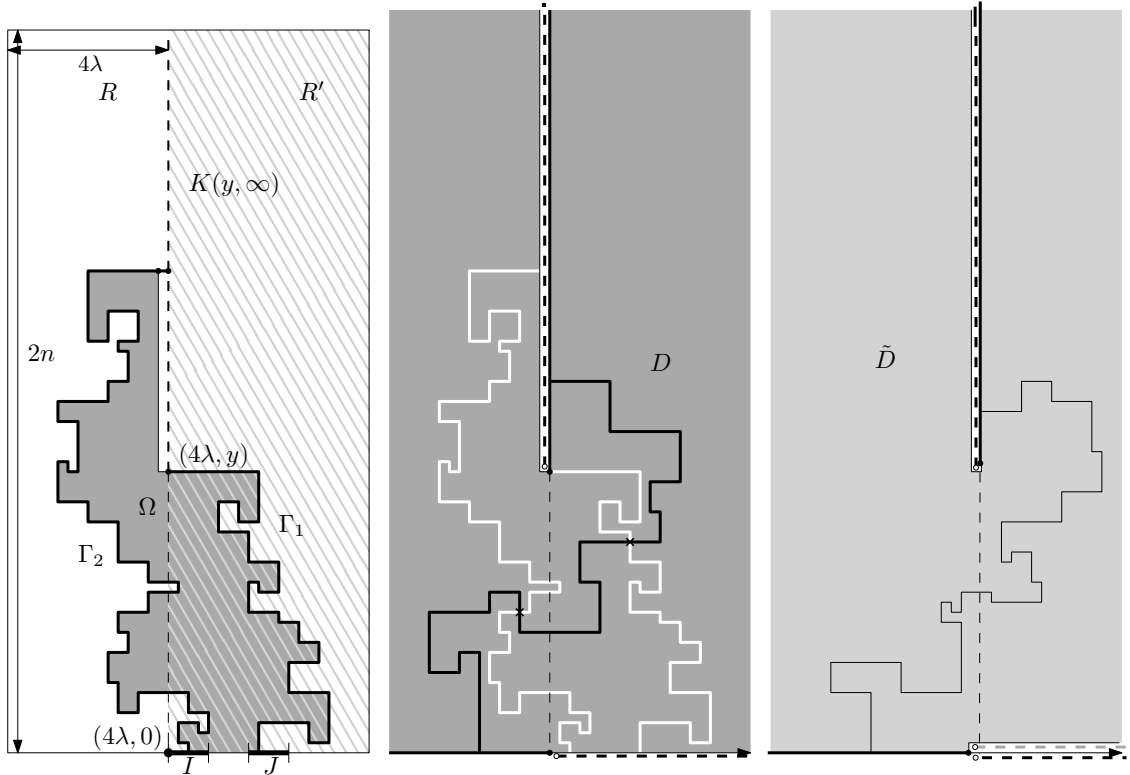

Figure 5.2: **Left.** The domain Ω . We depicted the part of the domain with free boundary conditions by putting dual wired boundary conditions on the associated dual arcs. The wired boundary conditions are depicted in bold. The rectangles R and R' are also specified (R' is in dashed). **Center.** The domain D . We depicted the domain Ω in white. The existence of an open path between $K(y, \infty)$ and A implies the existence of an open path between γ_1 and γ_2 in D (between the two crossings). **Right.** The domain \tilde{D} with one path from $K(y+1, \infty)$ to B . The pre image of this path by the reflection mapping D onto \tilde{D} is a dual-path in D preventing the existence of an open path from $K(y, \infty)$ to A .

between $K(y, \infty)$ and A . Second, one may unwire the arcs B and $K(y + 1, \infty)$, paying a multiplicative cost of q^2 . Using the previous inequality and the comparison between the boundary conditions described in this paragraph, we deduce

$$\phi_D^{\text{mix}} \left[K(y + 1, \infty) \xleftrightarrow{D} B \right] \leq q^2 \phi_D^{\text{mix}} \left[K(y, \infty) \xleftrightarrow{D} A \right].$$

Putting this inequality in (5.9) and then using (5.8), we find that

$$\phi_S^{1/0} \left[\gamma_1 \xleftrightarrow{\Omega} \gamma_2 \mid \Gamma_1 = \gamma_1, \Gamma_2 = \gamma_2 \right] \geq \phi_D^{\text{mix}} \left[K(y, \infty) \xleftrightarrow{D} A \right] \geq \frac{1}{1 + q^2}.$$

□

It follows from (5.7) and the probabilities of (i) and (ii) that

$$\phi_S^{1/0} \left[I \xleftrightarrow{R} J \right] \geq \frac{1}{1 + q^2} \times \frac{c_1^2}{18}.$$

Here again, $20k$ translations of the event above guarantee the occurrence of an open crossing from left to right in $[-kn, kn] \times [0, 2n]$. This occurs with probability larger than $(\frac{c_1^2}{18(1+q^2)})^{20k}$ thanks to the FKG inequality again. □

In the next lemma, we consider horizontal crossings in rectangular shaped domains with free boundary conditions on the bottom and wired elsewhere.

Lemma 3.6. *For all $k > 0$ and $\ell \geq 4/3$, there exists a constant $c = c(k, \ell) > 0$ such that for all $n > 0$,*

$$\phi_D^{1/0} [\mathcal{C}_h([-kn, kn] \times [0, n])] \geq c \tag{5.10}$$

with $D = [-kn, kn] \times [0, \ell n]$, and $\phi_D^{1/0}$ is the random-cluster measure with free boundary conditions on the bottom side, and wired on the three other sides.

Proof. For $\ell = 4/3$, the result follows directly from Lemma 3.5 since boundary conditions dominate boundary conditions in the strip $\mathbb{Z} \times [0, \frac{4n}{3}]$, and therefore there exists an horizontal crossing of the rectangle $[-kn, kn] \times [\frac{n}{3}, n]$ with probability bounded away from 0.

Now assume that the result holds for ℓ and let us prove it for $\ell + 1/3$. By comparison between boundary conditions in $[-kn, kn] \times [\frac{n}{3}, \ell n + \frac{n}{3}]$, we know that

$$\phi_D^{1/0} [\mathcal{C}_h([-kn, kn] \times [\frac{n}{3}, \frac{4n}{3}])] \geq c(k, \ell).$$

Conditioning on the highest such crossing, the boundary conditions below this crossing dominate the free boundary conditions on the bottom side of $[-kn, kn] \times [0, \frac{4n}{3}]$, and wired on the other three sides of $[-kn, kn] \times [0, \frac{4n}{3}]$. An application of the case $\ell = \frac{4}{3}$ enables us to set $c(k, \ell + \frac{1}{3}) = c(k, \ell)c(k, \frac{4}{3})$.

The proof follows from the fact that the probability in (5.10) is decreasing in ℓ . □

Lemma 3.7. *There exists a constant $C < \infty$ such that, for all $n \geq 1$,*

$$\phi_{\Lambda_{56n}}^0 [\mathcal{A}_{7n}] \leq C \phi_{\Lambda_{8n}}^0 [\mathcal{A}_n]^2.$$

Proof. Define $z_{\pm} = (\pm 5n, 0)$. If \mathcal{A}_{7n} occurs, the boundary conditions on Λ_{7n} dominate the wired boundary condition on Λ_{56n} due to the existence of the open circuit in $\Lambda_{14n} \setminus \Lambda_{7n}$. The use of Theorem 2.3 thus implies the existence of a constant $c_1 > 0$ such that, for all n ,

$$\phi_{\Lambda_{56n}}^0 [\mathcal{A}_n(z_+) \cap \mathcal{A}_n(z_-) | \mathcal{A}_{7n}] \geq \phi_{\Lambda_{56n}}^1 [\mathcal{A}_n(z_+) \cap \mathcal{A}_n(z_-)] \geq c_1.$$

It directly implies that for all n ,

$$\phi_{\Lambda_{56n}}^0 [\mathcal{A}_n(z_+) \cap \mathcal{A}_n(z_-)] \geq c_1 \phi_{\Lambda_{56n}}^0 [\mathcal{A}_{7n}]. \quad (5.11)$$

Now, examine the domain $D = [-56n, 56n] \times [2n, 56n]$ and consider the measure $\phi_D^{1/0}$ with free boundary conditions on the bottom and wired boundary elsewhere. Also set

$$R_+^* := [-56n - \frac{1}{2}, 56n + \frac{1}{2}] \times [2n + \frac{1}{2}, 3n - \frac{1}{2}].$$

Under $\phi_{\Lambda_{56n}}^0[\cdot | \mathcal{A}_n(z_+) \cap \mathcal{A}_n(z_-)]$, the boundary conditions on D are dominated by wired boundary conditions on the bottom and free boundary conditions on the other sides. As a consequence, Lemma 3.6 applied to $k = 56$ and $\ell = 54$ implies that

$$\phi_{\Lambda_{56n}}^0 [C_h^*(R_+^*) | \mathcal{A}_n(z_+) \cap \mathcal{A}_n(z_-)] \geq \phi_D^{1/0} [C_h^*(R_+^*)] \geq c_2 \quad (5.12)$$

for some universal constant $c_2 > 0$ independent of n . Similarly, with

$$R_-^* := [-56n - \frac{1}{2}, 56n + \frac{1}{2}] \times [-3n + \frac{1}{2}, -2n - \frac{1}{2}],$$

we find

$$\phi_{\Lambda_{56n}}^0 [C_h^*(R_-^*) | \mathcal{A}_n(z_+) \cap \mathcal{A}_n(z_-)] \geq c_2. \quad (5.13)$$

Define the event \mathcal{B}_n , illustrated on Fig. 5.3, which is the intersection of the events $\mathcal{A}_n(z_+)$, $\mathcal{A}_n(z_-)$, $C_h^*(R_+^*)$ and $C_h^*(R_-^*)$. Equations (5.11), (5.12) and (5.13) lead to the estimate

$$\phi_{\Lambda_{56n}}^0 [\mathcal{B}_n] \geq c_3 \phi_{\Lambda_{56n}}^0 [\mathcal{A}_{7n}], \quad (5.14)$$

where $c_3 > 0$ is a positive constant independent of n .

Assume \mathcal{B}_n occurs and define Γ_1^* to be the top-most horizontal dual-crossing of R_+^* and Γ_2^* to be the bottom-most horizontal dual-crossing of R_-^* . Note that these paths are dual paths. Let Ω^* be the set of dual-vertices in $R^* := [-3n + \frac{1}{2}, 3n - \frac{1}{2}]^2$ below Γ_1^* and above Γ_2^* . Exactly as in the proof of Lemma 3.5, when conditioning on Γ_1^* , Γ_2^* and everything outside Ω^* , the boundary conditions inside Ω^* are dual-wired on Γ_1^* and Γ_2^* , and dual-free elsewhere. The dual measure inside Ω^* therefore dominates the restriction to Ω^* of the dual measure on R^* with dual-wired boundary conditions on the top and

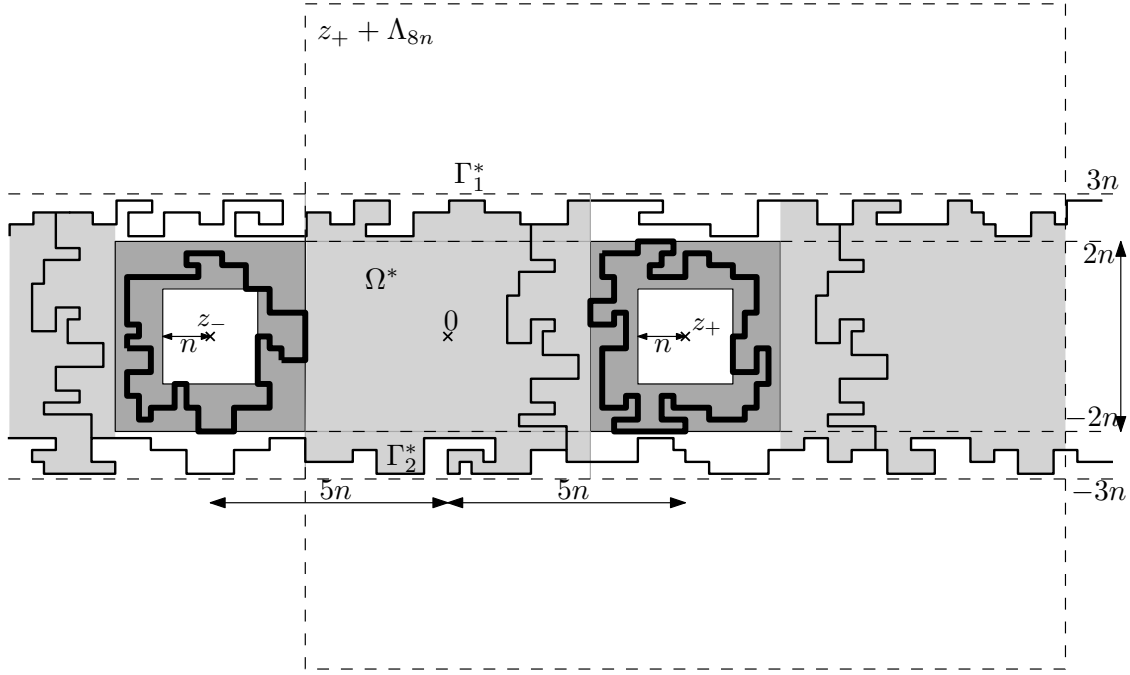

Figure 5.3: Primal open crossings are in bold, dual-open are in plain. The events $\mathcal{A}_n(z_+)$, $\mathcal{A}_n(z_-)$ and the existence of the dual horizontal crossings of R_+^* and R_-^* form \mathcal{B}_n . Conditionally on \mathcal{B}_n , Γ_1^* and Γ_2^* are connected in Ω^* by a dual-open path with probability larger than $1/(1+q^2)$.

bottom, and dual-free boundary conditions on the left and right sides. Using (5.3), we find

$$\phi_{\Lambda_{56n}}^0 [\mathcal{C}_n \mid \mathcal{B}_n] \geq \frac{1}{1+q^2},$$

where $\mathcal{C}_n = \{\Gamma_1 \overset{*}{\leftrightarrow} \Gamma_2 \text{ in } R^*\}$. Similar inequalities hold for the events

$$\begin{aligned} \mathcal{D}_n &= \{\Gamma_1 \overset{*}{\leftrightarrow} \Gamma_2 \text{ in } (-10n, 0) + R^*\}, \\ \mathcal{E}_n &= \{\Gamma_1 \overset{*}{\leftrightarrow} \Gamma_2 \text{ in } (10n, 0) + R^*\}. \end{aligned}$$

The FKG inequality thus implies

$$\phi_{\Lambda_{56n}}^0 [\mathcal{C}_n \cap \mathcal{D}_n \cap \mathcal{E}_n \mid \mathcal{B}_n] \geq \frac{1}{(1+q^2)^3}$$

which, together with (5.14), leads to

$$\phi_{\Lambda_{56n}}^0 [\mathcal{B}_n \cap \mathcal{C}_n \cap \mathcal{D}_n \cap \mathcal{E}_n] \geq \frac{c_3}{(1+q^2)^3} \phi_{\Lambda_{56n}}^0 [\mathcal{A}_{7n}]. \quad (5.15)$$

The event estimated in (5.15) implies in particular the existence of dual circuits in $z_+ + \Lambda_{8n}^*$ and $z_- + \Lambda_{8n}^*$ disconnecting $z_+ + \Lambda_{2n}^*$ from $z_- + \Lambda_{2n}^*$. Writing \mathcal{F}_n for the event that such dual circuits exist and using the comparison between boundary conditions one last

time (more precisely a “conditioning on the exterior-most circuit”-type argument), we obtain

$$\begin{aligned} \phi_{\Lambda_{8n}}^0 [\mathcal{A}_n]^2 &= \phi_{z_- + \Lambda_{8n}}^0 [\mathcal{A}_n(z_-)] \phi_{z_+ + \Lambda_{8n}}^0 [\mathcal{A}_n(z_+)] \\ &\geq \phi_{\Lambda_{56n}}^0 [\mathcal{A}_n(z_-) \mid \mathcal{A}_n(z_+) \cap \mathcal{F}_n] \phi_{\Lambda_{56n}}^0 [\mathcal{A}_n(z_+) \mid \mathcal{F}_n] \phi_{\Lambda_{56n}}^0 [\mathcal{F}_n] \\ &= \phi_{\Lambda_{56n}}^0 [\mathcal{A}_n(z_-) \cap \mathcal{A}_n(z_+) \cap \mathcal{F}_n] \\ &\geq \frac{c_3}{(1+q^2)^3} \phi_{\Lambda_{56n}}^0 [\mathcal{A}_{7n}]. \end{aligned}$$

This inequality implies the claim. \square

We need a last lemma before being able to prove Proposition 3.4.

Lemma 3.8. *Let $1 \leq k \leq n$,*

$$\phi_{\Lambda_n}^0 [0 \longleftrightarrow \partial\Lambda_k] \leq \sum_{m \geq k} 72m^4 \max_{\substack{a \in \{0\} \times [0, m] \\ b \in \{m\} \times [0, m]}} \phi_{[0, m]^2}^0 [a \longleftrightarrow b].$$

Proof. For $x = (x_1, x_2)$, define $\|x\|_\infty = \max\{|x_1|, |x_2|\}$.

Define \mathcal{C} to be the connected component of the origin. Consider the event that a and b are two vertices in \mathcal{C} maximizing the $\|\cdot\|_\infty$ -distance between each other. Since these vertices are at maximal distance from each other, they can be placed on the two opposite sides of a square box Λ in such a way that \mathcal{C} is included in this box. Let $\mathcal{A}_{\max}(a, b, \Lambda)$ the event that a and b are connected in Λ and that their cluster is contained in Λ .

We now wish to estimate the probability of $\mathcal{A}_{\max}(a, b, \Lambda)$. Let Λ^* be the subgraph of $(\mathbb{Z}^2)^*$ composed of dual-edges whose end-points correspond to faces touching Λ . Let \mathbf{C} be the set of dual self-avoiding circuits $\gamma = \{\gamma_0 \sim \gamma_1 \sim \dots \sim \gamma_m \sim \gamma_0\}$ on Λ^* surrounding a and b . As before, we denote by $\bar{\gamma}$ the interior of γ .

On the event \mathcal{C} , there exists $\gamma \in \mathbf{C}$ which is dual-open¹, and a and b are connected in $\bar{\gamma}$. As before, we may condition on the outermost dual-open circuit Γ in \mathbf{C} . We deduce as in the last proof that

$$\phi_{\Lambda_n}^\xi (a \longleftrightarrow b \text{ in } \bar{\gamma} \mid \Gamma = \gamma) = \phi_{\bar{\gamma}}^0 (a \longleftrightarrow b \text{ in } \bar{\gamma}) \leq \phi_\Lambda^0 (a \longleftrightarrow b \text{ in } \bar{\gamma}) \leq \phi_\Lambda^0 (a \longleftrightarrow b).$$

We now partition $\mathcal{A}_{\max}(a, b, \Lambda)$ into the events $\{\Gamma = \gamma\}$ to find

$$\phi_{\Lambda_n}^\xi (\mathcal{A}_{\max}(a, b, \Lambda)) \leq \phi_\Lambda^0 (a \longleftrightarrow b)$$

and therefore

$$\phi_{\Lambda_n}^\xi (\mathcal{A}_{\max}(a, b, \Lambda)) \leq \max_{\substack{a \in \{0\} \times [0, m] \\ b \in \{m\} \times [0, m]}} \phi_{[0, m]^2}^0 [a \longleftrightarrow b], \quad (5.16)$$

where $m = \|a - b\|_\infty$.

¹Note that this is true even when $\Lambda = \Lambda_n$ since free boundary conditions can be seen as dual-wired boundary conditions on Λ_n^* , and that therefore $\partial\Lambda_n^*$ provides us with a dual self-avoiding circuit in \mathbf{C} which is dual-open. A similar reasoning applies when Λ only shares some sides with Λ_n .

We may now use the fact that if 0 is connected to distance k , there exist a and b at distance $m \geq k$ of each others and a box Λ having a and b on opposite sides such that $\mathcal{A}_{\max}(a, b, \Lambda)$ occurs. Let us bound the number of choices for a, b and Λ .

For a fixed $m \geq k$, there are $|\Lambda_m| = (2m + 1)^2$ choices for a (since a must be at distance smaller or equal to m from the origin). Then a must be on the boundary of Λ and there are therefore $|\partial\Lambda| = 4m$ choices for Λ . The number of choices for b is bounded by $m + 1$ (it must be on the opposite sides of Λ). Therefore, for fixed m we can bound the number of possible triples (a, b, Λ) by $4m(2m + 1)^2(m + 1) \leq 72m^4$. We have been very wasteful in the previous reasoning and the bound on this number could be improved greatly but this will be irrelevant for applications.

Overall, (5.16) and a union bound gives

$$\phi_{\mathbb{Z}^2}^0 [0 \leftrightarrow \partial\Lambda_k] \leq \sum_{m \geq k} 72m^4 \max_{\substack{a \in \{0\} \times [0, m] \\ b \in \{m\} \times [0, m]}} \phi_{[0, m]^2}^0 [a \leftrightarrow b].$$

□

Proof of Proposition 3.4. Obviously the cases 1 and 2 cannot occur simultaneously. Suppose that the first case does not occur and let us prove that the second does.

For all $n \geq 1$, set $u_n = C\phi_{\Lambda_{8n}}^0 [\mathcal{A}_n]$, where C is defined as in Lemma 3.7. With this notation, Lemma 3.7 implies that $u_{7n} \leq u_n^2$ for any $n \geq 1$ which implies that for $0 \leq \ell, k \leq n$,

$$u_{7^k n_0} \leq u_{n_0}^{2^k} \tag{5.17}$$

for any positive $k \geq 0$ and $n_0 \geq 1$. Now, if $\liminf_{n \rightarrow \infty} \phi_{\Lambda_{8n}}^0 [\mathcal{A}_n] = 0$, then we may pick n_0 such that $u_{n_0} < 1$. By (5.17), there exists $c_1 > 0$ such that for all n of the form $n = 7^k n_0$,

$$u_n \leq \exp\left(-c_1 n^{\log 2 / \log 7}\right).$$

Fix $n = 7^k n_0$ and consider $\frac{n}{7} \leq m < n$. The FKG inequality and the comparison between boundary conditions imply that

$$\begin{aligned} \phi_{[0, m]^2}^0 [(0, k) \longleftrightarrow (m, \ell)] &\leq \left(\phi_{[-m, m] \times [0, m]}^0 [(-m, \ell) \longleftrightarrow (m, \ell)] \right)^{1/2} \\ &\leq \left(\phi_{\Lambda_{8n}}^0 [\mathcal{C}_h([-2n, 2n] \times [0, m])] \right)^{1/14} \\ &\leq \left(\phi_{\Lambda_{8n}}^0 [\mathcal{A}_n] \right)^{1/56} \leq \exp\left(-c_2 n^{\log 2 / \log 7}\right). \end{aligned}$$

In the first inequality, we used that if $(0, k) \longleftrightarrow (m, \ell)$ and $(-m, \ell) \longleftrightarrow (0, k)$, then $(-m, \ell) \longleftrightarrow (m, \ell)$. In the second inequality, we have used that if $(x, \ell) \longleftrightarrow (x + 2m, \ell)$ occur for $x = 2mj$ with $j \in \{-7, \dots, 7\}$, then $\mathcal{C}_h([-2n, 2n] \times [0, m])$ occurs. Finally in the third inequality we combined four crossings as in the proof of **P5** \Rightarrow **P5a**. Lemma 3.8 implies the claim. □

Theorem 1.3 follows directly from Proposition 3.4 and the following proposition:

Proposition 3.9. *If there exists $\alpha > 0$ such that for all $n \geq 1$,*

$$\phi_{\mathbb{Z}^2}^0 [0 \longleftrightarrow \partial\Lambda_n] \leq \exp(-n^\alpha),$$

then there exists $c > 0$ such that for all $n \geq 1$,

$$\phi_{\mathbb{Z}^2}^0 [0 \longleftrightarrow \partial\Lambda_n] \leq \exp(-cn).$$

We start by a lemma. Let $n \geq 1$ and $\theta \in [-1, 1]$. Define the *tilted strip* in direction θ :

$$S(n, \theta) := \{(x, y) \in \mathbb{Z}^2 : 0 \leq y - \theta x \leq n\}.$$

Write $\phi_{S(n, \theta)}^{1/0}$ for the random-cluster measure on the tilted strip $S(n, \theta)$ with wired boundary conditions on the top side and free on the bottom side (the boundary conditions at infinity are irrelevant since the tilted strip is essentially a one-dimensional graph).

We will also consider a truncated version of the tilted strip $S(n, \theta)$. For $m \geq 0$, consider the *truncated tilted strip*

$$S(n, m, \theta) := S(n, \theta) \cap \Lambda_m.$$

We will always assume that $\theta m \in \mathbb{N}$. Write $\phi_{S(n, m, \theta)}^{1/0}$ for the random-cluster measure with free boundary conditions on the bottom side and wired on the other three sides.

For simplicity, we will call the bottom side of the strip or the truncated strip the *free arc*, and the rest of the boundary the *wired arc*.

Lemma 3.10. *For all $m \geq n \geq 1$ and $\theta \in [-1, 1]$,*

$$\phi_{S(n, m, \theta)}^{1/0} [0 \longleftrightarrow \text{wired arc}] \geq \frac{1}{5m^2n^2}.$$

Proof. Fix $n \geq 0$ and $\theta \in [-1, 1]$. Let us work in the strip $S(2n, \theta)$. From now on, we drop the dependence in n and θ and write for instance $S = S(n, \theta)$ and $S(m) = S(2n, m, \theta)$. Beware that there is a slightly confusing notation here: the height of the strip is $2n$ while the one of the truncated strip is n .

For $x \in S$, define the translate $S_x(m) := x + S(m)$ of $S(m)$. We extend the definition of wired and free arcs to this context. Let $\mathcal{A}(x)$ be the event that x is connected to the wired arc of $S_x(m)$ and every open path from a vertex $y \notin S_x(m)$ to x intersects the wired arc (of $S_x(m)$). In other words, no open path starting from x “exits” $S_x(m)$ through the free arc (i.e. the bottom side).

We consider the random function $F : \mathbb{N} \rightarrow [0, 2n]$ defined by

$$F(k) := \min\{\ell : (k, \ell) \text{ is connected to the top side of } S\} - \theta k.$$

Recall that $\theta m \in \mathbb{N}$. Therefore, F can take only the $2nm + 1$ following values:

$$\left\{0, \frac{1}{m}, \dots, \frac{2nm-1}{m}, 2n\right\}.$$

On the event $\{F(0) \leq n\}$, there must exist $k \in \{-nm^2, \dots, nm^2\}$ such that $F(k) \leq n$ and $F(k') \geq F(k)$ for every $|k' - k| \leq m$. Otherwise, if there is no such k , then there exists a sequence $0 = k_0, \dots, k_{nm}$ with $|k_{i+1} - k_i| \leq m$ and $0 < F(k_{i+1}) < F(k_i)$. But this provides $nm + 1$ distinct values for F , all smaller or equal to n and strictly larger than 0, which is contradictory.

Now, for k satisfying $F(k) \leq n$ and $F(k') \geq F(k)$ for every $|k' - k| \leq m$, the event $\mathcal{A}((k, F(k)))$ is realized. In conclusion, if $F(0) \leq n$, then there exists $x \in S(n, nm^2, \theta)$ such that $\mathcal{A}(x)$ is realized and the union bound shows the existence of $x \in S(n, \theta)$ (the lower half of S) such that

$$\phi_S^{1/0}[\mathcal{A}(x)] \geq \frac{\phi_S^{1/0}[F(0) \leq n]}{|S(n, nm^2, \theta)|} = \frac{\phi_S^{1/0}[F(0) \leq n]}{n(2nm^2 + 1)}.$$

Consider the interface between the open cluster connected to the top side of the box and the dual-open cluster dual-connected to the bottom side. By duality, this interface intersects $\{0\} \times [0, n]$ with probability larger or equal to $1/2$. Thus, $\phi_S^{1/0}[F(0) \leq n] \geq \frac{1}{2}$ and therefore

$$\phi_S^{1/0}[\mathcal{A}(x)] \geq \frac{1}{5n^2m^2}.$$

In order to conclude, we simply need to prove that

$$\phi_{S(m)}^{1/0}[0 \longleftrightarrow \text{wired arc}] \geq \phi_S^{1/0}[\mathcal{A}(x)].$$

First, observe that since x is contained in the bottom half $S(n, \theta)$ of S , the set $S_x(m)$ is entirely included in S . Second, since there is no open path containing x and exiting $S_x(m)$ by the free arc, there exists a lowest dual-open path in $S_x(m)^*$, denoted Γ^* , preventing the existence of such a path, see Fig. 5.4. Let Ω be the set of vertices of $S_x(m)$ above Γ^* . The boundary conditions on Ω are dominated by free boundary conditions on the bottom side of $S_x(m)$ and wired on the three other sides of $S_x(m)$. If $\mathcal{A}(x)$ occurs, then conditionally on Γ^* , x is connected to the wired arc of $S_x(m)$ by an open path contained in Ω . Thus,

$$\begin{aligned} \phi_S^{1/0}[x \longleftrightarrow \text{wired arc of } S_x(m) | \Gamma^*] &\leq \phi_{S_x(m)}^{1/0}[x \longleftrightarrow \text{wired arc of } S_x(m)] \\ &= \phi_{S(m)}^{1/0}[0 \longleftrightarrow \text{wired arc of } S(m)]. \end{aligned}$$

We omitted a few lines to get the first inequality since we already mentioned such an argument. The equality follows from invariance under translations. Since the previous bound is uniform in the possible realizations of Γ^* , we deduce

$$\phi_S^{1/0}[\mathcal{A}(x)] \leq \phi_{S(m)}^{1/0}[0 \longleftrightarrow \text{wired arc of } S(m)].$$

The result follows readily. □

The next lemma will be used recursively in the proof of Proposition 3.9.

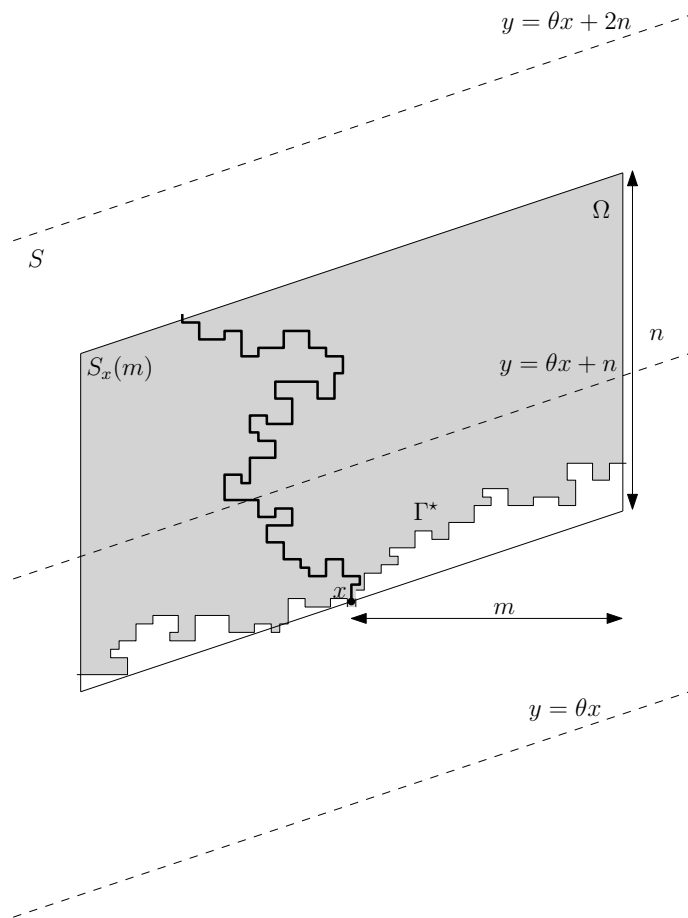

Figure 5.4: The event $\mathcal{A}(x)$. The bottom-most dual-path Γ^* .

Lemma 3.11. *Assume that there exists $\alpha > 0$ such that for all $n \geq 1$,*

$$\phi_{\mathbb{Z}^2}^0 [0 \longleftrightarrow \partial\Lambda_n] \leq \exp(-n^\alpha).$$

Then for $\varepsilon > 0$ small enough, there exists a constant $C < \infty$ such that for any $n \geq 1$, any $u \in \{-n\} \times [-n, n]$ and any $v \in \{n\} \times [-n, n]$,

$$\phi_{\Lambda_n}^0 [u \longleftrightarrow v] \leq e^{Cn^\varepsilon} \phi_{\mathbb{Z}^2}^0 [0 \longleftrightarrow \partial\Lambda_n]^2 + Cn^6 \sum_{\substack{k, \ell \geq n^\varepsilon \\ k+\ell=2n}} \phi_{\mathbb{Z}^2}^0 [0 \longleftrightarrow \partial\Lambda_k] \phi_{\mathbb{Z}^2}^0 [0 \longleftrightarrow \partial\Lambda_\ell].$$

Proof. Fix $\varepsilon > 0$. Let us translate the box Λ_n in such a way that $u = -v$; the new box is denoted by $\tilde{\Lambda}_n$. Define the set

$$D = \{z \in \tilde{\Lambda}_n : d(z, [u, v]) < n^\varepsilon\}.$$

As illustrated in Fig. 5.5, we consider the sets D_- and D_+ of points $z \in \tilde{\Lambda}_n$ lying re-

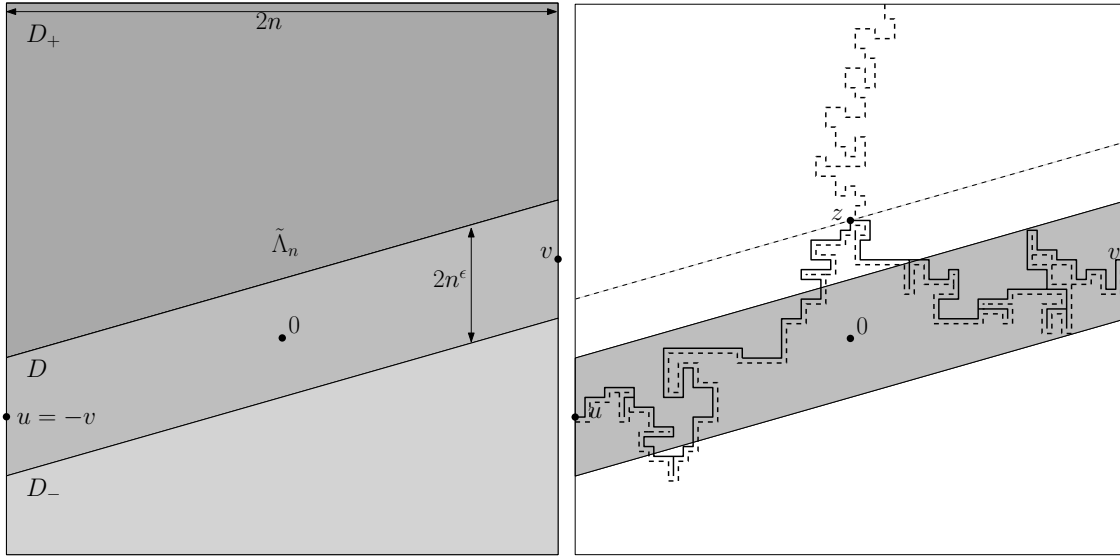

Figure 5.5: **Left.** The regions D , D_- and D_+ . Note that 0 is not necessarily at the center of $\tilde{\Lambda}_n$. **Right.** The situation before closing the edges surrounding z when $\mathcal{G}_n(z)$ and $\{z + (\frac{1}{2}, \frac{1}{2}) \xrightarrow{*} \partial\Lambda_n\}$ occurs. The dual-open paths are depicted in dash lines.

spectively below D and above D . On $\{u \xrightarrow{\tilde{\Lambda}_n} v\}$, define Γ^- and Γ^+ to be respectively the lowest and highest open (non-necessarily self-avoiding) paths connecting u to v . The event $\{u \xrightarrow{\tilde{\Lambda}_n} v\}$ is included in the union of the following three sub-events:

$$\mathcal{E}_- = \{u \xrightarrow{\tilde{\Lambda}_n} v\} \cap \{\Gamma^- \cap D_+ \neq \emptyset\}, \quad (5.18)$$

$$\mathcal{E}_+ = \{u \xrightarrow{\tilde{\Lambda}_n} v\} \cap \{\Gamma^+ \cap D_- \neq \emptyset\},$$

$$\mathcal{E} = \{u \xrightarrow{\tilde{\Lambda}_n} v\} \cap \{\Gamma^+ \subset D_+ \cup D\} \cap \{\Gamma^- \subset D_- \cup D\}.$$

In the rest of the proof, we will bound separately $\phi_{\Lambda_n}^0 [\mathcal{E}_-]$ (and therefore $\phi_{\Lambda_n}^0 [\mathcal{E}_+]$ by symmetry) and $\phi_{\Lambda_n}^0 [\mathcal{E}]$, hence the two terms on the right-hand side of the inequality in the statement.

Estimation of $\phi_{\tilde{\lambda}_n}^0[\mathcal{E}_-]$. For $z \in D_+ \cap \mathbb{Z}^2$, let $\mathcal{G}_n(z)$ be the event that:

- u is connected to v in $\tilde{\Lambda}_n$,
- $z \in \Gamma^-$ and $d(z, [u, v]) = \max_{z' \in \Gamma^- \cap D_+} d(z', [u, v])$.

Note that

$$\mathcal{E}_- = \bigcup_{z \in D_+} \mathcal{G}_n(z).$$

Conditionally on Γ^- , what is above Γ^- follows a random-cluster measure with wired boundary conditions on Γ^- and free on $\partial\tilde{\Lambda}_n$. Thus, by comparison between boundary conditions and Lemma 3.10 (with $m = n$ and $\theta = \frac{v_2 - u_2}{v_1 - u_1}$, where $u = (u_1, u_2)$ and $v = (v_1, v_2)$), we find that

$$\phi_{\tilde{\lambda}_n}^0 \left[z + (1/2, 1/2) \overset{*}{\leftrightarrow} \partial B_n^* \mid \mathcal{G}_n(z) \right] \geq \frac{1}{5(2n)^4},$$

When both $\mathcal{G}_n(z)$ and $\{z + (1/2, 1/2) \overset{*}{\leftrightarrow} \partial B_n^*\}$ occur, closing the four dual edges surrounding the vertex z disconnects Γ^- into two paths separated by dual-open circuits (see Fig. 5.5). The respective end-to-end distances ℓ and k of these paths satisfy $k + \ell \geq 2n - 2$.

Using the comparison between boundary conditions once-again, we find

$$\begin{aligned} \phi_{\tilde{\lambda}_n}^0[\mathcal{G}_n(z)] &\leq 5(2n)^4 \phi_{\tilde{\lambda}_n}^0 \left[\mathcal{G}_n(z) \cap \{z + (1/2, 1/2) \overset{*}{\leftrightarrow} \partial B_n^*\} \right] \\ &\leq \frac{80}{c_{\Gamma}^4} n^4 \sum_{\substack{k, \ell \geq n^\epsilon \\ k + \ell = 2n - 2}} \phi_{\mathbb{Z}^2}^0[u \leftrightarrow u + \partial\Lambda_k] \phi_{\mathbb{Z}^2}^0[v \leftrightarrow v + \partial\Lambda_\ell]. \end{aligned}$$

The finite energy property is used in the second line to close the edges around z . Summing over all possible $z \in D_+$ gives

$$\phi_{\tilde{\lambda}_n}^0[\mathcal{E}_-] \leq C_1 n^6 \sum_{\substack{k, \ell \geq n^\epsilon \\ k + \ell = 2n - 2}} \phi_{\mathbb{Z}^2}^0[0 \leftrightarrow \partial\Lambda_k] \phi_{\mathbb{Z}^2}^0[0 \leftrightarrow \partial\Lambda_\ell].$$

The finite energy property once again implies that $\phi_{\mathbb{Z}^2}^0[0 \leftrightarrow \partial\Lambda_{r+1}] \geq c_{\Gamma} \phi_{\mathbb{Z}^2}^0[0 \leftrightarrow \partial\Lambda_r]$ for any $r \geq 0$ and thus

$$\phi_{\tilde{\lambda}_n}^0[\mathcal{E}_-] \leq C_2 n^6 \sum_{\substack{k, \ell \geq n^\epsilon \\ k + \ell = 2n}} \phi_{\mathbb{Z}^2}^0[0 \leftrightarrow \partial\Lambda_k] \phi_{\mathbb{Z}^2}^0[0 \leftrightarrow \partial\Lambda_\ell].$$

Estimation of $\phi_{\tilde{\lambda}_n}^0[\mathcal{E}]$. First, we wish to justify that conditionally on the occurrence of \mathcal{E} , there exists an open path between u and v which is staying in D with probability close to 1. To see this, remark that any open path between u and v must lie in the region Ω between Γ^- and Γ^+ (see Fig. 5.6). Furthermore, conditioning on Γ^+ and Γ^- , the boundary conditions on Ω are wired. In particular, the configuration in Ω dominates the restriction to Ω of a configuration \tilde{w} sampled according to a random-cluster measure with wired boundary conditions at infinity. Since Γ^+ and Γ^- are already open, u and v are connected in D if there exists an open path in \tilde{w} from left to right in D . The complement of this

event is included in the event that a dual-vertex of D^* is dual-connected to distance n^ε of itself in $\tilde{\omega}$. The probability of this event can thus be bounded by $4n^{1+\varepsilon} \exp(-n^{\alpha\varepsilon})$ thanks to the assumption made on connection probabilities. We deduce

$$\phi_{\tilde{\lambda}_n}^0 \left[u \xleftrightarrow{D} v \right] \geq (1 - 4n^{1+\varepsilon} \exp(-n^{\alpha\varepsilon})) \phi_{\tilde{\lambda}_n}^0 [\mathcal{E}].$$

Now, consider the set of edges E of D intersecting the line $\{\frac{1}{2}\} \times \mathbb{R}$. Also define w_- and w_+ to be respectively the highest point of D_-^* and the lowest point of D_+^* with first coordinate equal to $\frac{1}{2}$. Let \mathcal{F} be the event that

- all the edges of E are closed,
- w_- and w_+ are dual-connected to $\partial\tilde{\lambda}_n^*$ in D_-^* and D_+^* respectively.

Consider the event $u \xleftrightarrow{D} v$ and modify the configuration by closing all edges in E . The finite energy property implies that

$$\begin{aligned} \phi_{\tilde{\lambda}_n}^0 \left[\mathcal{F} \cap \{u \leftrightarrow u + \partial\Lambda_n\} \cap \{v \leftrightarrow v + \partial\Lambda_{n-1}\} \right] \\ \geq \phi_{\tilde{\lambda}_n}^0 \left[u \xleftrightarrow{D} v \right] \times c_{\text{IT}}^{2\sqrt{2}n^\varepsilon} \times \left(\frac{1}{5(2n)^4} \right)^2, \end{aligned}$$

where the term $c_{\text{IT}}^{2\sqrt{2}n^\varepsilon}$ is a uniform lower bound for the probability that all edges in E are closed, and $[5(2n)^4]^{-2}$ comes from the fact that Lemma 3.10 gives

$$\begin{aligned} \phi_{\tilde{\lambda}_n}^0 \left[w_- \xleftrightarrow{*} \partial\tilde{\lambda}_n^* \text{ in } D_- \mid u \xleftrightarrow{D} v \right] &\geq \frac{1}{5(2n)^4} \quad \text{and} \\ \phi_{\tilde{\lambda}_n}^0 \left[w_+ \xleftrightarrow{*} \partial\tilde{\lambda}_n^* \text{ in } D_+ \mid u \xleftrightarrow{D} v \right] &\geq \frac{1}{5(2n)^4}. \end{aligned}$$

The event \mathcal{F} forces the existence of a dual path disconnecting the cluster of u and the cluster of v (see Fig. 5.6). Conditioning on the cluster of u and its boundary, the boundary conditions in what remain are dominated by free boundary conditions at infinity, and we deduce that

$$\phi_{\tilde{\lambda}_n}^0 [\mathcal{E}] \leq e^{c_2 n^\varepsilon} \phi_{\mathbb{Z}^2}^0 [0 \leftrightarrow \partial\Lambda_n] \phi_{\mathbb{Z}^2}^0 [0 \leftrightarrow \partial\Lambda_{n-1}] \leq \frac{e^{c_2 n^\varepsilon}}{c_{\text{IT}}} \phi_{\mathbb{Z}^2}^0 [0 \leftrightarrow \partial\Lambda_n]^2,$$

where once again we used insertion tolerance in the last inequality. The claim follows readily. \square

Remark 3.12. The previous lemma implies that $\phi_{[0,2n]^2}^0(u \leftrightarrow v)$ is bounded by the right hand-side of (5.18) for any u and v on two opposite sides of $[0, 2n]^2$. Let us argue that $\phi_{[0,2n-1]^2}^0(u' \leftrightarrow v')$ is also bounded by a universal constant C times the right-hand side of (5.18) uniformly on u' and v' on opposite sides of $[0, 2n-1]^2$. Indeed, the comparison between boundary conditions shows that

$$\phi_{[0,2n-1]^2}^0(u' \leftrightarrow v') \leq \phi_{[0,2n]^2}^0(u' \xleftrightarrow{[0,2n-1]^2} v').$$

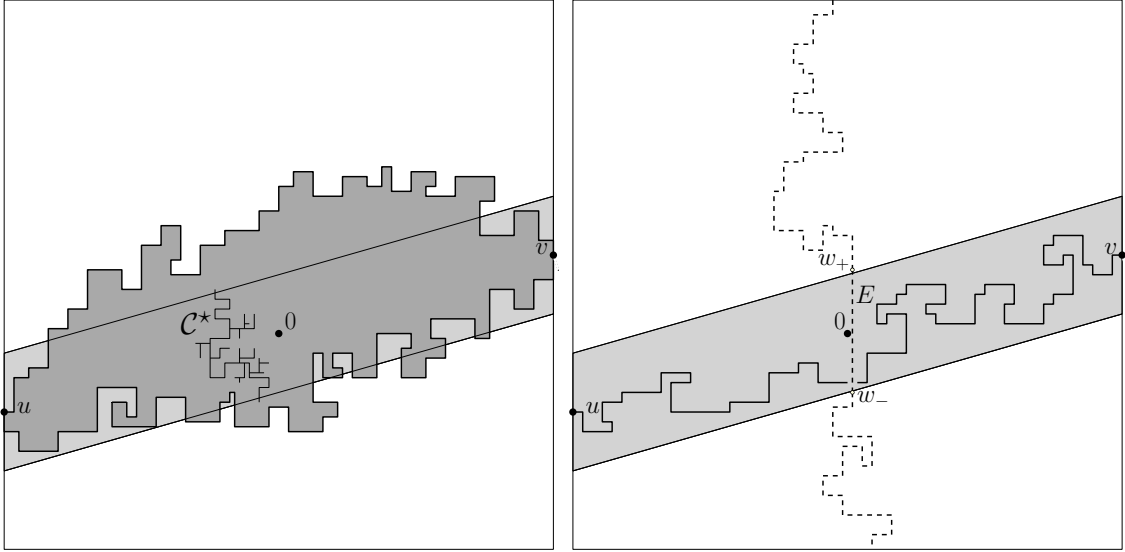

Figure 5.6: **Left.** The domain Ω between Γ_- and Γ_+ . Inside, a dual cluster \mathcal{C}^* preventing the existence of an open path from u to v in D . Since we assumed that connection probabilities decay as a stretched exponential, this cluster exists with very small probability. **Right.** Splitting the open path from u to v in two pieces.

Now let u and v be two neighbors of u' and v' on opposite sides of $[0, 2n]^2$. The finite energy property implies that

$$\phi_{[0, 2n-1]^2}^0(u' \leftrightarrow v') \leq c_{\Gamma} \phi_{[0, 2n]^2}^0(u \leftrightarrow v)$$

and we may apply the previous lemma.

Proof of Proposition 3.9. Assume that there exists $\alpha > 0$ such that

$$\phi_{\mathbb{Z}^2}^0[0 \longleftrightarrow \partial\Lambda_n] \leq \exp(-n^\alpha)$$

for any $n \geq 0$. Fix $\varepsilon < \beta < \alpha$ to be chosen later. Set

$$q_n = e^{n^\beta} \phi_{\mathbb{Z}^2}^0[0 \leftrightarrow \partial\Lambda_n].$$

Lemma 3.8 applied to $2n$ and Lemma 3.11 (more precisely Remark 3.12) imply that there

exists $C_3 > 0$ such that

$$\begin{aligned}
 q_{2n} &\leq e^{(2n)^\beta} \sum_{m \geq n} C_3 m^4 \left(e^{c_3 m^\varepsilon} \phi^0(0 \leftrightarrow \partial \Lambda_m)^2 \right. \\
 &\quad \left. + c_3 m^6 \sum_{\substack{k, \ell \geq m^\varepsilon \\ k + \ell = 2m}} \phi^0(0 \leftrightarrow \partial \Lambda_k) \phi^0(0 \leftrightarrow \partial \Lambda_\ell) \right) \\
 &\leq e^{(2n)^\beta} \sum_{m \geq n} C_3 m^4 \left(e^{c_3 m^\varepsilon} e^{-2m^\beta} q_m^2 + c_3 m^6 \sum_{\substack{k, \ell \geq m^\varepsilon \\ k + \ell = 2m}} e^{-(k^\beta + \ell^\beta)} q_k q_\ell \right) \\
 &\leq \left(\max_{\substack{k, \ell \geq n^\varepsilon \\ k + \ell \geq 2n}} q_k q_\ell \right) e^{(2n)^\beta} \sum_{m \geq n} C_3 m^4 \left(e^{c_3 m^\varepsilon} e^{-2m^\beta} + c_3 m^6 \sum_{\substack{k, \ell \geq m^\varepsilon \\ k + \ell = 2m}} e^{-(k^\beta + \ell^\beta)} \right) \\
 &\leq C_4 \max_{\substack{k, \ell \geq n^\varepsilon \\ k + \ell \geq 2n}} q_k q_\ell,
 \end{aligned}$$

where $C_4 < \infty$ is a constant independent of n . The existence of C_4 follows from a simple computation using $\varepsilon < \beta$ and the fact that $\beta < 1$ and $k, \ell \geq n^\varepsilon$ imply

$$e^{-(k^\beta + \ell^\beta)} \leq e^{-(k + \ell)^\beta} e^{-c_4 n^{\varepsilon\beta}}$$

for some constant $c_4 > 0$ ².

Let us now come back to the proof. The finite energy property implies the existence of $c_5 > 0$ such that $c_5 q_k \leq q_{k+1} \leq q_k / c_5$ for any $k \geq 0$. Using this fact, the previous inequality immediately extends to odd integers and there exists $C_5 < \infty$ such that

$$q_n \leq C_5 \max_{\substack{k, \ell \geq n^\varepsilon \\ k + \ell \geq n}} q_k q_\ell.$$

We unfortunately need to include the following technical trick. We do not know a priori that (q_n) is decreasing. For this reason, we set $Q_n = C_5 \max\{q_m : m \geq n\}$. For this definition, we get

$$Q_n \leq \max_{\substack{k, \ell \geq n^\varepsilon \\ k + \ell \geq n}} Q_k Q_\ell.$$

We are now in a position to conclude. The assumption implies that (Q_n) tends to zero. Pick n_0 such that $Q_n < 1$ for $n \geq n_0$. Since $(Q_n)_{n \geq 0}$ is decreasing, the maximum of $Q_k Q_\ell$ is not reached for $k \geq n$ or $\ell \geq n$ and we obtain that for $n \geq n_0$,

$$Q_n \leq \max_{\substack{n > k, \ell \geq n^\varepsilon \\ k + \ell \geq n}} Q_k Q_\ell.$$

²Let us make a small remark before proceeding forward with the proof. It was crucial to keep the division in the inequality of Lemma 3.11 between a term $k = \ell = m$ with a stretched exponential penalty $8m^3 e^{c_3 m^\varepsilon}$, and the general term $k + \ell = 2m$, for which we have only a polynomial penalty $8m^3 c_3 m^6$. If we would have replaced the polynomial bound by a stretched exponential one for every k and ℓ , the values of k or ℓ close to n^ε would have created difficulties since the correction would have been of the order of the largest of the two terms.

We can now proceed by induction to prove that for $n \geq n_0$,

$$Q_n \leq \exp(-c_6 n) \quad \text{where} \quad c_6 := \max_{n_0^{\epsilon} \leq n \leq n_0} -\frac{1}{n} \log(Q_n) > 0.$$

We therefore conclude that

$$\phi_{\mathbb{Z}^2}^0 [0 \longleftrightarrow \partial\Lambda_n] \leq n \exp(n^\beta) \cdot \frac{1}{C_5} \exp(-c_6 n).$$

□

4 Proof of Theorem 1.6

4.1 An input coming from the theory of parafermionic observables

We will harness the following theorem, which follows from the study of the parafermionic observable. For a complete exposition of the current knowledge on parafermionic observables and a proof of this statement, we refer to [DC13, Chapter 6].

Dobrushin domains. In order to properly state and use the result, we first define the notion of Dobrushin domain.

Let us start by defining the *medial lattice* $(\mathbb{Z}^2)^\diamond$, which is the graph with the centers of edges of \mathbb{Z}^2 as vertex set, and edges connecting nearest vertices. The vertices and edges of the medial lattice are called medial-vertices and medial-edges. This lattice is a rotated and rescaled (by a factor $1/\sqrt{2}$) version of \mathbb{Z}^2 . Edges of $(\mathbb{Z}^2)^\diamond$ are oriented counterclockwise around medial-faces having a vertex of \mathbb{Z}^2 at their center. Like that, the medial lattice can sometimes be seen as an oriented graph.

Let a^\diamond and b^\diamond be two distinct medial-vertices, and $\partial_{ab}^\diamond = \{v_0 \sim v_1 \sim \dots \sim v_n\}$, $\partial_{ba}^\diamond = \{w_0 \sim w_1 \sim \dots \sim w_m\}$ two paths of neighboring medial-vertices satisfying the following properties:

- The paths start from a^\diamond and end at b^\diamond , i.e. $v_0 = w_0 = a^\diamond$ and $v_n = w_m = b^\diamond$.
- The paths follow the orientation of the medial lattice.
- The path ∂_{ab}^\diamond goes counterclockwise, while ∂_{ba}^\diamond goes clockwise.
- The paths are edge-avoiding.
- The paths intersect only at a^\diamond and b^\diamond .

Note that $\partial_{ab}^\diamond \cup \partial_{ba}^\diamond$ is a non self-crossing edge-avoiding polygon. However, some vertices might be visited twice.

Definition 4.1 (medial Dobrushin domains). Let ∂_{ab}^\diamond and ∂_{ba}^\diamond be two paths as above, and let Ω^\diamond be the subgraph of $(\mathbb{Z}^2)^\diamond$ induced by the medial-vertices that are enclosed by or in the path $\partial_{ab}^\diamond \cup \partial_{ba}^\diamond$. Then, $(\Omega^\diamond, a^\diamond, b^\diamond)$ is called a *medial Dobrushin domain*. An example is given in Fig. 5.7.

As it stands, a^\diamond and b^\diamond have three incident medial-edges in E_{Ω^\diamond} . Call e_a and e_b the fourth medial-edges incident to a^\diamond and b^\diamond respectively.

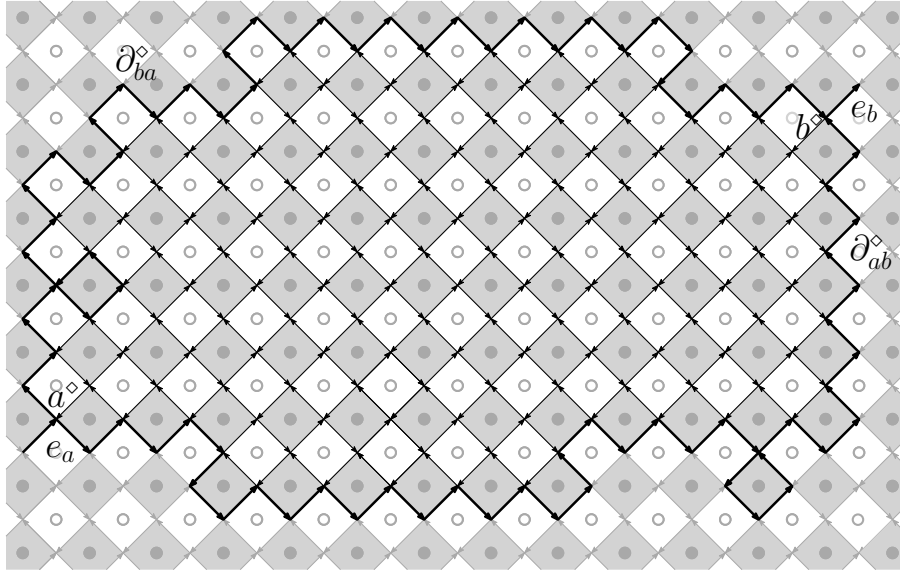

Figure 5.7: A medial Dobrushin domain. Note the position of e_a and e_b .

Definition 4.2 (primal and dual Dobrushin domains with two marked points). Let $(\Omega^\diamond, a^\diamond, b^\diamond)$ be a medial Dobrushin domain.

Let $\Omega \subset \mathbb{Z}^2$ be the graph with edge set composed of edges passing through end-points of medial-edges in $E_{\Omega^\diamond} \setminus \partial_{ab}^\diamond$ (if a medial-vertex is the end-point of a medial-edge in $E_{\Omega^\diamond} \setminus \partial_{ab}^\diamond$ and one in ∂_{ab}^\diamond , it is included) and vertex set given by the end-points of these edges. Let a and b be the two vertices of Ω bordered by e_a and e_b . The triplet (Ω, a, b) is called a *primal Dobrushin domain*. We denote by ∂_{ba} the set of edges corresponding to medial-vertices in $\partial\Omega^\diamond$ which are also end-points of medial-edges in ∂_{ba}^\diamond , and set $\partial_{ab} = \partial\Omega \setminus \partial_{ba}$.

Let $\Omega^* \subset \mathbb{Z}^*$ be the graph with edge set composed of dual-edges passing through medial-edges in $E_{\Omega^\diamond} \setminus \partial_{ba}^\diamond$ and vertex set given by the end-points of these dual-edges. Let a^* and b^* be the two dual-vertices of Ω^* bordered by e_a and e_b . The triplet (Ω^*, a^*, b^*) is called a *dual Dobrushin domain*. We denote by ∂_{ab}^* the set of dual-edges corresponding to medial-vertices in $\partial\Omega^\diamond$ which are also end-points of medial-edges in ∂_{ab}^\diamond , and set $\partial_{ba}^* = \partial\Omega^* \setminus \partial_{ab}^*$.

For a Dobrushin domain, let us define the Dobrushin boundary conditions on (Ω, a, b) to be wired on ∂_{ba} , and free on ∂_{ab} . The random-cluster measure with these boundary conditions and $p = p_c(q)$ is denoted by $\phi_\Omega^{a,b}$.

The main statement. Consider a Dobrushin domain (Ω, a, b) . The winding $W_\Gamma(e, e')$ of a curve Γ on the medial lattice between two medial-edges e and e' of the medial graph is the total signed rotation in radians that the curve makes from the mid-point of the edge e to that of the edge e' .

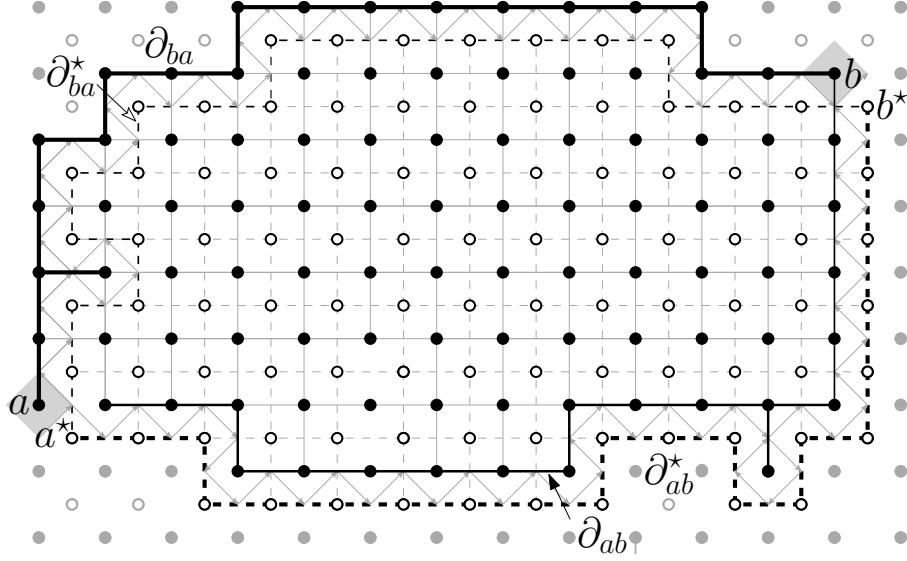

Figure 5.8: The primal and dual Dobrushin domains associated to a medial Dobrushin domain. Note the position of a, a^*, b and b^* .

For $x \in \partial_{ab}$, define $N(x)$ to be the number of neighboring vertices of x which are *not* in Ω . We also set

$$W(x) := \frac{1}{N(x) + 1} \sum_e W_{\partial_{ab}^\diamond}(e, e_b),$$

where the sum runs over medial-edges $e \in \partial_{ab}^\diamond$ bordering the face corresponding to x . Note that there are $N(x) + 1$ such medial-edges. This quantity can thus be interpreted as the average winding on adjacent medial-edges of $\partial_{ab}^\diamond \cup \partial_{ba}^\diamond$.

For $u \in \partial_{ba}^*$, define $N(u)$ to be the number of neighboring dual-vertices of u which are not in Ω . The quantity $W(u)$ is defined as before, with ∂_{ba}^\diamond replacing ∂_{ab}^\diamond .

Define $\sigma \in \mathbb{C}$ so that $\sin(\frac{\pi}{2}\sigma) = \frac{\sqrt{q}}{2}$ (for simplicity, we choose $\sigma \in [0, 1]$ for $q \in [0, 4]$, and $\sigma \in 1 - i\mathbb{R}_+$ for $q > 4$).

Theorem 4.3 ([DC13, Corollary 6.12 and Theorem 6.14]). *Let (Ω, a, b) be a Dobrushin domain, $q > 0$ and $p = p_c$. Then*

$$\begin{aligned} \sum_{x \in \partial_{ab}} \delta_x \phi_\Omega^{a,b} [x \leftrightarrow \partial_{ba}] - \sum_{u \in \partial_{ba}^*} \delta_u \phi_\Omega^{a,b} [u \overset{*}{\leftrightarrow} \partial_{ab}^*] \\ = 1 - \exp[i(\sigma - 1)W_{\partial_{ab}^\diamond}(e_a, e_b)], \end{aligned} \quad (5.19)$$

where $\delta_z := 2i \sin[(1 - \sigma)\frac{\pi}{4}N(z)] \exp[i(\sigma - 1)W(z)]$.

Furthermore, for $q = 4$, we also find

$$\sum_{x \in \partial_{ab}} \delta_x \phi_\Omega^{a,b} [x \leftrightarrow \partial_{ba}] - \sum_{u \in \partial_{ba}^*} \delta_u \phi_\Omega^{a,b} [u \overset{*}{\leftrightarrow} \partial_{ab}^*] = W_{\partial_{ab}^\diamond}(e_a, e_b), \quad (5.20)$$

where $\delta_z := \frac{\pi}{2}N(z)$.

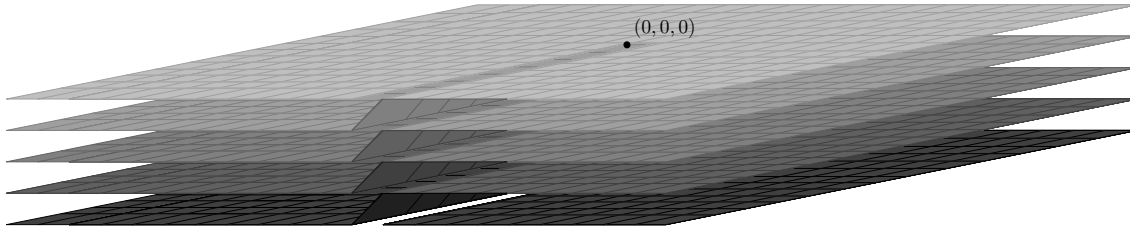
Figure 5.9: The graph \mathbb{U} .

The proof of this statement can be found in [DC13]. There, the factor $2i$ was forgotten in the before last displayed equation in the proof.

4.2 Proof of Theorem 1.6

The original proof of Theorem 1.6 can be found in [DC12]. However, we choose to present a streamlined proof here which is based on some of the new arguments of the previous section. In this section, we fix $1 \leq q < 4$ (and still $p = p_c(q)$). The case $q = 4$ follows the same proof with (5.20) instead of (5.19).

Set C_n to be the slit domain obtained by removing from Λ_n the edges between the vertices of $\{(0, k) : 0 \leq k \leq n\}$. We define Dobrushin boundary conditions on C_n to be wired on $\{(0, k) : 0 \leq k \leq n\}$ and free elsewhere. For simplicity, we now refer to $\{(0, k) : 0 \leq k \leq n\}$ as the *wired arc*. The measure on C_n with these boundary conditions is denoted $\phi_{C_n}^{\text{dobr}}$. Equivalently, one may obtain $\phi_{C_n}^{\text{dobr}}$ by taking $\phi_{\Lambda_n}^0 [\cdot | \omega(e) = 1 : \text{for all } e \text{ in wired arc}]$ and we therefore think of C_n as the box Λ_n with free boundary conditions and $\{(0, k) : 0 \leq k \leq n\}$ wired; see Fig. 5.10.

Lemma 4.4. *There exists $c > 0$ such that for any $n \geq 1$,*

$$\phi_{C_n}^{\text{dobr}} [(0, -n) \longleftrightarrow \text{wired arc}] \geq \frac{c}{n^{16}}.$$

The main estimate used in the proof of this lemma is provided by Theorem 4.3 applied in a well-chosen domain. Then, we compare boundary conditions in this domain to Dobrushin boundary conditions in C_n . To exploit the whole power of Theorem 4.3, we will consider a domain which is non-planar. Namely, let us introduce the following graph \mathbb{U} (see Fig. 5.9): the vertices are given by \mathbb{Z}^3 and the edges by

- $[(x_1, x_2, x_3), (x_1, x_2, x_3)]$ for every $x_1, x_2, x_3 \in \mathbb{Z}$,
- $[(x_1, x_2, x_3), (x_1 + 1, x_2, x_3)]$ for every $x_1, x_2, x_3 \in \mathbb{Z}$ such that $x_1 \neq 0$
- $[(0, x_2, x_3), (1, x_2, x_3)]$ for every $x_2 \geq 0$ and $x_3 \in \mathbb{Z}$,
- $[(0, x_2, x_3), (1, x_2, x_3 + 1)]$ for every $x_2 < 0$ and $x_3 \in \mathbb{Z}$.

This graph is the universal cover of $\mathbb{Z}^2 \setminus F$, where F is the face centered at $(\frac{1}{2}, -\frac{1}{2})$. It can also be seen at \mathbb{Z}^2 with a branching point at $(\frac{1}{2}, -\frac{1}{2})$. All definitions of dual and medial graphs extend to this context, as well as Theorem 4.3.

Proof. For $n \geq 1$, define

$$U_n := \{(x_1, x_2, x_3) \in \mathbb{U} : |x_1|, |x_2| \leq n \text{ and } |x_3| \leq n^5\}.$$

We wish to apply Theorem 4.3 to $(U_n, 0, 0)$. Even if the domain is non-planar, the proof works exactly in the same way and we get

$$\sum_{x \in \partial U_n} \delta_x \phi_{U_n}^0 [x \leftrightarrow 0] = 1 - \exp[i(\sigma - 1)\frac{3\pi}{2}].$$

To obtain this equality, we used that:

- $\partial_{ab} = \partial U_n$ and $\partial_{ba}^* = \emptyset$;
- $W(e_a, e_b) = \frac{3\pi}{2}$;
- The Dobrushin boundary conditions with $a = b = 0$ are simply free boundary conditions.

Since $|\delta_x| \leq 2$, we immediately get that

$$\sum_{x \in \partial U_n} \phi_{U_n}^0 [0 \leftrightarrow x] \geq c_1 \tag{5.21}$$

for some constant $c_1 = c_1(q) > 0$ independent of n .

We now wish to bootstrap this estimate to an estimate on C_n . Let us start by proving the following claim (observe that $|x_3| < n^5$ in the statement).

Claim: There exists $c_2 > 0$ (independent of n) such that there exists $x = (x_1, x_2, x_3) \in \partial U_n$ with $|x_3| < n^5$ and

$$\phi_{U_n}^0 [0 \leftrightarrow x] \geq \frac{c_2}{n^6}.$$

We will prove this fact by showing that vertices x with $|x_3| = n^5$ have very small probability of being connected to the origin and therefore cannot account for much in (5.21).

Proof of the Claim. Let R_0^* be the dual graph of the subgraph of \mathbb{U} with vertex set $R_0 := [-n, n] \times [0, n] \times \{0\}$, i.e. the graph with edge set $\{e^* : e \in E_{R_0}\}$ and vertex set given by the end-points of these edges. Note that uniformly in the state of edges outside R_0 , the boundary conditions in R_0 are dominated by wired boundary conditions on the “bottom side” $[-n, n] \times \{0\} \times \{0\}$ of R_0 , and free elsewhere. Passing to the dual model, we deduce that uniformly in the state of edges outside R_0 ,

$$\phi_{U_n}^0 \left[\left(-\frac{1}{2}, -\frac{1}{2}, 0\right) \overset{*}{\leftrightarrow} \partial U_n^* \text{ in } R_0^* \mid \text{edges outside } R_0 \right] \geq \phi_{R_0^*}^{1/0} \left[\left(-\frac{1}{2}, -\frac{1}{2}, 0\right) \overset{*}{\leftrightarrow} \partial U_n^* \text{ in } R_0^* \right],$$

where $\phi_{R_0^*}^{1/0}$ the (dual) random-cluster measure on R_0^* with free boundary conditions on the bottom and wired boundary conditions everywhere else. Lemma 3.10 (with $m = n$ and $\theta = 0$) thus implies that

$$\phi_{U_n}^0 \left[\left(-\frac{1}{2}, -\frac{1}{2}, 0\right) \overset{*}{\leftrightarrow} \partial U_n^* \text{ in } R_0^* \mid \text{edges outside } R_0 \right] \geq \frac{1}{5n^4}. \tag{5.22}$$

The same is also true for $R_k^* = (0, 0, k) + R_0^*$ with $|k| \leq n^5$.

If a vertex $x = (x_1, x_2, x_3) \in \partial U_n$ with $x_3 = n^5$ is connected to $(0, 0, 0)$, then none of the dual vertices $(-\frac{1}{2}, -\frac{1}{2}, k)$ are dual connected to ∂U_n in R_k^* for $0 < k < x_3$ (the symmetric holds for $x_3 = -n^5$). Equation (5.22) applied $|x_3| - 1$ times implies that

$$\phi_{U_n}^0 [0 \longleftrightarrow x] \leq \left(1 - \frac{1}{5n^4}\right)^{|x_3|-1}.$$

The probability is therefore exponentially small when $|x_3| = n^5$. Together with (5.21), the previous inequality implies that for n large enough,

$$\sum_{x \in \partial U_n: |x_3| < n^5} \phi_{U_n}^0 [0 \leftrightarrow x] \geq \frac{c_1}{2}.$$

The claim follows directly from the union bound, provided that c_2 is chosen small enough. ◇

Fix x given by the claim and rotate and translate vertically³ U_n in such a way that $x = (x_1, -n, 0)$ for some $-n \leq x_1 \leq n$. Consider C_n as a subgraph of U_n . The boundary conditions on C_n induced by the free boundary conditions on U_n are dominated by the Dobrushin boundary conditions on C_n defined above. Furthermore, the existence of an open path from x to the origin implies the existence of a path from x to the wired arc in C_n . Thus, the claim implies that

$$\phi_{C_n}^{\text{dobr}} [x \leftrightarrow \text{wired arc}] \geq \frac{c_2}{n^6}.$$

To conclude the proof, we need to obtain a lower bound for the probability that the vertex $(0, -n, 0)$ itself is connected to the wired arc. We use once again a “conditioning on the right-most and left-most paths type argument”. Since we now work on a sub-domain of \mathbb{Z}^2 , we drop the third coordinate from the notation.

We may assume that $x_1 \geq 0$ and that the two vertices $x = (x_1, -n)$ and $(-x_1, -n)$ are connected to the wired arc. The FKG inequality implies that this occurs with probability $(\frac{c_2}{n^6})^2$. Consider the right-most open path from $(x_1, -n)$ to the wired arc, and the left-most open path from $(-x_1, -n)$ to the wired arc. Let S be the part of C_n between these two paths, see Fig. 5.10. The boundary conditions in S dominate the free boundary conditions on the bottom of C_n , and wired elsewhere. We use a comparison between boundary conditions. The reasoning is the same as usual: we compare boundary conditions on S with the boundary conditions induced by boundary conditions on Λ_n with free boundary conditions on the bottom and wired boundary conditions on the other sides. Lemma 3.10 (applied to $2n$, $m = n$ and $\theta = 0$) thus implies that $(0, -n)$ is connected to the wired arc with conditional probability larger than $\frac{1}{20n^4}$, and we finally obtain

$$\phi_{C_n}^{\text{dobr}} [(0, -n) \longleftrightarrow \text{wired arc}] \geq \left(\frac{c_2}{n^6}\right)^2 \frac{1}{20n^4}.$$

³Seen as a graph, U_n is invariant by rotation by $\pi/2$ since the line where x_3 “increases” is invisible from inside U_n .

□

We are now in a position to prove Theorem 1.6. Let ∂_n be the set of vertices at distance $\frac{n}{16}$ of the vertex $(0, -n)$ in C_n . The reasoning is similar to the proof of Lemma 3.7 except that instead of isolating primal circuits around z_- and z_+ from each other, we will isolate the primal path from $(0, -n)$ to ∂_n from the wired arc.

Proof of Theorem 1.6. Introduce the three rectangles

$$\begin{aligned} R_{\text{right}}^* &:= \left[\frac{n}{16} + \frac{1}{2}, \frac{5n}{16} - \frac{1}{2} \right] \times \left[-(n + \frac{1}{2}), n + \frac{1}{2} \right], \\ R_{\text{left}}^* &:= \left[-\frac{5n}{16} + \frac{1}{2}, -\frac{n}{16} - \frac{1}{2} \right] \times \left[-(n + \frac{1}{2}), n + \frac{1}{2} \right], \\ R^* &:= \left[-\frac{5n}{16} + \frac{1}{2}, \frac{5n}{16} - \frac{1}{2} \right] \times \left[-\frac{3n}{4} + \frac{1}{2}, -\frac{n}{8} - \frac{1}{2} \right]. \end{aligned}$$

Define the three events $\mathcal{E} = \{(0, -n) \longleftrightarrow \partial_n \text{ in } C_n\}$, $\mathcal{F}_{\text{right}}$ and $\mathcal{F}_{\text{left}}$ that there exists a dual-open dual-path from bottom to top in R_{right}^* and R_{left}^* respectively. Let \mathcal{C} be the event that there exists a dual-open dual-path in R^* connecting a dual open path crossing R_{left}^* from top to bottom to a dual open path crossing R_{right}^* from top to bottom.

Conditioning on $\mathcal{F}_{\text{left}} \cap \mathcal{F}_{\text{right}} \cap \mathcal{C}$, boundary conditions on R_n are dominated by free boundary conditions in the plane. Therefore

$$\phi_{\mathbb{Z}^2}^0 \left[0 \leftrightarrow \partial \Lambda_{n/16} \right] \geq \phi_{C_n}^{\text{dobr}} \left[\mathcal{E} | \mathcal{F}_{\text{left}} \cap \mathcal{F}_{\text{right}} \cap \mathcal{C} \right] \geq \phi_{C_n}^{\text{dobr}} \left[\mathcal{E} \cap \mathcal{F}_{\text{left}} \cap \mathcal{F}_{\text{right}} \cap \mathcal{C} \right].$$

We now prove a lower bound on the term on the right:

$$\phi_{C_n}^{\text{dobr}} \left[\mathcal{E} \cap \mathcal{F}_{\text{left}} \cap \mathcal{F}_{\text{right}} \cap \mathcal{C} \right] = \phi_{C_n}^{\text{dobr}} \left[\mathcal{E} \right] \cdot \phi_{C_n}^{\text{dobr}} \left[\mathcal{F}_{\text{left}} \cap \mathcal{F}_{\text{right}} | \mathcal{E} \right] \cdot \phi_{C_n}^{\text{dobr}} \left[\mathcal{C} | \mathcal{E} \cap \mathcal{F}_{\text{left}} \cap \mathcal{F}_{\text{right}} \right].$$

First, Lemma 4.4 implies that $\phi_{C_n}^{\text{dobr}}(\mathcal{E}) \geq \frac{c}{n^{16}}$. Second, conditioned on everything on the left of $\{\frac{n}{16}\} \times [-n, n]$, boundary conditions on $[\frac{n}{16}, n] \times [-n, n]$ are dominated by wired boundary conditions on the left side and free elsewhere. In particular, boundary conditions for the dual model dominate free boundary conditions on the left side and wired elsewhere. Lemma 3.6 implies that $\phi_{C_n}^{\text{dobr}}[\mathcal{F}_{\text{right}} | \mathcal{E}] \geq c_2$ and the same lower bound holds true for $\phi_{C_n}^{\text{dobr}}[\mathcal{F}_{\text{left}} | \mathcal{F}_{\text{right}} \cap \mathcal{E}]$. We obtain

$$\phi_{C_n}^{\text{dobr}} \left[\mathcal{F}_{\text{left}} \cap \mathcal{F}_{\text{right}} | \mathcal{E} \right] \geq c_2^2.$$

Third, we turn to $\phi_{C_n}^{\text{dobr}}[\mathcal{C} | \mathcal{E} \cap \mathcal{F}_{\text{left}} \cap \mathcal{F}_{\text{right}}]$. Let S^* be the area of the dual graph in R^* between the right-most dual-open path from top to bottom in R_{right}^* and the left-most dual-open path crossing from top to bottom in R_{left}^* , see Fig. 5.10. The boundary conditions for the dual model on S^* dominate free boundary conditions on top and bottom, and wired elsewhere. The domain Markov property and the comparison between boundary conditions imply that boundary conditions for the dual model on S^* dominate free boundary conditions on top and bottom sides of R^* , and wired on the two other sides. Therefore, the probability of having a dual-open path in S^* crossing from left to right is larger than $1/(1+q^2)$ thanks to (5.3). In particular,

$$\phi_{C_n}^{\text{dobr}} \left[\mathcal{C} | \mathcal{E} \cap \mathcal{F}_{\text{left}} \cap \mathcal{F}_{\text{right}} \right] \geq \frac{1}{1+q^2}.$$

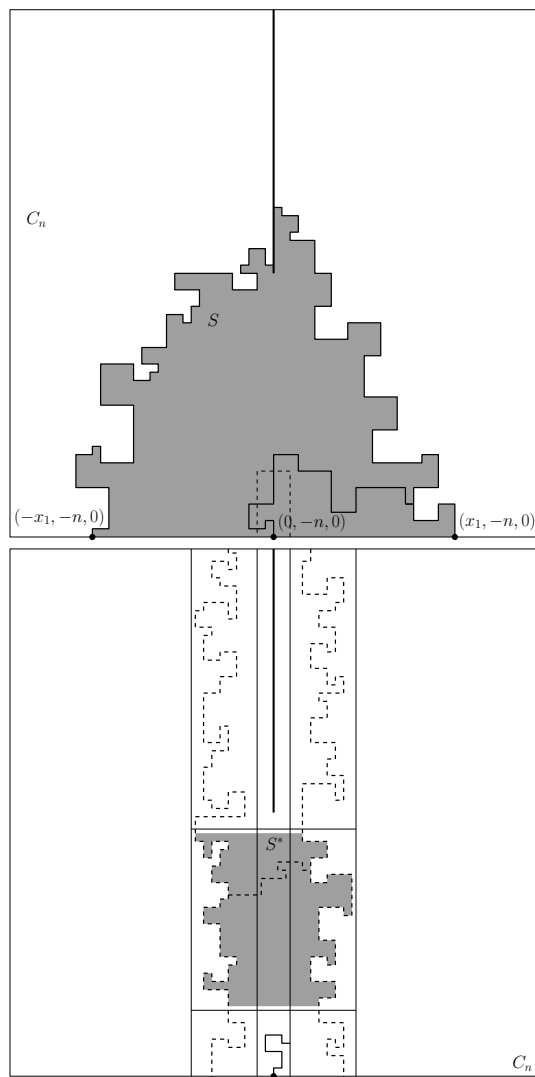

Figure 5.10: **Top.** The two paths connecting the wired arc to $(x_1, -n, 0)$ and $(-x_1, -n, 0)$ (or simply $(x_1, -n)$ and $(-x_1, -n)$) and the area S between them. **Bottom.** The two dual-open paths in the long rectangles R^*_{right} and R^*_{left} .

Putting everything together, we find that

$$\phi_{\mathbb{Z}^2}^0 \left[0 \leftrightarrow \partial \Lambda_{n/16} \right] \geq \frac{c}{n^{16}} \cdot c_2^2 \cdot \frac{1}{1+q^2}$$

and indeed

$$\lim_{n \rightarrow \infty} -\frac{1}{n} \log \left(\phi_{\mathbb{Z}^2}^0 \left[0 \leftrightarrow \partial \Lambda_n \right] \right) = 0.$$

□

4.3 Ordering for $q > 4$

As mentioned in the introduction, the phase transition of the random-cluster model (or equivalently of the Potts model) with $q > 4$ is expected to be discontinuous. In particular, this would mean that there exists an infinite cluster almost surely for the critical measure with wired boundary conditions. We are currently unable to prove this result. Nevertheless, we are able to prove the following (much) weaker result.

The graph \mathbb{U} is planar and we can define its dual graph, denoted $\tilde{\mathbb{U}}$. Notice that all the vertices of $\tilde{\mathbb{U}}$ have degree 4, except one vertex, denoted \mathbf{b} , which has infinite degree (it corresponds to the vertex at middle of the spiral). Given a finite subgraph \tilde{U} of $\tilde{\mathbb{U}}$, containing the vertex \mathbf{b} , we define the random cluster measure in \tilde{U} with wired boundary conditions: the boundary of \tilde{U} is given by \mathbf{b} together with all the vertices of \tilde{U} with degree strictly smaller than 4 in \tilde{U} . We can then define the random-cluster measure on $\tilde{\mathbb{U}}$ with wired boundary condition, denoted by $\phi_{\tilde{\mathbb{U}}}^1$, by taking the limit when \tilde{U} converge to $\tilde{\mathbb{U}}$. We fix a vertex \mathbf{v} of $\tilde{\mathbb{U}}$, disjoint from \mathbf{b} , and write $\mathbf{v} \longleftrightarrow \infty$ for the event that there exists an infinite open path from \mathbf{v} and disjoint from \mathbf{b} .

Proposition 4.5. *For $q > 4$, $\phi_{\tilde{\mathbb{U}}}^1(\mathbf{v} \longleftrightarrow \infty) > 0$.*

It would be very interesting to improve this result by bootstrapping this information to the geometry of the plane. As for today, we did not manage to do so. Let us mention a question whose understanding may help solving this problem. Consider the upper half-plane $\mathbb{H} = \mathbb{Z} \times \mathbb{N}$. Assume that there exists an infinite cluster in this plane (once again not using any boundary edge) for the random-cluster measure with wired boundary conditions on the boundary of \mathbb{H} . Can one show that there exists an infinite cluster for the random-cluster measure on \mathbb{Z}^2 with wired boundary conditions. Obviously, this is true for Bernoulli percolation since $\mathbb{H} \subset \mathbb{Z}^2$. This last fact is not sufficient to prove the claim for general cluster-weights $q > 1$ since the wiring on $\mathbb{Z}^2 \times \{0\}$ may influence the measure inside the upper half-plane by favoring open edges.

Let us now prove the proposition.

Proof. Consider the random-cluster measure on \mathbb{U} with free boundary conditions. Let us prove that $\mathbf{0} := (0, 0, 0)$ and $(0, 0, k)$ are connected to each other with probability decaying exponentially fast in $k \geq 0$. The Borel-Cantelli lemma would then imply that finitely many pairs of integers $k \geq 0$ and $\ell < 0$ are such that $(0, 0, k)$ and $(0, 0, \ell)$ are connected to

each other. This immediately shows the existence of an infinite dual-open cluster in the dual model, which is the random cluster on \tilde{U} with wired boundary conditions.

To prove this exponential decay, we invoke Theorem 4.3. Consider a finite Dobrushin subdomain U of \cup containing $\mathbf{0}$ and $(0,0,k)$, and such that $a = b = \mathbf{0}$. We further assume that $(0,0,k)$ belongs to the boundary of U (this allows us to make the term $\phi_U^0[\mathbf{0} \leftrightarrow (0,0,k)]$ appear as one of the $\phi_U^0[\mathbf{0} \leftrightarrow x]$ for $x \in \partial_{ab}$). The Dobrushin boundary conditions are simply the free boundary conditions in this case. Set $\tilde{\sigma} = i(\sigma - 1)$ which is a positive real number *since we assume that $q > 4$* . We find

$$\delta_x = -2 \sinh \left[\tilde{\sigma} \frac{\pi}{4} N(x) \right] \exp \left[\tilde{\sigma} W(x) \right] \leq 0.$$

This observation implies that

$$2 \sinh \left[\tilde{\sigma} \frac{\pi}{4} N(x) \right] \exp \left[\tilde{\sigma} W(x) \right] \phi_U^0[\mathbf{0} \leftrightarrow (0,0,k)] \leq \exp \left[\tilde{\sigma} W_{\partial_{ab}^\circ}(e_a, e_b) \right] - 1.$$

But $W(x) = 2\pi k$ and therefore we deduce that there exists $C = C(q) > 0$ not depending on k or the domain so that

$$\phi_U^0[\mathbf{0} \leftrightarrow (0,0,k)] \leq C e^{-2\pi\tilde{\sigma}|k|}.$$

By taking larger and larger subdomains U , we deduce that for any subdomain U containing $\mathbf{0}$ and such that $(0,0,k)$ is on the boundary of U ,

$$\phi_U^0[\mathbf{0} \leftrightarrow (0,0,k)] \leq C e^{-2\pi\tilde{\sigma}|k|}.$$

By applying this inequality for U equal to \cup minus one of the edges incident to $(0,0,k)$, the finite energy property implies that

$$\phi_\cup^0[\mathbf{0} \leftrightarrow (0,0,k)] \leq C e^{-2\pi\tilde{\sigma}|k|}.$$

□

Remark 4.6. The fact that $\sigma \in [0,1]$ for $q \leq 4$ and $\sigma = 1 - i\mathbb{R}_+$ for $q > 4$ explains the difference of behavior between $q \leq 4$ and $q > 4$ random-cluster models.

5 Proofs of other theorems

5.1 Proof of Theorem 1.7

This section contains the proof of Theorem 1.7.

Lemma 5.1. *Let $k \leq n$ and ξ some arbitrary boundary conditions on $\partial\Lambda_n$. There exist two couplings \mathbf{P} and \mathbf{Q} on configurations (ω_ξ, ω_1) with the following properties:*

- ω_ξ and ω_1 have respective laws $\phi_{\Lambda_n}^\xi$ and $\phi_{\Lambda_n}^1$.
- \mathbf{P} -almost surely, if ω_1^* contains a dual-open dual-circuit in $\Lambda_n^* \setminus \Lambda_k^*$ and Γ^* is the outermost such circuit, then Γ^* is also closed in ω_ξ , and furthermore ω_1 and ω_ξ coincide inside Γ^* .

- **Q-almost surely**, if ω_ξ contains an open circuit in $\Lambda_n \setminus \Lambda_k$ and $\tilde{\Gamma}$ is the outermost such circuit, then $\tilde{\Gamma}$ is also open in ω_1 , and furthermore ω_1 and ω_ξ coincide inside $\tilde{\Gamma}$.

Proof. We start by explaining how to sample $\phi_{\Lambda_n}^\xi$. The Domain Markov property enables us to construct a configuration as follows. Consider uniform random variables U_e on $[0, 1]$ for every edge e . Choose an edge e_1 and declare it open if U_{e_1} is smaller or equal to $\phi_{\Lambda_n}^\xi[\omega(e_1) = 1]$. Choose another edge e_2 and set it to open if $U_{e_2} \leq \phi_{\Lambda_n}^\xi[\omega(e_2) = 1 | \omega(e_1)]$. We iterate this procedure for every edge. Also note that we can stop the procedure after a certain number of edges and sample the rest of the edges according to the right conditional law. The domain Markov property guarantees that the measure thus obtained is $\phi_{\Lambda_n}^\xi$. Note that the choice of the next edge can be random, as long as it depends only on the state of edges discovered so far.

Of course, the previous construction is useless for one measure, but it becomes interesting if we consider two measures: one may sample both configurations based on the same random variables U_e with a specific way of choosing the next edges. Let us now describe the way we are choosing the edges:

- **Construction of P:** After t steps, the edge $e_{t+1} \in E_{\Lambda_n} \setminus E_{\Lambda_k}$ is chosen in such a way that it has one end-point connected to $\partial\Lambda_n$ by an open path in ω_1 , until it is not possible anymore. Then sample all remaining edges at once according to the correct conditional law. If there is a closed circuit surrounding Λ_k in ω_1 , then there was a time t such that at time $t + 1$, no undiscovered edges had an end-point which was connected to the boundary in ω_1 . Since this procedure guarantees that $\omega_1 \geq \omega_\xi$, no such edges were connected to the boundary in ω_ξ as well. Therefore, the configuration sampled inside the remaining domain is a random-cluster model with free boundary conditions in both cases. In particular, both configurations coincide in Λ_k .
- **Construction of Q:** After t steps, the edge $e_{t+1} \in E_{\Lambda_n} \setminus E_{\Lambda_k}$ is chosen in such a way that one end-point of e_{t+1}^* is dual-connected to $\partial\Lambda_n^*$ by a dual-open path in ω_ξ^* , until it is not possible anymore. Then sample all remaining edges according to the correct conditional law. If there is an open circuit surrounding Λ_k in ω_ξ , then there was a first time t such that the open circuit was discovered at time t . Once again, $\omega_1 \geq \omega_\xi$ and this circuit is also open in ω_1 . Then, the configuration inside the connected component of Λ_k in $\Lambda_n \setminus \{e_1, e_2, \dots, e_t\}$ will be sampled according to a random-cluster configuration with wired boundary conditions. In particular, both configurations coincide in Λ_k .

□

Theorem 1.7. It is clearly sufficient to prove that there exists $\alpha > 0$ such that

$$|\phi_{\Lambda_n}^\xi[A] - \phi_{\Lambda_n}^1[A]| \leq \left(\frac{k}{n}\right)^\alpha \phi_{\Lambda_n}^\xi[A]$$

for any event A depending on edges in Λ_k . Let E be the event that there exists a dual-open dual-circuit in ω_ξ^* included in $\Lambda_n^* \setminus \Lambda_k^*$. We deduce

$$\begin{aligned} \phi_{\Lambda_n}^\xi[A] &\geq \phi_{\Lambda_n}^\xi[A \cap E] = \mathbf{Q}[\omega_\xi \in A \cap E] \geq \mathbf{Q}[\omega_1 \in A \cap E] \\ &= \phi_{\Lambda_n}^1[A \cap E] \geq (1 - (k/n)^\alpha) \phi_{\Lambda_n}^1[A] \end{aligned}$$

where in the third inequality, we used the fact that if ω_1 belongs to $A \cap E$, then ω_1 and therefore ω_ξ belong to E . Since ω_1 and ω_ξ coincide in Λ_k , then $\omega_\xi \in A$. The existence of α in the last inequality follows exactly as in the proof of Lemma 3.2 from Property **P5a** applied in concentric annuli $\Lambda_{k2^{i+1}} \setminus \Lambda_{k2^i}$ with $0 \leq i \leq \log_2(n/k)$.

Reciprocally, if F denotes the event that there is an open circuit in $\Lambda_n \setminus \Lambda_k$, we find

$$\begin{aligned} \phi_{\Lambda_n}^1[A] &\geq \phi_{\Lambda_n}^1[A \cap F] = \mathbf{P}[\omega_1 \in A \cap F] \geq \mathbf{P}[\omega_\xi \in A \cap F] \\ &= \phi_{\Lambda_n}^\xi[A \cap F] \geq (1 - (k/n)^\alpha) \phi_{\Lambda_n}^\xi[A] \end{aligned}$$

where once again, we used in the third inequality that if $\omega_\xi \in A \cap F$, then ω_1 is in F , and since ω_1 and ω_ξ then coincide on Λ_k , we get that $\omega_1 \in A$. The last inequality is due to **P5a** once again. \square

5.2 Proof of Theorem 1.11

Definition of the exploration path. Before proving Theorem 1.11, let us define precisely the exploration path.

We start by defining the loop-configuration associated to a percolation-configuration. Fix a Dobrushin domain (Ω, a, b) and consider a configuration $\omega \in \{0, 1\}^{E_\Omega}$ together with its dual-configuration $\omega^* \in \{0, 1\}^{E_{\Omega^*}}$, see Fig. 5.11. We define the Dobrushin boundary conditions by taking the edges (between endpoints) of ∂_{ba} to be open, and the dual-edges of ∂_{ab}^* to be dual-open.

Through every vertex of the medial graph Ω^\diamond of Ω passes either an open edge of Ω or a dual-open dual-edge of Ω^* . Draw self-avoiding loops on Ω^\diamond as follows: a loop arriving at a vertex of the medial lattice always makes a $\pm\pi/2$ turn so as not to cross the open edge or dual-open dual-edge through this vertex, see Fig. 5.12. The loop representation contains loops together with a self-avoiding path going from a^\diamond to b^\diamond , see Fig. 5.12. This curve is called the exploration path and is denoted by γ .

Remark 5.2. The loops correspond to the interfaces separating clusters of ω from clusters of ω^* , and the exploration path corresponds to the interface between the cluster connected to ∂_{ba} and the cluster of ω^* connected to ∂_{ab}^* .

Approximation of domains. In the statement of Theorem 1.11, we consider an approximation of a simply connected domain Ω with two points a and b on its boundary. More precisely, $(\Omega_\delta, a_\delta, b_\delta)$ denotes a Dobrushin domain defined on the square lattice of mesh size δ , i.e. $\delta\mathbb{Z}^2$. All the definitions and result extend to this context in a direct fashion.

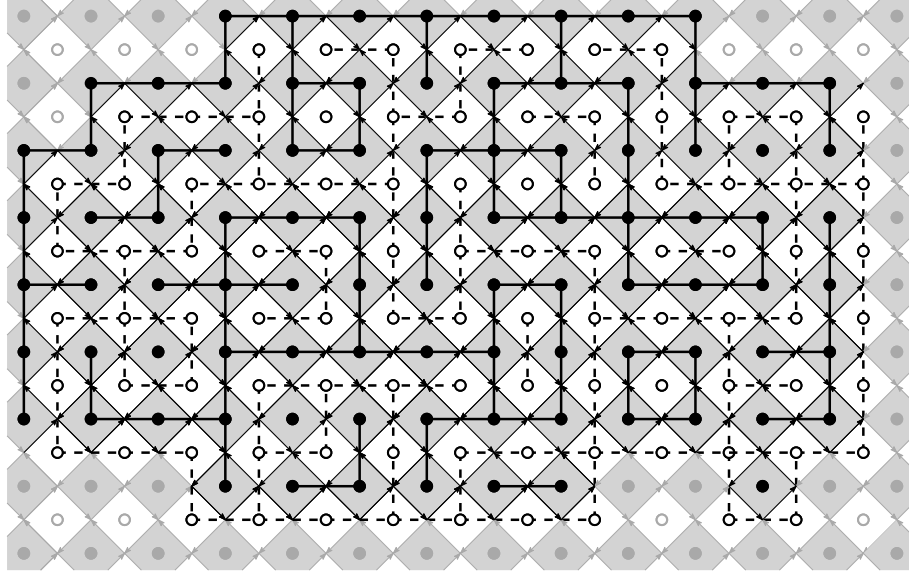

Figure 5.11: The configuration ω with its dual configuration ω^* .

A family of Dobrushin domain approximates a continuous domain (Ω, a, b) if $(\Omega_\delta, a_\delta, b_\delta)$ converges in the Carathéodory sense as δ tends to 0. This convergence is classical, we refer to [DC13, Chapter 3]. For smooth domains, it corresponds to the convergence in the Hausdorff sense.

In what follows, γ_δ denotes the exploration path in the Dobrushin domain $(\Omega_\delta, a_\delta, b_\delta)$.

Proof of Theorem 1.11. In order to prove Theorem 1.11, [KS12] shows that we only need to check the condition **G2** defined now. Consider a fixed domain (Ω, a, b) and a parametrized continuous curve Γ from a to b in Ω . A connected set C is said to disconnect $\Gamma(t)$ from b if it disconnects a neighborhood of $\Gamma(t)$ from a neighborhood of b in $\Omega \setminus \Gamma[0, t]$.

Fig. 5.13 will help the reader here. For any annulus $A = A(z, r, R) := z + (\Lambda_R \setminus \Lambda_r)$, let A_t be the subset of Ω satisfying $A_t := \emptyset$ if $\partial(z + \Lambda_r) \cap \partial(\Omega \setminus \Gamma[0, t]) = \emptyset$, and otherwise

$$A_t := \left\{ \begin{array}{l} z \in A \setminus \Gamma[0, t] \text{ such that the connected component of } z \\ \text{in } A \setminus \Gamma[0, t] \text{ does not disconnect } \Gamma(t) \text{ from } b \text{ in } \Omega \setminus \Gamma[0, t] \end{array} \right\}.$$

Consider the exploration path γ_δ as a continuous curve from a_δ^\diamond to b_δ^\diamond parametrized in such a way that it goes along one medial vertex in time 1 (in particular, after time n the path explored n medial-vertices). For simplicity, once the path reaches b_δ^\diamond , it remains at b_δ^\diamond for any subsequent time.

Condition G2 *There exists $C < 1$ such that for any (γ_δ) in $(\Omega_\delta, a_\delta, b_\delta)$, for any stopping time τ and any annulus $A = A(z, r, R)$ with $0 < Cr < R$,*

$$\phi_{\Omega_\delta}^{a_\delta, b_\delta} \left(\gamma_\delta[\tau, \infty] \text{ makes a crossing of } A \text{ contained in } A_\tau \mid \gamma_\delta[0, \tau] \right) < \frac{1}{2}.$$

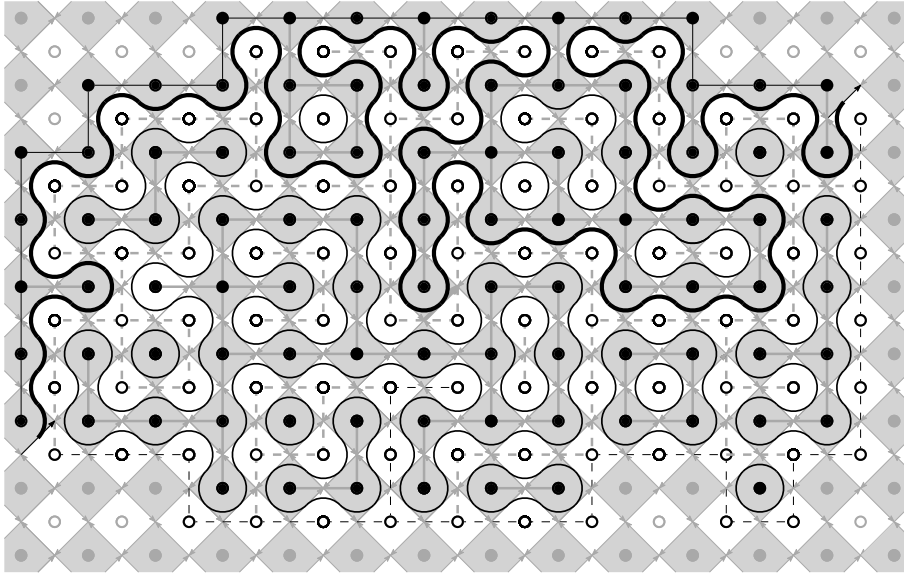

Figure 5.12: The loop representation associated to the primal and dual configurations in the previous picture. The exploration path is drawn in bold.

Above, “ $\gamma_\delta[\tau, \infty]$ makes a crossing of A contained in A_τ ” means that there exists a sub-path $\gamma_\delta[t_1, t_2]$ of the continuous path $\gamma_\delta[\tau, \infty]$ that intersects both the boundary of $z + \Lambda_r$ and the boundary of $z + \Lambda_R$, and such that $\gamma_\delta[t_1, t_2] \subset A_\tau$.

Before proving Condition **G2** (and therefore Theorem 1.11), let us introduce the notion of slit Dobrushin domain. Fig. 5.13 may give a good idea of what it is.

Fix a Dobrushin domain $(\Omega_\delta, a_\delta, b_\delta)$ and consider the exploration path γ_δ in the loop representation on Ω_δ . The path γ_δ can be seen as a random parametrized curve (the parametrization being simply given by the number of steps along the curve between a medial-vertex in γ_δ and a_δ°).

Definition 5.3. The *slit domain* $\Omega_\delta \setminus \gamma_\delta[0, n]$ is defined as the subdomain of Ω_δ constructed by removing all the primal edges crossed by $\gamma_\delta[0, n]$ and by keeping only the connected component of the remaining graph containing b_δ . It is seen as a Dobrushin domain by fixing the points c_δ and b_δ , where c_δ is the vertex of $\delta\mathbb{Z}^2$ bordered by the last medial edge of $\gamma_\delta[0, n]$.

Similarly, one may define the dual Dobrushin domain. The marked point is then c_δ^* , where c_δ^* is the dual-vertex of $(\delta\mathbb{Z}^2)^*$ bordered by the last medial edge of $\gamma_\delta[0, n]$. It is worth mentioning that the construction is symmetric for the dual Dobrushin domain: the dual of the slit domain $\Omega_\delta \setminus \gamma_\delta[0, n]$ is simply the subgraph of Ω_δ^* obtained by removing the dual-edges crossed by the curve.

Remark 5.4. The notation $\Omega_\delta \setminus \gamma_\delta[0, n]$ could somewhat be misleading, since Ω_δ is a subset of $\delta\mathbb{Z}^2$ and $\gamma_\delta[0, n]$ is a path of medial edges. Nevertheless, we allow ourselves some latitude here since we find this notation both concise and intuitive.

If one starts with Dobrushin boundary conditions on $(\Omega_\delta, a_\delta, b_\delta)$, then conditionally on $\gamma_\delta[0, n]$ the law of the configuration inside $\Omega_\delta \setminus \gamma_\delta[0, n]$ is a FK-Ising model with Dobrushin boundary conditions wired on $\partial_{b_\delta c_\delta}$ and free elsewhere. This comes from the fact that the exploration path $\gamma_\delta[0, n]$ “slides between open edges and dual-open dual-edges” and therefore the edges on its left must be open and the dual-edges on its right dual-open. This implies that the arc $\partial_{a_\delta c_\delta}$ must be wired (and therefore $\partial_{b_\delta c_\delta}$ is since $\partial_{b_\delta a_\delta}$ was already wired to start with) and the dual arc $\partial_{c_\delta^* a_\delta^*}$ is dual-wired.

We are now in a position to prove Condition **G2**.

Proof of Condition G2. Let $A(z, r, R)$ and A_τ as defined above. We can fix a realization of $\gamma_\delta[0, \tau]$, and work in the slit Dobrushin domain $(\Omega_\delta \setminus \gamma_\delta[0, \tau], c_\delta, b_\delta)$.

See A_τ as the union of connected components of the Dobrushin domain Ω_δ^\diamond seen as an open domain of \mathbb{R}^2 minus the path $\gamma_\delta[0, \tau]$. We denote generically a connected component by \mathcal{C} (we see it as a subset of \mathbb{R}^2).

The connected components can be divided into three classes:

- $\partial\mathcal{C}$ intersects both $\partial_{c_\delta b_\delta}^\diamond$ and $\partial_{b_\delta c_\delta}^\diamond$;
- $\partial\mathcal{C}$ intersects $\partial_{b_\delta c_\delta}^\diamond$ but not $\partial_{c_\delta b_\delta}^\diamond$.
- $\partial\mathcal{C}$ intersects $\partial_{c_\delta b_\delta}^\diamond$ but not $\partial_{b_\delta c_\delta}^\diamond$;

In fact, there cannot be any connected component of the first type. Indeed, let us assume that such a connected component \mathcal{C} does exist. Let γ be a self-avoiding path in \mathcal{C} going from $\partial_{b_\delta c_\delta}^\diamond$ to $\partial_{c_\delta b_\delta}^\diamond$. Topologically, c_δ^\diamond and b_δ^\diamond must be on two different sides of Γ in $(\Omega_\delta \setminus \gamma_\delta[0, \tau])^\diamond \setminus \Gamma$. But this means that \mathcal{C} disconnects c_δ from b_δ , and therefore that \mathcal{C} is not part of A_τ , which is contradictory.

We can therefore safely assume that the connected components are either of the second or third types. We now come back to the interpretation in terms of graphs.

Let S be the subgraph of $\Omega_\delta \setminus \gamma_\delta[0, \tau]$ given by the union of the connected components (seen as primal graphs this time) of the second type (see Fig. 5.13). This set is a subset of A_τ . Furthermore, the boundary conditions induced by the conditioning on $\gamma_\delta[0, \tau]$ are wired on $\partial S \setminus \partial A_\tau$. Therefore, conditioned on $\gamma_\delta[0, \tau]$ and the configuration outside $A(z, r, R)$, the configuration ω in S dominates $\omega'_{|_S}$, where ω' follows the law of a random-cluster model in $A(z, r, R)$ with free boundary conditions. In particular, if there exists an open circuit in ω' surrounding $z + \Lambda_r$ in $A(z, r, R)$, then the restriction of this path to S is also open in ω and it disconnects $z + \partial\Lambda_r$ from $z + \partial\Lambda_R$ in S . In particular, the exploration path $\gamma_\delta[\tau, \infty]$ cannot cross A_τ inside S since this would require the existence of a dual-open dual-path from the outer to the inner part of A_τ^* .

Property **P5a** implies that this open circuit exists in ω' with probability larger than a constant $c > 0$ not depending on δ , and that therefore $\gamma_\delta[\tau, \infty]$ cannot cross A_τ inside S with probability larger than c uniformly on the configuration outside A_τ .

Let now S^* be the subgraph of $\Omega_\delta^* \setminus \gamma_\delta[0, \tau]$ given by the union of the connected components (seen as dual graphs) of the third type. The same reasoning for the dual

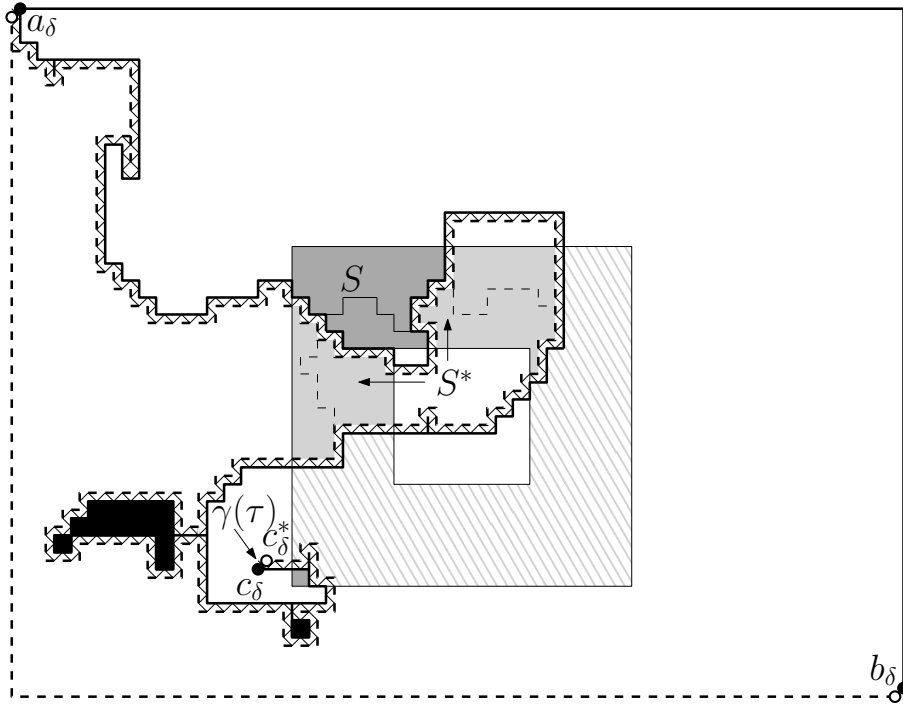

Figure 5.13: The dashed area is a connected component of $A \setminus \gamma_\delta[0, \tau]$ which is disconnecting $\gamma_\delta(\tau)$ from b_δ° , or equivalently c_δ from b_δ , and which is therefore not in A_τ . The black parts are not included in the slit domain since they corresponds to connected components that are not containing b_δ° . Conditioning on $\gamma_\delta[0, \tau]$ induces Dobrushin boundary conditions in the new domain. The dark grey area is S and the light-gray S^* . We depicted a blocking open path in S and a dual-open path in each connected component of S^* .

model implies that with probability $c > 0$, the exploration path $\gamma_\delta[\tau, \infty]$ cannot cross A_τ^* inside S^* .

Altogether, $\gamma_\delta[\tau, \infty]$ cannot cross A_τ with probability c^2 . Now, Proposition 3.1 shows that c can be taken to be equal to $1 - (1 - c_2)^{\lceil \log_2(R/r) \rceil}$. Since $R/r \geq C$, we can guarantee that $c^2 \geq 1/2$ by choosing C large enough.

◇

5.3 Proof of Theorem 1.13

Since we used Property **P5** several times in this article already, we present the proof of Theorem 1.13 without providing every detail. We start by a lemma. Define the upper half-plane $\mathbb{H} = \mathbb{Z} \times \mathbb{N}$.

Lemma 5.5. *Assume that there exists $c > 0$ such that for any $n \geq 1$,*

$$\phi_{\mathbb{H}}^0 [[-n, n] \times \{0\} \longleftrightarrow \mathbb{Z} \times \{n\}] \geq c.$$

Then, for any $\alpha > 0$ there exists $c(\alpha) > 0$ such that for every $n \geq 1$,

$$\phi_{[-n,n] \times [0,\alpha n]}^0 [\mathcal{C}_v([-n, n] \times [0, \alpha n])] \geq c(\alpha).$$

Proof. First, Property **P5** allows us to choose $\beta > 1$ so that for any $m \geq 1$,

$$\phi_{\mathbb{Z}^2}^1 [\mathcal{C}_h([0, (\beta - 1)m] \times [0, m])] \leq \frac{\epsilon}{3}.$$

Let

$$\mathcal{A}(m) := \left\{ [-m, m] \times \{0\} \xleftrightarrow{[-\beta m, \beta m] \times [0, m]} [-\beta m, \beta m] \times \{m\} \right\}.$$

With this choice of β , and because of the comparison between boundary conditions, we find that

$$\phi_{\mathbb{H}}^0 [\mathcal{A}(m)] \geq \frac{\epsilon}{3}.$$

Using Property **P5** for the dual model, we deduce that there exists $c_1 > 0$ such that for any $m \geq 1$,

$$\phi_{[-2\beta m, 2\beta m] \times [0, 2m]}^0 [\mathcal{F}(m) \cap \mathcal{A}(m)] \geq c_1,$$

where $\mathcal{F}(m)$ is the existence of a dual-path in the half-annulus

$$[-2\beta m, 2\beta m] \times [0, 2m] \setminus [-\beta m, \beta m] \times [0, m]$$

from $[\beta m, 2\beta m] \times \{0\}$ to $[-2\beta m, -\beta m] \times \{0\}$. (The occurrence of \mathcal{F}_n and \mathcal{A}_n is illustrated on Fig. 5.14.) After conditioning on the exterior most such dual path, the domain Markov property and the comparison between boundary conditions imply that

$$\phi_{[-2\beta m, 2\beta m] \times [0, 2m]}^0 [\mathcal{A}(m)] \geq c_1. \quad (5.23)$$

We now fix $\alpha \geq 2$ and $n \geq 1$. We assume without loss of generality that αn is an integer. Set $m = \lfloor n/(2\beta) \rfloor$. Define the following four events:

$$\mathcal{B}(m) = \left\{ [-\beta m, \beta m] \times \{\alpha n\} \xleftrightarrow{[-\beta m, \beta m] \times [\alpha n - m, \alpha n]} [-m, m] \times \{\alpha n - m\} \right\},$$

$$\mathcal{C}(m) = \mathcal{C}_h\left([- \beta m, \beta m] \times \left[\frac{m}{2}, m\right]\right),$$

$$\mathcal{D}(m) = \mathcal{C}_h\left([- \beta m, \beta m] \times \left[\alpha n - m, \alpha n - \frac{m}{2}\right]\right),$$

$$\mathcal{E}(m) = \mathcal{C}_v\left([- \beta m, \beta m] \times \left[\frac{m}{2}, \alpha n - \frac{m}{2}\right]\right).$$

Note that the event $\mathcal{B}(m)$ is the equivalent of the event $\mathcal{A}(m)$, but “at the top of the rectangle”. By (5.23) and comparison between boundary conditions, $\phi_{[-n,n] \times [0,\alpha n]}^0 [\mathcal{A}(m)]$ and $\phi_{[-n,n] \times [0,\alpha n]}^0 [\mathcal{B}(m)]$ are larger or equal to c_1 . Furthermore, Property **P5** also implies that $\phi_{[-n,n] \times [0,\alpha n]}^0 [\mathcal{C}(m)]$, $\phi_{[-n,n] \times [0,\alpha n]}^0 [\mathcal{D}(m)]$ are larger than $c_2 > 0$, and that $\phi_{[-n,n] \times [0,\alpha n]}^0 [\mathcal{E}(m)]$ is larger than $c_3(\alpha) > 0$.

Now observe that if the five events $\mathcal{A}(m), \dots, \mathcal{E}(m)$ occur simultaneously, then the rectangle $[-n, n] \times [0, \alpha n]$ is crossed vertically (see Fig. 5.15). The FKG inequality thus implies that

$$\begin{aligned} \phi_{[-n,n] \times [0,\alpha n]}^0 [\mathcal{C}_v([-n, n] \times [0, \alpha n])] &\geq \phi_{[-n,n] \times [0,\alpha n]}^0 [\mathcal{A}(m) \cap \mathcal{B}(m) \cap \mathcal{C}(m) \cap \mathcal{D}(m) \cap \mathcal{E}(m)] \\ &\geq c_1^2 \cdot c_2^3. \end{aligned}$$

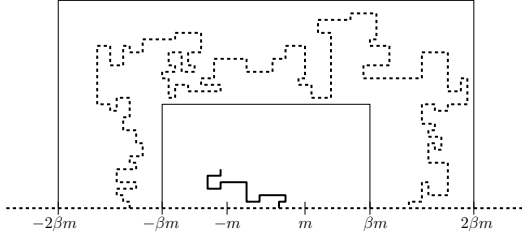

Figure 5.14: The occurrence of \mathcal{A} and \mathcal{F} in \mathbb{H} with free boundary conditions on $\mathbb{Z} \times \{0\}$

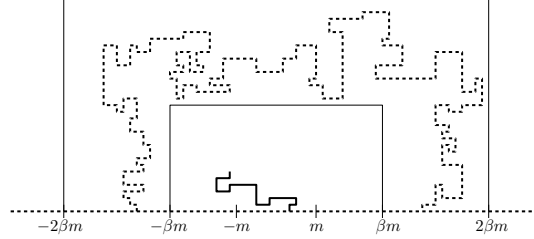

Figure 5.15: The occurrence of $\mathcal{A}, \dots, \mathcal{E}$ in $[-n, n] \times [0, \alpha n]$ with free boundary conditions

We just proved the result for $\alpha \geq 2$ with $c(\alpha) = c_1^2 c_2^2 c_3(\alpha) > 0$. For $\alpha \in (0, 2)$, simply apply the comparison between boundary conditions in the rectangle $[-\frac{\alpha n}{4}, \frac{\alpha n}{4}] \times [0, \alpha n]$ which has aspect ratio 2 and is included in $[-n, n] \times [0, \alpha n]$. \square

The previous lemma shows that in order to prove Theorem 1.13, we may focus on showing that there exists a constant $c > 0$ such that for any $n \geq 1$,

$$\phi_{\mathbb{H}}^0 [[-n, n] \times \{0\} \leftrightarrow \mathbb{Z} \times \{n\}] \geq c.$$

In order to do so, we use the second-moment method. Let $p_n = \phi_{\mathbb{H}}^0 [0 \leftrightarrow \mathbb{Z} \times \{n\}]$ and define

$$\mathbf{N} := \sum_{x \in [-n, n] \times \{0\}} \mathbf{1}_{x \leftrightarrow \mathbb{Z} \times \{n\}}.$$

By definition $\phi_{\mathbb{H}}^0 [\mathbf{N}] = (2n + 1)p_n$. Furthermore,

$$\begin{aligned} \phi_{\mathbb{H}}^0 [\mathbf{N}^2] &\leq (2n + 1) \sum_{x \in [-2n, 2n] \times \{0\}} \phi_{\mathbb{H}}^0 [0, x \leftrightarrow \mathbb{Z} \times \{n\}] \\ &\leq (2n + 1) \cdot C_6 \sum_{x \in [-2n, 2n] \times \{0\}} \phi_{\mathbb{H}}^0 [\Lambda_{2|x|} \leftrightarrow \mathbb{Z} \times \{n\}] \phi_{\mathbb{H}}^0 [0 \leftrightarrow \partial \Lambda_{|x|/4}]^2 \\ &\leq (2n + 1) \cdot C_7 \sum_{x \in [-2n, 2n] \times \{0\}} \phi_{\mathbb{H}}^0 [0 \leftrightarrow \mathbb{Z} \times \{n\}] \phi_{\mathbb{H}}^0 [0 \leftrightarrow \partial \Lambda_{|x|}] \\ &\leq (2n + 1) \cdot C_7 \cdot p_n \cdot 2 \sum_{k=0}^{2n} p_k. \end{aligned} \tag{5.24}$$

In the second, we used that

$$\{0, x \leftrightarrow \mathbb{Z} \times \{n\}\} \subset \{\Lambda_{2|x|} \leftrightarrow \mathbb{Z} \times \{n\}\} \cap \{0 \leftrightarrow \partial \Lambda_{|x|/4}\} \cap \{x \leftrightarrow x + \partial \Lambda_{|x|/4}\}$$

and Theorem 1.7 (more precisely a direct adaptation to the upper half-plane) to decouple the different events on the right side. In the third line, we used Property **P5** as follows. Let \mathcal{A} be the event that

- $\partial\Lambda_{|x|/8} \leftrightarrow \partial\Lambda_{4|x|}$,
- there exists an open path in $\Lambda_{|x|/4} \setminus \Lambda_{|x|/8}$ disconnecting 0 from infinity in \mathbb{H} ,
- there exists an open path in $\Lambda_{4|x|} \setminus \Lambda_{2|x|}$ disconnecting 0 from infinity in \mathbb{H} .

With this definition, we see that if $0 \leftrightarrow \partial\Lambda_{|x|/4}, \Lambda_{2|x|} \leftrightarrow \mathbb{Z} \times \{n\}$ and \mathcal{A} occur, then 0 is connected to $\mathbb{Z} \times \{n\}$. Now, the event \mathcal{A} has probability bounded away from 0 uniformly in x thanks to **P5**, so that the FKG inequality directly implies the third inequality of (5.24).

Let us now state the following claim.

Claim: There exists $C_8 > 0$ such that for any $n \geq 0$,

$$\sum_{k=0}^n p_k \leq C_8 n p_n.$$

Before proving the claim, let us finish the proof of Theorem 1.13. The claim and (5.24) imply that

$$\phi_{\mathbb{H}}^0[\mathbb{N}^2] \leq (2n+1)C_7 p_n 2(C_8 n p_n + n p_n) \leq C_7(C_8+1)(2n+1)2n p_n^2 \leq C_7(C_8+1)\phi_{\mathbb{H}}^0[\mathbb{N}]^2.$$

(We also used that $p_k \leq p_n$ for $k \geq n$.) By applying the Cauchy-Schwarz inequality, we find

$$\phi_{\mathbb{H}}^0[[-n, n] \times \{0\} \leftrightarrow \mathbb{Z} \times \{n\}] = \phi_{\mathbb{H}}^0[\mathbb{N} > 0] \geq \frac{\phi_{\mathbb{H}}^0[\mathbb{N}]^2}{\phi_{\mathbb{H}}^0[\mathbb{N}^2]} \geq \frac{1}{C_7(C_8+1)} > 0.$$

Proof of the Claim. We use Theorem 4.3. Recall that $q < 4$. Let \mathbb{V} be the subgraph of \mathbb{Z}^3 defined as follows: the vertices are given by \mathbb{Z}^3 and the edges by

- $[(x_1, x_2, x_3), (x_1, x_2 + 1, x_3)]$ for every $x_1, x_2, x_3 \in \mathbb{Z}$,
- $[(x_1, x_2, x_3), (x_1 + 1, x_2, x_3)]$ for every $x_1, x_2, x_3 \in \mathbb{Z}$ such that $x_1 \neq 0$,
- $[(0, x_2, x_3), (1, x_2, x_3)]$ for every $x_2 \geq -n$ and $x_3 < 0$,
- $[(0, x_2, x_3), (1, x_2, x_3 + 1)]$ for every $x_2 < -n$ and $x_3 < 0$,
- $[(0, x_2, x_3), (1, x_2, x_3)]$ for every $x_2 > n$ and $x_3 \geq 0$,
- $[(0, x_2, x_3), (1, x_2, x_3 + 1)]$ for every $x_2 \leq n$ and $x_3 \geq 0$.

For $\theta > 0$ and $n \geq 0$, let

$$V_{n,\theta} := \{(x_1, x_2, x_3) \in \mathbb{V} : |x_1| \leq n, |x_2| \leq 2n \text{ and } |x_3| \leq \theta\}.$$

We also set $a = (0, -n, 0)$ and $b = (0, n, 0)$ and see $V_{n,\theta}$ as a Dobrushin domain. Note that by definitions, boundary conditions are wired on the segment of the boundary ∂_{ab} between a and b , and free elsewhere. Theorem 4.3 (more precisely an extension to Dobrushin domains on \mathbb{V}) implies that

$$\sum_{x \in \partial_{ab}} \delta_x \phi_{V_{n,\theta}}^{a,b}[x \leftrightarrow \partial_{ba}] - \sum_{u \in \partial_{ba}^*} \delta_u \phi_{V_{n,\theta}}^{a,b}[u \overset{*}{\leftrightarrow} \partial_{ab}^*] = 1 - \exp[i(\sigma - 1)\frac{\pi}{2}]. \quad (5.25)$$

Note that $\operatorname{Re}(\delta_u) = 1 - \cos[(\sigma - 1)\frac{\pi}{2}]$ for $u \in \partial_{ba}^*$ and that $|\delta_x| \leq 1$ for every $x \in \partial_{ba}$. Let ∂ be the part of ∂_{ba} composed of vertices such that $|x_1| = n$ or $|x_2| = 2n$. We may choose $\theta = \theta(q) < 0$ so that $\operatorname{Re}(\delta_x) \leq 0$ for any $x \in \partial_{ba} \setminus \partial$ (for instance, one may take $\theta = \lceil (1 - \sigma)2\pi \rceil$).

With this choice of θ , taking the real part of (5.25) gives that

$$1 + \sum_{u \in \partial_{ab}^*} \phi_{V_{n,\theta}}^{a,b} [u \overset{*}{\leftrightarrow} \partial_{ba}^*] \leq \sum_{x \in \partial} \phi_{V_{n,\theta}}^{a,b} [x \leftrightarrow \partial_{ab}] \leq C_9 n p_n,$$

where in the second inequality we used the comparison between boundary conditions and Property **P5**.

Now, for a dual-vertex x of ∂_{ab}^* at distance k from a or b (let us assume without loss of generality that x is at distance k from a). Let $\Lambda_k^+ = [-k, k] \times [0, k]$. If the following three events occur simultaneously:

- $x \overset{*}{\leftrightarrow} x + \partial\Lambda_k^+$,
- the half-annulus $x + \partial\Lambda_k^+ \setminus \Lambda_{k/2}^+$ contains a dual-open dual path disconnecting x from the ∂_{ba}^* in $V_{n,\theta}$,
- that there exists a dual-open dual path disconnecting a from ∂ in

$$\{x \in V_{n,\theta} : k/2 \leq |(x_1, x_2) - (0, n)| \leq k\}$$

(this set is a topological rectangle winding around the singularity a at distance $k/2$ of it),

then x is connected by a dual-open path to ∂_{ba}^* . Now, the second and third events occur with probability bounded away from 0 uniformly in n thanks to **P5** and the fact that $\theta(q) < \infty$ does not depend on n . By conditioning on these two events and using the comparison between boundary conditions, we find that

$$\phi_{V_{n,\theta}}^{a,b} [x \overset{*}{\leftrightarrow} \partial_{ba}^*] \geq c_7 \phi_{x+\Lambda_k^+}^1 [x \overset{*}{\leftrightarrow} x + \partial\Lambda_k^+] \geq c_7 p_k,$$

where in the last inequality we used duality and the comparison between boundary conditions. In conclusion, we find

$$1 + 2c_7 \sum_{k=0}^n p_k \leq C_9 n p_n$$

and the conclusion follows immediately. ◇

Remark 5.6. Note that $\theta = \theta(q) < \infty$ for any $q < 4$, but that $\theta(q)$ tends to infinity as q tends to 4 and there is no such $\theta(q)$ for $q = 4$. This fact explains why this proof does not work for $q = 4$ (and should not work since the statement is expected to be false).

5.4 proof of Theorem 1.14

The Edwards-Sokal coupling shows that

$$\mu_{\mathbb{Z}^2, \beta_c(q), q}[\sigma_x = \sigma_0] - \frac{1}{q} = \phi_{\mathbb{Z}^2, p_c(q), q}^1[0 \leftrightarrow x].$$

Lemma 3.2 implies the existence of $\eta_2 > 0$ such that

$$\phi_{\mathbb{Z}^2, p_c(q), q}^1[0 \leftrightarrow x] \leq \frac{1}{|x|^{\eta_2}},$$

thus implying the second inequality of Theorem 1.14.

In order to obtain the first, we do not need **P5** but just Theorem 2.3. Indeed, assume that the following events occur simultaneously:

- $\mathcal{C}_h([0, 2^{n+1}] \times [0, 2^n])$ for any n so that $n \leq \log_2(4|x|)$,
- $\mathcal{C}_v([0, 2^n] \times [0, 2^{n+1}])$ for any n so that $n \leq \log_2(4|x|)$.

In such case, 0 is connected to $\partial\Lambda_{2|x|}$. Furthermore, the FKG inequality together with Theorem 2.3 show that these events occur simultaneously with probability larger than $c^{[\log_2(4|x|)]}$, where $c > 0$ is a constant not depending on x .

Thus, there exists $\eta > 0$ such that for any $x \in \mathbb{Z}^2$,

$$\phi_{\mathbb{Z}^2, p_c(q), q}^1[0 \leftrightarrow \partial\Lambda_{4|x|}] \geq |x|^{-\eta}.$$

Let $\mathcal{A}(n)$ be the event that there exists an open circuit in $\Lambda_{2n} \setminus \Lambda_n$ surrounding the origin. The FKG inequality and Theorem 2.3 one more time show that there exists $c > 0$ so that

$$\begin{aligned} \phi_{\mathbb{Z}^2, p_c(q), q}^1[0 \leftrightarrow x] &\geq \phi_{\mathbb{Z}^2, p_c(q), q}^1[0 \leftrightarrow \partial\Lambda_{3|x|}] \phi_{\mathbb{Z}^2, p_c(q), q}^1[x \leftrightarrow \partial\Lambda_{3|x|}] \phi_{\mathbb{Z}^2, p_c(q), q}^1[\mathcal{A}(|x|)] \\ &\geq \phi_{\mathbb{Z}^2, p_c(q), q}^1[0 \leftrightarrow \partial\Lambda_{4|x|}] \phi_{\mathbb{Z}^2, p_c(q), q}^1[x \leftrightarrow x + \partial\Lambda_{4|x|}] \phi_{\mathbb{Z}^2, p_c(q), q}^1[\mathcal{A}(|x|)] \\ &\geq c|x|^{-2|\eta|} \end{aligned}$$

and the proof follows by choosing η_1 small enough.

ABSENCE OF INFINITE CLUSTER FOR CRITICAL BERNOULLI PERCOLATION ON SLABS

6

This chapter corresponds to the submitted article [VT6] with the same title, written in collaboration with Hugo Duminil-Copin and Vladas Sidoravicius.

We prove that for Bernoulli percolation on a graph $\mathbb{Z}^2 \times \{0, \dots, k\}$ ($k \geq 0$), there is no infinite cluster at criticality, almost surely. The proof extends to finite range Bernoulli percolation models on \mathbb{Z}^2 which are invariant under $\pi/2$ -rotation and reflection.

Introduction

Determining whether a phase transition is continuous or discontinuous is one of the fundamental questions in statistical physics. Bernoulli percolation has offered the mathematicians a setup to develop techniques to prove either continuity or discontinuity of the phase transition, which in the case of continuity corresponds to the absence of an infinite cluster at criticality. Harris [Har60] proved that the nearest neighbor bond percolation model with parameter $1/2$ on \mathbb{Z}^2 does not contain an infinite cluster almost surely. Viewed together with Kesten's result that $p_c \leq 1/2$ [Kes80], it provided the first proof of such type of statement. Since the original proof of Harris, a few alternative arguments have been found for planar graphs (See, for example, a short argument by Y. Zhang [Gri99a, p 311]). In the late eighties, dynamic renormalization ideas were successfully applied to prove continuity in octants and half spaces of \mathbb{Z}^d , $d \geq 3$, [BGN91a, BGN91b]. The continuity was also proved for \mathbb{Z}^d with $d \geq 19$ using the lace expansion technique [HS94], and for non-amenable Cayley graphs using mass-transport arguments [BLPS99]. Despite all these developments, a general argument to prove the continuity of the phase transition for the nearest neighbor Bernoulli percolation on arbitrary lattices is still missing, and the fact that the Bernoulli percolation undergoes a continuous phase transition on \mathbb{Z}^3 still represents one of the major open questions in the field.

This article provides the proof of continuity for Bernoulli percolation on a class of

non-planar lattices, namely slabs. We wish to highlight that the lattices \mathbb{Z}^d with $d \geq 3$ do not belong to this class of graphs.

Consider the graph \mathbb{S}_k , called *slab* of width k , given by the vertex set $\mathbb{Z}^2 \times \{0, \dots, k\}$ and edges between nearest neighbors. In what follows, \mathbf{P}_p denotes the Bernoulli bond percolation measure with parameter p on \mathbb{S}_k defined as follows: every edge of $\mathbb{Z}^2 \times \{0, \dots, k\}$ is *open* with probability p (if it is not open, it is said to be *closed*) independently of the other edges. Let $p_c(k)$ be the critical parameter of Bernoulli percolation on \mathbb{S}_k . Let B be a subset of \mathbb{Z}^3 , the event $\{0 \xrightarrow{B} \infty\}$ denotes the existence of an infinite path of open edges in B starting from 0.

Theorem 0.7. *For any $k > 0$, $\mathbf{P}_{p_c(k)}[0 \xrightarrow{\mathbb{S}_k} \infty] = 0$.*

For *site* percolation on \mathbb{S}_2 , an *ad hoc* argument was provided in [DNS12]. Nevertheless, one of the major difficulty of the present theorem is absent of [DNS12], namely the fact that “crossing paths do not necessarily intersect”. This additional phenomenon, which is one of the main reasons why higher dimensional critical percolation is so difficult to study, requires the introduction of a new argument, based on the multi-valued map principle (see Lemma 1.3 below for further explanations).

Two generalizations The same proof works equally well (with suitable modifications) for any graph of the form $\mathbb{Z}^2 \times G$, where G is finite. This includes $G = \{0, \dots, k\}^{d-2}$ for $d \geq 3$.

Similarly, symmetric finite range percolation on \mathbb{Z}^2 can be treated via the same techniques (once again, relevant modifications must be done). Let us state the result in this setting. Let $\mathbf{p} \in [0, 1]^{\mathbb{Z}^2}$ be a set of edge-weight parameters, and $M > 0$. We consider functions \mathbf{p} 's that are M -supported (meaning $\mathbf{p}_z = 0$ for $|z| \geq M$) and invariant under reflection and $\pi/2$ -rotation (meaning that for all z , $\mathbf{p}_{iz} = \mathbf{p}_{\bar{z}} = \mathbf{p}_z$). Consider the graph with vertex set \mathbb{Z}^2 and edges between any two vertices and the percolation $\mathbf{P}_{\mathbf{p}}$ defined as follows: the edge (x, y) is open with probability \mathbf{p}_{x-y} , independently of the other edges.

Theorem 0.8. *Fix $M > 0$. The probability $\mathbf{P}_{\mathbf{p}}[0 \longleftrightarrow \infty]$ is continuous, when viewed as a function defined on the set of M -supported and invariant \mathbf{p} 's.*

From the slab to \mathbb{Z}^3 ? The fact that $\mathbb{Z}^2 \times \{0, \dots, k\}^{d-2}$ is approximating \mathbb{Z}^d when k tends to infinity suggests that the non-percolation on slabs could shed a new light on the problem of proving the absence of infinite cluster (almost surely) for critical percolation on \mathbb{Z}^d . Nevertheless, we wish to highlight that this is not immediate. Indeed, while $p_c(k)$ is known to converge to $p_c(\mathbb{Z}^3)$ [GM90], passing at the limit requires a new ingredient. For instance, a uniform control (in k) on the explosion of the infinite-cluster density for p tending to the critical point would be sufficient.

Proposition 0.9. *Let $f : [0, 1] \rightarrow \mathbb{R}$ be a continuous function such that $f(0) = 0$. If for any $k \geq 0$ and any $p \in (0, 1)$,*

$$\mathbf{P}_p[0 \xleftrightarrow{\mathbb{S}_k} \infty] \leq f(p - p_c(k)),$$

then $\mathbf{P}_{p_c(\mathbb{Z}^3)}[0 \xleftrightarrow{\mathbb{Z}^3} \infty] = 0$.

It is natural to expect that proving the existence of f is roughly of the same difficulty as attacking the problem directly on \mathbb{Z}^3 . Nevertheless, it could be that a suitable renormalization argument enables one to prove the existence of f .

Let us finish by recalling that several models undergo discontinuous phase transitions in high dimension and continuous phase transition in two dimensions (one may think of the 3 and 4-state Potts models). For most of these models, a discontinuous phase transition is expected to occur already in a slab. Theorem 0.7 shows that this is not the case for Bernoulli percolation.

What about other models? While this work is focused on the continuity of the phase transition for short range models, it is well known that the complete picture of phase transition for Bernoulli percolation is more complex. For one-dimensional long-range Bernoulli systems with power law decay, the transition may be discontinuous. Indeed, when the probabilities of edges of length r being open decay as $1/r^2$, the percolation density at criticality is strictly positive, see [AKN87].

Also, one may consider more general percolation models with dependence. On \mathbb{Z}^2 , the continuity of the phase transition was recently proven [VT5] for dependent percolation models known as random-cluster models with cluster-weight $q \in [1, 4]$ (the special case $q = 1$ corresponds to Bernoulli percolation). The continuity of the phase transition for $q = 1$ and 2 was previously established by Harris [Har60] and Onsager [Ons44] respectively. Furthermore, [LMMS⁺91] showed that the phase transition is discontinuous for q large enough.

Let us conclude this introduction by mentioning that the phase transition on \mathbb{Z}^d is expected to be discontinuous for $q > 4$ when $d = 2$ (we refer to [DC13] for details on this prediction), and for $q > 2$ when $d \geq 3$. The best results (for $q > 1$) in this direction are mostly restricted to integer values of q , for which the model is related to the Potts model. On the one hand, the fact that the phase transition is continuous for $q = 2$ (corresponding to the Ising model) is known for any $d \geq 3$ [ADCS13]. On the other hand for any $q \geq 3$, the random-cluster model undergoes a discontinuous phase transition above some dimension $d_c(q)$ [BCC06]. The proof of this result is based on Reflection-Positivity for the Potts model.

Notation. For a subset E of \mathbb{Z}^2 , let \bar{E} be the set of sites in \mathbb{S}_k whose two first coordinates are in E . A cluster in \bar{E} is a connected component of the graph given by all the vertices in \bar{E} and the open edges with two endpoints in \bar{E} . Let n be a positive integer, B a subset of

\mathbb{Z}^2 , and $X, Y \subset B$. We define

$$\begin{aligned} X \overset{B}{\longleftrightarrow} Y &= \{\text{there exists an open cluster in } \bar{B} \text{ connecting } \bar{X} \text{ to } \bar{Y}\}, \\ X \overset{|B|}{\longleftrightarrow} Y &= \{\text{there exists a unique open cluster in } \bar{B} \text{ connecting } \bar{X} \text{ to } \bar{Y}\}. \end{aligned}$$

Further we use the following notations: $B_n = [-n, n]^2$ and $\partial B_n = B_n \setminus B_{n-1}$.

1 Proof

Outline of the proof. We follow a well known approach: we assume that $\mathbf{P}_p[0 \overset{\mathbb{S}_k}{\longleftrightarrow} \infty] > 0$, and using this, we construct a finite-size criterion which is sufficient for percolation to occur. By continuity, this finite-size criterion is satisfied for percolation with parameters sufficiently close to p . This immediately implies that $\mathbf{P}_{p_c}[0 \overset{\mathbb{S}_k}{\longleftrightarrow} \infty] = 0$.

The proof is divided in three steps:

- First, we prove that $\mathbf{P}_p[0 \overset{\mathbb{S}_k}{\longleftrightarrow} \infty] > 0$ implies the existence of a certain event with a large probability. This step is new, and in particular, we invoke a gluing lemma to estimate probability of connections between open paths.
- The second step is classical. It consists in applying a block argument to deduce that percolation occurs for any q sufficiently close to p .
- The last step provides the proof of the gluing lemma. This lemma provides an answer to a difficulty encountered when doing renormalization in 3-dimensions (e.g. in [GM90]) *in the case of slabs*. When trying to construct long open connections by connecting two open paths together, the conditioning on the first path creates negative information along the path. As a consequence, one may construct open paths coming at distance one of the existing path, but the last edge can potentially be already explored and closed. This difficulty is one of the major obstacles in using a renormalization scheme to prove that $\mathbf{P}_{p_c}[0 \overset{\mathbb{Z}^3}{\longleftrightarrow} \infty] = 0$. In our case, the fact that slabs are quasi-planar enables us to overcome this difficulty.

From now on in this section, we fix p and k and we assume that

$$\mathbf{P}_p[0 \overset{\mathbb{S}_k}{\longleftrightarrow} \infty] > 0.$$

Since the ambient space is fixed, we will not refer to \mathbb{S}_k and will rather write $X \longleftrightarrow Y$ instead of $X \overset{\mathbb{S}_k}{\longleftrightarrow} Y$.

1.1 The finite-size criterion

The infinite cluster in \mathbb{S}_k being unique almost surely [AKN87, BK89], one can construct a sequence $(u_n)_{n \geq 1}$ such that $u_n \leq n/3$ and

$$\lim_{n \rightarrow \infty} \mathbf{P}_p \left[B_{u_n} \overset{|B_n|}{\longleftrightarrow} \partial B_n \right] = 1. \tag{6.1}$$

For simplicity, we set $S_n = B_{u_n}$. For $0 \leq \alpha \leq \beta \leq n$, we define the following event:

$$\mathcal{E}_n(\alpha, \beta) = \{S_n \xleftrightarrow{B_n} \{n\} \times [\alpha, \beta]\}.$$

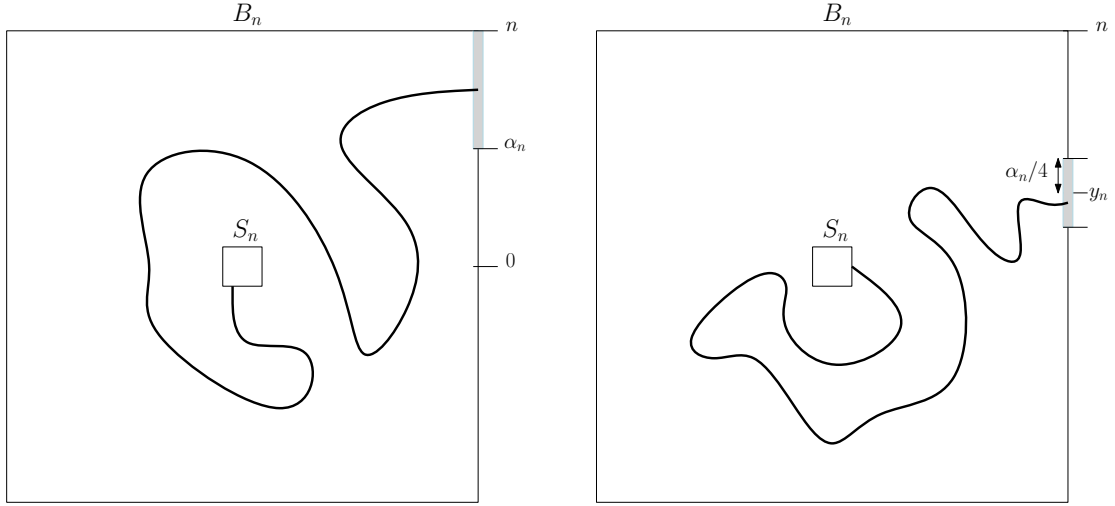

(a) The event $\mathcal{E}_n(\alpha_n, n)$.

(b) The event $\mathcal{E}_n(y_n - \alpha_n/4, y_n + \alpha_n/4)$.

Figure 6.1: The two events of Lemma 1.1.

Lemma 1.1. *There exist two sequences (y_n) and (α_n) with values in $[0, n]$, such that*

$$\begin{aligned} \lim_{n \rightarrow \infty} \mathbf{P}_p[\mathcal{E}_n(\alpha_n, n)] &= 1, \\ \lim_{n \rightarrow \infty} \mathbf{P}_p[\mathcal{E}_n(y_n - \alpha_n/4, y_n + \alpha_n/4)] &= 1. \end{aligned}$$

The proof relies on the following classical inequality, which is a straightforward consequence of the Harris-FKG inequality. Let $\mathcal{A}_1, \dots, \mathcal{A}_m$ be m increasing events. Then

$$\max_{i=1, \dots, m} \mathbf{P}_p[\mathcal{A}_i] \geq 1 - (1 - \mathbf{P}_p[\mathcal{A}_1 \cup \dots \cup \mathcal{A}_m])^{1/m}. \quad (6.2)$$

When the events are of equal probability, this inequality is known as ‘‘square-root trick’’. We use the same name for the generalization given by (6.2).

Proof of Lemma 1.1. Applying the square-root trick and using the symmetries of the box, we obtain

$$\mathbf{P}_p[\mathcal{E}_n(0, n)] \geq 1 - \left(1 - \mathbf{P}_p\left[S_n \xleftrightarrow{B_n} \partial B_n\right]\right)^{1/8}$$

which implies that $\mathbf{P}_p[\mathcal{E}_n(0, n)]$ also tends to 1 as n goes to infinity. Now, for $\alpha \in \{0, \dots, n-1\}$ we will use the decomposition

$$\mathcal{E}_n(0, n) = \mathcal{E}_n(0, \alpha) \cup \mathcal{E}_n(\alpha + 1, n).$$

The probability of the event $\mathcal{E}_n(0, 0)$ is smaller than some constant $c < 1$ uniformly in n and $\mathbf{P}_p[\mathcal{E}_n(0, n)]$ tends to 1, providing that for n large enough:

$$\mathbf{P}_p[\mathcal{E}_n(0, 0)] < \mathbf{P}_p[\mathcal{E}_n(1, n)].$$

In the same way, we also have for n large enough

$$\mathbf{P}_p[\mathcal{E}_n(0, n-1)] > \mathbf{P}_p[\mathcal{E}_n(n, n)].$$

The two inequalities above ensure that the inequality between $\mathbf{P}_p[\mathcal{E}_n(0, \alpha-1)]$ and $\mathbf{P}_p[\mathcal{E}_n(\alpha, n)]$ reverses for a non-trivial α . More precisely we can define $\alpha_n \in \{1, \dots, n-1\}$ by

$$\alpha_n = \max \{ \alpha \leq n-1 : \mathbf{P}_p[\mathcal{E}_n(0, \alpha-1)] < \mathbf{P}_p[\mathcal{E}_n(\alpha, n)] \},$$

and this choice implies that

$$\mathbf{P}_p[\mathcal{E}_n(0, \alpha_n-1)] < \mathbf{P}_p[\mathcal{E}_n(\alpha_n, n)] \text{ and } \mathbf{P}_p[\mathcal{E}_n(0, \alpha_n)] \geq \mathbf{P}_p[\mathcal{E}_n(\alpha_n+1, n)].$$

Therefore, two other uses of the square-root trick imply that $\mathbf{P}_p[\mathcal{E}_n(0, \alpha_n)]$ and $\mathbf{P}_p[\mathcal{E}_n(\alpha_n, n)]$ are larger than $1 - (1 - \mathbf{P}_p[\mathcal{E}_n(0, n)])^{1/2}$ and thus tends to 1 when n goes infinity. Finally, we decompose

$$\mathcal{E}_n(0, \alpha_n) = \mathcal{E}_n(0, \alpha_n/2) \cup \mathcal{E}_n(\alpha_n/2, \alpha_n)$$

and a last application of the square root trick allows to define $y_n = \alpha_n/4$ or $y_n = 3\alpha_n/4$ such that

$$\mathbf{P}_p[\mathcal{E}_n(y_n - \alpha_n/4, y_n + \alpha_n/4)] \geq 1 - \sqrt{1 - \mathbf{P}_p[\mathcal{E}_n(0, \alpha_n)]},$$

which concludes the proof of the lemma. □

Lemma 1.2. *There exist infinitely many n such that $\alpha_{3n} \leq 4\alpha_n$.*

Proof. A sequence of positive integers such that $\alpha_{3n} > 4\alpha_n$ for n large enough grows super-linearly. Since $\alpha_n \leq n$, we obtain the result. □

Let $n \geq 1$. Write $y = y_{3n}$ and define the following five subsets of \mathbb{Z}^2 (see Fig. 6.2 for an illustration):

$$\begin{aligned} B'_n &= (2n, y) + B_n, \\ S'_n &= (2n, y) + S_n, \\ Y_n^+ &= \{3n\} \times [y + \alpha_n, y + n], \\ Y_n^- &= \{3n\} \times [y - n, y - \alpha_n], \\ Z_n &= \{3n\} \times [y - \alpha_n, y + \alpha_n]. \end{aligned}$$

When n is such that $\alpha_{3n}/4 \leq \alpha_n$, we have

$$\mathbf{P}_p \left[S_{3n} \xleftrightarrow{B_{3n}} Z_n \right] \geq \mathbf{P}_p [\mathcal{E}_{3n}(y_{3n} - \alpha_{3n}, y_{3n} + \alpha_{3n})],$$

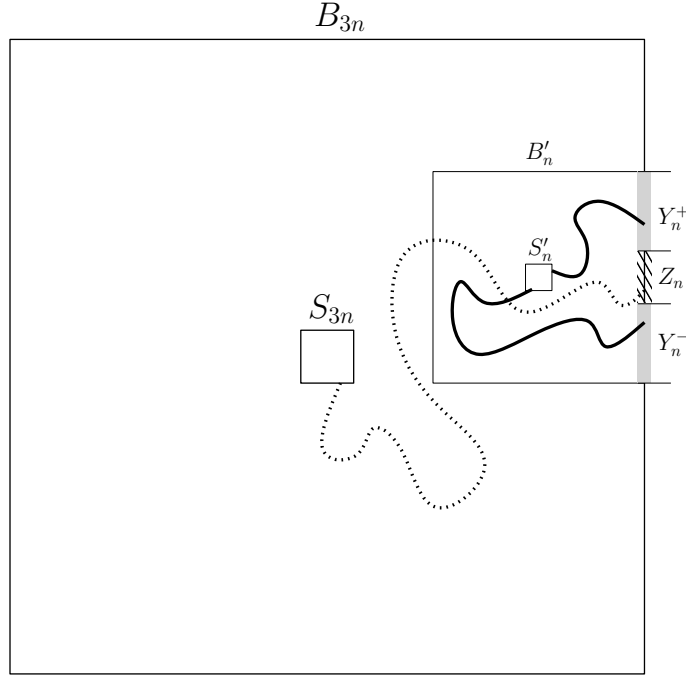

Figure 6.2: The events $S_{3n} \xleftrightarrow{B_{3n}} Z_n$ (the path is depicted by dots) and $\{S'_n \xleftrightarrow{B'_n} Y_n^-\} \cap \{S'_n \xleftrightarrow{B'_n} Y_n^+\}$ (the paths are depicted in bold).

and Lemmata 1.1 and 1.2 imply that

$$\limsup_{n \rightarrow \infty} \mathbf{P}_p \left[S_{3n} \xleftrightarrow{B_{3n}} Z_n \right] = 1. \quad (6.3)$$

Using Harris inequality and the invariance of \mathbf{P}_p under reflection, we deduce that

$$\mathbf{P}_p \left[S_{3n} \xleftrightarrow{B_{3n}} Z_n, S'_n \xleftrightarrow{B'_n} Y_n^-, S'_n \xleftrightarrow{B'_n} Y_n^+ \right] \geq \mathbf{P}_p \left[S_{3n} \xleftrightarrow{B_{3n}} Z_n \right] \mathbf{P}_p [\mathcal{E}_n(0, \alpha_n)]^2.$$

From Lemma 1.1 and (6.3), we finally obtain

$$\limsup_{n \rightarrow \infty} \mathbf{P}_p \left[S_{3n} \xleftrightarrow{B_{3n}} Z_n, S'_n \xleftrightarrow{B'_n} Y_n^-, S'_n \xleftrightarrow{B'_n} Y_n^+ \right] = 1. \quad (6.4)$$

We now intend to construct a path from $\overline{S_{3n}}$ to $\overline{S'_n}$. Projections of paths from $\overline{S_{3n}}$ to $\overline{Z_n}$ and from $\overline{S'_n}$ to $\overline{Y_n^-}$ and $\overline{Y_n^+}$ must intersect (as illustrated on Fig. 6.2), but the paths themselves have no reason to do so. This is one of the main difficulties when working with non-planar graphs. Let us assume for a moment that we have the following lemma at our disposition and let us finish the proof. Note that this lemma is a crucial ingredient of the proof, since it solves the problem of the intersection of paths on slabs.

Lemma 1.3 (Gluing Lemma). *For any $\varepsilon > 0$, there exists $\delta = \delta(\varepsilon, k) > 0$ such that for any n ,*

$$\mathbf{P}_p \left[S_{3n} \xleftrightarrow{B_{3n}} Z_n, S'_n \xleftrightarrow{B'_n} Y_n^-, S'_n \xleftrightarrow{B'_n} Y_n^+ \right] \geq 1 - \delta$$

implies

$$\mathbf{P}_p \left[S_{3n} \xleftrightarrow{B_{3n} \cup B'_n} S'_n \right] \geq 1 - \varepsilon.$$

Lemma 1.3 and (6.4) imply that

$$\limsup_{n \rightarrow \infty} \mathbf{P}_p \left[S_{3n} \xleftrightarrow{B_{4n}} S'_n \right] = 1. \quad (6.5)$$

Observe that

$$\begin{aligned} & \mathbf{P}_p \left[S_{3n} \xleftrightarrow{(2n,0)+B_{6n}} (4n,0) + S_{3n} \right] \\ & \geq \mathbf{P}_p \left[\{S_{3n} \xleftrightarrow{B_{4n}} S'_n\} \cap \{S'_n \xleftrightarrow{(4n,0)+B_{4n}} (4n,0) + S_{3n}\} \cap \{S'_n \xleftrightarrow{!B'_n!} \partial B'_n\} \right] \\ & \geq \mathbf{P}_p \left[\{S_{3n} \xleftrightarrow{B_{4n}} S'_n\} \cap \{S'_n \xleftrightarrow{(4n,0)+B_{4n}} (4n,0) + S_{3n}\} \right] + \mathbf{P}_p \left[S'_n \xleftrightarrow{!B'_n!} \partial B'_n \right] - 1 \\ & \geq \mathbf{P}_p \left[S_{3n} \xleftrightarrow{B_{4n}} S'_n \right]^2 + \mathbf{P}_p \left[S'_n \xleftrightarrow{!B'_n!} \partial B'_n \right] - 1. \end{aligned}$$

The first inequality followed from the fact that paths coming from $\overline{S_{3n}}$ and $\overline{(4n,0) + S_{3n}}$ and going to $\overline{S'_n}$ must be connected to each other in $\overline{B'_n}$ by uniqueness of the cluster in $\overline{B'_n}$ from $\overline{S'_n}$ to $\overline{\partial B'_n}$. The Harris inequality and the reflection across the axis $\{2n\} \times \mathbb{R}$ were used in the last inequality.

Using (6.5) and (6.1), we find

$$\limsup_{n \rightarrow \infty} \mathbf{P}_p \left[S_{3n} \xleftrightarrow{(2n,0)+B_{6n}} (4n,0) + S_{3n} \right] = 1. \quad (6.6)$$

1.2 The renormalization step

Fix $n \in \mathbb{N}$ to be chosen below. Call an edge $\{z, z'\}$ of $4n\mathbb{Z}^2$ *good* if

- $z + S_{3n} \xleftrightarrow{R_n} z' + S_{3n}$, with $R_n = \frac{z+z'}{2} + B_{6n}$,
- $z + S_{3n} \xleftrightarrow{!z+B_{3n}!} z + \partial B_{3n}$ and $z' + S_{3n} \xleftrightarrow{!z'+B_{3n}!} z' + \partial B_{3n}$.

Notice that the set of good edges follows a percolation law which is 4-dependent. In particular, there exists $\eta > 0$ such that whenever the probability to be good exceeds $1 - \eta$, the set of good edges percolates (this fact follows from a Peierls argument presented for example in [BBW05, Lemma 1], or from the classical result of [LSS97] comparing 4-dependent percolation to Bernoulli percolation).

Equations (6.6) and (6.1) guarantee the existence of n such that the \mathbf{P}_p -probability that an edge is good is larger than $1 - \eta$. Since being good depends only on the state of the edges in a finite box, there exists $q < p$ such that an edge is good with \mathbf{P}_q -probability larger than $1 - \eta$, and the set of good edges percolates for the percolation of parameter q .

By construction, an infinite path of good edges in the coarse-grained lattice immediately implies the existence of an infinite path of open edges in the original lattice.

As a consequence, $q \geq p_c(k)$ and therefore $p > p_c(k)$. This concludes the proof of $\mathbf{P}_{p_c(k)}[0 \longleftrightarrow \infty] = 0$ conditionally on Lemma 1.3.

1.3 The proof of Lemma 1.3 (the gluing Lemma)

First, observe that the lemma holds trivially for $k = 0$ by setting $\delta(\varepsilon, 0) = \varepsilon$. We therefore assume from now on that $k \geq 1$. We will be using the following lemma.

Lemma 1.4. *Let $s, t > 0$. Consider two events \mathcal{A} and \mathcal{B} and a map Φ from \mathcal{A} into the set $\mathfrak{P}(\mathcal{B})$ of subevents of \mathcal{B} . We assume that:*

1. *for all $\omega \in \mathcal{A}$, $|\Phi(\omega)| \geq t$,*
2. *for all $\omega' \in \mathcal{B}$, there exists a set S with less than s edges such that $\{\omega : \omega' \in \Phi(\omega)\} \subset \{\omega : \omega|_S = \omega'|_S\}$.*

Then,

$$\mathbf{P}_p[\mathcal{A}] \leq \frac{(2/\min\{p, 1-p\})^s}{t} \mathbf{P}_p[\mathcal{B}].$$

This lemma will enable us to bound from above the probability of \mathcal{A} when s is small and t is large.

Proof. It follows from exchanging the order of the summation on ω and on $\omega' \in \Phi(\omega)$:

$$\begin{aligned} \sum_{\omega \in \mathcal{A}} \mathbf{P}_p[\omega] &\leq \frac{1}{t(\min\{p, 1-p\})^s} \sum_{\omega \in \mathcal{A}} \mathbf{P}_p[\Phi(\omega)] \\ &= \frac{1}{t(\min\{p, 1-p\})^s} \sum_{\omega' \in \mathcal{B}} \text{Card}\{\omega : \omega' \in \Phi(\omega)\} \cdot \mathbf{P}_p[\omega'] \\ &\leq \frac{2^s}{t(\min\{p, 1-p\})^s} \sum_{\omega' \in \mathcal{B}} \mathbf{P}_p[\omega']. \end{aligned}$$

□

Let us now explain how the previous statement can be used to prove Lemma 1.3. Fix an arbitrary order \prec on edges emanating from each vertex of \mathbb{S}_k , which is invariant under translations of \mathbb{Z}^2 . Also fix an arbitrary order \ll on vertices of \mathbb{S}_k . Then, define a total order on self-avoiding paths from $\overline{S_{3n}}$ to $\overline{Z_n}$ by taking the lexicographical order: for two paths $\gamma = (\gamma_i)_{i \leq r}$ and $\gamma' = (\gamma'_i)_{i \leq r'}$, we set $\gamma < \gamma'$ if one of the following conditions occurs:

- $r < r'$ and $\gamma = (\gamma'_i)_{i \leq r}$,
- $\gamma_0 \ll \gamma'_0$,
- there exists $k < \min\{r, r'\}$ such that $\gamma_j = \gamma'_j$ for $j \leq k$ and $(\gamma_k, \gamma_{k+1}) \prec (\gamma'_k, \gamma'_{k+1})$.

Definition. Consider ω with at least one open path from $\overline{S_{3n}}$ to $\overline{Z_n}$. Define $\gamma_{\min}(\omega)$ to be the minimal (for the order defined above) open self-avoiding path from $\overline{S_{3n}}$ to $\overline{Z_n}$. Let $U(\omega)$ be the set of points z in B'_n with

$$\mathbf{P1} \quad \overline{\{z\}} \cap \gamma_{\min}(\omega) \neq \emptyset,$$

$\mathbf{P2} \quad z + B_1$ is connected to $\overline{S'_n}$ by an open path π , such that the distance between the canonical projections of π and γ_{\min} onto \mathbb{Z}^2 is exactly 1.

Write $\mathcal{X} = \{S_{3n} \xleftrightarrow{B_{3n}} Z_n, S'_n \xleftrightarrow{B'_n} Y_n^-, S'_n \xleftrightarrow{B'_n} Y_n^+\} \cap \{S_{3n} \xleftrightarrow{B_{3n} \cup B'_n} S'_n\}^c$. Proving Lemma 1.3 corresponds to proving that the probability of \mathcal{X} is small whenever the probability of $\{S_{3n} \xleftrightarrow{B_{3n}} Z_n, S'_n \xleftrightarrow{B'_n} Y_n^-, S'_n \xleftrightarrow{B'_n} Y_n^+\}$ is close to 1. We proceed in two steps, depending on whether the cardinality of $U(\omega)$ is large or not.

Fact 1.5. Fix $\varepsilon > 0$ and $t > 0$. There exists $\delta > 0$ so that

$$\mathbf{P}_p \left[S'_n \xleftrightarrow{B'_n} Y_n^-, S'_n \xleftrightarrow{B'_n} Y_n^+ \right] > 1 - \delta$$

implies $\mathbf{P}_p [\mathcal{X} \cap \{|U| < t\}] \leq \varepsilon$.

Proof of Fact 1.5. Let $\omega \in \mathcal{X}$ such that $|U(\omega)| < t$. Define ω' to be the configuration obtained from ω by closing, for any $z \in U(\omega)$, all the edges $\{u, v\}$ such that $u \in \overline{\{z\}}$ and v is connected to $\overline{S'_n}$ by an open path.

Observe that ω' cannot contain two open paths in $\overline{B'_n}$ from $\overline{S'_n}$ to $\overline{Y_n^-}$ and $\overline{Y_n^+}$ respectively. Indeed, an open path in ω' must be open in ω . Furthermore, two paths from $\overline{S'_n}$ to $\overline{Y_n^-}$ and $\overline{Y_n^+}$ respectively must intersect at least one set of the form $\overline{\{z\}}$ with z in $U(\omega)$. But this implies that one edge of one of these two paths was turned to closed in ω' , which is a contradiction. We therefore constructed a map

$$\Phi : \mathcal{X} \cap \{|U| < t\} \longrightarrow \{S'_n \xleftrightarrow{B'_n} Y_n^-, S'_n \xleftrightarrow{B'_n} Y_n^+\}^c$$

mapping a configuration ω to ω' . For any ω' in the image of Φ , the set $\{\omega : \Phi(\omega) = \omega'\}$ contains only configurations that are equal to ω' except possibly on the edges adjacent to $U(\omega')$. Here, we use the fact that $U(\omega') = U(\omega)$ and $\gamma_{\min}(\omega') = \gamma_{\min}(\omega)$ for any pre-image of ω' (since $\mathbf{P1}$ guarantees that no edge of $\gamma_{\min}(\omega')$ was closed in the process). Lemma 1.4 can be applied to obtain

$$\mathbf{P}_p [\mathcal{X} \cap \{|U| < t\}] \leq (2/\min\{p, 1-p\})^{6kt} \mathbf{P}_p \left[\left\{ S'_n \xleftrightarrow{B'_n} Y_n^-, S'_n \xleftrightarrow{B'_n} Y_n^+ \right\}^c \right].$$

Fact 1.5 follows immediately. \square

Fact 1.6. Fix $\varepsilon > 0$. For t large enough,

$$\mathbf{P}_p [\mathcal{X} \cap \{|U| \geq t\}] \leq \varepsilon \mathbf{P}_p \left[S_{3n} \xleftrightarrow{B_{3n} \cup B'_n} S'_n \right].$$

Proof of Fact 1.6. For $R \geq 1$ and $z = (z_1, z_2, z_3) \in \mathbb{S}_k$, we write $\overline{B_R}(z)$ for $\overline{(z_1, z_2) + B_R}$. Fix $R \geq 2$ in such a way that for any site $z \in \mathbb{S}_k$, for any three distinct neighbors u, v, w of z and any three distinct sites u', v', w' on the boundary of $\overline{B_R}(z)$, there exist three disjoint self-avoiding paths in $\overline{B_R}(z) \setminus \{z\}$ connecting u to u' , v to v' and w to w' . Note that such an R exists since in this section, k is assumed to be strictly larger than 0.

Remark. For the slab, one could take $R = 2$. Nevertheless, taking larger R becomes necessary when dealing with finite range percolation. Since the proof is not more complicated, we choose to present it with an arbitrary R .

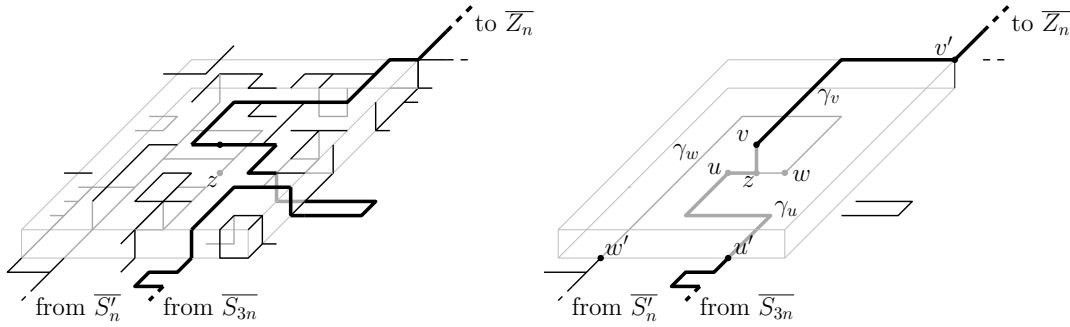

Figure 6.3: Two configurations ω and $\omega^{(z)}$. In both cases, γ_{\min} is depicted in bold, and closed edges are not drawn for clarity. Note that at the end of the construction, there are exactly three open edges connecting a vertex of $\overline{B_R}(z)$ to a vertex in the complement of $\overline{B_R}(z)$.

Fix $\omega \in \mathcal{X}$ such that $|U(\omega)| \geq t$ and pick $z \in U(\omega)$. Construct the configuration $\omega^{(z)}$ as follows (see Fig. 6.3 for an illustration of the construction):

1. Choose u, v, w in such a way that (z, u) , (z, v) and (z, w) are three distinct edges with $(z, v) \prec (z, w)$.

Define u' and v' to be respectively the first and last (when going from $\overline{S_{3n}}$ to $\overline{Z_n}$) vertices of $\gamma_{\min}(\omega)$ which are in $\overline{B_R}(z)$ (these two vertices exist and are distinct since $\gamma_{\min}(\omega)$ intersects the set $\overline{B_1}(z)$ by **P1**).

Choose w' on the boundary of $\overline{B_R}$ in such a way that there exists an open self-avoiding path π from w' to $\overline{S'_n}$, all the edges of which lie outside $\overline{B_R}(z)$ (this path exists by **P2**). Since $\omega \in \mathcal{X}$, we also have that w' is different from u' and v' (otherwise $S_{3n} \longleftrightarrow S'_n$ in ω).

2. Close all edges of ω in $\overline{B_{R+1}}(z)$ at the exception of the edges of $\overline{B_{R+1}}(z) \setminus \overline{B_R}(z)$ which are in $\gamma_{\min}(\omega)$ or π .
3. Open the edges (z, u) , (z, v) and (z, w) , together with three disjoint self-avoiding paths γ_u, γ_v and γ_w in $\overline{B_R}(z) \setminus \{z\}$ connecting u to u' , v to v' , and w to w' .

By construction, $\omega^{(z)}$ is in $\{S_{3n} \xleftrightarrow{B_{3n} \cup B'_n} S'_n\}$ and we can define the map

$$\begin{aligned} \Psi : \mathcal{X} \cap \{|U| > t\} &\longrightarrow \mathfrak{P}(S_{3n} \xleftrightarrow{B_{3n} \cup B'_n} S'_n) \\ \omega &\longmapsto \{\omega^{(z)}, z \in U(\omega)\}. \end{aligned}$$

We wish to apply Lemma 1.4. In order to do so, the following observation will be useful.

Working with the lexicographical order implies that $\gamma_{\min}(\omega^{(z)})$ and $\gamma_{\min}(\omega)$ necessarily coincide up to u' . Thanks to the second step, the degree of u' in $\omega^{(z)}$ is 2. This fact forces any self-avoiding open path from $\overline{S_{3n}}$ to $\overline{Z_n}$ containing the minimal path up to u' to contain γ_u . Now (this is the crucial point of the construction), we have that $(z, v) \prec (z, w)$. Therefore, even though there could exist an open path from z to $\overline{Z_n}$ passing by w , *the minimal path will still be going through v* . Hence, the continuation of the minimal path goes through v and thus contains γ_v for the same reason that it was including γ_u . From v' , the minimality of $\gamma_{\min}(\omega)$ implies that $\gamma_{\min}(\omega^{(z)})$ and $\gamma_{\min}(\omega)$ coincide from this vertex up to the end.

Since no site of $\gamma_{\min}(\omega)$ is connected to $\overline{S'_n}$ in ω (simply because $\omega \in \mathcal{X}$), the previous paragraph implies that z is *the only site on $\gamma_{\min}(\omega^{(z)})$ to be connected to $\overline{S'_n}$ without using any edge in $\gamma_{\min}(\omega^{(z)})$* .

We are now in a position to apply Lemma 1.4. The configurations $\omega^{(z)}$ are all distinct since either $\gamma_{\min}(\omega^{(z)}) \neq \gamma_{\min}(\omega^{(z')})$ (which readily implies that the configurations are distinct), or $\gamma_{\min}(\omega^{(z)}) = \gamma_{\min}(\omega^{(z')})$ but then $z = z'$ by the characterization of z (and z') above.

Furthermore, consider a pre-image ω of ω' and assume that $\omega' = \omega^{(z)}$ for some $z \in \mathbb{S}_k$. The discussion above shows that z is determined uniquely. Beside, the configurations ω and $\omega^{(z)}$ differ only in $\overline{B_{R+1}}(z)$.

In conclusion, the map Φ verifies the hypotheses of Lemma 1.4 with s equal to the number of edges in $\overline{B_{R+1}}$. This gives

$$\mathbf{P}_p[\mathcal{X} \cap \{|U| > t\}] \leq \frac{(2/\min\{p, 1-p\})^C}{t} \mathbf{P}_p \left[S_{3n} \xleftrightarrow{B_{3n} \cup B'_n} S'_n \right].$$

Choosing t large enough concludes the proof. \square

Fix $\varepsilon > 0$. Choosing first t as in Fact 1.6 and then δ as in Fact 1.5 conclude the proof of Lemma 1.3.

1.4 The proof of Proposition 0.9

Proof of Proposition 0.9. Recall the result of [GM90] yielding that $p_c(k)$ tends to $p_c(\mathbb{Z}^3)$ as k tends to infinity.

Let $p > p_c(\mathbb{Z}^3)$. Since the infinite cluster is unique almost surely, and since there exists an infinite cluster in Slab_k for any k sufficiently large (simply choose k so that $p_c(k) < p$),

we obtain that

$$\mathbf{P}_p[0 \xleftrightarrow{\mathbb{Z}^3} \infty] = \mathbf{P}_p\left[\bigcup_{k \geq 0} \{0 \xleftrightarrow{S_k} \infty\}\right],$$

from which we deduce that

$$\mathbf{P}_p[0 \xleftrightarrow{\mathbb{Z}^3} \infty] = \lim_{k \rightarrow \infty} \mathbf{P}_p[0 \xleftrightarrow{S_k} \infty] \leq \lim_{k \rightarrow \infty} f(p - p_c(k)) = f(p - p_c(\mathbb{Z}^3)).$$

As p tends to $p_c(\mathbb{Z}^3)$, the continuity of f implies that

$$\mathbf{P}_{p_c(\mathbb{Z}^3)}[0 \xleftrightarrow{\mathbb{Z}^3} \infty] = 0.$$

□

LOCALITY OF PERCOLATION FOR ABELIAN CAYLEY GRAPHS

7

This chapter corresponds to the published article [VT7] with the same title, written in collaboration with Sébastien Martineau.

We prove that the value of the critical probability for percolation on an abelian Cayley graph is determined by its local structure. This is a partial positive answer to a conjecture of Schramm: the function p_c defined on the set of Cayley graphs of abelian groups of rank at least 2 is continuous for the Benjamini-Schramm topology. The proof involves group-theoretic tools and a new block argument.

Introduction

In the paper [BS96], Benjamini and Schramm launched the study of percolation in the general setting of transitive graphs. Among the numerous questions that have been studied in this setting stands the question of locality: roughly, “does the value of the critical probability depend only on the local structure of the considered transitive graph?” This question emerged in [BNP11] and is formalized in a conjecture attributed to Oded Schramm. In the same paper, the particular case of (uniformly non-amenable) tree-like graphs is treated.

In the present paper, we study the question of locality in the context of abelian groups.

- Instead of working in the geometric setting of transitive graphs, we employ the vocabulary of groups — or more precisely of **marked groups**, as presented in section 1. This allows us to use additional tools of algebraic nature, such as quotient maps, that are crucial to our approach. These tools could be useful to tackle Schramm’s conjecture in a more general framework than the one presented in this paper, e.g. Cayley graphs of nilpotent groups.
- We extend renormalization techniques developed in [GM90] by Grimmett and Marstrand for the study of percolation on \mathbb{Z}^d (equipped with its standard graph structure). The Grimmett-Marstrand theorem answers positively the question of locality for the d -dimensional hypercubic lattice. With little extra effort, one can give a positive an-

swer to Schramm’s conjecture in the context of abelian groups, under a symmetry assumption. Our main achievement is to improve the understanding of supercritical bond percolation on general abelian Cayley graphs: such graphs do not have enough symmetry for Grimmett and Marstrand’s arguments to apply directly. The techniques we develop here may be used to extend other results of statistical mechanics from symmetric lattices to lattices which are not stable under any reflection.

0.5 Statement of Schramm’s conjecture

The following paragraph presents the vocabulary needed to state Schramm’s conjecture (for more details, see [BNP11]).

Transitive graphs. We recall here some standard definitions from graph theory. A graph is said to be **transitive** if its automorphism group acts transitively on its vertices. Let \mathfrak{G} denote the space of (locally finite, non-empty, connected) transitive graphs considered up to isomorphism. By abuse of notation, we will identify a graph with its isomorphism class. Take $\mathcal{G} \in \mathfrak{G}$ and o any vertex of \mathcal{G} . Then consider the **ball** of radius k (for the graph distance) centered at o , equipped with its graph structure and rooted at o . Up to isomorphism of rooted graphs, it is independent of the choice of o , and we denote it by $\mathcal{B}_{\mathcal{G}}(k)$. If $\mathcal{G}, \mathcal{H} \in \mathfrak{G}$, we set the distance between them to be 2^{-n} , where

$$n := \max\{k : \mathcal{B}_{\mathcal{G}}(k) \simeq \mathcal{B}_{\mathcal{H}}(k)\} \in \mathbb{N} \cup \{\infty\}.$$

This defines the Benjamini-Schramm distance on the set \mathfrak{G} . It was introduced in [BS01] and [BNP11].

Locality in percolation theory. We will use the standard definitions from percolation theory and refer to [Gri99b] and [LP14] for background on the subject. To any $\mathcal{G} \in \mathfrak{G}$ corresponds a critical parameter $p_c(\mathcal{G})$ for i.i.d. bond percolation. One can see p_c as a function from \mathfrak{G} to $[0, 1]$. The locality question is concerned by the continuity of this function.

Question 0.7 (Locality of percolation). *Consider a sequence of transitive graphs (\mathcal{G}_n) that converges to a limit \mathcal{G} .*

$$\text{Does the convergence } p_c(\mathcal{G}_n) \xrightarrow[n \rightarrow \infty]{} p_c(\mathcal{G}) \text{ hold?}$$

With this formulation, the answer is negative. Indeed, for the usual graph structures, the following convergences hold:

- $(\mathbb{Z}/n\mathbb{Z})^2 \xrightarrow[n \rightarrow \infty]{} \mathbb{Z}^2,$
- $\mathbb{Z}/n\mathbb{Z} \times \mathbb{Z} \xrightarrow[n \rightarrow \infty]{} \mathbb{Z}^2.$

In both cases, the critical parameter is constant equal to 1 all along the sequence and jumps to a non trivial value in the limit. The following conjecture, attributed to Schramm

and formulated in [BNP11], states that Question 0.7 should have a positive answer whenever the previous obstruction is avoided.

Conjecture 0.8 (Schramm). *Let $\mathcal{G}_n \xrightarrow{n \rightarrow \infty} \mathcal{G}$ denote a converging sequence of transitive graphs. Assume that $\sup_n p_c(\mathcal{G}_n) < 1$. Then $p_c(\mathcal{G}_n) \xrightarrow{n \rightarrow \infty} p_c(\mathcal{G})$.*

It is unknown whether $\sup_n p_c(\mathcal{G}_n) < 1$ is equivalent or not to $p_c(\mathcal{G}_n) < 1$ for all n . In other words, we do not know if 1 is an isolated point in the set of critical probabilities of transitive graphs. Besides, no geometric characterization of the probabilistic condition $p_c(\mathcal{G}) < 1$ has been established so far, which constitutes part of the difficulty of Schramm's conjecture.

0.6 The Grimmett-Marstrand theorem

The following theorem, proved in [GM90], is an instance of locality result. It was an important step in the comprehension of the supercritical phase of percolation.

Theorem 0.9 (Grimmett-Marstrand). *Let $d \geq 2$. For the usual graph structures, the following convergence holds:*

$$p_c \left(\mathbb{Z}^2 \times \{-n, \dots, n\}^{d-2} \right) \xrightarrow{n \rightarrow \infty} p_c \left(\mathbb{Z}^d \right).$$

Remark. Grimmett and Marstrand's proof covers more generally the case of edge structures on \mathbb{Z}^d that are invariant under both translation and reflection.

The graph $\mathbb{Z}^2 \times \{-n, \dots, n\}^{d-2}$ is not transitive, so the result does not fit exactly into the framework of the previous subsection. However, as remarked in [BNP11], one can easily deduce from it the following statement:

$$p_c \left(\mathbb{Z}^2 \times \left(\frac{\mathbb{Z}}{n\mathbb{Z}} \right)^{d-2} \right) \xrightarrow{n \rightarrow \infty} p_c \left(\mathbb{Z}^d \right). \quad (7.1)$$

Actually, after having introduced the space of marked abelian groups, we will see in section 1.3 that one can deduce from the Grimmett-Marstrand theorem a statement that is much stronger than convergence (7.1). We will be able to prove that $p_c(\mathbb{Z}^d) = \lim p_c(\mathcal{G}_n)$ for any sequence of abelian Cayley graphs \mathcal{G}_n converging to \mathbb{Z}^d with respect to the Benjamini-Schramm distance.

0.7 Main result

In this paper we prove the following theorem, which provides a positive answer to Question 0.7 in the particular case of Cayley graphs of abelian groups (see definitions in section 1).

Theorem 0.10. *Consider a sequence (\mathcal{G}_n) of Cayley graphs of abelian groups satisfying $p_c(\mathcal{G}_n) < 1$ for all n . If the sequence converges to the Cayley Graph \mathcal{G} of an abelian group, then*

$$p_c(\mathcal{G}_n) \xrightarrow{n \rightarrow \infty} p_c(\mathcal{G}). \quad (7.2)$$

We now give three examples of application of this theorem. Let $d \geq 2$, fix a generating set S of \mathbb{Z}^d , and denote by \mathcal{G} the associated Cayley graph of \mathbb{Z}^d .

Example 1: There exists a natural Cayley graph \mathcal{G}_n of $\mathbb{Z}^2 \times \left(\frac{\mathbb{Z}}{n\mathbb{Z}}\right)^{d-2}$ that is covered by \mathcal{G} . For such sequence, the convergence (7.2) holds, and generalizes (7.1).

Example 2: Consider the generating set of \mathbb{Z}^d obtained by adding to S all the $n \cdot s$, for $s \in S$. The corresponding Cayley graph \mathcal{H}_n converges to the Cartesian product $\mathcal{G} \times \mathcal{G}$, and we get

$$p_c(\mathcal{H}_n) \xrightarrow{n \rightarrow \infty} p_c(\mathcal{G} \times \mathcal{G}).$$

Example 3: Consider a sequence of vectors $x_n \in \mathbb{Z}^d$ such that $\lim |x_n| = \infty$, and write \mathcal{G}_n the Cayley graph of \mathbb{Z}^d constructed from the generating set $S \cup \{x_n\}$. Then the following convergence holds:

$$p_c(\mathcal{G}_n) \xrightarrow{n \rightarrow \infty} p_c(\mathcal{G} \times \mathbb{Z}).$$

The content of Example 2 was obtained in [dLSS11] when \mathcal{G} is the canonical Cayley graph of \mathbb{Z}^d , based on Grimmett-Marstrand theorem. In the statement above, \mathcal{G} can be any Cayley graph of \mathbb{Z}^d , and Grimmett-Marstrand theorem cannot be applied without additional symmetry assumption.

0.8 Questions

In this paper, we work with abelian groups because their structure is very well understood. An additional important feature is that the net formed by large balls of an abelian Cayley graph has roughly the same geometric structure as the initial graph. Since nilpotent groups also present these characteristics, the following question appears as a natural step between Theorem 0.10 and Question 0.7.

Question 0.11. *Is it possible to extend Theorem 0.10 to nilpotent groups?*

This question can also be asked for other models of statistical mechanics than Bernoulli percolation. In questions 0.12 and 0.13, we mention two other natural contexts where the locality question can be asked.

Theorem 2.1 of [Bod05] states that locality holds for the critical temperature of the Ising model for the hypercubic lattice. This suggests the following question.

Question 0.12. *Is it possible to prove Theorem 0.10 for the critical temperature of the Ising model instead of p_c ?*

Define c_n as the number of self-avoiding walks starting from a fixed root of a transitive graph \mathcal{G} . By sub-multiplicativity, the sequence $c_n^{1/n}$ converges to a limit called the connective constant of \mathcal{G} . In this context, the following question was raised by I. Benjamini [Ben13b]:

Question 0.13. *Does the connective constant depend continuously on the considered infinite transitive graph?*

0.9 Organization of the paper

Section 1 presents the material on marked abelian groups that will be needed to establish Theorem 0.10. In section 1.4, we explain the strategy of the proof, which splits into two main lemmas. Sections 2 and 3 are each devoted to the proof of one of these lemmas.

We drive the attention of the interested reader to Lemma 2.8. Together with the uniqueness of the infinite cluster, it allows to avoid the construction of “seeds” in Grimmett and Marstrand’s approach.

1 Marked abelian groups and locality

In this section, we present the space of marked abelian groups and show how problems of Benjamini-Schramm continuity for abelian Cayley graphs can be reduced to continuity problems for marked abelian group. Then, we provide a first example illustrating the use of marked abelian groups in proofs of Benjamini-Schramm continuity. Finally, section 1.4 presents the proof of Theorem 1.3, which is the marked group version of our main theorem.

General marked groups are introduced in [Gri85]. Here, we only define marked groups and Cayley graphs in the abelian setting, since we do not need a higher level of generality.

1.1 The space of marked abelian groups

Let d denote a positive integer. A (d) -marked abelian group is the data of an abelian group together with a generating d -tuple (s_1, \dots, s_d) , up to isomorphism. (We say that $(G; s_1, \dots, s_d)$ and $(G'; s'_1, \dots, s'_d)$ are isomorphic if there exists a group isomorphism from G to G' mapping s_i to s'_i for all i .) We write \mathbf{G}_d the set of the d -marked abelian groups. Elements of \mathbf{G}_d will be denoted by $[G; s_1, \dots, s_d]$ or G^\bullet , depending on whether we want to insist on the generating system or not. Finally, we write \mathbf{G} the set of all the marked abelian groups: it is the disjoint union of all the \mathbf{G}_d ’s.

Quotient of a marked abelian group. Given a marked abelian group $G^\bullet = [G; s_1, \dots, s_d]$ and a subgroup Λ of G , we define the quotient G^\bullet/Λ by

$$G^\bullet/\Lambda = [G/\Lambda; \bar{s}_1, \dots, \bar{s}_d],$$

where $(\bar{s}_1, \dots, \bar{s}_d)$ is the image of (s_1, \dots, s_d) by the canonical surjection from G onto G/Λ . Quotients of marked abelian groups will be crucial to define and understand the topology of the set of marked abelian groups. In particular, for the topology defined below, the quotients of a marked abelian group G^\bullet forms a neighbourhood of it.

The topology. We first define the topology on \mathbf{G}_d . Let \mathbf{ffi} denote the canonical generating system of \mathbb{Z}^d . To each subgroup Γ of \mathbb{Z}^d , we can associate an element of \mathbf{G}_d via the mapping

$$\Gamma \longmapsto [\mathbb{Z}^d; \mathbf{ffi}]/\Gamma. \quad (7.3)$$

One can verify that the mapping defined by (7.3) realizes a bijection from the set of the subgroups of \mathbb{Z}^d onto \mathbf{G}_d . This way, \mathbf{G}_d can be seen as a subset of $\{0, 1\}^{\mathbb{Z}^d}$. We consider on \mathbf{G}_d the topology induced by the product topology on $\{0, 1\}^{\mathbb{Z}^d}$. This makes of \mathbf{G}_d a Hausdorff compact space. Finally, we equip \mathbf{G} with the topology generated by the open subsets of the \mathbf{G}_d 's. (In particular, \mathbf{G}_d is an open subset of \mathbf{G} .)

Let us illustrate the topology with three examples of converging sequences:

- $[\mathbb{Z}/n\mathbb{Z}; 1]$ converges to $[\mathbb{Z}; 1]$.
- $[\mathbb{Z}; 1, n, \dots, n^d]$ converges to $[\mathbb{Z}^d; \mathbf{ffi}]$.
- $[\mathbb{Z}; 1, n, n+1]$ converges to $[\mathbb{Z}^2; \mathbf{ffi}_1, \mathbf{ffi}_2, \mathbf{ffi}_1 + \mathbf{ffi}_2]$.

Cayley graphs. Let $G^\bullet = [G; s_1, \dots, s_d]$ be a marked abelian group. Its Cayley graph, denoted $\text{Cay}(G^\bullet)$, is defined by taking G as vertex-set and declaring a and b to be neighbours if there exists i such that $a = b \pm s_i$. It is uniquely defined up to graph isomorphism. We write $B_{G^\bullet}(k) \subset G$ the ball of radius k in $\text{Cay}(G^\bullet)$, centered at 0.

Converging sequences of marked abelian groups. In the rest of the paper, we will use the topology of \mathbf{G} through the following proposition, which gives a geometric flavour to the topology. In particular, it will allow to do the connection with the Benjamini-Schramm topology through corollary 1.2.

Proposition 1.1. *Let (G_n^\bullet) be a sequence of marked abelian groups that converges to some G^\bullet . Then, for any integer k , the following holds for n large enough:*

1. G_n^\bullet is of the form G^\bullet/Λ_n , for some subgroup Λ_n of G , and
2. $\Lambda_n \cap B_{G^\bullet}(k) = \{0\}$.

Proof. Let d be such that $G^\bullet \in \mathbf{G}_d$. For n large enough, we also have $G_n^\bullet \in \mathbf{G}_d$. Let Γ (resp. Γ_n) denote the unique subgroup of \mathbb{Z}^d that corresponds to G^\bullet (resp. G_n^\bullet) via bijection (7.3). The group Γ is finitely generated: we consider F a finite generating subset of it. Taking n large enough, we can assume that Γ_n contains F , which implies that Γ is a subgroup Γ_n . We have the following situation

$$\mathbb{Z}^d \xrightarrow{\varphi} \mathbb{Z}^d/\Gamma \xrightarrow{\psi_n} \mathbb{Z}^d/\Gamma_n.$$

Identifying G with \mathbb{Z}^d/Γ and taking $\Lambda_n = \ker \psi_n = \Gamma_n/\Gamma$, we obtain the first point of the proposition.

By definition of the topology, taking n large enough ensures that $\Gamma_n \cap B_{\mathbb{Z}^d}(k) = \Gamma \cap B_{\mathbb{Z}^d}(k)$. We have

$$\begin{aligned} B_{\mathbb{Z}^d/\Gamma}(k) \cap \Lambda_n &= \varphi(B_{\mathbb{Z}^d}(k) \cap \Gamma_n) \\ &= \varphi(B_{\mathbb{Z}^d}(k) \cap \Gamma) \\ &= \{0\}. \end{aligned}$$

This ends the proof of the second point. \square

Corollary 1.2. *The mapping Cay from \mathbf{G} to \mathfrak{G} that associates to a marked abelian group its Cayley graph is continuous.*

1.2 Percolation on marked abelian groups

Via its Cayley graph, we can associate to each marked abelian group G^\bullet a critical parameter $p_c^\bullet(G^\bullet) := p_c(\text{Cay}(G^\bullet))$ for bond percolation. If G^\bullet is a marked abelian group, then $p_c^\bullet(G^\bullet) < 1$ if and only if the rank of G is at least 2. (We commit the abuse of language of calling rank of an abelian group the rank of its torsion-free part.) This motivates the following definition:

$$\tilde{\mathbf{G}} = \{G^\bullet \in \mathbf{G} : \text{rank}(G) \geq 2\}.$$

In the context of marked abelian groups, we will prove the following theorem:

Theorem 1.3. *Consider $G_n^\bullet \longrightarrow G^\bullet$ a converging sequence in $\tilde{\mathbf{G}}$. Then,*

$$p_c^\bullet(G_n^\bullet) \xrightarrow{n \rightarrow \infty} p_c^\bullet(G^\bullet).$$

Theorem 1.3 above states that p_c^\bullet is continuous on $\tilde{\mathbf{G}}$. It seems a priori weaker than Theorem 0.10. Nevertheless, the following lemma allows us to deduce Theorem 0.10 from Theorem 1.3.

Lemma 1.4. *Let G^\bullet be an element of $\tilde{\mathbf{G}}$. Assume it is a continuity point of the restricted function*

$$p_c^\bullet : \tilde{\mathbf{G}} \longrightarrow (0, 1).$$

Then its associated Cayley graph $\text{Cay}(G^\bullet)$ is a continuity point of the restricted function

$$p_c : \text{Cay}(\tilde{\mathbf{G}}) \longrightarrow (0, 1).$$

Proof. Assume, by contradiction, that there exists a sequence of marked abelian groups G_n^\bullet in $\tilde{\mathbf{G}}$ such that $\text{Cay}(G_n^\bullet)$ converges to some $\text{Cay}(G^\bullet)$ and $p_c^\bullet(G_n^\bullet)$ stays away from $p_c^\bullet(G^\bullet)$. Define d to be the degree of $\text{Cay}(G^\bullet)$. Considering n large enough, we can assume that all the G_n^\bullet 's lie in the compact set $\bigcup_{d' \leq d} \mathbf{G}_{d'}$. Up to extraction, one can then assume that G_n^\bullet converges to some marked abelian group G_∞^\bullet . This group must have rank at least 2. Since Cay is continuous, $\text{Cay}(G^\bullet) = \text{Cay}(G_\infty^\bullet)$ and Theorem 1.3 is contradicted by the sequence (G_n^\bullet) that converges to G_∞^\bullet . \square

We will also use the following theorem, which is a particular case of theorem 3.1 in [BS96].

Theorem 1.5. *Let G^\bullet be a marked abelian group and Λ a subgroup of G . Then*

$$p_c^\bullet(G^\bullet/\Lambda) \geq p_c^\bullet(G^\bullet).$$

1.3 A first continuity result

In this section, we will prove Proposition 1.6, which is a particular case of Theorem 0.10. We deem interesting to provide a short independent proof of it. This proposition epitomizes the scope of Grimmett-Marstrand results in our context. It also illustrates how marked groups can appear as useful tools to deal with locality questions. More precisely, Lemma 1.4 reduces some questions of continuity in the Benjamini-Schramm space to equivalent questions in the space of marked abelian groups, where the topology allows to employ methods of algebraic nature.

Proposition 1.6. *Let (G_n^\bullet) be a sequence in $\tilde{\mathbf{G}}$. Assume that $G_n^\bullet \xrightarrow{n \rightarrow \infty} [\mathbb{Z}^d; \mathbf{ffi}]$, where \mathbf{ffi} stands for the canonical generating system of \mathbb{Z}^d . Then*

$$p_c^\bullet(G_n^\bullet) \xrightarrow{n \rightarrow \infty} p_c^\bullet([\mathbb{Z}^d; \mathbf{ffi}]).$$

Proof. Since \mathbf{G}_d is open, we can assume that G_n^\bullet belongs to it. It is thus a quotient of $[\mathbb{Z}^d; \mathbf{ffi}]$, and Theorem 1.5 gives

$$\liminf p_c^\bullet(G_n^\bullet) \geq p_c^\bullet([\mathbb{Z}^d; \mathbf{ffi}]).$$

To establish the other semi-continuity, we will show that the Cayley graph of G_n^\bullet eventually contains $\mathbb{Z}^2 \times \{0, \dots, K\}$ as a subgraph (for K arbitrarily large), and conclude by applying Grimmett-Marstrand theorem.

Let us denote Γ_n the subgroup of \mathbb{Z}^d associated to G_n^\bullet via bijection (7.3). We call coordinate plane a subgroup of \mathbb{Z}^d generated by two different elements of the canonical generating system of \mathbb{Z}^d .

Lemma 1.7. *For any integer K , for n large enough, there exists a coordinate plane Π satisfying*

$$(\Pi + B_{\mathbb{Z}^d}(0, 2K + 1)) \cap \Gamma_n = \{0\}.$$

Proof of Lemma 1.7. To establish Lemma 1.7, we proceed by contradiction. Up to extraction, we can assume that there exists some K such that

$$\text{for all } \Pi, \quad (\Pi + B_{\mathbb{Z}^d}(0, 2K + 1)) \cap \Gamma_n \neq \{0\}. \quad (7.4)$$

We denote by v_n^Π a non-zero element of $(\Pi + B_{\mathbb{Z}^d}(0, 2K + 1)) \cap \Gamma_n$. Up to extraction, we can assume that, for all Π , the sequence $v_n^\Pi / \|v_n^\Pi\|$ converges to some v_Π . (The vector space \mathbb{R}^d is endowed with an arbitrary norm $\|\cdot\|$.) Since Γ_n converges pointwise to $\{0\}$, for any Π , the sequence $\|v_n^\Pi\|$ tends to infinity. This entails, together with equation (7.4), that v_Π is contained in the real plane spanned by

II. The incomplete basis theorem implies that the vector space spanned by the v_Π 's has dimension at least $d - 1$. By continuity of the minors, for n large enough, the vector space spanned by Γ_n as dimension at least $d - 1$. This entails that, for n large enough, Γ_n has rank at least $d - 1$, which contradicts the hypothesis that \mathbb{Z}^d/Γ_n has rank at least 2. \square

For any K , provided that n is large enough, one can see $\mathbb{Z}^2 \times \{-K, \dots, K\}^{d-2}$ as a subgraph of $\text{Cay}(G_n^\bullet)$. (Restrict the quotient map from \mathbb{Z}^d to G_n^\bullet to the $\Pi + B_{\mathbb{Z}^d}(0, K)$ given by Lemma 1.7 and notice that it becomes injective.) It results from this that

$$\limsup p_c^\bullet(G_n^\bullet) \leq p_c(\mathbb{Z}^2 \times \{-K, \dots, K\}^{d-2}).$$

The right-hand side goes to $p_c^\bullet([\mathbb{Z}^d; \mathbf{ff}])$ as K goes to infinity, by Grimmett-Marstrand theorem. This establishes the second semi-continuity. \square

Remark. Proposition 1.6 states exactly what Grimmett-Marstrand theorem implies in our setting. Together with Lemma 1.4, it entails that the hypercubic lattice is a continuity point of p_c on $\text{Cay}(\tilde{\mathbf{G}})$. Without additional idea, one could go a bit further: the proof of Grimmett and Marstrand adjusts directly to the case of Cayley graphs of \mathbb{Z}^d that are stable under reflections relative to coordinate hyperplanes. This statement also has a counterpart analog to Proposition 1.6. Though, we are still far from Theorem 1.3, since Grimmett-Marstrand theorem relies heavily on the stability under reflection. In the rest of the paper, we solve the locality problem for general abelian Cayley graphs. We do so directly in the marked abelian group setting, and do not use a “slab result” analog to Grimmett-Marstrand theorem.

1.4 Proof of Theorem 1.3

The purpose of this section is to reduce the proof of Theorem 1.3 to the proof of two lemmas (Lemma 1.8 and Lemma 1.9). These are respectively established in sections 2 and 3.

As in section 1.3, it is the upper semi-continuity of p_c^\bullet that is hard to establish: given G^\bullet and $p > p_c^\bullet(G^\bullet)$, we need to show that the parameter p remains supercritical for any element of $\tilde{\mathbf{G}}$ that is close enough to G^\bullet . To do so, we will characterize supercriticality by using a finite-size criterion, that is a property of the type “ $\mathbf{P}_p[\mathcal{E}_N] > 1 - \eta$ ” for some event \mathcal{E}_N that depends only on the states of the edges in the ball of radius N . The finite-size criterion we use is denoted by $\mathcal{FC}(p, N, \eta)$ and characterizes supercriticality through lemmas 1.8 and 1.9. Its definition involving heavy notation, we postpone it to section 2.5.

First, we work with a fixed marked abelian group G^\bullet . Assuming that $p > p_c^\bullet(G^\bullet)$, we construct in its Cayley graph a box that exhibits nice connection properties with high probability. This is formalized by Lemma 1.8 below, which will be proved in section 2.

Lemma 1.8. *Let $G^\bullet \in \tilde{\mathbf{G}}$. Let $p > p_c^\bullet(G^\bullet)$ and $\eta > 0$. Then, there exists N such that G^\bullet satisfies the finite-size criterion $\mathcal{FC}(p, N, \eta)$.*

Then, take $H^\bullet = G^\bullet / \Lambda$ a marked abelian group that is close to G^\bullet . Since $\text{Cay}(G^\bullet)$ and $\text{Cay}(H^\bullet)$ have the same balls of large radius, the finite criterion is also satisfied by H^\bullet . This enables us to prove that there is also percolation in $\text{Cay}(H^\bullet)$. As in Grimmett and Marstrand's approach, we will not be able to prove that percolation occurs in $\text{Cay}(H^\bullet)$ for the same parameter p , but we will have to slightly increase the parameter. Here comes a precise statement, established in section 3.

Lemma 1.9. *Let $G^\bullet \in \tilde{\mathbf{G}}$. Let $p > p_c^\bullet(G^\bullet)$ and $\delta > 0$. Then there exists $\eta > 0$ such that the following holds: if there exists N such that G^\bullet satisfies the finite-size criterion $\mathcal{FC}(p, N, \eta)$, then $p_c(H^\bullet) < p + \delta$ for any marked abelian group H^\bullet close enough to G^\bullet .*

Assuming these two lemmas, let us prove Theorem 1.3.

Proof of Theorem 1.3. Let $G_n^\bullet \xrightarrow{n \rightarrow \infty} G^\bullet$ denote a converging sequence of elements of $\tilde{\mathbf{G}}$. Our goal is to establish that $p_c^\bullet(G_n^\bullet) \xrightarrow{n \rightarrow \infty} p_c^\bullet(G^\bullet)$.

For n large enough, G_n^\bullet is a quotient of G^\bullet . (See Proposition 1.1.) By Theorem 1.5, for n large enough, $p_c^\bullet(G^\bullet) \leq p_c^\bullet(G_n^\bullet)$. Hence, we only need to prove that $\limsup p_c^\bullet(G_n^\bullet) \leq p_c^\bullet(G^\bullet)$.

Take $p > p_c$ and $\delta > 0$. By Lemma 1.8, we can pick N such that $\mathcal{FC}(p, N, \eta)$ is satisfied. Lemma 1.9 then guarantees that, for n large enough, $p_c^\bullet(G_n^\bullet) \leq p + \delta$, which ends the proof. \square

2 Proof of Lemma 1.8

Through the entire section, we fix:

- $G^\bullet \in \tilde{\mathbf{G}}$ a marked abelian group of rank greater than two,
- $p \in (p_c^\bullet(G^\bullet), 1)$,
- $\eta > 0$.

We write G^\bullet under the form $[\mathbb{Z}^r \times T; S]$, where T is a finite abelian group. Let $\mathcal{G} = (V, E) = (\mathbb{Z}^r \times T, E)$ denote the Cayley graph associated to G^\bullet . Paths and percolation will always be considered relative to this graph structure.

2.1 Between continuous and discrete

An element of $\mathbb{Z}^r \times T$ will be written

$$x = (x_{\text{free}}, x_{\text{tor}}).$$

For the geometric reasonings, we will use linear algebra tools. (The vertex set — $\mathbb{Z}^r \times T$ — is roughly \mathbb{R}^r .) Endow \mathbb{R}^r with its canonical Euclidean structure. We denote by $\| \cdot \|$ the associated norm and $\mathbb{B}(v, R)$ the closed ball of radius R centered at $v \in \mathbb{R}^r$. If the center is

0, this ball may be denoted by $\mathbb{B}(R)$. Set $R_S := \max_{s \in S} \|s_{\text{free}}\|$. In \mathcal{G} , we define for $k > 0$

$$\begin{aligned} B(k) &:= \{x : \|x_{\text{free}}\| \leq kR_S\} \\ &= (\mathbb{B}(kR_S) \cap \mathbb{Z}^d) \times T. \end{aligned}$$

Up to section 2.5, we fix an orthonormal basis $\mathbf{e} = (e_1, \dots, e_d)$ of \mathbb{R}^r . Define

$$\begin{aligned} \pi_{\mathbf{e}} : \quad \mathbb{R}^r &\longrightarrow \mathbb{R}^2 \\ \sum_{i=1}^r x_i e_i &\longmapsto (x_1, x_2). \end{aligned}$$

We now define the function Graph , which allows us to move between the continuous space \mathbb{R}^2 and the discrete set V . It associates to each subset X of \mathbb{R}^2 the subset of V defined by

$$\text{Graph}(X) := \left(\left(\pi_{\mathbf{e}}^{-1}(X) + \mathbb{B}(R_S) \right) \cap \mathbb{Z}^r \right) \times T. \quad (7.5)$$

In section 2.5, we will have to consider different bases. To insist on the dependence on \mathbf{e} , we will write $\text{Graph}_{\mathbf{e}}$.

If a and b belong to \mathbb{R}^2 , we will consider the segment $[a, b]$ and the parallelogram $[a, b, -a, -b]$ spanned by a and b in \mathbb{R}^2 , defined respectively by

$$\begin{aligned} [a, b] &= \{\lambda a + (1 - \lambda)b ; 0 \leq \lambda \leq 1\} \text{ and} \\ [a, b, -a, -b] &= \{\lambda a + \mu b ; |\lambda| + |\mu| \leq 1\} \end{aligned}$$

Write then $L(a, b) := \text{Graph}([a, b])$ and $R(a, b) := \text{Graph}([3a, 3b, -3a, -3b])$ the corresponding subsets of V .

The following lemma illustrates one important property of the function Graph connecting continuous and discrete.

Lemma 2.1. *Let $X \subset \mathbb{R}^2$. Let γ be a finite path of length k in \mathcal{G} . Assume that $\gamma_0 \in \text{Graph}(X)$ and $\gamma_k \notin \text{Graph}(X)$. Then the support of γ intersects $\text{Graph}(\partial X)$.*

Proof. It suffices to show that if x and y are two neighbours in \mathcal{G} such that $x \in \text{Graph}(X)$ and $y \notin \text{Graph}(X)$, then x belongs to $\text{Graph}(\partial X)$. By definition of Graph , we have $x_{\text{free}} \in \pi^{-1}(X) + \mathbb{B}(R_S)$, which can be restated as

$$\pi(\mathbb{B}(x_{\text{free}}, R_S)) \cap X \neq \emptyset. \quad (7.6)$$

By definition of R_S , we have $y_{\text{free}} \in \mathbb{B}(x_{\text{free}}, R_S)$ and our assumption on y implies that $\pi(y_{\text{free}}) \notin X$, which gives

$$\pi(\mathbb{B}(x_{\text{free}}, R_S)) \cap {}^c X \neq \emptyset. \quad (7.7)$$

Since $\pi(\mathbb{B}(x_{\text{free}}, R_S))$ is connected, (7.6) and (7.7) implies that

$$\pi(\mathbb{B}(x_{\text{free}}, R_S)) \cap \partial X \neq \emptyset$$

which proves that x belongs to $\text{Graph}(\partial X)$. □

2.2 Percolation toolbox

Probabilistic notation. We denote by \mathbf{P}_p the law of independent bond percolation of parameter $p \in [0, 1]$ on \mathcal{G} .

Connections. Let A, B and C denote three subsets of V . The event “there exists an open path intersecting A and B that lies in C ” will be denoted by “ $A \overset{C}{\leftrightarrow} B$ ”. The event “restricting the configuration to C , there exists a unique component that intersects A and B ” will be written “ $A \overset{!C!}{\leftrightarrow} B$ ”. The event “there exists an infinite open path that touches A and lies in C ” will be denoted by “ $A \overset{C}{\leftrightarrow} \infty$ ”. If the superscript C is omitted, it means that C is taken to be the whole vertex set.

This paragraph contains the percolation results that will be needed to prove Theorem 1.3. The following lemma, sometimes called “square root trick”, is a straightforward consequence of Harris-FKG inequality.

Lemma 2.2. *Let \mathcal{A} and \mathcal{B} be two increasing events. Assume that $\mathbf{P}_p[\mathcal{A}] \geq \mathbf{P}_p[\mathcal{B}]$. Then, the following inequality holds:*

$$\mathbf{P}_p[\mathcal{A}] \geq 1 - (1 - \mathbf{P}_p[\mathcal{A} \cup \mathcal{B}])^{1/2}.$$

The lemma above is often used when $\mathbf{P}_p[\mathcal{A}] = \mathbf{P}_p[\mathcal{B}]$, in a context where the equality of the two probabilities is provided by symmetries of the underlying graph (see [Gri99b]). This slightly generalized version allows to link geometric properties to probabilistic estimates without any symmetry assumption, as illustrated by the following lemma.

Lemma 2.3. *Let a and b be two points in \mathbb{R}^2 . Let $A \subset V$ be a subset of vertices of \mathcal{G} . Assume that*

$$\mathbf{P}_p[A \leftrightarrow L(a, b)] > 1 - \varepsilon^2 \text{ for some } \varepsilon > 0. \quad (7.8)$$

Then, there exists $u \in [a, b]$ such that both $\mathbf{P}_p[A \leftrightarrow L(a, u)]$ and $\mathbf{P}_p[A \leftrightarrow L(u, b)]$ exceed $1 - \varepsilon$.

Remark. The same statement holds when we restrict the open paths to lie in a subset C of V .

Proof. We can approximate the event estimated in inequality (7.8) and pick k large enough such that

$$\mathbf{P}_p[A \leftrightarrow L(a, b) \cap B(k)] > 1 - \varepsilon^2.$$

The set $L(a, b) \cap B(k)$ being finite, there are only finitely many different sets of the form $L(a, u) \cap B(k)$ for $u \in [a, b]$. We can thus construct $u_1, u_2, \dots, u_n \in [a, b]$ such that $u_1 = a$ and $u_n = b$, and for all $1 \leq i < n$,

1. $[a, u_i]$ is a strict subset of $[a, u_{i+1}]$,
2. $L(a, b) \cap B(k)$ is the union of $L(a, u_i) \cap B(k)$ and $L(u_{i+1}, b) \cap B(k)$.

Assume that for some i , the following inequality holds:

$$\mathbf{P}_p [A \leftrightarrow L(a, u_i) \cap B(k)] \geq \mathbf{P}_p [A \leftrightarrow L(u_{i+1}, b) \cap B(k)]. \quad (7.9)$$

Lemma 2.2 then implies that

$$\mathbf{P}_p [A \leftrightarrow L(a, u_i) \cap B(k)] > 1 - \varepsilon.$$

If inequality (7.9) never holds (resp. if it holds for all possible i), then A is connected to $L(\{a\})$ (resp. to $L(\{b\})$) with probability exceeding $1 - \varepsilon$. In these two cases, the conclusion of the lemma is trivially true. We can assume that we are in none these two situations, and define $j \in \{2, \dots, n - 1\}$ to be the smallest possible i such that inequality (7.9) holds. We will show the conclusion of Lemma 2.3 holds for $u = u_j$. We already have

$$\mathbf{P}_p [A \leftrightarrow L(a, u_j) \cap B(k)] > 1 - \varepsilon,$$

and inequality (7.9) does not hold for $i = j - 1$. Once again, Lemma 2.2 implies that

$$\mathbf{P}_p [A \leftrightarrow L(u_j, b) \cap B(k)] > 1 - \varepsilon.$$

□

Lemma 2.4. *Bernoulli percolation on \mathcal{G} at a parameter $p > p_c(\mathcal{G})$ produces almost surely a unique infinite component. Moreover, any fixed infinite subset of V is intersected almost surely infinitely many times by the infinite component.*

The first part of the lemma is standard (see [BK89] or [Gri99b]). The second part stems from the 0-1 law of Kolmogorov.

2.3 Geometric constructions

In this section, we aim to prove that a set connected to infinity with high probability also has “good” local connections. To formalize this, we need a few additional definitions. We say that $(a, b, u, v) \in (\mathbb{R}^2)^4$ is a good quadruple if

1. $u = \frac{a+b}{2}$,
2. $v \in [-a, b]$ and
3. $[a, b, -a, -b]$ contains the planar ball of radius R_S .

Property 3 ensures that the parallelogram $[a, b, -a, -b]$ is not too degenerate. To each good quadruple (a, b, u, v) , we associate the following four subsets of the graph \mathcal{G} :

$$\mathcal{Z}(a, b, u, v) = \{L(a, u), L(u, b), L(b, v), L(v, -a)\}.$$

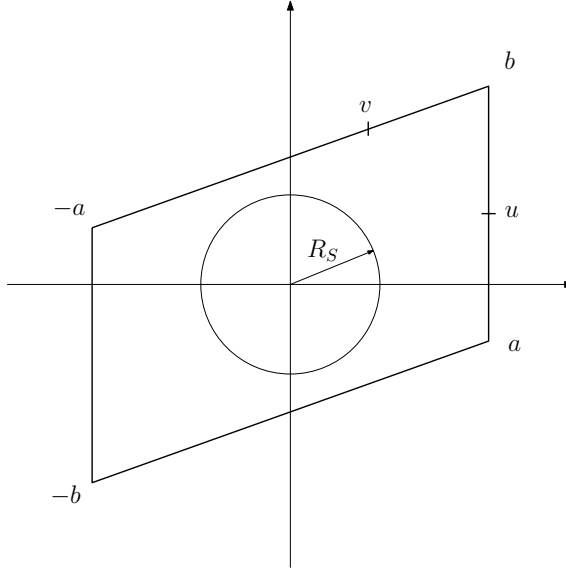

Figure 7.1: A good quadruple

Lemma 2.5. *Let A be a finite subset of V containing 0 and such that*

$$-A := \{-x; x \in A\} = A.$$

Let $k \geq 1$ be such that $B := B(k)$ contains A . Assume the following relation to hold for some $\varepsilon \in (0, 1)$:

$$\mathbf{P}_p [A \leftrightarrow \infty] > 1 - \varepsilon^{24}.$$

Then there exists a good quadruple (a, b, u, v) such that for any $Z \in \mathcal{Z}(a, b, u, v)$

- (i) $B \cap Z = \emptyset$,
- (ii) $\mathbf{P}_p \left[A \xleftrightarrow{R(a,b)} Z \right] > 1 - \varepsilon$.

Proof. Let $(n, h, \ell) \in \mathbb{N} \times \mathbb{R} \times \mathbb{R}_+$. Define $a := (n, h - \ell)$, $b := (n, h + \ell)$ and the three following subsets of V illustrated on Figure 7.2:

$$C(n, h, \ell) := \text{Graph}([a, b, -a, -b])$$

$$LR(n, h, \ell) := \text{Graph}([a, b] \cup [-a, -b]) = L(a, b) \cup L(-a, -b)$$

$$UD(n, h, \ell) := \text{Graph}([-a, b] \cup [-b, a]) = L(-a, b) \cup L(-b, a)$$

Let us start by focusing on the geometric constraint ((i)), which we wish to translate into analytic conditions on the triple (n, h, ℓ) . We fix n_B large enough such that

$$B \cap \text{Graph}(\mathbb{R}^2 \setminus (-n_B + 1, n_B - 1)^2) = \emptyset. \quad (7.10)$$

This way, any set defined as the image by the function Graph of a planar set in the complement of $(-n_B + 1, n_B - 1)^2$ will not intersect B . In particular, defining for $n > n_B$ and $h \in \mathbb{R}$

$$\ell_B(n, h) = n_B \left(1 + \frac{|h|}{n} \right),$$

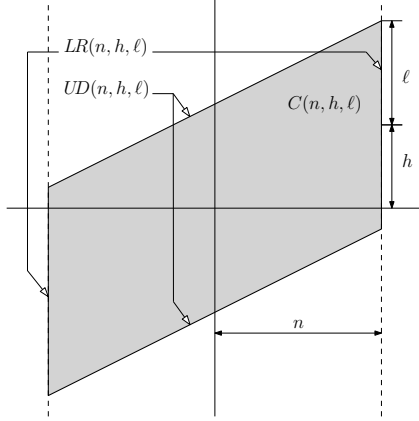

Figure 7.2: Pictures of the planar sets defining $C(n, h, \ell)$, $UD(n, h, \ell)$ and $LR(n, h, \ell)$

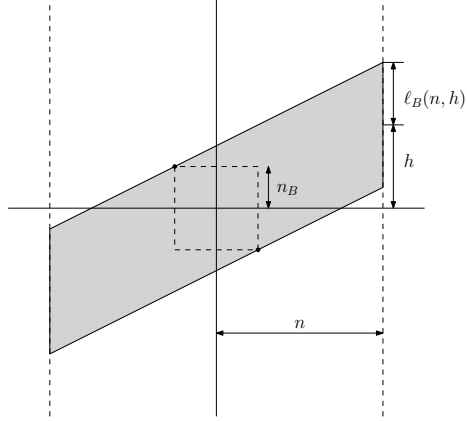

Figure 7.3: Definition of $\ell_B(n, h)$

the set $UD(n, h, \ell)$ does not intersect B whenever $\ell \geq \ell_B - 1$. (See Figure 7.3.) Suppose that A intersects the infinite cluster. By Lemma 2.4, $V \setminus C(n, h, \ell)$ — which is infinite — intersects the infinite cluster almost surely. Thus there exists an open path from A to $V \setminus C(n, h, \ell)$. By Lemma 2.1, A is connected to $UD(n, h, \ell) \cup LR(n, h, \ell)$ within $C(n, h, \ell)$, which gives the following inequality:

$$\mathbf{P}_p \left[\left(A \xleftrightarrow{C(n, h, \ell)} LR(n, h, \ell) \right) \cup \left(A \xleftrightarrow{C(n, h, \ell)} UD(n, h, \ell) \right) \right] > 1 - \varepsilon^{24}. \quad (7.11)$$

The strategy of the proof is to work with some sets $C(n, h, \ell)$ that are balanced in the sense that

$$\mathbf{P}_p \left[A \xleftrightarrow{C(n, h, \ell)} LR(n, h, \ell) \right] \text{ and } \mathbf{P}_p \left[A \xleftrightarrow{C(n, h, \ell)} UD(n, h, \ell) \right]$$

are close, and conclude with Lemma 2.2. We shall now prove two facts, which ensure that the inequality between the two afore-mentioned probabilities reverses for some ℓ between $\ell_B(n, h)$ and infinity.

Fact 2.6. *There exists $n > n_B$ such that, for all $h \in \mathbb{R}$, when $\ell = \ell_B(n, h)$*

$$\mathbf{P}_p \left[A \xleftrightarrow{C(n, h, \ell)} LR(n, h, \ell) \right] < \mathbf{P}_p \left[A \xleftrightarrow{C(n, h, \ell)} UD(n, h, \ell) \right].$$

Proof of fact 2.6. For $n > n_B + R_S$, define the following sets, illustrated on Figure 7.4:

$$\begin{aligned} X &= \text{Graph} \left(((-\infty, n_B) \times \mathbb{R}) \cup (\mathbb{R} \times [-n_B, \infty)) \right) \\ \partial X &= \text{Graph} \left((\{n_B\} \times (-\infty, -n_B]) \cup ([n_B, \infty) \times \{-n_B\}) \right) \\ X_n &= \text{Graph} \left(([-n, n_B) \times \mathbb{R}) \cup ([-n, n] \times [-n_B, \infty)) \right) \\ \partial_1 X_n &= \text{Graph} \left(\{-n\} \times \mathbb{R} \cup \{n\} \times [-n_B, \infty) \right) \\ \partial_2 X_n &= \text{Graph} \left((\{n_B\} \times (-\infty, -n_B]) \cup [n_B, n] \times \{-n_B\}) \right) \end{aligned}$$

Since the sequence of events $(A \xleftrightarrow{X_n} \partial_1 X_n)_{n > n_B + R_S}$ is decreasing, we have

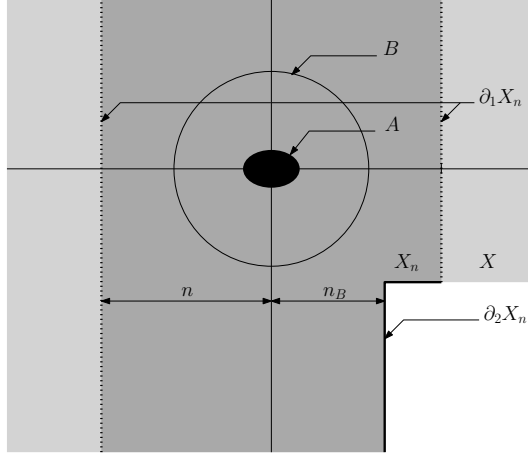

Figure 7.4: Planar pictures corresponding to X , X_n , $\partial_1 X_n$ and $\partial_2 X_n$

$$\begin{aligned} \lim_{n \rightarrow \infty} \mathbf{P}_p \left[A \xleftrightarrow{X_n} \partial_1 X_n \right] &= \mathbf{P}_p \left[\bigcap_{n > n_B + R_S} \left(A \xleftrightarrow{X_n} \partial_1 X_n \right) \right] \\ &\leq \mathbf{P}_p \left[A \xleftrightarrow{X} \infty \right] \\ &= \mathbf{P}_p \left[\left(A \xleftrightarrow{X} \infty \right) \cap \left(A \xleftrightarrow{X} \partial X \right) \right]. \end{aligned} \quad (7.12)$$

(The last equality results from the fact that the infinite set $V \setminus X$ intersects the infinite cluster almost surely.)

The sequence $(A \xleftrightarrow{X_n} \partial_2 X_n)_{n > n_B + R_S}$ is increasing, hence we have

$$\begin{aligned} \lim_{n \rightarrow \infty} \mathbf{P}_p \left[A \xleftrightarrow{X_n} \partial_2 X_n \right] &= \mathbf{P}_p \left[\bigcup_{n > n_B + R_S} \left(A \xleftrightarrow{X_n} \partial_2 X_n \right) \right] \\ &= \mathbf{P}_p \left[A \leftrightarrow \partial X \right]. \end{aligned} \quad (7.13)$$

Since $p \in (0, 1)$ and A is finite, the probability that A is connected to ∂X but intersects only finite clusters is positive. Thus the following strict inequality holds

$$\mathbf{P}_p \left[\left(A \xleftrightarrow{X} \infty \right) \cap \left(A \xleftrightarrow{X} \partial X \right) \right] < \mathbf{P}_p \left[A \leftrightarrow \partial X \right]. \quad (7.14)$$

From (7.12), (7.13) and (7.14), we can pick $n_1 > n_B + R_S$ large enough such that, for all $n \geq n_1$,

$$\mathbf{P}_p \left[A \xleftrightarrow{X_n} \partial_1 X_n \right] < \mathbf{P}_p \left[A \xleftrightarrow{X_n} \partial_2 X_n \right].$$

Fix $n \geq n_1$ and $h \geq 0$, then define $\ell = \ell_B(n, h)$. For these parameters, we have $A \subset$

$C(n, h, \ell) \subset X_n$ and $LR(n, h, \ell) \subset \partial_1 X_n$, which gives

$$\begin{aligned} \mathbf{P}_p \left[A \xleftrightarrow{C(n, h, \ell)} LR(n, h, \ell) \right] &\leq \mathbf{P}_p \left[A \xleftrightarrow{X_n} \partial_1 X_n \right] \\ &< \mathbf{P}_p \left[A \xleftrightarrow{X_n} \partial_2 X_n \right] \\ &\leq \mathbf{P}_p \left[A \xleftrightarrow{C(n, h, \ell)} \mathcal{UD}(n, h, \ell) \right]. \end{aligned}$$

The last inequality follows from the observation that each path connecting A to $\partial_2 X_n$ inside X_n has to cross $\mathcal{UD}(n, h, \ell)$.

The computation above shows that the following strict inequality holds for $n \geq n_1$, $h \geq 0$, and $\ell = \ell_B(n, h)$

$$\mathbf{P}_p \left[A \xleftrightarrow{C(n, h, \ell)} LR(n, h, \ell) \right] < \mathbf{P}_p \left[A \xleftrightarrow{C(n, h, \ell)} \mathcal{UD}(n, h, \ell) \right]. \quad (7.15)$$

In the same way, we find n_2 such that for all $n \geq n_2$ and $h \leq 0$, equation (7.15) holds for $\ell = \ell_B(n, h)$. Taking $n = \max(n_1, n_2)$ ends the proof of the fact. \square

In the rest of the proof, we fix n as in the previous fact. For $h \in \mathbb{R}$, define

$$\begin{aligned} \ell_{\text{eq}}(h) = \sup \left\{ \ell \geq \ell_B(n, h) - 1 : \right. &\mathbf{P}_p \left[A \xleftrightarrow{C(n, h, \ell)} \mathcal{UD}(n, h, \ell) \right] \\ &\geq \mathbf{P}_p \left[A \xleftrightarrow{C(n, h, \ell)} LR(n, h, \ell) \right] \left. \right\}. \end{aligned}$$

Fact 2.7. *For all $h \in \mathbb{R}$, the quantity $\ell_{\text{eq}}(h)$ is finite.*

Proof of fact 2.7. We fix $h \in \mathbb{R}$ and use the same technique as developed in the proof of the fact 2.6. Define

$$\begin{aligned} Y &= \text{Graph}([-n, n] \times \mathbb{R}) \\ \partial Y &= \text{Graph}(\{-n, n\} \times \mathbb{R}) \end{aligned}$$

In the same way we proved equations (7.12) and (7.13), we have here

$$\begin{aligned} \lim_{\ell \rightarrow \infty} \mathbf{P}_p \left[A \xleftrightarrow{C(n, h, \ell)} \mathcal{UD}(n, h, \ell) \right] &= \mathbf{P}_p \left[A \xleftrightarrow{Y} \infty \right] \\ \lim_{\ell \rightarrow \infty} \mathbf{P}_p \left[A \xleftrightarrow{C(n, h, \ell)} LR(n, h, \ell) \right] &= \mathbf{P}_p \left[A \leftrightarrow \partial Y \right] \end{aligned}$$

Thus, we can find a finite ℓ large enough such that

$$\mathbf{P}_p \left[A \xleftrightarrow{C(n, h, \ell)} \mathcal{UD}(n, h, \ell) \right] < \mathbf{P}_p \left[A \xleftrightarrow{C(n, h, \ell)} LR(n, h, \ell) \right].$$

\square

The quantity ℓ_{eq} plays a central role in our proof, linking geometric and probabilistic estimates. We can apply Lemma 2.2 with the two events appearing in inequality (7.11), to obtain the following alternative:

$$\text{If } \ell < \ell_{\text{eq}}(h), \quad \text{then } \mathbf{P}_p \left[A \xleftrightarrow{C(n,h,\ell)} \mathcal{UD}(n,h,\ell) \right] > 1 - \varepsilon^{12}. \quad (7.16a)$$

$$\text{If } \ell > \ell_{\text{eq}}(h), \quad \text{then } \mathbf{P}_p \left[A \xleftrightarrow{C(n,h,\ell)} \mathcal{LR}(n,h,\ell) \right] > 1 - \varepsilon^{12}. \quad (7.16b)$$

Fix $(h_{\text{opt}}, \ell_0) \in \mathbb{R} \times \mathbb{R}_+$ such that

$$\ell_{\text{eq}}(h_{\text{opt}}) < \ell_0 < \inf_{h \in \mathbb{R}} (\ell_{\text{eq}}(h)) + \frac{1}{6}. \quad (7.17)$$

With such notation, we derive from (7.16b)

$$\mathbf{P}_p \left[A \xleftrightarrow{C(n,h_{\text{opt}},\ell_0)} \mathcal{LR}(n,h_{\text{opt}},\ell_0) \right] > 1 - \varepsilon^{12}.$$

Another application of Lemma 2.2 ensures then the existence of a real number h_0 of the form $h_0 = h_{\text{opt}} + \sigma \ell_0/3$ (for $\sigma \in \{-2, 0, +2\}$) such that

$$\mathbf{P}_p \left[A \xleftrightarrow{C(n,h_{\text{opt}},\ell_0)} \mathcal{LR}(n,h_0,\ell_0/3) \right] > 1 - \varepsilon^4.$$

Recall that $\mathcal{LR}(n,h_0,\ell_0/3) = L(a_0, b_0) \cup L(-a_0, -b_0)$ with $a_0 = (n, h_0 - \ell_0/3)$ and $b_0 = (n, h_0 + \ell_0/3)$. By symmetry, the set A is connected inside $C(n, h_0, \ell_0/3)$ to $L(a_0, b_0)$ and to $L(-a_0, -b_0)$ with equal probabilities. Applying again Lemma 2.2 gives

$$\mathbf{P}_p \left[A \xleftrightarrow{C(n,h_{\text{opt}},\ell_0)} L(a_0, b_0) \right] > 1 - \varepsilon^2.$$

Then, use Lemma 2.3 to split $L(a_0, b_0)$ into two parts that both have a good probability to be connected to A : we can pick $u = (n, h) \in [a_0, b_0]$ such that both

$$\mathbf{P}_p \left[A \xleftrightarrow{C(n,h_{\text{opt}},\ell_0)} L(a_0, u) \right] \quad \text{and} \quad \mathbf{P}_p \left[A \xleftrightarrow{C(n,h_{\text{opt}},\ell_0)} L(u, b_0) \right]$$

exceed $1 - \varepsilon$. Finally, pick ℓ such that $\ell_{\text{eq}}(h) - 1/6 < \ell < \ell_{\text{eq}}(h)$. Define $a = u + (0, -\ell)$ and $b = u + (0, \ell)$. In particular, we have $u = (a + b)/2$. Our choice of ℓ_0 (see equation (7.17)) implies that $\ell > \ell_0 - 1/3 \geq 2\ell_0/3$, and the following inclusions hold:

$$\begin{aligned} L(a_0, u) &\subset L(a, u) \\ L(u, b_0) &\subset L(u, b) \\ C(n, h_{\text{opt}}, \ell_0) &\subset R(a, b) \end{aligned}$$

These three inclusions together with the estimates above conclude the point ((ii)) of Lemma 2.5 for $Z = L(a, u)$ and $Z = L(u, b)$.

Now, let us construct a suitable vector $v \in [-a, b]$ such that the point ((ii)) of Lemma 2.5 is verified for $Z = L(-a, v)$ and $Z = L(v, b)$. Equation (7.16a) implies that

$$\mathbf{P}_p \left[A \xleftrightarrow{C(n,h,\ell)} \mathcal{UD}(n, h, \ell) \right] > 1 - \varepsilon^{12}.$$

As above, using $\mathcal{UD}(n, h, \ell) = L(-a, b) \cup L(-b, a)$, symmetries and Lemma 2.2, we obtain

$$\mathbf{P}_p \left[A \xleftrightarrow{C(n,h,\ell)} L(-a, b) \right] > 1 - \varepsilon^6.$$

By Lemma 2.3, we can pick $v \in [-a, b]$ such that the following estimate holds for $Z = L(-a, v), L(v, b)$:

$$\mathbf{P}_p \left[A \xleftrightarrow{C(n,h,\ell)} Z \right] > 1 - \varepsilon^3 \geq 1 - \varepsilon.$$

It remains to verify the point ((i)). For $Z = L(a, u), L(u, b)$, it follows from $n > n_B$ and the definition of n_B , see equation (7.10). For $Z = L(-a, v), L(v, b)$, it follows from $\ell > \ell_B(n, h) - 1$ (see Fact 2.6) and the definition of $\ell_B(n, h)$. \square

2.4 Construction of Good Blocks

In this section, we will define a finite block together with a local event that “characterize” supercritical percolation — in the sense that the event happening on this block with high probability will guarantee supercriticality. This block will be used in section 3 for a coarse graining argument.

In Grimmett and Marstrand’s proof of Theorem 0.6, the coarse graining argument uses “seeds” (big balls, all the edges of which are open) in order to propagate an infinite cluster from local connections. More precisely, they define an exploration process of the infinite cluster: at each step, the exploration is successful if it creates a new seed in a suitable place, from which the process can iterate. If the probability of success at each step is large enough, then, with positive probability, the exploration process does not stop and an infinite cluster is created.

In their proof, the seeds grow in the unexplored region. Since we cannot control this region, we use the explored region to produce seeds instead. Formally, long finite self-avoiding paths will play the role of the seeds in the proof of Grimmett and Marstrand. The idea is the following: if a point is reached at some step of the exploration process, it must be connected to a long self-avoiding path, which is enough to iterate the process.

Lemma 2.8. *For all $\varepsilon > 0$, there exists $m \in \mathbb{N}$ such that, for any fixed self-avoiding path γ of length m ,*

$$\mathbf{P}_p [\gamma \leftrightarrow \infty] > 1 - \varepsilon.$$

Proof. By translation invariance we can restrict ourselves to self-avoiding paths starting at the origin 0. Fix $\varepsilon > 0$. For all $k \in \mathbb{N}$ we consider one self-avoiding path $\gamma^{(k)}$ starting

at the origin that minimizes the probability to intersect the infinite cluster among all the self-avoiding paths of length k :

$$\mathbf{P}_p \left[\gamma^{(k)} \leftrightarrow \infty \right] = \min_{\gamma: \text{length}(\gamma)=k} \mathbf{P}_p \left[\gamma \leftrightarrow \infty \right].$$

By diagonal extraction, we can consider an infinite self-avoiding path $\gamma^{(\infty)}$ such that, for any $k_0 \in \mathbb{N}$, $(\gamma_0^{(\infty)}, \gamma_1^{(\infty)}, \dots, \gamma_{k_0}^{(\infty)})$ is the beginning of infinitely many $\gamma^{(k)}$'s. By Lemma 2.4, $\gamma^{(\infty)}$ intersects almost surely the infinite cluster of a p -percolation. Thus, there exists an integer k_0 such that

$$\mathbf{P}_p \left[\left\{ \gamma_0^{(\infty)}, \gamma_1^{(\infty)}, \dots, \gamma_{k_0}^{(\infty)} \right\} \leftrightarrow \infty \right] > 1 - \varepsilon.$$

Finally, there exists m such that γ_m begins with the sequence

$$(\gamma_0^{(\infty)}, \gamma_1^{(\infty)}, \dots, \gamma_{k_0}^{(\infty)}),$$

thus it intersects the infinite cluster of a p -percolation with probability exceeding $1 - \varepsilon$. By choice of $\gamma^{(m)}$, it holds for any other self-avoiding path γ of length m that

$$\mathbf{P}_p \left[\gamma \leftrightarrow \infty \right] > 1 - \varepsilon.$$

□

We will focus on paths that start close to the origin. Let us define $\mathcal{S}(m)$ to be the set of self-avoiding paths of length m that start in $B(1)$.

Lemma 2.9. *For any $\eta > 0$, there exist two integers $m, N \in \mathbb{N}$ and a good quadruple (a, b, u, v) such that*

$$\forall \gamma \in \mathcal{S}(m), \forall Z \in \mathcal{Z}(a, b, u, v) \quad \mathbf{P}_p \left[\gamma \xrightarrow{R(a,b) \cap B(N)} Z \cap B(N) \right] > 1 - 3\eta.$$

Proof. By Lemma 2.8, we can pick m such that any self-avoiding path $\gamma \in \mathcal{S}(m)$ verifies

$$\mathbf{P}_p \left[\gamma \leftrightarrow \infty \right] > 1 - \eta.$$

Pick $k \geq m + 1$ such that

$$\mathbf{P}_p \left[B(k) \leftrightarrow \infty \right] > 1 - \eta^{24}.$$

The number of disjoint clusters (for the configuration restricted to $B(n+1)$) connecting $B(k)$ to $B(n)^c$ converges when n tends to infinity to the number of infinite clusters intersecting $B(k)$. The infinite cluster being unique, we can pick n such that

$$\mathbf{P}_p \left[B(k) \xrightarrow{!B(n+1)!} B(n)^c \right] > 1 - \eta. \tag{7.18}$$

Applying Lemma 2.5 with $A = B(k)$ and $B = B(n+1)$ provides a good quadruple (a, b, u, v) such that the following two properties hold for any $Z \in \mathcal{Z}(a, b, u, v)$:

- (i) $B(n+1) \cap Z = \emptyset$,
- (ii) $\mathbf{P}_p \left[B(k) \xleftrightarrow{R(a,b)} Z \right] > 1 - \eta$.

Note that condition (ii) implies in particular that $B(n+1)$ is a subset of $R(a,b)$. Equation (7.18) provides with high probability a “uniqueness zone” between $B(k)$ and $B(n)^c$: any pair of open paths crossing this region must be connected inside $B(n+1)$. In particular, when γ is connected to infinity, and $B(k)$ is connected to Z inside $R(a,b)$, this “uniqueness zone” ensures that γ is connected to Z by an open path lying inside $R(a,b)$:

$$\begin{aligned} & \mathbf{P}_p \left[\gamma \xleftrightarrow{R(a,b)} Z \right] \\ & \geq \mathbf{P}_p \left[\{ \gamma \leftrightarrow \infty \} \cap \left\{ B(k) \xleftrightarrow{!B(n+1)!} B(n)^c \right\} \cap \left\{ B(k) \xleftrightarrow{R(a,b)} Z \right\} \right] \\ & > 1 - 3\eta. \end{aligned}$$

The identity

$$\mathbf{P}_p \left[\gamma \xleftrightarrow{R(a,b)} Z \right] = \lim_{N \rightarrow \infty} \mathbf{P}_p \left[\gamma \xleftrightarrow{R(a,b) \cap B(N)} Z \cap B(N) \right]$$

concludes the proof of Lemma 2.9. □

2.5 Construction of a finite-size criterion

In this section, we give a precise definition of the finite-size criterion $\mathcal{FC}(p, N, \eta)$ used in lemmas 1.8 and 1.9. Its construction is based on Lemma 2.9.

Recall that, up to now, we worked with a fixed orthonormal basis \mathbf{e} , which was hidden in the definition of $\text{Graph} = \text{Graph}_{\mathbf{e}}$, see equation (7.5). In order to perform the coarse graining argument in any marked group G^\bullet/Λ close to G^\bullet , we will need to have the conclusion of Lemma 2.9 for all the orthonormal bases.

Denote by \mathfrak{B} the set of the orthonormal basis of \mathbb{R}^r . It is a compact subset of $\mathbb{R}^{r \times r}$. If we fix $X \subset \mathbb{R}^2$, a positive integer N and $\mathbf{e} \in \mathfrak{B}$ then the following inclusion holds for any orthonormal basis \mathbf{f} close enough to \mathbf{e} in \mathfrak{B} :

$$\text{Graph}_{\mathbf{e}}(X) \cap B(N) \subset (\text{Graph}_{\mathbf{f}}(X) + B(1)) \cap B(N). \quad (7.19)$$

We define $\mathcal{N}(\mathbf{e}, N) \subset \mathfrak{B}$ to be the neighbourhood of \mathbf{e} formed by the orthonormal bases \mathbf{f} for which the inclusion above holds. A slight modification of the orthonormal basis in Lemma 2.9 keeps its conclusion with the same integer N and the same vectors a, b, u, v , but with

- $Z + B(1)$ in place of Z
- and $R(a, b) + B(1)$ instead of $R(a, b)$.

In order to state this result properly, let us define:

$$\begin{aligned} \mathcal{Z}_{N, \mathbf{e}}(a, b, u, v) &= \{ (Z + B(1)) \cap B(N) : Z \in \mathcal{Z}_{\mathbf{e}}(a, b, u, v) \}; \\ R_{N, \mathbf{e}}(a, b) &= (R(a, b) + B(1)) \cap B(N). \end{aligned}$$

Note that we add the subscript \mathbf{e} here to insist on the dependence in the basis \mathbf{e} . This dependence was implicit for the sets Z and $R(a, b)$ which were defined via the function Graph.

We are ready to define the finite size criterion $\mathcal{FC}(p, N, \eta)$ that appears in lemmas 1.8 and 1.9.

Definition of the finite-size criterion. Let $N \geq 1$ and $\eta > 0$. We say that the finite-size criterion $\mathcal{FC}(p, N, \eta)$ is satisfied if for any $\mathbf{e} \in \mathfrak{B}$, there exist $m \geq 1$ and a good quadruple (a, b, u, v) such that:

$$\forall \gamma \in \mathcal{S}(m), \forall Z \in \mathcal{Z}_{N, \mathbf{e}}(a, b, u, v), \quad \mathbf{P}_p \left[\gamma \xleftrightarrow{R_{N, \mathbf{e}}(a, b)} Z \right] > 1 - \eta. \quad (7.20)$$

Proof of Lemma 1.8. Let $\eta > 0$. Given \mathbf{e} an orthonormal basis, Lemma 2.9 provides $m_{\mathbf{e}}, N_{\mathbf{e}} \in \mathbb{N}$, and a good quadruple $(a_{\mathbf{e}}, b_{\mathbf{e}}, u_{\mathbf{e}}, v_{\mathbf{e}})$ such that the following holds (we omit the subscript for the parameters m, a, b, u, v):

$$\forall \gamma \in \mathcal{S}(m), \forall Z \in \mathcal{Z}_{\mathbf{e}}(a, b, u, v), \quad \mathbf{P}_p \left[\gamma \xleftrightarrow{R_{\mathbf{e}}(a, b) \cap B(N_{\mathbf{e}})} Z \cap B(N_{\mathbf{e}}) \right] > 1 - \eta.$$

For any $\mathbf{f} \in \mathcal{N}(\mathbf{e}, N_{\mathbf{e}})$, we can use inclusion (7.19) to derive from the estimate above that for all $\gamma \in \mathcal{S}(m)$ and $Z \in \mathcal{Z}_{\mathbf{f}}(a, b, u, v)$,

$$\mathbf{P}_p \left[\gamma \xleftrightarrow{(R_{\mathbf{f}}(a, b) + B(1)) \cap B(N_{\mathbf{e}})} (Z + B(1)) \cap B(N_{\mathbf{e}}) \right] > 1 - \eta.$$

By compactness of \mathcal{B} , we can find a finite subset $\mathcal{F} \subset \mathcal{B}$ of bases such that

$$\mathcal{B} = \bigcup_{\mathbf{e} \in \mathcal{F}} \mathcal{N}(\mathbf{e}, N_{\mathbf{e}}).$$

For $N := \max_{\mathbf{e} \in \mathcal{B}_f} N_{\mathbf{e}}$, the finite-size criterion $\mathcal{FC}(p, N, \eta)$ is satisfied. □

3 Proof of Lemma 1.9

Through the entire section, we fix:

- $G^\bullet \in \tilde{\mathcal{G}}$ a marked abelian group of rank greater than two,
- $p \in (p_c^\bullet(G^\bullet), 1)$,
- $\delta > 0$.

Let $\mathcal{G} = (V, E)$ denote the Cayley graph associated to G^\bullet .

3.1 Hypotheses and notation

Let us start by an observation that follows from the definition of good quadruple at the beginning of section 2.3: there exists an absolute constant κ such that for any good quadruple (a, b, u, v) and any $w \in \mathbb{R}^2$,

$$\text{Card} \left\{ z \in \mathbb{Z}^2 : w + z_1 u + z_2 v \in [5a, 5b, -5a, -5b] \right\} \leq \kappa.$$

We fix κ as above and choose $\eta > 0$ such that

$$p_0 := \sup_{t \in \mathbb{N}} \{1 - (1 - \delta/\kappa)^t + \eta(1 - p)^{-t}\} > p_c^{\text{site}}(\mathbb{Z}^2). \quad (7.21)$$

We will prove that this choice of η provides the conclusion of Lemma 1.9. We assume that G^\bullet satisfies $\mathcal{FC}(p, N, \eta)$ for some positive integer N (which will be fixed throughout this section). Let us consider a marked abelian group $H^\bullet = G^\bullet/\Lambda$ of rank at least 2 and such that

$$\Lambda \cap B(2N + 1) = \{0\}.$$

(Notice that such H^\bullet 's form a neighbourhood of G^\bullet in $\tilde{\mathcal{G}}$ by Proposition 1.1.) Under these hypotheses, we will prove that $p_c(H^\bullet) < p + \delta$, providing the conclusion of Lemma 1.9.

The Cayley graph of $H^\bullet = G^\bullet/\Lambda$ is denoted by $\bar{\mathcal{G}} = (\bar{V}, \bar{E})$. For $x \in V$, we write \bar{x} for the image of x by the quotient map $G \rightarrow G/\Lambda$. This quotient map naturally extends to subsets of V and we write \bar{A} for the image of a set $A \subset V$.

3.2 Sketch of proof

Under the hypotheses above, we show that percolation occurs in $\bar{\mathcal{G}}$ at parameter $p + \delta$. The proof goes as follows.

Step 1: Geometric construction. We will construct a renormalized graph, that is a family of big boxes (living in $\bar{\mathcal{G}}$) arranged as a square lattice. In particular, there will be a notion of neighbour boxes. The occurrence of the finite-size criterion $\mathcal{FC}(p, N, \eta)$ will imply good connection probabilities between neighbouring boxes. This is the object of Lemma 3.2.

Step 2: Construction of an infinite cluster. The renormalized graph built in the first step will allow us to couple a $(p + \delta)$ -percolation on $\bar{\mathcal{G}}$ with a percolation on \mathbb{Z}^2 in such a way that the existence of an infinite component in \mathbb{Z}^2 would imply an infinite component in $\bar{\mathcal{G}}$. This event will happen with positive probability. The introduction of the parameter δ will allow us to apply a ‘‘sprinkling’’ technique in the coupling argument developed in the proof of Lemma 3.4.

3.3 Geometric setting: boxes and corridors

Since Λ has corank at least 2, we can fix an orthonormal basis $\mathbf{e} \in \mathcal{B}$ such that

$$\Lambda \subset \text{Ker}(\pi_{\mathbf{e}}) \times T. \quad (7.22)$$

Condition (7.22) ensures that sets defined in \mathcal{G} via the function $\text{Graph}_{\mathbf{e}}$ have a suitable image in the quotient $\bar{\mathcal{G}}$. More precisely, for any $x \in V$ and any planar set $X \subset \mathbb{R}^2$, we have

$$x \in \text{Graph}_{\mathbf{e}}(X) \iff \bar{x} \in \overline{\text{Graph}_{\mathbf{e}}(X)}. \quad (7.23)$$

According to $\mathcal{FC}(p, N, \eta)$, there exists $m < N$ and a good quadruple (a, b, u, v) such that

$$\forall \gamma \in \mathcal{S}(m), \forall Z \in \mathcal{Z}_{N, \mathbf{e}}(a, b, u, v), \quad \mathbf{P}_p \left[\gamma \xrightarrow{R_{N, \mathbf{e}}(a, b)} Z \right] > 1 - \eta.$$

We introduce here some subsets of $\overline{\mathcal{G}}$, that will play the role of vertices and edges in the renormalized graph.

Box. For z in \mathbb{Z}^2 , define

$$B_z := \overline{\text{Graph}(z_1 u + z_2 v + [a, b, -a, -b])}.$$

When z and z' are neighbours in \mathbb{Z}^2 for the standard graph structure, we write $z \sim z'$. In this case, we say that the two boxes B_z and $B_{z'}$ are neighbours.

Corridor. For z in \mathbb{Z}^2 , define

$$C_z := \overline{\text{Graph}(z_1 u + z_2 v + [4a, 4b, -4a, -4b])}.$$

We will explore the cluster of the origin in $\overline{\mathcal{G}}$. If the cluster reaches a box B_z , we will try to spread it to the neighbouring boxes ($B_{z'}$ for $z' \sim z$) by creating paths that lie in their respective corridors $C_{z'}$. For this strategy to work, we need the boxes to have good connection probabilities and the corridors to be ‘‘sufficiently disjoint’’: if the exploration is guaranteed to visit each corridor at most $\kappa + 1$ times, then we do need more than κ ‘‘sprinkling operations’’. These two properties are formalized by the following two lemmas.

Lemma 3.1. For all $\bar{x} \in V$,

$$\text{Card}\{z \in \mathbb{Z}^2 / \bar{x} \in C_z\} \leq \kappa. \quad (7.24)$$

Proof. By choice of the basis, equivalence (7.23) holds and implies, for any $z = (z_1, z_2) \in \mathbb{Z}^2$,

$$\bar{x} \in C_z \iff x \in \text{Graph}_{\mathbf{e}}(z_1 u + z_2 v + [4a, 4b, -4a, -4b])$$

By the last condition defining a good quadruple,

$$\bar{x} \in C_z \implies \pi(x) \in z_1 u + z_2 v + [5a, 5b, -5a, -5b]$$

The choice of κ at the beginning of the section (see equation (7.24)) concludes the proof. \square

Lemma 3.2. For any couple of neighbouring boxes $(B_z, B_{z'})$,

$$\forall \bar{x} \in B_z, \forall \gamma \in \mathcal{S}(m) \quad \mathbf{P}_p \left[\bar{x} + \bar{\gamma} \xrightarrow{C_{z'}} B_{z'} + \overline{B(1)} \right] > 1 - \eta. \quad (7.25)$$

Proof. We assume that $z' = z + (0, 1)$. The cases of $z + (1, 0)$, $z + (0, -1)$ and $z + (-1, 0)$ are treated the same way.

The assumption $\Lambda \cap B(2N + 1) = \{0\}$ implies that $\overline{R_{N, \mathbf{e}}(a, b)}$ is isomorphic (as a graph) to $R_{N, \mathbf{e}}(a, b)$. It allows us to derive from estimate (7.20) that

$$\mathbf{P}_p \left[\bar{\gamma} \xrightarrow{\overline{R_{N, \mathbf{e}}(a, b)}} \bar{Z} \right] > 1 - \eta. \quad (7.26)$$

Now let B_z and $B_{z'}$ be two neighbouring boxes. Let \bar{x} be any vertex of B_z . By translation invariance, we get from (7.26) that

$$\mathbf{P}_p \left[x + \bar{\gamma} \xleftrightarrow{\bar{x} + \overline{R_{N,e}(a,b)}} \bar{x} + \bar{Z} \right] > 1 - \eta.$$

Here comes the key geometric observation: there exists $Z \in \mathcal{Z}_{N,e}(a, b, u, v)$ such that

$$\bar{x} + \bar{Z} \subset B_{z'} + \overline{B(1)}.$$

This is illustrated on Figures 7.5 and 7.6 when $z = (0, 0)$ and $z' = (0, 1)$. Besides, $\bar{x} + \overline{R_N(a, b)} \subset C_{z'}$. Hence, by monotonicity, we obtain that

$$\mathbf{P}_p \left[\bar{x} + \bar{\gamma} \xleftrightarrow{C_{z'}} B_{z'} + \overline{B(1)} \right] > 1 - \eta.$$

□

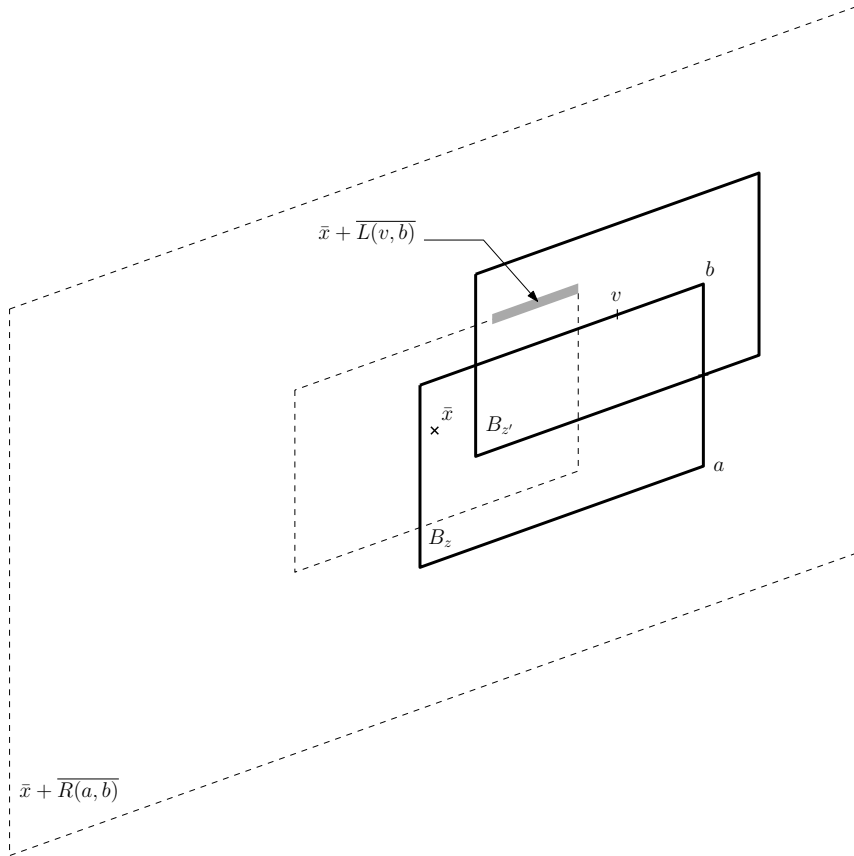

Figure 7.5: If \bar{x} is on the left of the box B_z , then $\bar{x} + \overline{L(v, b)} \subset B_{z'}$.

3.4 Probabilistic setting

Let ω_0 be Bernoulli percolation of parameter p on $\overline{\mathcal{Q}}$. In order to apply a “sprinkling argument”, we define for every $z \in \mathbb{Z}^2$ a sequence $(\xi^z(e))_{e \text{ edges in } C_z}$ of independent Bernoulli

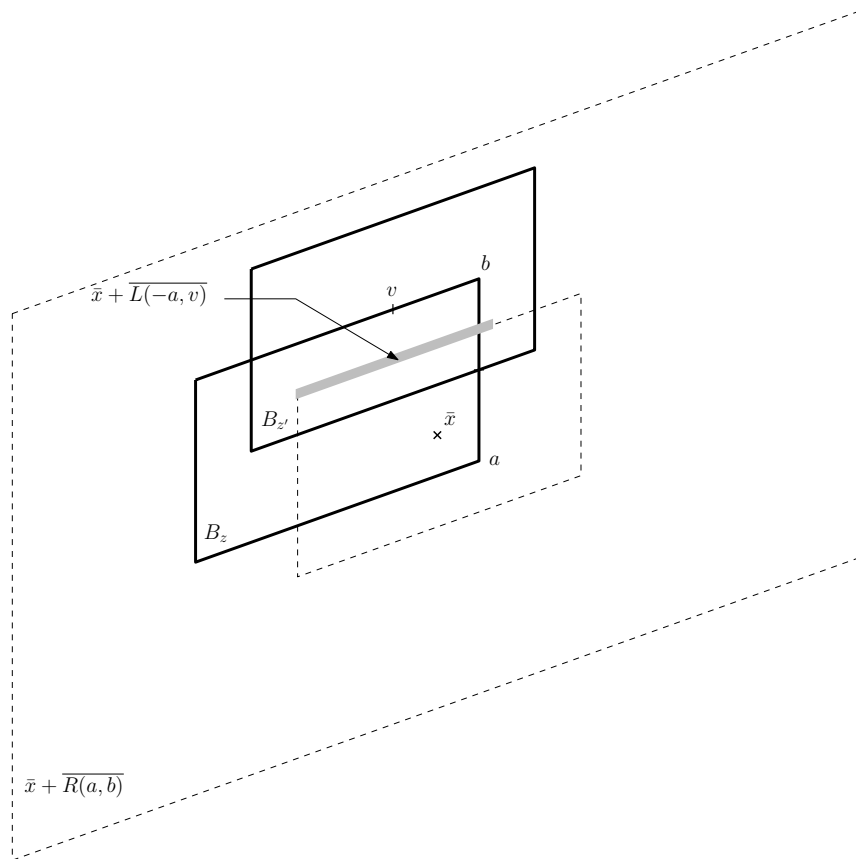

Figure 7.6: If \bar{x} is on the right of the box B_z , then $\bar{x} + \overline{L(-a, v)} \subset B_{z'}$.

variables of parameter $\frac{\delta}{\kappa}$. In other words, ξ^z is a $\frac{\delta}{\kappa}$ -percolation on C_z . We assume that ω_0 and all the $\xi^{z'}$'s are independent. Lemma 3.1 implies that at most $\kappa + 1$ Bernoulli variables are associated to a given edge e : $\omega_0(e)$ and the $\xi^z(e)$'s for z such that $e \subset C_z$.

To state lemma 3.3, we also need the notion of edge-boundary. The edge-boundary of a set A of vertices is the set of the edges of \mathcal{G} with exactly one endpoint in A . It is denoted by ΔA .

Lemma 3.3. *Let B_z and $B_{z'}$ be two neighbouring boxes. Let H be a subset of \overline{V} . Let $(\omega(e))_{e \in E}$ be a family of independent Bernoulli variables of parameter $\mathbf{P}[\omega(e) = 1] \in [p, 1)$ independent of $\xi^{z'}$. If there exists $\bar{x} \in B_z$ and $\bar{\gamma} \in \mathcal{S}(m)$ such that $\bar{x} + \bar{\gamma} \subset H$, then*

$$\mathbf{P} \left[H \xleftrightarrow[\omega \vee \xi^{z'}]{C_{z'}} B_{z'} + \overline{B(1)} \mid \forall e \in \Delta H, \omega(e) = 0 \right] \geq p_0.$$

Proof. In all this proof, the marginals of ω are assumed to be Bernoulli random variables of parameter p . The more general statement of Lemma 3.3 follows by a stochastic domination argument. The case $H \cap (B_{z'} + \overline{B(1)}) \neq \emptyset$ being trivial, we assume that $H \cap (B_{z'} + \overline{B(1)}) = \emptyset$.

Let $W \subset \Delta H$ be the (random) set of edges $\{\bar{x}, \bar{y}\} \subset C_{z'}$ such that

- (i) $\bar{x} \in H, \bar{y} \in C_{z'} \setminus H$ and
- (ii) there is an ω -open path joining \bar{y} to $B_{z'} + \overline{B(1)}$, lying in $C_{z'}$, but using no edge with an endpoint in H .

In a first step, we want to say that $|W|$ cannot be too small. The inclusions $\bar{x} + \bar{\gamma} \subset H \subset (B_{z'} + \overline{B(1)})^c$ imply that any ω -open path from $\bar{x} + \bar{\gamma}$ to $B_{z'} + \overline{B(1)}$ must contain at least one edge of W . Thus, there is no ω -open path connecting $\bar{x} + \bar{\gamma}$ to $B_{z'} + \overline{B(1)}$ in $C_{z'}$ when all the edges of W are ω -closed. Consequently, for any $t \in \mathbb{N}$, we have

$$\begin{aligned} \mathbf{P} \left[\left(\bar{x} + \bar{\gamma} \xleftrightarrow[\omega]{C_{z'}} B_{z'} + \overline{B(1)} \right)^c \right] &\geq \mathbf{P}[\text{all edges in } W \text{ are } \omega\text{-closed}] \\ &\geq (1 - p)^t \mathbf{P}[|W| \leq t]. \end{aligned}$$

To get the last inequality above, remark that the random set W is independent from the ω -state of the edges in ΔH . Using estimate (7.25), it can be rewritten as

$$\mathbf{P}[|W| \leq t] \leq \eta(1 - p)^{-t}. \tag{7.27}$$

We distinguish two cases. Either W is small, which has a probability estimated by equation (7.27) above; or W is large, and we use in that case that $B_{z'} + \overline{B(1)}$ is connected to H

as soon as one edge of W is $\xi^{z'}$ -open. The following computation makes it quantitative:

$$\begin{aligned}
 & \mathbf{P} \left[H \xleftrightarrow[\omega \vee \xi^{z'}]{C_{z'}} B_{z'} + \overline{B(1)} \mid \forall e \in \Delta H, \omega(e) = 0 \right] \\
 & \geq \mathbf{P} \left[\text{at least one edge of } W \text{ is } \xi^{z'}\text{-open} \mid \forall e \in \Delta H, \omega(e) = 0 \right] \\
 & = \mathbf{P} \left[\text{at least one edge of } W \text{ is } \xi^{z'}\text{-open} \right] \\
 & \geq \mathbf{P} \left[\text{at least one edge of } W \text{ is } \xi^{z'}\text{-open and } |W| > t \right] \\
 & \geq 1 - \mathbf{P} \left[\text{all the edges of } W \text{ are } \xi^{z'}\text{-open} \mid |W| > t \right] - \mathbf{P} \left[|W| \leq t \right].
 \end{aligned}$$

Using equation (7.27), we conclude that, for any t ,

$$\mathbf{P} \left[H \xleftrightarrow[\omega \vee \xi^{z'}]{C_{z'}} A \mid \forall e \in \Delta H, \xi^{z'}(e) = 0 \right] \geq 1 - (1 - \delta/\kappa)^t - \eta(1 - p)^{-t}. \quad (7.28)$$

Our choice of η in (7.21) make the right hand side of (7.28) larger than p_0 . \square

Lemma 3.4. *With positive probability, the origin is connected to infinity in the configuration*

$$\omega_{\text{total}} := \omega_0 \vee \bigvee_{z \in \mathbb{Z}^2} \xi^z.$$

Lemma 3.4 concludes the proof of Lemma 1.9 because ω_{total} is stochastically dominated by a $(p + \delta)$ -percolation. Indeed, $(\omega_{\text{total}}(e))_e$ is an independent sequence of Bernoulli variables such that, for any edge e ,

$$\mathbf{P} [\omega_{\text{total}}(e) = 1] \geq 1 - (1 - p)(1 - \delta/\kappa)^{\kappa} \geq p + \delta.$$

Proof of Lemma 3.4. The strategy of the proof is similar to the one described in the original paper of Grimmett and Marstrand: we explore the Bernoulli variables one after the other in an order prescribed by the algorithm hereafter. During the exploration, we define simultaneously random variables on the graph $\overline{\mathcal{G}}$ and on the square lattice \mathbb{Z}^2 .

Algorithm

- (0) Set $z(0) = (0, 0) \in \mathbb{Z}^2$. Explore the connected component H_0 of the origin in \mathcal{G} in the configuration ω_0 . Notice that only the edges of $H_0 \cup \Delta H_0$ have been explored in order to determine H_0 .
- If H_0 contains a path of $\mathcal{S}(m)$, set $X((0, 0)) = 1$ and $(U_0, V_0) = (\{0\}, \emptyset)$ and move to $(t = 1)$.
 - Else, set $X((0, 0)) = 0$ and $(U_0, V_0) = (\emptyset, \{0\})$ and move to $(t = 1)$.
- (t) Call unexplored the vertices in $\mathbb{Z}^2 \setminus (U_t \cup V_t)$. Examine the set of unexplored vertices neighbouring an element of U_t . If this set is empty, define $(U_{t+1}, V_{t+1}) = (U_t, V_t)$ and move to $(t + 1)$. Otherwise, choose such an unexplored vertex z_t . In the configuration $\omega_{t+1} := \omega_t \vee \xi^{z_t}$, explore the connected component H_{t+1} of the origin.
- If $H_{t+1} \cap B_{z_t} \neq \emptyset$, which means in particular that B_{z_t} is connected to 0 by an ω_{t+1} -open path, then set $X(z_t) = 1$ and $(U_{t+1}, V_{t+1}) = (U_t \cup \{z_t\}, V_t)$ and move to $(t + 1)$.
 - Else set $X(z_t) = 0$ and $(U_{t+1}, V_{t+1}) = (U_t, V_t \cup \{z_t\})$ and move to $(t + 1)$.

This algorithm defines in particular:

- a random process growing in the lattice \mathbb{Z}^2 ,

$$S_0 = (U_0, V_0), S_1 = (U_1, V_1), \dots$$

- a random sequence $(X(z_t))_{t \geq 0}$.

Lemma 3.3 ensures that for all $t \geq 1$, whenever z_t is defined,

$$\mathbf{P}[X(z_t) = 1 \mid S_0, S_1, \dots, S_{t-1}] \geq p_0 > p_c^{\text{site}}(\mathbb{Z}^2). \quad (7.29)$$

Estimate (7.29) states that each time we explore a new site z_t , whatever the past of the exploration is, we have a sufficiently high probability of success: together with Lemma 1 of [GM90], it ensures that

$$\mathbf{P}[|U| = \infty] > 0,$$

where $U := \bigcup_{t \geq 0} U_t$ is the set of z_t 's such that $X(z_t)$ equals 1. For such z_t 's, we know that B_{z_t} is connected to the origin of $\overline{\mathcal{G}}$ by an ω_{t+1} -open path. Hence, when U is infinite, there must exist an infinite open connected component in the configuration

$$\omega_0 \vee \bigvee_{t \geq 0} \xi^{z_t},$$

which is a subconfiguration of ω_{total} , and Lemma 3.4 is established. □

PUBLICATIONS AND PRE-PUBLICATIONS PRESENTED FOR THE PHD THESIS

- [VT1] A. Bálint, V. Beffara, and V. Tassion. Confidence intervals for the critical value in the divide and color model. *ALEA*, 10(2):667–679, 2013.
- [VT2] A. Bálint, V. Beffara, and V. Tassion. On the critical value function in the divide and color model. *ALEA*, 10(2):653–666, 2013.
- [VT3] Vent Tassion. A universal behavior in divide and color percolation. *In preparation*, 2014.
- [VT4] V. Tassion. Crossing probabilities for Voronoi percolation. *In preparation*, 2014.
- [VT5] H. Duminil-Copin, V. Sidoravicius, and V. Tassion. Continuity of the phase transition for planar Potts models with $1 \leq q \leq 4$. *In preparation*, 2014.
- [VT6] H. Duminil-Copin, V. Sidoravicius, and V. Tassion. Absence of percolation for critical bernoulli percolation on slabs. *Preprint arXiv:1401.7130*, 2013.
- [VT7] S. Martineau and V. Tassion. Locality of percolation for abelian Cayley graphs. *Preprint arXiv:1312.1946*, 2013.

BIBLIOGRAPHY

- [AB87] M. Aizenman and D. J. Barsky, *Sharpness of the phase transition in percolation models*, Communications in Mathematical Physics **108**(3), 489–526 (1987).
- [AB99] M. Aizenman and A. Burchard, *Hölder regularity and dimension bounds for random curves*, Duke Math. J. **99**(3), 419–453 (1999).
- [ABF87] M. Aizenman, D. J. Barsky and R. Fernández, *The phase transition in a general class of Ising-type models is sharp*, J. Statist. Phys. **47**(3-4), 343–374 (1987).
- [ADCS13] M. Aizenman, H. Duminil-Copin and V. Sidoravicius, *Random currents and continuity of Ising model's spontaneous magnetization*, Preprint arXiv:1311.1937 (2013).
- [AF86] M. Aizenman and R. Fernández, *On the critical behavior of the magnetization in high-dimensional Ising models*, J. Statist. Phys. **44**(3-4), 393–454 (1986).
- [Ahl73] L. V. Ahlfors, *Conformal invariants*, American Mathematical Soc., 1973.
- [Aiz98] M. Aizenman, *Scaling limit for the incipient spanning clusters*, in *Mathematics of multiscale materials*, pages 1–24, Springer, 1998.
- [AKN87] M. Aizenman, H. Kesten and C. M. Newman, *Uniqueness of the Infinite Cluster and Continuity of Connectivity Functions for Short and Long Range Percolation*, Commun. Math. Phys. **111**, 505–531 (1987).
- [Ale96] K. S. Alexander, *The RSW theorem for continuum percolation and the CLT for Euclidean minimal spanning trees*, The Annals of Applied Probability **6**(2), 466–494 (1996).
- [Ale98] K. S. Alexander, *On weak mixing in lattice models*, Probab. Theory Related Fields **110**(4), 441–471 (1998).

- [AN84] M. Aizenman and C. M. Newman, *Tree graph inequalities and critical behavior in percolation models*, *Journal of Statistical Physics* **36**(1-2), 107–143 (1984).
- [AV08] T. Antunović and I. Veselić, *Sharpness of the phase transition and exponential decay of the subcritical cluster size for percolation on quasi-transitive graphs*, *Journal of Statistical Physics* **130**(5), 983–1009 (2008).
- [Bax71] R. J. Baxter, *Generalized ferroelectric model on a square lattice*, *Studies in Appl. Math.* **50**, 51–69 (1971).
- [Bax73] R. J. Baxter, *Potts model at the critical temperature*, *Journal of Physics C: Solid State Physics* **6**(23), L445 (1973).
- [Bax89] R. J. Baxter, *Exactly solved models in statistical mechanics*, Academic Press Inc. [Harcourt Brace Jovanovich Publishers], London, 1989, Reprint of the 1982 original.
- [BBQ05] P. Balister, B. Bollobás and A. Quas, *Percolation in Voronoi tilings*, *Random Structures Algorithms* **26**(3), 310–318 (2005).
- [BBW05] P. Balister, B. Bollobás and M. Walters, *Continuum percolation with steps in the square or the disc*, *Random Structures Algorithms* **26**(4), 392–403 (2005).
- [BCC06] M. Biskup, L. Chayes and N. Crawford, *Mean-field driven first-order phase transitions in systems with long-range interactions*, *J. Stat. Phys.* **122**(6), 1139–1193 (2006).
- [BCM09] A. Bálint, F. Camia and R. Meester, *Sharp phase transition and critical behaviour in 2D divide and colour models*, *Stochastic Processes and their Applications* **119**(3), 937–965 (2009).
- [BDC12a] V. Beffara and H. Duminil-Copin, *Critical point and duality in planar lattice models*, 2012.
- [BDC12b] V. Beffara and H. Duminil-Copin, *The self-dual point of the two-dimensional random-cluster model is critical for $q \geq 1$* , *Probability Theory and Related Fields* **153**(3-4), 511–542 (2012).
- [BDCH12] S. Benoist, H. Duminil-Copin and C. Hongler, *Conformal invariance of crossing probabilities for the Ising model with free boundary conditions*, In preparation, 2012.
- [BDCS12] V. Beffara, H. Duminil-Copin and S. Smirnov, *On the critical parameters of the $q \geq 4$ random-cluster model on isoradial graphs*, 2012, In preparation.

BIBLIOGRAPHY

- [Ben13a] I. Benjamini, *Coarse Geometry and Randomness*, Springer, 2013.
- [Ben13b] I. Benjamini, Euclidean vs. Graph Metric, in *Erdős Centennial*, pages 35–57, Springer, 2013.
- [BGN91a] D. J. Barsky, G. R. Grimmett and C. M. Newman, Dynamic renormalization and continuity of the percolation transition in orthants, in *Spatial stochastic processes*, volume 19 of *Progr. Probab.*, pages 37–55, Birkhäuser Boston, Boston, MA, 1991.
- [BGN91b] D. J. Barsky, G. R. Grimmett and C. M. Newman, *Percolation in half-spaces: equality of critical densities and continuity of the percolation probability*, *Probab. Theory Related Fields* **90**(1), 111–148 (1991).
- [BH57] S. R. Broadbent and J. M. Hammersley, Percolation processes, in *Mathematical Proceedings of the Cambridge Philosophical Society*, volume 53, pages 629–641, Cambridge Univ Press, 1957.
- [BK89] R. M. Burton and M. Keane, *Density and uniqueness in percolation*, *Comm. Math. Phys.* **121**(3), 501–505 (1989).
- [BLPS99] I. Benjamini, R. Lyons, Y. Peres and O. Schramm, *Critical percolation on any nonamenable group has no infinite clusters*, *The Annals of Probability* **27**(3), 1347–1356 (1999).
- [BNP11] I. Benjamini, A. Nachmias and Y. Peres, *Is the critical percolation probability local?*, *Probability theory and related fields*, 1–9 (2011).
- [Bod05] T. Bodineau, *Slab percolation for the Ising model*, *Probability theory and related fields* **132**(1), 83–118 (2005).
- [BPZ84a] A. A. Belavin, A. M. Polyakov and A. B. Zamolodchikov, *Infinite conformal symmetry in two-dimensional quantum field theory*, *Nuclear Phys. B* **241**(2), 333–380 (1984).
- [BPZ84b] A. A. Belavin, A. M. Polyakov and A. B. Zamolodchikov, *Infinite conformal symmetry of critical fluctuations in two dimensions*, *J. Statist. Phys.* **34**(5-6), 763–774 (1984).
- [BR06a] B. Bollobás and O. Riordan, *The critical probability for random Voronoi percolation in the plane is $1/2$* , *Probability theory and related fields* **136**(3), 417–468 (2006).
- [BR06b] B. Bollobás and O. Riordan, *A short proof of the Harris–Kesten theorem*, *Bulletin of the London Mathematical Society* **38**(3), 470–484 (2006).

- [BR10] B. Bollobás and O. Riordan, *Percolation on Self-Dual Polygon Configurations*, in *An Irregular Mind*, edited by I. Bárány, J. Solymosi and G. Sági, volume 21 of *Bolyai Society Mathematical Studies*, pages 131–217, Springer Berlin Heidelberg, 2010.
- [BS96] I. Benjamini and O. Schramm, *Percolation Beyond Z^d , Many Questions And a Few Answers*, *Electron. Commun. Probab.* **1**, no. 8, 71–82 (1996).
- [BS98] I. Benjamini and O. Schramm, *Conformal invariance of Voronoi percolation*, *Communications in mathematical physics* **197**(1), 75–107 (1998).
- [BS01] I. Benjamini and O. Schramm, *Recurrence of distributional limits of finite planar graphs*, *Electron. J. Probab.* **6** (2001).
- [Bá10] A. Bálint, *Gibbsianness and non-gibbsianness in divide and color models*, *Annals of probability* **38**(4), 1609–1638 (2010).
- [CD88] J. T. Cox and R. Durrett, *Limit theorems for the spread of epidemics and forest fires*, *Stochastic processes and their applications* **30**(2), 171–191 (1988).
- [CDCH12] D. Chelkak, H. Duminil-Copin and C. Hongler, *Crossing probabilities in topological rectangles for the critical planar FK-Ising model*, preprint, 2012.
- [Cer13] R. Cerf, *A lower bound on the two-arms exponent for critical percolation on the lattice*, 2013.
- [CI13] D. Chelkak and K. Izyurov, *Holomorphic spinor observables in the critical Ising model*, *Comm. Math. Phys.* **322**(2), 303–332 (2013).
- [CLM07] L. Chayes, J. L. Lebowitz and V. Marinov, *Percolation Phenomena in Low and High Density Systems*, *Journal of Statistical Physics* **129**(3), 567–585 (2007).
- [CN07] F. Camia and C. Newman, *Critical percolation exploration path and SLE_6 : a proof of convergence*, *Probab. Theory Related Fields* **139**(3-4), 473–519 (2007).
- [CS12] D. Chelkak and S. Smirnov, *Universality in the 2D Ising model and conformal invariance of fermionic observables*, *Invent. Math.* **189**(3), 515–580 (2012).
- [DC12] H. Duminil-Copin, *Divergence of the correlation length for critical planar FK percolation with $1 \leq q \leq 4$ via parafermionic observables*, *J. Phys. A* **45**(49), 494013, 23 (2012).

- [DC13] H. Duminil-Copin, *Parafermionic observables and their applications to planar statistical physics models*, volume 25 of *Ensaio Matemáticos*, Brazilian Mathematical Society, 2013.
- [DCGP14] H. Duminil-Copin, C. Garban and G. Pete, *The Near-Critical Planar FK-Ising Model*, *Comm. Math. Phys.* **326**(1), 1–35 (2014).
- [DCHN11] H. Duminil-Copin, C. Hongler and P. Nolin, *Connection probabilities and RSW-type bounds for the two-dimensional FK Ising model*, *Comm. Pure Appl. Math.* **64**(9), 1165–1198 (2011).
- [DCS12] H. Duminil-Copin and S. Smirnov, *The connective constant of the honeycomb lattice equals $\sqrt{2 + \sqrt{2}}$* , *Ann. of Math. (2)* **175**(3), 1653–1665 (2012).
- [DDCH⁺14] C. D., H. Duminil-Copin, C. Hongler, A. Kemppainen and S. Smirnov, *Convergence of Ising interfaces to Schramm’s SLE curves*, *Comptes Rendus Mathematique* **352**(2), 157–161 (2014).
- [dLSS11] B. N. B. de Lima, R. Sanchis and R. W. C. Silva, *Critical point and percolation probability in a long range site percolation model on \mathbb{Z}^d* , *Stochastic processes and their applications* **121**(9), 2043–2048 (2011).
- [DNS12] M. Damron, C. M. Newman and V. Sidoravicius, *Absence of site percolation at criticality in $\mathbb{Z}^2 \times \{0, 1\}$* , Preprint ArXiv:1211.4138 (2012).
- [ES88] R. G. Edwards and A. D. Sokal, *Generalization of the Fortuin-Kasteleyn-Swendsen-Wang representation and Monte Carlo algorithm*, *Phys. Rev. D* (3) **38**(6), 2009–2012 (1988).
- [FK72] C. M. Fortuin and P. W. Kasteleyn, *On the random-cluster model. I. Introduction and relation to other models*, *Physica* **57**, 536–564 (1972).
- [FK80] E. Fradkin and L. P. Kadanoff, *Disorder variables and para-fermions in two-dimensional statistical mechanics*, *Nuclear Physics B* **170**(1), 1–15 (1980).
- [Gar01] O. Garot, *Limit Theorems for the painting of graphs by clusters*, *ESAIM: Probability and Statistics* **5**, 105–118 (1 2001).
- [GG06] B. T. Graham and G. R. Grimmett, *Influence and sharp-threshold theorems for monotonic measures*, *Ann. Probab.* **34**(5), 1726–1745 (2006).
- [GM90] G. R. Grimmett and J. M. Marstrand, *The supercritical phase of percolation is well behaved*, *Proceedings of the Royal Society of London. Series A: Mathematical and Physical Sciences* **430**(1879), 439 (1990).
- [GM13] G. R. Grimmett and I. Manolescu, *Universality for bond percolation in two dimensions*, *Ann. Probab.* **41**(5), 3261–3283 (09 2013).

- [GPG07] J. Gravner, D. Pitman and S. Gavrillets, *Percolation on fitness landscapes: Effects of correlation, phenotype, and incompatibilities*, *Journal of theoretical biology* **248**(4), 627–645 (2007).
- [GPS13a] C. Garban, G. Pete and O. Schramm, *Pivotal, cluster, and interface measures for critical planar percolation*, *Journal of the American Mathematical Society* **26**(4), 939–1024 (2013).
- [GPS13b] C. Garban, G. Pete and O. Schramm, *The scaling limits of near-critical and dynamical percolation*, Preprint arXiv:1305.5526 (2013).
- [Gri85] R. I. Grigorchuk, *Degrees of growth of finitely generated groups, and the theory of invariant means*, *Izvestiya: Mathematics* **25**(2), 259–300 (1985).
- [Gri99a] G. R. Grimmett, *Inequalities and entanglements for percolation and random-cluster models*, in *Perplexing problems in probability*, volume 44 of *Progr. Probab.*, pages 91–105, Birkhäuser Boston, Boston, MA, 1999.
- [Gri99b] G. R. Grimmett, *Percolation*, volume 321, Springer Verlag, 1999.
- [Gri06] G. R. Grimmett, *The random-cluster model*, volume 333 of *Grundlehren der Mathematischen Wissenschaften [Fundamental Principles of Mathematical Sciences]*, Springer-Verlag, Berlin, 2006.
- [Ham57] J. M. Hammersley, *Percolation Processes: Lower Bounds for the Critical Probability*, *The Annals of Mathematical Statistics* **28**(3), 790–795 (1957).
- [Har60] T. E. Harris, *A lower bound for the critical probability in a certain percolation process*, *Proc. Cambridge Philos. Soc.* **56**, 13–20 (1960).
- [HH08] C. Hsu and D. Han, *Asymptotic behaviors for percolation clusters with uncorrelated weights*, *Theoretical and Mathematical Physics* **157**(2), 1626–1635 (2008).
- [HK13] C. Hongler and K. Kytölä, *Ising interfaces and free boundary conditions*, *Journal of the American Mathematical Society* **26**(4), 1107–1189 (2013).
- [Hon10] C. Hongler, *Conformal invariance of Ising model correlations.*, in *Proceedings of ICMP 2012*, 2010.
- [HS94] T. Hara and G. Slade, *Mean-field behaviour and the lace expansion*, in *Probability and phase transition (Cambridge, 1993)*, volume 420 of *NATO Adv. Sci. Inst. Ser. C Math. Phys. Sci.*, pages 87–122, Kluwer Acad. Publ., Dordrecht, 1994.

BIBLIOGRAPHY

- [HS11] C. Hongler and S. Smirnov, *Critical percolation: the expected number of clusters in a rectangle*, *Probab. Theory Related Fields* **151**(3-4), 735–756 (2011).
- [Hä01] O. Häggström, *Coloring percolation clusters at random*, *Stochastic Processes and their Applications* **96**(2), 213 – 242 (2001).
- [Ken00] R. Kenyon, *Conformal invariance of domino tiling*, *Ann. Probab.* **28**(2), 759–795 (2000).
- [Ken01] R. Kenyon, *Dominos and the Gaussian free field*, *Ann. Probab.* **29**(3), 1128–1137 (2001).
- [Kes80] H. Kesten, *The critical probability of bond percolation on the square lattice equals $\frac{1}{2}$* , *Comm. Math. Phys.* **74**(1), 41–59 (1980).
- [Kes82] H. Kesten, *Percolation theory for mathematicians*, volume 2 of *Progress in Probability and Statistics*, Birkhäuser Boston, Mass., 1982.
- [Kes87] H. Kesten, *Scaling relations for 2D-percolation*, *Communications in Mathematical Physics* **109**(1), 109–156 (1987).
- [KN11] G. Kozma and A. Nachmias, *Arm exponents in high dimensional percolation*, *Journal of the American Mathematical Society* **24**(2), 375–409 (2011).
- [KS82] R. Kotecký and S. B. Shlosman, *First-order phase transitions in large entropy lattice models*, *Comm. Math. Phys.* **83**(4), 493–515 (1982).
- [KS12] A. Kemppainen and S. Smirnov, *Random curves, scaling limits and Loewner evolutions*, arXiv:1212.6215, 2012.
- [KW07] J. Kahn and N. Weininger, *Positive association in the fractional fuzzy Potts model*, *The Annals of Probability* **35**(6), 2038–2043 (2007).
- [Law05] G. F. Lawler, *Conformally invariant processes in the plane*, volume 114 of *Mathematical Surveys and Monographs*, American Mathematical Society, Providence, RI, 2005.
- [LMMS⁺91] L. Laanait, A. Messenger, S. Miracle-Solé, J. Ruiz and S. Shlosman, *Interfaces in the Potts model. I. Pirogov-Sinai theory of the Fortuin-Kasteleyn representation*, *Comm. Math. Phys.* **140**(1), 81–91 (1991).
- [LMR86] L. Laanait, A. Messenger and J. Ruiz, *Phases coexistence and surface tensions for the Potts model*, *Comm. Math. Phys.* **105**(4), 527–545 (1986).
- [LP14] R. Lyons and Y. Peres, *Probability on trees and networks*, volume 321, Cambridge University Press, current version available at <http://mypage.iu.edu/~rdlyons>, 2014.

- [LS12] E. Lubetzky and A. Sly, *Critical Ising on the square lattice mixes in polynomial time*, *Comm. Math. Phys.* **313**(3), 815–836 (2012).
- [LSS97] T. M. Liggett, R. H. Schonmann and A. M. Stacey, *Domination by product measures*, *Ann. Probab.* **25**(1), 71–95 (1997).
- [LSW04] G. F. Lawler, O. Schramm and W. Werner, *Conformal invariance of planar loop-erased random walks and uniform spanning trees*, *Ann. Probab.* **32**(1B), 939–995 (2004).
- [Men86] M. V. Menshikov, *Coincidence of critical-points in the percolation problems*, *Doklady akademii nauk sssr* **288**(6), 1308–1311 (1986).
- [Mer] Mersenne Twister, available at <http://www.math.sci.hiroshima-u.ac.jp>.
- [Ons44] L. Onsager, *Crystal statistics. I. A two-dimensional model with an order-disorder transition*, *Phys. Rev. (2)* **65**, 117–149 (1944).
- [Pei36] R. Peierls, *On Ising's model of ferromagnetism.*, *Math. Proc. Camb. Phil. Soc.* **32**, 477–481 (1936).
- [Pot52] R. B. Potts, *Some generalized order-disorder transformations*, in *Proceedings of the Cambridge Philosophical Society*, volume 48, pages 106–109, Cambridge Univ Press, 1952.
- [PSS09] Y. Peres, O. Schramm and J. Steif, *Dynamical sensitivity of the infinite cluster in critical percolation*, *Annales Institut Henri Poincare, Probabilites et Statistiques* **45**(2), 491 (2009).
- [RC06] V. Riva and J. Cardy, *Holomorphic parafermions in the Potts model and stochastic Loewner evolution*, *J. Stat. Mech. Theory Exp.* **12**, P12001, 19 pp. (electronic) (2006).
- [Roy90] R. Roy, *The Russo-Seymour-Welsh Theorem and the Equality of Critical Densities and the "Dual" Critical Densities for Continuum Percolation on \mathbb{R}^2* , *The Annals of Probability*, 1563–1575 (1990).
- [Rus78] L. Russo, *A note on percolation*, *Zeitschrift für Wahrscheinlichkeitstheorie und verwandte Gebiete* **43**(1), 39–48 (1978).
- [Rus81] L. Russo, *On the critical percolation probabilities*, *Zeitschrift für Wahrscheinlichkeitstheorie und verwandte Gebiete* **56**(2), 229–237 (1981).
- [RW07] O. Riordan and M. Walters, *Rigorous confidence intervals for critical probabilities*, *Physical Review E* **76**(1), 11110 (2007).

- [Sch07] O. Schramm, Conformally invariant scaling limits: an overview and a collection of problems, in *International Congress of Mathematicians. Vol. I*, pages 513–543, Eur. Math. Soc., Zürich, 2007.
- [Sim80] B. Simon, *Correlation inequalities and the decay of correlations in ferromagnets*, *Comm. Math. Phys.* **77**(2), 111–126 (1980).
- [Smi01] S. Smirnov, *Critical percolation in the plane: conformal invariance, Cardy’s formula, scaling limits*, *C. R. Acad. Sci. Paris Sér. I Math.* **333**(3), 239–244 (2001).
- [Smi06] S. Smirnov, Towards conformal invariance of 2D lattice models, in *International Congress of Mathematicians. Vol. II*, pages 1421–1451, Eur. Math. Soc., Zürich, 2006.
- [Smi10] S. Smirnov, *Conformal invariance in random cluster models. I. Holomorphic fermions in the Ising model*, *Ann. of Math. (2)* **172**(2), 1435–1467 (2010).
- [SSG11] O. Schramm, S. Smirnov and C. Garban, On the scaling limits of planar percolation, in *Selected Works of Oded Schramm*, pages 1193–1247, Springer, 2011.
- [Str65] V. Strassen, *The existence of probability measures with given marginals*, *The Annals of Mathematical Statistics*, 423–439 (1965).
- [SW78] P. D. Seymour and D. J. A. Welsh, *Percolation probabilities on the square lattice*, *Ann. Discrete Math.* **3**, 227–245 (1978), *Advances in graph theory* (Cambridge Combinatorial Conf., Trinity College, Cambridge, 1977).
- [VAW93] M. Q. Vahidi-Asl and J. C. Wierman, *Upper and lower bounds for the route length of first-passage percolation in Voronoï tessellations*, *Bull. Iranian Math. Soc.* **19**(1), 15–28 (1993).
- [vdBBV08] J. van den Berg, R. Brouwer and B. Vágvölgyi, Box-crossings and continuity results for self-destructive percolation in the plane, in *In and out of equilibrium 2*, pages 117–135, Springer, 2008.
- [Wer09] W. Werner, *Percolation et modèle d’Ising*, volume 16 of *Cours Spécialisés [Specialized Courses]*, Société Mathématique de France, Paris, 2009.
- [Wu82] F. Y. Wu, *The Potts model*, *Rev. Modern Phys.* **54**(1), 235–268 (1982).
- [Yan52] C. Yang, *The spontaneous magnetization of a two-dimensional Ising model*, *Phys. Rev. (2)* **85**, 808–816 (1952).