



HAL
open science

Stereoselective synthesis of the natural metabolite of tocopherol, (S)- γ -CEHC, and monofluorinated trisubstituted olefins

Mercedes Lecea Romera

► To cite this version:

Mercedes Lecea Romera. Stereoselective synthesis of the natural metabolite of tocopherol, (S)- γ -CEHC, and monofluorinated trisubstituted olefins. Other. Université de Strasbourg; Universidad autónoma de Madrid, 2012. English. NNT : 2012STRAF061 . tel-01064056

HAL Id: tel-01064056

<https://theses.hal.science/tel-01064056v1>

Submitted on 15 Sep 2014

HAL is a multi-disciplinary open access archive for the deposit and dissemination of scientific research documents, whether they are published or not. The documents may come from teaching and research institutions in France or abroad, or from public or private research centers.

L'archive ouverte pluridisciplinaire **HAL**, est destinée au dépôt et à la diffusion de documents scientifiques de niveau recherche, publiés ou non, émanant des établissements d'enseignement et de recherche français ou étrangers, des laboratoires publics ou privés.



THESIS IN COTUTELLE

Universidad Autónoma de Madrid
and
Université de Strasbourg

**STEREOSELECTIVE SYNTHESIS OF THE NATURAL
METABOLITE OF TOCOPHEROL, (S)- γ -CEHC, AND
MONOFLUORINATED TRISUBSTITUTED OLEFINS**

Mercedes LECEA ROMERA

Madrid-Strasbourg, January 2012

This Doctoral Thesis has been realized in the Department of Organic Chemistry of Faculty of Ciencias in the University Autónoma of Madrid and the laboratory of Stéréochimie in the Ecole Européen de Chimie, Polymères et Matériaux (ECPM) of the University of Strasbourg, under the supervision of Professor M. Carmen Carreño and Professor Françoise Colobert.

The development of this work has been financed by Ministerio de Ciencia e Innovación (MICINN) and Ministère de la Recherche Française. This PhD work has also been financed by research fellowships of Fundación Mutua Madrileña, Région de l'Alsace and European Doctoral College of the University of Strasbourg.



Ms Mercedes LECEA ROMERA was a member of the European Doctoral College of the University of Strasbourg during the preparation of her PhD, from 2008 to 2011, class Rosa Parks.

She has benefited from specific financial supports offered by the College and, along with her mainstream research, has followed a special course on topics of general European interests presented by international experts.

This PhD research project has been led with the collaboration of two universities: the University Autonome of Madrid (Spain) and the University of Strasbourg (France).

En primer lugar me gustaría agradecer a mi directora de tesis española, Dra. M. Carmen Carreño, por animarme a realizar el doble diploma de Ingenieur Chimiste y Licenciada en Ciencias Químicas, y haberme permitido realizar esta tesis doctoral en cotutela. Gracias por su disponibilidad y entusiasmo a lo largo de estos años, en los que he aprendido y me han ayudado a llegar hasta aquí.

Je tiens également à remercier le Professeur Françoise Colobert, l'intérêt qu'elle a apporté à ce sujet et la confiance qu'elle m'a accordée ont été pour moi d'un grand soutien. Je la remercie tout particulièrement pour la patience qu'elle m'a consacrée lors du temps que j'ai passée dans son laboratoire. J'ai beaucoup apprécié sa disponibilité et sa gentillesse.

Asimismo, quisiera agradecer al Dr. Antonio Urbano por toda la ayuda prestada y a la Dra. María Ribagorda por su cercanía.

En especial me gustaría agradecer a la Dra. Gloria Hernández por todo el trabajo que hemos compartido, su optimismo y perseverancia me han enseñado mucho. También me gustaría agradecer a Adrien Grassin por su aportación a esta tesis y sus ganas de aprender.

Agradecer también a mis compañeros de laboratorio con los que he tenido la suerte de compartir tantas horas de trabajo, gracias por su apoyo y compañerismo, porque he aprendido algo de todos y cada uno de ellos. Gracias a Leticia por todo su apoyo y amistad, contigo he compartido prácticamente todo durante la tesis, desde los matraces hasta las copas, has sido como una hermana para mí. Gracias a Alfonso y Álvaro por compartir consejos y desayunos, a Marcos por toda su ayuda y risas, gracias Ximo! A Menchu e Irene por todos esos momentos en la vitrina y fuera de ella, a Sandra por sus historias, y a Silvia Vila por todo lo compartido con tanto entusiasmo. A Silvia Barradas por todo su apoyo y cuidados. A Jaime, Ana y Carol por todas las risas y ánimos, a pesar de sólo ver el final... no dejéis que decaiga el labo!

A lo largo de este trabajo son muchas las personas con las que compartido horas de laboratorio y me han brindado su ayuda, consejos y amistad: Jorge, Alberto, Manu, Virtu, Alfonso, Alvarito, Tati...

Un grand merci aussi à mes collègues du laboratoire à Strasbourg que j'ai côtoyé pendant le temps que j'ai passée en France: Merci Irene pour ton amitié et tes attentions, à Marie et Nico pour m'accueillir et me faire sentir comme chez moi, et à Florence pour tous ces bons moments de « chungu du labo2».

Je tiens à remercier aussi tous les collègues du labo: Christophe, Don Antoine, Damien, Alex, Laure, Maida, qui ont partagé avec moi ce temps d'une façon ou d'une autre. Por supuesto también a la gran familia española: Luisito, gracias por todos esos emocionantes viajes en coche y conversaciones en los water's days. Juanjo por todos esos bailes y lágrimas de tanta risa. Rafeta por nunca decir no a cualquier plan por raro que fuera. A David, Marimeri, Rafa, Juanito... y a muchos más. Merci.

Me gustaría agradecer a mis amigos por todo su apoyo y por intentar comprenderme a lo largo de estos años. A Manute por acompañarme durante este viaje. A Laurita y Andrés porque sois los que mejor comprendéis lo que esto significa. A Loubna y Ana Rosa, porque siempre puedo contar con vosotras. A Marta por sus ánimos durante la escritura. Y a mucha gente más que me ayudan a seguir con su cariño y apoyo.

Por último me gusta agradecer a toda mi familia que siempre está ahí, a mis hermanos, Daniel y Luis, y en especial a mis padres, Luis y Charo, porque sin vosotros no hubiera sido capaz, os debo todo lo que soy.

*“Everything that is really great and inspiring is created
by the individual who can labor in freedom”*
-Albert Einstein, Out of My Later Years

“Nature does nothing uselessly”
-Aristotle, Politics

To my parents and brothers

ABBREVIATIONS

[α]	specific rotation
Å	angstrom(s)
Ac	acetyl
Anal.	combustion elemental analysis
aq	aqueous
Ar	aryl
atm	atmosphere(s)
9-BBN	9-borabicyclo[3.3.1]nonyl
Bn	benzyl
Boc	<i>tert</i> -butoxycarbonyl
bp	boiling point
<i>t</i> -Bu	<i>tert</i> -butyl
°C	degrees Celsius
calcd	calculated
cat	catalytic
COSY	correlation spectroscopy
Cp	cyclopentadienyl
<i>m</i> -CPBA	<i>meta</i> -chloroperoxybenzoic acid
δ	chemical shift in parts per million downfield from tetramethylsilane
d	day(s); doublet (spectral)
DAST	Diethylaminosulfur trifluoride
DBU	1,8-diazabicyclo[5.4.0]undec-7-ene
DCM	dichloromethane
DIBALH	diisobutylaluminum hydride
DMA	dimethylacetamide
DMAP	4-(<i>N,N</i> -dimethylamino)pyridine
DMF	<i>N,N</i> -dimethylformamide
DMSO	dimethyl sulfoxide
<i>dr</i>	diastereomer ratio
E1	unimolecular elimination EI electron impact
equiv	equivalent
<i>er</i>	enantiomer ratio
ESI	electrospray ionization
Et	ethyl

FAB	fast atom bombardment
g	gram(s)
GC	gas chromatography
h	hour(s)
HMPA	hexamethylphosphoric triamide (hexamethylphosphoramide)
HMQC	heteronuclear multiple quantum correlation
HOMO	highest occupied molecular orbital
HPLC	high-performance liquid chromatography
HRMS	high-resolution mass spectrometry
Hz	Hertz
IR	infrared
<i>J</i>	coupling constant (in NMR spectrometry)
LDA	lithium diisopropylamide
LHMDS	lithium hexamethyldisilazane, lithium bis(trimethylsilyl)amide
lit.	literature
μ	micro
m	multiplet
M	molar (moles per liter)
M+	parent molecular ion
<i>i</i> -Pr	isopropyl
Me	methyl
MHz	megahertz
min	minute(s)
mol	mole(s)
MOM	methoxymethyl
mp	melting point
MS	mass spectrometry
<i>m/z</i>	mass-to-charge ratio
NBS	<i>N</i> -bromosuccinimide
NFSI	<i>N</i> -fluorodibenzene-sulfonimide
NMO	<i>N</i> -methylmorpholine- <i>N</i> -oxide
NOESY	nuclear Overhauser effect spectroscopy
Nu	nucleophile
Ph	phenyl
ppm	part(s) per million
py	pyridine
q	quartet
qi	quintuplet

<i>R_f</i>	retention factor
rt	room temperature
s	singlet
sex	sextuplet
S _{N1}	unimolecular nucleophilic substitution
S _{N2}	bimolecular nucleophilic substitution
t	triplet
<i>t</i>	time
TBAF	tetrabutylammonium fluoride
TBS	<i>tert</i> -butyldimethylsilyl
THF	tetrahydrofuran
TMS	trimethylsilyl; tetramethylsilane
vol	volume
v/v	volume per unit volume

CHAPTER I: INTRODUCTION AND OBJECTIVES	3
CHAPTER II: ENANTIOSELECTIVE SYNTHESIS OF (S)-γ-CEHC, A NATURAL METABOLITE OF γ-TOCOPHEROL.....	17
I. STEREOSELECTIVE SYNTHESIS OF TETRAHYDROPYRANS (THP)	17
I.1. Intramolecular Cyclization BY C-O bond formation.....	19
I.1.1. Intramolecular cyclization by epoxide opening.....	19
I.1.2. Intramolecular 1,5-dihydroxyl cyclization	21
I.1.3. Intramolecular cyclization by hydroxyalkenes and hydroxyalkynes etherification	22
I.1.4. Reductive cyclization of hydroxyketones	26
I.2. Background of the research group.....	29
I.3. Results and discussion	34
I.3.1. Approach to the synthesis of 6-substituted-6-methyl-(<i>p</i> -tolylsulfinyl) tetrahydro-2 <i>H</i> -pyran-2-ones	34
II. STEREOSELECTIVE SYNTHESIS OF 2,2-DISUBSTITUTED CHROMANS.....	38
II.1. Biological properties	38
II.2. Asymmetric synthesis of chiral 2,2-substituted chromans.....	40
II.3. Introduction.....	48
II.3.1. Lewis acid mediated nucleophilic substitution reactions	48
II.3.2. Synthesis of 3,4-dihydro-2 <i>H</i> -1-benzopyrans (2 <i>H</i> -chromans)	50
II.4. Results and discussion.....	53

II.4.1. Synthesis of differently substituted 2-methoxy-2-(sulfinyl) methyl chromans	53
II.4.2. Synthesis of differently substituted 2-methyl-2-(sulfinyl) methyl chromans	58
II.4.3. Synthesis of differently substituted 2-allyl-2- (sulfinyl) methyl chromans	62
II.4.4. Mechanistic proposal.....	78
II.4.5. Synthesis of 2-substitued benzofurans.....	85
III. ASYMMETRIC TOTAL SYNTHESIS OF (S)-γ-CEHC	89
III.1. Biological properties.....	89
III.2. Previous reported synthesis of (S)-γ-CEHC	99
III.3. Asymmetric Synthesis of (S)-γ-CEHC monitored by sulfoxide	103
III.3.1. Synthesis of (<i>R</i>)-3-(2-methyl chroman-2-yl) propanoic acid.....	105
III.3.2. Enantioselective synthesis of (S)- γ -CEHC.....	108
IV. CONCLUSIONS.....	119
V. EXPERIMENTAL PART	121
CHAPTER III: STEREOSELECTIVE SYNTHESIS OF TRISUBSTITUTED MONOFLUORINATED OLEFINS.....	177
I. INTRODUCTION	177
I.1. Monofluorinated olefins.....	180
I.2. Synthesis of monofluorinated olefins	186
I.3. Reformatsky type reactions with β-keto sulfoxides	203

II. RESULTS AND DISCUSSION	207
II.1. Synthesis of (SR, E and Z)-methyl 3-fluoro-4-(p-tolylsulfinyl) but-2-enoate	207
II.2. Synthesis of mono fluorinated olefins from 3,3,3-trifluoropropionates and stabilized carbanions	210
II.3. Synthesis of mono fluorinated olefins from 3,3,3-trifluoropropanoic esters and Grignard reagents	221
II.4. Mechanism and stereochemistry.....	224
III. DIELS-ALDER REACTIONS OF MONOFLUORINATED TRISUBSTITUTED OLEFINS	229
III.1. Introduction	229
III.2. RESULTS AND DISCUSSION.....	235
III.3. Mechanistic proposal.....	249
IV. CONCLUSIONS	242
V. EXPERIMENTAL PART	250
RESUMEN EN ESPAÑOL.....	287
RESUME EN FRANÇAISE	295

CHAPTER I

INTRODUCTION AND OBJECTIVES

INTRODUCTION

Sulfoxides have been extensively used in asymmetric synthesis due to the excellent asymmetric inductions they provide in a wide range of reactions.¹ Among them, the diastereodivergent reduction of β -ketosulfoxides, first reported by Solladié in 1982,² has been one of the most exploited in synthetic applications. The best results were obtained with DIBALH which gave mainly the (*S*,*SR*)- β -hydroxysulfoxide in a highly diastereoselective manner (de ranging from 86% to 95%). The opposite absolute configuration in the new stereogenic hydroxylic carbon was achieved using the system DIBALH/ZnCl₂. After desulfurization with Raney-nickel optically active *R* and *S* methyl carbinols have been synthesized. A wide variety of enantiomerically pure methyl carbinols could be obtained by applying this methodology as can be seen in Scheme 1. 1.

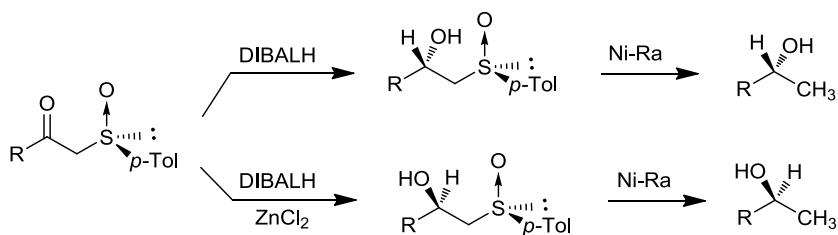

Scheme 1. 1

In 1990 the research groups of Solladié in Strasbourg and Carreño in Madrid, started a scientific collaboration, nowadays continued by Colobert and Carreño, mainly centered in the exploitation of this efficient process in asymmetric synthesis. Different applications of this divergent synthesis of carbinols from β -ketosulfoxides were developed.¹ Recently, an enantioselective access to different

¹ For reviews, see: a) M. C. Carreño, G. Hernández-Torres, M. Ribagorda, A. Urbano. *Chem Comm.* **2009**, 6129–6144. b) H. Kagan, in *Organosulfur Chemistry in Asymmetric Synthesis*, ed. T. Toru and C. Bolm, Wiley-VCH-Verlag, Weinheim, **2008**, 1–54. c) H. Pellissier, *Tetrahedron* **2006**, 62, 5559–5601. d) J. Legros, J. R. Dehli and C. Bolm, *Adv. Synth. Catal.*, **2005**, 347, 19–31. e) I. Fernández and N. Khair, *Chem. Rev.*, **2003**, 103, 3651–3705.

² a) Solladié, G.; Greck, C.; Demailly, G.; Solladié-Cavallo, A. *Tetrahedron Lett.* **1982**, 23, 5047. b) Solladié, G.; Greck, C.; Demailly, G. *Tetrahedron Lett.* **1985**, 26, 435-437.

sized *cis*- α - ω -disubstituted cyclic ethers has been developed allowing the asymmetric synthesis of different products. The total synthesis of the tetrahydropyran natural product Centrolobine,³ (Scheme 1. 2) was achieved by the combination of the stereocontrolled reduction of a β -ketosulfoxide (I) and the reductive cyclization of the β -hydroxysulfinyl ketone (II), with TMSOTf/Et₃SiH. Apart from Centrolobine, the procedure was applied to the total enantioselective synthesis of different natural tetrahydropyran derivatives such as the product isolated from the glandular secretion of Civet Cat,⁴ isolaurepan,⁵ and Lauthisan⁶ as well as some dihydroxy substituted tetrahydrofurans such as Goniiothalesdiol.⁷

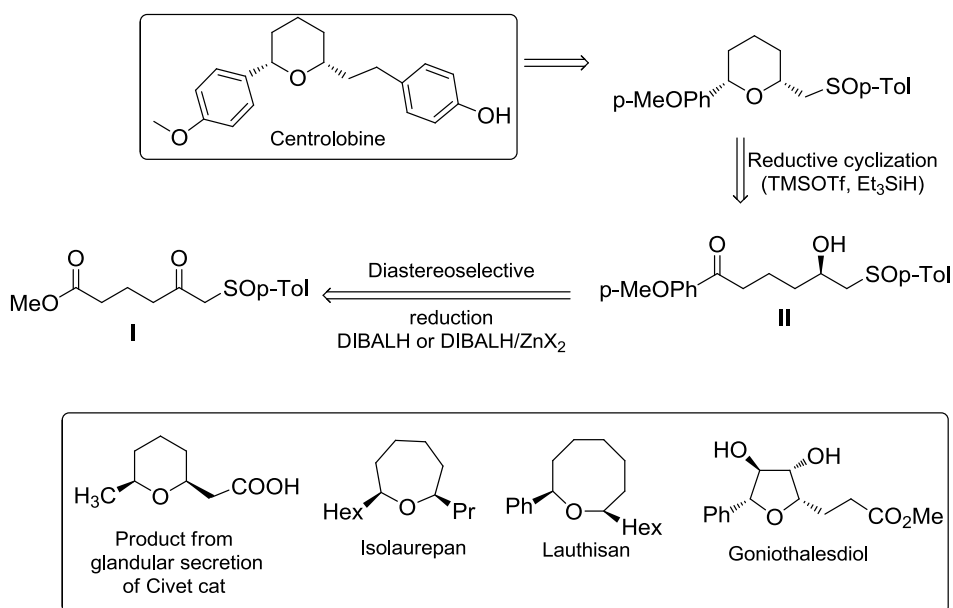

Scheme 1. 2

In all these syntheses, the stereogenic hydroxylic center was controlling the stereochemical course of the reductive cyclization step.

³ F. Colobert, M. C. Carreño, R. Des Mazery G. Solladié, *Org. Lett.* **2002**, *4*, 1723-1725

⁴ M. C. Carreño, R. Des Mazery, A. Urbano, F. Colobert, G. Solladié, *J. Org. Chem.* **2003**, *68*, 7779-7787

⁵ M. C. Carreño, R. Des Mazery, A. Urbano, F. Colobert, G. Solladié, *Org. Lett.* **2004**, *6*, 297-299

⁶ M. C. Carreño, R. Des Mazery, A. Urbano, F. Colobert, G. Solladié, *Org. Lett.* **2005**, *7*, 2039-2042

⁷ a) M. C. Carreño, G. Hernández-Torres, A. Urbano, F. Colobert, *Org. Lett.* **2005**, *7*, 5517-5520. b) G. Hernández-Torres M. C. Carreño, A. Urbano, F. Colobert, *Chem. Eur. J.* **2011**, *17*, 1283 - 1293.

Later on, a new stereoselective approach to the 2*H*-chroman unit, a structural component of several natural products and pharmaceuticals, was achieved through the direct transformation of an enantiopure 4-(2-hydroxyphenyl)-1-(*p*-tolylsulfinyl)-2-butanone (**IV**) into a sulfinyl-substituted 2*H*-chroman (**VI**), using again the reductive cyclization as the key step. In this approach, the homochiral sulfoxide was the sole responsible for the diastereoselectivity of the reaction.

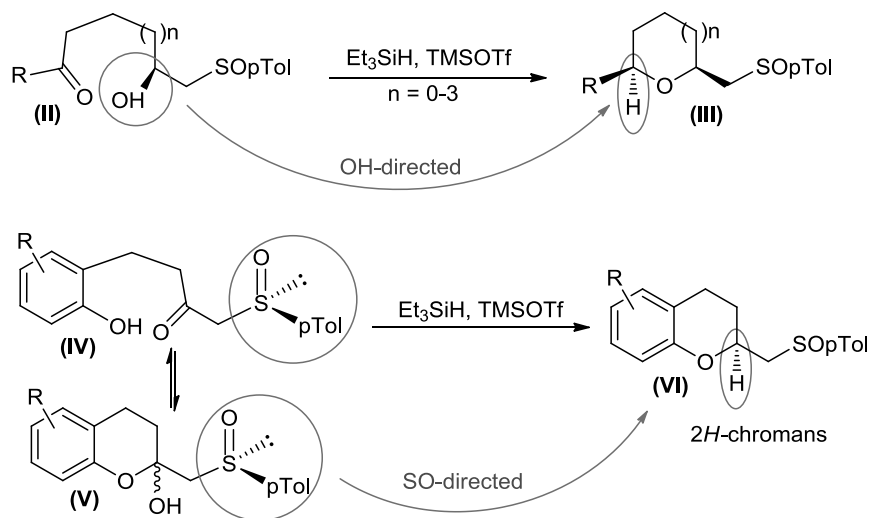

Scheme 1. 3

This novel enantioselective access to the hydrobenzopyran moiety (**VI**) with a defined stereochemistry at the C-2 stereogenic center, started from easily accessible ω -(*o*-hydroxyphenyl)-substituted β -ketosulfoxides **IV**. The, $\text{Et}_3\text{SiH}/\text{TMSOTf}$ -promoted reductive deoxygenation of the corresponding lactols **V**, in equilibrium with the former, allowed a direct access to the 2*H* chroman skeleton. An additional advantage of this method was the presence of the sulfoxide in the resulting 2*H*-chromans, allowing further synthetic exploitation. The utility of this approach was demonstrated by completion of the synthesis of (*S,R,R,R*)-Nebivolol, an antihypertensive drug currently in clinical use, following the key steps in the Scheme 1. 4 shown below for the synthesis of the 2*H*-chroman core precursor.⁸

⁸ M. C. Carreño, G. Hernández-Torres, A. Urbano, F. Colobert, *Eur. J. Org. Chem.* **2008**, 2035–2038.

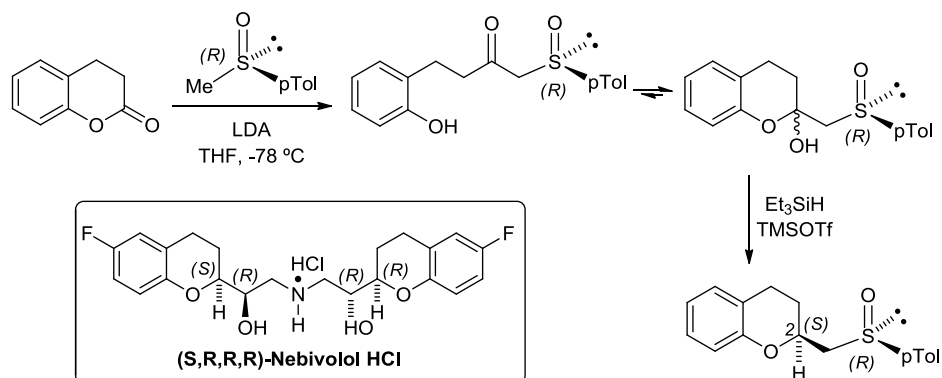

Scheme 1. 4

The application of the ketosulfinyl phenols to the generation of the quaternary centers present in the central core of the natural antioxidant tocopherol analogues⁹ was later considered. The first application reported was the synthesis of α -Tocopherol (Scheme 1. 5).¹⁰

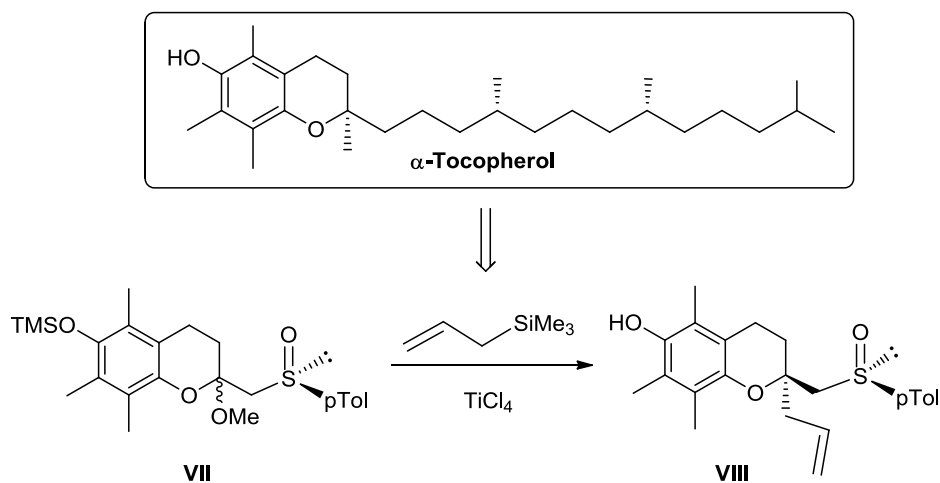

Scheme 1. 5

⁹ P. A. Dewick, "Medicinal Natural Products. A Biosynthetic Approach". 2^o edición. **2001**. Ed. Wiley, Chichester.

¹⁰ G. Hernández-Torres, A. Urbano, M. C. Carreño, F. Colobert, *Org. Lett.* **2009**, *11*, 4930-4933.

The key step in this total synthesis was the ionic substitution of the OMe group of the cyclic mixed ketal **VII** by an allyl group, with allyltrimethylsilane in the presence of TiCl_4 , as the Lewis acid. The formation of the quaternary center Of **VIII** was only controlled by the sulfoxide. The model reaction was developed by Gloria Hernández-Torres during her PhD, with the collaboration of Mercedes Lecea Romera, who developed this part of the research during the time of the experimental R&D stage of her Master degree.

Taking into account this precedent work, the first part of the present thesis was planned to follow this research. Initially, the application of the reductive cyclization reaction to the enantioselective synthesis of lactones was considered, since such structures are of high interest to the asymmetric synthesis of natural lactones.¹¹ A model reaction that will be checked is indicated in the Scheme 1. 6. Starting from glutaric anhydride, the synthesis of the β -ketosulfoxide had already been reported.¹² The reductive cyclization of the COOH under the reported conditions will be evaluated ($\text{TMSOTf}/\text{Et}_3\text{SiH}$).

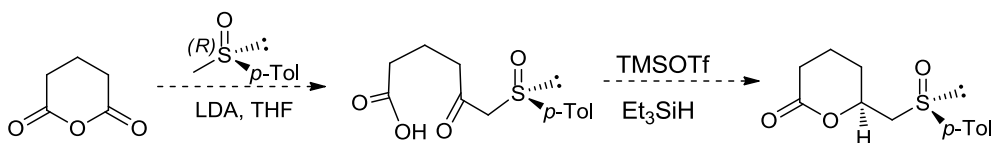

Scheme 1. 6

Lactone rings are a structural feature of many natural products with interesting biological properties. Tetrahydro-2*H*-pyran-2-one system with a chiral center in position C-6 is the core of different marine cyanobacteria metabolites. Among them, (-)-malyngolide is a δ -lactone displaying antibiotic activity against pathogenic species of *Staphylococcus*, *Mycobacterium*, *Pseudomonas* and related

¹¹ a) Neguishi, E.; Kotora, M.; *Tetrahedron* **1997**, 53, 6707-6738. b) Collins, I.; *J. Chem. Soc. Perkin Trans. 1* **1999**, 1377-1395. c) Carter, N. B.; Nadany, A. E.; Sweeney, J. B. *J. Chem. Soc. Perkin Trans. 1* **2002**, 2324-2342. d) Hoffmann, H. M. R.; Rabe, J. *Angew. Chem. Int. Ed. Engl.* **1985**, 24, 94-110.

¹² M. C. Carreño, J. L. García Ruano, M. C. Maestro, C. Pedregal, A. Rubio, G. Solladié. *J. Org. Chem.* **1991**, 56, 2317-2322

genera,¹³ (+)-tanikolide is a structurally related lactone with antifungal and molluscicidal properties¹⁴ (Figure 1. 1).

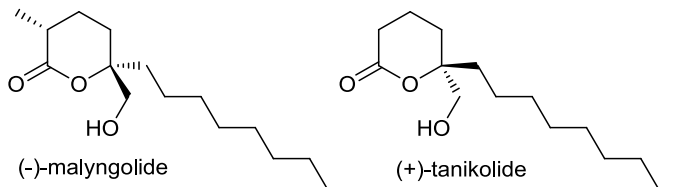

Figure 1. 1

The following part of this work was then focused on the generation of the quaternary center in the chroman core. With the aim of understand the factors influencing the stereoselectivity of the process, a study of the behavior at the sulfur atom shown in the following Figure 1. 2, with different substituents at the sulfoxides such as a *p*-TolSO, *t*-BuSO, *p*-MeOPhSO, *p*-NO₂PhSO, 2-NaphthylSO and 2-MeO-1-NaphthylSO (Figure 1. 2) will be carried out. It was important to know the relative importance of steric and stereoelectronic factors in the control of the stereoselective formation of the quaternary stereocenter.

¹³ Cardllina, II., J. H. ; Moore, R. E. ; Arnold, E. V. ; Clardy, J. J. *Org. Chem.* **1979**, *44*, 4039-4042.

¹⁴ Singh, I. P. ; Milligan, K. E. : Gerwick, W. H. *J. Nat. Prod.* **1999**, *62*, 1333-1335.

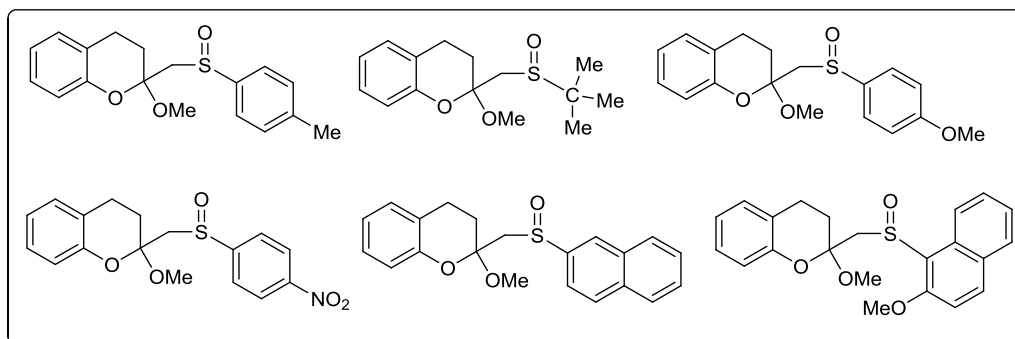
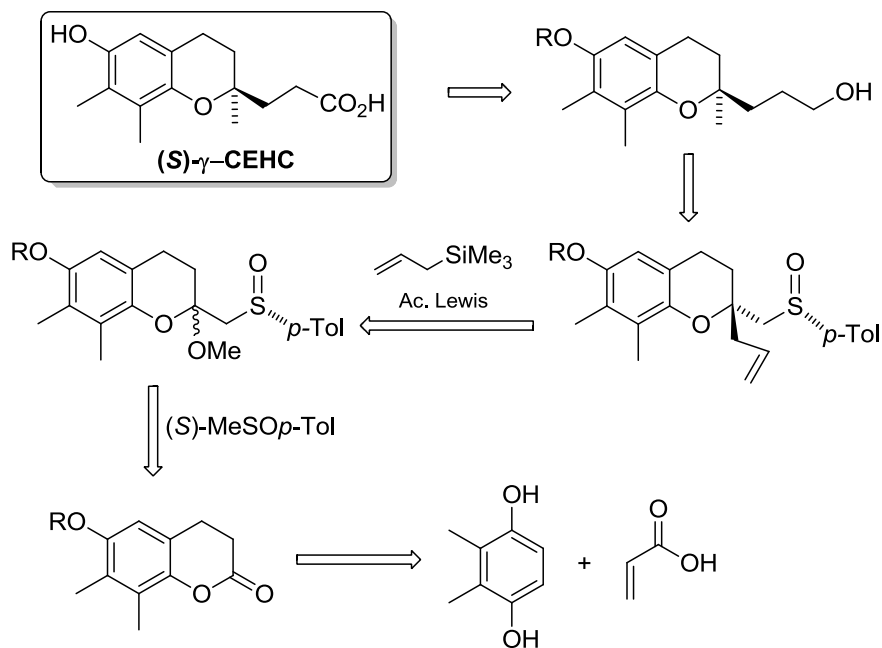

Figure 1. 2

A new total synthesis of the natural metabolite of γ -Tocopherol (*S*)- γ -CEHC, was also planned to apply this stereoselective methodology. Thus, this natural product was thought to be available following the retrosynthetic scheme shown, shown below forming the alcohol by desulfurization and anti Markovnikov hydroxylation of the allylic double bond. The allyl substituent at the quaternary center could be introduced by reductive deoxygenation of the mixed ketal in the presence of allyl trimethyl silane, in turn available from the lactone and the anion derived from enantiopure methyl *p*-tolyl sulfoxide (Scheme 1. 7). The lactone will be synthesized by alkylation-cyclization from 2,3-dimethylhydroquinone.



Scheme 1. 7

In the second part of this thesis, the stereocontrolled synthesis of monofluorinated olefins was planned as a consequence of an unexpected finding during the study of a Reformatsky-type reaction with γ -bromo- β -ketosulfoxide. As a continuation of the project directed to extend the applications of sulfoxides in asymmetric synthesis, the Reformatsky-type reaction of chiral nonracemic α -bromo- α' -*t*-butylsulfinyl ketone with aldehydes in the presence of SmI_2 had been studied, opening a stereoselective access to enantiomerically pure Reformatsky adduct 2-methyl-1,3-diol moieties, after the diastereoselective reduction of the resulting hydroxyl keto sulfoxide (Scheme 1. 8).¹⁵

¹⁵ a) Obringer, M.; Colobert, F.; Solladie', G. *Eur. J. Org. Chem.* **2006**, 1455-1467. b) Obringer, M.; Colobert, F.; Neugnot, B.; Solladie', G. *Org. Lett.* **2003**, *5*, 629-632. c) F. Colobert, S. Choppin, L. Ferreiro-Mederos, M. Obringer, S. Luengo-Arratta, A. Urbano, M. C. Carreño, *Org. Lett.* **2007**, *9*, 4451-4454.

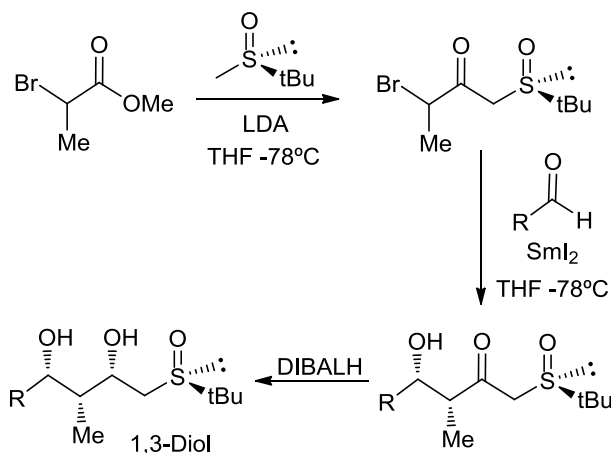

Scheme 1. 8

The short and efficient access to such highly substituted fragments prompted us to check the behavior of fluorinated substrates in such reactions. Nowadays there is a huge interest in fluorinated molecules due to their significant place in pharmaceutical/ medicinal,^{16,17} agrochemical,^{16,18} and material sciences.^{16,19} The unique properties of the fluorine atom is in the origin of this interest because the introduction of a fluorine atom can modulate the properties of a bioactive molecule since this may lead to changes in solubility, lipophilicity, metabolic stability, conformation, hydrogen-bonding ability, or chemical reactivity. As a result, many agrochemicals and pharmaceuticals on the market contain fluorine.²⁰ The impressive development, during the last 20 years, of synthetic methodologies in organic fluorine chemistry and the increasing understanding of the impact of fluorination on biological properties of a molecule have facilitated the design and synthesis of structurally diverse and sophisticated drug candidates. As part of these

¹⁶ T. Hiyama, in *Organofluorine Compounds: Chemistry and Applications*, ed. H. Yamamoto, Springer-Verlag, Berlin, **2000**.

¹⁷ Reviews: J.-P. Be'gue' and D. Bonnet-Delphon, *J. Fluorine Chem.*, **2006**, *127*, 992; K. L. Kirk, *J. Fluorine Chem.*, **2006**, *127*, 1013; K. Müller, C. Faeh and F. Diederich, *Science*, **2007**, *317*, 1881; L. Hunter, *Beilstein J. Org. Chem.*, **2010**; G. Landelle, M. Bergeron, M-O. Turcotte-Savard, J-P. Paquin, *Chem. Soc.Rev.* **2011**, 2867-2908.

W. K. Hagmann, *J. Med. Chem.*, **2008**, *51*, 4359; S. Purser, P. R. Moore, S. Swallow and V. Gouverneur, *Chem. Soc. Rev.*, **2008**, *37*, 320.

¹⁸ Review: P. Jeschke, *Chem. Bio. Chem.*, **2004**, *5*, 570.

¹⁹ Review: M. Pagliaro and R. Ciriminna, *J. Mater. Chem.*, **2005**, *15*, 4981.

²⁰ A. M. Thayer, *Chem. Eng. News*, **2006**, *84*, 15.

advances, many fluorinated analogues of natural compounds have been synthesized and investigated.

Taking into account possible future applications, we decided to carry out the reaction between the Lithium anion derived from methyl *p*-tolyl sulfoxide and methyl 3,3,3-trifluoro propanoate with this aim of synthesizing the fluorinated β -keto sulfoxide shown in Scheme 1. 9. The reaction cleanly evolved into a product which was characterized as methyl (*S,R,E*)-5-(*p*-tolylsulfinyl)-3-fluoro-2-propanoate.

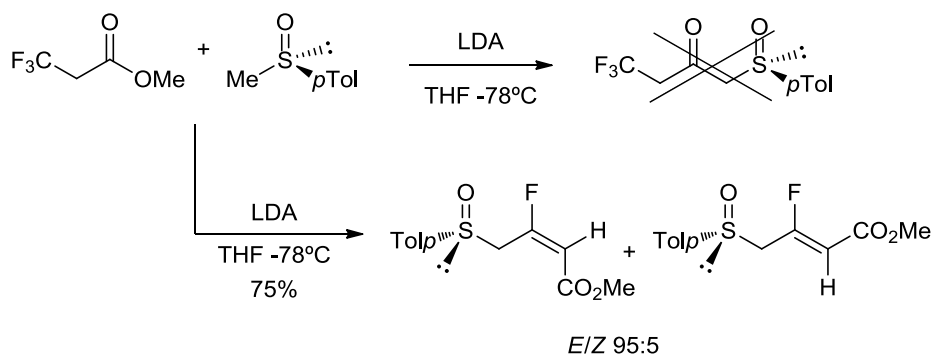

Scheme 1. 9

Within the various fluorinated derivatives known, monofluoroalkenes are of particular interest since they have potential applications in material sciences²¹ and in synthetic organic chemistry where they can be used as fluorinated synthons for further functionalization.²² In view of this interest, the second part of this thesis focused on the extension of this method to the synthesis of differently substituted monofluorinated olefins, following a similar reaction scheme, starting from alkyl 3,3,3-trifluoro propanoate and different lithium anions. Compounds shown in Scheme 1. 10 could be synthesized, using the nucleophile precursors indicated in Scheme 1. 10 (NuH).

²¹ For recent examples, see: a) F. Babudri, G. M. Farinola, F. Naso and R. Ragni, *Chem. Commun.*, **2007**, 1003; b) F. Babudri, A. Cardone, G. M. Farinola, C. Martinelli, R. Mendichi, F. Naso and M. Striccoli, *Eur. J. Org. Chem.*, **2008**, 1977.

²² a) G. Dutheuil, S. Couve-Bonnaire, X. Pannecoucke, *Angew. Chem., Int. Ed.*, **2007**, 46, 1290; b) P. Van der Veken, K. Senten, I. Kertesz, I. De Meester, A. M. Lambeir, M. B. Maes, S. Scharpe, A. Haemers, K. Augustyns, *J. Med. Chem.*, **2005**, 48, 1768; c) O. A. Wong and Y. A. Shi, *J. Org. Chem.*, **2009**, 74, 8377; d) G. Dutheuil, X. S. Lei, X. Pannecoucke, J. C. Quirion, *J. Org. Chem.*, **2005**, 70, 1911.

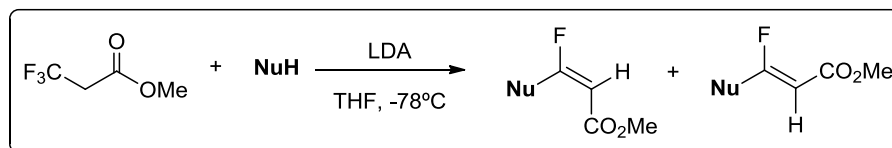

Nucleophile precursor: NuH

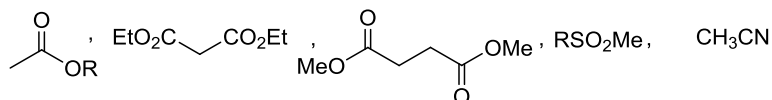

Monofluorinated olefins

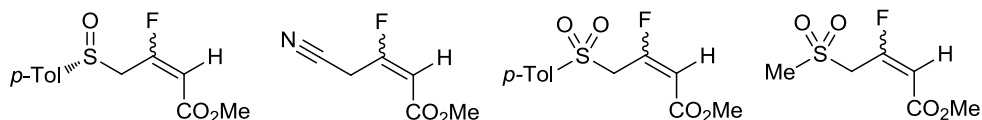

Scheme 1. 10

The reaction was also checked with Grignard reagents which had a similar behavior opening a direct stereoselective access to alkyl or aryl monofluorinated olefins (Scheme 1. 11).

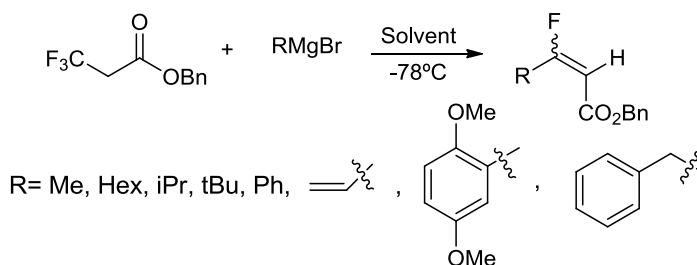

Scheme 1. 11

In the last chapter, the behavior of some of these olefins as dienophiles in Diels-Alder reactions with cyclopentadiene, chosen as a model diene, were studied.

CHAPTER II

ENANTIOSELECTIVE SYNTHESIS OF (S)- γ -CEHC, A NATURAL METABOLITE OF γ -TOCOPHEROL

I. STEREOSELECTIVE SYNTHESIS OF TETRAHYDROPYRANS (THP)

Stereoselective approaches to polysubstituted oxygen heterocycles continue to attract considerable attention due to the widespread appearance of these structural motifs in a large number of biologically active natural compounds, including structurally complex ionophore antibiotics,²³ marine macrolides,²⁴ brevetoxins,²⁵ and other polycyclic ethers.²⁶ Among the problems encountered when dealing with the synthesis of these structures, the stereoselective construction of tri- or tetrasubstituted tetrahydrofurans (THF) and tetrahydropyrans (THP) is one of the most challenging tasks that has been resolved using different strategies.²⁷

Apart from THP and THF rings, different membered cyclic ethers appear frequently in the skeleton of natural products. A representative structure of them is brevetoxine B, a marine neurotoxic polyether, isolated by K. Nakanishi and J. Clardy in 1981.²⁸ Since then, synthetic efforts had led to report a number of methods to

²³ a) Faul, M. M.; Huff, B. E. *Chem. Rev.* **2000**, *100*, 2407-2474. b) Shimizu, Y. *Chem. Rev.* **1993**, *93*, 1685-1698.

²⁴ Yeung, K.-S.; Paterson, I. *Chem. Rev.* **2005**, *105*, 4237-4313.

²⁵ Tanaka, T. *Chem. Rev.* **2005**, *105*, 4314-4347.

²⁶ a) Kang, E. J.; Lee, E. *Chem. Rev.* **2005**, *105*, 4348-4378. b) Inoue, M. *Chem. Rev.* **2005**, *105*, 4379-4405.

²⁷ For reviews, see: a) Wolfe, J. P.; Hay, M. B. *Tetrahedron* **2007**, *63*, 261-290. b) Wolfe, J. P. *Eur. J. Org. Chem.* **2007**, 571-582. c) Shindo, M. *Top. Heterocycl. Chem.* **2006**, 179-254. d) Clarke, P. A.; Santos, S. *Eur. J. Org. Chem.* **2006**, 2045-2053. e) Elliot, M. C. *J. Chem. Soc., Perkin Trans. 1* **2002**, 2301-2323 and earlier reviews in the same series. f) Norcross, R. D.; Paterson, I. *Chem. Rev.* **1995**, *95*, 2041-2114. g) Biovin, T. L. B. *Tetrahedron* **1987**, *43*, 3309-3362. Recent references on tetrahydrofurans: h) Pan, J.; Zhang, W.; Zhang, J.; Lu, S. *Tetrahedron Lett.* **2007**, *48*, 2781-2785. i) Chavre, S. N.; Choo, H.; Cha, J. H.; Pae, A. N.; Choi, K. I.; Cho, Y. S. *Org. Lett.* **2006**, *8*, 3617-3619. j) Hay, M. B.; Wolfe, J. P. *Tetrahedron Lett.* **2006**, *47*, 2793-2796. k) Akindede, T.; Marsden, S. P.; Cumming, J. G. *Org. Lett.* **2005**, *7*, 3685-3688. l) Hodgson, D. M.; Le Strat, F.; Avery, T. D.; Donohue, A. C.; Brućkl, T. *J. Org. Chem.* **2004**, *69*, 8796-8803. m) Renaud, P.; Beaufils, F.; Feray, L.; Schenk, K. *Angew. Chem., Int. Ed.* **2003**, *42*, 4230-4233. n) Villar, F.; Kolly-Kovac, T.; Equey, O.; Renaud, P. *Chem. Eur. J.* **2003**, *9*, 1566-1577. Recent references on tetrahydropyrans: o) Tian, G.-Q.; Shi, M. *Org. Lett.* **2007**, *9*, 2405-2408. p) Song, Z.; Hsung, R. P. *Org. Lett.* **2007**, *9*, 2199-2202. q) Liu, F.; Loh, T.-P. *Org. Lett.* **2007**, *9*, 2063-2066. r) Biermann, U.; Lutzen, A.; Metzger, J. O. *Eur. J. Org. Chem.* **2006**, 2631-2637. s) Jarvis, P. J.; Kariuki, B. M.; Cox, L. R. *Org. Lett.* **2006**, *8*, 4649-4652. t) Banerjee, B.; Roy, S. C. *Eur. J. Org. Chem.* **2006**, 489-497. u) Kataoka, K.; Ode, Y.; Matsumoto, M.; Nokami, J. *Tetrahedron* **2006**, *62*, 2471-2483. v) Bolla, M. L.; Patterson, B.; Rychnovsky, S. D. *J. Am. Chem. Soc.* **2005**, *127*, 16044-16045. w) Dubost, C.; Marko, I. E.; Bryans, J. *Tetrahedron Lett.* **2005**, *46*, 4005-4009.

²⁸ Lin, Y.-Y.; Risk, M.; Ray, S. M.; Van Engen, D.; Clardy, J.; Golik, J.; James, J. C.; Nakanishi, K. *J. Am. Chem. Soc.* **1981**, *103*, 6773.

synthesize not only the cyclic ether moiety, but also the polycyclic structures.^{29,30} The first total synthesis of brevetoxin was accomplished by K. C. Nicolaou in 1995 (Figure 2. 1).³¹

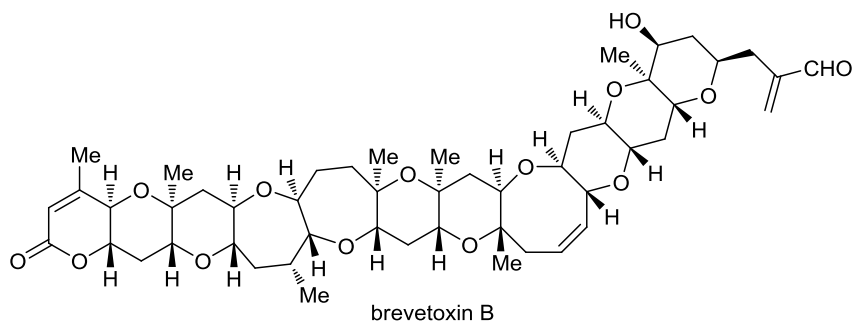

Figure 2. 1

The synthetic approaches reported to access to oxygenated heterocycles can be classified into two categories. The first strategy consists in the modification of a preexistent cyclic structure by cyclic ether expansion,³² by transformation of a lactone,³³ lactol and derivatives,³⁴ ketals³⁵ or spiranic compounds³⁶ reduction, or by a seul sugar transformation of sugars.³⁷ The second strategy is the most frequently used, based in intramolecular cyclization of an open structure generating C-C bond or C-O bond through a concerted mechanism to control the stereochemistry.

²⁹ Reviews of synthesis of natural marine polyethers: a) Alvarez, E.; Candenas, M.-L.; Perez, R.; Ravelo, J. L.; Martin, J. D. *Chem. Rev.* **1995**, *95*, 1953. b) Faul, M.M.; Huff, B.E. *Chem. Rev.* **2000**, *100*, 2407. c) Marmsäter, F. P.; West, F. G. *Chem. Eur. J.* **2002**, *8*, 4346. d) Fujiwara, K.; Murai, A. *Bull. Chem. Soc. Jpn.* **2004**, *77*, 2129. e) Nakata, T. *Chem. Rev.* **2005**, *105*, 4314. f) Inoue, M. *Chem. Rev.* **2005**, *105*, 4379. g) Sasaki, M. *Bull. Chem. Soc. Jpn.* **2007**, *80*, 856. h) Fuwa, H.; Sasaki, M. *Curr. Opin. Drug Discovery Dev.* **2007**, *10*, 784. i) Sasaki, M.; Fuwa, H. *Nat. Prod. Rep.* **2008**, *25*, 401. j) Nicolaou, K. C.; Frederick, M. O.; Aversa, R. J. *Angew. Chem. Int. Ed.* **2008**, *47*, 7182.

³⁰ Reviews of synthesis of cyclic ethers: a) Clarke, P. A.; Santos, S. *Eur. J. Org. Chem.* **2006**, 2045. b) Elliott, M. C. *J. Chem. Soc., Perkin Trans. 1*, **1998**, 4175. c) Elliott, M.C. *J. Chem. Soc., Perkin Trans. 1*, **2000**, 1291. d) Elliott, M.C.; Williams, E. J. *J. Chem. Soc., Perkin Trans. 1*, **2001**, 2303. d) Elliott, M. C. *J. Chem. Soc., Perkin Trans. 1*, **2002**, 2301.

³¹ Nicolaou, K. C.; Rutjes, F. P. J. T.; Theodorakis, E. A.; Tiebes, J.; Sato, M.; Untersteller, E. *J. Am. Chem. Soc.* **1995**, *117*, 1173.

³² a) Michel, J. P.; Ting, P. C.; Barlett, P. A. *J. Org. Chem.* **1985**, *50*, 2416. b) Nakata, T.; Schmid, G.; Vranesic, B.; Okigawa, M.; Smith-Palmer, T.; Kishi, Y. *J. Am. Chem. Soc.* **1978**, *100*, 2933.

³³ Evans, D. A.; Cee, V. J.; Smith, T. E.; Fitch, D. M.; Cho, P. S. *Angew. Chem. Int. Ed.* **2000**, *39*, 2533.

³⁴ Gartzten, O.; Misske, A. M.; Wolbers, P.; Hoffmann, H. M. R. *Synlett* **1999**, 1041.

³⁵ Kotsuki, H. *Synlett*, **1992**, 97 and references therein.

³⁶ Crimmins, M. T.; Rafferty, S. W. *Tetrahedron Lett.* **1996**, *37*, 5649.

³⁷ Hanessian, S.; *Total Synthesis of Natural Products: The Chiron Approach*, Ed. J. E. Baldwin, Pergamon, Oxford, **1983**, 291.

The synthetic methodologies developed for the preparation of different substituted tetrahydropyrans will be summarized in the following section, focusing in those based in the formation of C-O bond. Due to the wide number of synthesis published, the examples shown focused on the methods based on the cyclization forming the C-O bond through an OH nucleophilic addition to an electrophilic center. Other methods such as Prins cyclization,³⁸ radicalic cyclizations³⁹ or metathesis reactions⁴⁰ where a C-C bond is formed during the construction of the ring will not be included. Concerted procedures such as hetero Diels-Alder reactions⁴¹ or other methods described in the literature⁶⁵ will neither be mentioned.

I.1. INTRAMOLECULAR CYCLIZATION BY C-O BOND FORMATION

I.1.1. Intramolecular cyclization by epoxide opening

In 1981, K. C. Nicolau prepared one of the tetrahydropyran rings through the intramolecular epoxide opening by a hydroxy group under acid catalysis.⁴² In 1985, he described a more general method to prepare THP and THF structures based on the activation of 6-*endo* over 5-*exo* hydroxy epoxide opening.

The presence of an electron-rich double bond at a remote position from the hydroxy group helped the regiocontrolled opening of epoxide to the exclusive formation of the 6-*endo* cyclic product (pathway a). As shown in Scheme 2. 1, the π -orbital of the double bond, placed adjacent to the epoxide unit, acts as an activator of the C-O bond adjacent to it, stabilizing the δ^+ at the carbon "a" in the transition state **A**, which then proceeds to cleavage selectively and *endo* ring

³⁸ a) Arundale, E.; Mikeska, L. A. *Chem. Rev.* **1952**, *51*, 505. b) Adams, D. R.; Bhatnagar, S. P. *Synthesis*, **1977**, 661. c) Snider, B. B. in *Comprehensive Organic Synthesis*, ed. B. M. Trost, Pergamon Press, New York, **1991**, vol. 2, p. 527. d) Elsworth, J. D.; Willis, C. L. *Chem. Commun.* **2008**, 1587.

³⁹ Lee, E.; Choi, S. J.; Kim, H.; Han, H. O.; Kim, Y. K.; Min, S. J.; Son, S. H.; Lim, S. M.; Jang, W. S. *Angew. Chem. Int. Ed.* **2002**, *41*, 176.

⁴⁰ Basu, S.; Waldmann, H. *J. Org. Chem.* **2006**, *71*, 3977.

⁴¹ a) Lucas, B. S.; Luther, L. M.; Burke, S. D. *J. Org. Chem.* **2005**, *70*, 3757. b) Paterson, I.; Luckhurst, C. A. *Tetrahedron Lett.* **2003**, *44*, 3749.

⁴² a) Nicolaou, K. C.; Papahatjis, D. P.; Claremon, D. A.; Dole, R. E. *J. Am. Chem. Soc.* **1981**, *103*, 6967. b) Nicolaou, K. C.; Duggan, M. E.; Hwang, C. -K.; Somers, P. K. *J. Chem. Soc. Chem. Commun.* **1985**, 1359. c) Nicolaou, K. C.; Prasad, C. V. C.; Somers, P. K.; Hawang, C. -K. *J. Am. Chem. Soc.* **1989**, *111*, 5330.

closure. The alternative pathway b of *exo* ring closure to form a tetrahydropyran, leading to the smaller five membered ring **1** of compound (THF system), and proceeding via transition state **B** in which the incipient positive charge would accumulate on carbon “b”, was less favorable. This method has been used by a wide number of research groups to synthesize tetrahydropyran systems.⁴³

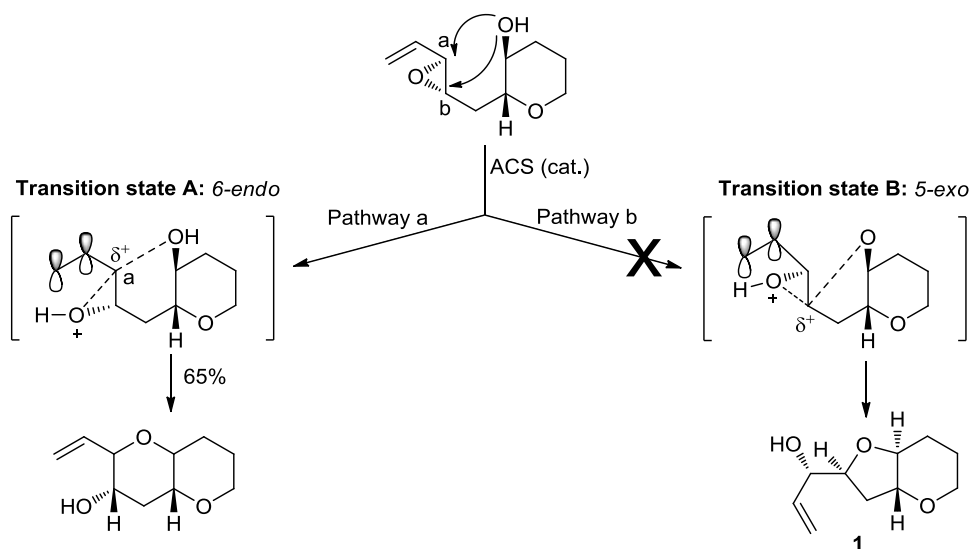

Scheme 2. 1

More than 20 years ago, Nakanishi put forth the hypothesis that the transformation of a polyepoxide into a ladder polyether structure could occur via a series or “cascade” of epoxide-opening events.⁴⁴ In 2007, T. F. Jamison described the epoxide-opening cascades promoted by water⁴⁵ based in this hypothesis. Polyene **2** was thus submitted to Shi epoxidation conditions in presence of Oxone[®] to give the corresponding polyepoxide **3**. The hydroxy group attached to the THP ring in this polyepoxide derivate, initially protected as TBS ether, incited a series of epoxide opening in water leading the polyether **4** (Scheme 2. 2).

⁴³ Smith III, A. B.; Jurica, J. A.; Walsh, S. P. *Org. Lett.* **2008**, *10*, 5625.

⁴⁴ Nakanishi, K. *Toxicon* **23** **1985**, 473.

⁴⁵ Vilotijevic, I.; Jamison, T. F. *Science* **2007**, *317*, 1189.

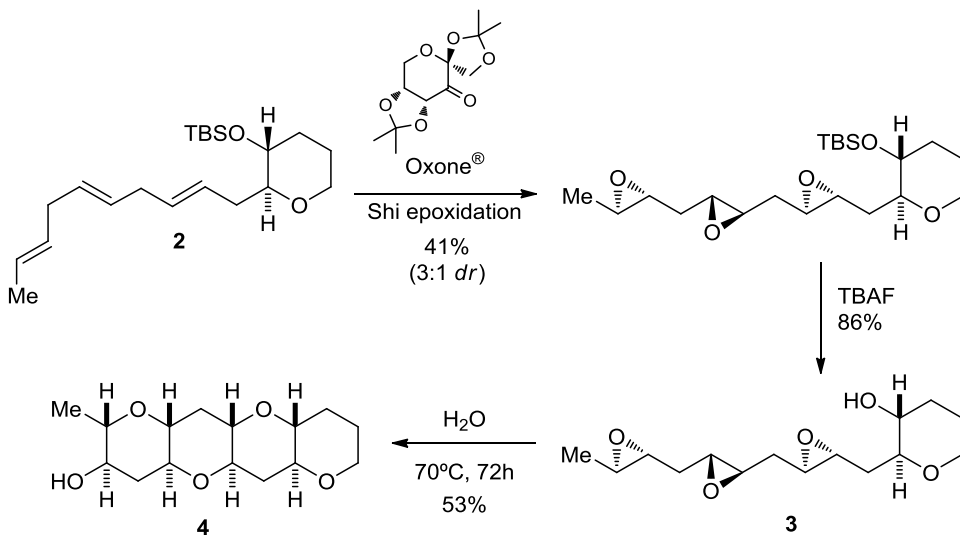

Scheme 2. 2

1.1.2. Intramolecular 1,5-dihydroxy cyclization

One of the most common methods reported to prepare tetrahydropyran systems is the S_N2 nucleophilic substitution of a halogen derivate or a synthetic equivalent by an alkoxide group. This intramolecular 1,5-dihydroxy cyclization needs the transformation of one of the hydroxy groups in a good leaving group, followed by acid or base catalyzed cyclization through a 6-*exo* process. According to the S_N2 mechanism, the transformation takes place with the retention of the configuration of the chiral center bearing the hydroxy group participating as a nucleophile in the process and with the inversion of the stereogenic center bearing the leaving group.

D. R. Williams used this method to synthesize the C1-C9 tetrahydropyranic unit of leucascandrolide A, a natural macrolide having anticancerous and antifungal properties. The formal synthesis of leucascandrolide A was published in 2003.⁴⁶ The

⁴⁶ a) Williams, D. R.; Clark, M. P.; Berliner, M. A. *Tetrahedron Lett.* **1999**, *63*, 2982. b) Williams, D. R.; Plummer, S. V., Patnaik, S. *Angew. Chem.* **2003**, *115*, 4064. Other examples: Ho, P-T. *Can. J. Chem.* **1982**, *60*, 90. Pattenden, G.; Plowright, A. T. *Tetrahedron Lett.* **2000**, *41*, 983.

transformation of hydroxy group present in **5** into a good leaving group such as tosyl derivate **6** and, after deprotection of the TBS group, whose cyclization occurred under treatment with NaH leading to the oxygenated cyclic system **7** in a 11:1 diastereomeric ratio, being the major isomer the *cis* product (Scheme 2. 3).

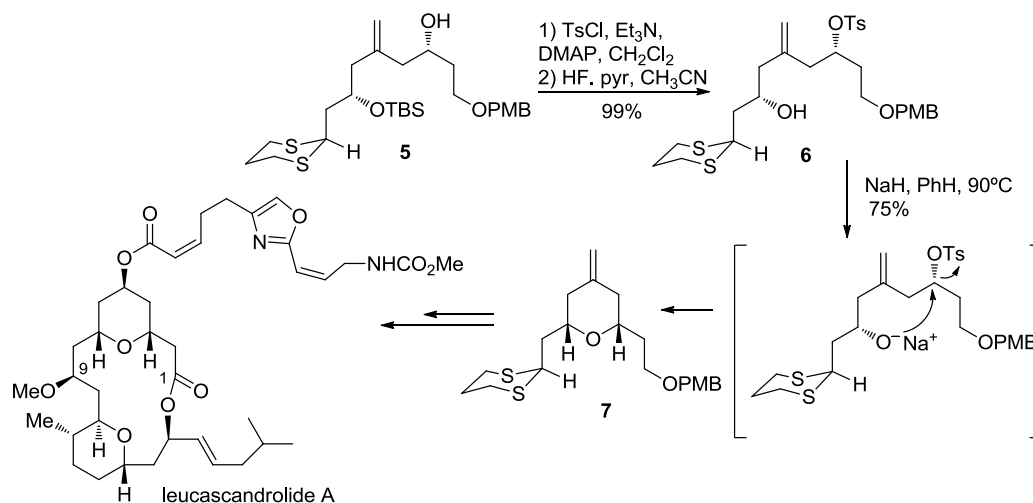

Scheme 2. 3

I.1.3. Intramolecular cyclization by hydroxyalkenes and hydroxyalkynes etherification

Hydroxyalkenes etherification

Intramolecular 1,4-addition of alcohols to electrophilic olefins is one of the most efficient methods to prepare tetrahydropyrans. Thus, the cyclization from hydroxyalkenes can be carried out with Michael acceptors^{79,80} or alkenes activated by iodine⁶⁵ or by metals (Hg,⁴⁷ Pt,⁴⁸ Pd^{85,87}).

⁴⁷ Petri, A. F.; Bayer, A.; Maier, E. *Angew. Chem. Int. Ed.* **2004**, *43*, 5821.

The conjugate intramolecular addition of the alkoxide to the α,β -unsaturated ester **8** led mostly to 2,6-*cis*-disubstituted tetrahydropyran **10** in a high selectivity which can be explained by the chair type transition state **9** represented where the hydrogen in the β position of the ester is in axial position on the most bulky group in equatorial position leading to the most stable transition state (Scheme 2. 4).

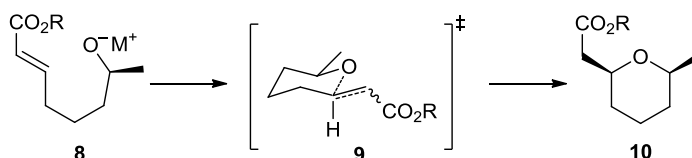

Scheme 2. 4

S.H. Kang applied this methodology in the synthesis of the tetrahydropyran B moiety of the (+)-lasonolide A **11** (Scheme 2. 5).⁴⁹

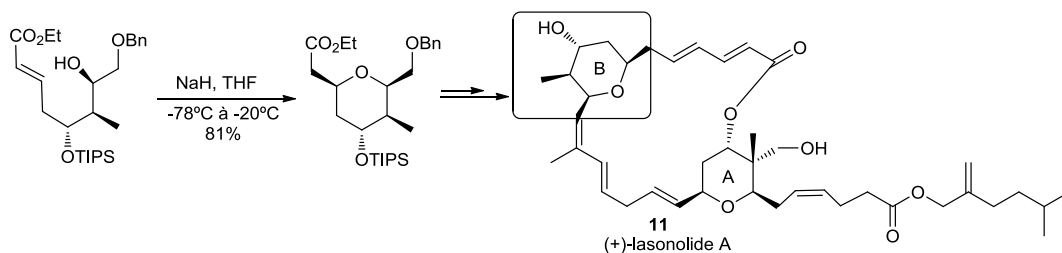

Scheme 2. 5

2,6-Substituted tetrahydropyrans can also be prepared by etherification of allylic or homolallylic alcohols by Palladium catalysis. J. L. Leighton used also the Pd catalyst Semmelhack alkoxyacylation⁵⁰ of an olefin to prepare the 2,6-disubstituted THP B unit of leucascandrolide A **14**.⁵¹ The reaction was carried out with diol **12** to give the 2,6-*cis*-disubstituted tetrahydropyran **13** in high diastereoselectivity. The reaction took place without protecting the hydroxy group at in C-9 (Scheme 2. 6).

⁴⁸ Qian, H.; Han, X.; Widenhoefer, R. A. *J. Am. Chem. Soc.* **2004**, *126*, 9536.

⁴⁹ Kang, S. H.; Kang, S. Y.; Kim, C. M.; Choi, H.; Jun, H. S.; Lee, B. M.; Park, C. M.; Jeong, J. W. *Angew. Chem. Int. Ed.* **2003**, *42*, 4779.

⁵⁰ Semmelhack, M. F.; Bodurow, C. *J. Am. Chem. Soc.* **1984**, *106*, 1496.

⁵¹ Hornberger, K. R.; Hamblett, C. L.; Leighton, J. L. *J. Am. Chem. Soc.* **2000**, *122*, 12894.

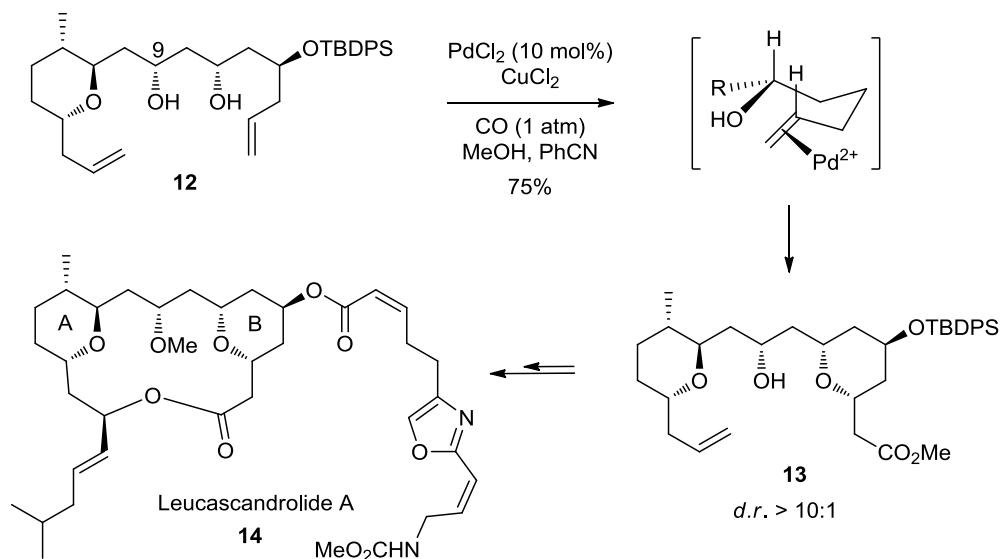

Scheme 2. 6

J. Uenishi described a stereospecific reaction catalyzed by palladium to obtain 2,6-*cis*-disubstituted THP.⁵² An intramolecular oxypalladation reaction took place with a 1,3 chiral transfer.

Thus, in presence of a catalytic amount of palladium (II), the diol **15** gave the tetrahydropyran **16** as the only diastereoisomer in good yield and in mild conditions (0°C in THF). Under these conditions, the formation of a new chiral center passed through a *syn*- $\text{S}_{\text{N}}2'$ stereospecific cyclization promoted by Pd (II) with a 6-*exo* ring closure. The mechanism involved the formation of π -allylic complex **A**, where the palladium is placed *syn* to the allylic hydroxy group. This complex is in equilibrium between **B** and **C** by ligand exchange in the hydroxy in position 4. The intramolecular nucleophilic addition *syn* to the electrophilic carbon gives the σ -PdCl-(OH) complex which generates the tetrahydropyran **16** after reductive elimination (Scheme 2. 7).

⁵² Kawai, N.; Lagrange, J. -M.; Ohmi, M.; Uenishi, J. *J. Org. Chem.* **2006**, *71*, 4530.

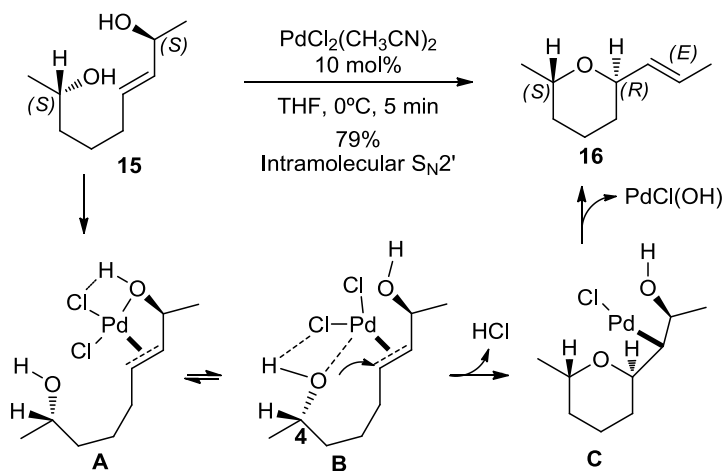

Scheme 2. 7

Hydroxyalkynes etherification

Trost *et al.* recently developed a tandem ruthenium-catalyzed redox isomerization-O-conjugate addition to synthesize THP rings.⁵³ They demonstrated that when Ru catalyst **18** was used in presence of a co-catalyst such as indium (III) triflate and camphorsulfonic acid, there was a redox isomerization of propargylic alcohols to enals or enones. This sequence can be applied towards the synthesis of tetrahydropyrans from the propargylic alcohols **17**. This method involves a second hydroxy group in the molecule which after isomerization leads to enal **20**, suffering a spontaneous cyclization to give cyclic ether **21** by a 1,4-conjugate addition (Scheme 2. 8).

⁵³ Trost, B. M.; Gutierrez, A. C.; Livingston, R. C. *Org. Lett.* **2009**, *11*, 2539.

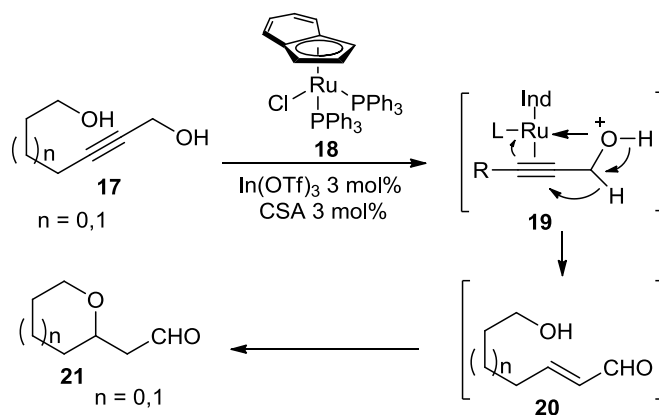

The 2,6-*cis*-disubstituted tetrahydropyran **23** was obtained in excellent diastereoselectivity, starting from an enantiomerically pure propargylic alcohol **22** (Scheme 2. 9).

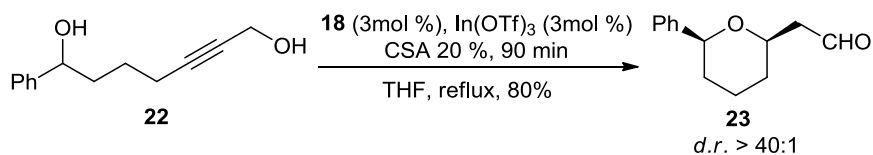

I.1.4. Reductive cyclization of hydroxyketones

In 1987, G. A. Olah described the synthesis of dissymmetric acyclic ethers by carbonyl reductive coupling with trialkyl silanes hydrides catalyzed by trimethyl silyl triflate.⁵⁴ Later on, K. C. Nicolau applied the same methodology to prepare oxepane

⁵⁴ Sassaman, M. B.; Kotian, K. D.; Surya Prakash, G. K.; Olah, G. A. *J. Org. Chem.* **1987**, *52*, 4314.

derivates in excellent yields.⁵⁵ This process involved the intramolecular addition of a hydroxy group to a carbonyl in presence of a reductive agent, Et₃SiH, and a catalyst, trimethyl silyl triflate. Thus, 7-phenyl-7-hydroxy-2-heptanone **24** was transformed into the racemic oxepane **25**. The stereoselectivity of this transformation was notoriously high, since *cis*-disubstituted derivate was obtained in excellent diastereoselectivity (Scheme 2. 10).

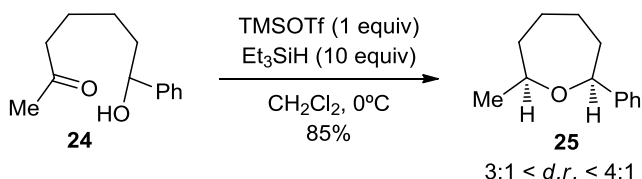

Scheme 2. 10

A year later, P. A. Evans used this method to the synthesis of the same natural product, (-)-Centrolobine **29** a natural product which has a 2,6-disubstituted THP skeleton, using BiBr₃ as Lewis acid. The precursor acyclic chiral alcohol **27** was prepared by enantioselective allylation of the aldehyde **26** with allyltributyl tin in presence of Ti(OPr)₄ and BINOL. The reductive cyclization was carried out with the silyl ether **28** in the presence of Et₃SiH and BiBr₃ (Scheme 2. 11).⁵⁶

⁵⁵ a) Nicolaou, K. C.; Hwang, C. K.; Nugiel, D. A. *J. Am. Chem. Soc.* **1989**, *111*, 4136 b) Nicolaou, K. C.; Hwang, C. K.; Duggan, M. E.; Nugiel, D. A.; Abe, Y.; Bal Reddy, K.; DeFrees, S. A.; Reddy, D. R.; Awartani, R. A.; Conley, S. R.; Rutjes, F. P. J. T.; Theodoraski, E. A. *J. Am. Chem. Soc.* **1995**, *117*, 10227.

⁵⁶ Evans, P. A.; Cui, J.; Gharpure, S. J. *Org. Lett.* **2003**, *5*, 3883.

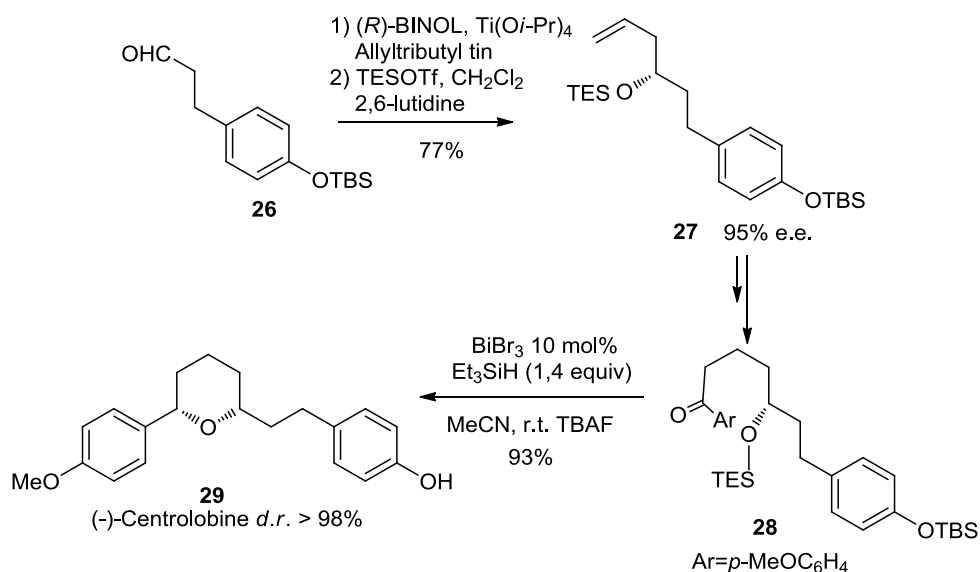

Scheme 2. 11

Due to the high *syn* selectivity of this reaction, it has been widely used in the synthesis of cyclic polyethers. Therefore, K. Sato used TMSOTf as Lewis acid to prepare the polytetrahydropyran **31** in total selectivity from the hydroxyketone **30** (Scheme 2. 12).⁵⁷

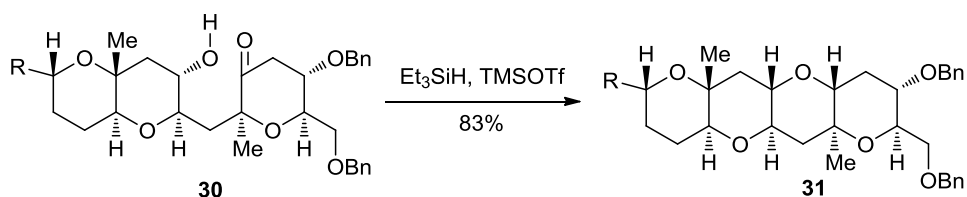

Scheme 2. 12

⁵⁷ Sato, K. ; Sasaki, M.; *Tetrahedron*, **2007**, *63*, 5977

I.2. BACKGROUND OF RESEARCH GROUP

In this context, our research group has recently was the first to apply the $\text{Et}_3\text{SiH/TMSOTf}$ methodology to the reductive cyclization of enantiopure hydroxy ketones and complete the synthesis of cyclic 2, ω -*cis*-disubstituted cyclic ethers of different size, **37** and **38**, (Figure 2. 2). The method relied on the use of enantiopure sulfoxide as source of chirality to obtain the hydroxy group which directed the cyclization.^{3,4,5,6,7a,15c} In turn, the enantiomerically pure β -hydroxy sulfoxides **33** and **34** were available by diastereoselective reduction of the corresponding β -keto sulfoxides **32** with DIBAL-H or DIBAL-H in the presence of a Lewis acid. The β -keto sulfoxides **32** could be prepared from acyclic esters or cyclic anhydrides in presence of the lithium anion derived from methyl-*p*-tolylsulfoxide (Scheme 2. 13).

Once the diastereomerically pure β -hydroxy sulfoxides **33** and **34** were obtained, the remaining ester group was transformed in the Weinreb amide to further control the addition of a Grignard reagent giving a ketone. Compounds **35** and **36** were submitted to reductive cyclization in presence of Et_3SiH and TMSOTf to give the *cis*-disubstituted cyclic ethers of different size, **37** and **38**, in excellent diastereoselectivities (Scheme 2. 13).

³ F. Colobert, M. C. Carreño, R. Des Mazery G. Solladié, *Org. Lett.* **2002**, *4*, 1723-1725

⁴ M. C. Carreño, R. Des Mazery, A. Urbano, F. Colobert, G. Solladié, *J. Org. Chem.* **2003**, *68*, 7779-7787

⁵ M. C. Carreño, R. Des Mazery, A. Urbano, F. Colobert, G. Solladié, *Org. Lett.* **2004**, *6*, 297-299

⁶ M. C. Carreño, R. Des Mazery, A. Urbano, F. Colobert, G. Solladié, *Org. Lett.* **2005**, *7*, 2039-2042

⁷ a) M. C. Carreño, G. Hernández-Torres, A. Urbano, F. Colobert, *Org. Lett.* **2005**, *7*, 5517-5520.

^{15c} F. Colobert, S. Chopin, L. Ferreiro-Mederos, M. Obringer, S. Luengo-Arratta, A. Urbano, M. C. Carreño, *Org. Lett.* **2007**, *9*, 4451-4454.

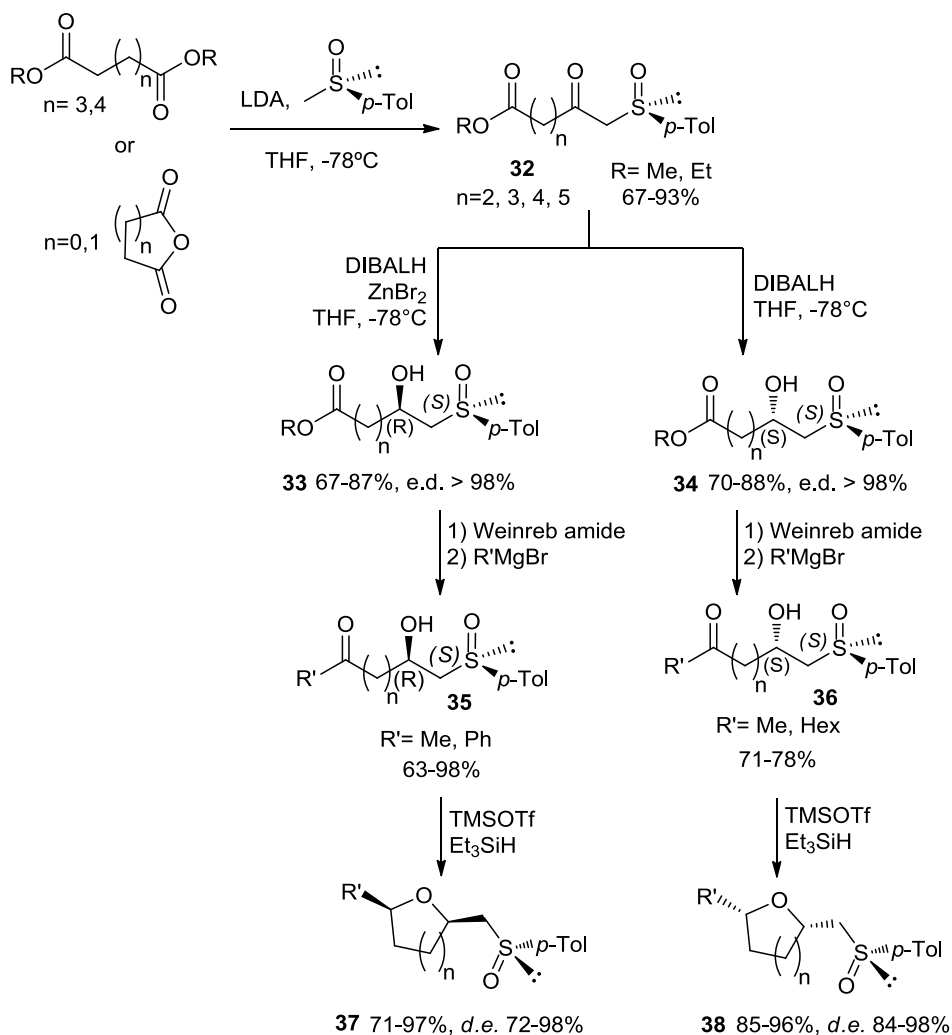

Scheme 2. 13

This methodology has been applied to the synthesis of different natural oxygenated THP derivatives. The total synthesis of (-)-centrolobine and of (+)-(*S,S*)-**39**, the natural enantiomer of glandular secretion of civet kat (*V. civetta*) used in perfumes, have been realized using this methodology in the key step.

Other cyclic ethers have been successfully prepared with this methodology (+)-Goniothalesdiol,⁷ a tetrahydrofuran derivative was obtained from (-)-*D*-

⁷a) M. C. Carreño, G. Hernández-Torres, A. Urbano, F. Colobert, *Org. Lett.* **2005**, *7*, 5517–5520. b) G. Hernández-Torres M. C. Carreño, A. Urbano, F. Colobert, *Chem. Eur. J.* **2011**, *17*, 1283 – 1293.

dimethylttrate, a 2,7-*cis*-disubstituted oxepane derivatives such as (+)-isolaurepane⁵ and the two enantiomers of *cis*-lauthisan **40** and **41**,⁶ were also enantioselectively synthesized (Figure 2. 2).

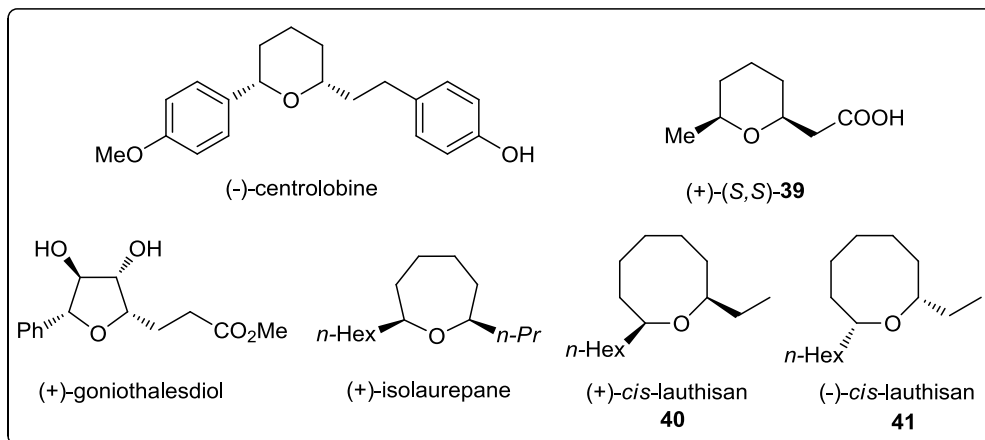
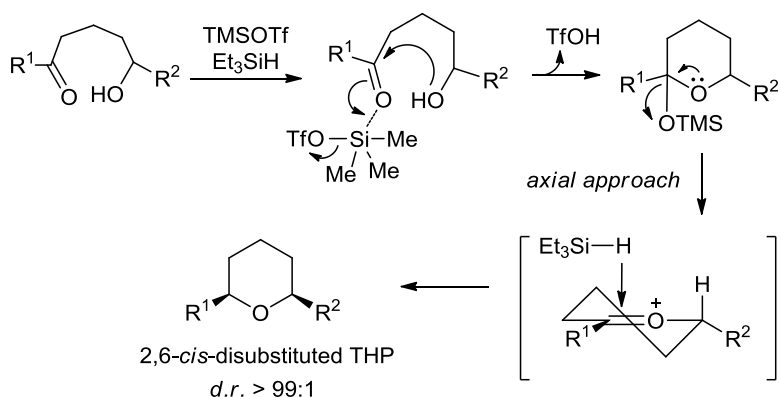

Figure 2. 2

The mechanism of this cyclization is shown in Scheme 2. 14. Thus, carbonyl group activation by TMSOTf favors the intramolecular nucleophilic addition by the hydroxy group. The axial attack of Et₃SiH to the oxocarbenium intermediate led to 2,6-*cis*-disubstituted THPs in a highly stereocontrolled way (Scheme 2. 14).

⁵ M. C. Carreño, R. Des Mazery, A. Urbano, F. Colobert, G. Solladié, *Org. Lett.* **2004**, *6*, 297–299.

⁶ M. C. Carreño, R. Des Mazery, A. Urbano, F. Colobert, G. Solladié, *Org. Lett.* **2005**, *7*, 2039–2042.



Scheme 2. 14

In these syntheses the enantiopure sulfoxide was controlling the absolute configuration of β -hydroxylic center, which in turn, was directing the stereochemical course of the reductive cyclization step.

This asymmetric strategy to cyclic ethers was later shown to be monitored by a sulfoxide in the construction of 3,4-dihydro-2*H*-1-benzopyrans (2*H*-chromans). In this case, sulfoxides are the sole asymmetric function directly involved in the generation of the chiral heterocyclic moiety from a mixture of 2-sulfinylmethyl substituted 2-chromanols **43**, in equilibrium with the δ -(*o*-hydroxyphenyl)-substituted β -keto sulfoxide **42**. In presence of Et_3SiH (3 equiv), followed by addition of TMSOTf (2 equiv) in CH_2Cl_2 at 0°C , this mixture involved the rapid formation of 2*H*-chroman **44** in excellent diastereomeric ratios and good yields (Scheme 2. 15).

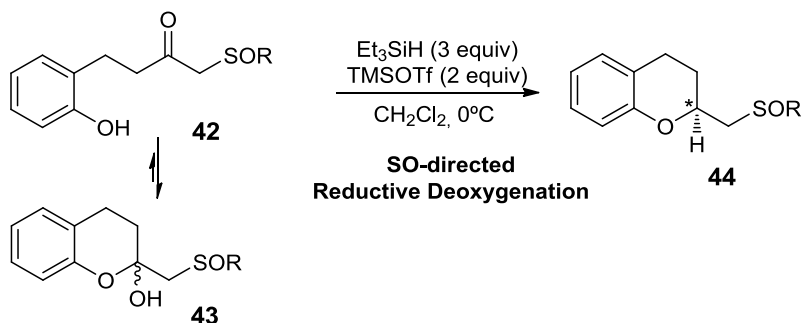

Scheme 2. 15

During the development of the work presented in this thesis, Dr. Hernandez Torres completed the synthesis of Nevibolol using this methodology as a key step.⁸

Taking into account these results, we thought to go further in the formation of cyclic ethers by reductive cyclization/deoxygenation of ω -hydroxy- β -keto sulfoxides. We thus decided to evaluate the possibility of using similar process in the synthesis of enantiopure lactones. We considered that a free carboxylic acid situated at the adequate distance from a β -keto sulfoxide could stereoselectively give an enantiopure lactone under reductive conditions. We thus envisaged the reaction shown in Scheme 2. 16 as a model in route to δ -lactones.

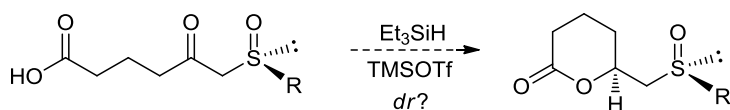

Scheme 2. 16

⁸ M. C. Carreño, G. Hernández-Torres, A. Urbano, F. Colobert, *Eur. J. Org. Chem.* **2008**, 2035–2038.

I.3. RESULTS AND DISCUSSION

I.3.1. Approach to the synthesis of 6-substituted-6-(*p*-tolylsulfinyl)methyl tetrahydro-2*H*-pyran-2-ones:

This part of the work corresponds to the reach for a short stereoselective access to lactones by reductive desoxygenation of hydroxyderivate **48**. The precursor (*SR*)-6-(*p*-tolylsulfinyl)methyl-5-oxohexanoic acid **47** we needed to check this direct route to a δ -lactone was easily available from glutaric anhydride by reaction with the lithium anion derived from the enantiopure (*SR*)-methyl-*p*-tolylsulfoxide **46**.

Thus, following the method described by P. Bravo,⁵⁸ this lithium anion was prepared from (*SR*)-methyl-*p*-tolylsulfoxide **46** (2 equiv) in presence of lithium diethylamide (LDA, 2.15 equiv) in THF at -78°C and added to a solution of glutamic anhydride (1 equiv) in THF at -78°C. The (*SR*)-6-(*p*-tolylsulfinyl)methyl-5-oxohexanoic acid **47** was obtained in 95% yield after flash chromatography as a 80:20 *dr* mixture of the β -keto sulfoxide acid open structure (*SR*)-6-(*p*-tolylsulfinyl)methyl-5-oxohexanoic acid **47** as the major product and the cyclic hemiketal, 6-hydroxy-6-(*p*-tolylsulfinyl)methyl tetrahydro-2*H*-pyran-2-one **48**, which was characterized as a C-6 diastereomeric mixture (Scheme 2. 17).

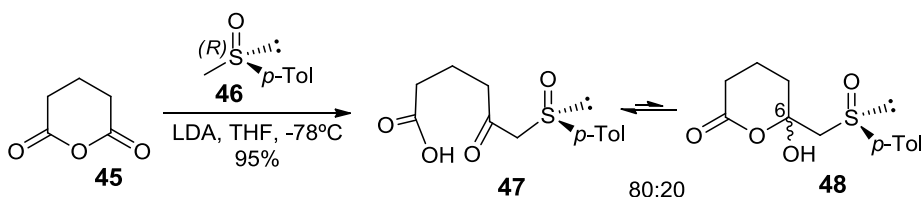

Scheme 2. 17

Thus, (*SR*)-6-(*p*-tolylsulfinyl)methyl-5-oxohexanoic acid **47** was submitted to reductive cyclization conditions ($\text{Et}_3\text{SiH/TMSOTf}$ in CH_2Cl_2) as shown in Table 2. 1. The mixture of (*SR*)-6-(*p*-tolylsulfinyl)methyl-5-oxohexanoic acid **47** and the cyclic hemiketal, 6-hydroxy-6-(*p*-tolylsulfinyl)methyl tetrahydro-2*H*-pyran-2-one **48** in

⁵⁸ Bravo, P.; Resnati, G. *Tetrahedron Lett.* **1985**, *26*, 5601.

0.35M reacted with 5 equivalents of Et_3SiH and 1.3 equivalents TMSOTf as Lewis acid during 5h at 0°C and 20h at room temperature. Under these conditions, 6-((methylsulfinyl)methyl)tetrahydro-2*H*-pyran-2-one **49** was obtained in a 70:30 *dr* mixture in only 20% yield (entry 1). When the reaction was carried out during 50h at 0°C the yield was even lower (10%) probably due to decomposition of the final product (entry 2). The dilution of the reaction mixture to 0.1M under same conditions led to the final product as expected but in traces (entry 3). Increasing the equivalents of TMSOTf to 2.5 equivalents did not lead to better results, the diastereoselectivity was poor (62:38) and the final product was observed in traces (entry 4). When the temperature increased to 40°C under same conditions, the diastereoselectivity slightly increased to 80:20 *dr*, but the yield was still very poor (entry 5). The use of 3 equivalents of Et_3SiH and 1.3 equivalents of TMSOTf at reflux for 3 h did not increase the yield (entry 6).

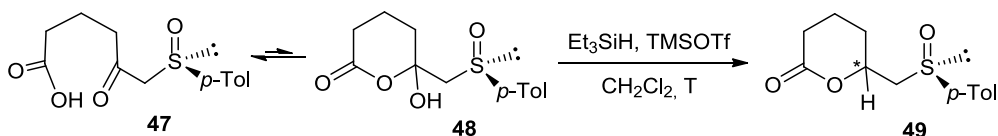

Entry	Et_3SiH	TMSOTf	Conc [M]	$^\circ\text{C}$ (time)	<i>d.r.</i>	Yield
1	5 equiv	1.3 equiv	0.35 M	0°C (5h) r.t. (20h)	70:30	20%
2			0.35 M	0°C (50h)		10%
3			0.1 M	0°C (24h) r.t. (20h)		traces
4		2.5 equiv	0.1 M	0°C (7h) r.t. (20h)	62:38	traces
5		2.5 equiv	0.35 M	40°C (3h)	80:20	17%
6		3 equiv	1.3 equiv	0.35 M	reflux (3h)	80:20

Table 2. 1

Other Lewis acids such as $\text{BF}_3\cdot\text{OEt}_2$ or TiCl_4 were tested under same reaction conditions but the desired product **49** was never observed.

Since the equilibrium between the open and closed hemiketal structure of the starting acid **47** was confirmed, the OH hemiketalic was protected to avoid the

shift of the equilibrium to the open chain form under the reaction conditions. Therefore the mixture of **47** and **48** was treated trimethyl orthoformate in methanol and catalytic amounts of *p*-toluensulfonic acid at 0°C. 6-(Methoxy-(*SR*)-6-(*p*-tolylsulfinyl)methyl tetrahydro-2*H*-pyran-2-one **50** was thus obtained in 60% yield, as an equimolecular mixture of diastereoisomers at C-6 of the pyranone (Scheme 2. 18).

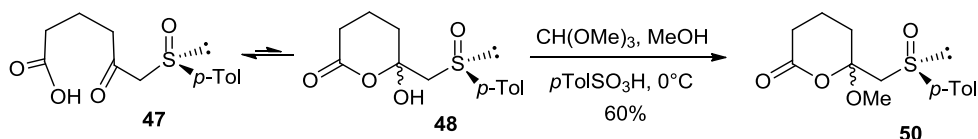

Scheme 2. 18

With the methoxy sulfinyl pyranone **50** in hand, reductive cyclization reaction conditions were tested. Treatment of compound **50** with 5 equivalents of Et_3SiH and 1.5 equivalents of TMSOTf in CH_2Cl_2 at 0°C and then leading the mixture to reach room temperature overnight, did not lead to the desired results (Scheme 2. 19). In all of the experiments we carried out, the starting material was recovered unchanged.

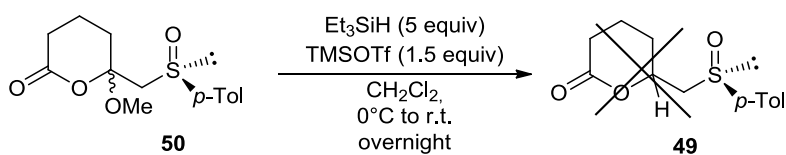

Scheme 2. 19

Different trials changing the conditions, mainly the number of equivalents of reactants and the temperature were made in order to achieve the formation of compound **49** without success.

A possible mechanism for this reaction is shown in Scheme 2. 20, the formation of compound **49** could result from the nucleophilic attack of the carboxylic acid to the carbonyl group of **47** previously activated by the TMSOTf, acting as a Lewis acid. After elimination of the TMSO group in the resulting product **A**, the oxocarbenium ion intermediate **B** must be attacked by Et_3SiH to give the

final lactone. Probably, the first step was difficulted due to the lower nucleophilicity of the acidic hydroxy group and the low stability of the oxocarbenium intermediate **B** which has in α -position a carbonyl group.

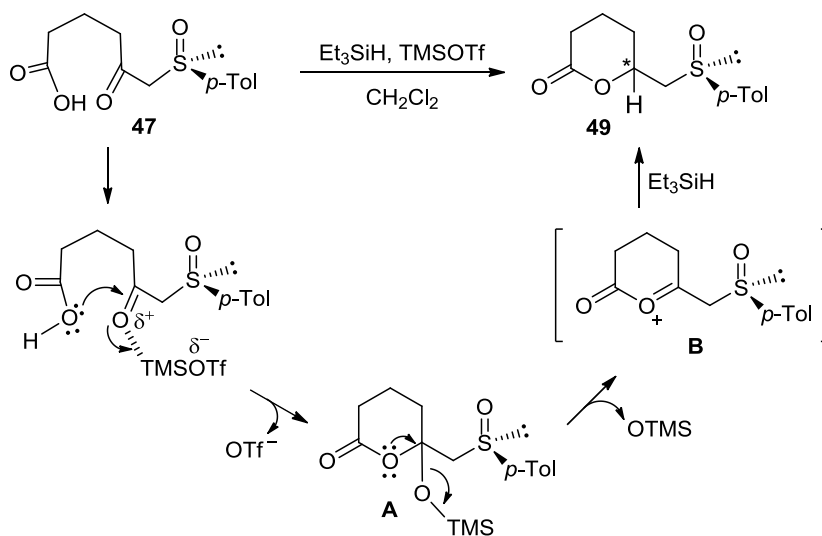

Scheme 2. 20

In view of the impossibility of obtaining compound **49** in a good yield, we decided to change our targets focusing on the stereoselective synthesis of benzopyran derivatives related to the synthesis of compounds of the family of vitamin E and their metabolites.

II. STEREOSELECTIVE SYNTHESIS OF 2,2-DISUBSTITUTED CHROMANS

II.1. BIOLOGICAL PROPERTIES

The chiral dihydrobenzopyran (chroman) moiety is the core of the structure of numerous natural products and synthetic analogs (Figure 2. 3) which present an extensive array of biological activities. As such, chiral chroman small molecules have played an important role in various therapeutic areas including cardiovascular diseases, diabetes, obesity, hypertension, cancer, central nerve system and endocrine disorders as well as infectious diseases. The most well-known chiral chromans are the vitamin E family, whose most significant members are α , β and γ -tocopherol (**51**, **52** and **53**). These compounds serve as natural lipophilic antioxidants and radical scavengers.⁵⁹ In addition, analogs of α -tocopherol (**51**), trolox (**54**)⁶⁰ and MDL-73404⁶¹ are believed to play a beneficial role against cardiovascular diseases due also to their antioxidant activity. In particular, MDL-73404 exhibits cardioprotective effects during a myocardial infarction.

Other chiral chromans have also displayed important biological properties. For example, visnadine (**56**)⁶² and nebivolol (**55**) have demonstrated vasodilatory or anti-hypertensive effects.⁶³ Enlitazone (**57**)⁶⁴ has been developed as clinical candidates to control the glucose level in diabetic patients. In the arena of infectious diseases, siccanin (**58**) is a potent antifungal drug;⁶⁵ Calanolides A (**59**) and B demonstrate excellent inhibition toward HIV-1 reverse transcriptase.⁶⁶ As an

⁵⁹ α -Tocopherol; Machlin, L. J., Ed.; Marcel Dekker: New York, NY, **1980**.

⁶⁰ Terao, K.; Niki, E. J. *Free Rad Biol. Med.* **1986**, *2*, 193.

⁶¹ Grisar, J. M.; Petty, M. A.; Bolkenius, F. N.; Dow, J.; Wagner, J.; Wagner, E. R.; Haegele, K. D.; Jong, W. D. J. *Med. Chem.* **1991**, *34*, 257.

⁶² a) Smith, E.; Pucci, L. A.; Bywater, L. G. *Science* **1952**, *115*, 520; b) Shanbhag, X. N.; Mesta, C. K.; Maheshwari, M. C.; Bhattacharyya, S. C. *Tetrahedron* **1965**, *21*, 3591.

⁶³ a) De Cree, J.; Geukens, H.; Leempoels, J.; Verhaegen, H. *Drug Dev. Res.* **1986**, *8*, 109; b) Van deWater, A.; Janssen, W.; Van Nueten, J.; Xhonneux, R.; De Cree, J.; Verhaegen, H.; Reneman, R. S.; Janssen, P. A. J. *J. Cardiovasc. Pharmacol.* **1988**, *11*, 552.

⁶⁴ Valsamakis, G.; Kumar, S. *Exp. Opin. Pharmacother.* **2000**, *1*, 1413 and references therein.

⁶⁵ Isabashi, K. *J. Antibiot., Ser. A* **1962**, *15*, 161.

⁶⁶ a) Kashman, Y.; Gustafson, K. R.; Fuller, R. W.; Cardellina, J. H., II; McMahon, J. B.; Currens, M. J.; Buckhiet, R. W., Jr.; Hughes, S. H.; Cragg, G. M.; Boyd, M. R. *J. Med. Chem.* **1992**, *35*, 273; b) Taylor, P. B.; Culp, J. S.; Debouck, C.; Johnson, R. K.; Patil, A. D.; Woolf, D. J.; Brooks, I.; Hertzberg, R. P. *J. Biol. Chem.* **1994**, *269*, 632.

example of a potential application in endocrinology, centchroman (**60**) is an estrogen antagonist with antifertility properties.⁶⁷

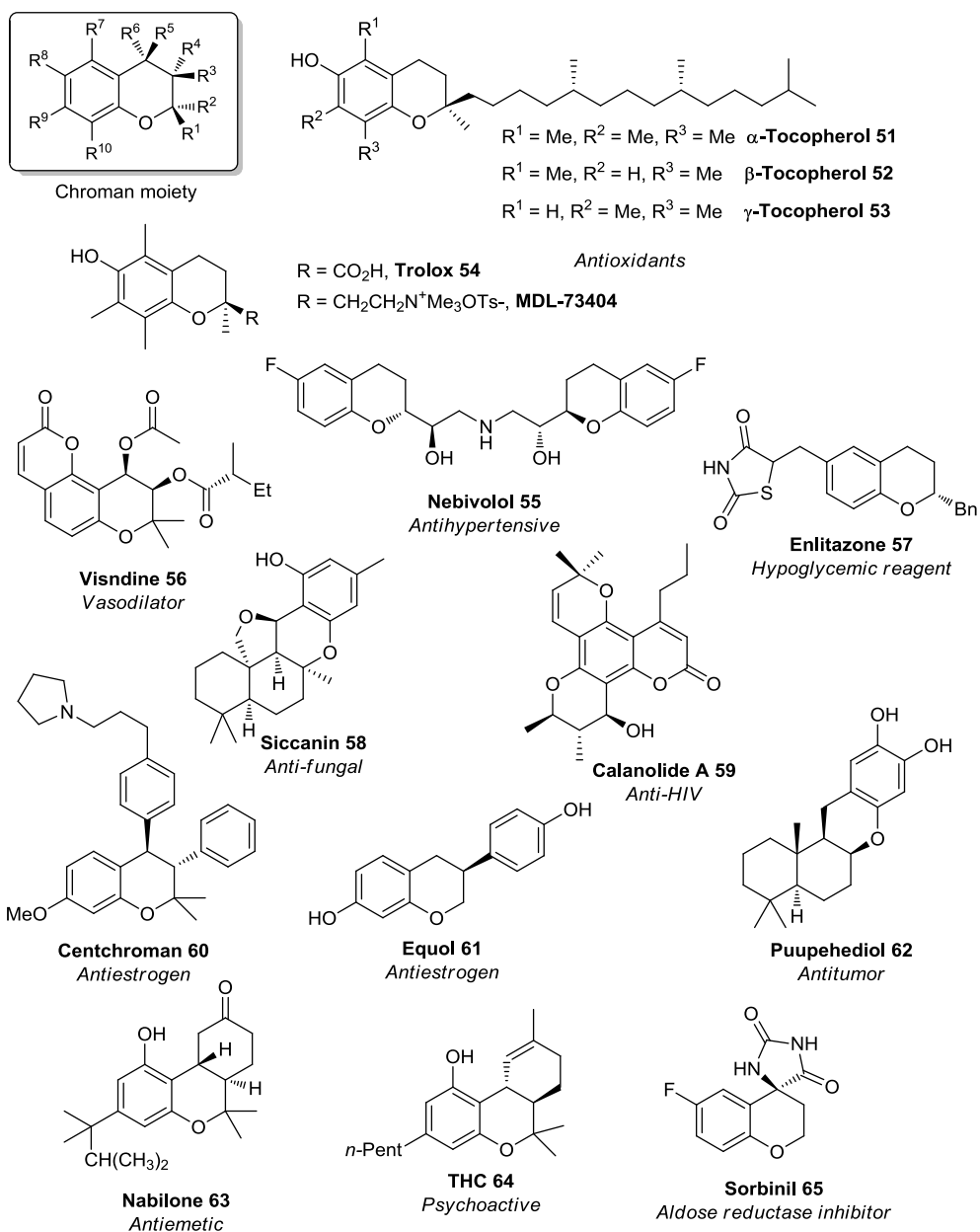

Figure 2.3

⁶⁷ Sankaran, M. S.; Prasad, M. R. N. *Contraception* **1974**, *9*, 279.

Biological activity related to oncology has also been reported for several compounds with a chroman structure. (S)-Equol (**61**) was found to give higher estrogenic activity than daidzein, and may decrease the proliferation of breast-cancer cells.⁶⁸ Puupehediol (**62**) and other analogs of puupehedione have shown various cytotoxic, antifungal, immunomodulatory.⁶⁹ Recently, they have also a good inhibitory effect against several cancer cell lines. In CNS (central nervous system) drug discovery, nabilone (**63**) is a synthetic cannabinoid with antiemetic and antiglaucoma.⁷⁰ The δ -1-tetrahydrocannabinol (THC) (**64**) binds to the cannabinoid receptor CB1, and exerts analgesic effects that, even at low doses, could be used for the treatment of pain. Sorbinil (**65**) functions as an aldo reductase inhibitor and to improve nerve conduction velocity in diabetic patients.⁷¹

II. 2. ASYMMETRIC SYNTHESIS OF CHIRAL 2,2-SUBSTITUTED CHROMANS

The methods described in the literature to generate the chiral center in position C-2 of the chroman core can be classified into different categories based on how chiral centers in chromans are generated.⁷²

The first strategy involves readily available chiral reagents as building blocks (chiral pool). The Nakai group developed in 2001 a synthetic route to achieve the vitamin E precursor (S)-**74**.⁷³ As shown in Scheme 2. 21, starting from D-glyceraldehyde acetonide **66** addition of vinyl Grignard, followed by Swern oxidation, afforded the ketone **67**. Reaction of **67** with the Grignard derived from aryl bromide **68**, in the presence of Cu (I), led to compound **69** whose chelation controlled diastereoselective methylation provided tertiary alcohol **70**, thereby

⁶⁸ a) Morito, K.; Hirose, T.; Kinjo, J.; Hirakawa, T.; Okawa, M.; Nohara, T.; Ogawa, S.; Inoue, S.; Muramatsu, M.; Masamune, Y. *Biol. Pharm. Bull.* **2001**, *24*, 351; b) Schmitt, E.; Dekant, W.; Sopper, H. *Toxicol. In Vitro* **2001**, *15*, 433.

⁶⁹ Barrero, A. F.; Alvarez-Manzaneda, E. J.; Chahboun, R. *Tetrahedron* **1999**, *55*, 15181.

⁷⁰ a) Ward, A.; Holmes, B. *Drugs* **1985**, *30*, 127; b) Stouter, R.W. *Anal. Profiles Drug Subs.* **1981**, *10*, 499.

⁷¹ Judzewitsch, R. G.; Jaspán, J. B.; Polonsky, K. S.; Weinberg, C. R.; Halter, J. B.; Halar, E.; Pfeifer, M. A.; Vukadinovic, C.; Bernstein, L.; Schneider, M.; Liang, K. Y.; Gabbay, K. H.; Rubenstein, A. H.; Porte, D. N. *Engl. J. Med.* **1983**, *308*, 119.

⁷² For reviews related to chromans and chromenes, see: a) Tang, Y.; Oppenheimer, J.; Song, Z.; You, L.; Zhang, X.; Hsung, R. P. *Tetrahedron* **2006**, *62*, 10785; b) Beaudry, C. M.; Malerich, J. P.; Trauner, D. *Chem. Rev.* **2005**, *105*, 4757; c) Hsung, R. P.; Kurdyumov, A. V.; Sydorenko, N. *Eur. J. Org. Chem.* **2005**, *23*; d) Shen, H.C., *Tetrahedron* **2009**, *65*, 3931-3952.

⁷³ Mikoshiba, H.; Midami, K.; Nakai, T. *Synlett* **2001**, 989.

establishing the absolute configuration of the quaternary chiral center of the chroman framework. Further oxidation to the quinone **71**, monoketal formation and hydrogenation afforded chroman diol **73**, which after several transformations led to the α -tocopherol precursor (*S*)-**74**.

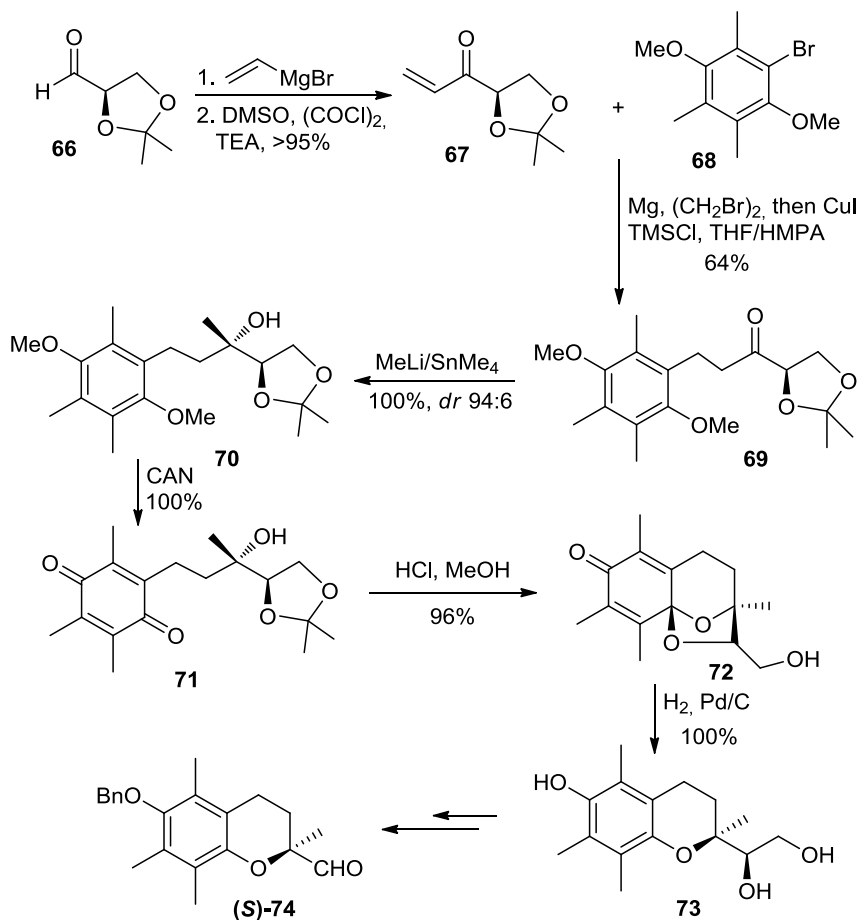

Scheme 2. 21

The Achiwa group reported an enzymatic kinetic resolution of racemic **76** with Lipase B in the presence of vinyl acetate to provide chiral chromanethanol (*S*)-**76** with good enantioselectivity (Scheme 2. 22).⁷⁴ To compensate the loss of the other half of the material during the process, the undesired *R*-isomer **77** was inverted to the *S*-isomer in 34% *ee* over three steps through oxidation to quinone,

⁷⁴ Mizuguchi, E.; Suzuki, T.; Achiwa, K. *Synlett* **1994**, 929.

reduction to hydroquinone and cyclization proceed with $\text{BF}_3 \cdot \text{Et}_2\text{O}$ with complete inversion to afford (S)-**76**.

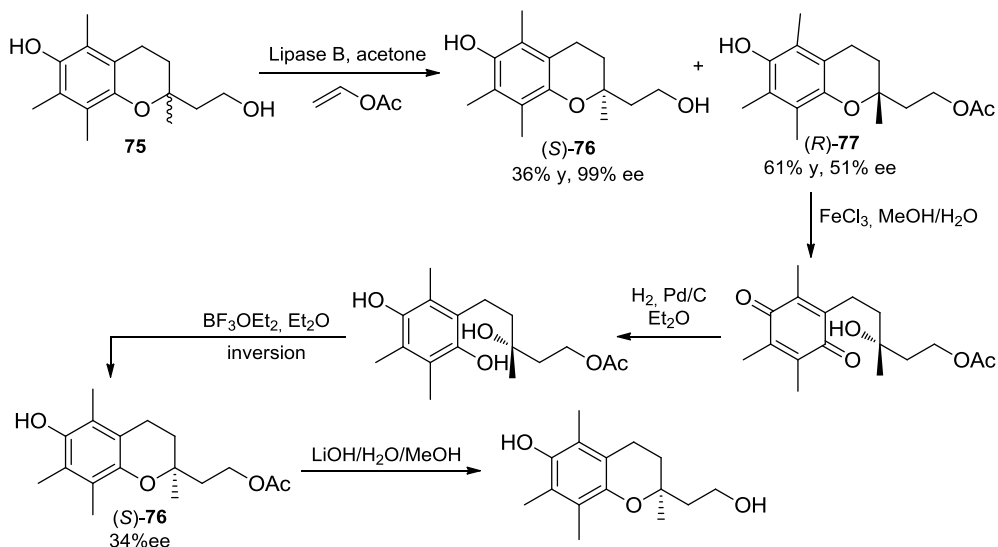

Scheme 2.22

To synthesize α -tocopherol (**51**), Oku's group performed a desymmetrization⁷⁵ of the prochiral diol silyl ether **78** with enantiopure ketone **79** to form the chiral spiroketal **80** as the major diastereoisomer. The subsequent TiCl_4 -promoted equatorial C–O bond cleavage of the spiroketal in presence of silyl enol ether **81** produced the selective alkylation of the equatorial position leading to compound **82** in 95% ee. Compound **82** could be later transformed into the chiral chroman **83** (>95% ee) (Scheme 2. 23).⁷⁶ Presumably, TiCl_4 preferred coordination with the less hindered equatorial oxygen was promoting the selective cleavage of the equatorial C–O bond and generating an intermediate oxocarbenium ion. Thus the incoming nucleophile silyl enol ether **81** through an equatorial attack to the positively charged sp^2 -hybridized C(1) carbon of the intermediate oxocarbenium ion explained the formation of compound **82** essentially as a single diastereoisomer.

⁷⁵ For reviews of desymmetrization of prochiral systems see: a) Schoffers, E.; Golebiowski, A.; Johnson, C. R. *Tetrahedron* **1996**, *52*, 3769; b) Otera, J. *Chem. Rev.* **1993**, *93*, 1449; c) *Enzymes Catalysis in Organic Synthesis*; Drauz, K., Waldman, H., Eds.; VCH Verlagsgesellschaft mbH: Weinheim, **1995**; Vols. 1 and 2.

⁷⁶ Harada, T.; Hayashiya, T.; Wada, I.; Iwa-ake, N.; Oku, A. *J. Am. Chem. Soc.* **1987**, *109*, 527.

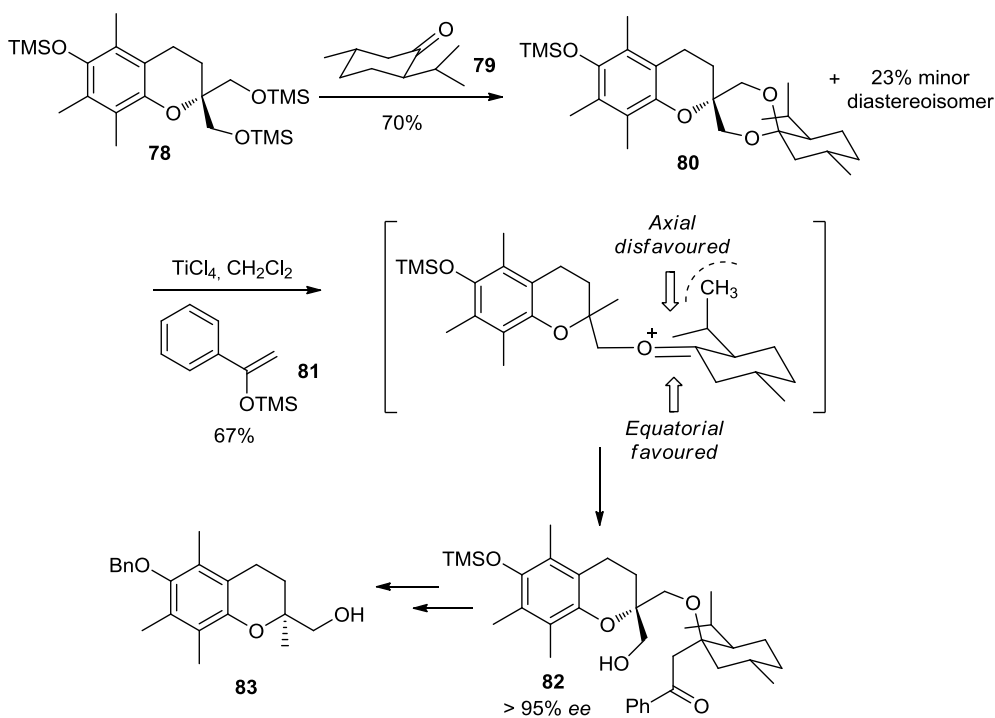

Scheme 2. 23

Asymmetric catalysis has also been used “en route” to chiral chroman skeletons. The Achiwa group applied the Sharpless asymmetric epoxidation of substrate **84** to form epoxide **85**, which was opened regioselectively with Red-Al (sodium bis(2-methoxyethoxy) aluminum hydride) to afford 1,3-diol **86**.⁷⁷ Cyclization of diol **86** was carried out in presence of Ph_3CBF_4 as Lewis acid to give the (*S*)-*O*-benzyl chromanethanol **87** in 78% ee. The absolute configuration of the tertiary carbinol was fully retained in the final chroman **87** as a consequence of a double inversion process through the formation of an oxetane intermediate (Scheme 2. 24).

⁷⁷ Mizuguchi, E.; Achiwa, K. *Synlett* **1995**, 1255.

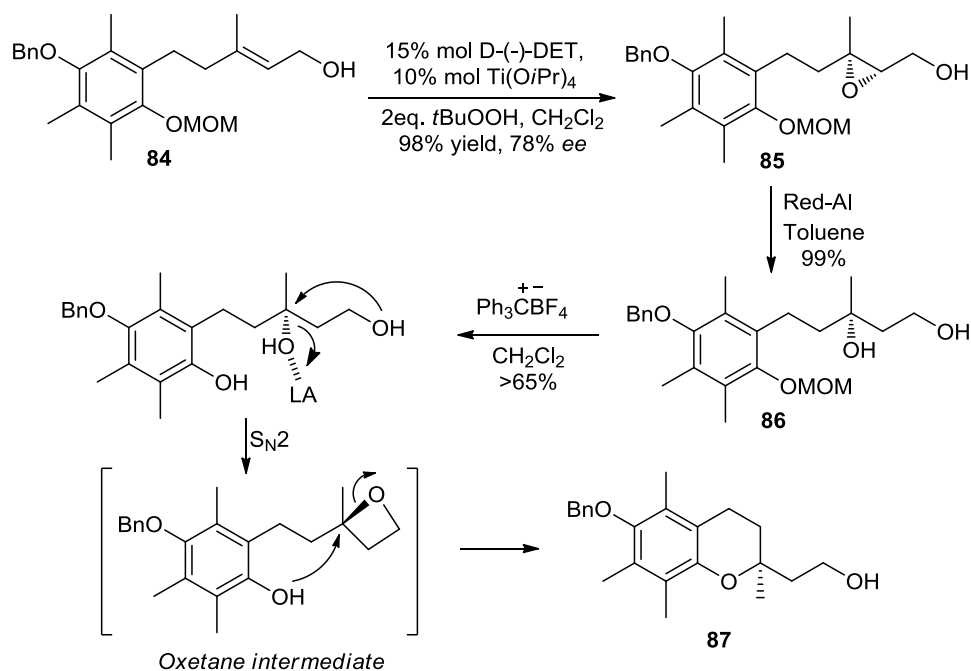

Scheme 2. 24

The Pd-catalyzed asymmetric allylic alkylation (AAA) of phenol allyl carbonate also has been an effective approach to chiral chromans. In the example shown in Scheme 2. 25, phenol **88** was transformed into the ether **91** by Pd catalyzed reaction with allyl carbonate **89** in the presence of the Trost chiral ligand **90** to form the tertiary ether **91** with excellent regioselectivity (92:8) and moderate *ee* (76%). The hydroboration, oxidation of the terminal double bond led to the primary carbinol whose transformation in the triflate, set the stage for electrophilic cyclization to assemble product **92**, the core of the tocopherol. Such strategy was also applied in the enantioselective total synthesis of calanolides A and B.⁷⁸

⁷⁸ Trost, B. M.; Toste, D. F. *J. Am. Chem. Soc.* **1998**, *120*, 9074.

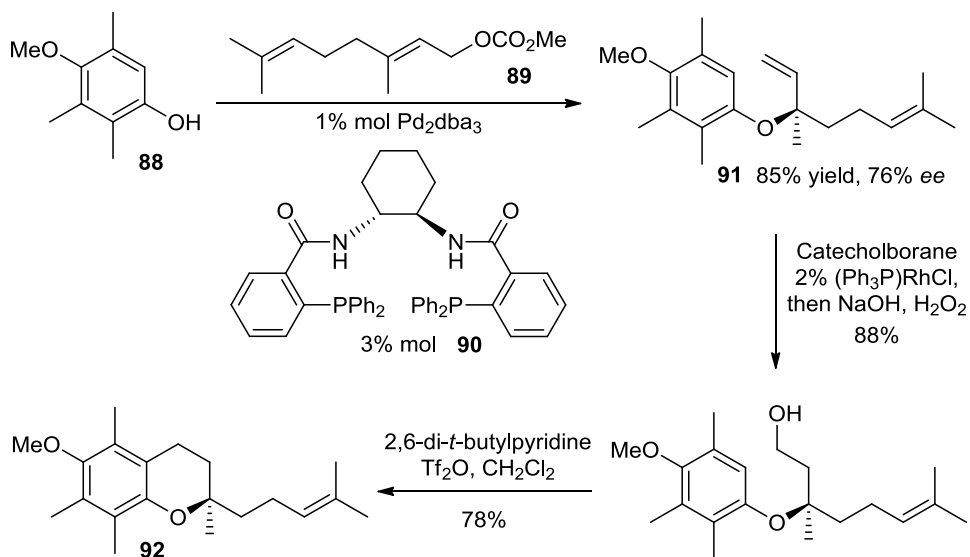

Scheme 2. 25

Fu and Chung reported in 2009 a chiral phosphine-catalyzed enantioselective cyclization to prepare chiral chromans in good *ees* (Scheme 2. 26).⁷⁹ In this transformation, the chiral phosphine **94** acted as a nucleophilic catalyst adding to alkynoate **93** to provide intermediate phosphonium salt **95**. The subsequent hydrogen shift originated a new intermediate **96**, which then underwent a ring closure by nucleophilic addition of the phenol to the electron poor double bond, and elimination of the phosphonium salt to produce chroman **97**.

⁷⁹ Chung, Y.K.; Fu, G.C. *Angew. Chem. Int. Ed.* **2009**, *48*, 2225-2227.

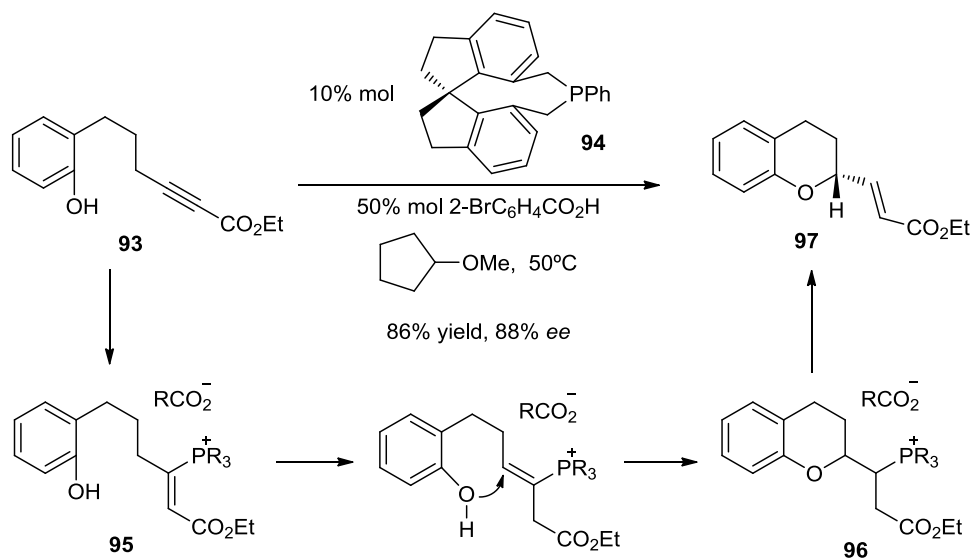

Scheme 2. 26

The use of chiral auxiliaries has been also reported to construct the chiral centers of chromans. An example directly related with the work presented in this thesis is the synthesis of α -tocopherol (**51**) by the group of Solladié in 1984. A chiral vinyl sulfoxide lithium anion **99** was employed to control the diastereoselectivity of the addition to aromatic aldehyde **98** resulting in the formation of the chiral secondary alcohol **100** (Scheme 2. 27).⁸⁰ A subsequent *syn* S_N2' reaction by nucleophilic attack of the phenol on the α,β -unsaturated sulfoxide **101**, was proposed to explain the formation of chromene **102** as a single diastereoisomer. The subsequent hydrogenation and reductive desulfurization then provided the enantiopure chroman **103**.

⁸⁰ Solladié, G.; Moine, G. *J. Am. Chem. Soc.* **1984**, *106*, 6097.

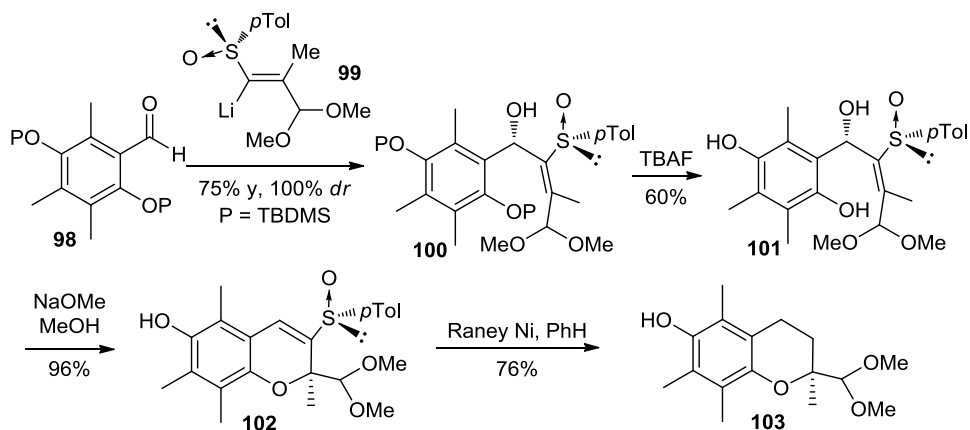

Scheme 2.27

In 2009, (*2R,4'RS,8'RS*)- α -Tocopherol **51** was prepared using, as the key step, a TiCl_4 -promoted (*S*)-sulfoxide-directed allylation of the ketal **103** with allyl trimethyl silane to efficiently generate stereogenic center in C-2 of the chroman moiety (Scheme 2.28).¹⁰

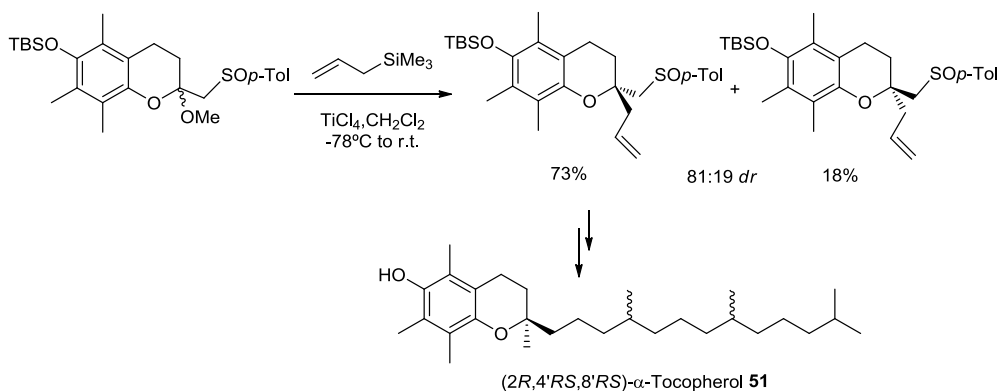

Scheme 2.28

¹⁰ M. C. Carreño, G. Hernández-Torres, A. Urbano, F. Colobert, *Org. Lett.* **2009**, *21*, 4930-3.

II.3. INTRODUCTION

II.3.1. Lewis acid mediated nucleophilic substitution reactions

The Lewis acid mediated nucleophilic substitution reactions of a variety of 2-alkoxy-, 2-hydroxy-, and 2-(acyloxy)-3,4-dihydro-2*H*-benzopyran (chromans) have been studied within the aim of developing new synthetic routes to 2-substituted chromans.⁸¹

In this context, Cohen⁸² reported the synthesis of 2-substituted-3,4-dihydro-2*H*-1-benzopyran based on the Lewis acid mediated of the ketal **104** with trimethylsilane cyanide, in the presence of TiCl_4 or $\text{BF}_3 \cdot \text{Et}_2\text{O}$ (Scheme 2. 29). The final yield of product **105** was dependent on the nature of the Lewis acid.⁸³

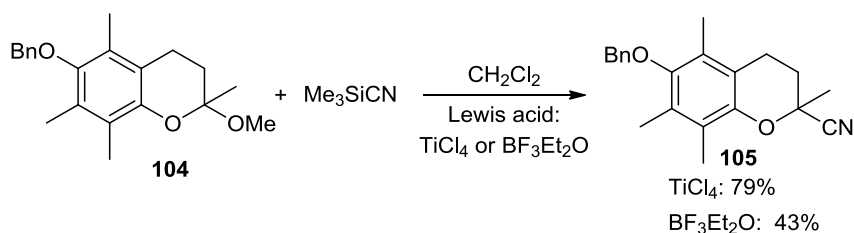

Scheme 2. 29

A key question in this approach was the regioselectivity of the process since compound **106** can also be cleaved in an endocyclic manner with rupture of the chroman system to generate **107** or in an exocyclic way to produce the unwanted phenol **108** (Scheme 2. 30). The balance of exocyclic vs. endocyclic ketal cleavage involves a variety of factors such as the substrate structure, the leaving group nature, the relative stability and rate of formation of the oxocarbenium ion intermediates, and the nature of the Lewis acid.

⁸¹ a) R. Doodeman, F. P.J.T. Rutjes, H. Hiemstra, *Tetrahedron Lett.* **2000**, *41*, 5979-5983; b) J. Cossy, H. Rakatoarisoa, P. Kahn, J.-R. Desmurs, *Tetrahedron Lett.* **2000**, *41*, 7203-7205.

⁸² N. Cohen, B. Schaer, G. Saucy, R. Borer, L. Todaro, Am-M. Chiu, *J. Org. Chem.* **1989**, *54*, 3282-3292.

⁸³ a) Goldsmith, D. J.; Helmes, C. T., Jr.; *Synth. Commun.* **1973**, *3*, 231-235. b) Iwasaki, H.; Takashi, K.; Yamamoto, Y.; Akiba, K. *Tetrahedron Lett.* **1987**, *28*, 6355-6358.

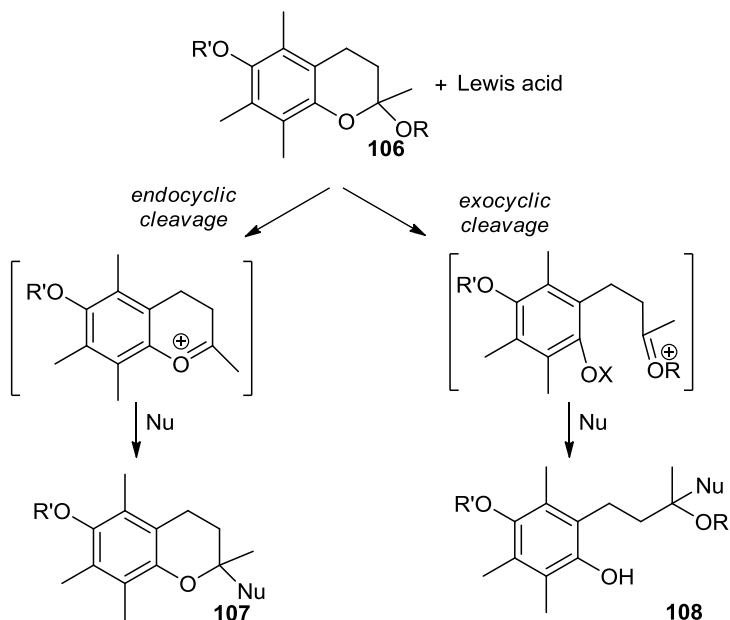

Scheme 2.30

When chiral ketal chroman spiroketal silyl **109** was submitted to the ionic nucleophilic substitution with trimethyl silane cyanide in presence of SnCl₄ as Lewis acid, the chroman cyanide **110** resulted as 1:1 epimers mixture (Scheme 2.31). This result suggested the S_N1 nature of these substitution processes. By contrast, the use of TiCl₄ as Lewis acid with the same chiral spiroketal chroman **109** led to the tetrahydropyran cyanide **111** with the free phenol group.

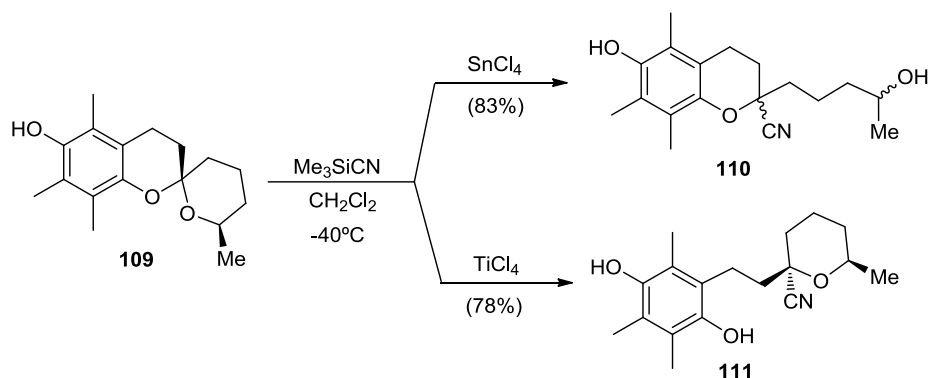

Scheme 2.31

II.3.2. Synthesis of 3,4-dihydro-2H-1-benzopyrans (2H-chromans)

The 2H-chroman skeleton appears in a serie of natural products with significant biological properties such as the important shikimate derived group of flavonoids,⁸⁴ in some antibiotics⁸⁵ and enzyme inhibitors.⁸⁶ Synthetic 2H-chromans are also valuable targets since several derivatives have been shown to possess important biological activities acting as hypoglycemic agents,⁸⁷ potent in vitro inhibitors of rhinovirus replication⁸⁸ and as anti-hypertensive agents.⁸⁹

As exposed in the previous section of this work, among the strategies nowadays available for the stereoselective synthesis of cyclic ethers,⁹⁰ our research group has developed the Et₃SiH/TMSOTf promoted synthesis of cyclic ethers by reductive cyclization of carbonyl compounds and enantiopure carbinols availables from diastereoselective reduction of β -keto sulfoxides.^{91,92} In this process the enantiopure sulfoxide was controlling the absolute configuration of β -hydroxylic center, which in turn, was directing the stereochemical course of the reductive cyclization step.

⁸⁴ P. M. Dewick, *Medicinal Natural Products. A Biosynthetic Approach*. 2nd Edition, John Wiley & Sons, Chichester, **2001**.

⁸⁵ I. M. Chandler, C. R. McIntyre, T. J. Simpson, *J. Chem. Soc., Perkin Trans. 1* **1992**, 2271–2284.

⁸⁶ a) H. Erdtman, *Svensk Kem. Tidskr.* **1944**, *56*, 95–101; b) G. Lindstedt, *Acta Chem. Scand.* **1950**, *4*, 1042–1046; c) E. Wollenweber, *Phytochemistry* **1982**, *20*, 1462–1464; d) T. Jaipetch, V. Reutrakul, P. Tuntiwachwuttikul, T. Santisuk, *Phytochemistry* **1983**, *22*, 625–626; e) H. Haberlein, K.-P. Tschiersch, *Biochem. System. Ecol.* **1998**, *26*, 97–103.

⁸⁷ G. Valsamakis, S. Kumar, *Exp. Opin. Pharmacother.* **2000**, *1*, 1413.

⁸⁸ D. J. Bauer, J. W. T. Selway, J. F. Batchelor, M. Tisdale, I. C. Caldwell, D. A. Young, *Nature* **1981**, *292*, 369–370.

⁸⁹ a) J. De Cree, H. Geukens, J. Leempoels, H. Verhaegen, *Drug Dev. Res.* **1986**, *8*, 109–117; b) A. Van de Water, W. Janssen, J. Van Nueten, R. Xhonneux, J. De Cree, H. Verhaegen, R. S. Reneman, P. A. J. Janssen, *J. Cardiovasc. Pharmacol.* **1988**, *11*, 552–563.

⁹⁰ For the formation of the C-2 stereocenter of 2H-chromans, see: a) E. T. Choi, M. H. Lee, Y. Kim, Y. S. Park, *Tetrahedron* **2008**, *64*, 1515–1522; b) C. Dittmer, G. Raabe, L. Hintermann, *Eur. J. Org. Chem.* **2007**, 5886–5898; c) X. Tian, S. D. Rychnovsky, *Org. Lett.* **2007**, *9*, 4955–4958; d) C. Welter, A. Dahnz, B. Brunner, S. Streiff, P. Dübon, G. Helmchen, *Org. Lett.* **2005**, *7*, 1239–1242; e) K. J. Hodgetts, *Tetrahedron* **2005**, *61*, 6860–6870; f) B. M. Trost, H. C. Shen, L. Dong, J.-P. Surivet, C. Sylvain, *J. Am. Chem. Soc.* **2004**, *126*, 11966–11983; g) M. Zhang, R. Reeves, Ch. Bi, R. Dally, G. Ladouceur, W. Bullock, J. Chin, *Tetrahedron Lett.* **2004**, *45*, 5229–5231; h) J. L. Gross, *Tetrahedron Lett.* **2003**, *44*, 8563–8565; i) M. A. Birkett, D. W. Knight, P. B. Little, M. B. Mitchell, *Tetrahedron* **2000**, *56*, 1013–1023.

⁹¹ Previous intermolecular synthesis of ethers from alkoxysilanes : a) M. B. Sassaman, G. K. S. Prakash, G. A. Olah, *Tetrahedron* **1988**, *44*, 3771–3780; b) M. B. Sassaman, K. D. Kotian, G. K. S. Prakash, G. A. Olah, *J. Org. Chem.* **1987**, *52*, 4314–4319.

⁹² Previous synthesis of cyclic ethers from alcohols: a) K. C. Nicolaou, C.-K. Hwang, M. E. Duggan, D. A. Nugiél, Y. Abe, K. B. Reddy, S. A. DeFrees, D. R. Reddy, R. A. Awartani, S. R. Conley, F. P. J. T. Rutjes, E. A. Theodorakis, *J. Am. Chem. Soc.* **1995**, *117*, 10227–10238; b) K. C. Nicolaou, C.-K. Hwang, D. A. Nugiél, *J. Am. Chem. Soc.* **1989**, *111*, 4136–4137; also see ref 31.

Inspired by this asymmetric strategy to cyclic ethers, the preparation of 3,4-dihydro-2*H*-1-benzopyrans (2*H*-chromans) was later achieved, using sulfoxides as the sole asymmetric inductor to directly generate this moiety from a phenol and a β -keto sulfoxide in a single step.^{7b}

The synthesis of the precursor β -keto sulfoxide was achieved by reaction of the lithium anion derived from the (*SR*)-methyl-*p*-tolylsulfoxide **46**⁹³ and commercially available dihydrocoumarine **112**. The (*SR*)-2-(*p*-tolylsulfinyl)methyl chroman-2-ol **114** was obtained as a mixture of the β -keto sulfinyl δ -2-hydroxy phenyl substituted open chain structure **113** and the cyclic hemiketal (*SR*)-2-(*p*-tolylsulfinyl)methyl chroman-2-ol **114a** and **114b** as the major product, and was characterized as a C-2 diastereomeric mixture (Scheme 2. 32).

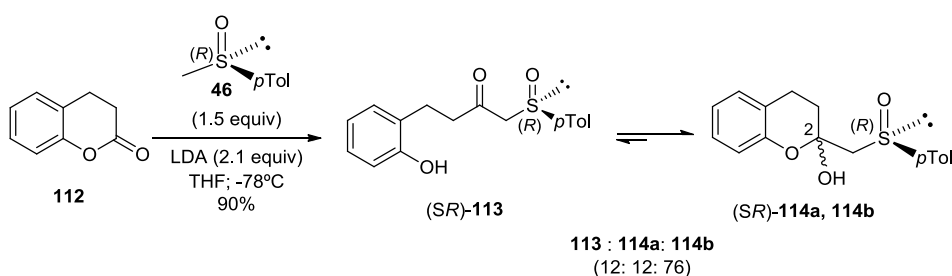

Scheme 2. 32

Treatment of the mixture of 2-(*p*-tolylsulfinyl)methyl substituted 2-chromanol **114**, in equilibrium with the δ -(*o*-hydroxyphenyl)-substituted β -keto sulfoxide **113**, with Et₃SiH (3 equiv), followed by addition of TMSOTf (2 equiv) in CH₂Cl₂ at 0°C, led to the rapid formation of 2*H*-chroman **115** in an excellent 95:5 diastereomeric ratio and 86% yield (Scheme 2. 33).

^{7b} G. Hernández-Torres M. C. Carreño, A. Urbano, F. Colobert, *Chem. Eur. J.* **2011**, *17*, 1283 – 1293.

⁹³ G. Solladié, J. Hutt, A. Girardin, *Synthesis* **1987**, 173-175.

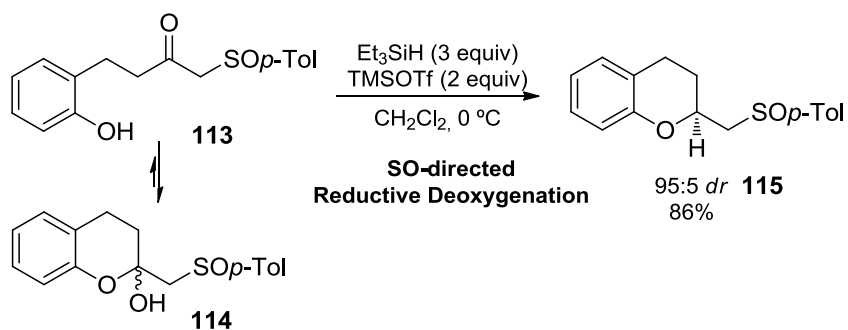

Scheme 2. 33

This $\text{Et}_3\text{SiH/TMSOTf}$ -promoted reductive deoxygenation of 2-(*p*-tolylsulfinyl)methyl substituted 2-chromanols was thus reported as a stereoselective route to 2*H*-chroman derivatives and could be applied to differently substituted sulfinyl derivatives.^{7b}

The reaction was applied to the asymmetric synthesis of the (*S,R,R,R*)-enantiomer of Nebivolol **55**,⁸ an anti-hypertensive drug. Thus the homochiral sulfoxide-directed reductive deoxygenation of the fluorinated substituted 2-(*p*-tolylsulfinyl)methyl-2-chromanols which allowed the stereoselective formation of the 2*H*-chromans further transformed into Nebivolol (Scheme 2. 34).

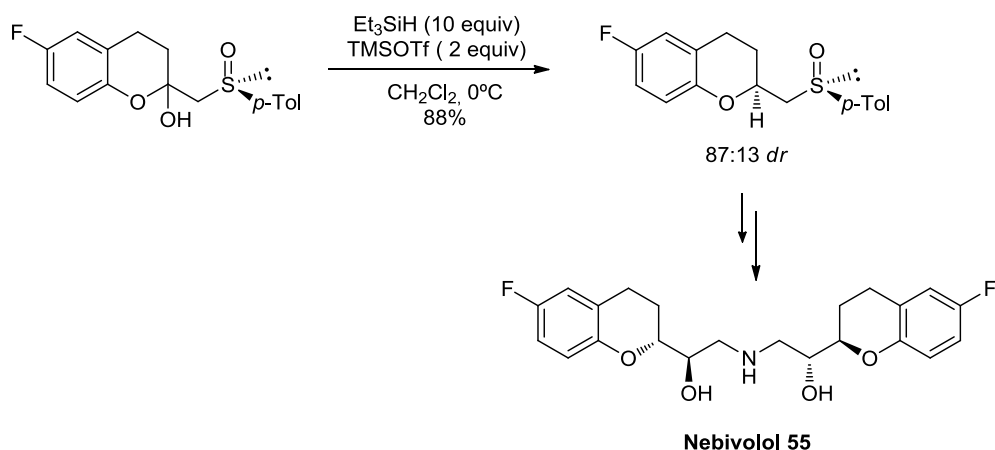

Scheme 2. 34

^{7b} G. Hernández-Torres M. C. Carreño, A. Urbano, F. Colobert, *Chem. Eur. J.* **2011**, *17*, 1283–1293.

⁸ M. C. Carreño, G. Hernández-Torres, A. Urbano, F. Colobert *Eur. J. Org. Chem.* **2008**, 2035–2038.

II.4. RESULTS AND DISCUSSION

As it was mentioned in the introduction chapter, this work is based in the results obtained previously in the methodologic study which led to the stereoselective synthesis of 2*H*-chromans.^{7b} With the aim of completing this work, the generation of a quaternary center in C-2 of the chroman moiety was investigated over the substrates synthesized in collaboration with Dr. Gloria Henández Torres.⁹⁴

II.4.1. Synthesis of differently substituted 2-methoxy-2-(sulfinyl) methyl chromans

This part of the thesis deals with the search for optimal conditions to generate the quaternary center of the 2,2-disubstituted-2*H*-chroman skeleton (**A**), starting from the 2-sulfinylsubstituted-2-chromanols **B** (Figure 2. 4), as an extensions of the work previously developed en route to vitamin E.⁸⁴

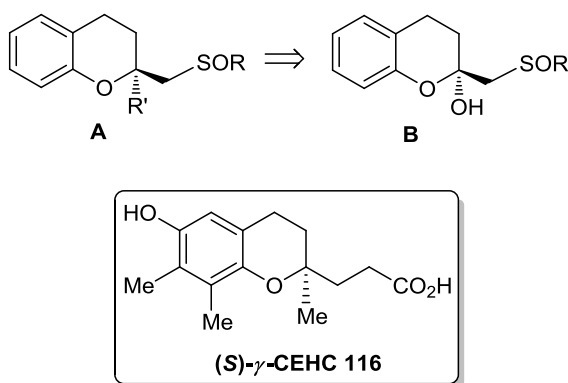

Figure 2. 4

^{7b} G. Hernández-Torres M. C. Carreño, A. Urbano, F. Colobert, *Chem. Eur. J.* **2011**, *17*, 1283 – 1293.

⁹⁴ G. Hernández Torres, PhD. 2008

⁸⁴ P. M. Dewick, *Medicinal Natural Products. A Biosynthetic Approach*. 2nd Edition, John Wiley & Sons, Chichester, **2001**.

With the best conditions to generate the quaternary center of **A** established, our final goal would be the synthesis of the natural metabolite (*S*)- γ - CEHC **116** (Figure 2. 4).

We initiated our study from the simplest system (*SR*)-2-(*p*-tolylsulfinyl)methyl-2-chromanol **114**, which had been previously synthesized and studied in the PhD work of Dr Hernandez Torres, in order to evaluate the influence of the nature of the sulfinyl substituent in the stereoselectivity of these reactions.

The reaction of the lithium anion derived from the (*SR*)-methyl-*p*-tolylsulfoxide **46** generated from LDA in THF at -78°C and the commercially available dihydrocoumarine **112**, led to the (*SR*)-2-(*p*-tolylsulfinyl)methyl chroman-2-ol **114**, which was obtained as a mixture of the β -keto sulfinyl δ -2-hydroxy phenyl substituted open chain structure **113**, and the cyclic hemiketal (*SR*)-2-(*p*-tolylsulfinyl)methylchroman-2-ol **114a** and **114b** as the major product, and was characterized as a C-2 diastereomeric mixture (Scheme 2. 35).

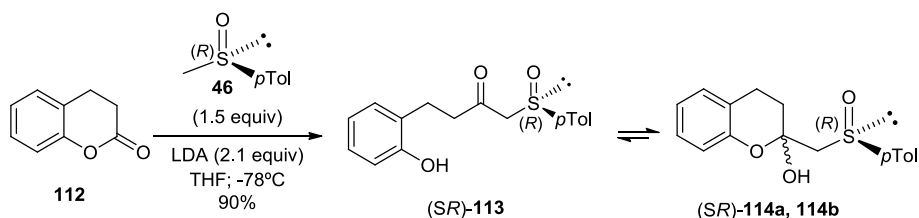

Scheme 2. 35

In accordance with the procedure previously reported to synthesize the *p*-tolyl sulfinyl chromanol (*SR*)-**114**, compounds **122-125** could be accessible by the addition of the lithium anion derived from the corresponding methyl sulfoxide **117-120** and the commercially available coumarine **112** as previously reported^{7b} (Scheme 2. 36). The synthesis was carried out using the racemic methyl sulfoxides **117-120** (Figure 2. 5), which were prepared by oxidation of the corresponding thioethers with *m*-CPBA. Methyl 2-methoxy naphthyl sulfoxide **121** was prepared enantiomerically pure.

^{7b} G. Hernández-Torres M. C. Carreño, A. Urbano, F. Colobert, *Chem. Eur. J.* **2011**, *17*, 1283 – 1293.

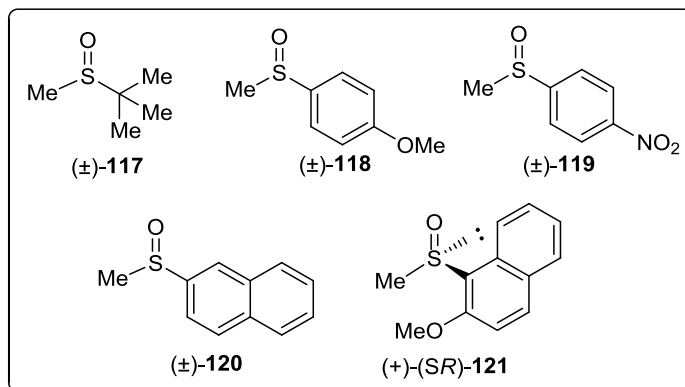
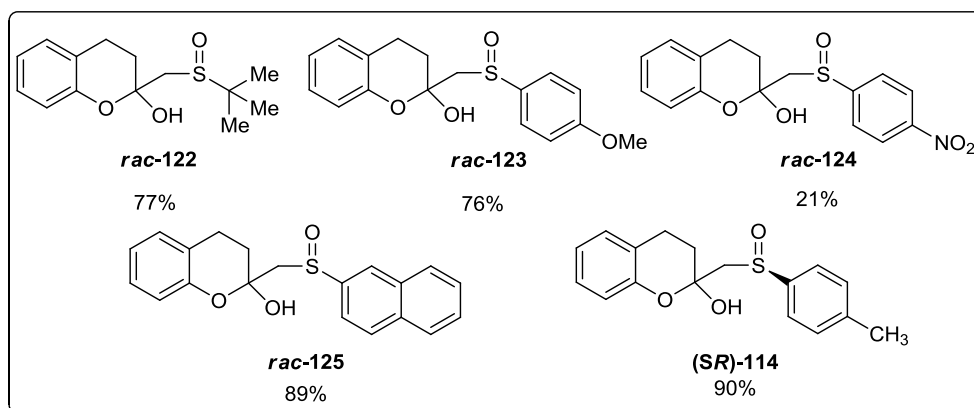
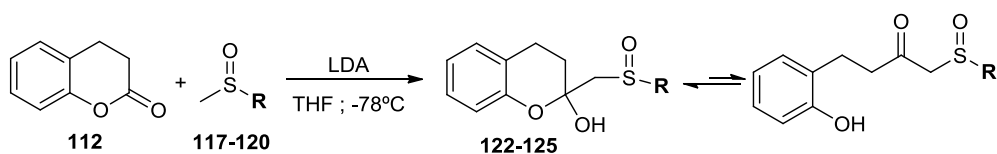

Figure 2. 5

The addition of the lithium derivative of the different methyl sulfoxides previously synthesized led to obtain the corresponding methyl sulfinylchromanols **122-125** in the yields indicated in Scheme 2. 36



Scheme 2. 36

t-Butyl and *p*-methoxyphenyl substituted chromanols **122** and **123** were isolated in 90, 77 and 76% yield respectively. *p*-Nitrophenylsulfinyl chromanol **124** was obtained in only 21% yield, probably due to the low solubility of the methyl *p*-

nitrophenylsulfoxide **119** in THF which made difficult the formation of the anion, recovering most of the starting sulfoxide after reaction. 2-Naphthylsulfinyl chromanol **126** was obtained in excellent yield (89%).

2-Methylsulfinyl chromanols **122-125** were characterized as epimeric mixtures at C-2 and the corresponding open β -keto sulfoxide structure in equilibrium. In all cases, the major product corresponded to one of the epimers at C-2 of the cyclic hemiketal.

Since the equilibrium between the open and the closed structure was confirmed, the hemiketalic OH was protected to avoid side reactions due to the opening in acidic or basic medium of the hydrobenzopyran ring. Therefore, chromanols **122-125** were transformed into the corresponding methyl ketal with trimethyl orthoformate in presence of *p*-toluenesulfonic acid in methanol at room temperature (Table 2. 2).

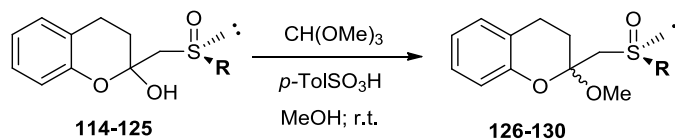

Entry	Chromanols	Product	Yield
1	(+)- 114	 (+)- 126	89%
2	(±)- 122	 (±)- 127	70 %
3	(±)- 123	 (±)- 128	97 %
4	(±)- 124	 (±)- 129	83 %
5	(±)- 125	 (±)- 130	66 %

Table 2. 2

Methoxy chromans **126-130** were prepared in moderate to good yields in all cases.

The (*SR*)-2-methoxy-2-(2-methoxy-1-naphthylsulfinyl)methyl chroman **132** was prepared in two steps by condensation of the (+)-methyl-2-methoxy-1-naphthylsulfoxide **121** with dihydrocoumarine **112** led to chromanol **131**. Without further purification chromanol **131** was treated with trimethyl orthoformate in presence of *p*-toluensulfonic acid in methanol at room temperature. Ketal **132** was thus prepared in a two steps process in 26% overall yield (Scheme 2. 37).

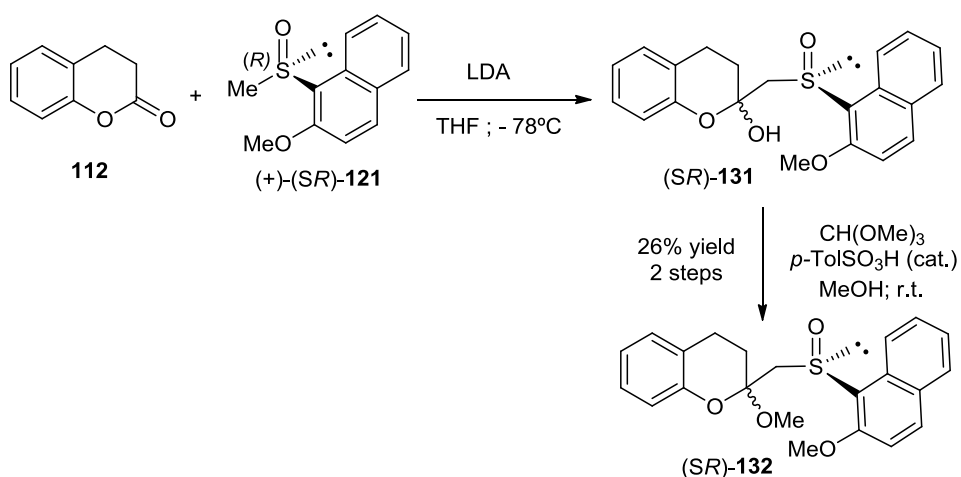

Scheme 2. 37

II.4.2. Synthesis of differently substituted 2-methyl-2-(sulfinyl) methyl chromans

The introduction of a methyl group in the chroman derivative to generate the quaternary center in C-2, was carried out by the reaction of (*SR*)-2-(*p*-tolylsulfinyl) methyl chroman-2-ol **114** with trimethyl aluminium (AlMe_3) in presence of different Lewis acids. The use of TMSOTf as Lewis acid led to the product **133** resulting from the 1,2-additions to the carbonyl group of the open β -keto sulfoxide compound **113**. A change in the order of reactant addition led to the endo and exocyclic elimination of the hemiketalic OH, giving compounds **134** and **135**, (Scheme 2. 38).

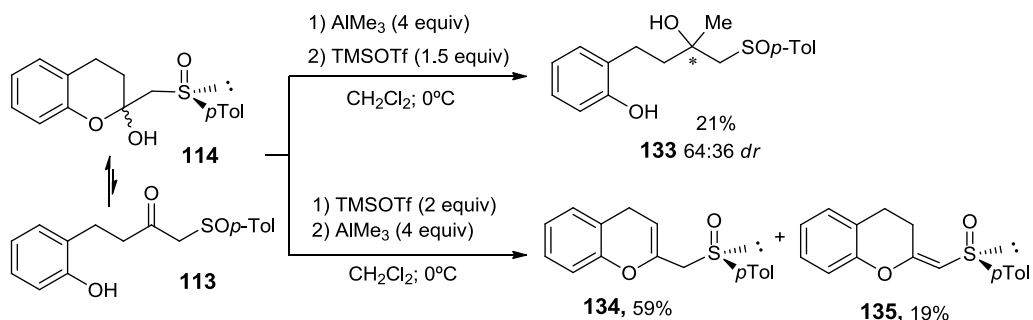

Scheme 2. 38

In order to avoid the formation of these undesired products, the reaction was carried out on the ketalic **126**. Therefore, (*SR*)-methoxy chroman **126** was treated with trimethylaluminum (AlMe_3) in presence of several Lewis acids. First attempts were made with TMSOTf and $\text{BF}_3 \cdot \text{OEt}_2$, recovering in both cases the starting material. The use of TiCl_4 allowed the introduction of the methyl group. Thus, titanium tetrachloride (1.4 equiv) was added to a solution of (*SR*)-2-methoxy-2-[(*p*-tolylsulfinyl)methyl] chroman **126** in CH_2Cl_2 at -78°C , followed by 4 equivalents of AlMe_3 and then allowed to warm up to room temperature. Under these conditions, a mixture of three products, which could be identified as two C-2 diastereoisomers (*2S,SR*) and (*2R,SR*)-**136** in 70:30 *dr*, and the endocyclic alkene **134** (Scheme 2. 39). The 70:30 mixture of the methyl substituted products **136** was isolated in 37% yield. Formation of the elimination product **134** could not be avoided by controlling the rate of AlMe_3 addition and at lower temperatures. In all

cases its formation was observed and compound **134** could be isolated by flash chromatography in yields ranging between 3 and 13%.

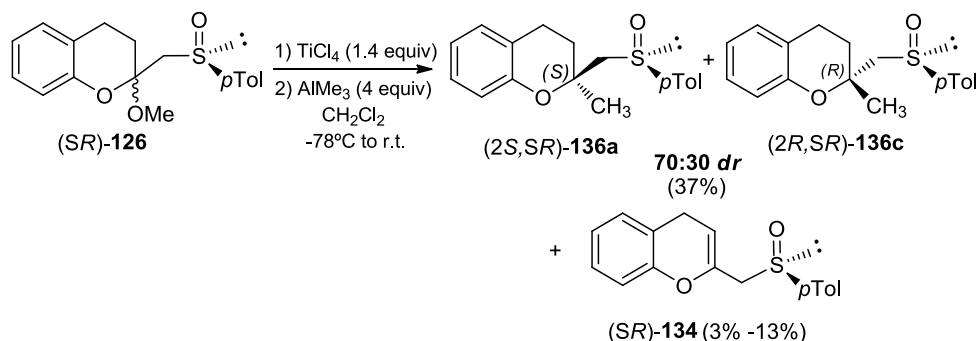

Scheme 2. 39

The increase of temperature over 0°C caused an increase of the amount of the elimination product **134**. The inversion in the order of addition of the reactants under the same reaction conditions led exclusively to the elimination product.

Other Lewis acids such as BiCl_3 , $\text{BF}_2\text{OTf}\cdot\text{OEt}_2$ and FeCl_3 were tested. In all cases starting material were recovered unchanged. The use of zirconium tetrachloride (ZrCl_4) led to the substitution desired product. Best results were obtained when a mixture of 4 equivalents of ZrCl_4 and AlMe_3 were added in CH_2Cl_2 at -78°C over a solution of the methoxy sulfinyl chroman (*SR*)-**126**. Under these conditions a 65:35 diastereoisomeric mixture of **136** was obtained in 53% yield (Scheme 2. 40). It was necessary to use 4 equivalents due to the low solubility of this Lewis acid in CH_2Cl_2 . Under these conditions, stereoselectivity of the reaction was not improved but the yield increased to 53% and the amount of elimination product decreased significantly, below 5%.

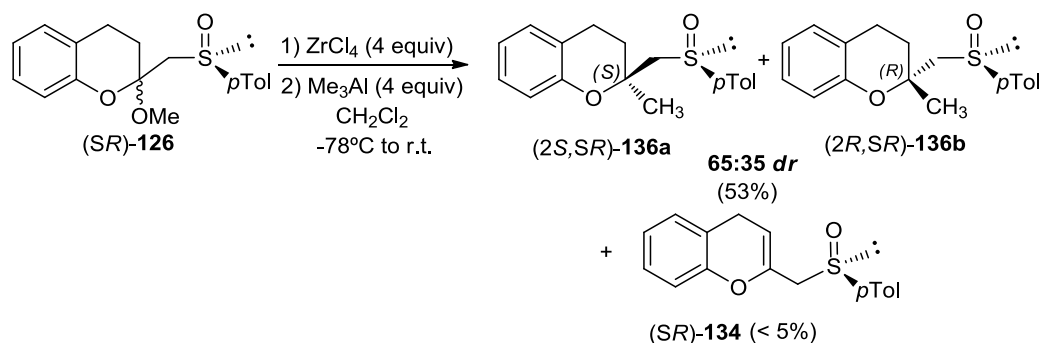

Scheme 2. 40

The use of ZnMe₂ led to a mixture of the desired products without increasing the temperature over -40°C. The stereoselectivity of the reaction was similar (67:33 *dr*) and the elimination product was obtained in 5% yield. Methylmagnesium bromide (MeMgBr) in presence of TiCl₄ at different temperatures led to complex mixtures. In all cases disappearance of the starting material was completed but the desired products were never observed.

In accordance with the results of these studies, the best conditions to prepare 2-methyl-2-(*p*-tolylsulfinyl) methyl chromans (2*S*, *SR*) and (2*R*, *SR*)-**136** corresponded to the reaction of (*SR*)-2-methoxy-2-(*p*-tolylsulfinyl) methyl chroman **126** with AlMe₃ and TiCl₄ as Lewis acid. The reaction gave a moderated stereoselectivity (70:30 *dr*) and yield (53%).

In order to improve the diastereoselectivity of the generation of the C-2 stereocenter of 2,2-substituted chromans, we proceeded to evaluate the role played by the nature of the sulfinyl substituent in the process. With this aim, 2-methoxy-2-methyl sulfinyl chromans **127-132** bearing a *t*-Bu, *p*-OMePh, *p*-NO₂Ph, 2-Naphthyl and 2-OMe-1-Naphthyl group, were submitted to the reaction with AlMe₃ in the presence of TiCl₄. Results are indicated in Table 2. 3

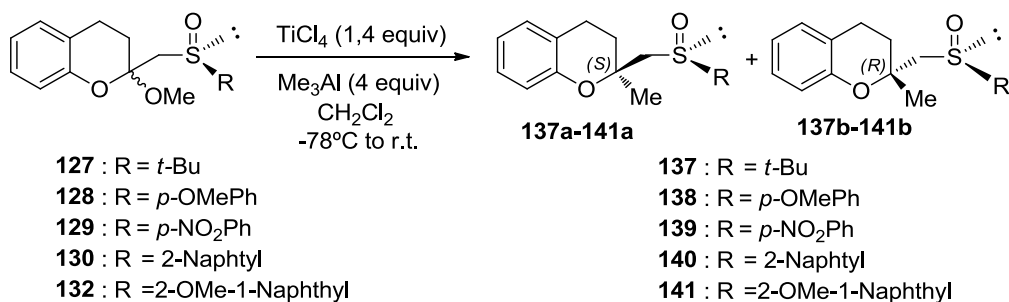

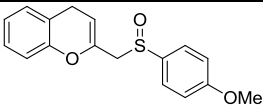
Entry	Starting Material (R)	Product (Yield)*	<i>d.r.</i>	Side products
1	127 (<i>t</i> -Bu)	137 (37%)	60: 40	Traces elimination product
2	128 (<i>p</i> -OMePh)	138 (28%)	59: 41	 142 (4%)
3	129 (<i>p</i> -NO ₂ Ph)	139 (21%)	Not determined	--
4	130 (2-Naphthyl)	140 (53%)	67: 33	--
5	132 (2-OMe-1-Naphthyl)	141 (70%)	66: 34	--

*Isolated after flash chromatography.

Table 2. 3

As can be seen, the reaction of the *t*-butyl substituted derivate **127** afforded a 60:40 mixture of **137a** and **137b** epimers at C-2 which was isolated in 37% yield. Traces of the product resulting from the OMe endocyclic elimination were also observed (entry 1, Table 2. 3). Similar results were obtained with the electron rich *p*-methoxyphenyl substituted sulfoxide giving of a 59:41 mixture of epimers in 28% yield (entry 2). The electron poor chroman derivate bearing the *p*-nitrophenyl substituted sulfoxide **129** gave also a poor result (entry 3). Compounds **139a** and **139b** were isolated in only 21% yield. The formation of a complex mixture prevented the determination of the diastereomeric ratio.

2-Naphthyl sulfinyl substituted chroman **130** provided the methyl substituted products **140** in 53% yield and 67:33 *dr*. Best results were obtained with 2-methoxy-1-naphthyl-1-sulfinyl chroman **132** (entry 5), The reaction of **132** with

Me₃Al in the presence of TiCl₄ allowed to prepare a 66:34 *dr* mixture of C-2 epimers **141** in 70% yield.

In conclusion, reactions 2-methoxy-2-methyl sulfinyl chromans **127-132** bearing different substituted sulfoxides with trimethyl aluminium in presence of TiCl₄ gave mixtures of epimeric 2-methyl-2-(sulfinylmethyl) chromans in moderate to good yields. The diastereoselectivity of the quaternary stereogenic center formation ranged from 67:33 to 59:41 *dr* of the (2*S*, *SR*) and (2*R*, *SR*)-epimers. The yields ranged from 21 to 70%. The moderate results obtained through the direct addition of methyl group, prompted us to turn out our attention to other nucleophiles to generate the stereogenic quaternary center.

II.4.3. Synthesis of differently substituted 2-allyl-2-(sulfinyl) methyl chromans

To achieve the stereoselective formation of the chiral C-2 tetrasubstituted chromans, we envisioned the introduction of an allyl group in the 2-methoxy-2-sulfinyl methyl chromans, previously prepared using the Lewis acid mediated cleavage of the OMe group and an allyl nucleophile. The stereoselective introduction of the allyl moiety at C-2 of the chroman unit would be interesting from the synthetic point of view, because it would allow future transformations in the side chain towards more complex molecules.

In agreement with the excellent diastereoselectivity previously achieved in our laboratory in the reductive substitution of 2-*p*-tolyl sulfinyl chromanol with Et₃SiH/TMSOTf,^{7b} we decided to check the formation of the quaternary stereocenter following a similar TMSOTf catalyzed reaction and allyl trimethyl silane as nucleophile. First attempts were realized on the 2-methoxy-2-(*p*-tolylsulfinyl)methyl chroman (*SR*)-**126** chosen as a model.

Thus, over a solution of 2-methoxy-2-(*p*-tolylsulfinylmethyl) chroman (*SR*)-**126** in CH₂Cl₂ at 0°C, were added 3 equivalents of trimethyl allyl silane followed by 2 equivalents of TMSOTf at the same temperature. After 4h, we did not observed further evolution of the reaction. We thus hydrolyzed the crude whose ¹H NMR spectrum evidenced the presence of a mixture of starting material, endocyclic elimination products **134** and hemiketal **114** (Scheme 2. 41). The reaction was then repeated with a higher excess of trimethyl allyl silane (5 equiv) at -78°C, but we did

^{7b} G. Hernández-Torres M. C. Carreño, A. Urbano, F. Colobert, *Chem. Eur. J.* **2011**, *17*, 1283 – 1293.

neither observe conversion. When the reaction mixture was led to reach room temperature, formation of compound **134**, resulting from the endocyclic elimination of MeOH, was observed as the evolution product.

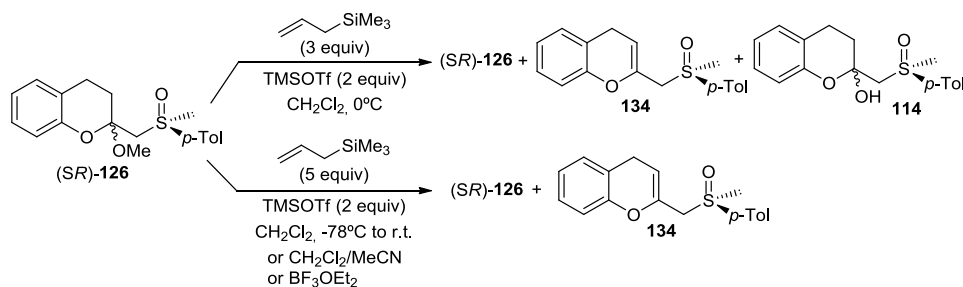

Scheme 2. 41

Finally, we decided to repeat the reaction of (*SR*)-**126** with a higher excess of trimethyl allyl silane (6 equiv) followed by the addition of TMSOTf (0.5 equiv) in $\text{CH}_2\text{Cl}_2/\text{MeCN}$ mixture (1:1). This solution was added to the methoxy chroman (*SR*)-**126** at 0°C . The use of MeCN could increase the acidity of TMSOTf,⁹⁵ speeding up the formation of the intermediate oxocarbenium ion, due to the absence of association with the solvent molecules. However, after 23 hours of reaction under these conditions, we only observed the formation of the endocyclic elimination product **134**.

The use of $\text{BF}_3\cdot\text{Et}_2\text{O}$ did not lead to better results, even after testing several temperatures (0°C , -20°C , -40°C and -78°C). In all cases the starting material was recovered together with small proportions of the elimination product **134**.

It is well known that allyl trialkyl silane reactions with carbonyl compounds or imines readily occur in the presence of a fluorine source such as tetra-*n*-butyl triphenylammonium fluoride (TBAT),⁹⁶ or tetra-*n*-butylammonium fluoride (TBAF). Catalytic amounts of Cu(I) salts alone or in combination with the fluoride are also efficient in promoting the transfer of an allyl group from allyl silanes.⁹⁷ The aim of these additives is to promote the formation of the allyl fluoro silicate, which is

⁹⁵ T. Yamanoi, Y. Oda, *Heterocycles* **2002**, *57*, 229-234.

⁹⁶TBAF comparison, nucleophilicity and basicity of F^- dependent of Si-F covalent bond in TBAT. a) A. S. Pilcher, H. L. Ammon, P. De Shong, *J. Am. Chem. Soc.* **1995**, *117*, 5166-5167. b) C. J. Handy, Y.-F. Lam, P. De Shong, *J. Org. Chem.* **2000**, *65*, 3542-3543.

⁹⁷a) Catalytic allylation with allyl trimethoxy silane, CuCl and TBAT: S. Yamasaki, K. Fujii, R. Wada, M. Kanai, M. Shibasaki, *J. Am. Chem. Soc.* **2002**, *124*, 6536. b) Catalytic allylation of ketones with allyl boranes, CuF_2 and Lewis acids: R. Wada, O. Kounosuke, K. Motomu, M. Shibasaki, *J. Am. Chem. Soc.* **2004**, *126*, 8910-8911.

much better nucleophile than the silane itself,⁹⁸ providing better reactivity facing different electrophiles to give the desired allylic product.

Thus, the reaction of (*SR*)-2-methoxy-2-(*p*-tolylsulfinyl)methyl chroman **126** with allyl trimethyl silane was attempted in the presence of the additives included in Table 2. 4.

When the reaction of (*SR*)-**126** and 3 equiv of allyl trimethyl silane (R = Me), was effected in the presence of 5 equiv of BF₃·OEt₂ and 1.2 equiv of Bu₄NF at -78°C, we did not observed evolution even after leading the mixture to reach room temperature (entry 1). The product resulting from the elimination of MeOH, **134** was obtained when TMSOTf as Lewis acid and CuI as additive were used (entry 2). The thioether resulting from the reduction of the sulfoxide **143** was observed when SnCl₄ and TBAT combination was used (entry 3). Lastly, the CuCl-TBAT combination, which produces CuF formation, with allyl trimethyl silane or allyl trimethoxy silane, and TMSOTf as Lewis acid, did neither lead to the desired products (entries 5 and 6).

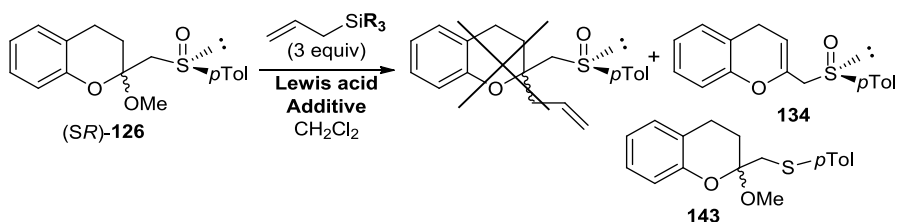

Entry	R	Lewis ac. (equiv)	Additive (equiv)	T (°C)	Product
1	CH ₃	BF ₃ ·OEt ₂ (5)	Bu ₄ NF (1.2)	-78°C-r.t.	--
2		TMSOTf (2)	CuI (0.2)	0°C-r.t.	134
3		SnCl ₄ (1.3)	TBAT (3)	-78°C-r.t.	134 + 143
4		TMSOTf (2)	TBAT (3)	0°C	--
5	CH ₃	TMSOTf (2)	0°C		
6	OCH ₃	TMSOTf (4)	-40°C		
7	CH ₂ =CHCH ₂	TiCl ₄ (1.4)	CuCl-TBAT (30 mol%)	-40°C	--

Table 2. 4

⁹⁸See allyl silane addition to C=N bond promoted by fluorine in aza-Sakurai reaction : a) G. K. Friestad, C. S. Korapala, H. Ding, *J. Org. Chem.* **2006**, *71*, 281-289. b) S. Kobayashi, C. Ogawa, H. Konishi, M. Sugiura, *J. Am. Chem. Soc.* **2003**, *125*, 6610-6611.

We thus decided to check the behavior of the reaction of (*SR*)-2-methoxy-2-(*p*-tolylsulfinyl)methyl chroman **126** with allyl trimethyl silane in the presence of 1.6 equivalents of titanium tetrachloride (TiCl_4) as Lewis acid at different temperatures. The results are represented in Table 2. 5. Under these conditions, a new product was observed which was characterized as two diastereomeric mixture resulting from the OMe substitution, (*2R,SR*) and (*2S,SR*)-allyl-2-(*p*-tolylsulfinyl)methyl chroman **144**.

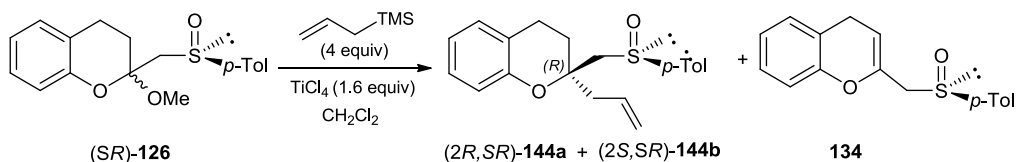

Entry	T	<i>d.r.</i> (144a : 144b)	Yield 144	Side products
1	0°C	--	--	134
2	-20°C	72 : 28	78%	134 (2%)
3	-40°C	77 : 23	86%	-
4	-78°C	81 : 19	75%	-

Table 2. 5

The final diastereomeric ratio was dependent on the temperature. When the reaction took place at 0°C, there was almost not evolution to the substitution compounds **144**, and a complex mixture was formed where product **134** resulting from the endocyclic elimination of MeOH and the starting material were detected. Almost total conversion to the desired products occurred when temperature of the reaction was below -20°C. A 72:28 mixture of diastereoisomers was formed under these conditions (entry 2). The diastereoselectivity increased at lower temperatures. Thus working at -40°C, a 77:23 *dr* mixture of (*2R, SR*)-**144a** and (*2S, SR*)-**144b** could be isolated in 86% yield (entry 3). Although at -78°C the diastereomeric ratio of **144a** and **144b** was better (81:19 *dr*, entry 4), the conversion was not completed and the yield was slightly lower.

The best conditions in terms of stereoselectivity were found at -78°C (81:19 *dr*) versus the obtained at -40°C (77:23 *dr*). However, the best yield in the

formation of the 2-allyl-2-(*p*-tolylsulfinyl) methyl chroman **144** resulted in the reaction carried out at -40°C (86%).

Diastereomeric ratios were determined by ^1H NMR from the crude reaction mixture by integration of the signals corresponding to the allylic $\text{CH}=\text{CH}_2$ fragment which appeared at δ 5.96-6.05 ppm ($\text{CH}=\underline{\text{C}}\text{H}_2$) and 5.25-5.31 ppm ($\underline{\text{C}}\text{H}=\text{CH}_2$) for the major diastereoisomer (*2R, SR*)-**144a**, and δ 5.77-5.85 ppm ($\text{CH}=\underline{\text{C}}\text{H}_2$) and 5.13-5.17 ($\underline{\text{C}}\text{H}=\text{CH}_2$) for the minor diastereoisomer (*2S, SR*)-**144b** (Figure 2. 6).

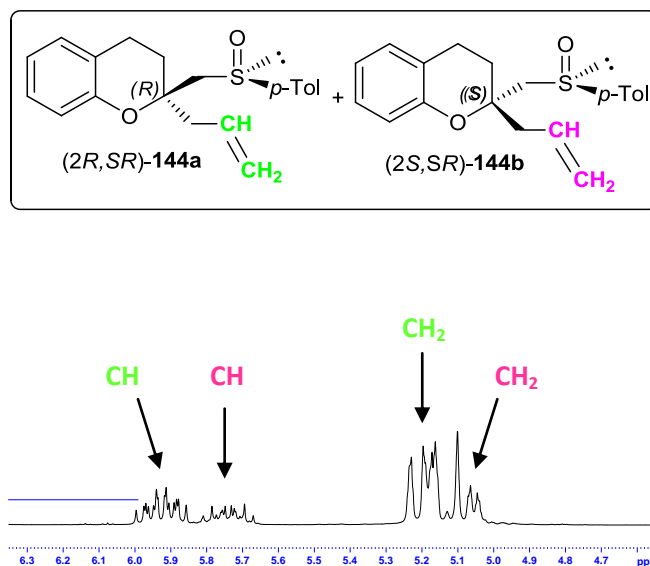
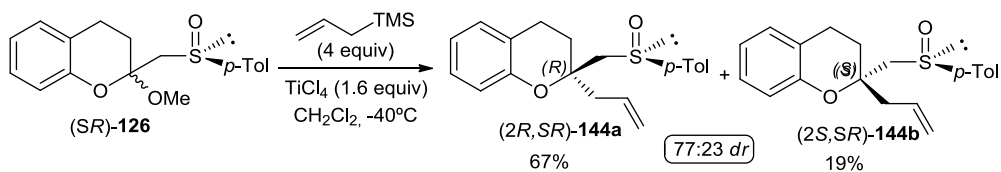

Figure 2. 6

Both diastereoisomers (*2R, SR*)-**144a** and (*2S, SR*)-**144b** were isolated pure by flash chromatography in 67% and 19% yield respectively from the 77:23 mixture obtained at -40°C (Scheme 2. 42). The absolute configuration of (*2R, SR*)-**144a** could be unequivocally established by X-ray diffraction (Figure 2. 7).



Scheme 2.42

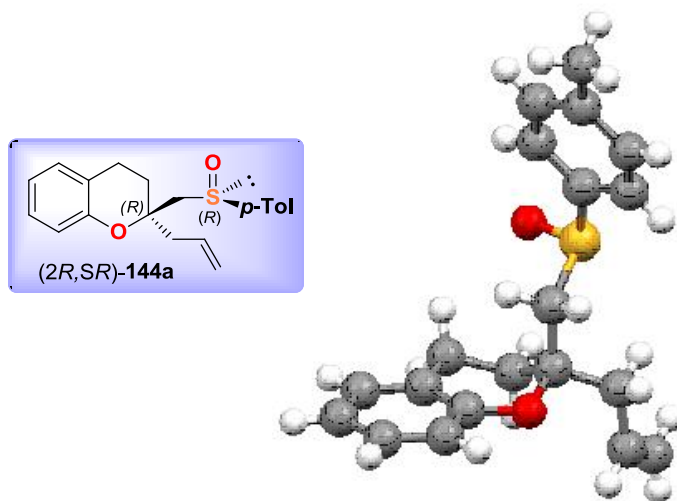
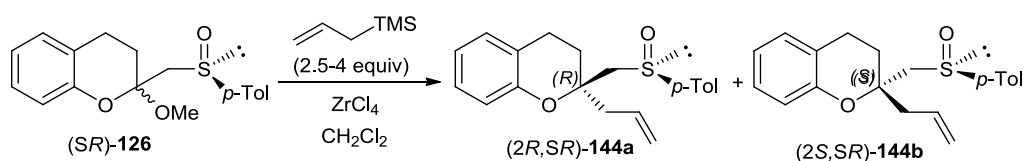

Figure 2.7

In order to improve the diastereoselectivity, we later checked the use of other Lewis acids. Thus, the reaction of (*SR*)-2-methoxy-2-(*p*-tolylsulfinylmethyl) chroman **126** with trimethyl allyl silane was carried out with titanium tetraisopropoxide ($\text{Ti}(i\text{PrO})_4$), titanium dichloride diisopropoxide ($\text{Ti}(i\text{PrO})_2\text{Cl}_2$) generated *in situ* from a 1:1 mixture of $\text{Ti}(i\text{PrO})_4$ and TiCl_4 , tin(IV) chloride (SnCl_4), aluminium trichloride (AlCl_3), zinc dichloride (ZnCl_2), bismuth(III) chloride (BiCl_3), iron(III) chloride (FeCl_3), scandium(III) triflate ($\text{Sc}(\text{OTf})_3$), boron difluoride triflate diethyl etherate ($\text{BF}_2\text{OTf}\cdot\text{OEt}_2$), which was prepared *in situ* from boron trifluoride diethyl etherate and trimethylsilyl triflate,⁹⁹ unfortunately they did not give positive results.

⁹⁹ E. L. Myers, C. P. Butts, V. K. Aggarwal, *Chem. Commun.* **2006**, 4434-4436.

Only the reaction with zirconium (IV) chloride ($ZrCl_4$) led to the 2-allyl chroman **144** formation. As shown in Table 2. 6, the elimination product **134** was the only product detected when the reaction took place at $0^\circ C$ (entry 1). When the reaction was carried out under the same conditions (4 equivalents of $ZrCl_4$) at $-40^\circ C$ (entry 2), allyl substituted products were observed in poor diastereoselectivity together with a 5% of elimination product **134**. Nevertheless, at $-40^\circ C$ diastereoisomers (*2R,S*R)-**144a** and (*2R,S*R)-**144b** were obtained in 74:26 *dr* when 2.5 equivalents of $ZrCl_4$ were used, and isolated in 80% yield after flash chromatography (entry 3).



Entry	$ZrCl_4$ (equiv)	Temp	<i>d.r.</i> (144a : 144b)	Yield	Other products
1	4	$0^\circ C$	--	0	134
2	4	$-40^\circ C$	68: 32	--	134 (5%)
3	2.5	$-40^\circ C$	74: 26	80%	134 (3%)

Table 2. 6

Moreover, the use of other solvents such as acetonitrile, nitromethane or dichloroethane in the best conditions found, did not lead to the final products **144** resulting from the OMe substitution of (*SR*)-**126** (Scheme 2. 43).

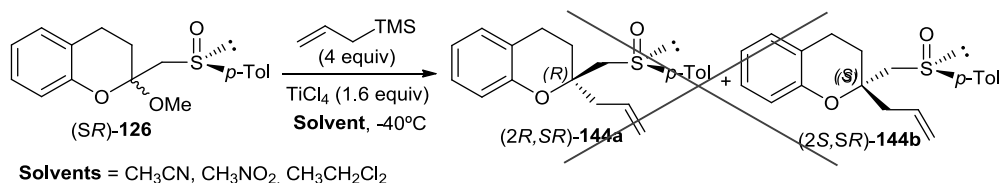

Scheme 2. 43

In order to improve the diastereoselectivity of the ionic substitution of the OMe at C-2 of the (*SR*)-2-methoxy-2-(*p*-tolylsulfinyl) methyl- chroman **126** with an allyl group, different allyl silanes were checked in combination with different Lewis acids. The different reactivity and nucleophilic power of the allylsilanes was known to be dependent on the silicon substitution. Patz had studied the different reactivity of allyltrialkylsilanes and could demonstrate that the nature of the alkyl group exerted a small influence on the rate of the allyl transfer reaction. As shown in Table 2. 7, among the allyl silanes studied, the most nucleophilic was allyl triisopropyl silane which reacted faster than the allyl-*t*-butyl dimethyl silane and allyl trimethyl silane. An allyl triphenyl silane was noticeably less reactive.¹⁰⁰

				
$K_{rel} (x 10^{-2} L mol^{-1}s^{-1})$	2.4	1.1	1.0	0.017

Table 2. 7

In the literature, tetraallylsilane has been proved to be as good as allyl transfer agent as other trialkylsilanes such as allyltrimethylsilane in nucleophilic reactions with N-acylhydrazones in combination with TBAT.^{100b} The improvement of the tetraallylsilane versus allyltrimethylsilane may be attributable to a slightly more electrophilic silicon atom, leading to greater fluoride ion affinity (Scheme 2. 44).

¹⁰⁰ a) J. Burfeindt, M. Patz, M. Müller, H. Mayr, *J. Am. Chem. Soc.* **1998**, *120*, 3629-3634; b) G. K. Friestad, C. S. Korapala, H. Ding, *J. Org. Chem.* **2006**, *71*, 281-289; c) G. Hagen, H. Mayr, *J. Am. Chem. Soc.* **1991**, *113*, 4954-4961; d) H. Mayr, R. Schneider, U. Grabis, *J. Am. Chem. Soc.* **1990**, *112*, 4460-4467.

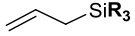
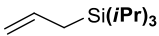
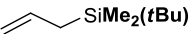
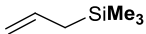
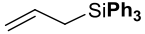
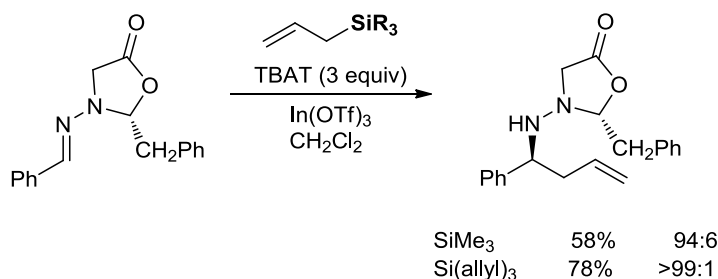

Scheme 2. 44

The diastereospecific addition of allyl group to aldehydes to give the corresponding homoallyl alcohols was reported in 2002.¹⁰¹ Thus, as shown in Scheme 2. 45 the addition of pinacol allylboronic esters to aldehydes with scandium (III) triflate as catalyst, led to the corresponding allyl alcohols in good yields and excellent selectivities.

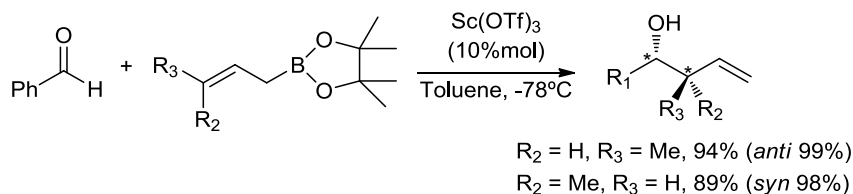

Scheme 2. 45

We thus tried these allylating agents under the reported conditions in order to evaluate their behavior on the substitution of the methoxy ketal group of (*SR*)-2-methoxy-2-(*p*-tolylsulfinylmethyl) chroman **126**. We tested the allyl transfer agents included in Table 2. 8 In all cases 4 equivalents of the allyl silane were used. For comparison, the best result previously obtained with allyl trimethyl silane is included (entry 1). When the methoxy *p*-tolylsulfinyl chroman **126** was treated with the most nucleophilic allyl triisopropylsilane and TiCl₄ (1.6 equiv) at -78°C, the 2-allyl sulfinyl chroman **144** was obtained in 80% yield as a 77: 23 *dr* mixture of (*2R,SR*)-**144a** and (*2S,SR*)-**144b** (entry 2, Table 2. 8).

When the tetraallyl silane was used under the same experimental conditions, TiCl₄ (1.6 equiv) at -78°C, a complex reaction mixture was observed where only traces of the final products (*2R,SR*)-**144a** and (*2S,SR*)-**144b** were detected (entry 3).

¹⁰¹ T. Ishiyama, T. Ahiko, N. Miyaoura, *J. Am. Chem. Soc.* **2002**, *124*, 12414-12415.

When the temperature of this reaction increased to -40°C , a similar result was observed (entry 4).

No reaction was observed with the trimethoxy allylsilane in combination with the TiCl_4 at -40°C (entry 5). The reaction with trichloro allylsilane, as allyl transfer agent in the presence of TiCl_4 (1.6 equiv) at -78°C , led to the elimination product **134** and the thioether resulting from the reduction of sulfoxide (entry 6).

Reaction of (*SR*)-2-methoxy-2-(*p*-tolylsulfinylmethyl) chroman **126** with allyl pinacol boronate in the presence of titanium tetrachloride or scandium (II) triflate as Lewis acid did not lead to the desired products, recovering a mixture of elimination product **134** and hemiketalic sulfinyl chroman **114** (entry 7) or the starting material (entry 8) respectively. Allyl tributyl stannane, in combination with TMSOTf at 0°C gave rise to a mixture of the elimination product **134** and the hemiketal **114** (entry 9, Table 2. 8).

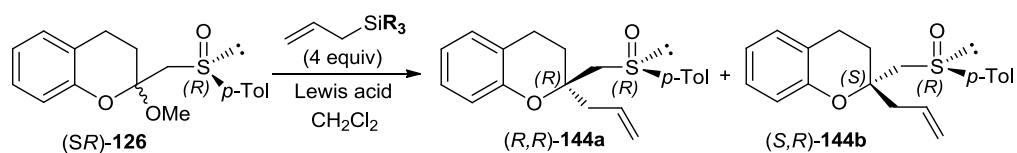

Entry		Lewis Ac	T (°C)	<i>d.r.</i> (144a: 144b)	Other products	
1		TiCl ₄	-40°C	77:23 (86%)	-	
2			-78°C	77: 23 (80%)	-	
3			-78°C	traces	-	
4			-40°C	traces	-	
5			-40°C	No reaction		
6			-40°C	-	 134 + 143	
7			0°C	-	 134 + 114	
8			Sc(OTf) ₃	-78°C to 0°C	No reaction	
9			TMSOTf	0°C	-	 134 + 114

Table 2. 8

The best results were thus obtained again as previously established, using allyl trimethyl silane as allyl transfer agent and TiCl_4 as Lewis acid.

The scope of the diastereoselective TiCl_4 -promoted sulfoxide-directed allylation of enantiopure sulfinyl ketal chroman with allyl trimethyl silane to efficiently generate the challenging (2*R*) stereocenter of the chromans was examined with the substituted sulfinyl chromans having different substituents at the sulfoxide (*t*-Butyl, *p*-methoxyphenyl, *p*-Nitrophenyl, 2-Naphthyl, 2-methoxy-1-naphthyl) we had previously synthesized **137-141**.

Results are indicated in Table 2. 9, all reactions were carried out with 1.4 equivalents of TiCl_4 and 4 equivalents of allyl trimethyl silane in CH_2Cl_2 at -40°C .

The used of a bulky substituent as *t*-butyl group, decreased substantially the diastereoselectivity to 57:43 and the yield (40%), also the product from the endocyclic elimination of MeOH was observed in 16% yield (entry 1).

When the reaction was carried out with an electron rich substituent in the sulfoxide the yield and the diastereoselectivity (51%, 66:34 *dr*) did not improve either (entry 2). An increase was observed with the *p*- NO_2Ph sulfoxide (entry 3), where the yield improved to 85% and the diastereoselectivity was still moderated, 69:31 *dr*.

The reaction with the naphthyl sulfoxide led to the allyl substituted chromans **148a** and **148b** (entry 4) in 63% yield and better diastereoselectivity (80:20 *dr*). The used of the 2-methoxy-1-naphthyl sulfinyl chromanol **132** drove to the allyl substituted product (entry 5) but in 45% yield with a diastereoselectivity of 58:42 *dr*.

In summary, the 2-Allyl-2-(alkyl or aryl) sulfinyl methyl chromans **144-149** resulting from the allyl transfer were formed in all cases as a mixture of epimers in C-2. However, yields and the diastereoselectivity were dependent on the nature of the sulfoxide substituent. The electron poor sulfur would increase the oxocarbenium intermediate electrophility, making easier the allyl silane attack. The best yields were observed with chromans bearing *p*-tolylsulfoxide and *p*-nitrophenylsulfoxide (entries 6 and 7).

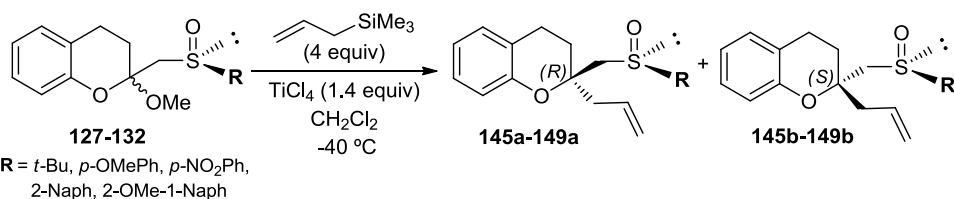

Entry	R	Products	Yield	<i>d.r.</i>
1	<i>t</i> -Bu (±) (127)	 145a + 145b	40% (16% elimination product)	(57: 43)
2	Ph- OMe (±) (128)	 146a + 146b	51%	(66: 34)
3	Ph- NO ₂ (±) (129)	 147a + 147b	85%	(69: 31)
4	2-Naph (±) (130)	 148a + 148b	63%	(80: 20)
5	2- OMe- 1-Naph (132)	 149a + 149b	45%	(58: 42)
6	<i>p</i> -Tol (126)	 144a + 144b	86%	(77: 23)

Table 2. 9

All these results are consistent with the proposed mechanism for the allyl transfer, as will be explained later. Our data probed that both, the steric hindrance and the electronic nature of the sulfoxide have a significant influence in the process. The *p*-tolyl (*SR*)-**126** and the 2-naphtyl sulfoxide **130**, with similar electronic properties, were the groups that offered the best results in terms of stereoselectivity.

In order to further improve the diastereoselectivity of these substrates, their reactions with allyl trimethyl silane and TiCl_4 were carried out at different temperatures. The results are indicated in Table 2. 10.

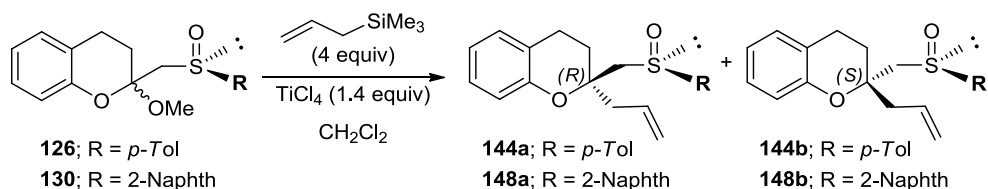

Entry	R	T	<i>dr</i>	Yield	Others
1	<i>p</i> -Tol	-78°C	81:19	75%	-
2		-40°C	77:23	86%	
3		-20°C	72:28	78%	
4		0°C	Low conversión		
5	2-Naphth	-78°C	77:23	70%	-
6		-40°C	80:20	63%	
7		-20°C	87:13	69%	
8		0°C	84:16	37%	

Table 2. 10

The more accessible *p*-tolyl sulfoxide reacted at -78°C giving a better diastereoselectivity (entry 1) than at -40°C (77:23, entry 2) whereas the *p*-tolyl at the lower temperature was better (entry 2). At higher temperature, the diastereoselectivity was lower (entry 3). The reaction at 0°C led mainly to the elimination product.

The naphthyl substituted substrate diastereoselectivities increased when the temperature rise to -20°C (entry 3, Table 2. 10) although the yield was moderate (69%). At 0°C reactions with methoxy sulfinyl chromans **126** and **130** gave also a significant amount of the endocyclic elimination product of MeOH (entry 4).

In accordance with these results we could establish that the better yield and diastereoselectivity of the allyl transfer was achieved in the reactions with *p*-tolyl sulfinyl substituted chroman (*SR*)-**126** at -78°C (81:19 *dr*, 75% yield) and the 2-naphthyl sulfinyl chroman **130** at -20°C (87:13 *dr*, 69% yield).

During the search of the best combination of reactants and conditions to obtain the tetrasubstituted chroman target, we found an unexpected reaction which is worth to be commented. When 2-methoxy-(*p*-tolylsulfinyl) methyl chroman (*SR*)-**126** was treated with TMSOTf (1.2 equiv) and allyl trimethyl silane using MeCN as solvent at 0°C , a product characterized as N-2-(*p*-tolylsulfinyl) methyl chroman-2-yl acetamide **150** was obtained in a stereoselective process. The reaction was later reproduced without the allyl trimethyl silane as shown in Scheme 2. 46 and the 2-acetamidyl sulfinyl chroman **150** was isolated in a 90% yield as 80:20 mixture of C-2 epimers.

This unexpected result could be explained on the basis of a Ritter type reaction.¹⁰² As shown in Scheme 2. 46, the OMe group of the starting ketal (*SR*)-**126** was activated by the Lewis acid which facilitates the loss of the OMe group to form the oxocarbenium ion intermediate **I**. This suffers the nucleophilic attack of the MeCN, used as solvent, to form an new intermediate **II** that reacts with water. After tautomerization of the acetamide aza enolic form we obtained the acetamidyl chroman **150**.

¹⁰² a) J. J. Ritter, P. P. Minieri, *J. Am. Chem. Soc.* **1948**, *70*, 4045-4048; b) D. Le Goanic, M.-C. Lallemand, E. Tillequin, T. Martens, *Tetrahedron Lett.* **2001**, *42*, 5175-5177.

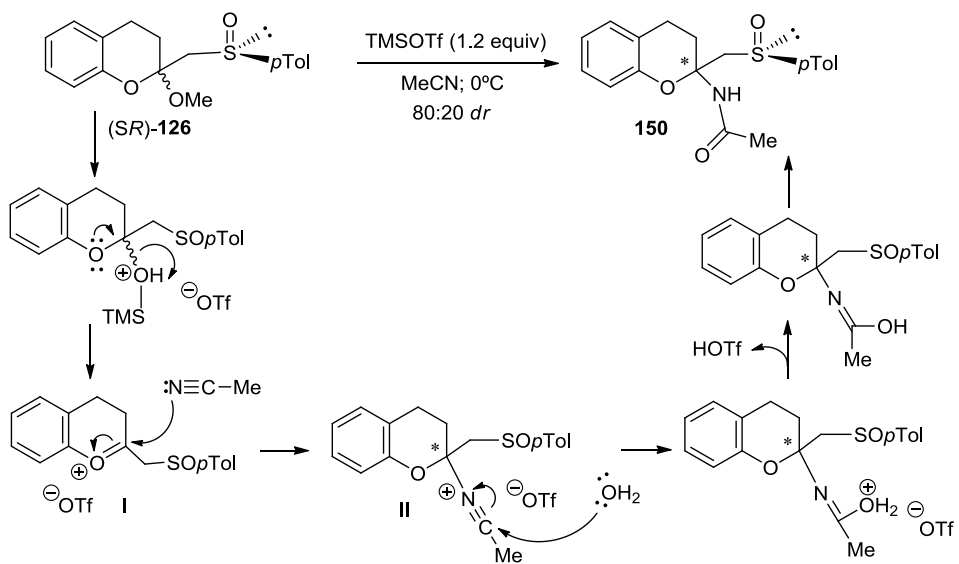

Scheme 2. 46

II.4.4. Mechanistic proposal

The mechanism and stereochemistry of nucleophilic substitutions of tetrahydropyran acetals, likely occurring through the intermediate formation of cyclic oxocarbenium ions, have been extensively studied by Woerpel. The main conclusions reached by this author are that electrostatic effects of the different ring substituents define a reactive conformation for the oxocarbenium intermediates which suffers a facial selective attack of the nucleophile mainly governed by stereoelectronic effects.¹⁰³ The stereoselectivity was shown to be only slightly affected by the solvent, the Lewis acid, the nature of the leaving group and the nucleophile. In connection with our work, the most significant results correspond to the study of differently substituted ribose derived acetals, as well as tetrahydropyranyl oxocarbenium ions bearing an exocyclic alkoxyalkyl substituent. The model proposed by Woerpel assumed that the stereoselectivity of the overall process depends on the conformational preference of the alkoxy group situated at C-3 of the six-membered ring oxocarbenium ions.

For example, the study of the Lewis acid-mediated nucleophilic substitution reactions of substituted tetrahydropyran acetates **151** by allyl trimethyl silane revealed that the diastereoselectivity was defined by the conformational preferences of the six-membered-ring cation intermediate which was formed in the presence of $\text{BF}_3 \cdot \text{OEt}_2$ and depended significantly upon the electronic nature of the substituent at C-3.¹⁰⁴ As can be seen in Scheme 2. 47, the nucleophilic addition of allyl trimethyl silane in presence of $\text{BF}_3 \cdot \text{Et}_2\text{O}$ as Lewis acid to 1-acetoxy-3-substituted pyran **151**, gave the opposite diastereoselectivity with 4-methyl substituted derivate (*cis/trans*, <1:99) and the OBn analogue (*cis/trans*, 89:11). These results can be understood taking into account the reactive conformation of the oxocarbenium intermediate in each case. Two conformations can participate in the conformational equilibrium of these species I and II. When X = Me the excellent 2,4-*trans* diastereoselectivity (>99:1) observed is not fully accounted for the moderate pseudoequatorial preference of the C-3 methyl substituted oxocarbenium ion (I, X = Me).

¹⁰³ P. Deslongchamps, *Stereoelectronic Effects in Organic Chemistry*; Pergamon: New York, **1983**; pp 209–221.

¹⁰⁴ L. Ayala, C. G. Lucero, J. A. C. Romero, S. A. Tabacco, K. A. Woerpel, *J. Am. Chem. Soc.* **2003**, *125*, 15521-15528.

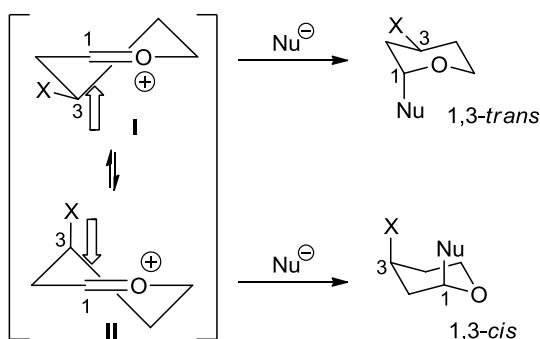
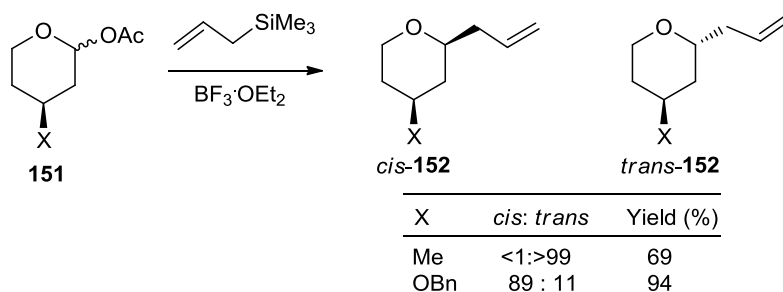

Scheme 2. 47

Although the pseudoaxial conformer **II** (X = Me) is likely to be present to a small extent,¹⁰⁵ it is less reactive, since the axial sterically favored nucleophilic attack on this conformer would develop a highly destabilizing *syn*-diaxial interaction. The axial nucleophilic attack on the pseudoequatorial conformer **I** (X = Me), where no destabilizing interactions develop, is largely preferred thus leading to the exclusively formation of the 2,4-*trans* isomer **152**. When X = OBn, conformer **II** situating the OBn group in a pseudoaxial disposition is stabilized by the interaction of the lone electron pair of the oxygen with the positive charge. Thus the axial attack of the nucleophile on this conformation would explain the major formation of the 2,4-*cis* tetrahydropyran derivative.

Other studies by Woerpel^{106,107,108} had evidence a higher stability of the conformers with an axial alkoxy group situated three carbons away from the

¹⁰⁵ Woods, R. J.; Andrews, C. W.; Bowen, J. P. *J. Am. Chem. Soc.* **1992**, *114*, 859-864.

¹⁰⁶ C. H. Larsen, B. H. Ridgway, J. T. Shaw, D. M. Smith, K. A. Woerpel, *J. Am. Chem. Soc.* **2005**, *127*, 10879–10884, and references therein.

¹⁰⁷ For the mechanism on the Lewis acid-catalyzed nucleophilic substitution of acetals, see: a) J. R. Krumper, W. A. Salamant, K. A. Woerpel, *Org. Lett.* **2008**, *10*, 4907–4910; b) S. R. Shenoy, D. M. Smith, K. A. Woerpel, *J. Am. Chem. Soc.* **2006**, *128*, 8671–8677; c) S. R. Shenoy, K. A. Woerpel, *Org. Lett.* **2005**, *7*, 1157–1160; d) T. Sannakia, R. S. Smith, *J. Am. Chem. Soc.* **1994**, *116*, 7915–7616; e) S. E.

cationic carbon of the oxocarbenium ion due to favored electrostatic interactions that arise between the electronegative axial oxygen and the close positive charge of the cationic center. The axial inside face attack of the nucleophile, favored by stereoelectronic effects, justified the major formation of the 1,3-*cis* disubstituted addition product. Exocyclic electrostatic interactions were also shown to contribute to the conformational stability of tetrahydropyran oxocarbenium ions. In such cases, the stereochemical course of the nucleophile approach is also preferentially governed by stereoelectronic effects. When polysubstituted derivatives are reacting, in accordance with the Curtin-Hammett principle, the reactive conformation could not be the most stable due to the interactions developing in the transition state.

The study of reductive cyclizations of 4-hydroxy-5-(*p*-tolylsulfinyl) ketones by treatment with TMSOTf/Et₃SiH has evidenced the role of the exocyclic sulfoxide of the intermediate oxocarbenium anion in the control of the reactive conformation and the stereochemistry of the reductive cyclization (Scheme 2. 48). The reaction of phenyl hydroxy sulfinyl ketone (*R,S*R)-**153** with TMSOTf and Et₃SiH, previously reported by us,^{4,7a} led to a 84:16 mixture of diastereoisomers, where the 2,5-*cis* disubstituted tetrahydrofuran *cis*-**154**, was the major. The methyl ketone analogue (*R,S*R)-**155** evolved even more stereoselectively, giving rise to the exclusive formation of diastereoisomer *cis*-**156**. The stabilization of the reactive conformation of the cyclic oxocarbenium ion by the electrostatic effect of the sulfoxide, explains these results. The bicyclic envelope-boat-like conformation **B** shown must react stereoselectively by the top face, according with a favored axial attack of the nucleophile. The phenyl group, present in the intermediate resulting from (*R,S*R)-**153** (**B**, R = Ph) could partially delocalize the positive charge, thus slightly diffracting the electrostatic stabilization by the sulfinyl oxygen. On the other hand, the donating character of the methyl group of the intermediate proceeding from (*R,S*R)-**155**, can contribute to concentrate the charge in the cationic center, thus increasing the electrostatic stabilization of **B** (R = Me), which finally evolve in a highly diastereoselective manner.

Denmark, N. G. Almstead, *J. Am. Chem. Soc.* **1991**, *113*, 8089–8110; f) T. Sammakia, R. S. Smith, *J. Am. Chem. Soc.* **1992**, *114*, 10998–10999; g) I. Mori, K. Ishihara, L. A. Flippin, K. Nozaki, H. Yamamoto, P. A. Bartlett, C. H. Heathcock, *J. Org. Chem.* **1990**, *55*, 6107–6115.

¹⁰⁸ Tetrahydropyran derivatives: a) M. T. Yang, K. A. Woerpel, *J. Org. Chem.* **2009**, *74*, 545–553; b) C. G. Lucero, K. A. Woerpel, *J. Org. Chem.* **2006**, *71*, 2641–2647; c) S. Chamberland, J. W. Ziller, K. A. Woerpel, *J. Am. Chem. Soc.* **2005**, *127*, 5322–5323; d) L. Ayala, C. G. Lucero, J. A. C. Romero, S. A. Tabacco, K. A. Woerpel, *J. Am. Chem. Soc.* **2003**, *125*, 15521–15528; e) J. A. C. Romero, S. A. Tabacco, K. A. Woerpel, *J. Am. Chem. Soc.* **2000**, *122*, 168–169.

⁴ M. C. Carreño, F. Colobert, R. Mazery, A. Urbano, G. Solladié, *J. Org. Chem.* **2003**, *68*, 7779–7787.

⁷ a) M. C. Carreño, G. Hernández-Torres, A. Urbano, F. Colobert, *Org. Lett.* **2005**, *7*, 5517–5520.

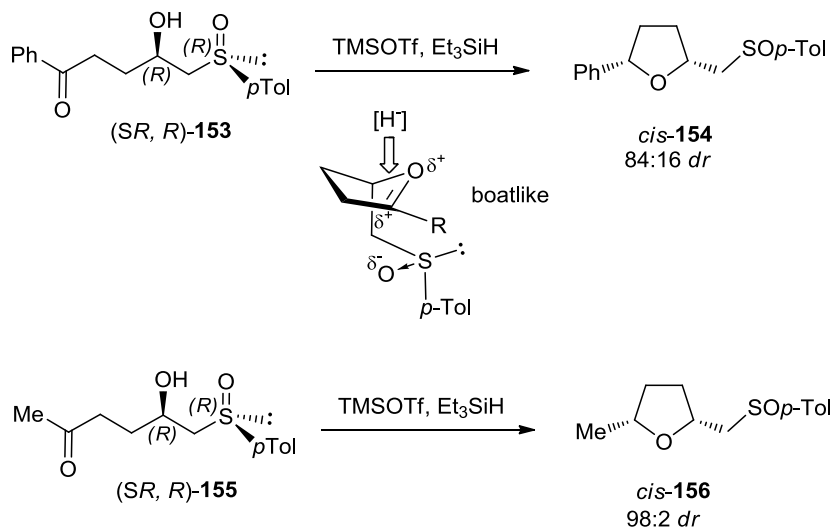

Scheme 2. 48

In the case of the bicyclic oxocarbenium ion analogues leading to the 2*H*-chromans, stereoelectronic effects of the sulfoxide must not be responsible for the stabilization of the reactive conformation, since the most electron rich sulfoxides gave poorer diastereoselectivities. We thus propose that, once the bicyclic oxocarbenium ion was formed, after ionic cleavage of the C2-O bond of (*SR*)-**114** by activation with the Lewis acid, the hydride of Et₃SiH was transferred with the assistance of the sulfinyl oxygen through a species such as **C**, adopting the chair-like geometry represented in Scheme 2. 49. This is a stable conformation since the bulky *p*-tolyl group of the sulfoxide is in a favorable equatorial position. The approach of the hydride from the lower face, in the axial direction, is favored from stereoelectronic effects.^{7b}

^{7b} G. Hernández-Torres M. C. Carreño, A. Urbano, F. Colobert, *Chem. Eur. J.* **2011**, *17*, 1283 – 1293.

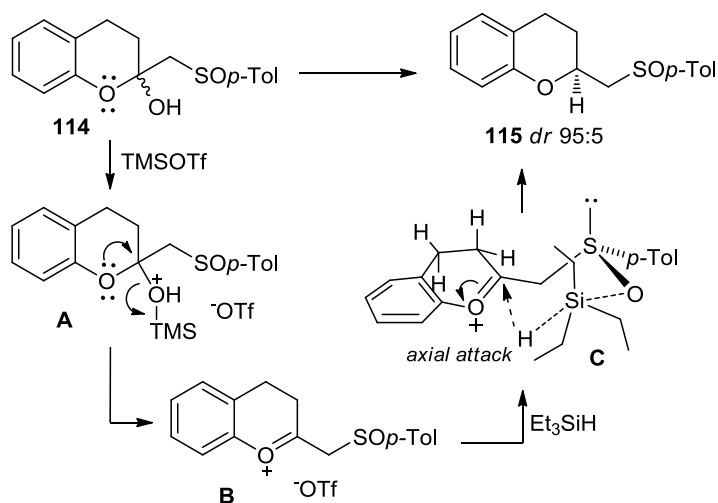

Scheme 2. 49

In the case of formation of the quaternary stereogenic center at C-2 of the chroman unit, the experimental observations highlighted that TiCl_4 was the most appropriate Lewis acid to obtain the desired products in a stereoselective fashion.

The TiCl_4 could have a double role. As shown in Scheme 2. 50, it could initially activate the mixed ketal (*SR*)-**126** (A) to favor the elimination of the OMe group and the formation of a stabilized oxocarbenium intermediate such as B. The remarkable level of diastereotopic face selection observed suggested a chelation controlled addition of the allyl trimethyl silane to a species such as C, situating the bulky *p*-tolyl group in the pseudoequatorial position. The chelate formed between the titanium and the oxygens of the oxocarbenium ion and the sulfoxide shows a tetragonal rigid bipyramide structure¹⁰⁹ with two apical chlorine atoms. The apical chlorine situated on the back is hindering the nucleophile approach from the bottom face thus directing the allyl trimethyl silane attack from the less hindered upper face (Scheme 2. 50). This approach is also favored by stereoelectronic factors since the nucleophile is attacking the deficient carbon in an axial direction.

¹⁰⁹ Duthaler, R. O.; Hafner, A. *Chem. Rev.* **1992**, *92*, 807-832, and references cited therein.

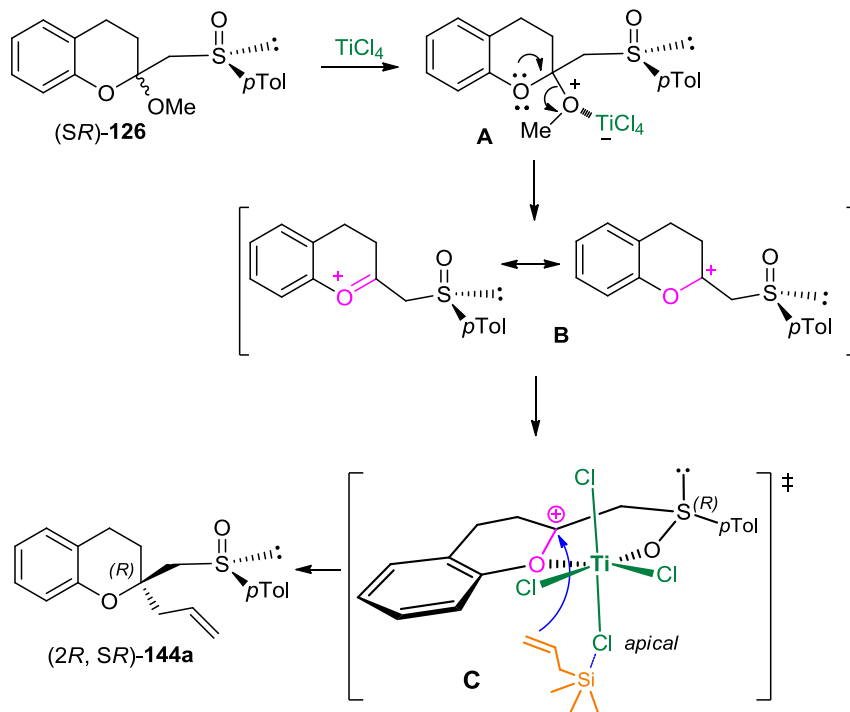

The different diastereoselectivities achieved with the differently substituted sulfoxides indicated in Table 2.9, could be justified on this mechanistic base.

The low yields and diastereoselectivities resulting from the *t*-Bu sulfoxides could be a consequence of the steric congestion existent the chelated species **C** (Figure 2.8). Elimination of the β -hydrogen would be competitive to liberate steric congestion.

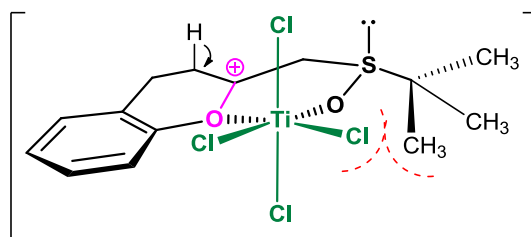

Figure 2.8

According with this mechanistic proposal, the more electron rich sulfoxides having the *p*-OMePh and 2-OMe-1-naphthyl substituents must have reacted in more diastereoselective manner. The poor diastereoselectivity achieved (66:34 for *p*-OMePh and 58:42 for 2-OMe-1-naphthyl) could be due to the competition of the OMe groups for the titanium Lewis acid thus decreasing the ability of TiCl₄ to assist the transfer of the allyl group.

The *p*-NO₂Ph substituted sulfoxide gave a better yield of the substitution product (85%) as expected on the base of the increased reactivity of the intermediate oxocarbenium ion, due to the electron withdrawing (EW) character of the NO₂ group which must increase the electrophility of the intermediate. In contrast, this EW effect must decrease the ability of the SO*p*-OMePh group to be associated with the TiCl₄, thus decreasing the diastereoselectivity.

An intermediate situation occurred with the *p*-tolyl (86%, 77:23 *dr*) and 2-naphthyl (63%, 80:20 *dr*) sulfoxides, which according with their yields and diastereoselectivities must be basic enough to associate the titanium. Steric effects must also be favoring the association of the allyl trimethyl silane to afford the (*S*, *R*)-epimer of the 2-allyl-2-(arylsulfinylmethyl) chroman as the major isomer.

II.4.5. Synthesis of 2-substitued benzofurans:

Furan derivatives constitute a versatile class of heterocycles because of their presence in many biologically active compounds and their applications in a wide range of chemical transformations.¹¹⁰ Among them, chiral benzofurans are an attractive type of oxygenated organic compounds since its skeleton is present in several natural products (pterocarpan, ligands) and other biologically active molecules such as (-)-serotobenine shown in Figure 2. 9. Therefore, efficient and enantioselective methods to construct such a moiety are strongly desirable. A series of nonstereoselective and stereoselective chemical syntheses have been reported in the literature.¹¹¹ Among them, chemoenzymatic methods, radical cyclizations and metal catalysis are the most frequently used to generate the heterocyclic moiety.

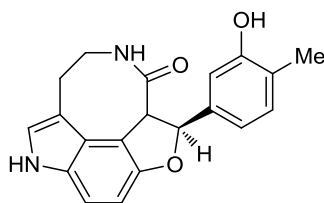

(-)-Serotobenine

Figure 2. 9

Taking into account the results we obtained in the formation of 2,2-disubstitued benzopyrans (chromans), we decided to evaluate the possibility of applying a similar methodology to the synthesis of 2,2-substitued benzofurans. For such an approach we planned to synthesize the simplest derivative **157** using the

¹¹⁰ a) Lipshutz, B. H. *Chem. Rev.* **1986**, *86*, 795. b) Durani, N.; Jain, R.; Saeed, A.; Dikshit, D. K.; Durani, S.; Kapil, R. S. *J. Med. Chem.* **1989**, *32*, 1700. c) McCallion, G. D. *Curr. Org. Chem.* **1999**, *3*, 67. d) Mortensen, D. S.; Rodriguez, A. L.; Carlson, K. E.; Sun, J.; Katzenellenbogen, B. S.; Katzenellenbogen, J. A. *J. Med. Chem.* **2001**, *33*, 3838.

¹¹¹ See for example: a) Engler, T. A.; Letavic, M. A.; Reddy, J. P. *J. Am. Chem. Soc.* **1991**, *113*, 5068. b) Petit, F.; Furtoss, R. *Synthesis* **1995**, 1517. c) Enders, D.; Va'zquez, J.; Raabe, G. *J. Chem. Soc., Chem. Commun.* **1999**, 701. d) Engler, T. A.; Letavic, M. A.; Iyengar, R.; La Tessa, K. O.; Reddy, J. P. *J. Org. Chem.* **1999**, *64*, 2391. e) Garzino, F.; Me'ou, A.; Brun, P. *Tetrahedron Lett.* **2000**, *41*, 9803. f) Kuwabe, S.-i.; Torraca, K. E.; Buchwald, S. L.-. *J. Am. Chem. Soc.* **2001**, *123*, 12202. g) Garzino, F.; Me'ou, A.; Brun, P. *Eur. J. Org. Chem.* **2003**, 1410. h) Kurosawa, W.; Kan, T.; Fukuyama, T. *Synlett* **2003**, 1028. i) Kaiser, S.; Smidt, S. P.; Pfaltz, A. *Angew. Chem., Int. Ed.* **2006**, *45*, 5194. j) Chuang, C.-P.; Tsai, A.-I. *Synthesis* **2006**, 675. k) Chuang, C.-P.; Chen, K.-P.; Hsu, Y.-L.; Tsai, A.-I.; Liu, S.-T. *Tetrahedron* **2008**, *64*, 7511. l) Adams, H.; Gilmore, N. J.; Jones, S.; Muldowney, M. P.; von Reuss, S. H.; Vemula, R. *Org. Lett.* **2008**, *10*, 1457. m) Mangas-Sanchez, J.; Busto, E.; Gotor-Fernandez, V.; *Org. Lett.* **2010**, *12*, 3498-3501.

TMSOTf/Et₃SiH reaction with the β-keto sulfoxide derivate prepared from the commercially available 2-coumarone **158** and (*SR*)-methyl-*p*-tolylsulfoxide **46** (Scheme 2. 51).

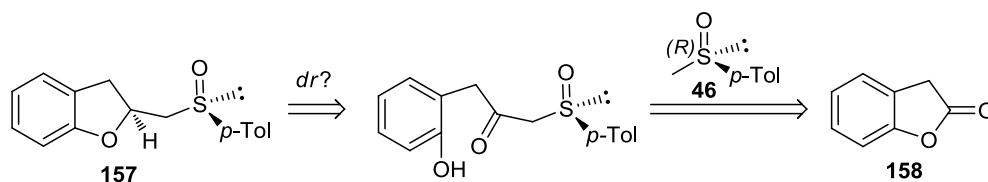

Scheme 2. 51

Thus, the lithium anion derived from (*SR*)-methyl-*p*-tolylsulfoxide **46** was added to the commercial 2-coumarone **158** in THF at -78°C. The starting material was recovered. In order to avoid the formation of the enolate of a benzyl anion in α to the carbonyl, the benzofuran protons in position C-3 were substituted for methyl groups following the procedure of Padwa et al.¹¹² Thus, to a solution of 2-coumarone in THF at -78°C, was added LDA (2.15 equiv) and CH₃I (2 equiv). 3,3-Dimethylbenzofuran-2(3*H*)-one **159** was isolated in poor yield (9%), (Scheme 2. 52). In spite of this low yield, we decided to go further to know the feasibility of our method.

Therefore, the lithium anion derived from (*SR*)-methyl-*p*-tolylsulfoxide **46** was added to a solution of 3,3-dimethylbenzofuran-2(3*H*)-one in THF at -78°C. The (*SR*)-2-(*p*-tolylsulfinyl)methyl-3,3,-dimethyl-2,3-dihydrobenzofuran-2-ol **160** was obtained in 24% yield as a mixture of the open chain β-keto sulfoxide δ-2-hydroxy phenyl substituted open structure **161** and the cyclic hemiketal (*SR*)-2-(*p*-tolylsulfinyl)methyl-3,3-dimethyl-2,3-dihydrobenzofuran-2-ol **160** which was the major product, which was characterized as a C-2 diastomeric mixture (Scheme 2. 52).

¹¹² Padwa, A.; Au, A.; Lee, G. A.; Owens, W. J. *Am. Chem. Soc.* **1976**, *98*, 3555.

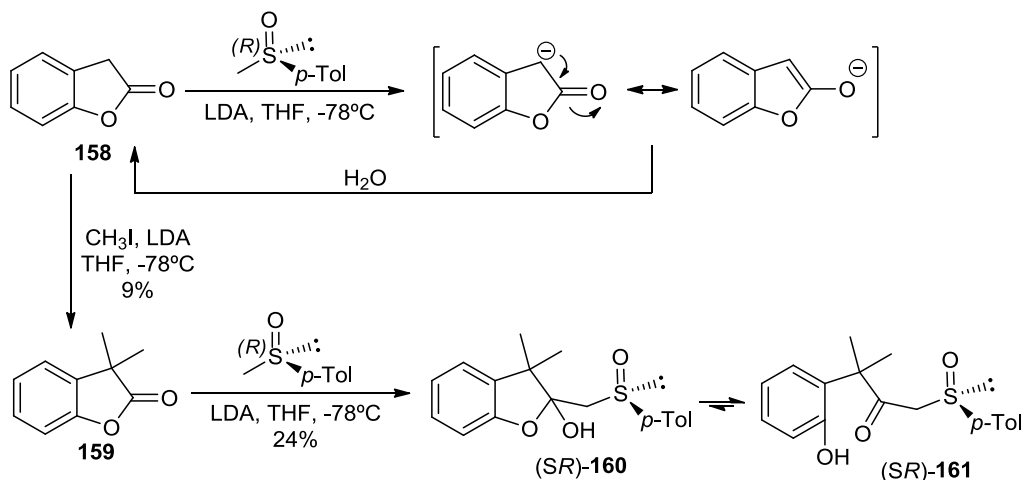

Scheme 2.52

With (*SR*)-2-(*p*-tolylsulfinyl)methyl-3,3-dimethyl-2,3-dihydrobenzofuran-2-ol **160** in hand, reductive cyclization conditions were tested. To a solution of the β -keto sulfoxide **161** in dichloromethane at 0°C was added 3 equivalents of Et₃SiH and 1.5 equivalents of TMSOTf (freshly distilled). After 6h at 0°C, the temperature was allowed to reach room temperature and the mixture was left overnight. 3,3-Dimethyl-(*SR*)-2-((methyl-*p*-tolylsulfinyl)methyl)-2,3-dihydrobenzofuran **162** was obtained in poor diastereoselectivity (65:35 *dr*), Scheme 2.53.

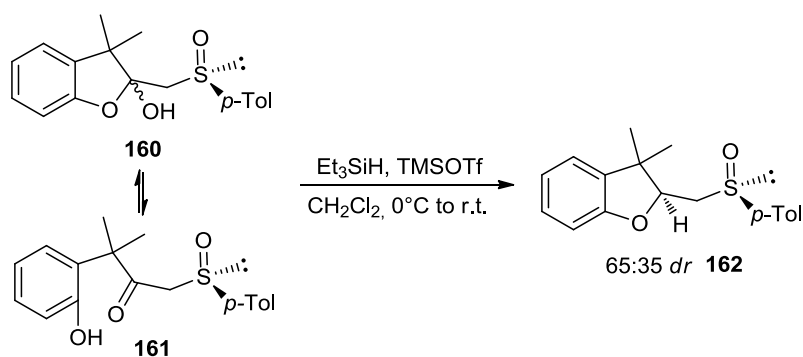

Scheme 2.53

III. ASYMMETRIC TOTAL SYNTHESIS OF (S)- γ -CEHC

III.1. Biological properties

As it was pointed out in the previous chapter, chiral benzopyran (chroman) moiety is the core of numerous natural products and synthetic analogs with important biological properties. The most well-known chiral chromans are the tocopherol family (vitamin E), serving as a natural lipophilic antioxidant and radical scavenger.

Vitamin E is one of the lipophilic vitamins which embrace all tocopherols and tocotrienols. The structure of Vitamin E family, α , β , γ and δ -tocopherol **51** and α -tocotrienol, differs on the methylation of the aromatic ring. Tocopherols possess a shikimate-derived aromatic moiety and a terpenoid side chain leading to a 6-chromanol framework with a (*R*) stereogenic center at C-2 and two (*R*) configured stereocenters at the saturated (Figure 3. 1). Trolox **54** lacks the sesquiterpene alkyl chain, having a carboxylic acid at C-2. Recent studies have shown that (2*S*)-configured tocopherols have no antioxidant effect in biological systems because they are not accepted as substrates by the *R*-tocopherol transfer protein (TTP), which is responsible for the transport of vitamin E into the tissue.¹¹³ On the other hand, the configuration of the stereogenic centers in the side chain seems to have no influence on the antioxidant effect.

¹¹³ a) Hoppe, P. P.; Krennrich, G. *Eur. J. Nutr.* **2000**, *39*, 183-193. b) Blatt, D. H.; Pryor, W. A.; Mata, J. E.; Rodriguez-Proteau, R. *J. Nutr. Biochem.* **2004**, *15*, 380-395.

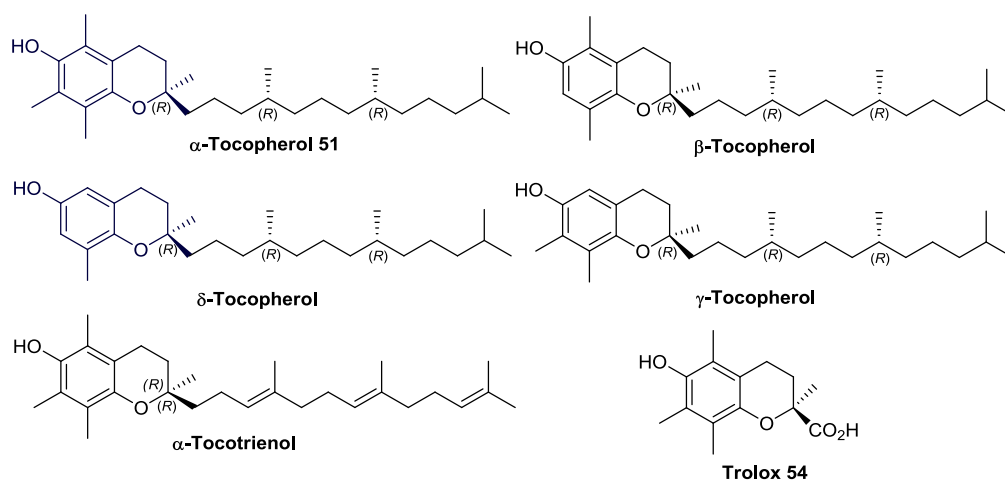

Figure 3. 1

(*R,R,R*)- α -Tocopherol (**51**) is the biologically most active member of the vitamin E family acting as a natural lipophilic antioxidant and radical scavenger.¹¹⁴ In particular, **51** protects polyunsaturated fatty acids, other components of the cell membrane, and low-density lipoproteins (LDL) by capturing highly reactive free radicals formed in the body as byproducts of natural oxidative metabolism.^{115,116} These free radicals are the cause of the irreversible destruction on cellular membranes. Most of the pathologies associated with the deficiency of vitamin E are caused by the harmful action of free radicals.¹¹⁷ Oxygenated radicals are particularly reactive and can attack any molecule being responsible of degradation

¹¹⁴ *Vitamin E-A Comprehensive Treatise*; Machlin, L. J.; Ed.; Marcel Dekker: New York, 1980.

¹¹⁵ a) Vatesary, G. T.; Smith, W. E.; Quach, H. T. *Lipids* **1989**, *24*, 1043–1047. b) Jacobson, H. N. *Free Radical Biol. Med.* **1987**, *3*, 209–213. c) Burton, G. W.; Joyce, A.; Ingold, K. U. *Arch. Biochem. Biophys.* **1983**, *221*, 281–290. d) Burton, G. W.; Joyce, A.; Ingold, K. U. *Lancet* **1982**, *2*, 327. e) Packer, J. E.; Slater, T. F.; Willson, R. L. *Nature* **1979**, *278*, 737–738. f) Simon, E. J.; Cross, C. S.; Milhorat, A. T. *J. Biol. Chem.* **1956**, *221*, 797–805.

¹¹⁶ a) Netscher, T. In *Lipid Synthesis and Manufacture*; Gunstone, F. P., Ed.; Academic Press: Sheffield, U.K., 1999; pp 250–267. b) Kreimayer, J.; Schmidt, M. *Pharm. Ztg.* **1998**, *143*, 823–828. c) Acuff, R. V.; Dunworth, R. G.; Webb, L. W.; Lane, J. R. *Am. J. Clin. Nutr.* **1998**, *67*, 459–464. d) Kiyose, C.; Maramatsu, R.; Kameyama, Y.; Ueda, T.; Igarashi, O. *Am. J. Clin. Nutr.* **1997**, *65*, 785–789. e) *Ullmans Encyclopedia of Industrial Chemistry*; Elvers, B., Ed.; Wiley-VCH: Weinheim, 1996; Vol. A27, pp 478–488. f) Ingold, K. U.; Burton, G. W.; Foster, D. O.; Hughes, L.; Lindsay, D. A.; Webb, A. *Lipids* **1987**, *22*, 163–172. g) Cheng, S. C.; Burton, G. W.; Ingold, K. U.; Foster, D. O. *Lipids* **1987**, *22*, 469–473.

¹¹⁷ G. W. Burton, K. U. Ingold, *Acc. Chem. Res.* **1986**, *19*, 194–201, and references cited therein.

of a wide number of biological macromolecules. The reaction with DNA bases has been studied in extent and it seems to be the cause of several types of cancer.

The vitamin E is known to provide valuable antioxidant properties, probably preventing the destruction of vitamin A and unsaturated fatty acids in biological membranes by free radical reactions. It is used commercially to retard rancidity of fatty materials in food manufacturing. There are also claims that it can reduce the effects of ageing and help to prevent heart disease. Its antioxidant effect is likely to arise by reaction with peroxy radicals, generating a resonance-stabilized free radical by one-electron phenolic oxidation that does not propagate the free radical reaction, but instead mops up further peroxy radicals (Scheme 3. 1). In due course, the tocopheryl peroxide is hydrolyzed to the tocopherylquinone.

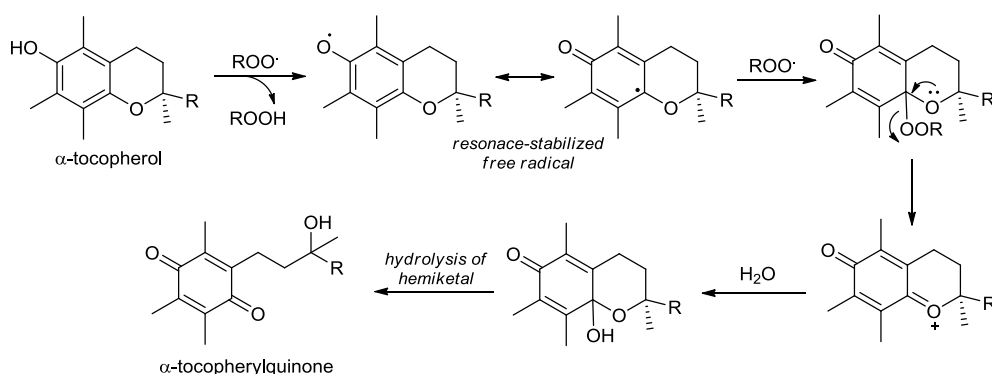

Scheme 3. 1

Ingold¹¹⁷ had demonstrated that the abstraction of the phenolic hydrogen by ROO^\bullet must be related to the stabilization of the phenoxyl radical by conjugative electron delocalization (Figure 3. 2), provided its p-type lone-pair orbital overlaps with the single occupied molecular orbital (SOMO) in the radical. The extent of such overlap will depend on the dihedral angle θ , between the p-type orbital on the oxygen atom and a perpendicular to the aromatic plane.

¹¹⁷ G. W. Burton and K. U. Ingold, *Acc. Chem. Res.* **1986**, *19*, 194-201.

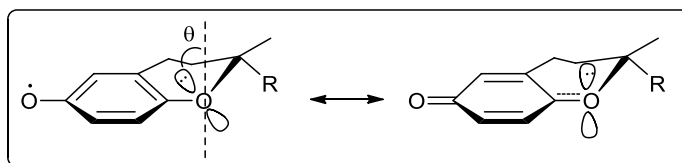

Figure 3. 2

A different role from oxygen radical scavenging has also been proposed for γ -tocopherol. In contrast to α -tocopherol, γ -tocopherol is a powerful nucleophile that traps electrophilic mutagens in lipophilic compartments.¹¹⁸ It thus complements glutathione, which similarly scavenges electrophilic mutagens in the aqueous phase of the cell. An electrophilic mutagen prone to react with γ -tocopherol is peroxynitrite. Thus, γ -tocopherol may protect lipids, DNA, and proteins from peroxynitrite dependent damage. Urinary γ -tocopherol excretion had not been investigated until the detection of a γ -tocopherol metabolite with an intact chroman structure and a shortened side chain.

Extracellular volume expansion is involved in several diseases including hypertension, congestive heart failure and cirrhosis of the liver. It is believed that a “natriuretic hormone” exists that controls sodium excretion and thereby regulates extracellular fluid volume.¹¹⁹ Many investigators in this field believe that this putative humoral substance may be responsible for hypertension and natriuresis, owing to inhibition of sodium transport. The inhibition of sodium transport is reflected in inhibition of the Na^+/K^+ -ATPase.

(*S*)- γ -CEHC (**116**), (2*S*)-2,7,8-trimethyl-2-(2'-Carboxy Ethyl)-6-Hydroxy Chroman (Figure 3. 3), was isolated from human uremic urine^{120,121} as the most

¹¹⁸ a) Cooney, R. W., France, A. A., Harwood, P. J., Hatch-Pigott, V., Custer, L. J., and Mordan, L. J. *Proc. Natl. Acad. Sci. USA* 90, **1993**, 1771–1775 b) Cooney, R. V., Harwood, P. J., Franke, A. A., Narala, K., Sundstrom, A. K., Berggren, P. O., and Mordan, L. J. *Free Rad. Biol. Med.* **1995**, 19, 259–269 c) Christen, S., Woodall, A. A., Shigenaga, M. K., Southwell-Keely, P. T., Duncan, M. W., and Ames, B. N. *Proc. Natl. Acad. Sci. USA*, **1997**, 94, 3217–3222.

¹¹⁹ De Wardener, H. E., Mills, I. H., Clapham, W. F. and Hayter, C. J. *Clin. Sci.* **1961**, 21: 249–258.

¹²⁰ a) Murray, E. D., Jr., Kantoci, D., Dewind, S. A., Bigornia, A. E., D'Amico, D. C., King, J. G., Jr., Pham, T., Levine, B. H., Jung, M. E. and Wechter, W. J. *Life Sci.* **1995**, 57 2145–2161. b) Wechter, W. J., Kantoci, D., Murray, E. D. Jr., D'Amico, D. C., Jung, M. E. and Wang, W.-H *Proc. Natl. Acad. Sci. U.S.A.* **1996**, 93, 6002–6007.

potent known inhibitor of the 70 pS ATP-sensitive K⁺ channel in the thick ascending limb cells of the kidney. Consequently, it was assumed to be natriuretic by virtue of inhibiting K⁺ excretion and thus K⁺ cycling *via* the Na⁺/K⁺/2Cl⁻ cotransporter.

(S)- γ -CEHC (**116**) was further found to be a major metabolite of (2R)- γ -tocopherol¹²¹ produced in the liver. It was originally named (S)-LLU- α by Wechter *et al.* in 1995,¹²⁰ and considered to be produced from oxidative degradation of the side chain of natural (R,R,R)- γ -tocopherol. This metabolite is readily oxidized and, furthermore, its rapid elimination causes it to have a very low bioavailability.

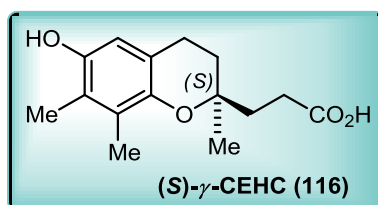

Figure 3. 3

Oxidation of tocopherols occurs primarily on the chroman ring producing tocopheronic acid, dimers, trimers and quinones followed by biliary excretion of the oxidation products. Some ω -oxidation has been presumed to occur with α -tocopherol followed by β -oxidation of the side chain (Scheme 3. 2). β -Oxidation terminates as the propionic acid side chain present in **116**. The side-chain oxidation mechanism proposed by Simon *et al.*¹²² starts with the ω -oxidation of the lipophilic chain. The side-chain oxidation continues by β -oxidation to γ -CMHHC (γ -6'-Carboxy-4'-Methyl Hexyl-6-Hydroxy Chroman), then to γ -CMBHC (γ -4'-Carboxy-4'-Methyl Butyl-6-Hydroxy Chroman) and terminates at the 3'-carbon residue leading to (S)- γ -CEHC (2'-Carboxy Ethyl-6-Hydroxy Chroman). Schultz *et al.*¹²³ suggested that the ω - and subsequent β -oxidation proceeds without prior oxidation of the

¹²¹ a) Murray, E. D., Jr., Wechter, W. J., Kantoci, D., Wang, W. H., Pham, T., Quiggle, D. D., Gibson, K. M. Leiplod D. D. and Anner, B. A. *J. Pharmacol. Exp. Ther.* **1997**, 282, 657–662

¹²² Simon, E. J., Eisengar.t., A., Sundheim, L. and Milhorat, A. T. *J. Biol. Chem.* **1956**, 221: 807–817

¹²³ Schultz, M., Leist, M., Petrzika, M., Gassmann, B. and Breigelius-Flohe, R. *Am. J. Clin. Nutr.* **62**: suppl, **1995**, 1527S–1534S.

chroman ring (Scheme 3. 2). Recent studies showed that (2*R*)- γ -tocotrienol is also metabolized to **116** in rats¹²⁴ and humans.¹²⁵

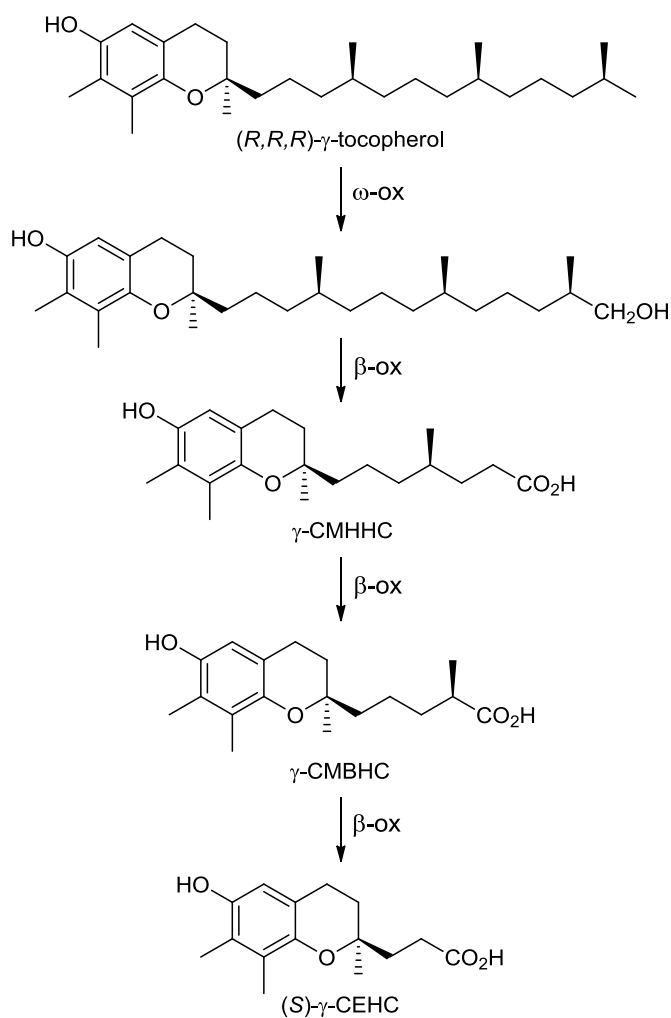

Scheme 3. 2

¹²⁴ Hattori, A.; Fukushima, T.; Yoshimura, H.; Abe, K.; Imai, K. *Biol. Pharm. Bull.* **2000**, *23*, 1395–1397.

¹²⁵ Lodge, J. K.; Ridington, J.; Leonard, S.; Vaule, H.; Traber, M. G. *Lipids* **2001**, *36*, 43–48.

γ -Tocopherols are also known as anti-/pro-nitrosating agents¹²⁶ at C-5. It is also possible that nitrogen oxides (NO_x) might react directly with the 4'-carbon atom on the lipophilic side chain of tocopherols, which is then easily attacked by peroxide. The resulting reaction would produce a chromanyl aldehyde that is subsequently oxidized to (*S*)- γ -CEHC (**116**) in the case of γ -tocopherol.

The isolated γ -CEHC is a single enantiomer **116** with the same absolute stereochemistry as the parent γ -tocopherol. It is thus apparent that the lipophilic side-chain oxidation proceeds without chroman ring oxidation. Because **116** is natriuretic (Na⁺ excretion) but not kaliuretic (K⁺ excretion) it might be involved in the regulation of Na⁺-K⁺ balance at the cellular level.^{127,128} Most important is the biological activities established for **116**^{120b,120b} are the first described for γ -tocopherol.

The structure of this compound was determined by spectroscopic analysis.^{120b} The absolute stereochemistry at C-2 was determined by X-ray analysis of an enantiopure amide shown in Figure 3. 4, and the resolution of the enantiomers was accomplished by chiral HPLC in 1997.¹²¹

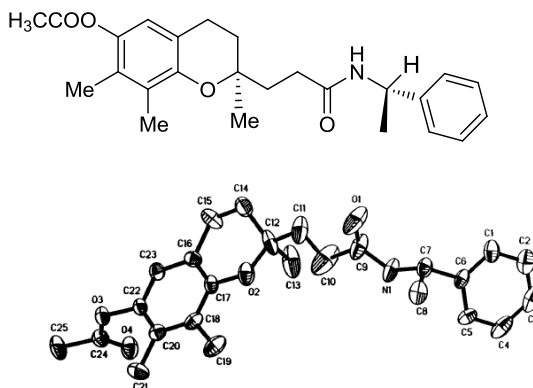

Figure 3. 4

¹²⁶ Kamal-Eldin, A. and Appelqvist, L.-Å. *Lipids*, **1996**, 31: 671–701.

¹²⁷ a) Appenroth, D.; Karge, E.; Kieβling, G.; Wechter, W. J.; Winnefeld, K.; Fleck, C. *Toxicology Lett.* **2001**, 122, 255–265. b) Takata, J.; Hidaka, R.; Yamasaki, A.; Hattori, A.; Fukushima, T.; Tanabe, M.; Matsunaga, K.; Karube, Y.; Imai, K. *J. Lipid Res.* **2002**, 43, 2196–2204.

¹²⁰ b) Wechter, W. L; Kantoci, D.; Murray Jr., E. D.; D'Amico, D. C.; Jung, M. E.; Wang, W.-H. *Proc. Natl. Acad. Sci. USA* **1996**, 93, 6002–6007.

¹²¹ a) Murray, E. D., Jr., Wechter, W. J., Kantoci, D., Wang, W. H., Pham, T., Quiggle, D. D., Gibson, K. M. Leiplod D. D. and Anner, B. A. *J. Pharmacol. Exp. Ther.* **1997**, 282, 657–662

¹²⁸ Review: Odinokov, V. N.; Spivak, A. Y.; Knyshenko, O. V. *Russ. J. Bioorg. Chem.* **2007**, 33, 359–375.

The study of racemic γ -CEHC (**116**) in vitro in various model oxidative reactions has shown that, by their high antioxidant properties, it is comparable with α -tocopherol, ascorbic acid, and Trolox **54**, a cardioprotective short-chain tocopherol analogue.¹²⁹ Therefore, short-chain hydrophilic analogues of tocopherols, such as **116**, are water-soluble metabolites of Vitamin E possessing unique properties distinguishing them from the initial liposoluble tocopherols. They also exhibit antiinflammatory and natriuretic action, being endogenous ligands.¹³⁰ It is possible that the oxidation/reduction equilibrium and hydrolysis/dehydration equilibrium (Scheme 3. 3) play a role in the modulation of natriuresis.

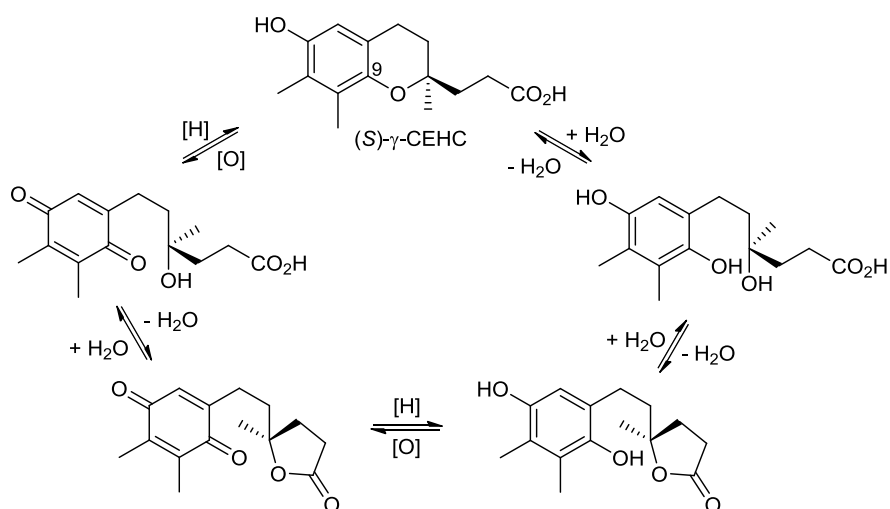

Scheme 3. 3

Moreover, this natural metabolite has been shown to inhibit the generation of prostaglandin E_2 , an important mediator produced during inflammatory process

¹²⁹ a) Yoshida, Y.; Niki, E. *Biofactors* 2002, 16, 93–103. b) Betancor-Fernandez, A.; Sies, H.; Stahl, W.; Polidori, M. C. *Free Radic. Res.* **2002**, 36, 915–921.

¹³⁰ Hensley, K.; Benaksas, E. J.; Bolli, R.; Comp, R.; Grammas, P.; Hamdheydari, L.; Mou, S.; Pye, Q. N.; Stoddard, M. F.; Wallis, G.; Williamson, K. S.; West, M.; Wechter, W. J.; Floyd, R. A. *Free Radic. Biol. Med.* **2004**, 36, 1–15.

via the cyclooxygenase-2-catalyzed oxidation of arachidonic acid.¹³¹ Thus, these multiple biological properties make (S)- γ -CEHC (**116**) to be a useful therapeutic agent and an attractive target for total synthesis.

The oxidation part of reductive-oxidative cycle of (S)- γ -CEHC (**116**), (Scheme 3. 4), was examined with FeCl₃-mediated oxidation and was found to proceed without racemization. Analysis of the oxidation mechanism suggested retention of configuration with the chroman ring opening between C-9 and oxygen.

Iron-(III)-chloride initiated the reaction by formation of the radical on the oxygen of the phenol hydroxy group. The radical exists in several resonance forms. Based on isolated products, the radical at C-9 seems to predominate. This radical reacts with iron-(III)-chloride producing a carbocation and the reduction to iron (II) chloride. Then, the carbocation can react with water to produce the unstable 9-hydroxy chroman hemiketal that evolves to the quinone. This quinone undergoes water abstraction and formation of the hydroquinone lactone **162** (Scheme 3. 4). Based on chiral HPLC analysis of the lactones produced from both enantiomers, it was demonstrated that the configuration at C-2 should be retained; thus, the chroman ring opening occurring between C-9 and the chroman ring oxygen.

¹³¹ a) Jiang, Q.; Elson-Schwab, I.; Cour.t.emanche, C.; Ames, B. N. *Proc. Natl. Acad. Sci. USA* **2000**, *97*, 11494–11499. b) Grammas, P.; Hamdheydari, L.; Benaksas, E. J.; Mou, S.; Pye, Q. N.; Wechter, W. J.; Floyd, R. A.; Stewart, C.; Hensley, K. *Res. Commun.* **2004**, *319*, 1047–1052.

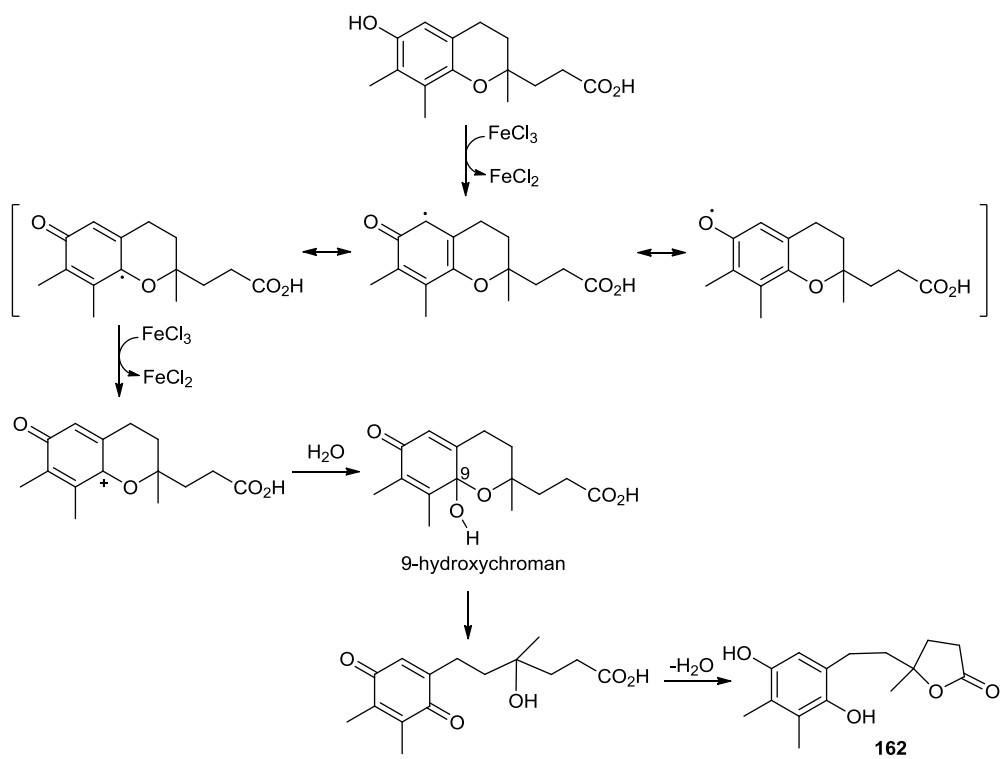

Scheme 3. 4

III.2. Previous reported synthesis of (*S*)- γ -CEHC

In 1996, Wechter *et al.*^{120b} described a racemic synthesis of γ -CEHC (**116**), the structure was proven from the readily available lactone **165**, prepared from vinyl magnesium bromide and ethyl levulinate **163**, and the commercially available 2,3-dimethylhydroquinone **164** which in presence of $\text{BF}_3 \cdot \text{Et}_2\text{O}$ afforded racemic **116** through a Fried-Crafts alkylation cyclization process, in moderated yield (Scheme 3. 5). The product of the double addition **166** was not possible to avoid. Although enantiopure **116** could be separated from its enantiomer by chiral HPLC, this process was not suitable for the preparation of large quantities of optically pure **116** or its analogues.

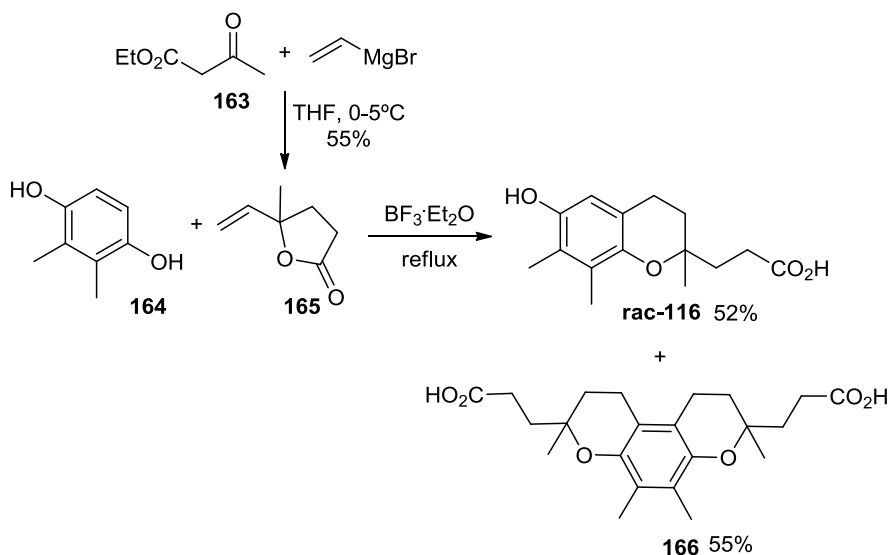

Scheme 3. 5

Apart from the synthesis developed in this PhD work, up to date there is only another total synthesis of the natural (*S*)-enantiomer of γ -CEHC (**116**), reported in

^{127b}) Takata, J.; Hidaka, R.; Yamasaki, A.; Hattori, A.; Fukushima, T.; Tanabe, M.; Matsunaga, K.; Karube, Y.; Imai, K. *J. Lipid Res.* **2002**, *43*, 2196–2204.

1999 by Jung *et al.* It was accomplished in 13 steps and 18% overall yield, starting from commercially available geraniol.¹³² The two key steps are a Sharpless asymmetric epoxidation¹³³ to generate the required stereogenic center and a Gassman-Sato process to join the alkyl chain to the phenolic moiety, and the cyclization of a triol with acid to give the corresponding chroman with retention of configuration at the tertiary alcohol center.

The synthesis began with the Sharpless asymmetric epoxidation of geraniol **167** to give the epoxy alcohol **168** in good yield (91%, 94% *ee*). The opening of the epoxide in presence of LiAlH_4 provided the 1,3-diol **169**. Tosylation of the primary alcohol and displacement with the sodium salt of isopropyl mercaptan, followed by acetylation of the tertiary alcohol gave the acetate **171** (Scheme 3. 6).

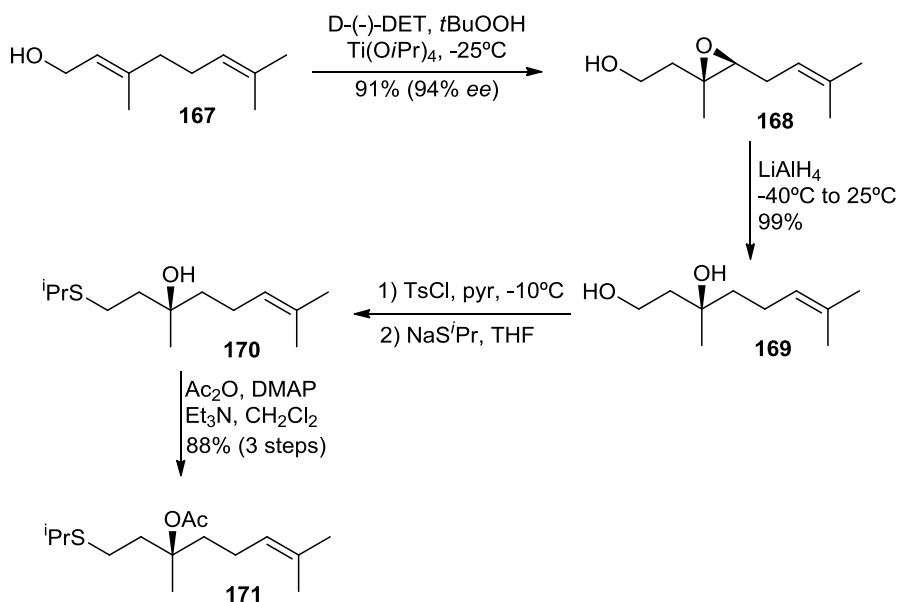

Scheme 3. 6

¹³² Jung, M. E.; MacDougall J. M, *Tetrahedron Lett.* **1999**, *40*, 6339–6342.

¹³³ (a) Katsuki, T.; Sharpless, K. B. *J. Am. Chem. Soc.* **1980**, *102*, 5976. (b) Hanson, R. M.; Sharpless, K. B. *J. Org. Chem.* **1986**, *51*, 1922.

The process developed by Gassman¹³⁴ to introduce the alkyl chain into the aromatic moiety **172** was based on the rearrangement of ylides formed from the treatment of oxasulfonium salt with triethylamine. The rearrangement of the ylides in a [2,3]-sigmatropic manner led to exclusive ortho substitution via an intermediate cyclohexadienone. Thus, it involves a chlorosulfonium salt prepared from sulfide **171** and sulfonyl chloride in the presence of the hydroquinone monoacetate **172**, prepared by acetylation of the commercially available dihydroquinone, as shown in Scheme 3. 7. This afforded a separable mixture of two products, the desired isopropylthio phenol **173** and the product of α -carbon activation, the phenol **174**.

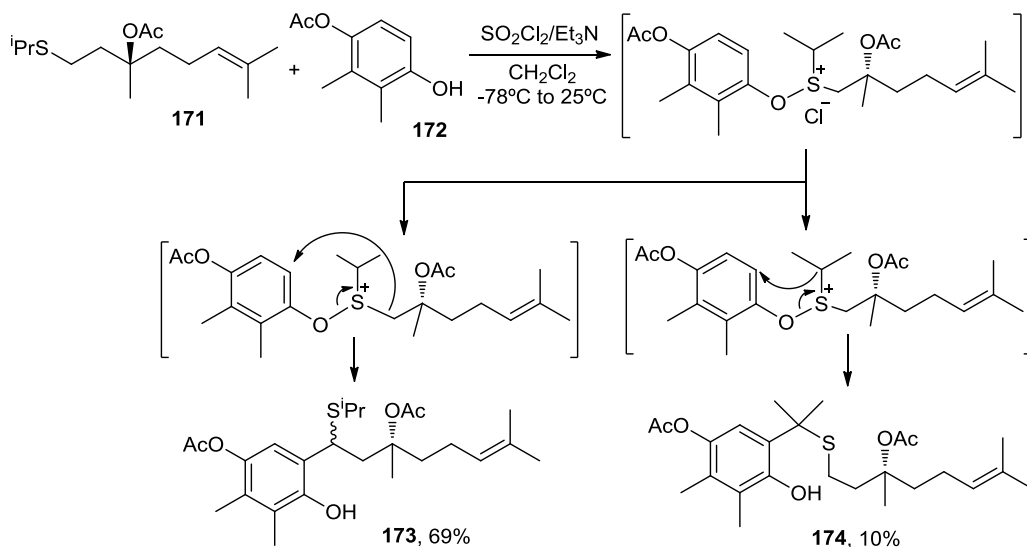

Scheme 3. 7

Reductive desulfuration with Raney nickel followed by hydride reduction to remove the acetate group, generated the dihydroquinone alcohol **176**. The last key step of the synthesis was the acid-catalyzed cyclization to afford the chroman. A solution of **176** in benzene at reflux with a catalytic amount of *p*-toluensulfonic acid produced the chroman **177** with mostly retention of the configuration at C-2 of the

¹³⁴ Gassman, P. G.; Amick, D. R. *J. Am. Chem. Soc.* **1978**, *100*, 7611.

benzopyran ring system. Acetylation of the hydroxy group¹³⁵ followed of ozonolysis of the trisubstituted alkene and reductive workup gave the aldehyde **179**. Then, sodium chlorite oxidation to obtain the acid and finally, basic hydrolysis of the acetate afforded γ -CEHC **116** (90% *ee*), (Scheme 3. 8). The enantiomer *R*- γ -CEHC could be synthesized by the same route using the *L*-(+)-DET in the initial Sharpless epoxidation of geraniol.

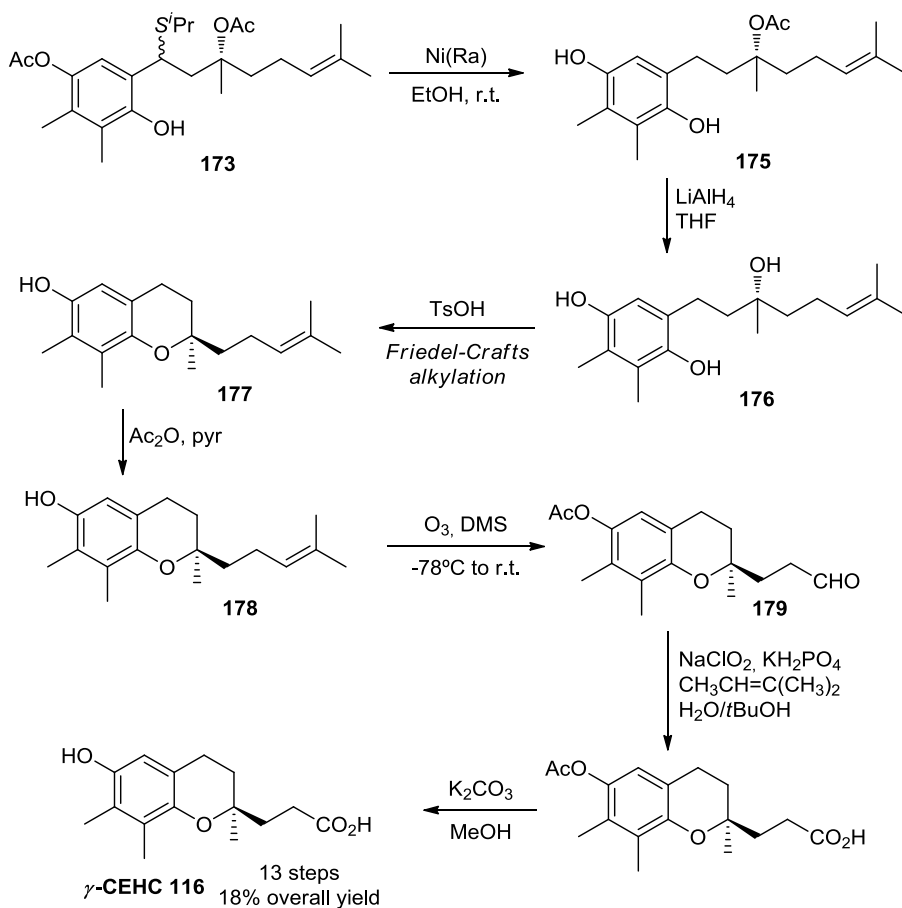

Scheme 3. 8

¹³⁵ Inoue, S.; Ikeda, H.; Sato, S.; Horie, K.; Ota, T.; Miyamoto, O.; Sato, K. *J. Org. Chem.* **1987**, *52*, 5495.

III.3. Asymmetric synthesis of (*S*)- γ -CEHC monitored by sulfoxide

The retrosynthetic analysis represented in Scheme 3. 9 has been considered to complete the asymmetric total synthesis of (*S*)- γ -CEHC (**116**), this proposal was based on the methodologic study presented in the previous section of this chapter, related to the enantioselective access to C-2 disubstituted chromans and based on the diastereoselective homochiral sulfoxide-directed^{1a} allylation to efficiently generate the stereogenic center at C-2 of the chroman moiety. As can be seen, the synthesis of (*S*)- γ -CEHC (**116**) could be achieved from an advanced intermediate such as (*SS,S*)-**180**, after desulfinylation, double bond transformation and phenolic OH deprotection. Taking into account the previous studies, the (*R*)-configured sulfoxide was inducing the (*R*)-configured C-2 quaternary stereocenter of the chroman. It is important to note that to induce the natural configuration at C-2 of the (*S*)- γ -CEHC (**116**), the configuration of the sulfoxide needed has to be (*S*).

Compound **180**, bearing the correct absolute configuration at the C-2 stereogenic center present in the final target, would be formed after a Lewis-acid-promoted diastereoselective (*S*)-sulfoxide-directed allylation of ketal intermediate (*SS*)-**181** following the method previously reported in this chapter. In accordance with the results presented in the previous section we decided to use methyl *p*-tolyl sulfoxide (**46**) as chiral inducer. Ketal (*SS*)-**181** could be obtained from 3,4-dihydrocoumarin **182** and (*SS*)-methyl *p*-tolyl sulfoxide (**46**). Finally, lactone **182** was planned to be synthesized from commercially available starting materials such as 2,3- dimethylhydroquinone (**182**) and acrylic acid (**184**). This was based on previous synthesis of the chroman core,^{127b} although this seemed to be a simple Friedel-Crafts alkylation and lactonization, several problems appeared which had to be circumvented.

^{1a}) Carreño, M. C.; Hernández-Torres, G.; Ribagorda, M.; Urbano, A. *Chem. Commun.* **2009**, 6129–6144.

^{127b}) Takata, J.; Hidaka, R.; Yamasaki, A.; Hattori, A.; Fukushima, T.; Tanabe, M.; Matsunaga, K.; Karube, Y.; Imai, K. *J. Lipid Res.* **2002**, *43*, 2196–2204.

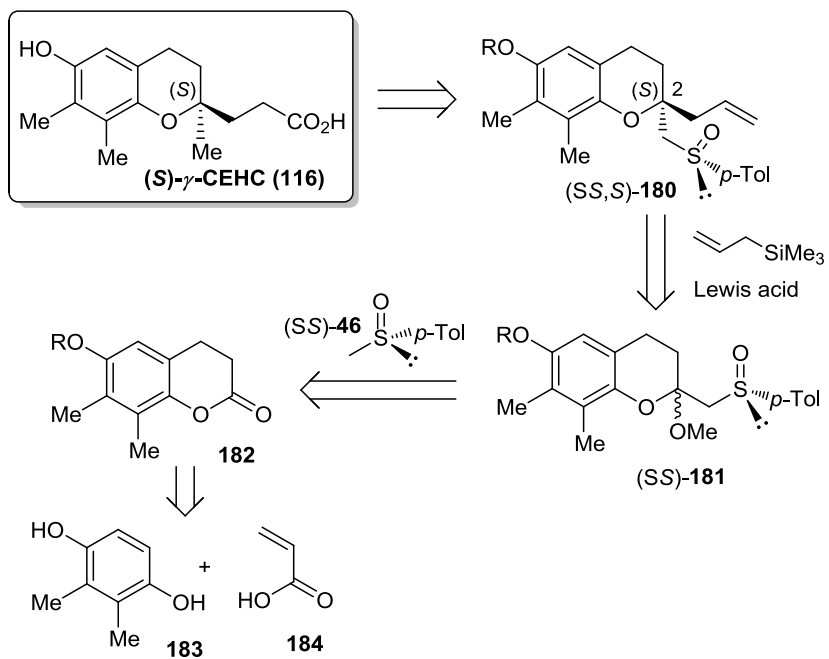

Scheme 3. 9

III.3.1. Synthesis of (*R*)-3-(2-methyl chroman-2-yl) propanoic acid

Previous to the total synthesis of (*S*)- γ -CEHC (**116**) we wanted to check out conditions to transform the substitution present in C-2 of the allyl-2-(*p*-tolylsulfinylmethyl)chroman into the dialkyl substituted quaternary center lacking the sulfoxide. Although reductive desulfinylation is a known procedure several reagents can be used with this aim. We thus thought about checking this transformation in a model system having a structure such as (*2R,SR*) and (*2S,SR*)-2-allyl-2-(*p*-tolylsulfinylmethyl)chroman **144**. This compound had been synthesized in the previous chapter in good yield (86%) and high diastereoselectivity (77:23 *dr*, Scheme 3. 10).

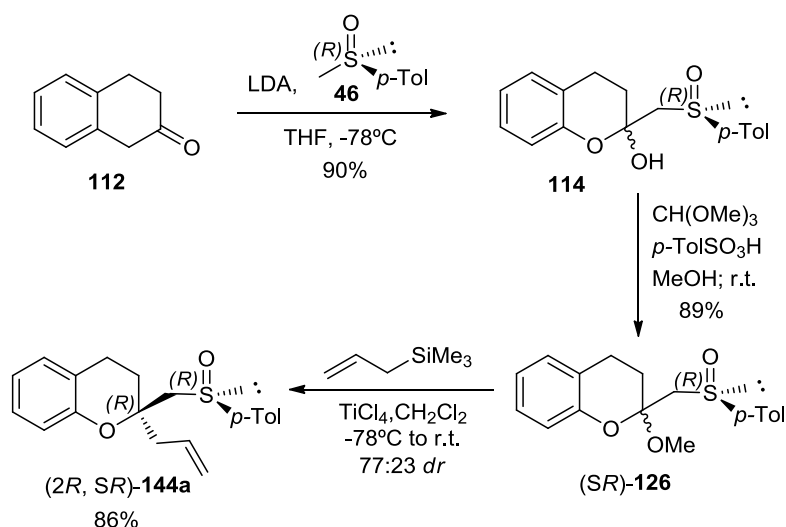

Scheme 3. 10

First, in order to remove the sulfinyl group several desulfinylation methods were tested over the 2-allyl-2-(*p*-tolylsulfinyl methyl) chroman **144** (Table 3. 1).

The use of Li/Naphthalene or sodium amalgam (Na(Hg)) led to the opening of the pyran ring compound **185**, was probably formed as consequence of the basicity of the medium. The combination of Zn and NH₄Cl or aluminum amalgam did not lead to better results, obtaining in both cases the reduction product **186**. Only with

Raney nickel in EtOH gave the desulfinylated product **187** without opening the hydrobenzopyran ring system. To avoid the reduction of the allyl moiety, it was decided to functionalize the double bond first before removing the sulfinyl group.

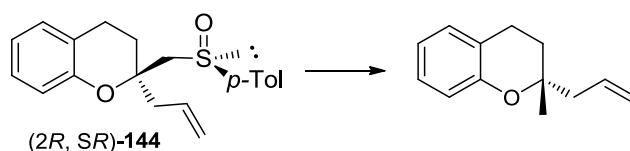

Entry	Conditions	Products
1	Li, Naphthalene, THF, -78°C	
2	Na(Hg), Na ₂ PO ₄ , MeOH, r.t	+ 144
3	Zn, NH ₄ Cl, THF/H ₂ O, r.t	+ 144
4	Al(Hg), THF/H ₂ O, r.t	+ 144
5	Ni Raney, EtOH, rt	

Table 3. 1

Therefore, the allyl moiety of **144** was transformed into the terminal carbinol **188**. Treatment of **188** with 9-BBN (0°C to rt, 2 d) followed by addition of H₂O₂ and NaOH (rt, 3 h) gave rise to the sulfinyl alcohol **188** which was not possible to purify by flash chromatography. Thus, the crude mixture was submitted to desulfinylation with Raney nickel (EtOH, rt, overnight) furnishing the 3'-hydroxypropyl chroman **189** with 55% yield for the two last steps. Then, to perform the direct oxidation of

the primary hydroxy group into the corresponding carboxylic acid, compound **189** treated with *t*-BuOOH, 5% mol CuCl in CH₃CN at rt, to provide the corresponding acid (*R*)-**190** in 24% yield, Scheme 3. 11.

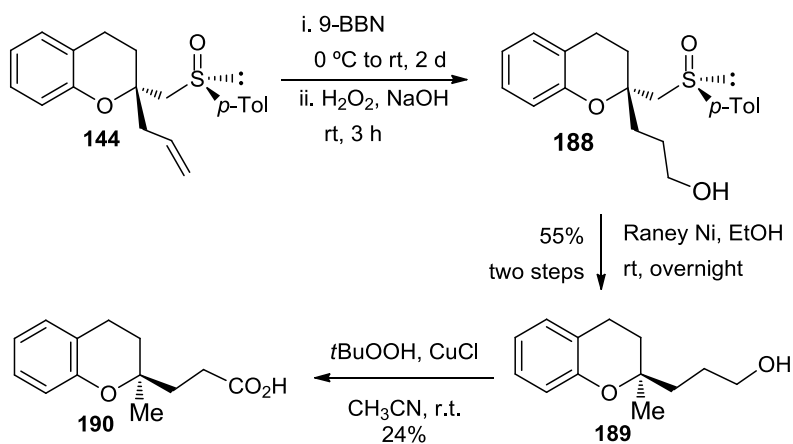

Scheme 3. 11

Although the yield of the last transformation had to be improved in the synthetic application proposed, this result encouraged us to complete the total synthesis of (*S*)- γ -CEHC (**116**).

III.3.2. Enantioselective synthesis of (S)- γ -CEHC

According to the retrosynthetic analysis shown in Scheme 3.9 and reported below, it was necessary to begin with the synthesis of the 6-hydroxy-7,8-dimethylchroman-2-one **190**. The most frequently used method to synthesize 3,4-dihydrocoumarins is the Friedel-Crafts alkylation of phenols with an excess of acrylic acid in the presence of an acid catalyst.¹³⁶

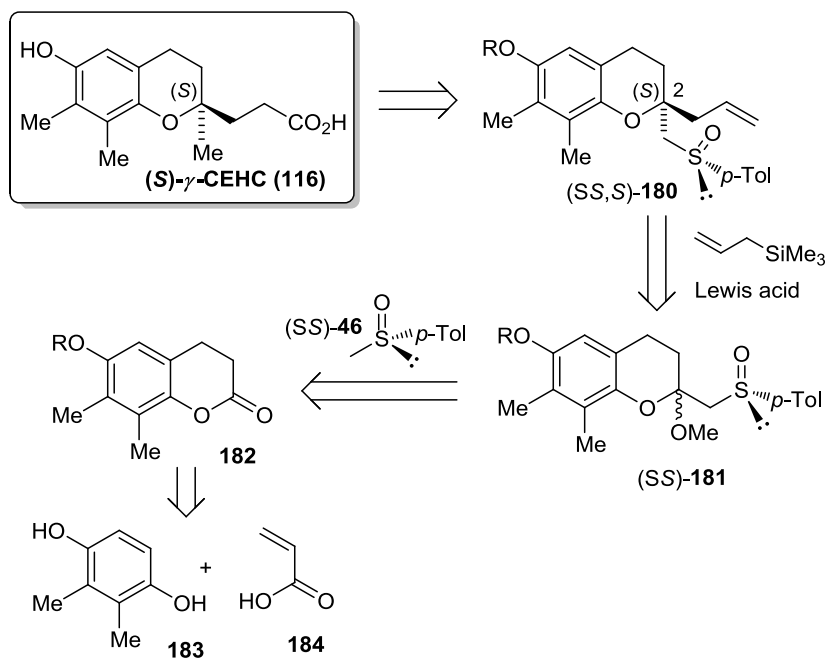

Scheme 3.9

Thus, the dihydrocoumarine derivative **182** could be synthesized from commercially available reagents 2,3-dimethyl-1,4-hydroquinone (**183**) and acrylic

¹³⁶ a) Hoefnagel, A. J.; Gunnewegh, E. A.; Downing, R. S.; Van Bekkum, H. *J. Chem. Soc., Chem. Commun.* **1995**, 225–226. b) Graham, S. R.; Murphy, J. A.; Kennedy, A.R. *J. Chem. Soc., Perkin Trans. 1* **1999**, 21, 3071–3073. c) Posakony, J.; Hirao, M.; Stevens, S.; Simon, J. A.; Bedalov, A. *J. Med. Chem.* **2004**, 47, 2635–2644.

acid (**184**) in the presence of the ion exchange resin Amberlyst 15[®] as acid catalyst (Scheme 3. 12). Nevertheless, the formation of **190** was accompanied with variable amounts of dicoumarin **191**, which could not be avoided. After several trials varying the amounts of acrylic acid (1.1-2 equiv) and Amberlyst (100-400 mg/mmol) at different reaction times, the best result was obtained by refluxing a mixture of **183** (1 equiv) and **184** (1.05 equiv) in toluene for 2 days. From the crude reaction mixture formed under these conditions, the dicoumarin **191** was precipitated with AcOEt (10% yield). The mother liquors were later concentrated and purified by flash column chromatography to obtain a 65 % yield of **190**.

Therefore, coumarine **190** was submitted to reaction with the lithium anion derived from (*SS*)-methyl *p*-tolyl sulfoxide (**46**)⁹³ in THF at -78°C furnishing sulfinyl chromanol (*SS*)-**192**, in moderated yield (55%), probably due to the acidity of the phenolic hydroxy group which can consume part of the lithium anion. The reaction of chromanol (*SS*)-**192** with trimethyl orthoformate in presence of *p*-toluensulfonic acid in methanol at room temperature, led to the methyl ketal (*SS*)-**193** in good yield (73%).

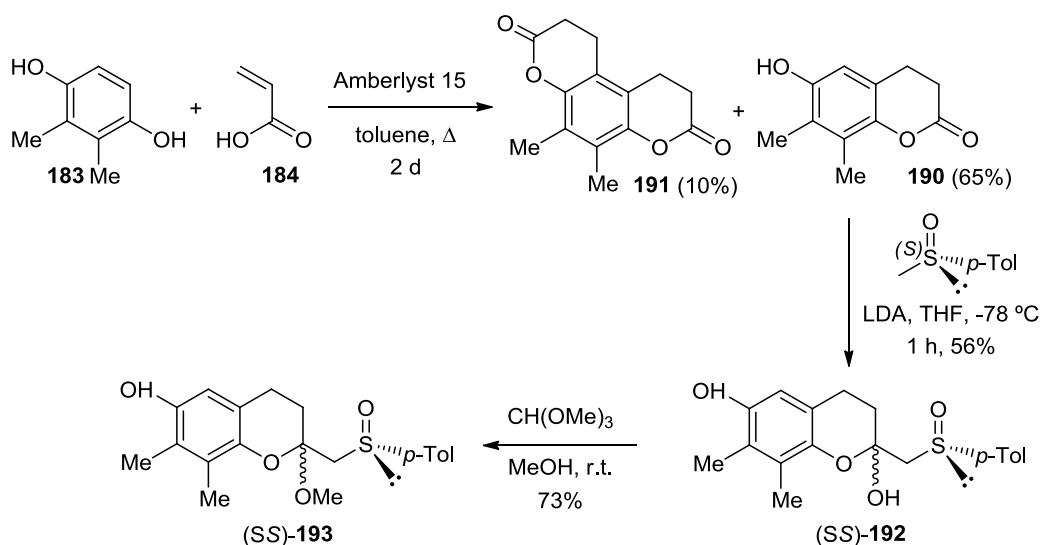

⁹³ G. Solladié, J. Hutt, A. Girardin, *Synthesis* **1987**, 173-175.

With the aim of improving the yield of the reaction between **190** and the lithium anion derivate from (SS)-methyl *p*-tolyl sulfoxide (**46**), the phenolic hydroxy group of (SS)-**193** was protected as silyl ether and as acetate. We wanted to evaluate the influence of the remote protecting group in the diastereoselectivity of the key step resulting in the formation of the C-2 stereogenic center of the chroman unit through the sulfoxide-directed Lewis acid-promoted nucleophilic allylation reaction.¹³⁷ The silyl ether derivative (SS)-**194** was prepared in quantitative from **193** by treatment with TBSOTf and 2,6-lutidine in CH₂Cl₂, whereas the acetate derivative (SS)-**195** was obtained in 81% with Ac₂O and DMAP in CH₂Cl₂ (Scheme 3. 13).

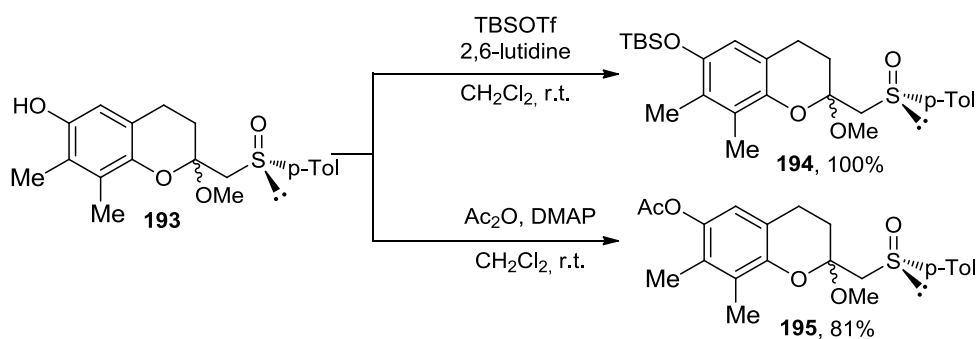

Scheme 3. 13

With these protected methyl ketals **194** and **195** in hand, we submitted them to the nucleophilic allylation reaction conditions developed in the previous chapter, to generate the (*S*) stereogenic center at C-2 of the chroman moiety present in the final target.

The reaction of the TBS protected methyl ketal **194** with allyl trimethyl silane (3 equiv) in the presence of TiCl₄ (1.6 equiv) at -78 °C in CH₂Cl₂, led to the expected (2*S*,*SS*) and (2*R*,*SS*)-2-allyl-2-(*p*-tolylsulfinyl methyl) chromans **196** in 85:15 *dr* and

¹³⁷ Cohen, N.; Schaer, B.; Saucy, G.; Borer, R.; Todaro, L.; Chiu, A.-M. *J. Org. Chem.* **1989**, *54*, 3282–3292.

67% yield. The similar reaction with the acetate **195** led to a mixture of diastereoisomers (*2S,SS*) and (*2R,SS*)-**197** in a lower 63:37 *dr*, Scheme 3. 14.

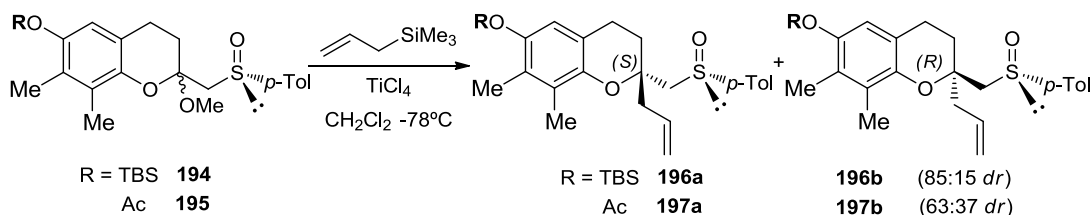

Scheme 3. 14

The silyl ether derivative (*SS*)-**194** was obviously chosen as the best protecting group of the phenolic hydroxy group. Thus, the overall yield of sulfinyl chroman methyl acetal **194** could be improved by changing the order of the reactions (Scheme 3. 15). The 6-(*t*-butyldimethyl silyloxy)-7,8-dimethyl chroman-2-one **198** was prepared from the 6-hydroxy-7,8-dimethylchroman-2-one **190** in excellent yield (100%) with TBSOTf and 2,6-lutidine in CH_2Cl_2 . Further, reaction of **198** with the lithium anion derived from (*SS*)-methyl *p*-tolyl sulfoxide (**46**)^{iError!} Marcador no definido. (LDA, THF, -78°C , 1h) provided the sulfinyl chromanol (*SS*)-**199**, in good yield (75%) as a mixture of diastereoisomers.

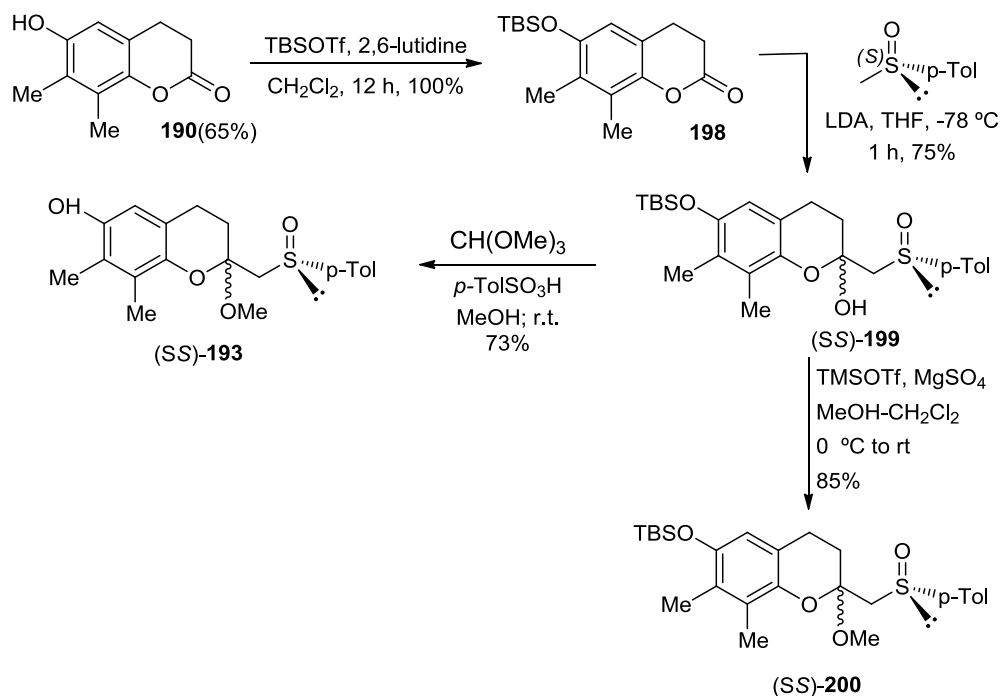

Scheme 3. 15

Ketalisation of (SS)-**199** could not be carried out under the conditions used previously because upon treatment of **199** with $\text{CH}(\text{OCH}_3)_3$ and *p*-T₂O₃H in MeOH, the isolated methyl ketal was compound **193** which had the phenolic group deprotected in 73% yield. Thus, ketalisation was effected with TMSOTf and MgSO_4 in CH_2Cl_2 and MeOH.¹³⁸ Under these conditions, 2-methoxy-3,4-dihydrobenzopyran (SS)-**200** was obtained as mixture of stereoisomers at C-2 in 85% yield (Scheme 3. 15).

Therefore compound (SS)-**200** was submitted to the key-step formation of the C-2 stereogenic center of the final chroman unit, using the best conditions previously found, which are indicated in Scheme 3. 16

Reaction of (SS)-**200** with allyl trimethyl silane (3 equiv) in the presence of TiCl_4 (1.6 equiv) at -78°C in CH_2Cl_2 , led to a 15:85 *dr* mixture of allyl sulfinyl chromans epimers at C-2, (SS,*R*)-**201** and (SS,*S*)-**201**. Both diastereoisomers could

¹³⁸ Li, X.; Ohtake, H.; Takahashi, H.; Ikegami, S. *Tetrahedron* **2001**, *57*, 4297–4309.

be separated after flash chromatography, being isolated pure in 12% and 67% yield, respectively (Scheme 3. 16).

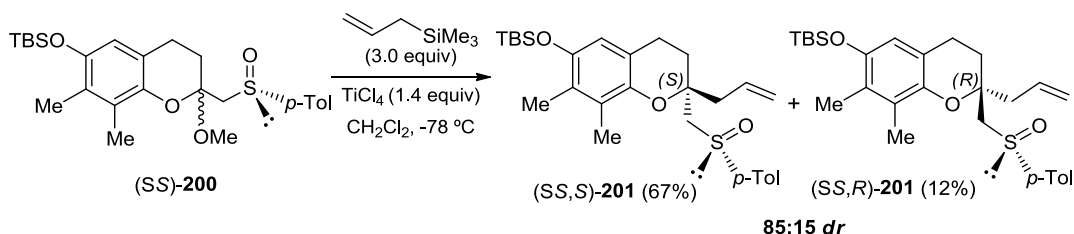

Scheme 3. 16

The diastereomeric ratio was determined by ^1H NMR analysis of the crude reaction mixture by integration of the signals corresponding to the allylic $\text{CH}=\text{CH}_2$ fragment.

The (*S*) absolute configuration of the newly created stereogenic center at C-2 of the major chroman (*SS,S*)-**201** could not be determined at this stage but, after transformation into the corresponding OH free derivative (*SS,S*)-**202** (TBAF, THF, 0°C , 15 min, 100%), suitable crystals were collected for a X-ray diffraction analysis, where the stereochemistry of the center at C-2 was unequivocally established (Scheme 3. 17).

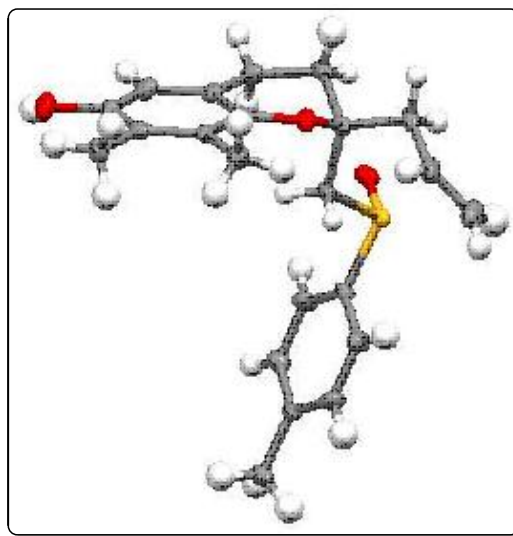
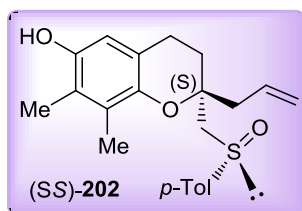
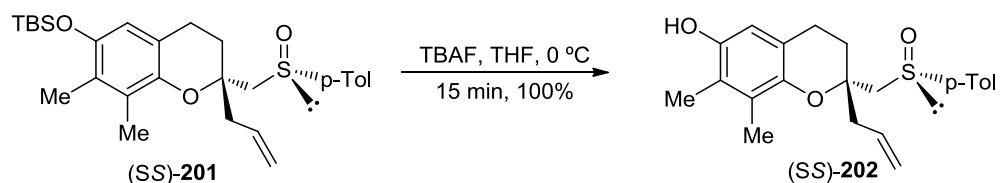

Scheme 3. 17

Following the mechanism proposed for the nucleophilic addition process in the previous chapter, the TiCl_4 could activate the mixed ketal **200** (**A**) to induce the elimination of the OMe group and the formation of a stabilized oxocarbenium intermediate such as **B**. The chelation controlled addition of the allyl trimethyl silane to a species such as **C**, situating the bulky *p*-tolyl group in the pseudoequatorial position. The chelate formed between the titanium, the oxygens of the oxocarbenium ion and the sulfoxide shows a rigid bipyramidal structure¹⁰⁹ with two apical chlorine atoms. The apical chlorine situated on the bottom is hindering the nucleophile approach from this face thus directing the allyl trimethyl silane attack from the less hindered upper face and leading to the **(SS,S)-201** (Scheme 3. 18).

¹⁰⁹ Duthaler, R. O.; Hafner, A. *Chem. Rev.* **1992**, *92*, 807-832, and references cited therein.

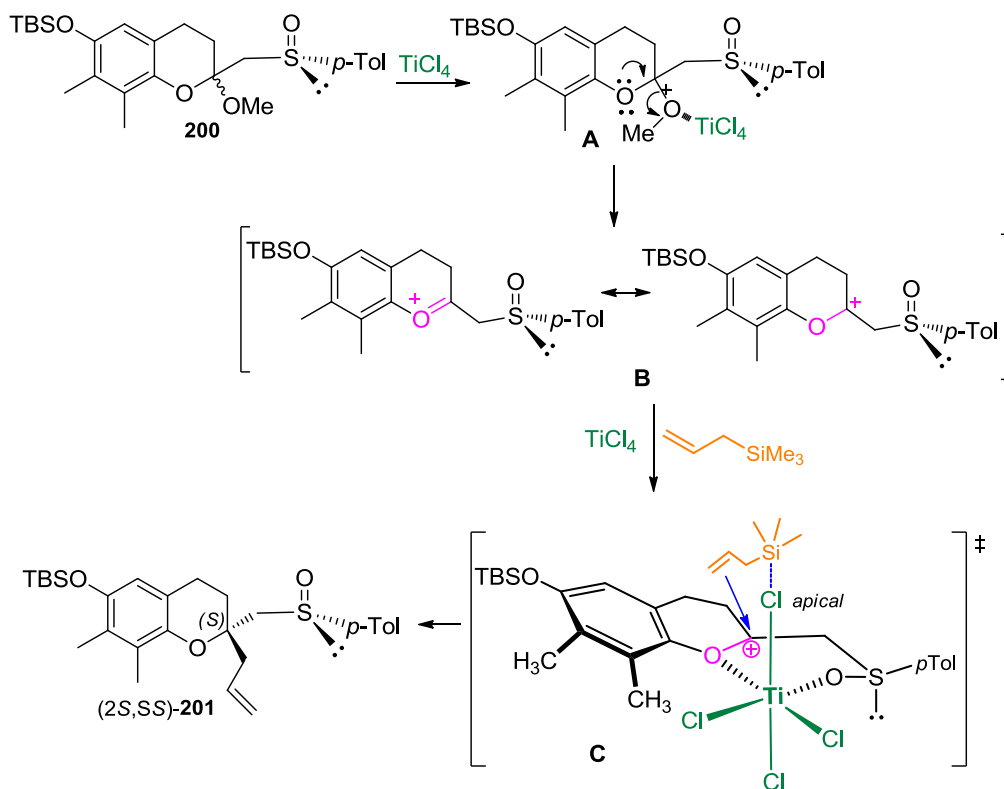

Scheme 3. 18

With allyl sulfinyl chroman (*SS,S*)-**201** in hand, we undertook the final steps towards the total synthesis of (*S*)- γ -CEHC (**116**), as shown in Scheme 3. 19. Firstly, the reaction of the allyl moiety of **201** with 9-BBN (0 °C to rt, 2 d) followed by treatment with H_2O_2 and NaOH (rt, 3 h) gave rise to the sulfinyl alcohol (*S*)-**203** which, without further purification, was submitted to desulfinylation with Raney Ni (EtOH, rt, overnight) furnishing the 2-(1'-hydroxypropyl)-2-methyl chroman (*S*)-**204** with 87% yield for the two last steps. Then, we tried to perform the direct oxidation of the primary OH of (*S*)-**204** into the corresponding carboxylic acid present in the final target, using the same conditions as in the previous approach [*t*-BuOOH, 5% mol CuCl, CH_3CN , rt],^{22a} but under these conditions, a mixture resulted where the carboxylic acid was not present.

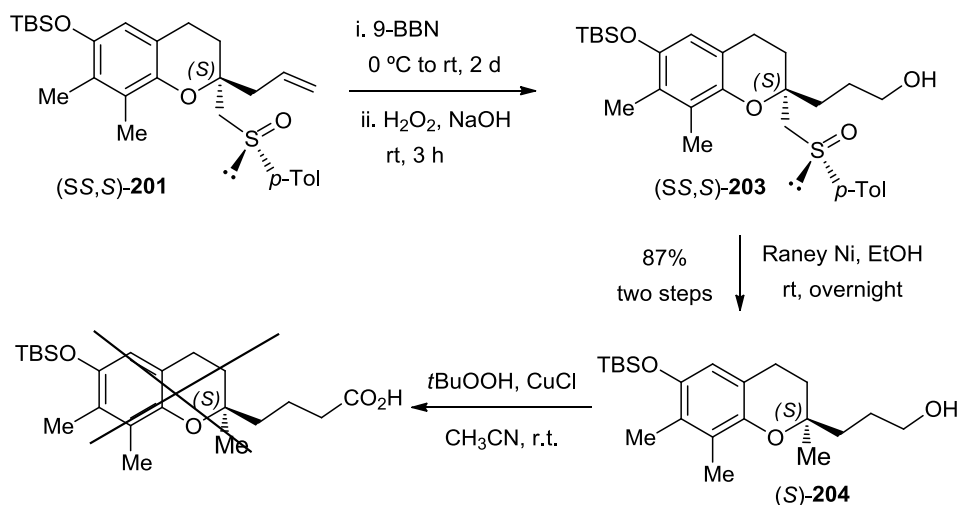

Scheme 3. 19

Several attempts were later tried for the direct oxidation of the primary carbinol into the carboxylic acid using different protocols¹³⁹ as shown in Table 3. 2. The use of ruthenium trichloride with NaIO₄ in a mixture of H₂O/CH₃CN/CCl₄ as solvents at room temperature gave a complex reaction mixture of unidentified products (entry 1),^{139b} similar results were obtained with 2.5% mol NiCl₂, NaOCl aq, CH₂Cl₂ at room temperature,^{139d} or chromium trioxide with H₅IO₆ in CH₃CN/H₂O at room temperature^{139e} led to both complex mixtures (entries 2 and 3). The reaction of 1'-hydroxypropyl chroman (S)-**204** with 0.3 equiv of TPAP, NMO, CH₃CN/H₂O at room temperature^{139c} led to a mixture of 44% of the aldehyde **206** and 40% of the desired acid **205** (entry 4). The increase of the number of equivalents of TPAP under same reaction conditions led to a complex mixture which was not possible to identify (entry 5).

¹³⁹ a) Mannam, S.; Sekar, G. *Tetrahedron Lett.* **2008**, *49*, 2457–2460; b) Ley, S. V.; Norman, J.; Griffith, W. P.; Marsden, S. P. *Synthesis* **1994**, 639–666; c) Grill, J. M.; Ogle, J. W.; Miller, S. A. *J. Org. Chem.* **2006**, *71*, 9291–9296; dd) Zhao, M.; Li, J.; Song, Z.; Desmond, R.; Tschäen, D. M.; Grabowski, E. J. J.; Reider, P. J. *Tetrahedron Lett.* **1998**, *39*, 5323–5326.

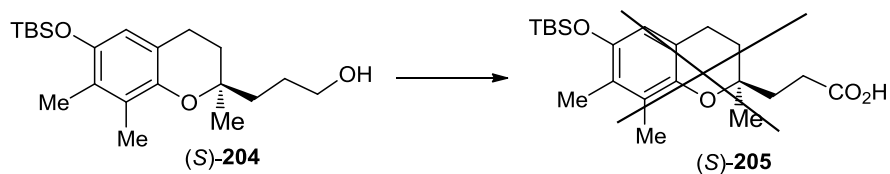

Entry	Conditions	Product
1	0.03eq RuCl ₃ , NaIO ₄ , H ₂ O/CH ₃ CN/CCl ₄ , rt	Complex mixture
2	2.5% molNiCl ₂ , NaOCl _{aq} , CH ₂ Cl ₂ , rt	Complex mixture
3	CrO ₃ , H ₅ IO ₆ , CH ₃ CN/H ₂ O, rt	Complex mixture
4	TPAP (0.3 equiv), NMO, CH ₃ CN/H ₂ O, rt	<p style="text-align: center;"> <chem>Cc1c(C)c(C)c(O[Si](C)(C)C)c1C2CC=OCC2</chem> + <chem>Cc1c(C)c(C)c(O[Si](C)(C)C)c1C2CC(C(=O)O)CC2</chem> </p> <p style="text-align: center;"> (S)-206 44% (S)-205 40% </p>
5	TPAP (>1 equiv), NMO, CH ₃ CN/H ₂ O, rt	Complex mixture

Table 3. 2

Although the acid (*S*)-205 could be isolated in 40% yield, this procedure was not useful for the total synthesis. In order to improve the yield, this oxidation process was attempted in two steps (Scheme 3. 20). Firstly, the treatment of alcohol (*S*)-204 with SO₃·Py in the presence of Et₃N (DMSO-CH₂Cl₂, 0°C to rt, 2 h) gave rise to the aldehyde intermediate (*S*)-206 which, without further purification, was transformed into the corresponding carboxylic acid (*S*)-205 by NaClO₂ oxidation

(NaH_2PO_4 , 2-methyl-2-butene, $t\text{-BuOH-H}_2\text{O}$, 0°C , 10 min).¹⁴⁰ The acid (*S*)-**205** was thus obtained in 76% yield for the two last steps. Finally, desilylation of compound (*S*)-**205** with TBAF (THF, 0°C , 15 min) took place in quantitative yield to afford (*S*)- γ -CEHC (**116**) $\{[\alpha]_{\text{D}}^{20} = +5.5$ (c 1.43, MeOH); lit³ $[\alpha]_{\text{D}}^{20} = +5.1$ (c 1.27, MeOH)}, showing >99% enantiomeric excess. For such determination, racemic **116** was synthesized following a similar route starting from the racemic methyl *p*-tolyl sulfoxide. The optimal separation of enantiomers by chiral HPLC was achieved using Daicel Chiralpack IA column with 9.5% *i*-PrOH and 0.5% AcOH in hexane, 1 mL min^{-1} , 25°C , 254 nm: $t_{\text{R}(2\text{R})} = 23.5$ min and $t_{\text{R}(2\text{S})} = 28.8$ min.

All physical and spectroscopic data of synthetic **116** were identical to those reported for the natural metabolite.

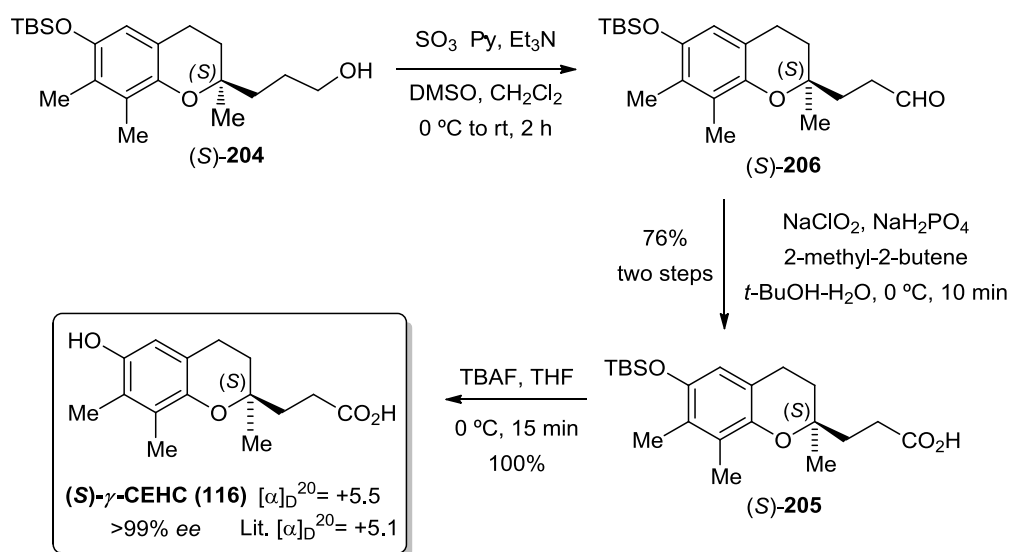

Scheme 3. 20

¹⁴⁰Kraus, G. A.; Roth, B. *J. Org. Chem.* **1980**, *45*, 4825–4830.

IV. CONCLUSIONS

In summary, a highly efficient strategy for the preparation of 2,2-disubstituted chiral chromans has been developed. The key step is a diastereoselective Lewis acid-promoted and sulfoxide-directed nucleophilic substitution of enantiopure sulfinyl ketal chroman to efficiently generate the quaternary stereocenter at C-2 of the 3,4-dihydro-2*H*-1-benzopyrans scaffolds (chromans).

The required sulfinyl ketal chromans were successfully synthesized in good yields and in two steps from the readily available corresponding methyl sulfoxides and the commercial dihydrocoumarine.

In this chapter, the total synthesis of the natural γ -tocopherol metabolite (*S*)- γ -CEHC [(*S*)-LLU- α] enantiopure was successfully achieved in a short and highly enantioselective manner in >99% *ee*. The synthesis was completed in 10 steps and 18.4% overall yield, from 2,3-dimethyl-1,4-hydroquinone and acrylic acid, using an enantiopure (*S*)-sulfoxide-directed nucleophilic allylation of a sulfinyl ketal intermediate as the key step to efficiently generate the stereogenic center at C-2 of the chroman moiety.

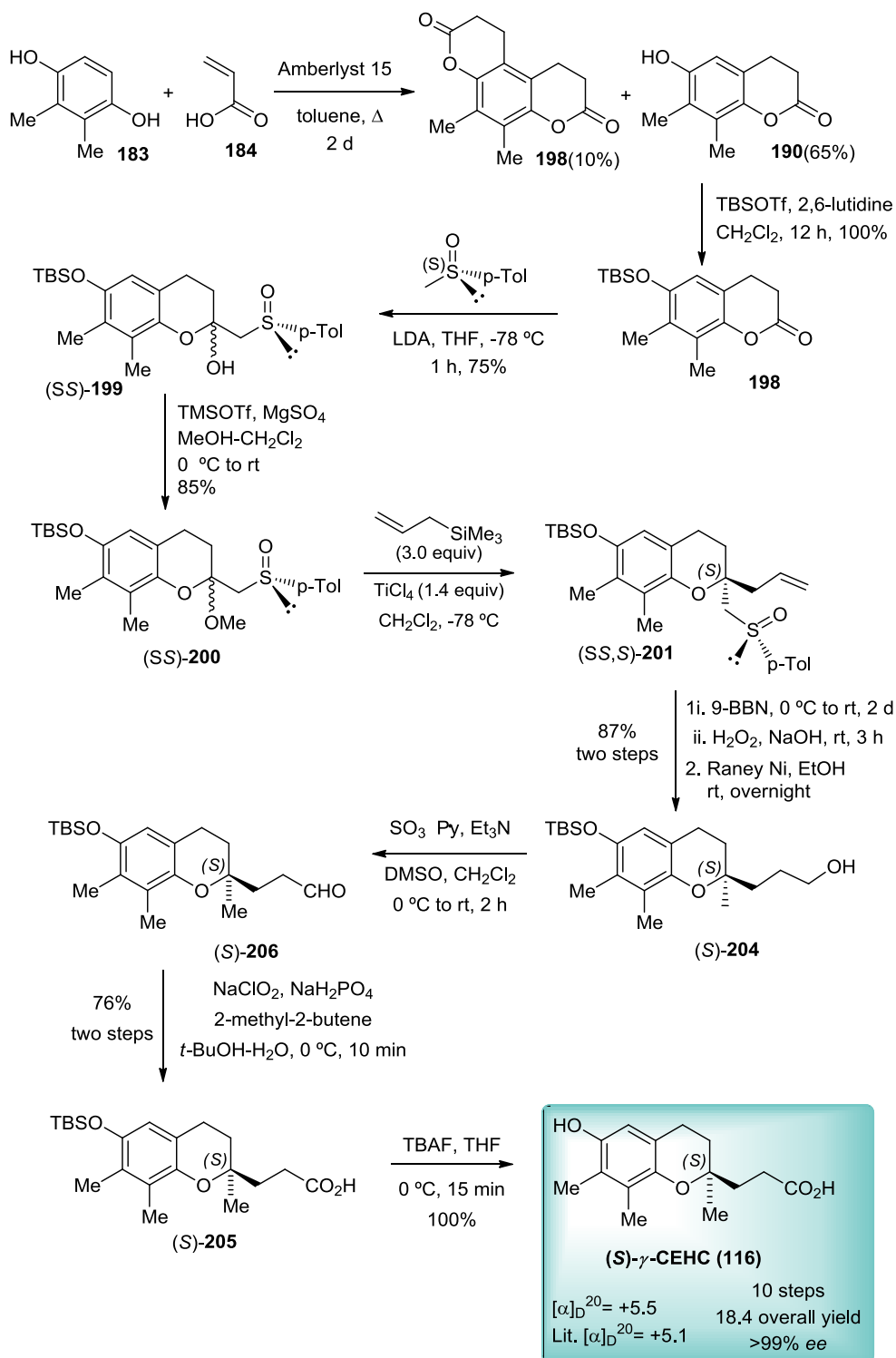

V. EXPERIMENTAL PART

GENERAL REMARKS

Solvents and reagents

Unless stated otherwise, reactions were performed in flame dried glassware under an argon or nitrogen atmosphere using dry solvents. Commercially obtained reagents were used as received. The commercial solution of *n*-butyllithium (1.6 M or 2.5 M in hexanes) was dosed before used using the protocol described by J. Suffert.¹⁴¹ Anhydrous solvents and reagents were distilled under argon atmosphere before used:

- Diethyl ether and THF over sodium and benzophenone.
- CH₂Cl₂ over CaH₂.
- Acetone, benzene and dimethylformamide over molecular sieves 4 Å.
- Diisopropylamine and triethylamine over KOH.
- DMSO over CaH₂.

All other reagent quality solvents were predried over activated molecular sieves and kept under an argon atmosphere.

Workup

For routine workup, hydrolysis was carried out with water, extractions with indicated solvent for each case, and solvent drying with MgSO₄.

Chromatography

Unless stated otherwise, flash chromatographic purification was done over silica gel following the flash chromatography protocol described by W. C. Still using MERCK Si 60 (40-63 μ m) silica as stationary phase.¹⁴²

¹⁴¹ Suffert, J. *J. Org. Chem.* **1989**, *54*, 509.

¹⁴² Still, W. C.; Kahn, M.; Mitra, A. *J. Org. Chem.* **1978**, *43*, 2923.

All reactions were monitored by thin layer chromatography that was performed on precoated sheets of silica gel 60, and flash column chromatography was done with silica gel 60 (230-400 mesh) of Merck. Eluting solvents are indicated in the text. The TLC were visualized by UV fluorescence quenching as well as by the following solutions:

- Phosphomolybdic acid solution: 25 g of phosphomolybdic acid + 10 g of cerium sulfate (IV) + 60 mL of sulfuric acid + 940 mL of water (or 20 mL of the commercial solution and 60 mL of ethanol).
- Mostain: 20 g de tetrahydrated molybdate ammonium + 0.2 g of cerium sulfate + 400 mL 10% of sulfuric acid.

Nuclear Magnetic Resonance (NMR)

The Nuclear Magnetic Resonance (NMR) spectra were registered in a Bruker Avance 300 apparatus (^1H 300 MHz, ^{13}C 75 MHz) at ECPM and at Universidad Autonoma de Madrid. Avance 400 apparatus (^1H 400 MHz, ^{13}C 100 MHz) was used for certain spectra done at ECPM and certain with an AC-500 (^1H 500 et ^{13}C 126 MHz) at “Servicio Interdepartamental de Investigación” (SIDI) at Universidad Autónoma de Madrid.

All chemical shifts (δ) are quoted in parts per million (ppm). The chemical shifts are referred to the applied NMR solvent (for CDCl_3 : ^1H NMR, 7.26 ppm and ^{13}C NMR, 77.0 ppm). The coupling constants (J) and the non-equivalence ($\Delta\nu$) are given in Hertz (Hz). Resonance patterns are reported with the following notations: br (broad), s (singlet), d (doublet), t (triplet), q (quartet), qi (quintuplet), sex (sextuplet) and m (multiplet).

Integration of well resolved signals in the ^1H NMR spectrum allowed to establish the diastereomers ratio.

Mass Spectroscopy (MS)

Mass spectroscopy (MS) realized by Electronic Impact (EI) and Fast Atom Bombardment (FAB) were registered by VG AutoSpec. In the case of small or fragile molecules the mass spectroscopy was realized by Electrospray (ESI) and registered by QSTAR. The data is expressed in m/z units.

Specific rotations

Specific rotations were determined at room temperature in a Perkin Elmer 241 polarimeter for sodium ($\lambda = 589$ nm) in a 10 cm glass tube. The concentration is done in g/100 mL and the solvent and concentrations are precised for each chiral compound.

X-Ray Diffraction

X-Rays were recorded at Universidad Autónoma de Madrid by César Pastor and Université de Strasbourg by Dr. Brelot by a diffractometer Kappa CCD Oxford Cryosystem liquid N₂ using monochromatic radiations Mo-K α = 0.71073 Å. Data of diffraction were corrected by absorption and analyzed with OpenMolen Package.

Microanalyses

Microanalyses were obtained by “Service de Microanalyses” at Servicio Interdepartamental (Sidi) of the University Autónoma of Madrid.

Melting point (mp)

Melting points were obtained on a Büchi 535 apparatus, in open capillary tubes and are uncorrected.

GENERAL PROCEDURES

General procedure for the synthesis of racemic methyl sulfoxides from the corresponding thioethers. Method A

 To a solution of the thioether (1equiv) in en CH_2Cl_2 (0.15M) and 0°C , were added small portions of *m*-CPBA (1.1 equiv). The mixture was stirred for the time indicated in each case. The reaction was followed by TLC (hexane/EtOAc, 1:4). Once the starting material was consumed, the mixture was hydrolyzed with a saturated aqueous of Na_2SO_3 , and extracted with CH_2Cl_2 , the organic layer was washed with a saturated aqueous of NaHCO_3 . After workup, it was purified by flash chromatography (hexane/EtOAc).

General procedure for the synthesis of 2-(alkyl or aryl sulfinyl) methyl chroman-2-ols from the corresponding chromanones. Method B

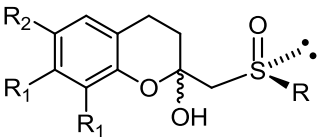

 To a solution of dry diisopropylamine (2.2 equiv) in THF (1.8M) at 0°C , a solution of *n*-BuLi 2.5M in hexanes (2.15 equiv) was added, under N_2 . The mixture was stirred for 30 min, cooled to -78°C and a solution of the corresponding methylsulfoxide (1.1-1.5 equiv) in THF (0.8-1M) was added dropwise. The reaction was allowed to reach -40°C , stirred for 1 hour and added, via cannula, to a solution of corresponding chromanone (1 equiv) in THF (1.5-2M), at -78°C . The reaction was stirred during the time indicated in each case and followed by TLC; once it is completed the mixture was hydrolyzed with a saturated aqueous ammonium chloride solution and extracted with EtOAc. After workup, the chromanol was purified as indicate in each case.

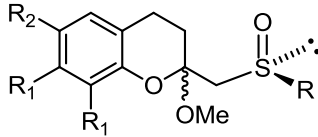
General procedure for the synthesis of 2-methoxy-2-(alkyl or aryl sulfinyl) methyl chromans. Method C

 To a mixture of sulfinyl chromanol (1 equiv) in dry methanol (0.4M), were added trimethyl orthoformate ($\text{CH}(\text{OCH}_3)_3$, 0.4M) and *p*-toluenesulfonic acid in catalytic amounts (0.11 equiv) at room temperature. The solution was stirred during the time indicated in each case and followed by TLC. Then the mixture is quenched with a saturated aqueous

of NaHCO₃ and extracted with Et₂O or EtOAc. After work up, it was purified by flash chromatography (hexane/EtOAc).

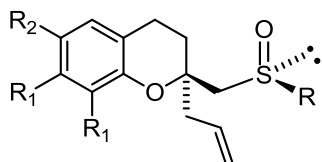
General procedure for the synthesis of 2-allyl-2-(alkyl or aryl sulfinyl) methyl chromans from the corresponding 2-methoxy-2-(alkyl or aryl sulfinyl) methyl chromans. Nucleophilic substitution. Method D.



To a solution of 2-methoxy-2-(sulfinyl) methyl chromans (1 equiv) in CH₂Cl₂ (0.08M) at the temperature indicated in each case, was added allyl trimethylsilane (2-4 equiv) and the Lewis acid, TiCl₄ or ZrCl₄ (1.4 equiv). The reaction was followed by TLC, stirred at the temperature and during the time indicated in each case. Then the mixture was hydrolyzed with a saturated aqueous NaHCO₃ solution and extracted with EtOAc. After workup, the product was purified by flash chromatography (hexane/EtOAc). Diastereomeric ratios were determined by ¹H-NMR.

General procedure for the synthesis of 2-methyl-2-(alkyl or aryl sulfinyl) methyl chromans from the corresponding 2-methoxy-2-(sulfinyl) methyl chromans. Nucleophilic substitution. Method E.

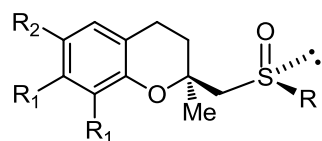

To a solution of 2-methoxy-2-(sulfinyl) methyl chromans (1 equiv) in CH₂Cl₂ (0.09M) at -78 °C, was added the Lewis acid, TiCl₄ or ZrCl₄ (1.4 equiv) and then the AlMe₃ (2M in heptanes). The reaction stirred for 2-4h and then the temperature was allowed to reach room temperature. Then the mixture was hydrolyzed with a saturated aqueous NaHCO₃ solution, saturated aqueous sodium tartrate and extracted with EtOAc. After workup, the product was purified by flash chromatography (hexane/EtOAc). Diastereomeric ratios were determined by ¹H-NMR.

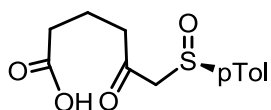
(SR)-5-Oxo-6-(*p*-tolylsulfinyl)hexanoic acid 47

To a solution of dry diisopropylamine (2 mL, 14.5 mmol) in THF (9 mL) at 0°C, a solution of *n*-BuLi 2.5 M in hexanes (5.6 mL, 14.19 mmol) was added, under N₂. The mixture was stirred for 30 min, cooled to -78 °C and a solution of (RS)-methyl-*p*-tolylsulfoxide (1.32 g, 8.58 mmol) in THF (11.3 mL) was added dropwise. The reaction was allowed to reach -40°C, stirred for 1 hour and added, via cannula, to a solution of glutaric anhydride (1 g, 6.6 mmol) in THF (4.3 mL), at -78°C. The mixture was stirred for 1 hour then raised to room temperature, hydrolyzed with water (30 mL) and extracted with EtOAc. To the aqueous layer is added HCl 1M until pH = 1, then extracted with EtOAc. After workup compound **47** was obtained in 95% yield (1.69 g), as yellow oil. A mixture of the cycled product

¹H NMR δ 1.38 (m, 0.6H), 1.84 (m, 2H), 2.31 (t, *J* = 6.1 Hz, 2H), 2.4 (s, 3.7H), 2.58 (q, *J* = 7.21Hz, 2H), 2.9 (m, 0.3H), 3.11 (m, 0.4H), 3.78 and 3.95 (AB system, *J* = 13.75 Hz, Δ*v* = 99.6 Hz, 2H), 7.32 and 7.52 (AA'BB' system, *J* = 8.1 Hz, 4H).

¹³C NMR δ 18.0, 21.4, 32.6, 32.9, 67.5, 124.3, 130.2, 138.8, 142.5, 177.7, 200.9

MS (EI) *m/z*: 268 (M⁺, 1), 154 (26), 139 (38), 115 (100)

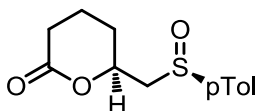
(S)-6-(SR)-(p-tolylsulfinylmethyl)tetrahydro-2H-pyran-2-one 49

To a solution of (SR)-5-oxo-6-(*p*-tolylsulfinyl)hexanoic acid **47** (150 mg, 0.56 mmol) in CH₂Cl₂ (5.6 mL), triethylsilyl hydride (446 μL, 2.79 mmol, 5 equiv) followed by trimethylsilyl triflate (131 μL, 0.72 mmol, 1.32 equiv) were added dropwise at 0°C, under argon. The reaction was stirred 5 h at 0°C and 24h at room temperature. After workup and flash chromatography (eluent hexane/EtOAc 1:1), compound (S,SR)-**49** was obtained in 20% yield as yellow oil.

^1H NMR δ 1.58 (m, 2H), 1.86 (m, 2H), 2.17 (m, 1H), 2.32 (s, 3H), 2.5 (m, 2H), 2.97 and 3.29 (ABX system, $J_{AB} = 13.8$ Hz, $J_{AX} = 4.7$ Hz and $J_{BX} = 8.14$ Hz, $\Delta\nu = 189.7$ Hz, 2H), 4.36 (m, 1H), 7.11 and 7.29 (AA'BB' system, $J = 8.1$ Hz, 4H).

^{13}C NMR δ 18.3, 21.0, 26.7, 29.5, 39.3, 79.0, 129.9, 130.6, 131.4, 137.0, 170.9

(*R*)-6-methoxy-6-(*p*-tolylsulfinylmethyl)tetrahydro-2*H*-pyran-2-one **50**

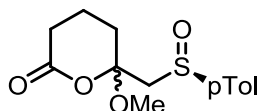

To a solution of (*SR*)-5-oxo-6-(*p*-tolylsulfinyl)hexanoic acid **47** (200 mg, 0.745 mmol) in dry MeOH (2.1 mL), trimethyl orthoformate (98 mL, 0.89 mmol, 1.2 equiv) and a catalytic amount of *p*-toluenesulfonic acid (14 mg, 0.1 equiv) were added. The mixture was stirred for 22 h at 20°C, quenched with a saturated aqueous ammonium chloride solution and extracted with EtOAc. After workup and flash chromatography (eluent hexane/EtOAc 1:1), compound **50** was obtained in 60% yield (127 mg), as a mixture of diastereoisomers at C-2, as yellow oil.

^1H NMR δ 1.85 (m, 2H), 2.31 (t, $J = 7$ Hz, 2H), 2.4 (s, 3H), 2.58 (m, 2H), 3.6 (s, 3H), 3.68 and 3.82 (AB system, $J = 9.1$ Hz, $\Delta\nu = 60.5$ Hz, 2H), 7.35 and 7.5 (AA'BB' system, $J = 8$ Hz, 4H).

^{13}C NMR δ 18.4, 21.4, 32.8, 43.9, 51.5, 67.8, 124.0, 130.3, 139.6, 142.5, 173.3, 200.8

(+)-(SR)-Methyl-*p*-tolylsulfoxide 46 ^{143,93}

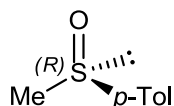

A solution of methyl magnesium iodide, prepared from methyl iodide (40.6 g, 0.29 mol) and magnesium (5.96 g, 0.24 mol) in anhydrous ethyl ether (250 mL), cooled at 0°C, was slowly added to a solution of (-)-(1*S*,2*R*,5*S*,*S**R*)-menthyl-*p*-toluenesulfinate (60 g, 0.20 mol) in anhydrous benzene (200 mL). After the addition, the mixture was stirred at room temperature for 2h and then hydrolyzed with saturated brine (200 mL). The oily residue was mixed with warm hexane till formation of a light white cloudy precipitate. Crystallization occurred at -5°C. White crystals were formed and recrystallized in ether-hexane, mother liquor were concentrated and submitted to the same treatment. (+)-(SR)-methyl-*p*-tolyl sulfoxide was prepared as white solid in 83% yield (26 g).

m.p. = 75-76°C

[α]_D²⁰ = + 145 (c 2, acetone). [Lit.: [α]_D²⁰ = +146 (c 2, acetone)]

¹H NMR δ 2.45 (s, 3H), 2.70 (s, 3H), 7.28 and 7.56 (AA'BB' system, *J* = 8.0 Hz, $\Delta\nu$ = 62.2 Hz, 4H).

(-)-(SS)-Methyl-*p*-tolylsulfoxide

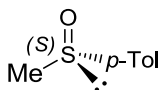

(SS)-Methyl-*p*-tolylsulfoxide was obtained following the same procedure but using (+)-(1*S*,2*R*,5*S*,*S**S*)-menthyl-*p*-toluenesulfinate.

[α]_D²⁰ = -145 (c 2, acetone). [Lit.: [α]_D²⁰ = -142 (c 1, acetone)]

¹⁴³K. K Andersen, W. Gafield, N. Papanicolaou, J. W. Foley, R. I. Perkins, *J. Am. Chem. Soc.* **1964**, *86*, 5637-5646.

⁹³G. Solladié, J. Hutt, A. Girardin, *Synthesis* **1987**, 173

m.p. = 73–76°C

(±)-Methyl-*p*-tolylsulfoxide

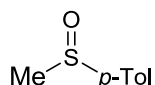

The oxidation of methyl-*p*-tolyl sulfide (2.43 mL, 18.08 mmol, 1 equiv) with *m*-CPBA following method A gave the methyl-*p*-tolyl sulfoxide which was purified by flash chromatography (hexane/EtOAc, 1:3) to give a colorless oil in 91% yield.

$^1\text{H NMR}$ (CDCl_3) δ 3.70 (s, 3H), 2.4 (s, 3H), 7.28 and 7.56 (AA'BB' system, $J = 8.0$ Hz, $\Delta\nu = 62.2$ Hz, 4H).

(±)-Methyl-*t*-butylsulfoxide 177¹⁴⁴

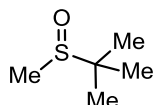

The oxidation of methyl-*t*-butyl sulfide (1.0g, 9.6 mmol, 1 equiv) with *m*-CPBA following method A gave the methyl-*t*-butylsulfoxide **177** which was purified by flash chromatography (hexane/EtOAc, 1:20) to give a colorless oil in 67% yield.

$^1\text{H NMR}$ (CDCl_3) δ 1.21 (s, 9H), 2.34 (s, 3H)

$^{13}\text{C NMR}$ (CDCl_3) δ 22.4, 31.5, 52.5

¹⁴⁴ a) D. A. Evans, M. M. Faul, L. Colombo, J. J. Bisaha, J. Clardy, D. Cherry, *J. Am. Chem. Soc.* **1992**, *114*, 5977-5985; b) P. B. Hitchcock, G. J. Rowlands, R. J. Seacome, *Org. Biomol. Chem.* **2005**, *3*, 3873-3876.

(±)-Methyl-*p*-methoxyphenyl sulfoxide 118¹⁴⁵

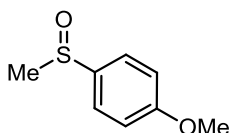

The oxidation of methyl *p*-anisyl sulfide (1.5g, 9.7 mmol, 1 equiv) with *m*-CPBA (1.8g, 10.7 mmol, 1.1 equiv) following method A (1h). After work up the ¹H-NMR showed 97% of conversion of the starting material. It was purified by flash chromatography (hexane/EtOAc, 1:5) to give colorless oil in 88% yield.

m.p. = 25-26°C

¹H NMR (CDCl₃) δ 2.63 (s, 3H), 3.78 (s, 3H), 6.97 and 7.53 (AA'BB' system, *J* = 8.9 Hz, Δ*v* = 168.8 Hz, 4H)

(±)-Methyl-*p*-nitrophenyl sulfoxide 119^{145b}

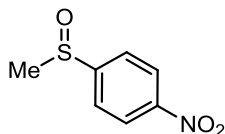

Following method A, (±)-methyl-(*p*-nitrophenyl)sulfoxide was obtained by oxidation of *p*-nitrotioanisol (1.2g, 7.0 mmol, 1 equiv) with *m*-CPBA (1.3g, 7.7 mmol, 1.1 equiv) in 1h. After work up it was purified by flash chromatography (hexane/EtOAc, 1:5) to give a beige solid in 81% yield.

Mp = 151.0-152.4 °C (CH₂Cl₂/hexane). [Lit.¹⁴⁶: mp = 152-153°C]

¹H NMR (CDCl₃) δ 2.80 (s, 3H), 7.85 and 8.40 (AA'BB' system, *J* = 8.9 Hz, Δ*v* = 166.5 Hz, 4H)

¹⁴⁵ a) H. Egami, T. Katsuki, *J. Am. Chem. Soc.* **2007**, *129*, 8940-8941. b) Y. Ferrand, R. Daviaud, P. Le Maux, G. Simmonneaux, *Tetr. Asymm.* **2006**, *17*, 952-960.

¹⁴⁶ F. G. Bordwell, P. J. Bouton, *J. Am. Chem. Soc.* **1957**, *79*, 717-722.

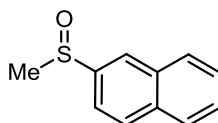
(±)-Methyl-2-naphthylsulfoxide 120¹⁴⁷

The oxidation of 2-methynaphthyl sulfide (1.0 g, 5.7 mmol, 1 equiv) with *m*-CPBA (1.1 g, 6.3 mmol, 1.1 equiv) following method A (1h) gave sulfoxide **120** which was purified by flash chromatography (hexane/EtOAc, 1:5) to give a white solid in 81% yield.

¹H NMR (CDCl₃) δ 2.79 (s, 3H), 7.58-7.62 (m, 3H), 7.89-7.97 (m, 3H), 8.22 (s, 1H)

¹³C NMR (CDCl₃) δ 43.8, 119.5, 124.1, 127.4, 127.8, 128.1, 128.5, 129.6, 132.9, 134.5, 142.9

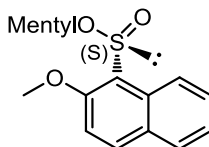
(-)-(1*R*,2*S*,5*R*)-Menthyl-(*S*)-2-methoxynaphthyl-1-sulfinylate¹⁴⁸

Thionyl chloride (2.7 mL, 38 mmol, 2 equiv) was added drop wise to 2-methoxynaphtalen (3.0 g, 19 mmol, 1 equiv). The mixture was stirred for 1h, when yellow solid formation begins then benzene (8 mL) is added. The reaction is heated to reflux until the solid is dissolved, then cooled down to 5°C. After 1h, 2-methoxynaphtalen-1-sulfinyl chloride began to crystallize. Once the crystals were filtered and washed with benzene and pentane, were used for the next step without further purification.

To a solution of (-)-menthol (15 mmol, 1.2 equiv) in 12 mL of CH₂Cl₂ at 0°C, was added drop wise 2-methoxynaphtalen-1-sulfinyl chloride (3.0 g, 12.4 mmol, 1 equiv) freshly prepared and dry pyridine (1.2 mL). The reaction is maintained at 0°C for 2h and allowed to reach room temperature overnight. The mixture was

¹⁴⁷ J. Legros, C. Bolm, *Chem. Eur. J.* **2005**, *11*, 1086-1092.

quenched with a solution of 10% HCl (8 mL). After workup, oil was dissolved in hot acetone (20 mL) and cooled down to 5°C. Crystals formed were filtered, the mother liquor is concentrated, concentrated HCl (3 drops) is added and the solution allowed once again to crystallize at 5°C. (-)-(1*R*,2*S*,5*R*)-Menthyl-(*S*)-2-methoxynaphthyl-1-sulfinate was obtained as a white solid in 70% yield.

mp = 100-102 °C (acetone). [Lit.:¹⁴⁸ 103 °C (acetone)]

[α]_D²⁰ = -184 (c 1.05, CHCl₃). [Lit.:¹⁴⁸ [α]_D²⁰ = -183 (c 1.2, CHCl₃)].

¹H NMR (CDCl₃) δ 0.88, 0.91 y 0.93 (3d, *J* = 6.9, 7.0 y 6.3 Hz, 9H), 1.00-1.70 (m, 6H), 2.27 (m, 2H), 4.01 (s, 3H), 4.20 (dt, *J* = 10.7 y 4.4 Hz, 1H), 7.22 (d, *J* = 7.9 Hz, 1H), 7.41 (dd, *J* = 7.9 y 7.0 Hz, 1H), 7.56 (dd, *J* = 8.6 and 7.0 Hz, 1H), 7.79 (d, *J* = 8.6 Hz, 1H), 7.94 (d, *J* = 8.6 Hz, 1H), 9.05 (d, *J* = 8.6 Hz, 1H).

(+)-(SR)-Methyl-2-methoxy-1-naphthyl sulfoxide 121¹⁴⁸

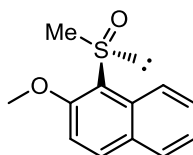

To a solution of (-)-(1*R*,2*S*,5*R*)-menthyl-(*S*)-2-methoxynaphthyl-1-sulfinate (735mg, 2.04mmol, 1eq) in benzene (4 mL) at 0°C, MeMgI 3M in Et₂O (0.82 mL, 2.45 mmol, 1.2 equiv) was added drop wise. After 10h, the mixture was quenched with a saturated aqueous NaHCO₃ solution and extracted with EtOAc. After workup, sulfoxide **121** was purified by flash chromatography (EtOAc/hexane 1:1) and isolated as white solid in 74% yield (330 mg).

Mp = 100-102 °C. [Lit.:^{148,148} 102-103°C]

[α]_D²⁰ = +175.3 (c 1.05 CHCl₃). [Lit.:¹⁴⁸ [α]_D²⁰ = +107 (c 0.1 CHCl₃)].

¹⁴⁸ S. G. Pyne, A. R. Hajipour, K. Prabakaran, *Tetrahedron Lett.*, **1994**, 35, 645-648.

$^1\text{H NMR}$ (CDCl_3) δ 3.10 (s, 3H), 4.04 (s, 3H), 7.27 (d, $J = 9.0$ Hz, 1H), 7.42 (td, $J = 7.7$ y 1.1 Hz, 1H), 7.56 (dt, $J = 7.6$ y 1.5 Hz, 1H), 7.82 (d, $J = 8.1$ Hz, 1H), 7.96 (d, $J = 9.1$ Hz, 1H), 9.05 (d, $J = 8.7$ Hz, 1H).

$^{13}\text{C NMR}$ (CDCl_3) δ 39.2, 56.9, 112.9, 122.5, 122.8, 124.5, 127.9, 128.8, 129.6, 132.0, 134.0, 155.9

(*SR*)-2-(*p*-Tolylsulfinyl)methyl chroman-2-ol **114**

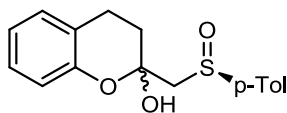

The chromanol **114** was obtained by nucleophilic addition of the lithium anion derived from (*SR*)-methyl-*p*-tolylsulfoxide **46** (1.5 g, 9.7 mmol, 1.5 equiv) to the commercial dihydrocoumarine (818 μL , 6.5 mmol, 1 equiv) following method B (1h). After workup, pale orange syrup was obtained, and diethyl ether was added until a precipitate appeared. The solid was filtered, washed with several portions of diethyl ether/hexane and dried, to obtain compound (*SR*)-**114** as a white solid, in 93% yield (1.86g). When the reaction was performed in a smaller scale, the precipitation of the product was not observed and the final mixture was purified by flash chromatography (hexane/EtOAc 1:1). Chromanol **114** was obtained as epimers mixture 87:13 at C-2 and/or in equilibrium with the open β -keto sulfoxide **113**. ^1H and ^{13}C -NMR data corresponds to the major chromanol **114**.

Mp: 115-116 $^\circ\text{C}$.

Rf 0.32 (hexane/EtOAc, 1:1)/ **Rf** 0.39 (hexane/EtOAc t, 1:2).

$[\alpha]_D^{20} = +196.5$ (c 1 CHCl_3)

$^1\text{H NMR}$ (CDCl_3) (major chromanol) δ 1.71 (tdd, $J = 12.6$, 5.6 y 1.6 Hz, 1H), 2.03 (ddd, $J = 12.9$, 6.0 y 2.8 Hz, 1H), 2.30 (s, 3H), 2.59 (ddd, $J = 16.4$, 5.6 y 2.6 Hz, 1H), 2.91 y 3.09 (AB system, $J = 12.8$ Hz, $\Delta\nu = 53.1$ Hz, 2H), 2.99-3.07 (m, 1H), 6.17 (d, $J = 1.6$ Hz, 1H), 6.80-7.09 (m, 4H), 7.27 and 7.52 (AA'BB' system, $J = 8.2$ Hz, $\Delta\nu = 74.3$ Hz, 4H).

¹³C NMR (CDCl₃) (major chromanol) δ 20.7, 21.4, 32.1, 63.5, 96.7, 117.3, 121.1, 121.8, 124.1 (2C), 127.4, 129.1, 130.3 (2C), 140.2, 142.3, 152.0

MS (EI) *m/z* (%): 77 (46), 91 (77), 107 (82), 124 (26), 140 (100), 145 (36), 149 (30), 163 (43), 302 (M⁺, 5).

HRMS (EI) calcd for C₁₇H₁₈O₃S (M⁺) 302.09766, found 302.09897.

(±)-2-(*t*-Butylsulfinyl)methyl chroman-2-ol **122**

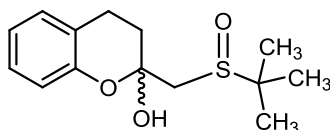

The chromanol **122** was obtained by nucleophilic addition of the lithium anion derived from methyl-*t*-butylsulfoxide **117** (520 mg, 4.33 mmol, 1.5 equiv) to the dihydrocoumarine **112** (365 μL, 2.88 mmol, 1 equiv) following method B (1h). After workup and flash chromatography (hexane/EtOAc 1:2), chromanol **122** was isolated in 77% yield (596 mg).

R_f 0.25 (hexane/EtOAc 1:2) / **R_f** 0.37 [(2x) hexane/EtOAc 1:2]

¹H RMN (CDCl₃) δ 1.32 (s, 9H), 1.85 (tdd, *J* = 12.8, 5.8 y 2.3 Hz, 1H), 2.18 (ddd, *J* = 13.0, 6.0 y 2.6 Hz, 1H), 2.70 (ddd, *J* = 16.2, 5.8 y 2.6 Hz, 1H), 2.83 and 2.96 (AB system, *J* = 12.3 Hz, Δ*v* = 71.4 Hz, 2H), 3.16 (ddd, *J* = 16.2, 12.5, 5.8 Hz, 1H), 6.53 (d, *J* = 2.3 Hz, 1H), 6.88-6.95 (m, 2H), 7.08-7.16 (m, 2H).

¹³C RMN (CDCl₃) δ 20.7, 22.5 (3C), 32.7, 49.6, 53.4, 97.0, 117.3, 121.0, 121.7, 127.4, 129.0, 152.0

MS (FAB⁺) *m/z* (%): 77 (15), 107 (35), 177 (10), 195 (100), 251 (90), 269 (M⁺+1, 19)

HRMS (FAB⁺) calcd for C₁₄H₂₁O₃S (M⁺) 269.1211, found 269.1212

(±)-2-(*p*-Methoxyphenylsulfinyl)methyl chroman-2-ol **123**

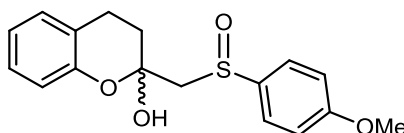

The chromanol **123** was obtained by nucleophilic addition of the lithium anion derived from (±)-methyl-(*p*-methoxyphenyl)sulfoxide **118** (1.3 g, 7.65 mmol, 1.4 equiv) to the dihydrocoumarine **112** (692 μ L, 5.46 mmol, 1 equiv) following method B (1h 30). After workup and flash chromatography (hexane/EtOAc 1:3), chromanol **123** was isolated as white solid in 76% yield (1.3 g), as a mixture 86:14 of diastereoisomers at C-2.

Mp: 102-103 °C.

R_f 0.31 (hexane/EtOAc 1:2)

¹H NMR (CDCl₃) δ 1.80 (tdd, $J = 12.6, 5.8$ y 2.1 Hz, 1H), 2.13 (ddd, $J = 12.8, 5.8$ y 2.8 Hz, 1H), 2.98 and 3.19 (AB system, $J = 12.8$ Hz, $\Delta\nu = 60.9$ Hz, 2H), 3.09-3.19 (m, 1H), 6.27 (d, $J = 2.1$ Hz, 1H), 6.89-7.00 (m, 2H), 7.12-7.19 (m, 2H), 7.07 and 7.68 (AA'BB' system, $J = 8.9$ Hz, $\Delta\nu = 160.3$ Hz, 4H)

¹³C NMR (CDCl₃) δ 20.9, 32.4, 55.8, 63.7, 96.9, 115.4 (2C), 117.5, 121.3, 121.9, 126.3 (2C), 127.6, 129.3, 134.6, 152.2, 162.8

MS (EI) m/z (%): 65 (21), 84 (75), 91 (30), 107 (100), 121 (29), 126 (51), 140 (93), 155 (92), 164 (28), 318 (M⁺, 3)

HRMS (EI) calcd for C₁₇H₁₈O₄S (M⁺) 318.09258, found 318.09250.

(±)-2-(*p*-Nitrophenylsulfinyl)methyl chroman-2-ol **124**

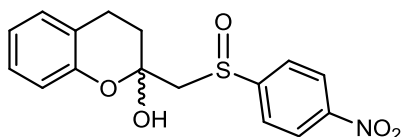

The chromanol **124** was obtained by nucleophilic addition of the lithium anion derived from (\pm)-methyl-(*p*-nitrophenyl)sulfoxide **119** (1.0 g, 5.4 mmol, 1.4 equiv) to the dihydrocoumarine **112** (489 μ L, 3.86 mmol, 1 equiv) following method B (1h30). The low solubility of the methyl-(*p*-nitrophenyl) sulfoxide **119** held up the reaction, recovering 0.8 equiv without any transformation. After workup and flash chromatography (hexane/EtOAc 1:2), chromanol **124** was isolated as orange oil in 21% yield (270 mg), as a mixture of three products, two epimers at C-2 and the open phenol in equilibrium in ratio 62:18:20 respectively.

R_f 0.42 (hexane/ EtOAc 1:2)

¹H NMR (CDCl₃) δ 1.83 (td, J = 12.7 and 5.8 Hz, 1H), 2.15 (ddd, J = 12.9, 5.9 and 2.9 Hz, 1H), 2.69 (ddd, J = 16.3, 5.6 y 2.8 Hz), 3.04-3.15 (m, 1H), 3.14 y 3.22 (AB system, J = 12.8 Hz, Δv = 21.2 Hz, 2H), 5.74 (large s, 1H), 6.89-6.94 (m, 2H), 7.08-7.16 (m, 2H), 7.87 and 8.37 (AA'BB' system, J = 8.4 Hz, Δv = 149.6 Hz, 4H)

¹³C NMR (CDCl₃) δ 20.6, 32.0, 63.9, 96.5, 117.2, 121.4, 121.6, 124.7 (2C), 126.0 (2C), 127.7, 129.2, 149.8, 151.1, 151.6

MS (EI) m/z (%):65 (44), 84 (100), 91 (46), 107 (88), 126 (37), 145 (83), 155 (49), 171 (12), 299 (9), 333 (M⁺1)

HRMS (EI) calcd for C₁₆H₁₅NO₅S (M⁺) 333.06709, found 333.06830

(\pm)-2-(2-Naphthylsulfinyl)methyl chroman-2-ol **125**

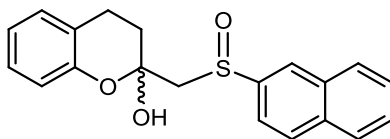

The chromanol **125** was obtained by nucleophilic addition of the lithium anion derived from (\pm)-methyl-(2-naphthyl) sulfoxide **120** (860 mg, 4.5 mmol, 1.2 equiv) to the dihydrocoumarine **112** (482 μ L, 3.80 mmol, 1 equiv) following method B (1h30). After workup and flash chromatography (hexane/AcOEt 1:2) product **125** was obtained as white solid in 89% yield (1.14g) as a mixture 85:15 of epimers at C-2.

Mp: 119-121°C.

R_f 0.37 (hexane/EtOAc 1:2)

¹H NMR (CDCl₃) δ 1.81 (tdd, $J = 12.6, 5.8$ and 2.1 Hz, 1H), 2.13 (ddd, $J = 12.8, 5.8$ and 2.6 Hz, 1H), 2.69 (ddd, $J = 16.4, 5.7$ and 2.6 Hz), 3.27 and 3.11 (AB system, $J = 12.8$ Hz, $\Delta v = 47.8$ Hz, 2H), 3.10-3.21 (m, 1H), 6.24 (d, $J = 2.2$ Hz, 1H), 6.91-7.03 (m, 2H), 7.10-7.21 (m, 2H), 7.61-7.65 (m, 2H), 7.70 (dd, $J = 1.7$ Hz, 1H), 7.91-7.99 (m, 2H), 8.03 (d, $J = 8.5$ Hz, 1H), 8.27 (s, 1H)

¹³C NMR (CDCl₃) δ 20.7, 32.1, 63.3, 96.8, 117.4, 119.5, 121.2, 121.7, 124.8, 127.5, 127.6, 128.2 (2C), 128.6, 129.2, 130.0, 132.9, 134.7, 140.4, 151.9

MS (FAB+) m/z (%): 77 (21), 89 (21), 145 (14), 175 (71), 321 (39), 338 (17), 339 (M⁺+H, 25), 677 (2M⁺+H, 11).

HRMS (FAB+) calcd for C₂₀H₁₈O₃S (M⁺+1) 338.09766, found 338.09930.

(SR)-2-Methoxy-2-(p-tolylsulfinyl)methyl chroman 126

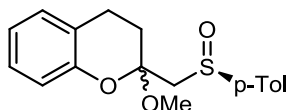

The methyl ketal **126** was obtained following method C (4h) from the chromanol **114** (1.81 g, 5.99 mmol, 1 equiv). After workup and flash chromatography (hexane/EtOAc 1:1), compound (SR)-**126** was obtained in 89% yield (1.68 g), as a mixture of diastereoisomers at C-2, as a white solid.

Mp: 79 °C.

R_f 0.43 (hexane/EtOAc 1:3)

[α]_D²⁰ = +122 (c 3.6 CHCl₃)

Diastereoisomer 1

¹H NMR (CDCl₃) δ 1.97-2.07 (m, 1H), 2.42 (s, 3H), 2.61 (ddd, *J* = 13.7, 6.1 y 3.3 Hz, 1H), 2.71 (ddd, *J* = 16.2, 5.7 y 3.3 Hz, 1H), 2.98-3.10 (m, 1H), 3.23 y 3.32 (AB system, *J* = 14.2 Hz, Δ*v* = 23.2 Hz, 2H), 3.34 (s, 3H), 6.80 (d, *J* = 8.1 Hz, 1H), 6.90 (td, *J* = 7.4 y 1.2 Hz, 1H), 7.07-7.13 (m, 2H), 7.33 and 7.58 (AA'BB' system, *J* = 8.0 Hz, Δ*v* = 72.6 Hz, 4H).

¹³C NMR (CDCl₃) δ 21.1, 21.4, 30.2, 49.5, 64.7, 97.5, 116.8, 121.3, 122.0, 124.0 (2C), 127.3, 129.3, 130.1 (2C), 140.8, 141.2, 151.2

Diastereoisomer 2

¹H NMR (CDCl₃) δ 2.26-2.33 (m, 2H), 2.43 (s, 3H), 2.67-2.72 (ddd, *J* = 16.1, 5.2 y 2.5 Hz, 1H), 2.98-3.13 (m, 1H), 3.22-3.34 (m, 5H), 6.78 (d, *J* = 8.2 Hz, 1H), 6.85 (td, *J* = 7.3 and 1.1 Hz, 1H), 7.08-7.15 (m, 2H), 7.28 y 7.54 (AA'BB' system, *J* = 8.1 Hz, Δ*v* = 76.2 Hz, 4H)

¹³C NMR (CDCl₃) δ 20.9, 21.4, 30.0, 49.4, 65.1, 97.6, 116.9, 121.4, 122.4, 124.1 (2C), 127.4, 129.3, 130.1 (2C), 141.3, 141.7, 151.6

MS (EI) *m/z* (%): 59 (21), 91 (18), 140 (40), 145 (100), 163 (17), 177 (34), 316 (M+, 0.3).

HRMS (EI) calcd for C₁₈H₂₀O₃S (M+) 316.11332, found 316.11432.

Elemental Analysis for C₁₈H₂₀O₃S: Calculated: C, 68.33; H, 6.37; O, 15.17; S, 10.13. Observed: C, 68.31; H, 6.44; S, 10.02

(±)-2-Methoxy-2-(*t*-butylsulfinyl)methyl chroman 127

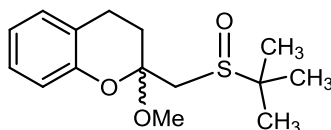

The methyl ketal **127** was obtained following method C (3d) from the chromanol **122** (477 mg, 1.78 mmol, 1 equiv). After workup and flash

chromatography (hexane/EtOAc 1:1), compound (SR)-**127** was obtained in 70% yield (340 mg), as a mixture 1:1 of diastereoisomers at C-2, as colorless oil.

$^1\text{H NMR}$ (CDCl_3) (2 diastereoisomers) δ 1.26 (s, 18H), 1.89- 2.07 (m, 2H), 2.29 (ddd, $J = 13.4, 6.2$ and 2.1 Hz, 1H), 2.51 (ddd, $J = 13.6, 6.0$ and 3.2 Hz, 1H), 2.57-2.68 (m, 2H), 2.70 and 3.13 (AB system, $J = 13.9$ Hz, $\Delta\nu = 127.8$ Hz, 2H), 2.83 and 3.21 (AB system, $J = 13.9$ Hz, $\Delta\nu = 112.2$ Hz, 2H), 3.26 (s, 3H), 3.29 (s, 3H), 6.80-6.89 (m, 4H), 7.02-7.10 (m, 4H)

$^{13}\text{C NMR}$ (CDCl_3) (2 diastereoisomers) δ 20.9, 21.1, 22.79 (6C), 30.1, 49.2, 49.4, 52.9, 53.5, 53.6, 53.9, 76.8, 77.2, 77.6, 97.9, 98.6, 116.7, 121.2, 121.3, 122.4, 122.5, 127.2, 129.20, 129.23, 151.5, 151.7

MS (EI) m/z (%): 57 (68), 91 (11), 107 (31), 146 (71), 163 (100), 193 (65), 282 (M^+ , 1)

HRMS (EI) calcd for $\text{C}_{15}\text{H}_{22}\text{O}_3\text{S}$ (M^+) 282.12896, found 282.12900

(\pm)-2-Methoxy-2-(*p*-methoxyphenylsulfinyl)methyl chroman 128

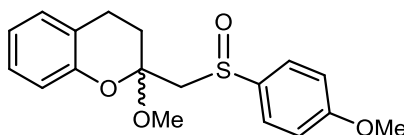

The methyl ketal **127** was obtained following method C (2d) from the chromanol **123** (950 mg, 2.98 mmol, 1 equiv). After workup and flash chromatography (hexane/EtOAc 1:1), compound **128** was obtained in 97% yield (960 mg), as a mixture 1:1 of diastereoisomers at C-2, as white solid.

Mp: 104-106 °C.

R_f 0.43 (hexane/EtOAc 1:2).

$^1\text{H NMR}$ (CDCl_3) δ 1.95-2.06 (m, 1H), 2.24-2.30 (m, 2H), 2.55-2.74 (m, 3H), 2.98-3.09 (m, 2H), 3.27 (s, 3H), 3.32 (s, 3H), 3.22-3.35 (m, 4H), 3.84 (s, 3H), 3.86 (s, 3H), 6.79-6.94 (m, 4H), 7.02-7.12 (m, 8H), 7.63 and 7.66 (2d, $J = 6.8$ Hz, 4H)

^{13}C NMR (CDCl_3) δ 20.9, 21.1, 30.0, 30.2, 49.3, 49.4, 55.5 (2C), 64.7, 65.1, 97.5, 98.0, 114.8 (2C), 114.9 (2C), 116.8, 116.9, 121.3, 121.4, 122.4, 122.5, 126.9 (2C), 126.0 (2C), 127.3 (2C), 129.2 (2C), 135.6, 136.0, 151.6, 151.7, 162.0, 162.1

MS (EI) m/z (%): 59 (10), 77 (9), 91 (8), 107 (7), 115 (11), 145 (67), 155 (100), 163 (30), 177 (19), 332 (M^+ , 0.2)

HRMS (EI) calcd for $\text{C}_{18}\text{H}_{20}\text{O}_4\text{S}$ (M^+) 332.10823, found 332.10760

(±)-2-Methoxy-2-(*p*-nitrophenylsulfinyl)methyl chroman **129**

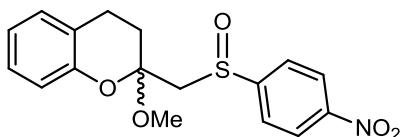

The methyl ketal **129** was obtained following method C (4d) from the chromanol **124** (204 mg, 0.61 mmol, 1 equiv). After workup and flash chromatography (hexane/EtOAc 1:1), compound **129** was obtained in 83% yield (176 mg), as a mixture 1:1 of diastereoisomers at C-2, as yellow solid.

Mp: 112-114 °C.

R_f (2 diastereoisomers) 0.54 and 0.6 (hexane/EtOAc 1:2).

^1H NMR (CDCl_3) δ 1.96-2.09 (m, 1H), 2.28-2.35 (m, 2H), 2.56 (ddd, $J = 13.6, 6.0$ and 3.8 Hz, 1H), 2.67-2.75 (m, 2H), 2.97-3.14 (m, 2H), 3.25 (s, 3H), 3.26 and 3.36 (AB system, $J = 13.8$ Hz, $\Delta v = 26.4$ Hz, 2H), 3.27 and 3.37 (AB system, $J = 13.8$ Hz, $\Delta v = 26.8$ Hz, 2H), 3.38 (s, 3H), 6.76-6.96 (m, 4H), 7.06-7.13 (m, 4H), 7.87 ad 8.37 (AA'BB' system, $J = 8.7$ Hz, $\Delta v = 149.1$ Hz, 4H), 7.91 and 8.39 (AA'BB' system, $J = 8.7$ Hz, $\Delta v = 142.6$ Hz, 4H)

^{13}C NMR (CDCl_3) δ 20.9, 21.2, 30.0, 30.1, 49.4, 49.6, 64.6, 65.0, 97.5, 98.0, 116.7, 116.8, 121.5, 121.7, 122.1, 122.2, 124.4 (4C), 126.1 (2C), 126.3 (2C), 127.4 (2C), 129.2, 129.3, 149.5 (2C), 151.3, 151.5, 152.1, 152.5

MS (EI) m/z (%): 197.0 (21), 201 (21), 267 (100), 299 (34), 316 (8), 330 (5), 347 (M^+ , 1)

HRMS (EI) calcd for $C_{17}H_{17}O_5S$ (M^+) 347.08274, found 347.08390

(\pm)-2-Methoxy-2-(2-naphthylsulfinyl)methyl chroman **130**

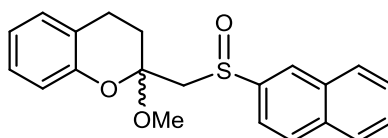

The methyl ketal **130** was obtained following method C (3d) from the chromanol **125** (850 mg, 2.50 mmol, 1 equiv). After workup and flash chromatography (hexane/EtOAc 2:1), compound **130** was obtained in 66% yield (582 mg), as a mixture 1:1 of diastereoisomers at C-2, as yellow solid.

Mp: 101-102°C

R_f 0.40 (hexane/EtOAc 1:1).

¹H NMR ($CDCl_3$) δ 2.02-2.12 (m, 1H), 2.28-2.42 (m, 2H), 2.61-2.78 (m, 3H), 3.01-23.17 (m, 2H), 3.28 (s, 3H), 3.30 and 3.44 (AB system, $J = 14.2$ Hz, $\Delta v = 43.2$ Hz, 2H), 3.31 and 3.40 (AB system, $J = 13.9$ Hz, $\Delta v = 24.4$ Hz, 2H), 3.39 (s, 3H), 6.79-6.96 (m, 4H), 7.07-7.17 (m, 4H), 7.57-7.71 (m, 6H), 7.88-8.04 (m, 6H), 8.27 (dd, $J = 1.54$ and 7.07Hz, 2H)

¹³C NMR ($CDCl_3$) δ 20.98; 21.17; 30.08; 30.27; 49.43; 49.61; 64.52; 64.95; 97.64; 98.10; 116.85; 116.91; 119.75; 119.94; 121.36; 121.46; 122.47; 124.60; 124.71; 127.34; 127.42; 127.90; 128.09; 128.54; 128.57; 129.29; 129.32; 129.65; 132.94; 134.51; 141.54; 141.92; 151.58; 151.67

MS (FAB+) m/z (%): 166 (38), 175 (52), 273 (24), 321 (100), 341.2 (14), 353 ($M^+ + H$, 43)

HRMS (FAB+) calcd for $C_{21}H_{21}O_3S$ ($M^+ + H$) 353.121142, found 353.121900

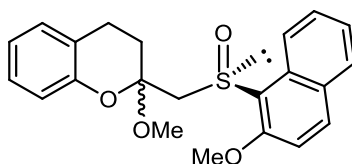
(SR)-2-Methoxy-2-(2-methoxy-1-naphthylsulfinyl)methyl chroman 132

The nucleophilic addition of the lithium anion derived from methyl-(2-methoxy-1-naphthyl) sulfoxide **121** (9.68 mmol, 1.3 equiv) to the dihydrocoumarine **112** (7.45 mmol, 1 equiv) following method B (2h30) gave the 2-[(2-methoxy-1-naphthylsulfinyl)methyl]-chroman-2-ol **131**. After workup, chromanol **131** was used for the next step without further purification. The methyl ketal **132** was obtained following method C (3d) from the chromanol **131** (9.26 mmol, 1 equiv). After workup and flash chromatography (hexane/EtOAc 2:1), compound (SR)-**132** was obtained in 26% yield.

Diastereoisomer 1

$$[\alpha]_D^{20} = +123 \text{ (c 0.13 CHCl}_3\text{)}$$

¹H NMR (CDCl₃) δ 2.05-2.17 (m, 1H), 2.64-2.76 (m, 2H), 3.01-3.13 (m, 1H), 3.28 (s, 3H), 3.76 and 4.01 (AB system, *J* = 14.2 Hz, Δ*v* = 76.7 Hz, 2H), 4.04 (s, 3H), 6.77 (dd, *J* = 1.3 and 8.4 Hz, 1H), 6.9 (dt, *J* = 7.3 and 1.1 Hz, 1H), 7.06-7.11 (m, 2H), 7.28 (d, *J* = 9.1 Hz, 1H), 7.42 (td, *J* = 8.0 and 1.4 Hz, 1H), 7.56 (td, *J* = 6.8 and 1.4 Hz, 1H), 7.8 (d, *J* = 8.0 Hz, 1H), 7.9 (d, *J* = 9.1 Hz, 1H), 9.03 (dd, *J* = 9.1 and 0.7 Hz, 1H)

¹³C NMR (CDCl₃) δ 21.1, 30.4, 49.4, 56.9, 59.0, 98.3, 112.9, 116.8, 121.2, 122.5, 122.6, 122.7, 124.5, 127.2, 128.0, 128.8, 129.2, 129.5, 132.3, 134.2, 151.8, 155.9.

Diastereoisomer 2

$$[\alpha]_D^{20} = +114 \text{ (c 0.18 CHCl}_3\text{)}$$

¹H NMR (CDCl₃) δ 2.15-2.28 (m, 1H), 2.38 (dd, *J* = 6.2 and 2.2 Hz, 1H), 2.66 (dd, *J* = 5.8 and 2.1 Hz, 1H), 3.02-3.13 (m, 1H), 3.32 (s, 3H), 3.75 and 4.09 (AB system, *J* = 13.7 Hz, Δ*v* = 101.7 Hz, 2H), 3.99 (s, 3H), 6.66 (d, *J* = 8.2 Hz, 1H), 6.88 (dt, *J* = 7.6 and 1.2 Hz, 1H), 7.07 (m, 2H), 7.28 (d, *J* = 9.3 Hz, 1H), 7.42 (td, *J* = 7.9 and 1.2 Hz, 1H),

7.56 (td, $J = 7.6$ and 1.2 Hz, 1H), 7.83 (d, $J = 8.0$ Hz, 1H), 7.98 (d, $J = 9.0$ Hz, 1H), 8.93 (d, $J = 8.6$ Hz, 1H)

^{13}C NMR (CDCl₃) δ 21.0, 29.8, 49.5, 56.8, 59.7, 97.9, 113.0, 116.8, 121.2, 122.4, 122.8, 122.9, 124.5, 127.2, 128.1, 128.8, 129.2, 129.4, 132.1, 134.2, 151.7, 156.2

(2*S*,*SR*) and (2*R*,*S**R*)-2-Methyl-2-(*p*-tolylsulfinyl)methyl chromans **136****



(67: 33)

2-Methylchroman **136** was obtained from (*S**R*)-2-methoxy-2-[(*p*-tolylsulfinyl)methyl] chroman **126** (60 mg, 0.36mmol, 1 equiv) by treatment with AlMe₃ (0.51 mmol, 3 equiv) and ZrCl₄ (0.238 mmol, 1.4 equiv) following method E (addition at -78°C and 10h increasing the temperature to rt). ^1H NMR analysis showed two epimers (2*R*,*S**R*) and (2*S*,*S**R*)- **136** mixture 67:33. After flash chromatography (CH₂Cl₂/hexane/EtOAc, 1:4:1) the mixture of epimers was isolated as colorless oil in 53% yield (30 mg) and 3% of MeOH (*S**R*)-**134** elimination product.

R_f 0.34 (hexane/EtOAc 1:2)

$[\alpha]_{\text{D}}^{20} = +82.2$ (c 0.76 CHCl₃)

^1H NMR (CDCl₃) δ 1.50 (s, 1.5H), 1.70 (s, 3H), 1.97-2.12 (m, 2H+1H), 2.39 (s, 3H), 2.41 (s, 1.5H), 2.79-2.87 (m, 2H+1H), 2.90 and 3.12 (AB system, $J = 13.7$ Hz, $\Delta\nu = 65.8$ Hz, 2H), 3.02 and 3.12 (AB system, $J = 13.8$ Hz, $\Delta\nu = 20.0$ Hz, 1H), 6.75-6.79 (m, 1H+ 0.5H), 6.82-6.87 (m, 1H + 0.5H), 7.04-7.10 (m, 2H + 1H), 7.26-7.33 (m, 2H + 1H), 7.49 and 7.55 (AA'BB' system, $J = 8.2$ Hz, 4H)

^{13}C NMR (CDCl₃) δ 21.3, 21.4, 21.7, 21.9, 25.1, 25.7, 30.2, 32.0, 68.3, 68.9, 74.7, 74.9, 117.3, 117.4, 120.4, 120.5, 120.7, 123.9 (2C), 124.0 (2C), 124.2, 127.4, 127.6, 129.5, 129.6, 129.9 (2C), 130.0 (2C), 141.4, 141.5, 141.8, 141.9, 152.8, 153.0

MS (EI) m/z (%): 91 (35), 107 (23), 139 (59), 161 (50), 283 (100), 300 (M⁺, 5)

HRMS (EI) calcd for $C_{18}H_{20}O_2S$ (M^+) 300.11840, found 300.11838

(±)-(2*S,*SR**) and (2*R**,*SR**)-2-Methyl-2-(*t*-butylsulfinyl)methyl chroman 137**

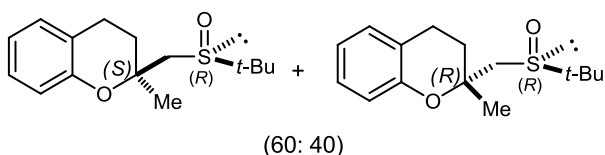

The mixture of 2-methylchromanes rac-(2*S**,*SR**)-**137** and rac-(2*R**,*SR**)-**137** were synthesized from 2-Methoxy-2-[(*t*-butylsulfinyl)methyl]chroman **127** (60 mg, 0.22 mmol, 1 equiv) treated with $TiCl_4$ (32 μ L, 0.30 mmol, 1.4 equiv) y Me_3Al (318 μ L, 0.64 mmol, 3 equiv) following method E (2h at $-78^\circ C$ and 2h at rt). 1H NMR analysis showed 60:40 mixture of two epimers (2*R**,*SR**) and (2*S**,*SR**)- **137**. After flash chromatography (hexane/EtOAc, 1:3) the mixture was isolated in 37% yield (22 mg).

R_f 0.20 (hexane/EtOAc 1:3)

1H NMR ($CDCl_3$) δ 1.23 (s, 9H), 1.28 (s, 5H), 1.42 (s, 3H), 1.50 (s, 1.5H), 1.96-2.14 (m, 2.5H), 2.28 (ddd, $J = 5.8$ Hz, 0.5H), 2.68 and 2.89 (AB system, $J = 13.5$ Hz, $\Delta\nu = 62.5$ Hz, 2H), 2.67 and 2.98 (AB system, $J = 13.6$ Hz, $\Delta\nu = 92.6$ Hz, 1H), 2.73-2.87 (m, 3H), 6.78 (d, $J = 8.1$ Hz, 1.5H), 6.85 (t, $J = 6.9$ Hz, 1.5H), 7.05-7.11 (m, 3H)

^{13}C NMR ($CDCl_3$) [*Major diastereoisomer*] δ 21.7, 22.8, 25.2, 31.7, 53.8, 56.1, 74.7, 117.3, 120.5, 120.8, 127.5, 129.6, 152.8. [*Minor diastereoisomer*] δ 21.8, 22.9, 24.8, 30.2, 53.8, 56.8, 74.8, 117.4, 120.4, 120.8, 127.6, 129.5, 152.9

MS (FAB+) m/z (%): 69 (49), 81 (31), 107 (36), 161 (23), 211 (20), 267 ($M^+ + 1$, 70)

HRMS (FAB+) calcd for $C_{15}H_{23}O_2S$ ($M^+ + 1$) 267.1419, found 267.1422

(\pm)-(2*S,*SR**) and (2*R**,*SR**)-2-Methyl-2-(*p*-methoxyphenylsulfinyl)methyl chroman **138****

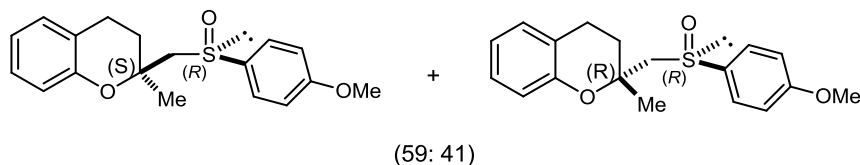

The mixture of 2-methylchromanes rac-(2*S**,*SR**)-**138** and rac-(2*R**,*SR**)-**138** were prepared from 2-methoxy-2-[(*p*-methoxyphenylsulfinyl)methyl]chroman **128** (30 mg, 0.09 mmol, 1 equiv) treated with TiCl₄ (14 μ L, 0.13 mmol, 1.4 equiv) y Me₃Al (180 μ L, 0.36 mmol, 4 equiv) following method E (3h at -78°C and 10h at rt). ¹H NMR analysis showed 59:41 mixture of two epimers (2*S**,*SR**) and (2*R**,*SR**)-**138**. After flash chromatography (hexane/EtOAc, 1:1) the mixture was isolated in 28% yield (8 mg).

R_f 0.36 (hexane/OEtAc 1:2)

¹H NMR (CDCl₃) δ 1.49 (s, 2H), 1.69 (s, 3H), 1.94-2.14 (m, 2H), 2.24-2.30 (m, 0.7H), 2.39-2.48 (m, 0.7H), 2.79-2.89 (m, 3.4H), 2.90 and 3.13 (AB system, *J* = 13.6 Hz, $\Delta\nu$ = 67.9 Hz, 2H), 3.01 and 3.11 (AB system, *J* = 13.7 Hz, $\Delta\nu$ = 25.2 Hz, 1.4H), 3.83 (s, 3H), 3.85 (s, 2H), 6.76 (t, *J* = 7.8 Hz, 1.7H), 6.82-6.88 (m, 1.7H), 6.99 and 7.54 (AA'BB' system, *J* = 8.9 Hz, $\Delta\nu$ = 165.9 Hz, 2H), 7.05 and 7.60 (AA'BB' system, *J* = 8.9 Hz, $\Delta\nu$ = 165.8 Hz, 1.4H), 7.03-7.12 (m, 3.4H)

¹³C NMR (CDCl₃) δ 21.7, 21.9, 25.1, 25.7, 30.2, 32.0, 55.5 (2C), 68.2, 68.8, 74.7, 74.9, 114.8 (2C), 114.9 (2C), 117.3, 117.4, 120.4, 120.5, 120.7, 121.4, 126.8 (2C), 126.9 (2C), 127.4, 127.6, 129.5 (2C), 135.9, 136.0, 152.8, 152.9, 161.9, 162.0

MS (FAB+) *m/z* (%): 77 (42), 107 (33), 156 (10), 289 (16), 307 (29), 317 (M⁺+1, 43)

MS (EI) *m/z* (%): 89 (38), 91 (44), 107 (30), 115 (63), 118 (60), 139 (35), 145 (100), 147 (83), 160 (23), 300 (M⁺-16, 21)

HRMS (EI) calcd for C₁₈H₂₀O₂S (M⁺-16) 300.1184, found 300.1181

(±)-(2*S,*SR**) and (2*R**,*SR**)-2-Methyl-2-(*p*-nitrophenylsulfinyl)methyl chroman **139****

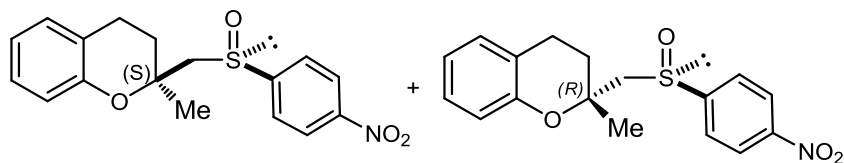

The mixture of 2-methylchromanes rac-(2*S**,*SR**)-**139** and rac-(2*R**,*SR**)-**139** were prepared from 2-methoxy-2-[(*p*-nitrophenylsulfinyl)methyl] chroman **129** (30 mg, 0.08 mmol, 1 equiv) treated with TiCl₄ (13 μL, 0.12 mmol, 1.4 equiv) y Me₃Al (171 μL, 0.34 mmol, 4 equiv) following method E (3h at -78°C). ¹H NMR analysis showed mixture of two epimers (2*S**,*SR**) and (2*R**,*SR**)- **139** which ratio could not be determinate. After flash chromatography (hexane/EtOAc, 1:1) the mixture was isolated in 21% yield (6 mg). Due to the complex mixture in ¹H NMR, it could not be characterized.

(±)-(2*S,*SR** and 2*R**,*SR**)-2-Methyl-2-(2-naphthylsulfinyl)methyl chroman **140****

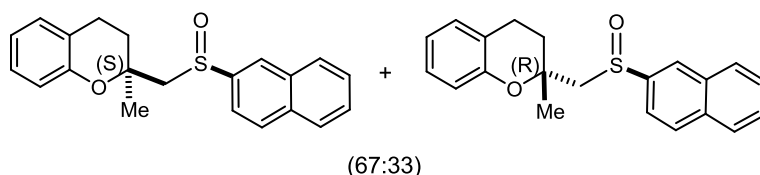

The mixture of 2-methylchromanes rac-(2*S**,*SR**)-**140** and rac-(2*R**,*SR**)-**140** were prepared from 2-methoxy-2-[(naphthylsulfinyl)methyl] chroman **130** (60 mg, 0.36mmol, 1 equiv) treated with TiCl₄ (26 μL, 0.238 mmol, 1.4 equiv) y Me₃Al (255 μL, 0.51 mmol, 3 equiv) following method E (3h at -78°C and 10h at rt). ¹H NMR analysis showed 67:33 mixture of two epimers (2*S*,*SR*) and (2*R*,*SR*)-**140**. After flash chromatography (hexane/EtOAc, 1:1) the mixture was isolated in 53% yield (30 mg) as yellow oil.

R_f 0.57 (hexane/EtOAc 1:1)

$^1\text{H NMR}$ (CDCl_3) δ 1.52 (s, 2H), 1.75 (s, 3H), 1.98-2.14 (m, 3H), 2.33-2.38 (m, 0.2H), 2.47-2.56 (m, 0.5H), 2.81-2.93 (m, 3H), 3.05-3.17 (AB system, $J = 13.7$ Hz, $\Delta\nu = 36.4$ Hz, 2H), 6.76-6.90 (m, 4H), 7.04-7.13 (m, 4H), 7.51 (dd, $J = 8.6$ and 1.9 Hz, 1H), 7.56-7.64 (m, 4H), 7.86-7.96 (m, 6H), 8.21 (dd, $J = 14.0$ and 1.7 Hz, 1H)

$^{13}\text{C NMR}$ (CDCl_3) δ 21.7, 21.9, 25.1, 25.6, 30.1, 30.2, 32.1, 68.2, 68.8, 74.7, 74.9, 116.8, 117.3, 117.4, 119.8, 119.9, 124.4, 124.5, 127.3, 127.5, 127.9, 128.0, 128.4, 128.5, 129.4, 129.5, 134.3, 134.4, 141.9, 142.0, 152.8

MS (FAB $^+$) m/z (%): 283 (100), 327 (92), 337 ($M^+ + 1$, 45)

HRMS (FAB $^+$) calcd for $\text{C}_{21}\text{H}_{21}\text{O}_2\text{S}$ ($M^+ + \text{H}$) 337.1262, found 337.1264

(*2S,S*R) and (*2R,S*R)-2-Methyl-2-(2-methoxynaphthyl-1-sulfinyl)methyl chroman **141**

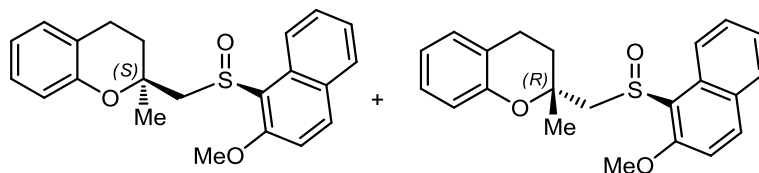

2-methylchromans **141** were prepared from 2-methoxy-2-[(2-methoxynaphthyl-1-sulfinyl)methyl] chroman **132** (60 mg, 0.15 mmol, 1 equiv) treated with TiCl_4 (24 μL , 0.22 mmol, 1.4 equiv) γ Me_3Al (234 μL , 0.468 mmol, 3 equiv) following method E (3h at -78°C and 10h at rt). $^1\text{H NMR}$ analysis showed 66:34 mixture of two epimers (*2S,S*R) and (*2R,S*R)- **141**. After flash chromatography (CH_2Cl_2 /hexane/ EtOAc , 1:2:2) the major isomer was isolated in 46% yield (15 mg) and a mixture of both isomers in 26% (15 mg), as yellow oil.

R_f [(*2S,S*R)-**141**] = 0.21 (CH_2Cl_2 / hexane/ EtOAc , 1:2:2).

$^1\text{H NMR}$ (CDCl_3) δ 1.61 (s, 3H), 2.01-2.10 (m, 1H), 2.41-2.50 (m, 1H), 2.81-2.86 (m, 2H), 3.41 γ 3.87 (AB system, $J = 13.8$ Hz, $\Delta\nu = 139.2$ Hz, 2H), 3.98 (s, 3H), 6.67 (dd, $J = 8.1$ and 1.1 Hz, 1H), 6.81 (dt, $J = 7.4$ and 1.1 Hz, 1H), 7.03-7.07 (m, 2H), 7.22 (s,

^1H NMR (CDCl₃) δ 7.41 (td, $J = 8.1$ and 1.1 Hz, 1H), 7.55 (td, $J = 6.8$ and 1.4 Hz, 1H), 7.81 (d, $J = 8.3$ Hz, 1H), 7.94 (d, $J = 9.1$ Hz, 1H), 8.97 (d, $J = 8.7$ Hz, 1H)

^{13}C RMN (CDCl₃) δ 21.8, 26.1, 30.1, 35.4, 56.8, 62.5, 75.2, 112.9, 117.4, 120.3, 120.5, 122.7, 124.5, 128.0, 128.8, 129.4, 132.0, 134.1, 153.1

EM (FAB⁺) m/z (%): 297 (20), 307 (18), 341 (34), 367 (M⁺+1, 100)

EMAR (FAB⁺) calcd for C₂₂H₂₃O₃S (M⁺+H) 367.1368, found 367.1378

(2*S*,*S*R and 2*R*,*S*R)-2-Allyl-2-(*p*-tolylsulfinyl)methyl chroman 144

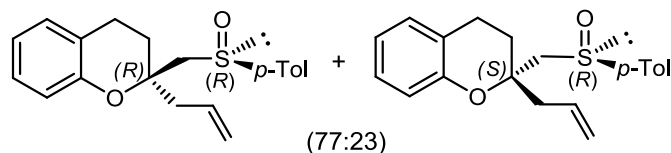

Chroman (2*R*,*S*R)-**144** was prepared from (*S*R)-2-methoxy-2-[(*p*-tolylsulfinyl)methyl]chroman **126** (57 mg, 0.18 mmol, 1 equiv) by treatment with allyl trimethyl silane (114 μL , 0.72 mmol, 3 equiv) and TiCl₄ (33 μL , 0.29 mmol, 1.6 equiv) following method D (1h30 at -40°C). ^1H NMR analysis showed 77:23 mixture of two epimers (2*R*,*S*R) and (2*S*,*S*R)-**144**. After flash chromatography (CH₂Cl₂/hexane/EtOAc, 1:1:0.1) the major isomer was isolated in 67% yield (40 mg) as white solid and (2*S*,*S*R)-**144** isomer in 19% yield (12 mg).

(2*R*,*S*R)-144:

m.p.= 66-70 °C

$[\alpha]_{\text{D}}^{20} = +104.1$ (c 0.93, CHCl₃)

R_f 0.52 (hexane/EtOAc 1:3)

^1H NMR (CDCl₃) (500 MHz) δ 2.04-2.17 (m, 2H), 2.39 (s, 3H), 2.76-2.82 (m, 2H), 2.86-2.92 (m, 2H), 2.92 and 3.15 (AB system, $J = 13.9$ Hz, $\Delta\nu = 67.1$ Hz, 2H), 5.25-5.31 (m, 2H), 6.01 (dddd, $J = 16.7, 10.1, 8.1$ and 6.3 Hz, 1H), 6.77 (dd, $J = 7.9$ and 0.9

Hz, 1H), 6.85 (td, $J = 7.5$ and 1.3 Hz, 1H), 7.05-7.10 (m, 2H), 7.28 and 7.47 (AA'BB' system, $J = 8.2$ Hz, $\Delta\nu = 57.2$ Hz, 4H)

^{13}C NMR (CDCl₃) δ 21.4, 21.5, 29.7, 41.9, 65.2, 76.4, 117.3, 119.8, 120.5, 120.9, 123.8 (2C), 127.4, 129.6, 129.9 (2C), 132.5, 141.4, 141.8, 152.7

MS (EI) m/z (%): 77 (16), 91 (25), 107 (100), 131 (23), 139 (74), 145 (41), 185 (28), 187 (12), 309 (85), 326 (M^+ , 4)

HRMS (EI) calcd for C₂₀H₂₂O₂S (M^+) 326.13405, found 326.13373

(2*S*,*S*R)- 144:

R_f 0.46 (hexane/EtOAc 1:3)

$[\alpha]_D^{20}$ = -50.8 (c 0.36, CHCl₃)

^1H NMR (CDCl₃) (500 MHz) δ 2.10 (dt, $J = 14.2$ and 5.9 Hz, 1H), 2.41 (s, 3H), 2.48 (ddd, $J = 14.5$, 8.5 and 5.9 Hz, 1H), 2.57 (d, $J = 7.2$ Hz, 2H), 2.83-2.89 (m, 2H), 3.01 and 3.13 (AB system, $J = 13.8$ Hz, $\Delta\nu = 57.5$ Hz, 2H), 5.13-5.18 (m, 2H), 5.77-5.85 (m, 1H), 6.81 (dd, $J = 8.2$ and 1.3 Hz, 1H), 6.88 (td, $J = 7.2$ and 1.3 Hz, 1H), 7.08-7.13 (m, 2H), 7.32 and 7.56 (AA'BB' system, $J = 8.1$ Hz, $\Delta\nu = 117.6$ Hz, 4H)

^{13}C NMR (CDCl₃) (500 MHz) δ 21.4, 21.6, 27.9, 42.0, 66.9, 76.5, 117.5, 119.9, 120.5, 120.6, 124.1 (2C), 127.6, 129.6, 130.0 (2C), 132.0, 141.5, 141.9, 152.9

MS (EI) m/z (%): 65 (10), 77 (20), 91 (26), 107 (100), 131 (23), 139 (77), 145 (41), 173 (23), 185 (22), 187 (12), 309 (85), 310 (23), 326 (M^+ , 4)

HRMS (EI) calcd for C₂₀H₂₂O₂S (M^+) 326.13405, found 326.13431

X-Ray Diffraction

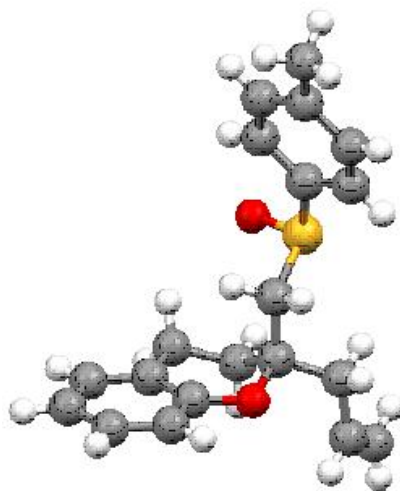

(±)-(2*S*^{*},*SR*^{*} and 2*R*^{*},*S**R*^{*})-2-Allyl-2-(*t*-butylsulfinyl)methyl chroman 145**

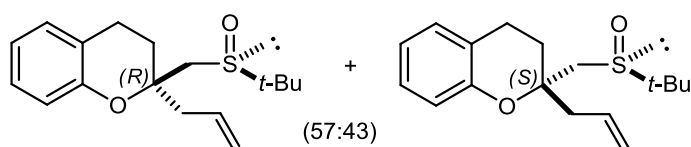

Chroman **145** was prepared from (*S*)-2-methoxy-2-[(*t*-butylsulfinyl)methyl]chroman **127** (40 mg, 0.14 mmol, 1 equiv) by treatment with allyl trimethyl silane (90 μ L, 0.56 mmol, 4 equiv) and TiCl_4 (22 μ L, 0.20 mmol, 1.4 equiv) following method D (1h at -40°C). ^1H NMR analysis showed 57:43 mixture of two epimers (*2R*^{*},*S**R*^{*}) and (*2S*^{*},*S**R*^{*})-**145**. After flash chromatography (hexane/EtOAc, 1:3) the major isomer was isolated in 26% yield as colorless oil and (*2S*,*S**R*)-**145** isomer in 14% yield.

(2*R*^{*},*SR*^{*})-145**

R_f 0.51 (2 x hexane/EtOAc, 1:3)

$^1\text{H NMR}$ (CDCl_3) δ 1.21 (s, 9H), 2.04-2.19 (m, 2H), 2.64 and 2.88 (AB system, $J = 13.5$ Hz, $\Delta\nu = 69.8$ Hz, 2H), 2.64-2.96 (m, 4H), 5.15-5.20 (m, 2H), 5.88-6.03 (m, 1H), 6.80 (d, $J = 8.1$ Hz, 1H), 6.85 (td, $J = 7.4$ and 1.0 Hz, 1H), 7.05-7.12 (m, 2H)

$^{13}\text{C NMR}$ (CDCl_3) δ 21.5, 22.8 (3C), 29.7, 42.0, 53.0, 53.9, 76.4, 117.3, 119.6, 120.5, 121.1, 127.4, 129.6, 132.4, 152.8

MS (FAB+) m/z (%): 57 (68), 77 (15), 91 (11), 107 (57), 131 (20), 145 (21), 173 (100), 236 (41), 292 (M^+ , 1)

HRMS (EI) calcd for $\text{C}_{17}\text{H}_{24}\text{O}_2\text{S}$ (M^+) 292.14970, found 292.14860

(2*S,*SR**)-145**

R_f 0.43 (2 x hexane/EtOAc, 1:3)

$^1\text{H NMR}$ (CDCl_3) δ 1.26 (s, 9H), 2.08 (dt, $J = 14.1$ and 6.3 Hz, 1H), 2.35 (ddd, $J = 14.4$, 8.3 and 6.1 Hz, 1H), 2.58 (d, $J = 7.3$ Hz, 2H), 2.94 and 2.65 (AB system, $J = 13.6$ Hz, $\Delta\nu = 84.6$ Hz, 2H), 2.73-2.85 (m, 2H), 5.13-5.19 (m, 2H), 5.86 (ddt, $J = 16.6$, 10.6 and 7.2 Hz, 1H), 6.80 (d, $J = 8.1$ Hz, 1H), 6.86 (td, $J = 7.5$ and 1.1 Hz, 1H), 7.06-7.13 (m, 2H)

$^{13}\text{C NMR}$ (CDCl_3) δ 21.6, 22.9 (3C), 28.1, 42.1, 53.7, 54.5, 76.3, 117.4, 119.7, 120.4, 120.5, 127.5, 129.5, 132.2, 152.9

(\pm)-(2*S,*SR** and 2*R**,*SR**)-2-Allyl-2-(*p*-methoxyphenylsulfinyl)methyl chroman **146****

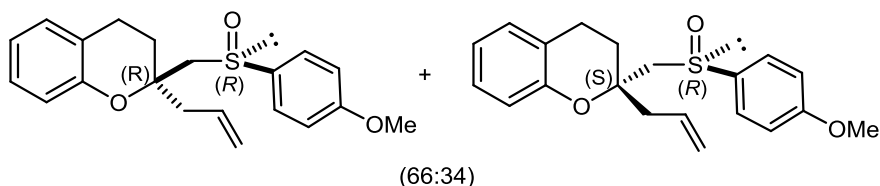

Chroman (\pm)-**146** was prepared from (*SR*)-2-methoxy-2-[(*p*-methoxyphenylsulfinyl) methyl] chroman **128** (47 mg, 0.14 mmol, 1 equiv) by treatment with allyl trimethyl silane (91 μL , 0.57 mmol, 4 equiv) and TiCl_4 (22 μL ,

0.20 mmol, 1.4 equiv) following method D (2h at -40°C). ^1H NMR analysis showed 66:34 mixture of two epimers ($2R^*,SR^*$) and ($2S^*,SR^*$)-**146**. After flash chromatography (hexane/EtOAc, 1:1) the major isomer was isolated in 32% yield (15 mg) as colorless oil and **146** isomer in 19% yield (9 mg).

(2R*,SR*)-146

R_f 0.41 (hexane/EtOAc, 1:2)

^1H NMR (CDCl_3) δ 2.01-2.17 (m, 2H), 2.72-2.91 (m, 4H), 2.91 and 3.15 (AB system, $J = 13.7$ Hz, $\Delta v = 68.7$ Hz, 2H), 3.83 (s, 3H), 5.23-5.31 (m, 2H), 5.99 (dddd, $J = 16.8$, 10.1, 8.0 and 6.3 Hz, 1H), 6.75 (d, $J = 8.2$ Hz, 1H), 6.85 (td, $J = 7.5$ and 1.2 Hz, 1H), 6.98 and 7.52 (AA'BB' system, $J = 8.9$ Hz, $\Delta v = 163.1$ Hz, 4H), 7.04-7.10 (m, 2H)

^{13}C NMR (CDCl_3) δ 21.5, 29.7, 41.9, 55.5, 65.1, 76.4, 114.8 (2C), 117.3, 119.8, 120.5, 120.9, 126.7 (2C), 127.4, 129.6, 132.5, 135.9, 152.7, 161.9

MS (FAB⁺) m/z (%): 77 (23), 107 (37), 219 (4), 325 (16), 343 ($M^+ + 1$, 89)

HRMS (FAB⁺) calcd for $\text{C}_{20}\text{H}_{23}\text{O}_3\text{S}$ ($M^+ + 1$) 343.1368, found 343.1369

(2S*,SR*)-146

R_f 0.36 (hexane/EtOAc, 1:2)

^1H NMR (CDCl_3) δ 2.00-2.17 (m, 1H), 2.46 (ddd, $J = 14.2$, 8.5 and 6.4 Hz, 1H), 2.56 (d, $J = 7.4$ Hz, 2H), 2.82-2.88 (m, 2H), 3.00 and 3.14 (AB system, $J = 13.8$ Hz, $\Delta v = 38.4$ Hz, 2H), 3.85 (s, 3H), 5.12-5.18 (m, 2H), 5.81 (ddt, $J = 16.5$, 10.8 and 7.3 Hz, 1H), 6.80 (d, $J = 8.1$ Hz, 1H), 6.87 (td, $J = 7.5$ and 1.2 Hz, 1H), 7.04 and 7.61 (AA'BB' system, $J = 8.9$ Hz, $\Delta v = 170.7$ Hz, 4H), 7.04-7.13 (m, 2H)

^{13}C NMR (CDCl_3) δ 21.6, 27.9, 42.0, 55.6, 66.7, 76.5, 114.8 (2C), 117.5, 119.8, 120.5, 122.5, 126.9, 127.6, 129.5 (2C), 132.0, 136.2, 152.9

MS (EI) m/z (%): 77 (25), 107 (70), 118 (32), 139 (56), 145 (36), 155 (89), 171 (29), 173 (100), 186 (24), 196 (11), 326 ($M^+ - 16$, 21)

MS (FAB⁺) m/z (%): 55 (54), 77 (18), 107 (32), 163 (8), 289 (7), 301 (26), 343 ($M^+ + 1$, 98)

HRMS (EI) calcd for $C_{20}H_{22}O_2S$ (M^+) 326.1341, found 326.1336

(\pm)-(2*S,*SR** and 2*R**,*SR**)-2-Allyl-2-(*p*-nitrophenylsulfinyl)methyl chroman 147**

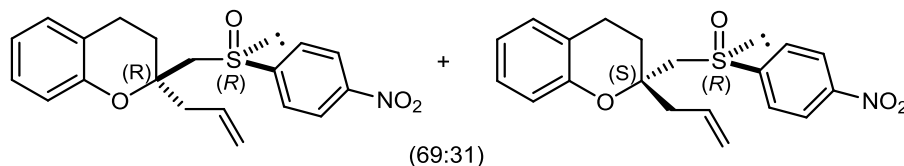

Chroman (\pm)-**147** was prepared from (*SR*)-2-methoxy-2-[(*p*-nitrophenylsulfinyl)methyl] chroman **129** (50 mg, 0.14 mmol, 1 equiv) by treatment with allyl trimethyl silane (91 μ L, 0.57 mmol, 4 equiv) and $TiCl_4$ (23 μ L, 0.20 mmol, 1.4 equiv) following method D (30min at $-40^\circ C$). 1H NMR analysis showed 69:31 mixture of two epimers (2*R**,*SR**) and (2*S**,*SR**)-**147**. After flash chromatography (hexane/EtOAc, 1:1) the major isomer (2*R**,*SR**)-**147** was isolated in 55% yield (28 mg) and (2*S**,*SR**)-**147** isomer in 30% yield (12 mg).

(2*R,*SR**)-147**

R_f 0.32 (hexane/EtOAc, 1:1)

1H NMR ($CDCl_3$) δ 2.04-2.11 (m, 2H), 2.74-2.95 (m, 4H), 3.18 and 3.02 (AB system, $J = 13.8$ Hz, 2H), 5.28-5.35 (m, 2H), 5.99 (dddd, $J = 16.9, 10.3, 8.1$ and 6.5 Hz, 1H), 6.79 (dd, $J = 8.1$ and 0.9 Hz, 1H), 6.88 (td, $J = 7.5$ and 1.2 Hz, 1H), 7.05-7.13 (m, 2H), 7.69 and 8.25 (AA'BB' system, $J = 8.9$ Hz, $\Delta\nu = 169.7$ Hz, 4H)

^{13}C NMR ($CDCl_3$) δ 21.3, 29.6, 41.7, 65.4, 76.3, 117.3, 120.3, 120.6, 120.9, 124.3 (2C), 126.0 (2C), 127.6, 129.6, 132.1, 149.4, 152.4, 152.6

MS (EI) m/z (%): 77 (29), 91 (31), 107 (79), 115 (28), 117 (21), 131 (26), 145 (100), 185 (32), 340 (32), 357 (M^+ , 2)

HRMS (EI) calcd for $C_{19}H_{19}NO_4S$ (M^+) 357.10348, found 357.10210

(2*S,*SR**)-147**

$^1\text{H NMR}$ (CDCl_3) δ 2.94-2.16 (m, 1H), 2.46-2.60 (m, 3H), 2.86-2.93 (m, 2H), 3.13 and 3.18 (AB system, $J = 14.0$ Hz, $\Delta\nu = 7.9$ Hz, 2H), 5.11-5.20 (m, 2H), 5.77 (ddt, $J = 17.6$, 10.3 and 7.5 Hz, 1H), 6.78-6.82 (m, 1H), 6.88-6.93 (m, 1H), 7.08-7.16 (m, 2H), 7.87 and 8.38 (AA'BB' system, $J = 9.0$ Hz, $\Delta\nu = 153.1$ Hz, 4H)

$^{13}\text{C NMR}$ (CDCl_3) δ 21.5, 28.0, 41.5, 67.6, 76.4, 117.3, 120.3, 120.9, 124.3 (2C), 126.2 (2C), 127.5, 127.7, 129.6, 131.5, 149.4, 152.6, 152.9

MS(EI) m/z (%): 77 (29), 91 (26), 107 (100), 131 (34), 146 (43), 185 (38), 340 (30), 357 (M^+ , 6)

HRMS (EI) calcd for $\text{C}_{19}\text{H}_{19}\text{NO}_4\text{S}$ (M^+) 357.10348, found 357.10270

(±)-(2*S,*SR** and 2*R**,*SR**)-2-Allyl-2-(2-naphthylsulfinyl)methyl chroman 148**

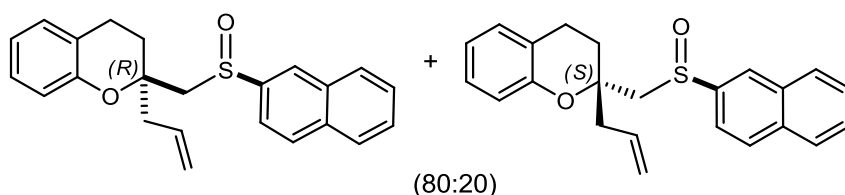

Chroman (±)-**148** was prepared from (*SR*)-2-methoxy-2-[(2-naphthylsulfinyl)methyl] chroman **130** (40 mg, 0.114 mmol, 1 equiv) by treatment with allyl trimethyl silane (54 μL , 0.34 mmol, 3 equiv) and TiCl_4 (18 μL , 0.16 mmol, 1.4 equiv) following method D (2h30 at -40°C). $^1\text{H NMR}$ analysis showed 80:20 mixture of two epimers (2*R**,*SR**) and (2*S**,*SR**)-**148**. After flash chromatography (hexane/EtOAc, 4:1) the major isomer (2*R**,*SR**)-**148** was isolated in 40% yield (17 mg) and (2*S**,*SR**)-**148** isomer in 22% yield (9 mg).

(2*R,*SR**)-148**

$R_f = 0.31$ (hexane/EtOAc, 4:1)

$^1\text{H NMR}$ (CDCl_3) δ 2.05-2.20 (m, 2H), 2.76-2.97 (m, 4H), 3.06 and 3.20 (AB system, $J = 14.0$ Hz, $\Delta\nu = 41.6$ Hz, 2H), 5.27-5.35 (m, 2H), 6.97-6.10 (m, 1H), 6.73 (d, $J = 8.5$ Hz, 1H), 6.84 (td, $J = 7.5$ and 1.2 Hz, 1H), 7.04-7.08 (m 2H), 7.50 (dd, $J = 8.7$ and 2.1 Hz, 1H), 7.54-7.57 (m, 2H), 7.86-7.93 (m, 3H), 8.17 (d, $J = 1.4$ Hz, 1H)

$^{13}\text{C NMR}$ (CDCl_3) δ 21.1; 29.7; 42.0; 65.0; 117.3; 119.7; 119.7; 119.9; 120.6; 120.85; 124.3; 127.3; 127.5; 127.7; 128.0; 128.5; 129.5; 129.6; 132.5; 132.9; 134.4; 142.0; 152.7

MS (FAB⁺) m/z (%): 283.17 (12), 327 (28), 345.12 (21), 363.14 ($\text{M}^+\text{+H}$, 100)

HRMS (FAB⁺) calcd for $\text{C}_{23}\text{H}_{23}\text{O}_2\text{S}$ ($\text{M}^+\text{+H}$) 363.1419, found 363.1412

(2*S,*SR**)-148**

$R_f = 0.26$ (hexane/EtOAc, 4:1)

$^1\text{H NMR}$ (CDCl_3) δ 2.0-2.18 (m, 2H); 2.50-2.60 (m, 2H), 2.87-2.92 (m, 2H), 3.16 (m, 2H), 5.12-5.17 (m, 2H), 5.74-5.88 (m, 1H), 6.81-6.90 (m, 2H), 7.09-7.14 (m, 2H), 7.57-7.60 (m, 2H), 7.63 (dd, $J = 8.6$ and 1.7 Hz, 1H), 7.89-7.99 (m, 3H), 8.23 (d, $J = 1.4$ Hz, 1H)

$^{13}\text{C NMR}$ (CDCl_3) δ 21.6, 27.9, 29.6, 41.9, 66.9, 117.5, 119.9, 120.0, 120.5, 120.6, 124.6, 127.3, 127.6, 127.7, 128.0, 128.5, 129.5, 129.5, 131.9, 132.9, 134.4, 142.2, 152.8

(2*S*,*SR* and 2*R*,*SR*)-2-Allyl-2-(2-methoxy-1-naphthylsulfinyl) methyl chroman 149

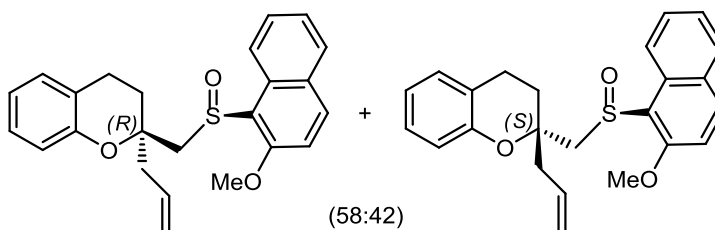

Chroman **149** was prepared from (*SR*)-2-methoxy-2-[(2-methoxy-1-naphthylsulfinyl) methyl] chroman **132** (48 mg, 0.126 mmol, 1 equiv) by treatment

with allyl trimethyl silane (60 μ L, 0.38 mmol, 3 equiv) and TiCl_4 (19.5 μ L, 0.18 mmol, 1.4 equiv) following method D (3h at -60°C). ^1H NMR analysis showed 58:42 mixture of two epimers (*2R,SR*) and (*2S,SR*)-**149**. After flash chromatography (hexane/EtOAc, 4:1) the major isomer (*2R,SR*)-**149** was isolated in 26% yield (12 mg) and (*2S,SR*)-**149** isomer in 19% yield (9 mg).

(2R,SR)-149

R_f 0.23 (hexane/EtOAc, 4:1)

^1H NMR (CDCl_3) δ 2.07-2.16 (m, 1H), 2.41-2.51 (m, 1H), 2.60-2.76 (m, 2H), 2.84 (t, $J = 6.7$ Hz, 2H), 2.36 and 2.95 (AB system, $J = 13.7$ Hz, $\Delta\nu = 173.7$ Hz, 2H), 3.97 (s, 3H), 5.16-5.24 (m, 2H), 5.83-5.97 (m, 1H), 6.65 (dd, $J = 1.1$ and 8.14 Hz, 1H), 6.82 (dt, $J = 1.2$ and 7.4 Hz, 1H), 7.02-7.07 (m, 2H), 7.23 (d, $J = 9.1$ Hz, 1H), 7.41 (td, $J = 1.1$ and 6.9 Hz, 1H), 7.54 (td, $J = 6.9$ and 1.4 Hz, 1H), 7.81 (d, $J = 8.1$ Hz, 1H), 7.94 (d, $J = 9.0$ Hz, 1H), 8.96 (d, $J = 8.6$ Hz, 1H)

^{13}C NMR (CDCl_3) δ 21.5, 27.8, 42.0, 42.6, 56.7, 59.8, 112.8, 117.2, 119.6, 120.3, 120.5, 124.4, 127.3, 127.9, 128.7, 129.4, 132.0, 132.4, 134.0, 152.9, 155.7

(2S,SR)-149

R_f 0.17 (hexane/EtOAc, 4:1)

^1H NMR (CDCl_3) δ 2.03-2.08 (m, 1H), 2.13-2.19 (m, 1H), 2.65-2.76 (m, 2H), 2.84 (t, $J = 6.6$ Hz, 2H), 3.51 and 3.85 (AB system, $J = 13.8$ Hz, $\Delta\nu = 102.7$ Hz, 2H), 3.89 (s, 3H), 5.17-5.26 (m, 2H), 5.88-6.04 (m, 1H), 6.46 (d, $J = 8.3$ Hz, 1H), 6.79 (dt, $J = 7.5$ and 1.0 Hz, 1H), 7.00-7.06 (m, 2H), 7.19 (d, $J = 9.0$ Hz, 1H), 7.37-7.42 (m, 1H), 7.54 (td, $J = 6.8$ and 1.2 Hz, 1H), 7.80 (d, $J = 8.8$ Hz, 1H), 7.93 (d, $J = 9.0$ Hz, 1H), 8.89 (d, $J = 8.6$ Hz, 1H)

^{13}C NMR (CDCl_3) δ 21.6, 29.5, 29.7, 42.1, 56.6, 58.5, 112.9, 117.2, 119.6, 120.3, 120.7, 124.4, 127.3, 127.9, 128.7, 129.3, 132.2, 132.3, 134.0, 152.8, 156.1

N-(2-(*p*-Tolylsulfinyl)methyl chroman-2-yl) acetamide **150**

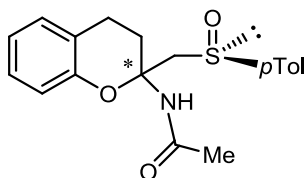

To a solution of (*SR*)-2-[(*p*-tolylsulfinyl)methyl]-2-chromanol **114** (30 mg, 0.01 mmol, 1 equiv) in CH₃CN (1 mL) at 0°C, was added drop wise 1.2 equiv of TMSOTf (23 μ L, 0.12 mmol). After 3h the mixture was quenched with H₂O and extracted with CH₂Cl₂. After workup and flash chromatography (hexane/EtOAc 1:1) acetamide **150** was isolated as 80:20 mixture of epimers at C-2 in 68% yield.

R_f 0.12 (hexane/EtOAc 1:3)

¹H RMN (CDCl₃) (2 diastereoisomers) δ 1.95 (s, 3H), 2.02 (s and m, 4H), 2.15-2.23 (m, 1H), 2.41 (s, 6H), 2.72-2.92 (m, 6H), 3.46 and 3.66 (AB system, $J = 13.8$ Hz, $\Delta\nu = 58.8$ Hz, 2H), 3.48 and 3.54 (AB system, $J = 13.5$ Hz, $\Delta\nu = 10.4$ Hz, 2H), 6.20 (large s, 1H), 6.41 (large s, 1H), 6.90-6.94 (m, 4H), 7.06-7.16 (m, 4H), 7.31-7.33 (m, 4H), 7.54-7.58 (m, 4H)

¹³C RMN (CDCl₃) (2 diastereoisomers) δ 20.9, 21.0, 21.2, 23.9, 24.3, 28.4, 29.9, 64.3, 65.8, 84.8, 86.0, 117.5, 117.7, 120.9, 121.0, 121.6, 121.8, 123.9, 124.1, 127.7, 127.8, 129.4, 130.0 (2C), 140.8, 141.1, 141.5, 141.6, 151.2, 151.6, 169.6 (2C)

MS (EI) m/z (%): 77 (10), 91 (22), 145 (100), 162 (73), 204 (M⁺-SO_pTol, 99), 343 (M⁺, 1)

3,3-Dimethylbenzofuran-2(3H)-one 159

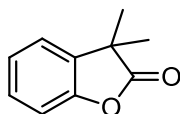

Following the procedure of Padwa *et al.*¹¹² To a solution of dry diisopropylamine (2.3 mL, 16.4 mmol) in THF (32 mL) at 0°C, a solution of *n*-BuLi 2.5 M in hexanes (6.4 mL, 16 mmol) was added, under N₂. The mixture was stirred for 30 min, cooled to -78°C and a solution of 2-coumaranone (1 g, 7.45 mmol) in THF (15 mL) was added dropwise. After 30 min the reaction mixture was warmed to ambient temperature and stirred for 2h, quenched with water (40 mL) and extracted with dichloromethane. After workup and flash chromatography (eluent hexane/EtOAc 5:1), compound **159** was obtained in 9% yield (109 mg) as an orange solid.

¹H NMR δ 1.43 (s, 6H); 7.13 (m, 4H)

¹³C NMR δ 25.5, 42.8, 60.4, 110.8, 122.7, 124.2, 128.5, 133.7, 152.2, 180.9

3,3-dimethyl-2-(SR)-(p-tolylsulfinylmethyl)-2,3-dihydrobenzofuran-2-ol 160

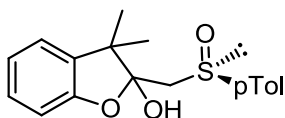

To a solution of dry diisopropylamine (145 μL, 1.034 mmol) in THF (1.5 mL) at 0°C, a solution of *n*-BuLi 1.6 M in hexanes (0.63 mL, 1.01 mmol) was added, under N₂. The mixture was stirred for 30 min, cooled to -78°C and a solution of (SR)-methyl-*p*-tolylsulfoxide **46** (94 mg, 0.611 mmol) in THF (1 mL) was added dropwise. The reaction was stirred for 1 hour, a solution of 3,3-dimethylbenzofuran-2(3H)-one **159** (76 mg, 0.47 mmol) in THF (1 mL), was added via cannula. The mixture was stirred for 2 hour, hydrolyzed with saturated aqueous ammonium chloride solution and extracted with EtOAc. After workup and flash

¹¹² Padwa, A.; Au, A.; Lee, G. A.; Owens, W. *J. Am. Chem. Soc.* **1976**, *98*, 3555.

chromatography (eluent hexane/EtOAc 3:1), compound (*SR*)-**160** was obtained in 24% yield (37 mg), as orange oil.

$^1\text{H NMR}$ δ 1.23 (s, 3H), 1.48 (s, 3H), 2.4 (s, 3H), 3.06 (s, 2H), 6.92 (m, 2H), 7.09 (m, 1H), 7.17 (m, 1H), 7.30 and 7.52 (AA'BB' system, $J = 8.3$ Hz, $\Delta\nu = 120.9$ Hz, 4H)

$^{13}\text{C NMR}$ δ 21.7, 24.7, 48.7, 58.3, 110.5, 112.3, 121.5, 122.4, 124.3, 128.2, 130.3, 136.2, 140.1, 142.5, 155.6

(*S*)-2-Methyl-2-propylchroman

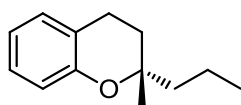

Raney Ni was added to a solution of (*SR*)-2-methoxy-2-[(*p*-tolylsulfinyl)methyl] chroman **144** (20 mg, 0.06 mmol) in EtOH at room temperature. The mixture was stirred overnight, then filtration over celite.

$^1\text{H NMR}$ (CDCl_3) δ 0.92 (t, $J = 7.15$ Hz, 3H), 1.27 (s, 3H), 1.42 (m, 2H), 1.58 (m, 2H), 1.79 (m, 2H), 2.72 (t, $J = 6.9$ Hz, 2H), 6.79 (m, 2H), 7.06 (m, 2H) $^{13}\text{C NMR}$ δ 14.6, 16.9, 22.1, 24.2, 30.9, 42.0, 59.6, 60.3, 117.2, 119.5, 121.2, 127.2, 129.4

MS (EI) m/z (%): 190.1366 ($\text{M}^+\text{+H}$, 32), 147.0804 (100), 145.0659 (42), 107.0504 (86)

HRMS (EI) calcd for $\text{C}_{13}\text{H}_{18}\text{O}$ ($\text{M}^+\text{+1}$) 190.1358, found 190.1366

(*R*)-3-(2-Methylchroman-2-yl)propan-1-ol **188**

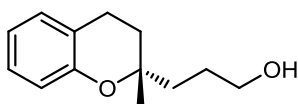

To (*2S,SR*)-2-allyl-2-(*p*-tolylsulfinyl)methyl chroman **144** (100 mg, 0.28 mmol, 1 equiv) without solvent at 0 °C under nitrogen was added 9-BBN (0.5M in

THF, 4 equiv). The mixture was warmed to room temperature and stirred for 24h. The hydroboration mixture was oxidized by adding aq. 3 *N*-NaOH / 30 %-H₂O₂ (vol./vol. = 4 mL) at 0°C, followed by stirring at room temperature overnight. The reaction mixture was diluted with ethyl acetate (5 mL) and washed with brine solution (20 mL). The aqueous layer was re-extracted with ethyl acetate. After workup the alcohol was used directly in the subsequent reaction without purification.

To a solution of the sulfinyl alcohol in EtOH (4 mL) was added Ni Raney, the mixture was stirred at room temperature overnight. After filtration over celite, the solvent was removed and the residue was chromatographed in alumina (hexane/EtOAc 3:1), the compound was obtained with 55% of yield as colorless oil (32 mg).

$[\alpha]_D^{20} = -43.7$ (*c* 1.51, CHCl₃)

¹H NMR (CDCl₃) δ 1.3 (s, 3H), 1.56 (m, 2H), 1.67-1.91 (m, 6H), 2.78 (t, *J* = 6.5 Hz, 2H), 3.67 (m, 2H), 6.79 (m, 2H), 7.09 (m, 2H)

¹³C NMR (CDCl₃) δ 22.1, 24.0, 26.9, 31.2, 36.1, 63.2, 75.8, 117.2, 119.7, 121.0, 127.3, 129.4, 153.7

MS (ES) *m/z* (%): 245.0783 (42), 229.1193 (60), 207.1365 (M⁺+1, 100), 189.1270 (57), 177.0536 (52)

HRMS (ES) calculated for C₁₃H₁₉O₂ (M⁺+1) 207.1379, found 207.1365

Sulfinyl alcohol intermediate:

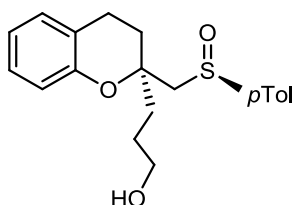

¹H RMN (CDCl₃) δ 1.34-1.84 (m, 32H), 1.93-2.03 (m, 4H), 2.15-2.25 (m, 1H), 2.32 (s, 3H), 2.70-2.75 (m, 2H), 2.81 and 3.15 (AB system, *J* = 13.7Hz, 2H), 3.60-3.67 (m, 2H),

3.69-3.77 (m, 3H), 6.73(dd, $J = 1, 8.1\text{Hz}$, 1H), 6.78 (dt, $J = 1.2, 7.4\text{Hz}$, 1H), 7.21 and 7.39 (AA'BB' system, $J = 8.5\text{ Hz}$, 4H)

(R)-3-(2-methylchroman-2-yl)propanoic acid **189**¹⁴⁹

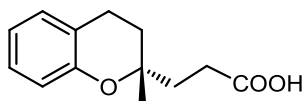

To a solution of CuCl 5% mol and (R)-3-(2-methylchroman-2-yl) propan-1-ol **189** (16 mg, 0.78 mmol, 1 equiv) in 0.2 mL of CH₃CN, was slowly added ^tBuOOH (78 μ L, 0.39 mmol, 5 equiv) at room temperature. After 3h of stirring, solvent was evaporated and to the resulting crude reaction mixture water was added. The pH of the reaction mixture was adjusted to 8.0 with saturated NaHCO₃ and was then extracted with EtOAc. The aqueous layer was acidified to pH = 2.0 using 2 N HCl and extracted with EtOAc. After work up, acid X was obtained in 24% yield.

¹H RMN (CDCl₃) δ 1.21 (s, 3H), 1.68-2.03 (m, 4H), 2.49 (t, $J = 8\text{ Hz}$, 2H), 2.72 (t, $J = 6.58\text{ Hz}$, 2H), 6.73 (m, 2H), 7.01 (m, 2H)

6-Hydroxy-7,8-dimethylchroman-2-one **190**

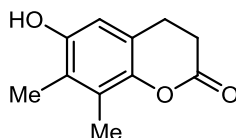

To a solution of 2,3-dimethylhydroquinone **183** (1 g, 7.24 mmol) and acidic resin "Amberlyst 15" (2.9 g) in toluene (21.7 mL), acrylic acid **184** (521 μ L, 7.60 mmol) was added dropwise, under argon. The reaction mixture was refluxed for two days, filtered, the solvent evaporated and the resulting residue diluted with EtOAc (100 mL). After filtration of the white precipitate, the filtrate was evaporated

¹⁴⁹ Sekar, G. *Tetrahedron Lett.* 49, **2008**, 2457-2460

and the residue purified by flash chromatography (eluent hexane/EtOAc 4:1) to give compound **190** in 65% yield (906 mg), as a yellow solid. Compound **198** was obtained as above in 10% yield, as a white solid.

Mp 123-126 °C

R_f 0.25 (hexane/EtOAc 2:1)

¹H NMR (CDCl₃) δ 2.16 (s, 3H), 2.21 (s, 3H), 2.71 (m, 2H), 2.88 (m, 2H), 4.98 (br s, 1H), 6.48 (s, 1H)

¹³C NMR (CDCl₃) δ 11.8, 12.1, 23.9, 29.4, 111.2, 120.3, 122.7, 126.3, 144.2, 149.8, 169.5

MS (FAB⁺) 154 (65), 192 (M⁺, 52), 193 (100)

HRMS (FAB⁺) calcd for C₁₁H₁₂O₃ (M⁺) 192.0786, found 192.0779

5,6-Dimethyl-1,2,9,10-tetrahydropyrano[3,2-*f*]chromene-3,8-dione **198**

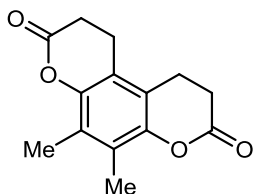

Mp 244-246 °C

¹H RMN (CDCl₃) δ 2.27 (s, 6H), 2.77-2.82 (m, 4H), 2.93-2.97 (m, 4H)

¹³C RMN (CDCl₃) δ 12.0, 20.8, 28.7, 117.28, 126.3, 146.5, 168.1

MS (EI) *m/z* (%): 148 (11), 161 (24), 175 (19), 176 (100), 204 (33), 218 (18), 246 (M⁺, 91)

HRMS (EI) calcd for C₁₄H₁₄O₄ (M⁺) 246.0892, found 246.0902

6-(*tert*-Butyldimethylsilyloxy)-7,8-dimethylchroman-2-one **198**

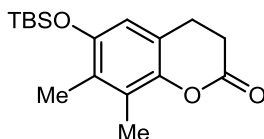

To a solution of phenol **190** (2.0 g, 10.42 mmol) and 2,6-lutidine (2.2 mL, 20.84 mmol) in CH₂Cl₂ (180 mL), *tert*-butyldimethylsilyl trifluoromethanesulfonate (3.6 mL, 15.63 mmol) was added. The reaction mixture was stirred for 8 hours, hydrolyzed with a saturated aqueous ammonium chloride solution (70 mL) and extracted with EtOAc. After workup and flash chromatography (eluent hexane/EtOAc 2:1), compound **198** was obtained in 100% yield (3.5 g), as a white solid.

mp 95-97 °C

R_f 0.69 (hexane/EtOAc 2:1)

¹H NMR (CDCl₃) δ 0.19 (s, 6H), 1.02 (s, 9H), 2.13 (s, 3H), 2.20 (s, 3H), 2.72 (m, 2H), 2.88 (m, 3H), 6.44 (s, 1H)

¹³C NMR (CDCl₃) δ -4.2, 12.3, 12.8, 14.2, 18.3, 24.1, 25.8, 29.5, 114.8, 119.8, 126.2, 127.6, 144.5, 149.6, 169.3

MS (FAB⁺) 306 (M⁺, 100), 307 (61)

HRMS (FAB⁺) calcd for C₁₇H₂₆O₃Si (M⁺) 306.1651, found 306.1662

(SS)-6-(*tert*-Butyldimethylsilyloxy)-7,8-dimethyl-2-(*p*-tolylsulfinylmethyl) chroman-2-ol **199**

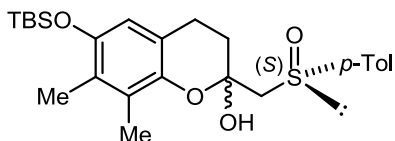

Compound (SS)-**199** was obtained by nucleophilic addition of the lithium anion derived from (SS)-methyl-*p*-tolylsulfoxide **46** (197 mg, 1.3 mmol) to a solution of chromanone **198** (300 mg, 1.0 mmol) in THF (3 mL), at $-78\text{ }^{\circ}\text{C}$ following method B (1h). After workup, pale orange syrup was obtained, and diethyl ether was added until a precipitate appeared. The solid was filtered, washed with several portions of diethyl ether/hexane and dried, to obtain compound (SS)- **199** as a white solid, in 74% yield (333 mg). When the reaction was performed in a smaller scale, the precipitation of the product was not observed and the final mixture was purified by flash chromatography (eluent hexane/EtOAc 2:1).

mp 133-136 $^{\circ}\text{C}$

R_f 0.26 (hexane/EtOAc 2:1)

¹H NMR (CDCl₃) δ 0.17 (s, 3H), 0.19 (s, 3H), 1.76 (ddt, $J = 2.0, 5.8$ and 13.1 Hz, 1H), 2.02-2.13 (m, 4H), 2.27 (s, 3H), 2.44 (s, 3H), 2.58 (ddd, $J = 2.5, 5.5$ and 15.9 Hz, 1H), 2.97-3.19 (m, 4H), 6.10 (d, $J = 1.9$ Hz, 1H), 6.39 (s, 1H), 7.49 (AA'BB' system, $J = 8.1$ Hz, 4H)

¹³C NMR (CDCl₃) δ -4.3, -4.1, 12.2, 12.8, 18.2, 21.0, 21.4, 25.9, 32.2, 63.9, 96.4, 115.7, 118.2, 124.0, 126.0, 126.6, 130.2, 140.5, 142.1, 143.9, 147.3

MS (FAB⁺) 385 (41), 460 (M⁺, 100), 461 (34)

HRMS (FAB⁺) calcd for C₂₅H₃₆O₄SSi (M⁺) 460.2104, found 460.2098

(SS)-6-(tert-Butyldimethylsilyloxy)-2-methoxy-7,8-dimethyl-2-(p-tolylsulfinylmethyl) chroman 200

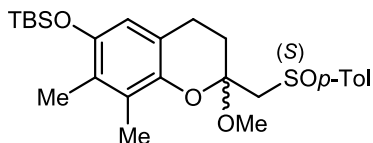

To a mixture of sulfinyl lactol (SS)-**199** (500 mg, 1.08 mmol), dry methanol (218 μ L) and anhydrous MgSO_4 (540 mg) in CH_2Cl_2 (5.4 mL), TMSOTf (39 μ L, 0.2 equiv) was added at 0°C, under N_2 . The solution was allowed to reach room temperature, stirred for 2 h and quenched with Et_3N (30 μ L). After evaporation of the solvent and flash chromatography (eluent hexane/EtOAc 2:1), compound (SS)-**200** was obtained as a yellow oil, in 85% yield (437 mg)

R_f 0.46 (hexane/EtOAc 2:1)

$[\alpha]_D^{20} = -71.6$ (c 2.0, CHCl_3)

$^1\text{H NMR}$ (CDCl_3) δ 0.19 (s, 6H), 1.01 (s, 9H), 1.99 (m, 1H), 2.09 (s, 3H), 2.11 (s, 3H), 2.24 (m, 1H), 2.41 (s, 3H), 2.57 (m, 1H), 2.97 (m, 1H), 3.26 (m, 5H), 6.37 (s, 1H), 7.34 and 7.59 (AA'BB' system, $J = 8.2$ Hz, 4H)

$^{13}\text{C NMR}$ (CDCl_3) δ -4.2, -4.1, 11.9, 12.7, 12.8, 14.2, 18.2, 21.3, 21.4, 25.7, 25.8, 25.9, 30.1, 30.4, 49.2, 49.3, 65.1, 65.6, 97.4, 97.8, 115.7, 115.8, 118.9, 119.0, 123.9, 124.0, 126.3, 126.3, 126.4, 130.0, 141.5, 141.6, 141.7, 141.9, 143.4, 143.5, 147.4

$\text{MS (FAB}^+)$ 415 (65), 459 (58), 474 (M^+ , 100)

$\text{HRMS (FAB}^+)$ calcd for $\text{C}_{26}\text{H}_{38}\text{O}_4\text{SSi}$ (M^+) 474.2260, found 474.2263

(*SS,S*)-2-Allyl-6-(*tert*-butyldimethylsilyloxy)-7,8-dimethyl-2-(*p*-tolylsulfinylmethyl)chroman **201**

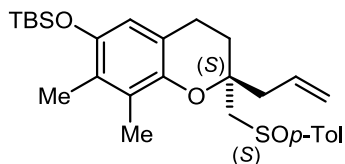

To a solution of sulfinyl ketal (*SS*)-**200** (1.49 g, 3.14 mmol) and allyl trimethylsilane (1.49 mL, 9.42 mmol, 3 equiv) in CH₂Cl₂ (46 mL) at -78°C, TiCl₄ (500 μL, 4.39 mmol, 1.4 equiv) was added. After stirring for 1 hour, the reaction mixture was hydrolyzed with a saturated aqueous NaHCO₃ solution (20 mL) and extracted with EtOAc. After workup and flash chromatography (eluent hexane/EtOAc 4:1), compound (*SS,S*)-**201** was obtained in 67% yield (1.2 g), as a yellow oil.

R_f 0.58 (hexane/EtOAc 2:1)

[α]_D²⁰ = -57.4 (*c* 1.2, CHCl₃)

¹H NMR (CDCl₃) δ 0.17 (s, 6H), 1.01 (s, 9H), 2.04 (m, 2H), 2.09 (s, 6H), 2.39 (s, 3H), 2.78 (m, 4H), 2.86 and 3.12 (AB system, *J* = 13.8 Hz, 2H), 5.25-5.32 (m, 2H), 6.00 (dddd, *J* = 6.4, 8.1, 10.1 and 14.5 Hz, 1H), 6.36 (s, 1H), 7.27 and 7.44 (AA'BB' system, *J* = 8.4 Hz, 4H)

¹³C NMR (CDCl₃) δ -4.2 (2C), 12.1, 12.8, 18.3, 21.3, 21.8, 25.8, 29.9, 41.9, 65.3, 115.9, 117.5, 119.5, 123.7 (2C), 126.9, 126.7, 129.9 (2C), 132.9, 141.2, 142.0, 144.5, 146.9

MS (FAB⁺) 484 (M⁺, 75), 485 (M⁺ + 1, 100)

HRMS (FAB⁺) calcd for C₂₈H₄₁O₃SSi (M⁺ + 1) 485.2546, found 485.2540

(SS,R)-2-Allyl-6-(tert-butyltrimethylsilyloxy)-7,8-dimethyl-2-(p-tolylsulfinylmethyl)chroman 201

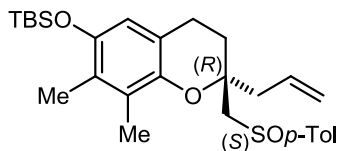

Compound (SS,R)- **201** was obtained following the previously described protocol, in 12% yield (180 mg)

$[\alpha]_D^{20} = -36.0$ (*c* 1.4, CHCl₃)

¹H NMR (CDCl₃) δ 0.19 (s, 6H), 1.01 (s, 9H), 2.04-2.10 (m, 2H), 2.08 (s, 3H), 2.11 (s, 3H), 2.39 (s, 3H), 2.57 (m, 1H), 2.75-2.81 (m, 1H), 2.99 and 3.12 (AB system, *J* = 13.7 Hz, 2H), 5.11-5.17 (m, 2H), 5.75-5.87 (m, 1H), 6.38 (s, 1H), 7.31 and 7.54 (AA'BB' system, *J* = 7.9 Hz, 4H)

¹³C NMR (CDCl₃) δ -4.2 (2C), 12.1, 12.9, 18.3, 21.4, 21.9, 25.9, 28.4, 42.0, 66.7, 76.0, 115.8, 117.0, 119.6, 124.0, 126.0 (2C), 126.8, 129.9, 132.4 (2C), 141.3, 142.1, 144.7, 146.9

MS (FAB⁺) *m/z* (%): 345 (50), 467 (9), 484 (M⁺, 100), 485 (M⁺ + H, 90)

HRMS (FAB⁺) calcd for C₂₈H₄₁O₃SSi (M⁺ + H) 485.2546, found 485.2534

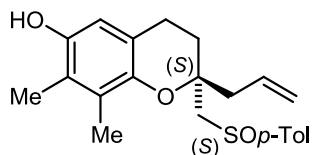
(SS,S)-2-Allyl-6-hydroxy-7,8-dimethyl-2-(p-tolylsulfinylmethyl)chroman**202**

To a solution of OTBS-protected chroman (SS,S)- **201** (106.5 mg, 0.22 mmol) in THF (4 mL), a solution of TBAF 1.0M in THF (265 μ L, 0.26 mmol, 1.2 equiv) was added at 0 °C. The mixture was stirred for 5 min, hydrolyzed with NH₄Cl and extracted with EtOAc. After workup and flash chromatography (eluent hexane/EtOAc 2:1), phenol (SS,S)- **202** was obtained in quantitative yield, as a crystalline white solid.

mp 172-173 °C

[α]_D²⁰ = -84.7 (*c* 0.36, CHCl₃)

¹H NMR (CDCl₃) δ 2.02-2.22 (m, 2H), 2.13 (s, 3H), 2.18 (s, 3H), 2.41 (s, 3H), 2.65-2.88 (m, 2H), 2.88 and 3.16 (AB system, *J* = 13.8 Hz, 2H), 4.50-4.65 (m, 1H), 5.25-5.32 (m, 2H), 6.03 (dddd, *J* = 18.3, 10.2, 8.2 and 6.4 Hz, 1H), 6.38 (s, 1H), 7.30 and 7.48 (AA'BB' system, *J* = 8.2 Hz, 4H)

¹³C NMR (CDCl₃) δ 11.8, 12.1, 20.2, 21.3, 30.0, 41.8, 65.0, 75.2, 117.1, 118.8, 119.4, 121.6, 122.8, 123.8 (2C), 129.9 (2C), 132.9, 141.2, 142.0, 144.2, 145.4

MS (FAB⁺) *m/z* (%): 55 (48), 231 (36), 371 (M⁺ + H, 100)

HRMS (FAB⁺) calcd for C₂₂H₂₇O₃S (M⁺ + 1) 371.1681, found 371.1676

X-Ray Diffraction

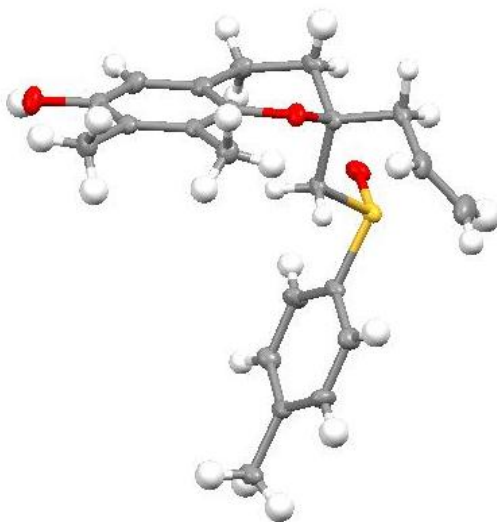

(*S*)-3-[6-(*tert*-Butyldimethylsilyloxy)-2,7,8-trimethylchroman-2-yl]propan-1-ol **204**

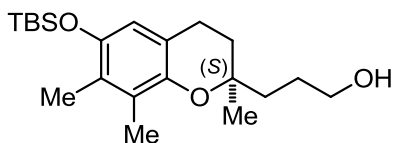

To allyl sulfoxide (*SS,S*)-**201** (400 mg, 0.83 mmol) without solvent at 0°C, a solution of 9-BBN 0.5M in THF (6.7 mL, 3.32 mmol, 4 equiv) was added, under nitrogen. After stirring at room temperature for 48 h, the reaction mixture was cooled to 0°C and a 50:50 solution of aqueous NaOH 3N and 30%-H₂O₂ (12 mL) was added. The mixture was stirred at room temperature for 3 h, diluted with EtOAc and washed with brine. After workup, compound (*SS,S*)-**203** was obtained and used in the next step without further purification.

To a solution of the above obtained sulfinyl alcohol (*SS,S*)-**203** in EtOH (4 mL), Ni Raney was added and the mixture was stirred at room temperature overnight. After filtration, evaporation of the solvent and flash chromatography in

alumina (eluent hexane/EtOAc 4:1), compound (S)-**204** was obtained in 87% yield for the two last steps, as a colorless oil.

R_f 0.42 (hexane/EtOAc 2:1)

$[\alpha]_D^{20} = +3.1$ (c 1.4, CHCl_3)

$^1\text{H NMR}$ (CDCl_3) δ 0.17 (s, 6H), 1.00 (s, 9H), 1.25 (s, 3H), 1.51-1.8 (m, 6H), 2.08 (s, 6H), 2.66-2.68 (m, 2H), 3.63-3.67 (m, 2H), 6.34 (s, 1H)

$^{13}\text{C NMR}$ (CDCl_3) δ -4.2, 12.1, 12.8, 18.2, 22.4, 22.7, 23.9, 25.2, 25.9, 27.0, 27.4, 31.6, 34.7, 36.2, 63.2, 72.2, 115.8, 117.6, 126.6, 126.2, 145.6, 146.2

$\text{MS (FAB}^+)$ 346 (48), 364 (M^+ , 100)

$\text{HRMS (FAB}^+)$ calcd for $\text{C}_{21}\text{H}_{36}\text{O}_3\text{Si}$ (M^+) 364.2434, found 364.2431

(S)-3-[6-(*tert*-Butyldimethylsilyloxy)-2,7,8-trimethylchroman-2-yl] propanoic acid
205

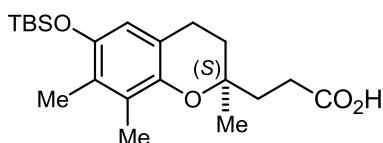

To a solution of alcohol (S)-**204** (100 mg, 0.274 mmol) in a 50:50 mixture of CH_2Cl_2 and DMSO (2.7 mL) at 0 °C, triethylamine (193 μL , 1.37 mmol) and the complex SO_3 -pyridine (174 mg, 1.1 mmol) were added. The reaction mixture was stirred at room temperature for 2 h, quenched with water, extracted with EtOAc and washed with brine. After workup, the resulting residue was filtered over alumina (eluent EtOAc), to obtain compound (S)-**205** which was used directly in the next step without further purification

$^1\text{H RMN}$ (CDCl_3) δ 0.17 (s, 6H), 1.00 (s, 9H), 1.23 (s, 3H), 1.70-2.10 (m, 4H), 2.06 (s, 3H), 2.08 (s, 3H), 2.62 (dt, $J = 1.6$ and 7.5 Hz, 2H), 2.67-2.73 (m, 2H), 6.34 (s, 1H), 9.80 (t, $J = 1.6$ Hz, 1H)

¹³C NMR (CDCl₃) δ -4.2 (2C), 12.1, 12.8, 18.2, 22.2, 23.7, 25.8, 31.7, 32.2, 38.6, 74.2, 115.8, 117.3, 126.7, 126.4, 145.3, 146.4, 202.5

To a solution of the above obtained aldehyde (*S*)-**206** in a 80:20 mixture of *t*-BuOH and water (2.25 mL) at 0 °C, 2-methyl-2-butene (0.5 mL, 1 mmol), NaH₂PO₄ (31 mg, 0.22 mmol) and NaClO₂ (71 mg, 0.78 mmol) were successively added. The reaction mixture was stirred at 0 °C for 10 min, diluted with water and extracted with CH₂Cl₂. After workup and flash chromatography, (eluent hexane/EtOAc 2:1, 5% MeOH), compound (*S*)-**205** was obtained in 76% yield (78 mg) for the two last steps, as a yellow oil.

R_f 0.27 (hexane/EtOAc 2:1)

[α]_D²⁰ = +5.3 (c 0.6, CHCl₃)

¹H NMR (CDCl₃) δ 0.17 (s, 6H), 1.00 (s, 9H), 1.24 (s, 3H), 1.73-2.05 (m, 6H), 2.07, (s, 3H), 2.08 (s, 3H), 2.56 (t, *J* = 7.9 Hz, 2H), 2.67-2.73 (m, 2H), 6.34 (s, 1H)

¹³C NMR (CDCl₃) δ -4.2, 12.0, 12.8, 18.2, 22.2, 23.5, 25.8, 27.0, 28.4, 31.6, 34.7, 74.1, 115.8, 117.4, 126.7, 126.4, 145.4, 146.4, 178.7

MS (FAB⁺) 378 (M⁺, 100)

HRMS (FAB⁺) calcd for C₂₁H₃₄O₄Si (M⁺) 378.2226, found 378.2233

(S)-3-(6-Hydroxy-2,7,8-trimethylchroman-2-yl) propanoic acid 116 [(S)- γ -CEHC] 116

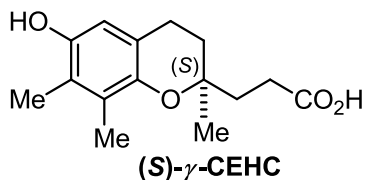

To a solution of carboxylic acid (*S*)-**205** (60 mg, 0.158 mmol) in THF (1.6 mL), tetrabutylammonium fluoride (0.2 mL, 0.205 mmol) was added, at 0 °C. The reaction mixture was stirred at 0°C for 15 minutes, hydrolyzed with a saturated aqueous ammonium chloride solution and extracted with EtOAc. After workup and flash chromatography (eluent hexane/EtOAc 2:1, 5% MeOH, 0.01% AcOH), compound (*S*)-**116** [(*S*)- γ -CEHC] was obtained in 100% yield (42 mg), as a white solid.

R_f 0.19 (hexane/EtOAc 2:1)

$[\alpha]_D^{20} = +5.5$ (c 1.43, MeOH). [Lit.: $[\alpha]_D^{20} = +5.1$ (c 1.27, MeOH)]

$^1\text{H NMR}$ (CDCl_3) δ 1.24 (s, 3H), 1.72-1.82 (m, 2H), 1.89 (ddd, $J = 7.2, 8.8$ and 14.1 Hz, 1H), 1.99-2.05 (m, 1H), 2.09 (s, 3H), 2.12 (s, 3H), 2.55 (ddd, $J = 1.9, 6.8$ and 8.8 Hz, 2H), 2.66-2.75 (m, 2H), 6.37 (s, 1H)

$^{13}\text{C NMR}$ (CDCl_3) δ 11.8, 11.9, 20.7, 22.1, 23.5, 28.4, 31.5, 34.6, 74.3, 112.1, 117.9, 121.8, 126.9, 145.2, 146.5, 176.8, 179.5

MS (FAB⁺) 264 (M^+ , 100)

HRMS (FAB⁺) calcd for $\text{C}_{15}\text{H}_{20}\text{O}_4$ (M^+) 264.1362, found 264.1364

HPLC: Daicel Chiralpack IA, 9.5% *i*-PrOH and 0.5% AcOH in hexane, 1 mL min^{-1} , 25°C, 254 nm: $t_{R(2R)} = 23.5 \text{ min}$ and $t_{R(2S)} = 28.8 \text{ min}$.

CHAPTER III

STEREOSELECTIVE SYNTHESIS OF TRISUBSTITUTED MONOFLUORINATED OLEFINS

I. INTRODUCTION

Fluorine is the most electronegative element in the periodic table ($\chi = 4.0$).¹⁵⁰ The three lone electron pairs on fluorine are held tightly due to the high electronegativity of the atom and, unlike oxygen or nitrogen, they are reluctant to get involved in resonance or interact strongly as hydrogen bonding acceptors.

The C–F bond is the strongest in organic chemistry (105.4 kcal mol⁻¹). The high electronegativity of fluorine has a number of obvious consequences leading to polarization imparting a less covalent and more electrostatic character to the C–F bond. This leads to a relatively large dipole (μ) and the dipole interacts with other dipoles that come close. As a consequence the preferred conformations and conformational equilibrium of organofluorine compounds can often be interpreted by considering electrostatic interactions.

Despite being the most abundant halogen in the Earth's crust, fluorine is almost completely absent from natural products chemistry.¹⁵¹ However, in contrast to the paucity of fluorinated molecules in nature, there are many synthetic (non-natural) organofluorine compounds with valuable biological activity.

Fluorinated molecules occupy a significant place in pharmaceutical/medicinal,^{16,17} agrochemical,¹⁸ and material sciences¹⁹ due to the unique properties of the fluorine atom. The introduction of a fluorine atom in a structure can modulate the properties of a bioactive molecule since this may lead to significant changes in solubility, lipophilicity, metabolic stability, conformation, hydrogen-

¹⁵⁰ L. Pauling, *The Nature of the Chemical Bond and the Structure of Molecules and Crystals: An Introduction to Modern Structural Chemistry*, Cornell University Press, Ithaca, NY, **1939**.

¹⁵¹ H. Deng, D. O'Hagan, C. Schaffrath, *Nat. Prod. Rep.* **2004**, *21*, 773–784.

¹⁶ T. Hiyama, in *Organofluorine Compounds: Chemistry and Applications*, ed. H. Yamamoto, Springer-Verlag, Berlin, **2000**.

¹⁷ Reviews: J.-P. Bégulé and D. Bonnet-Delphon, *J. Fluorine Chem.*, **2006**, *127*, 992; K. L. Kirk, *J. Fluorine Chem.*, **2006**, *127*, 1013; K. Muller, C. Faeh and F. Diederich, *Science*, **2007**, *317*, 1881; L. Hunter, *Beilstein J. Org. Chem.*, **2010**; G. Landelle, M. Bergeron, M.-O. Turcotte-Savard, J.-P. Paquin, *Chem. Soc. Rev.* **2011**, 2867–2908. W. K. Hagmann, *J. Med. Chem.*, **2008**, *51*, 4359; S. Purser, P. R. Moore, S. Swallow and V. Gouverneur, *Chem. Soc. Rev.*, **2008**, *37*, 320.

¹⁸ Review: P. Jeschke, *Chem. Bio. Chem.*, **2004**, *5*, 570.

¹⁹ Review: M. Pagliaro and R. Ciriminna, *J. Mater. Chem.*, **2005**, *15*, 4981.

bonding ability, or chemical reactivity. As a result, as many as 30–40% of agrochemicals and 20–25% of pharmaceuticals in the market are estimated to contain fluorine.²⁰

Fluorinated drugs can deeply alter various biological steps: binding with enzymes or receptors, metabolism leading to the clearance of the exogenous substance, absorption and transport and interference with enzymatic reactions.¹⁵²

The impressive development, during the last 20 years, of synthetic methodologies in organofluorine chemistry and the increasing understanding of the impact of fluorination on biological properties of a molecule have facilitated the design and synthesis of more and more structurally diverse and sophisticated drug candidates. As part of these advances, many fluorinated analogues of natural compounds have been synthesized and investigated.

Fluorinated drugs and drug candidates based on natural compounds are present in many therapeutic classes. Very important drugs, such as fluorocorticoid and fluorouracil derivatives, are intensively used in clinics. The main recent progress in this field concerns fluorinated-substituted nucleosides, alkaloids, macrolides, steroids, amino acids and prostaglandins.¹⁷ Most of the applications are found in anti-cancer, anti-viral and anti-infectious fields.

Some examples of fluorinated compounds having important biological properties are shown in Figure 3. 1. Thus, a fluorine substituted sugar is the fluorinated moiety of Clofarabine, a product used in the treatment of leukemia. A 2,5-difluoromethyl substituted aniline is included in the testosterone inhibitor Dutasteride, is commercially available by Glaxo. An analogue of vitamin D, Falcacitriol has been reported with two trifluoromethyl groups instead of the methyl substitution at C-23 of the natural Calcitriol. An antimicrobial triptopnan alkaloid called Vinflunine also contains two fluorine atoms in the active structure.

¹⁵² J.P. Bégué, D. Bonnet-Delpon, *Chimie bioorganique et Médicinale du Fluor*, EDP Science/CNRS, Paris, **2005**.

¹⁷ Reviews: J.-P. Bégué and D. Bonnet-Delpon, *J. Fluorine Chem.*, **2006**, *127*, 992; K. L. Kirk, *J. Fluorine Chem.*, **2006**, *127*, 1013; K. Muller, C. Faeh and F. Diederich, *Science*, **2007**, *317*, 1881; L. Hunter, *Beilstein J. Org. Chem.*, **2010**; G. Landelle, M. Bergeron, M.-O. Turcotte-Savard, J.-P. Paquin, *Chem. Soc. Rev.* **2011**, 2867-2908. W. K. Hagmann, *J. Med. Chem.*, **2008**, *51*, 4359; S. Purser, P. R. Moore, S. Swallow and V. Gouverneur, *Chem. Soc. Rev.*, **2008**, *37*, 320.

²⁰ A. M. Thayer, *Chem. Eng. News*, **2006**, *84*, 15.

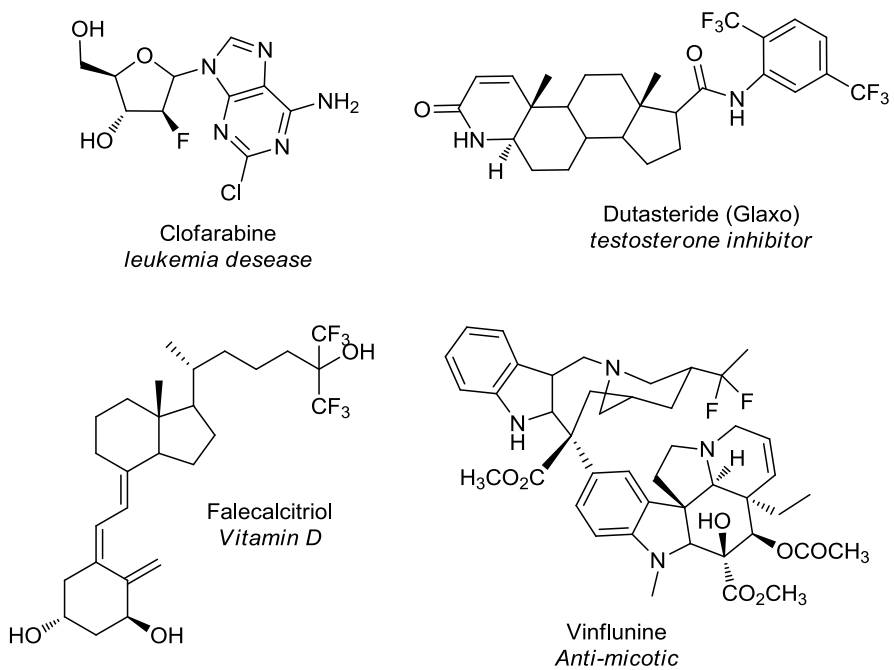

Figure 3. 1

1.1. MONOFLUORINATED OLEFINS

Within the various fluorinated motifs described, monofluoroalkene is of particular interest since it has potential applications in material sciences¹⁵³ and in synthetic organic chemistry where it can be used as a fluorinated synthon for further functionalization.¹⁵⁴

Peptides are promising candidates for the development of novel therapeutic agents for the treatment of human diseases. The idea of treating disease with molecules that the body itself synthesizes is very attractive, since high activity is expected. Progress in peptide chemistry has made the synthesis of small peptides a routine task. The design of small protein-like chains to mimic peptides and their development as drug-like compounds is of ongoing interest for both peptide and medicinal chemists. Indeed, peptidomimetics have emerged as valuable tools since they offer significant advantages over peptide-based drugs. The design of peptidomimetics as potential drugs requires the incorporation of structural elements possessing functionalities able to reproduce favorable geometry, electrostatic interactions, polarity, and hydrogen bonds of the natural analogues. The identification of functional groups that can act as bioisosteric replacements of the amide bond led to numerous syntheses of peptidomimetics.¹⁵⁵ Of the functionalities that can effectively mimic the amide bond, the carbon-carbon double bond of fluorinated alkenes has been the subject of several studies such as peptidomimetic, it is not exposed to proteolytic cleavage by enzymes in the digestive system and consequently possesses an extended lifetime. Peptide bonds exist in *cisoid-transoid* equilibrium whereas fluorinated alkene mimics do not isomerize and act either as a *cisoid* equivalent for *Z*-alkenes or as a *transoid* equivalent for *E*-alkenes.

¹⁵³ For recent examples, see: a) F. Babudri, G. M. Farinola, F. Naso and R. Ragni, *Chem. Commun.*, **2007**, 1003; b) F. Babudri, A. Cardone, G. M. Farinola, C. Martinelli, R. Mendichi, F. Naso and M. Striccoli, *Eur. J. Org. Chem.*, **2008**, 1977.

¹⁵⁴ a) G. Dutheuil, S. Couve-Bonnaire, X. Pannecoucke, *Angew. Chem., Int. Ed.*, **2007**, *46*, 1290; b) P. Van der Veken, K. Senten, I. Kertesz, I. De Meester, A. M. Lambeir, M. B. Maes, S. Scharpe, A. Haemers, K. Augustyns, *J. Med. Chem.*, **2005**, *48*, 1768; c) O. A. Wong and Y. A. Shi, *J. Org. Chem.*, **2009**, *74*, 8377; d) G. Dutheuil, X. S. Lei, X. Pannecoucke, J. C. Quirion, *J. Org. Chem.*, **2005**, *70*, 1911.

¹⁵⁵ J. Gante, *Angew. Chem., Int. Ed. Engl.*, **1994**, *33*, 1699–1720.

Peptides with olefin units are conformationally locked peptide bond isosteres and also have increased lipophilicity. However, the olefin bond has very high polarity and intramolecular hydrogen bonds are lost. The introduction of a fluorine atom onto the olefin moiety preserves the dipolar nature of the peptide linkage and may participate in hydrogen bonding between the backbone and the peptide bond surrogate even if the interaction energy is weaker than in natural peptides.¹⁵⁶ The hydrogen bond notion has been supported by recent studies despite the controversy on the existence of hydrogen bonds between the C–F group and –OH or –NH donors.

Fluorinated olefins have for these reasons emerged as reasonable steric and polar hydrophobic mimetics of the amide bond, despite the removal of hydrogen bonding capacity. The success appears to be due to the fluoroolefin dipole which, although weaker (~ 0.97 D versus 3.7 D of amide),¹⁵⁷ is oriented similarly to the amide dipole¹⁵⁸ (Figure 3. 2), and these analogues has been used successfully in medicinal chemistry studies.¹⁵⁹

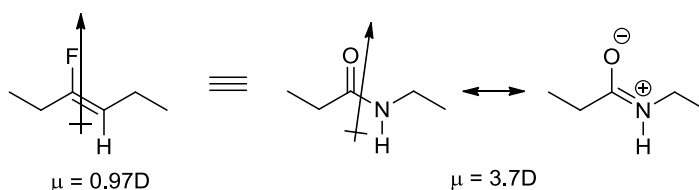

Figure 3. 2

The higher lipophilicity by the fluorine atom may facilitate the membrane penetration, in particular the blood– brain barrier passage. For these reasons, the fluoroolefin moiety is considered as an excellent mimic for the peptide bond (Figure 3. 3).

¹⁵⁶ a) J. J. Urban, B. G. Tillman and W. A. Cronin, *J. Phys. Chem. A*, **2006**, *110*, 11120–11129; b) D. O’Hagan and H. S. Rzepa, *Chem. Commun.*, **1997**, 645–65.

¹⁵⁷ R. J. Braham, S. L. R. Ellison, F. Schonholzer, W. A. Thomas, *Tetrahed.*, **1986**, *42*, 2101–2110.

¹⁵⁸ a) R. J. Abraham, S. L. R. Ellison, P. Schonholzer and W. A. Thomas, *Tetrahedron*, **1986**, *42*, 2101–2110; b) P. Cieplak, P. A. Kollman and J. P. Radomski, in *Molecular Design of Fluorine-Containing Peptide Mimetics*, ed. J. T. Welch, Washington, D. C., **1996**.

¹⁵⁹ S. Couve-Bonnaire, D. Cahard and X. Pannecoucke, *Org. Biol. Chem.*, **2007**, *5*, 1151–1157.

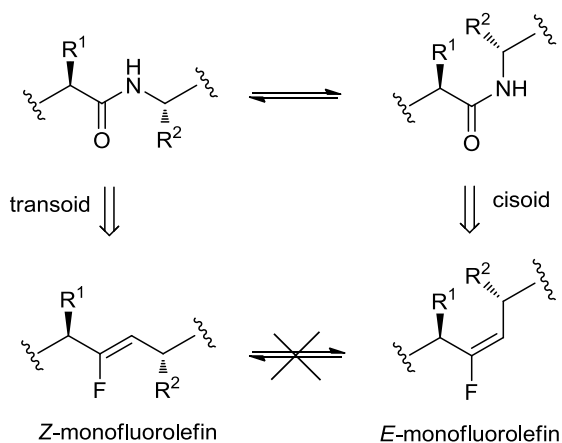

Figure 3. 3

In this context, a number of bioactive compounds with various pharmacological activities (anticancer,¹⁶⁰ antimicrobial,¹⁶¹ anti-HIV,¹⁶² anti-diabetic)¹⁶³ bearing this motif has been reported (Figure 3. 4).

¹⁶⁰ a) S. Osada, S. Sano, M. Ueyama, Y. Chuman, H. Kodama and K. Sakaguchi, *Bioorg. Med. Chem.* **2010**, *18*, 605. b) J. Kanazawa, T. Takahashi, S. Akinaga, T. Tamaoki and M. Okabe, *Anti-Cancer Drugs*, **1998**, *9*, 653.

¹⁶¹ a) R. J. Sciotti, M. Pliushchev, P. E. Wiedeman, D. Balli, R. Flamm, A. M. Nilius, K. Marsh, D. Stolarik, R. Jolly, R. Ulrich and S. W. Djuric, *Bioorg. Med. Chem. Lett.*, **2002**, *12*, 2121. b) Y. Asahina, K. Iwase, F. Iinuma, M. Hosaka and T. Ishizaki, *J. Med. Chem.*, **2005**, *48*, 3194.

¹⁶² S. Oishi, H. Kamitani, Y. Koderu, K. Watanabe, K. Kobayashi, T. Narumi, K. Tomita, H. Ohno, T. Naito, E. Kodama, M. Matsuoka and N. Fujii, *Org. Biomol. Chem.* **2009**, *7*, 2872.

¹⁶³ a) S. D. Edmondson, L. Wei, J. Xu, J. Shang, S. Xu, J. Pang, A. Chaudhary, D. C. Dean, H. He, B. Leiting, K. A. Lyons, R. A. Patel, S. B. Patel, G. Scapin, J. K. Wu, M. G. Beconi, N. A. Thornberry and A. E. Weber, *Bioorg. Med. Chem. Lett.*, **2008**, *18*, 2409. b) T. Deng, S. Shan, Z.-B. Li, Z.-W. Wu, C.-Z. Liao, B. Ko, X.-P. Lu, J. Cheng and Z.-Q. Ning, *Biol. Pharm. Bull.*, **2005**, *28*, 1192.

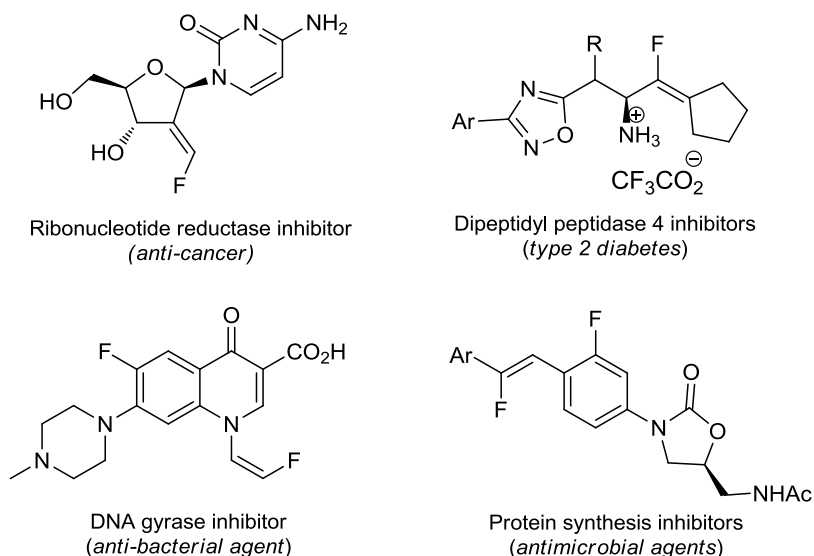

Figure 3. 4

These substrates have been also used to synthesize other interesting fluorinated derivatives. Trisubstituted monofluoroalkenes bearing either a halogen or a tributyltin group on the alkene are versatile precursors for the preparation of tri- or tetra-substituted monofluoroalkenes *via* transition metal catalyzed cross-coupling reactions. Suzuki, Negishi, Stille, Sonogashira and Heck couplings can be performed, thus giving access to a large variety of fluorinated molecules.

Suzuki cross-coupling reactions with fluorovinyl-halide derivatives were applied for the stereoselective synthesis of fluorinated analogues of insect sex pheromones,¹⁶⁴ for the preparation of fluorinated analogues of resveratrol¹⁶⁵ and for the design of conformationally restricted peptidomimetics.¹⁶⁶

Fluorinated enynes are interesting building blocks in the preparation of the fluorinated analogs of natural products. A stereospecific synthesis of these synthons was performed by Rolando and coworkers through Pd-catalyzed Sonogashira cross-coupling with 1-bromo-1-fluoroalkenes.¹⁶⁷ As an extension to

¹⁶⁴ T. Guan, M. Yoshida, D. Ota, T. Fukuhara and S. Hara, *J. Fluorine Chem.*, **2005**, 126, 1185.

¹⁶⁵ S. Eddarir, Z. Abdelhadi and C. Rolando, *Tetrahedron Lett.* **2001**, 42, 9127.

¹⁶⁶ D. R. Williams, M. W. Fultz, T. E. Christos and J. S. Carter, *Tetrahedron Lett.* **2010**, 51, 121.

¹⁶⁷ S. Eddarir, C. Francesch, H. Mestdagh and C. Rolando, *Tetrahedron Lett.* **1990**, 31, 4449.

their work on cross-coupling reaction, Hara and coworkers proposed an access to polyfunctionalized 1-fluoro-1,3-enynes,¹⁶⁸ 2-fluoro-1-iodoalkenes seemed to provide compounds (*E*)-**226** without by-products (Scheme 3. 1). Furthermore, these 2-fluoro-1-iodoalkenes were used in Pd-catalyzed Heck, Stille and carboalkoxylation reactions.¹⁶⁹

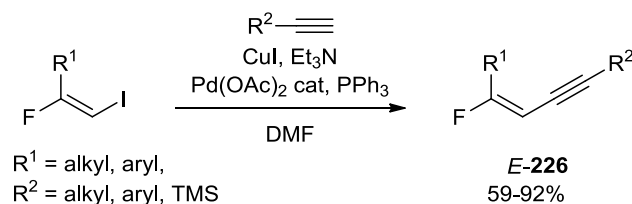

Scheme 3. 1

1-Bromo-1-fluoroalkenes **227** are also valuable starting materials for other metal-catalyzed reactions like Stille and Heck cross-couplings. The groups of McCarthy¹⁷⁰ and Burton¹⁷¹ have both developed efficient conditions for the cross-coupling reaction of β -bromo- β -fluorostyrenes with organostannanes (Scheme 3. 2). These bromofluoroalkenes can also undergo Heck reaction with methyl acrylate affording stereospecifically monofluorinated dienes, which unfortunately isomerize during silica gel purification,¹⁷² or a Pd-catalyzed carboalkoxylation leading to both (*Z*)- or (*E*)- α -fluoro- α,β -unsaturated esters (Scheme 3. 2).¹⁷³ In all these cases, the challenge remains the preparation of a single isomer of the starting alkene.

¹⁶⁸ M. Yoshida, S. Yoshikawa, T. Fukuhara, N. Yoneda and S. Hara, *Tetrahedron*, **2001**, 57, 7143.

¹⁶⁹ M. Yoshida, A. Komata and S. Hara, *Tetrahedron*, **2006**, 62, 8636.

¹⁷⁰ C. Chen, K. Wilcoxon, C. Q. Huang, N. Strack and J. R. McCarthy, *J. Fluorine Chem.*, **2000**, 101, 285.

¹⁷¹ J. Xu and D. J. Burton, *J. Org. Chem.* **2006**, 71, 3743.

¹⁷² J. Xu and D. J. Burton, *J. Fluorine Chem.* **2004**, 125, 725.

¹⁷³ J. Xu and D. J. Burton, *Org. Lett.* **2002**, 4, 831.

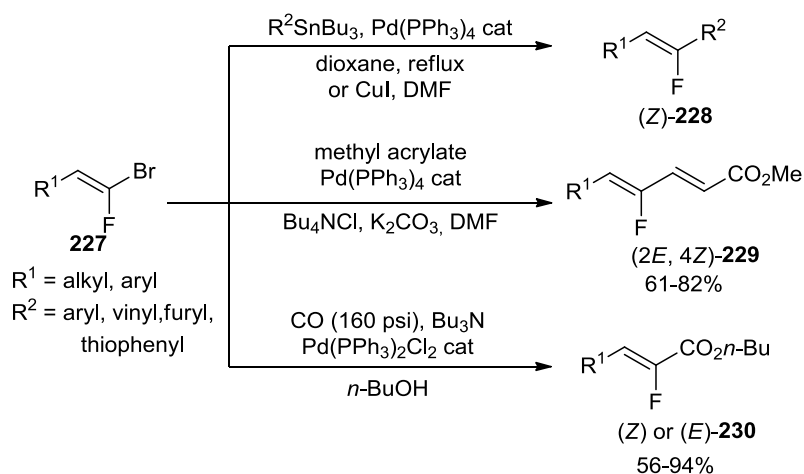

Scheme 3. 2

Fluorinated allyl building blocks are a simple way to incorporate a fluoroalkene unit on a molecule. Concerning trisubstituted fluoroalkenes, Shi and coworkers described an allylic substitution on a fluorinated palladium π -allyl complex with carbon-nucleophiles. This π -allyl complex was generated from the allylic acetate, and produced fluoroalkenes along with a small proportion of the related allylic fluoride (Scheme 3. 3).¹⁷⁴

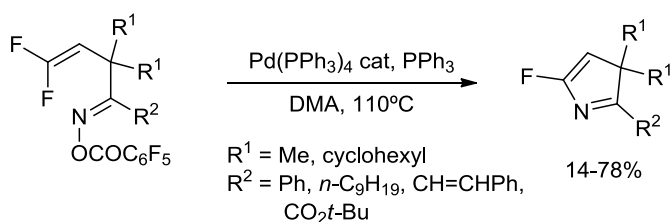

Scheme 3. 3

¹⁷⁴ G. Q. Shi, X. H. Huang and F. J. Zhang, *Tetrahedron Lett.* **1995**, *36*, 6305.

I.1. SYNTHESIS OF MONOFUORINATED OLEFINS

Monofluoroalkenes can be classified according to the substitution pattern as di-, tri- and tetra-substituted. To be efficient, their synthesis has to be stereocontrolled. The work developed in this part of the thesis focuses on trisubstituted monofluorinated olefins (Figure 3. 5).

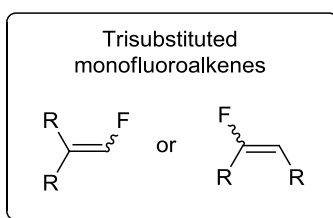

Figure 3. 5

Thus, only precedent work related to the synthesis of these compounds will be reviewed in the next paragraphs.

The first examples of trisubstituted monofluoroalkene synthesis reported by Schlosser and coworkers in 1969 applied the Wittig reaction to a ketone using a fluorinated phosphonium ylide.¹⁷⁵ The ylide was prepared from a phosphonium salt, $(\text{Ph}_3\text{PCH}_2\text{F})\text{BF}_4$ by treatment with *n*-BuLi. This remained the reactant of choice nowadays for the synthesis of terminal trisubstituted fluoroalkenes (Scheme 3. 4).¹⁷⁶

¹⁷⁵ a) M. Schlosser; M. Zimmermann, *Synthesis*, **1969**, 75. b) M. Schlosser; K. F. Christmann, *Synthesis*, **1969**, 38.

¹⁷⁶ a) Z. Du; M. J. Haglund; L. A. Pratt; K. L. Erickson, *J. Org. Chem.*, **1998**, 63, 8880. b) E. Roversi, R. Scopelliti; E. Solari; R. Estoppey; P. Vogel; P. Brana; B. Menendez ; J. A. Sordo, *Chem. Eur. J.*, **2002**, 8, 1336.

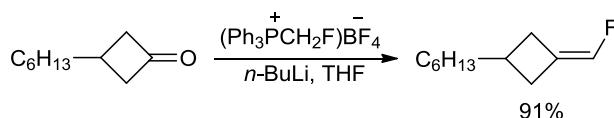

Scheme 3. 4

Zinc-promoted Wittig reactions starting from a fluorinated phosphonium salt have also been reported.¹⁷⁷ Conventional Wittig reactions as the one reported by Scholsser, where the phosphonium salt is deprotonated prior to reacting with the carbonyl compound have been used to synthesize vinyl fluoroacrylates from α,β -unsaturated aldehydes.^{178,179} As shown in Scheme 3. 5, reaction of ethyl 2-*E*-2-hexadecenoate with the fluorinated phosphonium salt and *n*-BuLi at 0°C afforded a *Z/E* mixture of the fluorinated alkene.

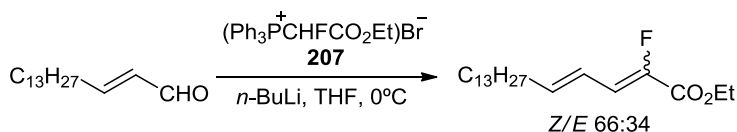

Scheme 3. 5

Suzuki and coworkers showed that electrophilic fluorination of a phosphonium ylide derived from bromoacetate was an alternative strategy for the synthesis of 3-alkyl or aryl substituted ethyl 2-fluoro acrylates, thus avoiding the use of expensive bromofluoroacetate which was necessary to synthesize the fluorinated phosphonium salt **207**. The crude salt resulting in the treatment of ethyl bromo acetate with triphenyl phosphine was deprotonated with NaH and further treated with Selectfluor[®]. In a one pot procedure, the ylide formed was added to the aldehydes producing the monofluoroalkenes although with moderate overall yields (Scheme 3. 6).¹⁸⁰ In most cases, fluoroacrylates were produced with

¹⁷⁷ D. J. Burton, Z. Y. Yang and W. M. Qiu, *Chem. Rev.*, **1996**, *96*, 1641.

¹⁷⁸ For the first reference to this method, see: A. Thenappan and D. J. Burton, *Tetrahedron Lett.*, **1989**, *30*, 3641.

¹⁷⁹ For recent applications, see: a) N. Fishkin, R. Yefidoff, D. R. Gollipalli and R. R. Rando, *Bioorg. Med. Chem.*, **2005**, *13*, 5189; b) G. S. Nikolova and G. Haufe, *Synthesis*, **2008**, 527.

¹⁸⁰ Y. Suzuki and M. Sato, *Tetrahedron Lett.*, **2004**, *45*, 1679.

moderate *Z*-selectivities, unlike other fluoroalkenes synthesized by the Wittig reaction, which are generally known to give *E/Z* ratios near unity.¹⁸¹

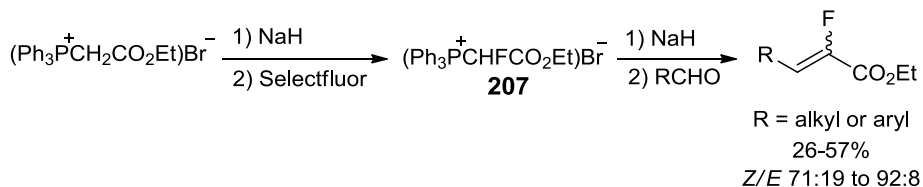

Scheme 3. 6

The Horner–Wadsworth–Emmons (HWE) reaction was also applied to the synthesis of monofluoroalkenes. Thus fluorinated phosphonate **208** was reacted in the presence of *n*-BuLi with carbonyl compounds to generate fluoroacrylates. In this paper, no stereochemistry was reported.¹⁸² In 1985, Moghadam and coworkers noticed that *Z/E* selectivity of similar reactions was temperature dependent (Scheme 3. 7).¹⁸³ Generally, the carbonyl compound had to be added at -78°C to achieve good *E*-selectivity. Some bulky substrates such as myrtenal did not react at -78°C , but surprisingly gave the *E*-isomer exclusively at higher temperatures.

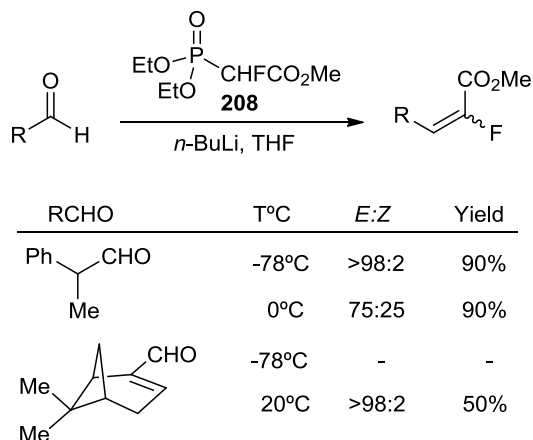

Scheme 3. 7

¹⁸¹ D. J. Burton, Z. Y. Yang and W. M. Qiu, *Chem. Rev.*, **1996**, 96, 1641.

¹⁸² H. Machleidt and R. Wessendorf, *Justus Liebigs Ann. Chem.*, **1964**, 674, 1.

¹⁸³ G. E. Moghadam and J. S. Penne, *Bull. Soc. Chim. Fr.*, **1985**, 448.

Synthesis of α -fluoro- α,β -unsaturated sulfones (fluorovinyl sulfones) by the HWE reaction was first carried out by Koizumi and coworkers in 1987 (Scheme 3. 8).¹⁸⁴ Aldehydes could be converted to fluorovinyl sulfones with *E/Z* selectivities ranging from ~50:50 to ~98:2. Reactions of aliphatic aldehydes were less selective.¹⁸⁵

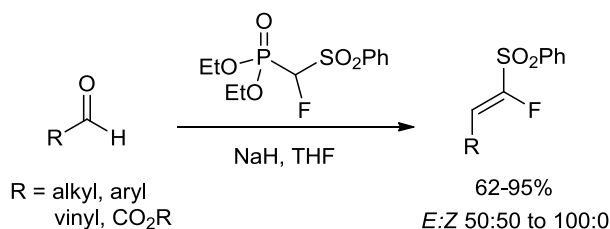

Scheme 3. 8

Aldehydes can be converted into trisubstituted fluoroacrylonitriles using a fluorinated cyanophosphonate. Reaction of the phosphonate anion **209**, prepared from fluoroacetonitrile and LHMDS, with aromatic aldehydes led to fluoroacrylonitriles in yields ranging from 45 to 82% and variable selectivities (Scheme 3. 9).¹⁸⁶

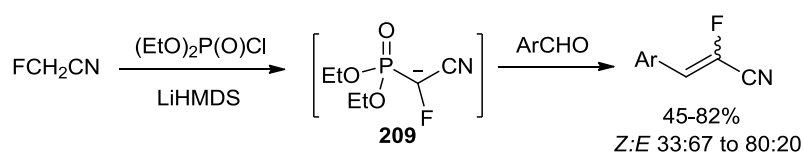

Scheme 3. 9

In 2003, Lequeux, Pazenok and coworkers described the synthesis of monofluoroalkenes derivatives using the Julia's procedure from 2-(1-fluoroethyl)

¹⁸⁴ T. Koizumi, T. Hagi, Y. Horie and Y. Takeuchi, *Chem. Pharm. Bull.*, **1987**, *35*, 3959.

¹⁸⁵ For recent examples, see: a) F. Tellier and R. Sauvêtre, *J. Fluorine Chem.*, **1996**, *76*, 181.; b) Z. Wang, A. Gonzalez and S. F. Wnuk, *Tetrahedron Lett.*, **2005**, *46*, 5313; c) D. Andrei and S. F. Wnuk, *J. Org. Chem.*, **2006**, *71*, 405; d) S. F. Wnuk, P. R. Sacasa, E. Lewandowska, D. Andrei, S. Cai and R. T. Borchardt, *Bioorg. Med. Chem.*, **2008**, *16*, 5424.

¹⁸⁶ a) E. Baader, W. Bartmann, G. Beck, P. Below, A. Bergmann, H. Jendralla, K. Keßeler and G. Wess, *Tetrahedron Lett.*, **1989**, *30*, 5115. b) T. B. Patrick and S. Nadji, *J. Fluorine Chem.*, **1990**, *49*, 147.

sulfonyl-1,3-benzothiazole **210** and aldehydes. This method allowed for the formation of tri- and tetra-substituted monofluoroalkenes with moderate to good yields, although poor *Z/E* selectivities (Scheme 3. 10).¹⁸⁷

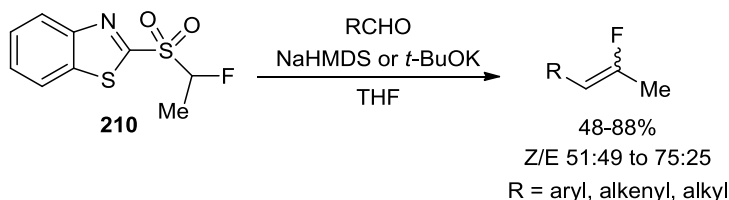

Scheme 3. 10

The use of 1-*tert*-butyl-1*H*-tetrazol-5-yl fluoromethylsulfone (**211**) as a reagent for the Julia–Kocienski fluoroolefination was recently reported by Hu and coworkers.¹⁸⁸ Terminal monofluoroalkenes were synthesized by reacting **211** with ketones, giving rise to the corresponding trisubstituted monofluoroalkenes in moderate to good yields, but again with poor to moderate *Z/E* selectivities (Scheme 3. 11).

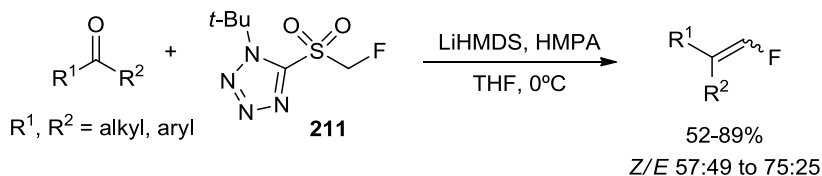

Scheme 3. 11

In 2009, Zajc and coworkers developed a synthesis of α -fluorovinyl Weinreb amides using fluorine bearing benzothiazolyl (BT) derived sulfone **212**.¹⁸⁹ Using sodium hydride in THF at room temperature allowed for a *Z*-selective condensation of the benzothiazolyl derived sulfones with aldehydes (Scheme 3. 12). The *Z*-fluoro

¹⁸⁷ D. Chevie, T. Lequeux, J. P. Demoute and S. Pazenok, *Tetrahedron Lett.*, **2003**, 44, 8127.

¹⁸⁸ L. G. Zhu, C. F. Ni, Y. C. Zhao and J. B. Hu, *Tetrahedron*, **2010**, 66, 5089.

¹⁸⁹ A. K. Ghosh, S. Banerjee, S. Sinha, S. B. Kang and B. Zajc, *J. Org. Chem.*, **2009**, 74, 3689.

Weinreb amide alkene resulted in excellent diastereoselectivity. The fluoro sulfones **213** bearing a ketone were also prepared and condensed with various aldehydes in presence of DBU to yield α -fluoroenones in good to excellent yields with complete selectivity for the *Z* isomer. The same research group also reported the synthesis of α -fluoroacrylonitriles using the nitrile bearing BT-sulfone **214**. The products were obtained under mild reaction conditions in generally excellent yields with aliphatic, aromatic, heteroaromatic, and unsaturated aldehydes, with a preference for the formation of (*Z*)- α -fluoroacrylonitriles (Scheme 3. 12).¹⁹⁰

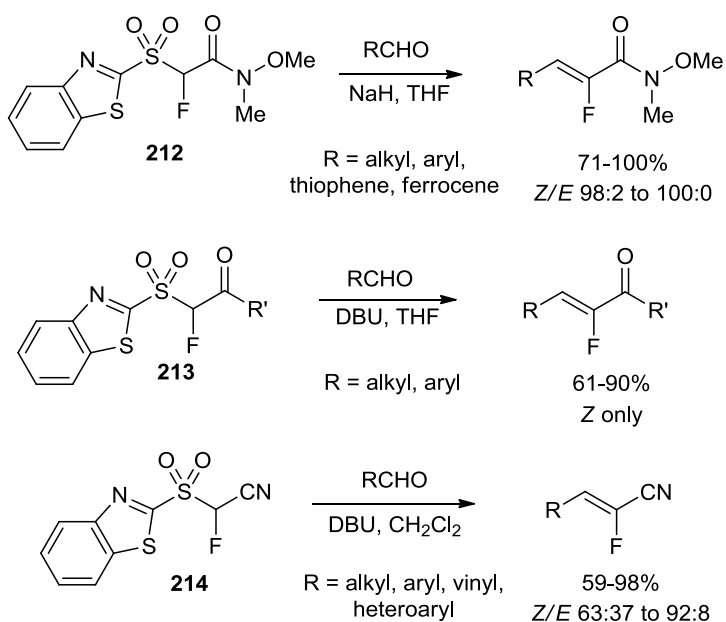

Scheme 3. 12

The first Peterson olefination was reported by Welch and Herbert in 1990 to synthesize fluoroacrylate.¹⁹¹ *Tert*-butyl α -fluoro- α -(trialkylsilyl)-acetate **215** was presented as a readily available reagent to synthesize monofluoro acrylate derivatives by reaction with aldehydes in the presence of bases such as LDA/^{*t*}BuOK

¹⁹⁰ M. del Solar, A. K. Ghosh and B. Zajc, *J. Org. Chem.*, **2008**, *73*, 8206.

¹⁹¹ J. T. Welch and R. W. Herbert, *J. Org. Chem.*, **1990**, *55*, 4782.

or NaHMDS.¹⁹² The resulting α -fluoroacrylates were obtained in moderate to good, Z/E ratios ranging from 58:42 to Z only (Scheme 3. 13).

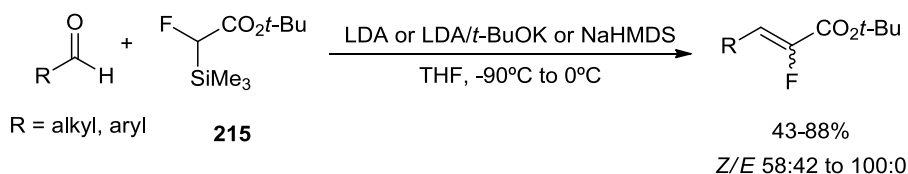

Scheme 3. 13

The yields and selectivities for the synthesis of fluoroacrylates and fluoro vinyl sulfones using Peterson olefination were similar to those using a Horner–Wadsworth–Emmons reaction, which is still the preferred olefination method for these fluoroalkenes.

Apart from the olefination strategies to synthesize monofluorinated trisubstituted olefins from aldehydes, aldol-like approaches have also been reported. Thus a Mukaiyama's reaction with the silyl enolate **216** derived from ethyl fluoroacetate, easily prepared using LDA and TMSCl, reacted with aromatic aldehydes and aliphatic aldehydes (Scheme 3. 14) leading to the exclusive formation Z-fluoroacrylates in most cases.¹⁹³ The yields obtained from aromatic aldehydes were higher than those from the aliphatic ones.

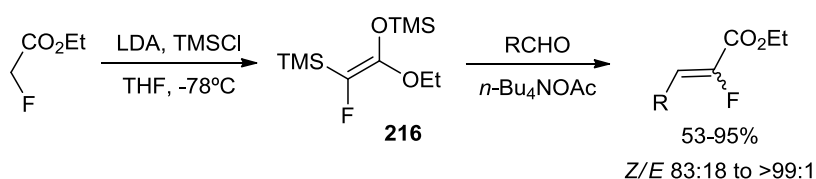

Scheme 3. 14

¹⁹² J. Lin and J. T. Welch, *Tetrahedron Lett.*, **1998**, 39, 9613.

¹⁹³ M. Michida and T. Mukaiyama, *Chem. Lett.*, **2008**, 37, 890.

Recently, Hu and coworkers described the reaction of anions derived from sulfoximines with aldehyde equivalents such as nitrones through an addition-elimination mechanism to give trisubstituted monofluorinated olefins (Scheme 3 15). This reaction was advantageous since the elimination of the sulfur and nitrogen moieties takes place directly to afford aryl-substituted fluoroalkenes without further manipulation. The driving force of this direct process the elimination of sulfonamide and nitrous benzene. However, the preparation of the sulfoximines and nitrones required several steps.¹⁹⁴

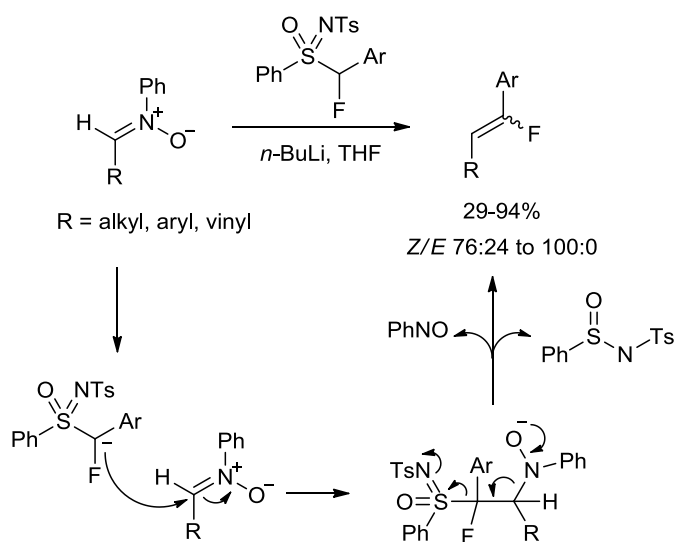

Scheme 3 15

The use of fluorinated selenides has also been reported for the synthesis of trisubstituted monofluoroalkenes. Thus, Fuchigami and coworkers in 1992 carried out an oxidative deselenenylation by reaction of a fluorinated selenide with H₂O₂ as shown in Scheme 3. 16.¹⁹⁵

¹⁹⁴ W. Zhang, W. Huang and J. Hu, *Angew. Chem., Int. Ed.*, **2009**, *48*, 9858.

¹⁹⁵ T. Fuchigami, T. Hayashi and A. Konno, *Tetrahedron Lett.* **1992**, *33*, 3161.

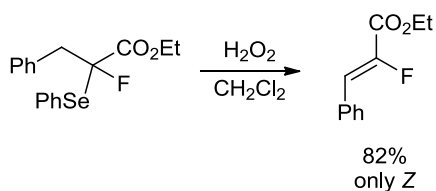

Scheme 3. 16

The preparation of α -fluoro- α,β -unsaturated ketones and esters was also achieved by reaction of α -diazoketones and α -diazoesters **217** with phenylselenyl bromide in the presence of AgF followed by oxidative deselenylation. The reaction occurred through the formation of phenylselenyl fluoride equivalent (Scheme 3. 17).¹⁹⁶ The “*in situ*” prepared “PhSeF” reacted with α -diazocarbonyl compounds to form the intermediate **218**, which could not be isolated but was oxidized to produce only the Z-fluoroalkenes in reasonable to good yields.

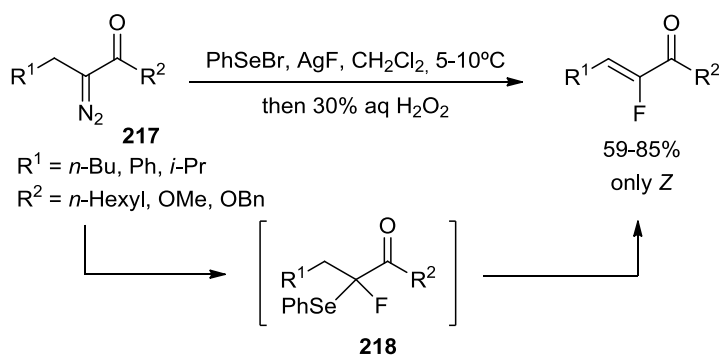

Scheme 3. 17

In 1991, Allmendinger developed an approach to the monofluorinated olefins based on the alkylation of ethyl phenylsulfinyl fluoroacetates anions **219** by

¹⁹⁶ Y. Usuki, M. Iwaoka and S. Tomoda, *J. Chem. Soc., Chem. Commun.*, **1992**, 1148.

alkyl halides followed by pyrolytic elimination of the sulfoxide. This led to the stereoselective formation of Z-monofluoroalkenoates (Scheme 3. 18).¹⁹⁷

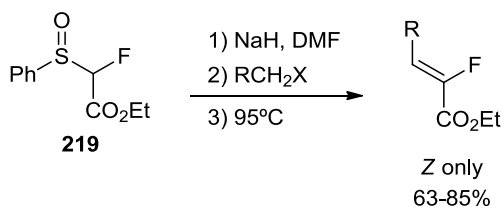

Scheme 3. 18

Olah, Prakash and coworkers reported in 2009 an efficient one-pot stereospecific synthesis of fluorovinyl sulfones (Scheme 3. 19).¹⁹⁸ Nucleophilic monofluoromethylation of benzyl/alkyl and propargyl halides using α -fluoro bisphenylsulfonyl methane **219** or other activated esters or ketones was carried out in the presence of cesium carbonate in acetonitrile. Monofluoromethylation followed by subsequent E1cb elimination occurred to furnish only the trisubstituted fluoroalkenes in moderate to good yields. The reaction was highly stereoselective with numerous benzyl halides. Nevertheless, the presence of the other isomer was observed with allylic or propargylic halides. The replacement of the sulfone moiety with hydrogen by reductive desulfonation¹⁹⁹ could be envisioned to access to corresponding terminal monofluoroalkenes.

¹⁹⁷ T. Allmendinger, *Tetrahedron*, **1991**, *47*, 4905.

¹⁹⁸ G. K. S. Prakash, S. Chacko, H. Vaghoo, N. Shao, L. Gurung, T. Mathew and G. A. Olah, *Org. Lett.*, **2009**, *11*, 1127.

¹⁹⁹ C. Na'jera and M. Yus, *Tetrahedron*, **1999**, *55*, 10547.

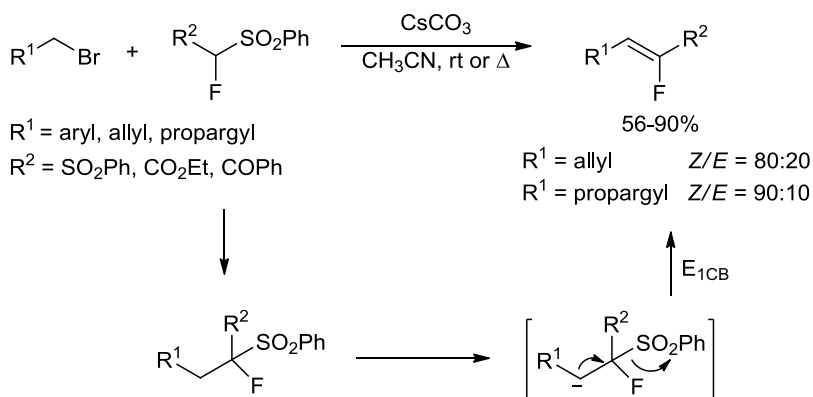

Scheme 3. 19

The preparation of fluorolactones could be achieved by treatment of sulfoxide **220** (Scheme 3. 20)²⁰⁰ or sulfide **221** (Scheme 3. 20)²⁰¹ with an electrophilic fluorine source (Selectfluor^{®200} or *p*-iodotoluene difluoride²⁰¹) and consecutive thermolysis causing an *syn*-pyrolytic elimination of the sulfoxide, generated in the case of the sulfide by oxidation.

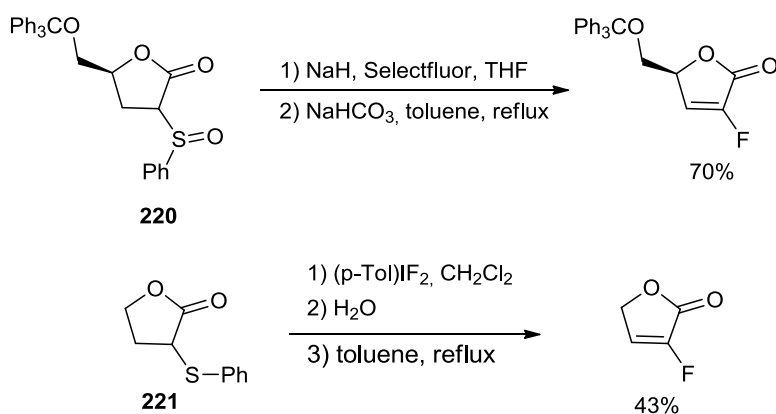

Scheme 3. 20

²⁰⁰ J. C. Caille, H. Miel, P. Armstrong and M. A. McKerver, *Tetrahedron Lett.* **2004**, 45, 863.

²⁰¹ W. B. Motherwell, M. F. Greaney and D. A. Tocher, *J. Chem. Soc., Perkin Trans. 1*, **2002**, 2809.

The *anti*-addition of a halide and a fluorine atom to a C–C double bond (bromofluorination as well as iodofluorination) and subsequent base-initiated elimination of hydrogen halide, is a method widely used for the preparation of trisubstituted fluoroalkenes. The stereoselectivity of the double bond formation can be controlled starting from appropriate isomer of alkene. Thus, single isomers of 1-fluoro-1-phenyl-1-propen could be prepared in moderate yields (for the two steps) by halofluorination-dehydrohalogenation of *Z* or *E* propenylbenzene (Scheme 3. 21).²⁰²

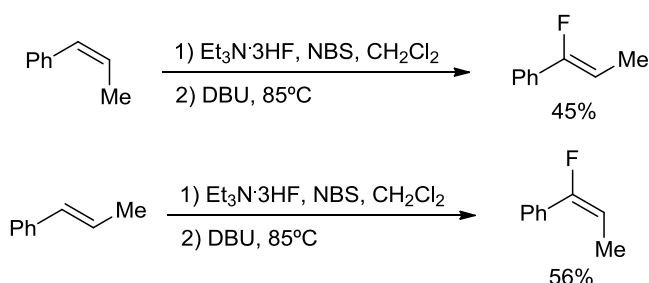

Scheme 3. 21

Fluorohydrins can also be used to prepare trisubstituted monofluoroalkenes. The hydroxy group had to be acetylated with acetic anhydride²⁰³ or activated with trifluoromethane-sulfonic anhydride,²⁰⁴ previous to the β -elimination to give the monofluoroalkenes. Dehydrofluorination in *gem*-difluoro compounds is also an alternative.²⁰⁵

Fluorinating reagents such as Deoxofluor,²⁰⁶ DAST²⁰⁷ (Figure 3.) and their derivatives²⁰⁸ are very effective for converting alcohols, ketones, aldehydes and carboxylic acids into their corresponding mono or difluorinated derivatives.

²⁰² O. A. Wong and Y. A. Shi, *J. Org. Chem.*, **2009**, *74*, 8377.

²⁰³ a) M.-J. Egron, D. Komiotis, I. Dorange, J. Herscovici, A. Ollapally and K. Antonakis, *Nucleosides, Nucleotides Nucleic Acids*, **2005**, *24*, 243. b) S. Manta, G. Agelis, T. Botic, A. Cencic and D. Komiotis, *Bioorg. Med. Chem.*, **2007**, *15*, 980.

²⁰⁴ C. J. Woltermann, Y. A. Lapin, K. B. Kunnen, D. R. Tueting and I. H. Sanchez, *Tetrahedron*, **2004**, *60*, 3445.

²⁰⁵ a) X.-L. Qiu, W.-D. Meng and F.-L. Qing, *Tetrahedron*, **2004**, *60*, 5201. b) J. Wang, Y. Jin, K. L. Rapp, R. F. Schinazi and C. K. Chu, *J. Med. Chem.*, **2007**, *50*, 1828. c) X. L. Qiu, X. H. Xu and F. L. Qing, *Tetrahedron*, **2010**, *66*, 789.

²⁰⁶ G. S. Lal, G. P. Pez, R. J. Pesaresi, F. M. Prozonc and H. S. Cheng, *J. Org. Chem.*, **1999**, *64*, 7048.

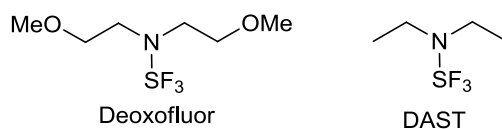
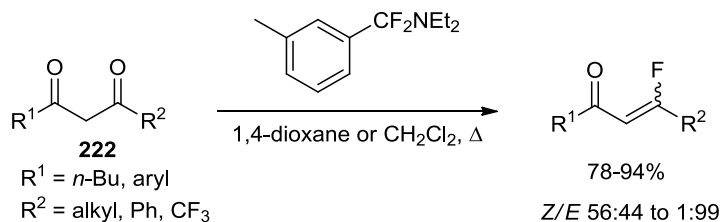

Figure 3. 5

Hara and coworkers described the deoxofluorination reaction of β -diketones such as **222** with N,N-dimethyl- α,α -difluoro-m-methylbenzylamine (DFMBA) giving β -fluoro- α,β -unsaturated ketones in good yields (Scheme 3. 22).²⁰⁹ In most cases, poor stereoselectivity was observed (except when $R^2 = t\text{-Bu}$, $Z/E = 99:1$) but only one regioisomer was obtained from the unsymmetrical β -diketones.



Scheme 3. 22

A strategy based on this was applied by Sarek and coworkers to the synthesis of the steroid trisubstituted fluoroalkene **223** en route to fluorinated derivatives of Betulinine using the enol ketone and DAST (Figure 3. 7).²¹⁰

²⁰⁷ W. J. Middleton, *J. Org. Chem.*, **1975**, *40*, 574.

²⁰⁸ A. L'Heureux, F. Beaulieu, C. Bennett, D. R. Bill, S. Clayton, F. LaFlamme, M. Mirmehrabi, S. Tadayon, D. Tovell and M. Couturier, *J. Org. Chem.*, **2010**, *75*, 3401.

²⁰⁹ K. Sano, T. Fukuhara and S. Hara, *J. Fluorine Chem.*, **2009**, *130*, 708.

²¹⁰ D. Biedermann, J. Sarek, J. Klinot, M. Hajduch and P. Dzubak, *Synthesis*, **2005**, 1157.

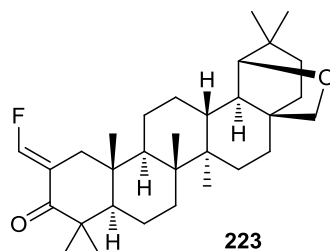
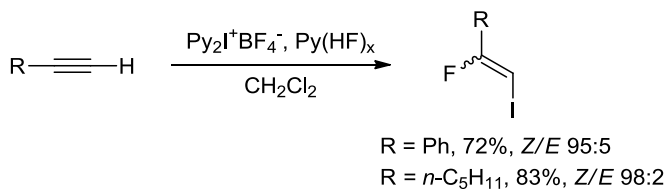

Figure 3. 7

Alkynes could also be transformed into fluorovinyl halides. Rolando and coworkers²¹¹ described an iodofluorination of a terminal alkyne using bis(pyridine)-iodonium tetrafluoroborate²¹² and pyridinium poly (hydrogen fluoride) (Scheme 3. 23).



Scheme 3. 23

In 2007, a gold (I) fluoride complex catalyzed hydrofluorination of alkynes has been reported by Sadighi and coworkers²¹³ in the presence of Et₃N·3HF (Scheme 3. 24). (*Z*)-Fluoroalkene **224** was thus synthesized in 82% yield as only product, but the regioselectivity of this reaction was sometimes none controlled.

²¹¹ S. Eddarir, C. Francesch, H. Mestdagh and C. Rolando, *Bull. Soc. Chim. Fr.*, **1997**, 134, 741.

²¹² J. M. Chalker, C. S. C. Wood and B. G. Davis, *J. Am. Chem. Soc.*, **2009**, 131, 16346.

²¹³ J. A. Akana, K. X. Bhattacharyya, P. Mueller and J. P. Sadighi, *J. Am. Chem. Soc.*, **2007**, 129, 7736.

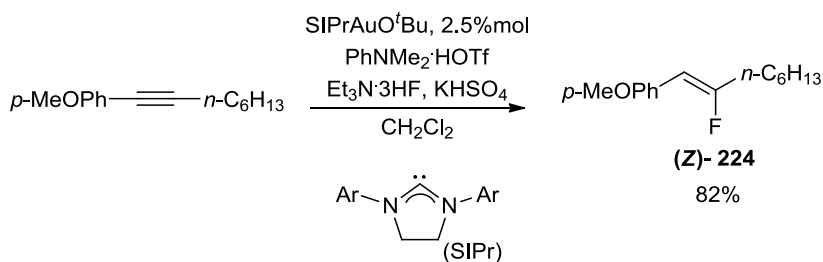

Scheme 3. 24

A recent publication on the fluorination of boronic acid species using stoichiometric amounts of Selectfluor[®] and AgOTf showed some examples of fluoroalkene synthesis. 1-Fluorocyclohexene was synthesized in 65% yield from the corresponding vinylboronic acid (Scheme 3. 25).²¹⁴

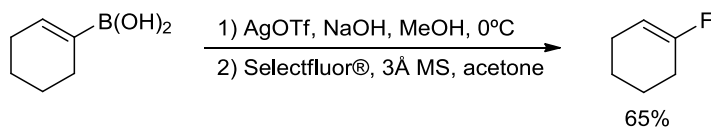

Scheme 3. 25

In 2009, Jiang and Shi and Ji and coworkers independently reported the synthesis of fluoroalkenes *via* the opening of methylene and vinylidene cyclopropanes using NFSI (Scheme 3. 26).^{215,216} Yields and selectivities for the two trisubstituted fluoroalkenes derived from methylene cyclopropanes were very similar in both cases (77–93%, *E:Z* = 80:20 and >98:2).

²¹⁴ T. Furuya and T. Ritter, *Org. Lett.*, **2009**, *11*, 2860.

²¹⁵ M. Jiang and M. Shi, *Tetrahedron*, **2009**, *65*, 5222.

²¹⁶ W. Fu, G. Zou, M. Zhu, D. Hong, D. Deng, C. Xun and B. Ji, *J. Fluorine Chem.*, **2009**, *130*, 996.

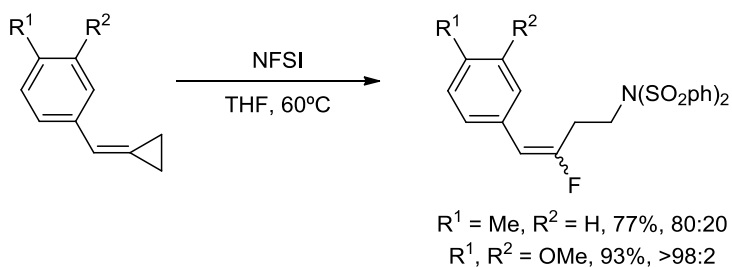

Scheme 3. 26

Gouverneur and coworkers described in 2005, a fluorodesilylation reaction of allenylmethylsilanes **231** with Selectfluor[®] which provided 2-fluoro-1,3-dienes **232** (Scheme 3. 27). The reaction is proposed to proceed through the fluorination at the central carbon of the allene moiety to generate a fluoroallyl cation, followed by the elimination of the silyl group to form the diene. Moderate selectivities (*E:Z* from 66 : 34 to 75:25) and variable yields (11–89%) were obtained.²¹⁷

²¹⁷ M. C. Pacheco and V. Gouverneur, *Org. Lett.*, **2005**, *7*, 1267.

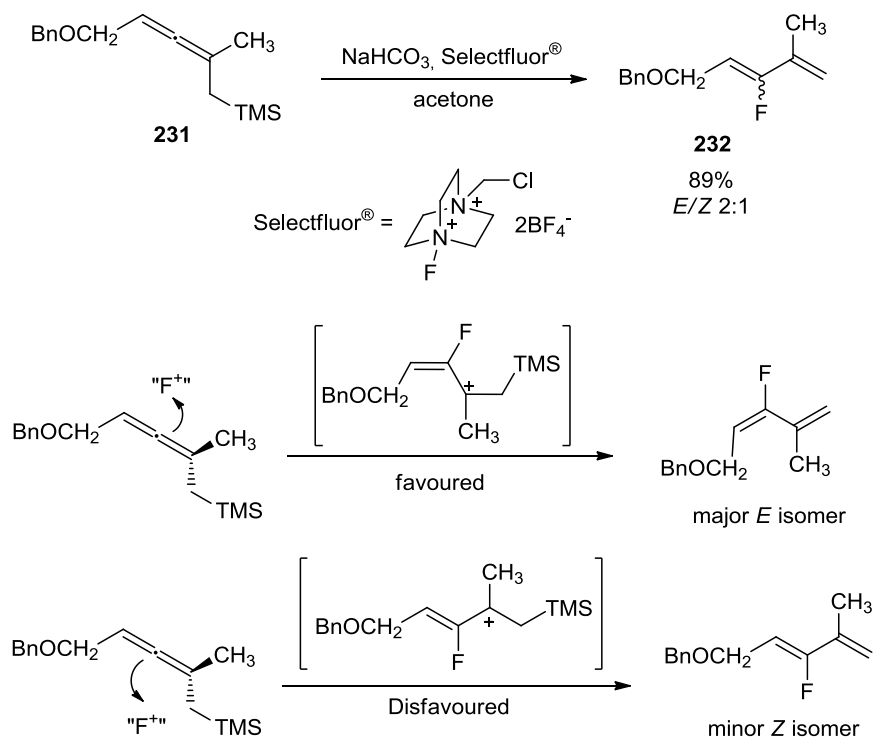

Scheme 3. 27

I.3. REFORMATSKY TYPE REACTIONS WITH β -KETO SULFOXIDES

Reformatsky's reactions have been recognized as among the most useful methods for the formation of carbon–carbon bonds, becoming a valuable tool in modern organic synthesis with great versatility in numerous inter- and intramolecular processes involving a great variety of electrophiles. As such, this methodology is considered a useful alternative to base-induced aldol reactions or, at the least, an important complement to other enolate reactions.

In general, the Reformatsky reaction is based on the use of an enolate generated by oxidative addition of a metal or a low-valent metal salt or complex to a carbon–halogen bond (or carbon–leaving group bond) activated by a vicinal carbonyl derived group, followed by a reaction of the enolate thus formed with an appropriate electrophile (Scheme 3. 28).²¹⁸

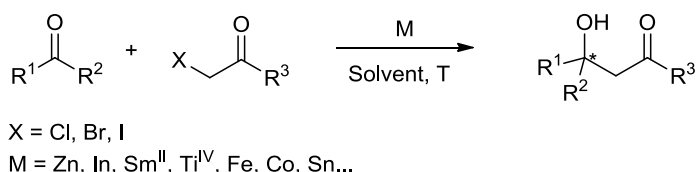

Scheme 3. 28

One of the advantages of the Reformatsky reaction is that it proceeds under neutral conditions, in contrast to the aldol reaction which, in general, requires a base to generate the enolate or an acid to activate the electrophile.

Our research group has recently developed a new asymmetric Reformatsky-type reaction using the sulfoxide as source of chirality. The α -bromo- α' -sulfinyl ketones bearing enantiopures sulfoxides react with aldehydes in presence of SmI_2

²¹⁸ Reviews: a) Gaudemar, M. *Organomet. Chem. Rev., Sect. A* **1972**, *8*, 183. b) Fürstner, A. *Synthesis* **1989**, 571. c) Ender, E. *Tetrahedron* **1992**, *48*, 9577. d) Fürstner, A. *Organozinc Reagents* **1999**, 287. e) Orsini, F.; Sello, G. *Curr. Org. Synth.* **2004**, *1*, 111. f) Ocampo, R.; Dolbier Jr., W. R. *Tetrahedron* **2004**, *60*, 9325. g) Ribeiro, C. M. R.; Cordeiro de Farias, F.M. *Mini-Reviews in Organic Chemistry* **2006**, *3*, 1. h) Cozzi, P. G. *Angew. Chem. Int. Ed.* **2007**, *46*, 2568. i) Cozzi, P. G. *Pure and Appl. Chem.* **2008**, *80*, 891.

leading to the Reformatsky product in good yields and selectivities (Scheme 3. 29).¹⁵

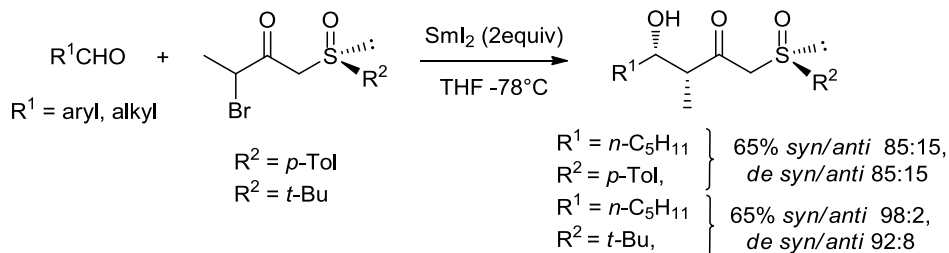

Scheme 3. 29

Following the method described by P. Bravo,⁵⁸ the preparation of the γ -bromo- β -keto sulfoxide was carried out by condensation of the lithium anion derived from the corresponding sulfoxide with the commercially available 2-bromo-2-methyl propionate (Scheme 3. 30).

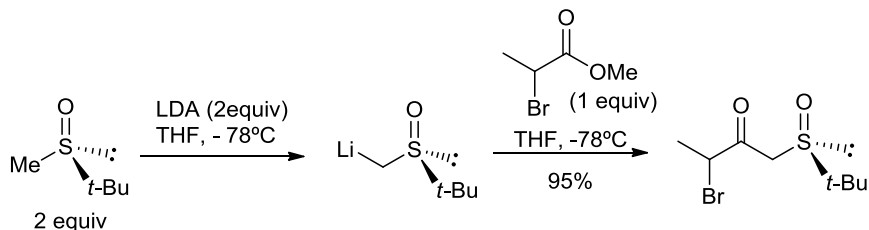

Scheme 3. 30

¹⁵ a) Obringer, M.; Colobert, F.; Solladie', G. *Eur. J. Org. Chem.* **2006**, 1455-1467. b) Obringer, M.; Colobert, F.; Neugnot, B.; Solladie', G. *Org. Lett.* **2003**, *5*, 629-632. c) F. Colobert, S. Choppin, L. Ferreiro-Mederos, M. Obringer, S. Luengo-Arratta, A. Urbano, M. C. Carreño, *Org. Lett.* **2007**, *9*, 4451-4454.

⁵⁸ Bravo, P.; Resnati, G. *Tetrahedron Lett.* **1985**, *26*, 5601.

This methodology has been applied to the synthesis of natural products such as C15-C26 fragment of (-)-Dictyostatine (Figure 3. 6).²¹⁹

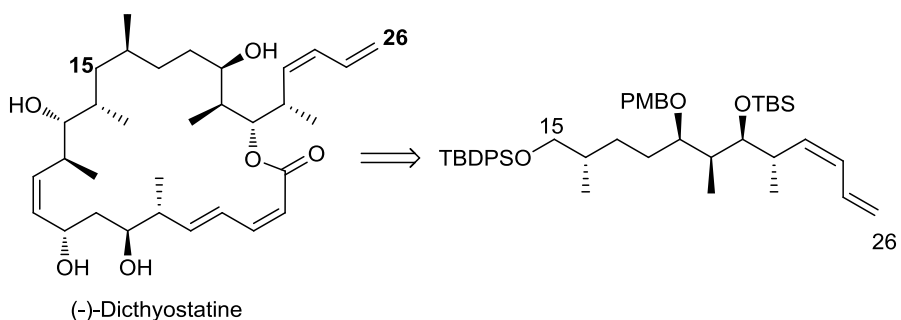
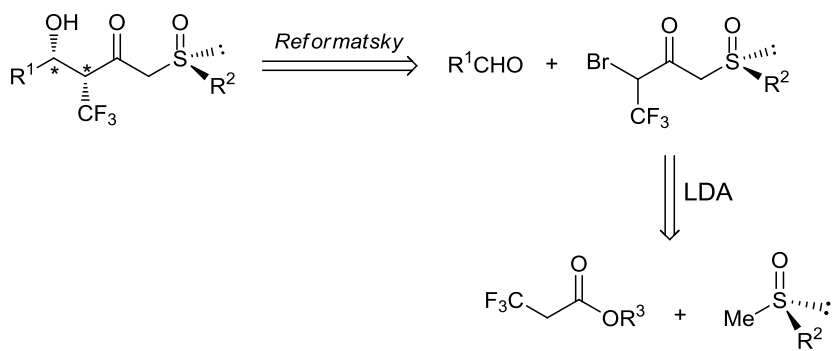

Figure 3. 6

In order to extend the scope of the asymmetric Reformatsky-type reaction developed in our group to the synthesis of fluorinated compounds, we thought of introducing of a trifluoromethyl moiety in a β -keto sulfoxide to further exploit the resulting substrates in synthesis. Out of the diversity of fluorinated intermediates, α -trifluoromethyl- β -hydroxy carboxylic acid derivatives are recognized as one of the most valuable synthetic intermediates in view of the extensive studies on the nonfluorinated analogues.

²¹⁹ L. Ferreiro-Mederos, S. Vila-Gisbert, A. Urbano, M.C. Carreño, F. Colobert, *Org. Biom. Chem.* **2011**, DOI:10.1039/C0OB00491J.

The preparation of γ -bromo- γ -trifluoromethyl- β -keto sulfoxide needed to carry out a Reformatsky-type reaction was proposed by condensation of the lithium anion derived from the sulfoxide with the α -trifluoromethyl ester as shown in Scheme 3. 31.



Scheme 3. 31

II. RESULTS AND DISCUSSION

II.1. Synthesis of (*SR*, *E* and *Z*)-methyl 3-fluoro-4-(*p*-tolylsulfinyl) but-2-enoate

To apply the retrosynthesis proposed, the addition of the lithium anion resulting in the treatment of the (*SR*)-methyl *p*-tolyl sulfoxide **46** with LDA in THF at -78°C to the commercially available methyl-3,3,3-trifluoropropionate **233** was effected. The expected $\gamma\text{-CF}_3\text{-}\beta\text{-keto}$ sulfoxide **234** was not even detected. After 3 hours, the mixture was hydrolyzed and purified. The final product was identified as the (*SR*, *E* and *Z*)-methyl 3-fluoro-4-(*p*-tolylsulfinyl) but-2-enoate **235**, it was isolated pure in 75% yield (Scheme 3. 32). This yield resulted from the use of 2 equivalents of methyl *p*-tolyl sulfoxide and 2 equivalents of LDA, since when 1 equivalent of the sulfoxide and 2 equivalents of LDA were used the yield of the final product dropped significantly.

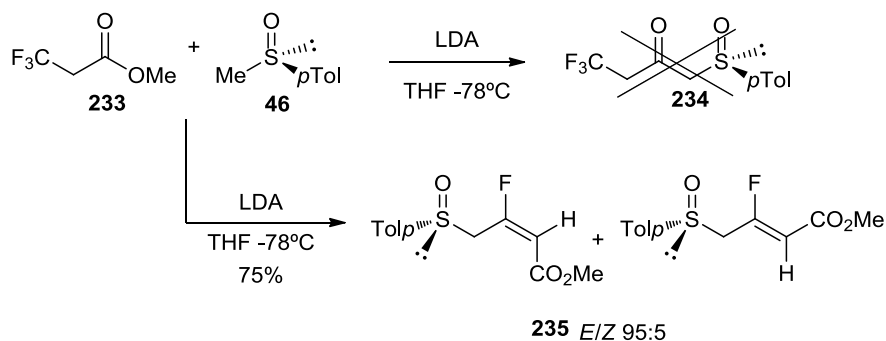

Scheme 3. 32

^1H NMR and ^{19}F NMR analysis of the product showed a 95:5 ratio of two alkene isomers. The ^1H NMR spectra allowed to determine that the major product had a coupling constant of $J_{\text{H-F}} = 17.5$ Hz and was thus assigned to the *E* isomer where the fluor atom and the olefinic proton are in the same face of the double bond. The minor isomer was characterized as the *Z* isomer where the $J_{\text{H-F}} = 32$ Hz as shown in Figure 3. 7. It was possible to separate them by recrystallization in

ether/hexane and the absolute configuration of the major isomer, (*SR-E*)-**235a** could be unequivocally established by X-ray diffraction (Figure 3. 8).

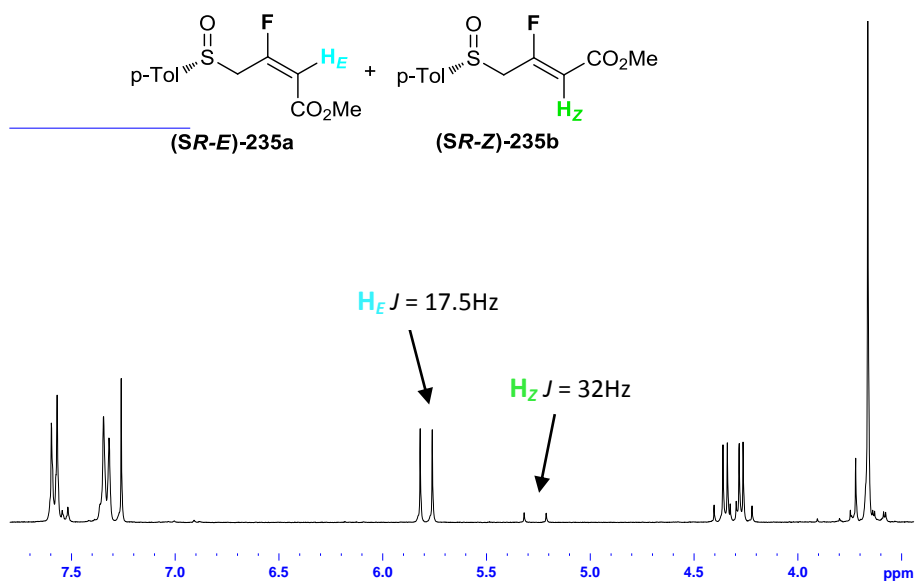

Figure 3. 7

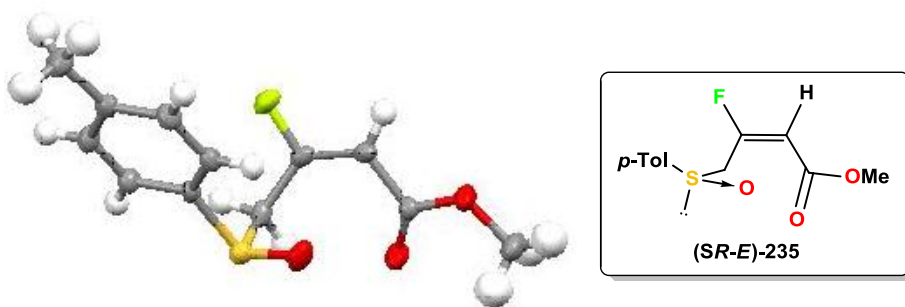
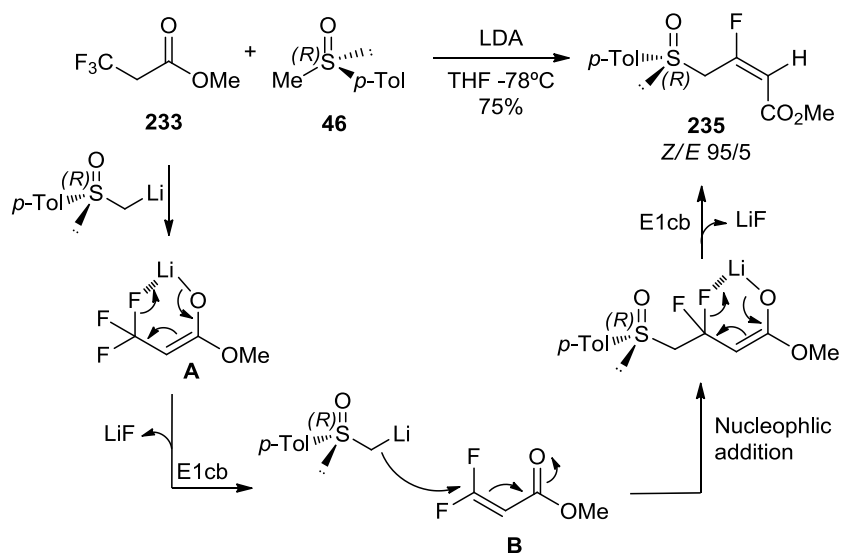

Figure 3. 8

A possible mechanistic pathway explaining the formation of (*SR,E*)-**235b** is indicated in Scheme 3. 33.



Scheme 3. 33

Thus in a first step, the lithium anion derived from the methyl-*p*-tolyl sulfoxide would act as a base taking a proton from the acidic CH₂ group of the methyl 3,3,3-trifluoropropionate. The resulting enolate **A** must evolve through a E1cb elimination process to the formation of methyl 3,3-*gem*difluoro propenoate **B**. A new equivalent of the lithium anion derived from the methyl-*p*-tolyl sulfoxide acting as a nucleophile could add in a conjugate manner, to the α,β -unsaturated ester, which through a new E1cb reaction could lose a fluorine atom to give the final monofluorinated alkene **235**.

Although we did not expect the formation of this monofluorinated olefin, the interest of the highly selective formation of (*SR,E*)-**235b** prompted us to investigate different carbanions such as those derived from CH₃SOt-Bu, CH₃NO₂, NO₂CH₂CO₂Et, CH₃CN, EtOAc, dimethyl malonate and dimethyl succinate as well as other organometallic species with basic and nucleophilic features.

II.2. Synthesis of monofluorinated olefins from 3,3,3-trifluoropropionates and stabilized carbanions

First attempts towards the synthesis of monofluorinated olefins were realized using the conditions previously used in the reaction between the methyl 3,3,3-trifluoropropionate **233** and methyl-*p*-tolyl sulfoxide **46**, two equivalents of lithium diisopropyl amine (LDA) to generate the lithium anion derived from the different nucleophiles and two equivalents of the corresponding precursors in THF at -78°C.

The results are recovered in Table 3. 1. Thus, to the commercially available methyl-3,3,3-trifluoropropionate **233** (1 equiv) was added the lithium anion derived from methyl-*t*-butyl sulfoxide **117** (2 equiv) previously generated from methyl-*t*-butyl sulfoxide **117** and LDA, in THF at -78°C. After 4 hours, the monofluorinated olefins **241a** and **241b** were obtained in a 80:20 *E/Z* ratio with 28% yield (entry 2, Table 3. 1). This low yield could be due to the presence of the bulky ^tBu substituent which could difficult the approach to the acidic CH in the first step of the proposed mechanism and/or to the intermediate enoate acceptor (see mechanistic proposal).

Similar results were observed with the lithium anion derived from sulfones **236** and **237**, whose corresponding monofluorinated olefins **242** and **243** were isolated in good selectivities (*E/Z* 83:17 and 85:15) but low yields (31% and 36%), (entries 3 and 4, Table 3. 1). However, the addition of the lithium anion derived from acetonitrile provided the monofluorinated olefin **244** in poor diastereoselectivity (48:52) and moderated yield (48%), (entry 5, Table 3. 1).

In contrast, the use of stabilized lithium anions of nucleophiles **239** and **240** bearing a nitro group did not lead to the desired fluorinated products (entries 6 and 7). These reactions are difficult to follow by TLC because the starting materials and/or the methyl 3,3-*gem*difluoropropenoate intermediate are volatile compounds. Thus even if this enoate intermediate was formed, the highly stabilized nature of the nucleophilic anion could be responsible of the lack of reactivity. We also tried to follow the evolution of the reaction mixture by gas chromatography (GC) without success.

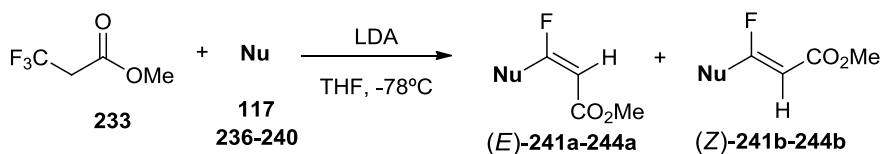

Entry	Nu	Products	<i>E/Z</i>	Yield
1	 46	 <i>(E)</i> -235a + <i>(Z)</i> -235b	95:5	75%
2	 177	 <i>(E)</i> -241a + <i>(Z)</i> -241b	80:20	28%
3	MeSO ₂ <i>p</i> Tol 236	 <i>(E)</i> -242a + <i>(Z)</i> -242b	83:17	31%
4	MeSO ₂ Me 237	 <i>(E)</i> -243a + <i>(Z)</i> -243b	85:15	36%
5	CH ₃ CN 238	 <i>(E)</i> -244a + <i>(Z)</i> -244b	48:52	48%
6	 239	-	-	-
7	CH ₃ NO ₂ 240	-	-	-

Table 3. 1

All the methyl-3-fluoro-3-substituted prop-2-enoates **241-244** obtained were isolated after flash chromatography, but isomer separation was not achieved. In all cases the major isomer observed by ^1H NMR spectra was the *E* isomer, where the fluorine atom and the olefinic proton were in the same face of the double bond as could be established from the values of the coupling constants, with a coupling constant of $J_{\text{H-F}} = 17$ Hz for the major isomers (*E*), and a coupling constant of $J_{\text{H-F}} = 32$ Hz for the minor isomer (*Z*) (Table 3. 2).

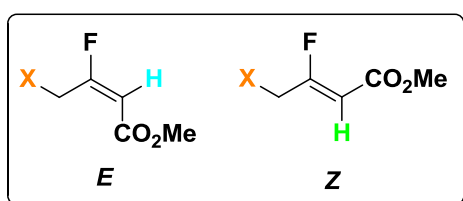

Product	<i>E/Z</i>	H_E (δ ppm)	H_Z (δ ppm)
	96:4	5.79 (d, $J = 17.5\text{Hz}$)	5.26 (d, $J = 32\text{Hz}$)
	80:20	5.85 (d, $J = 17.5$ Hz)	5.4 (d, $J = 32.2\text{Hz}$)
	83:17	5.75 (d, $J = 17.8\text{Hz}$)	5.33 (d, $J = 32\text{Hz}$)
	85:15	5.97 (d, $J = 17.2\text{Hz}$)	5.6 (d, $J = 31.8\text{Hz}$)
	48:52	5.29 (d, $J = 10.8\text{Hz}$)	5.11 (d, $J = 32.2\text{Hz}$)

Table 3. 2

In order to extend the scope of the synthesis of monofluorinated olefins, we envisioned the introduction of other ester moieties, leading to future transformations which would be interesting under synthetic point of view for application.

Therefore, the addition of the lithium anion derived from mono and diesters **245-249** to the commercially available methyl-3,3,3-trifluoropropionate **233** in THF at -78°C , led to the results shown in Table 3. 3.

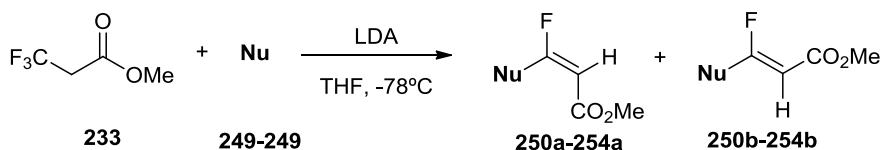







Entry	Nu	LDA	Products	E/Z	Yield
1	 245	2 eq	 250 (1:1) 251	90:10	40%
2	 246		 252a 252b	90:10	34%
3	 247		-	-	-
4	 248		-	-	-
5	 249		2eq	 253a (77:23) 253b	77:23
6	249	4 eq	 253a (50:50) 253b	50:50	31%

Table 3. 3

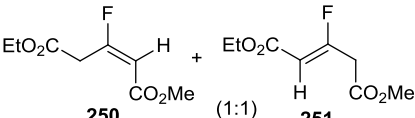
First attempts were performed with ethyl acetate **245** as the anion precursor (entry 1, Table 3. 3). The final isolated products were 1:1 mixture of regioisomeric monofluorinated olefins **250** and **251** that were formed as a consequence of the presence of two different esters in the final structure, a CO₂Me and a CO₂Et. According with the mechanism proposed, the formation of a mixture of regioisomeric monofluorinated olefins could be explained as consequence of the equilibrium existent between the enoate intermediates as indicated in Scheme 3. 34, formed after the addition of the enolate derived from the ethyl acetate to intermediate methyl 3,3-*gem*difluoro propenoate.

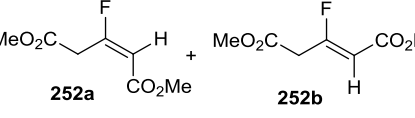

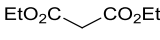
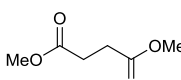
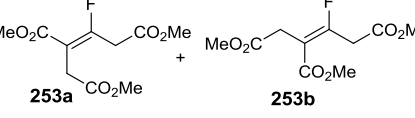
Scheme 3. 34

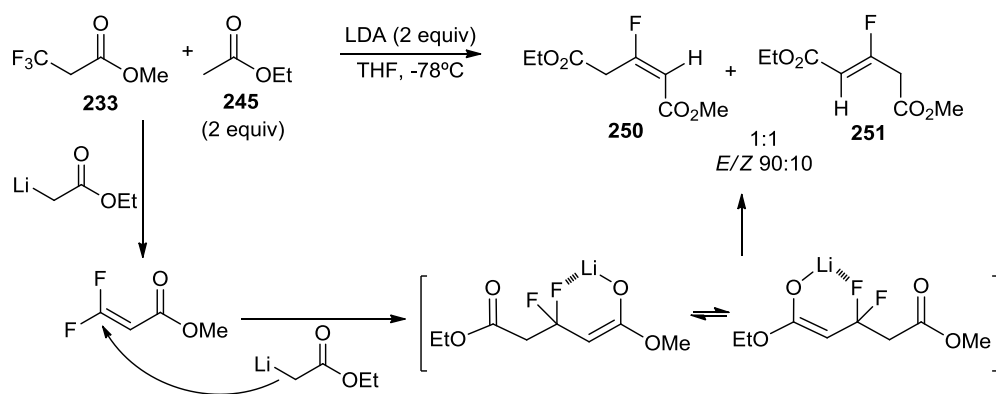
Both **250** and **251** presented a *E/Z* 90:10 ratio and the mixture was isolated after flash chromatography in 40% yield. Using methyl acetate **246** as the initial enolate precursor formation of a mixture of regioisomers, only dimethyl 3-fluoropent-2-enedioate **252** was formed as a *E/Z* 90:10 mixture (entry 2, Table 3. 3). When a bulky ester like *t*-butyl acetate **247** was tested under same conditions, formation of the monofluorinated olefins was not detected (entry 3).

The use of the enolate derived from diethyl malonate **248** as nucleophile did not lead to the monofluorinated olefin formation (entry 4). The addition of the lithium anion derived from dimethyl succinate **249** gave the tetrasubstituted monofluorinated olefin **253** in 77:23 selectivity and low yield (entry 5, Table 3. 3). In order to improve the yield of the reaction with dimethyl succinate, 4 equivalents of

the corresponding lithium anion where used under same reaction conditions to avoid double deprotonation of the ester (entry 6, Table 3. 3). Although the yield slightly increased, the diastereoselectivity dropped to give a 50:50 mixture of *E/Z* isomers. According with the mechanistic proposal, the reaction must take place through the initial formation of the intermediate methyl 3,3-*gem*difluoro propenoate, followed by the nucleophilic addition of the lithium anion derived from dimethyl succinate. The enolate resulting in this step must be in equilibrium between the two species shown in Scheme 3. 35. The evolution of each one through an E1cb mechanism, with elimination of a fluorine atom, explains the formation of the more stable tetrasubstituted monofluorinated olefin.

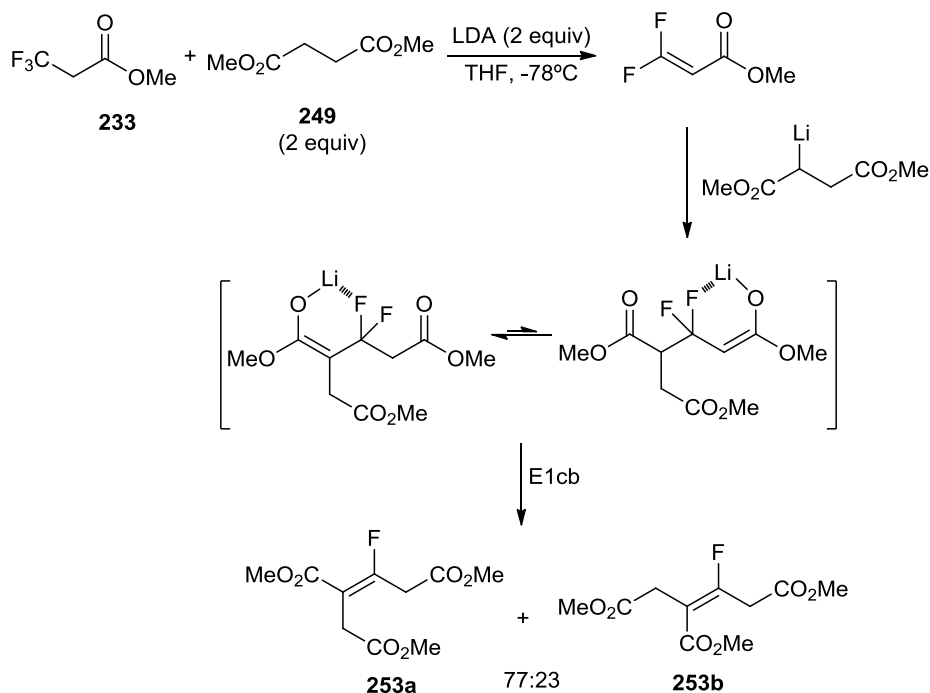

Scheme 3. 35

With the aim of improving the yield of the reactions, other bases were tested under same conditions. The reaction between the fluorinated starting material **233** and methyl acetate was chosen as model. Table 3. 4 shows the results obtained in

the preparation of dimethyl 3-fluoropent-2-enedioates **252a** and **252b** by addition of 2 equivalents of the lithium or sodium anion derived from methyl acetate **246** to methyl-3,3,3-trifluoropropionate **233** in THF at -78°C .

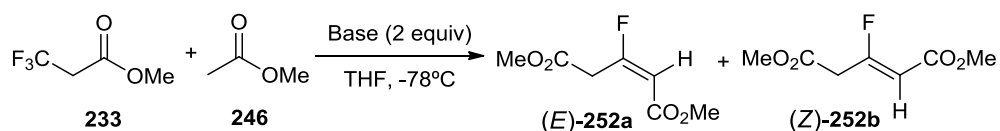

Entry	Base	t	E/Z	Yield
1	LDA	3h	90:10	34%
2	LDA	48h	89:11	33%
3	LDA*	3h	87:13	23%
4	LHMDS	3h	86:14	13%
5	NaHMDS	3h	85:15	8%

*addition of methyl 3,3,3-trifluoropropionate over the lithium anion

Table 3. 4

The result previously obtained under the conditions indicated (LDA) after 3 hours (**252a/252b** 90:10) in 34% yield is included in Table 3. 4 (entry 1). When the time of the reaction increased to 48h, the selectivity and the yield did not change (entry 2, Table 3. 4). Similar results were obtained when the methyl-3,3,3-trifluoropropionate **233** was added over the anion derived from methyl acetate **246** previously prepared with LDA (entry 3, Table 3. 4). Lithium and sodium hexamethyldisilazane (entries 4 and 5, Table 3. 4) were also used as bases. The results evidenced a similar diastereoselectivity in both cases but a significant decrease of the yield.

The effect of temperature was also evaluated. When the addition of the lithium anion derived from methyl acetate **246** to the methyl-3,3,3-trifluoropropionate **233** in THF was carried out at -78°C and the temperature was

further allowed to reach 0°C, a white solid was obtained, which was identified (*E*)-dimethyl-3-(diisopropylamino) pent-2-enedioate **254** (Scheme 3. 36). Its structure was confirmed by X-ray diffraction (Figure 3. 9). The formation of the enamine derivate can be explained through a nucleophile substitution on the monofluorinated olefin **252** initially formed, which in presence of the (*i*Pr)₂NLi, suffered a nucleophilic 1,4-addition to the α,β-insaturated ester followed again by a E1cb elimination of the fluorine atom (Scheme 3. 36).

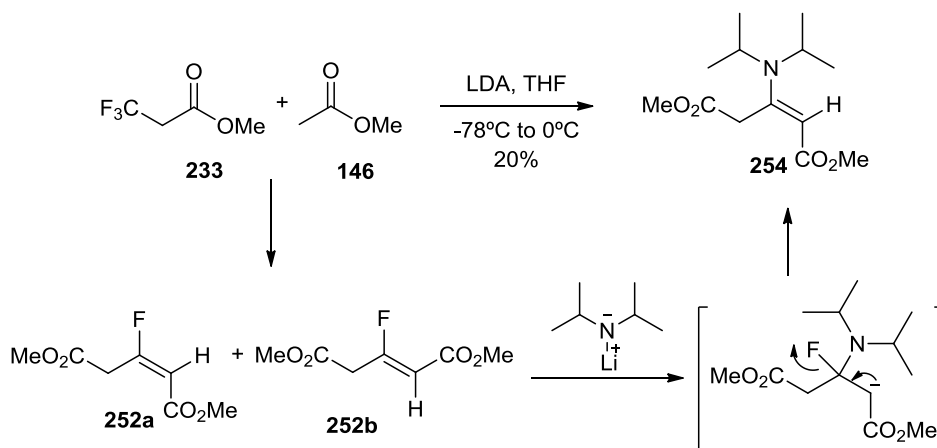

Scheme 3. 36

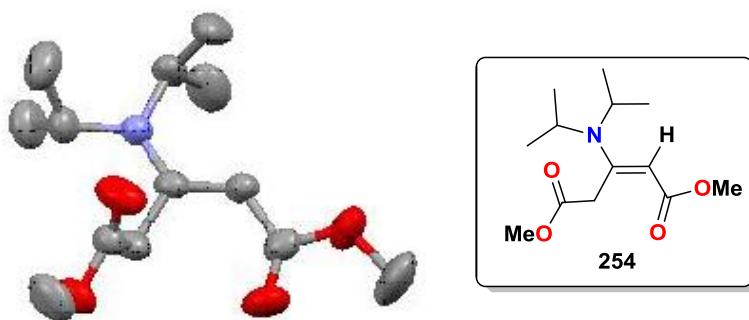
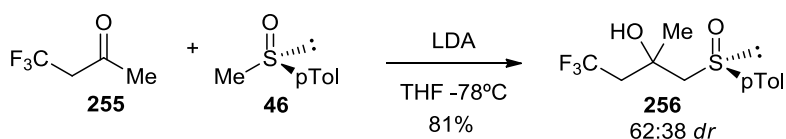

Figure 3. 9

The behavior of other fluorinated substrates such as 4,4,4-trifluorobutan-2-one **255** was also checked. Thus reaction of the lithium anion derived from methyl *p*-tolyl sulfoxide **46** with 4,4,4-trifluorobutan-2-one **255** in THF at -78°C , afforded a product which was isolated pure after flash chromatography in 81% and identified as 4,4,4-trifluoro-2-methyl-1-(*SR*)-*p*-tolylsulfinyl butan-2-ol **256** in a diastomeric ratio of 62:38 (Scheme 3. 37). This product arose from the direct addition of the α -lithium-sulfoxide to the carbonyl group of the starting material.



Scheme 3. 37

Looking for a reason explaining the low yields obtained in the reactions of methyl-3,3,3-trifluoropropionate **233** with different nucleophiles, we thought of the volatility of the starting material and the final product, that could be might lost during the treatment. To avoid this problem, the use of a trifluorinated ester with a higher boiling point was synthesized. The synthesis of benzyl 3,3,3-trifluoropropionate was carried out following the reported procedure from 3,3,3-trifluoropropionic acid. Thus, the commercially available 3,3,3-trifluoropropionic acid **257** was added dropwise to thionyl chloride **258** and DMF, and stirred for 3h at 70°C . After 3,3,3-trifluoropropanoyl chloride **258** formation and without any further purification, benzylic alcohol was added to the mixture and stirred at 40°C for 2h. Benzyl 3,3,3-trifluoropropanoate **259** was purified by distillation and isolated pure in 90% yield, (Scheme 3. 38).²²⁰

²²⁰ P. V. Ramachandran, G. Parthasarathy and P. D. Gagare, *Org. Lett.* **2010**, *12*, 4474-4477.

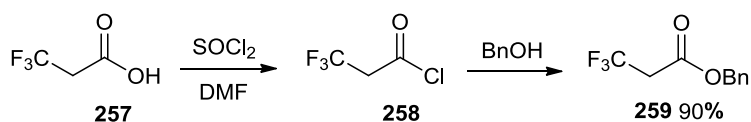

Scheme 3.38

With the benzylic trifluoropropionate in hand, it was submitted to reaction with the lithium anion derived from methyl *p*-tolyl sulfoxide **46** and dimethyl sulfone **237**. The results are depicted in Table 3.5.

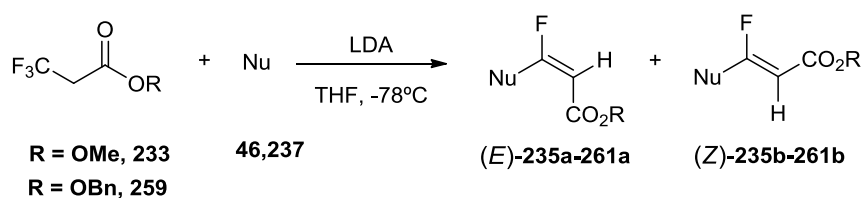

Entry	Nu	R = OMe		R = OBn	
		<i>E/Z</i>	Yield	<i>E/Z</i>	Yield
1		95:5	75%	87:13	51%
2	MeSO ₂ Me	85:15	36%	80:20	40%

Table 3.5

The addition of the lithium anion derived from the methyl *p*-tolyl sulfoxide **46** to benzyl 3,3,3-trifluoropropionate **259** gave the expected monofluorinated olefins **260a** and **260b** in *E/Z* 87:13 ratio and in 51% yield (entry 1). The monofluorinated sulfonyl olefins **261a** and **261b** were prepared from the lithium

anion derived from the dimethyl sulfone **237**, in good selectivity and 40% yield (entry 2).

The results shown in Table 3. 5, where both methyl and benzyl esters are included for comparison, evidenced that the use of benzyl group instead of methyl group in the ester moiety of the starting material did not improve the synthesis of the corresponding monofluorinated olefins since the *E/Z* selectivities decreased and yields were not higher.

II.3. Synthesis of monofluorinated olefins from 3,3,3-trifluoropropionic esters and Grignard reagents

In order to extend the synthetic methodology shown in the previous section to the synthesis of differently alkyl or aryl substituted monofluorinated olefins, we thought of evaluating the reaction between benzyl 3,3,3-trifluoropropionate **259** and different Grignard reagents. The results are depicted in Table 3. 6.

The first reaction carried out was effected with **259** and methyl magnesium bromide (2 equiv) in THF at -78°C . After 96 hours, the starting material had disappeared and, after workup, a 35% of (*E*)-benzyl-3-fluoropropenoate **262** was isolated pure after flash chromatography (entry 1). Taking into account the low yield of the final product recovered, the ^1H and ^{19}F NMR spectra of the crude reaction were carefully revised to detect the absence of the *Z* isomer. When smaller amounts of the Grignard reagent were used, the 3,3-difluoropropenoate intermediate was observed and could be characterized.

The behavior of hexyl magnesium bromide was similar. Upon reaction with benzyl 3,3,3-trifluoropropionate **259** in THF a 70% of conversion was observed after 3 hours (entry 2). The ^1H and ^{19}F NMR spectra of the crude reaction mixture evidenced the exclusive formation of the (*E*)-benzyl-2-nonenolate **263** that could be isolated pure in 50% yield. The reaction in toluene gave a 70:30 *E/Z* mixture of **263** with 95% of conversion which was isolated in 90% yield (entry 3).

When isopropyl magnesium bromide was the Grignard reagent reacting with benzyl 3,3,3-trifluoropropionate **259** in THF, the complete disappearance of the starting material was observed, although only a 48% yield of the product could be isolated in the reaction (entry 4). The product **264** was characterized as a 51:49 mixture of both *E* and *Z* isomers of the monofluorinated olefin. When the reaction was carried out under same conditions but in toluene as solvent, the product was obtained in *E/Z* 60:40 ratio (entry 5). The lack of stereoselectivity observed in these cases suggested a central role of sterics effects in the control of the structure of the final alkene.

The reaction of t Butyl and phenyl magnesium bromide with benzyl 3,3,3-trifluoropropionate **259** in THF did not lead to the expected fluorinated propenoate derivatives (entries 6 and 7).

When vinyl magnesium bromide reacted with benzyl 3,3,3-trifluoropropionate **259** in THF, conversion was complete and a 80:20 *E/Z* mixture of the monofluorinated alkene **265** could be isolated in 45% yield (entry 8). Surprisingly, when the solvent used was changed to toluene a 75% yield of the monofluorinated diene **265** as 80:20 mixture of *E/Z* geometrical isomers was isolated (entry 9).

Reaction of 2,4-dimethoxyphenyl magnesium bromide with benzyl 3,3,3-trifluoropropionate **259** in THF led to the formation of the trisubstituted monofluorinated olefins that could be isolated in 80% yield (entry 10). Surprisingly the major isomer in the mixture 30:70 corresponded to the *Z* olefin, as could be demonstrated by X-ray diffraction (Figure 3. 10). The use of toluene as solvent under the same conditions gave similar results, with a *E/Z* ratio of 32:68 in 63% yield (entry 11).

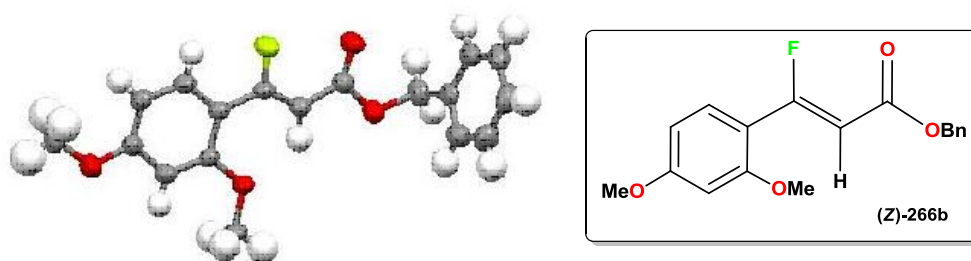
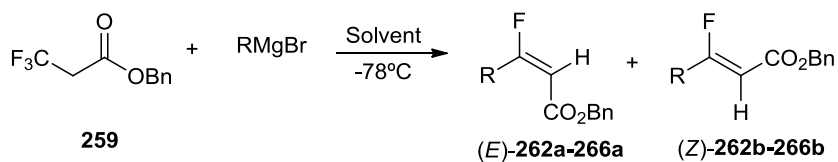

Figure 3. 10



Entry	R	Solvent	E/Z	Conv.	Yield	Products
1	Me	THF	100:0	100%	35%	 (E)-262
2	Hex	THF	100:0	70%	50%	 (E)-263a + (Z)-263b
3		Toluene	70:30	95%	90%	
4	<i>i</i> Pr	THF	51:49	100%	48%	 (E)-264a + (Z)-264b
5		Toluene	60:40	100%	-	
6	^t Bu	THF	-	-	-	-
7	Ph	THF	-	-	-	-
8	vinyl	THF	80:20	100%	45%	 (E)-265a + (Z)-265b
9		Toluene	80:20	100%	75%	
10	2,4-dimethoxybenzene	THF	30:70	100%	80%	 (E)-266a
11		Toluene	32:68	100%	63%	 (Z)-266b

Table 3. 6

II.4. Mechanism and stereochemistry

According to the results published in the literature by Mikami in 2006²²¹, the fluorine atom has been widely recognized to strongly coordinate metals. Metal enolates derived from carbonyl compounds are important nucleophiles in C-C bond-forming reactions for the synthesis of non-fluorinated compounds. However, the metal enolates of fluorinated carbonyl compounds have been severely limited to α -F metal enolates, which can be stabilized by M-F chelate structures (Eq. a, Scheme 3. 39). α -CF₃ Metal enolates have generally been known as unstable and difficult to prepare because of the rapid β -M-F elimination producing terminal *gem*-difluoroalkenes (Eq. b, Scheme 3. 39).

Once the *gem*-difluoroalkene is formed, the sp^2 -hybridized fluoro substituted carbon is highly electrophilic and reacts *via* addition-elimination pathway with nucleophiles by attack at the fluorinated sp^2 -carbon, giving monofluorinated substituted alkenes.

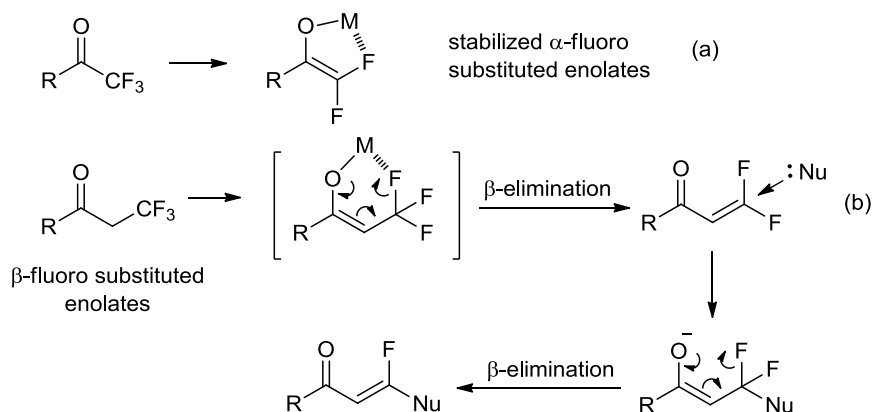

Scheme 3. 39

²²¹ K. Mikami, and Y. Itoh, *The Chemical Record* **2006**, *6*, 1-11.

As indicated in a previous section, the reaction of methyl 3,3,3-trifluoropropionate **233** with lithium anion derived from (*SR*)-methyl-*p*-tolyl sulfoxide **46** must occur following the mechanistic pathway shown in Scheme 3. 40.

Thus in a first step, the lithium anion derived from methyl-*p*-tolyl sulfoxide **46** would act as a base taking a proton from the acidic CH₂ group of the methyl 3,3,3-trifluoropropionate **233**. The resulting enolate **A** must evolve through a E1cb elimination process to the formation of methyl 3,3-*gem*difluoro propenoate **B** in accordance to the general behavior of these substrates shown in Scheme 3. 39. A new equivalent of the lithium anion derived from the methyl-*p*-tolyl sulfoxide acting as a nucleophile could add in a conjugate manner, to the α,β -insaturated ester, whose evolution through a new E1cb reaction eliminating a fluorine atom explains the formation of the final monofluorinated alkene **235**.

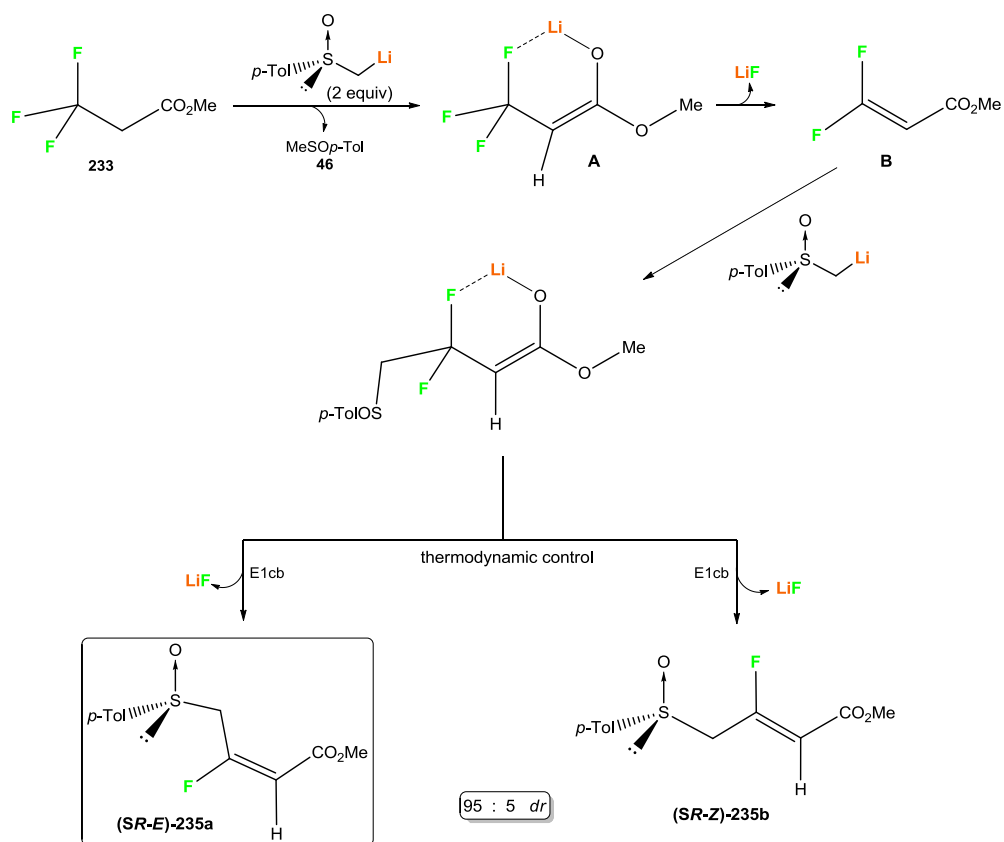

Scheme 3. 40

In accordance with this mechanism, the stereochemical result in the formation of olefin **235** must be a thermodynamically controlled process, where the final geometry of the double bond is dependent on the dipolar repulsive interactions of the *cis*-substituents.

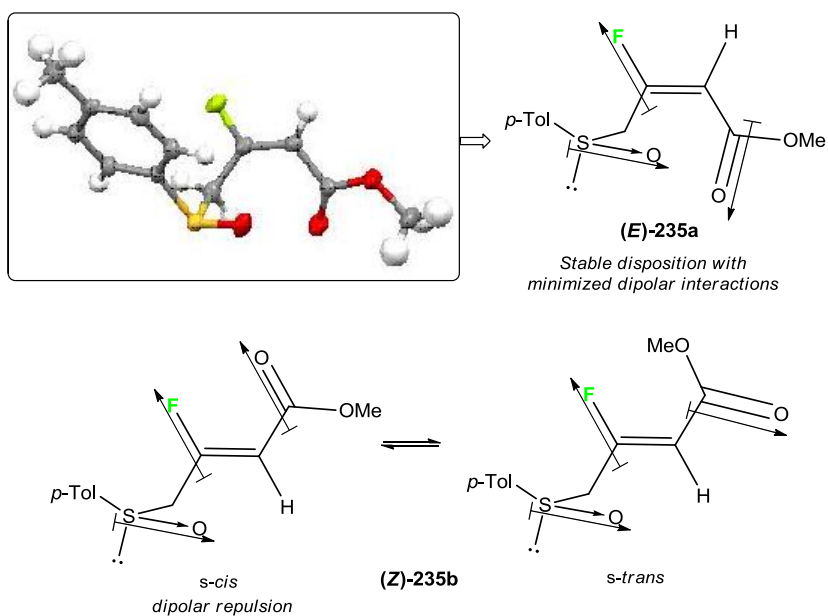

Figure 3. 11

As can be seen in the X-Ray structure of (*E*)-**235a**, the oxygens of the carbonyl group of the ester and the S=O of the sulfoxide are far from the F substituent in the alkene with the *E*-geometry. This is the most stable product since the *E* olefin has a stable disposition of the polar substituents, with minimized dipolar interactions. As can be seen in Figure 3. 11, a serious polar repulsion appears in the *Z* olefin, although two conformers *s-cis* and *s-trans* could participate in the equilibrium.

When the methyl *p*-tolyl sulfoxide is changed by other groups such as SO₂*p*-Tol or CO₂Me (*E*-**252a**, Figure 3. 12) the major formation of the *E*-isomer must be also a consequence of the higher stability of the final olefin, defined by minimized polar repulsions.

However, when the substituent is a C≡N group, a 48:52 mixture of *E* and *Z* isomers resulted. This must be due to the linear structure of the C≡N where the dipoles of C-F and C≡N are not interacting.

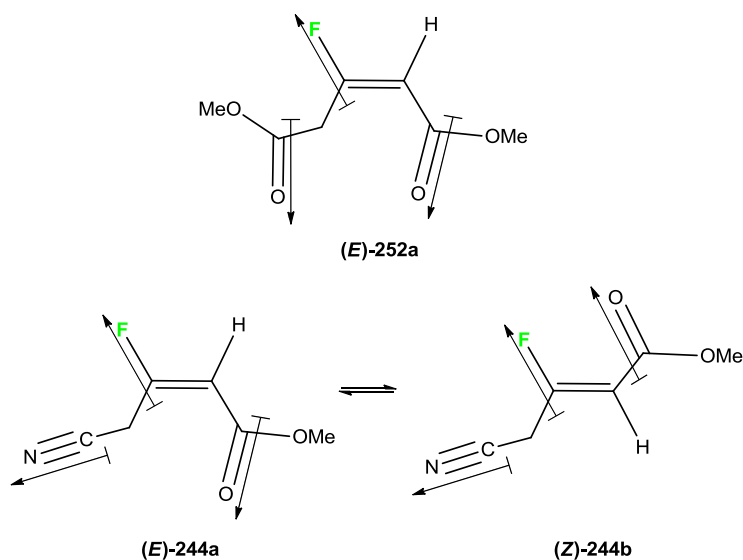

Figure 3. 12

In the case of the 2,4-dimethoxyphenyl substituted olefin, the major isomer **266b** is also the most stable, in spite of the 1,3-parallel disposition of the C-F and C=O bonds. The bulky and polar dimethoxy phenyl substituent is defining the stability (Figure 3. 13).

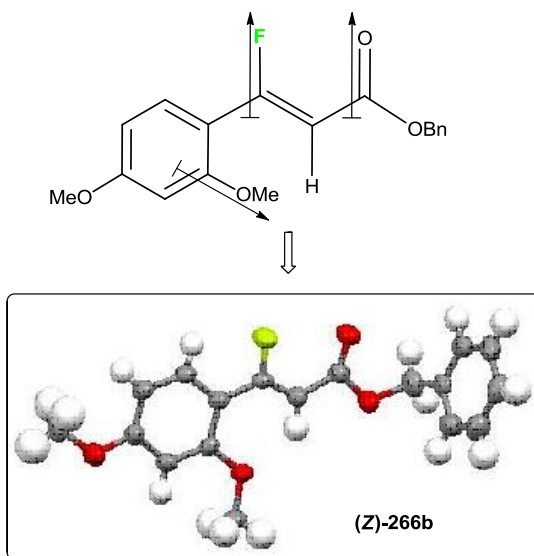

Figure 3. 13

II. DIELS-ALDER REACTIONS OF MONOFLUORINATED TRISUBSTITUTED OLEFINS

II.1. INTRODUCTION

The Diels-Alder reaction²²² has been established as one of the most powerful synthetic tools to generate highly functionalized cyclohexene rings, in a completely regio and stereocontrolled way. The success of this reaction is mostly due to the possible generation of four stereogenic centers in only one synthetic reaction step, due to a pericyclic concerted mechanism.

Many different versions of the Diels-Alder reaction have been reported, including intramolecular [4+2] cycloadditions, hetero Diels-Alder reactions, pressure-accelerated Diels-Alder reactions, use of chiral dienophiles, dienes, catalyst^{223,224} and Lewis acid accelerated Diels-Alder reactions.^{223,224}

Taking into account the possibilities offered by the Diels-Alder reaction in the field of organofluorine derivatives, fluorinated dienes or dienophiles have focused the attention of different groups in recent years to synthesize fluorinated adducts²²⁵. Fluoro substituents can exert regio and stereochemical control on the cycloaddition by biasing the reactive conformation of the reactants through orbital interactions.

The behavior of fluorinated olefins as dienophiles has been studied. Both α - and β -fluorostyrenes bearing different *para* substituents at the aromatic ring²²⁶ reacted only with 1,3-diphenylisobenzofuran as diene giving the corresponding adducts with different *endo/exo* selectivities which were dependent on the position of the fluoro substituent on the alkene. As can be seen in Scheme 3. 41,

²²² O. Diels and K. Alder, *Justus Liebigs Ann. Chem.* **1928**, 460, 98.

²²³ E. J. Corey, *Angew. Chem. Int. Ed.* **2002**, 41, 1650-1667.

²²⁴ a) W. Carruthers, *Cycloaddition Reactions in Organic Synthesis*, Pergamon, Oxford, **1990**. b) K. C. Nicolaou, Scott A. Snyder, Tamsyn Montagnon, and G. Vassilikogiannakis *Angew. Chem. Int. Ed.* **2002**, 41, 1668-1698.

²²⁵ Y. Lam, S. J. Stanway and V. Gouverneur, *Tetrahedron*, **2009**, 9905-9933.

²²⁶ Ernet, T.; Maulitz, A. H.; Wurthwein and E. U.; Haufe, G. *J. Chem. Soc., Perkin Trans. 1* **2001**, 1929-1938.

reactions of α -fluoro styrene afforded the Diels-Alder adducts with a poor *endo/exo* selectivity.

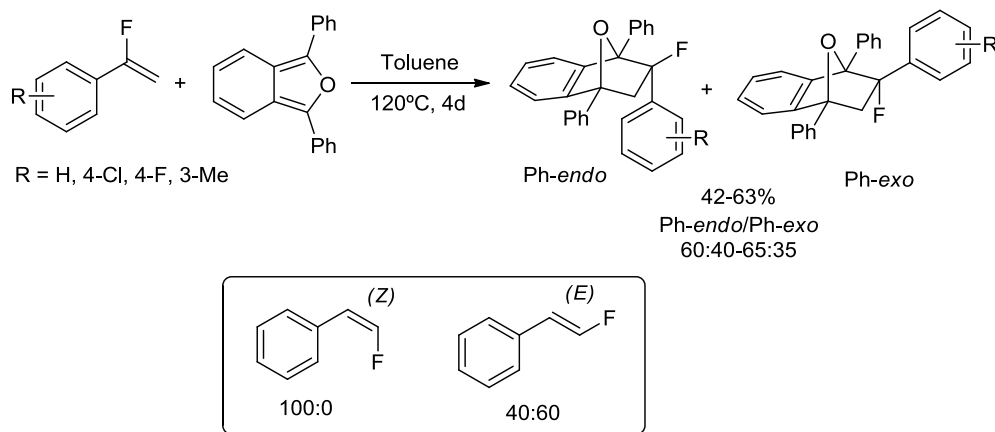

Scheme 3. 41

When the fluorine substituent is at the β -position, the *endo/exo* selectivity of the cycloaddition with 1,3-diphenylbenzofuran was highly dependent on the stereochemistry of the dienophilic olefin. (*Z*)- β -fluorostyrene led to the exclusive formation of the *endo* adduct whereas the (*E*)-isomer gave rise to a 60:40 ratio of *endo* and *exo* adducts.

The dienophilic reactivities of α -fluorinated acryloyl ketone **267a** and ester **268a** have been studied and compared with their nonfluorinated analogues, **267b** and **268b** (Scheme 3. 42).²²⁷ The Diels-Alder reactions of the nonfluorinated dienophiles **267b** and **268b** with cyclopentadiene are *endo*-selective, while the fluorinated analogues **267a** and **268a** gave moderate *exo*-selectivity, under thermal conditions refluxing toluene. The use of TiCl_4 as a Lewis-acid promoter improved the divergent selectivities in the same sense. In this case, the benzyl 2-fluoro acrylate **268a** evolved exclusively to the *exo* adduct evidencing that the presence of fluorine must be reducing the activation barrier of the *exo* approach. This was corroborated by the authors by theoretical calculations.

²²⁷ M.Essers, C. Mück-Lichtenfeld, and G. Haufe, *J. Org. Chem.* **2002**, *67*, 4715-4721.

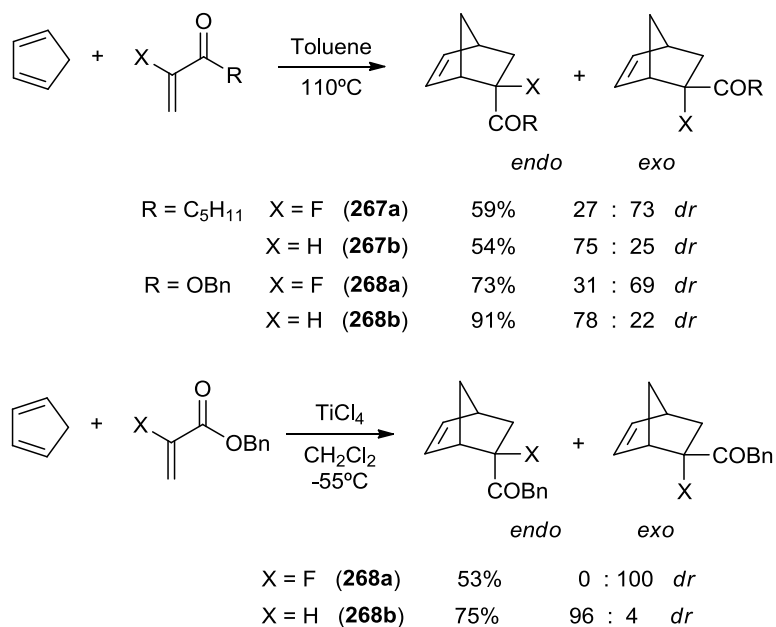

Scheme 3. 42

Fluorinated benzoquinones have also been used as dienophiles. The results of the reaction between a 2-chlorobenzoquinone having a fluorine substituent at C-6 with 2,3-dimethyl butadiene evidenced a higher reactivity of the nonfluorinated one (Scheme 3. 43).²²⁸ Thus, **269a** reacted with 2,3-dimethylbutadiene primarily through the chloro substituted double bond, in 95:5 ratio. Benzoquinone derivatives **269b**, which bear a trifluoromethoxy group in place of fluorine, displayed a similar level and sense of chemoselectivity than **269a**. The trifluoromethoxy group exerted a comparable influence than a fluoro substituent.

²²⁸ E. Magnier, P. Diter, and J.C. Blazejewski, *Tetrahedron Lett.* **2008**, *49*, 4575–4578.

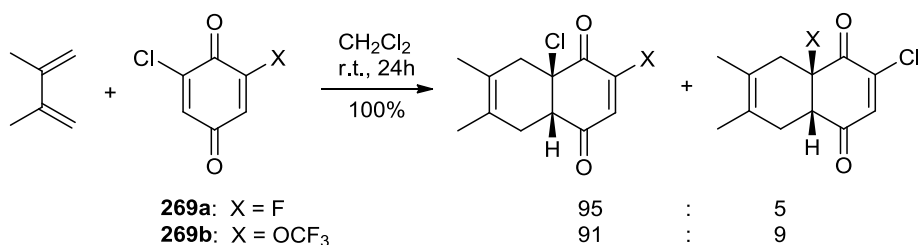

Scheme 3. 43

2-Fluoroacrylic ester **270a**, incorporating the 8-phenylmenthol chiral auxiliary in the ester moiety, underwent an asymmetric Diels–Alder reaction with cyclopentadiene in the presence of TiCl₄ or Et₂AlCl as Lewis acids (Scheme 3. 44).²²⁹ The *exo* adduct was formed (*exo/endo* 10:1) in a highly π -facial selective manner. For comparison, reactions of 2-chloro and 2-methyl substituted dienophile analogues, as well as the unsubstituted acrylate, are included. As can be seen, both 2-chlorinated (**270b**) and the 2-methyl substituted dienophiles (**270c**) also preferentially delivered the *exo* product with high π -facial selectivity. The 2-unsubstituted analogue **270d** gave the *endo* adduct as the major product.

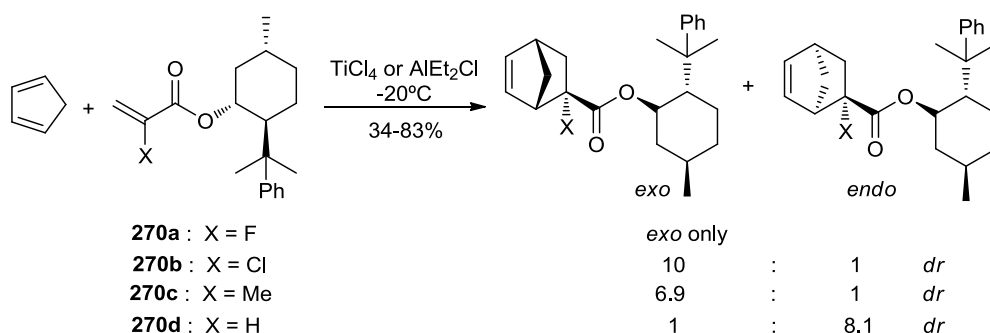

Scheme 3. 44

The high π -facial selectivity observed for the formation of the *exo* fluorinated adduct was rationalized on the basis of stabilizing fluorine-metal interactions in the

²²⁹ H. Ito, A. Saito and T. Taguchi, *Tetrahedron: Asymmetry* **1998**, *9*, 1989–1994.

dienophile complex of **270a** with the Lewis acid, which would favor the *transoid* conformer of the acrylic acid moiety shown in Figure 3. 14. In such conformation, the *si* face is the only accessible to the diene since the phenyl group of the 8-phenylmenthol auxiliary is hindering the *re* face of the dienophile to any diene approach. On the other hand, the *exo*-selective reactions of the methyl and chloro analogues **270c** and **270b** proceed with an eroded π -facial selectivity. The bulkier methyl group in **270c** would sterically difficult the coordination of the Lewis acid in the *transoid* conformer.

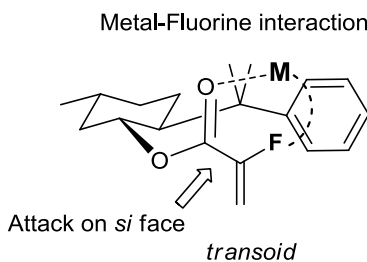
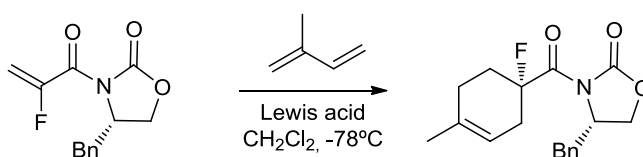

Figure 3. 14

The asymmetric Diels–Alder reactions of 2-fluoroacrylic acid derivatives incorporating an Evans-type oxazolidinone as the chiral auxiliary have also been explored (Scheme 3. 45).²³⁰ These substrates gave lower diastereoselectivities than those based of the 8-phenylmenthol as chiral auxiliary previously mentioned.



Lewis acid	Yield	<i>de</i>
Et ₂ AlCl	60%	70%
TiCl ₄	39%	44%
ZrCl ₄	78%	55%

Scheme 3. 45

²³⁰ H. Ito, A. Saito and T. Taguchi, *Tetrahedron: Asymmetry* **1998**, *9*, 1979–1987.

In the Lewis acid catalyzed cycloaddition of these fluorolefins, the *de* ranged from 70% (Et_2AlCl) to 44% (TiCl_4). The intramolecular Diels–Alder reaction of α -fluoroacrylate derivate **271a** was promoted by a bidentate aluminium complex formed from Me_3Al and 3,3',5,5'-tetrabromo-2,2'-biphenyl- 1,1'-diol (Br_4BIPOL).²³¹ Complete *cis* selectivity was observed. This was rationalized by the *endo*-boat transition state represented in Scheme 3. 46. The analogue substrate with a H instead of a fluorine, also gave the *cis* cycloadduct exclusively in the presence of the aluminium complex at a higher temperature. This was indicating a significant influence of the F atom on the reactivity of the dienophilic moiety.

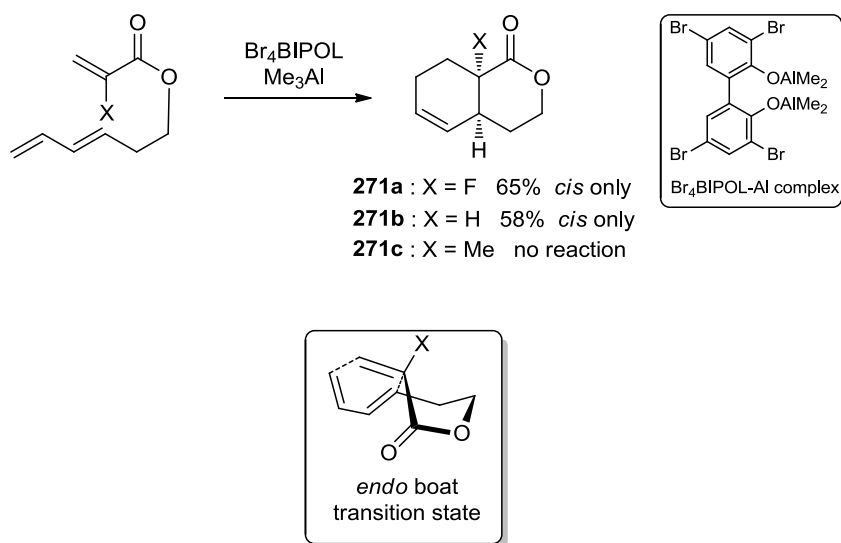

Scheme 3. 46

²³¹ A. Saito, H. Yanai, W. Sakamoto, K. Takahashi and T. Taguchi, *J. Fluorine Chem.* **2005**, *126*, 709-714.

II.2. RESULTS AND DISCUSSION

To evaluate the ability of the trisubstituted monofluorinated olefins we had synthesized to participate as dienophiles in the Diels-Alder reactions, we first attempted the cycloaddition between the (*E*)-methyl-3-fluoro-4-(*p*-tolylsulfinyl)-2-butenolate **235a** and cyclopentadiene under thermal conditions. Thus, using toluene or dichloromethane as solvents, both at room temperature or heating to reflux, the starting material was recovered unchanged (entries 1-3, Table 3. 7).

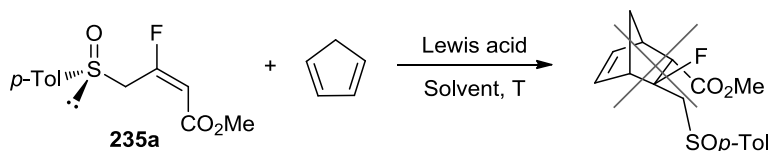

Entry	Solvent	Lewis acid	Temperature
1	Toluene	-	Reflux
2	CH ₂ Cl ₂	-	r.t.
3		-	Reflux
4		ZnBr ₂	r.t.
5		SnCl ₄	
6		TMSCl	
7		BF ₃ ·Et ₂ O	
8		MgBr ₂	

Table 3. 7

The reaction of (*E*)-methyl-3-fluoro-4-(*p*-tolylsulfinyl)-2-butenolate **235a** and cyclopentadiene (5 equiv) was checked then in the presence of different Lewis acids. As shown in Table 3. 7, no reaction was observed in the presence of ZnBr₂, SnCl₄, TMSCl, BF₃·Et₂O or MgBr₂ at room temperature (entries 4-8, Table 3. 7). When Et₂AlCl (2 equiv) was the Lewis acid, the reaction in dichloromethane at room temperature, led to an unexpected product, which was identified as methyl

5-chloro-2-*p*-tolylsulfinyl methyl tricyclo[2.2.1.0^{2,6}] heptane-3-carboxylate **272** (Scheme 3. 47) and was isolated in 48% yield after flash chromatography.

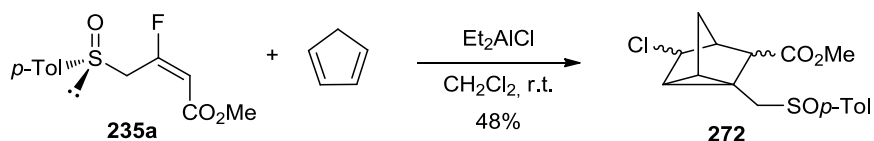

Scheme 3. 47

^1H NMR spectrum of the crude reaction mixture showed that the final product was a mixture of only two diastereomeric compounds out of the 64 possible diastereoisomers. On the basis of the NMR data, the relative configuration of diastereoisomers **272** could not be unequivocally established. Due to the presence of the stereogenic sulfoxide group in the structure, the number of diastereoisomers was too high to deduce the relative configuration of **272**. To simplify the configurational assignment, we proceeded to oxidize the mixture of diastereoisomers **272** with *m*-chloroperbenzoic acid in CH_2Cl_2 at room (Scheme 3. 48). The ^1H NMR spectrum of the crude mixture showed that only one diastereoisomer of sulfone **273** was formed. This result simplified the structural assignment since this was indicating that the relative configuration of all carbon stereocenters was the opposite.

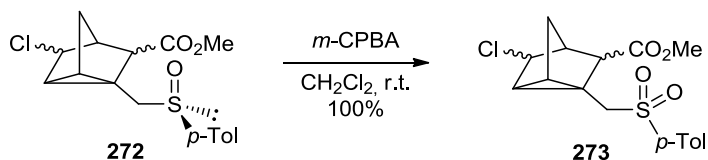

Scheme 3. 48

The methyl 5-chloro-2-(*p*-tolylsulfonyl) methyl tricyclo[2.2.1.0^{2,6}] heptane-3-carboxylate **273** was recrystallized in ether/hexane and its relative configuration was unequivocally established by X-ray diffraction (Figure 3. 15).

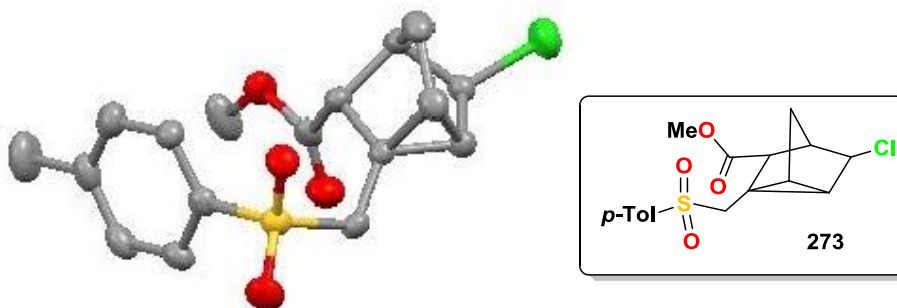

Figure 3. 15

Reaction of (*E*)-methyl-3-fluoro-4-(*p*-tolylsulfinyl)-2-butenolate **235a** with other dienes such as isoprene, 1-trimethylsilyloxy-1,3-butadiene, Danishefsky's diene, furan and 2-methoxyfuran (Figure 3. 16), was also tested under the same reaction conditions with (*E*)-methyl-3-fluoro-4-(*p*-tolylsulfinyl)-2-butenolate **235a** in the presence of Et₂AlCl as Lewis acid in dichloromethane at room temperature. No evolution was observed being in all cases the starting material recovered unchanged.

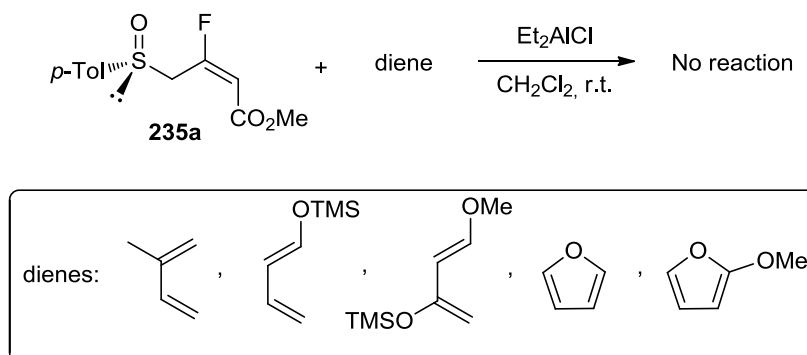
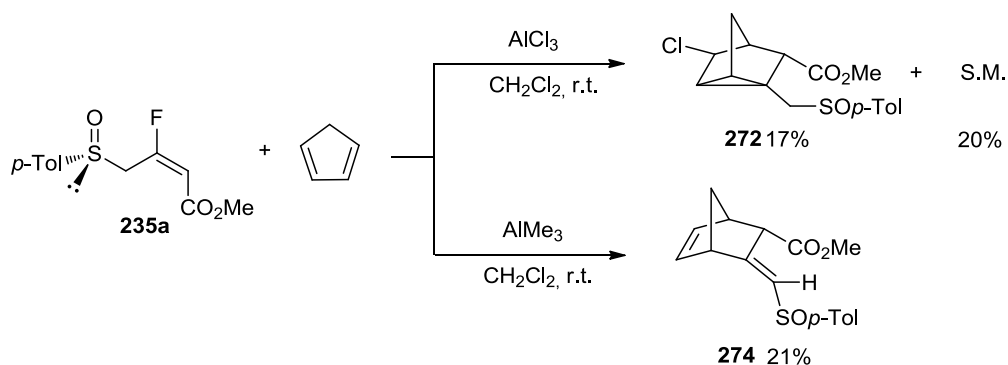

Figure 3. 16

The reaction of (*E*)-methyl-3-fluoro-4-*p*-tolylsulfinyl but-2-enoate **235a** and cyclopentadiene was carried out with other Lewis acids such as AlCl₃ and AlMe₃ in CH₂Cl₂ at room temperature (Scheme 3. 49). The use of AlCl₃ led to methyl 5-chloro-2-(*p*-tolylsulfinyl) methyl tricyclo[2.2.1.0^{2,6}] heptane-3-carboxylate **272**, but the reaction was not completed, 20% of the starting material was recovered. However, when the reaction was carried out in presence of AlMe₃ as Lewis acid, the formation of a different product was observed. After flash chromatography a product identified as (1*R*,2*S*,4*S*)-methyl-3-(*p*-tolylsulfinyl) methylene bicyclo[2.2.1] hept-5-ene-2-carboxylate **274** could be isolated in 21% yield.



Scheme 3. 49

The structure and stereochemistry of (1*R*,2*S*,4*S*)-methyl-3-(*p*-tolylsulfinyl) methylene bicyclo[2.2.1] hept-5-ene-2-carboxylate **274** was determined by ¹H NMR analysis with the help of NOESY and COSY spectra.

As can be seen in the NOESY spectra in Figure 3. 17 there is a n.O.e effect between the proton of the olefin in *gem*-position to the sulfoxide and the proton situated in α -position to the ester group.

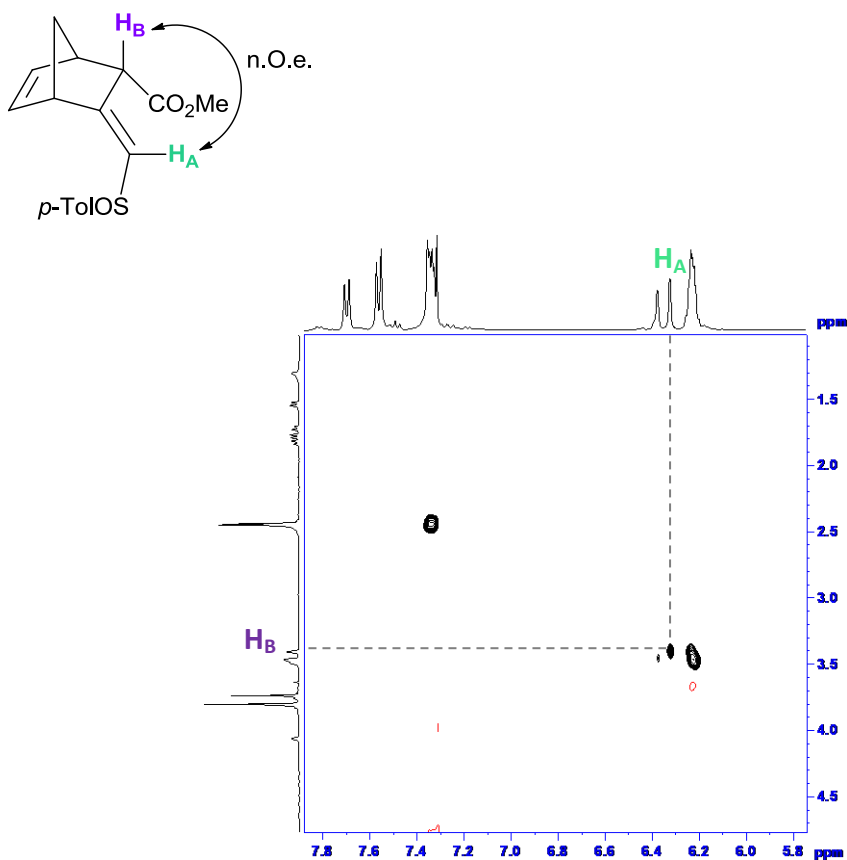
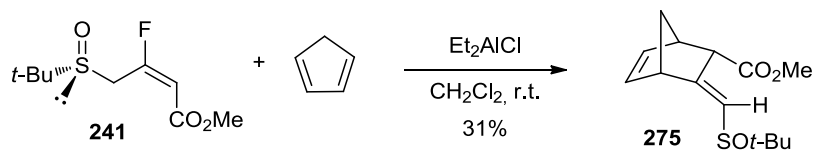

Figure 3. 17

When the substituent in the *p*-tolylsulfoxide of the monofluorinated olefin was changed by a bulkier group, such as *t*-Butyl sulfoxide **241**, the reaction with cyclopentadiene (5 equiv) under same conditions, Et₂AlCl (2 equiv) in CH₂Cl₂ at room temperature, led to the formation of (1*R*,2*S*,4*S*)-methyl-3-(*t*-butylsulfinyl) methylene bicyclo[2.2.1] hept-5-ene-2-carboxylate **275** which was isolated after flash chromatography in 31% yield (Scheme 3. 50).



Scheme 3. 50

Similar results were obtained when the methyl ester was changed by a benzyl group. In this case, the corresponding (1*R*,2*S*,4*S*)-benzyl-3-(*p*-tolylsulfinyl) methylene bicycle [2.2.1] hept-5-ene-2-carboxylate **276** resulting from HF elimination on the initially formed adduct, was isolated after flash chromatography in 30% yield (Scheme 3. 51).

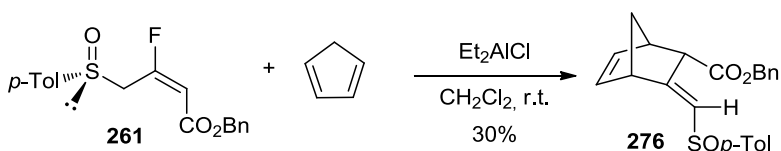

Scheme 3. 51

The Diels-Alder reaction of cyclopentadiene was also carried out with the (*E*)-dimethyl-3-fluoropent-2-enedioate **252**. Under same conditions [Et₂AlCl (2 equiv) in CH₂Cl₂ at r.t.] a mixture of compounds **277** and **278** was formed. Both compounds could be isolated after flash chromatography in 38% and 16% yield respectively (Scheme 3. 52).

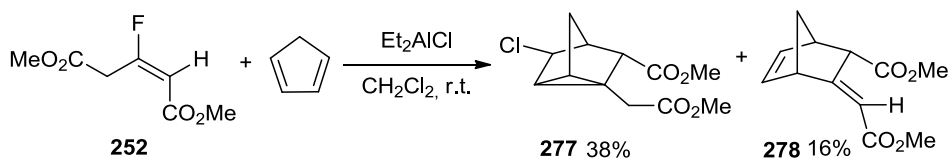

Scheme 3. 52

(*E*)-Methyl 4-cyano-3-fluorobut-2-enoate **244** also behaved as dienophile in the Diels-Alder reaction with cyclopentadiene in presence of Et₂AlCl in CH₂Cl₂ at room temperature. A mixture 1:1 of *Z* and *E* (1*R*,2*S*,4*S*)-methyl 3-cyanomethylene bicyclo[2.2.1] hept-5-ene-2-carboxylate **279a** and **279b** was identified in this case in 25% and 19% yield respectively. The different stereochemistry of the double bond in **279a** and **279b** was established on the base of the NOESY spectra.

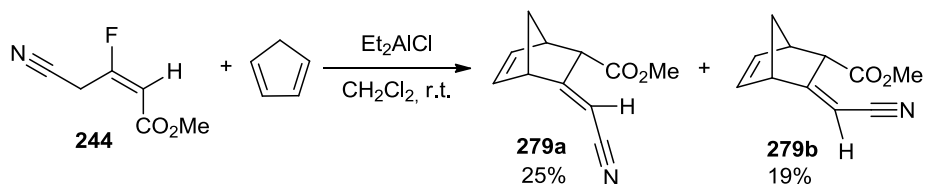

Scheme 3. 53

In order to extend the study of the reactivity of the monofluorinated olefins synthesized several reactions were attempted.

The addition of the methyl cuprate, prepared from CuI and MeLi , in THF at -20°C to the (*SR*, *E*)-methyl-3-fluoro-4-*p*-tolylsulfinyl but-2-enoate **235** led to the 1,4-addition/elimination product, (*R,Z* and *E*)-methyl 3-methyl-4-*p*-tolylsulfinyl but-2-enoate **280** in 75% yield (Scheme 3. 54). ^1H NMR spectra showed a 2:1 mixture of the *E* and *Z* non fluorinated olefins **280**.

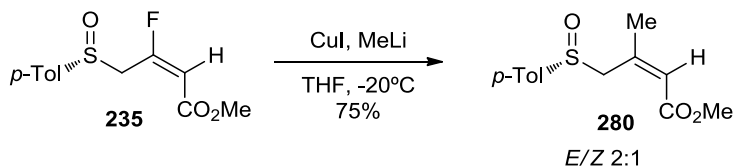

Scheme 3. 54

The reaction of (*SR*, *E*)-methyl-3-fluoro-4-*p*-tolylsulfinyl but-2-enoate **235** with trimethyl aluminum in CH_2Cl_2 at 0°C gave rise to the corresponding carbinol, (*R,Z*)-4-fluoro-2-methyl-5-(*p*-tolylsulfinyl)pent-3-en-2-ol **281** resulting from AlMe_3 addition to the ester group, which was isolated after flash chromatography in 35% yield (Scheme 3. 55).

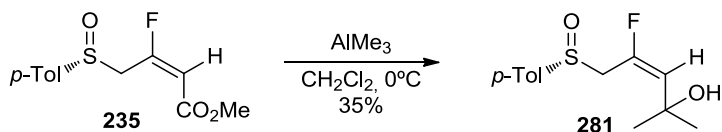

Scheme 3. 55

II.3. Mechanistic proposal

The results obtained in the study of these Diels-Alder reactions suggested that an aluminum derived Lewis acid was essential to promote the cycloaddition. Similar reactions found in the literature pointed out that fluorine substituents can act as potent regiocontrol elements. Fluorine-metal interactions are also useful in stereocontrol.

Marouka described in 1997, the highly selective epoxide opening of the fluorinated substrate **282b**, (Scheme 3. 56)²³² giving rise to the major formation of the carbinol resulting from the alkyne attack of the aluminium alkyne to the less substituted carbon of the epoxide. A mechanistic proposal explaining this result assumed an essential role of the fluorine atom facilitating the formation of a five-coordinate aluminium complex chelated to the fluorine and the epoxide oxygen.

The essential role of the fluorine atom assisting the regioselective transfer of the alkyne was demonstrated on the base of the regioselectivity observed on the epoxy opening of compound **282a** lacking the fluorine substituent.

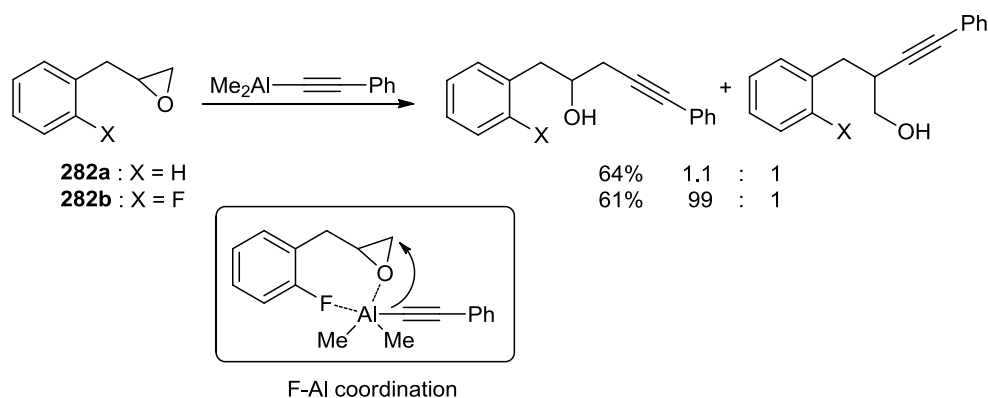

Scheme 3. 56

²³² T. Ooi, N. Kagoshima and K. Maruoka, *J. Am. Chem. Soc.* **1997**, *119*, 5754–5755.

Lewis acids are able to activate the C-F bonds of aliphatic organofluorine compounds effectively. Compared to the chlorine, bromine, and iodine atoms of haloalkanes, the fluorine atoms can coordinate to the metal centers of Lewis acids more strongly.

Among the various metals able to be chelated, aluminum has exceedingly high affinity toward fluorine (663.65 ± 6.3 KJ/mol Al-F bond), as can be deduced from the bond strengths in several diatomic molecules of metal-fluorine.^{233,234} The combination of this property with the well-known high oxygenophilicity of aluminum suggested that fluorine-assisted selective transformation of oxygen-containing organofluorine substrates seemed to be quite suitable.

The results of the reactions of cyclopentadiene with the trisubstituted monofluorinated olefins synthesized in this work could be explained taking into account these features of the association of fluorine and oxygen to Al. A summary of these reactions is included in Scheme 3. 57.

²³³ For example, the bond strengths in several diatomic molecules of metal-fluorine follow: Li-F, 577 ± 21 kJ/mol; Ti-F, 569 ± 34 kJ/mol; Si-F, 552.7 ± 2.1 kJ/mol; Sn-F, 466.5 ± 13 kJ/mol; Mg-F, 461.9 ± 5.0 kJ/mol. See: R. C. Weast, *Handbook of Chemistry and Physics*; 65th Edition, CRC Press: New York, **1984-1985**.

²³⁴ For the synthetic utility of forming the strong Al-F bonds, see: a) G. H. Posner, J. W. Ellis and J. Ponton, *J. Fluorine Chem.* **1981**, *19*, 191. b) G. H. Posner and S. R. Haines, *Tetrahedron Lett.* **1985**, *26*, 1823.

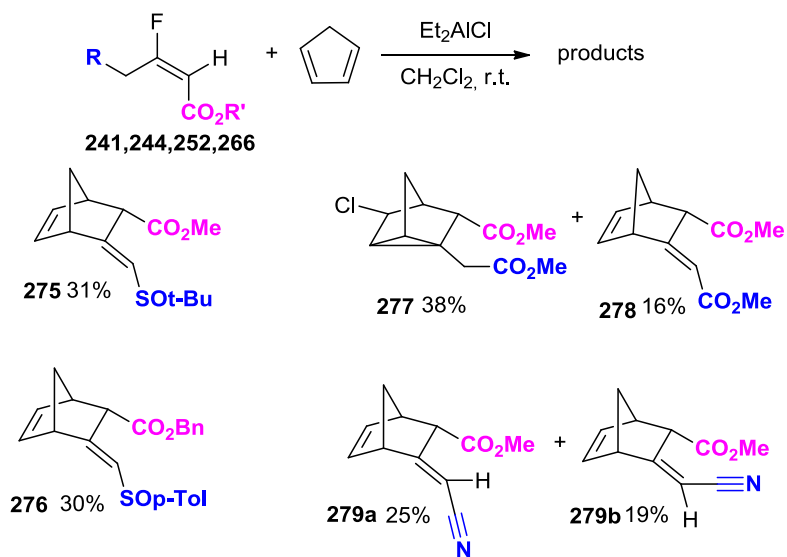
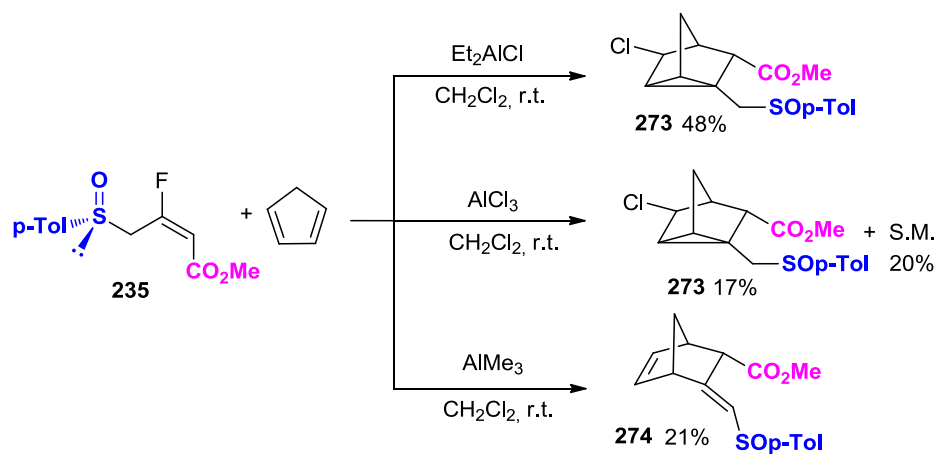

Scheme 3. 57

Several aspects of these results are noteworthy. The first one is the lack of chlorine incorporation in the final product with ^tBuSO bearing substrate **275** and when the CO₂Me of the olefin was changed by a CO₂Bn **276**.

Taking into account the formation of a mixture of chloroderivate **277** and elimination product **278** from dimethyl ester olefin **252**, we considered the possibility of incorporation of the chlorine once the elimination of HF had taken place. We thus, effected the reaction of (1*R*,2*S*,4*S*)-methyl-3-(*p*-tolylsulfinyl) methylene bicycle [2.2.1] hept-5-ene-2-carboxylate **274** with Et₂AlCl in dichloromethane at room temperature. After 24 hours, methyl 5-chloro-2-(*p*-tolylsulfinyl) methyl tricycle [2.2.1.0^{2,6}] heptane-3-carboxylate **273** was not detected (Scheme 3. 58), providing evidence that the bicyclic system **274** was not an intermediate of the reaction.

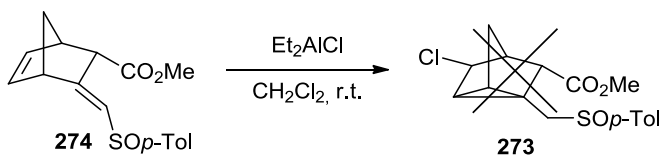

Scheme 3. 58

An important experimental characteristic of the formation of the chlorinated tricyclic derivative **273** in the reaction between (*E*)-methyl-3-fluoro-4-*p*-tolylsulfinyl but-2-enoate **235** and cyclopentadiene (5 equiv) with Et₂AlCl (2 equiv) as Lewis acid in dichloromethane at room temperature, was the need of an excess of the Lewis acid (2 equivalents) to reach the final product in a 48% yield.

All these data suggested a double role of Et₂AlCl in the overall process. The Et₂AlCl could initially coordinate to the sulfinylic oxygen and to the fluorine atom to form a six membered cyclic intermediate as shown in Scheme 3. 59. This coordination would be decreasing the LUMO energy²³⁵ of the dienophile, favoring the cycloaddition. In agreement with the relative stereochemistry of the product chloro tricyclic derivative **273** the approach between the cyclopentadiene and the

²³⁵ I. Fleming in "Frontier orbitals and organic chemical reactions" Ed. John Wiley and Sons, Chichester, 1976.

activated olefin must be *endo*, although no π -facial diastereoselectivity. The initially formed cycloadduct **A** (Diels-Alder product) still having a vicinal fluorine and a sulfoxide as substituent could also form an associated species with Et_2AlCl such as **B** represented in Scheme 3. 59.

This Al-F coordination activates the fluorine atom as a leaving group. The nucleophilic attack of a chlorine atom would promote the formation of the cyclopropane ring and the departing of the fluorine atom to form methyl 5-chloro-2-(*p*-tolylsulfinyl) methyl tricyclo [2.2.1.0^{2,6}] heptane-3-carboxylate **273** through a $\text{S}_{\text{N}}2'$ like reaction.

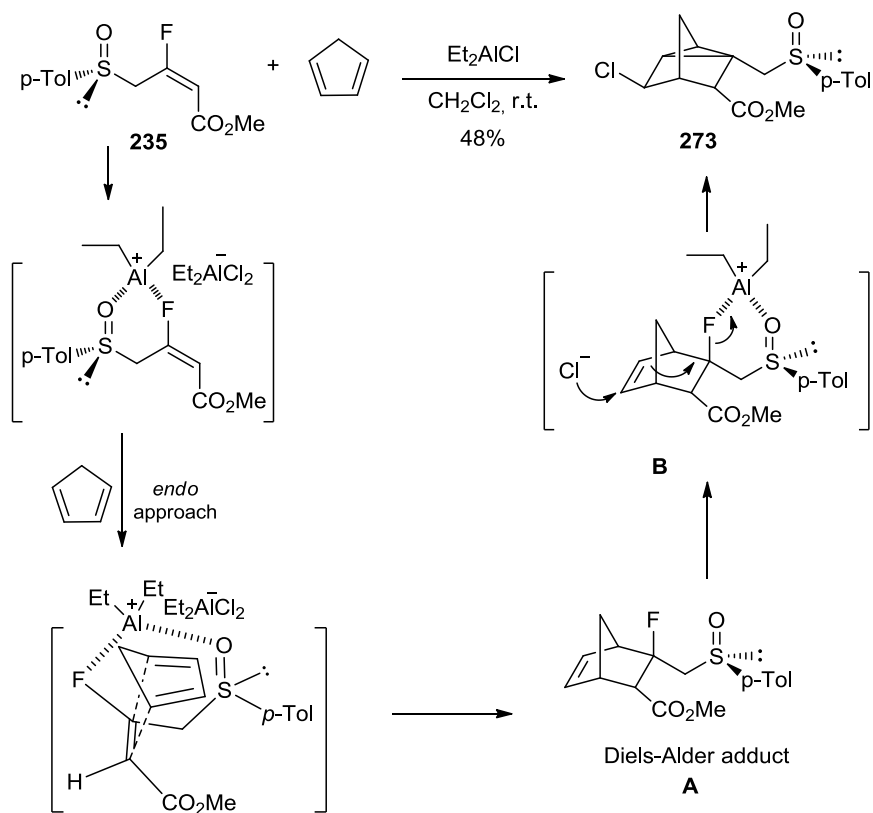

Scheme 3. 59

The absence of chlorine on the Lewis acid was Me_3Al or dienophiles when the substrate had a nitrile group instead of a carboxylate led to the elimination product **279**. These results suggested that when there is no formation of the six membered ring intermediate due to the presence of $\text{C}\equiv\text{N}$ group or no chlorine in the medium, the Diels-Alder cycloadduct suffers the fluorine elimination process assisted by Me_3Al or Et_2AlCl (Scheme 3. 60 and Scheme 3. 61).

This elimination gave a major *Z*-olefin probably as consequence of its higher stability due to the absence of steric interactions.

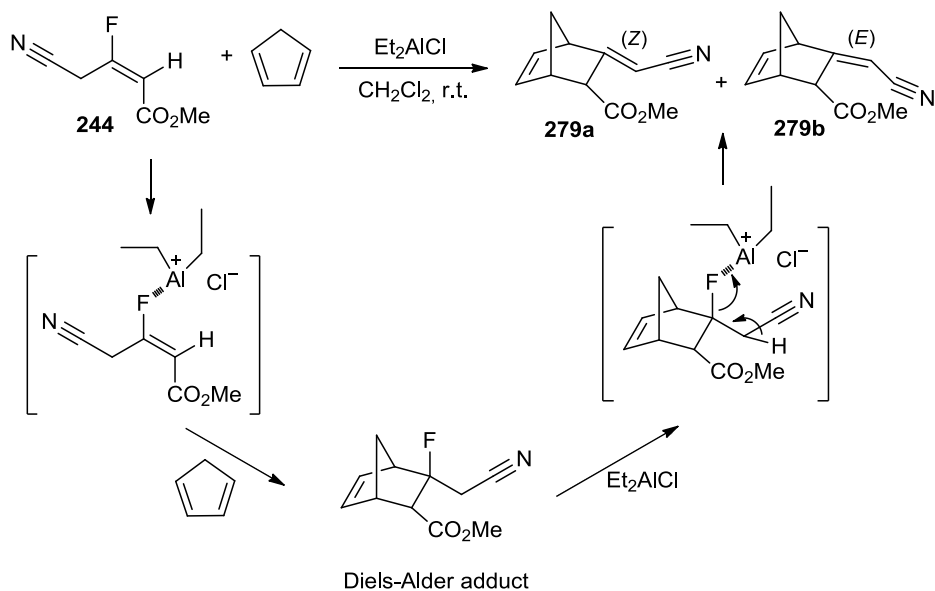

Scheme 3. 60

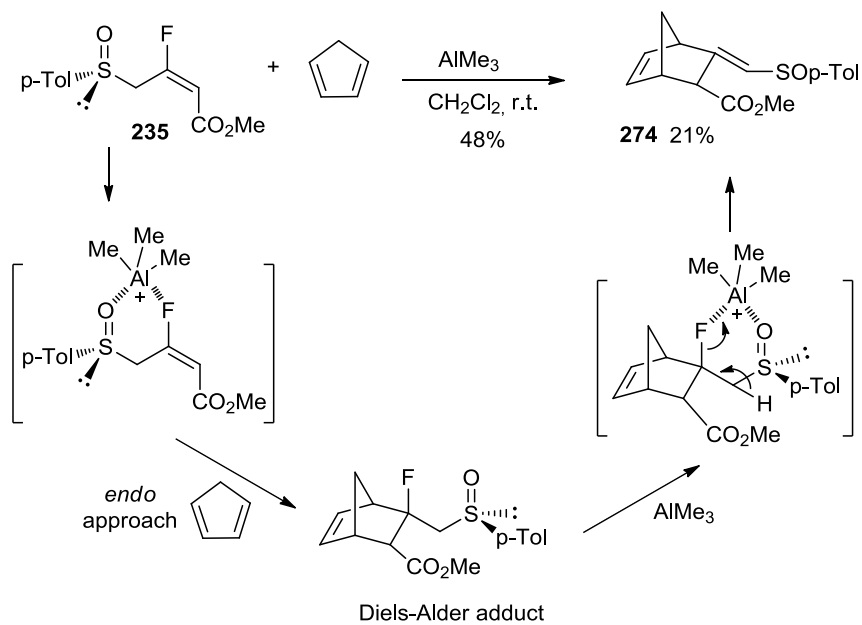

Scheme 3. 61

IV. CONCLUSIONS

We have described the stereoselective synthesis of monofluorinated trisubstituted olefins from 3,3,3-trifluoropropionate esters using lithium enolate anions or Grignard reagents. The mechanism involves the initial formation of 3,3-*gem*difluoro-2-propenoates through a E1cb elimination reaction followed of a 1,4-addition of the organometallic species and a second E1cb to give the final olefins.

Monofluorinated olefins were tested as dienophile in the Diels-Alder reaction with cyclopentadiene giving rise to tricyclic and bicyclic structures.

V. EXPERIMENTAL PART

GENERAL REMARKS

Solvents and reagents

Unless stated otherwise, reactions were performed in flame dried glassware under an argon or nitrogen atmosphere using dry solvents. Commercially obtained reagents were used as received. The commercial solution of *n*-butyllithium (1.6 M or 2.5 M in hexanes) was dosed before used using the protocol described by J. Suffert.¹⁴¹ Anhydrous solvents and reagents were distilled under argon atmosphere before used:

- Diethyl ether and THF over sodium and benzophenone.
- CH₂Cl₂ over CaH₂.
- Acetone, benzene and dimethylformamide over molecular sieves 4 Å.
- Diisopropylamine and triethylamine over KOH.
- DMSO over CaH₂.

All other reagent quality solvents were predried over activated molecular sieves and kept under an argon atmosphere.

Workup

For routine workup, hydrolysis was carried out with water, extractions with indicated solvent for each case, and solvent drying with MgSO₄.

Chromatography

Unless stated otherwise, flash chromatographic purification was done over silica gel following the flash chromatography protocol described by W. C. Still using MERCK Si 60 (40–63 μm) silica as stationary phase.¹⁴²

¹⁴¹ Suffert, J. *J. Org. Chem.* **1989**, *54*, 509.

¹⁴² Still, W. C.; Kahn, M.; Mitra, A. *J. Org. Chem.* **1978**, *43*, 2923.

All reactions were monitored by thin layer chromatography that was performed on precoated sheets of silica gel 60, and flash column chromatography was done with silica gel 60 (230-400 mesh) of Merck. Eluting solvents are indicated in the text. The TLC were visualized by UV fluorescence quenching as well as by the following solutions:

- Phosphomolybdic acid solution: 25 g of phosphomolybdic acid + 10 g of cerium sulfate (IV) + 60 mL of sulfuric acid + 940 mL of water (or 20 mL of the commercial solution and 60 mL of ethanol).
- Mostain: 20 g de tetrahydrated molybdate ammonium + 0.2 g of cerium sulfate + 400 mL 10% of sulfuric acid.

Nuclear Magnetic Resonance (NMR)

The Nuclear Magnetic Resonance (NMR) spectra were registered in a Bruker Avance 300 apparatus (^1H 300 MHz, ^{13}C 75 MHz) at ECPM and at Universidad Autonoma de Madrid. Avance 400 apparatus (^1H 400 MHz, ^{13}C 100 MHz) was used for certain spectra done at ECPM and certain with an AC-500 (1H 500 et 13C 126 MHz) at “Servicio Interdepartamental de Investigación” (SIdI) at Universidad Autónoma de Madrid.

All chemical shifts (δ) are quoted in parts per million (ppm). The chemical shifts are referred to the applied NMR solvent (for CDCl_3 : ^1H NMR, 7.26 ppm and ^{13}C NMR, 77.0 ppm). The coupling constants (J) and the non-equivalence ($\Delta\nu$) are given in Hertz (Hz). Resonance patterns are reported with the following notations: br (broad), s (singlet), d (doublet), t (triplet), q (quartet), qi (quintuplet), sex (sextuplet) and m (multiplet).

Integration of well resolved signals in the ^1H NMR spectrum allowed to establish the diastereomers ratio.

Mass Spectroscopy (MS)

Mass spectroscopy (MS) realized by Electronic Impact (EI) and Fast Atom Bombardment (FAB) were registered by VG AutoSpec. In the case of small or fragile molecules the mass spectroscopy was realized by Electrospray (ESI) and registered by QSTAR. The data is expressed in m/z units.

X-Ray Diffraction

X-Rays were recorded at Universidad Autónoma de Madrid by César Pastor and Université de Strasbourg by Dr. Brelot by a diffractometer Kappa CCD Oxford Cryosystem liquid N₂ using monochromatic radiations Mo-K α = 0.71073 Å. Data of diffraction were corrected by absorption and analysed with OpenMolen Package.

GENERAL PROCEDURES FOR THE SYNTHESIS OF MONOFLUORINATED OLEFINS

Method A:

To a solution of dry diisopropylamine (2.2 equiv) in THF (1.8M) at 0°C, a solution of *n*-BuLi 2.5M in hexanes (2.1 equiv) was added, under N₂. The mixture was stirred for 30 min, cooled to -78°C and a solution of the corresponding enolate precursor (2 equiv) in THF (0.8-1M) was added dropwise. The reaction was stirred for 1 hour and added, then a solution of methyl or benzyl 3,3,3-trifluoropropionate (1 equiv) in THF (1.5-2M) was added. The reaction was stirred during the time indicated in each case and followed by TLC. Once the reaction was completed the mixture was hydrolyzed with a saturated aqueous ammonium chloride solution and extracted with EtOAc. After workup, the mono fluorinated olefin was purified by flash chromatography (hexane/EtOAc).

Method B:

To a solution of methyl or benzyl 3,3,3-trifluoropropionate (1 equiv) in THF or toluene (0.25 M), was added the Grignard reagent (2-4 equiv) at -78°C in the solvent indicated in each case. The reaction was stirred during the time indicated in each case and followed by TLC. Once the reaction was completed the mixture was hydrolyzed with a saturated aqueous ammonium chloride solution and extracted with EtOAc. After workup, the mono fluorinated olefin was purified by flash chromatography (hexane/EtOAc).

(*SR*, *E* and *Z*)-Methyl 3-fluoro-4-(*p*-tolylsulfinyl)but-2-enoate **235**

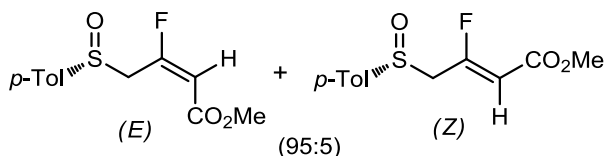

Sulfinyl monofluorinated olefin **235** was obtained by reaction of the lithium anion derived from (*SR*)-methyl-*p*-tolylsulfoxide **46** (2.5 g, 16.2 mmol, 3 equiv) to methyl-3,3,3-trifluoropropionate **233** (618 μL, 5.4 mmol, 1 equiv) following method A (1h). After workup, ¹H NMR analysis showed 95:5 mixture of two olefins *E/Z*.

Compound **235** was purified by flash chromatography (hexane/EtOAc 2:1) as a yellow solid in 75% yield (1.041 g). The major olefin was isolated by recrystallization in ether/hexane as a white solid.

$^1\text{H NMR}$ (CDCl_3) δ 2.42 (s, 3H), 3.66 (s, 3H), 4.24 and 4.38 (ABX system, $J_{AB} = 12.8$ Hz, $J_{AX} = 23.5$ Hz and $J_{BX} = 22.7$ Hz, $\Delta\nu = 14.6$ Hz, 2H), 5.79 (d, $J = 17.5$ Hz, 1H), 7.46 (AA'BB' system, $J = 8$ Hz, 4H)

$^{13}\text{C NMR}$ (CDCl_3) δ 21.4, 21.6, 51.8, 57.8, 58.1, 105.4 (d, $J = 23.4$ Hz), 124.2, 124.8, 129.9, 130.0, 139.8, 142.2, 165.5 (d, $J = 24.3$ Hz), 165.9 (d, $J = 272.7$ Hz)

$^{19}\text{F NMR}$ (CDCl_3) δ -74.95 (dt, $J = 20.8$ and 21.4 Hz, 1F)

X-Ray Diffraction

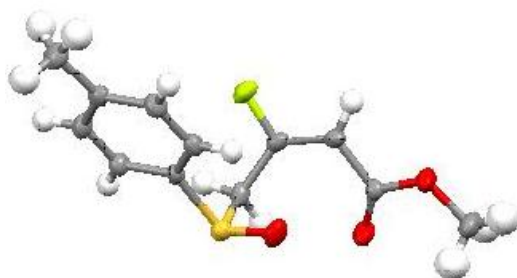

(*R,E* and *Z*)-Methyl 3-fluoro-4-(*t*-butylsulfinyl)but-2-enoate **241**

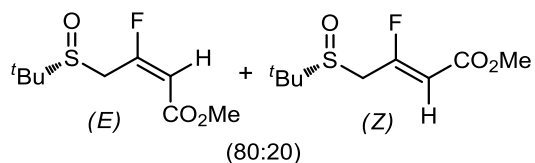

t-Butyl sulfinyl monofluorinated olefin **241** was obtained by reaction of the lithium anion derived from methyl-*t*-butylsulfoxide **177** (500 mg, 4.16 mmol, 3 equiv) and methyl-3,3,3-trifluoropropionate (158 μL , 1.38 mmol, 1 equiv) following

method A(1h). After workup, ^1H NMR analysis showed 80:20 mixture of two olefins *E/Z*. Compound **241** was purified by flash chromatography (EtOAc 100%) and isolated as yellow oil in 28% yield (87 mg).

^1H NMR (CDCl_3) δ 1.28 (s, 9H), 3.68 (s, 3H), 3.84 and 4.09 (ABX system, $J_{AB} = 12.6$ Hz, $J_{AX} = 22.6$ Hz and $J_{BX} = 23.6$ Hz, $\Delta\nu = 106$ Hz, 2H), 5.47 (d, $J = 32.2$ Hz, 0.25H), 5.85 (d, $J = 17.5$ Hz, 1H)

^{13}C NMR (CDCl_3) δ 22.6, 47.5 (d, $J = 23.5$ Hz), 51.8, 54.9, 105.0 (d, $J = 26.5$ Hz), 165.9 (d, $J = 23.7$ Hz), 168.0 (d, $J = 272.7$ Hz)

(*E* and *Z*)-Methyl 3-fluoro-4-tosylbut-2-enoates **242**

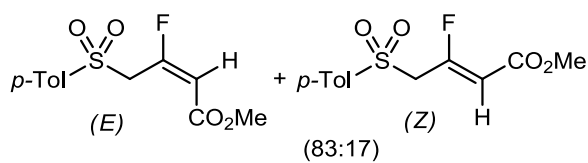

Monofluorinated olefin **242** was obtained by reaction of the lithium anion derived from methyl *p*-tolylsulfone **236** (890 mg, 5.24 mmol, 2 equiv) and methyl-3,3,3-trifluoropropionate (300 μL , 2.62 mmol, 1 equiv) following method A (4h). After workup, ^1H NMR analysis showed 83:17 mixture of two olefins *E/Z* and 40% of starting material. The mixture was purified by flash chromatography (hexane/EtOAc 3:1) as a white solid in 31% yield (218 mg).

^1H NMR (CDCl_3) δ 2.42 (s, 4H), 3.54 (s, 3H), 4.68 (d, $J = 21.6$ Hz, 2H), 5.75 (d, $J = 17.8$ Hz, 1H), 7.33 (m, 3H), 7.74 (m, 3H)

^{13}C NMR (CDCl_3) δ 21.6, 21.7, 51.8, 56.7 (d, $J = 24.8$ Hz), 106.5 (d, $J = 25.7$ Hz), 128.2, 128.6, 129.7, 130.1, 135.1, 135.5, 145.4, 146.0, 163.4 (d, $J = 273.2$ Hz), 164.8 (d, $J = 23.4$ Hz)

^{19}F NMR (CDCl_3) δ -78.7 (dt, $J = 17.2$ and 21.2 Hz, 1F), -81.0 (dt, $J = 31$ and 18.2 Hz, 0.09F)

HRMS (ESI): Calcd. for $\text{C}_{12}\text{H}_{14}\text{O}_4\text{FS}$ ($\text{M}^+ + \text{H}$): 273.0591; found 273.0602

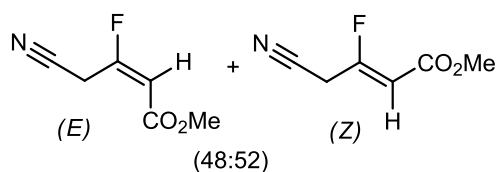
(E and Z)-methyl 4-cyano-3-fluorobut-2-enoate 244

Monofluorinated olefin **244** was obtained by reaction of the lithium anion derived from acetonitrile (274 μL , 5.24 mmol, 2 equiv) and methyl-3,3,3-trifluoropropionate (300 μL , 2.62 mmol, 1 equiv) following method A (3h). After workup, ^1H NMR analysis showed 48:52 mixture of two olefins *E/Z*. The mixture was purified by flash chromatography (hexane/EtOAc 3:1) as a yellow solid in 48% yield (179 mg).

^1H NMR (CDCl_3) δ 3.38 (d, $J = 16.5\text{Hz}$, 2H), 3.59 (d, $J = 20.4\text{Hz}$, 1.3H), 3.74 (m, 5.5H), 5.11 (d, $J = 32.2\text{Hz}$, 1H), 5.29 (d, $J = 10.8\text{Hz}$, 0.6H)

^{13}C NMR (CDCl_3) δ 36.9 (d, $J = 24.8\text{ Hz}$), 37.5 (d, $J = 25.6\text{ Hz}$), 52.8, 52.9, 82.6 (d, $J = 12.1\text{ Hz}$), 85.4 (d, $J = 40.8\text{ Hz}$), 112.0 (d, $J = 2.7\text{ Hz}$), 113.9 (d, $J = 19\text{ Hz}$), 165.9 (d, $J = 2.6\text{ Hz}$), 166.2 (d, $J = 1.7\text{ Hz}$), 169.2 (d, $J = 282.7\text{ Hz}$), 171.8 (d, $J = 277.8\text{ Hz}$)

HRMS (ESI): Calcd. for $\text{C}_6\text{H}_6\text{NO}_2\text{F}$: 143.0383; Found: 143.0377

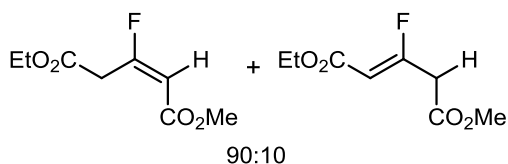
(E and Z)-1-ethyl 1-methyl 3-fluoropent-2 and 3-enedioate 250 and 251

Monofluorinated olefins **250** and **251** were obtained by reaction of the lithium anion derived from ethyl acetate (343 μL , 3.5 mmol, 2 equiv) and methyl-3,3,3-trifluoropropionate (200 μL , 1.75 mmol, 1 equiv) following method A (3h). After workup, ^1H and ^{19}F NMR analysis showed 90:10 mixture of two olefins *E/Z* and 1:1 mixture of regioisomeric olefins with the double bond in 2 and 3.

Compounds **250** and **251** were purified by flash chromatography (hexane/EtOAc 2:1) as a yellow solid in 40% yield (131 mg).

$^1\text{H NMR}$ (CDCl_3) δ 1.25 (t, $J = 7.14$ Hz, 3H), 3.28 and 3.30 (d, $J = 17.6$ Hz, 0.23H), 3.70 and 3.72 (2s, 3.4H), 3.89 and 3.91 (d, $J = 22.3$ Hz, 2H), 4.10-4.21 (m, 2.6H), 5.34 and 5.36 (d, $J = 32$ Hz, 0.11H), 5.75 and 5.76 (d, $J = 17.9$ Hz, 1H)

$^{13}\text{C NMR}$ (CDCl_3) δ 14.0 (2C), 35.9 (d, $J = 19.2$ Hz), 36.3 (d, $J = 19.2$ Hz), 51.5, 51.6, 52.4, 52.6, 60.6, 61.5, 61.8, 103.5 (d, $J = 26.9$ Hz), 103.9 (d, $J = 26.4$ Hz), 165.5 (d, $J = 25$ Hz), 166.0 (d, $J = 24.5$ Hz), 167.1 (d, $J = 2.2$ Hz), 167.6 (d, $J = 2.2$ Hz), 168.4 (d, $J = 272.7$ Hz), 168.9 (d, $J = 272.7$ Hz)

$^{19}\text{F NMR}$ (CDCl_3) δ -74.9 (dt, $J = 17.3$ and 23.17 Hz, 1F), -75.5 (dt, $J = 17.3$ and 23.17 Hz, 1F), -79.7 (dt, $J = 17.3$ and 32.18 Hz, 0.1F), -80.4 (dt, $J = 17.3$ and 32.18 Hz, 0.1F)

HRMS (FAB $^+$) calcd for $\text{C}_8\text{H}_{12}\text{O}_4\text{F}$ ($\text{M}^+ + \text{H}$) 191.0714, found 191.0719

(E and Z)-dimethyl 3-fluoropent-2-enedioate 252

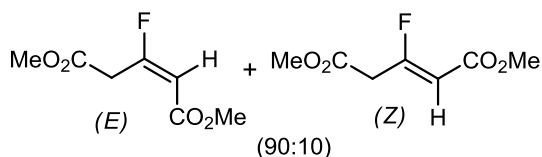

Monofluorinated olefin **252** was obtained by reaction of the lithium anion derived from methyl acetate (416 μL , 5.24 mmol, 2 equiv) and methyl-3,3,3-trifluoropropionate (300 μL , 2.62 mmol, 1 equiv) following method A (3h). After workup, $^1\text{H NMR}$ analysis showed 90:10 mixture of two olefins *E/Z*. The mixture was purified by flash chromatography (hexane/EtOAc 3:1) as a yellow solid in 34% yield (155 mg).

$^1\text{H NMR}$ (CDCl_3) δ 3.29 (d, $J = 17.8$ Hz, 0.5H), 3.70 (m, 6H), 3.90 (d, $J = 23.2$ Hz, 2H), 5.35 (d, $J = 32$ Hz, 0.2H), 5.75 (d, $J = 17.8$ Hz, 1H)

^{13}C NMR (CDCl_3) δ 35.9 (d, $J = 25.3$ Hz), 38.8 (d, $J = 27.3$ Hz), 51.5, 51.7, 52.5, 52.6, 102.2 (d, $J = 4.6$ Hz), 103.5 (d, $J = 27$ Hz), 166.0 (d, $J = 24.8$ Hz), 167.6 (d, $J = 2.2$ Hz), 168.7 (d, $J = 272.6$ Hz)

MS (EI) m/z (%): 113 (73), 125 (100), 145 (68), 177 ($\text{M}^+ + \text{H}$, 9)

HRMS (ESI): Calcd. for $\text{C}_7\text{H}_{10}\text{O}_4\text{F}$ ($\text{M}^+ + \text{H}$): 177.0557; Found: 177.0566

(Z and E) Trimethyl 3-fluorobut-2-ene-1,2,4-tricarboxylate 253

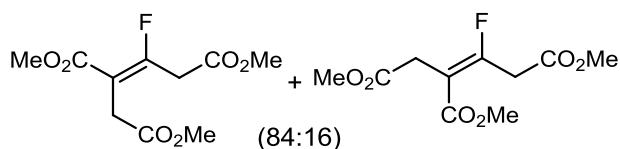

Monofluorinated olefin **253** was obtained by reaction of the lithium anion derived from dimethyl succinate (0.68 mL, 5.24 mmol, 2 equiv) and methyl-3,3,3-trifluoropropionate (300 μL , 2.62 mmol, 1 equiv) following method A (2h). After workup, ^1H NMR analysis showed 84:16 mixture of two olefins Z/E. The mixture was purified by flash chromatography (hexane/EtOAc 4:1) as colorless oil 23% yield (147 mg).

^1H NMR (CDCl_3) δ 3.43 (d, $J = 2.98\text{Hz}$, 1.89H), 3.71 (m, 9.37H), 3.93 (d, $J = 24.1\text{Hz}$, 2H)

^{13}C NMR (CDCl_3) δ 30.7 (d, $J = 7.2$ Hz), 37.1 (d, $J = 26.8$ Hz), 52.1, 52.2, 52.5, 110.1 (d, $J = 19.4$ Hz), 165.1 (d, $J = 272.6$ Hz), 166.2 (d, $J = 18$ Hz), 167.9 (d, $J = 1.6$ Hz), 170.5 (d, $J = 2.8$ Hz)

HRMS (ESI): Calcd. for $\text{C}_{10}\text{H}_{14}\text{O}_6\text{F}$ ($\text{M}^+ + \text{H}$): 249.0768; Found: 249.0780

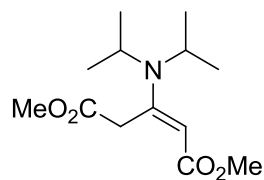
(E)-Dimethyl 3-diisopropylamino pent-2-enedioate 254

Monofluorinated olefin **254** was obtained by reaction of the lithium anion derived from methyl acetate (416 μL , 5.24 mmol, 2 equiv) and methyl-3,3,3-trifluoropropionate (300 μL , 2.62 mmol, 1 equiv) following method A. After addition the temperature was allowed to reach room temperature. After workup, ^1H NMR analysis showed only Z olefin. The product was purified by flash chromatography (hexane/EtOAc 4:1) as a white solid in 18% yield (120 mg).

^1H NMR (CDCl_3) δ 1.25 (d, $J = 6.9\text{Hz}$, 12H), 3.57 (s, 3H), 3.69 (s, 3H), 3.78 (set, $J = 6.8\text{Hz}$, 2H), 4.21 (s, 2H), 4.87 (s, 1H)

^{13}C NMR (CDCl_3) δ 20.5, 35.1, 48.0, 50.0, 52.0, 87.5, 154.2, 169.2, 170.6

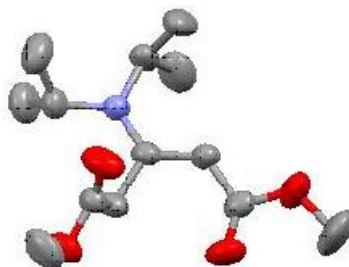
X-Ray Diffraction

Benzyl 3,3,3-trifluoropropanoate 259²²⁰

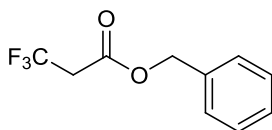

Under stirring, 3,3,3-trifluoropropanoic acid (15 g, 117.2 mmol) was added, dropwise to a mixture of thionyl chloride (8.1 mL, 111.3 mmol) and DMF (0.1 mL), at 40°C over a period of 15 min. The reaction mixture was warmed to 70-75°C and stirred for 3 h, cooled to room temperature. Then, benzylic alcohol (11.6 mL, 112 mmol) was added to the mixture and warmed up to 50°C for 2 h. The crude product was purified by distillation (b. p. 162-170°C).

¹H NMR (CDCl₃): δ 3.22 (q, *J* = 9.9 Hz, 2H), 5.21 (s, 2H), 7.38-7.34 (m, 5H)

¹³C NMR (CDCl₃): δ 39.5 (q, *J* = 30.9 Hz), 67.4, 123.3 (q, *J* = 276.6 Hz), 128.3, 128.5, 128.6, 134.8, 163.9

¹⁹F NMR (CDCl₃): δ -64.95 (t, *J* = 9.8 Hz, 1F)

MS (EI) C₁₀H₉F₃O₂ calc. 218.0555, found 218.0562

(*R*, *E* and *Z*)-Benzyl 3-fluoro-4-*p*-tolylsulfinyl but-2-enoate 260

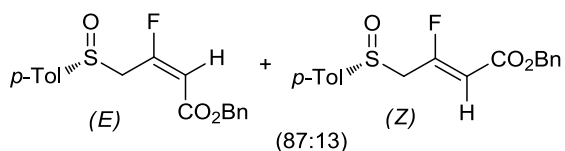

Sulfinyl monofluorinated olefin **260** was obtained by reaction of the lithium anion derived from (*SR*)-methyl-*p*-tolylsulfoxide **46** (1.76 g, 11.4 mmol, 2 equiv) to the commercial benzyl-3,3,3-trifluoropropanoate (1mL, 5.7 mmol, 1 equiv) following method A (1d). After workup, ¹H NMR analysis showed 87:13 mixture of

²²⁰ P. V. Ramachandran, G. Parthasarathy and P. D. Gagare, *Org. Lett.* **2010**, *12*, 4474-4477

two olefins *E/Z*. Compound **260** was purified by flash chromatography (hexane/EtOAc 2:1) as a yellow oil in 51% yield (958 mg).

$^1\text{H NMR}$ (CDCl_3) δ 2.39 (s, 3H), 4.28 and 4.38 (AB system, $J = \text{Hz}$, 2H), 5.09 (s, 2H), 5.82 (d, $J = 17.5\text{Hz}$, 1H), 7.30 and 7.55 (AA'BB' system, $J = 8.3\text{Hz}$, 4H), 7.35 (m, 5H)

$^{13}\text{C NMR}$ (CDCl_3) δ 21.4, 57.7, 58.1, 66.6, 105.4, 105.7, 124.2, 128.3, 128.5, 128.6, 129.9, 135.3, 139.8, 142.2, 164.4, 164.8, 165.1, 168.0

(*E* and *Z*)-Benzyl 3-fluoro-4-(methylsulfonyl)but-2-enoate **261**

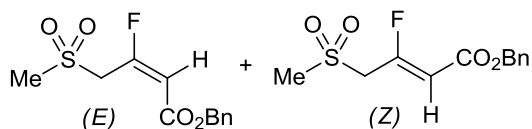

(80:20)

Sulfonyl monofluorinated olefin **261** was obtained by reaction of the lithium anion derived from dimethyl sulfone (429 mg, 4.56 mmol, 2 equiv) to the commercial benzyl-3,3,3-trifluoropropionate (400 μL , 2.28 mmol, 1 equiv) following method A (20h). After workup, $^1\text{H NMR}$ analysis showed 80:10 mixture of two olefins *E/Z*. Compound **261** was purified by flash chromatography (hexane/EtOAc 4:1) as a yellow oil in 40% yield (252 mg).

$^1\text{H NMR}$ (CDCl_3) δ 3.02 (s, 3H), 4.66 (d, $J = 22.5\text{Hz}$, 2H), 5.23 (s, 2H), 6.05 (d, $J = 17.2\text{Hz}$, 1H), 7.4 (m 5H)

$^{13}\text{C NMR}$ (CDCl_3) δ 41.8, 55.2, 55.6, 67.1, 106.6, 106.9, 128.4, 128.6, 128.7, 135.1, 161.9, 164.7, 164.9, 165.6

(E)-Benzyl 3-fluorobut-2-enoate 262

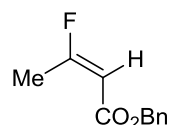

To a solution of benzyl 3,3,3-trifluoropropanoate **259** (400 μ L, 2.28 mmol, 1 equiv) in the corresponding solvent, THF or toluene (9.2 mL, 0.25 M), at -78°C , was added the methyl magnesium bromide (3.04 mL, 9.12 mmol, 4 equiv) following method B (96h). After workup, ^1H NMR analysis showed only olefin *E* was obtained. Compound **262** was purified by flash chromatography (hexane/EtOAc 4:1) as colorless oil in 35% yield (160 mg).

^1H NMR (CDCl_3) δ 2.39 (d, $J = 19.5$ Hz, 3H), 5.16 (s, 2H), 5.65 (d, $J = 19.2$ Hz, 1H), 7.39-7.31 (m, 5H)

^{13}C NMR (CDCl_3) δ 16.7 (d, $J = 24.2$ Hz), 66.2, 101.2 (d, $J = 29$ Hz), 128.3, 128.4, 128.7, 136.1, 166.3 (d, $J = 27$ Hz), 174.6 (d, $J = 271.1$ Hz)

^{19}F NMR (CDCl_3) δ -66.6 (qi, $J = 19.38$ Hz, 1F)

MS (EI) m/z : 194 ($[\text{M}]^+$, 16), 174 (7), 149 (31), 91 (47), 87 (100)

MS (EI) m/z : calcd for $\text{C}_{11}\text{H}_{11}\text{FO}_2$ $[\text{M}]^+$ 194.0743, found 194.0746

Benzyl 3,3-difluoroacrylate B

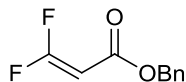

The intermediate was observed in ^1H NMR spectra of the crude in the reaction of compound **262**.

^1H NMR (CDCl_3) δ 5.02 (dd, $J = 21.45$ and 2.37 Hz, 1H), 5.16 (s, 3H), 7.36 (s, 5H)

MS (EI) m/z : 198 ($[\text{M}]^+$, 19), 178 (11), 134 (26), 108 (69), 91 (100)

MS (EI) m/z : calcd for $\text{C}_{10}\text{H}_8\text{F}_2\text{O}_2$ $[\text{M}]^+$ 198.0492, found 198.0488

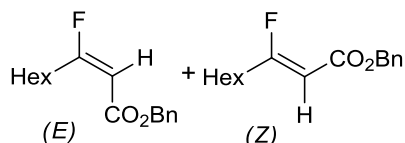
(E and Z)-Benzyl 3-fluoronon-2-enoate 263

To a solution of benzyl 3,3,3-trifluoropropanoate **259** (400 μL , 2.28 mmol, 1 equiv) in the corresponding solvent, THF or toluene (9.2 mL, 0.25 M), at -78°C , was added the hexyl magnesium bromide 2M in diethyl ether (3.24 mL, 6.84 mmol, 3 equiv) following method B (3h). After workup, ^1H NMR analysis showed olefin *E* and *Z* were obtained as indicated in each case. Compound **263** was purified by flash chromatography (hexane/EtOAc 100:1) as colorless oil.

THF: 70% yield, *E/Z* 100:0

Toluene: 90% yield, *E/Z* 70:30

(E)-263:

^1H NMR (CDCl_3) δ 0.90 (t, $J = 6\text{Hz}$, 3H), 1.31 (m, 6H), 1.60 (m, 3H), 2.82 (dt, $J_t = 7.5\text{Hz}$ and $J_d = 25.9\text{Hz}$, 2H), 5.17 (s, 2H), 5.63 (d, $J = 19.5\text{Hz}$, 1H), 7.37 (m, 5H)

^{19}F NMR (CDCl_3) δ -74.48 (dt, $J_t = 25.9\text{Hz}$ and $J_d = 19.6\text{Hz}$)

^{13}C NMR (CDCl_3) δ 14.0, 22.5, 25.9, 28.7, 29.7, 29.9, 31.4, 66.0, 100.4, 100.8, 128.18, 128.6, 135.9, 165.8, 166.2, 176.1, 179.7

(Z)-263:

^1H NMR (CDCl_3) δ 0.78-1.64 (m, 13H), 2.27 (dt, $J = 17.0, 7.5\text{ Hz}$, 2H), 5.36 – 5.10 (m, 3H), 7.42 – 7.27 (m, 5H)

^{13}C NMR (CDCl_3) δ 172.96 (d, $J = 287.5\text{ Hz}$), 163.74 (d, $J = 1.8\text{ Hz}$), 136.19, 128.68, 128.32, 128.29, 98.61 (d, $J = 5.1\text{ Hz}$), 66.05, 33.18 (d, $J = 23.6\text{ Hz}$), 31.52, 28.63, 25.64, 22.58, 14.13

MS (EI) m/z : 264 ($[\text{M}^+]$, 1), 244, (1), 157 (36), 91 (100)

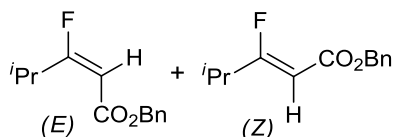
(E and Z)-benzyl 3-fluoro-4-methylpent-2-enoate 264

To a solution of benzyl 3,3,3-trifluoropropanoate **259** (400 μ L, 2.28 mmol, 1 equiv) in the corresponding solvent, THF or toluene (9.2 mL, 0.25 M), at -78°C , was added the isopropyl magnesium bromide 2.9M in 2-methyltetrahydrofuran (2.28 mL, 6.6 mmol, 3 equiv) following method B (3h). After workup, ^1H NMR analysis showed *E/Z* mixture of olefins was obtained as indicated in each case. Compound **264** was purified by flash chromatography (hexane/EtOAc 100:1) as colorless oil.

THF: 100% yield, *E/Z* 51:49

Toluene: 90% yield, *E/Z* 60:40

(E)-264:

^1H NMR (CDCl_3) δ 7.41 – 7.32 (m, 1H), 5.54 (d, $J = 19.8$ Hz, 1H), 5.17 (s, 1H), 3.86 (dsept, $J = 34.1, 6.9$ Hz, 1H), 1.18 (s, $J = 19.9$ Hz, 1H), 1.16 (s, 1H).

^{13}C NMR (CDCl_3) δ 181.36 (d, $J = 279.5$ Hz), 166.05 (d, $J = 27.0$ Hz), 136.10, 128.71, 128.36, 128.30, 99.01 (d, $J = 30.4$ Hz), 66.15, 28.51 (d, $J = 22.1$ Hz), 18.70, 18.68.

(Z)-264:

^1H NMR (CDCl_3) δ 7.41 – 7.29 (m, 5H), 5.30 – 5.15 (m, 3H), 2.51 (sept, $J = 7.0$ Hz, 1H), 1.17 (s, 3H), 1.14 (s, 3H).

^{13}C NMR (CDCl_3) δ 177.11 (d, $J = 289.0$ Hz), 163.91 (d, $J = 1.7$ Hz), 136.14, 128.64, 128.32, 128.26, 96.55 (d, $J = 5.4$ Hz), 66.03, 32.32 (d, $J = 23.3$ Hz), 19.12, 19.08.

MS (EI) m/z : 222 ($[\text{M}]^+$, 1), 202 (1), 115 (52), 91 (100)

MS (EI) m/z : calcd for $\text{C}_{13}\text{H}_{15}\text{FO}_2$ $[\text{M}]^+$ 222.1056, found 222.1061

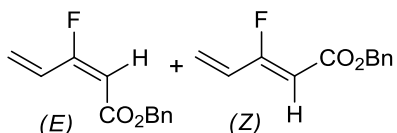
(E and Z)-benzyl 3-fluoropenta-2,4-dienoate 265

To a solution of benzyl 3,3,3-trifluoropropanoate **259** (400 μ L, 2.28 mmol, 1 equiv) in the corresponding solvent, THF or toluene (9.2 mL, 0.25 M), at -78°C , was added the vinyl magnesium bromide 1M in THF (6.84 mL, 6.8 mmol, 3 equiv) following method B (72h). After workup, ^1H NMR analysis showed *E/Z* mixture of olefins was obtained as indicated in each case. Compound **265** was purified by flash chromatography (hexane/EtOAc 9:1) as colorless oil.

THF: 45% yield, *E/Z* 80:20

Toluene: 75% yield, *E/Z* 80:20

(E)-265:

^1H NMR (CDCl_3) δ 7.53-7.26 (m, 6H), 5.98 (d, $J_{\text{trans}} = 17.7$ Hz, 1H), 5.65 (d, $J_{\text{H-F}} = 18.5$ Hz, 1H), 5.64 (qd, $J_{\text{cis}} = 11.7$ Hz, $J_{\text{gem}} = 3$ Hz, $J_{\text{H-F}} = 1.4$ Hz, 1H), 5.18 (s, 2H)

^{13}C NMR (CDCl_3) δ 168.3 (d, $J = 266$ Hz), 165.4 (d, $J = 25$ Hz), 135.8, 128.6, 128.3, 128.2, 125.9 (d, $J = 21$ Hz), 123.3 (d, $J = 8$ Hz), 101.9 (d, $J = 30$ Hz), 66.3

(Z)-265r:

^1H NMR (CDCl_3) δ 7.41 – 7.29 (m, 5H), 5.30 – 5.15 (m, 3H), 2.51 (sept, $J = 7.0$ Hz, 1H), 1.17 (s, 3H), 1.14 (s, 3H).

^{13}C NMR (CDCl_3) δ 177.11 (d, $J = 289.0$ Hz), 163.91 (d, $J = 1.7$ Hz), 136.14, 128.64, 128.32, 128.26, 96.55 (d, $J = 5.4$ Hz), 66.03, 32.32 (d, $J = 23.3$ Hz), 19.12, 19.08.

MS (EI) m/z : 206 ($[\text{M}]^+$, 1), 186 (11), 141 (26), 99 (31), 91 (100)

MS (EI) m/z : calcd for $\text{C}_{12}\text{H}_{11}\text{FO}_2$ $[\text{M}]^+$ 206.0743, found 206.0747

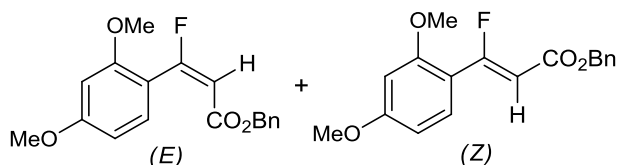
(E and Z)-Benzyl 3-(2,4-dimethoxyphenyl)-3-fluoroacrylate 266

To magnesium (0.1872 g, 7.7 mmol, 1.1 equiv) was added dropwise a solution of 1-bromo-2,4-dimethoxybenzene (1.04 mL, 7 mmol, 1 equiv) in the corresponding solvent (9.12 mL, 0.25 M). The mixture was stirred at room temperature for 2 hours, until magnesium particles disappeared.

To a solution of benzyl 3,3,3-trifluoropropanoate **259** (400 μ L, 2.28 mmol, 1 equiv) in the corresponding solvent, THF or toluene (9.2 mL, 0.25 M), at -78°C , was added the 2,4-dimethoxybenzyl magnesium bromide (4 equiv) following method B (96h). After workup, ^1H NMR analysis showed *E/Z* mixture of olefins was obtained as indicated in each case. Compound **266** was purified by flash chromatography (hexane/EtOAc 4:1) as orange oil.

THF: 80% yield, *E/Z* 30:70

Toluene: 63% yield, *E/Z* 32:68

(E)-266:

^1H NMR (CDCl_3) δ 7.45 – 6.87 (m, 5H), 6.41 (dd, $J = 8.6, 1.9$ Hz, 1H), 6.34 (s, 1H), 5.82 (d, $J = 16.4$ Hz, 1H), 4.99 (s, 2H), 3.74 (s, 3H), 3.62 (s, 3H).

^{13}C NMR (CDCl_3) δ 168.65 (d, $J = 268.9$ Hz), 165.35 (d, $J = 24.0$ Hz), 163.31 (d, $J = 1.9$ Hz), 159.06 (d, $J = 2.1$ Hz), 136.07, 132.02 (d, $J = 3.6$ Hz), 128.51, 128.23, 128.15 (s, $J = 10.8$ Hz), 112.94 (d, $J = 25.4$ Hz), 104.55, 102.91 (d, $J = 33.7$ Hz), 98.68, 66.04, 55.63, 55.54.

MS (EI) m/z : 316 ($[\text{M}]^+$, 4), 296 (3), 182 (47), 167 (50), 91 (100)

(Z)-266:

$^1\text{H NMR}$ (CDCl_3) δ 7.55 (d, $J = 8.7$ Hz, 1H), 7.42 – 7.04 (m, 5H), 6.46 (dd, $J = 8.8, 2.3$ Hz, 1H), 6.40 (d, $J = 1.4$ Hz, 1H), 6.23 (d, $J = 37.1$ Hz, 1H), 5.14 (s, 2H), 3.79 (s, 3H), 3.75 (s, 3H).

$^{13}\text{C NMR}$ (CDCl_3) δ 165.07 (d, $J = 1.2$ Hz), 163.66 (d, $J = 272.3$ Hz), 163.30 (s, $J = 108.8$ Hz), 159.51 (d, $J = 7.4$ Hz), 136.49, 129.93 (d, $J = 12.4$ Hz), 128.62, 128.36, 128.16, 112.28 (d, $J = 25.6$ Hz), 105.05 (d, $J = 1.6$ Hz), 99.34 (d, $J = 5.7$ Hz), 98.95 (d, $J = 2.6$ Hz), 65.95, 55.72, 55.62.

X-Ray Diffraction

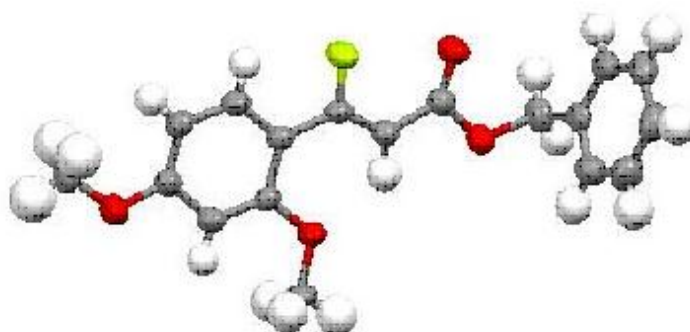

GENERAL PROCEDURE FOR DIELS-ALDER REACTIONS

To a solution of the monofluorinated olefin (1 equiv) in CH_2Cl_2 (0.8 mL) at room temperature were added 2 equivalents of the Lewis acid indicated in each case. After 5 min under stirring, cyclopentadiene (164 μL , 5 equiv) was added. The mixture was stirred during the time indicated in each case and followed by TLC; once the reaction is completed the mixture was hydrolyzed with a saturated aqueous ammonium chloride solution, poured into an erlenmeyer containing sodium potassium tartrate and stirred vigorously for 30 min. The organic layer was washed with brine. After work up, the product was isolated after flash chromatography (eluent cyclohexane/EtOAc 1:1).

(SR)-Methyl 5-chloro-2-(*p*-tolylsulfinyl) methyl tricyclo [2.2.1.0^{2,6}] heptane-3-carboxylate 272

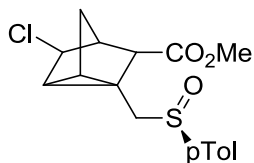

To a solution of (*SR,E*)-methyl 3-fluoro-4-(*p*-tolylsulfinyl)but-2-enoate **235a** (100 mg, 0.39 mmol, 1 equiv) in CH₂Cl₂ (0.8 mL) at room temperature was added 0.78 mL of Et₂AlCl 1M in hexanes. After 5 min under stirring, cyclopentadiene (164 μL, 5 equiv) was added. The mixture was stirred for 3 hours and the hydrolyzed with a saturated aqueous ammonium chloride solution, poured into an erlenmeyer containing sodium potassium tartrate and stirred vigorously for 30 min. The organic layer was washed with brine. After work up and flash chromatography (eluent cyclohexane/EtOAc 1:1), the product was isolated as white solid in 48% yield (63.2 mg).

¹H NMR (CDCl₃) δ 1.64 (m, 3H), 2.13 (dd, *J* = 11.2 and 3.7 Hz, 1H), 2.39 (d, *J* = 9.5 Hz, 1H), 2.40 (s, 3H), 2.68 (dd, *J* = 13.9 and 1.8 Hz, 1H), 2.79 (dd, *J* = 16 and 1.4 Hz, 1H), 3.65 (m, 4.3H), 4.23 (m, 1H), 7.3 and 7.50 (AA'BB' system, *J* = 8.13Hz, 4H)

¹³C NMR (CDCl₃) δ 19.3, 21.4, 24.1, 24.5, 24.9, 25.3, 31.4, 31.6, 42.2, 42.3, 50.2, 51.1, 51.8, 51.9, 57.7, 58.1, 61.5, 61.7, 124.0, 124.1, 129.9, 130.1, 140.8, 141.1, 141.6, 141.7, 172.2, 171.3

MS (EI) *m/z* (%): 338 (M⁺, 4), 201 (33), 199 (100), 138 (40), 105 (46)

Methyl 5-chloro-2-(*p*-tolylsulfonyl) methyl tricyclo [2.2.1.0^{2,6}] heptane-3-carboxylate 273

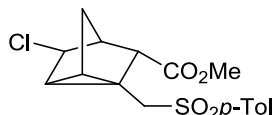

To a solution of (*SR*)-Methyl 5-chloro-2-(*p*-tolylsulfonyl) methyl tricyclo [2.2.1.0^{2,6}] heptane-3-carboxylate **272** (33 mg, 1 equiv) in CH₂Cl₂ at room temperature was added *m*-CPBA (18.5 mg, 1.1 equiv). After 2 hours under stirring, the mixture was hydrolyzed with Na₂S₂O₇ and extracted with CH₂Cl₂. The organic layer was washed with NaCO₃. After workup the product was isolated in 100% yield as white solid.

¹H NMR (CDCl₃) δ 1.4 (m, 3H), 1.55 (dd, *J* = 11.2 and 3.7 Hz, 1H), 2.09 (d, *J* = 9.5 Hz, 1H), 2.35 (s, 1H), 2.44 (s, 3H), 2.80 (d, *J* = 1.4 Hz, 1H), 2.85 (s, 1H), 3.72 (s, 3H), 4.12 (d, *J* = 1.4 Hz, 1H), 4.23 (s, 1H), 7.3 and 7.50 (AA'BB' system, *J* = 8.13 Hz, 4H)

¹³C NMR (CDCl₃) δ 18.7, 21.6, 22.7, 24.8, 31.5, 42.1, 49.7, 51.9, 55.7, 61.1, 128.1, 129.9, 136.9, 144.9, 172.2

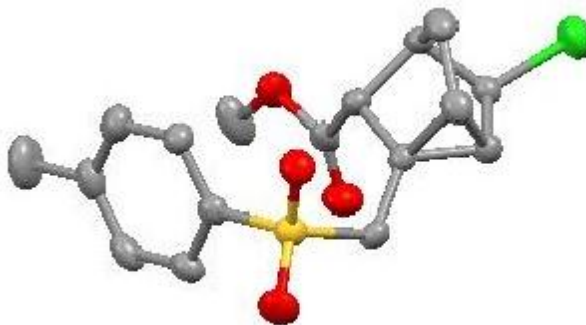
X-Ray Diffraction

(1*R*,2*S*,4*S*)-Methyl-3-(*p*-tolylsulfinyl) methylene bicyclo[2.2.1] hept-5-ene-2-carboxylate 274

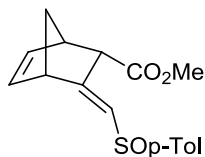

To a solution of (*SR,E*)-methyl 3-fluoro-4-(*p*-tolylsulfinyl)but-2-enoate **235a** (100 mg, 0.39 mmol, 1 equiv) in CH₂Cl₂ (0.8 mL) at room temperature was added 0.4 mL of Me₃Al 2M in hexanes. After 5 min under stirring, cyclopentadiene (164 μL, 5 equiv) was added. The mixture was stirred for 2 hours and the hydrolyzed with a saturated aqueous ammonium chloride solution, poured into an erlenmeyer containing sodium potassium tartrate and stirred vigorously for 30 min. The organic layer was washed with brine. After work up and flash chromatography (eluent cyclohexane/EtOAc 1:1), the product was isolated as yellow oil in 21% yield (25 mg).

¹H NMR (CDCl₃) δ 1.53 (d, *J* = 9 Hz, 1H), 1.71 (d, *J* = 9 Hz, 1H), 1.78 (d, *J* = 8.9 Hz, 1H), 1.82 (d, *J* = 8.9 Hz, 1H), 2.43 (s, 2H), 2.44 (s, 3H), 3.4 (s, 1H), 3.47 (m, 2H), 3.73 (s, 2H), 3.80 (s, 3H), 4.06 (m, 0.6H), 6.23 (m, 3H), 6.32 (s, 1H), 6.3 (s, 0.8H), 4.33 (m, 4.5H), 7.56 (d, *J* = 8Hz, 2H), 7.68 (d, *J* = 8.2 Hz, 1.3H)

¹³C NMR (CDCl₃) δ 21.3, 21.4, 46.5, 46.7, 49.3, 49.5, 49.9, 50.0, 52.2, 52.3, 52.9, 124.4, 124.6, 128.6, 129.7, 129.9, 134.1, 134.6, 135.6, 135.9, 140.7, 141.0, 141.2, 141.8, 150.8, 132.0, 171.4, 172.3

(1*R*,2*S*,4*S*)-Methyl-3-(*t*-butylsulfinyl) methylene bicyclo[2.2.1] hept-5-ene-2-carboxylate 275

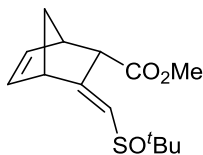

To a solution of (*S*,*R*)-methyl 3-fluoro-4-(*t*-butylsulfinyl)but-2-enoate **241** (87 mg, 0.39 mmol, 1 equiv) in CH_2Cl_2 (0.8 mL) at room temperature was added 0.4 mL of Et_2AlCl 1M in hexanes. After 5 min under stirring, cyclopentadiene (164 μL , 5 equiv) was added. The mixture was stirred for 6 hours and the hydrolyzed with a saturated aqueous ammonium chloride solution, poured into an erlenmeyer containing sodium potassium tartrate and stirred vigorously for 30 min. The organic layer was washed with brine. After work up and flash chromatography (eluent cyclohexane/EtOAc 1:1), the product was isolated as yellow oil in 31% yield (33 mg).

$^1\text{H NMR}$ (CDCl_3) δ 1.20 (s, 6H), 1.22 (s, 9H), 1.46 (d, $J = 8.7$ Hz, 0.7H), 1.57 (d, $J = 9$ Hz, 1H), 1.72 (m, 1.7H), 3.30 (s, 1.7H), 3.43 (s, 1.7H), 3.5 (m, 0.6H), 3.63 (s, 3H), 3.67 (s, 2H), 3.9 (m, 1H), 6.1 (m, 2.4H), 6.17 (m, 1.6H), 6.24 (s, 1H)

$^{13}\text{C NMR}$ (CDCl_3) δ 22.6, 22.7, 23.0, 46.6, 46.9, 48.8, 49.8, 50.3, 51.9, 52.2, 52.5, 53.1, 53.8, 54.6, 54.7, 120.4, 122.1, 133.9, 134.0, 135.2, 135.6, 135.9, 136.0, 154.4, 155.8, 171.4, 172.2

(1*R*,2*S*,4*S*)-Benzyl-3-(*p*-tolylsulfinyl) methylene bicyclo[2.2.1] hept-5-ene-2-carboxylate 276

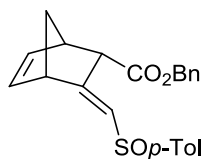

To a solution of (*SR,E*)-methyl 3-fluoro-4-(*p*-tolylsulfinyl)but-2-enoate **261** (100 mg, 0.39 mmol, 1 equiv) in CH₂Cl₂ (0.8 mL) at room temperature was added 0.78 mL of Et₂AlCl 1M in hexanes. After 5 min under stirring, cyclopentadiene (164 μL, 5 equiv) was added. The mixture was stirred for 2 hours and the hydrolyzed with a saturated aqueous ammonium chloride solution, poured into an erlenmeyer containing sodium potassium tartrate and stirred vigorously for 30 min. The organic layer was washed with brine. After work up and flash chromatography (eluent cyclohexane/EtOAc 1:1), the product was isolated as yellow oil in 30% yield (35 mg).

¹H NMR (CDCl₃) δ 7.53 (*J* = 8.2 Hz, 2H), 7.29-7.18 (m, 7H), 6.25 (d, *J* = 2.0 Hz, 2H), 5.06 (s, 1H), 3.99 (m, 1H), 3.38 (s, 1H), 3.33 (s, 1H), 2.31 (s, 3H), 1.69 (dt, *J* = 1.6 Hz, *J* = 9.1 Hz, 1H), 1.59 (d, *J* = 9 Hz)

¹³C NMR (CDCl₃) δ 171.9, 153.2, 141.1, 141.0, 136.0, 135.8, 134.8, 129.9, 128.8, 128.7, 128.5, 128.4, 67.2, 53.0, 50.1, 49.6, 46.8, 21.5

Methyl 5-chloro-2,2-methoxy-2-oxoethyl tricyclo[2.2.1.0^{2,6}] heptane-3-carboxylate 277

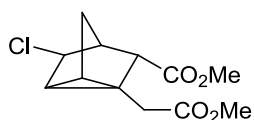

To a solution of dimethyl 3-fluoropent-2-enedioate **252** (152 mg, 0.86 mmol, 1 equiv) in CH₂Cl₂ (0.8 mL) at room temperature was added 1.73 mL of Et₂AlCl 1M in hexanes (2 equiv). After 5 min under stirring, cyclopentadiene (363 μL, 5 equiv) was added. The mixture was stirred for 3 hours and the hydrolyzed with a

saturated aqueous ammonium chloride solution, poured into an erlenmeyer containing sodium potassium tartrate and stirred vigorously for 30 min. The organic layer was washed with brine. After work up and flash chromatography (eluent cyclohexane/EtOAc 3:1), the product was isolated as colorless oil in 38% yield (86 mg).

$^1\text{H NMR}$ (CDCl_3) δ 1.46 (d, $J = 5.4$ Hz, 1H), 1.6 (m, 2H), 2.12 (d, $J = 11.3$ Hz, 1H), 2.34 (m, 2H), 2.75 (s, 1H), 2.98 (d, $J = 16.7$ Hz, 1H), 3.64 (s, 3H), 3.66 (s, 3H), 4.33 (s, 1H)

$^{13}\text{C NMR}$ (CDCl_3) δ 19.4, 24.4, 25.1, 31.4, 33.2, 42.4, 50.7, 51.5, 51.7, 62.2, 171.9, 172.6

MS (EI) m/z (%): 258 (M^+ , 20), 229 (30), 228 (100)

HRMS (EI): Calcd. for $\text{C}_{12}\text{H}_{15}\text{O}_4\text{Cl}$: 258.0659; Found: 258.0668

(1*R*,2*S*,4*S*,*E*)-Methyl 3,2-methoxy-2-oxoethylidene bicyclo[2.2.1] hept-5-ene-2-carboxylate 278

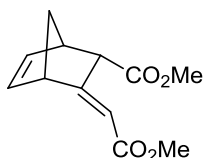

Compound was isolated from the previous reaction in 16% yield (31.3 mg).

$^1\text{H NMR}$ (CDCl_3) δ 1.5 (d, $J = 8.6$ Hz, 1H), 1.3 (d, $J = 8.6$ Hz, 1H), 3.3 (m, 1H), 3.43 (s, 1H), 3.63 (s, 6H), 3.82 (s, 1H), 5.99 (s, 1H), 6.15 (m, 2H)

$^{13}\text{C NMR}$ (CDCl_3) δ 46.3, 50.4, 50.6, 51.1, 51.6, 53.0, 112.9, 133.3, 135.7, 160.5, 166.9, 171.9

MS (EI) m/z (%): 222 (M^+ , 24), 191(30), 190 (45), 162 (100), 147 (38)

HRMS (EI): Calcd. for $\text{C}_{12}\text{H}_{14}\text{O}_4$: 222.0892; Found: 222.0897

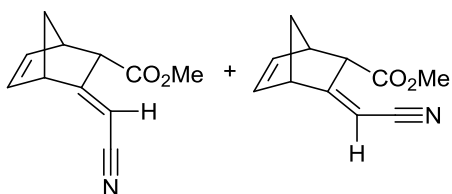
(1R,2S,4S)-Methyl 3-cyanomethylene bicyclo[2.2.1] hept-5-ene-2-carboxylate 279

To a solution of methyl 4-cyano-3-fluorobut-2-enoate **244** (179 mg, 1.25 mmol, 1 equiv) in CH_2Cl_2 (2.5 mL) at room temperature was added 2.5 mL of Et_2AlCl 1M in hexanes (2 equiv). After 5 min under stirring, cyclopentadiene (525 μL , 5 equiv) was added. The mixture was stirred for 4 hours and the hydrolyzed with a saturated aqueous ammonium chloride solution, poured into an erlenmeyer containing sodium potassium tartrate and stirred vigorously for 30 min. The organic layer was washed with brine. After work up and flash chromatography (eluent cyclohexane/EtOAc 3:1), the product was isolated as colorless oil in 44% total yield (104.2 mg).

279a:

$^1\text{H NMR}$ (CDCl_3) δ 1.54 (d, $J = 9.3$ Hz, 1H), 1.79 (d, $J = 9.3$ Hz, 1H), 3.34 (s, 1H), 3.5 (s, 1H), 3.65 (s, 3H), 3.8 (b, 1H), 4.43 (d, $J = 2$ Hz, 1H), 6.13 (b, 1H), 6.35 (m, 1H)

$^{13}\text{C NMR}$ (CDCl_3) δ 44.9, 48.9, 50.8, 51.8, 52.3, 91.9, 116.8, 132.9, 138.3, 166.0, 170.6

MS (EI) m/z (%): 189 (M^+ , 85), 188 (65), 157 (100), 129 (97)

HRMS (EI): Calcd. for $\text{C}_{11}\text{H}_{11}\text{O}_2\text{N}$: 189.0790; Found: 189.0792

279b:

$^1\text{H NMR}$ (CDCl_3) δ 1.6 (d, $J = 9.1$ Hz, 1H), 1.8 (d, $J = 9$ Hz, 1H), 3.4 (s, 1H), 3.46 (s, 1H), 3.67 (m, 1H), 3.77 (s, 3H), 5.49 (d, $J = 2.2$ Hz, 1H), 6.17 (m, 1H), 6.24 (m, 1H)

$^{13}\text{C NMR}$ (CDCl_3) δ 46.3, 50.1, 51.1, 52.2, 52.6, 93.0, 116.7, 133.5, 136.9, 165.9, 170.3

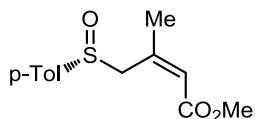
(*R,Z*)-Methyl 3-methyl-4-*p*-tolylsulfinyl but-2-enoate **280**

To a solution of CuI (245 mg, 1.28mmol) in THF (6.4 mL) at 0°C, 1.46 mL of MeLi 1.6M in hexanes was added; the mixture was stirred for 1h and cooled to -20°C. A solution of (*S,E*)-methyl 3-fluoro-4-(*p*-tolylsulfinyl)but-2-enoate (100 mg, 0.39 mmol) in THF (13 mL) was added dropwise. The mixture was stirred for 2 hour then hydrolyzed with a saturated aqueous ammonium chloride solution and extracted with EtOAc. After workup, ¹H NMR analysis showed 2:1 mixture of two olefins *Z/E*. compound **280** was purified by flash chromatography (hexane/EtOAc 3:1), and obtained in 75% yield as a yellow oil.

¹H NMR (CDCl₃) δ 1.99 (d, *J* = 1.40Hz, 3H), 2.17 (d, *J* = 1.36Hz, 1.5H), 2.40 (s, 5H), 3.45 and 3.55 (AB system, *J* = 12.1 Hz, Δ*v* = 29.5 Hz, 1.4H), 3.66 (m, 5H), 3.87 and 4.39 (AB system, *J* = 11.67 Hz, Δ*v* = 155.2, 2H), 5.65 (s, 0.5H), 5.89 (s, 1H), 7.31, 7.48 and 7.59 (2 AA'BB' system, *J* = 8.22 Hz, 6H)

¹³C NMR (CDCl₃) δ 19.7, 21.4, 21.5, 26.7, 51.1, 51.2, 61.8, 68.9, 119.9, 121.8, 124.1, 129.7, 129.9, 140.0, 140.9, 141.5, 142.0, 146.9, 149.5, 165.9, 166.3

MS (ESI) *m/z* (%): 253 (M⁺, 68), 221 (36), 139 (100)

HRMS (ESI): Calcd. for C₁₃H₁₇O₃S: 253.0892; Found: 253.0898

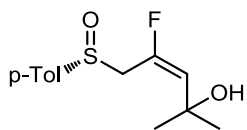
(*R,E*)-4-fluoro-2-methyl-5-*p*-tolylsulfinyl pent-3-en-2-ol **281**

To a solution of (*S,E*)-methyl 3-fluoro-4-(*p*-tolylsulfinyl)but-2-enoate (100 mg, 0.39 mmol) in CH₂Cl₂ (0.78 mL) at 0°C, 0.78 mL AlMe₃ 2M in hexanes was added, and stirred for 24h. The excess of organoaluminium was destroyed with methanol and the mixture was poured into an erlenmeyer containing AcOEt and sodium potassium tartrate and stirred vigorously for 30 min. The organic layer was washed with brine. After work

up and flash chromatography (eluent hexane/EtOAc 1:1), compound **281** was obtained in 35% yield as a yellow oil.

¹H NMR (CDCl₃) δ 1.33 (s, 3H), 1.37 (s, 3H), 2.42 (s, 3H), 3.70 and 4.35 (ABX system, $J_{AB} = 13.5$ Hz, $J_{AX} = 29.9$ Hz and $J_{BX} = 19.7$ Hz, $\Delta\nu = 175.5$ Hz, 2H), 4.10 (s, 1H), 5.72 (d, $J = 23$.Hz, 1H), 7.33 and 7.51 (AA'BB' system, $J = 8.1$ Hz, 4H)

¹³C NMR (CDCl₃) δ 21.4, 30.9 (d, $J = 2.7$ Hz), 31.9 (d, $J = 2.5$ Hz), 56.7 (d, $J = 29$ Hz), 68.5 (d, $J = 9.4$ Hz), 124.0, 124.5, 124.7, 130.1, 136.7, 142.3, 145.8, 149.1

REFERENCES

1. For reviews, see: a) M. C. Carreño, G. Hernández-Torres, M. Ribagorda, A. Urbano. *Chem Comm.* **2009**, 6129–6144. b) H. Kagan, in *Organosulfur Chemistry in Asymmetric Synthesis*, ed. T. Toru and C. Bolm, Wiley-VCH-Verlag, Weinheim, **2008**, pp. 1–54. c) H. Pellissier, *Tetrahedron* **2006**, *62*, 5559–5601. d) J. Legros, J. R. Dehli and C. Bolm, *Adv. Synth. Catal.*, **2005**, *347*, 19–31. e) I. Fernández and N. Khair, *Chem. Rev.*, **2003**, *103*, 3651–3705.
2. a) Solladié, G.; Greck, C.; Demailly, G.; Solladié-Cavallo, A. *Tetrahedron Lett.* **1982**, *23*, 5047. b) Solladié, G.; Greck, C.; Demailly, G. *Tetrahedron Lett.* **1985**, *26*, 435-437.
3. F. Colobert, M. C. Carreño, R. Des Mazery G. Solladié, *Org. Lett.* **2002**, *4*, 1723-1725
4. M. C. Carreño, R. Des Mazery, A. Urbano, F. Colobert, G. Solladié, *J. Org. Chem.* **2003**, *68*, 7779–7787
5. M. C. Carreño, R. Des Mazery, A. Urbano, F. Colobert, G. Solladié, *Org. Lett.* **2004**, *6*, 297–299
6. M. C. Carreño, R. Des Mazery, A. Urbano, F. Colobert, G. Solladié, *Org. Lett.* **2005**, *7*, 2039–2042
7. a) M. C. Carreño, G. Hernández-Torres, A. Urbano, F. Colobert, *Org. Lett.* **2005**, *7*, 5517–5520. b) G. Hernández-Torres M. C. Carreño, A. Urbano, F. Colobert, *Chem. Eur. J.* **2011**, *17*, 1283 – 1293.
8. M. C. Carreño, G. Hernández-Torres, A. Urbano, F. Colobert, *Eur. J. Org. Chem.* **2008**, 2035–2038.
9. P. A. Dewick, “*Medicinal Natural Products. A Biosynthetic Approach*”. 2^o edición. **2001**. Ed. Wiley, Chichester.
10. G. Hernández-Torres, A. Urbano, M. C. Carreño, F. Colobert, *Org. Lett.* **2009**, *11*, 4930-4933.
11. a) Neguishi, E.; Kotora, M.; *Tetrahedron* **1997**, *53*, 6707-6738. b) Collins, I.; *J. Chem. Soc. Perkin Trans. 1* **1999**, 1377-1395. c) Carter, N. B.; Nadany, A. E.; Sweeney, J. B. *J. Chem. Soc. Perkin Trans. 1* **2002**, 2324-2342. d) Hoffmann, H. M. R.; Rabe, J. *Angew. Chem. Int. Ed. Engl.* **1985**, *24*, 94-110.
12. M. C. Carreño, J. L. García Ruano, M. C. Maestro, C. Pedregal, A. Rubio, G. Solladié. *J. Org. Chem.* **1991**, *56*, 2317-2322
13. Cardllina, Il., J. H.; Moore, R. E.; Arnold, E. V.; Clardy, J. *J. Org. Chem.* **1979**, *44*, 4039-4042.
14. Singh, I. P.; Milligan, K. E.; Gerwick, W. H. *J. Nat. Prod.* **1999**, *62*, 1333-1335.
15. a) Obringer, M.; Colobert, F.; Solladié, G. *Eur. J. Org. Chem.* **2006**, 1455-1467. b) Obringer, M.; Colobert, F.; Neugnot, B.; Solladié, G. *Org. Lett.* **2003**, *5*, 629-632. c) F. Colobert, S. Choppin, L. Ferreiro-Mederos, M. Obringer, S. Luengo-Arratta, A. Urbano, M. C. Carreño, *Org. Lett.* **2007**, *9*, 4451–4454.
16. T. Hiyama, in *Organofluorine Compounds: Chemistry and Applications*, ed. H. Yamamoto, Springer-Verlag, Berlin, **2000**.
17. Reviews: J.-P. Bégué and D. Bonnet-Delphon, *J. Fluorine Chem.*, **2006**, *127*, 992; K. L. Kirk, *J. Fluorine Chem.*, **2006**, *127*, 1013; K. Muller, C. Faeh and F. Diederich, *Science*, **2007**, *317*, 1881; L. Hunter, *Beilstein J. Org. Chem.*, **2010**; G. Landelle, M. Bergeron, M-O. Turcotte-Savard, J-P. Paquin, *Chem. Soc. Rev.* **2011**, 2867-2908. W. K. Hagmann, *J. Med. Chem.*, **2008**, *51*, 4359; S. Purser, P. R. Moore, S. Swallow and V. Gouverneur, *Chem. Soc. Rev.*, **2008**, *37*, 320.
18. Review: P. Jeschke, *Chem. Bio. Chem.*, **2004**, *5*, 570.
19. Review: M. Pagliaro and R. Ciriminna, *J. Mater. Chem.*, **2005**, *15*, 4981.
20. A. M. Thayer, *Chem. Eng. News*, **2006**, *84*, 15.
21. For recent examples, see: a) F. Babudri, G. M. Farinola, F. Naso and R. Ragni, *Chem. Commun.*, **2007**, 1003; b) F. Babudri, A. Cardone, G. M. Farinola, C. Martinelli, R. Mendichi, F. Naso and M. Striccoli, *Eur. J. Org. Chem.*, **2008**, 1977.
22. a) G. Dutheuil, S. Couve-Bonnaire, X. Pannecoucke, *Angew. Chem., Int. Ed.*, **2007**, *46*, 1290; b) P. Van der Veken, K. Senten, I. Kertesz, I. De Meester, A. M. Lambeir, M. B. Maes, S. Scharpe, A. Haemers, K. Augustyns, *J. Med. Chem.*, **2005**, *48*, 1768; c) O. A. Wong and Y. A. Shi, *J. Org. Chem.*, **2009**, *74*, 8377; d) G. Dutheuil, X. S. Lei, X. Pannecoucke, J. C. Quirion, *J. Org. Chem.*, **2005**, *70*, 1911.
23. a) Faul, M. M.; Huff, B. E. *Chem. Rev.* **2000**, *100*, 2407-2474. b) Shimizu, Y. *Chem. Rev.* **1993**, *93*, 1685-1698.
24. Yeung, K.-S.; Paterson, I. *Chem. Rev.* **2005**, *105*, 4237-4313.
25. Tanaka, T. *Chem. Rev.* **2005**, *105*, 4314-4347.

26. a) Kang, E. J.; Lee, E. *Chem. Rev.* **2005**, *105*, 4348-4378. b) Inoue, M. *Chem. Rev.* **2005**, *105*, 4379-4405.
27. For reviews, see: a) Wolfe, J. P.; Hay, M. B. *Tetrahedron* **2007**, *63*, 261-290. b) Wolfe, J. P. *Eur. J. Org. Chem.* **2007**, 571-582. c) Shindo, M. *Top. Heterocycl. Chem.* **2006**, 179-254. d) Clarke, P. A.; Santos, S. *Eur. J. Org. Chem.* **2006**, 2045-2053. e) Elliot, M. C. *J. Chem. Soc., Perkin Trans. 1* **2002**, 2301-2323 and earlier reviews in the same series. f) Norcross, R. D.; Paterson, I. *Chem. Rev.* **1995**, *95*, 2041-2114. g) Biovin, T. L. B. *Tetrahedron* **1987**, *43*, 3309-3362. Recent references on tetrahydrofurans: h) Pan, J.; Zhang, W.; Zhang, J.; Lu, S. *Tetrahedron Lett.* **2007**, *48*, 2781-2785. i) Chavre, S. N.; Choo, H.; Cha, J. H.; Pae, A. N.; Choi, K. I.; Cho, Y. S. *Org. Lett.* **2006**, *8*, 3617-3619. j) Hay, M. B.; Wolfe, J. P. *Tetrahedron Lett.* **2006**, *47*, 2793-2796. k) Akindele, T.; Marsden, S. P.; Cumming, J. G. *Org. Lett.* **2005**, *7*, 3685-3688. l) Hodgson, D. M.; Le Strat, F.; Avery, T. D.; Donohue, A. C.; Brućkl, T. *J. Org. Chem.* **2004**, *69*, 8796-8803. m) Renaud, P.; Beauflis, F.; Feray, L.; Schenk, K. *Angew. Chem., Int. Ed.* **2003**, *42*, 4230-4233. n) Villar, F.; Kolly-Kovac, T.; Equey, O.; Renaud, P. *Chem. Eur. J.* **2003**, *9*, 1566-1577. Recent references on tetrahydropyrans: o) Tian, G.-Q.; Shi, M. *Org. Lett.* **2007**, *9*, 2405-2408. p) Song, Z.; Hsung, R. P. *Org. Lett.* **2007**, *9*, 2199-2202. q) Liu, F.; Loh, T.-P. *Org. Lett.* **2007**, *9*, 2063-2066. r) Biermann, U.; Lutzen, A.; Metzger, J. O. *Eur. J. Org. Chem.* **2006**, 2631-2637. s) Jervis, P. J.; Kariuki, B. M.; Cox, L. R. *Org. Lett.* **2006**, *8*, 4649-4652. t) Banerjee, B.; Roy, S. C. *Eur. J. Org. Chem.* **2006**, 489-497. u) Kataoka, K.; Ode, Y.; Matsumoto, M.; Nokami, J. *Tetrahedron* **2006**, *62*, 2471-2483. v) Bolla, M. L.; Patterson, B.; Rychnovsky, S. D. *J. Am. Chem. Soc.* **2005**, *127*, 16044-16045. w) Dubost, C.; Marko, I. E.; Bryans, J. *Tetrahedron Lett.* **2005**, *46*, 4005-4009.
28. Lin, Y.-Y.; Risk, M.; Ray, S. M.; Van Engen, D.; Clardy, J.; Golik, J.; James, J. C.; Nakanishi, K. *J. Am. Chem. Soc.* **1981**, *103*, 6773.
29. Reviews of synthesis of natural marine polyethers: a) Alvarez, E.; Candenas, M.-L.; Perez, R.; Ravelo, J. L.; Martin, J. D. *Chem. Rev.* **1995**, *95*, 1953. b) Faul, M.M.; Huff, B.E. *Chem. Rev.* **2000**, *100*, 2407. c) Marmsäter, F. P.; West, F. G. *Chem. Eur. J.* **2002**, *8*, 4346. d) Fujiwara, K.; Murai, A. *Bull. Chem. Soc. Jpn.* **2004**, *77*, 2129. e) Nakata, T. *Chem. Rev.* **2005**, *105*, 4314. f) Inoue, M. *Chem. Rev.* **2005**, *105*, 4379. g) Sasaki, M. *Bull. Chem. Soc. Jpn.* **2007**, *80*, 856. h) Fuwa, H.; Sasaki, M. *Curr. Opin. Drug Discovery Dev.* **2007**, *10*, 784. i) Sasaki, M.; Fuwa, H. *Nat. Prod. Rep.* **2008**, *25*, 401. j) Nicolaou, K. C.; Frederick, M. O.; Aversa, R. J. *Angew. Chem. Int. Ed.* **2008**, *47*, 7182.
30. Reviews of synthesis of cyclic ethers: a) Clarke, P. A.; Santos, S. *Eur. J. Org. Chem.* **2006**, 2045. b) Elliott, M. C. *J. Chem. Soc., Perkin Trans. 1*, **1998**, 4175. c) Elliott, M.C. *J. Chem. Soc., Perkin Trans. 1*, **2000**, 1291. d) Elliott, M.C.; Williams, E. *J. Chem. Soc., Perkin Trans. 1*, **2001**, 2303. d) Elliott, M. C. *J. Chem. Soc., Perkin Trans. 1*, **2002**, 2301.
31. Nicolaou, K. C.; Rutjes, F. P. J. T.; Theodorakis, E. A.; Tiebes, J.; Sato, M.; Untersteller, E. *J. Am. Chem. Soc.* **1995**, *117*, 1173.
32. a) Michel, J. P.; Ting, P. C.; Barlett, P. A. *J. Org. Chem.* **1985**, *50*, 2416. b) Nakata, T.; Schmid, G.; Vranesic, B.; Okigawa, M.; Smith-Palmer, T.; Kishi, Y. *J. Am. Chem. Soc.* **1978**, *100*, 2933.
33. Evans, D. A.; Cee, V. J.; Smith, T. E.; Fitch, D. M.; Cho, P. S. *Angew. Chem. Int. Ed.* **2000**, *39*, 2533.
34. Gartzten, O.; Misske, A. M.; Wolbers, P.; Hoffmann, H. M. R. *Synlett* **1999**, 1041.
35. Kotsuki, H. *Synlett*, **1992**, 97 and references therein.
36. Crimmins, M. T.; Rafferty, S. W. *Tetrahedron Lett.* **1996**, *37*, 5649.
37. Hanessian, S.; *Total Synthesis of Natural Products: The Chiron Approach*, Ed. J. E. Baldwin, Pergamon, Oxford, **1983**, 291.
38. a) Arundale, E; Mikeska, L. A. *Chem. Rev.* **1952**, *51*, 505. b) Adams, D. R.; Bhatnagar, S. P. *Synthesis*, **1977**, 661. c) Snider, B. B. in *Comprehensive Organic Synthesis*, ed. B. M. Trost, Pergamon Press, New York, **1991**, vol. 2, p. 527. d) Elsworth, J. D.; Willis, C. L. *Chem. Commun.* **2008**, 1587.
39. Lee, E.; Choi, S. J.; Kim, H.; Han, H. O.; Kim, Y. K.; Min, S. J.; Son, S. H.; Lim, S. M.; Jang, W. S. *Angew. Chem. Int. Ed.* **2002**, *41*, 176.
40. Basu, S.; Waldmann, H. *J. Org. Chem.* **2006**, *71*, 3977.
41. a) Lucas, B. S.; Luther, L. M.; Burke, S. D. *J. Org. Chem.* **2005**, *70*, 3757. b) Paterson, I.; Luckhurst, C. A. *Tetrahedron Lett.* **2003**, *44*, 3749.
42. a) Nicolaou, K. C.; Papahatjis, D. P.; Claremon, D. A.; Dole, R. E. *J. Am. Chem. Soc.* **1981**, *103*, 6967. b) Nicolaou, K. C.; Duggan, M. E.; Hwang, C. -K.; Somers, P. K. *J. Chem. Soc. Chem. Commun.*

- 1985, 1359. c) Nicolaou, K. C.; Prasad, C. V. C.; Somers, P. K.; Hawang, C. -K. *J. Am. Chem. Soc.* **1989**, *111*, 5330.
43. Smith III, A. B.; Jurica, J. A.; Walsh, S. P. *Org. Lett.* **2008**, *10*, 5625.
44. Nakanishi, K. *Toxicol* **1985**, 473.
45. Vilotijevic, I.; Jamison, T. F. *Science* **2007**, *317*, 1189.
46. a) Williams, D. R.; Clark, M. P.; Berliner, M. A. *Tetrahedron Lett.* **1999**, *63*, 2982. b) Williams, D. R.; Plummer, S. V.; Patnaik, S. *Angew. Chem.* **2003**, *115*, 4064. Other examples: Ho, P -T. *Can. J. Chem.* **1982**, *60*, 90. Pattenden, G.; Plowright, A. T. *Tetrahedron Lett.* **2000**, *41*, 983.
47. Petri, A. F.; Bayer, A.; Maier, E. *Angew. Chem. Int. Ed.* **2004**, *43*, 5821.
48. Qian, H.; Han, X.; Widenhoefer, R. A. *J. Am. Chem. Soc.* **2004**, *126*, 9536.
49. Kang, S. H.; Kang, S. Y.; Kim, C. M.; Choi, H.; Jun, H. S.; Lee, B. M.; Park, C. M.; Jeong, J. W. *Angew. Chem. Int. Ed.* **2003**, *42*, 4779.
50. Semmelhack, M. F.; Bodurow, C. *J. Am. Chem. Soc.* **1984**, *106*, 1496.
51. Hornberger, K. R.; Hamblett, C. L.; Leighton, J. L. *J. Am. Chem. Soc.* **2000**, *122*, 12894.
52. Kawai, N.; Lagrange, J. -M.; Ohmi, M.; Uenishi, J. *J. Org. Chem.* **2006**, *71*, 4530.
53. Trost, B. M.; Gutierrez, A. C.; Livingston, R. C. *Org. Lett.* **2009**, *11*, 2539.
54. Sassaman, M. B.; Kotian, K. D.; Surya Prakash, G. K.; Olah, G. A. *J. Org. Chem.* **1987**, *52*, 4314.
55. a) Nicolaou, K. C.; Hwang, C. K.; Nugiel, D. A. *J. Am. Chem. Soc.* **1989**, *111*, 4136 b) Nicolaou, K. C.; Hwang, C. K.; Duggan, M. E.; Nugiel, D. A.; Abe, Y.; Bal Reddy, K.; DeFrees, S. A.; Reddy, D. R.; Awartani, R. A.; Conley, S. R.; Rutjes, F. P. J. T.; Theodoraski, E. A. *J. Am. Chem. Soc.* **1995**, *117*, 10227.
56. Evans, P. A.; Cui, J.; Gharpure, S. J. *Org. Lett.* **2003**, *5*, 3883.
57. Sato, K.; Sasaki, M.; *Tetrahedron*, **2007**, *63*, 5977
58. Bravo, P.; Resnati, G. *Tetrahedron Lett.* **1985**, *26*, 5601.
59. α -Tocopherol; Machlin, L. J., Ed.; Marcel Dekker: New York, NY, **1980**.
60. Terao, K.; Niki, E. *J. Free Rad Biol. Med.* **1986**, *2*, 193.
61. Grisar, J. M.; Petty, M. A.; Bolkenius, F. N.; Dow, J.; Wagner, J.; Wagner, E. R.; Haegele, K. D.; Jong, W. D. *J. Med. Chem.* **1991**, *34*, 257.
62. a) Smith, E.; Pucci, L. A.; Bywater, L. G. *Science* **1952**, *115*, 520; b) Shanbhag, X. N.; Mesta, C. K.; Maheshwari, M. C.; Bhattacharyya, S. C. *Tetrahedron* **1965**, *21*, 3591.
63. a) De Cree, J.; Geukens, H.; Leempoels, J.; Verhaegen, H. *Drug Dev. Res.* **1986**, *8*, 109; b) Van deWater, A.; Janssen, W.; Van Nueten, J.; Xhonneux, R.; De Cree, J.; Verhaegen, H.; Reneman, R. S.; Janssen, P. A. *J. Cardiovasc. Pharmacol.* **1988**, *11*, 552.
64. Valsamakis, G.; Kumar, S. *Exp. Opin. Pharmacother.* **2000**, *1*, 1413 and references therein.
65. Isabashi, K. *J. Antibiot., Ser. A* **1962**, *15*, 161.
66. a) Kashman, Y.; Gustafson, K. R.; Fuller, R. W.; Cardellina, J. H., II; McMahon, J. B.; Currens, M. J.; Buckhiet, R. W., Jr.; Hughes, S. H.; Cragg, G. M.; Boyd, M. R. *J. Med. Chem.* **1992**, *35*, 273; b) Taylor, P. B.; Culp, J. S.; Debouck, C.; Johnson, R. K.; Patil, A. D.; Woolf, D. J.; Brooks, I.; Hertzberg, R. P. *J. Biol. Chem.* **1994**, *269*, 632.
67. Sankaran, M. S.; Prasad, M. R. N. *Contraception* **1974**, *9*, 279.
68. a) Morito, K.; Hirose, T.; Kinjo, J.; Hirakawa, T.; Okawa, M.; Nohara, T.; Ogawa, S.; Inoue, S.; Muramatsu, M.; Masamune, Y. *Biol. Pharm. Bull.* **2001**, *24*, 351; b) Schmitt, E.; Dekant, W.; Sopper, H. *Toxicol. In Vitro* **2001**, *15*, 433.
69. Barrero, A. F.; Alvarez-Manzaneda, E. J.; Chahboun, R. *Tetrahedron* **1999**, *55*, 15181.
70. a) Ward, A.; Holmes, B. *Drugs* **1985**, *30*, 127; b) Stouter, R.W. *Anal. Profiles Drug Subs.* **1981**, *10*, 499.
71. Judzewitsch, R. G.; Jaspan, J. B.; Polonsky, K. S.; Weinberg, C. R.; Halter, J. B.; Halar, E.; Pfeifer, M. A.; Vukadinovic, C.; Bernstein, L.; Schneider, M.; Liang, K. Y.; Gabbay, K. H.; Rubenstein, A. H.; Porte, D. N. *Engl. J. Med.* **1983**, *308*, 119.
72. For reviews related to chromans and chromenes, see: a) Tang, Y.; Oppenheimer, J.; Song, Z.; You, L.; Zhang, X.; Hsung, R. P. *Tetrahedron* **2006**, *62*, 10785; b) Beaudry, C. M.; Malerich, J. P.; Trauner, D. *Chem. Rev.* **2005**, *105*, 4757; c) Hsung, R. P.; Kurdyumov, A. V.; Sydorenko, N. *Eur. J. Org. Chem.* **2005**, *23*; d) Shen, H.C., *Tetrahedron* **2009**, *65*, 3931-3952.
73. Mikoshiba, H.; Midami, K.; Nakai, T. *Synlett* **2001**, 989.

74. Mizuguchi, E.; Suzuki, T.; Achiwa, K. *Synlett* **1994**, 929.
75. For reviews of desymmetrization of prochiral systems see: a) Schoffers, E.; Golebiowski, A.; Johnson, C. R. *Tetrahedron* **1996**, *52*, 3769; b) Otera, J. *Chem. Rev.* **1993**, *93*, 1449; c) *Enzymes Catalysis in Organic Synthesis*; Drauz, K., Waldman, H., Eds.; VCH Verlagsgesellschaft mbH: Weinheim, **1995**; Vols. 1 and 2.
76. Harada, T.; Hayashiya, T.; Wada, I.; Iwa-ake, N.; Oku, A. *J. Am. Chem. Soc.* **1987**, *109*, 527.
77. Mizuguchi, E.; Achiwa, K. *Synlett* **1995**, 1255.
78. Trost, B. M.; Toste, D. F. *J. Am. Chem. Soc.* **1998**, *120*, 9074.
79. Chung, Y.K.; Fu, G.C. *Angew. Chem. Int. Ed.* **2009**, *48*, 2225-2227.
80. Solladie, G.; Moine, G. *J. Am. Chem. Soc.* **1984**, *106*, 6097.
81. a) R. Doodeman, F. P.J.T. Rutjes, H. Hiemstra, *Tetrahedron Lett.* **2000**, *41*, 5979-5983; b) J. Cossy, H. Rakatoarisoa, P. Kahn, J.-R. Desmurs, *Tetrahedron Lett.* **2000**, *41*, 7203-7205.
82. N. Cohen, B. Schaer, G. Saucy, R. Borer, L. Todaro, Am-M. Chiu, *J. Org. Chem.* **1989**, *54*, 3282-3292.
83. a) Goldsmith, D. J.; Helmes, C. T., Jr.; *Synth. Commun.* **1973**, *3*, 231-235. b) Iwasaki, H.; Takashi, K.; Yamamoto, Y.; Akiba, K. *Tetrahedron Lett.* **1987**, *28*, 6355-6358.
84. P. M. Dewick, *Medicinal Natural Products. A Biosynthetic Approach*. 2nd Edition, John Wiley & Sons, Chichester, **2001**.
85. I. M. Chandler, C. R. McIntyre, T. J. Simpson, *J. Chem. Soc., Perkin Trans. 1* **1992**, 2271-2284.
86. a) H. Erdtman, *Svensk Kem. Tidskr.* **1944**, *56*, 95-101; b) G. Lindstedt, *Acta Chem. Scand.* **1950**, *4*, 1042-1046; c) E. Wollenweber, *Phytochemistry* **1982**, *20*, 1462-1464; d) T. Jaipetch, V. Reutrakul, P. Tuntiwachwuttikul, T. Santisuk, *Phytochemistry* **1983**, *22*, 625-626; e) H. Haberlein, K.-P. Tschiersch, *Biochem. System. Ecol.* **1998**, *26*, 97-103.
87. G. Valsamakis, S. Kumar, *Exp. Opin. Pharmacother.* **2000**, *1*, 1413.
88. D. J. Bauer, J. W. T. Selway, J. F. Batchelor, M. Tisdale, I. C. Caldwell, D. A. Young, *Nature* **1981**, *292*, 369-370.
89. a) J. De Cree, H. Geukens, J. Leempoels, H. Verhaegen, *Drug Dev. Res.* **1986**, *8*, 109-117; b) A. Van de Water, W. Janssen, J. Van Nueten, R. Xhonneux, J. De Cree, H. Verhaegen, R. S. Reneman, P. A. J. Janssen, *J. Cardiovasc. Pharmacol.* **1988**, *11*, 552-563.
90. For the formation of the C-2 stereocenter of 2H-chromans, see: a) E. T. Choi, M. H. Lee, Y. Kim, Y. S. Park, *Tetrahedron* **2008**, *64*, 1515-1522; b) C. Dittmer, G. Raabe, L. Hintermann, *Eur. J. Org. Chem.* **2007**, 5886-5898; c) X. Tian, S. D. Rychnovsky, *Org. Lett.* **2007**, *9*, 4955-4958; d) C. Welter, A. Dahnz, B. Brunner, S. Streiff, P. Dübon, G. Helmchen, *Org. Lett.* **2005**, *7*, 1239-1242; e) K. J. Hodgetts, *Tetrahedron* **2005**, *61*, 6860-6870; f) B. M. Trost, H. C. Shen, L. Dong, J.-P. Surivet, C. Sylvain, *J. Am. Chem. Soc.* **2004**, *126*, 11966-11983; g) M. Zhang, R. Reeves, Ch. Bi, R. Dally, G. Ladouceur, W. Bullock, J. Chin, *Tetrahedron Lett.* **2004**, *45*, 5229-5231; h) J. L. Gross, *Tetrahedron Lett.* **2003**, *44*, 8563-8565; i) M. A. Birkett, D. W. Knight, P. B. Little, M. B. Mitchell, *Tetrahedron* **2000**, *56*, 1013-1023.
91. Previous intermolecular synthesis of ethers from alkoxysilanes: a) M. B. Sassaman, G. K. S. Prakash, G. A. Olah, *Tetrahedron* **1988**, *44*, 3771-3780; b) M. B. Sassaman, K. D. Kotian, G. K. S. Prakash, G. A. Olah, *J. Org. Chem.* **1987**, *52*, 4314-4319.
92. Previous synthesis of cyclic ethers from alcohols: a) K. C. Nicolaou, C.-K. Hwang, M. E. Duggan, D. A. Nugiel, Y. Abe, K. B. Reddy, S. A. DeFrees, D. R. Reddy, R. A. Awartani, S. R. Conley, F. P. J. T. Rutjes, E. A. Theodorakis, *J. Am. Chem. Soc.* **1995**, *117*, 10227-10238; b) K. C. Nicolaou, C.-K. Hwang, D. A. Nugiel, *J. Am. Chem. Soc.* **1989**, *111*, 4136-4137; also see 31.
93. G. Solladié, J. Hutt, A. Girardin, *Synthesis* **1987**, 173-175.
94. G. Hernández Torres, PhD. 2008
95. T. Yamanoi, Y. Oda, *Heterocycles* **2002**, *57*, 229-234.
96. TBAF comparison, nucleophilicity and basicity of F- dependent of Si-F covalent bond in TBAT. a) A. S. Pilcher, H. L. Ammon, P. De Shong, *J. Am. Chem. Soc.* **1995**, *117*, 5166-5167. b) C. J. Handy, Y.-F. Lam, P. De Shong, *J. Org. Chem.* **2000**, *65*, 3542-3543.
97. a) Catalytic allylation with allyl trimethoxy silane, CuCl and TBAT: S. Yamasaki, K. Fujii, R. Wada, M. Kanai, M. Shibasaki, *J. Am. Chem. Soc.* **2002**, *124*, 6536. b) Catalytic allylation of ketones with allyl boranes, CuF₂ and Lewis acids: R. Wada, O. Kounosuke, K. Motomu, M. Shibasaki, *J. Am. Chem. Soc.* **2004**, *126*, 8910-8911.

98. See allyl silane addition to C=N bond promoted by fluorine in aza-Sakurai reaction : a) G. K. Friestad, C. S. Korapala, H. Ding, *J. Org. Chem.* **2006**, *71*, 281-289. b) S. Kobayashi, C. Ogawa, H. Konishi, M. Sugiura, *J. Am. Chem. Soc.* **2003**, *125*, 6610-6611.
99. E. L. Myers, C. P. Butts, V. K. Aggarwal, *Chem. Commun.* **2006**, 4434-4436.
100. a) J. Burfeindt, M. Patz, M. Müller, H. Mayr, *J. Am. Chem. Soc.* **1998**, *120*, 3629-3634; b) G. K. Friestad, C. S. Korapala, H. Ding, *J. Org. Chem.* **2006**, *71*, 281-289; c) G. Hagen, H. Mayr, *J. Am. Chem. Soc.* **1991**, *113*, 4954-4961; d) H. Mayr, R. Schneider, U. Grabis, *J. Am. Chem. Soc.* **1990**, *112*, 4460-4467.
101. T. Ishiyama, T. Ahiko, N. Miyaura, *J. Am. Chem. Soc.* **2002**, *124*, 12414-12415.
102. a) J. J. Ritter, P. P. Minieri, *J. Am. Chem. Soc.* **1948**, *70*, 4045-4048 ; b) D. Le Goanic, M.-C. Lallemand, E. Tillequin, T. Martens, *Tetrahedron Lett.* **2001**, *42*, 5175-5177.
103. P. Deslongchamps, *Stereoelectronic Effects in Organic Chemistry*; Pergamon: New York, **1983**; pp 209-221.
104. L. Ayala, C. G. Lucero, J. A. C. Romero, S. A. Tabacco, K. A. Woerpel, *J. Am. Chem. Soc.* **2003**, *125*, 15521-15528.
105. Woods, R. J.; Andrews, C. W.; Bowen, J. P. *J. Am. Chem. Soc.* **1992**, *114*, 859-864.
106. C. H. Larsen, B. H. Ridgway, J. T. Shaw, D. M. Smith, K. A. Woerpel, *J. Am. Chem. Soc.* **2005**, *127*, 10879-10884, and references therein.
107. For the mechanism on the Lewis acid-catalyzed nucleophilic substitution of acetals, see: a) J. R. Krumper, W. A. Salamant, K. A. Woerpel, *Org. Lett.* **2008**, *10*, 4907-4910; b) S. R. Shenoy, D. M. Smith, K. A. Woerpel, *J. Am. Chem. Soc.* **2006**, *128*, 8671-8677; c) S. R. Shenoy, K. A. Woerpel, *Org. Lett.* **2005**, *7*, 1157-1160; d) T. Sammakia, R. S. Smith, *J. Am. Chem. Soc.* **1994**, *116*, 7915-7616; e) S. E. Denmark, N. G. Almstead, *J. Am. Chem. Soc.* **1991**, *113*, 8089-8110; f) T. Sammakia, R. S. Smith, *J. Am. Chem. Soc.* **1992**, *114*, 10998-10999; g) I. Mori, K. Ishihara, L. A. Flippin, K. Nozaki, H. Yamamoto, P. A. Bartlett, C. H. Heathcock, *J. Org. Chem.* **1990**, *55*, 6107-6115.
108. Tetrahydropyran derivatives: a) M. T. Yang, K. A. Woerpel, *J. Org. Chem.* **2009**, *74*, 545-553; b) C. G. Lucero, K. A. Woerpel, *J. Org. Chem.* **2006**, *71*, 2641-2647; c) S. Chamberland, J. W. Ziller, K. A. Woerpel, *J. Am. Chem. Soc.* **2005**, *127*, 5322-5323; d) L. Ayala, C. G. Lucero, J. A. C. Romero, S. A. Tabacco, K. A. Woerpel, *J. Am. Chem. Soc.* **2003**, *125*, 15521-15528; e) J. A. C. Romero, S. A. Tabacco, K. A. Woerpel, *J. Am. Chem. Soc.* **2000**, *122*, 168-169.
109. Duthaler, R. O.; Hafner, A. *Chem. Rev.* **1992**, *92*, 807-832, and references cited therein.
110. a) Lipshutz, B. H. *Chem. Rev.* **1986**, *86*, 795. b) Durani, N.; Jain, R.; Saeed, A.; Dikshit, D. K.; Durani, S.; Kapil, R. S. *J. Med. Chem.* **1989**, *32*, 1700. c) McCallion, G. D. *Curr. Org. Chem.* **1999**, *3*, 67. d) Mortensen, D. S.; Rodriguez, A. L.; Carlson, K. E.; Sun, J.; Katzenellenbogen, B. S.; Katzenellenbogen, J. A. *J. Med. Chem.* **2001**, *33*, 3838.
111. See for example: a) Engler, T. A.; Letavic, M. A.; Reddy, J. P. *J. Am. Chem. Soc.* **1991**, *113*, 5068. b) Petit, F.; Furtoss, R. *Synthesis* **1995**, 1517. c) Enders, D.; Va'zquez, J.; Raabe, G. *J. Chem. Soc., Chem. Commun.* **1999**, 701. d) Engler, T. A.; Letavic, M. A.; Iyengar, R.; La Tessa, K. O.; Reddy, J. P. *J. Org. Chem.* **1999**, *64*, 2391. e) Garzino, F.; Me'ou, A.; Brun, P. *Tetrahedron Lett.* **2000**, *41*, 9803. f) Kuwabe, S.-i.; Torraca, K. E.; Buchwald, S. L-. *J. Am. Chem. Soc.* **2001**, *123*, 12202. g) Garzino, F.; Me'ou, A.; Brun, P. *Eur. J. Org. Chem.* **2003**, 1410. h) Kurosawa, W.; Kan, T.; Fukuyama, T. *Synlett* **2003**, 1028. i) Kaiser, S.; Smidt, S. P.; Pfaltz, A. *Angew. Chem., Int. Ed.* **2006**, *45*, 5194. j) Chuang, C.-P.; Tsai, A.-I. *Synthesis* **2006**, 675. k) Chuang, C.-P.; Chen, K.-P.; Hsu, Y.-L.; Tsai, A. I.; Liu, S.-T. *Tetrahedron* **2008**, *64*, 7511. l) Adams, H.; Gilmore, N. J.; Jones, S.; Muldowney, M. P.; von Reuss, S. H.; Vemula, R. *Org. Lett.* **2008**, *10*, 1457. m) Mangas-Sanchez, J.; Busto, E.; Gotor-Fernandez, V.; *Org. Lett.* **2010**, *12*, 3498-3501.
112. Padwa, A.; Au, A.; Lee, G. A.; Owens, W. *J. Am. Chem. Soc.* **1976**, *98*, 3555.
113. a) Hoppe, P. P.; Krennrich, G. *Eur. J. Nutr.* **2000**, *39*, 183-193. b) Blatt, D. H.; Pryor, W. A.; Mata, J. E.; Rodriguez-Proteau, R. *J. Nutr. Biochem.* **2004**, *15*, 380-395.
114. *Vitamin E-A Comprehensive Treatise*; Machlin, L. J.; Ed.; Marcel Dekker: New York, 1980.
115. a) Vatesary, G. T.; Smith, W. E.; Quach, H. T. *Lipids* **1989**, *24*, 1043-1047. b) Jacobson, H. N. *Free Radical Biol. Med.* **1987**, *3*, 209- 213. c) Burton, G. W.; Joyce, A.; Ingold, K. U. *Arch. Biochem. Biophys.* **1983**, *221*, 281-290. d) Burton, G. W.; Joyce, A.; Ingold, K. U. *Lancet*, **1982**, *2*, 327. e) Packer, J.

- E.; Slater, T. F.; Willson, R. L. *Nature* **1979**, *278*, 737–738. f) Simon, E. J.; Cross, C. S.; Milhorat, A. T. *J. Biol. Chem.* **1956**, *221*, 797–805.
- 116.** a) Netscher, T. In *Lipid Synthesis and Manufacture*; Gunstone, F. P., Ed.; Academic Press: Sheffield, U.K., 1999; pp 250–267. b) Kreimayer, J.; Schmidt, M. *Pharm. Ztg.* **1998**, *143*, 823–828. c) Acuff, R. V.; Dunworth, R. G.; Webb, L. W.; Lane, J. R. *Am. J. Clin. Nutr.* **1998**, *67*, 459–464. d) Kiyose, C.; Maramatsu, R.; Kameyama, Y.; Ueda, T.; Igarashi, O. *Am. J. Clin. Nutr.* **1997**, *65*, 785–789. e) *Ullmans Encyclopedia of Industrial Chemistry*; Elvers, B., Ed.; Wiley-VCH: Weinheim, **1996**; *27*, 478–488. f) Ingold, K. U.; Burton, G. W.; Foster, D. O.; Hughes, L.; Lindsay, D. A.; Webb, A. *Lipids* **1987**, *22*, 163–172. g) Cheng, S. C.; Burton, G. W.; Ingold, K. U.; Foster, D. O. *Lipids* **1987**, *22*, 469–473.
- 117.** G. W. Burton, K. U. Ingold, *Acc. Chem. Res.* **1986**, *19*, 194–201, and references cited therein.
- 118.** a) Cooney, R. W., France, A. A., Harwood, P. J., Hatch-Pigott, V., Custer, L. J., and Mordan, L. J. *Proc. Natl. Acad. Sci. USA* **90**, **1993**, 1771–1775 b) Cooney, R. V., Harwood, P. J., Franke, A. A., Narala, K., Sundstrom, A. K., Berggren, P. O., and Mordan, L. J. *Free Rad. Biol. Med.* **1995**, *19*, 259–269 c) Christen, S., Woodall, A. A., Shigenaga, M. K., Southwell-Keely, P. T., Duncan, M. W., and Ames, B. N. *Proc. Natl. Acad. Sci. USA*, **1997**, *94*, 3217–3222.
- 119.** De Wardener, H. E., Mills, I. H., Clapham, W. F. and Hayter, C. J. *Clin. Sci.* **1961**, *21*: 249–258.
- 120.** a) Murray, E. D., Jr., Kantoci, D., Dewind, S. A., Bigornia, A. E., D’Amico, D. C., King, J. G., Jr., Pham, T., Levine, B. H., Jung, M. E. and Wechter, W. J. *Life Sci.* **1995**, *57* 2145–2161. b) Wechter, W. J., Kantoci, D., Murray, E. D. Jr., D’Amico, D. C., Jung, M. E. and Wang, W.-H *Proc. Natl. Acad. Sci. U.S.A.* **1996**, *93*, 6002–6007.
- 121.** a) Murray, E. D., Jr., Wechter, W. J., Kantoci, D., Wang, W. H., Pham, T., Quiggle, D. D., Gibson, K. M. Leiplod D. D. and Anner, B. A. *J. Pharmacol. Exp. Ther.* **1997**, *282*, 657–662
- 122.** Simon, E. J., Eisengart, A., Sundheim, L. and Milhorat, A. T. *J. Biol. Chem.* **1956**, *221*: 807–817
- 123.** Schultz, M., Leist, M., Petrzika, M., Gassmann, B. and Breigelius-Flohe, R *Am. J. Clin. Nutr.* **62**: suppl, **1995**, 1527S–1534S.
- 124.** Hattori, A.; Fukushima, T.; Yoshimura, H.; Abe, K.; Imai, K. *Biol. Pharm. Bull.* **2000**, *23*, 1395–1397.
- 125.** Lodge, J. K.; Ridington, J.; Leonard, S.; Vaule, H.; Traber, M. G. *Lipids* **2001**, *36*, 43–48.
- 126.** Kamal-Eldin, A. and Appelqvist, L.-Å. *Lipids*, **1996**, *31*: 671–701.
- 127.** a) Appenroth, D.; Karge, E.; Kießling, G.; Wechter, W. J.; Winnefeld, K.; Fleck, C. *Toxicology Lett.* **2001**, *122*, 255–265. b) Takata, J.; Hidaka, R.; Yamasaki, A.; Hattori, A.; Fukushima, T.; Tanabe, M.; Matsunaga, K.; Karube, Y.; Imai, K. *J. Lipid Res.* **2002**, *43*, 2196–2204.
- 128.** Review: Odinokov, V. N.; Spivak, A. Y.; Knyshenko, O. V. *Russ. J. Bioorg. Chem.* **2007**, *33*, 359–375.
- 129.** a) Yoshida, Y.; Niki, E. *Biofactors* **2002**, *16*, 93–103. b) Betancor-Fernandez, A.; Sies, H.; Stahl, W.; Polidori, M. C. *Free Radic. Res.* **2002**, *36*, 915–921.
- 130.** Hensley, K.; Benaksas, E. J.; Bolli, R.; Comp, R.; Grammas, P.; Hamdheydari, L.; Mou, S.; Pye, Q. N.; Stoddard, M. F.; Wallis, G.; Williamson, K. S.; West, M.; Wechter, W. J.; Floyd, R. A. *Free Radic. Biol. Med.* **2004**, *36*, 1–15.
- 131.** a) Jiang, Q.; Elson-Schwab, I.; Courtemanche, C.; Ames, B. N. *Proc. Natl. Acad. Sci. USA* **2000**, *97*, 11494–11499. b) Grammas, P.; Hamdheydari, L.; Benaksas, E. J.; Mou, S.; Pye, Q. N.; Wechter, W. J.; Floyd, R. A.; Stewart, C.; Hensley, K. *Res. Commun.* **2004**, *319*, 1047–1052.
- 132.** Jung, M. E.; MacDougall J. M, *Tetrahedron Lett.* **1999**, *40*, 6339–6342.
- 133.** a) Katsuki, T.; Sharpless, K. B. *J. Am. Chem. Soc.* **1980**, *102*, 5976. b) Hanson, R. M.; Sharpless, K. B. *J. Org. Chem.* **1986**, *51*, 1922.
- 134.** Gassman, P. G.; Amick, D. R. *J. Am. Chem. Soc.* **1978**, *100*, 7611.
- 135.** Inoue, S.; Ikeda, H.; Sato, S.; Horie, K.; Ota, T.; Miyamoto, O.; Sato, K. *J. Org. Chem.* **1987**, *52*, 5495.
- 136.** a) Hoefnagel, A. J.; Gunnewegh, E. A.; Downing, R. S.; Van Bekkum, H. *J. Chem. Soc., Chem. Commun.* **1995**, 225–226. b) Graham, S. R.; Murphy, J. A.; Kennedy, A.R. *J. Chem. Soc., Perkin Tans. 1* **1999**, *21*, 3071–3073. c) Posakony, J.; Hirao, M.; Stevens, S.; Simon, J. A.; Bedalov, A. *J. Med. Chem.* **2004**, *47*, 2635–2644.
- 137.** Cohen, N.; Schaer, B.; Saucy, G.; Borer, R.; Todaro, L.; Chiu, A.-M. *J. Org. Chem.* **1989**, *54*, 3282–3292.
- 138.** Li, X.; Ohtake, H.; Takahashi, H.; Ikegami, S. *Tetrahedron* **2001**, *57*, 4297–4309.

139. a) Mannam, S.; Sekar, G. *Tetrahedron Lett.* **2008**, *49*, 2457–2460; b) Ley, S. V.; Norman, J.; Griffith, W. P.; Marsden, S. P. *Synthesis* **1994**, 639–666; c) Grill, J. M.; Ogle, J. W.; Miller, S. A. *J. Org. Chem.* **2006**, *71*, 9291–9296; dd) Zhao, M.; Li, J.; Song, Z.; Desmond, R.; Tschaen, D. M.; Grabowski, E. J. J.; Reider, P. J. *Tetrahedron Lett.* **1998**, *39*, 5323–5326.
140. Kraus, G. A.; Roth, B. *J. Org. Chem.* **1980**, *45*, 4825–4830.
141. Suffert, J. *J. Org. Chem.* **1989**, *54*, 509.
142. Still, W. C.; Kahn, M.; Mitra, A. *J. Org. Chem.* **1978**, *43*, 2923.
143. K. K Andersen, W. Gafield, N. Papanicolaou, J. W. Foley, R. I. Perkins, *J. Am. Chem. Soc.* **1964**, *86*, 5637–5646.
144. a) D. A. Evans, M. M. Faul, L. Colombo, J. J. Bisaha, J. Clardy, D. Cherry, *J. Am. Chem. Soc.* **1992**, *114*, 5977–5985; b) P. B. Hitchcock, G. J. Rowlands, R. J. Seacome, *Org. Biomol. Chem.* **2005**, *3*, 3873–3876.
145. a) H. Egami, T. Katsuki, *J. Am. Chem. Soc.* **2007**, *129*, 8940–8941. b) Y. Ferrand, R. Daviaud, P. Le Maux, G. Simmonneaux, *Tetr. Asymm.* **2006**, *17*, 952–960.
146. F. G. Bordwell, P. J. Bouton, *J. Am. Chem. Soc.* **1957**, *79*, 717–722.
147. J. Legros, C. Bolm, *Chem. Eur. J.* **2005**, *11*, 1086–1092.
148. S. G. Pyne, A. R. Hajipour, K. Prabhakaran, *Tetrahedron Lett.*, **1994**, *35*, 645–648.
149. Sekar, G. *Tetrahedron Lett.* **2008**, *49*, 2457–2460
150. L. Pauling, *The Nature of the Chemical Bond and the Structure of Molecules and Crystals: An Introduction to Modern Structural Chemistry*, Cornell University Press, Ithaca, NY, **1939**.
151. H. Deng, D. O'Hagan, C. Schaffrath, *Nat. Prod. Rep.* **2004**, *21*, 773–784.
152. J.P. Bégué, D. Bonnet-Delpon, *Chimie bioorganique et Médicinale du Fluor*, EDP Science/CNRS, Paris, **2005**.
153. For recent examples, see: a) F. Babudri, G. M. Farinola, F. Naso and R. Ragni, *Chem. Commun.*, **2007**, 1003; b) F. Babudri, A. Cardone, G. M. Farinola, C. Martinelli, R. Mendichi, F. Naso and M. Striccoli, *Eur. J. Org. Chem.*, **2008**, 1977.
154. a) G. Dutheuil, S. Couve-Bonnaire, X. Pannecoucke, *Angew. Chem., Int. Ed.*, **2007**, *46*, 1290; b) P. Van der Veken, K. Senten, I. Kertesz, I. De Meester, A. M. Lambeir, M. B. Maes, S. Scharpe, A. Haemers, K. Augustyns, *J. Med. Chem.*, **2005**, *48*, 1768; c) O. A. Wong and Y. A. Shi, *J. Org. Chem.*, **2009**, *74*, 8377; d) G. Dutheuil, X. S. Lei, X. Pannecoucke, J. C. Quirion, *J. Org. Chem.*, **2005**, *70*, 1911.
155. J. Gante, *Angew. Chem., Int. Ed. Engl.*, **1994**, *33*, 1699–1720.
156. a) J. J. Urban, B. G. Tillman and W. A. Cronin, *J. Phys. Chem. A*, **2006**, *110*, 11120–11129; b) D. O'Hagan and H. S. Rzepa, *Chem. Commun.*, **1997**, 645–65.
157. R. J. Braham, S. L. R. Ellison, F. Schonholzer, W. A. Thomas, *Tetrahedron*, **1986**, *42*, 2101–2110.
158. a) R. J. Abraham, S. L. R. Ellison, P. Schonholzer and W. A. Thomas, *Tetrahedron*, **1986**, *42*, 2101–2110; b) P. Cieplak, P. A. Kollman and J. P. Radomski, in *Molecular Design of Fluorine-Containing Peptide Mimetics*, ed. J. T. Welch, Washington, D. C., **1996**.
159. S. Couve-Bonnaire, D. Cahard and X. Pannecoucke, *Org. Biol. Chem.*, **2007**, *5*, 1151–1157.
160. a) S. Osada, S. Sano, M. Ueyama, Y. Chuman, H. Kodama and K. Sakaguchi, *Bioorg. Med. Chem.* **2010**, *18*, 605. b) J. Kanazawa, T. Takahashi, S. Akinaga, T. Tamaoki and M. Okabe, *Anti-Cancer Drugs*, **1998**, *9*, 653.
161. a) R. J. Sciotti, M. Pliushchev, P. E. Wiedeman, D. Balli, R. Flamm, A. M. Nilius, K. Marsh, D. Stolarik, R. Jolly, R. Ulrich and S. W. Djuric, *Bioorg. Med. Chem. Lett.*, **2002**, *12*, 2121. b) Y. Asahina, K. Iwase, F. Iinuma, M. Hosaka and T. Ishizaki, *J. Med. Chem.*, **2005**, *48*, 3194.
162. S. Oishi, H. Kamitani, Y. Kodera, K. Watanabe, K. Kobayashi, T. Narumi, K. Tomita, H. Ohno, T. Naito, E. Kodama, M. Matsuoka and N. Fujii, *Org. Biomol. Chem.* **2009**, *7*, 2872.
163. a) S. D. Edmondson, L. Wei, J. Xu, J. Shang, S. Xu, J. Pang, A. Chaudhary, D. C. Dean, H. He, B. Leiting, K. A. Lyons, R. A. Patel, S. B. Patel, G. Scapin, J. K. Wu, M. G. Beconi, N. A. Thornberry and A. E. Weber, *Bioorg. Med. Chem. Lett.*, **2008**, *18*, 2409. b) T. Deng, S. Shan, Z.-B. Li, Z.-W. Wu, C.-Z. Liao, B. Ko, X.-P. Lu, J. Cheng and Z.-Q. Ning, *Biol. Pharm. Bull.*, **2005**, *28*, 1192.
164. T. Guan, M. Yoshida, D. Ota, T. Fukuhara and S. Hara, *J. Fluorine Chem.*, **2005**, *126*, 1185.
165. S. Eddarir, Z. Abdelhadi and C. Rolando, *Tetrahedron Lett.* **2001**, *42*, 9127.
166. D. R. Williams, M. W. Fultz, T. E. Christos and J. S. Carter, *Tetrahedron Lett.* **2010**, *51*, 121.

167. S. Eddarir, C. Francesch, H. Mestdagh and C. Rolando, *Tetrahedron Lett.* **1990**, *31*, 4449.
168. M. Yoshida, S. Yoshikawa, T. Fukuhara, N. Yoneda and S. Hara, *Tetrahedron*, **2001**, *57*, 7143.
169. M. Yoshida, A. Komata and S. Hara, *Tetrahedron*, **2006**, *62*, 8636.
170. C. Chen, K. Wilcoxon, C. Q. Huang, N. Strack and J. R. McCarthy, *J. Fluorine Chem.*, **2000**, *101*, 285.
171. J. Xu and D. J. Burton, *J. Org. Chem.* **2006**, *71*, 3743.
172. J. Xu and D. J. Burton, *J. Fluorine Chem.* **2004**, *125*, 725.
173. J. Xu and D. J. Burton, *Org. Lett.* **2002**, *4*, 831.
174. G. Q. Shi, X. H. Huang and F. J. Zhang, *Tetrahedron Lett.* **1995**, *36*, 6305.
175. a) M. Schlosser; M. Zimmermann, *Synthesis*, **1969**, 75. b) M. Schlosser; K. F. Christmann, *Synthesis*, **1969**, 38.
176. a) Z. Du; M. J. Haglund; L. A. Pratt; K. L. Erickson, *J. Org. Chem.*, **1998**, *63*, 8880. b) E. Roversi, R. Scopelliti; E. Solari; R. Estoppey; P. Vogel; P. Brana; B. Menendez ; J. A. Sordo, *Chem. Eur. J.*, **2002**, *8*, 1336.
177. D. J. Burton, Z. Y. Yang and W. M. Qiu, *Chem. Rev.*, **1996**, *96*, 1641.
178. For the first reference to this method, see: A. Thenappan and D. J. Burton, *Tetrahedron Lett.*, **1989**, *30*, 3641.
179. For recent applications, see: a) N. Fishkin, R. Yefidoff, D. R. Gollipalli and R. R. Rando, *Bioorg. Med. Chem.*, **2005**, *13*, 5189; b) G. S. Nikolova and G. Haufe, *Synthesis*, **2008**, 527.
180. Y. Suzuki and M. Sato, *Tetrahedron Lett.*, **2004**, *45*, 1679.
181. D. J. Burton, Z. Y. Yang and W. M. Qiu, *Chem. Rev.*, **1996**, *96*, 1641.
182. H. Machleidt and R. Wessendorf, *Justus Liebigs Ann. Chem.*, **1964**, 674, 1.
183. G. E. Moghadam and J. S. Penne, *Bull. Soc. Chim. Fr.*, **1985**, 448.
184. T. Koizumi, T. Hagi, Y. Horie and Y. Takeuchi, *Chem. Pharm. Bull.*, **1987**, *35*, 3959.
185. For recent examples, see: a) F. Tellier and R. Sauvêtre, *J. Fluorine Chem.*, **1996**, *76*, 181.; b) Z. Wang, A. Gonzalez and S. F. Wnuk, *Tetrahedron Lett.*, **2005**, *46*, 5313; c) D. Andrei and S. F. Wnuk, *J. Org. Chem.*, **2006**, *71*, 405; d) S. F. Wnuk, P. R. Sacasa, E. Lewandowska, D. Andrei, S. Cai and R. T. Borchardt, *Bioorg. Med. Chem.*, **2008**, *16*, 5424.
186. a) E. Baader, W. Bartmann, G. Beck, P. Below, A. Bergmann, H. Jendralla, K. Keßeler and G. Wess, *Tetrahedron Lett.*, **1989**, *30*, 5115. b) T. B. Patrick and S. Nadji, *J. Fluorine Chem.*, **1990**, *49*, 147.
187. D. Chevie, T. Lequeux, J. P. Demoute and S. Pazenok, *Tetrahedron Lett.*, **2003**, *44*, 8127.
188. L. G. Zhu, C. F. Ni, Y. C. Zhao and J. B. Hu, *Tetrahedron*, **2010**, *66*, 5089.
189. A. K. Ghosh, S. Banerjee, S. Sinha, S. B. Kang and B. Zajc, *J. Org. Chem.*, **2009**, *74*, 3689.
190. M. del Solar, A. K. Ghosh and B. Zajc, *J. Org. Chem.*, **2008**, *73*, 8206.
191. J. T. Welch and R. W. Herbert, *J. Org. Chem.*, **1990**, *55*, 4782.
192. J. Lin and J. T. Welch, *Tetrahedron Lett.*, **1998**, *39*, 9613.
193. M. Michida and T. Mukaiyama, *Chem. Lett.*, **2008**, *37*, 890.
194. W. Zhang, W. Huang and J. Hu, *Angew. Chem., Int. Ed.*, **2009**, *48*, 9858.
195. T. Fuchigami, T. Hayashi and A. Konno, *Tetrahedron Lett.* **1992**, *33*, 3161.
196. Y. Usuki, M. Iwaoka and S. Tomoda, *J. Chem. Soc., Chem. Commun.*, **1992**, 1148.
197. T. Allmendinger, *Tetrahedron*, **1991**, *47*, 4905.
198. G. K. S. Prakash, S. Chacko, H. Vaghoo, N. Shao, L. Gurung, T. Mathew and G. A. Olah, *Org. Lett.*, **2009**, *11*, 1127.
199. C. Najera and M. Yus, *Tetrahedron*, **1999**, *55*, 10547.
200. J.C. Caille, H. Miel, P. Armstrong and M. A. McKervery, *Tetrahedron Lett.* **2004**, *45*, 863.
201. W. B. Motherwell, M. F. Greaney and D. A. Tocher, *J. Chem. Soc., Perkin Trans. 1*, **2002**, 2809.
202. O. A. Wong and Y. A. Shi, *J. Org. Chem.*, **2009**, *74*, 8377.
203. a) M.-J. Egron, D. Komiotis, I. Dorange, J. Herscovici, A. Ollapally and K. Antonakis, *Nucleosides, Nucleotides Nucleic Acids*, **2005**, *24*, 243. b) S. Manta, G. Agelis, T. Botic, A. Cencic and D. Komiotis, *Bioorg. Med. Chem.*, **2007**, *15*, 980.
204. C. J. Woltermann, Y. A. Lapin, K. B. Kunnen, D. R. Tueting and I. H. Sanchez, *Tetrahedron*, **2004**, *60*, 3445.

- 205.** a) X.-L. Qiu, W.-D. Meng and F.-L. Qing, *Tetrahedron*, **2004**, *60*, 5201. b) J. Wang, Y. Jin, K. L. Rapp, R. F. Schinazi and C. K. Chu, *J. Med. Chem.*, **2007**, *50*, 1828. c) X. L. Qiu, X. H. Xu and F. L. Qing, *Tetrahedron*, **2010**, *66*, 789.
- 206.** G. S. Lal, G. P. Pez, R. J. Pesaresi, F. M. Prozonic and H. S. Cheng, *J. Org. Chem.*, **1999**, *64*, 7048.
- 207.** W. J. Middleton, *J. Org. Chem.*, **1975**, *40*, 574.
- 208.** A. L'Heureux, F. Beaulieu, C. Bennett, D. R. Bill, S. Clayton, F. LaFlamme, M. Mirmehrabi, S. Tadayon, D. Tovell and M. Couturier, *J. Org. Chem.*, **2010**, *75*, 3401.
- 209.** K. Sano, T. Fukuhara and S. Hara, *J. Fluorine Chem.*, **2009**, *130*, 708.
- 210.** D. Biedermann, J. Sarek, J. Klinot, M. Hajduch and P. Dzubak, *Synthesis*, **2005**, 1157.
- 211.** S. Eddarir, C. Francesch, H. Mestdagh and C. Rolando, *Bull. Soc. Chim. Fr.*, **1997**, *134*, 741.
- 212.** J. M. Chalker, C. S. C. Wood and B. G. Davis, *J. Am. Chem. Soc.*, **2009**, *131*, 16346.
- 213.** J. A. Akana, K. X. Bhattacharyya, P. Mueller and J. P. Sadighi, *J. Am. Chem. Soc.*, **2007**, *129*, 7736.
- 214.** T. Furuya and T. Ritter, *Org. Lett.*, **2009**, *11*, 2860.
- 215.** M. Jiang and M. Shi, *Tetrahedron*, **2009**, *65*, 5222.
- 216.** W. Fu, G. Zou, M. Zhu, D. Hong, D. Deng, C. Xun and B. Ji, *J. Fluorine Chem.*, **2009**, *130*, 996.
- 217.** M. C. Pacheco and V. Gouverneur, *Org. Lett.*, **2005**, *7*, 1267.
- 218.** Reviews: a) Gaudemar, M. *Organomet. Chem. Rev., Sect. A* **1972**, *8*, 183. b) Fürstner, A. *Synthesis* **1989**, 571. c) Ender, E. *Tetrahedron* **1992**, *48*, 9577. d) Fürstner, A. *Organozinc Reagents* **1999**, 287. e) Orsini, F.; Sello, G. *Curr. Org. Synth.* **2004**, *1*, 111. f) Ocampo, R.; Dolbier Jr., W. R. *Tetrahedron* **2004**, *60*, 9325. g) Ribeiro, C. M. R.; Cordeiro de Farias, F.M. *Mini-Reviews in Organic Chemistry* **2006**, *3*, 1. h) Cozzi, P. G. *Angew. Chem. Int. Ed.* **2007**, *46*, 2568. i) Cozzi, P. G. *Pure and Appl. Chem.* **2008**, *80*, 891.
- 219.** L. Ferreira-Mederos, S. Vila-Gisbert, A. Urbano, M.C. Carreño, F. Colobert, *Org. Biom. Chem.* **2011**, DOI:10.1039/C0OB00491J.
- 220.** P. V. Ramachandran, G. Parthasarathy and P. D. Gagare, *Org. Lett.* **2010**, *12*, 4474-4477.
- 221.** K. Mikami, and Y. Itoh, *The Chemical Record* **2006**, *6*, 1-11.
- 222.** O. Diels and K. Alder, *Justus Liebigs Ann. Chem.* **1928**, *460*, 98.
- 223.** E. J. Corey, *Angew. Chem. Int. Ed.* **2002**, *41*, 1650-1667.
- 224.** a) W. Carruthers, *Cycloaddition Reactions in Organic Synthesis*, Pergamon, Oxford, **1990**. b) K. C. Nicolaou, Scott A. Snyder, Tamsyn Montagnon, and G. Vassilikogiannakis *Angew. Chem. Int. Ed.* **2002**, *41*, 1668-1698.
- 225.** Y. Lam, S. J. Stanway and V. Gouverneur, *Tetrahedron*, **2009**, 9905-9933.
- 226.** Ernet, T.; Maulitz, A. H.; Wurthwein and E. U.; Haufe, G. *J. Chem. Soc., Perkin Trans. 1* **2001**, 1929-1938.
- 227.** M. Essers, C. Mück-Lichtenfeld, and G. Haufe, *J. Org. Chem.* **2002**, *67*, 4715-4721.
- 228.** E. Magnier, P. Diter, and J.C. Blazejewski, *Tetrahedron Lett.* **2008**, *49*, 4575-4578.
- 229.** H. Ito, A. Saito and T. Taguchi, *Tetrahedron: Asymmetry* **1998**, *9*, 1989-1994.
- 230.** H. Ito, A. Saito and T. Taguchi, *Tetrahedron: Asymmetry* **1998**, *9*, 1979-1987.
- 231.** A. Saito, H. Yanai, W. Sakamoto, K. Takahashi and T. Taguchi, *J. Fluorine Chem.* **2005**, *126*, 709-714.
- 232.** T. Ooi, N. Kagoshima and K. Maruoka, *J. Am. Chem. Soc.* **1997**, *119*, 5754-5755.
- 233.** For example, the bond strengths in several diatomic molecules of metal-fluorine follow: Li-F, 577 ±21 kJ/mol; Ti-F, 569±34 kJ/mol; Si-F, 552.7±2.1 kJ/mol; Sn-F, 466.5±13 kJ/mol; Mg-F, 461.9±5.0 kJ/mol. See: R. C. Weast, *Handbook of Chemistry and Physics*; 65th Edition, CRC Press: New York, **1984-1985**.
- 234.** For the synthetic utility of forming the strong Al-F bonds, see: a) G. H. Posner, J. W. Ellis and J. Ponton, *J. Fluorine Chem.* **1981**, *19*, 191. b) G. H. Posner and S. R. Haines, *Tetrahedron Lett.* **1985**, *26*, 1823.
- 235.** I. Fleming in "Frontier orbitals and organic chemical reactions" Ed. John Wiley and Sons, Chichester, **1976**.



UNIVERSIDAD DE ESTRASBURGO - UNIVERSIDAD AUTONOMA DE MADRID

RESUMEN DE TESIS EN COTUTELA

Disciplina: Química

Especialidad: Química Orgánica

Candidata: LECEA ROMERA, Mercedes

Título: « ***Síntesis estereoselectiva del metabolito natural del tocoferol, (S)- γ -CEHC, y de olefinas monofluoradas trisustituidas.*** »

Realizada en:

Departamento de Química Orgánica C-1. Facultad de Ciencias, Universidad Autónoma de Madrid, España.

Laboratoire de Stéréochimie R2N2. Ecole européenne de Chimie, Polymères et Matériaux de Strasbourg (ECPM) Université de Strasbourg. Strasbourg. France. UMR 7509

Directores de Tesis: Prof. M. Carmen Carreño García (UAM)
Prof. Françoise Colobert (UdS)

Periodo: Noviembre 2007-Enero2012

« Síntesis estereoselectiva del metabolito natural del tocoferol, (S)- γ -CEHC, y de olefinas monofluoradas trisustituidas.»

Esta tesis doctoral ha sido realizada en cotutela entre la Universidad de Estrasburgo, en el laboratorio de estereoquímica de la Ecole Européenne de Chimie, Polymères et Matériaux, Université de Strasbourg, dirigido por la Profesora Françoise Colobert y la Universidad Autónoma de Madrid, en el Departamento de Química Orgánica, laboratorio dirigido por la Profesora M. Carmen Carreño.

La tesis consta de dos partes claramente diferenciadas.

I. Síntesis estereoselectiva de cromanos 2,2-disustituídos. Síntesis total de (S)- γ -CEHC

El desarrollo de nuevas metodologías que permiten controlar la configuración absoluta de centros estereogénicos y sus aplicaciones a la síntesis total de moléculas biológicamente activas, es uno de los objetivos más importantes de la síntesis orgánica actual. Recientemente, los grupos de investigación de las Universidades Autónoma de Madrid y de Estrasburgo (ECPM), han venido desarrollando una colaboración científica que ha conducido al desarrollo de dos nuevas aplicaciones de los sulfóxidos enantiopuros como fuente de quiralidad en síntesis asimétrica.

La unidad de cromano está presente en un gran número de productos naturales que poseen propiedades biológicas importantes, como los tocoferoles (vitamina E) y sus derivados (*Esquema 1*). La formación estereocontrolada del centro quiral en posición C-2 de la unidad de benzopirano (cromano) permitiría acceder a la síntesis de este tipo de estructuras.

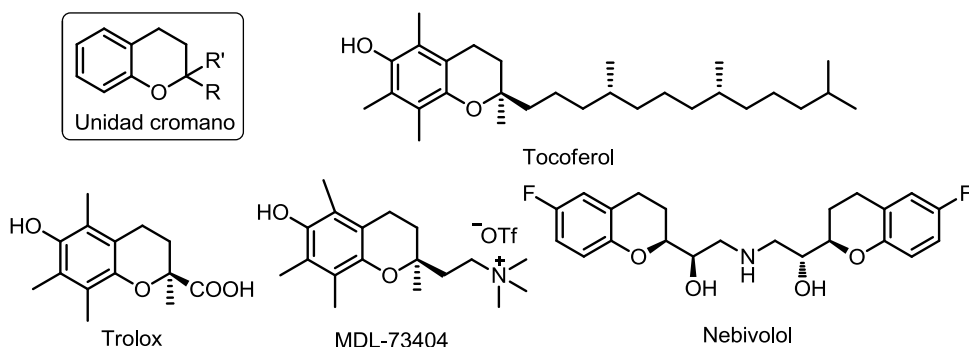

(Esquema 1)

La investigación desarrollada se ha centrado en encontrar una nueva vía de acceso enantioselectiva a las estructuras de los dihidrobenzopiranos (cromanos). La nueva metodología utiliza el grupo sulfóxido como inductor de quiralidad permitiendo acceder de manera enantioselectiva a cromanos 2,2-disustituidos, a partir de las sulfínil cromanonas correspondientes. La sustitución nucleófila de 2-sulfínilmetoxi cromanos, a través de un mecanismo iónico, ha permitido generar estereoselectivamente el centro estereogénico en posición C-2 (Esquema 2).

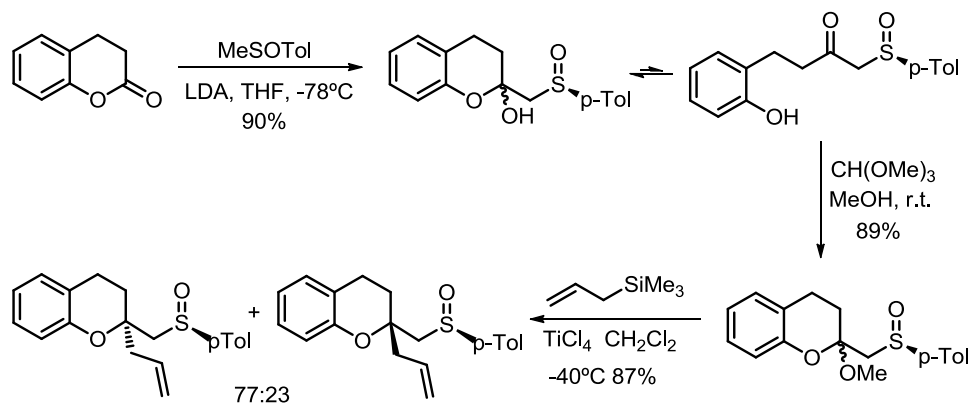

(Esquema 2)

El método ha sido aplicado a la síntesis total del metabolito natural del (2*R*)- γ -tocoferol, (S)- γ -CEHC, que posee propiedades antioxidantes comparables

a las del α -tocoferol, ácido ascórbico y Trolox.¹ Los análogos de cadena corta hidrófila del tocoferol son metabolitos de la vitamina E solubles en medio acuoso, y presentan propiedades antioxidantes y antiinflamatorias. Este metabolito, también presenta propiedades natriuréticas y, al contrario que otros diuréticos, este metabolito permite la liberación selectiva de iones de sodio sin afectar a la liberación de iones de potasio.² A pesar de presentar propiedades muy interesantes, en la bibliografía hasta el momento sólo se ha encontrado una síntesis total anterior a la presentada en esta tesis doctoral.³

La etapa clave de la síntesis descrita en este trabajo corresponde a la formación del alilsulfenil cromano, preparado por reacción del sulfenilmetoxi derivado con aliltrimetil silano en presencia de un ácido de Lewis (*Esquema 3*). Gracias a diferentes transformaciones sobre los grupos sulfenilo y alilo, la síntesis del metabolito (S)- γ -CEHC fué completada en 10 etapas de síntesis con un rendimiento global de 18.4%, a partir de la 2,3-dimetilhidroxi quinona comercial.⁴

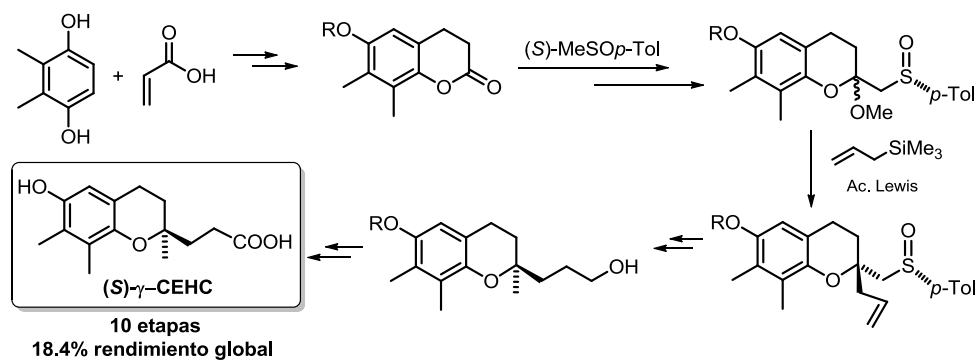

(Esquema 3)

II. Síntesis estereoselectiva de olefinas monofluoradas trisubstituidas

La segunda parte de esta tesis doctoral se centró en la síntesis de olefinas fluoradas. Los trabajos realizados relacionados con la química de flúor ilustran de manera significativa las investigaciones que se están llevando a

¹ Yoshida, Y., Niki, E. *Biofactors* **2002**, 16, 93–103; Betancor-Fernández, A., Sies, H.; Stahl, W., Polidori, M. C. *Free Radic. Res.* **2002**, 36, 915–921.

² Murray, E. D., Jr., Wechter, W. J., Kantoci, D., Wang, W.-H.; Pharm, T.; Quiggle, D. D., Gibson, K. M., Leipold, D., Anner, B. M. *J. Pharm. Exp. Ther.* **1997**, 282, 657–662.

³ Jung, M. E., MacDougall J. M, *Tetrahedron Lett.* **1999**, 40, 6339–6342.

⁴ Lecea M., Hernandez-Torres G., Urbano A., Carreño M.C., Colobert F., *Org. Lett.*, **2010**, 12, 580-583.

cabo en la optimización de moléculas punteras en farmacia y agroquímica. En la industria farmacéutica el mercado de compuestos fluorados supone un 18% aproximadamente. Los compuestos fluorados están también muy presentes el campo de los materiales biocompatibles y de la fitosanidad. El flúor es el elemento más electronegativo de la tabla periódica y presenta propiedades electrónicas muy particulares. Esto da lugar a algunos cambios en las propiedades físico-químicas de las moléculas que lo contienen, como su solubilidad, biodisponibilidad y estabilidad metabólica. Además, la posibilidad de observar, gracias a este átomo poco voluminoso y con alta densidad electrónica, nuevas interacciones intra- o intermoleculares que pueden dar lugar a una modificación de la conformación molecular sigue siendo hoy día de enorme interés para los investigadores.

En este contexto, la reacción indicada en el Esquema 4, consistente en la adición del anión litiado derivado del metil-*p*-tolil sulfóxido sobre el metil-3,3,3-trifluoropropionato comercial, permitió acceder de forma altamente estereoselectiva al isómero *E* (*E/Z* 95:5) de la olefina monofluorada con buen rendimiento (*Esquema 4*).

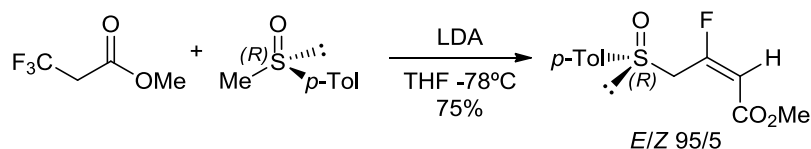

(*Esquema 4*)

A la vista de este excelente resultado, se llevó a cabo un estudio metodológico sobre la síntesis de distintas olefinas monofluoradas trisustituidas, utilizando diferentes bases/nucleófilos así como diferentes metales para generar los intermedios de tipo $M Nu$ (*Esquema 5*).

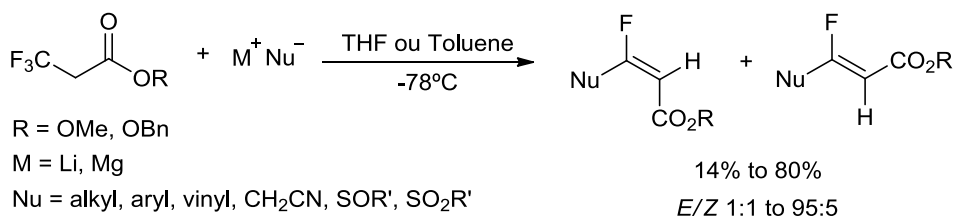

R = OMe, OBn

M = Li, Mg

Nu = alkyl, aryl, vinyl, CH₂CN, SOR', SO₂R'

(Schéma 5)

Para evaluar las posibles aplicaciones sintéticas de estas olefinas monofluoradas, se estudiaron las reacciones de Diels-Alder con ciclopentadieno, elegido como modelo. Este tipo de reacción ha sido muy utilizada en la síntesis total de productos complejos⁵ tales como los terpenos. Los terpenos fluorados han sido ampliamente utilizados en farmacia. Un ejemplo es el derivado fluorado de la artemisina que presenta actividad antipalúdica.

En la bibliografía existen escasos ejemplos de reacción de Diels-Alder con dienófilos fluorados debido a su difícil accesibilidad. Con las olefinas fluoradas obtenidas en este trabajo, las reacciones de Diels-Alder con ciclopentadieno sólo dieron resultados de interés en presencia de varios ácidos de Lewis.

El mejor resultado se obtuvo con Et₂AlCl como catalizador. En la reacción de la olefina indicada en el Esquema 6 se pudo aislar el derivado clorado tricíclico indicado, resultante de la formación inicial del aducto de Diels-Alder seguida de una pérdida del átomo de flúor (Esquema 6).

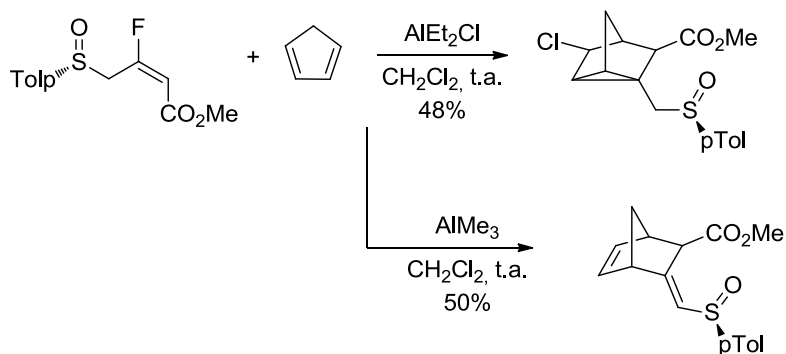

(Esquema 6)

⁵ Review: K. C. Nicolaou, S. A. Snyder, T. Montagnon, G. Vassilikogiannakis. *Angew. Chem. Int. Ed.* **2002**, *41*, 1668-1698

Conclusiones:

El trabajo realizado en esta tesis doctoral se ha centrado en dos objetivos fundamentales:

- La síntesis estereoselectiva de la unidad de cromano 2,2-disustituida utilizando el sulfóxido como único inductor de quiralidad ha sido conseguida con buenos rendimientos y buenas diastereoselectividades. La síntesis total de metabolito natural del α -tocoferol (S)- γ -CEHC, ha sido completada en diez etapas con un rendimiento global del 18.4%, utilizando como etapa clave la formación del alilsulfinil cromano, preparado a partir de su derivado sulfinil sustituido con aliltrimetil silano en presencia de TiCl_4 como ácido de Lewis.
- La síntesis estereoselectiva de olefinas monofluoradas trisustituidas a partir de 3,3,3- trifluoropropionatos de alquilo ha sido realizada con rendimientos entre moderados y buenos y selectividades en ciertos casos excelentes (95:5). La reacción de Diels-Alder del filodieno fluorado con el ciclopentadieno en presencia de un ácido de Lewis dio lugar a estructuras complejas inesperadas.

Publicaciones:

Mercedes Lecea, Gloria Hernández-Torres, Antonio Urbano, Carmen Carreño, Françoise Colobert, « *Enantioselective Total Synthesis of the Natural γ -Tocopherol Metabolite (S)- γ -CEHC [(S)- LLU- α]*» Organic Letters (ACS), 2010, 12, 580-583.

Comunicaciones en congresos:

Comunicación Oral: Gloria Hernández-Torres, Mercedes Lecea, Antonio Urbano, Carmen Carreño, Françoise Colobert « *Síntesis estereoselectiva de heterociclos oxigenados a partir de sulfóxidos* » V Symposium de Investigadores Jóvenes. RSEQ-Sigma-Aldrich. Santiago de Compostela, España. 9/11/08 al 12/11/08

Poster: Gloria Hernández-Torres, Mercedes Lecea, Antonio Urbano, Carmen Carreño, Françoise Colobert « *Stereoselective synthesis of 2,2-substituted chromans : Towards the total synthesis of natural products* » 16th European Symposium on Organic Chemistry. Praga, República Checa. 12/07/09 al 16/07/09

Poster: Mercedes Lecea, Gloria Hernández-Torres, Antonio Urbano, Carmen Carreño, Françoise Colobert « *Enantioselective Total Synthesis of the Natural γ -Tocopherol Metabolite (S)- γ -CEHC [(S)- LLU- α]* » VI Symposium de jóvenes investigadores. Real Sociedad de Química Española-Sigma Aldrich. Granada, España. 22/11/2009 al 1/11/2009

Comunicación oral: Mercedes Lecea, Gloria Hernández-Torres, Antonio Urbano, Carmen Carreño, Françoise Colobert « *Synthèse énantiosélective du métabolite (S)- γ -CEHC* » SECO 47 (Semaine d'Etudes en Chimie Organique) Seignosse, Francia. 16/05/2010 al 22/05/2010

Premios:

Premio Lilly de Investigación para estudiantes de doctorado concedido por el Comité Europeo de Relaciones Académicas de la Fundación Lilly, Septiembre 2011.

UNIVERSITE DE STRASBOURG - UNIVERSITE AUTONOME DE MADRID

RESUME DE LA THESE DE DOCTORAT

Discipline : Chimie
Spécialité (facultative) : Chimie Organique

Présentée par : LECEA ROMERA, Mercedes

Titre : « **Synthèse stéréosélective du métabolite naturel du tocophérol, (S)- γ -CEHC et d'oléfines monofluorées trisubstituées.** »

Unité de Recherche : UMR7509
Laboratoire de Stéréochimie R2N2. Ecole européenne de Chimie, Polymères et Matériaux de Strasbourg (ECPM) Université de Strasbourg. Strasbourg. France. UMR 7509

Departamento de Química Orgánica C-1. Facultad de Ciencias, Universidad Autónoma de Madrid, España.

Directeur de Thèse : Prof. Françoise Colobert (UdS)
Co-Directeur de Thèse : Prof. M. Carmen Carreño García (UAM)

Localisation : Université de Strasbourg et Université de Madrid

ECOLE DOCTORALES :

(cocher la case)

<input type="checkbox"/> ED – Sciences de l'Homme et des sociétés	<input type="checkbox"/> ED 269 – Mathématiques, sciences de l'information et de l'ingénieur
<input type="checkbox"/> ED 99 – Humanités	<input type="checkbox"/> ED 270 – Théologie et sciences religieuses
<input type="checkbox"/> ED 101 – Droit, sciences politique et histoire	<input type="checkbox"/> ED 413 – Sciences de la terre, de l'univers et de l'environnement
<input type="checkbox"/> ED 182 – Physique et chimie physique	<input type="checkbox"/> ED 414 – Sciences de la vie et de la santé
<input type="checkbox"/> ED 221 – Augustin Cournot	
<input checked="" type="checkbox"/> ED 222 – Sciences chimiques	

« Synthèse stéréosélective du métabolite naturel du tocophérol, (S)- γ -CEHC et d'oléfines monofluorées trisubstituées »

Cette thèse est réalisée en cotutelle entre l'Université Autonome de Madrid dans le laboratoire du Professeur Carmen Carreño et l'Université de Strasbourg dans le laboratoire de stéréochimie de l'ECPM dirigé par le professeur Françoise Colobert.

I. Synthèse stéréosélective de chromanes 2,2-disubstitués. Synthèse totale du (S)- γ -CEHC

Le développement de nouvelles méthodes permettant le contrôle de la configuration absolue des centres stéréogènes et leurs applications à la synthèse de molécules biologiquement actives, est un objectif prioritaire dans la synthèse organique actuelle. Notre groupe de recherche a développé ces dernières années des méthodes de synthèse asymétrique utilisant le sulfoxyde comme source de chiralité.

Le motif chromane est présente dans un grand nombre de produits naturels ayant des propriétés biologiques importantes, comme les tocophérols (vitamine E) est ses dérivés (Schéma 1). La génération contrôlée du centre en position C-2 de l'unité du benzopyrane permettra de synthétiser ce type de structures.

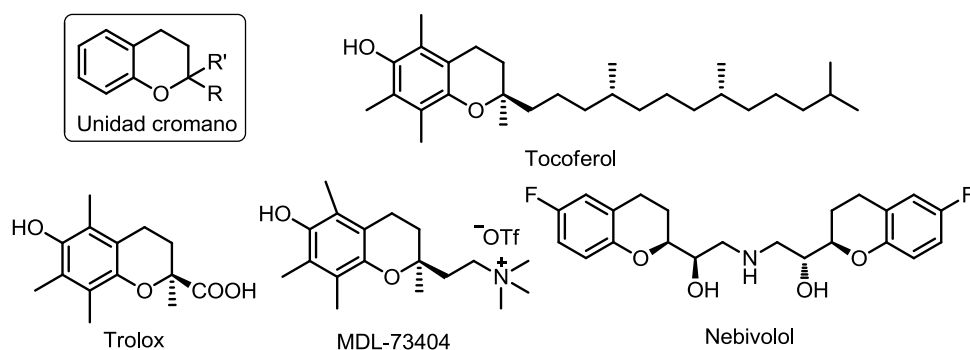

(Schéma 1)

Notre groupe de recherche s'intéresse à développer une nouvelle voie d'accès pour la synthèse énantiosélective des dihydrobenzopyranes (chromanes). Cette méthode utilisant le groupement sulfoxyde comme inducteur de chiralité permet d'accéder de manière énantiosélective aux

chromanes 2,2-disubstitués, à partir des chromanones correspondantes. La substitution nucléophile au niveau des 2-sulfinylméthoxy chromanes a permis de générer stéréosélectivement le centre stéréogène sur la position 2 (*Schéma 2*).

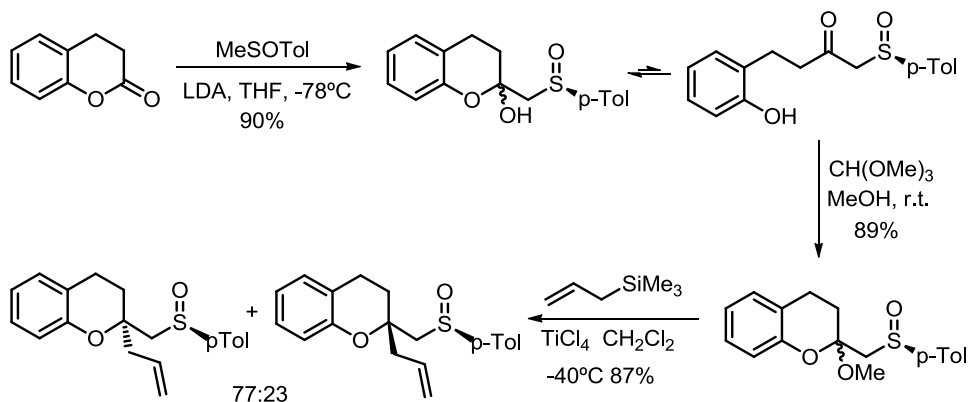

(*Schéma 2*)

Cette méthodologie a été appliquée à la synthèse énantiosélective du métabolite naturel (*S*)- γ -CEHC, c'est le métabolite du (*2R*)- γ -tocophérol, dont les propriétés antioxydantes sont comparables à celle de l' α -tocophérol, de l'acide ascorbique et du Trolox.¹ Les analogues de la chaîne courte hydrophile du tocophérol sont en effet des métabolites de la vitamine E solubles dans l'eau et possédant des propriétés antioxydantes, anti-inflammatoires et natriurétiques. Au contraire des autres diurétiques, ce métabolite, permet sélectivement la libération des ions sodium sans affecter la libération des ions potassium.² Malgré ses propriétés intéressantes, seule une synthèse stéréosélective de ce composé naturel est décrite dans la littérature.³

L'étape clé de la synthèse correspond à la formation d'allyle sulfinyle chromane, qui a été préparé par réaction du dérivé sulfinylé avec l'allyltriméthylsilane en présence d'un acide de Lewis (*Schéma 3*). Grâce à différentes transformations au niveau des groupements sulfinyle et allyle la synthèse du métabolite (*S*)- γ -CEHC a été réalisée en 10 étapes et avec

¹ Yoshida, Y., Niki, E. *Biofactors* **2002**, 16, 93–103; Betancor-Fernández, A., Sies, H.; Stahl, W., Polidori, M. C. *Free Radic. Res.* **2002**, 36, 915–921.

² Murray, E. D., Jr., Wechter, W. J., Kantoci, D., Wang, W.-H.; Pharm, T.; Quiggle, D. D., Gibson, K. M., Leipold, D., Anner, B. M. *J. Pharm. Exp. Ther.* **1997**, 282, 657–662.

³ Jung, M. E., MacDougall J. M, *Tetrahedron Lett.* **1999**, 40, 6339–6342.

18.4% de rendement global à partir de la 2,3-diméthylhydroxyquinone commerciale⁴.

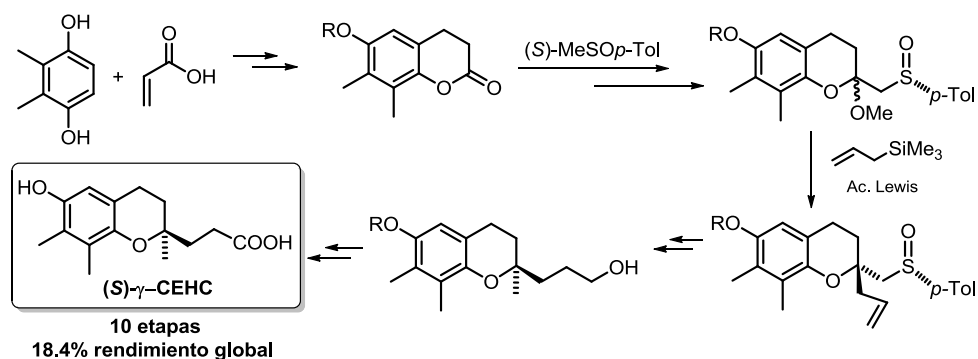

(Schéma 3)

II. Synthèse stéréosélective d'oléfines monofluorées trisubstituées

Les travaux en chimie du fluor illustrent de façon significative les recherches qui visent à l'optimisation des molécules à visée pharmaceutique et agrochimique. Les parts de marché des composés fluorés sur le marché pharmaceutique sont d'environ 18% avec 6 produits dans le "top 12". Ils sont également très présents dans le domaine des matériaux biocompatibles, et dans le domaine phytosanitaire. L'élément le plus électronégatif, le fluor présente des propriétés électroniques particulières. Il permet en effet de modifier les propriétés physico-chimiques des molécules, comme la solubilité, la biodisponibilité et la stabilité métabolique. De plus, la possibilité d'observer grâce à cet atome peu volumineux mais à haute densité électronique de nouvelles interactions intra- ou intermoléculaires ou une modification de la conformation moléculaire reste à nos jours toujours intrigant pour les chercheurs.

Dans ce contexte nous nous sommes proposés d'introduire un atome de fluor stéréogène dans des fragments complexes, c'est à dire le développement d'une réaction de Diels Alder asymétrique sur un diénophile fluoré porteur d'un auxiliaire chiral, le méthyl-*p*-tolyl-sulfoxyde. Ce type de réaction est utilisé dans la synthèse totale de produits complexes⁵ tels que les terpènes. Les terpènes fluorés ont prouvé leur utilité dans le domaine

⁴ Lecea M., Hernandez-Torres G., Urbano A., Carreño M.C., Colobert F., *Org. Lett.*, **2010**, *12*, 580-583.

⁵ Review: K. C. Nicolaou, S. A. Snyder, T. Montagnon, G. Vassilikogiannakis. *Angew. Chem. Int. Ed.* **2002**, *41*, 1668-1698

pharmaceutique ; il suffit de citer l'activité antipaludique du dérivé fluoré de l'artémisinine.

Dans la littérature il existe peu d'exemples de réaction de Diels Alder avec des diénophiles fluorés car ils sont difficilement accessibles. Notre groupe de recherche s'intéresse à développer une nouvelle voie d'accès pour la synthèse des oléfines fluorées. Le diénophile fluoré est obtenu en utilisant une méthode connue du laboratoire, par l'addition nucléophile de l'anion lithié du méthyl-*p*-tolyl-sulfoxyde sur le méthyl 3,3,3-trifluoropropionate (Schéma 4).

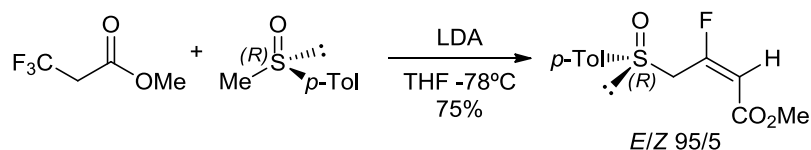

(Schéma 4)

Au vu de cette réactivité nous nous sommes proposés de faire une étude méthodologique sur la synthèse d'oléfines fluorées diversement substitués utilisant divers nucléophiles et différentes bases métallées (Schéma 5).

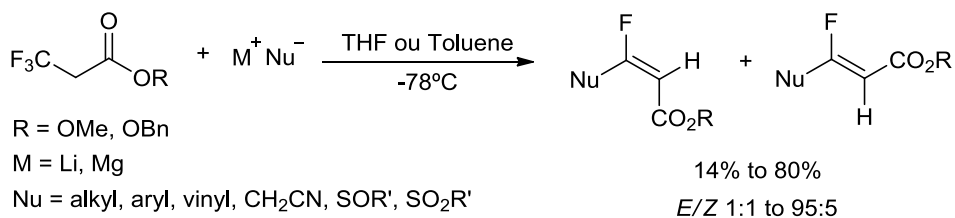

(Schéma 5)

Dans le but de vérifier la réactivité et les aspects stéréochimiques associés aux diénophiles synthétisés dans la réaction de Diels Alder, nous avons entrepris une étude méthodologique sur divers acides de Lewis, utilisant comme diène modèle le cyclopentadiène. En présence du diéthylchloroaluminium on obtient le produit résultant de la réaction de Diels Alder suivi d'une attaque nucléophile d'un atome de chlore sur la double liaison et de la perte du fluor. En présence de triméthyl aluminium, le produit obtenu est le résultat de la réaction de Diels Alder suivie de la perte de l'atome du fluor (Schéma 6).

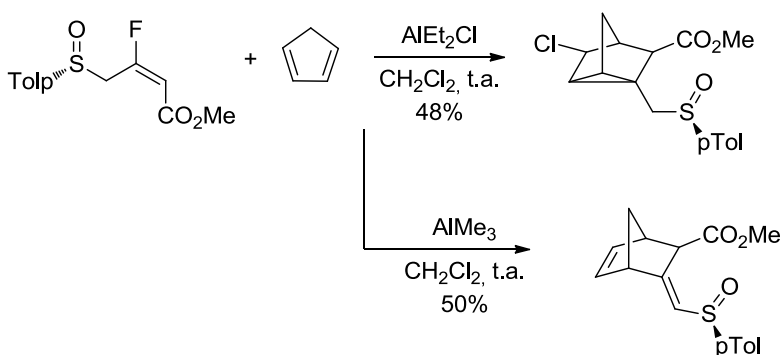

(Schéma 6)

Conclusions :

Le travail développé dans cette thèse est centré sur deux objectifs principaux :

- La synthèse stéréosélective du motif chromane 2,2-disubstitués utilisant le sulfoxyde comme seule source de chiralité a été réalisée avec de bons rendements et de bonnes diastéréosélectivités. La synthèse totale du métabolite naturel du tocophérol, (*S*)- γ -CEHC, a été réalisée en dix étapes de réaction avec un rendement global de 18.4% utilisant comme étape clé la formation d'allyle sulfonyle chromane, qui a été préparé par réaction du dérivé sulfonyle avec l'allyltriméthylsilane en présence d'un acide de Lewis.
- La synthèse stéréosélective d'oléfines monofluorées trisubstituées à partir de 3,3,3-trifluoropropionates commerciaux a été réalisée avec des rendements modérés et des sélectivités dans certains cas excellentes (95:5). La réaction de Diels-Alder entre le diénophile fluoré et le cyclopentadiène a conduit à des structures complexes inespérées.

Publications :

Mercedes Lecea, Gloria Hernández-Torres, Antonio Urbano, Carmen Carreño, Françoise Colobert, « *Enantioselective Total Synthesis of the Natural γ -Tocopherol Metabolite (S)- γ -CEHC [(S)- LLU- α]*» *Organic Letters* (ACS), 2010, 12, 580-583.

Communication au congrès :

Comunication Orale: Gloria Hernández-Torres, Mercedes Lecea, Antonio Urbano, Carmen Carreño, Françoise Colobert « *Síntesis estéreoselectiva de heterociclos oxigenados a partir de sulfóxidos* » V Simposium de Investigadores Jóvenes. RSEQ-Sigma-Aldrich. Santiago de Compostela, Espagne. 9/11/08 au 12/11/08

Poster: Gloria Hernández-Torres, Mercedes Lecea, Antonio Urbano, Carmen Carreño, Françoise Colobert « *Stereoselective synthesis of 2,2-substituted chromans : Towards the total synthesis of natural products* » 16th European Symposium on Organic Chemistry. Praga, République tchèque. 12/07/09 au 16/07/09

Poster: Mercedes Lecea, Gloria Hernández-Torres, Antonio Urbano, Carmen Carreño, Françoise Colobert « *Enantioselective Total Synthesis of the Natural γ -Tocopherol Metabolite (S)- γ -CEHC [(S)- LLU- α]* » VI Simposium de jóvenes investigadores. Real Sociedad de Química Española-Sigma Aldrich. Granada, Espgane. 22/11/200925 au /11/2009

Comunication orale: Mercedes Lecea, Gloria Hernández-Torres, Antonio Urbano, Carmen Carreño, Françoise Colobert « *Synthèse énantiosélective du métabolite (S)- γ -CEHC* » SECO 47 (Semaine d'Etudes en Chimie Organique) Seignosse, France. 16/05/2010 au 22/05/2010

Prix :

Prix Lilly de Recherche pour étudiants du Doctorat décerné par le Comité Européen des Relations Académiques de la Fondation Lilly, Septembre 2011.

