



**HAL**  
open science

# Reaction diffusion equation in heterogeneous media : persistence, propagation and effect of the geometry

Juliette Bouhours

► **To cite this version:**

Juliette Bouhours. Reaction diffusion equation in heterogeneous media : persistence, propagation and effect of the geometry. General Mathematics [math.GM]. Université Pierre et Marie Curie - Paris VI, 2014. English. NNT : 2014PA066134 . tel-01070608

**HAL Id: tel-01070608**

**<https://theses.hal.science/tel-01070608>**

Submitted on 1 Oct 2014

**HAL** is a multi-disciplinary open access archive for the deposit and dissemination of scientific research documents, whether they are published or not. The documents may come from teaching and research institutions in France or abroad, or from public or private research centers.

L'archive ouverte pluridisciplinaire **HAL**, est destinée au dépôt et à la diffusion de documents scientifiques de niveau recherche, publiés ou non, émanant des établissements d'enseignement et de recherche français ou étrangers, des laboratoires publics ou privés.

Équations de réaction-diffusion en  
milieux hétérogènes :  
Persistence, propagation et effet de la  
géométrie

THÈSE

présentée et soutenue publiquement le Juin 2014

pour l'obtention du diplôme de

Doctorat de l'université Paris VI Pierre et Marie Curie  
(spécialité mathématiques)

par

**Juliette BOUHOURS**

après avis des rapporteurs

devant le jury composé de

Mis en page avec la classe thloria.

## Remerciements





*Je dédicace cette thèse à Jacques et Annick.*



# Table des matières

|  |           |
|--|-----------|
| <b>Introduction générale</b>   | <b>1</b>  |
| 1 Équations de réaction-diffusion . . . . .  | 1         |
| 1.1 Cadre général . . . . .  | 1         |
| 1.2 Propagation en milieu homogène . . . . .   | 5         |
| 1.3 Propagation en milieu hétérogène . . . . .   | 10        |
| 2 Apports de la thèse . . . . .  | 15        |
| 2.1 Résultat de type Liouville pour des domaines extérieurs - application à la dynamique des populations . . . . . | 15        |
| 2.2 Équations de réaction-diffusion à vitesse forcée - application à la dynamique des populations . . . . .        | 18        |
| 2.3 Propagation dans des domaines cylindriques - modélisation médicale . . .                                       | 21        |
| 3 Perspectives . . . . .   | 30        |
| <b>General introduction</b>  | <b>35</b> |
| 4 Reaction diffusion equations . . . . .   | 35        |
| 4.1 General framework . . . . .  | 35        |
| 4.2 Propagation in homogeneous media . . . . .   | 39        |
| 4.3 Propagation in heterogeneous media . . . . .   | 44        |
| 5 Contribution of the thesis . . . . .   | 48        |
| 5.1 Liouville type theorem in exterior domains - application to population dynamics . . . . .                      | 49        |
| 5.2 Reaction diffusion equations with forced speed - application to population dynamics . . . . .                  | 51        |
| 5.3 Propagation in cylinders with varying cross section - Application to medical sciences . . . . .                | 54        |
| 6 Perspectives . . . . .   | 63        |

|                   |
|-------------------|
| <b>Chapitre 1</b> |
|-------------------|

|   |
|---|
| <b>Robustness of a Liouville type theorem in exterior domains</b> |
|---|

|       |   |    |
|-------|---|----|
| 1.1   | Introduction and main results . . . . .                                 | 70 |
| 1.1.1 | Problem and motivations . . . . .                                       | 70 |
| 1.1.2 | Main results . . . . .  | 71 |
| 1.1.3 | Examples . . . . .  | 72 |
| 1.2   | Robustness of the result for $C^{2,\alpha}$ perturbations . . . . .     | 74 |
| 1.2.1 | Proof of Theorem 1.1.1 . . . . .  | 74 |
| 1.2.2 | Proof of Proposition 1.2.1 . . . . .                                    | 75 |
| 1.3   | Counter example in the case of $C^0$ perturbations . . . . .            | 79 |
| 1.3.1 | Construction of a particular family of $C^0$ perturbations . . . . .    | 79 |
| 1.3.2 | Existence of a non constant solution $u_\varepsilon$ of (3.1) . . . . . | 81 |
| 1.4   | The associated parabolic problem and its properties . . . . .           | 83 |

## Chapitre 2

### A variational approach to reaction diffusion equations with forced speed in dimension 1

|       |   |     |
|-------|---|-----|
| 2.1   | Introduction and main results . . . . .   | 90  |
| 2.1.1 | Motivation: models on climate change . . . . .  | 90  |
| 2.1.2 | Framework . . . . .   | 91  |
| 2.1.3 | Main results . . . . .  | 91  |
| 2.2   | A variational approach to travelling waves . . . . .  | 93  |
| 2.3   | Convergence of the Cauchy problem . . . . .   | 97  |
| 2.3.1 | Convergence up to a subsequence . . . . .   | 98  |
| 2.3.2 | Uniqueness of the limit . . . . .   | 99  |
| 2.4   | On the stability of the trivial steady state 0 . . . . .                                    | 105 |
| 2.4.1 | Convergence to a non trivial travelling wave solution when 0 is linearly unstable . . . . . | 105 |
| 2.4.2 | Existence of travelling wave when 0 is linearly stable . . . . .                            | 107 |
| 2.5   | Examples and discussion . . . . .   | 109 |
| 2.5.1 | Numerical simulations . . . . .   | 109 |
| 2.5.2 | Non uniqueness of stable travelling waves . . . . .   | 113 |

## Chapitre 3

### Front blocking and propagation in cylinders with varying cross section

|       |   |     |
|-------|---|-----|
| 3.1   | Introduction . . . . .                          | 120 |
| 3.1.1 | The problem . . . . .                           | 120 |
| 3.1.2 | Motivations from medicine and biology . . . . . | 121 |
| 3.1.3 | Previous mathematical results . . . . .         | 123 |

|       |  |     |
|-------|--|-----|
| 3.1.4 | Notations and assumptions . . . . .  | 124 |
| 3.1.5 | Main results . . . . .   | 124 |
| 3.2   | Existence and Uniqueness of the entire solution . . . . .                  | 128 |
| 3.2.1 | Existence of an entire solution . . . . .                                  | 128 |
| 3.2.2 | Uniqueness of the solution . . . . .                                       | 133 |
| 3.3   | Propagation in the direction of decreasing cylinders . . . . .             | 134 |
| 3.3.1 | Existence of a particular subsolution . . . . .                            | 134 |
| 3.3.2 | Behaviour at large time . . . . .  | 136 |
| 3.4   | Propagation in widening cylinders - Blocking phenomenon . . . . .          | 139 |
| 3.4.1 | Reduced problem . . . . .  | 140 |
| 3.4.2 | Construction of a particular super solution . . . . .                      | 143 |
| 3.5   | Widening cylinders - Complete propagation . . . . .                        | 145 |
| 3.5.1 | The sliding ball method . . . . .  | 147 |
| 3.5.2 | Comparison with a particular sub solution . . . . .                        | 149 |
| 3.6   | Propagation in cylinders with general cross section . . . . .              | 150 |
| 3.6.1 | Propagation phenomena - Proof of Theorem 3.1.8 . . . . .                   | 151 |
| 3.6.2 | Perturbation results - Proof of Theorem 3.1.9 . . . . .                    | 154 |
| 3.7   | Complete propagation in general domains . . . . .                          | 157 |
| 3.7.1 | Star-shaped domains with respect to the direction of propagation . . . . . | 157 |
| 3.7.2 | Sliding ball . . . . .   | 162 |

## Chapitre 4

### Front blocking and propagation in cylindrical domains - Numerical simulations

|       |  |     |
|-------|--|-----|
| 4.1   | Description of the problem . . . . .   | 170 |
| 4.2   | Propagation in a straight cylinder with varying cross section . . . . .        | 174 |
| 4.2.1 | Abrupt widening of the domain . . . . .  | 175 |
| 4.2.2 | Progressive widening of the domain . . . . .                                   | 177 |
| 4.2.3 | Narrowing domain . . . . .   | 180 |
| 4.2.4 | Domain with an isthmus . . . . .   | 182 |
| 4.2.5 | Widening domains - the effect of the bistability threshold $\theta$ . . . . .  | 184 |
| 4.3   | Propagation in a curved cylinder . . . . .                                     | 186 |
| 4.3.1 | Propagation in a cylinder with Dirichlet or Robin boundary condition . . . . . | 186 |
| 4.3.2 | Propagation in a domain with favourable and unfavourable environment . . . . . | 192 |



# Introduction générale

*The reader will find an english translation of this introduction in the section named "General introduction" of this manuscript.*

Les différents travaux effectués pendant ma thèse s'articulent autour des phénomènes d'invasions biologiques en milieux hétérogènes. Le but de cette introduction est dans un premier temps de familiariser le lecteur avec les équations de réaction-diffusion en expliquant leur utilité en modélisation biologique et médicale et plus particulièrement leur intérêt dans la modélisation d'invasions biologiques, puis en rappelant les principaux résultats mathématiques connus sur le sujet. Nous énoncerons ensuite les différents résultats établis au cours de cette thèse. Puis nous finirons cette introduction en indiquant plusieurs axes de travail qu'il serait intéressant d'approfondir par la suite.

## 1 Équations de réaction-diffusion

Dans cette première partie nous rappelons brièvement l'intérêt des équations de réaction-diffusion et leurs différentes applications particulièrement adaptées à l'étude de phénomènes de propagation, en introduisant la notion d'ondes progressives. Nous poursuivrons ensuite par une présentation des résultats d'existence, d'unicité et de stabilité de ces ondes progressives dans le cadre homogène, puis hétérogène.

### 1.1 Cadre général

#### Motivations biologiques

Une première étape dans le processus de modélisation est de comprendre l'évolution d'une quantité par rapport au temps, c'est-à-dire la mise en équation de la variation de la quantité considérée par rapport au temps. En supposant que le temps est continu on obtient des équations différentielles ordinaires. Différents exemples et domaines d'application de ces processus de modélisation sont donnés dans le livre de J.D Murray [89]. Entre autre il est très connu en dynamique des populations que l'on peut modéliser l'évolution de la densité d'une population  $u$  de la manière suivante :

$$\frac{\partial u}{\partial t} = f(u), \quad t \geq 0$$

où  $f$  représente la fonction de croissance, englobant les termes de naissance, de mort, de migration... Nous verrons dans la section suivante les principales fonctions  $f$  utilisées.



On peut aussi modéliser les interactions entre plusieurs populations en étudiant des systèmes d'équations différentielles, avec par exemple le modèle de Lotka-Volterra qui modélise l'interaction entre une population "proie" et une population "prédateur". Plus généralement différents effets sont pris en compte : la compétition, le mutualisme au sein de la même population ou entre différentes populations. Ces équations sont également très utilisées en épidémiologie pour anticiper la propagation d'une maladie infectieuse telle que la grippe, la peste, le SIDA... où la population est divisée en plusieurs groupes tels que les personnes susceptibles d'être contaminées, les personnes contaminées et les personnes résistantes, qui interagissent entre elles. De tels systèmes de réaction-diffusion sont aussi beaucoup utilisés pour modéliser toutes sortes de réactions chimiques en utilisant la loi de masse.

Une description plus détaillée de tous ces modèles se trouve dans [89, Chapter 1, 3, 6 et 10].

Nous nous concentrons dans cette thèse sur les modèles scalaires, c'est-à-dire avec une seule équation.

En dehors des dynamiques de croissance modélisées par le terme de réaction  $f$ , il existe un autre phénomène important à prendre en compte dans la modélisation, les mouvements dans l'espace. En effet dans toute agglomération de particules telle que les cellules, les molécules chimiques, les animaux, les bactéries... chaque particule se déplace de manière aléatoire. On utilise souvent le terme de marche aléatoire. Chaque marche aléatoire suit une loi particulière mais de manière générale l'agglomérat se déplace selon un processus macroscopique que l'on nomme processus de diffusion, c'est-à-dire lorsque le déplacement spatial  $\Delta x$  est d'ordre  $\sqrt{\Delta t}$ , où  $\Delta t$  représente la variation temporelle. On obtient alors

$$\frac{\partial u}{\partial t} = D \frac{\partial^2 u}{\partial x^2}, \quad t \geq 0, x \in \mathbb{R},$$

où  $u$  représente la quantité dont on veut modéliser l'évolution,  $t$  le temps et  $x$  l'espace.

En combinant ces deux processus de réaction  $f$  et de diffusion, on obtient une équation de réaction-diffusion :

$$\frac{\partial u}{\partial t} - D \frac{\partial^2 u}{\partial x^2} = f(u), \quad t \geq 0, x \in \mathbb{R},$$

avec  $u \in \mathbb{R}^m$  ( $m = 1$  correspond à l'équation de réaction-diffusion scalaire,  $m > 1$  correspond à un système de réaction-diffusion lorsque différentes espèces interagissent entre elles). On peut généraliser cette équation de réaction-diffusion en dimension  $n \in \mathbb{N}^*$  :

$$\frac{\partial u}{\partial t} - D \Delta u = f(u), \quad t \geq 0, x \in \mathbb{R}^n,$$

où  $\Delta u = \sum_{k=1}^n \frac{\partial^2 u}{\partial x_k^2}$  est le laplacien de  $u$ . On pourra se référer à [89, chapitre 11] pour plus de détails.

### Quatre réactions usuelles

On s'intéressera ici à quatre classes de réactions particulières :

- Sans présence d'effet Allee, le cas KPP,
- En présence d'effet Allee faible, le cas monostable,

- En présence d'effet Allee fort, le cas bistable ou multistable,
- En présence d'un seuil pour qu'une réaction ait lieu, le cas ignition.

En 1798, Malthus introduit l'un des premiers modèles de dynamique des populations en supposant que les naissances et les morts sont proportionnelles à la taille de la population, et qu'il n'y a pas de migration. On obtient alors une fonction de réaction  $f(u) = au - bu$ . Mais ce modèle prédit alors une croissance exponentielle de la population, dès que  $a > b$ , ce qui n'est en général pas très réaliste. Verhulst introduit alors en 1838 la notion de "processus auto-régularisant" à travers la fonction

$$f(u) = au - bu - cu^2 = ru\left(1 - \frac{u}{K}\right),$$

où  $r$  représente le taux de croissance intrasec de la population et  $K$  sa capacité d'accueil (on renormalisera par la suite à  $K = 1$ ). Ces fonctions vérifient l'hypothèse suivante

$$f(0) = f(1) = 0, \quad f > 0 \text{ sur } [0, 1] \text{ et } f(u) \leq f'(0)u \text{ pour } u \in [0, 1].$$

On dira que ces fonctions sont de classe KPP.

En 1938 on introduit la notion d'effet Allee. On suppose que le taux de croissance "per capita"  $f(u)/u$  n'est plus maximum à l'origine  $u = 0$ , mais a tendance à être plus faible pour les petites populations. Cet effet traduit la nécessité d'avoir un nombre suffisant d'individus autour de soi pour mieux se reproduire. On distinguera alors l'effet Allee faible et l'effet Allee fort.

Dans le cas d'un effet Allee faible, on suppose que la croissance totale de la population est toujours positive, c'est-à-dire que  $f$  est une fonction positive. On dira que  $f$  est monostable.

Dans le cas d'un effet Allee fort la croissance est strictement négative pour les petites valeurs de  $u$ . Cela signifie que la croissance totale de la population est négative pour des petites populations. On suppose donc que  $f$  est négative proche de 0 et positive proche de 1, on dira alors que  $f$  est bistable ou multistable.

La dernière classe de fonctions concerne plutôt la modélisation de réaction chimique, on suppose qu'il faut que la population soit au dessus d'un certain seuil pour qu'une réaction ait lieu, en dessous de ce seuil il ne se passe rien, c'est-à-dire que  $f$  vaut 0 jusqu'à un certain seuil et est positive après. On dit que  $f$  est de type ignition.

En résumé, on considère donc quatre types de fonctions différentes :

- $f$  KPP, i.e  $f(0) = f(1) = 0$ ,  $f > 0$  sur  $(0, 1)$  et  $f(u) \leq f'(0)u$  pour  $u \in [0, 1]$ ,
- $f$  monostable, i.e  $f(0) = f(1) = 0$ ,  $f > 0$  sur  $(0, 1)$
- $f$  bistable ou multistable, i.e il existe  $0 < \theta_1 \leq \dots \leq \theta_k < 1$  tels que  $f(0) = f(\theta_i) = f(1) = 0$  pour tout  $i \in 1, \dots, k$ , et  $f < 0$  sur  $(0, \theta_1)$ ,  $f > 0$  sur  $(\theta_k, 1)$  et  $\int_0^1 f(s)ds > 0$ .
- $f$  ignition, i.e il existe  $\theta \in (0, 1)$  tel que  $f \equiv 0$  sur  $[0, \theta]$  et  $f > 0$  sur  $(\theta, 1)$ ,  $f(1) = 0$ .

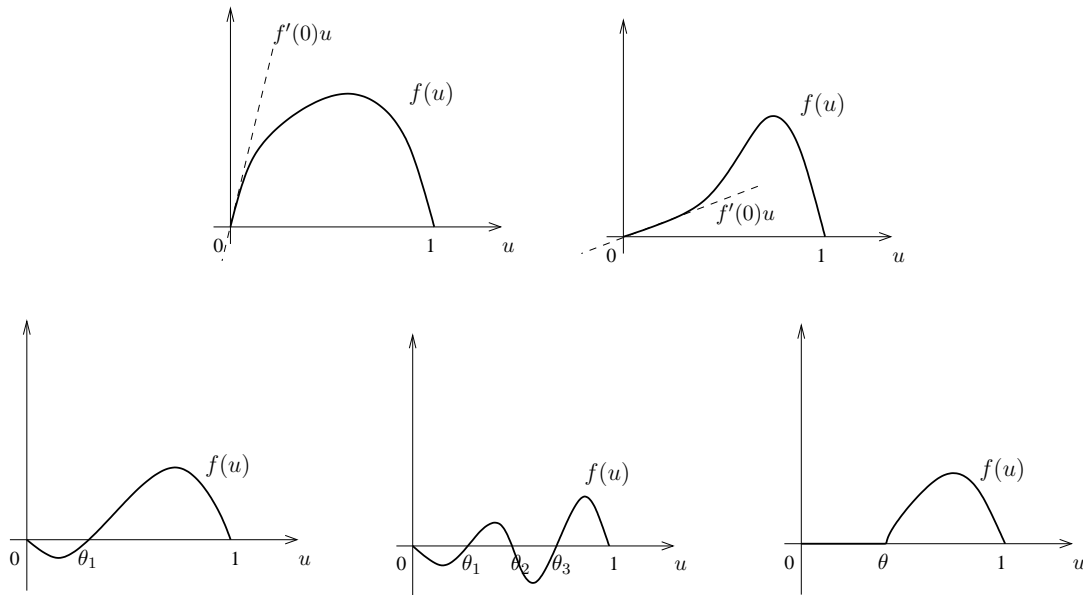

FIGURE 1 – De gauche à droite et de haut en bas : Fonction de type KPP, monostable, bistable, multistable et ignition.

### Invasions biologiques - Notion d'ondes progressives

Comme vu dans les sections précédentes, les équations de réaction-diffusion sont beaucoup utilisées pour modéliser l'évolution de quantités biologiques. On peut citer par exemple

- Le modèle de Fisher-KPP [41, 69] en 1937. Il est introduit pour modéliser l'invasion d'un gène dominant dans une population,
- Le modèle de Skellam [108] en 1951. Il est introduit pour modéliser l'invasion des rats laveurs en Europe depuis Prague ainsi que leur vitesse d'expansion,
- Le modèle de Turing [115] en 1952. Turing montre que des systèmes de réaction-diffusion simples peuvent modéliser des phénomènes complexes de morphogénèse en provoquant la formation de rayures ou de points sur la fourrure de certains animaux par exemple,
- Le modèle d'Hodgkin-Huxley [61] en 1952. Ils construisent un système de réaction-diffusion modélisant les échanges ioniques entre neurones, ce qui permet de comprendre comment le potentiel d'action dans les neurones est créé et se propage.

Cette liste est bien sûr non-exhaustive et il existe un grand nombre de phénomènes biologiques modélisés par des équations de réaction-diffusion.

On remarque donc que les équations de réaction-diffusion permettent entre autre la modélisation de phénomènes d'invasions biologiques et plus particulièrement l'invasion d'un état sur un autre, avec la notion d'onde progressive introduite simultanément par Fisher [41] et Kolmogorov-Petrovskii-Piskunov [69] en 1937. L'idée est de représenter la solution de notre équation de réaction-diffusion sous forme d'un front qui se déplace dans l'espace à une vitesse constante. Soit  $u$  la solution de notre équation de réaction-diffusion dans  $\mathbb{R}$  :

$$\frac{\partial u}{\partial t} - D \frac{\partial^2 u}{\partial x^2} = f(u), \quad t \geq 0, x \in \mathbb{R}.$$

On écrit alors notre solution sous la forme  $u(t, x) = \phi(x - ct)$  pour tout  $t \in \mathbb{R}$ ,  $x \in \mathbb{R}$ , avec  $(\phi, c)$  solution du problème suivant :

$$\begin{cases} -\phi''(r) - c\phi'(r) = f(\phi(r)), & r \in \mathbb{R}, \\ \phi(-\infty) = 1, & \phi(+\infty) = 0. \end{cases} \quad (1)$$

On dira que  $c$  est la vitesse de propagation. Ces solutions décrivent donc l'invasion de l'état 1 sur 0 si  $c > 0$  ou de l'état 0 sur 1 si  $c < 0$ , selon un profil constant  $\phi$  qui se déplace à la vitesse  $|c|$ .

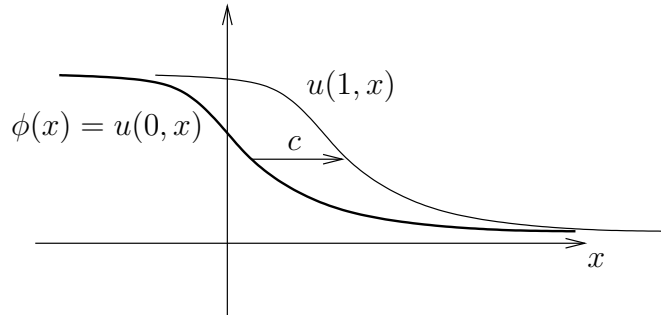

FIGURE 2 – Le profil  $\phi$  se déplaçant à une vitesse  $c > 0$ .

Cette notion d'onde progressive se généralise en dimension supérieure en écrivant

$$u(t, x) = \phi(x \cdot e - ct), \quad e \in \mathbb{S}^{n-1},$$

où  $(\phi, c)$  est solution de (1) et  $\mathbb{S}^{n-1} = \{x \in \mathbb{R}^n, |x| = 1\}$ . On dira que  $e$  est la direction de propagation du front.

On peut étendre cette notion aux systèmes de réaction-diffusion en supposant que  $\mathbf{u}(t, x) := \mathbf{U}(z)$  où  $z := x - ct$ ,  $\mathbf{u}$  et  $\mathbf{U}$  sont des fonctions à valeurs dans  $\mathbb{R}^m$ ,  $m > 1$ . On pourra se référer au Volume II du livre de J.D. Murray [90] pour plus de détails.

## 1.2 Propagation en milieu homogène

Dans cette section on rappelle quelques résultats d'existence, d'unicité et de stabilité connus sur les ondes progressives. On s'intéressera aussi aux différentes propriétés de ces solutions particulières. On finira cette section avec la notion de fronts de transition qui modélise encore l'invasion d'un état sur un autre mais de manière non nécessairement plane et à vitesse non nécessairement constante.

On considère le problème homogène suivant :

$$\begin{cases} \partial_t u(t, x) - \Delta u(t, x) = f(u(t, x)), & t > 0, x \in \mathbb{R}^n, n \geq 1, \\ u(0, x) = u_0(x), & x \in \mathbb{R}^n, \end{cases} \quad (2)$$

où  $f(0) = f(1) = 0$  et on s'intéresse aux solutions  $u \in [0, 1]$ . En effet on sait que si  $u_0$  est continue par morceaux et telle que  $0 \leq u_0(x) \leq 1$  pour tout  $x \in \mathbb{R}^n$  alors il existe une unique solution bornée  $u$  du problème homogène (2) telle que

$$0 \leq u(t, x) \leq 1, \quad \forall t \geq 0, x \in \mathbb{R}^n.$$

### Existence, unicité et stabilité des ondes progressives

Les premiers résultats parus concernant l'existence, l'unicité et la stabilité des ondes progressives sont ceux de Fisher [41] et Kolmogorov-Petrovskii-Piskunov [69] en 1937 pour les fonctions de type KPP et monostable. Dans leurs papiers respectifs, ils prouvent l'existence d'ondes progressives et introduisent la notion de vitesse asymptotique en dimension 1 [41] et 2 [69]. Ces résultats ont ensuite été étendus par Kanel [67, 66] aux fonctions de type ignition et bistable dans les années 1960.

L'existence, l'unicité et la stabilité de ces fronts dans le cadre homogène ont été intensément étudiées dans les années 1970-1980 entre autre par Aronson et Weinberger [3] et Fife et McLeod [40] en utilisant des méthodes d'équations aux dérivées partielles et par Bramson [21, 22] et Uchiyama [116] d'un point de vue probabiliste. On rappelle qu'on s'intéresse dans un premier temps à l'existence et l'unicité des solutions particulières de (2) de la forme

$$u(t, x) = \phi(x \cdot e - ct),$$

et  $(\phi, c)$  solution de l'équation différentielle ordinaire (1).

Il est connu (on pourra se référer à [3] par exemple) que dans les cas monostable, bistable et ignition, il existe une solution  $(\phi, c)$  de (1) avec  $c \times \int_0^1 f(s)ds \geq 0$ , i.e la vitesse de propagation  $c$  est du signe de  $\int_0^1 f(s)ds$ . De plus dans le cas bistable et ignition, il existe une unique vitesse  $c$  et un unique profil  $\phi$  (unique à translation près) solution du problème (1), alors que dans le cas KPP et monostable on a l'existence d'un continuum de vitesse  $c$  tel que le problème (1) a une solution, et donc une infinité de solutions  $(\phi_c, c)$  de (1). Plus précisément, pour le cas KPP et monostable, il existe une vitesse minimale  $c^* > 0$  telle que quelque soit  $c \geq c^*$  l'équation (1) a une solution  $\phi_c$  (unique à translation près). On dira alors que  $c^*$  (l'unique vitesse de propagation dans le cas bistable et ignition et la vitesse minimale de propagation dans le cas KPP et monostable) est la vitesse asymptotique de propagation du front dans le sens où

- Si  $u \in [0, 1]$  est solution du problème homogène (2) telle que  $u(0, \cdot) \equiv 0$  dans  $\mathbb{R}^n \setminus B_\rho$  pour un certain  $\rho > 0$ , où  $B_\rho$  est la boule de rayon  $\rho$  dans  $\mathbb{R}^n$ , alors pour tout  $c > c^*$  et pour tout  $y \in \mathbb{R}^n$

$$\lim_{t \rightarrow +\infty} \max_{|x-y| > ct} u(t, x) = 0.$$

- Si  $u \in [0, 1]$  est solution du problème homogène (2) et  $\liminf_{t \rightarrow +\infty} u(t, x) = 1$  uniformément sur tout compact de  $\mathbb{R}^n$ , alors pour tout  $c \in (0, c^*)$ , pour tout  $y \in \mathbb{R}^n$ ,

$$\liminf_{t \rightarrow +\infty} \min_{|x-y| < ct} u(t, x) = 1.$$

De plus on sait que dans le cas KPP,  $c^* = 2\sqrt{f'(0)}$  (on pourra par exemple se référer à [69] pour le cas  $f(u) = u(1-u)$  par exemple) et plus généralement dans le cas monostable (voir [53]),

$$c^* = \min_{\rho \in C^1([0,1]), \rho > 0, \rho(0)=0, \rho'(0)>0} \left( \sup_{u \in [0,1]} \rho'(u) + \frac{f(u)}{\rho(u)} \right).$$

De plus, concernant les phénomènes d'invasion et de stabilité des états stationnaires, on distingue deux comportements différents :

- Le "hair trigger effect" dans le cas KPP et monostable,
- L'effet de seuil dans le cas bistable et ignition.

Ce qu'on entend par "hair trigger effect", c'est que dans le cas KPP et monostable il suffit que la condition initiale soit non équivalente à 0, i.e décolle légèrement de 0, pour que la solution converge vers 1 dans  $\mathbb{R}^n$  à la vitesse  $c^*$ . Alors que pour les cas bistable et ignition il faut que la condition initiale soit suffisamment large sur une zone assez grande pour que la solution ne tende par vers 0. En dimension  $n \in \mathbb{N}$  quelconque, on a les résultats d'invasion suivants si  $u_0$  est à support compact

- Dans le cas KPP et monostable, si  $u_0 \not\equiv 0$ ,
  - Si  $c \in (0, c^*)$  alors  $\min_{|x| < ct} u(t, x) \rightarrow 1$  quand  $t \rightarrow +\infty$ ,
  - Si  $c > c^*$ , alors  $\max_{|x| > ct} u(t, x) \rightarrow 0$  quand  $t \rightarrow +\infty$ .
- Dans le cas bistable et ignition
  - Si  $\int_{\mathbb{R}^n} u_0$  est petite alors  $u(t, x) \rightarrow 0$  quand  $t \rightarrow +\infty$ ,
  - Si  $u_0 \geq \theta + \eta > \theta$  sur un domaine suffisamment grand alors
    - \* Si  $c \in (0, c^*)$  alors  $\min_{|x| < ct} u(t, x) \rightarrow 1$  quand  $t \rightarrow +\infty$ ,
    - \* Si  $c > c^*$ , alors  $\max_{|x| > ct} u(t, x) \rightarrow 0$  quand  $t \rightarrow +\infty$ .

En dimension 1, la stabilité des ondes progressives s'énonce différemment selon qu'on se trouve dans le cas KPP ou dans le cas bistable, et ignition,

- Si  $u_0 \not\equiv 0$  est à support compact, alors
  - Dans le cas bistable et ignition ([40]),
    - \* Si  $\int_{\mathbb{R}^n} u_0$  est petite alors  $u(t, x) \rightarrow 0$  quand  $t \rightarrow +\infty$ ,
    - \* Si  $u_0 \geq \theta + \eta > \theta$  sur un domaine suffisamment grand alors il existe  $\xi^+, \xi^- \in \mathbb{R}$  tels que

$$\begin{cases} u(t, x) - \phi(x - c^*t + \xi^+) \rightarrow 0, & \text{quand } t \rightarrow +\infty \text{ pour } x \geq 0, \\ u(t, x) - \phi(-x - c^*t + \xi^-) \rightarrow 0, & \text{quand } t \rightarrow +\infty \text{ pour } x \leq 0. \end{cases}$$

- Dans le cas KPP, il existe  $\lambda^* > 0$ ,  $\xi^\pm : (0, +\infty) \rightarrow \mathbb{R}$  tel que  $|\xi^\pm(t)| < C$  pour tout  $t > 0$ ,

$$\begin{cases} u(t, x) - \phi(x - c^*t + \frac{3}{2\lambda^*} \ln(t) + \xi^+(t)) \rightarrow 0, & \text{quand } t \rightarrow +\infty \text{ pour } x \geq 0, \\ u(t, x) - \phi(-x - c^*t + \frac{3}{2\lambda^*} \ln(t) + \xi^-(t)) \rightarrow 0, & \text{quand } t \rightarrow +\infty \text{ pour } x \leq 0. \end{cases}$$

Ces résultats de stabilité dans le cas KPP ont été prouvés par Bramson [22] en utilisant une méthode probabiliste et plus récemment par Hamel et al [58] en utilisant des méthodes d'équations aux dérivées partielles.

- Si on suppose de plus que  $u_0 \equiv \chi_{[-L, L]}$ , la fonction caractéristique de l'ensemble  $[-L, L]$ , pour  $L > 0$ , Zlatoš [124] a montré qu'il existe  $L_0 \geq 0$  tel que
  - \* si  $L < L_0$ ,  $u(t, x) \rightarrow 0$  uniformément sur  $\mathbb{R}$  quand  $t \rightarrow +\infty$ ,

- \* si  $L > L_0$ ,  $u(t, x) \rightarrow 1$  uniformément sur  $\mathbb{R}$  quand  $t \rightarrow +\infty$ ,
- Si  $u_0 \not\equiv 0$  n'est pas à support compact. On a alors le résultat suivant dans le cas bistable ou ignition (d'après [40]) :

$$\text{Si } \liminf_{x \rightarrow -\infty} u_0(x) < \theta < \limsup_{x \rightarrow +\infty} u_0(x),$$

alors il existe  $\xi \in \mathbb{R}$  tel que

$$u(t, x) - \phi(x - c^*t + \xi) \rightarrow 0 \quad \text{quand } t \rightarrow +\infty.$$

Pour plus de détails sur ces résultats de stabilité des fronts planaires on pourra se référer aux travaux suivants [72, 80, 81, 3, 10, 38] qui montrent de manière générale que les fronts planaires sont stables dans  $\mathbb{R}^n$  pour le cas bistable et ignition et à [58] ainsi que ses références pour le cas KPP. Pour ce qui est des non-linéarités de type multistable Fife et McLeod dans [40] montrent l'existence et l'unicité d'ondes progressives en dimension 1 sous certaines conditions. On suppose pour simplifier qu'il existe  $0 < \theta_1 < \theta_2 < \theta_3 < 1$  tels que  $f(0) = f(\theta_1) = f(\theta_2) = f(\theta_3) = f(1) = 0$  et  $f$  de type bistable sur l'intervalle  $[0, \theta_2]$  et sur  $[\theta_2, 1]$ . D'après ce qui précède, il existe un unique front  $(\phi_1, c_1)$ , respectivement  $(\phi_2, c_2)$  qui connecte 0 à  $\theta_2$ , respectivement  $\theta_2$  à 1. Dans leur papier Fife et McLeod prouvent l'existence et la stabilité d'un front qui connecte l'état 0 à l'état 1 si et seulement si  $c_1 < c_2$ . On parlera alors de train d'ondes. Hamel et Omrani dans [59] poursuivent l'étude de l'existence et la stabilité de ces fronts en dimension supérieure dans un cylindre droit  $\mathbb{R} \times \omega$ , où la section  $\omega$  est bornée et convexe.

### Notion de fronts tirés ou poussés

La notion de stabilité des ondes progressives a été étudiée par Stokes dans [110] où il introduit la notion de fronts tirés et de fronts poussés. Dans le cas KPP, on sait que la vitesse minimale de propagation, qui correspond aussi à la vitesse asymptotique de propagation de la solution, vaut  $c^* = 2\sqrt{f'(0)}$ . Dans le cas monostable cette vitesse minimale existe toujours mais peut être strictement supérieure à  $2\sqrt{f'(0)}$  à cause de l'effet Allee faible. Dans [110] Stokes définit les fronts tirés comme les fronts dont la vitesse minimale  $c^* = 2\sqrt{f'(0)}$  (cas KPP) ou les fronts de vitesse strictement plus grande que la vitesse minimale de propagation, i.e les couples  $(\phi_c, c)$  tels que  $c > c^*$  où  $c^*$  est la vitesse minimale de propagation dans le cas monostable. Il parle de front tirés car la vitesse de ces fronts (dans le cas KPP) est déterminée par le taux de croissance de la population autour de 0 donc par les "individus" le plus à l'avant du front.

Stokes définit ensuite les fronts poussés comme les fronts monostables de vitesse minimale  $c^* > 2\sqrt{f'(0)}$ , i.e le couple  $(\phi_{c^*}, c^*)$  où  $c^*$  est la vitesse minimale, ou comme les fronts bistables ou de type ignition, où dans ces cas il existe une unique vitesse  $c = c^*$  pour laquelle on aura des solutions de type onde progressive. Ces fronts sont appelés poussés car l'avancé du front ne dépend pas seulement de ce qui se passe en avant. Dans ce cas, le front est poussé par toute la population.

Dans son article Stokes prouve la stabilité des fronts poussés dans les cas non KPP.

Une notion un peu plus générale de fronts poussés et tirés a été introduite par Garnier et al dans [45, 46, 47, 102] où l'idée cette fois ci est de décomposer le front  $u$  en plusieurs composantes  $u_k$  qui vérifient l'équation suivante :

$$\begin{cases} \partial_t u_k(t, x) = \Delta u_k(t, x) + u_k(t, x) \cdot \frac{f(u(t, x))}{u(t, x)}, & t > 0, x \in \mathbb{R}, \\ u_k(0, x) = u_{k,0}(x), & x \in \mathbb{R}. \end{cases} \quad (3)$$

Ils étudient alors le comportement et le rôle de chacune de ces composantes dans la propagation du front. Ils montrent que dans le cas des fronts tirés toutes les composantes  $u_k$  tendent vers 0 sauf celle qui compose la partie la plus avant du front, ce qui correspond bien à la notion de fronts tirés introduite par Stokes. Alors que dans le cas des fronts poussés, ils montrent que chaque composante  $u_k$  tend vers une portion du front  $u$  et cela confirme bien l'importance de toute la population dans la propagation du front  $u$ . Ils redéfinissent alors la notion de fronts tirés et fronts poussés de cette manière

**Définition 1** (Front tiré [45]). *Un front  $u$  de vitesse  $c \in \mathbb{R}$  est dit tiré si pour tout groupe  $v$  vérifiant (3) et  $v_0$  à support compact tel que  $0 \leq v_0 \leq u(0, \cdot)$ ,  $v_0 \not\equiv 0$ , on a*

$$v(t, x + ct) \rightarrow 0 \text{ uniformément sur tout compact lorsque } t \rightarrow +\infty.$$

**Définition 2** (Front poussé [45]). *Un front  $u$  de vitesse  $c \in \mathbb{R}$  est dit poussé si pour tout groupe  $v$  vérifiant (3) et  $v_0$  à support compact tel que  $0 \leq v_0 \leq u(0, \cdot)$ ,  $v_0 \not\equiv 0$ , il existe un compact  $\mathcal{K}$  tel que*

$$\limsup_{t \rightarrow +\infty} \left( \sup_{x \in \mathcal{K}} v(t, x + ct) \right) > 0.$$

Ils peuvent alors étudier la différence entre les fronts tirés et poussés dans des cadres bien plus généraux tels que les équations intégro-différentielles, les équations de réaction-diffusion hétérogènes en espace, les équations de réaction-diffusion avec vitesse forcée...

Ils montrent par exemple que les fronts poussés favorisent la diversité génétique.

### Notion de fronts de transition

Plus récemment, plusieurs travaux ont été consacrés à l'existence de fronts non planaires. Ces types de fronts sont apparus naturellement dans le cadre hétérogène comme on le verra dans la section suivante. Précédemment on a défini la notion d'onde progressive ou de front de propagation planaire comme les solutions de (2) telles que  $u(t, x) = \phi(x \cdot e - ct)$ , avec  $c \in \mathbb{R}$  et  $e \in \mathbb{S}^{n-1}$ . Ces fronts sont qualifiés de planaires car les lignes de niveau sont des hyperplans. On remarque qu'il existe d'autres types de fronts. Par exemple dans le cas d'une non-linéarité bistable ou ignition Ninomiya et Taniguchi [94, 95] prouvent l'existence et la stabilité de fronts courbés en dimension 2, c'est-à-dire les solutions du problème homogène (2) de la forme  $u(t, x, y) = \phi(x, y - ct)$ . Un peu plus tard Hamel et al [55] étudient l'existence de front courbés avec des lignes de niveau de forme conique. Dans [56, 57] Hamel et Nadirashvili s'intéressent à la description de l'ensemble des solutions définies pour  $t \in \mathbb{R}$  de l'équation de réaction-diffusion Fisher-KPP en dimension 1 et en dimension  $n$ . Ils montrent qu'en dimension 1 il existe une variété de dimension 5 de solutions entières de l'équation de Fisher KPP (en rappelant que les ondes progressives au sens classique définies dans les sections précédentes représentent une variété de dimension 2 de solutions entières de l'équation de Fisher-KPP). Dans leur second papier [57] ils s'intéressent aux mêmes types de problèmes mais en dimension  $n$  et montrent l'existence de variétés de dimension infinie de solutions radiales et d'ondes progressives non planaires. Pour plus de détails sur ces ensembles de solutions, je vous renvoie aux articles [56, 57] et à leurs références.

On observe deux propriétés communes à toutes ces solutions :

- Elles convergent toutes vers 0 ou 1 loin de leurs lignes de niveau, uniformément en temps,
- Leurs lignes de niveaux se déplacent à une vitesse globale constante.



C'est dans ce cadre, entre autre, que Berestycki et Hamel introduisent la notion de fronts de transition dans [11, 12]. Ces fronts sont caractérisés par le fait que l'interface de transition entre 0 et 1 est uniformément borné en temps. Ces fronts englobent différentes notions de fronts construits dans un cadre hétérogène tels que les fronts pulsatoires, les fronts courbés dans des domaines  $\Omega \subset \mathbb{R}^n$ ... Nous reviendrons donc sur la notion de fronts de transition, leur définition mathématique et leurs propriétés dans la section suivante après avoir introduit les équations de réaction-diffusion hétérogènes.

### 1.3 Propagation en milieu hétérogène

Dans cette section nous abordons les différents résultats de ces dernières années sur les solutions de type "fronts" pour les équations de réaction-diffusion hétérogènes. Rappelons ce que nous entendons par équation de réaction-diffusion hétérogène,

$$\begin{cases} \partial_t u(t, x) - \nabla_x \cdot (A(t, x) \nabla_x u_x(t, x)) + q(t, x)u(t, x) = f(t, x, u) & \text{pour tout } t \in \mathbb{R}, x \in \Omega \subset \mathbb{R}^n, \\ B(t, x)[u(t, x)] = 0, & \text{pour tout } t \in \mathbb{R}, x \in \partial\Omega, \end{cases} \quad (4)$$

avec

- $\Omega$  un domaine de classe  $C^{2,\alpha}$  pour un certain  $\alpha > 0$ ,
- $(t, x) \mapsto A(t, x) = (a_{ij}(t, x))_{1 \leq i, j \leq n}$  la matrice de diffusion supposée de classe  $C^{1,\alpha}(\mathbb{R} \times \Omega)$ , et telle que

$$\gamma_1 |\xi|^2 \leq \sum_{1 \leq i, j \leq n} a_{ij}(t, x) \xi_i \xi_j \leq \gamma_2 |\xi|^2, \quad \text{pour tout } (t, x) \in \mathbb{R} \times \Omega, \xi \in \mathbb{R}^n,$$

pour  $0 < \gamma_1 \leq \gamma_2$ ,

- $(t, x) \mapsto q(t, x)$  le coefficient d'advection supposé  $C^{0,\alpha}(\mathbb{R} \times \Omega)$ ,
- $(t, x, s) \mapsto f(t, x, s)$  le terme de réaction supposé  $C^{0,\alpha}(\mathbb{R} \times \Omega)$  en  $(t, x)$  localement par rapport à  $s$ , et localement lipschitz en  $s$  uniformément par rapport à  $(t, x) \in \mathbb{R} \times \Omega$ .

On remarque que la régularité pourra changer selon les contextes.

Les conditions de bords générales  $B(t, x)[u(t, x)] = 0$  pour tout  $(t, x) \in \mathbb{R} \times \partial\Omega$  représentent dans la plupart des cas les conditions de type Dirichlet, Neumann ou Robin mais peuvent aussi décrire des conditions de bords plus générales de type non-linéaires.

Cette équation prend donc en compte la dépendance de la dispersion de la population par rapport au temps et à l'espace, la notion d'advection ou de convection ainsi que la dépendance du terme de réaction par rapport au temps et à l'espace (de manière à considérer des zones favorables et défavorables pour la population, zones qui peuvent se déplacer avec le temps par exemple). On remarque aussi que notre équation est posée sur  $\Omega \subset \mathbb{R}^n$  qui traduit par exemple la présence de contraintes géométriques lorsque  $\Omega \subsetneq \mathbb{R}^n$ .

C'est dans ce cadre très général que Berestycki et Hamel [11] ont défini la notion de fronts de transition qui généralise la notion d'ondes progressives au cadre hétérogène et inclut plusieurs notions d'ondes introduites dans des contextes hétérogènes particuliers (les ondes courbes dans les domaines courbés mais aussi d'autres solutions type fronts non planaires dans  $\mathbb{R}^n$  comme vu dans la section précédente, les fronts pulsatoires dans les milieux périodiques, etc...). On note qu'une première généralisation de la notion d'ondes progressives avait été introduite par

Matano [78] et Shen [105] en dimension 1 principalement, où ils définissent une solution de type front comme une solution qui est continue par rapport à son environnement (une définition plus précise sera donnée dans la suite de cette section). Nous commencerons par rappeler la définition de fronts de transition ainsi que leurs différentes propriétés, puis donnerons quelques références où l'existence et la non-existence de ces ondes a été prouvée. Nous terminerons cette partie en introduisant les équations d'intégré-différence ou intégré-différentielles qui sont utilisées pour modéliser une dispersion non locale de la population et pour lesquelles il peut y avoir existence ou non de solutions de type onde progressive.

### Fronts de transition

Soient  $p^+$  et  $p^-$  deux solutions entières de notre équation de réaction-diffusion hétérogène (4) définies pour tout  $t \in \mathbb{R}$ ,  $x \in \Omega$  (ces solutions peuvent être stationnaires, constantes...). On dénote par  $d_\Omega$ , la distance géodésique dans  $\bar{\Omega}$ , et soient  $A$  et  $B$  deux ensembles de  $\bar{\Omega}$ , on définit

$$d_\Omega(A, B) := \inf \{d_\Omega(x, y), (x, y) \in A \times B\}.$$

On a alors la définition suivante

**Définition 3** (Front de transition [11]). *Un front de transition entre deux solutions  $p^+$  et  $p^-$  pour l'équation (4) est une solution entière définie pour tout  $t \in \mathbb{R}$  telle que  $u \not\equiv p^\pm$  et tel qu'il existe des domaines disjoints non vides de  $\Omega$ ,  $\Omega_t^\pm$  qui vérifient pour tout  $t \in \mathbb{R}$ ,*

$$\begin{cases} \partial\Omega_t^- \cap \Omega = \partial\Omega_t^+ \cap \Omega =: \Gamma_t, & \Omega_t^- \cup \Omega_t^+ \cup \Gamma_t = \Omega, \\ \sup \{d_\Omega(x, \Gamma_t); t \in \mathbb{R}, x \in \Omega_t^\pm\} = +\infty. \end{cases} \quad (5)$$

avec

$$u(t, x) - p^\pm(t, x) \rightarrow 0 \text{ uniformément par rapport à } t \in \mathbb{R} \text{ et } x \in \Omega_t^\pm \text{ quand } d_\Omega(x, \Gamma_t) \rightarrow +\infty.$$

L'existence des domaines  $\Omega_t^\pm$  ainsi que les conditions (5) signifient que notre domaine  $\Omega$  peut être séparé en deux sous-domaines disjoints, sous-domaines qui peuvent évoluer avec le temps et que ces deux sous-domaines ont pour chaque temps  $t \in \mathbb{R}$  une direction non bornée. Cette définition traduit l'idée que le front de transition est une transition spatiale entre deux états  $p^+$  et  $p^-$  et que la zone de transition entre ces deux états est uniformément bornée par rapport à  $t \in \mathbb{R}$ .

Rappelons maintenant la définition d'une solution de type front introduite par Matano pour les solutions du problème suivant en dimension 1 :

$$\partial_t u(t, x) - a(x)\partial_{xx}u(t, x) - b(x)u_x(t, x) = f(x, u), \quad \text{pour tout } t \in \mathbb{R}, x \in \mathbb{R}, \quad (6)$$

avec  $f(x, 0) = f(x, 1) = 0$  pour tout  $x \in \mathbb{R}$ .

On suppose que  $(a, b, f)$  sont uniformément continues par rapport à  $x \in \mathbb{R}$  et on définit l'espace  $\mathcal{H}$  par

$$\mathcal{H} := \overline{\{(\pi_y a, \pi_y b, \pi_y f), y \in \mathbb{R}\}},$$

où  $\pi_y a(x) := a(x + y)$ ,  $\pi_y b(x) := b(x + y)$ ,  $\pi_y f(x, u) := f(x + y, u)$  et l'adhérence est associée à la topologie de la convergence locale.

**Définition 4** (D'après [78] et [105]). *Soit  $u : \mathbb{R} \times \mathbb{R} \times \mathcal{H} \rightarrow [0, 1]$  telle que pour tout  $(a_1, b_1, f_1) \in \mathcal{H}$ ,  $(t, x) \mapsto u(t, x; (a_1, b_1, f_1))$  est une solution de (6) avec les coefficients  $(a_1, b_1, f_1)$ . On dit que  $u$  est une solution de type front entre 0 et 1 selon Matano si*

- $u$  est continue,
- Il existe une fonction  $X : \mathbb{R} \rightarrow \mathbb{R}$  telle que

$$\lim_{x \rightarrow -\infty} u(t, x + X(t); (a, b, f)) = 1$$

et

$$\lim_{x \rightarrow +\infty} u(t, x + X(t); (a, b, f)) = 0,$$

uniformément par rapport à  $t \in \mathbb{R}$ ,

- $u(t, x + X(t); (a, b, f)) = u(0, x; \pi_{X(t)}(a, b, f))$  pour tout  $(t, x) \in \mathbb{R} \times \mathbb{R}$ .

On remarque donc que ces solutions de type front lorsqu'elles existent sont des fronts de transition mais la réciproque est fautive. On utilisera donc dans la suite la définition de Berestycki et Hamel de manière à rester le plus général possible. On remarque aussi que Lou, Matano et Nakamura [79, 74] définissent une notion de fronts progressifs dans des cylindres ondulants en dimension 2 et qu'ils obtiennent des résultats qui dépendent de l'angle d'ondulation de la frontière. On notera qu'une notion encore plus générale a récemment été introduite par Nadin [91] en dimension 1 où il définit la notion d'ondes critiques, connection temporelle entre deux états stationnaires. En effet, il montre que ces ondes critiques existent, sont uniques à translation près et sont monotones par rapport au temps dans des cadres très généraux où par exemple il a été prouvé que les fronts de transition n'existaient pas, alors que cette notion de fronts critiques et les définitions classiques de solutions de type front dans des cadres déjà connus se recoupent. Une autre notion a récemment été introduite par Ducrot, Giletti et Matano [39], celle de "terrasse" qui peut être vue comme la succession de plusieurs ondes progressives. Les auteurs montrent l'existence de ces solutions particulières de type fronts pour des équations de réaction-diffusion avec une non-linéarité hétérogène et périodique en espace, en dimension 1.

Dans la continuité de la définition de fronts de transition de Berestycki et Hamel, on peut définir la notion de vitesse de propagation globale, la notion d'invasion d'un état sur un autre, la notion de fronts de transition presque planaires, de fronts pulsatoires généralisés ou encore d'ondes fines. Toutes ces notions apporteront quelques précisions quant à la nature et aux propriétés des connections entre les deux états stationnaires. Nous rappelons ici la définition de certaines de ces notions.

**Définition 5** (Invasions [11]). *On dit que  $p^+$  envahit  $p^-$  si*

- $\Omega_s^+ \subset \Omega_t^+$  pour tout  $t \geq s$ ,
- $d_\Omega(\Gamma_t, \Gamma_s) \rightarrow +\infty$  quand  $|t - s| \rightarrow +\infty$

On a alors que

$$u(t, x) - p^\pm(t, x) \rightarrow 0 \text{ quand } t \rightarrow \pm\infty,$$

localement uniformément en  $x \in \overline{\Omega}$  par rapport à la distance  $d_\Omega$ .

Une invasion peut alors être vue comme une connection temporelle entre deux états, avec une zone de transition qui se déplace à l'infini quand le temps est grand et laisse un sous-domaine envahir tout l'espace.

Berestycki et Hamel, dans [11], définissent aussi la notion de fronts presque plans comme des fronts de transition tel que

$$\Gamma_t = \{x \in \Omega, x \cdot e = \xi_t\},$$

pour un certain  $\xi_t \in \mathbb{R}$ ,  $e \in \mathbb{S}^{n-1}$ . On sait alors que dans le cas bistable tout front de transition presque planaire dans  $\mathbb{R}^n$  est une onde progressive (au sens classique, invariante dans le repère mouvant  $x \cdot e - ct$  où  $c$  est la vitesse de propagation).

Remarquons que  $\Omega_t^\pm$  ne sont pas définis de manière unique et cela n'a donc pas de sens de définir une vitesse instantanée de propagation par rapport à  $\Gamma_t$  qui n'est pas défini de manière unique. La notion de vitesse moyenne globale de propagation se substitue à cette notion de vitesse instantanée (voir [11]).

Attention les fronts de transition n'ont pas nécessairement de vitesse moyenne globale. En effet dans le cas KPP on peut construire des fronts de transition dans  $\mathbb{R}$  qui ont une vitesse passée  $c_1$  (i.e quand  $t \rightarrow -\infty$ ) et une vitesse future  $c_2 \neq c_1$  (i.e quand  $t \rightarrow +\infty$ ) et ces fronts ne peuvent donc pas avoir de vitesse moyenne globale de propagation. Pour plus de détails quant à la construction de ces fronts on peut se référer à [11, section 5]. Un autre exemple de front de transition, qui ne rentre pas dans les définitions classiques de solution de type "fronts" est le front de transition invasif qui change de direction de propagation en fonction du temps ([11, section 6]).

### Résultats d'existence de fronts de transition

Plusieurs articles étudient l'existence de fronts de transition dans un cadre non homogène. Shen [106, 107], Nadin et Rossi [92] et Berestycki et Hamel [12] prouvent l'existence de fronts de transition (presque plans) dans le cas d'une hétérogénéité temporelle pour des équations bistables, KPP et monostables. On note aussi que Vakulenko et Volpert [117] ont aussi prouvé l'existence d'un autre type de fronts généralisés pour des systèmes de réaction-diffusion bistable perturbés. Mellet, Roquejoffre et Sire [86], Nolen et Ryzhik [97], Mellet et al [85] et Zlatoš [126] étudient l'existence et la stabilité des fronts de transitions dans les équations de réaction-diffusion non homogènes de type ignition. Dans l'ensemble de ces papiers il est prouvé que pour des équations de réaction-diffusion hétérogènes de type ignition en dimension 1, les fronts de transition existent toujours, sont uniques et stables. Nolen et al [96] et Zlatos [125] utilisent une méthode différente pour construire une multitude de fronts de transition pour des équations de réaction-diffusion non homogènes de type KPP en utilisant la linéarisation autour de 0. Dans un article récent Tuo, Zhu et Zlatos [112] utilise cette même méthode pour construire des fronts de transition dans des équations de type monostable.

Il existe donc plusieurs environnements hétérogènes où l'existence de fronts de transition est connue, cependant cette existence est remise en cause par Nolen et al [96], pour certaines équations de réaction de diffusion hétérogènes de type monostable en dimension 1. En effet, ils montrent que lorsque  $f$  est une non-linéarité de type KPP hétérogène fortement localisée, alors il existe des situations où les fronts de transition ne peuvent pas exister. Ce dernier résultat montre donc que l'existence de fronts de transition dans un cadre hétérogène pour des fonctions de type monostable n'est pas garantie même en dimension 1. De plus Lewis et Keener [73] mettent en évidence l'existence de phénomène de blocage d'ondes pour des équations de réaction-diffusion en dimension 1 dans un milieu d'excitabilité hétérogène. Le même type de phénomènes est observé par Grindrod et Lewis [52] en dimension 2 dans des domaines de diamètres variables en étudiant une équation eikonal comme limite d'un modèle de propagation. Lou, Matano et

Nakamura [79, 74] étudient l'existence de fronts de propagation pour des mouvements à courbure moyenne dans des cylindres ondulants en dimension 2 et montrent que la vitesse est ralentie en présence d'ondulations. Tous ces travaux indiquent donc que dans un cadre hétérogène général une multitude de phénomènes différents peut être observée (non existence de fronts de transition, ralentissement ou échec de propagation...). Les chapitres 1 et 3 de ce manuscrit se placent dans ce contexte. On y étudie l'existence de fronts de transition dans des équations de réaction-diffusion de type bistable hétérogène où le problème est posé dans un domaine  $\Omega \subsetneq \mathbb{R}^n$ .

### Équations non locales

Dans tout ce qui précède, nous avons supposé que la population se déplaçait de manière locale et ne se diffuse donc que dans un voisinage proche (vers leur voisins immédiats). Ce phénomène de diffusion est modélisé par l'opérateur du second ordre  $-\Delta$ . Cependant en 1899 Reid [100] remarque que certaines espèces d'arbres en Europe ont une vitesse de recolonisation trop rapide pour être expliquée par un modèle de réaction-diffusion classique. Il y aurait deux explications possibles à cela, l'existence d'évènements de dispersion à longue distance ou l'existence de refuges cryptiques qui accélérerait la recolonisation [103].

Des modèles d'équation intégréo-différence à queue lourde ont été introduits entre autre par Kot et al [70], Clark [31], Clark et al [32] de manière à modéliser ces évènements de dispersion à longue distance. Ces modèles sont de la forme suivante :

$$u_{n+1}(x) = \int_{\mathbb{R}} k(x, y) f[u_n(y)] dy, \quad n \in \mathbb{N}, x \in \mathbb{R}$$

où  $u_n$  est la densité de population à la génération  $n$ ,  $f$  représente la fonction de croissance (ou de réaction) et  $k$  le noyau de dispersion. Ces modèles intégréo-différence sont dits à queue lourde lorsque  $k$  est à décroissance lente ou non-exponentiellement borné. Il existe aussi une version continue de ces modèles, les équations intégréo-différentielles :

$$\partial_t u(t, x) = \int_{\mathbb{R}} k(x, y) u(t, y) dy - u(t, x) + f(u(t, x)), \quad t > 0, x \in \mathbb{R}.$$

On suppose dans tous ces modèles que la dispersion dépend seulement de la distance relative entre deux points, i.e  $k(x, y) = k(|x - y|)$  pour tout  $x, y \in \mathbb{R}$ . Ces équations d'intégréo-différence ou intégréo-différentielles modélisent donc une dispersion non locale de la population, avec  $k$  le noyau de dispersion. On distingue deux types de noyaux de dispersion

- Les noyaux de dispersion exponentiellement bornés ou à queue légère, où  $k$  décroît plus vite qu'une exponentielle dans le sens où il existe  $\eta > 0$  telle que

$$\int_{\mathbb{R}} k(x) e^{\eta|x|} dx < \infty.$$

- Les noyaux de dispersion non exponentiellement bornés ou à queue lourde, où  $k$  est à décroissance lente dans le sens où pour tout  $\eta > 0$ , il existe  $x_n \in \mathbb{R}$  tel que pour tout  $x \geq x_n$ ,

$$k(x) \geq e^{-\eta x}.$$

Différents travaux [2, 36, 113, 120, 24, 33] montrent que les résultats d'existence d'ondes progressives et de vitesse asymptotique restent vrais pour les équations intégréo-différentielles à décroissance rapide. À l'inverse ces résultats ne s'appliquent plus dans le cas des équations

intégré-différentielles à décroissance lente, [84, 121, 44] par exemple.

Pendant ma thèse je me suis concentrée sur l'étude d'équations de réaction-diffusion modélisant donc des phénomènes de dispersion locale, mais il pourrait être intéressant de comprendre si certains de mes résultats peuvent s'étendre aux cas de dispersion non locale (de courte ou longue distance), comme par exemple l'existence d'ondes progressives dans les modèles de réaction-diffusion avec vitesse forcée du chapitre 2.

## 2 Apports de la thèse

L'objectif de cette thèse est d'identifier et de comprendre certains phénomènes d'invasions biologiques en milieux hétérogènes variés. Dans un premier travail [19] (Chapitre 1), je m'intéresse à un problème de dynamique des populations en étudiant une équation de réaction-diffusion de type bistable dans un domaine extérieur perturbé. Ce problème est lié à la question de l'invasion d'une population soumise à un effet Allee fort face à un obstacle. Mon second travail en collaboration avec Nadin [20] (Chapitre 2) vise à comprendre la persistance d'une population face à un changement climatique. Pour cela on étudie une équation de réaction-diffusion avec un terme de réaction  $f$  général qui dépend de  $u$  la densité de population et de  $x - ct$  le mouvement de l'enveloppe climatique, i.e son environnement favorable. Dans un troisième travail en collaboration avec Berestycki et Chapuisat [6] (Chapitre 3), nous nous intéressons à l'invasion d'ondes de dépoliarisation dans le cerveau humain en considérant un problème de réaction-diffusion scalaire de type bistable posé dans des domaines cylindriques droits de section transverse variable. Dans un dernier chapitre, je présente des résultats de simulation numérique de la solution d'une équation de réaction-diffusion bistable dans des domaines cylindriques variés, ce qui me permet de valider les résultats prouvés dans le chapitre 3 ([6]) et d'obtenir d'autres propriétés plus qualitatives de ces solutions. Je considère aussi des cylindres courbés de rayon constant avec différents type de conditions au bord et étudie les propriétés de propagation des ondes bistables dans ces domaines. Tous ces résultats permettent de mieux comprendre les différents mécanismes responsables de l'invasion ou de l'extinction d'une espèce biologique dont l'évolution est modélisée par une équation de réaction-diffusion.

### 2.1 Résultat de type Liouville pour des domaines extérieurs - application à la dynamique des populations

Dans ce travail on considère une équation de réaction-diffusion de type bistable, où  $\int_0^1 f(s)ds > 0$ , posée dans  $\Omega = \mathbb{R}^n \setminus K$ , où  $K$  est un sous-espace compact de  $\mathbb{R}^n$ . On s'intéresse aux propriétés de propagation de la solution  $u$  notre densité de population en fonction de la forme de  $K$ . Ce problème intervient dans la modélisation de l'évolution d'une population soumise à un effet Allee fort lorsqu'elle doit faire face à un obstacle.

En l'absence d'obstacle (c'est-à-dire lorsque l'équation est posé sur  $\mathbb{R}^n$  tout entier) Aronson et Weinberger [3] ont montré que dès que la donnée initiale est suffisamment large (sur un domaine suffisamment étendu) la population envahit tout l'espace (stabilité des ondes progressives bistables dans  $\mathbb{R}^n$ ). Berestycki, Hamel et Matano [14] se sont intéressés à ce type de propriétés d'invasion dans des domaines extérieurs  $\Omega = \mathbb{R}^n \setminus K$ , c'est-à-dire en présence d'obstacles. Ils considèrent le problème suivant

$$\begin{cases} \partial_t u(t, x) - \Delta u(t, x) = f(u(t, x)), & \text{pour tout } t \in \mathbb{R}, x \in \Omega, \\ \partial_\nu u(t, x) = 0, & \text{pour tout } t \in \mathbb{R}, x \in \partial\Omega = \partial K, \end{cases}$$

où  $\nu$  représente la normale extérieure au domaine  $\Omega$  de norme 1,  $K$  est un sous-espace compact de  $\mathbb{R}^n$  non vide,  $f$  est une fonction bistable telle que  $\int_0^1 f(s)ds > 0$ . Ils montrent alors que pour des domaines  $K$  étoilés ou directionnellement convexes la population envahit tout l'espace alors qu'il existe d'autres types d'obstacles pour lesquels certaines parties de  $\Omega$  ne sont pas accessibles à la population. On rappellera brièvement ce qu'on entend par étoilé ou directionnellement convexe un peu plus bas (on pourra se référer au chapitre 1 section 1.1.3 ou aux articles [19, 14] pour des illustrations de domaines étoilés ou directionnellement convexes). Ils montrent dans tous les cas l'existence de front de transition (comme définis dans la section 1.3) reliant  $\phi$  l'onde progressive planaire bistable et une densité  $u_\infty$ , notre densité asymptotique (lorsque l'invasion de la population est complète  $u_\infty \equiv 1$ ).

Plus récemment des résultats de propagation dans des milieux avec obstacle ont été obtenus dans le cadre discret. Dans [62] Hoffman, Hupkes et VanVleck étudient l'existence de fronts de transition pour des équations différentielles sur des réseaux obstrués  $\Lambda \subset \mathbb{Z}^2$  qui correspondent au cadre discret des équations de réaction-diffusion dans des domaines extérieurs  $\Omega \subset \mathbb{R}^2$  avec Neumann au bord. Dans leur papier ils retrouvent alors des résultats similaires à [14] et montrent que lorsque l'obstacle est connexe et directionnellement convexe (dans le sens discret) alors il existe une solution entière de leur problème qui se comporte comme une onde progressive asymptotiquement en temps (i.e quand  $t \rightarrow \pm\infty$  pour tout  $(x, y) \in \Lambda$ ) et en espace (i.e quand  $|x| + |y| \rightarrow +\infty$ ,  $t \in \mathbb{R}$ ).

### Nos résultats de perturbation

Dans la continuité du travail de Berestycki, Hamel et Matano [14], je m'intéresse au problème suivant

$$\begin{cases} \partial_t u(t, x) - \Delta u(t, x) = f(u(t, x)), & \text{pour tout } t \in \mathbb{R}, x \in \Omega_\varepsilon, \\ \partial_\nu u(t, x) = 0, & \text{pour tout } t \in \mathbb{R}, x \in \partial\Omega_\varepsilon = \partial K_\varepsilon, \end{cases} \quad (7)$$

où  $\Omega_\varepsilon = \mathbb{R}^n \setminus K_\varepsilon$  et  $(K_\varepsilon)_{\varepsilon>0}$  une famille de sous-domaines compacts de  $\mathbb{R}^n$  qui converge vers un sous-domaine  $K$  étoilé ou directionnellement convexe. Les hypothèses sur  $f$  restent les mêmes.

**Définition 6** (Domaine étoilé).  *$K$  est dit étoilé, si  $K = \emptyset$ , ou s'il existe  $x \in \overset{\circ}{K}$  tel que, pour tout  $y \in \partial K$  et  $t \in [0, 1)$ , le point  $x + t(y - x)$  appartient à  $\overset{\circ}{K}$  et  $\nu_K(y) \cdot (y - x) \geq 0$ , où  $\nu_K(y)$  dénote le vecteur normal extérieur à  $K$  au point  $y$ .*

**Définition 7** (Domaine directionnellement convexe).  *$K$  est dit directionnellement convexe par rapport à l'hyperplan  $P$ , s'il existe un hyperplan  $P = \{x \in \mathbb{R}^n, x \cdot e = a\}$  où  $e$  est un vecteur unitaire de  $\mathbb{R}^n$  et  $a$  un nombre réel, tels que*

- pour toute droite  $\Sigma$  parallèle à  $e$  l'ensemble  $K \cap \Sigma$  est soit un segment soit l'ensemble vide,
- $K \cap P = \pi(K)$  où  $\pi(K)$  est la projection orthogonale de  $K$  sur  $P$ .

Dans un premier temps je généralise le résultat de Berestycki, Hamel et Matano aux domaines extérieurs qui sont des perturbations régulières (un sens plus précis est donné dans le théorème ci dessous) de domaines étoilés ou directionnellement convexes en prouvant ce théorème de type Liouville :

**Théorème 8.** *Soit  $(K_\varepsilon)_{0<\varepsilon\leq 1}$  une famille de sous-domaines compacts  $C^{2,\alpha}$  (pour un certain  $\alpha > 0$ ) de  $\mathbb{R}^n$ . Supposons que  $K_\varepsilon$  converge vers  $K$  pour la topologie  $C^{2,\alpha}$  quand  $\varepsilon$  tend vers 0,*

avec  $K$  étoilé ou directionnellement convexe. Alors il existe  $\varepsilon_0 > 0$  tel que pour tout  $0 < \varepsilon < \varepsilon_0$ , le problème elliptique suivant

$$\begin{cases} -\Delta u = f(u) & \text{dans } \mathbb{R}^n \setminus K_\varepsilon, \\ \partial_\nu u = 0 & \text{sur } \partial K_\varepsilon, \\ 0 < u \leq 1 & \text{dans } \mathbb{R}^n \setminus K_\varepsilon, \\ u(x) \rightarrow 1 \text{ quand } |x| \rightarrow +\infty & \text{uniformément par rapport à } x \in \mathbb{R}^n \setminus K_\varepsilon, \end{cases} \quad (8)$$

a une unique solution,  $u_\varepsilon \equiv 1$

La preuve de ce résultat repose sur la convergence de  $u$  vers 1 quand  $|x| \rightarrow +\infty$  uniformément par rapport à  $\varepsilon > 0$ .

Je m'intéresse ensuite à l'existence de familles de perturbations  $(K_\varepsilon)$  qui bloqueraient l'invasion de 1 dans certaines parties du domaine tout en convergeant vers un obstacle  $K$  étoilé ou directionnellement convexe, c'est-à-dire où le théorème de type Liouville précédent ne s'applique plus. Il est donc impossible que la convergence de ces perturbations soit  $C^{2,\alpha}$ , d'après le théorème précédent. Je construis alors un exemple de perturbations  $(K_\varepsilon)_{\varepsilon>0}$  qui convergent dans la topologie  $C^0$  vers une boule tel que l'invasion de la population est bloquée à certains endroits de  $\Omega_\varepsilon$  pour tout  $\varepsilon > 0$ . Plus précisément

**Théorème 9.** *Il existe  $(K_\varepsilon)_\varepsilon$  une famille de sous-domaines compacts de  $\mathbb{R}^n$  telle que  $K_\varepsilon \rightarrow B_{R_0}$  pour la topologie  $C^0$  quand  $\varepsilon \rightarrow 0$ , et pour tout  $\varepsilon > 0$  il existe une solution de  $u_\varepsilon$  de (8) telle que  $0 < u_\varepsilon < 1$  dans  $\mathbb{R}^n \setminus K_\varepsilon$ .*

On utilise la particularité géométrique de nos perturbations (voir Figure 3) pour construire par une méthode variationnelle une sur-solution de notre problème qui est proche de 0 à certains endroits de  $\Omega_\varepsilon$  quelque soit  $\varepsilon > 0$ , ce qui bloque l'invasion de 1 dans ces parties de  $\Omega_\varepsilon$ .

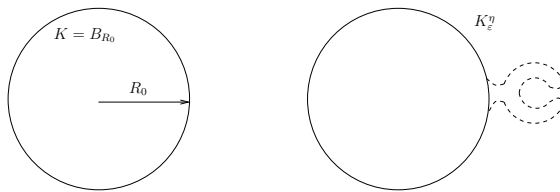

FIGURE 3 – Exemple de perturbations  $K_\varepsilon$  qui ont la particularité de faire apparaître des passages très étroits dans  $\Omega_\varepsilon = \mathbb{R}^n \setminus K_\varepsilon$ , et qui convergent vers un boule  $K$ , mais tel que 1 n'envahisse pas tout le domaine.

On peut alors se demander quelle est la topologie optimale de convergence de nos perturbations  $K_\varepsilon$  vers  $K$  pour conserver un résultat de type Liouville tel que le Théorème 8 ?

On a montré que la convergence pour la topologie  $C^{2,\alpha}$  était suffisante mais que la convergence pour la topologie  $C^0$  autorisait la construction de contre exemples. Nous concluons ce chapitre en appliquant le Théorème 8 au problème parabolique associé (7). On a le Corollaire suivant découlant de [14]



**Corollaire 10.** *On suppose que  $f$  est type bistable et qu'il existe une onde progressive planaire bistable  $(\phi, c)$  avec  $c > 0$ . Soit  $(K_\varepsilon)_{0 < \varepsilon \leq 1}$  une famille de sous-domaines compacts  $C^{2,\alpha}$  de  $\mathbb{R}^n$ . On suppose que  $K_\varepsilon$  converge vers  $K$  pour la topologie  $C^{2,\alpha}$  avec  $K \subset \mathbb{R}^n$  un domaine étoilé ou directionnellement convexe. Alors pour tout  $0 < \varepsilon \leq 1$ , il existe une solution entière  $u_\varepsilon$  du problème (7) telle que*

$$0 < u_\varepsilon < 1 \text{ et } \partial_t u_\varepsilon > 0 \text{ sur } \mathbb{R} \times \overline{\Omega_\varepsilon}.$$

*De plus il existe  $\varepsilon_0 > 0$  tel que pour tout  $0 < \varepsilon < \varepsilon_0$ ,*

$$u_\varepsilon(t, x) - \phi(x_1 + ct) \rightarrow 0$$

*quand  $t \rightarrow \pm\infty$  uniformément par rapport à  $x \in \overline{\Omega_\varepsilon}$ , et quand  $|x| \rightarrow +\infty$  uniformément par rapport à  $t \in \mathbb{R}$ .*

Ce corollaire prouve l'existence et l'unicité d'un front de transition, presque planaire, invasif entre 0 et 1 de vitesse moyenne globale  $c$ .

## 2.2 Équations de réaction-diffusion à vitesse forcée - application à la dynamique des populations

Depuis le travail pionnier de Fisher [41] et Kolmogorov-Petrovskii-Piskunov [69] en 1937 les équations de réaction-diffusion sont largement utilisées en dynamique des populations afin de modéliser l'invasion d'une population dans un milieu donné. Depuis quelques années on s'intéresse aux effets du réchauffement climatique sur des populations sensibles à la température. Pour modéliser ce phénomène on considère  $u$  une densité de population qui satisfait une équation de réaction-diffusion dont le terme de réaction  $f$  dépend aussi de  $z := x - ct$ , avec  $x \in \mathbb{R}$  l'espace (l'Équateur se trouvant à  $x = -\infty$  et le Pôle Nord à  $x = +\infty$ ),  $t > 0$  le temps,  $c > 0$  la vitesse du changement climatique se dirigeant de l'Équateur vers le Pôle Nord. Berestycki et al [9] en 2008 se sont intéressés à la persistance de la population face à un changement climatique en dimension 1 ( $x \in \mathbb{R}$ ) quand  $f$  vérifie l'hypothèse de KPP. Puis Berestycki et Rossi [17, 18] ont continué cette étude en dimension  $n$  quelconque. Dans ces trois différents travaux la persistance de la population dépend du signe de la valeur propre généralisée de l'opérateur linéarisé autour de l'état stationnaire trivial 0. Plus récemment Vo [118] s'intéresse aussi à cette question de persistance face à un changement climatique pour des fonctions de réaction  $f$  de type KPP qui ont un comportement plus général dans la zone défavorable. Popatov et Lewis [99] ainsi que Berestycki, Diekmann et Desvillettes [8] étudient ces mêmes questions mais pour des systèmes de réaction-diffusion de type KPP de manière à prendre en compte la compétition ou la coopération entre différentes espèces. Enfin Zhou et Kot [123] obtiennent les mêmes conclusions que Berestycki et al pour des équations intégro différence de type KPP qui prennent en compte une dispersion non locale de la population.

Dans le chapitre 2 ([20]), nous nous intéressons à cette même question de persistance de la population face à un changement climatique, dans le cas de dispersion locale, mais en considérant des non-linéarités  $f$  plus générales. On ne peut donc pas utiliser les méthodes de linéarisation de Berestycki et al qui sont propres au cas KPP où le comportement du linéarisé autour de 0 détermine le comportement général de la solution  $u$ .

## Nos résultats dans un cadre plus général pour une équation scalaire en dimension 1

Dans notre article nous nous intéressons au problème de réaction-diffusion suivant

$$\begin{cases} \partial_t u(t, x) - \partial_{xx} u(t, x) = f(x - ct, u(t, x)), & \text{pour tout } t \in \mathbb{R}^+, x \in \mathbb{R}, \\ u(0, x) = u_0(x), & \text{pour tout } x \in \mathbb{R}, \text{ bornée, à support compact,} \end{cases} \quad (9)$$

où  $f$  est une fonction de Carathéodory telle qu'il existe  $\delta > 0$ ,  $R > 0$  et  $M > 0$ ,

$$f(\cdot, 0) \equiv 0,$$

$s \mapsto f(z, s)$  est Lipschitz-continue, uniformément par rapport à  $z \in \mathbb{R}$ ,

$$f(\cdot, u) < -\delta u \text{ dans } \mathbb{R} \setminus (-R, R), \text{ pour tout } u \in (0, M),$$

$$f(\cdot, u) \leq 0 \text{ dans } \mathbb{R} \text{ pour tout } u > M.$$

Dans ce cadre on s'intéresse d'abord à l'existence de solutions de type ondes progressives, c'est-à-dire

$$u(t, x) := U(x - ct) > 0, \quad \text{pour tout } x \in \mathbb{R}, t > 0,$$

avec

$$U(\pm\infty) = 0.$$

On prouve le résultat suivant

**Théorème 11.** *On suppose qu'il existe  $u \in H^1(\mathbb{R})$  telle que*

$$E_0[u] := \int_{\mathbb{R}} \left( \frac{u_z^2}{2} - F(z, u) \right) dz < 0, \text{ avec } F(z, s) := \int_0^s f(z, t) dt,$$

alors il existe  $\bar{c} \geq \underline{c} > 0$ , tels que

- Pour tout  $c \in (0, \underline{c})$ , le problème (9) a une solution de type onde progressive  $U_c \in H_c^1(\mathbb{R})$  avec  $E_c[U_c] < 0$ , et  $H_c^1(\mathbb{R}) := H^1(\mathbb{R}, e^{cz} dz)$ ,
- Pour tout  $c > \bar{c}$ , le problème (9) n'a pas de solution de type onde progressive, c'est-à-dire que 0 est la seule solution du problème suivant

$$\begin{cases} -U''(z) - cU'(z) = f(z, U(z)), & z \in \mathbb{R}, \\ U(z) \geq 0, & z \in \mathbb{R}, \\ U(\pm\infty) = 0. \end{cases} \quad (10)$$

Ce résultat indique que pour des changements climatiques suffisamment lents la population est capable de suivre son enveloppe climatique et donc persiste, alors que, lorsque le changement est trop rapide, la population ne peut pas suivre son environnement favorable et s'éteint.

La preuve du Théorème 11 est basée sur une méthode variationnelle pour l'existence d'onde progressive, introduite par Heinze [60] et utilisée plus récemment par Lucia, Muratov et Novaga [75] pour prouver l'existence de fronts progressifs dans des systèmes de réaction-diffusion homogènes de type gradient dans des cylindres droits. L'idée est d'introduire le bon espace à poids et de résoudre un problème variationnel dans cet espace. Nous utilisons ces mêmes idées dans le cas d'une équation scalaire avec une non-linéarité qui dépend aussi de  $z = x - ct$  en utilisant notre hypothèse de domaine strictement défavorable en dehors d'une certaine boule, qui se déplace avec le temps, pour gérer les problèmes de décroissance à l'infini.

Dans un second temps, nous nous intéressons à la convergence en temps de la solution du problème de Cauchy dans le repère mouvant et nous prouvons le théorème suivant

**Théorème 12.** *Soit  $u_0 \in H^2(\mathbb{R})$  et  $u_0$  borné, à support compact. Alors l'unique solution  $u$  de (9) satisfait  $u \in L^2([0, T[, H_c^1(\mathbb{R}))$ ,  $u_t \in L^2([0, T[, L_c^2(\mathbb{R}))$ , pour tout  $T > 0$ , et  $t \mapsto u(t, \cdot - ct)$  converge vers une solution de (10) quand  $t \rightarrow +\infty$ .*

Nous prouvons ce résultat de convergence en utilisant des arguments variationnels inspirés d'un papier de Zelenyak [122] où il prouve la convergence des solutions de problèmes paraboliques de second ordre, admettant une formulation variationnelle, dans un domaine borné. Il a donc fallu trouver des contrôles de notre solution à l'infini de manière à palier le manque de compacité du problème venant du fait que notre équation est posée sur  $\mathbb{R}$ . On remarque que Matano [76] prouve la convergence des solutions d'un problème parabolique semi-linéaire dans des domaines bornés de  $\mathbb{R}$  en utilisant des arguments géométriques puis en utilisant le principe du maximum et que Du et Matano [38] étendent ce résultat aux domaines non bornés pour une non-linéarité  $f$  homogène. Leur méthode s'appuie sur la classification des solutions pour les problèmes homogènes et utilise un principe de réflexion que l'on ne peut pas utiliser dans notre cadre.

Nous discutons ensuite sur la persistance de la population lorsque l'état stationnaire trivial 0 devient stable et nous mettons l'accent sur le fait que dans un cadre général le signe de la valeur propre principale généralisée ne détermine pas la survie de la population ce qui vient directement en opposition avec les conclusions dans le cadre KPP. Soit  $\lambda_0$  la valeur propre généralisée de l'opérateur  $\mathcal{L}_0$ , avec  $\mathcal{L}_0 u := -u'' - f_s(z, 0)u$ , on distingue deux cas, lorsque l'état stationnaire 0 est linéairement instable, i.e  $\lambda_0 < 0$  et  $c < 2\sqrt{-\lambda_0}$ , et lorsque 0 est linéairement stable i.e  $\lambda_0 > 0$  ou  $c > 2\sqrt{-\lambda_0}$ ,  $\lambda_0 < 0$ . On a les résultats suivants

- Si 0 est supposé linéairement instable

**Proposition 13.** *Si  $\lambda_0 < 0$  et  $c < 2\sqrt{-\lambda_0}$ , soit  $u$  la solution de notre problème climatique (9), alors  $u(t, \cdot - ct)$  converge vers une onde progressive, i.e une solution non triviale du problème stationnaire (10), quand  $t$  tend vers  $+\infty$ .*

Pour montrer ce résultat on commence par prouver qu'il existe une solution non triviale de (10) et on utilise le Théorème 12 avec un principe de comparaison pour conclure quant à la convergence.

- Si 0 est supposé linéairement stable, on montre que dans certaines situations, il existe des solutions non triviales de (10), ce qui marque bien la particularité du cadre KPP.

**Proposition 14.** *On suppose que  $\lambda_0 + \frac{c^2}{4} > 0$ . Si*

$$\min_{u \in H_c^1(\mathbb{R})} E_c[u] := \int_{\mathbb{R}} e^{cz} \left\{ \frac{u_z^2}{2} - F(s, u) \right\} dx < 0,$$

*alors il existe au moins deux ondes progressives, i.e solutions non triviales de (10) et l'une d'elle est d'énergie positive.*

Ce résultat se démontre en utilisant le théorème du col après avoir vérifié que la condition de Palais-Smale était bien satisfaite.

On en déduit alors le corollaire suivant

**Corollaire 15.** *Pour  $c > 0$  petit, soit*

$$f(z, u) = \begin{cases} f_0(u) & \text{si } |z| < R, \\ -\delta u & \text{autrement,} \end{cases}$$

où  $R, \delta > 0$ ,  $f_0$  une fonction bistable, alors pour  $R$  suffisamment grand, il existe  $\tilde{u} \in H_c^1(\mathbb{R})$  solution de (10) telle que  $E_c[\tilde{u}] > 0$ .

Ce corollaire montre donc l'existence d'ondes progressives d'énergie positive mais donne aussi l'exemple d'un cadre assez général où il existe des ondes progressives d'énergie négative et donc des solutions asymptotiques stables de notre problème d'évolution.

Enfin nous examinons, d'un point de vue numérique, pour des non-linéarité  $f$  données, l'existence d'un seuil  $c^* > 0$  pour la vitesse critique tel que  $\underline{c} = \bar{c} = c^*$  dans Théorème 11, c'est-à-dire que lorsque  $c < c^*$  la population persiste (pour une donnée initiale suffisamment grande) alors que pour  $c > c^*$  la population s'éteint (quelque soit la donnée initiale). Nous donnons aussi quelques illustrations numériques des différents profils  $U$  pour différentes valeurs de  $c$  et de  $f$ .

### 2.3 Propagation dans des domaines cylindriques - modélisation médicale

Dans ce travail nous nous intéressons à la modélisation d'ondes de dépolarisation et leur propagation dans le cerveau. En effet la membrane d'un neurone a besoin d'être polarisée pour transmettre le message nerveux. En 1944 Leão [71] observe pour la première fois l'existence d'ondes de dépolarisation vastes et passagères dans le cerveau; elles se propagent lentement (3mm/min) et sont suivies quelques minutes après par un processus de repolarisation de la membrane du neurone. Ces ondes sont appelées des **Dépressions Corticales Envahissantes (DCE)** et bloquent donc la propagation du message nerveux dans le cerveau ce qui provoquent de nombreux symptômes (opacification de la rétine chez le poulet par exemple). Ces ondes sont facilement observables chez les rongeurs et il a été prouvé que chaque DCE augmente les dommages neurologiques de 30% pendant les accidents vasculaires cérébraux [87]. Les thérapies visant à bloquer ces ondes se sont montrées très prometteuses chez les rongeurs [35, 93] mais inefficaces chez l'humain. De plus ces ondes n'ont jamais vraiment été observées chez l'humain car les mesures d'observation sont trop invasives et requièrent que le patient subisse une opération du cerveau. Leur existence chez l'humain est donc encore débattue aujourd'hui. Cependant, l'aura, responsable d'hallucinations durant les migraines avec aura, aurait les mêmes caractéristiques de propagation dans le cerveau que ces DCEs. Il est donc important en neuro-chirurgie d'avoir des informations quant à l'existence de ces ondes dans le cerveau humain et la modélisation mathématique est alors utile dans ces circonstances.

Ces DCEs sont modélisées par une onde progressive bistable qui se propage, selon un profil donné, lentement dans la matière grise du cerveau [109, 27, 37, 51, 114]. L'état normalement polarisé est représenté par l'état stationnaire 0 alors que l'état complètement dépolarisé est représenté par l'état stationnaire 1. La variation d'épaisseur de la matière grise du cerveau humain pourrait bloquer la propagation de ces ondes et être une explication de l'inefficacité des thérapies visant à bloquer les DCEs dans le cerveau humain. Cette hypothèse a été étudiée numériquement dans [27, 37, 51] et analytiquement dans [29], où Chapuisat et Grenier étudient les phénomènes de blocage dans des cylindres infinis à section transversale rectangulaire en dimension 2 et 3. Le but de notre travail est entre autre d'étendre les résultats de Chapuisat et Grenier [29] à des domaines de section transversale plus générale. On rappelle que ces notions de blocage et ralentissement de propagation dues à des variations de la largeur du domaine en dimension 2 avaient déjà été introduites par Grindrod et Lewis [52] pour la modélisation de fibrillations ventriculaires et Lou, Matano et Nakamura [79, 74] dans des cylindres ondulants pour des équations de mouvement par courbure moyenne.

### Résultats d'invasion ou de blocage dans des cylindres droits à section transverse variable

Dans le chapitre 3 nous étudions le problème suivant

$$\begin{cases} \partial_t u(t, x) - \Delta u(t, x) = f(u(t, x)), & t \in \mathbb{R}, \quad x \in \Omega, \\ \partial_\nu u(t, x) = 0, & t \in \mathbb{R}, \quad x \in \partial\Omega, \end{cases} \quad (11)$$

où  $\Omega$  est un cylindre infini dans la direction  $x_1$  de section transverse variable tel que

$$\Omega \text{ est un domaine de } \mathbb{R}^n \text{ uniformément } C^{2,\alpha}, \quad (12)$$

$$\Omega \cap \{x \in \mathbb{R}^n, x_1 < 0\} = \mathbb{R}^- \times \omega, \quad \omega \subset \mathbb{R}^{n-1}. \quad (13)$$

La dernière hypothèse suppose que le changement de géométrie a lieu dans le demi espace  $\{x = (x_1, x') \in \mathbb{R} \times \mathbb{R}^{n-1}, x_1 > 0\}$ .

On suppose aussi que  $f \in C^{1,1}([0, 1])$  est une fonction bistable telle que

$$\int_0^1 f(s) ds > 0. \quad (14)$$

On s'intéresse alors à l'effet de la géométrie sur la solution du problème (11). On s'interroge sur l'existence d'ondes venant de gauche (i.e quand  $x_1 \rightarrow -\infty$ ), sur l'existence de phénomènes de propagation ou au contraire de blocage.

On commence par montrer que le problème est bien posé en étudiant l'existence et l'unicité des solutions du problème (11). On montre le théorème suivant

**Théorème 16.** *Soient  $\Omega \subset \mathbb{R}^n$  satisfaisant (12) et (13) et  $f \in C^{1,1}([0, 1])$  est une fonction bistable vérifiant (14), soit  $(\phi, c)$  l'unique onde progressive planaire bistable associée à  $f$  telle que  $\phi(0) = \theta$ , avec  $c > 0$ , alors il existe une unique solution entière du problème (11) telle que*

$$u(t, x) - \phi(x_1 - ct) \rightarrow 0 \text{ quand } t \rightarrow -\infty \text{ uniformément par rapport à } \bar{\Omega}. \quad (15)$$

De plus  $u$  vérifie  $u_t(t, x) > 0$ ,  $0 < u(t, x) < 1$  pour tout  $(t, x) \in \mathbb{R} \times \bar{\Omega}$ .

La preuve de ce théorème d'existence et d'unicité repose sur des arguments de [14, section 2.3-2.4], dont l'idée principale est de construire une sous- et une sur-solutions  $w^-, w^+$  du problème (11) pour des temps très négatifs,  $t < T < 0$  avec  $T < 0$  bien choisi, qui ont les bonnes propriétés asymptotiques quand  $t \rightarrow -\infty$  (i.e  $w^\pm(t, x) - \phi(x_1 - ct) \rightarrow 0$  uniformément par rapport à  $x \in \Omega$  quand  $t \rightarrow -\infty$ ). On construit alors la solution entière à partir du problème de Cauchy pour  $t \in (-n, +\infty)$  en prenant  $w^-(-n, \cdot)$  comme condition initiale et on fait tendre  $n$  vers  $+\infty$ . L'unicité se montre en utilisant le principe de comparaison parabolique pour des sous et sur-solutions bien choisies.

Comme  $u$  est croissante et uniformément bornée par rapport à  $t$ , on sait en utilisant les estimations paraboliques que  $u(t, x) \rightarrow u_\infty(x)$  pour tout  $x \in \Omega$  quand  $t \rightarrow +\infty$  et ce théorème prouve qu'il existe un front généralisé solution du problème (11) connectant 0 et  $u_\infty$  (en prenant par exemple  $\Omega_t^\pm := \{x \in \Omega, u(t, x) > (<) \theta\}$ ). Il existe donc bien une onde venant de  $-\infty$  (se propageant de gauche à droite). On s'intéresse alors aux différentes propriétés de  $u_\infty$  en fonction des hypothèses géométriques que vérifie  $\Omega$ .

On commence par étudier le cas où  $\Omega$  se rétrécit, dans le sens où le diamètre du cylindre est décroissant par rapport à  $x_1$  (voir Figure 4).

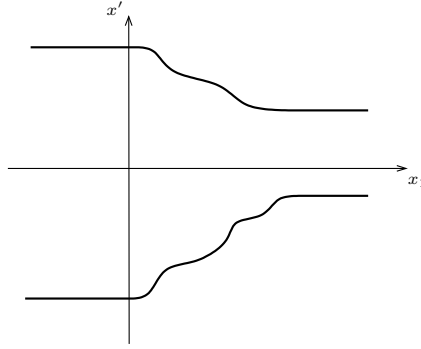

FIGURE 4 – Illustration en dimension 2 d'un domaine dont le diamètre est décroissant par rapport à la direction de propagation

On a le théorème suivant

**Théorème 17.** *On suppose que pour tout  $x \in \partial\Omega$ ,  $\nu_1(x) \geq 0$ , où  $\nu_1(x)$  est la première composante de la normale extérieure au point  $x$ . Dans ce cadre, sous les mêmes hypothèses sur  $\Omega$ ,  $f$  et  $(\phi, c)$  qu'au Théorème 16, la solution  $u$  du problème (11), satisfaisant (15), se propage à 1 dans  $\Omega$ , i.e  $u \rightarrow u_\infty$  quand  $t \rightarrow +\infty$  et  $u_\infty \equiv 1$  dans  $\Omega$ . De plus si on suppose que*

$$\Omega \cap \{x \in \mathbb{R}^n, x_1 > l\} = (l, +\infty) \times \omega_r,$$

Alors  $c$  est la vitesse asymptotique de propagation, i.e

$$\text{Pour tout } \hat{c} > c, \lim_{t \rightarrow +\infty} \sup_{x_1 > \hat{c}t} u(t, x) = 0,$$

$$\text{Pour tout } \hat{c} < c, \lim_{t \rightarrow +\infty} \inf_{x_1 < \hat{c}t} u(t, x) = 1.$$

Pour prouver ce résultat on utilise un principe de comparaison avec l'onde plane  $\phi$  qui est une sous-solution du problème.

Ce résultat affirme donc que dans le cas d'un rétrécissement il existe un front généralisé invasif connectant  $\phi$  et 1 et donc d'un point de vue de la modélisation des DCEs l'onde de dépolarisation envahit complètement le domaine.

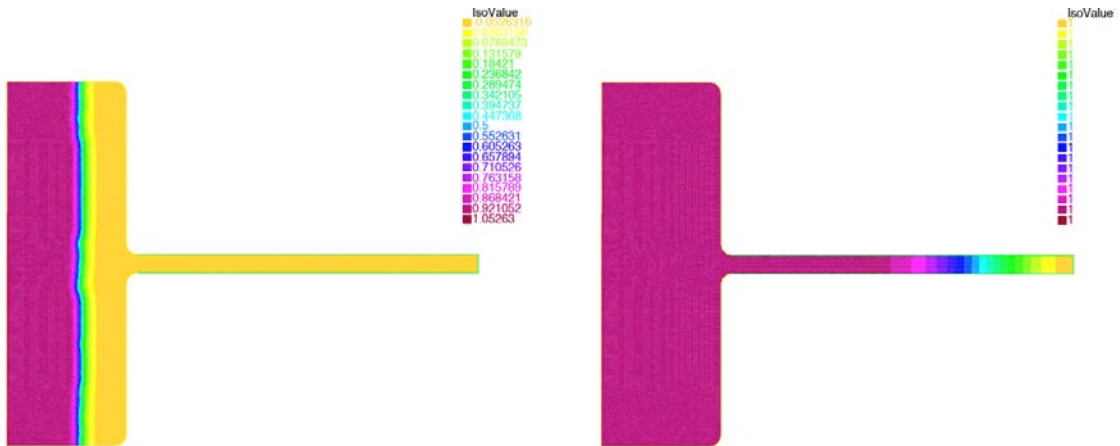

FIGURE 5 – Dans le cas d'un cylindre qui se rétrécit, l'onde se propage dans tout le domaine. De gauche à droite : valeur de la solution  $u$  pour différentes valeurs de  $t$  croissantes. Dans les parties jaunes la solution est proche de 0 et dans les parties violettes la solution est proche de 1

On s'intéresse ensuite au cas des cylindres qui s'élargissent (voir Figure 6) et on distingue deux comportements différents en fonction de la largeur du diamètre du cylindre de gauche (d'où provient l'onde).

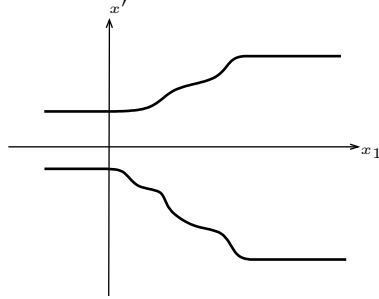

FIGURE 6 – Illustration en dimension 2 d'un domaine dont le diamètre est croissant par rapport à la direction de propagation

On commence par montrer qu'il existe des phénomènes de blocage :

**Théorème 18.** *Soit  $\varepsilon > 0$  le diamètre du cylindre de gauche  $\omega$  du domaine  $\Omega$  et on suppose que  $\Omega \cap \{x \in \mathbb{R}^n, x_1 > 1\}$  ne dépend pas de  $\varepsilon$ . Alors sous les mêmes hypothèses que dans le Théorème 16, il existe  $\varepsilon_0 > 0$  tel que pour tout  $\varepsilon < \varepsilon_0$ , l'unique solution  $u$  de (11), satisfaisant (15), est bloquée dans le grand cylindre, i.e  $u \rightarrow u_\infty$  quand  $t \rightarrow +\infty$  et  $u_\infty(x) \rightarrow 0$  quand  $x_1 \rightarrow +\infty$ .*

Pour prouver ce résultat on construit une sur-solution de notre problème dans un sous-domaine borné de  $\Omega$  par une méthode variationnelle. Cette sur-solution est proche de 0 proche de la frontière droite du sous-domaine et vaut 0 sur cette frontière. On passe ensuite à la limite du coté droit du sous-domaine de manière à obtenir une sur-solution sur la partie droite de  $\Omega$  qui tend vers 0 quand  $x_1 \rightarrow +\infty$  et on étend notre sur-solution par 1 à gauche pour obtenir une sur-solution sur  $\Omega$  tout entier. On compare ensuite cette sur-solution à notre solution en utilisant un principe de comparaison comme pour la preuve du Théorème 17.

Ce théorème montre donc que lorsque que le cylindre de gauche est suffisamment étroit, (indépendamment du cylindre de droite) l'onde est bloquée ce qui signifie au niveau médical que l'onde de dépolarisation est bloquée lorsqu'elle provient d'un endroit où l'épaisseur de la matière grise est très petite.

On montre ensuite que pour un cylindre gauche suffisamment large, la solution se propage dans tout le domaine

**Théorème 19.** *Sous les mêmes hypothèses que dans le Théorème 16, en supposant de plus que  $\Omega$  satisfait les propriétés géométriques suivantes :*

*Il existe  $R > 0$  tel que :*

$$\mathbb{R} \times B'_R = \{(x_1, x') \in \mathbb{R} \times \mathbb{R}^{n-1}, |x'| < R\} \subset \Omega,$$

*il existe  $L > 0$  tel que,*

$$\Omega \cap \{(x_1, x') \in \mathbb{R} \times \mathbb{R}^{n-1}, x_1 > L\} \text{ est convexe,}$$

pour tout  $x \in \partial\Omega \cap \{(x_1, x') \in \mathbb{R} \times \mathbb{R}^{n-1}, x_1 < L + R\}$ ,

$$\nu_1(x) \leq 0.$$

Alors il existe  $R_0 > 0$  tel que pour tout  $R > R_0$ , la solution  $u$  de (11), satisfaisant (15), se propage à 1 dans  $\Omega$ , i.e  $u \rightarrow u_\infty$  quand  $t \rightarrow +\infty$  et  $u_\infty \equiv 1$  dans  $\Omega$ .

Pour prouver ce résultat on introduit la solution maximale du problème de Dirichlet suivant

$$\begin{cases} -\Delta u = f(u) & \text{dans } B_R = \{x \in \mathbb{R}^n, |x| < R\}, \\ u = 0 & \text{sur } \partial B_R, \end{cases}$$

qu'on utilise comme sous-solution de notre problème pour une boule suffisamment translatée vers la gauche. On utilise ensuite une méthode de glissement ("sliding method") pour montrer qu'il existe  $\delta > 0$  tel que

$$u_\infty(x) > 1 - \delta, \quad \forall x \in \Omega \cap \{(x_1, x') \in \mathbb{R} \times \mathbb{R}^{n-1}, x_1 \geq L + R\} = \Omega_{L,R}.$$

On conclut en utilisant un principe de comparaison avec l'onde progressive planaire connectant 0 à  $1 - \delta$  se déplaçant de droite à gauche.

On montre donc qu'il existe un front généralisé invasif connectant 0 et 1 lorsque le diamètre du cylindre croît par rapport à la direction de propagation et que le cylindre initial (de gauche) est suffisamment large.

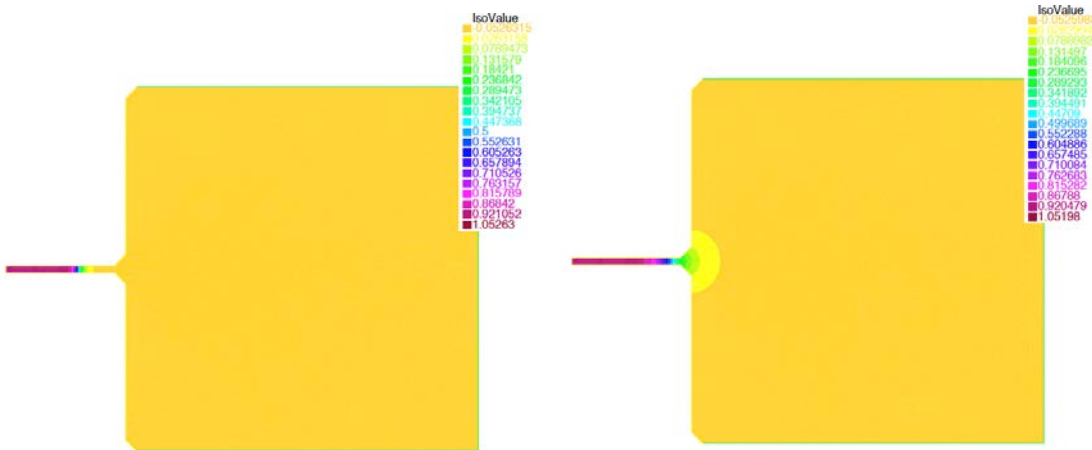

FIGURE 7 – Dans le cas d'un cylindre qui s'élargit, l'onde est bloquée à l'entrée de l'élargissement quand le cylindre de gauche est trop étroit. De gauche à droite : valeur de la solution  $u$  pour différentes valeurs de  $t$  croissantes. Dans les parties jaunes la solution est proche de 0 et dans les parties violettes la solution est proche de 1



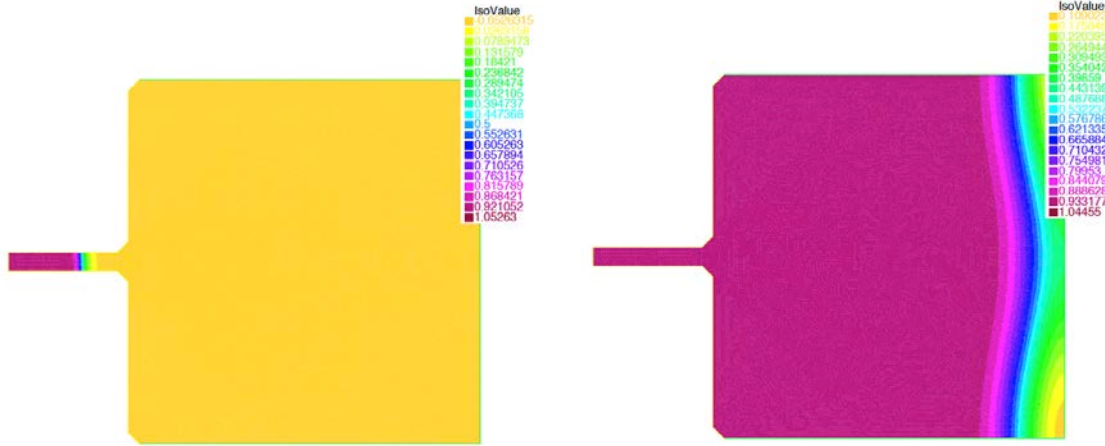

FIGURE 8 – L'onde se propage dans tout le domaine lorsque le cylindre de gauche est assez large. De gauche à droite : valeur de la solution  $u$  pour différentes valeurs de  $t$  croissantes. Dans les parties jaunes la solution est proche de 0 et dans les parties violettes la solution est proche de 1

On étudie ensuite les propriétés de propagation de notre front dans des cylindres plus généraux (qui ne vérifient pas nécessairement des propriétés de monotonie du diamètre par rapport à  $x_1$ , la direction de propagation). On commence par montrer que si notre domaine  $\Omega$  contient un cylindre droit de diamètre suffisamment grand alors il y a propagation de notre solution.

**Théorème 20.** *Soit  $R_1 > R_0 > 0$ , supposons que*

$$\Omega \subset \mathbb{R} \times B'_{R_1} = \{(x_1, x') \in \mathbb{R} \times \mathbb{R}^{n-1}, |x'| < R_1\}, \text{ pour un certain } R_1 > 0,$$

$$\mathbb{R} \times B'_{R_0} \subset \Omega, \text{ pour un certain } R_0 > 0,$$

Alors sous les mêmes hypothèses que dans le Théorème 16, il existe  $R^* > 0$  tel que pour tout  $R_0 > R^*$ , l'unique solution  $u$  de (11), satisfaisant (15) se propage, i.e  $u \rightarrow u_\infty$  quand  $t \rightarrow +\infty$  et  $\inf_{x \in \Omega} u_\infty(x) > 0$ .

Pour prouver ce résultat nous comparons notre solution à une solution particulière du problème auxiliaire posé sur le cylindre droit  $\mathbb{R} \times B'_{R_0}$  avec les conditions de Dirichlet au bord. Pour cette solution particulière nous considérons l'onde progressive construite par Lucia, Muratov et Novaga dans [75].

Nous montrons donc que lorsque notre domaine contient un cylindre droit suffisamment large, il existe un front généralisé invasif connectant 0 à  $u_\infty$  et que  $u_\infty > c_m > 0$  dans  $\Omega$ . Remarquons tout de même que la propagation peut être partielle et selon la géométrie de  $\Omega$  il peut y avoir des zones où la solution est proche de 0.

On montre ensuite que lorsque notre domaine  $\Omega$  est suffisamment proche d'un cylindre droit, au sens  $C^{2,\alpha}$ , alors il y a propagation complète de 1 dans  $\Omega$ .

**Théorème 21.** *On suppose que  $\omega$  dans (13) de diamètre  $r > 0$ . De plus on suppose que  $\Omega$  est proche d'un cylindre droit, au sens de la topologie  $C^{2,\alpha}$ , pour un certain  $\alpha \in (0, 1)$ , i.e :*

$$\text{Il existe } (\Omega_\varepsilon)_{\varepsilon > 0} \text{ une famille de cylindres infinis de } \mathbb{R}^n, \text{ telle que}$$

$$\Omega_\varepsilon \rightarrow \mathbb{R} \times \omega \text{ quand } \varepsilon \rightarrow 0 \text{ au sens de la topologie } C^{2,\alpha},$$

$$\Omega = \Omega_\varepsilon \text{ pour un certain } \varepsilon > 0.$$

Sous les mêmes hypothèses que dans le Théorème 16 sur  $\Omega$ ,  $f$  et  $(\phi, c)$ , il existe  $\varepsilon_0 > 0$  tel que pour tout  $0 < \varepsilon < \varepsilon_0$ , l'unique solution de (11) satisfaisant (15) se propage complètement à 1 dans  $\Omega$ . De plus comme dans le Théorème 17 si on suppose que

$$\Omega \cap \{x \in \mathbb{R}^n, x_1 > l\} = (l, +\infty) \times \omega_{R_0},$$

et  $\nu_1(x) \leq 0$  pour tout  $x \in \partial\Omega$ , alors  $c$  est la vitesse asymptotique de propagation, i.e

$$\text{Pour tout } \hat{c} > c, \quad \lim_{t \rightarrow +\infty} \sup_{x_1 > \hat{c}t} u(t, x) = 0,$$

$$\text{Pour tout } \hat{c} < c, \quad \lim_{t \rightarrow +\infty} \inf_{l < x_1 < \hat{c}t} u(t, x) = 1,$$

La preuve de ce résultat se fait par l'absurde en remarquant que la construction de notre solution entière  $u$  ne dépend pas de  $\varepsilon$  et que l'unique solution de notre problème (11) satisfaisant (15) dans un cylindre droit est l'onde progressive planaire  $\phi$  qui se propage à 1 dans tout le domaine.

On discute aussi d'hypothèses plus générales sur  $\Omega$  pour garantir une propagation complète de 1. On montrera que lorsque le domaine est étoilé par rapport à la direction de propagation, la propagation est complète.

**Théorème 22.** Soient  $R_1 \gg R_0 > 0$ , on suppose que

$$\begin{aligned} \Omega &\subset \mathbb{R} \times B'_{R_1}, \\ \mathbb{R} \times B'_{R_0} &\subset \Omega, \end{aligned}$$

Si on suppose que pour tout point  $x = (x_1, x') \in \partial\Omega$ , la normale extérieure  $\nu$  a un angle positif avec la direction  $x'$ , plus précisément  $\nu = (\nu_1, \nu')$  (avec  $\nu' \in \mathbb{R}^{N-1}$ ), on suppose :

$$\nu' \cdot x' \geq 0 \quad \text{pour tous les points } x = (x_1, x') \in \partial\Omega.$$

Alors en supposant les mêmes hypothèses que dans le Théorème 16 sur  $\Omega$  et  $f$ , la solution  $u$  de (11) satisfaisant (15) se propage à 1 dans  $\Omega$ , i.e

$$u(t, \cdot) \rightarrow u_\infty \text{ localement uniformément dans } \Omega \text{ as } t \rightarrow +\infty \text{ et } u_\infty \equiv 1 \text{ in } \Omega.$$

On prouve ce théorème en comparant  $u_\infty$  avec la solution du problème de Dirichlet homogène dans  $B'_{R_0}$  et en faisant des translations et des rotations du cylindre droit  $\mathbb{R} \times B'_{R_0}$  de manière à prouver que  $u_\infty > \theta$  dans  $\Omega$ .

On donne ensuite deux hypothèses sur  $\Omega$  en dimension  $n \in \mathbb{N}$  qui assurent une propagation complète, mais celles-ci sont difficiles à vérifier car elles dépendent de deux paramètres dont on connaît l'existence mais pour lesquels nous avons très peu d'informations.

Ce travail [6] (Chapitre 3) identifie donc les différentes propriétés de propagation d'une onde progressive bistable dans un cylindre droit à section transverse variable et permet de mieux comprendre les mécanismes responsables du blocage de la solution dans un environnement bistable. Une étude numérique de ces problèmes apporte des résultats plus fins et plus précis quant aux comportements de nos solutions par rapport à la variation de certains paramètres du problème.

### Simulations numériques

En parallèle de ces travaux, j'ai étudié numériquement le comportement de notre solution  $u$  dans différents domaines  $\Omega$ , cylindres droits de diamètre variable en dimension 2. Dans un premier temps je retrouve les mêmes comportements que ceux énoncés dans les théorèmes précédents, [6] (Chapitre 3), mais j'ai aussi pu approfondir ces résultats et j'obtiens les propriétés suivantes :

- L'existence d'un seuil  $R_0 > 0$  dans le rayon du cylindre de gauche pour les cylindres qui s'élargissent : Soit  $R$  le rayon du cylindre droit  $\mathbb{R}_+^* \times \omega$  alors si  $R < R_0$  la solution est bloquée à la sortie du cylindre droit, alors que si  $R > R_0$  la solution se propage à 1 dans tout le domaine,
- On étudie numériquement l'impact d'une ouverture progressive du cylindre droit vers un cylindre plus large, et on trouve qu'il existe un seuil de convexité/concavité tel que la solution se propage en dessous de ce seuil et au dessus de ce seuil la solution est bloquée à l'endroit du changement de géométrie. Cela signifie que la concavité de l'élargissement du cylindre favorise le blocage de la solution (voir Figure 9 et 10 pour des illustrations),

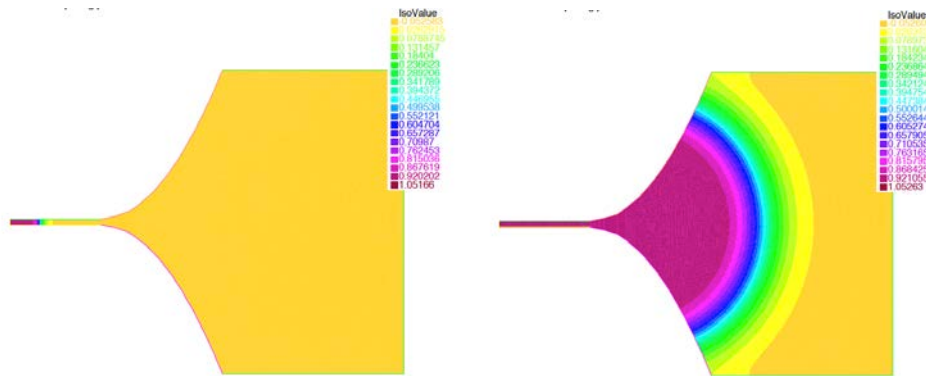

FIGURE 9 – Dans le cas d'un cylindre qui s'élargit progressivement, l'onde se propage dans tout le domaine lorsque l'ouverture est convexe. De gauche à droite : valeur de la solution  $u$  pour différentes valeurs de  $t$  croissantes. Dans les parties jaunes la solution est proche de 0 et dans les parties violettes la solution est proche de 1

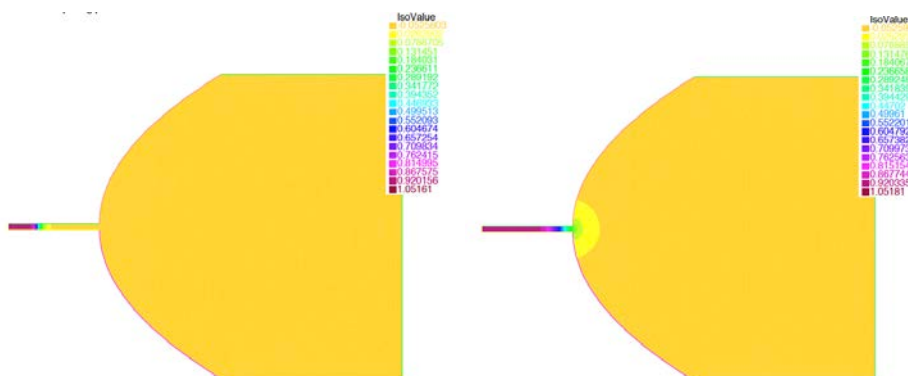

FIGURE 10 – Dans le cas d'un cylindre qui s'élargit progressivement, l'onde est bloquée à l'entrée de l'élargissement quand l'ouverture est concave. De gauche à droite : valeur de la solution  $u$  pour différentes valeurs de  $t$  croissantes. Dans les parties jaunes la solution est proche de 0 et dans les parties violettes la solution est proche de 1

- On s'intéresse aussi à des domaines plus généraux, en étudiant numériquement l'impact de

la présence d'un isthme de rayon  $R$  dans le domaine et on obtient les mêmes conclusions que pour le cylindre qui s'élargit (voir Figure 11 et 12 pour des illustrations).

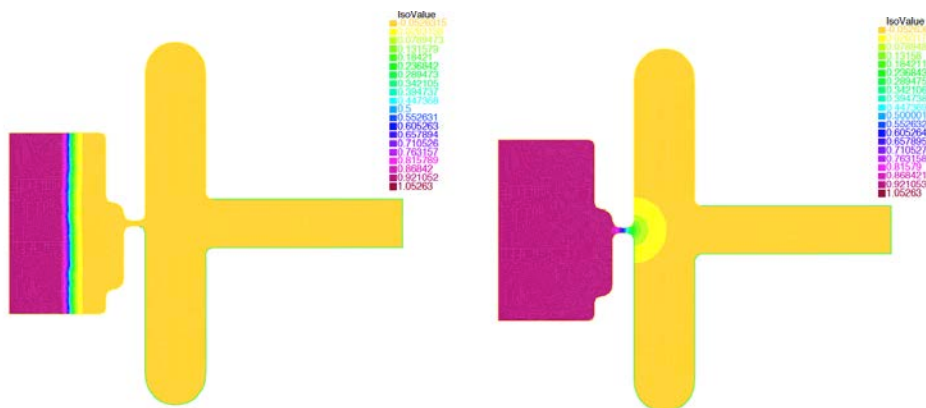

FIGURE 11 – En présence d'un isthme, l'onde est bloquée à la la sortie de l'isthme si le diamètre de celui ci est trop petit. De gauche à droite : valeur de la solution  $u$  pour différentes valeurs de  $t$  croissantes. Dans les parties jaunes la solution est proche de 0 et dans les parties violettes la solution est proche de 1

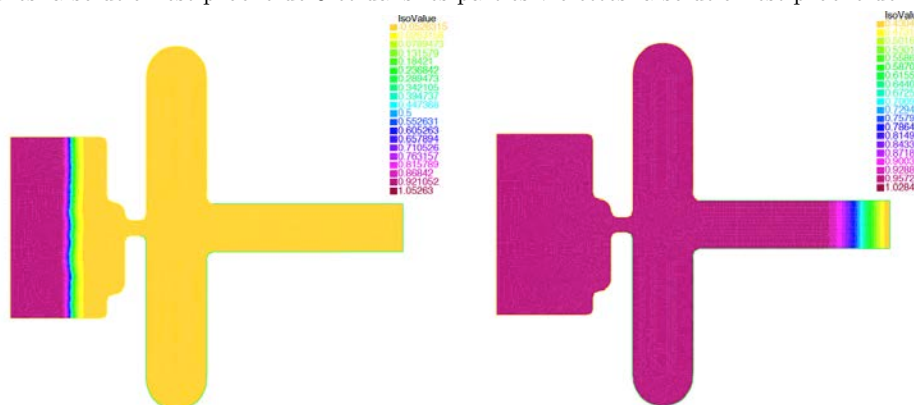

FIGURE 12 – En présence d'un isthme, l'onde se propage dans tout le domaine lorsque le diamètre de l'isthme est suffisamment grand. De gauche à droite : valeur de la solution  $u$  pour différentes valeurs de  $t$  croissantes. Dans les parties jaunes la solution est proche de 0 et dans les parties violettes la solution est proche de 1

- On étudie aussi l'effet du seuil de bistabilité  $\theta$  sur les phénomènes de blocage en étudiant l'évolution de la population pour différentes valeurs de  $\theta$  et différents diamètre  $\varepsilon > 0$  du cylindre de gauche. On remarque que si  $\theta$  est trop grand alors même pour des cylindres à gauche assez larges la solution est bloquée à la sortie du petit cylindre.

On peut aussi s'interroger sur les effets de la courbure d'un cylindre sur les phénomènes de blocage dans des cylindres courbés en considérant d'autres types de conditions aux bords que celles de Neumann. En effet pour des conditions de type Neumann aux bords, les solutions seront simplement réfléchies sur les bords et les phénomènes de blocage apparaissent donc plus difficiles à justifier dans des cylindres courbés de diamètre constant. Par contre on pourrait penser que pour des conditions de type Robin ou Dirichlet homogènes aux bords, la courbure du cylindre aurait un effet favorable sur le blocage de la solution. On étudie donc de manière numérique ce type de problèmes et on distingue deux types de phénomènes.

- Dans le cas de conditions au bord de type Robin ou Dirichlet alors la courbure ne semble pas avoir d'importance sur la propagation de la solution. Le paramètre qui paraît être

déterminant est le rayon du cylindre. En effet les résultats numériques semblent montrer qu'il existe un rayon  $R_0$  tel que si le rayon du cylindre  $R < R_0$  alors la solution tend vers 0, alors que si  $R > R_0$  la solution tend vers 1, quelque soit la courbure du domaine. Chapuisat et Joly [30] étudient une équation de réaction-diffusion avec une non-linéarité bistable dans le cylindre droit  $\mathbb{R} \times (-R, R)$  et une non-linéarité absorbante ( $f(u) = -\delta u$ ,  $\delta > 0$ ) à l'extérieur du cylindre et s'intéressent à l'existence de profils non triviaux en fonction de la valeur de  $R$ . Leur résultats mettent en évidence l'existence d'un rayon critique en dessous duquel la solution du problème parabolique tend vers 0 et au dessus duquel la solution du problème parabolique tend vers 1 en temps grands. Nos simulations numériques viennent donc appuyer ce résultat et présupposent que la courbure du cylindre n'a pas d'influence sur la propagation de la solution.

- Dans le cas de conditions aux bords de type Neumann pour la partie inférieure du cylindre et des conditions de Robin pour la partie supérieure, la courbure semble jouer un rôle déterminant dans la propagation de la solution. En effet en fixant le rayon du cylindre on observe que si la courbure du domaine est trop importante la solution sera bloquée à l'endroit du changement de direction.

Ces résultats numériques apportent donc plus de précisions sur nos résultats précédents concernant les phénomènes de propagation/blocage dans des cylindres droits à section variable. Ils ouvrent aussi quelques pistes quant au comportement de la solution du problème de réaction-diffusion bistable dans des cylindres courbés avec l'idée que la courbure du domaine n'aurait pas d'impact sur la propagation/blocage de notre solution lorsque l'on considère des conditions de Robin ou Dirichlet homogènes sur les bords du cylindre. Alors que l'on observe un changement de comportement de la solution sous l'effet de la courbure du domaine lorsque l'on considère des conditions de Neumann sur un bord du domaine et des conditions de type Robin ou Dirichlet homogènes sur l'autre bord. On pourrait donc penser que les conditions de type Neumann sur les bords du domaine seraient trop bénéfiques par rapport à l'effet de la courbure alors que les conditions de type Robin ou Dirichlet homogènes sur les bords du domaine seraient trop néphastes par rapport à l'effet de la courbure du domaine. Un moyen donc de faire jouer la courbure sur la propagation/blocage de notre solution serait de considérer des conditions de type Neumann sur une partie du bord et des conditions de type Robin ou Dirichlet homogènes sur une autre partie.

### 3 Perspectives

En résumé, depuis le début de ma thèse, j'ai travaillé sur l'évolution de différents types de population dans des environnements soumis à des changements de nature variée (changements climatiques, changements de géométrie du milieu) et plus particulièrement sur les phénomènes de propagation face à ces changements. Je serais intéressée de continuer l'étude de ces phénomènes de propagation dans des modèles plus complets.

### Invasion complète des dépressions corticales envahissantes dans des domaines cylindriques plus généraux

Dans le chapitre 3 ([6]) nous nous intéressons à la stabilité des solutions stationnaires du problème suivant

$$\begin{cases} -\Delta u = f(u) & \text{dans } \Omega, \\ \partial_\nu u = 0 & \text{sur } \partial\Omega, \\ u(x_1, x') \rightarrow 1 & \text{quand } x_1 \rightarrow -\infty, (x_1, x') \in \Omega, \end{cases} \quad (16)$$

pour  $\Omega = \{(x_1, x'), x_1 \in \mathbb{R}, x' \in \omega(x_1) \subset \mathbb{R}^{n-1}\}$ . Nous avons établis deux hypothèses géométriques qui assurent la stabilité de 1 pour le problème précédent (16) en dimension 2 et en dimension supérieure. Cependant, il est assez difficile de vérifier si ces deux dernières hypothèses sont satisfaites car elles dépendent de paramètres qui sont difficilement quantifiables. On peut alors s'interroger sur le type de domaines non bornés qui rendent les solutions stationnaires non constantes de (16) instables.

On peut aussi s'intéresser à l'existence et à l'unicité de fronts de transition dans des domaines cylindriques plus généraux, qui peuvent par exemple changer de direction de propagation ou avec des conditions au bord de type Robin, Dirichlet ou mixtes et voir si une courbure trop importante dans le cas de conditions mixtes bloquerait la propagation (ce qui se produit sur nos exemples numériques du chapitre 4).

### Existence d'une vitesse critique du changement climatique dans le cas bistable et monostable

Dans le chapitre 2 ([20, Théorème 2.1.1]) on montre qu'il existe deux vitesses  $0 < \underline{c} \leq \bar{c}$  tel qu'il existe des solutions de type onde progressive non triviale pour  $c < \underline{c}$  et que pour tout  $c > \bar{c}$  toutes solutions de type onde progressive est la solution nulle. On sait que si la fonction de réaction  $f$  vérifie des hypothèses de type KPP dans la zone favorable alors  $\underline{c} = \bar{c} = c^*$  en dimension 1 [9] et en dimension supérieure [17, 18]. On voudrait alors identifier les différents cadres pour lesquels  $\underline{c} = \bar{c} = c^*$ . On pourrait commencer par étudier ce qu'il se passe lorsque  $f$  est de type bistable, monostable ou ignition dans la zone favorable et égale à  $-\delta u$ , avec  $\delta > 0$ , en zone défavorable. Les simulations numériques appuient l'existence d'une vitesse critique dans ces différents cas.

### Hétérogénéité du milieu dans des problèmes modélisant l'effet du changement climatique

Nous avons étudié de manière indépendante d'un côté l'effet d'un changement climatique sur une population qui évolue dans  $\mathbb{R}$  ou de manière équivalente dans un cylindre droit de  $\mathbb{R}^n$  avec condition de Neumann au bord dans le chapitre 2 et d'un autre coté l'effet d'un changement de géométrie de l'environnement dans le chapitre 3. On pourrait alors s'intéresser à l'effet d'un changement climatique sur une population qui évolue dans un environnement à géométrie variable en étudiant une équation de réaction-diffusion de type bistable sur  $\Omega$ , avec  $f$  qui dépend de  $u$  et de  $z := x - ct$ ,  $\Omega := \{(x_1, x'), x_1 \in \mathbb{R}, x' \in \omega(x_1) \subset \mathbb{R}^{n-1}\}$ . Roques et al [104] ont étudié numériquement l'évolution d'une population soumise à un réchauffement climatique défavorable dans des bandes de largeur variable en dimension 2. Ils montrent que lorsque la population passe par une bande très étroite alors en fonction de la progressivité de l'ouverture de la bande, du coefficient de diffusion et de la vitesse du changement climatique la population s'adapte et réussit à suivre son enveloppe favorable ou elle s'éteint. Il serait intéressant d'utiliser les outils des chapitres 2 et 3 pour retrouver ces résultats analytiquement.

**Persistence de la population avec une dispersion non locale soumise à des changements climatiques**

Dans la continuité du chapitre 2, on pourrait considérer des équations de réaction-diffusion avec vitesse forcée mais avec des noyaux de convolution à la place du Laplacien de manière à modéliser des populations qui ont une dispersion non locale. Pour cela on utiliserait des modèles intégrodifférentiels ou des modèles d'intrégro-différence très utilisés par les biologistes. Zhou et Kot [123] ont étudié la persistance d'une population de type KPP dans ce cadre non local. Il serait intéressant de comprendre si les résultats de Zhou et Kot se retrouvent dans le cas d'une non-linéarité bistable. Jin et Lewis [63, 64] ont étudié la persistance d'une population avec une dispersion non locale et un flot unidirectionnel. Il serait intéressant d'étendre certains de ces résultats sur la persistance des populations dans les rivières à des populations soumises à un déplacement de leur environnement favorable.

**Modéliser la persistance de la population sensible au changement climatique dont le milieu fluctue de manière aléatoire**

L'introduction de fluctuations aléatoires dans l'environnement d'une population s'avère avoir un effet sur la persistance de cette population. On pourrait donc étudier la persistance d'une population biologique qui se disperse de manière non locale, soumise à un changement climatique comme dans la section précédente mais en intégrant la notion de stochasticité dans les fluctuations de son environnement. Pour cela nous pourrions utiliser un modèle intégrodifférentiel avec une zone favorable qui se déplace comme dans le papier de Zhou et Kot [123] et en ajoutant une dépendance aléatoire dans le terme de réaction pour prendre en compte les fluctuations aléatoires de l'environnement.

---

## Plan de thèse

Ce manuscrit s'organise de la manière suivante. Dans le chapitre 1 nous étudions une équation de réaction-diffusion bistable dans un domaine extérieur  $\Omega := \mathbb{R}^n \setminus K$  de manière à comprendre l'évolution de la densité d'une population lorsqu'elle fait face à un obstacle. Dans le chapitre 2 on s'intéresse à l'évolution de la densité d'une population faisant face à un changement climatique défavorable, en considérant une équation de réaction-diffusion avec vitesse forcée sur  $\mathbb{R}$ . Dans les chapitres 3 et 4 on considère une équation de réaction-diffusion dans des domaines cylindriques, qui modélise entre autre l'évolution d'une onde de dépolarisation dans le cerveau. Dans le chapitre 3 on étudie analytiquement ce problème dans des cylindres droits à section transverse variable alors que dans le chapitre 4 on étudie cette équation numériquement dans des cylindres droits à section transverse variable mais aussi dans des cylindres courbés avec des conditions mixtes aux bords.





# General introduction

*Le lecteur trouvera une traduction française de cette introduction à la partie nommée "Introduction générale" de ce manuscrit*

During my PhD I have been working on biological invasion phenomena in heterogeneous media. The motivation of this introduction is first of all to accustom the reader to reaction diffusion equations analysing their utility in biological modelling and reminding the main mathematical results on this subject. Then I will state the different results obtained during my thesis and will end up this introduction indicating several research topics that will be interesting to investigate in the sequel.

## 4 Reaction diffusion equations

In this first section we briefly remind the interest of reaction diffusion equations and their different applications particularly adapted to the study of propagation phenomena, introducing the notion of travelling waves. We will continue this section with a presentation of existence, uniqueness and stability results concerning these travelling waves in the homogeneous and heterogeneous framework.

### 4.1 General framework

#### Biological motivations

A first step in the modelling process is to understand the evolution of a quantity with respect to time, that is the formulation of an equation describing the variation in time of the previous quantity. Assuming that the time is continuous we obtain an ordinary differential equation. Several examples and areas of application of these modelling processes are given in the book of J.D. Murray [89]. Amongst other things, it is well known in population dynamics that we can model the evolution of the density of a population the following way :

$$\frac{\partial u}{\partial t} = f(u), \quad t \geq 0$$

where  $f$  represents the growth function, taking into account birth, death, migration... We will present the main functions  $f$  that are used in the literature in the next section.

We can also take into account the interactions between several populations in our models, analysing systems of differential equations, with for example the Lotka-Volterra system that models

the interaction between preys and predators. More generally several aspects are taken into account as the competition or the mutualism within a population or between different populations. These equations are also used in epidemiology to anticipate the propagation of an infectious disease as the flu, the HIV, the plague... where a population is divided in different groups such as the non infected population that is not protected against the epidemic, the infected population and the resisting population that interacts with each other. Such systems are also used in chemical reactions modelling, using the law of mass action.

One can find a detailed description of all these models in [89, Chapter 1, 3, 6 et 10].

We will focus here on scalar models, that is models with only one equation.

Besides these growth dynamics modelled by the reaction term  $f$ , there exists another important phenomenon that has to be considered in the modelling, the spatial movements of a population. Indeed in every agglomerate of particles such as cells, chemical molecules, animals, bacteria... each particle is randomly moving. We often use the notion of random walk. Each random walk follows a precise law but generally the agglomerate of particles is moving according to a macroscopic process that we call a diffusion process, that is when the movement in space  $\Delta x$  is of order  $\sqrt{\Delta t}$ , where  $\Delta t$  represents the variation in time. We thus obtain

$$\frac{\partial u}{\partial t} = D \frac{\partial^2 u}{\partial x^2}, \quad t \geq 0, x \in \mathbb{R},$$

where  $u$  represents the quantity we want to model,  $t$  the time and  $x$  the space.

Combining these two processes of reaction  $f$  on one side and diffusion on the other, we get a reaction diffusion equation :

$$\frac{\partial u}{\partial t} - D \frac{\partial^2 u}{\partial x^2} = f(u), \quad t \geq 0, x \in \mathbb{R},$$

with  $u \in \mathbb{R}^m$  ( $m = 1$  corresponds to the scalar reaction diffusion equation,  $m > 1$  corresponds to a system of reaction diffusion equations when several species interact with each other). We can also generalise this reaction diffusion equation in dimension  $n \in \mathbb{N}^*$  :

$$\frac{\partial u}{\partial t} - D \Delta u = f(u), \quad t \geq 0, x \in \mathbb{R}^n,$$

where  $\Delta u = \sum_{k=1}^n \frac{\partial^2 u}{\partial x_k^2}$  is the laplacian of  $u$ . We refer the reader to [89, chapter 11] for more details.

### Usual reaction terms

We will be interested here in four different classes of particular reaction terms :

- Without Allee effect, the KPP case,
- With a weak Allee effect, the monostable case,
- With a strong Allee effect, the bistable or multistable case,
- With the existence of a threshold for the reaction to take place, the combustion case.

In 1798, Malthus introduced one of the first model in population dynamics, assuming that the births and deaths are proportional to the size of the entire population and that there is no migration. He obtained a reaction term  $f(u) = au - bu$ . But this model forecasts an exponential growth of the population as soon as  $a > b$ , which is not realistic in most of the cases. Verhulst then introduce in 1838 the notion of a "self-regularising process" with the function

$$f(u) = au - bu - cu^2 = ru\left(1 - \frac{u}{K}\right),$$

where  $r$  represents the intrasec growth rate of the population and  $K$  the carrying capacity (we will normalised  $K = 1$  in the sequel). These functions satisfy the following property

$$f(0) = f(1) = 0, \quad f > 0 \text{ in } [0, 1] \text{ and } f(u) \leq f'(0)u \text{ for } u \in [0, 1].$$

We will say that these functions satisfy the KPP property.

In 1938, the notion of Allee effect is introduced. We assume that the per capita growth rate  $f(u)/u$  does not achieve its maximum at the origin  $u = 0$ , but is smaller for small populations. This effect models the necessity of having a sufficiently large number of individuals around to get a better reproduction rate. We will distinguish the weak and the strong Allee effect.

In the case of a weak Allee effect, we assume that the total growth of the population is always positive, that is the reaction term  $f$  is positive in  $(0, 1)$ . We will say that  $f$  is monostable.

In the case of a strong Allee effect, the growth is negative for small values of  $u$ . This means that the total growth of the population is negative for small populations. We will then assume that the reaction term  $f$  is negative close to 0 and positive close to 1 and we will say that  $f$  is bistable or multistable.

The last class of function is generally used in the modelling of chemical reactions, assuming that the population of particles has to be above some threshold to allow a reaction to take place, below this threshold nothing happens; that is the reaction term  $f$  is equal to 0 up to some value and is positive after. We say that  $f$  is of combustion type.

To sum up, we consider four types of reaction terms :

- $f$  KPP, i.e  $f(0) = f(1) = 0$ ,  $f > 0$  in  $(0, 1)$  and  $f(u) \leq f'(0)u$  for  $u \in [0, 1]$ ,
- $f$  monostable, i.e  $f(0) = f(1) = 0$ ,  $f > 0$  in  $(0, 1)$
- $f$  bistable or multistable, i.e there exist  $0 < \theta_1 \leq \dots \leq \theta_k < 1$  such that  $f(0) = f(\theta_i) = f(1) = 0$  for all  $i \in 1, \dots, k$ , and  $f < 0$  in  $(0, \theta_1)$ ,  $f > 0$  in  $(\theta_k, 1)$  and  $\int_0^1 f(s)ds > 0$ .
- $f$  combustion, i.e there exists  $\theta \in (0, 1)$  such that  $f \equiv 0$  in  $[0, \theta]$  and  $f > 0$  in  $(\theta, 1)$ ,  $f(1) = 0$ .

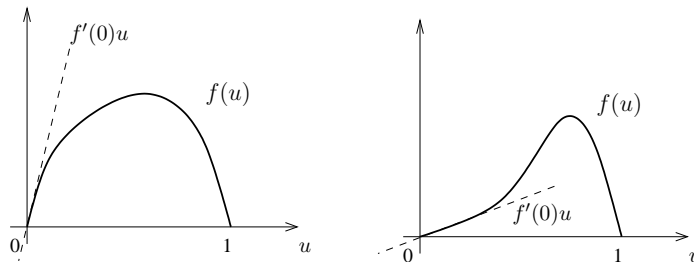

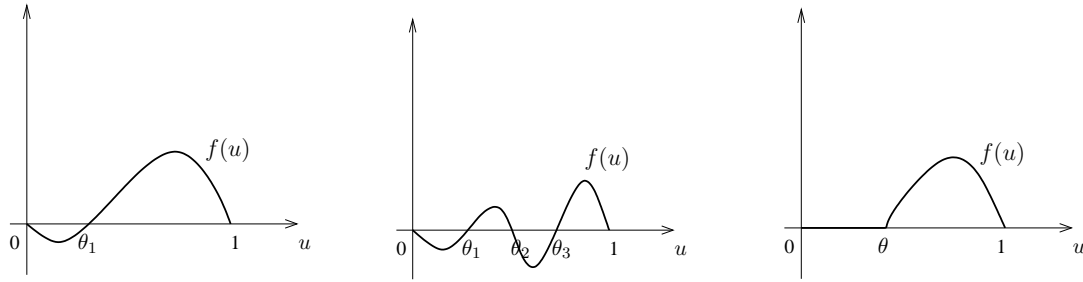

FIGURE 13 – From left to right, top to bottom : KPP function, monostable, bistable, multistable and combustion.

### Biological invasions - Notion of travelling waves

As it has already been seen in the previous subsections, reaction diffusion equations are used a lot to model the evolution of biological quantities. For instance we can list

- The Fisher-KPP model [41, 69] in 1937. It is introduced to model the invasion of a dominant gene in a population,
- The Skellam's model [108] in 1951. It is introduced to model the spread of raccoons and their speed of spreading in Europe,
- The Turing's model [115] in 1952. Turing pointed out that simple reaction diffusion systems are able to model complex phenomena of morphogenesis responsible of the formation of patterns as dots or stripes on the fur of some animals for example,
- The Hodgkin-Huxley's model [61] in 1952. They developed a system of reaction diffusion equations modelling ionic exchanges between neurones, which enable us to understand how the action potential in neurones is created and how it propagates.

This enumeration is non exhaustive of course and there exists a large number of biological phenomena modelled by reaction diffusion equations.

We notice, from the previous enumeration, that reaction diffusion equations are well adapted to the modelling of biological invasion phenomena, particularly to the invasion of one state on the other, with the notion of travelling waves introduced by Fisher [41] and Kolmogorov-Petrovskii-Piskunov [69] in 1937. The idea is to represent the solution of our reaction diffusion equation as a front moving with a constant speed in space. Let  $u$  be the the solution of our reaction diffusion equation in  $\mathbb{R}$  :

$$\frac{\partial u}{\partial t} - D \frac{\partial^2 u}{\partial x^2} = f(u), \quad t \geq 0, x \in \mathbb{R}.$$

We then write our solution as  $u(t, x) = \phi(x - ct)$  for all  $t \in \mathbb{R}, x \in \mathbb{R}$ , with  $(\phi, c)$  solution of the following problem :

$$\begin{cases} -\phi''(r) - c\phi'(r) = f(\phi(r)), & r \in \mathbb{R}, \\ \phi(-\infty) = 1, & \phi(+\infty) = 0. \end{cases} \quad (17)$$

We will say that  $c$  is the spreading speed. These solutions describe the invasion of the state 1 on 0 if  $c > 0$  or from the state 0 on 1 if  $c < 0$ , according to a constant profile  $\phi$  moving at a constant speed  $|c|$ .

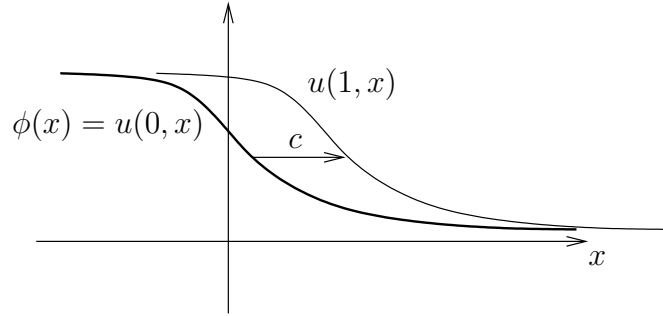
FIGURE 14 – The profile  $\phi$  moves with a speed  $c > 0$ .

This notion of travelling wave can be generalised to higher dimensions writing

$$u(t, x) = \phi(x \cdot e - ct), \quad e \in \mathbb{S}^{n-1},$$

where  $(\phi, c)$  is solution of (17) and  $\mathbb{S}^{n-1} = \{x \in \mathbb{R}^n, |x| = 1\}$ . We will say that  $e$  is the direction of propagation of the front.

We can also extend this notion to reaction diffusion systems assuming that  $\mathbf{u}(t, x) := \mathbf{U}(z)$  where  $z := x - ct$ ,  $\mathbf{u}$  and  $\mathbf{U}$  are  $\mathbb{R}^m$ -valued functions,  $m > 1$ . We refer the reader to the Part II of J.D. Murray's book [90] for more details.

## 4.2 Propagation in homogeneous media

In this section we recall some well-known existence, uniqueness and stability results on travelling waves. We will be interested in the different properties of these particular solutions. We will end up this section with the notion of transition fronts, which still models the invasion of one state on another but without assuming that the invasion is planar or with a constant speed.

We consider the following homogeneous problem :

$$\begin{cases} \partial_t u(t, x) - \Delta u(t, x) = f(u(t, x)), & t > 0, x \in \mathbb{R}^n, n \geq 1, \\ u(0, x) = u_0(x), & x \in \mathbb{R}^n, \end{cases} \quad (18)$$

where  $f(0) = f(1) = 0$  and we will be interested in solutions  $u \in [0, 1]$ . Indeed, we know that if  $u_0$  is piecewise continuous such that  $0 \leq u_0(x) \leq 1$  for all  $x \in \mathbb{R}^n$  then there exists a unique bounded solution  $u$  of the homogeneous problem (18) such that

$$0 \leq u(t, x) \leq 1, \quad \forall t \geq 0, x \in \mathbb{R}^n.$$

### Existence, uniqueness and stability of travelling waves

The first results concerning the existence, uniqueness and stability of travelling waves are due to Fisher [41] and Kolmogorov-Petrovskii-Piskunov [69] in 1937 for KPP and monostable functions. In their papers, they prove the existence of travelling waves and introduce the notion of asymptotic speed of propagation in dimension 1 [41] and 2 [69]. These results are extended by Kanel [67, 66] to combustion and bistable functions in the years of 1960.

The existence, uniqueness and stability of these fronts in the homogeneous framework have been intensively studied in the years of 1970-1980 by Aronson and Weinberger [3] and Fife and

McLeod [40], amongst others, using differential equation methods and by Bramson [21, 22] and Uchiyama [116] using a probabilistic approach. We remind that we are interested in the existence and uniqueness of particular solution of (18) such that

$$u(t, x) = \phi(x \cdot e - ct),$$

and  $(\phi, c)$  is a solution of the ordinary differential equation (17).

It is well known (see [3] for instance) that in the monostable, bistable and combustion case, there exists a solution  $(\phi, c)$  of (17) with  $c \times \int_0^1 f(s)ds \geq 0$ , i.e the speed of spreading  $c$  depends on the sign of  $\int_0^1 f(s)ds$ . Moreover in the bistable and combustion case, there exists a unique speed  $c$  and a unique profile  $\phi$  associated with  $c$  (unique up to translation) solution of problem (17), whereas in the KPP and monostable case, we have the existence of a continuum of speed  $c$  such that problem (17) has a solution, and then there exists an infinity of solution  $(\phi_c, c)$  of (17). More precisely, for the KPP and monostable case, there exists a minimal spreading speed  $c^* > 0$  such that for all  $c \geq c^*$  problem (17) has a solution  $\phi_c$  (unique up to translation). We will say that  $c^*$  (the unique spreading speed in the bistable and combustion case and the minimal spreading speed in the KPP and monostable case) is the asymptotic speed of spreading in the sense that

- If  $u \in [0, 1]$  is solution of the homogeneous problem (18) such that  $u(0, \cdot) \equiv 0$  in  $\mathbb{R}^n \setminus B_\rho$  for some  $\rho > 0$ , where  $B_\rho$  is the ball of radius  $\rho$  in  $\mathbb{R}^n$ , then for all  $c > c^*$  and for all  $y \in \mathbb{R}^n$ ,

$$\lim_{t \rightarrow +\infty} \max_{|x-y| > ct} u(t, x) = 0.$$

- If  $u \in [0, 1]$  is solution of the homogeneous problem (18) and  $\liminf_{t \rightarrow +\infty} u(t, x) = 1$  locally uniformly for  $x \in \mathbb{R}^n$ , then for all  $c \in (0, c^*)$ , for all  $y \in \mathbb{R}^n$ ,

$$\liminf_{t \rightarrow +\infty} \min_{|x-y| < ct} u(t, x) = 1.$$

Moreover we know that in the KPP case  $c^* = 2\sqrt{f'(0)}$  (see [69] for the case where  $f(u) = u(1-u)$  for example) and more generally in the monostable case (see [53]),

$$c^* = \min_{\rho \in C^1([0,1], \rho > 0, \rho(0)=0, \rho'(0) > 0)} \left( \sup_{u \in [0,1]} \rho'(u) + \frac{f(u)}{\rho(u)} \right).$$

Regarding invasion phenomena and stability of steady states, we distinguish two different behaviours :

- The "hair trigger effect" in the KPP and monostable case,
- The threshold effect in the bistable and combustion case.

What we mean by "hair trigger effect", is that in the KPP and monostable case, it is enough to start with a non trivial initial condition ( $u_0 \not\equiv 0$ ) for the solution of the parabolic problem to converge to 1 in  $\mathbb{R}^n$  with a speed  $c^*$ . Whereas in the bistable and combustion case, we need the initial condition to be large enough on a sufficiently large area to prove that the solution of the parabolic problem does not converge to 0. Assuming that  $u_0$  is compactly supported, we have the following results in any dimensions  $n \in \mathbb{N}$ ,

- In the KPP and monostable case, if  $u_0 \not\equiv 0$ ,
  - If  $c \in (0, c^*)$  then  $\min_{|x| < ct} u(t, x) \rightarrow 1$  when  $t \rightarrow +\infty$ ,
  - If  $c > c^*$ , then  $\max_{|x| > ct} u(t, x) \rightarrow 0$  when  $t \rightarrow +\infty$ .
- In the bistable and combustion case
  - If  $\int_{\mathbb{R}^n} u_0$  is small then  $u(t, x) \rightarrow 0$  when  $t \rightarrow +\infty$ ,
  - If  $u_0 \geq \theta + \eta > \theta$  on a sufficiently large area then
    - \* If  $c \in (0, c^*)$  then  $\min_{|x| < ct} u(t, x) \rightarrow 1$  when  $t \rightarrow +\infty$ ,
    - \* If  $c > c^*$ , then  $\max_{|x| > ct} u(t, x) \rightarrow 0$  when  $t \rightarrow +\infty$ .

In dimension 1, the stability of travelling waves is stated differently according to whether we are in the KPP case or in the bistable/combustion case,

- If  $u_0 \not\equiv 0$  is compactly supported, then
  - In the bistable or combustion case ([40]),
    - \* If  $\int_{\mathbb{R}^n} u_0$  is small then  $u(t, x) \rightarrow 0$  when  $t \rightarrow +\infty$ ,
    - \* If  $u_0 \geq \theta + \eta > \theta$  on a sufficiently large domain then there exists  $\xi^+, \xi^- \in \mathbb{R}$  such that
 
$$\begin{cases} u(t, x) - \phi(x - c^*t + \xi^+) \rightarrow 0, & \text{when } t \rightarrow +\infty \text{ for } x \geq 0, \\ u(t, x) - \phi(-x - c^*t + \xi^-) \rightarrow 0, & \text{when } t \rightarrow +\infty \text{ for } x \leq 0. \end{cases}$$
  - In the KPP case, there exist  $\lambda^* > 0$ ,  $\xi^\pm : (0, +\infty) \rightarrow \mathbb{R}$  such that  $|\xi^\pm(t)| < C$  for all  $t > 0$ ,

$$\begin{cases} u(t, x) - \phi(x - c^*t + \frac{3}{2\lambda^*} \ln(t) + \xi^+(t)) \rightarrow 0, & \text{when } t \rightarrow +\infty \text{ for } x \geq 0, \\ u(t, x) - \phi(-x - c^*t + \frac{3}{2\lambda^*} \ln(t) + \xi^-(t)) \rightarrow 0, & \text{when } t \rightarrow +\infty \text{ for } x \leq 0. \end{cases}$$

These stability results in the KPP case have been proved by Bramson [22] using a probabilistic approach and more recently by Hamel et al [58] using a partial differential equation approach.

- Moreover if we assume that  $u_0 \equiv \chi_{[-L, L]}$ , the characteristic function of  $[-L, L]$ , for  $L > 0$ , Zlatos [124] proved that there exists  $L_0 \geq 0$  such that
  - \* if  $L < L_0$ ,  $u(t, x) \rightarrow 0$  uniformly in  $\mathbb{R}$  when  $t \rightarrow +\infty$ ,
  - \* si  $L > L_0$ ,  $u(t, x) \rightarrow 1$  uniformly in  $\mathbb{R}$  when  $t \rightarrow +\infty$ ,
- If  $u_0 \not\equiv 0$  is not compactly supported. Then we have the following result in the bistable and combustion case (from [40]) :

$$\begin{aligned} & \text{If } \liminf_{x \rightarrow -\infty} u_0(x) < \theta < \limsup_{x \rightarrow +\infty} u_0(x), \\ & \text{then there exists } \xi \in \mathbb{R} \text{ such that} \\ & u(t, x) - \phi(x - c^*t + \xi) \rightarrow 0 \quad \text{when } t \rightarrow +\infty. \end{aligned}$$



For more details on these stability results, we refer the reader to the following papers (and references therein) [72, 80, 81, 3, 10, 38] that prove that in general planar travelling waves are stable in  $\mathbb{R}^n$  for the bistable and combustion case and to [58] and the references therein for the KPP case.

For multistable nonlinearities Fife and McLeod in [40] prove the existence and uniqueness of travelling waves in dimension 1 under some conditions. To simplify we assume that there exist  $0 < \theta_1 < \theta_2 < \theta_3 < 1$  such that  $f(0) = f(\theta_1) = f(\theta_2) = f(\theta_3) = f(1) = 0$  and  $f$  is bistable on  $[0, \theta_2]$  and on  $[\theta_2, 1]$ . Using the results we gave above, there exists a unique travelling wave  $(\phi_1, c_1)$ , respectively  $(\phi_2, c_2)$  connecting 0 to  $\theta_2$ , respectively  $\theta_2$  to 1. In their paper Fife and McLeod prove the existence and stability of a front connecting the state 0 to the state 1 if and only if  $c_1 < c_2$ . We will talk about train waves. Hamel and Omrani in [59] carry on the study of the existence and stability of these fronts in higher dimension in a straight cylinder  $\mathbb{R} \times \omega$ , where the cross section  $\omega$  is bounded and convex.

### Notion of pushed and pulled fronts

Stability of travelling waves have also been studied by Stokes in [110] where he introduces the notion of pulled and pushed fronts. In the KPP framework, we know that the minimal speed of propagation, which correspond also to the asymptotic spreading speed of the solution, is  $c^* = 2\sqrt{f'(0)}$ . In the monostable framework this minimal speed still corresponds to the asymptotic speed of propagation but can be strictly greater than  $2\sqrt{f'(0)}$  because of the weak Allee effect. In [110] Stokes defines the notion of pulled fronts as the ones which have a minimal speed  $c^* = 2\sqrt{f'(0)}$  (KPP case for instance) or the ones which have a spreading speed  $c$  greater than the minimal speed of propagation, i.e the solutions  $(\phi_c, c)$  such that  $c > c^*$  the minimal speed of propagation. He talks about pulled fronts because the spreading speed of these fronts (in the KPP case) is determined by the growth term at 0, and thus by the individuals at the front edge of the travelling wave.

He also defines the notion of pushed fronts as monostable travelling waves with minimal speed  $c^* > 2\sqrt{f'(0)}$ , i.e the solutions  $(\phi_{c^*}, c^*)$  where  $c^*$  is the minimal spreading speed, or as the bistable or combustion travelling waves, where in these cases there exists a unique spreading speed  $c = c^*$  for which there will exist a travelling wave solution. This fronts are said to be pushed because the advance of the front does not depend only on what is happening forward. In this case the travelling wave is pushed by all the population.

In his paper Stokes proves the stability of pushed fronts in the non-KPP frameworks.

A more general notion of pulled and pushed fronts has been introduced by Garnier et al in [45, 46, 47, 102] where the idea this time is to decompose the front  $u$  in several components  $u_k$  satisfying the following equation :

$$\begin{cases} \partial_t u_k(t, x) = \Delta u_k(t, x) + u_k(t, x) \cdot \frac{f(u(t, x))}{u(t, x)}, & t > 0, x \in \mathbb{R}, \\ u_k(0, x) = u_{k,0}(x), & x \in \mathbb{R}. \end{cases} \quad (19)$$

They study the behaviour and the role of each of the components in the propagation of the front. They prove that in the case of pulled fronts all the components  $u_k$  converge to 0 except the one that is at the front of the front, which fit with the notion of pulled fronts introduced by Stokes. Whereas in the case of pushed fronts, they prove that each component  $u_k$  converges to a portion of the front  $u$  and this confirms the significance of all the population in the propagation of  $u$ . They redefine the notion of pulled and pushed fronts the following way

**Definition 1** (Pulled front [45]). *A front  $u$  with speed  $c \in \mathbb{R}$  is pulled if for all  $v$  satisfying (19) and  $v_0$  compactly supported such that  $0 \leq v_0 \leq u(0, \cdot)$ ,  $v_0 \not\equiv 0$ , we have*

$$v(t, x + ct) \rightarrow 0 \text{ locally uniformly when } t \rightarrow +\infty.$$

**Definition 2** (Pushed front [45]). *A front  $u$  with speed  $c \in \mathbb{R}$  is pushed if for all  $v$  satisfying (19) and  $v_0$  compactly supported such that  $0 \leq v_0 \leq u(0, \cdot)$ ,  $v_0 \not\equiv 0$ , there exists a compact set  $\mathcal{K}$  such that*

$$\limsup_{t \rightarrow +\infty} \left( \sup_{x \in \mathcal{K}} v(t, x + ct) \right) > 0.$$

Then they can study the difference between pulled and pushed fronts in more general frameworks such as integro-differential equations, reaction diffusion equation heterogeneous in space, reaction diffusion with forced speed...

They prove for example that pushed fronts promote biodiversity.

### Notion of transition fronts

More recently, several papers have been dedicated to the existence of non planar travelling fronts. These kind of fronts appeared naturally in the heterogeneous framework as we will see in the following section. Previously we defined the notion of travelling wave or planar travelling front as the solution of (18) such that  $u(t, x) = \phi(x \cdot e - ct)$ , with  $c \in \mathbb{R}$  and  $e \in \mathbb{S}^{n-1}$ . These fronts are called planar because their level sets are hyperplans. We notice that there exist other types of fronts. For instance in the case of a bistable or combustion non linearity Ninomiya and Taniguchi [94, 95] prove the existence and stability of curved fronts in dimension 2, that is solution of the homogeneous problem (18) of the form  $u(t, x, y) = \phi(x, y - ct)$ . A little bit later Hamel et al [55] study the existence of curved fronts with conic level sets. In [56, 57] Hamel and Nadirashvili are interested in the description of all the solutions defined for all  $t \in \mathbb{R}$  of the Fisher-KPP reaction diffusion equation in dimension 1 and in dimension  $n$ . They proved that in dimension 1, there exists a dimension 5 manifold of these entire solutions of the Fisher-KPP equation (reminding that planar travelling fronts defined in the previous sections represent a dimension 2 manifold of entire solutions of the Fisher-KPP equation). In their second paper [57] they are interested in the same kind of problems but in dimension  $n$  and prove the existence of manifold of infinite dimension of radial solutions and non planar travelling fronts. For more details on these sets of solutions, one can see [56, 57] and the references therein.

We observe two properties that are shared by all these solutions :

- They converge to 0 or 1 far away from their level sets, uniformly with respect to time,
- Their level sets are moving at a constant global speed.

It is in this framework, for example, that Berestycki and Hamel introduce the notion of transition fronts in [11, 12]. These fronts are characterised by the fact that the spatial transition between 0 and 1 is uniformly bounded with respect to time. These fronts include different notions of particular travelling fronts built in different heterogeneous settings as the pulsating travelling fronts, the curved fronts in domains  $\Omega \subset \mathbb{R}^n$ ... We will come back on the notion of transition fronts, their mathematical definition and their properties in the following section after introducing reaction diffusion equations in the most general heterogeneous framework.

### 4.3 Propagation in heterogeneous media

In this section we state some of the recent results on front-like solutions for heterogeneous reaction diffusion equations. But first we say that  $u$  satisfies an heterogeneous reaction diffusion equations if  $u$  is a solution of the following problem,

$$\begin{cases} \partial_t u(t, x) - \nabla_x \cdot (A(t, x) \nabla_x u(t, x)) + q(t, x)u(t, x) = f(t, x, u) & \text{for all } t \in \mathbb{R}, x \in \Omega \subset \mathbb{R}^n, \\ B(t, x)[u(t, x)] = 0, & \text{for all } t \in \mathbb{R}, x \in \partial\Omega, \end{cases} \quad (20)$$

with

- $\Omega$  a  $C^{2,\alpha}$  domain of  $\mathbb{R}^n$ , for some  $\alpha > 0$ ,
- $(t, x) \mapsto A(t, x) = (a_{ij}(t, x))_{1 \leq i, j \leq n}$  the diffusion matrix assumed to be  $C^{1,\alpha}(\mathbb{R} \times \Omega)$ , such that

$$\gamma_1 |\xi|^2 \leq \sum_{1 \leq i, j \leq n} a_{ij}(t, x) \xi_i \xi_j \leq \gamma_2 |\xi|^2, \quad \text{for all } (t, x) \in \mathbb{R} \times \Omega, \xi \in \mathbb{R}^n,$$

for some  $0 < \gamma_1 \leq \gamma_2$ ,

- $(t, x) \mapsto q(t, x)$  the advection coefficient assumed to be  $C^{0,\alpha}(\mathbb{R} \times \Omega)$ ,
- $(t, x, s) \mapsto f(t, x, s)$  the reaction term assumed to be  $C^{0,\alpha}(\mathbb{R} \times \Omega)$  in  $(t, x)$  locally with respect to  $s$ , and locally lipschitz in  $s$  uniformly with respect to  $(t, x) \in \mathbb{R} \times \Omega$ .

Notice that the regularity could change depending on the circumstances.

The general boundary conditions  $B(t, x)[u(t, x)] = 0$  for all  $(t, x) \in \mathbb{R} \times \partial\Omega$  represent in most of the case the Dirichlet, Neuman or Robin boundary conditions but could also stand for more general nonlinear boundary conditions.

Thus this equation takes into account the dependence of the dispersal of the population with respect to time and space, the possibility of advection or convection effects and also the dependence of the reaction term with respect to time and space (to consider favourable and unfavourable areas for the population, areas that could move with time for example). Let us notice that this equation is set for  $x \in \Omega \subset \mathbb{R}^n$ , which expresses for example the presence of geometric constraints when  $\Omega \subsetneq \mathbb{R}^n$ .

It is in this general framework that Berestycki and Hamel [11] defined the notion of transition fronts, which generalises the notion of travelling waves to the heterogeneous framework and which includes several notions of front-like solutions already introduced in specific heterogeneous settings (curved travelling fronts in curved domains, non planar travelling waves in  $\mathbb{R}^n$ , pulsating travelling fronts in periodic media, etc ...). One remarks that a first generalisation of travelling wave solutions has been introduced by Matano [78] and Shen [105] in dimension 1, where they define a solution to be a front-like solution when it is continuous with respect to its environment (a more precise definition will be given later on). We start by recalling the definition of transition fronts and their different properties and then we will give some references where the existence of transition fronts is discussed. We finish this section introducing integro-difference or integro-differential equations, which are used to model non local dispersal and for which front-like solutions could exist.

### Transition fronts

Let  $p^+$  and  $p^-$  be two entire solutions of the heterogeneous equation (20) defined for all  $t \in \mathbb{R}$ ,  $x \in \Omega$  (these solutions can be stationary in time, constant...). We denote by  $d_\Omega$ , the geodesic distance in  $\bar{\Omega}$ , and let  $A$  and  $B$  be two domains of  $\bar{\Omega}$ , we define

$$d_\Omega(A, B) := \inf \{d_\Omega(x, y), (x, y) \in A \times B\}.$$

We have the following definition

**Definition 3** (Transition front [11]). *A transition front between two solutions  $p^+$  and  $p^-$  for equation (20) is an entire solution defined for all  $t \in \mathbb{R}$  such that  $u \not\equiv p^\pm$  and such that there exist non empty, disjoint sets  $\Omega_t^\pm \subset \Omega$  satisfying for all  $t \in \mathbb{R}$ ,*

$$\begin{cases} \partial\Omega_t^- \cap \Omega = \partial\Omega_t^+ \cap \Omega =: \Gamma_t, & \Omega_t^- \cup \Omega_t^+ \cup \Gamma_t = \Omega, \\ \sup \{d_\Omega(x, \Gamma_t); t \in \mathbb{R}, x \in \Omega_t^\pm\} = +\infty. \end{cases} \quad (21)$$

with

$$u(t, x) - p^\pm(t, x) \rightarrow 0 \text{ uniformly with respect to } t \in \mathbb{R} \text{ and } x \in \Omega_t^\pm \text{ as } d_\Omega(x, \Gamma_t) \rightarrow +\infty.$$

The existence of domains  $\Omega_t^\pm$  combined with conditions (21) mean that our domain  $\Omega$  can be split in two disjoint subdomains, that can evolve with time and that have for each time  $t$  an unbounded direction. This definition formally means that a transition front is a spatial transition between two states  $p^+$  and  $p^-$  and that the transition part between these two states is uniformly bounded with respect to time.

Let us recall briefly the definition of front-like solution introduced by Matano for solutions of the following problem in dimension 1 :

$$\partial_t u(t, x) - a(x)\partial_{xx}u(t, x) - b(x)u_x(t, x) = f(x, u), \quad \text{for all } t \in \mathbb{R}, x \in \mathbb{R}, \quad (22)$$

with  $f(x, 0) = f(x, 1) = 0$  for all  $x \in \mathbb{R}$ .

We assume that  $(a, b, f)$  are uniformly continuous with respect to  $x \in \mathbb{R}$  and we define the space  $\mathcal{H}$  by

$$\mathcal{H} := \overline{\{(\pi_y a, \pi_y b, \pi_y f), y \in \mathbb{R}\}},$$

where  $\pi_y a(x) := a(x+y)$ ,  $\pi_y b(x) := b(x+y)$ ,  $\pi_y f(x, u) := f(x+y, u)$  and the closure is associated with the topology of the local convergence.

**Definition 4** (From [78] and [105]). *Let  $u : \mathbb{R} \times \mathbb{R} \times \mathcal{H} \rightarrow [0, 1]$  be such that for all  $(a_1, b_1, f_1) \in \mathcal{H}$ ,  $(t, x) \mapsto u(t, x; (a_1, b_1, f_1))$  is a solution of (22) with the coefficients  $(a_1, b_1, f_1)$ . We say that  $u$  is a front-like solution between 0 and 1 if*

- $u$  is continuous,
- there exists a function  $X : \mathbb{R} \rightarrow \mathbb{R}$  such that

$$\lim_{x \rightarrow -\infty} u(t, x + X(t); (a, b, f)) = 1$$

and

$$\lim_{x \rightarrow +\infty} u(t, x + X(t); (a, b, f)) = 0,$$

uniformly with respect to  $t \in \mathbb{R}$ ,

- $u(t, x + X(t); (a, b, f)) = u(0, x; \pi_{X(t)}(a, b, f))$  for all  $(t, x) \in \mathbb{R} \times \mathbb{R}$ .

We notice that these front-like solutions, when they exist are transition fronts but the converse is not necessarily true. We will thus use in the sequel the definition of Berestycki and Hamel in order to stay general and to deal with problem in higher dimensions. Notice that Lou, Matano and Nakamura [79, 74] define a notion of front-like solutions for curvature dependent motions of plane curves in undulating cylindrical domains in dimension 2, the notion of recurrent travelling waves. Lastly we remark that a more general notion of front-like solutions has recently been introduced by Nadin [91] in dimension 1 where he defines the notion of critical waves, temporal connection between two steady states. He proves that these critical waves exist, are unique up to translation and monotonic with respect to time in general heterogeneous frameworks where it has been proved that transition fronts as defined by Berestycki and Hamel do not exist, whereas this notion of critical waves and the definition of classical front-like solutions in well known frameworks are the same. Another notion of front-like solutions has recently been introduced by Ducrot, Giletti and Matano in [39], the notion of terrasse that can be seen as the succession of several travelling waves. The authors prove the existence of these particular solutions for reaction diffusion equations with a nonlinearity that is heterogeneous and periodic with respect to space, in dimension 1.

Coming back the definition of transition fronts by Berestycki and Hamel, one can define the notion of global mean speed, the notion of invasion fronts, almost planar transition fronts, generalised pulsating fronts... All these notions bring some precisions on the type and on the properties of the transition between two steady states. We remind briefly here some of these notions that will be useful in the thesis.

**Definition 5** (Invasion fronts [11]). *We say that  $p^+$  invades  $p^-$  if*

- $\Omega_s^+ \subset \Omega_t^+$  for all  $t \geq s$ ,
- $d_\Omega(\Gamma_t, \Gamma_s) \rightarrow +\infty$  when  $|t - s| \rightarrow +\infty$

We then get that

$$u(t, x) - p^\pm(t, x) \rightarrow 0 \text{ when } t \rightarrow \pm\infty,$$

locally uniformly in  $x \in \bar{\Omega}$  with respect to the distance  $d_\Omega$ .

An invasion front can then be seen as a temporal connection between two steady states with a transition area that moves toward infinity as time grows large and let one subdomain invades the other.

Berestycki and Hamel, in [11], also define the notion of almost planar transition front as transition front such that

$$\Gamma_t = \{x \in \Omega, x \cdot e = \xi_t\},$$

for some  $\xi_t \in \mathbb{R}$ ,  $e \in \mathbb{S}^{n-1}$ . They proved that in the bistable case almost planar transition fronts in  $\mathbb{R}^n$  are classical travelling waves.

Let us notice that  $\Omega_t^\pm$  are not uniquely defined and it does not make sense to define an instantaneous spreading speed with respect to  $\Gamma_t$ . The notion of global mean speed in [11] replace the notion of spreading speed in this setting.

This does not mean that transition fronts always have a global mean speed. Indeed in the KPP case one can build transition fronts in  $\mathbb{R}$  that have a past speed  $c_1$  (i.e when  $t \rightarrow -\infty$ ) and a future speed  $c_2 \neq c_1$  (i.e when  $t \rightarrow +\infty$ ) and these fronts can not have a global mean speed. For more details on the construction of these solutions, one can look at [11, section 5]. Another example of transition fronts that is not included in the classical definitions of front-like solutions is an invasion front, whose direction of propagation changes with times ([11, section 6]).

### Existence results for transition fronts

Several articles study the existence of transition fronts in non homogeneous settings. Shen [106, 107], Nadin and Rossi [92] and Berestycki and Hamel [12] prove the existence of transition fronts (almost planar) when  $f$  is heterogeneous with respect to time in the bistable, monostable and KPP case. Vakulenko and Volpert [117] also proved the existence of another type of generalised transition fronts for perturbed bistable reaction diffusion systems. Mellet, Roquejoffre and Sire [86], Nolen and Ryzhik [97], Mellet et al [85] and Zlatoš [126] study the existence and the stability of transition fronts for combustion type heterogeneities. In all these papers it has been proved that for combustion like equations in dimension 1, transition fronts always exist, are unique and stable. Nolen et al [96] and Zlatoš [125] build a multitude of transition fronts for non homogeneous KPP equations using the linearisation around 0. In a recent paper Tuo, Zhu and Zlatoš [112] use this same approach to built transition fronts of monostable type equations. Thus there exist several heterogeneous frameworks where the existence of transitions fronts is proved, nevertheless this existence is questioned by Nolen et al [96], for some class of monostable type reaction diffusion equations in dimension 1. Indeed they show that when the nonlinearity  $f$  has a strongly localised heterogeneity then there exist some situations where transition fronts do not exist. This last result show that the existence of transition fronts in heterogeneous settings is not guarantee for monostable equation in dimension 1. Moreover Lewis and Keener [73] highlight the existence of blocking phenomena for reaction diffusion equations in dimension 1 in media with heterogeneous excitability. The same kind of phenomena is observed by Grindrod and Lewis [52] in dimension 2 in domains with varying diameters, studying an eikonal approximation as the limit of a propagation model. Lou, Matano and Nakamura [79, 74] study the existence of front-like solutions through the notion of recurrent waves, for curvature dependent motions of plane curves and prove that the speed of propagation is slowed down in the presence of undulations. All these papers thus indicates that in a heterogeneous framework, a multitude of phenomena can be observed (non existence of transition fronts, slowing down or failure of the propagation...). Chapters 1 and 3 of this thesis come up in this context. We study the existence of transition fronts for heterogeneous bistable reaction diffusion equations where the problem is set in a domain  $\Omega \subsetneq \mathbb{R}^n$ .

### Non local equations

In all that precedes we assumed that the population disperses locally and thus diffuses in a close neighbourhood. This diffusion phenomenon is modelled by the second order operator  $-\Delta$ . Nevertheless in 1899, Reid [100] notice that some species of trees in Europe have a recolonisation speed that is too fast to be explained by a classical reaction diffusion model. There would be two possible explanations to this phenomenon, the existence of longue range dispersal or the existence of cryptic refuge which accelerates the recolonisation [103].

Some models of integro-difference equations with heavy tail have been introduced by Kot et al [70], Clark [31], Clark et al [32], amongst others, in order to model this long range dispersal

phenomenon. These models have the following form :

$$u_{n+1}(x) = \int_{\mathbb{R}} k(x, y) f[u_n(y)] dy, \quad n \in \mathbb{N}, x \in \mathbb{R}$$

where  $u_n$  is the density of the population at generation  $n$ ,  $f$  represents the growth function and  $k$  the dispersal kernel. These integro-difference models are said to be heavy tail when  $k$  is not exponentially bounded. There also exists a continuous version of these models, the integro-differential equations :

$$\partial_t u(t, x) = \int_{\mathbb{R}} k(x, y) u(t, y) dy - u(t, x) + f(u(t, x)), \quad t > 0, x \in \mathbb{R}.$$

We assume that in all these models the dispersal kernel depends only on the relative distance between two points, i.e  $k(x, y) = k(|x - y|)$  for all  $x, y \in \mathbb{R}$ . These integro-difference or integro-differential equations take into account a non local dispersal of the population, with  $k$  the dispersal kernel. We distinguish two types of kernel  $k$

- The exponentially bounded kernels where  $k$  decreases faster than an exponential in the sense that there exists  $\eta > 0$  such that

$$\int_{\mathbb{R}} k(x) e^{\eta|x|} dx < \infty.$$

- The heavy tail kernels where  $k$  decreases slowly in the sense that for all  $\eta > 0$ , there exists  $x_n \in \mathbb{R}$  such that for all  $x \geq x_n$ ,

$$k(x) \geq e^{-\eta x}.$$

Several papers [2, 36, 113, 120, 24, 33] prove that existence results regarding travelling waves solutions and their asymptotic spreading speed stay true for integro-differential equations with exponentially bounded kernels. On the other hand these existence results do not hold anymore in the case of integro-differential equations with heavy tail kernels, [84, 121, 44] for example. During my PhD I have been focused on reaction diffusion equations modelling local dispersal phenomena, but it would be interesting to understand if some of my results could be extended in the case of non local dispersal, as for example the existence of travelling waves in reaction diffusion equations with forced speed in chapter 2.

## 5 Contribution of the thesis

The motivation of this thesis is to identify and to understand some biological invasion phenomena in various heterogeneous media. In a first project [19] (Chapter 1), I investigate a problem in population dynamics studying a bistable reaction diffusion equation in perturbed exterior domains. This problem is tied with the question of the invasion of a population subjected to a strong Allee effect, facing an obstacle. My second project in collaboration with Nadin [20] (Chapter 2) aims at understanding the persistence of a population facing unfavourable climate change. We study a scalar reaction diffusion equation with forced speed, i.e the reaction term  $f$  depends on the density of the population  $u$  and on  $x - ct$  the movement of the favourable area. In a third project in collaboration with Berestycki and Chapuisat [6] (Chapter 3), we investigate the invasion of a depolarisation wave in the human brain, considering a bistable reaction diffusion equation set in straight cylinders with varying cross section. In my last chapter,

I present numerical results for the solution of a bistable reaction diffusion equation in dimension 2 in cylindrical domains considering various boundary conditions. The first part confirms the analytical results I proved in Chapter 3 and give more precise informations on the behaviour of the solution. In a second part I study invasion properties in curved cylinders with various boundary conditions. All these results give a better understanding of the mechanisms responsible for the invasion or the extinction of biological species, whose evolution is modelled by a reaction diffusion equation.

### 5.1 Liouville type theorem in exterior domains - application to population dynamics

In this project we consider a bistable reaction diffusion equation, where  $\int_0^1 f(s)ds > 0$ , set in  $\Omega = \mathbb{R}^n \setminus K$ , where  $K$  is a compact subdomain of  $\mathbb{R}^n$ . We are interested in the properties of propagation of our solution  $u$ , the density of population, depending on the shape of  $K$ . This problem appears in the modelling of the evolution of the density of a population subjected to a strong Allee effect, facing an obstacle.

In the absence of obstacle (that is when the equation is set in  $\mathbb{R}^n$ ) Aronson and Weinberger [3] proved that for a sufficiently large initial data the population invades the entire domain (stability of the bistable travelling wave in  $\mathbb{R}^n$ ). Berestycki, Hamel and Matano [14] investigated these invasion properties in exterior domains  $\Omega = \mathbb{R}^n \setminus K$ , that is in the presence of obstacles. They consider the following problem

$$\begin{cases} \partial_t u(t, x) - \Delta u(t, x) = f(u(t, x)), & \text{for all } t \in \mathbb{R}, x \in \Omega, \\ \partial_\nu u(t, x) = 0, & \text{for all } t \in \mathbb{R}, x \in \partial\Omega = \partial K, \end{cases}$$

where  $\nu$  represents the outward unit normal on  $\partial\Omega$ ,  $K$  is a non empty, compact subdomain of  $\mathbb{R}^n$ ,  $f$  is a bistable function such that  $\int_0^1 f(s)ds > 0$ . They prove that when  $K$  is star-shaped or directionally convex, the population invades the entire domain, whereas there exists other kind of obstacles  $K$  for which the population is blocked outside some area of the domain. We will briefly recall what we mean by star-shaped and directionally convex domains below (one can look at chapter 1 section 1.1.3 or to [19, 14] for some illustrations). They prove that as soon as  $K$  is compact there exists a transition fronts (as defined in 4.3) between  $\phi$  the bistable planar travelling wave and an asymptotic density function  $u_\infty$  (when there is a complete invasion of the population  $u_\infty \equiv 1$ ).

More recently, some results on the propagation in exterior domains have been obtained in a discrete setting. In [62] Hoffman, Hupkes and VanVleck study the existence of transition fronts for lattice differential equations in  $\Lambda \subset \mathbb{Z}^2$ , which correspond to the discrete equivalent of reaction diffusion equations in exterior domains with Neumann boundary conditions. In their paper they get similar results as the ones in [14] and prove that when the obstacle is connexe and directionally convex (in a discrete meaning) then the entire solution of their problem behaves like a travelling wave asymptotically in time (i.e as  $t \rightarrow \pm\infty$  for all  $(x, y) \in \Lambda$ ) and in space (i.e as  $|x| + |y| \rightarrow +\infty$ , for all  $t \in \mathbb{R}$ ).



### Our perturbation results

In the continuity of the work of Berestycki, Hamel and Matano [14], I investigate the following problem

$$\begin{cases} \partial_t u(t, x) - \Delta u(t, x) = f(u(t, x)), & \text{for all } t \in \mathbb{R}, x \in \Omega_\varepsilon, \\ \partial_\nu u(t, x) = 0, & \text{for all } t \in \mathbb{R}, x \in \partial\Omega_\varepsilon = \partial K_\varepsilon, \end{cases} \quad (23)$$

where  $\Omega_\varepsilon = \mathbb{R}^n \setminus K_\varepsilon$  and  $(K_\varepsilon)_{\varepsilon>0}$  is a family of compact subdomains of  $\mathbb{R}^n$  which converges to a subdomain  $K$  star-shaped or directionally convex. The assumptions on  $f$  are the same than above.

**Definition 6** (Star-shaped domain).  *$K$  is star-shaped, if  $K = \emptyset$ , or there exists  $x \in \overset{\circ}{K}$  such that, for all  $y \in \partial K$  and  $t \in [0, 1)$ , the point  $x + t(y - x)$  belongs to  $\overset{\circ}{K}$  and  $\nu_K(y) \cdot (y - x) \geq 0$ , where  $\nu_K(y)$  is the outward unit normal to  $K$  at the point  $y$ .*

**Definition 7** (Directionally convex domain).  *$K$  is directionally convex with respect to some hyperplan  $P$ , if there exists an hyperplan  $P = \{x \in \mathbb{R}^n, x \cdot e = a\}$  where  $e$  is a unit vector of  $\mathbb{R}^n$  and  $a$  a real number, such that*

- for every line  $\Sigma$  parallel to  $e$  the set  $K \cap \Sigma$  is either a segment or the empty set,
- $K \cap P = \pi(K)$  where  $\pi(K)$  is the orthogonal projection of  $K$  on  $P$ .

The first step is to generalised the result of Berestycki, Hamel and Matano to exterior domains that are regular perturbations of star-shaped or directionally convex domains proving this Liouville type theorem :

**Theorem 8.** *Let  $(K_\varepsilon)_{0<\varepsilon\leq 1}$  be a family of  $C^{2,\alpha}$  (for some  $\alpha > 0$ ) compact subdomains of  $\mathbb{R}^n$ . Assume that  $K_\varepsilon$  converges to  $K$  in the  $C^{2,\alpha}$  topology when  $\varepsilon$  goes to 0, with  $K$  star-shaped or directionally convex. Then there exists  $\varepsilon_0 > 0$  such that for all  $0 < \varepsilon < \varepsilon_0$ , the following elliptic problem*

$$\begin{cases} -\Delta u = f(u) & \text{in } \mathbb{R}^n \setminus K_\varepsilon, \\ \partial_\nu u = 0 & \text{on } \partial K_\varepsilon, \\ 0 < u \leq 1 & \text{in } \mathbb{R}^n \setminus K_\varepsilon, \\ u(x) \rightarrow 1 \text{ when } |x| \rightarrow +\infty & \text{uniformly with respect to } x \in \mathbb{R}^n \setminus K_\varepsilon, \end{cases} \quad (24)$$

has a unique solution,  $u_\varepsilon \equiv 1$ .

The proof of this result relies on the convergence of  $u$  to 1 as  $|x| \rightarrow +\infty$  uniformly with respect to  $\varepsilon > 0$ .

Then I investigate the existence of a family of perturbations  $(K_\varepsilon)$  (still converging to an obstacle  $K$  star-shaped or directionally convex) which will block the invasion of 1 in some part of the domain  $\Omega$ , that is where the previous Liouville type theorem will not hold. It is thus impossible that the convergence of the obstacle takes place in the  $C^{2,\alpha}$  topology. I build an example of perturbations  $(K_\varepsilon)_{\varepsilon>0}$  which converge for the  $C^0$  topology to a ball, such that the invasion of 1 is blocked in some area of  $\Omega_\varepsilon$  for all  $\varepsilon > 0$ . More precisely

**Theorem 9.** *There exists  $(K_\varepsilon)_\varepsilon$  a family of compact subdomains of  $\mathbb{R}^n$  such that  $K_\varepsilon \rightarrow B_{R_0}$  for the  $C^0$  topology when  $\varepsilon \rightarrow 0$ , and for all  $\varepsilon > 0$  there exists a solution  $u_\varepsilon$  of (24) such that  $0 < u_\varepsilon < 1$  in  $\mathbb{R}^n \setminus K_\varepsilon$ .*

We use the geometry of our perturbation (see Figure 15) to construct, with a variational approach, a super solution of our problem that is close to 0 in some area of  $\Omega_\varepsilon$  for all  $\varepsilon > 0$ , which blocks the invasion of 1 in these parts of  $\Omega_\varepsilon$ .

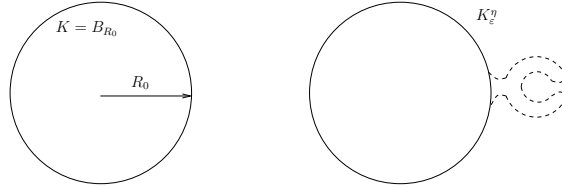

FIGURE 15 – Example of perturbations  $K_\varepsilon$  which have the particularity to create thin channels in  $\Omega_\varepsilon = \mathbb{R}^n \setminus K_\varepsilon$ , and which converge to a ball  $K$ , but such that 1 does not invades the entire domain.

We can thus wonder what is the optimal convergence regularity to keep a Liouville type result as Theorem 8?

We proved that the convergence for the  $C^{2,\alpha}$  topology was enough but that the convergence for the  $C^0$  topology allows the construction of counter examples. We conclude this chapter applying Theorem 8 to the associated parabolic problem (23). We obtain the following corollary from [14]

**Corollary 10.** *We assume that  $f$  is bistable and that there exists a bistable travelling wave  $(\phi, c)$  with  $c > 0$ . Let  $(K_\varepsilon)_{0 < \varepsilon \leq 1}$  be a family of  $C^{2,\alpha}$  compact subdomains of  $\mathbb{R}^n$ . We assume that  $K_\varepsilon$  converges to  $K$  for the  $C^{2,\alpha}$  topology with  $K \subset \mathbb{R}^n$  a star-shaped or directionally convex domain. Then for all  $0 < \varepsilon \leq 1$ , there exists an entire solution  $u_\varepsilon$  of the parabolic problem (23) such that*

$$0 < u_\varepsilon < 1 \text{ and } \partial_t u_\varepsilon > 0 \text{ in } \mathbb{R} \times \overline{\Omega_\varepsilon}.$$

Moreover there exists  $\varepsilon_0 > 0$  such that for all  $0 < \varepsilon < \varepsilon_0$ ,

$$u_\varepsilon(t, x) - \phi(x_1 + ct) \rightarrow 0$$

when  $t \rightarrow \pm\infty$  uniformly with respect to  $x \in \overline{\Omega_\varepsilon}$ , and when  $|x| \rightarrow +\infty$  uniformly with respect to  $t \in \mathbb{R}$ .

This corollary prove the existence and uniqueness of an almost planar invasion front between 0 and 1 with global mean speed  $c$ .

## 5.2 Reaction diffusion equations with forced speed - application to population dynamics

Since the pioneering works of Fisher [41] and Kolmogorov-Petrovskii-Piskunov [69] in 1937 reaction diffusion equations are largely used in population dynamics in order to model the invasion of a population in a given medium. For several years we have been interested in the effect of global warming on populations sensitive to temperature. To model the phenomenon we consider  $u$  a density function that satisfies some reaction diffusion equation with a nonlinear term  $f$  that depends also on  $z := x - ct$ , with  $x \in \mathbb{R}$  the space variable (the Equator being at  $x = -\infty$  and the North Pole at  $x = +\infty$ ),  $t > 0$  the time variable,  $c > 0$  the speed of the climate change travelling from the Equator toward the North Pole. Berestycki et al [9] in 2008 investigated the

questions of persistence of a population facing climate change in dimension 1 ( $x \in \mathbb{R}$ ) when  $f$  satisfies the KPP property. Then Berestycki and Rossi [17, 18] carried on this study in dimension  $n \in \mathbb{N}$ . In these three papers the persistence of the population depends on the sign of the principal eigenvalue of the linearised operator around the trivial steady state 0. More recently Vo [118] investigated the question of persistence in the presence of climate change for reaction functions  $f$  of KPP type that satisfy more general assumptions in the unfavourable area. Popatov and Lewis [99] as well as Berestycki, Diekmann and Desvillettes [8] study these same questions but for a KPP reaction diffusion system in order to take into account the competitive or cooperative effects between different species. Lastly Zhou and Kot [123] get the same conclusions than Berestycki et al regarding the persistence of a population facing climate change for KPP integro-difference equations which take into account a non local dispersal of the population.

In chapter 2 ([20]), we investigate this same question on the persistence of the population facing climate change, in the case of local dispersal, but considering more general nonlinearities  $f$ . In this framework we can not use the linearisation methods of Berestycki et al which are specific to the KPP case where the behaviour of the linearised operator around 0 determines the general behaviour of the solution  $u$ .

### Our results for general reaction diffusion equations with forced speed in dimension 1

In chapter 2 we investigate the following reaction diffusion problem

$$\begin{cases} \partial_t u(t, x) - \partial_{xx} u(t, x) = f(x - ct, u(t, x)), & \text{for all } t \in \mathbb{R}^+, x \in \mathbb{R}, \\ u(0, x) = u_0(x), & \text{for all } x \in \mathbb{R}, \text{ bounded, compactly supported,} \end{cases} \quad (25)$$

where  $f$  is a Carathéodory function such that there exist  $\delta > 0$ ,  $R > 0$  and  $M > 0$  with

$$\begin{aligned} f(\cdot, 0) &\equiv 0, \\ s \mapsto f(z, s) &\text{ is Lipschitz-continuous, uniformly with respect to } z \in \mathbb{R}, \\ f(\cdot, u) &< -\delta u \text{ in } \mathbb{R} \setminus (-R, R), \text{ for all } u \in (0, M), \\ f(\cdot, u) &\leq 0 \text{ in } \mathbb{R} \text{ for all } u > M. \end{aligned}$$

In this framework we start by investigating the existence of travelling wave solutions, that is solutions of the form

$$u(t, x) := U(x - ct) > 0, \quad \text{for all } x \in \mathbb{R}, t > 0,$$

with

$$U(\pm\infty) = 0.$$

We prove the following theorem

**Theorem 11.** *We assume that there exists  $u \in H^1(\mathbb{R})$  such that*

$$E_0[u] := \int_{\mathbb{R}} \left( \frac{u_z^2}{2} - F(z, u) \right) dz < 0, \quad \text{with } F(z, s) := \int_0^s f(z, t) dt,$$

*then there exist  $\bar{c} \geq \underline{c} > 0$ , such that*

- For all  $c \in (0, \underline{c})$ , problem (25) has a travelling wave solution  $U_c \in H_c^1(\mathbb{R})$  with  $E_c[U_c] < 0$ , and  $H_c^1(\mathbb{R}) := H^1(\mathbb{R}, e^{cz} dz)$ ,
- For all  $c > \bar{c}$ , problem (25) does not have travelling wave solution, in other words 0 is the unique solution of the following problem

$$\begin{cases} -U''(z) - cU'(z) = f(z, U(z)), & z \in \mathbb{R}, \\ U(z) \geq 0, & z \in \mathbb{R}, \\ U(\pm\infty) = 0. \end{cases} \quad (26)$$

This result indicates that for a sufficiently slow climate change, the population is able to keep track with its favourable environment and thus persists whereas when the climate change is too fast the population can not follow its favourable environment and goes extinct.

The proof of this Theorem 11 is based on a variational approach for the existence of travelling wave solutions, introduced by Heinze [60] and used more recently by Lucia, Muratov and Novaga [75] to prove the existence of travelling waves in homogeneous gradient-like reaction diffusion systems in straight cylinders. The idea is to introduce the right weighted space and to solve a variational problem in this weighted space. We used this same ideas in the case of a scalar reaction diffusion equation with a nonlinearity depending also on  $z = x - ct$  using our assumption that the environment is unfavourable outside some bounded interval, which moves with times, to handle problems of compactness at infinity.

Then we investigate the convergence in time of the solution of the initial valued problem in the moving frame and we prove the following theorem

**Theorem 12.** *Assume that  $u_0 \in H^2(\mathbb{R})$  and  $u_0$  bounded, compactly supported. Then the unique solution  $u$  of (25) satisfies  $u \in L^2([0, T[, H_c^1(\mathbb{R}))$ ,  $u_t \in L^2([0, T[, L_c^2(\mathbb{R}))$ , for all  $T > 0$ , and  $t \mapsto u(t, \cdot - ct)$  converges toward a solution of (26) when  $t \rightarrow +\infty$ .*

We prove this convergence result using variational arguments inspired from Zelenyak's paper [122] where he proves that solutions of second order parabolic problems in a bounded domain with a variational formulation, converges as time goes to infinity. We had to control the behaviour of our solution toward infinity in order to deal with the lack of compactness coming from the fact that our problem is set on  $\mathbb{R}$ . Notice that Matano [76] proves the convergence of solutions of a semi linear parabolic problem in bounded domains in  $\mathbb{R}$  using geometric arguments and maximum principle, and Du and Matano [38] extend this convergence result to unbounded domains for an homogeneous non linearity  $f$ . There methods rest on the classification of the stationary solutions and use a reflexion principle that can not be used in our framework.

We also discuss on the question of persistence of the population when the trivial steady state 0 becomes stable and we highlight the fact that in this general framework (without assuming the KPP property), the sign of the principal eigenvalue of the operator linearised at 0 does not determine whether the population survives or goes extinct in contrast with the results in the KPP setting. Let  $\lambda_0$  be the principal eigenvalue of the linear operator  $\mathcal{L}_0$ , with  $\mathcal{L}_0 u := -u'' - f_s(z, 0)u$ , we distinguish two cases, when the steady state 0 is linearly unstable, i.e  $\lambda_0 < 0$  and  $c < 2\sqrt{-\lambda_0}$ , and when 0 est linearly stable i.e  $\lambda_0 > 0$  or  $c > 2\sqrt{-\lambda_0}$ ,  $\lambda_0 < 0$ . We have the following results

- If 0 is assumed to be linearly unstable

**Proposition 13.** *If  $\lambda_0 < 0$  and  $c < 2\sqrt{-\lambda_0}$ , let  $u$  be the solution of our parabolic problem (25), then  $u(t, \cdot - ct)$  converges toward a travelling wave solution, i.e a non trivial solution of the stationary problem (26), when  $t$  goes to  $+\infty$ .*

To prove this result we start by proving that there exists a non trivial solution of (26) and we use Theorem 12 with a comparison principle to conclude regarding the convergence of the solution in the moving frame.

- If 0 is assumed to be linearly stable, we prove that in some cases, there exists non trivial solutions of (26), in contrast with the KPP framework.

**Proposition 14.** *We assume that  $\lambda_0 + \frac{c^2}{4} > 0$ . If*

$$\min_{u \in H_c^1(\mathbb{R})} E_c[u] := \int_{\mathbb{R}} e^{cz} \left\{ \frac{u_z^2}{2} - F(s, u) \right\} dx < 0,$$

*then there exist at least two travelling wave solutions, i.e non trivial solution of (26) and one of them has a positive energy.*

This result is proved using the mountain pass theorem, checking that the Palai-Smale condition is satisfied.

We deduce the following corollary

**Corollary 15.** *For  $c > 0$  small, let*

$$f(z, u) = \begin{cases} f_0(u) & \text{if } |z| < R, \\ -\delta u & \text{otherwise,} \end{cases}$$

*where  $R, \delta > 0$ ,  $f_0$  a bistable function, Then for  $R$  large enough, there exists  $\tilde{u} \in H_c^1(\mathbb{R})$  solution of (26) such that  $E_c[\tilde{u}] > 0$ .*

This corollary proves the existence of travelling wave solutions with positive energy but also gives an example of a general framework where there exist travelling wave solutions with negative energy and thus stable asymptotic solution to our parabolic problem when 0 is linearly stable.

Finally we investigate, from a numerical point of view, for given nonlinearities  $f$ , the existence of a critical speed  $c^* > 0$  such that  $\underline{c} = \bar{c} = c^*$  in Theorem 11, in other words when  $c < c^*$  the population persists (for an initial data  $u_0$  large enough) whereas for  $c > c^*$  the population dies (for all initial data  $u_0$ ). We also give some numerical illustrations of the different profiles  $U$  for different values of  $c$  and  $f$ .

### 5.3 Propagation in cylinders with varying cross section - Application to medical sciences

In this project we are interested in the modelling of depolarisation waves and their propagation in the brain. Indeed the membrane of a neurone needs to be polarised to be able to deliver nerve messages. In 1944, Leão [71] observes for the first time, the existence of large and transient depolarisation waves in the brain, which propagate slowly (3mm/min) and are followed several minutes later by a repolarisation process. These waves are called **Cortical Spreading**

**Depressions (CSD)** and block the propagation of nerve signals in the brain which provokes several symptoms (opacification of the retina for the chicken for example). These waves are easily observable in rodent and it has been proved that each CSD increases the neurological damages by 30% during strokes [87]. Therapies aiming at blocking these waves have promising results in rodent [35, 93] but are inefficient in humans. Moreover these waves have not been observed in human because the observability measures are too invasive for the human brain and require the patient to undergo through a head surgery. Their existence in human is still a matter of debate today. Nevertheless aura, responsible for hallucinations during migraine with aura, has the same propagation characteristics in the brain than CSDs. It is thus really important in neurosurgery to obtain informations on the existence of these waves in the human brain and mathematical modelling becomes useful in these circumstances.

These CSDs are modelled by a bistable travelling wave which propagates, according to a given profile, slowly in the grey matter of the brain [109, 27, 37, 51, 114]. The polarised state (or the rest state) is represented by the steady state 0 whereas the completely depolarised state is represented by the steady state 1. The variation of the grey matter thickness in the human brain could block the propagation of these waves and be an explanation of the inefficiency of therapies aiming at blocking the CSDs in the human brain. This hypothesis has been studied numerically in [27, 37, 51] and analytically in [29], where Chapuisat and Grenier study blocking phenomena in infinite cylinders with rectangular cross section in dimension 2 and 3. The motivation behind our work is to extend Chapuisat and Grenier's results to cylindrical domains with more general cross section. Let us remind that these blocking or slowing down phenomena caused by a variations in the width of the domain in dimension 2 had already been introduced by Grindrod and Lewis [52] to model ventricular fibrillations and by Lou, Matano et Nakamura [79, 74] in undulating cylinders for curvature dependant motions of plane curves.

### Propagation and blocking results in cylinders with varying cross section

In Chapter 3 we study the following problem

$$\begin{cases} \partial_t u(t, x) - \Delta u(t, x) = f(u(t, x)), & t \in \mathbb{R}, \quad x \in \Omega, \\ \partial_\nu u(t, x) = 0, & t \in \mathbb{R}, \quad x \in \partial\Omega, \end{cases} \quad (27)$$

where  $\Omega := \{(x_1, x') \in \mathbb{R} \times \mathbb{R}^{n-1}, x' \in \omega(x_1)\}$  is an infinite cylinder in the  $x_1$ - direction with varying cross section such that

$$\Omega \text{ is a uniformly } C^{2,\alpha} \text{ domain of } \mathbb{R}^n, \quad (28)$$

$$\Omega \cap \{x \in \mathbb{R}^n, x_1 < 0\} = \mathbb{R}^- \times \omega, \quad \omega \subset \mathbb{R}^{n-1}. \quad (29)$$

The last assumption means that the change in the geometry of the domain takes place in the half space  $\{x = (x_1, x') \in \mathbb{R} \times \mathbb{R}^{n-1}, x_1 > 0\}$ .

We also assume that  $f \in C^{1,1}([0, 1])$  is a bistable function such that

$$\int_0^1 f(s) ds > 0. \quad (30)$$

We investigate the effect of the geometry on the solution of problem (27). We wonder about the existence of waves coming from the left (i.e when  $x_1 \rightarrow -\infty$ ) and about the existence of propagation or on the contrary of blocking phenomena.

We start by proving that the problem is well defined, studying the existence and uniqueness of the solution of problem (27). We prove the following theorem

**Theorem 16.** *Let  $\Omega \subset \mathbb{R}^n$  satisfies (28) and (29) and  $f \in C^{1,1}([0, 1])$  be a bistable function satisfying (30), let  $(\phi, c)$  be the unique planar travelling wave associated to  $f$  such that  $\phi(0) = \theta$ , with  $c > 0$ , then there exists a unique entire solution of problem (27) such that*

$$u(t, x) - \phi(x_1 - ct) \rightarrow 0 \text{ when } t \rightarrow -\infty \text{ uniformly with respect to } \bar{\Omega}. \quad (31)$$

Moreover  $u$  satisfies  $u_t(t, x) > 0$ ,  $0 < u(t, x) < 1$  for all  $(t, x) \in \mathbb{R} \times \bar{\Omega}$ .

The proof of this existence and uniqueness theorem rests on arguments from [14, section 2.3-2.4], whose principal idea is to build a sub and super solutions  $w^-$ ,  $w^+$  of problem (27) for negative times,  $t < T < 0$  with  $T < 0$  well chosen, which have the good asymptotics properties as  $t \rightarrow -\infty$  (i.e  $w^\pm(t, x) - \phi(x_1 - ct) \rightarrow 0$  uniformly with respect to  $x \in \Omega$  when  $t \rightarrow -\infty$ ). We then build the entire solution from the associated initial valued problem for  $t \in (-n, +\infty)$  taking  $w^-(-n, \cdot)$  as the initial condition and we let  $n$  going to  $+\infty$ . The uniqueness is proved using the parabolic comparison principle for well chosen sub and super solutions.

As  $u$  is increasing and uniformly bounded with respect to  $t$ , using parabolic estimates, we get that  $u(t, x) \rightarrow u_\infty(x)$  locally uniformly for  $x \in \Omega$  as  $t \rightarrow +\infty$  and this theorem proves that there exists a transition front for problem (11) connecting 0 and  $u_\infty$  (taking  $\Omega_t^\pm := \{x \in \Omega, u(t, x) > (<) \theta\}$  for example). Thus there exists a wave coming from the left (propagating from left to right). We now investigate the different properties of  $u_\infty$  depending on the geometric assumptions satisfied by  $\Omega$ .

We start with the case of a narrowing cylinder in the sense that the diameter of  $\Omega$  decreases with respect to the direction of propagation  $x_1$  (see Figure 16).

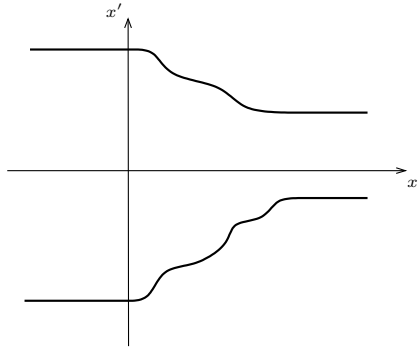

FIGURE 16 – Example in dimension 2 of a domain with a decreasing diameter with respect to the direction of propagation  $x_1$ .

We have the following theorem

**Theorem 17.** *We assume that for all  $x \in \partial\Omega$ ,  $\nu_1(x) \geq 0$ , where  $\nu_1(x)$  is the first component of the outward unit normal at  $x$ . In this framework, under the same assumptions on  $\Omega$ ,  $f$  and  $(\phi, c)$  than in Theorem 16, the solution  $u$  of problem (27), satisfying (31), propagates to 1 in  $\Omega$ , i.e  $u \rightarrow u_\infty$  when  $t \rightarrow +\infty$  and  $u_\infty \equiv 1$  in  $\Omega$ . Moreover if we assume that*

$$\Omega \cap \{x \in \mathbb{R}^n, x_1 > l\} = (l, +\infty) \times \omega_r,$$

Then  $c$  is the asymptotic spreading speed, i.e

$$\text{For all } \hat{c} > c, \lim_{t \rightarrow +\infty} \sup_{x_1 > \hat{c}t} u(t, x) = 0,$$

$$\text{For all } \hat{c} < c, \lim_{t \rightarrow +\infty} \inf_{x_1 < \hat{c}t} u(t, x) = 1.$$

To prove this theorem we use a comparison principle with the planar travelling wave  $\phi$  which is a sub solution of the problem.

This result asserts that in the case of a narrowing cylinder there exists an invasion front connecting 0 and 1 and from a modelling point of view the depolarisation wave invades the entire domain.

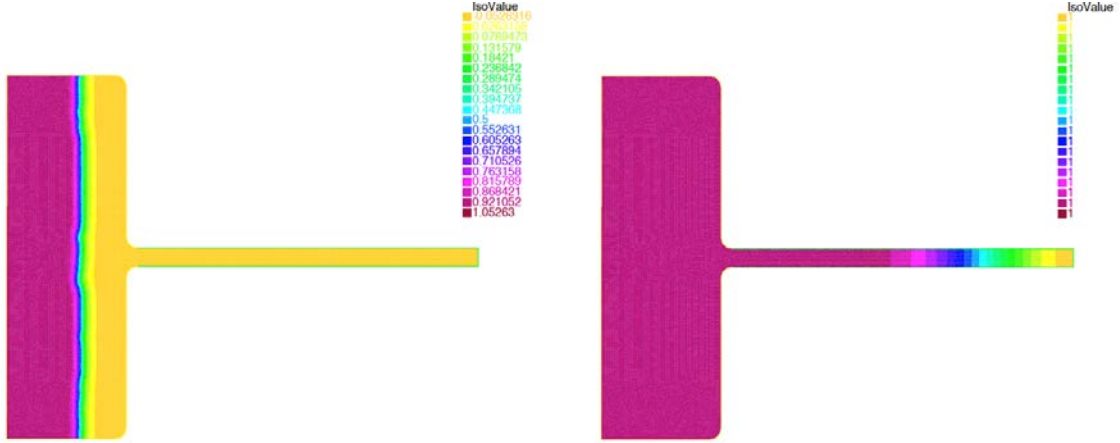

FIGURE 17 – In the case of a narrowing cylinder, the wave propagates in the entire domain. From left to right : value of the solution  $u$  for increasing values of  $t$ . In yellow areas the solution is close to 0 and in purple areas the solution is close to 1

Then we investigate the case of widening cylinders (see Figure 18) and we distinguish two different behaviours depending on the values of the diameter of the left cylinder (where the wave comes from).

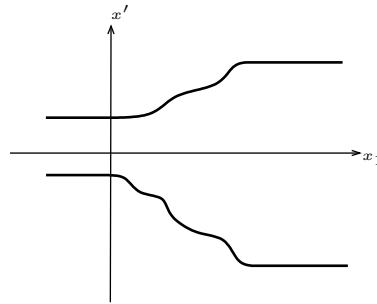

FIGURE 18 – Example of a widening cylinder in dimension 2, i.e when the diameter is increasing with respect to the direction of propagation.

We start by proving that there exist blocking phenomena.

**Theorem 18.** *Let  $\varepsilon > 0$  be the diameter of the left cylinder  $\omega$  and assume that  $\Omega \cap \{x \in \mathbb{R}^n, x_1 > 1\}$  does not depend on  $\varepsilon$ . Then under the same assumptions than in Theorem 16, there exists  $\varepsilon_0 > 0$  such that for all  $\varepsilon < \varepsilon_0$ , the unique solution  $u$  of (27), satisfying (31), is blocked in the big cylinder, i.e  $u \rightarrow u_\infty$  when  $t \rightarrow +\infty$  and  $u_\infty(x) \rightarrow 0$  when  $x_1 \rightarrow +\infty$ .*



To prove this result, we build, using a variational approach, a super solution of our problem in a bounded subdomain of  $\Omega$  (subdomain that is centred around the change of geometry). This super solution is close to 0 close to right boundary of the subdomain and is equal to 0 on the right boundary. We then take the limit as the right boundary goes to infinity to obtain a super solution on the right part of  $\Omega$  that converges to 0 as  $x_1 \rightarrow +\infty$  and we extend this super solution to 1 on the left part of  $\Omega$ . At the end we obtain a super solution that is equal to 1 before the change of geometry and that converges to 0 as  $x_1 \rightarrow +\infty$ . We use a comparison principle as in the proof of Theorem 17 to conclude that the solution of problem (27) goes to 0 as  $x_1 \rightarrow +\infty$ .

This theorem proves that when the left cylinder is narrow enough (independently of the width of the right cylinder), the wave is blocked, which means, from a medical point of view, that the depolarisation wave is blocked when it comes from an area where the thickness of the grey matter is small.

Then we prove that when the left cylinder is large enough, the solution propagates to 1 in the entire domain

**Theorem 19.** *Under the same assumptions than in Theorem 16, assuming also that  $\Omega$  satisfies the following geometric properties :*

*There exists  $R > 0$ ,*

$$\mathbb{R} \times B'_R = \{(x_1, x') \in \mathbb{R} \times \mathbb{R}^{n-1}, |x'| < R\} \subset \Omega,$$

*there exists  $L > 0$  such that,*

$$\Omega \cap \{(x_1, x') \in \mathbb{R} \times \mathbb{R}^{n-1}, x_1 > L\} \text{ is convex,}$$

*for all  $x \in \partial\Omega \cap \{(x_1, x') \in \mathbb{R} \times \mathbb{R}^{n-1}, x_1 < L + R\}$ ,*

$$\nu_1(x) \leq 0.$$

*then there exists  $R_0 > 0$  such that for all  $R > R_0$ , the solution  $u$  of (27), satisfying (31), propagates to 1 in  $\Omega$ , i.e  $u \rightarrow u_\infty$  when  $t \rightarrow +\infty$  and  $u_\infty \equiv 1$  in  $\Omega$ .*

To prove this result we introduce the maximal solution of the following Dirichlet problem

$$\begin{cases} -\Delta u = f(u) & \text{in } B_R = \{x \in \mathbb{R}^n, |x| < R\}, \\ u = 0 & \text{on } \partial B_R, \end{cases}$$

and we use it as a sub solution of our problem in a translated ball. We then use a sliding method to prove that there exists  $\delta > 0$  such that

$$u_\infty(x) > 1 - \delta, \quad \forall x \in \Omega \cap \{(x_1, x') \in \mathbb{R} \times \mathbb{R}^{n-1}, x_1 \geq L + R\} = \Omega_{L,R}.$$

We conclude using a comparison principle with the planar travelling wave connecting 0 to  $1 - \delta$  moving from right to left.

Thus we prove that there exists an invasion front connecting 0 to 1 when the diameter of the cylinder is increasing with respect to the direction of propagation and when the left cylinder is large enough.

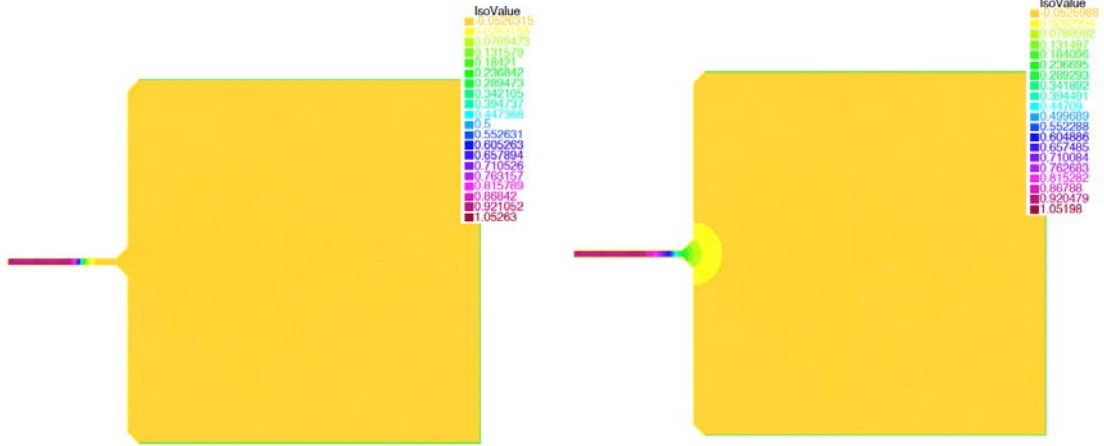

FIGURE 19 – In the case of a widening cylinder, the wave is blocked at the exit of the small cylinder, when the left cylinder is too thin. From left to right : values of the solution  $u$  for increasing values of  $t$ . In yellow areas the solution is close to 0 and in purple areas the solution is close to 1

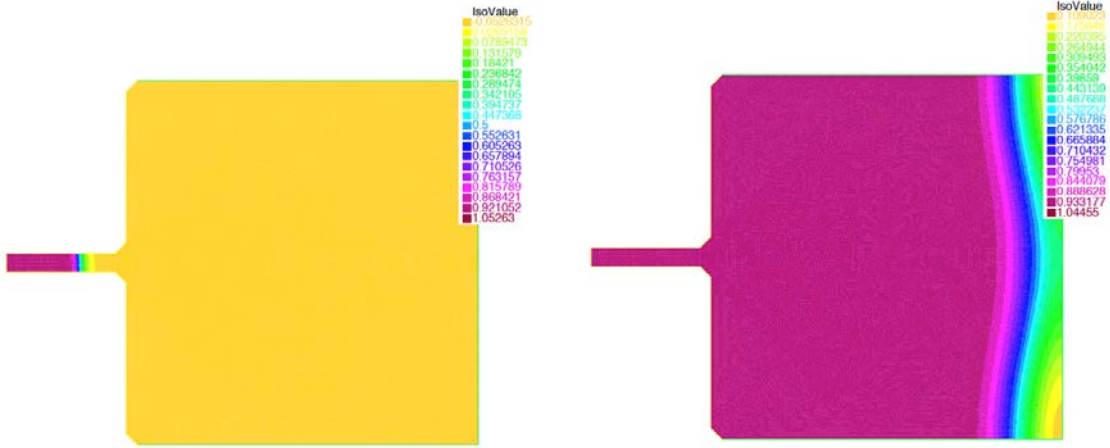

FIGURE 20 – The waves propagates in the entire domain when the left cylinder is large enough. From left to right : values of the solution  $u$  for increasing values of  $t$ . In yellow areas the solution is close to 0 and in purple areas the solution is close to 1

Next we study the propagation properties of our front in more general cylindrical domains (that does not necessarily satisfy a monotonicity property with respect to the direction of propagation). We start by proving that if  $\Omega$  contains a straight cylinder whose diameter is large enough then our solution propagates

**Theorem 20.** *Let  $R_1 > R_0 > 0$ , and assume*

$$\Omega \subset \mathbb{R} \times B'_{R_1} = \{(x_1, x') \in \mathbb{R} \times \mathbb{R}^{n-1}, |x'| < R_1\}, \text{ for some } R_1 > 0,$$

$$\mathbb{R} \times B'_{R_0} \subset \Omega, \text{ for some } R_0 > 0,$$

*Then under the same assumptions than in Theorem 16, there exists  $R^* > 0$  such that for all  $R_0 > R^*$ , the unique solution  $u$  of (27), satisfying (31) propagates, i.e  $u \rightarrow u_\infty$  when  $t \rightarrow +\infty$  and  $\inf_{x \in \Omega} u_\infty(x) > 0$ .*

To prove this result we compare our solution to a particular solution of the parabolic problem set on the straight cylinder  $\mathbb{R} \times B'_{R_0}$  with Dirichlet boundary conditions. For this particular

solution we consider the travelling wave build by Lucia, Muratov and Novaga in [75].

We proved that when the domain  $\Omega$  contains a sufficiently large straight cylinder, there exists an invasion front connecting 0 to  $u_\infty$  and that  $u_\infty > c_m > 0$  in  $\Omega$ . Let us notice that the propagation can be partial and depending on the geometry of  $\Omega$  there could exist areas in  $\Omega$  where the solution is close to 0.

Then we prove that when the domain  $\Omega$  is close enough to a straight cylinder, in the  $C^{2,\alpha}$  topology, there is complete propagation of 1 in  $\Omega$ .

**Theorem 21.** *We assume that  $\omega$  in (29) is of diameter  $r > 0$ . Moreover we assume that  $\Omega$  is close to a straight cylinder in the sense of the  $C^{2,\alpha}$  topology, for some  $\alpha \in (0, 1)$ , i.e :*

*There exists  $(\Omega_\varepsilon)_{\varepsilon>0}$  a family of infinite cylinders in  $\mathbb{R}^n$ , such that*

$$\Omega_\varepsilon \rightarrow \mathbb{R} \times \omega \text{ when } \varepsilon \rightarrow 0 \text{ for the } C^{2,\alpha} \text{ topology,}$$

$$\Omega = \Omega_\varepsilon \text{ for some } \varepsilon > 0.$$

*Under the same assumptions than in Theorem 16 on  $\Omega$ ,  $f$  and  $(\phi, c)$ , there exists  $\varepsilon_0 > 0$  such that for all  $0 < \varepsilon < \varepsilon_0$ , the unique solution of (27) satisfying (31) propagates to 1 in  $\Omega$ . Moreover if we assume, as in Theorem 17 that*

$$\Omega \cap \{x \in \mathbb{R}^n, x_1 > l\} = (l, +\infty) \times \omega_{R_0},$$

*and  $\nu_1(x) \leq 0$  for all  $x \in \partial\Omega$ , then  $c$  is the asymptotic spreading speed, i.e*

$$\text{For all } \hat{c} > c, \lim_{t \rightarrow +\infty} \sup_{x_1 > \hat{c}t} u(t, x) = 0,$$

$$\text{For all } \hat{c} < c, \lim_{t \rightarrow +\infty} \inf_{l < x_1 < \hat{c}t} u(t, x) = 1,$$

The proof of this theorem rest on the fact that the construction of the entire solution  $u$  does not depend on  $\varepsilon$  and that the unique solution of problem (27) satisfying (31) in a straight cylinder is the planar travelling wave  $\phi$  which propagates to 1 in the entire domain.

We also discuss more general assumptions on  $\Omega$  that ensure a complete propagation of 1 in  $\Omega$ . We give assumptions on  $\Omega$  that ensure complete propagation for domains that will be said to be *star-shaped with the direction of propagation* and that includes for examples oscillating cylinders or widening cylinders containing a large straight cylinder.

**Theorem 22.** *Let  $R_1 \gg R_0 > 0$ , assume that*

$$\Omega \subset \mathbb{R} \times B'_{R_1},$$

$$\mathbb{R} \times B'_{R_0} \subset \Omega,$$

*Then, assume that at each point on the boundary  $x = (x_1, x') \in \partial\Omega$ , the outward unit normal  $\nu$  makes a non-negative angle with the direction  $x'$ . More precisely, writing  $\nu = (\nu_1, \nu')$  (with  $\nu' \in \mathbb{R}^{N-1}$ ), we assume :*

$$\nu' \cdot x' \geq 0 \quad \text{for all points } x = (x_1, x') \in \partial\Omega.$$

*Then having the same assumptions that in Theorem 16 on  $\Omega$  and  $f$ , the solution  $u$  of (27) satisfying (31) propagates to 1 in  $\Omega$ , i.e*

$$u(t, \cdot) \rightarrow u_\infty \text{ locally uniformly in } \Omega \text{ as } t \rightarrow +\infty \text{ and } u_\infty \equiv 1 \text{ in } \Omega.$$

We prove this theorem comparing  $u_\infty$  with the solution of the Dirichlet boundary value problem in  $B'_{R_0}$  and sliding and rotating the cylinder  $\mathbb{R} \times B'_{R_0}$  to prove that  $u_\infty > \theta$  in  $\Omega$ .

We discuss two others assumptions on  $\Omega$  in dimension  $n \in \mathbb{N}$  that ensure complete propagation, but these assumptions are difficult to verify because they depend on two parameters, for which we only know the existence.

This work [6] (Chapitre 3) then identifies the different propagation properties of a bistable planar travelling wave in straight cylinder with varying cross section and gives a better understanding of the mechanisms responsible for blocking phenomena in a bistable environment. A numerical study of these problems bring more precisions on the behaviour of the solution with respect to the variation of some parameters of the problem.

### Numerical simulations

At the same time as these works on propagation properties in cylindrical domains, I studied numerically the behaviour of our solution in different domains  $\Omega$ , straight cylinders with varying cross section in dimension 2. I first get back the same results than the ones stated in the previous theorems ([6] or Chapter 3 of this thesis), but I was also able to get deeper results and I obtain the following properties

- The existence of a threshold  $R_0 > 0$  for the radius of the left cylinder in widening cylinders : Let  $R$  be the radius of the left cylinder  $\mathbb{R}^*_+ \times \omega$ , then if  $R < R_0$  the solution is blocked at the exit of the small cylinder, whereas if  $R > R_0$  the solution propagates to 1 in the entire domain,
- We study numerically the impact of a progressive widening and we find that there exists a concavity/convexity threshold such that the solution propagates below this threshold and that above this threshold the solution is blocked at the exit of the small cylinder. This means that the concavity of the widening is in favour of blocking phenomena (see Figure 21 and 22 for some illustrations),

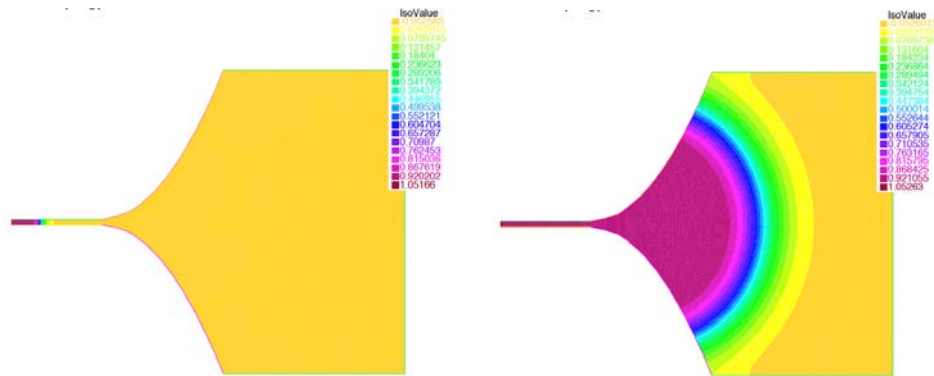

FIGURE 21 – In the case of progressive widening, the wave propagates when the opening is convex. From left to right : value of the solution  $u$  for increasing values of  $t$ . In yellow areas the solution is close to 0 and in purple areas the solution is close to 1.

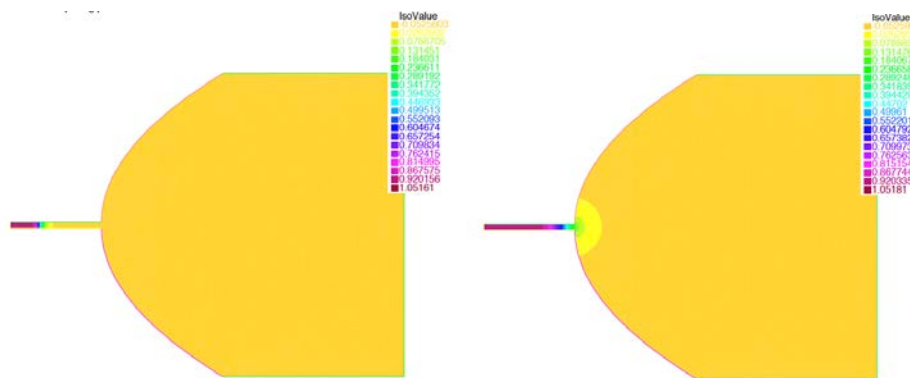

FIGURE 22 – In the case of progressive widening, the wave is blocked when the opening is concave. From left to right : value of the solution  $u$  for increasing values of  $t$ . In yellow areas the solution is close to 0 and in purple areas the solution is close to 1.

- We also investigate these propagation properties for more general domains, studying numerically the impact of an isthmus of radius  $R$  in the domain and we get the same results than in the case of a widening cylinder (see Figure 23 and 24 for some illustrations).

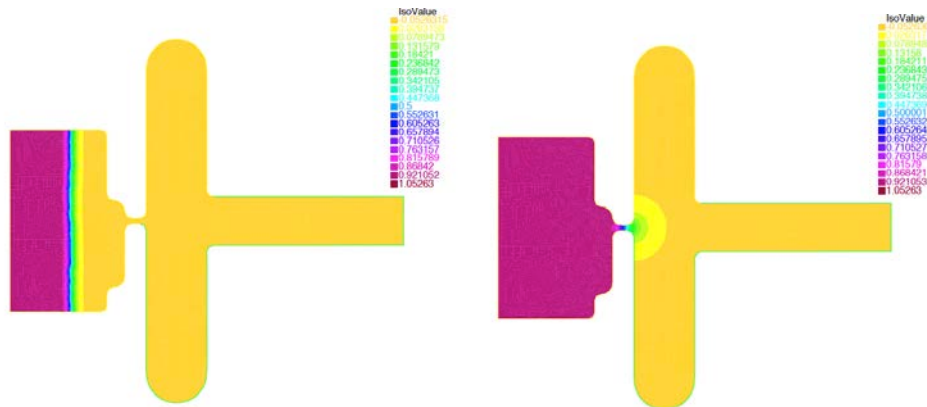

FIGURE 23 – In the presence of an isthmus, the wave is blocked at the exit of the isthmus if the diameter is too small. From left to right : Value of  $u$  for increasing values of  $t$ . In yellow areas the solution is close to 0 and in purple areas the solution is close to 1

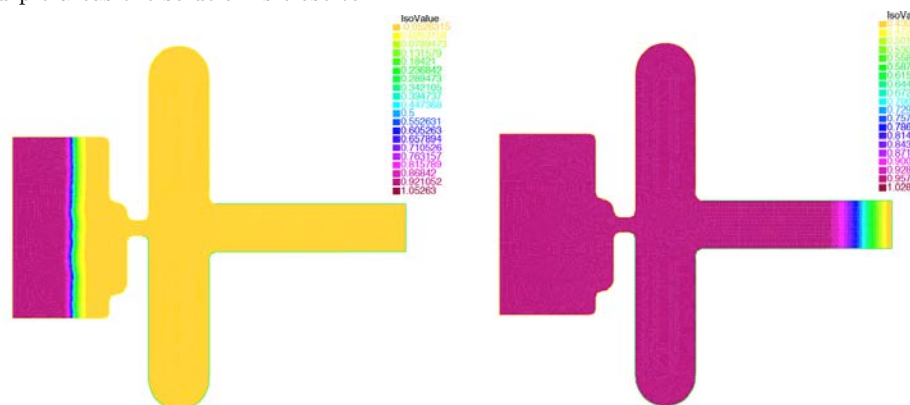

FIGURE 24 – In the presence of an isthmus, the wave propagates in the entire domain if the diameter of the isthmus is large enough. From left to right : Value of  $u$  for increasing values of  $t$ . In yellow areas the solution is close to 0 and in purple areas the solution is close to 1

- We study the impact of the bistability threshold  $\theta$  on blocking phenomena, studying the evolution of the solution  $u$  for different values of  $\theta$  and different diameters of the left cylinder  $\varepsilon > 0$ . We notice that when  $\theta$  is too large, then even for large values of  $\varepsilon$  the solution is blocked at the exit of the small cylinder.

We can also wonder about the effect of the curvature of a curved cylinder on blocking phenomena, considering different boundary conditions. Indeed for Neumann boundary conditions, the solutions will be reflected on the boundary and send back into the domain  $\Omega$  and blocking phenomena seem harder to justify for curved cylinders with constant diameter. On the other hand we could think that for Robin or Dirichlet boundary conditions, the curvature of the domain would be in favour of blocking phenomena. We thus study numerically these kind of problems and we distinguish two phenomena

- In the case of Dirichlet or Robin boundary conditions, the curvature of the cylinder does not seem to play a role in the propagation of the solution. The parameter that seems to be of interest here is the diameter of the curved cylinder. Indeed numerical simulations indicate that there exists a critical radius  $R_0$  such that if the radius of the cylinder  $R < R_0$  then the solution goes to 0, whereas if  $R > R_0$  the solution propagates to 1 in the entire cylinder, for any values of the curvature. Chapuisat and Joly [30] study a reaction diffusion equation with a bistable nonlinearity in a strip  $\mathbb{R} \times (-R, R)$  and an absorbing nonlinearity ( $f(u) = -\delta u$ ,  $\delta > 0$ ) outside of the strip and they investigate the existence of non trivial asymptotic profiles depending on the value of  $R$ . Their results highlight the existence of a critical radius below which the solution of the parabolic problem goes to 0 and above which the solution goes to 1 for large times. Our numerical simulations support this result and speculate that the result stay true for curved cylinder.
- In the case of Neumann boundary conditions for the bottom boundary and Robin or Dirichlet boundary conditions for the top boundary, the curvature of the cylinder seems to play a role in the propagation of the solution. Indeed fixing the radius of the cylinder at some value, we observe that if the curvature of the domain is too large the solution will be blocked at the change of direction.

These numerical results bring more precisions on our previous results regarding the propagation properties in straight cylinders with varying cross section. They also give some new leads concerning the behaviour of solution of bistable reaction diffusion equations in curved cylinders with the idea that the curvature of the domain would not have any effect on the propagation of the solution when we consider Robin or Dirichlet boundary conditions. Whereas we observe a change in the behaviour of the solution depending on the value of the curvature of the domain, when we consider Robin or Dirichlet boundary conditions on one side of the stripe and Neuman boundary conditions on the other side. We could think that Neumann boundary conditions would be to beneficial for the solution with respect to the impact of the curvature of the domain, whereas Robin or Dirichlet boundary conditions will be too harmful with respect to the effect of the curvature of the domain. Thus a good way to see the impact of the curvature would be to mix Neumann boundary conditions on one side and Dirichlet or Robin boundary conditions on the other side.

## 6 Perspectives

To sum up, since the beginning of my PhD, I have been working on the evolution of different kind of biological population densities in environment subjected to various changes (climate change,

change in the geometry of the medium...) and more particularly on propagation phenomena faced to these changes. I would be interested in carrying on these studies of propagation phenomena in more complete models.

### Complete invasion of Cortical Spreading Depressions in more general widening cylinders

In chapter 3 ([6]) we investigate the stability of the stationary solution of the following problem

$$\begin{cases} -\Delta u = f(u) & \text{in } \Omega, \\ \partial_\nu u = 0 & \text{on } \partial\Omega, \\ u(x_1, x') \rightarrow 1 & \text{as } x_1 \rightarrow -\infty, (x_1, x') \in \Omega, \end{cases} \quad (32)$$

for  $\Omega = \{(x_1, x'), x_1 \in \mathbb{R}, x' \in \omega(x_1) \subset \mathbb{R}^{n-1}\}$ . We gave two geometric properties that ensure the stability of 1 for problem (32) in dimension 2 and in dimension  $n \in \mathbb{N}$ . Nevertheless, these properties in dimension  $n \in \mathbb{N}$  seem difficult to verify because they depend on parameters for which we do not have a lot of informations. We can thus wonder about the kind of unbounded domains that lead non constant stationary solutions of (32) to be unstable.

We can also investigate the existence and uniqueness of transition fronts in more general cylindrical domains, as curved cylinders (in the shape of a U for example) or domains with different boundary conditions and see if a strong curvature could lead to blocking phenomena (which happens in our numerical simulations of chapter 4).

### Existence of a critical speed for climate change models

In chapter 2 ([20, Theorem 2.1.1]) we prove that there exist two speeds  $0 < \underline{c} \leq \bar{c}$  such that there exist travelling wave solutions for  $c < \underline{c}$  and that for all  $c > \bar{c}$  every front-like solution is the trivial solution 0. We know that in the KPP framework, we have that  $\underline{c} = \bar{c} = c^*$  in dimension 1 [9] and in higher dimension [17, 18]. We would like to identify the different frameworks for which  $\underline{c} = \bar{c} = c^*$ . We could start by studying what happens when  $f$  is bistable or monostable in the favourable area and equal to  $-\delta u$ , with  $\delta > 0$ , in the unfavourable area. Numerical simulations support the existence of a critical speed  $c^*$  in these different cases.

### Heterogeneity of the medium in problem modelling the effect of climate change

We study independently, on one side the effect of climate change on a population that evolves in  $\mathbb{R}$  (or in straight cylinder of  $R^n$  with Neumann boundary conditions) in chapter 2 and on the other side the effect of a change in the geometry of the domain in chapter 3. We could thus wonder what would be the outcome if we consider a population sensitive to climate change evolving in an heterogeneous medium studying a bistable reaction diffusion with forced speed in  $\Omega := \{(x_1, x'), x_1 \in \mathbb{R}, x' \in \omega(x_1) \subset \mathbb{R}^{n-1}\}$ . Roques et al [104] studied numerically the evolution of a population facing climate change in two dimensional strips with varying width. They proved that when the population exits a thin channel then depending on the degree of opening of the domain, on the diffusion coefficient and on the speed of the climate change the population persists and keep tracks with its favourable environment or goes extinct. It would be interesting to use arguments from chapter 2 and 3 to get these results analytically.

---

**Persistence of a population with non local dispersal, facing unfavourable climate change**

In the continuity of chapter 2, we could consider reaction diffusion equations with forced speed but replacing the diffusion term by a convolution term in order to take into account non local dispersal. Therefor we could use either integro-differential models or integro-difference models which are used a lot by biologists, to get persistence results for a population with non local dispersal in an environment facing unfavourable climate change. Zhou and Kot [123] studied the persistence of a KPP type population in a integro-difference model. It would be interesting to understand if the results of Zhou and Kot could be extended in a monostable or bistable framework. Jin and Lewis [63, 64] studied the persistence of a population with a non local dispersal and a unidirectional flow. It would be interesting to extend some of their results to population also facing a shifting of their favourable habitat.

**Modelling of the persistence of a population sensitive to climate change, whose environment is randomly fluctuating**

The introduction of random fluctuations in the environment of a population seems to have an impact on the persistence of the population. We could study the persistence of a biological population which disperses in a non local way, facing an unfavourable climate change as in the previous section but adding a notion of stochasticity in its favourable environment (instead of having the unidirectional flow assumption). We could use an integral-difference model with a shifting favourable area as in Zhou and Kot paper [123] and add a random variable in the growth term in order to take into account randomness in the fluctuations of the environment.



## Outline of the thesis

This thesis is organised the following way. In chapter 1 we study a bistable reaction diffusion equation in exterior domains  $\Omega := \mathbb{R}^n \setminus K$  in order to understand the evolution of the density of a population when it faces an obstacle. In chapter 2 we are interested in the evolution of the density of a population facing an unfavourable climate change, considering a reaction diffusion equation with forced speed in  $\mathbb{R}$ . In chapter 3 and 4 we consider a bistable reaction diffusion equation in cylindrical domains, which models the evolution of a depolarisation wave in the brain. In chapter 3 we study analytically this problem in straight cylinders with varying cross section whereas in chapter 4 we study this equation numerically in straight and curved cylinders with mixed boundary conditions.

## Chapitre 1

# Propagation en présence d'obstacles Application à la dynamique des populations



---

## Robustness for a Liouville type theorem in exterior domains

---

Dans ce chapitre, on s'intéresse à la robustesse d'un résultat de type Liouville pour une équation de réaction-diffusion dans un domaine extérieure  $\Omega = \mathbb{R}^N \setminus K$ , où  $K \subset \mathbb{R}^N$  est vu comme un obstacle. Dans leur article, Berestycki, Hamel et Matano (2009) [14] ont prouvé un théorème de type Liouville pour des domaines extérieures dont les obstacles sont étoilés ou directionnellement convexes. Le but de ce chapitre est de comprendre si ce résultat reste vrai lorsque l'on perturbe le domaine. Nous prouvons que le théorème de type Liouville est robuste dès que la perturbation est suffisamment proche d'un obstacle étoilé ou directionnellement convexe pour la topologie  $C^{2,\alpha}$ , alors que ce théorème devient faux si les perturbations ne sont pas assez régulières. On conclut ce chapitre par une application de notre théorème de type Liouville à l'existence de fronts de transition invasifs dans des domaines extérieurs.

À la fin de ce chapitre, en appendix, on présente un poster qui résume le contenu du chapitre et qui a été réalisé à l'occasion de la conférence "*Nonlinear Partial Differential Equations: Theory and Application to Complex System*" en l'honneur d'Hiroshi Matano à l'Institut des Hautes Études Scientifiques, Bures sur Yvette.

2010 *Mathematics Subject Classification*: 35K57, 35B51, 35B53.

*Mots clés*: Équation elliptique, résultat de type Liouville, obstacle, principe du maximum, équation parabolique, front de transition.

---

I would like to thank Henri Berestycki, Grégoire Nadin and François Hamel for their fruitful discussions and encouragements, Sylvain Arguillère for his geometric insights. This study was supported by the French "Agence Nationale de la Recherche" through the project PREFERED (ANR 08-BLAN-0313) and by the French "Région Ile de France" through the fellowship "Bourse Hors DIM".

## 1.1 Introduction and main results

### 1.1.1 Problem and motivations

This paper investigates the exterior domain problem:

$$\begin{cases} -\Delta u = f(u) & \text{in } \mathbb{R}^N \setminus K, \\ \partial_\nu u = 0 & \text{on } \partial K, \\ 0 < u \leq 1 & \text{in } \mathbb{R}^N \setminus K, \\ u(x) \rightarrow 1 \text{ as } |x| \rightarrow +\infty & \text{uniformly in } x \in \mathbb{R}^N \setminus K, \end{cases} \quad (1.1)$$

where  $K$  is a compact set of  $\mathbb{R}^N$ ,  $f$  is a bistable non-linearity.

This problem is motivated by the construction of generalized transition fronts for the associated parabolic problem

$$\begin{cases} u_t - \Delta u = f(u) & \text{for all } t \in \mathbb{R}, \quad x \in \mathbb{R}^N \setminus K, \\ \partial_\nu u = 0 & \text{for all } t \in \mathbb{R}, \quad x \in \partial K, \end{cases} \quad (1.2)$$

such that

$$\sup_{x \in \mathbb{R}^N \setminus K} |u(t, x) - \phi(x_1 - ct)| \rightarrow 0 \text{ as } t \rightarrow -\infty,$$

where  $\phi$  is a planar travelling wave connecting 1 to 0, i.e

$$\begin{cases} -\phi'' - c\phi' = f(\phi) & \text{in } \mathbb{R}, \\ \phi(-\infty) = 1, \quad \phi(+\infty) = 0. \end{cases} \quad (1.3)$$

It is proved in [14] that the unique solution of (1.2) converges toward a solution of (1.1) as  $t \rightarrow +\infty$ . Thus problem (1.1) determines whether there is a complete invasion or not, that is whether  $u(t, x) \rightarrow 1$  as  $t \rightarrow +\infty$  for all  $x \in \mathbb{R}^N \setminus K$ . More precisely, complete invasion is shown to hold if and only if (1.1) has no solution different from 1. In [14], Berestycki, Hamel and Matano have shown that if  $K$  is star shaped or directionally convex the unique solution of (1.1) is 1 (see at the end of this section for precise definitions of star shaped or directionally convex domain). The present paper examines under which conditions this Liouville type theorem is robust under perturbations of the domain. This is shown here to strongly depend on the smoothness of the perturbations that are considered. Indeed our main result is to show that it is true for  $C^{2,\alpha}$  perturbations but not for  $C^0$  ones. This is stated precisely in the next section. We leave as an open problem to determine what is the optimal space of regularity of the perturbation for which the result remains true.

In this paper  $f$  is assumed to be a  $C^{1,1}([0, 1])$  function such that

$$f(0) = f(1) = 0, \quad f'(0) < 0, \quad f'(1) < 0, \quad (1.4a)$$

and there exists  $\theta \in (0, 1)$  such that,

$$f(s) < 0 \quad \forall s \in (0, \theta), \quad f(s) > 0 \quad \forall s \in (\theta, 1). \quad (1.4b)$$

Moreover we suppose that  $f$  satisfies the following positive mass property,

$$\int_0^1 f(\tau) d\tau > 0. \quad (1.5)$$

Before stating the main results, let us explain what we mean by star-shaped or directionally convex obstacles.

**Definition 1.**  $K$  is called star-shaped, if either  $K = \emptyset$ , or there is  $x \in \overset{\circ}{K}$  such that, for all  $y \in \partial K$  and  $t \in [0, 1)$ , the point  $x + t(y - x)$  lies in  $\overset{\circ}{K}$  and  $\nu_K(y) \cdot (y - x) \geq 0$ , where  $\nu_K(y)$  denotes the outward unit normal to  $K$  at  $y$ .

**Definition 2.**  $K$  is called directionally convex with respect to a hyperplane  $P$  if there exists a hyperplane  $P = \{x \in \mathbb{R}^N, x \cdot e = a\}$  where  $e$  is a unit vector and  $a$  is some real number, such that

- for every line  $\Sigma$  parallel to  $e$  the set  $K \cap \Sigma$  is either a segment or empty,
- $K \cap P = \pi(K)$  where  $\pi(K)$  is the orthogonal projection of  $K$  onto  $P$ .

### 1.1.2 Main results

Our main result is the following Theorem

**Theorem 1.1.1.** *Let  $(K_\varepsilon)_{0 < \varepsilon \leq 1}$  be a family of  $C^{2,\alpha}$  compact sets of  $\mathbb{R}^N$ , for some  $\alpha > 0$ . Assume that  $K_\varepsilon \rightarrow K$  for the  $C^{2,\alpha}$  topology as  $\varepsilon \rightarrow 0$ , and  $K$  is either star-shaped or directionally convex with respect to some hyperplane  $P$ . Then there exists  $\varepsilon_0 > 0$  such that for all  $0 < \varepsilon < \varepsilon_0$ , the unique solution of (1.1) is  $u_\varepsilon \equiv 1$*

This theorem means that for obstacles that are compact sets in  $\mathbb{R}^N$  and close enough (in the  $C^{2,\alpha}$  sense) to some star-shaped or directionally convex domains, Problem (1.1) has a unique solution  $u_\varepsilon \equiv 1$ . And thus a sufficient condition for the Liouville theorem to be robust under perturbation is the  $C^{2,\alpha}$  convergence. On the other hand one can prove that the  $C^0$  convergence of the perturbation is not enough for the result to stay true. This is stated in the Theorem below.

**Theorem 1.1.2.** *There exists  $(K_\varepsilon)_\varepsilon$  a family of compact manifolds of  $\mathbb{R}^N$  such that  $K_\varepsilon \rightarrow B_{R_0}$  for the  $C^0$  topology as  $\varepsilon \rightarrow 0$ , and for all  $\varepsilon > 0$  there exists a solution  $u_\varepsilon$  of (1.1) such that  $0 < u_\varepsilon < 1$  in  $\mathbb{R}^N \setminus K_\varepsilon$ .*

#### Notations

We denote by  $B_{R_0}$  the ball of radius  $R_0$  centred at 0 in  $\mathbb{R}^N$ , i.e

$$B_{R_0} := \{x \in \mathbb{R}^N, |x| < R_0\},$$

and by  $B_r(x_0)$  the ball of radius  $r$  centred at  $x_0$  in  $\mathbb{R}^N$ , i.e

$$B_r(x_0) := \{x \in \mathbb{R}^N, |x - x_0| < r\},$$

**Remark 1.1.3** ( $C^0$  or  $C^{2,\alpha}$  convergence). When we write  $K_\varepsilon \rightarrow K$  for the  $X$  topology we mean that for each  $x_0$  in  $\partial K$ , and for some  $r > 0$  such that  $\partial K_\varepsilon \cap B_r(x_0) \neq \emptyset$  there exists a couple of functions  $\psi_\varepsilon$  and  $\psi$  defined on  $B_r(x_0)$ , parametrization of  $K_\varepsilon$  and  $K$ , such that,  $\psi_\varepsilon \in X(B_r(x_0))$  and  $\psi \in X(B_r(x_0))$  with  $\|\psi_\varepsilon - \psi\|_{X(B_r(x_0))} \rightarrow 0$  as  $\varepsilon \rightarrow 0$ .

For more details about the  $C^{2,\alpha}$  topology one can look at [49], chapter 6.

Then Theorem 1.1.1 and [14] yields some properties about the solution of the parabolic problem (1.2).

**Corollary 1.1.4.** Assume that  $f$  satisfies (1.4) and that there exists a solution  $\phi$  to (1.3) with  $c > 0$  (if  $f$  satisfies (1.4) and (1.5),  $\phi$  exists and  $c > 0$ ). Let  $(K_\varepsilon)_{0 < \varepsilon \leq 1}$  be a family of compact manifolds in  $\mathbb{R}^N$  such that  $K_\varepsilon \rightarrow K$  for the  $C^{2,\alpha}$  topology, with  $0 < \alpha < 1$  and where  $K \subset \mathbb{R}^N$  is either star-shaped or directionally convex with respect to some hyperplane  $P$ . Then for all  $0 < \varepsilon \leq 1$ , there exists an entire solution  $u_\varepsilon(t, x)$  of (1.2) such that

$$0 < u_\varepsilon < 1 \text{ and } \partial_t u_\varepsilon > 0 \text{ over } \mathbb{R} \times \overline{\Omega}_\varepsilon$$

and there exists  $\varepsilon_0 > 0$  such that for all  $0 < \varepsilon < \varepsilon_0$ ,

$$u_\varepsilon(t, x) - \phi(x_1 + ct) \rightarrow 0$$

as  $t \rightarrow \pm\infty$  uniformly in  $x \in \overline{\Omega}_\varepsilon$ , and as  $|x| \rightarrow +\infty$  uniformly in  $t \in \mathbb{R}$ .

**Remark 1.1.5.** For all  $0 < \varepsilon < \varepsilon_0$  the solution  $u_\varepsilon(t, x)$  given in Corollary 1.1.4 is a generalized, almost planar, invasion front between 0 and 1 with global mean speed  $c$ , in the sense that

$$\sup_{(t,x) \in \mathbb{R} \times \overline{\Omega}_\varepsilon, x_1 + ct \geq A} |u_\varepsilon(t, x) - 1| \xrightarrow{A \rightarrow +\infty} 0$$

$$\sup_{(t,x) \in \mathbb{R} \times \overline{\Omega}_\varepsilon, x_1 + ct \leq -A} |u_\varepsilon(t, x)| \xrightarrow{A \rightarrow +\infty} 0$$

Before proving the previous statements, let us give some examples of domains  $(K_\varepsilon)_\varepsilon$  and  $K$  to illustrate our results.

### 1.1.3 Examples

We assume that  $N = 2$  and we construct two families of obstacles; one which converges to a star shaped domain and the other which converges to a directionally convex domain. The black plain line represents the limit  $K$  and the dashed parts represent the small perturbations (of order  $\varepsilon$ ).

Star-shaped domain:

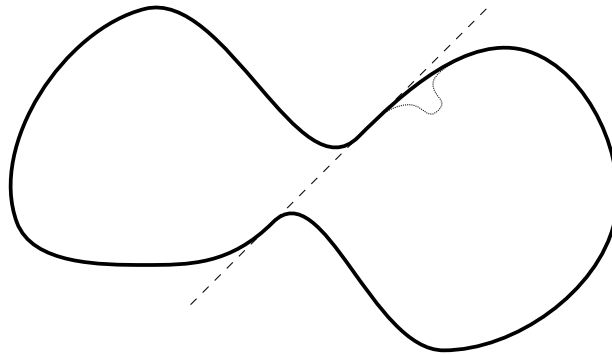

Figure 1.1 – Obstacles converging toward a star-shaped domain

The long-dashed line is used during the construction of  $K$  and it is on this line that we could find the center(s) of the domain (i.e the point  $x$  in Definition 1). We can clearly see that for all  $\varepsilon > 0$ ,  $K_\varepsilon$  is not star-shaped, because the points just behind the dashed area cannot be linked to the center  $x$  by a straight line.

Directionally convex domain:

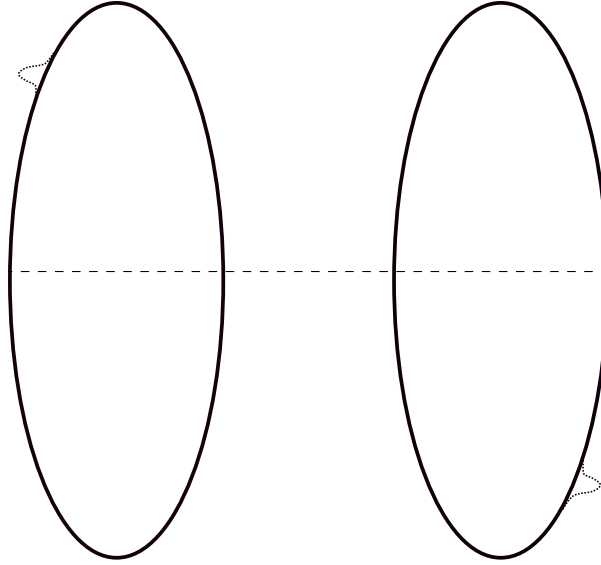

Figure 1.2 – Obstacles converging toward a directionally convex domain

In this second figure, the hyperplanes  $P$ , for which the plain black domain could be directionally convex are necessarily horizontal (i.e  $\{(x, y) \in \mathbb{R}^2 | (x, y) \cdot (0, 1) = a\}$ ) and  $a$  has to be 0 (assuming the centers of the ellipses are on the  $x$ -axis), else the second property in Definition 2 is not satisfied. Indeed the first property of Definition 2 eliminates every vertical hyperplanes  $P$  and the second property eliminates the diagonal ones. Adding small perturbations (of order  $\varepsilon$ ) on each side of each ellipse, one gets that for all  $\varepsilon > 0$ ,  $K_\varepsilon$  does not satisfy the second property of Definition 2.

One needs to be careful on the shape of the perturbations. Indeed considering an ellipse, which is star-shaped and directionally convex and adding on each side of the vertical axis some well chosen perturbations (keeping the domain smooth), the obstacle is not star-shaped, neither directionally convex anymore (see figure below),

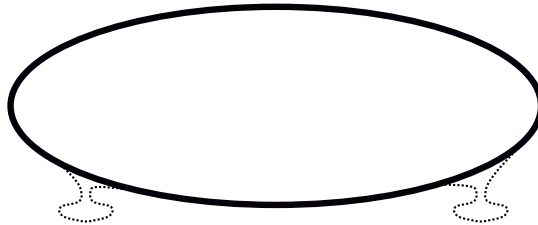

Figure 1.3 – Obstacles converging only in  $C^0$

and  $K_\varepsilon \rightarrow K$ , an ellipse, as  $\varepsilon \rightarrow 0$ , but the convergence of  $K_\varepsilon$  cannot be  $C^{2,\alpha}$  (see section 1.3 for more details) but only  $C^0$  which is not enough to get Theorem 1.1.1, as we will see in section



1.3.

We will prove Theorem 1.1.1 in section 1.2 below and Theorem 1.1.2 in section 1.3. We will end this paper by proving Corollary 1.1.4 in section 1.4

## 1.2 Robustness of the result for $C^{2,\alpha}$ perturbations

In this section we prove the robustness of the Liouville result when the perturbation is close to a star shaped or directionally convex domain in the  $C^{2,\alpha}$  topology. To prove Theorem 1.1.1, we will need the following Proposition:

**Proposition 1.2.1.** *For all  $0 < \delta < 1$ , there exists  $R = R_\delta$  such that, if  $u_\varepsilon$  is a solution of (3.1) with  $K_\varepsilon$ , then  $u_\varepsilon(x) \geq 1 - \delta$  for all  $|x| \geq R$  and for all  $0 < \varepsilon < 1$ .*

This proposition means that  $u_\varepsilon$  converges toward 1 as  $|x| \rightarrow +\infty$  uniformly in  $\varepsilon$ .

Let us first admit this result and prove Theorem 1.1.1.

### 1.2.1 Proof of Theorem 1.1.1

As  $u_\varepsilon$  is uniformly bounded for all  $\varepsilon > 0$ , using Schauder estimates, we know that up to a subsequence  $u_{\varepsilon_n} \rightarrow u_0$  in  $C_{\text{loc}}^2$  as  $n \rightarrow +\infty$  in the sense that for all  $r > 0$ ,

$$\|u_{\varepsilon_n} - u_0\|_{C^2(B_r \setminus (K_{\varepsilon_n} \cup K))} \rightarrow 0 \text{ as } n \rightarrow +\infty$$

and  $u_0$  satisfies:

$$\begin{cases} \Delta u_0 + f(u_0) = 0 & \text{in } \mathbb{R}^N \setminus K, \\ \nu \cdot \nabla u_0 = 0 & \text{on } \partial K. \end{cases}$$

Using Proposition 1.2.1 we get  $\lim_{|x| \rightarrow +\infty} u_0(x) = 1$ . And  $K$  is either star-shaped or directionally convex. We now recall the following results from [14]:

**Theorem** (Theorem 6.1 and 6.4 in [14]). *Let  $f$  be a Lipschitz-continuous function in  $[0, 1]$  such that  $f(0) = f(1) = 0$  and  $f$  is nonincreasing in  $[1 - \delta, 1]$  for some  $\delta > 0$ . Assume that*

$$\forall 0 \leq s < 1, \int_s^1 f(\tau) d\tau > 0.$$

*Let  $\Omega$  be a smooth, open, connected subset of  $\mathbb{R}^N$  (with  $N \geq 2$ ) with outward unit normal  $\nu$ , and assume that  $K = \mathbb{R}^N \setminus \Omega$  is compact. Let  $0 \leq u \leq 1$  be a classical solution of*

$$\begin{cases} \Delta u = f(u) & \text{in } \Omega, \\ \nu \cdot \nabla u = 0 & \text{on } \partial\Omega, \\ u(x) \rightarrow 1 & \text{as } |x| \rightarrow +\infty. \end{cases}$$

*If  $K$  is star shaped or directionally convex, then*

$$u \equiv 1 \text{ in } \bar{\Omega}.$$

It thus follows from the above Theorem that  $u_0 \equiv 1$ . It also proves that the limit  $u_0$  is unique and thus  $u_\varepsilon \rightarrow u_0$  as  $\varepsilon \rightarrow 0$  in  $C^2$  (and not only along a subsequence).

Now we need to prove that there exists  $\varepsilon_0 > 0$  such that  $u_\varepsilon \equiv 1$  for all  $0 < \varepsilon < \varepsilon_0$ . Assume that for all  $\varepsilon > 0$ ,  $u_\varepsilon \not\equiv 1$  in  $\Omega_\varepsilon = \mathbb{R}^N \setminus K_\varepsilon$ . Then there exists  $x_0 \in \overline{\Omega_\varepsilon}$  such that  $u_\varepsilon(x_0) = \min_{x \in \overline{\Omega_\varepsilon}} u_\varepsilon(x) < 1$  and  $x_0$ , which depends on  $\varepsilon$ , is uniformly bounded with respect to  $\varepsilon$  (using Proposition 1.2.1). Assume that  $u_\varepsilon(x_0) > \theta$ , as  $u_\varepsilon$  is a solution of (3.1), the Hopf lemma yields that,

$$\text{if } x_0 \in \partial K_\varepsilon \text{ then } \frac{\delta u_\varepsilon}{\delta \nu}(x_0) < 0,$$

which is impossible due to Neumann boundary conditions. Hence  $x_0 \in \Omega_\varepsilon$  and

$$-\Delta u_\varepsilon(x_0) = f(u_\varepsilon(x_0)) > 0,$$

which is impossible since  $x_0$  is a minimizer. So, for all  $0 < \varepsilon < 1$ ,

$$0 \leq \min_{x \in \overline{\Omega_\varepsilon}} u_\varepsilon(x) \leq \theta,$$

But  $\min_{x \in \overline{\Omega_\varepsilon}} u_\varepsilon \rightarrow 1$  as  $\varepsilon \rightarrow 0$  by Proposition 1.2.1 and the local uniform convergence to  $u_0 \equiv 1$ , which is a contradiction. Thus there exists  $\varepsilon_0$  such that for all  $\varepsilon < \varepsilon_0$ ,  $u_\varepsilon \equiv 1$ .  $\square$

### 1.2.2 Proof of Proposition 1.2.1

We will now prove Proposition 1.2.1, using the following lemma:

**Lemma 1.2.2.** *There exists  $\omega = \omega(r)$  with  $r \in \mathbb{R}^+$  such that*

$$\begin{cases} -\omega''(r) = f(\omega(r)), & \forall r \in \mathbb{R}_*^+, \\ \omega(0) = 0, \quad \omega'(0) > 0, \\ \omega' > 0, \quad 0 < \omega < 1 & \text{in } \mathbb{R}_+^*, \\ \lim_{r \rightarrow +\infty} \omega(r) = 1. \end{cases}$$

We can prove this lemma using some results about travelling fronts in the multistable case (a) or using an ODE approach (b).

#### Proof of Lemma 1.2.2

- (a) Proof using travelling waves

We know from [40] that there exists a unique solution  $(\omega_1, c_1) \in C^2(\mathbb{R}) \times \mathbb{R}$  of

$$\begin{cases} -\omega_1''(x) + c_1 \omega_1'(x) = f(\omega_1(x)) & \text{in } \mathbb{R}, \\ \omega_1(-\infty) = 0, \quad \omega_1(+\infty) = 1, \\ \omega_1' > 0, & \text{in } \mathbb{R}, \\ 0 < \omega_1 < 1, & \text{in } \mathbb{R}. \end{cases}$$

Because of (1.5),  $c_1 > 0$ . One can prove the existence and uniqueness of  $v \in C^2(\mathbb{R}^+)$

$$\begin{cases} v''(z) - cv'(z) + f(v(z)) = 0, & \forall z \in (0, +\infty), \\ v(0) = 0, \quad v(+\infty) = 1, \\ v'(z) > 0, & \forall z \in (0, +\infty), \\ 0 < v(z) < 1, & \forall z \in (0, +\infty), \end{cases}$$

for  $c \leq c_1$  (see [40, 59]). Then taking  $c = 0 \leq c_1$  there exists  $\omega \in C^2(\mathbb{R}^+)$  such that

$$\begin{cases} \omega''(z) + f(\omega(z)) = 0, & \forall z \in (0, +\infty), \\ \omega(0) = 0, \quad \omega(+\infty) = 1, \\ \omega'(z) > 0, & \forall z \in (0, +\infty), \\ 0 < \omega(z) < 1, & \forall z \in (0, +\infty). \end{cases}$$

The Hopf Lemma yields that  $\omega'(0) > 0$ . □

- (b) Proof using an ODE approach.

We want to prove the global existence and uniqueness of the following ODE:

$$\begin{cases} -\omega'' = f(\omega) & \text{in } (0, +\infty), \\ \omega(0) = 0, \\ \omega'(0) = \sqrt{2F(1)}, \end{cases} \quad (1.6)$$

where  $F(z) = \int_0^z f(s)ds$ . Using (1.5),  $F(1) > 0$ .

From Cauchy-Lipschitz theorem we know that there exists a unique maximal solution  $\omega$  of (1.6) in  $I \subset (0, +\infty)$ . To prove the global existence, i.e  $I = (0, +\infty)$ , let us prove that  $0 < \omega < 1$  in  $I$ .

We start by proving that  $\omega' > 0$ . We know that  $\omega'(0) > 0$ . Suppose that there exists  $r_0 \in I$  such that  $\omega'(r_0) = 0$ . Then multiplying (1.6) (1) by  $\omega'$  and integrating between 0 and  $r_0$ , one gets:

$$-F(1) + F(\omega(r_0)) = 0 = \int_1^{\omega(r_0)} f(z)dz. \quad (1.7)$$

Without loss of generality, we extend  $f$  linearly (as a  $C^1$  function) outside  $[0, 1]$ . Note that by the Maximum Principle any solution with such a  $f$  will take values in  $[0, 1]$ , hence is a solution of the original problem. The last equation (1.7) is impossible, which implies that  $\omega' > 0$  in  $I$  and thus  $\omega > 0$  in  $I$ .

Next assume by contradiction that there exists  $r_1 \in I$  such that  $\omega(r_1) = 1$ . Using the same method as above (multiplying by  $\omega'$  and integrating between 0 and  $r_1$ ) one gets:

$$\frac{(\omega'(r_1))^2}{2} - F(1) + F(1) = 0,$$

which is impossible. Hence  $0 < \omega < 1$  in  $I$ .

If we assume that  $I \subsetneq (0, +\infty)$ , i.e there exists  $r_\infty \in (0, +\infty)$  such that  $I = (0, r_\infty)$ , it means that  $\lim \omega(r) = +\infty$  as  $r \rightarrow r_\infty$ . This is impossible because  $0 < \omega < 1$  in  $I$ . Thus  $I = (0, +\infty)$ .

We have proved that there exists a unique global solution  $\omega$  of (1.6) and that  $\omega'(r) > 0$  and  $0 < \omega(r) < 1$  for all  $r \in (0, +\infty)$ . As  $\omega$  is increasing and bounded from above, it has a limit when  $r \rightarrow +\infty$  such that  $0 < \omega(+\infty) \leq 1$ . Moreover  $\omega(+\infty) > \theta$ . Indeed if we assume that  $\omega \leq \theta$  in  $\mathbb{R}_+$  then one gets that  $\omega$  is convex (since  $\omega'' = -f(\omega) \geq 0$ ) and increasing, it then goes to  $+\infty$  when  $r \rightarrow +\infty$ , which is impossible. It immediately follows from elliptic regularity

estimates that  $f(\omega(+\infty)) = 0$ . Hence  $\omega(+\infty) = 1$ .

One has proved Lemma 1.2.2.  $\square$

**Proof of Proposition 1.2.1.** Now we introduce a function  $f_\delta$  defined in  $[0, 1 - \frac{\delta}{2}]$ , satisfying the same bistability hypothesis as  $f$  but such that

- $f_\delta \leq f$  in  $[0, 1 - \frac{\delta}{2}]$ ,
- $f_\delta = f$  in  $[0, 1 - \delta]$ ,
- $f_\delta(1 - \frac{\delta}{2}) = 0$ .

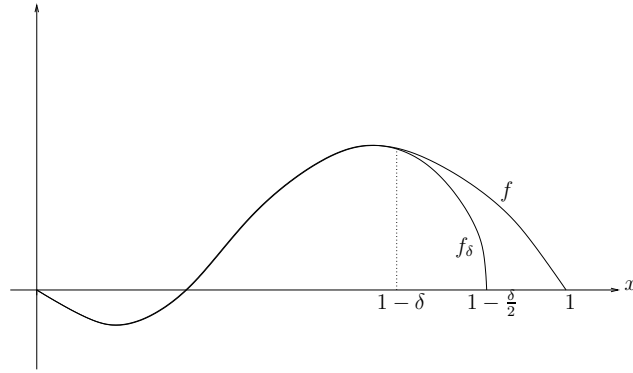

Figure 1.4 –  $f_\delta(x)$

Using the same arguments than in Lemma 1.2.2 there exists  $\omega = \omega_\delta$  such that

$$\begin{cases} -\omega_\delta''(x) = f_\delta(\omega_\delta(x)), & \text{for all } x \in (0, +\infty), \\ \omega_\delta(0) = 0, & \omega_\delta(+\infty) = 1 - \frac{\delta}{2}, \\ 0 < \omega_\delta < 1 - \frac{\delta}{2} & \text{in } (0, +\infty), \\ \omega_\delta' > 0 & \text{in } (0, +\infty). \end{cases}$$

As  $K_\varepsilon$  is a compact set of  $\mathbb{R}^N$ , there exists  $R_0 > 0$  such that  $K_\varepsilon \subset B_{R_0}$  for all  $\varepsilon > 0$ , where  $B_{R_0} := \{x \in \mathbb{R}^N, |x| < R_0\}$  is the ball of radius  $R_0$  centered at 0.

Next, for any  $R > R_0$  consider  $z(x) := \omega_\delta(|x| - R)$  for every  $x \in \mathbb{R}^N$  such that  $|x| \geq R$ . One gets, for all  $x \in \mathbb{R}^N$  such that  $|x| > R$ :

$$\Delta z(x) + f(z(x)) = \omega_\delta''(x) + \frac{N-1}{|x|} \omega_\delta'(x) + f(\omega_\delta(x)) = \frac{N-1}{|x|} \omega_\delta'(x) + f(\omega_\delta(x)) - f_\delta(\omega_\delta(x)) > 0.$$

So

$$-\Delta z < f(z) \quad \text{in } \mathbb{R}^N \setminus B_R. \quad (1.8)$$

We want to prove that

$$\omega_\delta(|x| - R_0) < u_\varepsilon(x), \quad \forall x \in \mathbb{R}^N, |x| \geq R_0.$$

We know from (1.1) that  $u_\varepsilon(x) \rightarrow 1$  as  $|x| \rightarrow +\infty$ . Hence there exists  $A = A(\varepsilon) > 0$  such that  $u_\varepsilon(x) \geq 1 - \frac{\delta}{3} \geq \omega(|x| - A)$ , for all  $|x| \geq A$ .

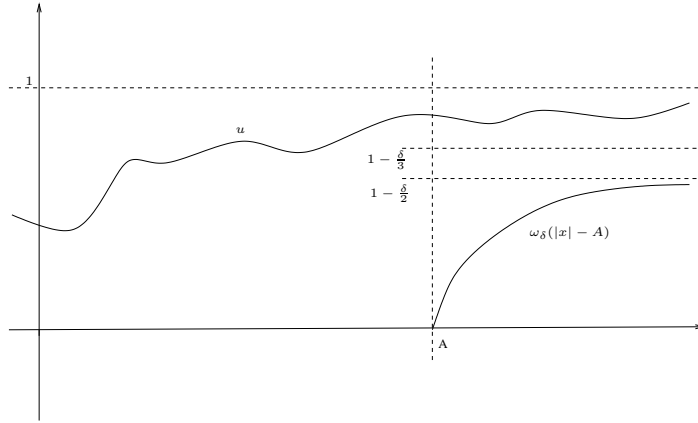
Figure 1.5 –  $u_\varepsilon$  and  $\omega_\delta(|\cdot| - A)$ 

Consider

$$\bar{R} = \inf \left\{ R \geq R_0; u_\varepsilon(x) > \omega_\delta(|x| - R), \text{ for all } |x| \geq R \right\}.$$

As  $\bar{R} \geq R_0$  and  $K_\varepsilon \subset B_{R_0}$ ,  $u_\varepsilon$  is always defined in  $\mathbb{R}^N \setminus B_{\bar{R}}$ . One will prove that  $\bar{R} = R_0$ . As  $\omega_\delta$  is increasing, we know that

$$\forall R \geq A \quad u_\varepsilon(x) \geq \omega_\delta(|x| - R), \quad \forall |x| \geq R.$$

Hence  $\bar{R} \leq A$ .

Assume that  $\bar{R} > R_0$ . Then there are two cases to study:

- either  $\inf_{|x| > \bar{R}} \left\{ u_\varepsilon(x) - \omega_\delta(|x| - \bar{R}) \right\} > 0$ , (1)
- or  $\inf_{|x| > \bar{R}} \left\{ u_\varepsilon(x) - \omega_\delta(|x| - \bar{R}) \right\} = 0$ . (2)

In the first case (1), one gets  $u_\varepsilon(x) > \omega_\delta(|x| - \bar{R})$  for all  $|x| > \bar{R}$ . As  $\nabla u_\varepsilon$  and  $\omega'_\delta$  are bounded one can translate  $\omega_\delta$  to the left such that both graphs touch at one point, i.e there exists  $R^* < \bar{R}$  such that  $u_\varepsilon(x) \geq \omega_\delta(|x| - R^*)$  for all  $|x| > R^*$ , and  $u_\varepsilon(x_0) = \omega_\delta(|x_0| - R^*)$  for some  $|x_0| > R^*$ . This contradicts the optimality of  $\bar{R}$ .

In the second case (2), there necessarily exists  $x_0$  with  $|x_0| > \bar{R}$  such that  $u_\varepsilon(x_0) = \omega_\delta(|x_0| - \bar{R})$ . Let  $v(x) := u_\varepsilon(x) - \omega_\delta(|x| - \bar{R})$ , for all  $|x| > \bar{R}$ . As  $u_\varepsilon$  is a solution of (1.1) and using (1.8),  $v$  satisfies:

$$\begin{cases} -\Delta v(x) > c(x)v(x) & \text{for all } x \in \mathbb{R}^N, |x| > \bar{R}, \\ v(x) > 0 & \text{for all } x \in \mathbb{R}^N, |x| = \bar{R}, \end{cases}$$

and  $v(x) \geq 0$ , for all  $|x| \geq \bar{R}$ . But there exists  $x_0$  such that  $|x_0| > \bar{R}$  ( $x_0$  is an interior point) and  $v(x_0) = 0$ , i.e  $v(\cdot)$  reaches its minimum 0 inside the domain. This implies, using the maximum principle, that  $v(\cdot) \equiv 0$ , which is impossible because  $v(\cdot) > 0$ , for all  $|x| = \bar{R}$ .

Then  $\bar{R} = R_0$  which does not depend on  $\varepsilon$  and

$$\forall |x| \geq R_0 \quad u_\varepsilon(x) \geq \omega_\delta(|x| - R_0).$$

As  $\omega_\delta(x) \rightarrow 1 - \frac{\delta}{2}$  as  $|x| \rightarrow +\infty$ , there exists  $\hat{R}$ , independent of  $\varepsilon$ , such that for all  $|x| > \hat{R} + R_0$ ,  $u_\varepsilon(x) > \omega_\delta(|x| - R_0) \geq 1 - \delta$ . One has proved Proposition 1.2.1.  $\square$

### 1.3 Counter example in the case of $C^0$ perturbations

Until now we have assumed that  $K_\varepsilon \rightarrow K$  in  $C^{2,\alpha}$ , in order to use the Schauder estimates and ensure the convergence of  $u_\varepsilon$  as  $\varepsilon \rightarrow 0$ . One can wonder if we can weaken this hypothesis: would the  $C^0$  or  $C^1$  convergence be enough to prove Theorem 1.1.1?

We prove that  $C^0$  perturbations are not smooth enough for the Liouville result to remain true.

#### 1.3.1 Construction of a particular family of $C^0$ perturbations

In this subsection we construct a family of obstacles that are neither star-shaped nor directionally convex but converges uniformly to  $K$  the ball of radius  $R_0$  which is convex. We want to prove that for all  $\varepsilon \in ]0, 1]$  there exists a solution of (1.1) which is not identically equal to 1. To do so we will use the counterexample of section 6.3 in [14].

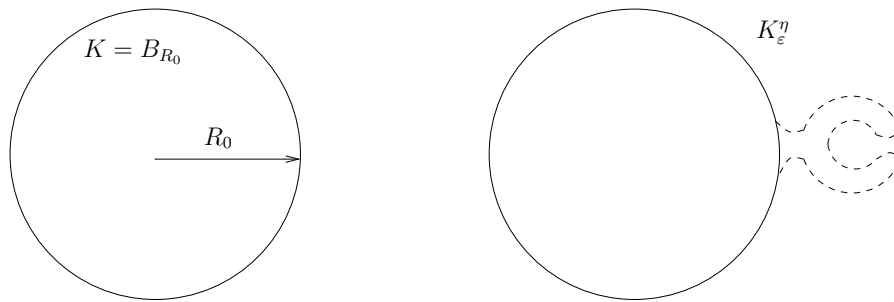

Figure 1.6 – Liouville counterexample

Zooming on the dashed part:

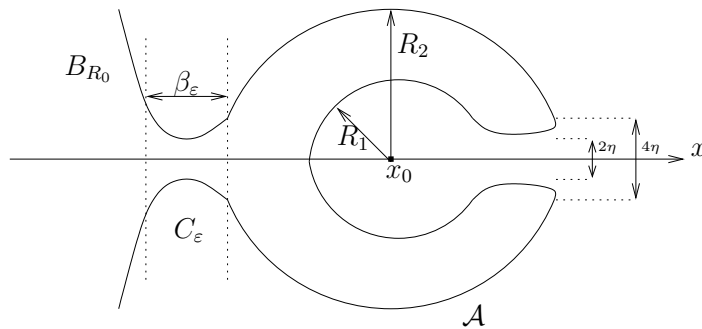

Figure 1.7 – Zoom on the perturbation  $V_\varepsilon$

We consider an obstacle  $K_1 = K_1^\eta$  (see figure 1.6 and 1.7), such that:

$$\begin{cases} (\mathcal{A} \cap \{x; x_1 \leq x_1^0\}) \cup B_{R_0} \cup C_1 \subset K_1^\eta, \\ \mathcal{A} \cap \{x; x_1 > x_1^0, |x'| > 2\eta\} \subset K_1^\eta, \\ K_1^\eta \subset (\mathcal{A} \cap \{x; x_1 > x_1^0, |x'| > \eta\}) \cup B_{R_0} \cup (\mathcal{A} \cap \{x; x_1 \leq x_1^0\}) \cup C_1. \end{cases}$$

where  $x' = (x_2, \dots, x_N)$  and  $\mathcal{A} = \{x : R_1 \leq |x - x^0| \leq R_2\}$ ,  $R_0, R_1 < R_2$ , are three positive constants,  $x^0 = (x_1^0, 0, 0, \dots, 0)$  is the center of the annular region  $\mathcal{A}$  with  $x_1^0 = R_0 + R_2 + \beta_\varepsilon$ ,  $C_\varepsilon$  is some corridor that links smoothly  $\mathcal{A}$  and  $B_{R_0}$  which length is  $\beta_\varepsilon$  and  $\eta > 0$ , small enough. The family  $(K_\varepsilon)$  is constructed by downsizing  $K_1$  such that for all  $0 < \varepsilon < 1$ ,  $\mathcal{A}_\varepsilon$  stays an annular region, with

- $x_0^\varepsilon = (R_0 + R_2^\varepsilon + \beta_\varepsilon, 0) \in \mathbb{R}^N$  converging to  $(R_0, 0) \in \mathbb{R}^N$ ,
- $R_1^\varepsilon = \varepsilon R_1, R_2^\varepsilon = \varepsilon R_2$ ,
- $\beta_\varepsilon$  converging to 0 as  $\varepsilon \rightarrow 0$ .

We have the following lemma.

**Lemma 1.3.1.**  $K_\varepsilon \rightarrow K$  for the  $C^0$  topology as  $\varepsilon \rightarrow 0$  but not for the  $C^1$  topology.

This Lemma is easily proved using smooth parametrisation of  $B_{R_0}$  and  $K_1$  and noticing that for all  $\varepsilon > 0$  there exists a point on the boundary of the perturbation that has an outward unit normal orthogonal to  $e_1 = (1, 0, \dots, 0)$ .

Let us give some details of the proof in dimension 2 ( $N = 2$ ). Let  $g$  be the parametrisation of  $K = B_{R_0}$ , i.e

$$K = \left\{ (x, y) \in \mathbb{R}^2 \mid (x, y) = g(t) = (R_0 \cos(t), R_0 \sin(t)) \quad \forall t \in [0, 2\pi[ \right\}.$$

Let  $f_\varepsilon$  be the parametrisation of  $K_\varepsilon$  for all  $0 < \varepsilon \leq 1$ . To define  $f_\varepsilon$ , we start with the case when  $\varepsilon = 1$ :

$$K_1 = \left\{ (x, y) \in \mathbb{R}^2 \mid (x, y) = f_1(t) = \begin{cases} g(t) & \forall t \in ]\gamma, 2\pi - \gamma[, \\ h(t) & \forall t \in [0, \gamma] \cup [2\pi - \gamma, 2\pi[ \end{cases} \right\},$$

where  $\gamma$  is some small positive number and  $h$  is such that  $f_1$  is a  $C^{2,\alpha}$  function. Now one can define  $f_\varepsilon$  and  $K_\varepsilon$ :

$$K_\varepsilon = \left\{ (x, y) \in \mathbb{R}^2 \mid (x, y) = f_\varepsilon(t) = \begin{cases} g(t) & \forall t \in ]\varepsilon\gamma, 2\pi - \varepsilon\gamma[, \\ h_\varepsilon(t) & \forall t \in [0, \varepsilon\gamma] \cup [2\pi - \varepsilon\gamma, 2\pi[ \end{cases} \right\},$$

where  $h_\varepsilon$  is such that  $f_\varepsilon$  is a  $C^{2,\alpha}$  function and such that for every  $(x, y) \in \mathcal{A} \cap K_\varepsilon$ ,  $(x, y) = h_\varepsilon(t) = \varepsilon h(t)$ . This last condition ensures that  $\mathcal{A}$  stays an annular region.

Then one can easily see that  $K_\varepsilon \rightarrow K$  as  $\varepsilon \rightarrow 0$  for the  $C^0$  topology, i.e  $\|f - f_\varepsilon\|_{C^0([0, 2\pi])} \rightarrow 0$  as  $\varepsilon \rightarrow 0$

Now assume that  $K_\varepsilon \rightarrow K$  as  $\varepsilon \rightarrow 0$  for the  $C^1$  topology. One can notice (see figure 3.8 below) that for  $\varepsilon = 1$  there exists a  $t_m \in [0, \gamma]$  such that  $f_1'(t_m) = e_1 = (1, 0)$  or  $\nu(x_m, y_m) = e_2 = (0, 1)$ , where  $\nu$  is the outward unit normal and  $(x_m, y_m) = f_1(t_m) \in \mathcal{A} \cap K_\varepsilon$ .

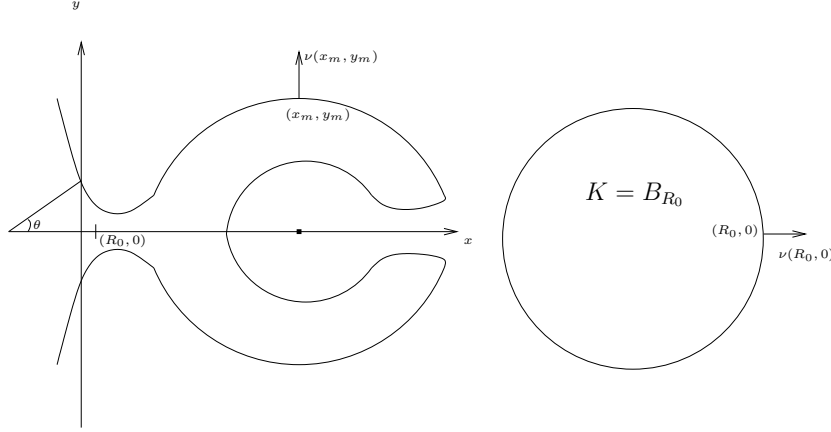

Figure 1.8 – Outward unit normal

Consider  $t_\varepsilon \in [0, \varepsilon\gamma]$  such that  $\nu(x_\varepsilon, y_\varepsilon) = e_2$ , where  $(x_\varepsilon, y_\varepsilon) = f_\varepsilon(t_\varepsilon)$  the point at the top of the big sphere in  $\mathcal{A}$ . This point always exists because we parametrize  $K_\varepsilon$  such that  $\mathcal{A}$  stays an annular region. As the convergence is  $C^1$  one should have that  $\nu(x_\varepsilon, y_\varepsilon) \rightarrow \nu(R_0, 0)$  as  $\varepsilon \rightarrow 0$ , because  $(x_\varepsilon, y_\varepsilon) \rightarrow (R_0, 0)$  as  $\varepsilon \rightarrow 0$ . But  $\nu(x_\varepsilon, y_\varepsilon) = e_2$  for every  $\varepsilon \in (0, 1]$  and  $\nu(R_0, 0) = e_1$ , which is impossible. The convergence can not be  $C^1$ .

### 1.3.2 Existence of a non constant solution $u_\varepsilon$ of (3.1)

We want to prove that for all  $0 < \varepsilon < 1$  there exists a solution  $0 < u_\varepsilon < 1$  of

$$\begin{cases} -\Delta u_\varepsilon = f(u_\varepsilon) & \text{in } \mathbb{R}^N \setminus K_\varepsilon^\eta = \Omega_\varepsilon^\eta, \\ \nu \cdot \nabla u_\varepsilon = 0 & \text{on } \partial K_\varepsilon^\eta = \partial \Omega_\varepsilon^\eta, \\ u_\varepsilon(x) \rightarrow 1 & \text{as } |x| \rightarrow +\infty. \end{cases} \quad (1.9)$$

We will follow the same steps as in [14], section 6. First, notice that it is enough to find  $\omega \not\equiv 1$  solution of

$$\begin{cases} -\Delta \omega = f(\omega) & \text{in } B_R \setminus K_\varepsilon^\eta, \\ \nu \cdot \nabla \omega = 0 & \text{on } \partial K_\varepsilon^\eta, \\ \omega = 1 & \text{on } \partial B_R, \end{cases} \quad (1.10)$$

for some  $R > 0$  large enough such that  $K_\varepsilon^\eta \subset B_R$ .

Indeed then  $\omega$  extended by 1 outside  $B_R$  is a supersolution of (1.9) and one can define:

$$\psi(x) = \begin{cases} 0 & \text{if } \{|x| < R\} \setminus K_\varepsilon^\eta, \\ U(|x| - R) & \text{if } |x| \geq R, \end{cases}$$

where  $U : \mathbb{R}^+ \rightarrow (0, 1)$  satisfies  $U'' + f(U) = 0$  in  $\mathbb{R}_+^*$ ,  $U(0) = 0$ ,  $U'(\xi) > 0 \forall \xi \geq 0$ ,  $U(+\infty) = 1$ . It exists as soon as (1.5) is satisfied (see proof of Lemma 1.2.2). As  $U(|\cdot| - R)$  is a subsolution,  $\psi$  is a subsolution of (1.9).

Hence there exists a solution  $\psi < u_\varepsilon < \omega$  of (1.9). If we prove that  $\omega \not\equiv 1$  then  $0 < u_\varepsilon < 1$  (with the maximum principle).



Now consider our problem (1.10) and replace  $\omega$  by  $v = 1 - \omega$ . The problem becomes

$$\begin{cases} -\Delta v = -f(1 - v) = g(v) & \text{in } B_R \setminus K_\varepsilon^\eta, \\ \nu \cdot \nabla v = 0 & \text{on } \partial K_\varepsilon^\eta, \\ v = 0 & \text{on } \partial B_R. \end{cases} \quad (1.11)$$

Using exactly the same arguments as in [14] one proves that, if we considere:

$$v_0(x) = \begin{cases} 1 & \text{if } x \in B_{R_2}(x^0) \setminus K_\varepsilon^\eta \cap \left\{ x; x_1 - x_1^0 \leq \frac{2R_1+R_2}{3} \right\}, \\ \frac{3}{R_2-R_1} \left( \frac{R_1+2R_2}{3} - (x_1 - x_1^0) \right) & \text{if } x \in B_{R_2}(x^0) \setminus K_\varepsilon^\eta \\ & \cap \left\{ x; \frac{2R_1+R_2}{3} \leq x_1 - x_1^0 \leq \frac{R_1+2R_2}{3} \right\}, \\ 0 & \text{if } x \in \left[ B_R \setminus (B_{R_2}(x^0) \cup C_\varepsilon \cup B_{R_0}(0)) \right] \\ & \cup \left[ B_{R_2}(x^0) \setminus K_\varepsilon^\eta \cap \left\{ x, x_1 - x_1^0 \geq \frac{R_1+2R_2}{3} \right\} \right], \end{cases} \quad (1.12)$$

then for  $\eta > 0$  small enough, there exist  $v \in H^1(B_R \setminus K_\varepsilon^\eta) \cap \{v = 0 \text{ on } \partial B_R\} = \bar{H}_0^1$ ,  $\delta > 0$  such that  $\|v - v_0\|_{H_0^1} < \delta$  and  $v$  is a local minimizer of the associated energy functional in  $\bar{H}_0^1$ . For more clarity we will give the main steps of the proof but for details see [14], section 6.3.

We refer to [10, 77] for other properties of nontrivial solution of elliptic equation in convex or strongly nonconvex (dumbbell-shaped) domain and also to [68] for the construction of local minimizers of a family of energy functionals that approximate perimeter functional in a fixed domain.

We introduce the energy functional in a domain  $D$ :

$$J_D(\omega) = \int_D \left\{ \frac{1}{2} |\nabla \omega|^2 - G(\omega) \right\} dx,$$

defined for functions of  $H^1(D)$ , where

$$G(t) = \int_0^t g(s) ds,$$

$g$  defined in (1.11). Using Proposition 6.6 in [14] one gets the following Corollary

**Corollary 1.3.2.** *In  $B_{R_1}(x^0)$ ,  $v_0 \equiv 1$  is a strict local minimum of  $J_{B_{R_1}(x^0)}$  in the space  $H^1(B_{R_1}(x^0))$ . More precisely, there exist  $\alpha > 0$  and  $\delta > 0$  for which*

$$J_{B_{R_1}(x^0)}(v) \geq J_{B_{R_1}(x^0)}(v_0) + \alpha \|v - v_0\|_{H^1(B_{R_1}(x^0))}^2,$$

for all  $v \in \bar{H}_0^1$  such that  $\|v - v_0\|_{B_R \setminus K_\varepsilon^\eta}^2 = \delta v \in H^1(B_{R_1}(x^0))$  such that  $\|v - v_0\|^2 \leq \delta$ .

And then using Proposition 6.8 of [14] and Corollary 1.3.2 one gets the following Corollary

**Corollary 1.3.3.** *There exist  $\gamma > 0$  and  $\eta_0 > 0$  (which depend on  $\varepsilon$ ) such that for all  $0 < \eta < \eta_0$  and  $v \in \bar{H}_0^1$  such that  $\|v - v_0\|_{B_R \setminus K_\varepsilon^\eta}^2 = \delta$ , then*

$$J_{B_R \setminus K_\varepsilon^\eta}(v_0) < J_{B_R \setminus K_\varepsilon^\eta}(v) - \gamma.$$

The proof of this corollary relies on the existence of a channel of width of order  $\eta > 0$  opening on the interior of the annular region  $\mathcal{A}$  (third assumption in (1.12)). This condition cannot be satisfied if the convergence of the obstacle is  $C^1$  (see Lemma 1.3.1).

The functional  $J_{B_R \setminus K_\varepsilon^\eta}$  admits a local minimum in the ball of radius  $\delta$  around  $v_0$  in  $H^1(B_R \setminus K_\varepsilon^\eta) \cap \{v = 0 \text{ on } \partial B_R\}$ . This yields a (stable) solution  $v$  of (1.11) for small enough  $\eta > 0$ . Furthermore, provided that  $\delta$  is chosen small enough, this solution does not coincide either with 1 or with 0 in  $B_R \setminus K_\varepsilon^\eta$ .

We have proved that for all  $\varepsilon \in ]0, 1]$ , there exists a solution  $u_\varepsilon$  of (1.1) such that  $u_\varepsilon \neq 1$ .

One has proved that  $C^0$  convergence of the domain is not sufficient and thus Theorem 1.1.1 does not hold.

One can conclude that if the perturbation is smooth in the  $C^{2,\alpha}$  topology, we still have a Liouville type result for bistable reaction diffusion equation in exterior domains. Whereas one can construct counterexample of this Liouville result for  $C^0$  perturbations. One question that is still open is thus the optimal space of regularity of the perturbation for the result to remain true under perturbation. For instance is the  $C^1$  convergence of the perturbation enough to get the result?

The main difficulties here would be the following

- We cannot apply Theorem 1.1.1 directly to prove the sufficiency of the  $C^1$  convergence. In deed without the  $C^{2,\alpha}$  convergence of the obstacles we cannot use Schauder theory. One can try to relax some assumptions on the regularity of the domain in the Schauder theory, as it has already been done in the literature ( $L^\infty$  assumption for coefficient in an elliptic or parabolic equation is enough to get the maximum principle). This remark refers to some technical arguments that will not be further explored in this chapter.
- One can try to construct a counterexample, as for the  $C^0$  convergence. The problem here would be that we could not use the energy arguments anymore because if we want the convergence to be  $C^1$ , the perturbations cannot draw any holes (most important argument in the construction of  $v_0$ ).

Thus the optimal space of convergence for the obstacles  $K_\varepsilon$  is still an open problem.

## 1.4 The associated parabolic problem and its properties

In this section we will use Theorem 1.1.1, to apply some results of [14] and derive Corollary 1.1.4. We investigate the following semilinear parabolic problem:

$$\begin{cases} \frac{\partial u_\varepsilon}{\partial t} = \Delta u_\varepsilon + f(u_\varepsilon) & \text{in } \Omega_\varepsilon = \mathbb{R}^N \setminus K_\varepsilon, \\ \nu \cdot \nabla u_\varepsilon = 0 & \text{on } \partial\Omega_\varepsilon = \partial K_\varepsilon, \end{cases} \quad (1.13)$$

where  $K_\varepsilon$  is a compact set in  $\mathbb{R}^N$ . Notice that in this section,  $u_\varepsilon$  is the solution of the parabolic problem.

**Proof of Corollary 1.1.4** We know from H. Berestycki, F. Hamel and H. Matano's paper [14]

that there exists an entire solution  $u_\varepsilon$  of (1.13) in  $\Omega_\varepsilon$  such that  $0 < u_\varepsilon(t, x) < 1$ ,  $\partial_t u_\varepsilon(t, x) > 0$  for all  $(t, x) \in \mathbb{R} \times \overline{\Omega_\varepsilon}$  and

$$u_\varepsilon(t, x) - \phi(x_1 + ct) \rightarrow 0 \text{ as } t \rightarrow -\infty \text{ uniformly in } x \in \overline{\Omega_\varepsilon},$$

and as  $|x| \rightarrow +\infty$  uniformly in  $t \in \mathbb{R}$ . Furthermore, there exists a classical solution  $u_{\varepsilon, \infty}$  of

$$\begin{cases} \Delta u_{\varepsilon, \infty} + f(u_{\varepsilon, \infty}) = 0 & \text{in } \Omega_\varepsilon = \mathbb{R}^N \setminus K_\varepsilon, \\ \nu \cdot \nabla u_{\varepsilon, \infty} = 0 & \text{on } \partial\Omega_\varepsilon = \partial K_\varepsilon, \\ 0 < u_{\varepsilon, \infty} \leq 1 & \text{in } \overline{\Omega_\varepsilon}, \\ \lim_{|x| \rightarrow +\infty} u_{\varepsilon, \infty}(x) = 1, \end{cases} \quad (1.14)$$

such that

$$u_\varepsilon(t, x) - \phi(x_1 + ct)u_{\varepsilon, \infty}(x) \rightarrow 0 \text{ as } t \rightarrow +\infty \text{ uniformly in } x \in \overline{\Omega_\varepsilon}.$$

Then using Theorem 1.1.1, there exists  $\varepsilon_0 < 1$  such that for all  $0 < \varepsilon < \varepsilon_0$ , the only solution  $u_{\varepsilon, \infty}$  of (1.14) is identically equal to 1. We have proved Corollary 1.1.4.  $\square$

We thus proved that when the obstacle is close in the  $C^{2, \alpha}$  topology to a star shaped or directionally convex domain, the steady state 1 invades the entire domain  $\Omega_\varepsilon$  and there exists an almost planar invasion front with global mean speed  $c$  between 0 and 1.

# Appendix

Poster presented at the poster session of the conference:

*Nonlinear Partial Differential Equations: Theory and Application to Complex System, Une conférence internationale en l'honneur d'Hiroshi Matano, Institut des Hautes Études Scientifiques, Bures sur Yvette.*

# Bistable traveling waves passing an obstacle: perturbation results

Juliette Bouhours

Université Pierre et Marie Curie, UMR 7598, Laboratoire J.L. Lions, F-75005 Paris, France

PhD student of Henri Berestycki (EHESS, CAMS Paris)

## Motivation

We study the existence of generalized transition fronts for a bistable reaction diffusion equation in  $\Omega_\varepsilon = \mathbb{R}^N \setminus K_\varepsilon$ , a perturbation of an exterior domain.

We prove the existence of generalized transition fronts when the perturbation  $K_\varepsilon$  is close, in the  $C^{2,\alpha}$  topology, to a smooth compact set  $K$  satisfying some geometric properties. We also give a counter-example when the perturbation is not smooth enough.

## The Parabolic Problem

This work is concerned with the following parabolic semi-linear problem:

$$\begin{cases} \partial_t u - \Delta u = f(u) & \text{in } \Omega_\varepsilon = \mathbb{R}^N \setminus K_\varepsilon, \\ \partial_\nu u = 0 & \text{on } \partial K_\varepsilon = \partial K_\varepsilon, \end{cases} \quad (1)$$

such that

$$|u(t, x) - \phi(x_1 + ct)| \rightarrow 0 \text{ as } t \rightarrow -\infty \text{ uniformly in } x \in \bar{\Omega}_\varepsilon, \quad (2)$$

where

- $(K_\varepsilon)_{0 < \varepsilon < 1}$  is a family of  $C^{2,\alpha}$ -compact sets in  $\mathbb{R}^N$ ,
- $f$  is of bistable type, i.e.  $f \in C^{1,1}([0, 1])$  such that,

$$\begin{aligned} \exists \theta \in (0, 1) [f(\theta) = f(1) = 0, f'(\theta) < 0, f'(1) < 0, \\ f(s) < 0 \forall s \in (0, \theta), f(s) > 0 \forall s \in (\theta, 1), \end{aligned} \quad (3)$$

with positive mass:

$$\forall 0 \leq s < 1, \int_s^1 f(\tau) d\tau > 0. \quad (4)$$

- $K_\varepsilon \rightarrow K$  in the  $C^{2,\alpha}$  topology as  $\varepsilon \rightarrow 0$ ,
- $K$  is a  $C^{2,\alpha}$  compact set of  $\mathbb{R}^N$ , star-shaped or directionally convex.
- $(\phi, c)$  solution of (6), with  $c > 0$ .

How does the shape of  $K$  influence the behavior of the solution of (1) and (2)?  
How does a propagating traveling waves interacts with our obstacles?

## Preliminary Results

For the Parabolic Problem

In [1] H. Berestycki, F. Hamel and H. Matano proved the existence of unique time global solution  $u_\varepsilon$  of (1) and (2), such that

$$|u(t, x) - \phi(x_1 + ct)| u_{\varepsilon, \infty}(x) \rightarrow 0 \text{ as } t \rightarrow \pm\infty \text{ uniformly in } x \in \bar{\Omega}_\varepsilon$$

where  $u_{\varepsilon, \infty}$  is a solution of (5).

For the Stationary Elliptic Problem

H. Berestycki, F. Hamel and H. Matano also proved that the unique solution of

$$\begin{cases} \Delta u_\infty + f(u_\infty) = 0 & \text{in } \Omega = \mathbb{R}^N \setminus K, \\ \nu \cdot \nabla u_\infty = 0 & \text{on } \partial\Omega = \partial K, \\ 0 < u_\infty \leq 1 & \text{in } \bar{\Omega}, \\ \lim_{|x| \rightarrow +\infty} u_\infty(x) = 1, \end{cases} \quad (5)$$

is  $u_\infty \equiv 1$  as soon as  $K$  is star-shaped or directionally convex.

## Obstacles - Some Examples

Star-shaped domain

**Definition 1.**  $K$  is called star-shaped, if either  $K = \emptyset$ , or there exists  $x \in \overset{\circ}{K}$  such that, for all  $y \in \partial K$  and  $t \in [0, 1)$ , the point  $x + t(y - x)$  lies in  $\overset{\circ}{K}$  and  $\nu_K(y) \cdot (y - x) \geq 0$ , where  $\nu_K(y)$  denotes the outward unit normal to  $K$  at  $y$ .



Figure 1: Example of star shaped obstacle directionally convex domain

**Definition 2.**  $K$  is called directionally convex with respect to a hyperplane  $P = \{x \in \mathbb{R}^N, x \cdot e = a\}$  where  $e$  is a unit vector and  $a$  is some real number, such that

- for every line  $\Sigma$  parallel to  $e$  the set  $K \cap \Sigma$  is either a single line or empty,
- $K \cap P = \pi(K)$  where  $\pi(K)$  is the orthogonal projection of  $K$  onto  $P$ .



Figure 2: Example of star shaped obstacle

## Main Results

**Theorem 3.** There exists  $\varepsilon_0 > 0$  such that for all  $0 < \varepsilon < \varepsilon_0$ , the unique solution of (5) in  $\Omega_\varepsilon$  is  $u_{\varepsilon, \infty} \equiv 1$

This means that for obstacles that are compact sets in  $\mathbb{R}^N$  and close enough (in the  $C^{2,\alpha}$  sense) to some star-shaped or directionally convex domains then the unique solution of (5) is the constant 1.

This Theorem yields some properties about the solution  $u_\varepsilon$  of the parabolic problem (1).

**Corollary 4.** Assume also that there exists  $(\phi, c)$  solution of

$$\begin{cases} \phi''(z) - c\phi'(z) + f(\phi(z)) = 0, & z \in \mathbb{R}, \\ \phi(-\infty) = 0, \phi(+\infty) = 1, \\ 0 < \phi(z) < 1, & z \in \mathbb{R}, \end{cases} \quad (6)$$

with  $c > 0$  (if  $f$  satisfies (3) and (4),  $\phi$  exists and  $c > 0$ ). Then for all  $0 < \varepsilon \leq 1$ , there exists an entire solution  $u_\varepsilon(t, x)$  of (1) such that  $0 < u_\varepsilon < 1$  and  $\partial_t u_\varepsilon > 0$  over  $\mathbb{R} \times \bar{\Omega}_\varepsilon$  and there exists  $\varepsilon_0 > 0$  such that for all  $0 < \varepsilon < \varepsilon_0$ ,

$$u_\varepsilon(t, x) - \phi(x_1 + ct) \rightarrow 0$$

as  $t \rightarrow \pm\infty$  uniformly in  $x \in \bar{\Omega}_\varepsilon$ , and as  $|x| \rightarrow +\infty$  uniformly in  $t \in \mathbb{R}$ .

## Generalized Transition Fronts

Let first give a formal definition of a generalized transition front.

**Definition 5.** A generalized transition front with interface  $\Gamma_t$  is a global in time solution, which stays together:

$$u(t, x) - p_\pm(t, x) \rightarrow 0 \text{ uniformly in } t \in \mathbb{R} \text{ and } x \in \bar{\Omega} \text{ as } d_{\Gamma_t}(x, \Gamma_t) \rightarrow +\infty,$$

where  $p_\pm$  are classical solutions of our problem and  $d_{\Gamma_t}$  is the geodesic distance in  $\Omega$ .

Then we also have the following corollary.

**Corollary 6.** For all  $0 < \varepsilon < \varepsilon_0$  the solution  $u_\varepsilon(t, x)$  given in Corollary 4 is a generalized, almost planar, invasion front between 0 and 1 with global mean speed  $c$ , in the sense that

$$\begin{aligned} \sup_{(t,x) \in \mathbb{R} \times \bar{\Omega}, x_1 + ct \geq A} |u_\varepsilon(t, x) - 1| &\xrightarrow{A \rightarrow +\infty} 0 \\ \sup_{(t,x) \in \mathbb{R} \times \bar{\Omega}, x_1 + ct \leq -A} |u_\varepsilon(t, x)| &\xrightarrow{A \rightarrow +\infty} 0 \end{aligned}$$

## Sketch of the Proofs

- Existence, uniqueness, monotonicity in  $t$ , from Berestycki, Hamel and Matano's paper
- Schauder theory  $\implies$  convergence of  $u_{\varepsilon, \infty}$  toward  $u$  solution of

$$\begin{cases} \Delta u + f(u) = 0 & \text{in } \Omega = \mathbb{R}^N \setminus K, \\ \nu \cdot \nabla u = 0 & \text{on } \partial\Omega = \partial K, \end{cases}$$

- $u_{\varepsilon, \infty} \rightarrow 1$  as  $|x| \rightarrow \infty$  uniformly in  $\varepsilon$  (Proposition 1)  $\implies u \rightarrow 1$  as  $|x| \rightarrow \infty$
- From Berestycki and al  $\implies u \equiv 1$
- By contradiction + comparison principle  $\implies$  there exists  $\varepsilon_0 > 0$  such that  $u_{\varepsilon, \infty} \equiv 1$  for all  $0 < \varepsilon < \varepsilon_0$
- Theorem from Berestycki and al finishes the proof

Main ideas for the proof of Proposition 1

- Existence of a function  $\omega$  in  $\mathbb{R}^+$  such that

$$\begin{cases} -\omega''(r) = f(\omega(r)), & \forall r \in \mathbb{R}^+, \\ \omega(0) = 0, \omega'(0) > 0, \\ \omega' > 0, 0 < \omega < 1 & \text{in } \mathbb{R}^+, \\ \lim_{r \rightarrow +\infty} \omega(r) = 1. \end{cases} \quad (7)$$

(using traveling waves argument or ODE approach)

- Define  $f_\delta$  with the same hypothesis than  $f$  but such that  $f_\delta \leq f$ ,  $f_\delta = f$  in  $[0, 1 - \delta]$  and  $f_\delta(1 - \frac{\delta}{2}) = 0$



- Existence of a function  $\omega_\delta$  in  $\mathbb{R}^+$  such that

$$\begin{cases} -\omega''(r) = f_\delta(\omega(r)), & \forall r \in \mathbb{R}^+, \\ \omega(0) = 0, \omega'(0) > 0, \\ \omega' > 0, 0 < \omega < 1 & \text{in } \mathbb{R}^+, \\ \lim_{r \rightarrow +\infty} \omega(r) = 1 - \frac{\delta}{2}. \end{cases} \quad (8)$$

- $z(x) = \omega_\delta(|x| - R)$  for all  $|x| \geq R$  is a sub solution of the elliptic problem
- One proves that

$$\bar{R} = \inf\{R \geq R_0; u_{\varepsilon, \infty}(x) > \omega_\delta(|x| - R), \text{ for all } |x| \geq R\} = R_0$$

is independent of  $\varepsilon$

As  $\omega_\delta(x) \rightarrow 1 - \frac{\delta}{2}$  when  $|x| \rightarrow +\infty$ , there exists  $\hat{R}$ , for all  $|x| > \hat{R} + R_0$ ,

$$u_\varepsilon(x) > 1 - \delta, \forall \varepsilon > 0.$$

## $C^{2,\alpha}$ Convergence

Definition

When we write  $K_\varepsilon \rightarrow K$  for the  $C^{2,\alpha}$  topology we mean that for each  $x_0 \in \partial K$ , and for some  $r > 0$  such that  $\partial K_\varepsilon \cap B_r(x_0) \neq \emptyset$  there exists a couple of parametrization of  $K_\varepsilon$  and  $K$ ,  $\psi_\varepsilon$  and  $\psi$ ,  $C^{2,\alpha}(B_r(x_0))$  functions such that  $\|\psi_\varepsilon - \psi\|_{C^{2,\alpha}(B_r(x_0))} \rightarrow 0$  as  $\varepsilon \rightarrow 0$ .

Examples of Perturbations

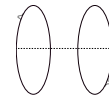

Figure 3: Example of a perturbation of a directionally convex domain that converges for the  $C^{2,\alpha}$  topology



Figure 4: Example of a perturbation of a star-shaped domain that converges for the  $C^{2,\alpha}$  topology



Figure 5: Example of perturbation that does not converge for the  $C^{2,\alpha}$  topology

Is the convergence in the  $C^{2,\alpha}$  topology necessary?  
Would a convergence in the  $C^0$  topology be enough?

## Optimal Space of Convergence

$C^0$  Convergence only

In this section we prove that the convergence of  $K_\varepsilon$  in the  $C^0$  topology is not enough.

- Construction of a family of obstacles  $(K_\varepsilon)_{0 < \varepsilon < 1}$  that converges toward  $K$  in the  $C^0$  topology only.

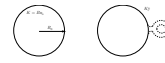

Figure 6: Liouville counterexample from [1]

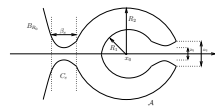

Figure 7: Zoom on the dash part

- Existence of  $u_{\varepsilon, \infty}$  solution of (5), that is not equivalent to 1
- We look for a solution of the following problem

$$\begin{cases} -\Delta \omega = f(\omega) & \text{in } B_R \setminus K_\varepsilon^R, \\ \nu \cdot \nabla \omega = 0 & \text{on } \partial K_\varepsilon^R, \\ \omega = 1 & \text{on } \partial B_R, \end{cases}$$

for some  $R > 0$  large enough such that  $K_\varepsilon^R \subset B_R$ .

$\implies \omega$  extended by 1 outside  $B_R$  is a super solution of (5).

- There exists  $\omega$  such that  $\|\omega - \omega_0\| < \delta$ , and  $\omega$  achieves a minimum of the energy functional

$$J_{B_R \setminus K_\varepsilon^R}(\omega) = \int_{B_R \setminus K_\varepsilon^R} \left[ \frac{1}{2} |\nabla \omega|^2 + F(\omega) \right] dx,$$

where  $F(t) = \int_0^1 f(s) ds$  and  $\omega_0$  a linear function equal to 1 outside  $B(x_0, R_2)$  and 0 inside  $B(x_0, R_1)$ .

- For  $\delta$  small enough  $\omega$  is a super solution of our problem and  $0 < \omega < 1$  in  $B_R$ . The Comparison principle implies that  $0 < u_{\varepsilon, \infty} < 1$ .

The convergence of the obstacles in the  $C^0$  topology is not enough.

Open Problem

Is the  $C^1$  topology the optimal space of convergence?

- The  $C^{2,\alpha}$  convergence is needed for the Schauder estimates
- A counter-example for the  $C^1$  convergence can not draw any holes.

## References

[1] H. Berestycki, F. Hamel and H. Matano, *Bistable traveling waves around an obstacle*, Comm. on Pure and Applied Math., Vol LXII, 0729-0788 (2009)

## Chapitre 2

# Propagation en présence de réchauffement climatique Application à la dynamique des populations



---

# A variational approach to reaction diffusion equations with forced speed in dimension 1

This work is in collaboration with Grégoire Nadin<sup>1,2</sup>

<sup>1</sup>Sorbonne Universités, UPMC Univ Paris 06, UMR 7598, Laboratoire Jacques-Louis Lions, F-75005, Paris, France,

<sup>2</sup> CNRS, UMR 7598, Laboratoire Jacques-Louis Lions, F-75005, Paris, France

---

Dans ce chapitre on étudie une équation de réaction-diffusion scalaire avec un terme de réaction non linéaire  $f$  dépendant de  $u$  et de  $x - ct$ , où  $x \in \mathbb{R}$  est la variable d'espace et  $t > 0$  la variable de temps. Ici,  $c > 0$  est un paramètre fixé modélisant la vitesse d'un changement climatique. On s'intéresse aux conditions de survie de la population par rapport à la valeur de  $c$  en déterminant le comportement en temps long de la solution du problème associé.

Ce problème a récemment été résolu dans le cas d'une non linéarité de type KPP. Dans ce chapitre, nous considérons des termes de réaction plus généraux, dont on suppose seulement qu'ils sont négatifs à l'infini. En utilisant une approche variationnelle nouvelle, nous construisons deux seuils  $0 < \underline{c} \leq \bar{c} < \infty$ , qui déterminent l'existence et la non existence d'ondes progressives dans ce cadre hétérogène précis. Nos résultats numériques soutiennent la conjecture  $\underline{c} = \bar{c}$ . On prouve ensuite que toute solution du problème parabolique pour une condition initiale donnée, converge en temps long soit vers 0 soit vers une onde progressive. Dans le cas d'une non linéarité de type bistable, où l'état stationnaire 0 est supposé stable, nos résultats conduisent à des phénomènes différents que ceux observés dans le cas KPP. Nous finissons ce chapitre en illustrant nos résultats précédents et en discutant de plusieurs problèmes ouverts à travers des simulations numériques.

2010 *Mathematics Subject Classification*: 35B40, 35C07, 35J20, 35K10, 35K57, 92D52

*Mots clés*: Équations de réaction-diffusion, ondes progressives, vitesse forcée, fonctionnelle d'énergie, comportement en temps long.

---



The research leading to these results has received funding from the European Research Council under the European Union's Seventh Framework Program (FP/2007-2013) / ERC Grant Agreement n.321186 - ReaDi- Reaction-Diffusion Equations, Propagation and Modelling. Juliette Bouhours is funded by a PhD fellowship "Bourse hors DIM" of the "Région Ile de France".

## 2.1 Introduction and main results

### 2.1.1 Motivation: models on climate change

Reaction diffusion problem are often used to model the evolution of biological species. In 1937, Kolmogorov, Petrovsky and Piskunov in [69], Fisher in [41] used reaction diffusion to investigate the propagation of a favorable gene in a population. One of the main notions introduced in [69, 41] is the notion of travelling waves, i.e solution of the form  $u(t, x) = U(x - ct)$  for  $x \in \mathbb{R}$ ,  $t > 0$  and some constant  $c \in \mathbb{R}$ . Since then a lot of papers have been dedicated to reaction diffusion equations and travelling waves in settings modelling all sorts of phenomena in biology. In this paper we are interested in the following problem,

$$\begin{cases} u_t - u_{xx} = f(x - ct, u), & x \in \mathbb{R}, t > 0, \\ u(0, x) = u_0(x), & x \in \mathbb{R}, \end{cases} \quad (\text{P})$$

where  $u_0$  is bounded, nonnegative and compactly supported.

This problem has been proposed in [9] to model the effect of climate change on biological species. In this setting  $u$  is the density of a biological population that is sensitive to climate change. We assume that the North Pole is found at  $+\infty$  whereas the equator is at  $-\infty$ , which gives a good framework to study the effect of global warming on the distribution of the population. The dependence on  $z$  in the reaction term takes into account the notion of favorable/unfavorable area depending on the latitude for populations which are sensitive to the climate/temperature of the environment. The constant  $c$  can be seen as the speed of the climate change. In such a setting, one will be interested to know when the population can keep track with its favorable environment despite the climate change and thus persists at large times. In [9] Berestycki et al studied the existence of non trivial travelling waves solution in dimension 1 when  $f$  satisfies the KPP property:  $s \in \mathbb{R}^+ \mapsto f(z, s)/s$  is decreasing for all  $z \in \mathbb{R}$ . They proved that in this framework, the persistence of the population depends on the sign of the principal eigenvalue of the linearized equation around the trivial steady state 0. Their results have been extended to  $\mathbb{R}^N$  in [17] and to infinite cylinders in [18] by Berestycki and Rossi. In [118] Vo studies the same type of problem with more general classes of unfavorable media toward infinity.

A similar model was developed by Popatov and Lewis in [99] and by Berestycki, Desvillettes and Diekmann in [8] in order to investigate a two-species competition system facing a climate change. These papers studied the effect of the speed of the climate change on the coexistence between the competing species. In [8] the authors pointed out the formation of a spatial gap between the two species when one is forced to move forward to keep up with the climate change and the other has limited invasion speed. The persistence of a species facing a climate change was also investigated mathematically through an integrodifference model by Zhou and Kot in [123].

The particularity of all these papers is the KPP assumption for the reaction term, where the linearized equation around 0 determines the behaviour of the solution of the nonlinear equation. As far as we know, such questions were only investigated numerically for other types of nonlinearities by Roques et al in [104], where the authors were mainly interested in the effects of the

geometry of the domain (in dimension 2) on the persistence of the population considering KPP and bistable nonlinearities.

### 2.1.2 Framework

In this paper we are interested in this persistence question, when the evolution of the density of the population is modelled by a reaction diffusion equation, with more general hypotheses on the nonlinearity  $f$  in the favorable area. Indeed we point out that we consider general nonlinearities  $f$ , without assuming  $f$  to satisfy the KPP property.

We will assume that  $f$  is a Carathéodory function satisfying the following hypotheses,

$$f(z, 0) = 0, \quad (2.1)$$

$$s \mapsto f(z, s) \text{ is Lipschitz-continuous uniformly with respect to } z \in \mathbb{R}, \quad (2.2)$$

$$\exists M > 0 \mid f(z, s) \leq 0, \quad \forall s \geq M \text{ and } z \in \mathbb{R}, \quad (2.3)$$

$$\exists R > 0, \delta > 0, \quad f(z, s) \leq -\delta s, \quad \forall |z| > R, s \in (0, M). \quad (2.4)$$

Assumption (2.1) means that when the population vanishes then no reaction takes place, i.e 0 is a steady state of the problem which corresponds to the extinction of the population. Hypothesis (2.3) models some overcrowding effect: the resources being limited, the environment becomes unfavorable when the population grows above some threshold  $M > 0$ . The last assumption (2.4) gives information on the boundedness of the favorable environment and postulates that outside a bounded region the environment is strictly unfavorable.

### 2.1.3 Main results

Up to a change of variable ( $z := x - ct$ ) Problem (P) is equivalent to

$$\begin{cases} u_t - u_{zz} - cu_z = f(z, u), & z \in \mathbb{R}, t > 0, \\ u(0, z) = u_0(z), & z \in \mathbb{R}, \end{cases} \quad (\tilde{P})$$

In our paper we investigate the existence of travelling waves solutions of (P), i.e nonnegative solution of the form  $u(t, x) = U(x - ct)$  for all  $x \in \mathbb{R}$ ,  $t > 0$  with  $U \not\equiv 0$ ,  $U(\pm\infty) = 0$ . This particular solutions are non trivial solutions of the following stationary problem

$$\begin{cases} -U_{zz} - cU_z = f(z, U), & z \in \mathbb{R}, \\ U(z) \geq 0, & z \in \mathbb{R}, \\ U(\pm\infty) = 0. \end{cases} \quad (S)$$

Solutions of (S) are also the stationary solutions of Problem ( $\tilde{P}$ ) and notice that 0 is a solution of (S) but not a travelling wave solution. We have the following theorem,

**Theorem 2.1.1.** *Assuming that there exists  $u \in H^1(\mathbb{R})$  such that*

$$E_0[u] := \int_{\mathbb{R}} \left( \frac{u_z^2}{2} - F(z, u) \right) dz < 0, \quad \text{with } F(z, s) := \int_0^s f(z, t) dt,$$

*then there exist  $\bar{c} \geq \underline{c} > 0$ , such that*

- *for all  $c \in (0, \underline{c})$ , (P) has a travelling wave solution  $U_c \in H_c^1(\mathbb{R}) = H^1(\mathbb{R}, e^{cz} dz)$  with  $E_c[U_c] < 0$ ,*

- For all  $c > \bar{c}$ , (P) has no travelling wave solution, that is 0 is the only solution of (S).

The proof of Theorem 2.1.1 is based on a variational approach, used in [75] to prove the existence of travelling front for gradient like systems of equations. We use the same variational formula but in the case of scalar equations and when  $f$  depends on  $z = x - ct$ .

Then we will be interested in the convergence of the Cauchy problem toward some travelling wave solutions.

**Theorem 2.1.2.** *Let  $u_0 \in H^2(\mathbb{R})$  and  $u_0$  bounded, compactly supported. Then the unique solution  $u$  of (P) satisfies  $u \in L^2([0, T[, H_c^1(\mathbb{R}))$ ,  $u_t \in L^2([0, T[, L_c^2(\mathbb{R}))$ , for all  $T > 0$ , and  $t \mapsto u(t, \cdot - ct)$  converges to a solution of (S) as  $t \rightarrow +\infty$ .*

Note that the limit of  $u$  in the previous theorem could be the trivial solution 0. And if  $t \mapsto u(t, \cdot - ct)$  converges to 0 as  $t \rightarrow +\infty$  this implies that the population goes extinct, whereas if  $t \mapsto u(t, \cdot - ct)$  converges to  $U_c > 0$  non trivial solution of (S) as  $t \rightarrow +\infty$  this means that there is persistence of the population and convergence to a travelling wave solution.

After proving these two main theorems, we study the existence of travelling wave solutions and the behaviour of the solution of the Cauchy problem ( $\tilde{P}$ ) depending on the linear stability of 0. Then we study the solution  $u$  of ( $\tilde{P}$ ) for particular  $f$ ,  $\delta$  and  $c$ .

- We prove that, as in the KPP framework, when 0 is linearly unstable the solution  $u$  of ( $\tilde{P}$ ) converges to a travelling wave solution. We also prove that in contrast with the KPP case, in bistable-like framework when 0 is linearly stable there still exists a travelling wave solution (see Proposition 2.4.3 and Corollary 2.4.4). This result emphasizes the particularity of the KPP framework where the linearity of 0 determines the existence of travelling wave solutions, which is not true in the general framework.
- In the last section we first study numerically the existence of a threshold  $c^*$  such that if  $c < c^*$  the population survives, i.e the solution of the Cauchy problem ( $\tilde{P}$ ) converges toward travelling waves for large times, while if  $c > c^*$  the population dies, i.e the solution of the Cauchy problem ( $\tilde{P}$ ) converges to 0 for large times, for  $f$  KPP, monostable and bistable in the favorable area. In view of the numerical results, we state the following conjecture:

**Conjecture 1.** *Let  $\underline{c} \leq \bar{c}$  be defined by Theorem 2.1.1 then  $\underline{c} = \bar{c} = c^*$ .*

We also plot the shape of the profile for different values of the parameter  $\delta$  and  $f$  bistable.

Then we give an example of nonlinearity  $f$  such that there exist several locally stable travelling wave solutions and illustrate this result with numerical simulations displaying the shape of the profile for different times.

## Organization of the paper

Theorem 2.1.1 concerning the stationary framework is proved using a variational method in section 2.2. Sections 2.3 and 2.4 are devoted to the study of the Cauchy problem (P). We prove Theorem 2.1.2 in section 2.3 and discuss the linear stability of 0 and its consequences on the convergence of the Cauchy problem in section 2.4. We give some examples and discuss possible improvements of our results with numerical insight in section 2.5.

## 2.2 A variational approach to travelling waves

The variational structure of travelling waves solutions of homogeneous reaction-diffusion equations is known since the pioneering work of Fife and McLeod [40]. However, this structure has only been fully exploited quite recently in order to derive existence and stability results for travelling waves in bistable equations in parallel by Heinze [60], Lucia, Muratov and Novaga [75] and then by Risler [101] for gradient systems (see also [43, 42] for various other applications). The situation we consider in the present paper is different. First, we deal with heterogeneous reaction-diffusion equations. The homogeneity was indeed a difficulty in earlier works, since the invariance by translation caused a lack of compactness. Here, the behaviour of the nonlinearity at infinity will somehow trap minimizing sequences in the favorable habitats where  $f$  is positive. Second, we consider general nonlinearities, including monostable ones. The variational approach is not a relevant tool in order to investigate such equations when the coefficients are homogeneous since travelling waves do not decrease sufficiently fast at infinity and thus have an infinite energy. Here, again, the behaviour of the nonlinearity at infinity forces an admissible exponential decay and we could thus define an energy and make use of it.

We are interested in the existence of travelling wave solution of equation (P), i.e

$$u(t, x) = U(x - ct) = U(z),$$

and  $U$  is a solution of the ordinary differential equation

$$\begin{cases} -U'' - cU' = f(z, U), & z \in \mathbb{R}, \\ U > 0 & \text{in } \mathbb{R}, \\ U(z) \rightarrow 0 & \text{as } |z| \rightarrow +\infty. \end{cases}$$

To study existence of non trivial travelling waves, we introduce the energy functional defined as follow

$$E_c[u] = \int_{\mathbb{R}} e^{cz} \left\{ \frac{u_z^2}{2} - F(z, u) \right\} dz, \quad \forall u \in H_c^1(\mathbb{R}),$$

where  $H_c^1(\mathbb{R}) = H^1(\mathbb{R}, e^{cx} dx)$  and

$$F(z, s) = \int_0^s f(z, t) dt.$$

One can notice that (2.1) and (2.2) ensure that  $\int_{\mathbb{R}} F(z, u) e^{cz} dz$  is well defined for all  $u \in H_c^1(\mathbb{R})$ .

We start by proving the first part of the Theorem and by pointing out the link between solutions

of (S) and the functional  $E_c$ .

**Lemma 2.2.1.** *Let  $u \in H_c^1(\mathbb{R})$  nonnegative,  $u$  is a critical point of the energy functional  $E_c$  if and only if  $u$  is a solution of (S). Moreover  $u \in W_{loc}^{2,p}(\mathbb{R})$ , for all  $p > 1$ .*

**Proof:** The first part of the proof is classical. Standard arguments yield that  $E_c$  is  $C^1$  and that its differential at  $u$  is given, for all  $w \in H_c^1(\mathbb{R})$ , by

$$dE_c[u](w) = \int_{\mathbb{R}} e^{cz} \{u_z w_z - f(z, u)w\} dz.$$

Moreover letting  $v(z) := u(z)e^{\frac{cz}{2}}$  for all  $z \in \mathbb{R}$ , then

$$v'' = \frac{c^2}{4}v - f(z, e^{-\frac{cz}{2}}v)e^{\frac{cz}{2}}, \quad \text{in } \mathbb{R},$$

and

$$\frac{v''(z)}{v(z)} \geq \delta + \frac{c^2}{4}, \quad \text{if } z \leq -R.$$

As  $u \in H_c^1(\mathbb{R})$ ,  $v(z) \rightarrow 0$  as  $z \rightarrow -\infty$  and we can apply [17, Lemma 2.2] we have that

$$v(z)e^{-\sqrt{\frac{c^2}{4} + \delta}z} \xrightarrow{z \rightarrow -\infty} 0,$$

which implies that

$$u(z) \leq e^{\gamma z}, \quad \forall z \leq R^-,$$

for some  $R^- < -R$  and  $\gamma > 0$ . This implies that  $u(z) \rightarrow 0$  as  $z \rightarrow -\infty$  and as  $u \in H_c^1(\mathbb{R})$ ,  $u(z) \rightarrow 0$  as  $z \rightarrow +\infty$ . Thus  $u \in H_c^1(\mathbb{R})$  is a critical point of  $E_c$  iff  $u$  is a weak solution of (S). Using classical Sobolev embeddings, and taking  $w$  smooth we prove the end of the lemma.  $\square$

Let us state a Poincaré type inequality that will be useful in the sequel, which is due to [75].

**Lemma 2.2.2** (Lemma 2.1 in [75]). *For all  $u \in H_c^1(\mathbb{R})$ ,*

$$\frac{c^2}{4} \int_{\mathbb{R}} e^{cz} u^2 dz \leq \int_{\mathbb{R}} e^{cz} u_z^2 dz$$

Now notice that we can always assume that a global minimizer of  $E_c$  is bounded and non negative.

**Remark 2.2.3.** *Considering  $\tilde{u} = \min\{u, M\}$ , we have*

$$F(z, u) - F(z, \tilde{u}) = \int_{\tilde{u}}^u f(z, s) ds = \begin{cases} 0 & \text{if } u < M, \\ \int_M^u f(z, s) ds & \text{otherwise,} \end{cases} \\ \leq 0.$$

Thus

$$E_c[u] \geq \int_{\mathbb{R}} e^{cz} \left\{ \frac{u_z^2}{2} - F(z, \tilde{u}) \right\} dz \geq \int_{\mathbb{R}} e^{cz} \left\{ \frac{\tilde{u}_z^2}{2} - F(z, \tilde{u}) \right\} dz = E_c[\tilde{u}].$$

As we want to minimize the energy functional,  $\tilde{u}$  will always be a better candidate than  $u$ . Similarly, taking  $\tilde{u} = \max\{0, u\}$  instead of  $u$  gives a lower energy.

Hypothesis (2.1) ensures that  $E_c(0) = 0$  and thus  $\inf_{u \in H_c^1(\mathbb{R})} E_c[u] \leq 0$ . Moreover, the following lemma yields that  $\inf_{u \in H_c^1(\mathbb{R})} E_c[u] > -\infty$ .

**Lemma 2.2.4.** *For all  $c > 0$ , there exists  $C > 0$  such that for all  $u \in H_c^1(\mathbb{R})$ ,  $E_c[u] \geq -C$ .*

**Proof:** We can assume that  $0 \leq u \leq M$  using Remark 2.2.3. For all  $u \in H_c^1(\mathbb{R})$ , using assumption (2.4),

$$E_c[u] \geq \int_{B_R} e^{cz} \left\{ \frac{u_z^2}{2} - F(z, u) \right\} dz + \int_{\mathbb{R} \setminus B_R} e^{cz} \left\{ \frac{u_z^2}{2} + \frac{\delta u^2}{2} \right\} dz \geq E_c^R[u],$$

where  $E_c^R[u] = \int_{B_R} e^{cz} \left\{ \frac{u_z^2}{2} - F(z, u) \right\} dz$ . This implies that  $\inf_{u \in H_c^1(\mathbb{R})} E_c[u] \geq \inf_{u \in H_c^1(-R, R)} E_c^R[u]$ . Using the assumptions on  $f$ , there exists  $C_0 > 0$  such that  $-F(z, s) > -C_0$  for all  $z \in B_R$  and  $s \in [0, M]$ . Thus there exists  $C > 0$  such that  $E_c^R[u] \geq -C$  for all  $u \in H_c^1(-R, R)$  and then

$$\inf_{u \in H_c^1(\mathbb{R})} E_c[u] \geq -C.$$

□

**Proposition 2.2.5.** *There exists  $u_\infty \in H_c^1(\mathbb{R})$  such that  $E_c[u_\infty] = \min_{u \in H_c^1(\mathbb{R})} E_c[u]$ .*

To prove Proposition 2.2.5 we consider  $(u_n)_n$  a minimizing sequence of  $E_c$  in  $H_c^1(\mathbb{R})$ , i.e such that  $E_c[u_n] \rightarrow \inf_{u \in H_c^1(\mathbb{R})} E_c[u] > -\infty$  as  $n \rightarrow +\infty$ . In view of Remark 2.2.3 we can assume that  $u_n$  is bounded for  $n$  large enough.

**Lemma 2.2.6.** *There exist  $N \in \mathbb{N}$ ,  $C_1 > 0$ , locally bounded with respect to  $c$ , such that for all  $n > N$ ,*

$$\|u_n\|_{H_c^1(\mathbb{R})}^2 = \int_{\mathbb{R}} e^{cz} \{(u_n)_z^2 + u_n^2\} dz \leq \frac{1 + C_1}{\min\{\frac{1}{2}, \frac{\delta}{2}\}}.$$

**Proof of Lemma 2.2.6:** For all  $u \in H_c^1(\mathbb{R})$ , bounded,

$$\begin{aligned} E_c[u] &\geq \int_{B_R} e^{cz} \left\{ \frac{u_z^2}{2} - F(z, u) \right\} dz + \int_{\mathbb{R} \setminus B_R} e^{cz} \left\{ \frac{u_z^2}{2} + \frac{\delta u^2}{2} \right\} dz, \\ &= \int_{B_R} e^{cz} \left\{ -F(z, u) - \frac{\delta u^2}{2} \right\} dz + \int_{\mathbb{R}} e^{cz} \left\{ \frac{u_z^2}{2} + \frac{\delta u^2}{2} \right\} dz, \\ &\geq -C_1 + \min\left\{ \frac{1}{2}, \frac{\delta}{2} \right\} \|u\|_{H_c^1(\mathbb{R})}^2, \end{aligned}$$

where  $C_1 = -\frac{1}{c}(C_0 - \frac{\delta M^2}{2})(e^{cR} - e^{-cR})$ , with  $C_0$  as in the proof of Lemma 2.2.4. Moreover as  $E_c[u_n] \rightarrow \inf_{u \in H_c^1(\mathbb{R})} E_c[u] \leq 0 = E_c[0]$ , there exists  $N \in \mathbb{N}$  such that for all  $n > N$ ,  $E_c[u_n] \leq 1$ .

Then using the previous computation we obtain the Lemma. □

One can now prove Proposition 2.2.5.

**Proof of Proposition 2.2.5:** From Lemma 2.2.6, if  $(u_n)$  is a minimizing sequence of  $E_c$  in  $H_c^1(\mathbb{R})$  then  $(u_n)$  is bounded in  $H_c^1(\mathbb{R})$ . Thus up to a subsequence  $(u_n)$  converges weakly to some  $u_\infty \in H_c^1(\mathbb{R})$ . One has:

$$\int_{\mathbb{R}} e^{cz} (u_\infty)_z^2 dz \leq \liminf_{n \rightarrow +\infty} \int_{\mathbb{R}} e^{cz} (u_n)_z^2 dz.$$

Moreover as  $u_n \in (0, M)$ , classical Sobolev injections yield that

$$u_n \rightarrow u_\infty \text{ in } C_{loc}(\mathbb{R}) \text{ as } n \rightarrow +\infty.$$

As  $F$  is bounded, the dominated convergence theorem gives, for all  $T \in \mathbb{R}$ ,

$$\int_{-\infty}^T e^{cz} F(z, u_n) dz \rightarrow \int_{-\infty}^T e^{cz} F(z, u_\infty) dz \quad \text{as } n \rightarrow +\infty.$$

Thus, as  $-\int_T^{+\infty} e^{cz} F(z, u_n) dz \geq 0$ , for all  $T > R$ ,

$$\begin{aligned} \liminf_{n \rightarrow +\infty} E_c[u_n] &\geq \int_{\mathbb{R}} e^{cz} \frac{(u_\infty)_z^2}{2} dz + \int_{-\infty}^T -e^{cz} F(z, u_\infty) dz, \\ &= E_c[u_\infty] + \int_T^{+\infty} e^{cz} F(z, u_\infty) dz, \\ &\geq E_c[u_\infty] - \int_T^{+\infty} C e^{cz} u_\infty^2 dz, \end{aligned}$$

the last inequality following from (2.2). As, for all  $\varepsilon > 0$ , there exists  $T > R$  such that  $\int_T^{+\infty} C e^{cz} u_\infty^2 dz < \varepsilon$ , since  $u_\infty \in H_c^1$ , we have

$$E_c[u_\infty] \leq \liminf_{n \rightarrow +\infty} E_c[u_n] = \inf_{u \in H_c^1(\mathbb{R})} E_c[u],$$

and the Proposition is proved.  $\square$

We have proved that the minimum is reached in  $H_c^1$ . This implies that there exists a solution  $U$  of (S) such that  $E_c[U] = \inf_{u \in H_c^1} E_c[u]$ .

We will now assume that

$$\exists u \in H^1(\mathbb{R}) \mid E_0[u] = \int_{\mathbb{R}} \left\{ \frac{u_z^2}{2} - F(z, u) \right\} dz < 0. \quad (H_0)$$

**Proposition 2.2.7.** *The function  $c \geq 0 \mapsto \inf_{u \in H_c^1(\mathbb{R})} E_c[u]$  is continuous.*

**Proof:** Let  $(c_n)_n$  a sequence in  $\mathbb{R}$  such that  $c_n \rightarrow c$  as  $n \rightarrow +\infty$ . From Proposition 2.2.5 we know that for all  $n \in \mathbb{N}$  there exists  $u_n \in H_{c_n}^1(\mathbb{R})$  such that  $\inf_{u \in H_{c_n}^1(\mathbb{R})} E_{c_n}[u] = E_{c_n}[u_n]$ . Let

$v_n := e^{\frac{c_n z}{2}} u_n \in H^1(\mathbb{R})$  and notice that

$$E_{c_n}[u_n] = \int_{\mathbb{R}} \left\{ \frac{(v_n)_z^2}{2} + \frac{c_n^2}{8} v_n^2 - e^{c_n z} F(z, e^{-\frac{c_n z}{2}} v_n) \right\} dz =: \tilde{E}_{c_n}[v_n].$$

Moreover the sequence  $(v_n)_n$  is uniformly bounded in  $H^1(\mathbb{R})$  by Lemma 2.2.6, as  $(c_n)_n$  is uniformly bounded, thus up to a subsequence,  $v_n \rightharpoonup v_\infty$  weakly in  $H^1(\mathbb{R})$  as  $n \rightarrow +\infty$ . Moreover for all  $v \in H^1(\mathbb{R})$ ,  $\tilde{E}_{c_n}[v] \rightarrow \tilde{E}_c[v]$  as  $n \rightarrow +\infty$ . As  $v_n$  is a minimizer, for all  $v \in H^1(\mathbb{R})$ ,

$$\tilde{E}_{c_n}[v_n] \leq \tilde{E}_{c_n}[v].$$

Passing to the limit and using the same arguments as in the proof of Proposition 2.2.5 we obtain

$$\tilde{E}_c[v_\infty] \leq \liminf_{n \rightarrow +\infty} \tilde{E}_{c_n}[v_n] \leq \tilde{E}_c[v], \quad \forall v \in H^1(\mathbb{R}).$$

This implies that  $\tilde{E}_c[v_\infty] = \inf_{v \in H^1(\mathbb{R})} \tilde{E}_c[v]$ , and letting  $u_\infty = e^{-\frac{cz}{2}} v_\infty$  we get the Proposition.  $\square$

By the continuity of  $c \mapsto \inf_{u \in H_c^1(\mathbb{R})} E_c[u]$  and using Proposition 2.2.5, the first part of Theorem 2.1.1 is proved.

This proposition will prove the second part of the Theorem

**Proposition 2.2.8.** *There exists  $\bar{c} > 0$  such that for all  $c > \bar{c}$ , 0 is the only solution of equation (S).*

**Proof:** Define

$$g(z, u) = \left( \sup_{s \geq u} \frac{f(z, s)}{s} \right) \times u, \quad \forall z \in \mathbb{R}, u \in \mathbb{R}^+.$$

Then  $g$  satisfies the following assumptions:

$$\begin{aligned} g(z, 0) &= 0, \quad \forall z \in \mathbb{R}, \\ u \mapsto g(z, u) &\text{ is Lipschitz-continuous uniformly with respect to } z \in \mathbb{R}, \\ g(z, s) &\leq 0, \quad \forall z \in \mathbb{R}, s \geq M, \\ \forall z \in \mathbb{R}, \quad u \mapsto \frac{g(z, u)}{u} &\text{ is decreasing,} \\ g(z, u) &\leq -\delta u, \quad \forall |z| > R. \end{aligned}$$

Hence we know from [17, Theorem 3.2] that there exists  $\bar{c} > 0$  such that if  $v$  is a solution of

$$-v_{zz} - cv_z = g(z, v) \quad \text{in } \mathbb{R}, \quad (2.5)$$

for  $c > \bar{c}$ , then  $v \equiv 0$ . Moreover for all  $z \in \mathbb{R}$ ,  $s \in \mathbb{R}$ ,  $g(z, s) \geq f(z, s)$ . Take  $c > \bar{c}$  and let  $u$  a solution of (S), then  $u$  is a subsolution of the associated KPP equation, i.e

$$-u'' - cu' \leq g(z, u) \quad \text{in } \mathbb{R}.$$

Let  $M > 0$  be as in condition (2.3), then  $w(z) = M$  for all  $z \in \mathbb{R}$  is a super solution of the associated KPP problem, i.e

$$-w'' - cw' \geq g(z, w) \quad \text{in } \mathbb{R},$$

and we can take  $M$  large enough such that  $u \leq M$  in  $\mathbb{R}$ . Thus there exists  $v$  a solution of the KPP problem (2.5), such that  $u(z) \leq v(z) \leq M$  for all  $z \in \mathbb{R}$ . But as  $c > \bar{c}$ ,  $v \equiv 0$ , which implies that (S) has no positive solution as soon as  $c > \bar{c}$  and the Proposition is proved.  $\square$

## 2.3 Convergence of the Cauchy problem

In this section we come back to the parabolic problem (P), that we remind below

$$\begin{cases} u_t - u_{xx} = f(x - ct, u) & x \in \mathbb{R}, t > 0, \\ u(0, x) = u_0(x) & x \in \mathbb{R}, \end{cases}$$

where  $u_0 \in H^2(\mathbb{R})$  is non negative, bounded and compactly supported.

Letting  $z := x - ct$ ,  $u$  satisfies the following problem

$$\begin{cases} \partial_t u - \partial_{zz} u - c\partial_z u = f(z, u) & \forall z \in \mathbb{R}, t > 0, \\ u(0, z) = u_0(z), & \text{for all } z \in \mathbb{R}. \end{cases} \quad (\tilde{P})$$

Defining  $v(t, z) = u(t, z)e^{\frac{c}{2}z}$  for all  $t > 0$ ,  $z \in \mathbb{R}$ , then  $v$  satisfies the following equation

$$v_t - v_{zz} + \frac{c^2}{4}v^2 = e^{\frac{c}{2}z} f(z, e^{-\frac{c}{2}z}v).$$



Classical arguments yield that as  $v(0, \cdot) \in H^2(\mathbb{R})$ , there exists a unique  $v$ , weak solution of the previous equation such that  $v \in L^2((0, T), H^2(\mathbb{R}))$  and  $v_t \in L^2((0, T), L^2(\mathbb{R}))$ , for all  $T > 0$ . And thus as soon as  $u_0 \in H^2(\mathbb{R})$ , there exists a unique  $u \in L^2([0, T[, H_c^2(\mathbb{R}))$ , with  $u_t \in L^2((0, T), L_c^2(\mathbb{R}))$  for all  $T > 0$ , solution of  $(\tilde{P})$ . Moreover  $u(t, x) > 0$  for all  $t > 0$ ,  $x \in \mathbb{R}$ . We will now prove Theorem 2.1.2 on the convergence of solution of  $(\tilde{P})$  as  $t \rightarrow +\infty$ . In [76] Matano proves the convergence of solutions of one dimensional semilinear parabolic equations in bounded domains using a geometric argument and the maximum principle and extended this result in [38] to unbounded domain for homogeneous  $f$ . Their method relies on classification of solutions for homogeneous problems and uses a reflexion principle which cannot be applied in our case. An alternative proof of this result was first given by Zelenyak in [122] using a variational approach. In [54] Hale and Raugel proved an abstract convergence result in gradient like systems which might apply in the present framework. It roughly states that if the kernel of the linearized equation near any equilibrium has dimension 0 or 1, then the solution of the Cauchy problem converges. We prove such an intermediate step in Lemma 2.3.6. We chose to prove directly the convergence of the Cauchy problem in section 2.3.2 using arguments inspired from Zelenyak's paper [122]. But we had to deal with some additional difficulties coming from the fact that our equation is set in  $\mathbb{R}$ , which induced a lack of compactness and the necessity of finding some controls at infinity. All of this is detailed in section 2.3.2. In the next section we start by pointing out the convergence up to a subsequence of the solution  $u$  of  $(\tilde{P})$ .

### 2.3.1 Convergence up to a subsequence

**Proposition 2.3.1.** *Let  $u \in L^2([0, T[, H_c^1(\mathbb{R}))$  for all  $T > 0$ , be the solution of  $(\tilde{P})$ . Then there exists a sequence  $(t_n)_n$  that goes to infinity as  $n \rightarrow +\infty$ , such that  $u(t_n, z)$  converges to a solution of (S) as  $n \rightarrow +\infty$  locally in  $z \in \mathbb{R}$ .*

**Proof of Proposition 2.3.1:** Standard arguments show that  $u(t, \cdot) \in H_c^1(\mathbb{R})$  for all  $t > 0$ ,  $t \mapsto E_c[u(t, \cdot)]$  is  $C^1$  and

$$\begin{aligned} \frac{d}{dt} E_c[u(t, \cdot)] &= \int_{\mathbb{R}} e^{cz} \{u_{zt}u_z - f(z, u)u_t\} dz, \\ &= \int_{\mathbb{R}} (e^{cz}u_z)u_{tz} dz - \int_{\mathbb{R}} e^{cz} f(z, u)u_t dz, \\ &= - \int_{\mathbb{R}} (cu_z + u_{zz})e^{cz}u_t dz - \int_{\mathbb{R}} e^{cz} f(z, u)u_t dz, \\ &= \int_{\mathbb{R}} (-cu_z - u_{zz} - f(z, u))e^{cz}u_t dz, \\ &= \int_{\mathbb{R}} -(u_t)^2 e^{cz} dz \leq 0. \end{aligned}$$

We know from Proposition 2.2.4 that  $E_c[u]$  is bounded from below. It implies that  $E_c[u] \rightarrow C$  as  $t \rightarrow +\infty$ , and there exists  $(t_n)_n$ , such that  $t_n \rightarrow +\infty$  and  $\frac{d}{dt} E_c[u](t_n) \rightarrow 0$  as  $n \rightarrow +\infty$ , i.e  $\|u_t(t_n, \cdot)\|_{L_c^2(\mathbb{R})} \rightarrow 0$  as  $n \rightarrow +\infty$ , which implies from standard arguments, that up to extraction  $u_t(t_n, z) \rightarrow 0$  as  $n \rightarrow +\infty$  for almost every  $z \in \mathbb{R}$ . Using Schauder Theory, we have that  $(u(t_n, z))_n$  converges toward  $u_\infty$  a stationary solution of  $(\tilde{P})$ , i.e a solution of (S), up to extraction.  $\square$

Now we investigate the uniqueness of the limit  $u_\infty$ .

### 2.3.2 Uniqueness of the limit

We want to prove that, considering compactly supported initial data  $u_0$ , the solution of our parabolic problem  $(\tilde{P})$  admits a unique limit. Define the  $\omega$ -limit set:

$$\Omega(u_0) = \bigcap_{t>0} \overline{\{u(\tau, \cdot), \tau \geq t\}}.$$

The closure is taken with respect to the topology of  $H_c^2(\mathbb{R})$ .

We first prove the following Lemma,

**Lemma 2.3.2.** *If  $w \in \Omega(u_0)$ , then  $w$  is a solution of the stationary equation*

$$-w_{zz} - cw_z = f(z, w) \quad \text{in } \mathbb{R}.$$

**Proof :** If  $w \in \Omega(u_0)$ , then there exists a sequence  $(t_n)_{n \geq 1}$  that converges to  $+\infty$  as  $n \rightarrow +\infty$  such that  $u(t_n, z) \rightarrow w(z)$  in  $H_c^1(\mathbb{R})$  as  $n \rightarrow +\infty$ . Let  $u^n(t, z) = u(t + t_n, z)$  for all  $t > 0$  and  $z \in \mathbb{R}$ , then using parabolic estimates,  $u^n \rightarrow \bar{w}$  as  $n \rightarrow +\infty$  (up to a subsequence) with  $\bar{w}$  solution of  $(\tilde{P})$  such that  $\bar{w}(0, z) = w(z)$  for all  $z \in \mathbb{R}$ . Moreover as  $E_c[u]$  is decreasing in  $t$  and bounded from below  $E_c[u^n(t, \cdot)] \rightarrow C$  as  $n \rightarrow +\infty$  and thus  $E_c[\bar{w}] = C$  for all  $t > 0$ . We have

$$\frac{d}{dt} E_c[\bar{w}] = 0,$$

this implies that  $\int_{\mathbb{R}} e^{cz} (\bar{w}_t)^2 dz = 0$ . We thus obtain that  $\bar{w} = w$  is a stationary solution of  $(\tilde{P})$ , i.e a solution of (S) and we have proved the Lemma.  $\square$

We can now state the main result of this section, from which Theorem 2.1.2 is immediatly derived.

**Theorem 2.3.3.** *The solution  $u$  of Problem  $(\tilde{P})$  converges exponentially to  $u_\infty$  a solution of (S) as  $t \rightarrow +\infty$ , i.e  $u \rightarrow u_\infty$  weakly in  $H_c^2(\mathbb{R})$  as  $t \rightarrow +\infty$  and*

$$\|u(t, \cdot) - u_\infty\|_{L_c^2(\mathbb{R})} \leq C_1 e^{-C_2 t}, \quad \text{for all } t \text{ large enough,}$$

with  $C_1, C_2$  positive constants.

We will need to prove some Lemmas before starting the proof of the Theorem.

Take  $w_0 \in \Omega(u_0)$ . Let

$$\begin{aligned} B : H_c^2(\mathbb{R}) &\rightarrow L_c^2(\mathbb{R}), \\ w &\mapsto w'' + cw' + f(z, w). \end{aligned}$$

We know that  $w_0$  is a stationary solution of (S), in other words,  $B(w_0) = 0$ . Define the linear operator:

$$\begin{aligned} \mathcal{L} := DB(w_0) : H_c^2(\mathbb{R}) &\rightarrow L_c^2(\mathbb{R}), \\ h &\mapsto h'' + ch' + f'_u(z, w_0(z))h. \end{aligned}$$

**Lemma 2.3.4.** *Assume that  $w \in H_c^2(\mathbb{R})$  is a positive, bounded solution of  $-w'' - cw' \leq -\delta w$  on  $\mathbb{R} \setminus (-R, R)$ , then  $w(z) \leq M e^{\lambda_+(z+R)}$  for all  $z \leq -R$  and  $w(z) \leq M e^{\lambda_-(z-R)}$  for all  $z > R$ , where  $\lambda_- < 0 < \lambda_+$  are the solutions of  $\lambda^2 + \lambda c = \delta$ . and  $M = \|w\|_{L^\infty(\mathbb{R})}$ .*

**Proof.** Define

$$\begin{aligned}\phi_-(z) &:= Me^{\lambda+(z+R)}, \quad \forall z < -R, \\ h(z) &:= w(z) - \phi(z), \quad \forall z < -R.\end{aligned}$$

Then  $h$  is solution of

$$\begin{cases} -h'' - ch' + \delta h \leq 0 & \text{for all } z < -R, \\ h(-\infty) = 0, \quad h(-R) \leq 0. \end{cases}$$

Assume that  $h$  achieves a maximum at  $z_0 \in (-\infty, -R)$ . This would imply that  $h(z_0) \leq 0$  and thus  $h \leq 0$  in  $(-\infty, -R]$ . Otherwise  $h$  is monotone on  $(-\infty, -R)$ , which also implies that  $h \leq 0$  in  $(-\infty, -R]$  and the first inequality is proved. The inequality on  $[R, \infty)$  is proved similarly.  $\square$

**Lemma 2.3.5.** *There exists  $z_- \in \mathbb{R}$  such that, if  $w_1, w_2 \in H_c^2(\mathbb{R})$  are two positive, bounded, solutions of  $w'' + cw' + f(z, w) = 0$  over  $\mathbb{R}$  with  $w_1(z) = w_2(z)$  for some  $z \leq z_-$ , then  $w_1 \equiv w_2$ .*

**Proof.** Let  $u := (w_1 - w_2)^2$ . This function satisfies

$$\begin{aligned}u'' + cu' &= 2(w_1' - w_2')^2 + 2(-f(z, w_1) + f(z, w_2))(w_1 - w_2) \\ &\geq -2f_u'(z, 0)u - 2| -f(z, w_1) + f(z, w_2) - f_u'(z, 0)(w_2 - w_1) ||w_1 - w_2|.\end{aligned}$$

On the other hand, Lemma 2.3.4 and the  $\mathcal{C}^1$  smoothness of  $f(z, s)$  with respect to  $s$  yields that there exists  $z_-$  such that

$$\forall z \leq z_-, \quad |f(z, w_2) - f(z, w_1) - f_u'(z, 0)(w_2 - w_1)| \leq \frac{\delta}{2}|w_2 - w_1|$$

where  $\delta$  is the constant defined by (2.4). We thus get

$$\forall z \leq z_-, \quad u'' + cu' \geq -2f_u'(z, 0)u - \delta u \geq \delta u$$

decreasing  $z_-$  once more if necessary.

It now follows from this inequation that  $u$  cannot reach any local maximum over  $(-\infty, z_-)$ . As  $u(-\infty) = 0$  and  $u \geq 0$ , it implies that  $u$  is nondecreasing. Lastly, if  $w_1(z) = w_2(z)$  for some  $z \leq z_-$ , then  $u(z) = 0$  and thus  $u \equiv 0$ , meaning that  $w_1 \equiv w_2$ .  $\square$

**Lemma 2.3.6.**

$$\dim \text{Ker} \mathcal{L} \in \{0, 1\}.$$

**Proof.** The Cauchy theorem yields that

$$\text{Ker} \mathcal{L} = \{h \in H_c^2(\mathbb{R}), \quad h'' + ch' + f_u'(z, w_0(z))h = 0\}$$

has at most dimension 2. If it has dimension 2, then it would mean that for all  $z_0 \in \mathbb{R}$  and for all couple  $(h_0, h_1)$ , the solution of

$$h'' + ch' + f_u'(z, w_0(z))h = 0, \quad h(z_0) = h_0, \quad h'(z_0) = h_1$$

belongs to  $H_c^2(\mathbb{R})$ . In particular  $h(-\infty) = 0$ .

But now the same arguments as in the proof of Lemma 2.3.5 yields that  $h^2$  is nondecreasing over  $(-\infty, z_-)$  and thus one reaches a contradiction by taking  $z_0 < z_-$  and  $(h_0, h_1)$  such that  $h_0 h_1 < 0$ .  $\square$

**Lemma 2.3.7.** *Assume that there exists  $v \in H_c^2(\mathbb{R})$  such that  $\mathcal{L}_w v = 0$  in  $\mathbb{R}$ . Then there exists a constant  $C = C(w)$  such that for all  $g \in L_c^2(\mathbb{R})$ , if  $u \in H_c^2(\mathbb{R})$  satisfies  $\mathcal{L}_w u = g$  in  $\mathbb{R}$  and  $\int_{\mathbb{R}} e^{cz} u(z) v(z) dz = 0$ , then*

$$\|u\|_{H_c^2(\mathbb{R})} \leq C \|g\|_{L_c^2(\mathbb{R})}.$$

Moreover, if  $W$  is a family of solutions  $w \in H_c^1(\mathbb{R})$  of (S) such that  $\text{Ker } \mathcal{L}_w \neq \{0\}$  for all  $w \in W$  and  $\sup_{w \in W} \|w\|_{H_c^1(\mathbb{R})} < \infty$ , then the constant  $C$  can be chosen to be the same for all  $w \in W$ .

**Proof.** Clearly the operator

$$\begin{aligned} T : (\text{Ker } \mathcal{L})^\perp &\rightarrow \text{Im } \mathcal{L} \\ h &\mapsto \mathcal{L}h \end{aligned}$$

is invertible and continuous. Hence the bounded inverse theorem yields that its inverse is continuous. Taking  $C$  its continuity constant, this means that for all  $g \in L_c^2(\mathbb{R})$  such that there exists  $u \in (\text{Ker } \mathcal{L})^\perp$  satisfying  $\mathcal{L}u = g$ , one has  $\|u\|_{H_c^2(\mathbb{R})} \leq C \|g\|_{L_c^2(\mathbb{R})}$  and the result follows.

Next, we first prove that there exists  $C > 0$  such that if  $W$  is a family of solutions  $w \in H_c^1(\mathbb{R})$  of (S) such that  $\text{Ker } \mathcal{L}_w \neq \{0\}$  for all  $w \in W$  and  $\sup_{w \in W} \|w\|_{H_c^1(\mathbb{R})} < \infty$ , then

$$\|u'\|_{L_c^2(\mathbb{R})} \leq C \|g\|_{L_c^2(\mathbb{R})}.$$

Assume that this is not true, there would exist a sequence  $(w_n)_n$  of solutions of (S), bounded in  $H_c^1(\mathbb{R})$ , such that  $\text{Ker } \mathcal{L}_{w_n} \neq \{0\}$  for all  $n$  and the associated constants  $C_n = C(w_n)$  converge to  $+\infty$  as  $n \rightarrow +\infty$ . In other words, there exist  $v_n \in \text{Ker } \mathcal{L}_{w_n}$  for all  $n$  and two sequences  $(u_n)_n$  in  $H_c^2(\mathbb{R})$  and  $(g_n)_n$  in  $L_c^2(\mathbb{R})$  such that  $\mathcal{L}_{w_n} u_n = g_n$  in  $\mathbb{R}$ ,  $\int_{\mathbb{R}} e^{cz} u_n(z) v_n(z) dz = 0$ ,  $\|u_n'\|_{L_c^2(\mathbb{R})} = 1$  for all  $n$  and  $\lim_{n \rightarrow +\infty} \|g_n\|_{L_c^2(\mathbb{R})} = 0$ . Up to multiplication, we can assume that  $\|v_n'\|_{L_c^2(\mathbb{R})} = 1$ . As  $(w_n)_n$  is bounded in  $H_c^1(\mathbb{R})$ , we can assume, up to extraction, that it converges locally uniformly to some function  $w_\infty \in H_c^1(\mathbb{R})$ . Similarly, the Poincaré inequality stated in Lemma 2.2.2 yields that  $(u_n)_n$  and  $(v_n)_n$  are indeed bounded in  $H_c^1(\mathbb{R})$  and we can thus define their weak limits  $u_\infty$  and  $v_\infty$  in  $H_c^1(\mathbb{R})$ . As  $u_n'' = -cu_n' - f_u'(z, w_n(z))u_n + g_n$ , multiplying by  $u_n e^{cz}$  and integrating over  $\mathbb{R}$ , as  $\|u_n'\|_{L_c^2(\mathbb{R})} = 1$ , we get

$$\int_{\mathbb{R}} e^{cz} f_u'(z, w_n) u_n^2 dz - 1 = \int_{\mathbb{R}} e^{cz} u_n g_n dz.$$

As  $u_n$  converge weakly in  $L_c^2$  and  $g_n \rightarrow 0$  in  $L_c^2$  as  $n \rightarrow +\infty$ , the right-hand side converges to 0 as  $n \rightarrow +\infty$ . Assuming  $u_n \rightarrow 0$  in  $L_c^2$  yields a contradiction. Indeed, using Lemma 2.3.4 for all  $n$ , for all  $\varepsilon > 0$  there exists  $r > 0$  such that  $w_n(z) < \varepsilon$  for all  $|z| > r$ . As  $f(z, \cdot)$  is  $C^1$ , for  $\varepsilon$  small enough,  $f_u'(z, w_n) < 0$  for all  $|z| > r$ . And we obtain

$$\int_{-r}^r e^{cz} f_u'(z, w_n) u_n^2 dz - 1 \geq \int_{\mathbb{R}} e^{cz} u_n g_n dz,$$

which yields a contradiction when we let  $n \rightarrow +\infty$ , as  $u_n \rightarrow 0$ , strongly in  $L_c^2([-r, r])$ . This implies that  $u_\infty \neq 0$ .

Using the same arguments with  $v_n$ , as  $\|v_n'\|_{L_c^2(\mathbb{R})} = 1$  for all  $n$ , we have that

$$1 - \int_{\mathbb{R}} e^{cz} f_u'(z, w_n) v_n^2 dz = 0.$$

On the other hand, it follows from Lemma 2.3.4 that one can apply the dominated convergence theorem using the bounds  $v_n(z) \leq M$  for all  $z < R$  and  $v_n(z) \leq M e^{\lambda_-(z-R)}$  for all  $z > R$ , since  $c < -2\lambda_-$ . We thus obtain

$$1 - \int_{\mathbb{R}} e^{cz} f_u'(z, w_\infty) v_\infty^2 dz = 0.$$

Moreover, classical elliptic regularity estimates yield that  $v_\infty$  satisfies  $\mathcal{L}_{w_\infty} v_\infty = 0$  in  $\mathbb{R}$ . Integrating by parts, we get

$$\int_{\mathbb{R}} e^{cz} \left\{ (v'_\infty)^2 - f'_u(z, w_\infty) v_\infty^2 \right\} dz = 0.$$

We thus conclude that  $\|v'_\infty\|_{L_c^2(\mathbb{R})} = 1$ . As  $L_c^2(\mathbb{R})$  is an Hilbert space, this indeed implies that  $(v'_n)_n$  converges strongly to  $v'_\infty$  in  $L_c^2(\mathbb{R})$  as  $n \rightarrow +\infty$ . Using the Poincaré type inequality given in Lemma 2.2.2 we have that  $v_n \rightarrow v_\infty$  in  $L_c^2$  as  $n \rightarrow +\infty$ . This implies that  $\int_{\mathbb{R}} e^{cz} u_\infty(z) v_\infty(z) dz = 0$ ,  $\mathcal{L}_{w_\infty} u_\infty = 0$  and  $\mathcal{L}_{w_\infty} v_\infty = 0$  over  $\mathbb{R}$ . Hence,  $\dim \text{Ker} \mathcal{L}_{w_\infty} = 2$ , which contradicts Lemma 2.3.6. Thus there exists  $C > 0$  such that if  $W$  is a family of solutions  $w \in H_c^1(\mathbb{R})$  of (S) such that  $\text{Ker} \mathcal{L}_w \neq \{0\}$  for all  $w \in W$  and  $\sup_{w \in W} \|w\|_{H_c^1(\mathbb{R})} < \infty$ , then

$$\|u'\|_{L_c^2(\mathbb{R})} \leq C \|g\|_{L_c^2(\mathbb{R})}.$$

Now to prove the last assertion of the Lemma we argue by contradiction and assume that it is not true. Then there would exist a sequence  $(w_n)_n$  of solutions of (S), bounded in  $H_c^1(\mathbb{R})$ , such that  $\text{Ker} \mathcal{L}_{w_n} \neq \{0\}$  for all  $n$  and the associated constants  $C_n = C(w_n)$  converge to  $+\infty$  as  $n \rightarrow +\infty$ . In other words, there exist  $v_n \in \text{Ker} \mathcal{L}_{w_n}$  for all  $n$  and two sequences  $(u_n)_n$  in  $H_c^2(\mathbb{R})$  and  $(g_n)_n$  in  $L_c^2(\mathbb{R})$  such that  $\mathcal{L}_{w_n} u_n = g_n$  in  $\mathbb{R}$ ,  $\int_{\mathbb{R}} e^{cz} u_n(z) v_n(z) dz = 0$ ,  $\|u_n\|_{H_c^2(\mathbb{R})} = 1$  for all  $n$  and  $\lim_{n \rightarrow +\infty} \|g_n\|_{L_c^2(\mathbb{R})} = 0$ .

But using the previous inequality we know that  $\|u'_n\|_{L_c^2} \leq C \|g_n\|_{L_c^2}$ , which implies  $u_n \rightarrow 0$  in  $H_c^1(\mathbb{R})$  as  $n \rightarrow +\infty$  by Lemma 2.2.2 and  $u''_n = -cu'_n - f'_u(x, w_n) u_n - g_n$ , which is impossible because  $\|u_n\|_{H_c^2(\mathbb{R})} = 1$ . This concludes the proof.  $\square$

**Lemma 2.3.8.** *Assume that for some  $T > 0$ , there exist two constants  $K, C > 0$  such that for all  $t \in [0, T]$ ,*

$$\int_t^\infty \int_{\mathbb{R}} e^{cz} u_t^2(s, z) ds dz \leq K e^{-Ct}.$$

*Then for all  $0 \leq t \leq \tau \leq T$ , one has:*

$$\|u(t, \cdot) - u(\tau, \cdot)\|_{L_c^2(\mathbb{R})} \leq \frac{\sqrt{K}}{1 - e^{-C/2}} e^{-Ct/2}.$$

**Proof:** This Lemma is similar to Lemma 4 in Zelenyak paper [122, Lemma 4]. As our solutions are defined on the full line  $\mathbb{R}$  instead of a segment, we obtain a control in  $L^2$  instead of  $L^1$ .

Assume first that  $|t - \tau| \leq 1$ . Then

$$\begin{aligned} \|u(t, \cdot) - u(\tau, \cdot)\|_{L_c^2(\mathbb{R})}^2 &= \int_{\mathbb{R}} e^{cz} \left| \int_t^\tau u_t(s, z) ds \right|^2 dz \\ &\leq \int_{\mathbb{R}} \int_t^\tau (\tau - t) e^{cz} u_t^2(s, z) ds dz \\ &\leq \int_{\mathbb{R}} \int_t^\infty e^{cz} u_t^2(s, z) ds dz \\ &\leq K e^{-Ct}. \end{aligned}$$

Next, if  $|t - \tau| > 1$ , let  $N = [\tau - t]$  the integer part of  $\tau - t$ . We compute:

$$\begin{aligned} \|u(t, \cdot) - u(\tau, \cdot)\|_{L_c^2(\mathbb{R})} &\leq \sum_{n=0}^{N-1} \|u(t+n, \cdot) - u(t+n+1, \cdot)\|_{L_c^2(\mathbb{R})} + \|u(t+N, \cdot) - u(\tau, \cdot)\|_{L_c^2(\mathbb{R})} \\ &\leq \sum_{n=0}^{N-1} \sqrt{K} e^{-C(t+n)/2} + \sqrt{K} e^{-C(t+N)/2} \\ &\leq \frac{\sqrt{K}}{1 - e^{-C/2}} e^{-Ct/2}, \end{aligned}$$

which ends the proof.  $\square$

**Proof of Theorem 2.3.3:** Assume that  $\Omega(u_0)$  is not an isolated point. Using Lemma 2.3.5 we can choose  $R$  large enough such that  $\Omega(u_0)$  is parametrized by the value of the function at  $-R$ , i.e  $\Omega(u_0) = \{w(\alpha, \cdot), w(\alpha, -R) = \alpha \text{ and } w \text{ is a stationary solution}\}$ . As  $u$  is bounded, the quantities  $0 \leq \alpha_1 = \liminf_{t \rightarrow +\infty} u(t, -R) < \alpha_2 = \limsup_{t \rightarrow +\infty} u(t, -R)$  are well-defined and classical connectedness and compactness arguments yield that  $\Omega(u_0)$  is the curve  $\{w(\alpha, \cdot), \alpha \in [\alpha_1, \alpha_2]\}$ .

For each  $w \in \Omega(u_0)$ ,  $v = \frac{\partial w}{\partial \alpha}$  exists in  $H_c^1(\mathbb{R})$  and is solution of

$$v(\alpha, -R) = 1 \quad \text{and} \quad \mathcal{L}_w v = v'' + cv' + f'_u(x, w)v = 0 \quad \text{over } \mathbb{R}.$$

We have  $v(\alpha, \cdot) \not\equiv 0$  in  $\mathbb{R}$ . Now we define for fixed  $t > 0$ ,

$$\alpha(t) = \arg \inf \{ \|u(t, \cdot) - w(\alpha, \cdot)\|_{L_c^2(\mathbb{R})}, \alpha \in [\alpha_1, \alpha_2] \} \xrightarrow{t \rightarrow +\infty} 0.$$

For each  $t > 0$ , if the inf is attained at an interior point  $\alpha(t) \in (\alpha_1, \alpha_2)$ , then

$$\frac{\partial}{\partial \alpha} \|u(t, \cdot) - w(\alpha, \cdot)\|_{L_c^2(\mathbb{R})} \Big|_{\alpha=\alpha(t)} = 0,$$

and thus

$$\int_{\mathbb{R}} e^{cz} (u(t, z) - w(\alpha, z)) \frac{\partial w}{\partial \alpha} \Big|_{\alpha=\alpha(t)} dz = 0.$$

We thus have for all  $t > 0$  such that  $\alpha(t) \in (\alpha_1, \alpha_2)$ :

$$\mathcal{L}_{w(\alpha(t), \cdot)} v = 0, \quad \int_{\mathbb{R}} e^{cz} (u - w)v \Big|_{\alpha=\alpha(t)} dz = 0 \quad \text{and} \quad \mathcal{L}_{w(\alpha(t), \cdot)} (u - w) = g,$$

with

$$g(t, x) := u_t(t, x) + b(t, x)(u(t, x) - w(\alpha(t), x)),$$

$$b(t, x) := f'_u(x, w(\alpha(t), x)) - \frac{f(x, u(t, x)) - f(x, w(\alpha(t), x))}{u(t, x) - w(\alpha(t), x)}.$$

Lemma 2.3.7 thus applies and gives

$$\|u(t, \cdot) - w(\alpha(t), \cdot)\|_{H_c^2(\mathbb{R})} \leq C \|u_t(t, \cdot)\|_{L_c^2(\mathbb{R})} + C \|b(t, \cdot)\|_{L_c^2(\mathbb{R})} \|u(t, \cdot) - w(\alpha(t), \cdot)\|_{L_c^2(\mathbb{R})},$$

for all  $t > 0$  such that  $\alpha(t) \in (\alpha_1, \alpha_2)$ . But as  $f = f(x, u)$  is of class  $\mathcal{C}^1$  with respect to  $u$  uniformly in  $x$  and as  $\lim_{t \rightarrow +\infty} \|u(t, \cdot) - w(\alpha(t), \cdot)\|_{L_c^2(\mathbb{R})} = 0$ , one has  $\|b(t, \cdot)\|_{L_c^2(\mathbb{R})} \rightarrow 0$  as  $t \rightarrow +\infty$  and it thus follows that, even if it means increasing  $C$ , for all admissible  $t > 0$ , one has

$$\|u(t, \cdot) - w(\alpha(t), \cdot)\|_{H_c^2(\mathbb{R})} \leq C \|u_t(t, \cdot)\|_{L_c^2(\mathbb{R})}.$$

and  $C$  is bounded independently of  $\alpha(t) \in (\alpha_1, \alpha_2)$ .

Now ending the proof as in Zelenyak [122], we have that for all  $t > 0$  and any  $w \in \Omega(u_0)$ , the solution  $u$  of our parabolic problem satisfies

$$\begin{aligned} E_c[u(t, \cdot)] - E_c[w] &= \frac{1}{2} \int_{\mathbb{R}} e^{cz} (u_z^2(t, z) - w_z^2(z)) dz - \int_{\mathbb{R}} e^{cz} (F(z, u(t, z)) - F(z, w(z))) dz \\ &= \frac{1}{2} \int_{\mathbb{R}} e^{cz} (u_z - w_z)^2 dz + \int_{\mathbb{R}} e^{cz} (u_z - w_z) w_z dz \\ &\quad - \int_{\mathbb{R}} e^{cz} f(z, w(z)) (u(t, z) - w(z)) dz + \int_{\mathbb{R}} e^{cz} C(t, z) (u(t, z) - w(z))^2 dz, \end{aligned}$$

where  $C = C(t, z)$  is a bounded and measurable function since  $f = f(z, u)$  is of class  $\mathcal{C}^1$  with respect to  $u$ , uniformly in  $z$ . As  $w$  is a stationary solution of (S), integrating by parts, we get

$$\begin{aligned} E_c[u(t, \cdot)] - E_c[w] &= \frac{1}{2} \int_{\mathbb{R}} e^{cz} (u_z - w_z)^2 dz + \int_{\mathbb{R}} e^{cz} C(t, x) (u(t, z) - w(z))^2 dz \\ &\leq \sup\{\frac{1}{2}, \|C\|_{L^\infty(\mathbb{R})}\} \|u(t, \cdot) - w\|_{H_c^1(\mathbb{R})}^2. \end{aligned}$$

Next, for all  $t > 0$  such that  $\alpha(t) \in (\alpha_1, \alpha_2)$ , gathering the previous inequalities, one gets

$$\frac{d}{dt} (E_c(u(t, \cdot) - E_c^\infty) = -\|u_t(t, \cdot)\|_{L_c^2(\mathbb{R})}^2 \leq -C \|u(t, \cdot) - w(\alpha(t), \cdot)\|_{H_c^2(\mathbb{R})}^2 \leq -C (E_c[u(t, \cdot)] - E_c^\infty), \quad (2.6)$$

where  $E_c^\infty := \lim_{t \rightarrow +\infty} E_c[u(t, \cdot)]$  is equal to  $E_c[w]$  for all  $w \in \Omega[u_0]$  since the energy converges as  $t \rightarrow +\infty$ .

Now let  $\alpha_0 \in (\alpha_1, \alpha_2)$  and take a sequence  $(t_n)_n$  such that

$$\lim_{n \rightarrow +\infty} t_n = +\infty \text{ and } \lim_{n \rightarrow +\infty} u(t_n, x) = w(\alpha_0, x).$$

There exists  $\eta > 0$  such that

$$\|w(\alpha_0, \cdot) - w(\alpha_1, \cdot)\|_{L_c^2(\mathbb{R})} > \eta \quad \text{and} \quad \|w(\alpha_0, \cdot) - w(\alpha_2, \cdot)\|_{L_c^2(\mathbb{R})} > \eta.$$

Choose  $N$  large enough such that  $\|u(t_N, \cdot) - w(\alpha_0, \cdot)\|_{L_c^2(\mathbb{R})} \leq \frac{\eta}{8}$  and for all  $t \geq t_N$

$$\sqrt{E_c^\infty - E_c[u(t, \cdot)]} \leq (1 - e^{-C/2}) \frac{\eta}{8}.$$

We set

$$\bar{t} = \inf \{t \geq t_N, \quad \|u(t, \cdot) - w(\alpha_0, \cdot)\|_{L_c^2(\mathbb{R})} \geq \min\{\|u(t, \cdot) - w(\alpha_1, \cdot)\|_{L_c^2(\mathbb{R})}, \|u(t, \cdot) - w(\alpha_2, \cdot)\|_{L_c^2(\mathbb{R})}\}\}.$$

Clearly  $\alpha(t) \neq \alpha_1$  and  $\alpha(t) \neq \alpha_2$ , that is,  $\alpha(t)$  is an interior point, for all  $t \in [t_N, \bar{t})$ . Hence, inequality (2.6) holds for all  $t \in [t_N, \bar{t})$ , i.e

$$E_c^\infty - E_c[u(t, \cdot)] \leq (E_c^\infty - E_c[u(t_N, \cdot)]) e^{-C(t-t_N)}.$$

By Lemma 2.3.8, one has for all  $t_N \leq t \leq \tau \leq \bar{t}$ :

$$\|u(t, z) - u(\tau, z)\|_{L_c^2(\mathbb{R})} \leq \frac{\sqrt{E_c^\infty - E_c[u(t_N, \cdot)]}}{1 - e^{-C/2}} e^{-C(t-t_N)/2} \leq \frac{\eta}{8} e^{-C(t-t_N)/2}. \quad (2.7)$$

If  $\bar{t}$  is finite then from the previous inequality we obtain that

$$\|u(\bar{t}, \cdot) - w(\alpha_0, \cdot)\|_{L_c^2(\mathbb{R})} \leq \|u(\bar{t}, \cdot) - u(t_N, \cdot)\|_{L_c^2(\mathbb{R})} + \|u(t_N, \cdot) - w(\alpha_0, \cdot)\|_{L_c^2(\mathbb{R})} \leq \frac{\eta}{4} \quad (2.8)$$

and, for  $k = 1$  and  $k = 2$ :

$$\|u(\bar{t}, \cdot) - w(\alpha_k, \cdot)\|_{L_c^2(\mathbb{R})} \geq \|w(\alpha_k, \cdot) - w(\alpha_0, \cdot)\|_{L_c^2(\mathbb{R})} - \|u(\bar{t}, \cdot) - w(\alpha_0, \cdot)\|_{L_c^2(\mathbb{R})} \geq \eta - \frac{\eta}{4} = \frac{3}{4}\eta. \quad (2.9)$$

Comparing (2.8) and (2.9) we conclude that  $\inf \|u(\bar{t}, \cdot) - w(\alpha, \cdot)\|_{L_c^2(\mathbb{R})}$  cannot be attained for  $\alpha = \alpha_k, (k = 1, 2)$ , and thus  $\bar{t} = \infty$ . We thus conclude that (2.7) holds for all  $\tau \geq t \geq t_N$  which proves that  $u$  converges strongly in  $L_c^2$ .  $\square$

## 2.4 On the stability of the trivial steady state 0

In this section we discuss the different behaviours of the solution of  $(\tilde{P})$  depending on the stability of 0 and the initial condition  $u_0$ . We first define what we mean by stability of the trivial steady state 0.

Let  $\mathcal{L}$  be the linearized operator around 0:

$$-\mathcal{L}u := -u'' - cu' - f_s(z, 0)u,$$

defined for all  $u \in H^1(\mathbb{R})$ . It is easy to check (using Lemma 2.3.4) that the operator  $\mathcal{L}$  admits a principal eigenfunction in  $H_c^1(\mathbb{R})$ , that is there exist  $(\lambda_c, \phi)$  such that

$$\begin{cases} -\mathcal{L}\phi = \lambda_c\phi & \text{in } \mathbb{R}, \\ \phi > 0 & \text{in } \mathbb{R}, \\ \phi \in H_c^1(\mathbb{R}). \end{cases} \quad (2.10)$$

This eigenvalue  $\lambda_c$  is also characterized as the generalized eigenvalue of  $\mathcal{L}$ :

$$\lambda_c(-\mathcal{L}, \mathbb{R}) := \sup \left\{ \lambda \in \mathbb{R}, \exists \phi \in W_{\text{loc}}^{2,1}(\mathbb{R}), \phi > 0, (\mathcal{L} + \lambda)\phi \leq 0 \text{ a.e in } \mathbb{R} \right\}.$$

One can look at [17] and references therein for more details about generalized eigenvalue. We know from [17, Proposition 1 - section 2] that, if we denote by  $\lambda(r)$  the principal eigenvalue of our problem on  $B_r$  with Dirichlet boundary condition, then  $\lambda(r) \rightarrow \lambda_c$  as  $r \rightarrow +\infty$  and there exists  $\phi_c \in W_{\text{loc}}^{2,p}(\mathbb{R})$ ,  $1 \leq p < +\infty$ , the principal eigenfunction solution of (2.10).

Letting  $v(x) = u(x)e^{\frac{cx}{2}}$ , then

$$-\mathcal{L}u = 0 \iff -\tilde{\mathcal{L}}v = -v'' + \frac{c^2}{4}v - f_s(z, 0)v = 0,$$

where  $\tilde{\mathcal{L}}$  is self adjoint. From [17, 16]

$$\lambda_c(-\mathcal{L}, \mathbb{R}) = \lambda_c(-\tilde{\mathcal{L}}, \mathbb{R}) = \inf_{\phi \in H^1(\mathbb{R}), \phi \neq 0} \frac{\int_{\mathbb{R}} \phi'(x)^2 + (\frac{c^2}{4} - f_s(x, 0))\phi(x)^2 dx}{\int_{\mathbb{R}} \phi(x)^2 dx}. \quad (2.11)$$

If we define  $\lambda_0$  as the generalized eigenvalue corresponding to  $c = 0$ , i.e when the medium does not move with time, then we have that

$$\lambda_c = \lambda_0 + \frac{c^2}{4}.$$

We will say that 0 is linearly stable (respectively unstable) if  $\lambda_c \geq 0$  (respectively  $\lambda_c < 0$ ). Let us notice that if 0 is stable in the steady frame, i.e  $\lambda_0 > 0$ , then 0 is necessarily stable in the moving frame.

### 2.4.1 Convergence to a non trivial travelling wave solution when 0 is linearly unstable

In this section we want to prove that when 0 is linearly unstable, i.e  $\lambda_0 < 0$  and  $c < 2\sqrt{-\lambda_0}$ , for  $u_0 \neq 0$  non negative initial condition, the solution  $u$  of  $(\tilde{P})$  converges to a non trivial travelling wave solution as time goes to infinity.



**Proposition 2.4.1.** Assume that  $\lambda_0 < 0$  and that  $f$  satisfies (2.1)-(2.4), then for all  $c < 2\sqrt{-\lambda_0}$ ,

$$\inf_{u \in H_c^1(\mathbb{R})} E_c[u] < 0,$$

i.e there exists a non trivial travelling wave solution of (S)

**Proof of Proposition 2.4.1:** Take  $\lambda$  such that  $\lambda_0 < \lambda < -c^2/4$ . It follows from (2.11) that there exists  $\phi_0 \in H^1(\mathbb{R})$  such that

$$\int_{\mathbb{R}} (\phi_0'(x)^2 - f_s(x, 0)\phi_0^2(x))dx \leq \lambda \int_{\mathbb{R}} \phi_0^2(x)dx.$$

Let

$$\phi_n(z) = \frac{\phi_0(z)e^{-\frac{c}{2}z}}{n} \quad \forall z \in \mathbb{R}.$$

Then we have the following computation:

$$\begin{aligned} E_c[\phi_n] &= \int_{\mathbb{R}} \left\{ \frac{|(\phi_0(z)e^{-\frac{c}{2}z})_z|^2}{2n^2} - F\left(z, \frac{\phi_0(z)e^{-\frac{c}{2}z}}{n}\right) \right\} e^{cz} dz, \\ &= \int_{\mathbb{R}} \frac{(\phi_0'(z))^2}{2n^2} + \frac{c^2}{4} \frac{(\phi_0(z))^2}{2n^2} \\ &\quad - \left( F(z, 0) + F_s(z, 0) \frac{\phi_0(z)e^{-\frac{c}{2}z}}{n} + F_{ss}(z, 0) \frac{(\phi_0(z)e^{-\frac{c}{2}z})^2}{2n^2} + o\left(\frac{(\phi_0(z)e^{-\frac{c}{2}z})^2}{n^2}\right) \right) e^{cz} dz, \\ &= \int_{\mathbb{R}} \frac{(\phi_0'(z))^2}{2n^2} + \frac{c^2}{4} \frac{(\phi_0(z))^2}{2n^2} \\ &\quad - \left( f(z, 0) \frac{\phi_0(z)e^{-\frac{c}{2}z}}{n} + f_s(z, 0) \frac{(\phi_0(z)e^{-\frac{c}{2}z})^2}{2n^2} + o\left(\frac{(\phi_0(z)e^{-\frac{c}{2}z})^2}{n^2}\right) \right) e^{cz} dz, \\ &\leq \int_{\mathbb{R}} \left( \lambda + \frac{c^2}{4} \right) \frac{(\phi_0(z))^2}{2n^2} dz + o\left(\frac{1}{n^2}\right). \end{aligned}$$

This implies that

$$\min_{u \in H_c^1(\mathbb{R})} E_c[u] \leq \left( \lambda + \frac{c^2}{4} \right) \int_{\mathbb{R}} \frac{(\phi_0(z))^2}{2n^2} dz + o\left(\frac{1}{n^2}\right) < 0,$$

for  $n$  large enough. The Proposition is proved.  $\square$

And we have the following Proposition to characterize the behaviour of  $u$  as time goes to infinity.

**Proposition 2.4.2.** If  $\lambda_0 < 0$ , for all  $c < 2\sqrt{-\lambda_0}$ , the solution  $u$  of  $(\tilde{P})$  converges to a non trivial solution of (S) as  $t \rightarrow +\infty$ .

**Proof of Proposition 2.4.2:** We will use the same argument as in [17, section 2.4]. We know that  $\lambda(R) \rightarrow \lambda_c$  as  $R \rightarrow +\infty$ , and  $\lambda_c < 0$  thus for  $R$  large enough  $\lambda(R) < 0$  and let  $\phi_R > 0$  be the principal eigenfunction. Define

$$\underline{U} = \begin{cases} \kappa\phi_R & \text{in } B_R, \\ 0 & \text{otherwise,} \end{cases}$$

Then for  $\kappa$  small  $\underline{U}$  is a subsolution of  $(\tilde{P})$  and  $\underline{U} \leq u(\tau, \cdot)$  in  $\mathbb{R}$  for some  $\tau > 0$  small,  $\bar{U} \equiv M \geq u_0$  in  $\mathbb{R}$  and is a super solution. Then the solution  $u$  of  $(\tilde{P})$  is greater than  $\underline{U}$  for all  $t > 0$  and  $x \in \mathbb{R}$ . Moreover using Theorem 2.1.2 we know that  $u$  converges to  $u_\infty \geq \underline{U}$  as  $t \rightarrow +\infty$ . And thus  $u$  converges to a non trivial travelling wave solution as  $t \rightarrow +\infty$ .  $\square$

### 2.4.2 Existence of travelling wave when 0 is linearly stable

In this section we use the same notations than in the previous one and assume now that

$$\lambda_c > 0.$$

We first state a result on the existence of a travelling wave with positive energy. This implies that we do not necessary have uniqueness of the profile  $U$  and that there exist profiles with positive energy.

**Proposition 2.4.3.** *Assume that  $\lambda_c > 0$ , if  $\min_{u \in H_c^1(\mathbb{R})} E_c[u] < 0$  then there exists at least two non trivial travelling wave solution of (S) and one of them has a positive energy.*

An easy application of this proposition is the following Corollary.

**Corollary 2.4.4.** *Let*

$$f(z, u) = \begin{cases} f_0(u) & \text{if } |z| < R, \\ -\delta u & \text{otherwise,} \end{cases}$$

where  $R, \delta > 0$ ,  $f_0$  is a bistable function., i.e

$$\begin{aligned} \text{There exists } \theta \in (0, 1) \text{ such that } f_0(0) = f_0(\theta) = f_0(1) = 0, \text{ and } f_0'(0) < 0, \quad f_0'(1) < 0, \\ f_0(s) < 0 \text{ for all } s \in (0, \theta), \quad f_0(s) > 0 \text{ for all } s \in (\theta, 1), \end{aligned}$$

with positive mass:

$$\int_0^1 f_0(\tau) d\tau > 0.$$

Then for  $R$  sufficiently large, there exists  $\tilde{u} \in H_c^1(\mathbb{R})$  solution of (S) such that  $E_c[\tilde{u}] > 0$ .

We highlight this result which is totally different from what is known when  $f$  satisfies the KPP property. Indeed in the present framework 0 is linearly stable, nevertheless we still have the existence of travelling wave solutions. This implies that outside the KPP framework the linearity of 0 does not determine the existence of travelling wave solutions and the persistence of the population.

**Proof of Corollary 2.4.4.** As  $f_s(z, 0) = f_0'(0) < 0$  if  $|z| < R$ ,  $-\delta < 0$  otherwise, one has  $\lambda_0 > 0$  and thus  $\lambda_c = \lambda_0 + c^2/4 > 0$ .

Moreover, as  $f_0$  has a positive mass, taking

$$u_{min}(z) = \begin{cases} 1 & \text{for all } |z| < R, \\ 0 & \text{for all } |z| > R + 1, \end{cases}$$

such that  $u_{min} \in H_c^1(\mathbb{R})$ , one can check that for  $R$  large enough  $E_c[u_{min}] < 0$  and  $\|u_{min}\|_{H_c^1} > r$ . Proposition 2.4.3 applies and gives the conclusion.  $\square$

To prove Proposition 2.4.3 we start with the following Lemma.

**Lemma 2.4.5.** *For all  $r > 0$  small enough, there exists  $\gamma > 0$  such that  $E_c[u] > \gamma$  for all  $u \in H_c^1(\mathbb{R})$  such that  $\|u\|_{H_c^1(\mathbb{R})} = r$ .*

**Proof of Lemma 2.4.5:** To prove this Lemma, we just need to prove that 0 achieves a strict local minimum, i.e  $dE_c[0] \equiv 0$  and  $d^2E_c[0] > 0$  in the sense that for all  $w \in H_c^1(\mathbb{R})$ ,  $w \neq 0$ ,  $d^2E_c[0](w, w) > 0$ , with

$$d^2E_c[0](w, w) = \int_{\mathbb{R}} e^{cz} \{w_z^2 - f_s(z, 0)w^2\} dz.$$

Using the equalities in (2.11) with  $\phi(z) = e^{cz/2}w(z)$ , we get,

$$d^2E_c[0](w, w) \geq \lambda_c \|w\|_{H_c^1(\mathbb{R})},$$

for all  $w \in H_c^1(\mathbb{R})$ , which proves the Lemma, as  $\lambda_c$  is assumed to be positive.  $\square$

Now to prove Proposition 2.4.3, we want to use the Mountain Pass Theorem, so we need to prove that our energy functional satisfies the Palais-Smale Condition.

**Lemma 2.4.6.** *If  $(u_n)_n$  is a sequence in  $H_c^1(\mathbb{R})$  such that  $E_c[u_n] \leq C$  for all  $n \in \mathbb{N}$  and  $dE_c[u_n] \rightarrow 0$  as  $n \rightarrow +\infty$  strongly in  $(H_c^1)^*$ , then there exists a subsequence, that we still call  $(u_n)_n$ , which converges strongly in  $H_c^1(\mathbb{R})$  toward a solution  $u$  of  $dE_c[u] = 0$ .*

**Proof of Lemma 2.4.6:** As  $E_c[u_n] \leq C$  for all  $n \in \mathbb{N}$  and using Lemma 2.2.4, we have

$$\|u_n\|_{H_c^1}^2 \leq \frac{C + C_1}{\min\{1, \delta\}},$$

which implies that, up to a subsequence,  $(u_n)$  converges weakly to  $u \in H_c^1(\mathbb{R})$ . Moreover for all  $w \in H_c^1(\mathbb{R})$ ,  $dE_c[u_n](w) \rightarrow 0$  as  $n \rightarrow +\infty$ , so

$$\begin{aligned} 0 &= \lim_{n \rightarrow +\infty} dE_c[u_n](w) \\ &= \lim_{n \rightarrow +\infty} \int_{\mathbb{R}} e^{cz} \{(u_n)_z w_z - f(z, u_n)w\} dz \\ &= \int_{\mathbb{R}} e^{cz} \{u_z w_z - f(z, u)w\} dz. \end{aligned}$$

Hence  $dE_c[u] \equiv 0$ .

Now let us prove that  $(u_n)$  converges strongly to  $u$  in  $H_c^1(\mathbb{R})$  as  $n \rightarrow +\infty$ . We just need to prove that  $\|u_n\|_{H_c^1(\mathbb{R})} \rightarrow \|u\|_{H_c^1(\mathbb{R})}$  as  $n \rightarrow +\infty$ , since  $H_c^1(\mathbb{R})$  is a Hilbert space. Taking  $w = u_n$  we get

$$\int_{\mathbb{R}} e^{cz} \{(u_n)_z^2 - f(z, u_n)u_n\} dz = \langle dE_c[u_n], u_n \rangle_{(H_c^1)^*, H_c^1} \quad (2.12)$$

And  $\langle dE_c[u_n], u_n \rangle_{(H_c^1)^*, H_c^1} \leq \|dE_c[u_n]\|_{(H_c^1)^*} \|u_n\|_{H_c^1} = o(1)$ , since  $(u_n)$  is bounded in  $H_c^1(\mathbb{R})$ . Hence,  $\langle dE_c[u_n], u_n \rangle \rightarrow 0$  as  $n \rightarrow +\infty$ .

As  $\langle dE_c[u], u \rangle = 0$ , we have that

$$\int_{\mathbb{R}} e^{cz} u_z^2 ds = \int_{\mathbb{R}} e^{cz} f(z, u)u dz.$$

Using the same arguments as in Proposition 2.2.5 we have that for all  $\varepsilon > 0$ ,

$$\lim_{n \rightarrow +\infty} \int_{\mathbb{R}} e^{cz} f(z, u_n)u_n dz \leq \int_{\mathbb{R}} e^{cz} f(z, u)u dz + \varepsilon.$$

This inequality and (2.12) implies that

$$\|u\|_{H_c^1(\mathbb{R})} \leq \liminf_{n \rightarrow +\infty} \|u_n\|_{H_c^1(\mathbb{R})} \leq \limsup_{n \rightarrow +\infty} \|u_n\|_{H_c^1(\mathbb{R})} \leq \|u\|_{H_c^1(\mathbb{R})} + \varepsilon,$$

for all  $\varepsilon > 0$ . One has proved the Lemma.  $\square$

**Proof of Proposition 2.4.3:** As assumed in the Proposition  $\min_{u \in H_c^1(\mathbb{R})} E_c[u] < 0$ . This minimum is reached for some  $u_{\min} \in H_c^1$  such that  $u_{\min} \neq 0$  and  $\|u_{\min}\|_{H_c^1} > r$  for  $r$  defined in Lemma 2.4.5 small enough. Then using the Mountain Pass Theorem, there exists  $\tilde{u} \in H_c^1$  such that  $dE_c[\tilde{u}] \equiv 0$  and  $E_c[\tilde{u}] \geq \gamma$ . We have proved Proposition 2.4.3.  $\square$

We want to prove that we can always find an initial condition  $u_0 \neq 0$  small enough such that  $u$  solution of  $(\tilde{P})$  converges to 0.

**Proposition 2.4.7.** *Let  $\lambda_c$  be the principal eigenvalue of  $-\mathcal{L}$ . If  $\lambda_c > 0$  then there exists  $u_0 \neq 0$  such that the solution  $u$  of  $(\tilde{P})$  converges to 0 as  $t \rightarrow +\infty$ .*

**Proof:** We noticed in the previous section that  $\lambda_c = \lambda_0 + \frac{c^2}{4}$  and if  $\lambda_0 > 0$ , then  $\lambda_c > 0$ . We know that there exists a positive function  $\phi \in W_{\text{loc}}^{2,p}(\mathbb{R})$ , for any  $1 \leq p < +\infty$ , such that

$$-\phi'' - c\phi' - f_s(z, 0)\phi = \lambda_c\phi \text{ in } \mathbb{R}.$$

Let  $w(t, z) := \kappa\phi(z)e^{-\delta t}$  for all  $t \geq 0$ ,  $z \in \mathbb{R}$ ,  $\kappa > 0$ ,  $\delta > 0$  some constants that we specify later. Then  $w$  satisfies the following equation

$$w_t - w_{zz} - cw_z = (f_s(z, 0) + \lambda_c - \delta)w.$$

As  $\lambda_c > 0$ , choosing  $\delta = \frac{\lambda_c}{2}$ , there exists  $\kappa > 0$  small enough such that

$$w_t - w_{zz} - cw_z \geq f(z, w).$$

Thus if  $u_0 \leq \kappa\phi$  in  $\mathbb{R}$ , using the weak parabolic maximum principle we have that for all  $t \geq 0$ ,  $z \in \mathbb{R}$ ,

$$u(t, z) \geq \kappa\phi(z)e^{-\delta t},$$

for some constants  $\kappa > 0$ ,  $\delta > 0$  small enough. This proves Proposition 2.4.7.  $\square$

## 2.5 Examples and discussion

### 2.5.1 Numerical simulations

In this section we illustrate the behaviour of the solution of the parabolic problem considering different type of reaction terms  $f$ , different values of  $\delta$  and  $c$ . We solve numerically the following problem

$$\begin{cases} \partial_t u - \partial_{zz} u - c\partial_z u = f(z, u), & \text{for } t \in [0, T], z \in [0, L], \\ u(0, x) = 1_{z \in [\frac{L}{2}-l, \frac{L}{2}+l]}, & \text{for } z \in [0, L], \\ u(t, 0) = 0, & \text{for } t \in [0, T], \\ u(t, L) = 0, & \text{for } t \in [0, T], \end{cases} \quad (2.13)$$

where

$$f(z, u) = \begin{cases} f_0(u) & \text{if } \frac{L}{2} - 2l < z < \frac{L}{2} + 2l, \\ -\delta u & \text{otherwise,} \end{cases}$$

with  $L > 0$ ,  $T > 0$  and  $0 < l < \frac{L}{10}$  some constants.

We approximate our problem ( $\tilde{P}$ ) by a Dirichlet boundary value problem. Indeed we know that the solution  $u$  of ( $\tilde{P}$ ) converges at least exponentially to 0 as  $z \rightarrow \pm\infty$  and using the comparison principle we have that for  $L$  large enough,  $\varepsilon > 0$ ,  $u^0(t, z) < u(t, z) < u^\varepsilon(t, z)$  for all  $t > 0$ ,  $x \in [0, L]$ , where  $u^0$  (respectively  $u^\varepsilon$ ) is the solution of ( $\tilde{P}$ ) for  $x \in [0, L]$  with  $u^0(t, 0) = u^0(t, L) = 0$  (respectively  $u^\varepsilon(t, 0) = u^\varepsilon(t, L) = \varepsilon$ ) for all  $t > 0$ . We observed that for  $\varepsilon$  small and  $L$  large  $u^0$  and  $u^\varepsilon$  have the same shape and behaviour, which implies that Problem (2.13) is a good approximation of ( $\tilde{P}$ ).

### Existence of a critical speed

We consider three types of reaction function  $f_0$ : the KPP case, the monostable case and the bistable case (see figure 2.1). We restrict our analysis to  $[0, T] \times [0, L]$  and take  $T$  and  $L$  large enough to act as if it was  $+\infty$ .

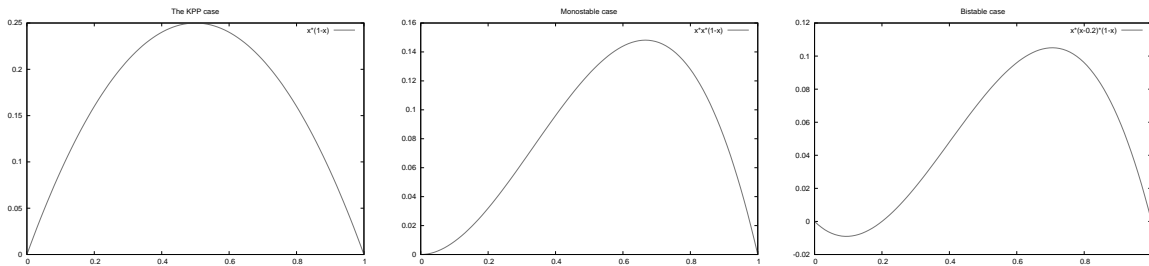

Figure 2.1 – Different type of reaction terms, from left to right:

KPP nonlinearity:  $f_0(u) = u(1 - u)$ , Monostable nonlinearity:  $f_0(u) = u^2(1 - u)$  and Bistable nonlinearity:  $f_0(u) = u(1 - u)(u - 0.2)$ .

In [9] and [17] the authors studied the asymptotic behaviour of the parabolic solution and more precisely the existence of non trivial travelling wave solution in the KPP case, i.e  $\frac{f_0(u)}{u}$  is maximal when  $u = 0$ . The authors proved that there exist travelling wave solutions if and only if  $\lambda_0 < 0$  and  $c < 2\sqrt{-\lambda_0}$ , where  $\lambda_0$  is the generalized eigenvalue when  $c = 0$ . In other words there exists a critical speed  $c^* = 2\sqrt{-\lambda_0}$  such that  $\underline{c} = \bar{c} = c^*$  in Theorem 2.1.1. In our paper we consider more general nonlinearities  $f$  and do not assume that  $f$  satisfies the KPP property. We proved in Theorem 2.1.1 that there exists  $\underline{c} \leq \bar{c}$  such that there exist travelling wave solutions for all  $c < \underline{c}$  and the only solution of (S) is 0 for all  $c > \bar{c}$ . We wonder if in this general framework, there still exists a critical speed  $c^*$  such that  $c^* = \underline{c} = \bar{c}$ . We investigate this conjecture numerically in the monostable and bistable case.

The existence of a critical speed has already been introduced in [104], where the authors highlight some monotonicity of the global population with respect to the speed  $c$ .

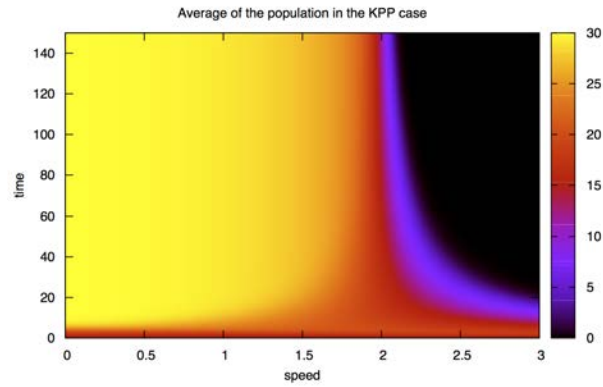

Figure 2.2 – Average of the population  $P(t) = \int_0^L u(t, x) dx$  for  $c \in [0, 3]$  in the KPP case ( $L=120$ )

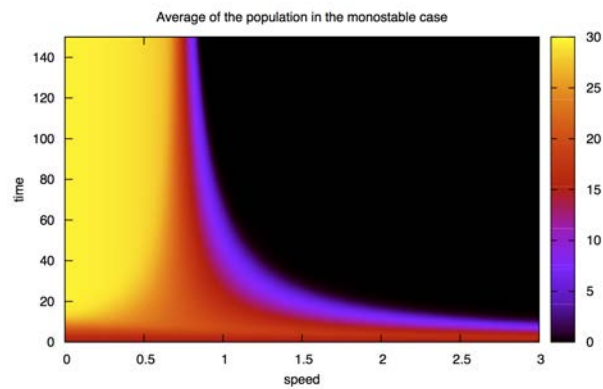

Figure 2.3 – Average of the population  $P(t) = \int_0^L u(t, x) dx$  for  $c \in [0, 3]$  in the monostable case ( $L=120$ )

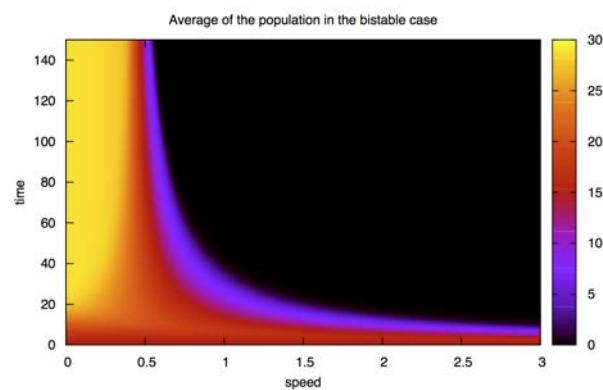

Figure 2.4 – Average of the population  $P(t) = \int_0^L u(t, x) dx$  for  $c \in [0, 3]$  in the bistable case ( $L=120$ )

Figure 2.2 displays the behaviour proved analytically in [9, 17]: there exists a critical speed  $c^*$  (around 2) such that for  $c < c^*$  the population survives whereas for  $c > c^*$  the population dies. In Figure 2.3 and 2.4 one can observe the same phenomenon but for lower critical speeds, which proves the existence of such a  $c^*$  in both cases (monostable and bistable).

Let us also notice that it has been proved in Proposition 2.4.3 and illustrated in Corollary 2.4.4, we still have persistence of the population even when  $\lambda_c > 0$  in the bistable cases (Figure 2.4 for  $c \in [0, 0.4]$ ).

### Shape of the solution in the moving frame

We now investigate the shape of the front when  $\delta$  varies and  $f$  is bistable, i.e

$$f_0(u) = u(1-u)(u-0.2).$$

When  $\delta$  is small (figure 2.6), a tail grows at the bottom of the front whereas the transition at the front edge of the front stays sharp when the speed  $c$  is small enough for the population to survive (see Figure 2.7, where the speed is too large and the population goes extinct). This tail is created by the movement of the favorable environment, indeed the death rate  $\delta$  is too small to kill the population which reproduced quickly in the favorable zone. On the other hand when  $c=0$ , both edges of the front become less and less sharp (figure 2.5).

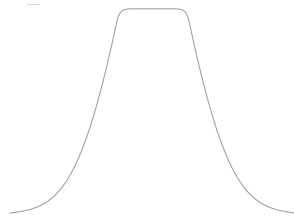

Figure 2.5 – Solution of (2.13) for  $\delta = 0.001$  and  $c = 0$  for  $t=150$ . The horizontal line on the right of each figure gives the scaling corresponding to 1 on the  $y$ -axis.

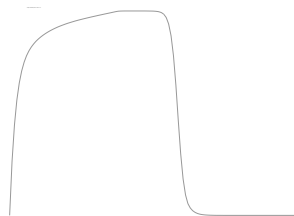

Figure 2.6 – Solution of (2.13) for  $\delta = 0.001$  and  $c = 0.4$  for  $t=150$ . The horizontal line on the right of each figure gives the scaling corresponding to 1 on the  $y$ -axis

Then we see that when  $c > 0$  (small enough for the population to survive), both edges of the front become sharper and sharper as  $\delta$  increases (Figures 2.6, 2.8 and 2.9).

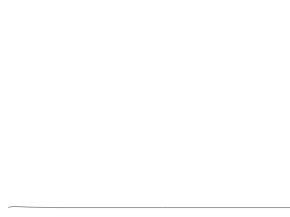

Figure 2.7 – Solution of (2.13) for  $\delta = 0.001$  and  $c = 0.8$  for  $t=150$ . The horizontal line on the right of each figure gives the scaling corresponding to 1 on the  $y$ -axis

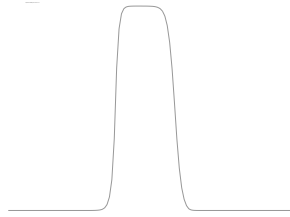

Figure 2.8 – Solution of (2.13) for  $\delta = 1$  and  $c = 0.4$  for  $t=150$ . The horizontal line on the right of each figure gives the scaling corresponding to 1 on the  $y$ -axis

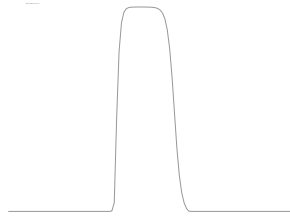

Figure 2.9 – Solution of (2.13) for  $\delta = 10$  and  $c = 0.4$  for  $t=150$ . The horizontal line on the right of each figure gives the scaling corresponding to 1 on the  $y$ -axis

### 2.5.2 Non uniqueness of stable travelling waves

We can also build  $f$  such that (S) has more than one stable solution with negative energies in the sense that the solutions are local minimizers of the energy functional.

**Proposition 2.5.1.** *There exists  $f(z, u)$  satisfying assumptions (2.1)-(2.4), such that there exist  $u^*$  and  $v^*$  solutions of (S) local minimizers of the energy functional with  $E_c[v^*] < E_c[u^*] < 0$ .*

Let  $f$  be as follow

$$f(z, u) = \begin{cases} f_0(u) & \text{if } |z| < R, \\ -\delta u & \text{otherwise,} \end{cases}$$

where  $f_0$  is a multi-stable function, i.e there exist  $0 < \theta_0 < 1 < \theta_1 < C$  such that

$$\begin{aligned} f(0) = f(\theta_0) = f(1) = f(\theta_1) = f(C) &= 0, \\ f(s) &< 0, \quad \text{for } s \in (0, \theta_0) \cup (1, \theta_1), \\ f(s) &> 0 \quad \text{for } s \in (\theta_0, 1) \cup (\theta_1, C), \end{aligned}$$



$\int_0^1 f_0(s)ds > 0$  and  $\int_0^C f_0(s)ds > \int_0^1 f_0(s)ds$  (one can look at Figure 2.10 for an example of  $f_0$ ), and  $\delta > 0$ .

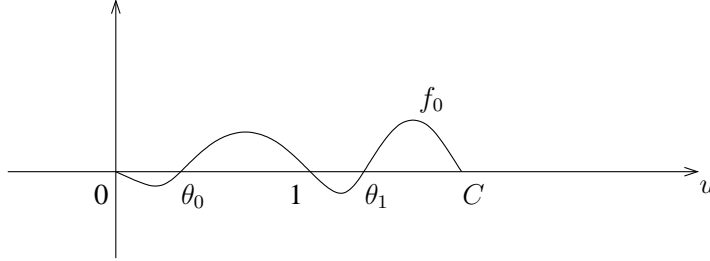

Figure 2.10 –  $f_0$  a multistable function such that  $\int_0^1 f_0(s)ds > 0$ , there exist  $0 < \theta_0 < 1 < \theta_1 < C$  such that  $f(0) = f(\theta_0) = f(1) = f(\theta_1) = f(C) = 0$ ,  $f(s) < 0$ , for  $s \in (0, \theta_0) \cup (1, \theta_1)$  and  $f(s) > 0$  for  $s \in (\theta_0, 1) \cup (\theta_1, C)$  with  $\int_0^C f_0(s)ds > \int_0^1 f_0(s)ds$ .

We start with the proof of the following Lemma.

**Lemma 2.5.2.** *There exists  $u^* \in H_c^1(\mathbb{R})$  a local minimizer of  $E_c[u]$  such that  $0 < u^* < 1$  in  $\mathbb{R}$ ,  $E_c[u^*] < 0$  and  $u^*$  is a solution of (S).*

**Proof of Lemma 2.5.2:** Define  $f^*$  such that

$$f^*(z, u) = \begin{cases} 0 & \text{if } z \in (-R, R) \text{ and } u \notin [0, 1], \\ f(z, u) & \text{otherwise,} \end{cases}$$

Using Proposition 2.2.5 we know that there exists  $u^*$ , travelling waves solution of (S) with  $f^*$  for some  $c > 0$  such that  $\min_{u \in H_c^1} E_c^*[u] = E_c^*[u^*]$ , where  $E_c^*$  is the energy functional associated with  $f^*$ .

We know that  $u^* \leq 1$  in  $\mathbb{R}$  by Remark 2.2.3. Thus  $u^*$  satisfies the following equation

$$-(u^*)'' - c(u^*)' = f(z, u^*),$$

and

$$E_c[u^*] = \min_{u \in H_c^1} E_c^*[u].$$

Taking

$$u_{min}(z) = \begin{cases} 1 & \text{for all } |z| < R, \\ 0 & \text{for all } |z| > R + 1, \end{cases}$$

such that  $u_{min} \in H_c^1(\mathbb{R})$ , one can check that for  $R$  large enough  $E_c^*[u_{min}] < 0$ , which implies that  $E_c[u^*] = \min_{u \in H_c^1} E_c^*[u] < 0$ . We have proved that there exists a solution  $u^* \in H_c^1(\mathbb{R})$  of (S), such that  $0 < u^*$  in  $\mathbb{R}$  and  $E_c[u^*] < 0$ . Now let us prove that  $u^*$  is a local minimizer. Using classical Sobolev injections, there exists  $\rho > 0$  small enough, such that

$$\|u - u^*\|_{H_c^1(\mathbb{R})} < \rho \implies \|u - u^*\|_{L^\infty(-R, R)} \leq \theta_1 - 1.$$

Now we prove that as soon as  $\|u - u^*\|_{H_c^1(\mathbb{R})} < \rho$ , then  $E_c[u] \geq E_c[u^*]$ .

$$\begin{aligned} E_c[u] &= \int_{\mathbb{R}} e^{cz} \left\{ \frac{(u')^2}{2} - F(z, u) \right\} dz, \\ &= E_c^*[u] + \int_{-R}^R e^{cz} \{F^*(z, u) - F(z, u)\} dz. \end{aligned}$$

As  $\|u - u^*\|_{L^\infty(-R, R)} \leq \theta_1 - 1$ ,  $f^*(z, u) \geq f(z, u)$  for all  $z \in (-R, R)$ , thus

$$\int_{-R}^R e^{cz} \{F^*(z, u) - F(z, u)\} dz \geq 0.$$

We have proved the Lemma. □

**Proof of Proposition 2.5.1:** Now we prove that there exists  $v^* \in H_c^1(\mathbb{R})$  solution of (S) such that  $E_c[v^*] < E_c[u^*] < 0$ . Let  $u_3$  be as follow,

$$u_3(z) = \begin{cases} C & \text{if } |z| < R, \\ 0 & \text{if } |z| > R + \varepsilon, \end{cases}$$

such that  $u_3 \in H_c^1(\mathbb{R})$ . Then

$$E_c[u_3] = - \left( \int_0^C f_0(s) ds \right) \frac{e^{cR} - e^{-cR}}{c} + \int_{R < |z| < R + \varepsilon} \left\{ \frac{(u_3'(z))^2}{2} + \frac{\delta u_3(z)^2}{2} \right\} e^{cz} dz.$$

Thus choosing  $C$  close enough to 1 and  $f_0 \gg 0$  in  $(\theta_1 + \eta, C - \eta)$  for some  $\eta > 0$ , small, we have

$$E_c[u_3] < E_c[u^*].$$

Using Proposition 2.2.5, we know that there exists  $v^* \in H_c^1(\mathbb{R})$  such that

$$E_c[v^*] = \min_{u \in H_c^1(\mathbb{R})} E_c[u] \leq E_c[u_3].$$

One has proved Proposition 2.5.1. □

We now illustrate the previous results. Choosing a specific reaction term

$$f_0(u) = u(1 - u)(u - 0.2)(1.1 - u)(1.5 - u)$$

and an appropriate initial condition we get different convergences as one can see in Figures 2.11, 2.12 and 2.13. We computed the same problem (2.13) that in section 2.5.1, with  $\delta = 1$  and  $f_0(u) = u(1 - u)(u - 0.2)(1.1 - u)(1.5 - u)$ . In the first two figures (2.11 and 2.12), one can see that depending on the initial condition, we get two different fronts but with a similar shape with sharp edge on both sides. On the other hand when  $c > 0$  the front edge takes the shape of a stairs, indeed in the favorable environment the population moves rapidly to 1 but need more time to grow from 1 to 1.5.

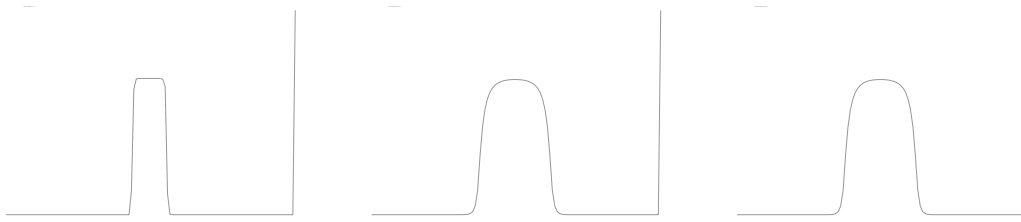

Figure 2.11 – Solution of (2.13) for  $u_0(x) = 1_{52.5 < x < 67.5}$  and  $c = 0$  for  $t = 0, 150$  and  $300$ . The horizontal line on the right of each figure gives the scaling corresponding to 1.5 (the maximum) on the  $y$ -axis

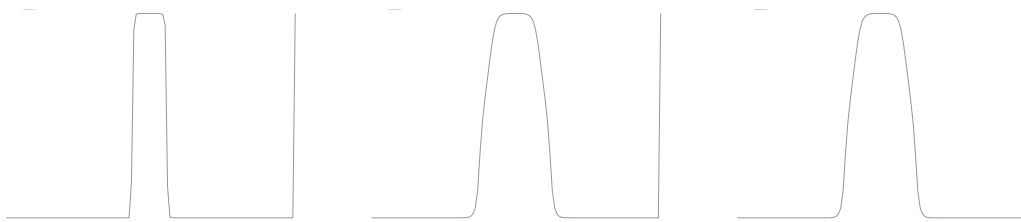

Figure 2.12 – Solution of (2.13) for  $u_0(x) = 1.5 \times 1_{52.5 < x < 67.5}$  and  $c = 0$  for  $t = 0, 150$  and  $300$ . The horizontal line on the right of each figure gives the scaling corresponding to 1.5 (the maximum) on the  $y$ -axis

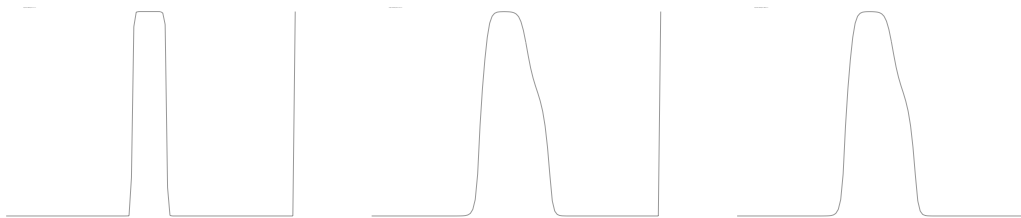

Figure 2.13 – Solution of (2.13) for  $u_0(x) = 1.5 \times 1_{52.5 < x < 67.5}$  and  $c = 0.2$  for  $t = 0, 150$  and  $300$ . The horizontal line on the right of each figure gives the scaling corresponding to 1.5 (the maximum) on the  $y$ -axis

## Chapitre 3

# Propagation d'une onde de dépolarisation dans le cerveau Application aux sciences médicales



---

# Front blocking and propagation in cylinders with varying cross section

Ce travail est en collaboration avec Henri Berestycki<sup>1</sup> et Guillemette Chapuisat<sup>1, 2</sup>

<sup>1</sup>EHESS, CAMS, UMR 8557, 190-198, avenue de France 75244 Paris Cedex 13, France

<sup>2</sup>Aix-Marseille Université, LATP, UMR 7353, 39 rue F. Joliot Curie 13453 Marseille Cedex 13, FRANCE

---

Dans ce chapitre on étudie une équation de réaction-diffusion de type bistable dans un cylindre infini de section transversale variable et on s'intéresse à l'existence de phénomènes de propagation (éventuellement partielle) ou au contraire à l'existence de phénomènes de blocage. Nous commençons par montrer l'existence et l'unicité d'une solution entière qui se comporte comme une onde progressive bistable classique en temps très négatif. Nous prouvons ensuite que dans le cas d'un diamètre qui décroît par rapport au sens de propagation, il y a propagation complète de l'état stationnaire 1 dans le domaine alors que lorsque le diamètre croît par rapport à la direction de propagation, la solution peut être bloquée face aux changements de géométrie. Nous montrons que ces phénomènes de blocage dépendent vivement du diamètre du petit cylindre (cylindre de gauche lorsque le sens de propagation va de gauche à droite). Considérant ensuite des cylindres infinis de section transversale plus générales (pas nécessairement des cylindres dont le diamètre est monotone par rapport à la direction de propagation) on prouve des résultats de propagation (au moins partielles) si notre cylindre contient un cylindre droit de diamètre suffisamment grand, ainsi que des résultats de propagation complète lorsque notre domaine est une perturbation régulière ( $C^{2,\alpha}$ ) d'un cylindre droit. Enfin nous concluons ce chapitre en discutant de conditions géométriques plus générale assurant la propagation complète de l'état stationnaire 1 dans le domaine.

À la fin de ce chapitre, en appendix, on présente un poster qui résume une partie du chapitre et qui a été réalisé à l'occasion de la conférence "*Biological invasions and evolutionary biology, stochastic and deterministic models*," à l'Université Claude Bernard Lyon 1, Lyon, France.

2010 *Mathematics Subject Classification*: 35B08, 35B30, 35B40, 35C07, 35K57, 92B05, 92C20

*Mots clés*: équations de réaction-diffusion, ondes progressives, fronts invasifs, sous- et sur-solutions, méthode de glissement, domaines étoilés, ondes de dépolariation.

---

The research leading to these results has received funding from the European Research Council under the European Union's Seventh Framework Program (FP/2007-2013) / ERC Grant Agreement n.321186 - ReaDi- Reaction-Diffusion Equations, Propagation and Modelling. This research has also been supported by the French "Agence Nationale de la Recherche" through the project PREFERED (ANR 08-BLAN-0313). Henri Berestycki was also supported by an NSF FRG grant DMS-1065979. Part of this work was carried out while he was visiting the Department of Mathematics at the University of Chicago. Juliette Bouhours is funded by a PhD fellowship "Bourse hors DIM" of the "Région Ile de France"

## 3.1 Introduction

### 3.1.1 The problem

In this paper we consider the following parabolic problem

$$\begin{cases} \partial_t u(t, x) - \Delta u(t, x) = f(u(t, x)), & \text{for } t \in \mathbb{R}, \quad x \in \Omega, \\ \partial_\nu u(t, x) = 0, & \text{for } t \in \mathbb{R}, \quad x \in \partial\Omega, \end{cases} \quad (3.1)$$

where  $\Omega$  is assumed to be an infinite cylinder in the  $x_1$ -direction with varying cross section, i.e

$$\Omega = \{(x_1, x'), x_1 \in \mathbb{R}, x' \in \omega(x_1) \subset \mathbb{R}^{N-1}\}$$

and  $\omega$  is assumed not to depend on  $x_1$  for  $x_1 < 0$ ,  $f$  to be bistable. We will give more precisions on the general assumptions in the next section. Our approach is threefold,

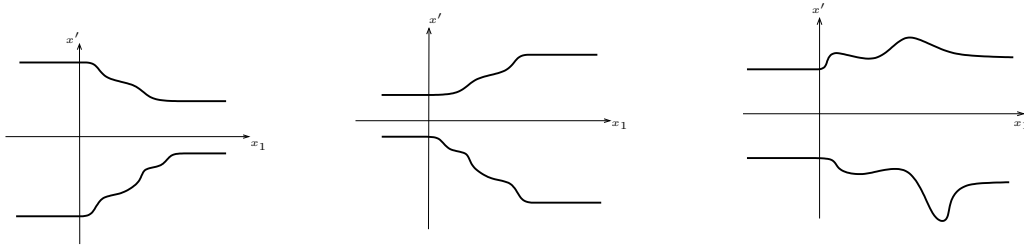

Figure 3.1 – Examples of domains  $\Omega$  we will consider throughout this paper

- We first study the existence of transition fronts in this setting, i.e the existence and uniqueness of an entire solution  $u$  of our parabolic problem (3.1), such that

$$u(t, x) - \phi(x_1 - ct) \rightarrow 0 \text{ as } t \rightarrow -\infty \text{ uniformly in } \bar{\Omega}, \quad (3.2)$$

where  $(\phi, c)$  is the bistable travelling wave solution, i.e solution of:

$$\begin{cases} \phi'' + c\phi' + f(\phi) = 0 & \text{in } \mathbb{R}, \\ \phi(-\infty) = 1, \phi(+\infty) = 0, \phi(0) = \theta. \end{cases} \quad (3.3)$$

- Then we investigate the existence of propagation or blocking phenomena for various geometries of  $\Omega$  and point out different behaviours of the solution depending on the monotonicity of the diameter with respect to the direction of propagation,

- Lastly, we argue on geometric conditions on  $\Omega$  that ensure a complete propagation in the domain.

### 3.1.2 Motivations from medicine and biology

These kind of problems and questions about the effect of geometry on propagation of waves, arise in several context of modelling in medicine and biology.

Equation (3.1) occurs in particular in the modelling of *Cortical Spreading Depressions (CSDs)* in the brain. A cortical spreading depression is a transient and large depolarisation of the membrane of neurons that propagates slowly (3mm/min) in the brain. The CSD are due to abnormal ionic exchanges between the intra- and extra-cellular space of the neuronal body that slowly diffuses in the brain. There are two stable states (the normal polarised rest state and the totally depolarised state) with a threshold on the ionic disturbances for passage from one stable state to the other. After a 3 or 4 minutes depolarisation, several mechanisms takes place to repolarise the neuron. Mathematical models studying theoretically CSDs focus generally on the depolarisation phase. That is why CSDs are modelled by a bistable reaction-diffusion equation like (3.1), where  $u$  represents the level of depolarisation, with  $u \equiv 0$  standing for the normal polarised state and  $u \equiv 1$  standing for the completely depolarised state. Besides, the depolarisation mechanism only takes place in the gray matter - a part of the brain where the neuronal bodies are - while ionic disturbances (and thus the depolarisation) diffuse and are absorbed in the white matter - a part of the brain where no neuron body and only axons can be found. The domain  $\Omega$  in equation (3.1) thus represents the gray matter of the brain.

Existence of CSDs in human brain is of utmost importance in the understanding of stroke or migraine with aura for example. CSDs were first observed by Leão in 1944 [71]. When neurons are depolarised, they can not propagate nerve impulses which generates lots of symptoms. For example, CSDs are suspected of being responsible for the aura during migraine with aura. The aura is a set of hallucinations, mainly visual and sensory, which appears during some migraine attacks. In ischemic strokes in rodent, it has been proved that each CSD increases the neurological damage by approximately 30% [87] and therapies aiming at blocking the appearance of CSDs have shown very promising results on rodent [35, 93]. Unfortunately they turned out to be inefficient in human. Despite intensive research, the CSDs in the human brain have never been clearly observed and their existence is still a matter of debate [1, 50, 82, 83, 119, 111, 5]. Mathematical modelling may help in understanding these discrepancies in observations. To understand the difficulties of biologists in observing CSDs, it is important to precise that due to the complex geometry of the human brain, only invasive measures can conclude precisely with the existence or not of CSDs. Except in vary special situations (head surgery for example), these measures are for ethical reasons impossible in human. Moreover the morphology of the human brain is very different from the rodent. In particular the gray matter of the human brain composes a thin layer at the periphery of the brain with its width varying a lot. The rest of the human brain is composed of white matter. On the opposite, the rodent brain is almost round and entirely composed of gray matter (see Figure 3.2). The variations of the grey matter thickness in the human brain could explain the inefficiency of therapies aiming at blocking CSD, by having a blocking effect on the CSD.

In [29], Chapuisat and Grenier first stated the hypothesis that the morphology of the human brain may prevent the propagation of CSDs over large distances, unifying observations of biologists. Several effects may be combined. First, variations of the gray matter thickness may



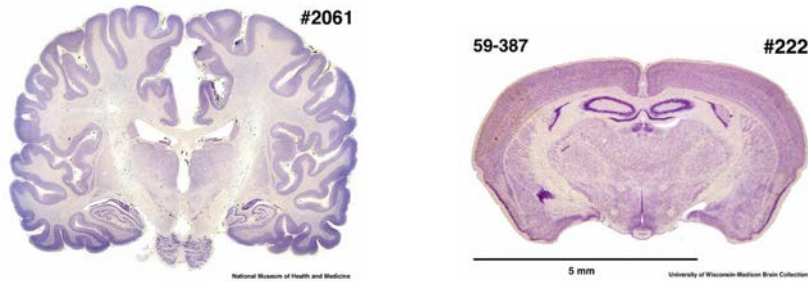

Figure 3.2 – Morphology of the brains. Left, human brain: gray matter is only a thin layer at the periphery of the brain. Right, rodent brain: it is almost entirely composed of gray matter. This images are from the University of Wisconsin and Michigan State Comparative Mammalian Brain Collections, and from the National Museum of Health and Medicine, available at the following website <http://www.brainmuseum.org/sections/index.html>. Preparation of all these images and specimens have been funded by the National Science Foundation, as well as by the National Institutes of Health.

prevent propagation of CSDs. This point is studied numerically in [37] and chapter 4 of this thesis and partly proved in [29]. Then the absorbing effect of the white matter may stop the propagation of CSDs in areas of the human brain where the gray matter is too thin. This phenomenon is studied in [28] and more recently in [7]. Finally the convolution of the human brain may also strengthen the absorption effect of the white matter and thus the blocking of the CSD. This point is studied numerically in [98] and chapter 4 of this thesis.

These results can be interpreted in a biological framework. If we assume that the mechanisms triggering CSDs are the same in human and in rodent, CSDs could be initiated in the human brain but only in areas where the gray matter is large enough and these CSDs will not propagate over large distances since they will be blocked by a sudden enlargement of the gray matter or if the gray matter becomes too thin compares to the white matter or if they cross a sharp convolution of the brain. On the opposite, in rodent brain that can be modelled by a ball of gray matter, CSDs could be triggered any where in the brain. This explain why biologists and physicians have so many difficulties in observing CSDs after stroke in human brain.

In the case of migraine with aura, the symptoms of aura correspond to a dysfunction of certain neurons. When translating the symptoms described by patients on a map of the cerebral areas, it is observed that the dysfunction of neurons propagate at a speed of 3mm/min which makes biologists and physicians think that the aura is due to CSDs. Now studying where the aura stops, it has been shown that it always stops at the bottom of a very deep sulkus. This phenomenon has been studied numerically in [51] and this reinforces the hypothesis of the importance of the morphology of the human brain in the propagation of CSDs. However a complete theoretical study of the influence of the geometry of the gray matter on the propagation of CSDs had never been obtained.

Blocking phenomena in domain with varying thickness is also of utmost importance in the study of ventricular fibrillations. Ventricular fibrillation is a state of electrical anarchy in part of the heart that leads to rapid chaotic contractions of the heart. It is deadly unless a normal rhythm can be restored by defibrillation. One of the medical hypotheses is that ventricular fibrillations arise from the generation of a circus excitation wave. These waves are not present in a healthy heart and an important medical problem is to understand how these waves can be triggered. Ashman and Hull [4] suggested that a myocardial infarct could create a circular area of cardiac tissue where excitation waves can propagate only in one way. Once an excitation wave would

enter this area, it would be trapped and the propagation of the wave would trigger ventricular fibrillations. Hence the question is to understand how cardiac fibres may propagate an excitation wave only in one direction. Cranefield [34] asserted that asymmetry of conduction in a normal cardiac fibre occurs due to variations of the diameter of the fibre. This asymmetry is strengthened by depression of excitability.

Mathematical models of excitation waves in the cardiac tissue may help to understand these phenomena. Cardiac cells as brain cells are excitable and the propagation of the depolarisation initialising the excitation wave can be modelled by a bistable reaction-diffusion equation as in (3.1). One of the important problems is thus to understand if the geometry of a fibre (or rather a fibre bundle) may trigger an asymmetry in the propagation of the travelling front and if geometrical properties of the domain may even block propagation of travelling waves in one direction but not in the other. Numerical studies [65, 88] have reinforced this hypothesis. Grindrod and Lewis [52] studied the propagation of the excitation in a Purkinje fibre bundle using an eikonal equation as an asymptotic model of propagation. They used biological values for all parameters and computed the approximated speed of the front. They proved that both an abrupt increase in the diameter of the bundles as well as an heterogeneous depression of cardiac tissues may prevent propagation of fronts in one direction preserving the propagation in the other direction. However this work is done with an asymptotic model and it is of importance to understand in which cases a travelling front may or may not propagate in a cylindrical domain.

Equation (3.1) can also be used to represent the evolution of a specie led by Allee effect dynamics. In [104], the authors studied numerically the evolution of the population in a complex domain when the population faces climate change. A term is added in the non-linearity of equation (3.1) to model the climate change. It is shown numerically that when these species have to move from a narrow pathway to a large meadow, for example, they do not survive if the change is too abrupt, whereas if it is progressive enough species do survive.

### 3.1.3 Previous mathematical results

In this paper, we are interested in the existence of invasion fronts (see the Introduction of the thesis for the definition) for a bistable reaction-diffusion equation in an infinite cylinder with varying cross section. This problem was already partly studied in [29] where they proved analytically that in two or three dimensions, if  $\Omega$  is the succession of two rectangles with different diameters  $r$  and  $R$ , then one can find conditions on  $r$  and  $R$  such that the solution is blocked when it goes from the small rectangle to the large rectangle. As the domain is not smooth, they used a symetrization method that will not work in other domains. In [14], the authors studied the existence of generalised transition front in exterior domain to analyse the interactions between travelling waves solutions and different kind of obstacles. They gave conditions on the shape of the obstacles that allows to prove the existence of propagation phenomena in the entire domain. They also constructed an obstacle that blocks the bistable travelling wave in some area of the domain. Here, we have tried to complete the results of [29] in more general domains by applying the techniques of [14].

These questions on the existence of invasion fronts had also been studied by Grindrod and Lewis [52] in 1991 in the modelling of depolarisation waves in cardiac fibres and by Lou Matano and Nakamura [79, 74] in 2006 and 2013. In [52] Grindrod and Lewis approximate the normal speed of the front using the Eikonal approximation and numerical simulations to point out that the presence of a symmetric narrowing and widening will decrease the average speed and that an abrupt widening could lead this speed to 0. More recently in [79, 74], Lou, Matano and

Nakamura study the effect of undulating boundary on the normal speed of propagation of a front analysing the law of motion of some curve representing the interface between two different phases. They point out the existence of stationary travelling waves when the undulations are non periodic or when the opening angle of the periodic undulation is too large.

### 3.1.4 Notations and assumptions

Here is some notations that we will use throughout this paper.

$$x = (x_1, x') \in \mathbb{R}^N, \text{ with } x_1 \in \mathbb{R} \text{ its first component and } x' \in \mathbb{R}^{N-1},$$

$$B_R(x_0) := \{x \in \mathbb{R}^N, |x - x_0| < R\}, \text{ the ball of radius } R \text{ and centered at } x_0 \text{ in } \mathbb{R}^N,$$

$$B'_R(x_0) := \{x \in \mathbb{R}^{N-1}, |x' - x'_0| < R\}, \text{ the ball of radius } R \text{ and centered at } x_0 \text{ in } \mathbb{R}^{N-1},$$

We will denote by  $B_R$  the ball of radius  $R$  and centered at 0 in  $\mathbb{R}^N$  and  $B'_R$  the ball of radius  $R$  and centered at 0 in  $\mathbb{R}^{N-1}$ .

Now let us be more precise on the assumptions of the domain  $\Omega$  and the function  $f$ . In this paper we will assume that

$$\Omega \text{ is a uniformly } C^{2,\alpha} \text{ subset of } \mathbb{R}^N, \quad (3.4)$$

$$\Omega \cap \{x \in \mathbb{R}^N, x_1 < 0\} = \mathbb{R}^- \times \omega, \quad \omega \subset \mathbb{R}^{N-1}, \quad (3.5)$$

and  $f \in C^{1,1}([0, 1])$  such that,

$$f(0) = f(\theta) = f(1) = 0, \quad f'(0) < 0, f'(1) < 0, \quad (3.6a)$$

and there exists  $\theta \in (0, 1)$

$$f(s) < 0 \quad \text{for all } s \in (0, \theta), \quad f(s) > 0 \text{ for all } s \in (\theta, 1). \quad (3.6b)$$

Moreover  $f$  is supposed to satisfy a mass property:

$$\int_0^1 f(s) ds > 0. \quad (3.7)$$

Condition (3.5) means that the change in the geometry of the domain takes place in the half space  $\mathbb{R}^+ \times \mathbb{R}^{N-1}$ .

### 3.1.5 Main results

We first prove the well-posedness of the problem with the following theorem.

**Theorem 3.1.1.** *Let  $\Omega \subset \mathbb{R}^N$  and  $f$  satisfy conditions (3.4)-(3.7), let  $(\phi, c)$  be the unique solution of (3.3), with  $c > 0$ , then there exists a unique entire solution of*

$$\begin{cases} \partial_t u(t, x) - \Delta u(t, x) = f(u(t, x)), & \text{for } t \in \mathbb{R}, \quad x \in \Omega, \\ \partial_\nu u(t, x) = 0, & \text{for } t \in \mathbb{R}, \quad x \in \partial\Omega, \end{cases}$$

such that

$$u(t, x) - \phi(x_1 - ct) \rightarrow 0 \text{ as } t \rightarrow -\infty \text{ uniformly in } \bar{\Omega}.$$

And  $u$  satisfies  $u_t(t, x) > 0$ ,  $0 < u(t, x) < 1$  for all  $(t, x) \in \mathbb{R} \times \bar{\Omega}$ .

One can notice that we did not make any assumptions on the change of diameter but the one that it takes place for  $x_1 > 0$ .

**Remark 3.1.2.** *This existence and uniqueness result is true for any domains that is a straight cylinder in the half space  $\{x \in \mathbb{R}^N, x_1 < M\}$  for some  $M \in \mathbb{R}$ , i.e there exists  $M \in \mathbb{R}$  such that  $\Omega \cap \{x \in \mathbb{R}^N, x_1 < M\} = (-\infty, M) \times \omega$ . This implies that the existence and uniqueness of the solution of (3.1) satisfying (3.2) is proved for general domains such as cylinders with varying cross section and changing direction for example.*

Then we investigate the existence of propagation phenomena, depending on the shape of the domain we are interested in. We start with the case when the diameter decreases with respect to the direction of propagation, and we have the following theorem:

**Theorem 3.1.3.** *Assume that for all  $x \in \partial\Omega$ ,  $\nu_1(x) \geq 0$ , where  $\nu_1(x)$  is the first component of the outward unit normal at  $x$ . In this framework, having the same assumptions on  $\Omega$ ,  $f$  and  $(\phi, c)$  than in Theorem 3.1.1, the solution  $u$  of (3.1) satisfying (3.2) propagates to 1 in  $\Omega$ , i.e*

$$u(t, \cdot) \rightarrow u_\infty \text{ as } t \rightarrow +\infty \text{ and } u_\infty \equiv 1 \text{ in } \Omega.$$

Moreover if we assume that

$$\Omega \cap \{x \in \mathbb{R}^N, x_1 > l\} = (l, +\infty) \times \omega_r,$$

for some  $l > 0$ ,  $\omega_R \subset \mathbb{R}^{N-1}$ , then  $c$  is the asymptotic speed of propagation, i.e

$$\forall \hat{c} > c, \lim_{t \rightarrow +\infty} \sup_{x_1 > \hat{c}t} u(t, x) = 0,$$

$$\forall \hat{c} < c, \lim_{t \rightarrow +\infty} \inf_{x_1 < \hat{c}t} u(t, x) = 1.$$

This Theorem means that there exists an invasion front connecting 0 and 1 for problem (3.1).

**Remark 3.1.4.** *The condition on  $\nu_1(x)$  means formally, that the diameter is non-increasing with respect to  $x_1$  (see the figure on the left in Figure 3.1 for an example in dimension 2).*

Next we study the case of an increasing diameter in the direction of propagation, and prove that if the diameter of the left-cylinder is too small then the solution  $u$  is blocked.

**Theorem 3.1.5.** *Let  $\varepsilon > 0$  be the diameter of the left cylinder, i.e  $\omega$  in condition (3.5) verifies  $\text{diam}(\omega) = \varepsilon$ . Suppose that  $\Omega \cap \{x \in \mathbb{R}^N, x_1 > 1\}$  does not depend on  $\varepsilon$ . Then having the same assumptions than in Theorem 3.1.1, there exists  $\varepsilon_0 > 0$  such that for all  $\varepsilon < \varepsilon_0$ , the unique solution  $u$  of (3.1), satisfying (3.2), is blocked in the big cylinder, i.e*

$$u(t, \cdot) \rightarrow u_\infty \text{ in } \Omega \text{ as } t \rightarrow +\infty \text{ and } u_\infty(x) \rightarrow 0 \text{ as } x_1 \rightarrow +\infty.$$

We highlight that in this framework the parameter that plays an important role is the width of the "left-cylinder",  $\varepsilon > 0$  small. Moreover the condition  $\Omega \cap \{x \in \mathbb{R}^N, x_1 > 1\}$  could be made more general by replacing 1 by any constant  $\eta \in (0, 1)$ .

**Remark 3.1.6.** *Notice that rescaling  $f$  by  $\lambda f$  for some  $\lambda$  positive then  $\varepsilon$  becomes  $\frac{\varepsilon}{\sqrt{\lambda}}$ , which means that if we increase the amplitude of  $f$  then the threshold  $\varepsilon_0$  decreases and the blocking phenomenon will appear for thinner channels.*

*Besides if we add a diffusion coefficient  $D > 0$  in front of the second order term (scaled to 1 in this paper) then  $\varepsilon$  becomes  $\sqrt{D}\varepsilon$ , which means that if  $D$  increases then the solution is blocked for larger diameters.*

On the other hand when the diameter of the left-cylinder is large enough then the solution is not blocked anymore and we have complete invasion of 1 in  $\Omega$ . We have the following theorem.

**Theorem 3.1.7.** *Let  $R > 0$  and  $L > 0$ , assume that  $\Omega$  satisfies the followings*

$$\begin{aligned} \mathbb{R} \times B'_R &= \{(x_1, x') \in \mathbb{R} \times \mathbb{R}^{N-1}, |x'| < R\} \subset \Omega, \\ \Omega \cap \{(x_1, x') \in \mathbb{R} \times \mathbb{R}^{N-1}, x_1 > L\} &\text{ is convex,} \\ \forall x \in \partial\Omega \cap \{(x_1, x') \in \mathbb{R} \times \mathbb{R}^{N-1}, x_1 < L + R\}, &\quad \nu_1(x) \leq 0. \end{aligned}$$

*Then under the same assumptions as in Theorem 3.1.1, there exists  $R^* > 0$  such that for all  $R > R^*$ , the unique solution  $u$  of (3.1), satisfying (3.2) propagates to 1 in  $\Omega$ , i.e*

$$u(t, \cdot) \rightarrow u_\infty \text{ as } t \rightarrow +\infty \text{ and } u_\infty \equiv 1 \text{ in } \Omega.$$

We thus point out two different behaviours of the solution in widening cylinders. If the diameter of the cylinder before the change in geometry is small, we prove that there exist blocking phenomena whereas if the diameter of the cylinder before the change of geometry is large enough the propagation of 1 is complete. One question that remains open is the existence of a threshold in the diameter of the cylinder before the change of geometry such that the solution is blocked below and completely propagates above.

Now considering more general domains (whose diameter is not monotonic with respect to  $x_1$ ), we prove that when  $\Omega$  contains a straight cylinder of radius  $R_0$  large enough, there is propagation.

**Theorem 3.1.8.** *Let  $R_1 > R_0 > 0$ , assume that*

$$\begin{aligned} \Omega &\subset \mathbb{R} \times B'_{R_1}, \\ \mathbb{R} \times B'_{R_0} &\subset \Omega, \end{aligned}$$

*Then having the same assumptions that in Theorem 3.1.1, there exists  $R^* > 0$  such that for all  $R_0 > R^*$ , the unique solution  $u$  of (3.1), satisfying (3.2) propagates, i.e*

$$u(t, \cdot) \rightarrow u_\infty \text{ in } \Omega \text{ as } t \rightarrow +\infty \text{ and } \inf_{x \in \Omega} u_\infty(x) > 0.$$

Notice that in this theorem the propagation may be partial and depending on the shape of  $\Omega$  there could be subdomains where the solution is close to 0 (see [14, 19] for example of domains where it happens).

We also prove a perturbation result. When  $\Omega$  is a smooth perturbation of a straight cylinder the solution is not blocked anymore and propagates to 1 in the entire domain at large time.

**Theorem 3.1.9.** *Assume that  $\omega$  in condition (3.5) is such that  $\text{diam}(\omega) = r > 0$ . Moreover suppose  $\Omega$  is closed to a straight cylinder in the  $C^{2,\alpha}$  topology, for some  $\alpha \in (0, 1)$ , i.e:*

$$\begin{aligned} \text{There exist } (\Omega_\varepsilon)_\varepsilon &\text{ a family of infinite cylinders in } \mathbb{R}^N, \delta > 0 \text{ such that} \\ \Omega_\varepsilon &\rightarrow \mathbb{R} \times \omega \text{ as } \varepsilon \rightarrow 0 \text{ for the } C^{2,\alpha} \text{ topology,} \\ \Omega &= \Omega_\delta. \end{aligned}$$

*Having the same assumption than in Theorem 3.1.1 on  $\Omega$ ,  $f$  and  $(\phi, c)$ , there exists  $\delta_0 > 0$  such that for all  $0 < \delta < \delta_0$ , the unique solution of (3.1) defined in Theorem 3.1.1 propagates to 1 at large times. Moreover as in Theorem 3.1.3 if we assume that there exists  $l > 0$  such that*

$$\Omega \cap \{x \in \mathbb{R}^N, x_1 > l\} = (l, +\infty) \times \tilde{\omega},$$

for some  $\tilde{\omega} \subset \mathbb{R}^{N-1}$  and  $\nu_1(x) \leq 0$  for all  $x \in \partial\Omega$ , then  $c$  is the asymptotic speed of propagation, i.e

$$\begin{aligned} \forall \hat{c} > c, \quad \lim_{t \rightarrow +\infty} \sup_{x_1 > \hat{c}t} u(t, x) &= 0, \\ \forall \hat{c} < c, \quad \lim_{t \rightarrow +\infty} \inf_{l < x_1 < \hat{c}t} u(t, x) &= 1, \end{aligned}$$

Finally we give geometric assumptions on  $\Omega$  that are sufficient to prove the propagation of 1 in the entire domain. These questions on the geometric assumptions of  $\Omega$  lead to the open problem of the instability of nonconstant steady state solutions of reaction diffusion equations in unbounded domains, problem that was solved by Matano in [77] and Casten and Holland in [25] for bounded domains. Indeed throughout this paper, we will be required to analyse, depending on the geometry of the domain, the stability of the solutions of the stationary problem

$$\begin{cases} -\Delta u = f(u) & \text{in } \Omega, \\ \partial_\nu u = 0 & \text{on } \partial\Omega, \\ u(x_1, x') \rightarrow 1 & \text{when } (x_1, x') \in \Omega, x_1 \rightarrow -\infty. \end{cases}$$

We prove for exemple in Theorem 3.1.5 that there exists a stable non constant solution of the previous stationary problem for some kind of widening cylinders, whereas 1 is the only stable solution for decreasing cylinders (Theorem 3.1.3).

We have the following theorem when  $\Omega$  is a straight cylinder with general varying cross section.

**Theorem 3.1.10.** *Let  $R_1 \gg R_0 > 0$ , assume that*

$$\begin{aligned} \Omega &\subset \mathbb{R} \times B'_{R_1}, \\ \mathbb{R} \times B'_{R_0} &\subset \Omega, \end{aligned}$$

*Then, assume that at each point on the boundary  $x = (x_1, x') \in \partial\Omega$ , the outward unit normal  $\nu$  makes a non-negative angle with the direction  $x'$ . More precisely, writing  $\nu = (\nu_1, \nu')$  (with  $\nu' \in \mathbb{R}^{N-1}$ ), we assume:*

$$\nu' \cdot x' \geq 0 \quad \text{for all points } x = (x_1, x') \in \partial\Omega. \quad (3.8)$$

*Then having the same assumptions that in Theorem 3.1.1 on  $\Omega$  and  $f$ , the solution  $u$  of (3.1) satisfying (3.2) propagates to 1 in  $\Omega$ , i.e*

$$u(t, \cdot) \rightarrow u_\infty \text{ locally uniformly in } \Omega \text{ as } t \rightarrow +\infty \text{ and } u_\infty \equiv 1 \text{ in } \Omega.$$

Here  $R_0$  is defined as the smallest radius for the existence of a positive solution of the associated Dirichlet boundary value problem in  $B'_{R_0}$  as we will see in section 3.7.

We call a domain that satisfies the property (3.8) a *star-shaped domain with respect to the  $x_1$ -axis*.

- The assumption (3.8) is a star-shaped type of property. It essentially says that any section in planes orthogonal to the  $x_1$ -axis is star shaped with respect to the trace of the axis in this plane. Hence the name “star shaped with respect to an axis”,
- We can also treat the case when “ $\Omega$  ends to the right”. Namely  $\Omega$  is asymptotically a straight cylinder as  $x_1 \rightarrow -\infty$ , and say is bounded to the right.

- We can combine various of our approaches to treat other situations as well.

This chapter will be organised as follow, we start with the proof of the existence of transition fronts (Theorem 3.1.1) in section 3.2. Then Theorem 3.1.3 is proved in section 3.3. In section 3.4 and 3.5 we study the effect of an increase in the diameter and prove Theorem 3.1.5 in section 3.4 whereas Theorem 3.1.7 is proved in section 3.5. We study propagation properties in more general domains in section 3.6 and prove Theorem 3.1.8 in section 3.6.1 and Theorem 3.1.9 in section 3.6.2. Finally we discuss geometrics assumption on general domains  $\Omega$  where the propagation is complete and prove Theorem 3.1.10 in section 3.7.

## 3.2 Existence and Uniqueness of the entire solution

### 3.2.1 Existence of an entire solution

In this section we start with the construction of sub- and super- solutions of our parabolic problem for small times, which will allow us to define an entire solution.

Assuming that the change in the geometry of the domain takes place in the half space  $\{x \in \mathbb{R}^N, x_1 > 0\}$  (as in figure 3.3), we define

$$w^+(t, x) = \begin{cases} 2\phi(-ct - \xi(t)), & \text{if } x_1 > 0, \\ \phi(x_1 - ct - \xi(t)) + \phi(-x_1 - ct - \xi(t)), & \text{if } x_1 \leq 0. \end{cases} \quad (3.9)$$

$$w^-(t, x) = \begin{cases} 0, & \text{if } x_1 > 0, \\ \phi(x_1 - ct + \xi(t)) - \phi(-x_1 - ct + \xi(t)), & \text{if } x_1 \leq 0. \end{cases} \quad (3.10)$$

The function  $\xi$  is such that

$$\dot{\xi}(t) = Me^{\lambda(ct + \xi(t))}, \quad \xi(-\infty) = 0,$$

where  $\lambda = \frac{1}{2} \left( c + \sqrt{c^2 - 4f'(0)} \right)$  and  $M$  is a positive constant that we fix later. So,

$$\xi(t) = \frac{1}{\lambda} \ln \left( \frac{1}{1 - Mc^{-1}e^{\lambda ct}} \right), \quad \forall t \leq \frac{1}{\lambda c} \ln \left( \frac{c}{M} \right).$$

We also assume that  $ct + \xi(t) \leq 0$  which is true as soon as  $t \leq \frac{1}{\lambda c} \ln \left( \frac{c}{c+M} \right) = \bar{T}_1$ . Slightly modifying the proof of [14]-section 2, we prove that  $w^+$  (respectively  $w^-$ ) is a super solution (respectively a sub solution) of our parabolic problem for time  $t \leq T$ ,  $T < 0$ .

We will start by giving some basic estimates, that we will use in the next sections.

### Basic estimates

From [14], consider  $(\phi, c)$  a travelling waves solution such that

$$\begin{cases} \phi'' + c\phi' + f(\phi) = 0 & \text{in } \mathbb{R}, \\ \phi(-\infty) = 1, \phi(+\infty) = 0. \end{cases}$$

There exist  $\alpha_0, \alpha_1, \beta_0$  and  $\beta_1$  positive constants such that

$$\begin{cases} \alpha_0 e^{-\lambda z} \leq \phi(z) \leq \beta_0 e^{-\lambda z}, & z > 0, \\ \alpha_1 e^{\mu z} \leq 1 - \phi(z) \leq \beta_1 e^{\mu z}, & z \leq 0. \end{cases}$$

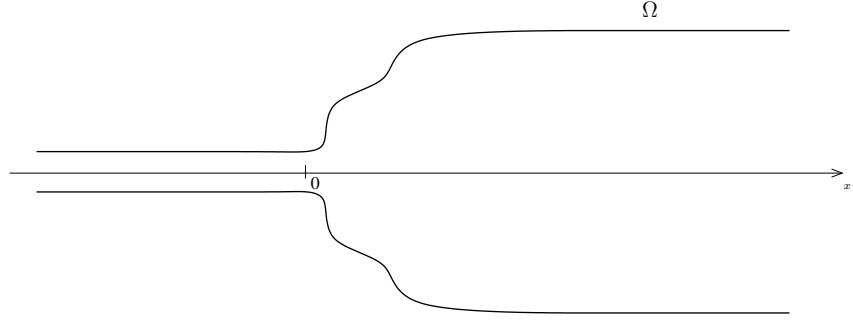

Figure 3.3 – The change in the diameter takes place in the half space  $\{x \in \mathbb{R}^N, x_1 > 0\}$

And there exist  $\gamma_0, \gamma_1, \delta_0$  and  $\delta_1$  positive constants such that

$$\begin{cases} -\gamma_0 e^{-\lambda z} \leq \phi'(z) \leq -\delta_0 e^{-\lambda z}, & z > 0, \\ -\gamma_1 e^{\mu z} \leq \phi'(z) \leq -\delta_1 e^{\mu z}, & z \leq 0, \end{cases}$$

where  $\lambda = \frac{1}{2}(c + \sqrt{c^2 - 4f'(0)})$  and  $\mu = \frac{1}{2}(-c + \sqrt{c^2 - 4f'(1)})$ .

Furthermore as  $f \in C^{1,1}$  one has

$$|f(u+v) - f(u) - f(v)| \leq Luv \quad \forall 0 \leq u, v \leq 1,$$

where  $L > 0$  some constant.

### Construction of the super solution

Let us start by proving that  $w^+$  is a super solution for  $t \leq \bar{T}$ , for some  $\bar{T} < 0$ .

For all  $x \in \partial\Omega$  such that  $x_1 > 0$ ,  $w^+$  does not depend on  $x$ , so the boundary of the domain can take any shape, the Neumann boundary condition will always be satisfied. For  $x \in \partial\Omega$  such that  $x_1 < 0$ ,  $w^+$  depends only on  $x_1$  and  $\nu_1(x) = 0$ , thus the Neumann boundary condition is satisfied and

$$\partial_\nu w^+(t, x) = 0, \quad \forall x \in \partial\Omega.$$

Now define  $\mathcal{L}w = \partial_t w - \Delta w - f(w)$ . We want to prove that  $\mathcal{L}w^+(t, x) \geq 0$  for all  $(t, x) \in \mathbb{R} \times \Omega$ .

For all  $x \in \Omega$  if  $x_1 > 0$ ,

$$\mathcal{L}w^+ = \underbrace{-2(\dot{\xi}(t) + c)\phi'(-ct - \xi(t))}_{(1)} - \underbrace{f(2\phi(-ct - \xi(t)))}_{(2)}.$$

For (1),  $-2(\dot{\xi}(t) + c) < 0$  as soon as it is well defined, i.e for all  $t \leq \bar{T}_1$ , and  $\phi'(-ct - \xi(t)) < 0$ . For (2), as  $\phi(+\infty) = 0$  there exists  $\bar{T}_2$  such that  $\phi(-ct - \xi(t)) \leq \frac{\theta}{2}$  for all  $t \leq \bar{T}_2$  (where  $\theta \in (0, 1)$  defined in (3.6), the largest number such that  $f(s) \leq 0$  for all  $0 \leq s \leq \theta$ ), which implies that  $f(2\phi(-ct - \xi(t))) \leq 0$  for all  $t \leq \bar{T}_2$ .

One has proved that  $\mathcal{L}w^+(t, x) > 0$  for all  $t \leq \min(\bar{T}_1, \bar{T}_2) = \bar{T}$  and  $x \in \{x \in \Omega, x_1 > 0\}$ .



Now if  $x \in \Omega$  and  $x_1 < 0$ ,  $w^+$  depends on  $t$  and  $x_1$ , and the left part of the domain  $\Omega$  has to be a straight cylinder, whose boundary does not vary in the  $x_1$  direction in order to satisfy the Neumann boundary condition. For all  $x \in \Omega$  such that  $x_1 < 0$ ,  $t < \bar{T}$ ,

$$\begin{aligned}\mathcal{L}w^+ &= -(c + \dot{\xi}(t))(\phi'(z_+) + \phi'(z_-)) - (\phi''(z_+) + \phi''(z_-)) - f(\phi(z_+) + \phi(z_-)), \\ &= -\dot{\xi}(t)(\phi'(z_+) + \phi'(z_-)) + f(\phi(z_+)) + f(\phi(z_-)) - f(\phi(z_+) + \phi(z_-)),\end{aligned}$$

where  $z_+ = x_1 - ct - \xi(t)$  and  $z_- = -x_1 - ct - \xi(t)$ .

We consider two cases,  $ct + \xi(t) \leq x_1 \leq 0$  to deal with  $z_+$  and  $z_-$  non negative, and  $x_1 < ct + \xi(t)$ . Starting with the case  $ct + \xi(t) \leq x_1 \leq 0$ , using basic estimates for  $f$  we have

$$\mathcal{L}w^+ \geq -Me^{\lambda(ct+\xi(t))}(\phi'(z_+) + \phi'(z_-)) - L\phi(z_+)\phi(z_-),$$

And using basic estimates for  $z_+$  and  $z_-$ ,

$$\begin{aligned}\mathcal{L}w^+ &\geq M\delta_0 e^{\lambda(ct+\xi(t))} e^{-\lambda(x_1-ct-\xi(t))} - L\beta_0^2 e^{-\lambda(x_1-ct-\xi(t))} e^{-\lambda(-x_1-ct-\xi(t))}, \\ &= e^{2\lambda(ct+\xi(t))} (M\delta_0 e^{-\lambda x_1} - L\beta_0^2), \\ &\geq 0,\end{aligned}$$

for  $M \geq \frac{L\beta_0^2}{\delta_0}$ .

Now if  $x_1 < ct + \xi(t)$ ,  $z_+ < 0$  and  $z_- > 0$ , and using basic estimates for  $f$ :

$$\mathcal{L}w^+ \geq -Me^{\lambda(ct+\xi(t))}(\phi'(z_+) + \phi'(z_-)) - L\phi(z_+)\phi(z_-),$$

Using basic estimates for  $z_+$  and  $z_-$ ,

$$\mathcal{L}w^+ \geq M\delta_1 e^{\lambda(ct+\xi(t))} e^{\mu(x_1-ct-\xi(t))} - L\beta_0 e^{-\lambda(-x_1-ct-\xi(t))}.$$

We need to consider two cases:  $\lambda \geq \mu$  and  $\lambda < \mu$ .

·  $\lambda \geq \mu$ :

$$\begin{aligned}\mathcal{L}w^+ &\geq M\delta_1 e^{\lambda(ct+\xi(t))} e^{\mu(x_1-ct-\xi(t))} - L\beta_0 e^{-\lambda(-x_1-ct-\xi(t))}, \\ &= e^{\lambda(ct+\xi(t))} (M\delta_1 e^{\mu x_1} e^{-\mu(ct+\xi(t))} - L\beta_0 e^{\lambda x_1}), \\ &\geq 0,\end{aligned}$$

for  $M \geq \frac{L\beta_0}{\delta_1}$ .

·  $\lambda < \mu$ :

In this case, as  $\lambda = \frac{1}{2}(c + \sqrt{c^2 - 4f'(0)})$  and  $\mu = \frac{1}{2}(-c + \sqrt{c^2 - 4f'(1)})$ , one has that  $m_0 := -f'(0) < -f'(1) =: m_1$ . And

$$f(u) + f(v) - f(u+v) = (m_1 - m_0)v + o(v^2) + o(v(1-u)),$$

for  $u \sim 1$  and  $v \sim 0$ .

In our framework, there exists  $L_1 < 0$  such that for all  $x_1 < ct + \xi(t) + L_1$ , one has

$$f(\phi(z_+)) + f(\phi(z_-)) - f(\phi(z_+) + \phi(z_-)) = (m_1 - m_0)\phi(z_-) + o(\phi(z_-)^2) + o(\phi(z_-)(1 - \phi(z_+))) > 0$$

Which implies that

$$\begin{aligned}\mathcal{L}w^+ &= -Me^{\lambda(ct+\xi(t))}(\phi'(z_+) + \phi'(z_-)) + f(\phi(z_+)) + f(\phi(z_-)) - f(\phi(z_+) + \phi(z_-)), \\ &\geq 0.\end{aligned}$$

For  $L_1 + ct + \xi(t) < x_1 \leq 0$ ,

$$\begin{aligned}\mathcal{L}w^+ &\geq e^{\lambda(ct+\xi(t))}(M\delta_1 e^{\mu(x_1-ct-\xi(t))} - L\beta_0 e^{\lambda x_1}), \\ &\geq e^{\lambda(ct+\xi(t))}(M\delta_1 e^{\mu L_1} - L\beta_0 e^{\lambda x_1}), \\ &\geq 0,\end{aligned}$$

for  $M \geq \frac{L\beta_0}{\delta_1 e^{\mu L_1}}$ .

One has proved that  $w^+$  is a super solution of our parabolic problem for  $t \leq \bar{T}$  and  $x \in \Omega$  as soon as  $M \geq \max\left(\frac{L\beta_0^2}{\delta_0}, \frac{L\beta_0}{\delta_1 e^{\mu L_1}}, \frac{L\beta_0}{\delta_1}\right)$ .

### Contruction of the sub solution

In this section we prove that  $w^-$  is a sub solution for  $t \leq \bar{T}$ . For the same reason than in section 3.2.1 the Neumann boundary condition is satisfied, i.e

$$\partial_\nu w^-(t, x) = 0, \quad \forall x \in \Omega.$$

As in the case of the super solution,  $w^-$  is defined by two different functions if  $x_1 > 0$  or  $x_1 < 0$ , so we need to consider the case  $x_1 > 0$ , which is trivial because  $w^- \equiv 0$ , and the case  $x_1 \leq 0$ . For  $x_1 \leq 0$ ,

$$\mathcal{L}w^- = Me^{\lambda(ct+\xi(t))}(\phi'(z_+) - \phi'(z_-)) + f(\phi(z_+)) - f(\phi(z_-)) - f(\phi(z_+) - \phi(z_-)),$$

where  $z_+ = x_1 - ct + \xi(t)$  and  $z_- = -x_1 - ct + \xi(t)$ .

If  $ct - \xi(t) < x_1 \leq 0$ , then  $0 \leq z_+ \leq z_-$  and fixing  $\phi$  to be the unique travelling wave solution of (3.3) such that  $\phi(0) = \theta$ , one has

$$\phi'(z_-) - \phi'(z_+) = \int_{z_+}^{z_-} \phi''(z) dz = \int_{z_+}^{z_-} -c\phi'(z) - f(\phi(z)) dz$$

As  $z_+ > 0$  and  $z_- > 0$ ,  $f(\phi(z)) \leq 0$  when  $z \in [z_+, z_-]$ . This implies that

$$\phi'(z_+) - \phi'(z_-) \leq -c(\phi(z_+) - \phi(z_-)).$$

Then

$$\begin{aligned}\mathcal{L}w^- &\leq -cMe^{\lambda(ct+\xi(t))}(\phi(z_+) - \phi(z_-)) + L(\phi(z_+) - \phi(z_-))\phi(z_-), \\ &\leq -cMe^{\lambda(ct+\xi(t))}(\phi(z_+) - \phi(z_-)) + L\beta_0 e^{-\lambda(-x_1-ct+\xi(t))}(\phi(z_+) - \phi(z_-)), \\ &= e^{\lambda ct} \left( -cMe^{\lambda \xi(t)} + L\beta_0 e^{-\lambda(-x_1-\xi(t))} \right) (\phi(z_+) - \phi(z_-)), \\ &\leq 0,\end{aligned}$$

for  $M \geq \frac{L\beta_0}{c}$ .

If  $x_1 \leq ct - \xi(t)$  as in the case of the super solution we need to consider the case when  $\lambda \geq \mu$  and  $\lambda < \mu$ . For  $\lambda \geq \mu$ ,

$$\mathcal{L}w^- \leq Me^{\lambda(ct+\xi(t))}(\phi'(z_+) - \phi'(z_-)) + L(\phi(z_+) - \phi(z_-))\phi(z_-).$$

As  $z_+ < 0$  and  $z_- > 0$ , using basic estimates,

$$\begin{aligned} \mathcal{L}w^- &\leq -Me^{\lambda(ct+\xi(t))} \left( \delta_1 e^{\mu(x_1-ct+\xi(t))} - \gamma_0 e^{-\lambda(-x_1-ct+\xi(t))} \right) + L\beta_0 e^{-\lambda(-x_1-ct+\xi(t))}, \\ &= -Me^{\lambda(x_1+ct+\xi(t))} \left( \delta_1 e^{\mu(-ct+\xi(t))} e^{(\mu-\lambda)x_1} - \gamma_0 e^{-\lambda(-ct+\xi(t))} - M^{-1}L\beta_0 e^{-2\lambda\xi(t)} \right), \\ &\leq -Me^{\lambda(x_1+ct+\xi(t))} \left( \delta_1 e^{\mu(-ct+\xi(t))} - \gamma_0 e^{-\lambda(-ct+\xi(t))} - M^{-1}L\beta_0 \right). \end{aligned}$$

There exists  $\underline{T}_1$  such that for all  $t \leq \underline{T}_1$ ,  $\delta_1 e^{\mu(-ct+\xi(t))} - \gamma_0 e^{-\lambda(-ct+\xi(t))} - M^{-1}L\beta_0 \geq 0$ . This yields to

$$\mathcal{L}w^-(t, x) \leq 0 \text{ for all } t \leq \underline{T}_1 \text{ and } x_1 < ct - \xi(t).$$

For  $x_1 < ct - \xi(t)$  and  $\lambda < \mu$  we prove that there exists  $\underline{T}_2 < 0$  such that

$$\mathcal{L}w^-(t, x) \leq 0 \text{ for all } t \leq \underline{T}_2 \text{ and } x_1 \leq ct - \xi(t),$$

with the same arguments than in the super solution case.

One has proved that  $w^-$  is a sub solution of our parabolic problem for  $t \leq \underline{T} = \min(\underline{T}_1, \underline{T}_2)$  and  $x \in \Omega$  as soon as  $M \geq \frac{L\beta_0}{c}$ .

We have proved that for all  $t \leq T = \min(\overline{T}, \underline{T})$  and for all  $x \in \Omega$  there exist a super- and a sub-solution  $w^+$  and  $w^-$  to our parabolic problem, defined by equations (3.9) and (3.41).

### Construction of the entire solution

We use the same arguments than in [14]. For more clarity we will write the main steps of the construction. The idea here is to construct a sequence of solution  $u_n$  defined for  $-n \leq t < +\infty$ , such that  $u_n$  converges toward an entire solution as  $n \rightarrow +\infty$ . Define  $u_n$  to be the solution of (3.1) for all  $t \geq -n$  with the initial condition

$$u_n(-n, x) = w^-(-n, x).$$

As  $w^- \leq w^+$  and using the comparison principle one proves that

$$u_n(t, x) \geq u_{n-1}(t, x) \text{ for all } t \in [-n+1, T], x \in \Omega.$$

Using the monotonicity of the sequence and parabolic estimates as  $n \rightarrow +\infty$ , one has that  $u_n$  converges to an entire solution  $u$  of (3.1) for all  $t \in \mathbb{R}$ ,  $x \in \Omega$ , and

$$w^-(t, x) \leq u(t, x) \leq w^+(t, x) \text{ for all } t \in (-\infty, T], x \in \Omega.$$

Let us prove that  $u_t > 0$  for all  $t \in \mathbb{R}$  and  $x \in \Omega$ . To do so one notices that  $w_t^- > 0$ . Indeed for  $x \in \Omega \cap \{x_1 \leq 0\}$ ,

$$w_t^-(t, x) = - \underbrace{(c + \dot{\xi}(t))}_{>0} (\phi'(z_+) - \phi'(z_-)),$$

and

- $c + \dot{\xi}(t) > 0$  for  $t$  sufficiently negative,
- $\phi'(z_+) - \phi'(z_-) \leq -c(\phi(z_+) - \phi(z_-))$ , with  $z_+ < z_-$

Using the monotonicity of  $\phi$  and the fact that  $z_- > z_+$ , one deduces that  $(u_n)_t(-n, x) > 0$  for  $n$  sufficiently large. Then using the maximum principle one has that

$$(u_n)_t(t, x) > 0 \text{ for all } t \in (-n, +\infty), x \in \Omega.$$

Letting  $n \rightarrow +\infty$  and using the strong maximum principle, one concludes that

$$u_t(t, x) > 0 \text{ for all } t \in \mathbb{R}, x \in \Omega.$$

So one has proved that there exists an entire solution to (3.1) such that

$$|u(t, x) - \phi(x_1 - ct)| \rightarrow 0 \text{ as } t \rightarrow -\infty \text{ uniformly in } x \in \Omega,$$

reminding that  $\xi(-\infty) = 0$ .

### 3.2.2 Uniqueness of the solution

In this section we want to prove that the entire solution constructed in section 3.2.1 is unique as soon as (3.2) is satisfied. This result is an extension of the parabolic maximum principle when the initial condition is given at  $t = -\infty$ . First we introduce, for  $0 < \eta \leq \frac{1}{2}$ ,

$$\Omega_\eta(t) = \{x \in \Omega : \eta \leq u(t, x) \leq 1 - \eta\}.$$

Using (3.2), there exist  $T_\eta \in \mathbb{R}$ ,  $M_\eta > 0$  such that,

$$\Omega_\eta(t) \subset \{x \in \Omega : |x_1 - ct| < M_\eta\}, \text{ for all } -\infty < t \leq T_\eta.$$

To prove the uniqueness of the solution of problem (3.1)-(3.2), we will need the following lemma:

**Lemma 3.2.1.** *For all  $\eta \in (0, \frac{1}{2}]$ , there exists  $\delta > 0$  such that*

$$u_t(t, x) \geq \delta \text{ for all } t \in (-\infty, T_\eta], x \in \Omega_\eta(t).$$

**Proof of Lemma 3.2.1:** The proof of the lemma is inspired from [14] section 3. The main difference being that  $\Omega$  is a straight cylinder and not an exterior domain as in [14]. We argue by contradiction and assume that there exist  $t_k \in (-\infty, T_\eta]$  and  $x_k \in \Omega_\eta(t)$  such that  $u_t(t_k, x_k) \rightarrow 0$  as  $k \rightarrow +\infty$ . Let  $u_k(t, x) = u(t + t_k, x_1 + x_{1,k}, x')$ , be defined for all  $t \in ]-\infty, 0]$ ,  $x = (x_1, x') \in \Omega$ . Using parabolic estimates,  $u_k \rightarrow u^*$  as  $k \rightarrow +\infty$  in  $C_{\text{loc}}^{1,2}$ , up to a subsequence. And  $u^*$  is a solution of (3.1) such that  $u_t^*(0, 0, x'_*) = 0$ ,  $u_t^*(t, x) \geq 0$  for all  $(t, x) \in (-\infty, 0] \times \Omega$ . Indeed as  $(x'_k)_k$  is bounded in  $\mathbb{R}^{N-1}$ , then up to a subsequence, it converges toward  $x'_*$  as  $k \rightarrow +\infty$ . The strong maximum principle on  $u_t^*$  yields that  $u_t^* \equiv 0$  for all  $t \leq 0$  and  $x \in \Omega$ , which is impossible because of (3.2).  $\square$

Then the end of the proof of the uniqueness of the solution is the same as in [14] section 3, we assume that there exists another solution  $v$  of (3.1) satisfying (3.2) and we prove that  $v \equiv u$  for all  $(t, x) \in \mathbb{R} \times \Omega$ . Define

$$W^+(t, x) = u(t + t_0 + \sigma\varepsilon(1 - e^{-\beta t}), x) + \varepsilon e^{-\beta t},$$

$$W^-(t, x) = u(t + t_0 - \sigma\varepsilon(1 - e^{-\beta t}), x) - \varepsilon e^{-\beta t},$$

for all  $\varepsilon \in (0, \eta)$  and  $t_0 \in (-\infty, T_\eta - \sigma\varepsilon]$ .

One proves that  $W^+$  and  $W^-$  are super and sub solutions of (3.1) for all  $t \in [0, T_\eta - t_0 - \sigma\varepsilon]$  such that  $W^-(0, x) \leq v(t_0, x) \leq W^+(0, x)$  for all  $x \in \Omega$ . We refer to [14] for more details. Then the maximum principle yields that

$$W^-(t, x) \leq v(t_0 + t, x) \leq W^+(t, x) \text{ for all } t \in [0, T_\eta - t_0 - \sigma\varepsilon], x \in \Omega.$$

And replacing  $t$  by  $t_0 + t$ , letting  $t_0 \rightarrow -\infty$  and then  $\varepsilon \rightarrow 0$  one has

$$u \equiv v \text{ for all } t \in \mathbb{R}, x \in \Omega.$$

To summarize, one has proved in section 3.2.1 and 3.2.2 that there exists a unique solution  $u$  of (3.1) that is defined for all  $t \in \mathbb{R}$  and  $x \in \Omega$  such that  $0 < u < 1$ ,  $u_t > 0$  for all  $(t, x) \in \mathbb{R} \times \Omega$  and  $|u(t, x) - \phi(x_1 - ct)| \rightarrow 0$  as  $t \rightarrow -\infty$  uniformly in  $x \in \Omega$ . Theorem 3.1.1 is thus proved.

In the next sections we will be interested in the behavior of this solution, considering different shapes of domain  $\Omega$ .

### 3.3 Propagation in the direction of decreasing cylinders

In this section we investigate the case when the diameter of the cross section decreases in the direction of propagation (see figure 3.4 or figures 3.1 in the Introduction) and prove Theorem 3.1.3. We recall that in this case we assume that  $\nu_1(x) \geq 0$  for all  $x \in \partial\Omega$ . One will prove that

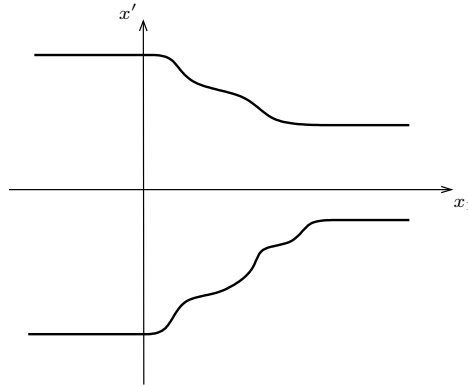

Figure 3.4 – Case of a sudden decrease in the diameter

the unique solution  $u$  of (3.1) such that (3.2) is satisfied can not be blocked and propagates to 1 at large times.

#### 3.3.1 Existence of a particular subsolution

We prove the following lemma.

**Lemma 3.3.1.** *Let  $(\phi, c)$  be the travelling wave solution defined by (3.3) and  $u$  be the unique solution of (3.1) such that (3.2) is satisfied. Then for all  $t \in \mathbb{R}$  and  $x \in \Omega$*

$$\phi(x_1 - ct) \leq u(t, x).$$

**Proof of Lemma 3.3.1:** Define  $v(t, x) = \phi(x_1 - ct)$  for all  $(t, x) \in \mathbb{R} \times \Omega$ ,  $v$  satisfies the following problem:

$$\begin{cases} \partial_t v - \Delta v = f(v) & \text{in } \mathbb{R} \times \Omega, \\ \partial_\nu v \leq 0 & \text{on } \mathbb{R} \times \partial\Omega, \\ |u(t, x) - v(t, x)| \rightarrow 0 & \text{as } t \rightarrow -\infty \text{ uniformly in } x \in \bar{\Omega}. \end{cases}$$

Indeed, as assumed in Theorem 3.1.3,  $\nu_1(x) \geq 0$  for all  $x \in \partial\Omega$  and as  $\phi$  is decreasing, this yields to  $\partial_\nu v \leq 0$  in  $\mathbb{R} \times \partial\Omega$ . Now to prove that  $v \leq u$  in  $\mathbb{R} \times \Omega$  we will use an argument from [14] (section 3 - uniqueness of the solution) already used in the proof of the uniqueness of  $u$  in section 3.2. Let us recall some notations:

$$\text{For all } \eta \in (0, \frac{1}{2}], \quad \Omega_\eta(t) = \{x \in \Omega : \eta \leq u(t, x) \leq 1 - \eta\}.$$

Then for all  $\eta \in (0, \frac{1}{2}]$ , there exists  $T_\eta \in \mathbb{R}$  and  $M_\eta > 0$  such that

$$\Omega_\eta(t) \subset \{x \in \Omega : |x_1 - ct| \leq M_\eta\} \text{ for all } -\infty < t \leq T_\eta,$$

because of (3.2). We proved that for all  $\eta \in (0, \frac{1}{2}]$ , there exists  $\delta > 0$  such that

$$u_t(t, x) \geq \delta \quad \text{for all } t \in (-\infty, T_\eta], x \in \Omega_\eta(t).$$

in Lemma 3.2.1.

Now choose  $\eta$  small enough such that

$$f'(s) \leq -\beta, \text{ for all } s \in [-2\eta, 2\eta] \cup [1 - 2\eta, 1 + 2\eta],$$

for some  $\beta > 0$ , where  $f$  is linearly extended outside  $[0, 1]$ , i.e

$$f(s) = \begin{cases} f'(0)s & \text{for } s < 0, \\ f(s) & \text{for } 0 \leq s \leq 1, \\ f'(1)(s - 1) & \text{for } s > 1. \end{cases} \quad (3.11)$$

Then because of (3.2), for all  $\varepsilon \in (0, \eta)$ , there exists  $t_\varepsilon \in \mathbb{R}$  such that

$$\sup_{x \in \Omega} |u(t, x) - v(t, x)| \leq \varepsilon \text{ for all } -\infty < t < t_\varepsilon.$$

Define  $v^+(t, x) = u(t + t_0 + \sigma\varepsilon(1 - e^{-\beta t}), x) + \varepsilon e^{-\beta t}$  for all  $t \in [0, T_\eta - t_0 - \sigma\varepsilon]$ , where  $t_0 < \min(T_\eta, t_\varepsilon)$ .

First notice that

$$v(t_0, x) \leq v^+(0, x) \text{ for all } x \in \Omega. \quad (3.12)$$

Let us prove that  $v^+$  is a super solution of our problem (3.1) for  $t \in [0, T_\eta - t_0 - \sigma\varepsilon]$ . For all  $t \in [0, T_\eta - t_0 - \sigma\varepsilon]$  and  $x \in \Omega$ ,

$$\begin{aligned} \mathcal{L}v^+(t, x) &= v_t^+(t, x) - \Delta v^+(t, x) - f(v^+(t, x)), \\ &= (1 + \sigma\varepsilon\beta e^{-\beta t})u_t(\bar{t}, x) - \beta\varepsilon e^{-\beta t} - \Delta u(\bar{t}, x) - f(u(\bar{t}, x) + \varepsilon e^{-\beta t}), \\ &= \sigma\varepsilon\beta e^{-\beta t}u_t(\bar{t}, x) - \beta\varepsilon e^{-\beta t} + f(u(\bar{t}, x)) - f(u(\bar{t}, x) + \varepsilon e^{-\beta t}), \\ &= \varepsilon e^{-\beta t} \left( \sigma\beta u_t(\bar{t}, x) - \beta - f'(u(\bar{t}, x) + \varepsilon e^{-\beta t}) \right), \end{aligned}$$

for some  $\kappa \in (0, 1)$ , where  $\bar{t} = t + t_0 + \sigma\varepsilon(1 - e^{-\beta t})$ .

Now if  $x \in \Omega_\eta(\bar{t})$ , one has that  $u_t \geq \delta$ , which implies that

$$\begin{aligned} \mathcal{L}v^+(t, x) &\geq \varepsilon e^{-\beta t} (\sigma\beta\delta - \beta - \max_{0 \leq s \leq 1} f'(s)) \\ &\geq 0, \end{aligned}$$

for  $\sigma$  large enough independent of  $\varepsilon$ .

If  $x \notin \Omega_\eta(\bar{t})$ , then  $u(\bar{t}, x) + \kappa\varepsilon e^{-\beta t} \in [0, 2\eta] \cup [1 - \eta, 1 + \eta]$ , and then  $f'(u(\bar{t}, x) + \kappa\varepsilon e^{-\beta t}) \leq -\beta$ .

And

$$\mathcal{L}v^+(t, x) \geq \varepsilon e^{-\beta t} (-\beta + \beta) = 0.$$

Thus  $\mathcal{L}v^+(t, x) \geq 0$  for all  $t \in [0, T_\eta - t_0 - \sigma\varepsilon]$ ,  $x \in \Omega$ . To summarize,  $v$  satisfies

$$\begin{cases} \partial_t v - \Delta v = f(v) & \text{in } [0, T_\eta - t_0 - \sigma\varepsilon] \times \Omega, \\ \partial_\nu v \leq 0 & \text{on } [0, T_\eta - t_0 - \sigma\varepsilon] \times \partial\Omega, \end{cases}$$

and  $v^+$  satisfies

$$\begin{cases} \partial_t v^+ - \Delta v^+ \geq f(v^+) & \text{in } [0, T_\eta - t_0 - \sigma\varepsilon] \times \Omega, \\ \partial_\nu v^+ = 0 & \text{on } [0, T_\eta - t_0 - \sigma\varepsilon] \times \partial\Omega, \end{cases}$$

Moreover  $v(t_0, x) \leq v^+(0, x)$  for all  $x \in \Omega$ , which yields, using the comparison principle,

$$v(t_0 + t, x) \leq v^+(t, x) \text{ for all } t \in [0, T_\eta - t_0 - \sigma\varepsilon] \text{ and } x \in \Omega.$$

Replacing  $t_0 + t$  by  $t$ , one has that for all  $t \in [t_0, T_\eta - \sigma\varepsilon]$  and  $x \in \Omega$

$$v(t, x) \leq u(t + \sigma\varepsilon(1 - e^{-\beta(t-t_0)}), x) + \varepsilon e^{-\beta(t-t_0)}.$$

Letting  $t_0 \rightarrow -\infty$ , we obtain,

$$v(t, x) \leq u(t + \sigma\varepsilon, x), \tag{3.13}$$

for all  $t \in (-\infty, T_\eta - \sigma\varepsilon]$ ,  $x \in \Omega$ . Then, using the comparison principle, (3.13) holds for all  $t \in \mathbb{R}$ ,  $x \in \Omega$  and letting  $\varepsilon \rightarrow 0$ , we get that

$$v(t, x) \leq u(t, x),$$

for all  $(t, x) \in \mathbb{R} \times \Omega$ .

One has proved the Lemma. □

### 3.3.2 Behaviour at large time

We are interested in the behaviour of our solution  $u$  at large time, i.e when  $t \rightarrow +\infty$ . We know that  $u$  is increasing in its first variable  $t$  and is bounded between 0 and 1. Using parabolic estimates one has that

$$u(t, x) \rightarrow u_\infty(x) \text{ as } t \rightarrow +\infty \text{ locally uniformly in } x \in \Omega.$$

As for all  $t \in \mathbb{R}$  and  $x \in \Omega$ ,  $\phi(x_1 - ct) \leq u(t, x)$ , it yields that for all  $x \in \Omega \cap \{x, x_1 \leq K\}$ , for all  $K \in \mathbb{R}^+$ ,  $u_\infty(x) = 1$  and so  $u(t, x) \rightarrow 1$  as  $t \rightarrow +\infty$  locally uniformly in  $x \in \Omega$ , which proves the propagation phenomenon.

We investigate the existence of  $c^* \in \mathbb{R}^+$ , an asymptotic spreading speed, such that

$$\text{For all } \hat{c} > c^*, \quad \limsup_{t \rightarrow +\infty, x_1 > \hat{c}t} u(t, x) = 0, \quad (3.14)$$

$$\text{For all } \hat{c} < c^*, \quad \liminf_{t \rightarrow +\infty, x_1 < \hat{c}t} u(t, x) = 1. \quad (3.15)$$

As  $u(t, x) \geq \phi(x_1 - ct)$  for all  $(t, x) \in \mathbb{R} \times \Omega$ , (3.15) holds for  $c^* = c$ .

To prove (3.14), first notice that  $|u(t, x) - \phi(x_1 - ct)| \rightarrow 0$  as  $t \rightarrow -\infty$ , which implies that for all  $\varepsilon > 0$  there exists  $T < 0$  such that for all  $t < T$ ,  $u(t, x) \leq \phi(x_1 - ct) + \varepsilon$ , and then for all  $\varepsilon > 0$  there exist  $T < 0$  and  $L > 0$  such that for all  $t < T$  and  $x_1 > L$ ,  $u(t, x) \leq \varepsilon$ .

So  $u$  satisfies the following problem

$$\begin{cases} u_t(t, x) - \Delta u(t, x) = f(u(t, x)), & \text{for } t \in [T, +\infty[, x \in [l, +\infty[ \times \omega_r, \\ \partial_\nu u(t, x) = 0, & \text{for } t \in [T, +\infty[, x \in [l, +\infty[ \times \partial\omega_r, \end{cases}$$

where  $0 < l < L$  such that  $\Omega \cap \{x, x_1 > l\} = [l; +\infty) \times \omega_r$  as assumed in the Theorem 3.1.3, with  $\omega_r$  a compact set of  $R^{N-1}$ ,  $\text{diam}(\omega_r) = r$  and with

$$u(t, l, x') \leq 1, \text{ for } t \in [T, +\infty[.$$

Define  $g : [l, +\infty[ \rightarrow [\varepsilon, 1]$  a smooth function that is equal to 1 in  $[l, L]$  and equal to  $\varepsilon$  in  $[L + 1, +\infty[$ , then  $u$  satisfies

$$u(T, x) \leq g(x_1), \text{ for } x \in [l, +\infty[ \times \omega_r.$$

Now let  $v$  be the solution of the following problem

$$\begin{cases} v_t(t, x) - \Delta v(t, x) = f(v(t, x)), & \text{for } t \in [T, +\infty[, x \in [l, +\infty[ \times \omega_r, \\ \partial_\nu v(t, x) = 0, & \text{for } t \in [T, +\infty[, x \in [l, +\infty[ \times \partial\omega_r, \\ v(t, l, x') = 1, & \text{for } t \in [T, +\infty[, x' \in \omega_r \\ v(T, x) = g(x_1), & \text{for } x \in [l, +\infty[ \times \omega_r. \end{cases}$$

Then the problem becomes uni-dimensional in space, i.e  $v$  is solution of

$$\begin{cases} v_t - v_{xx} = f(v) & \text{for } t \in [T, +\infty[, x \in [l, +\infty[, \\ v(t, l) = 1, & \text{for } t \in [T, +\infty[, \\ v(T, x) = g(x) & \text{for } x \in [l, +\infty[. \end{cases} \quad (3.16)$$

Moreover for all  $\eta > 0$ , introduce  $f_\eta$  (see Figure 3.5) a smooth function defined on  $[\eta, 1 + \eta]$  such that

$$f(\eta) = f(\theta) = f(1 + \eta) = 0$$

and

$$\begin{cases} f_\eta \equiv f & \text{in } [2\eta, 1 - \eta], \\ f_\eta > f & \text{in } [\eta, 2\eta] \cup [1 - \eta, 1]. \end{cases} \quad (3.17)$$

It is well known that the 1-D travelling front solution  $\phi_\eta$  associated with  $f_\eta$  is of speed  $c_\eta$ , i.e

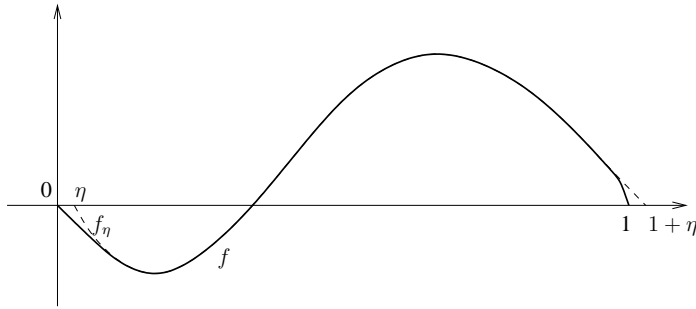

Figure 3.5 – Example of function  $f_\eta$  that satisfies (3.17).

$(\phi_\eta, c_\eta)$  satisfies

$$\begin{cases} \phi_\eta''(z) + c_\eta \phi_\eta'(z) + f_\eta(\phi_\eta) = 0 & \text{for all } z \in \mathbb{R}, \\ \phi_\eta(-\infty) = 1 + \eta, \quad \phi_\eta(+\infty) = \eta, \end{cases}$$

with  $c_\eta \rightarrow c$  as  $\eta \rightarrow 0$ . Let  $w$  be the solution of the extended problem with  $f_\eta$ , i.e

$$\begin{cases} w_t(t, x) - w_{xx}(t, x) = f_\eta(w(t, x)), & \text{for all } (t, x) \in (T, +\infty) \times \mathbb{R}, \\ w(T, x) = \tilde{g}_\eta(x), & \text{for all } x \in \mathbb{R}. \end{cases}$$

And  $\tilde{g}_\eta$  is the following,

$$\tilde{g}_\eta(x) = \begin{cases} 1 & \text{for } x \in [-L, L], \\ \eta & \text{for } x \geq L + 1. \end{cases}$$

Then using Fife and McLeod results, one knows that  $|w(t, x) - \phi_\eta(x - c_\eta t)| < K e^{-\mu t}$  for all

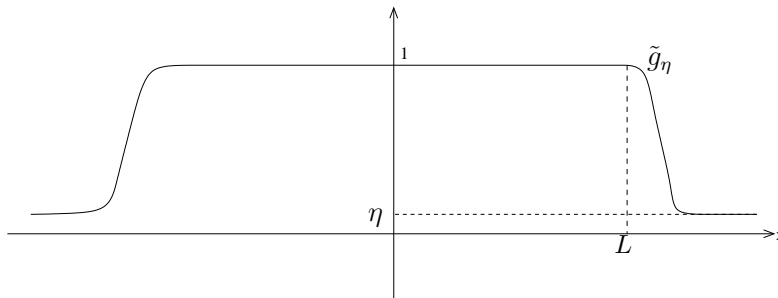
Figure 3.6 –  $\tilde{g}_\eta(x) = 1$  for all  $x \in [-L, L]$  and  $\tilde{g}_\eta(x) = \eta$  for  $|x| > L + 1$ .

$t \geq T$  and  $x > 0$ , for some positive constant  $K$  and  $\mu$ . Then for all  $\eta \geq \varepsilon$ , there exists  $t_0 > 0$  such that

$$\begin{cases} w_t(t, x) - w_{xx}(t, x) \geq f(w(t, x)), & \text{for all } (t, x) \in (T + t_0, +\infty) \times (l, +\infty), \\ w(T + t_0, x) \geq \tilde{g}_\eta(x), & \text{for all } x \in (l, +\infty), \\ w(t, l) \geq 1, & \text{for all } t \geq T + t_0. \end{cases}$$

This means that  $w$  is a super solution of (3.16) and  $w(t+t_0, x) \geq v(t, x)$  for all  $t \geq T$  and  $x \geq l$ . This yields that  $u(t, x_1, x') \leq w(t+t_0, x_1)$  for all  $t \geq T$  and  $(x_1, x') \in [l, +\infty) \times \omega_r$ . This implies that

$$\lim_{t \rightarrow +\infty} \sup_{x_1 > c_\eta(t+t_0)} u(t, x) \leq \eta.$$

For all  $\hat{c} > c$ , there exists  $\eta > 0$  such that  $\hat{c} > c_\eta + \frac{c_\eta t_0}{t}$  for all  $t > T_\infty$ , with  $T_\infty \gg 1$ , and  $\sup_{x_1 > \hat{c}t} u(t, x) \leq \sup_{x_1 > c_\eta(t+t_0)} u(t, x)$  for all  $t > T_\infty$ ,  $x \in \Omega$ . Then

$$\text{for all } \hat{c} > c, \lim_{t \rightarrow +\infty} \sup_{x_1 > \hat{c}t} u(t, x) \leq \eta.$$

As  $\eta > 0$  can be chosen as small as we want we obtain

$$\text{for all } \hat{c} > c, \lim_{t \rightarrow +\infty} \sup_{x_1 > \hat{c}t} u(t, x) = 0.$$

### 3.4 Propagation in widening cylinders - Blocking phenomenon

In this section we prove Theorem 3.1.5, i.e we want to prove that when the diameter of the left cylinder is small enough, then there exists a super solution of the elliptic problem that lies strictly between 0 and 1 and goes to 0 as  $x_1 \rightarrow +\infty$ . If such a solution exists it means that the solution  $u$  of (3.1) satisfying (3.2) can not propagate at large times.

One will first consider the reduced problem in  $\Omega' = \Omega \cap \{x = (x_1, x') \in \mathbb{R} \times \mathbb{R}^{N-1}, -1 < x_1\}$ , see figure 3.7. Indeed if we find a solution  $w$  of the following elliptic problem in  $\Omega'$ :

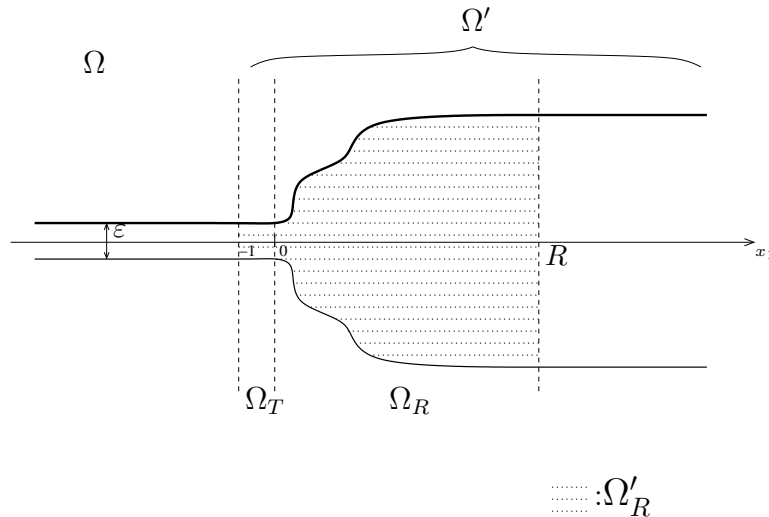

Figure 3.7 – Example of domain  $\Omega$  for  $N = 2$ , where  $\Omega' = \{x \in \Omega, x_1 > -1\}$ ,  $\Omega'_R = \{x \in \Omega, -1 < x_1 < R\} = \Omega_T \cup \Omega_R$

$$\begin{cases} \Delta w + f(w) = 0 & \text{in } \Omega', \\ \partial_\nu w = 0 & \text{on } \partial\Omega' \setminus \{x_1 = -1\}, \\ w \equiv 1 & \text{on } \{x_1 = -1\}, \end{cases} \quad (3.18)$$

then extending  $w$  by 1 outside  $\Omega'$ , we obtain a super solution of (3.1). Before looking for a solution of (3.18) we restrict our analysis to a bounded domain  $\Omega'_R = \Omega' \cap \{x_1 < R\}$  (see figure 3.7) and prove in section 3.4.1 that there exists a function  $0 < w_R < 1$  in  $\Omega'_R$  solution of:

$$\begin{cases} \Delta w + f(w) = 0 & \text{in } \Omega'_R, \\ \partial_\nu w = 0 & \text{on } \Gamma = \partial\Omega'_R \setminus (\{x_1 = -1\} \cup \{x_1 = R\}), \\ w \equiv 1 & \text{on } \{x_1 = -1\}, \\ w \equiv 0 & \text{on } \{x_1 = R\}. \end{cases} \quad (3.19)$$

Then we prove in section 3.4.2 that  $w_R \rightarrow w_\infty$  as  $R \rightarrow +\infty$ , where  $w_\infty$  is a solution of (3.18)

$$\begin{cases} \Delta w_\infty + f(w_\infty) = 0 & \text{in } \Omega' = \Omega \cap \{x_1 > -1\}, \\ \partial_\nu w_\infty = 0 & \text{on } \Gamma' = \partial\Omega' \setminus \{x_1 = -1\}, \\ w_\infty \equiv 1 & \text{on } \{x_1 = -1\}, \end{cases}$$

such that  $w_\infty \rightarrow 0$  as  $x_1 \rightarrow +\infty$  and conclude, using a comparison principle as in section 3.3, that  $u$ , solution of (3.1)-(3.2) is blocked in the large cylinder.

### 3.4.1 Reduced problem

For  $D \subset \mathbb{R}^N$ , we introduce the energy functional defined for all  $w \in H^1(D)$ , by

$$J_D(w) = \int_D \frac{1}{2} |\nabla w|^2 + F(w) dx,$$

where  $F(t) = \int_t^1 f(s) ds$ . Notice that using (3.7) and extending  $f$  linearly outside  $[0, 1]$ , as in (3.11),  $F(t) > 0$  for all  $t \in \mathbb{R}$  and  $F$  has the shape illustrated in Figure 3.8. Let

$$H_{1,0}^1 = \left\{ w \in H^1(\Omega'_R), w \equiv 1 \text{ on } \{x \in \partial\Omega'_R, x_1 = -1\} \text{ and } w \equiv 0 \text{ on } \{x \in \partial\Omega'_R, x_1 = R\} \right\}.$$

Finding a local minimizer of  $J_{\Omega'_R}$  in an open subset of  $H_{0,1}^1$  yields to a stable solution of (3.19).

We start by proving that  $w_0 \equiv 0$  on  $\Omega_R = \Omega'_R \cap \{x = (x_1, x') \in \mathbb{R} \times \mathbb{R}^{N-1}, 0 < x_1 < R\}$ , (see figure 3.7), locally minimizes  $J_{\Omega_R}$  on  $H^1(\Omega_R)$ .

**Proposition 3.4.1.** *There exist  $\delta > 0$  and  $\alpha > 0$  such that for all  $w \in H^1(\Omega_R)$  with*

$$\|w - w_0\|_{H^1(\Omega_R)} \leq \delta$$

one has

$$J_{\Omega_R}(w) \geq J_{\Omega_R}(w_0) + \alpha \|w - w_0\|_{H^1(\Omega_R)}^2.$$

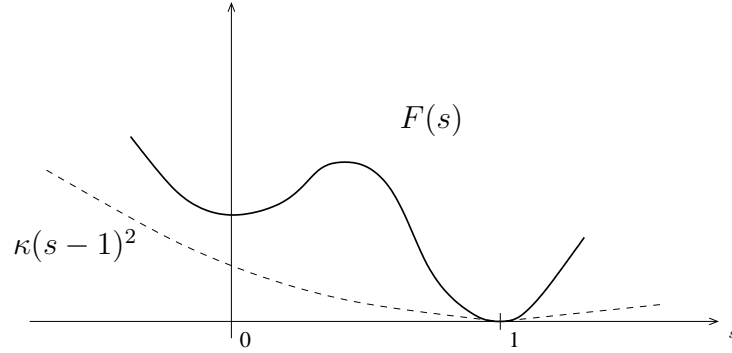

Figure 3.8 –  $F(s) = \int_s^1 f(t)dt$ , where  $f$  is a bistable function for  $s \in [0, 1]$  and is extended linearly outside  $[0, 1]$  as in (3.11).

**Proof of Proposition 3.4.1** Let us first notice that,

$$J_{\Omega_R}(w) = \int_{\Omega_R} \frac{1}{2} |\nabla w|^2 + F(0) + F'(0)w + \frac{F''(0)}{2} w^2 + \eta(w)w^2, \quad (3.20)$$

where  $\eta : \mathbb{R} \rightarrow \mathbb{R}$  is a continuous function such that  $\eta(s) \rightarrow 0$  as  $s \rightarrow 0$ . This can also be written as

$$J_{\Omega_R}(w) = J_{\Omega_R}(w_0) + \int_{\Omega_R} \frac{1}{2} |\nabla w|^2 - \frac{f'(0)}{2} w^2 + \eta(w)w^2. \quad (3.21)$$

As  $f'(0) < 0$ , there exists  $\alpha = \min(\frac{1}{2}, -\frac{f'(0)}{2}) > 0$  such that

$$\int_{\Omega_R} \frac{1}{2} |\nabla w|^2 - \frac{f'(0)}{2} w^2 \geq \alpha \|w - w_0\|_{H^1(\Omega_R)}^2$$

To simplify (3.21), we need to prove the following lemma:

**Lemma 3.4.2.** *If  $\eta : \mathbb{R} \rightarrow \mathbb{R}$  is the function defined in (3.20), we have,*

$$\left| \int_{\Omega_R} \eta(z) z^2 \right| \leq \varepsilon(z) \|z\|_{H^1(\Omega_R)}^2,$$

where  $\varepsilon(z) \rightarrow 0$  as  $\|z\|_{H^1(\Omega_R)} \rightarrow 0$

**Proof of Lemma 3.4.2:** As  $f$  is linear at infinity,  $F$  is quadratic at infinity, which implies that  $\eta$  is a bounded function from  $\mathbb{R}$  to  $\mathbb{R}$ , i.e there exists  $C \in \mathbb{R}^+$  such that  $|\eta(s)| \leq C$  for all  $s \in \mathbb{R}$ . This and the fact that  $\eta(s) \rightarrow 0$  as  $s \rightarrow 0$  imply that for all  $\varepsilon > 0$  there exists  $\delta(\varepsilon) > 0$  such that

$$|\eta(t)| \leq \varepsilon + \frac{C}{\delta(\varepsilon)^p} t^p.$$

So,

$$\left| \int_{\Omega_R} \eta(z) z^2 \right| \leq \varepsilon \|z\|_{H^1(\Omega_R)}^2 + \frac{C}{\delta(\varepsilon)^p} \|z\|_{L^{p+2}(\Omega_R)}^{p+2}. \quad (3.22)$$

Now using Sobolev embedding (cf [23], chapter 9),

$$H^1(\Omega_R) \subset L^{p+2}(\Omega_R), \quad (3.23)$$

for  $p$  small enough. From (3.22) and (3.23), we obtain,

$$\left| \int_{\Omega_R} \eta(z) z^2 \right| \leq \left( \varepsilon + \frac{C}{\delta(\varepsilon)^p} \|z\|_{H^1(\Omega_R)}^p \right) \|z\|_{H^1(\Omega_R)}^2,$$

and  $\varepsilon(z) = \varepsilon + \frac{C}{\delta(\varepsilon)^p} \|z\|_{H^1(\Omega_R)}^p \rightarrow \varepsilon$  as  $\|z\|_{H^1(\Omega_R)} \rightarrow 0$ . As  $\varepsilon$  is as small as we want, one has proved Lemma 3.4.2.  $\square$

From the previous lemma and (3.22), there exists  $\delta > 0$  small enough such that for all  $\|w - w_0\|_{H^1(\Omega_R)}^2 \leq \delta$  one has  $\alpha = \min(\frac{1}{2}, -\frac{f'(0)}{2}) + \varepsilon(w - w_0) > 0$ . This yields to

$$J_{\Omega_R}(w) \geq J_{\Omega_R}(w_0) + \alpha \|w - w_0\|_{H^1(\Omega_R)}^2.$$

One has proved Proposition 3.4.1.  $\square$

Now going back to our domain  $\Omega'_R$ , we define

$$w_0(x) = x_1^- = \begin{cases} |x_1| & \text{for } x_1 \in [-1, 0), \quad x \in \Omega, \\ 0 & \text{for } x_1 \in [0, R], \quad x \in \Omega. \end{cases}$$

The function  $w_0$  is in  $H_{0,1}^1$ . The next step is to prove the following proposition:

**Proposition 3.4.3.** *There exists  $\delta > 0$ , such that as soon as  $w \in H_{0,1}^1$  and*

$$\|w - w_0\|_{H^1(\Omega'_R)} = \delta$$

*one has*

$$J_{\Omega'_R}(w) > J_{\Omega'_R}(w_0).$$

This Proposition means that  $J_{\Omega'_R}$  admits a local minimizer in the open set

$$\{w \in H_{0,1}^1, \|w - w_0\| < \delta\}.$$

This minimiser  $w_R$  is a stable solution of (3.19) such that

$$0 < w_R < 1,$$

taking  $\delta$  small enough.

**Proof of Proposition 3.4.3:** For all  $w \in H_{0,1}^1$  such that  $\|w - w_0\|_{H^1(\Omega'_R)}^2 = \delta$ ,

$$J_{\Omega'_R}(w) - J_{\Omega'_R}(w_0) = \underbrace{J_{\Omega_T}(w) - J_{\Omega_T}(w_0)}_{(1)} + \underbrace{J_{\Omega_R}(w) - J_{\Omega_R}(w_0)}_{(2)}.$$

As  $\|w - w_0\|_{H^1(\Omega'_R)}^2 = \delta$ , one has that  $\|w - w_0\|_{H^1(\Omega_R)}^2 \leq \delta$  and one can use Proposition 3.4.1 to prove that (2) is bounded from below, i.e

$$J_{\Omega_R}(w) - J_{\Omega_R}(w_0) \geq \alpha \|w - w_0\|_{H^1(\Omega_R)}^2.$$

For (1), as  $f(0) = 0$ ,  $f'(0) < 0$  and  $F(1) = 0$ , there exist  $\kappa > 0$  and  $\nu > 0$  such that

$$F(s) \geq \kappa(s - 1)^2,$$

for all  $s \in \mathbb{R}$  (see Figure 3.8). This implies that

$$J_D(w) \geq \nu \|w - 1\|_{H^1(D)}^2, \tag{3.24}$$

for all  $D$  compact domain in  $\Omega'_R$ ,  $w \in H^1(D)$ . Moreover

$$J_{\Omega_T}(w_0) = \int_{\Omega_T} \frac{1}{2} |\nabla w_0|^2 + F(w_0) \leq C|\Omega_T| \text{ and } |\Omega_T| \leq \varepsilon^{N-1}. \tag{3.25}$$

From (3.24) and (3.25), we obtain

$$(1) \geq \nu \|w - 1\|_{H^1(\Omega_T)}^2 - C\varepsilon^{N-1}.$$

Using the convexity of  $\|\cdot\|_{H^1(\Omega_T)}^2$ , one has

$$\nu \|w - 1\|_{H^1(\Omega_T)}^2 \geq \frac{\nu}{2} \|w - w_0\|_{H^1(\Omega_T)}^2 - \nu \|w_0 - 1\|_{H^1(\Omega_T)}^2 \geq \frac{\nu}{2} \|w - w_0\|_{H^1(\Omega_T)}^2 - C\varepsilon^{N-1}.$$

So there exists  $\beta > 0$  such that

$$J_{\Omega'_R}(w) - J_{\Omega'_R}(w_0) \geq \beta \|w - w_0\|_{H^1(\Omega'_R)}^2 - C\varepsilon^{N-1}.$$

Taking  $\varepsilon > 0$  small enough, we get

$$J_{\Omega'_R}(w) - J_{\Omega'_R}(w_0) > 0.$$

One has proved Proposition 3.4.3 □

From Proposition 3.4.3, there exists a local minimizers  $w_R$  of the energy functional  $J_{\Omega'_R}$  that belongs to  $H^1_{0,1}$  such that  $\|w_R - w_0\| < \delta$ . This yields to a stable solution of (3.19). For  $\delta > 0$  small enough  $0 < w_R < 1$  using the maximum principle. Now we let  $R$  go to  $+\infty$ .

### 3.4.2 Construction of a particular super solution

In this section we construct a particular super solution of (3.1) that will allow us to conclude on the non propagation at large time. We start with the following Proposition:

**Proposition 3.4.4.** *Let  $w_R$  be the minimizer of the energy functional  $J_{\Omega'_R}$  defined in the previous section. When  $R \rightarrow +\infty$ ,  $w_R$  converges up to a subsequence toward  $w_\infty$  solution of*

$$\begin{cases} \Delta w_\infty + f(w_\infty) = 0 & \text{in } \Omega', \\ \partial_\nu w_\infty = 0 & \text{on } \Gamma = \partial\Omega' \setminus \{x_1 = -1\}, \\ w_\infty \equiv 1 & \text{on } \{x_1 = -1\}, \end{cases} \tag{3.26}$$

such that  $w_\infty \rightarrow 0$  as  $x_1 \rightarrow +\infty$ .

**Proof of Proposition 3.4.4:** As  $0 < w_R < 1$  and using Schauder estimates, there exists  $R_n \rightarrow +\infty$  as  $n \rightarrow +\infty$  such that  $w_{R_n} \rightarrow w_\infty$  in  $C_{loc}^2$  as  $n \rightarrow +\infty$  and  $w_\infty$  is a solution of (3.26). It remains to prove that the limit  $w_\infty \rightarrow 0$  as  $x_1 \rightarrow +\infty$ . Using Fatou's Lemma:

$$\begin{aligned} \|w_0 - w_\infty\|_{H^1(\Omega')}^2 &= \|(w_0 - \lim_{n \rightarrow +\infty} w_{R_n})1_{-1 < x_1 < R_n}\|_{H^1(\Omega')}^2 \\ &\leq \liminf_{n \rightarrow +\infty} \|(w_0 - w_{R_n})1_{-1 < x_1 < R_n}\|_{H^1(\Omega')}^2 \\ &\leq \delta \end{aligned}$$

Then arguing by contradiction, we assume that there exists  $(x_n = (x_{n,1}, x'_n))_{n \in \mathbb{N}}$  such that  $x_n \in \bar{\Omega}$  for all  $n \in \mathbb{N}$ ,  $x_{n,1} \rightarrow +\infty$  as  $n \rightarrow +\infty$  and  $w_\infty(x_n) > \alpha$ , for all  $n \in \mathbb{N}$ , where  $\alpha > 0$  small. As  $w_\infty \in C_{loc}^2$ , it implies that  $|\nabla w_\infty| \leq C$  on every compact set  $K$ . For all  $x \in B(x_n, \frac{\alpha}{2C}) \cap \Omega$ ,

$$|w_\infty(x) - w_\infty(x_n)| \leq \max_{x \in B(x_n, \frac{\alpha}{2C}) \cap \Omega} \|\nabla w_\infty\| |x - x_n|$$

So  $w_\infty(x) \geq \frac{\alpha}{2}$ , for all  $x \in B(x_n, \frac{\alpha}{2C}) \cap \Omega$ , for all  $n \in \mathbb{N}$ . This yields to

$$\|w_\infty - w_0\|_{L^2(K)} \geq \frac{\alpha}{2} |B_{\frac{\alpha}{2C}} \cap \Omega| \times (\text{number of } x_n \in K).$$

For  $K$  large enough,  $\|w_\infty - w_0\|_{L^2(K)} \geq \delta$  (as  $\Omega$  is assumed to be uniformly  $C^1$ ), which is impossible.  $\square$

**Remark 3.4.5.** *This argument could not work considering a decreasing diameter of the cross section, because one needs to go to the limit on the side where  $w_R \equiv 0$  to get a super solution, and if one defines  $w_0$  equal to 1 in  $\Omega_T$  and linearly goes to 0 in  $\Omega_R$  then we do not control the negative term  $-C\varepsilon^{N-1}$  as  $R \rightarrow \infty$ .*

*And if one put the transition "phase" in  $\Omega_T$  the negative term will be of order  $-CR_0^{N-1}$  which we can not control either. See Figure 3.9 for an insight of the geometry.*

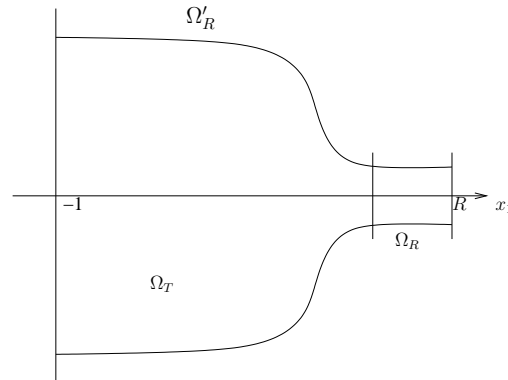

Figure 3.9 – Case of the decrease in the diameter, example in two dimensions. Restricting our analysis to a compact set and then letting  $R \rightarrow +\infty$  does not lead to the same conclusion.

Now extend  $w_\infty$  by 1 outside  $\Omega'$ , i.e

$$\tilde{w}_\infty(x) = \begin{cases} w_\infty(x) & \text{if } x \in \Omega', \\ 1 & \text{if } x \in \Omega \setminus \Omega'. \end{cases}$$

Then  $\tilde{w}_\infty$  is a super solution of the parabolic problem

$$\begin{cases} v_t - \Delta v = f(v) & \text{in } \Omega, \\ \partial_\nu v = 0 & \text{on } \partial\Omega, \end{cases}$$

Let us prove that  $u(t, x) \leq \tilde{w}_\infty(x)$  for all  $t \in \mathbb{R}$ . Let  $v(t, x) = \tilde{w}_\infty(x)$  for all  $(t, x) \in \mathbb{R} \times \Omega$ . As  $|u(t, x) - \phi(x_1 - ct)| \rightarrow 0$  as  $t \rightarrow -\infty$  uniformly in  $x \in \Omega$  and  $v(t, x) = 1$  for all  $x \in \Omega \cap \{x \in \mathbb{R}^N, x_1 < -1\}$ ,  $v(t, x) \rightarrow 0$  as  $x_1 \rightarrow +\infty$ , we obtain that  $\lim_{t \rightarrow -\infty} u(t, x) - v(t, x) \leq 0$  uniformly in  $x$ , i.e

$$\forall \varepsilon > 0, \exists t_\varepsilon, \forall t < t_\varepsilon \quad u(t, x) - v(t, x) < \varepsilon, \quad \forall x \in \Omega. \quad (3.27)$$

For all  $t_0 < t_\varepsilon$ , we define  $w(t, x) = u(t + t_0 - \sigma\varepsilon(1 - e^{-\beta t}), x) - \varepsilon e^{-\beta t}$ , for all  $(t, x) \in [0, T_\eta - t_0 - \sigma\varepsilon] \times \Omega$ , where  $\sigma > 0$  is some constant that we fix later and  $T_\eta$  is defined in section 3.2. From (3.27), we obtain that  $w(0, x) \leq v(t_0, x)$  for all  $x \in \Omega$ . Now we need to prove that

$$\begin{cases} w_t - \Delta w \leq f(w) & \text{in } [0, T_\eta - t_0 - \sigma\varepsilon] \times \Omega, \\ w_\nu = 0 & \text{on } [0, T_\eta - t_0 - \sigma\varepsilon] \times \partial\Omega. \end{cases}$$

The proof is the same than in section 3.3.1 and we leave it to the reader. We already proved that

$$\begin{cases} v_t - \Delta v \geq f(v) & \text{in } [0, T_\eta - t_0 - \sigma\varepsilon] \times \Omega, \\ \partial_\nu v \geq 0 & \text{on } [0, T_\eta - t_0 - \sigma\varepsilon] \times \partial\Omega, \\ w(0, x) \leq v(t_0, x) & \text{in } \Omega. \end{cases}$$

The comparison principle yields to  $w(t, x) \leq v(t_0 + t, x)$  for all  $(t, x) \in [0, T_\eta - t_0 - \sigma\varepsilon] \times \Omega$ . Then replacing  $t + t_0$  by  $t$ , letting  $t_0 \rightarrow -\infty$ , and  $\varepsilon \rightarrow 0$ , we obtains  $u(t, x) \leq v(t, x) = \tilde{w}_\infty(x)$  for all  $t \in \mathbb{R}$  and  $x \in \Omega$ . As  $u$  is increasing in  $t$  and bounded between 0 and 1  $u(t, x) \rightarrow u_\infty(x)$  as  $t \rightarrow +\infty$  for all  $x \in \Omega$  and  $u_\infty(x) \leq \tilde{w}_\infty(x)$  for all  $x \in \Omega$ . We have proved Theorem 3.1.5.

**Remark 3.4.6.** Notice that this blocking property hold for general domains which satisfies the following properties:

- there exists a domain  $D_0 \subset \Omega$  that does not depend on  $\varepsilon$ , the width of the thin cylinder,
- there exists of domain  $D_1 \supset \Omega$  of length 1 and diameter  $\varepsilon$ , i.e there exists  $c_1 \in \mathbb{R}$  such that  $D_1 = \{x \in \mathbb{R}^N, \quad c_1 < x_1 < c_1 + 1, \quad x' = (x_2, \dots, x_N) \in B_\varepsilon(0)\}$

You can see Figure 3.10 for some examples.

### 3.5 Widening cylinders - Complete propagation

In this section we prove Theorem 3.1.7, i.e we prove that when the diameter of the left cylinder is above some threshold and  $\Omega$  is a widening cylinder, there is complete invasion of 1 in the



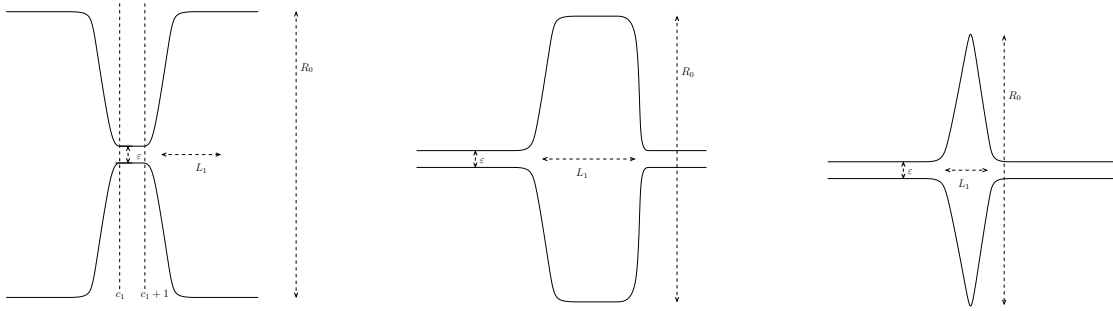

Figure 3.10 – Examples of domains where we can still have a blocking property, with  $R_0$ ,  $L_1$  and  $c_1$  constants that do not depend on  $\varepsilon$

entire domain  $\Omega$ . We assume that  $\Omega$  satisfies the following assumptions. There exists  $R > 0$  such that,

$$\mathbb{R} \times B'_R = \{(x_1, x') \in \mathbb{R} \times \mathbb{R}^{N-1}, |x'| < R\} \subset \Omega. \tag{3.28a}$$

There exists  $L > 0$  such that ,

$$\Omega \cap \{(x_1, x') \in \mathbb{R} \times \mathbb{R}^{N-1}, x_1 > L\} \text{ is convex.} \tag{3.28b}$$

For all  $x \in \partial\Omega \cap \{(x_1, x') \in \mathbb{R} \times \mathbb{R}^{N-1}, x_1 < L + R\}$ ,

$$\nu_1(x) \leq 0. \tag{3.28c}$$

Let us remind that we know from Theorem 3.1.1 that the unique solution of our parabolic

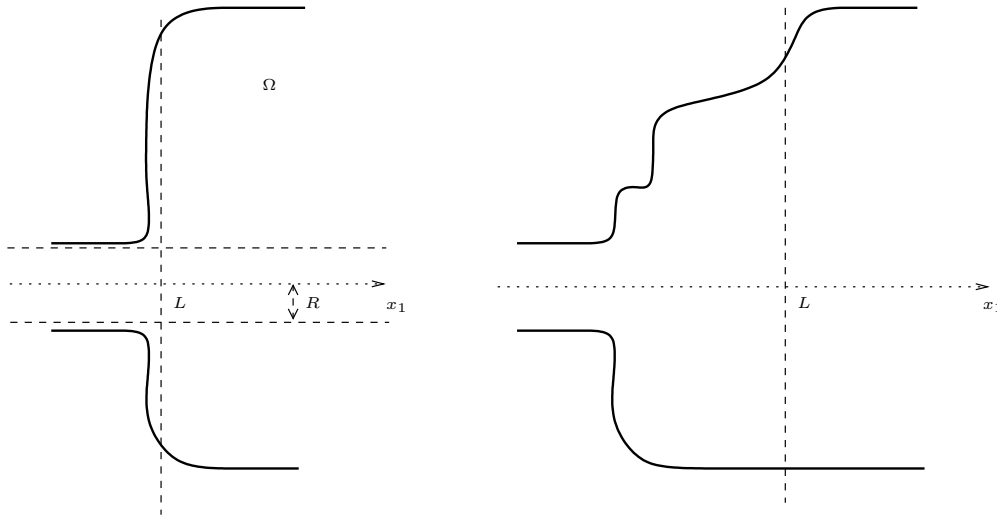

Figure 3.11 – Domains  $\Omega$  that satisfy (3.28)

problem is increasing in time. This implies, using parabolic estimates, that

$$u(t, x) \rightarrow u_\infty(x) \text{ as } t \rightarrow +\infty, \text{ locally uniformly in } x \in \Omega$$

and  $u_\infty$  is a solution of

$$\begin{cases} -\Delta u_\infty = f(u_\infty) & \text{in } \Omega, \\ \partial_\nu u_\infty = 0 & \text{on } \partial\Omega. \end{cases} \quad (3.29)$$

We will first prove that  $u_\infty$  is closed to 1 in  $\Omega \cap \{(x_1, x') \in \mathbb{R} \times \mathbb{R}^{N-1}, x_1 \geq L + R\} = \Omega_{L,R}$ , using a sliding method.

### 3.5.1 The sliding ball method

We first prove the following Lemma,

**Lemma 3.5.1.** *There exist  $R_0, \delta, \eta$  positive constants such that if  $R > R_0$*

$$\forall x \in \mathbb{R} \times B'_{R-\eta}, \quad u_\infty(x) > 1 - \delta,$$

and

$$1 - 2\delta > \beta, \quad \text{with } \beta := \inf \left\{ s \in [\theta, 1), \int_0^s f(t) dt > 0 \right\}.$$

**Proof of Lemma 3.5.1:** As  $|u(t, x) - \phi(x_1 - ct)| \rightarrow 0$  as  $t \rightarrow -\infty$  uniformly in  $x \in \Omega$ , and  $\phi(-\infty) = 1$ , for all  $\varepsilon > 0$ , there exists  $T < 0$  and  $M < 0$  such that for all  $x < M$

$$1 - 2\varepsilon < u(T, x) < 1.$$

As  $u$  is increasing in  $t$  and converging to  $u_\infty$  as  $t \rightarrow +\infty$  for all  $x < M$ ,

$$1 - 2\varepsilon < u_\infty(x) \leq 1.$$

Now consider the solution of this Dirichlet boundary value problem

$$\begin{cases} -\Delta u = f(u) & \text{in } B_R, \\ u = 0 & \text{on } \partial B_R, \end{cases} \quad (3.30)$$

where  $B_R = \{x \in \mathbb{R}^N, |x| < R\}$  is the ball of radius  $R$  centered at 0. We know from the paper of Berestycki and Lions [15] that there exists  $R_0$  (which depends on the non linearity  $f$ ) such that for all  $R < R_0$ , Problem (3.30) does not have positive solutions and for all  $R > R_0$ , Problem (3.30) has at least 2 solutions, one of them being the maximal solution, i.e above all the other solutions. We will denote this maximal solution by  $u_R$ . We also know that  $u_R$  is radially symmetric and decreasing with respect to  $|x|$ . Moreover it is shown in [15] that  $u_R \nearrow 1$  as  $R \rightarrow +\infty$  locally uniformly. Let us choose  $R$  large enough such that  $u_R > 1 - \delta$  in  $B_{R-\eta}$  for some  $\delta, \eta > 0$ , such that

$$1 - 2\delta > \beta, \quad \text{with } \beta := \inf \left\{ s \in [\theta, 1), \int_0^s f(t) dt > 0 \right\}.$$

As  $u_R < 1$  in  $B_R$ , there exists  $\varepsilon > 0$  such that  $u_R < 1 - 2\varepsilon$  in  $B_R$ . Problem (3.30) being translational invariant  $u_R^{x_0}(x) := u_R(x - x_0)$  for all  $x \in \mathbb{R}^N$  such that  $|x - x_0| < R$ , is the maximal solution of (3.30) in  $B_R(x_0)$  the ball of radius  $R$  centered at  $x_0 \in \Omega$ . For  $x_0 = (M - R, 0)$  and assuming that  $B_R(x_0) \subset \Omega$  we know from the strong maximum principle and the Hopf Lemma (if  $\overline{B_R(x_0)} \cap \partial\Omega \neq \emptyset$ ) that  $u_R < u_\infty$  in  $\overline{B_R(x_0)}$ .

As  $\Omega$  satisfies (3.28), particularly

$$(\mathbb{R} \times B'_R) \subset \Omega. \quad (\text{H1})$$

We translate  $B_R(x_0)$  in the  $x_1$ -direction until we find  $\bar{x} \in \Omega$ ,  $\bar{x}_0 = (x^0, 0, \dots, 0) \in \Omega$  such that  $\bar{x} \in \overline{B_R(\bar{x}_0)}$ ,  $u_R^{\bar{x}_0} \leq u_\infty$  in  $B_R(\bar{x}_0)$  and  $u_\infty(\bar{x}) = u_R^{\bar{x}_0}(\bar{x})$ . The functions  $u_\infty$  and  $u_R^{\bar{x}_0}$  being both solutions of the same elliptic equation in  $B_R(\bar{x}_0)$ , if  $\bar{x} \in B_R(\bar{x}_0)$  this implies that  $u_\infty \equiv u_R^{\bar{x}_0}$  in  $\overline{B_R(\bar{x}_0)}$  which is impossible as  $u_R^{\bar{x}_0} \equiv 0 < u_\infty$  in  $\partial B_R(\bar{x}_0) \cap \Omega$ . If  $\bar{x} \in \partial\Omega$  the Hopf Lemma yields a contradiction.

This implies that

$$u_\infty > 1 - \delta \text{ in } \mathbb{R} \times B_{R-\eta}.$$

□

To deal with what is happening in  $\Omega \setminus (\mathbb{R} \times B_{R-\eta})$ , we need the following assumption on the geometry of the domain  $\Omega$ .

Sliding ball assumption:

$$\begin{aligned} &\text{For all } x \in \Omega, \text{ there exists } a \in \Omega, \text{ such that } |x - a| < R - \eta, \ x^0 \in \mathbb{R}, \\ &\text{and } \gamma : [0, 1] \rightarrow \Omega \text{ continuous, such that } \gamma(0) = (x^0, 0, \dots, 0), \ \gamma(1) = a, \\ &\forall t \in [0, 1], \ \forall b \in \overline{B_R(\gamma(t))} \cap \partial\Omega, \ (b - \gamma(t)) \cdot \nu_b > 0, \end{aligned} \quad (\text{H2})$$

where  $\nu_b$  is the outward unit normal at  $b \in \partial\Omega$ . Assumption (H2) means that for all  $x \in \Omega$  there exists a ball of center  $a \in \Omega$  such that  $x \in B_{R-\eta}(a)$  and there exists a continuous path  $\gamma$  from  $a$  to  $(x^0, 0, \dots, 0)$  a point of the  $x_1$ -axis, such that for all  $x_t$  on this path,  $B_R(x_t) \cap \Omega$  is star shaped with respect to the center  $x_t$ . One can look at Figure 3.16 in section 3.7 for some illustrations. As  $\Omega \cap \{(x_1, x') \in \mathbb{R} \times \mathbb{R}^{N-1}, \ x_1 > L\}$  is convex, it satisfies the sliding ball assumption (H2) and we prove the following Lemma

**Lemma 3.5.2.**

$$\forall x \in \Omega \cap \{(x_1, x') \in \mathbb{R} \times \mathbb{R}^{N-1}, \ x_1 \geq L + R\} =: \Omega_{L,R}, \quad u_\infty(x) > 1 - \delta.$$

**Proof of Lemma 3.5.2:** We assume that there exists  $x \in \Omega_{L,R}$  such that  $u_\infty(x) < 1 - \delta$ . We know from Assumption (H2) that there exists  $a \in \Omega$ ,  $x^0 \in \mathbb{R}$  such that  $x \in B_{R-\eta}(a)$  and there exists a continuous path  $\gamma$  from  $(x^0, 0, \dots, 0)$  to  $a$ . We also know that  $u_R^{(x^0, 0)} < u_\infty$  in  $B_R(x^0, 0, \dots, 0)$  and  $u_R^a(x) > u_\infty(x)$ . Moving the ball along the path between  $(x^0, 0, \dots, 0)$  and  $a$ , there exists  $x_t$  on the path and  $\hat{x} \in \overline{B_R(x_t)} \cap \Omega$  such that  $u_R^{x_t} \leq u_\infty$  in  $B_R(x_t) \cap \Omega$  and  $u_R^{x_t}(\hat{x}) = u_\infty(\hat{x})$ . As  $u_R^{x_t} \equiv 0$  on  $\partial B_R(x_t)$  we must have  $\hat{x} \in B_R(x_t) \cap \Omega$  or  $\hat{x} \in \partial\Omega$ . But

- The function  $u_\infty - u_R^{x_t}$  is solution of an elliptic equation in  $B_R(x_t) \cap \Omega$  such that  $u_\infty - u_R^{x_t} \geq 0$  in  $B_R(x_t) \cap \Omega$ ,
- $u_\infty - u_R^{x_t} > 0$  on  $(\partial B_R(x_t)) \cap \Omega$ ,
- Knowing that  $u_R$  is radially symmetric and decreasing with respect to  $|x|$ ,  $(b - x_t) \cdot \nu_b > 0$  for all  $b \in (\partial\Omega) \cap B_R(x_t)$ , we have that

$$\partial_\nu(u_\infty - u_R^{x_t}) > 0 \text{ for all } x \in (\partial\Omega) \cap B_R(x_t),$$

especially  $\partial_\nu(u_\infty(\hat{x}) - u_R^{x_t}(\hat{x})) > 0$ , if  $\hat{x} \in \partial\Omega$ .

All of this yields a contradiction, using the Hopf Lemma if  $\hat{x} \in \partial\Omega$  or the maximum principle if  $\hat{x} \in B_R(x_t) \cap \Omega$ .

This implies that  $u_\infty > 1 - \delta$  in  $\Omega \cap \{(x_1, x') \in \mathbb{R} \times \mathbb{R}^{N-1}, x_1 \geq L + R\}$ .  $\square$

**Remark 3.5.3.**  $u_\infty > 1 - \delta$  in  $\Omega \cap \{(x_1, x') \in \mathbb{R} \times \mathbb{R}^{N-1}, x_1 \geq L + R\}$  implies that  $u_\infty(x) \rightarrow 1$  as  $x_1 \rightarrow +\infty$ .

### 3.5.2 Comparison with a particular sub solution

In this section we prove that  $u_\infty(x) \geq 1 - 2\delta$  for all  $x \in \Omega$  and thus  $u_\infty \equiv 1$  in  $\Omega$ , which ends the proof of Theorem 3.1.7.

As  $u(t, x) \rightarrow u_\infty(x)$  as  $t \rightarrow +\infty$  for all  $x \in \Omega$  we know that there exists  $T > 0$  such that

$$\forall t \geq T, x \in \Omega \cap \{(x_1, x') \in \mathbb{R} \times \mathbb{R}^{N-1}, x_1 > L + R\}, \quad u(t, x) \geq 1 - 2\delta.$$

Now define  $f_\delta \in C^{1,1}([0, 1 - 2\delta])$  as follows:

$$f_\delta(s) = \begin{cases} f(s) & \forall s \in [0, \beta], \\ 0 & \text{for } s = 1 - 2\delta, \end{cases} \quad (3.31)$$

with  $f_\delta \leq f$  in  $[0, 1 - 2\delta]$ . And consider  $(\phi_\delta, c_\delta)$  the travelling wave solution between 0 and  $1 - 2\delta$ , invading 0 from the right, i.e  $(\phi_\delta, c_\delta)$  is solution of

$$\begin{cases} -\phi_\delta'' - c_\delta \phi_\delta' = f_\delta(\phi_\delta) & \text{in } \mathbb{R}, \\ \phi_\delta(-\infty) = 0, \quad \phi_\delta(+\infty) = 1 - 2\delta, \quad c_\delta < 0. \end{cases} \quad (3.32)$$

Moreover as

$$\forall x \in \Omega, \quad u(t, x) - \phi(x_1 - ct) \rightarrow 0 \text{ as } t \rightarrow -\infty,$$

with  $(\phi, c)$  the travelling wave solution between 0 and 1 invading 0 from the left, we know that there exist  $M < 0$ ,  $\underline{T} < 0$  such that for all  $x \in \Omega \cap \{(x_1, x') \in \mathbb{R} \times \mathbb{R}^{N-1}, x_1 < M\}$ ,  $u(\underline{T}, x) \geq 1 - 2\delta$ .

As  $u$  is increasing in time, we get for all  $t > \underline{T}$ ,  $x \in \Omega \cap \{(x_1, x') \in \mathbb{R} \times \mathbb{R}^{N-1}, x_1 < M\}$ ,  $u(t, x) > 1 - 2\delta$ , and particularly

$$u(T, x) > 1 - 2\delta,$$

We can thus translate  $\phi_\delta$  on the right such that,

$$\forall x \in \Omega, \quad u(T, x) \geq \phi_\delta(x_1).$$

Let

$$v(t, x) = \phi_\delta(x_1 - c_\delta t),$$

and

$$w(t, x) = u(T + t, x),$$

for all  $x \in \Omega$ ,  $t > 0$ . Then for all  $t > 0$ ,  $x \in \Omega \cap \{(x_1, x') \in \mathbb{R} \times \mathbb{R}^{N-1}, x_1 < L + R\}$ ,

$$\partial_t v - \Delta v = f_\delta(v) \leq f(v),$$

with, for all  $t > 0$   $x \in \partial\Omega \cap \{(x_1, x') \in \mathbb{R} \times \mathbb{R}^{N-1}, x_1 < L + R\}$

$$\partial_\nu v(t, x) = \phi'_\delta(x_1 - c_\delta t) \times \nu_1(x) \leq 0,$$

and for all  $t \geq 0$   $x \in \Omega \cap \{(x_1, x') \in \mathbb{R} \times \mathbb{R}^{N-1}, x_1 = L + R\}$

$$v(t, x) \leq w(t, x)$$

Letting  $h(t, x) := v(t, x) - w(t, x)$  for all  $t \geq 0$ ,  $x \in \Omega \cap \{(x_1, x') \in \mathbb{R} \times \mathbb{R}^{N-1}, x_1 \leq L + R\}$ ,  $h$  satisfies the following problem

$$\begin{cases} \partial_t h - \Delta h \leq c(t, x)h, & \text{for } t > 0, x \in \Omega \cap \{(x_1, x') \in \mathbb{R} \times \mathbb{R}^{N-1}, x_1 < L + R\}, \\ \partial_\nu h \leq 0, & \text{for } t > 0, x \in \partial\Omega \cap \{(x_1, x') \in \mathbb{R} \times \mathbb{R}^{N-1}, x_1 < L + R\}, \\ h \leq 0, & \text{for } t \geq 0, x \in \Omega \cap \{(x_1, x') \in \mathbb{R} \times \mathbb{R}^{N-1}, x_1 = L + R\}, \\ h(0, x) \leq 0, & \text{for } x \in \Omega \cap \{(x_1, x') \in \mathbb{R} \times \mathbb{R}^{N-1}, x_1 < L + R\}, \end{cases}$$

with

$$c(t, x) = \begin{cases} \frac{f(v) - f(w)}{v - w}, & \text{for } v(t, x) \neq w(t, x), \\ f'(0), & \text{otherwise} \end{cases}$$

$c \in L^\infty$ . Applying the weak maximum principle we know that

$$\forall t \geq 0, x \in \Omega \cap \{(x_1, x') \in \mathbb{R} \times \mathbb{R}^{N-1}, x_1 \leq L + R\}, \quad h(t, x) \leq 0.$$

This implies that  $u(t, x) \geq \phi_\delta(x_1 - c_\delta(t - T))$  for all  $x \in \Omega$ ,  $t > T$  and letting  $t \rightarrow +\infty$  we get

$$\forall x \in \Omega, \quad u_\infty(x) \geq 1 - 2\delta > \theta.$$

Now we need to prove that  $u_\infty \equiv 1$  in  $\Omega$ . Assuming that  $u_\infty \not\equiv 1$ , there exists a sequence  $(x_n)_n$  in  $\Omega$  such that  $u_\infty(x_n) \rightarrow \inf_{x \in \Omega} u_\infty(x) \in [1 - 2\delta, 1)$  as  $n \rightarrow +\infty$ .

If  $(x_n)$  is bounded, up to extraction  $x_n \rightarrow \bar{x} \in \Omega$  and using elliptic estimates we have that

$$-\Delta u_\infty(\bar{x}) = f(u_\infty(\bar{x})) > 0,$$

which is impossible.

Let  $x_n = (x_n^1, x'_n)$ , assume  $x'_n$  is bounded and thus converges up to a subsequence (that we still call  $x'_n$ ) to  $x'$ . Assume now that  $|x_n^1| \rightarrow \infty$ , letting

$$u_n(x^1, x') := u_\infty(x^1 + x_n^1, x'), \quad \forall x = (x^1, x') \in \Omega,$$

we know that  $u_n \rightarrow \bar{u}$  as  $n \rightarrow +\infty$  and  $-\Delta \bar{u} = f(\bar{u})$  in  $\Omega$ . Thus

$$\Delta \bar{u}(0, \bar{x}') < 0,$$

which is impossible.

If  $(x'_n)$  is unbounded we also get a contradiction using the same arguments. This implies that  $u_\infty \equiv 1$  in  $\Omega$ .

### 3.6 Propagation in cylinders with general cross section

In this section we are interested in the existence of propagation phenomena in infinite cylinder without assuming any monotonicity on the diameter of the cylinder.

### 3.6.1 Propagation phenomena - Proof of Theorem 3.1.8

In this subsection we prove that if  $\Omega$  contains an infinite cylinder with large radius then there is propagation of 1 but the propagation may be partial depending on the shape of  $\Omega$ . We will prove Theorem 3.1.8 and thus assume that  $\Omega$  satisfies:

$$\begin{aligned}\Omega \subset \mathbb{R} \times B'_{R_1} &= \{(x_1, x') \in \mathbb{R} \times \mathbb{R}^{N-1}, |x'| < R_1\}, \text{ for some } R_1 > 0, \\ \mathbb{R} \times B'_{R_0} &\subset \Omega, \text{ for some } R_0 > 0,\end{aligned}$$

We recall our initial problem,

$$\begin{cases} \partial_t u - \Delta u = f(u), & \text{for all } t \in \mathbb{R}, x \in \Omega, \\ \partial_\nu u = 0, & \text{for all } t \in \mathbb{R}, x \in \partial\Omega, \\ |u(t, x) - \phi(x_1 - ct)| \rightarrow 0 & \text{as } t \rightarrow -\infty. \end{cases}$$

We know from Theorem 3.1.1 that  $u_t > 0$  for all  $t \in \mathbb{R}$  and  $0 < u < 1$  in  $\mathbb{R} \times \Omega$ . It implies that,  $u(t, x) \rightarrow u_\infty(x)$  locally uniformly in  $x \in \Omega$  as  $t \rightarrow +\infty$  and  $u_\infty$  satisfies

$$\begin{cases} \Delta u_\infty = f(u_\infty) & \text{in } \Omega, \\ \partial_\nu u_\infty = 0 & \text{on } \partial\Omega. \end{cases}$$

We will prove that there is a propagation phenomenon in the sense that  $\inf_{x \in \Omega} u_\infty(x) > 0$ . To prove this result we use a different approach than in the previous section, which is inspired from a variational approach to travelling wave introduced by Heinze in [60].

**Lemma 3.6.1.** *There exists  $R^* > 0$  such that for all  $R_0 > R^*$  the following Dirichlet problem,*

$$\begin{cases} \underline{u}_t - \Delta \underline{u} = f(\underline{u}) & \text{for all } t \in \mathbb{R}, \quad x \in \mathbb{R} \times B'_{R_0}, \\ \underline{u} = 0 & \text{for all } t \in \mathbb{R}, \quad x \in \mathbb{R} \times \partial B'_{R_0}, \end{cases}$$

has a non trivial travelling wave solution, i.e there exists  $w$  such that  $\underline{u}(t, x) = w(x_1 - \nu t, x')$  for all  $t \in \mathbb{R}, x \in \mathbb{R} \times B'_{R_0}$  for some  $\nu > 0$  and

$$\liminf_{z \rightarrow -\infty} w(z, x') = V(x'), \quad w(+\infty, x') = 0$$

where  $V$  is a positive solution of:

$$\begin{cases} -\Delta V = f(V) & \text{in } B'_{R_0}, \\ V = 0 & \text{on } \partial B'_{R_0}, \end{cases}$$

such that  $\int_{B'_{R_0}} \frac{|\nabla V|^2}{2} - \left( \int_0^V f(s) ds \right) dx' < 0$ .

**Proof:** This result follows from [75, Theorem 1.1, Proposition 6.2 and 6.6 and Corollary 6.7] which uses a variational method to prove the existence of travelling waves solution introduced by Heinze in [60]. We recall below the Theorem of Lucia-Muratov-Novaga.

**Theorem** (Theorem 1.1 and Proposition 6.6 in [75]). *If*

$$G(s) := \int_s^0 f(t)dt \in C^0(\mathbb{R}), \quad G(0) = G'(0) = 0, \quad G(s) \geq -Cs^2, \quad (3.33)$$

$$G \in C^{1,1}([0, 1]), \quad G(s) \geq G(\Pi_{[0,1]}(s)), \quad \text{where } \Pi_{[0,1]} \text{ is the projection on } [0, 1], \quad (3.34)$$

$$f'(0) < 0, \quad \inf_{v \in H_0^1(B_{R_0})} \int_{B_{R_0}} \frac{|\nabla v|^2}{2} - \left( \int_0^v f(s)ds \right) dx' < 0, \quad (3.35)$$

there exist  $\nu > 0$  and  $w$  a classical solution of

$$\begin{cases} -\Delta w - \nu \partial_{x_1} w = f(w), & \text{in } \mathbb{R} \times B_{R_0}, \\ w \equiv 0 & \text{on } \mathbb{R} \times \partial B_{R_0}, \\ 0 \leq w \leq 1 & \text{in } \mathbb{R} \times B_{R_0}, \end{cases}$$

such that for all  $x \in \mathbb{R} \times B_{R_0}$ ,  $|w(x_1, x')| \leq Ce^{-\lambda x_1}$  for some  $C > 0$  and  $\lambda > 0$ .

**Proposition 1** (Proposition 6.6 and Corollary 6.7 in [75]). *There exists  $V \in C^2(B_{R_0}) \cap C^1(\overline{B_{R_0}})$  such that*

$$\int_{B_{R_0}} \frac{|\nabla V|^2}{2} - \left( \int_0^V f(s)ds \right) dx' < 0$$

and

$$\liminf_{x_1 \rightarrow -\infty} w(x_1, \cdot) = V \quad \text{in } C^1(\overline{B_{R_0}}).$$

One can easily check that (3.33) and (3.34) are satisfied. Moreover taking

$$v(x') = \begin{cases} 1, & \text{for } x' \in B_{R-1}(0), \\ R - |x|, & \text{for } x' \in B_R(0) \setminus B_{R-1}(0). \end{cases}$$

There exists  $R^* > 0$  such that for all  $R > R^*$ ,

$$\int_{B_R} \frac{|\nabla v|^2}{2} - \left( \int_0^v f(s)ds \right) dx' < 0$$

and (3.35) is satisfied. One can thus apply the two results from [75] and get our Lemma.  $\square$

As  $V > 0$  in  $B_{R_0}(0)$ , there exist  $\eta > 0$ ,  $\delta > 0$  such that  $\delta \leq V \leq 1$  in  $B_{R_0-\eta}$ . Moreover one can always translate  $w$  such that

$$\lim_{t \rightarrow -\infty} w(x_1 - \nu t, x') - \phi(x_1 - ct) \leq 0, \quad \text{uniformly in } x \in \mathbb{R} \times B_{R_0}.$$

Then assuming that  $\mathbb{R} \times B_{R_0} \subset \Omega$  and using the same arguments that in sections 3.3 and 3.4 one can prove that

$$u(t, x) \geq \underline{u}(t, x) = w(x_1 - ct, x') \quad \text{for all } t \in \mathbb{R}, x \in \Omega,$$

when  $\underline{u}$  is extended by 0 in  $\Omega \setminus (\mathbb{R} \times B_{R_0})$ . Then letting  $t \rightarrow +\infty$  we have that for all  $x \in \mathbb{R} \times B_{R_0}$ ,

$$u_\infty(x_1, x') \geq V(x').$$

To prove Theorem 3.1.8, we will prove the following lemma.

**Lemma 3.6.2.** *We have*

$$\inf_{x \in \Omega} u_\infty(x) > 0$$

**Proof of the Lemma:** We argue by contradiction. Assume that there exists a sequence  $(x_n)_n$  in  $\Omega$  such that  $u_\infty(x_n) \rightarrow 0$  as  $n \rightarrow +\infty$ . Define

$$u_\infty^n(x) = u_\infty(x_1 + x_n^1, x') \text{ for all } x = (x_1, x') \in \Omega.$$

Then using parabolic estimates we know that  $u_\infty^n \rightarrow U$  as  $n \rightarrow +\infty$  (up to a subsequence) and  $U$  is solution of

$$\begin{cases} -\Delta U = f(U) & \text{in } \Omega, \\ \partial_\nu U = 0 & \text{on } \partial\Omega, \\ U \geq 0 & \text{in } \Omega. \end{cases}$$

Moreover we know that  $u_\infty(x_n) \rightarrow 0$  as  $n \rightarrow +\infty$  and  $x_n' \rightarrow \bar{x}'$  up to a subsequence as  $\Omega$  is bounded in the  $x'$  direction. This implies that  $U(0, \bar{x}') = 0$ , but  $U \geq \delta > 0$  in  $\mathbb{R} \times B_{R_0-\eta}$ , which is impossible. One has proved the Lemma.  $\square$

This proves Theorem 3.1.8.

One question that is still unanswered is whether  $\liminf_{x_1 \rightarrow -\infty} w(x_1, \cdot) = \lim_{x_1 \rightarrow -\infty} w(x_1, \cdot) = V_{R_0}$  the maximal solution of

$$\begin{cases} -\Delta V = f(V) & \text{in } B_{R_0}, \\ V = 0 & \text{on } \partial B_{R_0}. \end{cases}$$

This problem has to do with the fact that for  $R_0$  large enough, the maximal solution of the previous problem is linearly asymptotically stable (i.e its principal eigenvalue is positive).

One can notice that we would need more assumptions on the asymptotic geometry of  $\Omega$  (as  $x_1 \rightarrow +\infty$ ) to know whether 1 invades the domain or is blocked in some parts of  $\Omega$ . Indeed in domains as illustrated in Figure 3.12 there is propagation in the sense given above but the propagation could be blocked entering some parts of the domain. One can look at [14] or chapter 1 of this thesis to see arguments that lead to partial propagation and examples of domains where the propagation is partial.

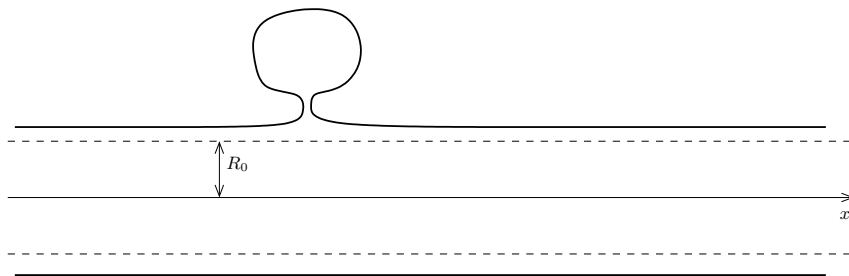

Figure 3.12 – Example of domain in dimension 2 where propagation could be blocked in the small area on the top of  $\Omega$ .



### 3.6.2 Perturbation results - Proof of Theorem 3.1.9

In this section we want to prove that when  $\Omega$  is a smooth perturbation of a straight cylinder the solution  $u$  of the parabolic problem (3.1) is not blocked and 1 invade the entire domain. This result is linked to the result of 1, where they prove the robustness of a Liouville type theorem under smooth perturbation.

One considers a domain  $\Omega$  as in Figure 3.13, and  $(\Omega_\varepsilon)_\varepsilon$  a family of infinite cylinders that converges to a straight cylinder as  $\varepsilon$  converges to 0 such that there exists  $\delta > 0$  with  $\Omega = \Omega_\delta$ . We recall

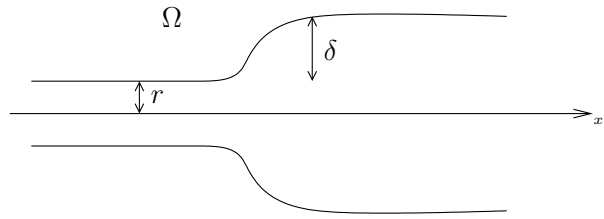

Figure 3.13 – Case of a small increase, of order  $\delta$ , of the diameter of the cylinder.

that

$$\Omega \cap \{x \in \mathbb{R}^N, x_1 < 0\} = \mathbb{R}_-^* \times \omega_r,$$

with  $r > 0$  fixed. One wants to study the behaviour of  $u_\varepsilon$  solution of

$$\begin{cases} \partial_t u - \Delta u = f(u) & \text{for } t \in \mathbb{R}, x \in \Omega_\varepsilon, \\ \partial_\nu u = 0 & \text{for } t \in \mathbb{R}, x \in \partial\Omega_\varepsilon, \\ u(t, x) - \phi(x_1 - ct) \rightarrow 0 & \text{as } t \rightarrow -\infty \text{ uniformly in } \overline{\Omega_\varepsilon}, \end{cases} \quad (3.36)$$

when  $\Omega_\varepsilon$  is closed to a straight cylinder in the  $C^{2,\alpha}$  topology. We will start by proving that the solution is not blocked.

**Lemma 3.6.3.** *There exists  $\delta_0 > 0$  such that for all  $0 < \varepsilon < \delta_0$  the solution  $u_\varepsilon$  of (3.36) converge to  $u_\infty$  as  $t \rightarrow +\infty$  and  $\inf_{x \in \Omega} u_\infty(x) > 0$ .*

**Proof of Lemma 3.6.3:** We first notice that  $|u_\varepsilon(t, x) - \phi(x_1 - ct)| \rightarrow 0$  as  $t \rightarrow -\infty$  uniformly in  $x \in \overline{\Omega_\varepsilon}$  for all  $\varepsilon$  (the construction of the entire solution is independent of  $\varepsilon$ ).

Using parabolic estimates, up to a subsequence,  $u_\varepsilon \rightarrow u$  in  $C_{\text{loc}}^{1,2}$  as  $\varepsilon \rightarrow 0$  and  $u$  is the solution of

$$\begin{cases} \partial_t u - \Delta u = f(u) & \text{for } t \in \mathbb{R}, x \in \Omega_0, \\ \partial_\nu u = 0 & \text{for } t \in \mathbb{R}, x \in \partial\Omega_0. \end{cases} \quad (3.37)$$

Furthermore as  $\lim_{t \rightarrow -\infty} |u(t, x) - \phi(x_1 - ct)| = 0$  uniformly in  $\Omega_0$ , and  $(t, x) \mapsto \phi(x_1 - ct)$  is solution of the same problem (3.37), we have that  $u(t, x) = \phi(x_1 - ct)$  for all  $(t, x) \in \mathbb{R} \times \Omega_0$ , with

the same justification than in section 3.2 (to prove the uniqueness of the solution  $u$  of problem (3.1) satisfying (3.2)) using a comparison principle with a sub and super solutions. This implies that for all  $\eta > 0$  there exists  $\delta_0$  such that for all  $0 < \varepsilon < \delta_0$ ,

$$u_\varepsilon(t, x) \geq \phi(x_1 - ct) - \eta \text{ for all } t \in \mathbb{R}, x \in \Omega_\varepsilon.$$

Using the monotonicity of  $u_\varepsilon$  with respect to  $t$  and parabolic estimates  $u_\varepsilon \rightarrow u_{\varepsilon, \infty}$  locally uniformly in  $\Omega$  as  $t \rightarrow +\infty$  and  $u_{\varepsilon, \infty}$  is solution of the stationary problem in  $\Omega_\varepsilon$  with Neumann boundary condition. Letting  $t \rightarrow +\infty$  in the previous inequality we have that

$$u_{\varepsilon, \infty}(x) \geq 1 - \eta \text{ for all } x \in \Omega_\varepsilon.$$

The lemma is proved. □

Now prove that our solution  $u_\varepsilon$  propagates to 1 in  $\Omega_\varepsilon$  as  $t \rightarrow +\infty$ .

**Lemma 3.6.4.** *For all  $x_1 \in \mathbb{R}$ , let  $\inf_{x', x \in \Omega_\varepsilon} u_\varepsilon(t, x_1, x') = k(t)$ . Then  $k(t) \nearrow 1$  as  $t \rightarrow +\infty$ .*

**Proof of Lemma 3.6.4:** We know that  $u_\varepsilon$  satisfies (3.36) and  $u_\varepsilon$  converges toward  $u_{\varepsilon, \infty}$  locally uniformly in  $x \in \Omega_\varepsilon$  as  $t \rightarrow +\infty$  and  $u_{\varepsilon, \infty}$  satisfies

$$\begin{cases} -\Delta u_{\varepsilon, \infty} = f(u_{\varepsilon, \infty}) & \text{in } \Omega_\varepsilon, \\ \partial_\nu u_{\varepsilon, \infty} = 0 & \text{in } \partial\Omega_\varepsilon, \end{cases}$$

Moreover using elliptic estimates  $u_{\varepsilon, \infty}$  converges to 1 locally uniformly in  $x \in \Omega_0$  as  $\varepsilon \rightarrow 0$ . Now assume that for all  $\varepsilon > 0$ ,  $u_{\varepsilon, \infty} \neq 1$ , it admits a minimum which is less or equal to  $\theta$  (because  $f$  is positive between  $\theta$  and 1), which is impossible.

Thus there exists  $\delta_0 > 0$  such that for all  $\varepsilon < \delta_0$ ,  $u_{\varepsilon, \infty} \equiv 1$  in  $\Omega_\varepsilon$ . □

We proved that there exists  $\delta_0$  such that for all  $\delta < \delta_0$  with  $\Omega = \Omega_\delta$ ,  $u$  converges to 1 as time goes to infinity. Now prove that if

$$\nu_1(x) \leq 0 \text{ for all } x \in \partial\Omega,$$

there exists an asymptotic speed of propagation  $c^* = c$  such that

$$\text{For all } \hat{c} > c^*, \lim_{t \rightarrow +\infty} \sup_{x_1 > \hat{c}t} u(t, x) = 0, \quad (3.38)$$

$$\text{For all } \hat{c} < c^*, \lim_{t \rightarrow +\infty} \inf_{x_1 < \hat{c}t} u(t, x) = 1. \quad (3.39)$$

for when  $\Omega = \Omega_\delta$  and  $\delta < \delta_0$ .

We can prove as in section 3.3.1 that in the case of an increase in the diameter of the cylinder  $v(t, x) = \phi(x_1 - ct)$  is a super solution of our initial problem. And then  $u(t, x) \leq \phi(x_1 - ct)$  for all  $(t, x) \in \mathbb{R} \times \Omega$ . This yields to (3.38) for  $c^* = c$ .

We want to prove (3.39) for  $\delta$  small enough and  $c^* = c$ . Notice that for all  $\delta < \delta_0$ ,  $u$  satisfies,

$$\begin{cases} \partial_t u - \Delta u = f(u), & \text{for all } t \in [t_0, +\infty[, x \in [l, +\infty[ \times \tilde{\omega}_{r, \delta}, \\ \partial_\nu u = 0, & \text{for all } t \in [t_0, +\infty[, x \in [l, +\infty[ \times \partial\tilde{\omega}_{r, \delta}, \end{cases}$$

for some  $t_0 > 0$  and with

$$u(t, l, x') \geq \inf_{x' \in \omega_{r, \delta}} u(t, l, x') \geq k(t), \text{ for all } t \in [t_0, +\infty[, x' \in \tilde{\omega}_{r, \delta}.$$

Define  $g$  a compactly supported smooth function such that  $g(x) = \theta_1$  for  $x \in [l, L - 1]$  and  $g(x) = 0$  for  $x > L$ , for some  $\theta_1 > 0$ ,  $L > l$  that we will fix later. Then for  $t_0$  large enough and  $L$  well chosen

$$u(t_0, x) \geq g(x_1), \text{ for all } x \in [l, +\infty[ \times \tilde{\omega}_{r,\delta}$$

is true because of Lemma 3.6.3 and 3.6.4. Now let  $v$  be the solution of

$$\begin{cases} \partial_t v - \Delta v = f(v), & \text{for all } t \in [t_0, +\infty[, x \in [l, +\infty[ \times \tilde{\omega}_{r,\delta}, \\ \partial_\nu v = 0, & \text{for all } t \in [t_0, +\infty[, x \in [l, +\infty[ \times \partial \tilde{\omega}_{r,\delta}, \\ v(t, l, x') = k(t), & \text{for all } t \in [t_0, +\infty[, x' \in \tilde{\omega}_{r,\delta}, \\ v(t_0, x) = g(x_1), & \text{for all } x \in [l, +\infty[ \times \tilde{\omega}_{r,\delta}. \end{cases}$$

Then  $v$  is uni-dimensional in space and satisfies

$$\begin{cases} \partial_t v - v_{xx} = f(v), & \text{for all } t \in [t_0, +\infty[, x \in [l, +\infty[, \\ v(t, l) = k(t), & \text{for all } t \in [t_0, +\infty[, \\ v(t_0, x) = g(x), & \text{for all } x \in [l, +\infty[. \end{cases} \quad (3.40)$$

For all  $\varepsilon > 0$  small, introduce  $f_\varepsilon$  a  $C^{1,1}$  function such that

$$\begin{cases} f_\varepsilon(-\varepsilon) = f_\varepsilon(\theta) = f_\varepsilon(1 - \varepsilon) = 0, \\ f_\varepsilon \equiv f & \text{in } [\varepsilon, 1 - 2\varepsilon], \\ f_\varepsilon \leq f & \text{in } [0, 1 - \varepsilon]. \end{cases}$$

Let  $w$  be the solution of

$$\begin{cases} w_t - w_{xx} = f_\varepsilon(w) & \text{in } [t_0, +\infty) \times \mathbb{R}, \\ w(t_0, x) = \tilde{g}(x) & \text{for all } x \in \mathbb{R}, \end{cases}$$

where  $\tilde{g}$  is equal to  $\theta_1$  for  $x \in [-L + 1, L - 1]$  and equal to  $-\varepsilon$  for  $|x| > L$ . We know that there exists a unique travelling front solution  $(\phi_\varepsilon, c_\varepsilon)$ , with  $c_\varepsilon > 0$  for  $\varepsilon$  small enough, solution of

$$\begin{cases} \phi_\varepsilon''(z) + c_\varepsilon \phi_\varepsilon'(z) + f_\varepsilon(\phi_\varepsilon) = 0 & \text{for all } z \in \mathbb{R}, \\ \phi_\varepsilon(-\infty) = 1 - \varepsilon, \quad \phi_\varepsilon(+\infty) = -\varepsilon, \end{cases}$$

with  $c_\varepsilon \rightarrow c$  as  $\varepsilon \rightarrow 0$ . Then using Fife and McLeod result, for  $L$  and  $\theta_1$  large enough, we have  $|w(t, x) - \phi_\varepsilon(x - c_\varepsilon t)| \leq K e^{-\gamma t}$ , for all  $t \geq t_0$ ,  $x > 0$ , and  $K, \gamma$  some positive constants.

Moreover choosing  $t_0$  large enough in order to get  $k(t) \geq 1 - \varepsilon$  for all  $t \geq t_0$ ,  $w$  is a sub solution of (3.40), and then using the comparison principle we obtain that  $w \leq v$  in  $[t_0, +\infty) \times [l, +\infty[$  and thus for all  $\delta \leq \delta_0$ ,  $w(t, x_1) \leq u(t, x)$  for all  $(t, x) \in [t_0, +\infty) \times [l, +\infty[ \times B_r$ . This implies that for all  $\delta < \delta_0$

$$\lim_{t \rightarrow +\infty} \inf_{l < x_1 < c_\varepsilon t} u(t, x) \geq 1 - \varepsilon.$$

For all  $\hat{c} < c$ , there exists  $\varepsilon > 0$  such that  $\hat{c} < c_\varepsilon$ , thus  $\inf_{l < x_1 < \hat{c} t} u(t, x) \geq \inf_{l < x_1 < c_\varepsilon t} u(t, x)$  for all  $(t, x)$ . And then

$$\lim_{t \rightarrow +\infty} \inf_{l < x_1 < \hat{c} t} u(t, x) \geq 1 - \varepsilon.$$

As  $\varepsilon > 0$  can be chosen as small as we want we obtain

$$\lim_{t \rightarrow +\infty} \inf_{l < x_1 < \hat{c} t} u(t, x) = 1.$$

### 3.7 Complete propagation in general domains

In this section we investigate sufficient conditions on our domain  $\Omega$  to get a complete propagation of 1 in  $\Omega$ . We remind that we proved the complete propagation of 1 in  $\Omega$  when

- $\Omega$  is a narrowing cylinder (in section 3.3),
- $\Omega$  is a cylinder which diameter increases in the direction of propagation and the radius of the small cylinder is large enough (section 3.5),
- $\Omega$  is a smooth perturbation of a straight cylinder (in section 3.6.2).

We also proved that there is blocking phenomenon if  $\Omega$  is a widening cylinder with a small cylinder having a radius small enough (section 3.4), whereas there is propagation in the sense that the solution is not blocked when  $\Omega$  contains a straight cylinder of radius large enough (but without assuming anything about the monotonicity of the diameter with respect to the direction of propagation).

We thus wonder what kind of geometric assumptions on  $\Omega$  would imply a complete propagation of 1 in the entire domain, i.e knowing that  $u(t, \cdot) \rightarrow u_\infty$  locally uniformly in  $\Omega$  with  $u_\infty$  solution of the following problem

$$\begin{cases} -\Delta u_\infty = f(u_\infty) & \text{in } \Omega, \\ \partial_\nu u_\infty = 0 & \text{on } \partial\Omega, \\ u_\infty(x) \rightarrow 1 & \text{as } x_1 \rightarrow -\infty, \end{cases}$$

we want to give sufficient conditions on the geometry of  $\Omega$  that implies that  $u_\infty \equiv 1$ . This question was treated for bounded domains  $\Omega$  in [25] and [77] for example but is still open for unbounded domains.

#### 3.7.1 Star-shaped domains with respect to the direction of propagation

In this section we assume that there exists  $R_1 \gg R_0 > 0$  such that

$$\mathbb{R} \times B'_{R_0} \subset \Omega,$$

and

$$\Omega \subset \mathbb{R} \times B'_{R_1}.$$

We proved in Theorem 3.1.8 (section 3.6.1) that there exists  $R^* > 0$  such that for all  $R_0 > R^*$ ,

$$u_\infty(x_1, x') > \varphi(x'), \quad \forall x = (x_1, x') \in \mathbb{R} \times B'_{R_0},$$

with  $\varphi$  a positive solution of the Dirichlet problem

$$\begin{cases} -\Delta \varphi = f(\varphi) & \text{in } B'_{R_0}, \\ \varphi \equiv 0 & \text{on } \partial B'_{R_0}. \end{cases}$$

We systematically extend  $\varphi$  by 0 outside  $B'_{R_0}$  so that  $\varphi$  is defined everywhere. We note that it satisfies  $\sup \varphi = \varphi(0) > \theta$  and  $0 \leq \varphi < 1$ .

The object of this subsection is to prove Theorem 3.1.10 of complete invasion, that is, that  $u_\infty \equiv 1$  in  $\Omega$ , when  $\Omega$  is star-shaped with respect to the direction of propagation  $x_1$ .

### Star-shaped domains with respect to the direction of propagation in dimension 2

Let assume in the part that  $N = 2$ , i.e  $B'_{R_0} = (-R_0, R_0)$ . We prove the following proposition  
We need to introduce some notations. Consider

$$\Sigma_h = \mathbb{R} \times (-R_0 + h, R_0 + h), \quad \forall h \in \mathbb{R}.$$

For all  $h \in \mathbb{R}$ , define

$$\varphi_h(x) = \varphi_y(x_2) = \begin{cases} \varphi(x_2 - h), & \forall x \in \Sigma_h \\ 0, & \forall x \in \mathbb{R}^2 \setminus \Sigma_h. \end{cases}$$

To prove Theorem 3.1.10 we use the following lemma,

**Lemma 3.7.1.** *For all  $x \in \Omega$ ,  $h \in \mathbb{R}$ ,  $u_\infty(x) \geq \varphi_h(x)$ .*

**Proof of Theorem 3.1.10:** We know from Lemma 3.7.1 that  $u_\infty(x) \geq \varphi_{x_2}(x) = \varphi(0) > \theta$  for all  $x \in \Omega$ . This implies that

$$\inf_{x \in \bar{\Omega}} u_\infty(x) > \theta.$$

And  $u_\infty \equiv 1$  with the same arguments than in section 3.5 (either assuming that the infimum is achieved or using a minimising sequence).  $\square$

**Proof of Lemma 3.7.1:** We assume that  $h > 0$  (the case  $h < 0$  is proven the same way and is left to the reader). We define

$$h^* := \{h \geq 0, u_\infty \geq \varphi_s \text{ in } \Omega, \quad \forall s \in [0, h]\}.$$

Assuming that  $h^* \in \mathbb{R}^+$ , by continuity  $u_\infty \geq \varphi_{h^*}$  in  $\Omega$  and there exist  $(h_n)_n \in \mathbb{R}^+$ ,  $(x_n)_n \in \mathbb{R}^2$  such that for all  $n \in \mathbb{N}$ ,  $h_n > h^*$ ,  $x_n = (x_1^n, x_2^n) \in \Omega \cap \Sigma_{h_n}$  with

$$u_\infty(x_n) < \varphi_{h_n}(x_n),$$

and

$$h_n \searrow h^* \text{ as } n \rightarrow +\infty.$$

We know that  $x_2^n \rightarrow \bar{x}_2$  as  $n \rightarrow +\infty$  (up to a subsequence) and

$$(1) \quad x_1^n \rightarrow \bar{x}_1 \text{ as } n \rightarrow +\infty \text{ up to a subsequence,}$$

or

$$(2) \quad x_1^n \rightarrow \pm\infty \text{ as } n \rightarrow +\infty.$$

If

$$(1) \quad x_1^n \rightarrow \bar{x}_1 \text{ as } n \rightarrow +\infty \text{ up to a subsequence,}$$

Then  $u_\infty(\bar{x}) = \varphi(\bar{x}_2 - h^*) > 0$ ,  $\bar{x} = (\bar{x}_1, \bar{x}_2) \in \bar{\Omega}$ .

- If  $\bar{x} \in \Omega$ , then as  $u_\infty \geq \varphi_{h^*}$  in  $\Omega$  and  $u_\infty - \varphi_{h^*}$  is a non negative super solution of an elliptic equation achieving its minimum 0 in  $\Omega$ . The maximum principle yields that  $u_\infty \equiv \varphi_{h^*}$  in  $\Omega$  which is impossible because  $u_\infty > 0$  in  $\Omega$ .

· If  $\bar{x} \in \partial\Omega$ , we first notice that

$$0 \leq \bar{x}_2 - h^* < R_0.$$

Indeed as  $\varphi$  is radially decreasing (as a solution of the elliptic Dirichlet boundary value problem  $-\varphi'' = f(\varphi)$  in a ball),  $\varphi$  is increasing in  $(-R_0, 0)$ , thus if  $-R_0 < \bar{x}_2 - h^* < 0$ , there would exist  $\delta > 0$  such that

$$\varphi(\bar{x}_2 - h^*) < \varphi(\bar{x}_2 - h^* + \delta),$$

which contradicts the definition of  $h^*$ . Thus  $\varphi'(\bar{x}_2 - h^*) \leq 0$ . But as  $u_\infty \geq \varphi$  in  $\Omega$  and  $u_\infty - \varphi_{h^*}$  is a non negative super solution of an elliptic equation achieving its minimum 0 at the boundary, the Hopf Lemma yields

$$\partial_\nu(u_\infty(\bar{x}) - \varphi(\bar{x}_2 - h^*)) < 0.$$

On the other hand,

$$\partial_\nu u_\infty(\bar{x}) = 0,$$

and

$$\partial_\nu \varphi(\bar{x}_2 - h^*) = \nu_x^2 \varphi'(\bar{x}_2 - h^*) \leq 0,$$

using the fact that  $\nu_x^2 \cdot x_2 \geq 0$  for all  $x = (x_1, x_2) \in \partial\Omega$  and  $\bar{x}_2 > 0$ . Thus

$$\partial_\nu(u_\infty(\bar{x}) - \varphi(\bar{x}_2 - h^*)) \geq 0,$$

which is impossible.

Now if

$$(2) \quad x_1^n \rightarrow \pm\infty \text{ as } n \rightarrow +\infty.$$

We consider  $\Omega_n = \Omega - x_1^n e_1$  and define

$$u_n^\infty(x) := u_\infty(x_1 + x_1^n, x_2), \quad \forall x \in \Omega_n.$$

As  $\Omega$  is uniformly  $C^{2,\alpha}$  we have (up to a subsequence) that  $\Omega_n \rightarrow \Omega^*$  for the  $C^2$  topology and

$$u_n^\infty \rightarrow u_\infty^* \text{ in } C_{loc}^2,$$

as  $n \rightarrow +\infty$ , with  $u_\infty^*$  solution of the same elliptic problem than  $u_\infty$  in  $\Omega^*$ . And

$$u_\infty^* \geq \varphi_{h^*} \text{ in } \Omega^* \text{ with } u_\infty^*(0, \bar{x}_2) = \varphi_{h^*}(\bar{x}_2).$$

And we use the same arguments that in the case where  $x_1^n \rightarrow \bar{x}_1$  as  $n \rightarrow +\infty$  to get a contradiction.

Thus  $h^*$  can not be finite and we proved Lemma 3.7.1.  $\square$

This proposition proves the complete propagation of 1 in domains that does not necessarily satisfy a monotonicity assumption with respect to the direction of propagation. One can look at Figure 3.14 for examples of domains that satisfy the sliding strip assumption and at Figure 3.15 for examples of domains that do not satisfy this assumption.

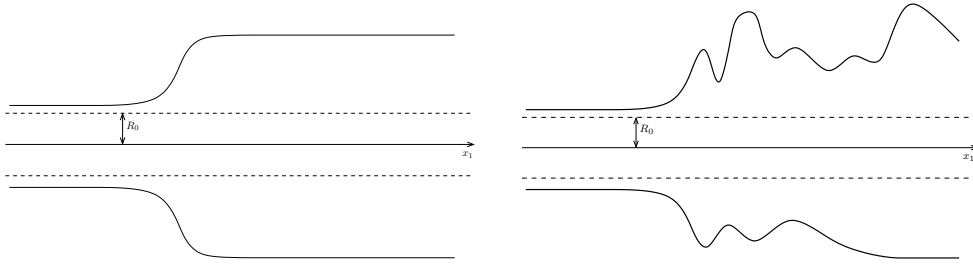

Figure 3.14 – Examples of domains that satisfy the sliding strip assumption in dimension 2.

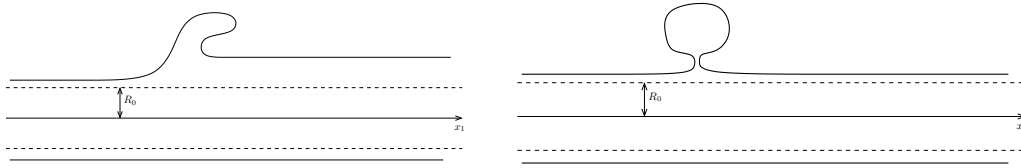

Figure 3.15 – Examples of domains that do not satisfy the sliding strip assumption in dimension 2.

### Star-shaped domains with respect to the direction of propagation in dimension $N \geq 3$

In this subsection we prove Theorem 3.1.10 in dimension  $N \geq 3$ .

**Proof of Theorem 3.1.10 in dimension  $N \geq 3$ :** By moving and rotating the axis of the cylinder, we will now construct from  $\varphi$  a new axisymmetric function that is a sub-solution. Let us remind that the coordinates of a point  $x \in \mathbb{R}^N$  are denoted  $x := (x_1, x')$  where  $x'$  stands for  $x' = (x_2, \dots, x_N)$ . Let  $h \geq 0$  a given real and  $e \in \mathbb{S}^{N-2}$  a given unit vector defining a direction in  $\mathbb{R}^{N-1}$ . We define, for all  $x' \in \mathbb{R}^{N-1}$ :

$$\psi_{h,e}(x') := \varphi(x' - he)$$

so that  $\psi_{h,e}(x') > 0$  on  $B_R(he) := B_R + he$ , and

$$\varphi_h(x') := \max_{e \in \mathbb{S}^{N-2}} \psi_{h,e}(x'). \quad (3.41)$$

Note that  $\varphi_h$  is axisymmetric (it depends only on  $|x'|$ ). But now,  $\varphi_h$  is not anymore decreasing away from the origin. Since  $\varphi_h$  is a supremum of a family of sub-solutions, it is a generalised sub-solution [13]. But we will only use classical sub-solutions. We consider it to be defined on all of  $\mathbb{R}^N$ , so that it is independent of the variable  $x_1$ .

By our previous analysis of invasion, we know that  $u_\infty(x) - \eta > \varphi(x') \equiv \varphi_0(x')$  for all  $x \in \Omega$  and for some sufficiently small  $\eta$ . Let us now define:

$$h^* := \sup\{h \geq 0; u_\infty(x) \geq \varphi_{h'}(x') \text{ for all } x \in \Omega, \text{ and for all } 0 \leq h' \leq h\} \quad (3.42)$$

Clearly;  $h^* \geq 0$  and assume that it is well defined and finite. By continuity, we know that  $u_\infty(x) \geq \varphi_{h^*}(x')$  for all  $x \in \Omega$ .

By definition of  $h^*$ , there exists a sequence  $h_n \searrow h^*$  and a sequence of point  $x_n \in \Omega$  such that  $u_\infty(x_n) < \varphi_{h_n}(x'_n)$  where  $x_n = (x_{1,n}, x'_n)$ . Without loss of generality, we can assume that the sequence is bounded. Indeed, if the sequence  $(x_n)$  is not bounded, then we can shift the origin by  $(x_n)$  so that now  $x_n = 0$  but the domain and the function now change with  $n$ . We can pass to the limit on these by a standard compactness argument.

Therefore, we can now assume that the sequence  $x_n$  converges to some point  $p = (p_1, q) \in \bar{\Omega}$ . In the limit, we get  $u_\infty(p) \leq \varphi_{h^*}(q)$  and since  $u_\infty \geq \varphi_{h^*}$  everywhere, we get  $u_\infty(p) = \varphi_{h^*}(q)$ . First, we observe that  $u_\infty(x, 0) \geq \max \varphi + \eta$  for all  $x \in \mathbb{R}$ , so that it is impossible that  $q = 0$ .  $p \in \Omega$ . Indeed, there exists some  $e \in \mathbb{S}^{N-2}$  such that  $u_\infty(p) = \varphi_{h^*}(q) = \psi_{h,e}(q) > 0$  and  $u_\infty \geq \psi_{h,e}$  everywhere. In view of the strong maximum principle (recall that  $u_\infty - \psi_{h,e}$  satisfies some linear elliptic equation, since  $u_\infty$  and  $\psi_{h,e}$  satisfy the same semi-linear equation), we infer that  $u_\infty \equiv \psi_{h,e}$ . But this is impossible as  $\psi_{h,e}$  vanishes somewhere.

It remains to consider the case that  $p \in \partial\Omega$ . Since  $u_\infty > 0$ , we know that  $h^* - R < |q| < h^* + R$ . Let us show that, necessarily,  $h^* \leq |q| < h^* + R$ . Indeed, suppose to the contrary that  $h^* - R < |q| < h^*$ . Recall that  $q \neq 0$ . In the region  $h^* - R < r < h^*$ , the function  $\varphi_h$  is decreasing with  $h$ . Thus, for small enough  $h^* - h > 0$  we see that  $\varphi_h(q) > \varphi_{h^*}(q) = u_\infty(p)$ . But this is in contradiction with the definition of  $h^*$  that requires  $u_\infty \geq \varphi_h$  for such an  $h$ . We have reached a contradiction and, therefore, we know that  $h^* \leq |q| < h^* + R$ . Now, for the point  $q$ , there exists a certain maximising direction  $e$  such that  $\psi_{h,e}(q) = \varphi_h(q)$ . Since  $\varphi$  is spherically symmetric decreasing away from the center [48], it is necessary for  $e$  to be maximising that  $e$  be aligned with the line from 0 to  $q$ , so that the distance from  $q$  to the center  $h^*e$  be minimised.

We have now reached a situation where  $u_\infty \geq \psi_{h^*,e}$  everywhere,  $u_\infty(p) = \psi_{h^*,e}(q)$ .

We compute the outward normal derivative to get

$$\partial_\nu \psi_{h^*,e}(q) = -|\nabla \psi_{h^*,e}(q)| \nu \cdot \frac{q}{|q|} \leq 0.$$

The minus sign comes from the information that  $h^* \leq |q| < h^* + R$ . The last inequality follows from our assumption

$$\nu \cdot \frac{q}{|q|} \geq 0 \quad \text{on} \quad \partial\Omega$$

This is impossible using the Hopf Lemma. Thus  $h^*$  can not be finite and

$$u_\infty(x) \geq \varphi_h(x), \quad \forall x \in \Omega, \quad h \geq 0.$$

The proof is thereby completed as in the previous subsection.  $\square$

Notice that this proposition prove the complete propagation of 1 in a large variety of domains  $\Omega$  and give a different proof of the propagation of 1 in widening cylinders, where the diameter of the small cylinder is large enough (Theorem 3.1.7).

In the next section we give an assumption that ensure complete propagation of 1 in domains  $\Omega$  in any dimension  $n \in \mathbb{N}$  that satisfies a sliding ball assumption as in section 3.5 but this assumption is hard to verify as it depends on parameters on which we have few informations apart from their existence.



### 3.7.2 Sliding ball

In this section the non linearity  $f$  is fixed and we give two sufficient geometric assumptions (H1) and (H2) so that there is complete propagation in domains satisfying these two conditions. First introduce some constants  $R$  and  $\eta(R)$  that we will need in the sequel of this section. Let  $R > 0$ , and define  $u_R$  to be the maximal positive solution of the Dirichlet problem

$$\begin{cases} -\Delta u = f(u), & \text{in } B_R, \\ u \equiv 0, & \text{on } \partial B_R. \end{cases}$$

We know from the paper of Berestycki and Lions [15] that for a fixed bistable nonlinearity  $f$ , there exist  $R_0$  and  $\delta > 0$  such that for all  $R > R_0$ ,  $u_R$  exists, is radially symmetric, decreasing with respect to  $|x|$  and  $u_R > \theta + \delta$  in  $B_{R-\eta(R)}$  for some constant  $\eta(R)$  depending on  $R$ ,  $\delta$  and  $f$ , such that  $R \mapsto R - \eta(R)$  is increasing.

We can now state the two geometric assumptions (H1) and (H2). For some  $R > 0$ ,

- Cylinder assumption

$$(\mathbb{R} \times B'_R) = \{(x_1, x') \in \mathbb{R} \times \mathbb{R}^{N-1}, |x'| < R\} \subset \Omega. \quad (\text{H1})$$

- Sliding ball assumption:

For all  $x \in \Omega$ , there exists  $a \in \Omega$ ,  $x^0 \in \mathbb{R}$ ,  $\gamma : [0, 1] \rightarrow \Omega$  continuous, such that

$$\begin{aligned} |x - a| &\leq R - \eta(R), & \gamma(0) &= (x^0, 0, \dots, 0), & \gamma(1) &= a, \\ \forall t \in [0, 1], & \forall b \in \overline{B_R}(\gamma(t)) \cap \partial\Omega, & (b - \gamma(t)) \cdot \nu_b &> 0. \end{aligned} \quad (\text{H2})$$

Then if  $\Omega$  satisfies (H1) and (H2) for a given  $R > R_0$  and  $\delta > 0$ , the unique solution  $u$  of (3.1), satisfying (3.2) completely propagates, i.e  $u \rightarrow u_\infty$  as  $t \rightarrow +\infty$  and  $u_\infty \equiv 1$  in  $\Omega$ .

The first assumption (H1) means that  $\Omega$  contains a straight cylinder of radius  $R > R_0$  and implies a partial propagation phenomenon using Theorem 3.1.8. Note that for small  $R$  there exist domains  $\Omega$ , where the propagation is blocked, as it is described in Theorem 3.1.5. The main idea of the second assumption is to slide the ball of radius  $R$  in  $\mathbb{R}^N$  along a continuous path connecting the  $x_1$ -axis to the center of the ball, to touch every point of  $\Omega$ . More precisely it means that for all  $x \in \Omega$  there exists a ball of center  $a \in \Omega$  such that  $x \in B_{R-\eta}(a)$  and there exists a continuous path  $\gamma$  from  $a$  to  $(x^0, 0, \dots, 0)$  a point of the  $x_1$ -axis, such that for all  $x_t$  on this path,  $B_R(x_t) \cap \Omega$  is star shaped with respect to the center  $x_t$ . We give some examples of domains  $\Omega$  where the sliding ball assumption holds or does not hold depending on  $\eta$  (see Figure 3.16) and one can notice that it is highly dependent on  $R$  and  $R - \eta$ , quantities that we can not completely quantify. Indeed  $\eta = \eta_R$  depends on  $R$  and we know that  $R \mapsto R - \eta_R$  is increasing, but we do not have informations on the way it increases and if  $\eta$  is closed to  $R$  then (H2) is more difficult to satisfy. The proof of the invasion of 1 in  $\Omega$  is the same than in section 3.5 but

we slide the ball in the entire domain  $\Omega$  to prove that

$$u_\infty > \theta + \delta \quad \text{in } \Omega,$$

where  $\delta > 0$  and  $\theta$  is the unstable equilibrium of  $f$  defined in (3.6). Indeed instead of sliding the ball of radius  $R - \eta$  in a part of  $\Omega$  which is convex we slide the ball in the entire domain to touch every point of  $\Omega$  up to the boundary. Then we use the same concluding arguments than in section 3.5 to prove that  $u_\infty \equiv 1$  in  $\Omega$ .

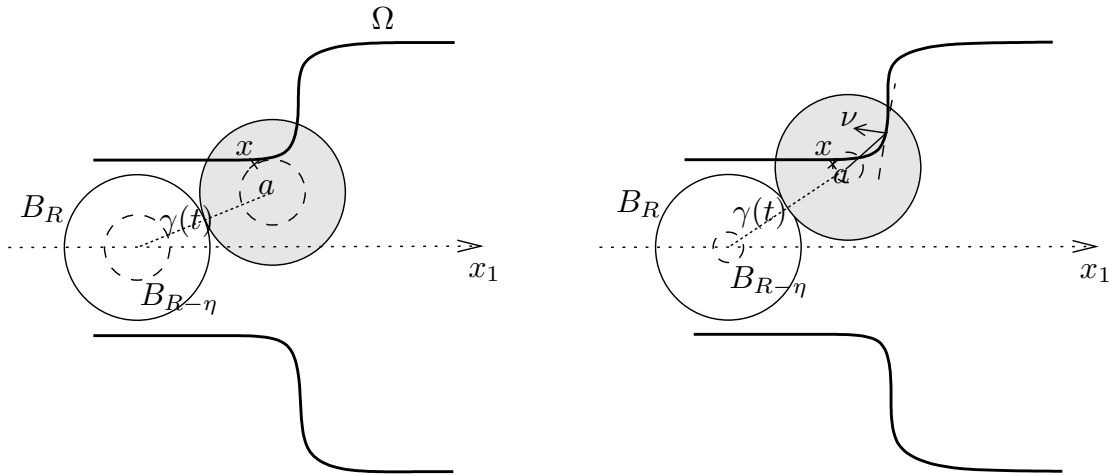

Figure 3.16 – Domains  $\Omega$  where the Sliding ball assumption (H2) holds for some  $\eta$  small (on the left) and does not hold if  $\eta$  is too large (on the right). **Figure on the left:** For every point in  $\bar{\Omega}$  we can slide a ball of radius  $R - \eta$  up to this point, along some path  $\{\gamma(t), t \in [0, 1]\}$  from the  $x_1$  axis, such that for all  $b \in \partial\Omega$  in the ball of radius  $R$  centered at  $\gamma(t)$ ,  $(b - \gamma(t)) \cdot \nu(x) > 0$ , for all  $t \in [0, 1]$ . **Figure on the right:** In this second figure, the constant  $\eta$  is larger and one can find a set a point in  $\bar{\Omega}$  that does not satisfy (H2), see Figure (3.17) which is a zoom of the area that does not satisfy the assumption and where we have more precision on the counterexample.

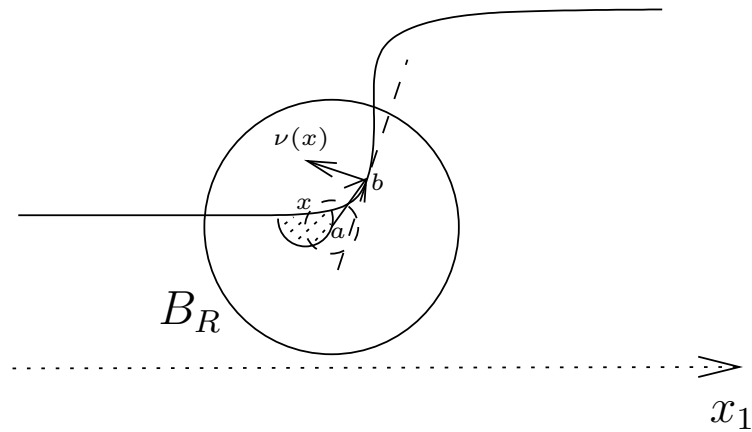

Figure 3.17 – Zoom in some area where  $(b - a) \cdot \nu(x) < 0$  for some  $b \in \partial\Omega \cap B_R(a)$ . The dotted part is the area where we can pick  $a$  such that  $|x - a| < R - \eta$  and we see that for all the point  $a$  in this area  $(b - a) \cdot \nu(x) < 0$ .

# Appendix

Poster presented at the poster session of the conference:

*Biological invasions and evolutionary biology, stochastic and deterministic models, Université  
Claude Bernard Lyon 1, Lyon, France.*

## Front blocking and propagation in cylinders with varying cross section

**Juliette Bouhours**

UPMC, UMR 7598, Laboratoire J.L. Lions, F-75005 Paris, France  
EHESS, CAMS, 190-198, avenue de France, 75244 Paris Cedex 13, France  
PhD student of **Henri Berestycki** (EHESS, CAMS Paris)

Work in collaboration with **H. Berestycki** (CAMS, Paris) and **G. Chapuisat** (LATP, Marseille)



### Cortical Spreading Depression (CSD) and Reaction Diffusion Equation



Figure 1: Human brain



Figure 2: Rodent brain

**Motivation:** Mathematical modeling of CSD in the human brain.

- Transient depolarization of the membrane of neurons which propagates slowly in the brain due to abnormal ionic exchange between the intra- and extra-cellular space,
- Probably responsible of the aura during migraine with aura, Increase the neurological damage in ischemic stroke in rodent,
- Therapies aiming at blocking the appearance of CSD in rodent have shown promising results, but **inefficient in human**,
- Modeling of a cortical spreading depression:
  - Two stable states: the normal polarized rest state 0, and the totally depolarized state 1,
  - Threshold on the ionic disturbances for passage from one stable state to the other,
  - Depolarization mechanisms takes place only in the grey matter.

#### Our problem

One can describe a CSD in the grey matter with the following parabolic problem:

$$\begin{cases} \partial_t u - \Delta u = f(u) & \text{in } \mathbb{R} \times \Omega, \\ \partial_\nu u = 0 & \text{on } \mathbb{R} \times \partial\Omega, \end{cases}$$

such that

$$\sup_{x \in \Omega} |u(t, x) - \phi(x_1 - ct)| \xrightarrow{t \rightarrow +\infty} 0,$$

- où
- $\phi$  is a traveling wave such that  $\phi(-\infty) = 1, \phi(+\infty) = 0$ , modeling the impulse of a CSD,
  - $\Omega$  an infinite cylinder whose cross section varies (widening or narrowing) to take into account the changes on the thickness of the grey matter,
  - $f$  a bistable function such that  $\int_s^1 f(s) ds > 0$  for all  $s \in [0, 1]$  to model the propagation of the CSD.

#### Existence and uniqueness

**Theorem 1.** We assume that  $\Omega$  is a straight cylinder for  $x_1 < 0$ , then there exists a solution  $u$  of the problem

$$\begin{cases} \partial_t u - \Delta u = f(u) & \text{dans } \mathbb{R} \times \Omega, \\ \partial_\nu u = 0 & \text{sur } \mathbb{R} \times \partial\Omega, \end{cases}$$

such that  $u_t > 0$  and  $0 < u < 1$  in  $\mathbb{R} \times \Omega$ . Moreover if  $u$  satisfies

$$\sup_{x \in \Omega} |u(t, x) - \phi(x_1 - ct)| \xrightarrow{t \rightarrow +\infty} 0,$$

then  $u$  is unique.

**Sketch of the proof:**

- Construction of particular sub- and super-solutions in  $(-n, T)$ ,
- Construction of the entire solution as the limit of a sequence of solution defined in  $[-n, +\infty)$ ,
- Comparison principle to prove that  $u$  is unique using the "initial" condition.

### Decrease in the thickness of the grey matter

We consider the following domain

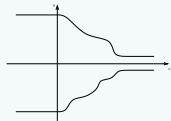

Figure 3: Geometry considered to model a reduction in the thickness of the grey matter

**Theorem 2.** We assume that,

- $\Omega$  is a straight cylinder for  $x_1 < 0$ ,
- The diameter of the cylinder is decreasing with respect to  $x_1$ .

$\implies$  **COMPLETE INVASION**  
our solution  $u$  propagates at a speed  $c^* > 0$ ,

$$\begin{cases} \forall c > c^*, & \lim_{t \rightarrow +\infty} \sup_{x_1 > ct} u(t, x) = 0, \\ \forall c < c^*, & \lim_{t \rightarrow +\infty} \sup_{x_1 < ct} u(t, x) = 1, \end{cases}$$

**Sketch of the proof:**

- The traveling wave solution  $\phi$  is a sub-solution + comparison principle  $\implies$  propagation to 1,
- Construction of sub- and super-solution for the asymptotic speed.



In the case of a decrease in the thickness of the grey matter, the totally depolarized state invades the domain.

### Increase in the thickness of the grey matter

We consider the following domain

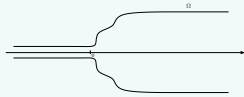

Figure 4: Geometry considered to model an increase in the thickness of the grey matter

**Theorem 3.** We assume that

- $\Omega$  is a straight cylinder for  $x_1 < 0$  with a diameter of order  $\varepsilon \ll 1$ ,
- $\Omega \cap \{x \in \mathbb{R}^N, x_1 > 0\}$  does not depend on  $\varepsilon$ .

$\implies$  **BLOCKING**  
There exists  $\varepsilon_0 > 0$  such that for all  $\varepsilon < \varepsilon_0$ , our solution  $u$  is blocked in the big cylinder, i.e

$u(t, x) \rightarrow u_\infty(x)$  as  $t \rightarrow +\infty$ , and  $u_\infty(x) \rightarrow 0$  when  $x_1 \rightarrow +\infty$ .

**Sketch of the proof:**

- Construction of a super-solution on a sub-domain  $\Omega_R^+ = \Omega \cap \{-1 < x_1 < R\}$  using an energy method,
- Letting  $R \rightarrow +\infty$  and extension of our super-solution to the entire domain  $\Omega$ .
- Comparison principle  $\implies$  our solution is blocked.

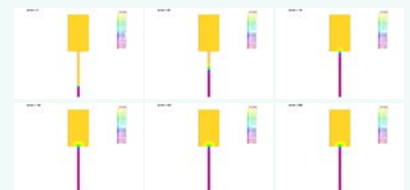

In the case of an increase in the thickness of the grey matter, the cortical spreading depression can be blocked, the totally depolarized state does not invade the entire domain.

### Progressive increase in the thickness of the grey matter

We consider the following domain

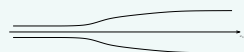

Figure 5: Geometry considered to model a progressive increase in the thickness of the grey matter

**Theorem 4.** We assume that

- The diameter of the domain is non-decreasing with respect to  $x_1$ ,
- Our domain  $\Omega$  is close to a straight cylinder in the  $C^{2,\alpha}$  topology, i.e  $\Omega = \Omega_\delta$  and  $\Omega_\delta \xrightarrow{C^{2,\alpha}} (\mathbb{R} \times \omega_\delta)$  when  $\delta \rightarrow 0$ .

$\implies$  **COMPLETE INVASION**  
There exists  $\delta_0 > 0$  such that  $\delta < \delta_0$ , our solution  $u_\delta$  converges to 1 when  $t \rightarrow +\infty$  in the entire domain  $\Omega_\delta$ .

**Sketch of the proof:**

- The unique solution in the straight cylinder is the traveling wave  $\phi$ ,
- Perturbation arguments  $\implies$  for  $\delta > 0$  small enough, our solution converges to 1.

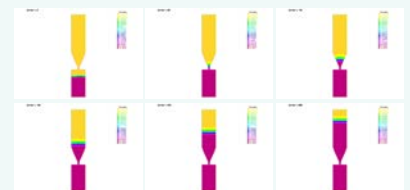

In the case of progressive increase in the thickness of the grey matter the totally depolarized state invades the entire domain.



## Chapitre 4

# Propagation dans des domaines cylindriques en dimension 2 Simulations numériques



---

## Front blocking and propagation in cylindrical domains - Numerical simulations

---

Dans ce chapitre nous étudions les problèmes de propagation de l'état stationnaire 1 pour des domaines cylindriques variés en dimension 2. Pour cela nous résolvons numériquement à l'aide du logiciel FreeFem++, une équation de réaction-diffusion bistable, pour une condition initiale de type fonction en escalier qui modélisent l'arrivée d'une onde progressive par la gauche du domaine. Les conditions aux bords du domaine varient selon les géométries choisies. Nous commençons par étudier les phénomènes de propagation dans des cylindres qui s'élargissent et plus particulièrement l'existence d'un seuil critique pour le diamètre du cylindre de gauche tel que en dessous de ce seuil la solution est bloquée à l'entrée de l'élargissement et au dessus de ce seuil l'état stationnaire 1 envahit tout le domaine. Nous étudions ensuite des domaines qui s'élargissent de manière progressive et on met en valeur l'existence d'un seuil critique dans le degré d'ouverture du domaine sous lequel l'état 1 envahit le domaine et au dessus duquel la solution est bloquée. Nous étudions aussi le comportement de la solution lorsque le domaine est un cylindre droit contenant un isthme plus ou moins étroit et retrouvons les mêmes résultats que dans le cas d'un cylindre qui s'élargit. Nous étudions aussi le rôle de  $\theta$  le seuil de bistabilité de  $f$  dans les phénomènes de blocage pour les cylindres qui s'élargissent.

Dans une deuxième partie nous résolvons le même problème de réaction-diffusion bistable mais dans des cylindres à courbure variable avec des conditions aux bords de type Dirichlet, Robin ou Robin/Neumann. Nous observons que dans le cas de conditions aux bords de type Dirichlet ou Robin de chaque côté du cylindre l'effet de la courbure est négligeable sur le blocage de la solution et le paramètre qui semble jouer un rôle essentiel est le diamètre du cylindre. Alors que si l'on considère des conditions de Robin et des conditions de Neumann de part et d'autre du cylindre alors pour un diamètre donné, la courbure du cylindre sera favorable au blocage de la solution.

---



## 4.1 Description of the problem

In this chapter we study numerically the effects of the geometry of the domain on the propagation of bistable generalised travelling fronts, which are particular entire solutions of a bistable reaction diffusion equation. This problem is motivated by the question of invasion of a steady state on another or on the contrary by the existence of blocking phenomena depending on the geometry of the domain. For example in ecology the density of specific populations satisfies a bistable reaction diffusion equation in some constrained and particular domain  $\Omega$ . In medical science a bistable reaction diffusion has been proposed to model the propagation of depolarisation wave in the brain. This depolarisation wave also called Cortical Spreading Depression may be responsible for some symptoms in the migraine with aura or may cause neurological damage during stroke. Several numerical and theoretical studies have already been carried out in [29, 14, 104, 28, 37, 51, 98]. We refer to the introduction in Chapter 3 for more details on the applications of bistable reaction diffusion equations in cylindrical domains. In this chapter we want to investigate numerically the existence of threshold in some parameters that explain either the propagation or the blocking phenomenon in various domains  $\Omega$ . We will be interested in this general problem

$$\begin{cases} \partial_t u - D\Delta u = f(x, u) & \text{for } t > 0, \quad x \in \Omega, \\ \delta u(t, x) - \gamma u_\nu(t, x) = 0 & \text{for } t > 0, \quad x \in \partial\Omega, \\ u(0, x) = u_0(x) & \text{for } x \in \Omega, \end{cases} \quad (4.1)$$

where  $f$ ,  $\delta$ ,  $\gamma$  and  $\Omega$  will vary depending on what we want to study. We will fix  $D = 10$ . Figure 4.1 gives some examples of domains  $\Omega$  we will consider throughout this chapter.

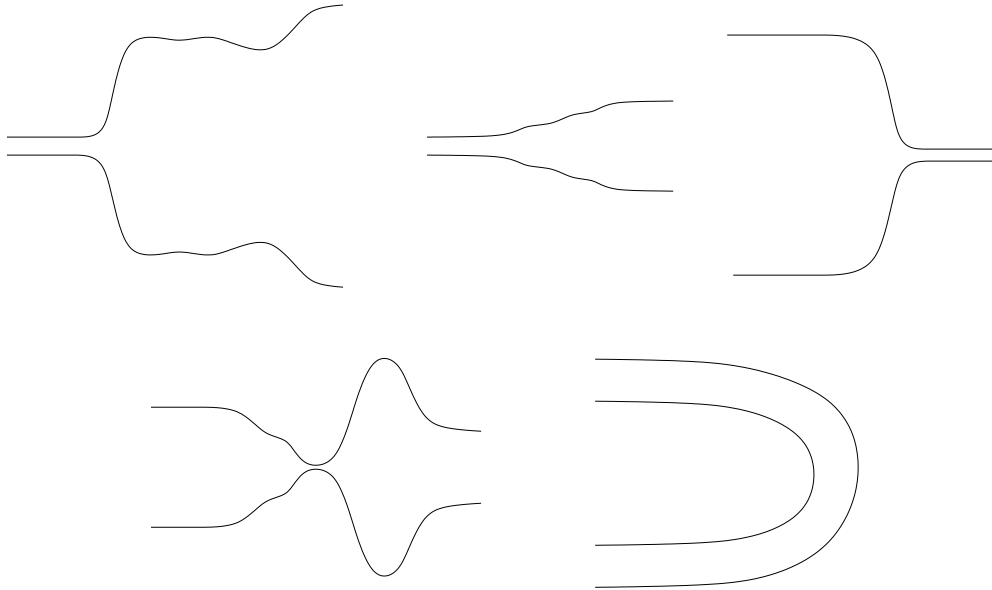

Figure 4.1 – Example of domains considered throughout this chapter, from left to right, top to bottom: a straight cylinder with a small diameter on the left side which suddenly increases, a straight cylinder with a small diameter on the left side which progressively increases, a straight cylinder which diameter decreases to become small on the right side, a straight cylinder with an isthmus and a curved cylinder.

In the first part of this chapter, we study the effect of an increase/decrease in the diameter of a straight cylinder on the solution  $u$  of (4.1), where  $f$  does not depend on  $x$  and with Neumann boundary conditions. More precisely, we investigate the same phenomena than the ones we

studied analytically in the previous chapter 3, and we consider the question whether an abrupt increase in the diameter can block the propagation of the solution or study the effect of a thin isthmus on the propagation of the solution. Let us notice that it has been proved in Chapter 3 that there exists a unique entire solution of the reaction diffusion problem

$$\begin{cases} \partial_t u(t, x) - \Delta u(t, x) = f(u(t, x)) & \text{for all } t \in \mathbb{R}, x \in \Omega, \\ \partial_\nu u(t, x) = 0 & \text{for all } t \in \mathbb{R}, x \in \partial\Omega, \\ \sup_{x \in \Omega} |u(t, x) - \phi(x_1 - ct)| \rightarrow 0 & \text{as } t \rightarrow -\infty, \end{cases}$$

where  $f$  is a smooth bistable function ( $f(s) := s(1-s)(s-\theta)$  for example),

$$\Omega := \{(x_1, x'), x_1 \in \mathbb{R}, x' \in \omega(x_1) \subset \mathbb{R}^{n-1}\}$$

and  $\omega(x_1) \equiv \omega$  for  $x_1 < 0$ ,  $(\phi, c)$  is the bistable planar travelling wave solution of

$$\begin{cases} -\phi'' - c\phi' = f(\phi), & \text{in } \mathbb{R}, \\ \phi(-\infty) = 1, \phi(0) = \theta, \phi(+\infty) = 0. \end{cases}$$

. In this first section we solve numerically the following problem with FreeFem++,

$$\begin{cases} \partial_t u - 10\Delta u = u(1-u)(u-0.2) & \text{for } t \in [0; 200], x \in \Omega, \\ \partial_\nu u = 0 & \text{for } t \in [0; 200], x \in \partial\Omega, \\ u(0, x) = 1_{[-60; -10]}(x) & \text{in } \Omega, \end{cases} \quad (4.2)$$

where  $\Omega$  is a straight cylinder with varying cross section as Figures 4.2, 4.3, 4.4 and 4.5, with Neumann boundary condition, i.e  $\gamma = 1$  and  $\delta = 0$ .

These problems have already been investigated in [37] and [26] where they study numerically the relation between the diameter of the small and the large cylinder that allows propagation of the solution  $u$ . In [29] and [6] these problems have also been study analytically and they proved that if the domain  $\Omega$  has an isthmus of diameter  $\varepsilon$  small enough, then the solution  $u$  is blocked, whereas if the diameter is large enough the solution propagates, and in the case of a narrowing cylinder (see Figure 4.4) the solution always propagates. In these numerical simulations we highlight the existence of a threshold in the blocking/propagation phenomena in the case of a widening cylinder or in the presence of an isthmus. We also investigate the case of a progressive widening of the cylinder. To study this propagation property we use the two different indicators of invasion: the average of the population  $\mathcal{A}(t)$

$$\mathcal{A}(t) := \frac{\int_{\Omega} u(t, x) dx}{|\Omega|},$$

and the maximal distance  $\mathcal{M}_d(t)$

$$\mathcal{M}_d(t) := \max \{x_1 \in [-10; 100], u(t, x_1, 0) > 0.01\},$$

at each time and for each diameter  $\varepsilon$ , where  $u$  is the solution of (4.2),  $|\Omega|$  is the Lebesgues measure of  $\Omega$ ,  $x = (x_1, x_2) \in \Omega \subset \mathbb{R}^2$ .

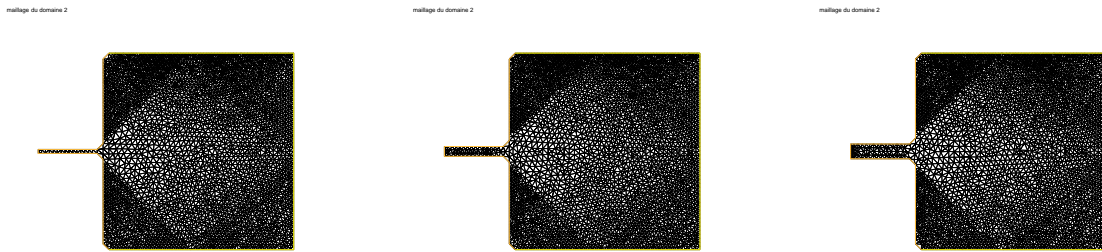

Figure 4.2 – Examples of the first domain we consider with a small left diameter (where the travelling front comes from) and an abrupt widening, independent of the diameter of the small cylinder. From left to right the length of the small diameter  $\varepsilon$  increases ( $\varepsilon = 2; 5; 7.5$ ).

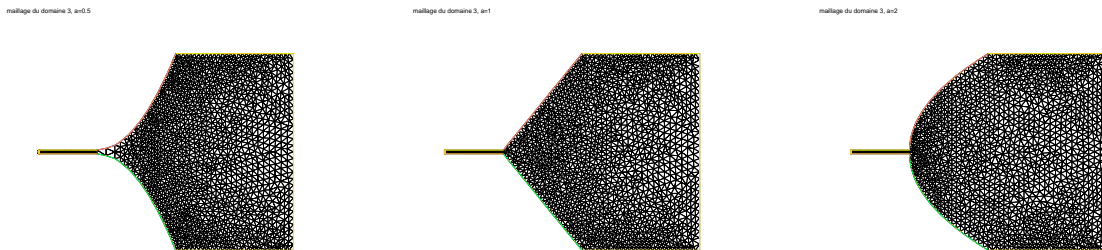

Figure 4.3 – Examples of domains with progressive widening, where the upper and lower boundaries can be parametrised as a power function, i.e  $x_2 = \pm x_1^\alpha$  for some  $\alpha > 0$ , at the location of the widening. From left to right,  $\alpha = 0.5; 1; 2$ .

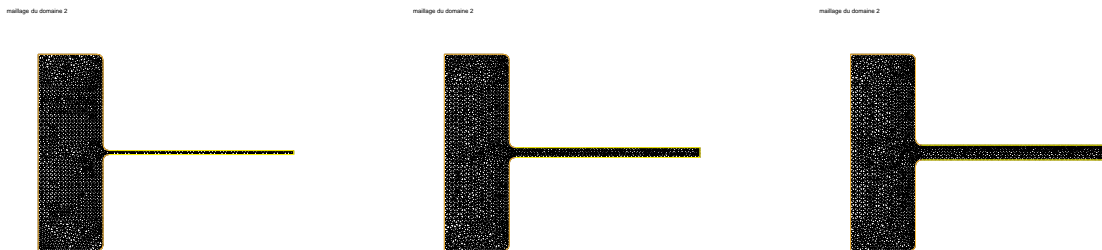

Figure 4.4 – Examples of narrowing domains. From left to right the length of the small diameter (on the right) increases,  $\varepsilon = 2; 5; 7.5$ .

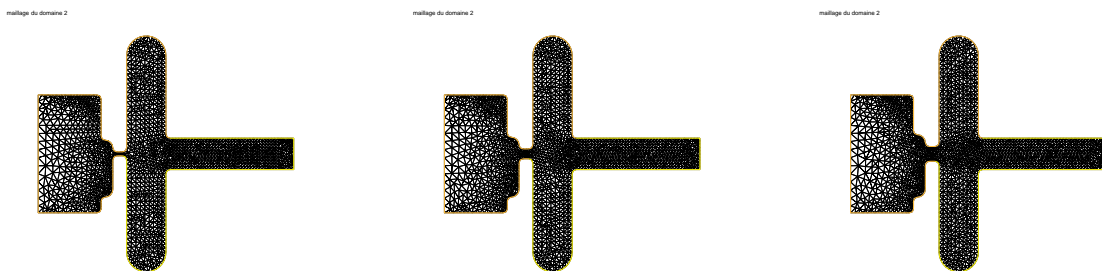

Figure 4.5 – Examples of domains containing an isthmus, with different length of diameter of the isthmus  $\varepsilon$ . From left to right  $\varepsilon = 2; 5; 7.5$ .

In the last subsection of the first part we study the effect of  $\theta$  the bistability threshold on blocking phenomena. In this subsection

$$f(x, s) = f(s) = s(1 - s)(s - \theta),$$

with  $\theta \in [0.1; 0.5]$  and we compute the average of the population and the maximal distance at the final time for the different values of  $\theta$  and  $\varepsilon$ .

In the second part of this chapter we will study the existence of a blocking phenomenon in curved cylinders with mixed boundary conditions. These problems are of particular interest in the modelling of cortical spreading depression in the brain in order to take into account the absorbing role of the white matter. In [30, 7] they prove that the solution of a bistable reaction diffusion equation in a cylinder with absorbing boundary conditions is blocked for small diameters and propagates for large diameters. We are interested in these kind of results but considering curved cylinders. We start by considering  $\Omega$  a curved cylinder with Dirichlet or Robin boundary conditions and investigate whether the curvature of the domain has an effect on the propagation of the solution. We solve the following problem with FreeFem++

$$\begin{cases} \partial_t u - 10\Delta u = f_0 u(1-u)(u-0.2) & \text{for } t \in [0; 400), \quad x \in \Omega, \\ \delta u - \gamma \partial_\nu u = 0 & \text{for } t \in [0; 400), \quad x \in \partial\Omega, \\ u(0, x) = 1_{[-60; -10]}(x) & \text{in } \Omega, \end{cases} \quad (4.3)$$

where  $\delta = 1$  and  $\gamma = 0$  in the case of Dirichlet boundary condition,  $\gamma = 1$ ,  $\delta = -2$  in the case of Robin boundary condition,  $f_0 = 1$  or  $f_0 = 2$ . In this first subsection we consider cylinders  $\Omega$  with a constant diameter but which change direction as in Figure 4.6.



Figure 4.6 – Examples of domains with Dirichlet or Robin boundary conditions on both sides of the cylinder with different curvatures, parametrised by the parameter  $\varepsilon$ , from left to right  $\varepsilon = 0$  the cylinder is straight,  $\varepsilon = 1.6$ , and  $\varepsilon = 3.2$  the cylinder is in the shape of a U.

Numerical simulations exhibit no threshold in the curvature of the cylinder above which the solution of (4.3) is blocked, whereas they indicate the existence of a threshold in the diameter of the cylinder below which the solution of (4.3) converges to 0 and this threshold seems to be the same in the curved or straight cylinder. This is different from the blocking phenomenon that we observe in the first section. In this setting, when the diameter of the cylinder is fixed, blocking phenomena do not seem to exist and either the solution propagates in the entire cylinder (straight or curved) or the solution goes to 0 in the entire domain. One argument that could explain these results is that assuming Dirichlet or Robin boundary conditions on both sides of the cylinder is too hostile. We could imagine a framework where the population is absorbed on one side of the cylinder (comparable to Robin boundary conditions) and reflected on the other side of the cylinder putting Neumann boundary conditions. This framework has already been introduced in [51] to understand propagation phenomena in the human brain.

In [51] they study numerically the effect of a change of direction of the grey matter in the brain on the propagation of spreading depressions and find that for some sets of parameters

(for the bistable non linearity, the diffusion coefficients, the unfavourableness of the exterior environment...) the spreading depression is blocked at the place where the cylinder changes direction. In the second part of this section we will consider a domain  $\Omega = \Omega_f \cup \Omega_u$  with Neumann boundary conditions on the boundary and

$$f(x, u) = \begin{cases} f_+(u) = f_0 u(1 - u)(u - 0.2) & \text{for } x \in \Omega_f, \\ f_-(u) = -\delta u & \text{for } x \in \Omega_u, \end{cases}$$

where  $f_0$  and  $\delta$  have the same values than in the first subsection. This means that  $\Omega_f$  is a favorable zone where the solution should be able to propagate and  $\Omega_u$  is an unfavourable zone where the solution  $u$  is absorbed. Examples of domains  $\Omega$  considered in this setting are given in Figure 4.7



Figure 4.7 – Examples of domains with favorable environment (in yellow or green) and unfavorable environment (in black) and Neumann boundary condition at the bottom of the cylinder

We investigate whether Neumann boundary conditions on one side of the favorable zone gives different results on the existence of blocking phenomena when the cylinder changes direction. Numerical simulations show that in this framework, for some values of the diameter of  $\Omega_f$ , there is a threshold in the curvature of the favourable domain above which the propagation is blocked and thus above which there exists non-constant stable steady state.

## 4.2 Propagation in a straight cylinder with varying cross section

In this section we solve numerically the reaction diffusion problem (4.1) with

- $f$  a bistable function, i.e  $f(x, s) = f(s) = s(1 - s)(s - \theta)$ , with  $\theta = 0.2$ ,
- $t \in [0; 200)$ ,
- $x \in \Omega$  a straight cylinder with varying cross section as Figures 4.2, 4.3, 4.4 and 4.5, with Neumann boundary condition, i.e  $\gamma = 1$  and  $\delta = 0$ .
- The change in the geometry takes place for  $x_1 > 0$ , i.e  $\omega(x_1) \equiv \omega$ , for all  $x_1 < 0$ ,
- We will vary the diameter of the small cylinder  $\varepsilon$  and compute at each time for each diameter the average of population

$$\mathcal{A}(t) := \frac{\int_{\Omega} u(t, x) dx}{|\Omega|},$$

and the maximal distance achieved by the population

$$\mathcal{M}_d(t) := \max \{x_1 \in [-10; 100], u(t, x_1, 0) > 0.01\},$$

where  $u$  is the solution of (4.2),  $|\Omega|$  is the Lebesgues measure of  $\Omega$ ,  $x = (x_1, x_2) \in \Omega \subset \mathbb{R}^2$ .

- $u_0$  is a step fonction,  $u_0 = 1_{[-60, -10]}$

#### 4.2.1 Abrupt widening of the domain

We start by solving the reaction diffusion problem with a domain  $\Omega$  that is a straight cylinder with a small left diameter and an abrupt widening independent of the size of the small diameter. We expose the existence of a threshold in the diameter of the small cylinder as one can see in Figure 4.8, where the average of the population  $\mathcal{A}(t)$  is plot for each diameter  $\varepsilon \in [2; 7.8]$  at each time  $t \in [0; 200]$ . In this framework we can see that when  $\varepsilon < 4.5$ , the solution  $u$  of problem (4.2) is blocked at the widening. Whereas when  $\varepsilon > 4.5$ , the solution  $u$  propagates to 1 in the entire domain. This validates what has been proved in chapter 3 and it also indicates the existence of a threshold in the diameter of the small cylinder under which the solution  $u$  is blocked and above which the solution  $u$  propagates in the entire domain.

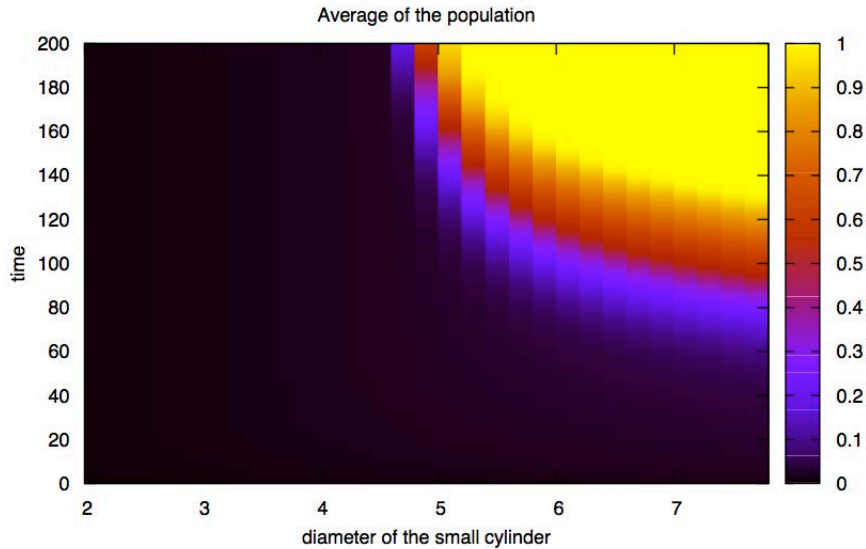

Figure 4.8 – Average of the population  $\mathcal{A}(t)$  for each diameter  $\varepsilon \in [2; 7.8]$  at each time  $t \in [0; 200]$ . This figure shows that the average of the population in the entire domain stands between 0 and 10% when the diameter is below 4.5, which corresponds to the fact that the population does not invade the entire domain, whereas when the diameter is above 4.5 the average of the population goes to 1 which means that the population invades the entire domain.

We used the maximal distance achieved by the population  $\mathcal{M}_d(t)$  as a second indicator for the blocking phenomenon. This second indicator confirms that the population does not go further than some value on the horizontal axis which validates the blocking phenomenon. The results are displayed in Figure 4.9 where we compute the maximal distance  $\mathcal{M}_d(t)$  for each diameter  $\varepsilon$  (on the horizontal axis) at each time  $t$  (on the vertical axis). We find the same results than in Figure 4.8 regarding the existence of a threshold in the diameter of the diameter of the small cylinder.

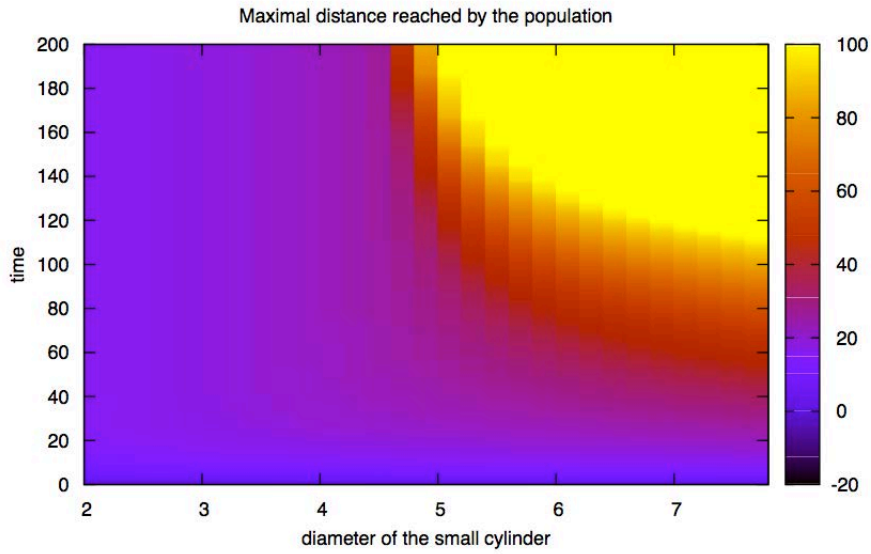

Figure 4.9 – Maximal distance  $\mathcal{M}_d(t)$ , for each diameter  $\varepsilon \in [2; 7.8]$  at each time  $t \in [0; 200]$ . The maximal distance achieved by the population is always greater or equal to 0, which corresponds to the location of the diameter increases. When the diameter of the small cylinder is below 4.5 the population does not go further  $x_1 = 20$  and is thus blocked at the widening, whereas when the diameter is above 4.5 the population goes up to  $x_1 = 100$  which is the right end of the domain.

Figures 4.10, 4.11 and 4.12 show the evolution of the solution  $u$  of Problem (4.2) at time  $t = 0; 100$  and  $200$  for different lengths of diameter  $\varepsilon = 2; 5$  and  $7.5$ .

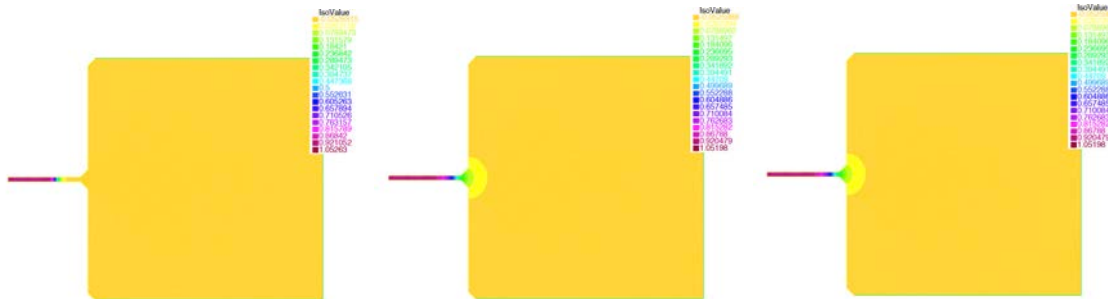

Figure 4.10 – The solution  $u(t, x)$  of (4.2) for  $x \in \Omega$  and  $t = 0; 100; 200$  (from left to right) and  $\varepsilon = 2$ . In yellow areas, the population density  $u$  is closed to 0, whereas in purple areas the density is closed to 1.

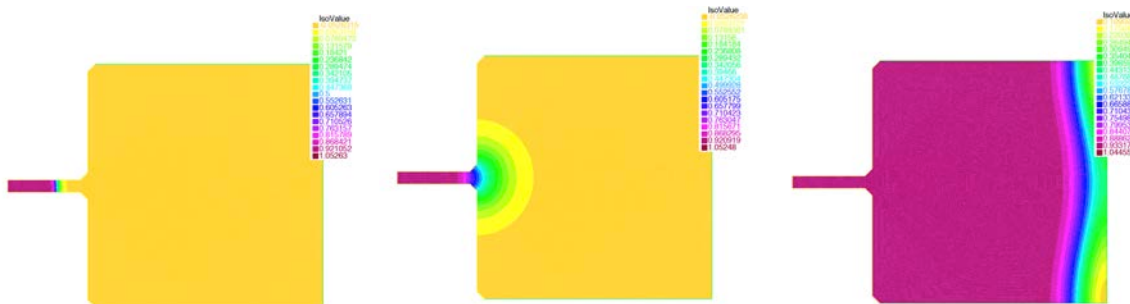

Figure 4.11 – The solution  $u(t, x)$  of (4.2) for  $x \in \Omega$  and  $t = 0; 100; 200$  (from left to right) and  $\varepsilon = 5$ . In yellow areas, the population density  $u$  is closed to 0, whereas in purple areas the density is closed to 1.



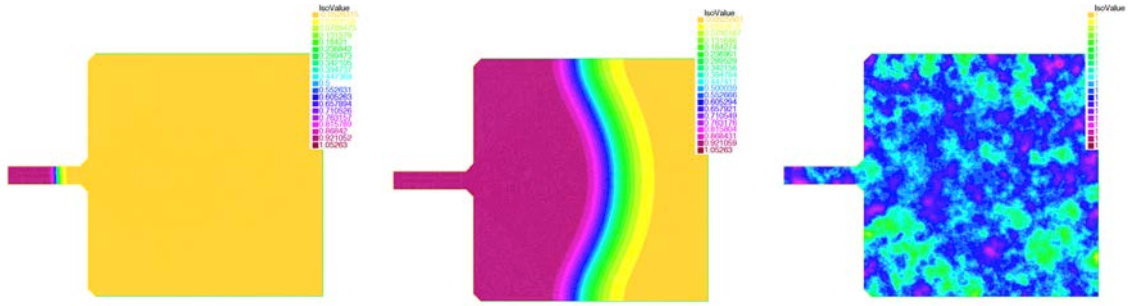

Figure 4.12 – The solution  $u(t, x)$  of (4.2) for  $x \in \Omega$  and  $t = 0; 100; 200$  (from left to right) and  $\varepsilon = 7.5$ . In yellow areas, the population density  $u$  is closed to 0, whereas in purple areas the density is closed to 1 for the first two figures. For the last figure on the right (corresponding to  $t = 200$ ) the population density is closed to 1 everywhere.

These figures show that for small value of  $\varepsilon$  the population is blocked at the location where the diameter increases, whereas for larger  $\varepsilon$  the population invades the domain and the larger  $\varepsilon$  the faster the invasion.

### 4.2.2 Progressive widening of the domain

In this section we study the same problem as in the previous one but with domains that widen progressively. We study domains in two dimensions, whose boundary behave as a power of the  $x_1$ -axis at the widening (the upper boundary at the location where the diameter increases is a translation of the curve of equation  $x_2 = x_1^\alpha$  with  $\alpha > 0$ ), i.e domains that evolve from a convex (for  $\alpha < 1$ ) to a concave (for  $\alpha > 1$ ) opening. Figure 4.13 and 4.14 respectively illustrate the average of the population  $\mathcal{A}(t)$  and the maximal distance  $\mathcal{M}_d(t)$ , for each power  $\alpha \in [0.1; 3.5]$  at each time  $t \in [0; 200]$ . Please notice that in these simulations the diameter of the left cylinder is fixed to some value that leads to a blocking of the solution in the previous section (i.e in the case of an abrupt widening). As it was illustrated in the previous section with the diameter of the left cylinder, it seems that there is a threshold in the power of the widening for which the solution is blocked when the widening is above this power and propagates when the power of the opening is below this threshold. We observe that the convexity of the widening of the cylinder favours the propagation of the solution, whereas the more concave the opening becomes the slower the solution propagates.



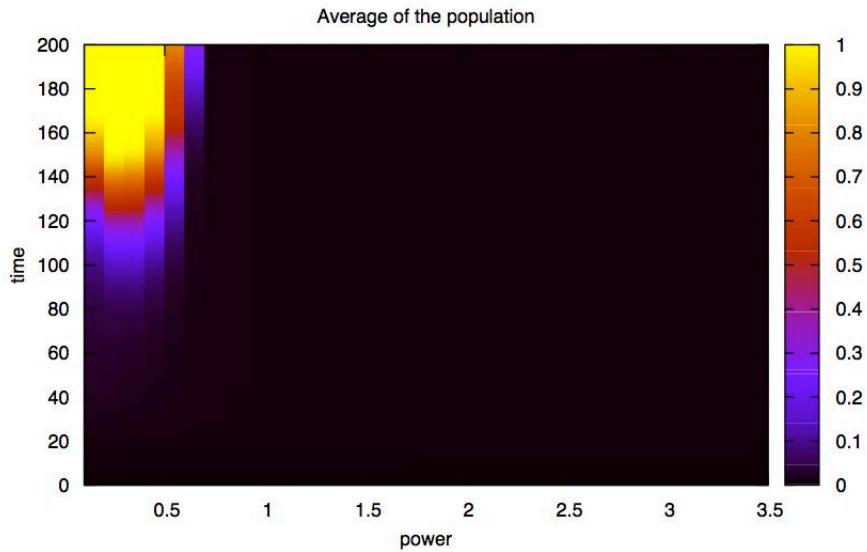

Figure 4.13 – Average of the population  $\mathcal{A}(t)$  for each power  $\alpha \in [0.1; 3.5]$  at each time  $t \in [0; 200]$ . For  $\alpha < 0.7$  the average of the population goes to 1 which means that the population invades the entire domain, whereas if  $\alpha > 0.7$  the average of the population stands between 0 and 10%, which means that the population does not invade the entire domain.

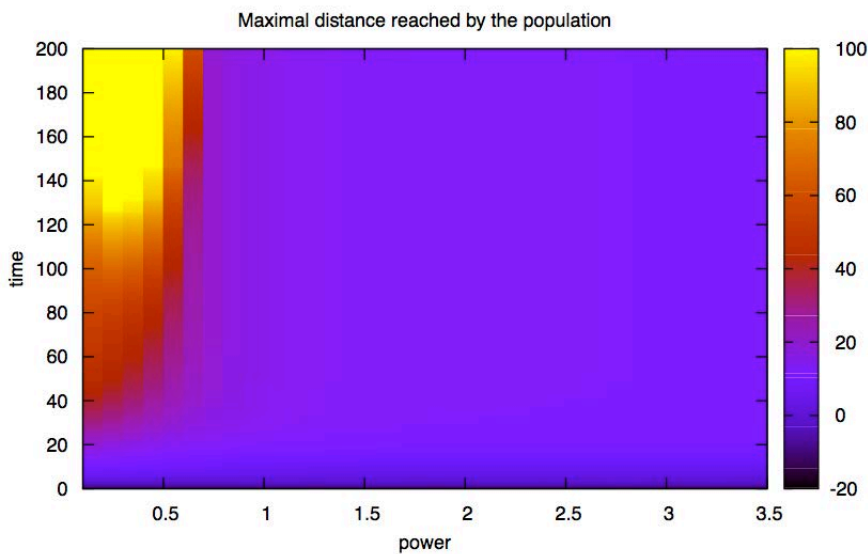

Figure 4.14 – Maximal distance  $\mathcal{M}_d(t)$  for each power  $\alpha \in [0.1; 3.5]$  at each time  $t \in [0; 200]$ . For  $\alpha < 0.7$ , the maximal distance achieved by the population is 100, the right end of the domain, which means that the population invades the domain, whereas if  $\alpha > 0.7$  the population does not go beyond  $x_1 = 20$  and thus is blocked at the location of the change of geometry.

In Figures 4.15, 4.16, 4.17 and 4.18 one can see the evolution of the solution of Problem (4.2) for different values of  $\alpha$  at different times  $t = 0, 100, 130$  and 200.

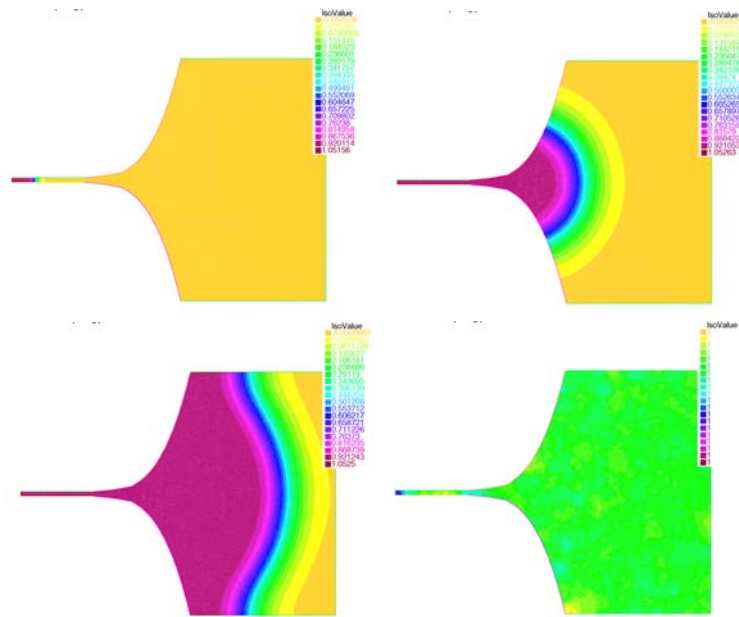

Figure 4.15 – The solution  $u(t, x)$  of (4.2) for  $x \in \Omega$  and  $t = 0; 100, 130, 200$  (from left to right, top to bottom) and  $\alpha = 0.3$ . In yellow areas, the density  $u$  is close to 0 and in purple areas the density is close to 1 for the first 3 figures. For the last figure (the right figure on the bottom) the density is close to 1 everywhere.

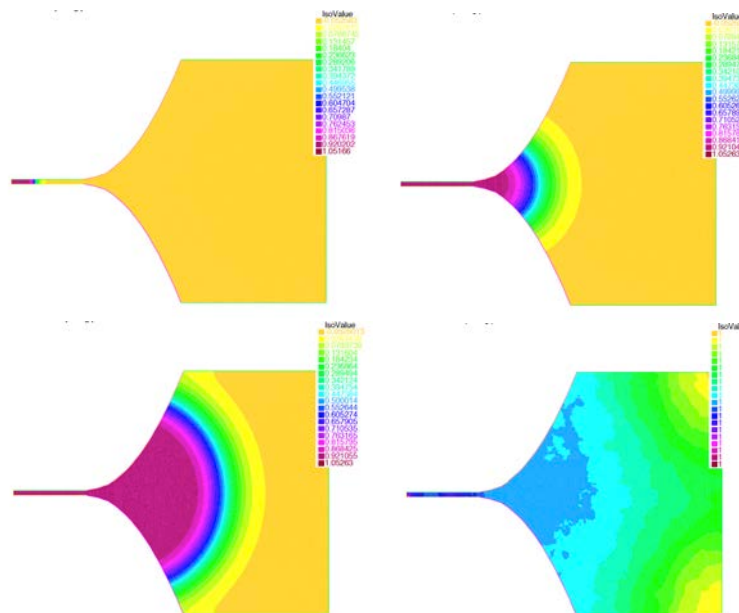

Figure 4.16 – The solution  $u(t, x)$  of (4.2) for  $x \in \Omega$  and  $t = 0; 100, 130, 200$  (from left to right, top to bottom) and  $\alpha = 0.5$ . In yellow areas, the density  $u$  is close to 0 and in purple areas the density is close to 1 for the first 3 figures. For the last figure (the right figure on the bottom) the density is close to 1 everywhere.

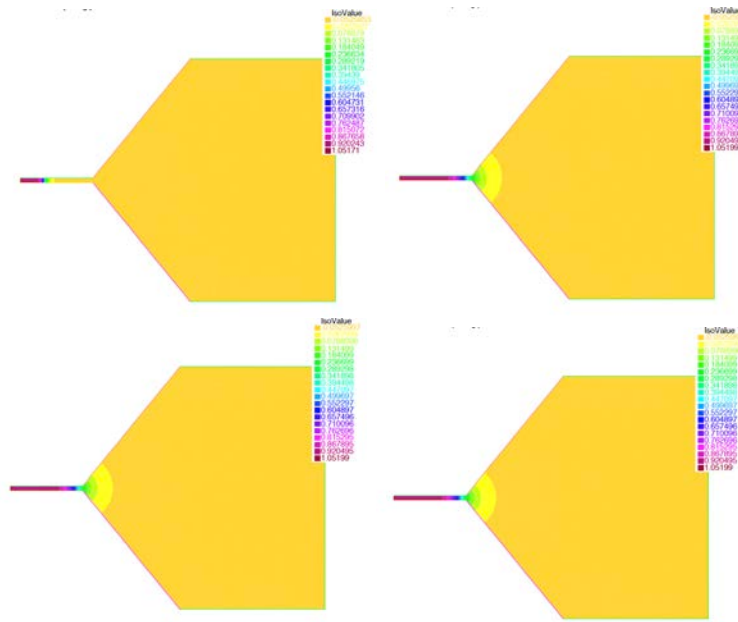

Figure 4.17 – The solution  $u(t, x)$  of (4.2) for  $x \in \Omega$  and  $t = 0; 100, 130, 200$  (from left to right, top to bottom) and  $\alpha = 1$ . In yellow areas, the density  $u$  is close to 0 and in purple areas the density is close to 1.

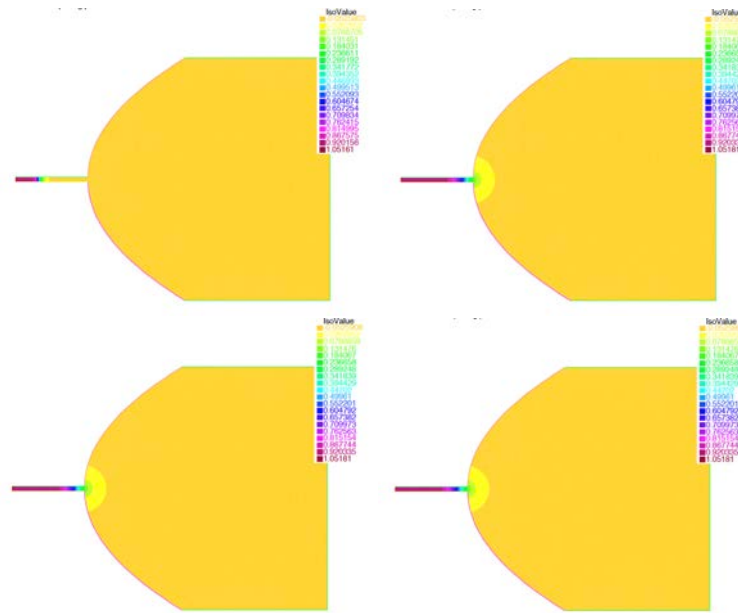

Figure 4.18 – The solution  $u(t, x)$  of (4.2) for  $x \in \Omega$  and  $t = 0; 100, 130, 200$  (from left to right, top to bottom) and  $\alpha = 2$ . In yellow areas, the density  $u$  is close to 0 and in purple areas the density is close to 1.

### 4.2.3 Narrowing domain

In this section we study the same problem than in the previous section but with a domain that has a decreasing diameter (in the direction of propagation), see figure 4.4.

We consider domains as in Figure 4.4 and we vary the length of the diameter of the right cylinder. Then we solve problem (4.2) in each domain and compute for each time  $t$  the average

of the population in the domain  $\mathcal{A}(t)$  and the maximal distance  $\mathcal{M}_d(t)$ . The results of these computations are displayed in Figures 4.19 and 4.20.

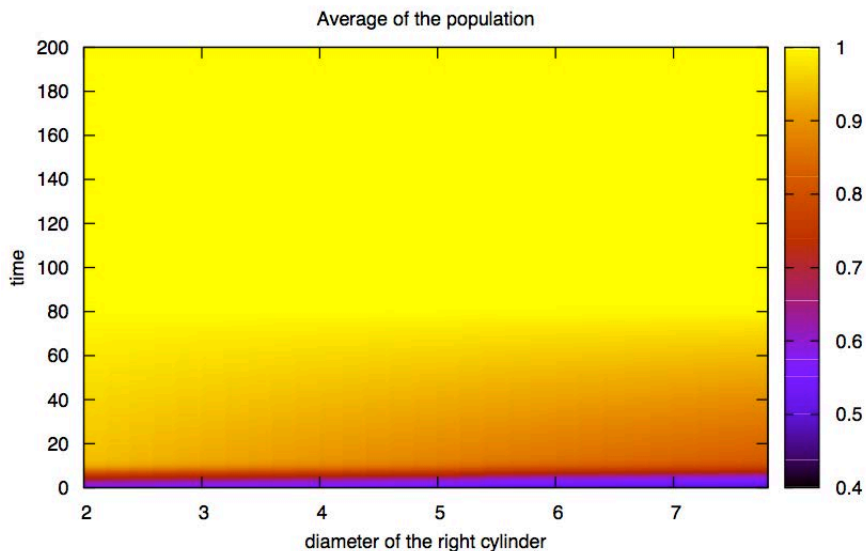

Figure 4.19 – Average of the population  $\mathcal{A}(t)$  for each diameter  $\varepsilon \in [2; 7.8]$  at each time  $t \in [0; 200]$ .

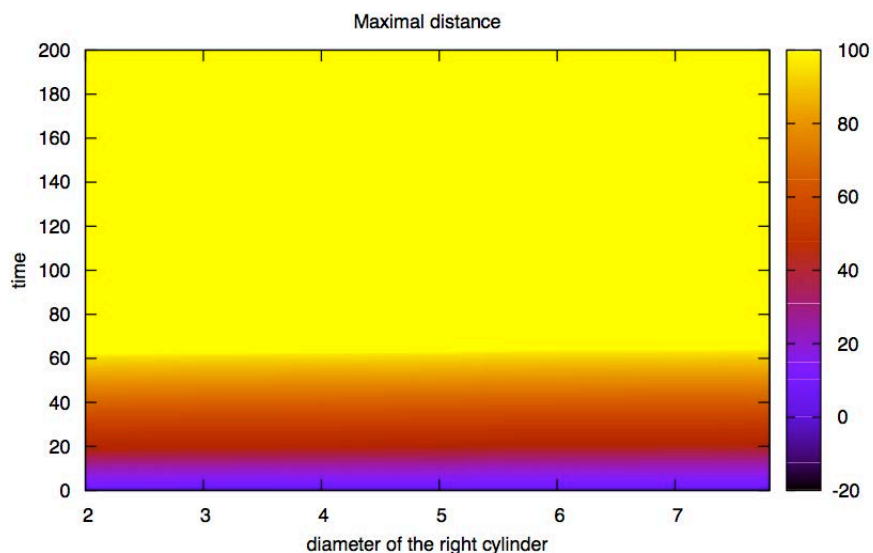

Figure 4.20 – Maximal distance  $f\mathcal{M}_d(t)$ , for each diameter  $\varepsilon \in [2; 7.8]$  at each time  $t \in [0; 200]$ .

We observe that in the case of a narrowing cylinder the solution  $u$  always propagates as it is proved analytically in Chapter 3. Indeed the average of the population goes to 1 as time grows and the maximal distance achieved by the population is 100 which corresponds to the right end of the domain. We also illustrate the evolution of the solution  $u$  with respect to time for different value of  $\varepsilon$  in Figure 4.21 ( $\varepsilon = 2$ ), 4.22 ( $\varepsilon = 5$ ) and 4.23 ( $\varepsilon = 7.5$ ).

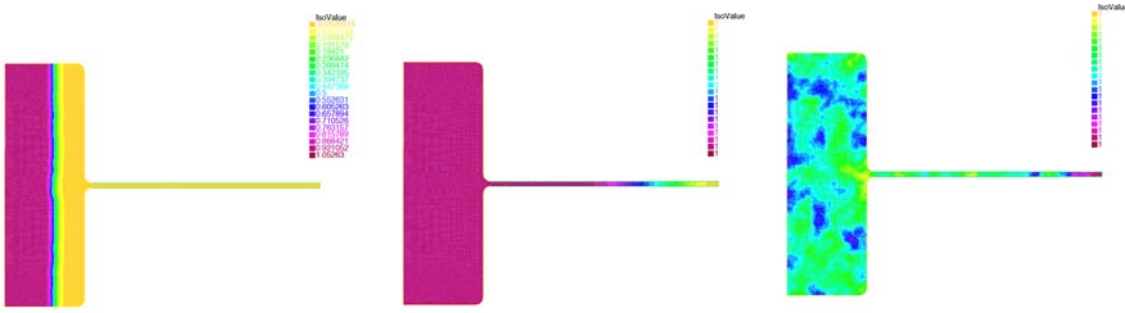

Figure 4.21 – The solution  $u(t, x)$  of (4.2) for  $x \in \Omega$  and  $t = 0; 100, 200$  (from left to right) and  $\varepsilon = 2$ . In yellow areas, the density is close to 0, whereas in purple areas the solution is close to 1 for the first two figures. For the last picture (on the right) the solution is close to 1 everywhere.

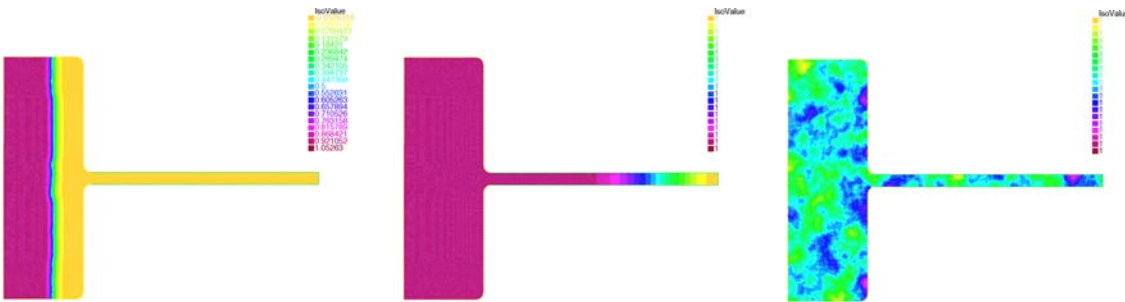

Figure 4.22 – The solution  $u(t, x)$  of (4.2) for  $x \in \Omega$  and  $t = 0; 100, 200$  (from left to right) and  $\varepsilon = 5$ . In yellow areas, the density is close to 0, whereas in purple areas the solution is close to 1 for the first two figures. For the last picture (on the right) the solution is close to 1 everywhere.

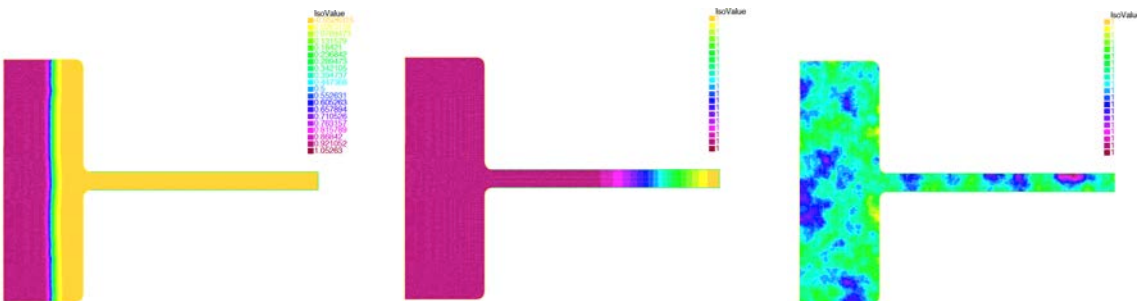

Figure 4.23 – The solution  $u(t, x)$  of (4.2) for  $x \in \Omega$  and  $t = 0; 100, 200$  (from left to right) and  $\varepsilon = 7.5$ . In yellow areas, the density is close to 0, whereas in purple areas the solution is close to 1 for the first two figures. For the last picture (on the right) the solution is close to 1 everywhere.

The front and its speed seem to be independent of the size of the small diameter as one can see in Figure 4.21, 4.22 and 4.23.

#### 4.2.4 Domain with an isthmus

In this section we still solve numerically Problem (4.2) in  $\Omega$ , where  $\Omega$  contains an isthmus, i.e. a small channel of diameter  $\varepsilon$ , see Figure 4.5 for an example of domains containing an isthmus of diameter  $\varepsilon$ , for different values of  $\varepsilon$ . We compute as in the previous sections the average of the population  $\mathcal{A}(t)$  and the maximal distance  $\mathcal{M}_d(t)$ , for each value of  $\varepsilon \in [2; 7.8]$  the diameter of the isthmus, at each time  $t \in [0; 200]$ . One can observe in Figure 4.24 and 4.25 that we have the

same threshold phenomena than in the case of an abrupt widening of the domain. The solution is blocked if the diameter of the isthmus is too small. This results confirms that the presence of an isthmus in the domain  $\Omega$  is responsible of the non-propagation of the solution.

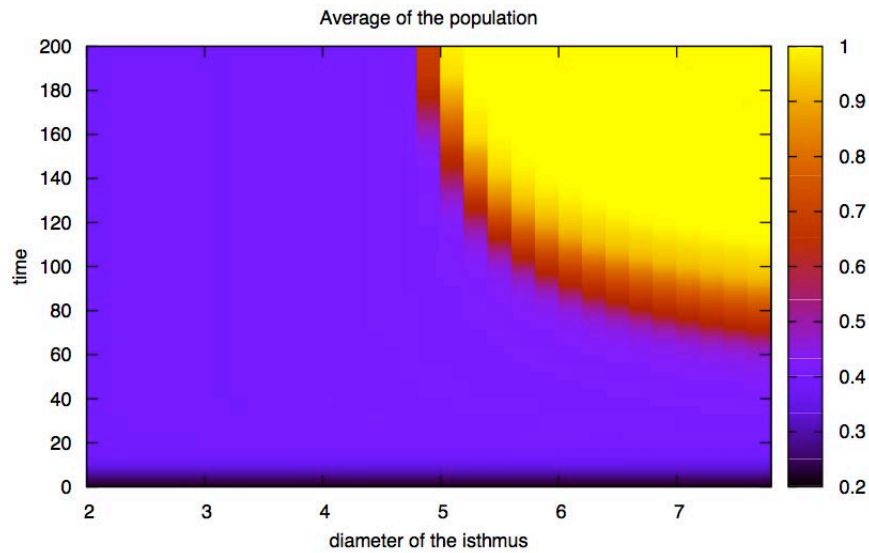

Figure 4.24 – Average of the population  $\mathcal{A}(t)$  for each diameter  $\varepsilon \in [2; 7.8]$  at each time  $t \in [0; 200]$ .

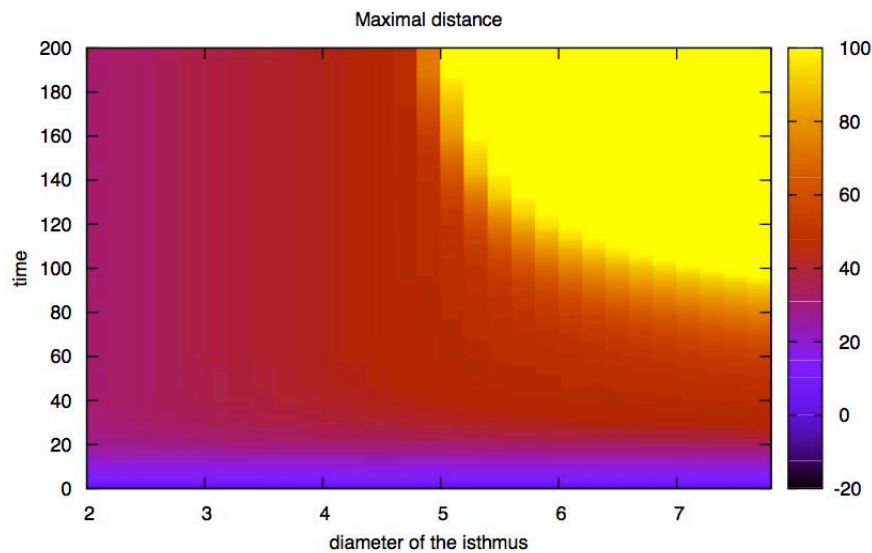

Figure 4.25 – Maximal distance  $\mathcal{M}_d(t)$ , for each diameter  $\varepsilon \in [2; 7.8]$  at each time  $t \in [0; 200]$ .

Figures 4.26, 4.27 and 4.28 display the shape of the front for different values of  $\varepsilon$  at different times  $t$ . One can observe that the narrowing part does not perturb the propagation of the front as it has already been shown in the previous section.

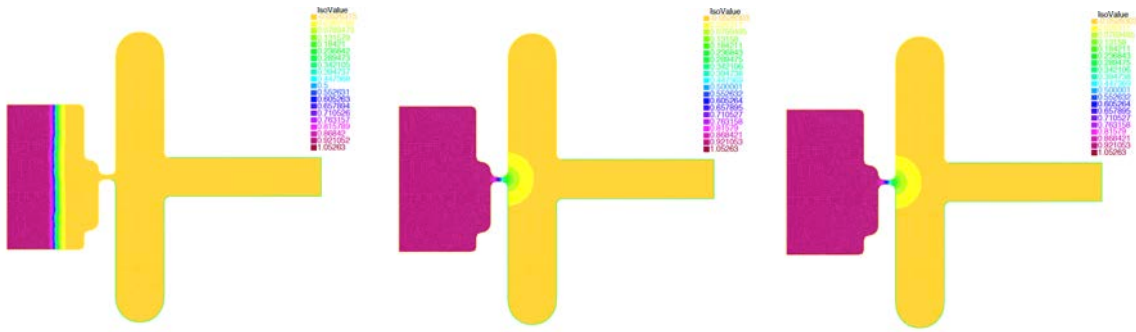

Figure 4.26 – The solution  $u(t, x)$  of (4.2) for  $x \in \Omega$  and  $t = 0; 100, 200$  (from left to right) and  $\varepsilon = 2$ . In yellow areas, the density is close to 0, whereas in purple areas the solution is close to 1.

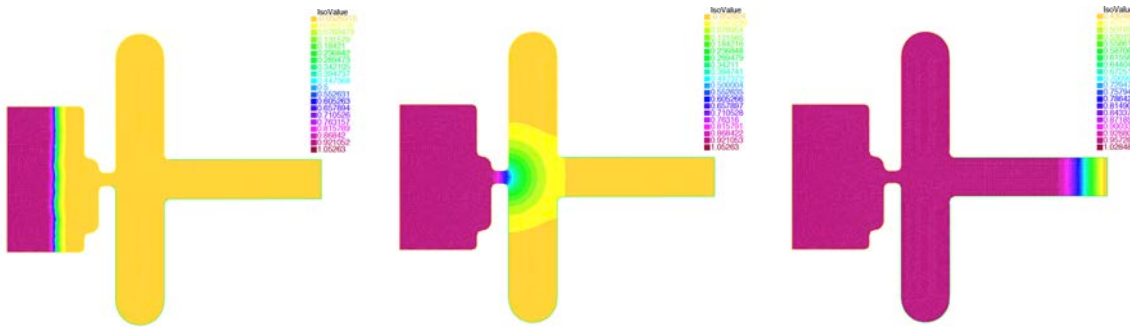

Figure 4.27 – The solution  $u(t, x)$  of (4.2) for  $x \in \Omega$  and  $t = 0; 100, 200$  (from left to right) and  $\varepsilon = 5$ . In yellow areas, the density is close to 0, whereas in purple areas the solution is close to 1.

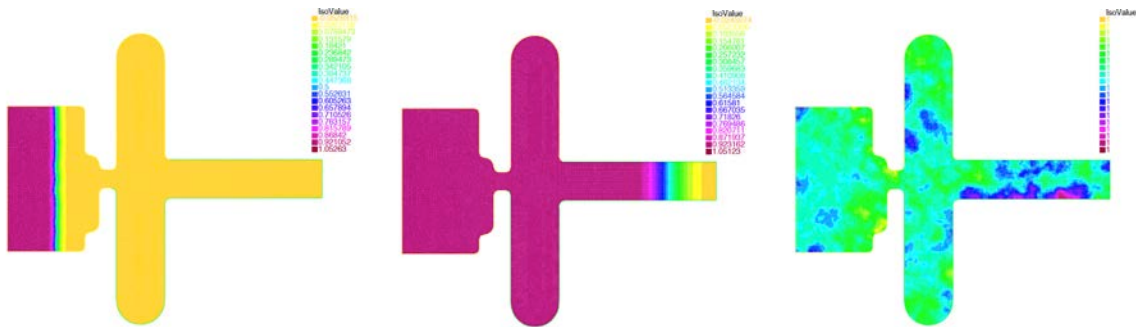

Figure 4.28 – The solution  $u(t, x)$  of (4.2) for  $x \in \Omega$  and  $t = 0; 100, 200$  (from left to right) and  $\varepsilon = 7.5$ . In yellow areas, the density is close to 0, whereas in purple areas the solution is close to 1 for the first two figures. For the last picture (on the right) the solution is close to 1 everywhere.

### 4.2.5 Widening domains - the effect of the bistability threshold $\theta$

In this subsection we discuss the relation between the bistability threshold  $\theta$  and the diameter of the small cylinder  $\varepsilon$  in a widening domain  $\Omega$  (as in Figure 4.2). As in the previous sections we compute the average of the population  $\mathcal{A}(t)$  and the maximal distance  $\mathcal{M}_d(t)$  at the final time  $t = 200$  for different values of  $\theta$  (the bistability threshold) and  $\varepsilon$  (the diameter of the small cylinder), when  $u$  is the solution of (4.2) in a widening cylinder. The results are displayed in Figures 4.29 and 4.30.



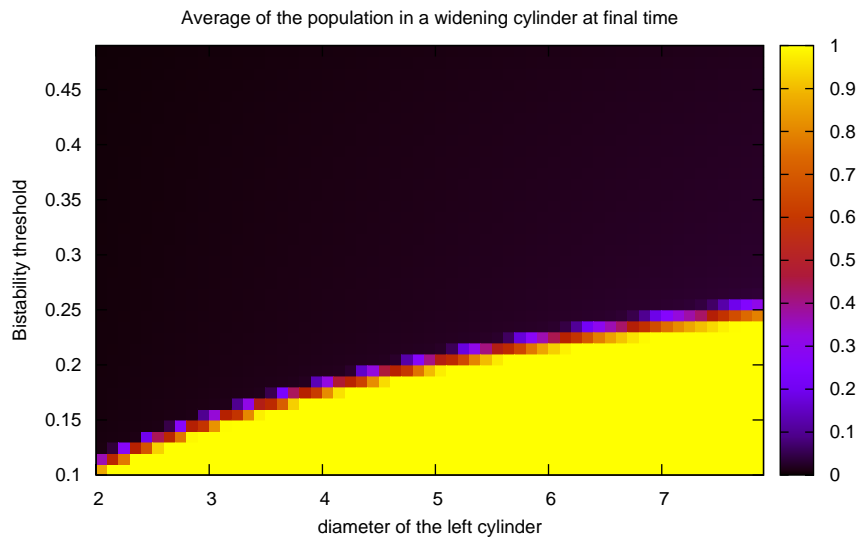

Figure 4.29 – Average of the population  $\mathcal{A}(t)$  at  $t = 200$  for each diameter  $\varepsilon \in [2; 7.8]$  and each bistability threshold  $\theta \in [0.1; 0.5]$ .

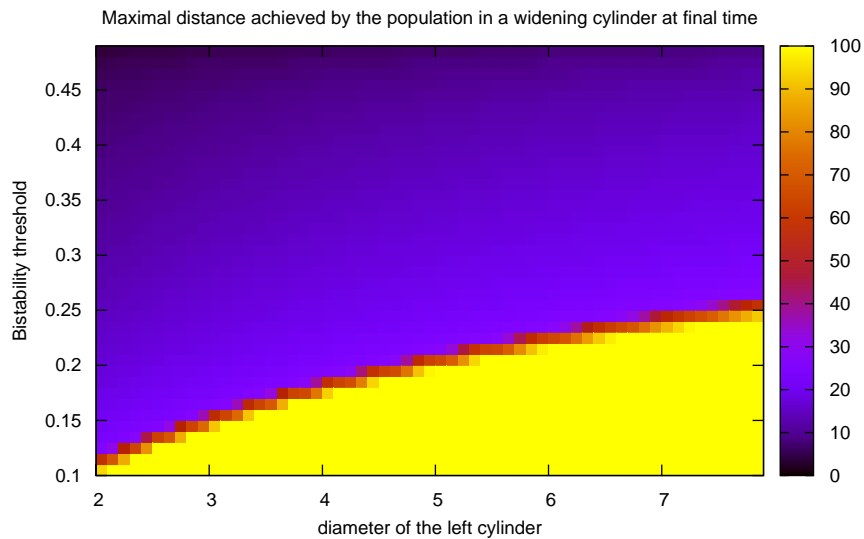

Figure 4.30 – Maximal distance  $\mathcal{M}_d(t)$ , at  $t = 200$ , for each diameter  $\varepsilon \in [2; 7.8]$  and each bistability threshold  $\theta \in [0.1; 0.5]$ .

Using the comparison principle we know that for fixed  $\varepsilon$  there exists a critical value of  $\theta$  such that the solution is blocked above and propagates below. Figures 4.29 and 4.30 show the relation between this critical value and the diameter of the small cylinder  $\varepsilon$ . We observe that the critical value is increasing with  $\varepsilon$  but the increase is slower and slower, i.e the curve is concave. This



indicates that  $\theta$  has a stronger effect on blocking phenomena than the diameter  $\varepsilon$ .

### 4.3 Propagation in a curved cylinder

In this section we are interested in the propagation of a front in a cylinder that changes direction. We investigate if the change of direction has an effect on the propagation of the solution  $u$  of (4.3) that we remind below

$$\begin{cases} \partial_t u - D\Delta u = f_0 u(1-u)(u-0.2) & \text{for } t \in [0; 400), \quad x \in \Omega, \\ \delta u - \gamma \partial_\nu u = 0 & \text{for } t \in [0; 400), \quad x \in \partial\Omega, \\ u(0, x) = 1_{[-60; -10] \times [0; \infty)}(x) & \text{in } \Omega, \end{cases}$$

or on the solution  $u$  of problem (4.4)

$$\begin{cases} \partial_t u - D\Delta u = f(x, u) & \text{for } t \in [0; 400), \quad x \in \Omega, \\ \partial_\nu u = 0 & \text{for } t \in [0; 400), \quad x \in \partial\Omega, \\ u(0, x) = 1_{[-60; -10] \times [0, d]}(x_1, x_2) & \text{for } x \in \Omega, \end{cases} \quad (4.4)$$

where  $\Omega := \Omega_f \cup \Omega_u$  is the union of a favourable area  $\Omega_f$ , which is a curved cylinder and an unfavourable area  $\Omega_u$ ,  $d$  in (4.4) is the diameter of the favourable cylinder  $\Omega_f$  and

$$f(s, x) = \begin{cases} f_+(s) & \text{if } x \in \Omega_f, \\ f_-(s) & \text{if } x \in \Omega_u, \end{cases}$$

#### 4.3.1 Propagation in a cylinder with Dirichlet or Robin boundary condition

We first study the evolution of the solution of bistable reaction diffusion equation in domains  $\Omega$  that are cylinders having a constant diameter and that change direction, with Dirichlet or Robin boundary conditions on both side of the cylinder (whereas in [51] they had Neumann boundary condition on one side of the cylinder). We thus solved Problem (4.3) in cylinders which changes direction, see Figure 4.6 for some examples. We remind that in this section

- $f(s) = f_0 s(1-s)(s-0.2)$ ,  $f_0 = 1$  in the case of Dirichlet boundary conditions,  $f_0 = 1$  or  $2$  in the case of Robin boundary conditions.
- $D = 10$ ,
- $t \in [0; 400)$ ,
- Dirichlet or Robin boundary conditions on the sides of the cylinder ( $\delta = 1$  and  $\gamma = 0$  or  $\gamma = 1$  and  $\delta = -2$ ),
- Neumann boundary condition at the left and right end of the cylinder,

#### Dirichlet boundary conditions

Figure 4.31 displays the average of the population for different lengths of diameter of the cylinder at each time in a straight cylinder versus a completely curved cylinder (U-shaped cylinder, the domain on the right in Figure 4.6) with Dirichlet boundary conditions.

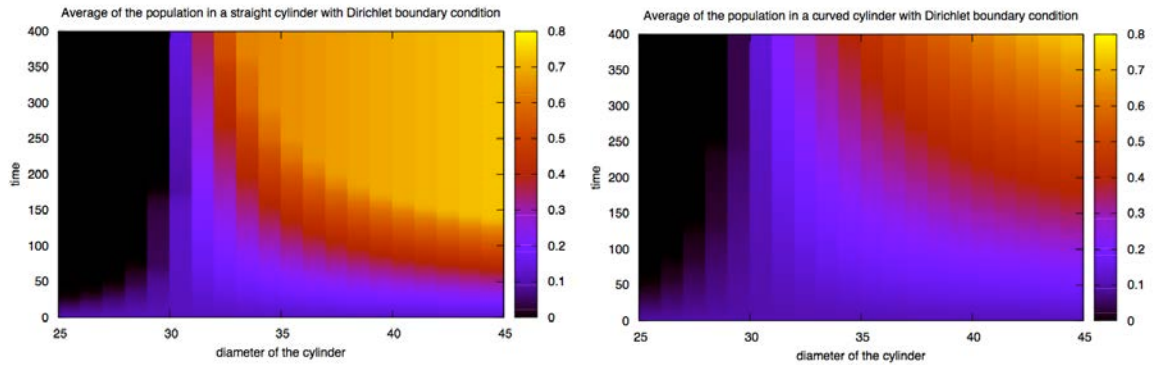

Figure 4.31 – Average of the population  $\mathcal{A}(t)$  for each diameter  $d \in [25; 45]$  at each time  $t \in [0; 400]$  in a straight and a completely curved cylinder, with Dirichlet boundary conditions.

In the case of Dirichlet boundary conditions there seems to be no difference in the propagation of the solution in the case of a straight cylinder or a completely curved cylinder. Indeed except for  $d \in [30; 31]$  we see that when the solution propagates in the straight cylinder, it slows down at the location of the curve in the curved cylinder but does not stop. We also computed the average of the population for different curvatures of the cylinder for a diameter  $d = 30.5$  and  $d = 31$  taking time  $t \in [0; 600)$  to see if there is a blocking phenomenon. One can see in Figure 4.32 that there is propagation in the entire domain whether the cylinder is curved or not for  $d = 31$ . The same results are observed for  $d = 30.5$  in Figure 4.33.

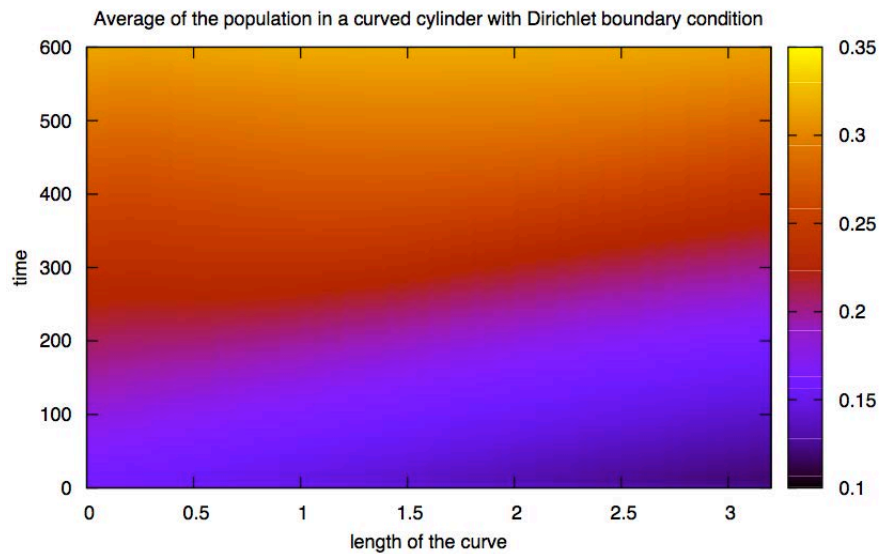

Figure 4.32 – Average of the population  $\mathcal{A}(t)$  for different curvatures (called length of curve in the figure)  $\varepsilon \in [0; \pi]$  at each time  $t \in [0; 600]$  in a cylinder of diameter 31.

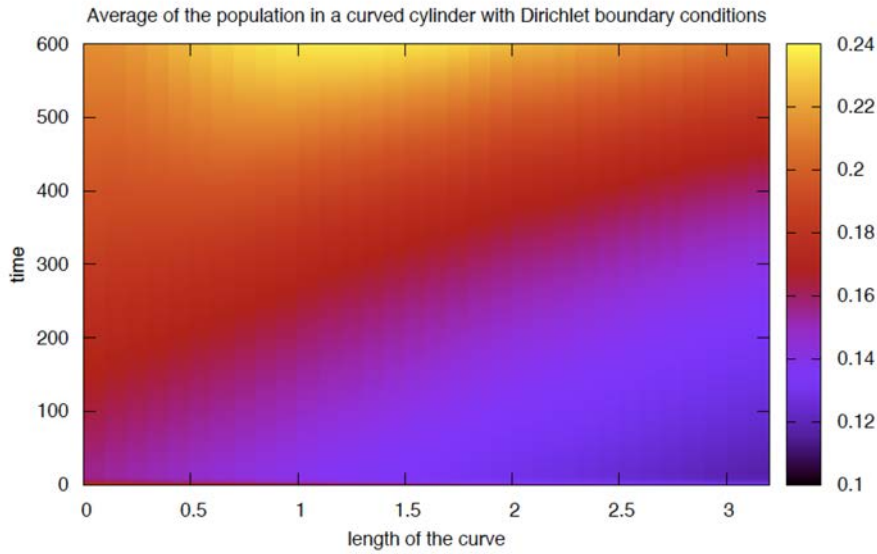

Figure 4.33 – Average of the population  $\mathcal{A}(t)$  for different curvatures (called length of curve in the figure)  $\varepsilon \in [0; \pi]$  at each time  $t \in [0; 600]$  in a cylinder of diameter 30.5.

We also plot in Figures 4.34, 4.35, 4.36, 4.37, the evolution of the solution  $u$  in  $\Omega$  for  $d = 30.1$  and  $d = 30.3$  for different values of  $t$  to see how the solution propagates in the domain, considering the case of a straight cylinder and of a U-shaped cylinder.

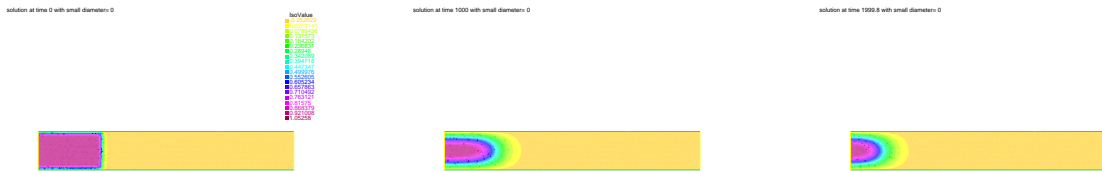

Figure 4.34 – The solution  $u(t, x)$  of (4.3) for  $x \in \Omega$  and  $t = 0, 1000, 2000$  (from left to right, top to bottom) and  $d = 30.1$ . In yellow areas, the density is close to 0, whereas in purple areas the solution is close to 1.

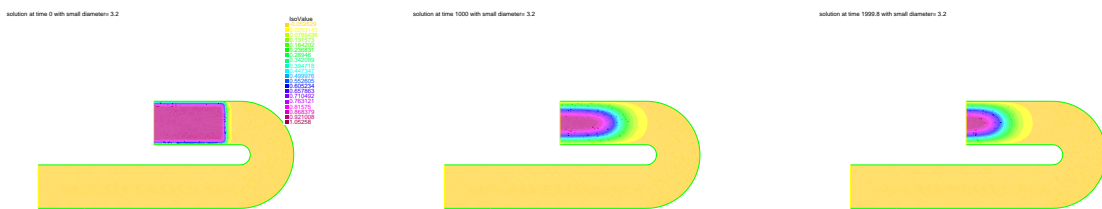

Figure 4.35 – The solution  $u(t, x)$  of (4.3) for  $x \in \Omega$  and  $t = 0, 1000, 2000$  (from left to right, top to bottom) and  $d = 30.1$ . In yellow areas, the density is close to 0, whereas in purple areas the solution is close to 1.

We see that for  $d = 30.1$ , in both cases the solution goes to 0.

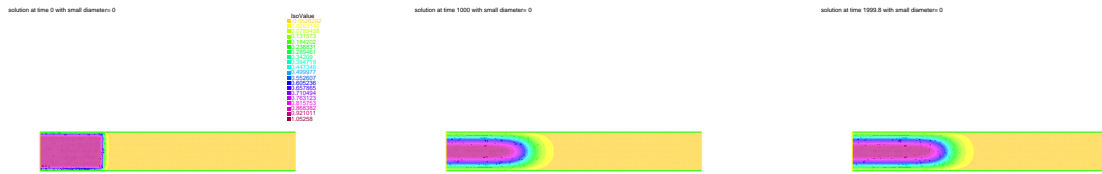

Figure 4.36 – The solution  $u(t, x)$  of (4.3) for  $x \in \Omega$  and  $t = 0, 1000, 2000$  (from left to right, top to bottom) and  $d = 30.3$ . In yellow areas, the density is close to 0, whereas in purple areas the solution is close to 1.

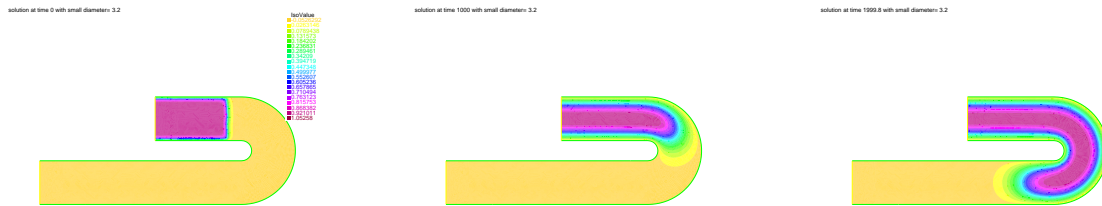

Figure 4.37 – The solution  $u(t, x)$  of (4.3) for  $x \in \Omega$  and  $t = 0, 1000, 2000$  (from left to right, top to bottom) and  $d = 30.3$ . In yellow areas, the density is close to 0, whereas in purple areas the solution is close to 1.

We had to take time up to 2000 to be able to observe propagation phenomena and we observe that there is no difference in the invasion behaviour between a straight and a U-shaped cylinder. All this results seem to confirm that in a cylinder with Dirichlet boundary conditions there is no difference of invasion property between a straight and a curved cylinder.

### Robin boundary condition

In Figure 4.38 we see the evolution of the average of the solution of Problem (4.3) with Robin boundary conditions, in a straight cylinder and in a completely curved cylinder at each time  $t \in [0; 400]$  for different diameters of the cylinder  $d$ . As in the case of Dirichlet boundary conditions we do not see a real difference in the behaviour of the solution in a straight cylinder or in a completely curved cylinder.

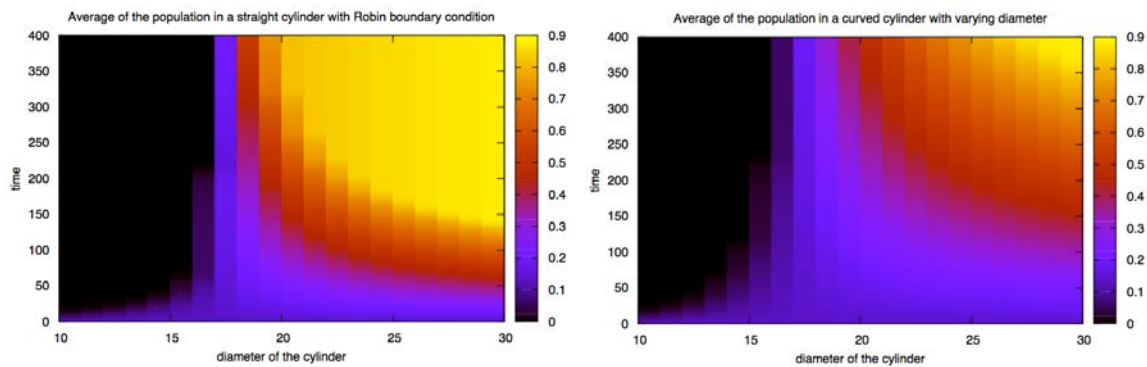

Figure 4.38 – Average of the population  $\mathcal{A}(t)$  for each diameter  $d \in [10; 30]$  at each time  $t \in [0; 400]$  in a straight and a completely curved cylinder, with Robin boundary conditions where  $\delta = -2, f_0 = 1$

From Figure 4.38 we see that for  $d \in [17; 19]$  there could be a difference in the behaviour of the propagation of the solution between a straight and curved cylinder. We thus solve our problem for  $d = 17; 17.5$  and  $d = 18$  for  $t \in [0; 600]$ .

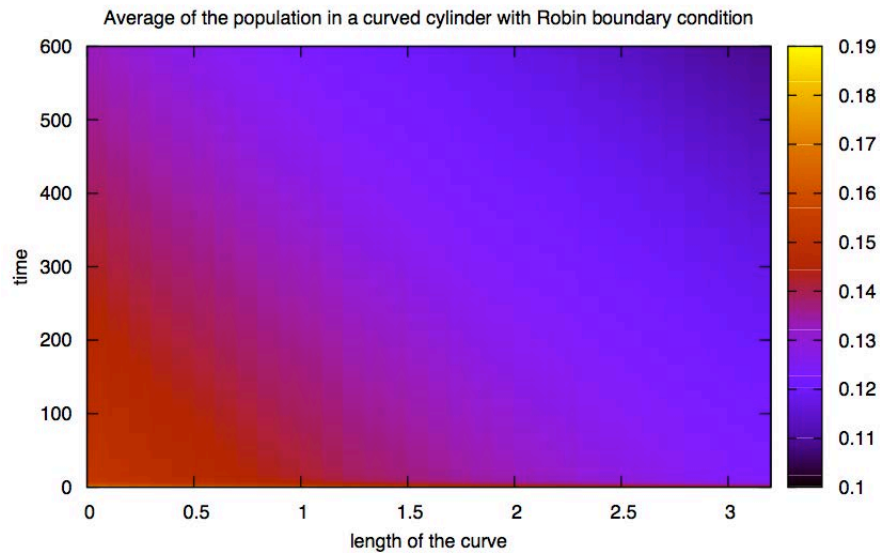

Figure 4.39 – Average of the population  $\mathcal{A}(t)$  for different curvatures (called length of curve in the figure)  $\varepsilon \in [0; \pi]$  at each time  $t \in [0; 600]$  in a cylinder of diameter 17.

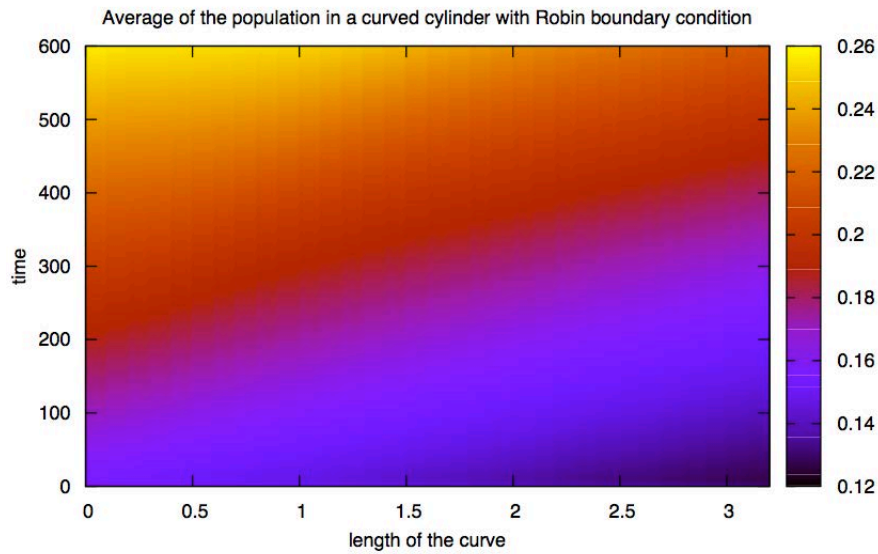

Figure 4.40 – Average of the population  $\mathcal{A}(t)$  for different curvatures (called length of curve in the figure)  $\varepsilon \in [0; \pi]$  at each time  $t \in [0; 600]$  in a cylinder of diameter 17.5.

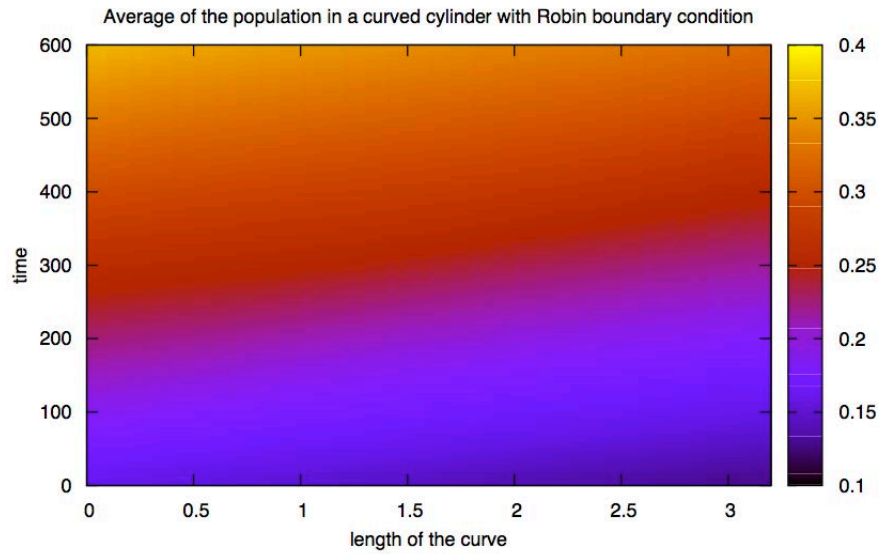

Figure 4.41 – Average of the population  $\mathcal{A}(t)$  for different curvatures (called length of curve in the figure)  $\varepsilon \in [0; \pi]$  at each time  $t \in [0; 600]$  in a cylinder of diameter 18.

Figure 4.39, 4.40 and 4.41 show that when the diameter of the cylinder is equal to 17, 17.5 or 18 then there is no difference in the propagation of the solution between a straight cylinder and a curved cylinder.

Moreover Figure 4.42, 4.43 and 4.44 displays the values of the solution  $u$  in  $\Omega$  for different curvatures, with  $d = 17.5$ . It also indicates that there is no real difference of propagation behaviour between a curved and a straight cylinder.

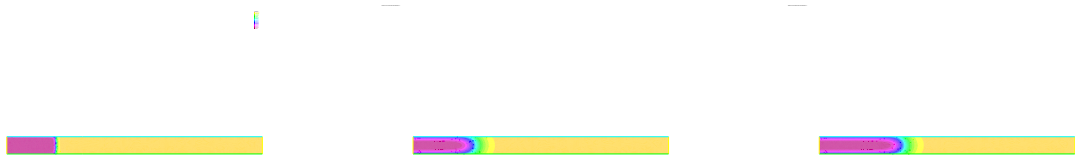

Figure 4.42 – The solution  $u(t, x)$  of (4.3) for  $x \in \Omega$  and  $t = 0, 200, 600$  (from left to right, top to bottom) and  $d = 17.5$ . In yellow areas, the density is close to 0, whereas in purple areas the solution is close to 1.

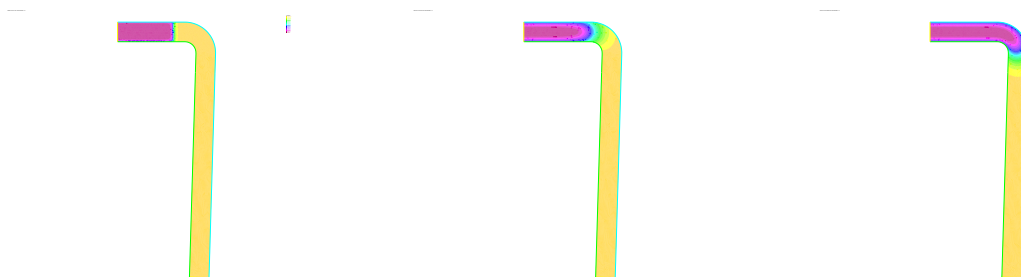

Figure 4.43 – The solution  $u(t, x)$  of (4.3) for  $x \in \Omega$  and  $t = 0; 200, 600$  (from left to right, top to bottom) and  $d = 17.5$ . In yellow areas, the density is close to 0, whereas in purple areas the solution is close to 1.

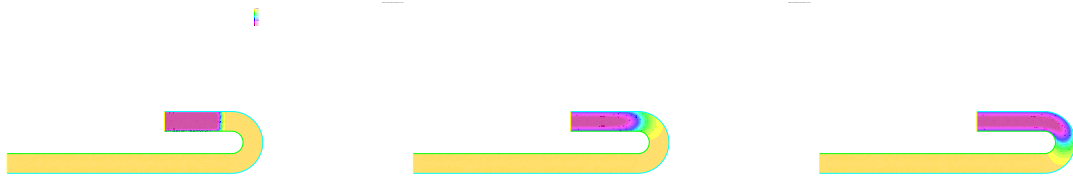

Figure 4.44 – The solution  $u(t, x)$  of (4.3) for  $x \in \Omega$  and  $t = 0; 200, 600$  (from left to right, top to bottom) and  $d = 17.5$ . In yellow areas, the density is close to 0, whereas in purple areas the solution is close to 1.

Indeed we observe that the propagation of the solution is slow due to Robin boundary conditions on both sides of the cylinder but is not stopped for large curvature.

We compute the solution  $u$  of problem (4.3) for another set of parameters to see if the behaviour of the solution with respect to the curvature changes from the previous setting. Figure 4.45 displays the average of the population for different diameters  $d$  in a straight and completely curved cylinder when  $f_0 = 2$  and  $\delta = -2$ .

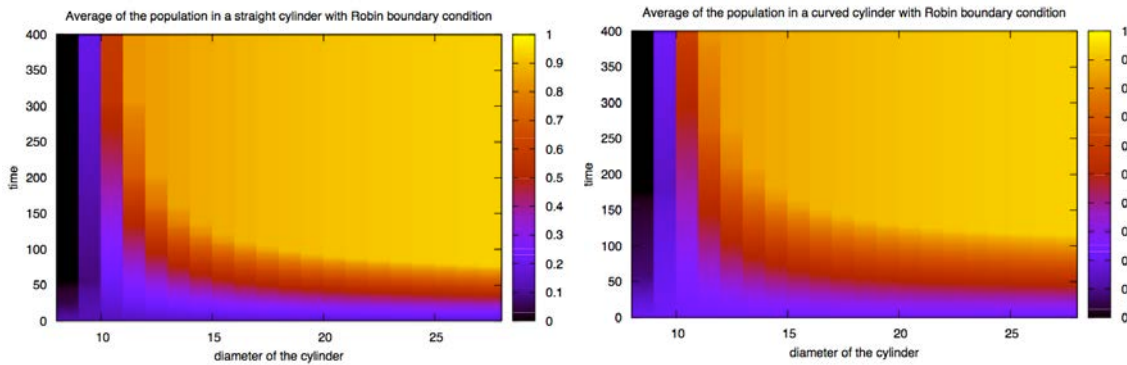

Figure 4.45 – Average of the population  $\mathcal{A}(t)$  for each diameter  $d \in [5; 30]$  at each time  $t \in [0; 400]$  in a straight and a completely curved cylinder, with Robin boundary conditions where  $\delta = -2, f_0 = 2$

With all these results there does not seem to be a significant difference of behaviour for the propagation of the solution of Problem (4.4) between a straight cylinder and a curved cylinder, when we put Dirichlet or Robin boundary conditions on both sides of the cylinder.

### 4.3.2 Propagation in a domain with favourable and unfavourable environment

In this section we used the ideas from [51] to see if one can find parameters where there is a difference in the propagation of the solution between a straight cylinder and a curved cylinder. In stead of considering only a cylinder for  $\Omega$  we consider  $\Omega$  as the union of two disjoint sets,  $\Omega_f$  a cylinder that changes direction and  $\Omega_u$  an unfavourable area which is located on the upper side of  $\Omega_f$ , with Neumann boundary conditions on  $\partial\Omega$ . In the favorable area the solution should be able to propagates, i.e.  $f$  is a bistable function and in the unfavourable area the solution is absorbed to 0, i.e  $f$  is a linear function of  $u$  with a negative coefficient. We will consider cylinders for  $\Omega_f$  (straight or curved) and investigate if the curvature has an effect on propagation phenomena. We thus study the following problem



$$\begin{cases} \partial_t u - D\Delta u = f(x, u) & \text{for } t \in [0; 400), \quad x \in \Omega, \\ \partial_\nu u = 0 & \text{for } t \in [0; 400), \quad x \in \partial\Omega, \\ u(0, x) = 1_{[-60; -10] \times [0, d]}(x_1, x_2) & \text{for } x \in \Omega, \end{cases}$$

where

- 

$$f(s, x) = \begin{cases} f_+(s) & \text{if } x \in \Omega_f, \\ f_-(s) & \text{if } x \in \Omega_u, \end{cases}$$

- $f_+(s) = f_0 s(1 - s)(s - 0.2),$

- $f_-(s) = -\delta s, \delta = 1 \text{ or } \delta = 2,$

- $t \in [0; 400),$

- $D = 10,$

- $d$  is the diameter of the cylinder  $\Omega_f$ .

Figure 4.7 gives some examples of domains considered in this section.

Figure 4.46 displays the average of the solution  $u$  of (4.4)

$$\mathcal{A}(t) := \frac{\int_{\Omega} u(t, x) dx}{|\Omega_f|}$$

in this setting of favourable/unfavourable environment, when  $\delta = 1$ . It shows a significant difference for the behaviour of the solution between the straight cylinder and the curved one.

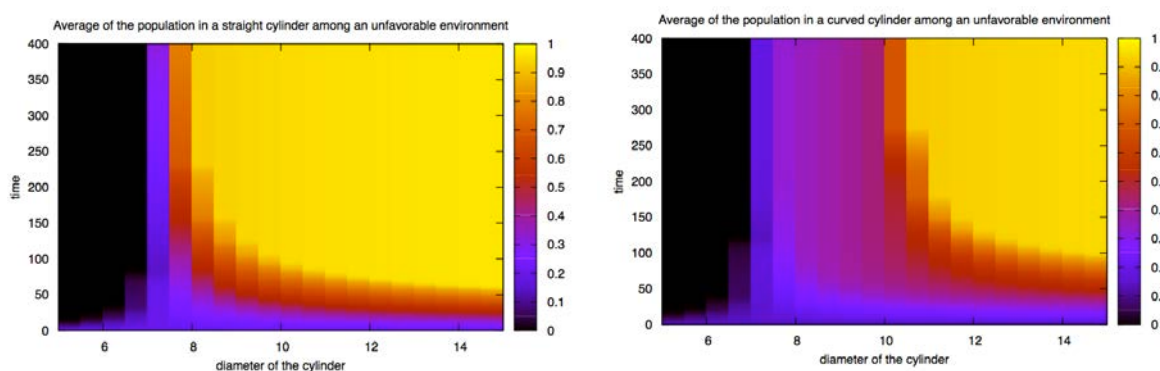

Figure 4.46 – Average of the population  $\mathcal{A}(t)$  for different diameters of the cylinder  $d \in [5; 15]$  at each time  $t \in [0; 400)$  in a straight cylinder and in a curved cylinder, when  $\delta = 1$

Figure 4.47 displays the solution  $u$  in  $\Omega$  for different times  $t$  in the straight cylinder setting. It is well seen that the solution propagates in the entire favourable area and dies out in the unfavourable area.



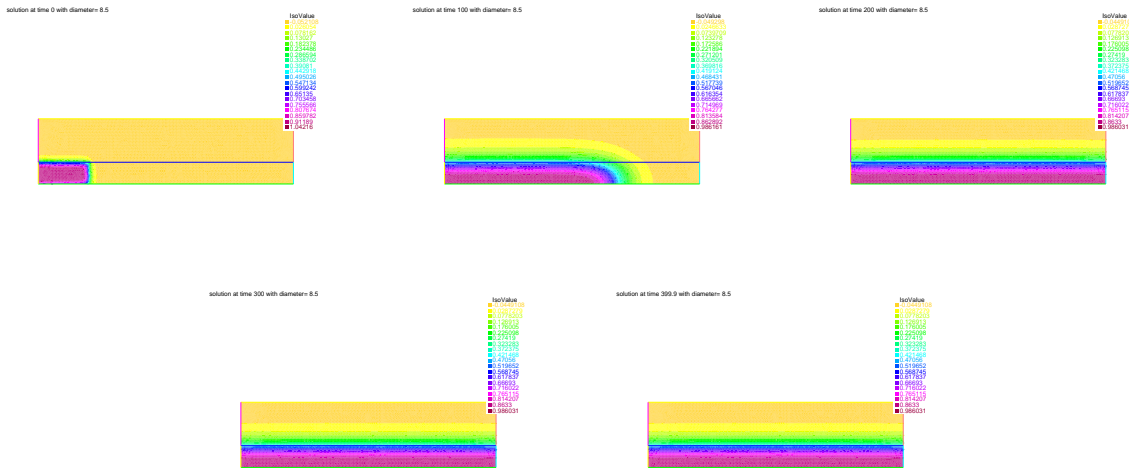

Figure 4.47 – Solution  $u$  of Problem (4.4) for different times  $t = 0; 100; 200; 300; 400$  (from left to right, top to bottom) in a straight cylinder setting, when  $\delta = 1$  and  $d = 8.5$ . In yellow areas, the density is close to 0, whereas in purple areas the solution is close to 1.

Whereas Figure 4.48 shows that the solution  $u$  is blocked at the change of direction of the cylinder.

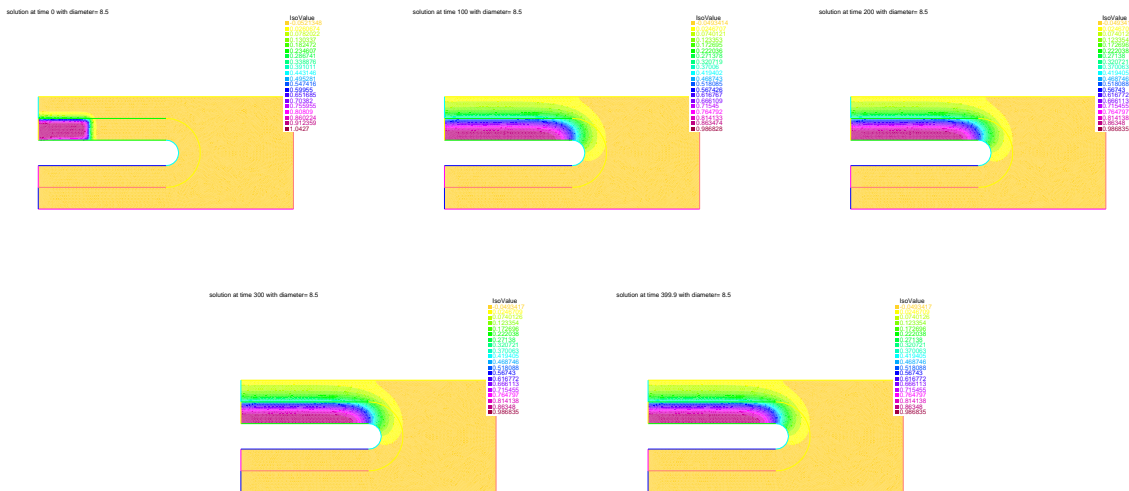

Figure 4.48 – Solution  $u$  of Problem (4.4) for different time  $t = 0; 100; 200; 300; 400$  (from left to right, top to bottom) in a curved cylinder setting, when  $\delta = 1$  and  $d = 8.5$ . In yellow areas, the density is close to 0, whereas in purple areas the solution is close to 1.

In this setting we can clearly see that the change of direction of the cylinder has a negative effect on the propagation of the solution  $u$ , see Figure 4.49.

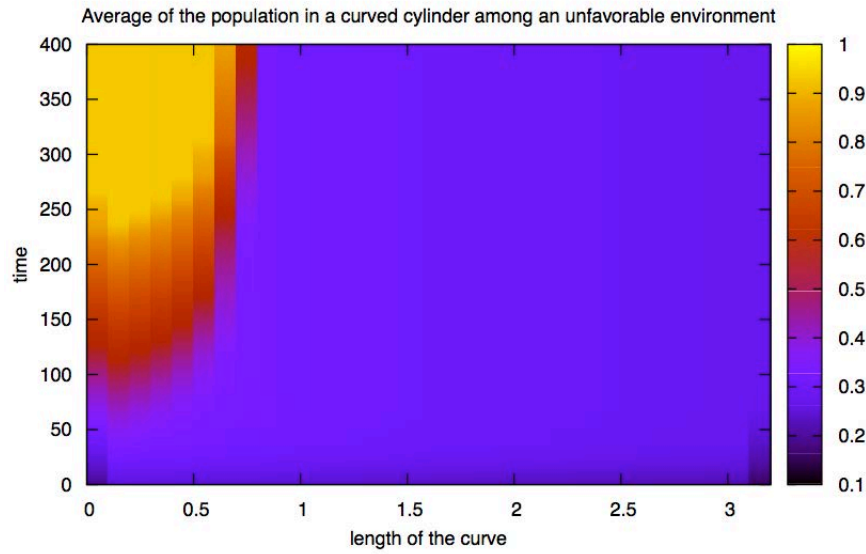

Figure 4.49 – Average of the population  $\mathcal{A}(t)$  for different curvatures (called length of the curve in the figure) of the cylinder  $\varepsilon \in [0; \pi]$  at each time  $t \in [0; 400]$  when the diameter of the cylinder is equal to 8.5 and  $\delta = 1$

We also solve Problem (4.4) for  $\delta = 2$  and find the same behaviour for the solution  $u$  as it can be seen in Figure 4.50.

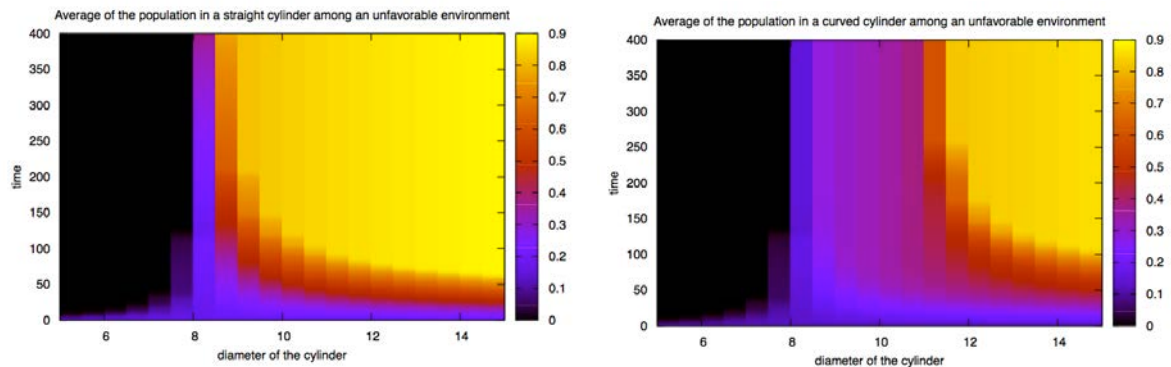

Figure 4.50 – Average of the population  $\mathcal{A}(t)$  for different diameters of the cylinder  $d \in [5; 15]$  at each time  $t \in [0; 400]$  in a straight cylinder and in a curved cylinder, when  $\delta = 2$

Indeed when the diameter of the cylinder is equal to 9 the solution invades the favourable area when it is a straight cylinder, whereas the solution is blocked when the favourable zone is a curved cylinder.



# Bibliographie

- [1] P.G. Aitken, J. Jing, J. Young, A. Friedman, and G.G. Somjen. Spreading depression in human hippocampal tissue in vitro. In *Third IBRO Congr. Montreal Abstr.*, volume 329. 1991.
- [2] D. G. Aronson. The asymptotic speed of propagation of a simple epidemic. In *Nonlinear diffusion (NSF-CBMS Regional Conf. Nonlinear Diffusion Equations, Univ. Houston, Houston, Tex., 1976)*, pages 1–23. Res. Notes Math., No. 14. Pitman, London, 1977.
- [3] D. G. Aronson and H. F. Weinberger. Multidimensional nonlinear diffusion arising in population genetics. *Adv. in Math.*, 30(1) :33–76, 1978.
- [4] R. Ashman and E. Hull. *Essentials of electrocardiography*. New York : Macmillan. 1945.
- [5] T. Back, J. G. Hirsch, K. Szabo, and A. Gass. Failure to demonstrate peri-infarct depolarizations by repetitive mr diffusion imaging in acute human stroke. *Stroke*, 31(12) :2901–2906, 2000.
- [6] H. Berestycki, J. Bouhours, and G. Chapuisat. Propagation and blocking phenomena in infinite cylinders with varying cross section. *in preparation*, 2014.
- [7] H. Berestycki and G. Chapuisat. Traveling fronts guided by the environment for reaction-diffusion equations. *Netw. Heterog. Media*, 8(1) :79–114, 2013.
- [8] H. Berestycki, L. Desvillettes, and O. Diekmann. Can climate change lead to gap formation? *in preparation*, 2014.
- [9] H. Berestycki, O. Diekmann, C. J. Nagelkerke, and P. A. Zegeling. Can a species keep pace with a shifting climate? *Bull. Math. Biol.*, 71(2) :399–429, 2009.
- [10] H. Berestycki and F. Hamel. Non-existence of travelling front solutions of some bistable reaction-diffusion equations. *Adv. Differential Equations*, 5(4-6) :723–746, 2000.
- [11] H. Berestycki and F. Hamel. Generalized travelling waves for reaction-diffusion equations. In *Perspectives in nonlinear partial differential equations*, volume 446 of *Contemp. Math.*, pages 101–123. Amer. Math. Soc., Providence, RI, 2007.
- [12] H. Berestycki and F. Hamel. Generalized transition waves and their properties. *Communications on Pure and Applied Mathematics*, 65(5) :592–648, 2012.
- [13] H. Berestycki and F. Hamel. *Reaction-Diffusion Equations and Propagation Phenomena*. Springer, Verlag, 2014, to appear.

- 
- [14] H. Berestycki, F. Hamel, and H. Matano. Bistable traveling waves around an obstacle. *Comm. Pure Appl. Math.*, 62(6) :729–788, 2009.
- [15] H. Berestycki and P.-L. Lions. Une méthode locale pour l’existence de solutions positives de problèmes semi-linéaires elliptiques dans  $\mathbf{R}^N$ . *J. Analyse Math.*, 38 :144–187, 1980.
- [16] H. Berestycki and L. Rossi. Generalizations and properties of the principal eigenvalue of elliptic operators in unbounded domains. *in preparation*.
- [17] H. Berestycki and L. Rossi. Reaction-diffusion equations for population dynamics with forced speed. I. The case of the whole space. *Discrete Contin. Dyn. Syst.*, 21(1) :41–67, 2008.
- [18] H. Berestycki and L. Rossi. Reaction-diffusion equations for population dynamics with forced speed. II. Cylindrical-type domains. *Discrete Contin. Dyn. Syst.*, 25(1) :19–61, 2009.
- [19] J. Bouhours. Robustness of a liouville type theorem in exterior domains. *Accepted in Journal of Dynamics and Differential Equations*, 2013. Preprint arXiv :1207.0329.
- [20] J. Bouhours and G. Nadin. A variational approach to reaction diffusion equations with forced speed in dimension 1. 2013. Preprint arXiv :1310.3689.
- [21] M. D. Bramson. Maximal displacement of branching Brownian motion. *Comm. Pure Appl. Math.*, 31(5) :531–581, 1978.
- [22] M. D. Bramson. Convergence of solutions of the Kolmogorov equation to travelling waves. *Mem. Amer. Math. Soc.*, 44(285) :iv+190, 1983.
- [23] H. Brezis. *Analyse fonctionnelle*. Collection Mathématiques Appliquées pour la Maîtrise. [Collection of Applied Mathematics for the Master’s Degree]. Masson, Paris, 1983. Théorie et applications. [Theory and applications].
- [24] J. Carr and A. Chmaj. Uniqueness of travelling waves for nonlocal monostable equations. *Proc. Amer. Math. Soc.*, 132(8) :2433–2439 (electronic), 2004.
- [25] R. G. Casten and C. J. Holland. Instability results for reaction diffusion equations with Neumann boundary conditions. *J. Differential Equations*, 27(2) :266–273, 1978.
- [26] G. Chapuisat. Ondes progressives et modélisation des accidents vasculaires cérébraux ischémiques. *PhD Thesis*, 2006.
- [27] G. Chapuisat. Discussion of a simple model of spreading depressions. In *Paris-Sud Working Group on Modelling and Scientific Computing 2006–2007*, volume 18 of *ESAIM Proc.*, pages 87–98. EDP Sci., Les Ulis, 2007.
- [28] G. Chapuisat. Existence and nonexistence of curved front solution of a biological equation. *J. Differential Equations*, 236(1) :237–279, 2007.
- [29] G. Chapuisat and E. Grenier. Existence and nonexistence of traveling wave solutions for a bistable reaction-diffusion equation in an infinite cylinder whose diameter is suddenly increased. *Comm. Partial Differential Equations*, 30(10-12) :1805–1816, 2005.

- 
- [30] G. Chapuisat and R. Joly. Asymptotic profiles for a traveling front solution of a biological equation. *Math. Models Methods Appl. Sci.*, 21(10) :2155–2177, 2011.
- [31] J.S. Clark. Why trees migrate so fast : Confronting theory with dispersal biology and the paleorecord. *Am. Nat.*, 152 :204–224, 1998.
- [32] J.S. Clark, C. Fastie, G. Hurtt, S.T. Jackson, C. Johnson, G.A King, M. Lewis, J. Lynch, S. Pacala, C. Prentice, E. W. Schupp, T. Webb III, and P. Wyckoff. Reid’s paradox of rapid plant migration. *Bioscience*, 48 :13–24, 1998.
- [33] J. Coville and L. Dupaigne. On a non-local equation arising in population dynamics. *Proc. Roy. Soc. Edinburgh Sect. A*, 137(4) :727–755, 2007.
- [34] P. F. Cranefield. *The Conduction of the Cardiac Impulse : The Slow Response and Cardiac Arrhythmias*, volume chap 2 and 5 of *New York : Futura*. 1975.
- [35] J. De Keyser, G. Sulter, and P. G. Luiten. Clinical trials with neuroprotective drugs in acute ischaemic stroke : are we doing the right thing? *Trends Neurosci.*, 22(12) :535–540, 1999.
- [36] O. Diekmann. Run for your life. A note on the asymptotic speed of propagation of an epidemic. *J. Differential Equations*, 33(1) :58–73, 1979.
- [37] M. A. Dronne, S. Descombes, E. Grenier, and H. Gilquin. Examples of the influence of the geometry on the propagation of progressive waves. *Math. Comput. Modelling*, 49(11–12) :2138–2144, 2009.
- [38] Y. Du and H. Matano. Convergence and sharp thresholds for propagation in nonlinear diffusion problems. *J. Eur. Math. Soc. (JEMS)*, 12(2) :279–312, 2010.
- [39] A. Ducrot, T. Giletti, and H. Matano. Existence and convergence to a propagating terrace in one-dimensional reaction-diffusion equations. 2013.
- [40] P. C. Fife and J. B. McLeod. The approach of solutions of nonlinear diffusion equations to travelling front solutions. *Arch. Ration. Mech. Anal.*, 65(4) :335–361, 1977.
- [41] R. A. Fisher. The wave of advance of advantageous genes. *Journal of Eugenics*, 1937.
- [42] T. Gallay and R. Joly. Global stability of travelling fronts for a damped wave equation with bistable nonlinearity. *Ann. Sci. Éc. Norm. Supér. (4)*, 42(1) :103–140, 2009.
- [43] T. Gallay and E. Risler. A variational proof of global stability for bistable travelling waves. *Differential Integral Equations*, 20(8) :901–926, 2007.
- [44] J. Garnier. Accelerating solutions in integro-differential equations. *SIAM J. Math. Anal.*, 43(4) :1955–1974, 2011.
- [45] J. Garnier. Analyse mathématique de modèles de dynamique des populations : équations aux dérivées partielles paraboliques et équations intégro-différentielles. *PhD Thesis*, 2012.
- [46] J. Garnier, T. Giletti, F. Hamel, and L. Roques. Inside dynamics of pulled and pushed fronts. *J. Math. Pures Appl. (9)*, 98(4) :428–449, 2012.

- [47] J. Garnier, L. Roques, and F. Hamel. Success rate of a biological invasion in terms of the spatial distribution of the founding population. *Bull. Math. Biol.*, 74(2) :453–473, 2012.
- [48] B. Gidas, Wei Ming Ni, and L. Nirenberg. Symmetry of positive solutions of nonlinear elliptic equations in  $\mathbf{R}^n$ . In *Mathematical analysis and applications, Part A*, volume 7 of *Adv. in Math. Suppl. Stud.*, pages 369–402. Academic Press, New York, 1981.
- [49] D. Gilbarg and N. S. Trudinger. *Elliptic partial differential equations of second order*. Classics in Mathematics. Springer-Verlag, Berlin, 2001. Reprint of the 1998 edition.
- [50] A. Gorji, D. Scheller, H. Straub, F. Tegtmeier, R. Köhling, J. M. Höhling, I. Tuxhorn, A. Ebner, P. Wolf, Hans Werner P., F. Ooppel, and E. J. Speckmann. Spreading depression in human neocortical slices. *Brain Res.*, 906(1-2) :74–83, 2001.
- [51] E. Grenier, M.A. Dronne, S. Descombes, H. Gilquin, A. Jaillard, M. Hommel, and J.-P. Boissel. A numerical study of the blocking of migraine by rolando sulcus. *Progress in Biophysics and Molecular Biology*, 97(1) :54 – 59, 2008.
- [52] P. Grindrod and M. A. Lewis. One-way blocks in cardiac tissue : a mechanism for propagation failure in purkinje fibres. *Bull of Math. Biology*, 53(6) :881–899, 1991.
- [53] K. P. Hadeler and F. Rothe. Travelling fronts in nonlinear diffusion equations. *J. Math. Biol.*, 2(3) :251–263, 1975.
- [54] J. K. Hale and G. Raugel. Convergence in gradient-like systems with applications to PDE. *Z. Angew. Math. Phys.*, 43(1) :63–124, 1992.
- [55] F. Hamel, R. Monneau, and J.-M. Roquejoffre. Existence and qualitative properties of multidimensional conical bistable fronts. *Discrete Contin. Dyn. Syst.*, 13(4) :1069–1096, 2005.
- [56] F. Hamel and N. Nadirashvili. Entire solutions of the KPP equation. *Comm. Pure Appl. Math.*, 52(10) :1255–1276, 1999.
- [57] F. Hamel and N. Nadirashvili. Travelling fronts and entire solutions of the Fisher-KPP equation in  $\mathbb{R}^N$ . *Arch. Ration. Mech. Anal.*, 157(2) :91–163, 2001.
- [58] F. Hamel, J. Nolen, J.-M. Roquejoffre, and L. Ryzhik. A short proof of the logarithmic Bramson correction in Fisher-KPP equations. *Netw. Heterog. Media*, 8(1) :275–289, 2013.
- [59] F. Hamel and S. Omrani. Existence of multidimensional travelling fronts with a multistable nonlinearity. *Adv. Differential Equations*, 5(4-6) :557–582, 2000.
- [60] S. Heinze. A variational approach to traveling waves. *Technical Report 85, Max Planck Institute for Mathematical Sciences, Leipzig*, 2001.
- [61] A. L. Hodgkin and A. F. Huxley. A quantitative description of membrane current and its application to conduction and excitation in nerve. *Journal of Physiology*, 117 :500–544, 1952.
- [62] A. Hoffman, H. K. Hupkes, and E. Van Vleck. Entire solutions for bistable lattice differential equations with obstacles. 2013.

- 
- [63] Y. Jin and M. A. Lewis. Seasonal influences on population spread and persistence in streams : critical domain size. *SIAM J. Appl. Math.*, 71(4) :1241–1262, 2011.
- [64] Y. Jin and M. A. Lewis. Seasonal influences on population spread and persistence in streams : spreading speeds. *J. Math. Biol.*, 65(3) :403–439, 2012.
- [65] R. W. Joyner. Mechanisms of unidirectional blocks in cardiac tissues. *Biophys. J.*, 35 :113–125, 1981.
- [66] Ja. I. Kanel'. Stabilization of solutions of the Cauchy problem for equations encountered in combustion theory. *Mat. Sb. (N.S.)*, 59 (101)(suppl.) :245–288, 1962.
- [67] Ja. I. Kanel'. Stabilization of the solutions of the equations of combustion theory with finite initial functions. *Mat. Sb. (N.S.)*, 65 (107) :398–413, 1964.
- [68] R. V. Kohn and P. Sternberg. Local minimisers and singular perturbations. *Proc. Roy. Soc. Edinburgh Sect. A*, 111(1-2) :69–84, 1989.
- [69] A.N. Kolmogorov, I.G. Petrovsky, and N.S. Piskunov. Etude de l'équation de la diffusion avec croissance de la quantité de la matière et son application à un problème biologique. *Bull. Univ. Etat Mosc. S'Or. Int. A*, 1 :1–26, 1937.
- [70] M. Kot, M. Lewis, and P. Van Den Driessche. Dispersal data and the spread of invading organisms. *Ecology*, 77 :2027–2042, 1996.
- [71] A. A. P. Leao. Pial circulation and spreading depression of activity in the cerebral cortex. *Journal of Neurophysiology*, 7(6) :391–396, 1944.
- [72] C. D. Levermore and J. X. Xin. Multidimensional stability of traveling waves in a bistable reaction-diffusion equation. II. *Comm. Partial Differential Equations*, 17(11-12) :1901–1924, 1992.
- [73] T. J. Lewis and J. P. Keener. Wave-block in excitable media due to regions of depressed excitability. *SIAM J. Appl. Math.*, 61(1) :293–316, 2000.
- [74] B. Lou, H. Matano, and K.-I. Nakamura. Recurrent traveling waves in a two-dimensional saw-toothed cylinder and their average speed. *J. Differential Equations*, 255(10) :3357–3411, 2013.
- [75] M. Lucia, C. B. Muratov, and M. Novaga. Existence of traveling waves of invasion for Ginzburg-Landau-type problems in infinite cylinders. *Arch. Ration. Mech. Anal.*, 188(3) :475–508, 2008.
- [76] H. Matano. Convergence of solutions of one-dimensional semilinear parabolic equations. *J. Math. Kyoto Univ.*, 18(2) :221–227, 1978.
- [77] H. Matano. Asymptotic behavior and stability of solutions of semilinear diffusion equations. *Publ. Res. Inst. Math. Sci.*, 15(2) :401–454, 1979.
- [78] H. Matano. Traveling waves in spatially random media. *Surikaisekikenkyusho Kokyuroku*, 1337 :1–9, 2003.



- 
- [79] H. Matano, K.-I. Nakamura, and B. Lou. Periodic traveling waves in a two-dimensional cylinder with saw-toothed boundary and their homogenization limit. *Netw. Heterog. Media*, 1(4) :537–568, 2006.
- [80] H. Matano and M. Nara. Large time behavior of disturbed planar fronts in the Allen-Cahn equation. *J. Differential Equations*, 251(12) :3522–3557, 2011.
- [81] H. Matano, M. Nara, and M. Taniguchi. Stability of planar waves in the Allen-Cahn equation. *Comm. Partial Differential Equations*, 34(7-9) :976–1002, 2009.
- [82] A. Mayevsky, A. Doron, T. Manor, S. Meilin, N. Zarchin, and G. E. Ouaknine. Cortical spreading depression recorded from the human brain using a multiparametric monitoring system. *Brain Res.*, 740(1-2) :268–274, 1996.
- [83] R.S. McLachlan and J.P. Girvin. Spreading depression of leao in rodent and human cortex. *Brain Res.*, 666(1) :133–136, 1994.
- [84] J. Medlock and M. Kot. Spreading disease : integro-differential equations old and new. *Math. Biosci.*, 184(2) :201–222, 2003.
- [85] A. Mellet, J. Nolen, J.-M. Roquejoffre, and L. Ryzhik. Stability of generalized transition fronts. *Comm. Partial Differential Equations*, 34(4-6) :521–552, 2009.
- [86] A. Mellet and Y. Roquejoffre, J.-M. and Sire. Generalized fronts for one-dimensional reaction-diffusion equations. *Discrete Contin. Dyn. Syst.*, 26(1) :303–312, 2010.
- [87] G. Mies, T. Iilima, and K.A. Hossman. Correlation between peri-infarct dc shifts and ischemic neuronal damage in rat. *Neuroreport*, 4(6) :709–711, 1993.
- [88] R. N. Miller. A simple model of delay, block and one way conduction in Purkinje fibers. *J. Math. Biol.*, 7(4) :385–398, 1979.
- [89] J. D. Murray. *Mathematical biology. I*, volume 17 of *Interdisciplinary Applied Mathematics*. Springer-Verlag, New York, third edition, 2002. An introduction.
- [90] J. D. Murray. *Mathematical biology. II*, volume 18 of *Interdisciplinary Applied Mathematics*. Springer-Verlag, New York, third edition, 2003. Spatial models and biomedical applications.
- [91] G. Nadin. Critical travelling waves for general heterogeneous one dimensional reaction-diffusion equations. *Preprint*, 2014.
- [92] G. Nadin and L. Rossi. Propagation phenomena for time heterogeneous KPP reaction-diffusion equations. *J. Math. Pures Appl. (9)*, 98(6) :633–653, 2012.
- [93] M. Nedergaard, A. J. Cooper, and S. A. Goldman. Gap junctions are required for the propagation of spreading depression. *J. Neurobiol.*, 28(4) :433–444, 1995.
- [94] H. Ninomiya and M. Taniguchi. Existence and global stability of traveling curved fronts in the Allen-Cahn equations. *J. Differential Equations*, 213(1) :204–233, 2005.
- [95] H. Ninomiya and M. Taniguchi. Global stability of traveling curved fronts in the Allen-Cahn equations. *Discrete Contin. Dyn. Syst.*, 15(3) :819–832, 2006.

- 
- [96] J. Nolen, J.-M. Roquejoffre, L. Ryzhik, and A. Zlatoš. Existence and non-existence of Fisher-KPP transition fronts. *Arch. Ration. Mech. Anal.*, 203(1) :217–246, 2012.
- [97] J. Nolen and L. Ryzhik. Traveling waves in a one-dimensional heterogeneous medium. *Ann. Inst. H. Poincaré Anal. Non Linéaire*, 26(3) :1021–1047, 2009.
- [98] C. Poggi, A. Moussa, F. Hubert, and G. Chapuisat. Numerical study of the stopping of aura during migraine. In *CEMRACS 2009 : Mathematical modelling in medicine*, volume 30 of *ESAIM Proc.*, pages 44–52. EDP Sci., Les Ulis, 2010.
- [99] A. B. Potapov and M. A. Lewis. Climate and competition : the effect of moving range boundaries on habitat invasibility. *Bull. Math. Biol.*, 66(5) :975–1008, 2004.
- [100] C. Reid. The origin of the british flora. *Dulau and Co*, 1899.
- [101] E. Risler. Global convergence toward traveling fronts in nonlinear parabolic systems with a gradient structure. *Ann. I. H. Poincaré*, 25 :381–424, 2008.
- [102] L. Roques, J. Garnier, F. Hamel, and E. K. Klein. Allee effect promotes diversity in traveling waves of colonization. *Proc. Natl. Acad. Sci. USA*, 109(23) :8828–8833, 2012.
- [103] L. Roques, F. Hamel, J. Fayard, B. Fady, and E. K. Klein. Recolonisation by diffusion can generate increasing rate of speed. *Theor. Popul. Biol.*, 77 :205–212, 2010.
- [104] L. Roques, A. Roques, H. Berestycki, and A. Kretzschmar. A population facing climate change : joint influences of allee effects and environmental boundary geometry. *Population Ecology*, 50 :215–225, 2008. 10.1007/s10144-007-0073-1.
- [105] W. Shen. Traveling waves in diffusive random media. *J. Dynam. Differential Equations*, 16(4) :1011–1060, 2004.
- [106] W. Shen. Traveling waves in time dependent bistable equations. *Differential Integral Equations*, 19(3) :241–278, 2006.
- [107] W. Shen. Existence, uniqueness, and stability of generalized traveling waves in time dependent monostable equations. *J. Dynam. Differential Equations*, 23(1) :1–44, 2011.
- [108] J. G. Skellam. Random dispersal in theoretical populations. *Biometrika*, 38(1/2) :196–218, 1951.
- [109] G. Somjen. *Ions in the Brain : Normal Function, Seizures, and Stroke*. Oxford University Press : New York. 2004.
- [110] A. N. Stokes. On two types of moving front in quasilinear diffusion. *Math. Biosci.*, 31(3-4) :307–315, 1976.
- [111] A. J. Strong, M. Fabricius, M. G. Boutelle, T. J. Hibbins, S. E. Hopwood, R. Jones, M. C. Parkin, and M. Lauritzen. Spreading and synchronous depressions of cortical activity in acutely injured human brain. *Stroke*, 33(12) :2738–2743, 2002.
- [112] T. Tao, B. Zhu, and A. Zlatoš. Transition fronts for inhomogeneous monostable reaction-diffusion equations via linearization at zero. 2013.

- 
- [113] H. R. Thieme. Density-dependent regulation of spatially distributed populations and their asymptotic speed of spread. *J. Math. Biol.*, 8(2) :173–187, 1979.
- [114] H. C. Tuckwell. Mathematical modeling of spreading cortical depression : spiral and reverberating waves. In *Collective dynamics : topics on competition and cooperation in the biosciences*, volume 1028 of *AIP Conf. Proc.*, pages 46–64. Amer. Inst. Phys., Melville, NY, 2008.
- [115] A. M. Turing. The chemical basis of morphogenesis. *Philosophical Transactions of the Royal Society of London. Series B, Biological Sciences*, 237(641) :37–72, 1952.
- [116] K. Uchiyama. The behavior of solutions of some nonlinear diffusion equations for large time. *J. Math. Kyoto Univ.*, 18(3) :453–508, 1978.
- [117] S. Vakulenko and V. Volpert. Generalized travelling waves for perturbed monotone reaction-diffusion systems. *Nonlinear Anal.*, 46(6, Ser. A : Theory Methods) :757–776, 2001.
- [118] H. H. Vo. Traveling fronts for equations with forced speed in mixed environments. *in preparation*, 2014.
- [119] M. Šramka, G. Brozek, J. Buresš, and P. Nádvorník. Functional ablation by spreading depression : possible use in human stereotactic surgery. *Appl. Neurophysiol.*, 40 :48–61, 1977.
- [120] H. F. Weinberger. Long-time behavior of a class of biological models. *SIAM J. Math. Anal.*, 13(3) :353–396, 1982.
- [121] H. Yagisita. Existence and nonexistence of traveling waves for a nonlocal monostable equation. *Publ. Res. Inst. Math. Sci.*, 45(4) :925–953, 2009.
- [122] T.I. Zelenyak. Stabilization of solutions of boundary value problems for a second order parabolic equation with one space variable. *Differentsial'nye Uravneniya*, 4(1) :34–45, 1968.
- [123] Y. Zhou and M. Kot. Discrete-time growth-dispersal models with shifting species ranges. *Theor Ecol*, 4 :13–25, 2011.
- [124] A. Zlatoš. Sharp transition between extinction and propagation of reaction. *J. Amer. Math. Soc.*, 19(1) :251–263 (electronic), 2006.
- [125] A. Zlatoš. Transition fronts in inhomogeneous Fisher-KPP reaction-diffusion equations. *J. Math. Pures Appl. (9)*, 98(1) :89–102, 2012.
- [126] A. Zlatoš. Generalized traveling waves in disordered media : existence, uniqueness, and stability. *Arch. Ration. Mech. Anal.*, 208(2) :447–480, 2013.

## Résumé

Dans cette thèse nous nous intéressons aux équations de réaction-diffusion et à leurs applications en sciences biologiques et médicales. Plus particulièrement on étudie l'existence ou la non-existence de phénomènes de propagation en milieux hétérogènes à travers l'existence d'ondes progressives ou plus généralement l'existence de fronts de transition généralisés. On obtient des résultats d'existence de phénomènes de propagation dans trois environnements différents. Dans un premier temps on étudie une équation de réaction-diffusion de type bistable dans un domaine extérieur. Cette équation modélise l'évolution de la densité d'une population soumise à un effet Allee fort dont le déplacement suit un processus de diffusion dans un environnement contenant un obstacle. On montre que lorsque l'obstacle satisfait certaines conditions de régularité et se rapproche d'un domaine étoilé ou directionnellement convexe alors la population envahit tout l'espace. On se questionne aussi sur les conditions optimales de régularité qui garantissent une invasion complète de la population. Dans un deuxième travail, nous considérons une équation de réaction-diffusion avec vitesse forcée, modélisant l'évolution de la densité d'une population quelconque qui se diffuse dans l'espace, soumise à un changement climatique défavorable. On montre que selon la vitesse du changement climatique la population s'adapte ou s'éteint. On montre aussi que la densité de population converge en temps long vers une onde progressive et donc se propage (si elle survit) selon un profil constant et à vitesse constante. Dans un second temps on étudie une équation de réaction-diffusion de type bistable dans des domaines cylindriques variés. Ces équations modélisent l'évolution d'une onde de dépolarisation dans le cerveau humain. On montre que l'onde est bloquée lorsque le domaine passe d'un cylindre très étroit à un cylindre de diamètre d'ordre 1 et on donne des conditions géométriques plus générales qui garantissent une propagation complète de l'onde dans le domaine. On étudie aussi ce problème d'un point de vue numérique et on montre que pour les cylindres courbés la courbure peut provoquer un blocage de l'onde pour certaines conditions aux bords.

## Abstract

In this thesis we are interested in reaction diffusion equations and their applications in biology and medical sciences. In particular we study the existence or non-existence of propagation phenomena in non homogeneous media through the existence of traveling waves or more generally the existence of transition fronts. First we study a bistable reaction diffusion equation in exterior domain modelling the evolution of the density of a population facing an obstacle. We prove that when the obstacle satisfies some regularity properties and is close to a star shaped or directionally convex domain then the population invades the entire domain. We also investigate the optimal regularity conditions that allow a complete invasion of the population. In a second work, we look at a reaction diffusion equation with forced speed, modelling the evolution of the density of a population facing an unfavourable climate change. We prove that depending on the speed of the climate change the population keeps track with the climate change or goes extinct. We also prove that the population, when it survives, propagates with a constant profile at a constant speed at large time. Lastly we consider a bistable reaction diffusion equation in various cylindrical domains, modelling the evolution of a depolarisation wave in the brain. We prove that this wave is blocked when the domain goes from a thin channel to a cylinder, whose diameter is of order 1 and we give general conditions on the geometry of the domain that allow propagation. We also study this problem numerically and prove that for curved cylinders the curvature can block the wave for particular boundary conditions.

