



HAL
open science

Characterization of protein factors targeting RNA into human mitochondria

Ali Gowher

► **To cite this version:**

Ali Gowher. Characterization of protein factors targeting RNA into human mitochondria. Genomics [q-bio.GN]. Université de Strasbourg, 2013. English. NNT : 2013STRAJ059 . tel-01071841

HAL Id: tel-01071841

<https://theses.hal.science/tel-01071841>

Submitted on 6 Oct 2014

HAL is a multi-disciplinary open access archive for the deposit and dissemination of scientific research documents, whether they are published or not. The documents may come from teaching and research institutions in France or abroad, or from public or private research centers.

L'archive ouverte pluridisciplinaire **HAL**, est destinée au dépôt et à la diffusion de documents scientifiques de niveau recherche, publiés ou non, émanant des établissements d'enseignement et de recherche français ou étrangers, des laboratoires publics ou privés.

Université de Strasbourg

2013

Ecole doctorale des Sciences de la Vie et de la Santé

THÈSE

présentée pour l'obtention du grade de

DOCTEUR DE L'UNIVERSITE DE STRASBOURG

Discipline : Sciences du Vivant

Domaine : Aspects moléculaires et cellulaires de la biologie

par

GOWHER Ali

**Characterization of protein factors targeting RNA into human
mitochondria**

Soutenue le 17 September 2013 devant le jury de thèse composé comme suit:

Professor Andre Schneider

Rapporteur externe

Dr Anne Lombès

Rapporteur externe

Dr Phillippe Giege

Examineur interne

Dr Ivan Tarasov

Directeur de thèse

UMR N°7156 UdS-CNRS

«Génétique Moléculaire, Génomique et Microbiologie»

TABLE OF CONTENTS

TABLE OF CONTENTS

LIST OF FIGURES

ACKNOWLEDGEMENTS

ABBREVIATIONS

1. Introduction	1
1.1. Origin and structure of mitochondria.....	1
1.2. Function of mitochondria.....	3
1.3. Human mitochondrial genome.....	5
1.3.1. Structure and composition	5
1.3.2. Nucleoid organization.....	7
1.4. Human mtDNA replication.....	8
1.4.1. Proteins participating in mtDNA replication	8
1.4.2. Mechanism of mtDNA replication.....	10
1.4.3. Initiation of Heavy strand replication	12
1.4.4. Initiation of light strand replication	13
1.5. Human mtDNA transcription.....	14
1.5.1. Transcription machinery	14
1.5.2. Transcription of mitochondrial DNA.....	15
1.5.3. Termination of transcription	16
1.5.4. Processing of RNA transcript	17
1.6. Translation of mitochondrial DNA.....	17
1.6.1. Translation machinery	18
1.6.2. Mitochondrial translation process.....	19
1.7. Macromolecular import into mitochondria.....	20
1.7.1. Mitochondrial protein import.....	20
1.7.2. Mitochondrial targeting and sorting signals	20
1.7.3. Mitochondrial protein import machinery.....	22
1.7.3.1. The TOM complex.....	22

1.7.3.2. The TIM23 complex	23
1.7.3.3. SAM complex	25
1.7.3.4. The MIA pathway	26
1.7.3.5. TIM22 complex	27
1.8. Nucleic acid import.....	29
1.8.1. DNA import into mitochondria.....	29
1.8.2. RNA import into mitochondria.....	29
1.8.2.1. RNA import into protozoans mitochondria	30
1.8.2.2. RNA import into Plant mitochondria.....	33
1.8.2.3. RNA import in Yeast mitochondria.....	35
1.8.2.4. RNA import in mammals.....	39
2. Results	49
2.1. Induced tRNA Import into Human Mitochondria: Implication of a Host	
Aminoacyl-tRNA-Synthetase.....	49
2.1.1. Summary	49
2.1.2. Publication 1	52
2.2. Human enolases facilitate tRK1-preKARS2 complex formation.....	53
2.3. Mutation in PNPT1, which Encodes a Polyribonucleotide Nucleotidyltransferase, impairs RNA import into mitochondria and causes respiratory chain deficiency..56	
2.3.1. Summary	56
2.3.2. Publication 2	58
2.4. PNPase overexpression increased RNA import into mitochondria.....	59
2.5. PNPase down-regulation decreased RNA import into mitochondria.....	61
2.6. Identification of proteins interacting with PNPase.....	62
3. Discussion	59
3.1. preKARS2 interacts with yeast tRK1 and its derivatives.....	59
3.2. Human enolases facilitate tRK1-preKARS2 complex formation.....	60
3.3. preKARS2 as a tRK1 carrier into human mitochondria.....	61
3.4. Mitochondrial import of small truncated RNAs.....	62
3.5. PNPase translocate RNA into the mitochondrial matrix	63
3.6. PNPase mutation affect mitochondrial translation	64

3.7. Divergent mechanisms for convergent goal	65
4. Conclusions and perspectives	73
5. Materials and Methods	76
5.1. Materials	76
5.1.1. Bacterial strains.....	76
5.1.2. Human cell lines	76
5.1.3. Plasmids and oligonucleotides.....	77
5.2. Methods	78
5.2.1. Electroporation of E. coli.....	78
5.2.2. Plasmid DNA preparation.....	78
5.2.3. Recombinant protein purification	78
5.2.4. Polymerase chain reaction (PCR)	79
5.2.5. RNA synthesis	80
5.2.6. Radioactive labeling and aminoacylation	80
5.2.7. Radioactive labeling of oligonucleotides probes	81
5.2.8. Electrophoretic mobility shift assay (EMSA).....	81
5.2.9. Cell culture.....	82
5.2.10. Transfection of human cell lines.....	83
5.2.10.1. Transfection with T7 transcript.....	83
5.2.10.2. Transient transfection with plasmid.....	84
5.2.10.3. Transient protein downregulation.....	84
5.2.11. Purification of mitochondria.....	85
5.2.12. In vitro import assay	86
5.2.13. Northern hybridization.....	86
5.2.14. Immunoblotting.....	87
5.2.15. Mitochondrial translation analysis in vivo.....	88
5.2.16. North-western blot	88
5.2.17. Cross linking immuno precipitation (CLIP)	89
5.2.18. Mass Spectromery Analysis.....	89
BIBLIOGRAPHY.....	91
RÉSUMÉ DU THÈSE.....	118

LIST OF FIGURES

Figure 1: Mitochondrion	2
Figure 2: Schematic of the mitochondrial electron transport chain	4
Figure 3: The human mitochondrial genome	6
Figure 4: Mitochondrial DNA replication machinery	8
Figure 5: Models of mitochondrial DNA replication.	11
Figure 6: Schematic representation of the D-loop regulatory region.	13
Figure 7: Targeting and Sorting Signals of mitochondrial precursor proteins.	21
Figure 8: The presequence pathway of protein import into mitochondria.....	23
Figure 9: Sorting and assembly machinery (SAM) of outer mitochondrial membrane	26
Figure 10: The machinery for import and assembly (MIA) of preprotein into mitochondrial intermembrane space	27
Figure 11: The carrier pathway of preprotein import into mitochondria.....	28
Figure 12: Overview of mitochondrial tRNA-import channels.....	34
Figure 13: Lysine tRNAs in <i>S. cerevisiae</i>	36
Figure 14: Mitochondrial tRNA import in <i>S. cerevisiae</i>	37
Figure 15: Structure of Human 5S rRNA..	42
Figure 16: Hypothetical mechanism of 5S rRNA intracellular traffic.....	44
Figure 17: Predicted structures of the yeast tRNA ^{Lys} (^{CUU}) and small synthetic RNAs	46
Figure 18: Protein purification and electrophoretic mobility shift assay.....	53
Figure 19: Interaction between labeled tRK1 and preKARS2 in the absence or presence of human enolases.	55
Figure 20: Implication of PNPase in mitochondrial RNA import <i>in vivo</i>	60
Figure 21: Implication of PNPase in mitochondrial RNA import <i>in vivo</i>	62

ACKNOWLEDGEMENTS

First of all, with utmost pleasure, I express my heartfelt and profound gratitude to **Dr. Ivan Tarassov**, my PhD supervisor, whose guidance, unflinching support and valuable feedback made this work possible. Thank you Ivan, for giving me the opportunity to join your lab, for introducing me to the field of mitochondrial research, for administrative and financial support during my 4th year of PhD, for your kind scientific assistance and for the great moments I passed in your garden parties.

I am highly indebted to **Dr. Nina Entelis**, my additional supervisor, for her excellent continuous support and guidance throughout my PhD. I am thankful to you Nina, for your kind advices and assistance, for your personal scientific interests in my work, and for your help in interpreting my experimental results on daily basis.

I am extremely grateful to **Prof. André Schneider, Dr. Anne Lombès, and Dr. Phillipe Giegé**, for accepting to be the members of my thesis jury, for their precious time and efforts to evaluate my thesis.

I am also thankful to **Dr. Mikhail Vysokikh**, a former postdoctoral fellow, who was my scientific guru during the last three years of my PhD. Mike you really were an invaluable help, and I want to thank you for all the scientific knowledge you taught me, for your brilliant assistance in every situation and for our close and fruitful cooperation. I wish you all the best for your bright future in Moscow.

I would like to extend my gratitude to all other members of our “Mito” group, past and present, especially Dr Alexandre Smirnov “Sacha”, Anne-Marie Heckel, Yann Tonin, Dr Tom Schirtz, Dr Caroline Comte, and Ilya for creating a scientifically motivating environment, for all their help, support, suggestions and friendship.

I also want to thank all our members of the UMR7156 for the great and very stimulating working atmosphere and for their kind help and discussions. I felt very happy among you during the past four years and I really enjoyed all our nice parties.

I am grateful to Higher Education Commission (HEC) of Pakistan, SFERE (Société française d'exportation des ressources éducatives), and Ivan Tarassov lab, for financing my study in France.

Finally, I am thankful to all my family members who have stood alongside me all these years. Words are meaningless to what they have given me. It is, I believe their prayers and spiritual support, which were a constant source of strength and inspiration to me that despite, many constraints, I was able to complete my work.

Gowher Ali

ABBREVIATIONS

ADP	adenosine diphosphate
ANT	adenine nucleotide transporter
ATAD3	ATPase family AAA domain-containing protein 3
ATP	adenosine triphosphate
BB	breakage buffer
BSA	bovine serum albumin
CLIP	crosslinking combined to immunoprecipitation
CSB	conserved sequence block
DEPC	diethylpyrocarbonate
DMEM	dulbecco modified Eagle's medium
DNA	deoxyribonucleic acid
Drp1	dynamain related protein 1
DTT	dithiothreitol
<i>E.coli</i>	<i>Escherichia coli</i>
EDTA	ethylenediaminetetraacetic acid
EMSA	electrophoretic mobility shift assay
Eno-2	enolase-2
FADH2	flavin adenine dinucleotide hydroquinone form
FRET	förster resonance energy transfer
HEPES	4-(2-hydroxyethyl)-1-piperazineethanesulfonic acid
HMG	high mobility group
HSP	heavy strand promoter
Hsp	heat-shock protein

ABBREVIATIONS

IFs	initiation factors
IMS	intermembrane space
IPTG	isopropyl β -D-1-thiogalactopyranoside
KDa	kilo Dalton
LB	lysogeny broth
LSP	light strand promoter
LSU	large subunit
Mfn	mitofusin
mtDNA	mitochondrial DNA
mtEFTu	mitochondrial elongation factor Tu
mtEFTs	mitochondrial elongation factor Ts
mtEFG	mitochondrial elongation factor G
mtRF	mitochondrial release factor
mtRPOL	mitochondrial RNA polymerase
mtSSB	mitochondrial single stranded DNA binding protein
MIA	mitochondrial intermembrane space import and assembly
MISS	mitochondrial intermembrane space signal
MMP	mitochondrial processing peptidase
MRPs	mitochondrial ribosomal proteins
MTS	mitochondrial targeting sequence
mRNA	messenger RNA
NADH	nicotinamide adenine dinucleotide reduced
OD	optical density

OPA1	optic atrophy 1
PAM	presequence translocase associated motor
PBS	phosphate buffered saline
PNPase	polynucleotide phosphorylase
POLG	mitochondrial DNA polymerase γ
PPR	pentatricopeptide repeat
RIC	RNA import complex
RITOLS	RNA incorporation throughout lagging strand
ROS	reactive oxygen species
rRNA	ribosomal RNA
PAGE	polyacrylamide gel electrophoresis
PCR	polymerase chain reaction
preMSK	precursor of <i>Saccharomyces cerevisiae</i> mitochondrial lysyltRNA-synthetase
preKARS2	precursor form of human mitochondrial lysyltRNA-synthetase
SAM	sorting and assembly machinery
<i>S.cerevisiae</i>	<i>Saccharomyces cerevisiae</i>
SDS	sodium dodecylsulfate
SELEX	systematic Evolution of Ligands by Exponential Enrichment
siRNA	small interfering RNA
SSC	saline sodium citrate buffer
ssDNA	single stranded DNA
TAB	tubulin antisense binding protein
TAS	termination associated sequence

ABBREVIATIONS

TBE	tris-borate-EDTA buffer
TCA	trichloro acetic acid
TFAM	mitochondrial transcription factor A
TIM	translocase of the inner membrane
TOM	translocase of the outer membrane
tRNA	transfer RNA
UV	ultra violet
VDAC	voltage Dependent Anion Channel
$\Delta\Psi$	electrochemical membrane potential

INTRODUCTION

1. Introduction

Mitochondria are intracellular organelle found in almost all eukaryotic cells. They have for long been known as the powerhouse of aerobic cells, providing energy in the form of ATP for the diverse uses of the cell *via* oxidative phosphorylation. The number of mitochondria per cell can vary from a few to ten thousand depending on the cell type. They contain the proteins needed for cellular respiration, the enzymes of citric acid cycle, the enzymes involved in fatty acid and amino acid oxidation and their own genetic system (mitochondrial DNA, enzymes for its replication, transcription and translation). In human, mitochondria contain a circular DNA of approximately 16 kb coding for 13 protein of respiratory chain as well as tRNA and rRNA needed for mitochondrial protein synthesis.

1.1. Origin and structure of mitochondria

Mitochondria has many features in common with bacteria, consolidating the hypothesis of mitochondria as endosymbionts of a primitive eukaryote (Margulis and Bermudes, 1985). The endosymbiotic theory postulates that mitochondria are derived from an ancient α -proteobacterium that was engulfed by an anaerobic protoeukaryotic cell. This event granted the host cell the advantage of aerobic respiration (Gray et al., 1999). The discovery of a separate genome in mitochondria (Nass and Nass, 1963) further strengthens the endosymbiotic origin of mitochondria. However, during the course of evolution, the loss of redundant genes and the transfer of genes from the endosymbiote to the host lead to the currently observed distribution of genes between the mitochondrial and nuclear genome (Gray et al., 1999).

The word mitochondria is derived from Greek word (mitos) meaning thread and (chondros) meaning granule thus describing the shape of these organelle when viewed under microscope. The diameter of mitochondria range from 0.5 to 1 μ m and is composed of four compartments carrying out specialized functions (**Fig. 1**). Early electron microscopy studies showed that the internal compartment of mitochondria called the mitochondrial matrix is surrounded by the outer and inner mitochondrial membranes (Palade, 1952; Sjostrand, 1953). The two membranes are separated by the intermembrane space. The outer membrane encloses the entire organelle and consist of a bilayer containing about 80% lipids. It contains numerous

transmembrane proteins, the most abundant being called porin or VDAC (voltage-dependent anion channel), which renders the membrane permeable to ions and smaller molecules while molecules larger than 5 KDa need to be actively transported across it (De Pinto and Palmieri, 1992; Mannella et al., 1992). The inner membrane has an inward folds called cristae resulting in a large surface area. Compared to outer membranes, the inner membrane has high protein to lipid ratio partly due to the presence of the respiratory chain complexes as well as a large number of proteins that transport peptides, metabolites or ions across this barrier. The inner membrane is impermeable to ions and macromolecules and specific protein channel control import of metabolites across it. Due to electron transport chain, a membrane potential $\Delta\psi$ is built up across the inner membrane which is required for the synthesis of adenosine triphosphate (ATP) and for the transport of various molecules across the membrane. The inner membrane surrounds the mitochondrial matrix which contain enzymes of citric acid cycle, β -oxidation of fatty acids and those of amino acid oxidation. The matrix also contains many copies of mitochondrial DNA (mtDNA) and all factors required for the replication, transcription and translation of mitochondrial genome.

A

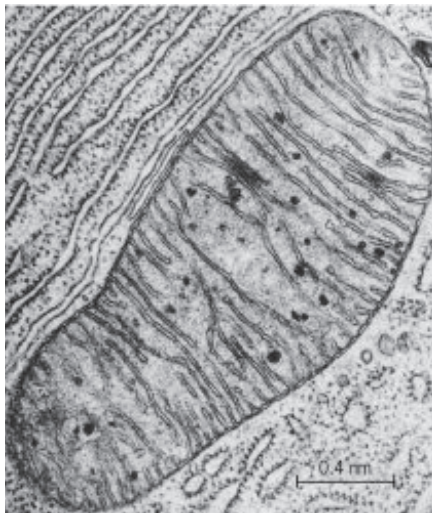

B

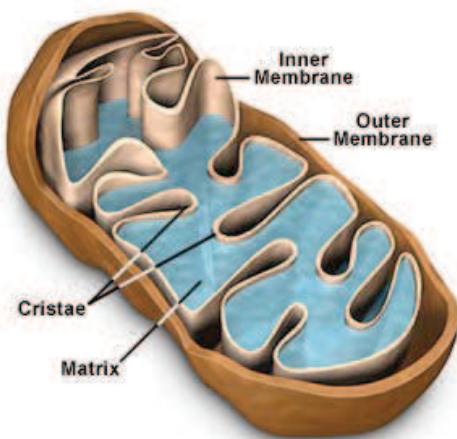

Figure 1: Mitochondrion

- (A). A transmission electromicrograph of mitochondrion (Courtesy of R. K. Porter)
(B). Schematic representation of structure of mitochondria.

Mitochondria are highly dynamic organelles that continuously undergo fusion and fission events (Chen and Chan, 2004). Depending on the needs of cell, mitochondria can form long chains or filaments and can undergo rapid rearrangement. Many of the key proteins involved in fusion and fission of mitochondria have been studied in mammals. The fusion of outer membranes requires large GTPase mitofusins (Mfn1 and Mfn2), while the fusion of inner membranes depend on optic atrophy 1(OPA1), a dynamin-like GTPase protein. The fission depends on the recruitment of Dynamin related protein (Drp1) from the cytosol to outer membrane, forming multimeric complexes that drive fission. Recent findings have shown that a precise balance between fusion and fission regulates the function and different mitochondrial morphologies under different physiological conditions or cell specific type. Enhanced fusion produces elongated interconnected mitochondria allowing the distribution of mtDNA, proteins and metabolites throughout mitochondrial network, resulting in homogenous population of mitochondria within a cell. Disruption of fusion process results in respiratory defects and loss of membrane potential (Chen and Chan, 2005). Fission allows mitochondrial proliferation during cell division and distributes mitochondria to parts of the cell with high energy demand.

1.2. Function of mitochondria

Mitochondria are often referred to as powerhouse of the cell and produce most of the cellular energy in the form of ATP through the process of oxidative phosphorylation. In this process, electrons from NADH and FADH₂ move through four large protein complexes (complex I-IV) of the respiratory chain embedded in the inner mitochondrial membrane (**Fig. 2**). Electron from NADH enters to the respiratory chain at Complex I (NADH dehydrogenase) and from FADH₂ at Complex II (succinate dehydrogenase) and are then transferred to ubiquinone (coenzyme Q). Complex III (cytochrome c oxidoreductase) then reduces ubiquinone, donating electrons to cytochrome c, a soluble heme protein of the inter membrane space. Finally, Complex IV (cytochrome c oxidase) oxidizes cytochrome c and transfers electrons to molecular oxygen (O₂) as final acceptor of electron and reduces it to water. The transport of electron release energy, which is used by complex I, III and IV to pump protons (H⁺) from the matrix into the intermembrane space (Mitchell, 1961) resulting in the generation of electrochemical gradient. The return of protons back into the matrix is coupled to the phosphorylation of ADP into ATP

though the function of Complex V, the ATP synthase (Boyer et al., 1973). At certain conditions, protons may leak across the inner membrane resulting in the conversion of energy into heat. This process is called uncoupling and is mediated by a proton channel called thermogenin.

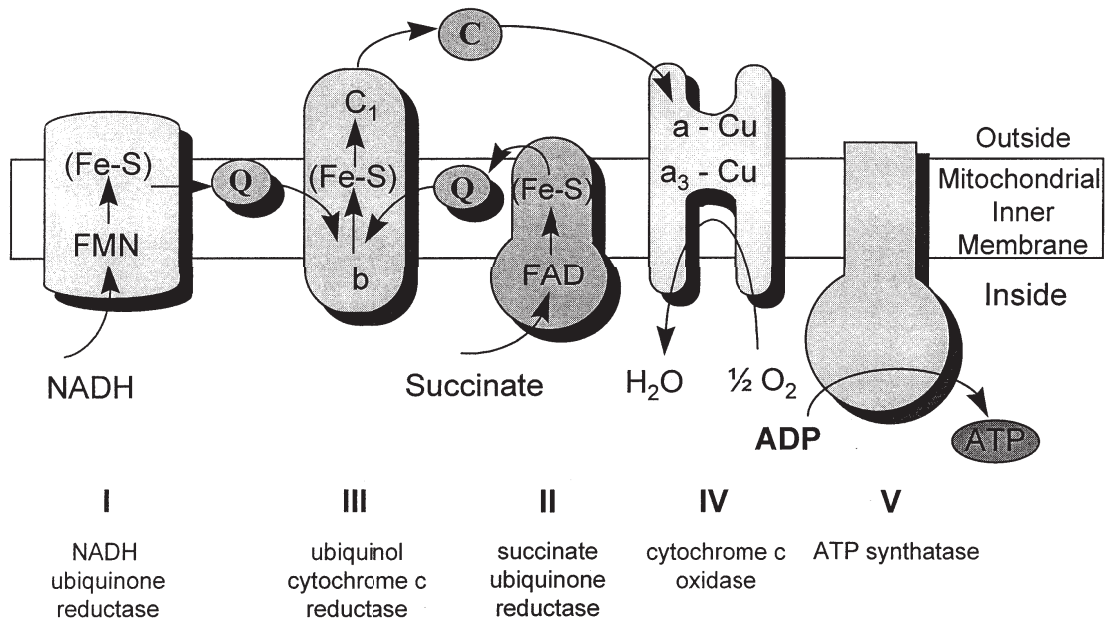

Figure 2: Schematic of the mitochondrial electron transport chain (Heales et al., 1999). The four complexes of the mitochondrial electron transport chain localized in the inner mitochondrial membrane. In addition, ATP synthetase, which is sometimes known as complex V, is shown. Q and C represent the mobile electron carriers, ubiquinone and cytochrome c, respectively.

The respiratory chain has been recognized as one of the major cellular generator of reactive oxygen species (ROS) which include superoxide (O_2^-), hydrogen peroxide (H_2O_2) and hydroxyl free radical (OH^\cdot) (Boveris et al., 1972; Chance et al., 1979). Superoxide is formed when electrons passing through electron transport chain leak out to molecular oxygen. Superoxide is rapidly dismutated by mitochondrial superoxide dismutase (Mn-SOD) to H_2O_2 (Boveris and Cadenas, 1975) which can be further converted to OH^\cdot in the presence of reducing equivalent such as Fe^{2+} . ROS are extremely reactive molecules and are believed to have important role in the process of aging and neurodegenerative diseases such as Parkinson's disease (Betarbet et al., 2000; Wallace, 1999).

In addition to oxidative phosphorylation, mitochondria play a central role in the metabolism of fatty acids, carbohydrates and amino acids. Fatty acids enter the mitochondria as

fatty acyl-CoA are broken down into acetyl-CoA in a process called β -oxidation producing one molecule of acetyl-CoA and reducing equivalents (one copy of each FADH₂ and NADH). The breakdown of amino acids occurs in two parts: the carbon skeleton is broken and enters the citric acid cycle at various stages of the cycle, while the amino group is either recycled or enter the urea cycle when present in excess. The initial steps of the urea cycle occur in the mitochondrial matrix and it is completed in the cytosol. The catabolic pathways of glycolysis, β -oxidation and amino acid oxidation produce acetyl-CoA, which enters the citric acid cycle (TCA cycle) in the mitochondrial matrix and converted into CO₂ under aerobic condition, yielding a molecule of ATP and reducing equivalents in the form of NADH and FADH₂.

Mitochondria have crucial role in iron homeostasis, being the unique site for haeme synthesis and the major site for Fe-S cluster biogenesis. In addition, mitochondria are able to transiently store calcium and thus affect cellular calcium concentration [Reviewd in (Giacomello et al., 2007)]. The mitochondrial uptake of Ca²⁺ modulate the spread and timing of cytosolic calcium signal (Drago et al.; Park et al., 2001). The increased intra mitochondrial Ca²⁺ levels, in turn, can regulate mitochondrial metabolism *via* activation of thee TCA cycle dehydrogenases, leading to increased ATP production (Jouaville et al., 1999).

1.3. Human mitochondrial genome

1.3.1. Structure and composition

Human mitochondrial DNA (mtDNA) was sequenced in 1981 by Anderson *et al.* It is a supercoiled double stranded DNA molecule of 16659 base pairs (**Fig. 3**) that encodes 22 tRNAs, two ribosomal RNAs (12S and 16S rRNA) and 13 proteins, which are essential subunits of complexes I, III, IV and V of the respiratory chain (McFarland et al., 2002). MtDNA is present in multiple copies per cell, with a variation in copy number ranging from 1000-6000 in most cell types to over 100 000 in the oocyte (Shmookler Reis and Goldstein, 1983; Shoubridge, 2000). It corresponds to approximately 0.3% of cellular DNA amount and is considered as semiautonomous, since mitochondrial maintenance and functioning depend on proteins encoded by genes of nuclear DNA. The two strands of mtDNA have different base composition, which results in different buoyant density of each strand in denaturing caesium chloride gradient

(Clayton, 1991; Kasamatsu and Vinograd, 1974). They are denoted as Heavy or H-strand (G-rich) and light or L-strand (C-rich). The genes located on the H-strand codes for two rRNAs (12S and 16S rRNA), 14 tRNAs, and 12 polypeptides while the L-strand codes for eight tRNAs and a single polypeptide corresponding to ND6 subunit (Attardi and Schatz, 1988). The mtDNA has a mutation rate 10-20 times higher than nuclear DNA (Lynch et al., 2006; Richter et al., 1988), which is thought to be caused by the lack of protective histones, limited DNA repair system and proximity to damaging reactive oxygen species (ROS) generated during oxidative phosphorylation.

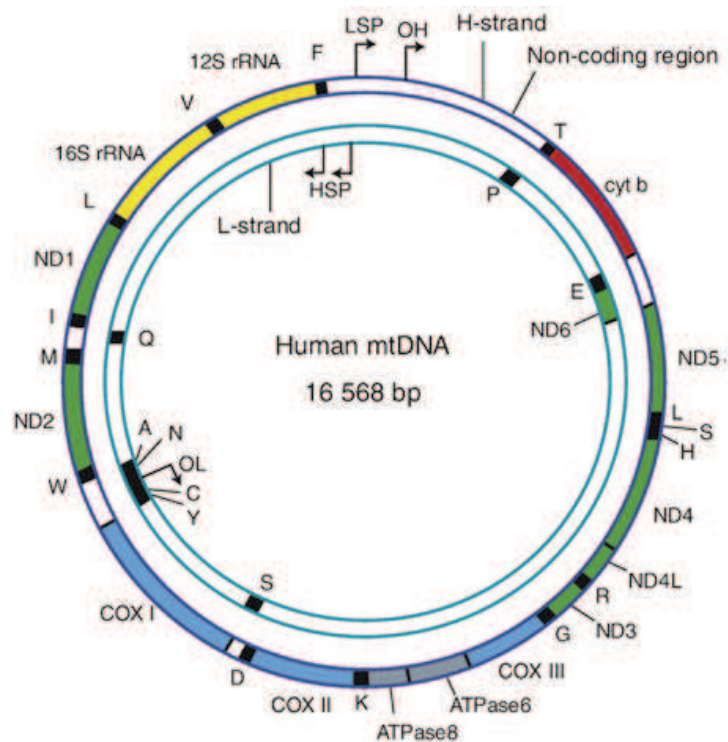

Figure 3: The human mitochondrial genome (Wanrooij and Falkenberg, 2010). Heavy- and (H-strand) light-strand (L-strand) are indicated. Complex I NADH dehydrogenase (ND) genes are shown in green; Complex III cytochrome b (Cytb) gene is shown in red; Complex IV cytochrome c oxidase genes are shown in light blue; Complex V ATP synthase (ATPase) genes are shown in gray. Transfer RNA genes in black and ribosomal RNA genes (rRNA) in yellow.

One of the main characteristics of mtDNA is its highly compact organization as all mRNA are immediately flanked by tRNA genes and lack introns (Anderson et al., 1981; Montoya et al., 1981). Some of the protein coding genes are overlapping, the 3'-CCA end of tRNA and, in many cases, part of the termination codons in messenger RNA (mRNA) are not

encoded in the mtDNA but are generated post-transcriptionally (Ojala et al., 1981). There are two non-coding regions that perform most of the regulatory functions. The major regulatory region contain a 1.1kb non-coding sequence, called the Displacement or D-loop, which is a triple stranded structure that arise when a nascent H-strand DNA segment of approximately 500-700 nucleotides displaces the parental H-strand during replication (Arnberg et al., 1971). It contains the origin of replication for the H-strand (O^H) and the promoter for the heavy and light strands transcription (HSP and LSP respectively). The sequence of D-loop is variable between species, but contains some conserved sequences which are believed to be involved in mtDNA replication. The second non-coding region is an approximately 30 nucleotides long segment which contain the origin of replication for the L-strand and is located inside the cluster of tRNA at about two-third of the mtDNA length from the O^H .

1.3.2. Nucleoid organization

The human mtDNA is organized in complexes with proteins called nucleoids (Garrido et al., 2003; Spelbrink et al., 2001). Analysis of mtDNA content of nucleoid suggests that an average nucleoid may contain 5-7 copies of mtDNA genome with diameter of approximately 70nm (Iborra et al., 2004). The packaging of mtDNA is achieved with the aid of DNA binding protein and more than 30 proteins have been identified that co-localize with mitochondrial nucleoids. The most abundant and undisputed proteins identified so far are mitochondrial transcription factor A (TFAM) and mitochondrial single stranded DNA binding protein (mtSSB) (Alam et al., 2003; Bogenhagen et al., 2008). TFAM is known to bind mtDNA as homodimer about every 30-40bp (Farge et al.; Kaufman et al., 2007; Kukat et al.) and is capable of compacting and coordinating the packaging of several mtDNA molecules into a single nucleoid-like structures *in vitro* (Kaufman et al., 2007). MtSSB is a single stranded DNA binding protein that is associated with mitochondrial DNA in all eukaryotes (Tiranti et al., 1991). In addition to mtSSB, other proteins of mtDNA replication machinery like the twinkle helicase (Garrido et al., 2003) and mtDNA polymerase γ (POLG) have been shown to reside in mitochondrial nucleoids. Recently, ATAD3 an AAA domain containing protein, has also been showed to be part of the nucleoid. One study suggests that ATAD3 is attached to the mtDNA at D-loop and is involved in nucleoid formation and segregation (He et al., 2007). The nucleoid has been proposed to be the

unit of inheritance in mitochondria. It is widely accepted that the segregation of nucleoids may control the inheritance of mutant mtDNAs, thus influencing the development of mitochondrial disorders.

1.4. Human mtDNA replication

1.4.1. Proteins participating in mtDNA replication

Mitochondria contain a unique enzymatic machinery involved in mitochondrial DNA replication. The minimal *in vitro* replisome has three important components (**Fig. 4**): The mitochondrial DNA polymerase γ (POLG), the helicase Twinkle and the mitochondrial single stranded DNA binding protein (mtSSB) (Korhonen et al., 2004). *In vivo*, a number of additional proteins are required for mtDNA replication, e.g. primase for lagging strand synthesis, and topoisomerase to relieve torsional stress.

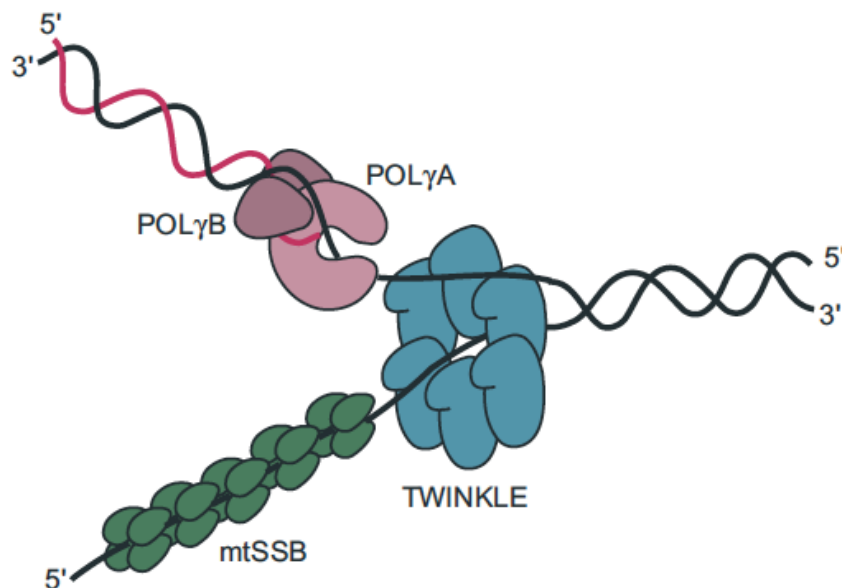

Figure 4: Mitochondrial DNA replication machinery (Falkenberg et al., 2007). The twinkle helicase unwind the duplex DNA template from 5'-3' direction. The mtSSB protein stabilize the unwound conformation and stimulate DNA synthesis by POLG holoenzyme.

DNA polymerase γ (POLG) is a heterotrimeric protein comprising of one catalytic subunit (Pol γ A) and dimeric accessory subunit (Pol γ B) (Kaguni, 2004; Korhonen et al., 2004; Lee et al., 2009). The human catalytic subunit Pol γ A has a molecular mass of 140kDa and

possess polymerase and 3'-5' exonucleolytic proofreading (Kaguni, 2004; Pinz and Bogenhagen, 2000). The human Pol γ B has a molecular mass of 55KDa and form a heterotrimer while in other mammalian species it forms a heterodimer at a ratio of 2:1 with Pol γ A (Carrodeguas et al., 2001). Pol γ B functions as processivity factor, accelerating the polymerization rate and causes a conformational change that enhance the affinity of catalytic subunit to bind a longer stretch of DNA template Lee 2010 (Lee et al.; Lim et al., 1999). In addition, a more recent study has suggested that POL γ B is the key factor that determines mtDNA copy number within the nucleoid as it is required for D-loop synthesis (Di Re et al., 2009).

The helicase Twinkle, was first identified in association with autosomal dominant progressive ophthalmoplegia, a mitochondrial disorder characterized by mtDNA deletions (Spelbrink et al., 2001). Due to its localization to mitochondrial nucleoids, the protein was named Twinkle (T7 gp4-like protein with intra mitochondrial nucleoid localization) (Spelbrink et al., 2001). Twinkle catalyses the unwinding of DNA duplex by disrupting the hydrogen bonds that hold the two strands together and provides single-stranded templates for DNA polymerase (Matson and Kaiser-Rogers, 1990). It shares a structural similarity to the C-terminal helicase part of bacteriophage T7 gene 4 protein which exhibits both helicase and primase activities (Spelbrink et al., 2001). Mammalian twinkle seems to lack primase activity (Spelbrink et al., 2001), while twinkle homologues in all other eukaryotes studied (Shutt and Gray, 2006) possess both helicase and primase activity. The protein consist of a C-terminal helicase domain and an N-terminal domain with a linker separating the two domains. Similar to the phage protein gp4, Twinkle is active as a hexameric ring (Spelbrink et al., 2001; Ziebarth et al., 2007). Hexamerization is dependent on the linker region (Hanninen et al., 2008; Spelbrink et al., 2001).

mtSSB protein binds single stranded DNA (ssDNA) during replication and is required for the maintenance of normal mtDNA level in human cells (Ruhanen et al., 2010). The protein has a molecular mass of 13-16 KDa and possesses sequence similarity to *E. coli* SSB (Tiranti et al., 1993). The mtSSB mediates the unwinding of mtDNA though its physical interaction with twinkle (Korhonen et al., 2003). The protein binds DNA as homotetramer with binding sequence of 50-70 nucleotides per tetramer. Moreover, mtSSB enhances mtDNA synthesis, probably though interactions with POLG (Farr et al., 1999) and twinkle (Korhonen et al., 2003).

Since mtDNA are supercoiled molecules, the activity of mitochondrial topoisomerase (mtTOP1) is required to relax the negative supercoils (Zhang et al., 2001). It is type 1B topoisomerase, so it may also catalyze the removal of positive supercoils resulting at the replication fork (Wang, 2002). The DNA ligase III gene encodes two protein, one of which is targeted into mitochondria (Lakshmipathy and Campbell, 1999). Ligase III is required for the proper maintenance of mtDNA (Lakshmipathy and Campbell, 2001). The mitochondrial form of ribonuclease H1 (RNaseH1) is implicated in removal of RNA primer in RNA-DNA hybrids (Cerritelli et al., 2003). TFAM is required for the synthesis of RNA primer prior to replication (Kang et al., 2007). mtRPOL provides the primer needed for mtDNA replication initiation at O^H and it is possible that mtRPOL also provide primer for replication initiation at O^L (Pham et al., 2006).

1.4.2. Mechanism of mtDNA replication

Two modes of mammalian mtDNA replication have been proposed: an asynchronous strand displacement model and a strand coupled bidirectional replication model (Brown et al., 2005). According to asynchronous strand displacement model, mammalian mtDNA is replicated unidirectionally from two distinct and strand specific origins (Kasamatsu and Vinograd, 1974). Replication of leading-strand is initiated first at O^H located within D-loop region and continues to span approximately two-third of the way around the genome until the origin of light strand replication O^L is exposed on the nascent H-strand (**Fig. 5**). The Replication of lagging strand is then initiated and proceeds in the opposite direction (Clayton, 1982). The new mtDNA molecules with completed strand synthesis are ligated to form close circular molecules before introduction of superhelical turns. The strand asymmetric replication model predicts that the lagging strand also undergoes continuous DNA synthesis without the need for repeated priming and thus without formation of Okazaki fragments.

In the strand coupled model, both leading and lagging strand of mtDNA are replicated bidirectionally (**Fig. 5**) from the same initiation cluster site (Yasukawa et al., 2005). Analysis of native two dimensional gel electrophoresis show the presence of double stranded DNA replication intermediates, indicating the conventional strand coupled replication of leading and lagging strands (Holt et al., 2000). It was subsequently found that in addition to dsDNA

replication intermediates, purified mitochondria contained an important amount of RNA-DNA duplex in the lagging strand of mitochondrial replication intermediates (Yang et al., 2002). This led to the model of RNA incorporation throughout lagging strand (RITOLS) where the lagging strand is initially synthesized as RNA followed by maturation into DNA (Yasukawa et al., 2006). RITOLS intermediates are sensitive to digestion by RNase H, meaning that the previously identified long ssDNA segments, which suggested strand displacement, may have resulted from inadvertent RNA degradation during mtDNA preparation (Yang et al., 2002). It is now thought that the bulk of mtDNA replication under normal conditions is of the RITOLS-type, with a low level of conventional strand-coupled replication occurring in parallel (Pohjoismaki et al., 2010).

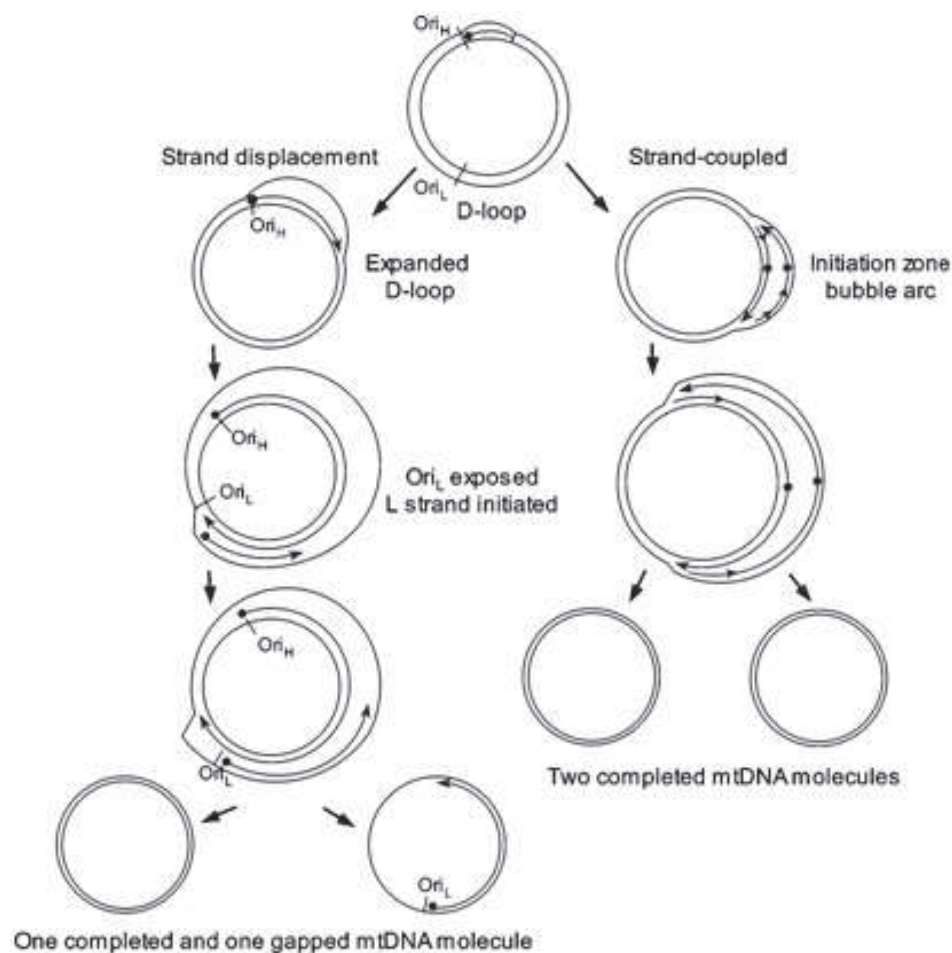

Figure 5: Models of mitochondrial DNA replication (Brown et al., 2005). The asymmetric or strand displacement model is shown in the left pathway while the strand-coupled

model is shown in the right pathway. Replication by the strand displacement model is initiated at OriH with single-stranded replication of the H-strand with displacement of the D-loop. This synthesis proceeds until OriL is exposed where synthesis of the L-strand is initiated in the opposite direction. In the strand-coupled model, bidirectional replication is initiated from a zone near OriH followed by progression of the two forks around the mtDNA circle.

1.4.3. Initiation of heavy strand replication

Initiation of H-strand replication require short RNA primers transcribed from L-strand promoter. Consequently, mtDNA replication is linked and dependent on mtRPOL and transcription factors required for L-strand transcription (Clayton, 1982; Falkenberg et al., 2002). In the D-loop region, mtRPOL synthesize an RNA primer beginning from LSP (**Fig. 6**). The switch from RNA to DNA occur in a region of D-loop that contained thee evolutionary conserved sequence blocks (CSBI, II and III) located downstream of LSP (Walberg and Clayton, 1983). The primary transcript is enzymatically processed by mitochondrial RNA processing ribonuclease (RNase MRP) (Topper et al., 1992) at specific location in the O^H region to yield the mature primer RNA 3'-termini. An RNase MRP independent mechanism has been proposed on the observation that CSBII promote termination of LSP-transcription *in vitro* (Pham et al., 2006). Recently, it has been demonstrated that formation of G-quadruplex structure in the newly synthesized transcript is involved in CSBII specific transcription termination (Wanrooij et al., 2010). The newly synthesized RNA primer remains annealed to DNA forming a stable R-loop structure. The mtPOLG initiate H-strand replication though extension of RNA primer (Lee and Clayton, 1996; Shadel and Clayton, 1997) and continue along the whole H-strand or terminate 700 bp downstream of O^H giving rise to 7S DNA. The nascent arrested H-strand remains annealed to their template L-strand and produce a triple stranded structure called D-loop structure (Clayton, 1991). The prematurely terminated H-strand maps approximately 50 nucleotides downstream of a short conserved sequence, called termination associated sequence (TAS) (Shadel and Clayton, 1997). TAS are short conserved sequence found in all vertebrates, located just upstream of the 3' end of arrested nascent H-strand (Doda et al., 1981). The mechanism which determines whether a nascent H-strand ends downstream of the TAS element or elongates over the entire length of the genome is not known but is likely to be a key regulator of the mtDNA copy number in a cell.

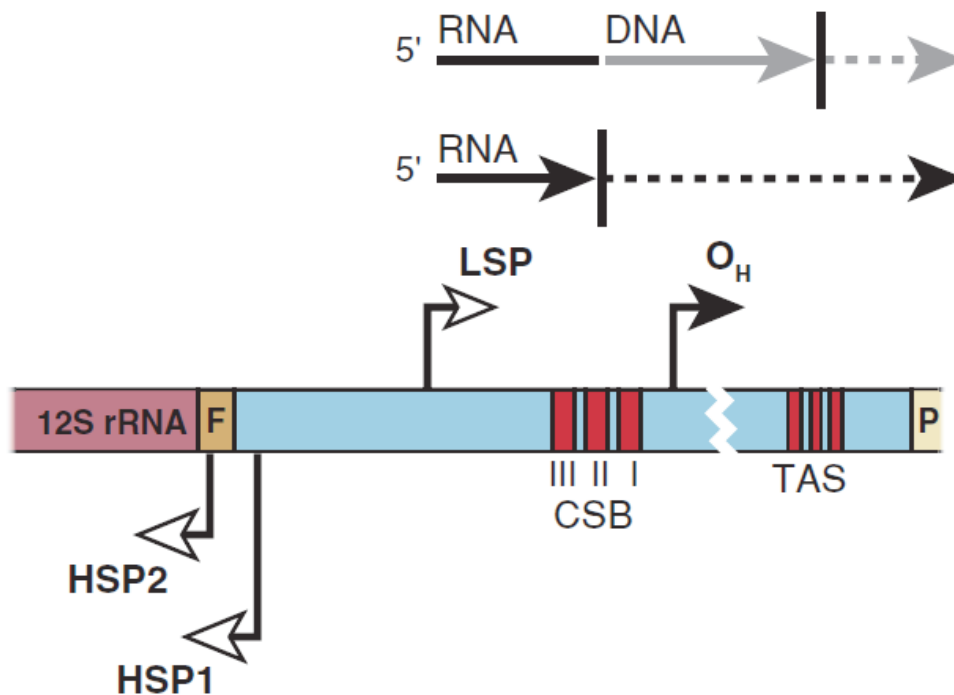

Figure 6: Schematic representation of the D-loop regulatory region (Falkenberg et al., 2007). The three conserved sequence blocks (CSB I, CSB II, and CSB III) are located just downstream of light-strand promoter (LSP). Transitions from the RNA primer to the newly synthesized DNA have been mapped to sequences within or near CSB II. The conserved termination-associated sequence (TAS) elements are located at the 3' end of the nascent D-loop strands and are proposed as a major regulation point of mtDNA replication. Abbreviations: HSP, heavy-strand promoter; LSP, light-strand promoter; OH, origin of H-strand DNA replication.

1.4.4. Initiation of light strand replication

The L-strand origin of replication O^L , was first identified in mouse and then in human mtDNA by 5'-end mapping of *in vivo* nascent L-strand (Tapper and Clayton, 1981). The O^L is a non-coding region of approximately 30 nucleotides in size flanked by $tRNA^{Cys}$ and $tRNA^{Asn}$ within WANCY ($tRNA^{Trp}$, $tRNA^{Ala}$, $tRNA^{Asn}$, $tRNA^{Cys}$, $tRNA^{Tyr}$) tRNA cluster. O^L is activated and adopt a distinct stem-loop structure only when it is exposed as single strand (Clayton, 1991). The stem-loop structure serve as recognition site for mtDNA primase that has the capacity to recognize O^L and provide short RNA primer for the synthesis of L-strand (Hixson et al., 1986; Wong and Clayton, 1986). RNA priming for daughter L-strand synthesis start at a T-rich loop region of the predicted O^L , and transition from RNA to DNA synthesis takes place at specific site near GC rich region at the base of the hairpin (Hixson et al., 1986; Wong and Clayton, 1986).

Once initiated, L-strand replication proceeds over the entire length of the strand and ends after the H-strand origin of replication.

1.5. Human mtDNA transcription

1.5.1. Transcription machinery

Transcription of mitochondrial DNA is essential for mitochondrial genes expression and also for producing RNA primer for the initiation of H-strand replication at O^H (Falkenberg et al., 2007). The basal mitochondrial transcription machinery consists of an organelle specific RNA polymerase (POLRMT) (Tiranti et al., 1997) and at least three transcription factors: mitochondrial transcription factor A (TFAM) (Fisher and Clayton, 1988), mitochondrial transcription factor B1 or B2 (TFB1M or TFB2M) for transcription initiation (Falkenberg et al., 2002; McCulloch et al., 2002) and mtTERF for termination of transcription (Fernandez-Silva et al., 1997).

Human mitochondria possess a single subunit RNA polymerase encoded in the nuclear DNA. The POLRMT gene encode a protein of 1230 amino acids, including a mitochondrial targeting sequence of 41 residues at N-terminal, which is cleaved after import into the mitochondria. The C-terminal part of the protein (520-1230) contains a series of conserved motifs homologous to phage RNA polymerases (Masters et al., 1987) but they also contain an N-terminal extension unique to mitochondrial RNA polymerase. The amino terminal region of the POLRMT contains two pentatricopeptide repeat motifs (PPR) in the N-terminal extension that seem to be implicated in RNA processing in the organelles (Mili and Pinol-Roma, 2003). In the absence of TFAM and one of the TFB1M or TFB2M, the POLRMT is unable to recognize the mitochondrial promoters DNA and initiate transcription and shows little and only non-specific polymerase activity (Prieto-Martin et al., 2001).

Human mitochondrial transcription factor A (TFAM) is a nuclear encoded protein containing 246 amino acids. Once imported into mitochondria, the first 42 residues from the N-terminal are eliminated to form the mature form. TFAM contains two tandem high mobility group (HMG) box domains separated by 27 amino acids linker region and followed by 25 amino acids basic C-terminal tail (Parisi and Clayton, 1991). HMG domains are believed to be involved in DNA binding and are found in a diverse family of proteins implicated in such processes as

transcription enhancement and chromatin packaging. The C-terminal region is required for specific DNA recognition and important for transcription activation (Fisher et al., 1992). Furthermore, it is the site of interaction with TFB1M (McCulloch and Shadel, 2003). Similar to other protein HMG-containing proteins, TFAM can bind, unwind and bend DNA without sequence specificity (Fisher et al., 1992).

The human mitochondrial transcription factor B (TFBM) can bind POLRMT and stimulate transcription at heavy and light strand promoters *in vitro*. This protein has two isoforms named TFB1M and TFB2M (Falkenberg et al., 2002). Both factors can form heterodimeric complex with mitochondrial RNA polymerase, but TFB2M shows at least two orders of higher activity in stimulating transcription than TFB1M. TFB1M and TFB2M are closely related to a family of rRNA methyltransferases, members of which dimethylate two adjacent adenosine bases near the 3'-end of the small rRNA subunit during ribosome biogenesis (Metodieff et al., 2009). Both factors still retain methyltransferase activity *in vivo* (Cotney et al., 2009; Cotney et al., 2007), however methyltransferase activity is not required for transcription initiation. In addition to binding mitochondrial RNA polymerase, TFB1M also interact with the C-terminal domain of TFAM (McCulloch and Shadel, 2003).

1.5.2. Transcription of mitochondrial DNA

In mammals, transcription of heavy and light strand of mtDNA is initiated from distinct promoters in the control region, the heavy strand (HSP1 and HSP2) and light strand (LSP) promoters (Montoya et al., 1982). H-strand transcription from HSP1 start 19 nucleotides upstream of tRNA^{Phe} gene, giving rise to a short polycistronic mRNA comprising 12S and 16S rRNA, tRNA^{Val} and tRNA^{Phe} (Montoya et al., 1983). The second H-strand transcription unit, that operates 20 times less efficiently, starts at HSP2 close to the 5'-end of 12S rRNA producing a polycistronic molecule covering almost the entire H-strand. Transcription from LSP starts about 150 nucleotides away from HSP1 initiation site producing a polycistronic transcript consisted of 8 tRNAs and a single mRNA encoding ND6 protein (Fernandez-Silva et al., 2003).

The major mammalian mitochondrial promoters containing HSP1 and LSP initiation points are functionally independent and have a bipartite structure consisting of a promoter element and an upstream regulatory element. The promoter is a 15bp consensus sequence motif

which surrounds the initiation point and is essential for transcription. The upstream regulatory element is located immediately upstream of initiation site (-12 to -39), and can be considered as enhancer that allows optimized transcription. It includes the binding site for TFAM which is located between position -17 to -35 relative to transcription initiation site (Fisher et al., 1987). The second transcription initiation site, HSP2, has a promoter with a limited similarity to 15 bp consensus sequence and, in addition, has no upstream TFAM binding site. *In vitro* studies of promoter analysis have failed to show any detectable HSP2 initiation activity. Based on this study, one major transcription initiation site is proposed for each strand of mtDNA. According to these data, transcription from HSP1 would produce both mRNA and rRNA and the regulation of ratio between them would be controlled only at the termination level (Clayton, 1992). More recently, it has been suggested that HSP2 however exists, and is regulated in an antagonistic manner compared to HSP1 and LSP. HSP2 would be active but in the absence of TFAM, which is required for transcription initiation at LSP and HSP (Zollo et al., 2012)

1.5.3. Termination of transcription

Termination of transcription at HSP1 transcription unit depends on mTERF where it terminates transcription through a base flipping mechanism (Yakubovskaya et al., 2010). mTERF interact specifically with a 28bp region at the 3'-end of tRNA^{Leu} gene (Fernandez-Silva et al., 1997; Martin et al., 2005) where it is believed to terminate HSP1 initiated transcription (Kruse et al., 1989). The mTERF protein family has four members termed mTERF1-4 (Linder et al., 2005). It was suggested that mTERFs 1-3 share a common binding site within HSP1 (Park et al., 2007; Wenz et al., 2009), so that the effect of mTERF1 (Martin et al., 2005) and mTERF2 (Wenz et al., 2009) is to increase transcription initiation, whereas mTERF3 is a negative regulator (Park et al., 2007). The function of mTERF 4 remains to be established. Termination of the L strand transcript is not studied in detail. Transcription termination site for HSP2 transcript is located immediately upstream of tRNA^{Phe} gene, and two protein factors are shown to be involved but their identities have not been reported (Camasamudram et al., 2003).

1.5.4. Processing of RNA transcript

The primary polycistronic transcripts synthesized from the initiation sites are processed to produce monocistronic tRNA, mRNA and rRNA (Montoya et al., 1981) after precise endonucleolytic cleavages at the 5' and 3'-end of the tRNAs. In the mtDNA, each of the protein coding and rRNA gene is indeed flanked by at least one tRNA sequence. The tRNA that is localized between them acts as the signal for the processing enzymes after acquiring the cloverleaf structure and is excised. This mode of RNA processing is known as tRNA punctuation model (Rossmann et al., 1995). Processing of the primary transcript is thought to require the action of four different enzymes. The tRNA is first cleaved at 5'-end (Rossmann et al., 1995) by mitochondrial RNaseP (Puranam and Attardi, 2001). The enzyme responsible for cleavage of 3'-end is tRNase Z (Levinger et al., 2001). The CCA tail is added to the 3'-end of each tRNA by an ATP(CTP):tRNA nucleotidyltransferase. The tRNAs are additionally modified for their proper functioning (Nagaike et al., 2001). The mRNA and rRNA are polyadenylated with a tail of 1-10 and 50-60A residues respectively by mitochondrial poly(A) polymerase (Tomecki et al., 2004). This post-transcriptional modification creates the stop codons for some mRNAs and may also be necessary for stabilization of some RNAs (Ojala et al., 1981).

1.6. Translation of mitochondrial DNA

Mitochondria have a separate machinery for the translation of mRNA encoded by mtDNA. The mitochondrial translation has a number of unique features not observed in prokaryotes or in cytoplasm of eukaryotic cells. Mitochondria use a genetic code that has several distinct differences from the universal genetic code (Osawa et al., 1992). For example, human mitochondria use the universal arginine codons AGG and AGA, in addition to UAA and UAG for translation termination. More recently, it was shown that mitoribosomes perform -1 frameshifting at the AGA and AGG codons predicted to terminate the two open reading frames (ORFs) in mitochondrial COX1 and ND6 respectively and consequently both ORFs terminate in the standard UAG codon (Temperley et al., 2010). The UGA codes for tryptophan instead of being a stop codon and AUA code for Met rather than serving as an Ile codon. Mitochondrial translation begins with formylated methionyl and the 5'-end of mRNA do not contain

methylguanylate cap structure (Grohmann et al., 1978) or leader sequence to facilitate ribosome binding (Montoya et al., 1981; Smits et al., 2010). Mitochondria use a simplified decoding mechanism that allows translation of all codons with only 22 tRNAs (Anderson et al., 1981; Barrell et al., 1980). In addition, mammalian mitochondria use a single tRNA^{Met} for both the initiation and elongation phases of translation depending on the presence or absence of formyl group respectively, whereas in prokaryotic and eukaryotic cytoplasmic translation systems, two specialized tRNA^{Met} species are used for translation initiation and elongation (Mikelsaar, 1983).

1.6.1. Translation machinery

The mitochondrial translation machinery consists of rRNA and tRNA encoded by mtDNA as well as many proteins encoded by nuclear DNA i.e. mitochondrial ribosomal protein (MRPs), initiation, elongation and termination factors and mitochondrial aminoacyl tRNA synthetases) (Jacobs and Turnbull, 2005).

Mitochondria contain two translation initiation factors (IFs) orthologous to prokaryotic IF2 and IF3 (Ma and Spremulli, 1995) and no ortholog of IF1 have been detected (Spremulli et al., 2004). So far, an insertion of conserved 37 amino acids in IF2 has been identified that seems to have assumed the role of IF1 (Gaur et al., 2008). Thee elongation factors named mtEFTu, mtEFTs and mtEFG have been identified in human mitochondria (Hammarsund et al., 2001; Ling et al., 1997; Xin et al., 1995). Contrary to bacteria, that have only one EFG functioning during elongation and termination of translation, mitochondria contain two EFG homologs, mtEFG1 and mtEFG2 (Hammarsund et al. 2001). The importance of mtEFG1 for protein synthesis has been demonstrated (Bhargava et al., 2004), the function of mtEFG2 in mitochondrial translation is still not clear. More recently, it was proposed that mtEFG1 catalyzes the translocation, whereas mtEFG2 function in ribosome recycling and lacks translocation activity (Tsuboi et al., 2009). The translation termination process in mitochondria has not been fully elucidated. Two release factors, mtRF1 and mtRF2 and a recycling factor (mtRRF) have been identified and partly characterized (Nozaki et al., 2008; Rorbach et al., 2008).

The mitoribosomes are constituted by two subunits named the small (SSU or 28S) and large (LSU 39S) subunit that comprise two ribosomal RNA (12S and 16S rRNA) and nearly 80 MRPs (Smirnov et al., 2011b; Smits et al., 2007). More recently, the third rRNA (5S) was also

detected in human mitoribosome (Smirnov et al., 2011b). 12S and 16S large rRNA have a reduced size comparing with bacterial ones, nevertheless mitoribosome contains a correspondingly higher content of protein, causing a greater molecular mass and size than bacterial ribosomes.

Mitochondrial tRNAs also deviate from the canonical tRNAs and are often shorter than bacterial or eukaryotic cytoplasmic tRNAs. They have large variations in the size of the D- and T-loops and lack multiple conserved nucleotides that are known to be involved in classical tertiary interactions creating the L-shape, which possibly results in a weaker tertiary structure. Several post-transcriptional base modification occur that appears to be more important for the proper tertiary structure and functioning of mitochondrial tRNAs compared with cytosolic tRNAs (Helm, 2006). tRNAs in mitochondria are aminoacylated by 19 different aminoacyl-tRNA synthetases, of which only two are encoded by the same gene as the cytosolic enzyme (Bonnefond et al., 2005). Only the gene for mitochondrial glutamyl-tRNA synthetase has not been found yet. In *S. cerevisiae*, it was shown that mitochondrial glutamyl-tRNA^{Gln} is generated by transamidation pathway involving nondiscriminating cytosolic glutamyl-tRNA synthetase and a trimeric tRNA dependent amidotransferase (Frechin et al., 2009).

1.6.2. Mitochondrial translation process

Protein synthesis cycles can be divided into three steps: Initiation, Elongation and Termination. The first step of initiation complex formation is sequence independent binding of mRNA to SSU (Bhargava and Spremulli, 2005; Liao and Spremulli, 1989). MtIF3 keeping apart the two subunit and forming complex with SSU, assists the mRNA to bind the SSU so that the start codon (AUG) is correctly positioned at the peptidyl (P) site of the mitoribosome. Binding of fMet-tRNA^{Met} to the SSU requires mtIF2, which is markedly enhanced by GTP (Liao and Spremulli, 1990; Ma and Spremulli, 1996). Recombining of the LSU with the SSU probably stimulates the dissociation of mtIF3 (Haque et al., 2008). Additionally, GTP hydrolysis by mtIF2 is triggered by the LSU, leading to its release from the complex.

In translation elongation, the elongation factor mtEFTu forms a ternary complex with GTP and an aminoacylated tRNA and deliver the aminoacyl tRNA to the acceptor (A) site of mitoribosome (Cai et al., 2000). When the codon-anticodon recognition occurs, GTP hydrolysis

on mtEFTu is stimulated by the mitoribosome, resulting in the release of mtEFTu•GDP, which is again converted into active mtEFTu•GTP form by mtEFTs (Akama et al., 2010). The elongation factor mtEFG1 with bound GTP catalyzes the translocation step, during which the tRNAs moves to the peptidyl (P) and exit (E) sites of the mitoribosome while mRNA advances by one codon. Subsequently, the tRNA leaves the mitoribosome via the E site and a new elongation cycle can start (Worriax et al., 1997).

Translation termination occurs when a stop codon enter the A site of mitoribosomes. A mitochondrial release factor, mtRF1a or possibly also mtRF1, recognizes the stop codon and causes the protein that is attached to the last tRNA molecule in the P site to be released (Chrzanowska-Lightowlers et al., 2011). After release of the newly synthesized protein, mtRRF and mtEFG2•GTP together enable the mitoribosomal subunits, tRNA and mRNA to dissociate from each other, making the components available for a new round of protein synthesis (Bertram et al., 2001).

1.7. Macromolecular import into mitochondria

1.7.1. Mitochondrial protein import

Based on proteomics analysis, it has been estimated that mitochondria contained ~1000 different proteins in yeast and ~1500 proteins in mammals (Pagliarini et al., 2008; Sickmann et al., 2003). Of these, only 1% are encoded by mitochondrial genome. The remaining proteins are encoded by nuclear DNA, synthesized often as precursor forms on cytosolic ribosomes and subsequently targeted to mitochondria and sorted into different sub mitochondrial compartments (Mokranjac and Neupert, 2009; Neupert and Herrmann, 2007; Schmidt et al., 2010).

1.7.2. Mitochondrial targeting and sorting signals

Nuclear encoded mitochondrial proteins are translated by cytosolic ribosomes and then imported into organelle by using several alternative mechanisms (Endo et al., 2003). Diverse signal sequences lead to the targeting and sorting of precursors to their sub mitochondrial destination (**Fig. 7**). The majority of mitochondrial matrix pre-proteins are equipped with a

typical amino terminal (N-terminal) presequence, named matrix targeting sequence (MTS), and they are directed to matrix in the absence of sorting information. MTS consists of 15-55 amino acids, rich in basic, positively charged and hydroxylated amino acids that has the potential to form amphipathic α -helices (Pfanner and Geissler, 2001; Roise et al., 1986). The amphipathic α helix possesses a hydrophobic surface that is recognized by Tom20 and a positively charged surface recognized by Tom22 (Saitoh et al., 2007; Yamano et al., 2008). Furthermore, the positive charge of presequences is the critical determinant for the electrophoretic effect of the membrane potential during translocation across the inner membrane (Krayl et al., 2007; van der Laan et al., 2007; van der Laan et al., 2006). Upon translocation into the matrix, the presequences are usually cleaved off by the highly conserved mitochondrial processing peptidase (MPP) (Taylor et al., 2001).

Additional hydrophobic sequences termed sorting sequences may be located after the presequence and arrest translocation at the mitochondrial inner membrane with the preprotein being released into the lipid phase (Glick et al., 1992). The sorting signal remains part of the mature inner membrane protein and participates in anchoring the protein in the membrane. In case of intermembrane space protein, the sorting signal is cleaved by the innermembrane peptidase (IMP) resulting in the release of mature protein into the inter membrane space (Gakh et al., 2002; Glick et al., 1992).

Targeting and sorting signals of mitochondrial precursor proteins				
A	Presequences and variations		Imported via	Destination of proteins
	Presequence Amphipathic α helix Typically cleaved after import		TOM TIM23 PAM	Matrix
	Presequence + uncleaved hydrophobic anchor (sorting signal)		TOM TIM23 (PAM)	Inner membrane
	Presequence + cleaved hydrophobic sorting signal (bipartite presequence)		TOM TIM23 (PAM)	Intermembrane space
B	Noncleavable signals of hydrophobic proteins			
	β signal		TOM SAM	Outer membrane (β -barrel)
	Signal-anchor sequence		Mim1	Outer membrane (α -helical)
	C tail anchor		?	Outer membrane (α -helical)
	Internal signal		(TOM) (SAM)	Inner membrane (metabolite carrier)
	Multiple internal signals		TOM Tim9-Tim10 TIM22	Inner membrane (metabolite carrier)
	Presequence-like internal signal (after hydrophobic region)		TOM TIM23	Inner membrane
C	Internal signal for intermembrane space			
	Cysteine-containing signal		TOM MIA	Intermembrane space

Figure 7: Targeting and Sorting Signals of mitochondrial precursor proteins (Chacinska et al., 2009). Mitochondrial precursor proteins contain cleavable or noncleavable targeting signals. The signals direct the precursor proteins to different sorting machineries. Presequences

are usually cleaved off by the mitochondrial processing peptidase in the matrix. Additional hydrophobic sorting signals can be removed by the inner membrane peptidase complex (IMP). MISS: Mitochondrial intermembrane space signal, MIA: mitochondrial intermembrane space assembly, Mim1: Mitochondrial import 1 protein, PAM: presequence translocase-associated motor, SAM: sorting and assembly machinery, TIM22: carrier translocase of the inner membrane, TIM23: translocase of inner membrane, TOM: translocase of the outer membrane.

Many proteins, however, are not synthesized with cleavable presequences but contain internal targeting signal that remain part of the imported protein (Habib et al., 2007; Neupert and Herrmann, 2007). Targeting sequences have been identified at the amino terminal (signal-anchored), at the carboxy terminal (tail-anchored) and in the middle of the protein (Kemper et al., 2008; Otera et al., 2007; Stojanovski et al., 2007). Mitochondrial outer membrane protein of the β -barrel type contain a signal in the carboxy terminal formed by the last β -strand (**Fig. 7B**) and is specifically recognized by the sorting and assembly machinery (SAM) of the outer membrane (Kutik et al., 2008).

Finally, the mitochondrial intermembrane space signal (MISS) was also identified, which directs noncleavable precursors into the intermembrane space (**Fig. 7C**). It includes cysteine residues that form mix disulfide bond with the intermembrane space receptor Mia40 (Milenkovic et al., 2007; Milenkovic et al., 2009).

1.7.3. Mitochondrial protein import machinery

1.7.3.1. The TOM complex

The import of nearly all mitochondrially targeted precursor proteins occurs via the translocase of outer membrane or TOM complex (**Fig. 8**). The central component of TOM is Tom40, an integral membrane protein with a β -barrel structure that forms protein conducting channel across the outer membrane through which the precursor protein pass (Hill et al., 1998). Tom20, Tom22 and Tom70 function as receptor for various classes of precursor proteins. Precursor proteins with N-terminal presequence initially interact with Tom20 (Saitoh et al., 2007), while other proteins with internal targeting signals interact with Tom70 receptor. From these receptors, the precursor proteins are transferred to the central receptor Tom22 (van Wilpe et al., 1999) and then inserted into the Tom40 channel. The small Tom protein Tom5 assist the assembly of Tom complex and support the insertion of precursor proteins from Tom22 into the

Tom40 channel (Becker et al.; Model et al., 2001; Wiedemann et al., 2003), while two other small Tom proteins, Tom6 and Tom7 antagonistically influence the stability of the TOM complex. Tom6 stabilizes the large TOM complex, whereas Tom7 favors its dissociation, thus supporting a dynamic organization of TOM complex (Becker et al., 2011; Dukanovic et al., 2009).

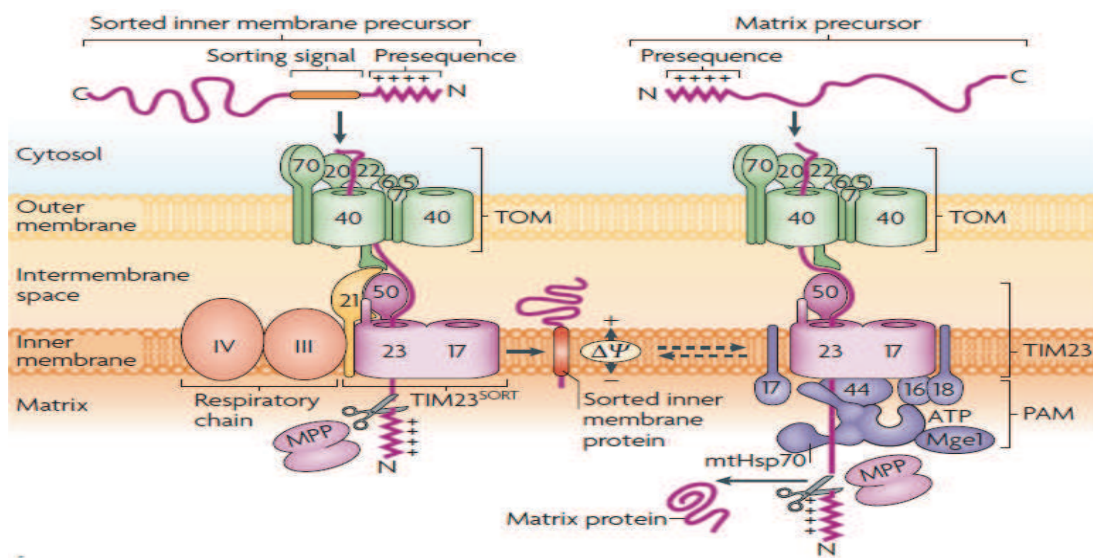

Figure 8: The presequence pathway of protein import into mitochondria (Schmidt et al., 2010). Precursor proteins are imported by translocase of outer membrane (TOM) complex, which involves recognition by receptor Tom20, Tom22 and Tom70 and translocation through Tom40 channel. The presequence translocase of inner membrane Tim23, comprising Tim23, Tim17 and Tim50, functions in two modular form. (left) Tim23 additionally contain Tim21, which transiently bind to TOM complex and supercomplex of respiratory chain, mediates the lateral release of protein containing hydrophobic sorting signal into intermembrane space. (Right) Tim23 lack Tim21 and interact with presequence translocase associated motor (PAM) and transport protein into the matrix. The membrane potential $\Delta\Psi$ drives translocation of presequence through Tim23 complex and ATP powers the matrix chaperone mtHSP70 of PAM. Mitochondrial processing peptidase removes the presequences.

1.7.3.2. The TIM23 complex

The passage of protein across the mitochondrial inner membrane occurs *via* the translocase of inner membrane or TIM23 complex (**Fig. 8**). The complex is composed of three essential subunits Tim23, Tim17, Tim50 and a more recently identified Tim21 (Chacinska et al., 2005). The core subunit of the complex is Tim23 that forms a $\Delta\Psi$ -dependent protein conducting

pore across the inner membrane (Alder et al., 2008; Truscott et al., 2001). (Mokranjac et al., 2009; Tamura et al., 2009). The Tim50 exposes a large domain to the inter membrane space and function as the first receptor for precursor protein after release from the TOM complex (Geissler et al., 2002; Yamamoto et al., 2002). The Tim50 then transfers a pre-protein to the Tim23 (Truscott et al., 2001). In addition, Tim50 has been proposed to maintain the Tim23 channel across the inner membrane in a closed state in order to prevent ion leakage and dissipation of $\Delta\psi$ in the absence of preprotein (Meinecke et al., 2006). Tim17 is involved in the stabilization and regulation of the channel formed by Tim23 and the differential sorting of preproteins (Chacinska et al., 2005; Martinez-Caballero et al., 2007). Tim21 binds competitively to Tom22 presumably to achieve the release of precursor protein from Tom22 (Albrecht et al., 2006; Chacinska et al., 2003).

In the absence of hydrophobic sorting domain, the translocation of presequence containing protein into the matrix requires the connection of TIM23 complex to the presequence translocase associated motor (PAM) (**Fig. 8 right**). The core component of PAM complex, the mitochondrial form of Hsp70 (mtHsp70) bind precursor proteins and pull them into the matrix in ATP dependent manner. Additional subunits regulates the activity of mtHSP70. The peripherally attached Tim44 assists the binding of mtHSP70 to the translocation channel while the ATPase activity of the chaperone is stimulated by Tim14 (Mokranjac et al., 2006; Mokranjac et al., 2003). Mge1 mediates nucleotide exchange on mtHsp70 enabling further cycle (Schneider et al., 1996). The PAM complex is associated with TIM23 only in the absence of Tim21 (Chacinska et al., 2005). In most cases, the final step in matrix targeting of a protein is the proteolytic cleavage of the presequence by the mitochondrial processing peptidase (Cavadini et al., 2002).

The sorting of proteins containing a bipartite signal requires association of TIM23 complex with Tim21 (**Fig. 8 left**). When Tim21 is bound to TIM23, precursors containing a stop-transfer signal following their N-terminal presequence are inserted into the channel and are laterally released into the inner membrane (van der Laan et al., 2006). The switch between Tim21 and PAM is mediated by the TIM23 complex protein Tim17 (Chacinska et al., 2005).

1.7.3.3. SAM complex

The mitochondrial outer membrane contains two major classes of membrane proteins: β -barrel proteins that are inserted into the lipid phase by multiple transmembrane β -strands, and α -helical proteins that are anchored in the membrane by one or more hydrophobic α -helical segments. The precursors of β -barrel proteins including VDAC (voltage-dependent anion-selective channel), Tom40, and Sam50 are initially targeted to the TOM complex and then translocated through the Tom40 channel into the inter membrane space (Model et al., 2001). The small Tim9-Tim10 and Tim8-Tim13 chaperone complexes in the inter membrane space bind the precursors (Wiedemann et al., 2004) and guide them to the sorting and assembly machinery for mitochondrial outer membrane proteins called the SAM complex (Paschen et al., 2003; Wiedemann et al., 2003). The SAM complex consists of core subunit Sam50 and two additional subunits Sam35 and Sam37 (**Fig. 9**). The two peripheral subunits Sam35 and Sam37 and the polypeptide transport associated domain (POTRA) of Sam50 help to recognize incoming precursors and release folded β -barrel proteins into the lipid phase (Kutik et al., 2008; Milenkovic et al., 2004; Paschen et al., 2003).

Different targeting and insertion pathways have been identified for insertion of α -helical proteins into the mitochondrial outer membrane. The membrane-anchored α -helix is localized either at the N-terminus (signal-anchored) or C-terminus (C-tail anchored) of proteins with a single trans membrane region. The outer membrane protein, Mim1 promotes the insertion of several so-called signal-anchored proteins (Becker et al., 2008; Hulett et al., 2008). Mim1 associates with a fraction of SAM core complexes, and acts in the assembly of signal-anchored Tom receptors and of the small Tom proteins. The receptors Tom20 and Tom70 are examples of N-terminally anchored proteins, whereas the small Tom proteins, Tom5, Tom6 and Tom7 are anchored through their C-terminal domains (Popov-Celeketic et al., 2008).

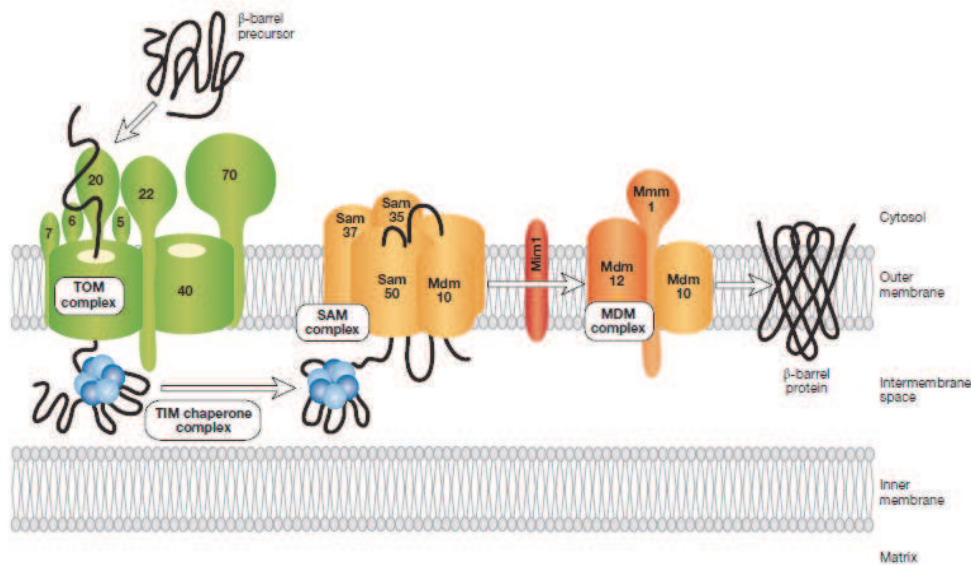

Figure 9: Sorting and assembly machinery (SAM) of outer mitochondrial membrane (Bolender et al., 2008). The precursor of β -barrel proteins are initially imported through TOM complex, interact with small TIM chaperones (Tim9-Tim10, Tim8-Tim13) in the inter membrane space and inserted into the outer membrane by SAM complex. Other outer membrane proteins like mitochondrial distribution and morphology complex (MDM) and mitochondrial import 1 (Mim1) support assembly of β -barrel proteins.

1.7.3.4. The MIA pathway

Numerous proteins of the mitochondrial intermembrane space (IMS) contain multiple cysteine residues implicated in the formation of disulfide bond or binding to cofactors. A mitochondrial IMS sorting signal (MISS) have been identified around these cysteine residues that target such proteins to the destined compartment *via* the MIA (mitochondrial intermembrane space import and assembly) complex (Chacinska et al., 2004; Milenkovic et al., 2009; Sideris et al., 2009). The core component of MIA machinery are import receptor Mia40 and the sulfhydryl oxidase Erv1 (Essential for Respiration and Vegetative growth 1 protein) that operates as a disulfide relay system in the IMS (Chacinska et al., 2004; Grumbt et al., 2007; Mesecke et al., 2005). Mia40 forms transient intermolecular disulfides with incoming precursor proteins as they emerge from TOM complex thereby trapping them in the IMS (Chacinska et al., 2004; Muller et al., 2008). In the next step, Mia40 catalyzes the formation of intra molecular disulfide bridges within the precursors, which leads to substrate release into the IMS and reduction of Mia40 (Chacinska et al., 2004; Grumbt et al., 2007; Muller et al., 2008). Reoxidation of Mia40 is

mediated by Erv1 which accepts electrons from Mia40 and transfers them via cytochrome c to respiratory chain (Bihlmaier et al., 2007; Dabir et al., 2007; Farrell and Thorpe, 2005) thus connecting oxidative folding to respiratory chain (**Fig. 10**).

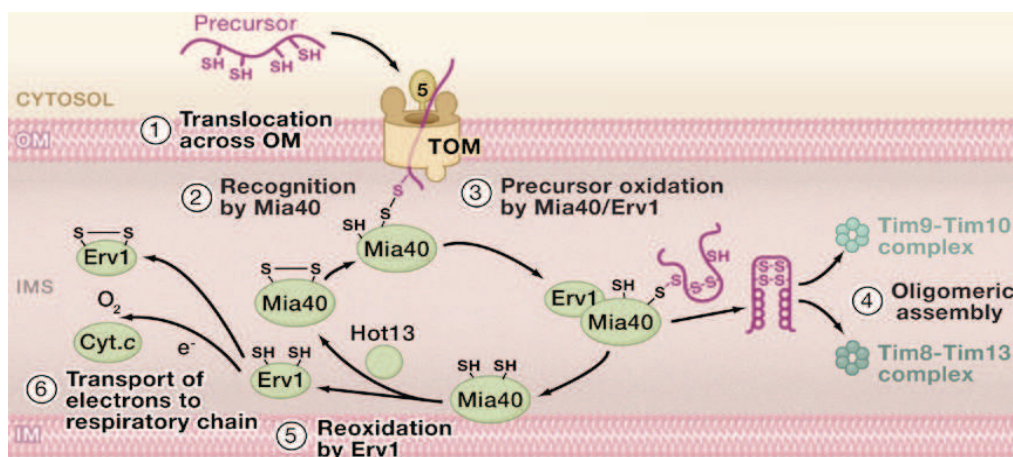

Figure 10: The machinery for import and assembly (MIA) of preprotein into the mitochondrial intermembrane space (Chacinska et al., 2009). The IMS receptor Mia40 binds to precursor via a transient disulfide bond. The sulfhydryl oxidase Erv1 cooperates with Mia40 in the oxidation of precursor protein. Erv1 reoxidizes Mia40 and transfers electron to cytochrome c (cyt C).

1.7.3.5. TIM22 complex

The precursor proteins destined for integration into the inner membrane contain internal targeting signal and are thus recognized and imported by the carrier translocase Tim22, also known as the protein insertion complex (Sirrenberg et al., 1996). The complex consists of three membrane proteins Tim22, Tim54 and Tim18 to which small Tim proteins Tim9-Tim10 bind peripherally *via* Tim12 (**Fig. 11**). After synthesis on cytosolic ribosomes, the carrier proteins are bound by protein chaperones Hsp70 and Hsp90 in order to prevent their aggregation and guide them to the outer membrane receptor Tom70 (Young et al., 2003). The carrier proteins transfer from Tom70 to Tom22 and then translocated into the intermembrane space through TOM complex. In IMS, the carrier protein interact with the soluble Tim9-Tim10 chaperone complex (Koehler et al., 1998), protecting them from aggregation in the aqueous environment of the IMS (Curran et al., 2002). Tim9 and Tim10 assemble with an additional small Tim12 protein to form

a membrane bound Tim9-Tim10-Tim12 complex at the outer surface of Tim22 complex (Neupert and Herrmann, 2007; Rehling et al., 2003). Tim9-Tim10 are directly involved in the transfer of precursor proteins to the carrier translocase of the inner membrane (TIM22 complex). The membrane integrated Tim54 subunit of the TIM22 complex, exposes a large domain to the inter membrane space and may provide a binding site for the Tim9-Tim10-Tim12 complex (Wagner et al., 2008). Insertion of the precursors into the lipid bilayer is then driven by the TIM22 complex that form a twin pore, whose gating is dependent on $\Delta\psi$ across the IMM and on the binding of precursor substrate (Peixoto et al., 2007; Rehling et al., 2003). Inserted membrane protein precursors are then laterally released into the lipid phase by an unknown mechanism, and assembled into their functional forms.

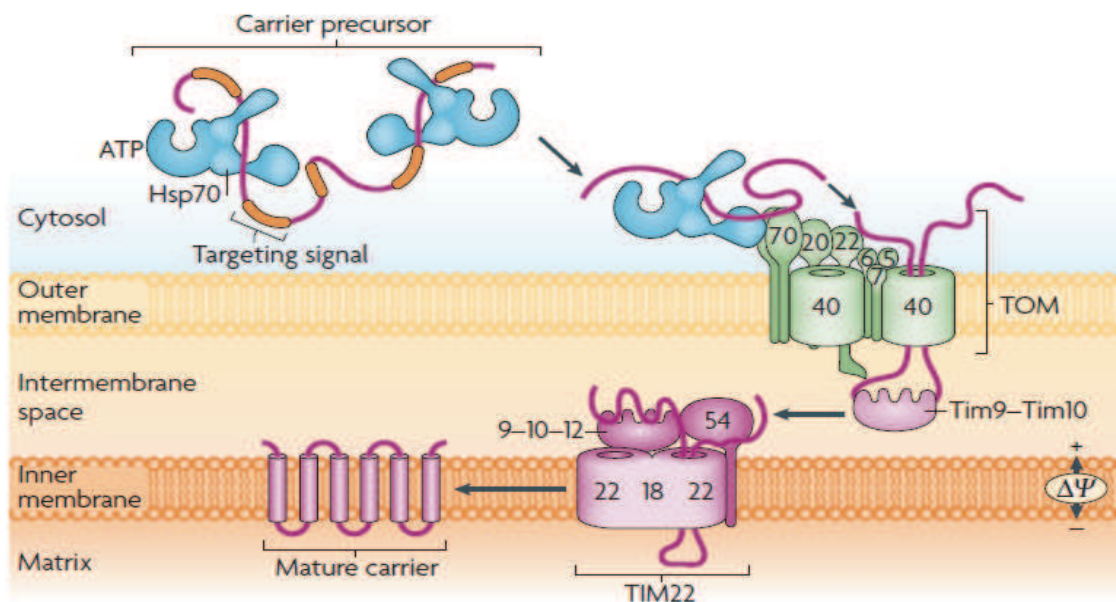

Figure 11: The carrier pathway of preprotein import into mitochondria (Schmidt et al., 2010). The receptor Tom70 possess binding site for precursor and chaperones. After translocation through Tom40, the precursor are transferred by Tim9-Tim10 chaperones through intermembrane space. The carrier translocase of inner membrane Tim22, drives the membrane insertion of imported proteins in a $\Delta\psi$ -dependent manner.

1.8. Nucleic acid import

1.8.1. DNA import into mitochondria

DNA import into isolated mitochondria was described for the first time in plant (Koulintchenko et al., 2003) and then in mammalian (Koulintchenko et al., 2006) and yeast mitochondria (Weber-Lotfi et al., 2009). The import process depend on the double stranded structure of DNA and presumably requires the electrochemical membrane potential. The DNA transport also depends on the outer membrane VDAC channel (Koulintchenko et al., 2006). Translocation though the inner membrane remains still unclear, although may involve adenine nucleotide transported (ANT) complex (Koulintchenko et al., 2003). Furthermore, it was shown that external hydrolysis of ATP significantly enhanced mitochondrial DNA import. This fact could be explained by a possible implication of outer membrane protein phosphorylation that was slightly increased upon incubation of mitochondria with ATP. Preparation of mitochondria in phosphatase inhibiting conditions also significantly increased mitochondrial DNA uptake, strengthening the previously mentioned hypothesis. For the moment, this phenomenon was only demonstrated *in vitro*.

1.8.2. RNA import into mitochondria

In addition to protein import, selective delivery of RNA into mitochondria represent another process indispensable for the proper functioning of mitochondria. A growing number of evidence support the idea that mitochondria commonly import specific RNAs from the cytoplasm (Adhya, 2008; Entelis et al., 2001a; Entelis et al., 2001b; Pan et al.; Rubio et al., 2008; Salinas et al., 2008; Schneider, 2011; Wang et al., 2010). The vast majority of RNAs imported into mitochondria are tRNA, however several other non-coding RNA are also reported as imported. tRNA import into mitochondria was first postulated in the protozoan *Tetrahymena*. Hybridization experiments showed that tRNA present in mitochondria did not all hybridize to mtDNA, suggesting that some were nuclear encoded and imported into mitochondria (Suyama, 1967). Subsequent research showed that RNA import was common to many species including protozoa, plants, yeast and mammals (Dorner et al., 2001; Li et al., 1994; Marechal-Drouard et

al., 1988; Martin et al., 1977, 1979). RNA, and more generally nucleic acid import is currently actively studied since gene therapy approaches could exploit this pathway to target therapeutics nucleic acids into the mitochondria, compensating negative effects of pathogenic mtDNA mutations.

1.8.2.1. RNA import into protozoans mitochondria

The protozoans are unicellular eukaryotic microorganisms extensively used for the study of tRNA import into mitochondria. In *Tetrahymena*, the majority of tRNA are imported from the cytoplasm (Gray et al., 1998). The mitochondrial genomes of trypanosomatids such as *T. brucei* and *Leishmania spp* are completely devoid of tRNA genes and all of their tRNA are imported from the cytoplasm (Hancock and Hajduk, 1990; Simpson et al., 1989). In these organisms, the cytosolic and mitochondrial tRNA pools are similar except initiator tRNA^{Met} and tRNA^{Sec} that have exclusively cytosolic localization (Geslain et al., 2006; Tan et al., 2002b) due to the bacterial type mitochondrial translation initiation using formylated methionine and the absence of selenoprotein in mitochondria. The elongator tRNA^{Met} imported from the cytoplasm function as both initiator and elongator. To function as initiator, methionine bound to this tRNA is formylated by an unusual tRNA^{Met}-formyltransferase that has specificity for elongator tRNA (Tan et al., 2002a). The formylated methionine function as the main determinant for recognition by the bacterial type translation initiation factor 2 (Charriere et al., 2005).

Different targeting signals were identified in protozoans tRNA that specify import and interact with cytosolic targeting factors. In *T. brucei*, 5' flanking sequences of precursor tRNA^{Leu} and dicistronic precursor containing tRNA^{Ser} and tRNA^{Leu}, were shown to function as import determinant, but majority of available data suggest that the import signals are usually found on mature tRNA (Sherrer et al., 2003; Tan et al., 2002b). Comparing the initiator and elongator tRNA^{Met} in this organism, it was shown that a sub region of T-stem (51-63) of both tRNA is sufficient and necessary to determine their localization (Crausaz Esseiva et al., 2004). The base pair U51-A63 in the non-imported initiator tRNA^{Met} function as import anti-determinant, resulting in its cytosolic localization. All other tRNA that carry a different base pairs at this position are imported into mitochondria. The initiator tRNA^{Met} bind to eukaryotic translation initiation factor 2 and is prevented from binding to eukaryotic translation elongation factor 1a

(eEF1a). Interestingly, the U51-A63 base pair function the main anti-determinants preventing binding of the translation elongation factor eEF1a to the initiator tRNA^{Met}. Consistent with this finding, it could be shown that interaction of tRNAs with the elongation factor eEF1a in cytosol may regulate their import into mitochondria of *T. brucei* (Bouzaidi-Tiali et al., 2007). tRNA^{Sec} contained the import anti-determinants (U8-U66) that prevents its binding to eEF1a and remains in the cytoplasm (Bouzaidi-Tiali et al., 2007). The protozoan *Tetrahymena pyriformis* possesses three isoacceptor for cytosolic tRNA^{Gln} with anticodon UUA, CUA and UUG, where only the latter is imported into mitochondria. All three tRNA^{Gln} have several differences in sequences localized in acceptor stem, D-arm and anticodon arm. However, detailed *in vivo* analysis showed that anticodon UUG function as import determinant and is crucial for mitochondrial import (Rusconi and Cech, 1996). Furthermore, the nucleotide substitution which transforms the anticodon UUA to UUG results in the mitochondrial localization of a normally non-imported tRNA^{Gln}. The cytosolic and mitochondrial Glutamine tRNA synthetase (GlnRS) cannot distinguish between the three tRNA^{Gln}, demonstrating the existence of another mitochondrial targeting factor for tRNA^{Gln(UUG)}. In *L. tarentolae*, *in vitro* study demonstrated that the D-arm was necessary and sufficient for the import of tRNA^{Tyr} into mitochondria (Mahapatra et al., 1998). However an extensive study of other tRNAs in this protozoan indicated the absence of consensus elements in D-arm of imported tRNAs, supporting the idea that other structural elements or sequences are necessary for import to occur (Suyama et al., 1998). Based on this data, distinct import determinant were identified in the D-arm for type-1 tRNA and in the variable or T-arm for typ-2 tRNA in *L. tarentolae* (Bhattacharyya et al., 2002). In addition, the cytosol specific thio-modification at the wobble position in tRNA^{Glu} and tRNA^{Gln} has been proposed to function as anti-determinant for mitochondrial import in *L. tarentolae* (Kaneko et al., 2003). The *in vitro* transcribed tRNA^{Gln} lacking such modification was shown to be imported more efficiently into mitochondria than natively purified thiomodified tRNA^{Glu} (Kaneko et al., 2003).

Like trypanosomatids, the mitochondrial genome of a protozoan apicomplexan does not contain tRNA genes. In *Toxoplasma gondii*, all cytoplasmic tRNA except initiator tRNA^{Met} are imported into mitochondria (Esseiva et al., 2004). However, in contrast to trypanosomatids no thiomodifications were detected in the tRNA^{Gln} of *T. gondii*, suggesting that thiolation is not involved in regulation of tRNA import in this protist (Esseiva et al., 2004).

Translocation of tRNA across the mitochondrial double membrane is far to be understood in protozoans. In all systems, import required external and probably internal ATP as well as, in some cases, electrochemical proton gradient (Mukherjee et al., 1999; Rubio et al., 2000; Yermovsky-Kammerer and Hajduk, 1999). *In vitro* tRNA import studies showed that pretreatment of the mitochondria with proteinase inhibited tRNA import in *T. brucei* and two *Leishmania* species, indicating the requirement of proteinaceous receptors on mitochondrial surface (Schneider, 2001). Furthermore, tRNA import into isolated mitochondria occurs without the need of cytosolic import factors in *L. tarentolae* and *L. tropica* (Mahapatra et al., 1998; Rubio et al., 2000). In *L. tropica*, tRNAs are first bound to outer mitochondrial membrane receptors. A putative 15-kDa receptor, TAB (tubulin antisense-binding protein), has first been proposed to perform this function, but its molecular identity has never been established (Fig. 12). In *T. brucei*, the plant functional homolog of VDAC was suggested to be an essential metabolite transporter and indispensable for normal growth but was not required for tRNA translocation across the outer membrane (Pusnik et al., 2009). In a more recent study, it was shown that ablation of Tim17 and mitochondrial heat-shock protein 70, which are component of inner membrane protein translocation machinery, strongly inhibit import of tRNA into mitochondria (Tschopp et al., 2011). The only tRNA import mechanism reported in trypanosomatids so far was the purification of a large multi-subunit complex of 640 kDa called RIC (RNA Import Complex) from the inner mitochondrial membrane of *Leishmania trophica* using affinity chromatography. The complex was shown to function in the ATP dependent import of tRNA into phospholipid vesicles (Bhattacharyya and Adhya, 2004; Bhattacharyya et al., 2003). Mass spectrometry analysis show that RIC is composed of 11 subunits, eight of which are nuclear encoded while the other three are encoded by mitochondrial DNA (Mukherjee et al., 2007). The two import receptor RIC1 and RIC8A, bind type-I and type II tRNA respectively. These interaction show an allosteric behaviour permitting the regulation of tRNA import (Bhattacharyya et al., 2002; Bhattacharyya et al., 2003). However, some of these results raised serious editorial concerns (Schekman, 2010) which still are not resolved.

1.8.2.2. RNA import into Plant mitochondria

The size of plant mitochondrial genome range from 200 to 2000Kb, but, surprisingly, none of them encode a full set of tRNAs required for mitochondrial translation (Dietrich et al., 1992). Plant mitochondrial DNA encode 14-16 tRNA, the remaining needed for mitochondrial translation are nuclear encoded and imported into mitochondria (Dietrich et al., 1996b; Kumar et al., 1996). The number as well as the identity of these imported tRNAs differ significantly even between closely related species, demonstrating the import specificity can rapidly evolve (Glover et al., 2001; Kumar et al., 1996). Aminoacyl tRNA synthetases were supposed to have an important role in mitochondrial tRNA import since they are highly specific toward their cognate tRNA. Indeed tRNA import is prevented *in vivo* upon abolishment of recognition by the cognate aaRS (Delage et al., 2003b; Dietrich et al., 1996a). In *Arabidopsis thaliana*, mutation U70C in the amino acceptor stem of tRNA^{Ala}, abolish aminoacylation by AlaRS and consequently inhibit import of mutant tRNA into tobacco mitochondria (Dietrich et al., 1996a). However, the coexpression of tRNA^{Ala} and AlaRS in yeast was not sufficient to direct the import of tRNA^{Ala} into mitochondria, indicating the existence of at least one additional protein factor implicated in the targeting of tRNA^{Ala} into mitochondria (Mireau et al., 2000). The existence of import determinants other than aminoacylation identity elements was strengthened by *in vivo* study using the tRNA^{Val} from *Arabidopsis thaliana*. When misacylated with methionine, mutant tRNA^{Val} (anticodon switch from CAA to CAU) was retained in the cytoplasm of transgenic tobacco cells (Delage et al., 2003b). The mutant tRNA^{Val} containing the D-arm of cytosol specific tRNA^{Met} is aminoacylated by valyl-tRNA synthetase but not imported into mitochondria (Delage et al., 2003b). Another example that aminoacylation is not prerequisite for tRNA import in plants was illustrated by *in vivo* import of tRNA^{Gly} into mitochondria of transgenic tobacco plants. Three cytosolic tRNA^{Gly} isoacceptors were identified in plants (Brubacher-Kauffmann et al., 1999), where in tobacco only the tRNA^{Gly(UCC)} is imported and the tRNA^{Gly(GCC)} is not. It was further shown that change of anticodon (UCC to GCC) and the replacement of the D-domain from tRNA^{Gly(GCC)} into the tRNA^{Gly(UCC)} backbone abolished the mitochondrial import of these mutant tRNA even if correctly aminoacylated (Salinas et al., 2005). Based on these studies, it is evident that aminoacylation alone is not sufficient to confer mitochondrial import to tRNA in plants. Furthermore, aminoacylation is essential for the nuclear export of tRNAs, so the absence

of mitochondrial import in transgenic plants could also be explained by a nuclear retention of non-aminoacylated tRNAs (Lund and Dahlberg, 1998).

In plants, translocation of tRNA at the level of outer membrane depends on voltage dependent anion channel (VDAC), which is the main metabolite transporter and the most abundant protein of the outer membrane (**Fig. 12**). VDAC has the ability to bind tRNA directly and *in vitro* import of tRNA is inhibited by using antibodies against VDAC. Import of tRNA is also inhibited when antibodies were used against Tom20 and Tom40, the component of TOM complex (Salinas et al., 2006). Based on these results, it was suggested that VDAC may be a major component of the tRNA import channel whereas Tom20 and Tom40 may function as import receptors (Salinas et al., 2006). *In vitro* import assays showed that translocation process did not need any added cytosolic protein factors but it was dependent on energy provided by ATP hydrolysis (Delage et al., 2003a). Import can be inhibited *in vitro* using valinomycin and oligomycin, suggesting the requirement of electrochemical membrane potential and/or functional respiratory chain.

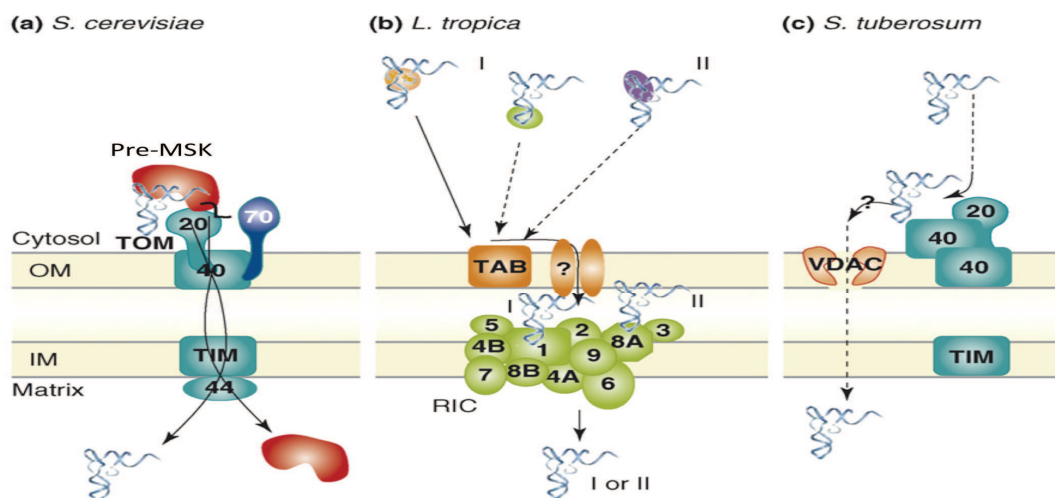

Figure 12: Overview of mitochondrial tRNA-import channels (Salinas et al., 2008). (a) In *S. cerevisiae*, nuclear encoded tRNA^{Lys(CUU)} (tRK1) interact with the precursor form of the mitochondrial lysyl-tRNA synthetase (pre-Msk1p) and cotranslocated through the protein-import channel. The protease-sensitive receptor TOM20 of the TOM complex and the major component TIM44 of the TIM complex are essential for tRNA import. (b) In *Leishmania tropica*, tRNAs are first bound to outer mitochondrial membrane receptors. A putative 15-kDa receptor, TAB (tubulin antisense-binding protein), has been proposed to perform this function. At the level of

the inner membrane, tRNAs reach a large multi-subunit complex called RNA-import complex (RIC), which contains at least 11 subunits. (c) In *Solanum tuberosum*, two major components of the TOM complex, TOM20 and TOM40, are important for tRNA binding at the mitochondrial surface. Then tRNAs are translocated through the pore of the voltage-dependent anion channel (VDAC). How tRNAs are translocated through the inner membrane remains unknown, but proteins and tRNAs are translocated *via* distinct pathways.

1.8.2.3. RNA import in Yeast mitochondria

The mitochondrial genome of yeast *S. cerevisiae* was ever thought to code for all the tRNAs needed for the mitochondrial translation (Foury et al., 1998). However, two tRNA species were also reported to be partially internalized by mitochondria. They are tRNA^{Lys(CUU)} (Martin et al., 1979) and two tRNA^{Gln} isoacceptors (Rinehart et al., 2005).

In *S. cerevisiae*, the nuclear encoded tRNA^{Gln(CUG)} and tRNA^{Gln(UUG)} were shown to be imported into mitochondria (**Fig. 14B**). The *in vitro* import of these tRNA into mitochondria was observed without addition of cytosolic factors and in the absence of amino acylation (Rinehart et al., 2005). The requirement of cytosolic tRNA^{Gln} for mitochondrial translation *in vivo* was shown by expressing a suppressor version of cytosolic tRNA^{Gln(CUG)} which was able to structurally or physically rescue an artificially introduced non sense mutation in mitochondrial encoded cytochrome oxidase subunit II gene. In this study it was shown that a fraction of cytosolic glutamyl-tRNA synthetase is also imported into the mitochondrion where it aminoacylates the imported tRNA^{Gln}. These results were more recently refuted by another study that no cytosolic tRNA^{Gln} is imported into mitochondria and that Gln-tRNA^{Gln} is formed inside mitochondria by transamidation pathway involving the mitochondrial encoded tRNA^{Gln}, the nondiscriminating cytosolic GluRS and the mitochondrial amidotransferase GatFAB (Frechin et al., 2009).

S. cerevisiae possess three isoacceptors for lysine tRNA: two isoacceptor tRNA^{Lys(CUU)} (tRK1) and tRNA^{Lys(UUU)} (tRK2) are nuclear DNA encoded while tRNA^{Lys(UUU)} (tRK3) is encoded by mitochondrial DNA (**Fig. 13A**). It was shown that tRK1 is partially imported into mitochondria while tRK2 remain exclusively in the cytoplasm (Martin et al., 1979).

A

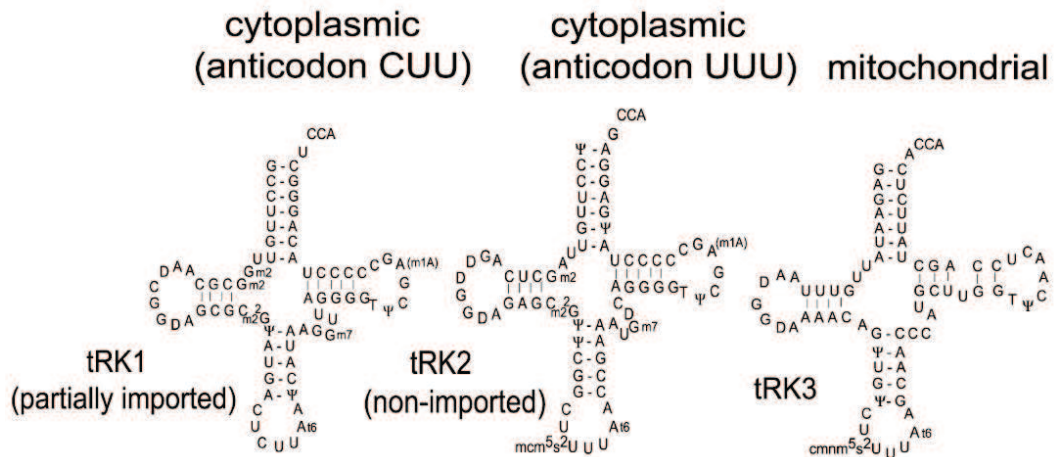

B

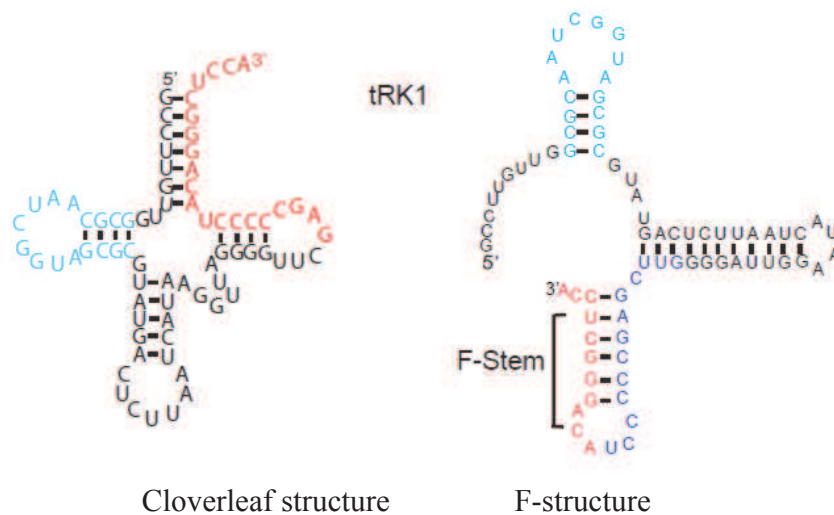

Figure 13: Lysine tRNA in *S. cerevisiae* (A) Cloverleaf structure of cytosolic and mitochondrial tRNA^{Lys} of *S. cerevisiae* (Kamenski et al., 2007). (B) tRK1 cloverleaf structure and alternative F-structure upon interaction with Eno2p (Kolesnikova et al., 2010).

The mechanism of tRK1 import into mitochondria and the import factors have been studied in detail (**Fig. 14A**). The fraction of tRK1 destined to be imported is first charged by cytosolic lysyl tRNA synthetase (LysRS), and diverted from the cytosolic translation machinery to mitochondrial import pathway by specifically binding to the glycolytic enzyme enolase (Entelis et al., 2006). Yeast contains two isoforms of enolase, Eno1p and Eno2p of which, only

Eno2p is able to bind aminoacylated tRK1 but not tRK2. It was shown that deletion of these two isoforms in yeast lead to an almost complete arrest of tRK1 import *in vivo*, whereas expression of Eno2p in the double deletion strain was able to complement this effect. The *in vitro* analysis, using in gel Forster resonance energy transfer (FRET) approach show that when bound to Eno2p, tRK1 adopt an alternative conformation called F-structure (**Fig. 13B**), where the 3' end is close to the T-loop region (Kolesnikova et al., 2010). Formation of this alternative structure is a crucial factor determining the specificity of tRK1 import by facilitating binding to the second import factor, the precursor of mitochondrial lysyl-tRNA synthetase (pre-Msk1p) The tRNA-Eno2p complex then transit towards the mitochondrial surface, where tRK1 is transferred to the Pre-Msk1p which is synthesized at the periphery of mitochondria (Entelis et al., 2006). The tRNA-pre-Msk1p complex was hypothesized to be coimported into the mitochondrial matrix using protein import pathway (Tarassov et al., 1995a, b), while enolase is incorporated into the glycolytic multi protein complex associated with mitochondrial outer membrane (Brandina et al., 2006).

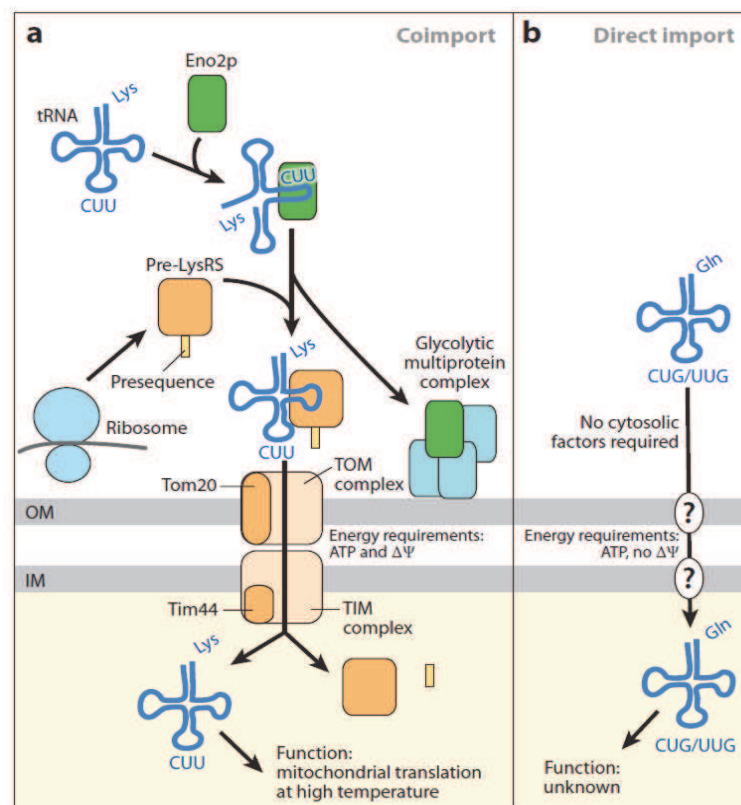

Figure 14: Mitochondrial tRNA import in *S. cerevisiae* (Schneider, 2011). (A) The yeast tRNA^{CUU} aminoacylated by cytosolic lysyl tRNA synthetase (lysRS) interact with glycolytic

enzyme Eno2p and deviate from the cytosolic translation machinery. Eno2p target tRK1 to the mitochondrial surface and function as chaperone that facilitate interaction of tRK1 with precursor of mitochondrial lysyl tRNA synthetase (pre-MSK) synthesized in the vicinity of mitochondria. The tRK1 is cotranslocated in complex with preMSK through protein import pathway. (B) Direct import of tRNA^{Gln} into yeast mitochondria. The import does not require the cytosolic import factors.

The function of imported tRK1 was not obvious for long time since the mitochondrial DNA of *S. cerevisiae* encodes lysine tRNA^{UUU} which due to its thio-modified wobble uridine (5-carboxymethylaminomethyl-2-thiouridine), can decode both AAA and AAG codons for lysine amino acid (Martin et al., 1990). Moreover, the imported tRNA^{Lys(CUU)} is most probably used for a single round of translation elongation because it cannot be recharged inside the mitochondria by the mitochondrial amino-acyl tRNA synthetase. However, an elegant series of experiments demonstrated that although the imported tRK1 is dispensable for growth of yeast at 30°C, it becomes essential for mitochondrial translation under temperature stress conditions (Kamenski et al., 2007). It was shown that at 37°C, the thio-modified wobble uridine of mitochondrially encoded tRNA^{LysUUU} becomes undermodified, thus preventing it from decoding AAG lysine codon. In such situation, the import of cytosolic tRNA^{LysCUU} is needed to decode the very rare AAG codon in mitochondria.

There are two cytosolic tRNA^{Lys} in yeast but only one is imported into mitochondria, indicating that the import is highly specific. The nucleotide sequences of tRK1 and tRK2 differ in 21 positions, suggesting that some nucleotides function as import determinant (**Fig. 13A**). Detailed analysis of both tRNAs show that the first nucleotide pair of amino acceptor stem (G1-C72), the discriminatory base (U73) in the acceptor stem and the anticodon are required for the efficient import of tRK1 into mitochondria (Entelis et al., 1998; Kolesnikova et al., 2002). The mutant tRK2 version containing (G1-C72) of tRK1 was shown to be imported into mitochondria. Other nucleotides of amino acceptor stem (C67, A68 and G69) were shown to be also important because the replacement of these nucleotides with that of tRK2 result in decrease efficiency of pre-Msk1p binding and of mitochondrial import capacity independently of amino acylation abilities (Entelis et al., 1998). The mutation of the discriminator base U73 of tRK1 resulted in a decreased import efficiency, while the introduction of U73 in tRK2 lead to an increased import of tRK2 transcripts, demonstrating that U73 also functions as specific import determinant (Kazakova et al., 1999). The anticodon region of tRK1 was shown to contain import

determinants because replacement of the anticodon arm of tRK1 by that of tRK2 completely inhibit mitochondrial import of mutant tRK1 *in vitro* and *in vivo*. The most important nucleotide in the anticodon was C34 because the introduction of this nucleotide into tRK2 confer mitochondrial import to this cytosolic tRNA. These import determinants are essential for the stabilization of alternative F-structure. The strictly cytosolic tRK2 containing different nucleotides at these positions is not able to form a stable F-structure. It was shown that the first base pair G1-C72 of tRK1 functioning as import determinant, favours the stability of F- stem and the discriminator base U73 indirectly affects the F-stem structure by influencing the stability of the first base pair of the amino acceptor stem (Lee et al., 1993). The anticodon nucleotides are involved in the formation of long hairpin in F-structure that determine overall structure stability (**Fig. 13B**). The nucleotide C34 of anticodon has an important role in stabilizing the F structure because the introduction of U34 at this position leads to formation of three consecutive non-canonical G-U base pairs destabilizing the long hairpin.

Once targeted to the mitochondrial surface, the tRK1 needs to be translocated across the mitochondrial double membrane (**Fig. 12**). The import process is dependent on energy provided by ATP and electrochemical membrane potential $\Delta\psi$. In yeast it was shown that an intact protein translocation machinery is required tRK1 import (Tarassov et al., 1995a). The roles of the preprotein import receptor TOM20 and TOM70 of the TOM complex and the protein component TIM44 of the TIM complex have been studied using an *in vitro* tRNA import system and appropriate mutant yeast strains. It was shown that deletion of TOM20 and TIM44 result in the inhibition of tRK1 import whereas deletion of TOM70 has no effect on tRK1 import into yeast mitochondria (Tarassov et al., 1995a). It is thought that tRK1 is cotranslocated in complex with pre-Msk1p through the protein import channel. However unfolding of proteins is a prerequisite for import into mitochondria, which raises the question of how the unfolded pre-Msk1p could form a complex with the tRNA^{Lys} during the import process essentially across the double membrane.

1.8.2.4. RNA import in mammals

Mammalian mitochondria encode full set of tRNAs required for the translation of mitochondrial genome (Anderson et al., 1981) and were thought not to import tRNA from the

cytoplasm. The only exception is marsupial where mitochondrial tRNA^{Lys} gene is deteriorated into a pseudogene and the cytoplasmic tRNA^{Lys} is imported into mitochondria (Dorner et al., 2001). In addition, the nucleus encoded tRNA^{Gln(CUG)} and tRNA^{Gln(UUG)} were shown to be imported into human mitochondria *in vivo* (Rubio et al., 2008). The *in vitro* import of these tRNA into mitochondria needs ATP and is independent of membrane potential and cytosolic protein factors (Rubio et al., 2008). Basing on the same reasoning as for the yeast system, the authors suggested that the modified wobble U34 of the mtDNA encoded tRNA^{Gln} would affect decoding CAG codon, according to the commonly agreed codon-anticodon recognition rules (Agris et al., 2007; Sprinzl and Vassilenko, 2005). So, to fulfill complete set of decoding, mitochondria must import corresponding nuclear encoded tRNA^{Gln(CUG)} and tRNA^{Gln(UUG)} isoacceptors from the cytosol. Import of RNA component of ribonucleoprotein complexes into mammalian mitochondria was also suggested. One example is the H1 RNA component of RNase P which is involve in the 5'-processing of precursor tRNAs. This RNA was shown to localize in nucleus as well as imported into mammalian mitochondria (Doersen et al., 1985; Wang et al., 2010; Wang et al.) since many species (but not all) do not possess corresponding genes in their mitochondrial genomes. In the case of mammalian cells, the first experimental evidence of the presence of RNase P RNA in the mitochondria was reported more than 20 years ago (Doersen et al., 1985), which corroborated with a further study (Puranam and Attardi, 2001). A series of experiments with truncated H1 RNA revealed that central 20 nucleotides forming stable stem loop structure is capable to direct the import this RNA into yeast and human mitochondria (Wang et al., 2010). Doersen and co worker showed previously that protein fractions isolated from nuclease treated mitochondria possess RNase P activity that was completely inhibited by addition of micrococcal nuclease (Doersen et al., 1985). However other studies report an RNA independent RNase P activity within mitochondria that require thee core proteins (Holzmann et al., 2008; Pavlova et al., 2012). Based on these results, one can hypothesized the presence of two distinct RNase P in mammalian mitochondria, where H1 RNA could be functioning in a capacity distinct from the protein-only RNase P enzyme within mitochondria. In a more recent study, it was shown that protein-only RNase P enzyme is required for correctly maturation of single tRNA genes, while RNA-containing RNase P may be required only for the processing of tandem singles (Wang et al., 2010).

The second example of imported RNAs is the RNA component of RNase MRP that function as site specific endoribonuclease involved in primer RNA cleavage during mitochondrial DNA replication (Chang and Clayton, 1987). It was shown that deleting the central coding region (118-175) of MRP RNA gene impaired the mitochondrial import, while deletion at the 5' or 3' ends did not affect import, illustrating that the central region is important for mitochondrial targeting (Li et al., 1994).

The 5S ribosomal RNA (5S rRNA) is an integral part of the large ribosomal subunit of almost all living organisms, but in mitochondria, its gene has only been found in plants and a few protists (Gray et al., 1999; O'Brien et al., 2009). In *S. cerevisiae*, cytosolic 5S rRNA is neither encoded on the mitochondrial genome nor imported from the cytosol, illustrating that mitochondrial ribosomes can, in principle, function without a 5S rRNA. In mammals, 5S rRNA is not encoded in mitochondrial DNA and a significant portion is imported into mitochondria, suggesting its implication in some important processes inside the organelle (Entelis et al., 2001a; Magalhaes et al., 1998; Yoshionari et al., 1994). Recently, 5S rRNA was shown to be associated with mitochondrial ribosomes (Smirnov et al., 2011b). 5S rRNA is relatively small molecule of approximately 120 nucleotides and is organized into a complex structure arranged in three major domains (Fig. 15). The α -domain is formed by helix I, β -domain is formed by helices II and III and loops B and C, while the γ -domain includes helices IV and V and loops D and E.

A

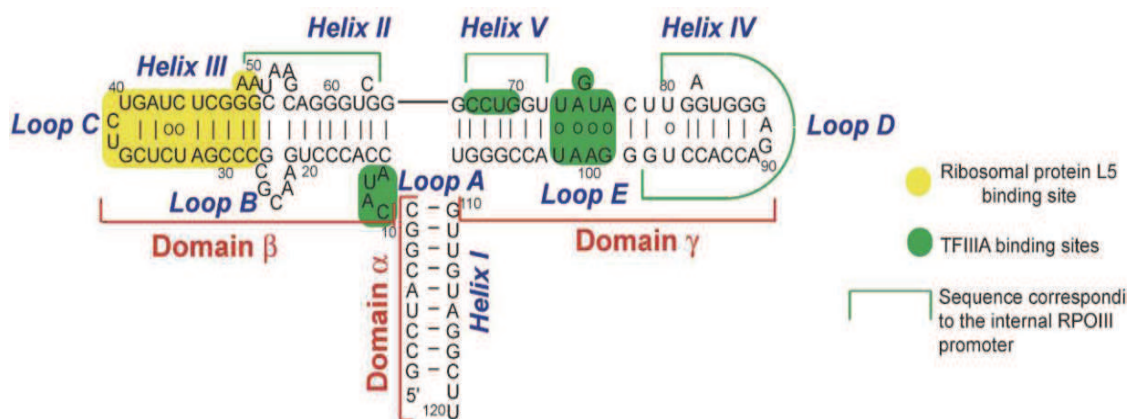

B

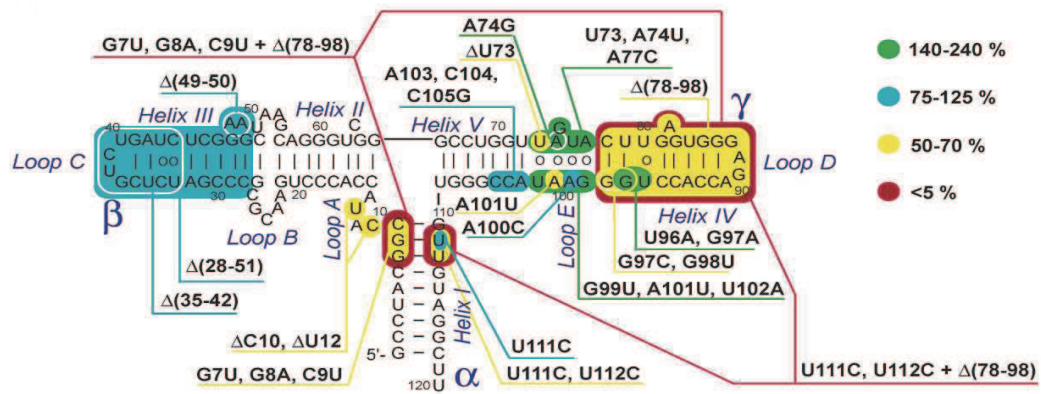

C

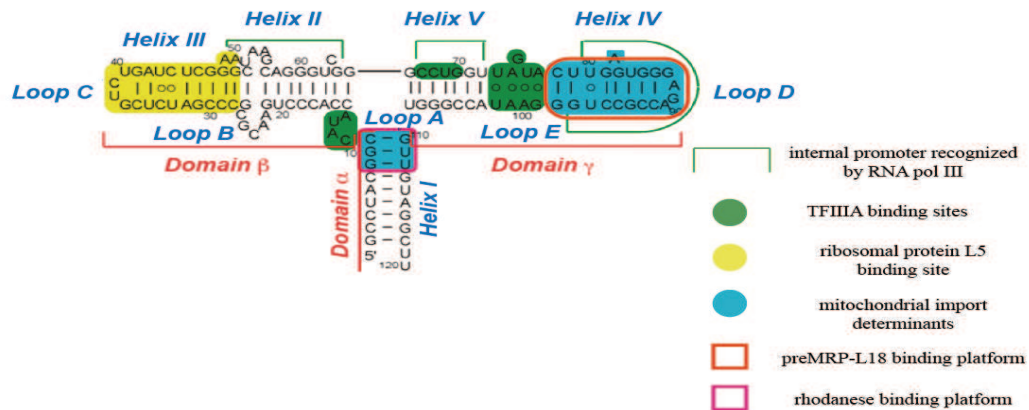

Figure 15: Structure of Human 5S rRNA. (A) Secondary structure of Human 5S rRNA. Binding sites for the transcription initiation factor III A (TFIIIA), for the ribosomal protein L5 and the promoter for RNA polymerase III are shown. (B) Mutation map of human 5S rRNA. Colors correspond to different import efficiencies *in vitro*. (C) Recapitulative map emphasizing binding platforms for the 5S rRNA import factors rhodanese and preMRP-L18, mitochondrial import determinant and structural elements mentioned in (A). (Smirnov et al., 2010a; Smirnov et al., 2011b; Smirnov et al., 2008).

Directed mutagenesis approach was used to determine the essential import determinants located in several structural domains of 5S rRNA (**Fig. 15B**). The β -domain has been shown to be dispensable for mitochondrial targeting of 5S rRNA because the domain itself is incapable of entering into mitochondria and deletion of conserved nucleotides (A49, A50) bulge in helix III, as well as of loop C $\Delta(35-42)$, both needed for binding of ribosomal proteins of the L18/eL5

family (Huber et al., 2001; Huber and Wool, 1984), did not significantly changed the 5S rRNA import efficiency (**Fig. 15B**). Furthermore, deletion of $\Delta(28-51)$, helix III and loop C and destructuring loop B structure did not affect the import efficiency of 5S rRNA. The α and γ domains were shown to be of great importance since 5S rRNA devoid of one of these sites result in decreased efficiency of import into isolated mitochondria, while destruction of both of them leads to complete loss of import capacity. In the γ -domain, breaking the distal part of helix V (A103G, C104G, C105G) and destabilizing loop E (A100C) are of little importance for 5S rRNA targeting to mitochondria. Interestingly, mutations (A74G, U73A, A74U, A77C, U96A, G97A, G99U, A101U, U102A) conferring a more closed and stable structure to the loop E and helix IV of γ -domain generated mutant 5S rRNA molecules displaying higher import efficiencies than the wild type (**Fig. 15B**). In the α -domain the loop A is a three-way junction, upon which the overall 3D structure of the molecule depends (Lescoute and Westhof, 2006). The deletion of two nucleotides ($\Delta C10$, $\Delta U12$) affecting the general conformation of 5S rRNA only weakly influence the import efficiency. However, the whole disruption of helix I (U111C+U112C, G7U, G8A, C9U) resulted in a twofold decrease of import efficiency. The deletion of helix IV and loop D in combination with one of helix I mutations (U111C, U112C or G7U, G8A, C9U) dramatically decreased 5S rRNA import capacity indicating that both of these regions are responsible for the import of 5S rRNA, although one of them is sufficient for 5S rRNA mitochondrial localization (Smirnov et al., 2008).

Mitochondrial import of 5S rRNA depends on cytosolic protein factors. After export from the nucleus, 5S rRNA is bound by the cytosolic ribosomal protein L5 and reimported into the nucleus where it is integrated into the ribosome or is captured by the precursor of the mitochondrial ribosomal protein L18 (preMRP-L18) that function as one of the 5S rRNA import factor (Smirnov et al., 2011b). This protein can interact with 5S rRNA *in vitro* and *in vivo* which strictly depends on the presence of helix IV and loop D located in the γ domain (**Fig. 15C**). Binding of preMRP-L18 conferring the structural rearrangement necessary for the interaction with the thiosulfate sulphurtransferase (rhodanese) enzyme that is presumed to be the carrier of 5S rRNA during its mitochondrial import (Smirnov et al., 2010a). The structural elements of 5S rRNA binding to this enzyme are located in the α -domain and to a lesser extent in the γ -domain (**Fig. 15C**). It was shown that pretreatment of cytosolic extract with rhodanese antibodies or knocking down the expression of the corresponding gene by siRNA *in vivo* cause a significant

decrease of 5S rRNA import. Thus preMRP-L18 protein, in combination with rhodanese was shown to be a minimal vehicle sufficient for the targeting of 5S rRNA into mitochondria (**Fig. 16**).

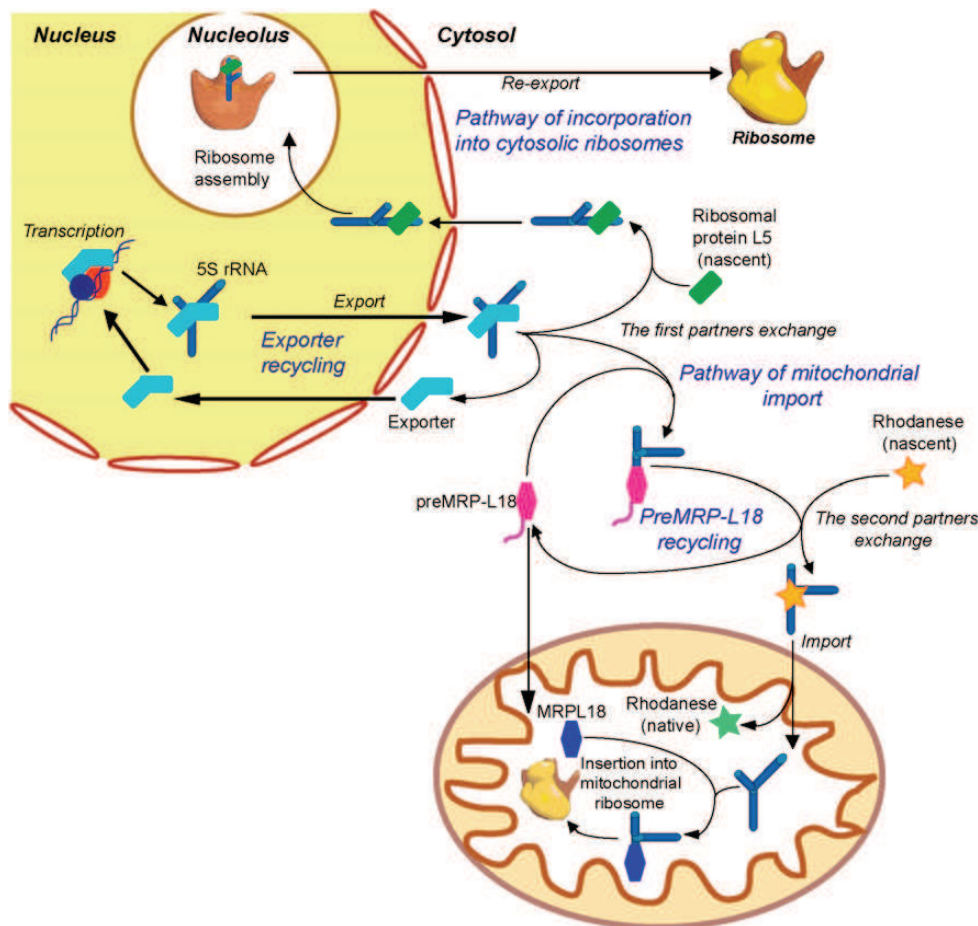

Figure 16: Hypothetical mechanism of 5S rRNA intracellular traffic (Smirnov et al., 2011b).

Translocation of 5S rRNA across the mitochondrial membranes depends on energy provided by ATP hydrolysis, on the electrochemical membrane potential $\Delta\Psi$ and on proteinase sensitive outer membrane receptors. The import requires intact and functional preprotein import machinery since destructured recombinant protein blocks protein import, also inhibit 5S rRNA import into mitochondria (Entelis et al., 2001a).

Recently, polynucleotide phosphorylase (PNPase), a 3'-5' exoribonuclease and poly A polymerase at least partially anchored to the mitochondrial inner membrane (Chen et al., 2006) was reported to participate in the translocation of H1 RNA into the mitochondrial matrix (Wang et al., 2010). Studies using *in vitro* and *in vivo* approaches have demonstrated a direct role for PNPase in regulating the import of these non-coding RNAs into mitochondria. The RNA import function of PNPase was separable from its RNA processing function, as an engineered point mutation that cripples its H1 RNA-processing activity has no effect on RNA import into mitochondria. However, the molecular mechanism by which PNPase distinguishes between RNAs processing versus import remains to be clarified. PNPase recognizes an RNA stem-loop structure which serves as import determinant (Wang et al., 2010).

In addition to the above mentioned natural RNA import, the yeast tRNA^{Lys(CUU)} was shown to be imported into human mitochondria by a similar mechanism described in yeast (Entelis et al., 2001a). Trying to identify the import determinants in tRK1 structure by SELEX experiment, a set of small artificial RNA derived from tRK1 were generated and the mutant versions were screened for their mitochondrial import. Several rounds of such a selection revealed a set of significantly altered sequences capable of efficient import into mitochondria. Interestingly, these RNAs had lost the normal secondary structure of a tRNA, however the D arm and the 3'-end (F-hairpin structure) were the primary regions conserved. These two regions presumably function as import determinant for the targeting of RNA into yeast and human mitochondria (Kolesnikova et al., 2010). Based on these import determinants, a set of artificial RNA molecules were generated (**Fig. 17**) and used as vector for targeting therapeutic oligonucleotides complementary to the mutant region in mtDNA. The first validation of these RNAs as a tool for antigenomic therapeutic strategy was recently described in the host laboratory (Comte et al., 2013b). The model concerned a large 8 kb long deletion from base 8363 to 15438 leading to Kerns Sayre Syndrome (KSS), characterized by significant changes in mitochondrial translation pattern. It was demonstrated that chimeric RNA molecules containing D-arm and F-hairpin plus an oligonucleotide complementary to the region surrounding the deletion were addressed into mitochondria of cultured human cells and that their import was accompanied by a reproducible decrease of the ratio between mutant and wild type mtDNA. This shift of heteroplasmy resulted in a restoration of normal mitochondrial translation pattern, thus producing a curative effect (Comte et al., 2013a).

A

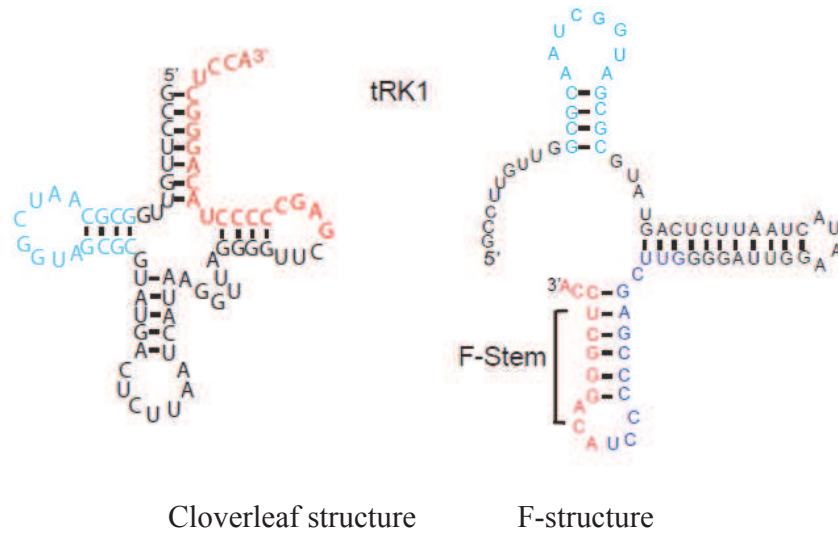

B

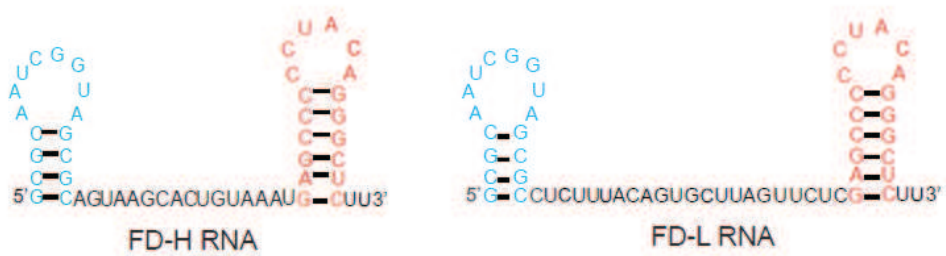

C

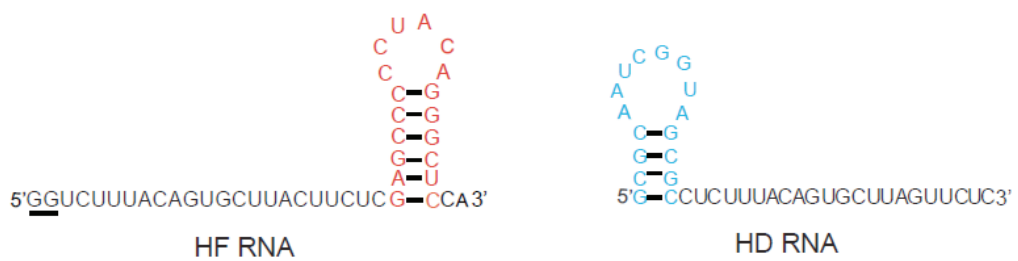

Figure 17: Predicted structures of the yeast tRNA^{Lys}(^{CUU}tRK1) and small synthetic RNAs (Kolesnikova et al., 2010). (A) The cloverleaf structure is shown at the left, the alternative

F-structure at the right. (B) Secondary structures of small synthetic “anti-replicative” RNAs composed of the tRK1 D-arm (in blue) and the F helix-loop structure (in red), separated by oligonucleotide stretches complementary to the heavy or light strands of human mitochondrial DNA (Comte et al., 2013). (C) Truncated RNA molecules derived from FD-L RNA lacking either the D-arm of tRK1 (HF RNA) or the F-hairpin (HD RNA). The nucleotides added to the 59-end of HF RNA to improve T7-transcription are underlined.

Mitochondrial targeting of these "therapeutic" molecules can be further improved if we better understand the molecular mechanism of their import, especially by identification and characterization of protein factors implicated in this process. This question was addressed in the present study.

OBJECTIVES

Thesis project and objectives

The objective of my thesis work was the characterization of protein factors participating in the targeting and translocation of RNA into human mitochondria. The import of yeast tRK1 and its derivatives into human mitochondria leads to the suggestion that human cell possesses the machinery needed for tRNA mitochondrial import. It was hypothesized that the cytosolic precursor of human mitochondrial lysyl-tRNA synthetase (preKARS2) could replace preMsk1p and serve as a carrier for the import of tRK1 and their derivatives into mitochondrial matrix (Sepuri et al., 2012). Secondly, in yeast Eno2p was shown to function as RNA chaperone facilitating tRK1 interaction with the yeast preMsk1p (Brandina et al., 2006). We aimed to verify if this sequence of molecular events stands true in human cells. Finally, Polynucleotide phosphorylase (PNPase)

localized in the mitochondrial innermembrane space was shown to function in the translocation of RNA from the intermembrane space into the mitochondrial matrix (Wang et al., 2010). So, the last objective of my study was to verify the involvement of PNPase in mitochondrial targeting of tRK1 related molecules into human mitochondria. The specific objectives of the PhD thesis were:

- To study the affinity of recombinant preKARS2 to tRK1 and its derivatives.
- To study the role of preKARS2 in targeting tRK1 and its derivatives towards mitochondria *in vitro* and *in vivo* in cultured human cell lines.
- To study the chaperone function of different isoforms of human enolases.
- To study the role of human PNPase in translocation of different RNAs from the intermembrane space into the mitochondrial matrix.

RESULTS

2. Results

2.1. Induced tRNA import into human mitochondria: implication of a host aminoacyl-tRNA-synthetase

2.1.1. Summary

The mechanism and protein factors involved in the targeting of tRNA^{Lys(CUU)} into yeast mitochondria has been studied in great detail. Trying to understand the import determinants in tRK1 structure by SELEX experiment, a set of small RNA derived from tRK1 with extremely high efficiency of import into mitochondria was generated. Furthermore, it was found that synthetic transcripts of yeast tRK1 and a number of their derivatives designed for therapeutic application could be specifically internalized by isolated human mitochondria *in vitro* in the presence of cytosolic factors as well as *in vivo*, indicating that the human cell possesses the machinery needed for tRNA mitochondrial import (Entelis et al., 2001b; Kolesnikova et al., 2010). It was suggested that the cytosolic precursor of human mitochondrial lysyl-tRNA synthetase (preKARS2) could replace preMsk1p and serve as a carrier for the import of tRK1 and their derivatives into mitochondrial matrix (Entelis et al., 2001b; Sepuri et al., 2012). In human cells, a single *KARS1* gene encodes both precursor of mitochondrial (preKARS2) and cytosolic Lysyl-tRNA-synthetases (KARS1), which are translated from two mRNAs generated by alternative splicing (Tolkunova et al., 2000). The splicing of exon1 to exon3 produced an mRNA encoding KARS1 while the inclusion of exon2 between exon1 and exon3 produced an mRNA encoding preKARS2, which upon import into mitochondria is converted to mature form of lysyl-tRNA synthetase (KARS2).

We studied the role of preKARS2 in targeting tRK1 and its derivatives into human mitochondria *in vitro* and *in vivo*. These results and their discussion are presented in the publication 1 (See below). Using electromobility shift assay (EMSA), we show that recombinant preKARS2 has an affinity to synthetic transcripts of yeast tRK1 and to its derivatives named FD-L and FD-H, containing D-arm and F-hairpin parts of tRK1. The mature mitochondrial isoform KARS2 lacking the mitochondrial targeting sequence was not able to interact with tRK1. The

interaction between these RNA and preKARS2 was also verified by North-western analysis. We found that these RNAs interact specifically with preKARS2 and their interaction decreased in the presence of 10 folds excess of non-labeled competitor RNA, while no decrease in interaction was observed when 5S rRNA was used as non specific competitor. Small truncated HF and HD RNAs derived from FD-L RNA lacking either D-arm of tRK1 (HF RNA or F-hairpin (HD RNA) were not able to interact with preKARS2, indicating the importance of presence of D-arm and F-hairpin together for interaction with preKARS2.

We next studied RNA mitochondrial targeting properties of preKARS2 using a standard *in vitro* import assay. The results obtained show that in the absence of protein factors, as expected, purified mitochondria were not able to internalize external tRK1. Addition of recombinant preKARS2 into the import mixture protects a portion of tRK1 and small FD-L and FD-H RNA from nuclease digestion, indicating their import into mitochondria (since no protection was detected without mitochondria). The amount of imported RNA increased upon addition of rabbit or yeast enolase to the import mixture in combination with preKARS2. This was in agreement with the previous study in yeast demonstrating that yeast enolase induces conformational changes in tRK1 enhancing its ability to interact with pre-Msk1p. Interestingly, truncated RNA molecules HF and HD, which are not able to interact with preKARS2, have not been directed into human mitochondria by these proteins. To check if mitochondrial targeting of truncated RNAs is still dependent on protein factors, we isolated crude proteins from HepG2 cells, fractionated them by gel-filtration and tested the main peaks, each representing a mixture of many proteins, for their ability to direct shorter RNAs into isolated human mitochondria. We detected an efficient import of both truncated RNAs in the presence of one protein fraction where preKARS2 was undetectable, thus demonstrating that mitochondrial import of HD and HF RNA molecules is dependent on protein factors other than preKARS2, at least in our *in vitro* system.

To further verify the role of preKARS2 in mitochondrial RNA targeting, *in vivo* import assay consisting in cell transfection with RNAs, was performed upon down-regulation of preKARS2. Cultured HepG2 cells were transfected with mitochondrially imported RNAs in conditions of siRNA-driven down-regulation of preKARS2 and RNA isolated from whole cell and purified mitochondria was analyzed by Northern hybridization. Compared to mitochondrial RNA import in control cells, a 2-fold decrease of tRK1 import and a 2.5-3-fold decrease of small

artificial FD-L and FD-H RNAs import into mitochondria was observed when preKARS2 was down-regulated.

We finally, tested import of tRK1 and its derivatives in cell over-expressing preKARS2. For this, HeLa Tet-off cells were transiently transfected with plasmid expressing preKARS2. The cells over-expressing preKARS2 were transfected with tRK1, FD-L and FD-H RNA and mitochondrial RNA import was analyzed by Northern blot hybridization. When compared to control cells transfected with an empty vector, a 2-fold increase in the mitochondrial import of all three RNA molecules was observed in cells over-expressing preKARS2, confirming that the amount of RNA molecules penetrating into mitochondria in human cells depends on the level of preKARS2 protein.

Taken together, we conclude that import of tRK1 and its derivatives (FD-L and FD-H RNA) depends on preKARS2, while truncated versions can be imported in preKARS2 independent manner.

2.1.2. Publication 1.

Ali Gowher, Alexandre Smirnov, Ivan Tarassov, Nina Entelis. Induced tRNA Import into Human Mitochondria: Implication of a Host Aminoacyl- tRNA-Synthetase

PLoS ONE, 2013, 8(6): e66228

Induced tRNA Import into Human Mitochondria: Implication of a Host Aminoacyl-tRNA-Synthetase

Ali Gowher, Alexandre Smirnov[‡], Ivan Tarassov, Nina Entelis*

Department of Molecular and Cellular Genetics, UMR 7156 Génétique Moléculaire, Génomique, Microbiologie (GMGM), CNRS - Université de Strasbourg, Strasbourg, France

Abstract

In human cell, a subset of small non-coding RNAs is imported into mitochondria from the cytosol. Analysis of the tRNA import pathway allowing targeting of the yeast tRNA^{Lys}_{CUU} into human mitochondria demonstrates a similarity between the RNA import mechanisms in yeast and human cells. We show that the cytosolic precursor of human mitochondrial lysyl-tRNA synthetase (preKARS2) interacts with the yeast tRNA^{Lys}_{CUU} and small artificial RNAs which contain the structural elements determining the tRNA mitochondrial import, and facilitates their internalization by isolated human mitochondria. The tRNA import efficiency increased upon addition of the glycolytic enzyme enolase, previously found to be an actor of the yeast RNA import machinery. Finally, the role of preKARS2 in the RNA mitochondrial import has been directly demonstrated *in vivo*, in cultured human cells transfected with the yeast tRNA and artificial importable RNA molecules, in combination with preKARS2 overexpression or downregulation by RNA interference. These findings suggest that the requirement of protein factors for the RNA mitochondrial targeting might be a conserved feature of the RNA import pathway in different organisms.

Citation: Gowher A, Smirnov A, Tarassov I, Entelis N (2013) Induced tRNA Import into Human Mitochondria: Implication of a Host Aminoacyl-tRNA-Synthetase. PLoS ONE 8(6): e66228. doi:10.1371/journal.pone.0066228

Editor: Enrique Pérez-Payá, Centro de Investigacion Principe Felipe and IBV-CSIC, Spain

Received: March 4, 2013; **Accepted:** May 2, 2013; **Published:** June 14, 2013

Copyright: © 2013 Gowher et al. This is an open-access article distributed under the terms of the Creative Commons Attribution License, which permits unrestricted use, distribution, and reproduction in any medium, provided the original author and source are credited.

Funding: This work was supported by CNRS (Centre National de Recherche Scientifique), University of Strasbourg, AFM (Association Française contre les Myopathies), ANR (Agence Nationale de la Recherche), FRM (Fondation pour la Recherche Médicale) and National Program "Investissement d'Avenir" (Labex MitoCross). A.G. was supported by Pakistan Government's HEC-SFERE PhD fellowship. The funders had no role in study design, data collection and analysis, decision to publish, or preparation of the manuscript.

Competing Interests: The authors have declared that no competing interests exist.

* E-mail: n.entelis@unistra.fr

[‡] Current address: Institut für Molekulare Infektionsbiologie, Würzburg, Germany

Introduction

Mitochondria are essential organelles of almost all eukaryotic cells and take part in several critical cellular processes. They contain their own genome and perform transcription and translation of their genetic material. However, the vast majority of biological macromolecules found in mitochondria are imported from the cytosol. For instance, the total number of mitochondrial protein species is about 850–900 whereas the mitochondrial genome codes for only 8 proteins in yeast and 13 ones in human cells, so all other proteins are imported from the cytosol. The mechanisms of protein import into mitochondria are described in detail and appear as universal for all eukaryotes [1,2]. The situation is different for RNA: several types of small non-coding RNAs were suggested to be imported into mitochondria in different species, and the mechanisms of these processes are believed to be different in each case (see for review [3,4,5]).

In yeast *Saccharomyces cerevisiae*, the cytosolic tRNA^{Lys}_{CUU} (further referred to as tRK1) is transcribed from a nuclear gene and then unequally redistributed between the cytosol (97–98%) and mitochondria (2–3%) [6]. The mitochondrial pathway was shown to be essential for mitochondrial translation at elevated temperatures, when the mtDNA-encoded isoacceptor tRNA^{Lys}_{UUU} becomes undermodified at the wobble position of the anticodon and loses its capacity to recognize the lysine AAG codon [7]. The mitochondrial targeting of tRK1 in yeast *in vitro* and

in vivo was shown to depend on the cytosolic precursor of mitochondrial lysyl-tRNA synthetase (preMSK1p), which serves as a carrier [8,9], and the glycolytic enzyme enolase (Eno2p) [10,11]. Analysis of conformational rearrangements in the RNA by *in-gel* FRET approach permitted to demonstrate that binding to the protein factors and the subsequent RNA import require formation of an alternative structure, different from the classic L-form tRNA model. In the complex with Eno2p, tRK1 adopts a particular conformation characterized by bringing together the 3'-end and the TΨC loop and forming a structure referred to as F-hairpin (Fig. 1A) [12]. We suggested that only those RNAs that are able to form a stable alternative F-stem proceed to the mitochondrial import pathway involving specific interactions with the carrier protein, preMSK1p, and membrane receptors [13].

Exploiting these data, a set of small RNA molecules based on the F-hairpin sequence, with a significantly improved efficiency of import not only into yeast but also into human mitochondria *in vitro* and *in vivo*, have been constructed. This opened a possibility to design a new vector system capable to target therapeutic oligoribonucleotides into deficient human mitochondria [12]. So far, the RNA import is the only known natural mechanism of nucleic acid delivery into human mitochondria. Since many incurable neuromuscular diseases have been associated with mtDNA mutations, the RNA import represents a promising tool for the future gene therapy. The allotopic (nuclear) expression of recombinant tRNA molecules importable into mitochondria has

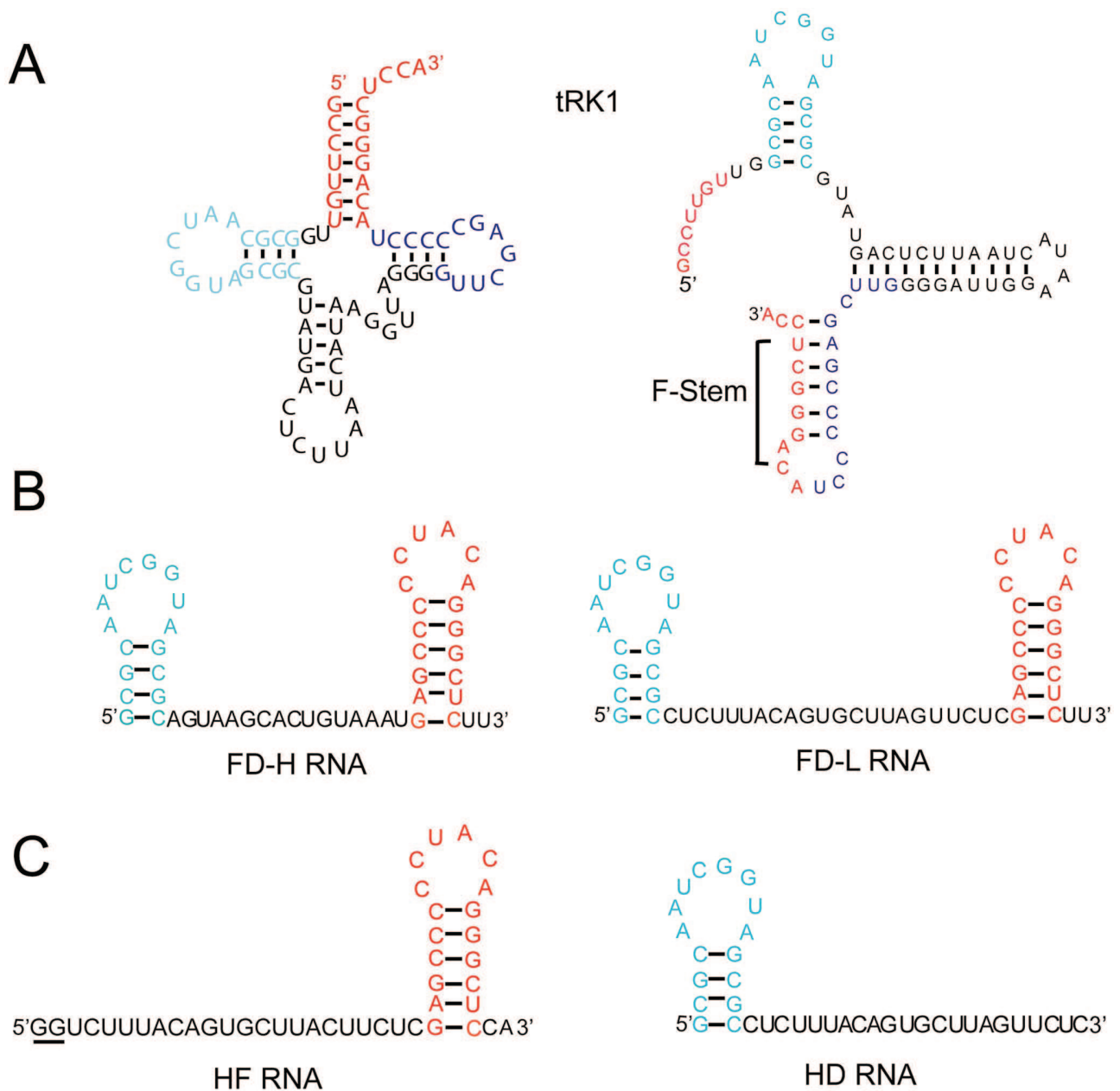

Figure 1. Predicted structures of the yeast tRNA^{Lys}CUU (tRK1) and small synthetic RNAs. (A) Two alternative structures of tRK1, as in [12]. The cloverleaf structure is shown at the left, the F-structure at the right. The tRK1 amino acceptor stem is in red, the D-arm in blue and the T-arm in purple. (B) Secondary structures of small synthetic "anti-replicative" RNAs composed of the tRK1 D-arm (in blue) and the F helix-loop structure (in red), separated by oligonucleotide stretches complementary to the heavy or light strands of human mitochondrial DNA [17]. (C) Truncated RNA molecules derived from FD-L RNA lacking either the D-arm of tRK1 (HF RNA) or the F-hairpin (HD RNA). The nucleotides added to the 5'-end of HF RNA to improve T7-transcription are underlined. For HF RNA, only one secondary structure ($dG = -11.6$ kcal/mol) was predicted by *Mfold*, for HD RNA, a structure with the minimal initial $dG = -5.9$ kcal/mol is shown. doi:10.1371/journal.pone.0066228.g001

been exploited to partially correct the pathogenic effect of mtDNA mutations in human cells [14,15,16]. Recently, we demonstrated that replication of mtDNA containing a pathogenic mutation can be specifically affected by RNA molecules bearing oligonucleotide stretches complementary to the mutated region. These molecules can be targeted into human mitochondria *in vivo* using artificially engineered RNA vectors based on the tRK1 alternative structure (Fig. 1A, B) [17]. To further develop and optimize this approach,

we need to understand the molecular mechanism of RNA targeting into human mitochondria, especially the protein factors participating in this process. This question is addressed in the present study.

It was previously found that the synthetic transcripts of yeast tRNAs^{Lys} and a number of their mutant versions could be specifically internalized by isolated human mitochondria in the presence of yeast or human soluble cytosolic proteins, indicating

that the human cell possesses the machinery needed for the tRNA mitochondrial import [18,19]. We also suggested that the cytosolic precursor of human mitochondrial lysyl-tRNA synthetase (preKARS2) could replace its yeast homologue preMSK1p and serve as a carrier for tRK1 [19]. In human cells, a single *KARS1* gene codes for both mitochondrial and cytosolic lysyl-tRNA-synthetases which are translated from two mRNAs generated by alternative splicing [20]. Here we use abbreviations KARS2 and preKARS2 for the mature mitochondrial enzyme and its cytoplasmic precursor, correspondingly, and KARS1 for the cytosolic enzyme. Recently, another research group has demonstrated that the recombinant KARS2 can substitute preMSK1p in targeting tRK1 into isolated yeast and mammalian mitochondria in the presence of the yeast cytosol [21].

Here we show that preKARS2 has an affinity to tRK1 and artificial RNA molecules containing the structural elements which determine the tRK1 mitochondrial import. These molecules can be targeted into isolated human mitochondria in the presence of preKARS2 and mammalian enolase, thus demonstrating a similarity to the yeast system. Finally, the role of preKARS2 in the RNA mitochondrial import is, for the first time, demonstrated *in vivo*, in human cells transfected with tRK1 and artificial importable RNA molecules.

Results

PreKARS2 Binds tRK1 and Artificial Importable RNA Molecules

To study the implication of the cytosolic precursor of human mitochondrial lysyl-tRNA synthetase (preKARS2) in the mitochondrial import of the yeast cytosolic tRNA^{Lys}_{CUU} (tRK1), we first analysed the interaction of the recombinant preKARS2 with a T7-transcript of tRK1 by EMSA (Fig. 2), using labeled RNA and increasing concentrations of the protein, as described [10]. The apparent K_d of the complex was estimated as 300+/-50 nM. Thus, the affinity of preKARS2 to tRK1 is only slightly lower than that of its yeast homolog, preMSK1p, with the apparent K_d previously evaluated as 280+/-60 nM [9]. Noteworthy, the recombinant protein lacking the mitochondrial targeting presequence predicted by Mitoprot [20] and thus corresponding to the mature mitochondrial enzyme KARS2 was not able to interact with tRK1 (Fig. 2A). This finding parallels our previous study suggesting a particular way of interaction between tRK1 and yeast preMSK1p which does not lead to the tRNA aminoacylation [8].

Previous analysis of RNA aptamers imported into human mitochondria permitted us to design short synthetic RNAs comprising two domains of the tRK1 alternative structure (Fig. 1 A, B) and characterized by a high efficiency of mitochondrial targeting [12,17]. The molecules referred to as FD-L and FD-H, containing the D-arm and F-hairpin parts of tRK1 separated by 17–22 nucleotides stretches, were able to form complexes with the recombinant preKARS2 with the apparent K_d of 400+/-50 nM, indicating a lower but still important affinity to preKARS2 (Fig. 2B). The specificity of the interaction was verified by North-Western hybridization in the presence of specific and nonspecific competitors (Fig. 2D). The data show that 30× molar excess of cold *E. coli* rRNA only partially decreased the interaction of preKARS2 with labeled tRK1 and FD-L RNA, whereas the 10× molar excess of cold FD-R RNA completely abolished this interaction.

To study more precisely the role of each of the two stem-loop RNA domains, we constructed truncated FD-L RNA molecules (Fig. 1C) lacking either the D-arm (HF RNA) or the F-hairpin (HD RNA) of tRK1. Neither molecule was able to interact with

preKARS2 (Fig. 2C), indicating the importance of the simultaneous presence of the D-arm and the F-hairpin for the RNA affinity to preKARS2.

PreKARS2 can Direct the RNA Import into Isolated Human Mitochondria

Previously, we suggested that preKARS2 might replace preMsk1p in the import of tRK1 into human mitochondria [19]. To demonstrate this directly, the *in vitro* import test was performed by incubating the proteins and the labeled RNA with purified mitochondria from HepG2 cells, as described [22]. We tested the recombinant preKARS2 in combination with rabbit enolase, since our previous study of the tRK1 import into yeast mitochondria had shown that yeast enolase recognizes the imported tRNA and favours its binding to preMSK1p [10].

Purified human mitochondria were not able to internalize the external tRK1 in the absence of protein factors (Fig. 3). Control reactions without mitochondria or in the absence of ATP (Fig. 3A) demonstrate that the proteins do not protect the RNA from nuclease digestion. Upon addition of mitochondria and the recombinant preKARS2, a portion of tRK1 and the small artificial RNAs FD-L and FD-H has been protected from nuclease degradation (Fig. 3 A, B), thus indicating their import into the mitochondria. The amount of the imported RNA was determined by comparison of the band density of the protected full-size RNA isolated from the mitoplasts after the import assay with that of an aliquot of the input labeled RNA, as shown in Fig. 3. As it was demonstrated previously [18,19], only a minor fraction (1–5%) of the tRK1 added to the import mixture is transported into the isolated human organelles, corresponding to the *in vivo* situation in yeast [6] [23].

The amount of the imported RNA increased upon addition of rabbit enolase to the import mixture in combination with preKARS2, however, the effect of enolase was dependent on the RNA structure. tRK1 was very poorly imported with preKARS2 alone but its import has been significantly improved upon addition of either rabbit or yeast enolase (Fig. 3A), demonstrating the interchangeability of the yeast and mammalian targeting systems. The recombinant human enolase (hEno1) had the same effect on the tRK1 import *in vitro* as the rabbit one (not shown).

In contrast to the situation with tRK1, the level of mitochondrial import of the FD-L and FD-H RNA molecules was rather high in the presence of preKARS2 alone and has only been slightly improved upon rabbit enolase addition (Fig. 3B). These data are in agreement with our model suggesting that only in the alternative F-conformation tRK1 acquires a high enough affinity to preMsk1p (Fig. 1A), and the RNA-chaperone activity of enolase is necessary for this structural rearrangement [12]. According to this suggestion, the presence of enolase should not be so important for the FD-L and FD-H RNA molecules, since they do not need the structural rearrangements for the interaction with preKARS2 and mitochondrial targeting.

As expected, the truncated RNA molecules HF and HD, which cannot interact with preKARS2, have not been directed into human mitochondria by this protein, independently of the presence of rabbit enolase (Fig. 3C).

Implication of preKARS2 in the RNA Mitochondrial Import *in vivo*

To compare the *in vitro* and *in vivo* import requirements, the role of preKARS2 in the mitochondrial RNA targeting was studied in cultured human cells. For this, we used the *in vivo* import assay on the cells transfected with RNA molecules, as described [12,24]. To

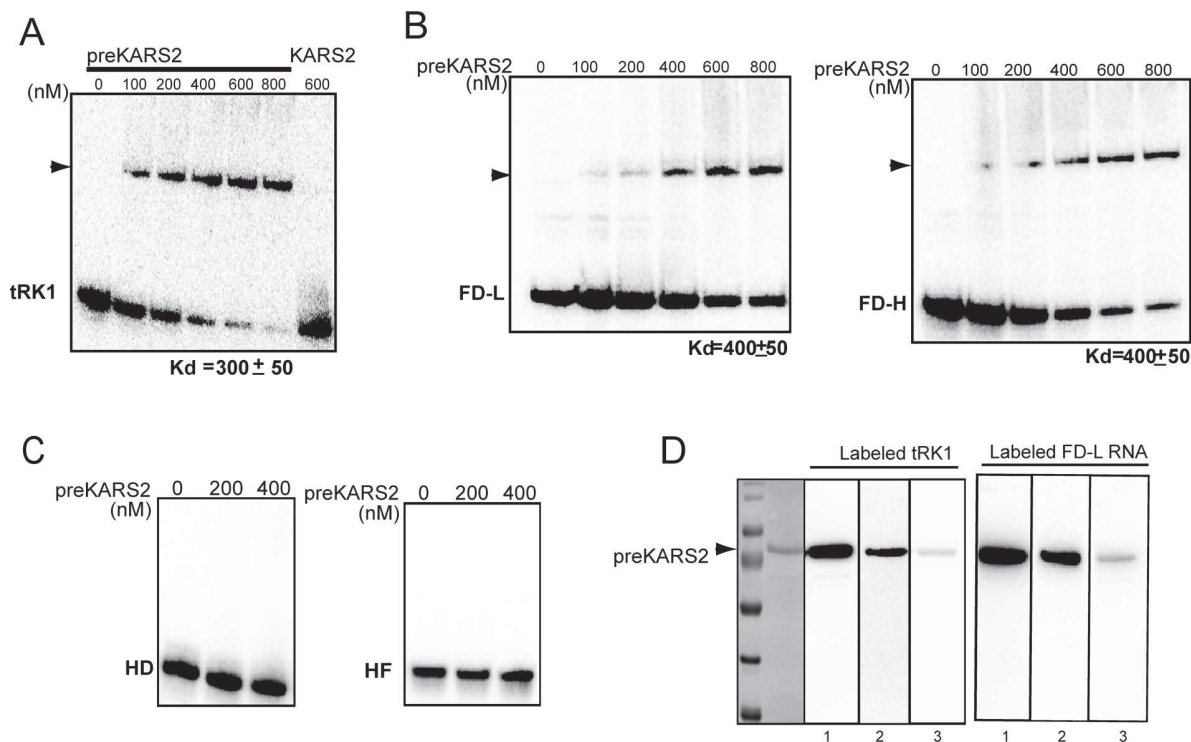

Figure 2. Interaction of the purified KARS2 and preKARS2 proteins with RNAs tested by EMSA. After incubation of 32 P-labeled tRK1 (A), FD-L and FD-H RNAs (B) or the truncated HD and HF RNAs (C) with increasing concentrations of the recombinant proteins (indicated above the panels, in nM), the complex formation was visualized by autoradiography. In each assay, the bottom band corresponds to the free RNA species, the RNA-protein complex is marked with an arrowhead. The deduced dissociation constants (K_d) for each RNA are given at the bottom of the panel (in nM). A representative of at least three independent experiments is shown for each RNA. (D) North-Western hybridization. Membrane stripes, containing equal amounts of preKARS2, were incubated with labeled RNAs (indicated above). Lane 1, no competitor added; lane 2, hybridization in the presence of $30\times$ molar excess of nonspecific competitor (rRNA *E. coli*); lane 3, hybridization in the presence of $10\times$ molar excess of nonlabeled RNA FD-R. Left panel represents the membrane stained with Ponceau Red.
doi:10.1371/journal.pone.0066228.g002

downregulate preKARS2, cultured human HepG2 cells were transiently transfected with a mixture of two siRNAs specifically designed against the part of the preKARS2 mRNA corresponding to the mitochondrial targeting sequence. Three days after the second transfection (see Methods section for details), a drop of more than 70% was observed for preKARS2 by Western blot (Fig. 4A). To evaluate the effect of the preKARS2 downregulation on the RNA import into mitochondria, the cells were transfected with purified T7-transcripts of tRK1, FD-L or FD-H. The whole cell RNA and mitochondrial RNA were isolated from the control and preKARS2-downregulated cells and analysed by Northern blot hybridization (Fig. 4B). The absence of signal in the mitochondrial RNA after hybridization with the probe against the cytoplasmic 5.8S rRNA indicates that the treatment of mitochondria with ribonuclease and digitonin removed all contamination by cytoplasmic RNA. The amount of tRK1 molecules internalized by the cells was quantified by Northern blot hybridization using known amounts of T7-transcripts loaded on the same gel as standards. By this approach, we could estimate that $10.8 \pm 0.5\%$ of the tRK1 added to the cells were internalized and could be detected in the full-size form 48 h after transfection. This value corresponds to $2.6 \pm 0.2 \times 10^6$ RNA molecules per cell, which number is in the range of most abundant cellular RNAs, for example, 5S rRNA, estimated previously as $3.6 \pm 0.5 \times 10^6$ RNA molecules per cell [19]. The number of tRK1 molecules in the mitochondrial fraction corresponded to $4.6 \pm 0.4 \times 10^4$ RNA molecules per cell, giving $2.5 \pm 0.3\%$ of the molecules imported

into mitochondria from the cellular pool, which perfectly correlates with our *in vitro* data.

We observed a clear difference in the mitochondrial RNA import between the control and preKARS2-downregulated cells: the tRK1 import decreased 2-fold, and a 2.5-3-fold reduction was observed for the small artificial FD-L and FD-H RNAs import (Fig. 4B).

To confirm the role of preKARS2 as a mitochondrial targeting factor for tRK1 and its derivatives, we tested the RNA mitochondrial import in cells overexpressing preKARS2. For this, we used HeLa Tet-Off cells transiently transfected with a plasmid expressing preKARS2 (generous gift of M. Mirande, Gif-sur-Yvette, France). In 48 h after transfection, a 2- to 3-fold increase of the preKARS2 protein amount in the cell extract was detected (Fig. 4C), in agreement with previously published data [25]. The cells overexpressing the preKARS2 protein were transfected with tRK1, FD-L or FD-H, and the mitochondrial RNA import was analysed by Northern blot hybridization (Fig. 4D), compared to control cells transfected with an empty vector. The mitochondrial import of all three RNA molecules, tRK1, FD-L and FD-H, increased 2-fold in the cells over-expressing preKARS2, confirming that the amount of the RNA molecules penetrating into mitochondria in human cells depends on the level of the preKARS2 protein expression.

All the data presented above clearly indicate the role of the human mitochondrial lysyl-tRNA synthetase preKARS2 in the mitochondrial targeting of yeast tRK1 and the artificial RNA

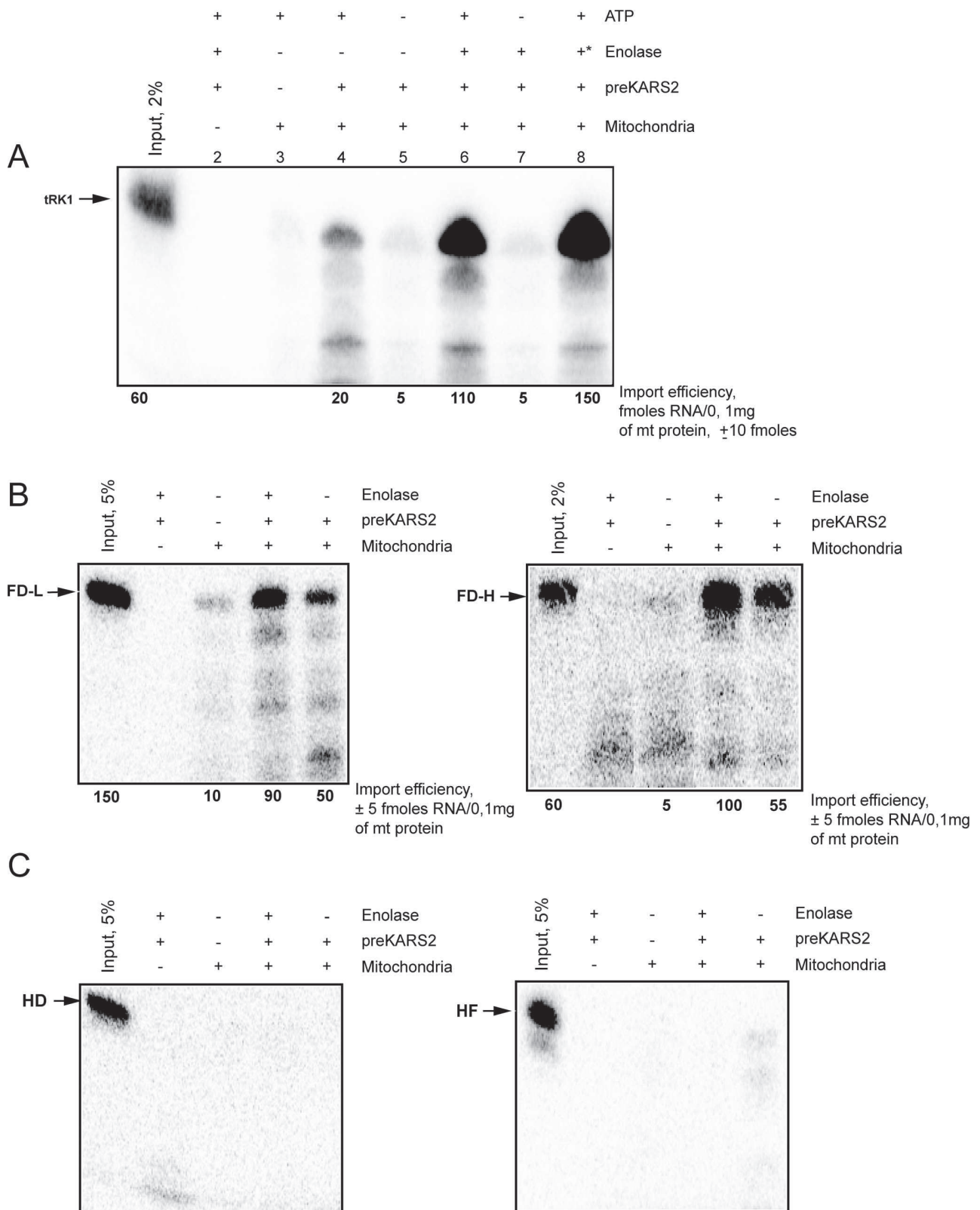

Figure 3. Import of RNA into isolated HepG2 mitochondria. Autoradiographies of RNA isolated from purified mitochondria and separated in denaturing 10% PAAG are presented. (A) Import of yeast tRK1, +*, yeast enolase was added instead of rabbit one. (B) Import of the small synthetic RNAs FD-L and FD-H. (C) Import of the truncated HD and HF RNAs. The name and position of the full-size RNA is indicated by an arrow on the left of each panel. Input, 2–5% of the RNA used for each assay (as indicated above the lane), corresponding to 60–150 fmoles of labeled RNA. Mitochondria

(+) corresponds to the complete import assay, Mitochondria (-) to the mock import assay without mitochondria used as a control for non-specific protein-RNA aggregation. The RNA import efficiency was calculated by comparing the signal with the input and is indicated below each lane. A representative of three independent experiments is presented for each RNA, \pm SD indicated.
doi:10.1371/journal.pone.0066228.g003

molecules containing two structural elements of the tRK1 alternative “import-active” fold, the D-arm and the F-hairpin.

Mitochondrial Import of Truncated RNA Molecules is not Dependent on preKARS2

Surprisingly, the small artificial RNA molecules containing either the D-arm or the F-hairpin (referred to as HD and HF, **Fig. 1C**), which were not imported into isolated human mitochondria *in vitro*, were internalized by mitochondria *in vivo* (**Fig. 5A, B**). A possible explanation of this discrepancy could be that our *in vitro* import conditions may not allow for a correct (predicted) folding of the short truncated RNA molecules. Nevertheless, the same RNAs internalized by cells, were able to be folded and imported into mitochondria.

To verify the specificity of our import test, we designed an artificial control RNA of a size similar to that of the HF and HD molecules (43 nt) but unrelated to yeast tRK1 and containing a short G-C stem and a long unstructured loop (**Fig. 5C**). This control RNA was not able to interact with the recombinant preKARS2 and to be imported into isolated human mitochondria in the presence of the purified proteins, preKARS2 and rabbit enolase (**Fig. 5C**, middle panel). Contrary to HD and HF RNAs, the control RNA was not detected in mitochondria of transfected HepG2 cells (**Fig. 5C**, right panel), indicating that not any short RNA molecule can be imported but only those containing the structural import determinants.

As it has been shown above, the HD and HF RNA molecules lack the capacity to interact with the recombinant preKARS2 and to be imported into isolated human mitochondria in the presence of preKARS2 and rabbit enolase (**Fig. 3C**). In agreement with these data, the *in vivo* import of these RNAs was not dependent on preKARS2, since no change in the amount of the RNA molecules transported into mitochondria was observed when preKARS2 had been transiently downregulated or overexpressed (**Fig. 5A, B**). This suggests implication of other protein factor(s) in the import of these RNAs into mitochondria *in vivo*.

To check if the mitochondrial targeting of the truncated RNAs is still dependent on protein factors, we isolated crude proteins from HepG2 cells, fractionated them by gel-filtration and tested the main peaks, each representing a mixture of many proteins, for their ability to direct RNA into isolated human mitochondria (**Fig. 5D**). We detected an efficient import of both truncated RNAs in the presence of one protein fraction (**Fig. 5E**), thus demonstrating that the *in vitro* mitochondrial import of the HD and HF RNA molecules is dependent on protein factors.

All presented data show that the RNA targeting into human mitochondria is a flexible process, allowing to import not only a full-size yeast tRNA but also its truncated versions. Import of tRK1 and the RNAs containing both tRK1 import determinants depends on the preKARS2 protein. Shorter truncated molecules were shown to be imported with a help of other, so far unidentified protein factor(s).

Discussion

PreKARS2 as a tRK1 Carrier to Human Mitochondria

In human cells, a subset of small non-coding RNA is imported into mitochondria from the cytosol [26], including some tRNAs (either in a natural or an artificial manner) [14,27], the RNA

components of RNase P and MRP endonuclease [28,29], and 5S rRNA [30,31]. Analysis of the cryptic tRNA import pathway, allowing the targeting of the yeast tRNA^{Lys}_{CUU} into human mitochondria, performed in the present study demonstrated a similarity between the tRK1 import mechanisms in yeast and human cells. In yeast cells, preMSK1p and Eno2p were identified as the tRK1 mitochondrial targeting factors [10,32]. A similar tRNA import pathway in human cells involves the orthologous proteins, preKARS2 and enolase. Moreover, the alternative folding of tRK1 as a determinant for the mitochondrial targeting in yeast [12] seems to be relevant in human cells as well, since we show that artificial RNA molecules containing two hairpin structures characteristic for the tRK1 alternative F-fold (**Fig. 1A**) can be efficiently imported into human mitochondria *in vitro* and *in vivo*, in a manner clearly dependent on the preKARS2 protein (**Fig. 3, 4**).

Aminoacyl-tRNA-synthetases is a group of enzymes responsible for the specific attachment of amino acids to their cognate tRNAs, thus performing a key step of translation (reviewed in [33]). In human cells, one gene *KARS1* codes for both mitochondrial and cytosolic lysyl-tRNA-synthetases which are produced from two mRNAs generated by alternative splicing [20]. PreKARS2 possesses a specific N-terminal sequence of 49 amino acid residues, which is the only difference from KARS1 [20,34]. The situation is opposite in yeast *S. cerevisiae* where the mitochondrial and cytosolic lysyl-tRNA-synthetases are encoded by distinct genes, *MSK1* and *KRS1* [35]. PreMSK1p plays an essential role in the mitochondrial targeting of the cytosolic tRNA^{Lys}_{CUU} (tRK1) in yeast [8]. Previously, it has been demonstrated that human preKARS2 overexpressed in yeast can partially complement the growth defect associated with the loss of *MSK1* and can additionally facilitate the import of tRK1 into isolated yeast mitochondria [21]. Here we demonstrate the direct interaction of preKARS2 (but not of its mature form) with yeast tRK1 and the involvement of this protein in the tRK1 import into human mitochondria *in vivo*.

Recently and rather surprisingly, the mature mitochondrial enzyme KARS2 was shown to interact with the human cytosolic tRNA^{Lys}₃ with an apparent K_d of 250+/-40 nM, but the presence of the mitochondrial targeting sequence in preKARS2 completely abolished the RNA-binding properties of the protein ($K_d > 1 \mu\text{M}$ for preKARS2) [34]. Since in human cells no import of tRNA^{Lys} into mitochondria had been observed [26], the apparent discrepancy between these and our data clearly indicates a different mode of preKARS2 interaction with either the non-importable cytosolic tRNA^{Lys}₃ or the importable tRK1. This is in agreement with our hypothesis that only the alternative fold of tRNA can be recognized by the precursor of mitochondrial lysyl-tRNA-synthetase functioning as an RNA mitochondrial carrier. Thus, only yeast tRK1 and some specially designed RNA molecules capable to adopt the alternative conformation can interact with preKARS2 and be targeted into human mitochondria.

RNA Targeting into Mitochondria: a Species-specific or a Universal Mechanism?

In general, each known case of RNA mitochondrial import appears somewhat special and thus not sufficient to establish a common RNA import mechanism [36]. The results of the present work, together with our previous data, enable us to revisit the

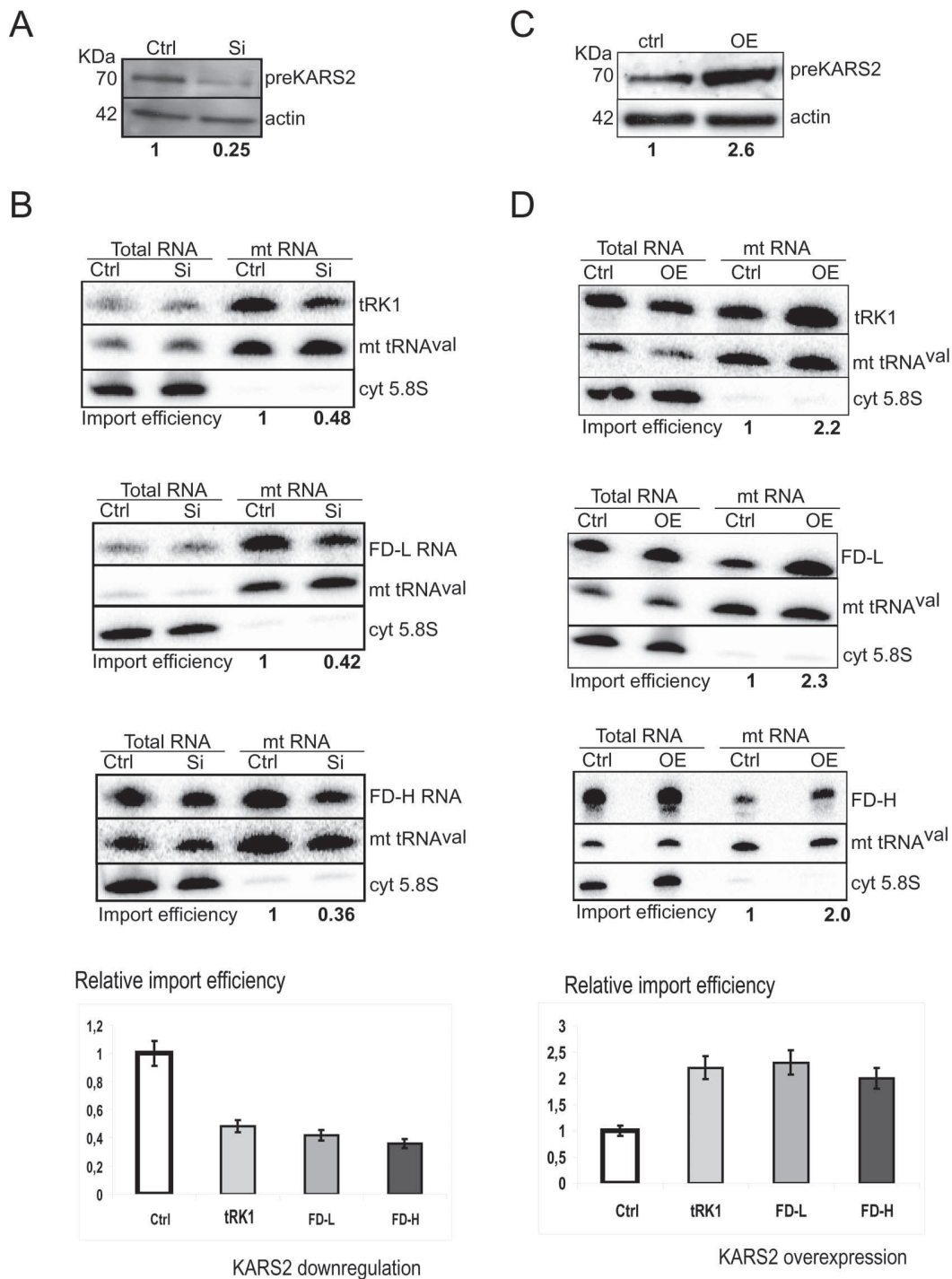

Figure 4. Implication of preKARS2 in the RNA mitochondrial import *in vivo*. (A) Western blot analysis of preKARS2 downregulation by RNA interference (Si). The level of preKARS2 in the cells transiently transfected with siRNAs against preKARS2 (Si) compared to the control cells transfected with a control siRNA (Ctrl) is indicated below the panel. The antibodies used for immunodecoration are shown on the right. (B) Northern blot hybridization of the total and purified mitochondrial (mtRNA) RNAs isolated from the control cells (Ctrl) and the cells transfected with siRNAs against preKARS2 (Si), in 32 h after transfection with tRK1, FD-L or FD-H RNA, as indicated. The hybridization probes are shown on the right. The mt tRNA^{val} probe was used as loading control, and the cytosolic 5.8S rRNA probe was used to confirm the absence of cytosolic RNA contamination in the mitochondrial RNA preparations. The relative RNA import efficiencies, taken as 1 for the control cells, are shown below each panel (see Methods for the import efficiency calculation). For each RNA, the results of at least three independent experiments are shown at the lower panel, \pm SD indicated. (C) Western blot analysis of preKARS2 overexpression (OE), the relative level of overexpression is indicated below the panel. Ctrl, control cells transfected with an empty vector. (D) Analysis of the *in vivo* import of tRK1 and the small synthetic FD-L and FD-H RNAs into mitochondria of the control cells (Ctrl) and the preKARS2-overexpressing (OE) cells in 48 h after transfection with the corresponding RNAs. All indications are as in B. doi:10.1371/journal.pone.0066228.g004

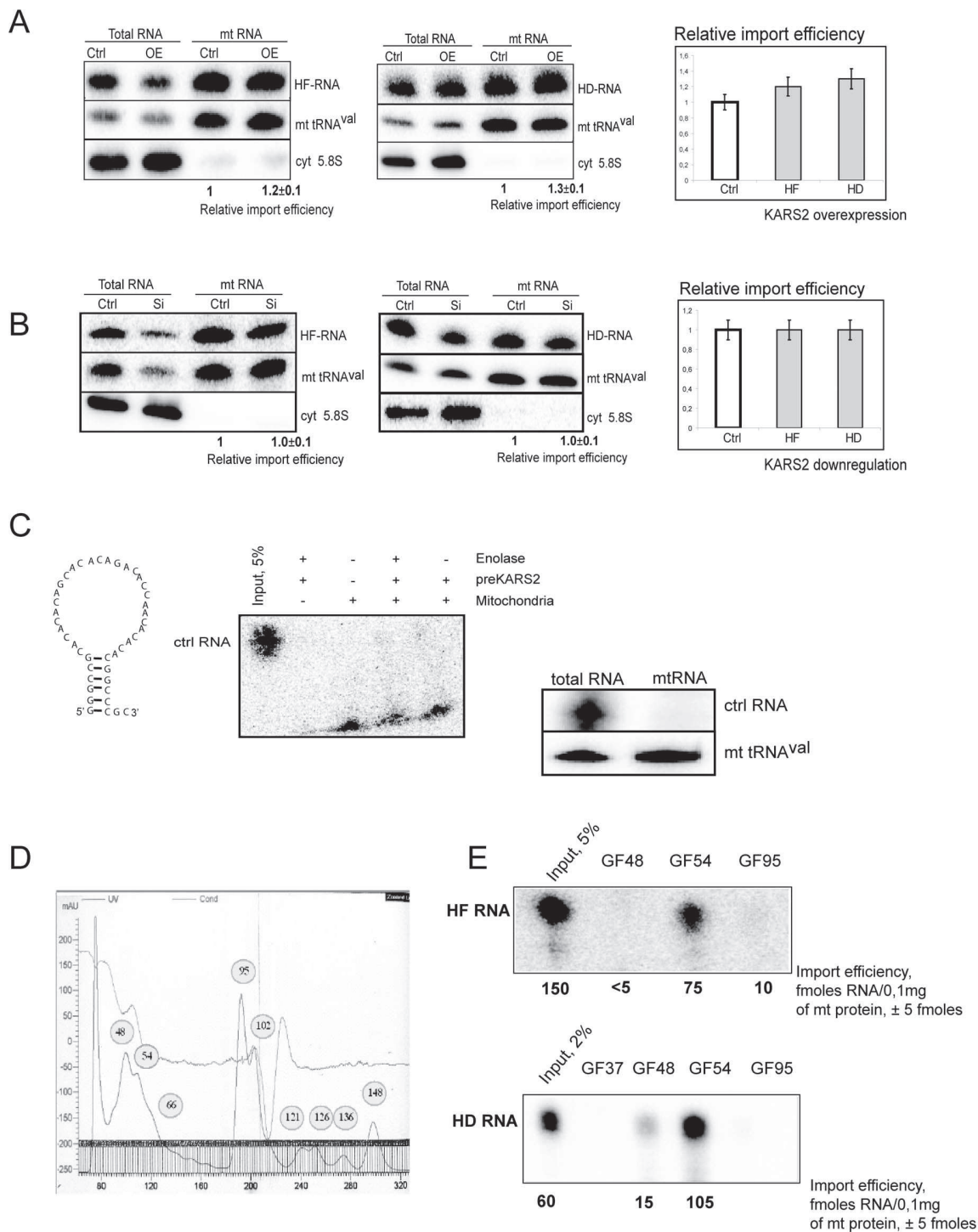

Figure 5. Import of small truncated RNAs into mitochondria. (A) *In vivo* import of the truncated HF (left panel) and HD (middle panel) RNAs in mitochondria of the control cells and the cells overexpressing preKARS2. **(B)** *In vivo* import of HF and HD RNAs in the control cells and the cells with downregulation of preKARS2. Hybridization probes are indicated on the right of the panels. Overexpression and downregulation of preKARS2 were confirmed by Western blot as in Fig. 4A, C. The relative import efficiencies are shown on the right panels, \pm SD calculated from three independent experiments. **(C)** Secondary structure (on the left) of the artificial control RNA, predicted by *Mfold*. The control RNA *in vitro* (middle panel, indications are as in Fig. 3) and *in vivo* (right panel) import tests. **(D)** OD₂₈₀ absorption profile of HepG2 proteins separated by gel filtration on a Sephacryl G-200 column. **(E)** Import of HF RNA (upper panel) and HD RNA (lower panel) into isolated HepG2 mitochondria in the presence of proteins from the gel filtration fractions indicated above the lanes. Input, 2–5% of RNA used for each assay. The RNA import efficiencies calculated by comparing with the inputs, in fmoles of imported RNA per 0.1 mg of mitochondrial protein, are given below each lane. On each panel, a representative of at least three independent experiments is shown, \pm SD indicated.
doi:10.1371/journal.pone.0066228.g005

paradigm of ‘extremely diversified’ RNA import pathways and to propose several rules which can be, if not universal, at least largely applicable to various RNA import systems.

Firstly, to be imported into mitochondria, an RNA should escape from the cytosolic channelling. According to this model, no free diffusion of macromolecules inside the cell is normally possible since all its components are well arranged in space and their movements are strictly regularized (channelled). Channelling was studied in detail on the example of tRNAs [37]. It was found that, starting from the very transcription event, a tRNA molecule is trapped in a standard sequence of events (processing, modification, nuclear export, translation) assured by protein components that function in a chain. They hand the tRNA from one to another avoiding its release into solution (reviewed in [38]). To make an RNA exit from the standard circuit, a well regulated deviation has to be provided by a special mitochondrial targeting factor which has a specific affinity to the cargo RNA. For example, in yeast cells, tRK1 is probably captured from the translation cycle by the glycolytic enzyme enolase and redirected to the mitochondrial surface [10]. The same event apparently exists in the artificial tRK1 import pathway in human cells, as we show here. In the case of the 5S rRNA import, this function is performed by the cytosolic precursor of mitochondrial ribosomal protein L18 (preMRP-L18) [31]. To assure the irreversible RNA withdrawing from the cytosolic channelling, the protein factor should possess a chaperone activity to change the RNA conformation, as it has been shown for tRK1 in the complex with yeast enolase [12] or for 5S rRNA and preMRP-L18 [31].

The next step of the pathway is a rapid discharge of the chaperone by another mitochondrial import factor. Examples of such a cascade were described in the yeast import mechanism where tRK1 is quickly transferred from enolase to the precursor of lysyl-tRNA synthetase [10]. A very similar case was observed for 5S rRNA in human cells where the mitochondrial enzyme rhodanese accepts 5S rRNA from preMRP-L18 [30]. For both mechanisms, a significant decrease in the apparent dissociation constant for the complex between the second protein factor and the RNA was found. Then, the second import factor works as a carrier transporting the RNA molecule into the mitochondria. The mechanism of RNA translocation across the double mitochondrial membranes is not yet understood. Most probably, it exploits the standard mitochondrial pre-protein localisation apparatus, since carriers usually have signals of mitochondrial localisation and it appears the most obvious way to reach the organelles. Nevertheless, one can not exclude alternative translocation mechanisms via different membrane channels [4,29,39].

Thus, for all RNA import systems in which the pre-mitochondrial (targeting) step of RNA import has been investigated, several universally present features can be outlined. Namely, in order to direct a cytosolic RNA to mitochondria one needs necessarily two protein factors, the first with a chaperone activity to withdraw the RNA from the cytosolic channelling, the second possessing the signal of mitochondrial localisation to target the RNA into the mitochondria. One of these proteins should be cognate, interacting with the imported RNA in a specific way and thus determining the selectivity of the RNA import (preLysRS for tRK1, preMRP-L18 for 5S rRNA). The other protein factor may be unrelated to RNA metabolism and hardly expected to participate in RNA transport, performing thereafter a “second job”, as enolase and rhodanese. Concerning enolase, many non-glycolytic “moonlighting” functions of this protein are known (reviewed in [40]). In *E. coli*, enolase is an integral component of the RNA degradosome; in yeast, it was identified as Hsp48 and participates in formation of vacuoles; enolase is found in the eye lens of many organisms and as a

plasminogen-binding receptor expressed on the surface of a variety of eukaryotic cells. Thus, the tRNA import into mitochondria seems to be one of many different functions of this enzyme. The mitochondrial enzyme rhodanese is less studied, in fact, even its function is still not clear. We can hypothesize that this protein may also have multiple functions which can be switched by its cellular re-localization.

The common rules described here can be applied in search for RNA import pathways in various eukaryotes. For instance, it appears that in plant cells, precursors of dually targeted cognate aminoacyl-tRNA synthetases combine both RNA targeting functions and thus may be the only essential tRNA import factors [36]. Probably, the same situation may be found in *Trypanosoma brucei*, where the cytosolic elongation factor eEF1a assures the specific targeting of almost all tRNAs to mitochondria [41].

Mitochondrial Import of Small RNA Molecules

The general rules of RNA import formulated above presume certain flexibility of the pathway. Indeed, various RNA molecules able to interact with import factors can be targeted into mitochondria even in organisms naturally importing only a very restricted number of RNA species, as we see here for the RNAs FD-H and FD-L. On the other hand, various proteins might perform the function of RNA import factors in certain conditions. This possibility is clearly demonstrated in the present work since the short truncated RNA molecules HD and HF, which have lost the capacity to interact with preKARS2, apparently can be targeted into human mitochondria with the help of other, still unidentified protein(s). This hypothesis is also in agreement with a recent publication claiming that preMSK1p may be dispensable for the tRK1 import into yeast mitochondria [21]. One can suggest that in the yeast strain used in this study, lacking the *MSK1* gene and thus devoid of actively respiring mitochondria, the small amount of tRK1 detected in the pro-mitochondria could be imported by a backup pathway with a help of alternative targeting protein(s).

Recently, a subset of microRNAs, small non-coding RNAs that associate with Argonaute proteins to regulate gene expression at the post-transcriptional level, has been localized to human mitochondria [42,43,44], as well as the AGO2 protein [45]. At least a part of these miRNAs and their precursors were supposed to be imported from the cytoplasm by an unknown mechanism. It would be tempting to hypothesize that small structured RNA molecules, such as HD and HF, might be recognized by the machinery of the miRNA import and targeted to mitochondria by AGO2 and/or another components of the RNA-inducible silencing complex (RISC), which could thus perform the “second job” as mitochondrial targeting factors, similarly to the enzymes enolase or rhodanese. This exiting possibility remains to be explored in future studies.

Materials and Methods

Plasmids and Antibodies

Plasmid pDEST17 expressing human mitochondrial lysyl-tRNA synthetase (KARS2) was kindly provided by M. Sissler (IBMC, Strasbourg). To produce the precursor of mitochondrial KARS2 (preKARS2) protein, the Quick change mutagenesis kit (Stratagene) was used to insert the mitochondrial targeting sequence at the N-terminus of the mitochondrial KARS2 protein. A thrombin cleavage site and a 6 × histidine tag at the N-terminus were deleted and a 6 × histidine tag was inserted at the C-terminus using the same approach. For this, the following oligonucleotides were used:

Mitochondrial Targeting Sequence Insertion

5'GCCACGCGGTTCTTTGACGCAAGCTGCTG-
TAAGGCTTGTTAGGGGGTCCCTGCG-
CAAACCTCCTGGGCAG 3'

5'CTGCCAGGAGGTTTTGCGCAGGGACCCCTAA-
CAAGCCTTACAGCAGCTTGCGTCAAA-
GAACCGCGTGGC 3'

Thrombin Cleavage Site and 6× His Tag Deletion

5' CTTTAAGAAGGAGATATACATATGTTGACG-
CAAGCTGCTGTAAGG3'

5' CCTTACAGCAGCTTGCGTCAACATATGTA-
TATCTCCTTCTTAAAG 3'

His Tag Insertion at the C-terminus of preKARS2

5' CAACAGTTGGCAGTTCTGTCCACCATCACCAT-
CACCATTGAGACCCAGCTTTCTTGTAC 3'

5' GTACAAGAAAGCTGGGTCTCAATGGTGATGGT-
GATGGTGGACAGAACTGCCAACTGTTG 3'

pTRE2hyg plasmid expressing preKARS2 and antibodies directed against the residues 25 to 42 of the preKARS2 protein described in [25] were kindly provided by Marc Mirande (Gif-sur-Yvette, France). Polyclonal antibodies against human actin were from Santa Cruz Biotechnology.

Purification of the Recombinant preKARS2 Protein

To obtain the recombinant KARS2 and preKARS2 proteins, *Escherichia coli* strain BL21 codon plus (DE3)-RIL cells (Stratagene) were transformed with the pDEST17 plasmid. The transformed cells were grown in 500 ml of LB medium to a cell density corresponding to $OD_{600} = 0.6$, then the protein expression was induced for 2 h at 37°C by addition of 0.5 mM isopropyl β -D-1-thiogalactopyranoside (IPTG) to the bacterial culture. The cells were harvested by centrifugation at 6000 g for 10 min, lysed with 1 mg/ml of lysozyme on ice for 30 min and then sonicated thrice for 20 sec in the buffer consisting of 50 mM NaH_2PO_4 , 300 mM NaCl and 20 mM imidazole. The cell lysate was centrifuged at 10,000 g for 15 min and the pellet was solubilized in the denaturing buffer consisting of 100 mM Tris-HCl (pH 8), 100 mM NaH_2PO_4 , 10 mM imidazole and 8 M urea. This was followed by centrifugation at 12000 g for 15 min and the supernatant was applied to a Ni-NTA column (Qjagen) for 2 h at 4°C. After binding, the column was washed three times with the denaturing buffer containing 20 mM imidazole to eliminate weakly bound bacterial proteins. The recombinant preKARS2 protein was eluted from the column with 200 mM imidazole, refolded by stepwise elimination of urea and finally dialyzed against 50 mM Tris-HCl (pH 8), 300 mM NaCl and 40% glycerol and stored at -20°C. The purity of the protein was checked by sodium dodecyl sulfate-polyacrylamide gel electrophoresis (SDS-PAGE) with Coomassie blue staining.

The recombinant yeast enolase Eno2p was isolated as described previously [10]. Enolase from rabbit muscles was from Sigma-Aldrich.

Recombinant RNA modeling. To predict secondary structures of recombinant RNA molecules and estimate their free energies (dG), the *Mfold* program [46,47] and IDT Sci-Tools OligoAnalyser 3.1 software [48] were used.

RNA synthesis and purification. The yeast tRK1 T7-transcript was obtained as described [32]. For small artificial RNAs, PCR amplification of the following oligonucleotides containing a T7 promoter at the 5'-end (underlined) was performed:

FD-L TAATACGACTCACTATAAGCGCAATCGG-
TAGCGCCTCTTTACAGTGCTTAGTTCTCGAGCCCC-
TACAGGGCTCTT

FD-H TAATACGACTCACTATAAGCGCAATCGG-
TAGCGCAGTAAGCACTGTAAATGAGCCCCCTA-
CAGGGCTCTT

HD: TAATACGACTCACTATAAGCGCAATCGG-
TAGCGCCTCTTTACAGTGCTTAGTTCTC

HF: TAATACGACTCACTATAAGGTCCTTTACAGTGCT-
TACTTCTCGAGCCCCCTACAGGGCTCCA

RNA transcripts were obtained *in vitro* using the Ribomax kit (Promega). Following transcription, the DNA template was removed by digestion with RQ1 RNase-Free DNase (Promega). RNAs were purified by 12% PAGE with 8 M urea and eluted from the gel with the RNA extraction buffer containing 0.5 M CH_3COONH_4 , 10 mM $Mg(CH_3COO)_2$, 0.1 mM EDTA and 0.1% SDS. The eluted RNA was precipitated with ethanol.

Electrophoretic mobility shift assay (EMSA). Purified RNA was dephosphorylated with alkaline phosphatase (Boehringer Mannheim) and labeled at the 5'-end with γ - ^{32}P -ATP using T4 polynucleotide kinase (Promega). The labeled RNA was denatured at 100°C and then slowly cooled down to the room temperature. For RNA binding assays, the appropriate amount of protein and labeled RNA were mixed in 20 μ l of the buffer containing 20 mM Tris-HCl pH 7.5, 150 mM NaCl, 10 mM $MgCl_2$, 5 mM DTT, 10% glycerol, 0.1 mg/ml BSA and incubated at 30°C for 15 min. The mixture was separated by native 8% PAGE in 0.5 \times Tris-borate buffer (pH 8.3) and 5% glycerol [49], followed by Typhoon-Trio (GE Healthcare) scanning and quantification as described in [50].

North-Western blot hybridisation. Recombinant pre-KARS2 was loaded on 10% SDS-PAAG and blotted to nitocellulose membrane. The membrane was incubated in 0.1 M Tris-HCl, 20 mM KCl, 2.5 mM $MgCl_2$, 0.1% Nonidet P40, pH7.5, at 4°C for 1 h with stirring, then washed several times with the same solution and blocked in 10 mM Tris-HCl, pH7.5, 5 mM $Mg(CH_3COO)_2$, 2 mM dithiothreitol, 2% BSA, 0.01% Triton X-100 for 5 min at 25°C. Then, the membrane was incubated for 2 h at 4°C in the import buffer without sorbitol, containing 1 nM [^{32}P]-labelled RNA, as in [10], washed with the same buffer without RNA and analysed by Typhoon-Trio (GE Healthcare) scanning and quantification.

***In vitro* import assay.** Mitochondria were isolated and verified for intactness as described [22]. The standard *in vitro* import assay into isolated mitochondria was performed as in [19]. For this, purified HepG2 mitochondria were incubated with radioactively labeled RNA and purified proteins in the import buffer: 0.6 M sorbitol, 20 mM HEPES-KOH (pH 7), 10 mM KCl, 2.5 mM $MgCl_2$, 5 mM DDT and 2 mM ATP. For a standard *in vitro* assay, we add 3 pmoles of labelled RNA per 0.1 ml of the reaction mixture containing 0.1 mg of mitochondria (measured by the amount of mitochondrial protein). This corresponds to the 100% RNA input. After incubation for 15 min at 34°C, 50 μ g/ml of RNase A (Sigma) was added and the reaction was incubated for additional 15 min to digest all unimported RNA. The mitochondria were washed three times with the buffer containing 0.6 M sorbitol, 10 mM HEPES-KOH (pH 6.7) and 4 mM EDTA, then resuspended in 100 μ l of the same buffer and treated with an equal volume of 0.2% digitonin (Sigma) solution to disrupt the mitochondrial outer membrane, followed by purification of mitoplasts. The mitoplast pellet was resuspended in the solution containing 100 mM CH_3COONa , **10 mM $MgCl_2$, 1% SDS and 0.05% diethylpyrocarbonate (DEPC), boiled for 1 min and RNA was extracted at 50°C**

with water-saturated phenol. RNA was precipitated with ethanol and separated by 12% PAGE containing 8 M urea, followed by quantification with the Typhoon-Trio scanner using the Image Quant-Tools software (GE Healthcare). The amount of the imported RNA was determined by comparison of the band density of the protected full-sized RNA isolated from the mitoplasts after the import assay with an aliquot (2–5%) of the RNA input.

Human Cell Culture, Overexpression and Downregulation of preKARS2

HeLa Tet-Off cells stably expressing the tetracycline-controlled transactivator (tTA) were purchased from Clontech Laboratories Inc. The HepG2 and HeLa Tet-Off cells were maintained in the Dulbecco modified Eagle's medium (DMEM, Invitrogen) with high glucose (4.5 g/l) supplemented with 10% fetal calf serum, 100 µg/ml of streptomycin and 100 µg/ml of penicillin (Gibco). For induction of protein expression in HeLa Tet-Off cells, the Tet system approved fetal bovine serum from Clontech was used. The cells were cultivated in a humidified atmosphere at 37°C and 5% of CO₂.

For overexpression of preKARS2, HeLa Tet-Off cells were grown to the 60% confluency and transfected with the pTRE2hyg plasmid expressing preKARS2 [25] using Lipofectamin 2000 (Sigma) according to the manufacturer's protocol. At the same time, the cells were transiently transfected with mitochondrially importable RNAs. After 48 h, the cells were analysed for the preKARS2 overexpression by Western blotting and for the RNA import by Northern hybridization.

To downregulate preKARS2, two 21-mer siRNAs corresponding to the mitochondrial targeting sequence of the human preKARS2 mRNA were synthesized. The sequences of the sense strands of these siRNAs are as follows: siRNA1:5' CAACTTGCTCCTTTTCACAGCG 3' and siRNA2:5' AAGGCAAGTCATTTTCTGAT 3'. As a negative control, a non-silencing siRNA (Ref: SR-CL000-005, Eurogentec) was used. Our optimized protocol consisted of two subsequent transfections: firstly, HepG2 cells were transfected in suspension with 40 nM of each siRNA using the RNAiMax transfection reagent (Invitrogen), according to the manufacturer's protocol. 24 h later, the cells formed a monolayer and were transfected again with 40 nM of each siRNA using Lipofectamine 2000 (Invitrogen). The cells were grown for 40 h after the second siRNA transfection and then transfected with one of mitochondrially importable RNAs. In 3 days after the second siRNA transfection, the downregulation was analysed by Western blotting, and the RNA import by Northern hybridization.

RNA Import Assay *in vivo*

For transfection of HepG2 and HeLa Tet-Off cells, 3 µg of RNA per 75 cm² flask were used. Transfection was performed with the Lipofectamine 2000 reagent (Invitrogen), according to the manufacturer's protocol. After 48 h, the cells were detached, mitochondria were isolated and purified as described above. The total and mitochondrial RNA were isolated with the TRIzol

reagent (Invitrogen), separated by 12% PAGE containing 8 M urea and analysed by Northern blot hybridization with 5'-³²P-labelled oligonucleotide probes:

anti-tRK1 (1–34): GAGTCATACGCGCTACC-GATTGCGCCAACAAGGC to detect tRK1, FD-L, FD-H and HD RNA;

anti-HF RNA probe: TGGAGCCCTGTAGGG;

anti-mt tRNA^{Val} probe: GTTGAATCTCCTAAGTG

and anti-cyt 5.8S rRNA probe: AAGTGACGCTCAGA-CAGGCA.

After quantification with the Typhoon-Trio scanner, the relative efficiency of the RNA import into mitochondria was calculated as a ratio between the signal obtained with the anti-tRK1 probe and that obtained with the probe against the host mitochondrial tRNA^{Val}, as described previously [24]. Because it is rather difficult to normalize exactly the amount of mitoplasts isolated from various cell lines, we load on the gel the mitochondrial RNA isolated from the same number of cells, and then use the hybridization signals corresponding to the mitochondrial tRNA^{Val} as a loading control. Thus, we take into account not the absolute intensity of hybridization signals but the ratios between the signals corresponding to the imported into mitochondria tRK1 (or FD-RNAs) and the host mitochondrial valine tRNA's gene transcript. To calculate the absolute import efficiencies for various RNAs, the total level of the RNAs in the transfected cells was taken into account. For this the relative import efficiencies were divided by the ratios calculated in the same way but for the total RNA preparations.

Immunoblotting

For Western immunodecoration, cells were lysed in the Laemmli buffer (50 mM Tris-HCl, pH 6.8, 2% SDS, 0.1% β-mercaptoethanol, 0.01% bromophenol blue and 10% glycerol) for 10 min at 90°C, and 30 µg of protein was separated by 10% SDS-PAGE. The proteins were electroblotted onto a nitrocellulose membrane and probed with a primary polyclonal antibody against preKARS2 and a commercially available polyclonal antibody against actin (G2308, Santa Cruz Biotechnology). Bands were visualized with anti-rabbit or anti-goat secondary antibodies conjugated with horseradish peroxidase using the ECL Plus Western Blotting detection reagent (GE Healthcare).

Acknowledgments

The authors are grateful to M. Mirande (Gif-sur-Yvette, France) and M. Sissler (Strasbourg, France) for the generous gift of plasmids and antibodies, to M. Vysokikh (Strasbourg) for mitochondria integrity measurements and to C. Comte (Strasbourg) for the design of truncated RNAs.

Author Contributions

Conceived and designed the experiments: IT NE. Performed the experiments: AG AS NE. Analyzed the data: AG AS IT NE. Wrote the paper: AG AS IT NE.

References

- Neupert W (1997) Protein import into mitochondria. *Annu Rev Biochem* 66: 863–917.
- Chacinska A, Koehler CM, Milenkovic D, Lithgow T, Pfanner N (2009) Importing mitochondrial proteins: machineries and mechanisms. *Cell* 138: 628–644.
- Tarassov I, Kamenski P, Kolesnikova O, Karicheva O, Martin RP, et al. (2007) Import of nuclear DNA-encoded RNAs into mitochondria and mitochondrial translation. *Cell Cycle* 6: 2473–2477.
- Salinas T, Duchene AM, Marechal-Drouard L (2008) Recent advances in tRNA mitochondrial import. *Trends Biochem Sci* 33: 320–329.
- Schneider A (2011) Mitochondrial tRNA import and its consequences for mitochondrial translation. *Annu Rev Biochem* 80: 1033–1053.
- Martin R, Schneller JM, Stahl A, Dirheimer G (1979) Import of nuclear deoxyribonucleic acid coded lysine-accepting transfer ribonucleic acid (anticodon C-U-U) into yeast mitochondria. *Biochemistry* 18: 4600–4605.

7. Kamenski P, Kolesnikova O, Jubenot V, Entelis N, Krasheninnikov IA, et al. (2007) Evidence for an Adaptation Mechanism of Mitochondrial Translation via tRNA Import from the Cytosol. *Mol Cell* 26: 625–637.
8. Tarassov I, Entelis N, Martin R (1995) Mitochondrial import of a cytoplasmic lysine-tRNA in yeast is mediated by cooperation of cytoplasmic and mitochondrial lysyl-tRNA synthetases. *EMBO J* 14: 3461–3471.
9. Kamenski P, Smirnova E, Kolesnikova O, Krasheninnikov IA, Martin RP, et al. (2010) tRNA mitochondrial import in yeast: Mapping of the import determinants in the carrier protein, the precursor of mitochondrial lysyl-tRNA synthetase. *Mitochondrion* 10: 284–293.
10. Entelis N, Brandina I, Kamenski P, Krasheninnikov IA, Martin RP, et al. (2006) A glycolytic enzyme, enolase, is recruited as a cofactor of tRNA targeting toward mitochondria in *Saccharomyces cerevisiae*. *Genes Dev* 20: 1609–1620.
11. Brandina I, Graham J, Lemaitre-Guillier C, Entelis N, Krasheninnikov I, et al. (2006) Enolase takes part in a macromolecular complex associated to mitochondria in yeast. *Biochim Biophys Acta* 1757: 1217–1228.
12. Kolesnikova O, Kazakova H, Comte C, Steinberg S, Kamenski P, et al. (2010) Selection of RNA aptamers imported into yeast and human mitochondria. *RNA* 16: 926–941.
13. Tarassov I, Entelis N, Martin RP (1995) An intact protein translocating machinery is required for mitochondrial import of a yeast cytoplasmic tRNA. *J Mol Biol* 245: 315–323.
14. Kolesnikova OA, Entelis NS, Jacquin-Becker C, Goltzene F, Chrzanoska-Lightowlers ZM, et al. (2004) Nuclear DNA-encoded tRNAs targeted into mitochondria can rescue a mitochondrial DNA mutation associated with the MERRF syndrome in cultured human cells. *Hum Mol Genet* 13: 2519–2534.
15. Karicheva OZ, Kolesnikova OA, Schirtz T, Vysokikh MY, Mager-Heckel AM, et al. (2011) Correction of the consequences of mitochondrial 3243A>G mutation in the MT-TL1 gene causing the MELAS syndrome by tRNA import into mitochondria. *Nucleic Acids Res* 39: 8173–8186.
16. Wang G, Shimada E, Zhang J, Hong JS, Smith GM, et al. (2012) Correcting human mitochondrial mutations with targeted RNA import. *Proc Natl Acad Sci U S A* 109: 4840–4845.
17. Comte C, Tonin Y, Heckel-Mager AM, Boucheham A, Smirnov A, et al. (2012) Mitochondrial targeting of recombinant RNAs modulates the level of a heteroplasmic mutation in human mitochondrial DNA associated with Kearns Sayre Syndrome. *Nucleic Acids Res*.
18. Kolesnikova OA, Entelis NS, Mireau H, Fox TD, Martin RP, et al. (2000) Suppression of mutations in mitochondrial DNA by tRNAs imported from the cytoplasm. *Science* 289: 1931–1933.
19. Entelis NS, Kolesnikova OA, Dogan S, Martin RP, Tarassov IA (2001) 5 S rRNA and tRNA Import into Human Mitochondria. Comparison of in vitro requirements. *J Biol Chem* 276: 45642–45653.
20. Tolkunova E, Park H, Xia J, King MP, Davidson E (2000) The human lysyl-tRNA synthetase gene encodes both the cytoplasmic and mitochondrial enzymes by means of an unusual alternative splicing of the primary transcript [In Process Citation]. *J Biol Chem* 275: 35063–35069.
21. Sepuri NB, Gorla M, King MP (2012) Mitochondrial Lysyl-tRNA Synthetase Independent Import of tRNA Lysine into Yeast Mitochondria. *PLoS One* 7: e35321.
22. Entelis N, Kolesnikova O, Kazakova H, Brandina I, Kamenski P, et al. (2002) Import of nuclear encoded RNAs into yeast and human mitochondria: experimental approaches and possible biomedical applications. *Genet Eng (N Y)* 24: 191–213.
23. Entelis NS, Krasheninnikov IA, Martin RP, Tarassov IA (1996) Mitochondrial import of a yeast cytoplasmic tRNA (Lys): possible roles of aminoacylation and modified nucleosides in subcellular partitioning. *FEBS Lett* 384: 38–42.
24. Smirnov A, Tarassov I, Mager-Heckel AM, Letzelter M, Martin RP, et al. (2008) Two distinct structural elements of 5S rRNA are needed for its import into human mitochondria. *RNA* 14: 749–759.
25. Kaminska M, Shalak V, Francin M, Mirande M (2007) Viral hijacking of mitochondrial lysyl-tRNA synthetase. *J Virol* 81: 68–73.
26. Mercer TR, Neph S, Dinger ME, Crawford J, Smith MA, et al. (2011) The human mitochondrial transcriptome. *Cell* 146: 645–658.
27. Rubio MA, Rinehart JJ, Krett B, Duvezin-Caubet S, Reichert AS, et al. (2008) Mammalian mitochondria have the innate ability to import tRNAs by a mechanism distinct from protein import. *Proc Natl Acad Sci U S A* 105: 9186–9191.
28. Puranam RS, Attardi G (2001) The RNase P associated with HeLa cell mitochondria contains an essential RNA component identical in sequence to that of the nuclear RNase P. *Mol Cell Biol* 21: 548–561.
29. Wang G, Chen HW, Oktay Y, Zhang J, Allen EL, et al. (2010) PNPASE Regulates RNA Import into Mitochondria. *Cell* 142: 456–467.
30. Smirnov A, Comte C, Mager-Heckel AM, Addis V, Krasheninnikov IA, et al. (2010) Mitochondrial enzyme rhodanese is essential for 5 S ribosomal RNA import into human mitochondria. *J Biol Chem* 285: 30792–30803.
31. Smirnov A, Entelis N, Martin RP, Tarassov I (2011) Biological significance of 5S rRNA import into human mitochondria: role of ribosomal protein MRP-L18. *Genes Dev* 25: 1289–1305.
32. Entelis NS, Kieffer S, Kolesnikova OA, Martin RP, Tarassov IA (1998) Structural requirements of tRNA^{Lys} for its import into yeast mitochondria. *Proc Natl Acad Sci U S A* 95: 2838–2843.
33. Antonellis A, Green ED (2008) The role of aminoacyl-tRNA synthetases in genetic diseases. *Annu Rev Genomics Hum Genet* 9: 87–107.
34. Dias J, Octobre G, Kobbi L, Comisso M, Flisiak S, et al. (2012) Activation of human mitochondrial lysyl-tRNA synthetase upon maturation of its premitochondrial precursor. *Biochemistry* 51: 909–916.
35. Diaz-Lazcoz Y, Aude JC, Nitschke P, Chiappello H, Landes-Devauchelle C, et al. (1998) Evolution of genes, evolution of species: the case of aminoacyl-tRNA synthetases. *Mol Biol Evol* 15: 1548–1561.
36. Duchene AM, Pujol C, Marechal-Drouard L (2008) Import of tRNAs and aminoacyl-tRNA synthetases into mitochondria. *Curr Genet*.
37. Negrutskii BS, Deutscher MP (1991) Channeling of aminoacyl-tRNA for protein synthesis in vivo. *Proc Natl Acad Sci U S A* 88: 4991–4995.
38. Belostotsky R, Frishberg Y, Entelis N (2012) Human mitochondrial tRNA quality control in health and disease: a channelling mechanism? *RNA Biol* 9: 33–39.
39. Salinas T, Duchene AM, Delage L, Nilsson S, Glaser E, et al. (2006) The voltage-dependent anion channel, a major component of the tRNA import machinery in plant mitochondria. *Proc Natl Acad Sci U S A* 103: 18362–18367.
40. Pancholi V (2001) Multifunctional alpha-enolase: its role in diseases. *Cell Mol Life Sci* 58: 902–920.
41. Bouzaidi-Tiali N, Aeby E, Charriere F, Pusnik M, Schneider A (2007) Elongation factor 1a mediates the specificity of mitochondrial tRNA import in *T. brucei*. *Embo J* 26: 4302–4312.
42. Barrey E, Saint-Auret G, Bonnamy B, Damas D, Boyer O, et al. (2011) Pre-microRNA and mature microRNA in human mitochondria. *PLoS One* 6: e20220.
43. Das S, Ferlito M, Kent OA, Fox-Talbot K, Wang R, et al. (2012) Nuclear miRNA regulates the mitochondrial genome in the heart. *Circ Res* 110: 1596–1603.
44. Sripada L, Tomar D, Prajapati P, Singh R, Singh AK, et al. (2012) Systematic analysis of small RNAs associated with human mitochondria by deep sequencing: detailed analysis of mitochondrial associated miRNA. *PLoS One* 7: e44873.
45. Bandiera S, Ruberg S, Girard M, Cagnard N, Hancin S, et al. (2011) Nuclear outsourcing of RNA interference components to human mitochondria. *PLoS One* 6: e20746.
46. Markham NR, Zuker M (2005) DINAMelt web server for nucleic acid melting prediction. *Nucleic Acids Res* 33: W577–581.
47. Markham NR, Zuker M (2008) UNAFold: software for nucleic acid folding and hybridization. *Methods Mol Biol* 453: 3–31.
48. Sugimoto N, Nakano S, Katoh M, Matsumura A, Nakamura H, et al. (1995) Thermodynamic parameters to predict stability of RNA/DNA hybrid duplexes. *Biochemistry* 34: 11211–11216.
49. Kaminska M, Deniziak M, Kerjan P, Barciszewski J, Mirande M (2000) A recurrent general RNA binding domain appended to plant methionyl-tRNA synthetase acts as a cis-acting cofactor for aminoacylation. *Embo J* 19: 6908–6917.
50. Francin M, Kaminska M, Kerjan P, Mirande M (2002) The N-terminal domain of mammalian Lysyl-tRNA synthetase is a functional tRNA-binding domain. *J Biol Chem* 277: 1762–1769.

2.2. Human enolases facilitate tRK1-preKARS2 complex formation

Previously, it was shown that yeast enolase (Eno2p) induces conformational changes in tRK1 structure enhancing its ability to interact with yeast pre-MSK1p (Entelis et al., 2006). Human cells have three isoforms of enolase (α , β , and γ) that are expressed in different tissues. We purified all three isoforms of human enolases as recombinant proteins from *E. coli* (Fig. 18A) and studied their interaction with labeled tRK1 using electrophoretic mobility shift assay (EMSA). We found that all three isoforms of human enolases display an affinity for tRK1 (Fig. 18B). In the presence of preKARS2 and enolase, no ternary complex was observed (tRK1-preKARS2-Enolase) but the tRK1 in complex with enolase was shifted to tRK1-preKARS2 complex (Fig. 18B).

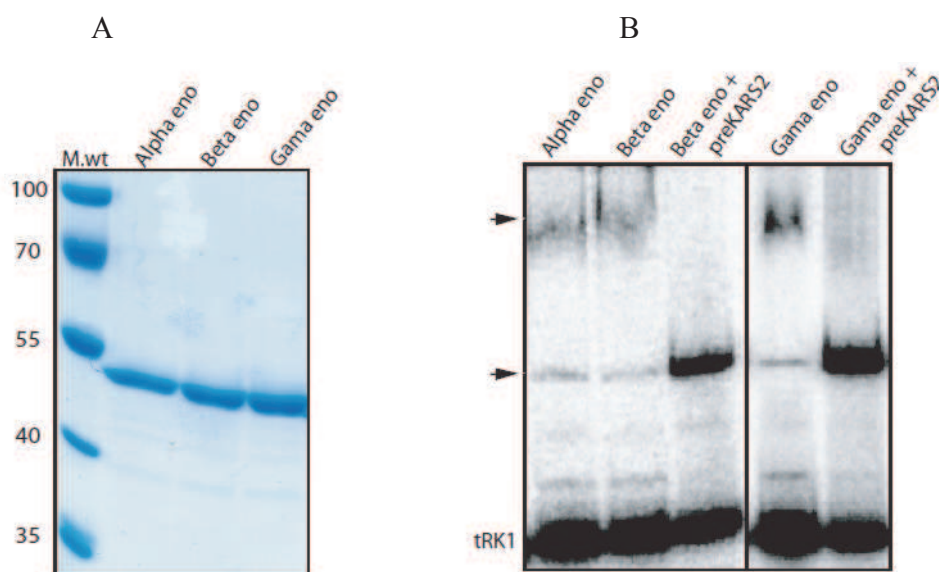
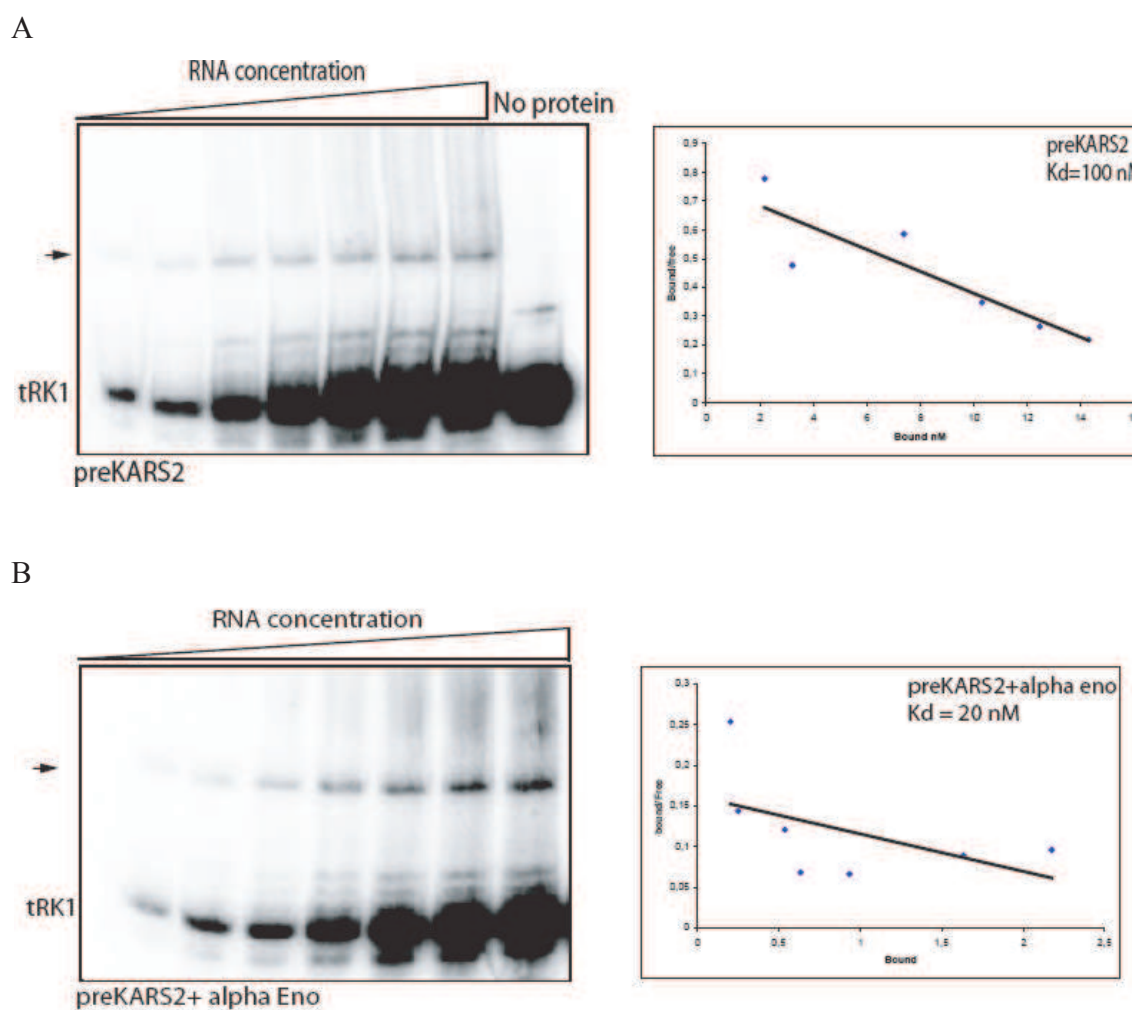

Figure 18: Protein purification and electrophoretic mobility shift assay. (A) Coomassie blue staining of purified recombinant human enolases (eno) after electrophoresis on SDS-PAGE. (B) Interaction of purified human enolases (1 μ M) and preKARS2 (0.8 μ M) proteins with ³²P-labeled tRK1 by EMSA. The RNA in complex with protein was separated from unbound RNA by native gel electrophoresis. The bottom band corresponds to the free RNA species; RNA-protein complexes are shown with an arrow.

To address the effect of human enolases on tRK1-preKARS2 complex formation, we performed EMSA assay in the presence of one or both proteins and varying amount of labeled RNA followed by Scatchard plot analysis. For this different concentration of labeled tRK1 (2-30nM) and fixed concentration of proteins (0.8 μ M of preKARS2 and 1 μ M of enolase) was used. The results obtained demonstrate that in the absence of enolase, preKARS2 interact tRK1 with a dissociation constant (K_d) of 100nM (**Fig. 19A**). Addition of enolase significantly improves the efficiency of tRK1-preKARS2 complex formation resulting in 4-5 fold decrease of K_d (from 100nM to 25nM -15nM) with different isoforms of enolase (**Fig. 19B**). These results show that human enolases facilitates the interaction between tRK1 and preKARS2, similarly to yeast Eno2, which acts as RNA chaperone facilitating tRK1 interaction with preMsk1p.



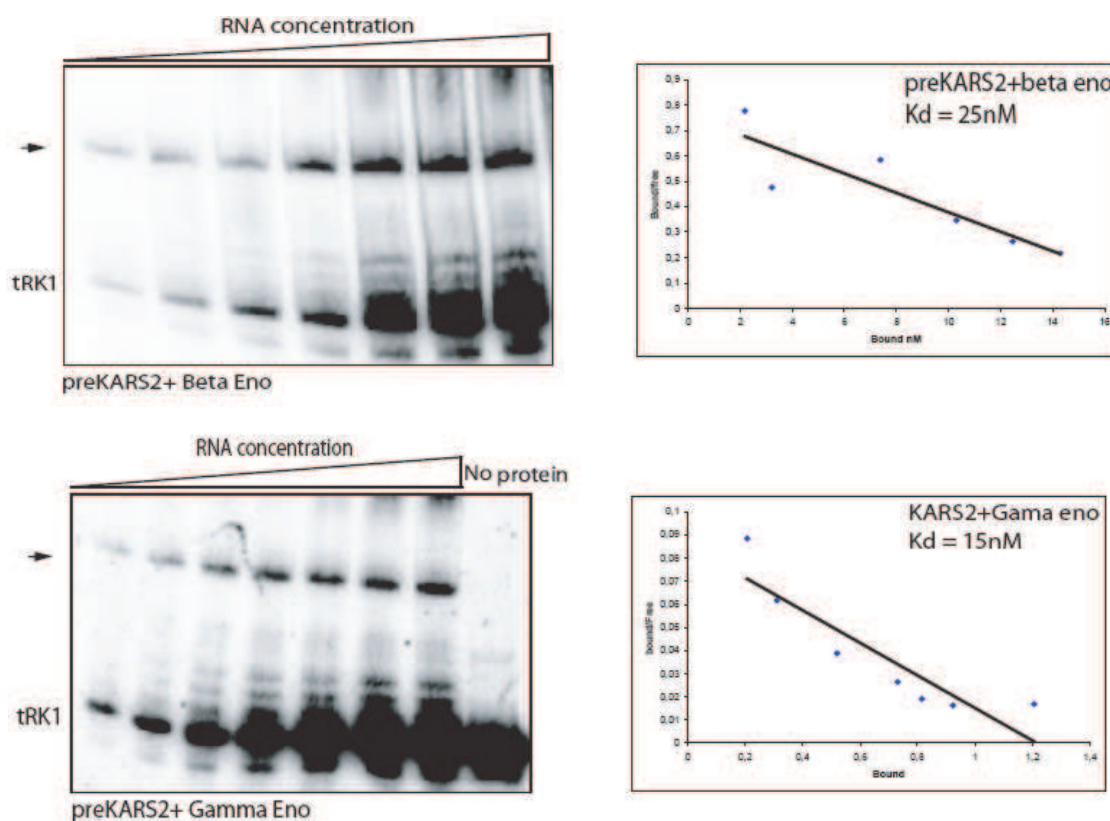

Figure 19: Interaction between labeled tRK1 and preKARS2 in the absence or presence of human enolases. Interaction of ^{32}P -labeled tRK1 (2-30nM) with preKARS2 (0.8 μM) in the absence or presence of human enolases (1 μM) using electrophoretic mobility shift assay. (A) Scatchard plot determination of preKARS2-tRK1 complex in the absence of enolases. (B) Scatchard plot determination of preKARS2-tRK1 complex in the presence of different isoforms of human enolases (1 μM). The RNA in complex with protein was separated from unbound RNA by native gel electrophoresis. The bottom band corresponds to the free RNA species; RNA-protein complex is shown with an arrow.

2.3. Mutation in PNPT1, which encodes a Polyribonucleotide nucleotidyltransferase, impairs RNA import into mitochondria and causes respiratory chain deficiency

2.3.1. Summary

Polynucleotide phosphorylase (PNPase) is an exoribonuclease and poly A polymerase at least partially localized in the mitochondrial intermembrane space (Chen et al., 2006; Rainey et al., 2006) and previously reported to function in the regulation of H1 RNA of RNase P and MRP RNA import into human mitochondria (Wang et al., 2010). Our colleagues from Hôpital Necker in Paris (team of Agnès Rötig), by using the exome sequencing in two siblings born to consanguineous parents, identified a homozygous PNPT1 missense mutation (c.1160A>G) that encode mitochondrial PNPase. The point mutation resulted in the transition of a neutral glutamine into a basic arginine (p.Gln387Arg) in the protein that affected the multimerization of protein.

My contribution in this study was then to analyze the import of different RNAs in patient's fibroblasts and translational defects in mitochondria (see below the publication). Total and mitochondrial RNA isolated from control and patients fibroblasts were analyzed for 5S RNA mitochondrial import. A 2-3 fold decrease of 5S rRNA import into mitochondria was observed in patient's fibroblast comparing to control cells. To model the effect of PNPase decrease in an independent cell line, we analyzed the import of 5S rRNA in HepG2 cells transiently transfected with siRNA against PNPase. Compared to control cells, a 3-4 folds decreased in PNPase expression was observed by western blot. This decreased in PNPase level was accompanied by 50-60% decrease of 5S rRNA import into mitochondria.

In parallel, we also studied the mitochondrial import of MRP RNA in patient's fibroblasts. This RNA is part of RNase MRP which is a site specific endoribonuclease involved in primer-RNA cleavage during the replication of mtDNA (Chang and Clayton, 1987). MRP RNA is 265 nt long in size and after its PNPase-dependent import into mitochondria, MRP RNA is believed to be at least partially processed into a 136 nt molecule containing a sequence capable of base pairing with a region of its mitochondrial RNA substrate (Topper and Clayton, 1990;

Wang et al., 2010). Analyzing control and subject fibroblasts, we found similar amounts of full-sized MRP RNA in total RNA preparations of both subjects and controls. Importantly, however, the 130-140 bp RNA species resulting from MRP-RNA maturation were detected in purified mitochondria of control, but not of subject fibroblasts. Our results suggest that mitochondrial import of at least two independent RNA species (5S rRNA and MRP RNA) is strongly affected by the PNPT1 mutation in the subjects cultured fibroblasts.

It was recently shown in my host laboratory that 5S rRNA is associated with mitochondrial ribosomes (Smirnov et al., 2011a), we tested the effect of abnormal 5S rRNA import in PNPase mutated cells on mitochondrial translation. Pulse-chase incorporation of ³⁵S-methionine into mitochondrially synthesized polypeptides showed, indeed a reproducible decrease in mitochondrial translation in patient's fibroblasts. The decrease was much less pronounced than that of the 5S rRNA import, suggesting that the residual 5S rRNA level was sufficient to ensure significant mitochondrial translation of RNA. Similarly, knocking down PNPase in control fibroblasts by siRNAs resulted in a mild translation defect as well. In order to confirm that the translational defect was due to the PNPase substitution, we transiently transfected subject fibroblasts with wild type PNPT1 cDNA. Transient cDNA expression induced a 160% increase of the PNPase 48 h after transfection. Moreover, an almost full restoration of protein synthesis rate was observed. Finally, over-expression of wild type PNPT1 cDNA in patient's fibroblasts restored both mitochondrial 5S rRNA and 136 bp MRP RNA amounts.

All these results clearly demonstrate the deleterious effect of the PNPT1 mutation on mitochondrial translation and provided the first description of a pathology directly linked to impaired RNA import.

2.3.2. Publication 2.

Vanessa Vedrenne*, Ali Gowher*, Pascale De Lonlay, Patrick Nitschke, Vale´rie Serre, Nathalie Boddaert, Cecilia Altuzarra, Anne-Marie Mager-Heckel, Florence Chetien, Nina Entelis, Arnold Munnich, Ivan tarassov, and Agne`s Rötig. Mutation in PNPT1, which Encodes a Polyribonucleotide Nucleotidyltransferase, Impairs RNA Import into Mitochondria and Causes Respiratory-Chain Deficiency.

The American Journal of Human Genetics, 2012, 91, 1–7

***Equal contribution in the work.**

Mutation in *PNPT1*, which Encodes a Polyribonucleotide Nucleotidyltransferase, Impairs RNA Import into Mitochondria and Causes Respiratory-Chain Deficiency

Vanessa Vedrenne,^{1,6} Ali Gowher,^{2,6} Pascale De Lonlay,³ Patrick Nitschke,⁴ Valérie Serre,¹ Nathalie Boddaert,³ Cecilia Altuzarra,⁵ Anne-Marie Mager-Heckel,² Florence Chretien,¹ Nina Entelis,² Arnold Munnich,^{1,3} Ivan Tarassov,² and Agnès Rötig^{1,*}

Multiple-respiratory-chain deficiency represents an important cause of mitochondrial disorders. Hitherto, however, mutations in genes involved in mtDNA maintenance and translation machinery only account for a fraction of cases. Exome sequencing in two siblings, born to consanguineous parents, with severe encephalomyopathy, choreoathetotic movements, and combined respiratory-chain defects allowed us to identify a homozygous *PNPT1* missense mutation (c.1160A>G) that encodes the mitochondrial polynucleotide phosphorylase (PNPase). Blue-native polyacrylamide gel electrophoresis showed that no PNPase complex could be detected in subject fibroblasts, confirming that the substitution encoded by c.1160A>G disrupts the trimerization of the protein. PNPase is predominantly localized in the mitochondrial intermembrane space and is implicated in RNA targeting to human mitochondria. Mammalian mitochondria import several small noncoding nuclear RNAs (5S rRNA, MRP RNA, some tRNAs, and miRNAs). By RNA hybridization experiments, we observed a significant decrease in 5S rRNA and MRP-related RNA import into mitochondria in fibroblasts of affected subject 1. Moreover, we found a reproducible decrease in the rate of mitochondrial translation in her fibroblasts. Finally, overexpression of the wild-type *PNPT1* cDNA in fibroblasts of subject 1 induced an increase in 5S rRNA import in mitochondria and rescued the mitochondrial-translation deficiency. In conclusion, we report here abnormal RNA import into mitochondria as a cause of respiratory-chain deficiency.

Mitochondrial disorders represent a heterogeneous group of genetic diseases characterized by an oxidative-phosphorylation (OXPHOS) deficiency. OXPHOS is carried out by the mitochondrial respiratory chain (RC), a complex pathway linking cellular respiration to the synthesis of adenosine triphosphate. The RC consists of five complexes composed of more than 80 distinct subunits, 13 of which are encoded by mtDNA. Moreover, several hundred nuclear genes are also needed for various functions of the RC. OXPHOS deficiency results from either mitochondrial or nuclear gene mutations.¹ Among them, multiple-RC deficiencies are associated with a variety of disease mechanisms that alter mtDNA maintenance, translation of mitochondrially encoded proteins, and cardiolipin synthesis.² Several point mutations and large deletions of mtDNA have been shown to cause multiple-RC deficiency. However, an increasing number of disease mutations are being identified in this group of mitochondrial diseases. Almost all of them encode mitochondrial proteins that are synthesized within the cytosol and further imported into the mitochondria. Mitochondria import not only proteins but also a few small RNAs that are essential for replication, transcription, and translation of the mitochondrial genome. Almost all species, including humans, import small RNAs. 5S rRNA (MIM 180420) is the most

abundant imported RNA in human mitochondria³ and is critical for mitochondrial translation. Two other RNAs are imported, and these are (1) MRP RNA (MIM 157660), a noncoding RNA component of RNase MRP, a site-specific endoribonuclease involved in primer RNA cleavage during replication of mtDNA⁴ and (2) RNase P RNA component (MIM 608513), thought to participate in the maturation of mitochondrial tRNA (mt-tRNA). In addition, several nuclear tRNAs were reportedly targeted to mitochondria either *in vitro*⁵ or *in vivo*^{6,7} and were shown to rescue a mtDNA mutation linked to myoclonic epilepsy associated with ragged-red fibers (MERFF) syndrome (MIM 545000).⁸ Finally, several nuclearly encoded miRNAs are localized in the mitochondria and could represent a new regulatory pathway for nuclear-mitochondrial cross-talk.⁹ The way in which these small RNAs are imported into the mitochondria is not well understood, and various mechanisms have been considered.^{3,6,10} Recently, the mitochondrial protein PNPase has been shown to facilitate mitochondrial import of 5S rRNA, MRP RNA, and RNaseP RNA into mammalian cells.¹¹ Here, we report an abnormal mitochondrial RNA import triggered by a PNPase mutation as a cause of mitochondrial RC deficiency.

Subject 1, a girl, was born to first-cousin, healthy Moroccan parents after a full-term pregnancy and normal

¹Université Paris Descartes-Sorbonne Paris Cité, Institut Imagine and Institut National de la Santé et de la Recherche Médicale U781, Hôpital Necker-Enfants Malades, 149 rue de Sèvres, 75015 Paris, France; ²UMR 7156, Université de Strasbourg and Centre National de la Recherche Scientifique, Génétique Moléculaire, Génomique, Microbiologie, 21 rue René Descartes, 67084 Strasbourg, France; ³Department of Pediatrics, Hôpital Necker-Enfants Malades, Université Paris Descartes, 149 rue de Sèvres, 75015 Paris, France; ⁴Plateforme Bioinformatique Paris Descartes, 149 rue de Sèvres, 75015 Paris, France; ⁵Service de Pédiatrie, Hôpital Saint-Jacques, 25030 Besançon, France

⁶These authors contributed equally to this work

*Correspondence: agnes.rotig@inserm.fr

<http://dx.doi.org/10.1016/j.ajhg.2012.09.001>. ©2012 by The American Society of Human Genetics. All rights reserved.

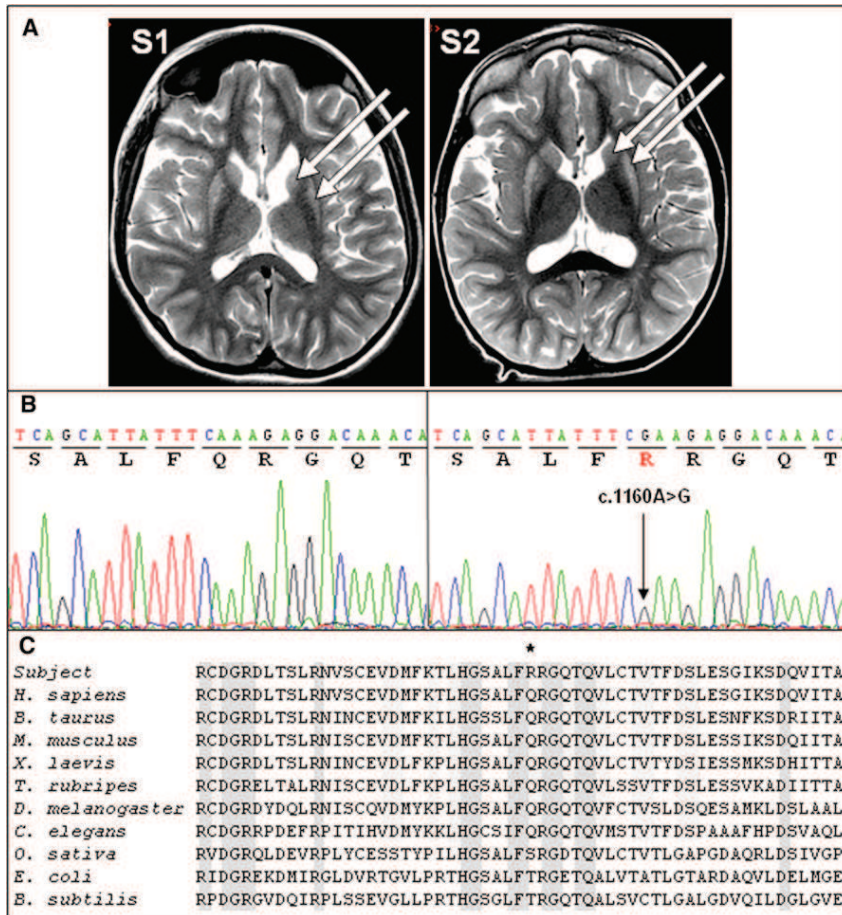

Figure 1. Brain MRIs and Sequence Analyses of the Affected Children

(A) Brain MRIs of subjects 1 (S1) and 2 (S2) at 14 and 3.5 years of age, respectively. The arrows show hyperintensities in the bilateral putamen and caudate nuclei.

(B) Sequence analysis of exon 13 of *PNPT1* (RefSeq accession number NM_033109) in a control (left) and subject 1 (right). The arrow indicates the mutation.

(C) Sequence alignment of the PNase proteins from human and nonhuman sources. The asterisk indicates the altered amino acid.

and she could smile, burst out laughing, and follow with her eyes with a direct gaze and no abnormal eye movements. Major swallowing difficulties required gastrostomy, and major retractions of the right hip and ankles prompted a consideration of multiple tenotomies.

The second child (subject 2), a boy, was also born after a full-term pregnancy and normal delivery. His birth weight was 3,580 g, his height was 50 cm, and his OFC was 36.5 cm. He also did well in the first few months of life and could smile and follow with his eyes, but he never acquired head control. At 6 months of age, he

delivery. Her birth weight was 3,470 g, her height was 49 cm, and her occipitofrontal circumference [OFC] was 35.5 cm. She did apparently well in the first months of life. She could smile and follow with her eyes at the age of 2 months and acquired head control at the age of 4 months. However, she presented with vomiting, poor eating, and swallowing difficulties of unexplained origin, and she could never sit unaided. At 9 months of age, she suddenly developed trunk hypotonia with disorganized, asynchronous, and erratic dystonic and choreoathetotic movements of all four limbs and bucofacial dyskinesias. She lost purposeful hand movements and could no longer hold her bottle. When she was first referred, she was a 10-year-old bed- and wheel-chair-bound, severely hypotrophic girl (weight = 17 kg [−3 standard deviations (SDs)]; OFC = 49 cm [−2.5 SDs]). She could neither stand nor sit unaided. Her voluntary movements were slow and markedly hampered by dystonia, dyskinesia, and choreoathetosis. She had global hypotonia, severe muscle weakness, no head control, and permanent bucofacial dyskinesias. Deep-tendon reflexes of the inferior limbs were barely detected, owing to muscle atrophy and permanent abnormal movements, but her nerve-conduction velocity was reduced (32–35 m/s; controls = 40–45 m/s). She could not speak, but she understood and obeyed simple orders. She was otherwise fully conscious and alert,

suddenly developed motor regression with trunk hypotonia and choreoathetotic movements. He lost the ability to hold his bottle and grasp. When he was first referred at 3.5 years old, he had major dystonia of the limbs, global hypotonia, and permanent choreoathetotic movements (his weight was 14.6 kg, and his height was 96 cm). All subject samples were acquired according to the Necker Hospital Ethical Committee, and informed consent was given prior to sample collection.

The two affected children therefore had a fixed, severe, but nonprogressive encephalopathy and mildly elevated plasma and cerebrospinal-fluid lactate. Brain magnetic resonance images (MRIs) (axial T2, fast-spin-echo-weighted images) of the two children showed hyperintensities in the bilateral putamen and caudate nuclei (Figure 1A). Neither white-matter involvement nor pontocerebellar anomalies were noted. Electroencephalographic evidence of clinically silent erratic myoclonies was noted.

A severe decrease in the activity of RC complexes III and IV was found in the liver of subject 1, whereas normal enzyme-activity values were found in her skeletal muscle biopsy and in cultured skin fibroblasts of subject 2 (Table 1). Histopathological examination showed predominant type I fibers, mild atrophy of type II fibers, and peripheral accumulation of abnormal mitochondria. Large-scale mtDNA deletions, mtDNA depletion, and

Table 1. Respiratory-Chain Activities in Liver Homogenate, Muscle Mitochondria, and Fibroblasts

	Liver Homogenate		Muscle Mitochondria		Fibroblasts	
	Subject 1	Control	Subject 1	Control	Subject 2	Control
Absolute Activity (nmol/min/mg of Protein)						
CI	20	25 ± 5	108	73 ± 15	14	13 ± 3
CII	140	146 ± 20	143	98 ± 20	28	21 ± 2
CIII	185	400 ± 60	2,343	1,458 ± 257	247	181 ± 20
CIV	48	187 ± 29	1,073	740 ± 146	132	103 ± 11
CV	149	112 ± 29	539	335 ± 68	61	65 ± 6
CS	48	61 ± 9	573	399 ± 70	75	75 ± 7
Activity Ratios						
CI/CS	0.41	0.41 ± 0.08	0.19	0.18 ± 0.02	0.19	0.17 ± 0.03
CII/CS	2.93	2.23 ± 0.30	0.25	0.25 ± 0.02	0.38	0.29 ± 0.02
CIII/CS	3.86	6.43 ± 0.85	4.09	3.91 ± 0.40	3.31	2.53 ± 0.20
CIV/CS	0.99	3.03 ± 0.38	1.87	1.96 ± 0.15	1.77	1.35 ± 0.11
CV/CS	3.11	1.80 ± 0.34	0.94	0.80 ± 0.06	0.27	0.27 ± 0.03

Abnormal values are in bold. The following abbreviations are used: CI–CV, complexes I–V; and CS, citrate synthase.

common point mutations were excluded by the use of appropriate techniques in liver DNA of the two children. Blue-native gel electrophoresis (BN-PAGE) in cultured skin fibroblasts showed normal RC assembly in subject 2.

To identify the causative nuclear gene mutation, we sequenced the exomes of subjects 1 and 2. The subjects' genomic DNA (1 µg) was isolated from blood leukocytes. We captured exons by the in-solution enrichment methodology (SureSelect Human All Exon Kits v.3, Agilent, Massy, France) by using the company's biotinylated oligonucleotide probe library (Human All Exon v.3 50 Mb, Agilent). Each genomic DNA sample was then sequenced on a sequencer as paired-end 75 bp reads (Illumina HI-SEQ2000, Illumina, San Diego, USA). Image analyses and base calling were performed with Real Time Analysis Pipeline v.1.9 with default parameters (Illumina). Sequences were aligned to the human genome reference sequence (hg19 assembly), and SNPs were called on the basis of the allele calls and read depth with the use of the CASAVA (Consensus Assessment of Sequence and Variation 1.8 [Illumina]) pipeline. From the 48,068 and 48,069 SNPs and indels identified in subjects 1 and 2, respectively, the pathogenic variant was selected according to the following criteria. (1) The known SNPs reported in dbSNP, 1000 Genomes, and the Exome Variant Server were excluded. (2) Intergenic variants were excluded because most mutations disrupt protein-coding sequences in Mendelian disorders. (3) Given the consanguinity of the parents, only homozygous variations were considered. (4) Finally, variations shared by both subjects 1 and 2 were selected. This filtering resulted in a list of 25 genes, only one of which (*PNPT1* [MIM 610316]) encodes a known mitochondrial protein. The homozygous c.1160A>G

mutation in exon 13 of *PNPT1* (RefSeq accession number NM_033109.3) on chromosome 2 resulted in the transition of a neutral glutamine into a basic arginine (p.Gln387Arg) in the protein. This change is predicted to be probably damaging and deleterious by PolyPhen and SIFT software, respectively. Sanger sequencing allowed us to confirm this mutation in the two affected individuals (Figure 1B) and showed that the parents were heterozygous and that the healthy brother was wild-type (WT) homozygous (not shown). We then sequenced *PNPT1* in a series of nine individuals with a similar clinical presentation and/or brain MRI, but we failed to detect any other mutations. Finally, this mutation was not found in 100 controls of north African origin. The p.Gln387 substitution lies in a highly conserved domain of the protein and is present in amino acid sequences from humans to *C. elegans* (Figure 1C).

PNPT1 encodes the mitochondrial polynucleotide phosphorylase, a 3'–5' exoribonuclease and poly-A polymerase (PNPase) predominantly located in the mitochondrial intermembrane space.¹² This protein assembles into a homo-oligomeric complex consisting of a trimer or a dimer of trimers.¹¹ We therefore studied the effect of the *PNPT1* mutation on the amount and multimerization of the PNPase. SDS-PAGE analysis of total-protein extracts from cultured skin fibroblasts showed a marked decrease in mutant protein because only 50%–60% of normal PNPase could be detected in subject 1 compared to the control (Figure 2A). However, the amounts of *PNPT1* transcripts were similar between the fibroblasts of subject 1 and control fibroblasts (not shown), suggesting that the p.Gln387Arg substitution destabilizes the mutant protein. Proteins (30 µg) solubilized from subject 1 mitoplasts were loaded on a 4%–16% acrylamide nondenaturing gradient

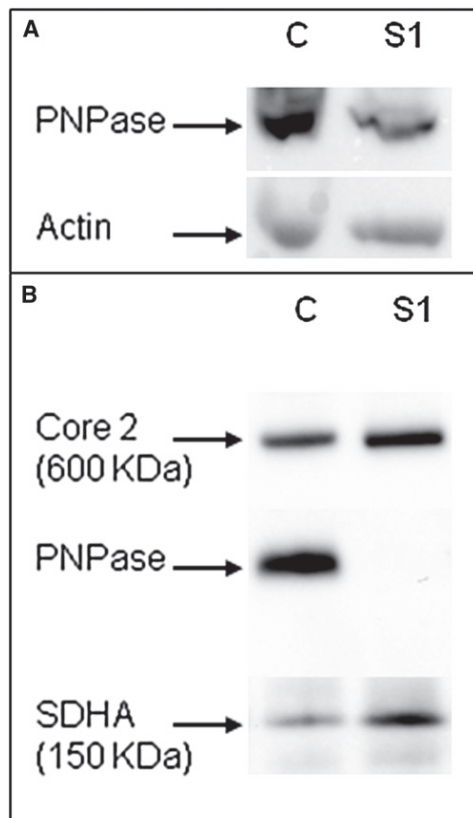

Figure 2. PNPase Analysis

(A) SDS-PAGE and immunoblot analysis of PNPase and actin in subject 1 (S1) and a control (C).
 (B) BN-PAGE analysis of mitochondria from cultured skin fibroblasts of subject 1 (S1) and a control (C) with PNPase antibodies. SDHA (complex II) and core 2 (complex III) were used as loading controls.

gel (Invitrogen).¹³ After electrophoresis, gels were transferred onto a membrane (GE Healthcare), processed for immunoblotting, and immunoblotted for PNPase. A ~260 kDa complex containing PNPase was detected in control fibroblasts and might represent PNPase trimers. This complex was totally absent from the subjects' cultured cells, whereas similar amounts of RC complexes II and III, used as loading tests, were detected in subjects and controls. No assembly intermediate could be detected in either subject or control mitoplasts (Figure 2B). The absence of PNPase complexes in the subjects' fibroblasts, despite a residual amount of mutant PNPase, suggests that the p.Gln387Arg substitution alters multimerization of the protein, although one cannot exclude that the mutation affects association with proteins from the mitochondrial inner membrane.

So far, the way in which small RNA is imported into mitochondria has remained poorly understood. However, it has been recently proposed that PNPase could be involved in RNA targeting to human mitochondria.¹¹ We therefore studied the possible impact of the PNPase substitution on mitochondrial RNA import. We isolated total and mitochondrial RNA (mtRNA) from cultured skin fibro-

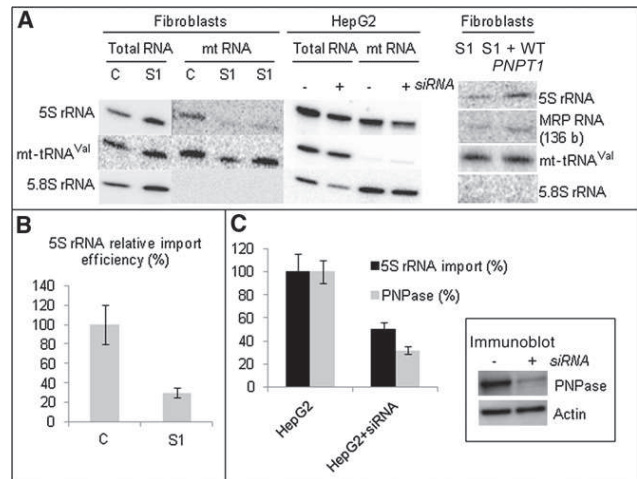

Figure 3. Quantification of Mitochondrial Import of 5S rRNA and MRP RNA by RNA Hybridization

(A) On the left, total and mtRNA from cultured skin fibroblasts of a control (C) and subject 1 (S1) were separated in denaturing 10% PAGE, transferred on Hybond-N filters, and hybridized with oligonucleotide-labeled probes for 5S rRNA, mt-tRNA^{Val}, and 5.8S rRNA. Two deposits (1 and 3 μg) of subject mtRNA were analyzed for 5S-rRNA-import analysis. In the middle is Northern blot hybridization with 5S-rRNA-specific, mt-tRNA^{Val}-specific, and 5.8S-rRNA-specific radio-labeled probes of total and mtRNA from HepG2 cells transfected or not with *PNPT1* siRNAs. On the right, Northern blot analysis of mtRNA after transient expression of WT *PNPT1* cDNA restored both 5S rRNA and 136 bp MRP RNA amounts in the mitochondria of subject 1 (S1) fibroblasts.

(B) Relative values of 5S rRNA import in subject 1 (S1) fibroblasts normalized to the control (C). Error bars correspond to two independent experiments.

(C) Relative 5S rRNA import and PNPase amount in control HepG2 and treated HepG2 + siRNA cells. The error bars correspond to two independent experiments. Immunoblot analysis of PNPase down-regulation is shown in the inset. The actin-specific antibody was used as a loading control.

blasts of subjects and controls^{8,14} and analyzed 5S rRNA import by Northern hybridization by using the following ³²P-labeled probes: 5'-CATCCAAGTACTACCAGGCC-3' for 5S rRNA, 5'-GGCCGCAAGTGCCTTCGAAG-3' for 5.8S rRNA (control for the absence of cytosolic contamination), and 5'-GTTGAAATCTCCTAAGTG-3' for mt-tRNA^{Val} (control for the absence of mtRNA degradation during the procedure). We observed a significant decrease in 5S rRNA import (70% ± 10%) into isolated and cytosol non-contaminated mitochondria from subject 1 compared to the control (Figure 3). To model the effect of PNPase decrease in an independent cell line, we analyzed mitochondrial import of 5S rRNA in a human immortalized HepG2 cell line in the presence of *PNPT1* siRNA. HepG2 cells were lipofectamine transfected with a mixture of three dsRNA duplexes (AAGAGUUACAUCUGAAGUCCU, AAAACCUCGAGCAUCUAGAAA, and AAAACAGGUGUACUAUUA)¹⁵ and analyzed 48 hr after a single transfection. Immunoblot analyses confirmed efficient knock-down of *PNPT1* given that the amount of PNPase was reduced by at least three to four times (Figure 3). This reduction was accompanied by a 50%–60% decrease in

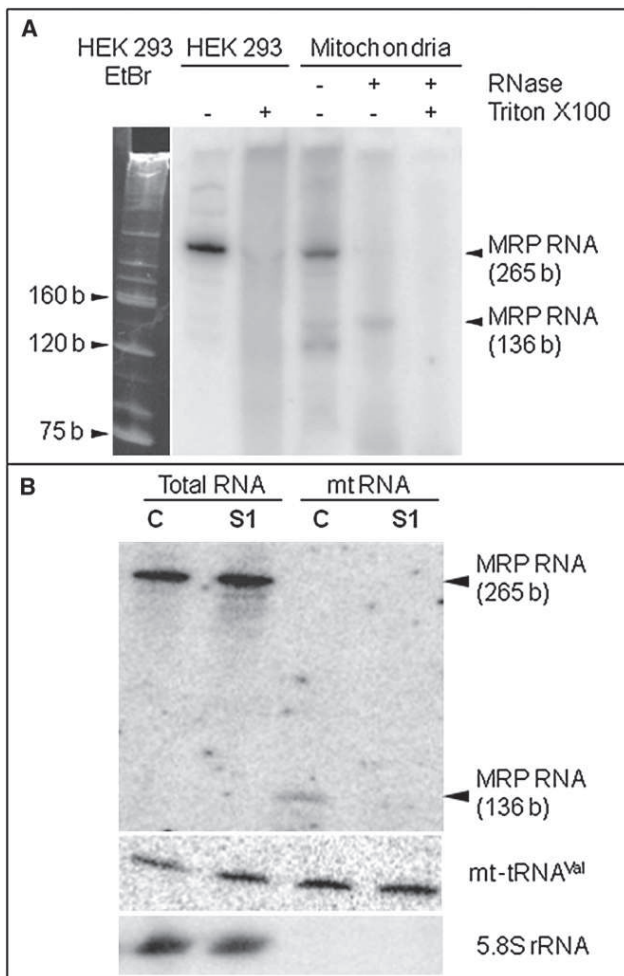

Figure 4. Analysis of MRP RNA

(A) Analysis of MRP RNA isolated from HEK 293 cells. The left panel shows ethidium-bromide (EtBr)-colored 10% denaturing polyacrylamide gel. The sizing of tRNA, 5S rRNA, and 5.8S rRNA, which were used as size markers, was confirmed by hybridization with corresponding oligonucleotide probes. The right panel shows a hybridization autoradiograph with MRP-RNA oligonucleotide-labeled probes of total RNA, total RNA after lysis of cells with Triton X-100 (1%), crude mtRNA, and mtRNA after mitochondria were treated with an RNase mixture.

(B) Analysis of mitochondrial import of MRP RNA by RNA hybridization. In the Northern blot analysis, total and mtRNA from cultured skin fibroblasts of a control (C) and subject 1 (S1) were hybridized with MRP-RNA, mt-tRNA^{Val}, and 5.8S rRNA oligonucleotide-labeled probes. Full-sized (265 bp) and processed forms of the MRP RNA (136 bp) are indicated.

5S rRNA in mitochondria. Why a three-to-four-times reduction of PNPase levels only reduced the 5S rRNA amount by half is questionable, but these results clearly confirm the importance of PNPase for 5S rRNA import.

MRP RNA is the RNA component of RNase MRP, a site-specific endoribonuclease involved in primer-RNA cleavage during the replication of mtDNA.⁴ MRP RNA is 265 nt long in size. After its PNPase-dependent import into mitochondria, MRP RNA is believed to be at least partially processed into a 136 nt molecule containing

a sequence capable of base pairing with a region of its mtRNA substrate.^{11,16} Indeed, we detected the processed form of MRP RNA in RNase-treated mitochondria of human embryonic kidney (HEK) 293 cells by Northern blot hybridization by using the ³²P-labeled probe 5'-GTGGGAAGCGGGGAATGTCTACG-3' (Figure 4A). Analyzing control and subject fibroblasts, we found similar amounts of full-sized MRP RNA in total-RNA preparations of both subjects and controls. Importantly, however, the 130–140 bp RNA species resulting from MRP-RNA maturation⁴ was detected in purified mitochondria from control, but not subject, fibroblasts (Figure 4B). The same amount of mt-tRNA^{Val} in purified mitochondria from controls and subjects ruled out RNA degradation. Our results suggest that mitochondrial import of at least two independent RNA species is strongly affected by the *PNPT1* mutation in the subjects' cultured fibroblasts. A decreased MRP RNA amount has apparently little impact on the level of mtDNA given that the mtDNA content in the subjects' fibroblasts was 42% of control values; this is usually considered normal given the large variability of control ranges. One can hypothesize that the mitochondrial import and processing of MRP RNA mostly impact the switch between asymmetrical and strand-coupled modes of mtDNA synthesis.¹⁷

Finally, considering that import of 5S rRNA has been shown to play an essential role in mitochondrial translation,³ we questioned whether mitochondrial protein synthesis was affected in the subjects' cells. Pulse-chase incorporation of ³⁵S-methionine into mitochondrially-synthesized polypeptides was tested in the presence of 0.5 mg/ml emetine for the inhibition of cytoplasmic translation.⁸ To assure correct quantification, we simultaneously performed immunoblotting by using an actin antibody. We found a reproducible mitochondrial-translation decrease mainly affecting COX subunits in subject, rather than control, fibroblasts (Figure 5A and C). The decrease was much less pronounced than that of the 5S rRNA import (58% ± 4% versus 30% ± 5%), suggesting that the residual 5S rRNA level was sufficient to ensure significant mitochondrial translation of RNA. Such a limited effect was previously observed when 5S rRNA import was only partially abolished.³ Similarly, knocking down PNPase in control fibroblasts with the use of *PNPT1*-specific siRNAs (as with HepG2 cells, see above) resulted in a translation defect as well (Figure 5A, right panel). In order to confirm that the translational defect was due to the PNPase substitution, we transiently transfected subject fibroblasts with WT *PNPT1* cDNA expressed under the control of the CMV promoter (cloned in pCMV6-XL4 vector, purchased in OriGene). Transient cDNA expression induced a 160% increase in the PNPase band intensity 48 hr after transfection (Figure 5). Moreover, an almost full restoration of protein-synthesis rate was observed (Figure 5). Finally, overexpression of WT *PNPT1* cDNA in subject fibroblasts restored both mitochondrial 5S rRNA and 136 bp MRP RNA amounts

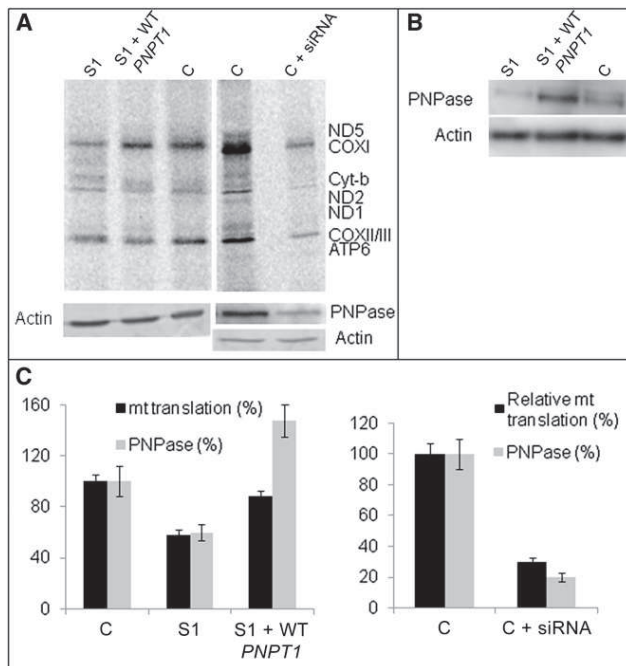

Figure 5. Analysis of Mitochondrial Translation in the Subjects Fibroblasts

(A) In vivo pulse-chase ^{35}S -methionin incorporation in mitochondrially synthesized polypeptides in fibroblasts of subject 1 (S1), S1 fibroblasts transiently transfected with WT *PNPT1* cDNA (S1 + WT *PNPT1*), control (C) fibroblasts, and control fibroblasts transfected with *PNPT1* siRNAs (C + siRNA). The mitochondrial-translation products on 12% SDS-PAGE are indicated according to the standard pattern.¹⁸ The bottom parts (loading control) show the immunoblot assay with antibodies against actin and PNPase.

(B) Quantification of the PNPase expression by immunoblot analysis was performed in parallel with unlabelled aliquots of the same cell lines.

(C) On the left are relative mitochondrial-translation products and PNPase levels in subject 1 (S1) fibroblasts, S1 fibroblasts transiently transfected with WT *PNPT1* cDNA (S1 + WT *PNPT1*), and control (C) fibroblasts. On the right are relative mitochondrial-translation products and PNPase levels in control fibroblasts transfected (C + siRNA) or not (C) with *PNPT1* siRNAs. For both diagrams, error bars correspond to two independent experiments.

(Figure 3A, right panel). These results clearly demonstrate the deleterious effect of the *PNPT1* mutation on mitochondrial translation and RNA import. It is worth remembering that although *PNPT1* silencing in HeLa cells has failed to alter the rate of mitochondrial translation,¹⁹ a clear defect in mitochondrial protein synthesis was observed in a liver-specific knockout of a *Pnpt1* mouse model and RNAi in HEK 293 cells,¹¹ where all mitochondrially-encoded polypeptides appeared to be uniformly affected. This apparent contradiction might be accounted for by HeLa cells' low glycolytic metabolism compared to active mitochondrial respiration in the liver. Also, because PNPase is involved in various functions such as noncoding RNA import¹¹ and mRNA polyadenylation,¹⁵ it should be hypothesized that different cells or tissues might require different functions of PNPase.

The exact function(s) of the human PNPase is not completely understood. It was found to be active in phosphorylation of RNA, but its localization in the mitochondrial intermembrane space (where no RNA is constantly present) suggests that it is not directly involved in the metabolism of mtRNA.²⁰ This protein has also been identified as a T cell leukemia-1 (TCL1) binding partner, whereas the biological implications of TCL1-PNPase complexes remain elusive.²¹ PNPase is also involved in the processing and adenylation of mitochondrial mRNA,¹⁹ but the most recent data support its crucial role in mitochondrial import of small RNAs needed for replication, transcription, and translation of the mitochondrial genome.¹¹

In conclusion, we report here a pathogenic *PNPT1* mutation in humans. This mutation destabilizes the protein and abrogates its multimerization. Moreover, we also show that this mutation alters mitochondrial RNA import and mitochondrial translation. These results strongly support the role of PNPase in the import of RNA into mitochondria and provide evidence for its crucial importance in maintaining a functional RC. Impaired RNA import into mitochondria therefore represents a disease mechanism in multiple-RC deficiency. Based on this single family, our study supports the importance of exome sequencing for the identification of rare disease-causing gene mutations.

Acknowledgments

This research was supported in part by the Association Française contre les Myopathies, the French Agence Nationale pour la Recherche, the GIS-Institut des maladies rares, the Institut National de la Santé et de la Recherche Médicale, the Centre National de la Recherche Scientifique, the Fondation pour la Recherche Médicale, and the National Program "Investissement d'Avenir" (Labex MitoCross). A.G. was supported by the Higher Education Commission, Pakistan (SFERE doctoral fellowship).

Received: May 23, 2012

Revised: July 10, 2012

Accepted: September 4, 2012

Published online: October 18, 2012

Web Resources

The URLs for data presented herein are as follows:

Online Mendelian Inheritance in man (OMIM), <http://www.omim.org>

PolyPhen, <http://genetics.bwh.harvard.edu/pph2/>

SIFT, <http://sift.jcvi.org/>

References

- Chinnery, P.F., and Turnbull, D.M. (2001). Epidemiology and treatment of mitochondrial disorders. *Am. J. Med. Genet.* 106, 94–101.
- Rötig, A. (2010). Genetic bases of mitochondrial respiratory chain disorders. *Diabetes Metab.* 36, 97–107.
- Smirnov, A., Entelis, N., Martin, R.P., and Tarassov, I. (2011). Biological significance of 5S rRNA import into human

- mitochondria: Role of ribosomal protein MRP-L18. *Genes Dev.* 25, 1289–1305.
4. Chang, D.D., and Clayton, D.A. (1987). A mammalian mitochondrial RNA processing activity contains nucleus-encoded RNA. *Science* 235, 1178–1184.
 5. Entelis, N.S., Kolesnikova, O.A., Dogan, S., Martin, R.P., and Tarassov, I.A. (2001). 5 S rRNA and tRNA import into human mitochondria. Comparison of in vitro requirements. *J. Biol. Chem.* 276, 45642–45653.
 6. Rubio, M.A., and Hopper, A.K. (2011). Transfer RNA travels from the cytoplasm to organelles. *Wiley Interdiscip Rev RNA* 2, 802–817.
 7. Rubio, M.A., Rinehart, J.J., Krett, B., Duvezin-Caubet, S., Reichert, A.S., Söll, D., and Alfonzo, J.D. (2008). Mammalian mitochondria have the innate ability to import tRNAs by a mechanism distinct from protein import. *Proc. Natl. Acad. Sci. USA* 105, 9186–9191.
 8. Kolesnikova, O.A., Entelis, N.S., Jacquin-Becker, C., Goltzene, F., Chrzanoska-Lightowers, Z.M., Lightowers, R.N., Martin, R.P., and Tarassov, I. (2004). Nuclear DNA-encoded tRNAs targeted into mitochondria can rescue a mitochondrial DNA mutation associated with the MERRF syndrome in cultured human cells. *Hum. Mol. Genet.* 13, 2519–2534.
 9. Bandiera, S., Rüberg, S., Girard, M., Cagnard, N., Hanein, S., Chrétien, D., Munnich, A., Lyonnet, S., and Henrion-Caude, A. (2011). Nuclear outsourcing of RNA interference components to human mitochondria. *PLoS ONE* 6, e20746.
 10. Salinas, T., Duchêne, A.M., and Maréchal-Drouard, L. (2008). Recent advances in tRNA mitochondrial import. *Trends Biochem. Sci.* 33, 320–329.
 11. Wang, G., Chen, H.W., Oktay, Y., Zhang, J., Allen, E.L., Smith, G.M., Fan, K.C., Hong, J.S., French, S.W., McCaffery, J.M., et al. (2010). PNPase regulates RNA import into mitochondria. *Cell* 142, 456–467.
 12. Chen, H.W., Rainey, R.N., Balatoni, C.E., Dawson, D.W., Troke, J.J., Wasiak, S., Hong, J.S., McBride, H.M., Koehler, C.M., Teitell, M.A., and French, S.W. (2006). Mammalian polynucleotide phosphorylase is an intermembrane space RNase that maintains mitochondrial homeostasis. *Mol. Cell. Biol.* 26, 8475–8487.
 13. Nijtmans, L.G., Henderson, N.S., and Holt, I.J. (2002). Blue Native electrophoresis to study mitochondrial and other protein complexes. *Methods* 26, 327–334.
 14. Zeharia, A., Shaag, A., Pappo, O., Mager-Heckel, A.M., Saada, A., Beinat, M., Karicheva, O., Mandel, H., Ofek, N., Segel, R., et al. (2009). Acute infantile liver failure due to mutations in the TRMU gene. *Am. J. Hum. Genet.* 85, 401–407.
 15. Nagaike, T., Suzuki, T., Katoh, T., and Ueda, T. (2005). Human mitochondrial mRNAs are stabilized with polyadenylation regulated by mitochondria-specific poly(A) polymerase and polynucleotide phosphorylase. *J. Biol. Chem.* 280, 19721–19727.
 16. Topper, J.N., and Clayton, D.A. (1990). Characterization of human MRP/Th RNA and its nuclear gene: Full length MRP/Th RNA is an active endoribonuclease when assembled as an RNP. *Nucleic Acids Res.* 18, 793–799.
 17. Holt, I.J. (2010). Zen and the art of mitochondrial DNA maintenance. *Trends Genet.* 26, 103–109.
 18. Enríquez, J.A., Cabezas-Herrera, J., Bayona-Bafaluy, M.P., and Attardi, G. (2000). Very rare complementation between mitochondria carrying different mitochondrial DNA mutations points to intrinsic genetic autonomy of the organelles in cultured human cells. *J. Biol. Chem.* 275, 11207–11215.
 19. Slomovic, S., and Schuster, G. (2008). Stable PNPase RNAi silencing: Its effect on the processing and adenylation of human mitochondrial RNA. *RNA* 14, 310–323.
 20. Portnoy, V., Palnizky, G., Yehudai-Resheff, S., Glaser, F., and Schuster, G. (2008). Analysis of the human polynucleotide phosphorylase (PNPase) reveals differences in RNA binding and response to phosphate compared to its bacterial and chloroplast counterparts. *RNA* 14, 297–309.
 21. French, S.W., Dawson, D.W., Chen, H.W., Rainey, R.N., Sievers, S.A., Balatoni, C.E., Wong, L., Troke, J.J., Nguyen, M.T., Koehler, C.M., and Teitell, M.A. (2007). The TCL1 oncoprotein binds the RNase PH domains of the PNPase exoribonuclease without affecting its RNA degrading activity. *Cancer Lett.* 248, 198–210.

2.4. PNPase overexpression increased RNA import into mitochondria

The presence of stem loop structure in H1 RNA and MRP RNA was suggested for the PNPase dependent mitochondrial import (Wang et al., 2010). So far, previous studies in my host laboratory also demonstrated that tRK1 and its shorter derivatives form similar hairpin structures (Comte et al., 2013b; Kolesnikova et al., 2010). We studied therefore the possible role of PNPase in mitochondrial targeting of tRK1 and its derivatives in cultured human cells stably overexpressing PNPase. Compared to control, a 3-4 folds increase in PNPase expression was observed on western blot (**Fig. 20A**). The cells overexpressing PNPase were transfected with recombinant RNAs and mitochondrial import was analyzed by Northern blot hybridization using specific probes (see Materials and Methods). The absence of signal after mitochondrial RNA hybridisation with the cytoplasmic 5.8S rRNA probe indicates that mitochondrial preparation was free of cytosolic contamination (**Fig. 20B**). Compared to the mitochondrial transcript of tRNA^{Val} as loading control, an increase from 1.8-2.6 folds was noticed in cells overexpressing PNPase, confirming that the amount of RNA molecules penetrating into mitochondria in human cells depends on the level of PNPase protein expression (**Fig. 20B**).

As described above, we have shown that mitochondrial targeting of tRK1 and its derivatives (FD-L and FD-H RNA) *in vitro* and *in vivo* depend on the preKARS2, while small truncated RNA (HF and HD RNA) needs some other protein factor(s) for its targeting toward mitochondria. Interestingly, we found that translocation of tRK1 and all its derivatives from the intermembrane space into the mitochondrial matrix depends on the level of PNPase expression (**Fig. 20C**).

A

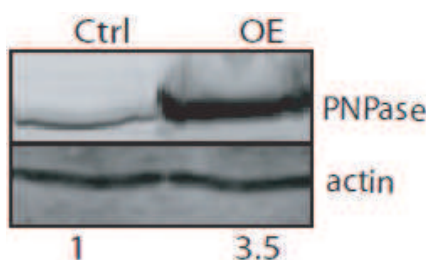

B

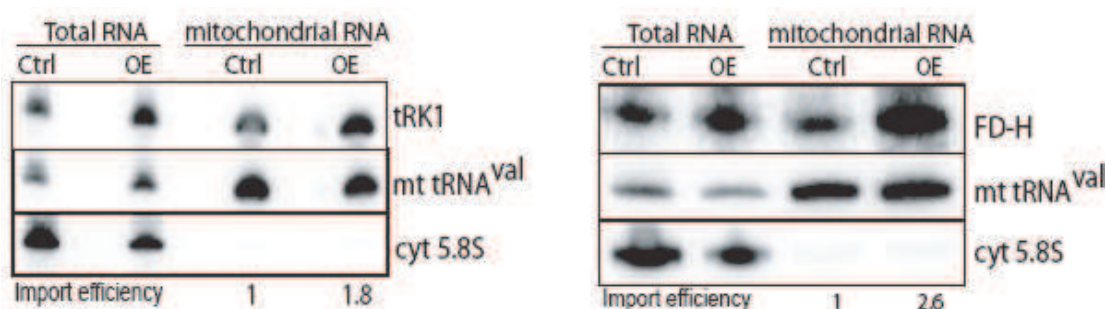

C

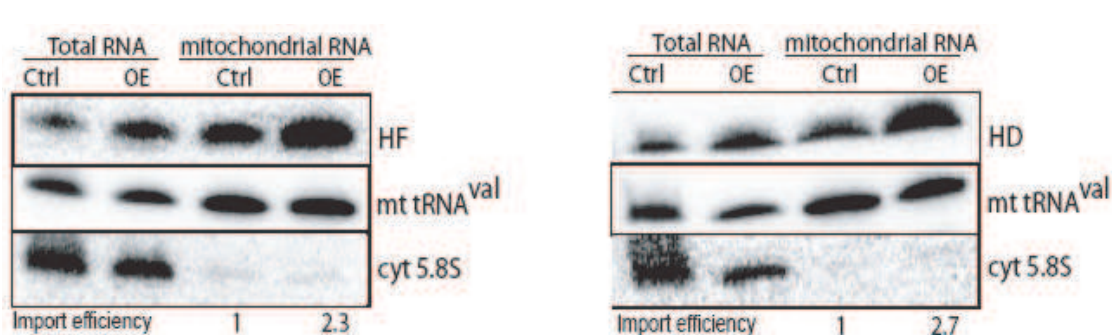

Figure 20: Implication of PNPase in mitochondrial RNA import *in vivo*. (A) Western blot analysis of PNPase overexpression in HEK293T cells stably expressing PNPase. Antibodies used for immunodetection are shown at the right. The level of overexpression (OE) comparing to control (ctrl) is shown at the bottom of the panel. (B and C) Northern blot hybridization of total and purified mitochondrial RNA isolated from control cells and cells overexpressing PNPase in 48h after transfection with tRK1 or its derivatives as indicated. Hybridisation probes are shown at the right. Mitochondrial (mt) tRNA^{val} probe was used as loading control, and cytosolic (Beyer et al.) 5.8S rRNA probe was used to check the absence of cytosolic RNA

contamination in the mitochondrial RNA preparations. The relative RNA import efficiencies, taken as 1 for control cells, are shown below each panel.

2.5. PNPase down-regulation decreased RNA import into mitochondria

We next studied the import of RNA in cells downregulating PNPase protein. For this, cultured human HepG2 cells were transiently transfected with a mixture of three siRNAs specifically designed against PNPase. On the third day after the second transfection, more than 3 folds decrease of PNPase was observed (**Fig. 21A**). To evaluate the effect of PNPase down-regulation on import of tRK1 and its derivatives into mitochondria, cells were transfected with mitochondrially imported RNA. Total and mitochondrial RNA were isolated from control and PNPase downregulated cells and analysed by northern blot hybridisation (**Fig. 21B**). The absence of signal after mitochondrial RNA hybridisation with the probe against cytoplasmic 5.8S rRNA indicates that the treatment of mitochondria with ribonuclease and digitonin removed all the cytosolic RNA contamination. When compared to the mitochondrial tRNA^{Val} as loading control, a 2-3 folds decrease in RNA import was observed in cells downregulating PNPase protein (**Fig 21B**).

A

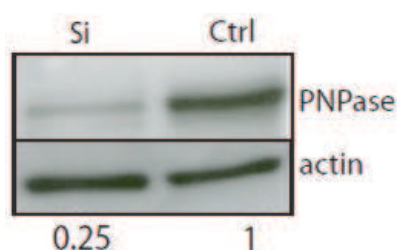

B

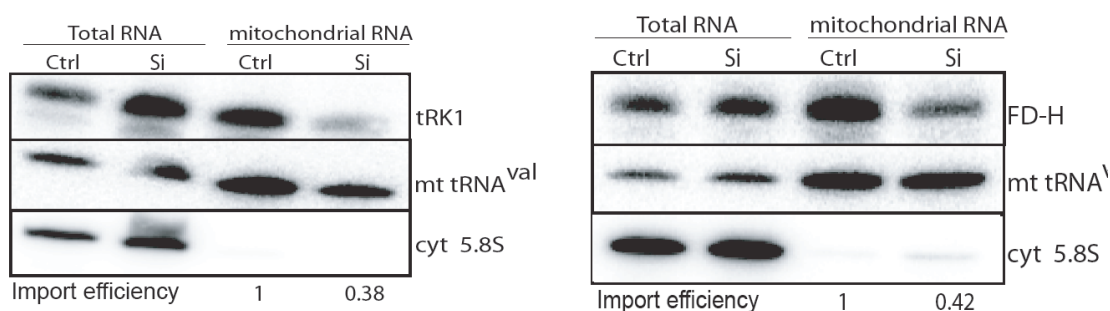

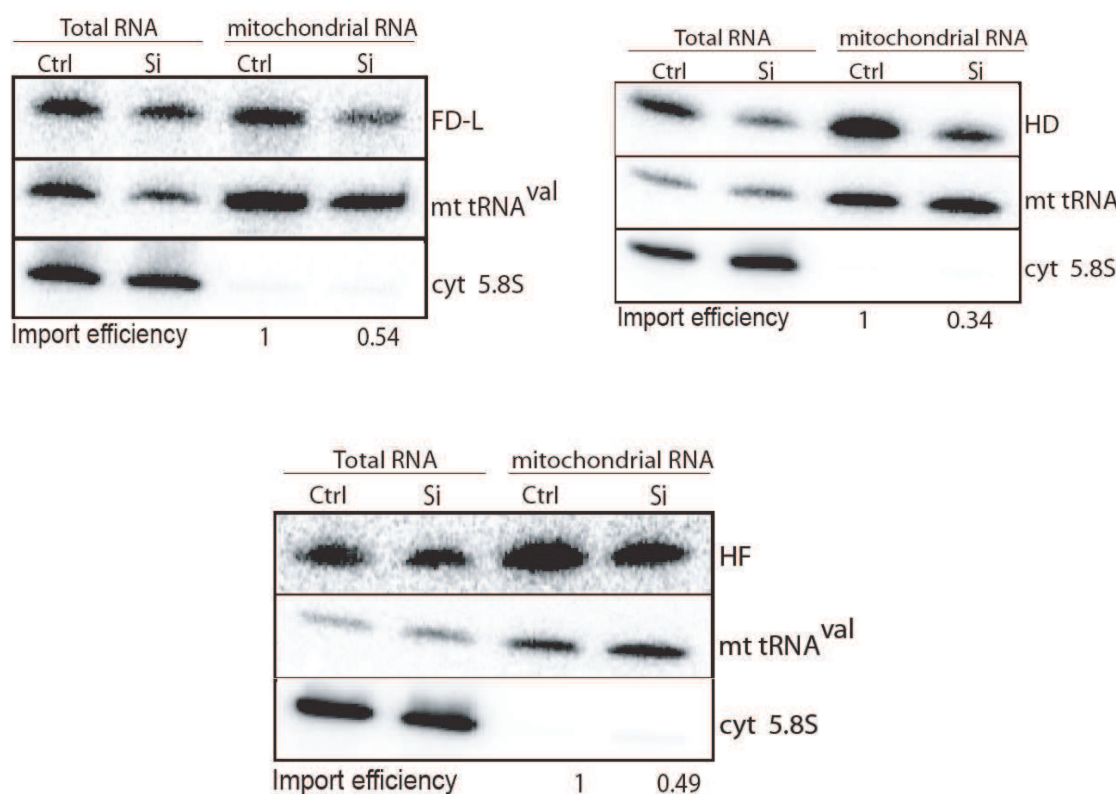

Figure 21: Implication of PNPase in mitochondrial RNA import *in vivo*. (A) Western blot analysis of PNPase down-regulation in HepG2 cells transiently transfected with siRNA (Si). Antibodies used for immunodetection are shown at the right. The level of down-regulation comparing to control (ctrl) is shown at the bottom of the panel. (B) Northern blot hybridization of total and purified mitochondrial RNA (mtRNA) isolated from control cells and cells downregulating PNPase after transfection with tRK1 or its derivatives as indicated. The hybridisation probes are shown at the right. Mitochondrial (mt) tRNA^{val} probe was used as loading control, and cytosolic 5.8S rRNA probe was used to check the absence of cytosolic RNA contamination in the mitochondrial RNA preparations. The relative RNA import efficiencies, taken as 1 for control cells, are shown below each panel.

All the data presented above clearly indicate the role of PNPase in the translocation of tRK1 and its derivatives into the mitochondrial matrix. Identification of proteins interacting with PNPase.

2.6. Identification of proteins interacting with PNPase

The exact role of PNPase in RNA import remains a complete mystery. The protein in its trimeric organization is able to form a channel for RNA in a completely unfolded state. So far, this channel is rather used for mRNA degradation function which is clearly not used for RNA

import. The other possibility is that its function is indirect, therefore we searched for its interactants in human mitochondria, to obtain further clues on its RNA-import function. The proteins interacting with PNPase were identified by crosslinking and immunoprecipitation (CLIP) approach. To this aim, whole cell lysates or purified mitochondria were crosslinked using 0.36M Formaldehyde. PNPase in complexes with other proteins were immunoprecipitated from the lysates using anti-PNPase antibodies and eluted proteins were identified by mass spectrometry analysis. The proteins identified reproducibly in three independent experiments are shown (**Table 1**). As a negative control, anti-aldolase antibodies were used.

Mitochondrial localization	Identified protein	Function
Outer membrane	Translocase of outer membrane (TOM70)	Part of the preprotein translocase complex of the outer mitochondrial membrane (TOM complex). Function as receptor that accelerates the import of all mitochondrial precursor proteins.
	Translocase of outer membrane (TOM40)	Channel-forming protein essential for import of protein precursors into mitochondria
	Translocase of outer membrane (TOM22)	Central receptor of the TOM complex. Responsible for recognition and translocation of mitochondrial precursor
	Translocase of outer membrane (TOM6)	part of the TOM complex. Stabilize the large TOM complex
	Voltage-dependent anion-selective channel protein (VDAC1, 2, 3)	Forms a channel through the mitochondrial outer membrane, that allows diffusion of small hydrophilic molecules
Inner membrane	Adenine nucleotide translocator (ANT2, ANT3)	Catalyzes the exchange of cytoplasmic ADP with mitochondrial ATP across the mitochondrial inner membrane. May participate in the formation of the permeability transition pore complex (PTPC) responsible for the release of mitochondrial products that triggers apoptosis
	ATPase family AAA domain-containing protein	Essential for mitochondrial network organization, mitochondrial metabolism and cell growth. May also participate in mitochondrial DNA replication.

Inner membrane	Adenine nucleotide translocator (ANT2, ANT3)	Catalyzes the exchange of cytoplasmic ADP with mitochondrial ATP across the mitochondrial inner membrane. May participate in the formation of the permeability transition pore complex (PTPC) responsible for the release of mitochondrial products that triggers apoptosis
	ATPase family AAA domain-containing protein (ATAD3A, ATAD3B)	Essential for mitochondrial network organization, mitochondrial metabolism and cell growth. May also participate in mitochondrial DNA replication. May bind to mitochondrial DNA D-loops and contribute to nucleoid

Table 1: Mitochondrial proteins interacting with PNPase identified by crosslinking and immunoprecipitation (CLIP) analysis. identified proteins were grouped according to their mitochondrial localization.

As we can see, the PNPase might interact with many other mitochondrial proteins of the outer and inner membrane. Noteworthy, many of the proteins can form or interact with channel (TOM, VDAC, IMMT) or were formerly described as potential nucleic acids mitochondrial import factors (ANT). ATAD proteins were also implicated in nucleoid composition. These results are clearly preliminary and further experiments are certainly needed to validate implication of these proteins in RNA import *via* PNPase.

DISCUSSION

3. Discussion

The integrity and function of mammalian mitochondria depends on the import of many macromolecules that are encoded by the nuclear genome and specifically addressed into the organelle. Compared to the mitochondrial protein import pathways, which have been well studied (Chacinska et al., 2009; Schmidt et al., 2010), the mechanism of importing RNAs into mitochondria, and the functions of imported RNAs, are less much understood. RNA import into mitochondria is now considered a quasisi-universal process, however the number and type of imported RNA as well as mechanism of import vary among species to a surprisingly significant extent. Critical questions about mitochondrial RNA import include the selectivity of RNAs, the factors targeting RNAs from the cytosol and the translocation pathways across the mitochondrial membranes (Duchene et al., 2009). In human cells, a subset of small non-coding RNA is imported into mitochondria from the cytosol (Mercer et al., 2011), including some tRNAs (either in a natural or an artificial manner)(Kolesnikova et al., 2004; Rubio et al., 2008), the RNA components of RNase P and MRP endonuclease (Puranam and Attardi, 2001; Wang et al., 2010), 5S rRNA (Smirnov et al., 2010a; Smirnov et al., 2011b) and micro RNA (Bandiera et al., 2011). The way in which these RNA are imported into mitochondria is not well understood and several mechanisms have been intensively studied (Rubio and Hopper, 2011; Salinas et al., 2008; Smirnov et al., 2011b). In the present work, we addressed the protein factors involved in the import of different RNA into human mitochondria.

3.1. preKARS2 interacts with yeast tRK1 and its derivatives

The import of yeast tRK1 into human mitochondria in the presence of yeast or human cytosolic factors suggests that human cell possesses the machinery needed for tRK1 mitochondrial import (Entelis et al., 2001a; Sepuri et al., 2012). We show direct interaction of preKARS2 with yeast tRK1 and its derivatives containing the import determinant of tRK1. The lost of this interaction upon preKARS2 maturation demonstrate the importance of mitochondrial targeting sequence (MTS). Previous studies in yeast show that maturation of preMsK1p inside

mitochondria also lead to a loss of tRK1 binding property (Entelis et al., 2006). Recently and rather surprisingly, the mature mitochondrial enzyme KARS2 was shown to interact with the human cytosolic tRNA^{Lys} 3 with an apparent K_d of 250±40 nM, but the presence of the MTS in preKARS2 completely abolished this specific RNA-binding property of the protein (K_d, 1mM for preKARS2) (Dias et al., 2012). Since in human cells no import of tRNA^{Lys} 3 into mitochondria had been observed *in vivo* (Mercer et al., 2011), the apparent discrepancy between these and our data clearly suggests a different mode of preKARS2 interaction with either the nonimportable cytosolic tRNA^{Lys} 3 or the importable tRK1. This is in agreement with our hypothesis that only the alternative fold of tRNA can be recognized by the precursor of mitochondrial lysyl tRNA-synthetase functioning as an RNA mitochondrial carrier (Kolesnikova et al., 2010). Thus, only tRK1 and some specially designed RNA molecules capable to adopt the alternative conformation can interact with preKARS2 in a way to facilitate mitochondrial import.

Aminoacyl-tRNA synthetases are a group of enzymes responsible for the specific attachment of amino acids to their cognate tRNAs, thus performing a key step of translation (reviewed in (Antonellis and Green, 2008)). In human cells, one gene KARS1 codes for both mitochondrial and cytosolic lysyl-tRNA-synthetases, which are produced from two mRNAs generated by alternative splicing (Tolkunova et al., 2000). In yeast, the cytoplasmic and mitochondrial isoforms of lysyl-tRNA synthetase are encoded by two distinct genes (Mirande et al., 1986). PreKARS2 thus possesses a specific N-terminal sequence of 49 amino acid residues, which is the only difference from KARS1 (Dias et al., 2012; Tolkunova et al., 2000). One can suggest therefore that this very motif either participate directly in the interaction, or modulate the overall structure of protein that allow interaction with imported tRNA.

3.2. Human enolases facilitate tRK1-preKARS2 complex formation

Many proteins exhibit unrelated functional activities within or outside the cell, a phenomenon termed as "Moonlighting". The function of a moonlighting protein can vary as a consequence of changes in cellular localization, cell type, oligomeric state, or cellular concentration of a ligand, substrate, cofactor or product (Jeffery, 1999). One example of a moonlighting protein is enolase, a glycolytic enzyme responsible for the catalysis of the

conversion of 2-phosphoglycerate to phosphoenolpyruvate in glycolysis. Enolase is also supposed to have additional non-glycolytic functions. In yeast, it was identified as Hsp48p and was also found in association with the cell wall (Edwards et al., 1999). Enolase was identified as tau-crystallin of turtle eye lens and as a strong plasminogen-binding receptor expressed on the surface of a variety of eukaryotic cells (Pancholi, 2001). Finally, in *E. coli*, enolase is an integral component of the RNA degradosome (Kuhnel and Luisi, 2001). As a matter of fact, enolases were already described to interact with nucleic acids. Interaction of yeast enolase with single stranded DNA was indeed reported previously (al-Giery and Brewer, 1992). In human cell, α -enolase mRNA also gives rise to an alternative translation product, a 37KDa c-myc binding protein (MBP) that can bind c-myc promoter (Chaudhary and Miller, 1995; Ray and Miller, 1991) and negatively regulate transcription of the protooncogene (Feo et al., 2000).

In yeast it was shown to be a part of tRK1 mitochondrial import apparatus (Entelis et al., 2006). Human cell possess three isoforms of enolase that expressed in different tissues. In addition to its role in glycolysis, we show that all three isoforms of human enolase can interact with tRK1. Besides specific affinity to yeast tRK1, all enolases were found to have the capacity to facilitate interaction between preKARS2 and tRK1 resulting in a decrease of K_d from 100nM to 25-15nM. In the presence of both proteins, tRK1-enolase complex was shifted to tRK1-preKARS2 one, while no ternary complex formation was ever detected. The results obtained here are in agreement with previous study of tRK1 import in yeast (Entelis et al., 2006). Using *in vitro* FRET approach, it was shown that in the presence of enolase, unlike the classical cloverleaf structure, the 3'-end of tRNA is close to the T-loop region (Kolesnikova et al., 2010). Based on these results we can hypothesize that human enolase also may induce conformational changes or stabilize a specific conformation to facilitate "import active" tRK1-preKARS2 complex formation.

3.3. preKARS2 as a tRK1 carrier into human mitochondria

Yeast tRK1 was previously reported to be imported into human mitochondria in the presence of yeast or human cytosolic factors (Kolesnikova et al., 2000). Analysis of the cryptic tRNA import pathway, allowing the targeting of the yeast tRK1 into human mitochondria,

performed in the present study demonstrated a similarity between tRK1 import mechanisms in yeast and human cells. In yeast cells, preMsk1p and Eno2p were identified as the tRK1 mitochondrial targeting factors (Entelis et al., 2006; Entelis et al., 1998). A similar tRNA import pathway in human cells involves the orthologous proteins, preKARS2 and enolase. Our studies suggest that the *in vitro* and *in vivo* import of tRK1 into mitochondria depends on preKARS2 protein. The *in vitro* import increases upon addition of recombinant yeast or rabbit enolase in combination with preKARS2, showing similarity with the *in vitro* import of tRK1 in yeast. preKARS2 overexpressed in yeast cells was recently shown to complement the growth defect associated with the loss of MSK1(mitochondrial isoform) and can additionally facilitate the import of tRK1 into isolated yeast, rat and human mitochondria (Sepuri et al., 2012). Moreover, the alternative folding of tRK1 as a determinant for the mitochondrial targeting in yeast (Kolesnikova et al., 2010) seems to be relevant in human cells as well, since we show that artificial RNA molecules containing two hairpin structures characteristic for the tRK1 alternative structure (F-structure) can be efficiently imported into human mitochondria *in vitro* and *in vivo*, in a manner clearly dependent on the preKARS2 protein.

3.4. Mitochondrial import of small truncated RNAs

We found that the mitochondrial import of small truncated tRK1 derivative (HF and HD RNA) was independent of preKARS2. The import of these RNA into isolated mitochondria in the presence of crude human cytosolic extract demonstrate nevertheless the implication of other still non-identified protein factor(s) in their mitochondrial targeting. This raised the idea that it may exist simultaneously several mechanisms of RNA targeting in to mitochondria. This possibility is clearly demonstrated in the present work since the small truncated RNAs which have lost the capacity to interact with preKARS2, apparently can be targeted into human mitochondria with the help of other, still unidentified protein(s). This hypothesis is also in agreement with a recent publication claiming that preMSK1p may be dispensable for the tRK1 import into yeast mitochondria (Sepuri et al., 2012). One can suggest that in the yeast strain used in this study, lacking the preMsk1p gene and thus devoid of actively respiring mitochondria, the small amount of tRK1 detected in the pro-mitochondria could be imported by a backup pathway with a help of alternative targeting protein(s). Mammalian mitochondria were also shown to

import nucleus encoded tRNA^{Gln(CUG)} and tRNA^{Gln(UUG)} from cytosol (Rubio et al., 2008). Unlike tRK1 import into yeast and human mitochondria, these tRNA were imported into isolated human mitochondria independent of cytosolic factors (Rubio et al., 2008), indicating the existence of different pathways in RNA mitochondrial targeting.

3.5. PNPase translocate RNA into the mitochondrial matrix

Polynucleotide phosphorylase (PNPase) is an exoribonuclease and poly A polymerase that plays an important role in the degradation, processing, and polyadenylation of RNA in prokaryotes and organelles (Das et al., 2011; Mohanty and Kushner, 2000). Human PNPase was discovered during a screen for genes implicated in cellular differentiation and senescence (Leszczyniecka et al., 2002). The function of human mitochondrial PNPase is not completely understood. The protein is mainly localized in the mitochondrial intermembrane space (Chen et al., 2006; Rainey et al., 2006) where no RNA population is present suggesting that at least this sub-population of PNPase is not directly involved in RNA metabolism (Portnoy et al., 2008). PNPase was also recently shown in the mitochondrial matrix in complex with hSUV3 where it form part of RNA degradosome (Borowski et al., 2013). The protein is also involved in the processing and adenylation of mtRNA (Slomovic and Schuster, 2008) however, the recent data support an important role of PNPase in regulating the import of nuclear encoded small RNA into mitochondrial matrix (Wang et al., 2010).

We used the *in vivo* overexpression and downregulation assays to study the implication of PNPase in the mitochondrial RNA import. In these assay, the import of tRK1 and its derivatives into mitochondria correlated with PNPase abundance. Additional nucleus-encoded RNAs such as 5S rRNA and MRP RNA that are imported into mitochondria, also showed PNPase dependent import. The mitochondrial import of RNase P and MRP RNA was shown previously to depend on PNPase and a stem-loop structure identified in these RNAs was predicted to be essential for the mitochondrial import of these RNA *via* PNPase (Wang et al., 2010). In a more recent study, the stem loop structure identified in RNase P RNA, appended to a non imported RNA directed the import of a fusion transcript into human mitochondria (Wang et al., 2012b). As a matter of fact, a stem-loop structure protects RNA from degradation by PNPase

in chloroplasts and stem-loop sequences in human RNase P and MRP RNAs could have a similar role, protecting these RNAs from PNPase degradation during import into mitochondrial matrix (Lisitsky et al., 1996; Yehudai-Resheff et al., 2001).

PNPase has two external domains (KH and S1) that bind RNA near the opening of a central processing pore in a trimeric complex (Carpousis, 2002; Symmons et al., 2000). It is not clear whether the same domains are used non-specifically or in some distinct manner to trigger PNPase RNA processing versus import functions. It is possible that the stem-loop structures interact with PNPase in a manner that triggers only import rather than processing. The GAPDH RNA can be a target of PNPase degradation *in vitro* (French et al., 2007), but when the stem-loop structure of RNase P or MRP RNA is attached to the 5'-end, GAPDH RNA is protected from PNPase degradation and efficiently imported into mitochondria (Wang et al., 2010).

3.6. PNPase mutation affect mitochondrial translation

Mitochondrial translation requires the import of nuclear encoded proteins and RNAs from the cytosol. Here we reported that a point mutation in PNPase (Gln 387Arg) affects the import of MRP RNA and 5S rRNA into mitochondria. More recently, another point mutation reported in PNPase (Glu 475Gly) was also shown to affect mitochondrial RNA import (von Ameln et al., 2012). MRP RNA is the RNA component of RNase MRP, a site specific endoribonuclease involved in primer-RNA cleavage during the replication of mtDNA (Chang and Clayton, 1987). 5S rRNA is the most abundant RNA imported into mitochondria where it may be a part of mitochondrial ribosomes and, therefore, play an important role in translation (Smirnov et al., 2011b). Indeed, we observed a reproducible decrease in mitochondrial translation mainly affecting COX subunits in patient's fibroblasts. The decrease was much less pronounced than that of the 5S rRNA import (58% \pm 4% versus 30% \pm 5%), suggesting that the residual 5S rRNA level was sufficient to ensure significant mitochondrial translation of RNA. Similar effect on mitochondrial RNA import and translation was noticed by transiently down-regulating PNPase expression in control fibroblasts and HepG2 cells. Such a limited effect was already observed when 5S rRNA import was only partially abolished (Smirnov et al., 2011b). The over-expression of PNPase in patient's fibroblasts resulted in a restoration of both 5S rRNA and MRP RNA import as well as mitochondrial translation, clearly demonstrating the deleterious

effects of PNPase mutation on mitochondrial RNA import and translation. Previous studies of PNPase silencing in HeLa cells failed to alter mitochondrial translation (Slomovic and Schuster, 2008), but a clear defect in mitochondrial protein synthesis was observed in liver specific knockout of PNPase mouse model and RNAi in HEK293T cells (Wang et al., 2012a). This apparent contradiction might be accounted for by HeLa cells low glycolytic metabolism compared to active mitochondrial respiration in the liver.

3.7. Divergent mechanisms for convergent goal

Mitochondrial import of different RNAs has been reported in nearly all studied organisms. In general, each known case of RNA mitochondrial import appears somewhat special and thus not sufficient to establish a common RNA import mechanism (Duchene et al., 2009). In order to be imported, an RNA molecule should escape from the cytosolic channeling, indicating that the decision to commit an RNA to import is taken in the cytosol. For example, in yeast cells, tRK1 is probably captured from the translation cycle by the glycolytic enzyme enolase and redirected to the mitochondrial surface (Entelis et al., 2006). The same event apparently exists in the artificial import of tRK1 and its derivatives in human cells where enolases may perform the same function. In the case of the 5S rRNA import, this function is performed by the cytosolic precursor of mitochondrial ribosomal protein L18 (preMRP-L18) (Smirnov et al., 2010b).

The next step of the pathway is a rapid discharge of the chaperone by another mitochondrial import factor. Examples of such a cascade were described in the yeast import mechanism where tRK1 is quickly transferred from enolase to the precursor of lysyl-tRNA synthetase (Entelis et al., 2006). In human, we show a role of preKARS2 in the mitochondrial targeting of tRK1 and its derivatives. A very similar case was observed for 5S rRNA in human cells where the mitochondrial enzyme rhodanese accepts 5S rRNA from preMRP-L18 (Smirnov et al., 2010a). The second import factor works as a carrier transporting the RNA molecule towards the mitochondrial surface. In plant cells, precursors of dually targeted cognate aminoacyl-tRNA synthetases combine both RNA targeting functions and thus may be the only essential tRNA import factors (Duchene et al., 2009). Probably, the same situation may be found in *Trypanosoma brucei*, where the cytosolic elongation factor eEF1a participates in the specific targeting of almost all tRNAs to mitochondria (Bouzaidi-Tiali et al., 2007).

The mechanism of RNA translocation across the double mitochondrial membranes is not yet understood. In yeast, tRK1 in complex with preMsK1p protein are most probably imported into mitochondria using the translocase of outer membrane (TOM) and innermembrane (TIM) (Tarassov et al., 1995a). The mitochondrial import of 5S rRNA requires intact and functional preprotein import machinery since destructured recombinant protein that blocks protein import, also inhibit 5S rRNA import into mitochondria (Entelis et al., 2001a). Nevertheless, one cannot exclude alternative translocation mechanisms via different membrane channels (Salinas et al., 2006; Salinas et al., 2008; Wang et al., 2010). In a recent study, human PNPase localized partially in the intermembrane space was shown to function in RNA translocation into the mitochondrial matrix (Wang et al., 2010). Indeed, we found that different RNA molecules (tRK1 and its derivatives, 5S rRNA and MRP RNA) containing stem loop structure reached to mitochondrial matrix in a PNPase dependent manner. PNPase has been shown to possess also RNase activity and a detail dissection of what constitute a trigger sequence for processing versus import activities needs to understand.

CONCLUSIONS AND PERSPECTIVES

4. Conclusions and perspectives

The results obtained during this work permitted to draw the following conclusions:

- The precursor of human mitochondrial lysyl tRNA synthetase (preKARS2) has affinity for yeast tRK1 and small artificial RNA containing tRK1 import determinants. The mature form of mitochondrial lysyl tRNA synthetase (KARS2) lacking the mitochondrial targeting sequence cannot interact with tRK1.
- All three isoforms of human enolases can interact with tRK1 and facilitate complex formation between preKARS2 and tRK1.
- Recombinant preKARS2 can target tRK1 and its derivatives into isolated human mitochondria. The *in vitro* import of these RNA increased upon addition of yeast or rabbit enolase into the import reaction in combination with preKARS2, thus demonstrating the similarity of human and yeast system.
- *In vivo*, in cultured human cells, the mitochondrial import of tRK1 and its derivatives named FD-L and FD-H RNA depends on the expression level of preKARS2 protein.
- Truncated RNAs lacking either D-arm or F-hairpin of tRK1 cannot interact with preKARS2, demonstrating that these two structures together are essential for interaction with preKARS2. *In vivo*, in cultured human cells, the mitochondrial targeting of these RNAs depend on protein factor(s) other than preKARS2.
- Polynucleotide phosphorylase (PNPase) localized in the intermembrane space (IMS) facilitates the mitochondrial import of tRK1 and its derivatives *in vivo*.
- Finally, we confirm PNPase dependent 5S rRNA and MRP RNA mitochondrial import in patient's fibroblasts containing a pathogenic point mutation in PNPase coding gene. The impaired import of these RNAs in mutant cells results in mitochondrial translation defects.

If the present study answered many of the questions raised in the beginning of my PhD work, there are still many of them remaining to be answered. *In vitro*, yeast and rabbit enolase enhanced the import of tRK1 and its derivatives into human mitochondria by facilitating interaction between preKARS2 and tRK1. In human, there exist three isoforms of enolases that are expressed in different tissues. The results obtained in the present study demonstrate that all

these isoforms can form complexes with tRK1 and facilitate interaction between tRK1 and preKARS2. It will be interesting to study the role of all these isoforms in tRK1 targeting towards mitochondria in combination with preKARS2 using a standard *in vitro* import assay. The study of tRK1 import *in vivo* in cultured human cell in condition of over-expression or down-regulation of different isoforms of enolase will provide further information about the RNA targeting properties of this enzyme. The *in vitro* studies show that tRK1 in complex with yeast eno2 adopt an alternative conformation, in which the 3'-end is close to the T-loop. Upon transfer of the tRNA to preMsk1p, this structure is converted to a conformation similar, but not identical, to the classical L shape. It will be interesting to verify such kinds of conformational changes by studying the crystal structure of tRK1 in complex with enolase alone or in combination with preMsk1p. This part of the work has already been started and preliminary results of tRK1 conformational changes in complex with yeast eno2 have been obtained.

The import of small truncated RNA (HF and HD) into isolated mitochondria only in the presence of crude cytosolic extract and independently of preKARS2 *in vivo* in cultured human cells demonstrate the implication of other protein factor(s) in their targeting towards mitochondria. The protein factor(s) interacting with these RNAs need to be identified followed by reconstitution of *in vitro* import with purified protein(s) and validation by *in vivo* approach (over-expression and down-regulation). This will further strengthen our knowledge of import directing protein factors and mechanisms of RNA mitochondrial import. In addition, future studies investigating tRK1 import in human should be focused on proteins of the mitochondrial membrane especially those of TOM complex that function as receptor(s) during the import of tRK1 and TIM proteins previously found as import factors in yeast (Tarassov et al., 1995a).

The function of PNPase localized in the IMS is far to be understood. The involvement of PNPase in the mitochondrial import of different RNAs (RNase P and MRP RNA, 5S rRNA, tRK1 and its derivatives) is now well established, however, the exact mechanism of PNPase implication in RNA mitochondrial import remains a complete mystery. The PNPase has two domains for binding RNA (KH and S1) and more experiments should be performed to understand whether the same domains are used in a non-specific or sequence discriminating manner to trigger RNA import or RNA processing activities.

PNPase RNA degradation and import activities are believed to be separable. In a recent study, it was reported that increased resistance of cancer cells to radiotherapy is due to phosphorylation of nuclear isoform of PNPase at serine 776 which is critical for its ribonuclease activity towards c-myc mRNA (Yu et al., 2012). The NetPhos 2.0 server predicts multiple phosphorylation site in PNPase and more work is required to understand whether RNA import and degradation activity of PNPase are regulated in phosphorylation dependent manner in the intermembrane space.

A fundamental question in considering RNA import into mammalian mitochondria also remains to be addressed. Are there distinct pathways, even PNPase-dependent and independent pathways, or is there one major import pathway with different RNA substrates requiring similar or distinct accessory factors? In the present work, we identify a number of mitochondrial outer and inner membrane proteins in complex with PNPase by CLIP analysis. Further experiments are certainly needed to validate implication of these proteins in RNA import *via* PNPase.

A new area of potential significance is the identification of additional imported RNA species and the elucidation of their functions inside mitochondria. More recently, micro RNAs were also reported to be imported into human mitochondria. It will be interesting to study whether these shorter RNA are also translocated into the mitochondrial matrix in PNPase dependent manner. Knowledge of the range of mitochondrial RNA import signals will provide extended information as to which RNAs are further potential candidates for import.

Many human neuromuscular diseases are associated with mutations in mtDNA and there is no efficient approach for overcoming mtDNA mutations in these diseases. Existing therapies target symptoms instead of mending primary defects. The use of RNA mitochondrial import pathway is currently actively studied since gene therapy approaches could exploit this pathway to target therapeutics nucleic acids into the mitochondria, compensating for pathogenic mtDNA mutations. The long term perspective includes the improvement of efficiency of therapeutic models based on RNA targeting to mitochondria. This seems to be a very attractive approach to cure the human pathologies associated with the mutations in the mitochondrial genome, since previously obtained data validated already the correcting capacity of RNA import for several very different types of mtDNA mutations (Comte et al., 2013b; Karicheva et al., 2011; Kolesnikova et al., 2004; Kolesnikova et al., 2000).

MATERIALS AND METHODS

5. Materials and Methods

5.1. Materials

5.1.1. Bacterial strains

BL21-CodonPlus(DE3)-RIL: F- *ompT*, *hsdS*(r-B m-B), *dcm*+, Tetr, *gal*, *endA*, Hte [*argU*, *ileY*, *leuW*, Cam^r] (Stratagene) for overexpression of recombinant proteins.

XL10-Gold: Tetr Δ (*mcrA*)183 Δ (*mcrCB-hsdSMR-mrr*)173 *endA1 supE44 thi-1 recA1 gyrA96 relA1 lac* Hte [F' *proAB lacIqZDM15 Tn10* (Tetr) Amy Cam^r] (Stratagen) for site directed mutagenesis.

DH5 α : F- Φ 80*lacZ* Δ M15 Δ (*lacZYA-argF*) U169 *recA1 endA1 hsdR17* (rK-, mK+) *phoA supE44 λ - thi-1 gyrA96 relA1* (Invitrogen) for cloning and plasmid production.

XL1 Blue: (*recA1 endA1 gyrA96 thi-1 hsdR17 supE44 relA1 lac* [F' *proAB lacIqZ.M15 Tn10* (Tet^r)] (Stratagene) for cloning and plasmid production.

5.1.2. Human cell lines

HepG2 cells: Hepatic carcinoma cells purchased in IGBMC (Strasbourg).

HEK293T cells: Human embryonic kidney cells stably overexpressing PNPase were provided by M. Teitell (UCLA, USA).

Fibroblast: Human skin fibroblast having point mutation in PNPase (Gln387Arg) were provided by Agnes Rotig (Hôpital Necker, Paris).

Hela tet-off cells: Human cervical carcinoma cells stably expressing the tetracycline-controlled transactivator (tTA) were purchased from Clontech Laboratories Inc. Inducible expression can be achieved by transfecting this cell line with a vector containing the gene of interest under the control of tetracyclin responsive promoter. Expression is induced by the withdrawal of tetracyclin from the culture medium.

5.1.3. Plasmids and oligonucleotides

For the production of recombinant human enolases, the cDNA of each isoform of human enolase cloned in pET3a (Amp^r) expression plasmid was used.

Plasmid pDEST17 expressing human mitochondrial lysyl tRNA synthetase (KARS2 protein) was kindly provided by M. Sissler (IBMC, Strasbourg). To produce the precursor of mitochondrial KARS2 (preKARS2) protein, Quick change mutagenesis kit (Stratagene) was used to insert mitochondrial targeting sequence (MTS) at the N-terminal of the mitochondrial KARS2 protein. Thombin cleavage site and 6x histidine tag at the N-terminal were deleted and 6x histidine tag was inserted at the C-terminal using Quick change mutagenesis. For this, the following oligonucleotides were used:

Mitochondrial targeting sequence insertion

5'-GCCACGCGGTTCTTTGACGCAAGCTGCTGTAAGGCTTGTTAGGGGGTCCCTGCGCAAAACCTCCTGGGCAG- 3'

Thombin cleavage site Mitochondrial targeting sequence KARS2 sequence

5'-CTGCCAGGAGGTTTTGCGCAGGGACCCCTAACAAAGCCTTACAGCAGCTTGCCTCAAAGAACCGCGTGCC - 3'

Thombin cleavage site and 6x His tag deletion

5'-CTTTAAGAAGGAGATATACATATGTTGACGCAAGCTGCTGTAAGG- 3'

Ribosome binding site Mitochondrial targeting sequence

5'-CCTTACAGCAGCTTGCCTCAACATATGTATATCTCCTTCTTAAAG - 3'

His tag insertion at C-terminal of preKARS2

5'-CAACAGTTGGCAGTTCTGTCCACCATCACCATCACCATTGAGACCCAGCTTTCTGTAC- 3'

preKARS2 C-terminal end 6x His-tag Plasmid sequence

5'-GTACAAGAAAGCTGGGTCTCAATGGTGATGGTGATGGTGACAGAACTGCCAACTGTTG-3'

Plasmids pCMV6-XL5 (to express human Enolase 1) and pcMV6-AC (to express human Enolase 2 and Enolase 3) were purchased from Origene. These plasmids provide expression of enolases in cultured human cells under the control of CMV promoter.

Plasmid pQCXIP expressing PNPase-HisPC in cultured human cells was kindly provided by M. Teitell (UCLA, USA).

pTRE2hyg plasmid expressing preKARS2 was kindly provided by Marc Mirande (LEMB, Gif-sur-Yvette). The plasmid contains tetracyclin response element upstream the CMV promoter and provide expression of protein under the control of tetracyclin.

5.2. Methods

5.2.1. Electroporation of *E. coli*

Plasmid DNA was mixed on ice with 50 μ l of commercial electrocompetent bacterial cells and transferred to 0.1cm cuvette (Gene pulse, Bio-Rad). Electroporation was performed at 1.5kV, 200 Ω and 25 μ F. Immediately after that, 1ml of LB media was added and cell suspension was kept at 37°C for 15min. The cells were then seeded on LB solid media containing antibiotic(s).

5.2.2. Plasmid DNA preparation

To multiply plasmid DNA, DH5 α or XL1 blue cells were transformed by electroporation and seeded on LB solid media containing antibiotics. The plasmid DNA was isolated using mini, midi or maxiprep kit (Qiagen). To isolate plasmid DNA for transfection of human cells, QiaFilter kit (Qiagen) was used to obtain plasmid DNA of high purity.

5.2.3. Recombinant protein purification

To obtain recombinant proteins, *Escherichia coli* strain BL21 codon plus (DE3)-RIL cells (Stratagene) were transformed with required plasmids. The transformed cells were grown in 500ml of LB broth to a cell density corresponding to A600= 0.6, then the protein expression was induced by the addition of 0.5mM Isopropyl β -D-1-thiogalactopyranoside to the bacterial culture. The cells were harvested by centrifugation at 6000g for 10 min, lysed with 1mg/ml of lysozyme on ice for 30 min and then sonicated 3x 20 sec in buffer consisting of 50mM NaH₂PO₄ pH8.0, 300mM NaCl and 20mM imidazole. The lysate was centrifuged at 10,000g for 15min and the supernatant were collected for protein purification in native condition. The pellet was solubilized in denaturing buffer consisting of 100mM Tris-HCl (pH 8), 100mM NaH₂PO₄,

20mM imidazole, 8M Urea and centrifuged at 10,000g for 15min. The presence of recombinant protein in native and denaturing lysates was checked by sodium dodecyl sulfate-polyacrylamide gel electrophoresis (SDS-PAGE). The affinity purification of recombinant proteins were performed using Ni-NTA column (Qiagen) for 2h at 4°C. After binding, the column was washed three times with buffer containing 20mM imidazole to eliminate weakly bounded bacterial proteins. The recombinant protein was then eluted by 200mM of imidazole in the same buffer. Proteins purified from urea solubilized fraction were refolded by stepwise elimination of urea by dialysis, and finally dialyzed against 50mM Tris-HCl (pH 8), 300mM NaCl and 40% glycerol and stored at -20°C. The purity of proteins was checked on SDS-PAGE with coomassie blue staining (Fermentas).

5.2.4. Polymerase chain reaction (PCR)

For T7 transcription of small artificial RNA, the following single strand DNA oligonucleotides containing T7 promoter at 5' end (underlined) were amplified using PCR.

FD-L: TAATACGACTCACTATAAGCGCAATCGGTAGCGCCTCTTTACAGTGCTTA
GTTCTCGAGCCCCCTACAGGGCTCTT

FD-H: TAATACGACTCACTATAAGCGCAATCGGTAGCGCAGTAAGCACTGTAAATGAGCCCC
CTACAGGGCTCTT

HD: TAATACGACTCACTATAAGCGCAATCGGTAGCGCCTCTTTACAGTGCTTAGTTCTC

HF: TAATACGACTCACTATAGGTCTTTACAGTGCTTACTTCTCGAGCCCCCTACAGGGCTCCA

The following primers were used:

Promoter T7: GGGATCCATAATACGACTCACTATA

FD rev: AAGAGCCCTGTAGGG

HD rev: GAGAACTAAGCACTG

HF rev: TGGAGCCCTGTAGGG

The polymerization reaction was performed in 50µl containing DNA (40ng), dNTPs (0.25mM each), two primer (0.5 µM each), polymerization buffer (Fermentas), and 2.5 units of

DNA polymerase (Econotaq, Lucigen). The amplification reaction was performed using denaturation (94°C), hybridization of primers (55°C) and elongation (72°C). The DNA amplified was analyzed on 10% native polyacrylamide gel electrophoresis (PAGE) and extracted with QIAquick Gel Extraction Kit (Qiagen).

5.2.5. RNA synthesis

S. cerevisiae tRK1 gene previously cloned in pUC119 vector under the control of T7 promoter was used for *in vitro* transcription. Prior to T7 transcription, the plasmid was linearized with BstNI enzyme (NEB restriction enzyme) to generate the CCA-termini. For T7 transcription of small artificial RNA, DNA amplified by PCR was used. RNA transcripts were obtained *in vitro* using T7 RNA polymerase (Ribomax kit, Promega) according to the manufacturer's protocol. Following transcription, DNA template was removed by digestion with RQ1 RNase-Free DNase (Promega) at 37°C for 15min. Transcription products were mixed with loading dye (98% (v/v) formamide, 5mM EDTA, 0.02% xylene-cyanol, 0.02% bromophenol blue) and separated on 12% PAGE with 8M Urea. The band corresponding to tRK1 or small artificial RNAs were cut from the gel under UV light and eluted in RNA elution buffer (0,5M ammonium acetate, 10mM magnesium acetate, 1mM EDTA, 1% SDS) supplemented with 1/10V acid phenol pH5 overnight at 4°C. RNAs eluted were precipitated with ethanol and resuspended in water.

5.2.6. Radioactive labeling and aminoacylation

Before labeling, T7 transcripts were dephosphorylated using 1U/μg of Calf intestinal phosphatase (Roche). The reaction was carried out in the supplier's buffer for 45min at 37°C. Following dephosphorylation, the reaction was deproteinated with phenol, RNA was precipitated with ethanol and dissolved in water. The transcripts were incubated at 90°C for 1min to unfold RNA and labeled at 5'ends with γ -³²P-ATP by T4 polynucleotide kinase (Promega). The labelled RNA was gel purified on a denaturing 12% PAGE with 8M Urea, eluted from the gel as described above and precipitated with ethanol. Before aminoacylation, tRK1 was heated at 90°C for 1min and refolded in the presence of 5mM MgCl₂ at room temperature for 10min.

Aminoacylation was carried out for 15min at 37°C in aminoacylation buffer (100mM Tris-HCl pH7,5; 30mM KCl; 10mM MgCl₂; 2mM ATP; 1mM DTT; 0,05mM lysine) and 1nM recombinant lysyl-tRNA-synthetase (KRS). Reaction was stopped adding 200µl acid phenol pH5, and aminoacylated tRK1 was precipitated from aqueous phase with ethanol and dissolved in water.

5.2.7. Radioactive labeling of oligonucleotides probes

The oligonucleotide probes (50 pmol) were incubated at 37°C for 45min in a mixture of 20µl containing 2µl of 10X buffer (Promega), 1-2 µl γ -ATP (10mCi/mL, 5000 Ci/mmol), 1U of Polynucleotide Kinase (Promega). The DEAE-cellulose column (DE-52, 1ml) was washed with 0.2M STE buffer (10mM Tris-Cl, pH 7.5, 0.2M NaCl, 1mM EDTA) and then the reaction mixture was loaded on it. The column was washed once more with 0.2M STE buffer to eliminate unbound γ -ATP. The labeled oligonucleotides were eluted from the column using 1M STE buffer (10mM Tris-Cl, pH 7.5, 1M NaCl, 1mM EDTA), mixed with an equal volume of prehybridization buffer (6xSSC, 10X Denhardt solution, 0.2% SDS) and either used for hybridization or stored at -20°C.

5.2.8. Electrophoretic mobility shift assay (EMSA)

Radioactively labeled RNA was denatured at 90°C and then slowly cooled to room temperature in the presence of 1mM EDTA. For RNA binding assay, increasing amount of protein (0.1-0.8µM) and fix concentration of labeled RNA (100nM) were mixed in 20µl of buffer containing 50 mM Tris-HCl pH 7.5, 136 mM KCl, 10 mM MgCl₂, 2 mM DTT, 0.01% BSA and incubated at 30°C for 15 min. The reaction mixture was mixed with a half volume of loading buffer (30%glycerol, Bromophenol blue and xylencyanol) and loaded on native 8% PAGE (8% acrylamide, 0.5xTris-borate buffer (pH 8.3), 5% glycerol). The RNA protein complexes were separated from unbound RNA by electrophoresis (200V and 10mA) at 4°C. The gel was fixed (10% ethanol, 10% acetic acid), dried and exposed to phosphorimager plate (Fuji). Autoradiographs were revealed using a Typhoon-Trio scanner and results were analyzed with the help of the Image QuantTMTL software (GE Healthcare).

For Scatchard plot analysis, several EMSA reactions were performed in the presence of constant concentration of proteins (0.8 μ M preKARS2 and 1 μ M enolase) and varying concentrations of radioactively labeled RNA (2nM to 25nM). Resulting autoradiographs were revealed using a Typhoon-Trio scanner and the signal corresponding to bound and free RNA were analyzed with the help of the Image QuantTMTL program. The Scatchard plot is a linearized form of binding curve described by the equation:

$$= -[\quad]$$

where [Bound RNA] and [Free RNA] are molar equilibrium concentrations of the RNA-protein complex and free RNA, respectively, and a is a constant. Thus, the linear regression of experimental data allows a calculation of the dissociation constant K_d .

5.2.9. Cell culture

Escherichia coli cells were grown in LB media (Lysogeny Broth, Luria Bertrani) (bacto-tryptone 10g/l, yeast extracts 5g/l, NaCl 5g/l). Depending on the plasmid, selection of transformants was performed in the presence of ampicillin (100 μ g/ml), kanamycin (30 μ g/ml) or hygromycin (20 μ g/ml).

Human cell lines were cultivated in Dulbecco modified Eagle's medium (DMEM, Invitrogen) with high glucose (4.5g/l) supplemented with 10% fetal calf serum, 100 μ g/ml of streptomycin and 100 μ g/ml of penicillin (Gibco). For the induction of protein expression in Hela Tet-off cells, tetracyclin-free fetal bovine serum from Clontech was used. The cells were cultivated in a humidified atmosphere at 37°C and 5% of CO₂. Transfection with plasmid or siRNA was performed in OptiMEM reduced serum medium without antibiotics (Invitrogen).

The cell lines were regularly tested for mycoplasma contamination using PCR based detection method (Dussurget and Roulland-Dussoix, 1994). The medium (2ml) was collected from the cultured cell and centrifuged at 300g for 5min. The supernatant collected were centrifuged at 13000g for 10min and the pellet was dissolved in 10 μ l water. The last solution

was used for PCR amplification of a fragment of 16S rRNA gene of mycoplasma *sp* by using thee genus specific primers:

RNA5: 5'-AGAGTTTGATCCTGGCTCAGGA-3'

RNA3: 5'-ACGAGCTGACGACAACCATGCAC-3'

UNI-: 5'-TAATCCTGTTTGCTCCCCAC-3'

These primers correspond to thee different regions of 16S rRNA sequence of mycoplasma *sp* and all thee primers were used in combination to increase the specificity and to avoid detection of nonmycoplasma bacteria. In the case of contamination, cells were cultivated for two weeks in the presence of 25µg/ml plasmocin (Invivogen), then re-tested by PCR.

To freeze cells for storage, aliquots of cell culture suspension were centrifuged at 600g for 5 min. The supernatant was aspirated and washed with 1x PBS. The pellet was re-suspended in 300µl of fetal calf serum containing 10% DMSO and transferred to progressive freezing cryobox (*Fisher Bioblock Scientific*). The tubes were store in cryobox for 24h at -80°C and then transfer to -180°C.

5.2.10. Transfection of human cell lines

5.2.10.1. Transfection with T7 transcript

Human cultured cells were transfected with T7 transcript of tRK1 or small artificial RNA in conditions of down-regulation or over-expression of a protein. For transfection of cells, 3µg of RNA per 75cm² flask were used. Prior to transfection, cells were kept for 2h in optiMEM (Invitrogen) with reduced serum and without antibiotics. Transfection was performed using Lipofectamine 2000 reagent (Invitrogen) according to the manufacturer's protocol. Briefly, 10µl of lipofectamin and RNA was diluted in 100µl of OptiMEM and incubated for 5min at room temperature. The lipofectamin-RNA complex were allowed to formed for 20min at room temperature and cells were incubated with the complexes for 6h in OptiMEM. After 32-48h, cells were detached and mitochondrial RNA import was analyzed by Northern blot hybridization.

5.2.10.2. Transient transfection with plasmid

For transient DNA transfection, cells were grown overnight in 75cm² flask to reach 60% of confluence. The cells were kept for 2h in OptiMEM (Invitrogen). The cells were transfected with plasmid using Lipofectamin 2000 (Invitrogen) according to the manufacturer's protocol. Briefly, 25µl of lipofectamin and 8µg of plasmid DNA was diluted in 100µl of OptiMEM and incubated for 5min at room temperature. The lipofectamin-plasmid DNA complex were allowed to formed for 20min at room temperature and cells were incubated with the complexes for 6h in OptiMEM. After 48h, protein expression was analyzed by western blot.

5.2.10.3. Transient protein downregulation

The down-regulation was performed using small interfering RNA (siRNA). The sequences of sense strand of each siRNA were:

siRNA against preKARS2:

siRNA1: 5'-CAACTTGCTCCTTTCACAGCG-3'

siRNA2: 5'-AAGGACAAGTCATTTTCTGAT-3'

siRNA against PNPase

siRNA1: 5'-GAAACAGGUGUAACUAUUA-3'

siRNA2: 5'-AAGAUUACAUCUGAAGUCCU-3'

siRNA3: 5'-AAAACCUCGAGCAUCUAGAAA-3'

As a negative control, non-silencing siRNA (Ref: SR-CL000-005, Eurogentec) was used. Our optimised protocol consisted of two subsequent transfections: HepG2 cells were transfected in suspension with 40nM of each siRNA using lipofectamin RNAiMax transfection reagent (Invitrogen) according to the manufacturer's protocol. Briefly, 30µl of lipofectamin and RNA was diluted in 100µl of OptiMEM and incubated for 5min at room temperature. The lipofectamin-RNA complex were allowed to form for 20min at room temperature. The cells were detached, washed with 1X PBS and plated in 75cm² plate. The complex was added to the cells in suspension and incubate for 6h in OptiMEM. 24h later, the cells formed a monolayer and were

transfected again with 40nM of each siRNA using Lipofectamine 2000 (Invitrogen). In 3 days after the second siRNA transfection, the downregulation was analysed by western blot.

5.2.11. Purification of mitochondria

Mitochondria from cultured human cells were isolated as described in (Entelis, 2002 #1) with minor modifications. Cells were detached in 1x Phosphate buffered saline (PBS, Sigma) (1,5 mM KH_2PO_4 , 150 mM NaCl, 3 mM Na_2HPO_4 , pH 7,4) containing 1mM EDTA and centrifuged at 600g for 5min. The cells pellet was resuspended in cold breakage buffer (BB): 0.6M Sorbitol, 10mM HEPES-KOH (pH 6.8), 1mM EDTA supplemented with 0.3%BSA. The cells were disrupted in 1.5ml BB on ice through a needle (No 16, 23GX1,0.6 25mm) using a syringe with at least 30 piston strokes. The suspension of disrupted cells were centrifuged (1500g, 4°C, 5min) to eliminate cell debris and the supernatant was transferred to new tube. This was followed by high speed centrifugation (13000rpm, 4°C, 30min) and the mitochondrial pellet was resuspended in BB buffer without BSA. Mitochondria were washed once more in this buffer, aliquoted in BB buffer, frozen in liquid nitrogen and store at -80C for *in vitro* import assays.

Mitochondria destined for RNA purification were treated with 2x RNase A solution (12,5-25 $\mu\text{g}/\text{ml}$ RNaseA (Sigma); 0,6M sorbitol; 10mM MgCl_2 ; 10mM HEPES-KOH pH6.7) for 10min at room temperature. RNase activity was then inhibited by addition of two volume of BB with 5mM EDTA and followed by three washes with the same buffer and centrifugation (13000g, 4°C, 15min). Mitoplasts (mitochondria without outer membrane) were generated by incubating the mitochondrial suspension with digitonin (20 μg per mg of mitochondrial protein) for 10min at room temperature, and washed twice with BB buffer. The mitoplast pellet was suspended in TRIzol reagent (Invitrogen) and kept at room temperature for 5min. Chloroform (100 μl for 500 μl TRIzol) was then added and mix vigorously for 15sec, followed by centrifugation at 10000g at 4°C. The upper (aqueous) phase was collected and RNA was precipitated with isopropanol for 2h at -20°C. RNA was pelleted at 13000g for 30min, washed with 80% and then absolute ethanol.

5.2.12. In vitro import assay

In vitro import assay into isolated mitochondria was carried out as described in (Entelis et al., 2001a) with minor modifications. Mitochondria frozen at -80°C were thawed at 37°C for 1min in breakage buffer (BB): 0.6M sorbitol, 10mM HEPES-KOH (pH 6.7), 1mMEDTA supplemented with 5mM succinate. Mitochondria were pelleted at 13000g for 10min and resuspended in appropriate volume of import buffer (0.6M Sorbitol, 20mM HEPES-KOH pH 6.7, 10mM KCl, 2.5mM MgCl_2 , 5mM DDT and 2mM ATP). For the import assay, 100 μg of mitochondrial proteins were incubated with radioactively labeled RNA and purified proteins (preKARS2 and enolase) in 100 μl of import buffer. After incubation for 15 min at 34°C , 100 μl of 2X RNase A (12,5-25 $\mu\text{g}/\text{ml}$ RNaseA (sigma), 0,6M sorbitol, 10mM MgCl_2 , 10mM HEPES-KOH pH 6.7) was added and the reaction was incubated for additional 10 min to digest all the RNA that was not imported into mitochondria. The reaction was stopped by adding two volume of BB buffer containing 5mM EDTA. Mitochondria were washed three times with BB buffer changing the tube each time, then re-suspended in 100 μl of the same buffer and treated with an equal volume of 0.2% digitonin (Sigma) solution to disrupt the mitochondrial outer membrane, followed by purification of mitoplasts. The mitoplast pellet was lysed in 100 μl lysis buffer (100mM CH_3COONa , 10mM MgCl_2 , 1%SDS and 0.05% Diethylpyrocarbonate), heated at 100°C for 1 min and RNA was extracted at 55°C by water saturated phenol pH5. RNA was precipitated with ethanol in the presence of 3 μg of *E. coli* tRNA for 2h at -20°C . The RNA pellet was analyzed in 12% PAGE containing 8M urea. The gel was fixed (10% ethanol, 10% acetic acid), dried and exposed to phosphoimager plate (Fuji). Autoradiographs were revealed using a Typhoon-Trio scanner and quantified with the help of the Image QuantTMTL software.

5.2.13. Northern hybridization

Total and mitochondrial RNAs were isolated from cells and purified mitochondria by using the TRIzol reagent (Invitrogen) according to the manufacturer's instruction and separated on denaturing 10% PAGE with 8M Urea. RNA was electroblotted overnight (10V, 200mA, 4°C) onto a Hybond-N membrane (Amersham) in transfer buffer (17mM NaH_2PO_4 , 8mM Na_2HPO_4 pH 6,5). After transfer, the membrane was dried at room temperature for 15min and RNAs were

covalently fixed to the Hybond-N membrane by UV irradiation (0.8 J/cm^2) for 3min in the Ultraviolet crosslinker (GE healthcare). Membranes were then prehybridized for 2h at 65°C in prehybridization buffer (6X SSC, 10X Denhardt's solution, 0.2%SDS) (20X SSC:175.3g/l NaCl, 88.2g/l sodium citrate, pH7.0) (50X Denhardt's solution: 10g/l ficoll, 10g/l polyvinylpyrrolidone, 10g/l BSA). The membrane was subsequently hybridized with $5'$ - ^{32}P -labelled oligonucleotide probe at appropriate temperature (T_m). The following oligonucleotides probes were used: anti-tRK1 probe (1-34): $5'$ -GAGTCATACGCGCTACCGATTGCGCCAACAAGGC- $3'$ to detect tRK1, FD-L, FD-H and HD RNA; anti-HF RNA probe: $5'$ -TGGAGCCCTGTAGGG- $3'$; anti-mt tRNA^{val} probe: $5'$ -GTTGAAATCTCCTAAGTG- $3'$; anti-5S rRNA probe: $5'$ -CATCCAAGTACTACCAGGCC- $3'$; anti-MRP RNA probe: $5'$ -GTGGGAAGCGGGGAATGTCTACG- $3'$ and anti-cyt 5.8S rRNA probe: $5'$ -GGCCGCAAGTGCGTTCGAAG- $3'$. After hybridization, membranes were washed three times for 10min each at 25°C in washing buffer (2X SSC, 0.1%SDS) and exposed to phosphorimager plate. The signal were analyzed using Typhoon-Trio scanner and imageQuantTMTL software. For rehybridization, membranes were stripped by washing three times for 15 min each in stripping buffer (0.2X SSC, 0.1%SDS) at 80°C .

After quantification, the relative efficiency of RNA import into mitochondria was calculated as a ratio between the signal obtained with anti-tRK1 probe and that obtained with the probe against the host mitochondrial tRNA^{Val} as described previously (Smirnov et al., 2008). To calculate the absolute import efficiency of each RNA into mitochondria, the total level of RNA in transfected cells was taken into account. For this the relative import efficiencies were divided by the ratios calculated in the same way but for total RNA preparations.

5.2.14. Immunoblotting

For western immunodecoration, cells were lysed in Laemmli's buffer (50mM Tris-HCL, pH 6.8, 2% SDS, 0.1% β -mercaptoethanol, 0.01% Brome phenol blue and 10% Glycerol) for 10 min at 90°C , and $30\mu\text{g}$ of protein were separated by 10% SDS-PAGE. Proteins were electroblotted onto nitrocellulose membrane in Tris-Glycine-SDS with 20% ethanol at 200mA in cold room for 2h. The membrane was blocked in 1X PBS containing 5% non-fat dry milk powder for 1h at room temperature and incubated with the appropriate amount of primary

antibody overnight at 4°C. The membrane was washed five times for 5min each with PBS and finally incubated with horseradish peroxidase conjugated secondary antibody for 1h at room temperature. After washing three times for 10min each in PBS containing 0.1% tween 20, specific bands were visualized using ECL Plus Western Blotting detection reagent (GE Healthcare). The following primary antibodies were used: polyclonal antibody against preKARS2 (a kind gift of Marc Mirande, Gif-sur-Yvette, France), antibody against PNPase (a kind gift of M. Teitell, USA), polyclonal antibody against actin (G2308, Santa Cruz Biotechnology), polyclonal antibody against enolase (sc-7455, Santa Cruz Biotechnology).

5.2.15. Mitochondrial translation analysis in vivo

Mitochondrial translation *in vivo* was performed as described previously (Kolesnikova et al., 2004) with minor modifications. Cells were grown to 70-80% confluence, washed once with DMEM medium lacking methionine (Sigma) and incubated in this medium for 10min at 37°C. After washing, cells were incubated for 15min at 37°C in DMEM medium lacking methionine in the presence of 50µg/ml of emetine to inhibit cytosolic translation. This was followed by 30 min incubation with 200µCi/ml S³⁵-methionine (400Ci/mmol) and finally 15 min chase in the normal growth medium with non-labeled methionine. The cell extract was prepared in Laemmli's buffer and incubated for 10min at 37°C. Protein were separated on 10% SDS-PAGE and electroblotted onto nitrocellulose membrane in Tris-Glycine-SDS with 20% ethanol at 200mA in cold room. The amount of protein to be loaded were primarily normalized to actin western blot. The signals were visualized and quantified using Typhoon-Trio scanner and Image QuantTMTL software or G-box luminescent scanner (Syngene).

5.2.16. North-western blot

Purified recombinant preKARS2 was loaded on 10%SDS-PAGE and, electroblotted to nitrocellulose membrane (200mA, 90V, 4°C). The protein was stained with coomassie and then renatured by incubating the membrane in renaturation buffer (100mM Tris-HCl pH 7.5, 20 mM KCl, 2.5 mM MgCl₂, and 0.1% Nonidet P-40 pH 7.5) overnight at 4°C. The membrane was washed several times with the same solution and then blocked in blocking buffer (10mM Tris-

HCl pH7.5, 5mM MgCl₂, 1% BSA, and 0.01% Triton X-100) for 5 min at 4°C. This was followed by incubation with 5'-³²P-labelled tRK1 or non-specific 5S rRNA in hybridization buffer (50mM Tris HCl pH7.5, 20mM KCl, 2.5mM MgCl₂, 2mM DTT, 1mM ATP) for 2h at 4°C. After hybridization, the membrane was washed in hybridization buffer and exposed to a PhosphoImager plate (Fuji). Autoradiographs were revealed using Typhoon Trio scanner and images were treated in ImageQuantTMTL software.

5.2.17. Cross linking immuno precipitation (CLIP)

Control and HEK293T cells overexpressing PNPase were harvested and washed with 1X PBS. Mitochondria were purified as described above and resuspended in BB buffer. Formaldehyde was added to purified mitochondria to a final concentration of 1%v/v (0.36M) and incubated at room temperature for 10 min with mild agitation. The crosslinking reaction was quenched with 0.25M Glycine (pH 7) followed by incubation for 5min at room temperature. Mitochondria were washed twice with BB buffer and resuspended in RIPA buffer (50mM Tris-HCl pH 7.5, 150mM NaCl, 2mM EDTA, 1%Triton X, 0.5% DDM) containing protease inhibitors (complete EDTA-free protease inhibitor cocktail tablet, Roche). The mitochondrial extract was prepared by three rounds of sonication 20sec each with an amplitude of 7. Between each cycle, the sample were kept on ice for 2min. The insoluble material was removed by centrifugation (14000g, 10min, 4°C) and the cleared lysates were applied to protein A sepharose beads pretreated with PNPase antibodies or aldolase antibodies as control. Immunoprecipitation was performed with mild agitation for 2h at room temperature. Following immunoprecipitation, beads were collected using centrifugation (6000g, 5min, 4°C) and washed three times with buffer. The crosslinking was reverse by incubating the samples (beads resuspended in 100µl RIPA buffer) at 70°C for 45min. The supernatant was collected using centrifugation (6000g, 5min, 4°C), separated on SDS-PAGE and analyzed by mass spectrometry.

5.2.18. Mass Spectrometry Analysis

Proteins immunoprecipitated in complex with PNPase were identified by mass spectrometry analysis using MALDI-TOF/TOFIII Smartbeam (Bruker), TripleTOF® 5600 (AB

SCIEX) and nanoLC-MS/MS (nanoU3000 (Dionex)-ESI-MicroTOFQII) (Bruker). Mass spectrometry data were analysed with the help of Mascot software (Matrix science). Mass spectrometry identification of proteins was done in collaboration with Philippe HAMMANN at the proteomic platform of the University of Strasbourg (Strasbourg Esplanade).

BIBLIOGRAPHY

BIBLIOGRAPGY

- Adhya, S. (2008). Leishmania mitochondrial tRNA importers. *Int J Biochem Cell Biol* *40*, 2681-2685.
- Agris, P.F., Vendeix, F.A., and Graham, W.D. (2007). tRNA's wobble decoding of the genome: 40 years of modification. *J Mol Biol* *366*, 1-13.
- Akama, K., Christian, B.E., Jones, C.N., Ueda, T., Takeuchi, N., and Spremulli, L.L. (2010). Analysis of the functional consequences of lethal mutations in mitochondrial translational elongation factors. *Biochim Biophys Acta* *1802*, 692-698.
- al-Giery, A.G., and Brewer, J.M. (1992). Characterization of the interaction of yeast enolase with polynucleotides. *Biochim Biophys Acta* *1159*, 134-140.
- Alam, T.I., Kanki, T., Muta, T., Ukaji, K., Abe, Y., Nakayama, H., Takio, K., Hamasaki, N., and Kang, D. (2003). Human mitochondrial DNA is packaged with TFAM. *Nucleic Acids Res* *31*, 1640-1645.
- Albrecht, R., Rehling, P., Chacinska, A., Brix, J., Cadamuro, S.A., Volkmer, R., Guiard, B., Pfanner, N., and Zeth, K. (2006). The Tim21 binding domain connects the preprotein translocases of both mitochondrial membranes. *EMBO Rep* *7*, 1233-1238.
- Alder, N.N., Jensen, R.E., and Johnson, A.E. (2008). Fluorescence mapping of mitochondrial TIM23 complex reveals a water-facing, substrate-interacting helix surface. *Cell* *134*, 439-450.
- Anderson, S., Bankier, A.T., Barrell, B.G., de Bruijn, M.H., Coulson, A.R., Drouin, J., Eperon, I.C., Nierlich, D.P., Roe, B.A., Sanger, F., *et al.* (1981). Sequence and organization of the human mitochondrial genome. *Nature* *290*, 457-465.
- Antonellis, A., and Green, E.D. (2008). The role of aminoacyl-tRNA synthetases in genetic diseases. *Annu Rev Genomics Hum Genet* *9*, 87-107.
- Arnberg, A., van Bruggen, E.F., and Borst, P. (1971). The presence of DNA molecules with a displacement loop in standard mitochondrial DNA preparations. *Biochim Biophys Acta* *246*, 353-357.
- Attardi, G., and Schatz, G. (1988). Biogenesis of mitochondria. *Annu Rev Cell Biol* *4*, 289-333.
- Bandiera, S., Ruberg, S., Girard, M., Cagnard, N., Hanein, S., Chretien, D., Munnich, A., Lyonnet, S., and Henrion-Caude, A. (2011). Nuclear outsourcing of RNA interference components to human mitochondria. *PLoS One* *6*, e20746.
- Barrell, B.G., Anderson, S., Bankier, A.T., de Bruijn, M.H., Chen, E., Coulson, A.R., Drouin, J., Eperon, I.C., Nierlich, D.P., Roe, B.A., *et al.* (1980). Different pattern of codon recognition by mammalian mitochondrial tRNAs. *Proc Natl Acad Sci U S A* *77*, 3164-3166.

- Becker, T., Guiard, B., Thornton, N., Zufall, N., Stroud, D.A., Wiedemann, N., and Pfanner, N. Assembly of the mitochondrial protein import channel: role of Tom5 in two-stage interaction of Tom40 with the SAM complex. *Mol Biol Cell* 21, 3106-3113.
- Becker, T., Pfannschmidt, S., Guiard, B., Stojanovski, D., Milenkovic, D., Kutik, S., Pfanner, N., Meisinger, C., and Wiedemann, N. (2008). Biogenesis of the mitochondrial TOM complex: Mim1 promotes insertion and assembly of signal-anchored receptors. *J Biol Chem* 283, 120-127.
- Becker, T., Wenz, L.S., Thornton, N., Stroud, D., Meisinger, C., Wiedemann, N., and Pfanner, N. Biogenesis of mitochondria: dual role of Tom7 in modulating assembly of the preprotein translocase of the outer membrane. *J Mol Biol* 405, 113-124.
- Becker, T., Wenz, L.S., Thornton, N., Stroud, D., Meisinger, C., Wiedemann, N., and Pfanner, N. (2011). Biogenesis of mitochondria: dual role of Tom7 in modulating assembly of the preprotein translocase of the outer membrane. *J Mol Biol* 405, 113-124.
- Bertram, G., Innes, S., Minella, O., Richardson, J., and Stansfield, I. (2001). Endless possibilities: translation termination and stop codon recognition. *Microbiology* 147, 255-269.
- Betarbet, R., Sherer, T.B., MacKenzie, G., Garcia-Osuna, M., Panov, A.V., and Greenamyre, J.T. (2000). Chronic systemic pesticide exposure reproduces features of Parkinson's disease. *Nat Neurosci* 3, 1301-1306.
- Beyer, I., Compte, N., Busuioc, A., Cappelle, S., Lanoy, C., and Cytryn, E. (2010). Anemia and transfusions in geriatric patients: a time for evaluation. *Hematology* 15, 116-121.
- Bhargava, K., and Spremulli, L.L. (2005). Role of the N- and C-terminal extensions on the activity of mammalian mitochondrial translational initiation factor 3. *Nucleic Acids Res* 33, 7011-7018.
- Bhargava, K., Templeton, P., and Spremulli, L.L. (2004). Expression and characterization of isoform 1 of human mitochondrial elongation factor G. *Protein Expr Purif* 37, 368-376.
- Bhattacharyya, S.N., and Adhya, S. (2004). tRNA-triggered ATP hydrolysis and generation of membrane potential by the leishmania mitochondrial tRNA import complex. *J Biol Chem* 279, 11259-11263.
- Bhattacharyya, S.N., Chatterjee, S., and Adhya, S. (2002). Mitochondrial RNA import in *Leishmania tropica*: aptamers homologous to multiple tRNA domains that interact cooperatively or antagonistically at the inner membrane. *Mol Cell Biol* 22, 4372-4382.
- Bhattacharyya, S.N., Chatterjee, S., Goswami, S., Tripathi, G., Dey, S.N., and Adhya, S. (2003). "Ping-pong" interactions between mitochondrial tRNA import receptors within a multiprotein complex. *Mol Cell Biol* 23, 5217-5224.
- Bihlmaier, K., Mesecke, N., Terziyska, N., Bien, M., Hell, K., and Herrmann, J.M. (2007). The disulfide relay system of mitochondria is connected to the respiratory chain. *J Cell Biol* 179, 389-395.

- Bogenhagen, D.F., Rousseau, D., and Burke, S. (2008). The layered structure of human mitochondrial DNA nucleoids. *J Biol Chem* 283, 3665-3675.
- Bolender, N., Sickmann, A., Wagner, R., Meisinger, C., and Pfanner, N. (2008). Multiple pathways for sorting mitochondrial precursor proteins. *EMBO Rep* 9, 42-49.
- Bonnefond, L., Fender, A., Rudinger-Thirion, J., Giege, R., Florentz, C., and Sissler, M. (2005). Toward the full set of human mitochondrial aminoacyl-tRNA synthetases: characterization of AspRS and TyrRS. *Biochemistry* 44, 4805-4816.
- Borowski, L.S., Dziembowski, A., Hejnowicz, M.S., Stepień, P.P., and Szczesny, R.J. (2013). Human mitochondrial RNA decay mediated by PNPase-hSuv3 complex takes place in distinct foci. *Nucleic Acids Res* 41, 1223-1240.
- Bouzaidi-Tiali, N., Aeby, E., Charriere, F., Pusnik, M., and Schneider, A. (2007). Elongation factor 1a mediates the specificity of mitochondrial tRNA import in *T. brucei*. *EMBO J* 26, 4302-4312.
- Boveris, A., and Cadenas, E. (1975). Mitochondrial production of superoxide anions and its relationship to the antimycin insensitive respiration. *FEBS Lett* 54, 311-314.
- Boveris, A., Oshino, N., and Chance, B. (1972). The cellular production of hydrogen peroxide. *Biochem J* 128, 617-630.
- Boyer, P.D., Cross, R.L., and Momsen, W. (1973). A new concept for energy coupling in oxidative phosphorylation based on a molecular explanation of the oxygen exchange reactions. *Proc Natl Acad Sci U S A* 70, 2837-2839.
- Brandina, I., Graham, J., Lemaitre-Guillier, C., Entelis, N., Krasheninnikov, I., Sweetlove, L., Tarassov, I., and Martin, R.P. (2006). Enolase takes part in a macromolecular complex associated to mitochondria in yeast. *Biochim Biophys Acta* 1757, 1217-1228.
- Brown, T.A., Cecconi, C., Tkachuk, A.N., Bustamante, C., and Clayton, D.A. (2005). Replication of mitochondrial DNA occurs by strand displacement with alternative light-strand origins, not via a strand-coupled mechanism. *Genes Dev* 19, 2466-2476.
- Brubacher-Kauffmann, S., Marechal-Drouard, L., Cosset, A., Dietrich, A., and Duchene, A.M. (1999). Differential import of nuclear-encoded tRNA^{Gly} isoacceptors into solanum Tuberosum mitochondria. *Nucleic Acids Res* 27, 2037-2042.
- Cai, Y.C., Bullard, J.M., Thompson, N.L., and Spremulli, L.L. (2000). Interaction of mitochondrial elongation factor Tu with aminoacyl-tRNA and elongation factor Ts. *J Biol Chem* 275, 20308-20314.
- Camasamudram, V., Fang, J.K., and Avadhani, N.G. (2003). Transcription termination at the mouse mitochondrial H-strand promoter distal site requires an A/T rich sequence motif and sequence specific DNA binding proteins. *Eur J Biochem* 270, 1128-1140.

- Carpousis, A.J. (2002). The Escherichia coli RNA degradosome: structure, function and relationship in other ribonucleolytic multienzyme complexes. *Biochem Soc Trans* 30, 150-155.
- Carrodeguas, J.A., Theis, K., Bogenhagen, D.F., and Kisker, C. (2001). Crystal structure and deletion analysis show that the accessory subunit of mammalian DNA polymerase gamma, Pol gamma B, functions as a homodimer. *Mol Cell* 7, 43-54.
- Cavadini, P., Gakh, O., and Isaya, G. (2002). Protein import and processing reconstituted with isolated rat liver mitochondria and recombinant mitochondrial processing peptidase. *Methods* 26, 298-306.
- Cerritelli, S.M., Frolova, E.G., Feng, C., Grinberg, A., Love, P.E., and Crouch, R.J. (2003). Failure to produce mitochondrial DNA results in embryonic lethality in Rnaseh1 null mice. *Mol Cell* 11, 807-815.
- Chacinska, A., Koehler, C.M., Milenkovic, D., Lithgow, T., and Pfanner, N. (2009). Importing mitochondrial proteins: machineries and mechanisms. *Cell* 138, 628-644.
- Chacinska, A., Lind, M., Frazier, A.E., Dudek, J., Meisinger, C., Geissler, A., Sickmann, A., Meyer, H.E., Truscott, K.N., Guiard, B., *et al.* (2005). Mitochondrial presequence translocase: switching between TOM tethering and motor recruitment involves Tim21 and Tim17. *Cell* 120, 817-829.
- Chacinska, A., Pfannschmidt, S., Wiedemann, N., Kozjak, V., Sanjuan Szklarz, L.K., Schulze-Specking, A., Truscott, K.N., Guiard, B., Meisinger, C., and Pfanner, N. (2004). Essential role of Mia40 in import and assembly of mitochondrial intermembrane space proteins. *EMBO J* 23, 3735-3746.
- Chacinska, A., Rehling, P., Guiard, B., Frazier, A.E., Schulze-Specking, A., Pfanner, N., Voos, W., and Meisinger, C. (2003). Mitochondrial translocation contact sites: separation of dynamic and stabilizing elements in formation of a TOM-TIM-preprotein supercomplex. *EMBO J* 22, 5370-5381.
- Chance, B., Sies, H., and Boveris, A. (1979). Hydroperoxide metabolism in mammalian organs. *Physiol Rev* 59, 527-605.
- Chang, D.D., and Clayton, D.A. (1987). A mammalian mitochondrial RNA processing activity contains nucleus-encoded RNA. *Science* 235, 1178-1184.
- Charriere, F., Tan, T.H., and Schneider, A. (2005). Mitochondrial initiation factor 2 of Trypanosoma brucei binds imported formylated elongator-type tRNA(Met). *J Biol Chem* 280, 15659-15665.
- Chaudhary, D., and Miller, D.M. (1995). The c-myc promoter binding protein (MBP-1) and TBP bind simultaneously in the minor groove of the c-myc P2 promoter. *Biochemistry* 34, 3438-3445.
- Chen, H., and Chan, D.C. (2004). Mitochondrial dynamics in mammals. *Curr Top Dev Biol* 59, 119-144.
- Chen, H., and Chan, D.C. (2005). Emerging functions of mammalian mitochondrial fusion and fission. *Hum Mol Genet* 14 Spec No. 2, R283-289.

- Chen, H.W., Rainey, R.N., Balatoni, C.E., Dawson, D.W., Troke, J.J., Wasiak, S., Hong, J.S., McBride, H.M., Koehler, C.M., Teitell, M.A., *et al.* (2006). Mammalian polynucleotide phosphorylase is an intermembrane space RNase that maintains mitochondrial homeostasis. *Mol Cell Biol* 26, 8475-8487.
- Chrzanowska-Lightowlers, Z.M., Pajak, A., and Lightowlers, R.N. (2011). Termination of protein synthesis in mammalian mitochondria. *J Biol Chem* 286, 34479-34485.
- Clayton, D.A. (1982). Replication of animal mitochondrial DNA. *Cell* 28, 693-705.
- Clayton, D.A. (1991). Replication and transcription of vertebrate mitochondrial DNA. *Annu Rev Cell Biol* 7, 453-478.
- Clayton, D.A. (1992). Transcription and replication of animal mitochondrial DNAs. *Int Rev Cytol* 141, 217-232.
- Comte, C., Tonin, Y., Heckel-Mager, A.M., Boucheham, A., Smirnov, A., Aure, K., Lombes, A., Martin, R.P., Entelis, N., and Tarassov, I. (2013). Mitochondrial targeting of recombinant RNAs modulates the level of a heteroplasmic mutation in human mitochondrial DNA associated with Kearns Sayre Syndrome. *Nucleic acids research* 41, 418-433.
- Cotney, J., McKay, S.E., and Shadel, G.S. (2009). Elucidation of separate, but collaborative functions of the rRNA methyltransferase-related human mitochondrial transcription factors B1 and B2 in mitochondrial biogenesis reveals new insight into maternally inherited deafness. *Hum Mol Genet* 18, 2670-2682.
- Cotney, J., Wang, Z., and Shadel, G.S. (2007). Relative abundance of the human mitochondrial transcription system and distinct roles for h-mtTFB1 and h-mtTFB2 in mitochondrial biogenesis and gene expression. *Nucleic Acids Res* 35, 4042-4054.
- Crausaz Esseiva, A., Marechal-Drouard, L., Cosset, A., and Schneider, A. (2004). The T-stem determines the cytosolic or mitochondrial localization of trypanosomal tRNAs^{Met}. *Mol Biol Cell* 15, 2750-2757.
- Curran, S.P., Leuenberger, D., Oppliger, W., and Koehler, C.M. (2002). The Tim9p-Tim10p complex binds to the transmembrane domains of the ADP/ATP carrier. *EMBO J* 21, 942-953.
- Dabir, D.V., Leverich, E.P., Kim, S.K., Tsai, F.D., Hirasawa, M., Knaff, D.B., and Koehler, C.M. (2007). A role for cytochrome c and cytochrome c peroxidase in electron shuttling from Erv1. *EMBO J* 26, 4801-4811.
- Das, S.K., Bhutia, S.K., Sokhi, U.K., Dash, R., Azab, B., Sarkar, D., and Fisher, P.B. (2011). Human polynucleotide phosphorylase (hPNPase(old-35)): an evolutionary conserved gene with an expanding repertoire of RNA degradation functions. *Oncogene* 30, 1733-1743.
- De Pinto, V.D., and Palmieri, F. (1992). Transmembrane arrangement of mitochondrial porin or voltage-dependent anion channel (VDAC). *J Bioenerg Biomembr* 24, 21-26.

- Delage, L., Dietrich, A., Cosset, A., and Marechal-Drouard, L. (2003a). In vitro import of a nuclearly encoded tRNA into mitochondria of *Solanum tuberosum*. *Mol Cell Biol* 23, 4000-4012.
- Delage, L., Duchene, A.M., Zaepfel, M., and Marechal-Drouard, L. (2003b). The anticodon and the D-domain sequences are essential determinants for plant cytosolic tRNA(Val) import into mitochondria. *Plant J* 34, 623-633.
- Di Re, M., Sembongi, H., He, J., Reyes, A., Yasukawa, T., Martinsson, P., Bailey, L.J., Goffart, S., Boyd-Kirkup, J.D., Wong, T.S., *et al.* (2009). The accessory subunit of mitochondrial DNA polymerase gamma determines the DNA content of mitochondrial nucleoids in human cultured cells. *Nucleic Acids Res* 37, 5701-5713.
- Dias, J., Octobre, G., Kobbi, L., Comisso, M., Flisiak, S., and Mirande, M. (2012). Activation of human mitochondrial lysyl-tRNA synthetase upon maturation of its premitochondrial precursor. *Biochemistry* 51, 909-916.
- Dietrich, A., Marechal-Drouard, L., Carneiro, V., Cosset, A., and Small, I. (1996a). A single base change prevents import of cytosolic tRNA(Ala) into mitochondria in transgenic plants. *Plant J* 10, 913-918.
- Dietrich, A., Small, I., Cosset, A., Weil, J.H., and Marechal-Drouard, L. (1996b). Editing and import: strategies for providing plant mitochondria with a complete set of functional transfer RNAs. *Biochimie* 78, 518-529.
- Dietrich, A., Weil, J.H., and Marechal-Drouard, L. (1992). Nuclear-encoded transfer RNAs in plant mitochondria. *Annu Rev Cell Biol* 8, 115-131.
- Doda, J.N., Wright, C.T., and Clayton, D.A. (1981). Elongation of displacement-loop strands in human and mouse mitochondrial DNA is arrested near specific template sequences. *Proc Natl Acad Sci U S A* 78, 6116-6120.
- Doersen, C.J., Guerrier-Takada, C., Altman, S., and Attardi, G. (1985). Characterization of an RNase P activity from HeLa cell mitochondria. Comparison with the cytosol RNase P activity. *J Biol Chem* 260, 5942-5949.
- Dorner, M., Altmann, M., Paabo, S., and Morl, M. (2001). Evidence for import of a lysyl-tRNA into marsupial mitochondria. *Mol Biol Cell* 12, 2688-2698.
- Drago, I., Pizzo, P., and Pozzan, T. After half a century mitochondrial calcium in- and efflux machineries reveal themselves. *EMBO J* 30, 4119-4125.
- Duchene, A.M., Pujol, C., and Marechal-Drouard, L. (2009). Import of tRNAs and aminoacyl-tRNA synthetases into mitochondria. *Curr Genet* 55, 1-18.
- Dukanovic, J., Dimmer, K.S., Bonnefoy, N., Krumpke, K., and Rapaport, D. (2009). Genetic and functional interactions between the mitochondrial outer membrane proteins Tom6 and Sam37. *Mol Cell Biol* 29, 5975-5988.

- Dussurget, O., and Roulland-Dussoix, D. (1994). Rapid, sensitive PCR-based detection of mycoplasmas in simulated samples of animal sera. *Appl Environ Microbiol* *60*, 953-959.
- Edwards, S.R., Braley, R., and Chaffin, W.L. (1999). Enolase is present in the cell wall of *Saccharomyces cerevisiae*. *FEMS Microbiol Lett* *177*, 211-216.
- Endo, T., Yamamoto, H., and Esaki, M. (2003). Functional cooperation and separation of translocators in protein import into mitochondria, the double-membrane bounded organelles. *J Cell Sci* *116*, 3259-3267.
- Entelis, N., Brandina, I., Kamenski, P., Krasheninnikov, I.A., Martin, R.P., and Tarassov, I. (2006). A glycolytic enzyme, enolase, is recruited as a cofactor of tRNA targeting toward mitochondria in *Saccharomyces cerevisiae*. *Genes Dev* *20*, 1609-1620.
- Entelis, N.S., Kieffer, S., Kolesnikova, O.A., Martin, R.P., and Tarassov, I.A. (1998). Structural requirements of tRNA^{Lys} for its import into yeast mitochondria. *Proc Natl Acad Sci U S A* *95*, 2838-2843.
- Entelis, N.S., Kolesnikova, O.A., Dogan, S., Martin, R.P., and Tarassov, I.A. (2001a). 5 S rRNA and tRNA import into human mitochondria. Comparison of in vitro requirements. *J Biol Chem* *276*, 45642-45653.
- Entelis, N.S., Kolesnikova, O.A., Martin, R.P., and Tarassov, I.A. (2001b). RNA delivery into mitochondria. *Adv Drug Deliv Rev* *49*, 199-215.
- Esseiva, A.C., Naguleswaran, A., Hemphill, A., and Schneider, A. (2004). Mitochondrial tRNA import in *Toxoplasma gondii*. *J Biol Chem* *279*, 42363-42368.
- Falkenberg, M., Gaspari, M., Rantanen, A., Trifunovic, A., Larsson, N.G., and Gustafsson, C.M. (2002). Mitochondrial transcription factors B1 and B2 activate transcription of human mtDNA. *Nat Genet* *31*, 289-294.
- Falkenberg, M., Larsson, N.G., and Gustafsson, C.M. (2007). DNA replication and transcription in mammalian mitochondria. *Annu Rev Biochem* *76*, 679-699.
- Farge, G., Laurens, N., Broekmans, O.D., van den Wildenberg, S.M., Dekker, L.C., Gaspari, M., Gustafsson, C.M., Peterman, E.J., Falkenberg, M., and Wuite, G.J. Protein sliding and DNA denaturation are essential for DNA organization by human mitochondrial transcription factor A. *Nat Commun* *3*, 1013.
- Farr, C.L., Wang, Y., and Kaguni, L.S. (1999). Functional interactions of mitochondrial DNA polymerase and single-stranded DNA-binding protein. Template-primer DNA binding and initiation and elongation of DNA strand synthesis. *J Biol Chem* *274*, 14779-14785.
- Farrell, S.R., and Thorpe, C. (2005). Augmenter of liver regeneration: a flavin-dependent sulfhydryl oxidase with cytochrome c reductase activity. *Biochemistry* *44*, 1532-1541.

- Feo, S., Arcuri, D., Piddini, E., Passantino, R., and Giallongo, A. (2000). ENO1 gene product binds to the c-myc promoter and acts as a transcriptional repressor: relationship with Myc promoter-binding protein 1 (MBP-1). *FEBS Lett* 473, 47-52.
- Fernandez-Silva, P., Enriquez, J.A., and Montoya, J. (2003). Replication and transcription of mammalian mitochondrial DNA. *Exp Physiol* 88, 41-56.
- Fernandez-Silva, P., Martinez-Azorin, F., Micol, V., and Attardi, G. (1997). The human mitochondrial transcription termination factor (mTERF) is a multizipper protein but binds to DNA as a monomer, with evidence pointing to intramolecular leucine zipper interactions. *EMBO J* 16, 1066-1079.
- Fisher, R.P., and Clayton, D.A. (1988). Purification and characterization of human mitochondrial transcription factor 1. *Mol Cell Biol* 8, 3496-3509.
- Fisher, R.P., Lisowsky, T., Parisi, M.A., and Clayton, D.A. (1992). DNA wrapping and bending by a mitochondrial high mobility group-like transcriptional activator protein. *J Biol Chem* 267, 3358-3367.
- Fisher, R.P., Topper, J.N., and Clayton, D.A. (1987). Promoter selection in human mitochondria involves binding of a transcription factor to orientation-independent upstream regulatory elements. *Cell* 50, 247-258.
- Foury, F., Roganti, T., Lecrenier, N., and Purnelle, B. (1998). The complete sequence of the mitochondrial genome of *Saccharomyces cerevisiae*. *FEBS Lett* 440, 325-331.
- Frechin, M., Senger, B., Braye, M., Kern, D., Martin, R.P., and Becker, H.D. (2009). Yeast mitochondrial Gln-tRNA(Gln) is generated by a GatFAB-mediated transamidation pathway involving Arc1p-controlled subcellular sorting of cytosolic GluRS. *Genes Dev* 23, 1119-1130.
- French, S.W., Dawson, D.W., Chen, H.W., Rainey, R.N., Sievers, S.A., Balatoni, C.E., Wong, L., Troke, J.J., Nguyen, M.T., Koehler, C.M., *et al.* (2007). The TCL1 oncoprotein binds the RNase PH domains of the PNPase exoribonuclease without affecting its RNA degrading activity. *Cancer Lett* 248, 198-210.
- Gakh, O., Cavadini, P., and Isaya, G. (2002). Mitochondrial processing peptidases. *Biochim Biophys Acta* 1592, 63-77.
- Garrido, N., Griparic, L., Jokitalo, E., Wartiovaara, J., van der Blik, A.M., and Spelbrink, J.N. (2003). Composition and dynamics of human mitochondrial nucleoids. *Mol Biol Cell* 14, 1583-1596.
- Gaur, R., Grasso, D., Datta, P.P., Krishna, P.D., Das, G., Spencer, A., Agrawal, R.K., Spremulli, L., and Varshney, U. (2008). A single mammalian mitochondrial translation initiation factor functionally replaces two bacterial factors. *Mol Cell* 29, 180-190.
- Geissler, A., Chacinska, A., Truscott, K.N., Wiedemann, N., Brandner, K., Sickmann, A., Meyer, H.E., Meisinger, C., Pfanner, N., and Rehling, P. (2002). The mitochondrial presequence translocase: an essential role of Tim50 in directing preproteins to the import channel. *Cell* 111, 507-518.

- Geslain, R., Aeby, E., Guitart, T., Jones, T.E., Castro de Moura, M., Charriere, F., Schneider, A., and Ribas de Pouplana, L. (2006). Trypanosoma seryl-tRNA synthetase is a metazoan-like enzyme with high affinity for tRNA^{Sec}. *J Biol Chem* 281, 38217-38225.
- Giacomello, M., Drago, I., Pizzo, P., and Pozzan, T. (2007). Mitochondrial Ca²⁺ as a key regulator of cell life and death. *Cell Death Differ* 14, 1267-1274.
- Glick, B.S., Brandt, A., Cunningham, K., Muller, S., Hallberg, R.L., and Schatz, G. (1992). Cytochromes c1 and b2 are sorted to the intermembrane space of yeast mitochondria by a stop-transfer mechanism. *Cell* 69, 809-822.
- Glover, K.E., Spencer, D.F., and Gray, M.W. (2001). Identification and structural characterization of nucleus-encoded transfer RNAs imported into wheat mitochondria. *J Biol Chem* 276, 639-648.
- Gray, M.W., Burger, G., and Lang, B.F. (1999). Mitochondrial evolution. *Science* 283, 1476-1481.
- Gray, M.W., Lang, B.F., Cedergren, R., Golding, G.B., Lemieux, C., Sankoff, D., Turmel, M., Brossard, N., Delage, E., Littlejohn, T.G., *et al.* (1998). Genome structure and gene content in protist mitochondrial DNAs. *Nucleic Acids Res* 26, 865-878.
- Grohmann, K., Amairic, F., Crews, S., and Attardi, G. (1978). Failure to detect "cap" structures in mitochondrial DNA-coded poly(A)-containing RNA from HeLa cells. *Nucleic Acids Res* 5, 637-651.
- Grumbt, B., Stroobant, V., Terziyska, N., Israel, L., and Hell, K. (2007). Functional characterization of Mia40p, the central component of the disulfide relay system of the mitochondrial intermembrane space. *J Biol Chem* 282, 37461-37470.
- Habib, S.J., Neupert, W., and Rapaport, D. (2007). Analysis and prediction of mitochondrial targeting signals. *Methods Cell Biol* 80, 761-781.
- Hammarsund, M., Wilson, W., Corcoran, M., Merup, M., Einhorn, S., Grander, D., and Sangfelt, O. (2001). Identification and characterization of two novel human mitochondrial elongation factor genes, hEFG2 and hEFG1, phylogenetically conserved through evolution. *Hum Genet* 109, 542-550.
- Hancock, K., and Hajduk, S.L. (1990). The mitochondrial tRNAs of Trypanosoma brucei are nuclear encoded. *J Biol Chem* 265, 19208-19215.
- Hanninen, S., Ahola, L., Pyykonen, T., Korhonen, H.T., and Mononen, J. (2008). Group housing in row cages: an alternative housing system for juvenile mink. *Animal* 2, 1809-1817.
- Haque, M.E., Grasso, D., and Spremulli, L.L. (2008). The interaction of mammalian mitochondrial translational initiation factor 3 with ribosomes: evolution of terminal extensions in IF3mt. *Nucleic Acids Res* 36, 589-597.
- He, J., Mao, C.C., Reyes, A., Sembongi, H., Di Re, M., Granycome, C., Clippingdale, A.B., Fearnley, I.M., Harbour, M., Robinson, A.J., *et al.* (2007). The AAA+ protein ATAD3 has displacement

- loop binding properties and is involved in mitochondrial nucleoid organization. *J Cell Biol* 176, 141-146.
- Heales, S.J., Bolanos, J.P., Stewart, V.C., Brookes, P.S., Land, J.M., and Clark, J.B. (1999). Nitric oxide, mitochondria and neurological disease. *Biochim Biophys Acta* 1410, 215-228.
- Helm, M. (2006). Post-transcriptional nucleotide modification and alternative folding of RNA. *Nucleic Acids Res* 34, 721-733.
- Hill, K., Model, K., Ryan, M.T., Dietmeier, K., Martin, F., Wagner, R., and Pfanner, N. (1998). Tom40 forms the hydrophilic channel of the mitochondrial import pore for preproteins [see comment]. *Nature* 395, 516-521.
- Hixson, J.E., Wong, T.W., and Clayton, D.A. (1986). Both the conserved stem-loop and divergent 5'-flanking sequences are required for initiation at the human mitochondrial origin of light-strand DNA replication. *J Biol Chem* 261, 2384-2390.
- Holt, I.J., Lorimer, H.E., and Jacobs, H.T. (2000). Coupled leading- and lagging-strand synthesis of mammalian mitochondrial DNA. *Cell* 100, 515-524.
- Holzmann, J., Frank, P., Loffler, E., Bennett, K.L., Gerner, C., and Rossmannith, W. (2008). RNase P without RNA: identification and functional reconstitution of the human mitochondrial tRNA processing enzyme. *Cell* 135, 462-474.
- Huber, P.W., Rife, J.P., and Moore, P.B. (2001). The structure of helix III in *Xenopus* oocyte 5 S rRNA: an RNA stem containing a two-nucleotide bulge. *J Mol Biol* 312, 823-832.
- Huber, P.W., and Wool, I.G. (1984). Nuclease protection analysis of ribonucleoprotein complexes: use of the cytotoxic ribonuclease alpha-sarcin to determine the binding sites for *Escherichia coli* ribosomal proteins L5, L18, and L25 on 5S rRNA. *Proc Natl Acad Sci U S A* 81, 322-326.
- Hulett, J.M., Lueder, F., Chan, N.C., Perry, A.J., Wolyneec, P., Likic, V.A., Gooley, P.R., and Lithgow, T. (2008). The transmembrane segment of Tom20 is recognized by Mim1 for docking to the mitochondrial TOM complex. *J Mol Biol* 376, 694-704.
- Iborra, F.J., Kimura, H., and Cook, P.R. (2004). The functional organization of mitochondrial genomes in human cells. *BMC Biol* 2, 9.
- Jacobs, H.T., and Turnbull, D.M. (2005). Nuclear genes and mitochondrial translation: a new class of genetic disease. *Trends Genet* 21, 312-314.
- Jeffery, C.J. (1999). Moonlighting proteins. *Trends Biochem Sci* 24, 8-11.
- Jouaville, L.S., Pinton, P., Bastianutto, C., Rutter, G.A., and Rizzuto, R. (1999). Regulation of mitochondrial ATP synthesis by calcium: evidence for a long-term metabolic priming. *Proc Natl Acad Sci U S A* 96, 13807-13812.

- Kaguni, L.S. (2004). DNA polymerase gamma, the mitochondrial replicase. *Annu Rev Biochem* 73, 293-320.
- Kamenski, P., Kolesnikova, O., Jubenot, V., Entelis, N., Krasheninnikov, I.A., Martin, R.P., and Tarassov, I. (2007). Evidence for an adaptation mechanism of mitochondrial translation via tRNA import from the cytosol. *Mol Cell* 26, 625-637.
- Kaneko, T., Suzuki, T., Kapushoc, S.T., Rubio, M.A., Ghazvini, J., Watanabe, K., and Simpson, L. (2003). Wobble modification differences and subcellular localization of tRNAs in *Leishmania tarentolae*: implication for tRNA sorting mechanism. *EMBO J* 22, 657-667.
- Kang, D., Kim, S.H., and Hamasaki, N. (2007). Mitochondrial transcription factor A (TFAM): roles in maintenance of mtDNA and cellular functions. *Mitochondrion* 7, 39-44.
- Karicheva, O.Z., Kolesnikova, O.A., Schirtz, T., Vysokikh, M.Y., Mager-Heckel, A.M., Lombes, A., Boucheham, A., Krasheninnikov, I.A., Martin, R.P., Entelis, N., *et al.* (2011). Correction of the consequences of mitochondrial 3243A>G mutation in the MT-TL1 gene causing the MELAS syndrome by tRNA import into mitochondria. *Nucleic Acids Res* 39, 8173-8186.
- Kasamatsu, H., and Vinograd, J. (1974). Replication of circular DNA in eukaryotic cells. *Annu Rev Biochem* 43, 695-719.
- Kaufman, B.A., Durisic, N., Mativetsky, J.M., Costantino, S., Hancock, M.A., Grutter, P., and Shoubridge, E.A. (2007). The mitochondrial transcription factor TFAM coordinates the assembly of multiple DNA molecules into nucleoid-like structures. *Mol Biol Cell* 18, 3225-3236.
- Kazakova, H.A., Entelis, N.S., Martin, R.P., and Tarassov, I.A. (1999). The aminoacceptor stem of the yeast tRNA(Lys) contains determinants of mitochondrial import selectivity. *FEBS Lett* 442, 193-197.
- Kemper, C., Habib, S.J., Engl, G., Heckmeyer, P., Dimmer, K.S., and Rapaport, D. (2008). Integration of tail-anchored proteins into the mitochondrial outer membrane does not require any known import components. *J Cell Sci* 121, 1990-1998.
- Koehler, C.M., Merchant, S., Oppliger, W., Schmid, K., Jarosch, E., Dolfini, L., Junne, T., Schatz, G., and Tokatlidis, K. (1998). Tim9p, an essential partner subunit of Tim10p for the import of mitochondrial carrier proteins. *EMBO J* 17, 6477-6486.
- Kolesnikova, O., Entelis, N., Kazakova, H., Brandina, I., Martin, R.P., and Tarassov, I. (2002). Targeting of tRNA into yeast and human mitochondria: the role of anticodon nucleotides. *Mitochondrion* 2, 95-107.
- Kolesnikova, O., Kazakova, H., Comte, C., Steinberg, S., Kamenski, P., Martin, R.P., Tarassov, I., and Entelis, N. (2010). Selection of RNA aptamers imported into yeast and human mitochondria. *RNA* 16, 926-941.
- Kolesnikova, O.A., Entelis, N.S., Jacquin-Becker, C., Goltzene, F., Chrzanowska-Lightowlers, Z.M., Lightowlers, R.N., Martin, R.P., and Tarassov, I. (2004). Nuclear DNA-encoded tRNAs targeted

- into mitochondria can rescue a mitochondrial DNA mutation associated with the MERRF syndrome in cultured human cells. *Hum Mol Genet* *13*, 2519-2534.
- Kolesnikova, O.A., Entelis, N.S., Mireau, H., Fox, T.D., Martin, R.P., and Tarassov, I.A. (2000). Suppression of mutations in mitochondrial DNA by tRNAs imported from the cytoplasm. *Science* *289*, 1931-1933.
- Korhonen, J.A., Gaspari, M., and Falkenberg, M. (2003). TWINKLE Has 5' -> 3' DNA helicase activity and is specifically stimulated by mitochondrial single-stranded DNA-binding protein. *J Biol Chem* *278*, 48627-48632.
- Korhonen, J.A., Pham, X.H., Pellegrini, M., and Falkenberg, M. (2004). Reconstitution of a minimal mtDNA replisome in vitro. *EMBO J* *23*, 2423-2429.
- Koulintchenko, M., Konstantinov, Y., and Dietrich, A. (2003). Plant mitochondria actively import DNA via the permeability transition pore complex. *EMBO J* *22*, 1245-1254.
- Koulintchenko, M., Temperley, R.J., Mason, P.A., Dietrich, A., and Lightowers, R.N. (2006). Natural competence of mammalian mitochondria allows the molecular investigation of mitochondrial gene expression. *Hum Mol Genet* *15*, 143-154.
- Krayl, M., Lim, J.H., Martin, F., Guiard, B., and Voos, W. (2007). A cooperative action of the ATP-dependent import motor complex and the inner membrane potential drives mitochondrial preprotein import. *Mol Cell Biol* *27*, 411-425.
- Kruse, B., Narasimhan, N., and Attardi, G. (1989). Termination of transcription in human mitochondria: identification and purification of a DNA binding protein factor that promotes termination. *Cell* *58*, 391-397.
- Kuhnel, K., and Luisi, B.F. (2001). Crystal structure of the Escherichia coli RNA degradosome component enolase. *J Mol Biol* *313*, 583-592.
- Kukat, C., Wurm, C.A., Spahr, H., Falkenberg, M., Larsson, N.G., and Jakobs, S. Super-resolution microscopy reveals that mammalian mitochondrial nucleoids have a uniform size and frequently contain a single copy of mtDNA. *Proc Natl Acad Sci U S A* *108*, 13534-13539.
- Kumar, R., Marechal-Drouard, L., Akama, K., and Small, I. (1996). Striking differences in mitochondrial tRNA import between different plant species. *Mol Gen Genet* *252*, 404-411.
- Kutik, S., Stojanovski, D., Becker, L., Becker, T., Meinecke, M., Kruger, V., Prinz, C., Meisinger, C., Guiard, B., Wagner, R., *et al.* (2008). Dissecting membrane insertion of mitochondrial beta-barrel proteins. *Cell* *132*, 1011-1024.
- Lakshmipathy, U., and Campbell, C. (1999). The human DNA ligase III gene encodes nuclear and mitochondrial proteins. *Mol Cell Biol* *19*, 3869-3876.
- Lakshmipathy, U., and Campbell, C. (2001). Antisense-mediated decrease in DNA ligase III expression results in reduced mitochondrial DNA integrity. *Nucleic Acids Res* *29*, 668-676.

- Lee, C.P., Mandal, N., Dyson, M.R., and RajBhandary, U.L. (1993). The discriminator base influences tRNA structure at the end of the acceptor stem and possibly its interaction with proteins. *Proc Natl Acad Sci U S A* *90*, 7149-7152.
- Lee, D.Y., and Clayton, D.A. (1996). Properties of a primer RNA-DNA hybrid at the mouse mitochondrial DNA leading-strand origin of replication. *J Biol Chem* *271*, 24262-24269.
- Lee, Y.S., Kennedy, W.D., and Yin, Y.W. (2009). Structural insight into processive human mitochondrial DNA synthesis and disease-related polymerase mutations. *Cell* *139*, 312-324.
- Lee, Y.S., Lee, S., Demeler, B., Molineux, I.J., Johnson, K.A., and Yin, Y.W. Each monomer of the dimeric accessory protein for human mitochondrial DNA polymerase has a distinct role in conferring processivity. *J Biol Chem* *285*, 1490-1499.
- Lescoute, A., and Westhof, E. (2006). Topology of three-way junctions in folded RNAs. *RNA* *12*, 83-93.
- Leszczyniecka, M., Kang, D.C., Sarkar, D., Su, Z.Z., Holmes, M., Valerie, K., and Fisher, P.B. (2002). Identification and cloning of human polynucleotide phosphorylase, hPNPase old-35, in the context of terminal differentiation and cellular senescence. *Proc Natl Acad Sci U S A* *99*, 16636-16641.
- Levinger, L., Jacobs, O., and James, M. (2001). In vitro 3'-end endonucleolytic processing defect in a human mitochondrial tRNA(Ser(UCN)) precursor with the U7445C substitution, which causes non-syndromic deafness. *Nucleic Acids Res* *29*, 4334-4340.
- Li, K., Smagula, C.S., Parsons, W.J., Richardson, J.A., Gonzalez, M., Hagler, H.K., and Williams, R.S. (1994). Subcellular partitioning of MRP RNA assessed by ultrastructural and biochemical analysis. *J Cell Biol* *124*, 871-882.
- Liao, H.X., and Spremulli, L.L. (1989). Interaction of bovine mitochondrial ribosomes with messenger RNA. *J Biol Chem* *264*, 7518-7522.
- Liao, H.X., and Spremulli, L.L. (1990). Identification and initial characterization of translational initiation factor 2 from bovine mitochondria. *J Biol Chem* *265*, 13618-13622.
- Lim, S.E., Longley, M.J., and Copeland, W.C. (1999). The mitochondrial p55 accessory subunit of human DNA polymerase gamma enhances DNA binding, promotes processive DNA synthesis, and confers N-ethylmaleimide resistance. *J Biol Chem* *274*, 38197-38203.
- Linder, T., Park, C.B., Asin-Cayuela, J., Pellegrini, M., Larsson, N.G., Falkenberg, M., Samuelsson, T., and Gustafsson, C.M. (2005). A family of putative transcription termination factors shared amongst metazoans and plants. *Curr Genet* *48*, 265-269.
- Ling, M., Merante, F., Chen, H.S., Duff, C., Duncan, A.M., and Robinson, B.H. (1997). The human mitochondrial elongation factor tu (EF-Tu) gene: cDNA sequence, genomic localization, genomic structure, and identification of a pseudogene. *Gene* *197*, 325-336.

- Lisitsky, I., Klaff, P., and Schuster, G. (1996). Addition of destabilizing poly (A)-rich sequences to endonuclease cleavage sites during the degradation of chloroplast mRNA. *Proc Natl Acad Sci U S A* *93*, 13398-13403.
- Lund, E., and Dahlberg, J.E. (1998). Proofreading and aminoacylation of tRNAs before export from the nucleus. *Science* *282*, 2082-2085.
- Lynch, M., Koskella, B., and Schaack, S. (2006). Mutation pressure and the evolution of organelle genomic architecture. *Science* *311*, 1727-1730.
- Ma, J., and Spremulli, L.L. (1996). Expression, purification, and mechanistic studies of bovine mitochondrial translational initiation factor 2. *J Biol Chem* *271*, 5805-5811.
- Ma, L., and Spremulli, L.L. (1995). Cloning and sequence analysis of the human mitochondrial translational initiation factor 2 cDNA. *J Biol Chem* *270*, 1859-1865.
- Magalhaes, P.J., Andreu, A.L., and Schon, E.A. (1998). Evidence for the presence of 5S rRNA in mammalian mitochondria. *Mol Biol Cell* *9*, 2375-2382.
- Mahapatra, S., Ghosh, S., Bera, S.K., Ghosh, T., Das, A., and Adhya, S. (1998). The D arm of tRNA^{Tyr} is necessary and sufficient for import into Leishmania mitochondria in vitro. *Nucleic Acids Res* *26*, 2037-2041.
- Mannella, C.A., Forte, M., and Colombini, M. (1992). Toward the molecular structure of the mitochondrial channel, VDAC. *J Bioenerg Biomembr* *24*, 7-19.
- Marechal-Drouard, L., Weil, J.H., and Guillemaut, P. (1988). Import of several tRNAs from the cytoplasm into the mitochondria in bean *Phaseolus vulgaris*. *Nucleic Acids Res* *16*, 4777-4788.
- Margulis, L., and Bermudes, D. (1985). Symbiosis as a mechanism of evolution: status of cell symbiosis theory. *Symbiosis* *1*, 101-124.
- Martin, M., Cho, J., Cesare, A.J., Griffith, J.D., and Attardi, G. (2005). Termination factor-mediated DNA loop between termination and initiation sites drives mitochondrial rRNA synthesis. *Cell* *123*, 1227-1240.
- Martin, R.P., Schneller, J.M., Stahl, A.J., and Dirheimer, G. (1977). Study of yeast mitochondrial tRNAs by two-dimensional polyacrylamide gel electrophoresis: characterization of isoaccepting species and search for imported cytoplasmic tRNAs. *Nucleic Acids Res* *4*, 3497-3510.
- Martin, R.P., Schneller, J.M., Stahl, A.J., and Dirheimer, G. (1979). Import of nuclear deoxyribonucleic acid coded lysine-accepting transfer ribonucleic acid (anticodon C-U-U) into yeast mitochondria. *Biochemistry* *18*, 4600-4605.
- Martin, R.P., Sibley, A.P., Gehrke, C.W., Kuo, K., Edmonds, C.G., McCloskey, J.A., and Dirheimer, G. (1990). 5-[[[(carboxymethyl)amino]methyl]uridine is found in the anticodon of yeast mitochondrial tRNAs recognizing two-codon families ending in a purine. *Biochemistry* *29*, 956-959.

- Martinez-Caballero, S., Grigoriev, S.M., Herrmann, J.M., Campo, M.L., and Kinnally, K.W. (2007). Tim17p regulates the twin pore structure and voltage gating of the mitochondrial protein import complex TIM23. *J Biol Chem* 282, 3584-3593.
- Masters, B.S., Stohl, L.L., and Clayton, D.A. (1987). Yeast mitochondrial RNA polymerase is homologous to those encoded by bacteriophages T3 and T7. *Cell* 51, 89-99.
- Matson, S.W., and Kaiser-Rogers, K.A. (1990). DNA helicases. *Annu Rev Biochem* 59, 289-329.
- McCulloch, V., Seidel-Rogol, B.L., and Shadel, G.S. (2002). A human mitochondrial transcription factor is related to RNA adenine methyltransferases and binds S-adenosylmethionine. *Mol Cell Biol* 22, 1116-1125.
- McCulloch, V., and Shadel, G.S. (2003). Human mitochondrial transcription factor B1 interacts with the C-terminal activation region of h-mtTFA and stimulates transcription independently of its RNA methyltransferase activity. *Mol Cell Biol* 23, 5816-5824.
- McFarland, R., Taylor, R.W., and Turnbull, D.M. (2002). The neurology of mitochondrial DNA disease. *Lancet Neurol* 1, 343-351.
- Meinecke, M., Wagner, R., Kovermann, P., Guiard, B., Mick, D.U., Hutu, D.P., Voos, W., Truscott, K.N., Chacinska, A., Pfanner, N., *et al.* (2006). Tim50 maintains the permeability barrier of the mitochondrial inner membrane. *Science* 312, 1523-1526.
- Mercer, T.R., Neph, S., Dinger, M.E., Crawford, J., Smith, M.A., Shearwood, A.M., Haugen, E., Bracken, C.P., Rackham, O., Stamatoyannopoulos, J.A., *et al.* (2011). The human mitochondrial transcriptome. *Cell* 146, 645-658.
- Mesecke, N., Terziyska, N., Kozany, C., Baumann, F., Neupert, W., Hell, K., and Herrmann, J.M. (2005). A disulfide relay system in the intermembrane space of mitochondria that mediates protein import. *Cell* 121, 1059-1069.
- Metodiev, M.D., Lesko, N., Park, C.B., Camara, Y., Shi, Y., Wibom, R., Hultenby, K., Gustafsson, C.M., and Larsson, N.G. (2009). Methylation of 12S rRNA is necessary for in vivo stability of the small subunit of the mammalian mitochondrial ribosome. *Cell Metab* 9, 386-397.
- Mikelsaar, R. (1983). Human mitochondrial genome and the evolution of methionine transfer ribonucleic acids. *J Theor Biol* 105, 221-232.
- Milenkovic, D., Gabriel, K., Guiard, B., Schulze-Specking, A., Pfanner, N., and Chacinska, A. (2007). Biogenesis of the essential Tim9-Tim10 chaperone complex of mitochondria: site-specific recognition of cysteine residues by the intermembrane space receptor Mia40. *J Biol Chem* 282, 22472-22480.
- Milenkovic, D., Kozjak, V., Wiedemann, N., Lohaus, C., Meyer, H.E., Guiard, B., Pfanner, N., and Meisinger, C. (2004). Sam35 of the mitochondrial protein sorting and assembly machinery is a peripheral outer membrane protein essential for cell viability. *J Biol Chem* 279, 22781-22785.

- Milenkovic, D., Ramming, T., Muller, J.M., Wenz, L.S., Gebert, N., Schulze-Specking, A., Stojanovski, D., Rospert, S., and Chacinska, A. (2009). Identification of the signal directing Tim9 and Tim10 into the intermembrane space of mitochondria. *Mol Biol Cell* 20, 2530-2539.
- Mili, S., and Pinol-Roma, S. (2003). LRP130, a pentatricopeptide motif protein with a noncanonical RNA-binding domain, is bound in vivo to mitochondrial and nuclear RNAs. *Mol Cell Biol* 23, 4972-4982.
- Mirande, M., Le Corre, D., Riva, M., and Waller, J.P. (1986). Cloning of yeast lysyl- and phenylalanyl-tRNA synthetase genes. *Biochimie* 68, 1001-1007.
- Mireau, H., Cosset, A., Marechal-Drouard, L., Fox, T.D., Small, I.D., and Dietrich, A. (2000). Expression of *Arabidopsis thaliana* mitochondrial alanyl-tRNA synthetase is not sufficient to trigger mitochondrial import of tRNA^{Ala} in yeast. *J Biol Chem* 275, 13291-13296.
- Mitchell, P. (1961). Coupling of phosphorylation to electron and hydrogen transfer by a chemi-osmotic type of mechanism. *Nature* 191, 144-148.
- Model, K., Meisinger, C., Prinz, T., Wiedemann, N., Truscott, K.N., Pfanner, N., and Ryan, M.T. (2001). Multistep assembly of the protein import channel of the mitochondrial outer membrane. *Nat Struct Biol* 8, 361-370.
- Mohanty, B.K., and Kushner, S.R. (2000). Polynucleotide phosphorylase functions both as a 3' right-arrow 5' exonuclease and a poly(A) polymerase in *Escherichia coli*. *Proc Natl Acad Sci U S A* 97, 11966-11971.
- Mokranjac, D., Bourenkov, G., Hell, K., Neupert, W., and Groll, M. (2006). Structure and function of Tim14 and Tim16, the J and J-like components of the mitochondrial protein import motor. *EMBO J* 25, 4675-4685.
- Mokranjac, D., and Neupert, W. (2009). Thirty years of protein translocation into mitochondria: unexpectedly complex and still puzzling. *Biochim Biophys Acta* 1793, 33-41.
- Mokranjac, D., Sichting, M., Neupert, W., and Hell, K. (2003). Tim14, a novel key component of the import motor of the TIM23 protein translocase of mitochondria. *EMBO J* 22, 4945-4956.
- Mokranjac, D., Sichting, M., Popov-Celeketić, D., Mapa, K., Gevorgyan-Airapetov, L., Zohary, K., Hell, K., Azem, A., and Neupert, W. (2009). Role of Tim50 in the transfer of precursor proteins from the outer to the inner membrane of mitochondria. *Mol Biol Cell* 20, 1400-1407.
- Montoya, J., Christianson, T., Levens, D., Rabinowitz, M., and Attardi, G. (1982). Identification of initiation sites for heavy-strand and light-strand transcription in human mitochondrial DNA. *Proc Natl Acad Sci U S A* 79, 7195-7199.
- Montoya, J., Gaines, G.L., and Attardi, G. (1983). The pattern of transcription of the human mitochondrial rRNA genes reveals two overlapping transcription units. *Cell* 34, 151-159.

- Montoya, J., Ojala, D., and Attardi, G. (1981). Distinctive features of the 5'-terminal sequences of the human mitochondrial mRNAs. *Nature* 290, 465-470.
- Mukherjee, S., Basu, S., Home, P., Dhar, G., and Adhya, S. (2007). Necessary and sufficient factors for the import of transfer RNA into the kinetoplast mitochondrion. *EMBO Rep* 8, 589-595.
- Mukherjee, S., Bhattacharyya, S.N., and Adhya, S. (1999). Stepwise transfer of tRNA through the double membrane of *Leishmania* mitochondria. *J Biol Chem* 274, 31249-31255.
- Muller, J.M., Milenkovic, D., Guiard, B., Pfanner, N., and Chacinska, A. (2008). Precursor oxidation by Mia40 and Erv1 promotes vectorial transport of proteins into the mitochondrial intermembrane space. *Mol Biol Cell* 19, 226-236.
- Nagaike, T., Suzuki, T., Tomari, Y., Takemoto-Hori, C., Negayama, F., Watanabe, K., and Ueda, T. (2001). Identification and characterization of mammalian mitochondrial tRNA nucleotidyltransferases. *J Biol Chem* 276, 40041-40049.
- Nass, M.M., and Nass, S. (1963). Intramitochondrial Fibers with DNA Characteristics. I. Fixation and Electron Staining Reactions. *J Cell Biol* 19, 593-611.
- Neupert, W., and Herrmann, J.M. (2007). Translocation of proteins into mitochondria. *Annu Rev Biochem* 76, 723-749.
- Nozaki, Y., Matsunaga, N., Ishizawa, T., Ueda, T., and Takeuchi, N. (2008). HMRF1L is a human mitochondrial translation release factor involved in the decoding of the termination codons UAA and UAG. *Genes Cells* 13, 429-438.
- O'Brien, E.A., Zhang, Y., Wang, E., Marie, V., Badejoko, W., Lang, B.F., and Burger, G. (2009). GOBASE: an organelle genome database. *Nucleic Acids Res* 37, D946-950.
- Ojala, D., Montoya, J., and Attardi, G. (1981). tRNA punctuation model of RNA processing in human mitochondria. *Nature* 290, 470-474.
- Osawa, S., Jukes, T.H., Watanabe, K., and Muto, A. (1992). Recent evidence for evolution of the genetic code. *Microbiol Rev* 56, 229-264.
- Otera, H., Taira, Y., Horie, C., Suzuki, Y., Suzuki, H., Setoguchi, K., Kato, H., Oka, T., and Mihara, K. (2007). A novel insertion pathway of mitochondrial outer membrane proteins with multiple transmembrane segments. *J Cell Biol* 179, 1355-1363.
- Pagliarini, D.J., Calvo, S.E., Chang, B., Sheth, S.A., Vafai, S.B., Ong, S.E., Walford, G.A., Sugiana, C., Boneh, A., Chen, W.K., *et al.* (2008). A mitochondrial protein compendium elucidates complex I disease biology. *Cell* 134, 112-123.
- Palade, G.E. (1952). The fine structure of mitochondria. *Anat Rec* 114, 427-451.
- Pan, T., Wang, H., Zhu, X., Zhou, W., Hou, Y., Yu, L., and Zhang, B. Mitochondrial genome of the *Emberiza pusilla* (Emberizidae: Emberiza). Mitochondrial DNA.

- Pancholi, V. (2001). Multifunctional alpha-enolase: its role in diseases. *Cell Mol Life Sci* 58, 902-920.
- Parisi, M.A., and Clayton, D.A. (1991). Similarity of human mitochondrial transcription factor 1 to high mobility group proteins. *Science* 252, 965-969.
- Park, C.B., Asin-Cayuela, J., Camara, Y., Shi, Y., Pellegrini, M., Gaspari, M., Wibom, R., Hultenby, K., Erdjument-Bromage, H., Tempst, P., *et al.* (2007). MTERF3 is a negative regulator of mammalian mtDNA transcription. *Cell* 130, 273-285.
- Park, M.K., Ashby, M.C., Erdemli, G., Petersen, O.H., and Tepikin, A.V. (2001). Perinuclear, perigranular and sub-plasmalemmal mitochondria have distinct functions in the regulation of cellular calcium transport. *EMBO J* 20, 1863-1874.
- Paschen, S.A., Waizenegger, T., Stan, T., Preuss, M., Cyrklaff, M., Hell, K., Rapaport, D., and Neupert, W. (2003). Evolutionary conservation of biogenesis of beta-barrel membrane proteins. *Nature* 426, 862-866.
- Pavlova, L.V., Gossringer, M., Weber, C., Buzet, A., Rossmann, W., and Hartmann, R.K. (2012). tRNA processing by protein-only versus RNA-based RNase P: kinetic analysis reveals mechanistic differences. *Chembiochem* 13, 2270-2276.
- Peixoto, P.M., Grana, F., Roy, T.J., Dunn, C.D., Flores, M., Jensen, R.E., and Campo, M.L. (2007). Awakening TIM22, a dynamic ligand-gated channel for protein insertion in the mitochondrial inner membrane. *J Biol Chem* 282, 18694-18701.
- Pfanner, N., and Geissler, A. (2001). Versatility of the mitochondrial protein import machinery. *Nat Rev Mol Cell Biol* 2, 339-349.
- Pham, X.H., Farge, G., Shi, Y., Gaspari, M., Gustafsson, C.M., and Falkenberg, M. (2006). Conserved sequence box II directs transcription termination and primer formation in mitochondria. *J Biol Chem* 281, 24647-24652.
- Pinz, K.G., and Bogenhagen, D.F. (2000). Characterization of a catalytically slow AP lyase activity in DNA polymerase gamma and other family A DNA polymerases. *J Biol Chem* 275, 12509-12514.
- Pohjoismaki, J.L., Holmes, J.B., Wood, S.R., Yang, M.Y., Yasukawa, T., Reyes, A., Bailey, L.J., Cluett, T.J., Goffart, S., Willcox, S., *et al.* (2010). Mammalian mitochondrial DNA replication intermediates are essentially duplex but contain extensive tracts of RNA/DNA hybrid. *J Mol Biol* 397, 1144-1155.
- Popov-Celeketic, J., Waizenegger, T., and Rapaport, D. (2008). Mim1 functions in an oligomeric form to facilitate the integration of Tom20 into the mitochondrial outer membrane. *J Mol Biol* 376, 671-680.
- Portnoy, V., Palnizky, G., Yehudai-Resheff, S., Glaser, F., and Schuster, G. (2008). Analysis of the human polynucleotide phosphorylase (PNPase) reveals differences in RNA binding and response to phosphate compared to its bacterial and chloroplast counterparts. *RNA* 14, 297-309.

- Prieto-Martin, A., Montoya, J., and Martinez-Azorin, F. (2001). A study on the human mitochondrial RNA polymerase activity points to existence of a transcription factor B-like protein. *FEBS Lett* 503, 51-55.
- Puranam, R.S., and Attardi, G. (2001). The RNase P associated with HeLa cell mitochondria contains an essential RNA component identical in sequence to that of the nuclear RNase P. *Mol Cell Biol* 21, 548-561.
- Pusnik, M., Charriere, F., Maser, P., Waller, R.F., Dagley, M.J., Lithgow, T., and Schneider, A. (2009). The single mitochondrial porin of *Trypanosoma brucei* is the main metabolite transporter in the outer mitochondrial membrane. *Mol Biol Evol* 26, 671-680.
- Rainey, R.N., Glavin, J.D., Chen, H.W., French, S.W., Teitell, M.A., and Koehler, C.M. (2006). A new function in translocation for the mitochondrial i-AAA protease Yme1: import of polynucleotide phosphorylase into the intermembrane space. *Mol Cell Biol* 26, 8488-8497.
- Ray, R., and Miller, D.M. (1991). Cloning and characterization of a human c-myc promoter-binding protein. *Mol Cell Biol* 11, 2154-2161.
- Rehling, P., Model, K., Brandner, K., Kovermann, P., Sickmann, A., Meyer, H.E., Kuhlbrandt, W., Wagner, R., Truscott, K.N., and Pfanner, N. (2003). Protein insertion into the mitochondrial inner membrane by a twin-pore translocase. *Science* 299, 1747-1751.
- Richter, C., Park, J.W., and Ames, B.N. (1988). Normal oxidative damage to mitochondrial and nuclear DNA is extensive. *Proc Natl Acad Sci U S A* 85, 6465-6467.
- Rinehart, J., Krett, B., Rubio, M.A., Alfonzo, J.D., and Soll, D. (2005). *Saccharomyces cerevisiae* imports the cytosolic pathway for Gln-tRNA synthesis into the mitochondrion. *Genes Dev* 19, 583-592.
- Roise, D., Horvath, S.J., Tomich, J.M., Richards, J.H., and Schatz, G. (1986). A chemically synthesized pre-sequence of an imported mitochondrial protein can form an amphiphilic helix and perturb natural and artificial phospholipid bilayers. *EMBO J* 5, 1327-1334.
- Rorbach, J., Richter, R., Wessels, H.J., Wydro, M., Pekalski, M., Farhoud, M., Kuhl, I., Gaisne, M., Bonnefoy, N., Smeitink, J.A., *et al.* (2008). The human mitochondrial ribosome recycling factor is essential for cell viability. *Nucleic Acids Res* 36, 5787-5799.
- Rossmannith, W., Tullo, A., Potuschak, T., Karwan, R., and Sbisà, E. (1995). Human mitochondrial tRNA processing. *J Biol Chem* 270, 12885-12891.
- Rubio, M.A., and Hopper, A.K. (2011). Transfer RNA travels from the cytoplasm to organelles. *Wiley Interdiscip Rev RNA* 2, 802-817.
- Rubio, M.A., Liu, X., Yuzawa, H., Alfonzo, J.D., and Simpson, L. (2000). Selective importation of RNA into isolated mitochondria from *Leishmania tarentolae*. *RNA* 6, 988-1003.

- Rubio, M.A., Rinehart, J.J., Krett, B., Duvezin-Caubet, S., Reichert, A.S., Soll, D., and Alfonzo, J.D. (2008). Mammalian mitochondria have the innate ability to import tRNAs by a mechanism distinct from protein import. *Proc Natl Acad Sci U S A* *105*, 9186-9191.
- Ruhanen, H., Borrie, S., Szabadkai, G., Tyynismaa, H., Jones, A.W., Kang, D., Taanman, J.W., and Yasukawa, T. (2010). Mitochondrial single-stranded DNA binding protein is required for maintenance of mitochondrial DNA and 7S DNA but is not required for mitochondrial nucleoid organisation. *Biochim Biophys Acta* *1803*, 931-939.
- Rusconi, C.P., and Cech, T.R. (1996). The anticodon is the signal sequence for mitochondrial import of glutamine tRNA in *Tetrahymena*. *Genes Dev* *10*, 2870-2880.
- Saitoh, T., Igura, M., Obita, T., Ose, T., Kojima, R., Maenaka, K., Endo, T., and Kohda, D. (2007). Tom20 recognizes mitochondrial presequences through dynamic equilibrium among multiple bound states. *EMBO J* *26*, 4777-4787.
- Salinas, T., Duchene, A.M., Delage, L., Nilsson, S., Glaser, E., Zaepfel, M., and Marechal-Drouard, L. (2006). The voltage-dependent anion channel, a major component of the tRNA import machinery in plant mitochondria. *Proc Natl Acad Sci U S A* *103*, 18362-18367.
- Salinas, T., Duchene, A.M., and Marechal-Drouard, L. (2008). Recent advances in tRNA mitochondrial import. *Trends Biochem Sci* *33*, 320-329.
- Salinas, T., Schaeffer, C., Marechal-Drouard, L., and Duchene, A.M. (2005). Sequence dependence of tRNA(Gly) import into tobacco mitochondria. *Biochimie* *87*, 863-872.
- Schekman, R. (2010). Editorial expression of concern for Choi et al., Use of combinatorial genetic libraries to humanize N-linked glycosylation in the yeast *Pichia pastoris*. *Proc Natl Acad Sci U S A* *107*, 7113.
- Schmidt, O., Pfanner, N., and Meisinger, C. Mitochondrial protein import: from proteomics to functional mechanisms. *Nat Rev Mol Cell Biol* *11*, 655-667.
- Schmidt, O., Pfanner, N., and Meisinger, C. (2010). Mitochondrial protein import: from proteomics to functional mechanisms. *Nat Rev Mol Cell Biol* *11*, 655-667.
- Schneider, A. (2001). Unique aspects of mitochondrial biogenesis in trypanosomatids. *Int J Parasitol* *31*, 1403-1415.
- Schneider, A. (2011). Mitochondrial tRNA import and its consequences for mitochondrial translation. *Annu Rev Biochem* *80*, 1033-1053.
- Schneider, H.C., Westermann, B., Neupert, W., and Brunner, M. (1996). The nucleotide exchange factor MGE exerts a key function in the ATP-dependent cycle of mt-Hsp70-Tim44 interaction driving mitochondrial protein import. *EMBO J* *15*, 5796-5803.
- Sepuri, N.B., Gorla, M., and King, M.P. (2012). Mitochondrial lysyl-tRNA synthetase independent import of tRNA lysine into yeast mitochondria. *PLoS One* *7*, e35321.

- Shadel, G.S., and Clayton, D.A. (1997). Mitochondrial DNA maintenance in vertebrates. *Annu Rev Biochem* 66, 409-435.
- Sherrer, R.L., Yermovsky-Kammerer, A.E., and Hajduk, S.L. (2003). A sequence motif within trypanosome precursor tRNAs influences abundance and mitochondrial localization. *Mol Cell Biol* 23, 9061-9072.
- Shmookler Reis, R.J., and Goldstein, S. (1983). Mitochondrial DNA in mortal and immortal human cells. Genome number, integrity, and methylation. *J Biol Chem* 258, 9078-9085.
- Shoubridge, E.A. (2000). Mitochondrial DNA segregation in the developing embryo. *Hum Reprod* 15 Suppl 2, 229-234.
- Shutt, T.E., and Gray, M.W. (2006). Twinkle, the mitochondrial replicative DNA helicase, is widespread in the eukaryotic radiation and may also be the mitochondrial DNA primase in most eukaryotes. *J Mol Evol* 62, 588-599.
- Sickmann, A., Reinders, J., Wagner, Y., Joppich, C., Zahedi, R., Meyer, H.E., Schonfisch, B., Perschil, I., Chacinska, A., Guiard, B., *et al.* (2003). The proteome of *Saccharomyces cerevisiae* mitochondria. *Proc Natl Acad Sci U S A* 100, 13207-13212.
- Sideris, D.P., Petrakis, N., Katrakili, N., Mikropoulou, D., Gallo, A., Ciofi-Baffoni, S., Banci, L., Bertini, I., and Tokatlidis, K. (2009). A novel intermembrane space-targeting signal docks cysteines onto Mia40 during mitochondrial oxidative folding. *J Cell Biol* 187, 1007-1022.
- Simpson, A.M., Suyama, Y., Dewes, H., Campbell, D.A., and Simpson, L. (1989). Kinetoplastid mitochondria contain functional tRNAs which are encoded in nuclear DNA and also contain small minicircle and maxicircle transcripts of unknown function. *Nucleic Acids Res* 17, 5427-5445.
- Sirrenberg, C., Bauer, M.F., Guiard, B., Neupert, W., and Brunner, M. (1996). Import of carrier proteins into the mitochondrial inner membrane mediated by Tim22. *Nature* 384, 582-585.
- Sjostrand, F.S. (1953). Electron microscopy of mitochondria and cytoplasmic double membranes. *Nature* 171, 30-32.
- Slomovic, S., and Schuster, G. (2008). Stable PNPase RNAi silencing: its effect on the processing and adenylation of human mitochondrial RNA. *RNA* 14, 310-323.
- Smirnov, A., Comte, C., Mager-Heckel, A.M., Addis, V., Krasheninnikov, I.A., Martin, R.P., Entelis, N., and Tarassov, I. (2010a). Mitochondrial enzyme rhodanese is essential for 5 S ribosomal RNA import into human mitochondria. *J Biol Chem* 285, 30792-30803.
- Smirnov, A., Comte, C., Mager-Heckel, A.M., Addis, V., Krasheninnikov, I.A., Martin, R.P., Entelis, N., and Tarassov, I. (2010b). Mitochondrial enzyme rhodanese is essential for 5 S ribosomal RNA import into human mitochondria. *The Journal of biological chemistry* 285, 30792-30803.

- Smirnov, A., Entelis, N., Martin, R.P., and Tarassov, I. (2011a). Biological significance of 5S rRNA import into human mitochondria: role of ribosomal protein MRP-L18. *Genes & development* 25, 1289-1305.
- Smirnov, A., Entelis, N., Martin, R.P., and Tarassov, I. (2011b). Biological significance of 5S rRNA import into human mitochondria: role of ribosomal protein MRP-L18. *Genes Dev* 25, 1289-1305.
- Smirnov, A., Tarassov, I., Mager-Heckel, A.M., Letzelter, M., Martin, R.P., Krasheninnikov, I.A., and Entelis, N. (2008). Two distinct structural elements of 5S rRNA are needed for its import into human mitochondria. *RNA* 14, 749-759.
- Smits, P., Smeitink, J., and van den Heuvel, L. Mitochondrial translation and beyond: processes implicated in combined oxidative phosphorylation deficiencies. *J Biomed Biotechnol* 2010, 737385.
- Smits, P., Smeitink, J., and van den Heuvel, L. (2010). Mitochondrial translation and beyond: processes implicated in combined oxidative phosphorylation deficiencies. *J Biomed Biotechnol* 2010, 737385.
- Smits, P., Smeitink, J.A., van den Heuvel, L.P., Huynen, M.A., and Ettema, T.J. (2007). Reconstructing the evolution of the mitochondrial ribosomal proteome. *Nucleic Acids Res* 35, 4686-4703.
- Spelbrink, J.N., Li, F.Y., Tiranti, V., Nikali, K., Yuan, Q.P., Tariq, M., Wanrooij, S., Garrido, N., Comi, G., Morandi, L., *et al.* (2001). Human mitochondrial DNA deletions associated with mutations in the gene encoding Twinkle, a phage T7 gene 4-like protein localized in mitochondria. *Nat Genet* 28, 223-231.
- Sprengli, L.L., Coursey, A., Navratil, T., and Hunter, S.E. (2004). Initiation and elongation factors in mammalian mitochondrial protein biosynthesis. *Prog Nucleic Acid Res Mol Biol* 77, 211-261.
- Sprinzi, M., and Vassilenko, K.S. (2005). Compilation of tRNA sequences and sequences of tRNA genes. *Nucleic Acids Res* 33, D139-140.
- Stojanovski, D., Guiard, B., Kozjak-Pavlovic, V., Pfanner, N., and Meisinger, C. (2007). Alternative function for the mitochondrial SAM complex in biogenesis of alpha-helical TOM proteins. *J Cell Biol* 179, 881-893.
- Suyama, Y. (1967). The origins of mitochondrial ribonucleic acids in *Tetrahymena pyriformis*. *Biochemistry* 6, 2829-2839.
- Suyama, Y., Wong, S., and Campbell, D.A. (1998). Regulated tRNA import in *Leishmania* mitochondria. *Biochim Biophys Acta* 1396, 138-142.
- Symmons, M.F., Jones, G.H., and Luisi, B.F. (2000). A duplicated fold is the structural basis for polynucleotide phosphorylase catalytic activity, processivity, and regulation. *Structure* 8, 1215-1226.

- Tamura, Y., Harada, Y., Shiota, T., Yamano, K., Watanabe, K., Yokota, M., Yamamoto, H., Sesaki, H., and Endo, T. (2009). Tim23-Tim50 pair coordinates functions of translocators and motor proteins in mitochondrial protein import. *J Cell Biol* 184, 129-141.
- Tan, T.H., Bochud-Allemann, N., Horn, E.K., and Schneider, A. (2002a). Eukaryotic-type elongator tRNA^{Met} of *Trypanosoma brucei* becomes formylated after import into mitochondria. *Proc Natl Acad Sci U S A* 99, 1152-1157.
- Tan, T.H., Pach, R., Crausaz, A., Ivens, A., and Schneider, A. (2002b). tRNAs in *Trypanosoma brucei*: genomic organization, expression, and mitochondrial import. *Mol Cell Biol* 22, 3707-3717.
- Tapper, D.P., and Clayton, D.A. (1981). Mechanism of replication of human mitochondrial DNA. Localization of the 5' ends of nascent daughter strands. *J Biol Chem* 256, 5109-5115.
- Tarassov, I., Entelis, N., and Martin, R.P. (1995a). An intact protein translocating machinery is required for mitochondrial import of a yeast cytoplasmic tRNA. *J Mol Biol* 245, 315-323.
- Tarassov, I., Entelis, N., and Martin, R.P. (1995b). Mitochondrial import of a cytoplasmic lysine-tRNA in yeast is mediated by cooperation of cytoplasmic and mitochondrial lysyl-tRNA synthetases. *EMBO J* 14, 3461-3471.
- Taylor, A.B., Smith, B.S., Kitada, S., Kojima, K., Miyaura, H., Otwinowski, Z., Ito, A., and Deisenhofer, J. (2001). Crystal structures of mitochondrial processing peptidase reveal the mode for specific cleavage of import signal sequences. *Structure* 9, 615-625.
- Temperley, R., Richter, R., Dennerlein, S., Lightowers, R.N., and Chrzanowska-Lightowers, Z.M. (2010). Hungry codons promote frameshifting in human mitochondrial ribosomes. *Science* 327, 301.
- Tiranti, V., Barat-Gueride, B., Bijl, J., DiDonato, S., and Zeviani, M. (1991). A full-length cDNA encoding a mitochondrial DNA-specific single-stranded DNA binding protein from *Xenopus laevis*. *Nucleic Acids Res* 19, 4291.
- Tiranti, V., Rocchi, M., DiDonato, S., and Zeviani, M. (1993). Cloning of human and rat cDNAs encoding the mitochondrial single-stranded DNA-binding protein (SSB). *Gene* 126, 219-225.
- Tiranti, V., Savoia, A., Forti, F., D'Apolito, M.F., Centra, M., Rocchi, M., and Zeviani, M. (1997). Identification of the gene encoding the human mitochondrial RNA polymerase (h-mtRPOL) by cyberscreening of the Expressed Sequence Tags database. *Hum Mol Genet* 6, 615-625.
- Tolkunova, E., Park, H., Xia, J., King, M.P., and Davidson, E. (2000). The human lysyl-tRNA synthetase gene encodes both the cytoplasmic and mitochondrial enzymes by means of an unusual alternative splicing of the primary transcript. *J Biol Chem* 275, 35063-35069.
- Tomecki, R., Dmochowska, A., Gewartowski, K., Dziembowski, A., and Stepien, P.P. (2004). Identification of a novel human nuclear-encoded mitochondrial poly(A) polymerase. *Nucleic Acids Res* 32, 6001-6014.

- Topper, J.N., Bennett, J.L., and Clayton, D.A. (1992). A role for RNAase MRP in mitochondrial RNA processing. *Cell* 70, 16-20.
- Topper, J.N., and Clayton, D.A. (1990). Characterization of human MRP/Th RNA and its nuclear gene: full length MRP/Th RNA is an active endoribonuclease when assembled as an RNP. *Nucleic Acids Res* 18, 793-799.
- Truscott, K.N., Kovermann, P., Geissler, A., Merlin, A., Meijer, M., Driessen, A.J., Rassow, J., Pfanner, N., and Wagner, R. (2001). A presequence- and voltage-sensitive channel of the mitochondrial preprotein translocase formed by Tim23. *Nat Struct Biol* 8, 1074-1082.
- Tschopp, F., Charriere, F., and Schneider, A. (2011). In vivo study in *Trypanosoma brucei* links mitochondrial transfer RNA import to mitochondrial protein import. *EMBO Rep* 12, 825-832.
- Tsuboi, M., Morita, H., Nozaki, Y., Akama, K., Ueda, T., Ito, K., Nierhaus, K.H., and Takeuchi, N. (2009). EF-G2mt is an exclusive recycling factor in mammalian mitochondrial protein synthesis. *Mol Cell* 35, 502-510.
- van der Laan, M., Meinecke, M., Dudek, J., Hutu, D.P., Lind, M., Perschil, I., Guiard, B., Wagner, R., Pfanner, N., and Rehling, P. (2007). Motor-free mitochondrial presequence translocase drives membrane integration of preproteins. *Nat Cell Biol* 9, 1152-1159.
- van der Laan, M., Wiedemann, N., Mick, D.U., Guiard, B., Rehling, P., and Pfanner, N. (2006). A role for Tim21 in membrane-potential-dependent preprotein sorting in mitochondria. *Curr Biol* 16, 2271-2276.
- van Wilpe, S., Ryan, M.T., Hill, K., Maarse, A.C., Meisinger, C., Brix, J., Dekker, P.J., Moczko, M., Wagner, R., Meijer, M., *et al.* (1999). Tom22 is a multifunctional organizer of the mitochondrial preprotein translocase. *Nature* 401, 485-489.
- von Ameln, S., Wang, G., Boulouiz, R., Rutherford, M.A., Smith, G.M., Li, Y., Pogoda, H.M., Nurnberg, G., Stiller, B., Volk, A.E., *et al.* (2012). A mutation in PNPT1, encoding mitochondrial-RNA-import protein PNPase, causes hereditary hearing loss. *Am J Hum Genet* 91, 919-927.
- Wagner, K., Gebert, N., Guiard, B., Brandner, K., Truscott, K.N., Wiedemann, N., Pfanner, N., and Rehling, P. (2008). The assembly pathway of the mitochondrial carrier translocase involves four preprotein translocases. *Mol Cell Biol* 28, 4251-4260.
- Walberg, M.W., and Clayton, D.A. (1983). In vitro transcription of human mitochondrial DNA. Identification of specific light strand transcripts from the displacement loop region. *J Biol Chem* 258, 1268-1275.
- Wallace, D.C. (1999). Mitochondrial diseases in man and mouse. *Science* 283, 1482-1488.
- Wang, G., Chen, H.W., Oktay, Y., Zhang, J., Allen, E.L., Smith, G.M., Fan, K.C., Hong, J.S., French, S.W., McCaffery, J.M., *et al.* (2010). PNPASE regulates RNA import into mitochondria. *Cell* 142, 456-467.

- Wang, G., Shimada, E., Koehler, C.M., and Teitell, M.A. (2012a). PNPASE and RNA trafficking into mitochondria. *Biochim Biophys Acta* 1819, 998-1007.
- Wang, G., Shimada, E., Zhang, J., Hong, J.S., Smith, G.M., Teitell, M.A., and Koehler, C.M. (2012b). Correcting human mitochondrial mutations with targeted RNA import. *Proc Natl Acad Sci U S A* 109, 4840-4845.
- Wang, J.C. (2002). Cellular roles of DNA topoisomerases: a molecular perspective. *Nat Rev Mol Cell Biol* 3, 430-440.
- Wang, X.Y., Cao, L., Liang, H.W., Li, Z., and Zou, G.W. Mitochondrial genome of the Shorthead catfish (*Pelteobagrus eupogon*). *Mitochondrial DNA* 24, 1-2.
- Wanrooij, P.H., Uhler, J.P., Simonsson, T., Falkenberg, M., and Gustafsson, C.M. (2010). G-quadruplex structures in RNA stimulate mitochondrial transcription termination and primer formation. *Proc Natl Acad Sci U S A* 107, 16072-16077.
- Wanrooij, S., and Falkenberg, M. (2010). The human mitochondrial replication fork in health and disease. *Biochim Biophys Acta* 1797, 1378-1388.
- Weber-Lotfi, F., Ibrahim, N., Boesch, P., Cosset, A., Konstantinov, Y., Lightowlers, R.N., and Dietrich, A. (2009). Developing a genetic approach to investigate the mechanism of mitochondrial competence for DNA import. *Biochim Biophys Acta* 1787, 320-327.
- Wenz, T., Luca, C., Torraco, A., and Moraes, C.T. (2009). mTERF2 regulates oxidative phosphorylation by modulating mtDNA transcription. *Cell Metab* 9, 499-511.
- Wiedemann, N., Kozjak, V., Chacinska, A., Schonfisch, B., Rospert, S., Ryan, M.T., Pfanner, N., and Meisinger, C. (2003). Machinery for protein sorting and assembly in the mitochondrial outer membrane. *Nature* 424, 565-571.
- Wiedemann, N., Truscott, K.N., Pfannschmidt, S., Guiard, B., Meisinger, C., and Pfanner, N. (2004). Biogenesis of the protein import channel Tom40 of the mitochondrial outer membrane: intermembrane space components are involved in an early stage of the assembly pathway. *J Biol Chem* 279, 18188-18194.
- Wong, T.W., and Clayton, D.A. (1986). DNA primase of human mitochondria is associated with structural RNA that is essential for enzymatic activity. *Cell* 45, 817-825.
- Woriac, V.L., Bullard, J.M., Ma, L., Yokogawa, T., and Spremulli, L.L. (1997). Mechanistic studies of the translational elongation cycle in mammalian mitochondria. *Biochim Biophys Acta* 1352, 91-101.
- Xin, H., Woriac, V., Burkhart, W., and Spremulli, L.L. (1995). Cloning and expression of mitochondrial translational elongation factor Ts from bovine and human liver. *J Biol Chem* 270, 17243-17249.

- Yakubovskaya, E., Mejia, E., Byrnes, J., Hambardjiev, E., and Garcia-Diaz, M. (2010). Helix unwinding and base flipping enable human MTERF1 to terminate mitochondrial transcription. *Cell* *141*, 982-993.
- Yamamoto, H., Esaki, M., Kanamori, T., Tamura, Y., Nishikawa, S., and Endo, T. (2002). Tim50 is a subunit of the TIM23 complex that links protein translocation across the outer and inner mitochondrial membranes. *Cell* *111*, 519-528.
- Yamano, K., Yatsukawa, Y., Esaki, M., Hobbs, A.E., Jensen, R.E., and Endo, T. (2008). Tom20 and Tom22 share the common signal recognition pathway in mitochondrial protein import. *J Biol Chem* *283*, 3799-3807.
- Yang, M.Y., Bowmaker, M., Reyes, A., Vergani, L., Angeli, P., Gringeri, E., Jacobs, H.T., and Holt, I.J. (2002). Biased incorporation of ribonucleotides on the mitochondrial L-strand accounts for apparent strand-asymmetric DNA replication. *Cell* *111*, 495-505.
- Yasukawa, T., Reyes, A., Cluett, T.J., Yang, M.Y., Bowmaker, M., Jacobs, H.T., and Holt, I.J. (2006). Replication of vertebrate mitochondrial DNA entails transient ribonucleotide incorporation throughout the lagging strand. *EMBO J* *25*, 5358-5371.
- Yasukawa, T., Yang, M.Y., Jacobs, H.T., and Holt, I.J. (2005). A bidirectional origin of replication maps to the major noncoding region of human mitochondrial DNA. *Mol Cell* *18*, 651-662.
- Yehudai-Resheff, S., Hirsh, M., and Schuster, G. (2001). Polynucleotide phosphorylase functions as both an exonuclease and a poly(A) polymerase in spinach chloroplasts. *Mol Cell Biol* *21*, 5408-5416.
- Yermovsky-Kammerer, A.E., and Hajduk, S.L. (1999). In vitro import of a nuclear encoded tRNA into the mitochondrion of *Trypanosoma brucei*. *Mol Cell Biol* *19*, 6253-6259.
- Yoshionari, S., Koike, T., Yokogawa, T., Nishikawa, K., Ueda, T., Miura, K., and Watanabe, K. (1994). Existence of nuclear-encoded 5S-rRNA in bovine mitochondria. *FEBS Lett* *338*, 137-142.
- Young, J.C., Hoogenraad, N.J., and Hartl, F.U. (2003). Molecular chaperones Hsp90 and Hsp70 deliver preproteins to the mitochondrial import receptor Tom70. *Cell* *112*, 41-50.
- Yu, Y.L., Chou, R.H., Wu, C.H., Wang, Y.N., Chang, W.J., Tseng, Y.J., Chang, W.C., Lai, C.C., Lee, H.J., Huo, L., *et al.* (2012). Nuclear EGFR suppresses ribonuclease activity of polynucleotide phosphorylase through DNAPK-mediated phosphorylation at serine 776. *J Biol Chem* *287*, 31015-31026.
- Zhang, H., Barcelo, J.M., Lee, B., Kohlhagen, G., Zimonjic, D.B., Popescu, N.C., and Pommier, Y. (2001). Human mitochondrial topoisomerase I. *Proc Natl Acad Sci U S A* *98*, 10608-10613.
- Ziebarth, T.D., Farr, C.L., and Kaguni, L.S. (2007). Modular architecture of the hexameric human mitochondrial DNA helicase. *J Mol Biol* *367*, 1382-1391.

Zollo, O., Tiranti, V., and Sondheimer, N. (2012). Transcriptional requirements of the distal heavy-strand promoter of mtDNA. *Proc Natl Acad Sci U S A* *109*, 6508-6512.

RÉSUMÉ DU THÈSE



UNIVERSITE DE STRASBOURG

RESUME DE LA THESE DE DOCTORAT

Discipline : Science du Vivent**Spécialité** : Aspects Moléculaire et Cellulaires de la Biologie**Présentée par** : Gowher Ali**Titre**: Characterization of proteins involved in RNA targeting into human mitochondria**Unité de Recherche** : UMR 7156, Université du Strasbourg-CNRS, France.
«Génétique Moléculaire, Génomique, Microbiologie»**Directeur de Thèse** : Ivan Tarassov**Localisation** : Doctorat de l'Université de Strasbourg (Strasbourg, France)**ECOLES DOCTORALES :**

<input type="checkbox"/> ED - Sciences de l'Homme et des sociétés <input type="checkbox"/> ED 99 – Humanités <input type="checkbox"/> ED 101 – Droit, sciences politique et histoire <input type="checkbox"/> ED 182 – Physique et chimie physique <input type="checkbox"/> ED 221 – Augustin Cournot <input type="checkbox"/> ED 222 - Sciences chimiques	<input type="checkbox"/> ED 269 - Mathématiques, sciences de l'information et de l'ingénieur <input type="checkbox"/> ED 270 – Théologie et sciences religieuses <input type="checkbox"/> ED 413 – Sciences de la terre, de l'univers et de l'environnement <input checked="" type="checkbox"/> ED 414 – Sciences de la vie et de la santé
---	---

Introduction et objectifs

L'adressage mitochondrial de l'ARN ("importation d'ARN) chez les eucaryotes est essentiel pour la biogenèse mitochondriale et donc la viabilité des cellules. La majorité des ARN importés dans les mitochondries sont des ARN de transfert (ARNt). D'autres petits ARN non codants, comme ARNr 5S, les microARN et les composants ARN de la RNase P et RNase MRP ont également été montré pour être encodée dans l'ADN nucléaire et ciblées dans la matrice mitochondriale. Les mécanismes de l'importation diffèrent dans différents organismes, même entre des espèces étroitement apparentées. L'importation d'ARN implique des protéines qui participent à chaque étape du ciblage mitochondrial: adressage ou translocation à travers les membranes mitochondriales. Chez les mammifères, l'ARNr 5S cytosolique a été documenté pour être en partie importé dans les mitochondries. Le précurseur cytosolique de MRP-L18 et la rhodanèse sont employées dans une chaîne moléculaire, qui permet un adressage spécifique et efficace des molécules d'ARNr 5S dans les mitochondries (Smirnov et al., 2010, 2011). Récemment, il a été montré que la polynucléotide phosphorylase (PNPase) localisée dans l'espace inter-membranaire mitochondrial est impliquée dans la translocation des ARN dans la matrice (Wang et al., 2010). Chez la levure *Saccharomyces cerevisiae*, une partie de l'ARNt^{Lys}_{CUU} (TRK1) cytosolique peut être spécifiquement reconnu par l'une des deux isoformes de l'enzyme glycolytique énoïase, Eno2p. Le complexe ARNt-énoïase est ensuite ciblé vers la surface mitochondriale, où TRK1 est repris par le précurseur de l'aminocyl-ARNt synthétase mitochondriale, preMSK1p, qui sert de cargo pour la translocation de TRK1 dans la matrice mitochondriale. Pour essayer de comprendre les déterminants des importations en TRK1, l'expérience SELEX a été menée. Un ensemble de petits ARN issus de TRK1 avec une très haute efficacité de l'importation dans la mitochondrie a été ainsi généré. En outre, il a été constaté que les transcrits de synthèse basés sur la séquence de TRK1 et un certain nombre de leurs dérivés destinés à des applications thérapeutiques pourraient être spécifiquement internalisés par les mitochondries humaines *in vitro* et *in vivo*, ce qui indique que la cellule humaine possède l'appareil moléculaire nécessaire pour l'importation d'ARNt. Il a été suggéré que le précurseur cytosolique de l'homme mitochondrial synthétase lysyl-ARNt (preKARS2) pourrait remplacer preMSK1p et servir comme cargo pour l'importation de Trk1 et de leurs dérivés dans la matrice mitochondriale (Sepuri et al., 2012).

Dans la continuation de ces études, le projet de mon travail de thèse était d'étudier les facteurs protéiques qui participent à l'adressage et la translocation des l'ARN dans les mitochondries humaines in vitro et in vivo.

Les principaux objectifs étaient les suivants:

1. étudier l'affinité de preKARS2 recombinant à TRK1 and ses dérivés "thérapeutiques";
2. étudier le rôle de preKARS2 dans le processus d'adressage de TRK1 et de ses dérivés vers les mitochondries in vitro et in vivo dans des lignées cellulaires humaines cultivées;
3. étudier le rôle de l'homme dans PNPase translocation des différents ARN à partir de l'espace inter dans la matrice mitochondriale;
4. étudier le rôle des différentes isoformes de l'enolase humaine dans le processus d'adressage mitochondrial d'ARN dans les cellules humaines.

Résultats

PreKARS2 lie les molécules d'ARN importables basées sur la séquence de TRK1

Pour étudier le rôle de preKARS2 dans le ciblage de Trk1 et leurs dérivés vers les mitochondries, nous avons d'abord analysé l'interaction entre preKARS2 recombinant avec le transcrite T7 de TRK1 utilisant l'approche de décalage de l'électromobilité (EMSA). Le Kd apparent du complexe a été estimée à 300 ± 50 nM, ce qui est comparable à celui avec son homologue de levure, preMSK1p. La forme mature mitochondriale KARS2 dépourvu de la séquence de ciblage mitochondrial n'était pas en mesure d'interagir avec TRK1. Les molécules nommées comme FD-L et FD-H, contenant les bras D et F de TRK1 réorganisés en épingle à cheveux et séparés par des séquences à vocation thérapeutique (Comte et al., Nucleic Acids Res, 2013), ont été également capables de former des complexes avec preKARS2 avec un Kd apparent inférieur mais encore important, de 400 ± 50 nM. L'interaction de ces ARN avec preKARS2 a également été vérifié par l'analyse North-Western. Nous avons constaté que ces ARN interagissent spécifiquement avec preKARS2 et leur interaction diminuait en présence d'ARN compétiteur spécifique, alors qu'aucune diminution interaction n'a été observée lorsque ARNr 5S a été utilisé en tant que concurrent non spécifique. Petits ARN tronqués HF et l'ARN HD provenant de FD-L ARN manquant soit le bras D, soit le bras F de TRK1 n'étaient pas en

mesure d'interagir avec preKARS2, indiquant l'importance de la présence simultanée de deux structure en épingle (D et F) pour se lier à la preKARS2.

PreKARS2 peut diriger l'importation d'ARN dans les mitochondries humaines isolées

Auparavant, il a été suggéré que preKARS2 pourrait remplacer preMSK1p et servir comme cargo pour l'importation de TRK1 et de leurs dérivés dans la matrice mitochondriale de levure. Pour le démontrer dans le système de cellules humaines, l'essai d'importation in vitro a été d'abord réalisé en incubant preKARS2 et ARN avec des mitochondries isolées à partir de cellules HepG2 humaines. Les résultats obtenus montrent que, en l'absence de facteurs protéiques, des mitochondries purifiées n'étaient pas en mesure d'internaliser TRK1 externe. Ajout de preKARS2 recombinant, résulte protection d'une partie de TRK1, FD-L et FD-H ARN de digestion à la nucléase, indiquant leur importation dans les mitochondries. La quantité d'ARN importés augmentait lors de l'ajout de l'énolase de lapin ou de la levure en combinaison avec preKARS2. Ce fut en accord avec l'étude précédente dans la levure qui démontre que l'énolase de levure induit des changements conformationnels de TRK1 qui améliorent sa capacité à interagir avec le pré-MSK1p (Entelis et al., Genes & Dev. 2006) et indique que les énolases humaines sont capables du même effet d'ARN-chapéron.

Comme on pouvait prévoir, les molécules d'ARN tronqué HF et HD, qui ne sont pas en mesure d'interagir avec preKARS2, n'ont pas été internalisées par les mitochondries humaines par cette protéine, soit en l'absence ou en présence de l'énolase. Pour vérifier si l'adressage mitochondrial des ARN tronqués était encore tributaire de facteurs protéiques, nous avons isolé les extraits protéiques bruts de cellules HepG2, fractionné par filtration sur gel et testé les principales fractions, chacune représentant un mélange de plusieurs protéines, pour leur capacité à diriger l'ARN dans les mitochondries humaines isolées. Nous avons détecté une importation efficace des deux ARN tronqués en présence d'une fraction protéique dépourvue de preKARS2, démontrant ainsi que l'importation mitochondriale des molécules tronquées est dépendante de facteurs protéiques autres que preKARS2.

PreKARS2 implication dans l'ARN mitochondrial importation in vivo

Pour étudier le rôle de preKARS2 dans le processus d'importation d'ARN dans les mitochondries, les essais d'importation in vivo ont été réalisés dans les conditions de la régulation négative de preKARS2 par les siARN. Les cellules HepG2 dans un état de répression

d'expression de preKARS2 ont été transfectées avec les ARN importés les ARN isolés à partir de cellules entières ou des mitochondries purifiées ont été analysées par lhybridation. Comparé à l'importation mitochondriale ARN dans les cellules témoins, nous avons constaté une baisse de 2 fois d'importation de TRK1 et une diminution de 2,5 à 3 fois de FD-L et FD-H dans les mitochondries des cellules ou preKARS2 a été réprimée.

Nous avons ensuite testé le rôle de preKARS2 comme facteur d'importation mitochondrial de TRK1 et de ses dérivés dans les cellule surexprimant preKARS2. Pour cela, les cellules Tet-off HeLa ont été transfectées de façon transitoire avec plasmide exprimant preKARS2 et 48h après la transfection, une augmentation d'un facteur 2-3 a en effet été observée. Les cellules surexprimant preKARS2 ont été transfectées avec TRK1, FD-L et l'ARN FD-H et les ARN mitochondriaux ont été analysé par hybridation Northern. Comparé au contrôle des cellules transfectées avec un vecteur vide, une augmentation de 2 fois de l'import mitochondrial des trois molécules d'ARN a été observée dans les cellules surexprimant preKARS2, confirmant que la quantité de molécules d'ARN dérivant de TRK1 qui pénètrent dans les mitochondries dans les cellules humaines dépend du niveau de protéine preKARS2.

PNPase et ARN translocation dans la matrice

Auparavant, il a été montré que l'ARN H1 de la RNase P et l'ARN de la RNase MRP peuvent interagir avec la polynucléotide phosphorylase (PNPase) et une translocation de l'espace de intermembrane dans la matrice d'une manière dépendante PNPase (Wang et al., 2010). Nous avons étudié l'implication de PNPase dans la translocation de TRK1 et de ses dérivés dans les mitochondries des cellules surexprimant la PNPase. Ces cellules ont été transfectées par TRK1 ou ses dérivés et après 48 heures de transfection, l'ARN mitochondrial a été analysé par hybridation Northern. Comparé au contrôle, une augmentation de 1,8 à 2,7 fois a été observée pour l'importation de TRK1 et de ses dérivés. Les petits ARN HF et HD qui n'ont pas été adressés à la mitochondrie par preKARS2, ont également été importé d'une manière dépendante de PNPase.

Le rôle de PNPase dans le processus d'importation mitochondrial d'ARN a été étudiée ensuite dans les conditions de régulation négative de la protéine. Les cellules HepG2 ont été transitoirement transfectées avec un mélange de deux siARN contre l'ARNm de PNPase. Après 72 heures de transfection, le niveau de PNPase avait diminué de 3-4 fois par rapport à contrôle.

Ces cellules ont été transfectées avec TRK1 ou ses dérivés et l'importation d'ARN a été analysé par hybridation Northern. Par rapport aux témoins, l'importation de tous les ARN testés avait diminué deux fois indiquant l'implication de PNPase dans le processus d'importation de l'ARN dans la matrice mitochondriale.

Impact d'une mutation pathogénique de PNPase sur l'importation d'ARN

Nos collègues de l'hôpital Necker (Paris) ont identifié des mutations pathogéniques dans le gène codant pour la PNPase (PNPT1). Ces mutations ont été à l'origine d'une encéphalopathie. Nous avons donc étudié les conséquences de ces mutations sur l'import mitochondrial d'ARN. Les cellules de fibroblastes humains ayant mutation ponctuelle dans PNPase (Gln387Arg) provoquant une encéphalopathie ont été utilisés pour étudier l'importation des ARNr 5S et RNase MRP dans les mitochondries. La mutation affecte la multimérisation de PNPase comme l'ont indiqué les tests par PAGE native. Une diminution de 2-3 fois d'importation mitochondriale de l'ARNr 5S a été observée dans des fibroblastes des patients comparant à des cellules témoin. Pour modéliser l'effet de la diminution PNPase dans une lignée cellulaire indépendante, nous avons analysé l'importation de l'ARNr 5S dans les cellules HepG2 ou l'expression de RNase MRP a été transitoirement diminuée par les siARN. La diminution de PNPase 3-4 fois a été accompagnée par une diminution de 50-60% de l'ARNr 5S dans les mitochondries.

L'ARNase MRP est une endoribonucléase spécifique au site impliqué dans le clivage de l'amorce ARN lors de la réplication de l'ADN mitochondrial. L'ARN MRP est 265 nt de taille et après son importation PNPase-dépendante dans les mitochondries, est censé au moins partiellement transformé en une molécule de 136 nt contenant une séquence capable d'appariement de bases avec une région de son substrat ARNmt. Nous avons trouvé des quantités similaires de l'ARN MRP entières dans les préparations d'ARN total des deux patients et des cellules témoin. Cependant, les espèces d'ARN résultant de la maturation mitochondriale de la MRP (130-140 nt) ont pu être détecté dans des mitochondries des cellules témoin, mais pas dans les fibroblastes des patients. Nos résultats suggèrent que l'importation mitochondriale d'au moins deux espèces d'ARN indépendantes est fortement affectée par les mutations de PNPT1 affectant son multimérisation.

La mutation de PNPase affecte la traduction mitochondriale

Nous avons ensuite testé l'effet de diminution d'import de l'ARNr 5S dans les cellules de patients contenant les mutations de la PNPase sur la traduction mitochondriale. Incorporation de ³⁵S-méthionine dans les polypeptides mitochondriaux a été significativement diminuée dans les fibroblastes de patients. La diminution a été beaucoup moins prononcée que celle de l'importation ARNr 5S (58% ± 4% contre 30% ± 5%), ce qui suggère que le niveau de l'ARNr 5S résiduel est suffisant pour assurer la traduction mitochondriale. De même, en inhibant l'expression de la PNPase dans les fibroblastes de contrôle par siARN, on peut avoir un effet similaire de traduction. Afin de confirmer que le défaut de la traduction est due à la mutation de la PNPase, nous avons transfectées de façon transitoire des fibroblastes de patients par l'ADNc contenant le gène sauvage PNPT1. Son expression a induit une augmentation de 160% de la bande PNPase 48 heures après la transfection. En outre, une restauration presque complète des taux de synthèse des protéines a été observée dans les mitochondries. Enfin, la surexpression de PNPT1 dans les fibroblastes restaurait le niveau de l'ARNr 5S mitochondrial et celui de la version maturé de l'ARN MRP. Ces résultats démontrent clairement l'effet délétère de la mutation PNPT1 sur la traduction mitochondriale et fournissent première description d'une pathologie directement liée aux troubles ARN importation.

Conclusion

L'étude présentée apporte un soutien fort à notre hypothèse selon laquelle les cellules humaines possèdent un mécanisme d'importation ARNt cryptique qui peut être activée en présence de molécules d'ARN importables. Nous montrons que preKARS2 humain a une affinité pour TRK1 et des molécules d'ARN artificiels contenant des éléments structurels qui déterminent leur import mitochondrial. Ces molécules peuvent être adressées dans les mitochondries isolées de l'homme en présence de preKARS2 et de l'énolase soit de levure, soit de mammifères, démontrant ainsi la similitude avec le système d'importation de levure. Enfin, le rôle de preKARS2 dans le processus d'importation de l'ARN est, pour la première fois, démontré *in vivo*, dans des cellules humaines transfectées par TRK1 ou par ces dérivés à capacité thérapeutique. Nous montrons également que la protéine PNPase localisée dans l'espace intermembranaire mitochondrial facilite l'importation mitochondriale de TRK1 et de ses dérivés dans des cellules humaines. Par ailleurs, nous démontrons que l'importation de l'ARNr 5S et de

l'ARN de la RNase MRP se trouve fortement diminué dans des fibroblastes de patients contenant une mutation ponctuelle pathogène dans le gène codant pour la PNPase.

Perspectives

La cellule humaine possède trois isoformes de enolase qui sont exprimées d'une manière spécifique dans les différents tissus. L'activité d'ARN-chapéron de ces isoformes doit être étudiée in vitro et in vivo dans des cellules humaines en culture. Les facteurs protéiques responsables du ciblage des l'ARN tronqués vers les mitochondries devraient également être identifiés et leur rôle dans l'importation de l'ARN doivent être vérifiées in vitro et in vivo.

La fonction de PNPase localisée dans l'espace intermembranaire est loin d'être comprise. D'autres expériences doivent être effectuées afin de comprendre si les mêmes domaines sont utilisés pour la fonction de transport d'ARN et de dégradation des messagers ou si, même cette protéine avait complètement perdu sa fonction de dégradation dans la mitochondrie. La PNPase possède plusieurs sites de phosphorylation et il serait envisageable que ses différentes fonctions et/ou localisation intracellulaires sont réglementées de manière dépendante de la phosphorylation.

La connaissance des signaux d'importation d'ARN mitochondriaux fournira des compléments d'information importants quant aux ARN construits à but thérapeutique. L'utilisation de la voie d'import d'ARN dans les mitochondries peut, en effet, ouvrir une nouvelle porte pour traiter des maladies graves associés aux mutations de l'ADNmt. La perspective à long terme inclut l'amélioration de l'efficacité des ARN thérapeutiques ciblant des mitochondries en exploitant la voie d'import ARN mitochondrial.

Publications and conferences

Publications

1. Vedrenne V, Gowher A, De Lonlay P, Nitschke P, Serre V, Boddaert N, Altuzarra C, Mager-Heckel AM, Chetien F, Entelis N, Munnich A, Tarassov I, Rotig A. **Mutation in PNPT1, which Encodes a Polyribonucleotide Nucleotidyltransferase, Impairs RNA**

Import into Mitochondria and Causes Respiratory-Chain Deficiency. Am J of Hum Gen. 2012; 91:1-7. **(Equal contribution)**

2. Gowher A, Smirnov A, Tarassov I, Entelis N. **Induced tRNA import into human mitochondria: implication of host aminoacyl-tRNA-synthetase.** PLoS ONE, 2013, 8(6): e66228

Conferences

1. Gowher A, Smirnov A, Tarassov I, Entelis N. Analysis of protein factors targeting RNA towards human mitochondria. Mitochondria in health, disease and death of the cell. France, 2013. **Oral presentation**
2. Gowher A, Vadrenne V, Rötig, A, Teitell M, Entelis N, Tarassov I. Characterization of proteins involved in RNA trafficking into human mitochondria. 4th World Congress on Targeting mitochondria. Germany 17-18 Oct, 2013. **Oral presentation**
3. I. Tarassov, N. Entelis, Y. Tonin, Gowher. A, C. Comte, A.-M Heckel, A. boucheham, a. Smirnov, K. Aure, A. Lombes, V. Vadrenne, V. Serre, P. Nitschke, A. Munnich, A. Rötig. Mitochondrial targeting of RNA: Source of pathology and tool for therapy. Cell Symposia Mitochondria: From signaling to disease. Portugal 2013. **Poster presentation**
4. Gowher A, Teitell M, Tarassov I, Entelis N. Characterization of proteins targeting yeast tRK1 and its derivatives into human mitochondria. "6ème colloque du réseau MeetOchondrie". France 2012. **Poster presentation**
5. Gowher A, Teitell M, Tarassov I, Entelis N. Characterization of proteins targeting yeast tRK1 and its derivatives into human mitochondria. 3è journées strasbourgeoises de rencontre autour des mitochondries. France, 2012. **Poster presentation**
6. N. Entelis, Y. Tonin, Gowher. A, A.-M Heckel, P. Kamenski, O. Karicheva. Cytosolic non-coding RNA are functional inside mitochondria. Cell Symposia, Functional RNAs, Spain, 2012. **Poster presentation**