



**HAL**  
open science

# Déterminants physiques et biologiques de l'infiltration: cas d'études de sols tropicaux en Afrique, en Asie et en Amérique Latine

Jean-Louis Janeau

► **To cite this version:**

Jean-Louis Janeau. Déterminants physiques et biologiques de l'infiltration: cas d'études de sols tropicaux en Afrique, en Asie et en Amérique Latine. Hydrologie. Université Toulouse III - Paul Sabatier, 2014. Français. NNT: . tel-01078254

**HAL Id: tel-01078254**

**<https://theses.hal.science/tel-01078254v1>**

Submitted on 28 Oct 2014

**HAL** is a multi-disciplinary open access archive for the deposit and dissemination of scientific research documents, whether they are published or not. The documents may come from teaching and research institutions in France or abroad, or from public or private research centers.

L'archive ouverte pluridisciplinaire **HAL**, est destinée au dépôt et à la diffusion de documents scientifiques de niveau recherche, publiés ou non, émanant des établissements d'enseignement et de recherche français ou étrangers, des laboratoires publics ou privés.



# THÈSE

En vue de l'obtention du

## DOCTORAT DE L'UNIVERSITÉ DE TOULOUSE

Délivré par *l'Université Toulouse III - Paul Sabatier*  
Discipline ou spécialité : *Hydrologie, hydrochimie, sol, environnement*

---

Présentée et soutenue par  
*Jean-Louis JANEAU*

Le 10 juillet 2014

**Titre :**

*Déterminants physiques et biologiques de l'infiltration: cas d'études de sols tropicaux en Afrique, en Asie et en Amérique Latine*

---

### JURY

*David Labat (Professeur d'Université, examinateur)*  
*Yves Le Bissonnais (Directeur de Recherche, rapporteur)*  
*Claude Hammecker (Chargé de Recherche, examinateur)*  
*Pierre Ribstein (Professeur d'Université, rapporteur)*  
*Jérôme Viers (Professeur d'Université, président du jury)*  
*Olivier Ribolzi (Directeur de Recherche, directeur de thèse)*

---

**Ecole doctorale :** *Sciences de l'Univers, de l'Environnement, de l'Espace (SDU2E)*  
**Unité de recherche :** *Géosciences Environnement Toulouse (GET)*

**Directeur(s) de Thèse :** *Dr. Olivier RIBOLZI*



# Remerciements

Ma curiosité naturelle pour les écosystèmes n'a fait que grandir au fil de 30 années d'expériences au service de la recherche pour le développement sur 3 continents. La mise en œuvre d'outils de mesure sur le terrain pour répondre à des questionnements scientifiques, et la collaboration étroite avec des chercheurs de différentes disciplines ont nourri mon envie de comprendre les processus et les facteurs responsables de l'infiltration et du ruissellement sous différents climats. Ce travail de thèse sur articles constitue une valorisation de mes acquis. Il permettra d'asseoir officiellement ma participation dans l'encadrement technique et scientifique de nombreux étudiants et partenaires des pays du Sud.

En premier lieu, je souhaite remercier Olivier Ribolzi qui m'a témoigné toute sa confiance aussi bien au cours d'expérimentation de terrain que pour la réalisation de cette thèse et qui en a accepté la direction.

Christian Valentin pour sa très longue et très amicale collaboration. A l'origine de mon embauche à l'IRD. Il m'a tout appris sur l'hydrodynamique superficielle et les « croûtes » et comme il le dit si bien « la lutte continue ».

Travaillant en étroite collaboration multidisciplinaire avec plusieurs collègues chercheurs, Claude Hammecker, Didier Orange, Olivier Planchon, Emma Rochelle-Newall. Ils m'ont encouragé à m'inscrire en thèse depuis quelques années déjà, qu'ils en soient vivement remerciés.

Je tiens aussi à remercier certains chercheurs avec qui j'ai passé des années de complicité intellectuelle et de « terrain » : Alain Casenave, Pierre Chevalier, Jean-Louis Perrin et Christophe Bouvier « mes » quatre hydrologues de référence à l'IRD mais aussi Jean-Pierre Bricquet qui m'a accueilli au sein de l'IBSRAM devenu IWMI en Thaïlande, m'initiant aux complexités de différents bassins versants à forte pente du sud-est asiatique ;

Olivier Grünberger qui m'a initié à la géochimie au cours de nombreuses missions dans les sebkhas du nord Mexique ;

Pascal Podwojewski, jamais avare de ces mots pour décrire la complexité des sols me permettant de faire des liens entre la pluie et le fonctionnement des sols en Equateur et en Afrique du sud ;

Christian Prat et Claude Zebrowski, avec qui j'ai compris l'importance de la recherche pour le développement sur leurs terrains d'étude : des sols indurés du Mexique et d'Equateur si peu propice à l'agriculture mais si important pour les plus démunis ;

Pascal Jouquet dont l'enthousiasme et l'humanité m'ont séduit, m'a permis de réaliser en peu de temps des expérimentations originales en conditions de terrain difficiles ;

Luc Descroix, l'hydrologue « sénégal-mexicano-alpin » rencontré aux confins du désert du Chihuahua toujours prêt à « dégainer » pour la cause hydrologique.

J'ai aussi grand plaisir à remercier chaleureusement mes nombreux collègues ingénieurs et techniciens de l'IRD mais aussi d'autres institutions (INRA, IPGP, INAMHI, UKZN). Cobus, Carlos, Jean, Jean-Luc, Jean-Marc, Joel, Gaby, Laurence, Norbert, Patrick, Roger ; j'ai maints fois échangé sur des problèmes techniques avec vous afin de pouvoir obtenir les données de terrain les plus fiables possibles. Merci à vous pour votre complicité professionnelle et personnelle.

Une pensée toute spéciale à « mes » assistants Diallo, Kouakou, Yao, Lupe, Tom, Nok, Doung, Hai, Rinh qui ont été des traducteurs avisés des us et coutumes de leurs pays en plus de leur langue d'origine.

Je n'oublie pas les nombreux partenaires d'Afrique de l'Ouest, d'Afrique du Sud, du Mexique, d'Equateur, de Thaïlande, et du Vietnam avec qui j'ai passé des années de coopération si enrichissantes tant sur le plan professionnel que personnel. Qu'ils soient tous profondément et sincèrement remerciés.

Les membres du jury sont aussi pour moi des collègues à l'écoute et notamment David Labat qui a été le lien fort entre mon expérience et l'écriture de cette thèse ; Jérôme Viers qui a été si attentif à mon parcours quelque peu atypique dans la recherche et enfin Claude Hammecker, Yves Le Bissonnais et Pierre Ribstein qui ont accepté d'être rapporteurs de cette thèse malgré un emploi du temps fort chargé.

Plus intimement, je remercie profondément Séraphine qui m'a permis de bien négocier un tournant de ma vie avec un bonheur sans limite et qui m'a donné le temps nécessaire à l'élaboration de cette thèse et bien sûr, je n'oublie pas mes deux fils, Lucas et Ivan qui ont été et sont des moteurs de mon existence.

## Table des matières

LISTE DES FIGURES .....	1
1. INTRODUCTION .....	3
1.1. CONTEXTE GÉNÉRAL .....	3
1.2. OBJECTIFS DE LA THÈSE.....	7
1.3. ETAT DE L'ART.....	7
1.3.1. EFFET DU GRADIENT DE PENTE SUR L'INFILTRATION .....	7
1.3.2. EFFET DE LA VÉGÉTATION SUR L'INFILTRATION .....	8
1.3.3. EFFET DES INGENIEURS DU SOL SUR L'INFILTRATION .....	10
1.3.4. EFFET DES PRATIQUES CULTURALES SUR L'INFILTRATION .....	12
1.4. STRUCTURE DE LA THÈSE .....	14
2. APPROCHE METHODOLOGIQUE : MESURE DE L'INFILTRATION ET DE LA DETACHABILITÉ DES SOLS .....	16
2.1. DESCRIPTION DU DISPOSITIF DE SIMULATION DE PLUIE UTILISÉ.....	19
2.2. VARIABLES MESURÉES A PARTIR DE L'HYDROGRAMME ET DU SOLIDOGRAMME...	21
2.3. LA DESCRIPTION DES ETATS DE SURFACE DU SOL.....	24
2.3.1. POURQUOI ÉTUDIER LES ÉTATS DE SURFACE DU SOL ? .....	24
2.3.2. INTÉRÊTS ET VALIDATION DE CETTE MÉTHODOLOGIE.....	25
2.4. CHOIX ET DESCRIPTION DES SITES D'ÉTUDES.....	26
3. LA PENTE, DÉTERMINANT PHYSIQUE DE L'INFILTRATION .....	28
4. LE COUVERT VÉGÉTAL, DÉTERMINANT BIOLOGIQUE DE L'INFILTRATION .....	43
5. LES INGÉNIEURS DU SOL, DÉTERMINANTS BIOLOGIQUES DE L'INFILTRATION.....	72
6. LES PRATIQUES CULTURALES, DÉTERMINANT DE L'INFILTRATION. ....	96
7. CONCLUSION .....	114
7.1. INTÉRÊTS DES ÉTUDES À L'ÉCHELLE FINE DU MÈTRE CARRÉ.....	120
7.2. APPORTS EN TERMES DE DÉVELOPPEMENT DES PAYS DU SUD. ....	121
7.3. PERSPECTIVES .....	121
8. RÉFÉRENCES .....	123

## LISTE DES FIGURES

Figure 1. Flux annuels de surface au sein du cycle de l'eau d'après Maidment (1993).....	3
Figure 2. Schéma de partition de la pluie adapté d'Ambroise (1999).....	4
Figure 3. Versant à forte pente au Nord de la Thaïlande.....	8
<b>Figure 4.</b> Turricules de vers de terre <i>Amyntas khami</i> . ....	11
Figure 5. Placage de récolte de termite produit entre deux cultures. ....	11
Figure 6. Scarabée bousier emportant une boulette de fèces pour enfouissement.....	12
Figure 7. Cultures sur la cangahua, cendres volcaniques en Equateur.....	13
<b>Figure 8.</b> Diagramme synthétique des éléments de l'étude des déterminants physiques et biologiques de l'infiltration. ....	14
Figure 9. Du micro-simulateur de pluie sur parcelle de 0.25 m <sup>2</sup> à la rampe d'aspersion sur parcelle de 80 m X 5 m.....	16
Figure 10. Grands simulateurs de pluie de type Swanson en Arizona. ....	17
Figure 11. Simulateurs de pluie sur parcelle de 1 m <sup>2</sup> . ....	17
Figure 12. Etude de la dispersion de la rouille de l'arachide sous simulation de pluie.....	18
Figure 13. Vue d'ensemble d'une expérimentation <i>in situ</i> sous simulation de pluie en Thaïlande. ....	20
Figure 14. Cadre métallique implanté dans le sol.....	20
Figure 15. Hydrogramme et solidogramme « théoriques » définis par Collinet and Valentin (1979) et Collinet (1988). ....	23
Figure 16. Mesure du nano relief (<5 cm) et du microrelief (<50 cm) à l'aide d'un distanciomètre laser Leica Disto pro.....	26
Figure 17. Défrichage par brûlis en vue d'établir la monoculture de maïs sur le bassin versant de Mae Yom au nord de la Thaïlande.....	28
Figure 18. Vue générale de l'écosystème Mogote au Nord Mexique. ....	43
Figure 19. Paysage de pâturage dégradé et envahi par <i>Acacia sieberiana</i> en Afrique du Sud.43	
Figure 20. Simulation de pluie sur végétation de type « <i>Mogote</i> ». ....	44
Figure 21. Prise de vue à basse altitude d'un pâturage spécifique dénommé « <i>Mogote</i> ». ....	44

Figure 22. Etude des bousiers sur parcelle de simulation de pluie et équipement de simulation de pluie utilisé au sein du pâturage sud-africain. ....	72
Figure 23. Simulation de pluie sur forte pente et turricules de vers de terre <i>Amyntas khami</i> au Nord Vietnam. ....	72
Figure 24. La <i>cangahua</i> , dépôt de cendre indurée en surface et réhabilitation de celle-ci au moyen de bulldozer. ....	96
Figure 25. Champ de maïs sur forte pente du nord de la Thaïlande. ....	115
Figure 26. Zone de pâturage extensif dans le Bolsón de Mapimí, Nord Mexique. ....	116
Figure 27. Erosion hydrique et surpâturage du piedmont du Drakensberg dédié à l'élevage bovin. ....	116
Figure 28. Dégradation des bouses de vaches par les scarabées fousseurs. ....	117
Figure 29. Microrelief induit par les turricule de vers et micro-agrégation des sols par les termites. ....	118
Figure 30. Préparation fine et grossière et encroûtement de la surface du sol de Cangahua. ....	119



## 1. INTRODUCTION

### 1.1. CONTEXTE GENERAL

Les préoccupations environnementales liées aux changements globaux sont majeures en ce début de XXI siècle ; elles concernent notamment le changement d'usage des terres (ex. surpâturages, déforestation, intensification de l'agriculture etc.) et les évolutions climatiques telles que l'intensification des pluies ou au contraire la diminution de celles-ci dans certaines parties du monde (GIEC, 2007). C'est dans ce contexte qu'est apparu le concept de zone critique. Définie comme l'environnement hétérogène situé entre la canopée et le substrat rocheux, cette zone est le siège d'interactions complexes entre le sol, l'eau, l'air et les organismes vivants (National Research Council, 2001; Lin, 2010). Elle est qualifiée de critique pour l'avenir des écosystèmes car elle constitue le plus gros réservoir de biodiversité continentale, joue un rôle centrale dans la régulation des flux d'eau, de carbone et de nutriments, et est extrêmement sensible aux changements globaux.

Les travaux de recherche exposés dans cette thèse, abordent des questionnements sur **l'hydrologie de surface**, qui recouvre de nombreuses problématiques liées au cycle de l'eau (Figure 1) telles que la prévision des crues et des inondations, la recharge des aquifères et des réservoirs de surface naturels et artificiels, l'érosion des sols etc.

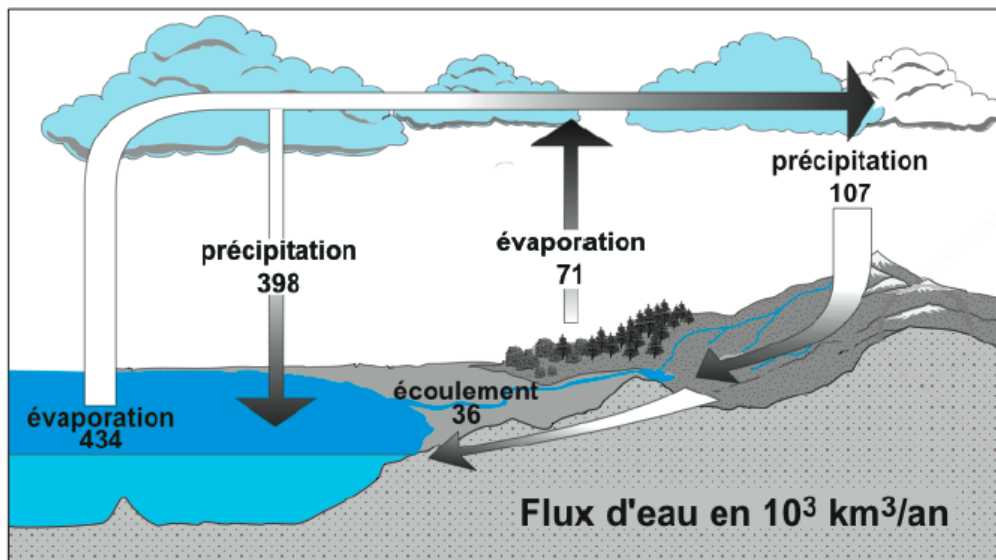

**Figure 1.** Flux annuels de surface au sein du cycle de l'eau d'après Maidment (1993).

Agent puissant de la morphogénèse et de la pédogénèse, l'eau est le principal vecteur des composés solides, dissous, colloïdaux. Comprendre les facteurs qui contrôlent les chemins empruntés par l'eau est une condition fondamentale et nécessaire pour comprendre la dynamique des composés qu'elle transporte. Depuis plusieurs décennies, les hydrologues

s'intéressent au devenir de l'eau de pluie au sein des bassins versants (Penman, 1963; Roche, 1963) et à l'origine de l'eau dans le réseau hydrographique (Hewlett, 1961). De nombreux travaux se sont intéressés à la **partition de la pluie en écoulements élémentaires sur les versants** (Kirkby, 1978) : (i) partage entre l'interception par la canopée (*canopy interception*), le ruissellement sur les troncs (*stemflow*) et l'égouttement (*throughfall*) (Quinn and Laflen, 1983; Luteyn, 1999; Zimmermann *et al.*, 2007); (ii) partage de l'égouttement et du ruissellement sur les troncs entre le ruissellement de surface (*overland flow*) et l'infiltration (Wang *et al.*, 2011); (iii) partage de l'infiltration entre écoulement interne latéral (*translatory flow*) et la recharge verticale de la nappe d'eau souterraine (Healy and Cook, 2002; Sophocleous, 2002; Seguis *et al.*, 2011). Parmi toutes ces partitions, le partage ruissellement/infiltration est particulièrement important car la surface du sol constitue une interface majeure entre la biosphère, l'hydrosphère et la lithosphère (Figure 2). Ce partage est déterminant pour les phénomènes d'érosion responsables des pertes en terre, la genèse et l'intensité des écoulements de base et de crue au sein du réseau hydrographique, le transfert de polluants vers les ressources en eaux superficielles ou souterraines.

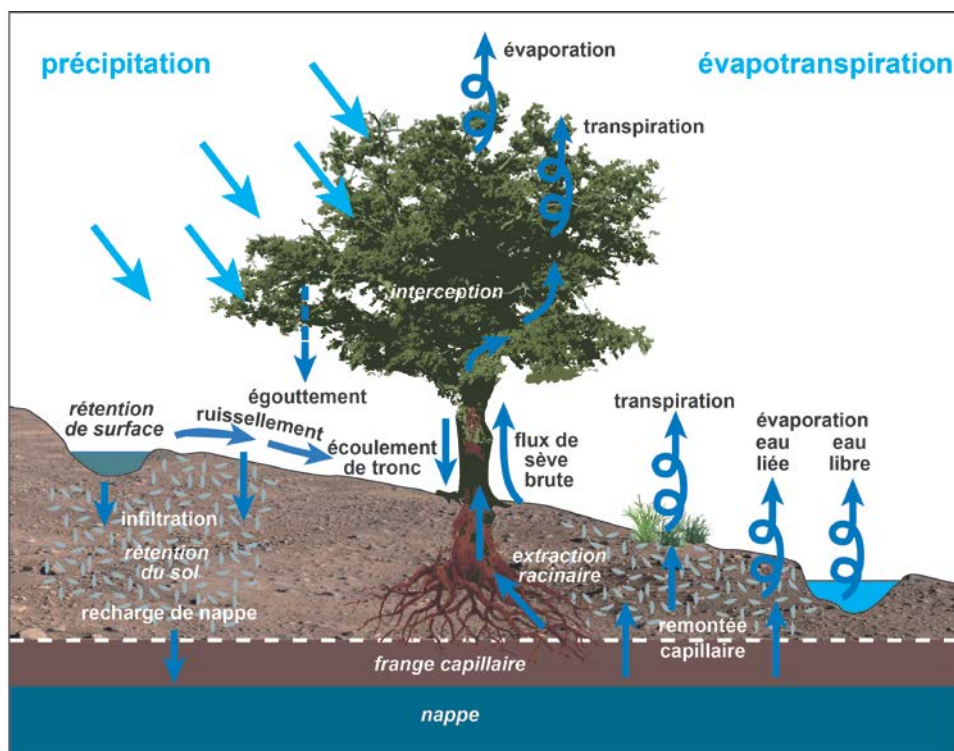

**Figure 2.** Schéma de partition de la pluie adapté d'Ambroise (1999).

En parallèle de ces travaux, d'autres études à l'échelle du bassin versant se sont intéressées à la recombinaison de ces écoulements élémentaires superficiels et souterrains dans le cours d'eau et à la circulation au sein des différents réservoirs (stockage superficiel dans les dépressions, dans les zones humides, dans le réseau de drainage) avec des vitesses différentes (Ambroise, 1999; Elsenbeer, 2001; Bracken and Croke, 2007).

Au sein de la zone critique, **la surface du sol** joue un rôle clef vis-à-vis des activités humaines car elle constitue une « plaque tournante » pour les flux d'eaux, de nutriments, de contaminants. La principale hypothèse sous-jacente aux travaux présentés dans cette thèse est que cette surface est extrêmement sensible aux variations du milieu. En effet, les changements globaux à l'œuvre sur la plupart des continents impactent fortement l'interface sol-atmosphère. Face à l'importance de cette interface pour le fonctionnement des écosystèmes, et les enjeux en termes de ressource en eau, les travaux présentés par la suite sont consacrés à l'analyse des déterminants de l'infiltration de l'eau à la surface du sol et à la genèse du ruissellement en milieu tropical.

**Les organisations superficielles du sol** jouent un rôle clé dans l'infiltration (Casenave and Valentin, 1989). La genèse de ces organisations dépend de deux facteurs principaux :

- L'eau qui mobilise des particules par humectation (éclatement, dispersion, fissuration), par l'effet de l'impact des gouttes de pluies (dispersion colloïdale, fractionnement des agrégats, transport par rejaillissement, dépôt et tassement), par le ruissellement (arrachement, transport, dépôt), par la dessiccation (retrait et induration).
- Le vent notamment en région aride à semi-humide qui arrache, transporte et effectue un tri granulométrique des matériaux (Belnap and Gillette, 1998; Ribolzi *et al.*, 2000; Gomes *et al.*, 2003; Rajot *et al.*, 2003).

D'autres facteurs peuvent également influencer la dynamique des états de surface du sol. Ainsi, Deluca *et al.* (1998), Poesen *et al.* (2003), Valentin *et al.* (2005) ont démontré que le passage répété d'animaux ou de moyens de transport générait des croûtes indurées avec un taux d'infiltration quasi nulle. Une longue prospection au sein du désert du Chihuahua, au nord du Mexique a montré l'importance des croûtes salines (Grünberger *et al.*, 2005). Certains ingénieurs du sol tels que les termites ont aussi un rôle important en termes de développement de croûtes de surface (Janeau and Valentin, 1987; Jouquet *et al.*, 2012). Enfin les pratiques culturales, notamment le labour et le sarclage qu'ils soient manuels ou mécanisés, jouent un rôle majeur sur la formation des états de surface et les pertes en sol potentielles.

Sur une courte distance (i.e. longueur de pente de l'ordre du mètre), le détachement est le processus d'érosion dominant à la surface au cours d'une averse (Roose and Sarrailh, 1989-90; Poesen *et al.*, 1990; Sharma *et al.*, 1991). La plupart des travaux énoncés précédemment montrent que la surface du sol est sensible à l'effet des gouttes de pluies qui détachent les particules, ainsi qu'au ruissellement qui les transporte, et à différents autres facteurs naturels (feu, vent) et anthropiques (passages d'engins, travaux culturels, etc.) qui dégradent la surface.

Le ruissellement et les particules en suspension qu'il transporte peuvent s'acheminer jusqu'à la rivière en aval, ou être stoppées sur les versants dans des dépressions. Les matières en suspension ainsi retenues pendant et après les averses peuvent sédimenter et former des croûtes de surface spécifiques. Ces dépressions sont liées à la microtopographie induite par la végétation (Bergkamp *et al.*, 1996; Yates *et al.*, 2000), la pluie et le ruissellement (Planchon *et al.*, 2000a) et très souvent par les pratiques culturales (Gupta *et al.*, 1991; Biolders *et al.*, 1996; Planchon *et al.*, 2002). Plus spécifiquement en fonction du type de labour, les possibilités et temps de rétention en surface peuvent être importants (Loch and Donnollan, 1983; Jones *et al.*, 1994; Rhoton *et al.*, 2002; Jester and Klik, 2005). Il faut donc alors mesurer ce microrelief pouvant affecter le ruissellement et stocker momentanément l'eau au sein de micro-dépressions superficielles. Cette mesure contribue à la compréhension de l'évolution de l'infiltration de la surface des sols (Abedini *et al.*, 2006). L'effet respectif sur l'infiltration de l'interception de l'eau de pluie par la végétation et du stockage de celle-ci dans les micro-dépressions superficielles est très variable et diminue au cours de l'averse. Il provoque en général un retard dans le démarrage du ruissellement. Ce retard peut être perçue à l'exutoire du bassin tout comme à celui de parcelles expérimentales de faible surface (Ambroise, 1999).

**L'infiltration**, processus au centre de cette thèse, est la pénétration de l'eau à la surface du sol. C'est le transfert de l'eau à travers les couches superficielles du sol, sous l'action de la gravité et des forces de succion. Il est décrit en détails dans de nombreux ouvrages de physique du sol (Kaouritchev, 1983; Youngs, 1988; Rieu and Sposito, 1991; Wen and Gomez Hernandez, 1996; Lozet and Mathieu, 1997).

Elle dépend non seulement des propriétés hydrodynamiques propres au sol en surface et en sub-surface (i.e. conductivité hydraulique, sorptivité, diamètre des pores fonctionnels, longueur capillaire, texture, structure etc.) mais également de l'intensité et de la quantité d'eau de pluie apportée, ainsi que de son état hydrique initial.

Dans ce travail de thèse, le choix a été délibéré de travailler sur le taux d'infiltration plutôt que de chercher à estimer les propriétés hydrodynamiques de la surface et des horizons sous-jacents. La raison en est que celles-ci sont délicates à mesurer (Vandervaere, 1995) et sont éminemment variables dans le temps et l'espace du fait de la réorganisation superficielle parfois rapide (Assouline, 2004; Ribolzi *et al.*, 2011). Ces propriétés hydrodynamiques sont d'autant plus susceptibles de varier fortement qu'il s'agit de milieux agropastoraux et/ou soumis à une forte activité biologique, qui sont nos cas d'études.

L'infiltration de l'eau dans les sols de nombreux écosystèmes tropicaux est particulièrement conditionnée par les types d'état de surfaces eux-mêmes dépendant des caractéristiques des précipitations (Valentin and Bresson, 1992; Peugeot, 1995; Zimmermann *et al.*, 2006). Je me

suis donc également intéressé aux propriétés de la surface du sol, en particulier à son encroûtement.

## 1.2. OBJECTIFS DE LA THESE

Les facteurs régissant l'infiltration sont largement décrits dans des manuels d'hydrologie anglophone (ASCE, 1996) ou francophone (Anctil *et al.*, 2012; Cosandey and Robinson, 2012). La plupart des travaux sur l'infiltration visent à comprendre l'effet des facteurs physiques tels que la longueur de pente et l'intensité de pluie (Planchon *et al.*, 2000a; Nicolas, 2010), la connectivité de la lame d'eau en surface (Allard, 1993; Harel, 2013). Cette thèse a pour objectif d'apporter des connaissances sur l'effet de facteurs assez peu étudiés bien que déterminant pour l'infiltration dans un grand nombre d'agroécosystèmes tropicaux. Il est tout d'abord question du gradient de pente. Ce facteur nous a semblé prioritaire car plus de 25% des terres cultivées tropicales ont une pente qui dépasse 40% (FAO, 2010). En raison des conditions de température et d'humidité, les sols tropicaux sont le support d'une activité biologique intense. Celle-ci étant fortement impactée par les activités humaines ces dernières décennies (e.g. déforestation, intensification de l'agriculture etc.), il nous a semblé également prioritaire d'étudier l'effet sur l'infiltration i) du couvert végétal, ii) de l'activité méso-faunique du sol, iii) et de pratiques culturales.

## 1.3. ETAT DE L'ART

### 1.3.1. EFFET DU GRADIENT DE PENTE SUR L'INFILTRATION

Le premier objectif de la thèse est l'étude de la relation entre le taux d'infiltration et la pente pour des gradients typiques de paysages collinaires à montagneux. L'étude présentée dans le premier chapitre de la thèse concerne des sols avec une pente comprise entre 16 et 63% au Nord de la Thaïlande en climat humide (cf. chapitre 2 : **Janeau JL**, Bricquet JP, Planchon O, Valentin C, 2003. Soil crusting and infiltration on steep slopes in northern Thailand. *European Journal of Soil Science* 54: 543-553).

**L'effet du gradient de pente sur l'infiltration** a retenu toute notre attention car, selon les conditions climatiques et morpho-pédologiques, il est au centre de débats scientifiques contradictoires depuis de nombreuses années. Aussi bien en Belgique (De Ploey *et al.*, 1976), en Serbie (Djorovic, 1980) qu'en milieu semi-aride en Inde Sharma *et al.* (1983) ont observés une diminution de l'infiltration avec l'augmentation du gradient de pente. Au Canada, Fox *et al.* (1997) précisent que l'augmentation de la pente réduit le taux d'infiltration jusqu'à atteindre un certain palier où l'infiltration est stable. En Belgique, Govers (1991) indique que les zones hautes et basses, à faible pentes d'un versant ruissellent plus que la plus grande longueur de pente au gradient le plus fort. Ces observations corroborent celles de Chaplot and Le Bissonnais (2000) en milieu tempéré, qui indiquent une

diminution de l'infiltration vers les faibles pentes en raison de la formation de croûtes de surface. Lal (1976) au Nigeria, Gumbs *et al.* (1986), à Trinidad et Mah *et al.* (1992) en Australie n'ont pas trouvé d'effet significatif de la pente pour des valeurs du gradient assez faibles allant de 2 à 10%. Selon Singer and Blackard (1982), il en va de même dans le cas de forte pente (>50%) en Californie.

Les hypothèses déjà testées sont donc nombreuses et contradictoires mais en 2002 aucun résultat n'était présent dans la littérature en milieu tropicale humide subissant de fortes pressions agricoles. Notre expérimentation sur des pentes fortes du Nord de la Thaïlande (Figure 3) a permis d'apporter une connaissance utile à la gestion future de ce type de milieu.



**Figure 3.** Versant à forte pente au Nord de la Thaïlande.

---

### 1.3.2. EFFET DE LA VEGETATION SUR L'INFILTRATION

Le deuxième objectif de la thèse a été d'évaluer l'impact de différents taux de couverture herbacée sur l'infiltration et la détachabilité des sols.

Une première étude a été menée en milieu semi-aride au Mexique (cf. Chapitre 3 : **Janeau JL**, Mauchamp A, Tarin G, 1999. The soil surface characteristics of vegetation stripes in northern Mexico and their influences on the system hydrodynamics - an experimental approach. *Catena* 37: 165-173).

La seconde étude a été menée en milieu subhumide en Afrique du Sud (cf. Chapitre 3 : Podwojewski P, **Janeau JL**, Chaplot V, Grellier S, Lorentz S, 2011, Influence of vegetal soil cover on water runoff and soil detachment in a sub-humid South African degraded rangeland. *Earth Surface Processes and Landforms* 36: 911-922).

**La végétation** contrôle l'infiltration du fait i) de ses parties aériennes (i.e. canopée, tronc) en interceptant une fraction de la pluie (Quinn and Laflen, 1983; Levia and Frost, 2003) et en modifiant le spectre des gouttes qui impactent le sol, et ii) de ses parties souterraines (système racinaire) en prélevant une partie de l'eau du sol et en modifiant ses propriétés hydrodynamiques de sub-surface (Bui and Box, 1992; Nanko *et al.*, 2011).

Une partie des précipitations est retenue par **interception** du couvert végétal. La quantité d'eau susceptible d'être interceptée varie considérablement en fonction de la morphologie des végétaux et du pourcentage de couverture au sol (Mauchamp and Janeau, 1993; Foot and Morgan, 2005), de la densité et de l'âge des végétaux que ce soit sous forêts (Brooks *et al.*, 1994), sous défriches forestières (Collinet, 1984), sous cultures (Frasson and Krajewski, 2011), pour des vignobles (Battany and Grismer, 2000), pour des pâturages (Weltz *et al.*, 1992; Arnaez *et al.*, 2007) et pour les zones arbustives (Johnson and Gordon, 1988; Greene *et al.*, 1994).

Si la végétation offre une grande surface basale ou foliaire, donc un important degré de couverture, la rétention d'eau peut atteindre jusqu'à 30 % de la précipitation totale pour une forêt mixte, 25 % pour les prairies et 15 % pour les cultures (Musy and Higy, 2004).

De nombreuses études montrent la diminution rapide de l'infiltration lors de dégradation du couvert végétal atteint par les feux (Emmerich and Cox, 1992; Hofstede *et al.*, 1995; Benavides-Solorio and MacDonald, 2001; Guerrero *et al.*, 2001; Poulénard *et al.*, 2001). Il en est de même pour le surpâturage qui éclaircit le couvert végétal et augmente le pourcentage de sol nu sensible à l'impact des gouttes et au rejaillissement des particules de sol (effet splash) qui contribuent à la formation de croûtes de surface (Casenave and Valentin, 1989; Hiernaux *et al.*, 1999; Rowntree *et al.*, 2004; Vetter, 2005).

Le couvert végétal est un des paramètres le plus pris en compte par de nombreuses disciplines scientifiques car il est à l'interface air-sol ou l'Homme à la majorité de ces activités (Bosch and Hewlett, 1982). C'est d'autant plus vrai dans les pâturages des zones tropicales dédiés à la production animale (Lambin *et al.*, 2003).

Pour les hydrologues et les écologues, il s'agit à la fois de comprendre les interactions entre type et densité de couvert en relation avec les ruissellements et types d'érosions potentiels (Gijssman, 1996). Depuis les années quatre-vingt-dix sous la pression démographique croissance et le changement d'usage des sols induit, ce type d'étude est mené sous de nombreux climats (Levia and Frost, 2003) permettant une croissance végétative significative et donc l'exploitation agropastorale du milieu i) en milieu de montagne humide (Molinillo and Monasterio, 1997) et sec (Thornes, 2007), ii) en milieu semi-aride d'Afrique de l'Ouest (Turner *et al.*, 2005) et du nord de la Chine (Zhao *et al.*, 2005), iii) en milieux tempérés (Quetier *et al.*, 2005; McIntyre and Lavorel, 2007).

Le couvert végétal est donc très étudié car il est le garant d'une protection du sol contre les phénomènes d'érosion (Collinet, 1988; Lal, 1998; Eswaran *et al.*, 2001; Rey *et al.*, 2004; Gyssels *et al.*, 2005; Valentin *et al.*, 2005; Neave and Rayburg, 2007) mais peu d'études se sont focalisées sur les pâturages en zone tropicale dont le couvert est altéré par une gestion aléatoire du bétail.

---

### 1.3.3. EFFET DES INGENIEURS DU SOL SUR L'INFILTRATION

L'objectif du travail présenté au chapitre 4 est d'évaluer l'impact des ingénieurs du sol sur l'hydrodynamique et le détachement de particules de sols. Le terme ingénieur du sol recouvre l'ensemble des invertébrés du sol, du nématode, aux acariens et collemboles, et enfin, des organismes de grande taille comme les coléoptères fousseurs, les vers de terre, les termites et l'essentiel des larves d'insectes. L'action importante, cumulée et répétée de ces ingénieurs du sol participe ainsi à la mise en place des services écosystémiques du sol. En modifiant l'agrégation et la porosité du sol, en décomposant la matière organique, ces organismes participent à l'infiltration et au stockage de l'eau dans les sols, au recyclage des nutriments, à la régulation du ruissellement de l'eau, au stockage du carbone. Ces processus sont à la base des services écosystémiques du sol (Poss *et al.*, 2000).

Nous avons eu l'opportunité de travailler sur 3 catégories d'ingénieurs du sol au sein de deux écosystèmes contrastés par leur climat ; humide au Vietnam et subhumide en Afrique du Sud.

Deux articles structurent cette partie de la thèse :

1) Le premier étudie le rôle sur l'infiltration des vers de terre et des termites dans des jachères sur des versants à forte pente au Nord du Vietnam (cf. Jouquet P., **Janeau JL**, Pisano A., Tran Sy Hai., Orange D., Luu Thi Nguyet Minh, Valentin C., 2012. Influence of earthworms and termites on runoff and erosion in a tropical steep slope fallow in Vietnam: A rainfall simulation experiment. *Applied Soil Ecology* 61: 161-168) ;



➤ Les **vers de terre** jouent un rôle clé dans le fonctionnement des sols. Ils construisent et maintiennent la structure du sol en creusant des galeries et en modifiant l'agrégation du sol (Cisneros, 1997; Lavelle *et al.*, 1997; Lavelle *et al.*, 1998; Blanchart *et al.*, 2004; W.R.B, 2006). Dans les zones tropicales, ce sont les vers de terre endogés qui dominent les peuplements (Figure 4). Ces organismes sont capables d'ingérer de grandes quantités de terre. Ainsi, un individu peut consommer jusqu'à 35 fois son propre poids de terre (Lavelle *et al.*, 1997; Lavelle *et al.*, 1998). Ces vers de terre sont donc en grande partie responsables de la formation et du maintien de la structure observée dans les sols de différents écosystèmes (Blanchart, 1992).



**Figure 4.** Turrucules de vers de terre *Amyntas khami*.

➤ Les **termites** sont d'une importance majeure de l'évolution des sols (Figure 5). Ils participent notamment à la restauration des sols encroûtés augmentant l'infiltration de l'eau et l'apport de matière organique au sol (Lavelle *et al.*, 1993; Mando *et al.*, 1996; Cisneros, 1997; Mettrop *et al.*, 2013). A l'inverse, les termites peuvent aussi dans certains cas générer des croûtes de surface, (Janeau and Valentin, 1987).



**Figure 5.** Placage de récolte de termite produit entre deux cultures.

Les **termites** et les **vers de terre** sont donc des ingénieurs du sol très abondants en milieu tropical où ils jouent un rôle clef dans la dynamique hydrique des sols par leurs influences sur la structure des sols (Lavelle *et al.*, 1997; Lavelle *et al.*, 1998; Jouquet *et al.*, 2006). L'amélioration de l'infiltration et la réduction de risques érosifs par présence de ces

ingénieurs du sol a été maintes fois mis en évidence (Mando *et al.*, 1996; Leonard and Rajot, 2001; Leonard *et al.*, 2004) mais curieusement peu d'études ont été menées sur forte pente.

2) Le second article porte sur l'influence des coléoptères fouisseurs (bousiers) sur l'infiltration des sols de pâturages dégradés et la pérennité de l'effet d'ouverture de macro pores de surface (cf. Brown J, Scholtz C, **Janeau JL**, Grellier S, Podwojewski P, 2010 Dung beetles (Coleoptera: Scarabaeidae): engineering improvements to the hydrological properties of soil. *Applied Soil Ecology* 46: 9-16).

➤ Les **scarabées fouisseurs** (scarabées bousiers) peuvent avoir aussi un rôle important dans l'évolution de la porosité des sols et de leur fertilité (Nichols *et al.*, 2008). Les excréments qui composent la nourriture principale de ces coléoptères saprophages/coprophages sont en effet collectés et enfouis à différentes profondeurs suivant les espèces pour stockage et alimentation des larves (Figure 6). Ce travail du sol engendre une modification de la porosité (Waterhouse, 1974; Herrick and Lal, 1995; Bang *et al.*, 2005) mais il n'existait pas d'étude se focalisant sur la quantification de l'infiltration soumis à l'influence de ces coléoptères fouisseurs.



**Figure 6.** Scarabée bousier emportant une boulette de fèces pour enfouissement.

#### 1.3.4. EFFET DES PRATIQUES CULTURALES SUR L'INFILTRATION

Dans le chapitre 5, nous nous sommes attachés à évaluer l'impact de pratiques culturales à des fins de réhabilitation de cendres indurées sur l'infiltration (cf. Podwojewski P, **Janeau JL**, Leroux Y, 2008. Effects of agricultural practices on the hydrodynamic of a deep tilled hardened volcanic ash-soil (*Cangahua*) in Ecuador. *Catena* 72: 179-190).

Afin de ne pas entrer dans la complexité des systèmes de culture, nous nous sommes limités à la description du travail du sol ayant une incidence directe sur l'infiltration. Ce travail du sol comprend en première importance, les labours qui part manipulation des masses de sols inversent les couches superficielles du sol, changent la taille des agrégats, la porosité du sol et mélangent la première couche du sol avec des résidus de récolte (Wagner and Fox, 2001). Les labours permettent aussi de former un mini relief (billons, buttes etc.) modifiant la rugosité et donc l'hydrodynamique de surface. Ils permettent également d'apporter au sol des

amendements organiques ayant un rôle sur la structure et donc l'infiltration. Le sarclage est aussi un élément clef de l'évolution de l'infiltration au cours du cycle cultural détruisant les croûtes de surface et augmentant la porosité mais il n'est pas abordé dans cette étude.

Si par le passé, deux études ont été menées pour estimer la sensibilité à l'érosion de sols indurés fragmentée par des engins lourds (De Noni *et al.*, 1989-1990; Baumann *et al.*, 1997), aucune étude n'avait été menée permettant de comparer les comportements hydrodynamiques et érosifs de différentes tailles de fragmentation des agrégats et d'intrants les plus adaptés à développer et maintenir une infiltration pérenne propice à l'agriculture.

Nous avons donc testé le comportement hydrique et érosif de cendres volcaniques indurées dénommées en Equateur « Cangahua » qui tentent d'être « réhabilitées » par différentes préparations du sol et différents amendements (de Noni *et al.*, 1993; De Noni *et al.*, 2001) pour obtenir un sol utilisé à des fins d'agriculture (Figure 7).



**Figure 7.** Cultures sur la cangahua, cendres volcaniques en Equateur.

#### 1.4. STRUCTURE DE LA THESE

L'introduction décrit le contexte et les objectifs suivis de l'état de l'art concernant les quatre déterminants étudiés de l'infiltration.

Dans le chapitre 2, nous décrivons l'approche méthodologique. Elle permet de mesurer l'infiltration et les pertes en sol sous simulation de pluie à l'échelle du mètre carré. Les surfaces élémentaires intégrant le couvert végétal, la surface du sol et les organisations pédologiques superficielles qui ont subi des transformations sont décrites grâce à la cartographie des états de surface. Les chapitres 3 à 6 reposent sur des articles parus dont les questions scientifiques apportent une connaissance des déterminants de l'infiltration pour des agroécosystèmes tropicaux spécifiques. Un diagramme synthétise résume cette étude des déterminants physiques et biologiques de l'infiltration (Figure 8).

La conclusion fournit une synthèse des travaux menés. Elle décrit l'intérêt de ces études à l'échelle du mètre carré pour la connaissance des milieux étudiés, pour la modélisation et enfin pour les pays du Sud.

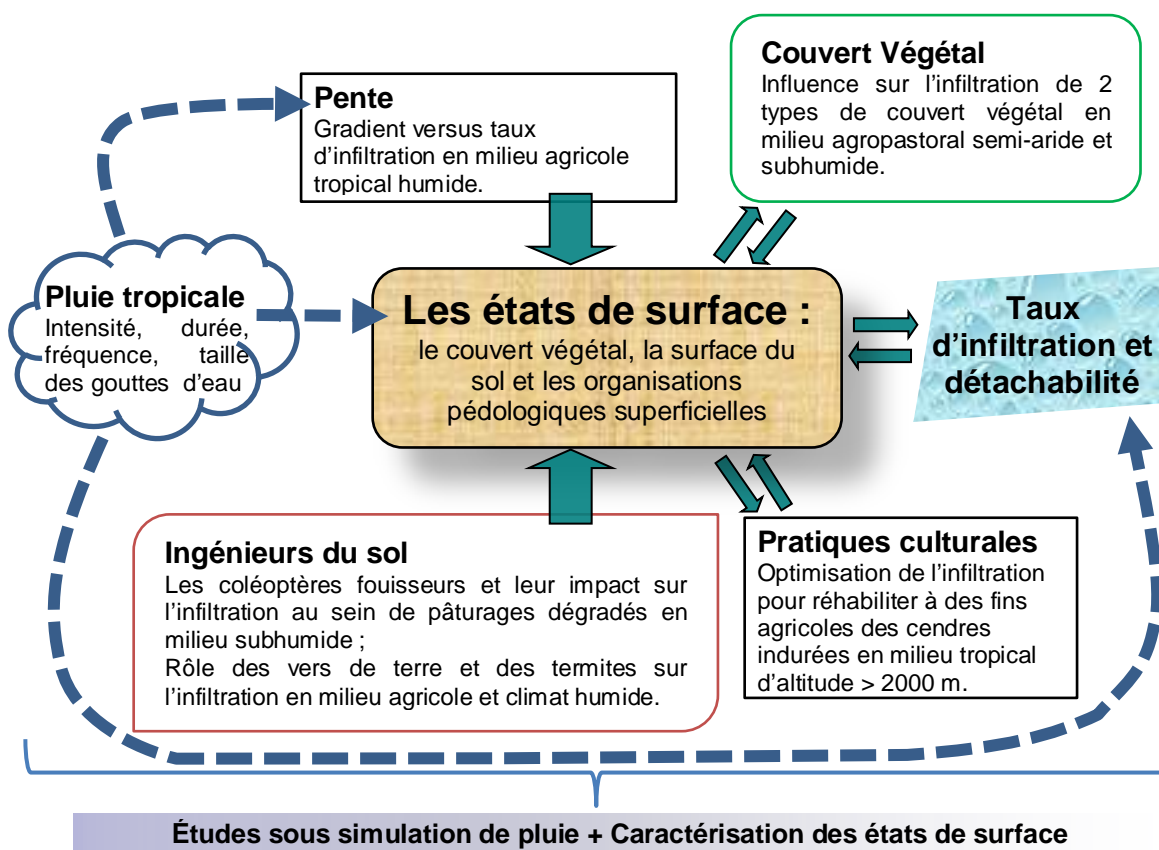

**Figure 8.** Diagramme synthétique des éléments de l'étude des déterminants physiques et biologiques de l'infiltration.

## Chapitre 1. Introduction

Contexte, objectifs et état de l'art.

## Chapitre 2. Approche méthodologique

Simulation de pluie et cartographie des états de surface



## Chapitre 3. La pente

Janeau JL, Bricquet JP, Planchon O, Valentin C (2003). *Soil crusting and infiltration on steep slopes in northern Thailand. European Journal of Soil Science* 54:543-553.



## Chapitre 4. Le couvert végétal

Podwojewski P, Janeau JL, Grellier S, Valentin C, Lorentz S, Chaplot V. 2011. *Influence of grass soil cover on water runoff and soil detachment under rainfall simulation in a sub-humid South African degraded rangeland. Earth Surface Processes and Landforms* 36: 911-922.



Janeau JL, Mauchamp A, Tarin G. 1999. *The soil surface characteristics of vegetation stripes in Northern Mexico and their influences on the system hydrodynamics - An experimental approach. Catena* 37: 165-173.



## Chapitre 5. Les ingénieurs du sol

Brown J, Scholtz CH, Janeau JL, Grellier S, Podwojewski P (2010) *Dung beetles (coleoptera: Scarabaeidae) can improve soil hydrological properties. Applied Soil Ecology* 46: 9-16.

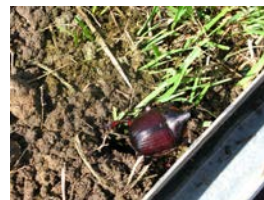

Jouquet P, Janeau JL, Pisano A, Hai Tran S, Orange D, Luu Thi Nguyet M, Valentin C (2012) *Influence of earthworms and termites on runoff and erosion in a tropical steep slope fallow in Vietnam: A rainfall simulation experiment. Applied Soil Ecology* 61:161-168.



## Chapitre 6. Les pratiques culturales

Podwojewski P, Janeau JL, Leroux Y (2008) *Effects of agricultural practices on the hydrodynamics of a deep tilled hardened volcanic ash-soil (cangahua) in Ecuador. Catena* 72:179-190.



## Chapitre 7. Conclusion et perspectives

## 2. APPROCHE METHODOLOGIQUE : MESURE DE L'INFILTRATION ET DE LA DETACHABILITE DES SOLS

La mesure de l'infiltration est sensible à toute modification si minime soit-elle, aussi toutes caractérisations de celles-ci est préférable *in situ* (Vandervaere, 1995). Afin d'estimer le taux d'infiltration, différentes méthodes peuvent être mises en œuvre. Certaines consistent à réaliser des essais d'infiltration à la surface du sol à partir d'une source circulaire sous pression positive tels les infiltromètres de type Munz avec ou sans anneau de garde (Ahuja *et al.*, 1976; Dunn and Phillips, 1991; Valentin, 1991; Chen and Liu, 2002; Gregory *et al.*, 2006; Lassabatere *et al.*, 2006; Lai *et al.*, 2012) ou négative tels les infiltromètres à membrane (Youngs, 1987; Perroux and White, 1988; Simunek *et al.*, 1998; Angulo-Jaramillo *et al.*, 2000; Vandervaere *et al.*, 2000a; b; Moody *et al.*, 2009). Dans les deux cas, les mesures sont très localisées (échelle de la placette de quelques dm<sup>2</sup>) et ne permettent pas une analyse du détachement et de l'effet de l'impact des gouttes sur les organisations superficielles et l'infiltration. Mon choix c'est donc porté sur les méthodes infiltrométriques sous pluies simulées qui recouvrent une plus grande surface d'investigation et permettent de reproduire l'effet des pluies naturelles tout en contrôlant la durée, l'intensité et l'énergie de la pluie.

**Les simulateurs de pluies** sont utilisés pour travailler à différentes échelles de quelques dizaines de cm<sup>2</sup> en laboratoire et du 1/4 de m<sup>2</sup> à 400 m<sup>2</sup> au champ (Figure 9). Le but de cette technique est d'apporter au sol une quantité d'eau sous forme d'une pluie artificielle ayant des caractéristiques similaires à celles d'une pluie naturelle notamment pour l'intensité, la durée et la fréquence. La taille des gouttes et l'énergies cinétique des pluies naturelles et des pluies simulées ont été comparées indiquant des corrélations très élevées pour des appareillages spécifiques (Asseline and Valentin, 1978; Hassel and Richter, 1992). Tous les simulateurs de pluie permettent d'étudier les interactions entre la dynamique des états de surface lors des averses d'intensité forte et la cinétique d'infiltration. Cependant l'échelle de la mesure est variable en fonction des objectifs visés et notamment pour la quantification des pertes en sol.



**Figure 9.** Du micro-simulateur de pluie sur parcelle de 0.25 m<sup>2</sup> à la rampe d'aspersion sur parcelle de 80 m X 5 m.

Les premiers appareils ont été conçus dès les années 1940 (Ellison and Pomerene, 1944) puis 1960 (Mutchler and Hermsmeier, 1965), notamment aux USA. Ces simulateurs de pluies de grande taille, de type Swanson (Swanson, 1965) et de type Bonn, Basel, Trier sont décrits par Streck and Cogo (2003), Kainz *et al.* (1992) et USDA (2005). Ils ont été très utilisés pour effectuer des mesures sur des parcelles de mesure de l'érosion (Wischmeier, 1959), de surface variant de 30 à 200m<sup>2</sup> (Figure 10). Les grands simulateurs de pluie permettent donc de comprendre les processus d'érosion sur des échelles permettant le suivi du détachement des particules mais aussi leur transport et leur dépôt par le ruissellement.

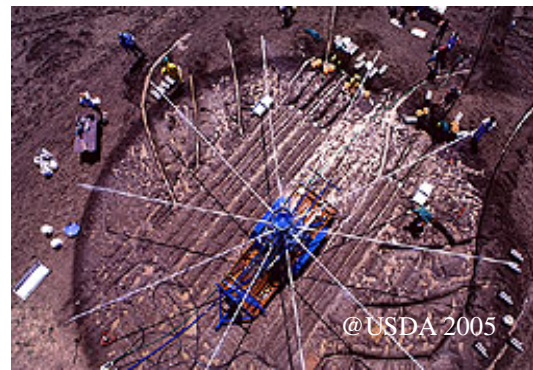

**Figure 10.** Grands simulateurs de pluie de type Swanson en Arizona.

Pour pouvoir travailler à des échelles plus petites et avec donc plus de possibilités de répétitions, des **mini**-simulateurs de pluie (Figure 11) ont été mis au point dans les années soixante-dix (Munn and Huntington, 1976; Grierson and Oades, 1977; Imeson, 1977; Asseline and Valentin, 1978; Meyer and Harmon, 1979).



**Figure 11.** Simulateurs de pluie sur parcelle de 1 m<sup>2</sup>.

D'autres plus sophistiqués, de 1 à 15 m<sup>2</sup> sont apparus dans les années 1980 jusqu'aux années 2000. Les plus petits simulateurs de pluie permettant des tests de mesures du taux d'infiltration ont été utilisés par Miller (1987), Tossell *et al.* (1987) et Ogden *et al.* (1997). D'autres ont permis de travailler avec des conditions de tailles de gouttes d'eau et donc

d'énergie cinétique différentes par modifications de pression et différents types de gicleurs (Esteves *et al.*, 2000; Planchon *et al.*, 2000a; Humphry *et al.*, 2002; Sanguesa *et al.*, 2010; Liu *et al.*, 2011). Certains auteurs ont travaillé à la fois en laboratoire et au champ avec des outils similaires (Agassi and Bradford, 1999; Wu *et al.*, 2010).

Les mini-simulateurs de pluie travaillant entre 1 et 15 m<sup>2</sup> offrent des possibilités très nombreuses de champs d'étude. Ils ont permis d'étudier les facteurs contrôlant l'infiltration et les processus de pertes en sol tel l'importance de la végétation sur petites parcelles d'un mètre carré (Wainwright *et al.*, 2000; Gabet and Dunne, 2003). Plus spécifiquement, l'évolution de la porosité structurale (Ahuja *et al.*, 1995) ou biologique (Brown *et al.*, 2010; Mettrop *et al.*, 2013) ainsi que l'incidence pour structuration des sols de la dispersion des eaux usées (Sort and Alcaniz, 1996) ont été caractérisés grâce à ces outils.

Egalement, les mesures de perte en sol à l'échelle du mètre carré sous simulation de pluies ont été nombreuses en milieux tempérés et tropicaux (Sharma *et al.*, 1995; Barthes *et al.*, 2000; Barthes and Roose, 2002). Certaines formes d'érosion telle l'affaissement des parois de ravine a aussi été testé grâce à cet outil (Chaplot *et al.*, 2011). De même, la susceptibilité des sol à l'érosion a été étudiée pour les passages de différents utilisateurs sur des cheminements piétonniers, animaliers ou dédié aux deux roues et tous terrains (Wilson and Seney, 1994) ; en milieu de pâturage ou forestier (Arnaev *et al.*, 2004; Croke *et al.*, 2005; Jordan and Martinez-Zavala, 2008).

Par ailleurs, les mini-simulateurs de pluies permettent aussi d'étudier la dispersion d'éléments fertilisants (Fierer and Gabet, 2002; Yang *et al.*, 2007), de pesticides (Wauchope *et al.*, 1995), de bactéries (Collins *et al.*, 2005) tout comme la dispersion par la pluie de pathogènes des végétaux (Savary and Janeau, 1986; Savary *et al.*, 2004; Chabrier *et al.*, 2008) (Figure 12).



Mini-simulateur de pluie sur champ d'arachide en Côte d'Ivoire.



La parcelle de mesure d'1 m<sup>2</sup> équipée de capteurs de spores.

**Figure 12.** Etude de la dispersion de la rouille de l'arachide sous simulation de pluie.

Un des intérêts majeurs des mini-simulateurs de pluies est leur versatilité d'usage notamment par leur consommation en eau modérée et par leur facilité de déplacement. Ainsi ont-ils été



utilisé en milieu naturel semi-aride (Boers *et al.*, 1992; Valentin and Casenave, 1992; Mauchamp and Janeau, 1993; Hamed *et al.*, 2002; Ohrstrom *et al.*, 2002; Assouline, 2004; Mandal *et al.*, 2005; Kato *et al.*, 2009); en milieu subhumide et forte pente (Loch and Donnollan, 1983; Ribolzi *et al.*, 2011) et humide (Clarke and Walsh, 2007) tout comme en milieu de moyenne et haute montagne (Blijenberg *et al.*, 1996; Poulénard *et al.*, 2001; Molina *et al.*, 2007) ou l'accès à l'eau peut-être modeste et les cheminements difficiles.

Dans les années quatre-vingt-dix des **micro**-simulateurs de pluies dont la mesure s'effectue sur moins 1/4 de mètre carré sont apparus. Leur utilisation est prévue pour des conditions extrêmes, à relief accidenté (Cerda *et al.*, 1997) et sous forêt dense (Clarke and Walsh, 2007) mais l'intérêt majeur est en laboratoire. Ils y sont le plus souvent utilisés pour déterminer des coefficients d'infiltration sur colonne de différents sols et différents paillis (Eldridge and Kinnell, 1997; Jayawardena and Bhuiyan, 1999; Adekalu *et al.*, 2007; Kinnell, 2009). Ils permettent aussi d'étudier la dispersion de pesticides (Wauchope *et al.*, 1995; Monquero *et al.*, 2008) ou pour des études très spécifiques telle la dégradation des turricules de vers de terre (Jouquet *et al.*, 2013).

## 2.1. DESCRIPTION DU DISPOSITIF DE SIMULATION DE PLUIE UTILISÉ

Deux éléments matériels principaux sont nécessaires à la mise en œuvre du simulateur de pluie de type ORSTOM (Asseline and Valentin, 1978) : le simulateur proprement dit et la parcelle métallique d'un mètre carré.

**Le simulateur est constitué d'un bâti-cadre** (Figure 13) ou d'une potence supportant une tête d'aspersion et muni d'un gicleur calibré fonctionnement à basse pression (0.5 bar) et à débit constant (alimentation par électropompe). Ce système est entouré de bâche coupe-vent évitant ainsi de perturber la forme de la pluie. Le système d'aspersion a évolué au cours du temps passant d'un système mécanique commandé manuellement à un système électromécanique commandé par un logiciel. Les caractéristiques des pluies sont similaires à celles des pluies naturelles oscillant entre 15 et 140 mm h<sup>-1</sup> pour la dernière génération de dispositif d'aspersion automatique CAPELEC CAP1700 que nous utilisons. Cette amplitude est obtenue en variant l'angle et la vitesse d'oscillation du gicleur, la superficie d'aspersion est alors modifiée changeant ainsi l'intensité de pluie et la taille des gouttes de pluie. Plus l'angle d'aspersion est grand et plus l'intensité de la pluie est faible.



**Figure 13.** Vue d'ensemble d'une expérimentation *in situ* sous simulation de pluie en Thaïlande.

Les différentes mesures sont réalisées sur la parcelle expérimentale située sous le bâti. Enfoncé de 10 à 20 cm de profondeur dans le sol, un cadre métallique de réception de l'eau de pluie est placé au centre de la parcelle afin d'effectuer les mesures sur 1 m<sup>2</sup> (Figure 14).

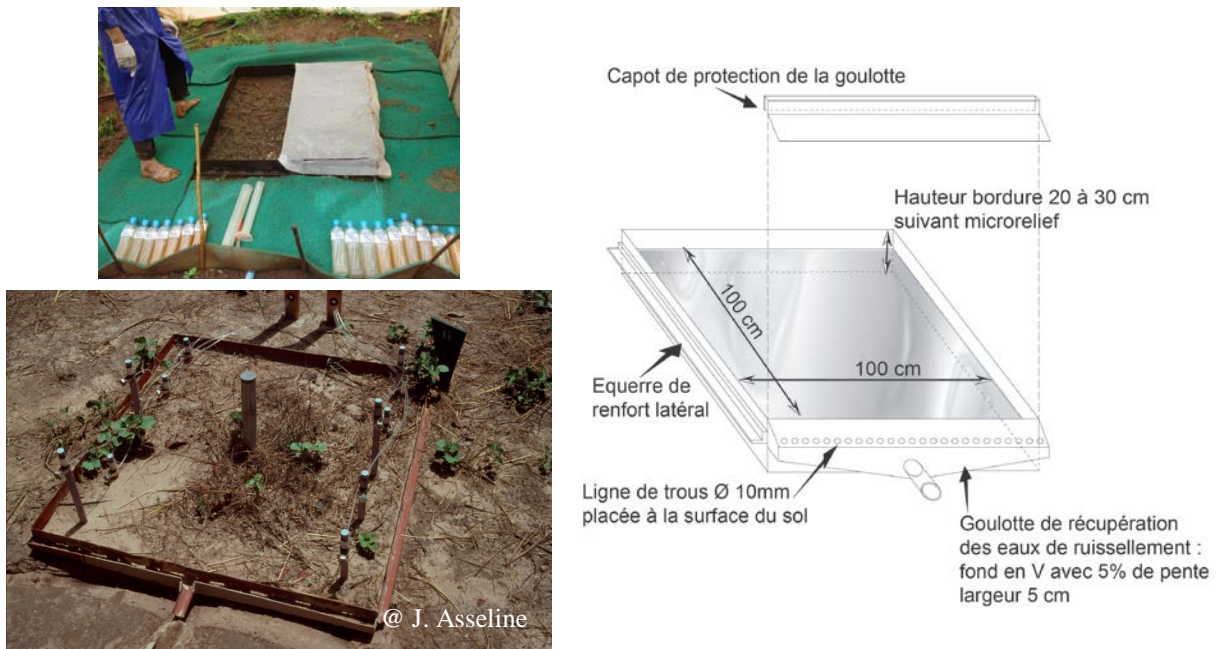

**Figure 14.** Cadre métallique implanté dans le sol.

Au sein de ce cadre en tôle qui dépasse de 10 cm de sol, il est souvent implanté d'autres outils permettant de mesurer la tension du sol, le front d'humectation, la rugosité. A noter également qu'une parcelle de calibration imperméable est placée sur ce cadre en début et en fin de pluie afin de quantifier avec précision l'intensité de la pluie apportée.

## 2.2. VARIABLES MESUREES A PARTIR DE L'HYDROGRAMME ET DU SOLIDOGRAMME

A l'exutoire des parcelles, les mesures de ruissellement et de flux solides reposent sur l'échantillonnage de l'écoulement. L'eau de ruissellement est récupérée en totalité ou à partir de prélèvements à pas de temps variable. Quatre phases sont généralement identifiées à partir de l'**hydrogramme** d'une pluie (Figure 15), celles-ci ont été définies et modifiées par Lafforgue (1977); Lafforgue and Casenave (1980); Collinet (1984); Casenave and Valentin (1989). On distingue ainsi:

- La **phase d'imbibition** qui correspond au temps compris entre le début de l'averse et l'apparition du ruissellement au temps  $t_i$ . L'infiltration est alors totale car l'intensité potentielle d'infiltration  $F(t)$  est en chaque point de la parcelle supérieure à l'intensité de pluie. Elle correspond à une hauteur de pluie, infiltrée ou stockée en surface ; c'est la pluie d'imbibition  $P_i$  exprimée en mm. Au temps  $t_i$ , les flaques débordent et l'eau qui ruisselle parvient à l'exutoire.

Durant cette phase d'imbibition on a :

$$L_r(t) = 0 \text{ et } D_m(t) = 0$$

$$P_u(t) - L_i(t) - S(t) = 0$$

Avec :

$L_r(t)$  = lame ruisselée à l'instant  $t$

$D_m(t)$  = Détention superficielle mobilisable à l'instant  $t$

$P_u(t)$  = Hauteur de pluie à l'instant  $t$

$L_i(t)$  = lame infiltrée à l'instant  $t$

$S(t)$  = lame stockée en surface à l'instant  $t$

- Le **régime transitoire** est une phase où l'eau commence à ruisseler à la surface du sol suite aux remplissages des dépressions puis aux débordements des flaques. La portion de la courbe de l'hydrogramme prend alors la forme d'un S allongé. La hauteur moyenne de la lame d'eau en mouvement à la surface ( $D_m$ ) augmente. Cette phase correspond à un régime transitoire pendant lequel :

$$I(t) - R(t) - F(t) - \frac{d D_m}{dt} + \frac{d S}{dt} = 0$$

Où :

$I(t)$  = Intensité de la pluie à l'instant  $t$

$R(t)$  = Intensité de ruissellement à l'instant  $t$

$F(t)$  = l'intensité d'infiltration à l'instant  $t$

- Le **régime d'écoulement permanent**  $R_x$  est établi lorsque à partir d'un temps  $t_m$ , un pallier de ruissellement constant est apparu ; le ruissellement est à son maximum pour une intensité de pluie donnée. Un régime d'écoulement permanent est caractérisé par :

$$R(t) = R_x \quad F(t) = F_n \quad \frac{dD_m}{dt} = 0 \quad \frac{dS}{dt} = 0$$

Avec :

$$I - R_x - F_n = 0$$

$R_x$  = Intensité maximale de ruissellement

$F_n$  = Intensité minimale d'infiltration.

- La **phase de vidange** débute à la fin de la pluie ; au temps  $t_u$ , le ruissellement s'amenuise jusqu'à s'annuler au temps  $t_f$ . La quantité d'eau qui s'écoule représente la fraction non infiltrée de la détention superficielle mobilisable.

Elle répond à l'équation:

$$L_r(t_f) - L_r(t_u) = D_m(t_u) + S(t_u) - S(t_f) + L_i(t_u) - L_i(t_f)$$

Ces équations sont utilisables pour une pluie d'intensité constante pour un type et un état d'humectation du sol et des caractéristiques d'états de surface définies. Au début et à la fin de chaque expérimentation, une mesure de l'humidité du sol est impérative au moins par méthode gravimétrique. Ces mesures sont dans la mesure du possible couplées à une évaluation de l'humectation du sol par un indice de précipitations antérieures. Ce dernier est calculé à partir de série pluviométrique d'une station météorologique de référence proche du site expérimental.

Cette eau de ruissellement chargée d'éléments solides détachés de la parcelle expérimentale est utilisée pour élaborer et quantifier le **solidogramme** étroitement lié à l'hydrogramme (Figure 15) car il est l'expression graphique des pertes en terre en fonction du temps de pluie et de ruissellement.

Le pic de concentration ( $C_s$ ,  $g \cdot l^{-1}$ ) a généralement lieu pendant la phase transitoire du ruissellement et la concentration est constante ( $C_x$ ,  $g \cdot l^{-1}$ ) pendant la phase de régime d'écoulement permanent. Le produit de la courbe de concentration par l'hydrogramme permet d'obtenir le débit solide pendant la durée de l'averse. L'intégration du solidogramme permet d'obtenir la détachabilité correspondant à la quantité de sol détaché sur un mètre carré ( $D$ ,  $g \cdot m^{-2}$ ) lors de l'essai.

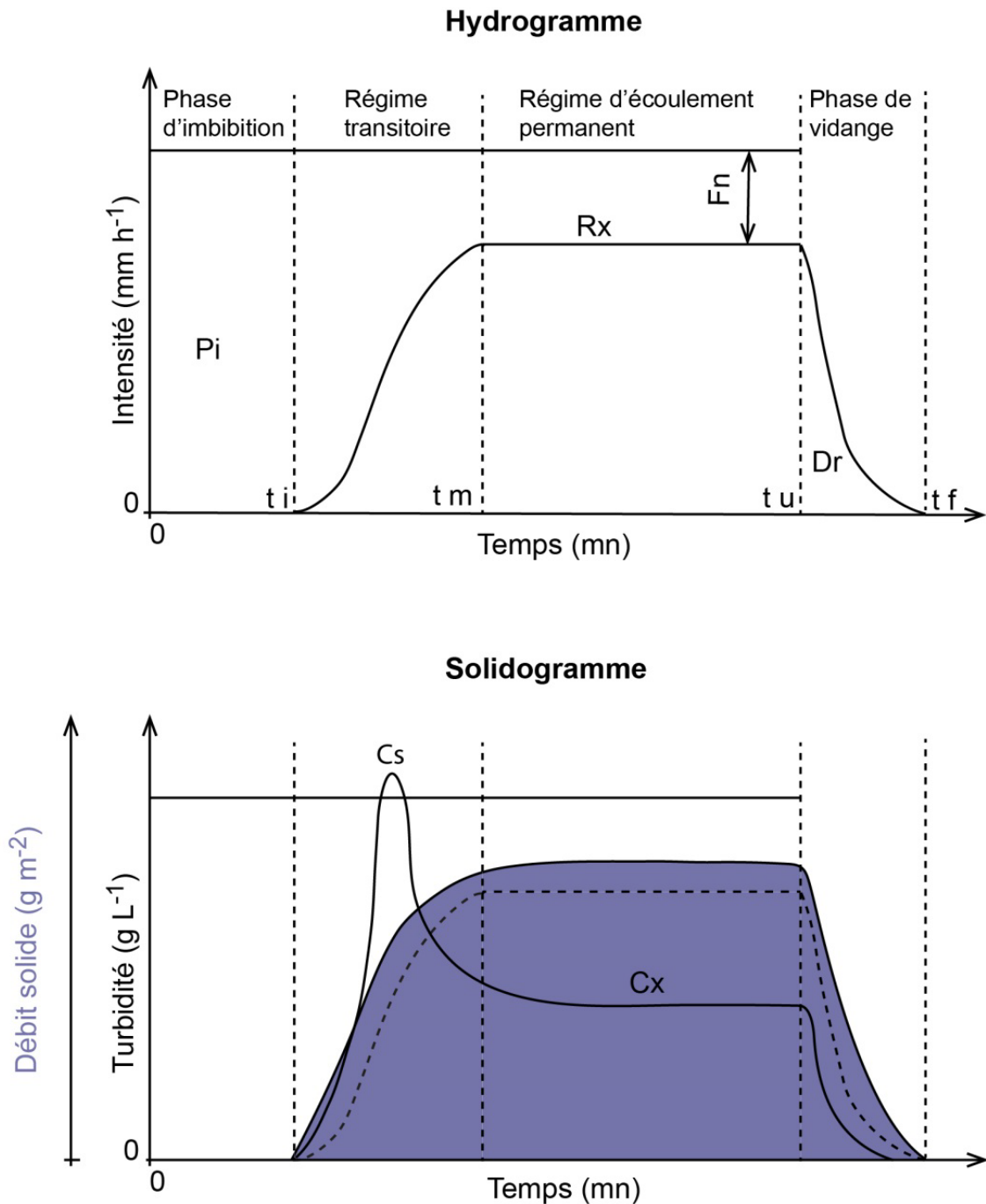

**Figure 15.** Hydrogramme et solidogramme « théoriques » définis par Collinet and Valentin (1979) et Collinet (1988).

**Lors des simulations de pluie présentées dans ce document**, nous avons veillé à ne pas dépasser la hauteur journalière de pluie de récurrence annuelle ou décennale et le total des pluies n'a jamais dépassé la valeur moyenne de la pluviométrie annuelle. Nous avons également respecté les composantes intensité-durée-fréquence d'une région donnée et d'un bassin versant donné pour lequel nous avons des données hydrologiques fiables.

## 2.3. LA DESCRIPTION DES ETATS DE SURFACE DU SOL

Que définit l'expression « états de surface » du sol ? A priori, ce terme regroupe les caractéristiques de la surface du sol mais pas seulement ; pour y répondre, je me référerai à la définition fournie par Casenave and Valentin (1989) qui sont à l'origine de cette appellation.

Ils définissent tout d'abord le concept de « surface élémentaire » nécessaire à la formulation « états de surface ». Le terme "*surface élémentaire*" désigne, à un instant donné, un ensemble homogène constitué par les éléments du milieu suivants :

- le couvert végétal (hauteur et le pourcentage d'occupation des végétaux au sol) ;
- la surface du sol (éléments grossiers, croûtes, microrelief, activité faunique) ;
- les organisations pédologiques superficielles qui ont subi des transformations, sous l'effet des facteurs météorologiques, fauniques ou anthropiques.

Le terme "*états de surface*" peut quant à lui désigner :

- une seule surface élémentaire ;
- la juxtaposition de plusieurs ;
- ou un système de surfaces élémentaires, c'est-à-dire un ensemble, au sein duquel jouent des interactions.

---

### 2.3.1. POURQUOI ETUDIER LES ETATS DE SURFACE DU SOL ?

A la fin des années trente, Duley (1939) décrivait déjà les états de surface comme un paramètre déterminant de l'infiltration de l'eau dans les sols. Woodward (1943) précisait que les capacités d'infiltration du complexe sol- plante subissaient l'effet des conditions de surface. Dans les années 1960-70, de nombreux scientifiques ; hydrologues, agronomes (Burwell *et al.*, 1966; Camus and Berthault, 1972) et pédologues (Collinet and Valentin, 1979; Johnson *et al.*, 1979) s'intéressèrent aux états de surface. En laboratoire des tests furent proposés (Touma *et al.*, 1984).

La typologie des états de surface et le concept de description à des fins cartographiques ont été établis en Afrique par Casenave et Valentin en 1989. Ils ont été utilisés par la suite dans de nombreux milieux dont certains sont présentés ici (Janeau *et al.*, 1999; Janeau *et al.*, 2003; Podwojewski *et al.*, 2008; Brown *et al.*, 2010; Podwojewski *et al.*, 2011; Jouquet *et al.*, 2012).

Les années 1990 ont été fructueuses en caractérisation de processus fins de genèse, d'évolution et de dégradation de la surface du sol (Bresson and Boiffin, 1990; Valentin and Bresson, 1992; Valentin and Casenave, 1992; Le Bissonnais and Singer, 1993; Eldridge and Greene, 1994; Auzet *et al.*, 1995; Le Bissonnais, 1996; Fox *et al.*, 1998; Singer and Le Bissonnais, 1998; Issa *et al.*, 2001).

Par la suite, en hydrologie notamment, les études incluant les états de surface comme facteurs incontournables de l'infiltration ont été nombreuses afin de comprendre à différentes échelles, du mètre carré à plusieurs dizaines de m<sup>2</sup> à celle de bassins versants, l'érodibilité, la genèse des crues (Albergel, 1988; Le Bissonnais *et al.*, 1998; Chaplot and Le Bissonnais, 2000; Descroix *et al.*, 2001; Cerdan *et al.*, 2002; Le Bissonnais *et al.*, 2005; Badorreck *et al.*, 2013) voire le bilan hydrique et érosifs de petits bassins versants (Perrin *et al.*, 2001; Valentin *et al.*, 2008).

Des études récentes portent sur la compréhension de l'infiltration en fonction de situation de zones à fortes pentes (Ribolzi *et al.*, 2011; Jouquet *et al.*, 2012) conquises de plus en plus par l'agriculture, souvent fort dommageable pour l'écosystème.

A plus large échelle, les états de surface sont étudiés par imagerie satellitaire afin de modéliser des cartes d'érosion (Metternicht and Fermont, 1998) et la dynamique spatiale et temporelle de la végétation (Qi *et al.*, 1994).

---

### 2.3.2. INTERETS ET VALIDATION DE CETTE METHODOLOGIE

Dès les années 60, les hydrologues de l'IRD cherchaient à classer les bassins versants étudiés en fonction de leurs coefficients de ruissellement pour un sol donné. Ils s'aperçurent très vite, notamment en zone sahélienne, de l'importance de la surface du sol sur l'infiltration, et décidèrent de s'associer à des pédologues dans les années 70 (Lafforgue, 1977; Collinet and Valentin, 1979). L'idée étant de comprendre les processus physiques pour mieux les prévoir.

Dans les années 90 et 2000, de nombreuses cartographies par cette méthode ont été effectuées au Sahel, au Mexique en zone semi-aride, en Equateur sur cendres indurées et zones brûlées et en Thaïlande sur sol fortement cultivé. Des simulations de pluie associées à cette cartographie spécifique ont permis de démontrer des corrélations très fortes entre type d'états de surface et coefficient d'infiltration (Janeau *et al.*, 1999; Poulenard *et al.*, 2001; Janeau *et al.*, 2003; Grünberger *et al.*, 2005; Podwojewski *et al.*, 2008).

Toutes ces études utilisant la caractérisation des états de surface et la simulation de pluie ont permis d'améliorer la compréhension des processus. Elles apportent aussi des données nécessaires à l'utilisation de modèles qui permettent une extension spatiale des résultats (Bui Tan Yen *et al.*, 2013).

Cette cartographie spécifique est en évolution, des études récentes proposent de prendre en compte :

- Les croûtes biologiques ayant des interactions non négligeables sur les flux de carbone (Grote *et al.*, 2010; Coe *et al.*, 2012; Wertin *et al.*, 2012) ou sur l'hydrodynamique et

les pertes en terre (Williams *et al.*, 1999; States and Christensen, 2001; Belnap *et al.*, 2009; Kidron and Tal, 2012; Steven *et al.*, 2012; Zhao and Xu, 2013),

- Des mesures spécifiques de la rugosité à l'aide d'un point quadrat (Sorrells and Glenn, 1991) ou grâce à des distanciomètres électromécaniques (Planchon *et al.*, 2000b; Mugler *et al.*, 2011; Ribolzi *et al.*, 2011) ou laser (Janeau *et al.*, 2003; Podwojewski *et al.*, 2011) (Figure 16) ou par méthode photogrammétrique (Taconet and Ciarletti, 2007).

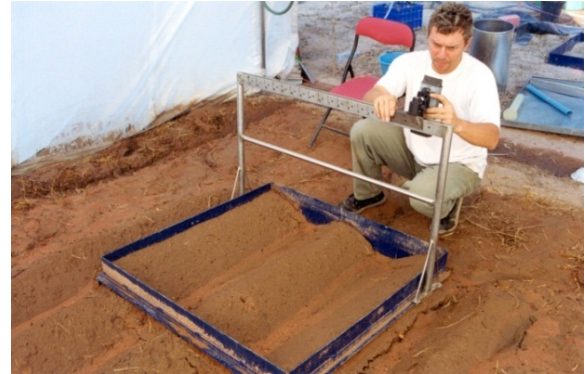

**Figure 16.** Mesure du nano relief (<5 cm) et du microrelief (<50 cm) à l'aide d'un distanciomètre laser Leica Disto pro.

Dans nos expérimentations, les états de surface, à savoir la combinaison de la végétation, des éléments grossiers, des croûtes structurales et d'érosion, de l'activité faunique déterminent le flux d'infiltration. Nous nous sommes intéressés à l'infiltration ainsi qu'au ruissellement de surface **dans des conditions données de sol, de microrelief, de pente, de climat et d'usages des terres spécifiques et contrastées.**

**La caractérisation des états de surface** permet d'établir des **unités cartographiques homogènes** en termes d'hydrodynamique superficielle et de détachabilité à l'échelle de bassin versant représentatif de zones spécifiques. **Leur classification** permet aussi d'installer des parcelles de mesures au sein de sites représentatifs du milieu étudié.

#### 2.4. CHOIX ET DESCRIPTION DES SITES D'ETUDES

Cette étude conduite en Amérique du Sud, en Asie du Sud-Est et en Afrique a permis de couvrir un large gradient pluviométrique, d'altitude et d'usage des sols (Tableau 1).

La diversité des sites expérimentaux présentés a permis d'étudier des déterminants physiques et biologiques spécifiques : pente, couvert végétal, ingénieurs du sol et les pratiques agricoles qui sous l'effet de la pluie génèrent des états de surface du sol très différents.



Nos études ont toujours été menées **au sein de bassin versant représentatif des régions étudiées** prenant en compte les aspects écologiques au sens larges et les caractéristiques socio-économiques. La taille de ces bassins versants varie de 0.5 à 1 km<sup>2</sup> en Asie car le modelé des paysages présente des pentes fortes, à 10 km<sup>2</sup> en Afrique du Sud et à 150 km<sup>2</sup> au nord du Mexique ou le climat génère des zones plus homogènes sur de grandes surfaces dotées de relief faible à modéré.

**Tableau 1.** Situations géographiques et climatiques des différents sites où ont été menées les expérimentations entre 1990 et 2012.

<b>Pays</b>	<b>Zone d'étude – altitude – usage des sols</b>	<b>Pluviométrie annuelle</b>	<b>Climat</b>
Mexique	Bassin versant de Mapimi, Désert de Chihuahua, réserve de Mapimi, Nord du Mexique. De 1000 à 1200 m. Pâturages extensifs	264 mm	Climat tropical semi-aride continental de moyenne altitude à pluies d'été et hiver frais*
Afrique du Sud	Bassin versant de Potshini, Province du Kwazulu Natal, région de Bergville, Est de l'Afrique du Sud. De 1200 à 1400 m. Pâturages extensifs.	684 mm	Climat de savane subtropical subhumide, de moyenne altitude à pluies de mousson et hiver frais sec**
Equateur	Bassin Versant de Tumbaco, Province de Quito, Nord de l'Equateur. De 2600 à 2800 m. Cultures vivrières	800 mm	Climat tropical subhumide à humide, de haute altitude à pluies de mousson et hiver frais**
Thaïlande	Bassin versant de Huai Ma Nai, Province de Phrae, région de Maeyom, Nord de la Thaïlande. De 300 à 400 m. Cultures vivrières et de rente.	1072 mm	Climat tropical humide, continental de basse altitude à pluies de mousson**
Vietnam	Bassin versant de Don Cao, Province de Hanoi, région de Tien Xuan, Nord du Vietnam. De 300 à 500 m. Cultures vivrières, plantations forestières, pâturages extensifs, aménagements périurbain.	1650 mm	Climat subtropical humide, subcontinental de basse altitude à pluies de mousson et hiver frais humide**

\*(Cornet, 1988), \*\*adapté de Peel *et al.* (2007)

### 3. LA PENTE, DETERMINANT PHYSIQUE DE L'INFILTRATION

Janeau JL, Bricquet JP, Planchon O, Valentin C (2003). *Soil crusting and infiltration on steep slopes in northern Thailand*. *European Journal of Soil Science* 54:543-553.

#### L'ENCROUTEMENT ET L'INFILTRATION DES SOLS SUR FORTES PENTES AU NORD DE LA THAÏLANDE.

**Contexte.** Cette étude a été menée sur un site expérimental situé en Asie du Sud-est et appartenant au réseau MSEC (*MultiScale Environmental Changes*) au sein du SOERE (Système d'Observation et d'Expérimentation sur le long terme pour la Recherche en Environnement) - RBV (Réseau de Bassin Versant) labellisé par Allenvi (Alliance national de recherche pour l'environnement). Représentatif d'une grande région du Nord de la Thaïlande, ce bassin versant est parcouru de collines convexes en amont de vallées irriguées pour la culture du riz, du soja, du maïs, et de l'ambérique. Ces collines sont illégalement défrichées par brûlis et cultivées depuis les années 1982 (Figure 17).



**Figure 17.** Défrichement par brûlis en vue d'établir la monoculture de maïs sur le bassin versant de Mae Yom au nord de la Thaïlande.

**Question scientifique.** Les propriétés hydrodynamiques des sols à forte pente sont mal connues. L'objectif de cette étude porte sur le déterminisme des coefficients d'infiltration et du détachement (érosion « *inter-rill* ») pour des sols nus et travaillés sur une faible

profondeur. Nous avons donc voulu quantifier les coefficients d'infiltration en fonction de la pente et les pertes en sol tout en déterminant les causes de ces valeurs.

**Méthodologie.** L'étude a été menée au sein du bassin versant de Mae Yom, dans la province de Phrae au Nord de la Thaïlande dont la précipitation annuelle est de 1072 mm. Quinze parcelles métalliques de 1 m<sup>2</sup> ont été installées en partie haute d'une toposéquence représentative d'un versant cultivé. Les parcelles ont été placées sur une zone avec un gradient de pente variant de 16 à 63%. Les sols à textures argilo-sableuses dominantes sont dérivés de schistes, gravillonnaires, peu profonds et modérément perméables à perméables. La densité apparente et l'humidité du sol ont été mesurées dans les premiers centimètres du sol grâce à des cylindres de 100 cm<sup>-3</sup> avec trois répétitions par parcelles avant et après la pluie. Des pluies simulées ont été effectuées sur chaque parcelles en utilisant un simulateur de type ORSTOM-DELTALAB. Les pieds du simulateur ont été ajustés à la pente grâce à ses pieds télescopiques pour obtenir deux pluies verticales d'intensités constante : 60 mm h<sup>-1</sup> durant 1 heure et 24 h après 120 mm h<sup>-1</sup> durant 30 minutes. La mesure du volume du ruissellement a été mesurée par récupération de celui-ci toutes les minutes après que le ruissellement ait débuté. Le taux d'infiltration a été calculé par la mesure du ruissellement par rapport au volume de pluie précipitée. Chaque parcelle a été labourée à la houe traditionnelle entre 7 et 10 cm de profondeur et égalisée en surface afin de reproduire un lit de semence. La mesure de la rugosité a été effectuée avant et après la simulation de pluie avec un distanciomètre laser. La stabilité structurale a été mesurée après la pluie sur des échantillons de surface par la méthode de Kemper W.D. and Roseneau R.C. (1986). La caractérisation des états de surface a été effectuée par la méthode Casenave and Valentin (1992) en évaluant notamment les taux de gravillons libres de ceux enchassés dans les croûtes structurales.

**Résultats.** Les proportions de graviers augmentent légèrement avec le gradient de pente alors que la densité apparente et l'humidité diminuent. Il n'y a pas de différence significative pour l'humidité du sol entre les différents profils de sols avant les simulations de pluies.

La stabilité des agrégats humides décroît avec l'augmentation de la pente avant les pluies. La pente n'a pas d'influence sur le diamètre du plus petit agrégat stable (MWD) avant ou après la pluie. La pluie ne change pas la valeur moyenne de MWD, 0.77 mm calculé pour les 15 parcelles. Par contre les états de surface du sol après la dernière pluie ont fortement évolué en relation avec la pente et la relation entre les éléments grossiers enchassés dans la croûte et la pente est forte.

Concernant les paramètres hydrologiques, le temps d'apparition de flaques varie entre 6 et 22 minutes pour la première pluie et de 9 à 100 secondes pour la deuxième. Il n'y a pas de relation entre le temps d'apparition des flaques et les autres variables, en particulier la pente. Un ruissellement est apparu sur chaque parcelle pour les deux pluies avec des volumes

différents mais aucune griffe d'érosion ou ravine n'est apparu au cours de l'expérimentation. Le taux constant d'infiltration de chaque parcelle a augmenté de façon significative avec l'augmentation du degré de pente au cours des deux pluies. A l'inverse, le coefficient de ruissellement ( $K_r$ ) a décliné de 0.78 pour les parcelles de pente faible, à 0.05 pour les plus pentues. La rétention d'eau récupérable après la fin de la pluie ( $D_r$ ) décroît drastiquement avec l'augmentation de la pente et ce pour les 2 pluies.

Les mesures de pertes en terre et topographique indiquent une décroissance significative des pertes moyennes en suspension avec l'augmentation de la pente pour les 2 pluies, et un affaissement de la surface plus prononcé sur les faibles pentes. Cet affaissement, compris entre 0.7 et 1.6 cm, est due à la fois aux pertes en terre et à la compaction.

La régression présentée dans le **tableau 5 de l'article** indique que le gradient de pente est la variable la plus significative pour la compaction et l'encroûtement des sols ainsi que pour l'apparition de gravillons inclus dans la croûte matricielle du sol. Il en est de même pour les variables hydrologiques et la détachabilité.

**Discussion.** Sous ces conditions spécifiques de texture et d'humidité si l'on se réfère à la classification de Valentin and Bresson (1992), les croûtes d'éclatement se forment dès la première pluie. Cependant pour les conditions de cette étude, les micro agrégats restent eux stables et subissent qu'un faible dispersément et affaissement. Cette stabilité structurale est probablement liée au relatif taux élevé de matière organique de ces sols.

L'augmentation de l'infiltration est nette quand la pente est plus forte. La formation des croûtes est très importante en condition de pentes faibles inférieures à 15% et un écoulement important se produit. Pour les pentes ayant un gradient de pente de 40%, il n'y a pas de formation de croûte et donc une meilleure infiltration relative est constatée.

L'encroûtement et la compaction sont liés à l'angle de l'impact des gouttes de pluies qui diminuent lorsque la surface de réception augmente; c'est le cas des pentes fortes où l'énergie cinétique a décliné de 27%.

Le détachement des particules et donc la perte en sol est la plus importante pour les pentes autour de 40% d'inclinaison. La cause en est la dispersion de l'énergie cinétique des gouttes de pluies et nos résultats démontrent une diminution rapide de la rétention récupérable en surface plus la pente augmente. Il est important de souligner qu'à l'état humide les matériaux du sol sous l'effet de l'impact des gouttes de pluie subissent un tri granulométrique générant des croûtes structurales peu perméables. Par contre, le fort taux de gravillons libres de ce sol favorise l'infiltration.

La **figure 8 de l'article** démontre que l'épaisseur du film d'eau à la surface du sol décroît avec l'augmentation du gradient de pente. La concentration des sédiments augmente de 0.5-3

$\text{g l}^{-1}$  à plus de  $5 \text{ g l}^{-1}$  quand la valeur de la détention récupérable en surface est de plus de 5.5 mm ce qui est le cas pour les faibles pentes inférieures à 20%. Ces observations confirment que l'effet splash qui est le paramètre le plus important de la détachabilité des sols, est fortement lié à l'épaisseur du film d'eau en surface.

La validité des résultats par mesures *in situ* est notable et complémentaire de la plupart des études de l'influence de la pente sur l'infiltration. Malgré quelques variations du gradient de pente inter répétitions, nos résultats *in situ* montrent que le gradient de pente est le facteur qui explique le plus clairement les variations des caractéristiques des états de surface, les caractéristiques hydrologiques et les pertes en terre. Des observations similaires ont été faites sous pluies naturelles sur ces mêmes parcelles (Bayer, 2001) et sur 15 autres parcelles d' $1 \text{ m}^2$  implantées au Nord Laos sur un gradient de pente de 34 à 82% (Huon and Valentin, 2001; Ribolzi *et al.*, 2011).

**Conclusion.** Au nord de la Thaïlande sur sol nu à forte pente, 15 parcelles d' $1 \text{ m}^2$  ont été installées sur un gradient de pentes variant de 16% à 63%. Elles ont été soumises à deux simulations de pluies ce qui nous a permis de démontrer i) qu'il existe une forte relation entre l'infiltration et le gradient de pente ; ii) que les croûtes d'éclatement sur ce sol argilo-sableux n'apparaissent pas mais que des croûtes d'agglomération (des micro agrégats) aux gravillons enchâssés et à faible perméabilité se développaient notamment sur faible pente ; iii) que la détachabilité décroît avec l'augmentation de pente ; iv) que la concentration en sédiment transporté est limitée sur forte pente par le film d'eau de ruissellement qui limite l'effet splash.

Ces résultats obtenus sous pluies simulées sont en accord avec des observations faites sous pluies naturelles sur le même site en Thaïlande et au Laos sur des sols de nature différente (structure micro-agrégée). Ce résultat obtenu sur sol nu semble indiquer le caractère générique de l'influence de la pente sur l'infiltration et sont très encourageants pour étendre ces recherches pour les sols tropicaux à différentes échelles et au niveau régional en prenant en compte bien sûr les différents types de couvert végétal.

# Soil crusting and infiltration on steep slopes in northern Thailand

J. L. JANEAU<sup>a</sup>, J. P. BRICQUET<sup>a</sup>, O. PLANCHON<sup>b</sup> & C. VALENTIN<sup>c</sup>

<sup>a</sup>*Institut de Recherche pour le Développement, International Water Management Institute, PO Box 1025, Jatujak, Bangkok 10903, Thailand,* <sup>b</sup>*Institut de Recherche pour le Développement, BP 1386 Dakar, Sénégal, and* <sup>c</sup>*Institut de Recherche pour le Développement, National Agriculture and Forest Institute, BP 06 Vientiane, Laos*

## Summary

Predicting the rate at which rain infiltrates on steep slopes is very uncertain. There is no consistent information in the literature. We have therefore related infiltrability to slope gradient under field conditions by experimenting on a gravelly loamy soil occupying the upper half of a cultivated convex hill in northern Thailand. Fifteen 1 m × 1 m plots with slope gradients ranging from 16 to 63% were established, and simulated rain was allowed to fall on them at controlled rates and for fixed times. We obtained the following results. The surface fell 0.4–7.2 mm due to compaction and soil loss. The proportions of crust (0–40%) and embedded gravel (10–60%), the runoff coefficient (0.05–0.78 mm<sup>-1</sup>), the mean sediment concentrations (0–5.6 g l<sup>-1</sup>), and soil detachment (10–313 g m<sup>-2</sup>) were more pronounced on the gentle slopes than on the steep ones. The steady final infiltration rate (1–107 mm hour<sup>-1</sup>) increased sharply with increasing slope gradient. Microaggregates tended to behave like sand and become tightly packed on gentle slopes (packing crust). These results suggest that the vertical component of kinetic energy, which is greater on gentle slopes, has a dominant role. Nevertheless, the differences in compaction and in sediment concentration could not be ascribed to the vertical component of kinetic energy alone. On steep slopes the horizontal component of the kinetic energy is transformed into shear stress, hampering the development of crusts so that water can still infiltrate. On steeper slopes, the water film was thinner, thereby limiting the role of splash. We conclude that the relationship between slope gradient and infiltrability depends on the nature of the soil and must be examined in the light of surface crusting processes.

## Introduction

Most recent models to predict soil erosion from small catchments use data on the spatial variation of soil infiltrability. These GIS-based models use infiltration attributes for each main soil unit. This approach may be questioned when it is applied to very steep slopes because under such conditions a soil map unit is rarely homogeneous, in terms of soil texture, stoniness, crustability, and soil depth. Furthermore, the classical methods of soil physics used to assess hydraulic conductivity can apply only to horizontal surfaces. Likewise, the prediction of soil infiltrability from topographic factors alone is risky since no one has shown an unequivocal relationship between slope gradient and infiltrability. Some authors have found no relation between the two (e.g. Singer & Blackard,

1982; Mah *et al.*, 1992). Others have reported a decrease in infiltration with increasing slope angle due to a decrease in depth of overland flow and surface storage (e.g. Chaplot & Le Bissonnais, 2000). Fox *et al.* (1997) observed decreasing infiltration rates with increasing gradient until a critical threshold was reached; thereafter the infiltration rate was steady and independent of slope gradient. More surprising is that in some studies the infiltration rate increased with increasing gradient. For interrill conditions, these trends have been ascribed to weaker crusting on steeper slopes because raindrops hit the soil at a more acute angle, and thus with less kinetic energy per unit area of surface (e.g. Poesen, 1986). Under tropical conditions, crusting hampers infiltration not only on loamy and clayey soils but also on sandy soils (Valentin, 1991) and gravelly ones (Valentin & Casenave, 1992). Surface crusts contribute to the redistribution of water and its concentration in the runoff areas (water-harvesting), which can be essential for the maintenance of vegetation (Greene,

Paper given at the Michel Rieu Memorial Colloquium, 8–10 October 2001, in Paris.

Correspondence: C. Valentin. E-mail: valentinird@laopdr.com

Received 7 November 2001; revised version accepted 12 July 2002

1992; Valentin *et al.*, 1999) and crop productivity (Rockström & Valentin, 1997).

Although agriculture is extending gradually on to steep lands in many parts of the world, there are few studies on very steep cultivated slopes. We therefore need better understanding of the relations between slope gradient, crusting and infiltration. We have investigated the effect of slope gradient on infiltrability, and determined the interactions with surface features such as crusts, stoniness and soil surface roughness and compaction, and we report our results below.

## Materials and methods

### The study site

Field research was carried out in the Mae Yom experimental catchment, 30 km east of Phrae Township in northern Thailand (64°69'54"E, 20°16'32"N, 440 m above sea level, Figure 1). The landscape is a typical one of convex hills adjacent to irrigated valleys. The hills have been cleared illegally and intensively cultivated since 1982. The average annual rainfall over the last 26 years is 1072 mm, with most falling during the monsoon season between May and September.



Figure 1 Location map of the experimental site in northern Thailand.

The soils are derived from shale and are very gravelly. They vary from moderately drained to well drained and are mostly shallow. The convex hilltops, as well as the uniform steep slopes, have loamy soils, which are very porous with a fine granular structure and are 0.5–0.7 m deep. On the foothills soils are generally deeper but otherwise similar (Podwojewski, 2001).

### Experimental design

Fifteen 1 m × 1 m plots were established for rainfall simulation experiments within a rectangular area of approximately 15 m × 30 m on the upper half of a typical catena. The plots were bounded by rigid metal frames inserted to a depth of 0.1 m (Figure 2). The plots were selected so that they all belonged to the same soil type (Luvisol) but differed greatly in slope gradient, ranging from 0.16 to 0.63 m m<sup>-1</sup> (Figure 3). The slope was accurately measured using a level. The topsoil thickness, as assessed from pits dug in each plot, varied between 8 and 41 cm with no clear relation to the gradient (Table 1). Particle-size analysis by the hydrometer method (Gee & Bauder, 1986) showed that clay contents increased with gradient from 14 to 28% and sand decreased from 60 to 40%, while silt remained nearly constant (26–30%). The organic matter content determined by the Walkley–Black method, as described by Nelson & Sommers (1986), varied little from plot to plot and was fairly large (3.9–4.7%), despite continuous cultivation (Table 1).

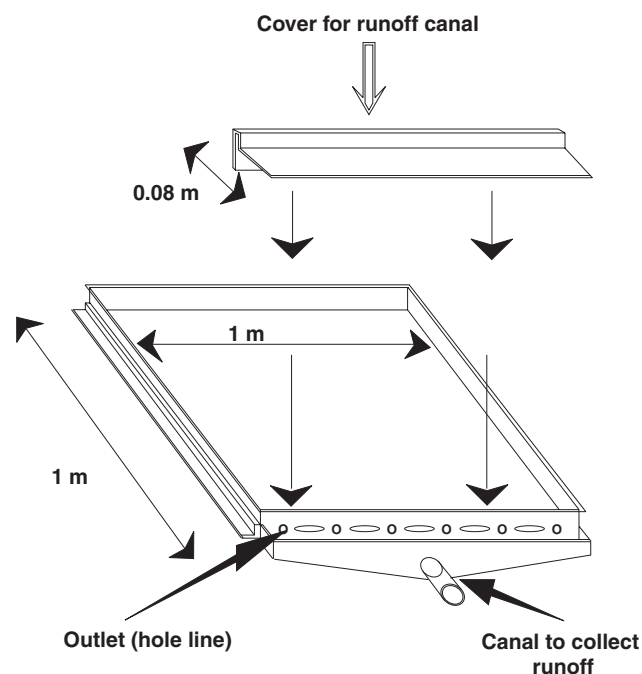

Figure 2 Metal frame and runoff canal used for each 1-m<sup>2</sup> plot submitted to rainfall simulation.

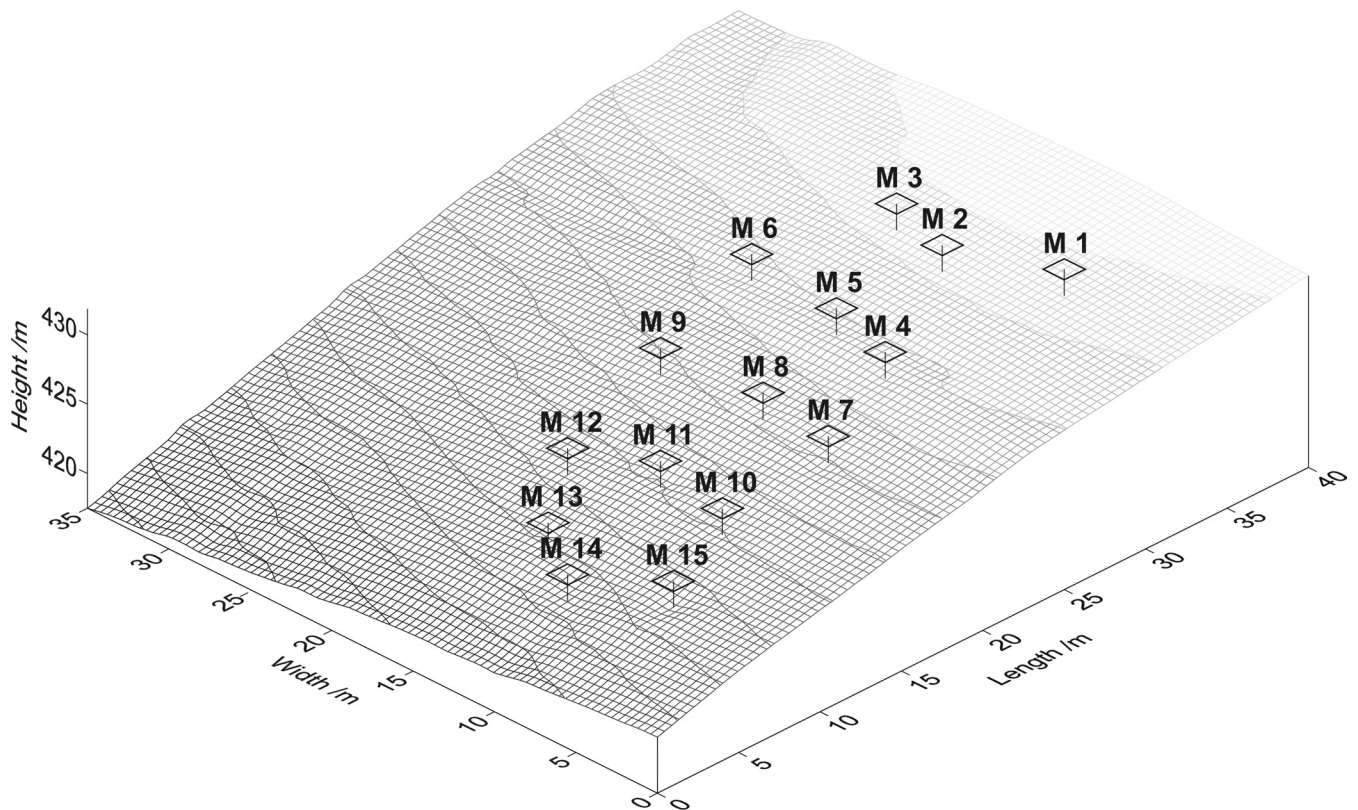

Figure 3 Topographic surface profile and setting of the experimental plots.

Before the rainfall simulation, each of the plots was hoed to a depth of 0.07–0.10 m and rolled, with aggregates crushed to less than 4 mm, to reproduce seedbed conditions (e.g. Fox *et al.*, 1997). Gravimetric soil moisture was determined before the tests in five plots along the slope (M3, M6, M8, M12 and M14) at depths 0–5 cm, 5–15 cm, 15–25 cm, 35–45 cm, 45–55 cm, 55–75 cm and 75–105 cm.

Surface roughness was measured on each plot before and after rainfall simulation with a laser distance meter (Leica Disto. Pro, laser class 2–635 nm) as a relief-meter on a 5-cm grid with elevational resolution of 1 mm. The distance meter was mounted 0.8 m above the plots on a frame fixed parallel to the surface. Random roughness ( $R_r$ ), as defined by Allmaras *et al.* (1966), was assessed as follows (Planchon *et al.*, 2002):

$$R_r = \left\{ \frac{1}{N-1} \sum_{i=1}^{n_r} \sum_{j=1}^{n_c} (z_{i,j} - z_{i\bullet} - z_{\bullet j} + z_{\bullet\bullet})^2 \right\}^{\frac{1}{2}}, \quad (1)$$

where  $n_r$  is the number of rows in the grid,  $n_c$  is the number of columns,  $z_{i\bullet}$ ,  $z_{\bullet j}$  and  $z_{\bullet\bullet}$  are the means, respectively, of row  $i$ , column  $j$ , and all the data, and  $N = n_r \times n_c$  is the total number of cells.

This equation provides the standard deviation of the elevation after subtraction of the means, calculated per line and per column, in order to remove the effects of the slope gradient and of the tillage-oriented roughness.

We collected from the hoed layer in each plot before and after rain samples of soil on which to assess aggregate stability and to determine the mean weight diameter of stable aggregates by the wet-sieving method of Kemper & Roseneau (1986). We estimated surface conditions visually using the method of Casenave & Valentin (1992). We included the recognition of various types of surface features such as crusts and gravel, either free or embedded in a crust (Valentin & Casenave, 1992), and we estimated surface gravel visually as the proportion of surface occupied by gravel. We brushed the surface gently to distinguish the surface gravel that was included in the crust and the free gravel that was readily removed by the brush. The bulk density of the upper 6 cm was assessed before and after the experiments in a 100-cm<sup>3</sup>

Table 1 Main topographic and soil characteristics of the experimental plots: mean, standard deviation (SD) and coefficient of determination,  $R^2$ , of each variable as regressed on the slope gradient

	Slope gradient /m m <sup>-1</sup>	Topsoil depth /m	Sand	Silt	Clay /%	Organic matter
Mean	0.388	0.20	49	28	22	4.2
SD	0.179	0.09	6	2	5	0.3
$R^2$		0.14	0.71	0.06	0.68	0.25



cylinder (height 6 cm, diameter 4.6 cm), with three replications per plot. These cylinders were also used to assess the percentage of gravimetric gravel and gravimetric soil moisture before the rains in the uppermost 6 cm of soil.

After the rains, undisturbed samples of surface soil were collected in steel Kubiena boxes from each plot, air-dried and impregnated with polyester resin. Thin sections, 55 mm by 25 mm, were prepared and examined with SEM (Backscattered Electron Scanning Image, BESI mode) at low resolution. We placed particular emphasis on the arrangement, microstructure and porosity. Surface crusts were classified in the typology proposed by Valentin & Bresson (1992).

The plots were subjected to simulated rain with ORSTOM's portable field simulator (Casenave & Valentin, 1992), with drop size distribution and kinetic energy similar to those of tropical rain of the same intensity ( $20 \text{ J mm}^{-1} \text{ m}^{-2}$  at  $60 \text{ mm hour}^{-1}$ ,  $24 \text{ J mm}^{-1} \text{ m}^{-2}$  at  $120 \text{ mm hour}^{-1}$ ). The multistage feet of the simulator's tower were adjusted to compensate for the slope differences and simulate vertical rain. We calibrated the intensity by collecting all of the rain before each test and after simulation from an impermeable  $1\text{-m}^2$  pan placed horizontally and directly over the plot. For a given intensity, the plots did not all receive the same quantity of rain because a plot of length  $l$  on a slope of gradient  $\alpha$  has a projection of only  $l/\cos\alpha$  in the horizontal plane. The experiments were conducted from late November to early December 2000. The first run, on dry soil, lasted for 1 hour at an intensity of  $60 \text{ mm hour}^{-1}$ ; the second run, 22 hours later, lasted 30 minutes at an intensity of  $120 \text{ mm hour}^{-1}$ . These two events corresponded to a return period of 2 years in northern Thailand. Gravimetric soil moisture was monitored on five plots to a depth of 0.95 m, before the rain, and 0.5, 1, 2 hours, 1, 2, 3, 10 and 15 days after the second run.

Time to ponding was measured for each plot and each run. We determined runoff rates by taking volumetric samples of the water discharged from a trough placed along the lowest side of the plot (Figure 2) every minute after runoff had begun. The infiltration rate was determined as the difference between the rainfall intensity times  $\cos\alpha$  and the runoff rate. For each rain event, the infiltration rate decreased to a constant, denoted hereafter as the final infiltration rate (FIR). We collected samples of runoff water at intervals ranging from 1 to 3 minutes, depending on the runoff intensity. On each plot we measured the volume of runoff after the cessation of the rain.

Because of the even surface (little roughness) and the steep slope gradient, we considered that no puddle could form, and we neglected the proportion of the running water at the soil surface that could infiltrate after the end of the rain. Thus, we estimated the mean depth of overland flow at the end of the rain ( $D_r$ ) from the volume of runoff after the end of the rain, divided by the plot area ( $1 \text{ m}^2$ ).

## Results

### Initial conditions

The proportion of gravel, whether expressed gravimetrically or by areal percentage, increased slightly with slope gradient, but neither bulk density nor the soil moisture of the seedbed varied with slope (Table 2). No significant difference was found among the soil moisture profiles before the rain events.

### Wet aggregate stability, gravel and surface crusts

Wet aggregate stability decreased somewhat with increasing gradient before the rain (Table 2), but there was no relation between the two afterwards. Slope had no influence on mean weight diameter of stable aggregates (MWD) either before or after the rain. Rain did not change the mean value of MWD,  $0.77 \text{ mm}$ , calculated for the 15 plots. The condition of the soil surface after the last rain event varied greatly with slope (Table 3), and there was a clear relation between slope and the percentage of embedded gravel (i.e. included in a surface crust, Figure 4).

Micromorphological examination showed that the crust was mostly of the packing type, consisting of skeleton grains or stable microaggregates tightly packed at the soil surface with very few macropores (Figure 5).

### Hydrological variables

Time to ponding ranged from 6 to 22 minutes during the first run and from 9 to 100 s during the second run. No relation was found between time to ponding and other variables. In particular, time to ponding was not influenced by gradient. Runoff was generated from each plot during the two rain events. Rills did not occur at any stage of the experiment. The steady final infiltration rate measured on each plot increased sharply with

**Table 2** Main surface conditions before the rainfall experiments: mean, standard deviation (SD) and coefficient of determination,  $R^2$ , of each variable as regressed on the slope gradient

	Slope gradient / $\text{m m}^{-1}$	Wet aggregate stability / $\text{kg kg}^{-1}$	Gravimetric gravel / $\text{kg kg}^{-1}$	Surface gravel / $\text{m}^2 \text{ m}^{-2}$	Bulk density / $\text{g cm}^{-3}$	Soil moisture / $\text{kg kg}^{-1}$
Mean	0.388	0.719	0.680	0.490	1.28	0.018
SD	0.179	0.059	0.075	0.156	0.07	0.003
$R^2$		0.31	0.45	0.39	0.02	0.26

**Table 3** Main surface conditions after the rainfall experiments: mean, standard deviation (SD) and coefficient of determination,  $R^2$ , of each variable as regressed on the slope gradient

	Slope /m m <sup>-1</sup>	Free aggregates /m <sup>2</sup> m <sup>-2</sup>	Free gravel /m <sup>2</sup> m <sup>-2</sup>	Crust /m <sup>2</sup> m <sup>-2</sup>	Embedded gravel /m <sup>2</sup> m <sup>-2</sup>
Mean	0.388	0.07	0.30	0.22	0.40
SD	0.179	0.14	0.25	0.15	0.16
$R^2$		0.12	0.66	0.56	0.76

increasing slope gradient for the two rain storms (Figure 6). Conversely, the runoff coefficient ( $K_r$ , the runoff:rainfall ratio) calculated for the two runs decreased from 0.78 on gentler slopes to 0.05 on steeper slopes (Figure 7). The evaluated mean depth of overland flow ( $D_o$ ) decreased sharply with increasing slope for the two rain events (Figure 8).

#### *Sediment concentration, detachment and compaction*

Mean concentration of sediment (Figure 9), as well as soil detachment (Figure 10), sharply decreased with the slope gradient. The mean random roughness ( $R_r = 3.4$  mm) of the surface of the plots did not change during the rainfall simulations, while the standard deviation increased from 0.3 to 0.4 mm. In contrast, the mean distance to the reference plane increased during the rain events. This lowering of the surface was much more pronounced for the gentler slopes than for the steeper ones. Considering that lowering of the surface level was due to soil detachment plus compaction, compaction appeared to be the major factor (Figure 11).

#### *Interactions among factors*

As shown in Table 4, there were highly significant correlations among topographic and soil variables (slope gradient and sand

percentage), surface features (free gravel, embedded gravel, crust percentages and lowering of the surface), hydrological variables (FIR,  $D_o$  of the first and second rains and the mean  $K_r$ ) and soil detachment.

Stepwise regression indicated that slope gradient was the best predictor for compaction, crust, embedded gravel, an impervious surface (crust plus embedded gravel), hydrological variables and soil detachment (Table 5).

## Discussion

#### *Crusting processes and compaction*

According to the classification proposed by Valentin & Bresson (1992) and for these conditions of soil texture and moisture, slaking crusts should have formed at the onset of the first rain. Instead of slaked aggregates, we observed very stable microaggregates that tended to behave like sand and became tightly packed. This aggregate stability can be attributed to the fairly large content of organic matter. Soil containing less organic matter would have been more likely to slake. As a result of rapid wetting, slaking crusts would have developed at the onset of the first rain on every plot, regardless of kinetic energy. We could not have then established any relationship between infiltration and slope gradient. This accords with the observations of Singer & Blackard (1982) and of Mah *et al.*

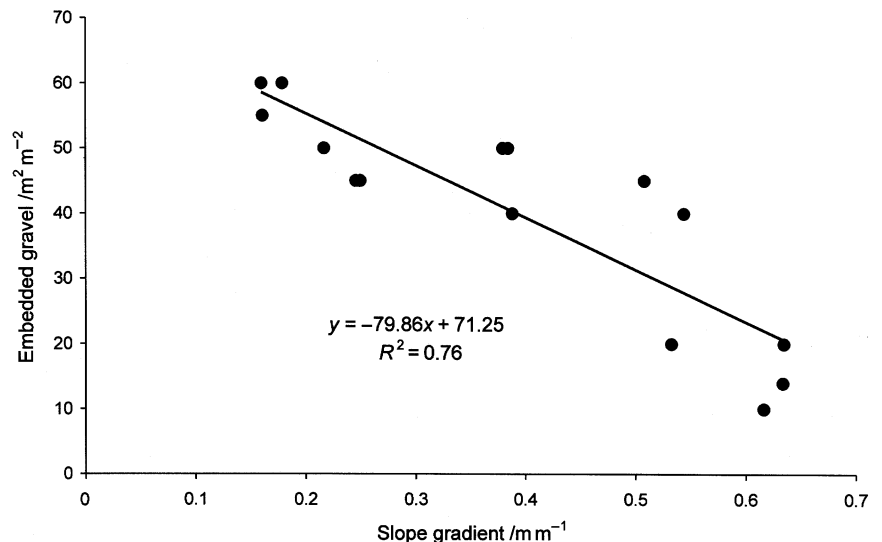

**Figure 4** Per cent of embedded gravel ( $y$ ) as affected by slope gradient ( $x$ ).

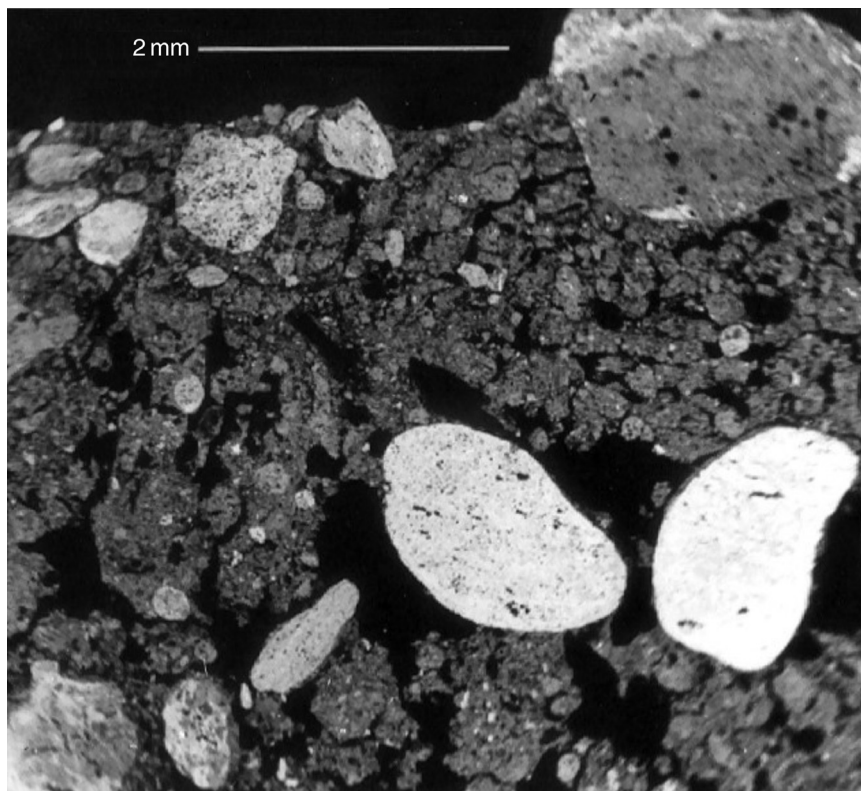
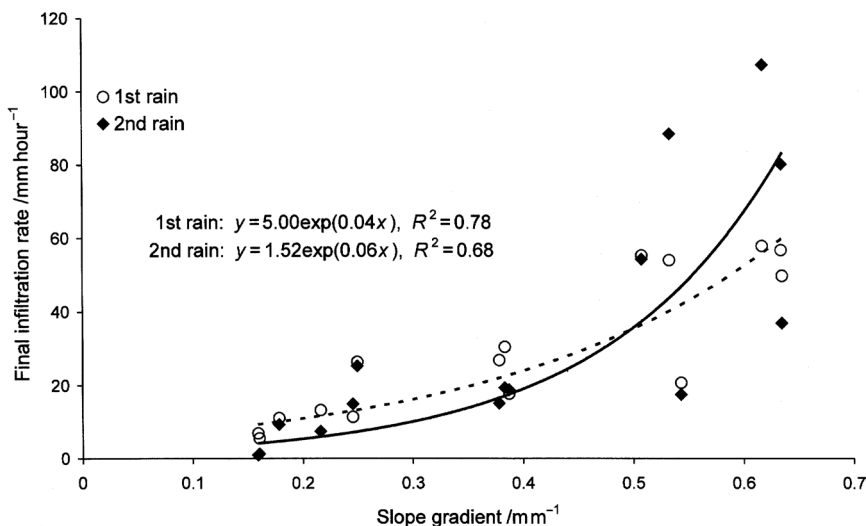

**Figure 5** Micrograph from a thin section from plot M1. Note the embedded gravel in the packing crust made of packed microaggregates.

(1992). With much runoff, rills could have occurred on the steeper slopes to disrupt crusts and therefore to favour greater infiltration, as suggested by Poesen (1986). Another possible cause of limited infiltration on gentler slopes might have been a greater proportion of depositional crusts that are less permeable than structural crusts (Valentin, 1991). But during these experiments, we observed neither rills nor depositional crusts.

This absence of depositional crust confirms that no puddle formed during the experiments. The more pronounced development of the packing crust and embedded gravel on gentler

slopes supports the hypothesis that the vertical component of kinetic energy is the principal cause (Poesen, 1986). The depth of rain received on a slope gradient of  $63 \text{ m m}^{-1}$  was roughly 86% of that on a  $0.16 \text{ m m}^{-1}$  slope. In addition, the energy flux density, normal for the surface, decreased in the same proportion. The kinetic energy was thus decreased by 27% from the gentlest to the steepest slopes. Although this hypothesis is supported by the greater compaction on gentler slopes, the vertical component of kinetic energy is insufficient to explain the differences in compaction (from 7 to 2 mm) recorded on



**Figure 6** Final infiltration rate ( $y$ ) as affected by slope gradient ( $x$ ) for the two rains.

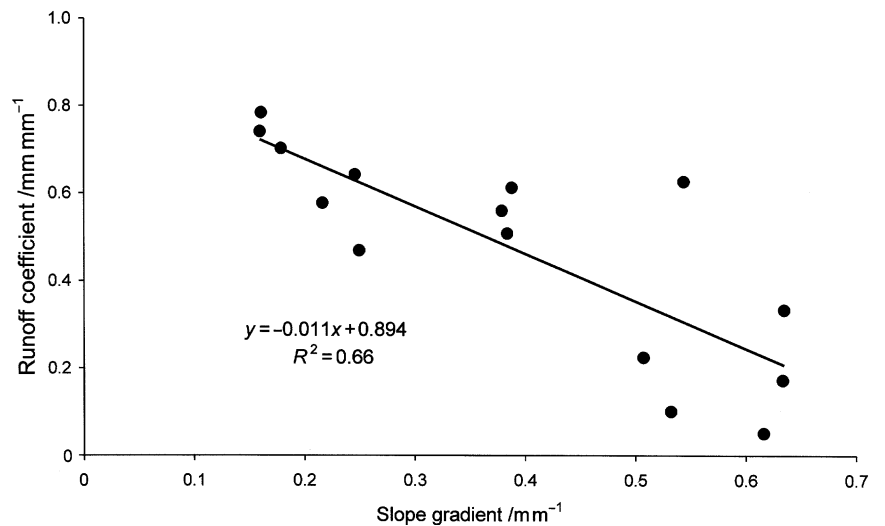

**Figure 7** Runoff coefficient ( $y$ ) as affected by slope gradient ( $x$ ). Runoff coefficient was calculated as the ratio between the sum of the runoff volume and the accumulated volume of rainfall for the two rains.

the two extreme slope gradients. This suggests that on the steep slopes, the horizontal component of kinetic energy could be dissipated into shear stress. As the angle of impact of the raindrops decreases, greater components of force act parallel to the surface (e.g. Cruse *et al.*, 2000). This results in slight translocation of the aggregates at the soil surface, which would hamper the compaction and packing. Clearly this hypothesis deserves further theoretical and experimental study.

*Soil detachment*

Again, the differences observed between the much greater detachment rates on the gentler slopes cannot be ascribed solely to the effect of the difference of vertical kinetic energy. When wet, granular materials (such as very sandy soils) receive shocks (or impacts), they tend to undergo a rapid sieving, with the coarser particles at the top and the finer ones at the

bottom, and to form a sieving crust (Valentin & Bresson, 1992; Bielders *et al.*, 1996). These crusts limit infiltration and foster detachment because the upper sand grains can be easily removed by the overland flow (Valentin, 1996). Thus the rapid detachment observed on the gentler slopes can be explained by this sieving process, but no sieving crust was observed. Moreover, a negative relation was observed between detachment rate and slope angle, which is very unusual.

Our experiments showed that the thickness of the water film decreased sharply as the slope gradient increased (Figure 8). The concentration of sediment increased from 0.5–3 g l<sup>-1</sup> to more than 5 g l<sup>-1</sup> when a film thickness of 5.5 mm was exceeded, namely for a slope gradient less than 0.20 mm<sup>-1</sup>. These observations confirm that splash, which is the major component of soil detachment on microplots, depends closely on the thickness of the film of water. Splash results from the compression of the water at the soil surface and thus requires an optimal film thickness for the greatest efficiency (e.g. Kinnel, 1993).

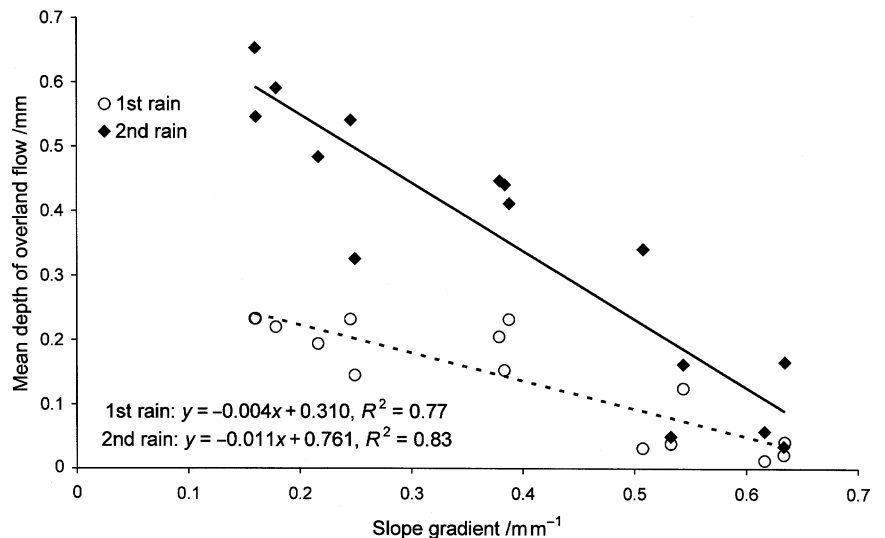

**Figure 8** Mean depth of overland flow ( $y$ ) as affected by slope gradient ( $x$ ) for the two rains.

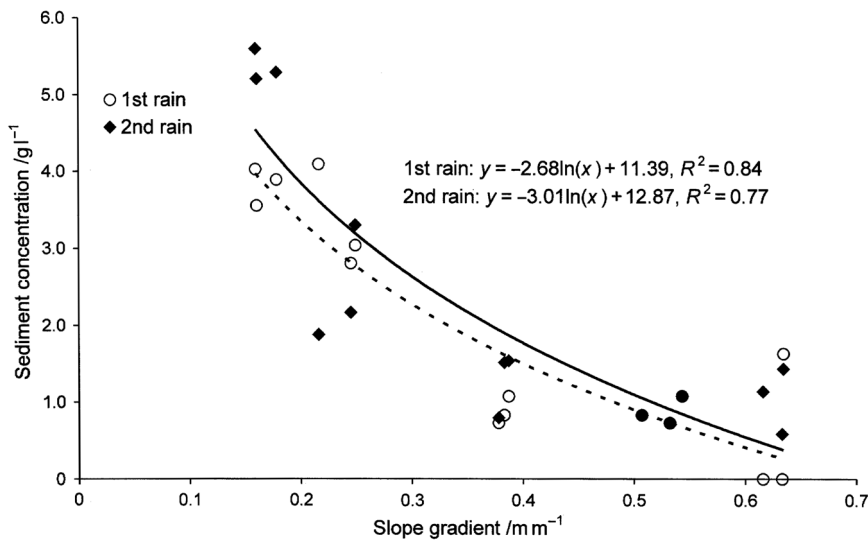

**Figure 9** Sediment concentration ( $y$ ) as affected by slope gradient ( $x$ ) for the two rains.

*Validity of the results under natural conditions*

Most previous research on the influence of slope gradient on infiltration has been done in a laboratory on one specific soil material sieved through a 4-mm sieve and packed into boxes inclined at various gradients. We preferred to carry out this type of study in the field, even though there was likely to be some variation in the gradient. Our results showed that despite some influence of sand content, gradient was the main factor explaining the variation in surface features, hydrological characteristics and soil detachment.

Similar positive relationships between infiltration and gradient were obtained under natural rain on these 15 plots (Bayer, 2001) and on fifteen 1 m × 1 m plots with gradients ranging from 34 to 82 mm<sup>-1</sup> in northern Laos (Huon & Valentin, 2001).

*Soil and landform implications*

During the rainy season, the soil is not left bare but is covered with crops, weeds and vegetation litter. Under such conditions, there is little erosion by splash, but runoff can still be sufficient to remove the clay-size particles. The observed textural difference of the topsoil would thus substantiate more active sheet erosion on the gentler slopes. This difference might also be due, however, to more frequent cultivation.

Although it is risky to apply the results for soil detachment from microplot studies to hillslope dynamics, our results suggest that the very steep slope should remain rather stable while the gentler slope should tend to become level. With such a simple geomorphological model, the landscape should evolve from convex hills to plateaux separated by steep slopes. This accords with the model of landscape evolution proposed by Penck (1924). Two items of field evidence tend to substantiate

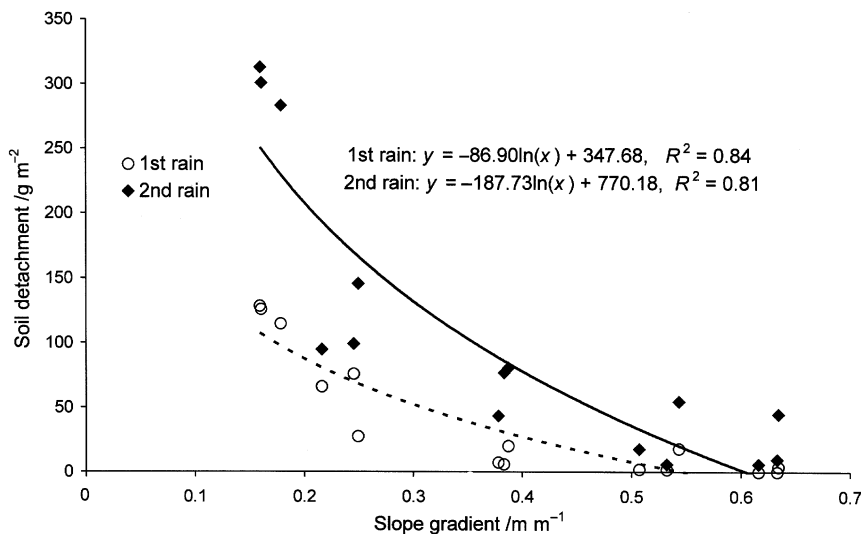

**Figure 10** Soil detachment ( $y$ ) as affected by slope gradient ( $x$ ) for the two rains.

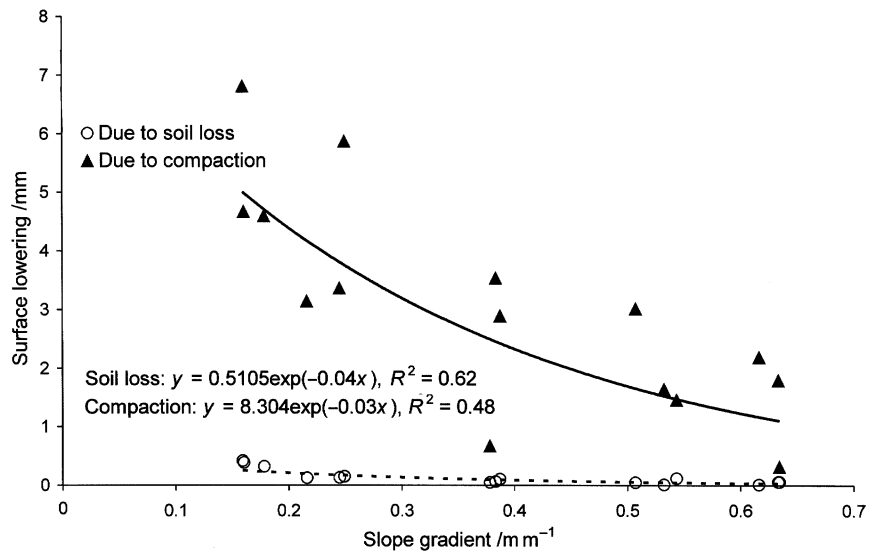

**Figure 11** Contribution of soil loss and compaction ( $x$ ) to the lowering of the plot surface ( $y$ ).

this idea. First, the gullies that originate from the hilltops do not broaden and deepen down the hillslopes, suggesting that the steep slopes do not contribute to their formation and development, and thus confirming great infiltrability. Secondly, the weathering zone does not conform to the topography. Although it is not clear on the 15 plots, a more extensive survey in the region has shown that the soils tend to be shallower on the hilltops than on the hillslopes (Podwojewski, 2001). This lack of conformity with Penck, however, suggests that the landscape is no longer in equilibrium with the climate that prevailed during the soil formation. Convex hillslopes that have probably developed under a more humid environment (e.g. Thomas *et al.*, 1999) would not remain stable under drier conditions, especially after forest clearance.

**Conclusions**

Fifteen 1 m × 1 m plots were established on slopes ranging in gradient from 0.16 to 0.63 m m<sup>-1</sup> in northern Thailand, submitted to two rainfall simulation tests. We found a clear positive relationship between infiltration and slope gradient. Soil detachment decreased sharply with increasing slope.

Slaking crusts did not develop on this loamy soil but a packing crust, of tightly packed microaggregates, did. This crust with its embedded gravel was mostly on the gentler sloping plots. Furthermore, compaction was more pronounced on the gentler slopes. To some extent the vertical component of the kinetic energy, which is greater on gentler slopes, was the cause. However, we think that the lateral component was dissipated on the steepest slope by shear strain resulting in a

**Table 4** Correlations among main variables expressed as the Pearson correlation coefficient,  $r$

	Slope gradient	Sand	Free gravel	Crust	Embedded gravel	Lowering	FIR <sub>1</sub> <sup>a,b</sup>	FIR <sub>2</sub>	$D_{r1}$	$D_{r2}$	$K_r$	Detachment
Slope gradient	1.000											
Sand	-0.844	1.000										
Free gravel	0.811	-0.555	1.000									
Crust	-0.746	0.617	-0.751	1.000								
Embedded gravel	-0.871	0.740	-0.915	0.769	1.000							
Lowering	-0.794	0.723	-0.517	0.410	0.649	1.000						
FIR <sub>1</sub>	0.881	-0.775	0.795	-0.929	-0.834	-0.600	1.000					
FIR <sub>2</sub>	0.775	-0.734	0.806	-0.918	-0.882	-0.468	0.902	1.000				
$D_{r1}$	-0.878	0.785	-0.793	0.868	0.834	0.545	-0.961	-0.878	1.000			
$D_{r2}$	-0.909	0.859	-0.812	0.744	0.928	0.668	-0.848	-0.848	0.890	1.000		
$K_r$	-0.812	0.752	-0.789	0.944	0.858	0.531	-0.970	-0.958	0.935	0.849	1.000	
Detachment	-0.849	0.754	-0.649	0.714	0.727	0.808	-0.790	-0.668	0.722	0.781	0.771	1.000

<sup>a</sup>Final infiltration rate.

<sup>b</sup>The subscripts 1 and 2 refer to the rain event number.

**Table 5** Results of stepwise regressions

Dependent variable	Predictor	Adjusted $R^2$
Compaction	Slope gradient,	0.60
	topsoil depth,	0.85
	and sand	0.90
Crust	Slope gradient	0.52
Embedded gravel	Slope gradient,	0.74
	and initial surface gravel	0.84
Crust + embedded gravel	Slope gradient	0.72
FIR <sub>1</sub> <sup>a,b</sup>	Slope gradient	0.76
FIR <sub>2</sub>	Slope gradient	0.57
$K_r$	Slope gradient	0.63
$D_{r1}$	Slope gradient	0.80
$D_{r2}$	Slope gradient	0.81
Detachment	Slope gradient,	0.70
	and initial soil moisture	0.77

<sup>a</sup>Final infiltration rate.

<sup>b</sup>The subscripts 1 and 2 refer to the rain event number.

slight translocation of microaggregates that hampered the formation of the crust. We attribute the limited concentration of sediment on the steeper slopes to the thinner film of water on the surface, which limited detachment by splash. Because similar results have been obtained under natural rain in northern Laos, these results appear to be valid for mountain soils with highly stable microaggregates. Our data should encourage more research on the physical processes involved in soil erosion on very steep slopes.

### Acknowledgements

This research is part of the Management of Soil Erosion Project coordinated by the International Water Management Institute involving Thailand, Lao PDR, Vietnam, Indonesia, the Philippines and Nepal. We thank particularly the Royal Forest Department and the Land Development Department in Thailand, and the French Ministry of Foreign Affairs.

### References

- Allmaras, R.R., Burwell, R.E., Larson, W.E. & Holt, R.F. 1966. *Total porosity and random roughness of the interrow zone as influenced by tillage*. USDA Conservation Research Report 7, US Department of Agriculture, St Paul, MN.
- Bayer, A. 2001. *Influence de la pente sur l'infiltration et la perte en terre dans le nord de la Thaïlande*. Mémoire de fin d'étude, ISTOM, Cergy-Pontoise, France.
- Bielders, C.L., Baveye, P., Wilding, L., Drees, R. & Valentin, C. 1996. Tillage-induced spatial distribution of surface crusts on a sandy Paleustult from Togo. *Soil Science Society of America Journal*, **60**, 843–855.
- Casenave, A. & Valentin, C. 1992. A runoff capability classification system based on surface features criteria in the arid and semi-arid areas of West Africa. *Journal of Hydrology*, **130**, 213–249.
- Chaplot, V. & Le Bissonnais, Y. 2000. Field measurements of interrill erosion under different slopes and plot sizes. *Earth Surface Processes and Landforms*, **25**, 145–153.
- Cruse, R.M., Berghoefer, B.E., Mize, C.W. & Ghaffarzadeh, M. 2000. Water drop impact angle and soybean protein amendment effects on soil detachment. *Soil Science Society of America Journal*, **64**, 1474–1478.
- Fox, D.M., Bryan, R.B. & Price, A.G. 1997. The influence of slope angle on final infiltration rate for interrill conditions. *Geoderma*, **80**, 181–194.
- Gee, G.W. & Bauder, J.W. 1986. Hydrometer method. Particle-size analysis. In: *Methods of Soil Analysis: Part 1, Physical and Mineralogical Methods*, 2nd edn (ed. A. Klute), pp. 404–408. American Society of Agronomy, Madison, WI.
- Greene, R.S.B. 1992. Soil physical properties of three geomorphic zones in a semi-arid mulga woodland. *Australian Journal of Soil Research*, **30**, 55–69.
- Huon, S. & Valentin, C. 2001. *Impact de la pratique de défriche-brûlis sur la dynamique de la matière organique et l'érosion hydrique et aratoire d'un petit bassin versant au Laos*. Rapport 2000, Programme National Sols et Erosion, Paris.
- Kemper, W.D. & Roseneau, R.C. 1986. Wet sieving. Aggregate stability and size distribution. In: *Methods of Soil Analysis: Part 1, Physical and Mineralogical Methods*, 2nd edn (ed. A. Klute), pp. 435–442. American Society of Agronomy, Madison, WI.
- Kinnell, P.I. 1993. Runoff as a factor influencing experimentally determined interrill erodibilities. *Australian Journal of Soil Science*, **31**, 333–342.
- Mah, M.G.C., Douglas, L.A. & Ringrose-Voase, A.J. 1992. Effects of crust development and surface slope on erosion by rainfall. *Soil Science*, **154**, 37–43.
- Nelson, D.W. & Sommers, L.E. 1986. Organic carbon. In: *Methods of Soil Analysis: Part 2, Chemical and Microbiological Properties*, 2nd edn (ed. A. Klute), pp. 983–1001. American Society of Agronomy, Madison, WI.
- Penck, W. 1924. *Morphological Analysis of Land Forms: A Contribution to Physical Geology*. Translated in 1953 from the 1924 version by H. Czech and K.C. Boswell, reprinted 1972; originally published in German. Macmillan, London.
- Planchon, O., Esteves, M., Silvera, N. & Lapetite, J.-M. 2002. Micro-relief induced by tillage: measurement and modelling of surface storage capacity. *Catena*, **46**, 141–157.
- Podwojewski, P. 2001. *Soil Survey of the Mae-Yom Site*. IRD, Bondy, France.
- Poesen, J. 1986. Surface sealing as influenced by slope angle and position of simulated stones in the top layer of loose sediments. *Earth Surface Processes and Landforms*, **11**, 1–10.
- Rockström, M. & Valentin, C. 1997. Hillslope dynamics of on-farm generation of surface water flows: the case of rainfed cultivation of pearl millet on sandy soil in the Sahel. *Agricultural Water Management*, **33**, 183–210.
- Singer, M.J. & Blackard, J. 1982. Slope angle–interrill soil loss relationships for slopes up to 50%. *Soil Science Society of America Journal*, **46**, 1270–1273.
- Thomas, M., Thorp, M. & McAlister, J. 1999. Equatorial weathering, landform development and the formation of white sands in north western Kalimantan, Indonesia. *Catena*, **36**, 205–232.
- Valentin, C. 1991. Surface crusting in two alluvial soils of northern Niger. *Geoderma*, **48**, 201–222.

- Valentin, C. 1996. Soil erosion under global change. In: *Global Change and Terrestrial Ecosystems* (eds B.H. Walker & W.L. Steffen), pp. 317–338. Cambridge University Press, Cambridge.
- Valentin, C. & Bresson, L.M. 1992. Morphology, genesis and classification of soil crusts in loamy and sandy soils. *Geoderma*, **55**, 225–245.
- Valentin, C. & Casenave, A. 1992. Infiltration into sealed soils as influenced by gravel cover. *Soil Science Society of America Journal*, **56**, 1667–1673.
- Valentin, C., d'Herbès, J. & Poesen, J. 1999. Soil and water components of vegetation patterning. *Catena*, **37**, 1–24.



#### 4. LE COUVERT VEGETAL, DETERMINANT BIOLOGIQUE DE L'INFILTRATION

Deux études spécifiques ont été menées pour ce déterminant i) au sein du mogote au Mexique (Figure 18) ; ii) au sein de pâturages dégradés d'Afrique du Sud (Figure 19).

Janeau JL, Mauchamp A, Tarin G. 1999. *The soil surface characteristics of vegetation stripes in Northern Mexico and their influences on the system hydrodynamics - An experimental approach. Catena 37: 165-173.*



**Figure 18.** Vue générale de l'écosystème Mogote au Nord Mexique.

Podwojewski P, Janeau JL, Grellier S, Valentin C, Lorentz S, Chaplot V. 2011. *Influence of grass soil cover on water runoff and soil detachment under rainfall simulation in a sub-humid South African degraded rangeland. Earth Surface Processes and Landforms 36: 911-922.*



**Figure 19.** Paysage de pâturage dégradé et envahi par *Acacia sieberiana* en Afrique du Sud.

## LES CARACTERISTIQUES DE LA SURFACE DU SOL AU SEIN DU FORMATION VEGETALE SPECIFIQUE DU NORD MEXIQUE ET LEURS INFLUENCES SUR L'HYDRODYNAMIQUE DE CET ECOSYSTEME. UNE APPROCHE EXPERIMENTALE.

**Contexte.** En milieux semi-arides du nord Mexique, de l'est australien et du Sahel, les formations végétales évoluent en fonction d'une dynamique particulière des eaux de ruissellement à la surface du sol (Montana, 1990; Greene, 1992; Greene *et al.*, 1994; Silvertown and Wilson, 1994; Muldavin *et al.*, 2001; Dunkerley, 2002a; Dunkerley, 2002b). Le « *Mogote* » que nous avons étudié est une succession de bandes de végétation alternées de surfaces nues qui sont perpendiculaires au sens de la plus grande pente. L'expérimentation s'est déroulée au sein d'une formation végétale dénommée *Mogote* (Figure 20 et 21) qui couvre la majorité de désert de Chihuahua au Mexique et aux USA (Schlesinger *et al.*, 1996; Reynolds *et al.*, 1999; Ludwig *et al.*, 2005) et 32 % de la réserve de la biosphère.



**Figure 20.** Simulation de pluie sur végétation de type « *Mogote* ».

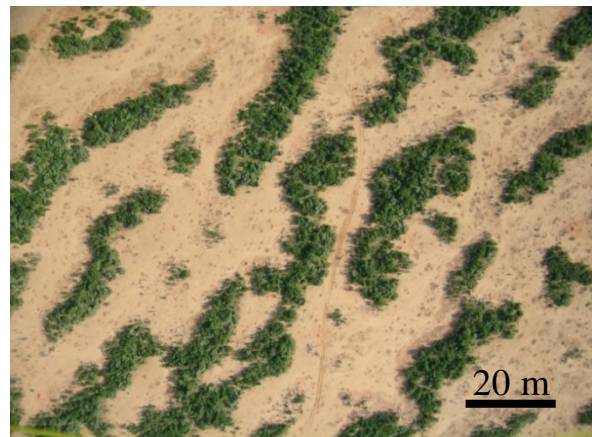

**Figure 21.** Prise de vue à basse altitude d'un pâturage spécifique dénommé « *Mogote* ».

**Question scientifique.** Quels sont les états de surface qui caractérise le *Mogote*? Comment se développe ce milieu ou certains végétaux ont besoin physiologiquement de quantité d'eau supérieure aux précipitations annuelles? Quelles sont les surfaces contributives? Sont-elles variables?

**Matériels et méthodes.** Les études ont été menées au Nord du Mexique, dans la réserve de la biosphère de Mapimi (26°29' à 26°52'N; 103°31' à 103°58'W). La moyenne des pluies annuelles y est de 264 mm avec une saison des pluies très marquée et des épisodes pluvieux intenses et courts. Le « *Mogote* » est une succession de bandes de végétation alternées de surfaces nues qui sont perpendiculaires au sens de la plus grande pente. Il est composé de quatre zones distinctes tant par leur couvert végétal que par leurs surfaces de sol. On y trouve un impluvium inter bande de végétation puis un front pionnier, la zone centrale très végétalisée et enfin une zone de sénescence. Afin de caractériser ces quatre zones tant au

point de vue morphologique que de l'hydrodynamique, la description des états de surface a été effectuée en adoptant la méthodologie développée par Casenave and Valentin (1992). Le micro relief a été mesuré à l'aide d'un point quadrat (360 mesures au mètre carré). La caractérisation hydrodynamique du milieu a été réalisée à l'aide d'un simulateur de pluie type Asseline and Valentin (1978) à l'échelle d'1 m<sup>2</sup>. Cinq pluies d'intensité constante (12, 25, 50, 75 et 100 mm h<sup>-1</sup>) ont été apportées durant 40 minutes avec dix jours de ressuyage entre deux intensités. Le ruissellement a été mesuré durant une minute toutes les deux minutes. Cette expérimentation a été menée en début de saison sèche.

**Résultats.** Ils sont cartographiques fournissant des descriptions fines du milieu : i) La partie amont sans végétation est formée de croûte structurale à trois micro-horizons avec des sables en surface et quelques éléments grossiers et ponctuellement de croûtes d'érosion indurée ; ii) La zone pionnière à végétation basse avec une croûte de décantation majoritaire ; iii) La zone centrale où se développe la végétation tant basse qu'arbustive d'où la présence de litière discontinue où les croûtes structurales sont fines et à un horizon ; iv) La zone sénescence (aval) où la végétation est fortement dégradée avec des croûtes structurales et d'érosion sur un micro relief plus accentué, **cf. Figure 1 de l'article.**

Du point de vue hydrologique, nous avons quantifié la pluie d'imbibition aussi bien en conditions initiales hydriques « sèches » qu'humide. Elle est peu corrélée avec l'intensité de la pluie mais elle est bien corrélée avec la présence de végétation et litière (parcelle 3 et 4) et la discontinuité forte des croûtes (parcelle 1 et 2). Le coefficient d'infiltration  $K_i$  (exprimé en % de la pluie totale) est faible logiquement pour les zones les plus encroûtées et il augmente quand l'état hydrique initial est sec **cf. Tableau 3 de l'article.** Le coefficient de ruissellement  $R_x$  (mm h<sup>-1</sup>) est positivement corrélé avec l'intensité de pluie et le faible couvert végétal de la partie amont du *Mogote*.

**Discussion.** Les variations de  $K_i$  sont en relation directe avec les caractéristiques de la surface du sol. L'infiltration est toujours plus forte en présence de végétation, de litière, de racines et d'activité biologique qu'en présence de sols nus.

Le rôle de la pluie est prépondérant sur la dégradation des micro-agrégats du sol et la redistribution des particules fines responsable de l'encroûtement du sol. Les types de croûtes peuvent être différents mais leurs caractéristiques hydrodynamiques peuvent être similaires.

La dynamique de l'écosystème *Mogote* est liée à l'alternance de surface nue très encroûtées avec un faible taux d'infiltration et donc favorable au ruissellement, et de surface avec un couvert végétal dense et des sols caractérisés par un taux d'infiltration élevé. La végétation sur ces surfaces atténue l'énergie cinétique des gouttes d'eau et limite l'effet splash. Les réorganisations superficielles de types croûtes sont quasi inexistantes. En outre, la végétation permet le développement d'une litière favorable à une activité biologique importante et une

meilleure porosité. A l'opposé, la faible porosité des croûtes en zone nue d'inter bande de végétation peut générer jusqu'à 95 % de ruissellement qui s'infiltrera dans la prochaine bande de végétation.

**Conclusion.** Ce biotope spécifique alternant des zones nues et des zones de végétation peut donc capter le fort ruissellement des rares et irrégulières précipitations. Les conditions climatiques générales du Nord Mexique avec de fortes intensités de pluie et des tailles de gouttes importantes (énergie cinétique forte) favorisent le développement de surfaces de sols dénudées. Celles-ci permettent d'alimenter la strate végétative qui se développe perpendiculairement à la pente.

Cependant cet écosystème est en équilibre fragile. Il peut être rompu par un déficit hydrique ou par des activités pastorales mal contrôlées (l'élevage étant la principale ressource du milieu) créant des griffes d'érosion puis des ravines. Il faut donc protéger cet écosystème en réduisant l'impact érosif des activités humaines. La charge animale doit être gérée en fonction des évolutions du couvert végétal et le traçage des pistes doit être parallèle à cette alternance de bandes de végétation et de bandes de sol nues.

# The soil surface characteristics of vegetation stripes in Northern Mexico and their influences on the system hydrodynamics An experimental approach

Jean Louis Janeau <sup>a,\*</sup>, André Mauchamp <sup>b,1</sup>, Gerardo Tarin <sup>c</sup>

<sup>a</sup> *Instituto de Ecología, A.P. 632, 34000 Durango, Dgo, Mexico*

<sup>b</sup> *Instituto de Ecología, A.P. 63, 91000 Xalapa, Ver., Mexico*

<sup>c</sup> *Cenid-Raspa, A.P. 225 B, 35078 Gomez Palacio, Dgo, Mexico*

Received 25 July 1996; received in revised form 4 November 1997; accepted 10 February 1998

---

## Abstract

Vegetation stripes were described in arid areas of Africa, Australia and México. They depend on the local concentration of rain water after runoff. In México, we described the soil surface characteristics of vegetation stripes and performed rainfall simulations to analyze its hydrodynamic behaviour. Simulations were performed on plots characterized by the four soil surface features represented in the stripes. Four types of surface crusts were found in the stripes, erosion, sedimentation, and two types of structural crusts. The less vegetated plots had relatively impervious crusts with low preponding rains and high constant runoff rates. On the contrary, the highly vegetated plot had a thin crust and abundant litter which allowed a high infiltration rate. Runoff rates were positively related to rainfall intensity. Those relationships between surface characteristics and runoff determine the fate of rain water and may allow the prediction of the amount of runoff for a specific rain on a given plot. © 1999 Published by Elsevier Science B.V. All rights reserved.

*Keywords:* Chihuahuan desert; Soil surface features; Vegetation stripes; Rainfall simulation; Hydrodynamics; Mexico

---

---

\* Corresponding author. Orstom, A.P. 17116596, Quito, Ecuador.

<sup>1</sup> Present address: Station Biologique de la Tour du Valat, Le Sambuc, 13200 Arles, France.

## 1. Introduction

The vegetation stripes, called 'mogotes' in Northern México, correspond to a very similar formation known as the 'brousse tigrée' described in Sahelian Africa (Clos Arceduc, 1956; Hemming, 1965; White, 1971) or the 'mulga groves' in Australia (Litchfield and Mabbut, 1962; Tongway and Ludwig, 1990). In Northern México, it is an important source of forage for the cattle and a source of fire wood. It is a succession of densely vegetated stripes and bare soil areas (Cornet et al., 1988; Montaña and Breimer, 1988; Delhoume, 1988). The vegetation stripes are approximately 50 m wide per 200 to 300 m long and are separated by bare soil stripes of about 250 m wide. They are found on slopes less than 1% and are parallel to the contour lines. The climatic and topographic conditions in which such striped patterns are found in Africa are similar to those of Northern México (Gallais, 1967; in Mauritania, Audry and Rossetti, 1962; in Mali, Leprun, unpublished;<sup>2</sup> in Niger, Ambouta, 1984; in Burkina Faso, Serpantie et al., 1992). In Mapimí, average annual rainfall is 264 mm and slope 0.9 to 1.1%. A very gentle upslope movement of the stripes is evidenced by the structure of the vegetation and the presence of remnants of trees and shrubs in the bare zone just downslope of a stripe (Mauchamp et al., 1993). This dynamics is due to a preferential establishment of seedlings at the upper edge which receives more water from runoff, and on the contrary, an increased mortality at the lower edge (Cornet et al., 1988; Montaña, 1992; Mauchamp et al., 1993). Several authors suggested that a progressive modification of the 11 soil surface features was responsible for the dynamics. These modifications would lead to changes in the infiltration rates and the water storage capacity of the soil, and would further affect the vegetation dynamics (Boaler and Hodge, 1964; White, 1971; Yeaton et al., 1977; Cornet et al., 1988; Montaña, 1992; Mauchamp, 1992). Soil surface features are characterised by the vegetation itself, the superficial pedological structure and result from complex interactions between flora, fauna, meteorological and possibly anthropological factors (Casenave and Valentin, 1992).

To characterise the spatial variability of the soil surface features and their role in the hydrodynamics of the vegetation stripes, we first described them along a transect perpendicular to the main axis of a stripe together with the detailed topography. The transect (Fig. 1) crossed a bare zone (Plot 1) and the pioneer (Plot 2), central (Plot 3) and senescence (Plot 4 in limit) zones of a stripe. Rainfall simulations were then used to analyse the relationship between these soil surface features and infiltration and runoff.

## 2. Site description and methods

The study was conducted in the Mapimi Biosphere Reserve (Chihuahuan desert, México, 26°N, 103°W). Mean annual rainfall is 264 mm (Standard deviation 65 mm, from 12 yr observation at the Reserve Station) and mean annual temperature is 20.8°C

---

<sup>2</sup> Leprun, J.C., 1978. Etude de l'évolution d'un système d'exploitation Sahélien au Mali. Unpub. report, Orstom, D.G.R.S.T., Paris, France.

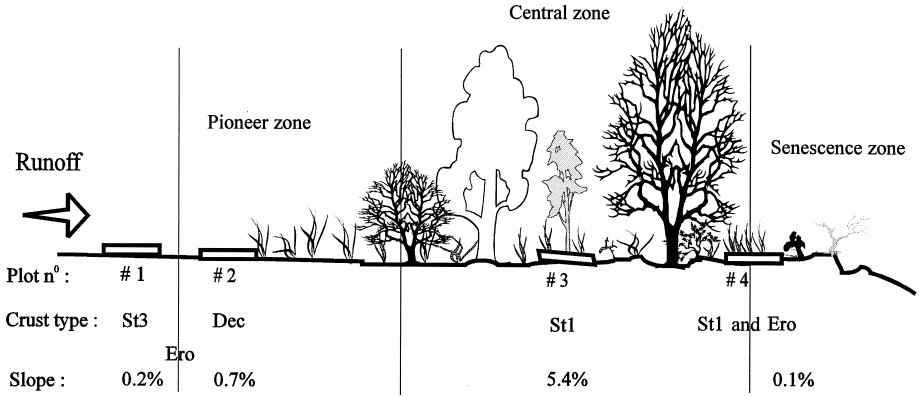

Fig. 1. Cross-section of a vegetation stripe along the main slope. The figure shows the plots 1–4 for the rainfall simulation experiments with their slope and their dominant crust characteristics.

with strong seasonal amplitudes. Most of the rain occurs as heavy showers from July to October. The soil is a luvic yermosol with less than 1% organic matter, on fine and medium alluviums resting on siltstones. The vegetation striped patterns cover 32% of the Reserve area, 25% of which are densely vegetated stripes (Montaña and Breimer, 1988).

A transect across the stripe was carefully described for soil and vegetation cover. Four plots corresponding to the main four zones of the vegetation stripes were set for rainfall simulations. On each  $1 \times 1$  m plot, the soil surface features and the microtopography were measured on a regular grid of 380 points. Vertical needles maintained by a metallic frame were used to measure the topography. The soil surface features were characterised according to the typology of Casenave and Valentin (1992) on each of the 380 points. Structural crusts with one layer (st1), are formed by the splash effect at the first rainfall, they are fragile and about 1 mm thick. Structural crusts with three layers (st3), are formed by a vertical granulometric selection with a leaching of the fine elements under the rainfall effect (Valentin and Bresson, 1992). They can be up to 5 mm thick according to the amount of sand. The erosion crusts (ero), result from water and wind erosion of structural crusts, are about 1 mm thick and hardened. Sedimentation crusts (dec), result from the deposition of fine particles transported by runoff, are 2 cm thick with small 1 cm deep cracks and are composed of several microlayers which tend to curl up.

The rainfall simulator developed by Asseline and Valentin (1978) is a sprinkling device on top of a 4 m high tower enclosed in a large canvas to avoid wind. A calibrated nozzle fed by a constant waterflow oscillates with a controlled angle which allows the modification of the frequency with which the sprinkler passes over the plot. Rainfall intensity ranges between 15 to 130 mm/h. The size and kinetic energy of the raindrops are similar to those of natural rainfall of same intensities. Each plot was limited by a metallic frame inserted approximately 5 cm into the soil. The lower side of the frame had a gutter and the water running from the plot could be collected and measured. Each plot was submitted to five rains of constant intensity (12, 25, 50, 75 and 100 mm/h) with 10 days drying between two intensities. The 40 min rains were applied to initially

dry soil, and repeated 30 min later on wet soil. We registered the time when runoff started. Runoff water was then collected during 1 min periods with 2 min intervals at the beginning and with 5 min intervals as soon as the constant runoff rate was reached. The data allowed the calculation of (1) the preponding rain, that is the amount of water infiltrated before the runoff started including surface storage, (2) the coefficient of infiltration  $K_i$  which is the proportion of the rain that infiltrated at the end of the simulation, and (3)  $R_x$ , the runoff intensity once a constant rate is reached. The simulations were performed from September 1989 to February 1990, during the cold and dry season.

### 3. Results

In Fig. 1, a schematic presentation is given of the experimental plots 1–4. The bare area, upslope from the stripe, had a ‘st3’ structural crust (plot 1, Table 1), with a discontinuous cover of coarse elements. Locally, it presented thin and hardened erosion crusts where runoff had removed the sand and coarse elements. Plot 1 had an average slope of 0.2% and a maximum micro relief of 5 mm. Within the stripes, plots 2, 3 and 4 corresponded to the three zones identified by Cornet et al. (1988), respectively the pioneer, central and senescence zones, plot 4 being in fact at the limit of the central and senescence zones. Plot 2 was characterised by an accumulation of silt with sand and a few coarser elements. It had a typical decantation crust (Plot 2, dec, Table 1) (Janeau and Ruiz de Esparza Villareal, 1992). It had an average slope of 0.7%. Curled up plates present a 1.5 cm micro relief. In the central zone, we observed two different situations. Where the vegetation was dense, there was no crust or a fragile drying crust (st1, plot 3) because of the absence of splash effect and the important faunal activity (Table 1). The main species were a tree, *Prosopis glandulosa* Torr. var. *torreyana* (Benson) M.C. Johnst., ‘honey mesquite’, two shrub species, *Flourensia cernua* DC., ‘tarbush’, and *Lippia graveolens* and a grass, *Hilaria mutica* (Buckl.) Benth., ‘tobosa grass’. Where there were openings in the vegetation cover, particularly due to trampling by cattle, an erosion crust appeared locally and infiltration was much lower than on vegetated areas.

Table 1  
Characteristics of the four rainfall simulations plots

	Vegetation cover		Crust composition			Type of crust
	Standing vegetation	Dry litter	Coarse elements	Sand	Crust (loam and clays)	
Plot 1, bare zone between stripes	–	–	16.4	59.4	24.2	st3 75%, ero 25%
Plot 2, pioneer zone	1.1	2.2	–	–	96.7	ero 15%, dec 85%
Plot 3, central with tree	83.8	13.1	–	–	3.1	st1 100%
Plot 4, central with grass cover	27.1	65.7	–	–	7.2	st1 90%, ero 10%

The proportion for each type of cover is given as a percentage of the plot surface (one m<sup>2</sup>). ‘St1’ and ‘st3’ are structural crusts with 1 and 3 microlayers, respectively, ‘ero’ is an erosion crust, ‘dec’ is a depositional crust; as referred to the classification of Valentin and Bresson (1992).



Table 2

Preponding rainfall (mm) as influenced by the rain intensity and the initial condition of the plot, dry or wet

Intensity mm/h	Initial condition	Plot 1	Plot 2	Plot 3	Plot 4
12	dry	3.4	2.7	8.0	8.0
	wet	1.0	0.9	8.0	8.0
25	dry	2.9	2.9	4.8	16.7
	wet	1.4	1.2	1.8	2.4
50	dry	2.1	3.0	3.7	11.3
	wet	1.2	1.6	2.3	3.6
75	dry	2.5	2.6	5.5	11.1
	wet	1.7	2.0	3.0	3.2
100	dry	2.1	3.0	7.9	14.1
	wet	1.5	2.2	2.7	3.3

Plot 3 had a steeper slope (5.4%) and had a strong micro relief, up to five cm, due to the bunch grass *Hilaria mutica* and trampling by cattle. Vegetation and litter were abundant and the soil had a high porosity. Plot 4 was almost flat (slope 0.1%) with more than 65% of its surface covered by litter and had a 2.5 cm micro relief. Our plots did not include an area with major trampling effect. Finally, the senescence zone was characterised by a sharp erosion step of 5 to 10 cm due to running water during heavy rains. It had an erosion crust composed of one micro-layer. The vegetation was scarce, with dead trunks and a few degraded grass clumps. No plot was established in the senescence zone.

Under dry and wet conditions, the preponding rain ranged from 1 to 16.7 mm and was not clearly related to the rain intensities (Table 2). On average for the five intensities, it increased from the plots located in the upper, less vegetated zones to the more densely vegetated areas. For the simulation on dry soil, plots 1 and 2 had the lowest average values (2.6 and 2.8 mm, respectively, S.E. 0.2 and 0.07,  $n = 5$ ), plot 3 had 6 (S.E. 0.7,  $n = 5$ ) and plot 4 had the highest (12.2 mm, S.E. 1.3,  $n = 5$ ). For the 12

Table 3

Infiltration coefficient  $K_i$  (% of the total rain applied) and final infiltration rates FIR (mm/h) as influenced by initial soil moisture and rainfall intensity  $I_p$  (mm/h)

Initial	$I_p$	Plot 1		Plot 2		Plot 3		Plot 4	
		FIR	$K_i$	FIR	$K_i$	FIR	$K_i$	FIR	$K_i$
dry	12	3.6	65.2	2.8	61.9	> 12	100	> 12	100
wet		3.4	43.0	1.3	34.5	> 12	100	> 12	100
dry	25	5.1	42.9	7.1	48.1	21.6	94.7	> 25	100
wet		3.1	23.2	4.6	25.5	16.4	73.6	19.9	89.8
dry	50	7	17.7	6.2	25.4	30.4	81.5	10	59.8
wet		7.3	13.4	6.5	16.8	22.1	52.5	8.5	31.9
dry	75	5	16.7	13.2	22.5	31	56.0	25.7	66.4
wet		4.1	8.9	16.9	24.0	20.5	35.4	17.7	29.8
dry	100	6.6	13.0	9.5	18.7	43	57.9	23.6	48.5
wet		6.8	9.3	8.4	8.3	35.6	39.5	24	31.6

Rainfall simulations were performed on 1 m<sup>2</sup> plots and lasted 40 min.

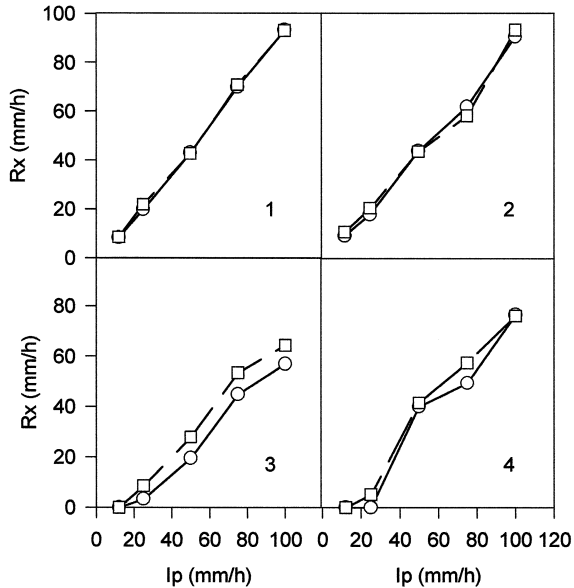

Fig. 2. Relationship between the constant runoff rate  $R_x$  and the rainfall intensity for the plots 1 to 4 for dry (circles) and wet (squares) initial conditions.

and 25 mm/h intensities, 100% of the rain infiltrated and hence, the preponding rain was limited by the total amount of rain rather than the soil characteristics. Preponding rain was lower under wet initial conditions and averaged 1.5 mm for the plots 1 and 2, 3.8 mm for plots 3 and 4 (Table 2). The infiltration coefficients  $K_i$  ranged from 8–10% of the rain for non-vegetated plots and high rainfall intensities, to 100% for vegetated plots with the lowest rainfall intensity (Table 3). They were different depending on the initial conditions, always higher for dry soil, even when there was no clear difference of the constant runoff rate  $R_x$ . They were also systematically higher for vegetated plots than bare soils. The constant runoff rates were similar for plots 1 and 2, reaching more than 90% of the rain for the highest intensity, and lower for plots 3 and 4 (Fig. 2). On plot 3,  $R_x$  was positively related with rainfall intensity but the slope was lower. On that plot, the final infiltration rate reached a maximum of 43 mm/h for the 100 mm/h rain (Table 3).

#### 4. Discussion and conclusions

The variations we observed of the total infiltration coefficient  $K_i$  show the relationship between the infiltration capacity of soils and their surface features.  $K_i$  was always higher for plots with vegetation than for bare soil plots 1 and 2. Aggregate breakdown may occur under vegetation cover due to air entrapment compression under fast wetting. It is not the case in our study where dense vegetation and litter limit the impact of raindrops and prevent splash effects, as also found elsewhere (e.g., Casenave and

Valentin, 1992). Moreover, biological activity, litter and roots favour superficial porosity and a better infiltration capacity. Our experiment was performed at the beginning of the dry season, with very few annual plants and a relatively low grass cover. During the rainy season, the effects of the vegetation on plots 3 and 4 would be even stronger than in the dry season and an annual plant cover may modify the infiltration capacity in the pioneer zone (Plot 2). The constant runoff rate  $R_x$  is reached when the infiltration stabilised at its minimum level for a fixed rainfall intensity. It depends on the soil surface features and is clearly reduced by the presence of vegetation (Fig. 2, plot 3–4). The similarity of  $R_x$  for non-vegetated plots, for both dry and humid initial conditions, shows that the crusts, although having a different structure, have the same hydraulic characteristics.  $R_x$  relates to the increase in rainfall intensity and the soil moisture conditions for the vegetated plots. The effect of micro-relief could be observed on plot 3 where it caused the formation of small puddles and thus changed the conditions of infiltration which took place under a water layer. The formation of small puddles during the experiment forced infiltration and the increase of  $R_x$  with intensity was limited.

The vegetation interacts with the crust type to determine its hydrodynamic characteristics. Plots 1 and 2, without vegetation, had different crust types but similar infiltration parameters. On the other hand, plots 3 and 4 had the same crust types, also had similar infiltration parameters, although they had different vegetation. Moreover, at the scale of a single shrub, we could show, in a previous study (Mauchamp and Janeau, 1993), the existence of an additional interaction between the vegetation and rainfall and infiltration. The canopy of the main shrub species of the stripes, *F. cernua* DC. ('tarbush'), Asteraceae, intercepts the rain and funnels it down to the basis of the plant where infiltration can be very high. We recorded infiltrations as high as 445 mm in a four h period on a 0.1 m<sup>2</sup> surface surrounding the base of the shrub (Mauchamp and Janeau, 1993). The very high infiltration rates at the shrub basis was due to the presence of litter, an important faunal activity and the axis splitting phenomenon which was observed frequently for this species. Under the rest of the crown, there was a relatively more impervious crust with two superficial microlayers.

As underlined by most authors, the existence and maintenance of this type of pattern is due to the concentration effect of rainfall in 30 to 25% of the landscape, which thus benefits from a more favourable water balance. The characteristics of surface crusts, which have strong feedback relationships with the vegetation, determine the local runoff patterns. Low porosity crusts from the inter-stripe areas give birth to runoff as high as 95%, which then infiltrates in the following stripe. There, a higher porosity due to biological activity and the absence of a splash effect promotes infiltration and allows the maintenance of a dense vegetation cover. As observed during our simulations, surface characteristics influence preponding rain and runoff rates. They greatly influence rainfall that causes significant runoff and hence the maintenance of the striped pattern. In the Mapimi area, winter rains of low intensity do not cause runoff and, although important for certain species of the formation, they play no role in the maintenance of the striped pattern.

When compared for infiltration parameters, our data coincided well with the estimations provided by Casenave and Valentin (1992) for similar soil surface features (Table 4). Our data, combined with a careful evaluation of the proportions of surface crusts in

Table 4

Comparison of the infiltration coefficients  $K_i$  (%) predicted in Sahelian Africa by Casenave and Valentin (1992) (Estimated) and the coefficients observed during this study (Observed) in Northern Mexico for an intensity of 50 mm/h

Dry soil		Wet soil	
Estimated	Observed	Estimated	Observed
ero: 15–30; st3: 25–40	Plot 1: 17.7	ero: 20–30; st3:10–25	Plot 1: 13.4
st3: 25–40; dec: 35–55	Plot 2: 25.4	st3: 10–25; dec: 25–45	Plot 2: 16.8
st1: 80–90	Plot 3: 81.5	st1: 75–85	Plot 3: 59.8
st1 + V < 50%: 60–70; ero: 15–30	Plot 4: 59.8	st1 + V < 50%: 50–60; ero: 20–30	Plot 4: 31.9

V < 50% = less than 50% vegetation cover.

the stripes and interstripe areas might allow the evaluation of the amounts of runoff to be included in a simulation model of the stripes hydrodynamics (Mauchamp et al., 1994). Moreover, our results allow the prediction of the fate of a stripe after a disturbance that would replace a type of crust by another, for example trampling. Trampling causes the destruction of the vegetation, the formation of impervious crusts and a preferential area for water flow where it acquires a sufficient velocity to cause erosion. These small gullies then drain the water from the stripe and locally leads to vegetation death, disturbing the pattern. For the same reasons, trails created by human activities have to be, when possible, parallel to the main axis of the stripes.

## Acknowledgements

The authors thank the Instituto de Ecología (Durango, DGO, Mexico), the staff of the Mapimi Biosphere Reserve, C. Valentin, and A. Johnson for their comments and corrections on the manuscript. The stay in Mexico of A. Mauchamp was supported by a M.A.B., Young Scientist Grant (UNESCO) and the stay in Mexico of J.L. Janeau was supported by the ORSTOM.

## References

- Ambouta, K., 1984. Contribution à l'édaphologie de la brousse tigrée de l'Ouest Nigérien. Thèse doctorale, Université de Nancy I, 116 pp.
- Asseline, J., Valentin, C., 1978. Construction et mise au point d'un infiltromètre à aspersion. Cah. Orstom, sér Hydrol. XV (4), 321–349.
- Audry, P., Rossetti, Ch., 1962. Observations sur les sols et la végétation en Mauritanie du Sud-Est et sur la bordure adjacente du Mali (1959 et 1961). Prospection écologique. Etudes en Afrique Occidentale. Projet du fonds spécial des Nations-Unies relatif au criquet pèlerin. F.A.O., Rome, 267 pp., multigr., 33 Figs., 70 Réfs., 26 photos, 1 carte h.t. à 1/200 000e.
- Boaler, S.B., Hodge, C.A.H., 1964. Observations of vegetation arcs in the Northern region, Somali Republic. J. Ecol. 52, 511–544.
- Casenave, A., Valentin, C., 1992. A runoff capability classification system based on surface features criteria in the arid and semi-arid areas of West Africa. J. Hydrol. 130, 231–249.

- Clos Arceduc, M., 1956. Etude sur photographies aériennes d'une formation végétale sahélienne: la brousse tigrée. Bulletin de l'Institut Français d'Afrique Noire A-18, 677–684.
- Cornet, A., Delhoume, J.P., Montaña, C., 1988. Dynamics of striped vegetation patterns and water balance in the Chihuahuan Desert. In: During, H.J., Werger, M.J.A., Willems, J.H. (Eds.), Diversity and Pattern in Plant Communities. pp. 221–231. The Hague SPB Academic Publishing, 278 pp.
- Delhoume, J.P., 1988. Distribution spatiale des sols le long d'une toposéquence représentative. In: Montaña, C. (Ed.), Estudio integrado de los recursos vegetación, suelo y agua en la reserva de la biosfera de Mapimí. Ambiente natural y humano. Instituto de Ecología, México, Publ. 23, pp. 135–165.
- Gallais, J., 1967. Le delta intérieur du Niger et ses bordures. Etude morphologiques. CNRS, Centre de Recherches et Documentation Cartographiques et Géographiques. Mém. et Doc., Nouvelle série, Vol. 3, 153 pp., 30 Figs., 16 pl. photos, + 1 carte h.t. à 1/2000.000e.
- Hemming, C.F., 1965. Vegetation arcs in Somaliland. J. Ecol. 53, 57–68.
- Janeau, J.L., Ruiz de Esparza Villareal, R., 1992. Cartographie des états de surface d'une toposéquence représentative du bassin versant de San Ignacio. In: Actas del seminario de Mapimí. Instituto de ecología, México., pp. 161–175.
- Litchfield, W.H., Mabbut, J.A., 1962. Hardpan in soils of semi arid Western Australia. J. Soil Sci. 13, 148–159.
- Mauchamp, A., 1992. L'hétérogénéité spatiale, sa dynamique et ses implications dans une mosaïque de végétation en zone aride. Thèse de doctorat, Université de Montpellier II, France.
- Mauchamp, A., Janeau, J.L., 1993. Water funneling by the crown of *Flourensia cernua*, a Chihuahuan Desert shrub. J. Arid Environ. 25, 299–306.
- Mauchamp, A., Montaña, C., Lepart, J., Rambal, S., 1993. Ecotone dependent recruitment of a desert shrub (*Flourensia cernua*) in vegetation stripes. Oikos 68, 107–116.
- Mauchamp, A., Rambal, S., Lepart, J., 1994. Simulating the dynamics of a vegetation mosaic: a spatialized functional model. Ecol. Modelling 71, 107–130.
- Montaña, C., 1992. The colonization of bare areas in two phase mosaics of an arid ecosystem. J. Ecol. 80, 315–327.
- Montaña, C., Breimer, R.F., 1988. Major vegetation and environment units. In: Montaña, C. (Ed.), Estudio integrado de los recursos vegetación, suelo y agua en la reserva de la biosfera de Mapimí. Ambiente natural y humano. Instituto de ecología, México, Publ. 23, pp. 99–114.
- Serpantie, G., Tezenas du Moncel, L., Valentin, C., 1992. La dynamique des états de surface d'un territoire agropastoral soudano-sahélien sous aridification climatique: conséquences et propositions. In: L'aridité: une contrainte pour le développement. Orstom, collection Didactiques, pp. 419–447.
- Tongway, D.J., Ludwig, J.A., 1990. Vegetation and soil patterning in semi arid mulga lands of Eastern Australia. Aust. J. Ecol. 15, 23–34.
- Valentin, C., Bresson, L.M., 1992. Morphology, genesis and classification of soils crusts in loamy and sandy soils. Geoderma 55, 225–245.
- White, L.P., 1971. Vegetation stripes on sheet wash surfaces. J. Ecol. 57, 549–553.
- Yeaton, R.I., Travis, J., Gilinsky, E., 1977. Competition and spacing in plant communities: the Arizona upland association. J. Ecol. 65, 587–595.

## INFLUENCE DU COUVERT HERBACE SUR LE RUISSELLEMENT ET LE DETACHEMENT SOUS SIMULATION DE PLUIE AU SEIN D'UN PATURAGE DEGRADE EN MILIEU SUBHUMIDE D'AFRIQUE DU SUD.

**Contexte.** De nombreuses études ont été menées en milieu tempéré, en milieu aride et semi-aride sur l'influence du couvert végétal sur le ruissellement et sur l'érosion. Cependant en milieu semi-humide peu d'étude ont quantifié ces paramètres. Dans le nord-est de l'Afrique du Sud, au sein de pâturages dégradés par une trop forte charge en bétail à l'hectare, une érosion hydrique forte et une forte invasion par un *Acacia* (Grellier *et al.*, 2012a) ; il a été mis en évidence i) que les processus et mécanismes de l'érosion hydrique sont fortement liés aux échelles spatiales et temporelles ; ii) que les eaux de surface et de sub-surface ont un impact fort sur les ravines ; iii) que la présence d'arbres augmente l'érosion en ravine dans ce milieu ; iv) qu'il est donc important de gérer cette couverture végétale afin de préserver les pâturages indispensables à la survie des populations locales (Grellier *et al.*, 2012b).

**Question scientifique.** Nous avons donc voulu comprendre l'évolution de l'hydrodynamique et de la détachabilité en fonction du pourcentage de couvert herbacé à différents stades de dégradation d'une zone ayant alternée pâturage/culture/pâturage.

**Matériels et méthodes.** L'étude a été menée en Afrique du Sud dans la province du KwaZulu Natal, proche de la ville de Bergville située en piedmont du massif du Drakensberg, celui-ci formant une grande partie du Lesotho. Nous avons travaillé au sein du bassin versant de Potshini (28°48'40"S et 29° 21'40"E à la station météorologique). Ce petit bassin d'une superficie approximative de 10 km<sup>2</sup> est représentatif de celui de la *Tukhela river* (30 000 km<sup>2</sup>).

Le climat est subtropical humide avec un été (d'octobre à mars) pluvieux. La pluviométrie annuelle moyenne est de 684 mm, l'évaporation potentielle de 1600 mm avec une moyenne annuelle de température de 13°C (Schulze, 1997). L'altitude de ce bassin versant oscille entre 1200 et 1400 m au-dessus du niveau de la mer et il présente des paysages à pente douce avec une moyenne de pente de 15 % excepté en partie haute du bassin versant où les pentes atteignent de 60 à 70 % ; toutes ces zones sont consacrées au pâturage extensif de bovins. Les parties basses du bassin versant sont relativement plates (<5 %) et sont majoritairement utilisées pour les cultures vivrières (maïs principalement, pois et un peu de maraîchage) de la communauté Zouloue. La végétation est un pâturage de type « *Northern KwaZulu Natal moist Grassland* » dominé par des touffes de *Themeda traindra*, *Hyparrhenia hirta* et *Sporobolus africanus* (Mucina and Rutherford, 2006). Les sols sont de texture sableuse fine issus de roches sédimentaires, disposées en couches de grès et de schistes (King, 2002). De nombreux dykes et seuils de dolérite du Karoo ont pénétrés ces successions d'horizons et sous l'effet du climat se sont érodés en blocks arrondis de 10 à plus de 50 cm de diamètre associés à des sols

d'argile rougeâtre. Des couches de grès forment de grands pans de paysages quasi horizontaux que les agriculteurs cultivent en aménageant de petites terrasses. Certaines de ces zones sont abandonnées, utilisées comme zones de pâturage coïncidant avec une érosion forte due à l'érosion hydrique, au surpâturage et aux cheminements des animaux. L'invasion de ces pâturages par l'*Acacia siberiana* est de plus en plus marquée depuis le milieu des années 80 réduisant d'autant plus la surface et la qualité de ces pâturages supportant une très (trop) lourde charge en bétail (Grellier, 2011).

En partie basse d'une colline, une parcelle de 50 X 10 m placée en longueur dans le sens de la pente a été sélectionnée. Son gradient de dégradation va de surfaces nues à un couvert herbacé en touffes plus ou moins discontinu, représentatif des pâturages du bassin versant. Six classes de dégradation de la surface du sol ont été définies et 18 parcelles d'1 m<sup>2</sup> ont été installées dont 15 parcelles plus ou moins enherbées classées de A à E au sein de la parcelle et 3 parcelles classées F en amont sur sol érodé et totalement nu (**cf. figure 2 de l'article**).

Les états de surface ont été décrits suivant les critères établis pour les sols sableux par Valentin and Bresson (1992). La rugosité du sol a été mesurée grâce à un distanciomètre laser (391 points de mesure au m<sup>2</sup>) et à chaque point a été noté le type d'état de surface. La végétation a été soigneusement coupée, séchée et pesée à la fin du cycle de pluie.

La compaction du sol a été mesurée à l'aide d'un pénétromètre de masse (nombre de coup d'un poids de 2.2 kg tombant de 1 m pour enfoncer un cône calibré à 10 cm et à 90 cm). La densité apparente et l'humidité ont été mesurées grâce à un cylindre pour l'épaisseur 0-10 cm du sol. Les majeurs du sol, le carbone total, le pH et la texture ont été mesurés pour chaque parcelle.

Grâce à un simulateur de pluie CAPELEC CAP1700, deux pluies ont été apportées en saison sèche à 24 h d'intervalle : 30 mm h<sup>-1</sup> pour la première et 60 mm h<sup>-1</sup>, les deux pluies durant 30 minutes. Ces intensités sont représentatives de la région. Les paramètres mesurés au cours de ces pluies ont été la pluie d'imbibition (Pr ; mm), le coefficient (Kru ; %) et taux de ruissellement (R ; L m<sup>-2</sup>) et la concentration en sédiment des eaux de ruissellement (SC ; g L<sup>-1</sup>). Une analyse en composantes principales via le logiciel ADE4 a permis de décrire et de visualiser les relations entre les paramètres du sol, des états de surface et de la pluie.

**Résultats.** L'humidité de la surface du sol est homogène avant les pluies sur les 15 parcelles mais après le cycle de pluie, les 3 parcelles les plus enherbées sont aussi les plus « humides ». Pour la densité apparente, 3 catégories se distinguent en fonction du couvert décroissant ; ce sont les parcelles nues qui possèdent la densité apparente et la compaction les plus fortes.

Les pluies d'infiltration sont les plus importantes sur les parcelles les plus végétalisées notamment durant la première pluie. Au cours de la seconde seules les parcelles à fort couvert végétal (classe A) continuent à avoir une infiltration importante.

Aucun ruissellement n'apparaît sur les parcelles enherbées lors de la première pluie mais l'infiltration décroît rapidement au cours de la seconde pluie une fois le ruissellement débuté convergeant vers un coefficient d'infiltration de  $<5 \text{ mm h}^{-1}$ .

La concentration en sédiment dans les eaux de ruissellement augmente en fonction de la surface d'occupation du couvert végétal mais peu de différence sont constatées entre les deux intensités de pluie exceptée pour les parcelles nues à fort taux de sédimentation (jusqu'à  $60.2 \text{ g L}^{-1}$ ).

Les pertes en terre augmentent fortement entre les parcelles de classe enherbées de classe A ( $0.9 \text{ g}$ ) à E ( $106 \text{ g}$ ) pour la première pluie puis encore plus pour la seconde pluie de  $3.9$  à  $389 \text{ g}$ . Les parcelles nues de classes F passent de  $179 \text{ g}$  à  $1709 \text{ g}$  pour les deux pluies.

L'analyse statistique présente en axe F1 (cf. **figure 3 de l'article**), les principaux facteurs les plus influents qui sont la perte en sédiment, la densité apparente et le taux de compaction. Les croûtes, la pluie d'imbibition et le taux de ruissellement sont liés plus étroitement à l'axe F2. On constate une tendance linéaire du taux de dégradation de la surface du sol de la classe A à la classe E avec certains seuils en classe C et D. La classe F est notablement différenciée par le fait de reposer sur un horizon B ; les paramètres du sol proprement dit sont donc ceux qui influencent le plus les caractéristiques hydrodynamiques et l'érosion et sont présentées séparément.

**Discussion.** Cette expérimentation corrobore les travaux définis dans la synthèse de Seeger (2007); l'influence du couvert végétal sur le ruissellement et l'érosion n'est pas clairement établie. La pluie d'imbibition est fortement corrélée au coefficient de ruissellement pour les deux pluies. Le coefficient de ruissellement est en relation directe avec la présence de croûte mais pas de la végétation. Pour les parcelles A à E, le taux d'infiltration décroît rapidement avec un maintien à  $5 \text{ mm h}^{-1}$ . Étonnamment, les parcelles F ont un taux d'infiltration qui décroît moins que pour les autres parcelles. Les microfissures liées au phénomène de gonflement-retrait des argiles et les micro-agrégats sont plus présents que les croûtes sur cet horizon B.

Pour la deuxième pluie, Pr et Kru sont liés à la porosité du sol et donc avec les densités apparentes les plus faibles. L'infiltration décroît très rapidement vers une très faible intensité d'infiltration ( $2 \text{ mm h}^{-1}$ ) pour toutes les parcelles et cela indépendamment du couvert végétal. La parcelle où le taux d'infiltration est le plus important est elle-même sujette à une forte et brusque décroissance de l'infiltration confirmant qu'une fois la porosité de surface fermée, le ruissellement se développe très rapidement. A noté toutefois le maintien d'une infiltration probablement liée à la présence de micro canaux des nombreuses termites observées dans cette zone qui est fortement dégradée par le passage d'animaux.

La perte en sol est importante comparée à une autre expérimentation réalisée en conditions similaires au Kenya (Snelder and Bryan, 1995). Il n'y a pas de relation importante entre le taux de ruissellement et la perte en sol. La détachabilité est liée à la présence de micro-



agrégats facilement transportable et la perte en sol est en relation directe avec la dégradation du couvert végétal. Cerda (1998); Greene and Hairsine (2004); Gyssels *et al.* (2005) ont démontré que sur du long terme, la végétation améliorait l'infiltration par augmentation de la stabilité structurale et la cohésion des agrégats. Cette relation complexe est aussi vérifiée sous simulation à l'échelle du mètre carré en milieu semi-aride au Kenya et en Mongolie. Plusieurs auteurs reprennent ces résultats pour expliquer l'effet du surpâturage dans ces milieux semi-arides. Notre étude révèle des similitudes avec une autre menée en Australie et les différences s'explique par le type de croûtes présentes sous la végétation. A l'échelle de la parcelle, les touffes d'herbes ont un fort pouvoir de piégeage des particules et la détachabilité est donc bien moindre que sur sol nu ou la saturation de la porosité et le ruissellement important génèrent une forte érosion par concentration du ruissellement.

Les résultats obtenus à l'échelle du mètre carré permettent de fournir des informations sur les facteurs et processus responsables des pertes en sols. D'après la littérature, sur le site de Potshini en conditions semi-humide la dégradation du milieu semble liée aux cheminements du bétail qui génère de l'érosion hiérarchisée et à l'existence d'anciennes parcelles cultivées et abandonnées au profit de l'élevage mais en condition de surpâturage. Cette observation est aussi valable pour une autre province méridionale d'Afrique du Sud, en Amérique latine et en Espagne.

**Conclusion.** Indépendamment de la biomasse végétale et de l'intensité des pluies, la diminution de l'infiltration de l'eau dans ces zones de pâturages et d'anciennes cultures associées est notable et rapide pour toutes les parcelles. La formation des croûtes y compris en zones les plus enherbées est le paramètre majeur de réduction de l'infiltration. Quelques parcelles montrent cependant de meilleurs taux d'infiltration suggérant la présence d'une activité biologique plus forte induisant une meilleure porosité.

Il n'y pas de relation directe entre le ruissellement et le taux de pertes en terre. La dégradation du couvert végétal dans ces pâturages sous ces climats semi-humides conduit à une augmentation des pertes en terre.

Les pertes en terre sont directement liées avec la densité apparente et la compaction des sols ; une fois le premier horizon dégradé, l'horizon B plus sensible à l'érosion s'altère très vite par exportation des micro-agrégats.

Cette étude démontre que les sols dégradés par des passages d'animaux qui génèrent localement des zones compactées et les champs abandonnés avec des sols nus sont plus sensibles à l'érosion que des prairies naturelles sujettes au surpâturage.

# Influence of grass soil cover on water runoff and soil detachment under rainfall simulation in a sub-humid South African degraded rangeland

Pascal Podwojewski,<sup>a\*</sup> Jean Louis Janeau,<sup>a</sup> Séraphine Grellier,<sup>a</sup> Christian Valentin,<sup>c</sup> Simon Lorentz<sup>b</sup> and Vincent Chaplot<sup>a</sup>

<sup>a</sup> IRD, UMR Bioemco c/o School of Bioresources Engineering and Environmental Hydrology–Rabie Saunders Building, University of KwaZulu-Natal, Private Bag X01, Scottsville 3209, South Africa

<sup>b</sup> School of Bioresources Engineering and Environmental Hydrology Rabie Saunders Building, University of Kwazulu-Natal, Private Bag X01, Scottsville 3209, South Africa

<sup>c</sup> IRD, UMR Bioemco, Centre IRD d'Île de France 32, avenue Henri Varagnat, 93143 Bondy Cedex, France

Received 7 May 2010; Revised 8 November 2010; Accepted 15 November 2010

\*Correspondence to: P. Podwojewski, IRD, UMR Bioemco c/o School of Bioresources Engineering and Environmental Hydrology–Rabie Saunders Building, University of KwaZulu-Natal, Private Bag X01, Scottsville 3209, South Africa. Email: pascal.podwojewski@ird.fr

ESPL

Earth Surface Processes and Landforms

**ABSTRACT:** In most regions of the world overgrazing plays a major role in land degradation and thus creates a major threat to natural ecosystems. Several feedbacks exist between overgrazing, vegetation, soil infiltration by water and soil erosion that need to be better understood. In this study of a sub-humid overgrazed rangeland in South Africa, the main objective was to evaluate the impact of grass cover on soil infiltration by water and soil detachment. Artificial rains of 30 and 60 mm h<sup>-1</sup> were applied for 30 min on 1 m<sup>2</sup> micro-plots showing similar sandy-loam Acrisols with different proportions of soil surface coverage by grass (Class A: 75–100%; B: 75–50%; C: 50–25%; D: 25–5%; E: 5–0% with an outcropping A horizon; F: 0% with an outcropping B horizon) to evaluate pre-runoff rainfall (*Pr*), steady state water infiltration (*I*), sediment concentration (*SC*) and soil losses (*SL*). Whatever the class of vegetal cover and the rainfall intensity, with the exception of two plots probably affected by biological activity, *I* decreased regularly to a steady rate <2 mm h<sup>-1</sup> after 15 min rain. There was no significant correlation between *I* and *Pr* with vegetal cover. The average *SC* computed from the two rains increased from 0.16 g L<sup>-1</sup> (class A) to 48.5 g L<sup>-1</sup> (class F) while *SL* was varied between 4 g m<sup>-2</sup> h<sup>-1</sup> for A and 1883 g m<sup>-2</sup> h<sup>-1</sup> for F. *SL* increased significantly with decreasing vegetal cover with an exponential increase while the removal of the A horizon increased *SC* and *SL* by a factor of 4. The results support the belief that soil vegetation cover and overgrazing plays a major role in soil infiltration by water but also suggest that the interrill erosion process is self-increasing. Abandoned cultivated lands and animal preferred pathways are more vulnerable to erosive processes than simply overgrazed rangelands. Copyright © 2011 John Wiley & Sons, Ltd.

**KEYWORDS:** soil degradation; interrill erosion; rainfall simulation; soil cover; runoff; infiltration

## Introduction

Soil erosion by water is a widespread land degradation problem in most parts of the world. It is exacerbated by social and political factors as well as anthropogenic factors: intensive land use, high population density, overstocking and overgrazing aggravate soil erosion (Lal, 1998). In this context, it is necessary to carry on research and improved understanding of the land-use changes and their impact on land cover and the hydrology of the degraded areas.

Most of the studies that correlated infiltration rate, soil loss and vegetal cover have been processed on small plots with rainfall simulation. After the synthesis made by Cerdan *et al.* (2010) based on erosion plot data in Europe, the correlation between soil loss and alteration of the vegetal cover appear clearly in the Mediterranean ecosystems, where the soil cover is often patchy. Many other studies of soil erosion have been

conducted in semi-arid lands with patches of shrub/grass and gravel at the soil surface in all continents (Valentin *et al.*, 1999; Dunjó *et al.*, 2004; Ludwig *et al.*, 2005; Kato *et al.*, 2006, 2009; Neave and Rayburg, 2007). A number of studies related the erosion processes to the influence of various forms of soil cover, such as the presence of crusts and seals, the canopy cover of different plant morphologies (Bochet *et al.*, 2006), or the contact cover of a mulch or cryptogams (Greene and Hairsine, 2004).

The soil cover has a multiple role to control the erosion processes (Rey *et al.*, 2004; Neave and Rayburg, 2007). (i) Soil cover reduces soil detachment by dissipating the kinetic energy of raindrops, by reducing the runoff velocity by increasing the pre-pounding rainfall and the infiltration rate, and by maintaining the soil aggregates with the root system. (ii) Soil cover increases the entrapment of fine eroded particles by acting as filters. In the case of grasses, this interception

depends on the size and shape of the plants. (iii) Soil cover also maintains higher soil surface moisture contents for a long time. This effect is useful in reducing the rate of wetting beneath the soil cover and hence the tendency of aggregates to slake (Cerdà, 1998; Greene and Hairsine, 2004).

However, very few studies have been performed in semi-humid grasslands with gradual changes in soil surface coverage by a sole grass vegetation. In South Africa, where water erosion occurs on 70% of the land (Meadows and Hoffman, 2003), the semi-humid region of the Midlands of KwaZulu-Natal is one of those most affected by water erosion. Extensive erosion in rangelands is due to inappropriate land management practices combined with highly acidic soils of low productivity (Le Roux *et al.*, 2007). By decreasing the soil cover and by creating preferential compacted pathways, overstocking and overgrazing are often considered to be the major cause of land degradation, especially in the rural communal areas (Sonneveld *et al.*, 2005).

The nature of rural agriculture by smallholders in South Africa is changing because of demographic changes: farm populations are ageing, rural males are migrating to urban areas and HIV/AIDS is having a significant impact on a large number of working adults. It is responsible for the reduction in the labour force for farming, resulting in millions of children becoming orphans and disrupting the transmission of agricultural knowledge from one generation to the next (Hoffman *et al.*, 1999). Some authors pointed out the high erodibility of abandoned cultivated fields that return to rangeland (Rowntree *et al.*, 2004) creating speculation on the effects of historical land-use changes and abandoned lands (Kakembo and Rowntree, 2003). This impacts on the productivity and the quality of water leaving these upper catchment regions to downstream users. The grazing lands of the communal areas were generally perceived to be approximately twice as degraded as those in the commercial areas (Hoffman and Todd, 2000). Cattle constitute the second part of the Zulu smallholders' livelihood because it is an important cultural asset. In these particular, large, unplanned rural settlements, ranging in size from hundreds to thousands of homesteads, the stocking rate contributed to the combined degradation index model (Hoffmann and Todd, 2000). Repetitive footpaths and cattle trails concentrate water runoff rapidly leading to the formation of large gullies. In the province of KwaZulu-Natal, specific studies have been made of main gully erosion features and the gully system called 'dongas' (Botha *et al.*, 1994; Botha, 1996), and the high susceptibility of the subsurface material to erosion (Watson *et al.*, 1984; Reinks *et al.*, 2000). In this context, very few studies have been conducted on the processes that initiate linear erosion and no particular studies have focused on the different steps of inter-rill erosion.

In order to understand the evolution of hydrodynamics and detachment soil rate with different stages of degradation of a

rangeland by overstocking, two rainfall simulations were conducted on 1 m<sup>2</sup> experimental plots in an abandoned cultivated terrace showing progressive stages of vegetal degradation, from total grass soil cover to completely bare surfaces. The main objective was to evaluate the impact of grass cover on soil infiltration by water and sheet erosion. A second objective was to relate soil erosion to other environmental factors including soil surface features and top-soil physical and chemical characteristics.

## Materials and methods

### Description of the study site

The study area is located within the Kwazulu-Natal province of South Africa (Figure 1) in the upper part of the Potshini SSI experimental catchment in the 'midlands', downstream of the Drakensberg Mountains (28°48'40"S and 29° 21'40"E). It is located in the headwaters of the Tukhela basin (30,000 km<sup>2</sup>). In the upper part of Potshini catchment, overgrazing occurs with compacted cattle pathways, and patches of vegetal cover degraded by the cattle of local communities, while downstream a large reservoir is used for intensive irrigated crop growing (Kongo and Jewitt, 2006).

The climate is sub-tropical humid and within the summer (October–March) rainfall area. At Bergville, located 10 km to the east, the mean annual precipitation over the last 30 years has been 684 mm, with a potential evaporation of 1600 mm and a mean annual temperature of 13°C (Schulze, 1997).

The altitude at the base of the rainfall simulation site is estimated to be 1350 m asl. The relief is relatively smooth with a mean slope gradient of about 15% but with steep slopes on the upper watershed that may reach gradients of 50–70% with flat areas in the downstream section. The study site is located middle slope.

The vegetation of the site is classified as a grassland biome: the 'Northern KwaZulu-Natal moist Grassland' usually dominated by *Themeda triandra* in tussocks, *Hyparrhenia hirta* and *Sporobolus africanus* (Mucina and Rutherford, 2006).

Soils are formed on fine-grained sandstone, shale, siltstone and mudstone that alternate in horizontal successions (King, 2002). Many dykes, and sills from the Karoo Dolerite, are intruded in these horizontal layers giving specific weathering features of individualized rounded blocks from 10 to >50 cm in diameter and associated reddish clayey soil. Hard sandstone layers form horizontal steps. Farmers cultivated on these steps after building small terraces that are still operated east of the trial. However, some of them have been abandoned, and used as rangeland; they coincide with severe sheet erosion patches with many animal pathways (Figure 1).

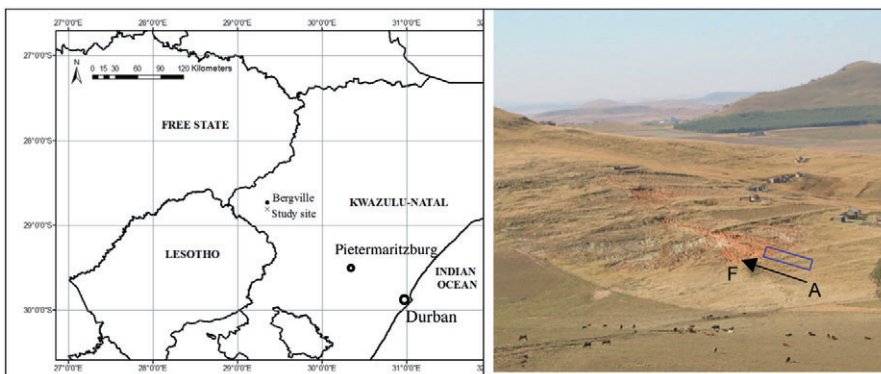

**Figure 1.** Location and overview of the study site in KwaZulu-Natal province, South Africa. Location of our area of experiment from not degraded A vegetal class cover to very degraded F vegetal class cover, in a rangeland and abandoned fields in the Zulu community of Potshini. This figure is available in colour online at [wileyonlinelibrary.com/journal/espl](http://wileyonlinelibrary.com/journal/espl)

**Table I.** Main analytical data of the surface horizon (0–10 cm) of the plots before the rainfall simulation

Class	plot	Grain size content (g kg <sup>-1</sup> )			pH		Exchangeable cations (Cmol <sup>l(+)</sup> kg <sup>-1</sup> )							C g kg <sup>-1</sup>	N g kg <sup>-1</sup>	C/N
		Clay	Silt	Sand	KCl	Water	Ca <sup>++</sup>	Mg <sup>++</sup>	K <sup>+</sup>	Na <sup>+</sup>	S	CEC	V%			
Class A	1	217	194	590	4.1	5.5	1.88	1.09	0.78	0.87	4.61	4.86	95	22.4	0.24	11
	2	209	175	616	4.1	5.1	1.41	1.10	1.10	1.26	4.87	4.53	100	10.2	0.12	9.9
	3	105	91	804	4.3	5.4	1.18	0.86	0.56	0.78	3.38	3.17	100	12.5	0.15	10.8
Class B	4	131	128	741	4.2	5.5	1.29	0.68	0.70	0.79	3.48	3.02	100	9.0	0.12	9.1
	5	195	193	613	4.1	5.2	1.24	0.92	0.67	1.02	3.85	3.99	97	14.7	0.16	10.5
	6	155	140	706	4.1	5.4	0.89	0.81	0.82	0.76	3.28	3.55	92	15.5	0.17	10.8
Class C	7	150	118	732	4.2	5.5	0.94	0.53	0.39	0.70	2.56	1.94	100	7.2	0.08	9.7
	8	182	181	637	4.0	5.3	0.97	0.75	0.61	0.72	3.05	3.67	83	8.7	0.11	9.7
	9	119	97	785	4.2	5.8	0.51	0.65	0.73	0.81	2.70	2.57	100	4.9	0.04	9.2
Class D	10	175	122	704	4.0	4.9	0.66	0.36	0.19	0.72	1.92	1.79	100	5.5	0.09	9.5
	11	143	160	697	4.0	5.4	0.66	0.67	0.54	0.75	2.62	3.02	87	6.2	0.06	9.5
	12	121	111	769	4.0	5.4	0.39	0.62	0.47	0.77	2.25	2.70	83	5.2	0.09	9
Class E	13	197	144	659	4.0	5.0	0.76	0.42	0.31	0.79	2.28	3.10	74	5.8	0.09	9.8
	14	145	109	746	4.0	5.0	0.76	0.42	0.36	0.72	2.26	2.58	87	4.7	0.07	8.5
	15	121	120	759	4.0	5.3	0.59	0.59	0.41	0.75	2.34	2.89	81	6.2	0.07	10.2
Class F	16	334	153	513	3.9	4.7	0.22	0.56	0.18	0.10	1.07	4.33	25	0	0	
	17	349	138	513	4.0	4.9	0.68	0.93	0.10	0.78	2.49	3.84	65	1.2	0	2.9
	18	344	156	500	3.9	4.6	0.08	1.02	0.11	0.07	1.28	6.46	20	0	0	

Three deep soil profiles were dug out to 1 m depth as references in the immediate proximity of the erosion plots with the same name. They were located as follows: upstream of the catena; Plot 14 with high degree of vegetal degradation; at middle slope, Plot 8 with medium degree of vegetal degradation; and downslope, Plot 2 with no vegetal degradation. The general soil type is an Acrisol (WRB, 1998) with brown colour at soil surface (7.5 YR4/4) to reddish (5YR 4/6) in depth. The A horizon is 15–18 cm thick and has fine granular structure when the soil surface is not bare. It has a sandy loamy texture (55 to 70% of sands in the upper 40 cm horizon), with a high proportion of fine sands (>45%). Profiles are slightly enriched in sand (+5%) and depleted in clay (–2%) in the AB horizon. The clay content increases from 15–17% at the soil surface to over 30% below 60 cm depth, in the Bt horizon which has a massive structure. Upstream, in severely eroded surfaces, the complete A horizon has been eroded, the reddish B (2.5YR 4/6) horizon outcrops and the soil surface is completely bare. Soils are generally acidic (pH 4.9–5.2), very low in exchangeable cations (2–4 cmol<sup>(+)</sup> kg<sup>-1</sup>) and soil carbon content ranges from 0.35% in bare surfaces to 2.6% with total grass cover (Table I).

## Experimental design

The study area is about 50 m long and 10 m wide stretched out along the steepest slope direction (Figure 1). It is situated at the foothill of the sloping land unit under pasture and at the limit of a degraded area and exhibits, at the upper limit, clear evidence of soil degradation, with areas of bare soil, isolated tall grass tussocks and the presence of pedestals and exposed roots, whereas down slope those surface features disappear and the soil surface is entirely covered with all sizes of grasses.

Downstream to upstream, six classes of soil vegetal cover have been evaluated using a grid of 2 × 2 m from non to very degraded vegetal soil cover Class A: 75–100%; B: 75–50%; C: 50–25%; D: 25–5%; E: 5–0% with an outcropping A horizon; F: 0% with an outcropping B horizon (Figure 2). Fifteen 1 m<sup>2</sup> experimental runoff plots, three replicates per vegetal class cover numbered from Class A (plot 1) to class E (plot 15) were

selected within the study plot. Three additional runoff plots (plots 16–18, Class F) were established upstream of the study plot on a very degraded completely bare soil surface, compacted by trampling, where the A horizon had been eroded. The plots were bounded by rigid metal frames inserted to a depth of 0.1 m (Janeau *et al.*, 2003).

## Selected surface features and topsoil characteristics

Soil surface features in each plot were characterized before the rainfall simulation. Surface crusts were classified using the classification of Valentin and Bresson (1992). Surface roughness was determined on each plot after rainfall simulation with a laser distance meter (Leica Disto. Pro, laser class 2–635 nm, LEICA geosystems AG, CH-9435 Heerbrugg, Switzerland) as a relief-meter on a 5 cm grid (19 × 19 = 361 points) with an elevation resolution of 1 mm. The distance meter was mounted 0.8 m above the plots on a frame fixed parallel to the surface. Random roughness (*R<sub>r</sub>*), was calculated as the standard deviation of elevations following the formula of Planchon *et al.* (2002). On each surface roughness measurement point, the nature of the soil cover (bare soil, grass or creeping vegetation) was determined and the soil cover percentage extrapolated for 1 m<sup>2</sup>. The grass vegetation was at the end of its cycle and the aerial grass biomass (g m<sup>-2</sup>) was cut and weighed after drying in an oven at 60°C for 48 h for each plot, before the soil surface roughness and vegetal cover measurements were taken.

Subsequent soil compaction was measured using a penetrometer in all plots, following rainfall simulation. Penetration resistance measurements were made by counting the number of drops of a 2.2 kg cone from a height of 1 m necessary to penetrate to 10 cm and on to 90 cm. This measurement was replicated three times in each plot.

Samples were collected from the 0–10 cm top layer in each plot. The determination of soil moisture (SW<sub>0-1</sub>) and soil bulk density (BD<sub>0-1</sub>) were performed by extracting undisturbed soil cores (250 mL). Three replicates per microplot were oven dried at 105 °C for 24 h. Soils were sieved to obtain three particle-size fractions (AFNOR 2003, X31-107,): clay (<2 µm), silt

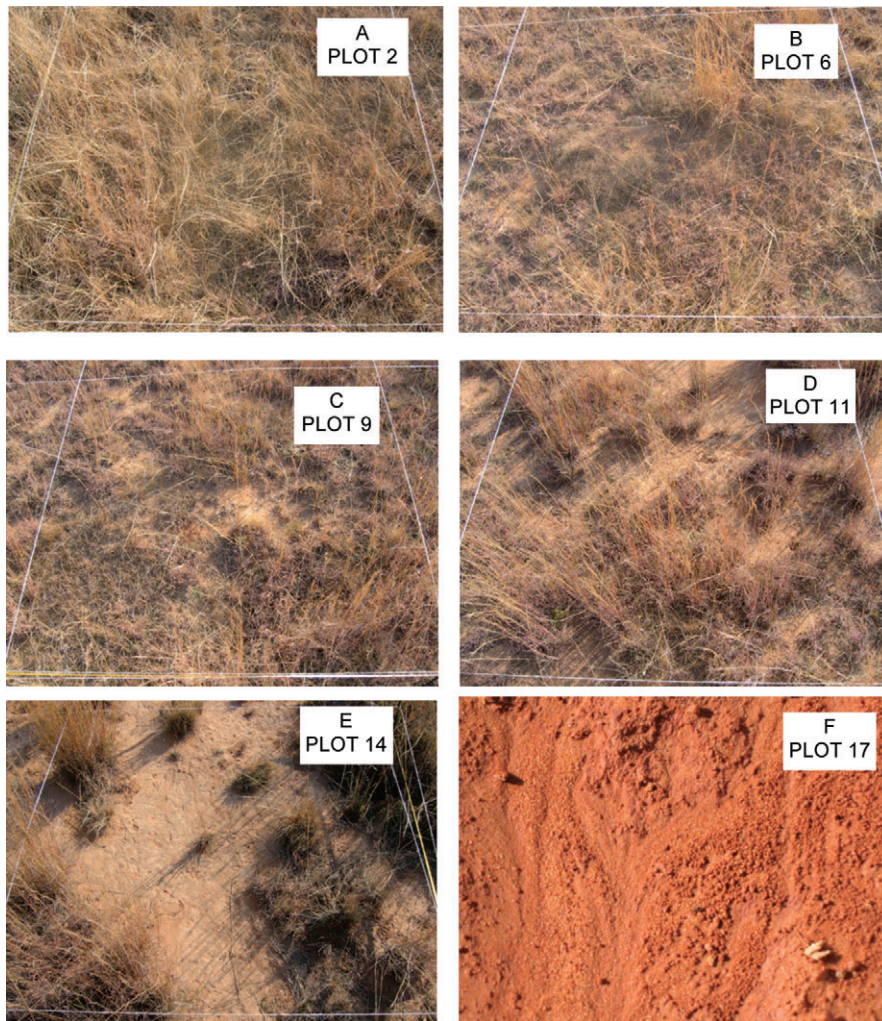

**Figure 2.** Soil surface features of selected plots before installation of the erosion plots. The classes correspond to an approximate percentage vegetal cover: Class A: 75–100%; B: 75–50%; C: 50–25%; D: 25–5%; E: 5–0% with an outcropping A horizon; F: 0% with an outcropping B horizon. For plot 17: soil surface after the rainfall. Erosion crusts and sedimentary crust cover the whole surface. Many micro-aggregates that have been transported in the micro-channels are just deposited at the surface of the sedimentary crust. This figure is available in colour online at [wileyonlinelibrary.com/journal/espl](http://wileyonlinelibrary.com/journal/espl)

(2–50  $\mu\text{m}$ ) and sand (50–2000  $\mu\text{m}$ ). Soil pH was determined in 1:2.5 soil : water suspensions and total soil C content was measured with an elemental analyzer (LECO CNS, LECO Africa Pty., Ltd. Kempton Park, South Africa). The cation exchange capacity (CEC) and the exchangeable cations were determined by exchange ammonium acetate at pH 7.0.

### Rainfall simulations

To gather information on  $I$ ,  $Pr$ ,  $KRu$ ,  $SC$  and  $SL$  at the different classes of soil cover (from A to F) while controlling rainfall, a rainfall simulator was used that generated artificial rains with controlled parameters (drops size, intensity and duration) over 1  $\text{m}^2$  plots (Asseline and Valentin, 1978). The objective was to simulate rainfalls that mimicked the natural rainfall in terms of height, intensities and kinetic energies. In natural rainfall, intensity varies, this is why two intensities were used. Each rainfall simulation consisted of two successive runs to study the influence of initial moisture conditions on runoff generation. Each run lasted 30 min. The first run had 30  $\text{mm h}^{-1}$  rainfall intensity (about 22  $\text{J m}^{-2} \text{mm}^{-1}$ ). The second run occurred 24 h after the end of the first run and had 60  $\text{mm h}^{-1}$  rainfall intensity (about 27  $\text{J m}^{-2} \text{mm}^{-1}$ ). These rainfall intensities of 30  $\text{mm h}^{-1}$  and 60  $\text{mm h}^{-1}$  are, respectively, the average and the extreme values for 30 min rainfall intensities measured in the Drakensberg area over 5 years (Nel and Sumner, 2007). Rainfall simulation was conducted at the beginning of July in the dry season to avoid natural rain disturbance during all simulations on the site.

### Evaluation of $Pr$ , $I$ , $KRu$ , $SC$ , $SL$

The following parameters were measured (Casenave and Valentin, 1992). The pre-runoff rainfall where  $Pr$  (mm) is the height of cumulated water that infiltrates into the soil in addition to the height of water stored on the soil surface during the pre-runoff rainfall phase.

The minimum infiltration rate ( $I$   $\text{mm h}^{-1}$ ), which is the difference between the rainfall intensity ( $R$   $\text{mm h}^{-1}$ ) and the stabilized runoff intensity ( $Rux$   $\text{mm h}^{-1}$ ):  $I = R - Rux$ . The infiltration rates  $I = f(I)$  are linked to variations in the surface characteristics and the initial soil water contents (Collinet and Valentin, 1985).

The runoff coefficient  $KRu$  (%) with  $KRu = (Lr + Dr) / Pr \times 100$  where  $Pr$  is rainfall (mm)  $Lr$  is the runoff (mm), and  $Dr$  (mm) is the part of the surface storage which runs off the plot after the end of the rainfall. The time necessary to collect each sample of 500  $\text{cm}^3$  of runoff water from the plot was monitored during the whole simulation.

The sediment concentration ( $SC$  in  $\text{g L}^{-1}$ ) and the soil losses ( $SL$  in  $\text{g m}^{-2}$ ) were measured using linear interpolation of nine 500  $\text{cm}^3$  samples for 30  $\text{mm h}^{-1}$  rain and 14 samples for 60  $\text{mm h}^{-1}$  rain.

### Statistical analyses

Soil bulk density and soil surface moisture data were interpolated using geostatistics by ordinary kriging to generate maps with a mesh of 0.5 m.

A principal component analysis (PCA) was made using the ADE4 program (Thioulouse *et al.*, 1997) and a matrix of 15 samples and 30 variables. A permutation test was used to test the significance of the groupings suggested by PCA. A factorial plan of the 18 samples studied is represented by the average value and the three replicates for each of the six vegetal cover classes (A, B, C, D, E and F). The samples 16, 17 and 18 from the class F degraded bare soil cover were not included in the correlation matrix because they correspond to the surface of a compacted Bt horizon and not to the surface of an A horizon. Differences were considered significant only for  $P < 0.05$ .

## Results

### Soil moisture, bulk density and soil compaction

The soil moisture of the surface horizon (SW) before the rainfall simulation shows homogenous low values ( $5.7 \pm 1.3\%$ ) in the 15 plots with vegetal cover (Table II). The soil moisture content of Class E plots, with higher clay content, is also much higher (from 9 to 15%). The bulk density shows three categories of values: Class A plots, where the bulk density has an average of  $1.25 \pm 0.06 \text{ g cm}^{-3}$ ; Class B to Class E plots, with a bulk density average of  $1.39 \pm 0.06 \text{ g cm}^{-3}$ ; Class F plots, with an average of  $1.51 \pm 0.02 \text{ g cm}^{-3}$ . The soil surface of these plots can be considered a compacted Bt horizon, with higher values than the bulk density measured in the Bt horizon of the three control plots 14, 8 and 2, respectively, with values of  $1.38$ ,  $1.32$  and  $1.23 \text{ g cm}^{-3}$ . This compaction is confirmed by penetrometry, when 239 ( $\pm 25$ ,  $n: 9$ ) drops were necessary to force the penetrometer to 90 cm depth, while an average of 108 ( $\pm 31$ ,  $n: 48$ ) were necessary for Class B to Class E plots and only 59 drops ( $\pm 14$ ,  $n: 9$ ) for the Class A plots with lowest bulk density. High values for penetrometry (173 and 177) are localized at the soil surface on old eroded termite mounds in plot 7.

### Pre-runoff rainfall values

Pre-runoff rainfall ( $Pr$ ) data obtained for the  $30 \text{ mm h}^{-1}$  (rain 1) and  $60 \text{ mm h}^{-1}$  (rain 2) with 30 min duration are shown in Table III. For the first rain, corresponding to a total rain amount of 15 mm,  $Pr_{30}$  ranged between 2.6 mm for class E and 11.6 mm for class A.  $Pr > 15 \text{ mm}$  (100% of the rain infiltrated) was observed in two replicates of class A. Conversely, lower  $Pr$  values corresponded to plots with low grass cover. A minimum of 1.5 mm was observed for Plot 14 (Class E). Bare plots from Class F soil cover show a relative high infiltration rate during this first run, with an average  $Pr_{30}$  of 5.4 mm, almost twice the average of E class soil cover.

After the second type of rain (30 mm total), only plot 1 (Class A) had complete infiltration. There is a constant decrease in  $Pr_{60}$  from 3 mm on average in soils with high vegetal cover (Class A) to  $< 1 \text{ mm}$  for completely bare soils (Class F).

### Runoff and infiltration rate

The values of runoff rate ( $KRu$ ) are presented in Table III. After the first run of 15 mm total rain, no runoff was observed on plots 1 and 3 with complete grass cover (Class A). For the other plots, the infiltration rate decreased with time. On plots with vegetal soil cover, the infiltration rate decrease is sharp after

the beginning of the runoff and converges to a steady state of less than  $5 \text{ mm h}^{-1}$ .  $KRu_{30}$  ranges from 43 to 72% in the plots with grass cover (Class A to Class E). On bare soils (Class F), it ranges from 28 to 43%, a relatively low value.

In the second run (30 mm total),  $KRu_{60}$  was lowest (0 and 36%) in plots 1 and 2, respectively, with high grass cover (Class A); however, in all other vegetal classes it was much higher than for the first run, ranging from 82 to 99%, with the exception of plot 9 (55%).

### Sediment concentration

The sediment concentration showed an increase from  $0.12$  to  $11.4 \text{ g L}^{-1}$  from Class A to degraded Class E plots during the first run and from  $0.21$  to  $13.3 \text{ g L}^{-1}$  for the second run. For each plot, the sediment concentration showed no major difference between 30 and  $60 \text{ mm h}^{-1}$  rain intensity. However, for the Class F bare plots, the sediment concentration varied from an average of  $36.7 \text{ g L}^{-1}$  to  $60.2 \text{ g L}^{-1}$  for 30 to  $60 \text{ mm h}^{-1}$  rain intensity, which is very high.

### Soil loss

Soil loss increased sharply from the first set of class A plots to the bare surface (Class F) (Table III). The soil loss in the first run ranged from an average of 0.9 g for Class A plots with  $> 50\%$  of grass cover and 430 g of biomass to 106 g for Class E plots ( $< 6\%$  grass cover on average and 100 g of biomass) and from 3.9 to 389 g on average in the second run. These values were much higher for the Class F bare plots, with 179 g and 1709 g, respectively, for the two runs.

### Statistical analysis

Chemical and physical parameters of the soil surface of each plot are presented in Tables I and III. The results of the PCA (Figure 3(A)) shows in the correlation circle F1 (48.67% of the total variability) that the main factors controlling the PCA are the sediment loss, bulk density or rate of soil compaction, and that those having less effect are the organic carbon content, the cations contents, and the vegetal soil cover or the vegetal biomass. The surface occupied by structural and erosion crusts, pre-runoff rainfall and runoff rate are more closely linked to the F2 axis (26.58% of the variability) but with less influence on the discrimination.

The rate of degradation shows a linear trend from the less degraded surfaces Class A plots, with a large distance from the other group where the most degraded (Class E) compose the other extremity of that axis (Figure 3(B)). On this linear trend, two thresholds can be observed between these classes: a slight degradation of grass cover (distance between Class A plots and other plots) will have a strong effect on all parameters of the PCA. When the degradation of soil cover becomes more important a smaller threshold separates Class C and class D plots.

The three Class F plots localized on an eroded B horizon can be completely distinguished from all other plots. Their  $Pr$ ,  $KRu$ ,  $SL$  and  $SC$  values, related to their more clayey texture, respond differently from all other plots. For this reason the results and comments about these plots will be presented separately. For the same reason, the correlation matrix between all parameters has only been made with the 15 plots having vegetal soil cover and a non-eroded A horizon (Table IV).

**Table II.** Vegetal soil cover data and soil surface physical properties and soil surface features

PLOT	Class %	Vw (g)	Vc (%)	Rough.	BD (g cm <sup>-3</sup> )	Hits 90	Hits10	SW (%)	FAg %	FG %	FS %	ST %	ERO %	Res %	Ter %	Wo %	Alg %	CC %	WC %	WH cm	PD cm
1	Class A	429	48	0.968	1.29	52	10	8.64	45	0	5	5	0	45	0	0	0	32	85	15	0
2	75-100	396	52	1.034	1.15	48	10	6.99	20	0	22	40	0	18	3	0	3	25	78	20	0
3		471	55	0.829	1.22	83	12	4.76	23	0	18	20	0	38	3	0	0	28	80	28	0
4	Class B	209	41	0.838	1.39	93	17	4.53	21	0	25	40	2	12	0	0	4	18	72	16	0
5	75-50	336	39	0.962	1.32	115	13	7.05	39	1	5	25	0	30	3	1	0	23	70	43.5	0
6		176	47	1.141	1.42	77	14	4.97	31	0	5	40	0	24	4	0	1	18	66	25	0
7	Class C	242	32	1.347	1.38	154	19	4.35	15	0	15	45	3	22	1	0	1	20	48	24	0
8	50-25	323	25	1.319	1.22	119	15	5.06	20	0	20	37	3	20	1	0	0	17	52	27.5	4
9		229	28	0.856	1.33	119	15	5.29	16	0	12	40	2	30	2	2	2	20	57	35	1
10	Class D	171	14	1.394	1.40	110	16	5.24	10	0	15	56	2	17	0	0	0	16	30	16.5	3
11	25-5	177	18	0.892	1.23	93	10	6.41	12	0	14	57	1	16	0	0	1	12	27	38.5	2
12		134	11	1.607	1.48	83	11	4.58	40	0	5	44	0	10	0	0	0	8	18	33	4
13	Class E	109	8	3.972	1.38	116	12	5.4	7	0	5	49	35	4	1	0	1	8	12	27	0
14	5-0	103	4	1.055	1.23	130	13	7.67	4	0	3	27	63	3	0	0	0	3	5	23.5	0.5
15		98	5	0.887	1.42	87	8	4.62	12	0	3	58	23	3	0	0	0	2	4	6.5	0
16	Class F	0	0	0.666	1.54	235	32	9.8	95	5	0	0	0	0	0	0	0	0	0	0	0
17	0	0	0	0.505	1.50	241	27	17.2	95	5	0	0	0	0	0	0	0	0	0	0	0
18		0	0	0.634	1.52	240	27	15.4	95	5	0	0	0	0	0	0	0	0	0	0	0

Class: estimated grass soil cover Class A: 75-100%; B: 75-50%; C: 50-25%; D: 25-5%; E: 5-0%; Vw: grass biomass; Vc: surface soil grass cover; *Rough*: soil roughness index; *BD*: bulk density 0-10 cm; hits: soil compaction; *SW*: soil moisture; *FAg*: free aggregates; *FG*: free gravel; *FS*: free sand; *ST*: structural crust; *ERO*: erosion crust; *G*: gravel crust; *Ch*: charcoal; *Res*: plant residues.

*Tot*: total of the previous variables (=100 %).

*Ter*: termite constructions; *Wo*: worm casts; *Alg*: algae; *CC*: contact cover; *WC*: weed cover; *WH*: weed height; *PD*: pedestal feature

**Table III.** Pre-runoff rainfall values, runoff rate, soil losses and sediment concentration values measured in all plots during the 2 rains

	<i>Pr</i> (mm)		<i>Kru</i> (%)		Soil loss (g)		Sediment concentration (g l <sup>-1</sup> )	
	Rain 1 30 mm h <sup>-1</sup>	Rain 2 60 mm h <sup>-1</sup>	Rain 1 30 mm h <sup>-1</sup>	Rain 2 60 mm h <sup>-1</sup>	Rain 1 30 mm h <sup>-1</sup>	Rain 2 60 mm h <sup>-1</sup>	Rain 1 30 mm h <sup>-1</sup>	Rain 2 60 mm h <sup>-1</sup>
Plot 1	>15.0	33.5	0	0	0	0.4	0	0.17
Plot 2	4.7	6.2	55	36.1	2.7	3	0.35	0.29
Plot 3	>15.0	2.2	0	89.0	0	5.9	0	0.17
Class A – average	>11.6	14.0	18.3	41.7	0.9	3.1	0.12	0.21
SD		17.0	31.8	44.8	1.6	2.8	0.2	0.07
Plot 4	4.2	3.3	65.4	98.1	24.6	57.4	2.54	1.88
Plot 5	2.8	2.6	66.4	97.2	12	22.9	1.31	0.71
Plot 6	2.8	3.5	72.4	90.5	22.5	49.9	2.16	1.72
Class B – average	3.2	3.2	68.1	95.3	19.7	43.4	2.00	1.44
SD	0.8	0.5	3.8	4.2	6.8	18.1	0.63	0.63
Plot 7	2.0	2.3	69.9	99.1	27.6	159	2.86	4.31
Plot 8	6.9*	2.5	20.9*	92.6	7.5*	90.9	2.50	3.31
Plot 9	3.2	3.8	55.7	54.7	14.3	62.9	1.59	3.74
Class C – average	4.0	2.8	48.8	82.1	16.5	104.3	2.32	3.79
SD	0.8	0.8	10.0	24.0	9.4	49.4	0.65	0.50
Plot 10	4.7	3.0	53.0	87.0	64.1	105.8	9.02	4.07
Plot 11	3.7	2.7	56.3	87.5	45.9	50.9	6.52	1.98
Plot 12	4.5	1.5	56.0	86.9	36.9	179.7	4.21	6.42
Class D – average	4.3	2.4	55.1	87.1	48.9	112.1	6.58	4.15
SD	0.5	0.8	1.8	0.3	13.9	64.6	2.4	2.22
Plot 13	1.7	1.0	65.8	96.2	191.8	305.6	18.21	10.88
Plot 14	1.5	0.9	68.0	98.9	86.1	647.8	9.59	21.19
Plot 15	4.5	2.0	43.2	88.6	41.3	214.0	6.56	7.89
Class E – average	2.6	1.3	59.0	94.6	106.4	389.2	11.45	13.32
SD	1.7	0.6	13.7	5.3	77.3	228.6	6.0	6.98
Plot 16	4.9	1.0	32.2	82.2	189.9	1335	42.48	51.36
Plot 17	6.6	1.1	28.1	87.1	134.4	1612	35.46	60.72
Plot 18	4.7	0.7	43.4	96.6	212.3	2166	32.42	68.55
Class F – average	5.4	0.9	34.5	88.6	178.9	1704	36.79	60.21
SD	1.0	0.2	7.9	7.3	40.1	423	5.16	8.61

\* Mechanical failure during the simulation for Plot 8 during the first rain; value of *Pr* over-estimated, values of *Kru* and soil loss underestimated.

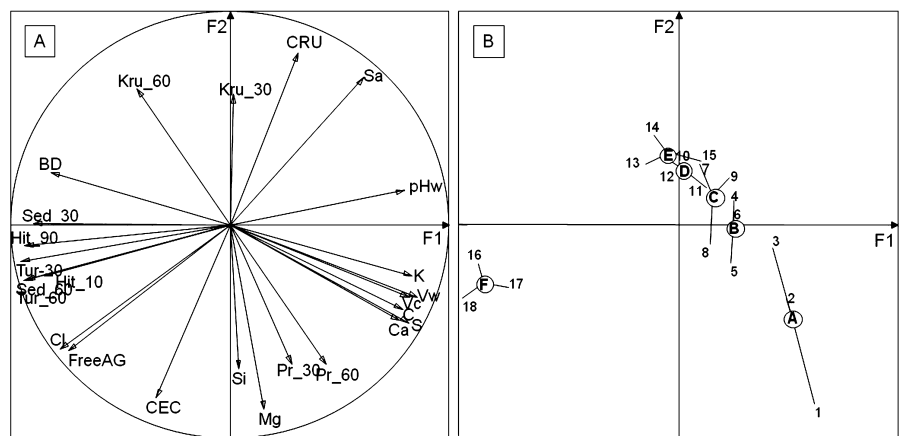

**Figure 3.** PCA performed on the analytical parameters of soil surface and rainfall simulation. (A) Correlation circle of the analytical parameters with factor 1 (48.7% of total variance) and factor 2 (26.6% of total variance) of the PCA analysis. (B) Factorial plan of the 18 samples studied grouped by three replicates for each of the six vegetal cover classes (A,B,C,D,E,F).

**Discussion**

**Influence of vegetation cover on runoff and erosion**

Our data show better correlation between the pre-runoff rainfall, or detachment rate, and the plant cover mass rather than the soil cover percentage at ground level. However, no correlation was found between runoff rate and vegetal soil cover (Table IV). The synthesis of Seeger (2007) showed that runoff rate and vegetal cover were rarely correlated. He suggested a

threshold with an important increase of infiltration with over 60% soil cover, however, in our experiment no clear threshold appeared.

**Pre runoff rainfall values, runoff and infiltration rate**

*Pr* is highly correlated with *Kru* for both rains (Table IV). For the first rain, *KRu*<sub>30</sub> was not linked to the soil grass cover, but to the surface covered by structural and erosion crusts (Table II). On



**Table IV.** Correlation matrix

	Pr_30	Kru_30	SL_30	SC_30	Pr_60	Kru_60	SL_60	SC_60	Vw	Vc	BD	Hit_90	Clay	Sand	FAg	CRU
Pr_30	1															
Kru_30	-0.91*	1														
R_30	-0.91*	0.98*														
SL_30	-0.28	0.04	1													
SC_30	-0.14	-0.15	0.91*	1												
Pr_60	0.62*	-0.48	-0.32	-0.28	1											
Kru_60	-0.52*	0.38	0.24	0.24	-0.84*	1										
R_60	-0.38	0.29	0.24	0.17	-0.76*	0.96*	1									
SL_60	-0.08	-0.16	0.83*	0.90*	-0.24	0.23	0.99*	1								
SC_60	-0.08	-0.18	0.83*	0.93*	-0.24	0.21	0.99*	0.99*	1							
Vw	0.55*	-0.29	-0.79*	-0.78*	0.48*	-0.48	-0.72*	-0.73*	1							
Vc	0.41	-0.08	-0.76*	-0.73*	0.41	-0.42	-0.67*	-0.68*	0.89*	1						
Rough	-0.28	0.29	0.26	-0.07	-0.09	0.15	-0.25	-0.26	-0.04	-0.12	1					
Slo%	-0.55*	0.38	0.55*	0.43	-0.49*	0.53*	0.48*	0.45	-0.69*	-0.55*	0.41	1				
BD	-0.28	0.02	0.58*	0.68*	-0.51*	0.58*	0.68*	0.69*	-0.80*	-0.74*	0.72*	0.72*	1			
Hit_90	-0.21	-0.09	0.77*	0.89*	-0.38	0.39	0.90*	0.91*	-0.70*	-0.67*	0.65*	0.93*	0.93*	1		
Hit_10	-0.10	-0.13	0.68*	0.85*	-0.27	0.24	0.83*	0.85*	-0.58*	-0.46	0.41	0.78*	0.46	0.46	1	
Clay	0.04	-0.25	0.72*	0.86*	0.03	-0.07	0.85*	0.86*	-0.48	-0.44	-0.28	-0.02	-0.96*	-0.96*	-0.96*	1
Silt	0.11	-0.14	0.02	0.06	0.44	-0.35	0.04	0.04	0.22	0.17	-0.24	-0.62*	0.46	1	1	1
Sand	-0.07	0.25	-0.59*	-0.71*	-0.17	0.17	-0.70*	-0.71*	0.31	0.30	-0.24	-0.62*	-0.96*	-0.80*	-0.80*	-0.80*
FAg	0.19	-0.36	0.57*	0.79*	0.03	-0.04	0.83*	0.85*	-0.45	-0.35	0.58*	0.75*	0.88*	0.64*	0.64*	0.64*
CRU	-0.52*	0.55*	-0.13	-0.40	-0.29	0.30	-0.47*	-0.49*	-0.08	-0.16	-0.20	-0.44	-0.65*	0.70*	0.70*	0.70*
pHw	0.16	0.03	-0.82*	-0.81*	0.26	-0.25	-0.77*	-0.76*	0.59*	0.63*	-0.49	-0.66*	-0.78*	0.30	0.30	0.30
Ca	0.48*	-0.20	-0.65*	-0.63*	0.65*	-0.52*	-0.60*	-0.60*	0.82*	0.80*	-0.80*	-0.64*	-0.28	0.10	0.10	0.10
Mg	0.51*	-0.39	-0.21	-0.06	0.44	-0.51*	0.15	0.13	0.41	0.48	-0.31	-0.06	0.36	-0.46	-0.45	-0.45
K	0.15	0.12	-0.76*	-0.76*	0.38	-0.53*	-0.70*	-0.71*	0.74*	0.84*	-0.74*	-0.77*	-0.48	0.30	0.43	0.05
Na	0.06	0.20	-0.72*	-0.73*	0.23	-0.35	-0.74*	-0.72*	0.65*	0.61*	-0.75*	-0.74*	-0.52*	0.39	0.60*	0.33
S	0.39	-0.09	-0.74*	-0.69*	0.55*	-0.59*	-0.62*	-0.62*	0.83*	0.86*	-0.83*	-0.71*	-0.31	0.12	-0.33	-0.08
CEC	0.30	-0.35	0.36	0.42	0.29	-0.31	0.57*	0.54*	-0.04	0.01	0.05	0.32	0.71*	-0.78*	0.70*	-0.67*
C	0.50*	-0.22	-0.66*	-0.67*	0.71*	-0.51*	-0.63*	-0.64*	0.79*	0.82*	-0.70*	-0.70*	-0.34	0.12	-0.29	-0.12

Pr\_30: pre-runoff rainfall (mm) for 30 mm h<sup>-1</sup> rainfall; Kru: runoff rate (%); R: runoff water (L m<sup>-2</sup>); SL: sediment detachment (g m<sup>-2</sup>); SC: concentration in runoff water (g L<sup>-1</sup>).  
\* Significant correlation at P < 0.05 level.

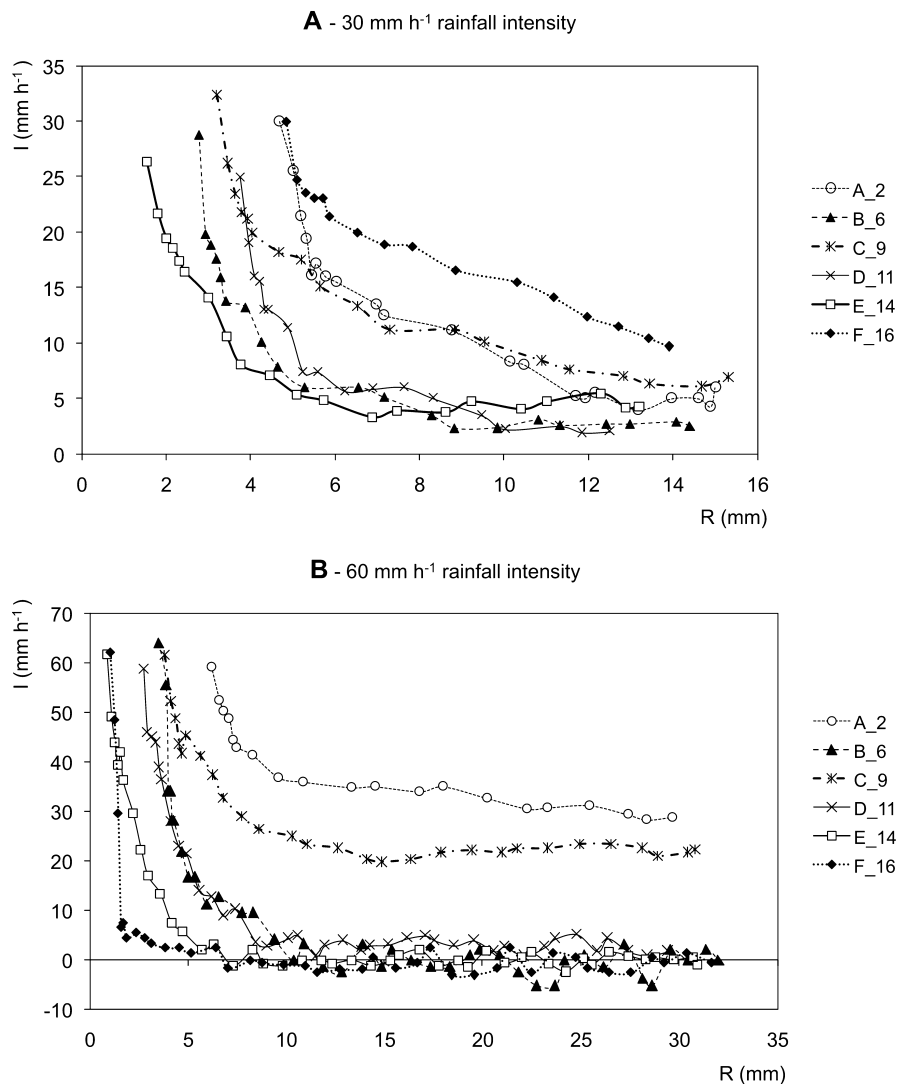

**Figure 4.** Relation between the amount of rainfall in 30 min ( $R$  mm) and the infiltration rate ( $I$  mm h<sup>-1</sup>). Graph A for the 30 mm h<sup>-1</sup> rain, Graph B for the 60 mm h<sup>-1</sup> rain.

plots with vegetal soil cover (Class A to E), the infiltration rate decreased with time with a steady state infiltration rate of less than 5 mm h<sup>-1</sup>, which clearly indicates that infiltration is controlled by crusts (Figure 5(A)) (Le Bissonais and Singer, 1992; Casenave and Valentin, 1992).

Class F with bare soils (example plot 16 in Figure 4(A)) shows a regular decrease of infiltration rate, surprisingly lower than in plots with vegetal cover. Even if this surface is compacted and with high bulk density,  $Pr_{30}$  is higher than on the sandy flat surface of plots from Class A to E. The presence of the micro-cracks and micro-aggregates at the soil surface, and hence the lower crust cover of the B more clayey horizon, favours a higher infiltration. On these bare surfaces, crusts are broken by a shrink–swell process and dispersed by trampling.

For the second rain,  $Pr_{60}$  and  $Kru_{60}$  are associated with the highest porosity, underlined by the lowest bulk density. The decrease in infiltration is very rapid for all plots independently of the vegetal cover (Figure 4(B)). The infiltration rates converge to an average of  $2 \pm 2$  mm h<sup>-1</sup> dependent on the uncertainty of the water pressure in the rainfall simulator sprinkler that controls the rainfall intensity. Even plot 13, with 100% infiltration rate after 30 mm rain, shows after 90 mm rainfall a sudden decrease in its infiltration rate to less than 5 mm h<sup>-1</sup> (data not shown). This confirms the results of the first rain that soil surface pores become sealed, and limit water infiltration. Only very few plots (plot 2 or 9) show a higher constant infiltration rate. This constant infiltration rate is very probably linked to the presence of large channels of termites. Many

termites' mounds of *Cubitermes* sp. are present in the experimental site and the presence of *Odontotermes* sp. has been detected. These *Macrotermittinae* generate fungus-comb chambers not visible from the soil surface with very large channels. Some mammal activity (mouse, rat-maul) are also very active in the area. On the clayey surface class F soils, the soil surface crusts were formed during the first rain; the small cracks are filled and are probably sealed, based on the slight swell of the soil aggregates. Therefore the decrease in infiltration rate was faster than in all other soil cover class plots.

In contrast to the data of Bochet *et al.* (2006) or Cerdà (1999) there is no relationship between the soil grass cover and the relative runoff volume. Many of these studies were conducted on different vegetal type soil cover showing differences in water interception. Measurements made by Molina *et al.* (2007) in the Southern Ecuadorian Andes showed highly variable runoff coefficients related to the vegetal cover. Degraded and abandoned land are important sites of runoff generation, and generated more runoff than rangeland or arable land.

### Soil loss

The soil loss rate is high compared with values measured in similar conditions of rainfall simulation in degraded rangeland of Kenya, where only the extreme values for <25% soil cover were in accord with Class E values of detachment (Snelder and Bryan, 1995). All other values of soil loss and sediment con-

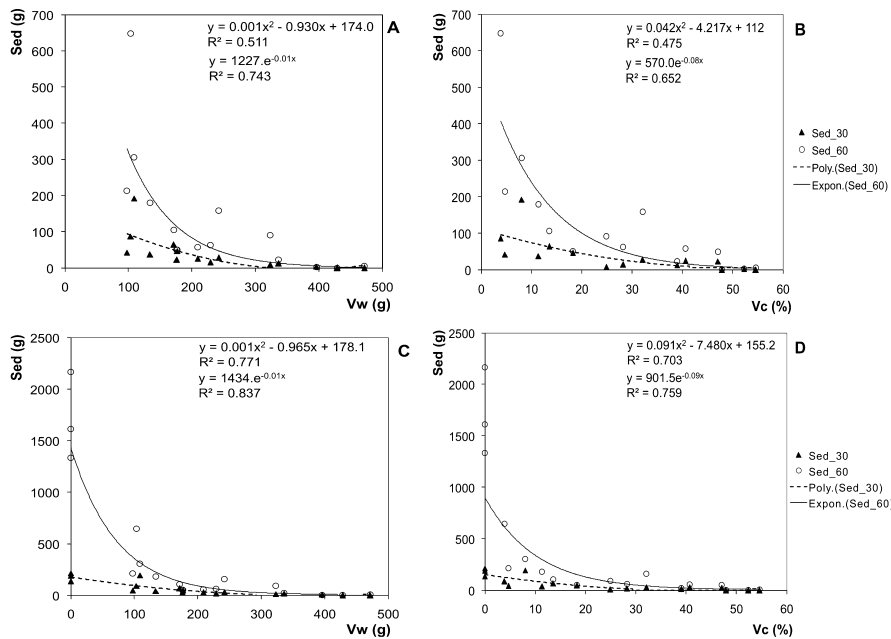

**Figure 5.** Graph A: relation in 15 plots between soil detachment (*Sed* in g) and above ground biomass (*Vw* in g.). Graph B: relation between soil detachment (*Sed* in g) and surface soil cover (*Vc* in %). Graphs C and D: same relation but in 18 plots including the three bare surface plots.

centration for a soil cover of 0–25% in Kenya were similar to our Class B soil cover values. Compared with the rangelands of Kenya, which are Eutric or Calcaric Fluvisols or Cambisols, the Acrisols of our study site are much sandier and with lower pH and  $Ca^{++}$  contents, probably leading to lower soil structure stability and higher erodibility.

There is no good relation between runoff rate and soil detachment (Table IV). The detachment rate values are linked to the presence of free aggregates prone to be transported. The increase of soil loss is strongly related with the degradation of the vegetal cover, with a second-order polynomial relation ( $ax^2 - bx + c$ ) with ( $R^2 = 0.475$ ) for the 30 mm  $h^{-1}$  rain (Figure 5 graph A). This relation is stronger with the grass biomass decrease (*Vw*:  $R^2 = 0.51$ ). For the 60 mm  $h^{-1}$  rain, the soil loss related to decreasing soil cover is exponential ( $R^2 = 0.65$ ). For the grass biomass decrease, the relation is better ( $R^2 = 0.74$ ) (Figure 5 graph B). By including the three bare plots in this correlation, Figure 5 (graphs C and D) is a typical exponential response of decreasing erosion with an increase in soil cover for both rainfall intensities ( $R^2 = 0.70$  and  $0.76$ , respectively). The correlation was better with biomass increase ( $R^2 = 0.77$  and  $0.83$ , respectively). This exponential increase of soil loss in relation to the vegetal cover decrease is in good agreement with the conclusions of Elwell and Stocking (1976) for their evaluation of the erodibility of cultivated fields in Rhodesia (Zimbabwe), however, the type of soil cover and the biomass weight were not specified in their study.

In the long term, vegetation influences the fluxes of water and sediments by increasing the soil aggregate stability and cohesion, and by improving water infiltration. This complex relationship has usually been reported as a negative exponential curve between vegetation cover and erosion rates for a wide range of environmental conditions (Cerdà, 1998; Greene and Hairsine, 2004; Gyssels *et al.*, 2005). Rainfall simulations at plot level confirm this relation in semi-arid degraded rangelands of Kenya, on soils with much higher infiltration rates with a much lower correlation factor (Snelder and Bryan, 1995) or in Mongolia (Kato *et al.*, 2006, 2009). This model has been adopted by Van de Koppel *et al.* (1997) and more recently by Gyssels *et al.* (2005) to explain the effects of overgrazing in semi-arid grassland systems.

In Australian semi-arid rangelands at level of small watersheds, hillslopes with bare patches are responsible for an

increase of 6 to 9 times in runoff and up to 60 times more sediment than hillslopes with high mean soil cover (Bartley *et al.*, 2006). In our study, these strong differences between bare and grassy patches are observed only for detachment rate. The lower differences in runoff are probably due to crusts under the grasses that are likely to be formed at the onset of the rainy season and not much biodisturbed after that.

Grass tussocks have very good ability to retain particles from detachment and their fine roots bind the micro-aggregates (Gyssels *et al.*, 2005; De Baets *et al.*, 2006). On bare soils, when the topsoil has been eroded, micro-aggregates from the B horizon are not bounded by the dense root network of grasses, the detachment occurs mainly as a form of micro-aggregates. The sediment loss and sediment concentration values are correlated with bulk density and with soil resistance to penetration measured by the penetrometer (Table IV). With rapid saturation of pores and high runoff rate, bare soil patches are rapidly prone to erosion by concentrated runoff.

### Extrapolation of results on a larger scale

As suggested by Wainwright *et al.* (2000), the small-plot experiments allow definition of the controlling factors on runoff and soil loss processes, and highlight the importance of vegetation controls. It can be used to elucidate some of the more complex interactions. Movements of nutrients may thus affect the spatial sustainability of plant growth. If the topsoil, which is naturally enriched in carbon and  $Ca^{++}$ , is eroded, the slaking of aggregates will be easier and the natural soil resistance to erosion will be weakened, and soil infiltration reduced by the outcrops of a clayey B horizon. Nutrients such as  $K^+$  and  $Ca^{++}$  are leached from the topsoil in these desaturated and acidic soils (Table I), and the bare soil will be much less suitable for natural vegetal re-growth. The inter-rill erosion will have strong positive feedback and erosion can be accelerated where the entire soil layer has been eroded and the parent rock outcrops at less than 100 m from the experimental site (Figure 1).

In the Potshini site, in a semi-humid climate, degradation seems to be linked with both clear animal pathways that tend to emphasize linear erosion (Le Roux *et al.*, 2007) and land abandonment of a former cultivated terrace rather than general

overgrazing (Figure 1). Similar observations have been reported by Kakembo and Rowntree (2003) or Rowntree *et al.* (2004) in Eastern Cape Province. They conclude that severe sheet erosion with incipient rilling has been in constant progression during recent decades, related to abandoned cultivation, and with poor cattle management. Such degradation of abandoned field has been observed and documented in many other places (Harden, 1996; Lasanta *et al.*, 2000; Dunj3 *et al.*, 2003). Our study is in agreement with the conclusions of the multi-scale synthesis made by Ries (2010) relating to the degradation of Mediterranean ecosystems. The relation between the vegetal soil cover and the runoff is highly variable. Runoff and erosion rates can be high in the abandoned fields, and are often concentrated on trails and pathways.

## Conclusions

During the rainfall simulation process, there was no positive relationship between  $P_r$  and the plot grass cover, but the relationship with grass biomass was positive. The decrease of the infiltration is very rapid for all plots independently of the vegetal cover or the rainfall intensity. The infiltration rates converge to an average of  $2 \pm 2 \text{ mm h}^{-1}$ , suggesting that crusting is the major process limiting the water infiltration with time, including on plots with high vegetal cover. Some plots show much higher constant infiltration rate ( $>20 \text{ mm h}^{-1}$ ), suggesting the presence of preferential channels possibly from termite activity.

There was no relationship between surface runoff and soil detachment rate. The degradation of soil grass-cover in semi-humid grasslands leads to an exponential increase of soil loss, with better correlation with the decrease of the above ground biomass rather than with soil cover loss.

The soil loss is positively correlated with bulk density and soil compaction. The erosion processes show strong positive feedback where eroded soils become more prone to further erosion. Once the surface horizon has been eroded, the B horizon outcrops. This horizon is very susceptible to erosion by the exportation of micro-aggregates.

Our study suggests that animal preferential pathways with compacted channels and abandoned cultivated lands with bare surfaces after harvest are more exposed to erosion processes than simply overgrazed rangelands.

*Acknowledgments*—This study was supported by the joint PROTEA programme founded by the South African/French science and technology research cooperation. The study was organized and managed after a field-school session as the result of the collaboration of scientists from the Institut de Recherche pour le Développement (IRD, France) and the school of Bio-resources Engineering and Environmental Hydrology of the University of Kwazulu-Natal at Pietermaritzburg. The authors thank the Farmer's Support Group of UKZN for facilitating research at the Potshini catchment area and the Potshini community for allowing access to the research site.

## References

- AFNOR. 2003. NF X31-107. Qualité du sol – Détermination de la distribution granulométrique des particules du sol – Méthode à la pipette. Thème: Propriétés physiques des sols. Septembre.
- Asseline J, Valentin C. 1978. Construction et mise au point d'un infiltromètre à aspersion. *Cahiers ORSTOM, série hydrologie* **XV**: 321–349.
- Bartley R, Roth C, Ludwig J, McJannet D, Liedloff A, Cornfield J, Hawdon A, Abott B. 2006. Runoff and erosion from Australia's tropical semi-arid rangelands: influence of ground cover for differing space and time scales. *Hydrological Processes* **20**: 3317–3333.
- Bochet E, Poesen J, Rubio JL. 2006. Runoff and soil loss under individual plants of a semi-arid Mediterranean shrubland: influence of plant morphology and rainfall intensity. *Earth Surface Processes and Landforms* **31**: 536–549.
- Botha GA. 1996. The geology and palaeopedology of late Quaternary colluvial sediments in Northern KwaZulu-Natal. *Memoire* **83**, Council for Geoscience, South Africa.
- Botha GA, Wintle AG, Vogel JC. 1994. Episodic late quaternary palaeogully erosion in northern KwaZulu-Natal, South Africa. *Catena* **23**: 327–340.
- Casenave A, Valentin C. 1992. A runoff capability classification system based on surface features criteria in the arid and semi-arid areas of West Africa. *Journal of Hydrology* **130**: 213–249.
- Cerdà A. 1998. The influence of aspect and vegetation on seasonal changes in erosion under rainfall simulation on a clay soil in Spain. *Canadian Journal of Soil Science* **78**: 321–330.
- Cerdà A. 1999. Parent material and vegetation affect soil erosion in eastern Spain. *Soil Science Society of American Journal* **63**: 362–368.
- Cerdan O, Govers G, Le Bissonnais Y, Van Oost K, Poesen J, Saby N, Gobin A, Vacca A, Quinton J, Auerswald K, Klik A, Kwaad FJPM, Raclot D, Ionita I, Rejman J, Rouseva S, Muxart T, Roxo MJ, Dostal T. 2010. Rates and spatial variations of soil erosion in Europe: a study based on erosion plot data. *Geomorphology* **122**: 167–177.
- Collinet J, Valentin C. 1985. Evaluation of factors influencing water erosion in West Africa using rainfall simulation. In: Challenges in African Hydrology and Water Resources. *IAHS Publ* **144**: 451–461.
- De Baets S, Poesen J, Gyssels G, Knapen A. 2006. Effects of grass roots on the erodibility of topsoils during concentrated flow. *Geomorphology* **76**: 54–67.
- Dunj3 G, Pardini G, Gispert M. 2003. Land use effects on abandoned terraced soils in a Mediterranean catchment, NE Spain. *Catena* **52**: 23–37.
- Dunj3 G, Pardini G, Gispert M. 2004. The role of land-use cover on runoff generation and sediment yield at a microplot scale, in a small Mediterranean catchment. *Journal of Arid Environments* **57**: 99–116.
- Elwell HA, Stocking MA. 1976. Vegetal cover to estimate soil erosion hazard in Rhodesia. *Geoderma* **15**: 61–70.
- Greene R, Hairsine PB. 2004. Elementary processes of soil-water interactions and thresholds in soil surface dynamics: a review. *Earth Surface Processes and Landforms* **29**: 1077–1091.
- Gyssels G, Poesen J, Bochet E, Li Y. 2005. Impact of plant roots on the resistance of soils to erosion by water: a review. *Progress in Physical Geography* **29**(2): 189–217.
- Harden C. 1996. Interrelationships between land abandonment and land degradation: a case from the Ecuadorian Andes. *Mountain Resources and Development* **16**(3): 274–280.
- Hoffman MT, Todd S, Ntshona Z, Turner S. 1999. Land degradation in South Africa Department of Environment Affairs and Tourism, Pretoria. <http://www.sanbi.org/landdeg/>
- Hoffman MT, Todd S. 2000. A national review of land degradation in South Africa: the influence of biophysical and socio-economic factors. *Journal of Southern African Studies* **26**(4): 743–758.
- Janeau JL, Briquet JP, Planchon O, Valentin C. 2003. Soil crusting and infiltration on steep slopes in northern Thailand. *European Journal of Soil Science* **54**: 1–11.
- Kakembo V, Rowntree KM. 2003. The relationship between land use and soil erosion in the communal lands near Peddie Town, Eastern Cape, South Africa. *Land Degradation and Development* **14**: 39–49.
- Kato H, Onda Y, Tanaka Y, Davaa G, Oyunbaatar D. 2006. Field measurement of infiltration rates using an oscillating nozzle rainfall simulator in Mongolia 2006 International Workshop on Terrestrial Change in International Workshop on Terrestrial Change in Mongolia. *Tokyo-Joint Workshop of AMPEX, IORGC and RAISE Projects*. <http://raise.suiri.tsukuba.ac.jp/IWSTCM2006/index.html>
- Kato H, Onda Y, Tanaka Y, Asano M. 2009. Field measurement of infiltration rates using an oscillating nozzle rainfall simulator in the cold semi-arid grassland of Mongolia. *Catena* **76**: 173–181.

- King GM. 2002. An explanation of the 1:500 000 general hydrogeological map. Department of Water Affairs and Forestry, Pretoria, Republic of South Africa.
- Kongo VM, Jewitt GPW. 2006. Preliminary investigation of catchment hydrology in response to agricultural water use innovations: a case study of the Potshini catchment – South Africa. *Physics and Chemistry of the Earth* **31**: 976–987.
- Lal R. 1998. Soil erosion impact on agronomic productivity and environment quality. *Critical Review in Plant Science* **17**: 319–464.
- Lasanta T, García-Ruiz JM, Pérez-Rontomé C, Sancho-Marcén C. 2000. Runoff and sediment yield in a semi-arid environment: the effect of land management after farmland abandonment. *Catena* **38**: 265–278.
- Le Bissonnais Y, Singer M. 1992. Crusting, runoff and erosion response to soil water content and successive rainfalls. *Soil Science Society of American Journal* **56**: 1898–1903.
- Le Roux JJ, Newby TS, Sumner PD. 2007. Monitoring soil erosion in South Africa at a regional scale: review and recommendations. *South African Journal of Science* **103**: 329–335.
- Ludwig JA, Wilcox BP, Breshears DD, Tongway DJ, Imeson AC. 2005. Vegetation patches and runoff-erosion as interacting ecohydrological processes in semi-arid landscapes. *Ecology* **86**: 288–297.
- Meadows ME, Hoffman TH. 2003. Land degradation and climate change in South Africa. *The Geographical Journal* **169**(2): 168–177.
- Molina A, Govers G, Vanacker V, Poesen J, Zeelmaekers E, Cisneros F. 2007. Runoff generation in a degraded Andean ecosystem: interaction of vegetation cover and land use. *Catena* **71**: 357–370.
- Mucina L, Rutherford MC. 2006. The vegetation of South Africa, Lesotho and Swaziland. *Strelitzia* **19**. South African National Biodiversity Institute, Pretoria.
- Neave M, Rayburg S. 2007. A field investigation into the effects of progressive rainfall-induced soil seal and crust development on runoff and erosion rates: the impact of soil cover. *Geomorphology* **87**: 378–390.
- Nel W, Sumner PD. 2007. Intensity, energy and erosivity attributes of rainstorms in the KwaZulu-Natal Drakensberg, South Africa. *South African Journal of Science* **103**: 398–402.
- Planchon O, Esteves M, Silvera N, Lapetite JM. 2002. Microrelief induced by tillage: measurement and modelling of surface storage capacity. *Catena* **46**: 141–157.
- Reinks SM, Botha GA, Hughes JC. 2000. Some physical and chemical properties of sediments exposed in a gully (donga) in northern Kwazulu-Natal, South Africa and their relationship to the erodibility of the colluvial layers. *Catena* **39**: 11–31.
- Rey F, Ballais JL, Marre A, Rovéra G. 2004. Rôle de la végétation dans la protection contre l'érosion hydrique. *C.R. Geoscience* **336**: 991–998.
- Ries JB. 2010. Methodologies for soil erosion and land degradation assessment in mediterranean-type ecosystems. *Land Degradation and Development* **21**: 171–187.
- Rowntree K, Duma M, Kakembo V, Thornes J. 2004. Debunking the myth of overgrazing and soil erosion. *Land Degradation and Development* **15**: 203–214.
- Schulze RE. 1997. *South African Atlas of Agrohydrology and Climatology*. Water Research Commission Report TT82/96, Pretoria, RSA.
- Seeger M. 2007. Uncertainty of factors determining runoff and erosion processes as quantified by rainfall simulations. *Catena* **71**: 56–67.
- Snelder DJ, Bryan RB. 1995. The use of rainfall simulation tests to assess the influence of vegetation density on soil loss on degraded rangelands in the Baringo District, Kenya. *Catena* **25**: 105–116.
- Sonneveld MPW, Everson JM, Veldkamp A. 2005. Multi-scale analysis of soil erosion dynamics in KwaZulu Natal, South Africa. *Land Degradation and Development* **16**: 287–301.
- Thioulouse J, Chessel D, Dolédec S, Olivier JM. 1997. ADE-4: a multivariate analysis and graphical display software. *Statistics and Computing* **7**: 75–83.
- Valentin C, Bresson LM. 1992. Morphology, genesis and classification of soil crusts in loamy and sandy soils. *Geoderma* **55**: 225–245.
- Valentin C, d'Herbe's J, Poesen J. 1999. Soil and water components of vegetation patterning. *Catena* **37**: 1–24.
- Van de Koppel J, Rietkerk M, Weissing F. 1997. Catastrophic vegetation shifts and soil degradation in terrestrial grazing systems. *TREE* **12**: 352–356.
- Wainwright J, Parsons AJ, Abrahams AD. 2000. Plot-scale studies of vegetation, overland flow and erosion interactions: case studies from Arizona and New Mexico. *Hydrological Processes* **14**: 2921–2943.
- Watson A, Price Williams D, Goudie AS. 1984. The palaeoenvironmental interpretation of colluvial sediments and palaeosols of the late Pleistocene hypothermal in southern Africa. *Palaeogeography, Palaeoclimatology, Palaeoecology* **45**: 225–249.
- World Reference Base for Soil Resources (WRB). 1998. World Soil Resources Reports, FAO Rome. **84**.

## 5. LES INGENIEURS DU SOL, DETERMINANTS BIOLOGIQUES DE L'INFILTRATION.

Deux études spécifiques ont été menées pour ce déterminant. La première étude s'intéresse à l'influence des scarabées fousseurs (bousiers) sur l'infiltration au sein de pâturages dégradés d'Afrique du Sud (Figure 22). La deuxième étudie l'influence sur l'infiltration des termites et des vers de terre sur fortes pentes au nord du Vietnam (Figure 23).

Brown J, Scholtz CH, **Janeau JL**, Grellier S, Podwojewski P (2010) *Dung beetles (coleoptera: Scarabaeidae) can improve soil hydrological properties. Applied Soil Ecology* 46: 9-16.



**Figure 22.** Etude des bousiers sur parcelle de simulation de pluie et équipement de simulation de pluie utilisé au sein du pâturage sud-africain.

Jouquet P, **Janeau JL**, Pisano A, Hai Tran S, Orange D, Luu Thi Nguyet M, Valentin C (2012) *Influence of earthworms and termites on runoff and erosion in a tropical steep slope fallow in Vietnam: A rainfall simulation experiment. Applied Soil Ecology* 61:161-168.



**Figure 23.** Simulation de pluie sur forte pente et turricules de vers de terre *Amyntas khami* au Nord Vietnam.

## *LES SCARABEES FOUSSEURS (COLEOPTERE: SCARABAEIDAE) PEUVENT-ILS AMELIORER LES PROPRIETES HYDROLOGIQUES D'UN SOL ?*

**Contexte.** Il existe plus de 650 espèces de scarabées en Afrique du Sud et l'on a comptabilisé jusqu'à 7000 scarabées sur une bouse d'éléphant. Leur importance est majeure par leur potentiel à creuser des galeries de 0.1 à 1 m de profondeur afin d'y déposer de la matière organique pour le développement de leurs larves. Les scarabées fouisseurs plus connus sous l'appellation de scarabées bousiers sont fort étudiés pour leurs rôles multiples au sein des écosystèmes de savanes africaines (Fincher, 1981; Nichols *et al.*, 2008) mais ils n'ont été que peu analysés au niveau de leur rôle sur l'hydrodynamique des sols. Ce rôle est d'autant plus important à connaître sur des pâturages fragilisés par un surpâturage générant du ruissellement et de l'érosion.

**Question scientifique** L'objectif de cette étude est d'estimer sous simulation de pluie l'influence des scarabées fouisseurs sur l'hydrodynamique de surface et de sub-surface, les pertes en sols à un instant donné puis six mois après enfin de comparer la densité apparente et l'humidité des sols sur parcelles avec et sans scarabées bousiers.

**Matériels et méthodes.** L'expérimentation a été menée sur le bassin versant de Potshini en Afrique du Sud (décrit au chapitre précédent). Les pluies ont été réalisées avec un simulateur de pluie type CAPELEC. Neuf parcelles d'1 m<sup>2</sup> ont été installées sur un pâturage protégé des vaches par un enclos dont. Trois sont des contrôles sans bouse de vaches et les autres amendées par 6 kg de bouses de vaches chacune. La végétation a été minutieusement coupée pour éviter une interaction avec la pluie tombant sur les bouses « standardisées » (poids, surface au sol, type de MO). La quantité et la distribution au sol des bouses ont été choisis afin d'être représentative d'une déjection moyenne journalière de vache.

Afin d'obtenir une humidité homogène pour l'ensemble des parcelles, une pluie d'imbibition de 50 mm a été effectuée 24 h avant chaque cycle composé de deux pluies. Ces cycles ont eu lieu à 6 mois d'intervalle (décembre 2008 et juillet 2009). Deux autres pluies de 30 mm h<sup>-1</sup> durant 30 minutes ont eu lieu 48 h et 72 h après la dépose des bouses sur les parcelles. Les paramètres mesurés sont la pluie d'imbibition, les coefficients d'infiltration et de ruissellement et les pertes en sol (exportation hors de la parcelle d'1 m<sup>2</sup>).

La prise des échantillons de sol pour la mesure de densité apparente et de l'humidité a été effectuée à trois profondeurs différentes (10, 20, 30 cm), 2 et 5 jours après la mise en place des bouses sur les parcelles.

Les données ont été analysées statistiquement (ANOVA) grâce au logiciel SPSS version 17.

**Résultats.** Très rapidement après la dépose des bouses au sol, les vols de scarabées ont « colonisés » celles-ci. En 48 h, plus aucune activité de scarabée n'était visible, seul subsistaient des pores de 2 à 15 mm de diamètre en surface.

La **figure 1 de l'article** permet d'apprécier les pluies d'imbibition et les taux d'infiltration qui ont été systématiquement plus importantes pour les parcelles avec bouses que pour les

contrôles et cela pour les 2 cycles de pluies simulée à 6 mois d'intervalle. Elle présente aussi les résultats en termes d'érodibilité ; les parcelles avec bouses pour les deux cycles de pluie possèdent des taux d'exportation en sédiment et les pertes en sol supérieurs par rapport aux parcelles de contrôle.

Les traitements statistiques, pour décembre 2008, démontrent clairement une densité apparente plus élevée et une humidité moindre pour les contrôles 2 et 5 jours après l'application des bouses sur l'ensemble des parcelles. Les résultats sont similaires six mois après et pour les 3 profondeurs d'observations.

**Discussion.** Trois résultats notables sont apparus. Le premier est qu'après la dépose des bouses sur les parcelles, 48 h d'activité des scarabées bousiers ont permis à la pluie d'imbibition et à la lame infiltrée d'augmenter significativement. Le deuxième est que la porosité a augmenté significativement dans les premiers 10 cm du sol. Enfin le troisième concerne l'infiltrabilité qui a persisté durant 6 mois pour ce sol limoneux sableux.

Les analyses statistiques montrent une forte différence du taux d'infiltration entre les contrôles et les parcelles avec bouses dans la plupart des situations. Les pluies d'imbibition montrent moins de différences. L'explication de ce résultat s'explique par la rémanence de l'activité des jeunes scarabées qui remontent en surface quelques semaines à quelques mois après leur dépose souterraine par les géniteurs.

Ces insectes ont permis d'augmenter la porosité du sol dans les 10 premiers centimètres qui sont aussi la zone la plus dense en termes d'enracinement améliorant ainsi l'apport d'eau et de nutriments aux végétaux. L'apport en matière organique fraîche (bouse) est aussi important en termes d'apport d'humidité au sol. Cette amélioration de l'infiltration dans les 10 premiers centimètres est confortée par le fait que les zones situées à 20 et 30 cm sont plus humides qu'en proche surface (0-10 cm) six mois après. Une autre raison est que dans cette région spécifique, la taille des scarabées est majoritairement inférieure à 20 mm de largeur et que les tunnels sont donc relativement petits et peu profonds.

Le dernier point marquant est l'exportation des sédiments excavés et apportés en surface par les scarabées qui n'a lieu qu'au cours de la première simulation de pluie puisque en juin 2009, l'exportation est quasi nulle démontrant la temporalité de cette perte en terre. Simultanément cette perte en terre est « compensée » par les augmentations de matière organique en profondeur et par l'augmentation de l'infiltration.

Il est à noter que si les parcelles « contrôles » ont montré une faible dispersion de résultats au cours de l'ensemble de l'expérimentation ; les écarts constatés sur parcelles avec bouses s'expliquent par la variation de taille des espèces de scarabées (< 5 mm à 40 mm de largeur) « dégradant » les bouses.

**Conclusion.** En Afrique du Sud, le facteur de dégradation principale des zones d'élevage est l'excès de bétail à l'hectare et le surpâturage par réduction du couvert végétal et compaction des sols (Harrison and Shackleton, 1999). Tout comme les termites (Leonard *et*



*al.*, 2004), les scarabées jouent un rôle dans la restauration des sols encroûtés augmentant l'infiltration de l'eau et l'apport de matière organique au sol. Ces résultats pourraient être controversés pour des types de sol plus sableux mais ils possèdent des types de scarabées aux capacités de forage plus ou moins important lissant l'impact d'un trop grand drainage lié à la porosité induite par les scarabées; par ailleurs l'apport de matière organique est toujours bénéfique aux sols.

Certes l'extrapolation de ces résultats obtenus à l'échelle du mètre carré est complexe car la distribution du bétail est aléatoire mais ils expriment une tendance et fournissent des pistes pour des études à plus large échelle.



Contents lists available at ScienceDirect

## Applied Soil Ecology

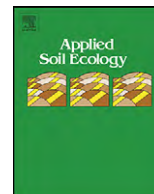
journal homepage: [www.elsevier.com/locate/apsoil](http://www.elsevier.com/locate/apsoil)

## Dung beetles (Coleoptera: Scarabaeidae) can improve soil hydrological properties

Jacqueline Brown<sup>a,\*</sup>, Clarke H. Scholtz<sup>a</sup>, Jean-Louis Janeau<sup>b</sup>, Seraphine Grellier<sup>b</sup>, Pascal Podwojewski<sup>b</sup><sup>a</sup> Department of Zoology and Entomology, University of Pretoria, Lynnwood Road, Hatfield, Pretoria, Gauteng, 0002, South Africa<sup>b</sup> Institut de Recherche pour le Développement c/o School of Bioresources Engineering and Environmental Hydrology, University of KwaZulu-Natal, Scottsville, 3209, South Africa

## ARTICLE INFO

## Article history:

Received 26 January 2010

Received in revised form 24 May 2010

Accepted 26 May 2010

## Keywords:

Bulk density

Erosion

Infiltration

Land degradation

Paracoprid beetles

Runoff

## ABSTRACT

Although dung beetles are known to perform a multitude of ecosystem services, their effects on water infiltration, runoff, porosity, moisture and erosion of soil have never been thoroughly researched. Maintenance of these hydrological properties is important in agro-ecosystem functioning where overgrazing results in negative impacts on the soil. The study site was located in the Potshini catchment in Kwazulu-Natal (South Africa), an area heavily grazed by livestock. We conducted two rainfall simulations on three 1 m<sup>2</sup> control (no dung) and six dung-treated plots in December 2008, and repeated the study in June 2009 on the same plots. Natural populations of dung beetles were allowed to colonise the dung. Simulations were conducted for 30 min at an intensity of 30 mm h<sup>-1</sup>. Key variables calculated were pre-runoff amounts (*Pi*), infiltration ratios (*Ki*), and soil losses. Samples were collected for bulk density determination during the same time periods in order to measure differences in porosity and moisture in control and dung-treated plots at different depths. Using multivariate statistics we found significant differences between dung-treated and control plots in three of four simulations. After 48 h of beetle activity, *Pi* and *Ki* values were significantly increased and remained at elevated levels six months later. Soil losses were initially higher in dung-treated plots than controls, but had declined to less than control values after six months. Bulk density in the A-horizon (0–10 cm) was significantly reduced after 48 h of beetle activity and remained so for six months. No difference in bulk density was observed at greater depths. Soil moisture initially increased significantly in the A-horizon, as well as at 20 and 30 cm depths after six months of activity. We conclude that dung beetles positively influence hydrological properties of the soil by increasing water infiltration and soil porosity, and reducing surface water runoff. Contrasting effects on soil losses are problematic to reconcile from this study. High losses initially observed may be offset in the long-term by reductions associated with the increased infiltration ratios, though this remains to be confirmed.

© 2010 Elsevier B.V. All rights reserved.

## 1. Introduction

Southern Africa has approximately 650 species of dung beetles, of which paracoprid (tunnelling) dung beetles comprise about 70 percent (Davis et al., 2008). They bury dung in tunnels excavated beneath dung pads that range from 10 to 103 cm in depth depending on the species (Edwards and Aschenborn, 1987). The dung is utilised as a medium for feeding and reproduction. Beetles either feed on the dung fluids or use the whole dung as food provisions for their larvae. Dung is buried in a chamber at the end of the burrow and either simply packed where it can be fed on or an egg is laid in it, or made into a ball onto which an egg is laid (Fincher, 1981). Beetle larvae remain in the soil from a few weeks to months before emerging as adults (Halffter and Edmonds, 1982). During peak activity in the summer months (October to February), the beetles may bury

entire dung pads within a few hours leaving no trace behind except excavated soil in their wake (Waterhouse, 1974). Beetles compact the soil on the tunnel sides and in their brood chambers, and leave a lightly packed back-fill of soil behind them as the tunnel progresses. Thus the only soil at the surface is that generated to initiate the excavation (Halffter and Edmonds, 1982). The amount of soil brought to the surface is proportional to the size of the beetle. High numbers of beetles are involved with more than 7000 individuals counted in a single elephant dung pat in the Kruger National Park in South Africa (Waterhouse, 1974).

Dung beetles provide numerous ecosystem services, many of which have been well studied and published in the literature. Most studies have focussed on services that are beneficial to the functioning of agro-ecosystems (Fincher, 1981; Losey and Vaughan, 2006; Nichols et al., 2008). The results of their tunnelling and dung burial are known to increase plant yield as well as the percentage of nitrogen content in pasture herbage (Waterhouse, 1974; Bang et al., 2005). Dung that is rapidly buried by beetles loses only 5–15% of its nitrogen, while volatilization results in the loss of 80% of nitrogen if

\* Corresponding author. Tel.: +27 71 492 3920.

E-mail address: [jbrown@zoology.up.ac.za](mailto:jbrown@zoology.up.ac.za) (J. Brown).

dung remains on the soil surface (Gillard, 1967). Their high rates of dung disposal by breaking up and burying dung have been shown to reduce the survival of livestock insect pests that breed in dung (Bornemissza, 1970; Waterhouse, 1974; Doube, 1986; Edwards and Aschenborn, 1987) and reduce the effects of pasture fouling due to the presence of dung pads (MacLusky, 1960). The emphasis on these services is justified, as the extensive treatment of livestock with veterinary parasiticides in agro-ecosystems can negatively impact on dung beetle communities (Floate et al., 2004). In addition, habitat modification of grasslands by grazing livestock alters soil temperature, moisture levels and vegetation density which leads to changes in dung beetle community structure (Davis et al., 2004).

It has also been implied that dung beetles improve water infiltration in soil, (Waterhouse, 1974; Bang et al., 2005), although to date this effect has not been convincingly shown. In a comprehensive review of the ecosystem services provided by dung beetles, Nichols et al. (2008) highlighted the need for further research into the physical effects of dung beetles on soil structure. Ranging in width from 1 to 50 mm, their simple and compound tunnels create macro-pores relative to their body size in the soil (Halffter and Edmonds, 1982) that theoretically influence infiltration ratios, porosity, soil moisture and aeration, and reduce surface water runoff. Based on studies that have shown how subterranean activity by termites (Elkins et al., 1986; Léonard et al., 2004) and ants (Wang et al., 1996) has increased infiltration ratios and reduced runoff, we can reasonably expect similar results from dung beetles. Reduced porosity and infiltration are characteristic of degraded soils as a result of vegetation removal through overgrazing, and improvements to these properties enhance plant growth thereby aiding in soil restoration (Snyman and Du Preez, 2005). While improved infiltration ratios lead to reduced soil loss, soil excavated to the surface from tunnelling beetles is likely to be exported during rainfall events making their overall influence on soil loss difficult to predict.

The objectives of this study were to: (i) test the influence of dung beetles on water infiltration ratios, runoff, porosity and soil loss. This was done using standardised rainfall simulations on soil to which dung had been added to attract beetles, and comparing results with soil to which no dung had been added; (ii) establish the duration of effects with repeated rainfall simulations on the same plots six months later; (iii) compare soil porosity and moisture during the same time periods by measuring bulk density in the presence and absence of dung beetles.

## 2. Materials and methods

### 2.1. The study area

Sampling and rainfall simulations were carried out in the Potshini Catchment area (10 km<sup>2</sup>) in the foothills of the Drakensberg mountains, Kwazulu-Natal, South Africa (28°48'37"S, 29°21'19"E; elevation 1285 m a.s.l.). The vegetation in the area is Northern Kwazulu-Natal moist grassland (Mucina and Rutherford, 2006) which is being transformed by livestock farming practices into savannoid woodland by encroaching trees, mainly *Acacia sieberiana* var. *woodii*. Small-scale farmers utilise the area for grazing cattle and goats. Heavy grazing also exacerbates the already naturally eroded slopes of the undulant topography.

The dominant soil type is a Luvisol which originates from colluvium parent-rock of different origins (W.R.B., 1998). Based on three soil profile observations, the A-horizon is 15–18 cm thick with a fine granular structure and a sandy loam texture. The clay content increases from 20% at the soil surface to over 40% at 50 cm depth in the Bt-horizon which has a very clear coarse blocky structure. The climate is sub-tropical humid and the catchment falls within the summer (October to March) rainfall area. At the town of Bergville,

10 km to the North, the mean annual precipitation over the last 30 years was 684 mm with a mean annual temperature of 13 °C (Schulze, 1997). The average rainfall intensity in the Drakensberg area is 30 mm h<sup>-1</sup> (Nel and Sumner, 2007).

### 2.2. Rainfall simulations

#### 2.2.1. Preparation of plots

A total of nine 1 m<sup>2</sup> steel plot frames were embedded approximately 5 cm into the soil surface, 6 m apart (Janeau et al., 2003). The plots were set out in three rows of three with two dung-treated and one control plot per row, giving a total of six treated plots and three controls. On all plots the proportion of vegetation cover and number of grass tufts were estimated. These variables were initially included in multivariate analyses, but were excluded from the final analysis as they had low factor loadings in the PCA and explained very little variation between the plots. Vegetation (grasses and forbs) was then cut to ground level to minimise the effect of rainfall interception and the angle of slope was averaged at 6.6%. An area of 3 m<sup>2</sup> including each plot was evenly wet with 50 mm of water one day prior to simulations in order to standardise antecedent soil moisture levels. The plots were fenced to protect them from interference by livestock. In December 2008 a mixture of 70% cattle and 30% pig dung was used to make 1 kg wet weight (average 180 g dry weight) standardised dung pats, three of which were placed in the same diagonal arrangement on each of the dung-treated plots. Natural populations of dung beetles were then able to colonise the dung. Each dung pat was approximately 20 cm in diameter and all three pats were calculated to cover approximately 0.09 m<sup>2</sup>. Dung pat size, quantity and arrangement were selected to simulate a single defecation by wandering cattle in a natural setting where they deposit about 2.5 kg of faeces between 10 and 24 times a day in one large, or several smaller pats (Rosenberger et al., 1977). Bornemissza (1960) found that the average area that grass-fed cattle covered in dung was 1 m<sup>2</sup> per day. Dung of any kind attracts a mix of species and individual dung pats may have differential attraction for reasons including the degree of moisture, pat size, pat position and nutritional composition (Barth et al., 1994). The limited number of pats used in this study may have attracted low numbers of beetles, so a mixture of cattle and pig dung was used to give the best representivity of beetle species in the area. No dung was placed on the control plots. One natural rainfall event occurred during the simulations in December and for the duration of this rainfall a 3 m<sup>2</sup> area including the plots was completely protected with PVC sheeting.

#### 2.2.2. Simulation procedure

Simulations were conducted in December 2008 after dung application, and repeated on the same plots in June 2009 without the further application of dung to measure the duration of effects. Simulations using equipment and methods developed by Asseline and Valentin (1978) were used to determine infiltration ratios, pre-runoff amounts and soil losses by generating artificial rain with controlled parameters (intensity and duration) over each plot. These were essentially the following: a 4 m high metal frame covered in plastic sheeting was assembled and positioned over one plot at a time. A sprinkler nozzle mounted at the top of the structure delivered a measured amount of 'rain' to each plot centred within a 3 m<sup>2</sup> area. Dung beetles were expected to have buried most of the dung within two days of placement (Waterhouse, 1974; Kruger et al., 1998), but it was unknown whether the full extent of their underground tunnelling would have been attained within this time or was continued for a longer period. Therefore, each plot received two successive rainfall simulations 48 and 72 h after dung application in order to assess any variation in effects after visible surface activity had ceased. As it was only possible to treat three plots per

day, one row of three plots was completed each day for a total of six days for the two simulations. Each simulation was carried out at an intensity of  $30 \text{ mm h}^{-1}$  for 30 min. The same rainfall intensity was used in June 2009 with two rainfall simulations conducted 24 h apart. This enabled a comparison to be made with results from December 2008 where any changes in parameters over the 24 h period may have been due to continued beetle activity or as a result of changes associated with the first rainfall simulation like differing antecedent moisture levels. The down-slope side of the plot was installed so that holes in the steel were flush with the soil surface and runoff water could flow via a gutter into a PVC pipe for collection in 500 ml bottles.

Pre-runoff amounts ( $P_i$ , mm) were calculated as  $P_i = w_i + S_i$  where  $w_i$  (mm) is the cumulative depth of water that infiltrates into the soil at time  $t_i$ ; and  $S_i$  (mm) is the depth of accumulated water at the surface during the pre-runoff stage (Podwojewski et al., 2007). Soil surface and moisture conditions prior to rainfall can affect  $P_i$  rates.

The difference between rainfall (mm) and runoff (mm) was calculated as the total infiltrated rain. Infiltration ratios ( $K_i$ ) were calculated as a ratio  $K_i = (SL_i/SP_u) \times 100$  where  $SL_i$  is the total infiltrated rainfall depth and  $SP_u$  is the total rainfall depth (Casenave and Valentin, 1992).

### 2.3. Soil loss

Following the methods described by Gee and Bauder (1986) for grain size analysis, the soil in each 500 ml bottle was obtained by evaporating the water in beakers on hot plates and mineralising any organic matter with the addition of  $\text{H}_2\text{O}_2$ . This was done to eliminate the mass of organic matter that may have been higher on plots where dung had been applied. In this way, sediment losses alone were compared. The soil was then weighed and the combined weight from all the samples provided the total soil loss ( $\text{g m}^{-2}$ ) for each plot. The sediment concentration ( $\text{g L}^{-1}$ ) was also calculated but was not included in multivariate analyses as its calculation is dependent on soil losses.

### 2.4. Soil bulk density and moisture

Soil samples for bulk density determination were collected in December 2008 and June 2009 following different protocols. In both instances the core method of sampling described by Blake and Hartge (1986) was followed using a  $250 \text{ cm}^{-3}$  metal cylinder. Bulk density samples were also used to calculate soil moisture gravimetrically.

Initial sampling involved the placement of six 1 kg dung pats adjacent to the site of the established plots. A mixture of 70% cattle and 30% pig dung was used for the pats. These were arranged in two rows of three dung pats with a third row of three control sites where no dung was placed. Natural populations of dung beetles colonised the pats and three samples of the top 10 cm of soil were collected from beneath three dung pats, two days and five days after dung placement, as well as from the control sites.

Samples obtained in June were from the actual plots after rainfall simulations had been completed. In each of the plots, three samples were taken at depths of 0–10 cm, 10–20 cm, and 20–30 cm. These were taken from three locations corresponding to the original placement of the dung pats on the dung-treated plots. Samples from control plots were obtained in the same pattern. All samples were weighed to obtain the wet weight and then oven-dried at  $105^\circ\text{C}$  for 72 h and re-weighed to determine dry weight. Soil moisture was calculated in  $\text{g kg}^{-1}$  related to soil dry mass using methods described by Garten (1986).

## 2.5. Data analysis

### 2.5.1. Rainfall simulations

A generalized linear mixed model (GLMM) using a logarithmic link function was selected to establish the effect of treatment, time and interaction effects on  $P_i$ ,  $K_i$ , sediment concentration and soil loss on the plots. Selection was based on the unbalanced design and repeated measures used in this study (Quinn and Keogh, 2006). Analysis was completed using SPSS Version 17.

With no a priori presumptions of sample relationships, multivariate analyses were used to detect groupings in the data using a principal components analysis (PCA). The PCA was based on product-moment correlation co-efficients (McGarigal et al., 2002). In order to assess the integrity of the identified groups, a posteriori analysis was used that maximised the variation between groups and minimised variation within groups. To test for statistically significant differences between the groups, discriminant analysis was used followed by a multivariate analysis of variance (MANOVA) (McGarigal et al., 2002). Analyses were undertaken using algorithms in Statistica Version 8 (StatSoft, Inc. Tulsa OK). The three variables used were pre-runoff amounts ( $P_i$ ), infiltration ratios ( $K_i$ ) and soil losses.

In all analyses the results of the first rainfall were analysed separately to those from the second for each simulation period in order to avoid effects of temporal pseudo-replication (Hurlbert, 1984).

### 2.5.2. Soil bulk density and moisture

The data were analysed using descriptive univariate statistics and were examined prior to analysis to ensure the assumptions of homogeneity of variance and normality were met. Samples obtained in December 2008 were analysed with a one-way analysis of variance (ANOVA) using two days, five days and control as fixed factors. A Tukey's HSD post hoc test was used to compare group means between factors. Samples taken in June 2009 were analysed with a multifactor ANOVA (Quinn and Keogh, 2006). The crossed factors in analysis were depth (0–10; 10–20; 20–30 cm) and treatment (control and dung-treated) and main as well as interaction effects were analysed. All statistical analyses were completed using Statistica Version 8 (StatSoft, Inc. Tulsa OK).

## 3. Results

Within minutes of dung placement on the plots, dung beetles rapidly flew in from surrounding areas and orientated to the pats. They immediately began feeding on the dung and burrowing into the soil taking dung with them. The dung pats appeared to be in continuous motion while beetles were active. After 48 h of activity all that remained at the surface was loose, excavated soil where the dung had been and a thin, dry crust of dung above this. Many holes from 2 to 15 mm wide were clearly visible at the soil surface after excavated soil and remaining dung had been partially washed away after the first rainfall simulation. A similar pattern was observed at all dung pats placed during the study. After initial rainfall simulations, the re-growth of vegetation on dung-treated plots was noticeably thicker and higher than on the controls. But when re-cut to ground level in June 2009 there was no obvious difference in the vegetation cover between the plots.

### 3.1. Rainfall simulations

The pre-runoff amounts were significantly higher on dung-treated than control plots after 48 h of activity and the difference was sustained for six months ( $P=0.006$ ) (Fig. 1a). Pre-runoff amounts on controls remained at a similar level over time ranging from a mean of  $1.2 \text{ mm} \pm 0.53$  to  $2.15 \text{ mm} \pm 0.94$ . They were

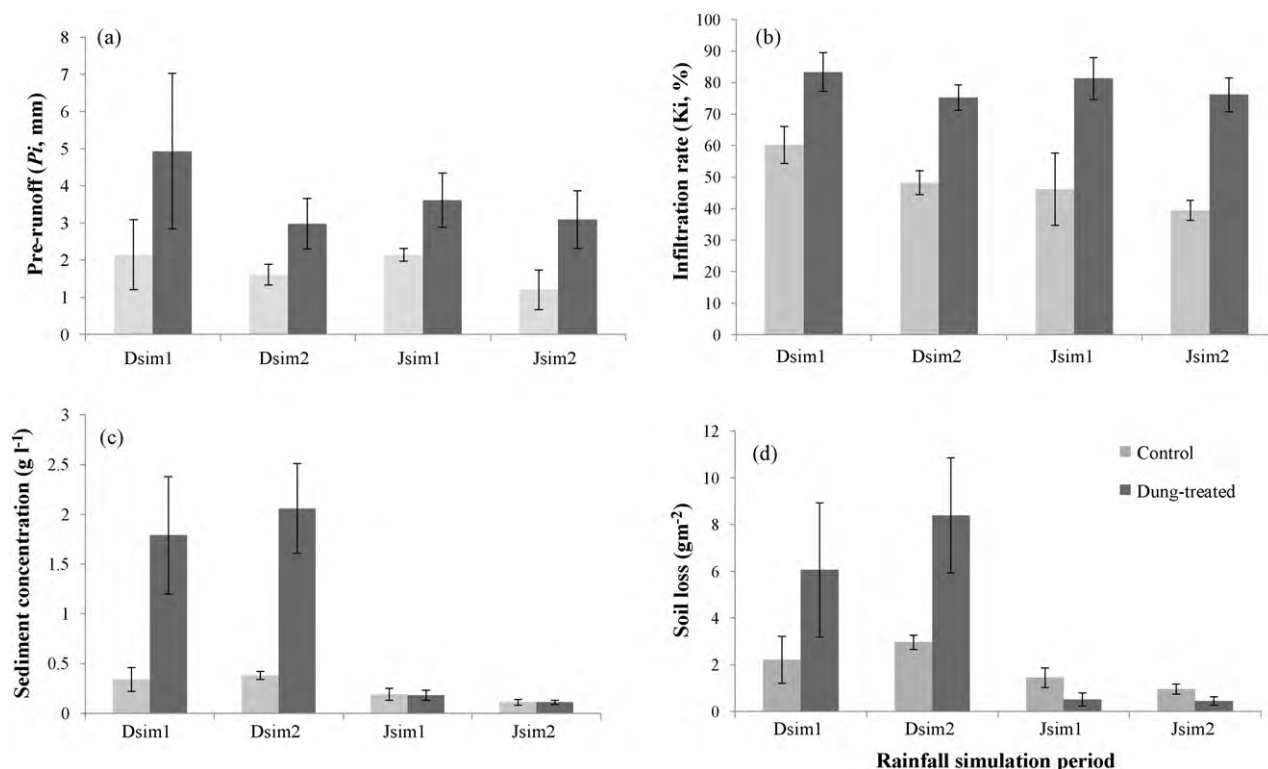

**Fig. 1.** Mean  $\pm$  SE values of the pre-runoff amounts (a), infiltration ratios (b) sediment concentration (c) and soil losses (d) associated with control ( $n = 3$ ) and dung-treated ( $n = 6$ ) plots during two rainfall simulations in December 2008 (Dsim1 and Dsim2) and June 2009 (Jsim1 and Jsim2).

**Table 1** Bulk density ( $\text{g cm}^{-3}$ ) and soil moisture ( $\text{g kg}^{-1}$ ) values (mean  $\pm$  SE) comparing control sites to those where beetles were active after dung application for two days and five days respectively.

	Control: C	Two days of beetle activity: 2	Five days of beetle activity: 5	$F^{\dagger}$
Bulk Density ( $\text{g cm}^{-3}$ )	1.34 $\pm$ 0.03 <sup>2,5</sup>	1.23 $\pm$ 0.0 <sup>C</sup>	1.23 $\pm$ 0.0 <sup>C</sup>	$F_{2,24} = 5.74^{**}$
Moisture ( $\text{g kg}^{-1}$ )	151.91 $\pm$ 4.67 <sup>2,5</sup>	203.90 $\pm$ 7 <sup>C</sup>	202.09 $\pm$ 4.9 <sup>C</sup>	$F_{2,24} = 25.42^{***}$

Values differed significantly to treatments in superscript (C = control, 2 = two days, 5 = five days), (Tukey's HSD).

<sup>†</sup> One-way analysis of variance ( $F$ ).

\*\*\*  $P < 0.001$ .

\*\*  $P < 0.01$ .

more variable on dung-treated plots ranging from 2.98 mm  $\pm$  0.68 to 4.93 mm  $\pm$  2.09.

The mean infiltration ratio on the dung-treated plots was significantly higher than controls after 48 h of dung beetle activity and during both simulations six months later ( $P = < 0.001$ ) (Fig. 1b). Controls showed a decreasing trend over time with a significant difference between the first simulation in December and the second in June ( $P = 0.019$ ). Mean infiltration ratios in the dung-treated plots ranged from 75.21%  $\pm$  3.99 (11.25 L infiltrated) to 83.31%  $\pm$  6.16 (12.4 L infiltrated). By comparison, mean infiltration ratios in the control plots ranged from 39.4%  $\pm$  3.19 (5.9 L infiltrated) to 60.22%  $\pm$  5.83 (10.2 L infiltrated).

Sediment concentrations differed significantly between control and dung-treated plots ( $P = < 0.001$ ) as well as over time

( $P = < 0.001$ ). Mean sediment concentration was significantly higher in dung-treated plots than controls during both simulations in December 2008 (Fig. 1c) and decreased in dung-treated plots and controls from December to June when differences between treatments were not significant.

While the pattern of soil loss appeared similar to that of sediment concentration (Fig. 1d), the treatment effect was not significant. This was surprising as mean soil losses from dung-treated plots after 48 and 72 h were over double those from controls. However, there was a high amount of variation in dung-treated-plot results as observed in their large standard errors (Fig. 1d). Time had a significant overall effect ( $P = < 0.001$ ) with higher soil losses on dung-treated plots in both December simulations than those in June. This was not

**Table 2** Multifactor analysis of variance of the effect of beetles (treatment) and depth (10, 20, 30 cm) on bulk density and soil moisture six months after beetle activity.

Source	Bulk density				Soil moisture		
	d.f.	MS	$F$	$P$	MS	$F$	$P$
Treatment: T	1	0.06	8.66	0.004	251.28	40.02	<0.001
Depth: D	2	0.14	18.71	<0.001	146.47	23.33	<0.001
T $\times$ D	2	0.04	5.8	0.005	3.26	0.51	0.597
Residual	75	0.01			6.28		

**Table 3**

Bulk density ( $\text{g cm}^{-3}$ ) and soil moisture ( $\text{g kg}^{-1}$ ) values (mean  $\pm$  SE) at different depths comparing control sites to those where dung was applied six months previously. Superscript letters associated with mean values indicate significant differences between means of  $P < 0.05$  (C = control, D = dung-treated, 10, 20, 30 = cm depth).

	Soil depth	Control: C	Six months after dung application: D
Bulk Density ( $\text{g cm}^{-3}$ )	10 cm	1.38 $\pm$ 0.04 <sup>D10</sup>	1.23 $\pm$ 0.0 <sup>C10;C20;C30;D20;D30</sup>
	20 cm	1.45 $\pm$ 0.02 <sup>D10</sup>	1.41 $\pm$ 0.02 <sup>D10</sup>
	30 cm	1.43 $\pm$ 0.03 <sup>D10</sup>	1.45 $\pm$ 0.02 <sup>D10</sup>
Soil moisture ( $\text{g kg}^{-1}$ )	10 cm	181.42 $\pm$ 15.8 <sup>C20;C30</sup>	209.79 $\pm$ 4.3 <sup>C20;C30;D20;D30</sup>
	20 cm	145.65 $\pm$ 8.8 <sup>C10;D10;D20;D30</sup>	177.07 $\pm$ 4.7 <sup>C20;C30;D10</sup>
	30 cm	129.59 $\pm$ 10.2 <sup>C10;D10;D20;D30</sup>	171.27 $\pm$ 3.1 <sup>C20;C30;D10</sup>

reflected in control plots which did not significantly differ over time.

### 3.2. Bulk density and soil moisture

The December 2008 ANOVA showed that mean bulk density in the control sites was significantly higher than sites with beetles (Table 1). The Tukey's HSD test established a significant difference between the control sites and sites where beetles were active for two days and five days. There was no difference in the results between the sites after two and five days which is reflected in their identical mean values. Similar results were observed for soil moisture values that were significantly higher in the dung-treated than control plots, and again there was no difference between two and five days.

Results of the multifactor ANOVA for bulk density and soil moisture in June 2009 are presented in Table 2 along with mean values and Tukey's HSD results in Table 3. There was a significant treatment effect with mean bulk density higher in the control plots than those where the beetles had been active six months earlier. The depth effect was also significant with lower bulk density in the first 10 cm of soil in both dung-treated and control plots than at greater depths of 10–20 and 20–30 cm. The interaction between depth and treatment was significant, reflecting the fact that the effect of beetle activity was confined to the top 10 cms. Mean bulk density values at 0–10 cm on dung-treated sites were exactly the same after five days of beetle activity in December 2008 (Table 1) as they were six months later in June 2009 on the dung-treated plots (Table 3). A similar trend was observed in the control plots.

The multifactor ANOVA showed significant effects of treatment and depth on soil moisture results but no interaction effect

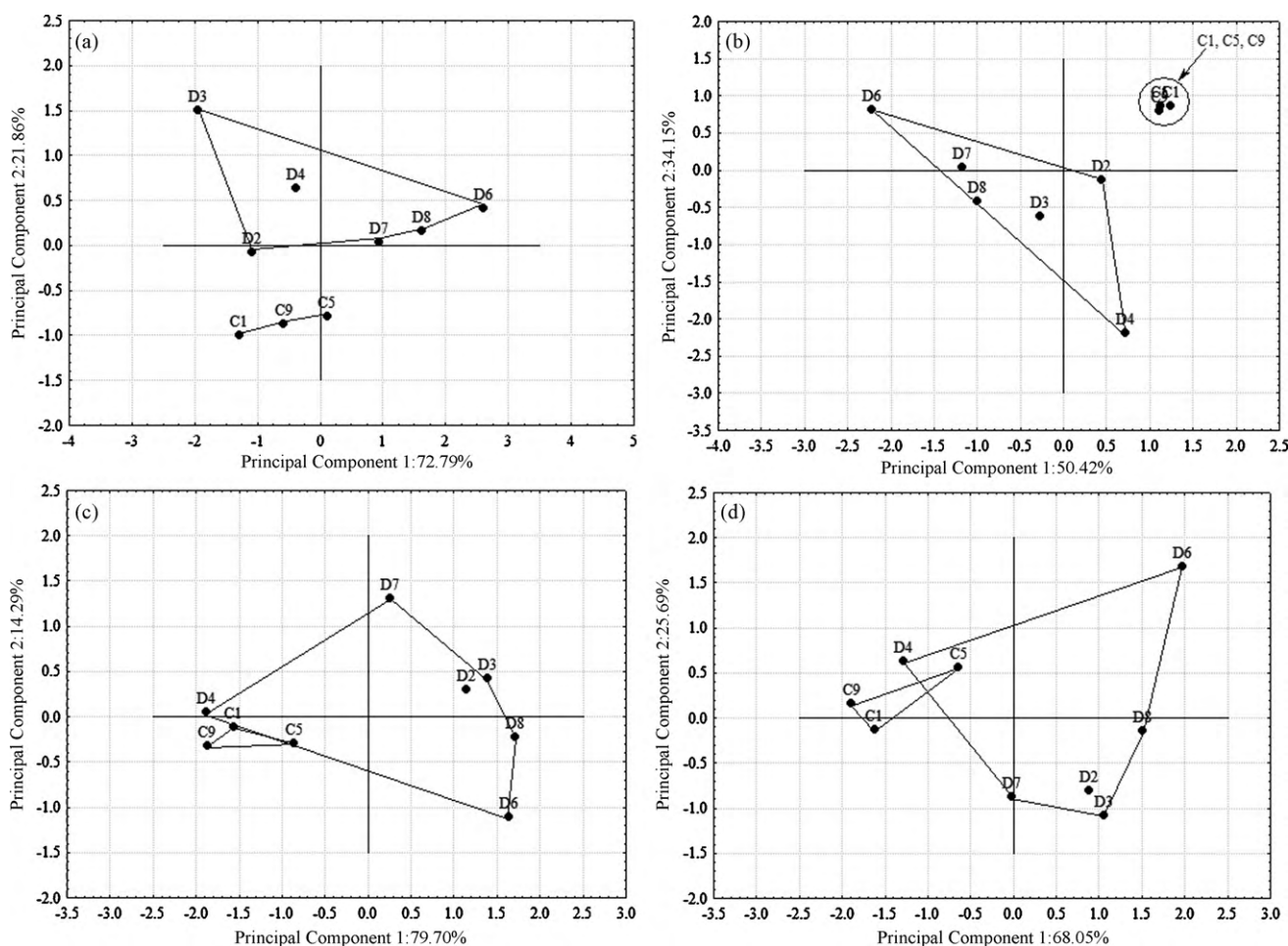

**Fig. 2.** Principal components analysis (PCA) performed using three variables (infiltration ratios, pre-runoff amounts and soil losses) for three control (C) and six dung-treated (D) plots after two rainfall simulations in December 2008 (a and b) and June 2009 (c and d). Principal component axes one and two are plotted.

**Table 4**  
Factor loadings of the three variables in principal component I and II (PC I and PC II) from the principal components analysis (PCA) shown in Fig. 2.

Variable	December Rain 1		December Rain 2		June Rain 1		June Rain 2	
	PC I	PC II	PC I	PC II	PC I	PC II	PC I	PC II
Pre-runoff	0.94	0.13	-0.87	0.09	0.84	-0.53	0.61	0.79
Infiltration	0.87	0.41	-0.85	-0.22	0.90	0.34	0.90	-0.30
Soil loss	-0.72	0.68	0.11	-0.98	-0.93	-0.14	-0.92	0.22
% Trace	72.79	21.86	50.42	34.15	79.70	14.29	68.05	25.69

(Table 2). Mean soil moisture was significantly higher in dung-treated plots than control plots at depths of 20 and 30 cm but not at 10 cm (Table 3). This is in contrast to results observed six months earlier where soil moisture was higher on dung-treated plots in the first 10 cm of soil (Table 1). Both control and dung-treated plots had significantly higher moisture values in the first 10 cm of soil than at 10 and 20 cm where results were very similar in both treatments.

### 3.3. Principal components analysis

Results of the PCA of rainfall simulations are presented in Fig. 2 and related factor loadings in Table 4. After 48 h of beetle activity the dung-treated plots were clearly differentiated from the controls (Fig. 2a). Separation of the control and dung-treated plots was mainly along the second axis where the highest factor loading came from soil loss at 0.68 (Table 4) in the second principal component (PC II). After 72 h of activity the plots were even more distinctly separated with controls tightly clustered apart from dung-treated plots (Fig. 2b). The oblique angle of separation of the plots along both axes was due to high loadings of pre-runoff at -0.87 and infiltration at -0.85 in PC I, and soil loss at -0.98 in PC II (Table 4). The combined first and second principal components accounted for 94.65% and 84.58% of total variation in simulations after 48 and 72 h respectively (Table 4).

The distinction between control and dung-treated plots was clearly maintained in both rainfall simulations six months later, with the main difference being that dung-treated plot four clustered with the controls apart from the other dung-treated plots (Fig. 2c and d). Separation of the plots in the first simulation (Fig. 2c) was at an oblique angle along both axes driven by soil loss at -0.93 and infiltration at 0.90 in PC I, and pre-runoff at -0.53 in PC II (Table 4). Plots in the second simulation (Fig. 2d) mainly separated along the first axis with almost identical factor loadings to the first simulation of -0.92 from soil loss and 0.90 from infiltration in PC I. The first two principal components accounted for a total variation of 93.99% in the first simulation and 93.74% in the second (Table 4).

The discriminant analysis showed significant differences between dung-treated and control plots in all simulations except the first in June 2009 (Table 5). Results from the first simulation in June 2009 showed that most variables for dung-treated plot four were more similar to the mean values for the control plots (Fig. 1a, b and d) with an infiltration ratio of 50%, soil loss of  $1.89 \text{ g m}^{-2}$  and a pre-runoff amount of 1.5 mm. This was a contributing factor to the lack of a significant result in the discriminant analysis for this

**Table 5**  
Discriminant analysis of three variables (pre-runoff amount, infiltration ratio and soil loss) on dung-treated and control plots after two rainfall simulations in December 2008 and June 2009.

	d.f.	F	P
Dec. 2008 Simulation one	5	8.31	0.021*
Simulation two	5	23.95	0.002**
Jun. 2009 Simulation one	5	3.14	0.124
Simulation two	5	7.96	0.023*

\*\*  $P < 0.01$ .

\*  $P < 0.05$ .

simulation and resulted in the grouping of the plot with controls in the PCA (Fig. 2b and d).

## 4. Discussion

There are three interesting findings in this study. The first is that after 48 h of dung beetle activity, pre-runoff amounts and infiltration ratios are increased and sustained at significantly higher levels for at least six months in a sandy loam soil type. The clear separation of control from dung-treated plots in the PCA results was influenced by infiltration ratios more often than pre-runoff values. The infiltration ratios showed less variation than pre-runoff which probably impacted on this result. Separation of the plots in both June PCAs was affected most strongly by soil losses and infiltration ratios. These results are important because the presence of remnant dung on the soil surface could be suspected of influencing our initial results. However, the sustained increase in pre-runoff and infiltration rates observed six months later, long after the crust of dung had disintegrated, indicate that any influence was minor. It is not known how long these improvements are maintained beyond six months, but increased infiltration ratios associated with termites were found to persist at similar levels for four years in sandy soil (Léonard et al., 2004). In addition, increased infiltration ratios and pre-runoff amounts were very similar over the duration of this study showing no indication of decreasing from initial levels six months later. Theoretically, the life cycle of paracoprid dung beetles is in itself a reinforcing process in maintaining these improvements because once the adults have tunnelled into the soil and deposited their eggs, the next generation of beetles will tunnel out of the soil and emerge weeks or months later (Halffter and Edmonds, 1982). However, it was not possible to confirm whether beetles in this study deposited eggs, and if or when any new beetles emerged.

The second finding is that dung beetles increase porosity in the A-horizon as shown by decreased bulk density in the first 10 cm of soil as well as the sustained higher pre-runoff amounts. This is the major zone of plant root development, and increased porosity and infiltration ratios are beneficial to plant growth by facilitating the supply of water and nutrients to roots and increasing aeration (Snyman, 2005). This is reflected in higher moisture levels in the A-horizon where beetles not only increase porosity but introduce organic matter (dung) with a higher moisture holding capacity. The lack of variation in bulk density and soil moisture results between 48 and 72 h after initial dung placement shows that the majority of subterranean beetle activity had taken place within the first 48 h. Had beetle activity continued beyond this time, our results would have shown a continued increase in soil moisture and decrease in bulk density, but these results remained the same. The sustained lower bulk density in the A-horizon increases water infiltration to deeper layers of soil, again reflected in the higher moisture values observed at depths of 20 and 30 cm on dung-treated plots after six months. Presumably, the decay of introduced organic matter in the A-horizon leads to reduced soil moisture at this depth after six months. Bulk density is a reflection of soil porosity and is a useful parameter relating to ecosystem function. Low soil porosity results in restricted root growth, decreased aeration, and lower water infiltration ratios (F.A.O., 2006). In this respect, the refilled tunnels of

a paracoprid dung beetle were observed by Brussaard and Hijdra (1986) to have higher porosity than surrounding soil leading to a higher concentration of plant roots in the tunnels themselves.

As dung beetles are known to tunnel to depths of 103 cm (Edwards and Aschenborn, 1987) it was noteworthy that bulk density was not affected at depths greater than 10 cm. In a study assessing the biogeographical composition of dung beetle assemblages along an altitudinal gradient in the same province, tunnelling tribes were found to account for  $86.6 \pm 9.6\%$  abundance between 500 and 1500 m a.s.l. (Davis et al., 1999). Therefore a lack of tunnelling dung beetles in the community assemblage cannot be the reason. One possible explanation may be that bulk density samples in the first sampling period were only collected to 10 cm so there may have been an effect at deeper levels that was not observed or not sustained for six months. Secondly, beetles in the larger size classes are known to tunnel to greater depths than smaller individuals (Halffter and Edmonds, 1982) and very few large beetles (>20 mm wide) were observed at the site. In addition, the increased clay content in the Bt-horizon may have restricted beetle activity at depths beyond the A-horizon. Similar results to these findings were observed by Bang et al. (2005) who reported high air permeability of soil associated with three dung beetle species to a depth of 10 cm, but no effect at 20 cm.

The third interesting finding is that there is a high initial pulse of soil loss associated with soil excavated to the surface by the beetles. While not found to be statistically significant, this variable is positively correlated with sediment concentration which did show significant differences between treatments in December but not in June. Soil loss also had the highest loadings in three out of four of the PCAs, emphasising the role of this variable in differentiating treatments. There was no difference in either sediment concentration or soil losses between treatment plots in June, which confirms that the initial soil loss is temporary. While soil losses in June were slightly lower on dung-treated than control plots, this difference was not significant. This result was unforeseen as one could reasonably predict significantly reduced soil losses resulting from the sustained improvement in infiltration rates over time. Similar trends have been observed for other soil fauna like earthworms that improve infiltration rates and porosity, but deposit soil casts on the surface that contribute to soil losses (Blanchart et al., 2004). Unfortunately this study cannot provide a total comparative soil loss budget over time as it is impossible to say at what point during the six-month period the soil losses were reduced in the plots where beetles were active. Given that the infiltration ratios increased with immediate effect in association with dung beetles however, it is likely that once the initially excavated soil had been exported a sustained reduction in soil loss would be observed concurrently with increased infiltration ratios. This remains to be tested conclusively.

Close grouping of the control plots in all PCA results shows they were similar over the course of the study. There was consistent variation between the dung-treated plots as reflected in their more dispersed grouping in the PCAs. A large proportion of this variation is almost certainly due to diversity in the size distribution, abundance and extent of activity associated with natural populations of beetles. Beetles ranging in width from <5 mm to 40 mm (one large *Heliocopris* sp.) were observed at the pats and this range conceivably reflects that of tunnel widths excavated by the beetles. While an estimate of the numbers of beetles per pat would have been helpful in explaining the variation in this study, this requires removal of the soil beneath the pat in order to count the beetles using the Berlese method (Kruger et al., 1998). The results of our study were dependent on the soil remaining undisturbed and as a result this could not be done. Factors like soil moisture levels have been shown to affect the depth to which beetles tunnel, with nests constructed at twice the depth in moist soil than in dry soil at the same location (Edwards, 1986). Variation in the location of tunnel

entrances on the micro-topography of the plots could also influence infiltration ratios. While termites significantly increase infiltration ratios, the extent of their effects was also observed to vary and was attributed to seasonal and temperature-related changes in activity, and arbitrary re-filling of holes with soil transported during rain events (Léonard et al., 2004). During this study, no termite or ant activity was observed on the surface of any of the plots. While dung beetles were found in bulk density samples, no other significant soil fauna were observed, indicating a lack of other activity below the surface. We thus conclude that ants and termites made no contribution to the results obtained. Despite the low slope angle on the plots, it is conceivable that subterranean water may have moved downstream affecting antecedent moisture levels in plots. It is not possible to confirm whether the contrasting results observed on dung-treated plot four originated from biotic (beetles) or abiotic (soil) factors as there were no obvious surface differences. But the infiltration ratios may have been under-calculated as a result of a faulty connection between the PVC pipe and the gutter of the metal frame on that plot. As the vegetation was cut on all the plots exposing greater soil area, another factor that may have played a role in inter-plot variation is temperature related degrees of evaporation of infiltrated rain from the soil surface (Snyman, 1988). Particularly between the first and second simulation, this would influence antecedent moisture levels resulting in differences in subsequent pre-runoff amounts and infiltration ratios.

The main factors driving land degradation in communal areas in South Africa are overstocking and overgrazing (Harrison and Shackleton, 1999). Overgrazing leads to reduced vegetation cover and increased soil exposure which has been shown to result in high soil losses and compaction (Elkins et al., 1986). Along with termites (Léonard et al., 2004), dung beetles play a restorative role by improving the infiltration properties of crusted soils. This is important in mediating the effects of land degradation by reducing surface water runoff and improving plant growth and nutritional content (Bang et al., 2005). It is important to recall that dung beetle communities themselves are affected by overgrazing (Davis et al., 2004), so while they may mediate the effects of this process, there is likely to be a threshold beyond which their beneficial activities are reduced.

The application of these findings to other soil types is debatable. Dung beetle communities have been shown to differ across sand and clay soil types. While overall abundance does not differ, sandy soils are dominated by larger paracoprid beetles than clay soils (Davis, 1996). In well-drained sandy soils the management objective may be to reduce drainage in order to increase soil-water availability for plants, in which case tunnelling dung beetles may intensify porosity. However the introduction of organic matter (dung) into the soil is known to improve soil structure thereby enhancing water infiltration and reducing soil erosion (Thurow et al., 1986). The extrapolation of our results from  $1 \text{ m}^{-2}$  to a larger area where livestock are naturally grazing and depositing dung is complex. Cattle will congregate near feeding or watering areas, and otherwise disperse as they forage. Correspondingly their dung will occur in higher concentrations in some areas than others leading to variation in the effects of dung beetle activity on the soil.

While this study provides several valuable insights, opportunities for further research remain. Rainfall simulations offer limited scope for replication so infiltration ratios could be further investigated using tension or double ring infiltrometry at higher replications over a range of soil types and slopes. Long-term measures of soil losses at regular intervals could provide the basis for a soil loss comparison over time. While there are challenges relating economic values to water and soil, it may be possible to calculate the value of these ecosystem services after extrapolation to a larger spatial scale and consideration of the multitude of variables involved.



## Acknowledgements

Thanks to the S.A. National Research Foundation for funding, and to Prof. C.T. Chimimba for valuable suggestions on statistical analyses.

## References

- Asseline, J., Valentin, C., 1978. Construction et mise au point d'un infiltromètre à aspersion. *Cah. Orstom, sér Hydrol.* 14, 321–349.
- Bang, H.S., Lee, J.H., Kwon, O.S., Na, Y.E., Jang, Y.S., Kim, W.H., 2005. Effects of paracoprid dung beetles (Coleoptera: Scarabaeidae) on the growth of pasture herbage and on the underlying soil. *Appl. Soil Ecol.* 29, 165–171.
- Barth, D., Karrer, M., Heinze-Mutz, E.M., Elster, N., 1994. Colonization and degradation of cattle dung: aspects of sampling, fecal composition, and artificially formed pats. *Environ. Entomol.* 23, 571–578.
- Blake, G.R., Hartge, K.H., 1986. Bulk density. In: Klute, A. (Ed.), *Methods of Soil Analysis. Part 1. Physical and Mineralogical Methods*. Agronomy Monograph No 9, Book Series, 2nd ed. Soil Science Society of America, Madison, WI, pp. 363–375.
- Blanchart, E., Albrecht, A., Brown, G., Decaens, T., Duboiset, A., Lavelle, P., Mariani, L., Roose, E., 2004. Effects of tropical endogenic earthworms on soil erosion. *Agric. Ecosyst. Environ.* 104, 303–315.
- Bornemissza, G.F., 1960. Could dung eating insects improve our pastures? *J. Aust. Inst. Agric. Sci.* 26, 54–56.
- Bornemissza, G.F., 1970. Insectary studies on the control of dung breeding flies by the activity of the dung beetle, *Onthophagus gazella* F. (Coleoptera: Scarabaeinae). *J. Aust. Entomol. Soc.* 9, 31–41.
- Brussaard, L., Hijdra, R.D.W., 1986. Some effects of scarab beetles in sandy soils of the Netherlands. *Geoderma* 37, 325–330.
- Casenave, A., Valentin, C., 1992. A runoff capability classification system based on surface features criteria in semi-arid areas of West Africa. *J. Hydrol.* 130, 231–249.
- Davis, A.L., Scholtz, C.H., Chown, S.L., 1999. Species turnover, community boundaries and biogeographical composition of dung beetle assemblages across an altitudinal gradient in South Africa. *J. Biogeogr.* 26, 1039–1055.
- Davis, A.L.V., 1996. Community organisation of dung beetles (Coleoptera: Scarabaeidae): differences in body size and functional group structure between habitats. *Afr. J. Ecol.* 34, 258–275.
- Davis, A.L., Scholtz, C.H., Dooley, C.H., Bham, N., Kryger, U., 2004. Scarabaeine dung beetles as indicators of biodiversity, habitat transformation and pest control chemicals in agro-ecosystems. *S. Afr. J. Sci.* 100, 1–10.
- Davis, A.L., Frolov, A.V., Scholtz, C.H., 2008. *The African Dung Beetle Genera*. Protea Book House, Pretoria, South Africa.
- Doube, B.M., 1986. Biological control of the buffalo fly in Australia: the potential of the southern African dung fauna. In: Patterson, R.S., Rutz, D.A. (Eds.), *Biological Control of Muscoid Flies*, vol. 61. Miscellaneous Publications of the Entomological Society of America.
- Edwards, P.B., 1986. Phenology and field biology of the dung beetle *Onitis caffer* Boheman (Coleoptera: Scarabaeidae) in southern Africa. *Bull. Entomol. Res.* 76, 433–446.
- Edwards, P.B., Aschenborn, H.H., 1987. Patterns of nesting and dung burial in *Onitis* dung beetles: implications for pasture productivity and fly control. *J. Appl. Ecol.* 24, 837–851.
- Elkins, N.Z., Sabol, G.V., Ward, T.J., Whitford, W.G., 1986. The influence of subterranean termites on the hydrological characteristics of a Chihuahuan desert ecosystem. *Oecologia* 68, 521–528.
- Fincher, G.T., 1981. The potential value of dung beetles in pasture ecosystems. *J. Georgia Entomol. Soc.* 16, 301–316.
- Floate, K.D., Wardhaugh, K.G., Boxall, A.B.A., Sherratt, T.N., 2004. Fecal residues of veterinary parasiticides: nontarget effects in the pasture environment. *Annu. Rev. Entomol.* 50, 153–179.
- Food and Agriculture Organisation of the United Nations, 2006. *Guidelines for Soil Description*. FAO, Rome, p. 50.
- Garten, W.H., 1986. Water content. In: Klute, A. (Ed.), *Methods of Soil Analysis. Part 1. Physical and Mineralogical Methods*. Agronomy Monograph No 9, Book Series, 2nd ed. Soil Science Society of America, Madison, WI, pp. 493–544.
- Gee, G.W., Bauder, J.W., 1986. Particle size analysis. In: Klute, A. (Ed.), *Methods of Soil Analysis. Part 1. Physical and Mineralogical Methods*. Agronomy Monograph No 9, Book Series, 2nd ed. Soil Science Society of America, Madison, WI, pp. 383–411.
- Gillard, P., 1967. Coprophagous beetles in pasture ecosystems. *J. Aust. Inst. Agric. Sci.* 33, 30–34.
- Halffter, G., Edmonds, W.D., 1982. *The nesting Behaviour of Dung Beetles (Scarabaeinae): An Ecological and Evolutionary Approach*. Instituto de Ecología, México D. F.
- Harrison, Y.A., Shackleton, C.M., 1999. Resilience of South African communal grazing lands after the removal of high grazing pressure. *Land Degrad. Dev.* 10, 225–239.
- Hurlbert, S.H., 1984. Pseudoreplication and the design of ecological field experiments. *Ecol. Monogr.* 54, 187–211.
- Janeau, J.L., Briquet, J.P., Planchon, O., Valentin, C., 2003. Soil crusting and infiltration on steep slopes in northern Thailand. *Eur. J. Soil Sci.* 54, 1–11.
- Kruger, K., Scholtz, C.H., Reinhardt, K., 1998. Effects of the pyrethroid flumethrin on colonisation and degradation of cattle dung by adult insects. *S. Afr. J. Sci.* 94, 130–133.
- Léonard, J., Perrier, E., Rajot, J.L., 2004. Biological macropores effect on runoff and infiltration: a combined experimental and modelling approach. *Agric. Ecosyst. Environ.* 104, 277–285.
- Losey, J.E., Vaughan, M., 2006. The economic value of ecological services provided by insects. *BioScience* 56, 311–315.
- Macluskus, D.S., 1960. Some estimates of the areas of pasture fouled by excreta of dairy cows. *Grass For. Sci.* 15, 181–188.
- McGarigal, K., Cushman, S., Stafford, S., 2002. *Multivariate Statistics for Wildlife and Ecology Research*. Springer-Verlag, New York, USA.
- Mucina, L., Rutherford, M.C. (Eds.), 2006. *The vegetation of South Africa, Lesotho and Swaziland. Strelitzia 19*. South African National Biodiversity Institute, Pretoria, RSA.
- Nel, W., Sumner, P.D., 2007. Intensity, energy and erosivity attributes of rainstorms in the KwaZulu-Natal Drakensberg, South Africa. *S. Afr. J. Sci.* 103, 398–402.
- Nichols, E., Spector, S., Louzada, J., Larsen, T., Amezcua, S., Favila, M.E., 2008. Ecological functions and ecosystem services provided by Scarabaeinae dung beetles. *Biol. Cons.* 141, 1461–1474.
- Podwojewski, P., Janeau, J.L., Leroux, Y., 2007. Effects of agricultural practices on the hydrodynamics of a deep tilled hardened volcanic ash-soil (Cangahua) in Ecuador. *Catena* 72, 179–190.
- Quinn, G.P., Keogh, M.J., 2006. *Experimental Design and Data Analysis for Biologists*. Cambridge University Press, Cambridge, UK.
- Rosenberger, G., Dirksen, G., Grunder, H.-D., Grunert, E., Krause, D., Stober, M., Mack, R., 1977. *Clinical Examination of Cattle*. Verlag Paul Parey, Berlin, DE.
- Schulze, R.E., 1997. *South African Atlas of Agrohydrology and Climatology*. TT82/96. Water Research Commission, Pretoria, RSA.
- Snyman, H.A., 1988. Measuring water-use efficiency from rangeland in the Central Grassveld from Evapotranspiration. *Water S. A.* 14, 153–158.
- Snyman, H.A., 2005. Rangeland degradation in a semi-arid South Africa. I. Influence on seasonal root distribution, root/shoot ratios and water-use efficiency. *J. Arid Environ.* 60, 457–481.
- Snyman, H.A., Du Preez, C.C., 2005. Rangeland degradation in a semi-arid South Africa. II. Influence on soil quality. *J. Arid Environ.* 60, 483–507.
- Thurow, T.L., Blackburn, W.H., Taylor, C.A., 1986. Hydrologic characteristics of vegetation types as affected by livestock grazing systems. *J. Range Manage.* 39, 505–509.
- Wang, D., Lowery, B., Norman, J., MacSweeney, K., 1996. Ant burrow effects on water flow and hydraulic properties of Sparta sand. *Soil Tillage Res.* 37, 83–93.
- Waterhouse, D.F., 1974. The biological control of dung. *Sci. Am.* 230, 101–108.
- W.R.B., 1998. *World Reference Base for Soil Resources*. World Soil Resources Reports, no. 84. FAO, Rome, p. 88.

## ***INFLUENCE DES VERS DE TERRE ET DES TERMITES SUR LE RUISSELLEMENT ET L'ÉROSION AU SEIN D'UNE JACHÈRE SUR FORTE PENTE AU VIETNAM : UNE EXPERIMENTATION SOUS SIMULATION DE PLUIE.***

**Contexte.** Les vers de terre et les termites, ingénieurs du sol, sont d'une importance primordiale dans la régulation des processus géochimiques, dans l'apport de nutriments pour les plantes, pour le maintien et l'amélioration de la structure et pour l'hydrodynamique des sols (Lavelle *et al.*, 1997). L'érosion est un problème majeur pour l'environnement et la santé publique générant pertes en terre, diminution de la fertilité des sols, sédimentation des retenues et réduction de la biodiversité (Abrahams, 2002; de Chazal and Rounsevell, 2009). Plusieurs études ont démontré que les ingénieurs du sol influencent notablement l'hydrodynamique (amélioration de l'infiltration) et la redistribution de nutriments dans l'ensemble de l'écosystème. Cependant, les agrégats biogéniques sont sensibles à l'impact des gouttes de pluies pouvant générer des croûtes de surface et de l'érosion en nappe (Kinnell, 2005). De nombreuses études ont démontré que des turricules sèches et indurées augmentant le microrelief et donc l'infiltration en zones à faible pente et sous climat tempéré mais peu de recherche ont été effectuées en milieu tropical sur forte pente où les volumes et intensités de pluies sont très élevées.

**Question scientifique.** Cette étude s'attache donc à démontrer le rôle des vers de terre et des termites sur l'hydrodynamique, la détachabilité et les pertes en éléments nutritifs des sols. Deux hypothèses sont testées dans cette étude: i) l'augmentation d'ingénieurs du sol améliore l'infiltration et diminue la perte en sol ; ii) le microrelief induit par les vers de terre et les termites augmente significativement le ruissellement, les pertes en nutriments et les pertes en sols.

**Matériels et méthodes.** Cette étude a été menée sur le bassin versant de Dong Cao dans la province de Hanoi 20°57 N, 105°29 E au Vietnam. La simulation de pluie a été menée dans une jeune jachère (1 an) sur des Acrisols dont la pente moyenne est de 37 %. La cartographie des états de surface a été menée sur chacune des 18 parcelles d'1 m<sup>2</sup> étudiées. Une granulométrie des agrégats biogéniques développées par les ingénieurs du sol a été définie. Elle varie du millimètre pour les dépôts de micro-agrégats libres à des turricules pouvant atteindre 20 cm de hauteur. La végétation aérienne a été coupée délicatement et les résidus végétaux ôtés des parcelles afin d'éviter toute protection de la surface.

Deux pluies d'intensités constantes (90 mm h<sup>-1</sup>) ont été menées durant 40 minutes à 24 h d'intervalle. Ces pluies sont représentatives du milieu étudié. Les paramètres mesurés sont la lame ruisselée totale durant chaque évènement (Lr), la détention récupérable après la fin de la pluie (Dr) et le coefficient de ruissellement (KR<sub>x</sub>). Une quinzaine de prélèvements d'eau a été effectuée lors de chaque simulation. Ils ont été filtrés afin de mesurer les quantités de matières solides exportées avec le ruissellement. Le carbone total et l'azote ont été mesurés en

laboratoire par les méthodes de Walkley–Black et Kjeldahl respectivement. Le phosphore a été déterminé par spectrophotométrie.

Pour les sols, la densité apparente a été déterminée pour chaque parcelles ; des analyses ont été effectuées afin de déterminer les principales caractéristiques chimiques et physiques du sol. La macrofaune a été évaluée par la méthode manuelle mise au point par le programme *Tropical Soil Biology and Fertility* (TSBF) de l'UNESCO sur des blocs de sol en place (Anderson and Ingram, 1993).

Les états de surface et le microrelief ont été finement décrits par la méthode Casenave and Valentin (1989) avec une attention toute spéciale sur les types de micro agrégats développés par les ingénieurs du sol et les surfaces occupées par des croûtes de surface ou des algues. Cent « carreaux » de 10 X 10 cm ont été décrits au sein de chaque parcelles afin d'augmenter la précision des observations. Les données ainsi obtenues ont ensuite été analysées (ANOVA) grâce au logiciel R.

**Résultats.** Avant la simulation de pluie : la pente, les teneurs en C, N et P, l'humidité du sol, la texture et la densité apparente sont homogènes. Une large gamme d'occupation de la surfaces par les turricules (0 à 70 %) a été comptabilisée sur l'ensemble des parcelles ; les surfaces encroûtées avec ou sans algues sont plus faibles. Le pourcentage d'occupation du sol par les turricules est fortement corrélé avec la présence d'algues, les petits agrégats et la présence de termites. Les algues n'ont pas d'effet significatif sur les paramètres hydrodynamiques.

Après les deux pluies simulées : la quantité de turricules, d'algues et d'agrégats libres ne change pas. Par contre les surfaces encroûtées et celles avec présence de termites évoluent sensiblement ; les placages de termites disparaissent après la 1<sup>ère</sup> pluie et des croûtes structurales se forment, **cf. figure 2 de l'article.**

Concernant le ruissellement, pour la 1<sup>ère</sup> pluie, la présence de turricules réduit le taux de ruissellement à l'inverse de la présence de croûtes. La présence des termites induit une augmentation nette de Dr. Pour la 2<sup>ème</sup> pluie, les tendances se maintiennent et s'accroissent. Pour les deux pluies, il n'y a pas de relation entre la pluie d'imbibition et les caractéristiques de surface du sol.

Les pertes en terre sont étroitement reliées à la présence de croûtes et à celle de turricules. Ainsi plus le pourcentage de surface occupée par des croûtes est important et plus les pertes de sol sont fortes. A l'inverse, plus la présence de turricules est élevée et plus elle diminue l'exportation de sédiment hors de la parcelle, **cf. figure 3 de l'article.**

La « qualité » des eaux de ruissellement est marquée par une réduction de la conductivité et une augmentation du pH. La présence de turricule augmente la perte en phosphore durant la 1<sup>ère</sup> pluie mais il n'y a pas de relation pour l'azote et le phosphore pour la 2<sup>ème</sup> pluie. La présence de croûtes induit elle une augmentation de la perte en N et P.

**Discussion.** Les ingénieurs du sol influencent profondément la formation et l'évolution des états de surface par la présence des turricules de vers notamment d'*Amyntas khami* (Jouquet et al., 2008a; Jouquet et al., 2008b).

Nos résultats montrent que la présence de turricules est étroitement associée à celles des algues. La dynamique des croûtes dépend fortement de la quantité initiale des turricules de vers plus que de la quantité de vers présents. Les turricules protègent la surface du sol et augmentent l'infiltration tandis que les croûtes favorisent le ruissellement et les pertes en terre. La présence de termites produit de petits agrégats et contribue à la formation de croûte et à plus de détachabilité.

Nous avons constaté durant les pluies une évolution des états de surface où les micros agrégats se transformaient en croûtes structurales. Cependant, les agrégats supérieurs à 2 mm issus de dégradation de turricules restaient stables en débit des fortes intensités de pluie apportées au sol. L'abondance et la diversité de la macrofaune ne sont pas en relation avec les paramètres hydrodynamiques et les pertes en sol. La présence de turricules limite le ruissellement. Même si *A. Khami* est difficile à observer, celui-ci joue un rôle plus important que les termites dont la présence paraît plus évidente.

Dans notre cas, les turricules n'ont pas été affectées par l'intensité de pluie car leur stabilité est très forte. De plus, le microrelief des turricules intercepte et conduit l'eau à la surface du sol. Ce phénomène de captage et d'écoulement le long du turricule réduit l'énergie cinétique des gouttes d'eau ; il apporte ainsi une eau à la surface du sol plus facilement « infiltrable ». Cette résistance à la dégradation par l'impact des gouttes d'eau et à « l'effet splash » explique les faibles pertes en sol sur les parcelles riches en turricules. Les croûtes ont des effets totalement inverses.

Blanchart *et al.* (2004) ; Shipitalo and Le Bayon (2004) ont démontré que certaines termites pouvaient améliorer la porosité du sol par leurs galeries et terriers et augmenter ainsi l'infiltration. Toutefois, dans notre cas les termites fourragères produisent des placages sensibles au rejaillissement des particules ce qui favorise le développement de croûtes et les pertes en sol par ruissellement.

Il est bien connu que le cycle des éléments nutritifs est fort dépendant des ingénieurs du sol mais peu d'études ont été réalisées sur forte pente où le ruissellement important peut réduire la fertilité des sols. Pour la qualité des eaux de ruissellement, les turricules à forte résistance structurale favorisent la rétention de l'azote et du phosphore dissous. Cette résistance à la libération d'ions en général a un effet négatif sur la diminution de la conductivité et entraîne une augmentation du pH par faible flux des ions  $H^+$ . La présence de turricules est donc associée à la réduction de la perte d'azote et de phosphore par ruissellement. A l'inverse, la présence de croûtes génère des exportations en N et P importantes.

**Conclusion.** Le but de cette étude a été d'étudier le rôle des ingénieurs du sol dans l'équilibre entre les processus hydrodynamiques et la fertilité de sols à forte pente au Nord du

Vietnam. Nos résultats indiquent que la présence de turricules de vers de terre à forte stabilité structurale augmente l'infiltration et réduit les pertes en terre et en nutriments. Par contre, du fait de leur faible stabilité et de leur sensibilité au splash, les placages de termites favorisent l'encroûtement, le ruissellement et les pertes en terre.



## Influence of earthworms and termites on runoff and erosion in a tropical steep slope fallow in Vietnam: A rainfall simulation experiment

Pascal Jouquet<sup>a,b,\*</sup>, Jean-Louis Janeau<sup>a,b</sup>, Alexandro Pisano<sup>a</sup>, Hai Tran Sy<sup>b</sup>, Didier Orange<sup>a,b</sup>, Luu Thi Nguyet Minh<sup>c</sup>, Christian Valentin<sup>a</sup>

<sup>a</sup> IRD, UMR 211 BIOEMCO (CNRS, IRD, ENS, UPMC, University Paris XII, AgroParisTech), 32 Avenue H. Varagnat, 93143 Bondy Cedex, France

<sup>b</sup> SFRI, Dong Ngac, Tu Liem, Hanoi, Viet Nam

<sup>c</sup> Institute of Chemistry, VAST, Ho Quang Viet, Hanoi, Viet Nam

### ARTICLE INFO

#### Article history:

Received 6 February 2012

Received in revised form 13 April 2012

Accepted 22 April 2012

#### Keywords:

Erosion

Earthworm

Termite

Biogenic aggregates

Rainfall simulation

Transfer

### ABSTRACT

Earthworms and termites, as soil engineers, play a major role in the regulation of biogeochemical processes and the provision of ecosystem services. They create biogenic aggregates on the soil surface, e.g., earthworm casts and termite sheetings, which can influence soil erosion and the downward transfer of fertility. We assessed the effect of the micro-relief generated by earthworms and termites on soil hydrodynamic properties, and soil and nutrient losses. Eighteen 1 m × 1 m plots were established for rainfall simulation experiments (2 runs of 40 min rain, intensity 90 mm h<sup>-1</sup>) in a steep slope fallow in Northern Vietnam. The soil surface of the micro-plots differed in the proportions of earthworm casts and termite sheetings. The results confirmed the importance of soil biostructures in the regulation of pedohydrological properties of soils. Although globular water-stable earthworm casts promote water infiltration in soil and decrease soil and nutrient losses, the unstable termite sheetings break-down rapidly and generate structural crusts which foster water runoff and soil detachment. No relation was observed between the abundance or biomass of earthworms or termites and the pedohydrological properties measured during the rainfall simulations. This therefore suggests that soil engineers can have greater impact on ecosystem functioning through their biogenic structures rather than as a result of their own abundance or biomass.

© 2012 Elsevier B.V. All rights reserved.

### 1. Introduction

Ecosystem engineers play a key role in modifying the chemical, physical and biological properties of their habitats (Jones et al., 1994, 1997). Earthworms, termites and ants are the major soil engineers (Lavelle et al., 1997; Jouquet et al., 2006) and their importance in the regulation of biogeochemical processes and ecosystem services, such as the supply of nutrients for plants and the maintenance of soil structure and water regulation, have been largely demonstrated (Lavelle et al., 2006). They produce or displace soil aggregates in and on top of the soil (i.e., biogenic aggregates), galleries and nest structures (the biopores), which impact soil physico-chemical properties, soil biodiversity and fertility (see Lavelle and Spain, 2005 for a review).

Soil erosion is a worldwide environmental and public health problem leading to direct losses of soil fertility and other on-site and off-site negative impacts such as reservoir siltation, water

quality degradation and biodiversity loss (Pimentel, 2006). Land use change, with the loss of the protective vegetation cover, is frequently considered as the main human factor contributing to soil erosion (De Chazal and Rounsevell, 2009). For instance, there have been a considerable number of studies on the influence of vegetation cover on water infiltration, soil crust formation, and soil loss (Greene and Hairsine, 2004; Podwojewski et al., 2011 and references herein). However, several studies reported that soil engineers may also significantly influence water infiltration, soil erosion and the diffusion of nutrients throughout ecosystems. Although most of these studies were on earthworms (see Shipitalo and Le Bayon, 2004 for a review), several studies also demonstrated a significant impact of termites (Holt and Lepage, 2000; Jouquet et al., 2011b). Earthworm burrows, termite galleries and subterranean nest structures can increase water infiltration (Mando et al., 1996; Lamandé et al., 2003; Léonard et al., 2004; Blanco-Canqui and Lal, 2009) and then concomitantly reduce the risks of soil erosion. However, unstable biogenic aggregates (e.g., freshly emitted earthworm casts, termite sheetings) accumulated on the soil surface are prone to dislocation by the rain and can increase seal formation and soil erosion. Water stable aggregates (e.g., old earthworm casts and termite nests), on the other hand, enhance soil roughness, increase water infiltration, protect the soil

\* Corresponding author at: IRD, UMR 211 BIOEMCO (CNRS, IRD, ENS, UPMC, University Paris XII, AgroParisTech), 32 Avenue H. Varagnat, 93143 Bondy Cedex, France. Tel.: +33 1 48 02 55 53; fax: +33 1 48 02 55 53.

E-mail address: [pascal.jouquet@ird.fr](mailto:pascal.jouquet@ird.fr) (P. Jouquet).

from crusting and thus decrease soil detachment (Nooren et al., 1995; Blanchart et al., 2004; Shipitalo and Le Bayon, 2004; Jouquet et al., 2004, 2008a, 2010). Surprisingly, very few studies have been conducted in sloping lands of the tropics which are characterized by intense rainfall events, soil degradation, rapid biogeochemical cycling and large populations of soil engineers. More information is therefore required on how soil engineers contribute to overland fluxes of matter and nutrients in tropical uplands.

The objective of this study was to assess the influence of earthworms and termites, as key soil bioturbators on soil hydrodynamics, as well as soil and nutrient losses. Rainfall simulations were conducted in a steep slope fallow in northeastern Vietnam on 1-m<sup>2</sup> micro-plots, which differed in the proportions of earthworm casts and termite sheetings. Our hypotheses were that (i) an increase in soil engineer abundance results in a concomitant enhancement of water infiltration and soil detachment rates and (ii) the soil micro-relief created by earthworm and termite bioturbation significantly influences water runoff intensity, soil detachment rates and nutrient losses. We expected that highly stable earthworm casts would increase water infiltration and decrease soil detachment, whereas sheetings produced by termites are more prone to fragmentation and would thus increase soil detachment. As a consequence we assumed that earthworms favor the retention of nutrients and decrease the amount of dissolved nutrients lost with water runoff, whereas termites would increase nutrient leaching into runoff.

## 2. Material and methods

### 2.1. Description of the study site

This study was carried out in the experimental and long term monitoring catchment (46 ha) of the MSEC (Management Soil Erosion Consortium) project (Valentin et al., 2008). The study site is located in Dong Cao village, in north-eastern Vietnam, approximately 50 km south-west of Hanoi (20°57'N, 105°29'E). The annual rainfall ranges from 1500 to 1800 mm, of which 80–85% occurs from April to October. The air humidity is always high, between 75% and 100%. The mean daily temperature varies from 15 °C to 25 °C. The soil is an Acrisol (WRB, 1998).

The rainfall simulations were carried out in a 1 year fallow (3 ha) field where cattle grazing was temporarily excluded. In this ecosystem, the anecic earthworm *Amyntas khami* deposits globular water-stable casts (CAST) on the soil surface (Jouquet et al., 2008b). These biogenic structures can reach more than 20 cm in height but are often broken into smaller water stable aggregates by livestock trampling, human traffic and raindrop impacts (Fig. 1). Thus, most of CAST are dispersed on the soil surface without any links with subterranean galleries. The soil surface is also covered with smaller sized biogenic aggregates (<5 mm) but their origin is difficult to determine visually (Jouquet et al., 2009). They could come from the fragmentation of *A. khami*'s casts, the activity of other earthworm species (*Pheretima leucocirca*, *Ph. californica*, *Dichogaster modigliani* and other unidentified *Pheretima* sp., Mathieu et al., 2007) or the fragmentation of subangular aggregates produced through the action of plant roots or the mechanical disturbance of the soil surface (Jouquet et al., 2008a). Termites, especially fungus-growing termites (Macrotermitinae) and ants also produce free soil aggregates which are easily identifiable because of their small size (<1 mm) and granular shape, and because they are aggregated into sheetings which cover the litter (Fig. 1).

### 2.2. Rainfall simulations

Eighteen 1 m × 1 m plots were established for rainfall simulation experiments. The plots were bordered by iron frames inserted to

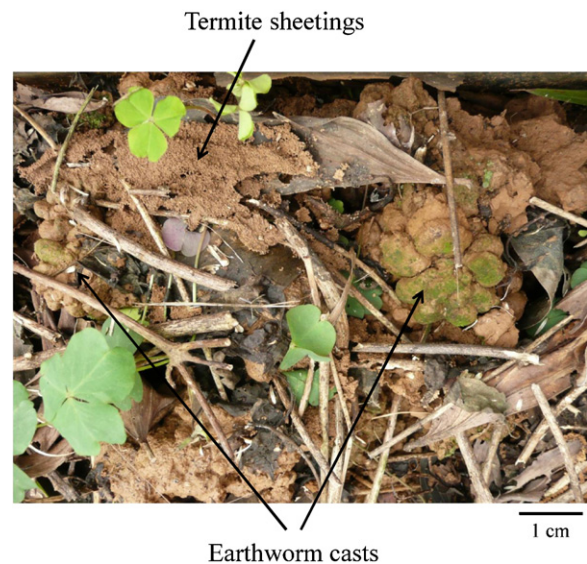

Fig. 1. Illustration of earthworm casts produced by *Amyntas khami* and termite sheetings covering the soil surface.

Photo: P. Jouquet (2011).

a depth of 10 cm, as described by Janeau et al. (2003) and Ribolzi et al. (2011). The plots were selected so that they all had almost the same slope (~37%, Table 1) but differed greatly in soil microrelief. The aerial biomass of the vegetation was carefully cut and plant residues were removed to avoid a protection of the soil surface by the vegetation cover.

The plots were subjected to simulated rain with ORSTOM's portable field simulator (Casenave and Valentin, 1992) set 4 m above the floor, with a drop size distribution and kinetic energy similar to that of tropical rain of the same intensity (Asseline and Valentin, 1978). The multistage feet of the simulator's tower were adjusted to compensate for the slope differences and to simulate vertical rain. We calibrated the intensity by collecting the rain before each run and after simulation from an impermeable 1-m<sup>2</sup> pan placed directly over the plot. The experiments were conducted in March 2011, at the end of the winter season, to avoid natural rain disturbance. Two rainfall events (total amount of rain per event:  $TR = 60$  mm) were simulated for 40 min in each plot (intensity  $90 \text{ mm h}^{-1}$ ,  $\sim 585 \text{ J m}^{-2}$ ) with approximately 24 h between the two runs. The two events corresponded to a return period of 10 years in the study watershed. The water used to simulate the rain was collected from a stream. This water had a pH of 6.6 and a low conductivity ( $\sim 95 \mu\text{S}$ ).

For each plot and each run, the pre-runoff rainfall ( $Pr$  mm) was the volume of rainfall water necessary to cause runoff. Discharged water after runoff initiation was sampled every minute and was used to measure (i) the total volume of runoff water during the rainfall experiment ( $Lr$  mm), (ii) the volume of runoff water after the rainfall event ( $Dr$  mm), and (iii) the runoff water coefficient ( $KR\%$ ), which is the ratio between the total amount of runoff water ( $Lr + Dr$ ) and the total amount of rainfall water ( $TR$ ).

Each water sample was filtered through GF/F membrane filters (Whatman,  $0.7 \mu\text{m}$  porosity) to measure suspended solids and nutrient concentrations. Soil losses per run ( $SL_1$  and  $SL_2 \text{ g m}^{-2}$ ) were obtained after drying at  $60^\circ\text{C}$  and the cumulated amount of soil loss after the two runs ( $SLt = SL_1 + SL_2, \text{ g m}^{-2}$ ) was assessed using linear interpolation of fifteen  $500 \text{ cm}^3$  samples per run. Water pH and conductivity were measured for each sample. Total nitrogen and phosphorus were evaluated in the filtrate solution according to Standard Methods for the Examination of Water and Wastewater (Clesceri et al., 1999). Total nitrogen was determined using

**Table 1**

Main physicochemical properties in the 0–10 cm soil layer before the rainfall experiment (SOIL,  $n = 18$ ) and above-ground earthworm casts produced by *Amyntas khami* (CAST,  $n = 9$ ): slope (%), bulk density ( $\text{g cm}^{-3}$ ), moisture (% dry weight), particle size fraction (sand, silt and clay, in %), soil pH, CEC ( $\text{cmol kg}^{-1}$ ), total C, N and P content (%). Standard errors are in parenthesis.

	Slope	Density	Moisture	Sand	Silt	Clay	pH <sub>KCl</sub>	CEC	C	N	P
SOIL	36.9 (1.0)	0.98 (0.12)	49.3 (1.1)	28.9 (1.2)	31.0 (0.6)	39.5 (0.9)	3.8 (0.0)	14.7 (0.8)	2.25 (0.11)	0.19 (0.01)	0.17 (0.01)
CAST				32.5 (2.3)	32.4 (0.6)	35.1 (2.0)	4.4 (0.1)	16.0 (1.4)	4.20 (0.12)	0.32 (0.01)	0.23 (0.02)

the Kjeldahl method after digestion of the sample in sulfuric acid and total P was determined in water samples after sodium persulfate digestion and mineralization at 110 °C of the acidic phase. The exportation of N and P during the rainfall simulations were assessed by measuring the concentration of N and P in the rain water.

### 2.3. Soil analyses before the rainfall simulations

The soil bulk density (BD) of the upper 10 cm was assessed before the experiment in the direct vicinity of each plot with a 250 cm<sup>3</sup> cylinder. These cylinders were also used to assess soil moisture prior to the simulated rainfall events. Soil samples were also collected near the plots to assess the main soil physical and chemical properties. Soil texture was determined by the hydrometer method to obtain three particle size fractions: clay (<2 μm), silt (2–50 μm) and sand (50–2000 μm). Soil pH was determined after extraction in KCl (pH<sub>KCl</sub>). Total soil C and N contents were determined according to the Walkley–Black and Kjeldahl methods, respectively. Total P content was determined with a spectrophotometer after acid digestion (H<sub>2</sub>SO<sub>4</sub> and HClO<sub>4</sub>). The cation exchange capacity (CEC) was determined using the ammonium acetate method at pH7.

Soil macrofauna abundance and diversity were assessed following the standard TSBF method (Anderson and Ingram, 1993). Soil sample blocks 25 cm × 25 cm wide × 30 cm deep were manually removed in the vicinity of the 1-m<sup>2</sup> plot and soil macroinvertebrates > 2 mm in size were removed by hand-sorting, counted, classified into taxonomic groups or at the morpho-species level and weighed (fresh weight) in the case of earthworms.

### 2.4. Evaluation of the soil micro-relief

Soil surface micro-relief was assessed according to the field method proposed by Casenave and Valentin (1992) before and after the two rainfall simulations. This method is frequently used in the tropics (i.e., Janeau et al., 2003; Podwojewski et al., 2008, 2011; Rouw et al., 2010) for the description of soil micro-relief. It consists in the visual determination of the proportions of surface occupied by gravel, litter residues, structural crust (CRUST), algae (ALGAE), free soil aggregates (i.e., aggregates on the soil surface and not anchored in the soil matrix) smaller (Ag < 2) or larger (Ag > 2) than 2 mm, earthworm globular casts produced by *A. khami* (CAST), and free aggregates deposited by termites (termite sheetings: TERMITE). Soil microrelief was assessed by two different scientists with a frame in wood dividing the surface of the plots into 100 squares (100 cm<sup>2</sup> each square). Their data were compared in order to reach precise description of the proportion of soil features. The proportion of gravel, plant residues and soil accumulated by ants was assessed in the field but not considered in this study because of the small areas that these features occupied. ALGAE included a community of organisms with different components such as microscopic algae, cyanobacteria, microfungi and mosses. Although it was impossible to determine the origin of Ag < 2 and Ag > 2, most of these soil aggregates were likely to come from the fragmentation of CAST or smaller earthworm casts produced by other earthworm species, or the accumulation on the soil surface of belowground soil

aggregates associated with plant roots during weeding (Jouquet et al., 2009). In these soils, CRUST result from the tight packing of highly stable micro-aggregates (Janeau et al., 2003; Ribolzi et al., 2011).

### 2.5. Statistical analyses

Pearson correlation coefficients were used to express correlations among the main soil surface features. Relationships between earthworm abundance and biomass and the percentage of soil covered by free unidentified aggregates and CAST were tested through linear models. A two-way repeated measure analysis of variance (ANOVA), with time as the repeated measure, was used to assess the influence of the two rainfall simulation events on the soil features. Because the percentage of CAST, free aggregates and soil covered by algae did not vary during the experiment, these values were not integrated in the analysis. *T*-tests were used to assess differences in treatment means.

Linear regressions were used to assess the influence of the micro-relief made by earthworms and termites, and soil biodiversity (total number of soil macrofauna, total number of earthworm individuals, and total biomass of earthworms) on water infiltration, soil detachment and nutrient fluxes.

All statistical calculations were carried out using R (R Development Core Team, 2008). Differences among treatments were declared at the <0.05 probability level of significance.

## 3. Results

### 3.1. Initial soil properties, soil surface features and biodiversity

The slope, C, N and P contents, soil moisture, texture and bulk density of the surface horizon before the rainfall simulations were homogenous (Table 1). A wide range of CAST was recorded (from 0 to 70% of the soil surface). The surface percentage covered by free aggregates was also very high with surface ranging from 0.5 to 71% and from 3 to 73%, respectively for Ag < 2 and Ag > 2. Lower surface areas were recorded for CRUST (0.5–28%), TERMITE (0–18%), and ALGAE (0–4.5%).

**Table 2**

Correlation matrix between the main surface features (algae (ALGAE), structural crust (CRUST), free soil aggregates < 2 mm (Ag < 2), free soil aggregates > 2 mm (other than CAST) (Ag > 2), earthworm casts produced by *Amyntas khami* (CAST), and termite sheetings (TERMITE), in % soil surface).

	ALGAE	CRUST	Ag < 2	Ag > 2	CAST	TERMITE
ALGAE	1					
CRUST	−0.18	1				
Ag < 2	−0.19	0.35	1			
Ag > 2	0.20	0.11	0.57*	1		
CAST	0.62**	−0.48*	−0.34	−0.04	1	
TERMITE	−0.33	0.40	0.48*	0.33	−0.40	1

$n = 18$ .

\*  $P < 0.05$ .

\*\*  $P < 0.01$ .



CAST were significantly and positively correlated with ALGAE and negatively correlated with CRUST (Table 2). In addition,  $Ag < 2$  was positively correlated with  $Ag > 2$  and with TERMITE.

In total, two termite morphospecies (one fungus-growing termite species and one soil feeding species) were sampled in only four plots. When present, the average density of termites was  $420 \text{ ind m}^{-2}$  (standard error, SE: 120). Earthworms were sampled in all the plots (average density:  $171.6 \text{ ind m}^{-2}$ , SE: 120; average weight:  $44.4 \text{ g m}^{-2}$ , SE: 32.9) and five earthworm morphospecies (*Ph. leucocirca* and four other morphospecies) were described. Except *Ph. leucocirca*, all individuals were juveniles and thus impossible to identify. *A. khami*, responsible for the edification of CAST, was not sampled. Interestingly, none of the surface features was linearly correlated to the abundance and biomass of the five earthworm species and the density of termites ( $P > 0.05$  in all the cases).

### 3.2. Evolution of the soil surface after the two rainfall events

The soil micro-relief was slightly affected by the two rainfall events. In all the plots, the amount of CAST, ALGAE and free soil aggregates did not change. However, the soil surface covered by TERMITE and CRUST was affected by the two runs. While TERMITE initially covered 4.5% of the soil surface on average, the features disappeared after the first run. In contrast, the surface covered by CRUST increased from 3.4 (SE: 0.8) to 14.3% (SE: 3.1) in average ( $P < 0.001$ ).

A significant negative linear regression was measured between the initial soil surface covered by CAST and CRUST measured after the two runs ( $y = -0.29x + 19.01$ ,  $R^2 = 0.36$ ,  $P = 0.019$ , Fig. 2). Conversely, positive linear regressions were measured between CRUST measured at the end of the experiment and the initial soil surface covered by CRUST ( $y = 2.90x + 3.44$ ,  $R^2 = 0.50$ ,  $P = 0.003$ ) or TERMITE ( $y = 0.89x + 9.48$ ,  $R^2 = 0.54$ ,  $P = 0.001$ ). All the other soil feature parameters, soil macrofauna abundance and earthworm biomass were not related to CRUST measured after the two runs ( $P > 0.05$  in all the case).

### 3.3. Water runoff and soil loss

Correlations between soil features and hydrological properties and soil losses are shown in Table 3. For the first run, only CAST, CRUST, and TERMITE had an influence on water infiltration. Interestingly, CAST and CRUST had opposite effects. While CAST was negatively correlated with  $Lr$ ,  $Dr$  and  $KRx$ , CRUST was positively correlated with the same variables. As a consequence, CAST led to a decrease in  $SL_1$  while CRUST enhanced it. TERMITE was also positively related to  $Dr$  but it did not have an impact on other hydrological properties or soil losses. ALGAE,  $Ag < 2$  and  $Ag > 2$  did not correlate with any of the hydrological variables.

For the second run, the same trend was observed. CRUST had a positive effect on water runoff and soil loss (i.e., positive linear relation with  $Lr$ ,  $Dr$ ,  $KRx$  and  $SL_2$ ) and we observed a negative relationship between CAST and the same variables. For all the significant linear regressions,  $R^2$  values were higher after the second run than the first. TERMITE were not observed after the first run and it was therefore impossible to test their effects. No relationship was observed between the other soil surface features (ALGAE,  $Ag < 2$  and  $Ag > 2$ ) and the hydrological variables. Interestingly, no relationship was observed between  $Pr$  and the soil surface features for the two runs.

A significant negative linear regression was found between the initial soil surface covered by CAST and the total amount of soil lost ( $SLt$ ) ( $y = -0.90x + 62.10$ ,  $R^2 = 0.40$ ,  $P = 0.007$ , Fig. 3). Conversely, the initial soil surface covered by CRUST was positively and linearly correlated to  $SLt$  ( $y = 5.28x + 26.53$ ,  $R^2 = 0.39$ ,  $P = 0.012$ ). All the other soil feature parameters were not related to  $SLt$  ( $P > 0.05$  in all the

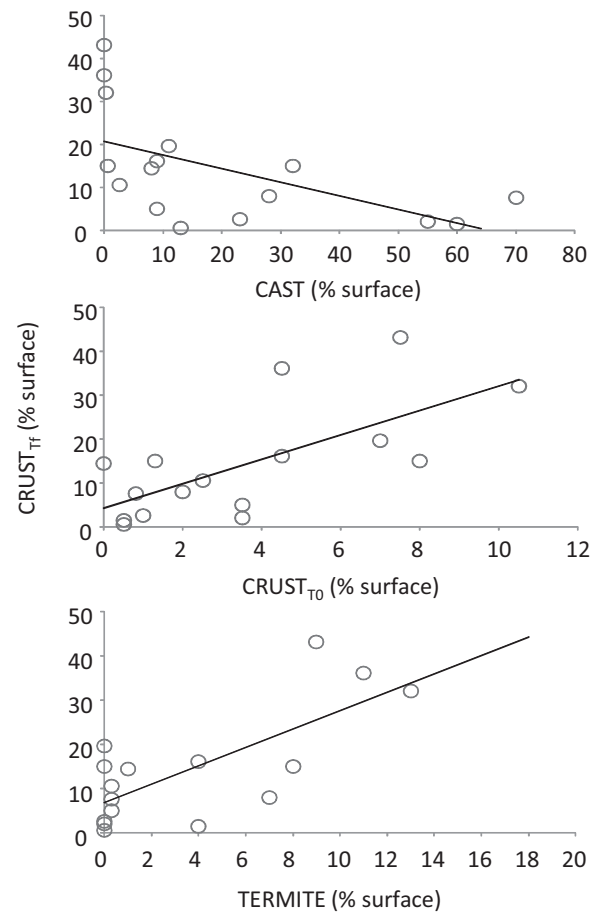

Fig. 2. Relationship between earthworm casts produced by *Amyntas khami* (CAST, %), the surface covered by structural crusts ( $CRUST_{T0}$ , %) or the soil sheetings made by termites (TERMITE, %) before the rainfall simulation and the surface covered by structural crusts at the end of the two simulated rainfall events ( $CRUST_{TF}$ , %). Linear regression lines are fitted ( $n = 18$ ).

case). Soil macrofauna abundance and earthworm biomass were not related to any of the hydrological variables ( $P > 0.05$  in all the case).

### 3.4. Water runoff quality

Correlations between soil micro-relief and water runoff quality are shown in Table 4. CAST significantly decreased water conductivity (only for the first run) and increased water pH (for the two runs). Interestingly, although CAST enhanced the loss of dissolved P during the first run, negative linear regressions were found between CAST and the total amount of N and P in water runoff after the second run. Although CAST had different effects in the two runs, the overall effect of CAST on the loss of dissolved N and P remained negative ( $y = -0.11x + 8.10$ ,  $R^2 = 0.27$ ,  $P = 0.032$ , and  $y = -0.11x + 7.99$ ,  $R^2 = 0.44$ ,  $P = 0.003$ , respectively for N and P, Fig. 4a).

CRUST also had an important effect on water runoff quality. A negative linear regression was found between CRUST and water pH for both runs. Conversely, a positive linear regression occurred between CRUST and the total amount of N and P lost with water runoff. However, this regression was only significant for the second run. Finally, the overall effect of CRUST was to increase the quantity of N and P lost with water runoff ( $y = 0.74x + 3.58$ ,  $R^2 = 0.26$ ,  $P = 0.039$ , and  $y = 0.60x + 3.88$ ,  $R^2 = 0.29$ ,  $P = 0.027$ , respectively for N and P, Fig. 4b).

**Table 3**

Correlation between the main surface features (earthworm casts produced by *Amyntas khami* (CAST), structural crust (CRUST), termite sheetings (TERMITE), free soil aggregates < 2 mm (Ag < 2), free soil aggregates > 2 mm (other than CAST) (Ag > 2), and algae (ALGAE), in % soil surface) before the rainfall simulation (1st run) or after the first run (2nd run) and hydrological properties (*Pr*, *Lr*, *Dr*, *KRx*) and soil losses (*SL*) for the two runs of the rainfall simulation. Only significant results are displayed, ns = non significant regression, *n* = 18 samples.

		<i>F</i>	<i>R</i> <sup>2</sup>	<i>P</i> -value
<b>1st run</b>				
CAST	<i>Lr</i> <sub>1</sub> (mm)	-0.38 <i>x</i> + 30.95	0.27	0.001
	<i>Dr</i> <sub>1</sub> (mm)	-0.006 <i>x</i> + 0.43	0.28	0.002
	<i>KRx</i> <sub>1</sub> (%)	-0.64 <i>x</i> + 53.80	0.28	0.001
	<i>SL</i> <sub>1</sub> (g m <sup>-2</sup> )	-0.73 <i>x</i> + 55.2	0.28	0.028
CRUST	<i>Lr</i> <sub>1</sub> (mm)	2.73 <i>x</i> + 15.50	0.28	0.029
	<i>Dr</i> <sub>1</sub> (mm)	0.05 <i>x</i> + 0.15	0.35	0.013
	<i>KRx</i> <sub>1</sub> (%)	4.54 <i>x</i> + 25.80	0.28	0.029
	<i>SL</i> <sub>1</sub> (g m <sup>-2</sup> )	5.74 <i>x</i> + 21.21	0.38	0.008
TERMITE	<i>Dr</i> <sub>1</sub> (mm)	1.94 <i>x</i> + 85.46	0.25	0.027
Ag < 2	ns			
Ag > 2	ns			
ALGAE	ns			
<b>2nd run</b>				
CAST	<i>Lr</i> <sub>2</sub> (mm)	-0.49 <i>x</i> + 44.22	0.39	0.007
	<i>Dr</i> <sub>2</sub> (mm)	-0.008 <i>x</i> + 0.66	0.35	0.012
	<i>KRx</i> <sub>2</sub> (%)	-0.80 <i>x</i> + 73.39	0.39	0.007
	<i>SL</i> <sub>2</sub> (g m <sup>-2</sup> )	-0.90 <i>x</i> + 62.10	0.45	0.003
CRUST	<i>Lr</i> <sub>2</sub> (mm)	1.25 <i>x</i> + 20.44	0.54	<0.001
	<i>Dr</i> <sub>2</sub> (mm)	0.02 <i>x</i> + 0.26	0.53	<0.001
	<i>KRx</i> <sub>2</sub> (%)	2.06 <i>x</i> + 34.15	0.53	<0.001
	<i>SL</i> <sub>2</sub> (g m <sup>-2</sup> )	1.78 <i>x</i> + 24.29	0.37	<0.001
Ag < 2	ns			
Ag > 2	ns			
ALGAE	ns			

**Table 4**

Correlation between the main surface features (earthworm casts produced by *Amyntas khami* (CAST), structural crust (CRUST), termite sheetings (TERMITE), free soil aggregates < 2 mm (Ag < 2), free soil aggregates > 2 mm (other than CAST) (Ag > 2), and algae (ALGAE), in % soil surface) before the rainfall simulation (1st run) or after the first run (2nd run) and water runoff quality (conductivity, pH, and total amount of N and P) for the two runs of the rainfall simulation.

		<i>F</i>	<i>R</i> <sup>2</sup>	<i>P</i> -value
<b>1st run</b>				
CAST	Conductivity (μS)	-0.22 <i>x</i> + 92.00	0.31	0.020
	pH <sub>1</sub>	0.008 <i>x</i> + 6.81	0.33	0.016
	P <sub>1</sub> (mg m <sup>-2</sup> )	1.94 <i>x</i> + 85.46	0.25	0.011
CRUST	pH <sub>1</sub>	-0.06 <i>x</i> + 7.18	0.38	0.009
TERMITE	pH <sub>1</sub>	-0.027 <i>x</i> + 7.09	0.24	0.048
Ag < 2	ns			
Ag > 2	ns			
ALGAE	Ω <sub>1</sub> (μS)	-3.67 <i>x</i> + 92.19	0.27	0.032
<b>2nd run</b>				
CAST	pH <sub>2</sub>	0.008 <i>x</i> + 6.83	0.31	0.019
	N <sub>2</sub> (mg m <sup>-2</sup> )	-0.043 <i>x</i> + 3.94	0.43	0.004
	P <sub>2</sub> (mg m <sup>-2</sup> )	-0.005 <i>x</i> + 5.35	0.49	0.001
CRUST	pH <sub>2</sub>	-0.02 <i>x</i> + 7.22	0.45	0.003
	N <sub>2</sub> (mg m <sup>-2</sup> )	0.11 <i>x</i> + 1.84	0.60	<0.001
	P <sub>2</sub> (mg m <sup>-2</sup> )	0.13 <i>x</i> + 1.80	0.60	<0.001
Ag < 2	ns			
Ag > 2	Conductivity (μS)	-0.14 <i>x</i> + 92.04	0.24	0.046
ALGAE	P <sub>2</sub> (mg m <sup>-2</sup> )	-0.67 <i>x</i> + 4.12	0.24	0.046

Only significant results are displayed (*n* = 18 samples).

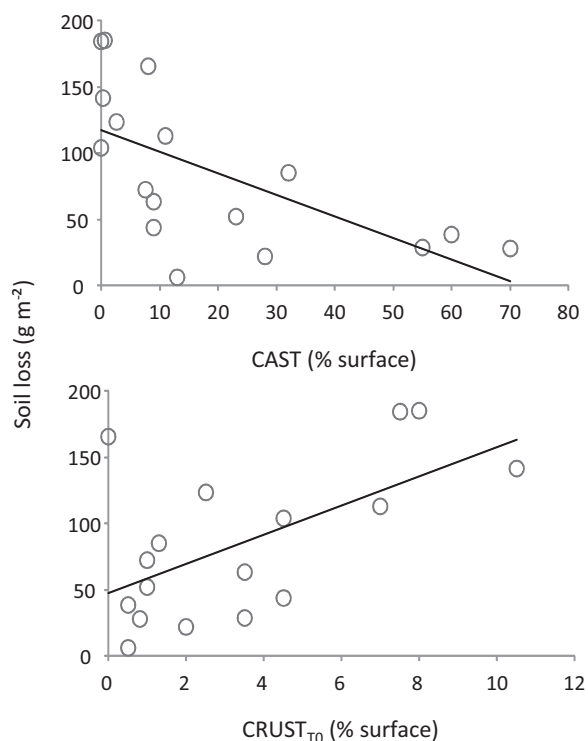

**Fig. 3.** Relationship between earthworm casts produced by *Amyntas khami* (CAST, %), the initial surface covered by structural crusts (CRUST<sub>0</sub>, %) and the quantity of soil loss measured after the two simulated rainfall events (soil loss, g m<sup>-2</sup>). Linear regression lines are fitted (*n* = 18).

For the first run, TERMITE was negatively correlated with water pH and ALGAE correlated negatively to water conductivity. However, these two trends were not confirmed during the second run where TERMITE did not have an impact on the water quality and ALGAE did not affect water conductivity. A significant negative linear regression was measured between Ag > 2 and water conductivity for the second run. Finally, although ALGAE was significantly negatively correlated with total amount of P lost with runoff water for the second run, ALGAE did not affect the cumulated loss of P during the two runs (data not shown, *P* > 0.05).

No significant relationship was observed between the biodiversity variables and water runoff quality.

## 4. Discussion

### 4.1. Soil engineers influence soil surface features

Numerous studies have described the ability of soil engineers to modify soil micro-relief through the creation of biogenic structures or displacement of soil aggregates. However, how these biogenic aggregates interact with each other and the other main soil surface features remains unknown. At our field site, we previously observed that *A. khami* produces water-stable casts on the soil surface (CAST) (Jouquet et al., 2008a,b). Although it has a significant impact on soil surface characteristics, this earthworm species was not sampled in the top soil layer. Field observations reveal that this species is able to move rapidly down until deep soil layers when a perturbation occurs. This behavior explain why it was not sampled during our experiment, and thus the absence of a relationship between soil surface features (CAST, Ag < 2 and Ag > 2) and the diversity and abundance of earthworms in the first cm of the soil layer.

CAST was positively correlated with the surface occupied by ALGAE. Indeed, ALGAE were almost exclusively observed on CAST or small hills which probably corresponded to previous accumulations of CAST. Consequently, as suspected in a previous laboratory study (Jouquet et al., 2011a), CAST are likely to be long lasting structures in situ which can therefore act as refuges for the slow development of ALGAE. A positive feedback loop may even stabilize these CAST once they had been colonized by microphytes. Indeed,

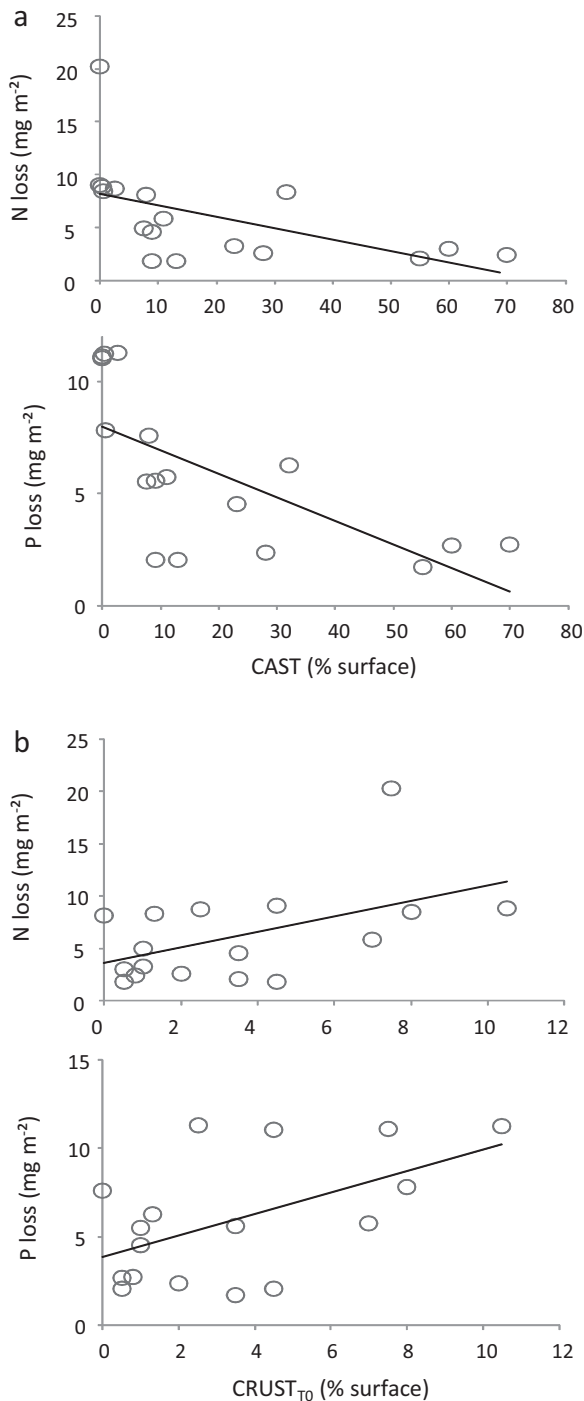

**Fig. 4.** Relationship between (a) earthworm casts produced by *Amyntas khami* (CAST, %) or (b) the initial surface covered by structural crusts (CRUST<sub>10</sub>, %) and the quantity of dissolved N and P measured in the water runoff after the two simulated rainfall events (mg m<sup>-2</sup>). Linear regression lines are fitted ( $n = 18$ ).

in drier areas ALGAE were reported to stabilize crusts (Malam Issa et al., 2009).

Interestingly, a negative relationship was observed between CAST and CRUST. CRUST are major structural features of surface soils. They are thin and highly dense soil layers which hamper water infiltration and foster soil detachment (Assouline, 2004). Their formation at the surface of bare soils exposed to the direct impact of raindrops is dominated by a wide variety of abiotic and biotic factors (Assouline, 2004; Fang et al., 2007). To date, researchers have seldom considered the influence of soil engineers on crust

formation. However, our data suggest that the dynamics of CRUST is dependent on the initial presence of earthworm activities. How CAST negatively influence CRUST formation remains unknown but we assume that the high soil structural stability of CAST (Jouquet et al., 2008b) and their positive effect on water infiltration led to increased protection of the soil surface against crusting.

No correlation was observed between CAST and either type of free aggregate ( $Ag < 2$  and  $Ag > 2$ ), thus suggesting that CAST and these soil aggregates observed on the soil surface are not linked. These results are consistent with the specific organization of CAST observed by Jouquet et al. (2011a,b).  $Ag > 2$  can be described as hierarchically organized aggregates with smaller aggregates ( $< 500 \mu\text{m}$ ) inside larger soil aggregates ( $500\text{--}2000 \mu\text{m}$  and  $2000\text{--}5000 \mu\text{m}$ ). CAST, however, appear to be a simple accumulation of small size aggregates  $< 500 \mu\text{m}$ . Consequently, the rain breaks CAST down into small size aggregates  $< 500 \mu\text{m}$  and this process is not linked with the formation of  $Ag < 2$  and  $Ag > 2$ . Theoretically, the transport of these small size aggregates in water runoff could generate CRUST (Assouline, 2004) or increase soil loss. However, the negative relations between CAST and CRUST on one hand, and CAST and SL on the other hand suggest that the main impact of CAST was to improve the protection of the soil surface against crusting and soil loss.

The positive correlations of  $Ag < 2$  with both  $Ag > 2$  and TERMITE suggest that  $Ag < 2$  can originate from: (1) termite foraging activity and the creation of sheetings made of small size aggregates cemented together with saliva (Holt and Lepage, 2000) and (2) the progressive fragmentation of bigger soil aggregates ( $Ag > 2$ ) produced by earthworm species, other than *A. khami*, and/or plant roots.

#### 4.2. Soil engineers influence water runoff and soil detachment

In this study, the key variables predicting water runoff and soil loss were highlighted by the gradual changes in soil surface features following the two simulated rainfall events. Free aggregates ( $Ag < 2$  and  $Ag > 2$ ) did not have an influence on water runoff and soil detachment. Despite the high rainfall intensity, these aggregates remained stable during the two runs. Surprisingly, in contrast to our first hypothesis, soil macrofauna abundance and diversity were not related to any of the variables describing water runoff and soil losses. However, as initially expected (hypothesis 2), although *A. khami* was never sampled, its casts have negative influences on water runoff and soil detachment. Indeed, CAST abundance lowered *Lr*, *Dr*, *KRx* and *SL*. These results therefore showed that: (i) the impact of soil engineers on ecosystem functioning can be through their biogenic structures (the casts of *A. khami* in our case) rather than necessarily due to their own abundance or biomass, and (ii) some soil engineer species, which can sometimes be less abundant or more difficult to observe (*A. khami* in this study), can play a much more important role in ecosystem functioning than other more abundant species (the five earthworm and two termite morpho-species found in our study site).

The mechanisms by which earthworm casts influence water runoff and soil loss were reviewed in Shipitalo and Le Bayon (2004) and Blanchart et al. (2004). In our case, CAST were not influenced by raindrop impacts because of their high water stability (Jouquet et al., 2008a,b). In a mechanism similar to stemflow (Levia and Frost, 2003; Muzylo et al., 2009; Lin, 2010), the interception of the raindrops by CAST also led to subsequently flow of rainwater down to the ground. This “castflow”, together with increased soil roughness, slows water runoff velocity, and thus fosters water infiltration. Finally, although soil bulk density below CAST was not significantly different from that measured in areas without CAST ( $1.06 \pm 0.10$  and  $0.98 \pm 0.12$  for soil bulk density below CAST and in areas without CAST, respectively), and because most of CAST

were not anchored to the soil surface, it is likely that burrows below CAST also increased water infiltration (Bastardie et al., 2003; Lamandé et al., 2003; Zehe et al., 2010). This result is in agreement with Casenave and Valentin (1992) who showed that infiltration was clearly increased in semi-arid tropics where casts covered more than 20% of the soil surface. The net effect of earthworms on soil erosion remains unclear and is site specific (e.g., dependent on the earthworm species, soil properties and land slope) (Shipitalo and Protz, 1988; Le Bayon and Binet, 2001; Shipitalo and Le Bayon, 2004; Jouquet et al., 2010). In our study, the greater water infiltration in the presence of casts and their high stability, as shown by the non-fragmentation of CAST during the two runs, explained their negative effect on soil loss.

The second most important factor explaining the hydroopedological variables measured in this study was the surface covered by CRUST. In our study, these soil surface features had exactly the opposite effect of CAST (i.e., in increasing *Lr*, *Dr*, *KRx* and consequently *SL*). These results are in agreement with several studies which reported the negative influence of crusts on soil permeability, water infiltration and soil detachment (Valentin, 1996; Assouline, 2004; Podwojewski et al., 2011). The negative impact of CAST on CRUST (shown in Table 2), showed that in addition to the above mention direct impacts of CAST on water infiltration and soil loss, CAST also indirectly improved water infiltration and decreased soil loss by decreasing the proportion of CRUST on the soil surface.

Termites produce galleries and below-ground nests which act as preferential channels that increase water infiltration (Holt and Lepage, 2000; Jouquet et al., 2011a,b). Consequently, the stimulation of termite activity generally leads to the perforation of crusts and an increase in water infiltration (Mando et al., 1996; Mando and Stroosnijder, 1999; Léonard et al., 2004). However, termite foraging activity can also lead to the creation of sheetings on the soil surface. Termite sheetings are made up of small aggregates slightly cemented together with saliva. Linear regressions demonstrated that CRUST were partly attributable to the fragmentation of these unstable biogenic aggregates on the soil. This finding confirmed observations made in the Côte d'Ivoire in Africa by Valentin et al. (2004). Due to the erosive effect of the first run, termite sheetings collapsed, leading to the creation and extension of existing crusts which enhanced water runoff and soil detachment. As a consequence, although statistically termite sheetings did not directly correlated with any of the hydroopedological variables of this study, their foraging activity indirectly favored water runoff and soil detachment through the extension and formation of CRUST.

#### 4.3. Soil engineers influence water runoff quality

The importance of soil engineers as major actors in nutrient cycling and hydrological processes has been widely acknowledged (see Lavelle and Spain, 2005 for a review). However, the retention or loss of dissolved forms of nutrients by earthworms and termites, with implications for nutrient management, has seldom been studied in steep-slope tropical ecosystems where the export of soluble nutrients in water runoff could drastically affect soil fertility and water quality.

Soil engineers have a strong influence on the availability of total and dissolved N and P in soil (Lavelle et al., 1992; Bignell and Eggleton, 2000; Mariani et al., 2007; Chapuis-Lardy et al., 2011; Jouquet et al., 2011a). In a laboratory experiment, Jouquet et al. (2007) found that the higher N content in CAST was associated with an increased diffusion of dissolved N in water. Although it is difficult to compare this result with those obtained in the present study made in situ without considering water infiltration, our findings suggest that CAST has a negative effect on the diffusion of nutrients in water runoff. Two hypotheses can be made: firstly, the high structural stability of CAST may have led to an increase in the

retention of dissolved N and P, as well as ions in general, as shown by the negative effect of CAST on water conductivity and positive effect on water pH (i.e., lower flux of H<sup>+</sup>). Another explanation lies in the fact that only water runoff was sampled during this experiment and a significant proportion of ions could have also leached out with infiltration water. Interestingly, CAST decreased the loss of dissolved N only during the second run and had a positive and then negative impact on P, during the first and second run, respectively. These latter results suggest that the dissolution of nutrients from CAST in water runoff was slowed down, progressive and not constant during the two rainfall simulation events. As a consequence, CAST not only favor water infiltration but also decrease soil and nutrient loss in water runoff.

Water runoff quality was also influenced by the development of CRUST on the soil surface. As expected from the hydroopedological data, CRUST had exactly the opposite effect on the water runoff quality as CAST. The conductivity and quantity of dissolved N and P in water runoff increased and water runoff pH decreased when the proportion of CRUST increased.

## 5. Conclusion

The aim of this study was to determine how soil engineers affect the balance between processes that lead to the conservation or loss of matter and nutrients from the system. Our results suggest that soil engineers have a greater impact on ecosystem functioning through their soil biogenic structures (i.e., earthworm casts and termite sheetings) than due to their own abundance of biomass. A distinction between two types of biostructures can be inferred from our results. Although measurements made following rainfall simulations on 1-m<sup>2</sup> microplots cannot be generalized to describe overall hillslope dynamics, our results suggest that the globular and giant earthworm casts produced by *A. khami* tend to significantly improve water infiltration and decrease soil and nutrient losses in the field. On the other hand, granular termite sheetings were unstable, or less stable than the energy provided by the raindrop impacts. They collapsed and enhanced the surface of soil covered by CRUST and then indirectly enhanced water runoff and the export of soil and dissolved nutrients.

## Acknowledgments

This project was supported financially by the French Institutes AFD (PAMPA/RIME project) and IRD through the unit research UMR 211 BIOEMCO and through the financial support of the JEA1-BioGEOQ. Loam and his colleagues are thanked for their help in the field. We acknowledge with gratitude Tran Minh Tien for his help in soil analyses and the SFRI (Soils and Fertilizers Research Institute) Vietnamese institute for providing access to the site.

## References

- Anderson, J.M., Ingram, J.S.I., 1993. Tropical Soil Biology and Fertility. A Handbook of Methods. CAB International, Wallingford, Oxon, UK.
- Asseline, J., Valentin, C., 1978. Construction et mise au point d'un infiltromètre à aspersion. Cah. ORSTOM, sér. Hydrol. 15, 321–349.
- Assouline, S., 2004. Rainfall-induced soil surface sealing: a critical review of observations, conceptual models, and solutions. Vadose Zone J. 3, 570–591.
- Bastardie, F., Capowiez, Y., de Dreuzy, J.R., Cluzeau, D., 2003. X-ray tomographic and hydraulic characterization of burrowing by three earthworm species in repacked soil cores. Appl. Soil Ecol. 24, 3–16.
- Bignell, D.E., Eggleton, P., 2000. Termites in ecosystems. In: Abe, T., Bignell, D.E., Higashi, M. (Eds.), Termites: Evolution, Sociality, Symbiosis, Ecology. Kluwer Academic Publishers, pp. 363–387.
- Blanchart, E., Albrecht, A., Brown, G., Decaens, T., Duboisset, A., Lavelle, P., Mariani, L., Roose, E., 2004. Effects of tropical endogeic earthworms on soil erosion. Agric. Ecosyst. Environ. 104, 303–315.

- Blanco-Canqui, H., Lal, R., 2009. Crop residue removal impacts on soil productivity and environmental quality. *Crit. Rev. Plant Sci.* 28, 139–163.
- Casenave, A., Valentin, C., 1992. A runoff capability classification system based on surface features criteria in the arid and semi-arid areas of West Africa. *J. Hydrol.* 130, 213–249.
- Chapuis-Lardy, L., Le Bayon, R.C., Brossard, M., Lopez-Hernandez, D., Blanchart, E., 2011. Role of soil macrofauna in P cycling. In: Bünemann, E.K., Oberson, A., Frossard, E. (Eds.), *Phosphorus in Action – Biological Processes in Soil Phosphorus Cycling*. Springer Soil Biology Series 26. Springer, NY, USA, pp. 199–213.
- Clesceri, L.S., Greenberg, A.E., Eaton, A.D., 1999. *Standard Methods for the Examination of Water and Wastewater*, 20th ed. APAH 1015, 15th Street, NW, Washington, DC 20005, ESN 0-87553-235-7.
- De Chazal, J., Rounsevell, M.D.A., 2009. Land-use and climate change within assessments of biodiversity change: a review. *Global Environ. Change* 19, 306–315.
- Fang, H.Y., Cai, Q.G., Chen, H., Li, Q.Y., 2007. Mechanism of formation of physical soil crust in desert soils treated with straw checkerboards. *Soil Till. Res.* 93, 222–230.
- Greene, R.S.B., Hairsine, P.B., 2004. Elementary processes of soil and water interaction and thresholds in soil surface dynamics: a review. *Earth Surf. Proc. Land.* 29, 1077–1091.
- Holt, A.J., Lepage, M., 2000. Termite and soil properties. In: Abe, T., Bignell, D.E., Higashi, M. (Eds.), *Termites: Evolution, Sociality, Symbioses, Ecology*, vol. 18. Kluwer Academic Publishers, Netherlands, pp. 389–407.
- Janeau, J.L., Bricquet, J.P., Planchon, O., Valentin, C., 2003. Soil crusting and infiltration on steep slopes in northern Thailand. *Eur. J. Soil Sci.* 54, 543–553.
- Jones, C.G., Lawton, J.H., Shachak, M., 1994. Organisms as ecosystem engineers. *Oikos* 69, 373–386.
- Jones, C.G., Lawton, J.H., Shachak, M., 1997. Positive and negative effects of organisms as physical ecosystem engineers. *Ecology* 78, 1946–1957.
- Jouquet, P., Tessier, D., Lepage, M., 2004. The soil structural stability of termite nests: role of clays in *Macrotermes bellicosus* (Isoptera, Macrotermitinae) mound soils. *Eur. J. Soil Biol.* 40, 23–29.
- Jouquet, P., Dauber, J., Lagerlof, J., Lavelle, P., Lepage, M., 2006. Soil invertebrates as ecosystem engineers: intended and accidental effects on soil and feedback loops. *Appl. Soil Ecol.* 32, 153–164.
- Jouquet, P., Bernard-Reversat, F., Bottinelli, N., Orange, D., Rouland Lefevre, C., Tran Duc, T., Podwojewski, P., 2007. Influence of changes in land use and earthworm activities on carbon and nitrogen dynamics in a steepland ecosystem in Northern Vietnam. *Biol. Fertil. Soils* 44, 69–77.
- Jouquet, P., Podwojewski, P., Bottinelli, N., Mathieu, J., Ricoy, M., Orange, D., Toan Duc, T., Valentin, C., 2008a. Above-ground earthworm casts affect water runoff and soil erosion in Northern Vietnam. *Catena* 74, 13–21.
- Jouquet, P., Bottinelli, N., Podwojewski, P., Hallaire, V., Tran Duc, T., 2008b. Chemical and physical properties of earthworm casts as compared to bulk soil under a range of different land-use systems in Vietnam. *Geoderma* 146, 231–238.
- Jouquet, P., Zangerle, A., Rumpel, C., Brunet, D., Bottinelli, N., Tran Duc, T., 2009. Relevance and limitations of biogenic and physico-genic classification: a comparison of approaches for differentiating the origin of soil aggregates. *Eur. J. Soil Sci.* 60, 1117–1125.
- Jouquet, P., Henry-des-Tureaux, T., Mathieu, J., Thuy Doan, T., Tran Duc, T., Orange, D., 2010. Utilization of near infrared reflectance spectroscopy (NIRS) to quantify the impact of earthworms on soil and carbon erosion in steep slope ecosystem: a study case in Northern Vietnam. *Catena* 81, 113–116.
- Jouquet, P., Phuong, N.T., Hanh, N.H., Henry-des-Tureaux, T., Chevallier, T., Tran Duc, T., 2011a. Laboratory investigation of organic matter mineralization and nutrient leaching from earthworm casts produced by *Amyntas khami*. *Appl. Soil Ecol.* 47, 24–30.
- Jouquet, P., Traore, S., Choosai, C., Hartmann, C., Bignell, D., 2011b. Influence of termites on ecosystem functioning. Ecosystem services provided by termites. *Eur. J. Soil Biol.* 47, 215–222.
- Lamandé, M., Hallaire, V., Curmi, P., Pères, G., Cluzeau, D., 2003. Changes of pore morphology, infiltration and earthworm community in a loamy soil under different agricultural managements. *Catena* 54, 637–649.
- Lavelle, P., Blanchart, E., Martin, A., Spain, A.V., Martin, S., 1992. Impact of soil fauna on the properties of soils in the humid tropics. Myths and science of soils of the tropics. *Soil Sci. Soc. Am. J.* 29, 157–177.
- Lavelle, P., Bignell, D., Lepage, M., 1997. Soil function in a changing world: the role of invertebrate ecosystem engineers. *Eur. J. Soil Biol.* 33, 159–193.
- Lavelle, P., Spain, A.V., 2005. *Soil Ecology*. Kluwer Academic Publishers, Netherlands, 654 pp.
- Lavelle, P., Decaëns, T., Aubert, M., Barot, S., Blouin, M., Bureau, F., Margerie, P., Mora, P., Rossi, J.P., 2006. Soil invertebrates and ecosystem services. *Eur. J. Soil Biol.* 42, 3–15.
- Le Bayon, R.C., Binet, F., 2001. Earthworm surface casts affect soil erosion by runoff water and phosphorus transfer in a temperate maize crop. *Pedobiologia* 45, 430–442.
- Léonard, J., Perrier, E., Rajot, J.L., 2004. Biological macropores effect on runoff and infiltration: a combined experimental and modelling approach. *Agric. Ecosyst. Environ.* 104, 277–285.
- Levia, D.F., Frost, E.E., 2003. A review and evaluation of stemflow literature in the hydrological and biogeochemical cycles of forested and agricultural ecosystems. *J. Hydrol.* 274, 1–29.
- Lin, H., 2010. Linking principles of soil formation and flow regimes. *J. Hydrol.* 393, 3–19.
- Malam Issa, O., Défarge, C., Trichet, J., Valentin, C., Rajot, J.L., 2009. Microbiotic soil crusts in the Sahel of Western Niger and their influence on soil porosity and water dynamics. *Catena* 77, 48–55.
- Mando, A., Stroosnijder, L., Brussaard, L., 1996. Effects of termites on infiltration into crusted soil. *Geoderma* 74, 107–113.
- Mando, A., Stroosnijder, L., 1999. The biological and physical role of mulch in the rehabilitation of crusted soil in the Sahel. *Soil Use Manage.* 15, 123–127.
- Mariani, L., Jimenez, J.J., Torres, E.A., Amezcua, E., Decaëns, T., 2007. Rainfall impact effects on ageing casts of a tropical anecic earthworm. *Eur. J. Soil Sci.* 58, 1525–1534.
- Mathieu, J., Jouquet, P., Bottinelli, N., Podwojewski, P., Vu Quang, M., Tran Thi, B., Đức Toàn, T., Duy Phai, D., Orange, D., 2007. Ảnh hưởng của thềm canh đến hệ động vật trong đất ở miền bắc Việt Nam. *Vietnam Soil Science* 28, 54–58.
- Muzlyo, A., Llorens, P., Valente, F., Keizer, J.J., Domingo, F., Gash, J.H.C., 2009. A review of rainfall interception modelling. *J. Hydrol.* 370, 191–206.
- Nooren, C.A.M., van Breemen, N., Stoorvogel, J.J., Jongmans, A.G., 1995. The role of earthworms in the formation of sandy surface soils in a tropical forest in Ivory Coast. *Geoderma* 65, 135–148.
- Pimentel, D., 2006. Soil erosion: a food and environmental threat. *Environ. Dev. Sustain.* 8 (119), 137.
- Podwojewski, P., Orange, D., Jouquet, P., Valentin, C., Nguyen Van, T., Janeau, J.L., Duc Toan, T., 2008. Land-use impacts on surface runoff and soil detachment within agricultural sloping lands in Northern Vietnam. *Catena* 74, 109–118.
- Podwojewski, P., Janeau, J.L., Grellier, S., Valentin, C., Lorentz, S., Chaplot, V., 2011. Influence of grass soil cover on water runoff and soil detachment under rainfall simulation in a sub-humid South African degraded rangeland. *Earth Surf. Proc. Land.* 36, 911–922.
- R Development Core Team, 2008. *R: A Language and Environment for Statistical Computing*. R Foundation for Statistical Computing, Vienna, Austria, ISBN 3-900051-07-0. Accessed at [www.R-project.org](http://www.R-project.org).
- Rouw, A., Huon, S., Souleuth, B., Jouquet, P., Pierret, A., Ribolzi, O., Valentin, C., Bourdon, E., Chantharath, B., 2010. Possibilities of carbon and nitrogen sequestration under conventional tillage and no-till cover crop farming (Mekong valley, Laos). *Agric. Ecosyst. Environ.* 136, 148–161.
- Ribolzi, O., Patin, J., Bresson, L.M., Latschack, K.O., Mouche, E., Sengtaheuanghoung, O., Silvera, N., Thiébaux, J.P., Valentin, C., 2011. Impact of slope gradient on soil surface features and infiltration on steep slopes in northern Laos. *Geomorphology* 127, 53–63.
- Shipitalo, M.J., Protz, R., 1988. Factors influencing the dispersibility of clay in worm casts. *Soil Sci. Soc. Am. J.* 52, 764–769.
- Shipitalo, M.J., Le Bayon, R.C., 2004. Quantifying the effects of earthworms on soil aggregation and porosity. In: Edwards, C.A. (Ed.), *Earthworm Ecology*, 2nd ed. CRC Press, Washington, pp. 183–200.
- Valentin, C., 1996. Soil erosion under global change. In: Walker, B.H., Steffen, W.L. (Eds.), *Global Change and Terrestrial Ecosystems*. Cambridge University Press, Cambridge, pp. 317–338.
- Valentin, C., Rajot, J.L., Mitja, D., 2004. Responses of soil crusting, runoff and erosion to following in the sub-humid and semi-arid regions of West Africa. *Agric. Ecosyst. Environ.* 104, 287–302.
- Valentin, C., Agus, F., Alamban, R., Boosaner, A., Bricquet, J.P., Chaplot, V., de Guzman, T., de Rouw, A., Janeau, J.L., Orange, D., Phachomphonh, K., Do Duy, P., Podwojewski, P., Ribolzi, O., Silvera, N., Subagyono, K., Thiébaux, J.P., Tran Duc, T., Vadari, T., 2008. Runoff and sediment losses from 27 upland catchments in Southeast Asia: impact of rapid land use changes and 606 conservation practices. *Agric. Ecosyst. Environ.* 128, 225–238.
- WRB. World Reference Base for Soil Resources, 1998. *World Soil Resources Reports*, No. 84. FAO, Rome, 88 pp.
- Zehe, E., Blume, T., Blöschl, G., 2010. The principle of maximum energy dissipation: a novel thermodynamic perspective on rapid water flow in connected soil structures. *Philos. Trans. R. Soc. B: Biol. Sci.* 365, 1377–1386.

## 6. LES PRATIQUES CULTURALES, DETERMINANT DE L'INFILTRATION.

Au sein du sillon volcanique andin en Equateur, de nombreux sols sont de très vieilles cendres indurées (Figure 24) impropres à la culture en l'état (Winckell and Zebrowski, 1992). Dans les années 1990, à la demande de l'état Equatorien, ces cendres appelées *Cangahua* ont fait l'objet de réhabilitation au moyen d'engins lourds. Il est important de noter qu'il existe des sols similaires dénommés *Tepetates* au Mexique et *Telpetates* au Nicaragua.

Podwojewski P, Janeau JL, Leroux Y (2008) *Effects of agricultural practices on the hydrodynamics of a deep tilled hardened volcanic ash-soil (cangahua) in Ecuador. Catena* 72:179-190.



**Figure 24.** La *cangahua*, dépôt de cendre indurée en surface et réhabilitation de celle-ci au moyen de bulldozer.

### ***EFFETS DES PRATIQUES CULTURALES SUR L'HYDRODYNAMIQUE DE SOLS VOLCANIQUES INDURES (CANGAHUA) ET REHABILITES PAR LABOUR PROFOND EN EQUATEUR.***

**Contexte.** En Equateur, les sols volcaniques indurés représentent environ 15% de la surface agraire des zones d'altitude. Sous la pression démographique, il est important de trouver une solution pour les exploiter et les valoriser. Depuis la fin des années 1990, ce matériau est fracturé à grande échelle à l'aide d'engin sur chenille trainant un à plusieurs socs ou dents (chisel) ou manuellement afin d'obtenir un « sol ». Toutefois, suivant le type de structure obtenue et les pratiques culturales, ce sol est sujet à une érosion plus ou moins importante.

**Question scientifique.** Quel est l'impact d'un labour profond de la Cangahua sur l'hydrodynamique et les pertes en sol ? Quelles sont les pratiques agronomiques les plus adaptées à la réhabilitation de ce sol ?

**Méthodologie.** Cette étude a été menée à 20 km de Quito dans la ferme expérimentale de la faculté d'agronomie de l'université centrale de Quito sur une période de 36 mois. Les

données chimiques et physiques de cette cangahua ont été obtenues par Quantin and Zebrowski (1997).

Après fragmentation jusqu'à 40 cm de profondeur et exposition à des pluies naturelles, les agrégats obtenus ont été classifiés pour l'ensemble des dix parcelles expérimentales. Nous avons obtenus deux préparations de surface distinctes : fine (agrégats de diamètre moyen 5 cm) et grossière (agrégats compris entre 5 et 10 cm). Des mesures de densités apparentes au cylindre de 200 cm<sup>3</sup> ont été effectuées dans les 15 premiers centimètres du sol avant et après chaque étape importante du cycle cultural.

Dans une première étape (1<sup>ère</sup> année), trois cycle de pluies (S1, S2, S3) ont été produites sur des parcelles de référence (sol non cultivé) avec pour chaque cycle, trois pluies (t0, t+3h, t+12h) composées de quatre intensités (20, 40, 60 et 80 mm h<sup>-1</sup>). Pour chaque pluie un maximum de 50 mm a été apporté (15 minutes de pluie pour chaque intensité). Le 2<sup>ème</sup> cycle de simulation de pluie (S2) a eu lieu un mois après le premier (S1) sur un sol où toute la végétation avait été retirée, et dont la surface avait reçue 93 mm de pluie naturelle. Le 3<sup>ème</sup> cycle de pluie (S3) a été mené sur un sol labouré qui a eu pour effet de détruire les croûtes formées précédemment lors des pluies artificielles et naturelles.

Dans la deuxième étape (2<sup>ème</sup> année), quatre traitements différents (2 amendements organiques, 1 minéral, 1 sans amendement) ont été apportés sur 8 parcelles (+ 2 témoins) dont le sol a été préalablement labouré jusqu'à 50 cm de profondeur. Une 4<sup>ème</sup> simulation de pluie (S4) de caractéristiques identiques aux trois autres décrites précédemment a été effectuée après récolte sur sol nu avec deux classes d'agrégats (fins et grossiers) au cours de la 3<sup>ème</sup> année d'expérimentation.

Nous avons caractérisé avec attention la pluie d'imbibition (Pi, mm) ; l'intensité minimale d'infiltration (Fn, mm h<sup>-1</sup>), le coefficient de ruissellement (KRu, mm h<sup>-1</sup>) et les pertes en sol (g m<sup>-2</sup>).

**Résultats.** La densité du sol apparaît plus faible sous structure grossière que sous structure fine, elle décline progressivement en fonction du nombre de pluies reçues. L'apport de matière organique provenant des amendements donne des sols à densité apparente plus faible.

Le volume de pluie d'imbibition (Pi) est réduit de façon drastique après la première pluie pour l'ensemble des parcelles mais de façon plus forte pour les parcelles à structure grossière. Les parcelles avec amendements organiques présentent une pluie d'imbibition médiane à l'ensemble des parcelles.

Le taux minimum d'infiltration (Fn) augmente dans un premier temps avec l'intensité de pluie et il diminue entre la première et la 3<sup>ème</sup> pluie, que ce soit sous structure fine ou grossière, **cf. figure 3 de l'article**. Pour la 4<sup>ème</sup> simulation de pluie, l'intensité d'infiltration augmente jusqu'à la deuxième intensité de pluie (40 mm h<sup>-1</sup>) puis décroît sur les parcelles labourées et avec apports organiques (MO) et engrais verts (GREEN) ; par contre elle continue

d'augmenter sur les parcelles avec engrais minéraux (NPK) et sur sol nu (BARE). Pour la troisième pluie, l'infiltration s'homogénéise pour tous les traitements, **cf. figure 4 de l'article**.

Le coefficient de ruissellement (Kru) a été faible pour toutes les parcelles bien qu'augmentant légèrement au cours des pluies en S1. Le ruissellement augmente rapidement et régulièrement en S2. Pour le cycle S3 qui a lieu après un labour, le Kru est faible pour la première pluie mais le ruissellement augmente rapidement pour les 2 autres pluies. Lors de S4 qui a eu lieu après le dernier cycle cultural, les valeurs de ruissellement apparaissent élevées dès la première pluie notamment pour les parcelles avec apport de matières organiques et d'engrais verts. Le ruissellement augmente rapidement au cours de la 2<sup>ème</sup> et plus modérément au cours de la 3<sup>ème</sup> pluie sur toutes les parcelles.

Les pertes en sol surviennent dès 20 mm h<sup>-1</sup> d'intensité de pluie et augmentent significativement lorsque l'intensité est supérieure à 40 mm h<sup>-1</sup> avec un maximum pour les 2 plus fortes intensités (60 et 80 mm h<sup>-1</sup>), **cf. tableau 7 de l'article**. Pour les trois premiers cycles de pluies (S1, S2, S3) sur sol non cultivé, les pertes en terre ont augmenté de façon progressive de la première à la troisième pluie. Sur l'essai agronomique, toutes les parcelles ont développé une exportation de sol mais de façon plus ou moins importante, le taux le plus haut étant la parcelle témoin.

**Discussion.** Les travaux de Podwojewski and Germain (2005) n'ont pas pu démontrer d'effet du type d'amendements, de préparation du sol, de densité racinaire sur la stabilité structurale des agrégats de la cangahua. La stabilité structurale de la cangahua est déterminée par la composition minérale induisant des propriétés spécifiques de gonflement-retrait. Ces auteurs ont également démontré que le ruissellement sur la cangahua non travaillée est de quasi 100 % et qu'au cours du temps sous différentes pratiques culturales, les propriétés physiques liées à la texture limono-sableuse induisent une sensibilité à l'érosion.

Avant la mise en place d'essais agronomiques et immédiatement après la préparation du sol (fine et grossière), le ruissellement était très faible mais son accroissement a été constant en fonction des intensités de pluie et de l'évolution des états de surface de la cangahua « travaillée ».

Un mois après avoir subi des pluies naturelles, la structure de la cangahua « réhabilitée » s'altérant, le ruissellement augmente. Ce phénomène est le plus important sous préparation fine (agrégats <5 cm) qui favorise la formation de croûtes structurales et d'érosion. La surface préparée grossièrement (gros agrégats assimilables à des pierres) limite cependant le ruissellement favorisant le drainage vertical (Poesen, 1986; Poesen *et al.*, 1990; Cerda, 2001). Après chaque travail du sol, le ruissellement diminue puis remonte rapidement dès la fermeture de la porosité de surface.



Concernant les effets post traitements agronomiques, le ruissellement augmente rapidement dès la première pluie en raison de l'encroûtement rapide et de la saturation en eau du à la faible porosité des agrégats de la cangahua. Des croûtes structurales et d'érosion se forment sous l'impact des gouttes d'eau générant l'éclatement des agrégats et la reptation/rejaillissement de particules fines (effet splash) dès la première pluie. Une relation négative s'établit alors entre le coefficient d'infiltration et l'intensité de pluie (Valentin, 1991; Le Bissonnais and Singer, 1992). La « restauration » de l'infiltration après labour est de courte durée. La formation des croûtes a augmenté fortement au fur et à mesure des pratiques culturales et une fois les croûtes formées, le coefficient de ruissellement est resté sensiblement stable.

Sur certaines parcelles à gros agrégats, quand ceux-ci sont bien conservés, l'infiltration est plus importante que sur préparation fine. Sur d'autres parcelles situées notamment en partie ouest de l'essai où les agrégats possèdent une stabilité structurale plus faible, l'influence du labour mécanique a été plus importante. Ce dernier associé aux pluies a généré des agrégats enchâssés à la surface du sol qui peut alors ruisseler de façon similaire à la préparation fine. L'apport de matière organique augmente la porosité du sol mais pas sa conductivité hydraulique, le ruissellement restant élevé après tous les cycles culturaux et quel que soit l'amendement apporté.

Les agrégats grossiers se fragmentent en petits agrégats propices à la formation de croûtes de surface. Durant cette étude la formation des croûtes due à la composition limono-sableuse de la cangahua a toujours été rapide et indépendante de l'humidité des sols. Les trois cycles culturaux n'ont pas eu d'influence significative sur le taux d'érosion.

Le coefficient de corrélation permet d'apprécier la relation entre le ruissellement et les pertes en sol a été important que pour la première pluie, **cf. tableau 7 de l'article**. Au cours des 2<sup>èmes</sup> et 3<sup>èmes</sup> pluies cette relation a diminué significativement ; si le ruissellement a bien augmenté, les pertes en sol n'ont que peu évolué. La dégradation des gros agrégats et la formation de croûtes génèrent une augmentation forte du ruissellement sans forte perte en terre. Quand la surface du sol est à forte rugosité, le ruissellement est dans un premier temps faible mais une fois les gros agrégats dégradés et cimentés par des croûtes, le ruissellement augmente.

La stabilité des agrégats et le coefficient de ruissellement des parcelles cultivées sont étroitement corrélés à partir des 2<sup>ème</sup> et 3<sup>ème</sup> pluies. A noter que la partie ouest du site expérimental a une stabilité structurale plus faible responsable d'une érosion plus forte. Nous avons donc 3 types de comportements i) un groupe de parcelles localisées à l'est du champ expérimental (WFf, GREENc, NPKc, NPKf) dont les agrégats sont relativement stables générant des taux de ruissellement et d'érosion « limités » respectivement <60% et

<200 g m<sup>-2</sup>; ii) un groupe de parcelles également enrichi en matière organique (WfC, GREENf, OMf, OMc) ayant des agrégats fragiles générant un fort taux de ruissellement (>70%) et d'érosion (284 à 435 g m<sup>-2</sup>); iii) la parcelle nue (BAREc) à stabilité structurale faible avec un ruissellement croissant au cours des pluies (de 20 à 80%) et un fort taux d'érosion (>2000 g m<sup>-2</sup>).

La cangahua s'altère sous l'effet du climat plus ou moins vite et les fragments du matériau évoluent vers un sol à structure dense et à forte sensibilité à l'érosion. Cette transformation semble encore plus importante dans les parcelles enrichies en MO ou l'activité biologique est plus importante. Velasquez and Flores (1997), ont observé que les fragments indurés de cendres volcaniques avait une stabilité structurale plus forte que les nouveaux agrégats développés sous l'influence d'activité biologique. Ces derniers sont aussi plus sensibles à l'érosion que les fragments indurés non travaillés.

Les conséquences géomorphologiques et agronomiques de la réhabilitation de la cangahua sont multiples. Cette longue expérimentation démontre la nécessité d'opter pour une préparation grossière de la surface du sol limitant le risque de fort ruissellement et d'érosion. Il faut cependant être prudent car trop d'infiltration pourrait engendrer des glissements de terrains par accumulation d'eau dans l'épaisseur de cangahua travaillée (Perrin *et al.*, 2000). La préparation de surface fine engendre la formation de croûtes qui peut générer une hiérarchisation du ruissellement et la formation de ravines. Pour toutes ces raisons, la mise en place de terrasses à formation progressive et mur de contention sont recommandés pour pouvoir cultiver ces cendres indurées.

Si au Mexique, les pluies les plus fortes apparaissent au moment où les sols indurés sont les plus couverts par les cultures (Navarro and Prat, 1996.), ce n'est pas le cas au sein du sillon inter-andin en Equateur (deux saisons des pluies distinctes) d'où le risque accru d'érosion de la cangahua. Il faut donc prévoir plutôt qu'un apport de matière organique non probant en terme de limitation de l'érosion, un couvert de prairies qui limitera l'effet splash et la compaction de ces sols limono-sableux. La production agricole végétale peut aussi être envisagée en limitant au maximum le travail du sol.

**Conclusion.** On a constaté que dans les premiers temps qui suivent la préparation fine ou grossière de la cangahua, l'infiltration était importante mais qu'après un mois de pluie naturelle la formation de croûtes limitait fortement l'infiltration. Cet encroûtement rapide est plus important sur sol nu et quand les agrégats sont fins. Après un labour, l'infiltration augmente temporairement mais diminue progressivement avec les pluies. L'hydrodynamique de cette cangahua fragmentée dépend plus de son évolution pédologique que de tous amendements organiques et de toutes cultures. Après trois cycles culturaux, il n'y a pas de différence significative d'amélioration en termes de stabilité structurale et d'hydrodynamique du sol que ce soit pour la préparation grossière ou fine de celui-ci. L'apport de matière

organique qui génère une nouvelle structure à la cangahua tout comme les labours n'ont donc pas permis d'améliorer ni la structure de ce sol pauvre en argile, ni l'infiltration.

Il est donc recommandé de préparer i) la surface du sol grossièrement pour limiter les risques d'érosion notamment en début de production végétale ; ii) de travailler la cangahua sur pentes faibles sous un couvert de prairies qui pourrait contribuer progressivement à l'amélioration de la structure du « nouveau » sol et limiter le ruissellement.



# Effects of agricultural practices on the hydrodynamics of a deep tilled hardened volcanic ash–soil (*Cangahua*) in Ecuador

P. Podwojewski, J.L. Janeau\*, Y. Leroux

IRD c/o School of Bioresources Engineering and Environmental Hydrology, Rabie Saunders Building- University of KwaZulu-Natal-Box X01-Scottsville, Pietermaritzburg, 3209-South Africa

Received 21 March 2006; received in revised form 13 April 2007; accepted 9 May 2007

## Abstract

The rehabilitation of indurate pyroclastic formations of the Ecuadorian Sierra (*cangahua*) paves the way for the development of new agricultural areas. The material derived from the fragmentation of the hardened volcanic ashes is strongly prone to pluvial erosion, essentially because it has a fine silty–sandy texture, and because contains no organic matter and no clay minerals. Rainfall simulation was implemented before and after three cycles of cultivation to assess the evolution of soil structure and its susceptibility to erosion. The cultivated plots were <1% slope and the rainfall simulation tests were conducted after the harvest on bare surfaces. Two soil preparations, (coarse and fine) and four different agricultural practices, (organic matter, green manure, mineral fertilization, and zero fertilization) were evaluated; as well reference/control plots (uncultivated bare plots).

Surface soil crusting occurred rapidly within the cultivated plots when compared to the recent tilled *cangahua*. Runoff and soil loss were generally higher on plots with lower structural stability and generally exhibited higher clay content. In agreement with the structural stability measured in a laboratory, organic matter inputs increase the soil porosity. This condition had no effect on the structural stability of the soil, resistance to crusting, and therefore little impact on surface runoff and erosion. The preferred option for land with these soils would be no tillage and a permanent soil cover (pasture) if they were to be utilised for agriculture.

© 2007 Elsevier B.V. All rights reserved.

**Keywords:** Agricultural practices; *Cangahua*, Ecuador; Runoff; Soil loss; Volcanic ash–soil

## 1. Introduction

In northern Ecuador, the so-called *cangahua* is a series of old volcanic ashes (>10,000 years old), that have hardened (Zebrowski, 1997). They are referred to *tepetates* in Mexico and *talpetates* in Nicaragua (Quantin, 1992; Servenay and Prat, 2003). These soils are found in the inter-cordillera valley, at low altitudes, between 2200 and 3000 m above sea level (m a.s.l.; Winckell and Zebrowski, 1992). In Ecuador such soils cover 800 km<sup>2</sup>, or approximately 15% of the cultivated surface of the sierra or mountain area (Zebrowski, 1997).

The hard *cangahua* is covered locally by a layer of loose sandy ash (up to 50 cm thick) of Holocene age. Recent, uncontrolled mechanized practices have promoted the loss of uncon-

solidated topsoil through erosion resulting in the hard *cangahua* becoming exposed and the land often becoming stripped. (De Noni et al., 2001).

These hardened *cangahua* layers can be fractured using a deep chisel plough to produce a “soil” in which crops can be grown. Since this “new soil” is particularly prone to erosion (De Noni et al., 1989–90; Baumann et al., 1997), a first trial was made on small plots of *cangahua*. The experimental area was chiselled by hand and exposed to the seasonal rains at the experimental farm of the Central University of Ecuador. Three rainfall simulations were conducted on these plots in order to compare the hydrodynamic behaviour, runoff and soil loss of plots with different sizes of *cangahua* fragments (Leroux, Janeau 1997). Later, an agronomic trial was established on larger plots broken up by bulldozer (Podwojewski and Germain, 2005) and a fourth rainfall simulation was conducted during this trial (Table 1). This was undertaken in order to compare the

\* Corresponding author. Tel.: +27 33 260 61 40; fax: +27 33 260 58 18.  
E-mail address: [jean-louis.janeau@ird.fr](mailto:jean-louis.janeau@ird.fr) (J.L. Janeau).



Fig. 1. Experimental site in Andes Cordillera–Ilalo Volcano, Quito province.

### 2.1. Chemical and physical properties of the cangahua

The *cangahua* is a geological formation of rhyo-dacitic ashes that varies at different soil depths from 50 to 80 cm thick that have hardened shortly after their emission (Podwojewski and Germain, 2005). The characteristic chemical properties of the *cangahua* at La Tola determined in previous studies are presented in Table 2 (Quantin and Zebrowski, 1997; De Noni et al., 2001).

After fragmentation and exposure to natural rains, the fragments will breakdown over time into elementary particles. The particle size distributions measured in the surface horizon of the eastern and western part of the trial before the experiments are presented in Table 2. The results indicate a trend towards an homogenous, bi-phased distribution with large amounts of fine sand and fine silt (Table 2), as well as with limited amounts of well ordered and well crystallized clays (Podwojewski and Germain, 2005).

### 2.2. The study and experimental designs

Four rainfall simulations were conducted over a 36 month period. Three initial rainfall simulations (S1, S2, S3) were conducted prior to the establishment of agronomic treatments. The results presented in this paper focus on rainfall simulations that were conducted on two plots with two contrasting coarse and fine soil preparations (Leroux, Janeau, 1997). These initial rainfalls were considered as a reference (test plots) on uncultivated bare removed *cangahua*, before the agronomical trial. The last simulation (S4) occurred after the third cropping cycle (Table 1) on all different amendments.

Prior the agronomic experiment, three initial rainfall simulations were undertaken in the centre of two plots 9 m<sup>2</sup>, these were manually tilled to a depth of 40 cm. Each of the plots were prepared to produce surfaces with contrasting average clod size, ranging from an average of 5 cm in size, to a coarser group of between 5 to 10 cm. The second rainfall simulation (S2) occurred one month after the first simulation (S1) on a surface that was devoid of all vegetation and had been exposed to 93 mm of precipitation. The third (S3) was conducted after a soil tillage which broke the structural crust produced during the previous rainfall events.

hydrodynamic behaviours of uncultivated plots from cultivated plots and to compare plots with different fertilizers inputs.

## 2. Materials and methods

The study was undertaken on the experimental farm of the Faculty of Agronomic Science of the Central University of Ecuador. The farm is situated in close proximity to the city of Tumbaco, near the Ilaló volcano, 20 km east of Quito at an altitude of 2465 m (Fig. 1). The *cangahua* present in the area is representative of the layers described by Winckell and Zebrowski (1992). The annual average rainfall is 800 mm, with a bimodal distribution. The dominant wet period is from January to June, with a minor period occurring from October to November or December. The mean monthly temperature is 15.7 °C with only minor annual variations (Pourrut, 1994).

Table 1  
Calendar of the different rainfall simulations

Year	J	F	M	A	M	J	J	A	S	O	N	D
1				S1	S2	S3						
2												
3						S4						

	Vicia sp.
	Hordeum vulgare
	Zea mays
	Pisum sativum

S1, S2, S3, S4: Rainfall simulation

Table 2  
Main chemical properties of the surface horizon (0–10 cm) at the La Tola site before the first rainfall simulation

Exchangeable cations					Organic matter <sup>a</sup>			P	pH		Grain size distribution <sup>b</sup>				
Ca <sup>2+</sup>	Mg <sup>2+</sup>	K <sup>+</sup>	Na <sup>+</sup>	CEC	C	N	C/N	P	in water	in KCl	CS	FS	CSi	FSi	C
/cmol (+) kg <sup>-1</sup>					/g kg <sup>-1</sup>			/mg kg <sup>-1</sup>			/%				
7.9	5.5	0.7	0.4	18.8	4.1	0.54	7.6	457	6.85	5.20	20.7	30.4	9.8	32.7	6.4
					12.1	1.35	9.0				23.7	27.4	5.4	34.2	9.3

CS: coarse sand 2000–200 μm; FS: fine sand 200–50 μm; CSi: coarse silt 50–20 μm; FSi: fine silt 20–2 μm; C: clay < 2 μm.

<sup>a</sup> Contents before the first rainfall simulation (S1) and the highest values in OM plots before the last simulation (S4).

<sup>b</sup> Contents in the eastern part of the field in the plot WFc (without fertilizer with coarse treatment) and in the plot GREENf (plot with green manure and fine soil treatment) in the western part of the field according to Fig. 2.

During the agronomic trial described by Podwojewski and Germain, (2005), the fourth rainfall simulation was implemented on five distinct terrace of the *cangahua*, chiselled to a depth of 50 cm with a bulldozer and levelled into flat terraces. Each terrace comprised two plots of approximately 100 m<sup>2</sup> (Fig. 2), with a general slope <1% oriented in a Westerly direction. Initially, the *cangahua* on five of the plots was fragmented into coarse fragments (c) (20 cm in diameter) and five into fine fragments (f) (<10 cm in diameter).

Five contrasting management treatments were applied on both sets of *cangahua* fragment sizes during the five cropping cycles (Fig. 2). They were as follows:

1. O.M.: Incorporation of 40 t ha<sup>-1</sup> on a dry weight of fresh cow manure prior to the first cropping cycle. This consisted of 10 t ha<sup>-1</sup> of cow manure applied after each cropping cycle giving a total application rate of cover the study period of 70 t ha<sup>-1</sup> with an incorporation of fresh cattle manure

representing 40 t ha<sup>-1</sup> of dry material before the first cultivation and a complement of 10 t ha<sup>-1</sup> after each cultivation cycle.

2. GREEN: after each cultivation cycle, all the residues of previous cultivation were incorporated, and chemical fertilizers added as a complement, giving a cumulative application rate of N and P equivalent to 10 t ha<sup>-1</sup> of cow manure of the O.M. plots.
3. NPK: An initial inorganic fertilizer application of 300 kg N ha<sup>-1</sup> 80 kg P ha<sup>-1</sup> with an additional application of 50 kg N ha<sup>-1</sup> and 10 kg P ha<sup>-1</sup> over each cropping cycle. No K was applied.
4. WF: cultivation without fertilizers.
5. BARE: plots maintained bare and uncultivated.

The final rainfall simulation (S4) occurred after the harvest of the fourth crop of *Vicia sp*, barley (*Hordeum vulgare*), maize (*Zea mays*) and pea (*Pisum sativum*), when the cultivated plots were bare (Tables 1 and 3). The simulations were conducted on 9 plots. Three replications were undertaken: two at the edges of cultivated plots, one in the centre. A storm destroyed the rainfall

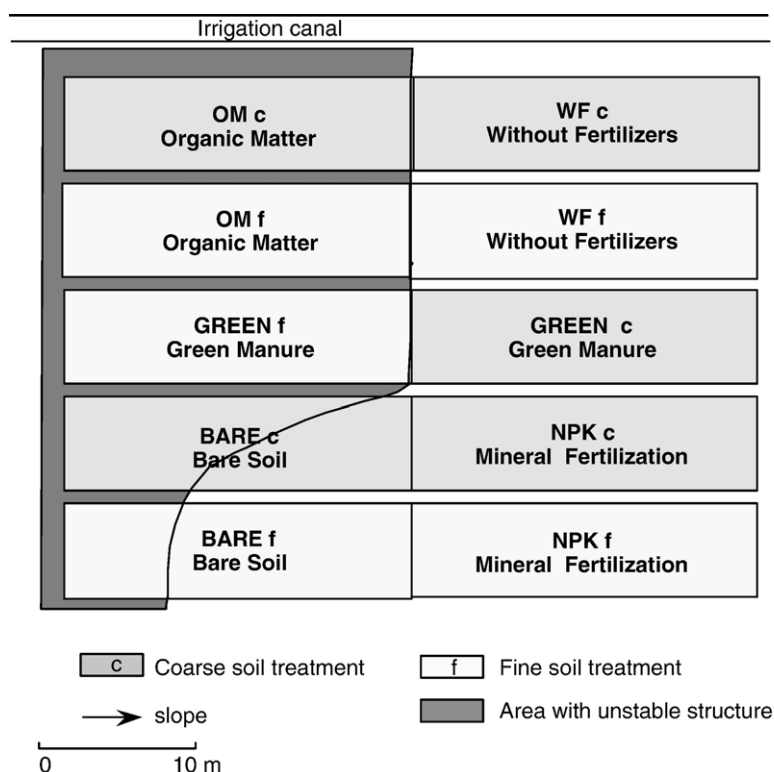

Fig. 2. Plots distribution on the field.

Table 3  
Synthesis of the four different rainfall simulations S1 to S4 made on the fragmented *cangahua*

Simulation	Number of plots	Plot type	Size of plot	Rainfall per plot	Location in plot
S1 test	2	Coarse–fine	9 m <sup>2</sup>	1	Center
S2 test S1+1 month	2	Coarse–fine	9 m <sup>2</sup>	1	Center
S3 test S2+1 month	2	Coarse–fine	9 m <sup>2</sup>	1	Center
S4 CULTIVATED	9	1.WF coarse–3.WF fine	100 m <sup>2</sup>	3	1 center
S3+2 years of cultivation		2.OM coarse–4.OM fine			2 each edge
		5.GREEN fine–6.GREEN coarse			
		7.NPK coarse–9.NPK fine			
		8.BARE coarse		2 <sup>a</sup>	2 each edge <sup>a</sup>

WF: without fertilizer; OM: organic matter inputs; GREEN: green manure inputs; NPK: chemical fertilizers inputs.

<sup>a</sup> Only Western side completed, pump broke down for high rainfall intensities.

simulator during the last trial on the plot 8 (BARE, coarse preparation), which was uncompleted.

### 2.3. Measurement of bulk density

The bulk density was determined using a cylinder size of 200 cm<sup>3</sup> in the upper horizon (0–15 cm) with 5 replicates. The bulk density was measured before the second simulation (S2) after one month of exposure to natural rains, before the third rainfall (S3). In addition, further records were taken on each agronomic plot at early stages of cultivation first before (T1) and after (T2) the cycle of pea. The latter was done before the fourth rainfall simulation (S4) in the upper horizon (0–15 cm) with six replicates, 3 on top of the ridges, 3 between the ridges.

### 2.4. Rainfall simulation

The rainfall simulator (Asseline and Valentin, 1978) generated artificial rains with controlled parameters (intensity and duration)

Table 4A  
Evolution of the bulk density (in g cm<sup>-3</sup>)

Plot	S2	S3	T1	T2 Top of ridge	T2 Inter-ridge
Test–coarse	1.11±0.09	1.12			
Test–fine	1.35±0.11	1.14			
1. WFc			1.11±0.03	1.10±0.01	1.18±0.04
2. Omc			1.02±0.04***	0.96±0.02***	1.07±0.01***
3. Wff			1.17±0.03	1.13±0.06	1.16±0.01
4. Omf			1.02±0.03***	1.00±0.05***	1.06±0.02***
5. GREENc			1.08±0.06*	1.12±0.07	1.14±0.05
6. GREENf			1.08±0.08*	1.08±0.06	1.16±0.01
7. NPKc			1.08±0.03	1.08±0.01	1.14±0.02
8. BAREc			1.17±0.10	1.15±0.03	
9. NPKf			1.13±0.05*	1.12±0.05	1.20±0.02
10. BAREf			1.29±0.06*	1.22±0.13	

Marked differences significant at  $p < 0.05$  (\*) and  $p < 0.001$  (\*\*); NS not significant.

Table 4B  
Statistics ANOVA for the bulk density between different plots

T1 and T2	Significant Differences
Coarse x Fine	NS
T1XT2	NS
Ridge x Inter-ridge	***

Marked differences significant at  $p < 0.05$  (\*) and  $p < 0.001$  (\*\*); NS not significant.

over 1 m<sup>2</sup> plots. The primary objective was to simulate rainfalls that mimicked the natural rainfall in terms of height, intensities and kinetic energies. In natural rainfall, intensities varies, this is why four intensities were used (Casenave and Valentin, 1992). Each rainfall simulation consisted of three successive runs to study the influence of initial moisture conditions on run off generation. The second run occurred 3 h after the end of the first run, and the third run 12 h after the end of the first rain event. Each run lasted 60 min and comprised four continuous sub-runs of 15 min with intensities of 20, 40, 60 and 80 mm h<sup>-1</sup>. Total rainfall applied over each simulation was approximately 50 mm. It is of note that the rainfall intensities of 60 and 80 mm h<sup>-1</sup> may be viewed as extremely high but observed during exceptional

Table 5  
Pre-runoff rainfall values (Pi in mm)

Preparation	Pi (mm)					
	Coarse			Fine		
	Rain 1	Rain 2	Rain 3	Rain 1	Rain 2	Rain 3
Test						
Simulation 1	48.2	8.3	6.9	39.3	6.0	7.3
Simulation 2	4.7	1.7	1.7	3.3	2.3	2.0
Simulation 3	8.4	2.4	1.7	9.7	6.5	4.3
Simulation 4						
WF-Plot 1	12.2	2.6	2.9	13.5	1.6	1.3
Plot 2	16.9	6.9	5.9	17.1	4.0	3.7
Plot 3	16.4	4.2	3.9	17.1	2.6	2.3
Average	15.2	4.6	4.2	15.9	2.7	2.4
O.M.-Plot 1	12.7	1.6	2.3	16.8	6.3	5.0
Plot 2	19.1	6.3	6.0	17.2	7.6	6.2
Plot 3	13.8	3.0	3.0	17.1	4.1	3.1
Average	15.2	3.6	3.8	17.0	6.0	4.8
GREEN Plot 1	7.7	0.3	0.7	9.6	2.3	1.7
Plot 2	14.3	2.4	2.4	11.0	3.7	4.0
Plot 3	6.3	3.6	2.6	17.2	4.6	3.9
Average	9.4	2.1	1.9	12.6	3.5	3.2
NPK-Plot 1	21.7	7.6	6.3	17.0	5.0	3.3
Plot 2	26.1	10.3	7.6	17.4	6.2	5.1
Plot 3	21.8	8.3	8.3	29.4	13.9	9.1
Average	23.2	8.7	7.4	21.3	8.4	5.8
BARE-Plot 1	16.5	0.7	0.7			
Plot 2	29.4	9.1	5.1			
Average	22.9	4.9	2.9			
Total average for all rains and all preparations	16.7	5.0	4.1			

No significant difference between the plots and the preparations.

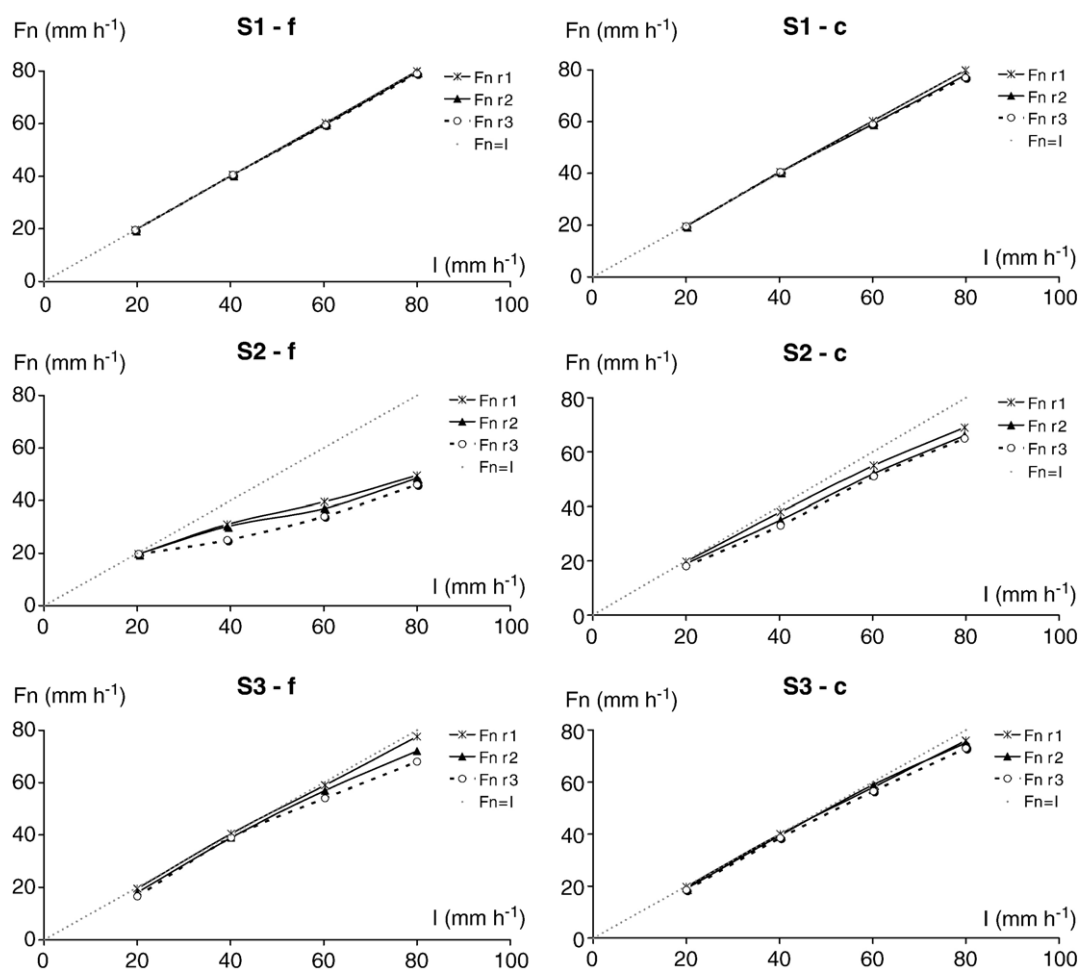

Fig. 3. Relation between rainfall intensity ( $I$ ) and infiltration rate in a permanent regime ( $F_n$ ) before agronomic experiment.

annual events at the site (Meteorological Station of INAMHI)<sup>1</sup> (Perrin et al., 2001). This high intensity rainfall corresponded to exceptional yearly rainfall (De Noni et al., 1989-90), generally two to three events have rainfall intensities higher than 40 mm h<sup>-1</sup> during 15 min. The following parameters have been measured (Casenave and Valentin, 1992).

The pre-runoff rainfall ( $P_i$ , mm) was calculated as follows:  $P_i = w_i + S_i$ , (i) where  $w_i$ , (mm) is the height of cumulated water that infiltrates into the soil at time  $t_i$ ; and  $S_i$ , (mm) is the height of water stored on the soil surface during the pre-runoff rainfall phase. The pre-runoff rainfall ( $P_i$ ) depends on soil moisture conditions prior to the rainfall event and the soil surface conditions.

After Lafforgue (1977),  $w_i = C(H_s - H_o)$ , where  $C$  coefficient related to rain intensity;  $H_s - H_o$ : deficit of saturation (mm);  $H_s$  soil moisture after the rain;  $H_o$  soil moisture prior to the rain. The soil moisture deficit was obtained over a depth of 0–20 cm.

The minimum infiltration rate ( $F_n$  mm h<sup>-1</sup>) which is the difference between the rainfall intensity ( $I$  mm h<sup>-1</sup>) and the stabilized runoff intensity ( $R_x$  mm h<sup>-1</sup>):

$$F_n = I - R_x.$$

The steady-state infiltration rate  $f_c$ , was also linearly related to the rainfall intensity  $I$  as follows:  $f_c = \alpha I + \beta$ .

The infiltration rate  $f_n = f(I)$ , and  $I_1$  values are linked to the variations of the surface characteristics and the initial soil water contents (Collinet and Valentin, 1979; Lelong et al., 1993).

The runoff coefficient  $K_{Ru}$  (%) with  $K_{Ru} = (L_r + D_r) / P_u * 100$ .

$P_u$ : the rainfall (mm)  $L_r$ : the runoff (mm), and  $D_r$  (mm) the part of the surface storage which runs off the plot after the end of the rainfall.

The pre-runoff rainfall volume and the runoff coefficient indicate the velocity of runoff and production, respectively. Runoff water was collected at intervals depending on runoff rates. The turbidity (suspended sediment related to water volume) and the soil losses (g m<sup>-2</sup>) were measured.

### 3. Results

#### 3.1. Soil porosity

The bulk density of *cangahua* material prior to any tillage operations was 1.5 g cm<sup>-3</sup> with a porosity of 40%. After fragmentation and exposure to natural rains, before S2, the bulk density declined to 1.11 g cm<sup>-3</sup> under the coarse preparation treatment, while in finely tilled soils (1.35 g cm<sup>-3</sup>) fine particles filled the macropores (Table 4A and 4B). Before S3

<sup>1</sup> INAMHI: Instituto Nacional de Meteorología y Hidrología (Ecuador).



both land preparations treatments had the same bulk density ( $1.13 \text{ g cm}^{-3}$ ).

After 3 cycles of cultivation, bulk density of the surface horizons (0–15 cm) of all plots showed limited variation for the

same plot. Bulk density varied as a function of organic matter inputs. Bulk density ranged from  $1.02$  to  $1.08 \text{ g cm}^{-3}$  on plots with organic fertilizers (green and organic manure) that were introduced by deep soil tillage, whilst on plots without organic

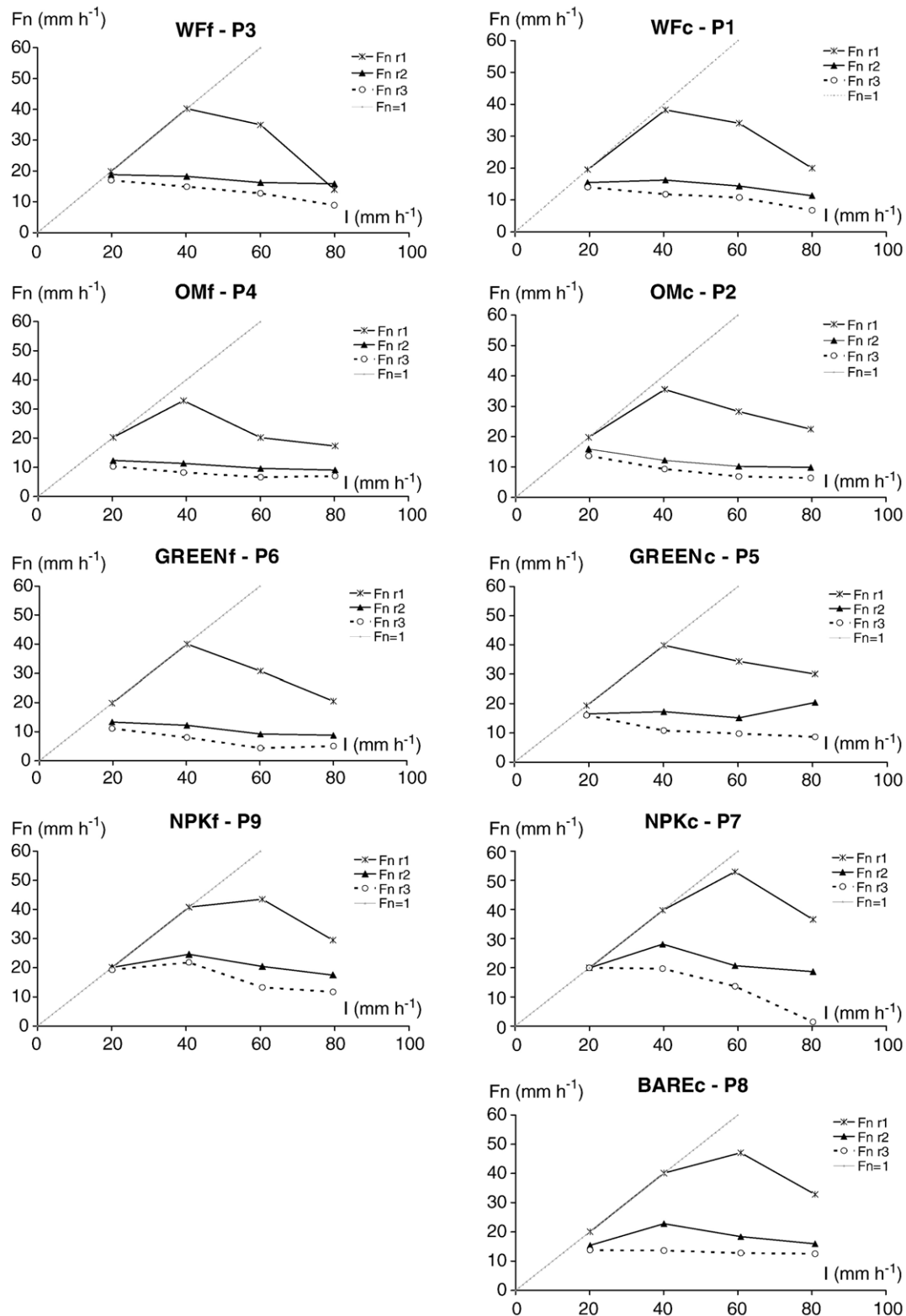

Fig. 4. Relation between rainfall intensity (I) and infiltration rate in a permanent regime (Fn) during the agronomic experiment after 2 years of cultivation. S1, S2, S3: the successive simulations; SFT: Soil Fine Treatment; SCT: Soil Coarse Treatment; r1, r2, r3: the successive rains.

fertilization bulk density ranged from 1.08 to 1.29 g cm<sup>-3</sup>. Compared to the plots without fertilizers (WF), the plots with organic matter (OM) showed a significant decrease in their bulk density. This was significantly less than for green manure (GREEN) and also a significant increase of bulk density for bare plots (BARE). After the cycle of green pea at T2, only plots enriched in organic matter (OM) have a significant decrease of their bulk density (Table 4A and 4B). No significant difference was noticed between coarse and fine preparation.

Between the ridges, the soil indicates clear evidence of crusting, the bulk density increases significantly on an average by 5% and a corresponding decrease in porosity. Between the ridges both erosion crusts and deposition crusts are visible.

### 3.2. Pre-runoff rainfall values $P_i$

Pre-runoff rainfall values are presented for each plot in Table 5. On test plots, for S1 during the first run, pre-runoff rainfall values are high 48 and 39 mm respectively for coarse and fine preparation. For the second and third run, the pre-runoff rainfall values sharply decreased to 4.7 and 3.3 mm. During S2,  $P_i$  values were very low after visible soil tillage, during S3,  $P_i$  values increased again for both preparations from 8.4 to 9.7 mm. However, the subsequent decrease was also rapid for the second and third rain event. In all simulations, the decrease of  $P_i$  was greater in the coarse fragmented plots.

Within the cultivated plots,  $P_i$  values were higher during the first rain event prior to the formation of a surface crust and decrease slowly between the second and the third rain (Table 5). There was no clear significant difference between the plots preparation (coarse or fine) or between the plots treatments. Organic matter plots (OM), which had the higher porosity in their surface layer, exhibited intermediate  $P_i$  values ranging from 12 to 19 mm.

### 3.3. The minimum infiltration rate

The infiltration capacity of each rain event is shown in Fig. 3. For all test plots that received simulation S1, S2 and S3, the infiltration rate increased with rain intensity. In general there was a slight decrease in infiltration rate between the first ( $r_1$ ) and the third ( $r_3$ ) rain event. During S1, the infiltration is rather complete for both plots and for the three rain intensities. During S2, after one month exposed to natural rain since a rainfall of 60 mm h<sup>-1</sup>, the infiltration was not complete. Thus, for both soil preparations, the overall infiltration rate decreased consistently from the first to the third rain event from 88 to 83% for coarse preparation and from 76 to 67% for fine preparation. During S3, after the removal of the soil surface, and the crust destruction, the infiltration rate was similar to the rain intensity but with a small decrease from the first to the third rain for high intensities, especially for the fine treatment.

The infiltration capacity of each rain of S4 is presented in Fig. 4. During the first rain, the infiltration rate increased until the second intensity (40 mm h<sup>-1</sup>), then it decreases on tilled plots (OM and Green), while its still increasing on NPK and bare plots. There is a general decrease of infiltration for high rainfall intensities. During the second rain infiltration rate

values were lower than for the first rain event. It was observed that there was an increase in the infiltration rate for only mineral fertilizers (NPK) and bare (BARE) plots, for the second intensity (40 mm h<sup>-1</sup>). This phenomenon was noted before a decrease of infiltration rate at higher intensities. On all other plots, the infiltration rate was rather constant or decreased since the first rain intensity (20 mm h<sup>-1</sup>). For the third rain event, the infiltration rate remained constant and decreased with increasing intensity.

### 3.4. Runoff coefficient

The values of the runoff coefficient (Kru) are presented in Table 6A, 6B, 6C. In the test plots, during S1, the Kru values were lower than 5% with a slight increase from the first to the third rain event. However, during S2, the Kru coefficient increased rapidly and regularly from the first to the third rain event from 12 to 16% on coarse preparation and from 24 to 32% on fine preparation. During S3 after soil surface removal, the Kru value was low again but only for the first rain event ( $\leq 3\%$ ). Thereafter, it increased rapidly and regularly from the first to the third rain event from 3 to 13% and 2 to 7% for coarse and fine preparation respectively (Table 6A, 6B, 6C).

For the cultivated plots (S4), during the first rain, the higher values of the runoff coefficient occurred on the OM (organic matter) plots from 26 to 65%. These values were still high on GREEN plots while on NPK and BARE soils the values were lower from 11 to 37%.

For the second period of rain, a large increase of the runoff coefficient was observed at all the plots. OM and GREEN plots still had the highest values of runoff coefficient but the increase was also very important in NPK and BARE plots.

Table 6A  
Runoff water coefficient (Kru in %)

Preparation	Kru (%)					
	Coarse			Fine		
	Rain 1	Rain 2	Rain 3	Rain 1	Rain 2	Rain 3
Test						
Simulation 1	0.4	1.7	4.4	0.1	0.3	0.5
Simulation 2	12.1	16.2	16.4	23.8	28.7	32.5
Simulation 3	3.4	6.7	13.3	1.6	6.2	7.4
Simulation 4						
WF-Plot 1	45.7	54.9	85.7	35.6	64.7	35.8*
Plot 2	29.1	62.9	70.0	1.1*	51.5	61.3
Plot 3	40.7	67.5	73.6	39.6	70.7	77.6
O.M.-Plot 1	65.6	85.8	91.3	53.3	80.4	88.8
Plot 2	47.1	76.0	81.4	44.0	71.8	76.9
Plot 3	35.9	66.2	75.4	26.0	66.7	74.1
GREEN Plot 1	40.1	73.8	82.3	45.4	83.3	91.5
Plot 2	25.4	55.5	68.8	27.6	65.0	72.9
Plot 3	32.5	34.9	72.2	43.0	80.3	85.8
NPK-Plot 1	18.3	52.0	64.2	37.1	67.1	76.5
Plot 2	19.1	48.6	67.1	29.5	55.3	64.1
Plot 3	20.7	50.7	57.3	14.1	41.9	54.5
BARE-Plot 1	32.4	81.2	87.1			
Plot 2	11.1	40.7	57.3			

\*Values underestimated, without the 80 mm.h<sup>-1</sup> rain event due to pump break down.

Table 6B  
Significant rainfall event effect

Treatment	Rain 1	Rain 2	Rain 3	LSD <sub>0.05</sub>
Kru (%)	35.5	63.6	74.3	2.02

Table 6C  
Significant plot effect

Treatment	OM	GREEN	WF	NPK	LSD <sub>0.05</sub>
Kru (%)	67	60	57.7	46.6	6.63

LSD<sub>0.05</sub> = Least significant difference (%).

For the third period of rain, all the plots showed a moderate increase of runoff. The total runoff had large values over 70% in most of the plots located in the western part of the trial (Fig. 2). Compared to the first occurrence, the increase of the runoff coefficient seemed to be the same, approximately 40%, in all plots except on the bare plots where the increase was 40 to 55%.

### 3.5. Soil loss

Soil losses are generated with rains over 20 mm h<sup>-1</sup> in intensity and increased significantly with rainfall intensity when

$I > 40 \text{ mm h}^{-1}$  (Table 7). Soil loss increased sharply between 60 and 80 mm h<sup>-1</sup>. Soil detachment generally increases from the first to the third rain event.

Prior to the implementation of agronomic treatments, soil loss was negligible after the first rainfall simulation (Table 7). For S2, the total soil loss for both the coarse and fine land preparation treatments was very similar (135 g m<sup>-2</sup>). For S3, after the soil tillage, on the coarse plot the soil loss values were still high and decreased slowly from the first to the third rain event. For the fine preparation the soil loss was relatively constant and was half of that recorded during the second rain event.

For the last simulation (S4), on cultivated plots, at a level of 50 mm of rain in 1 h during each period of precipitation the soil loss varied from 30 to approximately 180 g m<sup>-2</sup>, except for the bare surface where soil loss was much higher than for the other plots (from 400 g m<sup>-2</sup> to over 800 g m<sup>-2</sup>). The highest rate of soil loss was observed on plots located to the west of the experiment (Fig. 2).

## 4. Discussion

As previously reported after four years of cultivation, soil preparation, organic matter inputs, root density and mucilage production had no effect on the aggregate structure stability

Table 7  
Correlation ( $R^2$ ) between runoff water coefficient (Kru %) and soil loss (g m<sup>-2</sup>) for each rain

$I$ (mm h <sup>-1</sup> )	$R^2$	20	40	60	80	Cumulated
		g m <sup>-2</sup> SD	g m <sup>-2</sup> SD	g m <sup>-2</sup> SD	g m <sup>-2</sup> SD	
WFC-r1	0.97*	0.0	0.0	26.4±17.1	93.4±48.6	119.8±64.7
r2	0.68 <sup>NS</sup>	0.5±0.8	11.7±5.9	52.8±30.2	77.0±55.5	142.0±87.8
r3	0.63 <sup>NS</sup>	0.0	14.5±10.2	42.1±36.1	116.6±127.5	173.2±173.8
WFF- r1	0.99***	0.0	0.0	16.7±7.3	45.4±0.6	62.1±7.8
r2	0.90*	0.0	4.9±4.5	23.7±2.7	29.3±4.3	57.9±11.6
r3	0.83 <sup>NS</sup>	0.3±0.5	4.5±6.4	17.4±5.7	24.1±4.2	46.3±16.8
OMc- r1	0.89 <sup>NS</sup>	0.0	2.3±4.0	20.1±22.6	63.0±21.2	85.4±42.3
r2	0.72 <sup>NS</sup>	0.0	7.2±6.3	30.7±11.2	57.9±21.8	95.8±30.5
r3	0.57 <sup>NS</sup>	0.0	7.3±6.4	28.4±10.4	67.3±26.3	103.0±33.3
OMf- r1	0.90*	0.0	2.3±4.0	24.3±29.8	79.9±25.9	106.5±58.0
r2	0.67 <sup>NS</sup>	0.0	7.8±13.6	40.3±27.4	64.0±45.9	112.2±86.9
r3	0.68 <sup>NS</sup>	0.1±0.1	15.4±19.0	52.9±33.4	90.4±56.0	158.7±106.9
GREENc-r1	0.98*	0.0	0.0	11.0±12.6	33.2±19.9	44.2±32.4
r2	0.68 <sup>NS</sup>	0.0	7.3±6.4	17.7±10.9	45.0±33.2	69.8±54.4
r3	0.70 <sup>NS</sup>	0.0	4.8±5.1	27.9±28.7	47.0±57.0	79.7±90.5
GREENf-r1	0.98**	0.0	0.0	21.1±18.3	71.6±22.8	92.7±41.1
r2	0.78 <sup>NS</sup>	0.0	11.0±9.5	41.2±13.8	66.0±27.8	118.2±50.6
r3	0.54 <sup>NS</sup>	0.0	11.2±10.0	48.4±16.8	116.8±64.7	176.4±90.9
NKPc-r1	0.99**	0.0	0.0±	0.7±1.2	35.4±8.9	36.1±9.1
r2	0.95*	0.0	4.6±5.6	18.5±6.9	33.9±20.5	57.0±32.3
r3	0.89 <sup>NS</sup>	0.0	2.4±2.8	11.7±1.3	22.1±5.0	36.3±7.0
NKPf-r1	0.98*	0.0	0.0	3.5±6.1	24.6±11.4	28.1±15.1
r2	0.84 <sup>NS</sup>	0.0	2.4±4.1	22.7±18.6	19.2±11.2	44.3±28.2
r3	0.67 <sup>NS</sup>	0.0	2.1±3.7	11.1±6.6	35.9±47.2	49.1±57.4
BAREc-r1	0.97*	0.0	0.0	32.3	424.6	456.8
r2	0.67 <sup>NS</sup>	0.0	82.2	248.6	603.9	934.7
r3	0.61 <sup>NS</sup>	0.0	74.1	236.7	503.5	814.2
BAREf-r1						
r2						
r3						

ANOVA test: NS not significant, \*\*\* significant at  $p < 0.0005$ , \*\* significant at  $p < 0.005$ , \* significant at  $p < 0.05$ .

Soil loss (g m<sup>-2</sup>) and standard deviation (SD) for each simulated rainfall intensity  $I$  (mm h<sup>-1</sup>) and cumulated soil loss values.

(Podwojewski and Germain, 2005). Initial structural stability of fragments is determined by their mineralogical composition: clay-rich materials with their shrink-swell properties are less stable than materials containing low amounts of clay, with lower shrink-swell properties and higher Fe contents extracted by citrate–bicarbonate–dithionite ( $\text{Fe}_{\text{cbd}}$ ). These contrasting attributes are a result of progressive weathering and therefore, influence erosion processes.

In the massive *cangahua* before removal, permeability is very low due to the small access to the pores. The runoff is about 100%, generating a level of vertical discontinuity for water internal drainage and thus makes the horizons above this layer very erodible.

#### 4.1. Infiltration rate and runoff

##### 4.1.1. Before implementation of agronomic treatments

Immediately after the removal of *cangahua*, the runoff coefficient was negligible. A constant increase of infiltration rate is a function of rainfall intensity and is the result of an heterogeneous soil surface (Lafforgue, 1977; Collinet and Valentin, 1982). The higher the deficit in water saturation, the higher the slope of the function and the  $I_1$  value ( $\text{mm h}^{-1}$ ). One month of exposure to natural rain, soil structural degradation was rapid resulting in increased runoff, which was significantly higher under the finely prepared treatments as a result of surface crusting (i.e. erosion and structural crusts). The surface irregularities of the coarsely prepared treatments limited runoff. The coarse fragments of *cangahua* acted like stones and close after their fragmentation. As suggested by Poesen (1986) Poesen and Ingelmo-Sanchez (1992) or Cerdá (2001), coarse elements favours the vertical drainage. After soil treatment, the runoff was low again, but increased rapidly after each rain event, with small differences between both preparations.

##### 4.1.2. After agronomic treatments imposed

The significant reduction of saturated hydraulic conductivity since the first rain event, during the simulated rainfall (Table 6B) generating a higher runoff rate suggests a strong reduction of the surface soil porosity since the first rain event due to rapid surface crusting (Valentin, 1991; Casenave and Valentin, 1992). Crust formation by slaking due to the kinetic energy of raindrops (splash effect) or reduction in structural porosity due to settling leads to a negative relation between infiltration rate  $f(n)$  and rainfall intensity ( $I$ ) (Valentin, 1991; Le Bissonnais and Singer, 1992). After crust formation,  $K_{\text{sat}}$  does not vary, as the reduced hydraulic conductivity appear to be independent of the kinetic energy of the rainfall drops. The restoration of infiltration after tillage was very short. Over three cycles of cultivation soil crusting drastically increases, especially on plots with organic fertilization (GREEN, OM) which had higher tillage (Biielders et al., 1996).

When blocks of *cangahua* are relatively well conserved, as in the test rains and after 3 cultivation cycles (NPK and GREEN), the infiltration rate is higher on the coarse preparation. Conversely, on the other plots which are generally located on the west of the experiment, the influence of soil

mechanical tillage was stronger and the aggregate stability weaker (Podwojewski and Germain, 2005), thus the coarse preparation of *cangahua* indicates an increased element of degradation in hydraulic conductivity, similar to the fine preparation (Valentin, 1994). The inputs of organic manure, at rates of up to  $70 \text{ t ha}^{-1}$  after 3 cycles of cultivation improves the soil porosity but did not improve the hydraulic conductivity (Table 6C). These plots due to a higher content in swelling clays show the lowest pre-runoff rainfall, a faster degradation of the soil structure, rapid crust formation, a lower infiltration rate, and higher runoff as mentioned by Collinet (1988).

Coarse fragments break down into smaller aggregates, that bridge and block voids and eventually lead to a crust development (Freebairn et al., 1991). During this work, due to the sandy-silty texture of these soils, the formation of crusts was rapid (Poesen, 1986) and independent of the initial moisture (Geeves et al., 1995). After 3 cycles of cultivation, soil preparation did not influence the erosion rate significantly.

#### 4.2. Correlation between runoff and soil loss

The correlation between runoff and soil loss was significant only for the first rain (Table 7). For the rains 2 and 3 the correlation gets lower. This may in part be due to the blasting of coarse fragments and the development of a crust, therefore, increasing the runoff without the associated loss of soil. When the soil has a rough surface, it has limited runoff, but the coarser elements were eroded with a rather high soil-loss until a smooth crust developed. From that moment runoff increased but there were limited surface roughness irregularities which became

Table 8A  
Soil loss ( $\text{g m}^{-2}$ ) and structural stability ( $\text{g } 100 \text{ g}^{-1}$ )

Soil detachment	Soil loss ( $\text{g m}^{-2}$ )				Unstable wet aggregates
	Rain 1 $\text{g m}^{-2}$	Rain 2 $\text{g m}^{-2}$	Rain 3 $\text{g m}^{-2}$	Total rains $\text{g m}^{-2}$	UWA $\text{g } 100 \text{ g}^{-1}$
Simulation 1					
Coarse	+0	+0	+0	+0	
Fine	+0	+0	+0	+0	
Simulation 2					
Coarse	31.3	77.1	30.7	139.1	
Fine	26.8	61.7	45.1	133.6	
Simulation 3					
Coarse	46.2	37.0	26.7	109.9	
Fine	19.9	17.2	20.0	57.1	
Simulation 4					
WFC	119.8	142.0	173.2	435.0	23.7±4.1
WFF	62.1	57.9	46.3	166.3	12.8±0.6
OMc	85.4	95.8	103.0	284.2	39.5±2.9
OMf	106.5	112.2	158.7	377.4	23.9±5.9
GREENc	44.2	69.8	79.7	193.7	13.4±3.2
GREENf	92.7	118.2	176.4	387.2	30.9±6.3
NPKc	36.1	57.0	36.3	129.5	13.0±6.7
NPKf	28.1	44.3	49.1	121.5	8.2±1.4
BAREc	456.8	934.7	814.2	2205.7	49.3±14.7
BAREf					20.2±4.5

Plots located on the western part of the trial, with higher erosion rate and unstable aggregates plots are overprinted in grey.

Table 8B

Significant plot effect

Treatment	OM	GREEN	WF	NPK	LSD <sub>0.05</sub>
Soil loss (g m <sup>-2</sup> )	117.8	97.4	104	43.7	41.07

LSD<sub>0.05</sub> = Least significant difference (g m<sup>-2</sup>).

eroded. The crust therefore, could be viewed as temporary erosion reducer. This process occurs mainly during the test events (S1, S2 and S3). This would explain also why OM plots have a very high runoff rate but a less important rate of soil loss (Table 8A).

4.3. Correlation between soil detachment and aggregate stability on cultivated plots

There is a good relationship between the loss of the structural stability of the aggregates (UWA) and the Kru coefficient (Table 8B Fig. 5) but only for the second and third rain, in

agreement with many observations made on sandy volcanic ash–soils (Barthès et al, 2000; Barthès and Roose, 2002). However in general, the highest rate of soil loss was observed on plots located to the west of the experiment (Fig. 2), which also corresponds to plots with the lowest structural stability (Podwojewski and Germain, 2005).

We can consider three types of behaviour: 1) A group of stable fragments (Wf<sub>f</sub>, GREEN<sub>c</sub>, NPK<sub>c</sub>, NPK<sub>f</sub>) located at the east of the experiment, which demonstrated limited susceptibility to runoff and to erosion; 2) a group of plots also often enriched in organic matter (Wf<sub>c</sub>, GREEN<sub>f</sub>, OM<sub>f</sub> and OM<sub>c</sub>) which indicated more fragile fragments and corresponding higher values of runoff and erosion. The value of OM<sub>f</sub> must also be noted as it demonstrates very strong runoff susceptibility but limited erosion; 3) the plot BARE<sub>c</sub> could be characterised by a weak structural stability, limited runoff but a very strong detachability.

The *cangahua* can be considered as a rock in weathering process with higher swelling clay contents in the western part of

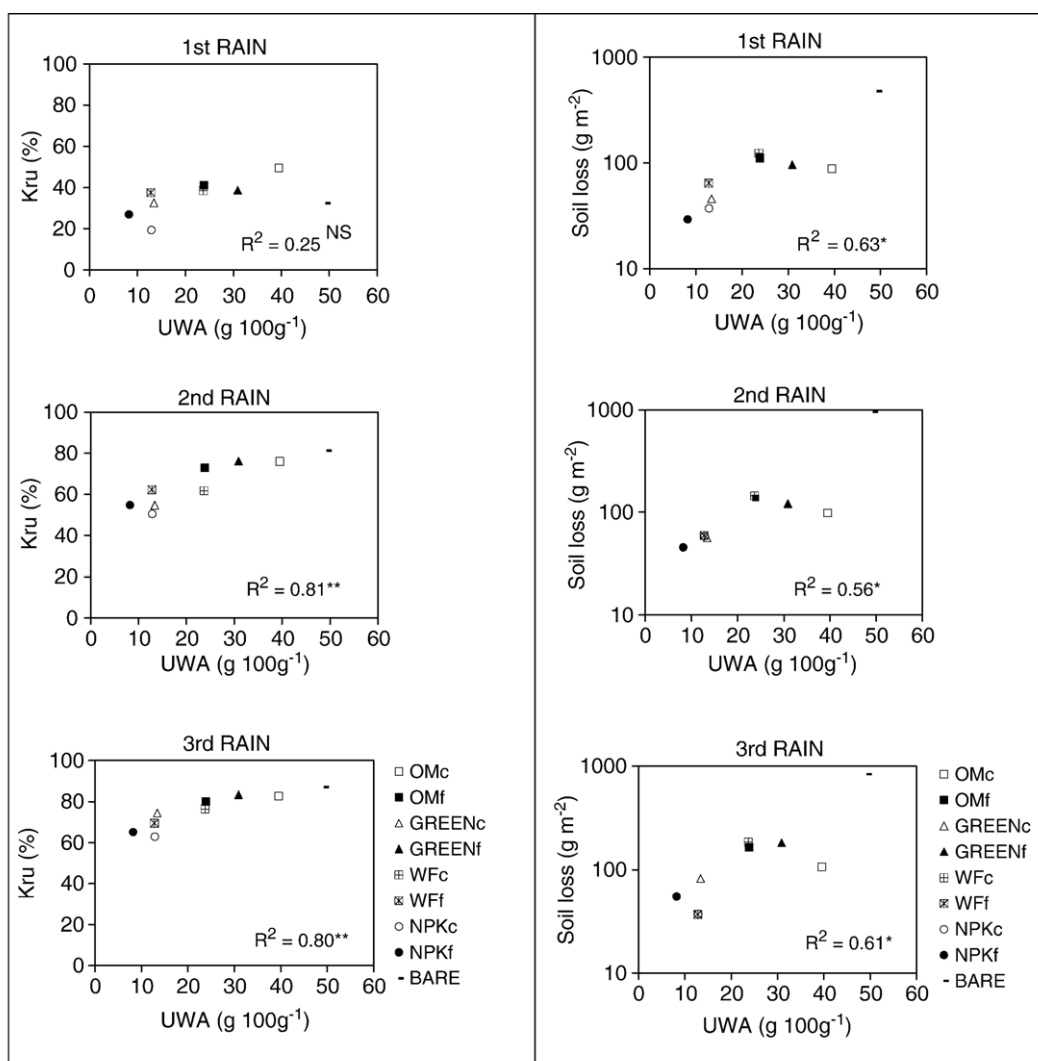

Marked differences significant at p<0.05 (\*) and p<0.001 (\*\*); NS not significant

Fig. 5. Relation between unstable wet aggregates (UWA) coefficient and runoff rate (Kru%) and soil loss (g m<sup>-2</sup>) after the three following rain events.

the trial, especially in places where the BARE and OM plots are located (Fig. 2). During this process, a transition between the soil fragments to a soil structure was observed. This transformation seems to be higher in the presence of strong biological activity, in plots enriched with organic matter. As suggested by Velasquez and Flores (1997), cemented fragments of hardened volcanic ashes have a stronger stability than the recently formed aggregates due to biological activity which are therefore more prone to erosion than the previously soil fragments.

#### 4.4. Geomorphologic and agronomic consequences

Coarse soil preparation and the conservation of hard fragments temporarily limit the risk of runoff and erosion. However rapid infiltration can lead to the accumulation of water at the top of an impermeable untilled *cangahua* layer and therefore, can generate landslides (Perrin et al., 2000). Fine soil preparation increases the crusting of the topsoil. It could limit erosion by increasing runoff but only in the first steps of the erosion process. The concentrated runoff can lead rapidly to the formation of gullies (De Noni et al., 2001; Poesen et al., 2003), first step to the removal of the hardened layers.

Due to rapid crusting and strong sensitivity to erosion, flat terraces are recommended. Because of the high cost of work, terraces of slow formation with a limited slope of 10 to 15% and protected downstream by a wall in a *cangahua* itself have been experimented with successfully and are now adopted in some agricultural communities (De Noni et al., 1989–90; Zebrowski, 1997).

In Mexico, where considerable work has been done on erodibility of *tepetates*, rainfall occurs once a year during a well-defined rainy season. In case of annual traditional crops like maize, the higher intensity corresponds to a period with maximum vegetation development so that the soil cover is at its maximum. However, in Ecuador, there are two distinct rainy seasons and very heavy rains can occur between two cultivation cycles the bare soil can be exposed to erosion (Baumann et al., 1997; De Noni et al., 1989–90).

As high inputs of organic matter are not very efficient at improving soil structure; they are also unlikely to be used widely because of their high cost and limited availability. The best solution for agricultural development of the *cangahua* surface may be the planting of a perennial grass pasture. The fibrous root system of the grasses not only ramifies and opens up the soil but also encompasses individual crumbs in a net-like web to form crusts resistant to the slaking action of water (Tisdall and Oades, 1982; Kay, 1990; Reid and Goss, 1993). Any other cultivation must be made with minimum tillage.

## 5. Conclusion

In the early stages of *cangahua* removal, water infiltration is very high. However, after one month of natural rains, crusting limits water infiltration. Crusting occurs rapidly especially

when the soil is left without soil cover and when it has fine fragments. After soil tillage, the runoff is only temporarily reduced, and increases regularly after each rain.

At early stages after fragmentation and cultivation, the hydrodynamic of fragmented *cangahua* depends more on its pedologic evolution than on any amendment or treatment. After three cycles of cultivation, there are no major differences in the performance between coarse and fine preparation. In these silty–sandy soils, crusting is very fast and limits the pre-ponding rain even in plots with higher porosity. Runoff and erosion develop after cultivation and are particularly important in plots with the highest rate of unstable aggregates with high expansive clay content. The introduction of organic matter probably generates a new pedological structure, but does not improve general structural stability, probably because it is present in insufficient amounts in these low clay content soils. However, organic matter fertilizers need more tillage and the new pedological structure is much weaker than the lithological fragments that form the initial structure.

To avoid any risks of erosion, soil preparation should be coarse to limit the effect of erosion in the early stages of plant development. These soils must be cultivated on flat areas, be protected by a perennial crop (pasture), which may produce an improvement in soil stability though its roots and slowly develop a new stable pedological structure different from the fragmented lithological structure.

## Acknowledgements

The authors thank the Central University of Ecuador, the staff and students of the IRD-CANGAHUA program, Christian Valentin (IRD) and Andrew Noble (IWMI-SEA Bangkok) and anonymous reviewers for comments on the manuscript. The stay in Ecuador by the authors was supported by IRD.

## References

- Asseline, J., Valentin, C., 1978. Construction et mise au point d'un infiltromètre à aspersion. Cah. ORSTOM. Série hydrologie, vol. XV (4), pp. 321–349.
- Barthès, B., Roose, E., 2002. Aggregate stability as an indicator of soil susceptibility to runoff and erosion; validation at several levels. *Catena* 47, 133–149.
- Barthès, B., Azontonde, A., Boli, B.Z., Prat, C., Roose, E., 2000. Field scale run-off and erosion in relation to topsoil aggregate stability in three tropical regions (Benin, Cameroon, Mexico). *European Journal of Soil Research* 51, 485–495.
- Baumann, J., Fechter-Escamilla, U., Werner, G., 1997. Recultivation of eroded and indurated volcanic-ash soils. A contribution to securing agricultural production in the Central Mexican Highlands. *Applied Geography and Development* 50, 7–20.
- Bielders, C.L., Baveye, P., Wilding, L.P., Drees, L.R., Valentin, C., 1996. Tillage-induced spatial distribution of surface crusts on a sandy Paleustult from Togo. *Soil Science Society of America Journal* 60, 843–855.
- Cerdá, A., 2001. Effects of rock fragment cover on soil infiltration, interrill runoff and erosion. *European Journal of Soil Science* 52, 59–68.
- Casenave, A., Valentin, C., 1992. A runoff capability classification system based on surface features criteria in semi-arid areas of West Africa. *Journal of Hydrology* 130, 231–249.
- Collinet, J., 1988. Comportements hydrodynamiques et érosifs de sols de l'Afrique de l'Ouest. Evolution des matériaux et des organisations sous

- simulation de pluies. *Ph. D.*, Université Louis Pasteur, Strasbourg, France, 521 p.
- Collinet, J., Valentin, C., 1979. Analyse des différents facteurs intervenant sur l'hydrodynamique superficielle. Nouvelles perspectives. Applications agronomiques. Cah. Orstom. Série Pédol., vol. XVII (4), pp. 283–328.
- Collinet, J., Valentin, C., 1982. Effects of rainfall intensity and soil surface heterogeneity on steady infiltration rate. Proc. 12th Int. Congr. Soil Sci., New Dehli, vol. 22.
- De Noni, G., Viennot, M., Trujillo, G., 1989–90. Mesures de l'érosion dans les Andes en Equateur. Cah. ORSTOM, sér. pédol., vol. XXV (1-2), pp. 183–196.
- De Noni, G., Viennot, M., Asseline, J., Trujillo, G., 2001. Terres d'altitude, terres de risque. La lutte contre l'érosion dans les Andes équatoriennes. Latitudes, vol. 23. IRD, Paris.
- Freebairn, D.M., Gupta, S.C., Rawls, W.J., 1991. Influence of aggregate size and microrelief on development of surface soil crusts. Soil Science Society of America Journal 55, 188–195.
- Geeves, G.W., Hairsine, P.B., Moore, I.D., 1995. In: So, H.B., Smith, G.D., Raine, S.R., Schafer, B.M., Loch, R.J. (Eds.), Sealing, Crusting, and Hardsetting Soils: Productivity and Conservation. Australian Society of Soil Science Inc., Queensland Branch, Brisbane, Australia, pp. 145–150.
- Kay, B., 1990. Rates of change of soil structure under different cropping system. Advances in Soil Science 12, 1–52.
- Lafforgue, A., 1977. Inventaire et examen des processus élémentaires de ruissellement et d'infiltration sur parcelles. Application à une exploitation méthodique des données obtenues sous pluies simulées. Cah. ORSTOM, sér. Hydrol., vol. 14 (4), pp. 243–299.
- Le Bissonnais, Y., Singer, M., 1992. Crusting, runoff and erosion response to soil water content and successive rainfalls. Soil Science Society of America Journal 56, 1898–1903.
- Lelong, F., Roose, E., Darhout, R., Trevisan, D., 1993. Susceptibilité au ruissellement et à l'érosion en nappe de divers types texturaux de sols cultivés ou non cultivés du territoire français. Expérimentation sous pluies simulées. Science Du Sol 31 (4), 251–279.
- Leroux, Y., Janeau, J.L., 1997. Caracterización hidrodinámica de un suelo volcánico endurecido del Ecuador (cangahua), influencia de los estados de superficie. In: Zebrowski, C., Quantin, P., Trujillo, G. (Eds.), Memorias del III Simposio Internacional sobre Suelos volcánicos endurecidos, (Quito, diciembre de 1996), IRD, PUCE, UCE, Quito, pp. 430–442.
- Perrin, J.L., Fourcade, B., Poulernard, J., Richard, D., Sierra, A., 2000. Quito face à un risque d'origine naturelle: les laves torrentielles. Revue de Géographie Alpine n°2, 43–57.
- Perrin, J.L., Bouvier, C., Janeau, J.L., Ménez, G., Cruz, F., 2001. Rainfall/runoff processes in a small peri-urban catchment in the Andes Mountains. The Rumiurcu Quebrada, Quito, Ecuador. Hydrological Processes 15, 843–854.
- Podwojewski, P., Germain, N., 2005. Evolution of the soil structure in a deep tilled hardened volcanic ashsoil (Cangahua) in Ecuador. European Journal of Soil Science 39, 39–51.
- Poesen, J., 1986. Surface sealing on loose sediments: the role of texture, slope and position of stones in the top layer. In: Callebaut, F., Gabriels, D., De Boodt, M. (Eds.), Assessment of soil surface sealing and crusting. Flanders Centre for Soil Erosion and Soil Conservation, Université de Gand, Belgique, pp. 354–362.
- Poesen, J., Ingelmo-Sanchez, F., 1992. Runoff and sediment yield from topsoils with different porosity as affected by rock fragment cover and position. Catena 19, 451–474.
- Poesen, J., Nachtergale, J., Vertstraeten, G., Valentin, C., 2003. Gully erosion and environmental change. Importance and research needs. Catena 50 (2-4), 91–134.
- Pourrut P., 1994. L'eau en Equateur, principaux acquis en hydroclimatologie. Collection Etude et Thèses. Orstom, Paris. 147pp.
- Quantin, P., 1992. L'induration des matériaux volcaniques pyroclastiques en Amérique latine: Processus géologiques et pédologiques. In: Zebrowski, et al. (Eds.), Terra, Numero Especial Suelos Volcánicos Endurecidos, vol. 10, pp. 24–33.
- Quantin, P., Zebrowski, C., 1997. Analyse préliminaire (chimie, minéralogie, pétrographie) de quelques types de cangahua. Los suelos con cangahua en el Ecuador. In: Zebrowski, C., Quantin, P., Trujillo, G., (Eds.), Memoria del III Simposio Internacional sobre Suelos Endurecidos (Quito, diciembre de 1996) IRD, PUCE, UCE, Quito, pp. 29–47.
- Reid, J.B., Goss, M.J., 1981. Effect of living roots of different plant species on the aggregate stability of two arable soils. Journal of Soil Science 32, 521–541.
- Servenay, A., Prat, C., 2003. Erosion extension of indurated volcanic soils of Mexico by aerial photographs and remote sensing analysis. Geoderma 117, 367–375.
- Tisdall, J.M., Oades, J.M., 1982. Organic matter and water-stable aggregates in soils. Journal of Soil Science 33, 141–163.
- Valentin, C., 1991. Surface crusting in two alluvial soils of northern Niger. Geoderma 48, 201–222.
- Valentin, C., 1994. Surface sealing as affected by various rock fragments covers in West Africa. Catena 23, 87–97.
- Velasquez, A.S., Flores, D.R., 1997. Formación de agregados estables a partir de un duripán del estado de Morelos (México) por parte de especies vegetales perennes en condiciones de invernadero. In: Zebrowski, C., Quantin, P., Trujillo, G., (Eds.), Memoria del III Simposio Internacional sobre Suelos Endurecidos (Quito, diciembre de 1996) IRD, PUCE, UCE, Quito, pp. 170–177.
- Winckell, A., Zebrowski, C., 1992. La cangahua en Equateur: le contexte paléogéographique de sa formation. In: Zebrowski, et al. (Eds.), Terra, Numero Especial Suelos Volcánicos Endurecidos, vol. 10, pp. 107–112.
- Zebrowski, C., 1997. Los suelos con cangahua en el Ecuador. In: Zebrowski, C., Quantin, P., Trujillo, G., (Eds.), Memoria del III Simposio Internacional sobre Suelos Endurecidos (Quito, diciembre de 1996) IRD, PUCE, UCE, Quito, pp. 128–137.

## 7. CONCLUSION

Les changements globaux affectent considérablement la zone intertropicale où la déforestation annuelle est de l'ordre de 13 millions d'ha an<sup>-1</sup> (FAO, 2010; FAO and JRC, 2012). L'érosion hydrique souvent liée aux facteurs anthropogéniques y est très forte (Lal, 2003). Depuis les années soixante-dix, les changements d'usages des terres y sont très rapides (Holdren and Ehrlich, 1974) et les agriculteurs sont amenés à travailler dans des zones marginales très pentues aux taux d'érosion très élevés >100 Mg km<sup>-2</sup> a<sup>-1</sup> (Valentin *et al.*, 2008) et/ou dans des zones à faible pluviométrie (Veron *et al.*, 2006). Il est donc important de s'interroger à propos de ces changements sur les propriétés hydriques du sol (Lal, 2000; Ribolzi, 2006; Patin *et al.*, 2012).

Les travaux présentés dans cette thèse visaient à améliorer nos connaissances sur les déterminants biologiques et physiques du partage de la pluie entre ruissellement et infiltration de sols d'agroécosystèmes tropicaux. La surface du sol a été le fil conducteur de ces différentes études.

Ces travaux ont été menés au sein d'écosystèmes spécifiques sur trois continents et cinq pays. Ils ont été présentés au travers de six publications basées sur des études réalisées au sein de bassins versants représentatifs de régions où l'action de l'Homme est forte notamment sur l'interaction entre l'eau et le sol.

- a) **Au Nord de la Thaïlande**, en climat tropical humide, sur des collines à fortes pentes totalement cultivées (Figure 25), **la caractérisation de l'influence de la pente sur l'infiltration** a permis de constater i) que sur les pentes faibles, l'énergie cinétique forte de la pluie a un rôle déterminant sur l'infiltration par compaction de la surface et par la formation de croûtes ii) que sur fortes pentes, la composante verticale de l'énergie cinétique des gouttes d'eau étant réduite, la formation de croûtes de surface est limitée; que le film d'eau en surface est peu épais limitant l'effet splash et la formation de croûte. Cependant la compaction constatée et l'exportation de sédiments ne sont pas seulement expliqués par le seul facteur pluie et l'effet splash, les caractéristiques texturales et structurales du sol influençant directement l'encroûtement de ceux-ci.

C'est l'observation de la formation des états de surface qui a permis de mettre en relation directe l'infiltration et la pente démontrant une forte variabilité de l'infiltration le long du versant.

L'exploitation de ce milieu de forte pente est encore possible sous réserve de maintenir un couvert végétal ou au moins les résidus végétaux des cultures notamment dans les zones de concentration du ruissellement. Des études socio-économiques et physiques appliquées (paillage, inter-cultures, géotextile, plantes de couverture) ont été menées dans ce sens (Renaud, 1997; Lefroy *et al.*, 2000; Chearnkiatpradab, 2005; Croke and Hairsine, 2006) avec



des essais menés par le *Land Development Department* (2000-2012) et la section « eaux et forêts » du *National Park, Wildlife and Plant Conservation Department de Thaïlande*.



**Figure 25.** Champ de maïs sur forte pente du nord de la Thaïlande.

**b) Au nord du Mexique**, en milieu semi-aride, la classification des états de surface a révélé une distribution particulière au sein du *Mogote* qui est une des formations végétales représentatives du désert de Chihuahua. Quatre unités cartographiques ont été caractérisées de l'amont vers l'aval : 1) une large surface quasi plane sans végétation et fortement encroûtée ; 2) un front pionnier étroit où la végétation s'implante au sein de dépôts limono-sableux ; 3) une bande de végétation herbacée et arbustive très peu encroûtée à fort microrelief ; 4) une zone de senescence où une érosion en micro marche d'escalier est visible. Le constat est qu'elles sont indissociables au niveau hydrodynamique pour un bon fonctionnement de cet écosystème végétal xérophyte. Ces états de surface ont pu être classifiés en zones actives végétalisées où l'infiltration est la plus forte et en zones contributives variables couvertes de surfaces encroûtées permettant aux pluies de ruisseler et de concentrer le ruissellement.

Cet écosystème qui possède des limites physiques en terme de ressource en eau et en production végétale associée supporte un élevage extensif (Figure 26) mais un usage rationnel est possible sous réserve d'un contrôle de la densité de bétail en fonction de la biomasse végétale disponible (Barral and Hernandez, 1992; Barral *et al.*, 1993). **Les états de surface et leur évolution sont donc des indicateurs pertinents pour la gestion de ce type de milieu.**



**Figure 26.** Zone de pâturage extensif dans le Bolsón de Mapimí, Nord Mexique.

- c) **En Afrique du Sud**, une campagne de simulation de pluie a été menée dans un climat semi-humide en piedmont du massif du Drakensberg (formant une grande partie du Lesotho, « château d'eau » de l'Afrique du Sud) au sein de zones agropastorales dégradées par une forte charge animale et par une gestion déficiente des parcours (Figure 27). Cette étude a permis de **quantifier l'évolution des pertes en terre et le taux d'infiltration en fonction de la densité du couvert herbacé**.



**Figure 27.** Erosion hydrique et surpâturage du piedmont du Drakensberg dédié à l'élevage bovin.

Les résultats ont mis en évidence que les zones surpâturées étaient moins sensibles à l'érosion que les zones de cultures abandonnées et de cheminement d'animaux dédiés à nouveau à la

pâture. L'analyse de l'infiltration a montré qu'elle diminuait sensiblement en raison de la compaction des sols et de la diminution du couvert végétal.

Les pressions fortes sur les terres sont dues à l'histoire du pays (raisons politiques et sociologiques) qui a vu des réquisitions puis des restitutions de terres. A l'origine, elles étaient utilisées par des chasseurs devenus éleveurs puis elles ont été cultivées de façon intense pendant plusieurs décades. Depuis 1994, les terres sont redevenues à usage pastorale mais avec intensification de la densité des troupeaux de bovins. Ces évolutions de l'usage des terres ont engendré un appauvrissement du sol et une érosion intense (Eswaran *et al.*, 2001; Asner *et al.*, 2004). L'application rapide de mesures de gestion rationnelle des pâturages est donc nécessaire afin d'éviter l'accentuation du déséquilibre de la ressource en eau du sol.

**d)** En **Afrique du Sud**, dans la province du KwaZulu-Natal, une deuxième expérimentation a été menée au sein de pâturages dégradés par une forte charge animale. Le but a été de caractériser l'influence des scarabées fousseurs (bousiers) sur l'évolution de la porosité du sol et par conséquent sur l'infiltration de l'eau dans les sols à surface compactée. Deux campagnes de mesures de l'infiltration et de la détachabilité ont été menées sous simulation de pluie après la mise en place des bouses sur les parcelles expérimentales d'un m<sup>2</sup> (Figure 28). Ces mesures en deux temps ont permis d'observer la pérennité de l'augmentation de la porosité développée par les scarabées fousseurs.

Dans les deux cas, les coefficients d'infiltration ont augmentés de façon significative. Les micro-agrégats remontés en surface par les coléoptères sont rapidement réorganisés en surface. La densité apparente des dix premiers centimètres du sol a été réduite significativement et reste notable sur les six mois de l'expérimentation. L'humidité des sols de l'horizon A, a également augmenté jusqu'à 30 cm de profondeur au temps T2.



**Figure 28.** Dégradation des bouses de vaches par les scarabées fousseurs.

Ces résultats démontrent l'importance et la pérennité de la macroporosité induite par les scarabées fousseurs. En termes d'amélioration de l'infiltration, ils corroborent les études

menées sur d'autres ingénieurs du sol que sont les termites par Beven and Germann (1982); Elkins *et al.* (1986); Mando (1997); Leonard and Rajot (2001); Leonard *et al.* (2004).

e) **Au Nord du Vietnam** en climat tropical humide au sein d'un petit bassin versant à fortes pentes, le travail du sol effectué par les termites et les vers de terre est remarquable en termes de maintien de la structure. Le microrelief et la porosité générés par ces ingénieurs du sol est notable illustrant le volume de sol transformé (Figure 29).



**Figure 29.** Microrelief induit par les turrice de vers et micro-agrégation des sols par les termites.

Les mesures sous simulation de pluie ont permis d'estimer la dynamique de l'infiltrabilité sur le versant avec comme principal résultat **une augmentation de l'infiltration en présence forte de turrice** et au contraire **une formation de croûte de surface par dégradation des placages de termites instables sous l'effet de l'impact des gouttes de pluie et le rejaillissement des particules (effet « splash »)**. Des croûtes de types structurales alors formées augmentent le ruissellement et les pertes en sol.

f) **En climat d'altitude de l'Equateur** au sein du sillon inter-andin une expérimentation longue avec plusieurs campagnes de simulation de pluie a permis de **caractériser l'évolution à moyen terme des techniques de réhabilitation de la Cangahua pour une mise en culture intensive**. L'apparition des croûtes sur ces cendres indurées est rapide au sein des zones fraîchement labourées quel que soit la préparation fine ou grossière du sol (Figure 30). La rapide diminution de l'infiltration quel que soit le type d'amendement et le cycle cultural est aussi étroitement liée à la texture limono-sableuse qui sous l'influence de l'impact des gouttes de pluies induit une structure compactée. Cette « nouvelle » structure du sol joue un rôle fondamental sur le ruissellement et l'érodibilité puisque les parcelles à la stabilité structurale les plus faibles possèdent les coefficients d'infiltration les plus faibles.

La meilleure option de gestion de ces sols consiste à ne pas effectuer de labour après le premier défonçage du sol et de maintenir un couvert végétal permanent.



**Figure 30.** Préparation fine et grossière et encroûtement de la surface du sol de Cangahua.

**Les points communs** à ces six articles sont les états de surface et leurs évolutions sous l'effet de la pluie. Que la pente soit forte ou faible, cultivée ou non, nos expérimentations ont démontré que l'infiltration d'un sol peut-être totalement modifiée par l'évolution de son encroûtement et de son couvert végétal ou par la préparation culturale. Si bien sûr l'écosystème du Nord Mexique et celui du Nord-est de l'Afrique du Sud ne sont que peu comparables, l'usage de ceux-ci est identique, le bétail exploitant le couvert végétal. Dans les deux cas, le couvert végétal est d'autant plus efficace en termes d'infiltration qu'il absorbe l'énergie cinétique des gouttes de pluie et qu'il maintient une bonne porosité à la surface du sol. Dans le cas du *Mogote*, la présence de larges zones dénudées et encroûtées en alternance avec les bandes de végétation herbacée et arbustive permet une surcharge hydrique nécessaire au développement de la végétation.

Cependant, évoquer l'action protectrice d'un couvert végétal naturel ou cultivé ne suffit pas à expliciter les taux d'infiltration notamment en milieu agricole ; il faut aussi étudier l'impact des techniques culturales sur du long terme (cf. notre expérimentation sur trois ans en Equateur). En effet, les pratiques culturales qui contribuent à l'évolution de l'infiltration, permettent aussi d'obtenir des couverts de cultures recouvrant une forte proportion du sol durant les périodes de l'année où les pluies sont les plus agressives.

Enfin, caractériser l'influence des ingénieurs du sol sur l'infiltration permet d'estimer si la structure du sol permet en l'état de maintenir une hydrodynamique superficielle favorable à l'exploitation des sols ou s'il doit recevoir des apports d'amendements organiques contribuant à la potentielle réhabilitation de l'infiltration (cf. notre cas d'étude avec les bousiers).

## 7.1. INTERETS DES ETUDES A L'ECHELLE FINE DU METRE CARRE

Les mesures sous simulation de pluie (ou pluies naturelles) à l'échelle du 1 m<sup>2</sup> permettent une caractérisation fine des processus hydrologiques et une compréhension des mécanismes qui déterminent le partage de la pluie à l'interface sol-atmosphère. Les données en termes de variations de ruissellement et de détachabilité sont obtenues à des échelles de temps de la minute ce qui permet d'observer l'évolution et les seuils des propriétés hydrodynamiques de surface.

Considérant la complexité des agroécosystèmes, l'usage dans ce contexte du simulateur de pluie à l'échelle du mètre carré permet une répétitivité des mesures et de tester un nombre important de surfaces en un laps de temps restreint aussi bien en milieux naturels que cultivés. Cette méthode permet de couvrir la variabilité géographique et spatiale des milieux à l'échelle fine.

Les observations à l'échelle du mètre carré sont également utiles à la compréhension des processus à l'échelle du versant et bassin versant. Elles permettent notamment de paramétrer des modèles hydrologiques en vue de la prévision des débits à plus large échelle. Nous avons ainsi de nombreux modèles hydrologiques, soit conceptuels utilisés en sédimentation ou en agriculture notamment ; soit des modèles empiriques et des modèles physiques plus spécialisés dans les sols et érosion qui utilisent les données obtenues sous simulation de pluies ou sous pluies naturelles (Bajracharya *et al.*, 1992; Duiker *et al.*, 2001; Pudasaini *et al.*, 2004; Wang and Smith, 2004; Patin *et al.*, 2012).

Au niveau agronomique, elles permettent de définir et de tester des scénarios d'usage des terres (mosaïque paysagère) afin de mieux gérer la ressource en eau « verte » disponible pour les cultures et les pâturages. Au niveau sanitaire, il est possible d'étudier la dispersion des pathogènes et de polluants.

Les six expérimentations menées illustrent l'importance des états de surface définis principalement comme la végétation et les organisations morpho-pédologiques superficielles. Ils sont deux facteurs ayant un rôle déterminant sur l'hydrodynamique superficielle des sols aussi bien en milieu semi-aride, subhumide et humide notamment dès que le sol est travaillé. De plus, le rôle prépondérant des ingénieurs du sol au sens large englobant les bousiers, coléoptères enfouisseurs de matière organique a aussi été démontré.

Il a été aussi observé que le microrelief et le nanorelief à l'échelle du mètre carré sont également déterminants pour la genèse du ruissellement en nappe puis sa concentration entre agrégats, inter touffe ou à l'interface de différents états de surface.

L'eau étant un vecteur majeur du transport de matières dans les agroécosystèmes, ces travaux contribuent à expliciter la formation des chemins de l'eau permettant le transport des éléments dissous et des pathogènes au sein du bassin versant mais aussi jusqu'au niveau des retenues.

## 7.2. APPORTS EN TERMES DE DEVELOPPEMENT DES PAYS DU SUD.

Je ne peux conclure sans parler de recherche pour le développement dans les pays du sud car c'est la mission de l'IRD dont je suis un des nombreux acteurs depuis 30 ans. Outre que ces expérimentations ont permis d'apporter des connaissances pour des milieux spécifiques souvent fragilisés par l'Homme, elles ont aussi été des lieux d'échanges et de formation de nombreux collègues et étudiants des pays concernés. De ces cas d'études, les limites d'utilisation de certains paramètres physiques et biologiques des écosystèmes concernés ont été mises en exergue ; leurs gestions agropastorales pourraient en être améliorées.

Les changements politiques de la gestion de l'eau tels ceux générés par le bassin versant transfrontalier du Mékong et la combinaison des changements d'usages des sols liés aux évolutions climatiques, démographiques et de politiques régionales (barrage) démontrent toute la pertinence de la recherche pour comprendre l'impact de ces évolutions à l'échelle locale. Les petits exploitants agropastoraux des zones tropicales (105 pays et 49.9% de la surface de ces pays) représente en majorité une des populations les plus pauvres ; ils occupent les terres marginales, fragiles ou dégradées à faible production agricole et ils dépendent de l'eau de pluie pour leur survie ; ils sont donc particulièrement sensibles aux aléas climatiques.

Il y a une vraie demande à la fois de la part des agriculteurs/éleveurs et de la part des décideurs pour interagir avec la recherche pour le développement.

## 7.3. PERSPECTIVES

Les recherches complémentaires futures à l'aide de ces outils pourraient porter sur d'autres interactions entre facteurs biotiques et abiotiques de différents écosystèmes fragilisés par l'activité humaine. Ainsi et récemment, une étude en milieu tropicale humide (Nord Vietnam) sur l'exportation par le ruissellement du carbone organique dissous issu de différentes pratiques culturales a été menée, elle fait l'objet d'un article soumis (Janeau *et al.*, (Sub.)).

La dispersion des polluants (pesticides et eaux d'irrigation de qualité suburbaine) et la dynamique des nématodes et de bactéries transportés par l'eau et les sédiments, le long de toposéquences représentatives, sont des sujets d'actualité. Dans un créneau de recherche fondamentale, l'étude de l'évolution des croûtes salines et riches en cyanobactéries en partie haute de mangrove intéressent les spécialistes de ces milieux. Enfin des expérimentations combinant simulations de pluies et caractérisation des états de surface sont prévues sur mésocosmes terrestres (1 m<sup>2</sup> et 1 m<sup>3</sup>) pour tester le pouvoir de réhabilitation de l'infiltration de vers de terre sur le premier horizon du sol.

Dans le cadre de l'évolution actuelle des climats, le réchauffement de la planète confirmé par les études du GIEC accroît la fréquence des évènements extrêmes. La ceinture tropicale sera affectée fortement par les changements à venir et ainsi les sécheresses seront-elles plus fréquentes tout comme les fortes précipitations générant des inondations (cas récents du Vietnam et de la Thaïlande) qui détruisent les cultures et polluent l'eau douce. Le second paramètre d'évolution du milieu est la forte démographie dans ces pays qui génère des changements drastiques d'usage des sols. Ces changements climatiques et ces changements d'usage des sols (compétition arbres-herbes, mise en culture par défriche-brulis) évoluent très vite. Dans ce contexte, développer des études de l'ensemble des déterminants physiques et biologiques, des systèmes anthropisés et naturels à l'interface sol-atmosphère est donc pertinent. Mieux connaître ces facteurs permettra de mieux gérer la ressource en eau des bassins versants et par voie de conséquence l'usage de ceux-ci.



## 8. REFERENCES

- Abedini MJ, Dickinson WT, Rudra RP. 2006. On depression storage: The effect of DEM spatial resolution. *Journal of Hydrology* **318**: 138-150. 10.1016/j.jhydrol.2005.06.010.
- Abrahams PW. 2002. Soils: their implications to human health. *Science of the Total Environment* **291**: 1-32. 10.1016/S0048-9697(01)01102-0.
- Adekalu KO, Olorunfemi IA, Osunbitan JA. 2007. Grass mulching effect on infiltration, surface runoff and soil loss of three agricultural soils in Nigeria. *Bioresource Technology* **98**: 912-917. 10.1016/j.biortech.2006.02.044.
- Agassi M, Bradford JM. 1999. Methodologies for interrill soil erosion studies. *Soil & Tillage Research* **49**: 277-287. 10.1016/S0167-1987(98)00182-2.
- Ahuja LR, Elswaify SA, Rahman A. 1976. Measuring hydrologic properties of soil with a double ring infiltrometer and multiple depth tensiometers. *Soil Science Society of America Journal* **40**: 494-499.
- Ahuja LR, Johnsen KE, Heathman GC. 1995. Macropore transport of a surface applied bromide tracer, model evaluation and refinement. *Soil Science Society of America Journal* **59**: 1234-1241.
- Albergel J. 1988. *Genèse et prédétermination des crues au Burkina Faso. Du m<sup>2</sup> au km<sup>2</sup>, étude des paramètres hydrologiques et leur évolution*. Éditions de l'ORSTOM-INSTITUT FRANÇAIS DE RECHERCHE SCIENTIFIQUE POUR LE DÉVELOPPEMENT EN COOPÉRATION. Etudes et thèses. PARIS.
- Allard D. 1993. Some Connectivity Characteristics of a Boolean Model. *Acta Stereologica* **12**: 191-196.
- Ambroise B. 1999. *La dynamique du cycle de l'eau dans un bassin versant : processus, facteurs, modèles*. Editions HGA. Bucarest.
- Anctil F, Rousselle J, Lauzon N. 2012. *Hydrologie. Cheminements de l'eau. 2ème édition, Presses internationales polytechniques*. Montréal.
- Anderson JM, Ingram JSI. 1993. Tropical Soil Biology and Fertility. A Handbook of Methods. CAB International, Wallingford, Oxon, UK. 44-46.
- Angulo-Jaramillo R, Vandervaere JP, Roulier S, Thony JL, Gaudet JP, Vauclin M. 2000. Field measurement of soil surface hydraulic properties by disc and ring infiltrometers - A review and recent developments. *Soil & Tillage Research* **55**: 1-29. 10.1016/S0167-1987(00)00098-2.
- Arnaev J, Larrea V, Ortigosa L. 2004. Surface runoff and soil erosion on unpaved forest roads from rainfall simulation tests in northeastern Spain. *Catena* **57**: 1-14. 10.1016/j.catena.2003.09.002.
- Arnaez J, Lasanta T, Ruiz-Flano P, Ortigosa L. 2007. Factors affecting runoff and erosion under simulated rainfall in Mediterranean vineyards. *Soil & Tillage Research* **93**: 324-334. 10.1016/j.still.2006.05.013.

ASCE. 1996. *Hydrology Handbook. ASCE Manuals and Reports on Engineering Practice N°28*. Task Committee on Hydrology Handbook of Management Group D of ASCE. USA: Baltimore MD.

Asner GP, Elmore AJ, Olander LP, Martin RE, Harris AT. 2004. Grazing systems, ecosystem responses, and global change. *Annual Review of Environment and Resources* **29**: 261-299. 10.1146/annurev.energy.29.062403.102142.

Asseline J, Valentin C. 1978. Construction et mise au point d'un infiltromètre à aspersion. *ORSTOM - Série Hydrologie* **15**: 321-349.

Assouline S. 2004. Rainfall-induced soil surface sealing: A critical review of observations, conceptual models, and solutions. *Vadose Zone Journal* **3**: 570-591.

Auzet AV, Boiffin J, Ludwig B. 1995. Concentrated flow erosion in cultivated catchments: Influence of soil surface state. *Earth Surface Processes and Landforms* **20**: 759-767. 10.1002/esp.3290200807.

Badorreck A, Gerke HH, Huettl RF. 2013. Morphology of physical soil crusts and infiltration patterns in an artificial catchment. *Soil & Tillage Research* **129**: 1-8. 10.1016/j.still.2013.01.001.

Bajracharya RM, Elliot WJ, Lal R. 1992. Interrill erodibility of some Ohio soils based on field rainfall simulation. *Soil Science Society of America Journal* **56**: 267-272.

Bang HS, Lee JH, Kwon OS, Na YE, Jang YS, Kim WH. 2005. Effects of paracoprid dung beetles (Coleoptera : Scarabaeidae) on the growth of pasture herbage and on the underlying soil. *Applied Soil Ecology* **29**: 165-171. 10.1016/j.apsoil.2004.11.001.

Barral H, Hernandez L. 1992. *Resena del poblamiento y de la ganaderia en el bolson de Mapimi. In Estudio de la relaciones agua-suelo-vegetacion en una zona arida del Norte de Mexico orientado a la utilizacion racional de estos recursos para la ganaderia extensiva de bovinos, Xalapa : Instituto de Ecologia, 1992, p. 257-269. Delhoume J.-P., Maury M.E., Editors.*

Barral H, Orona Castillo I, Anaya E. 1993. Manejo ganadero en relacion con el recurso agua. Loyer J.-Y. EAJ, Jasso Ibarra R., Moreno Diaz L. . Estudio de los factores que influncian los escurrimientos y el uso del agua en la region hidrológica 36, Mexico (MEX). Paris. CENID-RASPA, ORSTOM. 287-304.

Barthes B, Azontonde A, Boli BZ, Prat C, Roose E. 2000. Field-scale run-off and erosion in relation to topsoil aggregate stability in three tropical regions (Benin, Cameroon, Mexico). *European Journal of Soil Science* **51**: 485-495. 10.1046/j.1365-2389.2000.00322.x.

Barthes B, Roose E. 2002. Aggregate stability as an indicator of soil susceptibility to runoff and erosion; validation at several levels. *Catena* **47**: 133-149. 10.1016/s0341-8162(01)00180-1.

Battany MC, Grismer ME. 2000. Rainfall runoff and erosion in Napa Valley vineyards: effects of slope, cover and surface roughness. *Hydrological processes* **14**: 1289-1304. 10.1002/(sici)1099-1085(200005)14:7<1289::aid-hyp43>3.0.co;2-r.

- Baumann J, Fechter-Escamilla U, Werner G. 1997. "Recultivation of eroded and indurated volcanic-ash soils. A contribution to securing agricultural production in the Central Mexican Highlands". *Applied Geography and Development* **50**: 7-20.
- Bayer A. 2001. *Influence de la pente sur l'infiltration et la perte en terre dans le nord de la Thaïlande. Mémoire de fin d'étude, ISTOM, Cergy-Pontoise, France.*
- Belnap J, Gillette DA. 1998. Vulnerability of desert biological soil crusts to wind erosion: the influences of crust development, soil texture, and disturbance. *Journal of Arid Environments* **39**: 133-142. 10.1006/jare.1998.0388.
- Belnap J, Reynolds RL, Reheis MC, Phillips SL, Urban FE, Goldstein HL. 2009. Sediment losses and gains across a gradient of livestock grazing and plant invasion in a cool, semi-arid grassland, Colorado Plateau, USA. *Aeolian Research* **1**: 27-43. 10.1016/j.aeolia.2009.03.001.
- Benavides-Solorio J, MacDonald LH. 2001. Post-fire runoff and erosion from simulated rainfall on small plots, Colorado Front Range. *Hydrological processes* **15**: 2931-2952. 10.1002/hyp.383.
- Bergkamp G, Cammeraat LH, MartinezFernandez J. 1996. Water movement and vegetation patterns on shrubland and an abandoned field in two desertification-threatened areas in Spain. *Earth Surface Processes and Landforms* **21**: 1073-1090. 10.1002/(sici)1096-9837(199612)21:12<1073::aid-esp640>3.0.co;2-8.
- Beven K, Germann P. 1982. Macropores and water flow in soils. *Water Resources Research* **18**: 1311-1325. 10.1029/WR018i005p01311.
- Bielders CL, Baveye P, Wilding LP, Drees LR, Valentin C. 1996. Tillage-induced spatial distribution of surface crusts on a sandy Paleustult from Togo. *Soil Science Society of America Journal* **60**: 843-855.
- Blanchart E, Albrecht A, Brown G, Decaens T, Duboisset A, Lavelle P, Mariani L, Roose E. 2004. Effects of tropical endogeic earthworms on soil erosion. *Agriculture Ecosystems & Environment* **104**: 303-315. 10.1016/j.agee.2004.01.031.
- Blijenberg HM, DeGraaf PJ, Hendriks MR, DeRuiter JF, VanTetering AAA. 1996. Investigation of infiltration characteristics and debris flow initiation conditions in debris flow source areas using a rainfall simulator. *Hydrological processes* **10**: 1527-1543. 10.1002/(sici)1099-1085(199611)10:11<1527::aid-hyp399>3.3.co;2-6.
- Boers TM, Vandeurzen F, Eppink L, Ruytenberg RE. 1992. Comparison of infiltration rates measured with an infiltrometer, a rainsimulator and a permeameter for erosion research in S.E Nigeria. *Soil Technology* **5**: 13-26. 10.1016/0933-3630(92)90003-j.
- Bosch JM, Hewlett JD. 1982. A review of catchment experiments to determine the effects of vegetation changes on water yield and evapotranspiration. *Journal of Hydrology* **55**: 3-23. 10.1016/0022-1694(82)90117-2.
- Bracken LJ, Croke J. 2007. The concept of hydrological connectivity and its contribution to understanding runoff-dominated geomorphic systems. *Hydrological processes* **21**: 1749-1763. 10.1002/hyp.6313.

- Bresson LM, Boiffin J. 1990. Morphological characterization of soil crust development stages on an experimental field. *Geoderma* **47**: 301-325. 10.1016/0016-7061(90)90035-8.
- Brooks SM, Richards KS, Nussbaum R. 1994. Simulator experiments of the varied consequences of rain forest logging for runoff and erosion. *Geografiska Annaler Series a-Physical Geography* **76**: 143-152. 10.2307/521033.
- Brown J, Scholtz CH, Janeau JL, Grellier S, Podwojewski P. 2010. Dung beetles (Coleoptera: Scarabaeidae) can improve soil hydrological properties. *Applied Soil Ecology* **46**: 9-16. 10.1016/j.apsoil.2010.05.010.
- Bui EN, Box JE. 1992. Stemflow, rain throughfall and erosion under canopies of corn and sorghum. *Soil Science Society of America Journal* **56**: 242-247.
- Bui Tan Yen, Orange D, Visser SM, Chu TH, Laissus M, Poortinga A, Tran DT, Stroosnijder L. 2013. Lumped surface and sub-surface runoff for erosion modeling within a small hilly watershed in northern Vietnam. *Hydrological processes* 10.1002/hyp.9860.
- Burwell RE, Allmara S, Sloneker LL. 1966. Structural alteration of soil surfaces by tillage and rainfall. *Soil Water Conservation* **21**: 61-63.
- Camus H, Berthault C. 1972. Influence du couvert végétal sur la perméabilité des sols du bassin représentatif de Korhogo (Côte d'ivoire). *Cahier O.R.S.T.O.M, sér. Hydrologie* **IX**: 3-13.
- Casenave A, Valentin C. 1989. *Les états de surface de la zone sahélienne. Influence sur l'infiltration*. Editions de l'Orstom. Didactiques C, 32 Av Henri Varagnat - 93143 Bondy cedex - France.
- Casenave A, Valentin C. 1992. A runoff capability classification system based on surface features criteria in semiarid areas of West Africa. *Journal of Hydrology* **130**: 231-249. 10.1016/0022-1694(92)90112-9.
- Cerda A. 1998. The influence of aspect and vegetation on seasonal changes in erosion under rainfall simulation on a clay soil in Spain. *Canadian Journal of Soil Science* **78**: 321-330.
- Cerda A. 2001. Effects of rock fragment cover on soil infiltration, interrill runoff and erosion. *European Journal of Soil Science* **52**: 59-68. 10.1046/j.1365-2389.2001.00354.x.
- Cerda A, Ibanez S, Calvo A. 1997. Design and operation of a small and portable rainfall simulator for rugged terrain. *Soil Technology* **11**: 163-170. 10.1016/s0933-3630(96)00135-3.
- Cerdan O, Souchere V, Lecomte V, Couturier A, Le Bissonnais Y. 2002. Incorporating soil surface crusting processes in an expert-based runoff model: Sealing and Transfer by Runoff and Erosion related to Agricultural Management. *Catena* **46**: 189-205. 10.1016/s0341-8162(01)00166-7.
- Chabrier C, Carles C, Queneherve P, Cabidoche Y-M. 2008. Nematode dissemination by water leached in soil: Case study of *Radopholus similis* (Cobb) Thorne on nitisol under simulated rainfall. *Applied Soil Ecology* **40**: 299-308. 10.1016/j.apsoil.2008.05.004.
- Chaplot V, Brown J, Dlamini P, Eustice T, Janeau JL, Jewitt G, Lorentz S, Martin L, Nontokozo-Mchunu C, Oakes E, Podwojewski P, Revil S, Rumpel C, Zondi N. 2011. Rainfall

simulation to identify the storm-scale mechanisms of gully bank retreat. *Agricultural Water Management* **98**: 1704-1710. 10.1016/j.agwat.2010.05.016.

Chaplot V, Le Bissonnais Y. 2000. Field measurements of interrill erosion under different slopes and plot sizes. *Earth Surface Processes and Landforms* **25**: 145-153. 10.1002/(sici)1096-9837(200002)25:2<145::aid-esp51>3.0.co;2-3.

Chearnkiatpradab B. 2005. *Expert system for slope stabilization*. Chu J, Phoon KK and Yong KY, Geotechnical Engineering for Disaster Mitigation and Rehabilitation.

Chen SK, Liu CWI. 2002. Analysis of water movement in paddy rice fields (I) experimental studies. *Journal of Hydrology* **260**: 206-215. 10.1016/s0022-1694(01)00615-1.

Cisneros F. 1997. Influencia de la vegetación sobre la hidrodinámica de los suelos en una toposecuencia representativa de la cuenca Rumihurcu Tesis de Grado. Universidad Central de Ecuador, Facultad de Ciencias Agrícolas, Quito, Ecuador., Quito, Ecuador.

Clarke MA, Walsh RPD. 2007. A portable rainfall simulator for field assessment of splash and slopewash in remote locations. *Earth Surface Processes and Landforms* **32**: 2052-2069. 10.1002/esp.1526.

Coe KK, Belnap J, Sparks JP. 2012. Precipitation-driven carbon balance controls survivorship of desert biocrust mosses. *Ecology* **93**: 1626-1636.

Collinet J. 1984. Hydrodynamique superficielle et erosion comparées de quelques sols ferrallitiques sur défriches forestières traditionnelles (Côte d'Ivoire). IAHS. Challenges in Africa Hydrology and Water Resources. Proceedings of the Harare Symposium. . Harare, Zimbabwe. IAHS 144.

Collinet J. 1988. Comportements hydrodynamiques et érosifs de sols d'Afrique de l'Ouest. Evolution des matériaux et des organisations sous simulation de pluie. Doctorat de l'Université L. Pasteur de Strasbourg, mention : géologie-pédologie. Université Louis Pasteur, Strasbourg.

Collinet J, Valentin C. 1979. Analyse des différents facteurs intervenant sur l'hydrodynamique superficielle. Nouvelles perspectives. Applications agronomiques. *Cahier ORSTOM, série pédologie* **17**: 233-328.

Collins R, Elliott S, Adams R. 2005. Overland flow delivery of faecal bacteria to a headwater pastoral stream. *Journal of Applied Microbiology* **99**: 126-132. 10.1111/j.1365-2672.2005.02580.x.

Cornet A. 1988. *Principales caractéristiques physiques, In. Estudio integrado de los recursos vegetation, suelos y agua en la reserva de la biosfera de Mapimi*. Instituto de Ecologia. Mexico DF. 45-77.

Cosandey C, Robinson M. 2012. *Hydrologie continentale*. Éditions Armand COLIN collection U, 2ème édition.

Croke J, Mockler S, Fogarty P, Takken I. 2005. Sediment concentration changes in runoff pathways from a forest road network and the resultant spatial pattern of catchment connectivity. *Geomorphology* **68**: 257-268. 10.1016/j.geomorph.2004.11.020.

- Croke JC, Hairsine PB. 2006. Sediment delivery in managed forests: a review. *Environmental Reviews* **14**: 59-87. 10.1139/a05-016.
- de Chazal J, Rounsevell MDA. 2009. Land-use and climate change within assessments of biodiversity change: A review. *Global Environmental Change-Human and Policy Dimensions* **19**: 306-315. 10.1016/j.gloenvcha.2008.09.007.
- de Noni G, Trujillo G, Viennot M. 1993. Ensayo de analisis historico, social y economico de la cangahua en el Ecuador *In Geografia agraria : esbozos de la problematica agraria en el Ecuador, Quito (ECU), Quito : Corporacion Editora Nacional, Colegio de Geografos, (Estudios de Geografia). Lopez Freddy (ed.)* 58-65.
- De Noni G, Viennot M, Asseline J, Trujillo G. 2001. Terres d'altitude, terres de risque. La lutte contre l'érosion dans les Andes équatoriennes. *Latitudes* **23**: 113-115.
- De Noni G, Viennot M, Trujillo G. 1989-1990. Mesures de l'érosion dans les Andes en Equateur. *Cah. ORSTOM, sér. pédol., XXV(1-2)*: 183-196.
- De Ploey J, Savat J, Moeyersons J. 1976. The differential impact of some soil loss factors on flow, runoff creep and rainwash. *Earth Surface Processes and Landforms* **1**: 151-161.
- Deluca TH, Patterson WA, Freimund WA, Cole DN. 1998. Influence of llamas, horses, and hikers on soil erosion from established recreation trails in western Montana, USA. *Environmental Management* **22**: 255-262. 10.1007/s002679900101.
- Descroix L, Viramontes D, Vauclin M, Barrios JLG, Esteves M. 2001. Influence of soil surface features and vegetation on runoff and erosion in the Western Sierra Madre (Durango, Northwest Mexico). *Catena* **43**: 115-135. 10.1016/s0341-8162(00)00124-7.
- Djorovic M. 1980. Slope effect on runoff and erosion. In De Boodt MaG, D. (Eds). *Assessment of Erosion*,. 215-225.
- Duiker SW, Flanagan DC, Lal R. 2001. Erodibility and infiltration characteristics of five major soils of southwest Spain. *Catena* **45**: 103-121. 10.1016/s0341-8162(01)00145-x.
- Duley FL. 1939. Surface factors affecting the rate of intake of water by soils. *Soil Science Society of America Proceedings* **4**: 60-64.
- Dunkerley D. 2002a. Systematic variation of soil infiltration rates within and between the components of the vegetation mosaic in an Australian desert landscape. *Hydrological processes* **16**: 119-131. 10.1002/hyp.357.
- Dunkerley DL. 2002b. Infiltration rates and soil moisture in a groved mulga community near Alice Springs, arid central Australia: evidence for complex internal rainwater redistribution in a runoff-runon landscape. *Journal of Arid Environments* **51**: 199-219. 10.1006/jare.2001.0941.
- Dunn GH, Phillips RE. 1991. Macroporosity of a well drained soil under no till and conventional tillage. *Soil Science Society of America Journal* **55**: 817-823.
- Eldridge DJ, Greene RSB. 1994. Microbiotic soil crusts. A review of their roles in soil and ecological processes in the rangelands of Australia. *Australian Journal of Soil Research* **32**: 389-415. 10.1071/sr9940389.

- Eldridge DJ, Kinnell PIA. 1997. Assessment of erosion rates from microphyte-dominated calcareous soils under rain-impacted flow. *Australian Journal of Soil Research* **35**: 475-489. 10.1071/s96072.
- Elkins NZ, Sabol GV, Ward TJ, Whitford WG. 1986. The influence of subterranean termites on the hydrological characteristics of a Chihuahuan desert ecosystem. *Oecologia* **68**: 521-528. 10.1007/bf00378766.
- Ellison WD, Pomeroy WH. 1944. A rainfall applicator. *Agricultural Engineering* **25**: 220-225.
- Elsenbeer H. 2001. Hydrologic flowpaths in tropical rainforest soilscapes - a review. *Hydrological processes* **15**: 1751-1759. 10.1002/hyp.237.
- Emmerich WE, Cox JR. 1992. Hydrologic characteristics immediately after seasonal burning on introduced and native grasslands. *Journal of Range Management* **45**: 476-479. 10.2307/4002905.
- Esteves M, Planchon O, Lapetite JM, Silvera N, Cadet P. 2000. The 'EMIRE' large rainfall simulator: Design and field testing. *Earth Surface Processes and Landforms* **25**: 681-690. 10.1002/1096-9837(200007)25:7<681::aid-esp124>3.0.co;2-8.
- Eswaran H, Lal R, Reich PF. 2001. *Land degradation: An overview*. Bridges EM, Hannam ID, Oldeman LR, DeVries WTP, Scherr SJ and Sombatpanit S, Response to Land Degradation.
- FAO. 2010. *Global forest resources assessment 2010, Main report*. Food and Agriculture Organization of the United Nations and European Commission Joint Research Centre, FAO Forestry Paper. Rome.
- FAO and JRC. 2012. *Global forest land-use change 1990–2005*. Food and Agriculture Organization of the United Nations and European Commission Joint Research Centre, E.J. Lindquist RDA, A. Gerrand, K. MacDicken, F. Achard, R. Beuchle, A. Brink, H.D. Eva, and P. Mayaux JS-M-AH-JS. FAO Forestry Paper. Rome.
- Fierer NG, Gabet EJ. 2002. Carbon and nitrogen losses by surface runoff following changes in vegetation. *Journal of Environmental Quality* **31**: 1207-1213.
- Fincher GT. 1981. The potential value of dung beetles in pasture ecosystems. *Journal of the Georgia Entomological Society* **16**: 316-333.
- Foot K, Morgan RPC. 2005. The role of leaf inclination, leaf orientation and plant canopy architecture in soil particle detachment by raindrops. *Earth Surface Processes and Landforms* **30**: 1509-1520. 10.1002/esp.1207.
- Fox DM, Bryan RB, Price AG. 1997. The influence of slope angle on final infiltration rate for interrill conditions. *Geoderma* **80**: 181-194. 10.1016/s0016-7061(97)00075-x.
- Fox DM, Le Bissonnais Y, Bruand A. 1998. The effect of ponding depth on infiltration in a crusted surface depression. *Catena* **32**: 87-100. 10.1016/s0341-8162(98)00042-3.

- Frasson RpdM, Krajewski WF. 2011. Characterization of the drop-size distribution and velocity-diameter relation of the throughfall under the maize canopy. *Agricultural and Forest Meteorology* **151**: 1244-1251. 10.1016/j.agrformet.2011.05.001.
- Gabet EJ, Dunne T. 2003. Sediment detachment by rain power. *Water Resources Research* **39**: 10.1029/2001wr000656.
- GIEC. 2007. *Bilan 2007 des changements climatiques. Contribution des Groupes de travail I, II et III au quatrième Rapport d'évaluation du Groupe d'experts intergouvernemental sur l'évolution du climat. Équipe de rédaction principale, Pachauri, R.K. et Reisinger, A.* GIEC, Genève, Suisse.
- Gijsman AJ. 1996. Soil aggregate stability and soil organic matter fractions under agropastoral systems established in native savanna. *Australian Journal of Soil Research* **34**: 891-907. 10.1071/sr9960891.
- Gomes L, Arrue JL, Lopez MV, Sterk G, Richard D, Gracia R, Sabre M, Gaudichet A, Frangi JP. 2003. Wind erosion in a semiarid agricultural area of Spain: the WELSONS project. *Catena* **52**: 235-256. 10.1016/s0341-8162(03)00016-x.
- Govers G. 1991. A field study on topographical and topsoil effects on runoff generation. *Catena* **18**: 91-111. 10.1016/0341-8162(91)90009-m.
- Greene RSB. 1992. Soil physical properties of 3 geomorphic zones in a semi-arid mulga woodland. *Australian Journal of Soil Research* **30**: 55-69. 10.1071/sr9920055.
- Greene RSB, Hairsine PB. 2004. Elementary processes of soil-water interaction and thresholds in soil surface dynamics: A review. *Earth Surface Processes and Landforms* **29**: 1077-1091. 10.1002/esp.1103.
- Greene RSB, Kinnell PIA, Wood JT. 1994. Role of plant cover and stock trampling on runoff and soil erosion from semiarid wooded rangelands. *Australian Journal of Soil Research* **32**: 953-973. 10.1071/sr9940953.
- Gregory JH, Dukes MD, Jones PH, Miller GL. 2006. Effect of urban soil compaction on infiltration rate. *Journal of Soil and Water Conservation* **61**: 117-124.
- Grellier S. 2011. Hillslope encroachment by *Acacia sieberiana* in a deep-gullied grassland of KwaZulu-Natal (South Africa). PhD thesis. University of Pierre and Marie Curie, Paris, France.
- Grellier S, Barot S, Janeau JL, Ward D. 2012a. Grass competition is more important than seed ingestion by livestock for *Acacia* recruitment in South Africa. *Plant Ecology* **213**: 899-908. 10.1007/s11258-012-0051-3.
- Grellier S, Kemp J, Janeau JL, Florsch N, Ward D, Barot S, Podwojewski P, Lorentz S, Valentin C. 2012b. The indirect impact of encroaching trees on gully extension: A 64 year study in a sub-humid grassland of South Africa. *Catena* **98**: 110-119. 10.1016/j.catena.2012.07.002.
- Grierson IT, Oades JM. 1977. Rainfall simulator for field studies of runoff and soil erosion. *Journal of Agricultural Engineering Research* **22**: 37-44. 10.1016/0021-8634(77)90091-9.



- Grote EE, Belnap J, Housman DC, Sparks JP. 2010. Carbon exchange in biological soil crust communities under differential temperatures and soil water contents: implications for global change. *Global Change Biology* **16**: 2763-2774. 10.1111/j.1365-2486.2010.02201.x.
- Grünberger O, Reyes Gomez V, Janeau JL. 2005. *Las playas del desierto Chihuahuense (parte mexicana). Influencia de las sales en ambientes árido y semiárido. Ediciones Instituto de Ecología, A.C. – IRD Francia. Xalapa, Veracruz, Mexico. 355p.*
- Guerrero C, Mataix-Solera J, Navarro-Pedreno J, Garcia-Orenes F, Gomez I. 2001. Different patterns of aggregate stability in burned and restored soils. *Arid Land Research and Management* **15**: 163-171. 10.1080/15324980151062823.
- Gumbs E, Lindsay JI, Nasir M, Angella M. 1986. Soil erosion studies in the northern mountain range, Trinidad, under different crop and soil management. In: Soil erosion and conservation. Madison, USA. Soil Conservation Society of America. 90-98.
- Gupta SC, Lowery B, Moncrief JF, Larson WE. 1991. Modeling tillage effects on soil physical properties. *Soil & Tillage Research* **20**: 293-318. 10.1016/0167-1987(91)90045-y.
- Gyssels G, Poesen J, Bochet E, Li Y. 2005. Impact of plant roots on the resistance of soils to erosion by water: a review. *Progress in Physical Geography* **29**: 189-217. 10.1191/0309133305pp443ra.
- Hamed Y, Albergel J, Pepin Y, Asseline J, Nasri S, Zante P, Berndtsson R, El-Niazy M, Balah M. 2002. Comparison between rainfall simulator erosion and observed reservoir sedimentation in an erosion-sensitive semiarid catchment. *Catena* **50**: 1-16. 10.1016/s0341-8162(02)00089-9.
- Harel MA. 2013. Modélisation du ruissellement sur une surface à infiltrabilité aléatoire par la théorie des files d'attente. thèse de Docteur. GRN - UPMC, Paris.
- Harrison YA, Shackleton CM. 1999. Resilience of South African communal grazing lands after the removal of high grazing pressure. *Land Degradation & Development* **10**: 225-239. 10.1002/(sici)1099-145x(199905/06)10:3<225::aid-ldr337>3.0.co;2-t.
- Hassel JM, Richter G. 1992. Comparison of German and Swiss rainfall simulators, rain structure and kinetic energy. *Zeitschrift Fur Pflanzenernahrung Und Bodenkunde* **155**: 185-190. 10.1002/jpln.19921550305.
- Healy RW, Cook PG. 2002. Using groundwater levels to estimate recharge. *Hydrogeology Journal* **10**: 91-109. 10.1007/s10040-001-0178-0.
- Herrick JE, Lal R. 1995. Soil physical property changes during dung decomposition in a tropical pasture. *Soil Science Society of America Journal* **59**: 908-912.
- Hewlett JD. 1961. Soil moisture as source of base flow from steep mountain watershed. *US Forest Service, Southeastern Forest Experiment Station, Asheville, North Carolina*
- Hiernaux P, Biélers CL, Valentin C, Bationo A, Fernandez-Rivera S. 1999. Effects of livestock grazing on physical and chemical properties of sandy soils in Sahelian rangelands. *Journal of Arid Environments* **41**: 231-245. 10.1006/jare.1998.0475.

- Hofstede RGM, Chilito EJ, Sandovals EM. 1995. Vegetative structure, microclimate, and leaf growth of a Paramo tussock grass species in undisturbed, burned and grazed conditions. *Vegetatio* **119**: 53-65.
- Holdren JP, Ehrlich PR. 1974. Human population and the global environment. *American scientist* **62**: 282-92.
- Humphry JB, Daniel TC, Edwards DR, Sharpley AN. 2002. A portable rainfall simulator for plot-scale runoff studies. *Applied Engineering in Agriculture* **18**: 199-204.
- Huon S, Valentin C. 2001. *Impact de la pratique de défriche-brûlis sur la dynamique de la matière organique et l'érosion hydrique et aratoire d'un petit bassin versant au Laos. Rapport 2000, programme national " sols et érosion", IRD Paris, France.*
- Imeson AC. 1977. A simple field portable rainfall simulator for difficult terrain. *Earth Surface Processes and Landforms* **2**: 431-436.
- Issa OM, Le Bissonnais Y, Defarge C, Trichet J. 2001. Role of a cyanobacterial cover on structural stability of sandy soils in the Sahelian part of western Niger. *Geoderma* **101**: 15-30.
- Janeau JL, Bricquet JP, Planchon O, Valentin C. 2003. Soil crusting and infiltration on steep slopes in northern Thailand. *European Journal of Soil Science* **54**: 543-553. 10.1046/j.1365-2389.2003.00494.x.
- Janeau JL, Gillard L-C, Jouquet P, Le Thi Phuong Quynh, Luu Thi Nguyet Minh, Ngo Quoc Anh, Orange D, Tran Duc Toan, Tran Sy Hai, Trinh Anh Duc, Valentin C, Rochelle-Newall E. (Sub.). Small upland, farmed catchments export high loads of soil DOC to downstream aquatic systems in tropical watersheds. *Agriculture Ecosystems & Environment* **Sub.:**
- Janeau JL, Mauchamp A, Tarin G. 1999. The soil surface characteristics of vegetation stripes in Northern Mexico and their influences on the system hydrodynamics - An experimental approach. *Catena* **37**: 165-173. 10.1016/s0341-8162(98)00059-9.
- Janeau JL, Valentin C. 1987. Relationships between termite mounds of Trinervitermes and soil surface, rearrangement, runoff and erosion. *Revue d'Ecologie et de Biologie du Sol* **24**: 637-647.
- Jayawardena AW, Bhuiyan RR. 1999. Evaluation of an interrill soil erosion model using laboratory catchment data. *Hydrological processes* **13**: 89-100. 10.1002/(sici)1099-1085(199901)13:1<89::aid-hyp677>3.0.co;2-t.
- Jester W, Klik A. 2005. Soil surface roughness measurement - methods, applicability, and surface representation. *Catena* **64**: 174-192. 10.1016/j.catena.2005.08.005.
- Johnson CB, Mannering TV, Moldenhauer WC. 1979. Influence of surface roughness and clod size and stability on soil and water losses. *Soil Science Society of America Journal* **43**: 772-777.
- Johnson CW, Gordon ND. 1988. Runoff and erosion from rainfall simulator plots on sagebrush rangeland. *Transactions of the Asae* **31**: 421-427.
- Jones OR, Hauser VL, Popham TW. 1994. No tillage effects on infiltration, runoff and water conservation on dryland. *Transactions of the Asae* **37**: 473-479.

- Jordan A, Martinez-Zavala L. 2008. Soil loss and runoff rates on unpaved forest roads in southern Spain after simulated rainfall. *Forest Ecology and Management* **255**: 913-919. 10.1016/j.foreco.2007.10.002.
- Jouquet P, Bottinelli N, Kerneis G, Henry-des-Tureaux T, Doan TT, Planchon O, Tran TD. 2013. Surface casting of the tropical *Metaphire posthuma* increases soil erosion and nitrate leaching in a laboratory experiment. *Geoderma* **204-205**: 10-14.
- Jouquet P, Bottinelli N, Podwojewski P, Hallaire V, Duc TT. 2008a. Chemical and physical properties of earthworm casts as compared to bulk soil under a range of different land-use systems in Vietnam. *Geoderma* **146**: 231-238. 10.1016/j.geoderma.2008.05.030.
- Jouquet P, Dauber J, Lagerlof J, Lavelle P, Lepage M. 2006. Soil invertebrates as ecosystem engineers: Intended and accidental effects on soil and feedback loops. *Applied Soil Ecology* **32**: 153-164. 10.1016/j.apsoil.2005.07.004.
- Jouquet P, Janeau J-L, Pisano A, Hai Tran S, Orange D, Luu Thi Nguyet M, Valentin C. 2012. Influence of earthworms and termites on runoff and erosion in a tropical steep slope fallow in Vietnam: A rainfall simulation experiment. *Applied Soil Ecology* **61**: 161-168. 10.1016/j.apsoil.2012.04.004.
- Jouquet P, Podwojewski P, Bottinelli N, Mathieu J, Ricoy M, Orange D, Toan Duc T, Valentin C. 2008b. Above-ground earthworm casts affect water runoff and soil erosion in Northern Vietnam. *Catena* **74**: 13-21. 10.1016/j.catena.2007.12.006.
- Kainz M, Auerswald K, Vohringer R. 1992. Comparison of German and Swiss rainfall simulators, utility, labor demands and costs. *Zeitschrift Fur Pflanzenernahrung Und Bodenkunde* **155**: 7-11. 10.1002/jpln.19921550103.
- Kaouritchev I. 1983. *Manuel pratique de pédologie*. Editions MIR Moscou.
- Kato H, Onda Y, Tanaka Y, Asano M. 2009. Field measurement of infiltration rate using an oscillating nozzle rainfall simulator in the cold, semiarid grassland of Mongolia. *Catena* **76**: 173-181. 10.1016/j.catena.2008.11.003.
- Kemper W.D., Roseneau R.C. 1986. *Wet sieving*. In *Methods of soil analysis: Part 1, Physical and Mineralogical Properties, 2nd edition*. American Society of Agronomy, Madison, WI. 435-442.
- Kidron GJ, Tal SY. 2012. The effect of biocrusts on evaporation from sand dunes in the Negev Desert. *Geoderma* **179**: 104-112. 10.1016/j.geoderma.2012.02.021.
- Kinnell PIA. 2005. Raindrop-impact-induced erosion processes and prediction: a review. *Hydrological processes* **19**: 2815-2844. 10.1002/hyp.5788.
- Kinnell PIA. 2009. The impact of slope length on the discharge of sediment by rain impact induced saltation and suspension. *Earth Surface Processes and Landforms* **34**: 1393-1407. 10.1002/esp.1828.
- Kirkby MJ. 1978. *Hillslope hydrology*. Wiley, Chichester. 389.
- Lafforgue A. 1977. Inventaire et examen des processus élémentaires de ruissellement et d'infiltration sur parcelles. *Cahiers ORSTOM, série Hydrologie* **XIV(4)**: 299-344.

- Lafforgue A, Casenave A. 1980. Derniers résultats obtenus en zone tropicale sur les modalités de transfert pluie-débit par l'emploi de simulateurs de pluie. *La houille blanche* **4-5**: 243-249.
- Lai JB, Luo Y, Ren L. 2012. Numerical Evaluation of Depth Effects of Double-Ring infiltrometers on Soil Saturated Hydraulic Conductivity Measurements. *Soil Science Society of America Journal* **76**: 867-875. 10.2136/sssaj2011.0048.
- Lal R. 1998. Soil erosion impact on agronomic productivity and environment quality. *Critical Reviews in Plant Sciences* **17**: 319-464. 10.1016/s0735-2689(98)00363-3.
- Lal R. 2000. Soil management in the developing countries. *Soil Science* **165**: 57-72. 10.1097/00010694-200001000-00008.
- Lal R. 2003. Soil erosion and the global carbon budget. *Environment International* **29**: 437-450. 10.1016/s0160-4120(02)00192-7.
- Lambin EF, Geist HJ, Lepers E. 2003. Dynamics of land-use and land-cover change in tropical regions. *Annual Review of Environment and Resources* **28**: 205-241. 10.1146/annurev.energy.28.050302.105459.
- Land Development Department. 2000-2012. Soil and Water Conservation. Thailand. [http://www.ldd.go.th/web\\_eng56/Research/Soil\\_and\\_Water\\_Conservation.html](http://www.ldd.go.th/web_eng56/Research/Soil_and_Water_Conservation.html)
- Lassabatere L, Angulo-Jaramillo R, Ugalde JMS, Cuenca R, Braud I, Haverkamp R. 2006. Beerkan estimation of soil transfer parameters through infiltration experiments - BEST. *Soil Science Society of America Journal* **70**: 521-532. 10.2136/sssaj2005.0026.
- Lavelle P, Barois I, Blanchart E, Brown G, Brussaard L, Decaens T, Fragoso C, Jimenez JJ, Kajondo KK, Martinez MD, Moreno A, Pashanasi B, Senapati B, Villenave C. 1998. Earthworms as a resource in tropical agroecosystems. *Nature & Resources* **34**: 26-41.
- Lavelle P, Bignell D, Lepage M, Wolters V, Roger P, Ineson P, Heal OW, Dhillion S. 1997. Soil function in a changing world: the role of invertebrate ecosystem engineers. *European Journal of Soil Biology* **33**: 159-193.
- Lavelle P, Blanchart E, Martin A, Martin S, Spain A, Toutain F, Barois I, Schaefer R. 1993. A hierarchical model for decomposition in terrestrial ecosystems. Applications to soils of the humid tropics. *Biotropica* **25**: 130-150. 10.2307/2389178.
- Le Bissonnais Y. 1996. Aggregate stability and assessment of soil crustability and erodibility .1. Theory and methodology. *European Journal of Soil Science* **47**: 425-437.
- Le Bissonnais Y, Benkhadra H, Chaplot V, Fox D, King D, Daroussin J. 1998. Crusting, runoff and sheet erosion on silty loamy soils at various scales and upscaling from m(2) to small catchments. *Soil & Tillage Research* **46**: 69-80. 10.1016/s0167-1987(97)00079-2.
- Le Bissonnais Y, Cerdan O, Lecomte V, Benkhadra H, Souchere V, Martin P. 2005. Variability of soil surface characteristics influencing runoff and interrill erosion. *Catena* **62**: 111-124. 10.1016/j.catena.2005.05.001.
- Le Bissonnais Y, Singer MJ. 1992. Crusting, runoff and erosion response to soil water content and successive rainfalls. *Soil Science Society of America Journal* **56**: 1898-1903.

- Le Bissonnais Y, Singer MJ. 1993. Seal formation, runoff, and interrill erosion from seventeen California soils. *Soil Science Society of America Journal* **57**: 224-229.
- Lefroy RDB, Bechstedt HD, Rais M. 2000. Indicators for sustainable land management based on farmer surveys in Vietnam, Indonesia, and Thailand. *Agriculture Ecosystems & Environment* **81**: 137-146. 10.1016/S0167-8809(00)00187-0.
- Leonard J, Perrier E, Rajot JL. 2004. Biological macropores effect on runoff and infiltration: a combined experimental and modelling approach. *Agriculture Ecosystems & Environment* **104**: 277-285. 10.1016/j.agee.2003.11.015.
- Leonard J, Rajot JL. 2001. Influence of termites on runoff and infiltration: quantification and analysis. *Geoderma* **104**: 17-40. 10.1016/S0016-7061(01)00054-4.
- Levia DF, Frost EE. 2003. A review and evaluation of stemflow literature in the hydrologic and biogeochemical cycles of forested and agricultural ecosystems. *Journal of Hydrology* **274**: 1-29. 10.1016/S0022-1694(02)00399-2.
- Lin H. 2010. Earth's Critical Zone and hydrogeology: concepts, characteristics, and advances. *Hydrology and Earth System Sciences* **14**: 25-45.
- Liu H, Lei TW, Zhao J, Yuan CP, Fan YT, Qu LQ. 2011. Effects of rainfall intensity and antecedent soil water content on soil infiltrability under rainfall conditions using the run off-on method. *Journal of Hydrology* **396**: 24-32. 10.1016/j.jhydrol.2010.10.028.
- Loch RJ, Donnollan TE. 1983. Field rainfall simulator studies on 2 clay soils of the Darling Downs, Queensland. 1 The effects of plot length and tillage orientation on erosion processes and runoff and erosion rates. *Australian Journal of Soil Research* **21**: 33-46. 10.1071/SR9830033.
- Lozet J, Mathieu C. 1997. *Dictionnaire de la science du sol*. Editions Lavoisier - Paris - France. Edition è,
- Ludwig JA, Wilcox BP, Breshears DD, Tongway DJ, Imeson AC. 2005. Vegetation patches and runoff-erosion as interacting ecohydrological processes in semiarid landscapes. *Ecology* **86**: 288-297. 10.1890/03-0569.
- Luteyn JL. 1999. Páramos. A checklist of plant diversity, geographical distribution and botanical literature, *Memoirs of the New York Botanical Gardens* Vol. 84. New York. pp 278.
- Mah MGC, Douglas LA, Ringrosevoase AJ. 1992. Effects of crust development and surface slope on erosion by rainfall. *Soil Science* **154**: 37-43. 10.1097/00010694-199207000-00005.
- Maidment DR. 1993. *Handbook of hydrogeology*. Mc Graw Hill.
- Mandal UK, Rao KV, Mishra PK, Vittal KPR, Sharma KL, Narsimlu B, Venkanna K. 2005. Soil infiltration, runoff and sediment yield from a shallow soil with varied stone cover and intensity of rain. *European Journal of Soil Science* **56**: 435-443. 10.1111/j.1365-2389.2004.00687.x.
- Mando A. 1997. The impact of termites and mulch on the water balance of crusted Sahelian soil. *Soil Technology* **11**: 121-138. 10.1016/S0933-3630(97)00003-2.

- Mando A, Stroosnijder L, Brussaard L. 1996. Effects of termites on infiltration into crusted soil. *Geoderma* **74**: 107-113. 10.1016/s0016-7061(96)00058-4.
- Mauchamp A, Janeau JL. 1993. Water funnelling by the crown of *Flourensia Cernua*, a Chihuahuan desert shrub. *Journal of Arid Environments* **25**: 299-306. 10.1006/jare.1993.1062.
- McIntyre S, Lavorel S. 2007. A conceptual model of land use effects on the structure and function of herbaceous vegetation. *Agriculture Ecosystems & Environment* **119**: 11-21. 10.1016/j.agee.2006.06.013.
- Metternicht GI, Fermont A. 1998. Estimating erosion surface features by linear mixture modeling. *Remote Sensing of Environment* **64**: 254-265. 10.1016/s0034-4257(97)00172-7.
- Mettrop IS, Cammeraat LH, Verbeeten E. 2013. The impact of subterranean termite activity on water infiltration and topsoil properties in Burkina Faso. *Ecohydrology* **6**: 324-331. 10.1002/eco.1271.
- Meyer LD, Harmon WC. 1979. Multiple intensity rainfall simulator for erosion research on row sideslopes. *Transactions of the Asae* **22**: 100-103.
- Miller WP. 1987. A solenoid operated variable intensity rainfall simulator. *Soil Science Society of America Journal* **51**: 832-834.
- Molina A, Govers G, Vanacker V, Poesen J, Zeelmaekers E, Cisneros F. 2007. Runoff generation in a degraded Andean ecosystem: Interaction of vegetation cover and land use. *Catena* **71**: 357-370. 10.1016/j.catena.2007.04.002.
- Molinillo M, Monasterio M. 1997. Pastoralism in paramo environments: Practices, forage, and impact on vegetation in the Cordillera of Merida, Venezuela. *Mountain Research and Development* **17**: 197-211. 10.2307/3673848.
- Monquero PA, Amaral LR, Binha DP, Silva AC, Silva PV. 2008. Leaching potential of herbicides in soil under different rainfall simulations. *Planta Daninha* **26**: 403-409.
- Montana C. 1990. A floristic structural gradient related to land forms in the Southern Chihuahuan desert. *Journal of Vegetation Science* **1**: 669-674. 10.2307/3235574.
- Moody JA, Kinner DA, Ubeda X. 2009. Linking hydraulic properties of fire-affected soils to infiltration and water repellency. *Journal of Hydrology* **379**: 291-303. 10.1016/j.jhydrol.2009.10.015.
- Mucina L, Rutherford M. 2006 The vegetation of South Africa, Lesotho and Swaziland. *Strelitzia* 19. South African National Biodiversity Institute, Pretoria
- Mugler C, Planchon O, Patin J, Weill S, Silvera N, Richard P, Mouche E. 2011. Comparison of roughness models to simulate overland flow and tracer transport experiments under simulated rainfall at plot scale. *Journal of Hydrology* **402**: 25-40. 10.1016/j.jhydrol.2011.02.032.
- Muldavin EH, Neville P, Harper G. 2001. Indices of grassland biodiversity in the Chihuahuan Desert ecoregion derived from remote sensing. *Conservation Biology* **15**: 844-855. 10.1046/j.1523-1739.2001.015004844.x.

- Munn JR, Huntington GL. 1976. Portable rainfall simulator for erodibility and infiltration measurements on rugged terrain. *Soil Science Society of America Journal* **40**: 622-624.
- Musy A, Higy C. 2004. *Hydrologie*. Collection gérer l'environnement. Presse polytechniques et universitaires romandes, Lausanne, CH 1015.
- Mutchler CK, Hermsmeier LF. 1965. A review of rainfall simulators. *Transactions of the American Society of Agricultural Engineers* **726**: 67-68.
- Nanko K, Onda Y, Ito A, Moriwaki H. 2011. Spatial variability of throughfall under a single tree: Experimental study of rainfall amount, raindrops, and kinetic energy. *Agricultural and Forest Meteorology* **151**: 1173-1182. 10.1016/j.agrformet.2011.04.006.
- National Research Council. 2001. *Basic research opportunities in earth science*. National Research Council Press NA. Washington DC, USA.
- Navarro H, Prat C. 1996. Habilitacion agricola de los tepetates de los valles de Mexico y de Tlaxcala. In: Bovin, P. (Ed.), *El Campo Mexicano*. CEMCA, Mexico, pp. 253- 291.
- Neave M, Rayburg S. 2007. A field investigation into the effects of progressive rainfall-induced soil seal and crust development on runoff and erosion rates: The impact of surface cover. *Geomorphology* **87**: 378-390. 10.1016/j.geomorph.2006.10.007.
- Nichols E, Spector S, Louzada J, Larsen T, Amequita S, Favila ME, Scarabaeinae Res N. 2008. Ecological functions and ecosystem services provided by Scarabaeinae dung beetles. *Biological Conservation* **141**: 1461-1474. 10.1016/j.biocon.2008.04.011.
- Nicolas M. 2010. Etude expérimentale et numérique du ruissellement de surface : effet des variations d'intensité de la pluie. Applications à une parcelle de vigne en Cévennes-Vivarais. Thèse de Doctorat. Université Joseph Fourier, Grenoble 1.
- Ogden CB, vanEs HM, Schindelbeck RR. 1997. Miniature rain simulator for field measurement of soil infiltration. *Soil Science Society of America Journal* **61**: 1041-1043.
- Ohrstrom P, Persson M, Albergel J, Zante P, Nasri S, Berndtsson R, Olsson J. 2002. Field-scale variation of preferential flow as indicated from dye coverage. *Journal of Hydrology* **257**: 164-173. 10.1016/S0022-1694(01)00537-6.
- Patin J, Mouche E, Ribolzi O, Chaplot V, Sengtahevanghoung O, Latsachak KO, Soullileuth B, Valentin C. 2012. Analysis of runoff production at the plot scale during a long-term survey of a small agricultural catchment in Lao PDR. *Journal of Hydrology* **426**: 79-92. 10.1016/j.jhydrol.2012.01.015.
- Peel MC, Finlayson BL, McMahon TA. 2007. Updated world map of the Koppen-Geiger climate classification. *Hydrology and Earth System Sciences* **11**: 1633-1644.
- Penman HL. 1963. Vegetation et Hydrology. *Commonwealth Bureau of Soils Technical Communication 53, Commonwealth Agricultural Bureaux, Farnham Royal, Bucks (UK)*, 124 pp.
- Perrin JL, Bouvier C, Janeau JL, Menez G, Cruz F. 2001. Rainfall/runoff processes in a small peri-urban catchment in the Andes mountains. The Rumihurcu Quebrada, Quito (Ecuador). *Hydrological processes* **15**: 843-854. 10.1002/hyp.190.

- Perrin JL, Fourcade B, Poulenard J, Richard D, Sierra A. 2000. Quito face à un risque d'origine naturelle: les laves torrentielles. *Revue de géographie alpine* **2**: 43-57.
- Perroux KM, White I. 1988. Designs for disk permeameters. *Soil Science Society of America Journal* **52**: 1205-1215.
- Peugeot C. 1995. Influence de l'encroûtement superficiel du sol sur le fonctionnement hydrologique d'un versant sahéleïn (Niger). Expérimentations *in situ* et modélisation. PhD - Spécialité: Mécanique. Université Joseph Fourier - Grenoble 1, Grenoble.
- Planchon O, Cadet P, Lapetite JM, Silvera N, Esteves M. 2000a. Relationship between raindrop erosion and runoff erosion under simulated rainfall in the Sudano-Sahel: Consequences for the spread of nematodes by runoff. *Earth Surface Processes and Landforms* **25**: 729-741. 10.1002/1096-9837(200007)25:7<729::aid-esp128>3.0.co;2-c.
- Planchon O, Esteves M, Silvera N, Lapetite JM. 2000b. Raindrop erosion of tillage induced microrelief: possible use of the diffusion equation. *Soil & Tillage Research* **56**: 131-144. 10.1016/s0167-1987(00)00134-3.
- Planchon O, Esteves M, Silvera N, Lapetite JM. 2002. Microrelief induced by tillage: measurement and modelling of Surface Storage Capacity. *Catena* **46**: 141-157. 10.1016/s0341-8162(01)00163-1.
- Podwojewski P, Germain N. 2005. Short-term effects of management on the soil structure in a deep tilled hardened volcanic-ash soil (Cangahua) in Ecuador. *European Journal of Soil Science* **56**: 39-51. 10.1111/j.1365-2389.2004.00638.x.
- Podwojewski P, Janeau JL, Grellier S, Valentin C, Lorentz S, Chaplot V. 2011. Influence of grass soil cover on water runoff and soil detachment under rainfall simulation in a sub-humid South African degraded rangeland. *Earth Surface Processes and Landforms* **36**: 911-922. 10.1002/esp.2121.
- Podwojewski P, Janeau JL, Leroux Y. 2008. Effects of agricultural practices on the hydrodynamics of a deep tilled hardened volcanic ash-soil (Cangahua) in Ecuador. *Catena* **72**: 179-190. 10.1016/j.catena.2007.05.003.
- Poesen J. 1986. Surface sealing as influenced by slope angle and position of simulated stones in the top layer of loose sediments. *Earth Surface Processes and Landforms* **11**: 1-10. 10.1002/esp.3290110103.
- Poesen J, Ingelmosanchez F, Mucher H. 1990. The hydrological response of soil surfaces to rainfall as affected by cover and position of rock fragments in the top layer. *Earth Surface Processes and Landforms* **15**: 653-671. 10.1002/esp.3290150707.
- Poesen J, Nachtergaele J, Verstraeten G, Valentin C. 2003. Gully erosion and environmental change: importance and research needs. *Catena* **50**: 91-133. 10.1016/s0341-8162(02)00143-1.
- Poss R, Ruellan A, Blanchart E, Brauman A, Grimaldi M, Grunberger O, Barbiero L, Chaplot V, Monga O, Bernoux M 2000. *Les sols, des milieux vivants très fragiles*. l'IRD Ltd. Suds en ligne. IRD Montpellier. <http://www.mpl.ird.fr/suds-en-ligne/sols/index.html>



- Poulenard J, Podwojewski P, Janeau JL, Collinet J. 2001. Runoff and soil erosion under rainfall simulation of Andisols from the Ecuadorian Paramo: effect of tillage and burning. *Catena* **45**: 185-207. 10.1016/s0341-8162(01)00148-5.
- Pudasaini M, Shrestha S, Riley S. 2004. Application of Water Erosion Prediction Project (WEPP) to estimate soil erosion from single storm rainfall events from construction sites. SuperSoil 2004: 3rd Australian New Zealand Soils Conference, Published on CDROM. .
- Qi J, Chehbouni A, Huete AR, Kerr YH, Sorooshian S. 1994. A modified soil adjusted vegetation index. *Remote Sensing of Environment* **48**: 119-126. 10.1016/0034-4257(94)90134-1.
- Quantin P, Zebrowski C. 1997. Analyse préliminaire (chimie, minéralogie, pétrographie) de quelques types de cangahua. Zebrowski Claude QP, Trujillo G., Villamar M.D. (collab.). Suelos volcanicos endurecidos. Qito, Ecuador. Quito : UE, ORSTOM, PUCE, UCE 3.
- Quetier F, Marty P, Lepart J. 2005. Farmers' management strategies and land use in an agropastoral landscape: roquefort cheese production rules as a driver of change. *Agricultural Systems* **84**: 171-193. 10.1016/j.agsy.2004.05.005.
- Quinn NW, Laflen JM. 1983. Characteristics of raindrop throughfall under corn canopy. *Transactions of the Asae* **26**: 1445-1450.
- Rajot JL, Alfaro SC, Gomes L, Gaudichet A. 2003. Soil crusting on sandy soils and its influence on wind erosion. *Catena* **53**: 1-16. 10.1016/s0341-8162(02)00201-1.
- Renaud F. 1997. Financial cost-benefit analysis of soil conservation practices in northern Thailand. *Mountain Research and Development* **17**: 11-18. 10.2307/3673909.
- Rey F, Ballais JL, Marre A, Rovéra G. 2004. Rôle de la végétation dans la protection contre l'érosion hydrique. *C.R. Geoscience* **336**: 991-998.
- Reynolds JF, Virginia RA, Kemp PR, de Soyza AG, Tremmel DC. 1999. Impact of drought on desert shrubs: Effects of seasonality and degree of resource island development. *Ecological Monographs* **69**: 69-106.
- Rhoton FE, Shipitalo MJ, Lindbo DL. 2002. Runoff and soil loss from midwestern and southeastern US silt loam soils as affected by tillage practice and soil organic matter content. *Soil & Tillage Research* **66**: 1-11. 10.1016/s0167-1987(02)00005-3.
- Ribolzi O. 2006. Génèse des crues, chemins de l'eau et transferts de solutés sur les petits bassins versants méditerranéens et tropicaux, Mémoires des sciences de la terre n° 2006-09. Université Pierre et Marie Curie. UFR des sciences de la Terre, 4 place Jussieu, 75252 Paris cedex 5, France.
- Ribolzi O, Auque L, Bariac T, Casenave A, Delhoume JP, Gathelier R, Pot V. 2000. Study of sub-surface water and solute flows using isotopic and chemical tracers under simulated rainfall conditions in Sahelian microdunes. *Comptes Rendus De L Academie Des Sciences Serie Ii Fascicule a-Sciences De La Terre Et Des Planetes* **330**: 53-60. 10.1016/s1251-8050(00)00101-4.
- Ribolzi O, Patin J, Bresson LM, Latschack KO, Mouche E, Sengtaheuanghoung O, Silvera N, Thiebaut JP, Valentin C. 2011. Impact of slope gradient on soil surface features and

- infiltration on steep slopes in northern Laos. *Geomorphology* **127**: 53-63. 10.1016/j.geomorph.2010.12.004.
- Rieu M, Sposito G. 1991. Fractal fragmentation, soil porosity, and soil water properties.1.1 Theory. *Soil Science Society of America Journal* **55**: 1231-1238.
- Roche M. 1963. *Hydrologie de surface*. Ed. Gauthier-Villars. Paris.
- Roose E, Sarrailh JM. 1989-90. Erodibilité de quelques sols tropicaux Vingt années de mesure en parcelles d'érosion sous pluies naturelles. *Cah. ORSTOM, sér. Pédol.* **20 (1-2)**: 7-30.
- Rowntree K, Duma M, Kakembo V, Thornes J. 2004. Debunking the myth of overgrazing and soil erosion. *Land Degradation & Development* **15**: 203-214. 10.1002/ldr.609.
- Sanguesa C, Arumi J, Pizarro R, Link O. 2010. A rainfall simulator for the in situ study of superficial runoff and soil erosion. *Chilean Journal of Agricultural Research* **70**: 178-182.
- Savary S, Janeau JL. 1986. Rain induced dispersal in *Puccinia arachidis* studied by means of rainfall simulator. *Netherlands Journal of Plant Pathology* **92**: 163-174. 10.1007/bf01999798.
- Savary S, Janeau JL, Allorent D, Escalante M, Avelino J, Willocquet L. 2004. Effects of simulated rainfall events on spore dispersal and spore stocks in three tropical pathosystems. *Phytopathology* **94**: S92-S92.
- Schlesinger WH, Raikes JA, Hartley AE, Cross AE. 1996. On the spatial pattern of soil nutrients in desert ecosystems. *Ecology* **77**: 364-374. 10.2307/2265615.
- Schulze RE. 1997 *South African Atlas of Agrohydrology and Climatology*. Water Research Commission, TT82/96 R. Pretoria, RSA.
- Seeger M. 2007. Uncertainty of factors determining runoff and erosion processes as quantified by rainfall simulations. *Catena* **71**: 56-67. 10.1016/j.catena.2006.10.005.
- Seguis L, Kamagate B, Favreau G, Descloitres M, Seidel JL, Galle S, Peugeot C, Gosset M, Le Barbe L, Malinur F, Van Exter S, Arjounin M, Boubkraoui S, Wubda M. 2011. Origins of streamflow in a crystalline basement catchment in a sub-humid Sudanian zone: The Donga basin (Benin, West Africa) Inter-annual variability of water budget. *Journal of Hydrology* **402**: 1-13. 10.1016/j.jhydrol.2011.01.054.
- Sharma K, Singh H, Pareek O. 1983. Rain water infiltration into a bar loamy sand. *Hydrological Sciences Journal* **28**: 417-424.
- Sharma PP, Gupta SC, Foster GR. 1995. Raindrop induced soil detachment and sediment transport from interrill areas. *Soil Science Society of America Journal* **59**: 727-734.
- Sharma PP, Gupta SC, Rawls WJ. 1991. Soil detachment by single raindrops of varying kinetic energy. *Soil Science Society of America Journal* **55**: 301-307.
- Shipitalo MJ, Le Bayon RC. 2004. Quantifying the effects of earthworms on soil aggregation and porosity. In: Edwards, C.A. (Ed.), *Earthworm Ecology*. , 2nd ed. CRC Press, Washington, pp. 183-200.

- Silvertown J, Wilson JB. 1994. Community structure in a desert perennial community. *Ecology* **75**: 409-417. 10.2307/1939544.
- Simunek J, Angulo-Jaramillo R, Schaap MG, Vandervaere JP, van Genuchten MT. 1998. Using an inverse method to estimate the hydraulic properties of crusted soils from tension-disc infiltrometer data. *Geoderma* **86**: 61-81. 10.1016/s0016-7061(98)00035-4.
- Singer MJ, Blackard J. 1982. Slope angle interhill soil loss relationships for slopes up to 50 percent. *Soil Science Society of America Journal* **46**: 1270-1273.
- Singer MJ, Le Bissonnais Y. 1998. Importance of surface sealing in the erosion of some soils from a Mediterranean climate. *Geomorphology* **24**: 79-85. 10.1016/s0169-555x(97)00102-5.
- Snelder DJ, Bryan RB. 1995. The use of rainfall simulation tests to assess the influence of vegetation density on soil loss on degraded rangelands in the Baringo district, Kenya. *Catena* **25**: 105-116. 10.1016/0341-8162(95)00003-b.
- Sophocleous M. 2002. Interactions between groundwater and surface water: the state of the science. *Hydrogeology Journal* **10**: 52-67. 10.1007/s10040-001-0170-8.
- Sorrells L, Glenn S. 1991. Review of Sampling Techniques used in Studies of Grassland Plant Communities. *Oklahoma Academy of Science Proceedings* **71**: 43-45.
- Sort X, Alcaniz JM. 1996. Contribution of sewage sludge to erosion control in the rehabilitation of limestone quarries. *Land Degradation & Development* **7**: 69-76. 10.1002/(sici)1099-145x(199603)7:1<69::aid-ldr217>3.0.co;2-2.
- States JS, Christensen M. 2001. Fungi associated with biological soil crusts in desert grasslands of Utah and Wyoming. *Mycologia* **93**: 432-439. 10.2307/3761728.
- Steven B, Gallegos-Graves LV, Yeager CM, Belnap J, Evans RD, Kuske CR. 2012. Dryland biological soil crust cyanobacteria show unexpected decreases in abundance under long-term elevated CO<sub>2</sub>. *Environmental Microbiology* **14**: 3247-3258. 10.1111/1462-2920.12011.
- Streck EV, Cogo NP. 2003. Reconsolidation of the soil surface after tillage discontinuity, with and without cultivation, related to erosion and its prediction with RUSLE. *Revista Brasileira De Ciencia Do Solo* **27**: 141-151.
- Swanson NP. 1965. Rotating bomm rainfall simulator. *Transactions of the American Society of Agricultural Engineers* **8**: 71-72.
- Taconet O, Ciarletti V. 2007. Estimating soil roughness indices on a ridge-and-furrow surface using stereo photogrammetry. *Soil & Tillage Research* **93**: 64-76. 10.1016/j.still.2006.03.018.
- Thornes JB. 2007. Modelling soil erosion by grazing: recent developments and new approaches. *Geographical Research* **45**: 13-26. 10.1111/j.1745-5871.2007.00426.x.
- Tossell RW, Dickinson WT, Rudra RP, Wall GJ. 1987. A portable rainfall simulator. *Canadian Agricultural Engineering* **29**: 155-162.
- Touma J, Vachaud G, Parlange JY. 1984. Air and water flow in a sealed, ponded vertical soil column, experiment and model. *Soil Science* **137**: 181-187. 10.1097/00010694-198403000-00008.

- Turner MD, Hiernaux P, Schlecht E. 2005. The distribution of grazing pressure in relation to vegetation resources in semi-arid West Africa: The role of herding. *Ecosystems* **8**: 668-681. 10.1007/s10021-003-0099-y.
- USDA. 2005. Erosion and sedimentation. Rainfall simulator. Agricultural Research Service, <http://ars.usda.gov/Aboutus/docs.htm?docid=10018&page=2>.
- Valentin C. 1991. Surface crusting in two alluvial soils of Northern Niger. *Geoderma* **48**: 201-222. 10.1016/0016-7061(91)90045-u.
- Valentin C, Agus F, Alamban R, Boosaner A, Bricquet JP, Chaplot V, de Guzman T, de Rouw A, Janeau JL, Orange D, Phachomphonh K, Phai DD, Podwojewski P, Ribolzi O, Silvera N, Subagyono K, Thiebaut JP, Toan TD, Vadari T. 2008. Runoff and sediment losses from 27 upland catchments in Southeast Asia: Impact of rapid land use changes and conservation practices. *Agriculture Ecosystems & Environment* **128**: 225-238. 10.1016/j.agee.2008.06.004.
- Valentin C, Bresson LM. 1992. Morphology, genesis and classification of surface crusts in loamy and sandy soils. *Geoderma* **55**: 225-245. 10.1016/0016-7061(92)90085-l.
- Valentin C, Casenave A. 1992. Infiltration into sealed soils as influenced by gravel cover. *Soil Science Society of America Journal* **56**: 1667-1673.
- Valentin C, Poesen J, Li Y. 2005. Gully erosion: Impacts, factors and control. *Catena* **63**: 132-153. 10.1016/j.catena.2005.06.001.
- Vandervaere JP. 1995. Caracterisation hydrodynamique du sol in situ par infiltrométrie à disques. Analyse critique des régimes pseudo-permanents, méthodes transitoires et cas des sols encroûtés. PhD. Université Joseph Fournier - Grenoble I, Grenoble.
- Vandervaere JP, Vauclin M, Elrick DE. 2000a. Transient flow from tension infiltrometers: I. The two-parameter equation. *Soil Science Society of America Journal* **64**: 1263-1272.
- Vandervaere JP, Vauclin M, Elrick DE. 2000b. Transient flow from tension infiltrometers: II. Four methods to determine sorptivity and conductivity. *Soil Science Society of America Journal* **64**: 1272-1284.
- Velasquez AS, Flores DR. 1997. Formación de agregados estables a partir de un duripán del estado de Morelos (México) por parte de especies vegetales perennes en condiciones de invernadero. In: Zebrowski, C., Quantin, P., Trujillo, G., (Eds.), Memoria del III Simposio Internacional sobre Suelos Endurecidos (Quito, diciembre de 1996) IRD, PUCE, UCE, Quito, pp. 170-177.
- Veron SR, Paruelo JM, Oesterheld M. 2006. Assessing desertification. *Journal of Arid Environments* **66**: 751-763. 10.1016/j.jaridenv.2006.01.021.
- Vetter S. 2005. Rangelands at equilibrium and non-equilibrium: recent developments in the debate. *Journal of Arid Environments* **62**: 321-341. 10.1016/j.jaridenv.2004.11.015.
- W.R.B. 2006. *World Reference Base for soil resources. World soil resources reports, n°103. FAO, Rome, 128 p.*

- Wagner LE, Fox FA. 2001. *Simulation of tillage and other management operations in WEPS*. Amer Soc Agr Engineers. Ascough JC and Flanagan DC, Soil Erosion Research for the 21st Century, Proceedings. St Joseph.
- Wainwright J, Parsons AJ, Abrahams AD. 2000. Plot-scale studies of vegetation, overland flow and erosion interactions: case studies from Arizona and New Mexico. *Hydrological processes* **14**: 2921-2943. 10.1002/1099-1085(200011/12)14:16/17<2921::aid-hyp127>3.0.co;2-7.
- Wang EL, Smith CJ. 2004. Modelling the growth and water uptake function of plant root systems: a review. *Australian Journal of Agricultural Research* **55**: 501-523. 10.1071/ar03201.
- Wang XP, Wang ZN, Berndtsson R, Zhang YF, Pan YX. 2011. Desert shrub stemflow and its significance in soil moisture replenishment. *Hydrology and Earth System Sciences* **15**: 561-567. 10.5194/hess-15-561-2011.
- Waterhouse DF. 1974. The biological control of dung. *Scientific American* **230**: 101-108.
- Wauchope RD, Graney RL, Cryer S, Eadsforth C, Klein AW, Racke KD. 1995. Pesticides report .34. Pesticide runoff: Methods and interpretation of field studies. *Pure and Applied Chemistry* **67**: 2089-2108. 10.1351/pac199567122089.
- Weltz MA, Arslan AB, Lane LJ. 1992. Hydraulic roughness coefficients for native rangelands. *Journal of Irrigation and Drainage Engineering-Asce* **118**: 776-790. 10.1061/(asce)0733-9437(1992)118:5(776).
- Wen XH, Gomez Hernandez JJ. 1996. Upscaling hydraulic conductivities in heterogeneous media: An overview. *Journal of Hydrology* **183**: R9-R32. 10.1016/s0022-1694(96)80030-8.
- Wertin TM, Phillips SL, Reed SC, Belnap J. 2012. Elevated CO<sub>2</sub> did not mitigate the effect of a short-term drought on biological soil crusts. *Biology and Fertility of Soils* **48**: 797-805. 10.1007/s00374-012-0673-6.
- Williams JD, Dobrowolski JP, West NE. 1999. Microbiotic crust influence on unsaturated hydraulic conductivity. *Arid Soil Research and Rehabilitation* **13**: 145-154. 10.1080/089030699263384.
- Wilson JP, Seney JP. 1994. Erosional impact of Hikers, horses, motorcycles and off road bicycles on mountain trails in Montana. *Mountain Research and Development* **14**: 77-88. 10.2307/3673739.
- Winckell A, Zebrowski C. 1992. La Cangahua en Equateur : le contexte paléogéographique de sa formation. In: Zebrowski et al.(Eds) Terra. Numero especial Suelos Volcanicos Endurecidos. **10**: 107-112.
- Wischmeier WH. 1959. A rainfall erosion index for a universal soil loss equation. *Soil Science Society of America Proceedings* **23**: 246-249.
- Woodward L. 1943. Infiltration capacities of some plant-soil complexes on Utah range watershed lands. *Transactions American Geophysical Union* **24**: 468-475.

Wu SF, Wu PT, Feng H, Bu CF. 2010. Influence of amendments on soil structure and soil loss under simulated rainfall China's loess plateau. *African Journal of Biotechnology* **9**: 6116-6121.

Yang L-X, Yang G-S, Yuan S-F, Wu Y. 2007. Characteristics of soil phosphorus runoff under different rainfall intensities in the typical vegetable plot of Taihu Basin. *Huan jing ke xue = Huanjing kexue / [bian ji, Zhongguo ke xue yuan huan jing ke xue wei yuan hui "Huan jing ke xue" bian ji wei yuan hui.]* **28**: 1763-9.

Yates CJ, Norton DA, Hobbs RJ. 2000. Grazing effects on plant cover, soil and microclimate in fragmented woodlands in south-western Australia: implications for restoration. *Austral Ecology* **25**: 36-47. 10.1111/j.1442-9993.2000.tb00005.x.

Youngs EG. 1987. Estimating hydraulic conductivity values from ring infiltrometer measurements. *Journal of Soil Science* **38**: 623-632.

Youngs EG. 1988. Soil physics and hydrology. *Journal of Hydrology* **100**: 411-431. 10.1016/0022-1694(88)90194-1.

Zhao WZ, Xiao HL, Liu ZM, Li J. 2005. Soil degradation and restoration as affected by land use change in the semiarid Bashang area, northern China. *Catena* **59**: 173-186. 10.1016/j.catena.2004.06.004.

Zhao Y, Xu M. 2013. Runoff and Soil Loss from Revegetated Grasslands in the Hilly Loess Plateau Region, China: Influence of Biocrust Patches and Plant Canopies. *Journal of Hydrologic Engineering* **18**: 387-393. 10.1061/(asce)he.1943-5584.0000633.

Zimmermann A, Wilcke W, Elsenbeer H. 2007. Spatial and temporal patterns of throughfall quantity and quality in a tropical montane forest in Ecuador. *Journal of Hydrology* **343**: 80-96. 10.1016/j.jhydrol.2007.06.012.

Zimmermann B, Elsenbeer H, De Moraes JM. 2006. The influence of land-use changes on soil hydraulic properties: Implications for runoff generation. *Forest Ecology and Management* **222**: 29-38. 10.1016/j.foreco.2005.10.070.



**TITLE:** Biotic and abiotic factors driving water infiltration in tropical soils. Study cases in Africa, in Asia and Latin America

---

The influence of physical factors (gradient slope, farming practices) and biological factors (plant cover, soil engineers) on water infiltration in soils was assessed in different climates (Mexico, Ecuador, South Africa, Thailand, Vietnam).

Rainfall simulations and soil surface feature cartography were used to test and analyze the soil surface hydrodynamic behavior and soil detachability. Low slope gradients and cultural practices supposed to promote good aggregated structure are not always synonymous with low infiltration. Indeed, they do not always limit the impact of raindrops and can lead to increased crust formation and runoff. In contrast, vegetation cover and soil engineers play a major role in the sustainable maintenance of infiltration including in soils with a deteriorated surface structure.



**AUTEUR : Jean-Louis JANEAU**

**TITRE : *Déterminants physiques et biologiques de l'infiltration des sols tropicaux : cas d'études en Afrique, en Asie et en Amérique Latine***

**DIRECTEUR DE THESE :** Dr. Olivier Ribolzi

**DATE ET LIEU DE SOUTENANCE :** 10 juillet 2014 à Toulouse

---

**RESUME**

L'étude de l'infiltration de l'eau dans le sol en fonction des états de surface a été abordée sous différents climats (Mexique, Equateur, Afrique du Sud, Thaïlande, Vietnam) en testant l'influence des déterminants physiques (gradient de pente, pratiques culturales) et biologiques (couvert végétal, ingénieurs du sol) sur l'infiltration.

La simulation de pluie et la description des états de surface ont été utilisées pour tester et analyser les comportements hydrodynamiques superficiels et la détachabilité des sols. Les faibles gradients de pente et certaines pratiques culturales sensés favoriser une structure bien agrégée ne sont pas synonymes de faible infiltration. En effet, ceux-ci ne permettent pas nécessairement de limiter l'impact des gouttes de pluie et la formation de croûtes favorables au ruissellement. Par contre, le couvert végétal et les ingénieurs du sol jouent un rôle majeur pour un maintien durable de l'infiltration y compris sur des sols à la structure superficielle dégradée.

---

**MOTS CLES :** activité biologique des sols - climats tropicaux - couvert végétal - croûtes - écosystèmes tropicaux – infiltration – mètre carré - pente – pratiques culturales - simulation de pluie.

---

**DISCIPLINE ADMINISTRATIVE :** Hydrologie, hydrochimie, sol, environnement

---

**INTITULE ET ADRESSE DE L'U.F.R.:** Géosciences Environnement Toulouse (GET), UR242 de l'IRD - Observatoire Midi-Pyrénées (OMP). 14, avenue Edouard Belin 31400 Toulouse France.