



HAL
open science

Contrôle de l'activité photosynthétique du phytoplancton en milieu côtier : utilisation de la fluorescence spectrale et de la fluorimétrie modulée

Emilie Houliez

► **To cite this version:**

Emilie Houliez. Contrôle de l'activité photosynthétique du phytoplancton en milieu côtier : utilisation de la fluorescence spectrale et de la fluorimétrie modulée. Biodiversité et Ecologie. Université de Lille 1, 2012. Français. NNT: . tel-01084544

HAL Id: tel-01084544

<https://theses.hal.science/tel-01084544>

Submitted on 19 Nov 2014

HAL is a multi-disciplinary open access archive for the deposit and dissemination of scientific research documents, whether they are published or not. The documents may come from teaching and research institutions in France or abroad, or from public or private research centers.

L'archive ouverte pluridisciplinaire **HAL**, est destinée au dépôt et à la diffusion de documents scientifiques de niveau recherche, publiés ou non, émanant des établissements d'enseignement et de recherche français ou étrangers, des laboratoires publics ou privés.

UNIVERSITE DES SCIENCES ET TECHNOLOGIES DE LILLE

Ecole Doctorale Sciences de la Matière, du Rayonnement et de l'Environnement – ED 104

Laboratoire d'Océanologie et de Géosciences – UMR 8187

THESE

Pour l'obtention du grade de :

DOCTEUR DE L'UNIVERSITE DES SCIENCES ET TECHNOLOGIES DE LILLE

Discipline : Géosciences, Ecologie, Paléontologie, Océanographie

Présentée par

Emilie HOULIEZ

**Contrôle de l'activité photosynthétique du phytoplancton
en milieu côtier – Utilisation de la fluorescence spectrale et
de la fluorimétrie modulée**

Soutenue le 25 Septembre 2012

Devant le jury composé de :

Dr Rodney Forster, CEFAS, Lowestoft, Royaume-Unis
Pr Yvan Lagadeuc, Université de Rennes 1
Dr Louis Peperzak, NIOZ, Pays-Bas
Pr Bernard Queguiner, Université de la Méditerranée
Pr Sébastien Lefebvre, Université de Lille 1
Dr Felipe Artigas, Université du Littoral Côte d'Opale
Dr François Schmitt, DR CNRS, Université de Lille 1
Dr Fabrice Lizon, Université de Lille 1

Rapporteur
Rapporteur
Examineur
Examineur
Examineur
Examineur
Directeur de thèse
Co-encadrant

**Control of phytoplankton photosynthetic activity in coastal
system – Use of spectral fluorescence and modulated
fluorometry**

Avant propos

Cette thèse n'aurait pu être réalisée sans l'allocation de recherche qui m'a été octroyée par le Ministère de l'Enseignement Supérieur et de la Recherche (MESR, France) pour une durée de trois ans.

Ce travail s'inscrit en partie dans le programme INTERREG IV A DYMAPHY "2 Mers Seas Zeeën" cofinancé par l'Union Européenne (fonds FEDER).

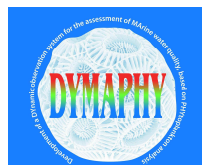

Remerciements

Je tiens à remercier, dans un premier temps, les personnes qui ont accepté d'évaluer mon travail : Yvan Lagadeuc et Rodney Forster en qualité de rapporteurs. Bernard Queguiner, Louis Peperzak, Sébastien Lefebvre et Felipe Artigas qui ont bien voulu examiner cette thèse et faire partie du jury.

Que toutes les personnes qui ont contribué de près où de loin au bon déroulement de mon travail se voient ici remerciées.

Mes premiers remerciements sont bien sûr adressés à mes deux encadrants Fabrice Lizon et François Schmitt sans qui cette thèse n'aurait pu être.

Merci à toi Fabrice pour la confiance que tu m'as accordée en me proposant ce travail. Merci pour la liberté dont j'ai pu bénéficier, pour l'encadrement sans faille et sans relâche, pour ta disponibilité au jour le jour et pour tous les conseils que tu as su me prodiguer avec patience (et il t'en a fallu de la patience pour essayer de convaincre la tête de mule que je suis !).

Merci à François d'avoir pris la direction de ma thèse. Merci pour l'intérêt porté à mon travail bien qu'il soit éloigné de votre domaine de prédilection. Merci pour les conseils sur la rédaction de mes articles et de mon manuscrit, les recommandations concernant la participation aux colloques et la recherche de postes. Et pour finir, merci de m'avoir accordé une aide financière qui m'a permis de participer au colloque ASLO de Puerto Rico.

Je ne m'étends pas plus au sujet de mes encadrants. Il y aurait pourtant encore bien des choses à dire... Qu'ils soient ici chaleureusement remerciés pour tout le travail fourni et pour leur aide précieuse qui m'a permis de progresser tout au long de ces années de thèse.

Merci à Felipe Artigas pour toute l'aide apportée avec enthousiasme, joie et bonne humeur que ce soit sur terre ou en mer. Merci d'avoir toujours été disponible, d'avoir trouvé des financements pour mener à bien nos recherches et d'avoir été mon guide pour mon premier voyage en avion suivi de mon premier colloque international. Merci également d'avoir relu et corrigé mes articles.

Merci à Sébastien Lefebvre qui m'a toujours ouvert la porte de son bureau. Merci de m'avoir appris à ne plus travailler comme un bœuf en me formant à l'utilisation de MATLAB. Ça n'a pas du être facile de former quelqu'un pour qui la programmation ressemble à du chinois. Merci pour ta patience car sans toi je serais certainement encore en train de tracer des courbes PE. Merci aussi d'avoir pris le temps de me former à l'utilisation de CANOCO. Merci pour tous les conseils et les encouragements et merci d'avoir si souvent su trouver les mots pour me redonner confiance en moi.

Merci à Valérie Gentilhomme de m'avoir appris à dompter cette machine infernale qu'est l'Alliance. Merci pour les conseils sur l'analyse des sels nutritifs et pour tout ton travail dans la gestion de mes heures d'enseignement. Merci également d'avoir participé à mes comités de thèse.

Merci à Méliotus Thyssen pour les analyses cytométriques de mes nombreux échantillons et pour sa compagnie et bonne humeur pendant cette semaine passée à Puerto Rico.

Merci à Vincent Cornille pour son aide technique pendant mes nombreuses sorties en mer et pour la filtration des échantillons destinés au dosage de la chlorophylle.

Merci aux marins du Sépia II : Greg, Nono et Charlie pour le pilotage du bateau et pour leur aide pendant les sorties en mer. C'était plutôt sympa ces petites croisières à secousses ! Je garde un souvenir mémorable du face à face avec le ferry dans le brouillard : même pas peur !

Merci à Jessica Chicheportiche pour l'analyse des chlorophylles, le passage des échantillons au cytomètre et pour l'aide apportée pendant les manips de comparaison du FluoroProbe et du cytomètre en flux.

Merci aux étudiants d'IUT qui ont participé à l'analyse de mes chlorophylles : Mélodie, Pierre, Késia et Emeline.

Merci à Xavier Mériaux qui m'a appris à analyser les \bar{a}_{phy}^* et à utiliser le spectro. Merci de m'avoir prêté le matériel nécessaire, d'avoir répondu à toutes mes questions avec gentillesse et d'avoir traité mes spectres d'absorption.

Merci à Elsa Breton pour les souches de phytoplancton et pour ses conseils sur les méthodes de culture.

Merci à Maxine Thorel pour le travail réalisé pendant son stage de M1. Je te souhaite beaucoup de succès pour ta thèse.

.

Merci à Eric Lecuyer pour la maintenance de la sonde CTD.

Merci à Hubert Loisel de m'avoir laissé une petite place dans son labo mais également d'avoir répondu à mes questions sur les \bar{a}_{phy}^* .

Merci à Vincent Vantrepotte pour son aide dans ma réponse aux reviewers sur la mesure des \bar{a}_{phy}^* .

Merci à Rachid Amara d'avoir accepté de me fournir un code d'accès qui m'a permis de travailler à la MREN dans de bonnes conditions.

Merci à Alain Lefebvre pour les données des comptages phytoplanctoniques du SRN.

Merci à Nicole Degros pour les analyses pigmentaires.

Je remercie l'équipe enseignante de la Station Marine de Wimereux : Valérie, Fabienne, Nicolas, François, Lionel, Fabrice et Sébastien de m'avoir considérée comme l'une des leurs. Merci de m'avoir si bien conseillée et accompagnée dans mes premiers pas en tant qu'enseignante. Merci également de m'avoir si souvent déposée près de chez moi en rentrant de Lille.

Je remercie toutes les personnes qui font de la Station Marine de Wimereux un lieu agréable pour travailler :

Mes petits voisins de couloir Michel et Thierry pour les mots gentils du matin et les encouragements. Promis je n'oublie pas la place de secrétaire si ça ne marche pas pour moi dans la recherche !

Josette, l'ange gardien de la station, qui a toujours gardé un œil sur moi quand j'allais faire mes prélèvements ou lorsque je restais travailler tard le soir.

Philippe qui veille au maintien du bon fonctionnement du réseau informatique.

Evelyne, Katia, Laurence et Aurélia pour leur aide dans toutes mes démarches administratives. Moi qui n'aime pas faire les papiers, j'étais bien contente d'avoir quelqu'un pour m'aider.

Christine et Christelle pour l'entretien de mon espace de travail.

Didier et Dominique pour toutes les réparations.

Les autres thésards, compagnons d'infortune, pour les repas animés du midi.

Je remercie sincèrement Frédéric Olivier qui, le temps d'un stage de M2, m'a donné le goût de la recherche scientifique et m'a sorti de l'abîme dans lequel je me trouvais vis-à-vis des statistiques. Sans toi, je n'aurais certainement pas fait de thèse à l'heure qu'il est.

Merci à Ernest Michaux pour sa formidable invention qui m'a permis de me défouler le temps d'une demi-journée par week-end et d'oublier un peu la thèse.

Enfin, je remercie ma famille et mes amis pour leur amour et leur soutien durant les moments difficiles ou mes périodes de doutes (et il y en a eu !). Merci d'avoir toujours respecté mes choix. Merci de m'avoir supportée (dans les deux sens du terme) pendant ces années de thèse. Merci de m'avoir toujours écoutée même lorsque je vous cassais les oreilles avec mes histoires de labo, de phytoplancton, de thèse et d'articles. Merci d'être toujours là pour moi et pardon si je n'ai pas été aussi disponible que vous l'auriez souhaité.

A mon grand-père qui m'a transmis son amour de la mer...

Table des matières

<u>INTRODUCTION GENERALE : CONTEXTE ET OBJECTIFS</u>	<u>27</u>
<u>PREMIERE PARTIE: PHYTOPLANCTON ET PRODUCTION PRIMAIRE</u>	<u>39</u>
1 PHOTOSYNTHESE ET PRODUCTION PRIMAIRE	43
1.1 DEFINITIONS ET REACTIONS	43
1.2 LES PHOTOSYSTEMES II (PSII)	44
1.3 LA CHAINE DE TRANSPORT DES ELECTRONS	50
2 LA FLUORESCENCE POUR L'ETUDE DE LA PRODUCTION PRIMAIRE	51
2.1 INTRODUCTION	51
2.2 DEFINITION ET ORIGINE DE LA FLUORESCENCE	55
2.3 ANALYSE DES QUENCHING PAR LA METHODE DES PULSES SATURANTS	58
2.4 RENDEMENTS QUANTIQUES	66
2.5 TAUX DE TRANSPORT DES ELECTRONS	74
2.6 COURBES ETR VERSUS E ET PARAMETRES PHOTOSYNTHETIQUES	78
2.7 LE TAUX DE TRANSPORT DES ELECTRONS UNE MESURE DE LA PRODUCTION PRIMAIRE ?	83
3 PHYTOPLANCTON ET PRODUCTION PRIMAIRE EN MANCHE ORIENTALE	85
3.1 CARACTERISTIQUES HYDRODYNAMIQUES DE LA MANCHE ORIENTALE	85
3.2 SUCCESSIONS PHYTOPLANCTONIQUES	87
3.3 PRODUCTION PRIMAIRE ET PARAMETRES PHOTOSYNTHETIQUES	88
<u>DEUXIEME PARTIE: UTILISATION DE LA FLUORESCENCE SPECTRALE ET DE LA FLUORIMETRIE MODULEE POUR L'ETUDE DU PHYTOPLANCTON EN MANCHE ORIENTALE</u>	<u>95</u>
CHAPITRE I : SUIVI DES DYNAMIQUES DES HAPTOPHYTES EN UTILISANT LE FLUOROPROBE: UNE APPLICATION EN MANCHE ORIENTALE POUR LA SURVEILLANCE DE <i>PHAEOCYSTIS GLOBOSA</i>	101
CHAPITRE II: UTILISATION DU PHYTO-PAM POUR ESTIMER L'ACTIVITE PHOTOSYNTHETIQUE DU PHYTOPLANCTON PAR GROUPES D'ALGUES: PERFORMANCES ET LIMITES	135
CHAPITRE III: UTILISATION DES RAPID LIGHT CURVES (RLC) ET DES STEADY STATE LIGHT CURVES (SSLC) POUR LA CARACTERISATION <i>IN SITU</i> DE L'ACTIVITE PHOTOSYNTHETIQUE DU PHYTOPLANCTON	177
CONCLUSIONS GENERALES	195

TROISIEME PARTIE: DYNAMIQUES DE L'ACTIVITE PHOTOSYNTHETIQUE DU PHYTOPLANCTON EN MANCHE ORIENTALE 201

CHAPITRE IV: VARIABILITE SPATIO-TEMPORELLE DE L'ACTIVITE PHOTOSYNTHETIQUE DU PHYTOPLANCTON DANS UN ECOSYSTEME MACROTIDAL (LE DETROIT DU PAS-DE-CALAIS, MANCHE ORIENTALE) 205

CHAPITRE V: VARIABILITE A COURT-TERME ET CONTROLE DE L'ACTIVITE PHOTOSYNTHETIQUE DU PHYTOPLANCTON DANS UN ECOSYSTEME MACROTIDAL (LE DETROIT DU PAS-DE-CALAIS, MANCHE ORIENTALE) 241

CHAPITRE VI: DYNAMIQUES DE L'ACTIVITE PHOTOSYNTHETIQUE DU PHYTOPLANCTON DANS UN ECOSYSTEME MACROTIDAL (LE DETROIT DU PAS-DE-CALAIS, MANCHE ORIENTALE) : ECHELLES DE TEMPS DE LA VARIABILITE ET CONTROLE ENVIRONNEMENTAL 273

SYNTHESE ET PERSPECTIVES 309

REFERENCES 347

Liste des Figures

PREMIERE PARTIE : PHYTOPLANCTON ET PRODUCTION PRIMAIRE

FIG. 1. LES DIFFÉRENTS GROUPES PIGMENTAIRES.....	45
FIG. 2. SCHÉMA D'UN PHYCOBILISOME DE CYANOBACTÉRIE	46
FIG. 3. ORGANISATION DES PHOTOSYSTÈMES II ET CHAÎNE DE TRANSPORT DES ÉLECTRONS	49
FIG. 4. COURBES D'INDUCTION DE FLUORESCENCE OBTENUES CHEZ L'ALGUE VERTE <i>ANKISTRODESMUS</i> EN UTILISANT UN SINGLE TURNOVER FLASH (« ST », AXE DES ABCISSES DU BAS 0-0,02 MS), OU UN MULTIPLE TURNOVER FLASH D'UNE DURÉE DE 50 MS (« MT », AXE DES ABCISSES DU HAUT 0-0,15 S) DÉLIVRÉS PAR UNE LAMPE XÉNON.....	54
FIG. 5. COURBE D'INDUCTION DE LA FLUORESCENCE DE LA CHL A	56
FIG. 6. DIAGRAMME REPRÉSENTANT LA DISSIPATION DE L'ÉNERGIE LUMINEUSE ABSORBÉE AU NIVEAU DES PSII EN FONCTION DE LEUR ÉTAT	60
FIG. 7. ANALYSE DES QUENCHING PAR LA MÉTHODE DES PULSES SATURANTS	60
FIG. 8. COURBE DE RÉPONSE À LA LUMIÈRE	79
FIG. 9. PRINCIPAUX SECTEURS DE LA MANCHE.....	85

DEUXIEME PARTIE : UTILISATION DE LA FLUORESCENCE SPECTRALE ET DE LA FLUORIMETRIE

MODULE POUR L'ETUDE DU PHYTOPLANCTON EN MANCHE

Chapitre I: Suivi des dynamiques des Haptophytes en utilisant le FluoroProbe: une application en Manche orientale pour la surveillance de *Phaeocystis globosa*

FIG. 1.1. ORIGINAL FINGERPRINTS (A, B, D AND E) AND THE NEW FINGERPRINT OF <i>PHAEOCYSTIS GLOBOSA</i> (C).....	112
FIG. 1.2. FLUOROPROBE CLASSIFICATION OF 17 PHYTOPLANKTON PURE CULTURES USING EITHER THE FOUR ORIGINAL FINGERPRINTS OR THREE ORIGINAL FINGERPRINTS + <i>PHAEOCYSTIS GLOBOSA'S</i> FINGERPRINT.....	118
FIG. 1.3. MEASURED (A,B, D AND E) AND EXPECTED (C AND F) RELATIVE PROPORTIONS OF <i>PHAEOCYSTIS GLOBOSA</i> IN DIFFERENT MIXTURES WITH <i>ASTERIONELLOPSIS GLACIALIS</i> (A,B,C) OR <i>ASTERIONELLOPSIS GLACIALIS</i> + <i>CRYPTOMONAS MACULATA</i> (D,E,F)	120

FIG. 1.4. RESULTS OF THE FLUOROPROBE DETECTION OF <i>ASTERIONELLOPSIS GLACIALIS</i> (BROWN ALGAE), <i>CRYPTOMONAS MACULATA</i> (CRYPTOPHYTA) AND <i>CHLAMYDOMONAS REGINAE</i> (GREEN ALGAE) IN DIFFERENT MIXTURES WITH DIFFERENT PROPORTIONS	121
FIG. 1.5. RELATIONSHIPS BETWEEN THE MEASURED AND THE EXPECTED CHLOROPHYLL A CONCENTRATIONS FOR <i>PHAEOCYSTIS GLOBOSA</i> (A), <i>ASTERIONELLOPSIS GLACIALIS</i> (BROWN ALGAE) (B) AND <i>CRYPTOMONAS MACULATA</i> (CRYPTOPHYTA) (C)	123
FIG. 1.6. TEMPORAL VARIATIONS IN THE BIOMASS OF FOUR PHYTOPLANKTON GROUPS MEASURED WITH THE FLUOROPROBE AT HIGH TIDE IN 2009	125
FIG. 1.7. TEMPORAL DYNAMICS OF <i>PHAEOCYSTIS GLOBOSA</i> MEASURED AT HIGH TIDE IN 2009	126

Chapitre II: Utilisation du Phyto-PAM pour estimer l'activité photosynthétique du phytoplancton par groupes d'algues: performances et limites

FIG. 2.1. NON-METRIC MULTIDIMENSIONAL SCALING ORDINATION (MDS) OF THE REFERENCE SPECTRA	152
FIG. 2.2. RAPID LIGHT RESPONSE CURVES (RLC) MEASURED ON DIFFERENT PURE CULTURES (BLACK CIRCLES) AND OBTAINED AFTER THE DECONVOLUTION OF THE FLUORESCENCE SIGNALS MEASURED ON 2-SPECIES MIXTURES (WHITE CIRCLES)	154
FIG. 2.3. PHOTOSYNTHETIC PARAMETERS EXTRACTED FROM RLC CURVES	155
FIG. 2.4. RAPID LIGHT RESPONSE CURVES (RLC) MEASURED ON THE PURE CULTURES OF <i>PHAEOCYSTIS GLOBOSA</i> AND <i>ASTERIONELLOPSIS GLACIALIS</i> (BLACK CIRCLES) AND OBTAINED AFTER THE DECONVOLUTION OF THE FLUORESCENCE SIGNALS MEASURED ON MIXTURES (WHITE CIRCLES)	157
FIG. 2.5. PHOTOSYNTHETIC PARAMETERS EXTRACTED FROM RLC CURVES	158
FIG. 2.6. PHOTOSYNTHETIC PARAMETERS EXTRACTED FROM RLC CURVES MEASURED ON PURE CULTURES USING DIFFERENT SETS OF REFERENCE SPECTRA	160
FIG. 2.7. PHOTOSYNTHETIC PARAMETERS EXTRACTED FROM THE DECONVOLUTION OF RLC CURVES MEASURED ON PURE CULTURES AND MIXTURES OF <i>SCENEDESMUS SP.</i> + <i>MICROCYSTIS AERUGINOSA</i> USING DIFFERENT SETS OF REFERENCE SPECTRA	161
FIG. 2.8. PHOTOSYNTHETIC PARAMETERS EXTRACTED FROM THE DECONVOLUTION OF RLC CURVES MEASURED ON PURE CULTURES AND MIXTURES OF <i>SYNECHOCOCCUS SP.</i> (CONDITION 2) + <i>THALASSIOSIRA OCEANICA</i> (CONDITION 2) USING DIFFERENT SETS OF REFERENCE SPECTRA	163
FIG. 2.9. PHOTOSYNTHETIC PARAMETERS EXTRACTED FROM THE DECONVOLUTION OF RLC CURVES MEASURED ON PURE CULTURES AND MIXTURES OF <i>SYNECHOCOCCUS SP.</i> (CONDITION 2) + <i>PHAEOCYSTIS GLOBOSA</i> (CONDITION 2) USING DIFFERENT SETS OF REFERENCE SPECTRA	164

Fig. 2.10. PHOTOSYNTHETIC PARAMETERS EXTRACTED FROM THE DECONVOLUTION OF RLC CURVES MEASURED ON PURE CULTURES AND MIXTURES OF <i>ASTERIONELLOPSIS GLACIALIS</i> (CONDITION 2) + <i>PHAEOCYSTIS GLOBOSA</i> (CONDITION 2) USING DIFFERENT SETS OF REFERENCE SPECTRA	166
---	-----

Chapitre III: Utilisation des Rapid Light Curves (RLC) et des Steady State Light Curves (SSLC) pour la caractérisation *in situ* de l'activité photosynthétique du phytoplancton

Fig. 3.1. CARTE DU DÉTROIT DU PAS-DE-CALAIS AVEC UN ZOOM SUR LA ZONE D'ÉCHANTILLONNAGE	182
---	-----

Fig. 3.2. VARIATIONS JOURNALIÈRES DES PARAMÈTRES PHOTOSYNTHÉTIQUES α [en $\mu\text{mol e}^- \text{mg chl } a^{-1} \text{ s}^{-1}$ ($\mu\text{mol photons m}^{-2} \text{ s}^{-1})^{-1}$] (A, B), ETR_m [en $\mu\text{mol e}^- \text{mg chl } a^{-1} \text{ s}^{-1}$] (C, D) ET E_k [en $\mu\text{mol photons m}^{-2} \text{ s}^{-1}$] (E, F) ISSUS DES RLC ET DES N-SSLC.....	186
---	-----

Fig. 3.3. VARIATIONS SAISONNIÈRES DES PARAMÈTRES PHOTOSYNTHÉTIQUES α [en $\mu\text{mol e}^- \text{mg chl } a^{-1} \text{ s}^{-1}$ ($\mu\text{mol photons m}^{-2} \text{ s}^{-1})^{-1}$] (A), ETR_m [en $\mu\text{mol e}^- \text{mg chl } a^{-1} \text{ s}^{-1}$] (B) ET E_k [en $\mu\text{mol photons m}^{-2} \text{ s}^{-1}$] (C) ISSUS DES RLC ET DES N-SSLC	189
---	-----

Fig. 3.4. RELATIONS LINÉAIRES ENTRE α_{RLC} ET $\alpha_{\text{N-SSLC}}$ [en $\mu\text{mol e}^- \text{mg chl } a^{-1} \text{ s}^{-1}$ ($\mu\text{mol photons m}^{-2} \text{ s}^{-1})^{-1}$] AUX ÉCHELLES JOURNALIÈRE (A) ET SAISONNIÈRE (B) ET ENTRE ETR_{mRLC} ET $\text{ETR}_{\text{mN-SSLC}}$ [en $\mu\text{mol e}^- \text{mg chl } a^{-1} \text{ s}^{-1}$] À L'ÉCHELLE SAISONNIÈRE (C)	189
---	-----

TROISIEME PARTIE: DYNAMIQUES DE L'ACTIVITE PHOTOSYNTHETIQUE DU PHYTOPLANCTON EN MANCHE ORIENTALE

Fig. P.1. SAMPLING PERIODS AND SCALES STUDIED	204
--	-----

Chapitre IV: Variabilité spatio-temporelle de l'activité photosynthétique du phytoplancton dans un écosystème macrotidal (le Détroit du Pas-de-Calais, Manche orientale)

Fig. 4.1. MAP OF THE STRAIT OF DOVER WITH ENLARGED AREA REPRESENTING THE LOCATION OF SAMPLING STATIONS.....	212
--	-----

Fig. 4.2. SEASONAL VARIATION OF DISSOLVED NUTRIENTS CONCENTRATION IN SURFACE WATERS DURING THE SAMPLING PERIOD..	219
---	-----

Fig. 4.3. SPATIO-TEMPORAL DISTRIBUTION OF A) SALINITY, B) LIGHT ATTENUATION COEFFICIENT (K_{PAR}) AND C) TOTAL BIOMASS (CHLOROPHYLL A CONCENTRATION) IN SURFACE WATERS	221
---	-----

FIG. 4.4. SEASONAL VARIATION OF PHYTOPLANKTON ASSEMBLAGES SHOWN AS THE PROPORTION OF TOTAL BIOMASS FOR EACH OF THE MAJOR GROUPS IDENTIFIED BY THE FLUOROPROBE AT STATION S1	223
FIG. 4.5. SPATIO-TEMPORAL VARIATIONS OF CHL A-SPECIFIC ABSORPTION COEFFICIENTS (\bar{a}_{phy}^*) IN SURFACE WATERS	224
FIG. 4.6. SPATIO-TEMPORAL VARIATIONS OF A) THE MAXIMUM QUANTUM YIELD (F_v/F_m), B) THE MAXIMAL LIGHT UTILIZATION EFFICIENCY (α), C) THE LIGHT SATURATION COEFFICIENT (E_k) AND D) THE MAXIMUM ELECTRON TRANSPORT RATE (ETR_m) IN SURFACE WATERS	225
FIG. 4.7. RELATIONSHIPS BETWEEN THE MAXIMAL LIGHT UTILIZATION EFFICIENCY (α) AND THE MAXIMUM ELECTRON TRANSPORT RATE (ETR_m)	226
FIG. 4.8. RATIO E_k/E_m AT STATIONS S1 (FILLED CIRCLES), S3 (OPEN CIRCLES), S5 (FILLED TRIANGLES), S7 (OPEN TRIANGLES) AND S9 (FILLED SQUARES)	227
FIG. 4.9. SPATIO-TEMPORAL VARIABILITY OF PHOTOSYNTHETIC PARAMETERS REPRESENTED BY BOX PLOTS OF COEFFICIENTS OF VARIATION (%)	229
FIG. 4.10. REDUNDANCY ANALYSIS (RDA)	231

Chapitre V: Variabilité à court terme et contrôle de l'activité photosynthétique du phytoplancton dans un écosystème macrotidal (le Déroit du Pas-de-Calais, Manche orientale)

FIG. 5.1. MAP OF THE STRAIT OF DOVER WITH ENLARGED AREA REPRESENTING THE LOCATION OF SAMPLING STATION (S)	248
FIG. 5.2. COMPOSITION OF PHYTOPLANKTON ASSEMBLAGES DURING EACH SAMPLING PERIOD	255
FIG. 5.3. HOURLY VARIATIONS OF THE MAXIMUM ELECTRON TRANSPORT RATE (ETR_m) (IN BLACK) AND PAR IRRADIANCE (E IN GREY)	259
FIG. 5.4. HOURLY VARIATIONS OF THE MAXIMAL LIGHT UTILIZATION EFFICIENCY (α) (IN BLACK) AND PAR IRRADIANCE (E IN GREY)	261
FIG. 5.5. HOURLY VARIATIONS OF THE MAXIMUM QUANTUM YIELD (F_v/F_m) (IN BLACK) AND PAR IRRADIANCE (E IN GREY)	263
FIG. 5.6. HOURLY VARIATIONS OF THE LIGHT SATURATION COEFFICIENT (E_k) (IN BLACK) AND PAR IRRADIANCE (E IN GREY)	265

Chapitre VI: Dynamiques de l'activité photosynthétique du phytoplancton dans un écosystème macrotidal (le Déroit du Pas-de-Calais, Manche orientale): échelles de temps de la variabilité et contrôle environnementale

FIG. 6.1. MAP OF THE STRAIT OF DOVER WITH ENLARGED AREA REPRESENTING THE LOCATION OF SAMPLING STATION (S)	281
--	-----

Fig. 6.2. PHYSICOCHEMICAL PARAMETERS AT SEASONAL SCALE.....	288
Fig. 6.3. TEMPORAL VARIATIONS OF TAXONOMIC COMPOSITION OF ASSEMBLAGES IDENTIFIED BY THE FLUOROPROBE.	289
Fig. 6.4. PHOTOSYNTHETIC PARAMETERS AT SEASONAL SCALE	291
Fig. 6.5. MEAN CHL A-SPECIFIC ABSORPTION COEFFICIENT (\bar{a}^*_{phy}) IN $m^2 (mg\ chl\ a)^{-1}$	293
Fig. 6.6. VARIABILITY OF PHOTOSYNTHETIC PARAMETERS AT DIFFERENT TIME SCALES REPRESENTED BY BOX PLOTS OF COEFFICIENTS OF VARIATION (%)	294

SYNTHESE ET PERSPECTIVES

Fig. S.1. VARIABILITÉ DES PARAMÈTRES PHOTOSYNTHÉTIQUES AUX DIFFÉRENTES ÉCHELLES SPATIALES ET TEMPORELLES REPRÉSENTÉE PAR DES BOÎTES À MOUSTACHES DES COEFFICIENTS DE VARIATION (%).....	324
--	-----

Liste des tableaux

PREMIERE PARTIE : PHYTOPLANKTON ET PRODUCTION PRIMAIRE

TABLEAU I. LISTE DES MODÈLES LES PLUS UTILISÉS POUR DÉCRIRE LES COURBES DE RÉPONSES À LA LUMIÈRE	81
---	----

DEUXIEME PARTIE: UTILISATION DE LA FLUORESCENCE SPECTRALE ET DE LA FLUORIMETRIE

MODULEE POUR L'ETUDE DU PHYTOPLANKTON EN MANCHE ORIENTALE

Chapitre I: Suivi de la dynamique des Haptophytes en utilisant le FluoroProbe: une application en Manche orientale pour la surveillance de *Phaeocystis globosa*

TABLE 1.I. DIVISION, SPECIES, STRAIN CODE, CULTURE MEDIUM AND ORIGIN OF THE 18 PHYTOPLANKTON CULTURES EXAMINED	112
---	-----

TABLE 1.II. STUDENT'S TEST COMPARING OF ABSOLUTE CHLOROPHYLL A CONCENTRATIONS OF GREEN ALGAE, BROWN ALGAE, CRYPTOPHYTA, FLAGELLATED CELLS AND COLONIAL CELLS OF <i>P. GLOBOSA</i> IN DIFFERENT MIXTURES.....	123
---	-----

Chapitre II: Utilisation du Phyto-PAM pour estimer l'activité photosynthétique du phytoplancton par groupes d'algues: performances et limites

TABLE 2.I. DIVISION, SPECIES, STRAIN CODE, ORIGIN AND AREA COLLECTED OF THE 11 PHYTOPLANKTON CULTURES EXAMINED.....	144
--	-----

TABLE 2.II. WITHIN-GROUP SIMILARITY AND BETWEEN-GROUP DISSIMILARITY OF REFERENCE SPECTRA	151
---	-----

TABLE 2.III. WITHIN-SPECIES SIMILARITY AND BETWEEN-SPECIES DISSIMILARITY OF REFERENCE SPECTRA	151
--	-----

TROISIEME PARTIE: DYNAMIQUES DE L'ACTIVITE PHOTOSYNTHETIQUE DU PHYTOPLANKTON EN
MANCHE ORIENTALE

Chapitre V: Variabilité à court-terme et contrôle de l'activité photosynthétique du
phytoplancton dans un écosystème macrotidal (le Détroit du Pas-de-Calais, Manche orientale)

TABLE 5.I. PHYSICOCHEMICAL PARAMETERS.....	255
TABLE 5.II. PHOTOSYNTHETIC PARAMETERS.....	257
TABLE 5.III. STEPWISE MULTIPLE LINEAR REGRESSION EQUATIONS RELATING PHOTOSYNTHETIC PARAMETERS TO ENVIRONMENTAL FACTORS AND ASSOCIATED STATISTICS.....	266

Chapitre VI: Dynamiques de l'activité photosynthétique du phytoplancton dans un écosystème
macrotidal (le Détroit du Pas-de-Calais, Manche orientale): échelles de temps de la variabilité
et contrôle environnementale

TABLE 6.I. STEPWISE MULTIPLE LINEAR REGRESSION EQUATIONS RELATING THE MAXIMUM QUANTUM YIELD (F_v/F_m) TO ENVIRONMENTAL FACTORS AND PHYTOPLANKTON GROUPS, AND ASSOCIATED STATISTICS	297
TABLE 6.II. STEPWISE MULTIPLE LINEAR REGRESSION EQUATIONS RELATING THE MAXIMAL LIGHT UTILIZATION EFFICIENCY (α).....	298
TABLE 6.III. STEPWISE MULTIPLE LINEAR REGRESSION EQUATIONS RELATING THE MAXIMUM ELECTRON TRANSPORT RATE (ETR_m) TO ENVIRONMENTAL FACTORS AND PHYTOPLANKTON GROUPS, AND ASSOCIATED STATISTICS	299
TABLE 6.IV. STEPWISE MULTIPLE LINEAR REGRESSION EQUATIONS RELATING THE LIGHT SATURATION COEFFICIENT (E_k) TO ENVIRONMENTAL FACTORS AND PHYTOPLANKTON GROUPS, AND ASSOCIATED STATISTICS	300

SYNTHESE ET PERSPECTIVES

TABLE S.I. CARACTÉRISTIQUES DU FLUOROPROBE ET DU PHYTO-PAM	314
---	-----

Liste des symboles et des abréviations

Paramètre	Signification	Unités
α	Efficacité maximale d'utilisation de la lumière	$\mu\text{mol e}^- \text{mg chl } a^{-1} \text{ s}^{-1}$ ($\mu\text{mol photons m}^{-2} \text{ s}^{-1}$) ⁻¹
\bar{a}^*_{phy}	Coefficient d'absorption spécifique de la chlorophylle <i>a</i>	$\text{m}^2 (\text{mg chl } a)^{-1}$
Chl	Chlorophylle	
CR, RC	Centre(s) réactionnel	
E	Intensité lumineuse	$\mu\text{mol photons m}^{-2} \text{ s}^{-1}$
E_k	Coefficient de saturation lumineuse	$\mu\text{mol photons m}^{-2} \text{ s}^{-1}$
ETR	Taux de transport des électrons	$\mu\text{mol e}^- \text{mg chl } a^{-1} \text{ s}^{-1}$
ETR _m	Taux de transport maximum des électrons	$\mu\text{mol e}^- \text{mg chl } a^{-1} \text{ s}^{-1}$
rETR	Taux de transport relatif des électrons	unités relatives
rETR _m	Taux de transport relatif maximum des électrons	unités relatives
F ₀	Niveau de fluorescence minimal obtenu après une acclimatation au noir	unités relatives
F ₀ '	Niveau de fluorescence minimal obtenu après une acclimatation à la lumière	unités relatives
F _m	Niveau de fluorescence maximum obtenu après l'application d'un flash de lumière saturante sur un échantillon acclimaté au noir	unités relatives
F _m '	Niveau de fluorescence maximum obtenu après l'application d'un flash de lumière saturante sur un échantillon acclimaté à la lumière	unités relatives
FRR	Fast repetition rate	
$\Delta F/F_m'$, ΦPSII	Rendement quantique effectif	unités relatives
F_v/F_m	Rendement quantique maximum	unités relatives
LED	Diode électroluminescente	
LHC	Antenne photosynthétique	
NO ₂ ⁻	Nitrite	
[NO ₂ ⁻]	Concentration en nitrite	μM
NO ₃ ⁻	Nitrate	
[NO ₃ ⁻]	Concentration en nitrate	μM
NPQ, qN	Quenching non photochimique	unités relatives
N-SSLC	Non sequential steady-state light curve	
OD	Densité optique	
PO ₄ ⁻³	Phosphate	
[PO ₄ ⁻³]	Concentration en phosphate	μM
PAM	modulation d'impulsions en amplitude (Pulse Amplitude Modulated)	
PAR	Eclairement disponible pour la photosynthèse (Photosynthetically Active Radiation)	$\mu\text{mol photons m}^{-2} \text{ s}^{-1}$
PCB	Phycocyanobiline(s)	
PC	Phycocyanine	

PE	Phycoérythrine	
PEB	Phycoérythroiline	
Phe	Phaeophytine	
PS	Photosystème(s)	
PSI	Photosystème(s) I	
PSII	Photosystème(s) II	
PUB	Phycourobiline	
qE	Quenching énergie-dépendant	
qI	Quenching de photoinhibition	
qP	Quenching photochimique	unités relatives
qT	Quenching d'état de transition	
RDA	Analyse canonique de redondance	
RLC	Rapid Light Curve	
RUBISCO	Ribulose-1,5-bisphosphate carboxylase oxygenase	
Si(OH) ₄	Silicate	
[Si(OH) ₄]	Concentration en silicate	μM

List of symbols and abbreviations

Parameter	Meaning	Units
α	Maximal light utilization efficiency	$\mu\text{mol e}^- \text{ mg chl } a^{-1} \text{ s}^{-1}$ ($\mu\text{mol photons m}^{-2} \text{ s}^{-1}$) ⁻¹
\bar{a}_{phy}^*	Chlorophyll <i>a</i> specific absorption coefficient	$\text{m}^2 (\text{mg chl } a)^{-1}$
Chl	Chlorophyll	
CR, RC	Reaction center(s)	
E	Irradiance	$\mu\text{mol photons m}^{-2} \text{ s}^{-1}$
E_k	Light saturation coefficient	$\mu\text{mol photons m}^{-2} \text{ s}^{-1}$
ETR	Electron transport rate	$\mu\text{mol e}^- \text{ mg chl } a^{-1} \text{ s}^{-1}$
ETR _m	Maximum electron transport rate	$\mu\text{mol e}^- \text{ mg chl } a^{-1} \text{ s}^{-1}$
rETR	Relative electron transport rate	relative units
rETR _m	Maximum relative electron transport rate	relative units
F ₀	Minimal fluorescence level after dark acclimation	relative units
F ₀ '	Minimal fluorescence level in light acclimated state	relative units
F _m	Maximum fluorescence level obtained after the application of a saturation pulse on dark acclimated sample	relative units
F _m '	Maximum fluorescence level obtained after the application of a saturation pulse on light acclimated sample	relative units
FRR	Fast repetition rate	
$\Delta F/F_m'$, ΦPSII	Effective quantum yield	relative units
F_v/F_m	Maximum quantum yield	relative units
LED	Light-emitting diodes	
LHC	Light harvesting complex (antennae)	
NPQ, qN	Non-photochemical quenching	relative units
NO ₂ ⁻	Nitrite	
[NO ₂ ⁻]	Nitrite concentration	μM
NO ₃ ⁻	Nitrate	
[NO ₃ ⁻]	Nitrate concentration	μM
N-SSLC	Non sequential steady-state light curve	
OD	Optical density	
PO ₄ ⁻³	Phosphate	
[PO ₄ ⁻³]	Phosphate concentration	μM
PAM	Pulse Amplitude Modulated	
PAR	Photosynthetically Active Radiation	$\mu\text{mol photons m}^{-2} \text{ s}^{-1}$
PE	Phycoerythrin	
PEB	Phycoerythrobilin	
PCB	Phycocyanobilin(s)	
PC	Phycocyanin	
Phe	Phaeophytin	

PS	Photosystem(s)	
PSI	Photosystem(s) I	
PSII	Photosystem(s) II	
PUB	phycourobilin	
qE	Energy-dependent quenching	
qI	Photoinhibitory quenching	
qP	Photochemical quenching	relative units
qT	State-transition quenching	
RDA	Redundancy analysis	
RLC	Rapid Light Curve	
RUBISCO	Ribulose-1,5-bisphosphate carboxylase oxygenase	
Si(OH) ₄	Silicate	
[Si(OH) ₄]	Silicate concentration	μM

Introduction générale :

Contexte et objectifs

Le phytoplancton constitue une part importante des producteurs primaires des écosystèmes marins. A ce titre, il occupe une place primordiale dans les cycles biogéochimiques et dans la structuration des réseaux trophiques (Pauly & Christensen 1995, Cloern 1996). Il intervient notamment dans le cycle du carbone et sa contribution semble suffisante pour influencer le réchauffement climatique (Geider et al. 2001). On estime, en effet, qu'à l'échelle mondiale, le phytoplancton qui ne représente qu'1 à 2 % de la biomasse chlorophyllienne assimile chaque année environ 41 à 43 milliards de tonnes de carbone (Falkowski & Raven 2007). La part jouée par les écosystèmes côtiers dans cette fixation de carbone n'est pas négligeable. En effet, bien qu'ils ne représentent que 7% de la surface des océans, les écosystèmes côtiers sont le siège de fortes productions phytoplanctoniques. On estime qu'ils supportent chaque année 14 à 30% de la production primaire océanique mondiale (Gattuso et al. 1998) et qu'ils sont responsables d'environ 40% de la séquestration du carbone dans les océans (Muller-Karger et al. 2005). Cette production phytoplanctonique est essentielle pour les activités humaines puisqu'elle influence notamment les activités de pêche et de conchyliculture (ex : Chassot et al. 2010). A une époque, où la concentration atmosphérique du dioxyde de carbone est une préoccupation mondiale, comprendre le rôle des organismes phototrophes dans le contrôle des flux de carbone est plus que jamais primordial (Beardall et al. 2009).

Chez le phytoplancton, la fixation du carbone est effectuée par le biais de la production primaire dont le mécanisme principal est la photosynthèse oxygénique. Cette production de matière organique est le résultat des interactions entre les forçages physico-chimiques (tels que la lumière, la disponibilité des nutriments, la température et les conditions hydrodynamiques) et la réponse biologique qui inclut la réponse physiologique et la structure des communautés (Falkowski & Raven 2007).

Dans les écosystèmes côtiers à fort hydrodynamisme, comme la Manche orientale, les paramètres physico-chimiques sont hautement variables dans le temps et dans l'espace. Les trois principaux facteurs influençant la production primaire phytoplanctonique que sont la lumière (Anning et al. 2000), la température (Davison 1991, Claquin et al. 2008) et la disponibilité en nutriments (Cullen et al. 1992, Lippemeier et al. 1999) varient sur une large gamme d'échelles. Les variations de température et de la disponibilité en nutriments se déroulent principalement à des échelles de temps allant de la journée à la saison (MacIntyre et al. 2000). Par opposition, la lumière peut varier à des échelles de temps beaucoup plus courtes, allant de la seconde à la journée (Litchman & Klausmeier 2001). Ainsi, même si les communautés phytoplanctoniques restaient à une profondeur constante dans la zone euphotique, l'environnement lumineux change avec la course journalière du soleil, les variations saisonnières de l'éclairement et le passage de nuages. A cela, vient s'ajouter l'influence du mélange vertical de la colonne d'eau qui expose le phytoplancton à des changements d'intensité et de qualité de la lumière et à de possibles gradients de température et de disponibilité en nutriments (MacIntyre et al. 2000).

La co-variation de ces différents facteurs est de plus fréquente et plusieurs d'entre eux peuvent être impliqués simultanément dans le contrôle de l'activité photosynthétique du phytoplancton (Shaw & Purdie 2001). En effet, la variabilité environnementale peut agir directement sur l'état physiologique de chaque espèce phytoplanctonique (Lohrenz et al.

1994, Lizon et al. 1995) ou indirectement au travers des changements de la composition spécifique qui, à son tour, change les capacités photosynthétiques des assemblages phytoplanctoniques (Jouenne et al. 2005, 2007). En conséquence, les processus photosynthétiques relatifs à la production primaire, qui incluent les mécanismes de photoacclimatation, sont constamment modifiés à différentes échelles dans le temps et dans l'espace (Falkowski & Raven 2007).

L'activité photosynthétique et l'état d'acclimatation du phytoplancton sont caractérisés par le biais des courbes de réponse à la lumière (PE) qui permettent la détermination des paramètres photosynthétiques (Henley 1993, MacIntyre & Kana 2002). Bien que l'activité photosynthétique et l'état d'acclimatation du phytoplancton aient été étudiés dans différents écosystèmes à des échelles temporelles et spatiales différentes (ex: Côté & Platt 1983, Erga & Skjoldal 1990, Macedo et al. 2001), les stratégies d'acclimatation du phytoplancton et les facteurs contrôlant la variabilité des paramètres photosynthétiques ne sont pas encore totalement compris. C'est particulièrement vrai dans les écosystèmes côtiers à fort hydrodynamisme en raison de la complexité des interactions physico-chimiques et biologiques qui régissent l'activité photosynthétique du phytoplancton dans ce type de milieux. Dans ces milieux, la variabilité spatiale a principalement été étudiée dans les estuaires et les baies (ex : Kocum et al. 2002, Azevedo et al. 2010). D'un point de vue temporel, l'importance relative de la variabilité des paramètres photosynthétiques aux différentes échelles de temps a rarement été comparée car leur variabilité à court-terme a reçu peu d'attention.

Ce manque de données dans les écosystèmes à fort hydrodynamisme s'explique en partie par des contraintes méthodologiques. En effet, l'activité photosynthétique du phytoplancton a traditionnellement été étudiée par le biais des mesures d'oxygène (Gaarder & Gran 1927, Montford 1969) et/ou des méthodes basées sur l'utilisation de traceurs isotopiques

du carbone (Steemann Nielsen 1952, Hama et al. 1983). En plus d'être coûteuses, ces méthodes nécessitent des temps d'incubation relativement longs de l'ordre de 40 min à 24 heures. De telles contraintes, limitent la résolution spatio-temporelle des mesures de l'activité photosynthétique. En effet, dans des écosystèmes à fort hydrodynamisme où la variabilité des conditions environnementales est élevée et la compréhension de l'activité photosynthétique requiert un échantillonnage conséquent dans le temps et l'espace, l'utilisation de telles méthodes devient vite laborieuse et difficile à mettre œuvre.

L'utilisation des techniques basées sur la fluorescence de la chlorophylle *a*, telles que la fluorimétrie Fast Repetition Rate (FFRF) (Kolber et al. 1998) et la fluorimétrie par modulation d'impulsions en amplitude (PAM, Pulse Amplitude Modulated fluorometry) (Schreiber et al. 1986), permet de contourner ces problèmes. Ces méthodes, qui ne nécessitent aucun temps d'incubation et mesurent en temps réel l'activité photosynthétique du phytoplancton, ont le potentiel d'augmenter considérablement la résolution spatio-temporelle à laquelle les paramètres physiologiques du phytoplancton peuvent être mesurés (Kolber & Falkowski 1993). Il est donc important d'améliorer notre connaissance des relations entre la fluorescence (et les paramètres photosynthétiques qui en découlent) et les facteurs environnementaux (Moore et al. 2005). D'autant que la compréhension des relations entre conditions environnementales et paramètres photosynthétiques est nécessaire pour améliorer les estimations de la productivité océanique (Sakshaug et al. 1997, Platt et al. 2008), pour modéliser le fonctionnement des écosystèmes (Grangeré et al. 2009) et pour appréhender les potentiels impacts des pressions anthropiques et climatiques sur les écosystèmes.

En Manche orientale, comme dans la plupart des écosystèmes à fort hydrodynamisme, la variabilité et le contrôle de l'activité photosynthétique du phytoplancton ont principalement été étudiés en mesurant les paramètres photosynthétiques avec la méthode du carbone 14 (Lizon et al. 1995, Lizon 1997, Jouenne et al. 2005, 2007). Seul Vantrepotte (2003) a utilisé la

fluorimétrie modulée pour décrire la variation des paramètres photosynthétiques. Cependant, le travail de Vantrepotte (2003) a été réalisé dans un but de modélisation, à l'échelle régionale, de la production primaire appliquée à la télédétection, et la problématique du contrôle de l'activité photosynthétique du phytoplancton n'a pas été abordée. Les données disponibles sur le contrôle de l'activité photosynthétique du phytoplancton sont soit limitées au contrôle de la variabilité verticale et journalière au sein d'une colonne d'eau avec une stratégie d'échantillonnage centrée sur le printemps et l'été (Lizon et al. 1995, Jouenne et al. 2005) soit cantonnées à une zone estuarienne et une baie (Jouenne et al. 2007). Par conséquent, peu de données sur le contrôle de l'activité photosynthétique du phytoplancton à différentes échelles spatiales et temporelles sont disponibles dans les zones les plus dynamiques de la Manche orientale comme le Détroit du Pas-de-Calais. De plus, la variabilité interjournalière et journalière des paramètres photosynthétiques aux différentes saisons n'a pas été abordée et aucune de ces études n'a comparé l'importance relative des variations observées à différentes échelles spatiales et temporelles.

Cette thèse a donc pour but de caractériser la dynamique et le contrôle de l'activité photosynthétique du phytoplancton dans le Détroit du Pas-de-Calais. Il s'agit :

- (1) de caractériser la variabilité spatiale et temporelle des paramètres photosynthétique du phytoplancton à différentes échelles,
- (2) d'identifier et de hiérarchiser les principaux facteurs de contrôle de cette variabilité,
- (3) de mettre en évidence d'éventuelles relations entre les propriétés photosynthétiques de la communauté phytoplanctonique naturelle et sa composition taxonomique afin d'identifier les propriétés photosynthétiques spécifiques à chacun des groupes phytoplanctoniques.

Pour atteindre ces objectifs, notre choix méthodologique s'est porté sur l'utilisation de la fluorescence spectrale et de la fluorimétrie modulée.

La **première partie** de cette thèse est un état de l'art. Elle présente les bases théoriques associées à la photosynthèse et à l'utilisation de la fluorescence. Elle a pour but d'aider le lecteur dans sa compréhension des principaux chapitres de cette thèse.

L'utilisation de la fluorescence spectrale et de la fluorimétrie modulée nécessite, dans un premier temps, de tester leur efficacité et leur adéquation vis-à-vis des groupes phytoplanctoniques rencontrés en Manche orientale. Ces considérations méthodologiques font l'objet de la **deuxième partie** qui se structure en trois chapitres. Le premier chapitre est consacré à l'utilisation du FluoroProbe, fluorimètre multi longueurs d'ondes, qui permet l'estimation de la biomasse phytoplanctonique par groupes. Le second chapitre traite de l'utilisation du Phyto-PAM pour la caractérisation de l'activité photosynthétique par groupes phytoplanctoniques. Dans le troisième chapitre, l'utilisation des Rapid Light Curves (RLC) et des Steady State Light Curves (SSLC) pour la caractérisation *in situ* de l'activité photosynthétique du phytoplancton a été comparée.

La **troisième partie** rapporte les résultats acquis sur le terrain. Elle est composée de trois chapitres. Dans le premier chapitre, la variabilité spatio-temporelle de l'activité photosynthétique du phytoplancton a été caractérisée le long d'un transect côte-large. Le second chapitre caractérise la variabilité à court terme de l'activité photosynthétique du phytoplancton tandis que le troisième chapitre compare l'importance relative de la variabilité des paramètres photosynthétiques à différentes échelles de temps allant de l'échelle horaire à l'échelle pluriannuelle.

General introduction:

Context and objectives

Phytoplankton constitutes an important part of marine ecosystems primary producers. Therefore, it is of primary importance in biogeochemical cycles and in the structuring of food webs (Pauly & Christensen 1995, Cloern 1996). It notably influences the carbon cycle and its contribution seems to be sufficient to influence the global warming (Geider et al. 2001). Indeed, at global scale, it is estimated that phytoplankton that represents only 1 to 2% of the global chlorophyllous biomass assimilates each year about 41 to 43 milliards of tons of carbon (Falkowski & Raven 2007). The part played by coastal ecosystems in this carbon fixing is not negligible. Indeed, although they represent only 7% of the ocean's surface, coastal ecosystems present strong phytoplankton productions. It was estimated that each year they produce 14 to 30% of the global oceanic primary production (Gattuso et al. 1998) and are responsible for about 40% of the carbon sequestration in the oceans (Muller-Karger et al. 2005). This phytoplankton production is essential for human activities because it notably influences the fishing and shellfish farming activities (e.g. Chassot et al. 2010). In an era when atmospheric concentration of carbon dioxide is a global concern, understanding the role of phototrophs in the global carbon cycle is becoming more important than ever (Beardall et al. 2009).

In phytoplankton, the carbon fixing is carried out through the main mechanism of primary production: the oxygenic photosynthesis. This production of organic matter is the result of interplays between physicochemical forcing (such as light, nutrient availability,

temperature and hydrodynamic conditions) and the biological response including the physiological response and the communities structure (Falkowski & Raven 2007).

In coastal ecosystems with a strong hydrodynamism, such as the eastern English Channel, the physicochemical parameters are highly variables in space and time. The three main factors influencing the phytoplankton primary production that are light (Anning et al. 2000), temperature (Davison 1991, Claquin et al. 2008) and nutrient availability (Cullen et al. 1992, Lippemeier et al. 1999) vary on a large range of scales. Variations in temperature and nutrient availability principally take place on temporal scale ranging from days to seasons (MacIntyre et al. 2000). By opposition, light can varies on shorter time scales ranging from seconds to days (Litchman & Klausmeier 2001). Therefore, even for phytoplankton communities remaining at a constant depth within the euphotic area, the light environment is changing in response to the course of sunlight in the daytime, seasonal variations in irradiance and cloud movements. In addition, the vertical mixing of the water column exposes phytoplankton to changes in both the intensity and the spectral quality of light and possible gradients of temperature and nutrient availability (MacIntyre et al. 2000).

The co-variation of these factors is frequent and several of them may be simultaneously implied in the control of phytoplankton photosynthetic activity (Shaw & Purdie 2001). Indeed, environmental variability can act directly on the physiological state of each phytoplankton species (Lohrenz et al. 1994, Lizon et al. 1995) or indirectly through changes in species composition, which in turn change the photosynthetic capacities of assemblages (Jouenne et al. 2005, 2007). Consequently, the photosynthetic processes of primary production, including the photoacclimation mechanisms, are constantly modified on different scales in time and space (Falkowski & Raven 2007).

The photosynthetic activity and photoacclimation status of phytoplankton is characterised through the photosynthesis-light response (PE) curves which allow the

determination of the photosynthetic parameters (Henley 1993, MacIntyre & Kana 2002). While the photosynthetic activity and photoacclimation status of phytoplankton have been studied in different ecosystems at different spatial and temporal scales (e.g.: Côté & Platt 1983, Erga & Skjoldal 1990, Macedo et al. 2001), the photoacclimation strategies and the factors controlling the variability in photosynthetic parameters remain poorly understood. It is particularly true in coastal ecosystems with a strong hydrodynamism because of the complex physicochemical and biological interplays which govern the phytoplankton photosynthetic activity in this kind of environments. In these systems, the spatial variability of photosynthetic parameters was principally studied in estuaries and bays (e.g.: Kocum et al. 2002, Azevedo et al. 2010). In a temporal point of view, the relative importance of the variability in photosynthetic parameters occurring on each time scale has seldom been compared because the short-term variability of these parameters has received little attention.

The lack of data in these ecosystems is due in part to methodological limitations. Indeed, the photosynthetic activity has traditionally been measured using oxygen (Gaarder & Gran 1927, Montford 1969) and/or carbon isotope tracers methods (Steemann Nielsen 1952, Hama et al. 1983). These methods, in addition to being expensive, require relatively long incubation times (between 40 min to 24 hours). Such constraints limit the spatio-temporal resolution for studying photosynthetic activity. Indeed, in highly variable coastal ecosystems where the variability in environmental conditions is high and the understanding of photosynthetic activity requires a consequent sampling in space and time, the use of such methods become rapidly laborious and difficult to implement.

The use of the techniques based on chlorophyll *a* fluorescence, such as the fast repetition rate fluorometry (FRRF) (Kolber et al. 1998) and pulse amplitude modulated (PAM) fluorometry (Schreiber et al. 1986), allow to overcome these problems. These methods, that do not require incubation times and measure phytoplankton photosynthetic

activity in real-time, have the potential to greatly extend the spatio-temporal resolution at which phytoplankton physiological parameters can be measured (Kolber & Falkowski 1993). It is therefore important to improve our understanding of the relationships between fluorescence (and derived photosynthetic parameters) and environmental factors (Moore et al. 2005). Particularly since the understanding of relationships between environmental conditions and photosynthetic parameters is necessary to enhance the estimations of the oceanic productivity (Sakshaug et al. 1997, Platt et al. 2008), to model the functioning of ecosystems (Grangeré et al. 2009) and to grasp the potential effects of anthropogenic and climate forcing on ecosystems.

In the eastern English Channel, like in most coastal ecosystems with a strong hydrodynamism, the variability and control of phytoplankton photosynthetic activity have been mainly studied using isotopic carbon (^{14}C). Only Vantrepotte (2003) has used the modulated fluorometry to describe the variability of phytoplankton photosynthetic parameters. However, the work of Vantrepotte (2003) was realised for modelling the primary production at a regional scale using remote sensing data and the problematic of the control of phytoplankton photosynthetic activity was not tackled. The available data about the control of phytoplankton photosynthetic activity are either limited to the control of the vertical and diel variability of phytoplankton photosynthetic parameters within a water column, with a sampling strategy focused on spring and summer (Lizon et al. 1995, Jouenne et al. 2005), or limited to an estuarine bay-area (Jouenne et al. 2007). Consequently, few data are available about the variability and control of phytoplankton photosynthetic activity at different spatial and temporal scales in the most highly dynamic areas of the eastern English Channel such as the Strait of Dover. Moreover, the between-days and hourly variability of phytoplankton photosynthetic parameters during each season of year has not been investigated and none of

these studies has compared the relative importance of the variability occurring at different spatial and temporal scales.

Therefore, this thesis has for objective to characterise the dynamic and control of phytoplankton photosynthetic activity in the Strait of Dover. More precisely, this thesis aims:

(1) to characterise the spatial and temporal variability of phytoplankton photosynthetic parameters over different scales,

(2) to identify and classify according to a hierarchical system the main factors controlling this variability,

(3) to underline eventual relationships between the photosynthetic properties of natural phytoplankton community and its taxonomic composition to identify the photosynthetic properties specific to each phytoplankton group.

To attain these objectives, we chose to use the spectral fluorescence and modulated fluorometry.

The **first part** of this thesis is a state of art. It presents the theoretical bases associated with photosynthesis and the use of fluorescence. It has for goal to help the reader in its understanding of the main parts of this thesis.

The use of spectral fluorescence and modulated fluorometry requires, in a first time, to test their efficiency and accuracy towards the phytoplankton groups encountered in the eastern English Channel. These methodological considerations are the subject of the **second part**. This part is structured in three chapters. The first chapter is dedicated to the use of the FluoroProbe, a spectral fluorometer that allows the estimation of phytoplankton biomass by algal groups. The second chapter deals with the use of the Phyto-PAM to characterise the photosynthetic activity by algal groups. In the third chapter, the use of rapid light curves (RLC) and steady state light curves (SSLC) to characterise phytoplankton photosynthetic activity *in situ* is compared.

The **third part** reports the results acquired in the field. In the first chapter, the spatio-temporal variability of phytoplankton photosynthetic activity was characterised along an inshore-offshore transect. The second chapter characterises the short-term variability of phytoplankton photosynthetic activity whereas the third chapter compares the relative importance of the variability of phytoplankton photosynthetic parameters occurring at different time scales ranging from hourly to pluriannual scales.

Première partie:
Phytoplancton et production primaire

First part:
Phytoplankton and primary production

Avant propos

Cette partie est un état de l'art. Elle introduit les réactions de la photosynthèse, la production primaire et la mesure, l'interprétation et la terminologie générale de la fluorescence. Cette section a pour but d'aider le lecteur dans sa compréhension des principes de base associés à l'utilisation de la fluorescence. Le lecteur déjà familier avec ces principes peut directement passer à la deuxième partie.

Preface

This part is a state of art. It introduces photosynthetic reactions, primary production and the measurement, interpretation and general terminology of fluorescence. This section serves to help the reader in its understanding of the basic principles associated with the use of fluorescence. The reader already well-versed in these principles can pass directly to the second part.

1 PHOTOSYNTHESE ET PRODUCTION PRIMAIRE

1.1 Définitions et réactions

Bien qu'il n'y ait pas de consensus sur la définition de la production primaire (Williams 1993), en océanologie, celle-ci est couramment définie comme : l'ensemble des processus conduisant à la synthèse de matière organique à partir de composés inorganiques (comme le CO₂, l'eau et les éléments minéraux) et d'une source d'énergie. Chez le phytoplancton marin, la production primaire s'effectue par le biais de la photosynthèse oxygénique.

La photosynthèse oxygénique est un processus endogène complexe qui peut être décrit comme une chaîne d'événements en cascade qui commence avec la capture de photons par les pigments photosynthétiques et se poursuit par le rejet d'oxygène et la fixation du carbone (Kroon et al. 1993). Ce processus permet de transformer l'énergie électromagnétique de la lumière en énergie chimique. L'énergie lumineuse est ainsi utilisée pour la synthèse d'hydrates de carbone et est stockée par la production primaire de biomasse (Falkowski & Raven 2007). La réaction globale de la photosynthèse peut être résumée par l'équation suivante :

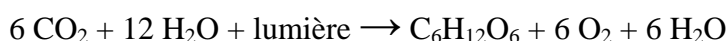

Cette réaction comprend en réalité plusieurs étapes intermédiaires réparties en deux catégories : les réactions claires (chaîne de transport des électrons) et les réactions sombres (cycle de Calvin). Les premières sont localisées au sein de sacs membranaires, appelés thylacoïdes, séparant le cytosol (chez les procaryotes) ou stroma (chez les eucaryotes) du lumen. Les thylacoïdes sont libres dans le cytosol chez les procaryotes et confinés dans un

chloroplaste chez les cellules eucaryotes. Les réactions sombres sont quant à elles localisées au niveau du stroma ou cytosol.

1.2 Les photosystèmes II (PSII)

Le signal de fluorescence, capté par les fluorimètres qui ont été utilisés dans cette thèse, étant principalement émis au niveau des PSII (ex : Pfündel 1998, Schreiber 2004, Jakob et al. 2005), une rapide description de leur structure et de leur fonctionnement s'avère nécessaire.

D'un point de vue fonctionnel, les PSII peuvent être décrits comme une « enzyme » qui catalyse l'oxydation des molécules d'eau sous le contrôle de la lumière. En réalisant cette opération, les PSII permettent aux électrons d'entrer dans la chaîne de transport des électrons et fournissent une partie de l'énergie nécessaire qui permet en dernière étape de réduire le carbone inorganique. Ce sont ces photosystèmes (PS) qui portent la plupart des premiers accepteurs primaires d'électrons de cette chaîne (Huot & Babin 2010). D'un point de vue structurel, les PS (que ce soit le PSI ou le PSII) sont des complexes protéiques transmembranaires composés d'un centre réactionnel (CR) surmonté d'une antenne pigmentaire.

1.2.1 L'antenne pigmentaire

Toutes les réactions lumineuses de la photosynthèse oxygénique commencent par l'absorption d'un photon par un complexe protéine-pigment (le LHCII chez les algues

eucaryotes, le phycobilisome chez les cyanobactéries) appelé antenne photosynthétique qui a pour rôle l'acheminement de l'énergie lumineuse jusqu'au centre réactionnel des PSII (CRII). Chez les algues eucaryotes et les cyanobactéries, la composition pigmentaire et la structure de ces antennes sont fortement variables. Quatre groupes principaux peuvent de ce fait être différenciés : les cyanobactéries, les algues vertes, les algues brunes et le groupe mixte (Fig. 1).

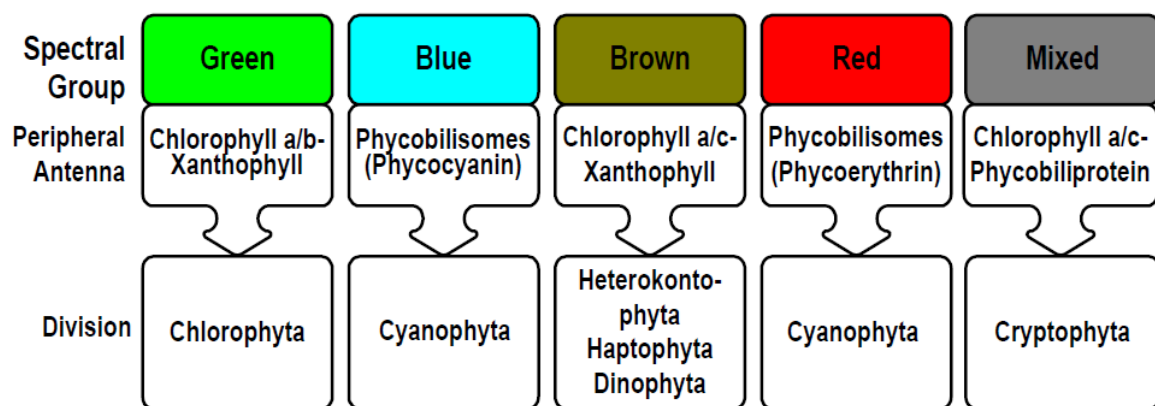

Fig. 1. Les différents groupes pigmentaires (Beutler et al. 2002)

Chez les algues vertes, l'antenne périphérique est constituée de chlorophylle *a* (chl *a*), de chlorophylle *b* (chl *b*) et de xanthophylles. Chez les algues brunes, elle se compose de chl *a*, de chlorophylle *c* (chl *c*) et de xanthophylles (souvent fucoxanthine ou péridine). L'antenne périphérique des cyanobactéries est particulière. Elle est, en effet, composée de phycobilisomes (Fig. 2) c'est-à-dire des complexes macromoléculaires constitués d'un cœur, en contact direct avec la membrane des thylacoïdes du côté stroma, sur lequel sont fixées six projections radiales (bras) (Everroad et al. 2006). Les principaux constituants des phycobilisomes sont diverses classes de protéines (les phycobiliprotéines) qui portent des chromophores (molécules colorées). Il existe quatre types de phycobiliprotéines qui diffèrent par la composition de leurs chromophores. L'allophycocyanine n'est présente qu'au niveau du

cœur des phycobilisomes. Elle porte des chromophores de couleur bleue : appelés phycocyanobilines (PCB). La partie basale des bras (ou l'ensemble des bras chez certaines souches de cyanobactéries) est composée de phycocyanine (PC). Celle-ci porte uniquement de la phycocyanobiline ou une combinaison de phycocyanobiline et de phycoérythrobiline (PEB, chromophore de couleur rouge) (Longhi et al. 2003). Les phycobiliprotéines qui constituent la partie distale des bras sont plus variables. Cette partie peut être composée de phycoérythrine (PE) ou, plus rarement, de phycoérythrocyanine (Six et al. 2008). La PE porte toujours de la PEB et peut, dans certains cas, porter aussi une phycobiline orange, la phycourobiline (PUB) (Longhi et al. 2003). Les cyanobactéries sont généralement classées en deux catégories : les cyanobactéries riches en PC (groupe bleu sur la Fig. 1) et les cyanobactéries riches en PE (groupe rouge sur la Fig. 2). Le groupe mixte comprend les Cryptophytes qui ont une combinaison de chl *a* et de chl *c* avec un phycobilisome qui peut être constitué soit de PE soit de PC (Beutler et al. 2002).

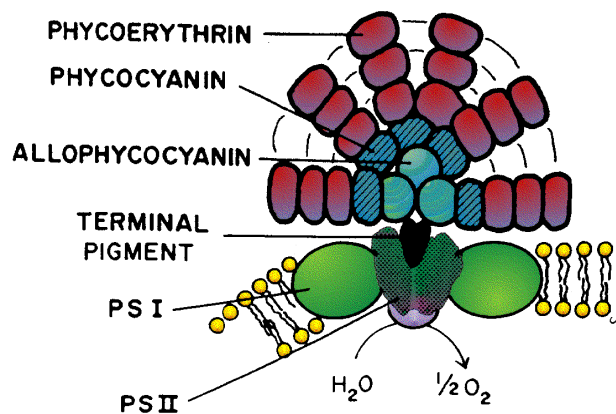

Fig. 2. Schéma d'un phycobilisome de cyanobactérie (Beutler 2003)

Ces différences de composition et de structure de l'antenne périphérique confèrent à chacun des groupes pigmentaires des propriétés spectrales spécifiques. Ainsi chaque groupe peut être identifié à partir de son spectre d'excitation de fluorescence. En effet, les algues vertes présentent deux maxima de fluorescence (un à 470 nm, l'autre à 650 nm) dus aux

chlorophylles a et b. A cause de la phycoyanine, les cyanobactéries fluorescent principalement à 610 nm. Les algues brunes ont un maximum de fluorescence à 525 nm qui s'explique par la présence de fucoxanthine chez les Bacillariophyceae et de péricidine chez les Dinophyceae. Enfin, chez le groupe mixte, le maximum de fluorescence se situe autour de 570 nm à cause de la phycoérythrine.

1.2.2 Le centre réactionnel

Structure

Selon Huot et Babin (2010), le CRII est un complexe protéique composé :

- d'une antenne interne (CP24, CP26, CP29) dont la fonction principale est le transfert (et la régulation) de l'énergie absorbée de l'antenne photosynthétique vers les protéines centrales CP43 et CP47 ;
- d'un cœur composé de quatre protéines (D1, D2, CP47, CP43). Les protéines D1 et D2, qui forment un hétérodimère) portent les premiers accepteurs d'électrons, le site de fragmentation des molécules d'eau (le groupe manganèse) et le site de la séparation de charge (chlorophylle P680). Les protéines CP43 et CP47 sont principalement impliquées dans le transfert de l'énergie de l'antenne interne vers le site de la séparation de charge ;
- de protéines structurelles (représentées en gris clair sur la Fig. 3) qui forment la partie du complexe impliqué dans l'absorption de l'oxygène situé du côté lumen du PSII et facilitent l'action du groupe manganèse ;

- plusieurs protéines de faible poids moléculaire (représentées en gris foncé sur la Fig. 3) dont la plupart ont des fonctions inconnues. L'une d'elles (PsbS représentée en vert sur la Fig. 3) joue un rôle dans la dissipation de l'énergie excédentaire et dans la régulation du transfert de l'énergie de l'antenne vers le cœur du PSII.

Fonctionnement

Pendant les réactions claires, la première étape de la photosynthèse est l'absorption de l'énergie lumineuse au niveau des PSII. L'énergie d'excitation qui atteint le PSII est capturée au niveau de l'antenne pigmentaire. Elle est ensuite transférée très rapidement (en quelques picosecondes) au CRII : au niveau des chlorophylles du complexe P680 qui entre alors dans un état excité (P680*) (Oxborough 2004). Quelques picosecondes plus tard, une séparation de charge se déroule au niveau de P680* : un électron est cédé à une phaeophytine (Phe → Phe⁻) et le CR devient un radical chargé positivement (P680⁺). P680⁺ retourne à son état de base (P680) en acceptant un électron provenant d'un groupe manganèse via un résidu de tyrosine Yz (Fig. 3). Phe⁻ continue le transport des électrons en réduisant une quinone (Q_A → Q_A⁻) qui, à son tour, réduit une plastoquinone (Q_B → Q_B⁻) et se réoxyde. C'est seulement après que ce processus ait pris place que l'énergie d'un autre photon peut être acceptée par le CRII. Avec la répétition de ce processus, Q_B⁻ accepte un second électron et arrache un proton à chacune des deux molécules d'eau situées dans le stroma pour devenir la plastoquinone PQH₂.

PQH₂ est larguée dans la membrane du thylacoïde et rejoint le stock de plastoquinones (PQ). Lorsque la concentration des PQ dépasse celle de Q_A d'un facteur 5 à 30, le stock de PQ sert de stockage d'électrons entre les PSII et PSI (Kolber & Falkowski 1993).

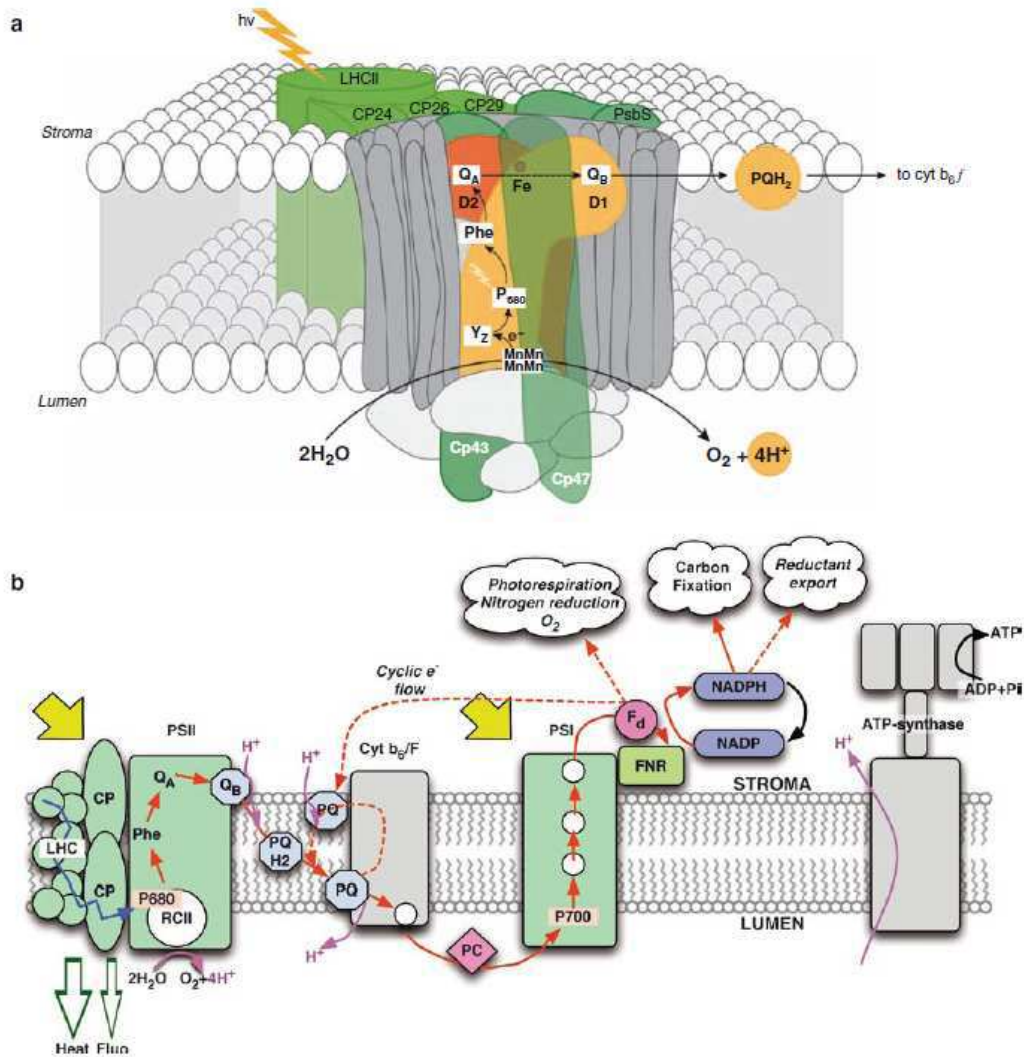

Fig. 3. Organisation des photosystèmes II et chaîne de transport des électrons. (a) Organisation des PSII. Se référer ci-dessus texte (parties 1.2.2 et 1.3) pour de plus amples détails. (b) Représentation schématique des réactions claires de la photosynthèse. De gauche à droite sont représentées quatre complexes protéiques : le photosystème II (PSII), les cytochromes b6-f (cyt b6-f), le photosystème I (PSI) et l'ATP synthase. Les flèches rouges continues indiquent un transport linéaire du flux d'électron tandis que les flèches rouges en pointillés représentent des voies alternatives. Au niveau du PSII sont représentés schématiquement : l'antenne photosynthétique (LHCII) et deux protéines CP, le centre réactionnel (RCII), la phaeophytine (Phe), le premier accepteur d'électrons (la quinone Q_A) et le second accepteur d'électrons (la quinone Q_B). Entre le PSII et le cyt b6-f est représenté le pool de plastoquinones. Le transporteur d'électrons entre le cyt b6-f et le dimer de chlorophylle *a* du PSI (P700) est une plastocyanine (PC). L'accepteur final des électrons en aval du PSI est une ferrédoxine (Fd) qui avec la ferrédoxine-NADP réductase (FNR) réduit le NADP en NADPH. Les voies alternatives d'utilisation des électrons sont représentées par des nuages blancs. Sont aussi représentés les sources de protons (H^+) vers le lumen issues de la séparation des molécules d'eau et du transport par les plastoquinones, ainsi que le principal flux de H^+ issu du transport via un complexe protéique : l'ATP-synthase (Huot & Babin 2010)

Après que quatre photons ont été absorbés et que quatre séparations de charges se sont déroulées, deux PQ réduites sont transférées vers la membrane des thylacoïdes et quatre charges positives sont accumulées dans le complexe manganèse. Ce complexe chargé positivement arrache deux électrons à deux molécules d'eau et conduit à la formation d'oxygène et d'hydrogène (Huot & Babin 2010).

Il est important de noter que chaque Q_B doit accepter deux électrons (et deux protons) pour se transformer en PQH₂, tandis que Q_A ne peut accepter qu'un électron à la fois. Bien que la séparation de charge sur les accepteurs secondaires (réoxydation de Q_A^-) se déroule en un temps constant de 0,6 ms, la réoxydation de PQH₂ est contrôlée par les réactions sombres de la photosynthèse (2-15 ms). Ainsi, lorsque l'intensité lumineuse augmente et que les réactions sombres atteignent leur capacité maximale, le stock de PQ se réduit progressivement et la ré-oxydation de Q_A^- ralentit ce qui conduit à la fermeture des CR et à la réduction du rendement quantique de la photosynthèse (Falkowski & Kolber 1993).

1.3 La chaîne de transport des électrons

Une fois transférée vers la membrane des thylacoïdes, les PQ diffusent au sein de la membrane pour atteindre le cytochrome b₆-f (cyt b₆-f) où elles s'attachent à un site de liaison sur la partie de la membrane située du côté du lumen et transfèrent leur électron au cyt b₆-f (Fig. 3). Une plastocyanine transfère ensuite les électrons du cyt b₆-f vers le centre réactionnel du PSI (CRI) composé d'une paire de chlorophylles spéciales nommées P700. Ce transfert d'électrons des PSII aux PSI est couplé à un pompage de protons au niveau du cytochrome b₆/f. Ces protons, ajoutés à ceux issus de la photolyse de l'eau, engendrent un gradient de pH

de part et d'autre de la membrane du thylacoïde qui fournit l'énergie nécessaire à l'activation d'un complexe ATP synthase.

Pour que les P700 puissent accepter les électrons de la plastocyanine, celles-ci doivent être oxydées. Cette oxydation se déroule à travers une deuxième réaction sous le contrôle de la lumière où un photon est absorbé au niveau du PSI et conduit au transfert d'un électron au premier accepteur d'électrons du PSI. L'électron de la plastocyanine peut ensuite réduire P700. L'électron transféré au premier accepteur d'électrons du PSI est ensuite transféré par le biais de plusieurs molécules pour finalement réduire une ferrédoxine.

Au niveau de cette ferrédoxine, plusieurs voies sont possibles. Soit l'électron est utilisé pour fournir le pouvoir réducteur nécessaire à la formation du NADPH qui sera utilisé dans les réactions sombres de la photosynthèse et conduira à la fixation de carbone. A noter que dans ce cas, deux électrons sont nécessaires à la formation d'une molécule de NADPH. Soit l'électron est utilisé dans des voies alternatives (ex : les réactions de Mehler, la photorespiration, la réduction de l'azote, transport cyclique des électrons autour du PSI).

2 LA FLUORESCENCE POUR L'ETUDE DE LA PRODUCTION PRIMAIRE

2.1 Introduction

Cette partie a pour but d'aider le lecteur à comprendre le fonctionnement des fluorimètres qui ont été utilisés dans cette thèse. Elle se veut essentiellement informative et ne se prétend, en aucun cas, exhaustive car plusieurs excellentes revues et ouvrages traitant de la fluorescence de la chl *a*, son principe et ses applications ont déjà été publiés. Pour de plus

amples informations sur le sujet, le lecteur peut consulter : Krause & Weis (1984, 1991), Falkowski & Kolber (1993), Rohacek & Bartak (1999), Samson et al. (1999), Maxwell & Johnson (2000), Rohacek (2002), Oxborough (2004), Papageorgiou & Gorvindjee (2004), Baker (2008) et Suggett et al. (2010b). La fluorescence de la chl *a* dont il est question dans cette partie est la fluorescence dite « active » ou « variable ». Elle est induite par l'excitation des organismes photosynthétiques avec une lumière artificielle et est à différencier de la fluorescence « passive » (ou naturelle) qui utilise la lumière du soleil.

Ces dernières années, l'utilisation de la fluorescence active de la chl *a* pour étudier l'écophysiologie des végétaux s'est répandue et est maintenant omniprésente dans ce genre d'étude. Cette tendance s'explique en partie par la prise de conscience des limites des méthodes traditionnelles de mesure de la production primaire que sont l'incorporation du carbone radioactif (^{14}C , méthode de Steemann Nielsen (1952)) et la mesure des échanges d'oxygène (Gaarder & Gran 1927.)

Il est, en effet reconnu dans la littérature, que la méthode de l'oxygène n'est pas suffisamment sensible pour certaines mesures *in situ*. Son utilisation est, par exemple, difficile dans les zones oligotrophes (Sakshaug et al. 1997, Gilbert et al. 2000) et la concentration des échantillons peut introduire des artefacts dans les données (Mountford 1969).

La méthode du ^{14}C , bien qu'elle soit la méthode la plus utilisée et qu'elle reste la méthode de référence (Moigis & Gocke 2003), souffre également d'un certain nombre de problèmes. Tout d'abord, elle demande des incubations relativement longues (de l'ordre de 40 minutes jusqu'à 24 heures) qui peuvent altérer l'état de photoacclimatation des microalgues qui sont isolées de leur milieu naturel. Il devient alors difficile d'extrapoler les résultats de ces incubations à la colonne d'eau (Gilbert et al. 2000 et références citées). Ce problème est connu sous la nom d'effet bouteille (« bottle effect », Falkowski & Kolber (1993), Kolber & Falkowski (1993). Il est également reconnu que la technique du ^{14}C peut sous-estimer la

production primaire (Peterson 1980) et que la différenciation entre la production primaire brute ou nette n'est pas clairement définie avec cette méthode (Gilbert et al. 2000, Beardall et al. 2009). D'autres articles citent aussi le coût des opérations et les précautions à prendre pendant la manipulation des radio-isotopes qui rendent leur utilisation fastidieuse (ex :Falkowski & Kolber 1993).

Tous ces problèmes ont stimulé la recherche de méthodes alternatives (Falkowski & Kolber 1993). C'est ainsi que la fluorescence chlorophyllienne s'est présentée comme une méthode prometteuse. Elle présente effectivement beaucoup d'avantages. Elle ne nécessite pas de périodes d'incubation (ce qui l'affranchit de l'effet bouteille) et elle est relativement non invasive. Elle mesure la photosynthèse brute (ex : Beardall et al. 2009). Elle permet de réaliser des mesures spatio-temporelles avec une plus haute résolution que les méthodes classiques grâce à la rapidité des mesures et elle nécessite peu de manipulations de l'échantillon (ex :White & Critchley 1999). De plus, ces 20 dernières années, des progrès considérables ont été fait dans l'amélioration de la sensibilité et de la portabilité des fluorimètres ce qui a permis leur application aux environnements aquatiques (Schreiber et al. 1995b, Schreiber 2004, Jakob et al. 2005).

En dépit de la simplicité des mesures, l'interprétation des données de fluorescence reste complexe et controversée (Maxwell & Johnson 2000). C'est particulièrement le cas pour l'étude des microalgues marines car bien que les mesures de la fluorescence chlorophyllienne ont été utilisées depuis plusieurs années pour étudier la physiologie des plantes supérieures terrestres, ce n'est que récemment que les appareils de mesure ont acquis une sensibilité suffisante pour être utilisés sur les microalgues aquatiques (Schreiber et al. 1995b). Même si des progrès considérables ont été réalisés depuis 1995, une partie de nos connaissances est toujours basée sur l'étude des plantes supérieures et certaines de ces connaissances restent inadaptées aux microalgues marines.

Deux méthodes pour mesurer la fluorescence variable en milieu aquatique ont été développées au milieu des années 80 : la méthode du Fast Repetition Rate fluorometer (FRRF) de Falkowski et al. (1986) et Kolber et al. (1998) et la méthode PAM (Pulse Amplitude Modulation) de Schreiber et al. (1986). Ces méthodes estiment l'efficacité photochimique des PSII par le biais de rapports entre des niveaux de fluorescence. Des flashes de lumière suffisamment brefs pour saturer provisoirement l'activité photochimique des PSII sont utilisés pour obtenir un niveau maximum de fluorescence.

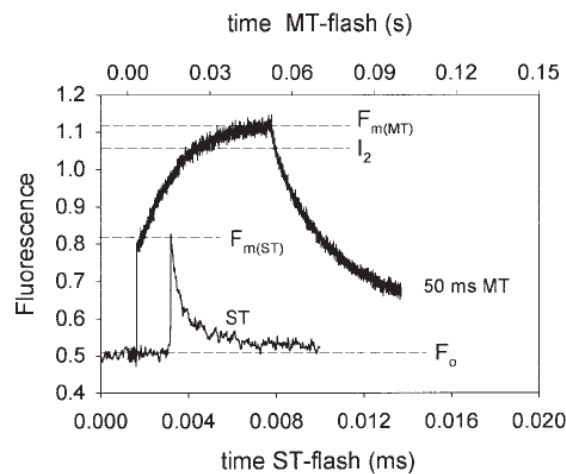

Fig. 4. Courbes d'induction de fluorescence obtenues chez l'algue verte *Ankistrodesmus* en utilisant un single turnover flash (« ST », axe des abscisses du bas 0-0,02 ms), ou un multiple turnover flash d'une durée de 50 ms (« MT », axe des abscisses du haut 0-0,15 s) délivrés par une lampe xénon (Kromkamp & Forster 2003)

Selon Kromkamp and Forster (2003), c'est le type de flash utilisé pour provoquer la fermeture des PSII qui permet de faire la distinction entre ces méthodes. En effet, les méthodes du pump and probe et du FRRF utilisent un flash de lumière de courte durée appelé single turnover flash (ST) qui ne permet qu'à une seule séparation de charge de se dérouler pendant la durée du flash et ne provoque la réduction que de l'accepteur primaire des PSII (Q_A). La méthode PAM utilise quant à elle un flash de lumière de plus longue durée de l'ordre de 50 à 1000 ms qui provoque des séparations de charges multiples jusqu'à ce que l'ensemble

des accepteurs d'électrons des PSII soit réduit (c'est-à-dire tous les accepteurs primaires Q_A , l'ensemble des accepteurs secondaires Q_B mais aussi le pool de plastoquinones). Ce type de flash appelé multiple turnover flash permet ainsi d'atteindre un niveau maximum de fluorescence, appelé $Fm_{(MT)}$, plus élevé que celui qui est atteint avec un single turnover flash : le niveau $Fm_{(ST)}$ (Fig. 4).

Pour cette thèse, nous avons retenu la méthode PAM. Les prochains paragraphes ne s'appliqueront donc qu'à cette méthode. Toutefois, si le lecteur souhaite obtenir de plus amples informations sur les différentes méthodes de mesure de la fluorescence variable en milieu marin, il peut, par exemple, consulter l'article de Falkowski et al. (2004).

2.2 Définition et origine de la fluorescence

La fluorescence est la réémission d'énergie sous la forme de photons (donc de lumière) lorsqu'une molécule revient d'un état excité à son état de base. Dans le cas de la fluorescence de la chl *a*, l'énergie lumineuse reçue par l'antenne du PSII est transmise aux molécules de chl *a* qui passent de leur état fondamental stable à un état excité instable (Oxborough 2004, Papageorgiou & Govindjee 2004, Perkins et al. 2010).

Au cours de la désexcitation de ces molécules, l'énergie absorbée peut emprunter trois voies : la plus grande partie est utilisée pour la photochimie (première séparation de charge et transport photosynthétique des électrons) et l'énergie excédentaire, qui n'a pas été utilisée pour la photochimie, est dissipée sous forme de chaleur et de fluorescence. Comme ces trois voies sont en compétition et qu'il est admis que la somme de ces processus est égale à 1, l'augmentation de l'efficacité de l'une des voies conduit à la diminution du rendement des deux autres. Ainsi en mesurant, le rendement de la fluorescence chlorophyllienne, des

informations sur les changements de l'efficacité de la photochimie et de la dissipation thermique peuvent être obtenues (Oxborough 2004).

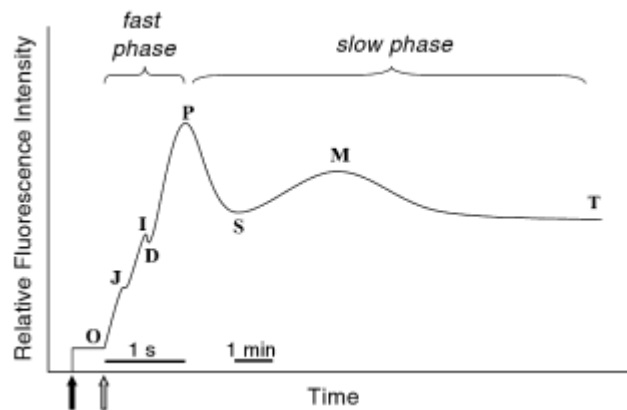

Fig. 5. Courbe d'induction de la fluorescence de la chl *a*. La flèche noire représente l'activation de la lumière de mesure non actinique et la flèche blanche l'application d'une forte lumière actinique d'après Cosgrove & Borowitzka (2010)

Les premiers à avoir observé les variations du rendement de fluorescence sont Kautsky et Hirsch (1931). Ils ont découvert que la fluorescence de la chlorophylle varie dans le temps lorsqu'une plante (ou une algue), acclimatée à l'obscurité, est transférée sous une forte lumière actinique. Cette cinétique de la fluorescence est appelée courbe de Kautsky ou courbe d'induction de la fluorescence (Fig. 5).

Cette courbe est composée de deux phases principales :

- une phase rapide au cours de laquelle le rendement de fluorescence augmente au fur et à mesure que les CR des PSII se ferment en réponse à l'exposition à la lumière actinique. La fluorescence passe ainsi de son point d'origine (point O où tous les CR sont ouverts) à son point maximal (point P où tous les CR sont fermés) en passant par deux points d'inflexion (les points J et I) et dans certains cas, une déclivité (le point D). Cette phase (appelée O-J-I-P) reflète donc les changements de l'état redox des centres réactionnels des PSII.

- une phase longue où le rendement de fluorescence diminue (points S, M et T). Ce phénomène est appelé « quenching ». Il s'explique par deux processus : 1) l'augmentation du taux de transport des électrons en aval des PSII dû à l'activation lumineuse des enzymes du cycle de Calvin : c'est le quenching photochimique (photochemical quenching) et 2) l'augmentation simultanée de l'efficacité de la dissipation de l'énergie excédentaire sous forme de chaleur : le quenching non photochimique (non photochemical quenching).

Pour une description détaillée de la courbe de Kautsky, consulter Cosgrove & Borowitzka (2010).

La phase rapide de la courbe de Kautsky est souvent utilisée pour estimer le rendement quantique de la photochimie. L'origine de la courbe d'induction de Kautsky (point O) est ainsi utilisée pour mesurer le rendement minimal de fluorescence noté F_0 tandis que le point P est utilisé pour mesurer le rendement maximal de fluorescence noté F_m . La méthode appliquée est celle des pulses saturants dont Schreiber et ses collaborateurs (Schreiber et al. 1986) sont parmi les premiers à l'avoir appliquée et qui a ensuite été décrite en détails (ex :Schreiber et al. 1995a, Schreiber et al. 1995c, Schreiber 2004). Cette méthode se base sur la méthode de doublement de la lumière (« light doubling method ») de Bradbury and Baker (1981).

2.3 Analyse des quenching par la méthode des pulses saturants

2.3.1 Principe

Les performances photosynthétiques d'un organisme ne peuvent être correctement décrites, à partir des mesures de fluorescence, qu'en estimant correctement la contribution des quenching photochimique et non photochimique au signal de fluorescence. Cette estimation est rendue possible grâce à la technique des pulses saturants qui permet de « bloquer » momentanément la photochimie de façon à mesurer le rendement de fluorescence en présence uniquement du quenching non photochimique. Pour bien comprendre cette technique, il convient de considérer deux cas de figure : 1) l'échantillon a été acclimaté au noir et 2) l'échantillon a été acclimaté à une certaine intensité lumineuse.

Lorsque l'échantillon a été acclimaté à l'obscurité, le stock de Q_A est complètement oxydé et tous les CRII sont ouverts. Le rendement de fluorescence est alors minimal (F_0). Dans ce cas de figure, l'énergie lumineuse reçue par le CR est principalement utilisée pour la photochimie et la dissipation thermique est négligeable. Cet état est généralement atteint après une acclimatation à l'obscurité suffisamment longue pour permettre : l'ouverture des PSII, l'oxydation de la chaîne de transport des électrons, la relaxation des mécanismes de photoprotection (cycle des xanthophylles¹) et la dissipation du gradient de pH de part et d'autre de la membrane des thylacoïdes (Ralph & Gademann 2005). Pour mesurer cet état, la lumière de mesure doit être suffisamment faible pour ne pas réduire les Q_A et provoquer la

¹ Cycle au cours duquel l'énergie lumineuse absorbée est dissipée sous forme de chaleur par les caroténoïdes : la zéaxanthine chez les algues vertes, ou la diatoxanthine chez les algues brunes.

fermeture des CRII (Schreiber 2004). Il est établi que la valeur F_0 , dans le cas où l'échantillon est bien acclimaté à l'obscurité, est proportionnelle à la quantité de chl *a* contenue dans les cellules. Ce paramètre est appelé fluorescence de base et est utilisé comme estimateur de la biomasse (Sakshaug et al. 1997, Kühl et al. 2001). Une fois cette mesure réalisée, la méthode des pulses saturants consiste à appliquer un flash de lumière de forte intensité de façon à fermer tous les CRII (réduire toutes les Q_A) et à réduire provisoirement la photochimie à zéro. Le rendement de fluorescence atteint alors une valeur maximale (F_m) équivalente à celle qui serait atteinte en absence de quenching photochimique.

Si l'échantillon est acclimaté à une lumière actinique (qui déclenche la photosynthèse), une partie des PSII est fermée. Le rendement de fluorescence avant le flash saturant (F_0') est alors inférieur au rendement de fluorescence minimal F_0 observé après acclimatation à l'obscurité car le quenching non photochimique réduit le rendement de fluorescence. Il en est de même pour la valeur du rendement obtenue pendant le flash saturant (F_m') qui est faible que F_m . La valeur à l'état stable avant le flash saturant est appelée F . Les figures 6 et 7 résument le principe de l'analyse des quenching par la méthode des pulses saturants.

2.3.2 Quenching photochimique

Les analyses des quenching comparent les rendements de fluorescence durant un flash saturant sous conditions de lumière actinique (F_m' et F) avec les valeurs d'acclimatation à l'obscurité F_0 et F_m . Dans la littérature, un grand nombre de coefficients ont été proposés pour quantifier les quenching photochimiques et non photochimiques et les mêmes paramètres sont souvent référencés de différentes façons. Bien que plusieurs tentatives ont été faites pour

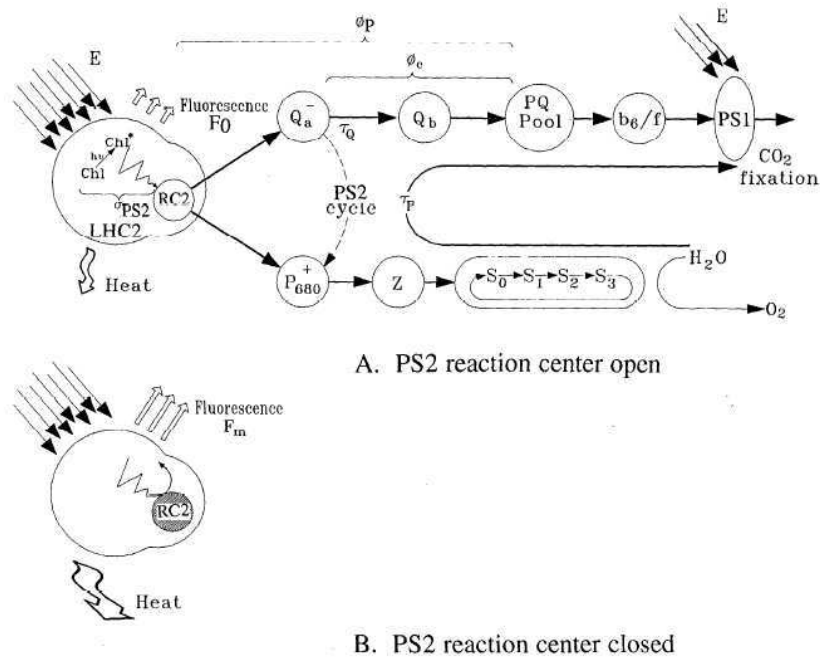

Fig. 6. Diagramme représentant la dissipation de l'énergie lumineuse absorbée au niveau des PSII en fonction de leur état. La largeur des flèches représente de façon non proportionnelle le rendement relatif de chaque voie de dissipation. A) PSII ouvert : la majorité de l'énergie lumineuse absorbée est utilisée pour la photochimie, la fluorescence est faible et la dissipation thermique est négligeable. B) PSII fermé : la photochimie est « bloquée », la fluorescence et la dissipation thermique sont élevées (Kolber & Falkowski 1993)

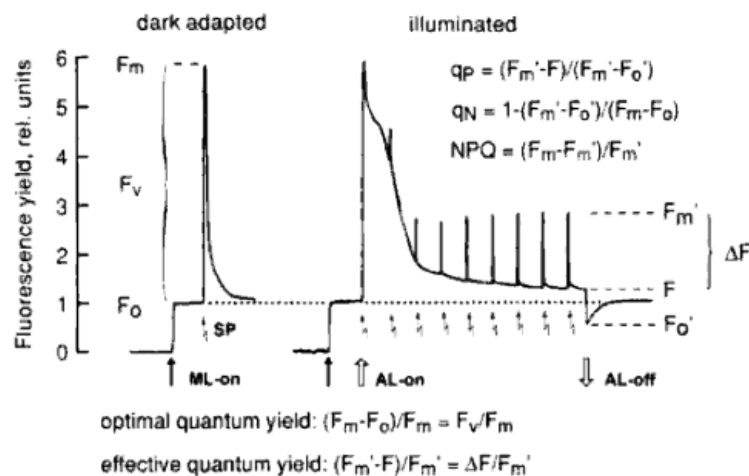

Fig. 7. Analyse des quenching par la méthode des pulses saturants. Niveaux de fluorescence et définition des paramètres de la fluorescence. F_0 : rendement de fluorescence après acclimatation à l'obscurité. F_m : rendement maximal de fluorescence, d'un échantillon acclimaté à l'obscurité, atteint durant un flash saturant. F_v : augmentation du rendement de fluorescence durant un flash saturant. F_m' : rendement maximal de fluorescence d'un échantillon acclimaté à une certaine intensité lumineuse atteint durant un flash saturant. F_0' : rendement minimal de fluorescence observé immédiatement après le transfert d'un échantillon acclimaté à une certaine intensité lumineuse à l'obscurité. q_p : coefficient de quenching photochimique. q_N : coefficient de quenching non photochimique. NPQ : paramètre de quenching non photochimique. ML : lumière de mesure de faible intensité. AL : lumière actinique. SP : pulse saturant (Schreiber 2004)

établir une terminologie commune (van Kooten & Snel 1990, Maxwell & Johnson 2000, Baker & Oxborough 2004), les publications récentes continuent à utiliser des termes différents pour décrire les mêmes signaux de fluorescence ou les mêmes paramètres, et parfois, un même terme peut être utilisé pour décrire différents paramètres (Baker & Oxborough 2004). Les termes qui sont utilisées ici sont les plus utilisés et la nomenclature employée est celle de van Kooten and Snel (1990).

Le quenching photochimique, qP, peut être défini comme la probabilité qu'un CRII soit capable de réaliser la séparation de charge à un instant donné. Il mesure donc la capacité de conversion de l'énergie lumineuse absorbée au niveau des PSII, en énergie chimique (capacité photochimique) (Krause & Weis 1991, Kolber & Falkowski 1993, Kromkamp & Forster 2003, Morris & Kromkamp 2003, Suggett et al. 2003). Il dépend de l'état redox de Q_A . Dans le cas où tous les CRII sont ouverts (Q_A oxydé), qP est maximal (= 1) et le rendement de fluorescence est faible. A l'inverse, quand tous les CRII sont fermés (à cause de la réduction de Q_A), qP est égal à zéro et le rendement de fluorescence est maximal (Ting & Owens 1993). Il est important de noter que qP ne peut pas être directement utilisé pour estimer la proportion de PSII ouverts (ou l'état redox de Q_A). En effet, bien que de nombreux auteurs l'ont utilisé dans ce but (Maxwell & Johnson 2000), cette application de qP ne prend pas en considération le fait que la relation entre le rendement de fluorescence et la proportion de CRII ouverts n'est pas toujours linéaire. Les premiers à avoir montré cette non linéarité sont (Joliot and Joliot 1964) qui ont trouvé que la relation peut également être curviligne. Cette relation est en réalité complexe car elle dépend du degré de connectivité entre les CRII et de l'importance du quenching non photochimique (Baker & Oxborough 2004, Oxborough 2004).

qP peut être calculé avec l'équation suivante : $qP = (F_m' - F) / (F_m' - F_0')$.

Le problème avec cette formulation est que F_0' peut être difficile à mesurer. En effet, normalement F_0' est mesuré sur des échantillons acclimatés à une certaine intensité lumineuse

dans la rouge lointain et en absence de lumière actinique, avant ou après le pulse saturant utilisé pour mesurer F_m' . Il est ainsi supposé qu'en mesurant F_0' sous ces conditions, Q_A est fortement oxydée, à cause de l'excitation préférentielle du PSI par l'intensité dans le rouge lointain, et que le niveau de la fluorescence du quenching non photochimique ne change pas entre les mesures de F et F_0' . Or, ce n'est pas toujours le cas car une grande partie du quenching non photochimique suit les changements du gradient de pH de part et d'autre de la membrane des thylacoïdes. Et comme dans la plupart des cas, le gradient de pH diminue très rapidement dès que la lumière actinique est éteinte, et il y a seulement une petite fenêtre de temps pendant laquelle il est possible de déterminer la véritable valeur de F_0' (Oxborough & Baker 1997). Certains auteurs ont donc remplacé F_0' par F_0 (ex : Kolber & Falkowski 1993, Ralph & Gademann 2005) mais ce remplacement peut conduire à une surestimation de qP. Oxborough and Baker (1997) ont donc proposé une méthode alternative de calcul de F_0' :

$$F_0' = F_0 / [(F_v/F_m) + (F_0/F_m')] \text{ avec } F_v = (F_m - F_0)$$

2.3.3 Quenching non photochimique

En pratique, la fluorescence ne suit pas une simple relation inverse avec la photochimie puisque le rendement de fluorescence n'augmente pas proportionnellement à la fermeture des CRII aux fortes irradiances. Ce rendement a effectivement une relation complexe avec l'irradiance puisqu'il augmente dans un premier temps au fur et à mesure que les CRII se ferment puis décroît aux fortes irradiances. Le quenching de fluorescence, induit par les irradiances élevées, n'est pas dû à la réduction de Q_A . Il est donc appelé quenching non photochimique (Kolber & Falkowski 1993).

Le principe de la répartition du signal de fluorescence entre les quenching photochimique et non photochimique repose sur le fait que la séparation de charge cesse dès que l'échantillon est placé à l'obscurité. Ainsi, quand l'échantillon est exposé à la lumière, les deux types de quenching contribuent au rendement de fluorescence. Par contre quand il est placé à l'obscurité, le quenching de fluorescence restant est dû uniquement au quenching non photochimique. Ce quenching est induit par le gradient de pH au niveau de la membrane des thylacoïdes, les états de transition (redistribution de la lumière absorbée entre les photosystèmes) et par la photoinhibition (Buschmann 1999). Le site principal du développement du quenching non photochimique est supposé être l'antenne pigmentaire (Ting & Owens 1993, Oxborough & Baker 1997). Etant donné la diversité de structure de l'antenne pigmentaire, on peut s'attendre à ce que les mécanismes du quenching non photochimique varient entre les taxa (Ting & Owens 1993).

Le quenching non photochimique a trois composants principaux qui peuvent être évalués à partir de l'analyse de leur cinétique de relaxation à l'obscurité après une période d'illumination : le quenching énergie-dépendant (qE), le quenching d'état de transition (qT) et le quenching de photoinhibition (qI). A noter que des précautions doivent être prises au cours l'évaluation de ces paramètres car les caractéristiques de leur cinétique de relaxation peuvent varier en fonction de l'histoire lumineuse des cellules et des conditions environnementales dans lesquelles sont réalisées les mesures (Ting & Owens 1992, Baker 2008).

En général, sous lumière modérée à saturante, le composant principal du quenching non photochimique est qE. C'est le composant qui se relaxe le plus rapidement à l'obscurité. Dans la littérature, les temps de relaxation varient entre 30-60 s (Ralph & Gademann 2005) et 1-3 min (White & Critchley 1999). qE est associé au quenching qui se déroule au niveau de l'antenne de PSII. Il est régulé par le gradient de pH de part et d'autre de la membrane des

thylacoïdes et par le cycle des xanthophylles (mécanisme impliqué dans la photoprotection) (Ralph et al. 2010). Ce gradient de pH, en plus de fournir l'énergie nécessaire à la formation de l'ATP, peut changer la conformation des antennes pigmentaires des PSII et activer des enzymes qui interviennent dans le cycle des xanthophylles (Baker 2008). qE est contrôlé par le gradient de pH qui diminue lorsque l'intensité lumineuse devient saturante. Ce type de contrôle permet à qE de répondre rapidement (en quelques secondes) aux variations de l'intensité lumineuse. Cette réponse est suffisamment rapide pour que les cellules puissent, par exemple, s'adapter à la diminution de l'intensité lumineuse pendant le passage de nuages. qE est le composant principal du NPQ en conditions de lumière modérée à saturante (Ralph et al. 2010).

Le composant qT est important uniquement aux faibles lumières et a un temps de relaxation plus long que qE puisqu'il se relaxe en 10 à 20 min (Masojidek et al. 1999). Il est impliqué dans les changements d'état de transition qui interviennent dans la répartition de l'énergie lumineuse entre les PSII et PSI. Chez les algues, le mécanisme exact de fonctionnement des états de transition n'est pas encore totalement connu (Wagner et al. 2006). Les états de transition ont été décrits chez les cyanobactéries, les Rhodophytes et chez la plupart des algues vertes. Par opposition, chez les chromophytes, les états de transition sont faibles ou absents (Johnsen & Sakshaug 2007 et références citées) et il semble que ce groupe ne développe pas ou très peu de qT (Lavaud 2007, Brunet & Lavaud 2010).

qI devient dominant avec des niveaux de lumière dépassant largement le niveau nécessaire pour saturer la photosynthèse ou quand des stress limitent sévèrement la consommation des réducteurs produits par le transport photosynthétique des électrons (NADPH/NADPH⁺ et ATP) (Baker 2008). C'est le composant du quenching non photochimique qui a le temps de relaxation le plus long (d'une dizaine de minutes à quelques heures) (Maxwell & Johnson 2000). Sous lumière saturante, qI se met en place lorsque qE

n'est plus suffisant (Krause & Weis 1991). A noter que ce quenching est beaucoup moins bien compris que qE et qu'il fait référence à la fois aux processus photoprotectants et aux photodommages des CRII (Maxwell & Johnson 2000, Müller et al. 2001 et références citées). La distinction entre qE et qI peut se faire à l'aide des valeurs de F_0 et de F_m . Gilmore et al (1996) indiquent, en effet, que les mécanismes photoprotectants, comme ceux impliqués dans qE, diminuent de façon proportionnelle F_0 et F_m tandis que la photoinhibition, responsable de qI, augmente le niveau de F_0 et diminue le niveau de F_m .

Pour de plus amples informations sur les différents composants du quenching non photochimique, le lecteur est invité à consulter Krause & Weis (1991), Müller et al. (2001), Krause & Jahns (2004a).

Dans la littérature, il existe deux coefficients permettant d'évaluer le quenching non photochimique : $qN = 1 - (F_m' - F_0') / (F_m - F_0)$ et $NPQ = (F_m - F_m') / F_m'$.

qN est une mesure de la fraction du maximum de fluorescence variable ($F_m - F_0$), après acclimatation à l'obscurité, qui est dissipée en plaçant l'échantillon à la lumière. Ce coefficient a deux inconvénients majeurs : il nécessite l'estimation de F_0' et il peut être influencé par la photochimie (2004b). Il est donc conseillé d'utiliser préférentiellement le quenching de Stern-Volmer : NPQ qui est plus robuste (Ralph & Gademann 2005). NPQ mesure la fraction de l'énergie lumineuse absorbée qui est dissipée par des processus autres que la photochimie. Il est plus sensible à la dissipation de l'énergie au sein de la matrice pigmentaire des antennes des PSII (contenant des xanthophylles, où le quenching énergie dépendant se déroule) et relativement insensible aux faibles niveaux du quenching non photochimique qui sont principalement associés aux états de transition (Ralph & Gademann 2005).

La méthode des pulse saturants ne permet pas seulement l'estimation des quenching photochimiques et non photochimiques. Elle évalue, en effet, l'efficacité avec laquelle la

lumière absorbée est utilisée pour la photosynthèse (Suggett et al. 2009) et permet ainsi d'obtenir une bonne estimation du rendement quantique de la conversion de l'énergie au niveau des PSII.

2.4 Rendements quantiques

2.4.1 Définition et types de rendements quantiques

Le rendement quantique (généralement symbolisé par Φ) correspond au nombre d'électrons produits par le résultat de l'absorption d'un photon par une seule séparation de charge au niveau du PSII (Kromkamp & Forster 2003). Ce rendement est fortement dépendant de l'histoire lumineuse des cellules et de l'efficacité photochimique des PSII. Il est maximum après une période d'acclimatation à l'obscurité : c'est-à-dire quand les molécules de l'accepteur primaire des électrons (quinones) sont complètement oxydées et prêtes à recevoir les électrons.

A partir des mesures de fluorescence, il ainsi est possible d'estimer deux types de rendements quantiques : le rendement quantique optimal (F_v/F_m) et le rendement quantique effectif ($\Delta F/F_m'$).

Le rendement quantique optimal correspond à l'efficacité photochimique maximale en absence de quenching non-photochimique. Il est donc nécessaire de placer l'échantillon à l'obscurité pendant 15 à 30 minutes avant de réaliser la mesure afin de permettre l'ouverture complète des PSII (Kromkamp & Forster 2003). Ce rendement peut être calculé à partir de l'équation suivante : $F_v/F_m = (F_m - F_0)/F_m$

Durant l'illumination de l'échantillon, le rendement quantique des PSII est diminué par la fermeture des CR (diminution du quenching photochimique) et par la stimulation de la dissipation thermique (augmentation du quenching non photochimique) (Schreiber 2004) ce qui donne le rendement quantique effectif des PSII également appelé paramètre de Genty.

Celui-ci mesure la proportion de la lumière, absorbée au niveau des PSII, qui est utilisée pour la photochimie et se calcule grâce à l'équation suivante :

$$\Delta F/F_m' = (F_m' - F)/F_m' \text{ (Genty et al, 1989)}$$

Il s'agit en fait du produit du quenching photochimique et de l'efficacité maximale des PSII après acclimatation à la lumière. Autrement dit, l'efficacité totale des PSII à la lumière est égale au nombre de centres réactionnels ouverts multiplié par l'efficacité de ces centres réactionnels ouverts. Ce paramètre prend en compte à la fois les effets des quenching photochimiques et non photochimiques sur le rendement quantique de la photosynthèse après acclimatation à la lumière.

Comme le signalent Kromkamp and Forster dans leur article de 2003, ces deux paramètres F_v/F_m et $\Delta F/F_m'$ ont souvent été confondus et mal utilisés dans la littérature. Or, il est important de signaler que ces deux paramètres reflètent des processus fondamentalement différents. Les mesures du rendement photosynthétique après acclimatation à l'obscurité (F_v/F_m) reflètent uniquement les processus qui se déroulent au niveau du CR des PSII ou de ses pigments antennaires. A l'inverse, le rendement photochimique après acclimatation à la lumière ($\Delta F/F_m'$), intègre également tous les processus en aval des PSII qui influencent l'état redox du pool de plastoquinones et le niveau de fermeture des PSII, ainsi que la quantité de quenching non photochimique associée à la photoinhibition.

2.4.2 Effets des facteurs environnementaux sur le rendement quantique optimal

De nombreux auteurs ont mis en évidence que le rendement de fluorescence est étroitement lié au rendement quantique chez différentes espèces de plantes et sous différentes conditions physiologiques (Schreiber 2004). Il ressort de ces observations que la valeur de F_v/F_m dépend de nombreux facteurs environnementaux dont les principaux sont la lumière, les nutriments et la température (Wozniak et al. 2002). Ce rapport a, de ce fait, été largement utilisé comme un indice de « santé algale » sensible à l'histoire lumineuse et nutritive à court terme (heure) des cellules (Kromkamp & Forster 2003). Ainsi chez une espèce donnée, les valeurs de F_v/F_m diminuent en réponse aux stress environnementaux tels que la limitation en nutriments, la photoinhibition ou l'exposition à des radiations UV (Vassiliev et al. 1994, Ragni et al. 2008). Chez le phytoplancton, en conditions contrôlées, F_v/F_m peut atteindre une valeur maximale de 0,65 (Falkowski & Kolber 1993) lorsqu'il est mesuré avec un flash de lumière de courte durée (single turnover saturation pulse) ou ~0,83 lorsqu'il est mesuré avec un flash de lumière de longue durée (multiple turnover saturation pulse) (Magnusson 1997, Cosgrove & Borowitzka 2010).

Lumière

La lumière est responsable d'une grande part de la variabilité de F_v/F_m dans les océans. Certains travaux ont ainsi rapporté une relation linéaire négative entre la lumière et F_v/F_m (Magnusson 1997, Wozniak et al. 2002). D'autres études ont mis en évidence l'apparition de cycles journaliers de ce rendement en fonction des variations d'intensité lumineuse et

l'existence d'une variabilité verticale de F_v/F_m dans la colonne d'eau (Owens et al. 1980, Falkowski & Kolber 1993, Magnusson 1997, Belshe et al. 2007, Serôdio et al. 2008, Raateoja et al. 2009). D'autres encore, ont mis en évidence la diminution de F_v/F_m en réponse à la photoinhibition (ex :Richter et al. 1990).

Cependant, F_v/F_m n'indique pas nécessairement le potentiel de la plante (ou algue) à réaliser la photosynthèse, car des limitations peuvent survenir dans la chaîne de transport des électrons, en particulier au niveau des réactions sombres, sans affecter l'efficacité des PSII (Kromkamp & Forster 2003). Des mesures journalières, chez des macroalgues, ont ainsi montré que F_v/F_m pouvait avoir de faibles valeurs simultanément aux taux de transports d'électrons les plus élevés (Ensminger et al. 2001).

Autre point important, même chez des cellules en « bonne santé », F_v/F_m n'est pas toujours maximal à l'obscurité. Chez certaines algues, F_v/F_m peut décroître à l'obscurité à cause du quenching non photochimique résultant de la formation du gradient de protons à travers la membrane des thylacoïdes et du déclenchement réversible de l'activité de l'ATPase. Chez les diatomées, la formation du gradient de pH, à l'obscurité, a été attribuée à la chlororespiration (Schreiber et al. 1995b, Dijkman & Kroon 2002, Serôdio et al. 2005a, Serôdio et al. 2005b). Dans ce processus, les électrons sont donnés à l' O_2 dans la membrane des thylacoïdes par une plastoquinone-réductase via PQ. La réduction de PQ provoque alors la diminution de F_m (Nixon 2000). Néanmoins, d'autres processus physiologiques tels que les mécanismes de concentration du CO_2 et l'accumulation d'acétate durant la dégradation des lipides, peuvent aussi contribuer à la diminution du pH du lumen des thylacoïdes et induire la dépoxydation des xanthophylles (Serôdio et al. 2005a) qui vont contribuer à la diminution de F_m . Dans tous ces cas de figure, le F_v/F_m maximal est atteint en conditions de faibles lumières.

Température

Peu d'études se sont intéressées aux effets de la température sur les valeurs de F_v/F_m chez le phytoplancton marin. Ce manque de travaux de recherche peut en partie être expliqué par la relative stabilité de la température du milieu marin par rapport à l'intensité lumineuse et à la disponibilité des nutriments. Les seules données disponibles concernent des diatomées benthiques marines. Geel et al (1997), Longhi et al (2003) et Morris and Kromkamp (2003) aboutissent à des résultats similaires : F_v/F_m diminue légèrement lorsque la température augmente (6% de diminution par augmentation de 10°C, et aux températures supérieures à 30°C, F_v/F_m diminue de façon plus prononcée pour atteindre une valeur proche de zéro à 40°C. Cette diminution des valeurs de F_v/F_m aux fortes températures s'explique par l'influence de la température sur le pH intracellulaire, sur les protéines composant les PSII (les fortes températures peuvent dénaturer les protéines pigmentaires), et sur la photorespiration qui est plus importante lorsque la température augmente. La température optimale de photosynthèse est, quant à elle, dépendante des propriétés thermolabiles des composants des PSII et est fonction de la photoacclimatation. D'après Morris and Kromkamp (2003), cette température optimale serait comparable pour les algues issues de régions climatiques similaires.

Disponibilité des nutriments

Les composants de l'appareil photosynthétique, les enzymes et les protéines sont riches en azote (N) et en fer (Fe), et le phosphore (P) joue un rôle crucial dans le métabolisme cellulaire (c'est un composant des membranes) et dans la transduction de l'énergie (c'est un composant de l'ATP, de l'ADP et du $NADP^+/NADPH$). Les cellules phytoplanctoniques sont

incapables de synthétiser ces éléments et doivent se les procurer dans leur milieu de vie. Ainsi la limitation de la disponibilité de l'un de ces éléments peut conduire à une diminution du rendement quantique maximal de la photosynthèse : F_v/F_m (Beardall et al. 2001). La diminution de F_v/F_m en réponse à la limitation en N, P ou Fe a été observée chez différentes espèces dans différentes conditions (ex : Kolber et al. 1988). Voilà pourquoi F_v/F_m est largement accepté comme étant influencé par les stress nutritifs, et la diminution de F_v/F_m a été utilisée comme un indicateur de stress nutritifs ou de déséquilibre (ex : Cleveland & Perry 1987, Kolber et al. 1988). De fortes valeurs de F_v/F_m (0,60-0,70) sont ainsi supposées refléter l'absence de stress et sont considérées comme indicatrices d'un bon état physiologique. A l'inverse, la diminution de ce rendement est attribuée à la présence de stress.

Bien que différentes études viennent conforter ces suggestions (ex : Kolber et al. 1998, Lippemeier et al. 2001), des résultats contradictoires ont également été obtenus avec des valeurs de F_v/F_m élevées et constantes même en présence de stress (ex : Cullen et al. 1992, MacIntyre et al. 1997, Parkhill et al. 2001, Kruskopf & Flynn 2006). Par conséquent, de récentes publications Parkhill et al. (2001) et Kruskopf & Flynn (2006) remettent en cause l'utilisation du F_v/F_m comme un indicateur des stress nutritifs. Ces auteurs ont en effet montré à partir d'expériences en laboratoire, que le stress nutritif ne provoque pas systématiquement une diminution du F_v/F_m et qu'après plusieurs générations les cellules phytoplanctoniques soumises à différents types de stress nutritifs peuvent retrouver des valeurs élevées de F_v/F_m et rester insensibles à certains stress (F_v/F_m élevé et constant). De plus, la réponse aux stress nutritifs peut dépendre de l'espèce considérée. Kruskopf and Flynn (2006) ont, par exemple, observé que chez *Dunaliella primalecta*, le F_v/F_m augmentait jusqu'à épuisement des nitrates puis diminuait après son épuisement tandis que chez *Scrippsiella trochoidea* le F_v/F_m restait stable (0,65-0,7) pendant tout le cycle de croissance à la fois en condition de limitation par l'azote et par le phosphore. Ces auteurs indiquent de ce fait, que le F_v/F_m est uniquement une

mesure de l'efficacité photosynthétique maximale des PSII et qu'il ne doit pas être utilisé pour toute autre fin. Ainsi, l'absence de changement du F_v/F_m ne peut être interprétée comme une absence de stress même si les changements de F_v/F_m indiquent que quelque chose affecte la photochimie et reflètent certainement l'incapacité des cellules à faire face aux déséquilibres physiologiques (Kruskopf & Flynn 2006).

Composition des communautés phytoplanctoniques

Les valeurs de F_v/F_m varient également en fonction de la composition des communautés phytoplanctoniques et contiennent une sorte de « signature taxonomique » qui se superpose à la variabilité physiologique (Koblizek et al. 2001, Suggett et al. 2003, Yentsch et al. 2004, Suggett et al. 2009). Elles sont, par exemple, plus élevées dans les eaux bien mélangées dominées par des diatomées à croissance rapide que dans les eaux stratifiées dominées par des flagellés eucaryotes de petite taille. La même tendance a également été observée en séparant par classes de taille les membres d'une même communauté et en mesurant le F_v/F_m pour chacune des classes. Dans ce cas, les plus fortes valeurs de F_v/F_m ont été observées pour la classe de taille la plus élevée et les plus faibles pour la classe de taille la plus faible (Moore et al. 2005, Suggett et al. 2009).

Des variations des valeurs de F_v/F_m entre groupes phytoplanctoniques pigmentaires ont également été observées chez des algues cultivées dans des conditions similaires (ex : Koblizek et al. 2001, Suggett et al. 2003, Yentsch et al. 2004). Par exemple, il a été montré que le F_v/F_m des algues contenant de la chlorophylle *c* est élevé avec des valeurs aux alentours de 0,73 tandis que celui des cyanobactéries est faible (entre 0,1 et 0,4) même si certaines cyanobactéries comme certaines espèces appartenant aux genres *Cyanotheca* et *Anabaena*

peuvent présenter des valeurs de F_v/F_m normales (aux alentours de 0,60-0,65). Ces faibles valeurs chez les cyanobactéries s'expliquent par la présence des phycobilisomes qui émettent également de la fluorescence qui est mesurée en même temps que le niveau de fluorescence F_0 des PSII et contribue ainsi à la sous-estimation des valeurs de F_v/F_m (Kromkamp et al. 2001). De telles différences entre groupes pigmentaires ne sont pas surprenantes lorsque l'on sait que les capacités d'absorption de l'énergie lumineuse sont l'un des facteurs de pression opérant dans la sélection des groupes phytoplanctoniques au cours de l'évolution et, que les différences de structure de l'antenne pigmentaire agissent sur les capacités des PSII à capturer l'énergie lumineuse et sur l'efficacité avec laquelle cette énergie est utilisée (Suggett et al. 2009 et références citées).

Ainsi, les mesures de fluorescence ne peuvent être interprétées comme l'unique reflet des stress physiologiques. La considération des différents facteurs de contrôle du F_v/F_m illustrent la difficulté d'interprétation de ses variations en milieu naturel puisque les variations observées résultent de l'action combinée des changements des communautés phytoplanctoniques et des conditions environnementales. Par conséquent, les mesures de F_v/F_m reflètent non seulement les contrôles environnementaux à court terme comme les variations de l'intensité lumineuse mais également les contrôles à plus long terme tels que la composition des communautés phytoplanctoniques.

2.5 Taux de transport des électrons

D'après Kromkamp and Forster (2003), ce serait l'introduction de $\Delta F/F_m'$ par Genty et al. en (1989) et les observations que ce paramètre s'accorde bien avec les rendements quantiques des autres processus photosynthétiques tels que l'évolution de l'oxygène et la fixation du CO₂ qui auraient conduit à l'utilisation massive de ce paramètre pour convertir le rendement quantique des PSII en taux de transport des électrons.

Le taux de transport des électrons (ETR, Electron Transport Rate), initialement décrit par Schreiber et al. (1994), dépend de la quantité de lumière absorbée par l'antenne pigmentaire des PSII et de l'efficacité avec laquelle cette lumière est utilisée par les CRII pour réaliser la séparation de charge (Perkins et al. 2010). Il est calculé à partir de $\Delta F/F_m'$ et de l'éclairement disponible pour la photosynthèse (PAR : Photosynthetically-Active Radiation). Deux types de taux de transport des électrons peuvent être calculés : un taux de transport relatif (rETR) et un taux de transport absolu (ETR).

2.5.1 Taux de transport relatif des électrons

Le taux de transport relatif des électrons (en unités relatives) peut être utilisé dans les situations où des informations sur les changements relatifs de ce taux de transport sont suffisantes. Dans la littérature, il existe plusieurs équations permettant de calculer ce paramètre. L'équation la plus courante est la suivante : $rETR = \Delta F/F_m' \times PAR$

Certains auteurs (ex : Gilbert et al. 2000, Jakob et al. 2005, Cosgrove & Borowitzka 2006) ajoutent à l'équation un facteur de correction de 0,5 basé sur l'hypothèse que seule la moitié de la lumière absorbée est dirigée vers les PSII, l'autre moitié étant utilisée par les PSI

pour équilibrer la pression d'excitation entre les deux photosystèmes. D'autres encore (ex : Beer et al. 1998, Durako et al. 2003, Schreiber 2004), incluent dans le calcul, un facteur théorique d'absorption de la lumière égale à 0,84. Cette valeur correspond à la part de la lumière incidente qui est absorbée au niveau des feuilles des plantes supérieures.

Il est important de noter que dans tous les cas, le calcul de ce taux de transport relatif d'électrons suppose que l'absorption de lumière par les PSII reste constante pendant la durée des mesures et entre les différents traitements. Cette hypothèse est irréaliste en milieu naturel où les fluctuations de lumière sont bien connues et présente l'inconvénient de rendre difficile la comparaison des rETR entre publications (Perkins et al. 2010). Ce taux de transport relatif a tout de même été utilisé à plusieurs reprises comme mesure du taux de photosynthèse par différents auteurs et dans différentes conditions aussi bien pour des études au laboratoire que des études *in situ* que ce soit chez des espèces phytoplanctoniques (ex : Geel et al. 1997, Gilbert et al. 2000, Cosgrove & Borowitzka 2006), microphytobenthiques (ex : Hartig et al. 1998, Serôdio et al. 2006a, Cruz & Serôdio 2008), des zostères (ex : Ralph & Gademann 2005), des plantes supérieures (ex : White & Critchley 1999) ou des macroalgues (ex : Gévaert et al. 2003).

2.5.2 Taux de transport absolu des électrons

Le passage du taux de transport relatif au taux de transport absolu des électrons nécessite de connaître la quantité de lumière absorbée au niveau des PSII. Si cette estimation s'avère extrêmement difficile chez certains autotrophes comme les macroalgues ou le microphytobenthos (Perkins et al. 2010) et justifie l'utilisation du taux de transport relatif des électrons, ce n'est pas le cas du phytoplancton pour lequel plusieurs méthodes d'estimation

ont été proposées. Chez le phytoplancton, l'estimation de la quantité de lumière absorbée au niveau des PSII et le calcul du taux de transport absolu des électrons diffèrent selon la méthode employée : FRRF ou PAM.

Les FRRF permettent la mesure *in situ* de la « functional absorption cross section » des PSII (σ_{PSII}) (en $\text{\AA}^2 (\text{quanta})^{-1}$) qui correspond à la fraction de la lumière absorbée au niveau des PSII pour réaliser la photochimie (Kromkamp & Forster 2003, Suggett et al. 2004). Le taux de transport absolu des électrons (en $\mu\text{mol électrons} (\text{mg chl } a)^{-1} \text{ s}^{-1}$) est ainsi calculé à partir de l'équation suivante :

$$\text{ETR} = \Delta F/F_m' \times \text{PAR} \times \sigma_{\text{PSII}} \times n_{\text{PSII}} \times 0.00675$$

où n_{PSII} ($\text{mol RCII} (\text{mol chl } a)^{-1}$) correspond au nombre de PSII et le facteur 0.00675 sert à convertir les $\text{\AA}^2 (\text{quanta})^{-1} \text{ mol RCII} (\text{mol chl } a)^{-1}$ en $\text{m}^2 (\text{mg chl } a)^{-1}$ (Suggett et al. 2004, Suggett et al. 2010b).

Contrairement aux FRRF, les fluorimètres PAM ne permettent pas la mesure de σ_{PSII} . Par conséquent, le calcul du taux de transport absolu des électrons nécessite de mesurer de façon indépendante le coefficient d'absorption spécifique des PSII ($a_{\text{PSII}}^{\text{chl}}$, en $\text{m}^2 (\text{mg chl } a)^{-1}$) également appelé « optical absorption cross section » des PSII (Kromkamp & Forster 2003, Suggett et al. 2004, Johnsen & Sakshaug 2007). Le taux de transport absolu des électrons (en $\mu\text{mol électrons} (\text{mg chl } a)^{-1} \text{ s}^{-1}$) est ainsi calculé à partir de l'équation suivante:

$$\text{ETR} = \Delta F/F_m' \times \text{PAR} \times \bar{a}_{\text{phy}}^* \times P = \Delta F/F_m' \times \text{PAR} \times a_{\text{PSII}}^{\text{chl}}$$

Le coefficient d'absorption spécifique de la chlorophylle (\bar{a}_{phy}^*) peut-être mesuré assez facilement par le biais de méthodes optiques en utilisant un spectrophotomètre (ex : Kishino et al. 1985, Tassan & Ferrari 1995, 1998, Mitchell et al. 2003) ou par la reconstruction du spectre d'absorption à partir de mesures des concentrations pigmentaires par HPLC (Bidigare et al. 1990). Cependant, le calcul du $a_{\text{PSII}}^{\text{chl}}$ à partir du \bar{a}_{phy}^* nécessite d'utiliser un facteur (que nous appellerons P) qui représente la part de la lumière absorbée qui est dirigée vers les PSII

par rapport à celle acheminée vers les PSI. La valeur de ce facteur P n'est pas aisée à déterminer.

Généralement, une valeur de 0,50 est attribuée à P ce qui indique que seule la moitié de la lumière est absorbée par les PSII, l'autre moitié étant utilisée par les PSI (Gilbert et al. 2000, Kromkamp & Forster 2003). Si cette hypothèse a été validée par Suggett et al. (2004) pour une large gamme d'espèces de diatomées, d'algues vertes, d'Haptophytes et une Cryptophyte ($0.48 < P < 0.58$), des résultats contradictoires ont également été rapportés notamment chez les cyanobactéries du genre *Synechococcus* ($0.25 < P < 0.32$) et le pélagophyte *Aureococcus anophagefferens* ($0.34 < P < 0.36$). Suggett et al. (2004) avaient utilisé une combinaison de méthodes biophysiques et optiques pour estimer les valeurs de P.

En utilisant une autre méthode, Johnsen & Sakshaug (2007) arrivent à des estimations de P comprises entre 0.45 et 0.82 pour une large gamme d'espèces de diatomées, d'algues vertes, d'Haptophytes et de Cryptophytes et des valeurs de P égales à 0.36 pour les cyanobactéries. Ce qui correspond à des estimations généralement plus élevées que les valeurs rapportées par Suggett et al. (2004). A l'heure actuelle, la question de savoir dans quelle mesure ces différences sont entièrement dues à la méthodologie, aux conditions de cultures ou aux différences d'espèces n'a pas encore été complètement résolue. Même si Suggett et al. (2010a) ont montré qu'au moins une partie de ces différences provient de la méthodologie employée.

Les estimations de \bar{a}_{phy}^* et de σ_{PSII} servent à prendre en considération les variations de l'absorption de la lumière par les PSII dans le calcul des taux de transport des électrons. Ces considérations sont nécessaires lorsque l'on sait que ces paramètres varient avec la composition spécifique mais également pour une espèce donnée en fonction des réarrangements pigmentaires qui s'opèrent au cours des processus d'acclimatation en réponse aux facteurs environnementaux tels que la lumière ou la disponibilité des nutriments

(Dubinsky 1991, Dubinsky & Stambler 2009). Il a ainsi été montré que le \bar{a}_{phy}^* peut varier d'un facteur 10 (Cosgrove & Borowitzka 2010 et références citées). De ce fait, pour les études en conditions fortement variables telles qu'en milieu naturel, il est préférable d'utiliser le taux de transport absolu des électrons plutôt que le rETR même si le calcul du taux de transport absolu des électrons nécessite l'utilisation d'un certain nombre d'hypothèses concernant notamment la valeur de P dans le cas du PAM où de n_{PSII} dans le cas du FRRF.

2.6 Courbes ETR versus E et paramètres photosynthétiques

rETR et ETR sont donc des mesures du taux de photosynthèse. A ce titre, ils peuvent être utilisés pour tracer des courbes de réponse à la lumière : les courbes ETR *versus* E qui s'apparentent aux courbes photosynthèse-irradiance (PE) obtenues à partir des mesures classiques des échanges gazeux (O_2 et CO_2) (Schreiber 2004).

La construction de cette courbe consiste à soumettre les cellules phytoplanctoniques à des paliers de lumière avec des intensités croissantes ou décroissantes et à mesurer pour chacun de ces paliers le taux de transport des électrons. La courbe obtenue se caractérise par trois régions principales : la région limitée par la lumière, la région de saturation par la lumière et la région de photorégulation (Fig. 8) (Schreiber 2004).

La région limitée par la lumière (notée (1) sur la figure 8) s'observe aux faibles éclairagements. Le taux de photosynthèse y est proportionnel à l'intensité lumineuse et la pente initiale de la courbe est une fonction des réactions claires de la photosynthèse (Chalker 1980). Lorsque l'intensité lumineuse augmente, le taux de photosynthèse, qui est limité par la capacité de transport de la chaîne des électrons, atteint progressivement sa valeur maximale.

La courbe se termine donc par un plateau (noté (2) sur la figure 8) où l'augmentation de l'intensité lumineuse n'augmente plus le taux de photosynthèse : c'est la région de saturation par la lumière.

Si l'intensité lumineuse continue d'augmenter après l'atteinte du taux maximal de photosynthèse, une réduction de l'activité photosynthétique (notée (3) sur la figure 8) peut prendre place et l'extrémité de la courbe s'infléchit. Cette réduction de l'activité photosynthétique est souvent attribuée à de la régulation ou de la photoinhibition selon le temps d'exposition à l'intensité lumineuse (Sakshaug et al. 1997).

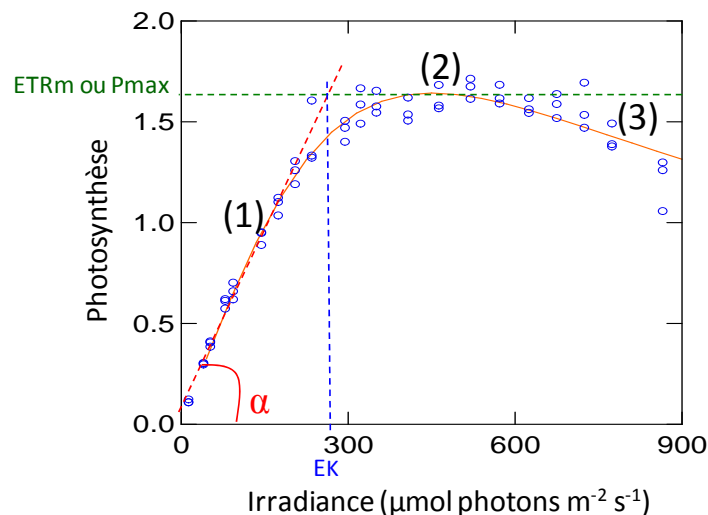

Fig. 8. Courbe de réponse à la lumière. Les trois régions principales et les paramètres photosynthétiques sont représentés (voir le texte pour de plus amples détails)

Il est ensuite possible d'ajuster aux données un modèle qui décrit la relation photosynthèse-lumière pour en déduire les paramètres photosynthétiques des microalgues. La pente aux faibles éclaircements (α , Fig. 8) correspond à l'efficacité maximale d'utilisation de la lumière. Le plateau atteint à saturation lumineuse mesure la capacité photosynthétique soit le taux de transport maximum des électrons (ETR_m , Fig. 8) dans le cas des courbes ETR vs E obtenues par fluorescence ou le taux de production maximal (P_{max}) dans le cas des courbes PE

obtenues à partir des échanges gazeux (Schreiber 2004). La capacité photosynthétique dépend de la concentration et/ou de l'activité du stock de RUBISCO et des différents composants de la chaîne de transport des électrons (MacIntyre & Kana 2002). A partir de ces deux paramètres, il est possible de calculer le paramètre $E_k = \alpha / ETR_m$ qui correspond graphiquement au point d'intersection entre la pente initiale de la courbe et le plateau (Fig. 8). E_k (également appelé I_k dans la littérature) est en fait l'intensité lumineuse de saturation c'est-à-dire l'intensité lumineuse à partir de laquelle le nombre de photons arrivant au niveau des PSII dépasse les capacités de transport de la chaîne des électrons. E_k est lié aux quenching ainsi aux intensités lumineuses inférieures à E_k , c'est le quenching photochimique qui domine tandis qu'aux intensités lumineuses supérieures c'est le quenching non photochimique qui prend le dessus (Ralph & Gademann 2005). De ce fait, E_k est couramment utilisé pour décrire le niveau de photoacclimatation du phytoplancton (Sakshaug et al. 1997, Tillmann et al. 2000). Il est ainsi considéré que les valeurs de E_k sont proches de l'intensité lumineuse rencontrée dans le milieu naturel lorsque le phytoplancton est totalement photoacclimaté.

Différents modèles permettant de décrire la relation photosynthèse-lumière existent et peuvent être utilisés pour obtenir les paramètres photosynthétiques à partir des courbes ETR vs E (Tableau I). Certains incluent un terme pour la photoinhibition ou régulation d'autres pas. Comme aucun modèle n'est parfait, aucune formulation ne peut être recommandée par rapport aux autres et comme il n'existe, à l'heure actuelle, aucune méthode de référence pour l'analyse des courbes ETR vs E, le choix du modèle utilisé reste subjectif (Sakshaug et al. 1997). Ce choix se fait généralement en fonction de la bonne adéquation du modèle vis-à-vis du jeu de données à analyser.

Tableau I. Liste des modèles les plus utilisés pour décrire les courbes de réponses à la lumière (Duarte 2006). P = taux de photosynthèse (couramment exprimé en $\text{mg C mg Chl}^{-1} \text{h}^{-1}$), E = intensité lumineuse (en $\mu\text{mol photons m}^{-2} \text{s}^{-1}$), E_k = coefficient de saturation lumineuse. Pour de plus amples détails sur les différents paramètres voir Duarte (2006)

No	Equation	Category	Type	Source
1	$P = \begin{cases} \alpha E, & E < P_{\max}/\alpha \\ P_{\max} & \end{cases}$	Saturation models		Blackman (1919)
2	$P = P_{\max} \frac{E/E_k}{(1 + (E/E_k)^m)^{1/m}} \quad m = 1$			Baly (1935)
3	$m = 2$			Smith (1936)
4	$P = P_{\max} \left[1 - \exp\left(1 - \frac{E}{E_k}\right) \right]$			Webb et al. (1974)
5	$P = P_{\max} \tanh(\alpha E/P_{\max})$			Jassby and Platt (1976)
6	$P = P_{\max} \left[\frac{I}{E_{opt}} \exp\left(1 - \frac{E}{E_{opt}}\right) \right]^n$ $n = 1$ (n empirical integer)	Photoinhibition models	Empirical and static	Steele (1962)
7	$n \neq 1$			Parker (1974)
8	$P = P_s \left[1 - \exp\left(-\frac{\alpha E}{P_s}\right) \right] \exp\left(\frac{\beta E}{P_s}\right)$ where $E_{opt} = \frac{P_s}{\alpha} \ln\left(\frac{\alpha + \beta}{\beta}\right)$			Platt et al. (1980)

No	Equation	Category	Type	Source
8	$P_{\max} = P_s \left(\frac{\alpha}{\alpha + \beta} \right) \left(\frac{\beta}{\alpha + \beta} \right)^{\beta/\alpha}$ β – empirical coefficient that determines photoinhibition	Photoinhibition models	Empirical and static	
9	$P = P_{\max} \frac{E/E_k}{(1 + (E/E_k)^u)^{1+v}/u}$ different combinations of u and v produce saturation or inhibition curves			Iwakuma and Yasuno (1983)
10	$P(E, t) = P_{\max}(E, t) \tanh(\alpha E/P_{t(E, t)})$ where, $P_{t(E, t)} = P_{\max}(E, t) \exp\left(-\frac{1}{\gamma} \int_0^t E^{1/a} dt\right)$ γ – timescale for photoinhibition a – controls the degree of nonlinearity of the rate response to light intensity	Saturation model	Empirical and dynamic	Franks and Marra (1994)
11	$P(E, t) = \frac{(1 - \exp(-t/tr)) \tanh(E/E_k)}{1 + (1 - \exp(-t/t_i)) K_i (E - E_{crit})}$ E_{crit} – Critical light level above which photoinhibition may occur; tr – response time to changing light; t – exposure time to a particular light level; t_i – photoinhibition development time	Photoinhibition models	Empirical and dynamic	Pahl-Wostl and Imboden (1990)

Tableau I (suite)

No	Equation	Category	Type	Source
12	$P = \frac{E}{aE^2 + bE + c}$ where, $a = \frac{1}{\alpha E_{opt}^2}$ $b = \frac{1}{P_{max}} - \frac{2}{\alpha E_{opt}}$ $c = \frac{1}{\alpha}$	Photoinhibition models	Mechanistic and static	Eilers and Peeters (1988)
13	$P^2 - \mu P + (\chi \exp(\beta E) + \alpha) EP + \alpha \mu E = 0$ where, μ is a parameter proportional to oxygen liberation from water; χ is a parameter that controls the extension of the saturation plateau; β is the photoinhibition parameter			Fasham and Plant (1983)
14	$P(E, t) = \frac{E}{\left(1 - \exp\left(-\frac{t}{t_i}\right)\right) aE^2 + bE + c}$		Mechanistic and dynamic	Duarte and Ferreira (1997) derived from Eilers and Peeters (1988) and Pahl-Wostl and Imbodem (1990) models (see above)

Toutefois, la comparaison des paramètres photosynthétiques obtenus à partir de modèles différents doit se faire avec prudence. En effet, quelques auteurs (ex : Frenette et al. 1993, Pachepsky et al. 1996, Sakshaug et al. 1997, MacIntyre & Kana 2002, Duarte 2006) ont comparé les paramètres photosynthétiques obtenus en utilisant différents types de modèles sur un même jeu de données. Il en ressort que l'estimation des paramètres photosynthétiques varie en fonction du modèle choisi. Frenette et al. (1993) ont ainsi montré que les estimations de α et P_{max}^2 étaient systématiquement différentes lorsqu'ils comparaient les résultats obtenus à partir des modèles de Webb et al. (1974), Jassby and Platt (1976) et Platt et al. (1980), α s'avérant particulièrement sensible. Ces différences proviendraient des contraintes différentes entre les modèles vis-à-vis de la forme de la relation photosynthèse-lumière. A la vue de ces différences de résultats, Sakshaug et al. (1997) conseillent de toujours conserver le

² Ici il s'agit de P_{max} et non de ETR_m car la méthode utilisée pour mesurer les courbes photosynthèse-lumière était dans ce cas précis celle du

¹⁴C. Néanmoins les conclusions restent applicables aux courbes ETR vs E .

fichier avec les données brutes afin de pouvoir utiliser des modèles différents pour comparer ses données à celles issues de la littérature et d'utiliser un seul modèle pour traiter l'ensemble d'une série de données.

2.7 Le taux de transport des électrons une mesure de la production primaire ?

L'un des objectifs de l'utilisation de la fluorescence en écologie aquatique était de pouvoir mesurer la production primaire en se libérant des contraintes méthodologiques associées aux mesures traditionnelles des échanges gazeux (cf. partie 2.1.). En effet, la mesure de la fluorescence peut être faite *in situ* sans aucune période d'incubation qui isole le phytoplancton de son environnement naturel pendant de longues périodes de temps (Kolber & Falkowski 1993, Suggett et al. 2010a). De plus, la rapidité des mesures permet de suivre l'activité photosynthétique du phytoplancton avec une plus grande résolution spatio-temporelle que les échanges gazeux. En dépit de ces avantages, le taux de transport des électrons, n'est pas l'unité de la production primaire. En effet, la mesure du taux de photosynthèse est habituellement faite à partir des mesures de l'émission d'oxygène ou de la fixation du CO₂ et la production primaire est exprimée en unité de carbone ou d'oxygène.

La conversion du taux de transport des électrons en unité de carbone ou d'oxygène nécessite de connaître soit le nombre de moles d'électrons nécessaire pour fixer une mole de carbone, soit le nombre de moles d'électrons nécessaire pour produire une mole d'oxygène. En connaissant le nombre de moles d'électrons nécessaire pour produire une mole d'oxygène, la production primaire d'oxygène peut être calculée à partir du taux de transport des électrons en utilisant l'équation suivante (Kromkamp & Forster 2003):

$$P^B (\mu\text{mol O}_2 (\text{mg chl } a)^{-1} \text{ s}^{-1}) = \Phi_e \times \text{ETR}$$

La même approche peut être utilisée pour convertir le taux de transport des électrons en taux de fixation du carbone mais il faut également connaître le quotient photosynthétique (PQ) qui décrit la proportion de moles d'O₂ produites par mole de CO₂ fixée:

$$P^B (\mu\text{mol C } (\text{mg chl } a)^{-1} \text{ s}^{-1}) = \Phi_e \times \text{ETR} \times \text{PQ}^{-1}$$

Une valeur théorique constante de 0,25 est généralement attendue pour Φ_e ce qui signifie qu'un minimum de quatre séparations de charge est nécessaire pour produire une mole d'oxygène (Gilbert et al. 2000, Kromkamp & Forster 2003).

Différentes études ont utilisé la régression entre le taux de transport des électrons et la mesure des échanges gazeux (O₂ et/ou CO₂) pour définir la valeur exacte de Φ_e et de PQ^{-1} (voir table 3 de Suggett et al. 2010a et table 2 de Perkins et al. 2010). Si des valeurs proches de 0,25 ont été trouvées pour Φ_e , des valeurs inférieures ont également été rapportées (0,2-0,1) (Suggett et al. 2010a). Il a également été montré que la valeur de PQ dépend de la source d'azote utilisée pour la croissance. Des valeurs de PQ proches de 1 ont été trouvées lorsque l'ammonium était la seule source d'azote tandis que des valeurs proches de 1,3 ont été trouvées dans le cas du nitrate (Perkins et al. 2010 et références citées). De plus, si la majorité des études ont montré que la relation entre le taux de transfert des électrons et la mesure des échanges gazeux était linéaire d'autres ont trouvé des relations qui s'éloignaient de la linéarité (voir table 3 de Suggett et al. 2010a et table 2 de Perkins et al. 2010). La réconciliation de ces différents résultats est rendue difficile par le nombre de méthodologies différentes qui ont été employées dans ces différentes études mais également par l'absence de référence idéale permettant de juger de la qualité des mesures du taux de transport des électrons et des échanges gazeux. L'éloignement de la linéarité dans la relation entre le taux de transport des électrons et les échanges gazeux a été attribuée à différentes voies alternatives d'utilisation des électrons (Beardall et al. 2009). Cependant, le fonctionnement de ces diverses voies a

rarement été quantifié de façon indépendante. A l'heure actuelle, peu d'informations sont disponibles sur le rôle exact de ces voies alternatives dans la relation entre le taux de transport des électrons et les échanges gazeux. De plus, la part des erreurs méthodologiques n'a pas non plus été quantifiée (voir Suggett et al. 2010a pour de plus amples détails à ce sujet). Dans l'état actuel de la recherche, il reste encore difficile de réconcilier les méthodes de mesure de la production primaire.

3 PHYTOPLANCTON ET PRODUCTION PRIMAIRE EN MANCHE ORIENTALE

3.1 Caractéristiques hydrodynamiques de la Manche orientale

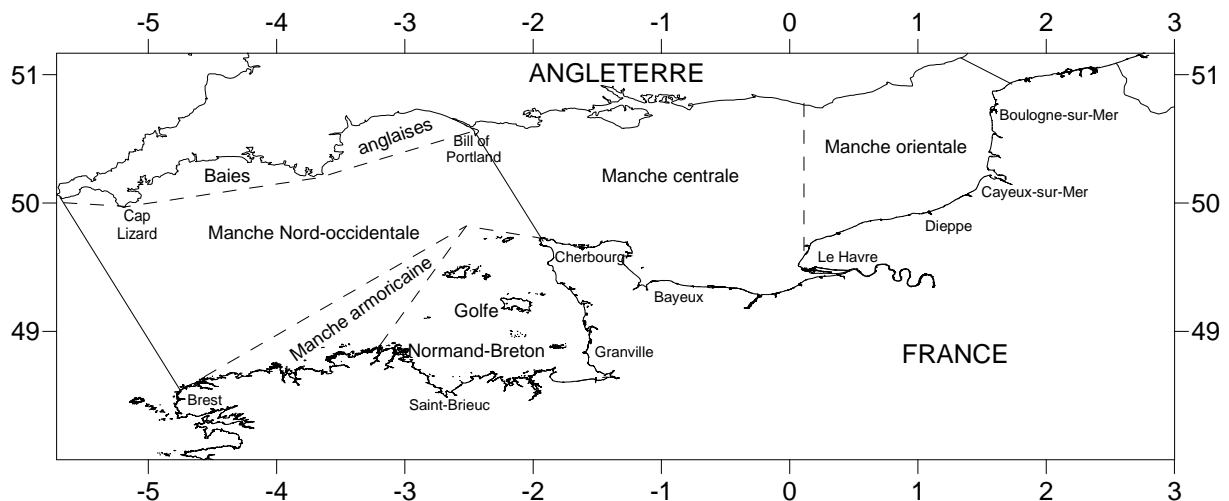

Fig. 9. Principaux secteurs de la Manche (d'après Cabioch 1968)

La Manche est une mer épicontinentale qui s'étend sur 77 000 Km². Cette mer est bordée au nord par l'Angleterre et au sud par la France. Elle est classiquement divisée en deux

grands bassins : le bassin oriental et le bassin occidental (Fig. 9) (Cabioch 1968). Le bassin occidental est sub-divisé en quatre secteurs : les Baies Anglaises situées au nord d'une ligne joignant le Cap Lizard au Bill of Portland, la Manche Nord-Occidentale, la Manche Armoricaïne et le Golfe Normand-Breton. Le bassin oriental est quant à lui subdivisé en deux grands secteurs : la Manche centrale et la Manche orientale.

La Manche orientale est une mer à fortes marées caractérisée par un régime mégatidal. Le marnage peut y atteindre 9 m en période de vives-eaux et se situe parmi les plus importants au monde après la Baie de Fundy (Canada, 15 m), le Bristol Channel (Angleterre, 12 m) et le Golfe Normand-Breton (environ 12 m). En Manche orientale, les courants sont puissants et alternatifs. Le flot est orienté au nord-est et le jusant au sud-ouest (Cabioch 1968, Salomon & Breton 1991). La dérive résiduelle des masses d'eau se dirige vers la Mer du Nord à une vitesse d'environ 2,7 milles par jour (Salomon & Breton 1991). Le resserrement en entonnoir au niveau du Déroit du Pas-de-Calais provoque l'amplification de l'amplitude de marée et de la vitesse des courants. C'est donc le Déroit du Pas-de-Calais qui présente les courants de marée les plus élevés de la Manche (3,7 nœuds en période de vive-eau) (Salomon & Breton 1991).

Le long des côtes françaises de la Manche orientale, ce régime marégraphique favorise la formation d'une masse d'eau côtière bien individualisée des eaux du large appelée « fleuve côtier » (Brylinski et al. 1991). L'individualité de ce « fleuve côtier » est entretenu par de nombreux apports fluviaux qui s'échelonnent de la Baie de Seine au Déroit du Pas-de-Calais et dont les principaux sont ceux de la Seine et de la Somme qui totalisent un débit annuel moyen d'environ $500 \text{ m}^3 \text{ s}^{-1}$ (Brylinski & Lagadeuc 1990). La transition entre cette masse d'eau côtière et les eaux du large constitue une zone frontale plus ou moins stable dont la dynamique est contrôlée par la marée (Brylinski & Lagadeuc 1990). Au niveau de ces eaux, il existe un gradient prononcé de la côte vers le large de la bathymétrie et de nombreux

paramètres hydrologiques tels que la salinité, la turbidité et la concentration en sels nutritifs (pour une revue détaillée du sujet voir Brylinski 1993).

3.2 Successions phytoplanctoniques

La Manche orientale et le Sud de la Mer du Nord sont soumis à une forte saisonnalité des conditions environnementales et plusieurs communautés phytoplanctoniques se succèdent au fil des saisons (ex: Guiselin 2010, Grattepanche et al. 2011, Lefebvre et al. 2011). Les communautés phytoplanctoniques sont dominées par différentes espèces des diatomées pendant l'été, l'automne et l'hiver. Au cours du printemps, trois blooms phytoplanctoniques se succèdent (Gieskes & Kraay 1975, Cadée & Hegeman 1986, Breton et al. 2000, Rousseau et al. 2000, Rousseau et al. 2002, Tungaraza et al. 2003, Stelfox-Widdicombe et al. 2004, Muylaert et al. 2006, Seuront et al. 2006, Guiselin 2010, Grattepanche et al. 2011, Lefebvre et al. 2011). Le premier bloom est un bloom de diatomées. Ce bloom est suivi par une phase très productive où la concentration en chlorophylle peut atteindre $60 \mu\text{g.L}^{-1}$ (ex: Lamy et al. 2006, Seuront et al. 2006, Schapira et al. 2008, Lamy et al. 2009). Cette période est dominée par l'Haptophyte *Phaeocystis globosa* qui peut représenter plus de 80% de l'abondance phytoplanctonique (ex : Breton et al. 2000, Grattepanche et al. 2011). A la suite du bloom de *P. globosa*, les diatomées dominant de nouveau la communauté phytoplanctonique et forment un deuxième bloom. La composition taxonomique des blooms de diatomées peut varier d'une année à l'autre. Cependant, le premier bloom de diatomées est généralement caractérisé par la présence des genres *Thalassiosira*, *Lauderia*, *Dytilum*, *Skeletonema* et *Chaetoceros*. Pendant le bloom de *P. globosa*, les genres *Rhizosolenia* et de *Nitzschia* sont rencontrés. Enfin,

pendant le deuxième bloom, les diatomées sont généralement représentées par les genres *Rhizosolenia*, *Guinardia* et *Chaetoceros*.

3.3 Production primaire et paramètres photosynthétiques

Dans le bassin oriental de la Manche, les premiers travaux sur la production primaire phytoplanctonique ont été réalisés dans le Déroit du Pas-de-Calais (Quisthoudt 1987, Brylinski et al. 1988, Gentilhomme 1988, Brunet et al. 1992). Ces travaux visaient à caractériser la distribution spatiale de la biomasse phytoplanctonique et de la production primaire le long du gradient hydrologique associé au « fleuve côtier ». La production primaire était estimée en utilisant la technique du ^{14}C avec des incubations de longue durée (4h) sous une lumière saturante ou sous des conditions de lumière *in situ* simulées. Ces études ont montré que la biomasse phytoplanctonique et la production primaire tendent à diminuer de la côte vers le large (Quisthoudt 1987, Brylinski et al. 1988, Gentilhomme 1988) tandis que la productivité présente une forte variabilité sur un transect côte-large (Brunet et al. 1992).

Les travaux suivants ont caractérisé la production primaire et l'activité photosynthétique potentielle du phytoplancton à partir des courbes PE ou ETR vs E. Lizon et al. (1995), Lizon (1997) et Jouenne et al. (2005, 2007) ont utilisé la technique du ^{14}C avec des temps d'incubation de 40 minutes tandis que Vantrepotte (2003) a utilisé la fluorimétrie modulée (Phyto-PAM). Vantrepotte (2003) a mesuré les paramètres photosynthétiques à partir de sequential steady-state light curves³ (S-SSLC) construites en exposant les échantillons,

³ Les sequential steady-state light curves sont des courbes ETR vs E au cours desquelles un seul échantillon est soumis à l'ensemble des paliers de lumière et le niveau de fluorescence (F ou F') à chaque palier de lumière est mesuré lorsqu'une valeur stable est atteinte.

préalablement acclimatés pendant 15 minutes à l'obscurité, à 8 paliers d'intensités lumineuses croissantes (de 1 à 1388 $\mu\text{mol photons m}^{-2} \text{s}^{-1}$) pendant 2 minutes.

Lizon et al. (1995) et Lizon (1997) ont étudié l'influence du mélange vertical de la colonne d'eau sur la variabilité des paramètres photosynthétiques et les capacités d'acclimatation du phytoplancton sous différentes conditions de marée dans le Détroit du Pas-de-Calais. La répercutions de cette variabilité sur le calcul des bilans journaliers de production primaire a ensuite été évaluée. Ces auteurs ont montré que l'amplitude de variation des paramètres photosynthétiques et les capacités d'acclimatation du phytoplancton au sein de la colonne d'eau sont inversement proportionnelles à l'intensité du mélange vertical des eaux. Ils ont ainsi observé des variations significatives de la capacité photosynthétique maximale ($P_{\text{max}}^{\text{B}}$) et de l'efficacité photosynthétique (α^{B}) en fonction du gradient vertical de lumière en conditions de faible mélange vertical (mortes-eaux), tandis qu'en conditions de mélange plus intense (vives-eaux), ces paramètres photosynthétiques tendaient à être plus homogènes sur la colonne d'eau. Une variabilité spatiale des gradients verticaux des paramètres photosynthétiques a également été mise en évidence. En effet, pour des coefficients de marée identiques, des différences dans les gradients verticaux des paramètres photosynthétiques ont pu être observées entre les eaux côtières et les eaux du large. D'après Lizon (1997), ces différences pourraient faire référence à des variations spatiales de l'énergie auxiliaire injectée dans le milieu. D'un point de vue temporel, sur une période de 36 heures, les variations de $P_{\text{max}}^{\text{B}}$ et de α^{B} ne montraient aucun cycle journalier clair tandis que l'intensité lumineuse de saturation (E_k) montrait un cycle jour/nuit. Le contrôle de la variabilité journalière des paramètres photosynthétiques et de la biomasse phytoplanctonique n'a, cependant, pas été complètement élucidé en raison de la complexité de l'écosystème. Il a été mis en évidence que la variabilité temporelle et la variabilité spatiale (au sein de la colonne d'eau) des paramètres photosynthétiques peuvent avoir des répercutions considérables sur les bilans

journaliers de production. Si ces variabilités ne sont pas considérées ou si les paramètres photosynthétiques sont mesurés à des moments différents de la marée, la production photosynthétique journalière peut être sous ou surestimée de 2,6% à plus de 100% (Lizon 1997).

Dans le contexte de la modélisation à une échelle régionale de la production photosynthétique appliquée à la télédétection, Vantrepotte (2003) a caractérisé la variabilité des paramètres photosynthétiques en Manche orientale. La zone d'étude était constituée de 18 transects côte-large répartis le long des côtes françaises entre le Havre et le cap Gris-Nez. La variabilité des paramètres photosynthétiques et de la biomasse chlorophyllienne a été étudiée à l'échelle spatiale (à mésoéchelle et au sein d'une colonne d'eau) et à deux échelles temporelles (saisonniers et journaliers). La variabilité « saisonnière » a été abordée grâce à des échantillonnages effectués en février, mars, mai et juillet 2000. La variabilité journalière a été étudiée au mois de juillet 2000 en périodes de morte-eau (durant 12 heures) et de vive-eau (durant 24 heures) au niveau d'un point fixe situé au large de Wimereux. La variabilité des paramètres photosynthétiques n'a, cependant, pas été interprétée en termes de capacité d'acclimatation du phytoplancton car la compréhension du contrôle de l'activité photosynthétique du phytoplancton n'était pas le sujet de ce travail. Il s'agissait ici de décrire la variabilité des paramètres photosynthétiques à différentes échelles spatiales et temporelles afin de prendre en considération ces variations dans la paramétrisation de la production photosynthétique à partir de données satellitaires et dans le calcul de bilans de production primaire journaliers.

La variabilité spatiale à mésoéchelle des paramètres photosynthétiques n'a pas été décrite en détails. Vantrepotte (2003) indique, cependant, que la distribution des paramètres photosynthétiques était fortement hétérogène sur la zone d'étude avec des patrons de répartition différents selon la période d'échantillonnage considérée. Cependant, la zone

d'étude étant très étendue, les échantillonnages ont été étalés sur plusieurs jours. La variabilité journalière des paramètres photosynthétiques a donc pu entraîner un biais dans la discrimination spatiale de ces paramètres. A l'échelle de la colonne d'eau, des variations des paramètres photosynthétiques en fonction de la profondeur ont été observées. α augmentait de la surface vers le fond. Ce schéma de variation était plus marqué en période de morte-eau qu'en période de vive-eau et l'amplitude de variation de α était d'autant plus forte que l'intensité lumineuse de surface était élevée. ETR_m et E_k suivaient le même patron de variation. En période de morte-eau, ces paramètres augmentaient à partir du milieu de la colonne d'eau jusqu'au fond, tandis qu'en période de vive-eau, ils diminuaient progressivement de la surface jusqu'au fond.

A l'échelle « saisonnière », les variations des paramètres photosynthétiques ont été caractérisées en comparant la moyenne de chaque paramètre calculée sur l'ensemble de la zone d'étude à chaque période d'échantillonnage (février, mars, mai et juillet). Les valeurs de ETR_m et de α augmentaient progressivement entre février et mai puis diminuaient entre mai et juillet. Les plus faibles valeurs de E_k ont été observées en février ($129 \mu\text{mol photons m}^{-2} \text{ s}^{-1}$) tandis qu'en mars, mai et juillet, les valeurs de E_k étaient similaires (environ $200 \mu\text{mol photons m}^{-2} \text{ s}^{-1}$). A l'échelle journalière, des patrons de variations différents ont été observés aux différentes profondeurs échantillonnées. En surface, α et F_v/F_m variaient inversement à l'intensité lumineuse, tandis qu'en profondeur, ces paramètres restaient relativement stables au cours de la journée. ETR_m et E_k montraient les mêmes patrons de variations. Ces paramètres restaient relativement stables dans les eaux de surface. A l'inverse, à proximité du fond, ces paramètres restaient stables les premières heures de la journée, augmentaient au maximum d'intensité lumineuse et diminuaient en fin de journée.

Vantrepotte (2003) indique que la mésoéchelle n'est pas l'échelle la plus appropriée pour la compréhension de la variabilité spatiale des paramètres photosynthétiques dans un but

de paramétrisation. Selon lui, la réalisation d'un modèle régional de production primaire nécessiterait de fractionner la zone d'étude en provinces écologiques biologiquement homogènes en terme de composition spécifique du phytoplancton. Ce fractionnement permettrait d'étudier plus précisément les cinétiques de variation des paramètres photosynthétiques dans chacune de ces zones. D'autre part, l'évolution des paramètres photosynthétiques et de la biomasse chlorophyllienne doit également être considérée sur la verticale.

Jouenne et al. (2005, 2007) ont étudié l'influence de la structure des communautés phytoplanctoniques sur les variations temporelles de la production primaire intégrée sur la profondeur (P_z) et des paramètres photosynthétiques (α^B , P_{\max}^B et E_k). Ces études ont été réalisées en Manche centrale : dans la Baie des Veys et dans l'estuaire de la rivière Vire. Deux échelles ont été considérées : l'échelle d'un cycle de marée (12 heures, en avril et en juin) (Jouenne et al. 2005) et l'échelle pluriannuelle (sur une période de 18 mois) (Jouenne et al. 2007). Une interaction forte entre la Baie des Veys et l'estuaire de la rivière Vire a été mise en évidence. Deux fois par jour, soit à chaque demi-cycle de marée, l'estuaire de la rivière Vire est une source d'eau douce, de matières en suspension, de nutriments, de biomasse chlorophyllienne et d'espèces phytoplanctoniques pour la Baie de Veys. Cette interaction est plus ou moins forte et dépend de l'intensité du mélange de la colonne d'eau.

Une relation a été établie entre les changements dans la structure des communautés phytoplanctoniques (en terme de biovolume, d'espèces dominantes et de diversité) et la variabilité temporelle de P_z et des paramètres photosynthétiques aussi bien à l'échelle d'un cycle de marée qu'à l'échelle pluriannuelle. Cette relation montre l'importance des échanges phytoplanctoniques entre la Baie des Veys et l'estuaire de la rivière Vire et des successions saisonnières des communautés phytoplanctoniques dans le contrôle de la production primaire. A l'échelle d'un cycle de marée, la variation des paramètres photosynthétiques et les

capacités d'acclimatation du phytoplancton étaient également influencées par l'intensité du mélange de la colonne d'eau. Lorsque les conditions de mélanges étaient faibles, la photoacclimatation à court-terme était possible. Dans ce cas de figure, la variabilité des paramètres photosynthétiques était « E_k -dépendante » c'est-à-dire que α^B et P_{\max}^B variaient séparément et P_{\max}^B contrôlait les variations de E_k . A l'inverse, lorsque les conditions de mélanges étaient fortes, la variabilité des paramètres photosynthétiques était « E_k -indépendante ». α^B et P_{\max}^B étaient alors corrélés positivement et la variabilité de E_k était éloignée de l'intensité lumineuse incidente, signe d'une capacité d'acclimatation limitée. A l'échelle pluriannuelle, une variation saisonnière de P_z , α^B et P_{\max}^B a été observée. Ces paramètres étaient forts entre Juillet et Septembre et faibles du mois de Novembre au mois de Mai. A cette échelle de temps, les nutriments, la lumière, la température et les successions phytoplanctoniques contrôlaient la variabilité des paramètres photosynthétiques et de la production primaire.

Deuxième partie:

**Utilisation de la fluorescence spectrale et
de la fluorimétrie modulée pour l'étude du
phytoplancton en Manche orientale**

Second part:

*Use of spectral fluorescence and modulated
fluorometry for the study of phytoplankton in
the eastern English Channel*

Avant propos

La fluorescence spectrale et la fluorimétrie PAM sont les deux principales techniques utilisées dans cette thèse. Comme les résultats d'un travail de recherche dépendent toujours de la méthode de mesure utilisée, lorsqu'on utilise des méthodes qui ne sont pas reconnues comme méthodes de référence et qui n'ont pas encore été utilisées dans notre zone d'étude, il est recommandé de tester leur fiabilité avant d'entamer tout travail de recherche. Ces considérations méthodologiques font l'objet de cette deuxième partie.

Dans le premier chapitre, la possibilité d'utiliser le FluoroProbe pour le suivi de l'Haptophyte *Phaeocystis globosa* a été testée. Le FluoroProbe est un fluorimètre multi longueurs d'ondes qui permet d'estimer la biomasse phytoplanctonique par groupes. Il a initialement été développé pour une utilisation en limnologie. Il a donc été conçu pour estimer la biomasse de quatre groupes d'algues : les algues brunes (Heterokontophyte et Dinophyte), les cyanobactéries à phycocyanine, les algues vertes (Chlorophyte) et le groupe des « Cryptophyte » qui comprend les cryptophytes et les cyanobactéries à phycoérythrine. En Manche orientale, les communautés phytoplanctoniques sont dominées par les Diatomées, les Dinoflagellés, l'Haptophyte *P. globosa* et les cryptophytes avec un rôle important des Diatomées et de *P. globosa* qui forment des blooms au printemps (Lefebvre et al. 2011). Dans sa configuration initiale, le FluoroProbe n'était pas adapté pour le suivi des communautés phytoplanctoniques de la Manche orientale. Nous avons donc testé la possibilité de faire la distinction entre *P. globosa* et les autres algues brunes. Ce travail a fait l'objet d'un article publié dans la revue « Journal of Plankton Research ».

Dans le second chapitre, l'utilisation du Phyto-PAM pour la caractérisation de l'activité photosynthétique par groupes phytoplanctoniques a été testée. Le Phyto-PAM est un fluorimètre PAM multi longueurs d'ondes qui permet d'obtenir les paramètres

photosynthétiques par groupes d'algues. Comme le FluoroProbe, le Phyto-PAM a initialement été développé pour une utilisation en limnologie. Il a ainsi été conçu pour discriminer trois groupes phytoplanctoniques : les algues brunes, les algues vertes et les cyanobactéries à phycocyanine. Cette configuration n'étant pas parfaitement adaptée aux groupes phytoplanctoniques rencontrés en Manche orientale, nous avons testé son efficacité à travers une série d'expériences de laboratoire.

Enfin, dans le dernier chapitre, l'utilisation des Rapid Light Curves (RLC) et des Steady State Light Curves (SSLC) pour la caractérisation de l'activité photosynthétique du phytoplancton aux échelles journalières et saisonnières a été comparée. Ce travail a été publié dans les actes du 26^e Forum des Jeunes Océanographes.

Preface

The spectral fluorescence and PAM fluorometry are the two main techniques used in this thesis. Because the results of a research work are always dependent on the measuring methods applied, using methods not considered as reference methods and not yet used in the area of interest requires tests on their reliability before to start any research work. These methodological considerations are the subject of this second part.

In the first chapter, the possibility of using the FluoroProbe for monitoring the Haptophyte *Phaeocystis globosa* was tested. The FluoroProbe is a spectral fluorometer allowing phytoplankton biomass estimations by algal groups. It was initially developed to be used in limnology and was so designed to estimate the biomass of four algal groups: brown algae (Heterokontophyta and Dinophyta), cyanobacteria (cyanobacteria with phycocyanin), green algae (Chlorophyta) and Cryptophyta (Cryptophyta and cyanobacteria with phycoerythrin). In the eastern English Channel, phytoplankton communities are dominated by Diatoms, Dinoflagellates, the Haptophyte *P. globosa* and Cryptophytes with Diatoms and *P. globosa* blooming during spring (Lefebvre et al. 2011). Consequently, in its initial configuration, the FluoroProbe was not suitable for monitoring the English Channel phytoplankton communities. Therefore, the possibility to use the FluoroProbe for discriminating this Haptophyte from the other brown algae was tested before to employ this probe during field studies. This work was published in the “Journal of Plankton Research”.

In the second chapter, the Phyto-PAM reliability in characterising the photosynthetic activity by phytoplankton groups was tested. The Phyto-PAM is a 4-wavelength PAM fluorometer allowing photosynthetic parameters estimations by algal groups. Like the FluoroProbe, the Phyto-PAM was initially developed to be used in limnology. It was thus designed to discriminate three algal groups: brown algae, green algae and cyanobacteria with

phycocyanin. This configuration being not perfectly suitable to the English Channel phytoplankton groups, we tested its reliability through a series of laboratory experiments with a particular attention to the discrimination between diatoms and *P. globosa*.

Finally, in the last chapter, the use of rapid light curves (RLC) and steady state light curves (SSLC) to characterise the photosynthetic activity at diel and seasonal scales was compared. This work was published in the proceedings of the “26^e Forum des Jeunes Océanographes”.

Chapitre I

Suivi des dynamiques des Haptophytes en utilisant le FluoroProbe: une application en Manche orientale pour la surveillance de *Phaeocystis globosa*

*Spectral fluorometric characterization of Haptophyte dynamics using the
FluoroProbe: an application in the eastern English Channel for monitoring
Phaeocystis globosa*

Emilie Houliez^{1*}, Fabrice Lizon¹, Melilotus Thyssen²,

Luis Felipe Artigas², François G. Schmitt¹

¹ Université Lille Nord de France, Université des Sciences et Technologies de Lille – Lille 1, Laboratoire d'Océanologie et de Géosciences - CNRS, UMR 8187, Station Marine de Wimereux, 28 Avenue Foch, 62930 Wimereux, France

² Université Lille Nord de France, Université du Littoral Côte d'Opale Laboratoire d'Océanologie et de Géosciences, – CNRS, UMR 8187, Maison de la Recherche en Environnement Naturel, 32 Avenue Foch, 62930 Wimereux, France

*Corresponding author: houliez-emilie@voila.fr

Résumé

Dans cette étude, nous avons examiné la possibilité d'utiliser le FluoroProbe pour la surveillance de l'Haptophyte *Phaeocystis globosa* dans les eaux côtières de la Manche orientale. Le FluoroProbe a été recalibré en enregistrant une nouvelle empreinte de référence pour *P. globosa* et l'utilisation de cette nouvelle empreinte a été testée par le biais d'une série d'expériences de laboratoire et *in situ*. Les dynamiques annuelles de *P. globosa* estimées en utilisant le FluoroProbe et par cytométrie en flux étaient similaires. Une forte relation a été trouvée entre les estimations de la biomasse de *P. globosa* par le FluoroProbe, exprimées en terme d'équivalent chlorophylle *a* par litre (eq. $\mu\text{g L}^{-1}$), et les comptages par cytométrie en flux ($r = 0.889$, $P < 0,001$, $n = 121$). Le FluoroProbe peut être utilisé pour détecter aussi bien les cellules flagellées que les cellules coloniales de *P. globosa* mais pas pour faire la distinction entre ces deux types cellulaires lorsqu'ils sont mélangés aux seins d'assemblages. L'utilisation de la nouvelle empreinte enregistrée pour *P. globosa* améliore la détection d'*Isochrysis sp.* Ceci suggère la possibilité d'utiliser le FluoroProbe pour surveiller d'autres Haptophytes en calibrant l'appareil avec des espèces représentatives de la région d'intérêt. Cependant, il est important de noter que la détection de *P. globosa* au niveau spécifique était possible, en Manche orientale, parce que c'est la seule Haptophyte présentant une biomasse suffisante pour être détectée par le FluoroProbe. Dans les zones où plusieurs espèces d'Haptophytes sont présentes simultanément, leur discrimination sera impossible et dans de telles situations, le FluoroProbe peut être utilisé pour surveiller les dynamiques du groupe des Haptophytes.

Mots clés : fluorescence spectrale, *Phaeocystis globosa*, Haptophytes, efflorescences algales, quantification du phytoplancton, chlorophylle *a*

Abstract

In this study, we examined the possibility of using the FluoroProbe for monitoring the dynamics of the Haptophyte *Phaeocystis globosa* in the coastal waters of the eastern English Channel. The FluoroProbe was recalibrated by recording a new fingerprint for *P. globosa* and the use of this new fingerprint was tested through a series of laboratory and *in situ* experiments. The annual dynamics of *P. globosa* estimated using the FluoroProbe and by flow cytometry were similar. A strong relationship was found between the FluoroProbe estimates of *P. globosa* biomass expressed in terms of chlorophyll *a* equivalent per litre (eq. $\mu\text{g L}^{-1}$) and flow cytometric cell counts ($r = 0.889$, $P < 0.001$, $n = 121$). The FluoroProbe can be used to detect the flagellated cells as well as the colonial cells of *P. globosa* but not to distinguish these two cell types in mixed assemblages. The use of the new fingerprint recorded for *P. globosa* improved the detection of *Isochrysis sp.* This suggests the possibility of using the FluoroProbe to monitor Haptophytes other than *P. globosa* by calibrating the device with species representative of the region of interest. However, it is important to note that the detection of *P. globosa* at the species level was possible in the eastern English Channel because it was the only Haptophyte species present with a biomass sufficient to be detected by the FluoroProbe. In areas where several Haptophyte species are simultaneously present, their discrimination will be impossible and in such situations, the FluoroProbe can be used to monitor the dynamics of the combined Haptophyte group.

Keywords: spectral fluorescence, *Phaeocystis globosa*, Haptophytes, algal blooms, phytoplankton quantification, chlorophyll *a*

1 INTRODUCTION

Haptophyte microalgae are an important component of the world's oceanic phytoplankton, blooming seasonally in different ecosystems (Zapata et al. 2004). Among Haptophytes, the genus *Phaeocystis* is one of the most widespread and can produce nearly monospecific blooms reaching a high carbon biomass (up to 10 mg C L⁻¹) in several coastal and oceanic waters (Schoemann et al. 2005). In the eastern English Channel and southern Bight of the North Sea, *Phaeocystis globosa* is the dominant Haptophyte (Astoreca et al. 2009, Lefebvre et al. 2011). This species forms massive blooms of mucilaginous colonies during spring (Cadée & Hegeman 2002, Seuront et al. 2006, Schapira et al. 2008, Blauw et al. 2010). One of the most visible manifestations of these blooms is the accumulation of foam on the seashore during their termination phase. Although different hypotheses have been proposed to explain the formation of these blooms (Lancelot et al. 1987, Peperzak et al. 1998, Meyer et al. 2000) and the success of this species (Veldhuis & Wassmann 2005), the environmental factors controlling *P. globosa* blooms remain poorly understood. This may be due in part to the complexity of its life cycle that makes its monitoring difficult.

P. globosa has a polymorphic life cycle exhibiting phase alternation between different types of free-living cells (vegetative non-motile, vegetative flagellates and microzoospores) of 3-8 µm in diameter and mucilaginous colonies usually reaching millimetres in size (Peperzak et al. 2000, Schoemann et al. 2005, Rousseau et al. 2007). The colonies of *P. globosa* are relatively easy to identify with a light microscope, but the flagellated cells are more difficult to recognize because of their small size and the difficulty of detecting their haptonema (a characteristic organelle of the class) under the light microscope. Moreover, the various

fixatives used for preservation may damage the cells, rendering their enumeration somewhat imprecise (Antajan et al. 2004).

Several alternative techniques to the light microscopy have been proposed to monitor the species of the genus *Phaeocystis*, such as electron microscopy (Puigserver et al. 2003, Guiselin et al. 2009), r-RNA targeted sandwich hybridization (Zhen et al. 2008), ribosomal DNA analysis (Gaebler et al. 2007) or pigment analysis by HPLC (Wright et al. 1996). However, these methods have the limitations of being costly, laborious and destructive while providing limited coverage in space and time and rarely in real time (Millie et al. 2002, Gregor & Marsalek 2004, Gregor et al. 2005, Richardson et al. 2010). Moreover, these techniques, as well as the traditional techniques of cell counts by microscopy, require an experienced analyst and are costly in terms of man-hours (Beutler et al. 2002).

Recently, flow cytometry has also been suggested as a method for monitoring species of the genus *Phaeocystis* (Rutten et al. 2005, Veldhuis et al. 2005, Guiselin 2010). Although flow cytometry facilitates the monitoring of *Phaeocystis* species by considerably reducing the time of sample analysis and by enhancing the objectiveness of enumeration and the recognition of flagellated cells, some shortcomings persist. Colonial cells of *Phaeocystis* frequently reach several millimetres size, while current flow cytometers are equipped with narrow nozzles (the more efficient are able to analyse cells with a maximum size of 1000 μm). Consequently, depending on the colonial cells and flow cytometer nozzle sizes, colonial cells of *Phaeocystis* are either counted as single entities or disrupted prior to entering the flow cytometer nozzle, making enumeration of this cell type somewhat imprecise and dependent on the flow cytometer type used (Veldhuis et al. 2005, Guiselin 2010). Moreover, even if flow cytometry allows *in situ* collection of data at relatively high frequency (typically several times an hour), this method remains costly, and subsequent data processing and interpretation are still needed and are time-consuming despite the introduction of several automated recognition

techniques such as neural networks and automated statistical techniques (e.g. Balfourt et al. 1992, Carr et al. 1996, Caillault et al. 2009, Malkassian et al. 2011).

From this perspective there is a clear demand for tools and methods that can simplify phytoplankton quantification for monitoring purposes particularly since the assessment of changes in phytoplankton assemblages is a prerequisite for fully understanding primary production processes and for the assessment of water quality (Beutler et al. 2002, Gregor et al. 2005).

The use of spectral fluorescence would be a good alternative for identifying *P. globosa* if, in the region of interest, *P. globosa* is the only abundant Haptophyte. This method is based on selective excitation of the differing antenna and accessory pigments between taxonomic groups of algae with sequential light excitations using several light emitting diodes (for a review of this method see MacIntyre et al. 2010). Several spectral fluorometers with varying excitation wavelength exist. These include the Mini-Tracka II (Chelsea Instruments, UK), the C6 platform for Cyclops-7-sensors (Turner Designs, USA), the Algae Online Monitor (Photon Systems Instruments, Czech Republic), the Multi-Exciter (JFE Alc Co., Ltd, Japan) or the Algae Online Analyser (AOA) and the FluoroProbe both from bbe-Moldaenke (Kiel, Germany) (Richardson et al. 2010). Here we used the FluoroProbe described by Beutler *et al.* (2002).

The first *in situ* application of the FluoroProbe was carried out by Leboulanger *et al.* (2002). These authors monitored, after a reconfiguration of the device, the dynamics of the toxic cyanobacterium *Planktothrix rubescens* in Lake Bourget (France) and showed its utility for monitoring cyanobacteria. Later, Gregor and Marsalek (2004) validated the use of this probe for total chlorophyll *a* (chl *a*) determination in rivers and reservoirs by comparing their results with a standard spectrophotometry method. In a second study, Gregor *et al.* (2005) tested the performance of the FluoroProbe in monitoring phytoplankton community

composition in different eutrophic freshwater reservoirs in the Czech Republic and found a relatively good agreement between the FluoroProbe's determinations and cell counts by microscopy. Working in the Gulf of Mexico, See *et al.* (2005) reported mis-classification by the FluoroProbe of certain brown algae as either brown algae/green algae or brown algae/Cryptophyta mixtures; specifically it was the case where Haptophytes were classified as a brown algae/green algae mixture. Similar results of mis-classification of Haptophytes were also obtained by Richardson *et al.* (2010) and MacIntyre *et al.* (2010) working with the AOA a spectral fluorometer that functions on the same principle as the FluoroProbe.

The aim of this work was to test the possibility of using the FluoroProbe for monitoring the dynamics of the Haptophyte *P. globosa* in the coastal waters of the eastern English Channel. We tested the hypothesis that the FluoroProbe is not able to correctly discriminate Haptophytes and we tried to answer the following questions:

- (1) Is the FluoroProbe able to discriminate the Haptophyte *P. globosa*? Is a reconfiguration of its fingerprints necessary?
- (2) How does the use of a new fingerprint for *P. globosa* affect the discrimination of other phytoplankton groups?
- (3) To what extent can the FluoroProbe discriminate the *P. globosa* signal in the presence of other groups of microalgae? Is the FluoroProbe able to discriminate the different life cycle stages of *P. globosa*?
- (4) What are the effects of each algal group concentration within a phytoplankton assemblage on the FluoroProbe discriminations? How does the number of algal groups within a phytoplankton assemblage modify the quality of the FluoroProbe classifications?
- (5) Are the results of the *P. globosa* discrimination by the FluoroProbe comparable to a cell counts method such as flow cytometry?

For the purpose of the present study, a new fingerprint was recorded to discriminate *P. globosa* and then validated by several laboratory and *in situ* experiments.

2 METHOD

2.1 Fluorescence measurements

2.1.1 Spectral fluorescence background

Measurements of spectral fluorometers are based on the principle of differentiation of algal populations by the spectral fluorescence approach. It is known that chlorophyll fluorescence is mainly emitted by chl *a* of photosystem II (PSII) antenna system, which consists of an evolutionarily conserved chl *a*-containing core and species-dependent peripheral antenna composed of differing accessory pigments (Rowan 1989, Jeffrey et al. 1997). In the “green” lineage, the peripheral antenna contains chl *a*, chl *b* and xanthophyll. In the “blue” lineage, phycobilisomes (principally composed of phycocyanin) function as peripheral antenna. The members of the “brown” lineage contain chl *a*, chl *c* and xanthophyll (often fucoxanthin or peridinin). The peripheral antenna of the “red” lineage is composed of phycobilisomes, as in the “blue” lineage; however, the phycoerythrin is the major pigment instead of phycocyanin and the peripheral antenna also contains chl *a* and chl *c* (Rowan 1989, Jeffrey et al. 1997). The spectral fluorescence approach is based on selective excitation of the differing antenna and accessory pigments between taxonomic groups of algae using light of varying wavelengths to obtain characteristic fluorescence excitation spectra (Yentsch & Yentsch 1979, Millie et al. 2002). Each of the four lineages is characterized by a specific excitation spectrum called a “fingerprint” resulting from the composition of their peripheral

antenna (Beutler et al. 2002). Using a mathematical technique such as Gaussian decomposition of spectra or linear unmixing, it is possible to determine the phytoplankton composition and chl *a* concentration associated with each algal group, within an unknown sample, by fitting the measured excitation spectra using a library of fingerprints that serve as a reference (MacIntyre et al. 2010).

2.1.2 The FluoroProbe

The FluoroProbe (bbe-Moldaenke, Kiel, Germany) is a spectral fluorometer able to discriminate four spectral algal groups: brown algae (Heterokontophyta and Dinophyta), cyanobacteria (cyanobacteria with phycocyanin), green algae (Chlorophyta) and Cryptophyta (Cryptophyta, Rhodophyta, cyanobacteria with phycoerythrin) in mixed assemblages. It uses five light emitting diodes (470, 525, 570, 590 and 610 nm) for sequential light excitation of accessory pigments and the relative fluorescence intensity of chl *a* is measured between 690 and 710 nm. The excitation spectrum obtained is compared by linear unmixing to a library of four fingerprints stored in the probe and the relative concentration of each algal group expressed in terms of the equivalent amount of chl *a* per litre (eq. $\mu\text{g L}^{-1}$) as well as the total chl *a* concentration are calculated. An additional diode (370 nm) is used for the excitation and subsequent subtraction of the fluorescence of dissolved organic matter (“yellow substances”). For a detailed description of the FluoroProbe, see Beutler *et al.* (2002). In this study, all fluorescence measurements were made using the 25 mL cuvette of the FluoroProbe.

2.2 A new fingerprint for *Phaeocystis globosa*

As purchased, our FluoroProbe was provided with fingerprints for brown algae, cyanobacteria, green algae and Cryptophyta (original fingerprints, Fig. 1.1). To discriminate the Haptophyte *P. globosa*, we recorded a new fingerprint using natural coastal water dominated by this species (>90 % determined by cell counts from flow cytometry and microscopic observations, data not shown). The probe was first immersed in 4 L of ultra-filtered (0.2 μm) coastal water to obtain a “natural blank” and then in 4 L of natural coastal water dominated by *P. globosa* (with a known chlorophyll concentration) to calibrate the new fingerprint (Fig. 1.1). The fingerprints obtained with cultures of *P. globosa* were similar to those obtained with natural coastal water. Consequently, only the recorded field signature was used for the subsequent detection of this species.

2.3 Laboratory experiments

To determine to what extent the FluoroProbe can discriminate the signal of *P. globosa* in the presence of other microalgae and how the use of this fingerprint potentially affects the discrimination of other groups, seventeen species belonging to different phytoplankton groups (Table 1.I) were used to carry out a series of laboratory experiments. All cultures were grown under a 12 h light-dark cycle in white light Osram powerstart HQI-T 250W/D daylight (170 $\mu\text{mol photons m}^{-2} \text{ s}^{-1}$) at 15°C. Cultures were regularly diluted with fresh medium to ensure they were nutrient replete.

Table 1.I. Division, species, strain code, culture medium and origin of the 18 phytoplankton cultures examined

Division	Species	Strain code	Culture medium	Origin
Haptophyta	<i>Phaeocystis globosa</i>	PLY 575	Keller's ESW	Plymouth Laboratory
	<i>Phaeocystis globosa</i>	PLY 699	Keller's ESW	Plymouth Laboratory
Chlorophyta	<i>Isochrysis sp.</i>		f/2	LOG Wimereux
	<i>Chlorella autotrofica</i>		f/2	LOG Wimereux
	<i>Scenedesmus sp.</i>		BG 11	Laboratory ECOBIO Rennes
Cyanobacteria	<i>Chlamydomonas reiniae</i>	PLY 399	Erd Schreiber	Plymouth Laboratory
	<i>Microcystis aeruginosa</i>		BG 11	Laboratory ECOBIO Rennes
	<i>Gloeotheca sp.</i>		f/2	LOG Wimereux
Cryptophyta	<i>Anabaena cylindrica</i>		f/2	LOG Wimereux
	<i>Rhodomonas marina</i>		f/2	LOG Wimereux
	<i>Cryptomonas maculata</i>	PLY 175	Erd Schreiber	Plymouth Laboratory
Rhodophyta	<i>Porphyridium cruentum</i>		f/2	LOG Wimereux
	<i>Rhodella maculata</i>	PLY 470	Erd Schreiber	Plymouth Laboratory
Bacillariophyta	<i>Thalassiosira oceanica</i>		f/2	LOG Wimereux
	<i>Actinoptychus sp.</i>		f/2	LOG Wimereux
	<i>Coscinodiscus sp.</i>		f/2	LOG Wimereux
	<i>Schroederella sp.</i>		f/2	LOG Wimereux
	<i>Asterionellopsis glacialis</i>	PLY 607	Erd Schreiber	Plymouth Laboratory

Culture medium: Keller's ESW (Keller et al., 1987); f/2 (Guillard and Ryther, 1962; Guillard, 1975); BG 11 (Allen, 1968; Allen and Stanier, 1968; Rippka et al., 1979); Erd Schreiber (Tompkins et al., 1995)

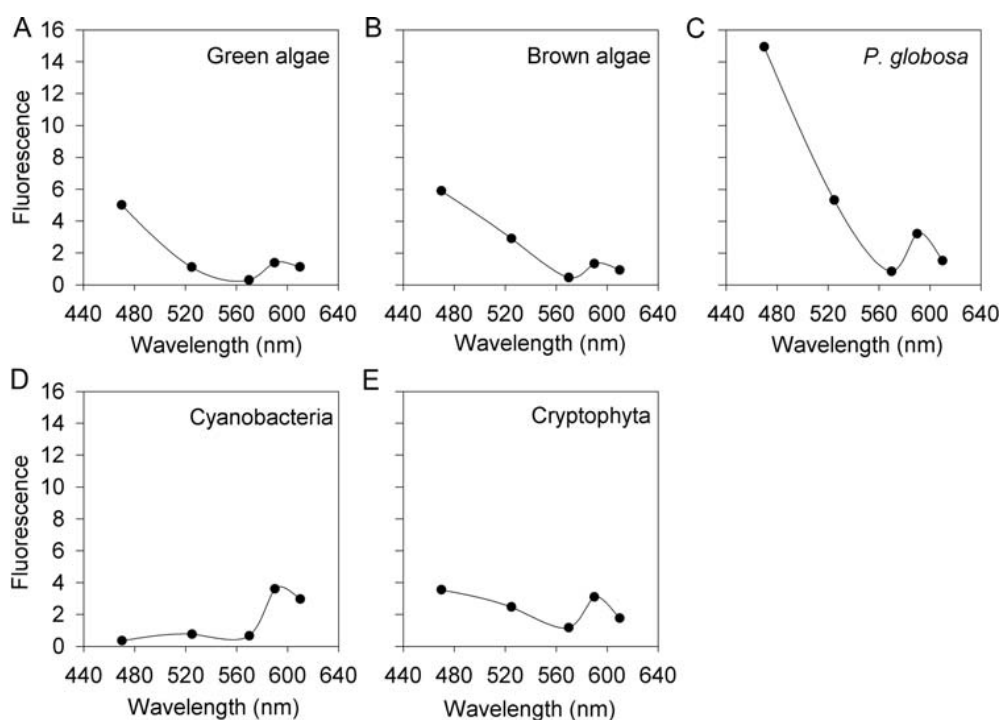

Fig. 1.1. Original fingerprints (A, B, D and E) and the new fingerprint of *Phaeocystis globosa* (C). Values are expressed in relative fluorescence for each excitation wavelength

2.3.1 Experiment 1

As indicated above, the phytoplankton composition of an unknown sample is determined by fitting the measured excitation spectra by a library of fingerprints that serve as a reference. The FluoroProbe determinations of algal groups are therefore strongly dependent on the fingerprints used and when a new fingerprint is employed it is essential to verify that it does not affect the discrimination of other groups. The potential error in the discrimination of the different groups caused by the use of the fingerprint of *P. globosa* was evaluated by comparing the discrimination of these groups using the original fingerprints (brown algae, cyanobacteria, green algae and Cryptophyta) with their discrimination using the fingerprint of *P. globosa*. These tests were done on pure cultures.

One of the disadvantages of the FluoroProbe is that it is only able to discriminate four phytoplankton groups so that the addition of a new fingerprint is only possible if one of the four default fingerprints is disabled. The potential effect on the discrimination of the different algal groups by the fingerprint of *P. globosa* was therefore evaluated by alternately replacing the four original fingerprints by the fingerprint of *P. globosa*. For example, the error in the prediction of cyanobacteria was evaluated by successively using three combinations of fingerprints (cyanobacteria + *P. globosa* + brown algae + Cryptophyta; cyanobacteria + green algae + *P. globosa* + Cryptophyta; cyanobacteria + green algae + brown algae + *P. globosa*). This operation was repeated for each phytoplankton group.

2.3.2 Experiment 2

The quality of the discrimination of the *P. globosa* signal in the presence of other microalgae was evaluated using different mixtures of algae with different proportions (the proportions are detailed in Figs 1.3 and 1.4). For this purpose, only three phytoplankton groups were considered because they are the dominant groups in the eastern English Channel. Three species were used: *Asterionellopsis glacialis* (Bacillariophyta), *Cryptomonas maculata* (Cryptophyta) and *P. globosa*. As *P. globosa* has a heteromorphic life cycle with colonial and flagellated cells, two cultures of *P. globosa* (one culture of flagellated cells and one culture of colonial cells) were used. Additional mixtures were made with algal groups for which the FluoroProbe was initially developed, i.e. a Bacillariophyta: *A. glacialis*, a Cryptophyta: *C. maculata* and a Chlorophyta: *Chlamydomonas reginae* to determine the quality of the discrimination of these groups and to compare the results with the discrimination of *P. globosa*. The subsamples of culture were diluted in ultra-filtered (0.2 µm) sea water to make the different mixtures. The contributions of each group in the different mixtures were determined using the FluoroProbe. Samples were filtered for chl *a* concentration measurements (see below) and these concentrations were used to calculate the expected proportions.

2.4 Field measurements

To validate the use of the new fingerprint for *in situ* monitoring of *P. globosa*, samples were taken in the coastal waters (50°45'57.42''N, 1°35'55.17''E) of the eastern English Channel (France). Sampling was carried out each week during 2009 and on several dates in

the spring 2010. All samples were taken at high and low tide. They were placed into opaque containers and brought back to laboratory for determination of phytoplankton assemblage composition by the FluoroProbe and flow cytometry. Analyses with the FluoroProbe were always done within the 20 min following the sampling.

2.5 Chlorophyll *a* measurements

Chl *a* concentrations of pure culture and mixtures were determined by filtering known volumes of culture through Whatman 47 mm GF/F glass-fibre filters. The filters were stored at -80°C and subsequently extracted in 90% acetone. Chl *a* concentration was evaluated by fluorometry using a Turner Designs Model 10-AU fluorometer. The fluorescence was measured before and after acidification with HCl (Lorenzen 1966, Aminot & K  rouel 2004). The fluorometer was calibrated using known concentrations of commercially purified chl *a* (Sigma).

2.6 Flow cytometry

Samples were fixed for 15 min with glutaraldehyde 0.25% final concentration and stored at -80°C for later analysis. Thawed samples were analysed using a Cytosense Benchtop (CytoBuoy BV, Netherlands) equipped with a blue laser beam (488 nm, 50 mW). This instrument records the pulse shape of each particle passing through the laser beam at a speed of 2 m.s⁻¹. For each particle, full pulse profile digitizing electronics enables morphological analysis. The pulse shape of the forward (FW) and sideward (SWS) scatter signals, the red

(FLR, 668 - 734 nm), orange (FLO, 601 - 668 nm) and yellow (FLY, 536 - 601 nm) fluorescences were collected. Ten micrometre orange fluorescent polystyrene beads (Invitrogen Fluorosphere) were used as an external standard and analysed before and after each set of measurements to normalize scatter and fluorescence signals. Ultra-filtered (0.2 μm) sea water was used as sheath fluid and samples were run at $4.5 \mu\text{L}\cdot\text{s}^{-1}$. Data were analysed using the Cytoclus software (CytoBuoy, bv). *P. globosa* was identified from the pulse shape and the profile using the levels of chl *a* fluorescence (FLR), the FW and the SWS according to Guiselin (2010), Rutten *et al.* (2005) and Veldhuis *et al.* (2005). The Cytosense is able to analyse a wide range of cell sizes (1 to 800 μm and a few millimetres in length): flagellated as well as colonial cells of *P. globosa* were consequently both enumerated. Although the larger colonial cells (millimetre size) are theoretically too large for the flow cytometer nozzle, the gelatinous mucus of the colonies is fluid enough to pass through the orifice (Veldhuis *et al.* 2005).

2.7 Statistical analysis

Fisher's exact test (one tail) was used to compare relative proportions of algal groups within mixtures. This test is advised when the Chi-square test assumptions are not respected; particularly when any expected frequency is < 1 or when 20% of expected frequencies ≤ 5 (Scherrer 2007). It was run using the R-software (R Development Core Team, 2011). Absolute concentrations were compared using Student's t-test (Scherrer 2007). Pearson's correlation analysis and simple linear regressions were performed to evaluate the relationships between the measured and the expected absolute chl *a* concentrations for *P. globosa*, *A. glacialis* (brown algae) and *C. maculata* (Cryptophyta); and between the FluoroProbe's

results and cell abundances determined by flow cytometry (Scherrer 2007). These statistical procedures were performed using the software SYSTAT 10.

3 RESULTS

3.1 Experiment 1: potential errors in the discrimination of algae groups induced by the fingerprint of *P. globosa*

The potential errors in the discrimination of different phytoplankton species induced by the fingerprint of *P. globosa* were evaluated by comparison of their discrimination using the original fingerprints with their discrimination using the fingerprint of *P. globosa* (Fig. 1.2). Only the discrimination of Chlorophyta and three species of Bacillariophyta (*Thalassiosira oceanica*, *Actynoptychus sp.* and *A. glacialis*) were significantly different using the fingerprint of *P. globosa* ($P < 0.01$, Fisher's exact test). The error in the discrimination of Bacillariophyta was lower than the Chlorophyta discrimination and affected the proportions of chl *a* that were already incorrectly classified by the FluoroProbe using the original fingerprints. With the original fingerprints, *P. globosa* ($n = 20$) was incorrectly classified as a mixture of brown algae ($23 \pm 0.2\%$) and green algae ($77 \pm 0.2\%$). Using the *P. globosa* fingerprint, all the signal was attributed to *P. globosa* except when this fingerprint was used at the same time as the fingerprint of green algae: in this case $69 \pm 0.4\%$ of the signal was still mis-classified as green algae. Using the fingerprint of *P. globosa* improved the discrimination of other Haptophytes. Indeed, with the original fingerprints, the signal of *Isochrysis sp.* ($n = 12$) was incorrectly classified as $44 \pm 0.3\%$ of green algae and $56 \pm 0.3\%$ of brown algae

whereas with the fingerprint of *P. globosa* only $9 \pm 0.7\%$ of the signal was incorrectly classified as brown algae.

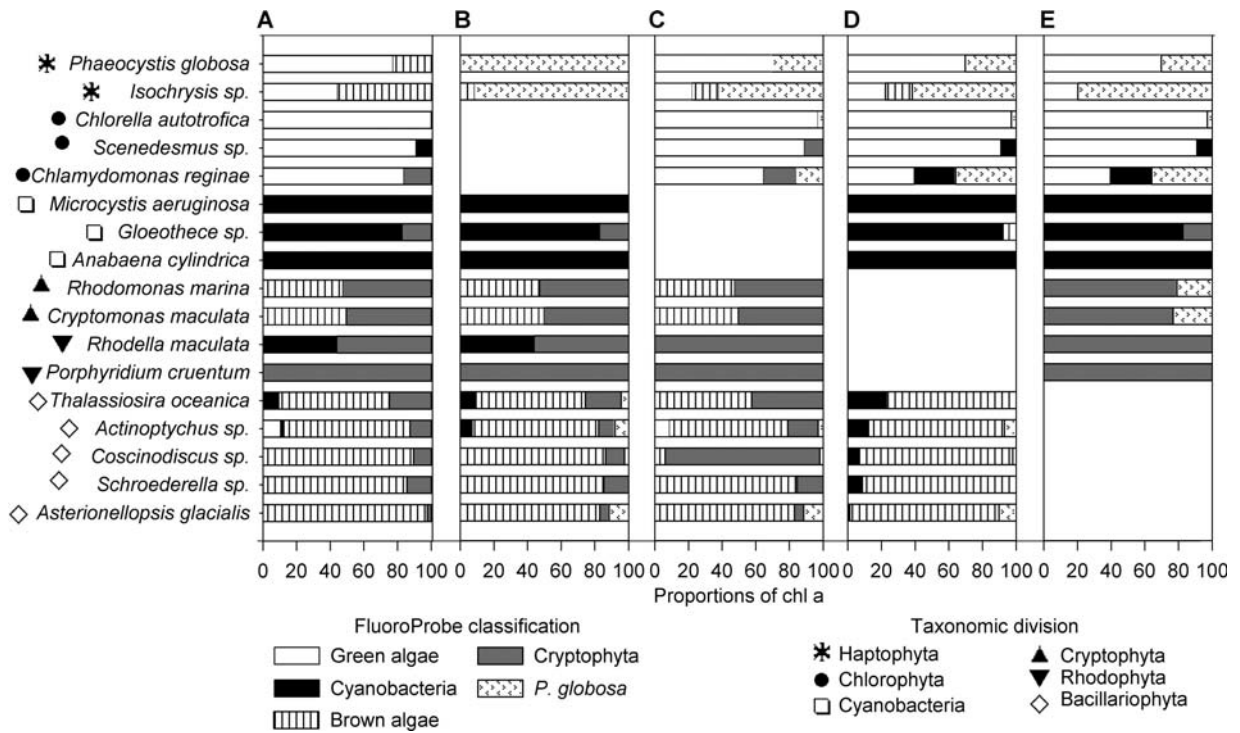

Fig. 1.2. FluoroProbe classification of 17 phytoplankton pure cultures using either the four original fingerprints or three original fingerprints + *Phaeocystis globosa*'s fingerprint. Original fingerprints (Cyanobacteria + brown algae + green algae + Cryptophyta) (A). Fingerprints of Cyanobacteria + brown algae + Cryptophyta + *Phaeocystis globosa* (B). Fingerprints of green algae + brown algae + Cryptophyta + *Phaeocystis globosa* (C). Fingerprints of Cynaobacteria + green algae + brown algae + *Phaeocystis globosa* (D). Fingerprints of Cynaobacteria + green algae + Cryptophyta + *Phaeocystis globosa* (E). Colours correspond to the FluoroProbe classification whereas symbols situated in front of the species names correspond to the taxonomic division of species

3.2 Experiment 2: ability of the FluoroProbe to discriminate the signal of *P. globosa* in mixed assemblages

3.2.1 Relative contributions

No significant statistical difference between the discrimination of the two life cycle stages of *P. globosa* in different assemblages was found ($P > 0.05$, Fisher's exact test; Fig. 1.3 A versus B and D versus E). The results of the discrimination by groups using the fingerprint of *P. globosa* are in relatively good agreement with the expected relative proportions for mixtures of two phytoplankton groups. Indeed, even though visually there were some differences, the same trend was observed and no significant statistical difference was found between the observed and the expected relative proportions ($P > 0.05$, Fisher's exact test; Fig. 1.3 A versus C and B versus C). Nevertheless, when *P. globosa* represents $> 55\%$ of the mixture, as it was the case in mixtures 8, the FluoroProbe failed to discriminate Bacillariophyta and the totality of the signal was classified as *P. globosa* (Fig. 1.3 A and B, mixtures 8). For mixtures of three phytoplankton groups, the discrimination of algal groups was more difficult with significant differences between the observed and the expected relative proportions ($P < 0.02$, Fisher's exact test; Fig. 1.3 D versus F and E versus F). Indeed, the FluoroProbe underestimated brown algae (by 1.9-4.6 times), overestimated Cryptophyta (by 1.8-3.3 times) and in certain mixtures, Bacillariophyta were not detected (Fig. 1.3 D, mixtures 7 and 8). In contrast, no significant difference was found between the observed and the expected relative proportions of *P. globosa* ($P > 0.05$, Fisher's exact test).

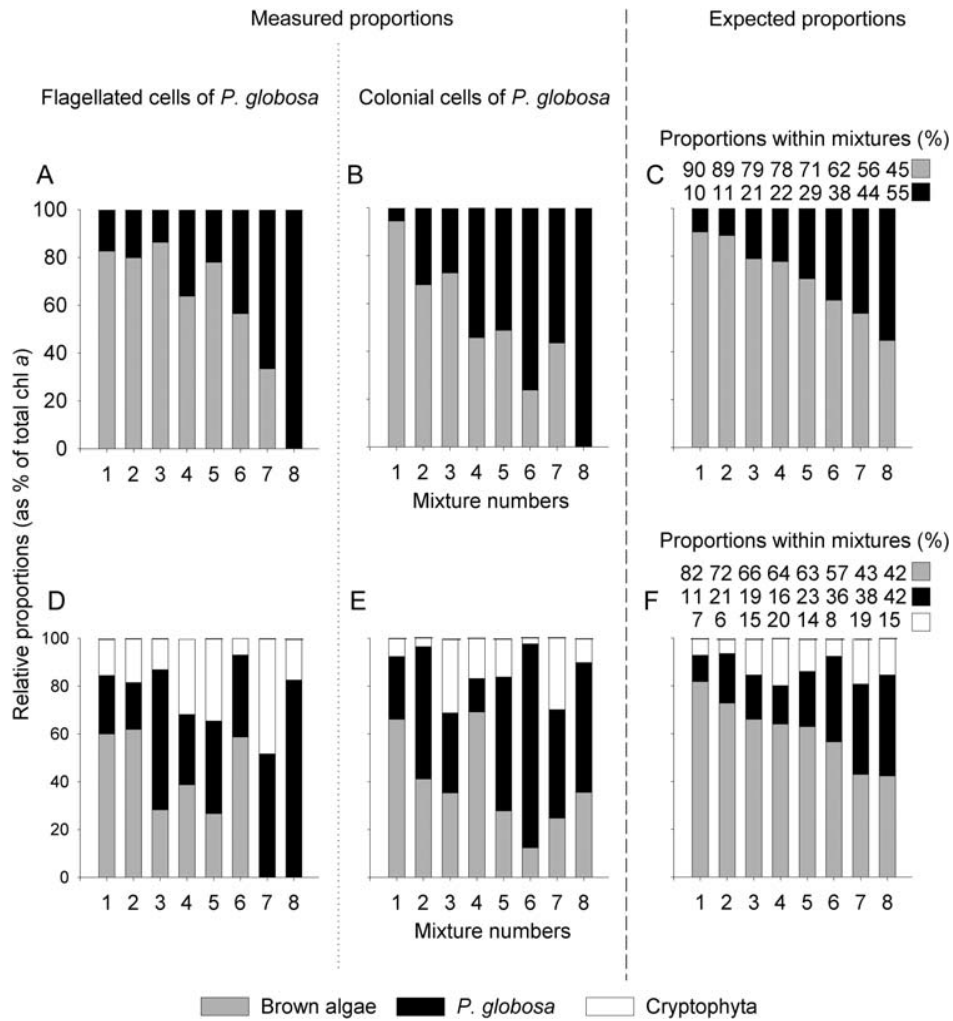

Fig. 1.3. Measured (A,B, D and E) and expected (C and F) relative proportions of *Phaeocystis globosa* in different mixtures with *Asterionellopsis glacialis* (A,B,C) or *Asterionellopsis glacialis* + *Cryptomonas maculata* (D,E,F). A and D correspond to mixtures with flagellated cells of *Phaeocystis globosa*, and B and E to mixtures with its colonial cells. *Phaeocystis globosa* is in black, *Asterionellopsis glacialis* is in grey and *Cryptomonas maculata* is in white. The bottom x axis corresponds to the different mixture numbers. The top x numbers in C and F correspond to the proportions used to make the mixtures. The measured proportions were obtained using the FluoroProbe whereas the expected proportions were calculated from the chlorophyll *a* concentrations

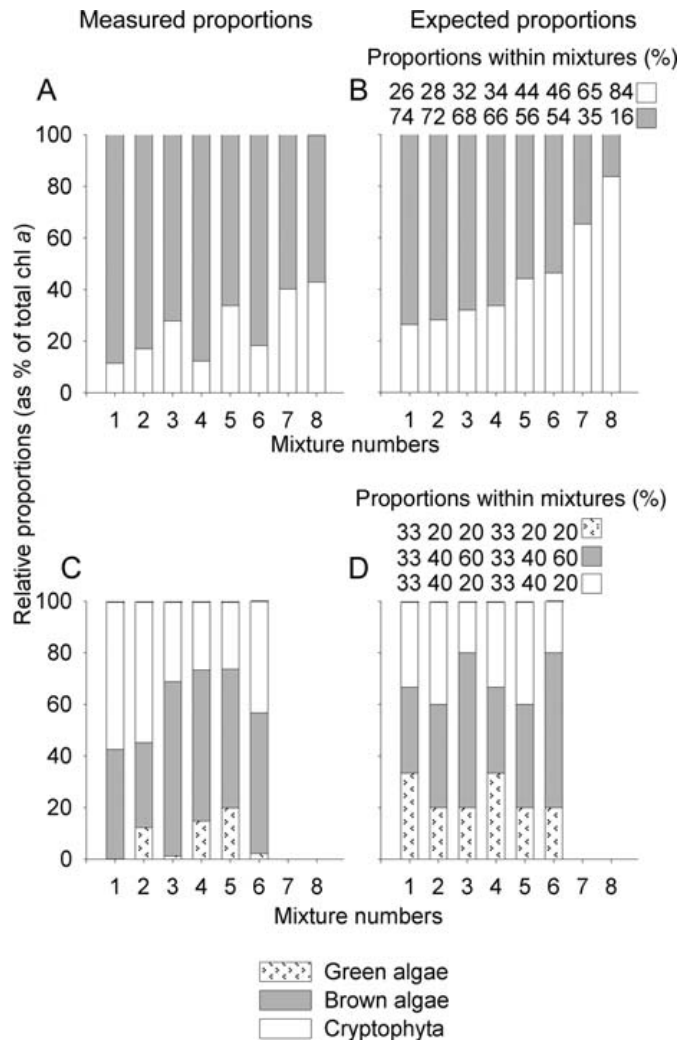

Fig. 1.4. Results of the FluoroProbe detection of *Asterionellopsis glacialis* (brown algae), *Cryptomonas maculata* (Cryptophyta) and *Chlamydomonas reinhardtii* (green algae) in different mixtures with different proportions. The relative proportions measured with the FluoroProbe are represented in the left side panel (A and C) and the expected relative proportions calculated from the chlorophyll *a* concentrations are in the right side panel (B and D). Each line corresponds to different mixtures of cultures combined in different proportions: *Asterionellopsis glacialis* + *Cryptomonas maculata* (A and B) and *Cryptomonas maculata* + *Asterionellopsis glacialis* + *Chlamydomonas reinhardtii* (C and D). The bottom x axis corresponds to the different mixture numbers. The top x numbers in B and D correspond to proportions used to make mixtures

To determine if these results were specific to the use of the *P. globosa* fingerprint, mixtures were made with algal groups for which the FluoroProbe was initially developed, i.e. a Bacillariophyte: *A. glacialis*, a Cryptophyte: *C. maculata* and a Chlorophyte: *C. reginae* (Fig. 1.4). The same trends as with the fingerprint of *P. globosa* were observed: with mixtures of two algal groups, the results were actually in accordance with the expected relative proportions and no significant difference was found between the observed and expected proportions ($P > 0.05$, Fisher's exact test; Fig. 1.4 A and B). With mixtures of three algal groups significant differences were found between the observed and the expected relative proportions ($P < 0.001$, Fisher's exact test). Cryptophyta were overestimated (by 1.7-2.6 times) and green algae were underestimated (by 1.6-16.1 times) whereas brown algae were not significantly different ($P > 0.05$, Fisher's exact test) (Fig. 1.4 C and D). In certain mixtures green algae were not detected (Fig. 1.4 C, mixtures 1, 3 and 6).

3.2.2 Absolute concentrations

Absolute concentrations of brown algae and Cryptophyta within mixtures were significantly different between the FluoroProbe assessments and the expected chl *a* concentrations whereas no significant difference was found for *P. globosa* (Table 1.II). Similarly to the relative proportions, no significant difference between the absolute concentrations of the two life cycle stages of *P. globosa* was found. The FluoroProbe-derived chl *a* concentrations relative to the expected concentrations of each algal group in mixtures are shown in Fig. 1.5. The disagreement between the expected and the measured chl *a* concentrations was not greater for *P. globosa* (using the new fingerprint) than for the algal groups for which the FluoroProbe was initially developed. Indeed, the coefficient of

Table 1.II. Student's test comparing of absolute chlorophyll *a* concentrations of green algae, brown algae, Cryptophyta, flagellated cells and colonial cells of *P. globosa* in different mixtures

Mixtures	Type of comparison	Group	P-value
Flagellated cells of <i>P. globosa</i> + <i>A. glacialis</i>	Observed versus Expected	Brown algae	0.013
		<i>P. globosa</i>	0.342
Colonial cells of <i>P. globosa</i> + <i>A. glacialis</i>	Observed versus Expected	Brown algae	0.006
		<i>P. globosa</i>	0.387
<i>C. maculata</i> + <i>A. glacialis</i>	Observed versus Expected	Cryptophyta	< 0.001
		Brown algae	0.186
Flagellated cells of <i>P. globosa</i> + <i>A. glacialis</i> + <i>C. maculata</i>	Observed versus Expected	<i>P. globosa</i>	0.185
		Cryptophyta	0.442
		Brown algae	0.003
Colonial cells of <i>P. globosa</i> + <i>A. glacialis</i> + <i>C. maculata</i>	Observed versus Expected	<i>P. globosa</i>	0.361
		Cryptophyta	0.001
		Brown algae	0.007
<i>P. globosa</i> + <i>A. glacialis</i>	Flagellated cells versus Colonial cells	<i>P. globosa</i>	0.187
		Brown algae	0.945
<i>P. globosa</i> + <i>A. glacialis</i> + <i>C. maculata</i>	Flagellated cells versus Colonial cells	<i>P. globosa</i>	0.143
		Brown algae	0.574
		Cryptophyta	0.485

Significant P-values are indicated in bold.

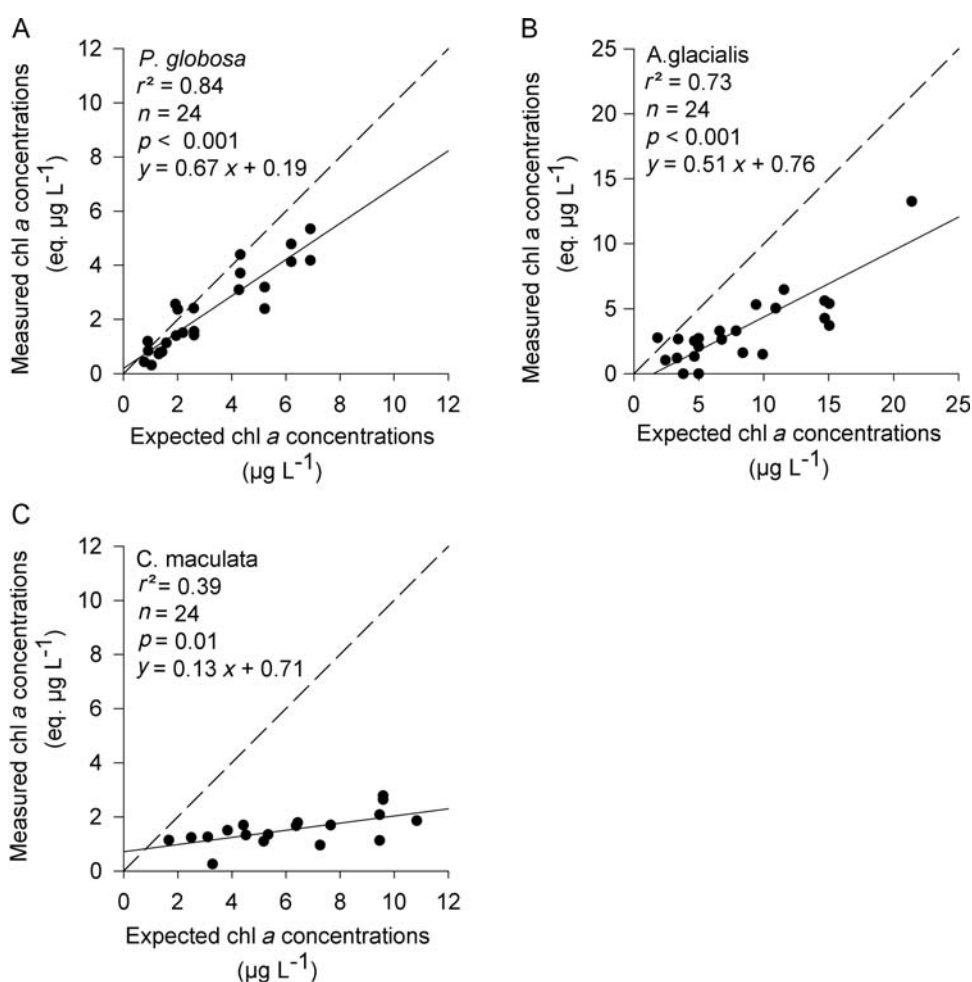

Fig. 1.5. Relationships between the measured and the expected chlorophyll *a* concentrations for *Phaeocystis globosa* (A), *Asterionellopsis glacialis* (brown algae) (B) and *Cryptomonas maculata* (Cryptophyta) (C). The measured proportions were obtained using the FluoroProbe, whereas the expected proportions were calculated from the chlorophyll *a* concentrations. Solid line is the regression line. Dotted line indicates the 1:1 ratio. Some points are superimposed

determination of the relationships between measured and expected concentrations for *P. globosa* was higher ($r^2 = 0.84$, $P < 0.001$) than the coefficient for other groups ($r^2 = 0.73$, $P < 0.001$ and $r^2 = 0.39$, $P = 0.01$ for *A. glacialis* and *C. maculata*, respectively), and the slope of the regression was closer to 1 for *P. globosa*. For each of these species, the slope of the regression was significantly different from 1 and indicated that the FluoroProbe underestimated chl *a* concentrations.

3.3 *In situ* use of the FluoroProbe to detect *P. globosa*

The fingerprint of *P. globosa* was field-tested using the FluoroProbe to monitor changes in phytoplankton community structure in the coastal waters of the eastern English Channel. The FluoroProbe's taxonomic classification using the original fingerprints or the fingerprint of *P. globosa* are shown in Fig. 1.6. With the original fingerprints, the classification was dominated by brown algae throughout the monitoring period with a minor contribution of Cryptophyta and cyanobacteria. The contribution of green algae was also low except during the spring bloom (from April to June) where their contribution was close to that of brown algae (Fig. 1.6 A). Using the fingerprint of *P. globosa*, the classification showed a clear succession of phytoplankton communities during the bloom period (from February to August). The *P. globosa* bloom occurred from mid-April to mid-May and disappeared at the end of spring. This bloom was followed by and preceded by two blooms of brown algae (first bloom from February to mid-April; second bloom from May to August). Cryptophyta and cyanobacteria showed the same trends than using the original fingerprints and their contributions stayed low (Fig. 1.6 B).

Biomass values for *P. globosa* expressed in eq. $\mu\text{g chl } a \text{ L}^{-1}$ were compared with cell counts from flow cytometry. The annual pattern of *P. globosa* variation was similar, as determined both from the FluoroProbe (Fig. 1.7 A) and from flow cytometry (Fig. 1.7 B). There was a strong linear relationship between the two methods ($y = 7.03 \times 10^{-4} x$, $r = 0.889$, $P < 0.001$, $n = 121$; Fig. 1.7 C).

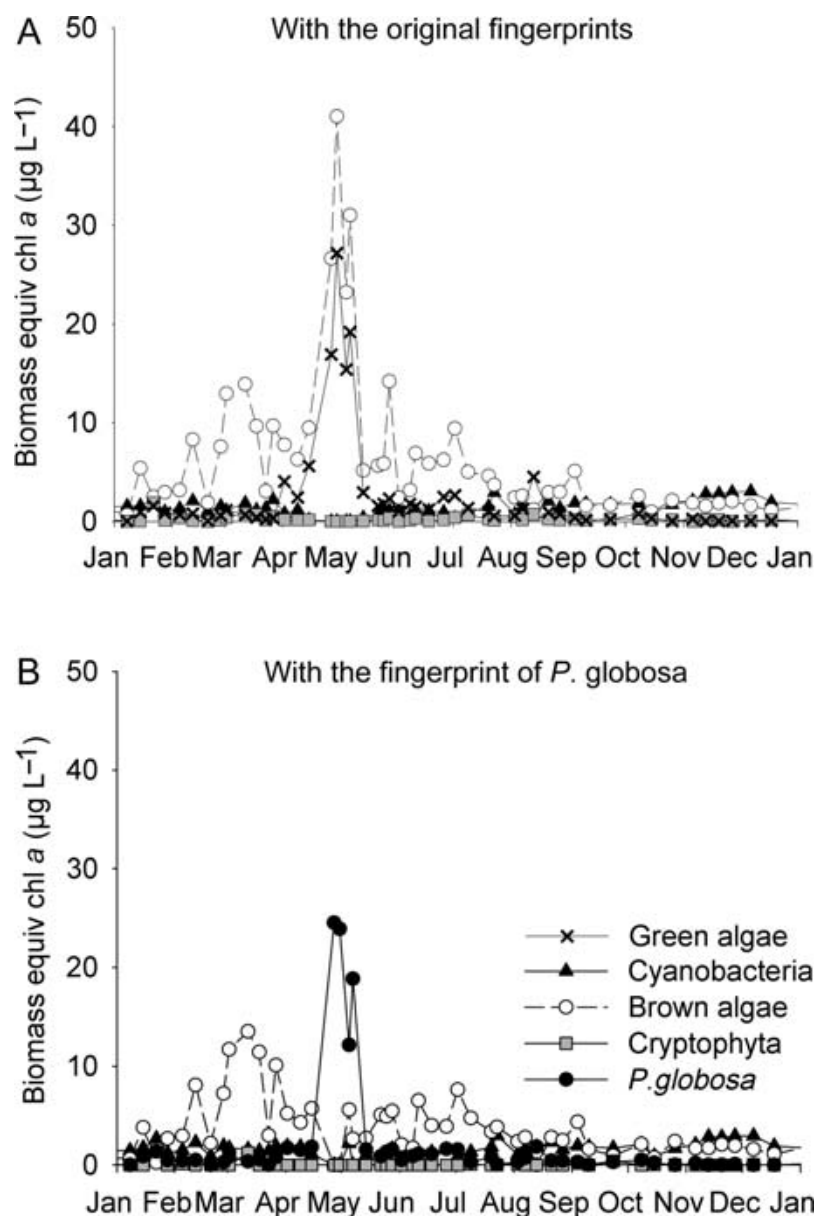

Fig. 1.6. Temporal variations in the biomass of four phytoplankton groups measured with the FluoroProbe at high tide in 2009. Results were obtained using either the four original fingerprints (cyanobacteria + green algae + brown algae + Cryptophyta) (A) or the fingerprints for cyanobacteria + brown algae + *Phaeocystis globosa* + Cryptophyta (B). The relative amount of each phytoplankton group is expressed in terms of the equivalent amount of chlorophyll *a* per litre (eq. $\mu\text{g.L}^{-1}$)

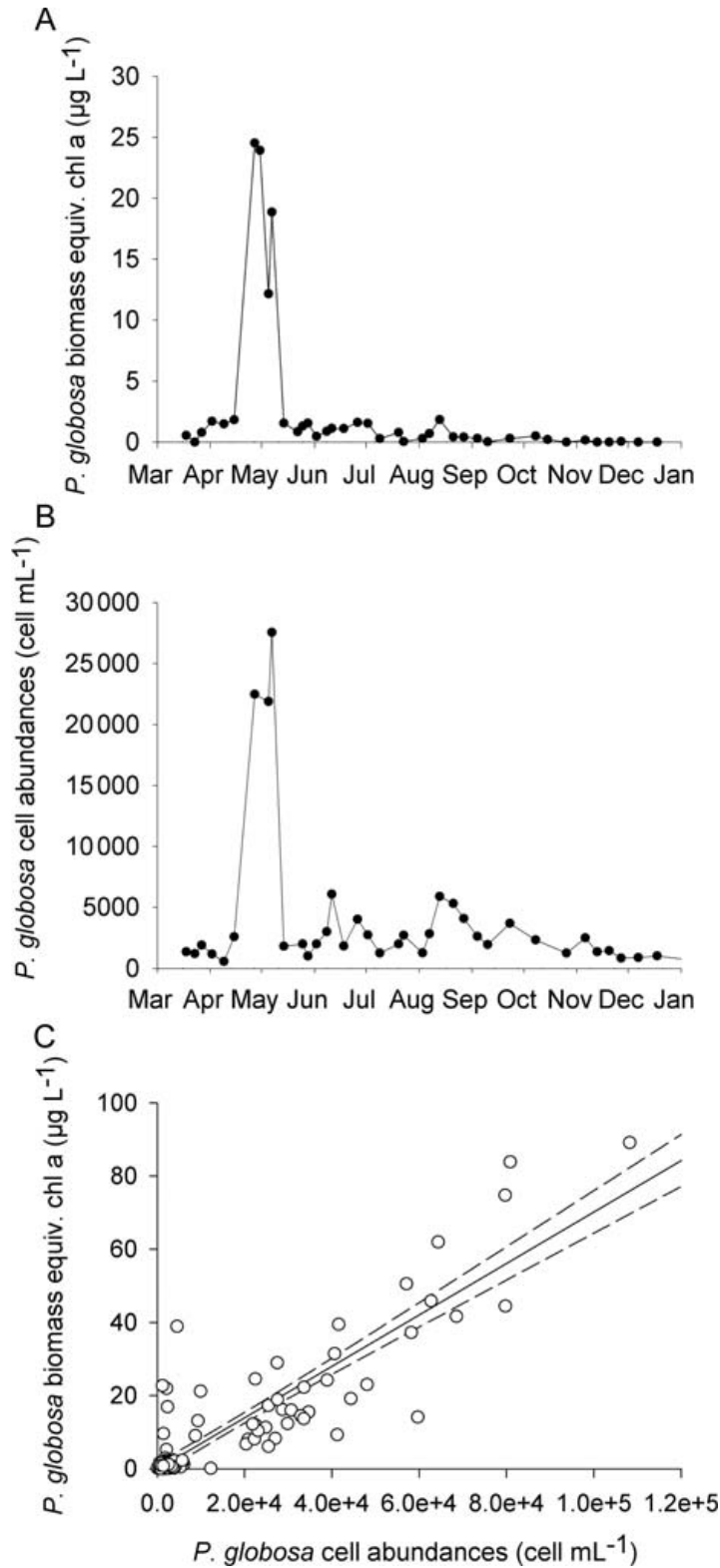

Fig. 1.7. Temporal dynamics of *Phaeocystis globosa* measured at high tide in 2009. Biomass of *Phaeocystis globosa* measured with the FluoroProbe in equivalent amount of chl *a* per liter (eq. $\mu\text{g L}^{-1}$) by the FluoroProbe (A). Cell abundances of *Phaeocystis globosa* (cell mL^{-1}) determined by flow cytometry (B). Relationship between the FluoroProbe results and cell abundances determined by flow cytometry ($y = 7.03 \times 10^{-4} x$, $r = 0.889$, $P < 0.001$, $n = 121$) (C). In (C), the solid line is the regression line and confidence intervals (95%) for the regression line are indicated by dashed curves. This relationship was obtained by pooling data from samples taken at high and low tide in 2009 and 2010

4 DISCUSSION

4.1 The necessity of using new fingerprints

Using the original fingerprints, *P. globosa* was classified by the FluoroProbe as a brown algae/green algae mixture. Indeed, the field test on the annual changes in phytoplankton community structure showed that using the original fingerprints, the classification was dominated by brown algae except during April-May where the contribution of green algae was close to brown algae. In contrast, cytometric analyses did not report the presence of green algae but the presence of the Haptophyte *P. globosa*.

Similar observations of mis-classification of Haptophytes were reported by MacIntyre *et al.* (2010), Richardson *et al.* (2010) and See *et al.* (2005) who compared predictions of algal group composition by the FluoroProbe or the AOA to those derived from taxonomic classifications using CHEMTAX (Mackey *et al.* 1996) based on high-performance liquid chromatography (HPLC) pigment concentrations. Working in the Gulf of Mexico, MacIntyre *et al.* (2010) and See *et al.* (2005) obtained similar results: the fluorescence-based classification showed a dominance of green algae (> 60%) with a minor contribution of brown algae, while the pigment-based classification showed a dominance of diatoms and dinoflagellates and detected the presence of 19'-hexanoyloxyfucoxanthin: a characteristic pigment of Haptophytes (Jeffrey *et al.* 1997). In these studies, the apparent dominance of green algae may therefore be due in part to the presence of Haptophytes especially since culture experiments, conducted by Richardson *et al.* (2010) and See *et al.* (2005) showed, respectively, the mis-classification of *Isochrysis galbana* and *Emiliana huxleyi*. *I. galbana* was classified as a mixture of brown algae ($60 \pm 1.7\%$) and green algae ($40 \pm 2\%$) and *E. huxleyi* was classified as 75% of green algae and 25% of brown algae.

These authors concluded that the reasons underlying the mis-classification of Haptophytes are unclear and proposed two hypotheses. The first is that a single group of brown algae (generally diatoms) is used as a calibration species' for fingerprints, whereas in natural samples, brown algae could be really a combination of diatoms, dinoflagellates and Haptophytes so that variations in the shape of the calibration versus non-calibration species spectral signatures result in mis-identifications. The second is that there are pigment similarities between green algae and Haptophytes. Although they failed to identify a unique reason for this mis-classification, their observations suggest that it is most likely related to the shape of the fingerprint of Haptophytes.

The record of a new fingerprint for the Haptophyte *P. globosa* allowed us to observe that the shape of this fingerprint differs effectively from the fingerprint of brown algae (Fig. 1.1). The goal of our study was not to identify the reasons why the shape of the *P. globosa* fingerprint is different from other brown algae but to study the possibility of using these differences as an advantage for discriminating this species from other phytoplankton groups. Our results demonstrated that it is possible to use this new fingerprint to monitor the dynamics of *P. globosa* without a major effect on the identification of other phytoplankton groups.

4.2 Efficiency of the *P. globosa* fingerprint in laboratory experiments

Laboratory experiments showed relatively good agreement between the observed and the expected relative proportions of *P. globosa* in different mixtures and the use of the *P. globosa* fingerprint did not strongly affect the classification of other groups because the same results were obtained using either the original fingerprints or the *P. globosa* fingerprint. Only

the discrimination of green algae and brown algae species could be affected by the use of the *P. globosa* fingerprint.

The major interference was observed between the fingerprints of green algae and *P. globosa* so that it is not possible to use these two fingerprints at the same time. The reasons underlying this interference are not clear but could be related to the shape of the *P. globosa* fingerprint that shows a certain similarity with that of green algae. This group is rarely encountered in ecosystems where *P. globosa* is present. The fingerprint of *P. globosa* can therefore be used to replace the fingerprint of this group.

The detection of brown algae is affected when *P. globosa* represents > 55% of the total biomass. In this case, the FluoroProbe is unable to detect their presence and the whole signal is classified as *P. globosa*. In the field, a similar situation of strong dominance by *P. globosa* can be observed during the spring blooms; however, during these periods diatom biomass is always low when *P. globosa* represents > 55% of the total biomass and these periods are short. For example, during the years 2007, 2008 and 2009, these periods represented a mean duration of ± 1 month with a mean diatom biomass of $122 \pm 78 \mu\text{C L}^{-1}$ whereas the mean *P. globosa* biomass was $377 \pm 251 \mu\text{C L}^{-1}$ (Grattepanche et al. 2011).

The tests with the two life cycle stages of *P. globosa* (flagellated and colonial cells) did not show any significant difference between the discrimination of these two life cycle stages in different assemblages. Consequently, the FluoroProbe can be used to detect the flagellated cells as well as the colonial cells of *P. globosa*. Although the FluoroProbe is not able to differentiate these two life cycles, it has at least the advantage of not underestimating the part played by the flagellated cells in the dynamics of *P. globosa* in comparison with traditional methods of cell counts with a microscope. Moreover, this probe is very easy to use. It can rapidly generate data on the spatio-temporal dynamics of phytoplankton groups and does not require any particular specialized training from the user.

4.3 Efficiency of the *P. globosa* fingerprint in an *in situ* study

The *in situ* use of the *P. globosa* fingerprint to monitor the changes in phytoplankton community structure - in the coastal waters of the eastern English Channel - showed a clear succession of phytoplankton blooms during the spring with the *P. globosa* bloom that occurred in April-May and preceded and followed two blooms of brown algae. The annual dynamics of *P. globosa* determined by the FluoroProbe and from flow cytometry were similar and a strong relationship was found between the values of *P. globosa* expressed in equiv. $\mu\text{g chl } a \text{ L}^{-1}$ and cell abundances from flow cytometry. These observations are very consistent with the spring phytoplankton successions reported by Grattepanche *et al.* (2011) during the same year (2009) next to our study site and are in agreement with the previously reported phytoplankton successions during the spring blooms in the eastern English Channel (Breton *et al.* 2000, Seuront *et al.* 2006) and the North Sea (Gieskes & Kraay 1975, Cadée & Hegeman 1986, Rousseau *et al.* 2000, Rousseau *et al.* 2002, Tungaraza *et al.* 2003, Stelfox-Widdicombe *et al.* 2004, Muylaert *et al.* 2006). Although the use of the *P. globosa* fingerprint can lead to an underestimation of diatoms during the spring *P. globosa* bloom, when this species represents > 55% of the total biomass (cf. laboratory experiments), the estimations of brown algae are much closer to the previously reported phytoplankton successions (Breton *et al.* 2000, Seuront *et al.* 2006) and to the microscopic observations of Grattepanche *et al.* (2011) using this fingerprint than using the original fingerprints.

4.4 Absolute chl *a* concentrations and potential limits of the method

Errors in absolute concentration assessments could be for various reasons. The FluoroProbe underestimations of chl *a* concentrations, observed in our study, were probably caused by the fact that the FluoroProbe is calibrated according to HPLC analysis, whereas expected chl *a* concentrations were evaluated by fluorometry. It is known that HPLC usually provides lower chl *a* concentrations than spectrophotometric or fluorometric methods. This is due to allomers and other chlorophyll derivatives that are detected as chl *a* in spectrophotometric and fluorometric methods, while they are separated chromatographically by HPLC (Meyns et al. 1994, Jeffrey et al. 1997). Our results agree with results of Gregor *et al.* (2005) and Gregor and Marsalek (2004) that reported the FluoroProbe underestimations of chl *a* concentrations in comparison with a spectrophotometric method. The calibration is probably not the unique error factor in absolute concentration determination. Variations in the ratio of fluorescence to chl *a* (F^{chl}) were probably also involved.

According to MacIntyre *et al.* (2010 and references therein), F^{chl} varies between species, with light exposure, nutrient availability and cell size. The classification algorithm used by the FluoroProbe for assessing chl *a* concentration does not integrate these variations and uses an invariant F^{chl} for each algal group. Consequently, natural variations in F^{chl} result in mis-classifications by the FluoroProbe. Moreover, the FluoroProbe has an open measuring chamber; it is, therefore, susceptible to additional variation in F^{chl} due to bright actinic light when it is used *in situ*. To limit this, it is advised to always use the FluoroProbe equipped with its black plastic case or to use the Flow-Through unit (bbe Moldaenke, Kiel, Germany).

To summarize, although the FluoroProbe did a relatively good job at monitoring the dynamics of *P. globosa*, as it is the case with all spectral fluorometers, determination of absolute contributions of phytoplankton groups can be subject to some bias (MacIntyre et al. 2010). These biases are not related to the use of the *P. globosa* fingerprint but are related to the spectral fluorescence technique and the capacities of the FluoroProbe *per se*. Until a new classification algorithm integrating F^{chl} variations is proposed, it is recommended to complement measurements conducted with the FluoroProbe with less frequent discrete sample collections for microscopic or flow cytometric analyses. However, even if the FluoroProbe does not completely replace the traditional methods of cell counts, it has the advantage of considerably reducing the number of samples to analyse by using these methods. The FluoroProbe remains a very good tool for monitoring the *P. globosa* dynamics because it is able to detect the flagellated cells as well as the colonial cells of *P. globosa*, but also because, its high frequency measurements will never be equalled by the more accurate but more expensive and laborious traditional cell counts methods.

If we have to answer to the question “Which is the more appropriate method for monitoring *P. globosa* dynamics?” we shall answer that this depends on the kind of information required. The FluoroProbe is an excellent tool for projects requiring both a low-cost analysis and an easy to use method for obtaining real-time information at high spatio-temporal resolution about *P. globosa* dynamics (without differentiation between flagellated and colonial cells of *P. globosa*) together with the knowledge of the relative contribution of the major phytoplankton groups. For those looking for information about *P. globosa* dynamics at high resolution with a precise knowledge of absolute contributions of the major phytoplankton groups, the FluoroProbe coupled with less frequent sample collections for cell counting is a good combination. In such a situation, the interest of the FluoroProbe is that it provides higher spatio-temporal resolution and reduces the number of samples for cell

counting. Such a combination reduces the time and cost of sample analysis in comparison with a monitoring program that would be carried out (as far as possible) at the same resolution but that would be only based on cell counting methods (flow cytometry or microscopic observations). Finally, if the objectives are to obtain precise counts of colonial and flagellated cells of *P. globosa* with detailed information about the species composition of the phytoplankton community, the traditional microscopy coupled with an enumeration of flagellated cells of *P. globosa* by flow cytometry or electron microscopy is probably the only solution. However, in this case, standard routine measurements with high spatio-temporal resolution are very likely excluded mainly because of the costs and time needed to carry out such analyses.

5 CONCLUSIONS

Overall results of this study enable us to envisage the use of the FluoroProbe for long-term monitoring of the population dynamics of *P. globosa* with a higher temporal resolution than classical cell count methods. Indeed, good agreement was found between the FluoroProbe's results and cell counts by flow cytometry. The advantages of the FluoroProbe are its acquisition frequency (2 s) that permits a large amount of data to be obtained in very short time and the fact that all measurements are performed on-line without any delay between the measurement and the obtaining of final results. This offers the possibility of collecting information on the dynamics of *P. globosa* at rates comparable with physico-chemical data that may improve our knowledge on the environmental factors controlling these blooms and may open new research tracks. Finally, the improvement of the detection of *Isochrysis sp.* using the *P. globosa* fingerprint suggests that the FluoroProbe may be used to

monitor the dynamics of other Haptophytes in other ecosystems by calibrating the device with species representative of the region of interest. It is nevertheless, important to bear in mind that when using the FluoroProbe, the monitoring of Haptophytes at the species level is only possible in areas where a single Haptophyte species is encountered. In areas where several species are simultaneously present, the FluoroProbe will be unable to distinguish them and, in this case, it can be used for monitoring the dynamics of the combined Haptophyte group.

ACKNOWLEDGEMENTS

The authors are grateful to Elsa Breton for providing cultures and her advice on culture maintenance and to Mélodie Penel and Jessica Chicheportiche for chlorophyll *a* analyses. They thank Yvan Lagadeuc and Stéphane Fraisse for *Microcystis aeruginosa* and *Scenedesmus sp.* cultures. Sébastien Lefebvre and Tammi L. Richardson are acknowledged for their critical reading and constructive comments on a previous draft of the manuscript. Finally, we thank the associate editor and two anonymous reviewers for their remarks.

FUNDING

This study forms part of the PhD thesis of E. Houliez. This work was financially supported by a grant from the French “Ministère de l’Enseignement Supérieur et de la Recherche” and the DYMAPHY INTERREG IVA “2 Mers Seas Zeeën” project co-funded by the European Union (ERDF funds).

Chapitre II

Utilisation du Phyto-PAM pour estimer l'activité photosynthétique du phytoplancton par groupes d'algues: performances et limites

*Use of the Phyto-PAM to estimate phytoplankton photosynthetic activity by
algal groups: performances and limits*

Résumé

Les performances du Phyto-PAM pour estimer l'activité photosynthétique différenciée en groupes ont été évaluées à travers une série d'expériences de laboratoire sur des cultures d'algues. Une attention particulière a été donnée à la discrimination des espèces phytoplanctoniques communément rencontrées en Manche orientale. La possibilité de distinguer les performances photosynthétiques des Diatomées de celles de *Phaeocystis globosa* aux seins d'assemblages plurispécifiques a été évaluée. Des spectres de références ont été mesurés sur cultures d'algues appartenant à différents groupes phytoplanctoniques cultivées sous différentes conditions et sur des échantillons naturels dominés par des Diatomées ou *P. globosa*. La capacité du Phyto-PAM à différencier l'activité photosynthétique de différentes algues au sein de mélanges composés de deux espèces a ensuite été évaluée en utilisant différents jeux de spectres de références. La fiabilité des estimations des paramètres photosynthétiques différenciés en groupes dépend fortement de l'adéquation des spectres de référence. La forme des spectres de référence varie entre les différentes espèces d'un même groupe mais également pour une espèce donnée en réponse à différentes conditions environnementales. L'utilisation de spectres de référence qui ne correspondent pas à la composition taxonomique et à l'état physiologique des groupes d'algues au sein des assemblages à analyser conduit à de conséquentes erreurs d'estimation des paramètres photosynthétiques. La capacité du Phyto-PAM à différencier les performances photosynthétiques de *P. globosa* de celles des Diatomées au sein d'assemblages dépend non seulement des spectres de références utilisés mais également de la concentration des espèces au sein des assemblages. Ceci invalide clairement la possibilité d'utiliser le Phyto-PAM dans ce but.

Mots clés : paramètres photosynthétiques, fluorescence de la chlorophylle *a*, Phyto-PAM, phytoplancton

Abstract

The performances of the Phyto-PAM to estimate photosynthetic activity differentiated into groups were investigated through a series of experiments on laboratory grown algae cultures. A particular attention was given to the discrimination of phytoplankton species commonly found in the eastern English Channel. The possibility to distinguish the photosynthetic performances of Diatoms from those of *Phaeocystis globosa* in mixed assemblages was evaluated. Reference spectra were measured on algae cultures belonging to different algal groups grown under different conditions and on natural samples dominated by Diatoms or *P. globosa*. The ability of the Phyto-PAM to differentiate the photosynthetic activity of different algae in two species-mixed assemblages was then evaluated using different sets of reference spectra. The reliability of estimations of photosynthetic parameters differentiated into groups strongly depends on suitable reference spectra. The shape of reference spectra vary between different species belonging to the same algal group but also for a given species in response to different environmental conditions. The use of reference spectra that do not correspond to the taxonomic composition and physiological status of algal groups within mixed assemblages results in significant errors in photosynthetic parameters estimations. The ability of the Phyto-PAM to differentiate the photosynthetic parameters of *P. globosa* from those of Diatom in mixed assemblages is not only dependent on the reference spectra used but also on the species concentration within assemblages. This clearly invalidates the possibility to use the Phyto-PAM with this aim in view.

Keywords: photosynthetic parameters, chlorophyll *a* fluorescence, Phyto-PAM, phytoplankton

1 INTRODUCTION

Our understanding of phytoplankton role in aquatic ecosystems depends on our ability to accurately measure phytoplankton photosynthetic activity. In the field, phytoplankton photosynthetic activity is highly variable in space and time and results from complex interplays between physical, chemical and biological factors (Falkowski & Raven 2007).

Phytoplankton photosynthetic activity and photoacclimation status are characterised through the photosynthesis-light response (PE) curves which allow the determination of photosynthetic parameters (Henley 1993, MacIntyre & Kana 2002). Several measuring methods can be used to construct PE curves. The more traditional techniques are based either on the incorporation of carbon isotope tracers (Stemann Nielsen 1952, Hama et al. 1983) or oxygen evolution (Gaarder & Gran 1927, Montford 1969). These techniques are time-consuming and suffer from several restrictions like the so-called bottle effect, incubation duration and possible limited sensitivity (Gilbert et al. 2000, Beardall et al. 2009).

More recently, techniques based on *in vivo* chlorophyll *a* fluorescence were introduced and are now widely accepted in aquatic ecology (Suggett et al. 2010b). The most frequently used are the fast repetition rate fluorometry (FRR) (Kolber et al. 1998) and pulse amplitude modulated (PAM) fluorometry (Schreiber et al. 1986). Most of instruments based on these techniques employ a single waveband to excite fluorescence and a single waveband to detect it. Generally, fluorescence is excited using light-emitting diodes (LEDs) with a peak emission around 470 nm and is measured with a photomultiplier around 700 nm.

These techniques as well as carbon isotope tracers and oxygen methods allow the measurement of photosynthetic activity at community level. However, photosynthetic abilities vary among phytoplankton groups and among species from a same group (Juneau & Harrison

2005, Lavaud 2007, Dimier et al. 2009b). It was suggested that such differences can influence the competition among phytoplankton species, species successions and phytoplankton diversity (Meyer et al. 2000, Litchman & Klausmeier 2001). Consequently, the possibility to measure the photosynthetic activity at species or functional group level has the potential to greatly enhance our understanding of phytoplankton ecophysiology. It is for reaching these expectations that new fluorometers using the spectral fluorescence to differentiate several algal groups have been designed.

The spectral fluorescence is based on selective excitation of the differing antenna and accessory pigments between taxonomic groups of algae with sequential light excitations using several LEDs (for a review of this method see MacIntyre et al. 2010). This method was first designed for taxonomic discrimination of phytoplankton groups in mixed natural communities (Yentsch & Yentsch 1979, Yentsch & Phinney 1985) and was readjusted to be used on PAM fluorometers. The Phyto-PAM (Heinz Walz GmbH, Effeltrich, Germany) is one of these spectral PAM fluorometers (Kolbowski & Schreiber 1995). It employs 4 wavelengths to differentiate chlorophyll content and photosynthetic activity of three phytoplankton groups (brown algae, green algae and cyanobacteria) in mixed unknown communities.

Few authors have published data validating the use of the Phyto-PAM as a reliable approach to estimate chlorophyll content and photosynthetic activity both differentiated into the main algal groups. To our knowledge only Jakob et al. (2005) have tested the reliability of the Phyto-PAM. However, these authors have focused on its reliability to estimate chlorophyll content and have only tested its reliability to measure photosynthetic activity on natural community with > 96% diatom content. Therefore, in the study of Jakob et al. (2005), the Phyto-PAM has not been used to discriminate photosynthetic activity of the main algal groups mixed in different assemblages and its reliability to do such operation has not been fully tested. This is the topic of the present study.

In the current study, the performances of the Phyto-PAM to differentiate the photosynthetic activity of various algal groups in mixed assemblages of two species were investigated through a series of laboratory experiments. A particular attention was given to the discrimination of phytoplankton groups commonly found in the eastern English Channel and the possibility to distinguish the photosynthetic performances of Diatoms from those of *P. globosa* in mixed assemblages was evaluated. The distinction between the chlorophyll content of Diatoms and that of *P. globosa* was found to be possible with an other spectral fluorometer, the FluoroProbe (bbe-Moldaenke, Kiel, Germany) (Houliez et al. 2012). Because the distinction of phytoplankton groups functions on the same principle for both spectral fluorometers, we hypothesized that the Phyto-PAM is also able to distinguish *P. globosa* from Diatoms in mixed assemblages. We tried to answer the following questions:

- (1) What are the effects of different light acclimation states (and their physiological consequences) on the measurement of photosynthetic activity differentiated into groups?
- (2) How does the use of different calibration sets for the assessment of photosynthetic activity affect the estimations of photosynthetic parameters differentiated into groups?
- (3) Is it possible to make the distinction between the photosynthetic performances of Diatoms and those of *P. globosa* using the Phyto-PAM?
- (4) Does the concentration of each algal group within the unknown phytoplankton assemblage affect the estimations of photosynthetic parameters differentiated into groups?

2 MATERIALS AND METHODS

2.1 The Phyto-PAM

The experiments were carried out with the Phyto-PAM (Heinz Walz GmbH, Effeltrich, Germany) equipped with the Optical Unit ED101-US. A detailed description of this device can be found in Schreiber (1998) and Jakob et al. (2005). Briefly, the Phyto-PAM allows the discrimination of chlorophyll (chl) content and photosynthetic activity of three algal groups (brown algae, green algae and cyanobacteria) in mixed unknown assemblages. The probe measures fluorescence emitted by the chlorophyll *a* of photosystems II (PSII) following excitation of photosynthetic accessory pigments specific to each algal group. It uses four LEDs emitting at different wavelengths (470, 520, 645 and 665 nm) for sequential light excitation of accessory pigments and measures fluorescence intensity at wavelengths above 710 nm. The primary data obtained are four independent fluorescence signals (one by wavelength) which are further processed by the PhytoWin-software to obtain a fluorescence signal by phytoplankton groups. The fluorescence signal by phytoplankton groups is calculated from the original 4-wavelengths fluorescence signals by an on-line deconvolution routine based on previously stored reference spectra (1 reference spectra by algal group). The exact functioning of the Phyto-PAM deconvolution routine is kept secret by the manufacturer. However, its functioning is similar to the FluoroProbe deconvolution procedure because the linear unmixing method detailed in Beutler et al. (2002) is an extension of the approach of Kolbowski & Schreiber (1995). The reliability of the deconvolution procedure depends on the choice of reference spectra.

This procedure is based on three assumptions (Beutler et al. 2002):

- (1) the reference spectra of each algal group are linearly independent so that it is impossible to reproduce the signature of one taxon by the weighted sum of the others.
- (2) the shape of reference spectrum of an algal group is constant i.e. independent on the species composition, the physiological status of cells and the density of cells.
- (3) the difference between the environmental parameters holding during the determination of the reference spectra and those in the current measurement do not affect the reliability of the estimations of chlorophyll content and photosynthetic parameters both differentiated into groups.

2.2 Algal material and culture conditions

Nine species of marine microalgae (*Asterionellopsis glacialis*, *Coscinodiscus sp.*, *Phaeocystis globosa*, *Pseudonitzschia sp.*, *Rhizosolenia sp.*, *Rhodomonas marina*, *Schroederella sp.*, *Synechococcus sp.*, *Thalassiosira oceanica*) and two freshwater species (*Scenedesmus sp.* and *Microcystis aeruginosa*) (Table 2.I) were used in a series of laboratory experiments. The marine species were grown at 15°C in non axenic conditions at a light intensity of 170 $\mu\text{mol photons m}^{-2} \text{s}^{-1}$ under a 12h light-dark cycle. The culture medium was composed of sterile natural sea water enriched with F/2 medium supplements (500 mL flasks filled with 250 mL of medium) and was changed twice per week to maintain cultures in exponential growth (semi-continuous culture mode). The freshwater species were grown at 22°C in semi-continuous cultures, in BG 11 medium, at a light intensity of 5 $\mu\text{mol photons m}^{-2} \text{s}^{-1}$ under a 12h light-dark cycle.

To evaluate the effects of different growth conditions on the shape of reference spectra and the estimations of photosynthetic parameters, cultures of *P. globosa*, *Coscinodiscus sp.*, *T. oceanica* and *Synechococcus sp.* were acclimated during three weeks at 300 and 15 $\mu\text{mol photons m}^{-2} \text{s}^{-1}$ under a 12h light-dark cycle (conditions 1 and 2 respectively). The cultures acclimated under both conditions did not have the same initial concentration. Consequently, nutrient conditions were not identical when photosynthetic activity was measured. All cultures were illuminated with a white light Osram powerstart HQI-T 250W/D daylight and neutral LEE filters were used to obtain the investigated light levels.

Table 2.I. Division, species, strain code, origin and area collected of the 11 phytoplankton cultures examined

Division	Species	Strain code	Origin	Area collected
Haptophyta	<i>Phaeocystis globosa</i>		LOG Wimereux	English Channel
Cyanobacteria	<i>Microcystis aeruginosa</i>		Laboratory ECOBIO Rennes	
	<i>Synechococcus sp.</i>	PLY 712	Plymouth Laboratory	English Channel
Bacillariophyta	<i>Thalassiosira oceanica</i>		LOG Wimereux	English Channel
	<i>Pseudonitzschia sp.</i>		LOG Wimereux	English Channel
	<i>Coscinodiscus sp.</i>		LOG Wimereux	English Channel
	<i>Schroederella sp.</i>		LOG Wimereux	English Channel
	<i>Rhizosolenia sp.</i>		LOG Wimereux	English Channel
	<i>Asterionellopsis glacialis</i>	PLY 607	Plymouth Laboratory	English Channel
Chlorophyta	<i>Scenedesmus sp.</i>		Laboratory ECOBIO Rennes	
Cryptophyta	<i>Rhodomonas marina</i>		LOG Wimereux	English Channel

2.3 Measurements of reference spectra

As purchased, the Phyto-PAM was provided with reference spectra for brown algae, green algae and cyanobacteria (initial reference spectra). The reference spectrum of brown algae was measured on a culture of *Phaeodactylum tricornutum* grown in seawater at a light intensity of 100 $\mu\text{mol photons m}^{-2} \text{s}^{-1}$. A culture of *Chlorella vulgaris* grown at a light intensity of 100 $\mu\text{mol photons m}^{-2} \text{s}^{-1}$ was used to obtain the reference spectrum of green

algae. Finally, the reference spectra of cyanobacteria was measured on a culture of *Synechocystis sp.* (PCC 6803) grown at 30°C at a light intensity of 50 $\mu\text{mol photons m}^{-2} \text{ s}^{-1}$.

The Phyto-PAM determinations of taxonomic composition of unknown samples are based on three reference spectra. The reliability of measurements of chl content and photosynthetic parameters differentiated into groups strongly depends on the Phyto-PAM performances in correctly identify the taxonomic composition of assemblages which in turn depend on the choice of reference spectra. To evaluate the effects of different choices of reference spectra on the reliability of chl content and photosynthetic parameters measurements, new reference spectra were measured on each algal culture grown under the different conditions (see section 2.2) and stored within the software of the Phyto-PAM. For comparison, additional reference spectra were measured on natural samples (from the coastal waters of the eastern English Channel) dominated by Diatoms or *P. globosa*. Prior to measurements of reference spectra, microalgae were dark acclimated for 3 minutes. All reference spectra were measured with a measuring light frequency of 32 Hz (equivalent to 22 $\mu\text{mol photons m}^{-2} \text{ s}^{-1}$). These new reference spectra were compared with the initial reference spectra.

2.4 Photosynthetic activity

Photosynthetic activity was obtained by measuring rapid light curves (RLC). All measurements were done in duplicates. The fluorescence terminology used in the present study follows van Kooten and Snel (1990). Before the start of RLC, microalgae were dark-acclimated for 3 minutes and fluorescence levels F_0 and F_m were determined respectively before and after a saturating pulse (200 ms at around 4000 $\mu\text{mol photons m}^{-2} \text{ s}^{-1}$) to obtain the

maximum quantum yield ($F_v/F_m = (F_m - F_0)/F_m$). Samples were then exposed for 10 s to 20 increasing light levels (from 22 to 1384 $\mu\text{mol photons m}^{-2} \text{s}^{-1}$). Light levels (E) were measured using the Spherical Micro Quantum Sensor US-SQS (Heinz Walz GmbH, Effeltrich, Germany). At each light level, the effective quantum yield of photosystem II (Φ_{PSII} also noted $\Delta F/F_m'$) was measured by applying a saturating pulse and was calculated according to Genty et al. (1989) :

$$\Phi_{\text{PSII}} = \Delta F/F_m' = (F_m' - F)/F_m'$$

where F_m' is the maximum fluorescence emitted by the light-acclimated sample after a saturating pulse and F is the fluorescence level of the light-acclimated sample measured just prior to the saturating pulse.

Φ_{PSII} was then used to calculate the relative electron transport rate (rETR):

$$\text{rETR} = \Phi_{\text{PSII}} \times E$$

where E ($\mu\text{mol photons m}^{-2} \text{s}^{-1}$) is the actinic irradiance.

RLC were fitted using the model of Eilers and Peeters (1988) to estimate the maximal light utilization efficiency (α) which correspond to the initial slope of the curve, the maximum relative electron transport rate (rETR_m) which is the asymptote of the curve and the light saturation coefficient (E_k) calculated as rETR_m/α . Curve fitting was achieved using the downhill simplex method of the Nelder-Mead model, and standard deviation of parameters was estimated by an asymptotic method. All fittings were tested by analyses of variance ($P < 0.001$), residues being tested for normality and homogeneity of variance, and parameters significance by Student's t-test ($P < 0.05$). All the curve fitting processes and associated statistics were coded under MATLAB R2010b.

2.5 Laboratory experiments

The reliability of the Phyto-PAM to distinguish the photosynthetic parameters of different phytoplankton groups in the presence of other microalgae was evaluated using different 2-species mixtures. For each case studied, the photosynthetic parameters of the two algae were first measured separately on pure cultures. The two algae were then mixed and the photosynthetic parameters of algae within the mixture were measured. The deconvolution procedure is based on reference spectra. A maximum of three reference spectra can be used at the same time. Because the reliability of deconvolution procedure depends on the selection of reference spectra, the manufacturer advises to inactivate the reference spectra corresponding to an algal group if it is known that a sample does not contain a species belonging to this algal group. The photosynthetic parameters of pure cultures were thus measured activating only the reference spectrum corresponding to the culture. While with mixtures, the two reference spectra corresponding to the mixture composition were activated and the third reference spectrum was inactivated. To compare the Phyto-PAM performances in the recognition of algal groups in mixed assemblages, chl content measurements were made on each pure cultures and mixtures. The chl content was measured with a measuring light frequency of 32 Hz (equivalent to $22 \mu\text{mol photons m}^{-2} \text{s}^{-1}$) after a dark acclimation of 3 minutes before the start of RLC.

In a first experiment, the reliability of the Phyto-PAM to distinguish the photosynthetic parameters of *M. aeruginosa*, *Scenedesmus sp.*, *P. globosa*, *Synechococcus sp.*, *T. oceanica* and *A. glacialis* within different 2-species mixtures was evaluated using RLC. Six mixtures were considered: *M. aeruginosa* + *Scenedesmus sp.*, *P. globosa* + *Synechococcus sp.*, *A. glacialis* + *P. globosa.*, *P. globosa* + *T. oceanica* and *Synechococcus*

sp. + *T. oceanica* (two mixtures). The two mixtures *Synechococcus sp.* + *T. oceanica* were different in the concentration of species within mixture. The deconvolution procedure was based on the reference spectra corresponding to the cultures used to make the mixtures.

In a second experiment, the effects of the chl concentration on the distinction between the photosynthetic performances of *A. glacialis* and those of *P. globosa* were evaluated using RLC. *A. glacialis* and *P. globosa* were mixed under different proportions in seven mixtures: (1) 80% *P. globosa* + 20% *A. glacialis*, (2) 70% *P. globosa* + 30% *A. glacialis*, (3) 65% *P. globosa* + 35% *A. glacialis*, (4) 50% *P. globosa* + 50% *A. glacialis*, (5) 35% *P. globosa* + 65% *A. glacialis*, (6) 30% *P. globosa* + 70% *A. glacialis* and (7) 20% *P. globosa* + 80% *A. glacialis*. The subsamples of culture were diluted in ultra-filtered (0.2 μm) sea water to make the different mixtures. The deconvolution procedure was based on the reference spectra corresponding to the cultures used to make the mixtures. The chlorophyll *a* concentration of *A. glacialis* and *P. globosa* pure cultures and the total chlorophyll *a* concentration of mixtures were determined using the FluoroProbe with the 25 mL cuvette. This probe is considered as a reliable approach to estimate the total chl content of samples (Leboulanger et al. 2002, Gregor & Marsalek 2004, MacIntyre et al. 2010).

In a third experiment, the influence of different calibration sets on the photosynthetic parameters estimations was evaluated. As indicated in section 2.1., the primary data obtained using the Phyto-PAM are four independent fluorescence signals which are further processed by the PhytoWin-software to obtain a fluorescence signal by phytoplankton group. The software calculates the fluorescence signal by phytoplankton group from the original 4-wavelengths fluorescence data using an on-line deconvolution routine based on previously stored reference spectra in such a way that the reliability of deconvolution is dependent on the proper choice of reference spectra. Because the Phyto-PAM saves the original 4-wavelengths independent fluorescence signals in a file, it is possible to use the PhytoWin-software to *a*

posteriori recalculate the fluorescence signal differentiated into algal groups using different calibration sets of reference spectra. This method was used to process the 4-wavelengths independent fluorescence signals measured on the pure cultures and the different 2-species mixtures during RLC in the experiments 1 and 2. Only the cultures grown under condition 2 were selected. Different sets of reference spectra were alternately used on the same data sets. For *P. globosa* + *A. glacialis*, the tests were made on the mixture 65% *P. globosa* + 35% *A. glacialis*.

2.6 Statistics

The reference spectra were compared with multivariate analyses performed with PRIMER 6 (PRIMER-E Ltd., Plymouth, UK). A matrix of pair-wise Bray-Curtis similarity coefficient was constructed and then used to perform cluster and MDS (multidimensional scaling) analysis to evaluate the resemblances between reference spectra within and between algal groups. An analysis of similarities (one-way ANOSIM, Clarke & Warwick 1994) was used to test the significance of the differences in reference spectra. The similarity percentages routine (SIMPER) was used to identify the level of within algal group and between algal group similarities in reference spectra. Comparisons of RLC and photosynthetic parameters were performed using the method of Ratkowski (1983) for non-linear models.

3 RESULTS

3.1 Reference spectra

There were significant differences (ANOSIM, $R = 0.85$, $P < 0.001$) between the reference spectra of the three main algal groups (brown algae, green algae and cyanobacteria) with a dissimilarity ranging between 14 and 48%. However, there was also variability within the statistically different groups such that within-group similarity was less than 100% (Table 2.II). In other words, reference spectra within a group were not totally identical.

The highest within-group variability was observed between the cyanobacteria species: 48% of dissimilarity (SIMPER analysis) i.e. a dissimilarity higher than that between green algae and brown algae and of the same order of magnitude as that between green algae and cyanobacteria. Indeed, the shape of the reference spectra of *Synechococcus sp.* was sufficiently different from that of the other cyanobacterias to form a distinct group on the MDS plot (Fig. 1). The reference spectra of *Synechococcus sp.* presented a maximum of fluorescence at 520 nm, while the other cyanobacteria (*Synechocystis sp.* and *M. aeruginosa*) showed a high level of fluorescence at 645 nm. By contrast, there were no significant differences between the reference spectra of *M. aeruginosa* and those of *Synechocystis sp.* (ANOSIM, $P > 0.05$). The shape of the reference spectra of the different species belonging to the green algae group was not significantly different (ANOSIM, $P > 0.05$).

The reference spectra reflected statistically-significant differences between the different species of brown algae (ANOSIM, $R = 0.68$, $P = 0.001$) (Table 2.III). The highest dissimilarities were observed between the reference spectra of *P. globosa* and those of Diatoms species (between 5 and 11% of dissimilarity, SIMPER analysis; ANOSIM, $R = 1$, $P = 0.008$). The shape of the reference spectra of *P. globosa* was slightly different from Diatoms

Table 2.II. Within-group similarity and between-group dissimilarity of reference spectra. N refers to the number of taxa within the group, not to the number of samples analysed. Similarity is the within-group similarity defined by the SIMPER test. Dissimilarity is between-group dissimilarity (= 100%-Similarity). The significance of the between-group dissimilarity was tested by ANOSIM. The ANOSIM R statistics and P value are reported for each pair-wise comparison

Algal Groups	N	% Similarity	% Dissimilarity with Brown algae	% Dissimilarity with Green algae	% Dissimilarity with Cyanobacteria
Brown algae	8	93.78			
Green algae	2	94.52	13.58 R = 0.89; P = 0.001		
Cyanobacteria	3	52.00	43.95 R = 0.94; P = 0.001	47.73 R = 0.40; P = 0.008	

Table 2.III. Within-species similarity and between-species dissimilarity of reference spectra. N refers to the number of samples analysed. Similarity is the within-group similarity defined by the SIMPER test. Dissimilarity is between-species dissimilarity (= 100% -Similarity). The significance of the between-species dissimilarity was tested by ANOSIM. The ANOSIM R statistics and P value are reported for each pair-wise comparison. n.s. = not significant

Species	N	% Similarity	% Dissimilarity with <i>P. globosa</i>	% Dissimilarity with <i>T. oceanica</i>	% Dissimilarity with <i>Coscinodiscus sp.</i>	% Dissimilarity with <i>Pseudonitzschia sp.</i>	% Dissimilarity with <i>Rhizosolenia sp.</i>	% Dissimilarity with <i>Schroederella sp.</i>	% Dissimilarity with <i>P. tricornutum</i>
<i>P. globosa</i>	10	96.94							
<i>T. oceanica</i>	9	96.06	4.56 R = 0.27; P = 0.025						
<i>Coscinodiscus sp.</i>	9	98.71	11.5 R = 0.98; P = 0.002	9.22 R = 94; P = 0.002					
<i>Pseudonitzschia sp.</i>	3	98.82	5.75 R = 0.65; P = 0.015	4.9 n.s.	5.48 R = 1.00 ; P = 0.036				
<i>Rhizosolenia sp.</i>	3	99.90	7.51 R = 0.76; P = 0.015	5.79 n.s.	3.62 R = 1.00 ; P = 0.036	1.77 n.s.			
<i>Schroederella sp.</i>	3	99.90	11.22 R = 0.96; P = 0.015	9.19 R = 1.00; P = 0.036	1.13 n.s.	5.16 n.s.	3.29 n.s.		
<i>P. tricornutum</i>	3	99.90	6.52 R = 0.65; P = 0.015	5.18 n.s.	4.69 R = 1.00 ; P = 0.036	0.77 n.s.	1.11 n.s.	4.34 n.s.	
Natural diatoms	8	98.73	10.53 R = 0.98; P = 0.001	8.21 R = 0.88; P = 0.001	1.83 R = 0.29; P = 0.029	4.64 R = 1.00; P = 0.022	2.82 R = 0.93; P = 0.022	2.27 R = 0.57; P = 0.022	3.85 R = 1.00; P = 0.022

and differed in its relative magnitude at 520 nm. Within Diatoms, only the reference spectra of *Schroederella sp.*, *P. tricornutum*, *Rhizosolenia sp.* were not significantly different from each other and from the other Diatoms species. The reference spectra of the other Diatoms species differed in their relative magnitude at 470 and 645 nm but the shape of the reference spectra stayed relatively well conserved. The dissimilarity between Diatoms species was low and ranged between 1 and 9%. The reference spectra of diatoms and *P. globosa* measured on cultures were not significantly different from those measured on natural assemblages. The reference spectra of *R. marina* were grouped with brown algae and were positioned between brown algae and *Synechococcus sp.* on the MDS plot (Fig. 2.1).

For a given species, the modifications of the shape of reference spectra induced by different growth conditions could be of the same order of magnitude as inter-species differences within a single algal group (between 2 and 10% of dissimilarity). The highest dissimilarity was observed between the reference spectra measured on *Synechococcus sp.* that differed in their relative magnitude at 470 and 625 nm.

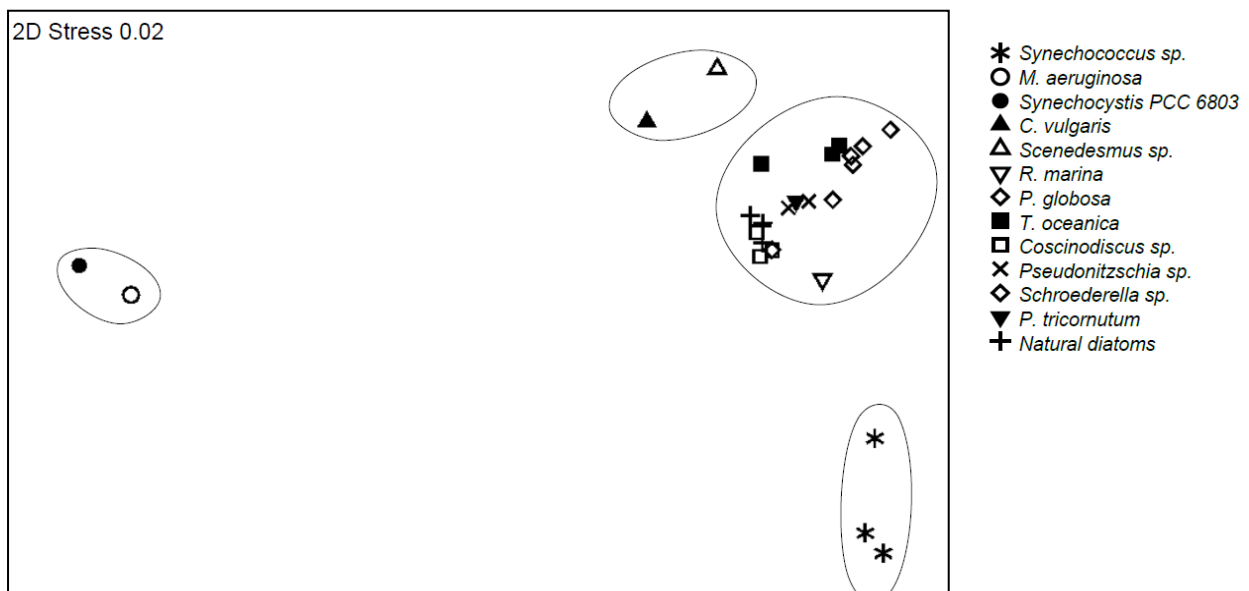

Fig. 2.1. Non-metric multidimensional scaling ordination (MDS) of the reference spectra. The distance between any pair of points is inversely proportional to their similarity. Contours are the groups derived from the cluster analysis (86% of similarity). The very low value of stress refers to the minor distortion imposed by reducing the multidimensional matrix to a 2-dimensional representation

3.2 Experiment 1: estimation of photosynthetic parameters differentiated into groups

In a first experiment, the reliability of the Phyto-PAM to distinguish the photosynthetic parameters of different phytoplankton groups, within different 2-species mixtures, was evaluated. The results depended on the taxonomic composition of mixtures (Fig. 2.2).

For the mixture *P. globosa* + *A. glacialis*, significant differences were found between the PE curves measured on pure cultures and those resulting from the deconvolution of the fluorescence signals measured on the mixture (Ratkowski test for non linear model, $P < 0.001$) (Fig. 2.2 F). For all other mixtures, the deconvolution procedure resulted in a PE curve not significantly different from that measured on pure culture for one of the two species while, for the other species, the PE curves were significantly different (Fig. 2.2 A-E).

The deconvolution of the mixtures *Scenedesmus sp.* + *M. aeruginosa* (Fig. 2.3 A), *Synechococcus sp.* + *T. oceanica* (mixture 1) (Fig. 2.3 B) and *P. globosa* + *Synechococcus sp.* (Fig. 2.3 D) resulted in an overestimation of $rETR_m$ and E_k of *M. aeruginosa*, *T. oceanica* and *P. globosa*. The photosynthetic activity of *T. oceanica* was not detected after the deconvolution of the fluorescence signal measured on the mixture *Synechococcus sp.* + *T. oceanica* (mixture 2) (Fig. 2.3 C). Finally, when *P. globosa* was mixed with diatoms (*A. glacialis* or *T. oceanica*), the deconvolution failed to discriminate the photosynthetic activity of *P. globosa* from that of diatoms (Fig. 2.3 E and F). In the first mixture (*P. globosa* + *T. oceanica*) (Fig. 2.3 E), the detection of the photosynthetic activity of *P. globosa* was correct but that of *T. oceanica* was completely false. In the second mixture (Fig. 2.3 F), the photosynthetic activity of *A. glacialis* was not detected.

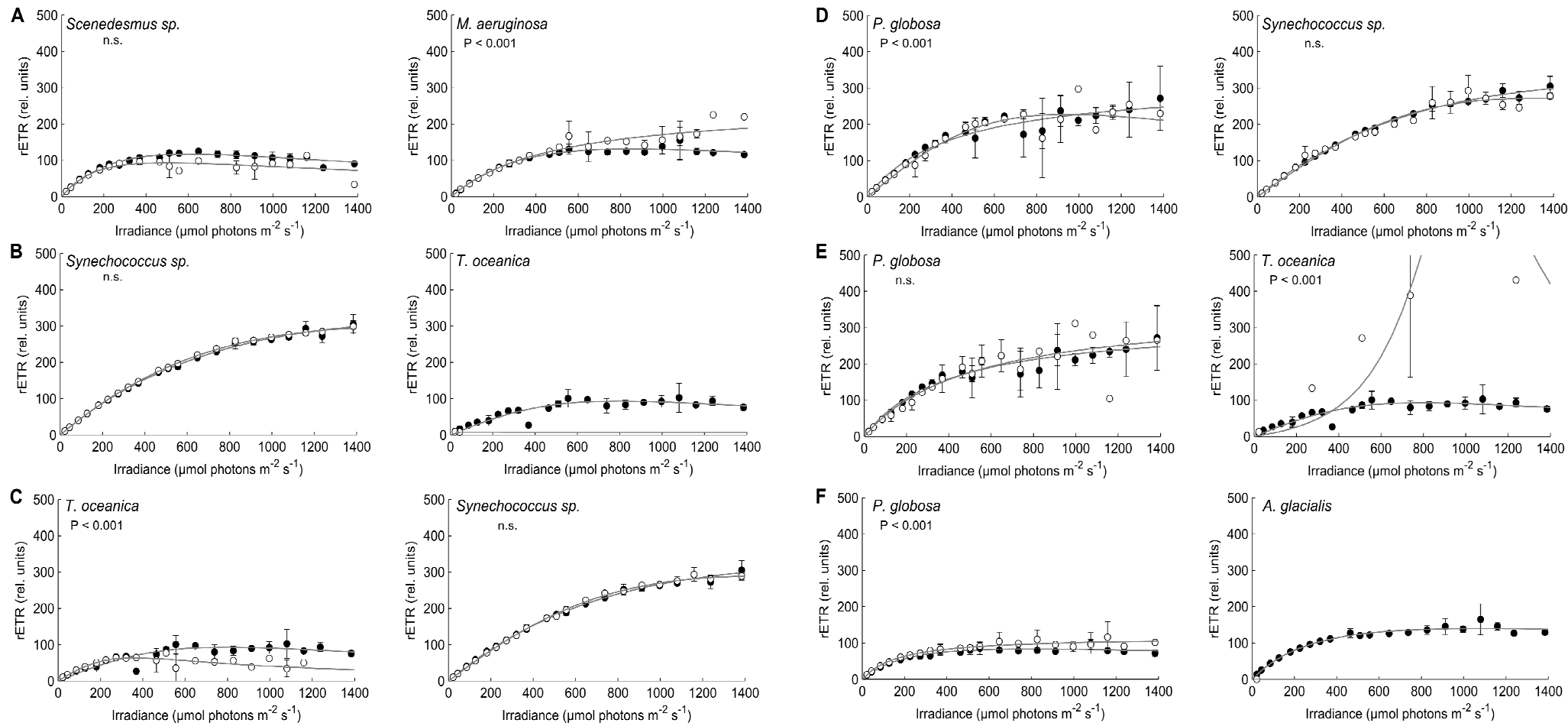

Fig. 2.2. Rapid light response curves (RLC) measured on different pure cultures (black circles) and obtained after the deconvolution of the fluorescence signals measured on 2-species mixtures (white circles). A) Mixture *Scenedesmus sp.* + *Microcystis aeruginosa*. B) Mixture *Synechococcus sp.* + *Thalassiosira oceanica* (mixture 1). C) Mixture *Synechococcus sp.* + *Thalassiosira oceanica* (mixture 2). D) Mixture *Phaeocystis globosa* + *Synechococcus sp.* E) Mixture *Phaeocystis globosa* + *Thalassiosira oceanica*. F) Mixture *Phaeocystis globosa* + *A. glacialis*. Values are mean \pm SD of two independent measurements. Significant differences between RLC measured on pure culture and those obtained after the deconvolution were determined using the method of Ratkowski (1983) for non linear models (P values are indicated, n.s. = not significant)

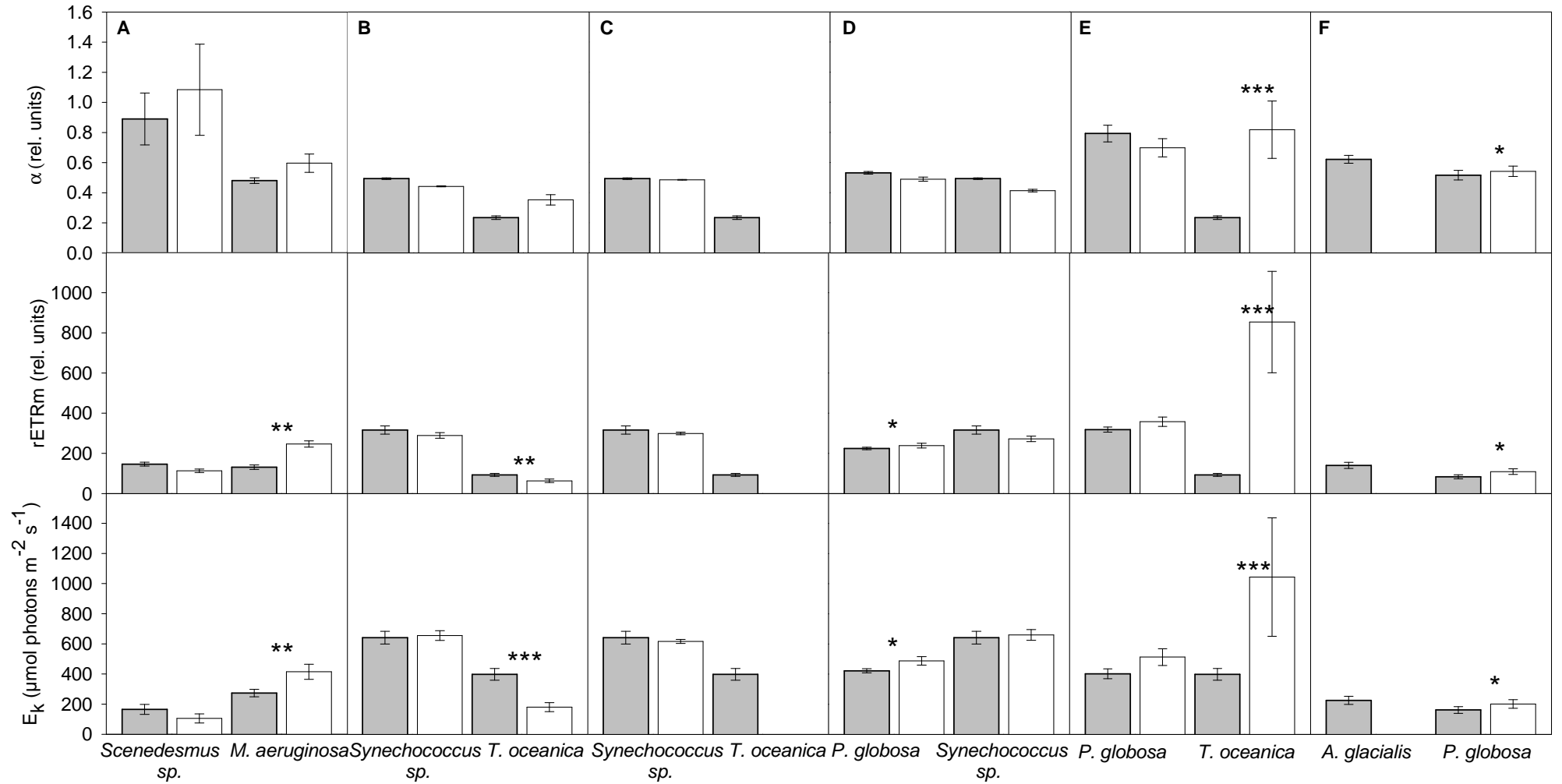

Fig. 2.3. Photosynthetic parameters extracted from RLC curves (Fig. 2.2). A) Mixture *Scenedesmus sp.* + *Microcystis aeruginosa*. B) Mixture *Synechococcus sp.* + *Thalassiosira oceanica* (mixture 1). C) Mixture *Synechococcus sp.* + *Thalassiosira oceanica* (mixture 2). D) Mixture *Phaeocystis globosa* + *Synechococcus sp.* E) Mixture *Phaeocystis globosa* + *Thalassiosira oceanica*. F) Mixture *Phaeocystis globosa* + *A. glacialis*. Values are mean \pm SD of two independent measurements. Significant differences between RLC were determined using the method of Ratkowski (1983) for non linear models (n.s. not significant, * $P \leq 0.05$, ** $P \leq 0.01$, *** $P \leq 0.001$). In grey, photosynthetic parameters measured on pure cultures. In white, photosynthetic parameters obtained after the deconvolution of the fluorescence signals measured on mixtures

In this experiment, the chlorophyll *a* concentration of each species within mixtures was not balanced and the worst results were obtained with the mixtures showing the highest differences of concentration between species: *Synechococcus sp.* + *T. oceanica* (mixture 2), *A. glacialis* + *P. globosa* and *P. globosa* + *T. oceanica*. Indeed, the concentration of *Synechococcus sp.* was 5 times higher ($54.32 \mu\text{g.L}^{-1}$) than that of *T. oceanica* ($10.65 \mu\text{g.L}^{-1}$) and the concentration of *P. globosa* was respectively 5 ($19.67 \mu\text{g.L}^{-1}$) and 23 times higher ($242.67 \mu\text{g.L}^{-1}$) than that of *A. glacialis* ($3.75 \mu\text{g.L}^{-1}$) and *T. oceanica* ($10.65 \mu\text{g.L}^{-1}$). In the mixture *Synechococcus sp.* + *T. oceanica* (mixture 1), the concentrations were almost identical: respectively $12.45 \mu\text{g.L}^{-1}$ and $10.65 \mu\text{g.L}^{-1}$.

Using the Phyto-PAM to estimate the chl content of species within the mixtures *Synechococcus sp.* + *T. oceanica* (mixture 2) and *P. globosa* + *A. glacialis*, the presence of *T. oceanica* and *A. glacialis* was respectively not detected (data not shown).

3.3 Experiment 2: effects of concentration on the distinction between the photosynthetic performances of Diatoms and those of *P. globosa*

Significant differences were found between the PE curves measured on pure cultures and those resulting from the deconvolution of the fluorescence signals measured on mixtures (Ratkowski test for non linear model, $P < 0.001$) (Fig. 2.4), with exception of *A. glacialis* in the mixture 80% *A. glacialis* + 20% *P. globosa* ($P = 0.056$) (Fig. 2.4 G). When a species dominated the mixture $> 80\%$, the deconvolution did not detect the chl content (not shown)

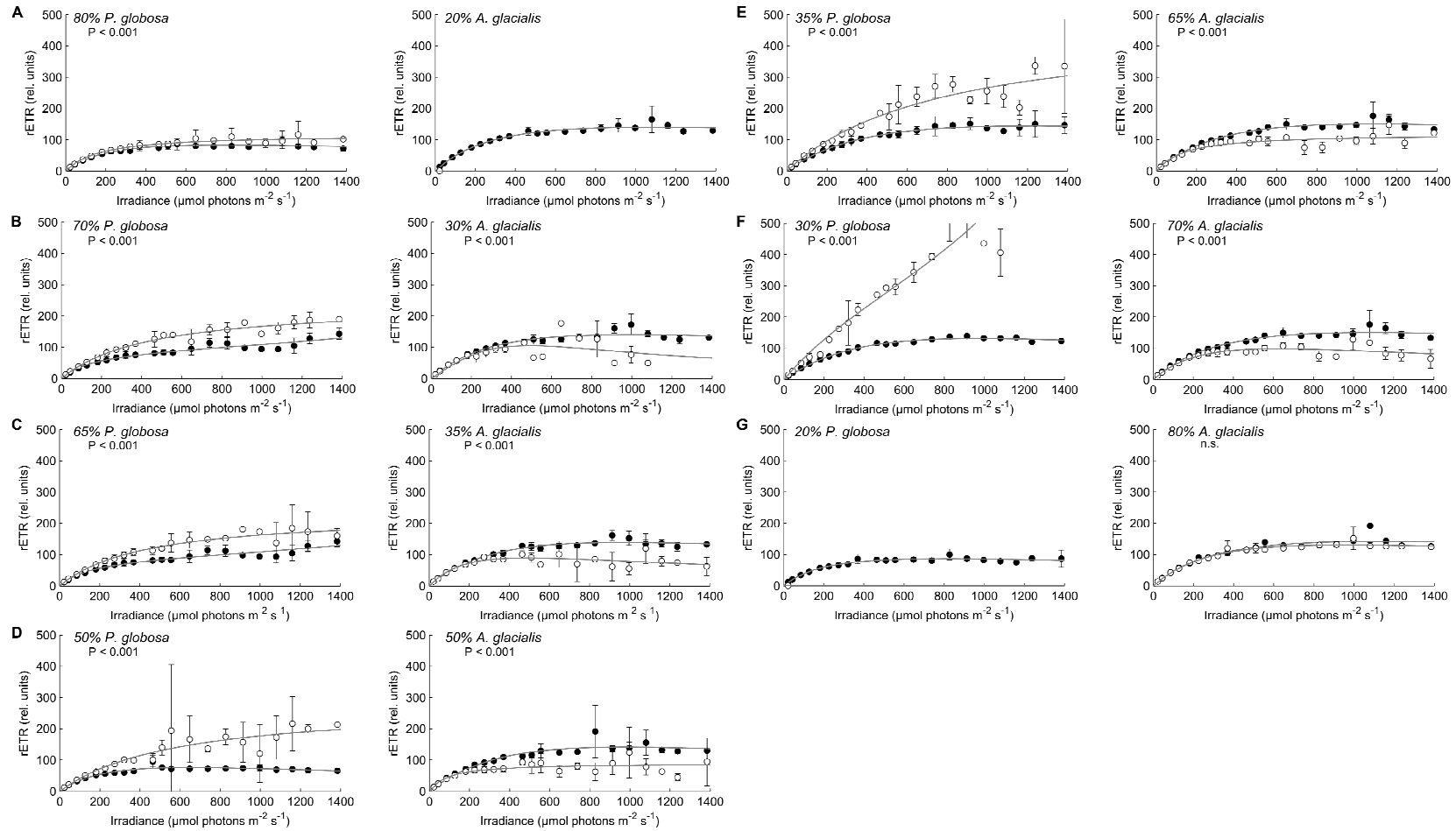

Fig. 2.4. Rapid light response curves (RLC) measured on the pure cultures of *Phaeocystis globosa* and *Asterionellopsis glacialis* (black circles) and obtained after the deconvolution of the fluorescence signals measured on mixtures (white circles). A) Mixture 80% *P. globosa* + 20% *A. glacialis*, B) Mixture 70% *P. globosa* + 30% *A. glacialis*, C) Mixture 65% *P. globosa* + 35% *A. glacialis*, D) Mixture 50% *P. globosa* + 50% *A. glacialis*, E) Mixture 35% *P. globosa* + 65% *A. glacialis*, F) Mixture 30% *P. globosa* + 70% *A. glacialis* and F) Mixture 20% *P. globosa* + 80% *A. glacialis*. Values are mean \pm SD of two independent measurements. Significant differences between RLC measured on pure culture and those obtained after the deconvolution were determined using the method of Ratkowski (1983) for non linear models (P values are indicated, n.s. = not significant)

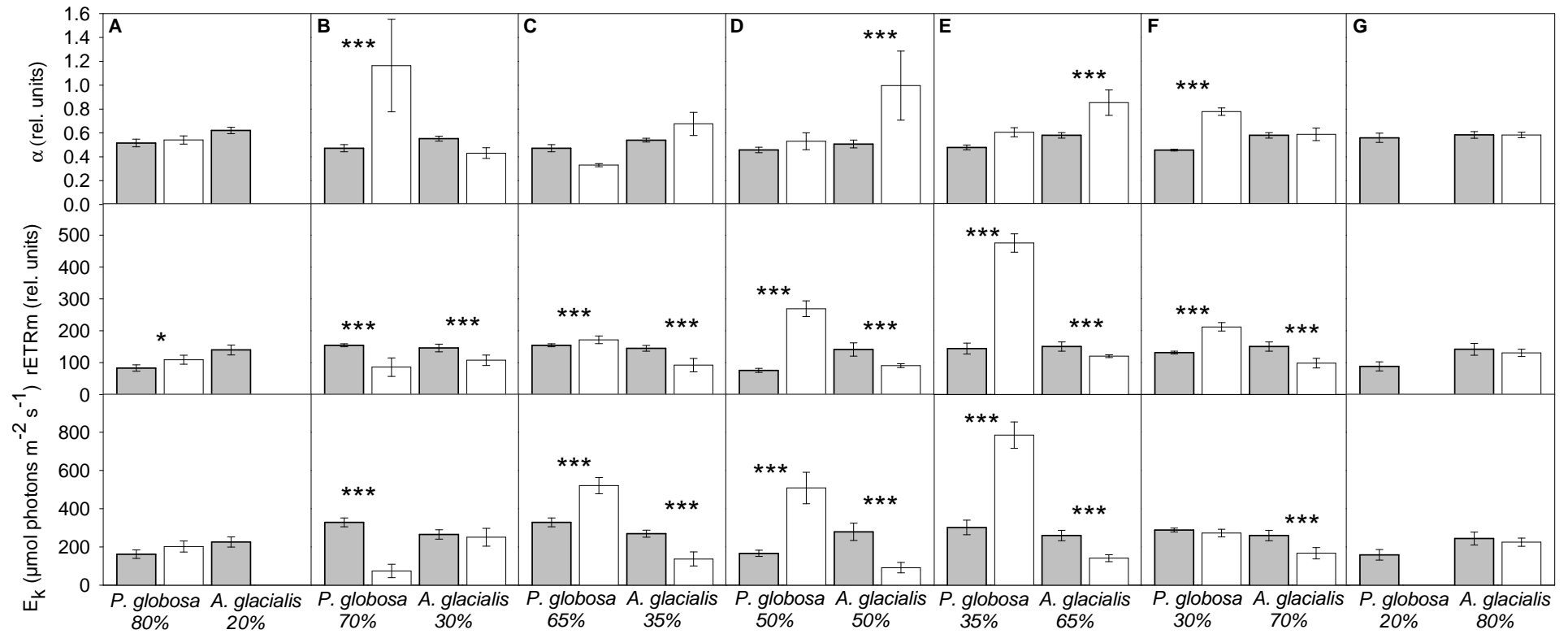

Fig. 2.5. Photosynthetic parameters extracted from RLC curves (Fig. 2.4). A) Mixture 80% *P. globosa* + 20% *A. glacialis*, B) Mixture 70% *P. globosa* + 30% *A. glacialis*, C) Mixture 65% *P. globosa* + 35% *A. glacialis*, D) Mixture 50% *P. globosa* + 50% *A. glacialis*, E) Mixture 35% *P. globosa* + 65% *A. glacialis*, F) Mixture 30% *P. globosa* + 70% *A. glacialis* and G) Mixture 20% *P. globosa* + 80% *A. glacialis*. Values are mean \pm SD of two independent measurements. Significant differences between RLC were determined using the method of Ratkowski (1983) for non linear models (n.s. not significant, * $P \leq 0.05$, ** $P \leq 0.01$, *** $P \leq 0.001$). In grey, photosynthetic parameters measured on pure cultures. In white, photosynthetic parameters obtained after the deconvolution of the fluorescence signals measured on mixtures

and photosynthetic activity of the other species (mixtures 80% *P. globosa* + 20% *A. glacialis* and 80% *A. glacialis* + 20% *P. globosa*) (Fig. 2.4 A and G). Errors in the estimations of the photosynthetic parameters after the deconvolution depended on the concentrations of species within mixtures but, generally the photosynthetic parameters of *P. globosa* were overestimated while those of *A. glacialis* were underestimated (Fig. 2.5). These inaccuracies resulted from the deconvolution procedure because, using the original 4-wavelengths fluorescence signals to construct PE curves, no significant differences between the PE curves measured on the 7 different mixtures were found whatever the wavelength considered (Ratkowski test for non linear model, $P > 0.05$, data not shown).

3.4 Experiment 3: calibration sets and estimations of photosynthetic parameters

The use of different calibration sets to measure photosynthetic activity on pure cultures has no effect on the estimations of photosynthetic parameters (Fig. 2.6). Indeed, no significant differences were found between the PE curves and photosynthetic parameters measured using the reference spectrum corresponding to the culture and those measured using other reference spectra (same species grown under different growth conditions or other species belonging to the same algal group) (Ratkowski test for non linear model, $P > 0.05$).

By contrast, the use of reference spectra that did not correspond to the composition of the assemblage currently analysed had strong consequences on the estimations of photosynthetic parameters and estimation errors depended not only on the reference spectra used but also on the composition of the assemblage considered.

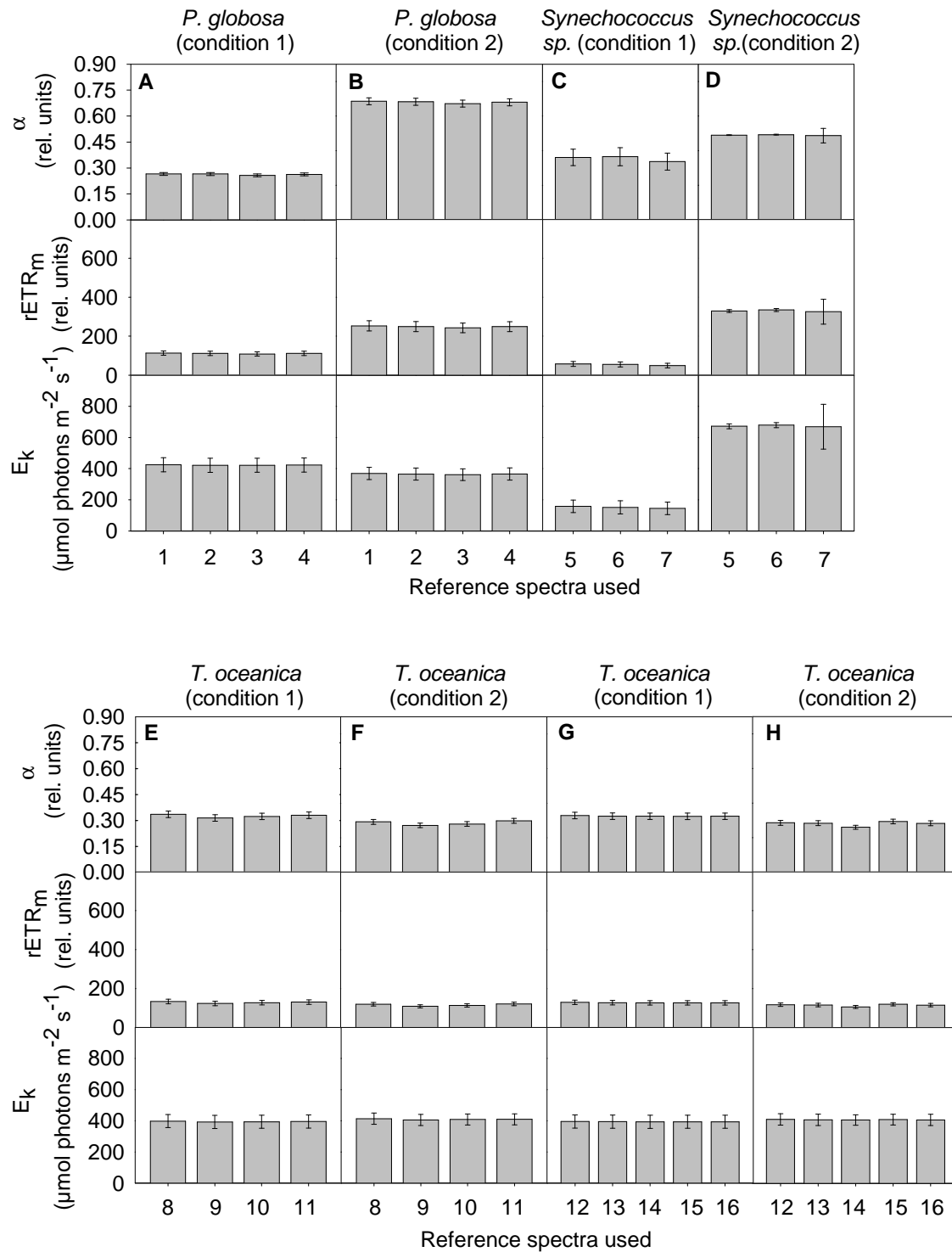

Fig. 2.6. Photosynthetic parameters extracted from RLC curves measured on pure cultures using different sets of reference spectra. A) *P. globosa* (condition 1), B) *P. globosa* (condition 2), C) *Synechococcus sp.* (condition 1), D) *Synechococcus sp.* (condition 2), E and G) *Thalassiosira oceanica* (condition 1), F and H) *Thalassiosira oceanica* (condition 2). Values are mean \pm SD of two independent measurements. Reference spectra used: 1 = *P. globosa* (condition 1), 2 = *P. globosa* (condition 2), 3 = mixture of *P. globosa* condition 1 + condition 2, 4 = natural sample dominated by *P. globosa*, 5 = *Synechococcus sp.* (condition 1), 6 = *Synechococcus sp.* (condition 2), 7 = mixture of *Synechococcus sp.* condition 1 + condition 2, 8 = *Thalassiosira oceanica* (condition 1), 9 = *Thalassiosira oceanica* (condition 2), 10 = mixture of *Thalassiosira oceanica* condition 1 + 2, 11 = natural sample dominated by Diatoms, 12 = *Phaeodactylum tricornutum*, 13 = *Schroederella sp.*, 14 = *Rhizosolenia sp.*, 15 = *Pseudonitzschia sp.*, 16 = *Coscinodiscus sp.*

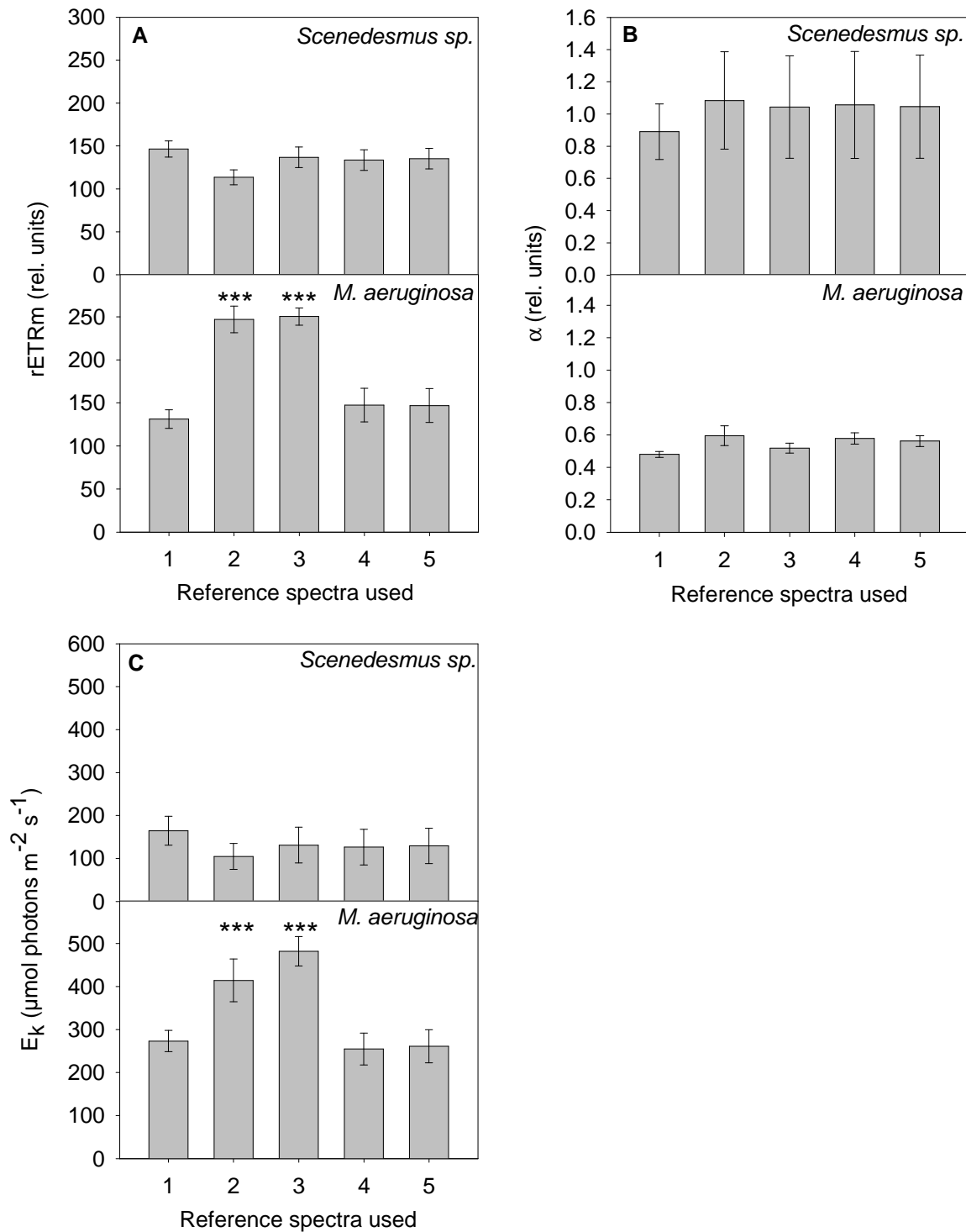

Fig. 2.7. Photosynthetic parameters extracted from the deconvolution of RLC curves measured on pure cultures and mixtures of *Scenedesmus sp.* + *Microcystis aeruginosa* using different sets of reference spectra. A) Maximum relative electron transport rate (rETR_m), B) Maximal light utilization efficiency (α) and C) light saturation coefficient (E_k). Values are mean \pm SD of two independent measurements. Significant differences between RLC were determined using the method of Ratkowski (1983) for non linear models (n.s. not significant, * P < 0.05, ** P < 0.01, *** P < 0.001). 1 = photosynthetic parameters obtained from RLC measured on pure cultures. 2-5 = photosynthetic parameters obtained from the deconvolution of RLC measured on mixtures of *Scenedesmus sp.* + *Microcystis aeruginosa* using different sets of reference spectra. Reference spectra used: 2 = *Scenedesmus sp.* + *Microcystis aeruginosa*, 3 = *Scenedesmus sp.* + *Synechocystis sp.* (PCC 6803), 4 = *Chlorella vulgaris* + *Microcystis aeruginosa* and 5 = *Chlorella vulgaris* + *Synechocystis sp.* (PCC 6803)

With assemblages composed of *Scenedesmus sp.* and *M. aeruginosa*, the use of different reference spectra for the recognition of the green algae group has no effect on the estimations of *Scenedesmus sp.* photosynthetic parameters (Fig. 2.7). The values of $rETR_m$ and E_k of *M. aeruginosa* obtained after the deconvolution of the fluorescence signal measured on mixture were significantly higher than that obtained on pure cultures only when the reference spectra of *Scenedesmus sp.* was used for the recognition of the green algae group (Fig. 2.7 A and C). The photosynthetic parameters of *M. aeruginosa* were just as well estimated using the reference spectra of *M. aeruginosa* than using the reference spectra of *Synechocystis sp.* for the recognition of cyanobacteria.

In the case of assemblages composed of *Synechococcus sp.* and *T. oceanica* (Fig. 2.8), the photosynthetic activity of *T. oceanica* was not detected and the values of $rETR_m$ and E_k of *Synechococcus sp.* were underestimated, when the reference spectra *Synechococcus sp.* (condition 1) was used for the recognition of cyanobacteria. When the reference spectra *Synechococcus sp.* (condition 2) was used for the recognition of cyanobacteria, the values of photosynthetic parameters of *T. oceanica* varied according to the reference spectra used for the recognition of brown algae. Using the reference spectrum of *Synechocystis sp.* for the recognition of cyanobacteria, *Synechococcus sp.* was classified as a brown algae and its photosynthetic activity was confounded with that of *T. oceanica*.

With assemblages composed of *Synechococcus sp.* and *P. globosa* (Fig. 2.9), the photosynthetic activity of *P. globosa* was not detected when the reference spectra *Synechococcus sp.* (condition 1) was used for the recognition of cyanobacteria. When the reference spectra *Synechococcus sp.* (condition 2) was used, the photosynthetic parameters of *P. globosa*, measured using the different reference spectra of *P. globosa* for the recognition of brown algae, were not significantly different from those measured on pure cultures. The estimations of photosynthetic parameters of *Synechococcus sp.* varied according to the

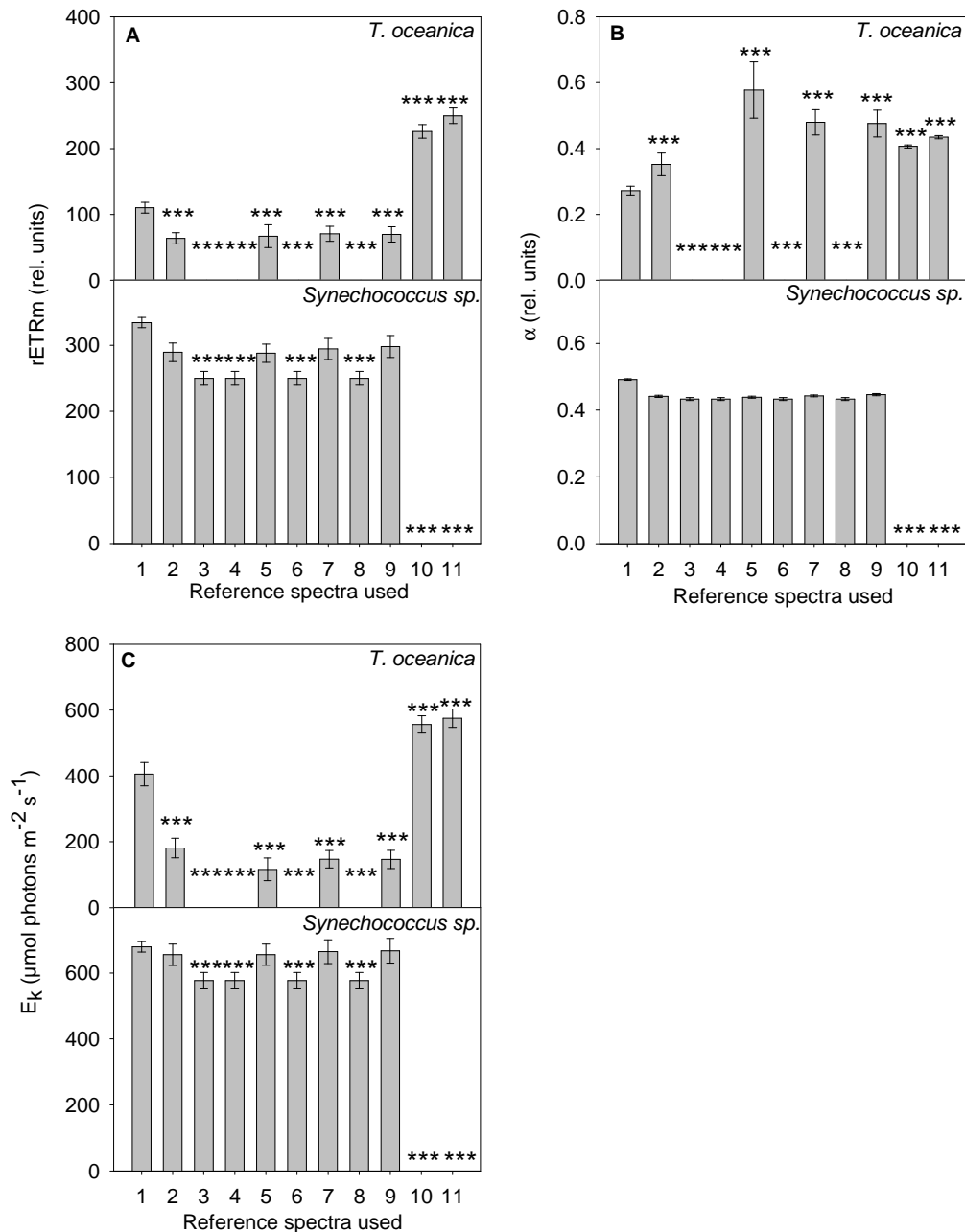

Fig. 2.8. Photosynthetic parameters extracted from the deconvolution of RLC curves measured on pure cultures and mixtures of *Synechococcus sp.* (condition 2) + *Thalassiosira oceanica* (condition 2) using different sets of reference spectra. A) Maximum relative electron transport rate (rETR_m), B) Maximal light utilization efficiency (α) and C) light saturation coefficient (E_k). Values are mean ± SD of two independent measurements. Significant differences between RLC were determined using the method of Ratkowski (1983) for non linear models (n.s. not significant, * P ≤ 0.05, ** P ≤ 0.01, *** P ≤ 0.001). 1 = photosynthetic parameters obtained from RLC measured on pure cultures. 2-11 = photosynthetic parameters obtained from the deconvolution of RLC measured on mixtures of *Synechococcus sp.* + *Thalassiosira oceanica* using different sets of reference spectra. Reference spectra used: 2 = *Synechococcus sp.* (condition 2) + *Thalassiosira oceanica* (condition 2), 3 = *Synechococcus sp.* (condition 1) + *Thalassiosira oceanica* (condition 1), 4 = *Synechococcus sp.* (condition 2) + *Thalassiosira oceanica* (condition 1), 5 = *Synechococcus sp.* (condition 2) + *Thalassiosira oceanica* (condition 1), 6 = *Synechococcus sp.* (condition 1) + *Phaeodactylum tricoratum*, 7 = *Synechococcus sp.* (condition 2) + *Phaeodactylum tricoratum*, 8 = *Synechococcus sp.* (condition 1) + natural sample dominated by Diatoms, 9 = *Synechococcus sp.* (condition 2) + natural sample dominated by Diatoms, 10 = *Synechocystis sp.* (PCC 6803) + *Thalassiosira oceanica* (condition 2) and 11 = *Synechocystis sp.* (PCC 6803) + *Thalassiosira oceanica* (condition 1)

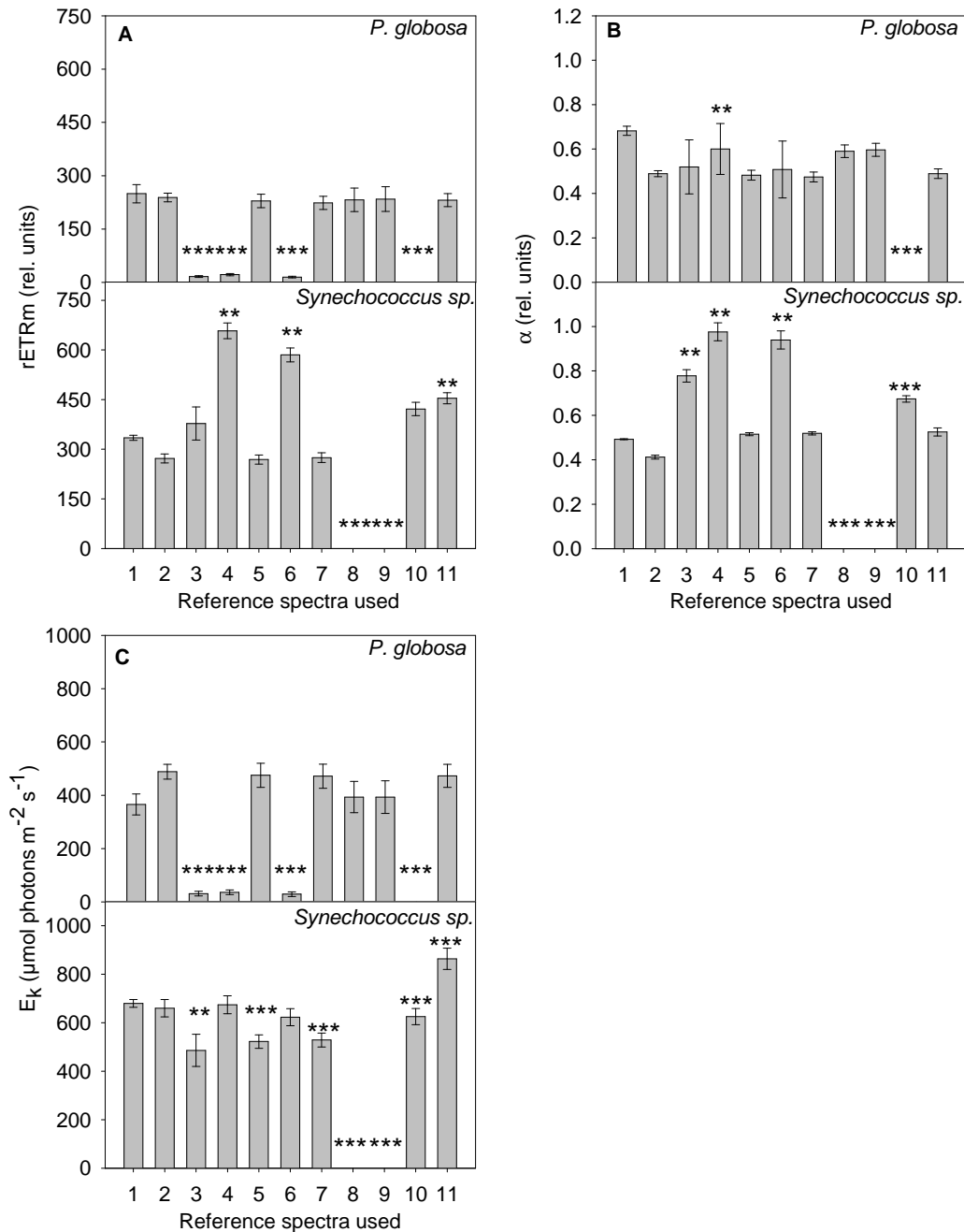

Fig. 2. 9. Photosynthetic parameters extracted from the deconvolution of RLC curves measured on pure cultures and mixtures of *Synechococcus sp.* (condition 2) + *Phaeocystis globosa* (condition 2) using different sets of reference spectra. A) Maximum relative electron transport rate ($rETR_m$), B) Maximal light utilization efficiency (α) and C) light saturation coefficient (E_k). Values are mean \pm SD of two independent measurements. Significant differences between RLC were determined using the method of Ratkowski (1983) for non linear models (n.s. not significant, * $P \leq 0.05$, ** $P \leq 0.01$, *** $P \leq 0.001$). 1 = photosynthetic parameters obtained from RLC measured on pure cultures. 2-11 = photosynthetic parameters obtained from the deconvolution of RLC measured on mixtures of *Synechococcus sp.* + *Phaeocystis globosa* using different sets of reference spectra. Reference spectra used: 2 = *Synechococcus sp.* (condition 2) + *Phaeocystis globosa* (condition 2), 3 = *Synechococcus sp.* (condition 1) + *Phaeocystis globosa* (condition 1), 4 = *Synechococcus sp.* (condition 1) + *Phaeocystis globosa* (condition 2), 5 = *Synechococcus sp.* (condition 2) + *Phaeocystis globosa* (condition 1), 6 = *Synechococcus sp.* (condition 1) + natural sample dominated by *Phaeocystis globosa*, 7 = *Synechococcus sp.* (condition 2) + natural sample dominated by *Phaeocystis globosa*, 8 = *Synechocystis sp.* (PCC 6803) + *Phaeocystis globosa* (condition 2), 9 = *Synechocystis sp.* (PCC 6803) + *Phaeocystis globosa* (condition 1), 10 = *Synechococcus sp.* (condition 2) + *Phaeodactylum tricorutum*, 11 = *Synechococcus sp.* (condition 1) + *Phaeodactylum tricorutum*

reference spectra used for the recognition of cyanobacteria. When the reference spectrum of *Synechocystis sp.* was used for the recognition of cyanobacteria, *Synechococcus sp.* was classified as a brown algae and, its photosynthetic activity was confounded with that of *P. globosa*. Activating only two reference spectra (cyanobacteria + brown algae) and inactivating the third reference spectrum (green algae), the photosynthetic activity of *P. globosa* could be evaluated using a reference spectra measured on a culture of Diatom for the recognition of brown algae. By contrast, when the three reference spectra (cyanobacteria + brown algae + green algae) were activated, *P. globosa* was classified as a mixture of brown algae and green algae.

The deconvolution of the fluorescence signal measured on assemblages composed of *P. globosa* and *A. glacialis* overestimated $rETR_m$ and E_k of *P. globosa* and underestimated $rETR_m$ of *A. glacialis* whatever the reference spectra used (Fig. 2.10). Using the reference spectra *P. globosa* (condition 1) for the recognition of this species, the values of α of *A. glacialis* were underestimated.

4 DISCUSSION

4.1 Variations in reference spectra

4.1.1 Inter-group and inter-species variability

Ordination on the MDS plot showed that the reference spectra of brown algae, green algae and cryptophyte were more similar to each other than to cyanobacteria. Differences in the reference spectra of algal groups can be attributed to differences in pigments (Poryvkina et al. 1994, MacIntyre et al. 2010).

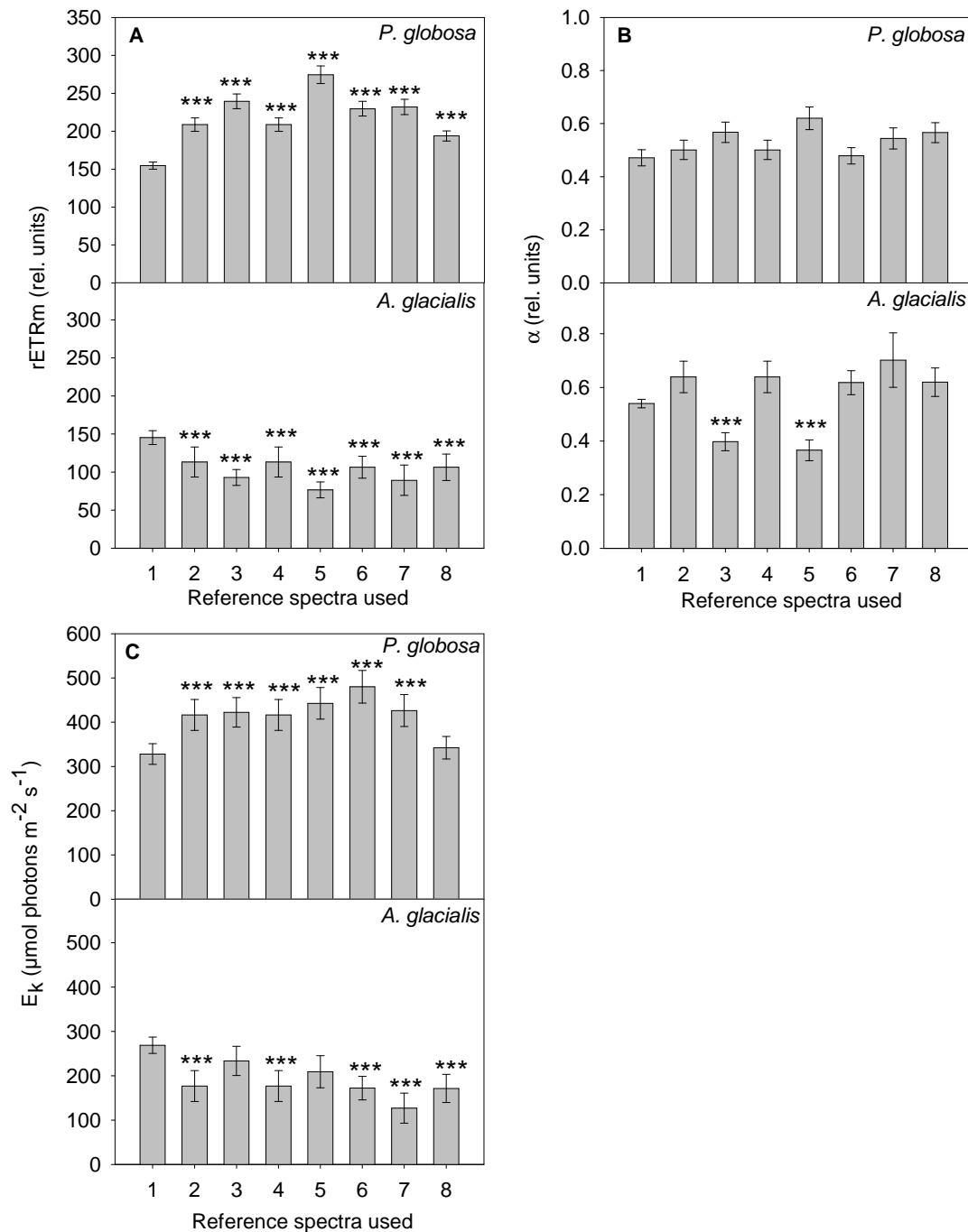

Fig. 2.10. Photosynthetic parameters extracted from the deconvolution of RLC curves measured on pure cultures and mixtures of *Asterionellopsis glacialis* (condition 2) + *Phaeocystis globosa* (condition 2) using different sets of reference spectra. A) Maximum relative electron transport rate (rETR_m), B) Maximal light utilization efficiency (α) and C) light saturation coefficient (E_k). Values are mean ± SD of two independent measurements. Significant differences between RLC were determined using the method of Ratkowski (1983) for non linear models (n.s. not significant, * P ≤ 0.05, ** P ≤ 0.01, *** P ≤ 0.001). 1 = photosynthetic parameters obtained from RLC measured on pure cultures. 2-8 = photosynthetic parameters obtained from the deconvolution of RLC measured on mixtures of *Asterionellopsis glacialis* + *Phaeocystis globosa* using different sets of reference spectra. Reference spectra used: 2 = *Asterionellopsis glacialis* (condition 2) + *Phaeocystis globosa* (condition 2), 3 = *Asterionellopsis glacialis* (condition 2) + *Phaeocystis globosa* (condition 1), 4 = *Asterionellopsis glacialis* (condition 2) + natural sample dominated by *Phaeocystis globosa*, 5 = *Phaeodactylum tricornerutum* + *Phaeocystis globosa* (condition 1), 6 = *Phaeodactylum tricornerutum* + *Phaeocystis globosa* (condition 2), 7 = *Phaeodactylum tricornerutum* + natural sample dominated by *Phaeocystis globosa*, 8 = natural sample dominated by Diatoms + natural sample dominated by *Phaeocystis globosa*

The position of reference spectra on the MDS plot reflected thus the well known differences in the organisation and composition of pigments between eukaryotes and prokaryotes. Indeed, chlorophylls and carotenoids are dominant in eukaryotes, while phycobilipigments arranged in phycobilisomes (phycoerythrin, phycoerythrocyanin, phycocyanin and allophycocyanin) are the main light harvesting pigments in cyanobacteria (Rowan 1989, Jeffrey et al. 1997). Although cryptophytes have also phycobilipigments, cyanobacteria and cryptophytes reference spectra stay different because of the differences in the distribution of pigments in the phycobilisome vs. the antenna/lumen and because of the presence of *c* chlorophylls as accessory pigments in the cryptophytes (Grossman et al. 1995, MacIntyre et al. 2010).

On the MDS plot, the *Synechococcus sp.* reference spectra were placed in an independent group from other cyanobacteria and were closest to the cryptophyte. This makes sense because like cryptophytes, this *Synechococcus sp.* strain was phycoerythrin-rich resulting in high excitation at 520 nm while, the other cyanobacteria (*Synechocystis sp.* and *M. aeruginosa*) were phycocyanin-rich and presented high excitation at 645 nm. This difference in reference spectra between phycocyanin-rich and phycoerythrin-rich cyanobacteria was previously observed with other multi-wavelength fluorometers, such as the FluoroProbe and Algae Online Analyser (AOA), and was used as a method to distinguish these two types of cyanobacteria in mixed assemblages (Leboulanger et al. 2002, Beutler et al. 2004).

Reference spectra of eukaryotes differed from each other primarily in their relative magnitude at 470-550 nm. According to MacIntyre et al. (2010), this is the region of the spectrum that is most sensitive to the presence and abundance of photosynthetic carotenoid in brown algae, phycoerythrin in cryptophytes or their absence in green algae. The comparison of the brown algae reference spectra showed that they clustered in a single group but with

significant within-group dispersion. The similarity comparisons between the different brown algae were, however, higher than between the brown algae and the other algal groups.

The highest dissimilarity within the brown algae group was between the reference spectra of *P. globosa* and those of Diatoms. These differences were previously observed by Houliez et al. (2012) using the FluoroProbe and were used as a way to successfully discriminate this species from other brown algae. However, it is important to note that the shape of the reference spectra of *P. globosa* was less different from that of Diatoms using the Phyto-PAM than using the FluoroProbe. It is probably because the Phyto-PAM has a lower number of LEDs 4 vs. 5 in the FluoroProbe but also because the wavelengths of LEDs are not identical between both probes. The reasons underlying the differences between the reference spectra of *P. globosa* and those of Diatoms are not clear. However, because the comparison is based on the shape of reference spectra, these differences, as well as the differences between the Diatoms species, reflect variations in the spectral dependence arising from inter-species differences in the chl *a* specific absorption coefficient and the effective quantum yield of fluorescence for the given excitation wavelengths. These in turn reflect changes in the ratio of pigments, the internal concentration of pigments, the degree of pigment packaging, the quantum yield of photosynthesis and the likelihood of excess energy being re-emitted as fluorescence rather than directed into other dissipative pathways (MacIntyre et al. 2010).

4.1.2 Intra-specific variability in response to different growth conditions

Such changes in reference spectra can also occur for a single species because of changes in the constituents and functioning of the photosynthetic apparatus in response to acclimation to variability in growth conditions such as nutrient availability (Laws & Bannister 1980, Kolber et al. 1988, Sosik & Mitchell 1991), temperature (Sosik & Mitchell 1994, Anning et al. 2001, Claquin et al. 2008) and irradiance (Anning et al. 2000, MacIntyre & Kana 2002). This is why, in the present study, for a given species, the modifications of the shape of reference spectra induced by different growth conditions could be of the same order of magnitude as inter-species differences within a single algal group.

The variability of the eukaryotes reference spectra was lower than that of cyanobacteria. The same observation was made by Beutler et al. (2002) and MacIntyre et al. (2010) using respectively the FluoroProbe and AOA. This highest variability results from the high acclimative plasticity of cyanobacteria that functions differently from the acclimation in eukaryotes. Indeed, while eukaryotes acclimate principally through changes in chlorophylls and carotenoids contents, the acclimation in cyanobacteria is mediated by changes in the phycoerythrin and phycocyanin content in the phycobilisomes (Dubinsky & Stambler 2009). It is these changes in the phycobilisomes that are the main cause of variations in spectral reference spectra because they modify the optical absorption cross section of the light harvesting complex (LHC) (Beutler et al. 2003).

All these observations clearly invalidate the assumption (2) of Beutler et al. (2002) (see section 2.1) because the shape of reference spectra of an algal group can be variable and dependent on the species composition and the physiological status of cells. Although, the

results of our study fit in with the observations made by Beutler et al. (2002) that previous growth conditions have a small effect on the shape of reference and that intra-specific and inter-specific variability within a group are small compare to inter-group variability except for cyanobacteria, the effects of such changes on photosynthetic parameters estimations must be tested.

4.2 Estimation of photosynthetic parameters differentiated into groups

With the reference spectra corresponding to the cultures used to make the mixtures, the accuracy of photosynthetic parameters estimations depended on the taxonomic composition of mixtures and on the chl concentration of species within mixtures. In mixtures for which differences of concentration between species were low and species belonged to different algal groups (*Scenedesmus sp.* + *M. aeruginosa*, *P. globosa* + *Synechococcus sp.*, *Synechococcus sp.* + *T. oceanica* (mixture 2)), the photosynthetic parameters of one of the two species were relatively well evaluated, while those of the other species were over- or underestimated. When mixtures were strongly dominated by one species (*A. glacialis* + *P. globosa* and *Synechococcus sp.* + *T. oceanica*), the chl content and photosynthetic activity of the other species was not detected. The reasons why the presence of certain species was not detected in mixtures strongly dominated by other species are not clear. Indeed, using the Phyto-PAM for chl content measurements on mixed assemblages, Jakob et al. (2005) did not report this problem. In their experiments, the chl content of each species within mixed assemblages was always detected even when one algal group was dominating. This inaccuracy may be specific to the species investigated in the current study. Indeed, the

Synechococcus sp. strain was phycoerythrin-rich. In its current configuration, the Phyto-PAM was not optimised to detect this kind of cyanobacteria because, contrary to the FluoroProbe, it has no LEDs to specifically excite the phycoerythrin around 550-570 nm. With the LEDs of the Phyto-PAM, the reference spectrum of *Synechococcus sp.* differs from that of Brown algae only in its relative fluorescence amplitude at 470 and 525 nm. It is perhaps insufficient to discriminate these two algal groups when one algal group is dominating.

The tests made on the mixtures composed of *A. glacialis* and *P. globosa* showed the difficulty to distinguish the photosynthetic performances of Diatoms from those of *P. globosa* in mixed assemblages. Indeed, the photosynthetic parameters of *P. globosa* were overestimated, while those of *A. glacialis* were underestimated and the rate of over- and underestimation depended on species concentration within mixtures. These discrepancies between the measurements made on pure cultures and the results from the deconvolution procedure resulted probably from the similarity between the reference spectra. This similarity probably invalidated the assumption of linear independence in reference spectra (assumption (1) of Beutler et al. (2002), see section 2.1).

4.3 Effects of calibration sets on the estimations of photosynthetic parameters

Using the spectral fluorescence, the reliability of measurements depends entirely on the reference spectra, and accurate identification of algal groups depends on invariant reference spectra within algal groups. In view of the results obtained with the different laboratory cultures grown under different conditions, considerable differences in the reference spectra between natural phytoplankton species living under variable environmental conditions

but also between natural phytoplankton and laboratory cultures can be expected. It is thus essential to evaluate the consequences of such variations in reference spectra on chl content and photosynthetic activity measurements.

The effects of reference spectra variations on chl content measurements, using the Phyto-PAM, were evaluated by Jakob et al. (2005). These authors reported underestimations of the chl content of low light grown cultures when the Phyto-PAM was calibrated with reference spectra measured on cultures of the same species but grown under medium light. They made the same observation on natural samples from the river Saar and Saale dominated by Diatoms when the Phyto-PAM was calibrated with reference spectra measured on cultures of *P. tricornutum* grown under low and medium light. By contrast, using reference spectra measured on natural samples from the river Saale, the chl content of the natural samples from the river Saar was correctly evaluated because the hydrographic conditions were similar in both rivers. These results demonstrate the importance of proper calibration for the accurate measurements of chl content with the Phyto-PAM. Moreover, it is necessary to emphasize that the experiments of Jakob et al. (2005), on the effects of different reference spectra on chl content measurements, were performed on pure cultures of a limited number of species and on natural samples dominated by a single algal group. Consequently, in these experiments, the Phyto-PAM was not evaluated in its plenary performances because the uncertainties concerning potential deconvolution errors were limited. Indeed, the impact of small variations in reference spectra of selected taxa may be different on mixed assemblages since the demands on the deconvolution of fluorescence signals are higher. Accordingly, the impact of variations in reference spectra must also be evaluated on mixed cultures.

Because the photosynthetic parameters estimations are based on the same deconvolution procedure as chl content, similar importance of proper calibration can be expected. The effects of different reference spectra were evaluated on pure cultures and

different 2-species mixtures. As in the case of chl content, the use of different calibration sets to measure photosynthetic activity on pure cultures has minor effects on the estimations of photosynthetic parameters. By contrast, the use of reference spectra that did not correspond to the composition of the assemblage currently analysed (in term of species or physiological status of cells) had strong consequences on the estimations of photosynthetic parameters. The errors of estimation depended not only on the reference spectra used but also on the taxonomic composition of the assemblage considered. Moreover, the use of a given reference spectra impacted not only the photosynthetic parameters estimations of the species belonging to the same algal group as the reference spectra but also those of the other phytoplankton species present in the assemblage. All these observations demonstrate the importance of proper calibration also for photosynthetic parameters measurements.

Accurate calibrations of reference spectra seemed particularly important for cyanobacteria. Indeed, using the reference spectrum of *Synechococcus sp.* (condition 1) for the recognition of cyanobacteria in mixed assemblages while photosynthetic activity was measured on *Synechococcus sp.* cultures grown under condition 2, resulted in the absence of detection of the photosynthetic activity of the other species. This is because the reference spectra of *Synechococcus sp.* measured on cultures grown under condition 1 and 2 were different. The variations in reference spectra of cyanobacteria with environmental conditions were recognize as a problem for the application of the spectral fluorescence by Beutler et al. (2003, 2004). These authors succeeded to overcome this problem using additional excitation wavelengths associated with several detection channels and completing the deconvolution procedure with models describing energy pathways in the cyanobacterial photosynthetic apparatus. The case of *Synechococcus sp.* also demonstrated the importance to measure specific reference spectra for phycoerythrin-rich species. Indeed, using reference spectra of phycocyanin-rich cyanobacteria species to measure the *Synechococcus sp.* photosynthetic

activity resulted in the classification of the *Synechococcus sp.* fluorescence signal in the brown algae group. The misattribution of the phycoerythrin-rich cyanobacteria fluorescence signal and the necessity to measure additional reference spectra for this type of cyanobacteria was previously observed with the FluoroProbe (Leboulanger et al. 2002). However, because the FluoroProbe has an additional excitation wavelength for the excitation of phycoerythrin (570 nm), the phycoerythrin-rich cyanobacteria fluorescence signal was confounded with that of cryptophytes. The use of the phycoerythrin-rich cyanobacteria reference spectrum can be problematic in environments where phycoerythrin-rich and phycocyanin-rich cyanobacteria are simultaneously present because with the Phyto-PAM a maximum of three reference spectra can be used at the same time. To use the reference spectrum of phycoerythrin-rich cyanobacteria at the same time as the reference spectrum of phycocyanin-rich cyanobacteria, it is necessary to replace either the reference spectrum of brown algae or that of green algae by the reference spectrum of phycoerythrin-rich cyanobacteria.

The test of different calibration sets on the mixture *A. glacialis* + *P. globosa* demonstrated that in addition to be dependent on the species concentration, the estimations of photosynthetic parameters of these species in mixed assemblages is also strongly dependent on the reference spectra used. The use of reference spectra measured on natural samples did not enhance the results. This clearly indicates that it is not possible to differentiate the photosynthetic performances of Diatoms from those of *P. globosa* in mixed assemblages using the present version of the Phyto-PAM.

5 CONCLUSIONS

The presented results illustrate the fundamental limitations of the Phyto-PAM to differentiate the photosynthetic parameters into groups. It is particularly true for the species commonly found in the eastern English Channel. Reliable estimations of photosynthetic parameters differentiated into groups strongly depend on suitable reference spectra. It was found that reference spectra can be different between species belonging to the same algal group but also for a given species in response to different environmental conditions. The use of reference spectra that did not correspond to the taxonomic composition and physiological status of algal groups within mixed assemblages resulted in significant errors in photosynthetic parameters estimations. This would constitute a problem for the application of the Phyto-PAM in the field because for the calibration of reference spectra normally only laboratory cultures are available and *a priori* information on the physiological status of each algal groups within natural assemblages are lacking.

The concentration of species within mixed assemblages seems to have the potential to impact on the results of the measurements of photosynthetic parameters differentiated into groups. However, because these effects were observed on a limiting number of species and mainly on mixtures for which the Phyto-PAM was not optimised, these results cannot be generalized and are only valid for the species of the eastern English Channel. Further research on this subject using mixtures composed of phycocyanin-rich cyanobacteria, green algae and brown algae are needed to confirm these effects.

The tests made on the distinction between the photosynthetic parameters of *P. globosa* and those of Diatoms clearly invalidate the possibility to use the Phyto-PAM with this aim in view. Indeed, the photosynthetic parameters estimations of these species in mixed

assemblages are not only dependent on the reference spectra used but also on the species concentration within assemblages. This is probably because the reference spectra are not sufficiently different to allow a correct deconvolution of fluorescence signals.

A great part of the Phyto-PAM limitations in differentiating the photosynthetic parameters into groups comes from one hand the variability in the shape of reference spectra and the inability of deconvolution procedure to account for these dynamic changes and on the other hand, the lack of suitable reference spectra for the differentiation of particular algal groups such as Haptophytes, Dinoflagellates and species containing phycoerythrin (cyanobacteria and Cryptophytes). The question arises as to whether the instrument could be further extended to overcome these problems.

Chapitre III

Utilisation des Rapid Light Curves (RLC) et des Steady State Light Curves (SSLC) pour la caractérisation *in situ* de l'activité photosynthétique du phytoplancton

Use of Rapid Light Curves (RLC) and Steady State Light Curves (SSLC) for in situ characterisation of phytoplankton photosynthetic activity

Emilie Houliez^{1*}, Fabrice Lizon¹, François G. Schmitt¹

¹ Université Lille Nord de France, Université des Sciences et Technologies de Lille – Lille 1, Laboratoire d'Océanologie et de Géosciences - CNRS, UMR 8187, Station Marine de Wimereux, 28 Avenue Foch, 62930 Wimereux, France

*Email: emilie.houliez@ed.univ-lille1.fr

Résumé

L'utilisation des rapid light curves (RLC) et des steady state light curves (SSLC), pour la caractérisation *in situ* de l'activité photosynthétique du phytoplancton, à différentes échelles de temps, a été comparée. La possibilité d'utiliser les paramètres photosynthétiques des RLC pour prédire ceux de SSLC a été évaluée. Les résultats montrent que les RLC sont un bon outil pour la caractérisation de l'activité photosynthétique à différentes échelles temporelles.

Mots clés: activité photosynthétique, phytoplancton, rapid light curves, steady state light curves

Abstract

The use of rapid light curves (RLC) and steady state light curves (SSLC), for *in situ* characterization of phytoplankton photosynthetic activity, at different time scales, was compared. The possibility to use RLC to predict SSLC photosynthetic parameters was evaluated. The results showed that RLC are a good tool to characterize photosynthetic activity at different temporal scales.

Keywords: photosynthetic activity, phytoplankton, rapid light curves, steady state light curves

1 INTRODUCTION

Dans son environnement naturel, le phytoplancton est soumis à des variations importantes de l'intensité lumineuse, de la disponibilité des éléments nutritifs, des conditions hydrodynamiques et de la température (MacIntyre et al. 2000). Pour faire face à de telles fluctuations, le phytoplancton a développé différentes stratégies d'acclimatation pour maintenir son activité photosynthétique le plus près possible de son optimum.

Ces différentes stratégies, qui s'opèrent à différentes échelles de temps, sont étudiées par le biais des courbes de réponse à la lumière (P vs E) (Henley 1993). La construction de ces courbes consiste à soumettre le phytoplancton à des paliers d'intensité lumineuse croissante (ou décroissante) et à mesurer son rendement photosynthétique à chaque palier de lumière. Un modèle mathématique, décrivant la relation photosynthèse-lumière (ex :Webb et al. 1974, Platt et al. 1980, Eilers & Peeters 1988), est ensuite ajusté au nuage de points obtenu afin de dériver les paramètres photosynthétiques.

Trois paramètres sont ainsi obtenus:

- la capacité photosynthétique maximale lorsque la lumière devient saturante (P_{max} ou ETR_m , selon la méthode de mesure utilisée)
- l'efficacité maximale d'utilisation de la lumière (α)
- le coefficient de saturation lumineuse (E_k , indice utilisé pour caractériser le niveau de photoacclimatation) qui se calcule par le rapport P_{max}/α .

Plusieurs méthodes peuvent être utilisées pour construire ces courbes. Parmi les plus récentes, on trouve la fluorimétrie par modulation d'impulsions en amplitude (PAM, Pulse Amplitude Modulated fluorometry) (Schreiber et al. 1986) qui rend possible l'enregistrement de l'activité des photosystèmes II (PSII) en temps réel (Serôdio et al. 2005b, Cruz & Serôdio

2008). Cette méthode se base sur la mesure de la fluorescence modulée de la chlorophylle *a* (qui provient essentiellement des PSII) et permet la construction de courbes P vs E particulières puisqu'elles représentent le taux de transport des électrons (ETR, Electron Transport Rate) en fonction de l'intensité lumineuse (E). Deux types de courbes ETR vs E peuvent être obtenus : les courbes rapides (RLC, Rapid Light Curves) et les courbes à l'état stable (SSLC, Steady State Light Curves).

Les SSLC s'apparentent aux traditionnelles courbes P vs E basées sur les échanges gazeux (ex : méthodes de Gaarder & Gran 1927, Steemann Nielsen 1952) puisqu'elles mesurent l'activité photosynthétique à l'état stable et permettent de caractériser les états d'acclimatation à long terme du phytoplancton. Deux types de SSLC peuvent être construits : les sequential steady state light curves (S-SSLC) au cours desquelles un seul échantillon est soumis à l'ensemble des paliers de lumière et les non sequential steady state light curves (N-SSLC) où chaque palier de lumière est appliqué à un sous-échantillon différent. Par rapport aux courbes P vs E traditionnelles, les SSLC ont l'avantage d'être moins fastidieuses à utiliser et sont moins coûteuses.

Les RLC consistent à utiliser des paliers de lumière de très courte durée (de l'ordre de 10 à 30s) ce qui permet de limiter l'acclimatation pendant la durée de la courbe et de préserver l'état initial d'acclimatation des microalgues. Elles mesurent, ainsi, les capacités photosynthétiques qui étaient opérationnelles au moment du prélèvement de l'échantillon (Perkins et al. 2010) et informent sur l'état d'acclimatation à l'histoire lumineuse récente (acclimatation à court terme) (White & Critchley 1999, Ralph & Gademann 2005, Serôdio et al. 2005b, Cruz & Serôdio 2008, Perkins et al. 2010). Ce type de courbe peut être réalisé en 1,5 à 2 min ce qui lui confère un avantage opérationnel considérable dans le cadre de mesures *in situ*. Les RLC ont d'ailleurs été utilisées pour caractériser l'activité photosynthétique de

différents organismes autotrophes dans différents environnements (Serôdio et al. 2005b et références citées) et sont couramment employées pour l'étude du microphytobenthos.

En dépit de ces différents avantages, les RLC restent peu utilisées pour caractériser l'activité photosynthétique du phytoplancton. Cette étude a donc pour objectifs : 1) de comparer l'utilisation des RLC et des N-SSLC pour la caractérisation *in situ* de la photoacclimatation à court et long terme du phytoplancton ; 2) d'évaluer la possibilité d'utiliser les paramètres photosynthétiques des RLC pour prédire ceux des N-SSLC.

2 MATERIELS ET METHODES

2.1 Site d'étude et méthodes d'échantillonnage

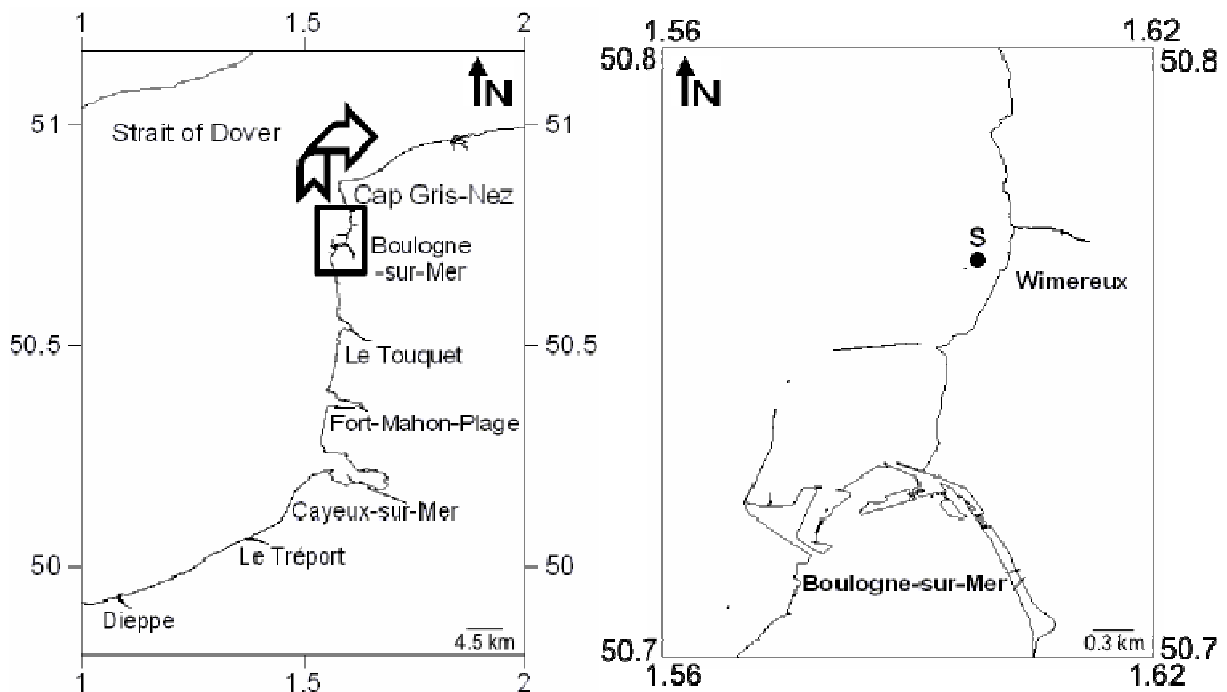

Fig. 3.1. Carte du Détroit du Pas-de-Calais avec un zoom sur la zone d'échantillonnage. Le point de prélèvement (S) est représenté par un rond noir. Les coordonnées sont en degrés décimaux

Les microalgues phytoplanctoniques ont été collectées dans les eaux de surface de l'estran de Wimereux (50°45'57.42''N, 1°35'55.17''E) (Fig. 3.1). Les prélèvements ont été réalisés selon deux protocoles différents en fonction de l'échelle de temps considérée pour la comparaison des RLC et des N-SSLC. Pour l'étude à l'échelle saisonnière, les échantillonnages ont été effectués avec une fréquence hebdomadaire entre février 2009 et mars 2010. Pour l'échelle journalière, les prélèvements ont été réalisés les 18 et 26 mars 2010 (pendant la phase de croissance du bloom de *Phaeocystis globosa*) avec une fréquence d'échantillonnage de 1h45 du lever au coucher du soleil. Ces deux dates ont été choisies parce que d'une part, la composition taxonomique des communautés phytoplanctoniques était comparable entre les deux jours : les communautés étaient dominées par *P. globosa* (Houliet et al., en préparation). D'autre part, les conditions de lumière étaient très différentes ce qui permet une comparaison de la réponse des RLC et des N-SSLC sous deux conditions de lumière contrastées.

2.2 Activité photosynthétique

L'activité photosynthétique du phytoplancton a été obtenue par fluorimétrie PAM. Toutes les mesures ont été réalisées à l'aide du Phyto-PAM (Heinz Walz GmbH, Effeltrich, Allemagne). Avant la construction des RLC et des N-SSLC, les échantillons ont été acclimatés à l'obscurité et les niveaux de fluorescence F_0 et F_m ont été déterminés pour obtenir le rendement photosynthétique optimal : $F_v/F_m = (F_m - F_0)/F_m$. A noter que la terminologie employée dans cet article est celle de van Kooten and Snel (1990).

Les RLC ont été construites en exposant les échantillons 10 s à 20 paliers d'intensité lumineuse croissante (de 22 à 1384 $\mu\text{mol photons m}^{-2} \text{s}^{-1}$). A chaque palier, les niveaux de

fluorescence F_m' et F' ont été mesurés en appliquant un pulse de lumière saturante et le rendement quantique effectif des PSII a été calculé selon Genty et al. (1989) :

$$\Phi_{PSII} = \Delta F / F_m' = (F_m' - F) / F_m'$$

$\Delta F / F_m'$ a ensuite été utilisé pour calculer les ETR :

$$ETR = \Phi_{PSII} \times E \times 0,5 \times \bar{a}_{phy}^*$$

où E ($\mu\text{mol photons m}^{-2} \text{s}^{-1}$) est l'intensité de la lumière actinique ; 0,5 est un facteur de correction parce que le transport d'un électron nécessite deux photons (un par photosystème) et \bar{a}_{phy}^* ($\text{m}^2 (\text{mg chl } a)^{-1}$) est le coefficient d'absorption spécifique normalisé par la concentration en chlorophylle a et moyenné entre 400 et 700 nm. Ce coefficient a été mesuré selon la méthode de Mitchell et al. (2000).

Les N-SSLC ont été construites en utilisant les mêmes paliers de lumière que ceux utilisés pour la construction des RLC. La mesure des niveaux de fluorescence F_m' et F' a été réalisée après 5 min d'acclimatation aux paliers de lumière de sorte que l'état stable soit atteint à chaque palier. Pour éviter les potentiels effets cumulatifs de photoacclimatation rapide pendant la construction de la courbe (Perkins et al. 2006), chaque palier de lumière a été appliqué à un sous échantillon différent. Le rendement quantique effectif des PSII et les ETR ont été calculés avec les formules utilisées pour les RLC.

Les courbes de réponse à la lumière ainsi obtenues ont été ajustées en utilisant le modèle de Eilers and Peeters (1988) et l'efficacité maximale d'utilisation de la lumière (α), les taux de transport maximum des électrons (ETR_m) et le coefficient de saturation lumineuse (E_k) ont été dérivés.

3 RESULTATS ET DISCUSSION

3.1 Variations à différentes échelles de temps des paramètres photosynthétiques issus des RLC et des N-SSLC

Il est admis, dans la littérature, que les SSLC permettent de caractériser le statut d'acclimatation à long terme des organismes autotrophes. En effet, les SSLC se basent sur la mesure de l'activité photosynthétique à l'état stable. C'est-à-dire que les paliers de lumière utilisés ont une durée suffisamment longue pour permettre à l'échantillon de stabiliser son activité photosynthétique vis-à-vis de la lumière qui lui est fournie à chaque palier. Il en résulte que l'état d'acclimatation transitoire de l'échantillon à l'histoire lumineuse récente (acclimatation à court terme) est atténué voire totalement éliminé pendant la construction de la courbe. Dans ces conditions, seuls les effets de la photoacclimatation à long terme peuvent être détectés et ce type de courbe informe sur les capacités photosynthétiques potentielles des microalgues sous une gamme d'intensités lumineuses (White & Critchley 1999, Serôdio et al. 2006b, Cruz & Serôdio 2008, Perkins et al. 2010).

A l'inverse, les paliers de lumière utilisés pour la construction des RLC ont une durée trop courte pour altérer complètement l'état d'acclimatation à court terme (White & Critchley 1999, Ralph & Gademann 2005). Les RLC sont donc fortement affectées par les variations de l'histoire lumineuse récente (Serôdio et al. 2005b, Perkins et al. 2006, Serôdio et al. 2006b) et informent sur les capacités photosynthétiques opérationnelles au moment de la mesure.

Dans le cas d'un suivi des variations journalières de l'activité photosynthétique, cette préservation du statut de photoacclimatation, à court terme, peut être un avantage pour

caractériser la réactivité de l'activité photosynthétique face aux variations rapides des paramètres environnementaux. Ainsi, à cette échelle de temps, les RLC devraient détecter des variations des paramètres photosynthétiques non décelables par les SSLC et s'ajuster au plus près des variations de la lumière incidente.

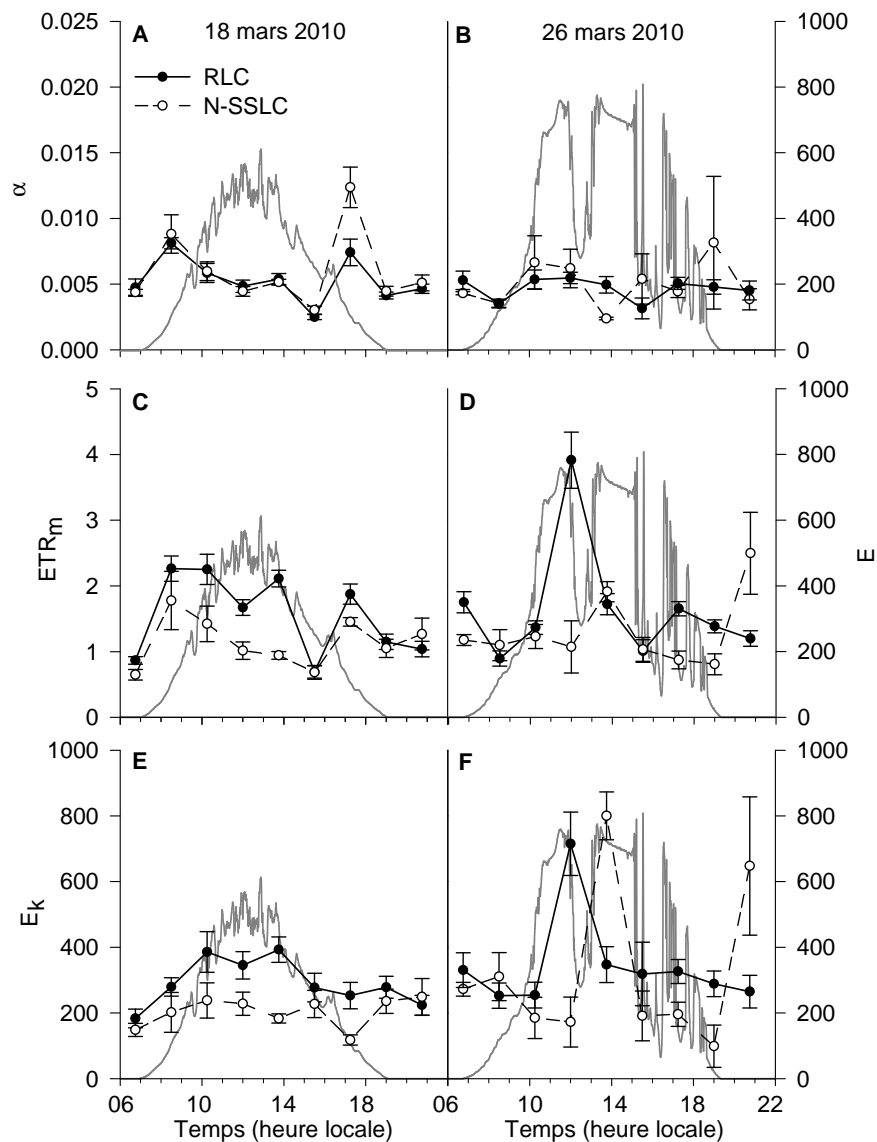

Fig. 3.2. Variations journalières des paramètres photosynthétiques α [en $\mu\text{mol e}^- \text{mg chl } a^{-1} \text{s}^{-1}$ ($\mu\text{mol photons m}^{-2} \text{s}^{-1})^{-1}$] (A, B), ETR_m [en $\mu\text{mol e}^- \text{mg chl } a^{-1} \text{s}^{-1}$] (C, D) et E_k [en $\mu\text{mol photons m}^{-2} \text{s}^{-1}$] (E, F) issus des RLC et des N-SSLC. Les valeurs sont les moyennes \pm écart-type de trois mesures indépendantes. Les courbes grises représentent l'intensité lumineuse E [en $\mu\text{mol photons m}^{-2} \text{s}^{-1}$]

Les résultats de cette étude montrent effectivement de plus fortes variations journalières des ETR_m issus des RLC (ETR_{mRLC}) que des ETR_m issus des N-SSLC ($ETR_{mN-SSLC}$) (Fig. 3.2) avec des coefficients de variation au cours de la journée plus élevés pour ETR_{mRLC} (18 mars : CV = 54% ; 26 mars : CV = 40%) que pour $ETR_{mN-SSLC}$ (18 mars : CV = 42% ; 26 mars : CV = 33%). Les variations des ETR_{mRLC} sont, de plus, plus proches des variations de l'intensité lumineuse que les variations des $ETR_{mN-SSLC}$. Par exemple, le 26 mars, l'augmentation de l'intensité lumineuse qui s'est déroulée entre 9H40 et 11H30 a été immédiatement suivie par l'augmentation de ETR_{mRLC} tandis que $ETR_{mN-SSLC}$ est resté relativement stable (Fig. 3.2D). Les variations de α sont, par contre, du même ordre de grandeur et restent proches entre les RLC et N-SSLC puisque, dans le cas présent, ce paramètre semble peu sensible aux fluctuations de l'intensité lumineuse. En raison de la relative stabilité de α , les variations de ETR_m sont ici proportionnellement suivies par des variations de E_k . E_{kRLC} est, de ce fait, beaucoup plus variable que $E_{kN-SSLC}$.

La différence de réponse entre α et ETR_m vis-à-vis de l'histoire lumineuse récente semble ici liée au type de photoacclimatation mis en œuvre par le phytoplancton. En effet, la photoacclimatation s'effectue ici par le biais des modifications de ETR_m mais pas de α . Ce type de photoacclimatation est reconnu comme reflétant les modifications de l'activité des enzymes du cycle de Calvin (principalement la RUBISCO) et/ou des composants de la chaîne de transport des électrons (MacIntyre & Kana 2002, Behrenfeld et al. 2004). Il se différencie d'autres types de photoacclimatation où les variations de ETR_m s'accompagnent de modifications du paramètre α . Dans ce cas, en plus de refléter les modifications de l'activité des enzymes du cycles de Calvin et des composants de la chaîne de transport des électrons, ces types de photoacclimatation sont associés à des changements des complexes capturant l'énergie lumineuse (concentration en pigments accessoires photosynthétiquement actifs,

rapport PSII : PSI) et/ou à l'activité des réactions claires de la photosynthèse et des PSII (quenching non photochimique (NPQ) et photoinhibition) (Behrenfeld et al. 2004).

En travaillant sur des cultures et des communautés naturelles, Serôdio et al. (2006b) et Cruz and Serôdio (2008) ont montré que, chez le microphytobenthos, les RLC peuvent fournir des informations sur l'état de photoacclimatation à court terme mais également sur le statut d'acclimatation à long terme supposé être exclusivement obtenu avec les SSLC. Il a ainsi été montré que les microalgues acclimatées aux faibles lumières montrent une diminution monotone de α_{RLC} lorsque la lumière incidente augmente tandis que celles acclimatées aux fortes lumières montrent une réponse de α_{RLC} qui se déroule en deux temps avec une augmentation de α_{RLC} proportionnellement à la lumière puis une diminution de α_{RLC} à partir d'une certaine intensité lumineuse. Si les RLC permettent également de caractériser l'état d'acclimatation à long terme, à l'échelle saisonnière, les variations des paramètres photosynthétiques des RLC devraient être proches de celles des paramètres photosynthétiques des N-SSLC puisque l'influence des variations à court terme de l'intensité lumineuse sur les paramètres photosynthétiques est beaucoup moins forte à cette échelle de temps. Nos résultats sont en accord avec cette hypothèse puisque les variations de α_{RLC} et ETR_{mRLC} suivent les mêmes tendances que les variations de $\alpha_{\text{N-SSLC}}$ et $\text{ETR}_{\text{mN-SSLC}}$ (Fig. 3.3) avec des coefficients de variation du même ordre de grandeur ($\text{CV } \alpha_{\text{RLC}} = 74\%$, $\text{CV } \alpha_{\text{N-SSLC}} = 73\%$; $\text{CV } \text{ETR}_{\text{mRLC}} = 68\%$, $\text{CV } \text{ETR}_{\text{mN-SSLC}} = 69\%$).

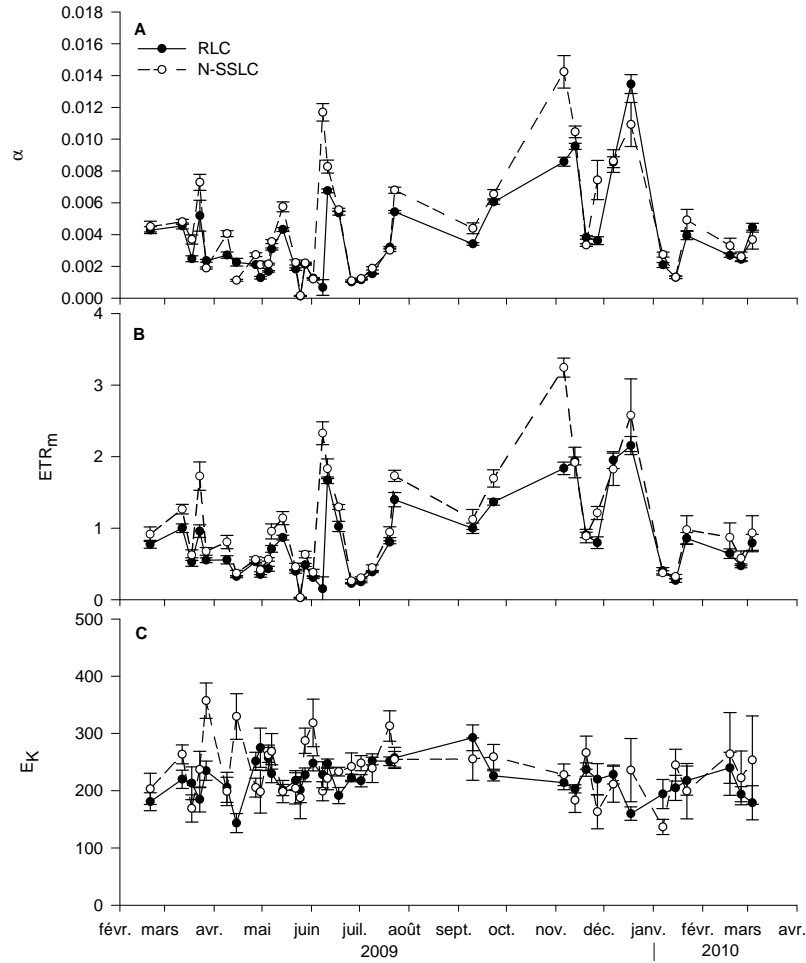

Fig. 3.3. Variations saisonnières des paramètres photosynthétiques α [en $\mu\text{mol e}^- \text{mg chl } a^{-1} \text{s}^{-1}$ ($\mu\text{mol photons m}^{-2} \text{s}^{-1})^{-1}$] (A), ETR_m [en $\mu\text{mol e}^- \text{mg chl } a^{-1} \text{s}^{-1}$] (B) et E_k [en $\mu\text{mol photons m}^{-2} \text{s}^{-1}$] (C) issus des RLC et des N-SSLC. Les valeurs sont les moyennes \pm écart-type de trois mesures indépendantes

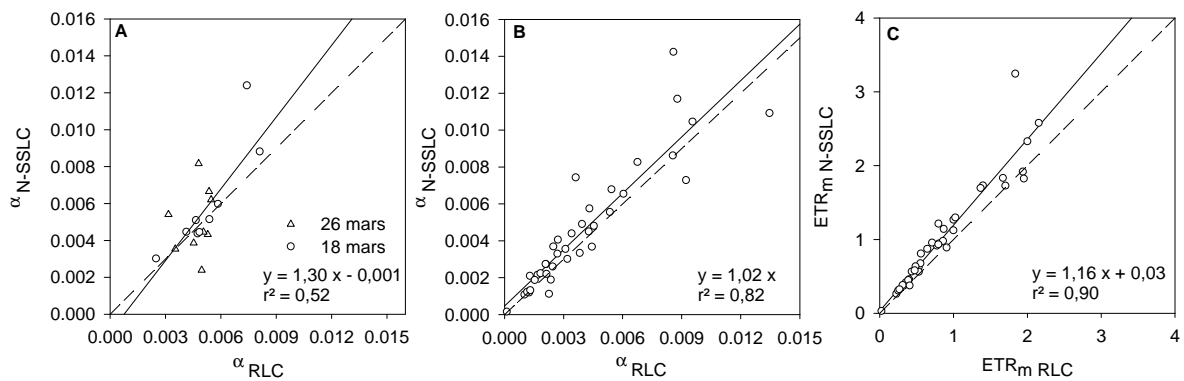

Fig. 3.4. Relations linéaires entre α_{RLC} et α_{N-SSLC} [en $\mu\text{mol e}^- \text{mg chl } a^{-1} \text{s}^{-1}$ ($\mu\text{mol photons m}^{-2} \text{s}^{-1})^{-1}$] aux échelles journalière (A) et saisonnière (B) et entre ETR_{mRLC} et $ETR_{mN-SSLC}$ [en $\mu\text{mol e}^- \text{mg chl } a^{-1} \text{s}^{-1}$] à l'échelle saisonnière (C). Les lignes en pointillés indiquent le rapport 1:1

3.2 Utilisation des RLC pour évaluer le statu d'acclimatation à long terme : relations entre RLC et N-SSLC

L'un des objectifs de cette étude était de déterminer les relations entre les paramètres photosynthétiques issus des RLC et ceux issus des N-SSLC, à différentes échelles de temps et sous différentes conditions lumineuses, dans le but, d'évaluer la possibilité d'utiliser les RLC pour prédire les paramètres photosynthétiques à l'état stable et de caractériser le statu d'acclimatation à long terme du phytoplancton dans le cadre de mesures *in situ*.

Dans le cas du microphytobenthos, Serôdio et al. (2006b) et Cruz and Serôdio (2008) ont montré que la relation entre les paramètres photosynthétiques issus des RLC et ceux issus des SSLC est fortement influencée par l'intensité lumineuse incidente. Ainsi, l'utilisation des RLC pour déduire directement les paramètres photosynthétiques des N-SSLC n'est possible qu'aux faibles lumières pour α et uniquement aux fortes lumières pour ETR_m . De sorte que Ek_{SSLC} , l'indicateur du statut de photoacclimatation à long terme le plus utilisé, ne peut être estimé par le rapport $\alpha_{RLC}/rETR_{mRLC}$.

En ce qui concerne le paramètre Ek , nos résultats confirment leurs observations puisqu'aucune corrélation significative n'a pu être mise en évidence entre Ek_{RLC} et Ek_{N-SSLC} quelle que soit l'échelle de temps considérée. A noter tout de même que même si la corrélation entre Ek_{RLC} et Ek_{N-SSLC} n'est pas significative, les conclusions sur le statu d'acclimatation du phytoplancton qui peuvent être extraites de ces deux indices restent les mêmes à l'échelle saisonnière. Par contre, nos résultats montrent que, chez le phytoplancton, la relation entre les RLC et les N-SSLC semble d'avantage dépendre de l'échelle de temps

considérée que de l'intensité lumineuse incidente. En effet, à l'échelle journalière, la corrélation entre α_{RLC} et $\alpha_{\text{N-SSLC}}$ est significative ($p < 0,001$; $r^2 = 0,52$) lorsque tous les résultats obtenus les 18 et 26 mars sont combinés (Fig. 3.3A) tandis qu'aucune corrélation n'a pu être mise en évidence entre ETR_{mRLC} et $\text{ETR}_{\text{mN-SSLC}}$ et ce en dépit des fortes intensités lumineuses rencontrées au cours de ces deux journées.

A l'échelle saisonnière, c'est pendant les périodes où l'intensité lumineuse incidente était la plus forte (de mars à fin août) que la liaison entre les RLC et les N-SSLC semble la plus proche (Fig. 3.3). Et en considérant, l'ensemble des données récoltées entre février 2009 et mars 2010, des corrélations significatives entre ETR_{mRLC} et $\text{ETR}_{\text{mN-SSLC}}$ et entre α_{RLC} et $\alpha_{\text{N-SSLC}}$ ont été trouvées ($p < 0,001$; $r^2 = 0,90$ et $r^2 = 0,83$ respectivement) avec des pentes relativement proches de 1 (1,16 et 1,02 respectivement) malgré les variations saisonnières de l'intensité lumineuse incidente (Fig. 3.4, B et C). Seule la pente de la régression ETR_{mRLC} vs $\text{ETR}_{\text{mN-SSLC}}$ est significativement différente de 1.

Ainsi, à l'échelle journalière, l'évaluation du statu d'acclimatation à long terme du phytoplancton par le biais des RLC semble difficile en raison de la forte sensibilité des RLC au statu de photoacclimatation à court terme. La corrélation significative qui a été trouvée entre α_{RLC} et $\alpha_{\text{N-SSLC}}$, à cette échelle de temps, semble, en effet, refléter d'avantage la stratégie d'acclimatation à court terme du phytoplancton, plutôt qu'une réelle liaison entre α_{RLC} et $\alpha_{\text{N-SSLC}}$. Il est d'ailleurs fortement probable que cette relation devienne invalide pour des communautés phytoplanctoniques présentant une stratégie d'acclimatation à court terme qui favoriserait la variabilité de α .

Par contre, à l'échelle saisonnière, l'utilisation de ETR_{mRLC} et α_{RLC} pour décrire le statut de photoacclimatation à long terme semble possible à condition de corriger les valeurs des ETR_{mRLC} en utilisant l'équation de la droite de régression (ETR_{mRLC} vs $\text{ETR}_{\text{mN-SSLC}}$) (Fig. 3.4C). En effet, en termes de valeurs absolues des paramètres photosynthétiques, les RLC

peuvent conduire à une sous-estimation de α et de ETR_m par rapport aux N-SSLC en particulier pendant la période estivale.

3.3 Validité des résultats

Les résultats présentés dans cette étude sont basés sur les paramètres photosynthétiques issus de la mesure des ETR absolus contrairement aux résultats obtenus chez le microphytobenthos qui sont basés sur la mesure des ETR relatifs. C'est-à-dire que le calcul des ETR a ici été réalisé en prenant en considération le coefficient d'absorption spécifique de la chlorophylle (\bar{a}_{phy}^*) qui quantifie la part de la lumière disponible absorbée au niveau des PSII pour réaliser la photosynthèse.

En milieu naturel, le \bar{a}_{phy}^* est fortement variable (Dubinsky 1991, Cosgrove & Borowitzka 2010) puisqu'il dépend du cortège pigmentaire de l'antenne des PSII. Ce cortège pigmentaire peut, en effet, être différent d'une espèce phytoplanctonique à une autre ce qui rend le \bar{a}_{phy}^* taxonomiquement dépendant (Suggett et al. 2004). De plus, pour une espèce donnée, le \bar{a}_{phy}^* varie en fonction des réarrangements pigmentaires qui s'opèrent au cours des processus d'acclimatation vis-à-vis des variations des facteurs environnementaux tels que la lumière ou la disponibilité des nutriments (Dubinsky & Stambler 2009).

Si la non considération du \bar{a}_{phy}^* , chez le microphytobenthos, se justifie par sa difficulté de mesure sans perturbation majeure des communautés microphytobenthiques (Kromkamp et al. 1998, Serôdio et al. 2006b, Perkins et al. 2010), il n'en est rien chez le phytoplancton pour lequel plusieurs méthodes de mesure, relativement faciles à mettre en œuvre, ont été proposées (ex : Kishino et al. 1985, Tassan & Ferrari 1995, Mitchell et al. 2000).

Nous recommandons donc d'utiliser les ETR absolus pour l'étude *in situ* de l'activité photosynthétique du phytoplancton puisque les variations de ETR_m et de α sont physiologiquement liées au \bar{a}_{phy}^* . De plus, l'utilisation des ETR relatifs à la place des ETR absolus est susceptible de modifier les résultats des relations entre ETR_{mRLC} et $ETR_{mN-SSLC}$ ou entre α_{RLC} et α_{N-SSLC} . Nos résultats montrent, en effet, qu'en travaillant sur les ETR relatifs : 1) la corrélation entre α_{RLC} et α_{N-SSLC} n'est plus significative à l'échelle saisonnière ; 2) les corrélations qui subsistent entre ETR_{mRLC} et $ETR_{mN-SSLC}$, à l'échelle saisonnière, et entre α_{RLC} et α_{N-SSLC} , à l'échelle journalière, sont de moins bonne qualité puisque des r^2 plus faibles qu'en utilisant les ETR absolus ont été obtenus (ETR_{mRLC} vs $ETR_{mN-SSLC}$: $r^2 = 0,56$ et α_{RLC} vs α_{N-SSLC} : $r^2 = 0,41$ en utilisant les ETR relatifs contre 0,90 et 0,52 en utilisant les ETR absolus). Les résultats présentés dans cet article sont donc applicables uniquement dans le cadre de l'utilisation des ETR absolus.

4 CONCLUSIONS

Les résultats de cette étude montrent l'utilité des RLC pour la caractérisation *in situ* des variations à court terme et à long terme de l'activité photosynthétique du phytoplancton. A l'échelle journalière, les RLC sont fortement dépendantes de l'histoire lumineuse récente et du statu d'acclimatation à court terme du phytoplancton ce qui permet de déceler des variations rapides de l'activité photosynthétique qui ne peuvent être détectées en utilisant les N-SSLC. Cette capacité représente un avantage pour la caractérisation *in situ* de la réponse de l'activité photosynthétique vis-à-vis des changements rapides des conditions environnementales, notamment dans les environnements hautement variables tels que les écosystèmes côtiers à fort hydrodynamisme. D'autre part, les RLC peuvent être utilisées pour

caractériser l'acclimatation à long terme dans le cadre d'un suivi saisonnier de l'activité photosynthétique. Leur utilisation dans ce cadre présente un avantage opérationnel du fait du temps nécessaire à leur construction en comparaison aux N-SSLC. Les RLC se révèlent donc être un bon outil pour la caractérisation rapide des variations spatio-temporelles de l'activité photosynthétique du phytoplancton.

REMERCIEMENTS

Nous remercions Xavier Mériaux pour son aide lors de l'analyse des \bar{a}_{phy}^* et Sébastien Lefebvre pour ses précieux conseils sur l'utilisation de Matlab.

Conclusions générales

Dans cette partie, la fiabilité des méthodes employées dans cette thèse a été évaluée avant leur application dans le cadre d'études de terrain.

Dans un premier temps, la possibilité d'utiliser le FluoroProbe pour la surveillance des dynamiques des principaux groupes phytoplanctoniques de la Manche orientale a été testée avec une attention particulière portée sur la distinction entre l'Haptophyte *P. globosa* et les autres algues brunes. Il a été montré que cette distinction est possible mais requière la recalibration du FluoroProbe avec une nouvelle empreinte de référence pour *P. globosa*. En utilisant cette nouvelle empreinte de référence, la méthode est suffisamment sensible pour estimer l'abondance des différents groupes d'algues et pour suivre les dynamiques des principaux groupes phytoplanctoniques de la Manche orientale. Cependant, comme c'est le cas avec tous les fluorimètres spectraux, la détermination des contributions absolues des groupes phytoplanctoniques en terme de concentration en chl *a* peut être sujette aux biais.

Dans les prochaines parties de cette thèse, cette technique a été utilisée durant les études de terrain, comme une méthode grossière pour suivre les principaux changements dans la structure des assemblages phytoplanctoniques.

Dans le second chapitre, les performances et les limites du Phyto-PAM dans la mesure des paramètres photosynthétiques différenciés par groupes d'algues ont été étudiées. Comme dans le cas du FluoroProbe, une attention particulière a été donnée aux espèces courantes de la Manche orientale et la possibilité de faire la distinction entre les performances photosynthétiques de *P. globosa* et celles des Diatomées au sein d'assemblages plurispécifiques a été évaluée. En utilisant le Phyto-PAM, la fiabilité des estimations des paramètres photosynthétiques différenciés par groupes d'algues est fortement dépendante des empreintes de référence utilisées pour la calibration de chaque groupe. Il a été démontré que

l'utilisation de spectres de référence qui ne correspondent pas à la composition taxonomique et/ou à l'état physiologique des groupes d'algues au sein des assemblages conduit à des erreurs d'estimation des paramètres photosynthétiques conséquentes. Ceci constitue un problème pour l'application du Phyto-PAM en milieu naturel puisque la calibration des spectres de référence s'effectue à partir de culture d'algues élevées en laboratoire et parce qu'on ne connaît pas d'avance l'état physiologique de chacun des groupes d'algues constituant les assemblages naturels. Les tests sur la distinction entre les performances photosynthétiques de *P. globosa* et celles des Diatomées indiquent que les estimations des paramètres photosynthétiques de ces espèces, lorsqu'elles sont mélangées au sein d'assemblages plurispécifiques, dépendent non seulement des spectres de référence utilisées mais également de la concentration des espèces au sein des assemblages. Ceci invalide clairement l'utilisation du Phyto-PAM pour faire la distinction entre les performances photosynthétiques de *P. globosa* et celles des Diatomées. En Manche orientale, ces deux groupes composent la majeure partie de la biomasse phytoplanctonique et sont suivis par les Dinoflagellés et les Cryptophytes en terme d'abondance (Lefebvre et al. 2011). La composition pigmentaire des Dinoflagellés et des Diatomées est trop similaire pour être différenciée par fluorescence spectrale et, contrairement au FluoroProbe, le Phyto-PAM n'a pas de LEDs pour exciter spécifiquement la phycoérythrine des Cryptophytes. Par conséquent, le signal de fluorescence des Dinoflagellés, des Cryptophytes, de *P. globosa* et des Diatomées est confondu et classé dans le groupe des algues brunes. Pour conclure, dans sa configuration actuelle, le Phyto-PAM est incapable de faire la distinction entre les principaux groupes phytoplanctoniques de la Manche orientale.

Face aux difficultés pour calibrer correctement les spectres de référence et parce que le Phyto-PAM est incapable de faire la distinction entre les principaux groupes phytoplanctoniques de la Manche orientale, pour les études de terrain, nous avons décidé de

ne pas utiliser le signal de fluorescence issu de la procédure de déconvolution. Nous avons utilisé le signal brut de fluorescence obtenu après l'excitation à 470 nm. De cette manière, le Phyto-PAM a été utilisé comme un fluorimètre PAM classique avec une seule longueur d'onde d'excitation. Par conséquent, seule l'activité photosynthétique au niveau de la communauté a été mesurée.

Dans le troisième chapitre, l'utilisation de deux méthodologies (les RLC et les N-SSLC) associées à l'utilisation de la fluorescence pour l'estimation *in situ* de l'activité photosynthétique du phytoplancton a été comparée au cours d'un travail de terrain. Cette étude valide l'utilisation des RLC pour caractériser l'activité photosynthétique du phytoplancton aux échelles journalières et saisonnières. Les RLC sont donc la méthodologie qui a été employée durant les études de terrain présentées dans les prochaines parties de cette thèse.

General conclusions

In this part the reliability of the methods employed in this thesis was evaluated before their application in field studies.

First, the possibility of using the FluoroProbe for monitoring the dynamics of the main phytoplankton groups of the eastern English Channel was tested with a particular attention given to the distinction between the Haptophyte *P. globosa* and the other brown algae. This distinction was found to be possible but requires the recalibration of the FluoroProbe with a new fingerprint for *P. globosa*. Using this new fingerprint, the method is sensitive enough to be used as a good first-order approximation of phytoplankton group abundances and to track the dynamics of the main phytoplankton groups of the eastern English Channel. However, as it is the case with all spectral fluorometers, the determination of absolute contributions of phytoplankton groups in term of chl *a* concentration can be subject to some bias.

In the next parts of this thesis, this technique was used, during field studies, as a crude method for tracking the main changes in phytoplankton assemblages.

In the second chapter, the performances and limits of the Phyto-PAM in the measurement of photosynthetic parameters differentiated into algal groups were investigated. As in the case of the FluoroProbe, a particular attention was given to the species commonly found in the eastern English Channel and the possibility to make the distinction between the photosynthetic performances of Diatoms and those of *P. globosa* in mixed assemblages was evaluated. The reliability of the Phyto-PAM estimations of photosynthetic parameters differentiated into algal groups was found to be strongly dependent on the group specific calibration of reference spectra. It was demonstrated that the use of reference spectra that do not correspond to the taxonomic composition and/or physiological status of algal groups within mixed assemblages results in significant errors in photosynthetic parameters

estimations. This constitutes a problem for the application of the Phyto-PAM in the field because for the calibration of reference spectra normally only laboratory cultures are available and *a priori* information on the physiological status of each algal groups within natural assemblages are lacking. The tests made on the distinction between the photosynthetic performances of *P. globosa* and those of Diatoms indicated that the photosynthetic parameters estimations of these species in mixed assemblages are not only dependent on the reference spectra used but also on species concentration within assemblages. This clearly invalidates the possibility to use the Phyto-PAM to make the distinction between the photosynthetic performances of *P. globosa* and those of Diatoms in mixed assemblages. In the eastern English Channel, these two groups compose the main part of phytoplankton biomass and are followed by Dinoflagellates and Cryptophytes in term of abundance (Lefebvre et al. 2011). The pigment composition of Dinoflagellates and Diatoms are too similar to be differentiated by spectral fluorescence and, contrary to the FluoroProbe, the Phyto-PAM has no LEDs to specifically excite the phycoerythrin of Cryptophytes. Consequently, the fluorescence signal of Dinoflagellates, Cryptophytes, *P. globosa* and Diatoms is confounded and classified in the brown algae group. To conclude, in its present configuration, the Phyto-PAM is unable to make the distinction between the main phytoplankton groups of the eastern English Channel.

For field studies, faced with the difficulties to correctly calibrate the reference spectra and because the Phyto-PAM is unable to make the distinction between the main phytoplankton groups of the eastern English Channel, we decided to not use the fluorescence signals resulting from the deconvolution procedure. We used the original fluorescence signal resulting from excitation at 470 nm. In this manner, the Phyto-PAM was used as a classical single wavelength PAM fluorometer and only the photosynthetic activity at community level was measured.

In the third chapter, the use of two fluorescence methodologies (RLC and N-SSLC) for *in situ* assessment of phytoplankton photosynthetic activity was compared during a field work. This study validates the use of RLC to characterize the phytoplankton photosynthetic activity at diel and seasonal scales. RLC are therefore the methodology that was employed during the field studies presented in the next part of this thesis.

Troisième partie:

**Dynamiques de l'activité photosynthétique
du phytoplancton en Manche orientale**

Third part:

*Dynamics of phytoplankton activity in the
eastern English Channel*

Avant propos

Cette partie présente les résultats des études de terrain des dynamiques de l'activité photosynthétique du phytoplancton dans les eaux côtières du Déroit du Pas-de-Calais. Trois jeux de données ont été acquis afin de caractériser l'activité photosynthétique du phytoplancton à différentes échelles spatiales et temporelles :

- le premier jeu de données est un suivi de la variabilité spatio-temporelle des paramètres photosynthétiques le long d'un transect côte-large
- le second jeu de données caractérise la variabilité des paramètres photosynthétiques à court-terme (de l'échelle horaire à l'échelle d'un cycle de marée morte-eau / vive-eau)
- le troisième jeu de données permet de caractériser la variabilité des paramètres photosynthétiques à une plus grande l'échelle temporelle allant de la variabilité à l'échelle d'une semaine à la variabilité pluriannuelle.

Les périodes d'échantillonnages sont représentées sur la Fig. P.1.

Preface

This part presents the results of field studies of phytoplankton photosynthetic activity in the coastal waters of the Strait of Dover. Three data sets were acquired to characterise dynamics of phytoplankton photosynthetic activity at different spatial and temporal scales:

- the first data set is a monitoring of spatio-temporal variability in photosynthetic parameters along an inshore-offshore transect
- the second data set characterise short-term variability of photosynthetic parameters (from hourly scale to the scale of a tidal cycle neap tide / spring tide)
- the third data set characterise variability at a longer time scale from variability at the scale of a week to pluriannual variability

Sampling periods are represented in Fig. P.1. below.

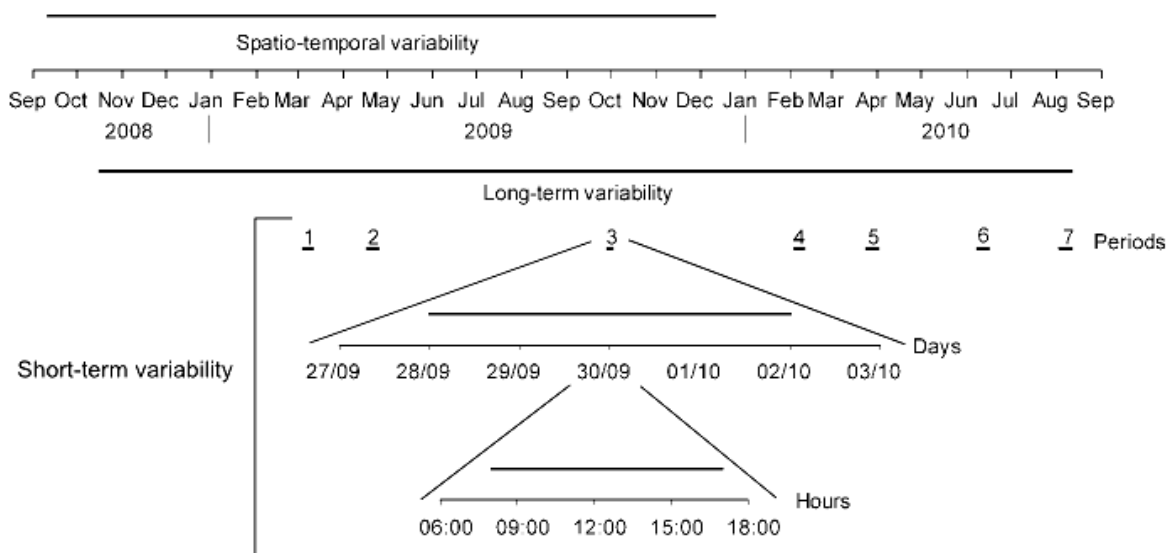

Fig. P.1. Sampling periods and scales studied

Chapitre IV

Variabilité spatio-temporelle de l'activité photosynthétique du phytoplancton dans un écosystème macrotidal (le Déroit du Pas-de-Calais, Manche orientale)

Spatio-temporal variability of phytoplankton photosynthetic activity in a macrotidal ecosystem (the Strait of Dover, eastern English Channel)

Emilie Houliez^{1*}, Fabrice Lizon¹, Luis Felipe Artigas²,

Sébastien Lefebvre¹, François G. Schmitt¹

¹ Université Lille Nord de France, Université des Sciences et Technologies de Lille – Lille 1, Laboratoire d'Océanologie et de Géosciences - CNRS, UMR 8187, Station Marine de Wimereux, 28 Avenue Foch, 62930 Wimereux, France

² Université Lille Nord de France, Université du Littoral Côte d'Opale Laboratoire d'Océanologie et de Géosciences, – CNRS, UMR 8187, Maison de la Recherche en Environnement Naturel, 32 Avenue Foch, 62930 Wimereux, France

*Corresponding author: emilie.houliez@ed.univ-lille1.fr

Phone : +33 3 21 99 29 22

Fax : +33 3 21 99 29 01

Résumé

Les paramètres photosynthétiques, les assemblages phytoplanctoniques et les paramètres physico-chimiques ont été analysés, dans le Déroit du Pas-de-Calais, le long d'un transect côte-large, entre Septembre 2008 et Décembre 2009. Les échantillons ont été collectés chaque semaine au niveau de neuf stations uniquement en surface ou en surface et en profondeur. L'activité photosynthétique a été obtenue en mesurant des courbes rapides de réponse à la lumière (Rapid Light Curves, RLC) en utilisant la fluorescence par modulation d'impulsions en amplitude (PAM, Pulse Amplitude Modulated fluorometry). Les variations temporelles de l'efficacité maximale d'utilisation de la lumière (α), du taux de transport maximum des électrons (ETR_m) et du coefficient de saturation lumineuse (E_k) étaient plus grandes que les variations spatiales (dans les dimensions verticales et horizontales) tandis que la variabilité temporelle du rendement quantique maximum (F_v/F_m) était du même ordre de grandeur que sa variabilité spatiale au sein de la colonne d'eau (dans la dimension verticale). ETR_m et α étaient positivement corrélés et la pente de la relation variait significativement entre les différentes profondeurs et saisons. Les plus fortes valeurs du ETR_m et de α ont été obtenues en été (Juin) et en fin d'automne – début de l'hiver (Septembre-Octobre et Décembre) et les plus faibles au printemps (Mars-Avril). La variabilité spatiale de ces paramètres était plus forte verticalement qu'horizontalement. Les différences entre les profondeurs étaient particulièrement prononcées au niveau de la station la plus proche de la côte où la réponse photosynthétique semble être contrôlée par l'histoire lumineuse des cellules. Les variations saisonnières de l'activité photosynthétique étaient principalement liées aux assemblages phytoplanctoniques, à la lumière et à la température tandis que l'histoire lumineuse des cellules au sein de la colonne d'eau pourrait être le facteur le plus important dans la variabilité en fonction de la profondeur.

Mots clés : paramètres P-E, phytoplancton, variabilité spatiale et temporelle, fluorescence variable de la chlorophylle *a*, photosynthèse

Abstract

Photosynthetic parameters, phytoplankton assemblages and physicochemical parameters were analysed in the Strait of Dover along an inshore-offshore transect between September 2008 and December 2009. The samples were collected weekly at 9 stations only at the surface or at both surface and depth. The photosynthetic activity was obtained by measuring Rapid Light Curves (RLC) using Pulse Amplitude Modulated (PAM) fluorometry. Temporal variability of the maximal light utilization efficiency (α), maximum electron transport rate (ETR_m) and light saturation coefficient (E_k) were greater than spatial variability (in horizontal and vertical dimensions) whereas temporal variability of the maximum quantum yield (F_v/F_m) was of the same order of magnitude as its spatial variability within the water column (in vertical dimension). ETR_m and α were positively correlated and the slope of the relation varied significantly between the different depths and seasons. The highest values of ETR_m and α were obtained in summer (June) and late autumn - early winter (September-October & December) and the lowest in spring (March-April). The spatial variability of these parameters was higher vertically than horizontally. Differences between depths were particularly pronounced at the station nearest to the coast where photosynthetic response seems to be controlled by the light history of the cells. Seasonal variability in photosynthetic activity was mostly related to phytoplankton assemblages, light and temperature whereas the light history of the cells within the water column could be the most important factor in depth variability.

Keywords: P-E parameters, phytoplankton, spatial and temporal variability, variable chlorophyll *a* fluorescence, photosynthesis

1 INTRODUCTION

Phytoplankton primary production forms the basis of aquatic food web and is a key process in biogeochemical cycles (Cloern 1996, Falkowski & Raven 2007). This production of organic matter is dependent on phytoplankton photosynthetic activity. Phytoplankton assemblages have the capacity to rapidly adjust their photosynthetic activity in response to changes in environmental conditions so that under natural conditions, their photosynthetic activity is constantly modified. Results from previous laboratory and field studies highlighted several factors influencing phytoplankton photosynthetic activity. The main factors are light (Anning et al. 2000, Dimier et al. 2009a, Gameiro et al. 2011), nutrient availability (Cullen et al. 1992, Lippemeier et al. 1999, Lippemeier et al. 2001), temperature (Davison 1991, Claquin et al. 2008) and phytoplankton community structure (Shaw & Purdie 2001, Van Hilst & Smith Jr 2002, Jouenne et al. 2007). In the field, co-variation of these factors is frequent and several of them may be simultaneously implied in the photosynthetic variability of natural phytoplankton assemblages (Shaw & Purdie 2001). Indeed, environmental variability can act directly on the physiological state of each phytoplankton species (Lohrenz et al. 1994, Lizon et al. 1995) or indirectly through changes in species composition, which in turn change the photosynthetic capacities of assemblages (Macedo et al. 2001, Jouenne et al. 2005).

While temporal variability of photosynthetic parameters has been extensively studied in different ecosystems over different time scales including seasonal (e.g. Mallin et al. 1991, Tillmann et al. 2000, Macedo et al. 2001, Jouenne et al. 2007), daily (e.g. Côté & Platt 1983, Vandavelde et al. 1989) and diel scales (e.g. Harding Jr. et al. 1982, Erga & Skjoldal 1990, Lizon et al. 1995, Jouenne et al. 2005), their spatio-temporal variability has been less frequently characterized notably in highly variable systems where photosynthetic parameters

were mainly studied in estuaries and bays (e.g. Kocum et al. 2002, Azevedo et al. 2010). The scarcity of spatio-temporal characterization of photosynthetic parameters in highly variable systems may be due in part to methodological limitations. Indeed, the photosynthetic activity has traditionally been measured using oxygen (Gaarder & Gran 1927, Montford 1969) and/or carbon isotope tracers methods (Steemann Nielsen 1952, Hama et al. 1983). These methods, in addition to being expensive, require complex incubation procedures that are both laborious and time-consuming. Such technical constraints limit consequently the spatio-temporal resolution for studying photosynthetic activity and their use becomes rapidly difficult and laborious in highly dynamic ecosystems where frequent samplings at different scales are necessary to fully understanding photosynthetic processes.

An adequate tool to overcome this problem is the use of the more recent techniques, based on *in vivo* chlorophyll *a* fluorescence, such as the fast repetition rate fluorometry (FRRF) (Kolber et al. 1998) and pulse amplitude modulated (PAM) fluorometry (Schreiber et al. 1986) that have the potential to greatly extend the spatio-temporal resolution at which phytoplankton physiological parameters can be measured *in situ* (Kolber & Falkowski 1993). It is therefore important to improve our understanding of the relationships between fluorescence (and derived photosynthetic parameters of natural communities) and environmental factors (Moore et al. 2005).

In the eastern English Channel, like in most highly variable systems, phytoplankton photosynthetic activity has been mainly studied in an estuarine-bay area using isotope tracer method (^{14}C). While temporal variability of photosynthetic activity was relatively well characterized by Jouenne et al. (2005, 2007), data on spatial variability are scarce and limited either to the vertical dimension (with a focus on the spring and summer periods) (Lizon et al. 1995, Jouenne et al. 2005) or to an estuarine bay-area (Jouenne et al. 2007). Moreover, considering the pronounced hydrographical and topographical differences in different parts of

the eastern English Channel, results from one part are not directly assignable to other sub-regions of the eastern English Channel. As a result, very few data are available on spatio-temporal dynamics of photosynthetic activity in the most highly hydrodynamic areas of the eastern English Channel such as the Strait of Dover.

The Strait of Dover is a shallow shelf area with a strong hydrodynamism. The tidal range (between 3 to 9 m) is one of the largest in the world, and tides are characterized by a residual circulation parallel to the coast, with coastal waters drifting from the English Channel into the North Sea. This coastal circulation is referred to as the “coastal flow” (Brylinski et al. 1991). Coastal waters are influenced by fresh-water run-off from the Seine Estuary to the Strait of Dover and separated from offshore waters by a transient, tidally controlled frontal area. Low salinity, high turbidity, high phytoplankton biomass and high productivity (Brunet et al. 1992, Brunet et al. 1993) characterize these waters.

The aim of this study was to characterize the spatio-temporal variability of phytoplankton photosynthetic activity along an inshore-offshore transect situated in the Strait of Dover and to relate as far as possible the observed variations to environmental factors. Considering the complex nature of currents and spatial heterogeneity of water circulation in this area, a strong spatio-temporal variability of phytoplankton photosynthetic activity was expected.

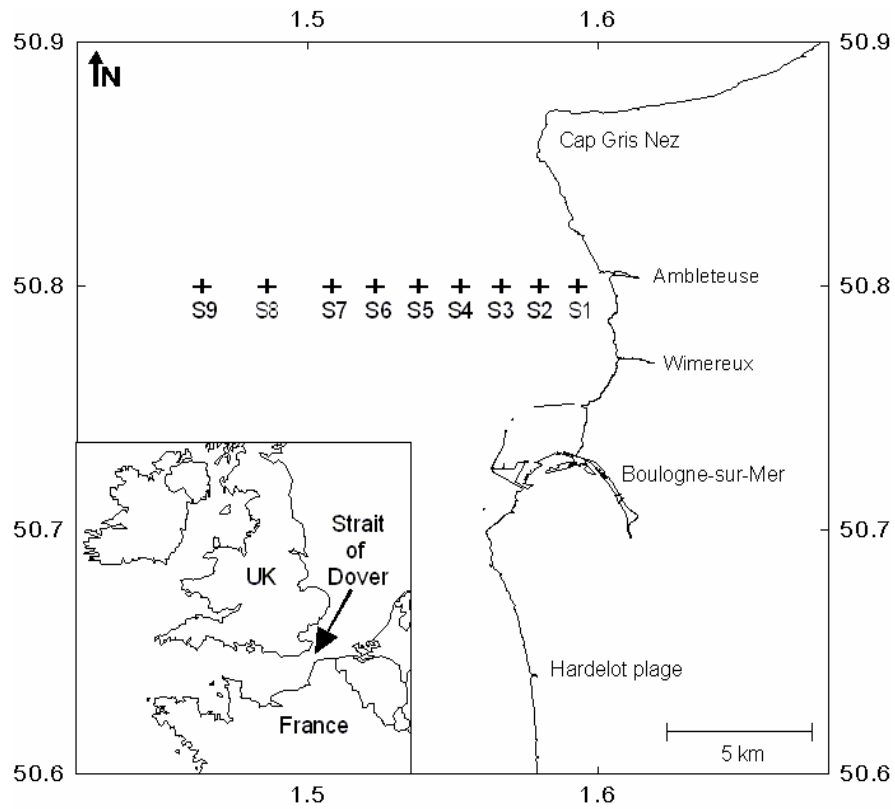

Fig. 4.1. Map of the Strait of Dover with enlarged area representing the location of sampling stations. Crosses indicate sampling stations

2 MATERIALS AND METHODS

2.1 Methodology and physicochemical measurements

From September 2008 to December 2009, samples were collected approximately weekly (on 28 dates depending on weather and ship availability) at nine stations along an inshore-offshore transect (Fig. 4.1) aboard the RV “Sepia II” (CNRS, INSU). For each sampling date, the stations were visited at the same hour each morning. At each sampling station, profiles (with a resolution of 0.25 m) of sea water temperature, salinity, and light were obtained with a CTD Seabird probe (SBE 19) equipped with a PAR sensor (QSP 2300, Biospherical Instrument). Water samples for biological and chemical measurements were collected only at the surface at stations S2, S4, S6 & S8 and at both surface and depth at stations S1, S3, S5, S7 & S9 using 8 L Niskin bottles. Surface samples were taken at a depth of 1 m whereas depth samples were taken at 1 m from the bottom i.e. at a depth of 6, 18, 22, 27 & 51 m respectively for stations S1, S3, S5, S7 & S9. Nutrients (NO_3^- , NO_2^- , Si(OH)_4 , PO_4^{3-}) concentrations were measured with an Alliance Integral Futura Autoanalyser II according to the method of Aminot and K erouel (2007).

2.2 Chlorophyll *a* and phytoplankton assemblages

Chlorophyll *a* (chl *a*) concentrations were determined by filtering known volumes of water samples through Whatman 47 mm GF/F glass-fibre filters. The filters were stored at -80°C and subsequently extracted in 90% acetone. Chl *a* concentration was evaluated by

fluorometry using a Turner Designs fluorometer (Model 10-AU) calibrated using known concentrations of commercially purified chl *a* (Sigma). The fluorescence was measured before and after acidification with HCl (Lorenzen 1966, Aminot & K  rouel 2004).

The composition of phytoplankton assemblages was investigated *in situ* using a submersible spectral fluorometer (the FluoroProbe, bbe-Moldaenke, Kiel, Germany). This probe was coupled with the CTD Seabird probe. For a detailed description of the FluoroProbe see Beutler et al. (2002). Briefly, using excitation spectra of chl *a* fluorescence, the FluoroProbe is able to discriminate four spectral algal groups in mixed populations: brown algae (diatoms + dinoflagellates), cyanobacteria (cyanobacteria with phycocyanin), green algae (Chlorophyta) and “Cryptophyta” (Cryptophyta, Rhodophyta, cyanobacteria with phycoerythrin). In our study area, the dominant groups are diatoms and the Haptophyte *Phaeocystis globosa*. Consequently, the FluoroProbe was recalibrated in order to successfully discriminate this Haptophyte from the other brown algae. The fingerprint obtained for *P. globosa* was used instead of the fingerprint of green algae. Further details on this calibration and the FluoroProbe functioning are provided in Houliez et al. (2012).

2.3 Photosynthetic activity

Photosynthetic activity of phytoplankton was obtained by measuring rapid light curves (RLC) using Pulse Amplitude Modulated fluorometry (PAM). All measurements were done in triplicate using a Phyto-PAM fluorometer (Heinz Walz GmbH, Effeltrich, Germany). For a detailed description of the Phyto-PAM, see Kolbowski and Schreiber (1995) and Schreiber (1998). The fluorescence terminology follows van Kooten and Snel (1990). Before the start of the RLC, microalgae were dark-acclimated for 15 minutes and fluorescence levels F_0 and F_m

were determined respectively before and after a saturating pulse (200 ms at around 4000 $\mu\text{mol photons m}^{-2} \text{ s}^{-1}$) to obtain the maximum quantum yield ($F_v/F_m = (F_m - F_0)/F_m$). Samples were then exposed for 10 s to 20 increasing light levels (from 22 to 1384 $\mu\text{mol photons m}^{-2} \text{ s}^{-1}$). Light levels (E) were measured using the Spherical Micro Quantum Sensor US-SQS (Heinz Walz GmbH, Effeltrich, Germany). At each light level, the effective quantum yield of photosystem II (ΦPSII also noted $\Delta F/F_m'$) was measured by applying a saturating pulse and was calculated according to Genty et al. (1989) :

$$\Phi\text{PSII} = \Delta F/F_m' = (F_m' - F)/F_m'$$

where F_m' is the maximum fluorescence emitted by the light-acclimated sample after a saturating pulse and F is the fluorescence level of the light-acclimated sample measured just prior to the saturating pulse.

ΦPSII was then used to calculate the absolute electron transport rate (ETR):

$$\text{ETR} = \Phi\text{PSII} \times E \times 0.5 \times \bar{a}_{\text{phy}}^*$$

where E ($\mu\text{mol photons m}^{-2} \text{ s}^{-1}$) is the actinic irradiance, 0.5 is a multiplication factor because the transport of one electron requires two photons (one per photosystem) (Gilbert et al. 2000, Kromkamp & Forster 2003), \bar{a}_{phy}^* ($\text{m}^2 (\text{mg chl } a)^{-1}$) is the spectrally averaged (400-700 nm) chlorophyll *a* specific absorption coefficient (see below for its measurement).

Light response curves were fitted using the model of Eilers and Peeters (1988) to estimate the maximal light utilization efficiency (α) which correspond to the initial slope of the curve, the maximum electron transport rate (ETR_m) which is the asymptote of the curve and the light saturation coefficient (E_k) calculated as ETR_m/α . This model was used to fit all the data because it is founded on physiological mechanisms and described at best the data points in the overall cases.

Fitting were achieved by using the downhill simplex method of the Nelder-Mead model, and standard deviation of parameters was estimated by an asymptotic method. All

fittings were tested by analyses of variance ($P < 0.001$), residues being tested for normality and homogeneity of variance, and parameters significance by Student's t-test ($P < 0.05$). All the curve fitting processes and associated statistics were coded under MATLAB R2010b.

E_k indicates the irradiance at which light and dark reactions of photosynthesis are balanced. It has frequently been used to describe the phytoplankton photoacclimation state (Sakshaug et al. 1997, Behrenfeld et al. 2004). To characterize this state more easily, the ratio E_k/E_m was calculated where E_m is the mean water column irradiance ($\mu\text{mol photons m}^{-2} \text{ s}^{-1}$). An E_k/E_m ratio close to 1 illustrates a photoacclimated state: the light-harvesting is optimised and E_k and E_m are almost equal. A low E_k/E_m ratio (less than 1) indicates that light is too high to be efficiently used: there is an imbalance between light-harvesting and downstream photosynthetic reactions and this situation can result in photoinhibition. A high ratio (above 1) indicates a lack of photoacclimation and a potential light limitation: the phytoplankton photosynthetic abilities are too high in comparison with the mean water column irradiance (Tillmann et al. 2000).

2.4 Mean chl *a*-specific absorption coefficients

The mean chl *a*-specific absorption coefficients (\bar{a}_{phy}^*) were obtained by measuring the optical density (OD) spectrum of samples filtered on Whatman GF/F filters according to the method of Mitchell et al. (2003). The OD spectrum was measured on the wet glass-fibre filter attached on a quartz glass plate between 300 and 800 nm with 0.5 nm increments using a dual beam spectrophotometer (UV-2450, Shimadzu). A clean filter wetted with ultra-filtered (0.2 μm) sea water was used as a reference. The OD of the filter sample was corrected for the optical path length across the filter and the algal deposit on top of it, yielding the OD

corresponding to the same sample in suspension, using mean β -correction factors according to Mitchell (1990). The average OD 750–800 nm was used to correct for scattering. The de-pigmented particle absorption spectrum was obtained after extraction of the pigments in a solution of 98% methanol. The spectral absorption coefficient for phytoplankton pigments, $a_{\text{phy}}(\lambda)$, was calculated by subtracting the de-pigmented particle absorption spectrum to the absorption coefficient of total filtered particles and was normalized to the chlorophyll *a* concentration to obtain the chl *a*-specific absorption: $a_{\text{phy}}^*(\lambda)$. Finally, the mean absorption coefficient between 400 and 700 nm, \bar{a}_{phy}^* in $\text{m}^2 (\text{mg chl } a)^{-1}$, was calculated.

2.5 Data analyses

2.5.1 Light environment within the water column

The light attenuation coefficient (K_{par} in m^{-1}) was estimated by solving the equation $K_{\text{par}} = (\ln E_0 - \ln E_{z_t})/Z_t$ where E_0 is the irradiance at the surface ($\mu\text{mol photons m}^{-2} \text{s}^{-1}$), E_{z_t} is the irradiance at depth Z_t ($\mu\text{mol photons m}^{-2} \text{s}^{-1}$) and Z_t is the maximum depth in m (Millie et al. 2002). The mean water column irradiance (E_m , $\mu\text{mol photons m}^{-2} \text{s}^{-1}$) was determined as $E_m = E_0 [1 - \exp(-K_{\text{par}} Z_t)] / K_{\text{par}} Z_t$ (Jellison & Melack 1993). The euphotic depth (Z_{eu}) was taken as the depth where there was 1% of the surface irradiance. The depth of the mixed layer was considered the same as total depth at each sampling site, as no stratification in water column was observed.

2.5.2 Univariate and multivariate statistical analyses

Differences between stations were estimated performing Kruskal-Wallis tests whereas differences between surface and depth samples were estimated using the Mann-Whitney U test (Scherrer 2007). These statistical procedures were executed using Statistica 6. Coefficient of variation (CV) was used to quantify variability in space and time (Scherrer 2007).

An analysis of similarities (one-way ANOSIM, Clarke & Warwick 1994) was used to test the significance of the differences in phytoplankton communities between stations and seasons. The analysis was based on a Euclidean similarity matrix and was performed using PRIMER 6 (PRIMER-E Ltd., Plymouth, UK).

A redundancy analysis (RDA) was performed to characterize the relationships between photosynthetic parameters and environmental variables. The data in the photosynthetic parameters matrix were centered, standardized and Log transformed prior to analysis. Environmental variables included in the model were selected using a manual forward selection and testing their significance at 5%-level with an unrestricted Monte Carlo permutation test (499 permutations). At each step, the variable with the highest extra fit was included in the model. The procedure was stopped when the additional effect of the variable with the highest extra fit was not significant (p value > 5%). The RDA was conducted using CANOCO 4.5 and the results were visualised with CanoDraw for windows (ter Braak & Smilauer 2002).

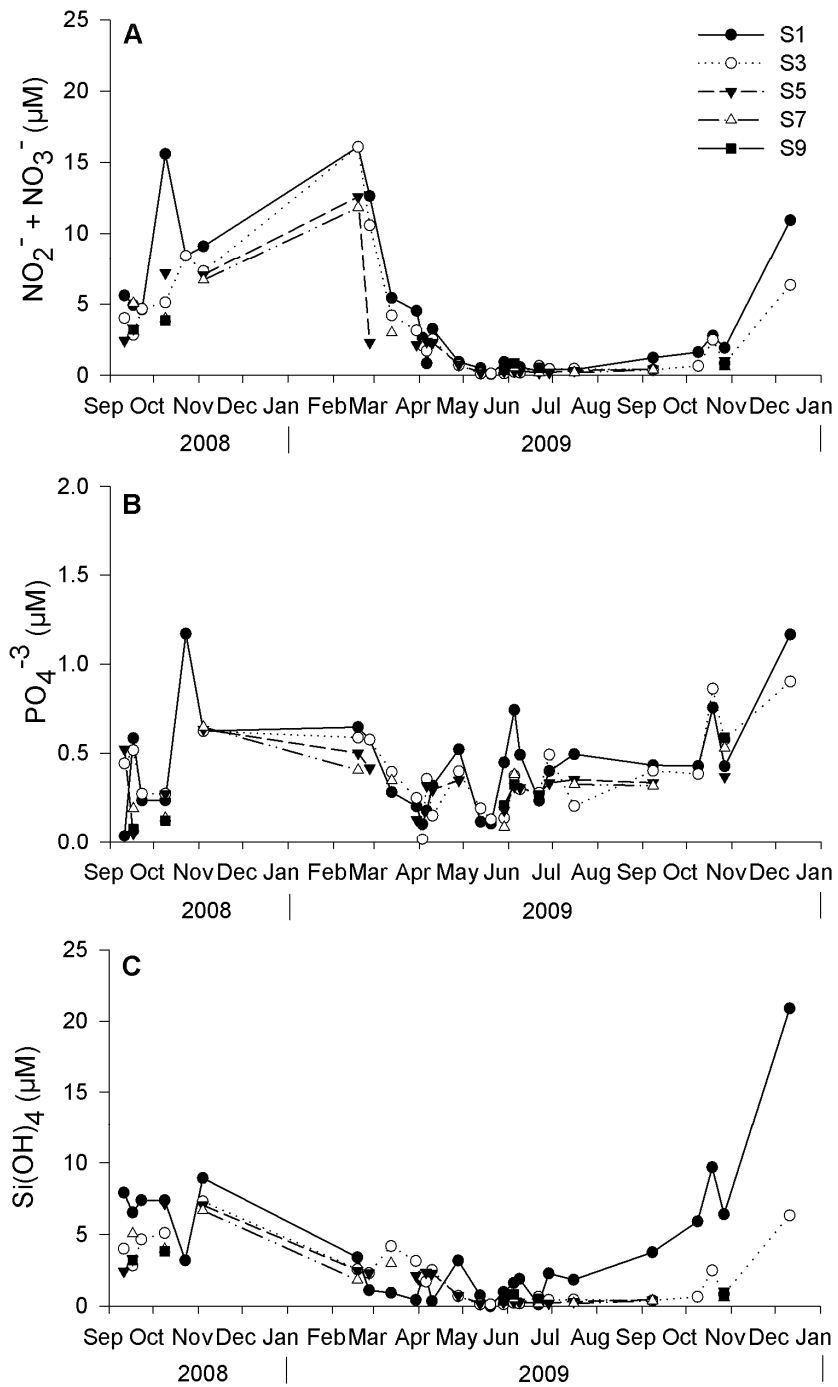

Fig. 4.2. Seasonal variation of dissolved nutrients concentration in surface waters during the sampling period. A) Nitrite and nitrate ($\text{NO}_2^- + \text{NO}_3^-$, μM), B) Phosphate (PO_4^{-3} , μM) and C) Silicate ($\text{Si}(\text{OH})_4$, μM) at stations S1 (filled circles), S3 (open circles), S5 (filled triangles), S7 (open triangles) and S9 (filled squares)

3 RESULTS

3.1 Environmental parameters

$\text{NO}_2^- + \text{NO}_3^-$ and Si(OH)_4 showed a clear seasonal variation (Fig. 4.2 A & C). They increased from September to February and decreased rapidly between March and May to reach their lowest values between May and September. PO_4^{3-} did not follow the same seasonal pattern as those of $\text{NO}_2^- + \text{NO}_3^-$ and Si(OH)_4 (Fig. 4.2 B). All year round, PO_4^{3-} values were low ($< 1.5 \mu\text{M}$). PO_4^{3-} increased punctually between September and November 2008 and between October and December 2009 and, reached their lowest concentrations in April and mid-May 2009. Nutrient concentrations were not significantly different in their vertical (Mann-Whitney U test, $P > 0.05$) and horizontal distributions (Kruskal-Wallis test, $P > 0.05$).

Sea temperature showed typical seasonal variations of temperate northern regions and ranged between 5.06°C in winter (February) and 18.90°C in summer (July). Salinity (Fig. 4.3, A) ranged between 30.3 and 34.7 with lowest values observed during spring (between March and May) and December 2009. No significant statistical differences in vertical (Mann-Whitney U test, $P > 0.05$) and horizontal distributions (Kruskal-Wallis test, $P > 0.05$) of temperature and salinity were observed.

The mean water column irradiance (E_m) was higher in the coastal waters than in the offshore waters because of the water column depth lower at the coast. Indeed, at station S1, the euphotic depth exceeded the water column depth whereas in the open sea stations only 45% of the water column was lighted. At S1, at 1 m from the bottom, the light irradiance ranged between 2.67 to $271.10 \mu\text{mol photons m}^{-2} \text{s}^{-1}$ in December and June respectively with an annual average of $45.29 \pm 54.54 \mu\text{mol photons m}^{-2} \text{s}^{-1}$. Light extinction coefficient (K_{par}) (Fig. 4.3, B) was high in spring (in March and in late April - early May) and in October 2009.

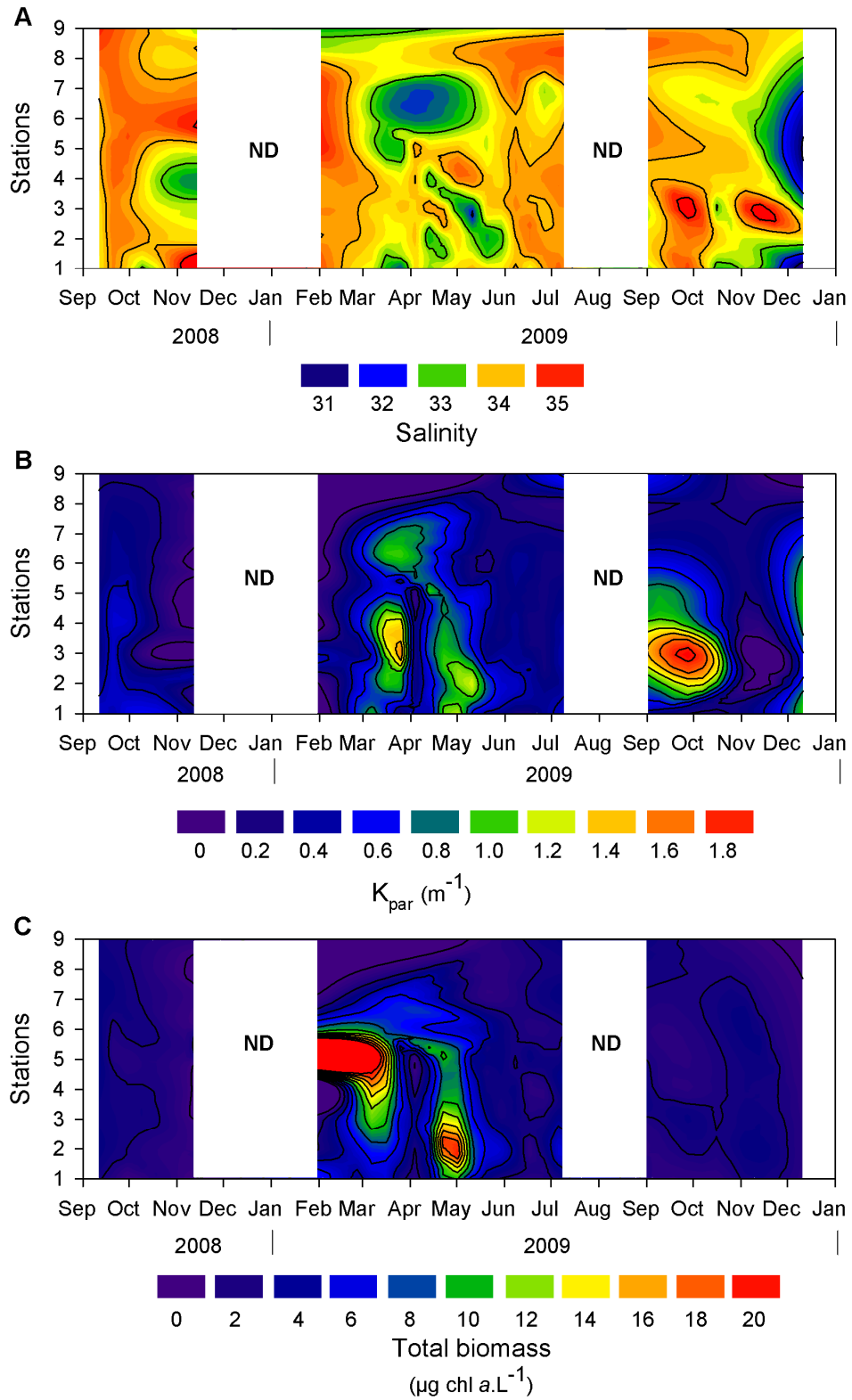

Fig. 4.3. Spatio-temporal distribution of A) salinity, B) light attenuation coefficient (K_{par}) and C) total biomass (chlorophyll *a* concentration) in surface waters. ND: no data

The annual mean K_{par} increased between stations S1 and S2 (from 0.44 to 0.53 m^{-1}) and then decreased gradually from stations S3 to S9. The euphotic zone depth (Z_{eu}) varied without any identifiable seasonal pattern. The ratio $Z_{\text{eu}}/Z_{\text{t}}$ was high at station S1 (> 1.00), relatively stable between stations S2 and S8 (around 0.60) and equal to 0.47 at station S9.

3.2 Phytoplankton biomass, assemblages composition and chl *a*-specific absorption coefficient

Total phytoplankton biomass (chl *a*) (Fig. 4.3, C) showed strong seasonal variation with maximum biomass in spring (late February - mid May, 39.6 $\mu\text{g.L}^{-1}$) and minima in autumn / winter (October – February, 0.1 $\mu\text{g.L}^{-1}$). Total phytoplankton biomass was significantly higher at depth than at surface at stations S1 to S6 (Mann-Whitney U test, $P < 0.01$) whereas no significant vertical differences were observed at open sea stations (stations S7 to S9). Horizontal distribution of phytoplankton biomass was heterogeneous (Kruskal-Wallis test, $P = 0.04$). It generally increased from stations S1 to S5 with maxima around stations S3 and S4 and then decreased from stations S6 to S9. This trend changed only between February and March with the maximum biomass located between stations S4 and S6.

In spring, two consecutive phytoplankton blooms were observed: a first bloom from late February to early April identified by the FluoroProbe as a “diatoms + dinoflagellates” bloom and a second bloom from April to mid-May identified as a *P. globosa* bloom. According to the FluoroProbe classifications, “diatoms + dinoflagellates” were always present and dominated the phytoplankton community except in May where *P. globosa* was the dominant species (Fig. 4.4, A & B). “Cryptophyta” were present all along the year with a low contribution to total biomass between February and July and a relatively high contribution

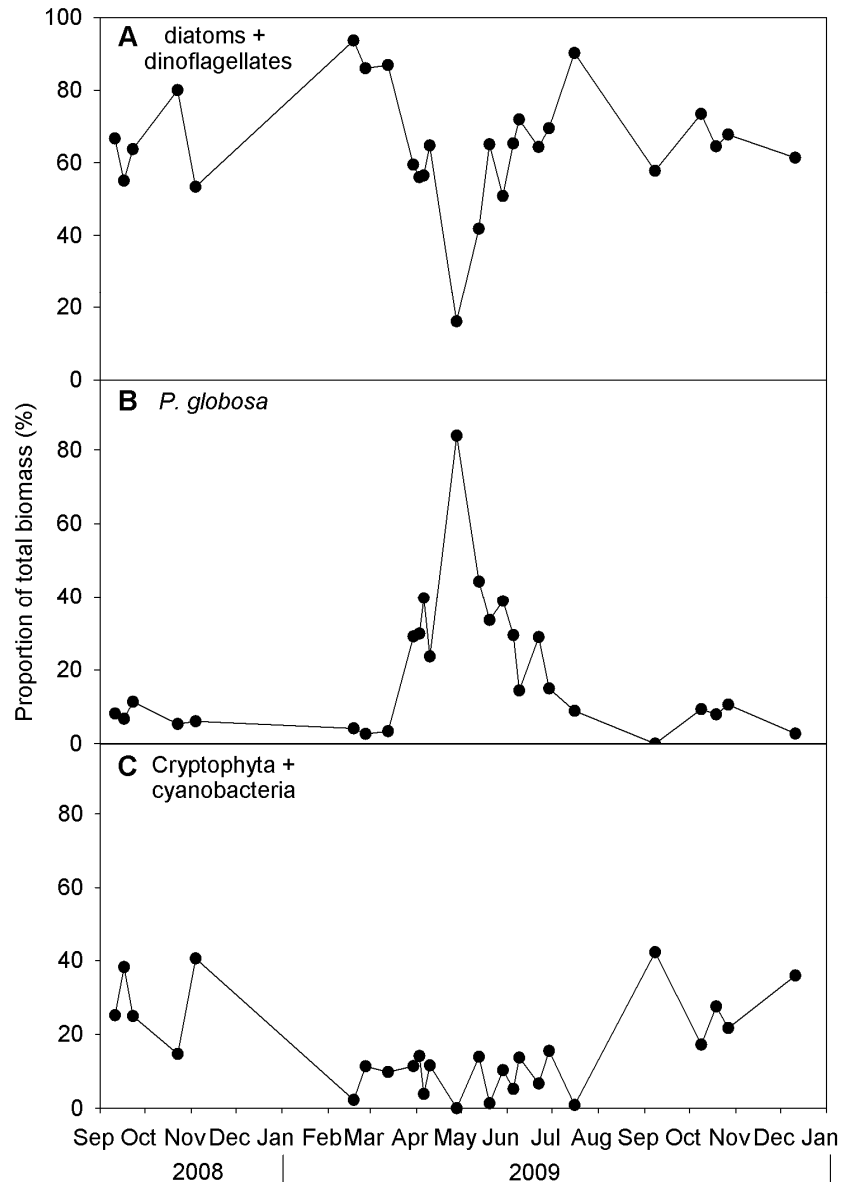

Fig. 4.4. Seasonal variation of phytoplankton assemblages shown as the proportion of total biomass for each of the major groups identified by the FluoroProbe at station S1

between September and December (Fig. 4.4, C). Analysis of similarities (ANOSIM) showed no spatial difference in phytoplankton composition between stations ($r = 0.036$, $P > 0.05$) and between surface and bottom waters ($r = 0.058$, $P > 0.05$). In contrast, significant dissimilarities were found between seasons ($r = 0.313$, $P = 0.001$) revealing seasonality on species composition with spring and summer having the highest pairwise test r value ($r = 0.352$, $P = 0.001$) while summer and winter had the lower ($r = 0.105$, $P = 0.042$).

$a_{\text{phy}}^*(440)$ varied between 0.010 and 0.185 $\text{m}^2 (\text{mg chl } a)^{-1}$, while $a_{\text{phy}}^*(676)$ varied between 0.009 and 0.054 $\text{m}^2 (\text{mg chl } a)^{-1}$. No significant vertical (Mann-Whitney U test, $P > 0.05$) and horizontal (Kruskal-Wallis test, $P > 0.05$) spatial difference was observed for \bar{a}_{phy}^* . It ranged from 0.006 to 0.058 $\text{m}^2 (\text{mg chl } a)^{-1}$ and was high in summer (June) and in late autumn - early winter (September-October & December 2009) (Fig. 4.5).

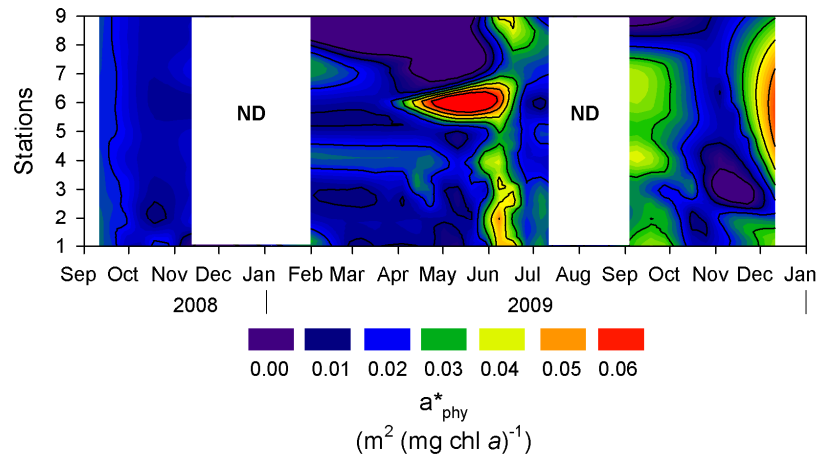

Fig. 4.5. Spatio-temporal variations of chl *a*-specific absorption coefficients (\bar{a}_{phy}^*) in surface waters. ND: no data

3.3 Photosynthetic parameters

F_v/F_m ranged from 0.22 to 0.81. The highest values were observed in late autumn - early winter whereas the lowest were observed in spring (after the “diatoms + dinoflagellates” bloom and during the *P. globosa* bloom) and in October 2009. No significant horizontal spatial variation of F_v/F_m was found (Kruskal-Wallis test, $P > 0.05$) (Fig. 4.6, A). In contrast, there were significant vertical differences with F_v/F_m higher at depth than at surface for all stations at all seasons (Mann-Whitney U test, $P < 0.001$).

ETR_m ranged from 0.19 to 8.80 $\mu\text{mol } e^- \text{mg chl } a^{-1} \text{ s}^{-1}$ and α from 0.001 to 0.020 $\mu\text{mol } e^- \text{mg chl } a^{-1} \text{ s}^{-1} (\mu\text{mol photons } \text{m}^{-2} \text{ s}^{-1})^{-1}$. The highest values of ETR_m and α were observed in

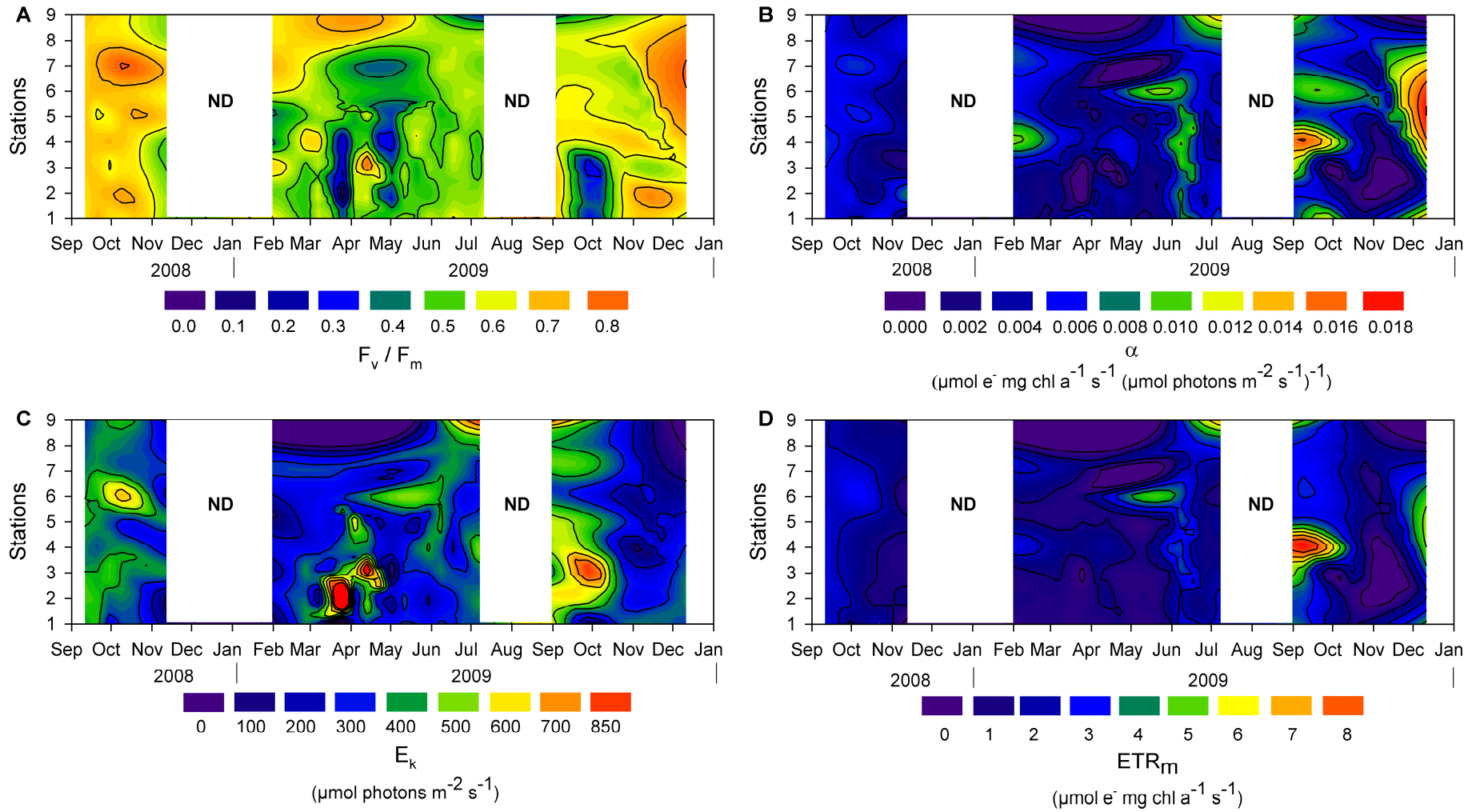

Fig. 4.6. Spatio-temporal variations of A) the maximum quantum yield (F_v/F_m), B) the maximal light utilization efficiency (α), C) the light saturation coefficient (E_k) and D) the maximum electron transport rate (ETR_m) in surface waters. ND: no data

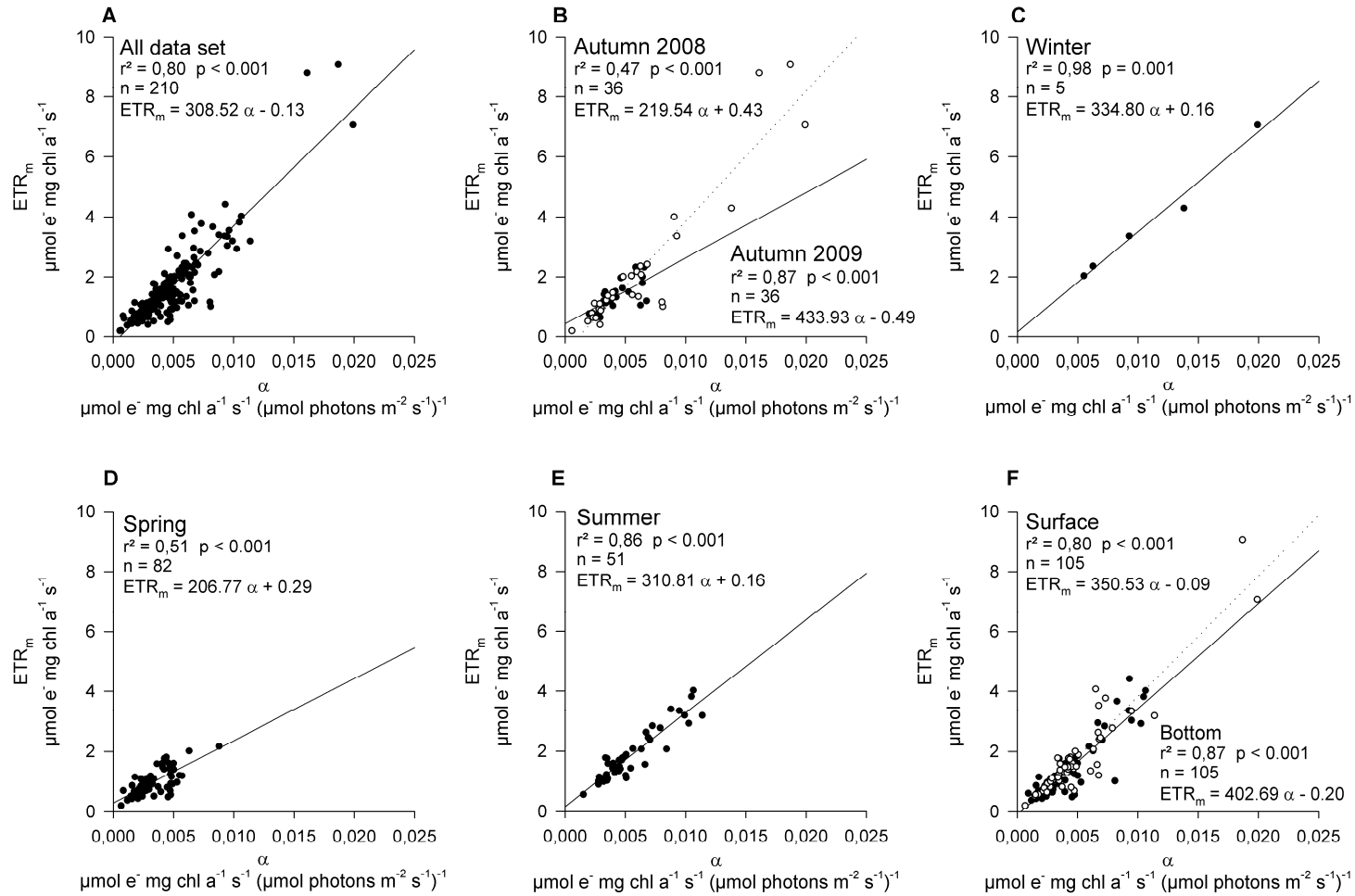

Fig. 4.7. Relationships between the maximal light utilization efficiency (α) and the maximum electron transport rate (ETR_m) A) for pooled data, B) in autumn 2008 (filled circles, solid line) & 2009 (open circles, dotted line), C) in winter, D) in spring, E) in summer and F) in surface (filled circles, solid line) and bottom waters (open circles, dotted line). Data were analysed by least-square regression. Regression equation, p value and coefficient of determination are presented

summer (June) and in late autumn - early winter (September-October & December 2009) and the lowest in spring (March-April) (Fig. 4.6, B & D). Spatially, ETR_m and α varied without any identifiable gradient between coastal and offshore waters (Fig. 4.6, B & D) and no significant difference between surface and depth was found except at station S1 where ETR_m was significantly higher at depth than at surface (Mann-Whitney U test, $P < 0.001$). ETR_m and α were positively correlated ($r^2 = 0.80$, $P < 0.001$, entire data set) with determination coefficient and slope of the regression that varied with season and sampling depth (the slopes were significantly different, $P < 0.001$) (Fig. 4.7). These different slopes indicated significant changes in E_k .

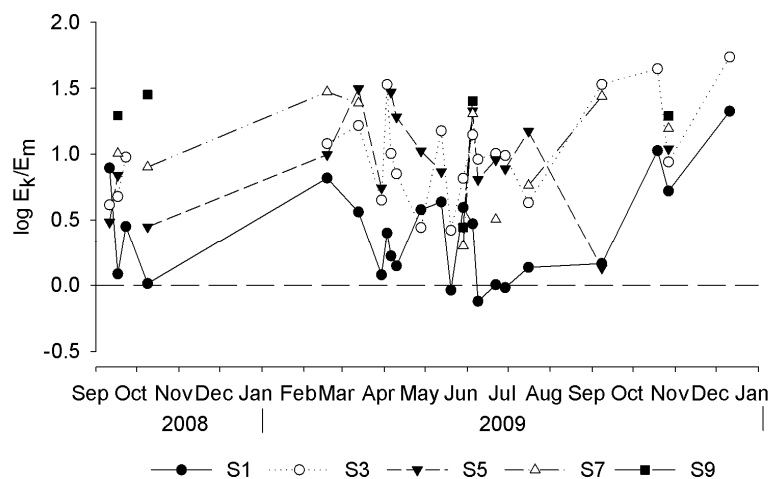

Fig. 4.8. Ratio E_k/E_m at stations S1 (filled circles), S3 (open circles), S5 (filled triangles), S7 (open triangles) and S9 (filled squares)

The E_k values ranged between 108 and 841 $\mu\text{mol photons m}^{-2} \text{s}^{-1}$. The highest values of E_k were observed in March-April 2009 and September-October 2008 & 2009 in coastal waters (Fig. 4.6, C). No significant spatial variability in horizontal dimension was found (Kruskal-Wallis test, $P > 0.05$). Within the water column, E_k was not significantly different except at S1 where it was higher at depth than at surface waters (mean values: 300 & 357 $\mu\text{mol photons m}^{-2} \text{s}^{-1}$ at surface and depth respectively, Mann-Whitney U test: $P < 0.005$). The

ratio E_k/E_m was generally above 1 (Fig. 4.8). E_k/E_m increased from coastal to offshore waters and showed a seasonal variation with the highest values in autumn - winter (between September and February) and the lowest in spring and summer (from March to August).

In mean, the spatio-temporal variability of F_v/F_m and E_k was respectively 3 and 2 times lower than ETR_m and α variations (Fig. 4.9). Temporal variability of α , ETR_m and E_k was greater than spatial variability whereas temporal variability of F_v/F_m was of the same order of magnitude as its spatial variability within the water column (Fig. 4.9). Spatial variability of these different parameters was higher in vertical than in horizontal dimension.

3.1 Relationships between photosynthetic parameters, phytoplankton assemblages and environmental parameters

The photosynthetic parameters were related to environmental variables and phytoplankton assemblages using a RDA (Fig. 4.10). The two first axes of the RDA explained 27.6% of the photosynthetic parameters variance (inertia) with 22.5% for the first axis and 5.1% for the second. The forward selection resulted in 6 environmental variables significantly ($P < 0.05$) accounting for 98.9% of the photosynthetic parameters variance explained by the two first axes of the RDA (Fig. 4.10, A). Temperature and biomass of *P. globosa* explained more than the half of the photosynthetic parameters variance (respectively 10.9 and 6.3%). The photosynthetic parameters were not significantly variable in the horizontal dimension (the

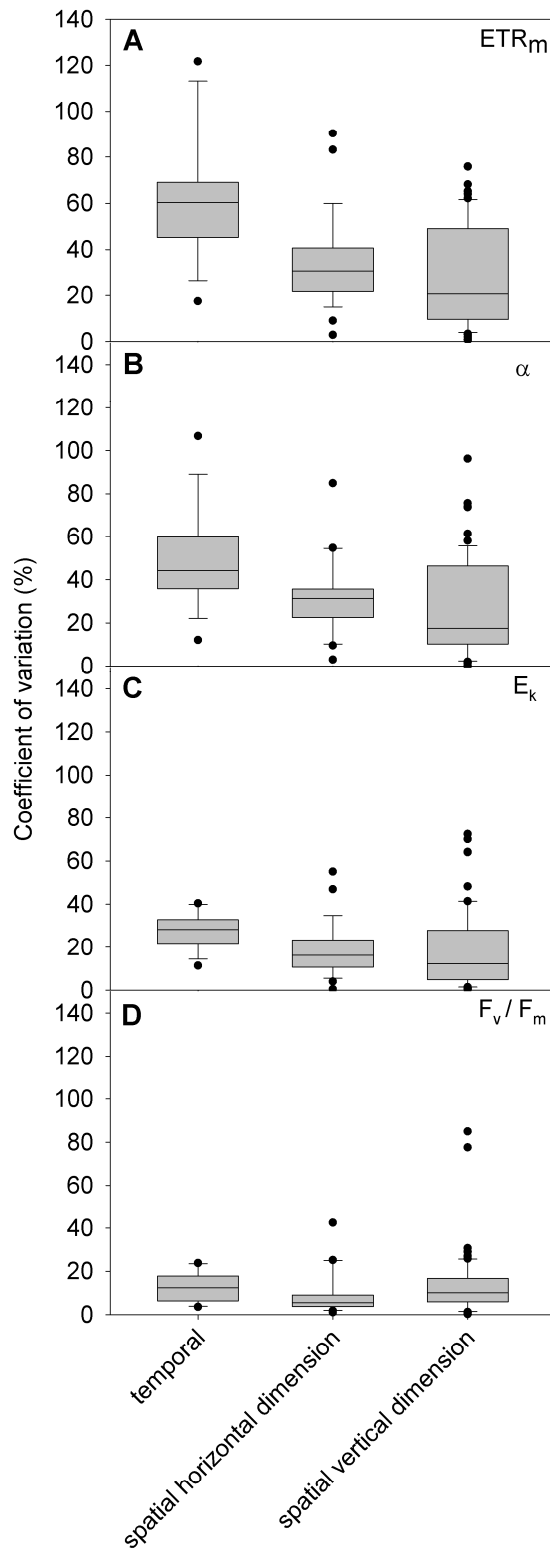

Fig. 4.9. Spatio-temporal variability of photosynthetic parameters represented by box plots of coefficients of variation (%). A) Maximum electron transport rate (ETR_m), B) Maximal light utilization efficiency (α), C) Light saturation coefficient (E_k) and D) Maximum quantum yield (F_v/F_m). Outliers are indicated by black points

distance from the coast was not selected by the forward selection procedure). By contrast, F_v/F_m was significantly higher at depth than at surface. All the photosynthetic parameters were positively correlated with temperature and negatively correlated with the biomass of *P. globosa* and chl *a* concentration revealing a seasonal variation of photosynthetic parameters. This seasonality is well visible on the sample ordination plot (Fig. 4.10, B) that shows two clusters defined by the chlorophyll *a* concentration and four groups defined by temperature. The RDA also indicated a link between F_v/F_m , K_{par} and $NO_2^- + NO_3^-$ concentrations (Fig. 4.10, A). \bar{a}_{phy}^* explained a higher part of the α variability than F_v/F_m . The effects of light and $Si(OH)_4$ concentrations, although not shown explicitly in the ordination diagram, are included through their significant positive correlation with temperature and $NO_2^- + NO_3^-$ respectively

4 DISCUSSION

4.1 Dynamics of physicochemical parameters, phytoplankton and chl *a*-specific absorption coefficient

The spatial variability in physicochemical parameters and phytoplankton assemblages was low. No significant gradient of temperature, salinity and nutrients was found between coastal and offshore stations and between surface and depth waters. Only the phytoplankton biomass, E_m and k_{par} were spatially heterogeneous. The heterogeneous distribution of the phytoplankton biomass between the coastal and offshore stations agrees with the results of Brunet et al. (1992). During our study, the distinction of the “coastal flow” by the gradient of

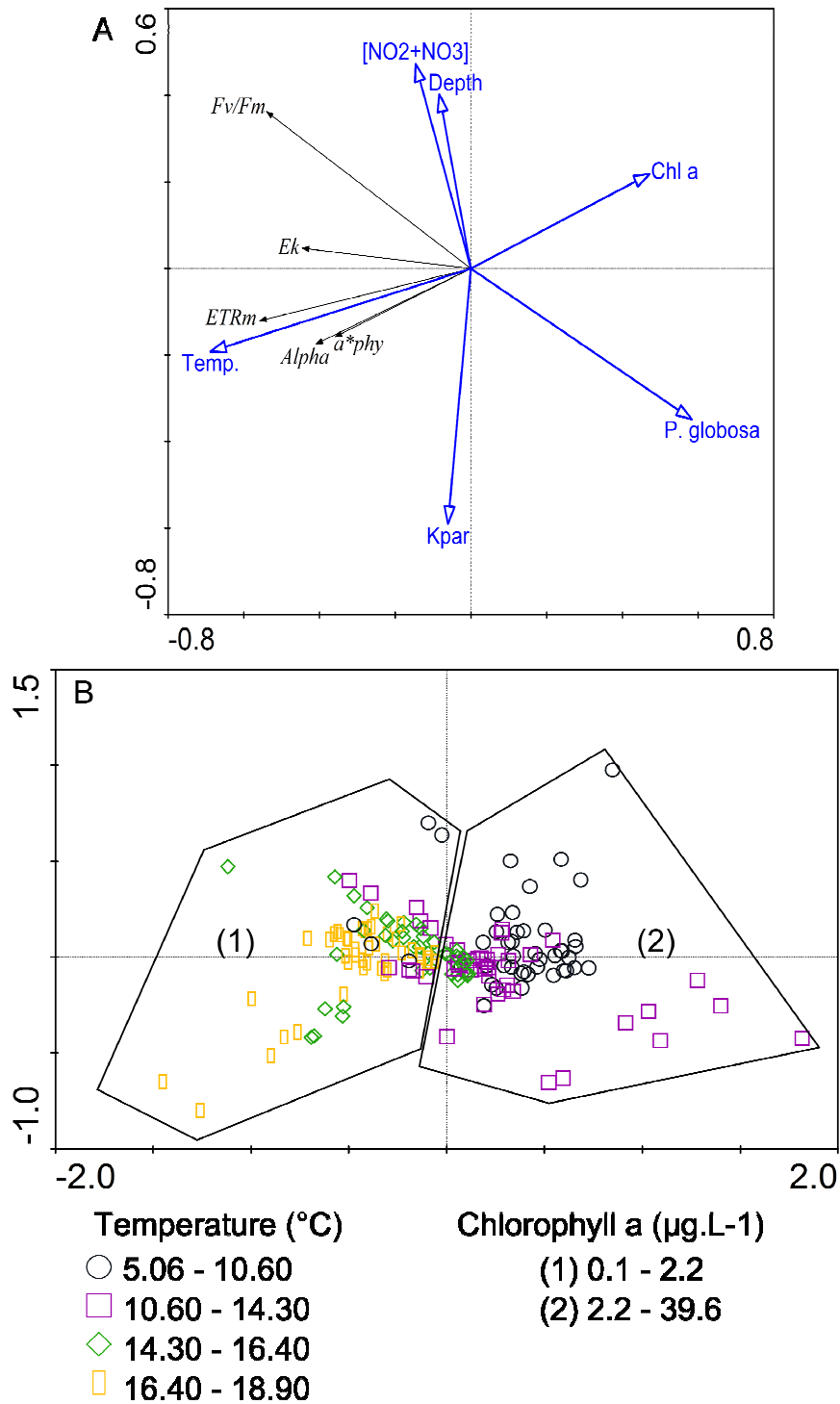

Fig. 4.10. Redundancy analysis (RDA). A) Ordination biplot showing the photosynthetic parameters in relation to environmental and biological variables. Eigenvalues on the first and second axis are respectively 0.225 and 0.050. The cumulative variance of the species-environmental relation expressed by the four canonical axes is equal to 100%. [NO₂.NO₃]: nitrite + nitrate concentration, depth: water column depth, chl a: chlorophyll *a* concentration, *P. globosa*: biomass of *Phaeocystis globosa* (FluoroProbe estimation), K_{par}: light attenuation coefficient, \bar{a}^*_{phy} : mean chl *a*-specific absorption coefficient, Alpha: maximal light utilization efficiency, Temp.: temperature, ETR_m: maximum electron transport rate, E_k: light saturation coefficient, F_v/F_m: maximum quantum yield. B) Sample ordination plot. The symbols represent the temperature groups and the polygons define the groups of chlorophyll *a* concentrations

salinity and density (Brylinski et al. 1991) was not evident probably because the samplings were done in different tidal conditions. Indeed, the frontal area is somewhat unstable and tidally controlled (details are indicated in Brunet et al. 1992). Temporal variations of physicochemical parameters and phytoplankton biomass were typical of eastern English Channel and North Sea coastal ecosystems (e.g. Gentilhomme & Lizon 1998, Lamy et al. 2006, Lamy et al. 2009, Grattepanche et al. 2011). ANOSIM analysis showed significant seasonality in phytoplankton assemblages with a certain similarity between summer and winter phytoplankton assemblages and great shifts in spring. The FluoroProbe measurements of phytoplankton composition indicated that “diatoms + dinoflagellates” dominated throughout the study period except during a short period in spring where the Haptophyte *P. globosa* became the dominant species after a “diatoms + dinoflagellates” bloom. These observations are very consistent with the spring phytoplankton successions reported by Grattepanche et al. (2011), during the same year (2009) next to our study site, and are in agreement with the previously reported phytoplankton successions during the spring blooms in the eastern English Channel (Breton et al. 2000, Seuront et al. 2006, Lefebvre et al. 2011) and the North Sea (Gieskes & Kraay 1975, Cadée & Hegeman 1986, Rousseau et al. 2000, Rousseau et al. 2002, Tungaraza et al. 2003, Stelfox-Widdicombe et al. 2004, Muylaert et al. 2006).

\bar{a}_{phy}^* was seasonally variable with high values in summer and late autumn-early winter. Our \bar{a}_{phy}^* values are consistent with the range reported in Danish coastal waters (Staehr et al. 2004) and, $a_{\text{phy}}^*(440)$ is comparable to values reported by Vantrepotte et al. (2007) in the eastern English Channel by limiting our data set to the same periods of year (February, March, May, June and July).

4.2 Photosynthetic activity dynamics

The goal of this study was to determine if the variability in photosynthetic parameters is higher in space or in time and to relate this variability to environmental conditions. Photosynthetic parameters were spatially variable; however, the spatial variability was lower than temporal.

4.2.1 Spatial variability

In the same way as environmental parameters, the spatial variability of photosynthetic parameters was low and no significant gradient between the coastal and offshore waters was found. In contrast, a significant vertical difference was observed for F_v/F_m at all stations and at S1, ETR_m and E_k were also significantly higher at depth than at surface. The vertical difference for F_v/F_m was confirmed by the RDA. These variations with depth were probably associated to light conditions, particularly the light history of the cells. Indeed, in an experimental study simulating the vertical transport of *Thalassiosira weissflogii* within a shallow water column, Van De Poll et al. (2010) found decreases of the quantum yield efficiency at surface waters associated with photoprotective mechanisms in response to light fluctuations within the water column. Our data are insufficient to link the variations of F_v/F_m to photoprotective mechanisms. However, the higher ETR_m and E_k values observed at depth at S1 while at other stations these parameters were not significantly variable with depth, supports the hypothesis of a control by the light history of the cells. Indeed, station S1 only differs from other stations by its depth and the light conditions within the water column. These results are in accordance with the findings of Lizon et al. (1995) and Jouenne et al.

(2005) who showed that, in the eastern English Channel, photoacclimation to a given light intensity can occur at neap tide, during calm conditions, when light oscillations are slower than the physiological acclimation time of phytoplankton. In this manner, they highlighted the strong links between tide, mixing conditions and photoacclimation. The relationships between the water column depth and the photosynthetic status of phytoplankton, observed in the present study, illustrates again the importance of light fluctuations rate in controlling phytoplankton photosynthetic activity in highly dynamic systems such as the Strait of Dover.

4.2.2 Temporal variability

The RDA showed a clear seasonal variability of photosynthetic parameters and indicated that water temperature and biomass of *P. globosa* were the most influential factors on photosynthetic parameters. It also showed that K_{par} and $\text{NO}_2^- + \text{NO}_3^-$ concentrations modified F_v/F_m . However, the effect of temperature might be confounded, because temperature and irradiance were positively correlated, which in this case will result in an overstatement of its effects (Gameiro et al. 2011).

The highest values of F_v/F_m were observed in late autumn - early winter whereas the lowest were observed in spring (after the “diatoms + dinoflagellates” bloom and during the *P. globosa* bloom) and in October 2009. It is known that the rapid changes in F_v/F_m are a function of light, nutrients, temperature, species composition, and recent history of environmental conditions (Corno et al. 2008). Our results showed shifts to low values of F_v/F_m in spring and autumn 2009 where variations in K_{par} and $\text{NO}_2^- + \text{NO}_3^-$ concentrations occurred simultaneously with changes in phytoplankton assemblages. Changes in phytoplankton assemblages concerned diatoms species successions and shifts from diatoms to

P. globosa dominance (Grattepanche et al. 2011). Although data on F_v/F_m values for Haptophyte microalgae are scarce, no great differences with diatom's F_v/F_m values have been reported. For diatoms and Haptophytes, in absence of nutrient and light stresses, F_v/F_m values range between 0.50 and 0.69 (Juneau & Harrison 2005, Suggett et al. 2007, Kroppenske et al. 2010). Consequently, the low F_v/F_m values observed in spring and autumn 2009 (~ 0.22) were not a taxonomic signature (Suggett et al. 2009) and probably reflected a difficulty of phytoplankton to cope with changes in environmental conditions such as changes in K_{par} and nutrient conditions.

According to Sakshaug et al. (1997), α is quantitatively related to F_v/F_m and \bar{a}_{phy}^* ($\alpha = F_v/F_m \times \bar{a}_{phy}^*$). The RDA showed that \bar{a}_{phy}^* explained a greater part of the α variability than F_v/F_m . This indicates a control of α by changes in pigmentation and pigment package effects. Indeed, it has been shown that the primary sources of variability in \bar{a}_{phy}^* are changes in pigment composition and in pigment package effects in response to changes in phytoplankton assemblages and physiological acclimations to varying environmental conditions (light, temperature and nutrient availability) (e.g. Sosik & Mitchell 1995, Bricaud et al. 2004).

ETR_m and α were always positively correlated and marked seasonal variations were observed for both parameters. The highest values of ETR_m and α were obtained in summer and in late autumn - early winter and the lowest in spring. High photosynthetic parameters in summer are common in temperate northern ecosystems and have previously been described in different studies (e.g. Tillmann et al. 2000, Jouenne et al. 2007, Gameiro et al. 2011). These summer high values have been associated to high water temperature and increased light availability. Positive relationship between the maximum photosynthetic rate (P_{max}^B) and temperature is a feature common to most field studies (Côté & Platt 1983, Lohrenz et al. 1994, Tillmann et al. 2000, Gameiro et al. 2011) and laboratory experiments also shown relationships between temperature and photosynthetic parameters (ETR_m and α) (Morris &

Kromkamp 2003, Lefebvre et al. 2007, Claquin et al. 2008). These observations are in accordance with the fact that enzymes, which are temperature dependant, are involved in the photosynthetic process (Côté & Platt 1983). In our study, although ETR_m and α were significantly correlated to temperature, high values were also observed in late autumn - early winter so that temperature and light availability could not be the sole factors driving photosynthetic parameters variability; phytoplankton community structure was probably also in cause.

Indeed, these high values coincided with periods where the FluoroProbe indicated relatively high contributions of “Cryptophyta” to total biomass. Cryptophycean flagellated cells are known to photosynthesize with a high efficiency in low-light conditions as these encountered in autumn and winter (Hammer et al. 2002). Cyanobacteria with phycoerythrine are small cell size species and certain previous studies found an inverse relationship between the cell biovolume and photosynthetic parameters (Malone & Neale 1981, Côté & Platt 1983, Montecino & Quiroz 2000). In the North Sea, a similar situation with a possible relationship between phytoplankton community changes and high values of photosynthetic parameters in autumn was observed by Shaw and Purdie (2001) and was related to shifts toward relatively high contribution of dinoflagellates to total cell carbon. The FluoroProbe does not allow the distinction between diatoms and dinoflagellates. Consequently, our data were insufficient to exclude a possible combined role of dinoflagellates and “Cryptophyta”. Although, “Cryptophyta” did not appear as the major factor driving photosynthetic parameters variability in multivariate analyses, we suggest that the high values of photosynthetic parameters in late autumn - early winter may be attributable to interspecific differences between the photosynthetic characteristics of phytoplankton groups encountered in late autumn - early winter and those encountered in spring.

These observations illustrate the multivariate facet of photosynthetic response control of natural phytoplankton assemblages within highly dynamic systems and show the difficulty in identifying the most important environmental factors affecting the variability of photosynthetic parameters. Indeed, changes in environmental conditions may influence photosynthesis directly through physiological acclimations but also indirectly through changes in species composition.

In comparison to ETR_m and α , E_k showed a lower variability. In spite of the different methods employed to measure photosynthetic parameters (fluorescence *vs.* carbon fixation), our E_k values are within the range reported for other coastal systems (Lohrenz et al. 1994, Tillmann et al. 2000, Macedo et al. 2001, Shaw & Purdie 2001, Azevedo et al. 2010). During our study period, the ratio E_k/E_m was generally above 1 revealing a poor photoacclimation and a possible light limitation of phytoplankton assemblages. Similar results of light limitation in an highly dynamic ecosystem were obtained by Tillmann et al. (2000) in the North Sea and were ascribed to the turbidity of waters.

The low variability of E_k and the positive correlation between ETR_m and α , observed in the present study, can be associated with the “ E_k -independent” variability of photosynthetic parameters described by Behrenfeld et al. (2004). Contrary to the “ E_k -dependent” variability that results predominantly from photoacclimation, the “ E_k -independent” variability is not well understood and no clear physiological explanation is at present available. Behrenfeld et al. (2004) proposed a few potential explanations implicating nutrient availability, growth-dependent changes in ATP and reductant demands or phytoplankton community structure.

The “ E_k -independent” variability has been previously reported by other authors in field studies (Côté & Platt 1983, Harding Jr. et al. 1985, Lohrenz et al. 1994, Moline et al. 1998, Jouenne et al. 2005, Azevedo et al. 2010) but none of them permitted to reach a decision between the different explanations of Behrenfeld et al. (2004). Recently, with a mesocosm

experiment, Claquin et al. (2010) obtained an “ E_k -independent” variability only after 8 days of experimentation. In spite of different dynamics of phytoplankton species successions between the different nutrient enriched mesocosms, they observed the same trend in dynamics of photosynthetic parameters so that the “ E_k -independent” variability observed in their study could not have been ascribed to phytoplankton taxonomy. They suggested that such regulation of photosynthetic activity appears when photosynthetic parameters are driven by growth constraints associated to frequent nutrient additions which do not allow replete nutrient conditions to be reached but lead to physiological equilibrium. These observations strengthen the hypothesis of Behrenfeld et al. (2004) that co-variations in photosynthetic parameters result from growth-dependent changes in ATP and reductant demands. In our case, although this hypothesis could be appropriate to our data set because of the absence of significant correlations between photosynthetic parameters, E_m and nutrient concentrations, a potential influence of phytoplankton assemblages could not be excluded particularly since the slopes of the relationship between α and ETR_m were different between each season (Côté & Platt 1983, Harding Jr. et al. 1985).

5 CONCLUSIONS

The results obtained from this study suggest that in the Strait of Dover:

- (1) Temporal variability of photosynthetic parameters is “ E_k -independent” and is higher than spatial variability.
- (2) Photoacclimation at seasonal scale is not obvious and could be masked by phytoplankton successions. In contrast, short term photosynthetic response to light conditions within the water column seems to be efficient and dependent to the light history of the cells.

(3) The structure of phytoplankton assemblages, light and water temperature are the most influential factors on photosynthetic parameters.

ACKNOWLEDGEMENTS

We thank the captain and the crew of the RV “Sepia II” for their help during fieldwork, Vincent Cornille for his technical assistance during samplings and water filtrations for chlorophyll *a* analyses, Valérie Gentilhomme for her help during laboratory measurements of nutrient concentrations, Mélodie Penel and Jessica Chicheportiche for chlorophyll *a* analyses, Xavier Mériaux for the processing of optical density spectrum and Eric Lecuyer for the maintenance of the CTD probe. This study forms part of the PhD thesis of E.H. financially supported by a grant from the French “Ministère de l’Enseignement Supérieur et de la Recherche” and the DYMAPHY INTERREG IVA “2 Mers Seas Zeeën” project co-funded by the European Union (ERDF funds).

Chapitre V

Variabilité à court-terme et contrôle de l'activité photosynthétique du phytoplancton dans un écosystème macrotidal (le Détroit du Pas-de-Calais, Manche orientale)

*Short-term variability and control of phytoplankton photosynthetic activity in
a macrotidal ecosystem (the Strait of Dover, eastern English Channel)*

Résumé

Les changements à court-terme de l'activité photosynthétique du phytoplancton ont été étudiés durant les différentes périodes de l'année, dans les eaux côtières d'un écosystème macrotidal (le Déroit du Pas-de-Calais, Manche orientale). Pendant chaque période d'échantillonnage, les échantillons ont été prélevés toutes les 1h45, du levé du jour à la tombée de la nuit, durant au moins cinq jours répartis le long d'un cycle de marée mortes eaux – vives eaux complet. Les paramètres photosynthétiques ont été obtenus en mesurant des Rapid Light Curves (RLC), en utilisant la fluorimétrie par modulation d'impulsions en amplitude (PAM), et associés aux conditions environnementales et à la composition taxonomique du phytoplancton. L'activité photosynthétique journalière du phytoplancton a été caractérisée par une importante variabilité à court-terme associée aux changements rapides des conditions environnementales, en particulier les changements de lumière, de température et des conditions nutritives, tandis que les changements des assemblages phytoplanctoniques semblaient d'importance secondaire. F_v/F_m variait en fonction de la lumière et pouvait passer du maximum physiologique à des valeurs proches de 0,30 au cours d'une seule journée. Ces variations suggèrent l'opération de mécanismes photoprotectants. ETR_m et α étaient généralement corrélés positivement et montraient une grande variabilité journalière associée aux variations de la lumière et des nutriments. Ces paramètres fluctuaient significativement d'heure en heure au sein de la journée et les patrons de variations intrajournaliers changeaient de façon significative entre les jours de chaque période d'échantillonnage. F_v/F_m , ETR_m et α étaient non seulement dépendants des conditions de lumière du jour de l'échantillonnage mais également de celles des trois jours précédents. L'indice de photoacclimatation E_k était généralement distant de la lumière incidente indiquant une capacité d'acclimatation limitée avec une faible optimisation de la capture de l'énergie lumineuse au cours de la journée.

Mots clés: paramètres P-E, variabilité à court-terme, phytoplancton, photosynthèse, fluorescence de la chlorophylle *a*

Abstract

Short-term changes in phytoplankton photosynthetic activity were studied during different periods of year in the coastal waters of a macrotidal ecosystem (the Strait of Dover, eastern English Channel). During each sampling period, samples were taken every 1.45 h., from sunrise to sunset, during at least five days distributed along a complete spring-neap tide cycle. The photosynthetic parameters were obtained by measuring Rapid Light Curves (RLC) using Pulse Amplitude Modulated (PAM) fluorometry and were related to environmental conditions and phytoplankton taxonomic composition. The diel photosynthetic activity of phytoplankton was characterized by a large short-term variability associated to the rapidly changing environmental conditions, in particular changes in light, temperature and nutrient conditions, while changes in phytoplankton assemblages seemed of secondary importance at this time scale. F_v/F_m showed clear light-dependent changes and could vary from physiological maxima to values close to 0.30 during the course of one day suggesting the operation of photoprotective mechanisms. ETR_m and α were generally positively correlated and showed a large diel variability in relation to light and nutrients variations. These parameters fluctuated significantly from hour to hour within each day and the intraday pattern of variation changed significantly among days of each sampling period. F_v/F_m , ETR_m and α were not only dependent on the light conditions of the sampling day but also on those of the three previous days. The photoacclimation index E_k was generally distant from the incident irradiance indicating a restricted acclimation capacity with a poor optimization of light harvesting during the day.

Keywords: P-E parameters, short-term variability, phytoplankton, photosynthesis, chlorophyll *a* fluorescence

1 INTRODUCTION

Coastal ecosystems are dynamic environments in which phytoplankton must cope with rapid changes in resources, particularly irradiance (Schubert et al. 2001). In such systems, phytoplankton experiences strong temporal light variations in relation to seasonal or diel cycles but also unpredictable short-term changes caused by cloud cover, focusing of light by surface waves, or movement of phytoplankton cells through the light gradient within the water column induced by advection and/or turbulence associated with currents, tide and wind mixing. These different processes modify the light environment of cells and, in extreme cases, cells can be transported through a light gradient ranging from darkness to full sunlight in few minutes (MacIntyre et al. 2000). Consequently, microalgae seldom experience constant conditions especially in well-mixed tidally controlled systems as the eastern English Channel.

Fluctuations in the underwater light climate strongly influence phytoplankton photosynthetic productivity (Marra 1978, Lewis et al. 1984, Cullen & Lewis 1988, Lizon et al. 1995, Lizon et al. 1998). Unpredictable fluctuations, and specially their extremes (darkness and excess light), can be harmful for photosynthetic activity because they can lead to an imbalance between the harvesting of light energy and its use for photochemical processes and carbon fixation (Long et al. 1994, Dubinsky & Schofield 2010). Because its survival and growth depend on its ability to cope with fluctuating conditions, phytoplankton has developed various mechanisms allowing them to rapidly acclimate to new light environment (Richardson et al. 1983). These mechanisms named photoacclimation are highly time dependent ranging from short-term non-photochemical quenching (NPQ) that operates on time scales of several seconds to minutes to long-term changes in photosynthetic unit size and structure that take place within a matter of hours to days (MacIntyre et al. 2000, Lavaud 2007).

Laboratory experiments have shown that photoacclimation processes depend on light regime (fluctuating vs. stable and high light vs. low light) and light history of cells (e.g. Buma et al. 1993, Anning et al. 2000, Harris et al. 2005, Van De Poll et al. 2007), together with growth phase (Lavaud et al. 2002, Lavaud et al. 2003, Dimier et al. 2009b) and nutrient state (Staeher et al. 2002, Van De Poll et al. 2005). Other recent studies have shown that the capacity and effectiveness of photoprotection is species/taxa dependent (e.g. Van Leeuwe et al. 2005, Kulk et al. 2011), related to the ecological niche where cells grow (Strzepek & Harrison 2004, Lavaud et al. 2007, Six et al. 2008) and may influence species distribution and succession (Meyer et al. 2000, Kropuenske et al. 2010, Mills et al. 2010). Under natural conditions, the effective impact of light fluctuations may be enhanced by the combined effects of a number of other factors such as nutrients availability, changes in temperature, water mixing, changes in phytoplankton community composition and competition between phytoplankton species. Such combinations of factors are very difficult to replicate indoor and laboratory studies are thus likely to fail to realistically describe the short-term photosynthetic responses of phytoplankton in its natural environment.

Surprisingly, in well mixed coastal ecosystems, the *in situ* short-term photosynthetic responses of phytoplankton have received little attention. Indeed, investigations on the *in situ* diel variability of phytoplankton photophysiological parameters have mainly focussed on relatively stable oligotrophic areas (e.g. Claustre et al. 1994, Vaultot & Marie 1999) or stratified waters (e.g. Brunet et al. 2008) and when studies concerned dynamic systems, they were generally based on only three sample points per day (e.g. Neale & Richerson 1987, Madariaga 1995, Azevedo et al. 2010), on samples isolated in bottles or deck microcosms (e.g. Lohrenz et al. 1994, MacCaull & Platt 1977) or were focussed on a single or two seasons during the year (e.g. Lizon et al. 1995, Jouenne et al. 2005). Moreover, the study of

phytoplankton photophysiological parameters has traditionally been based on the construction of steady-state light responses curves (SSLC).

While informative on the potential photosynthetic capacity of phytoplankton under a range of light intensities, SSLC may be inadequate to characterize the short-term photoacclimation status of phytoplankton (White & Critchley 1999). Indeed, SSLC require light steps long enough to allow the stabilisation of photosynthetic processes under each irradiance level. As a consequence, the transient effects of recent light history, defining the short-term photoacclimation status present before the start of the curve, are attenuated or eliminated during its construction (Cruz & Serôdio 2008) and only the effects of long-term photoacclimation (hours to days) can be detected and characterized by SSLC (White & Critchley 1999, Perkins et al. 2006). By contrast, the light steps of rapid light response curves (RLC) are too short to completely alter the photoacclimation status formed before the construction of the curve (White & Critchley 1999, Ralph & Gademann 2005). RLC are therefore strongly affected by the recent light history and can be used to characterize the dynamics of fast photoprotective mechanisms through the non-photochemical quenching (NPQ) processes as well as the short and long-term photoacclimation status (Cruz & Serôdio 2008).

The objectives of this work were (1) to characterize the *in situ* short-term variability in phytoplankton photosynthetic activity in a coastal ecosystem characterized by a strong hydrodynamism: the Strait of Dover, during the different seasons of year and under different tidal conditions; (2) to relate these changes to the variability in environmental factors and phytoplankton community composition. Because each season is characterized by different phytoplankton assemblages and environmental conditions and because photosynthetic competences are species/taxon dependent, short-term photosynthetic responses specific to each season and phytoplankton assemblages were expected. Samplings were carried out in the

coastal waters of Wimereux, during seven sampling periods distributed on the different seasons. During each sampling period, samples were taken every 1.45 h. from sunrise to sunset during at least five days distributed along a complete spring-neap tide cycle. The photosynthetic activity was characterised using RLC and, physicochemical parameters and phytoplankton assemblages composition were studied.

2 MATERIALS AND METHODS

2.1 Study area

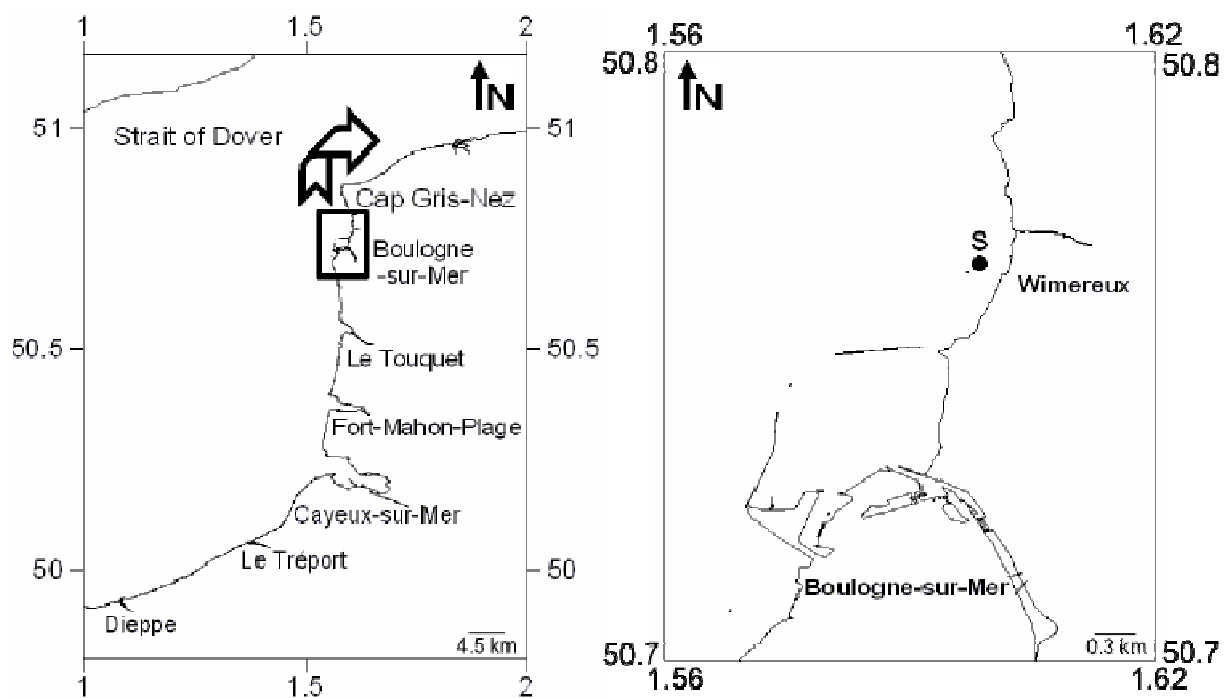

Fig. 5.1. Map of the Strait of Dover with enlarged area representing the location of sampling station (S). Coordinates are in decimal degrees

The Strait of Dover is a shallow shelf area with a strong hydrodynamism. The tidal range (between 3 to 9 m) is one of the largest in the world, and tides are characterized by a

residual circulation parallel to the coast, with coastal waters drifting from the English Channel into the North Sea. This coastal circulation is referred to as the “coastal flow” (Brylinski et al. 1991). Coastal waters are influenced by fresh-water run-off from the Seine Estuary to the Strait of Dover and separated from offshore waters by a transient, tidally controlled frontal area. Low salinity, high turbidity, high phytoplankton biomass and high productivity (Brunet et al. 1992, Brunet et al. 1993) characterize these waters. The Strait of Dover is characterized by seasonal changes in phytoplankton composition (e.g. Grattepanche et al. 2011, Lefebvre et al. 2011). Summer, autumn and winter are dominated by Diatoms. Spring is the period where phytoplankton biomass reaches its maximum and clear succession in phytoplankton communities occurs. Each year, the Haptophyte *Phaeocystis globosa* forms massive blooms between March and May and this bloom is preceded and followed by two different Diatoms blooms (Breton et al. 2000, Seuront et al. 2006, Schapira et al. 2008).

2.2 Sampling

The study was completed in the coastal waters of Wimereux ($50^{\circ}45'57.42''\text{N}$, $1^{\circ}35'55.17''\text{E}$) (Fig. 5.1). Samplings were carried out during 42 days distributed on seven sampling periods: 5 to 11 March 2009, 17 to 25 April 2009, 28 September to 2 October 2009, 3 to 10 February 2010, 24 March to 02 April 2010, 8 to 16 June 2010 and 3 to 12 August 2010. During each sampling period, samples were taken every 1.45 h. from sunrise to sunset during at least five days distributed along a complete spring-neap tide cycle for biological and chemical measurements.

2.3 Physicochemical measurements, chlorophyll *a* and phytoplankton community structure

Sea water temperature and salinity were obtained by using a conductivity meter (Cond. 315i, WTW, Weilheim, Germany). Nutrients (NO_3^- , NO_2^- , Si(OH)_4 , PO_4^{-3}) were measured with an Alliance Integral Futura Autoanalyser II according to the method of Aminot and K  rouel (2007). Incident photosynthetically active radiation (PAR in $\mu\text{mol quanta m}^{-2} \text{s}^{-1}$) was measured continuously (1 measurement by minute) with a 4π spherical quantum sensor (ultra-miniature MDS-MkV/L, JFE Alec Electronics co. LTD., Kobe, Japan).

Chlorophyll *a* (chl *a*) concentrations were determined by filtering known volumes of water samples through Whatman 47 mm GF/F glass-fibre filters. The filters were stored at -80°C and subsequently extracted in 90% acetone. Chl *a* concentration was evaluated by fluorometry using a Turner Designs fluorometer (Model 10-AU) calibrated with known concentrations of commercially purified chl *a* (Sigma). The fluorescence was measured before and after acidification with HCl (Lorenzen 1966, Aminot & K  rouel 2004).

The composition of phytoplankton community structure was investigated using a submersible spectral fluorometer (the FluoroProbe, bbe-Moldaenke, Kiel, Germany) after the recalibration of fingerprints (further details are provided in Houliez et al. 2012). The measurements of samples were made using the 25 mL cuvette of the FluoroProbe.

2.4 Photosynthetic activity

Photosynthetic activity of phytoplankton was obtained by measuring rapid light curves (RLC) using Pulse Amplitude Modulated fluorometry (PAM). All measurements were done in triplicate using a Phyto-PAM fluorometer (Heinz Walz GmbH, Effeltrich, Germany). For a detailed description of the Phyto-PAM, see Kolbowski and Schreiber (1995) and Schreiber (1998). The fluorescence terminology follows van Kooten and Snel (1990). Before the start of the RLC, microalgae were dark-acclimated for 15 minutes and fluorescence levels F_0 and F_m were determined respectively before and after a saturating pulse (200 ms at around $4000 \mu\text{mol photons m}^{-2} \text{s}^{-1}$) to obtain the maximum quantum yield ($F_v/F_m = (F_m - F_0)/F_m$). Samples were then exposed for 10 s to 20 increasing light levels (from 22 to $1384 \mu\text{mol photons m}^{-2} \text{s}^{-1}$). Light levels (E) were measured using the Spherical Micro Quantum Sensor US-SQS (Heinz Walz GmbH, Effeltrich, Germany). At each light level, the effective quantum yield of photosystem II (ΦPSII also noted $\Delta F/F_m'$) was measured by applying a saturating pulse and was calculated according to Genty et al. (1989) :

$$\Phi\text{PSII} = \Delta F/F_m' = (F_m' - F)/F_m'$$

where F_m' is the maximum fluorescence emitted by the light-acclimated sample after a saturating pulse and F is the fluorescence level of the light-acclimated sample measured just prior to the saturating pulse.

ΦPSII was then used to calculate the absolute electron transport rate (ETR):

$$\text{ETR} = \Phi\text{PSII} \times E \times 0.5 \times \bar{a}_{\text{phy}}^*$$

where E ($\mu\text{mol photons m}^{-2} \text{s}^{-1}$) is the actinic irradiance, 0.5 is a multiplication factor because the transport of one electron requires two photons (one per photosystem) (Gilbert et

al. 2000, Kromkamp & Forster 2003), \bar{a}_{phy}^* ($\text{m}^2 (\text{mg chl } a)^{-1}$) is the spectrally averaged (400-700 nm) chlorophyll *a* specific absorption coefficient (see below for its measurement).

Light response curves were fitted using the model of Eilers and Peeters (1988) to estimate the maximal light utilization efficiency (α) which correspond to the initial slope of the curve, the maximum electron transport rate (ETR_m) which is the asymptote of the curve and the light saturation coefficient (E_k) calculated as ETR_m/α . The model of Eilers and Peeters (1988) was used to fit all the data because it is founded on physiological mechanisms and described at best the data points in the overall cases.

Curve fitting was achieved using the downhill simplex method of the Nelder-Mead model, and standard deviation of parameters was estimated by an asymptotic method. All fittings were tested by analyses of variance ($P < 0.001$), residues being tested for normality and homogeneity of variance, and parameters significance by Student's t-test ($P < 0.05$). All the curve fitting processes and associated statistics were coded under MATLAB R2010b.

2.5 Mean chl *a*-specific absorption coefficients

The mean chl *a*-specific absorption coefficients (\bar{a}_{phy}^*) were obtained by measuring the optical density (OD) spectrum of samples filtered on Whatman GF/F filters according to the method of Mitchell et al. (2003). The OD spectrum was measured on the wet glass-fibre filter attached on a quartz glass plate between 300 and 800 nm with 0.5 nm increments using a dual beam spectrophotometer (UV-2450, Shimadzu). A clean filter wetted with ultra-filtered (0.2 μm) sea water was used as a reference. The OD of the filter sample was corrected for the optical path length across the filter and the algal deposit on top of it, yielding the OD corresponding to the same sample in suspension, using mean β -correction factors according to

Mitchell (1990). The average OD 750–800 nm was used to correct for scattering. The de-pigmented particle absorption spectrum was obtained after extraction of the pigments in a solution of 98% methanol. The spectral absorption coefficient for phytoplankton pigments, $a_{\text{phy}}(\lambda)$, was calculated by subtracting the de-pigmented particle absorption spectrum to the absorption coefficient of total filtered particles and was normalized to the chlorophyll *a* concentration to obtain the chl *a*-specific absorption: $a_{\text{phy}}^*(\lambda)$. Finally, the mean absorption coefficient between 400 and 700 nm, \bar{a}_{phy}^* in $\text{m}^2 (\text{mg chl } a)^{-1}$, was calculated.

2.6 Data analyses

An analysis of similarities (one-way ANOSIM, Clarke & Warwick 1994) was used to test the significance of the differences in phytoplankton communities within days (hourly scale), between the days of each sampling periods (daily scale) and between the different sampling periods. The analysis was based on a Euclidean similarity matrix and was performed using PRIMER 6 (PRIMER-E Ltd., Plymouth, UK).

The significance of the relative contribution of taxonomic groups, sampling periods, tide conditions (neap tide, spring tide), daily and hourly scales to the total variability in photosynthetic parameters was evaluated using a mixed-effects nested ANOVA model. In this model, the main nesting factor (taxonomic group) was fixed and the nested factors: sampling periods (dominated by each taxonomic group), tide conditions (within each sampling period), days (within each tide conditions) and hours (within each day) were randomized. These analyses were performed using the least square method (method of moments) with the JMP 9.0.2 (SAS) software following the instructions of Sall et al. (2007).

Coefficients of variation (CV) were used to quantify the variability of photosynthetic parameters (Scherrer 2007).

Relationships of photosynthetic parameters with environmental variables were quantified using stepwise multiple linear regression analysis. The environmental variables tested were: light, water temperature, nutrient concentrations (NO_3^- , NO_2^- , $\text{Si}(\text{OH})_4$, PO_4^{3-}), salinity, tidal range which characterizes the spring-neap tide cycle, water height which characterizes the high-low tide cycle, and assemblage composition (in term of chl *a* concentration by groups and relative proportions of total biomass). Environmental variables included in the model were selected using a forward selection and significance of the model was tested by F tests. As advised by Blanchet et al. (2008), the stopping criteria were the alpha significance level and the adjusted coefficient of multiple determination of the global model built using all environmental variables. This procedure avoids inflated Type I error and the overestimation of the amount of explained variance. This analysis was performed using MINITAB 12.2 (MINITAB Inc, USA).

Table 5.I. Physicochemical parameters: mean (SE) and coefficient of variation. E: PAR irradiance ($\mu\text{mol photons m}^{-2} \text{s}^{-1}$), water temperature ($^{\circ}\text{C}$), $\text{NO}_2^- + \text{NO}_3^-$ (μM), Si(OH)_4 (μM) and PO_4^{3-} (μM)

	Day length	E		Temperature		Salinity		$\text{NO}_2^- + \text{NO}_3^-$		Si(OH)_4		PO_4^{3-}	
		m (SE)	CV	m (SE)	CV	m (SE)	CV	m (SE)	CV	m (SE)	CV	m (SE)	CV
March 2009	11h10	473 (384)	81	7.3 (0.9)	12	31.5 (2.1)	7	8.1 (2.7)	34	5.2 (4.6)	87	0.7 (0.3)	42
April 2009	13h30	255 (306)	120	11.7 (1.3)	11	32.7 (1.3)	4	2.4 (1.9)	79	5.5 (2.1)	37	0.6 (0.2)	35
September 2009	12h00	211 (274)	130	16.9 (1.1)	7	34.1 (0.2)	1	2.3 (0.8)	33	10.1 (2.6)	26	1.1 (0.3)	24
February 2010	9h25	68 (139)	204	5.3 (1.0)	18	26.6 (3.8)	13	5.6 (2.3)	41	4.3 (3.3)	78	0.5 (0.2)	47
March 2010	12h30	169 (236)	140	8.4 (1.1)	13	32.9 (0.6)	1	1.5 (1.4)	94	1.8 (0.9)	52	0.7 (0.2)	33
June 2010	16h21	244 (275)	113	15.7 (1.1)	7	33.9 (0.4)	1	2.6 (2.3)	89	1.2 (1.2)	99	0.9 (0.3)	29
August 2010	15h12	432 (309)	72	19.7 (1.2)	6	34.6 (0.1)	1	0.7 (0.6)	82	0.8 (0.9)	112	1.2 (0.3)	20

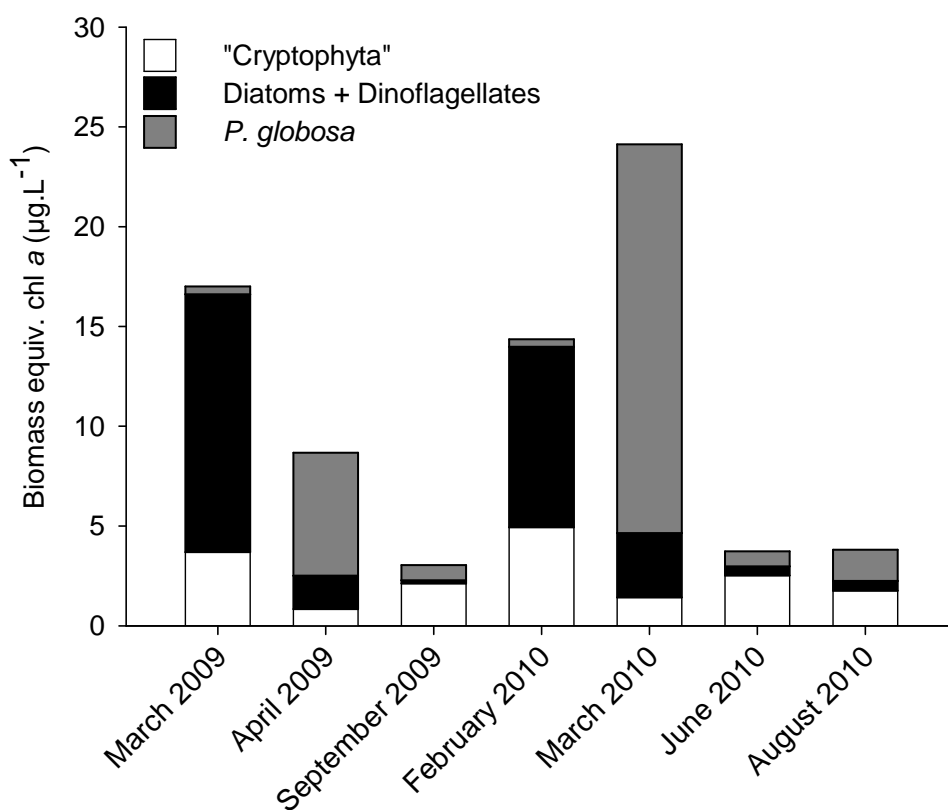

Fig. 5.2. Composition of phytoplankton assemblages during each sampling period. The relative amount of each phytoplankton group is expressed in terms of equivalent amount of chlorophyll *a* per litre

3 RESULTS

3.1 Physicochemical conditions

Different light conditions, representative of the natural hourly and daily variability, were encountered during each sampling period with high hourly variability in February 2010 and March 2010 (Table 5.I). This parameter was the more variable because it changed from hour to hour within each day and the intraday pattern of variation varied among days of each sampling period. Moreover, the maximum irradiance varied according to season. Salinity stayed relatively stable within day and between the different days of each sampling period. The highest values were observed in August 2010 and the lowest in February 2010. Each day, temperature increased during the photoperiod while its day to day variability was low. During the day, temperature increased from 1.3 to 3.5°C in March 2009 and September 2009, 0.5 to 4.5°C in April 2009 and March 2010 and 1.3 to 4.5°C in April 2009, March 2010 and August 2010. During the day, nutrient concentrations increased with the flood of the tide and decreased with the ebb. Nutrients were high in February and low in spring (April or March) and summer (June-August). As indicated by the coefficients of variation (CV) it was in February 2010 that environmental conditions were the more variable during the day.

3.2 Phytoplankton biomass, community composition

For each sampling period, phytoplankton composition did not vary significantly during the day and between the different days of each sampling period (ANOSIM, $P > 0.05$). By contrast, different communities were encountered during the different sampling periods

Table 5.II. Photosynthetic parameters: mean (SE) and coefficients of variation (%) and tide conditions. ETR_m in $\mu\text{mol e}^- \text{mg chl } a^{-1} \text{s}^{-1}$, α in $\mu\text{mol e}^- \text{mg chl } a^{-1} \text{s}^{-1}$ ($\mu\text{mol photons m}^{-2} \text{s}^{-1}$) $^{-1}$, E_k in $\mu\text{mol photons m}^{-2} \text{s}^{-1}$, \bar{a}_{phy}^* in m^2 ($\text{mg chl } a$) $^{-1}$. NT = neap tide, ST = spring tide

	Tide	ETR_m		α		E_k		F_v/F_m		\bar{a}_{phy}^*	
		m (se)	CV	m (se)	CV	m (se)	CV	m (se)	CV	m (se)	CV
4 March 2009	NT	0.42 (0.04)	10	0.0019 (0.0002)	9	221 (36)	16	0.61 (0.04)	7	0.008 (0.001)	13
5 March 2009	NT	0.39 (0.05)	14	0.0016 (0.0003)	19	247 (40)	16	0.53 (0.05)	10	0.007 (0.002)	24
6 March 2009	NT	0.36 (0.05)	15	0.0017 (0.0003)	18	218 (29)	13	0.53 (0.07)	13	0.008 (0.001)	10
9 March 2009	ST	0.41 (0.06)	15	0.0017 (0.0001)	7	246 (26)	11	0.54 (0.08)	16	0.008 (0.001)	17
10 March 2009	ST	0.44 (0.04)	10	0.0018 (0.0003)	14	253 (39)	16	0.59 (0.03)	5	0.006 (0.001)	14
11 March 2009	ST	0.43 (0.04)	9	0.0019 (0.0001)	4	226 (18)	8	0.59 (0.03)	5	0.006 (0.001)	9
17 April 2009	NT	1.41 (0.84)	60	0.0055 (0.0040)	73	314 (152)	48	0.51 (0.08)	15	0.023 (0.010)	42
18 April 2009	NT	1.28 (0.88)	69	0.0060 (0.0044)	73	216 (16)	7	0.55 (0.05)	9	0.022 (0.012)	53
20 April 2009	NT	0.96 (0.51)	53	0.0041 (0.0030)	73	283 (108)	38	0.48 (0.09)	18	0.017 (0.007)	44
21 April 2009	NT	0.83 (0.48)	58	0.0038 (0.0028)	73	241 (62)	26	0.44 (0.09)	21	0.022 (0.012)	52
22 April 2009	ST	0.59 (0.34)	58	0.0058 (0.0038)	66	118 (64)	54	0.46 (0.08)	17	0.022 (0.012)	52
23 April 2009	ST	0.70 (0.39)	56	0.0036 (0.0026)	74	225 (68)	30	0.48 (0.08)	18	0.015 (0.007)	45
24 April 2009	ST	0.66 (0.49)	74	0.0034 (0.0026)	76	276 (243)	88	0.47 (0.11)	24	0.017 (0.008)	46
25 April 2009	ST	1.03 (0.79)	77	0.0047 (0.0048)	102	247 (50)	20	0.51 (0.09)	17	0.020 (0.011)	54
28 September 2009	NT	1.78 (0.82)	46	0.0063 (0.0034)	53	294 (55)	19	0.59 (0.04)	7	0.031 (0.017)	56
29 September 2009	NT	1.34 (0.35)	26	0.0054 (0.0020)	37	263 (64)	24	0.51 (0.04)	7	0.029 (0.008)	28
30 September 2009	NT	1.65 (0.24)	15	0.0061 (0.0018)	29	285 (66)	23	0.53 (0.04)	8	0.035 (0.006)	21
1 October 2009	ST	1.26 (0.51)	41	0.0054 (0.0014)	26	231 (49)	21	0.51 (0.04)	7	0.016 (0.009)	54
2 October 2009	ST	1.15 (0.14)	12	0.0063 (0.0010)	17	187 (33)	18	0.46 (0.03)	7	0.035 (0.007)	21
3 February 2010	ST	1.14 (0.81)	71	0.0050 (0.0040)	81	241 (32)	13	0.65 (0.04)	7	0.016 (0.009)	54
4 February 2010	ST	1.12 (0.82)	73	0.0044 (0.0035)	80	267 (57)	21	0.65 (0.03)	5	0.018 (0.013)	73
5 February 2010	ST	0.61 (0.41)	67	0.0027 (0.0022)	83	253 (44)	16	0.63 (0.05)	8	0.009 (0.004)	50
8 February 2010	NT	0.87 (0.29)	33	0.0052 (0.0016)	30	173 (44)	22	0.66 (0.01)	2	0.015 (0.006)	39
9 February 2010	NT	0.69 (0.36)	52	0.0034 (0.0016)	48	207 (31)	15	0.63 (0.04)	7	0.013 (0.007)	51
10 February 2010	NT	1.63 (0.65)	40	0.0082 (0.0039)	47	208 (50)	24	0.56 (0.03)	6	0.037 (0.017)	46
24 March 2010	NT	1.10 (0.33)	30	0.0039 (0.0012)	32	298 (85)	28	0.49 (0.08)	17	0.018 (0.005)	28
25 March 2010	NT	1.21 (0.42)	34	0.0040 (0.0008)	20	295 (52)	18	0.59 (0.03)	5	0.016 (0.003)	17
26 March 2010	NT	1.76 (1.11)	63	0.0046 (0.0010)	22	369 (174)	47	0.49 (0.08)	16	0.020 (0.009)	43
31 March 2010	ST	0.85 (0.32)	38	0.0038 (0.0023)	59	239 (36)	15	0.57 (0.01)	2	0.016 (0.004)	29
1 April 2010	ST	0.80 (0.25)	32	0.0026 (0.0008)	31	307 (43)	14	0.48 (0.03)	7	0.015 (0.005)	36
2 April 2010	ST	0.82 (0.36)	45	0.0032 (0.0015)	46	258 (35)	14	0.52 (0.07)	13	0.019 (0.008)	43
08 June 2010	NT	1.01 (0.29)	29	0.0047 (0.0016)	34	217 (11)	5	0.52 (0.05)	9	0.024 (0.006)	26
09 June 2010	NT	0.82 (0.18)	22	0.0039 (0.0007)	19	210 (24)	11	0.52 (0.05)	9	0.019 (0.004)	23
10 June 2010	NT	1.19 (0.35)	30	0.0056 (0.0022)	40	222 (47)	21	0.55 (0.05)	9	0.027 (0.007)	27
14 June 2010	ST	1.14 (0.43)	38	0.0048 (0.0016)	33	237 (14)	6	0.51 (0.06)	12	0.027 (0.018)	65
15 June 2010	ST	1.64 (1.14)	70	0.0065 (0.0045)	69	251 (38)	15	0.46 (0.06)	14	0.035 (0.017)	50
16 June 2010	ST	0.81 (0.25)	30	0.0033 (0.0011)	32	248 (31)	13	0.47 (0.06)	12	0.014 (0.007)	51
3 August 2010	NT	0.69 (0.15)	21	0.0025 (0.0007)	26	280 (77)	27	0.50 (0.10)	21	0.012 (0.001)	15
4 August 2010	NT	0.70 (0.15)	21	0.0029 (0.0007)	24	243 (26)	11	0.56 (0.04)	7	0.013 (0.002)	18
5 August 2010	NT	0.63 (0.20)	33	0.0026 (0.0006)	22	238 (55)	23	0.55 (0.04)	8	0.012 (0.004)	32
11 August 2010	ST	0.44 (0.20)	46	0.0022 (0.0012)	56	211 (23)	11	0.55 (0.05)	10	0.009 (0.003)	34
12 August 2010	ST	0.67 (0.49)	72	0.0027 (0.0017)	64	274 (32)	13	0.50 (0.11)	23	0.011 (0.005)	43

(ANOSIM, $P = 0.001$) (Fig. 5.2). March 2009 and February 2010 were periods of “diatoms + dinoflagellates” blooms with a low contribution of “Cryptophyta”. In April 2009 and March 2010, it was the Haptophyte *Phaeocystis globosa* that bloomed and dominated the community with a small contribution of “diatoms + dinoflagellates” and “Cryptophyta”. September 2009, June 2010 and August 2010, were dominated by “Cryptophyta” with a very low contribution of “diatoms + dinoflagellates” and *P. globosa*.

During the day, total chl *a* biomass followed the light cycle. It increased with the morning increase of irradiance, was maximal when irradiance reached its maximum and then decreased until the end of the photoperiod. Total chl *a* biomass was low in September 2009, June 2010 and August 2010 and high in March 2009, April 2009, February 2010 and March 2010. Although similar phytoplankton composition was observed between March 2009 and February 2010 and between April 2009 and March 2010, the total chl *a* biomass was different. It was higher in March 2009 than in February 2010 while it was lower in April 2009 than in March 2010. By contrast, total chl *a* biomass was of the same order of magnitude in September 2009, June 2010 and August 2010.

3.3 Photosynthetic parameters and mean chl *a*-specific absorption coefficients

For each sampling period, the hourly variability of ETR_m and α was of the same order of magnitude (Table 5.II) and these both parameters were positively correlated ($0.44 < r^2 < 0.90$, $P < 0.001$) with different determination coefficients and slopes for each sampling period. The highest and lowest values of ETR_m and α were respectively observed in September 2009 and March 2009. The standard deviations and CV observed for ETR_m and α

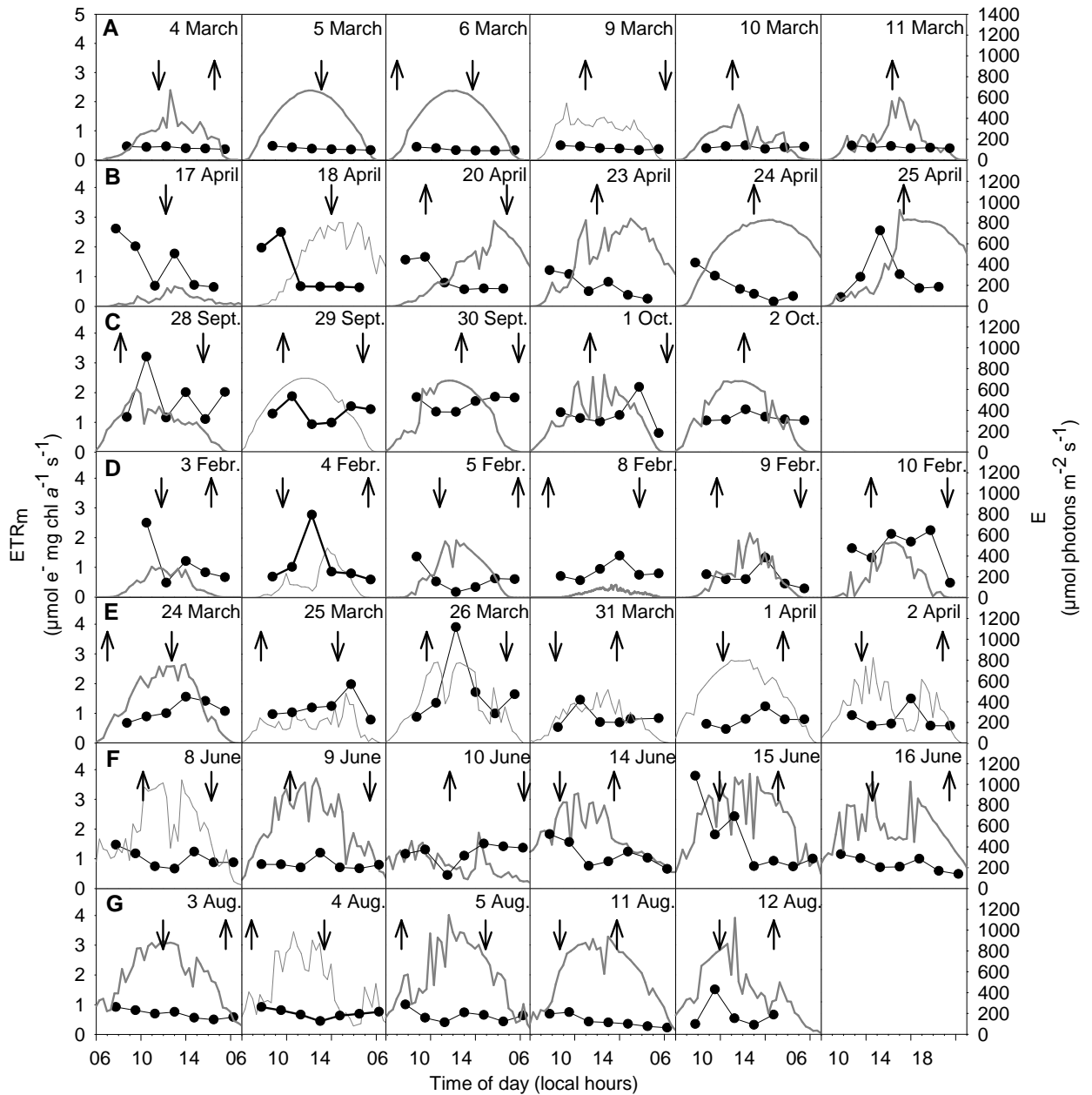

Fig. 5.3. Hourly variations of the maximum electron transport rate (ETR_m) (in black) and PAR irradiance (E in grey) in A) March 2009, B) April 2009, C) September-October 2009, D) February 2010, E) March-April 2010, F) June 2010 and G) August 2010. \uparrow High tide \downarrow Low tide

provided evidence of considerable diurnal variation of these parameters (Table 5.II). This variability was confirmed by the results of the nested ANOVA that indicated a significant variability on hourly time scale ($P < 0.001$) but not among the different taxonomic groups, sampling periods, tide conditions (neap tide, spring tide) and days in each sampling period ($P > 0.05$). The highly significant interaction day x hour for ETR_m ($P = 0.014$) indicated also that not only this parameter varied significantly from hour to hour within each day but also that the intraday pattern of variation changed significantly among days of each sampling period. As shown by the CV, the within day variability of ETR_m and α was high in April 2009 whereas the lowest variability was observed in March 2009.

No diel pattern common to the different sampling days was discernible in ETR_m and α variability (Fig. 5.3 & 5.4) but, three main patterns of diel variation were observed. In the first pattern, ETR_m and α showed an inverse relationships with irradiance variation. They decreased monotonically with the irradiance increase, reached their minimum when irradiance was at its maximum and then increased following the afternoon decrease in irradiance (e.g. 30 September and 5 February). In the second pattern, ETR_m and α followed variations of irradiance and reached their maximum when irradiance was at its maximum (e.g. 4 February and 26 March). In the third pattern, ETR_m and α decreased from the morning to the afternoon or stayed relatively stable throughout the photoperiod (e.g. March 2009 and 15 June). Each kind of pattern was not specific to a given sampling period or a particular phytoplankton community structure and was not associated to a specific pattern of irradiance variation. In other words, during a same sampling period different patterns of diel variation of photosynthetic parameters were encountered, a same pattern of variation was observed under different light climates and the periods with the same community structure were not characterized by the same pattern of variation.

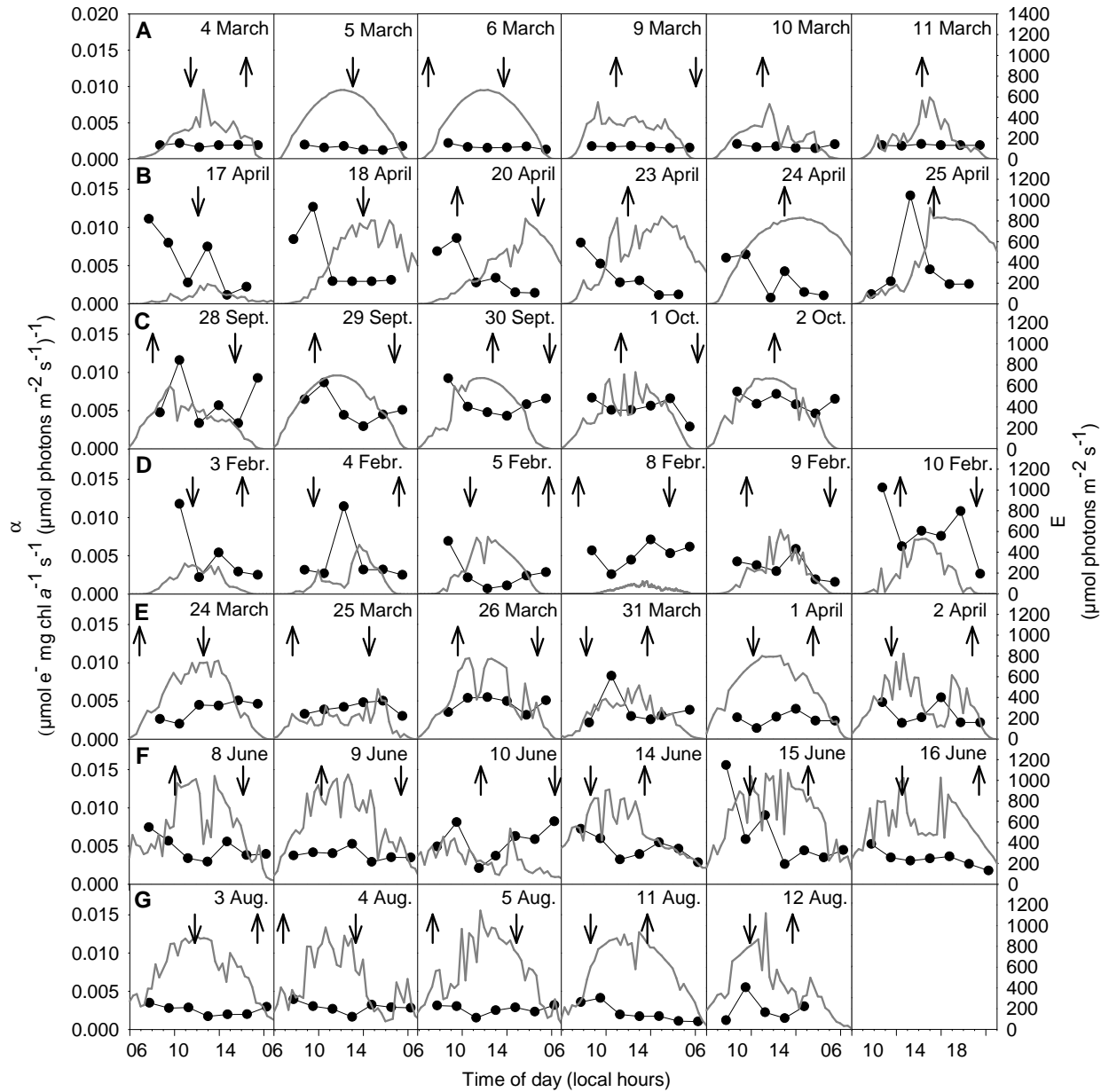

Fig. 5.4. Hourly variations of the maximal light utilization efficiency (α) (in black) and PAR irradiance (E in grey) in A) March 2009, B) April 2009, C) September-October 2009, D) February 2010, E) March-April 2010, F) June 2010 and G) August 2010. \uparrow High tide \downarrow Low tide

Mean chl *a*-specific absorption coefficients (\bar{a}_{phy}^*) ranged between 0.003 and 0.065 m² (mg chl *a*)⁻¹ (Table 5.II) and showed the patterns of variation than ETR_m (data not shown).

F_v/F_m (Fig. 5.5) was variable within day ($P < 0.001$) and between the day of each sampling period ($P < 0.001$) and, in the same way as ETR_m, its intraday pattern of variation changed significantly among days of each sampling period (interaction day x hour, $P < 0.001$). No significant differences were found among the different taxonomic groups, tide conditions and sampling periods ($P > 0.05$). As indicated by the coefficients of variation, overall variations of F_v/F_m were relatively small in comparison with those of ETR_m and α (Table 5.II). The hourly variability of F_v/F_m was high in April 2009 whereas the lowest variability was observed in February 2010. A clear inverse relationship was found between F_v/F_m and irradiance on all days of each sampling period except during overcast day (8 February 2010, 25 March 2010 and 31 March 2010) where irradiance was low all the day and F_v/F_m stayed relatively stable (around 0.65 the 8 February and around 0.60 the 25 & 31 March 2010). The other days, F_v/F_m either showed a progressive decline through the day (e.g. 5 March) or decreased with the morning increase in irradiance (with a morning decrease that could reach 48%), stayed low during a short period when irradiance reached its maximum and then recovered monotonically following the afternoon decrease in irradiance (e.g. 29 September). When F_v/F_m decreased at maximum irradiance, the recovery in comparison with early morning value was always complete with values at the end of the day very close to those observed the morning. The highest differences were observed in June 2010 and August 2010 and differences were only of 13.1%. On all investigated days, the minimum fluorescence level (F_0) showed a lower magnitude of variation than the maximum fluorescence level (F_m). During the day, both fluorescence levels varied always conjointly and showed the same trend as F_v/F_m .

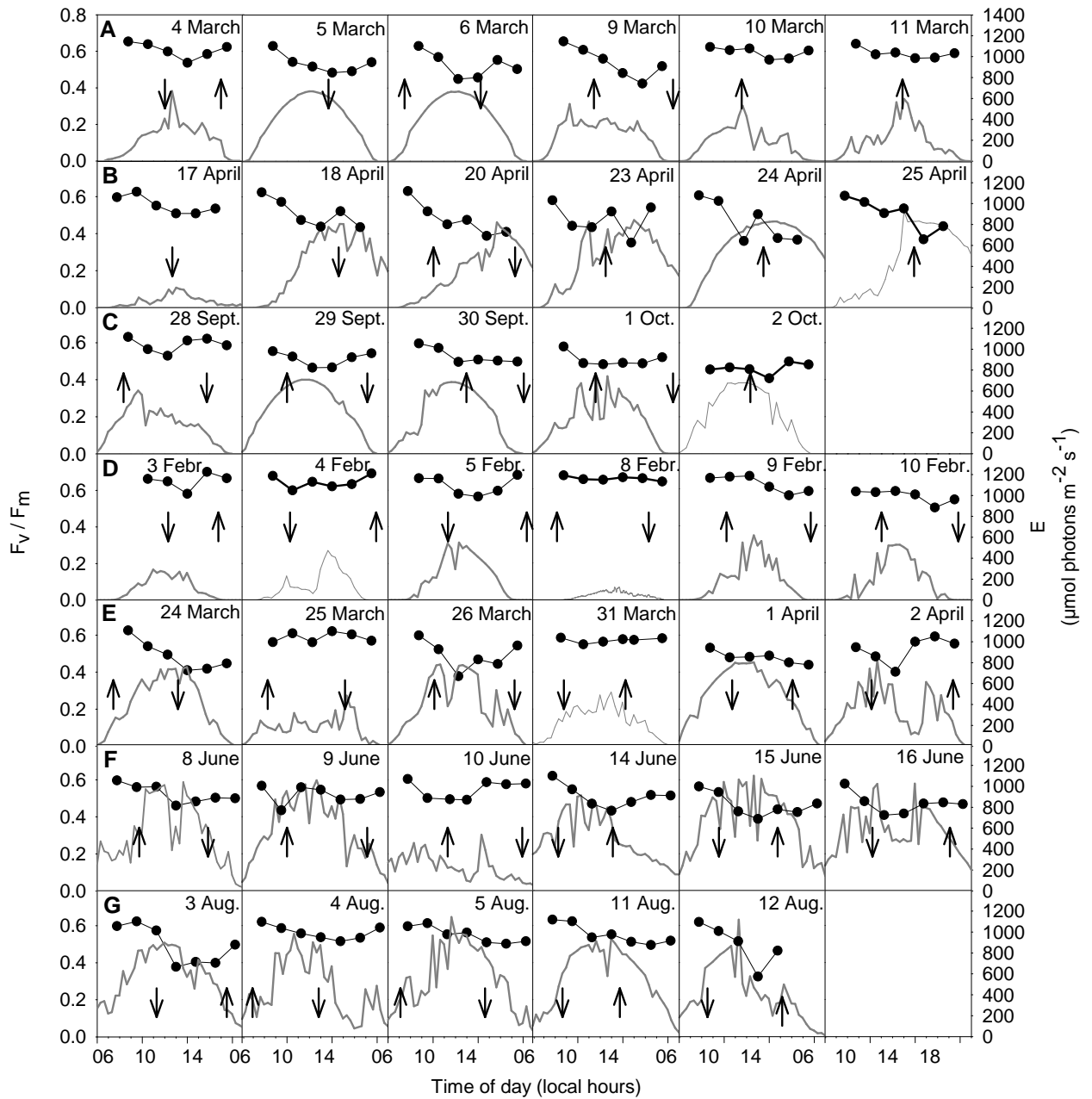

Fig. 5.5. Hourly variations of the maximum quantum yield (F_v/F_m) (in black) and PAR irradiance (E in grey) in A) March 2009, B) April 2009, C) September-October 2009, D) February 2010, E) March-April 2010, F) June 2010 and G) August 2010. \uparrow High tide \downarrow Low tide

E_k (Fig. 5.6) was significantly variable at hourly scale ($P < 0.001$) but not among the different taxonomic groups, sampling periods, tide conditions and days in each sampling periods ($P > 0.05$). Some days, E_k stayed relatively stable during the day ($CV < 10$) and showed a lower variability than ETR_m and α (Table 5.II). Other days, as indicated by the coefficients of variation, the hourly variability of E_k was of the same order of magnitude as ETR_m and α (e.g. in March 2009). The highest interday variability of E_k was observed in April 2009 and March 2010. Changes in E_k were always small compared to incident irradiance. The mean daily value of E_k was frequently around 200-250 $\mu\text{mol photons m}^{-2} \text{s}^{-1}$.

3.4 Relationships between photosynthetic parameters and environmental variables

In an effort to identify associations between the observed variations of photosynthetic parameters and environmental conditions, stepwise multiple linear regressions were performed (Table 5.III). The relationships between photosynthetic parameters and environmental variables were found to differ between the different sampling periods. However, as suggested by the hourly patterns of variation, light is an important factor in the control of the short-term variability in photosynthetic parameters.

During the bloom periods (March 2009, April 2009, February 2010 & March 2010), light or temperature were identified as the best predictors for F_v/F_m . In September 2009 & June 2010, F_v/F_m was controlled by a combined effect of light and nutrients and in August 2010, it was associated with nutrients and temperature (August 2010). Apart in September 2009 where Si(OH)_4 concentrations were identified as the best factor explaining ETR_m variations, this parameter was always related to light. According to the sampling period

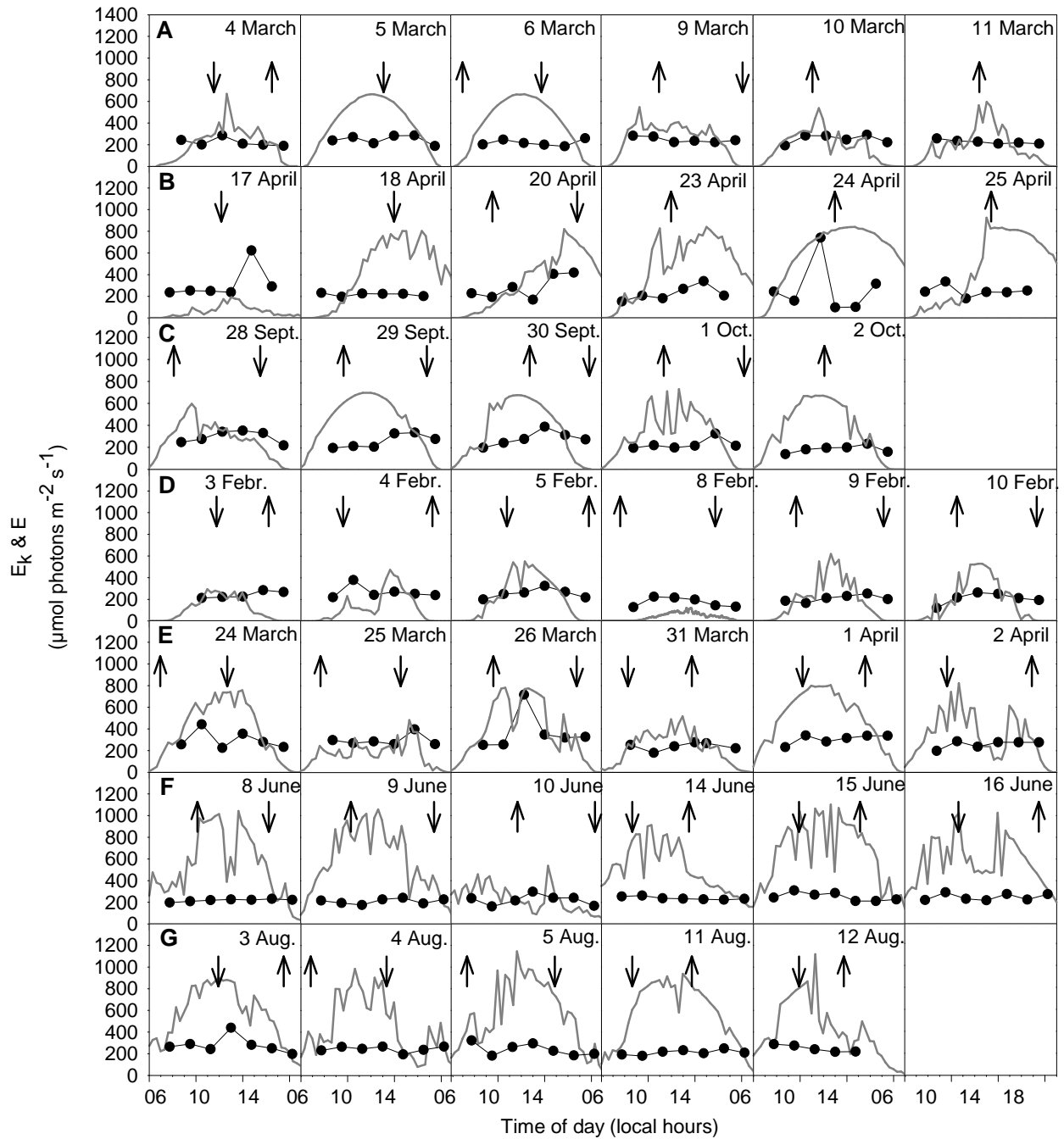

Fig. 5.6. Hourly variations of the light saturation coefficient (E_k) (in black) and PAR irradiance (E in grey) in A) March 2009, B) April 2009, C) September-October 2009, D) February 2010, E) March-April 2010, F) June 2010 and G) August 2010. \uparrow High tide \downarrow Low tide

considered, light was the sole factor retained by the analysis (April 2009, March 2010 & June 2010) or was associated with salinity (March 2009, February 2010 & August 2010). α was related to temperature in March 2009, September 2009 and August 2010, to light in April 2009, February 2010 and June 2010 and to an association of light and Si(OH)_4 concentrations in March 2010. E_k was linked to light in September 2009 and an association of light and Si(OH)_4 concentrations in February 2010. During the other periods, E_k was not significantly related to any of the environmental variables considered.

Table 5.III. Stepwise multiple linear regression equations relating photosynthetic parameters to environmental factors and associated statistics. r^2 = adjusted coefficient of multiple determination (in %)

	Regression equation	r^2	F	P	n
March 2009	$F_v/F_m = 0.94 - (0.05 \times \text{temperature})$	55.8	42.99	< 0.001	36
	$\text{ETR}_m = 0.30 - (1.3\text{E}^{-5} \times \text{light}) + (5.77\text{E}^{-3} \times \text{salinity})$	71.3	41.07	< 0.001	36
	$\alpha = 3.43\text{E}^{-3} - (2.16\text{E}^{-4} \times \text{temperature})$	28.7	13.68	< 0.001	36
April 2009	$F_v/F_m = 0.57 - (1.74\text{E}^{-4} \times \text{light})$	38.8	29.20	< 0.001	48
	$\text{ETR}_m = 1.38 - (2.00\text{E}^{-6} \times \text{light})$	48.8	42.92	< 0.001	48
	$\alpha = -23.10 + (5.00\text{E}^{-5} \times \text{light})$	23.0	13.44	0.001	48
September 2009	$F_v/F_m = 0.55 - (1.31\text{E}^{-4} \times \text{light}) - (0.01 \times [\text{Si(OH)}_4]) + (0.16 \times [\text{PO}_4^{-3}])$	66.8	17.42	< 0.001	30
	$\text{ETR}_m = 2.19 - (0.07 \times [\text{Si(OH)}_4])$	15.4	5.11	0.032	30
	$\alpha = 0.02 - (6.82\text{E}^{-4} \times \text{temperature})$	14.0	4.57	0.041	30
February 2010	$E_k = -278.00 + (8.14\text{E}^{-3} \times \text{light})$	49.7	27.63	< 0.001	30
	$F_v/F_m = 0.692 - (2.57\text{E}^{-3} \times \text{light})$	45.6	27.61	< 0.001	35
	$\text{ETR}_m = 2.57 + (1.00\text{E}^{-5} \times \text{light}) - (0.06 \times \text{salinity})$	30.0	6.86	0.003	35
March 2010	$\alpha = 3.44\text{E}^{-3} + \text{light}$	23.8	10.32	0.003	35
	$E_k = 148 + (0.38 \times \text{light}) - (5.97 \times [\text{Si(OH)}_4])$	51.4	15.54	< 0.001	35
	$F_v/F_m = 0.65 - (3.90\text{E}^{-4} \times \text{light})$	59.6	54.6	< 0.001	36
June 2010	$\text{ETR}_m = 1.56 - (3.00\text{E}^{-6} \times \text{light})$	20.0	9.26	0.004	36
	$\alpha = 3.69\text{E}^{-3} - \text{light} + (4.71\text{E}^{-4} \times [\text{Si(OH)}_4])$	24.8	5.94	0.006	36
	$F_v/F_m = 0.76 - (2.90\text{E}^{-4} \times \text{light}) - (0.02 \times [\text{Si(OH)}_4])$	52.8	21.11	< 0.001	42
August 2010	$\text{ETR}_m = 5.09 - (3.30\text{E}^{-5} \times \text{light})$	31.3	18.21	< 0.001	42
	$\alpha = 1.24\text{E}^{-2} - (9.00\text{E}^{-6} \times \text{light})$	28.7	16.08	< 0.001	42
	$F_v/F_m = 1.52 - (0.05 \times \text{temperature}) - (0.03 \times [\text{Si(OH)}_4])$	89.0	121.55	< 0.001	33
August 2010	$\text{ETR}_m = -25.10 - (1.80\text{E}^{-5} \times \text{light}) + (0.75 \times \text{salinity})$	34.7	7.96	0.002	33
	$\alpha = 8.84\text{E}^{-3} - (3.17\text{E}^{-4} \times \text{temperature})$	17.0	6.33	0.017	33

ETR_m , α and E_k seemed to be not only dependent on light conditions during sampling day but also on light exposure during the previous days. Indeed, stronger relationships between irradiance and these photosynthetic parameters were obtained when irradiance of the previous days was considered in addition to irradiance of the sampling day. The best results were obtained considering the irradiance averaged over the 3 days before sampling and sampling day. F_v/F_m seemed as dependent on light conditions during the day as those during the 3 previous days. The effects of light and temperature on photosynthetic parameters might

be confounded because temperature and light were always positively correlated. In the same way, Si(OH)_4 , $\text{NO}_2^- + \text{NO}_3^-$ and salinity were positively correlated.

4 DISCUSSION

The diel photosynthetic activity of phytoplankton was characterized by a large short-term variability associated to the rapidly changing environmental conditions. F_v/F_m showed clear light-dependent changes and could vary from physiological maxima to values close to 0.30 during the course of one day. During overcast days, F_v/F_m stayed relatively stable. This result indicates that the diurnal changes of F_v/F_m were light dependent not due to a circadian periodicity (Serôdio et al. 2008). The wide range of diel variation was mainly due to the strong decrease of F_v/F_m around midday. The photoresponse of F_v/F_m was clearly reversible, since values increased again toward the end of the photoperiod suggesting the operation of photoprotective mechanisms rather than a photoinhibition (Falkowski & Kolber 1993, Schofield et al. 1998, Ralph et al. 2002). The parallel variations of F_m and F_0 observed during the day supports the occurrence of photoprotective mechanisms because damages to the photosynthetic apparatus normally result in the decrease of F_m and the increase of F_0 (Schofield et al. 1998, Müller et al. 2001, Ralph et al. 2002). The values of F_v/F_m in morning (between 0.53 and 0.68) suggest that phytoplankton was in relatively good physiological state whatever the period of year and nutrient conditions.

ETR_m and α were generally positively correlated and showed a great diel variability in relation to light and nutrients variations. This diel variability was of the same order of magnitude for both parameters. The dependence of ETR_m and α to long term light history (3 days) is consistent with the observations of Platt and Jassby (1976), Jones (1978) and Savidge

(1988) who found that photosynthetic parameters correlated most strongly with the average irradiance of the preceding 3 to 5 days. This corresponds to the time necessary for changing from a high-light to a low-light acclimated state (Savidge 1988 and references herein). These results suggest that the optimal use of incident irradiance would focus on between-days rather than within-day variability (MacIntyre & Cullen 1996). Changes in the photoacclimation index E_k were generally small in comparison with incident irradiance fluctuations indicating a restricted acclimation capacity with a poor light harvesting and optimization during the day. No clear cyclical diel variations of ETR_m , α and E_k could be identified.

These different observations are not consistent with what is expected for phytoplankton fully photoacclimated or for endogenous daily photosynthetic rhythms. Indeed, diel periodicity of photosynthetic parameters has been attributed to a combination of endogenous physiological oscillations as well as responses to environmental light conditions (e.g. MacCaull & Platt 1977, Henley 1993). It has been found that P_{max} (or ETR_m according to the method used) generally begin to increase during the final hours of night, peak in morning or near noon, and then reach a minimum late in the photoperiod or early in evening (MacCaull & Platt 1977, Erga & Skjoldal 1990, Henley 1993, Behrenfeld et al. 2004).

Photoacclimation responses to environmental light conditions has been associated with independent changes in α and ETR_m (P_{max}) that alter E_k in such a way that values and trend of variation of E_k are all the more close to light conditions that phytoplankton is acclimated to its light environment (Behrenfeld et al. 2004, Behrenfeld et al. 2008). Endogenous oscillations of α and P_{max} have been widely reported in phytoplankton both in culture and in the field (MacCaull & Platt 1977, Prézelin et al. 1977, Prézelin & Sweeney 1977, Harding Jr. et al. 1981, Harding Jr. et al. 1982, Harding Jr. et al. 1983, Kana et al. 1985, Prézelin et al. 1986, Prézelin et al. 1987, Erga & Skjoldal 1990, Bruyant et al. 2005). Such oscillations have been shown to be cyclical, independent on short term changes in irradiance, maintained in the dark

or under constant irradiance and to be not necessarily accompanied by changes in chlorophyll *a* concentration (Erga & Skjoldal 1990, Henley 1993). Endogenous variations have been reported for both α and P_{\max} with variations of α either directly correlated with P_{\max} (e.g. Harding Jr. et al. 1987, Erga & Skjoldal 1990) or independent on P_{\max} (e.g. Putt & Prézelin 1985). It is usually believed that diel oscillations in photosynthetic parameters are due to an endogenous mechanism (circadian clock) which is entrained by changes in environmental factors (Enright 1970, Stross et al. 1973).

Insofar as in our study ETR_m and α were positively correlated, varied without any identifiable diel cycle and were not insensitive to light conditions, their variability could therefore not be attributed to a complete photoacclimation response nor to endogenous oscillations. However, in systems with water column permanently well mixed, such as the Strait of Dover, a clear photoacclimation response can be difficult to observe because of the high level of variability in environmental conditions that make complete photoacclimation extremely difficult. In the eastern English Channel, a similar situation was previously observed by Lizon et al. (1995) and Jouenne et al. (2005). Indeed, in spite of the light gradient within the water column, Lizon et al. (1995) observed significant co-variations of P_{\max}^B and α^B with depth but no significant variations of E_k . In the study of Jouenne et al. (2005), the photosynthetic parameters were extremely variable and showed a poor optimization according to light conditions during the period with a high vertical mixing rate whereas, during the low mixing conditions, a clear short-term photoacclimation was observed.

It is possible that the high variability in environmental conditions is not the only explanation because the low variability of E_k and the positive correlation between ETR_m and α , observed in the present study, can be associated with a particular kind of photosynthetic response: the “ E_k -independent” variability described by Behrenfeld et al. (2004). Contrary to the “ E_k -dependent” variability that results from photoacclimation processes, the mechanistic

basis for the “ E_k -independent” behaviour is largely unresolved. Behrenfeld et al. (2008) attributes this kind of variability to specific metabolic processes that decouple the carbon fixation from photosynthesis and result predominantly from growth-dependent changes in ATP and reductants demands. Four primary processes determining the relative fraction of ATP and reductants dedicated to the carbon fixation and thus responsible to the “ E_k -independent variability” have been identified by Behrenfeld et al. (2008) but, the reasons why this kind of variability dominates in certain environments as well as the cellular and environmental factors controlling the four primary processes stay to define.

Our data did not show any specific daily responses for any of the photosynthetic parameters among the periods dominated by different taxonomic groups. Indeed, the photosynthetic parameters were highly variable during periods with the same phytoplankton composition. This suggests a secondary role of taxonomic composition in comparison with changes in environmental parameters such as light, temperature and nutrients. However, the FluoroProbe is a crude method for phytoplankton assemblage analysis. In its current configuration, this probe is only able to discriminate four algal groups (“diatoms + dinoflagellates”, *P. globosa*, “Cryptophyta” and cyanobacteria) (Houliez et al. 2012) and does not permit the distinction between some taxonomic groups present in the eastern English Channel (e.g. diatoms and dinoflagellates). Consequently, some changes in phytoplankton assemblages such as shifts in dominant species within an algal group or changes in the relative proportions of diatoms and dinoflagellates may have pass unnoticed. In addition, PAM fluorometry measures the photosynthetic activity of phytoplankton community as a whole. Different species of a single taxonomic group can have different photosynthetic capacities when they are exposed to identical conditions (Juneau & Harrison 2005, Dimier et al. 2009b) and the physiological status of a single species can also be highly variable and changes rapidly in response to environmental conditions. It is thus possible that some species

within a single taxonomic group were more active than the others but our method of measurement did not adequately characterize these responses. Consequently, *in situ* the distinction between variations in photosynthetic parameters related to shifts in assemblages composition from those related to the physiological status of species within assemblages is not clear because the different status of species composing the assemblages can “muddle” the signal measured at the community scale.

5 CONCLUSIONS

Our results did not support the hypothesis that each period of year, characterized by different phytoplankton assemblages, has specific short-term variability in photosynthetic parameters. Photosynthetic parameters are highly variable from one day to another as well as from hour to hour within a single day. Interactions between light, temperature and nutrient availability are responsible for this variability while changes in phytoplankton assemblages seem of secondary importance at these time scales. Values of the light saturation coefficient (E_k) indicate that phytoplankton was rarely photoacclimated and reveal a poor light harvesting and optimization. However, the variability in photosynthetic parameters observed in the present study can be associated with a particular kind of photosynthetic response: the “ E_k -independent” variability. The physiological basis of this photosynthetic response is largely unresolved. The reasons why this kind of photosynthetic response dominates in certain environments as well as in what extent this reflects the difficulty of phytoplankton to cope with environmental conditions, results from the measurement of photosynthetic parameters at community scale or, is an acclimation strategy stay to define. Further researches on this subject are still required.

Chapitre VI

Dynamiques de l'activité photosynthétique du phytoplancton dans un écosystème macrotidal (le Déroit du Pas-de-Calais, Manche orientale) : échelles de temps de la variabilité et contrôle environnemental

*Phytoplankton photosynthetic activity dynamics in a macrotidal ecosystem
(the Strait of Dover, eastern English Channel): time scales of variability and
environmental control*

Résumé

La variabilité de l'activité photosynthétique du phytoplancton a été étudiée dans les eaux côtières du Déroit du Pas-de-Calais et associée aux conditions environnementales. Les données de l'activité photosynthétique du phytoplancton, collectées, entre Octobre 2008 et Août 2010, à différentes échelles de temps (horaire à pluriannuelle), sont présentées. Les paramètres photosynthétiques comprenant le rendement quantique maximum (F_v/F_m), l'efficacité maximale d'utilisation de la lumière (α), le taux de transport maximum des électrons (ETR_m) et le coefficient de saturation lumineuse (E_k) ont été mesurés en utilisant la fluorimétrie par modulation d'impulsions en amplitude (PAM). Des informations sur la composition taxonomique des assemblages phytoplanctoniques et les paramètres physicochimiques ont également été collectées. Des changements marqués des paramètres photosynthétiques ont été observés aux différentes échelles de temps étudiées. La variabilité des paramètres photosynthétiques à l'échelle sous-saisonnière (de l'échelle horaire à l'échelle mensuelle) pouvait être du même ordre de grandeur que la variabilité à l'échelle saisonnière. Aux courtes échelles de temps (de l'heure à l'échelle d'un cycle de marée mortes eaux / vives eaux), il n'y avait aucun cycle de variation journalière des paramètres photosynthétiques. Il y avait un déclin de ETR_m et de α au cours de la journée aussi souvent qu'il y avait un pic au maximum d'intensité lumineuse. Les conditions lumineuses, la température et la disponibilité des nutriments étaient les principaux facteurs influençant les paramètres photosynthétiques. L'utilisation optimale de l'intensité lumineuse incidente semblait centrée sur la variabilité interjournalière plutôt que sur la variabilité au cours de la journée indiquant une capacité d'acclimatation limitée. Aux plus longues échelles de temps (de l'échelle semi-mensuelle à l'échelle interannuelle), les interactions étroites entre les changements dans la composition des communautés phytoplanctoniques et les changements des paramètres physicochimiques contrôlaient la variabilité des paramètres photosynthétiques. Quelle que soit l'échelle de temps et la période de l'année considérée, la variabilité des paramètres photosynthétiques était « E_k -indépendante ».

Mots clés : paramètres P-E, phytoplancton, photosynthèse, fluorescence de la chlorophylle *a*

Abstract

The temporal variability in phytoplankton photosynthetic activity was studied in the coastal waters of the Strait of Dover and related to environmental conditions. Phytoplankton photosynthetic activity data collected, from October 2008 and August 2010, at different time scales (from hourly to pluriannual scales), are presented. Photosynthetic parameters including the maximum quantum yield (F_v/F_m), the maximal light utilization efficiency (α), the maximum electron transport rate (ETR_m) and the light saturation coefficient (E_k) were measured using Pulse Amplitude Modulated (PAM) fluorometry. Information on taxonomic composition of phytoplankton assemblages and physicochemical parameters were also collected. Marked changes in photosynthetic parameters were observed at the different time scales investigated. The variability of photosynthetic parameters at sub-seasonal scale (from hourly to monthly scales) could be of the same order of magnitude as the variability at seasonal scale. At short time scale (from hour to the scale of a neap-spring tide cycle), there was no consistent pattern of diel periodicity in photosynthetic parameters. There was a decline of ETR_m and α during the day as often as there was a peak at the maximum of irradiance. Light conditions, temperature and nutrient availability were the main influencing factors on photosynthetic parameters. The optimal use of incident irradiance seemed focused on the between-days rather than within-day variability indicating a restricted acclimation capacity. At longer time scales (from fortnightly to interannual scales), close interplays between shifts in community taxonomic composition and changes in physicochemical parameters controlled the variability of photosynthetic parameters. Whatever the time scale and period of year considered, variability in photosynthetic parameters was “ E_k -independent”.

Keywords: P-E parameters, phytoplankton, photosynthesis, chlorophyll *a* fluorescence

1 INTRODUCTION

The ways in which phytoplankton photosynthetic activity adjusts to environmental conditions are of interest because phytoplankton forms the basis of coastal ecosystems food webs and phytoplankton primary production is a key process in biogeochemical cycles (Cloern 1996, Falkowski & Raven 2007). In coastal ecosystems with permanently well mixed water column, phytoplankton communities are exposed to a highly dynamic environment characterized by considerable variations of environmental conditions on a wide range of time scales (MacIntyre et al. 2000). While changes in nutrients and temperature occur mainly on time scales of days to seasons, the variability of light occurs on a higher number of time scales and shows the highest variations in amplitude and frequency (MacIntyre et al. 2000, Raven & Geider 2003, Dubinsky & Schofield 2010). Light variations are caused by seasonal and diel astronomical cycles but also unpredictable short-term changes associated with cloud cover, focusing of light by surface waves, or movements of phytoplankton cells through the light gradient within the water column (MacIntyre et al. 2000).

In such systems, variations of primary production and phytoplankton biomass are the result of the interplay of a number of abiotic factors such as irradiance, temperature, nutrients, transport processes but also of biological relationships like competition and grazing (Butron et al. 2009). Consequently, phytoplankton seldom experiences constant conditions and responds to this variability through diverse acclimative processes modifying its photosynthetic activity on a wide range of time scales ranging from short-term photoprotective mechanisms operating in several seconds / minutes to long-term modifications of photosynthetic apparatus taking place within a matter of days (MacIntyre et al. 2000, Lavaud 2007).

The photosynthetic activity and photoacclimation status of phytoplankton is characterised through the photosynthesis-light response (PE) curves which allow the determination of photosynthetic parameters (Henley 1993, MacIntyre & Kana 2002). While the hourly, daily, fortnightly, seasonal and annual variability of phytoplankton photosynthetic parameters has been examined separately in different studies (e.g. Côté & Platt 1983, Erga & Skjoldal 1990, Macedo et al. 2001), the relative importance of the variability occurring on each of these time scale has seldom been compared. This comparison is of interest because the significance of the variability on annual and seasonal scales cannot be correctly evaluated without information on the variability taking place on shorter time scales (Serôdio & Catarino 2000). Moreover, the majority of studies deal with the seasonal variations of photosynthetic parameters. It is particularly true in well mixed coastal ecosystems where short-term photosynthetic responses of phytoplankton have received little attention. This concentration of the sampling effort on the detection of seasonal (month to month) trends without considering the variability taking place at shorter time-scale may result in an unrealistic picture of dynamics in phytoplankton photosynthetic activity because of aliasing (Serôdio & Catarino 2000). Moreover, this implicitly suggests that season is the scale where photosynthesis is the more variable. The existing evidences indicate that this may not be the case in all ecosystems. Particularly in coastal and estuarine systems where significant variability has been detected at hourly and daily scales (Lizon et al. 1995, Jouenne et al. 2005, Struski & Bacher 2006, Pannard et al. 2008).

The scarcity of data at different times scale, in highly dynamic systems, is due in part to methodological limitations. Indeed, phytoplankton photosynthetic activity has been traditionally measured using oxygen (Gaarder & Gran 1927, Montford 1969) and/or carbon isotope tracers methods (Steemann Nielsen 1952, Hama et al. 1983). These methods are considered to be difficult to use, expensive and laborious. Moreover, they require incubation

times limiting the temporal resolution of measurements. Active fluorescence techniques such as the Fast Repetition Rate fluorometry (FRRF) and Pulse Amplitude Modulated (PAM) fluorometry have the potential to greatly extend the scales at which phytoplankton photosynthetic parameters can be measured *in situ* because they do not require incubations and are easy to use. It is therefore important to improve our understanding of the relationships between fluorescence derived photosynthetic parameters and environmental conditions (Moore et al. 2005).

In the eastern basin of the English Channel, like in most highly variable systems, available data on phytoplankton photosynthetic activity have been mainly acquired using the isotope tracer method (^{14}C) (Lizon et al. 1995, Jouenne et al. 2005, 2007). Only one recent article have used the PAM fluorometry (Napoléon et al. 2012). The short term (Lizon et al. 1995, Jouenne et al. 2005) and seasonal variability (Jouenne et al. 2007, Napoléon et al. 2012) of phytoplankton photosynthetic parameters have been studied separately. However, the data available on the short-term variability are limited in time. Indeed, during each sampling period, data were collected during a single day or during 36h, and sampling periods were focused on a single or two seasons (Lizon et al. 1995, Jouenne et al. 2005). At longer time scales, the sampling effort was focused on the detection of seasonal trends and samples were taken on a fortnightly (Jouenne et al. 2007) or monthly basis (Napoléon et al. 2012). Consequently, no data on the between day and hourly variability of phytoplankton photosynthetic parameters during each season of year are available. Moreover, the relative importance of the variability occurring on the different time scales has not been compared using a temporally nested sampling design which prevents pseudoreplication in time. The consideration of the different time scales of variability is necessary. Indeed, without information on the variability at short-time scales, variations between successive monthly or fortnightly observations cannot be interpreted as representing a seasonal trend because, in the

presence of within-month fluctuations, such a low sampling frequency can lead to an apparent seasonal trend with little relation to the true pattern of variation as a result of aliasing (Platt & Denman 1975, Serôdio & Catarino 2000).

The objectives of the current study are thus: 1) to characterise dynamics of phytoplankton activity at different time scales in a well mixed tidally controlled coastal system and 2) to relate as far as possible the variability observed to environmental conditions and phytoplankton composition. The goal is to determine if phytoplankton photosynthetic activity varied with a seasonal basis and if the factors controlling the photosynthetic parameters are the same whatever the time scale considered. Because, in well mixed coastal ecosystems, environmental conditions vary on a wide range of time scales and because phytoplankton responds to this variability through diverse acclimative processes taking place on different time scales, a high variability in photosynthetic activity was expected with different factors controlling this variability according to the time scale considered. Samplings were carried out in the coastal waters of Wimereux at different time scales ranging from hours to years. Photosynthetic activity was measured with rapid light curves (RLC) using PAM fluorometry and data on variations in physicochemical parameters and phytoplankton assemblages composition were collected.

2 MATERIALS AND METHODS

2.1 Study area and samplings

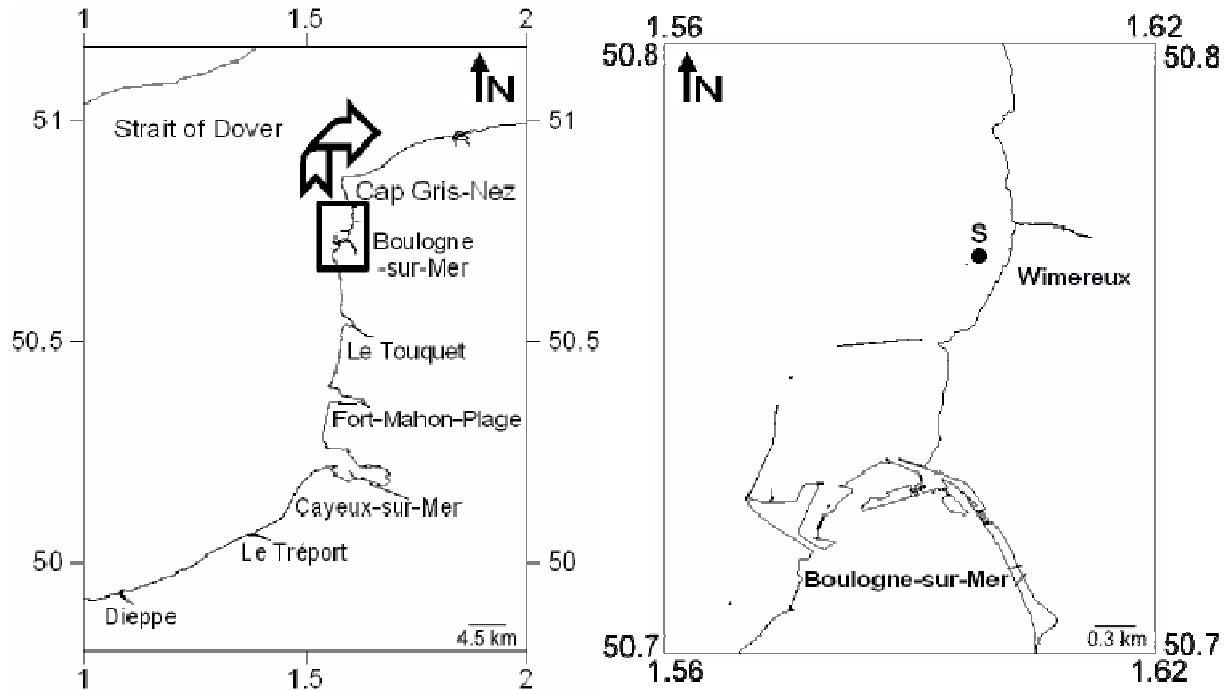

Fig. 6.1. Map of the Strait of Dover with enlarged area representing the location of sampling station (S). Coordinates are in decimal degrees

The Strait of Dover is a shallow shelf area with a strong hydrodynamism controlled by tide. Further, details on this area are given in Brunet et al. (1992) and the previous chapters (IV and V).

Two data sets based on two sampling strategies were used in the present study: a first set based on a pluriannual study and a second data set based on diel cycles. Diel cycles were used in a second article (chapter V) to describe the short-term variability in phytoplankton photosynthetic activity and are used in the present study to compare the variability at different time scales. All samples were carried out in the coastal waters of Wimereux ($50^{\circ}45'57.42''\text{N}$, $1^{\circ}35'55.17''\text{E}$) (Fig. 6.1). During the pluriannual study, samples were collected weekly from

October 2008 to August 2010 in the surface waters (in the first meter of the water column) at high and low tide. During diel cycles, samplings were carried out during 42 days distributed on seven sampling periods: 5 to 11 March 2009, 17 to 25 April 2009, 28 September to 2 October 2009, 3 to 10 February 2010, 24 March to 02 April 2010, 8 to 16 June 2010 and 3 to 12 August 2010. During each of these sampling periods, samples were taken every 1.45 h. from sunrise to sunset during at least five days distributed along a complete spring-neap tide cycle.

2.2 Physicochemical measurements and phytoplankton community structure

Sea water temperature and salinity were obtained using a thermosalinometer (Cond. 315i, WTW, Weilheim, Germany). Nutrients (NO_3^- , NO_2^- , $\text{Si}(\text{OH})_4$, PO_4^{3-}) were measured with an Alliance Integral Futura Autoanalyser II according to the method of Aminot and K  rouel (2007). Incident photosynthetically active radiation (PAR in $\mu\text{mol quanta m}^{-2} \text{s}^{-1}$) was measured continuously (1 measurement by minute) with a 4π spherical quantum sensor (ultra-miniature MDS-MkV/L, JFE Alec Electronics co. LTD., Kobe, Japan).

The composition of phytoplankton community structure was investigated using a submersible spectral fluorometer (the FluoroProbe, bbe-Moldaenke, Kiel, Germany) after the recalibration of fingerprints (further details are provided in Houliez et al. 2012). The measurements of samples were made using the 25 mL cuvette of the FluoroProbe.

2.3 Photosynthetic activity

Measurements of photosynthetic activity were conducted as in Houliez et al. (submitted, Chapter IV). Photosynthetic parameters were obtained by measuring Rapid Light Curves (RLC) using Pulse Amplitude Modulated fluorometry (PAM). All measurements were done in triplicate using a Phyto-PAM fluorometer (Heinz Walz GmbH, Effeltrich, Germany). Samples were dark-acclimated for 15 minutes and the minimum fluorescence level (F_0) and maximum fluorescence level (F_m) were determined respectively before and after a saturating pulse (200 ms at around $4000 \mu\text{mol photons m}^{-2} \text{s}^{-1}$) to obtain the maximum quantum yield ($F_v/F_m = (F_m - F_0)/F_m$). Samples were then exposed for 10 s to 20 increasing light levels (from 22 to $1384 \mu\text{mol photons m}^{-2} \text{s}^{-1}$) to construct light response curves. At each light level, the absolute electron transport rate (ETR) was calculated as follows:

$$\text{ETR} = (F_m' - F)/F_m' \times E \times 0.5 \times \bar{a}_{\text{phy}}^*$$

where F and F_m' are respectively the fluorescence levels before and after the saturating pulse, E ($\mu\text{mol photons m}^{-2} \text{s}^{-1}$) is the actinic irradiance, 0.5 is a multiplication factor because the transport of one electron requires two photons (one per photosystem) (Gilbert et al. 2000, Kromkamp & Forster 2003), \bar{a}_{phy}^* ($\text{m}^2 (\text{mg chl } a)^{-1}$) is the spectrally averaged (400-700 nm) chlorophyll a specific absorption coefficient (see below for its measurement).

Light response curves were fitted using the model of Eilers and Peeters (1988) to estimate the maximal light utilization efficiency (α), the maximum electron transport rate (ETR_m) and the light saturation coefficient (E_k) calculated as ETR_m/α .

2.4 Mean chl *a*-specific absorption coefficients

The mean chl *a*-specific absorption coefficients (\bar{a}_{phy}^*) were obtained by measuring the optical density (OD) spectrum of samples filtered on Whatman GF/F filters according to the method of Mitchell et al. (2003). The OD spectrum was measured on the wet glass-fibre filter attached on a quartz glass plate between 300 and 800 nm with 0.5 nm increments using a dual beam spectrophotometer (UV-2450, Shimadzu). A clean filter wetted with ultra-filtered (0.2 μm) sea water was used as a reference. The OD of the filter sample was corrected for the optical path length across the filter and the algal deposit on top of it, yielding the OD corresponding to the same sample in suspension, using mean β -correction factors according to Mitchell (1990). The average OD 750–800 nm was used to correct for scattering. The de-pigmented particle absorption spectrum was obtained after extraction of the pigments in a solution of 98% methanol. The spectral absorption coefficient for phytoplankton pigments, $a_{\text{phy}}(\lambda)$, was calculated by subtracting the de-pigmented particle absorption spectrum to the absorption coefficient of total filtered particles and was normalized to the chlorophyll *a* concentration (see below for its measurement) to obtain the chl *a*-specific absorption: $a_{\text{phy}}^*(\lambda)$. Finally, the mean absorption coefficient between 400 and 700 nm, \bar{a}_{phy}^* in $\text{m}^2 (\text{mg chl } a)^{-1}$, was calculated.

Chlorophyll *a* (chl *a*) concentrations were determined by filtering known volumes of water samples through Whatman 47 mm GF/F glass-fibre filters. The filters were stored at -80°C and subsequently extracted in 90% acetone. Chl *a* concentration was evaluated by fluorometry using a Turner Designs fluorometer (Model 10-AU) calibrated with known concentrations of commercially purified chl *a* (Sigma). The fluorescence was measured before and after acidification with HCl (Lorenzen 1966, Aminot & K  rouel 2004).

2.5 Data analyses

An analysis of similarities (one-way ANOSIM, Clarke & Warwick 1994) was used to test the significance of the differences in phytoplankton communities at the different scales considered. The analysis was based on a Euclidean similarity matrix and was performed using PRIMER 6 (PRIMER-E Ltd., Plymouth, UK).

Coefficients of variation (CV) were used to quantify the variability of photosynthetic parameters at each time scale (Scherrer 2007).

The significance of the relative contribution of each time scale to the total variability was evaluated using a mixed-effects nested ANOVA model. Data from the pluriannual study were used to compare the variability at annual, seasonal, monthly and fortnightly time scales. In this model, the main nesting factor (year) was fixed and the nested factors season (season within each year), month (within each season) and weeks (within each month) were randomized. Data from the diel cycles were used to compare the variability at seasonal, spring-neap tide cycle, days and hour scales. In this model, the main nesting factor (season) was fixed and the nested factors (tide conditions within each season), days (within each tide conditions) and hours (within each day) were random. These analyses were performed using the least square method (method of moments) with the JMP 9.0.2 (SAS) software following the instructions of Sall et al. (2007).

Relationships of photosynthetic parameters with environmental variables were quantified using stepwise multiple linear regression analysis. The variables tested were: light, water temperature, nutrient concentrations ($\text{NO}_3^- + \text{NO}_2^-$, $\text{Si}(\text{OH})_4$, PO_4^{3-}), salinity and assemblage composition (in term of chl *a* concentration by groups and relative proportions of total biomass). Environmental variables included in the model were selected using a forward

selection and significance of the model was tested by F tests. As advised by Blanchet et al. (2008), the stopping criteria were the alpha significance level and the adjusted coefficient of multiple determination of the global model built using all environmental variables. This procedure avoids inflated Type I error and the overestimation of the amount of explained variance. This analysis was performed using MINITAB 12.2 (MINITAB Inc, USA).

3 RESULTS

3.1 Physicochemical parameters

Results presented in this section describe the seasonal variations of physicochemical parameters. Their short-term variations were previously detailed in chapter V.

The physicochemical parameters were not significantly different between low and high tide (Mann Whitney U test, $P > 0.05$). The dynamics of PAR and sea water temperature (Fig.6.2 A & B) followed the classical seasonal evolution of temperate northern regions with low values in winter (January – February) and high values in summer (August). Temperature ranged between 3.90 and 22.54°C and maximal daily PAR between 131.67 and 1163.67 $\mu\text{mol photons m}^{-2} \text{ s}^{-1}$. Salinity (Fig.6.2 C) ranged from 28.2 to 34.8 and showed decreases more pronounced at low tide than at high tide.

$\text{NO}_2^- + \text{NO}_3^-$ and Si(OH)_4 showed a clear seasonal variation (Fig.6.2 D & E). $\text{NO}_2^- + \text{NO}_3^-$ increased between September and February and decreased rapidly between March and May to reach their lowest values between May and September. A similar seasonal pattern of variation was observed between both years; however, the maximum concentration was 1.5 times higher in 2010 than in 2009. In 2008-2009, Si(OH)_4 increased between October and

December and decreased rapidly between January and April to reach their lowest values between May and August. In 2009-2010, these variations occurred earlier in the year and maximum concentrations were 3 times higher than during the previous year. Si(OH)_4 reached their maximum at the end of November and decreased between December and the end of January to reach their minimum between February and August. PO_4^{-3} did not follow the same seasonal pattern as those of $\text{NO}_2^- + \text{NO}_3^-$ and Si(OH)_4 (Fig. 6.2 F). PO_4^{-3} concentrations stayed relatively stable between October 2008 and November 2009 (with values around 0.8 μM) whereas they showed the same profile as Si(OH)_4 from November 2009.

3.1 Phytoplankton biomass and assemblage composition

Total phytoplankton biomass (chl *a*) showed strong seasonal variations with maxima in spring / summer (February to August, 88.88 $\mu\text{g.L}^{-1}$) and minima in autumn / winter (October to January, 1.90 $\mu\text{g.L}^{-1}$).

At short time scale, phytoplankton composition did not vary significantly during the day and between the different days of each sampling period (ANOSIM, $P > 0.05$). At seasonal scale, no significant differences in phytoplankton composition at high and low tide were found. “Cryptophyta” were always present but with a low biomass all year round in 2009 whereas in 2010, a bloom of “Cryptophyta” was observed at the same time as the “diatoms + dinoflagellates” bloom (in February-March) (Fig. 6.3). “Cryptophyta” were dominant from October 16th 2008 to January 8th 2009 and from September 23th to December 18th 2009. *P. globosa* was principally present in spring and dominated from April 30th to May 07th 2009 and from March 18th to May 06th 2010. “Diatoms + dinoflagellates” dominated the rest of the time and were present all year round.

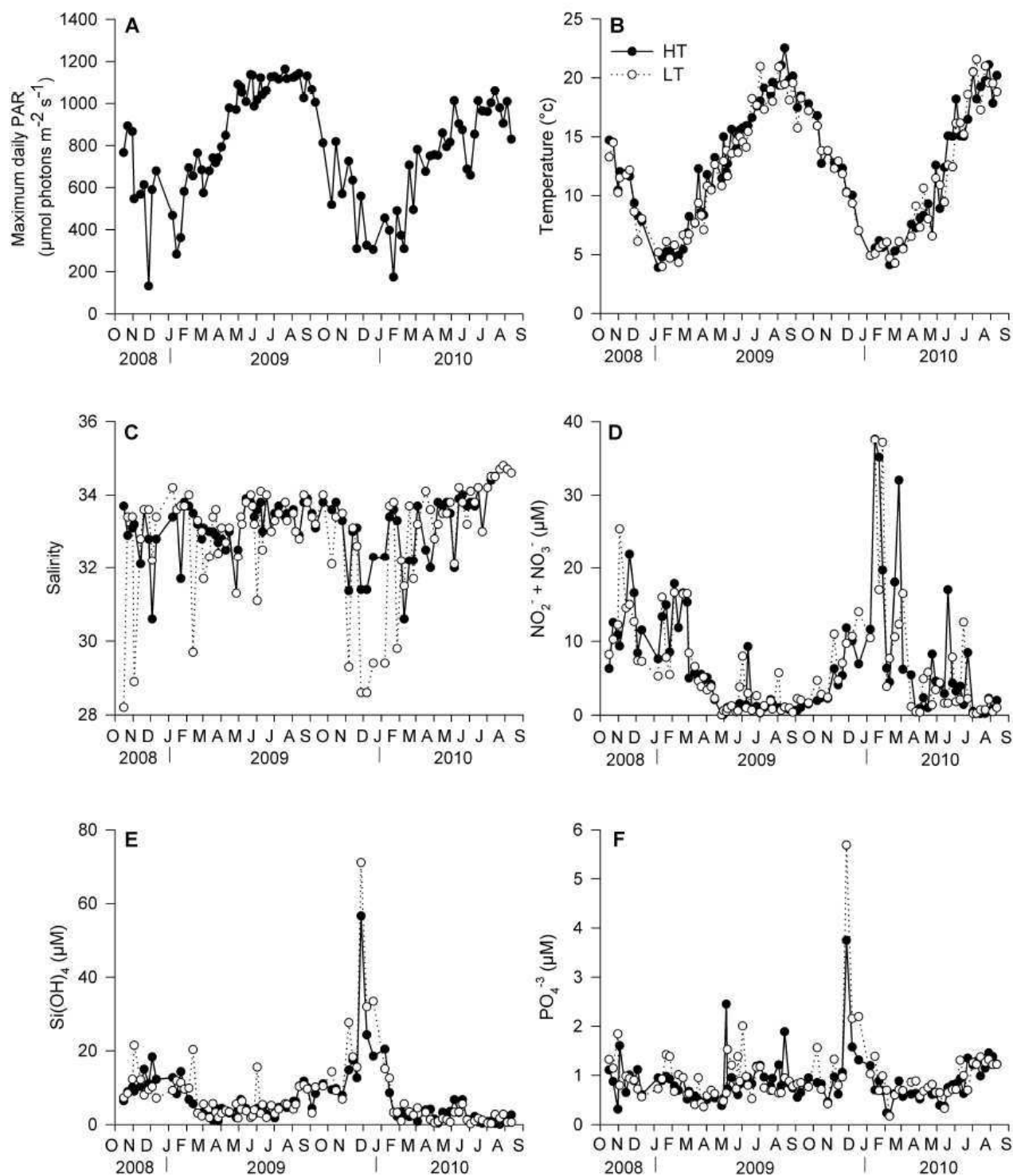

Fig. 6.2. Physicochemical parameters at seasonal scale. A) Maximum incident daily PAR ($\mu\text{mol photons m}^{-2} \text{s}^{-1}$), B) Temperature ($^{\circ}\text{C}$), C) Salinity, D) Nitrite and nitrate ($\text{NO}_2^- + \text{NO}_3^-$, μM), E) Phosphate (PO_4^{3-} , μM) and F) Silicate (Si(OH)_4 , μM). HT: high tide. LT: low tide

In spring 2009, three consecutive phytoplankton blooms were observed. *P. globosa* bloomed from mid-April to mid-May and disappeared at the end of spring (Fig. 6.3). This bloom was preceded by and followed by two blooms of “diatoms + dinoflagellates” (a first bloom from February to mid-April and a second bloom from May to August). In 2010, the *P. globosa* bloom started earlier (from mid-March) and reached a maximum of biomass 2.8 times higher than in 2009. This bloom was preceded by a “diatoms + dinoflagellates” bloom (between February and March) but, contrary to 2009, it was not followed by a second bloom of “diatoms + dinoflagellates”. The “diatoms + dinoflagellates” bloom preceding the *P. globosa* bloom in 2010 had a maximum of biomass 2.5 times higher than in 2009.

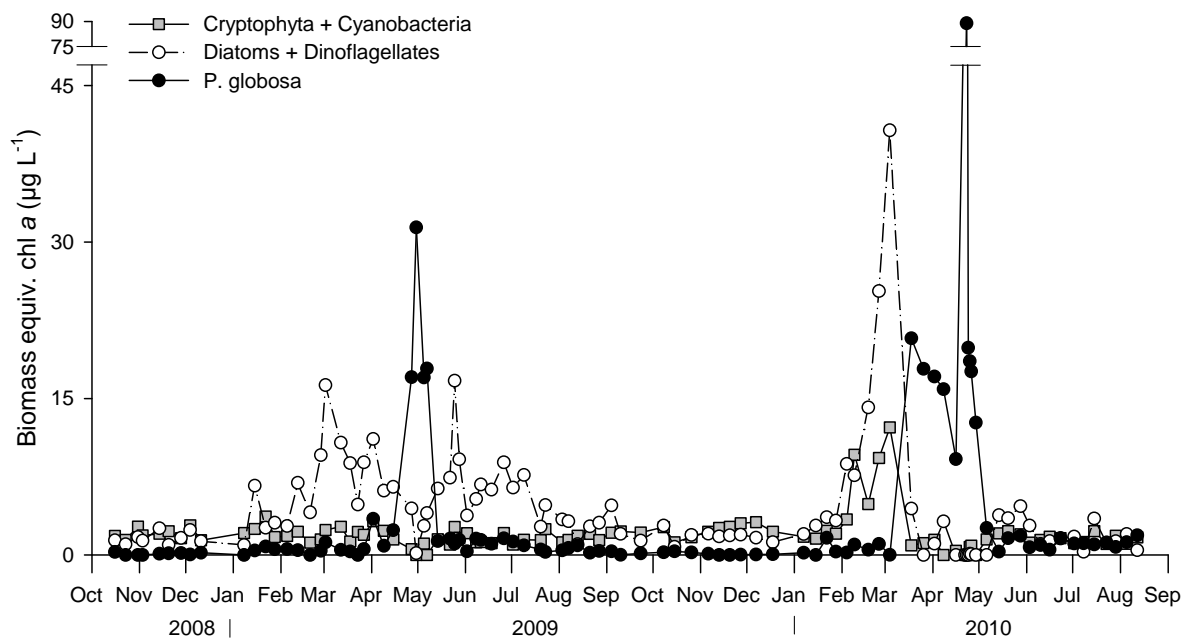

Fig. 6.3. Temporal variations of taxonomic composition of assemblages identified by the FluoroProbe. The relative amount of each phytoplankton group is expressed in terms of the equivalent amount of chlorophyll *a* per litre. Values are the mean of the measurements made at high and low tide

3.2 Photosynthetic parameters and mean chl *a*-specific absorption coefficients

3.2.1 Short-term variability

Variations of photosynthetic parameters at short time scale were presented in chapter V. Briefly, during sunny days, F_v/F_m showed an inverse relation with light and decreased when irradiance was at its maximum while, during overcast days, it stayed relatively stable. ETR_m and α were always positively correlated. ETR_m and α were highly variable during the day and showed no diel cycle common to the different sampling days. ETR_m and α varied according to three main patterns of variation. Each pattern of variation was not specific to a given sampling period or a particular phytoplankton community structure and was not associated to a specific light climate. \bar{a}_{phy}^* showed the same variations than ETR_m . Changes in E_k were always small compared to incident irradiance fluctuations and varied from one day to another. Some days, E_k stayed relatively stable in comparison with ETR_m and α , whereas, other days, the hourly variability of E_k was of the same order of magnitude as the variability of ETR_m and α .

3.2.2 Variability at longer time scales

F_v/F_m ranged from 0.28 to 0.68. It varied without any clear seasonal cycle and showed a high variability at sub-seasonal scale (from week to week and from month to month) (Fig. 6.4 A). Nevertheless, F_v/F_m showed a certain similarity between both years. It tended to increase between September and January.

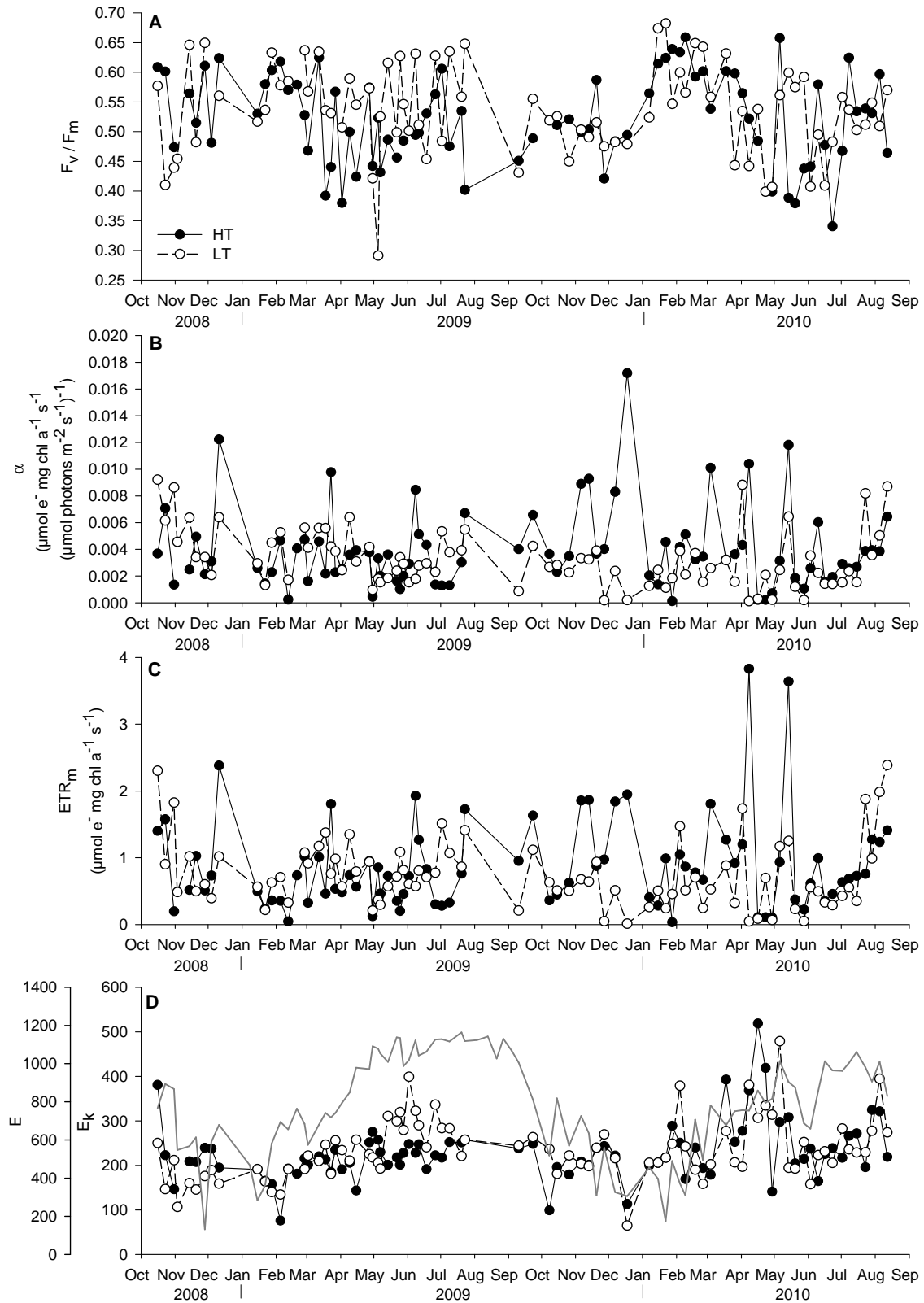

Fig. 6.4. Photosynthetic parameters at seasonal scale. A) Maximum quantum yield (F_v/F_m), B) Maximal light utilization efficiency (α), C) Maximum electron transport rate (ETR_m) and D) Light saturation coefficient (E_k) (in black and white) and incident PAR (in grey) in $\mu\text{mol photons m}^{-2} \text{ s}^{-1}$. HT: high tide. LT: low tide

It showed a great variability during the bloom periods (between mid-January and August 2009 and between February and May 2010), and reached a minimum at the termination phase of *P. globosa* bloom (at the beginning of May). Finally, it increased again after the bloom period (from May to August). Low values of F_v/F_m (< 0.50) were observed punctually during the same periods in 2008-2009 and 2009-2010. These low values were observed between July and September, in December and during the spring bloom periods with the lowest values at the termination phase of *P. globosa* blooms.

ETR_m ranged from 0.01 to 3.83 $\mu\text{mol e}^- \text{mg chl a}^{-1} \text{s}^{-1}$ and α from 0.0001 to 0.0122 $\mu\text{mol e}^- \text{mg chl a}^{-1} \text{s}^{-1} (\mu\text{mol photons m}^{-2} \text{s}^{-1})^{-1}$ (Fig. 6.4 B & C). ETR_m and α showed a great variability and varied without any clear seasonal cycle. High values of ETR_m and α were obtained in summer, late autumn-early winter and punctually during the spring blooms. ETR_m and α were always positively correlated with determination coefficient and slope of the regression that varied with seasons and years.

E_k ranged from 65 to 519 $\mu\text{mol photons m}^{-2} \text{s}^{-1}$ with an annual mean of 231 $\mu\text{mol photons m}^{-2} \text{s}^{-1}$ (Fig. 6.4 D). E_k varied with the seasonal cycle of incident irradiance but, during summer, changes in E_k were small in comparison with incident irradiance. The lowest values of E_k were observed in winter (between December and February) and the highest in late spring - early summer (between April and August).

\bar{a}_{phy}^* (Fig. 6.5) ranged between 0.001 and 0.055 $\text{m}^2 (\text{mg chl a})^{-1}$ and showed the same variations than ETR_m and α .

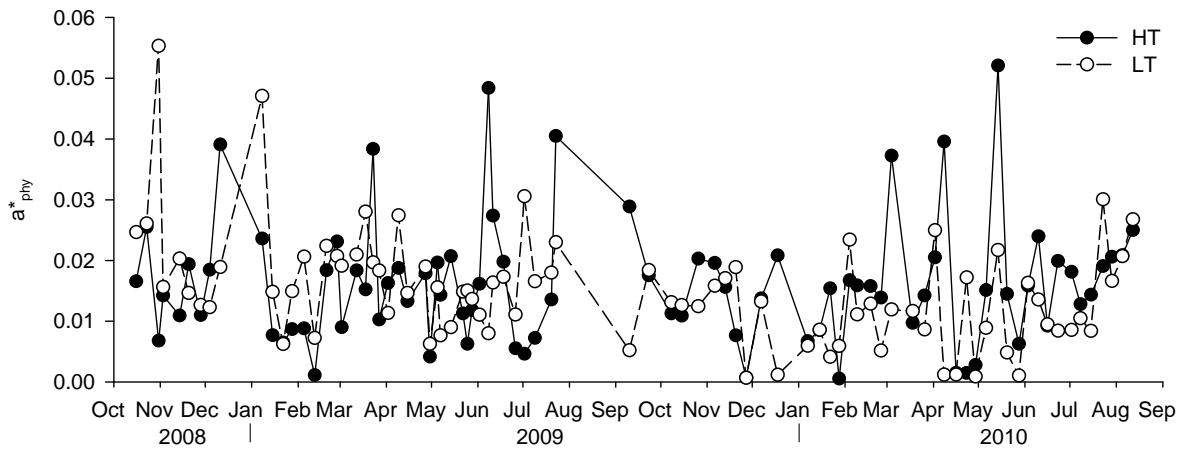

Fig. 6.5. Mean chl a-specific absorption coefficient (\bar{a}^*_{phy}) in $m^2 (mg\ chl\ a)^{-1}$

3.2.3 Variability at different time scales

F_v/F_m was the parameter that varied at the highest number of time scales. F_v/F_m was significantly variable at seasonal ($P < 0.001$), fortnightly ($P < 0.001$), daily ($P < 0.001$) and hourly scales ($P < 0.001$). ETR_m and E_k were significantly variable at fortnightly (ETR_m : $P < 0.001$; E_k : $P = 0.023$) and hourly scales (ETR_m and E_k : $P < 0.001$). α was significantly variable at seasonal ($P = 0.036$) and fortnightly ($P < 0.001$) scales. The highly significant interaction day x hour for ETR_m and F_v/F_m (ETR_m : $P = 0.014$; F_v/F_m : $P < 0.001$), indicates that not only these parameters varied from hour to hour within each day but also that the hourly pattern of variation varied among days of each sampling period. The coefficients of variation (Fig. 6.6) showed that it was at the fortnightly and monthly scales that α and ETR_m were the most variable while, F_v/F_m and E_k were variable during the day as much as at the fortnightly and monthly scales.

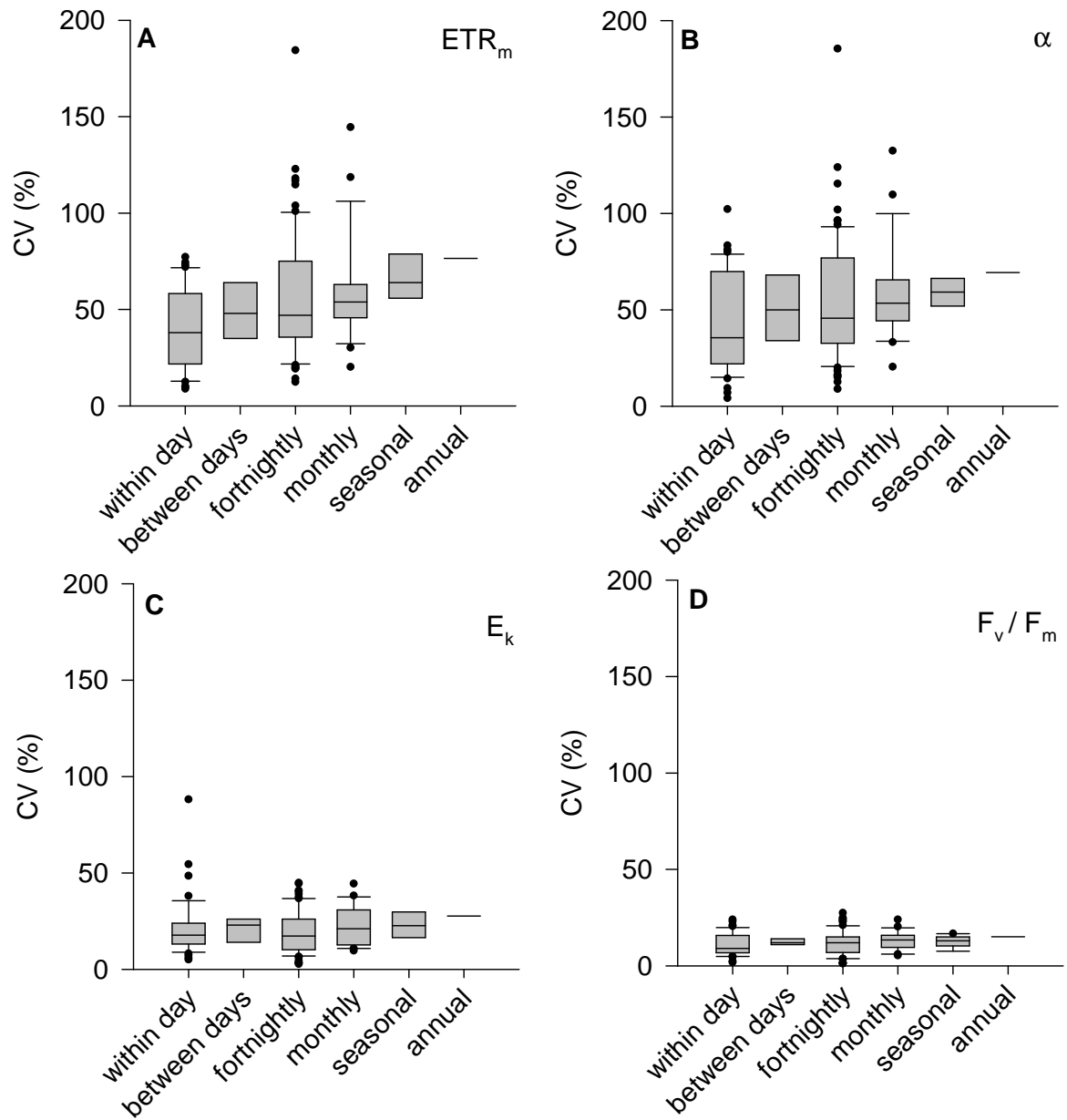

Fig. 6.6. Variability of photosynthetic parameters at different time scales represented by box plots of coefficients of variation (%). A) Maximum electron transport rate (ETR_m), B) Maximal light utilization efficiency (α), C) Light saturation coefficient (E_k) and D) Maximum quantum yield (F_v/F_m). Black points represent outliers

3.3 Relationships between photosynthetic parameters and environmental factors

To identify the main environmental factors influencing the variability of phytoplankton photosynthetic activity, relationships between photosynthetic parameters and environmental variables were studied at different time scales using stepwise multiple linear regressions. The factors controlling the variability of photosynthetic parameters were found to differ according to the time scale considered.

The results at short time scales were presented in chapter V. Light was the main factor influencing the short-term variability of photosynthetic parameters and was followed by temperature and nutrients. At these time scales, the role of phytoplankton assemblages seemed of secondary importance.

At longer time scales (from monthly to pluriannual scales), the factors influencing the photosynthetic parameters differed according to the photosynthetic parameter and time scale considered. At these time scales, the structure of phytoplankton assemblages has a higher influence on the variability of photosynthetic parameters than at short-time scales.

The photosynthetic parameters were mainly controlled by temperature, light, nutrients and phytoplankton composition. The main factor controlling F_v/F_m changed between the different scales considered (Table 6.I). However, temperature, light, the proportions of “diatoms + dinoflagellates” and PO_4^{-3} influenced F_v/F_m whatever the time scale considered. By contrast, α was related to different factors from a time-scale to another (Table 6.II). At pluriannual and annual scales, α was controlled by the proportion of “Crytophyta”. At seasonal scale, the variability of α resulted from the interplay between phytoplankton composition, light and salinity. Finally, at monthly scale, α was controlled by different factors

from one month to an other including temperature, light, nutrients, salinity, and phytoplankton composition.

The factors controlling ETR_m were the most difficult to identify because, during several periods, ETR_m was not significantly related to any of the environmental variables considered (Table 6.III). At annual scale, environmental factors related to ETR_m differed between 2008-2009 and 2009-2010. In 2008-2009, ETR_m was related to $Si(OH)_4$, PO_4^{-3} , the proportion of “Cryptophyta” and salinity, while in 2009-2010, it was only related to $NO_3^- + NO_2^-$. At seasonal scale, ETR_m was associated to only one factor (light or the proportion of “Cryptophyta”) or to the combination of light, the proportion of *P. globosa* and salinity. At monthly scale, light and temperature were the main factors influencing ETR_m and were followed by nutrients, salinity and the proportion of *P. globosa*. However, the principal factor changed from one month to an other.

In 2008-2009, E_k was related to light, temperature, nutrients ($NO_3^- + NO_2^-$ and PO_4^{-3}) and the proportion of “diatoms + dinoflagellates”, while in 2009-2010, it was only related to the proportion of *P. globosa* (Table 6.IV). At seasonal scale, E_k was associated with the proportion of *P. globosa* (in autumn 2008), temperature (in winter 2009 and 2010 and in spring 2010) or PO_4^{-3} (in spring 2009). At monthly scale, the factors controlling E_k differed from one month to an other but temperature, light, phytoplankton composition and nutrients were the main factors influencing E_k .

Table 6.I. Stepwise multiple linear regression equations relating the maximum quantum yield (Fv/Fm) to environmental factors and phytoplankton groups, and associated statistics. Only periods with significant results are presented. Blanks correspond to not selected variables. * $P \leq 0.05$, ** $P \leq 0.01$, *** $P \leq 0.001$. C = constant. Diat. = proportion of “diatoms + dinoflagellates” (FluoroProbe estimation), *P. globosa* = proportion of *P. globosa* (FluoroProbe estimation), Crypt. = proportion of “Cryptophyta” (FluoroProbe estimation). r^2 = adjusted coefficient of multiple determination (in %)

F _v /F _m	C	Temperature	Light	Diat.	<i>P. globosa</i>	Crypt.	[NO ₂ ⁻ +NO ₃ ⁻]	[Si(OH) ₄]	[PO ₄ ⁻³]	Salinity	r ²	F	P	n	
Pluriannual	2008-2010	0.59	- 3.98E-03	- 1.29E-04	8.37E-04							24.1	13.56	***	160
Annual	2008-2009	0.56	- 3.71E-03	- 1.60E-03	1.22E-03							22.8	9.15	***	85
	2009-2010	0.57	- 5.68E-03		8.84E-04							26.9	10.09	***	75
Seasonal	winter 2009	0.73	- 3.77E-02	2.30E-04								47.9	8.81	**	18
	spring 2009	0.44			1.18E-03							15.2	6.75	*	33
	summer 2009	1.45	- 4.40E-02			- 3.70E-03						76.1	18.56	***	12
	autumn 2009	0.52						- 1.14E-03				23.0	6.38	*	20
	winter 2010	0.27		- 1.68E-04			- 1.47E-03			- 2.17E-02	1.48E-02	51.7	6.09	**	20
	spring 2010	3.83			1.39E-03						- 1.00E-01	44.6	10.65	***	25
	summer 2010	0.55						- 2.44E-02				55.9	20.04	***	16
Monthly	Mar-2009	0.86	- 3.81E-02									47.5	8.23	*	9
	Apr-2009	0.83		- 7.86E-04								34.5	5.73	*	10
	May-2009	0.27			2.32E-03				9.86E-02			73.5	16.27	***	10
	Jun-2009	- 0.43		8.96E-04								37.6	6.42	*	10
	Jul-2009	1.66	- 5.96E-02									54.3	9.31	*	8
	Sep-2009	2.24	- 9.80E-02									87.1	21.31	*	4
	Nov-2009	475.00								- 22.10		65.3	14.20	**	8
	Jan-2010	- 0.05					- 3.57E-03			2.44E-02		95.3	71.99	***	8
	May-2010	1.18	- 8.04E-02			- 1.55E-03			6.30E-01			91.2	25.24	**	8
Jun-2010	0.63	- 1.30E-02					- 1.36E-02	8.91E-02			96.6	66.72	***	8	

Table 6.II. Stepwise multiple linear regression equations relating the maximal light utilization efficiency (α) to environmental factors and phytoplankton groups, and associated statistics. Only periods with significant results are presented. Blanks correspond to not selected variables. * $P \leq 0.05$, ** $P \leq 0.01$, *** $P \leq 0.001$. C = constant. Diat. = proportion of “diatoms + dinoflagellates” (FluoroProbe estimation), *P. globosa* = proportion of *P. globosa* (FluoroProbe estimation), Crypt. = proportion of “Cryptophyta” (FluoroProbe estimation). r^2 = adjusted coefficient of multiple determination (in %)

α		C	Temperature	Light	Diat.	<i>P. globosa</i>	Crypt.	[NO ₂ ⁻ +NO ₃ ⁻]	[Si(OH) ₄]	[PO ₄ ⁻³]	Salinity	r ²	F	P	n
Pluriannual	2008-2009	2.60E-03					3.30E-05					5.3	9.83	**	160
Annual	2008-2009	2.51E-02					4.10E-05					11.8	12.22	***	85
Seasonal	spring 2009	1.68E-03					1.02E-04					26.4	12.46	***	33
	winter 2010	- 8.80E-04		1.10E-05	3.50E-05							31.3	5.33	*	20
	summer 2010	- 4.65E-02		- 1.70E-05							1.94E-03	47.0	7.64	**	16
Monthly	Oct-2008	2.90E-04								5.18E-03		64.0	9.88	*	6
	Feb-2009	- 1.74E-02	1.55E-03					8.02E-04				91.9	34.98	**	7
	Mar-2009	4.40E-04					2.21E-04					41.3	6.63	*	9
	Apr-2009	1.64E-02	- 6.13E-04	- 1.40E-05								62.9	8.62	*	10
	Oct-2009	- 1.00E-02	7.91E-04	7.00E-06								78.1	9.91	*	6
	Nov-2009	3.87E+00	1.20E-01				- 7.70E-01					67.3	8.21	*	8
	Dec-2009	- 2.17E-01			6.46E-03							96.7	90.26	*	4
	Apr-2010	1.60E-01					- 2.10E-04				- 4.08E-03	89.8	36.03	***	9
	May-2010	2.03E-03	1.57E-03							-3.03E-02		82.5	17.52	**	8
Jul-2010	2.10E-01		- 2.50E-05		9.40E-05					- 5.79E-03	75.2	10.12	**	10	

Table 6.III. Stepwise multiple linear regression equations relating the maximum electron transport rate (ETR_m) to environmental factors and phytoplankton groups, and associated statistics. Only periods with significant results are presented. Blanks correspond to not selected variables. * $P \leq 0.05$, ** $P \leq 0.01$, *** $P \leq 0.001$. C = constant. Diat. = proportion of “diatoms + dinoflagellates” (FluoroProbe estimation), *P. globosa* = proportion of *P. globosa* (FluoroProbe estimation), Crypt. = proportion of “Cryptophyta” (FluoroProbe estimation). r^2 = adjusted coefficient of multiple determination (in %)

ETR_m		C	Temperature	Light	Diat.	<i>P. globosa</i>	Crypt.	[NO ₂ +NO ₃]	[Si(OH) ₄]	[PO ₄ ³⁻]	Salinity	r^2	F	P	n
Annual	2008-2009	4.98					1.64E-02		- 7.39E-02	0.30	- 0.13	18.9	5.90	***	85
	2009-2010	0.98						- 1.86E-02				4.0	4.05	*	75
Seasonal	spring 2009	0.44					1.96E-02					21.8	9.94	**	33
	winter 2010	0.30		2.36E-03								21.5	6.21	*	20
	summer 2010	- 22.40		- 2.90E-03		1.83E-02					0.70	65.5	10.51	***	16
Monthly	Oct-2008	2.47		- 6.61E-03						0.92		82.3	12.65	*	6
	Feb-2009	- 2.12	0.40	- 2.43E-03				0.07				96.2	51.94	**	7
	Apr-2009	3.59	- 0.14	- 2.86E-03								68.5	10.79	**	10
	Oct-2009	15.60	-5.85E-02					- 0.15			- 0.42	98.0	81.39	*	6
	Apr-2010	10.80		- 5.72E-03		- 6.01E-02						94.4	67.95	***	9
	Jul-2010	30.50		- 5.10E-03		2.36E-02					- 0.80	84.8	17.79	**	10

Table 6.IV. Stepwise multiple linear regression equations relating the light saturation coefficient (E_k) to environmental factors and phytoplankton groups, and associated statistics. Only periods with significant results are presented. Blanks correspond to not selected variables. * $P \leq 0.05$, ** $P \leq 0.01$, *** $P \leq 0.001$. C = constant. Diat. = proportion of “diatoms + dinoflagellates” (FluoroProbe estimation), *P. globosa* = proportion of *P. globosa* (FluoroProbe estimation), Crypt. = proportion of “Cryptophyta” (FluoroProbe estimation). r^2 = adjusted coefficient of multiple determination (in %)

E_k		C	Temperature	Light	Diat.	<i>P. globosa</i>	Crypt.	[NO ₂ ⁻ +NO ₃ ⁻]	[Si(OH) ₄]	[PO ₄ ⁻³]	Salinity	r^2	F	P	n
Pluriannual	2008-2010	172.00		5.92E-02		0.65						16.3	16.54	***	160
Annual	2008-2009	111.00	2.52	3.19E-02	0.51			- 2.13		42.3		34.6	9.90	***	85
	2009-2010	214.00				1.07						21.8	21.64	***	75
Seasonal	autumn 2008	167.00				9.35						30.7	7.65	*	16
	winter 2009	120.00	10.20									24.7	6.59	*	18
	spring 2009	194.00								56.00		22.4	10.25	**	33
	winter 2010	- 28.00	46.90									33.0	10.35	**	20
	spring 2010	404.00	-11.70									14.1	4.93	*	25
Monthly	Oct-2008	1059.00					- 14.50					88.0	37.62	**	6
	Nov-2008	181.00			0.64	10.80		- 3.89				98.9	179.13	***	7
	Jan-2009	224.00		- 0.13								77.4	14.67	*	5
	Mar-2009	38.00			2.24							40.6	6.46	*	9
	Jun-2009	39.00			2.53				13.10			64.4	9.13	*	10
	Sep-2009	589.00	- 19.00									94.9	56.66	*	4
	Nov-2009	1.95E-02		6.22E-04		- 3.96E-03						69.1	8.82	*	8
	Dec-2009	- 1894.00		6.48								90.2	28.47	*	4
	Mar-2010	2661.00		-1.37							- 42.20	86.6	17.13	*	6
	May-2010	3071.00									- 84.00	48.8	7.68	*	8
Aug-2010	530.00					- 6.86					86.4	20.02	*	4	

4 DISCUSSION

In the Strait of Dover, the interplays between day/night, tidal and seasonal cycles in physicochemical parameters and the successions of phytoplankton assemblages make the phytoplankton photosynthetic activity highly variable at different time scales.

4.1 Short-term variability of photosynthetic activity

At short time scale (from hour to the scale of a spring-neap tide cycle), F_v/F_m showed clear light dependent changes suggesting the operation of photoprotective mechanisms during the day. By contrast, there was no consistent pattern of diel periodicity of ETR_m , and α . There was a decline of ETR_m and α during the day as often as there was a peak at the maximum of irradiance. This is not consistent with what is expected for phytoplankton fully photoacclimated or for endogenous daily photosynthetic rhythms (MacCaull & Platt 1977, Erga & Skjoldal 1990, Henley 1993, Behrenfeld et al. 2004). However, in highly dynamics systems, such as the Strait of Dover, where environmental conditions varied from hour to hour in response to meteorological and mixing conditions, clear diel cycle can be more difficult to observe because in such conditions photoacclimation is extremely difficult. The same situation with no clear diel periodicity in photosynthetic parameters was previously observed in estuaries (e.g. Azevedo et al. 2010) and in the eastern English Channel during spring (e.g. Lizon et al. 1995, Jouenne et al. 2005). This difficulty of acclimation is sustained by the E_k variability that changed from one day to an other. Some days, E_k stayed relatively stable during the day and showed a lower variability than ETR_m and α while other days, its

variability was of the same order of magnitude as the variability of ETR_m and α . However, whatever the period of year, changes in E_k were generally small in comparison with incident irradiance fluctuations indicating a restricted acclimation capacity with a poor optimization of light harvesting during the day. The optimal use of incident irradiance seemed focused on the between-days rather than within-day variability (see chapter V for more details). At these time scales, light, temperature and nutrients were the main factors influencing the variability of photosynthetic parameters while taxonomic composition of assemblages seemed to play a secondary role. Indeed, the phytoplankton groups were not retained by the stepwise multiple linear regressions and photosynthetic parameters were highly variable during the periods with the same phytoplankton composition (see chapter V for more details).

4.2 Variations of photosynthetic parameters at longer time-scales

Physicochemical parameters and phytoplankton biomass showed clear seasonal changes. These variations are typical of northern temperate ecosystems (e.g. Gentilhomme & Lizon 1998, Glé et al. 2008, Grattepanche et al. 2011) and the successions in phytoplankton assemblages were similar to that previously recorded in the eastern English Channel (e.g. Grattepanche et al. 2011, Lefebvre et al. 2011) and the North Sea (e.g. Gieskes & Kraay 1975, Rousseau et al. 2002, Muylaert et al. 2006).

In spite of these clear seasonal variations in physicochemical parameters and taxonomic composition of phytoplankton assemblages, no clear cyclical seasonal variations of F_v/F_m , ETR_m and α could be observed. Indeed, these parameters showed a high variability at sub-seasonal scale (from week to week and from month to month) which could be of the same

order of magnitude as the variability at seasonal scale and the patterns of variations differed between both years investigated.

Few studies reported results of *in situ* monitoring of F_v/F_m variations at these time scales. To our knowledge, in the English Channel, only two studies deal with variations of F_v/F_m at these time scales (Aiken et al. 2004, Napoléon et al. 2012). These studies reported contrasting results. In the English coasts, Aiken et al. (2004) found weekly fluctuations of F_v/F_m without any clear seasonal cycle whereas Napoléon et al. (2012) found different results between the French and English coasts. In the French coasts, F_v/F_m was high throughout the year and showed no seasonal cycle while in the English coasts, F_v/F_m decreased between April and September. Although, our study site is situated in the French coasts, our F_v/F_m variations were more similar to the observations made in the English coast particularly the results of Aiken et al. (2004). However, in the study of Napoléon et al. (2012), samplings were carried out on a monthly basis and some sub-seasonal variations of F_v/F_m may have pass unnoticed.

It is known that rapid changes in F_v/F_m are a function of species composition and recent history of environmental factors such as light, nutrients and temperature (Corno et al. 2008) and, low values of F_v/F_m (< 0.50) are considered as reflecting a physiological stress (Parkhill et al. 2001). During our study, low F_v/F_m values were observed punctually during the same periods in 2008-2009 and 2009-2010 with the lowest values reached at the termination phase of *P. globosa* blooms. Although, the highest shifts in F_v/F_m happened in spring when great changes in phytoplankton assemblages occurred, these low F_v/F_m values (0.44 to 0.28) were not a “taxonomic signature” (Suggett et al. 2009). Indeed, in literature, Diatom and Haptophytes’s values of F_v/F_m range between 0.50 and 0.69 in absence of physiological stress (Juneau & Harrison 2005, Kruskopf & Flynn 2006, Suggett et al. 2007, Kropuenske et al. 2010). The low F_v/F_m values, observed in the present study, probably reflected the difficulty

of phytoplankton to cope with changes in environmental conditions such as changes in light and nutrient conditions. The low values of F_v/F_m observed during the transitions between the blooms of “diatoms + dinoflagellates” (first and/or second bloom) and those of *P. globosa* and at the end of the second bloom of “diatoms + dinoflagellates” were also probably associated to the presence of senescent cells.

Studies of photosynthetic parameters on a seasonal basis reported different results in coastal waters. Some studies showed seasonal cyclical variations of α and ETR_m (e.g. Lohrenz et al. 1994, Jouenne et al. 2007, Gameiro et al. 2011) while, others indicated that these parameters tend to vary little on a seasonal basis (e.g. Gowen & Bloomfield 1996, Shaw & Purdie 2001) or reported a seasonal variation for ETR_m but not for α (e.g. Tillmann et al. 2000). In the present study, α and ETR_m were always positively correlated and their range of variation was similar. No clear seasonal cycle was observed in spite of their high variability. High values of ETR_m and α were obtained in summer, late autumn-early winter and punctually during the spring blooms. High photosynthetic parameters in summer are common in temperate northern ecosystems and were associated to high water temperature and increased light availability (e.g. Tillmann et al. 2000, Jouenne et al. 2007, Gameiro et al. 2011). In our study, light availability and temperature were not the sole factors controlling photosynthetic parameters at these time scales because high values of photosynthetic parameters were also observed in late autumn-early winter when light availability and temperature were decreasing.

The high values observed in late autumn-early winter and punctually during the spring blooms seem indicate a role of phytoplankton community composition. Indeed, in late autumn-early winter, the high values of ETR_m and α coincided with periods where the FluoroProbe indicated relatively high contributions of “Cryptophyta” to total biomass and, in spring, they corresponded to transition periods between different successive blooms.

Moreover, at some scales, stepwise multiple linear regressions associated ETR_m and α with phytoplankton groups particularly *P. globosa* and “Cryptophyta”. In the North Sea and English Channel, relationships between photosynthetic parameters dynamics and phytoplankton community structure were previously found by Shaw & Purdie (2001) and Jouenne et al. (2005, 2007). The later authors explained that microalgae species modify their trophic environment by assimilating nutrients and thus influence indirectly photosynthetic activity through close interplays between shifts in community composition and changes in the physicochemical characteristics of the environment (negative feedback). This explains the selection of nutrients in our stepwise multiple linear regressions. The strong resemblance between α and \bar{a}_{phy}^* variations sustains the role of assemblages composition in photosynthetic parameters variability (MacIntyre & Kana 2002). Indeed, \bar{a}_{phy}^* explained a greater part of the α variability than F_v/F_m . This indicates a control of α by changes in pigmentation and package effect in response to changes in phytoplankton assemblages and physiological acclimations (e.g. Sosik & Mitchell 1995, Bricaud et al. 2004).

E_k has frequently been used to describe the adjustments of photosynthetic activity to changing environmental conditions, particularly the conditioning of microalgae to available PAR, and express the phytoplankton photoacclimation state (Sakshaug et al. 1997, Behrenfeld et al. 2004). In spite of the different methodologies used to measure the photosynthetic parameters (fluorescence vs. carbon fixation), our E_k values were within the range reported in other coastal systems (Lohrenz et al. 1994, Tillmann et al. 2000, Macedo et al. 2001, Shaw & Purdie 2001, Struski & Bacher 2006). In our study, at seasonal scale, E_k showed a lower variability than ETR_m and α but was not completely stable. The seasonal trends in this parameter generally corresponded to the seasonal changes in incident surface irradiance except during summer where changes in E_k were small in comparison with incident irradiance fluctuations. The dependence of E_k on light is consistent with field and laboratory studies

which shown variations of E_k according to light conditions to which algae were exposed (e.g. Maranon & Holligan 1999, Kropuenske et al. 2010). Few, however, illustrated the seasonal dependence of E_k . In field studies, seasonal variations of E_k were reported by Moline et al. (1998) and observed but not mentioned or discussed in the articles of Tillmann et al. (2000), Moran & Estrada (2005) and Gameiro et al. (2011). Seasonal variations of E_k were also observed in the laboratory experiments of Lefebvre et al. (2007) in which *Skeletonema costatum* was exposed to culture conditions simulating the seasonal variations of temperature, photoperiod and incident light intensity.

4.3 The Strait of Dover, an ecosystem dominated by the E_k -independent variability

In our study, whatever the time scale and period of year considered, ETR_m and α were always positively correlated. According to Behrenfeld et al. (2004), this kind of variation belong to a certain category of PE curve variability: the “ E_k -independent variability” where parallel changes in ETR_m and α are one of the basis of the photosynthetic response. Contrary to the “ E_k -dependent variability” that results from photoacclimation, the “ E_k -independent variability” is not well understood and no clear physiological explanation is available at the present time. Behrenfeld et al. (2004) suggested a few potential explanations implicating pigment variability, changes in the fraction of PSII photochemically competent, growth-dependent changes in ATP and reductants demands, nutrient availability or phytoplankton community structure. The “ E_k -independent variability” was previously reported by other authors in field studies (Côté & Platt 1983, Harding Jr. et al. 1985, Lohrenz et al. 1994, Moline et al. 1998, Jouenne et al. 2005, Azevedo et al. 2010) but none of them permitted to

clearly identify the environmental conditions leading to this variability. In highly dynamic ecosystems, it has been suggested (Jouenne et al. 2005, Azevedo et al. 2010) that this phenomenon occurs when short-term acclimation is limited by frequent changes in environmental conditions and taxonomic composition of assemblages. Although, this last hypothesis could be appropriate for explaining the “ E_k -independent” variability in the Strait of Dover, further investigations are required to fully resolve the physiological basis of this kind of variability.

5 CONCLUSIONS

This study provides new insights into the functioning and variability of phytoplankton activity at different time scales in the Strait of Dover. The use of a temporally nested sampling design showed that, in this system, the variability of photosynthetic parameters can be as high at seasonal scale as at hourly and fortnightly scales. These results have important consequences for the design of sampling programs. The usual practice of sampling with a monthly basis for detecting the seasonal trends does not provide information on the within-month variability of phytoplankton photosynthetic activity. This practice can result in erroneous seasonal patterns due to aliasing because in presence of sub-monthly variability, the seasonal trend obtained using such low sampling frequency depends on the date of sampling. Moreover, the understanding of the factors influencing photosynthetic activity depends on the time scale considered. Indeed, it was found that different factors influence the photosynthetic parameters at short time scale (from hour to the scale of a neap-spring tide cycle) or at longer time-scale (from fortnightly to pluriannual scale). At short time scale, light, temperature and nutrients were the main factors influencing the photosynthetic parameters variability while

taxonomic composition of assemblages seemed to play a secondary role. By contrast, at longer time-scales, close interplays between shifts in community composition and changes in the physicochemical parameters (mainly light, temperature and nutrients) controlled the variability of photosynthetic parameters. The extent to which photosynthetic parameters were directly influenced by resource limitation, or indirectly reflected environmental forcing through shifts in community structure could not be fully quantified with the current data set. Further research with a more detailed taxonomic description of assemblages may enhance the understanding of their role in the dynamics of photosynthetic activity in the Strait of Dover.

Synthèse et perspectives

1 RAPPELS DU CONTEXTE ET DES OBJECTIFS DE LA THESE

En dépit de leur faible étendue par rapport à l'océan mondial, les écosystèmes côtiers sont parmi les plus productifs au monde (Gattuso et al. 1998) et leur impact sur les bilans biogéochimiques globaux est maintenant clairement reconnu (Borges 2005). Cependant, de nombreuses incertitudes persistent quant au rôle exact de ces eaux en tant que source ou puits dans les cycles biogéochimiques globaux (Crossland et al. 2005). Ces écosystèmes reçoivent des apports massifs de matières organiques et de nutriments d'origine terrestre, échangent d'importantes quantités de matière et d'énergie avec les océans et constituent l'une des zones les plus actives de la biosphère (Gattuso et al. 1998). Ils sont également le siège de nombreuses activités humaines (pêche, aquaculture, tourisme...) puisque plus de la moitié de la population mondiale dépend de ces zones (Crossland et al. 2005). Ces dernières années, les pressions anthropiques et climatiques sur les écosystèmes côtiers se sont accentuées (Halpern et al. 2008, Goberville et al. 2011) et d'importantes modifications de leur fonctionnement sont à prévoir avec des conséquences possibles sur la production primaire phytoplanctonique qui constitue la base des réseaux trophiques de ces systèmes (Cloern 1996, Falkowski & Raven 2007, Cloern & Jassby 2008). Comprendre le rôle des phototrophes dans le cycle global du carbone et dans le fonctionnement des écosystèmes côtiers est ainsi plus que jamais primordial (Geider et al. 2001).

Cette compréhension n'est possible qu'avec une bonne estimation de la production primaire qui à son tour repose sur la connaissance précise de la dynamique et du contrôle de

l'activité photosynthétique et de la biomasse du phytoplancton. Parmi les écosystèmes côtiers, c'est au sein des systèmes à fort hydrodynamisme que la connaissance de ces processus est la moins aboutie principalement en raison de la complexité des interactions physico-chimiques et biologiques dans ces systèmes. L'un des principaux défis réside dans la possibilité de mesurer simultanément les variations de la biomasse et de l'activité photosynthétique du phytoplancton avec une fréquence comparable aux variations des facteurs environnementaux qui se déroulent à différentes échelles spatiales et temporelles.

Dans ce contexte, cette thèse avait pour but de caractériser la dynamique de l'activité photosynthétique du phytoplancton dans un écosystème à fort hydrodynamisme contrôlé par la marée. Les objectifs fixés étaient :

- 1) la caractérisation de la variabilité de l'activité photosynthétique du phytoplancton à différentes échelles spatiales et temporelles.
- 2) l'identification et la hiérarchisation des paramètres de contrôle de cette variabilité.
- 3) la mise en évidence d'éventuelles relations entre les propriétés photosynthétiques de la communauté phytoplanctonique naturelle et sa composition taxonomique afin d'identifier les propriétés photosynthétiques spécifiques à chacun des groupes phytoplanctoniques.

Pour atteindre ces objectifs, notre choix méthodologique s'est porté sur l'utilisation de la fluorescence spectrale et de la fluorimétrie modulée. Ces méthodes ont été choisies parce qu'elles ont le potentiel d'améliorer considérablement la résolution spatiale et temporelle des mesures de l'activité photosynthétique et de la dynamique des groupes phytoplanctoniques. Cependant, ces méthodes sont également relativement récentes et certaines méthodologies sont encore en phase de développement et/ou ont été peu employées en milieu marin. C'est particulièrement vrai pour la fluorescence spectrale. Il était donc nécessaire, dans un premier temps, de déterminer leur adéquation vis-à-vis des particularités de la Manche orientale que ce soit en terme de dynamique des conditions environnementales ou en terme de composition

taxonomique des communautés phytoplanctoniques. Ces considérations méthodologiques ont fait l'objet de la deuxième partie de cette thèse. Dans la troisième partie, les principaux résultats des suivis terrain de l'activité photosynthétique du phytoplancton ont été présentés et discutés. Les paragraphes ci-dessous résument les principaux résultats obtenus et exposent les perspectives pour de futurs travaux de recherche.

2 LA FLUORESCENCE SPECTRALE POUR L'ETUDE DES GROUPES PHYTOPLANCTONIQUES

2.1 Utilisation du FluoroProbe pour le suivi des groupes phytoplanctoniques en Manche orientale

Dans le premier chapitre, la possibilité d'utiliser le FluoroProbe pour le suivi de l'Haptophyte *P. globosa* a été évaluée au travers une série d'expériences de laboratoire et de mesures *in situ* dans les eaux côtières de Wimereux. Les résultats ont montré que le FluoroProbe était capable de distinguer cette espèce au sein d'assemblages naturels moyennant la recalibration de l'appareil avec une nouvelle empreinte spécifique à la reconnaissance de cette espèce. Ces résultats offrent la possibilité de suivre à moindre coût la dynamique des principaux groupes phytoplanctoniques de la Manche orientale avec une forte résolution spatiale et temporelle. Cependant, comme c'est le cas avec tous les fluorimètres spectraux, la reconnaissance des groupes n'est pas parfaite et reste sujette aux erreurs d'identification. Ces erreurs sont liées à l'algorithme de déconvolution qui n'intègre pas : 1) les variations du rapport fluorescence sur chlorophylle, 2) les modifications de la forme des empreintes de référence associées aux changements du contenu pigmentaire de l'antenne

photosynthétique et du pigment packaging en fonction des conditions environnementales et/ou entre les espèces d'un même groupe.

2.2 Performance et limites du Phyto-PAM pour le suivi de l'activité photosynthétique par groupes phytoplanctoniques

Dans le second chapitre, les performances et les limites du Phyto-PAM dans la détermination des paramètres photosynthétiques par groupes phytoplanctoniques ont été évaluées avec une attention particulière portée sur la distinction des groupes spécifiques à la Manche orientale. Les résultats soulignent les difficultés d'utilisation de cet appareil. La fiabilité de l'estimation des paramètres photosynthétiques par groupes d'algues est, en effet, fortement dépendante du choix et de la qualité des empreintes de référence. L'utilisation d'empreintes de références non adaptées à la composition des assemblages à analyser (en termes d'espèce et/ou d'état physiologique des algues) peut conduire à des erreurs d'estimation non négligeables. De plus, dans la mesure où les expériences en laboratoire ont montré que pour un groupe d'algue donné, la forme des empreintes de référence peut varier d'une espèce à l'autre mais également pour une espèce donnée en fonction des conditions de culture, une forte variabilité de la forme des empreintes de références peut être attendue en milieu naturel avec des conséquences possibles sur la qualité des estimations des paramètres photosynthétiques par groupes. D'où la difficulté d'utilisation de ce type d'appareil en milieu naturel.

Contrairement au FluoroProbe, l'utilisation du Phyto-PAM ne permet pas de faire la distinction entre *P. globosa* et les diatomées. En effet, lorsque ces espèces sont mélangées au sein d'assemblages, les estimations de leurs paramètres photosynthétiques sont non seulement dépendantes de la qualité des empreintes de référence utilisées mais également de la concentration des espèces au sein des assemblages. Ces résultats invalident clairement la possibilité d'utiliser ce PAM pour évaluer de façon spécifique les performances photosynthétiques de *P. globosa* et des Diatomées en particulier en milieu naturel où la concentration des espèces et la forme des empreintes de référence sont susceptibles de varier très rapidement. L'effet de la concentration sur l'estimation des paramètres photosynthétiques résulte de la procédure de déconvolution puisque l'analyse des signaux bruts de fluorescence (mesurés après l'excitation par les quatre longueurs d'onde) n'a montré aucune déviation des courbes PE et de la qualité de l'estimation des paramètres photosynthétiques en fonction de la concentration des espèces au sein des assemblages. Par conséquent, si la différenciation des paramètres photosynthétiques des principaux groupes phytoplanctoniques de la Manche orientale ne semble pas possible avec la version actuelle du Phyto-PAM, cet appareil peut tout de même être utilisé pour mesurer l'activité photosynthétique à l'échelle de la communauté en utilisant les signaux bruts de fluorescence qui sont indépendants de la procédure de déconvolution.

Table S.I. Caractéristiques du FluoroProbe et du Phyto-PAM

	FluoroProbe	Phyto-PAM
Mesures	Concentration totale en chlorophylle <i>a</i>	Concentration totale en chlorophylle <i>a</i>
	Concentration en chlorophylle <i>a</i> par groupes d'algues	Concentration en chlorophylle <i>a</i> par groupes d'algues
	Quantité de substances jaunes	Paramètres photosynthétiques (F_v/F_m , α , ETR_m , E_k) de la communauté et par groupes d'algues
LEDs d'excitation	470, 525, 570, 590 and 610 nm pour l'excitation des pigments	470, 520, 645 and 665 nm pour l'excitation des pigments
	370 nm pour les substances jaunes	
Détection de la fluorescence	690-710 nm	> 710 nm
Source de lumière actinique		660 nm
Groupes d'algues reconnus	Cyanobactéries riches en phycocyanine	Cyanobactéries riches en phycocyanine
	Algues brunes	Algues brunes
	Algues vertes	Algues vertes
	« Cryptophyta » (Cryptophyte, Rhodophyte, cyanobactéries riches en phycoérythrine)	

2.3 Vers l'amélioration du FluoroProbe et du Phyto-PAM...

Le tableau S.I. résume les principales caractéristiques du FluoroProbe et du Phyto-PAM.

Que ce soit pour le FluoroProbe ou le Phyto-PAM, une part importante des limitations associées à la qualité de la discrimination des principaux groupes phytoplanctoniques résulte de :

1) la variabilité des empreintes de référence en fonction des espèces et/ou des réponses physiologiques des algues vis-à-vis des conditions environnementales qui n'est pas prise en considération dans l'actuelle procédure de déconvolution,

2) l'utilisation d'un rapport chlorophylle sur fluorescence constant dans la procédure de déconvolution,

3) l'absence d'empreintes de référence permettant la différenciation de certains groupes comme les Dinoflagellés.

La question qui en découle est : comment ces instruments pourraient être améliorés pour obtenir une meilleure qualité de discrimination des groupes phytoplanctoniques ?

Les variations de la forme des empreintes de références, entre espèces d'un même groupe ou pour une espèce donnée en fonction des conditions de vie, sont le résultat des changements du contenu pigmentaire de l'antenne photosynthétique et du pigment packaging. Dans le cas des cyanobactéries et des Cryptophytes, Beutler et al. (2003, 2004) ont réussi à résoudre le problème de la variation de la forme des empreintes de référence en utilisant un nouveau fluorimètre couplé à une nouvelle procédure de déconvolution. Chez les cyanobactéries et les Cryptophytes, les variations de la forme des empreintes de référence résultent principalement des changements du contenu en phycoérythrine et phycocyanine au cours de la photoacclimatation. Beutler et al. (2003, 2004) ont donc mis au point un fluorimètre qui possède sept longueurs d'ondes d'excitation et quatre canaux de détection afin de mesurer séparément le signal de fluorescence émis par la phycocyanine, la phycoérythrine, les PSII et les PSI. En couplant ces informations avec une nouvelle procédure de déconvolution, les variations de la forme des empreintes de référence liées aux changements du contenu pigmentaire peuvent être considérées dans l'attribution du signal de fluorescence aux différents groupes et les erreurs d'identification sont ainsi limitées. Cette procédure permet également de faire la discrimination entre les Cryptophytes et les cyanobactéries à phycoérythrine ce qui n'est actuellement pas possible avec le FluoroProbe et le Phyto-PAM. La distinction entre les deux types de cyanobactéries (riches en phycoérythrine et riches en phycocyanine) est aussi améliorée. Au final, cette procédure permet la différenciation de cinq

groupes phytoplanctoniques: les cyanobactéries riches en phycoérythrine, les cyanobactéries riches en phycocyanine, les cryptophytes, les algues vertes et les algues brunes). Il pourrait être envisagé d'inclure ce genre de procédure au fonctionnement du FluoroProbe et du Phyto-PAM ce qui améliorerait considérablement la détection des cyanobactéries et des Cryptophytes.

Cependant, cela ne réglerait pas toutes les erreurs de discrimination liées aux modifications de la forme des empreintes de référence. En effet, ce type de procédure ne peut pas être appliqué aux algues vertes et brunes parce que la chlorophylle *b* et les xanthophylles n'émettent qu'un faible signal de fluorescence (Mimuro & Akimoto 2003, Trissl 2003). Il n'est donc pas possible de suivre spécifiquement les variations de ces pigments par le biais de la fluorescence. De plus, comme le signalent Jakob et al. (2005), une grande partie de la variation des empreintes de référence et du rapport chlorophylle sur fluorescence provient des modifications du pigment packaging dont la mesure ne peut pas être améliorée en utilisant des longueurs d'excitation et/ou des canaux de détection supplémentaires.

Le pigment packaging, tout comme les variations du contenu pigmentaire de l'antenne photosynthétique, modifient la fonctionnelle absorption cross-section des PSII (σ_{PSII}). Par conséquent, en considérant les variations de σ_{PSII} dans la procédure de déconvolution, la discrimination des groupes pourrait être améliorée. Bien que σ_{PSII} peut être mesurée depuis plusieurs années en utilisant la méthode du pump and probe (Mauzerall 1972, Falkowski et al. 1986, Kolber et al. 1990) ou du FRRF (Kolber et al. 1998), ces informations ne pouvaient pas être utilisées dans le cas de la fluorescence spectrale. En effet, le pump and probe et le FRRF utilisent des LEDs qui émettent à une seule longueur d'onde (généralement dans le bleu ou dans le rouge). Comme σ_{PSII} est dépendante des groupes mais également des longueurs d'ondes utilisés pour faire la mesure, mesurer σ_{PSII} à une seule longueur d'onde n'est pas suffisant dans le cadre de la fluorescence spectrale.

Le récent développement d'un nouveau fluorimètre PAM (le multi-color PAM, Schreiber et al. in press) qui permet de mesurer σ_{PSII} à six longueurs d'ondes différentes pourrait permettre d'utiliser ces informations pour améliorer la discrimination des groupes phytoplanctoniques par fluorescence spectrale.

Comme l'avaient suggéré Jakob et al. (2005), la corrélation entre le rapport fluorescence sur chlorophylle et σ_{PSII} pour chacun des groupes d'algues pourrait ainsi être défini sous différents états de photoacclimatation et utilisée pour remplacer les valeurs du rapport fluorescence sur chlorophylle actuellement considérées comme constantes dans la procédure de déconvolution. Il est dommage que les longueurs d'onde du multi-color PAM ne correspondent pas parfaitement aux longueurs d'ondes utilisées par le Phyto-PAM et le FluoroProbe.

Sans améliorer le fonctionnement du Phyto-PAM et du FluoroProbe actuels, une procédure de déconvolution des signaux de fluorescence par groupes pourrait être associée au multi-color PAM. Cet appareil étant capable de mesurer σ_{PSII} aux différentes longueurs d'onde, les variations naturelles de ce paramètre pourraient directement être prises en considération dans la procédure de déconvolution ce qui devrait améliorer la fiabilité de la discrimination des groupes. De plus, par rapport au Phyto-PAM, le multi-color PAM possède deux longueurs d'ondes d'excitation supplémentaires qui devraient permettre de différencier d'autres groupes phytoplanctoniques. De plus, contrairement au Phyto-PAM, cet appareil a le potentiel pour permettre la mesure directe du taux de transport absolu des électrons par groupes d'algues puisqu'il permet de mesurer σ_{PSII} aux différentes longueurs d'onde. La mesure du taux de transport absolu des électrons par groupes phytoplanctoniques n'est pas possible avec le Phyto-PAM car les méthodes optiques actuelles (ex : Tassan & Ferrari 1998, Mitchell et al. 2003) ne permettent pas de mesurer le coefficient spécifique d'absorption de la chlorophylle *a* à l'échelle des groupes phytoplanctoniques sur des assemblages naturels. Par conséquent, seul

le taux de transport relatif des électrons pour chaque groupe phytoplanctonique peut être mesuré avec la version actuelle le Phyto-PAM.

Pour conclure, l'amélioration de la qualité de la discrimination des principaux groupes phytoplanctoniques, en utilisant le FluoroProbe et le Phyto-PAM, doit passer : soit par l'amélioration de la procédure de déconvolution seule, soit par le développement de nouvelles versions de ces appareils qui seraient dotées de longueurs d'onde d'excitation et/ou canaux de détection supplémentaires associés à une nouvelle procédure de déconvolution. L'ajout de longueurs d'ondes supplémentaires pourrait être intéressant puisque, comme le montre la comparaison entre les capacités de discrimination du FluoroProbe et du Phyto-PAM, la différenciation des groupes phytoplanctoniques dépend des longueurs d'onde d'excitation qui sont utilisées (cf. le cas de *P. globosa* et des Cryptophytes).

Outre l'amélioration de la méthode, l'utilisation du FluoroProbe et du Phyto-PAM soulève d'autres questions. En effet, la qualité des résultats de la classification taxonomique de ces appareils est fortement dépendante de la calibration des empreintes de référence. Il est donc conseillé d'adapter les empreintes de référence vis-à-vis des groupes phytoplanctoniques spécifiques à la région d'intérêt. La question qui en découle alors est : comment calibrer ce type d'appareils dans le cadre de campagnes à grande échelle traversant différents milieux caractérisés par différentes structures de communautés phytoplanctoniques ? En effet, l'utilisation d'empreintes de référence spécifiques à chacun des milieux traversés n'invalide-t-elle pas la possibilité de comparer les résultats qui sont alors acquis avec une méthodologie différente ? A l'inverse, l'utilisation d'un unique jeu d'empreintes de référence ne peut-elle pas conduire à des erreurs de classification trop importantes pour accorder une confiance suffisante dans les résultats obtenus ?

3 UTILISATION DES RLC ET DES N-SSLC POUR LA CARACTERISATION DE L'ACTIVITE PHOTOSYNTHETIQUE DU PHYTOPLANCTON

Les courbes de réponse à la lumière sont utilisées pour caractériser l'activité photosynthétique et l'état d'acclimatation des autotrophes (Henley 1993, MacIntyre & Kana 2002). Les RLC et les N-SSLC sont deux méthodologies employées pour la construction de ces courbes par le biais de la fluorescence modulée.

Les N-SSLC sont basées sur la mesure du taux de transfert des électrons à l'état stable c'est-à-dire que la durée des paliers de lumière est suffisamment longue pour permettre l'acclimatation avec l'expression complète des effets de la réduction/oxydation de Q_A et de l'induction/relaxation du NPQ (Perkins et al. 2010). Les N-SSLC ont donc pour but de caractériser l'état de photoacclimatation à long terme et sont utilisées pour déterminer les capacités photosynthétiques potentielles sous une gamme d'intensités lumineuses (White & Critchley 1999, Serôdio et al. 2006b, Cruz & Serôdio 2008, Perkins et al. 2010).

A l'inverse, les RLC visent à limiter au maximum l'acclimatation pendant la durée de la courbe afin de préserver l'état d'acclimatation à court terme qui permet de caractériser les capacités photosynthétiques opérationnelles (Serôdio et al. 2005b, Perkins et al. 2006, Serôdio et al. 2006b, Herlory et al. 2007). Les RLC ont été employées pour caractériser l'activité photosynthétique de différents organismes autotrophes tels que les macroalgues, les algues de glace, les coraux et les herbiers (Serôdio et al. 2005b et références citées) et sont couramment appliquées aux assemblages microphytobenthiques (ex : Serôdio et al. 2005b, Perkins et al. 2006, Serôdio et al. 2006b, Herlory et al. 2007, Cruz & Serôdio 2008, Serôdio et al. 2008, Lefebvre et al. 2012). Cependant, en dépit des potentiels avantages que peut présenter cette

méthodologie, celle-ci reste peu employée pour l'étude *in situ* de l'activité photosynthétique du phytoplancton. Probablement parce qu'elle soulève certaines questions sur l'interprétation physiologique des paramètres photosynthétiques issus de ces courbes en particulier en comparaison avec les autres méthodes (Perkins et al. 2006, Serôdio et al. 2006b, Herlory et al. 2007, Cruz & Serôdio 2008, Lefebvre et al. 2012).

Dans le troisième chapitre, l'utilisation des RLC et des N-SSLC pour la caractérisation *in situ* de l'activité photosynthétique du phytoplancton à différentes échelles de temps a été comparée. D'une part, cette approche montre que la caractérisation de la réponse photosynthétique du phytoplancton, par le biais des courbes de réponse à la lumière basées sur la fluorescence, est fortement dépendante de la façon dont la stimulation lumineuse est imposée aux microalgues. D'autre part, elle met en évidence l'avantage méthodologique que peuvent présenter les RLC pour la caractérisation de l'activité photosynthétique du phytoplancton dans un environnement aussi dynamique que la Manche orientale.

En effet, la courte durée nécessaire à la construction des RLC (3 à 4 minutes contre 1h40 pour les N-SSLC dans le cas d'une courbe comportant 20 paliers de lumière en appliquant des paliers d'une durée de 10s pour les RLC et de 5 minutes pour les N-SSLC) permet la réplication des mesures et l'investigation des variations temporelles et spatiales de l'activité photosynthétique du phytoplancton avec une plus forte résolution. Outre ces avantages opérationnels, à l'échelle journalière, les RLC permettent de détecter des ajustements de l'appareil photosynthétique aux conditions de lumière incidente qui passent inaperçus en utilisant la méthodologie des N-SSLC. A cette échelle, l'utilisation des paramètres photosynthétiques issus des RLC pour décrire le statut d'acclimatation à long terme du phytoplancton n'est pas possible puisque les RLC sont fortement sensibles à l'histoire lumineuse récente. Par contre, à une plus grande échelle de temps (de l'échelle hebdomadaire à annuelle), les paramètres photosynthétiques issus des RLC et de N-SSLC

suivent les mêmes tendances. A ces échelles, les RLC peuvent donc être utilisées pour caractériser le statut d'acclimatation à long terme du phytoplancton car l'influence des variations à court terme de l'intensité lumineuse sur les paramètres photosynthétiques est beaucoup moins forte qu'à l'échelle journalière. Les RLC sont donc un bon outil pour la caractérisation des variations spatio-temporelles de l'activité photosynthétique du phytoplancton en particulier dans les systèmes à fort hydrodynamisme comme la Manche orientale où la réponse photosynthétique à court terme vis-à-vis des variations rapides des conditions environnementales doit être appréhendée.

Cependant, l'interprétation des RLC et la comparaison des paramètres photosynthétiques avec d'autres études doivent être faites avec prudence. En effet, différents auteurs ont montré que les estimations des paramètres photosynthétiques par le biais des RLC sont fortement dépendantes de la méthodologie employée (Perkins et al. 2006, Herlory et al. 2007, Lefebvre et al. 2012). Les valeurs obtenues dépendent de l'histoire lumineuse des cellules précédant la construction de la RLC mais également de l'ordre d'application (c'est-à-dire intensités lumineuses croissantes ou décroissantes), de la durée et de l'intensité des paliers de lumière employés pendant la construction de la RLC. Ainsi, seules les données acquises avec une méthodologie similaire peuvent être comparées.

4 DYNAMIQUES DE L'ACTIVITE PHOTOSYNTHETIQUE DU PHYTOPLANCTON EN MANCHE ORIENTALE

Dans la troisième partie de cette thèse, la dynamique de l'activité photosynthétique du phytoplancton a été caractérisée grâce à un travail de terrain et d'analyse d'échantillons conséquents. Les trois jeux de données obtenus ont mis en évidence les différentes échelles de variation des paramètres photosynthétiques et la multiplicité des facteurs impliqués dans le contrôle de cette variabilité.

Il a été montré que le niveau de variabilité dépend de l'échelle et des paramètres photosynthétiques considérés (Fig. S.1). La variabilité de α est toujours du même ordre de grandeur que la variabilité de ETR_m et la variabilité de ces deux paramètres est toujours supérieure à la variabilité de E_k (en moyenne 2 fois supérieure) et de F_v/F_m (en moyenne 4 fois supérieure). La variabilité spatiale (entre la côte et le large ou au sein de la colonne d'eau) de α et de ETR_m est plus faible que leur variabilité temporelle (quelle que soit l'échelle de temps considérée) tandis que variabilité de E_k et de F_v/F_m peut être du même ordre de grandeur dans l'espace et dans le temps. D'un point de vu temporel seul, la variabilité journalière des paramètres photosynthétiques peut être du même ordre de grandeur que leur variabilité aux échelles saisonnières et annuelles.

Au niveau spatial, aucun gradient des paramètres photosynthétiques n'a pu être mis en évidence entre la côte et le large. Par opposition, sur la verticale, une différence significative a pu être observée entre les eaux de surface et de fond. En effet, au niveau de toutes les stations échantillonnées, F_v/F_m était plus faible en surface qu'au fond et, au niveau de la station la plus côtière (S1), en plus de F_v/F_m , ETR_m et E_k étaient également plus faibles en surface qu'au fond. Ces variations des paramètres photosynthétiques, au sein de la colonne d'eau,

semblaient liées aux conditions lumineuses ; en particulier, l'histoire lumineuse des cellules en lien avec la profondeur.

Au niveau temporel, différentes échelles ont été investiguées. A court-terme (de l'échelle horaire à l'échelle d'un cycle de marée mortes-eaux/vives-eaux), des variations considérables des paramètres photosynthétiques ont été observées. Les jours de beau temps, F_v/F_m montrait une relation inverse avec la lumière au cours de la journée tandis qu'il restait relativement stable lorsque le ciel était nuageux. Ces résultats suggèrent la mise en place de mécanismes de photoprotection au maximum journalier d'intensité lumineuse. α , ETR_m et E_k ne montraient aucun cycle journalier clair. Un déclin de ces paramètres a pu être observé aussi souvent qu'une augmentation au maximum journalier d'intensité lumineuse, signe d'une faible capacité d'acclimatation au cours de la journée. Les paramètres photosynthétiques étaient variables au cours de la journée mais montraient également des patrons de variation différents d'un jour à l'autre. A cette échelle, la structure des communautés semblait avoir un rôle secondaire. Les variations des paramètres photosynthétiques étaient, en effet, la résultante des interactions entre les modifications de la disponibilité en éléments nutritifs et de l'intensité lumineuse avec une utilisation optimale de la lumière focalisée sur les variations interjournalières.

A plus long terme (de la semaine à l'échelle pluriannuelle), aucun cycle saisonnier de F_v/F_m , α et ETR_m n'a pu être mis en évidence. A l'inverse, les variations de E_k semblaient suivre les variations saisonnières de l'intensité lumineuse sauf en été où les variations de ce paramètre étaient faibles par rapport aux variations de l'intensité lumineuse. A ces échelles, la variabilité des paramètres photosynthétiques est la résultante des interactions entre les changements de la structure des communautés et des conditions environnementales telles que la lumière, la température et la disponibilité en éléments nutritifs. Cependant, les résultats

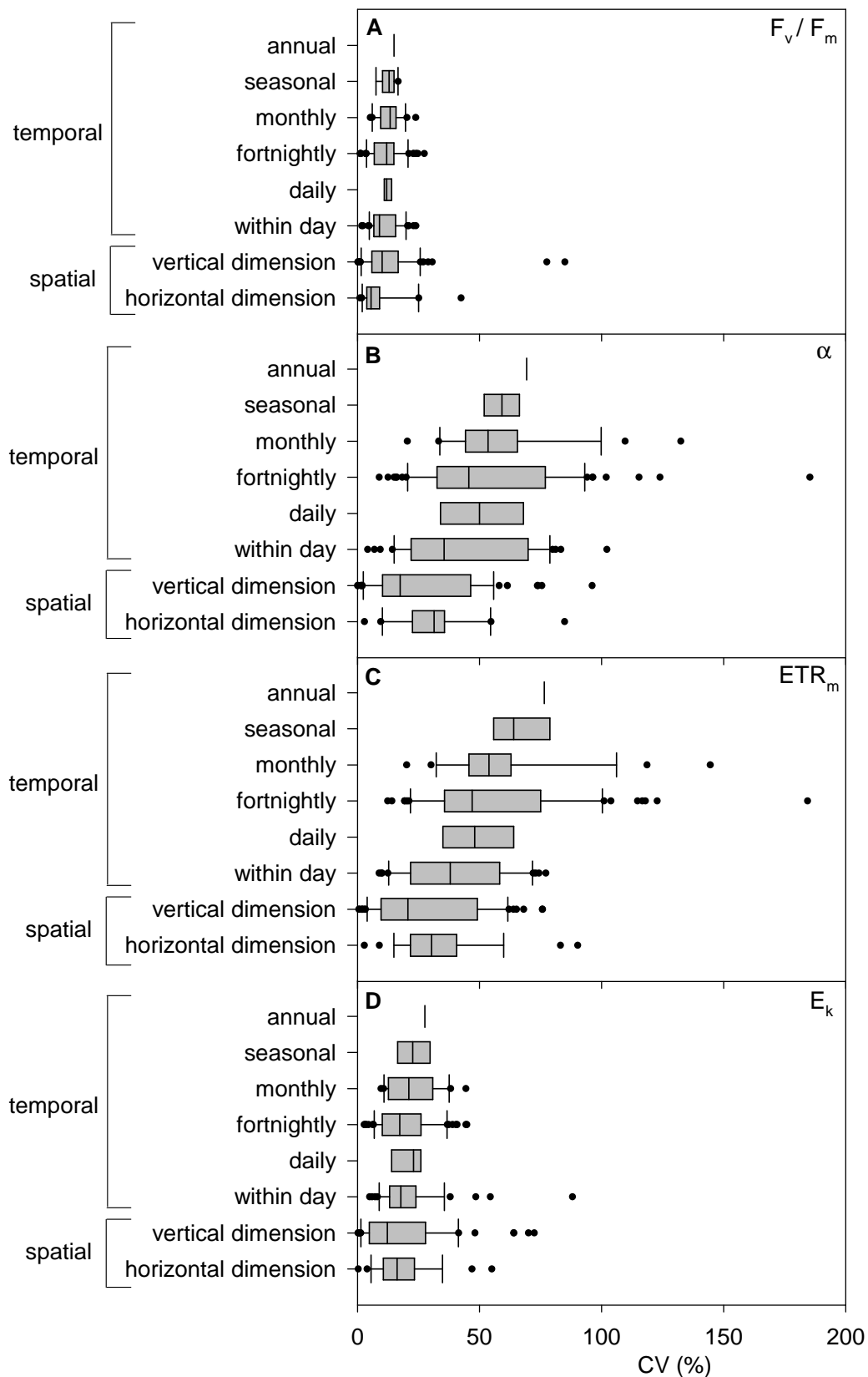

Fig. S.1. Variabilité des paramètres photosynthétiques aux différentes échelles spatiales et temporelles représentée par des boîtes à moustaches des coefficients de variation (%). A) Rendement quantique maximum (F_v/F_m), B) Efficacité maximale d'utilisation de la lumière (α), C) Taux de transport maximum des électrons (ETR_m) et D) coefficient de saturation lumineuse (E_k). Les points noirs représentent les valeurs extrêmes

actuels ne permettent pas de déterminer clairement dans quelle mesure la variation des paramètres photosynthétiques résulte directement de la limitation en ressources (lumière, éléments nutritifs...) ou reflète indirectement les forçages environnementaux au travers des successions phytoplanctoniques. En effet, aucune propriété photosynthétique spécifique à chacun des groupes phytoplanctoniques n'a pu être mise en évidence.

De plus, quelle que soit l'échelle spatiale ou temporelle considérée, la variabilité des paramètres photosynthétiques était E_k -indépendante. La base physiologique de cette réponse photosynthétique est, à l'heure actuelle, largement incomprise. Les raisons pour lesquelles ce type de réponse photosynthétique domine dans certains systèmes mais aussi dans quelle mesure cette réponse reflète la difficulté du phytoplancton à faire face aux conditions environnementales, est le résultat des mesures de l'activité photosynthétique à l'échelle de la communauté ou est une stratégie d'acclimatation restent à définir. Ces observations reflètent l'aspect multivarié du contrôle de l'activité photosynthétique du phytoplancton dans les systèmes à fort hydrodynamisme comme la Manche orientale et soulignent la difficulté à identifier clairement les principaux facteurs influençant la variabilité des paramètres photosynthétiques dans ce type de milieu.

5 PERSPECTIVES

Les perspectives qui découlent de ce travail de thèse se réfèrent aux deux principaux axes de recherche développés: l'utilisation de la fluorescence spectrale pour le suivi des groupes phytoplanctoniques et la compréhension du contrôle et de la dynamique de l'activité photosynthétique du phytoplancton dans les écosystèmes à fort hydrodynamisme.

L'amélioration de la détection des groupes phytoplanctoniques en utilisant la fluorescence spectrale nécessite une meilleure compréhension des facteurs affectant la variation du rapport chlorophylle sur fluorescence pour les différents groupes phytoplanctoniques et de l'impact des conditions environnementales sur la forme des empreintes de référence. La connaissance des effets de la variabilité de la forme des empreintes de référence sur la qualité de la discrimination des groupes doit être approfondie, notamment dans le cas du FluoroProbe. En effet, si MacIntyre et al. (2010) ont commencé à appréhender ce problème, l'impact de cette variabilité n'a été testé que sur des cultures pures et sur un nombre limité d'espèces. Il serait nécessaire de poursuivre ces investigations sur des mélanges plurispécifiques et de considérer d'autres espèces et conditions environnementales. Les potentiels effets de la concentration des espèces au sein des assemblages doit également être approfondie. Notamment dans le cas du Phyto-PAM puisque nous n'avons testé cet effet que sur des groupes pour lesquels cet appareil n'a pas été optimisé. Il conviendrait de répéter ces investigations avec d'autres groupes en utilisant notamment des cyanobactéries à phycocyanine, des algues vertes et des algues brunes. L'amélioration du fonctionnement de ces appareils grâce à la révision de la procédure de déconvolution et/ou l'ajout d'autres longueurs d'onde d'excitation et canaux de détection est également à envisager. L'évaluation des performances et des limites de ces appareils pour le suivi des groupes phytoplanctoniques doit aussi être poursuivie dans différents milieux en comparant les résultats obtenus avec d'autres méthodes comme la microscopie, la cytométrie en flux ou l'HPLC.

La compréhension du contrôle de l'activité photosynthétique du phytoplancton dans le Détroit du Pas-de-Calais nécessite d'étudier de façon plus détaillée l'effet des variations de la structure des communautés et de la diversité phytoplanctonique. Il serait nécessaire de réaliser un suivi de la variabilité des paramètres photosynthétiques couplé à une analyse détaillée de la structure des communautés par microscopie. Le rôle des mécanismes de photoprotection

(NPQ, cycle des xanthophylles, cycle des électrons autour des PSII...) devra également être considéré en particulier pour la compréhension de la variabilité à court terme des paramètres photosynthétiques au sein de la colonne d'eau ou au cours de la journée. Une meilleure compréhension de la relation E_k -indépendante est également nécessaire afin de déterminer les raisons pour lesquelles ce type de variabilité domine dans ce système et dans quelle mesure cette variabilité correspond à une stratégie d'acclimatation/adaptation, reflète la difficulté du phytoplancton à faire face à certaines conditions environnementales ou, est le résultat de la mesure des paramètres photosynthétiques à l'échelle de la communauté.

Dans un cadre plus général d'utilisation de la fluorescence modulée, il conviendrait également d'approfondir notre connaissance des facteurs influençant F_v/F_m afin de pouvoir faire la différence entre les effets des conditions environnementales et la « signature taxonomique » des espèces (Suggett et al. 2009) notamment les différences entre groupes phytoplanctoniques et l'effet de la présence de cellules sénescents doivent encore être défini ou approfondi.

Enfin, dans le cadre d'une compréhension du rôle de la production primaire dans le cycle global du carbone, des efforts de recherche supplémentaires sont nécessaires pour faire le lien entre le taux de transport des électrons (mesuré par fluorimétrie modulée) avec les mesures de la production primaire basées sur les échanges gazeux. Pour atteindre ce but, nous devons en apprendre davantage sur la régulation de la fixation du carbone par les facteurs de contrôle environnementaux et les voies alternatives d'utilisation des électrons.

Synthesis and future directions

1 REMINDER OF THE THESIS CONTEXT AND OBJECTIVES

In spite of their low surface area in comparison with global ocean, coastal ecosystems are among the most productive of the world (Gattuso et al. 1998) and their impact on global biogeochemical budgets is now clearly recognized (Borges 2005). However, numerous uncertainties remain on the exact role of these waters in so far as carbone source or sink in global biogeochemical cycles (Crossland et al. 2005). These ecosystems receive massive inputs of terrestrial organic matter and nutrients, exchange large amounts of matter and energy with the open ocean and constitute one of the most active areas of the biosphere (Gattuso et al. 1998). They are also at the center of numerous human activities (fishing, shellfish farming, tourism...) since more than the half of human population depends on these areas (Crossland et al. 2005). These last years, the anthropogenic pressures on these areas increased (Halpern et al. 2008, Goberville et al. 2011) and large modifications of their functioning can be expected with potential impacts on phytoplankton primary production which constitutes the basis of food webs in these systems (Cloern 1996, Falkowski & Raven 2007, Cloern & Jassby 2008). Understanding the role of phototrophs in the global carbon cycle and the functioning of coastal ecosystems is more important than ever (Geider et al. 2001).

This understanding is only possible with accurate estimation of primary production which in turn requires a precise knowledge of the dynamic and control of phytoplankton photosynthetic activity and biomass. Among coastal ecosystems, it is in the most highly

dynamic systems that these processes are the less well understood particularly because of the complexity of biological and physicochemical interplays in these systems. One of the main challenges is to find a way to measure simultaneously the variations in phytoplankton biomass and photosynthetic activity at rates comparable to fluctuations in environmental factors which occur at different temporal and spatial scales.

In this context, this thesis had for goal to characterise dynamics of phytoplankton photosynthetic activity in a coastal ecosystem with a strong hydrodynamism controlled by the tide. The setted objectives were:

- (1) the characterisation of the variability of phytoplankton photosynthetic activity over different spatial and temporal scales,
- (2) the identification and classification according to a hierarchical system of the main factors controlling this variability,
- (3) the highlight of eventual relationships between the photosynthetic properties of natural phytoplankton community and its taxonomic composition to identify the photosynthetic properties specific to each phytoplankton group.

To attain these objectives, we chose to use the spectral fluorescence and modulated fluorometry. These methods were chosen because they have the potential to greatly enhance the spatial and temporal resolution at which measurements of phytoplankton photosynthetic activity and dynamics of phytoplankton groups are carried out. However, these methods are relatively recent and some of them are still at a development stage and/or have been little employed in marine systems. It is particularly true for spectral fluorescence. It was thus necessary, in a first time, to define their accuracy towards the eastern English Channel particularities whether it was in terms of dynamics of environmental conditions or in terms of taxonomic composition of phytoplankton communities. These methodological considerations were the subject of the second part of this thesis. In the third part the main results of field

studies have been presented and discussed. The paragraphs below summarize the main results and present future directions of research.

2 SPECTRAL FLUORESCENCE FOR STUDYING PHYTOPLANKTON GROUPS

2.1 Use of the FluoroProbe for monitoring the phytoplankton groups of the eastern English Channel

In the first chapter, the possibility to use the FluoroProbe for monitoring the Haptophyte *P. globosa* dynamics was evaluated through a series of laboratory experiences and field measurements in the coastal waters of Wimereux. The results showed that the FluoroProbe is able to distinguish this species within mixed natural assemblages on condition to recalibrate the probe with a new specific fingerprint for this species. These results offer the possibility to monitor at low-cost the dynamics of the main phytoplankton groups of the eastern English Channel with a high spatial and temporal resolution. However, as it is the case with all spectral fluorometers, the recognition of phytoplankton groups is not perfect and remains subject to erroneous identifications. These errors are related to the procedure of deconvolution which does not integrate: 1) the variations in the ratio of fluorescence to chlorophyll and 2) the modifications in the shape of reference spectra associated to changes in pigment content and pigment packaging in response to environmental conditions and/or between the species of a same algal group.

2.2 Performance and limits of the Phyto-PAM in the estimation of phytoplankton photosynthetic activity by algal groups

In the second chapter, the performances and limits of the Phyto-PAM in the determination of photosynthetic parameters differentiated into algal groups were evaluated with a particular attention given to the distinction of the phytoplankton groups commonly found in the eastern English Channel. The results highlight the difficulties in using this probe. Indeed, the reliability of estimations of photosynthetic parameters differentiated into algal groups strongly depends on the choice and quality of reference spectra. The use of reference spectra not adapted towards the composition of assemblages to analyse (in terms of species and/or physiological states of algae) can result in non negligible errors of estimation. Moreover, since the laboratory experiments showed that for a given algal group the shape of reference spectra can vary between species but also for a given species according to culture conditions, a strong variability in the shape of reference spectra can be expected in the field with possible consequences on the quality of estimations of photosynthetic parameters differentiated into algal groups. This highlights the difficulties in using this probe in the field.

Contrary to the FluoroProbe, the Phyto-PAM is unable to distinguish *P. globosa* from diatoms in mixed assemblages. Indeed, when these species are mixed within assemblages the estimations of their photosynthetic parameters not only depend on the quality of the reference spectra used but also on the species concentration within assemblages. These results clearly invalidate the possibility to use the Phyto-PAM to specifically estimate the photosynthetic performances of *P. globosa* and diatoms, particularly in the field where species concentration and the shape of reference spectra are expected to rapidly change in response to

environmental conditions. The effect of concentration on the estimations of photosynthetic parameters results from the deconvolution procedure since the analysis of the original 4-wavelengths fluorescence signals did not show any significant differences between the PE curves and in the quality of the photosynthetic parameters estimations according to the species concentration within assemblages. Consequently, even if the differentiation of the photosynthetic parameters of the main phytoplankton groups of the eastern English Channel does not seem possible with the current version of the Phyto-PAM, this probe can still be used to measure phytoplankton photosynthetic activity at community level using the 4-wavelengths fluorescence signals which do not depend on the deconvolution procedure.

Table S.I. Characteristics of the FluoroProbe and Phyto-PAM

	FluoroProbe	Phyto-PAM
Measurements	Total chlorophyll <i>a</i> concentration	Total chlorophyll <i>a</i> concentration
	Chlorophyll <i>a</i> concentration by algal groups	Chlorophyll <i>a</i> concentration by algal groups
	Quantity of yellow substances	Photosynthetic parameters (F_v/F_m , α , ETR_m , E_k) at community level and differentiated into algal groups
Excitation LEDs	470, 525, 570, 590 and 610 nm for pigments excitation	470, 520, 645 and 665 nm for pigments excitation
	370 nm for yellow substances	
Fluorescence detection	690-710 nm	> 710 nm
Actinic light source		660 nm
Algal groups differentiated	Phycocyanin-rich cyanobacteria	Phycocyanin-rich cyanobacteria
	Brown algae	Brown algae
	Green algae	Green algae
	« Cryptophyta » (Cryptophyta, Rhodophyta, phycoerythrin-rich cyanobacteria)	

2.3 Towards the improvement of the FluoroProbe and Phyto-PAM...

The table S.I. summarizes the main technical characteristics of the FluoroProbe and Phyto-PAM.

Whether it was for the FluoroProbe or Phyto-PAM, an important part of their limitation in discriminating the main phytoplankton groups results from:

- 1) the variability of reference spectra according species and/or physiological responses of algae to environmental conditions which is not take into consideration in the current procedure of deconvolution,
- 2) the use of a constant ratio of fluorescence to chlorophyll into the procedure of deconvolution,
- 3) the absence of specific reference spectra allowing the differentiation of certain groups such as the Dinoflagellates.

The question arises as to whether these instruments could be further extended to enhance the quality of discrimination of phytoplankton groups.

Inter- and intra-species variations in the shape of reference spectra are the result of changes in pigment content and pigment packaging. In the case of cyanobacteria and Cryptophytes, Beutler et al. (2003, 2004) succeeded to overcome the problem of variations in the shape of reference spectra originating from acclimative changes in phycocyanin and phycoerythrin contents employing a new type of fluorometer. This probe features seven excitation wavelengths and four detection channels and is able to measure the fluorescence signal preferentially emitted by phycocyanin, phycoerythrin, PSII and PSI. Coupling this

system with a new algorithm of deconvolution, variations in the shape of reference spectra originating from acclimative changes can be taken into consideration in the signal attribution to the different algal groups and the errors of identification are thus limited. This procedure also allows the discrimination between Cryptophytes and phycoerythrin-rich cyanobacteria which is not possible with the current version of the FluoroProbe and the Phyto-PAM. The distinction between both kinds of cyanobacteria (phycocyanin-rich and phycoerythrin-rich) is also enhanced. In the end, this procedure allows the differentiation of five algal groups (phycocyanin-rich cyanobacteria, phycoerythrin-rich cyanobacteria, Cryptophytes, green algae and brown algae) in mixed assemblages. It could be envisaged including this procedure in the functioning of FluoroProbe and Phyto-PAM which would improve the detection of cyanobacteria and Cryptophytes.

However, this would not overcome all the errors of discrimination associated with changes in the shape of reference spectra. Indeed, this kind of procedure is not applicable to green and brown algae because chl *b* and xanthophylls display a very low fluorescence signal (Mimuro & Akimoto 2003, Trissl 2003). Consequently, it is not possible to measure specifically the variations in the amount of these pigments via fluorescence. Moreover, as pointed out by Jakob et al. (2005), a great part of variations in reference spectra also comes from changes in pigments packaging which assessment is not improved by additional excitation or detection wavelengths.

Pigment packaging as well as changes in light harvesting pigments modify the functional absorption cross-section of PSII (σ_{PSII}). Consequently, to consider the variability of σ_{PSII} into the deconvolution procedure may improve the discrimination of algal groups. Although, σ_{PSII} can be measured using the pump-and-probe method (Mauzerall 1972, Falkowski et al. 1986, Kolber et al. 1990) or the fast repetition rate (FRR) fluorometry (Kolber et al. 1998), these information could not be applied to the spectral fluorescence.

Indeed, the pump-and-probe and FRR fluorometers use LEDs emitting at a single wavelength (generally in blue or red) since σ_{PSII} is not only group- but also wavelength-specific, these values cannot give suitable information for spectral fluorescence.

The recent development of a new PAM fluorometer (the multi-color PAM, Schreiber et al. in press) which allows the measurement of σ_{PSII} at six wavelengths would improved chl content and photosynthetic parameters quantification by spectral fluorometry.

Indeed, as suggested by Jakob et al. (2005), it would be possible to use the multi-color PAM to define the group-specific correlation between the ratio chlorophyll into fluorescence (F^{chl}) and σ_{PSII} of algae from different acclimation states and/or different taxa. And then to use this correlation to replace the constant values of F^{chl} into the deconvolution procedure. It is a pity that the wavelengths of the multi-color PAM do not correspond to those of the Phyto-PAM and FluoroProbe.

Without improve, the functioning of the current versions of the Phyto-PAM and FluoroProbe, a procedure of deconvolution of fluorescence signals into algal groups could be adapted to the multi-color PAM. This probe being able to measure σ_{PSII} at different wavelengths, the natural variations of this parameter would be directly taken into consideration during the procedure of deconvolution which would improve the discrimination of algal groups. Moreover, in comparison with the Phyto-PAM, the multi-color PAM has two additional wavelengths. These additional wavelengths would allow the differentiation of additional phytoplankton groups. Moreover, contrary to the Phyto-PAM, this probe has the potential to directly measure the absolute electron transport rate differentiated into groups because it allows the measurement of σ_{PSII} at different wavelengths. The measurement of the absolute electron transport rate differentiated into groups is not possible using the Phyto-PAM because the current optical methods (e.g. Tassan & Ferrari 1998, Mitchell et al. 2003) do not allow the measurement of the chl *a* specific absorption coefficient differentiated into groups

on natural mixed assemblages. Consequently, only the relative electron transport rate differentiated into groups can be measured with the current version of the Phyto-PAM.

To conclude, the improvement of the quality of the FluoroProbe and the Phyto-PAM discriminations of the main phytoplankton groups requires the improvement of the procedure of deconvolution alone or the development of new versions of these probes featuring additional excitation and/or detection wavelengths associated with a new procedure of deconvolution. Additional excitation wavelengths would be interesting because, as the comparison of the FluoroProbe and Phyto-PAM performances demonstrates, the differentiation of phytoplankton groups depends on the excitation wavelengths used (see the cases of *P. globosa* and Cryptophytes).

In addition to the method improvement, the use of the FluoroProbe and Phyto-PAM arises other questions. Indeed, the quality of the results of the taxonomic classification of these probes strongly depends on the calibration of reference spectra. Consequently, it is advice to calibrate these probes with reference spectra measured on species representative of the region of interest. The questions arisen are: How to calibrate these kinds of probes in the context of scientific cruises at high spatial scales crossing different systems characterized by different structures of phytoplankton assemblages? Does the comparison of results still valid if different sets of reference spectra are used for each system crossed? Indeed, the use of different sets of reference spectra can be assimilated to the use of different methodologies. By opposition, can a single set of reference spectra be used? Indeed, the use of a single set of reference spectra could result in errors of classification too high to have a sufficient confidence in the results obtained.

3 USE OF RLC AND N-SSLC TO CHARACTERISE PHYTOPLANKTON PHOTOSYNTHETIC ACTIVITY

Photosynthesis-light response curves (PE) are used to characterise photosynthetic activity and photoacclimation status of autotrophs (Henley 1993, MacIntyre & Kana 2002). RLC and N-SSLC are two methodologies employed to construct PE curves via the modulated fluorescence.

N-SSLC are based on the measurement of the electron transport rate at steady-state i.e. that the duration of light steps is long enough to allow acclimation with a complete expression of the effects of Q_A reduction/oxidation and NPQ induction/reversal (Perkins et al. 2010). Consequently, N-SSLC characterise the long-term photoacclimation status and are used to assess the potential photosynthetic capacities under a range of light conditions (White & Critchley 1999, Serôdio et al. 2006b, Cruz & Serôdio 2008, Perkins et al. 2010).

By opposition, RLC aim at limiting acclimation during the time-course of the curve for preserving the short-term acclimation state which allows to describe the effective photosynthetic capacities (Serôdio et al. 2005b, Perkins et al. 2006, Serôdio et al. 2006b, Herlory et al. 2007). RLC were employed to characterise photosynthetic activity of different autotrophic organisms including macroalgae, ice microalgae, coral and seagrasses (Serôdio et al. 2005b and reference herein) and are widely applied on microphytobenthic assemblages (e.g. Serôdio et al. 2005b, Perkins et al. 2006, Serôdio et al. 2006b, Herlory et al. 2007, Cruz & Serôdio 2008, Serôdio et al. 2008, Lefebvre et al. 2012). However, in spite of the potential advantages of this methodology, it remains few applied for studying phytoplankton photosynthetic activity *in situ*. Most probably because this methodology raises some questions about the physiological interpretation of photosynthetic parameters extracted from these

curves, particularly in comparison with the other methodologies (Perkins et al. 2006, Herlory et al. 2007, Cruz & Serôdio 2008, Lefebvre et al. 2012).

In the third chapter, the use of RLC and N-SSLC to characterise phytoplankton photosynthetic activity *in situ* at different time scales was compared. On one hand, this study showed that the characterization of phytoplankton photosynthetic activity via PE curves measured using the modulated fluorometry, strongly depends on the way in which light stimulations are imposed on microalgae. On the other hand, this study highlights the methodological advantages of RLC to characterise phytoplankton photosynthetic activity in a highly dynamic environment such as the eastern English Channel.

Indeed, the short duration of RLC (3 to 4 minutes *versus* 1h40 for N-SSLC for a curve constituted of 20 light steps using light steps of 10 s for RLC and 5 min for N-SSLC) makes the replication of measurements possible and allows investigating the temporal and spatial variations of phytoplankton photosynthetic activity with a higher resolution. In addition to these operational advantages, at diel scale, RLC allow to detect short-term responses of photosynthetic apparatus which pass unnoticed using N-SSLC. At this time-scale, the use of photosynthetic parameters extracted from RLC to describe the long-term acclimation status is not possible because RLC are strongly influenced by the recent light history. By contrast, at longer time-scales (from weekly to annual scales), photosynthetic parameters extracted from RLC and those extracted from N-SSLC showed the same patterns. At these time-scales, RLC can be used to characterise the long-term acclimation status of phytoplankton because the influence of short-term variations in irradiance on photosynthetic parameters are lower than at diel scale. RLC are a good tool to characterise spatio-temporal dynamics of phytoplankton photosynthetic activity particularly in systems with a strong hydrodynamism such as the eastern English Channel where short-term responses of photosynthesis to the rapid variations of environmental conditions must be measured.

However, the interpretation of RLC and the comparison of photosynthetic parameters with other studies must be made with caution. Indeed, several authors showed that the estimations of photosynthetic parameters using RLC strongly depend on the methodology employed (Perkins et al. 2006, Herlory et al. 2007, Cruz & Serôdio 2008, Lefebvre et al. 2012). The values obtained depend on the order (i.e. increasing or decreasing irradiance steps), duration and intensity of light steps used for building RLC. Consequently, only the results acquired with the same methodology can be compared.

4 DYNAMICS OF PHYTOPLANKTON PHOTOSYNTHETIC ACTIVITY IN THE EASTERN ENGLISH CHANNEL

In the third part of this thesis, dynamics of phytoplankton photosynthetic activity were characterised thanks to consequent field work and samples analyses. The three data sets obtained highlight the different scales of variation of photosynthetic parameters and the multiplicity of factors implicated in the control of this variability.

It was found that the level of variability depends on the scale and photosynthetic parameters considered. The variability of α was always of the same order of magnitude than the variability of ETR_m and the variability of these two parameters was always higher than the variability of E_k (2 times higher in average) or F_v/F_m (4 times higher in average). The spatial variability (between coastal and offshore waters and within the water column) of α and ETR_m was lower than their temporal variability (whatever the time-scale considered) whereas the variability of E_k and F_v/F_m could be of the same order of magnitude in space and time. The diel variability of photosynthetic parameters could be of the same order of magnitude than the variability at seasonal or annual scales.

In space, no gradient of photosynthetic parameters was found between the coastal and offshore waters. By opposition, within the water column, significant differences were found between the surface and depth. Indeed, F_v/F_m was lower at surface than at depth at all stations and at the station nearest to the coast (S1), in addition to F_v/F_m , ETR_m and E_k were also lower at surface than at depth. These variations of photosynthetic parameters, within the water column, seemed to be related to light conditions; particularly the light history of cells with a relation with the depth of the water column.

In time, different scales were investigated. At short-time scales (from hourly to the scale a spring-neap tide cycle), considerable variations of photosynthetic parameters were observed. During sunny days, F_v/F_m showed an inverse relation with light during the day while it stayed relatively stable during overcast days. These results suggested the occurrence of photoprotective mechanisms when irradiance reached its maximum. α , ETR_m , and E_k did not showed any clear diel cycle. There was a decline of these parameters during the day as often as there was a peak at the maximum of irradiance. This indicates a restricted capacity of photoacclimation during the day. Photosynthetic parameters were variables during the day but the intraday pattern of variation also changed from one day to an other. At these time scales, the structure of assemblages seemed to have a secondary role. Indeed, the variations of photosynthetic parameters were the results of the interplay between changes in nutrients availability and light conditions with the optimal use of incident irradiance focused on the between-days rather than the within-day variability.

At longer time-scales (from weekly to pluriannual scales), no clear seasonal cycle of F_v/F_m , α and ETR_m was found. By contrast, the variations of E_k seemed to be related to the seasonal variations of incident light intensity except during summer where the variations of this parameter were small in comparison with light fluctuations. At these time-scales, the

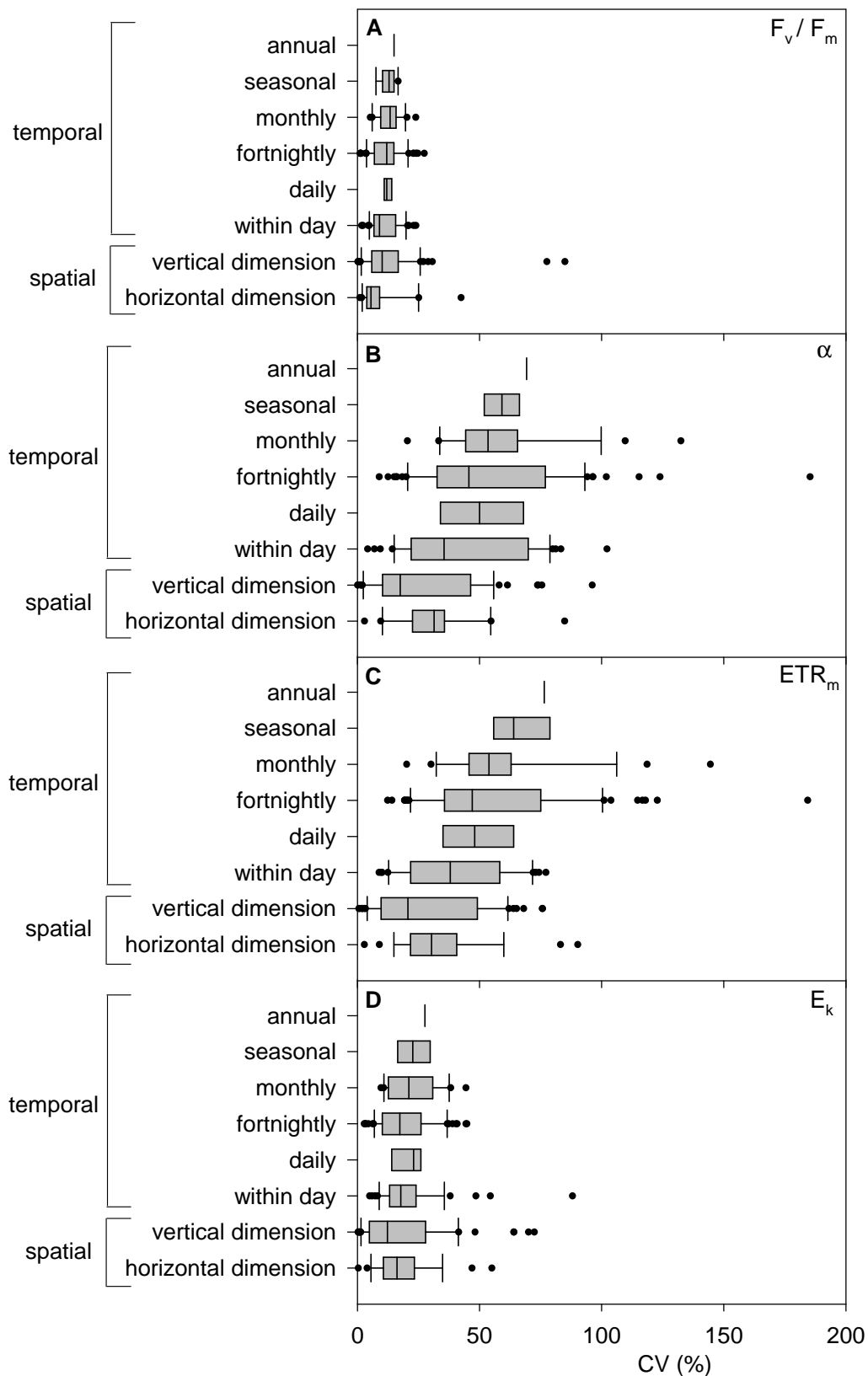

Fig. S.1. Variability of photosynthetic parameters at different spatial and temporal scales represented by box plots of coefficients of variation (%). A) Maximum quantum yield (F_v/F_m), B) Maximal light utilization efficiency (α), C) Maximum electron transport rate (ETR_m) and D) Light saturation coefficient (E_k). Black points represent outliers

variability of photosynthetic parameters was the result of the interplays between changes in community structure and environmental conditions such as light, temperature and nutrient availability. However, the extent to which photosynthetic parameters were directly influenced by resource limitation (light, nutrients...), or indirectly reflected environmental forcing through shifts in community structure could not be fully quantified with the present data set. Indeed, no photosynthetic properties specific to each phytoplankton group could be found.

Moreover, whatever the spatial or temporal scale considered, the variability of photosynthetic parameters was “ E_k -independent”. The physiological basis of this kind of photosynthetic response is largely unresolved. The reasons why this kind of photosynthetic response dominates in certain environments as well as in what extent this reflects the difficulty of phytoplankton to cope with environmental conditions, results from the measurement of photosynthetic parameters at community scale or, is an acclimation strategy stay to define. These observations reflect the multivariate control of phytoplankton photosynthetic activity in systems with a high hydrodynamism such as the eastern English Channel and highlight the difficulty to clearly identify the main factors influencing the variability of photosynthetic parameters in this kind of system.

5 FUTURE DIRECTIONS

The future directions resulting from this work refer to the two research axes developed: the use of spectral fluorescence for monitoring phytoplankton community composition and the understanding of the control and dynamics of phytoplankton photosynthetic activity in highly dynamic coastal ecosystems.

The improvement of the detection of phytoplankton groups using spectral fluorescence requires understanding how environmental factors affect the ratio F^{chl} of each phytoplankton group, and to what extent reference spectra are impacted by environmental conditions. A best knowledge of the effects of the variability in the shape of reference spectra on the quality of the discrimination of phytoplankton groups is required particularly in the case of the FluoroProbe. Indeed, although MacIntyre et al. (2010) began to work on this problematic, the impact of variations in the shape of reference spectra have been tested on pure cultures of a limited number of species. It would be necessary to continue these investigations on mixed assemblages and to consider other species and environmental conditions. The potential effects of species concentration within assemblages require also further experiments particularly in the case of the Phyto-PAM. Indeed, we only tested these effects on a limiting number of species and mainly on mixtures for which the Phyto-PAM was not optimised. These investigations should be repeated using other groups notably phycocyanin-rich cyanobacteria, green algae and brown algae. The deconvolution procedure of the FluoroProbe and Phyto-PAM should be revised and the possibility of using additional excitation and detection wavelengths should be considered. The performance and limits of these probes in the discrimination of algal groups should be evaluated in other ecosystems and the results should be compared with other methods such as microscopy, flow cytometry or HPLC.

The understanding of the control of phytoplankton photosynthetic activity, in the Strait of Dover, requires studying the effects of phytoplankton community structure and species diversity with more details. It would be necessary to combine the measurements of phytoplankton photosynthetic activity with an exhaustive study of phytoplankton community composition by microscopy. The role of photoprotective mechanisms (NPQ, xanthophyll cycle, PSII electron cycle...) should be considered particularly for understanding the short-term variability of photosynthetic parameters within the water column or during the day.

Further researches on the “ E_k -independent” variability of photosynthetic parameters are required to understand the reasons why this kind of photosynthetic response dominates in certain environments as well as in what extent this is an acclimation strategy, reflects the difficulty of phytoplankton to cope with environmental conditions or results from the measurement of photosynthetic parameters at community scale.

In a more general context of use of the modulated fluorimetry, a best understanding of the factors influencing F_v/F_m is required to be able to differentiate the effects of environmental factors from the “taxonomic signature” (Suggett et al. 2009), notably the differences between phytoplankton groups and the effect of the presence of senescent cells should be studied in details.

Finally, in the context of the understanding of the role of primary production in the global carbon cycle, further researches are required for reconciling the electron transport rate measured using the modulated fluorimetry with gas exchange-based productivity measurements. To reach this goal, we have to much learn about how environmental forcing and alternative sinks of electrons regulate the fixation of carbone.

Références

- Aiken J, Fishwick J, Moore G, Pemberton K (2004) The annual cycle of phytoplankton photosynthetic quantum efficiency, pigment composition and optical properties in the western English Channel. *Journal of Marine Biological Association of the United Kingdom* 84:301-313
- Aminot A, K  rouel R (2004) *Hydrologie des   cosyst  mes marins. Param  tres et analyses.* Editions de l'Ifremer, Brest. pp. 335
- Aminot A, K  rouel R (2007) Dosage automatique des nutriments dans les eaux marines. Editions de l'Ifremer. p. 188
- Anning T, Harris G, Geider RJ (2001) Thermal acclimation in the marine diatom *Chaetoceros calcitrans* (Bacillariophyceae). *European Journal of Phycology* 36:233-241
- Anning T, MacIntyre HL, Pratt SM, Sammes PJ, Gibb S, Geider RJ (2000) Photoacclimation in the marine diatom *Skeletonema costatum*. *Limnology and Oceanography* 45:1807-1817
- Antajan E, Chr  tiennot-Dinet MJ, Leblanc C, Daro MH, Lancelot C (2004) 19'-Hexanoyloxyfucoxanthin may not be the appropriate pigment to trace occurrence and fate of *Phaeocystis*: The case of *P. globosa* in Belgian coastal waters. *Journal of Sea Research* 52:165-177
- Astoreca R, Rousseau V, Ruddick K, Knechciak C, Van Mol B, Parent JY, Lancelot C (2009) Development and application of an algorithm for detecting *Phaeocystis globosa* blooms in the Case 2 Southern North Sea waters. *Journal of Plankton Research* 31:287-300
- Azevedo IC, Duarte P, Bordalo AA (2010) Temporal and spatial variability of phytoplankton photosynthetic characteristics in a southern European estuary (Douro, Portugal). *Marine Ecology Progress Series* 412:29-44
- Baker NR (2008) Chlorophyll fluorescence: A probe of photosynthesis *in vivo*. *Annual review of plant biology* 59:89-113
- Baker NR, Oxborough K (2004) Chlorophyll fluorescence as a probe of photosynthetic productivity. In: Papageorgiou G, Govindjee (eds) *Chlorophyll Fluorescence : a Signature of Photosynthesis*, Vol 19. Kluwer Academic Publishers, Dordrecht, The Netherlands, p 65-82
- Balfoort HW, Snoek J, Smiths JRM, Breedveld LW, Hofstraat JW, Ringelberg J (1992) Automatic identification of algae: Neural network analysis of flow cytometric data. *Journal of Plankton Research* 14:575-589
- Beardall J, Ihnken S, Quigg A (2009) Gross and net primary production: Closing the gap between concepts and measurements. *Aquatic Microbial Ecology* 56:113-122
- Beardall J, Young E, Roberts S (2001) Approaches for determining phytoplankton nutrient limitation. *Aquatic Sciences* 63:44-69
- Beer S, Ilan M, Eshel AW, A., Bricknel I (1998) Use of pulse amplitude modulated (PAM) fluorometry for *in situ* measurements of photosynthesis in two Red Sea faviid corals. *Marine Biology* 131:607-612
- Behrenfeld MJ, Halsey KH, Milligan AJ (2008) Evolved physiological responses of phytoplankton to their integrated growth environment. *Philosophical Transactions of the Royal Society B: Biological Sciences* 363:2687-2703

- Behrenfeld MJ, Prasil O, Babin M, Bruyant F (2004) In search of a physiological basis for covariations in light-limited and light-saturated photosynthesis. *Journal of Phycology* 40:4-25
- Belshe EF, Durako MJ, Blum JE (2007) Photosynthetic rapid light curves (RLC) of *Thalassia testudinum* exhibit diurnal variation. *Journal of Experimental Marine Biology and Ecology* 342:253-268
- Beutler M (2003) Spectral fluorescence of chlorophyll and phycobilins as an *in-situ* tool of phytoplankton analysis - models, algorithms and instruments. PhD-thesis, Christian-Albrechts-Universität.
- Beutler M, Wiltshire KH, Arp M, Kruse J, Reineke C, Moldaenke C, Hansen UP (2003) A reduced model of the fluorescence from the cyanobacterial photosynthetic apparatus designed for the *in situ* detection of cyanobacteria. *Biochimica et Biophysica Acta - Bioenergetics* 1604:33-46
- Beutler M, Wiltshire KH, Meyer B, Moldaenke C, Lüring C, Meyerhöfer M, Hansen UP, Dau H (2002) A fluorometric method for the differentiation of algal populations *in vivo* and *in situ*. *Photosynthesis Research* 72:39-53
- Beutler M, Wiltshire KH, Reineke C, Hansen UP (2004) Algorithms and practical fluorescence models of the photosynthetic apparatus of red cyanobacteria and Cryptophyta designed for the fluorescence detection of red cyanobacteria and cryptophytes. *Aquatic Microbial Ecology* 35:115-129
- Bidigare RR, Ondrusek ME, Morrow JH, Kiefer DA (1990) *In vivo* absorption properties of algal pigments. *Proceedings of SPIE - The International Society for Optical Engineering* 1302:289-302
- Blanchet FG, Legendre P, Borcard D (2008) Forward selection of explanatory variables. *Ecology* 89:2623-2632
- Blauw AN, Los FJ, Huisman J, Peperzak L (2010) Nuisance foam events and *Phaeocystis globosa* blooms in Dutch coastal waters analyzed with fuzzy logic. *Journal of Marine Systems* 83:115-126
- Borges AV (2005) Do we have enough pieces of the jigsaw to integrate fluxes in the coastal ocean? *Estuaries* 28:3-27
- Bradbury M, Baker NR (1981) Analysis of the slow phases of the *in vivo* chlorophyll fluorescence induction curve. Changes in the redox state of photosystem II electron acceptors and fluorescence emission from photosystem I and II. *Biochimica et Biophysica Acta* 548:128-138
- Breton E, Brunet C, Sautour B, Brylinski JM (2000) Annual variations of phytoplankton biomass in the eastern English Channel: comparison by pigment signatures and microscopic counts. *Journal of Plankton Research* 22:1423-1440
- Bricaud A, Claustre H, Ras J, Oubelkheir K (2004) Natural variability of phytoplanktonic absorption in oceanic waters: Influence of the size structure of algal populations. *Journal of Geophysical Research C: Oceans* 109:1-12
- Brunet C, Brylinski JM, Frontier S (1992) Productivity, photosynthetic pigments and hydrology in the coastal front of the eastern English Channel. *Journal of Plankton Research* 14:1541-1552
- Brunet C, Brylinski JM, Lemoine Y (1993) *In situ* variations of the xanthophylls diatoxanthin and diadinoxanthin: photoadaptation and relationships with a hydrodynamical system in the eastern English Channel. *Marine Ecology Progress Series* 102:69-77
- Brunet C, Casotti R, Vantrepotte V (2008) Phytoplankton diel and vertical variability in photobiological responses at a coastal station in the Mediterranean Sea. *Journal of Plankton Research* 30:645-654

- Brunet C, Lavaud J (2010) Can the xanthophyll cycle help extract the essence of the microalgal functional response to a variable light environment? *Journal of Plankton Research* 32:1609-1617
- Bruyant F, Babin M, Genty B, Prasil O, Behrenfeld MJ, Claustre H, Bricaud A, Garczarek L, Holtzendorff J, Koblizek M, Dousova H, Partensky F (2005) Diel variations in the photosynthetic parameters of *Prochlorococcus* strain PCC 9511: Combined effects of light and cell cycle. *Limnology and Oceanography* 50:850-863
- Brylinski JM (1993) Ecohydrodynamique pelagique en Manche orientale. HDR Thesis. Université des Sciences et Technologies de Lille, France., PhD Thesis. Université des Sciences et Technologies de Lille, France
- Brylinski JM, Bentley D, Quisthoudt C (1988) Discontinuité écologique et zooplancton (copépodes) en Manche orientale. *Journal of Plankton Research* 10:503-513
- Brylinski JM, Lagadeuc Y (1990) L'interface eaux côtières/eaux du large dans le Pas-de-Calais (côte française): une zone frontale. *Comptes Rendus de l'Académie des Sciences* 311:535-540
- Brylinski JM, Lagadeuc Y, Gentilhomme V, Dupont JP, Lafite R, Dupeuple PA, Huault MF, Auger Y, Puskaric E, Wartel M, Cabioch L (1991) Le "fleuve côtier": un phénomène hydrologique important en Manche orientale. Exemple du Pas-de-Calais. *Oceanologica Acta* 11:197-203
- Buma AGJ, Noordeloos AAM, Larsen J (1993) Strategies and kinetics of photoacclimation on three Antarctic nanophytoflagellates. *Journal of Phycology* 29:407-417
- Buschmann C (1999) Photochemical and non-photochemical quenching coefficients of the chlorophyll fluorescence : comparison of variation and limits. *Photosynthetica* 37:214-224
- Butron A, Iriarte A, Madariaga I (2009) Size-fractionated phytoplankton biomass, primary production and respiration in the Nervion-Ibaizabal estuary: A comparison with other nearshore coastal and estuarine ecosystems from the Bay of Biscay. *Continental Shelf Research* 29:1088-1102
- Cabioch L (1968) Contribution à la connaissance des peuplements benthiques de la Manche occidentale. *Cahiers de Biologie Marine* 9:493-720
- Cadée GC, Hegeman J (1986) Seasonal and annual variations in *Phaeocystis pouchetii* (Haptophyceae) in the westernmost inlet of the Wadden Sea during 1973 to 1985 period. *Netherlands Journal of Sea Research* 20:29-36
- Cadée GC, Hegeman J (2002) Phytoplankton in the Marsdiep at the end of the 20th century; 30 years monitoring biomass, primary production, and *Phaeocystis* blooms. *Journal of Sea Research* 48:97-110
- Caillault E, Hébert PA, Wacquet G (2009) Dissimilarity-based classification of multidimensional signals by conjoint elastic matching: Application to phytoplanktonic species recognition *Communications in Computer and Information Science*, p 153-164
- Carr MR, Tarran GA, Burkill PH (1996) Discrimination of marine phytoplankton species through the statistical analysis of their flow cytometric signatures. *Journal of Plankton Research* 18:1225-1238
- Chalker B (1980) Modelling light saturation curves for photosynthesis : an exponential function. *Journal of Theoretical Biology* 84:205-215
- Chassot E, Bonhommeau S, Dulvy NK, Mélin F, Watson R, Gascuel D, Le Pape O (2010) Global marine primary production constrains fisheries catches. *Ecology Letters* 13:495-505
- Claquin P, Ni Longphuir S, Foullaron P, Huonnic P, Ragueneau O, Klein C, Leynaert A (2010) Effects of simulated benthic fluxes on phytoplankton dynamic and

- photosynthetic parameters in a mesocosm experiment (Bay of Brest, France). *Estuarine, Coastal and Shelf Science* 86:93-101
- Claquin P, Probert I, Lefebvre S, Véron B (2008) Effects of temperature on photosynthetic parameters and TEP production in eight species of marine microalgae. *Aquatic Microbial Ecology* 51:1-11
- Clarke KR, Warwick RM (1994) Change in marine communities: an approach to statistical analysis and interpretation. Natural Environment Research Council, UK: 144 pp
- Claustre H, Kerhervé P, Marty JC, Prieur L (1994) Phytoplankton photoadaptation related to some frontal physical processes. *Journal of Marine Systems* 5:251-265
- Cleveland JS, Perry MJ (1987) Quantum yield, relative specific absorption and fluorescence in nitrogen-limited *Chaetoceros gracilis*. *Marine Biology* 94:489-497
- Cloern JE (1996) Phytoplankton bloom dynamics in coastal ecosystems: A review with some general lessons from sustained investigation of San Francisco Bay, California. *Reviews of Geophysics* 34:127-168
- Cloern JE, Jassby AD (2008) Complex seasonal patterns of primary producers at the land-sea interface. *Ecology Letters* 11:1294-1303
- Corno G, Letelier RM, Abbott MR, Karl DM (2008) Temporal and vertical variability in photosynthesis in the North Pacific Subtropical Gyre. *Limnology & Oceanography* 53:1252-1265
- Cosgrove JJ, Borowitzka M (2006) Applying Pulse Amplitude Modulation (PAM) fluorometry to microalgae suspensions : stirring potentially impacts fluorescence. *Photosynthesis Research* 88:343-350
- Cosgrove JJ, Borowitzka M (2010) Chlorophyll fluorescence terminology : an introduction. In: Suggett DJ, al e (eds) *Chlorophyll a Fluorescence in Aquatic Sciences : Methods and Applications*. Springer, p 1-17
- Côté B, Platt T (1983) Day-to-day variations in the spring-summer photosynthetic parameters of coastal marine phytoplankton. *Limnology & Oceanography* 28:320-344
- Crossland CJ, Kremer HH, Lindeboom HJ, Marshall Crossland JI, Le Tissier MDA (2005) *Coastal Fluxes in the Anthropocene*. Springer, Berlin. 231 pp.
- Cruz S, Serôdio J (2008) Relationship of rapid light curves of variable fluorescence to photoacclimation and non-photochemical quenching in a benthic diatom. *Aquatic Botany* 88:256-264
- Cullen JJ, Lewis MR (1988) The kinetics of algal photoadaptation in the context of vertical mixing. *Journal of Plankton Research* 10:1039-1063
- Cullen JJ, Yang X, MacIntyre HL (1992) Nutrient limitation of marine photosynthesis. In: Falkowski P, Woodhead AD (eds) *Primary productivity and biogeochemical cycles in the sea*. New York, USA : Plenum Press, p 31-45
- Davison IR (1991) Environmental effects on algal photosynthesis : temperature. *Journal of Phycology* 27:2-8
- Dijkman NA, Kroon BMA (2002) Indications for chlororespiration in relation to light regime in the marine diatom *Thalassiosira weissflogii*. *Journal of Photochemistry and Photobiology B: Biology* 66:179-187
- Dimier C, Brunet C, Geider R, Raven JA (2009a) Growth and photoregulation dynamics of the picoeukaryote *Pelagomonas calceolata* in fluctuating light. *Limnology and Oceanography* 54:823-836
- Dimier C, Giovanni S, Ferdinando T, Brunet C (2009b) Comparative Ecophysiology of the Xanthophyll Cycle in Six Marine Phytoplanktonic Species. *Protist* 160:397-411

- Duarte P (2006) Photosynthesis - Irradiance Relationships in Marine Microalgae. In: Subba Rao D (ed) Algal Cultures Analogues of Blooms and Applications Science Publishers, Enfield, NH, pp 639-670
- Dubinsky Z (1991) The functional and optical absorption cross-sections of phytoplankton photosynthesis. In: Falkowski P, Woodhead AD (eds) Primary productivity and biogeochemical cycles in the sea. Springer (US), p 31-46
- Dubinsky Z, Schofield O (2010) From the light to the darkness: thriving at the light extremes in the oceans *Hydrobiologia* 639:153-171
- Dubinsky Z, Stambler N (2009) Photoacclimation processes in phytoplankton: Mechanisms, consequences, and applications. *Aquatic Microbial Ecology* 56:163-176
- Durako MJ, Kunzelman JI, Kenworthy WJ, Hammerstrom KK (2003) Depth-related variability in the photobiology of two populations of *Halophila johnsonii* and *Halophila decipiens*. *Marine Biology* 142:1219-1228
- Eilers PHC, Peeters JCH (1988) A model for the relationship between light intensity and the rate of photosynthesis in phytoplankton. *Ecological Modelling* 42:199-215
- Enright JT (1970) Ecological aspects of endogenous rhythmicity. *Annual Review of Ecology, Evolution and Systematics* 1:221-238
- Ensminger I, Xyländer M, Hagen C, Braune W (2001) Strategies providing success in a variable habitat: III. Dynamic control of photosynthesis in *Cladophora glomerata*. *Plant, Cell and Environment* 24:769-779
- Erga SR, Skjoldal HR (1990) Diel variations in photosynthetic activity of summer phytoplankton in Lindaspollene, western Norway. *Marine Ecology Progress Series* 65:73-85
- Everroad C, Six C, Partensky F, Thomas JC, Holtzendorff J, Wood AM (2006) Biochemical Bases of Type IV Chromatic Adaptation in Marine *Synechococcus spp.* *Journal of Bacteriology* 188:3345-3356
- Falkowski P, Koblizek M, Gorbunov M, Kolber Z (2004) Development and Application of Variable Chlorophyll Fluorescence Techniques in Marine Ecosystems. In: Papageorgiou G, Govindjee (eds) Chlorophyll Fluorescence : a Signature of Photosynthesis, Vol 19. Kluwer Academic Publishers, Dordrecht, The Netherlands, p 757-778
- Falkowski PG, Kolber Z (1993) Estimation of phytoplankton photosynthesis by active fluorescence. *ICES Marine Science Symposia* 197:92-103
- Falkowski PG, Raven JA (2007) Aquatic Photosynthesis, 2nd edition. Blackwell Science. 500 pp.
- Falkowski PG, Wyman KD, Ley AC, Mauzerall D (1986) Relationship of steady state photosynthesis to fluorescence in eucaryotic algae. *Biochimica et Biophysica Acta* 849:183-192
- Frenette JJ, Demers S, Legendre L, Dobson J (1993) Lack of agreement among models for estimating the photosynthetic parameters. *Limnology & Oceanography* 38:679-687
- Gaarder T, Gran HH (1927) Production of plankton in the Oslo Fjord. *Rapports et Procès-Verbaux des Réunions Conseil Permanent International pour l'Exploration de la Mer* 42:1-48
- Gaebler S, Hayes PK, Medlin LK (2007) Method used to reveal genetic diversity in the colony-forming prymnesiophytes *Phaeocystis antarctica*, *P. globosa* and *P. pouchetti*-preliminary results. *Biogeochemistry* 83:19-27
- Gameiro C, Zwolinski J, Brotas V (2011) Light control on phytoplankton production in a shallow and turbid estuarine system. *Hydrobiologia* 669:249-263

- Gattuso JP, Frankignoulle M, Wollast R (1998) Carbon and carbonate metabolism in coastal aquatic ecosystems. *Annual Review of Ecology and Systematics* 29:405-434
- Geel C, Versluis W, Snel JFH (1997) Estimation of oxygen evolution by marine phytoplankton from measurement of the efficiency of Photosystem II electron flow. *Photosynthesis Research* 51:61-70
- Geider RJ, Delucia EH, Falkowski PG, Finzi AC, Philip Grime J, Grace J, Kana TM, La Roche J, Long SP, Osborne BA, Platt T, Colin Prentice I, Raven JA, Schlesinger WH, Smetacek V, Stuart V, Sathyendranath S, Thomas RB, Vogelmann TC, Williams P, Ian Woodward F (2001) Primary productivity of planet earth: Biological determinants and physical constraints in terrestrial and aquatic habitats. *Global Change Biology* 7:849-882
- Gentilhomme V (1988) Contribution à l'étude de l'interface eaux côtières/eaux du large en Manche orientale: données sur la production primaire. DEA. Université Aix Marseille II, France.
- Gentilhomme V, Lizon F (1998) Seasonal cycle of nitrogen and phytoplankton biomass in a well-mixed coastal system (eastern English Channel). *Hydrobiologia* 361:191-199
- Genty B, Briantais JM, Baker NR (1989) The relationship between the quantum yield of photosynthetic electron transport and quenching of chlorophyll fluorescence. *Biochimica et Biophysica Acta* 990:87-92
- Gévaert F, Créach A, Davoult D, Migné A, Levavasseur G, Arzel P, Holl AC, Lemoine Y (2003) *Laminaria saccharina* photosynthesis measured in situ: Photoinhibition and xanthophyll cycle during a tidal cycle. *Marine Ecology Progress Series* 247:43-50
- Gieskes WWC, Kraay GW (1975) The phytoplankton spring bloom in Dutch coastal waters of the North Sea. *Netherlands Journal of Sea Research* 9:166-196
- Gilbert M, Domin A, Becker A, Wilhelm C (2000) Estimation of primary productivity by chlorophyll a in vivo fluorescence in freshwater phytoplankton. *Photosynthetica* 38:111-126
- Gilmore AM, Hazlett TL, Debrunner PG, Govindjee (1996) Comparative Time-Resolved Photosystem II Chlorophyll a Fluorescence Analyses Reveal Distinctive Differences between Photoinhibitory Reaction Center Damage and Xanthophyll Cycle-Dependent Energy Dissipation. *Photochemistry and Photobiology* 64:552-563
- Glé C, Del Amo Y, Sautour B, Laborde P, Chardy P (2008) Variability of nutrients and phytoplankton primary production in a shallow macrotidal coastal ecosystem (Arcachon Bay, France). *Estuarine, Coastal and Shelf Science* 76:642-656
- Goberville E, Beaugrand G, Sautour B, Tréguer P (2011) Evaluation of coastal perturbations: A new mathematical procedure to detect changes in the reference state of coastal systems. *Ecological Indicators* 11:1290-1300
- Gowen RJ, Bloomfield SP (1996) Chlorophyll standing crop and phytoplankton production in the western Irish Sea during 1992 and 1993. *Journal of Plankton Research* 18:1735-1751
- Grangeré K, Lefebvre S, Ménesguen A, Jouenne F (2009) On the interest of using field primary production data to calibrate phytoplankton rate processes in ecosystem models. *Estuarine, Coastal and Shelf Science* 81:169-178
- Grattepanche JD, Breton E, Brylinski JM, Lecuyer E, Christaki U (2011) Succession of primary producers and micrograzers in a coastal ecosystem dominated by *Phaeocystis globosa* blooms. *Journal of Plankton Research* 33:37-50
- Gregor J, Geris R, Marsalek B, Hetesa J, Marvan P (2005) *In situ* quantification of phytoplankton in reservoirs using a submersible spectrofluorometer. *Hydrobiologia* 548:141-151

- Gregor J, Marsalek B (2004) Freshwater phytoplankton quantification by chlorophyll a: a comparative study of *in vitro*, *in vivo* and *in situ* methods. *Water Research* 38:517-522
- Grossman AR, Bhaya D, Apt KE, Kehoe DM (1995) Light-harvesting complexes in oxygenic photosynthesis: diversity, control, and evolution. *Annual Review of Genetics* 29:231-288
- Guiselin N (2010) Caractérisation des événements phytoplanctoniques en zone côtière: tests de techniques alternatives et développement d'indicateurs de qualité des masses d'eau. PhD Thesis. Université du Littoral Côte d'Opale, France.
- Guiselin N, Courcot L, Artigas LF, Le Jéloux A, Brylinski JM (2009) An optimised protocol to prepare *Phaeocystis globosa* morphotypes for scanning electron microscopy observation. *Journal of Microbiological Methods* 77:119-123
- Halpern BS, Walbridge S, Selkoe KA, Kappel CV, Micheli F, D'Agrosa C, Bruno JF, Casey KS, Ebert C, Fox HE, Fujita R, Heinemann D, Lenihan HS, Madin EMP, Perry MT, Selig ER, Spalding M, Steneck R, Watson R (2008) A global map of human impact on marine ecosystems. *Science* 319:948-952
- Hama T, Miyazaki T, Ogawa Y, Iwakuma T, Takahashi M, Otsuki A, Ichimura S (1983) Measurement of photosynthetic production of a marine phytoplankton population using a stable ^{13}C isotope. *Marine Biology* 73:31-36
- Hammer A, Schumann R, Schubert H (2002) Light and temperature acclimation of *Rhodomonas salina* (Cryptophyceae): photosynthetic performance. *Aquatic Microbial Ecology* 29:287-296
- Harding Jr. LW, Fisher Jr. TR, Tyler MA (1987) Adaptive responses of photosynthesis in phytoplankton: specificity to time-scale of change in light *Biological Oceanography* 4:403-437
- Harding Jr. LW, Meeson BW, Fisher Jr. TR (1985) Photosynthesis patterns in Chesapeake Bay phytoplankton: short- and long-term responses of P-I curve parameters to light. *Marine Ecology Progress Series* 26:99-111
- Harding Jr. LW, Meeson BW, Prézelin BB, Sweeney BM (1981) Diel periodicity of photosynthesis in marine phytoplankton. *Marine Biology* 61:95-105
- Harding Jr. LW, Meeson BW, Tyler MA (1983) Photoadaptation and diel periodicity of photosynthesis in the dinoflagellate *Prorocentrum mariae-lebouriae*. *Marine Ecology Progress Series* 13:73-85
- Harding Jr. LW, Prézelin BB, Sweeney BM, Cox JL (1982) Diel oscillations of the photosynthesis-irradiance (P-I) relationship in natural assemblages of phytoplankton. *Marine Biology* 67:167-168
- Harris GN, Scanlan DJ, Geider RJ (2005) Acclimation of *Emiliania huxleyi* (Prymnesiophyceae) to photon flux density. *Journal of Phycology* 41:851-862
- Hartig P, Wolfstein K, Lippemeier S, Colijn F (1998) Photosynthetic activity of natural microphytobenthos populations measured by fluorescence (PAM) and ^{14}C -tracer methods: A comparison. *Marine Ecology Progress Series* 166:53-62
- Henley WJ (1993) Measurement and interpretation of photosynthetic light-response curves in algae in the context of photoinhibition and diel changes. *Journal of Phycology* 29:729-738
- Herlory O, Richard P, Blanchard GF (2007) Methodology of light response curves: application of chlorophyll fluorescence to microphytobenthic biofilms. *Marine Biology* 153:91-101
- Houliiez E, Lizon F, Thyssen M, Artigas LF, Schmitt FG (2012) Spectral fluorometric characterization of Haptophyte dynamics using the FluoroProbe: an application in the

- eastern English Channel for monitoring *Phaeocystis globosa* *Journal of Plankton Research* 34:136-151
- Huot Y, Babin M (2010) Overview of fluorescence protocols: theory, basic concepts, and practice. In: Suggett DJ, al e (eds) *Chlorophyll a Fluorescence in Aquatic Sciences : Methods and Applications*, p 31-74
- Jakob T, Schreiber U, Kirchesch V, Langner U, Wilhelm C (2005) Estimation of chlorophyll content and daily primary production of the major algal groups by means of multiwavelength-excitation PAM chlorophyll fluorometry: Performance and methodological limits. *Photosynthesis Research* 83:343-361
- Jassby AD, Platt T (1976) Mathematical formulation of the relationship between photosynthesis and light for phytoplankton. *Limnology & Oceanography* 21:627-642
- Jeffrey SW, Mantoura RS, Wright SW (1997) Eds. *Phytoplankton pigments in oceanography: guidelines to modern methods*. United Nations Educational, Scientific and Cultural Organization, Paris. 661 pp
- Jellison R, Melack JM (1993) Algal photosynthetic activity and its response to meromixis in hypersaline Mono Lake, California. *Limnology & Oceanography* 38:818-837
- Johnsen G, Sakshaug E (2007) Biooptical characteristics of PSII and PSI in 33 species (13 pigment groups) of marine phytoplankton, and the relevance for pulse amplitude-modulated and fast-repetition-rate fluorometry. *Journal of Phycology* 43:1236-1251
- Joliot P, Joliot A (1964) Etudes cinétiques de la réaction photochimique libérant l'oxygène au cours de la photosynthèse. *Comptes Rendus de l'Académie des Sciences de Paris* 258:4622-4625
- Jones RI (1978) Adaptations to fluctuating irradiance by natural phytoplankton communities. *Limnology & Oceanography* 23:920-926
- Jouenne F, Lefebvre S, Véron B, Lagadeuc Y (2005) Biological and physicochemical factors controlling short-term variability in phytoplankton primary production and photosynthetic parameters in a macrotidal ecosystem (eastern English Channel). *Estuarine, Coastal and Shelf Science* 65:421-439
- Jouenne F, Lefebvre S, Véron B, Lagadeuc Y (2007) Phytoplankton community structure and primary production in small intertidal estuarine-bay ecosystem (eastern English Channel, France). *Marine Biology* 151:805-825
- Juneau P, Harrison PJ (2005) Comparison by PAM fluorimetry of photosynthetic activity of nine marine phytoplankton grown under identical conditions. *Photochemistry and Photobiology* 81:649-653
- Kana TM, Watts JL, Glibert PM (1985) Diel periodicity in the photosynthetic capacity of coastal and offshore phytoplankton assemblages. *Marine Ecology Progress Series* 25:131-139
- Kautsky H, Hirsch A (1931) Neue Versuche zur Kohlensäureassimilation. *Naturwissenschaften* 19:1432-1904
- Kishino M, Takahashi N, Okami N, Ichimura S (1985) Estimation of the spectral absorption coefficients of phytoplankton in the sea. *Bulletin of Marine Science* 37:634-642
- Koblizek M, Kaftan D, Nedbal L (2001) On the relationship between the non-photochemical quenching of the chlorophyll fluorescence and the Photosystem II light harvesting efficiency. A repetitive flash fluorescence induction study. *Photosynthesis Research* 68:141-152
- Kocum E, Underwood GJC, Nedwell DB (2002) Simultaneous measurement of phytoplanktonic primary production, nutrient and light availability along a turbid, eutrophic UK east coast estuary (the Colne Estuary). *Marine Ecology Progress Series* 231:1-12

- Kolber Z, Falkowski PG (1993) Use of active fluorescence to estimate phytoplankton photosynthesis *in situ*. *Limnology and Oceanography* 38:1646-1665
- Kolber Z, Wyman KD, Falkowski PG (1990) Natural variability in photosynthetic energy conversion efficiency: A field study in the Gulf of Maine. *Limnology & Oceanography* 35:72-79
- Kolber Z, Zehr J, Falkowski P (1988) Effects of Growth Irradiance and Nitrogen Limitation on Photosynthetic Energy Conversion in Photosystem II *Plant Physiology* 88:923-929
- Kolber ZS, Prasil O, Falkowski PG (1998) Measurements of variable chlorophyll fluorescence using fast repetition rate techniques: Defining methodology and experimental protocols. *Biochimica et Biophysica Acta - Bioenergetics* 1367:88-106
- Kolbowski J, Schreiber U (1995) Computer-controlled phytoplankton analyser based on a 4-wavelengths PAM chlorophyll fluorometer. In: Mathis P (ed) *Photosynthesis: from Light to Biosphere (V)*. Kluwer Academic Publishers, Dordrecht, The Netherlands, p 825-828
- Krause GH, Jahns P (2004a) Modulated Chlorophyll Fluorometry and its Application in Plant Science. In: Papageorgiou G, Govindjee (eds) *Chlorophyll Fluorescence : a Signature of Photosynthesis*, Vol 19. Kluwer Academic Publishers, Dordrecht, The Netherlands, p 493-495
- Krause GH, Jahns P (2004b) Non-photochemical energy dissipation determined by chlorophyll fluorescence quenching : characterization and function In: Papageorgiou G, Govindjee (eds) *Chlorophyll Fluorescence : a Signature of Photosynthesis*, Vol 19. Kluwer Academic Publishers, Dordrecht, The Netherlands, p 463-495
- Krause GH, Weis E (1984) Chlorophyll fluorescence as a tool in plant physiology. II. Interpretation of fluorescence signals. *Photosynthesis Research* 5:139-157
- Krause GH, Weis E (1991) Chlorophyll fluorescence and photosynthesis : the basics. *Annual Review of Plant Physiology and Plant Molecular Biology* 42:313-349
- Kromkamp J, Barranguet C, Peene J (1998) Determination of microphytobenthos PSII quantum efficiency and photosynthetic activity by means of variable chlorophyll fluorescence. *Marine Ecology Progress Series* 162:45-55
- Kromkamp J, Domin A, Dubinsky Z, Lehmann C, Schanz F (2001) Changes in photosynthetic properties measured by oxygen evolution and variable chlorophyll fluorescence in a simulated entrainment experiment with the cyanobacterium *Planktothrix rubescens*. *Aquatic Sciences* 63:363-382
- Kromkamp J, Forster R (2003) The use of variable fluorescence measurements in aquatic ecosystems: differences between multiple and single turnover measuring protocols and suggested terminology. *European Journal of Phycology* 38:103-112
- Kroon B, Prézelin BB, Schofield O (1993) Chromatic regulation of quantum yields for photosystem II charge separation, oxygen evolution, and carbon fixation in *Heterocapsa pygmaea* (Pyrrophyta). *Journal of Phycology* 29:453-462
- Kropuenske LR, Mills MM, Van Dijken GL, Alderkamp AC, Mine Berg G, Robinson DH, Welschmeyer NA, Arrigo KR (2010) Strategies and rates of photoacclimation in two major southern ocean phytoplankton taxa: *Phaeocystis Antarctica* (Haptophyta) and *Fragilariopsis cylindrus* (Bacillariophyceae). *Journal of Phycology* 46:1138-1151
- Kruskopf M, Flynn K (2006) Chlorophyll content and fluorescence responses cannot be used to gauge reliably phytoplankton biomass, nutrient status or growth rate. *New Phytologist* 169:525-536
- Kühl M, Glud RN, Borum J, Roberts R, Rysgaard S (2001) Photosynthetic performance of surface-associated algae below sea ice as measured with a pulse-amplitude-modulated (PAM) fluorometer and O₂ microsensors. *Marine Ecology Progress Series* 223:1-14

- Kulk G, Van De Poll WH, Visser RJW, Buma AGJ (2011) Distinct differences in photoacclimation potential between prokaryotic and eukaryotic oceanic phytoplankton. *Journal of Experimental Marine Biology and Ecology* 398:63-72
- Lamy D, Artigas LF, Jauzein C, Lizon F, Cornille V (2006) Coastal bacterial viability and production in the eastern English Channel: A case study during a *Phaeocystis globosa* bloom. *Journal of Sea Research* 56:227-238
- Lamy D, Obernosterer I, Laghdass M, Artigas LF, Breton E, Grattepanche JD, Lecuyer E, Degros N, Lebaron P, Christaki U (2009) Temporal changes of major bacterial groups and bacterial heterotrophic activity during a *Phaeocystis globosa* bloom in the eastern English Channel. *Aquatic Microbial Ecology* 58:95-107
- Lancelot C, Billen G, Sournia A, Weisse T, Colijn F, Velduis MJW, Davis A, Wassman P (1987) *Phaeocystis* blooms and nutrient enrichment in the continental coastal zones of the North Sea. *Ambio* 16:38-46
- Lavaud J (2007) Fast regulation of photosynthesis in Diatoms: mechanisms, evolution and ecophysiology. *Functional Plant Science and Biotechnology* 1:267-287
- Lavaud J, Rousseau B, Etienne AL (2003) Enrichment of the light-harvesting complex in diadinoxanthin and implications for the nonphotochemical fluorescence quenching in diatoms. *Biochemistry* 42:5802-5808
- Lavaud J, Rousseau B, Van Gorkom HJ, Etienne AL (2002) Influence of the diadinoxanthin pool size on photoprotection in the marine planktonic diatom *Phaeodactylum tricorutum*. *Plant Physiology* 129:1398-1406
- Lavaud J, Strzeppek RF, Kroth PG (2007) Photoprotection capacity differs among diatoms: Possible consequences on the spatial distribution of diatoms related to fluctuations in the underwater light climate. *Limnology and Oceanography* 52:1188-1194
- Laws EA, Bannister TT (1980) Nutrient- and light-limited growth of *Thalassiosira fluviatilis* in continuous culture with implications for phytoplankton growth in the ocean. *Limnology and Oceanography* 25:457-473
- Leboulanger C, Dorigo U, Jacquet S, Le Berre B, Paolini G, Humbert JF (2002) Application of a submersible spectrofluorometer for rapid monitoring of freshwater cyanobacterial blooms: a case study. *Aquatic Microbial Ecology* 30:83-89
- Lefebvre A, Guiselin N, Barbet F, Artigas LF (2011) Long-term hydrological and phytoplankton monitoring (1992-2007) of three potentially eutrophic systems in the eastern English Channel and the Southern Bight of the North Sea. *ICES Journal of Marine Science* 68:2029-2043
- Lefebvre S, Mouget JL, Lavaud J (2012) Duration of rapid light curves for determining the photosynthetic activity of microphytobenthos biofilm *in situ*. *Aquatic Botany* 95:1-8
- Lefebvre S, Mouget JL, Loret P, Rosa P, Tremblin G (2007) Comparison between fluorimetry and oximetry techniques to measure photosynthesis in the diatom *Skeletonema costatum* cultivated under simulated seasonal conditions. *Journal of Photochemistry and Photobiology B: Biology* 86:131-139
- Lewis MR, Horne EPW, Cullen JJ, Oakey NS, Platt T (1984) Turbulent motions may control phytoplankton photosynthesis in the upper ocean. *Nature* 311:49-50
- Lippemeier S, Hartig P, Colijn F (1999) Direct impact of silicate on the photosynthetic performance of the diatom *Thalassiosira weissflogii* assessed by on- and off-line PAM fluorescence measurements. *Journal of Plankton Research* 21:269-283
- Lippemeier S, Klaus RH, Vanselow KH, Hartig P, Colijn F (2001) In-line recording of PAM fluorescence of phytoplankton cultures as a new tool for studying effects of fluctuating nutrient supply on photosynthesis. *European Journal of Phycology* 36:89-100

- Litchman E, Klausmeier CA (2001) Competition of phytoplankton under fluctuating light. *American Naturalist* 157:170-187
- Lizon F (1997) Photoadaptation et évaluation de la production photosynthétique du phytoplancton en relation avec les caractéristiques hydrodynamiques de la Manche orientale. PhD thesis. Université de Paris VI, France.
- Lizon F, Lagadeuc Y, Brunet C, Aelbrecht D, Bentley D (1995) Primary production and photoadaptation of phytoplankton in relation with tidal mixing in coastal waters. *Journal of Plankton Research* 17:1039-1055
- Lizon F, Seuront L, Lagadeuc Y (1998) Photoadaptation and primary production study in tidally mixed coastal waters using a Lagrangian model. *Marine Ecology Progress Series* 169:43-54
- Lohrenz S, Fahnenstiel GL, Redalje DG (1994) Spatial and temporal variations of photosynthetic parameters in relation to environmental conditions in coastal waters of the northern Gulf of Mexico. *Estuaries* 17:779-795
- Long SP, Humphries S, Falkowski PG (1994) Photoinhibition of photosynthesis in nature. *Annual Review of Plant Physiology and Plant Molecular Biology* 45:633-662
- Longhi M, Schloss I, Wiencke C (2003) Effect of irradiance and temperature on photosynthesis and growth of two Antarctic benthic diatoms, *Gyrosigma subsalinum* and *Odontella litigiosa*. *Botanica Marina* 46:276-284
- Lorenzen CJ (1966) A method for continuous measurement of *in vivo* chlorophyll concentration. *Deep-Sea Research (Part I, Oceanographic Research Papers)* 13:223-247
- MacCaull WA, Platt T (1977) Diel variations in the photosynthetic parameters of coastal phytoplankton. *Limnology & Oceanography* 22:723-731
- Macedo MF, Duarte P, Mendes P, Ferreira JG (2001) Annual variation of environmental variables, phytoplankton species composition and photosynthetic parameters in a coastal lagoon. *Journal of Plankton Research* 23:719-732
- MacIntyre HL, Cullen JJ (1996) Primary production by suspended and benthic microalgae in a turbid estuary: time-scales of variability in San Antonio Bay, Texas. *Marine Ecology Progress Series* 145:245-268
- MacIntyre HL, Kana TM (2002) Photoacclimation of photosynthesis irradiance response curves and photosynthetic pigments in microalgae and cyanobacteria. *Journal of Phycology* 38:17-38
- MacIntyre HL, Kana TM, Geider RJ (2000) The effect of water motion on short-term rates of photosynthesis by marine phytoplankton. *Trends in Plant Science* 5:12-17
- MacIntyre HL, Lawrenz E, Richardson TL (2010) Taxonomic discrimination of phytoplankton by spectral fluorescence. In: Suggett D.J. *et al.* (ed) *Chlorophyll a Fluorescence in Aquatic Sciences : Methods and Applications*, p 129-169
- MacIntyre JG, Cullen JJ, Cembella AD (1997) Vertical migration, nutrition and toxicity in the dinoflagellate *Alexandrium tamarense*. *Marine Ecology Progress Series* 148:201-216
- Mackey MD, Mackey DJ, Higgins HW, Wright SW (1996) CHEMTAX - A program for estimating class abundances from chemical markers: Application to HPLC measurements of phytoplankton. *Marine Ecology Progress Series* 144:265-283
- Madariaga I (1995) Photosynthetic characteristics of phytoplankton during the development of a summer bloom in the Urdaibai Estuary, Bay of Biscay. *Estuarine, Coastal and Shelf Sciences* 40:559-575
- Magnusson G (1997) Diurnal measurements of Fv/Fm used to improve productivity estimates in microalgae *Marine Biology* 130:203-208

- Malkassian A, Nerini D, Van Dijk MA, Thyssen M, Mante C, Gregori G (2011) Functional analysis and classification of phytoplankton based on data from an automated flow cytometer. *Cytometry Part A* 79 A:263-275
- Mallin MA, Paerl HW, Rudek J (1991) Seasonal phytoplankton composition, productivity and biomass in the Neuse River estuary, North Carolina. *Estuarine, Coastal and Shelf Science* 32:609-623
- Malone TC, Neale PJ (1981) Parameters of light-dependent photosynthesis for phytoplankton size fractions in temperate estuarine and coastal environments. *Marine Biology* 61:289-297
- Maranon E, Holligan PM (1999) Photosynthetic parameters of phytoplankton from 50°N to 50°S in the Atlantic Ocean. *Marine Ecology Progress Series* 176:191-203
- Marra J (1978) Phytoplankton photosynthetic response to vertical movement in a mixed layer. *Marine Biology* 46:203-208
- Masojidek J, Torzillo G, Koblizek M, Kopecky J, Bernardini P, Sacchi A, Komenda J (1999) Photoadaptation of two members of the Chlorophyta (*Scenedesmus* and *Chlorella*) in laboratory and outdoor cultures : changes in chlorophyll fluorescence quenching and the xanthophyll cycle. *Planta* 209:126-135
- Mauzerall D (1972) Light-induced changes in *Chlorella*, and primary photoreaction for the production of oxygen *Proceedings of the National Academy of Sciences* 69:1358-1362
- Maxwell K, Johnson GN (2000) Chlorophyll fluorescence - a practical guide. *Journal of Experimental Botany* 51:659-668
- Meyer AA, Tackx M, Daro N (2000) Xanthophyll cycling in *Phaeocystis globosa* and *Thalassiosira sp.*: A possible mechanism for species succession. *Journal of Sea Research* 43:373-384
- Meyns S, Illi R, Ribic B (1994) Comparisons of chlorophyll-a analysis by HPLC and spectrophotometry: where do the differences come from ? *Archiv für Hydrobiologie* 132:129-139
- Millie DF, Schofield OME, Kirkpatrick GJ, Johnsen G, Evens TJ (2002) Using absorbance and fluorescence spectra to discriminate microalgae. *European Journal of Phycology* 37:313-322
- Mills MM, Kropuenske LR, Van Dijken GL, Alderkamp AC, Berg GM, Robinson DH, Welschmeyer NA, Arrigo KR (2010) Photophysiology in two southern ocean phytoplankton taxa: Photosynthesis of *Phaeocystis Antarctica* (prymnesiophyceae) and *Fragilariopsis Cylindrus* (bacillariophyceae) under simulated mixed-layer irradiance. *Journal of Phycology* 46:1114-1127
- Mimuro M, Akimoto S (2003) Carotenoids of light harvesting systems: energy transfer processes from fucoxanthin and peridinin to chlorophyll. In: Larkum AWD, Douglas SE, Raven J (eds) *Photosynthesis in Algae* Kluwer Academic Publisher, Dordrecht, The Netherlands, p 335-349
- Mitchell B (1990) Algorithms for determining the absorption coefficient of aquatic particulates using the quantitative filter technique (QFT). *Ocean Optics* X:137-148
- Mitchell BG, Bricaud A, Carder K, Cleveland J, Ferrari G, Gould R, Kahru M, Kishino M, Maske H, Moisan T, Moore L, Nelson N, Phinney D, Reynolds R, Sosik H, Stramski D, Tassan S, Trees C, Weidemann A, Wieland J, Vodacek A (2000) Determination of spectral absorption coefficients of particles, dissolved material and phytoplankton for discrete water samples. In: Fargion GS, Mueller JL, McClain CR (eds) *Ocean Optics Protocols for Satellite Ocean Color Sensor Validation. Revision 2*, NASA Technical Memorandum 2000-209966, p 125-153

- Mitchell BG, Kahru M, Wieland J, Stramska M (2003) Determination of spectral absorption coefficients of particles, dissolved material and phytoplankton for discrete water samples. In: Mueller JL, Fargion GS, McClain CR (eds) Ocean Optics Protocols for Satellite Ocean Color Sensor Validation. Revision 4-Volume IV, NASA Technical Memorandum 2003-211621, p 39-64
- Moigis AG, Gocke K (2003) Primary production of phytoplankton estimated by means of the dilution method in coastal waters. *Journal of Plankton Research* 25:1291-1300
- Moline MA, Schofield O, Boucher NP (1998) Photosynthetic parameters and empirical modelling of primary production: A case study on the Antarctic Peninsula shelf. *Antarctic Science* 10:45-54
- Montecino V, Quiroz D (2000) Specific primary production and phytoplankton cell size structure in an upwelling area off the coast of Chile (30°S). *Aquatic Sciences* 62:364-380
- Montford K (1969) Measuring dissolved oxygen as an indicator of primary productivity. *Chesapeake Science* 10:327-330
- Moore CM, Lucas MI, Sanders R, Davidson R (2005) Basin-scale variability of phytoplankton bio-optical characteristics in relation to bloom state and community structure in the Northeast Atlantic. *Deep-Sea Research (Part I, Oceanographic Research Papers)* 2005:401-419
- Moran XAG, Estrada M (2005) Winter pelagic photosynthesis in the NW Mediterranean. *Deep-Sea Research Part I: Oceanographic Research Papers* 52:1806-1822
- Morris EP, Kromkamp JC (2003) Influence of temperature on the relationship between oxygen- and fluorescence-based estimates of photosynthetic parameters in a marine benthic diatom (*Cylindrotheca closterium*). *European Journal of Phycology* 38:133-142
- Mountford K (1969) Measuring dissolved oxygen as an indicator of primary production. *Chesapeake Science* 10:327-330
- Muller-Karger FE, Varela R, Thunell R, Luerssen R, Hu C, Walsh JJ (2005) The importance of continental margins in the global carbon cycle. *Geophysical Research Letters* 32:L01602
- Müller P, Li XP, Niyogi K (2001) Non-Photochemical Quenching. A Response to Excess Light Energy. *Plant Physiology* 125:1558-1566
- Muylaert K, Gonzales R, Franck M, Lionard M, Van der Zee C, Cattrijsse A, Sabbe K, Chou L, Vyverman W (2006) Spatial variation in phytoplankton dynamics in the Belgian coastal zone of the North Sea studied by microscopy, HPLC-CHEMTAX and underway fluorescence recordings. *Journal of Sea Research* 55:253-265
- Napoléon C, Raimbault V, Fiant L, Riou P, Lefebvre S, Lampert L, Claquin P (2012) Spatiotemporal dynamics of physicochemical and photosynthetic parameters in the central English Channel. *Journal of Sea Research* 69:43-52
- Neale PJ, Richerson PJ (1987) Photoinhibition and the diurnal variation of phytoplankton photosynthesis-I. Development of a photosynthesis-irradiance model from studies of *in situ* responses. *Journal of Plankton Research* 9:167-193
- Nixon PJ (2000) Chlororespiration. *Philosophical Transactions of the Royal Society B: Biological Sciences* 355:1541-1547
- Owens TG, Falkowski P, Whitlege TE (1980) Diel periodicity in cellular chlorophyll content in marine diatoms. *Marine Biology* 59:71-77
- Oxborough K (2004) Imaging of chlorophyll *a* fluorescence: theoretical and practical aspects of an emerging technique for the monitoring of photosynthetic performance. *Journal of Experimental Botany* 55:1195-1205

- Oxborough K, Baker NR (1997) Resolving chlorophyll a fluorescence images of photosynthetic efficiency into photochemical and non-photochemical components - calculation of qP and F_v'/F_m' without measuring F_0' . *Photosynthesis Research* 54:135-142
- Pachepsky LB, Haskett JD, Acock B (1996) An adequate model of photosynthesis - I. Parameterization, validation and comparison of models. *Agricultural Systems* 50:209-225
- Pannard A, Claquin P, Klein C, Le Roy B, Véron B (2008) Short-term variability of the phytoplankton community in coastal ecosystem in response to physical and chemical conditions' changes. *Estuarine, Coastal and Shelf Science* 80:212-224
- Papageorgiou G, Govindjee (2004) Eds. Chlorophyll *a* fluorescence : A signature of photosynthesis. *Advances in photosynthesis and respiration*, Vol. 19. Dordrecht, Springer. 818 pp.
- Parkhill JP, Maillet G, Cullen JJ (2001) Fluorescence-based maximal quantum yield for PSII as a diagnostic of nutrient stress. *Journal of Phycology* 37:517-529
- Pauly D, Christensen V (1995) Primary production required to sustain global fisheries. *Nature* 374:255-257
- Peperzak L, Colijn F, Gieskes WWC, Peeters JCH (1998) Development of the diatom-*Phaeocystis* spring bloom in the Dutch coastal zone of the North Sea: the silicon depletion versus the daily irradiance threshold hypothesis *Journal of Plankton Research* 20:517-537
- Peperzak L, Colijn F, Vrieling EG, Gieskes WWC, Peeters JCH (2000) Observations of flagellates in colonies of *Phaeocystis globosa* (Prymnesiophyceae): a hypothesis for their position in the life cycle. *Journal of Plankton Research* 22:2181-2203
- Perkins RG, Kromkamp J, Serôdio J, Lavaud J, Jesus B, Mouget JL, Lefebvre S, Forster R (2010) The Application of Variable Chlorophyll Fluorescence to Microphytobenthic Biofilms. In: Suggett DJ (ed) *Chlorophyll a Fluorescence in Aquatic Sciences : Methods and Applications* Springer Dordrecht Heidelberg, London, New York, pp 237-275
- Perkins RG, Mouget JL, Lefebvre S, Lavaud J (2006) Light response curve methodology and possible implications in the application of chlorophyll fluorescence to benthic diatoms. *Marine Biology* 149:703-712
- Peterson BJ (1980) Productivity and the ^{14}C - CO_2 method : a history of the reproductivity problem. *Annual Review of Ecology, Evolution and Systematics* 11:359-385
- Pfündel E (1998) Estimating the contribution of Photosystem I to total leaf chlorophyll fluorescence. *Photosynthesis Research* 56:185-195
- Platt T, Denman KL (1975) Spectral analysis in ecology. *Annual Review of Ecology, Evolution and Systematics* 6:189-210
- Platt T, Gallegos CL, Harrison WG (1980) Photoinhibition of Photosynthesis in Natural Assemblages of Marine Phytoplankton. *Journal of Marine Research* 38:687-701
- Platt T, Jassby AD (1976) The relationship between photosynthesis and light for natural assemblages of coastal marine phytoplankton. *Journal of Phycology* 12:421-430
- Platt T, Sathyendranath S, Forget MH, White III GN, Caverhill C, Bouman H, Devred E, Son S (2008) Operational estimation of primary production at large geographical scales. *Remote Sensing of Environment* 112:3437-3448
- Poryvkina L, Babichenko S, Kaitala S, Kuosa H, Shalajonok A (1994) Spectral fluorescence signatures in the characterization of phytoplankton community composition. *Journal of Plankton Research* 16:1315-1327

- Prézélin BB, Bidigare RR, Matlick HA, Putt M, Ver Hoven B (1987) Diurnal patterns of size-fractionated primary productivity across a coastal front. *Marine Biology* 96:563-574
- Prézélin BB, Meeson BW, Sweeney BM (1977) Characterization of photosynthetic rhythms in marine dinoflagellates. I. Pigmentation, photosynthetic capacity and respiration. *Plant Physiology* 60:384-387
- Prézélin BB, Putt M, Glover HE (1986) Diurnal patterns in photosynthetic capacity and depth-dependent photosynthesis-irradiance relationships in *Synechococcus sp.* and larger phytoplankton in three water masses in the Northwest Atlantic Ocean. *Marine Biology* 91:205-217
- Prézélin BB, Sweeney BM (1977) Characterization of photosynthetic rhythms in marine dinoflagellates. II. Photosynthesis-irradiance curves and *in vivo* chlorophyll a fluorescence. *Plant Physiology* 60:388-392
- Puigserver M, Chrétiennot-Dinet MJ, Nezan E (2003) Some Prymnesiaceae (Haptophyta, Prymnesiophyceae) from the Mediterranean Sea, with the description of two new species: *Chrysochromulina lanceolata* sp. nov. and *C. pseudolanceolata* sp. nov. *Journal of Phycology* 39:762-774
- Putt M, Prézélin BB (1985) Observations of diel patterns of photosynthesis in cyanobacteria and nanoplankton in the Santa Barbara channel during "El Niño". *Journal of Plankton Research* 7:779-790
- Quisthoudt C (1987) Production primaire phytoplanctonique dans le détroit du Pas-de-Calais (France): variations spatiales et annuelles au large du Cap Gris-Nez. *Comptes Rendus de l'Académie des Sciences de Paris* 304:245-250
- Raateoja M, Mitchell BG, Wang H, Olivo E (2009) Effect of water column light gradient on phytoplankton fluorescence transients. *Marine Ecology Progress Series* 376:85-101
- Ragni M, Airs R, Leonardos N, Archer S, Geider RJ (2008) Photoinhibition of PSII in *Emiliania huxleyi* (Haptophyta) under high light stress : the roles of photoacclimation, photoprotection and photorepair. *Journal of Phycology* 44:670-683
- Ralph PJ, Gademann R (2005) Rapid light curves : a powerful tool to assess photosynthetic activity. *Aquatic Botany* 82:222-237
- Ralph PJ, Polk SM, Moore KA, Orth RJ, Smith Jr WO (2002) Operation of the xanthophyll cycle in the seagrass *Zostera marina* in response to variable irradiance. *Journal of Experimental Marine Biology and Ecology* 271:189-207
- Ralph PJ, Wilhelm C, Lavaud J, Jakob T, Petrou K, Kranz SA (2010) Fluorescence as a tool to understand changes in photosynthetic electron flow regulation. In: Suggett DJ, al e (eds) *Chlorophyll a Fluorescence in Aquatic Sciences : Methods and Applications*. Springer, p 75-89
- Ratkowski DA (1983) Non linear regression modeling. A unified practical approach. Marcal Dekker, New York, p 276.
- Raven JA, Geider JR (2003) Adaptation, Acclimation and Regulation in Algal Photosynthesis. In: Larkum AWD, Douglas SE, Raven JA (eds) *Photosynthesis in algae* Kluwer Academic Publishers, Dordrecht, The Netherlands, pp 385-412
- Richardson K, Beardall J, Raven JA (1983) Adaptation of unicellular algae to irradiance: an analysis of strategies. *New Phytologist* 93:157-191
- Richardson TL, Lawrenz E, Pinckney JL, Guajardo RC, Walker EA, Paerl HW, MacIntyre HL (2010) Spectral fluorometric characterization of phytoplankton community composition using the Algae Online Analyser. *Water Research* 44:2461-2472
- Richter M, Rühle W, Wild A (1990) Studies on the mechanism of photosystem II photoinhibition I. A two-step degradation of D1-protein. *Photosynthesis Research* 24:229-235

- Rohacek K (2002) Chlorophyll fluorescence parameters : the definitions, photosynthetic meaning, and mutual relationships. *Photosynthetica* 40:13-29
- Rohacek K, Bartak M (1999) Technique of the modulated chlorophyll fluorescence : basic concepts, useful parameters, and some applications. *Photosynthetica* 37:339-363
- Rousseau V, Becquevort S, Parent JY, Gasparini S, Daro N, Tackx M, Lancelot C (2000) Trophic efficiency of the planktonic food web in a coastal ecosystem dominated by *Phaeocystis* colonies. *Journal of Sea Research* 43:357-372
- Rousseau V, Chrétiennot-Dinet MJ, Jacobsen A, Verity P, Whipple S (2007) The life cycle of *Phaeocystis*: state of knowledge and presumptive role in ecology. *Biogeochemistry* 83:29-47
- Rousseau V, Leynaert A, Daoud N, Lancelot C (2002) Diatoms succession, silicification and availability in Belgian coastal waters (southern North Sea). *Marine Ecology Progress Series* 236:61-73
- Rowan KS (1989) *Photosynthetic Pigments of Algae*. Cambridge Univ Press, Cambridge, 334 pp
- Rutten TPA, Sandee B, Hofman ART (2005) Phytoplankton monitoring by high performance flow cytometry: A successful approach? *Cytometry Part A* 64:16-26
- Sakshaug E, Bricaud A, Dandonneau Y, Falkowski PG, Kiefer DA, Legendre L, Morel A, Parslow J, Takahashi M (1997) Parameters of photosynthesis: Definitions, theory and interpretation of results. *Journal of Plankton Research* 19:1637-1670
- Sall J, Creighton L, Lehman A (2007) *JMP Start Statistics: A Guide to Statistics and Data Analysis Using JMP*. 4th Edition. Cary, NC: SAS Institute Inc. 607 pp.
- Salomon JC, Breton M (1991) Courants résiduels de marée dans la Manche. *Oceanologica Acta* sp 11:47-53
- Samson G, Prasil O, Yaakoubd B (1999) Photochemical and thermal phases of chlorophyll *a* fluorescence. *Photosynthetica* 37:163-182
- Savidge G (1988) Influence of inter- and intra-daily light-field variability on photosynthesis by coastal phytoplankton. *Marine Biology* 100:127-133
- Schapiro M, Vincent D, Gentilhomme V, Seuront L (2008) Temporal patterns of phytoplankton assemblages, size spectra and diversity during the wane of a *Phaeocystis globosa* spring bloom in hydrologically contrasted coastal waters. *Journal of the Marine Biological Association of the United Kingdom* 88:649-662
- Scherrer B (2007) *Biostatistique*, Volume 1, 2e édition. Gaëtan Morin éditeur. 816 pp.
- Schoemann V, Becquevort S, Stefels J, Rousseau V, Lancelot C (2005) *Phaeocystis* blooms in the global ocean and their controlling mechanisms: A review. *Journal of Sea Research* 53:43-66
- Schofield O, Evens TJ, Millie DF (1998) Photosystem II quantum yields and xanthophyll-cycle pigments of the macroalga *Sargassum natans* (Phaeophyceae): Responses under natural sunlight. *Journal of Phycology* 34:104-112
- Schreiber U (1998) Chlorophyll fluorescence: New instruments for special applications. In: G. G (ed) *Photosynthesis: Mechanisms and Effects*, Vol 5, p 4253-4258
- Schreiber U (2004) Pulse-Amplitude-Modulation (PAM) fluorometry and saturation pulse method : an overview. In: Papageorgiou G, Govindjee (eds) *Chlorophyll Fluorescence : a Signature of Photosynthesis*, Vol 19. Kluwer Academic Publishers, Dordrecht, The Netherlands, p 279-319
- Schreiber U, Bilger W, Neubauer C (1994) Chlorophyll fluorescence as a noninvasive indicator for rapid assessment of in vivo photosynthesis In: Schulze ED (ed) *Ecophysiology of Photosynthesis*. Springer-Verlag, Berlin, p 49-70

- Schreiber U, Bilger W, Neubauer C (1995a) Chlorophyll fluorescence as a noninvasive indicator for rapid assessment of in vivo photosynthesis In: Ecophysiology of Photosynthesis. Eds E.D. Schulze and M.M. Caldwell, Springer-Verlag, Berlin, p 49-70
- Schreiber U, Bilger W, Schliwa U (1986) Continuous recording of photochemical and non-photochemical quenching with a new type of modulation fluorometer. *Photosynthesis Research* 10:51-62
- Schreiber U, Endo T, Mi H, Asada K (1995b) Quenching analysis of chlorophyll fluorescence by saturation pulse method : particular application aspects relating to the study of eukaryotic algae and cyanobacteria. *Plant and Cell Physiology* 36:873-882
- Schreiber U, Hormann H, Neubauer C, Klughammer C (1995c) Assessment of photosystem II photochemical quantum yield by chlorophyll fluorescence quenching analysis. *Australian Journal of Plant Physiology* 22:209-220
- Schreiber U, Klughammer C, Kolbowski J (in press) Assessment of wavelength-dependent parameters of photosynthetic electron transport with a new type of multi-color PAM chlorophyll fluorometer. *Photosynthesis Research*
- Schubert H, Sagert S, Forster RM (2001) Evaluation of the different levels of variability in the underwater light field of a shallow estuary. *Helgoland Marine Research* 55:12-22
- See JH, Campbell L, Richardson TL, Pinckney JL, Shen R, Guinasso Jr NL (2005) Combining new technologies for determination of phytoplankton community structure in the northern Gulf of Mexico. *Journal of Phycology* 41:305-310
- Serôdio J, Catarino F (2000) Modelling the primary productivity of intertidal microphytobenthos: time scales of variability and effects of migratory rhythms. *Marine Ecology Progress Series* 192:13-30
- Serôdio J, Coelho H, Vieira S, Cruz S (2006a) Microphytobenthos vertical migratory photoresponse as characterised by light-response curves of surface biomass. *Estuarine, Coastal and Shelf Science* 68:547-556
- Serôdio J, Cruz S, Vieira S, Brotas V (2005a) Non-photochemical quenching of chlorophyll fluorescence and operation of the xanthophyll cycle in estuarine microphytobenthos. *Journal of Experimental Marine Biology and Ecology* 326:157-169
- Serôdio J, Vieira S, Cruz S (2008) Photosynthetic activity, photoprotection and photoinhibition in intertidal microphytobenthos as studied *in situ* using variable chlorophyll fluorescence. *Continental Shelf Research* 28:1363-1375
- Serôdio J, Vieira S, Cruz S, Barroso F (2005b) Short-term variability in the photosynthetic activity of microphytobenthos as detected by measuring rapid light curves using variable fluorescence. *Marine Biology* 146:903-914
- Serôdio J, Vieira S, Cruz S, Coelho H (2006b) Rapid light-response curves of chlorophyll fluorescence in microalgae: Relationship to steady-state light curves and non-photochemical quenching in benthic diatom-dominated assemblages. *Photosynthesis Research* 90:29-43
- Seuront L, Vincent D, Mitchell JG (2006) Biologically induced modification of seawater viscosity in the eastern English Channel during a *Phaeocystis globosa* spring bloom. *Journal of Marine Systems* 61:118-133
- Shaw PJ, Purdie DA (2001) Phytoplankton photosynthesis-irradiance parameters in the near-shore UK coastal waters of the North Sea: Temporal variation and environmental control. *Marine Ecology Progress Series* 216:83-94
- Six C, Finkel ZV, Rodriguez F, Marie D, Partensky F, Campbell DA (2008) Contrasting photoacclimation costs in ecotypes of the marine eukaryotic picoplankter *Ostreococcus*. *Limnology and Oceanography* 53:255-265

- Sosik HM, Mitchell BG (1991) Absorption, fluorescence, and quantum yield for growth in nitrogen- limited *Dunaliella tertiolecta*. *Limnology & Oceanography* 36:910-921
- Sosik HM, Mitchell BG (1994) Effects of temperature on growth, light absorption, and quantum yield in *Dunaliella tertiolecta* (Chlorophyceae). *Journal of Phycology* 30:833-840
- Sosik HM, Mitchell BG (1995) Light absorption by phytoplankton, photosynthetic pigments and detritus in the California Current System. *Deep-Sea Research Part I: Oceanographic Research Papers* 42:1717-1748
- Staehr PA, Henriksen P, Markager S (2002) Photoacclimation of four marine phytoplankton species to irradiance and nutrient availability. *Marine Ecology Progress Series* 238:47-59
- Staehr PA, Markager S, Sand-Jensen K (2004) Pigment specific *in vivo* light absorption of phytoplankton from estuarine, coastal and oceanic waters. *Marine Ecology Progress Series* 275:115-128
- Steemann Nielsen E (1952) The Use of Radio-active Carbon (C^{14}) for Measuring Organic Production in the Sea. *ICES Journal of Marine Science* 18:117-140
- Stelfox-Widdicombe CE, Archer SD, Burkill PH, Stefels J (2004) Microzooplankton grazing in *Phaeocystis* and diatom-dominated waters in the southern North Sea in spring. *Journal of Sea Research* 51:37-51
- Stross RG, Chisholm SW, Downing TA (1973) Causes of daily rhythms in photosynthetic rates of phytoplankton. *The Biological Bulletin* 145:200-209
- Struski C, Bacher C (2006) Preliminary estimate of primary production by phytoplankton in Marennes-Oléron Bay, France. *Estuarine, Coastal and Shelf Science* 66:323-334
- Strzepek RF, Harrison PJ (2004) Photosynthetic architecture differs in coastal and oceanic diatoms. *Nature* 431:689-692
- Suggett DJ, Le Floc H E, Harris GN, Leonardos N, Geider RJ (2007) Different strategies of photoacclimation by two strains of *Emiliania huxleyi* (Haptophyta). *Journal of Phycology* 43:1209-1222
- Suggett DJ, MacIntyre HL, Geider RJ (2004) Evaluation of biophysical and optical determinations of light absorption by photosystem II in phytoplankton. *Limnology and Oceanography : Methods* 2:316-332
- Suggett DJ, Moore CM, Geider JR (2010a) Estimating Aquatic Productivity from Active Fluorescence Measurements. In: Suggett DJ (ed) *Chlorophyll a Fluorescence in Aquatic Sciences : Methods and Applications* Springer Dordrecht Heidelberg, London, New York, pp 103-127
- Suggett DJ, Moore CM, Hickman AE, Geider RJ (2009) Interpretation of fast repetition rate (FRR) fluorescence: signatures of phytoplankton community structure versus physiological state. *Marine Ecology Progress Series* 376:1-19
- Suggett DJ, Oxborough K, Baker NR, MacIntyre HL, Kana TM, Geider RJ (2003) Fast repetition rate and pulse amplitude modulation chlorophyll a fluorescence measurements for assessment of photosynthetic electron transport in marine phytoplankton. *European Journal of Phycology* 38:371-384
- Suggett DJ, Prasil O, Borowitzka M (2010b) Eds. *Chlorophyll a fluorescence in aquatic sciences: Methods and Applications*. Springer. 323 pp.
- Tassan S, Ferrari GM (1995) An alternative approach to absorption measurements of aquatic particles retained on filters. *Limnology and Oceanography* 40:1358-1368
- Tassan S, Ferrari GM (1998) Measurement of light absorption by aquatic particles retained on filters: Determination of the optical pathlength amplification by the 'transmittance-reflectance' method. *Journal of Plankton Research* 20:1699-1709

- ter Braak CJF, Smilauer P (2002) CANOCO Reference Manual and CanoDraw for Windows User's Guide: Software for Canonical Community Ordination (version 4.5). Microcomputer Power, Ithaca, NY, USA. 352 pp.
- Tillmann U, Hesse KJ, Colijn F (2000) Planktonic primary production in the German Wadden sea. *Journal of Plankton Research* 22:1253-1276
- Ting CS, Owens TG (1992) Limitations of the Pulse-Modulated Technique for Measuring the Fluorescence Characteristics of Algae. *Plant Physiology* 100:367-373
- Ting CS, Owens TG (1993) Photochemical et Nonphotochemical Fluorescence Quenching Processes in the Diatom *Phaeodactylum tricornutum*. *Plant Physiology* 101:1323-1330
- Trissl HW (2003) Modeling the excitation energy capture in thylakoid membranes. In: Larkum AWD, Douglas SE, Raven J (eds) *Photosynthesis in Algae* Kluwer Academic Publisher, Dordrecht, The Netherlands, p 245-276
- Tungaraza C, Rousseau V, Brion N, Lancelot C, Gichuki J, Baeyens W, Goeyens L (2003) Contrasting nitrogen uptake by diatom and *Phaeocystis*-dominated phytoplankton assemblages in the North Sea. *Journal of Experimental Marine Biology and Ecology* 292:19-41
- Van De Poll WH, Buma AGJ, Visser RJW, Janknegt PJ, Villafane VE, Helbling EW (2010) Xanthophyll cycle activity and photosynthesis of *Dunaliella tertiolecta* (Chlorophyceae) and *Thalassiosira weissflogii* (Bacillariophyceae) during fluctuating solar radiation. *Phycologia* 49:249-259
- Van De Poll WH, Van Leeuwe MA, Roggeveld J, Buma AGJ (2005) Nutrient limitation and high irradiance acclimation reduce par and UV-induced viability loss in the antarctic diatom *Chaetoceros brevis* (Bacillariophyceae). *Journal of Phycology* 41:840-850
- Van De Poll WH, Visser RJW, Buma AGJ (2007) Acclimation to a dynamic irradiance regime changes excessive irradiance sensitivity of *Emiliania huxleyi* and *Thalassiosira weissflogii*. *Limnology and Oceanography* 52:1430-1438
- Van Hilst CM, Smith Jr WO (2002) Photosynthesis/irradiance relationships in the Ross Sea, Antarctica, and their control by phytoplankton assemblage composition and environmental factors. *Marine Ecology Progress Series* 226:1-12
- van Kooten O, Snel JFH (1990) The use of chlorophyll fluorescence nomenclature in plant stress physiology. *Photosynthesis Research* 25:147-150
- Van Leeuwe MA, Van Sikkelerus B, Gieskes WWC, Stefels J (2005) Taxon-specific differences in photoacclimation to fluctuating irradiance in an Antarctic diatom and a green flagellate. *Marine Ecology Progress Series* 288:9-19
- Vandevelde T, Legendre L, Demers S, Therriault JC (1989) Circadian variations in photosynthetic assimilation and estimation of daily phytoplankton production. *Marine Biology* 100:525-531
- Vantrepotte V (2003) Caractérisation Bio-Optique des eaux côtières en Manche orientale pour l'estimation de la production primaire et le suivi des poussées phytoplanctoniques : Application à la télédétection satellitaire "couleur de l'eau" en milieu côtier. PhD Thesis. Université du Littoral Côte d'Opale, France.
- Vantrepotte V, Brunet C, Mériaux X, Lécuyer E, Vellucci V, Santer R (2007) Bio-optical properties of coastal waters in the Eastern English Channel. *Estuarine, Coastal and Shelf Science* 72:201-212
- Vassiliev IR, Prasil O, Wyman KD, Kolber Z, Hanson AK, Prentice JE, Falkowski P (1994) Inhibition of PSII photochemistry by PAR and UV radiation in natural phytoplankton communities. *Photosynthesis Research* 42:51-64

- Vaulot D, Marie D (1999) Diel variability of photosynthetic picoplankton in the equatorial Pacific. *Journal of Geophysical Research C: Oceans* 104:3297-3310
- Veldhuis MJW, Brussaard CPD, Noordeloos AAM (2005) Living in a *Phaeocystis* colony: A way to be a successful algal species. *Harmful Algae* 4:841-858
- Veldhuis MJW, Wassmann P (2005) Bloom dynamics and biological control of a high biomass HAB species in European coastal waters: A *Phaeocystis* case study. *Harmful Algae* 4:805-809
- Wagner H, Jakob T, Wilhelm C (2006) Balancing the energy flow from captured light to biomass under fluctuating light conditions. *New Phytologist* 169:95-108
- Webb WL, Newton M, Starr D (1974) Carbon dioxide exchange of *Alnus rubra* : a mathematical model. *Ecologia* 17:281-291
- White AJ, Critchley C (1999) Rapid light curves : a new fluorescence method to assess the state of the photosynthetic apparatus. *Photosynthesis Research* 59:63-72
- Williams PJIB (1993) On the definition of plankton production terms. *ICES Marine Science Symposia* 197:9-19
- Wozniak B, Dera J, Ficek D, Ostrowska M, Majchrowski R (2002) Dependence of the photosynthesis quantum yield in oceans on environmental factors. *Oceanologia* 44:439-459
- Wright SW, Thomas DP, Marchant HJ, Higgins HW, Mackey MD, Mackey DJ (1996) Analysis of phytoplankton of the Australian sector of the Southern Ocean: Comparisons of microscopy and size frequency data with interpretations of pigment HPLC data using the 'CHEMTAX' matrix factorisation program. *Marine Ecology Progress Series* 144:285-298
- Yentsch CS, Phinney DA (1985) Spectral fluorescence: an ataxonomic tool for studying the structure of phytoplankton populations. *Journal of Plankton Research* 7:617-632
- Yentsch CS, Yentsch CM (1979) Fluorescence spectral signatures: the characterization of phytoplankton populations by the use of excitation and emission spectra. *Journal of Marine Research* 37:471-483
- Yentsch CS, Yentsch CM, Phinney DA, Lapointe BE, Yentsch SFW (2004) The odyssey of new production. *Journal of Experimental Marine Biology and Ecology* 300:15-30
- Zapata M, Jeffrey SW, Wright SW, Rodriguez F, Garrido JL, Clementson L (2004) Photosynthetic pigments in 37 species (65 strains) of Haptophyta: Implications for oceanography and chemotaxonomy. *Marine Ecology Progress Series* 270:83-102
- Zhen Y, Mi T, Yu Z (2008) Detection of *Phaeocystis globosa* using sandwich hybridization integrated with nuclease protection assay (NPA-SH). *Journal of Environmental Sciences* 20:1481-1486

Contrôle de l'activité photosynthétique du phytoplancton en milieu côtier – Utilisation de la fluorescence spectrale et de la fluorimétrie modulée

Résumé :

Les dynamiques de l'activité photosynthétique du phytoplancton ont été caractérisées dans un écosystème côtier macrotidal (le Détroit du Pas-de-Calais, Manche orientale) et associées aux conditions environnementales.

Dans un premier temps, l'efficacité et la précision de la fluorescence spectrale et de la fluorimétrie modulée (PAM), vis-à-vis des principaux groupes de la Manche orientale, ont été évaluées. Il a été montré que le FluoroProbe (fluorimètre spectral multi-longueur d'ondes) est un bon outil pour suivre la dynamique des communautés phytoplanctoniques. Il permet notamment de faire la distinction entre *P. globosa* et les autres algues brunes. Il a été mis en évidence que les Rapid Light Curves permettent la mesure des variations rapides de l'activité photosynthétique du phytoplancton.

Dans un deuxième temps, la variabilité spatiale et temporelle des paramètres photosynthétiques a été étudiée à différentes échelles, entre Septembre 2008 et Août 2010. Le niveau de variabilité et les facteurs de contrôle des paramètres photosynthétiques dépendent de l'échelle considérée. Au niveau spatial, aucun gradient des paramètres photosynthétiques n'a été trouvé entre la côte et le large. A l'inverse, au sein de la colonne d'eau, des variations du rendement quantique maximum (F_v/F_m), du taux de transport maximum des électrons (ETR_m) et du coefficient de saturation lumineuse (E_k), en lien avec l'histoire lumineuse des cellules, ont été observées. Aux courtes échelles de temps (de l'heure à l'échelle d'un cycle de marée morte-eau/vive-eau), des variations considérables des paramètres photosynthétiques ont été observées. Les conditions lumineuses et la disponibilité des nutriments étaient les principaux facteurs de contrôle. Aux plus grandes échelles de temps (de l'échelle semi-mensuelle à l'échelle pluriannuelle), F_v/F_m , α (l'efficacité maximale d'utilisation de la lumière) et ETR_m variaient sans cycle saisonnier clair. Par opposition, E_k suivait le cycle saisonnier de la lumière sauf en été où ses changements étaient faibles au regard de la variabilité de la lumière. A ces échelles, les interactions entre les successions des communautés phytoplanctoniques et les changements de lumière, de température et de disponibilité en nutriments contrôlaient la variabilité de l'activité photosynthétique.

Mots clés : phytoplancton, paramètres photosynthétiques, fluorescence de la chlorophylle *a*, Pulse Amplitude Modulated (PAM) fluorometry, fluorescence spectrale, Rapid Light Curves (RLC), Manche orientale

Control of phytoplankton photosynthetic activity in coastal system – Use of spectral fluorescence and modulated fluorometry

Abstract:

Dynamics of phytoplankton photosynthetic activity were characterised in a macrotidal coastal ecosystem (the Strait of Dover, eastern English Channel) and related to environmental conditions.

In a first time, the efficiency and accuracy of the spectral fluorescence and Pulse Amplitude Modulated Fluorometry (PAM), towards the phytoplankton groups of the eastern English Channel, were evaluated. It was showed that the FluoroProbe (a multiwavelength spectral fluorometer) is a good tool for monitoring the dynamic of phytoplankton communities. It is notably able to make the distinction between *P. globosa* and the other brown algae. It was found that Rapid Light Curves allow the measurement of rapid changes in phytoplankton photosynthetic activity.

In a second time, spatial and temporal variability of photosynthetic parameters were studied at different scales, between September 2008 and August 2010. The level of variability and controlling factors of photosynthetic parameters depend on the scale considered. In space, no gradient of photosynthetic parameters was found between coastal and offshore waters. By contrast, within the water column, variations of the maximum quantum yield (F_v/F_m), the maximum electron transport rate (ETR_m) and the light saturation coefficient (E_k) in relation to the light history of cells were observed. At short time scale (from hour to the scale of a neap-spring tide cycle), considerable variations of photosynthetic parameters were observed. Light conditions, temperature and nutrient availability were the main controlling factors. At longer time scale (from fortnightly to inter-annual scales), F_v/F_m , α (the maximal light utilization efficiency) and ETR_m varied without any clear seasonal cycle. By contrast, E_k followed the seasonal variations of light except during summer where its changes of E_k were small compared to the light variability. At these time scales, close interplays between shifts of phytoplankton communities and changes of light, temperature and nutrient availability controlled the variability of photosynthetic parameters.

Keywords: phytoplankton, photosynthetic parameters, chlorophyll *a* fluorescence, Pulse Amplitude Modulated (PAM) fluorometry, Rapid Light Curves (RLC), eastern English Channel