



HAL
open science

Comportements en temps long et à grande échelle de quelques dynamiques de collision

Julien Reygner

► **To cite this version:**

Julien Reygner. Comportements en temps long et à grande échelle de quelques dynamiques de collision. Probabilités [math.PR]. Université Pierre et Marie Curie, 2014. Français. NNT : . tel-01087575v1

HAL Id: tel-01087575

<https://theses.hal.science/tel-01087575v1>

Submitted on 26 Nov 2014 (v1), last revised 7 Mar 2015 (v2)

HAL is a multi-disciplinary open access archive for the deposit and dissemination of scientific research documents, whether they are published or not. The documents may come from teaching and research institutions in France or abroad, or from public or private research centers.

L'archive ouverte pluridisciplinaire **HAL**, est destinée au dépôt et à la diffusion de documents scientifiques de niveau recherche, publiés ou non, émanant des établissements d'enseignement et de recherche français ou étrangers, des laboratoires publics ou privés.



Université Pierre et Marie Curie

École Doctorale de Sciences Mathématiques de Paris Centre

THÈSE DE DOCTORAT

Discipline : Mathématiques

Présentée par

Julien Reygner

Comportements en temps long et à grande échelle de quelques dynamiques de collision

Soutenue le 24 novembre 2014 devant le jury composé de

M. François Bolley	Université Pierre et Marie Curie – Paris 6	Examineur
M. François Bouchut	Université Paris-Est Marne-la-Vallée	Examineur
M. Patrick Cattiaux	Université Paul Sabatier – Toulouse 3	Rapporteur
M. Francis Comets	Université Denis Diderot – Paris 7	Président du jury
M. Benjamin Jourdain	École des Ponts ParisTech	Directeur de thèse
M. Raphaël Lefevre	Université Denis Diderot – Paris 7	Examineur
M. Florent Malrieu	Université François Rabelais – Tours	Examineur
M. Lorenzo Zambotti	Université Pierre et Marie Curie – Paris 6	Directeur de thèse

après les rapports de MM. Patrick Cattiaux et Franco Flandoli.

Cette thèse a été préparée au

Laboratoire de Probabilités et Modèles Aléatoires
Université Pierre et Marie Curie
4, place Jussieu
75252 Paris,

et au

Centre d'Enseignement et de Recherche en Mathématiques et Calcul Scientifique
École des Ponts ParisTech
6 et 8, avenue Blaise Pascal
Cité Descartes — Champs sur Marne
77455 Marne la Vallée,

dans le cadre de l'école doctorale

École Doctorale de Sciences Mathématiques de Paris Centre
Université Pierre et Marie Curie
4, place Jussieu
75252 Paris.

*Cette thèse est dédiée à mon grand-père, Jacques Vergnaud,
à la curiosité duquel je dois un intérêt certain pour les sciences.*

Remerciements

Benjamin Jourdain et Lorenzo Zambotti ont accepté très spontanément de se partager mon encadrement, sans jamais me reprocher par la suite de ne pas être assez investi dans l'un ou l'autre des sujets sur lesquels j'ai travaillé. Je veux donc d'abord les remercier pour leur confiance et leur patience à mon égard, ainsi que pour leur constante disponibilité.

Pendant ces trois ans de thèse, j'ai énormément appris de leur intuition mathématique et de leur exigence de rigueur et de clarté dans les raisonnements. Si j'espère avoir réussi à en faire transparaître un peu dans les pages qui suivent, je crois avoir encore beaucoup de progrès à faire, et je souhaite sincèrement pouvoir continuer longtemps de travailler avec eux deux.

Je suis très reconnaissant à Patrick Cattiaux et Franco Flandoli d'avoir accepté d'écrire un rapport sur ce manuscrit, en dépit de son épaisseur. Leurs commentaires m'ont été très précieux, et leurs encouragements, en particulier sur les parties les plus prospectives, sont autant de raisons de poursuivre ce travail.

En me proposant de partir en stage à Rome il y a plus de cinq ans, Francis Comets a joué un rôle important dans mon orientation vers les probabilités. Ses conseils ont depuis toujours été d'une grande valeur, et je suis particulièrement honoré de sa présence dans mon jury. J'en profite ici pour saluer Alexandre Gaudillière, Fabio Martinelli et François Simenhaus, auxquels je dois une formidable première expérience de la recherche.

Les articles et cours de François Bolley et Florent Malrieu ont guidé mes premiers pas dans cette thèse, et je les remercie de l'intérêt qu'ils portent aujourd'hui à mes travaux. Je me réjouis de leur participation à mon jury, ainsi que de celle de François Bouchut, qui représente la communauté EDPiste à laquelle s'adressent les travaux qui concluent ce manuscrit.

J'ai enfin eu un très grand plaisir à travailler régulièrement avec Raphaël Lefevre, Mauro Mariani et Régis Monneau, en grande partie grâce à leur enthousiasme communicatif. Ils m'ont offert de nouveaux points de vue sur les problèmes que nous avons étudiés, et j'espère que nos collaborations respectives ne s'arrêteront pas au strict prolongement des travaux présentés dans cette thèse.

Au cours de ces trois années, j'ai eu la chance de croiser beaucoup de mathématiciens expérimentés qui ont pris le temps de s'intéresser à mes travaux, pourtant pas toujours très aboutis, et de répondre aux questions que je me posais, souvent triviales. Je remercie pour cela Jean-Baptiste Bardet, Thierry Bodineau, Francis Comets, Franco Flandoli, Martin Hairer, François Huveneers, Florent Malrieu, Felix Otto, Giovanni Samaey, Gabriel Stoltz et Denis Talay.

Je remercie également Jean-François Delmas, Benjamin Jourdain et Tony Lelièvre de l'intérêt qu'ils ont porté, et du temps qu'ils ont consacré, à mes aventures post-doctorales.

Bien qu'écrire une thèse soit un exercice essentiellement solitaire, l'ambiance d'un (ou de deux) laboratoire a une grande influence sur le moral d'un doctorant. Pour avoir réussi à conserver le mien plutôt au dessus du niveau moyen, je remercie l'ensemble des doctorants et post-doctorants du CERMICS et du LPMA que j'ai eu la chance de côtoyer. Il est évidemment beaucoup trop risqué de se lancer dans une liste exhaustive, mais que chaque personne qui lira ces lignes sache combien j'ai apprécié le temps que nous avons partagé, au travail mais aussi (surtout) à la Perla, à la Gueuze, à l'Inévitable, à la Muraille du Phénix, au faux italien à côté de l'INRIA, sur les bords de la Seine, dans les rues de Saint-Flour ou encore au casino de Forges-les-Eaux.

Je ne peux néanmoins pas ne pas citer Maxence, spécialiste des questions difficiles posées

seulement après 19h ; Charline, ma duale topologique¹ et rouage essentiel de l'import/export de potins vers Palaiseau et au-delà ; et Cyril, pour les longues conversations qui ont *inévitablement* mené à un enthousiasmant début de collaboration, et avec lequel même ne rien comprendre à un problème de maths est un plaisir.

Enfin, l'animation du groupe de travail Transport Thermique a été une expérience humaine et scientifique très agréable, et j'en remercie l'ensemble des participants pour leur motivation et la qualité de leurs exposés.

Le déroulement de cette thèse a été grandement facilité par les secrétariats du CERMICS et du LPMA, que je remercie chaleureusement. J'y associe également l'Institut Universitaire de France et l'Agence Nationale de la Recherche, grâce auxquels les questions matérielles ne se sont jamais posées. Par ailleurs, réaliser ce doctorat en tant qu'ingénieur des Ponts, des Eaux et des Forêts m'a permis de disposer d'une très grande liberté dans la conduite de mes recherches. Je remercie pour cela le Ministère de l'Écologie, du Développement durable et de l'Énergie, et je formule le souhait que mes jeunes camarades continuent d'avoir l'opportunité de bénéficier d'une telle formation par la recherche, y compris fondamentale.

Toute ma gratitude va enfin à mes amis et ma famille pour leur accompagnement, à mon frère pour être l'homme le plus drôle du monde, et à Sara, pour tout ce qu'il nous reste encore à vivre ensemble.

1. Que l'auteur original de cette métaphore me permette de la reprendre ici à mon compte...

Résumé : comportements en temps long et à grande échelle de quelques dynamiques de collision

Cette thèse est composée de trois parties, dont chacune est consacrée à l'étude d'un système de particules en interaction, probabiliste ou déterministe, et à l'intérieur duquel les interactions se produisent uniquement aux collisions entre les particules.

La première partie présente l'étude du modèle d'échange complet, introduit en physique pour décrire le transport de la chaleur dans une classe de matériaux poreux dits *aérogels*. Nous proposons une étude heuristique et numérique des états stationnaires hors de l'équilibre de ce modèle dans le Chapitre 2, puis nous introduisons un cadre formel permettant d'obtenir des résultats d'ergodicité rigoureux dans le Chapitre 3.

La deuxième partie s'intéresse aux systèmes de particules interagissant à travers leur rang, qui décrivent l'évolution de processus de diffusion sur la droite réelle dont les coefficients de dérive et de diffusion ne dépendent que de leur rang. Nous obtenons dans le Chapitre 4 un résultat de propagation du chaos pour ces systèmes, et nous décrivons également le comportement en temps long du processus de diffusion non-linéaire associé. Nous complétons ces résultats dans le Chapitre 5, et les appliquons à l'étude de la distribution du capital et de la performance des portefeuilles dans le modèle d'Atlas, introduit en théorie des portefeuilles stochastiques, dans le Chapitre 6.

Dans la troisième partie, nous introduisons une version multitype du système de particules étudié dans la deuxième partie. Nous obtenons dans le Chapitre 7 un résultat de propagation du chaos similaire à celui du Chapitre 4, ce qui nous permet de donner une interprétation probabiliste à une classe de systèmes paraboliques d'équations aux dérivées partielles non-linéaires, dits *systèmes diagonaux*. En vue d'approcher les solutions de systèmes diagonaux hyperboliques, nous décrivons au Chapitre 8 la limite de ce système de particules, lorsque l'intensité du bruit dans le système diminue. Nous appelons cette limite *dynamique des particules collantes multitype*, et présentons au Chapitre 9 l'utilisation de cette dynamique dans l'étude des systèmes diagonaux hyperboliques d'équations aux dérivées partielles non-linéaires. Nous obtenons en particulier un résultat de stabilité en distance de Wasserstein pour les solutions de tels systèmes, grâce à une étude détaillée de notre système de particules.

Mots-clés : systèmes de particules, collisions, comportement en temps long, transport thermique, billard stochastique, propagation du chaos, processus non-linéaire, distance de Wasserstein, modèle d'Atlas, limite petit bruit, dynamique des particules collantes, systèmes hyperboliques.

Abstract: long time and large scale behaviour of a few collisional dynamics

This thesis contains three parts, each one of which is dedicated to the study of an interacting particle system, where interactions are either probabilistic or deterministic and only occur at collisions between particles.

The first part is dedicated to the study of the Complete Exchange Model, which was introduced in physics in order to describe heat transport in a class of porous materials called *aerogels*. We provide a heuristic and numerical study of nonequilibrium steady states of the model in Chapter 2, and then we introduce a formal framework allowing to obtain rigorous ergodicity results in Chapter 3.

The second part addresses rank-based interacting particles, which are diffusion processes on the real line with drift and diffusion coefficients depending only on their rank. We obtain a propagation of chaos result for such systems in Chapter 4 and also describe the long time behaviour of the associated nonlinear diffusion process. These results are completed in Chapter 5, and applied to the study of capital distribution and portfolio performance in the Atlas model, which was introduced in Stochastic Portfolio Theory, in Chapter 6.

In the third part, we introduce a multitype version of the particle system of the second part. A propagation of chaos result, similar to Chapter 4, is obtained in Chapter 7 and allows us to provide a probabilistic interpretation to a class of parabolic systems of nonlinear partial differential equations, called *diagonal systems*. In order to approximate the solution to hyperbolic diagonal systems, we describe the small noise limit of this particle system in Chapter 8. We call *Multitype Sticky Particle Dynamics* the resulting particle system, and describe in Chapter 9 how to use this particle system to study hyperbolic diagonal systems of nonlinear partial differential equations. In particular, we obtain a stability result in Wasserstein distance for the solutions to such systems, thanks to a detailed study of our particle system.

Keywords: particle systems, collisions, long time behaviour, thermal transport, stochastic billiards, propagation of chaos, nonlinear processes, Wasserstein distance, Atlas model, small noise limit, sticky particle dynamics, hyperbolic systems.

Table des matières

1	Introduction	1
1.1	Introduction de la Partie I	1
1.2	Introduction de la Partie II	10
1.3	Introduction de la Partie III	19
I	Le modèle d'échange complet	29
2	Thermodynamique du modèle d'échange complet	31
2.1	Introduction	31
2.2	The deterministic CEM	33
2.3	The thermalised CEM	35
2.4	Conclusions	41
2.A	Derivation of the expression of L^f , L^{dr} and L^i	42
2.B	Computation of pairwise marginal statistics	44
3	États stationnaires hors de l'équilibre du modèle d'échange complet	47
3.1	Introduction	47
3.2	Model and results	49
3.3	General sketch of the proof	52
3.4	Two useful auxiliary considerations	55
3.5	The sequence of observation times	61
3.6	Proof of Theorem 3.2.5	69
3.A	A formal construction of the billiard process	77
3.B	Recurrence of the set Θ	79
II	Systèmes de particules interagissant à travers leur rang	91
4	Propagation du chaos et comportement en temps long	93
4.1	Introduction	93
4.2	Probabilistic approximation of the solution	97
4.3	Contraction of the Wasserstein distance between two solutions	105
4.4	Convergence to equilibrium	111
4.A	Proof of Proposition 4.2.2	116
4.B	Proof of Proposition 4.3.4	122
5	Grands systèmes stationnaires de particules	131
5.1	Introduction	131
5.2	Stationary distributions	133
5.3	Expression and convergence of the Laplace transforms	136
5.4	Completion of the proof of Theorem 5.1.2	143

6	Le modèle d'Atlas en champ moyen	145
6.1	Introduction	145
6.2	The mean-field Atlas model	150
6.3	The weighted capital measure	155
6.4	Capital distribution curves	159
6.5	Performance of diversity weighted portfolios	161
6.A	Proof of Proposition 6.3.1	168
6.B	Long time behaviour of the asymptotic capital measure	173
III	La dynamique des particules collantes multitype	179
7	Interprétation probabiliste de systèmes paraboliques	181
7.1	Introduction	181
7.2	Mild solutions to the system of Fokker-Planck equations	184
7.3	The nonlinear martingale problem	186
7.4	The multitype rank-based particle system	188
8	Limite petit bruit de processus de diffusion interagissant à travers leur ordre	193
8.1	Introduction	193
8.2	The two-particle case	196
8.3	The rank-based case	201
8.4	The order-based case	210
8.5	Conclusion	216
8.A	Proofs in the two-particle case	217
9	Dynamique des particules collantes multitype et systèmes hyperboliques	225
9.1	Introduction	225
9.2	Main definitions and results	226
9.3	The Multitype Sticky Particle Dynamics	238
9.4	The uniform L^p stability estimates	246
9.5	Construction of solutions	277
9.A	Proofs of technical results	290
	Bibliographie	305

Chapitre 1

Introduction

Ce manuscrit est composé de trois parties, essentiellement indépendantes. De manière générique, chaque partie est consacrée à l'étude d'un système de particules, à l'intérieur duquel les interactions se font par collision :

- le modèle d'échange complet, introduit en physique pour décrire le transfert de la chaleur dans les aérogels, dont on étudie numériquement et théoriquement les états stationnaires hors de l'équilibre dans la Partie **I**;
- les diffusions interagissant à travers leur rang, pour lesquelles on établit des résultats de propagation du chaos et de convergence à l'équilibre, et dont on discute l'application à un modèle de marché financier dans la Partie **II**;
- la dynamique des particules collantes multitype, que l'on définit et utilise dans la Partie **III** pour résoudre des systèmes hyperboliques d'équations aux dérivées partielles non-linéaires.

Chaque partie est divisée en deux ou trois chapitres. Cette introduction donne un résumé rapide de chacun de ces chapitres, et décrit l'articulation de ceux-ci à l'intérieur de chaque partie.

1.1 Partie **I** : le modèle d'échange complet

Les travaux présentés dans la première partie de ce manuscrit s'inscrivent dans le contexte général de l'étude du transport de la chaleur dans les matériaux. Considérons par exemple une barre de métal dont les extrémités sont mises en contact avec deux thermostats, de températures différentes. Après une phase transitoire, on observe expérimentalement qu'un régime stationnaire s'établit, sous lequel un courant d'énergie traverse la barre en allant du thermostat chaud vers le thermostat froid. L'équation qui relie la valeur de ce courant d'énergie au gradient de la température en un point donné est appelée loi de Fourier, ou de Fick, et s'écrit génériquement

$$\mathcal{J}(x) = -\kappa(\mathcal{T})\nabla\mathcal{T}(x), \quad (1.1)$$

où $\mathcal{J}(x)$ est le courant d'énergie au point x , $\mathcal{T}(x)$ est la température et $\kappa(\mathcal{T})$ est la *conductivité thermique* du matériau. Cette loi empirique est observée dans de nombreux systèmes dirigés par un mécanisme général de diffusion. Un des buts de la physique statistique hors de l'équilibre est d'établir rigoureusement une telle loi de comportement macroscopique, à partir d'une description microscopique de la matière.

Une réponse satisfaisante à ce problème serait d'exhiber un modèle microscopique, dans lequel les molécules interagissent selon les équations de la mécanique classique, et pour lequel un comportement moyen de quantités macroscopiques telles que la température et le courant d'énergie pourrait être rigoureusement décrit. Un tel programme nécessite de prouver des résultats de *mélange*, ou d'*ergodicité*, sur la dynamique microscopique, ce qui est extrêmement difficile pour des modèles décrivant des évolutions complètement déterministes; nous renvoyons aux articles de revue de Bonetto, Lebowitz et Rey-Bellet [24] ainsi que Lepri, Livi et Politi [104] pour un exposé détaillé des travaux allant dans ce sens.

Une réponse physiquement moins satisfaisante, mais plus accessible à la théorie, consiste à introduire de l'aléa dans le modèle microscopique, afin d'en améliorer les propriétés d'ergodicité. Cet aléa peut prendre plusieurs formes : l'évolution microscopique peut être purement aléatoire, ou la superposition d'un mécanisme déterministe et d'un bruit perturbatif, ou encore purement déterministe et c'est alors l'interaction avec les thermostats qui est modélisée par un processus stochastique. La littérature pour chacune de ces trois familles de modèles est très abondante et il n'est pas possible d'en faire un état complet ici ; citons néanmoins :

- les travaux de Bertini, De Sole, Gabrielli, Jona-Lasinio et Landim, dont une présentation synthétique est faite dans [15], et qui concernent l'étude, d'un point de vue thermodynamique, de la classe des *stochastic lattice gases* qui entrent dans la première catégorie ci-dessus ;
- les articles de Olla, Varadhan et Yau [111] et Fritz, Funaki et Lebowitz [67] sur l'étude de l'ergodicité de système hamiltoniens bruités, qui entrent dans la deuxième catégorie ci-dessus, et pour lesquels la loi de Fourier a été étudiée ensuite par Basile, Bernardin et Olla [14, 12] ;
- les travaux de Eckmann, Hairer, Pillet et Thomas, présentés dans [53], qui s'intéressent à des chaînes d'oscillateurs déterministes mises en contact avec des thermostats représentés par des processus stochastiques.

Le modèle auquel la Partie I de ce manuscrit est consacrée appartient à la troisième catégorie ci-dessus : il s'agit d'un modèle d'évolution déterministe, hamiltonien, mis en contact avec deux thermostats qui introduisent de l'aléa dans le système. Nous proposons une étude numérique de ses propriétés thermodynamiques, puis développons un formalisme mathématique permettant d'obtenir des résultats d'ergodicité — au moins partiellement.

1.1.1 Le modèle d'échange complet

Un aérogel est un matériau synthétique constitué d'un réseau de cellules solides à l'intérieur desquelles sont confinées des molécules de gaz. Expérimentalement, on constate que ces matériaux sont d'excellents isolants thermiques ; ils sont actuellement utilisés dans l'industrie aéronautique et dans celle du bâtiment. Afin d'en comprendre les propriétés thermiques, Gaspard et Gilbert [68] ont proposé le modèle microscopique suivant : en deux dimensions, le réseau solide est représenté par des disques, centrés en chaque sommet de \mathbb{Z}^2 , de rayon $\rho \in]0, 1/2[$. À l'intérieur de chaque cellule se trouve une molécule de gaz, qui est représentée par un disque de rayon $r \in]0, 1/2[$ tel que :

- r est assez grand pour que la molécule reste confinée dans la cellule ;
- r est assez petit pour que deux molécules dans des cellules voisines puissent se toucher lorsqu'elles sont proches de leur interface commune.

Ce modèle est décrit sur la Figure 1.1.

Si les collisions d'une molécule contre les bords de la cellule ou contre les molécules voisines se font de manière élastique, et qu'il n'y pas d'interaction entre les molécules en dehors des collisions, alors l'évolution jointe des positions et des vitesses des molécules est décrite par le Hamiltonien

$$H(\mathbf{q}, \mathbf{p}) = \frac{|\mathbf{p}|^2}{2} + V(\mathbf{q}),$$

où le potentiel $V(\mathbf{q})$ prend la forme

$$V(\mathbf{q}) = \begin{cases} 0 & \text{si } \mathbf{q} \in \Omega, \\ +\infty & \text{si } \mathbf{q} \notin \Omega, \end{cases} \quad (1.2)$$

et Ω est un sous-ensemble de $(\mathbb{R}^2)^{\mathbb{Z}^2}$ qui décrit l'ensemble des configurations *physiquement admissibles*, c'est-à-dire pour lesquelles les disques ne s'intersectent pas.

En utilisant les propriétés dispersives de la dynamique d'une molécule isolée dans une cellule, Gaspard et Gilbert ont expliqué la faible conductivité thermique du matériau par le fait que les collisions entre deux molécules voisines, et donc les échanges d'énergie, sont des événements *rare*s dans ce système. Cette observation a motivé l'étude de plusieurs modèles similaires ; en particulier,

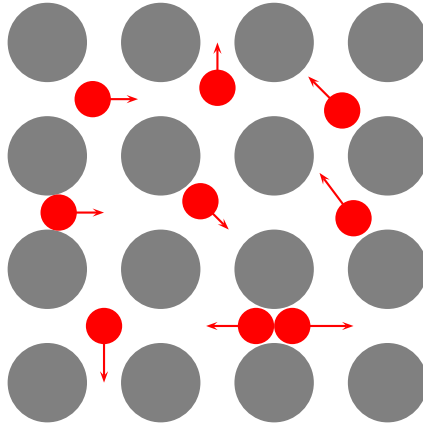

FIGURE 1.1 – Le modèle d’aérogel de Gaspard et Gilbert : les disques gris, de rayon ρ , délimitent les cellules solides. Les disques rouges, de rayon r , représentent les molécules de gaz. Chaque molécule est confinée dans sa cellule, mais deux molécules voisines peuvent tout de même entrer en collision : c’est le cas des molécules en bas à droite de la figure.

Gilbert et Lefevre [71] ont proposé un modèle unidimensionnel, possédant un Hamiltonien dont le potentiel est de la forme (1.2), et qui est décrit de la manière suivante : N molécules sont placées sur les sommets du réseau $\{1, \dots, N\}$. Chaque molécule évolue dans une cellule unidimensionnelle de longueur 1. Le mouvement de la molécule à l’intérieur de sa cellule est ballistique, et lorsque la molécule arrive à une extrémité de la cellule, elle est réfléchiée avec la même vitesse. On note $q_i(t) \in [0, 1]$ la position de la i -ème molécule au temps $t \geq 0$, et $p_i(t) \in \mathbb{R}$ sa vitesse. Lorsque deux molécules voisine i et $i+1$ sont telles que $|q_i(t) - q_{i+1}(t)| = 1 - a$, ce que l’on appelle une *collision*, alors les deux molécules échangent leur vitesse : $p_{i+1}(t) := p_i(t^-)$ et $p_i(t) := p_{i+1}(t^-)$. La longueur $a \in [0, 1]$ est appelée *paramètre d’interaction*.

Ce modèle est représenté sur la Figure 1.2. Il a également été étudié par Prosen et Campbell [119] sous le nom de *modèle Bing-Bang pseudo-intégrable*; dans ce manuscrit, nous conservons la dénomination *modèle d’échange complet* de Gilbert et Lefevre.

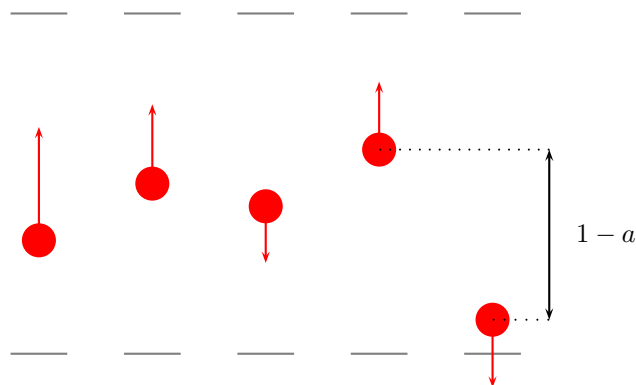

FIGURE 1.2 – Le modèle d’échange complet pour $N = 5$ molécules. L’écart entre les positions des molécules 4 et 5 a atteint la valeur $1 - a$, ces molécules doivent donc échanger leur vitesse.

Nous nous intéressons alors au cas où ce système est mis en contact avec des thermostats à ses deux extrémités. Ces thermostats sont modélisés ainsi : lorsque l'une des deux molécules 1 ou N atteint un bord de sa cellule, la norme de sa vitesse est mise à jour aléatoirement, indépendamment de la vitesse incidente, selon une densité de probabilité qui dépend du bord de la cellule. On note $\phi^{1,+}$ et $\phi^{1,-}$ les densités de mise à jour associées aux bords $q_1 = 0$ et $q_1 = 1$ de la cellule 1, et $\phi^{N,+}$ et $\phi^{N,-}$ les densités de mise à jour associées aux bords $q_N = 0$ et $q_N = 1$ de la cellule N .

Un choix physiquement pertinent de densités de mise à jour est

$$\phi^{1,+}(p) = \phi^{1,-}(p) = \frac{p}{T_L} \exp\left(-\frac{p^2}{2T_L}\right), \quad \phi^{N,+}(p) = \phi^{N,-}(p) = \frac{p}{T_R} \exp\left(-\frac{p^2}{2T_R}\right), \quad (1.3)$$

avec $T_L, T_R > 0$. En effet, si $a = 0$, alors ce choix assure que la mesure invariante du processus $(q_1(t), p_1(t))_{t \geq 0}$ est donnée par le produit

$$\frac{1}{\sqrt{2\pi T_L}} \exp\left(-\frac{p^2}{2T_L}\right) dq dp,$$

ce qui correspond à la distribution de Maxwell-Boltzmann à la température T_L pour la vitesse. On obtient la même distribution, à la température T_R , pour le processus $(q_N(t), p_N(t))_{t \geq 0}$. Les molécules en contact avec les thermostats sont donc *thermalisées* par ceux-ci. Pour ce choix de densité de mise à jour, les thermostats sont dits *maxwelliens* [24].

La Partie I contient deux chapitres. Le Chapitre 2 présente le comportement thermodynamique du modèle d'échange complet, de manière heuristique et numérique. Le Chapitre 3 propose une étude rigoureuse de l'ergodicité du processus des positions et vitesses des molécules lorsque le système est mis en contact avec les thermostats décrits ci-dessus, en se restreignant au cas de $N = 2$ molécules.

1.1.2 Conjectures et résultats numériques

Pour tout $t \geq 0$, nous notons $(\mathbf{q}(t), \mathbf{p}(t)) \in [0, 1]^N \times \mathbb{R}^N$ l'ensemble des positions et des vitesses des N molécules. Nous commençons par étudier le modèle à l'équilibre thermodynamique, c'est-à-dire lorsque $(\mathbf{q}(t), \mathbf{p}(t))$ est distribué sous la mesure produit :

- de la distribution uniforme des positions sur $[0, 1]^N$ conditionnellement à

$$\forall i \in \{1, \dots, N-1\}, \quad |q_i - q_{i+1}| \leq 1 - a;$$

- de la distribution de Maxwell-Boltzmann à température T pour chacune des vitesses.

D'après la description du modèle donnée ci-dessus, le transfert d'énergie le long de la chaîne ne s'effectue que par collision. Il est donc naturel de s'attendre à ce que la conductivité thermique $\kappa(T)$ du matériau soit reliée à la fréquence $\nu(a, T)$ des collisions entre molécules.

Nous montrons dans la Section 2.3 du Chapitre 2 que, pour un nombre de molécules N fixé, la fréquence des collisions à l'équilibre entre les molécules i et $i+1$ s'écrit

$$\nu_{i,i+1}^N(a, T) = C_{i,i+1}^N(a) \sqrt{\frac{T}{\pi}},$$

où $C_{i,i+1}^N(a)$ est une constante qui ne dépend que du paramètre d'interaction a et de i et N . Évidemment, lorsque $a = 0$, il n'y a pas de collision et $C_{i,i+1}^N(a) = 0$. Nous observons par intégration numérique que lorsque le nombre de particules tend vers l'infini, $C_{i,i+1}^N(a)$ devient constant le long de la chaîne, égal à une certaine valeur $C(a)$ finie et non-nulle. Nous définissons ainsi la *fréquence macroscopique de collision*

$$\nu(a, T) := C(a) \sqrt{\frac{T}{\pi}}.$$

Hors de l'équilibre thermodynamique, c'est-à-dire lorsque le système est mis en contact avec des réservoirs maxwelliens de températures respectives T_L et T_R , nous définissons l'énergie de la

i -ème molécule par $E_i^N(t) := p_i(t)^2/2$, et le courant local d'énergie $j_{i,i+1}^N(t)$ est formellement donné par

$$\frac{d}{dt}E_i^N(t) = j_{i-1,i}^N(t) - j_{i,i+1}^N(t).$$

En supposant que la dynamique est ergodique, c'est-à-dire que la loi de $(\mathbf{q}(t), \mathbf{p}(t))$ converge, en temps long, vers une unique mesure dite *état stationnaire hors de l'équilibre*, nous définissons la température de la i -ème molécule par

$$T_i^N := \langle p_i^2 \rangle,$$

où $\langle \cdot \rangle$ désigne l'espérance sous l'état stationnaire hors de l'équilibre. Le courant stationnaire d'énergie est défini par

$$j^N := \langle j_{i,i+1}^N \rangle,$$

il ne dépend pas de i puisque sous l'état stationnaire, la dérivée temporelle de l'énergie de chaque particule s'annule.

Sous une hypothèse d'*équilibre local* classique (voir [71]), nous dérivons formellement dans la Section 2.3 du Chapitre 2 l'identité

$$j^N = -\nu_{i,i+1}^N \left(a, \frac{T_i^N + T_{i+1}^N}{2} \right) (T_{i+1}^N - T_i^N), \quad (1.4)$$

ce qui est l'expression microscopique la loi de Fourier (1.1) dans laquelle la conductivité thermique est donnée par la fréquence de collision. En plongeant le réseau $\{1, \dots, N\}$ dans $[0, 1]$ et en passant à la limite du grand nombre de particules dans l'identité ci-dessus, nous nous attendons donc à ce que, pour un matériau macroscopique, unidimensionnel, de longueur 1 et mis en contact à ses deux extrémités avec des thermostats de températures respectives T_L et T_R , le courant d'énergie et la température dans le régime stationnaire vérifient

$$\forall x \in [0, 1], \quad \mathcal{J} = -C(a) \sqrt{\frac{\mathcal{T}}{\pi}} \partial_x \mathcal{T}(x), \quad \mathcal{T}(0) = T_L, \quad \mathcal{T}(1) = T_R,$$

où \mathcal{J} est constant le long du matériau. Cette relation s'intègre et donne le profil de température

$$\forall x \in [0, 1], \quad \mathcal{T}(x) = \left((1-x)T_L^{3/2} + xT_R^{3/2} \right)^{2/3}, \quad (1.5)$$

qui était déjà obtenu par Gilbert et Lefevre [71]. Signalons que ce type de profil macroscopique non-linéaire apparaît également dans d'autres modèles hamiltoniens; voir Dhar [49], Eckmann et Young [54], Gaspard et Gilbert [70, 69].

Nous obtenons enfin un profil de température par simulation numérique, que nous comparons à (1.5). Nous constatons alors que le profil expérimental est linéaire entre T_L et T_R , ce qui est en désaccord avec le profil théoriquement attendu. En comparant nos travaux à d'autres résultats numériques de Ryals et Young [124], nous concluons que la description de l'état d'équilibre local qui mène à la loi de Fourier (1.4) n'est pas correcte et doit être affinée.

1.1.3 Étude de l'ergodicité dans le cas de deux molécules

Le but du Chapitre 3 est d'établir des résultats rigoureux d'ergodicité pour le processus $(\mathbf{q}(t), \mathbf{p}(t))_{t \geq 0}$ lorsque le système est mis en contact avec des thermostats. En toute généralité, ce processus est de Markov, et son évolution est déterministe entre les mises à jour des vitesses des molécules 1 et N . Il entre donc dans la classe des Processus de Markov Déterministes par Morceaux, auxquels est consacré par exemple l'ouvrage de Davis [46].

Afin de réduire la complexité formelle du problème, nous nous restreignons au cas de $N = 2$ molécules. Nous notons alors

$$X(t) := (q_1(t), q_2(t); p_1(t), p_2(t)) \in \bar{\Omega} \times \mathbb{R}^2,$$

où

$$\bar{\Omega} := \{(q_1, q_2) \in [0, 1]^2 : |q_1 - q_2| \leq 1 - a\}.$$

Remarquons que le processus $(X(t))_{t \geq 0}$ décrit le mouvement d'une boule de billard évoluant sur la table bidimensionnelle $\bar{\Omega}$, qui est représentée sur la Figure 1.3, selon les règles suivantes :

- aux réflexions sur les murs « droits », c'est-à-dire définis par $q_1 \in \{0, 1\}$ ou $q_2 \in \{0, 1\}$, la composante tangentielle de la vitesse est conservée tandis que la composante normale de la vitesse est mise à jour indépendamment de la vitesse incidente, selon une densité qui ne dépend que du mur ;
- les réflexions sur les murs « obliques », c'est-à-dire définis par $|q_1 - q_2| = 1 - a$, sont spéculaires.

On suppose à partir de maintenant que $a < 1/2$.

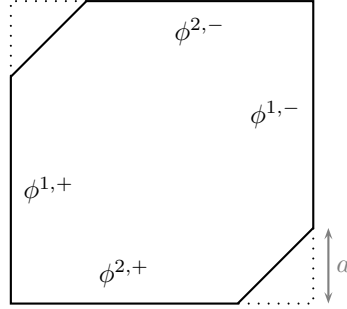

FIGURE 1.3 – La table de billard $\bar{\Omega}$. Les densités de mise à jour associées à chaque mur droit sont indiquées.

Certaines configurations de l'espace des phases $\bar{\Omega} \times \mathbb{R}^2$ ne sont pas physiquement admissibles : par exemple, $X(t)$ ne peut pas être situé sur le bord de $\bar{\Omega}$ et avoir une vitesse qui pointe vers l'extérieur de $\bar{\Omega}$. On souhaite également éviter les collisions dans les coins de la table, pour lesquelles les règles de réflexion sont *a priori* ambiguës. Nous définissons dans le Chapitre 3 un sous-ensemble \mathcal{X} de $\bar{\Omega} \times \mathbb{R}^2$, appelé ensemble des configurations admissibles, qui exclut ce type de configurations. Pour tout $x \in \mathcal{X}$, presque sûrement, le processus $(X(t))_{t \geq 0}$ initialisé à x est bien défini et prend ses valeurs dans \mathcal{X} pour tout $t \geq 0$. Nous notons \mathbf{P}_x la loi de ce processus dans l'espace des trajectoires continues à droite avec une limite à gauche $D([0, +\infty), \mathcal{X})$, et l'espérance sous \mathbf{P}_x est notée \mathbf{E}_x .

1.1.3.1 Description du comportement en temps long

Commençons par remarquer qu'il y a beaucoup de mesures invariantes triviales pour le processus $(X(t))_{t \geq 0}$:

- si la configuration initiale est de la forme $x = (q_1, q_2; 0, 0) \in \mathcal{X}$, alors la boule de billard reste à la même position (q_1, q_2) à tout temps positif et δ_x est une mesure invariante ;
- de même si $x = (q_1, q_2; p_1, p_2) \in \mathcal{X}$ avec $p_1 = 0$, ou $p_2 = 0$, ou encore $p_1 = -p_2$ et $1 - a < q_1 + q_2 < 1 + a$, alors le mouvement de la boule de billard est piégé dans une orbite périodique.

Notons \mathcal{X}_{nd} l'ensemble des configurations admissibles $x \in \mathcal{X}$ qui ne correspondent pas aux cas décrits ci-dessus. La notation nd en indice signifie *non-dégénéré*, car $\mathcal{X} \setminus \mathcal{X}_{\text{nd}}$ est négligeable pour la mesure de Lebesgue sur $\bar{\Omega} \times \mathbb{R}^2$.

Le but du Chapitre 3 est d'établir le résultat suivant.

Affirmation 1.1.1. *Il existe une mesure de probabilité π_{nd} sur $\bar{\Omega} \times \mathbb{R}^2$, telle que, pour tout $x \in \mathcal{X}_{\text{nd}}$, pour toute fonction continue et bornée $f : \bar{\Omega} \times \mathbb{R}^2 \rightarrow \mathbb{R}$,*

$$\lim_{t \rightarrow +\infty} \mathbf{E}_x[f(X(t))] = \int_{\bar{\Omega} \times \mathbb{R}^2} f d\pi.$$

Nous n'énonçons pas ce résultat sous la forme d'un théorème, car nous en donnons une preuve incomplète. Celle-ci est décrite dans les deux paragraphes suivants.

1.1.3.2 Stratégie générale de la preuve

Notre preuve repose sur la notion de processus de renouvellement markovien.

Définition 1.1.2. Une suite de variables aléatoires $(Y_n, \tau_n)_{n \geq 0}$ à valeurs dans un espace $\mathcal{Y} \times [0, +\infty)$ est un processus de renouvellement markovien si la suite $(Y_n, \tau_{n+1} - \tau_n)_{n \geq 0}$ est une chaîne de Markov, à valeurs dans $\mathcal{Y} \times (0, +\infty)$, homogène en temps, et dont le noyau de transition

$$N(y, t; dz ds) := \mathbb{P}(Y_1 \in dz, \tau_2 - \tau_1 \in ds | Y_0 = y, \tau_1 - \tau_0 = t)$$

ne dépend pas de la coordonnée t .

Si la suite $(\tau_n)_{n \geq 0}$ est presque sûrement non-bornée, alors on définit, pour tout $t \geq \tau_0$, $M(t) := m$ si et seulement si $\tau_m \leq t < \tau_{m+1}$. Le processus à temps continu $(Y_{M(t)})_{t \geq 0}$ est dit *semi-markovien*. Il peut être rendu markovien en le complétant par la coordonnée $t - \tau_{M(t)}$.

Définition 1.1.3. Soit $(Y_n, \tau_n)_{n \geq 0}$ un processus de renouvellement markovien à valeurs dans $\mathcal{Y} \times [0, +\infty)$, tel que presque sûrement, $\sup_{n \geq 0} \tau_n = +\infty$. Pour tout $t \geq \tau_0$, définissons $M(t)$ comme ci-dessus. Le processus semi-markovien complété associé à $(Y_n, \tau_n)_{n \geq 0}$ est le processus à temps continu $(Y_{M(t)}, t - \tau_{M(t)})_{t \geq \tau_0}$.

Nous proposons maintenant d'introduire une discrétisation temporelle du processus $(X(t))_{t \geq 0}$ le long d'une suite croissante de temps aléatoires $(\tau_n)_{n \geq 0}$, que nous appelons suite des *instants d'observation*, construite de la façon suivante : nous nous donnons

- un sous-ensemble $\mathcal{Y} \subset \mathcal{X}_{\text{nd}}$, que nous appelons *section* de la table de billard ;
- une fonction mesurable $\tau_{\text{obs}} : \mathcal{Y} \rightarrow (0, +\infty)$, que nous appelons *temps d'observation*, telle que pour tout $y \in \mathcal{Y}$, $\mathbf{P}_y(X(\tau_{\text{obs}}(y)) \in \mathcal{Y}) = 1$;

et définissons

$$\begin{aligned} \tau_0 &:= \inf\{t \geq 0 : X(t) \in \mathcal{Y}\}, \\ \forall n \geq 0, \quad \tau_{n+1} &:= \tau_n + \tau_{\text{obs}}(X(\tau_n)). \end{aligned}$$

Pour tout $n \geq 0$, nous notons $Y_n := X(\tau_n) \in \mathcal{Y}$.

Par construction, les τ_n sont des temps d'arrêt pour le processus $(X(t))_{t \geq 0}$. D'après la propriété de Markov forte, nous déduisons que la suite $(Y_n, \tau_n)_{n \geq 0}$ est un processus de renouvellement markovien. Si nous choisissons τ_{obs} de sorte à assurer que, \mathbf{P}_x -presque sûrement, la suite $(\tau_n)_{n \geq 0}$ est non-bornée, alors nous obtenons l'identité suivante : pour toute fonction continue et bornée $f : \Omega \times \mathbb{R}^2 \rightarrow \mathbb{R}$,

$$\forall t \geq 0, \quad \mathbf{E}_x[f(X(t))] = \mathbf{E}_x[f(X(t))\mathbf{1}_{\{t < \tau_0\}}] + \mathbf{E}_x[P_{t-\tau_{M(t)}}f(Y_{M(t)})\mathbf{1}_{\{t \geq \tau_0\}}], \quad (1.6)$$

où $(Y_{M(t)}, t - \tau_{M(t)})_{t \geq 0}$ est le processus semi-markovien complété associé à $(Y_n, \tau_n)_{n \geq 0}$, et

$$P_t f(y) := \mathbf{E}_y[f(X(t))]$$

est le semi-groupe du processus $(X(t))_{t \geq 0}$. Dans la Section 3.3 du Chapitre 3, nous appelons *factorisation* du processus $(X(t))_{t \geq 0}$ par le processus de renouvellement markovien $(Y_n, \tau_n)_{n \geq 0}$ l'identité (1.6). Au moins formellement, il est clair que cette formule permet d'obtenir l'Affirmation 1.1.1 à partir d'un résultat de convergence du processus semi-markovien complété.

Le comportement en temps long d'un processus semi-markovien complété est donné par le théorème de renouvellement markovien, qui existe sous plusieurs formes, mais repose généralement sur deux hypothèses fondamentales :

- l'ergodicité de la chaîne de Markov $(Y_n)_{n \geq 0}$;
- l'intégrabilité de $\tau_1 - \tau_0$ sous la mesure invariante de la chaîne $(Y_n)_{n \geq 0}$.

L'ergodicité de la chaîne de Markov $(Y_n)_{n \geq 0}$ est exprimée en terme de récurrence au sens de Harris.

Définition 1.1.4 (Section VII.3, [7]). Soit $(Y_n)_{n \geq 0}$ une chaîne de Markov, homogène en temps, à valeurs dans un espace \mathcal{Y} . Cette chaîne est dite *récurrenente* au sens de Harris s'il existe $R \subset \mathcal{Y}$, $r \geq 1$, $\epsilon > 0$ et une mesure de probabilité λ sur \mathcal{Y} tels que :

- (i) pour tout $y \in \mathcal{Y}$, $\mathbb{P}(\exists n \geq 1 : Y_n \in R | Y_0 = y) = 1$;
(ii) pour tout $y \in R$, pour tout $B \subset \mathcal{Y}$, $\mathbb{P}(Y_r \in B | Y_0 = y) \geq \epsilon \lambda(B)$.

La première condition ci-dessus exprime la récurrence de la chaîne dans l'ensemble R . La seconde condition est appelée *condition de Doeblin locale*, ou encore *condition de minoration* [109, 76]. La définition que nous utilisons ici, comme beaucoup des notions de théorie du renouvellement markovien, provient du livre d'Asmussen [7].

Une chaîne de Markov récurrente au sens de Harris possède une mesure invariante σ -finie, et cette mesure est unique à multiplication près. Lorsque cette mesure est bornée, alors la chaîne possède une unique mesure de probabilité invariante, et est dite *positive récurrente* au sens de Harris.

Le théorème de renouvellement markovien que nous utilisons est dû à Alsmeyer [2].

Théorème 1.1.5 (Corollaire 1, [2]). *Soit $(Y_n, \tau_n)_{n \geq 0}$ un processus de renouvellement markovien tel que $\sup_{n \geq 0} \tau_n = +\infty$ presque sûrement, et soit $(Y_{M(t)}, t - \tau_{M(t)})_{t \geq 0}$ le processus semi-markovien complété associé. Supposons que :*

- la chaîne de Markov $(Y_n)_{n \geq 0}$ est positive récurrente au sens de Harris, on note alors ν son unique mesure de probabilité invariante ;
- $\mathbb{E}_\nu[\tau_1 - \tau_0] < +\infty$;
- le processus de renouvellement markovien est non-arithmétique ;

alors pour toute fonction $g : \mathcal{Y} \times [0, +\infty) \rightarrow \mathbb{R}$ suffisamment régulière,

$$\lim_{t \rightarrow +\infty} \mathbb{E} [g(Y_{M(t)}, t - \tau_{M(t)})] = \frac{1}{\mathbb{E}_\nu[\tau_1 - \tau_0]} \int_{y \in \mathcal{Y}} \int_{s=0}^{+\infty} g(y, s) \mathbb{P}(\tau_1 - \tau_0 > s | Y_0 = y) ds \nu(dy).$$

La condition de non-arithméticité est l'équivalent des conditions de non-périodicité dans les théorèmes de renouvellement classiques, nous ne détaillons pas son contenu ici.

Le Théorème 1.1.5 permet formellement d'obtenir l'Affirmation 1.1.1, dans laquelle la mesure ergodique π_{nd} est alors donnée par

$$\int_{x \in \mathcal{X}_{\text{nd}}} f(x) \pi_{\text{nd}}(dx) = \frac{1}{\bar{\mu}} \int_{y \in \mathcal{Y}} \int_{s=0}^{\tau_{\text{obs}}(y)} P_s f(y) \nu(dy) ds,$$

où

$$\bar{\mu} := \int_{y \in \mathcal{Y}} \tau_{\text{obs}}(y) \nu(dy).$$

1.1.3.3 La suite des instants d'observation

Nous précisons maintenant notre choix de temps $(\tau_n)_{n \geq 0}$ le long desquels le processus $(X(t))_{t \geq 0}$ est discrétisé. Notre but est que le processus de renouvellement markovien $(Y_n, \tau_n)_{n \geq 0}$ défini par $Y_n := X(\tau_n)$ vérifie les hypothèses du Théorème 1.1.5 ; en particulier, nous souhaitons montrer que la chaîne de Markov $(Y_n)_{n \geq 0}$ est positive récurrente au sens de Harris. Nous devons pour cela construire un sous-ensemble $R \subset \mathcal{Y}$ dans lequel la condition de Doeblin locale est vérifiée, ce qui nécessite d'avoir une expression relativement maniable du noyau de transition de cette chaîne de Markov.

Nous nous appuyons sur la remarque suivante, formulée dans la Section 3.4 du Chapitre 3 : lorsque la boule de billard arrive sur un bord oblique, on obtient une description équivalente de la dynamique en laissant la boule poursuivre sa trajectoire en ligne droite dans l'image de la table par la symétrie d'axe le bord oblique. Notons $(\tilde{X}(t))_{t \geq 0}$ le processus obtenu en répétant cette opération à chaque réflexion sur un bord oblique ; il décrit le mouvement d'une boule de billard sur une table $\tilde{\Omega}$ qui est cette fois infinie, mais dont tous les bords sont thermalisés : par cette opération de *dépliage* de la trajectoire, nous éliminons les réflexions spéculaires. On retrouve le processus original $X(t)$ à partir du processus déplié $\tilde{X}(t)$ par la fonction dite de *pliage*

$$\mathfrak{F} : \tilde{\Omega} \times \mathbb{R}^2 \rightarrow \bar{\Omega} \times \mathbb{R}^2.$$

Notons que l'opération de pliage/dépliage est classique dans l'étude des billards (déterministes) polygonaux [75, 131].

Il est alors possible de découper la table $\tilde{\Omega}$ en bandes, à l'intérieur desquelles les composantes $(\tilde{q}_1(t), \tilde{p}_1(t))$ et $(\tilde{q}_2(t), \tilde{p}_2(t))$ du processus $\tilde{X}(t)$ évoluent de manière indépendante, et telles que le temps mis par le processus déplié pour traverser chaque bande est une fonction déterministe τ_{obs} de la configuration à l'entrée de la bande. En définissant \mathcal{Y} comme l'image par la fonction de pliage des bords de ces bandes, nous obtenons une discrétisation $(Y_n, \tau_n)_{n \geq 0}$ pour laquelle nous pouvons écrire explicitement le noyau de transition de la chaîne de Markov $(Y_n)_{n \geq 0}$. Cette idée est illustrée sur la Figure 1.4.

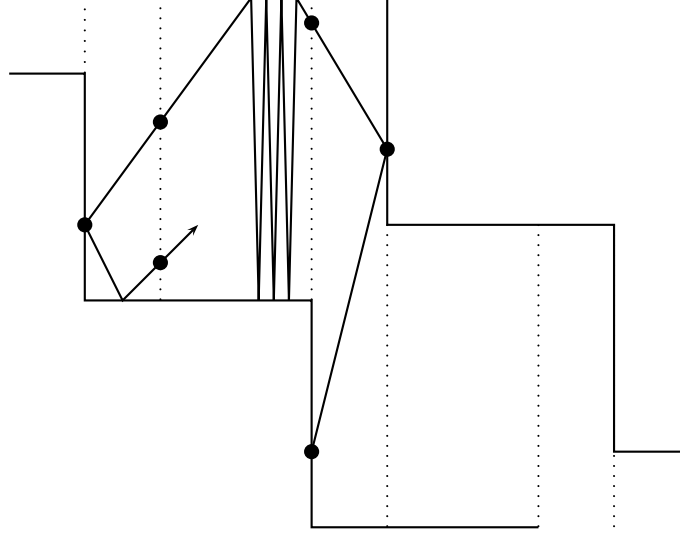

FIGURE 1.4 – Un exemple de trajectoire dépliée. Les bandes sont délimitées par le prolongement de tous les murs verticaux, ce prolongement est marqué en pointillés. Le temps mis par la boule pour traverser une bande est donné par la largeur de la bande divisée par la composante normale (par rapport au bord de la bande) de la vitesse au moment où la boule se trouve sur le bord de la bande. Tant que la boule reste dans une bande, ses composantes horizontale et verticale évoluent indépendamment. La chaîne $(Y_n)_{n \geq 0}$ est obtenue en repliant les configurations obtenues à chaque instant d'observation sur le processus déplié.

Pour ce choix de temps d'observation, et sous des hypothèses sur les densités de mise à jour $\phi^{1,+}$, $\phi^{1,-}$, $\phi^{2,+}$ et $\phi^{2,-}$ que nous ne détaillons pas ici mais qui sont vérifiées dans le cas des réservoirs maxwelliens (1.3), nous obtenons dans la Section 3.6 du Chapitre 3 que la chaîne de Markov $(Y_n)_{n \geq 0}$ est récurrente au sens de Harris. Dans le cas où

$$\phi^{1,+} = \phi^{2,+} =: \phi^+, \quad \phi^{1,-} = \phi^{2,-} =: \phi^-, \quad (1.7)$$

ce que nous convenons d'appeler *équilibre thermodynamique*, nous pouvons par ailleurs construire explicitement une mesure de probabilité invariante pour la chaîne de Markov $(Y_n)_{n \geq 0}$, ce qui entraîne le caractère positif de la récurrence. Hors de l'équilibre thermodynamique, nous laissons cette question ouverte.

1.1.3.4 Bilan des résultats obtenus

Pour le choix d'instant d'observation présenté ci-dessus, nous savons prouver que la chaîne $(Y_n)_{n \geq 0}$ est récurrente au sens de Harris, mais nous devons admettre les deux hypothèses suivantes :

- la récurrence est positive ;

- sous l'hypothèse précédente, si ν est l'unique mesure de probabilité invariante de la chaîne de Markov $(Y_n)_{n \geq 0}$, alors

$$\int_{y \in \mathcal{Y}} \tau_{\text{obs}}(y) \nu(dy) < +\infty.$$

Nous pouvons néanmoins prouver ces deux hypothèses dans le cas de l'équilibre thermodynamique (1.7).

Nous obtenons alors le résultat suivant.

Théorème 1.1.6 (Théorème 3.2.5, Chapitre 3). *Sous des hypothèses sur les densité de mise à jour que nous ne détaillons pas ici, mais qui sont vérifiées pour les réservoirs maxwelliens (1.3), et en supposant :*

- soit que nous sommes à l'équilibre thermodynamique (1.7) ;
- soit que les deux hypothèses ci-dessus sont vérifiées ;

alors le résultat de l'Affirmation 1.1.1 est valide.

1.1.4 Perspectives

Les résultats numériques du Chapitre 2 montrent que le transport de l'énergie dans le modèle d'échange complet n'est pas bien compris. Essentiellement, on s'attend à ce que le confinement des particules dans les cellules amortisse la nature ballistique de leur mouvement, et rende ainsi la propagation de l'énergie plus diffusive. Le fait que le profil de température observé expérimentalement ne correspond pas à celui prévu par la loi de Fourier montre que cette idée doit être revue et précisée ; cela fait l'objet d'un travail en cours avec Raphaël Lefevère.

Bien sûr, le prolongement le plus naturel et immédiat des travaux présentés dans le Chapitre 3 consiste en l'amélioration du Théorème 1.1.6, dans l'énoncé duquel on souhaiterait retirer les hypothèses introduites au paragraphe 1.1.3.4. À plus long terme, on espère ensuite adapter la méthode de discrétisation décrite ci-dessus pour des chaînes comportant un nombre arbitraire N de molécules, et obtenir ainsi un résultat complet d'ergodicité hors de l'équilibre thermodynamique. Un tel résultat serait un premier pas important vers l'étude rigoureuse du modèle d'échange complet.

1.2 Partie II : systèmes de particules interagissant à travers leur rang

Soient b, σ deux fonctions continues de $[0, 1]$ dans \mathbb{R} . Pour tout $u \in [0, 1]$, définissons

$$A(u) := \int_{v=0}^u \sigma^2(v) dv, \quad B(u) := \int_{v=0}^u b(v) dv. \quad (1.8)$$

La Partie II est consacrée à l'étude du problème de Cauchy

$$\begin{cases} \partial_t F_t(x) = \frac{1}{2} \partial_x^2 (A(F_t(x))) - \partial_x (B(F_t(x))), \\ F_0(x) = H * m(x), \end{cases} \quad (1.9)$$

où $H * m$ désigne la fonction de répartition de la mesure de probabilité m sur \mathbb{R} . Compte-tenu de la forme de la condition initiale, il est naturel de chercher des solutions $(F_t)_{t \geq 0}$ telles que, pour tout $t \geq 0$, F_t reste la fonction de répartition d'une mesure de probabilité P_t sur \mathbb{R} . En prenant la dérivée formelle en espace de (1.9), il vient

$$\begin{cases} \partial_t P_t(x) = \frac{1}{2} \partial_x^2 (\sigma^2(H * P_t(x)) P_t) - \partial_x (b(H * P_t(x)) P_t), \\ P_0 = m, \end{cases} \quad (1.10)$$

que l'on interprète aisément comme l'équation de Fokker-Planck associée au processus de diffusion scalaire $(X_t)_{t \geq 0}$, solution de

$$\begin{cases} dX_t = b(H * P_t(X_t))dt + \sigma(H * P_t(X_t))dW_t, \\ H * P_t = F_t \text{ est la fonction de répartition de } X_t, \end{cases} \quad (1.11)$$

où la variable aléatoire X_0 est distribuée selon m , et $(W_t)_{t \geq 0}$ est un mouvement brownien standard à valeurs dans \mathbb{R} , indépendant de X_0 .

Les coefficients de l'équation différentielle stochastique (1.11) présentent la particularité de dépendre de la loi de la variable aléatoire X_t , et non seulement de sa valeur. De telles équations différentielles stochastiques, et par extension, le processus de diffusion $(X_t)_{t \geq 0}$ lui-même, sont dits *non-linéaires au sens de McKean* [108]. Une procédure de *linéarisation* consiste alors à introduire n copies $(X_t^{1,n})_{t \geq 0}, \dots, (X_t^{n,n})_{t \geq 0}$, dirigées par n mouvements browniens $(W_t^1)_{t \geq 0}, \dots, (W_t^n)_{t \geq 0}$ indépendants, et dans lesquelles la loi P_t est remplacée par la distribution marginale μ_t^n de la mesure empirique

$$\mu_t^n := \frac{1}{n} \sum_{i=1}^n \delta_{(X_t^{i,n})_{t \geq 0}},$$

qui est une variable aléatoire à valeurs dans l'espace $\mathcal{P}(C([0, +\infty[, \mathbb{R}))$ des mesures de probabilité sur l'ensemble des trajectoire continues.

On obtient alors le système de n équations différentielles stochastiques

$$dX_t^{i,n} = b \left(\frac{1}{n} \sum_{j=1}^n \mathbb{1}_{\{X_t^{j,n} \leq X_t^{i,n}\}} \right) dt + \sigma \left(\frac{1}{n} \sum_{j=1}^n \mathbb{1}_{\{X_t^{j,n} \leq X_t^{i,n}\}} \right) dW_t^i, \quad (1.12)$$

où les variables aléatoires $X_0^{1,n}, \dots, X_0^{n,n}$ sont indépendantes et identiquement distribuées selon m , et W^1, \dots, W^n sont des mouvements browniens standard dans \mathbb{R} , indépendants et indépendants de $X_0^{1,n}, \dots, X_0^{n,n}$.

Ce système possède une interprétation très simple : il décrit le mouvement de n particules sur la droite réelle, telles que la particule de rang j dans l'ordre croissant des positions a un coefficient de dérive égal à $b(j/n)$ et un coefficient de diffusion égal à $\sigma^2(j/n)$. Lorsque deux particules se croisent, elles échangent leurs coefficients de dérive et de diffusion. Ce système est donc naturellement appelé système de particules, ou de diffusions, interagissant à travers leur rang.

Indépendamment de leur intérêt dans l'étude des solutions d'équations aux dérivées partielles du type (1.9), les systèmes de diffusions interagissant à travers leur rang jouent un rôle important dans la théorie des portefeuilles stochastiques introduite par Fernholz [58], et plusieurs travaux récents leur ont été consacrés. Les propriétés de bonne définition de ces système et des questions liées ont été abordées par Fernholz, Ichiba, Karatzas et Prokaj [61], Ichiba, Karatzas et Shkolnikov [79], Ichiba et Karatzas [78], Pal et Shkolnikov [116]. Leur comportement en temps long a été étudié par Pal et Pitman [115], Jourdain et Malrieu [89], Ichiba, Pal and Shkolnikov [80], puis Ichiba, Papathanakos, Banner, Karatzas and Fernholz [81]. Des propriétés asymptotiques, lorsque n tend vers l'infini, ont été obtenues par Chatterjee et Pal [41] et Shkolnikov [127].

La Partie II propose une étude du lien entre le système de particules introduit ci-dessus et l'équation aux dérivées partielles (1.9). On s'intéresse en particulier au comportement en temps long de ces deux objets. On donne enfin une application de nos résultats à un modèle de marché financier, dit *modèle d'Atlas en champ moyen*, dans lequel les prix des actions interagissent à travers leur rang.

1.2.1 Propagation du chaos

L'approximation du processus non-linéaire (1.11) par le système de particules (1.12) décrite ci-dessus est généralement rendue valide par un résultat de *propagation du chaos* [130] : lorsque le nombre de particules augmente, la mesure empirique μ_t^n échantillonne de mieux en mieux la loi P_t

du processus non-linéaire, de sorte que les particules se comportent asymptotiquement comme des copies indépendantes et identiquement distribuées du processus non-linéaire.

Pour le système de particules (1.12), des résultats de propagation du chaos ont été obtenus par Bossy et Talay [25, 26], qui ont également donné des estimations de convergence pour un schéma numérique associé, puis Jourdain [82, 83, 85] sous diverses hypothèses sur les fonctions b et σ . Ces résultats sont présentés dans l'article de revue [87]; nous les complétons dans la Section 4.2 du Chapitre 4 en établissant le Théorème 1.2.1 de passage à la limite dans l'équation aux dérivées partielles (1.9), puis le Théorème 1.2.2 de passage à la limite dans l'équation différentielle stochastique (1.11).

Théorème 1.2.1 (Proposition 4.2.1, Chapitre 4). *Supposons que la mesure de probabilité m a un moment d'ordre 1 fini, et que la fonction A définie par (1.8) est strictement croissante, c'est-à-dire que l'ensemble des zéros de σ est d'intérieur vide. Alors :*

- *il existe une unique solution faible $(F_t)_{t \geq 0}$ de l'équation (1.9) (dans une classe appropriée, que nous ne précisons pas ici) ;*
- *pour tout $t \geq 0$, μ_t^n converge en probabilité dans $\mathcal{P}(\mathbb{R})$ vers une mesure de probabilité $P(t)$ sur \mathbb{R} ;*
- *pour tout $t \geq 0$, F_t est la fonction de répartition de $P(t)$.*

Théorème 1.2.2 (Corollaire 4.2.13, Chapitre 4). *Supposons que la mesure de probabilité m a un moment d'ordre 1 fini, que σ ne s'annule pas sur $]0, 1[$ et :*

- *si $\sigma(0) = 0$ alors le support de m n'est pas borné inférieurement ;*
- *si $\sigma(1) = 0$ alors le support de m n'est pas borné supérieurement ;*

alors :

- *il existe une unique solution faible $(X_t)_{t \geq 0}$ de l'équation différentielle stochastique (1.11) ;*
- *la mesure empirique μ^n converge en probabilité dans $\mathcal{P}(C([0, +\infty[, \mathbb{R}))$ vers la loi P du processus non-linéaire $(X_t)_{t \geq 0}$;*
- *pour tout $t \geq 0$, la distribution marginale P_t de P au temps t coïncide avec la mesure $P(t)$ obtenue dans le Théorème 1.2.1.*

1.2.2 Comportement en temps long du processus non-linéaire

Dans les Sections 4.3 et 4.4 du Chapitre 4, on s'intéresse au comportement en temps long du processus non-linéaire $(X_t)_{t \geq 0}$, ou de manière équivalente, de la solution $(F_t)_{t \geq 0}$ de l'équation (1.9).

1.2.2.1 Distances du χ_2 et de Wasserstein

Les convergences que nous énonçons sont mesurées en distance du χ_2 et en distance de Wasserstein, définies ci-dessous.

Définition 1.2.3. *Soit E un espace métrique, et soient μ, ν deux mesures de probabilité définies sur la tribu borélienne de E . On appelle distance du χ_2 de μ par rapport à ν , et l'on note $\chi_2(\mu|\nu)$, la quantité*

$$\chi_2(\mu|\nu) := \begin{cases} \sqrt{\int_{x \in E} \left(\frac{d\mu}{d\nu}(x) - 1 \right)^2 \nu(dx)} & \text{si } \mu \ll \nu, \\ +\infty & \text{sinon,} \end{cases}$$

où $\mu \ll \nu$ signifie que μ est absolument continue par rapport à ν , auquel cas $d\mu/d\nu$ désigne la dérivée de Radon-Nikodym de μ par rapport à ν .

Notons que, si $\mu \ll \nu$, alors

$$\chi_2^2(\mu|\nu) = \text{Var}_\nu \left(\frac{d\mu}{d\nu} \right). \quad (1.13)$$

Définition 1.2.4. Soient $d \geq 1$ et μ, ν deux mesures de probabilité définies sur la tribu borélienne de \mathbb{R}^d . Pour tout $p \geq 1$, on appelle distance de Wasserstein d'ordre p entre μ et ν , et l'on note $W_p(\mu, \nu)$, la quantité

$$W_p(\mu, \nu) := \inf_{(X, Y) \in \Pi(\mu, \nu)} \left(\mathbb{E} \left[\sum_{i=1}^d |X_i - Y_i|^p \right] \right)^{1/p},$$

où $\Pi(\mu, \nu)$ désigne l'ensemble des couples aléatoires (X, Y) de lois marginales μ et ν .

Notons que les distances χ_2 et W_p peuvent prendre la valeur $+\infty$.

Expliquons brièvement la raison pour laquelle ces deux distances apparaissent naturellement ici.

D'une part, les mesures invariantes du processus non-linéaire et du système de particules vérifient génériquement une *inégalité de Poincaré* [5, Définition 2.5.4]. Pour un processus de Markov possédant une unique mesure invariante μ , une telle inégalité sur μ est classiquement équivalente à la décroissance exponentielle de la variance sous μ des fonctions test le long du semi-groupe [5, Théorème 2.5.5]. D'après (1.13), la distance du χ_2 mesure exactement cette variance, c'est donc la distance naturelle pour quantifier la convergence à l'équilibre de processus de diffusion dont la mesure invariante vérifie une inégalité de Poincaré.

D'autre part, les travaux d'Otto [112] ont montré que les équations d'évolution non-linéaires du type (1.9) entretiennent des liens forts avec la théorie du transport optimal, et la distance de Wasserstein s'est récemment révélée être particulièrement adaptée à l'étude du comportement en temps long de ces équations. Nous renvoyons aux livres de Villani [135] et Ambrosio, Gigli et Savaré [3] pour un exposé détaillé de ces liens. Dans le contexte plus particulier des équations de Fokker-Planck, linéaires ou non, des résultats de convergence à l'équilibre en distance de Wasserstein utilisant les outils du transport optimal ont été obtenus en particulier par Carrillo et Toscani [38], Carrillo, McCann et Villani [37] et, plus récemment, Bolley, Gentil et Guillin [21, 22]. La Définition 1.2.4 permet également de borner $W_p(\mu, \nu)$ en construisant un couplage explicite, c'est-à-dire un élément (X, Y) de $\Pi(\mu, \nu)$ pour lequel on sait estimer $(\mathbb{E}[\sum_{i=1}^d |X_i - Y_i|^p])^{1/p}$; Cattiaux et Guillin [39] et Eberle [52] ont utilisé de tels arguments probabilistes dans ce contexte.

Signalons enfin qu'il est possible de relier la distance du χ_2 et la distance de Wasserstein quadratique W_2 via une inégalité de transport. Plus précisément, on dit qu'une mesure de probabilité ν sur \mathbb{R}^d vérifie l'*inégalité de transport- χ_2* de constante $C > 0$ si, pour toute mesure de probabilité μ sur \mathbb{R}^d , $W_2(\mu, \nu) \leq \sqrt{C} \chi_2(\mu|\nu)$. Jourdain [88] a montré qu'une telle inégalité implique nécessairement une inégalité de Poincaré, et que la réciproque est vraie lorsque $d = 1$.

1.2.2.2 Existence d'un équilibre

Commençons par établir une condition nécessaire à l'existence d'un équilibre pour le processus $(X_t)_{t \geq 0}$ en observant que, pour tout $t \geq 0$,

$$\mathbb{E}[X_t] = \mathbb{E}[X_0] + \int_{s=0}^t \mathbb{E}[b(F_s(X_s))] ds = \mathbb{E}[X_0] + tB(1), \quad (1.14)$$

où l'on rappelle que d'après (1.8),

$$B(1) = \int_{u=0}^1 b(u) du.$$

Pour que le processus ne diverge pas à l'infini en temps long, il est nécessaire de s'assurer que son taux de croissance moyen $B(1)$ s'annule.

Sous cette condition, on peut alors s'intéresser à l'équation stationnaire correspondant à (1.9), qui s'écrit

$$0 = \frac{1}{2} \partial_x^2 (A(F_\infty)) - \partial_x (B(F_\infty)). \quad (1.15)$$

L'ensemble des distributions stationnaires du processus non-linéaire est obtenu en résolvant cette équation différentielle ordinaire sur \mathbb{R} .

Proposition 1.2.5 (Proposition 4.4.1, Chapitre 4). *Si l'ensemble des zéros de σ est d'intérieur vide, et B vérifie $B(1) = 0$ et $B(u) > 0$ pour tout $u \in]0, 1[$, alors l'ensemble des fonctions de répartition F_∞ sur \mathbb{R} qui résolvent (1.15) est l'ensemble des translations de la fonction Ψ^{-1} , c'est-à-dire l'ensemble des fonctions $F_\infty : x \mapsto \Psi^{-1}(x + \bar{x})$ pour \bar{x} décrivant \mathbb{R} , où Ψ est la fonction continue et strictement croissante définie sur $]0, 1[$ par*

$$\forall u \in]0, 1[, \quad \Psi(u) = \int_{v=1/2}^u \frac{\sigma^2(v)}{2B(v)} dv.$$

Sous les hypothèses de la Proposition 1.2.5, et à condition que Ψ^{-1} soit la fonction de répartition d'une mesure de probabilité possédant un moment d'ordre 1 fini, une mesure invariante pour le processus non-linéaire est donc entièrement caractérisée par son espérance. En particulier, sous l'hypothèse $B(1) = 0$, (1.14) implique que pour tout $t \geq 0$, $\mathbb{E}[X_t] = \mathbb{E}[X_0]$. Ainsi s'attend-on à ce que X_t converge génériquement vers la mesure invariante possédant la même espérance que m .

1.2.2.3 Convergence à l'équilibre

Le premier résultat de convergence à l'équilibre pour le processus non-linéaire est dû à Jourdain et Malrieu [89], dans le cas où σ^2 est constant et strictement positif. Remarquons que dans ce cas :

- pour tout $t > 0$, la loi P_t du processus non-linéaire X_t possède une densité p_t par rapport à la mesure de Lebesgue sur \mathbb{R} ;
- sous les hypothèses de la Proposition 1.2.5, toutes les mesures invariantes du processus non-linéaire possèdent une densité strictement positive sur \mathbb{R} .

Théorème 1.2.6 (Théorème 2.4, [89]). *Supposons que σ^2 est constant et strictement positif, et :*

- $B(1) = 0$ et $B(u) > 0$ pour tout $u \in]0, 1[$;
- b est de classe C^1 , $b(0) > 0$ et $b(1) < 0$;

alors il existe $\eta > 0$ tel que, dès que m vérifie :

- m admet un moment d'ordre 1 fini ;
- m possède une densité p_0 par rapport à la mesure de Lebesgue sur \mathbb{R} ;
- $\chi_2(p_0|p_\infty) \leq \eta$, où p_∞ est la mesure invariante du processus non-linéaire de même espérance que m ;

et que la fonction $(t, x) \mapsto p_t(x)$ est assez régulière, alors il existe $\lambda > 0$ tel que

$$\forall t \geq 0, \quad \chi_2(p_t|p_\infty) \leq \exp(-\lambda t) \chi_2(p_0|p_\infty).$$

Demander que p_0 soit proche de p_∞ est très restrictif et ne semble pas nécessaire dans les exemples traités par Jourdain et Malrieu. Nous avons donc cherché à étendre le Théorème 1.2.6 en retirant cette hypothèse.

Notre premier résultat dans cette direction est une propriété de contraction de la distance de Wasserstein entre deux solutions de (1.9) partant de conditions initiales différentes. Si $(F_t)_{t \geq 0}$ et $(G_t)_{t \geq 0}$ sont deux telles solutions, alors pour tout $p \geq 1$, on note $W_p(F_t, G_t)$ la distance de Wasserstein entre les mesures de probabilité dont F_t et G_t sont les fonctions de répartition respectives.

Proposition 1.2.7 (Proposition 4.3.1, Chapitre 4). *Sous les hypothèses du Théorème 1.2.1, soient $(F_t)_{t \geq 0}$ et $(G_t)_{t \geq 0}$ deux solutions de l'équation aux dérivées partielles (1.9), de conditions initiales respectives F_0 et G_0 . Alors pour tout $p \geq 1$, la distance de Wasserstein $W_p(F_t, G_t)$ est décroissante au cours du temps.*

Dans l'énoncé ci-dessus, lorsque $W_p(F_0, G_0) = +\infty$, alors $W_p(F_t, G_t)$ reste infini à tout temps. Bolley, Brenier et Loeper [20] ont établi un résultat similaire dans le cas hyperbolique $\sigma = 0$, nous y revenons dans la Partie III.

Cette proposition ne nécessite aucune hypothèse de régularité sur les fonctions $(F_t)_{t \geq 0}$ et $(G_t)_{t \geq 0}$. Sa preuve est entièrement probabiliste, et repose sur un argument de couplage des mouvements browniens réfléchis qui décrivent la statistique d'ordre du système de particules. En supposant plus de régularité sur $(F_t)_{t \geq 0}$ et $(G_t)_{t \geq 0}$, on peut quantifier la décroissance énoncée en

obtenant une expression explicite de la dissipation de $W_p(F_t, G_t)$, dans l'esprit des travaux récents de Bolley, Gentil et Guillin [21, 22]. Cette expression est donnée dans la Proposition 4.3.4 du Chapitre 4; elle nous permet enfin d'obtenir le résultat suivant de convergence à l'équilibre.

Théorème 1.2.8 (Théorème 4.4.6, Chapitre 4). *Supposons que :*

- pour tout $u \in [0, 1]$, $\sigma^2(u) > 0$;
- les coefficients b et σ sont assez réguliers pour que, pour tout $t > 0$, la loi P_t du processus de diffusion non-linéaire X_t admette une densité p_t par rapport à la mesure de Lebesgue sur \mathbb{R} , et la fonction $(t, x) \mapsto p_t(x)$ soit une solution au sens classique de l'équation de Fokker-Planck non-linéaire (1.10);
- les coefficients b et σ vérifient les hypothèses de la Proposition 1.2.5 et sont tels que les mesures invariantes du processus de diffusion non-linéaire aient un moment d'ordre 1 fini;
- la mesure de probabilité m a un moment d'ordre 1 fini, et vérifie $W_2(m, \Psi^{-1}) < +\infty$.

Soient alors $(F_t)_{t \geq 0}$ la solution de (1.9) issue de $F_0 := H * m$, et F_∞ la fonction de répartition de la mesure invariante du processus non-linéaire de même espérance que m . Alors

$$\forall 1 \leq q < \sup\{p \geq 2 : W_p(m, \Psi^{-1}) < +\infty\}, \quad \lim_{t \rightarrow +\infty} W_q(F_t, F_\infty) = 0.$$

Le Théorème 1.2.8 ne nécessite plus de condition de proximité entre m et la mesure invariante correspondante, ce qui améliore donc l'énoncé du Théorème 1.2.6. En revanche, il ne fournit pas de vitesse de convergence à l'équilibre. Ce problème est discuté dans la sous-section suivante.

1.2.3 Vitesse de convergence à l'équilibre

Afin d'obtenir une vitesse de convergence à l'équilibre pour le processus non-linéaire, il est assez naturel d'envisager le programme suivant :

- obtenir une vitesse de convergence à l'équilibre pour le système de particules uniforme en le nombre de particules;
- prouver un résultat de propagation du chaos uniforme en temps pour le système de particules.

On peut alors conclure que le processus non-linéaire converge à l'équilibre à la même vitesse que le système de particules.

Ce programme a été appliqué par Malrieu [106, 107] puis Cattiaux, Guillin et Malrieu [40] pour l'équation des milieux granulaires et un système de particules en interaction de champ moyen associé. Dans ce cas, la mesure invariante du système de particules vérifie une inégalité de Sobolev logarithmique [5, Définition 2.6.1], de constante uniforme en le nombre de particules, ce qui entraîne la décroissance exponentielle uniforme de l'entropie relative de la loi du système par rapport à sa mesure invariante. Les propriétés de tensorisation de l'entropie relative, combinées à la propagation du chaos uniforme en temps, permettent alors d'obtenir la décroissance exponentielle de l'entropie relative de la loi du processus non-linéaire par rapport à sa mesure invariante, au même taux.

Dans le cas des systèmes de particules interagissant à travers leur rang et pour un coefficient de diffusion σ^2 constant et strictement positif, Jourdain et Malrieu [89] ont prouvé que la mesure invariante du système de particules vérifie une inégalité de Poincaré de constante uniforme en le nombre de particules, ce qui entraîne la décroissance exponentielle uniforme de la distance du χ_2 entre la loi du système de particules et sa mesure invariante. Malheureusement, il n'y a pas de propagation du chaos uniforme en temps, et la distance du χ_2 ne possédant pas les mêmes propriétés de tensorisation que l'entropie relative, on ne peut pas conclure directement. On donne néanmoins des résultats partiels pour cette approche dans le Chapitre 5.

1.2.3.1 Comportement en temps long du système de particules

Jourdain et Malrieu [89] ont décrit le comportement en temps long du système de particules (1.12), dans lequel σ^2 est constant et strictement positif, et les coefficients $b(j/n)$, $j \in$

$\{1, \dots, n\}$, donnant la dérive instantanée de la particule en j -ème position, sont remplacés par leur approximation

$$b_n(j) := n \left(B \left(\frac{j}{n} \right) - B \left(\frac{j-1}{n} \right) \right).$$

Nous conservons la notation $(X_t^{1,n}, \dots, X_t^{n,n})_{t \geq 0}$ pour désigner le système de particules avec ces coefficients modifiés. Notons qu'alors l'hypothèse $B(1) = 0$, nécessaire à l'existence d'un équilibre pour le processus non-linéaire, implique que

$$\sum_{j=1}^n b_n(j) = 0.$$

Remarquons maintenant que le système de particules ne peut pas admettre d'équilibre : en effet, la projection du processus $(X_t^{1,n}, \dots, X_t^{n,n})_{t \geq 0}$ le long de la direction $(1, \dots, 1)$ est un mouvement brownien réel de variance σ^2 . On fait disparaître cette singularité en introduisant

$$(Z_t^{1,n}, \dots, Z_t^{n,n})_{t \geq 0},$$

la projection orthogonale du système de particules sur l'hyperplan

$$M_n := \{(z_1, \dots, z_n) \in \mathbb{R}^n : z_1 + \dots + z_n = 0\}.$$

Notons que projeter un vecteur de \mathbb{R}^n sur M_n revient à retirer à chaque coordonnée la valeur moyenne de ces coordonnées. Autrement dit, le processus $(Z_t^{1,n}, \dots, Z_t^{n,n})_{t \geq 0}$ décrit les positions des particules par rapport au centre de masse du système.

Pal et Pitman ont alors obtenu le résultat suivant.

Théorème 1.2.9 (Théorème 8, [115]). *Supposons que σ^2 est constant et strictement positif, et que $B(1) = 0$. Alors le processus $(Z_t^{1,n}, \dots, Z_t^{n,n})_{t \geq 0}$ converge à l'équilibre, en variation totale, si et seulement si les nombres $b_n(1), \dots, b_n(n)$ vérifient*

$$\forall j \in \{1, \dots, n-1\}, \quad \sum_{k=1}^j b_n(k) > 0. \quad (1.16)$$

Dans ce cas, l'unique mesure invariante du système admet la densité

$$p_\infty^n(z) := \frac{1}{\mathcal{Z}_n} \exp \left(\frac{2}{\sigma^2} \sum_{j=1}^n b_n(j) z_{(j)} \right), \quad \mathcal{Z}_n := \int_{z \in M_n} \exp \left(\frac{2}{\sigma^2} \sum_{j=1}^n b_n(j) z_{(j)} \right) dz < +\infty$$

par rapport à la mesure de surface sur M_n , où $z_{(1)} \leq \dots \leq z_{(n)}$ désigne le réordonnement croissant de (z_1, \dots, z_n) .

La condition (1.16), appelée dans la suite *condition de stabilité*, est l'exact analogue discret de la condition $B(u) > 0$ pour tout $u \in]0, 1[$ qui apparaît dans le Théorème 1.2.8. Jourdain et Malrieu ont introduit une condition plus forte d'uniforme concavité pour B :

(UC) Il existe $\alpha > 0$ tel que, pour tous $u, v \in [0, 1]$ avec $u \leq v$, $b(v) - b(u) \leq -\alpha(v - u)$.

Cette condition permet d'obtenir le Théorème 1.2.10, qui donne une vitesse de convergence à l'équilibre pour le système projeté.

Avant d'énoncer ce résultat, rappelons que l'on note p_t la densité du processus non-linéaire X_t , p_∞ la densité de la mesure invariante possédant la même espérance que m . Notons p_t^n la densité de $(Z_t^{1,n}, \dots, Z_t^{n,n})$ par rapport à la mesure de surface sur M_n et $p_t^{1,n}$ la densité de la loi marginale de $Z_t^{1,n}$ par rapport à la mesure de Lebesgue sur \mathbb{R} . Par échangeabilité, $p_t^{1,n}$ est également la densité de la loi marginale de $Z_t^{i,n}$ par rapport à la mesure de Lebesgue sur \mathbb{R} , pour tout $i \in \{1, \dots, n\}$. De même, la densité p_∞^n est symétrique en (z_1, \dots, z_n) , de sorte que la densité marginale $p_\infty^{1,n}$ de la première coordonnée est également la densité marginale de la i -ème coordonnée, pour tout $i \in \{1, \dots, n\}$.

Théorème 1.2.10 (Théorème 2.12, [89]). *Supposons que σ^2 est constant et strictement positif, que $B(1) = 0$ et que la condition (UC) est vérifiée. Alors il existe $\lambda > 0$, dépendant de α et σ^2 , tel que pour tout $n \geq 1$,*

$$\chi_2(p_t^n | p_\infty^n) \leq \exp(-\lambda t) \chi_2(p_0^n | p_\infty^n).$$

Proposition 1.2.11 (Proposition 2.11, [89]). *Supposons que σ^2 est constant et strictement positif, que $B(1) = 0$ et que b est lipschitzienne, et que la mesure de probabilité m admet un moment d'ordre 2 fini. Alors, pour tout $t \geq 0$, il existe $K(t) \in [0, +\infty[$ tel que*

$$W_2(p_t^{1,n}, p_t) \leq \frac{K(t)}{\sqrt{n}}.$$

Le Théorème 1.2.10 donne un taux de convergence à l'équilibre uniforme en le nombre de particules, ce qui est donc encourageant en vue du programme énoncé ci-dessus. Malheureusement, le résultat de propagation du chaos obtenu à la Proposition 1.2.11 n'est pas uniforme en temps, et l'on ne peut donc pas conclure directement.

1.2.3.2 Convergence de $p_\infty^{1,n}$

Malgré la non-uniformité en temps de la propagation du chaos dans la Proposition 1.2.11, on aimerait pouvoir obtenir une vitesse de convergence à l'équilibre pour le processus non-linéaire en procédant de la manière suivante : écrivons, pour tous $t \geq 0$ et $n \geq 1$,

$$W_2(p_t, p_\infty) \leq W_2(p_t, p_t^{1,n}) + W_2(p_t^{1,n}, p_\infty^{1,n}) + W_2(p_\infty^{1,n}, p_\infty). \quad (1.17)$$

D'après la Proposition 1.2.11, le premier terme du membre de droite ci-dessus disparaît si n tend vers l'infini à t fixé. Le troisième terme est traité dans le Chapitre 5, où nous établissons le résultat suivant.

Proposition 1.2.12 (Théorème 5.1.2, Chapitre 5). *Supposons que σ^2 est constant et strictement positif, que $B(1) = 0$ et que b est strictement décroissante. Alors, pour tout $r \geq 1$,*

$$\lim_{n \rightarrow +\infty} W_r(p_\infty^{1,n}, p_\infty) = 0.$$

En revanche, le second terme dans le membre de droite de (1.17) pose problème : idéalement, on souhaiterait transposer le résultat du Théorème 1.2.10 à la distance de Wasserstein entre les marginales respectives $p_t^{1,n}$ et $p_\infty^{1,n}$ de p_t^n et p_∞^n . En supposant par exemple que l'on puisse montrer que p_∞^n vérifie l'inégalité de transport- χ_2 de constante C uniforme en n , alors il vient, pour tout $t \geq 0$,

$$W_2(p_t^{1,n}, p_\infty^{1,n}) \leq \frac{1}{\sqrt{n}} W_2(p_t^n, p_\infty^n) \leq \sqrt{\frac{C}{n}} \chi_2(p_t^n | p_\infty^n) \leq \sqrt{\frac{C}{n}} \exp(-\lambda t) \chi_2(p_0^n | p_\infty^n).$$

Mais le terme $\chi_2(p_0^n | p_\infty^n)$ croît géométriquement avec n , et le membre de droite ci-dessus explose lorsque n tend vers l'infini. Nous n'avons pas réussi à surmonter cette difficulté.

1.2.4 Le modèle d'Atlas en champ moyen

Indépendamment de leur intérêt dans l'approximation des solutions d'équations du type (1.9), les systèmes de diffusions interagissant à travers leur rang ont fait l'objet d'une attention assez importante en théorie des portefeuilles stochastiques. En effet, Fernholz a montré [58, 62] que sur un marché *asymptotiquement stable* en temps, la dynamique des prix des actifs est assez bien approchée par les exponentielles de systèmes de diffusions interagissant à travers leur rang. En particulier, le modèle d'Atlas, dans lequel la croissance globale du marché est portée par l'actif le plus bas, permet de retrouver les courbes de distribution du capital observées empiriquement. Ce modèle a été introduit par Fernholz [58] et étudié en détail par Banner, Fernholz et Karatzas [11], voir aussi [62, 81].

Dans ce contexte, on s'intéresse généralement à la répartition du capital entre les compagnies présentes sur le marché [11, 41, 62, 125], et à la gestion de portefeuilles [11, 62]. Ces questions sont généralement étudiées en analysant d'abord la stabilité en temps long du marché [11, 115, 89, 80, 81] pour un nombre fixé n d'actifs, puis en faisant tendre ce nombre d'actifs vers l'infini dans un marché stationnaire [11, 41, 125]. Les résultats essentiels dans cette direction sont présentés dans l'article de revue de Fernholz et Karatzas [62] ; plus généralement, la théorie des portefeuilles stochastiques est introduite dans le livre de Fernholz [58].

Dans le Chapitre 6, nous appelons *modèle d'Atlas en champ moyen* le modèle de marché dans lequel les logarithmes des prix des actifs sont donnés par (1.12), et nous proposons de raisonner dans l'ordre inverse de celui décrit ci-dessus : nous utilisons d'abord les résultats du Chapitre 4 pour donner une description asymptotique, lorsque la taille du marché augmente, du comportement de chaque actif. Le phénomène de propagation du chaos implique que ceux-ci se comportent approximativement comme des copies indépendantes d'une même dynamique non-linéaire. Le comportement en temps long de cette dynamique, et donc la stabilité du marché asymptotique, sont déterminés par nos résultats de convergence à l'équilibre. Nous renvoyons à la Section 6.2 du Chapitre 6 pour une présentation détaillée de ces résultats.

Nous nous intéressons ensuite à la distribution du capital et à la sélection de portefeuilles pour le marché asymptotique dans le modèle d'Atlas en champ moyen. Dans la Section 6.4 du Chapitre 6, nous retrouvons la transition de phase observée par Chatterjee et Pal [41] : selon les paramètres du modèle, pour un grand marché et en régime stationnaire,

- soit l'intégralité du capital est concentrée par un petit nombre de compagnies ;
- soit le capital est bien réparti sur le marché et aucune compagnie ne concentre une portion macroscopique du capital total.

Dans le second cas, nous obtenons une description assez fine de la *densité de capital* sur le marché, qui exhibe les mêmes propriétés qualitatives que les courbes de distribution du capital empiriquement observées [58].

Dans la Section 6.5 du Chapitre 6, nous comparons enfin les performances d'une famille de portefeuilles, qui réalise une interpolation entre :

- le portefeuille neutre, qui investit la même somme sur chaque actif ;
- le portefeuille de marché, qui investit sur chaque actif une somme proportionnelle au prix de cet actif.

Empiriquement [118, 117], on constate que le portefeuille neutre est plus performant que le portefeuille de marché. Ce fait est généralement expliqué par l'effet de *rééquilibrage*, à savoir que les investisseurs vendent les actifs avec un prix élevé et achètent les actifs de faible prix. Le portefeuille neutre est insensible à cet effet, alors que le portefeuille de marché donne plus de poids aux actifs dont les prix sont les plus élevés, ce qui va dans le sens opposé de l'effet de rééquilibrage. Notons que les hypothèses $B(0) = B(1) = 0$ et $B(u) > 0$ pour $u \in]0, 1[$, nécessaires à la stabilité du processus non-linéaire dans le Théorème 1.2.8, traduisent cet effet de rééquilibrage : la dynamique des petits actifs est dirigée par la quantité $b(0) \geq 0$, alors que celle des grands actifs est dirigée par $b(1) \leq 0$.

Cette observation a été vérifiée dans le modèle d'Atlas par Banner, Fernholz et Karatzas [11]. Dans le modèle d'Atlas en champ moyen, l'expression de la mesure invariante du processus non-linéaire nous permet de calculer explicitement le rendement asymptotique des portefeuilles. Nous mettons alors en évidence l'influence de la volatilité sur le rendement des portefeuilles : si celle-ci est une fonction décroissante du prix de l'actif, alors nous confirmons que le portefeuille neutre a un meilleur taux de croissance que le portefeuille de marché. Dans le cas contraire, il est possible de construire des modèles dans lesquels le portefeuille de marché est meilleur que le portefeuille neutre. À notre connaissance, un tel phénomène n'a encore jamais été observé.

1.2.5 Perspectives

Comme nous l'avons souligné dans la Sous-section 1.2.3, la question principale encore ouverte dans les travaux de la Partie II est la vitesse de convergence à l'équilibre du processus non-

linéaire, en dehors des hypothèses du Théorème 1.2.6. Nous renvoyons à cette sous-section pour une présentation détaillée des stratégies proposées dans cette direction.

1.3 Partie III : la dynamique des particules collantes multitype

Les résultats de propagation du chaos exposés dans le Chapitre 4 permettent de donner une représentation probabiliste des solutions de l'équation aux dérivées partielles (1.9). La motivation initiale des travaux présentés dans cette partie est la suivante : peut-on construire une représentation similaire pour les solutions d'un système d'équations aux dérivées partielles non-linéaires ?

Les systèmes *diagonaux* d'équations aux dérivées partielles permettent effectivement de développer une telle théorie. Ce sont les systèmes de la forme

$$\forall \gamma \in \{1, \dots, d\}, \quad \begin{cases} \partial_t u^\gamma + \lambda^\gamma(\mathbf{u}) \partial_x u^\gamma = \frac{\sigma^2}{2} \partial_x^2 u^\gamma, \\ u^\gamma(0, x) = u_0^\gamma(x), \end{cases} \quad (1.18)$$

où la fonction inconnue

$$\mathbf{u} = (u^1, \dots, u^d)$$

est définie sur $[0, +\infty) \times \mathbb{R}$ et à valeurs dans \mathbb{R}^d . On suppose ici que $\sigma^2 > 0$, que pour tout $\gamma \in \{1, \dots, d\}$, la condition initiale u_0^γ est la fonction de répartition d'une mesure de probabilité m^γ sur \mathbb{R} , ce que l'on note naturellement $u_0^\gamma = H * m^\gamma$, et que le champ de vitesses

$$\boldsymbol{\lambda} = (\lambda^1, \dots, \lambda^d)$$

est défini sur $[0, 1]^d$ et à valeurs dans \mathbb{R}^d . Comme dans la Partie II, on cherche alors des solutions $\mathbf{u} = (u^1, \dots, u^d)$ telles que, pour tout $\gamma \in \{1, \dots, d\}$, pour tout $t \geq 0$, $u^\gamma(t, \cdot)$ reste la fonction de répartition d'une mesure de probabilité sur \mathbb{R} .

Le système (1.18) est dit *parabolique*. On s'intéresse également à sa version *hyperbolique*, donnée par

$$\forall \gamma \in \{1, \dots, d\}, \quad \begin{cases} \partial_t u^\gamma + \lambda^\gamma(\mathbf{u}) \partial_x u^\gamma = 0, \\ u^\gamma(0, x) = u_0^\gamma(x). \end{cases} \quad (1.19)$$

On commence par introduire un système *multitype* de particules interagissant à travers leur rang, qui étend le système étudié dans la Partie II et permet d'approcher les solutions de systèmes paraboliques (1.18). On décrit ensuite la limite petit bruit de ce système de particules, que l'on appelle *dynamique des particules collantes multitype*. On montre enfin que, lorsque le nombre de particules tend vers l'infini, la dynamique des particules collantes multitype permet effectivement d'approcher les solutions de systèmes hyperboliques (1.19). Les liens entre ces différents objets sont résumés sur la Figure 1.5.

Remarque 1.3.1. Dans toute la Partie III, les objets notés en caractères gras (par exemple \mathbf{u} et $\boldsymbol{\lambda}$ ci-dessus) sont les objets de dimension d . Les coordonnées de tels objets sont notées en caractères maigres et repérées par des lettres grecques, génériquement γ ou α, β , placées en exposant.

Les énoncés de nos résultats font intervenir les conditions de continuité suivantes sur le champ de vitesses $\boldsymbol{\lambda} = (\lambda^1, \dots, \lambda^d)$.

(C) Pour tout $\gamma \in \{1, \dots, d\}$, la fonction λ^γ est continue sur $[0, 1]^d$.

(LC) Il existe une constante $L_{LC} \in [0, +\infty[$ telle que

$$\forall \gamma \in \{1, \dots, d\}, \quad \forall \mathbf{u}, \mathbf{v} \in [0, 1]^d, \quad |\lambda^\gamma(\mathbf{u}) - \lambda^\gamma(\mathbf{v})| \leq L_{LC} \sum_{\gamma'=1}^d |u^{\gamma'} - v^{\gamma'}|.$$

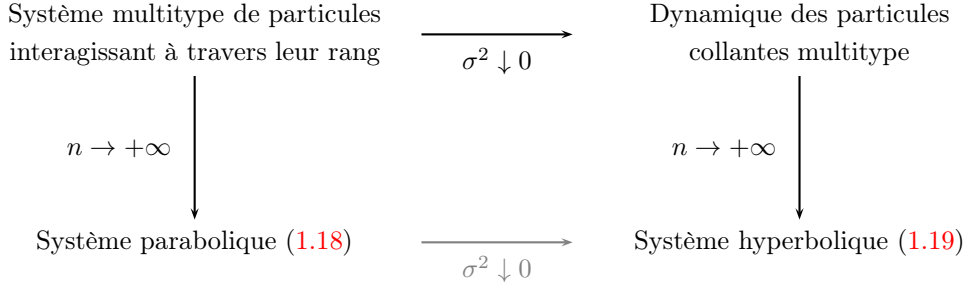

FIGURE 1.5 – Liens formels entre système multitype de particules interagissant à travers leur rang, dynamique des particules collantes et systèmes paraboliques (1.18) et hyperboliques (1.19). Dans ce manuscrit, on ne s'intéresse pas directement à la flèche grisée.

1.3.1 Systèmes multitypes de particules interagissant à travers leur rang

Supposons ici que $\sigma^2 = 1$. La construction d'un système de particules, similaire à celui introduit dans la Partie II, permettant d'approcher les solutions du système parabolique (1.18), est présentée dans le Chapitre 7. En prenant la dérivée en espace de (1.18), on obtient que les dérivées $(p_t^1, \dots, p_t^d)_{t \geq 0}$ d'une solution \mathbf{u} vérifient le système

$$\forall \gamma \in \{1, \dots, d\}, \quad \begin{cases} \partial_t p_t^\gamma = \frac{1}{2} \partial_x^2 p_t^\gamma + \partial_x (\lambda^\gamma (H * p_t^1(x), \dots, H * p_t^d(x)) p_t^\gamma), \\ p_0^\gamma = m^\gamma, \end{cases}$$

que l'on interprète comme le système d'équations de Fokker-Planck vérifié par les lois marginales P_t^1, \dots, P_t^d des coordonnées du processus de diffusion

$$\mathbf{X} = (X^1(t), \dots, X^d(t))_{t \geq 0}$$

à valeurs dans \mathbb{R}^d et solution de l'équation différentielle stochastique non-linéaire

$$\forall \gamma \in \{1, \dots, d\}, \quad \begin{cases} dX^\gamma(t) = \lambda^\gamma (H * P_t^1(X^\gamma(t)), \dots, H * P_t^d(X^\gamma(t))) dt + dW^\gamma(t), \\ P_t^\gamma \text{ est la loi de } X^\gamma(t), \end{cases} \quad (1.20)$$

où $\mathbf{W} = (W^1(t), \dots, W^d(t))_{t \geq 0}$ est un mouvement brownien standard dans \mathbb{R}^d , et $\mathbf{X}(0)$ est une variable aléatoire dans \mathbb{R}^d , indépendante de \mathbf{W} , et telle que, pour tout $\gamma \in \{1, \dots, d\}$, la loi marginale de $X^\gamma(0)$ est m^γ .

Afin de linéariser l'équation différentielle stochastique non-linéaire ci-dessus, on introduit n processus

$$\mathbf{X}_{k,n} = (X_{k,n}^1(t), \dots, X_{k,n}^d(t))_{t \geq 0}, \quad k \in \{1, \dots, n\},$$

dans \mathbb{R}^d , vérifiant, pour tous $k \in \{1, \dots, n\}$ et $\gamma \in \{1, \dots, d\}$,

$$dX_{k,n}^\gamma(t) = \lambda^\gamma \left(\frac{1}{n} \sum_{j=1}^n \mathbb{1}_{\{X_{j,n}^1(t) \leq X_{k,n}^\gamma(t)\}}, \dots, \frac{1}{n} \sum_{j=1}^n \mathbb{1}_{\{X_{j,n}^d(t) \leq X_{k,n}^\gamma(t)\}} \right) dt + dW_k^\gamma(t),$$

où les processus

$$\mathbf{W}_k = (W_k^1(t), \dots, W_k^d(t))_{t \geq 0}, \quad k \in \{1, \dots, n\},$$

sont des mouvements browniens standard dans \mathbb{R}^d indépendants, et les variables aléatoires

$$\mathbf{X}_{1,n}(0), \dots, \mathbf{X}_{n,n}(0)$$

sont indépendantes et identiquement distribuées selon la mesure produit $m^1 \otimes \dots \otimes m^d$, indépendamment de $\mathbf{W}_1, \dots, \mathbf{W}_n$.

Les processus $X_{k,n}^\gamma$ peuvent être vus comme décrivant les positions dans un système de $d \times n$ particules évoluant sur la droite réelle de la façon suivante :

- chaque particule possède un *type* $\gamma \in \{1, \dots, d\}$, et il y a n particules de chaque type ;
- la dérive de chaque particule dépend de son rang parmi les particules de son propre type, mais également parmi chaque sous-système de particules d'un type donné.

Dans la suite, ce système de particules est appelé système *multitype* de particules interagissant à travers leur rang.

Le lien entre ce système de particules et le système parabolique (1.18) est éclairci dans le Théorème 7.1.4 du Chapitre 7.

Théorème 1.3.2 (Théorème 7.1.4, Chapitre 7). *Sous l'hypothèse (LC), la mesure empirique*

$$\mu_n := \frac{1}{n} \sum_{k=1}^n \delta_{\mathbf{X}_{k,n}} \in \mathbb{P}(C([0, +\infty[, \mathbb{R}^d))$$

converge en probabilité, dans $\mathbb{P}(C([0, +\infty[, \mathbb{R}^d))$, vers la loi P de l'unique solution faible de l'équation différentielle stochastique non-linéaire (1.20).

De plus, la fonction $\mathbf{u} = (u^1, \dots, u^d) : [0, +\infty[\times \mathbb{R} \rightarrow [0, 1]^d$ définie par, pour tout $\gamma \in \{1, \dots, d\}$,

$$\forall (t, x) \in [0, +\infty[\times \mathbb{R}, \quad u^\gamma(t, x) := H * P_t^\gamma(x),$$

est l'unique solution (dans une classe que nous ne précisons pas ici) du système parabolique (1.18) avec $\sigma^2 = 1$.

1.3.2 Limite petit bruit des systèmes multitypes de particules interagissant à travers leur rang

Afin de construire une approximation des solutions du système hyperbolique (1.19), on souhaite déterminer la limite *petit bruit*, c'est-à-dire lorsque σ^2 tend vers 0, du système multitype de particules interagissant à travers leur rang introduit ci-dessus.

Dans ce but, on pose $\epsilon := \sigma^2/2$, et l'on souligne la dépendance en ϵ du système de particules en notant désormais $(\mathbf{X}_{1,n}^\epsilon(t), \dots, \mathbf{X}_{n,n}^\epsilon(t))_{t \geq 0}$ le processus de diffusion à valeurs dans $(\mathbb{R}^d)^n$ défini par

$$dX_{k,n}^{\epsilon,\gamma}(t) = \lambda^\gamma \left(\frac{1}{n} \sum_{j=1}^n \mathbb{1}_{\{X_{j,n}^{\epsilon,1}(t) \leq X_{k,n}^{\epsilon,\gamma}(t)\}}, \dots, \frac{1}{n} \sum_{j=1}^n \mathbb{1}_{\{X_{j,n}^{\epsilon,d}(t) \leq X_{k,n}^{\epsilon,\gamma}(t)\}} \right) dt + \sqrt{2\epsilon} dW_k^\gamma(t). \quad (1.21)$$

Le coefficient de dérive de ce processus de diffusion est génériquement une fonction discontinue de $(\mathbb{R}^d)^n$ dans lui-même ; ainsi la limite petit bruit de ce processus n'est-elle pas couverte par la théorie de Freidlin et Wentzell [65]. Nous introduisons donc des méthodes *ad hoc* pour déterminer cette limite, et traitons d'abord le cas scalaire $d = 1$, puis le cas de systèmes de dimension supérieure vérifiant la condition d'uniforme stricte hyperbolicité (USH) que nous introduisons dans le paragraphe 1.3.2.2 ci-dessous.

1.3.2.1 Limite petit bruit dans le cas scalaire

Dans le cas $d = 1$, il n'y a qu'un type de particules et (1.21) décrit simplement l'évolution d'un système de particules interagissant à travers leur rang tel que celui étudié dans la Partie II, avec des coefficients de variance constants. Par souci de lisibilité, nous ne faisons plus mention du type des particules, et notons donc $(X_{1,n}^\epsilon(t), \dots, X_{n,n}^\epsilon(t))_{t \geq 0}$ le système de particules, et $\lambda(1/n), \dots, \lambda(n/n)$ les coefficients de dérive.

La particule qui voyage en j -ème position possède donc une dérive instantanée $\lambda(j/n)$. Lorsque l'intensité ϵ de l'agitation brownienne diminue, et tant que cette particule ne croise pas d'autre

particule, sa trajectoire se concentre donc autour de la droite de pente $\lambda(j/n)$. Supposons que $\lambda(j/n) > \lambda((j+1)/n)$, de sorte que les particules en j -ème et $(j+1)$ -ème position finissent par entrer en collision. Alors celles-ci échangent leurs coefficients de dérive, et gardent donc une orientation qui tend à les rapprocher. Très naturellement, les particules qui entrent en collision restent donc collées dans la limite petit bruit. Elles forment un amas dont il est facile de voir que la vitesse est donnée par la moyenne des vitesses incidentes. Plus généralement, lorsque plusieurs amas entrent en collision, ils se collent et forment un seul gros amas, dont la vitesse est déterminée par la conservation de la masse (on convient que toutes les particules ont la même masse) et de la quantité de mouvement.

Cette dynamique limite est appelée *dynamique des particules collantes* et a été introduite par Zel'dovitch [141] pour décrire le mouvement des galaxies. Nous prouvons dans la Section 8.3 du Chapitre 8 qu'elle décrit effectivement la limite petit bruit du processus (1.21), dans un sens que nous ne précisons pas ici. Brenier et Grenier [29] puis Jourdain [86] ont montré que cette dynamique permet d'approcher la solution de l'équation hyperbolique (1.19) avec $d = 1$ dans le sens suivant.

Théorème 1.3.3 ([29, 86]). *Soit $(x_{1,n}(0), \dots, x_{n,n}(0))_{n \geq 1}$ une suite de conditions initiales telles que, pour tout $n \geq 1$,*

$$x_{1,n}(0) \leq \dots \leq x_{n,n}(0),$$

et dont les mesures empiriques

$$\mu_n(0) := \frac{1}{n} \sum_{k=1}^n \delta_{x_{k,n}(0)}$$

convergent étroitement vers la mesure de probabilité m sur \mathbb{R} .

Pour tout $n \geq 1$, soit $(x_{1,n}(t), \dots, x_{n,n}(t))_{t \geq 0}$ le processus décrivant les positions du système de particules collantes suivant :

- *la particule d'indice $k \in \{1, \dots, n\}$ est en position initiale $x_{k,n}(0)$, et possède la vitesse initiale $\lambda(k/n)$ et la masse initiale $1/n$;*
- *les particules voyagent à vitesse constante sur la droite réelle tant qu'elles n'entrent pas en collision ;*
- *aux collisions, les particules se collent et forment un amas dont la vitesse est déterminée par la conservation de la masse et de la quantité de mouvement.*

Alors, pour tout $t \geq 0$, la mesure empirique

$$\mu_n(t) := \frac{1}{n} \sum_{k=1}^n \delta_{x_{k,n}(t)}$$

converge étroitement vers une mesure de probabilité $\mu(t)$ sur \mathbb{R} , telle que la fonction

$$u : \begin{cases} [0, +\infty[\times \mathbb{R} & \rightarrow & [0, 1] \\ (t, x) & \mapsto & (H * \mu(t))(x) \end{cases}$$

est l'unique solution entropique de la loi de conservation scalaire

$$\begin{cases} \partial_t u + \partial_x (\Lambda(u)) = 0, \\ u(0, x) = H * m(x), \end{cases} \quad (1.22)$$

où la fonction de flux $\Lambda : [0, 1] \rightarrow \mathbb{R}$ est définie par

$$\forall u \in [0, 1], \quad \Lambda(u) := \int_{v=0}^u \lambda(v) dv.$$

Dans le cas scalaire, le diagramme décrit sur la Figure 1.5 est donc parfaitement complété, en prenant pour « bonne » notion de solution de l'équation hyperbolique la solution entropique de la loi de conservation (1.22). On renvoie à l'article de Jourdain [85] pour une étude plus détaillée du cas scalaire.

1.3.2.2 Limite petit bruit dans le cas uniformément strictement hyperbolique

Dans le cas de la dimension supérieure $d \geq 2$, la limite petit bruit du processus défini par (1.21) est beaucoup moins claire. Évidemment, tant qu'il n'y a pas de collision entre des particules de type différent, chaque système de particules d'un type donné suit la dynamique des particules collantes pour des coefficients de vitesse donnés par l'ordre global du système. Plus précisément, on s'attend à ce que, dans la limite petit bruit, les particules de type $\gamma \in \{1, \dots, d\}$ suivent la dynamique des particules collantes dans laquelle la particule en k -ème position parmi les particules de type γ , qui est notée $\gamma : k$ dans la suite, possède une vitesse initiale donnée par

$$\lambda^\gamma \left(\omega_{\gamma:k}^1, \dots, \omega_{\gamma:k}^{\gamma-1}, \frac{k}{n}, \omega_{\gamma:k}^{\gamma+1}, \dots, \omega_{\gamma:k}^d \right), \quad (1.23)$$

où, pour tout $\gamma' \neq \gamma$,

$$\omega_{\gamma:k}^{\gamma'} := \frac{1}{n} \times \text{nombre de particules de type } \gamma' \text{ situées à gauche de } \gamma : k.$$

Tant qu'il n'y a pas de collision entre des particules de type différent, l'ordre global du système ne change pas, et les coefficients de vitesse donnés par (1.23) ne sont pas affectés.

Déterminer l'ordre des particules résultant d'une collision entre particules de types différents est en revanche beaucoup plus difficile. On constate en effet que les deux phénomènes suivants peuvent se produire et poser problème :

- dans la limite petit bruit, la collision demeure aléatoire, c'est-à-dire que l'ordre des particules après la collision est aléatoire ;
- un amas contenant des particules de plusieurs types se forme.

Dans le premier cas, nous ne pouvons pas déterminer en général la probabilité de chaque ordre possible. Dans le second cas, nous ne savons pas calculer explicitement la vitesse des amas formés. Nous discutons de ces questions dans le Chapitre 8, en remarquant que le processus donné par (1.21) s'inscrit dans le cadre un peu plus général de processus de diffusion interagissant à travers leur ordre, c'est-à-dire de processus de diffusion à valeurs dans \mathbb{R}^N et dont le coefficient de dérive ne dépend de la valeur du processus qu'à travers l'ordre de ses coordonnées. Le Chapitre 8 donne quelques résultats partiels sur la limite petit bruit de tels processus.

Nous éliminons les deux phénomènes décrits ci-dessus en travaillant sous la condition d'uniforme stricte hyperbolicité suivante.

(USH) Uniforme stricte hyperbolicité : il existe une constante $L_{\text{USH}} \in]0, +\infty[$ telle que

$$\forall \gamma \in \{1, \dots, d-1\}, \quad \inf_{\mathbf{u} \in [0,1]^d} \lambda^\gamma(\mathbf{u}) - \sup_{\mathbf{u} \in [0,1]^d} \lambda^{\gamma+1}(\mathbf{u}) \geq L_{\text{USH}}.$$

Alors, en utilisant les mêmes arguments qu'au Chapitre 8, nous obtenons la description suivante de la limite petit bruit de (1.21) : tant qu'il n'y a pas de collision entre particules de types différents, chaque système de particules d'un type donné suit la dynamique des particules collantes avec des coefficients déterminés par l'ordre global du système *via* (1.23). Lors d'une collision entre amas de types différents, les amas se croisent sans se coller et s'ordonnent par type décroissant. Les coefficients de vitesse de chaque amas sont alors mis à jour en prenant le nouvel ordre global du système. Cette dynamique est appelée *dynamique des particules collantes multitype* ; une trajectoire typique est représentée sur la Figure 1.6.

1.3.3 Dynamique des particules collantes multitype

Le Chapitre 9 est consacré à l'étude du lien entre la dynamique des particules collantes multitype introduite ci-dessus, et le système hyperbolique (1.19). L'espace d'état naturel pour la dynamique des particules collantes multitype est le produit cartésien D_n^d , où D_n est le polyèdre

$$D_n := \{(x_1, \dots, x_n) \in \mathbb{R}^n : x_1 \leq \dots \leq x_n\}.$$

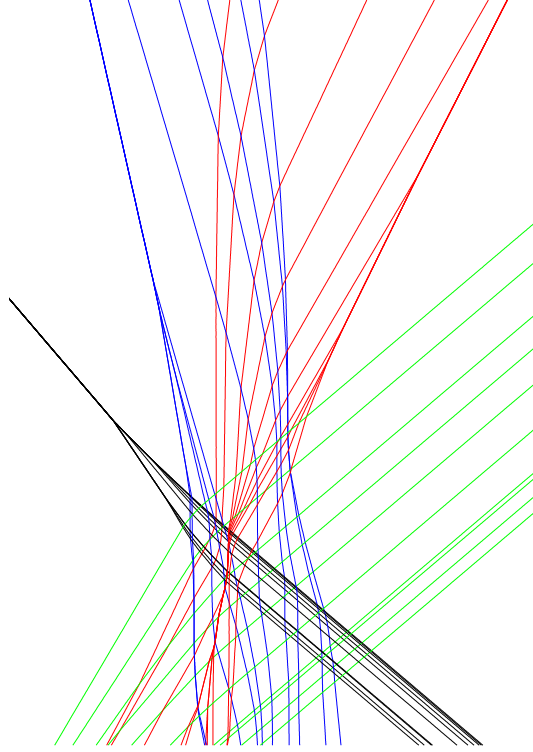

FIGURE 1.6 – Un exemple de trajectoire de la dynamique des particules collantes multitype. Les positions des particules sont représentées en abscisses, et le temps est en ordonnée. Chaque couleur est associée à un type de particule. Les particules de même type se collent aux collisions, et les collisions entre amas de types différents peuvent modifier les vitesses des amas, voire faire éclater ceux-ci.

Un élément typique de D_n^d est appelé une *configuration* et noté

$$\mathbf{x} = (x_k^\gamma)_{1 \leq \gamma \leq d, 1 \leq k \leq n},$$

où x_k^γ désigne la position de la k -ème particule de type γ . Pour tout $p \in [1, +\infty]$, nous définissons la distance $\|\cdot\|_p$ sur D_n^d par

$$\forall p \in [1, +\infty[, \quad \|\mathbf{x} - \mathbf{y}\|_p = \left(\frac{1}{n} \sum_{\gamma=1}^d \sum_{k=1}^n |x_k^\gamma - y_k^\gamma|^p \right)^{1/p},$$

$$\|\mathbf{x} - \mathbf{y}\|_\infty = \sup_{1 \leq \gamma \leq d, 1 \leq k \leq n} |x_k^\gamma - y_k^\gamma|.$$

La dynamique des particules collantes multitype définit un flot $(\Phi(\cdot; t))_{t \geq 0}$ dans D_n^d .

1.3.3.1 Notion de solution probabiliste

La première tâche dans l'étude du système hyperbolique (1.19) consiste à définir proprement ce que l'on entend par une *solution* de ce système. En effet, le produit $\lambda^\gamma(\mathbf{u}) \partial_x u^\gamma$ n'est bien défini, au sens des distributions, que si u^γ est régulier. Or, les solutions que nous cherchons à obtenir sont des fonctions de répartition, et peuvent donc éventuellement être discontinues.

Considérons par exemple le cas scalaire évoqué au paragraphe 1.3.2.1, où u_0 est la fonction de Heaviside et λ est décroissante. Alors on peut introduire une approximation par la dynamique

des particules collantes, dans laquelle la position initiale de chaque particule est 0. Comme λ est décroissante, toutes les particules restent collées et voyagent en un seul amas, de vitesse

$$\frac{1}{n} \sum_{k=1}^n \lambda\left(\frac{k}{n}\right).$$

Il en résulte aisément que la solution obtenue à la limite s'écrit $u(t, x) = \mathbf{1}_{\{x \geq t\bar{\lambda}\}}$, où

$$\bar{\lambda} = \int_{v=0}^1 \lambda(v) dv,$$

et cette solution est effectivement discontinue.

Remarque 1.3.4. Nous pouvons formuler les deux remarques suivantes sur ce cas, et qui sont à la base de notre notion de solution pour le système hyperbolique (1.19) :

- (i) si nous remplaçons, dans la définition de la dynamique des particules collantes, la vitesse initiale $\lambda(k/n)$ de la particule en k -ème position par son approximation

$$n \int_{v=(k-1)/n}^{k/n} \lambda(v) dv = \frac{\Lambda(k/n) - \Lambda((k-1)/n)}{1/n},$$

ce que nous avons d'ailleurs fait pour étudier le comportement en temps long des systèmes de particules interagissant à travers leur rang au Chapitre 5, alors pour tout $n \geq 1$, la fonction de répartition empirique des particules *est exactement* la solution $u(t, x)$ que nous cherchons à approcher ;

- (ii) la « bonne vitesse » à mettre devant le terme $\partial_x u$ dans la formulation non-conservative de (1.22) est ici $\bar{\lambda}$, c'est-à-dire la *valeur moyenne de λ sur la discontinuité de u* .

La seconde remarque ci-dessus peut être précisée, et rendue plus générale, en observant que si F est la fonction de répartition d'une mesure de probabilité m sur \mathbb{R} , alors la distribution $\partial_x(\Lambda(F))$ coïncide avec la mesure de Radon $\lambda\{F\}(x)m(dx)$, où, pour tout $x \in \mathbb{R}$,

$$\lambda\{F\}(x) := \int_{\theta=0}^1 \lambda((1-\theta)F(x^-) + \theta F(x)) d\theta,$$

et $F(x^-)$ est la limite à gauche de F en x . Avec cette définition, une formulation équivalente de (1.22) est

$$\begin{cases} \partial_t u + \lambda\{u\} \partial_x u = 0, \\ u(0, x) = H * m(x), \end{cases}$$

ce qui correspond à la version scalaire du système (1.19), dans laquelle nous avons convenu d'interpréter le produit $\lambda(u)\partial_x u$ comme la distribution $\lambda\{u\}\partial_x u$.

Nous gardons la même convention dans le cas général et introduisons ainsi la notion de *solution probabiliste* du système hyperbolique (1.19).

Définition 1.3.5 (Définition 9.2.12, Chapitre 9). *Une solution probabiliste du système hyperbolique (1.19) est une fonction*

$$\mathbf{u} = (u^1, \dots, u^d) : [0, +\infty[\times \mathbb{R} \rightarrow \mathbb{R}^d$$

telle que :

- pour tout $t \geq 0$, pour tout $\gamma \in \{1, \dots, d\}$, la fonction $u^\gamma(t, \cdot)$ est la fonction de répartition d'une mesure de probabilité sur \mathbb{R} ;
- la fonction \mathbf{u} est une solution, au sens faible, du système d'équations

$$\forall \gamma \in \{1, \dots, d\}, \quad \begin{cases} \partial_t u^\gamma + \lambda^\gamma\{\mathbf{u}\} \partial_x u^\gamma = 0, \\ u^\gamma(0, x) = u_0^\gamma(x), \end{cases}$$

où, pour tout $\gamma \in \{1, \dots, d\}$,

$$\lambda^\gamma\{\mathbf{u}\}(t, x) := \int_{\theta=0}^1 \lambda^\gamma(u^1(t, x), \dots, (1-\theta)u^\gamma(t, x^-) + \theta u^\gamma(t, x), \dots, u^d(t, x)) d\theta,$$

et $\lambda^\gamma\{\mathbf{u}\}\partial_x u^\gamma$ est interprétée comme la mesure de Radon de densité $\lambda^\gamma\{\mathbf{u}\}(t, \cdot)$ par rapport à la mesure de probabilité $\partial_x u^\gamma(t, \cdot)$ sur \mathbb{R} .

Cette notion est introduite et discutée dans la Section 9.2 du Chapitre 9.

1.3.3.2 Existence d'une solution *via* le système de particules

Nous nous intéressons maintenant à la construction de solutions probabilistes, au sens de la Définition 1.3.5, du système hyperbolique (1.19), à partir de la dynamique des particules collantes multitype. En raison du point (i) de la Remarque 1.3.4, nous modifions légèrement cette dynamique en remplaçant la vitesse initiale de la k -ème particule de type γ , donnée à (1.23), par la valeur

$$n \int_{v=(k-1)/n}^{k/n} \lambda^\gamma(\omega_{\gamma:k}^1, \dots, \omega_{\gamma:k}^{\gamma-1}, v, \omega_{\gamma:k}^{\gamma+1}, \dots, \omega_{\gamma:k}^d) dv.$$

Cette nouvelle définition, qui ne change rien à la nature de la dynamique, nous permet de montrer dans la Proposition 9.2.15 du Chapitre 9 que, pour toute configuration initiale, les fonctions de répartition empiriques de chacun des d systèmes de particules fournissent une solution exacte, au sens de la Définition 1.3.5, du système hyperbolique (1.19).

Nous combinons ensuite cette observation à :

- un résultat de fermeture, énoncé à la Proposition 9.2.14, de l'ensemble des solutions probabilistes du système hyperbolique (1.19) ;
- un résultat de compacité, énoncé à la Proposition 9.5.6, pour une famille de dynamiques de particules collantes multitypes dont les configurations initiales sont obtenues en discrétisant les conditions initiales u_0^1, \dots, u_0^d du système hyperbolique (1.19) ;

et obtenons le résultat d'existence suivant.

Théorème 1.3.6 (Théorème 9.2.17, Chapitre 9). *Sous les hypothèses (C) et (USH), pour tout choix de mesures de probabilité m^1, \dots, m^d sur \mathbb{R} , il existe une solution probabiliste, au sens de la Définition 1.3.5, du système hyperbolique (1.19) avec les conditions initiales u_0^1, \dots, u_0^d définies par, pour tout $\gamma \in \{1, \dots, d\}$, $u_0^\gamma := H * m^\gamma$.*

1.3.3.3 Stabilité uniforme pour le système de particules

Le résultat central du Chapitre 9, énoncé et prouvé dans la Section 9.4 de celui-ci, est l'estimation de stabilité uniforme au niveau discret décrite dans le Théorème 1.3.7 ci-dessous. Nous établissons ce résultat sous l'hypothèse supplémentaire de *Genuine Nonlinearity* :

(GNL) Pour tout $\gamma \in \{1, \dots, d\}$, λ^γ est de classe C^1 sur $[0, 1]^d$ et

$$\begin{cases} \text{soit} & \forall \mathbf{u} \in [0, 1]^d, \quad \partial_\gamma \lambda^\gamma(\mathbf{u}) > 0, \\ \text{soit} & \forall \mathbf{u} \in [0, 1]^d, \quad \partial_\gamma \lambda^\gamma(\mathbf{u}) < 0, \end{cases}$$

où $\partial_\gamma \lambda^\gamma$ désigne la dérivée partielle de λ^γ par rapport à u^γ .

Théorème 1.3.7 (Théorème 9.2.22, Chapitre 9). *Sous les hypothèses (LC), (USH) et (GNL), alors pour tout $p \in [1, +\infty]$, il existe une constante $\mathcal{L}_p \in [1, +\infty[$ dépendant de d, L_{LC}, L_{USH} mais pas de n , telle que pour tous $\mathbf{x}, \mathbf{y} \in D_n^d$, pour tous $s, t \geq 0$,*

$$\|\Phi(\mathbf{x}; s) - \Phi(\mathbf{y}; t)\|_p \leq \mathcal{L}_p \|\mathbf{x} - \mathbf{y}\|_p + |t - s| L_{C,p},$$

où

$$\forall p \in [1, +\infty), \quad L_{C,p} := \left(\sum_{\gamma=1}^d \sup_{\mathbf{u} \in [0,1]^d} |\lambda^\gamma(\mathbf{u})|^p \right)^{1/p},$$

$$L_{C,\infty} := \sup_{1 \leq \gamma \leq d} \sup_{\mathbf{u} \in [0,1]^d} |\lambda^\gamma(\mathbf{u})|.$$

La preuve de ce résultat est longue et plutôt technique. Nous en donnons donc une brève description ici. Commençons par remarquer qu'il suffit d'obtenir le Théorème 1.3.7 pour les cas particuliers $p = 1$ et $p = \infty$, les cas intermédiaires s'en déduisent ensuite grâce au théorème de Riesz-Thorin. Ces deux cas extrémaux sont traités en deux grandes étapes : nous établissons d'abord une version *locale* de nos estimations L^1 et L^∞ , c'est-à-dire pour des configurations initiales \mathbf{x} et \mathbf{y} proches (dans un sens que nous précisons ci-dessous). Nous intégrons ensuite cette estimation locale le long d'un chemin qui interpole deux configurations initiales \mathbf{x} et \mathbf{y} arbitraires, et sur lequel nous pouvons appliquer notre estimation locale de proche en proche.

Précisons d'abord ce que nous entendons par *configurations initiales proches*. Dans la Sous-section (9.4.2), nous appelons *configurations à collisions binaires* les configurations $\mathbf{x} \in D_n^d$ telles que, dans la dynamique des particules collantes multitype démarrée en \mathbf{x} , les collisions n'impliquent que deux types de particules distincts. Pour de telles configurations, nous encodons les propriétés topologiques des trajectoires des particules dans un graphe, appelé *graphe de collision*, dont les sommets représentent les collisions entre amas de types différents. Pour deux configurations \mathbf{x} et \mathbf{y} partageant le même graphe de collision, nous utilisons la contractivité de la dynamique des particules collantes type par type afin d'écrire un système récursif d'inéquations, posé sur les sommets du graphe, vérifié par les quantités

$$\sum_{\gamma: k \in c} |\Phi_k^\gamma(\mathbf{x}; t) - \Phi_k^\gamma(\mathbf{y}; t)|$$

aux instants de collision, où la somme porte sur l'ensemble des particules $\gamma : k$ appartenant à l'amas c impliqué dans la collision. Le problème devient donc purement algébrique, et sa résolution nous permet d'obtenir les estimations L^1 et L^∞ attendues.

La procédure d'interpolation permettant de passer des estimations locales en \mathbf{x} , \mathbf{y} à un résultat global est décrite dans la Sous-section 9.4.3. Nous utilisons ici les propriétés géométriques des trajectoires des particules, afin de construire un chemin entre deux configurations données \mathbf{x} et \mathbf{y} le long duquel deux configurations suffisamment proches partagent le même graphe de collision.

1.3.3.4 Stabilité et propriété de semi-groupe

La valeur de la constante \mathcal{L}_p donnée dans le Théorème 1.3.7 est explicite et ne dépend pas de n , ce qui nous permet de passer à la limite du grand nombre de particules dans l'estimation de stabilité. Nous en déduisons le théorème suivant, qui est le résultat principal du Chapitre 9, et dans lequel nous définissons, pour tous $\mathbf{m} = (m^1, \dots, m^d)$, $\mathbf{m}' = (m'^1, \dots, m'^d) \in P(\mathbb{R})^d$,

$$\forall p \in [1, +\infty[, \quad W_p^{(d)}(\mathbf{m}, \mathbf{m}') := \left(\sum_{\gamma=1}^d W_p(m^\gamma, m'^\gamma)^p \right)^{1/p};$$

$$W_\infty^{(d)}(\mathbf{m}, \mathbf{m}') := \sup_{1 \leq \gamma \leq d} W_\infty(m^\gamma, m'^\gamma).$$

Théorème 1.3.8 (Théorème 9.2.25, Chapitre 9). *Pour tout $\mathbf{m}^* \in P(\mathbb{R})^d$, notons $\mathcal{P}_{\mathbf{m}^*}$ l'ensemble des vecteurs de mesures de probabilité $\mathbf{m} \in P(\mathbb{R})^d$ tels que*

$$W_1^{(d)}(\mathbf{m}, \mathbf{m}^*) < +\infty.$$

Alors, sous les hypothèses du Théorème 1.3.7, il existe une famille d'opérateurs $(\mathbf{S}_t)_{t \geq 0}$ de $\mathcal{P}_{\mathbf{m}^}$ tels que :*

- (i) pour tout $\mathbf{m} = (m^1, \dots, m^d) \in \mathcal{P}_{\mathbf{m}^*}$, la fonction $\mathbf{u} = (u^1, \dots, u^d) : [0, +\infty[\times \mathbb{R} \rightarrow [0, 1]^d$ définie par $u^\gamma(t, x) := H * (S_t^\gamma \mathbf{m})(x)$ est une solution probabiliste du système hyperbolique (1.19) avec les conditions initiales u_0^1, \dots, u_0^d données par $u_0^\gamma := H * m^\gamma$;
- (ii) pour tout $p \in [1, +\infty]$, pour tous $\mathbf{m}, \mathbf{m}' \in \mathcal{P}_{\mathbf{m}^*}$, pour tous $s, t \geq 0$,

$$W_p^{(d)}(\mathbf{S}_t \mathbf{m}, \mathbf{S}_s \mathbf{m}') \leq \mathcal{L}_p W_p^{(d)}(\mathbf{m}, \mathbf{m}') + |t - s| L_{C,p},$$

où les constantes \mathcal{L}_p et $L_{C,p}$ ont été introduites dans le Théorème 1.3.7 ;

- (iii) $(\mathbf{S}_t)_{t \geq 0}$ est un semi-groupe sur $\mathcal{P}_{\mathbf{m}^*}$.

Ce théorème est démontré dans la Section 9.5 du Chapitre 9. Dans le cas scalaire, un résultat équivalent a été obtenu par Bolley, Brenier et Loeper [20], mais par une méthode qui n'utilise pas la dynamique des particules collantes. De fait, si les liens entre les dynamiques de particules collantes et les lois de conservation scalaires ont été bien étudiés [27, 29, 110, 28, 31], il semble que notre travail soit le premier à appliquer une méthode particulière à des systèmes hyperboliques d'équations. Notons cependant que les schémas que nous obtenons présentent de fortes similitudes avec les méthodes dites de Wave Front Tracking [30], qui sont connues pour donner des résultats de stabilité [10, 16, 17], au moins en distance W_1 , comparables à ceux du Théorème 1.3.8.

1.3.4 Perspectives

Nous proposons deux perspectives de recherche dans lesquelles les résultats de la Partie III peuvent être approfondis et généralisés.

1.3.4.1 Limite petit bruit de processus de diffusion interagissant à travers leur ordre

Dans le Chapitre 8, nous généralisons la question de la limite petit bruit des systèmes multitypes de particules interagissant à travers leur rang en introduisant la notion de processus de diffusion *interagissant à travers leur ordre*. Nous donnons une description de la limite petit bruit de tels processus dans certains cas particuliers, mais laissons ouverte la question d'une description exhaustive.

Cette question nous semble néanmoins très intéressante, car à notre connaissance il n'existe pas d'étude aussi générale de la limite petit bruit de processus de diffusion, à coefficient de dérive irrégulier, en grande dimension (voir l'introduction du Chapitre 8). Nous détaillons ce problème et émettons quelques conjectures dans la Section 8.5 du Chapitre 8.

1.3.4.2 Systèmes hyperboliques et dynamique des particules collantes multitype

Les Théorèmes 1.3.7 et 1.3.8 sont obtenus en particulier sous l'hypothèse (GNL). Dans un travail en cours avec Benjamin Jourdain et Régis Monneau, nous établissons ces deux théorèmes en retirant cette hypothèse. L'hypothèse (USH) reste néanmoins fondamentale car elle permet la bonne définition de la dynamique des particules collantes multitype.

On peut ensuite s'intéresser à des systèmes hyperboliques du type (1.19), dans lesquels les conditions initiales u_0^1, \dots, u_0^d ne sont plus monotones, mais seulement à variation bornée. Autrement dit, ce sont les fonctions de répartition de mesures signées sur la droite réelle. Dans le cas scalaire $d = 1$, on peut encore introduire un système de particules collantes permettant d'approcher la solution entropique de la loi de conservation correspondante, en attribuant un signe aux particules et en annihilant deux particules de signes opposés lorsqu'elles entrent en collision [85, 86]. Dans le cas général $d \geq 1$, il est naturel de souhaiter adapter les résultats du Chapitre 9 pour un système de particules collantes multitype, possédant également un signe et obéissant à la même règle d'annihilation.

Première partie

Le modèle d'échange complet

Chapitre 2

Thermodynamique du modèle d'échange complet

Ce chapitre présente, d'un point de vue formel, les propriétés thermodynamiques conjecturées pour le modèle d'échange complet, et les illustre par des simulations numériques. Nous mettons ici l'accent sur la compréhension globale du modèle, et non sur la rigueur des preuves.

2.1 Introduction

2.1.1 Heat transfer by local collisions

This chapter is concerned with the mathematical description of heat transfer by local collisional dynamics in porous materials, such as aerogels. Aerogels are derived from gels, where the liquid component is replaced with gas. Experimentally, they exhibit very low thermal conductivity. Based on systems of semi-dispersing billiards introduced by Bunimovich, Liverani, Pellegrinotti and Suhov [34], Gaspard and Gilbert argued in [68] that low thermal conductivity can be explained by the fact that such systems typically entail very few interactions between energy carriers.

As a simple model of such a system, Gilbert and Lefevre [71] introduced the *Complete Exchange Model* (CEM) as the lattice Hamiltonian dynamics described below. This model was also proposed by Prosen and Campbell in [119], where it was called *pseudo-integrable Bing Bang model*. There, it was remarked that the study of this system is equivalent to the study of a stochastic billiard in higher dimensions; see Chapter 3 for developments in this direction.

In the present chapter, we introduce the basic thermodynamic properties of the CEM and state a few conjectures with respect to the profile of temperature and the energy current in the nonequilibrium steady state. These conjectures are then confronted with numerical experiments.

2.1.2 The deterministic complete exchange model

Consider a system of N point molecules with unit mass, each one being confined in a one-dimensional cell of unit length, located on the lattice $\{1, \dots, N\}$. For $i \in \{1, \dots, N\}$, the position of the i -th molecule in its cell is denoted by $q_i(t) \in [0, 1]$, while its velocity is denoted by $p_i(t) \in \mathbb{R}$. Each molecule moves at constant velocity in its cell, changing the sign of the velocity at each reflection at the boundaries of the cell. The interaction between a pair of neighbouring molecules, say $(i, i+1)$, occurs when the difference between the relative positions of the two molecules reaches the value $1 - a$, *i.e.*

$$|q_i(t) - q_{i+1}(t)| = 1 - a.$$

Then, the molecules i and $i+1$ exchange their velocities, *i.e.*

$$p_i(t) = p_{i+1}(t^-), \quad p_{i+1}(t) = p_i(t^-).$$

The parameter $a \in [0, 1)$ is called the *interaction parameter*. We shall distinguish the following interaction regimes:

1. the noninteracting case $a = 0$,
2. weak interactions $a \ll 1$,
3. moderate interactions $a < 1/2$,
4. strong interactions $a \geq 1/2$.

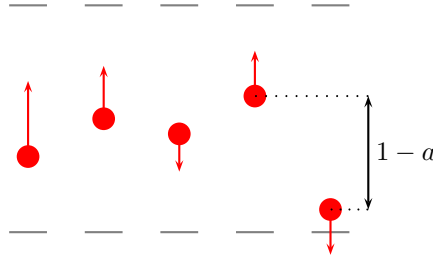

Figure 2.1: The deterministic Complete Exchange Model, with $N = 5$ molecules.

Formally, the joint process $(\mathbf{q}(t), \mathbf{p}(t))_{t \geq 0}$ evolves according to the Hamiltonian

$$H^N(\mathbf{q}, \mathbf{p}) = \sum_{i=1}^N \left(\frac{p_i^2}{2} + V_{\text{pin}}(q_i) \right) + \sum_{i=1}^{N-1} V_{\text{int}}(q_i, q_{i+1}),$$

on the phase space $\mathbb{R}^N \times \mathbb{R}^N$, where the pinning and interaction potentials are respectively of hard wall and hard sphere type, namely

$$V_{\text{pin}}(q) = \begin{cases} 0 & \text{if } q \in [0, 1], \\ +\infty & \text{otherwise,} \end{cases} \quad V_{\text{int}}(q, q') = \begin{cases} 0 & \text{if } |q - q'| < 1 - a, \\ +\infty & \text{otherwise.} \end{cases}$$

This model shall be referred to as the deterministic CEM.

2.1.3 Thermal baths

In order to study thermal transport along the chain of molecules, the edge molecules 1 and N are put in contact with reservoirs, the action of which is modelled by stochastic updates of the velocities of the molecules at the boundaries of their respective cells. More precisely, when $q_1(t) = 0$ or $q_1(t) = 1$, then the modulus of the velocity of the first molecule is drawn, independently of the incoming velocity, according to the probability density

$$\phi_L(v) = \frac{v}{T_L} \exp\left(-\frac{v^2}{2T_L}\right)$$

on $[0, +\infty)$. Similarly, when $q_N(t) = 0$ or $q_N(t) = 1$, then the modulus of the velocity of the N -th molecule is drawn, independently of the incoming velocity, according to the probability density

$$\phi_R(v) = \frac{v}{T_R} \exp\left(-\frac{v^2}{2T_R}\right)$$

on $[0, +\infty)$.

When there is no interaction, *i.e.* $a = 0$, the choice of these update densities ensures that the marginal steady state of the first molecule (q_1, p_1) is the product measure

$$\frac{1}{\sqrt{2\pi T_L}} \exp\left(-\frac{p_1^2}{2T_L}\right) dq_1 dp_1$$

of the uniform distribution for the positions and the Maxwell-Boltzmann distribution at temperature¹ T_L for the velocities; a similar statement obviously holds for the marginal steady state of the N -th molecule (q_N, p_N) . Therefore, such reservoirs are usually called *Maxwellian reservoirs* [24].

This model shall be referred to as the thermalised CEM.

2.1.4 Outline of the chapter

The outline of the chapter is as follows: we derive a few properties of the deterministic CEM in Section 2.2, while Section 2.3 is dedicated to the study of the thermalised CEM. We first compute the frequency of collisions between neighbouring molecules at thermal equilibrium. Then, under two assumptions of ergodicity and local thermal equilibrium, we define the nonequilibrium steady state temperatures and energy currents, and derive an expression of the Fourier law in which the thermal conductivity is given by the frequency of collisions. This fact was already obtained by Gilbert and Lefevre [71] for the CEM and is in agreement with more general results by Gaspard and Gilbert [70, 69].

The Fourier law provides us with a theoretical macroscopic temperature profile, which we compare with numerical simulations. There, we observe that the experimental temperature profile does not match theoretical expectations. We conclude that the local thermal equilibrium assumption has to be refined, in a fashion that was also discussed by Ryals and Young [124].

Throughout the chapter, we denote $[\cdot]^+ := \max(\cdot, 0)$ and $[\cdot]^- := \max(-\cdot, 0)$.

2.2 The deterministic CEM

This section is dedicated to the study of the process $(\mathbf{q}(t), \mathbf{p}(t))_{t \geq 0}$ in the deterministic CEM. This process takes its values in the phase space $\bar{\Omega} \times \mathbb{R}^N$, where

$$\bar{\Omega} = \{\mathbf{q} = (q_1, \dots, q_N) \in [0, 1]^N : \forall i \in \{1, \dots, N-1\}, |q_{i+1} - q_i| \leq 1 - a\}.$$

The volume of $\bar{\Omega}$ depends on both the number N of molecules and the interaction parameter a ; it shall be denoted by $V^N(a)$.

2.2.1 Infinitesimal evolution and Liouville equation

We begin by giving a formal description of the infinitesimal evolution of the dynamics. Certainly, the process of positions $(\mathbf{q}(t))_{t \geq 0}$ is continuous, while the process of velocities $(\mathbf{p}(t))_{t \geq 0}$ is piecewise constant and right continuous. We shall denote by $\mathbf{p}(t^-)$ the left limit of \mathbf{p} in t .

Then, for $f : \bar{\Omega} \times \mathbb{R}^N \rightarrow \mathbb{R}$,

$$\frac{d}{dt} f(\mathbf{q}(t), \mathbf{p}(t)) = \mathbf{L}^{\text{det}} f(\mathbf{q}(t), \mathbf{p}(t^-)), \quad \mathbf{L}^{\text{det}} = L^{\text{f}} + L^{\text{dr}} + L^{\text{i}}, \quad (2.1)$$

where the operators L^{f} , L^{dr} and L^{i} are defined as follows.

- L^{f} represents the action of the free motion,

$$L^{\text{f}} f(\mathbf{q}, \mathbf{p}) = \mathbf{p} \cdot \nabla_{\mathbf{q}} f(\mathbf{q}, \mathbf{p}).$$

- L^{dr} represents the action of the deterministic reflection of the molecules at the boundaries of their cell,

$$L^{\text{dr}} f(\mathbf{q}, \mathbf{p}) = \sum_{i=1}^N \{ [p_i]^- \delta_{q_i=0} + [p_i]^+ \delta_{q_i=1} \} (f(\mathbf{q}, \mathbf{p}_{-i}) - f(\mathbf{q}, \mathbf{p})),$$

where $\mathbf{p}_{-i} := (p_1, \dots, p_{i-1}, -p_i, p_{i+1}, \dots, p_N)$.

1. Throughout the chapter, we take the convention that the Boltzmann constant k_B is worth 1.

- L^i represents the action of the interactions between molecules,

$$L^i f(\mathbf{q}, \mathbf{p}) = \sum_{i=1}^{N-1} \left\{ [p_{i+1} - p_i]^+ \delta_{q_{i+1}-q_i=1-a} + [p_i - p_{i+1}]^+ \delta_{q_{i+1}-q_i=-(1-a)} \right\} \\ \times (f(\mathbf{q}, \mathbf{p}_{i \leftrightarrow i+1}) - f(\mathbf{q}, \mathbf{p})),$$

where $\mathbf{p}_{i \leftrightarrow i+1} := (p_1, \dots, p_{i+1}, p_i, \dots, p_N)$ and $\delta_{q_{i+1}-q_i=\pm(1-a)}$ refers to the pullback of the distribution δ_0 along the application $(\mathbf{q}, \mathbf{p}) \mapsto q_{i+1} - q_i \pm (1-a)$ on $\bar{\Omega} \times \mathbb{R}^N$.

The derivation of these expressions is explained in Appendix 2.A. Let us underline the similarity of L^{dr} with the infinitesimal generator L' , defined by

$$L' f(\mathbf{q}, \mathbf{p}) = \sum_{i=1}^N \lambda_i(q_i, p_i) (f(\mathbf{q}, \mathbf{p}_{-i}) - f(\mathbf{q}, \mathbf{p})),$$

of a classical Markov jump process in which the velocity of the i -th molecule is reversed at rate $\lambda_i(q_i, p_i)$: the operator L^{dr} is indeed a degenerate version of L' , where velocity reversions occur certainly when (and only when) $q = 0$ and $q = 1$, with a rate corresponding to the incoming velocity of the molecule.

If the initial configuration of the system is distributed according to the probability distribution π_0 on the phase space $\bar{\Omega} \times \mathbb{R}^N$, the law $\pi(t)$ of $(\mathbf{q}(t), \mathbf{p}(t))$ satisfies the Liouville equation

$$\frac{d}{dt} \pi(t) = (\mathbf{L}^{\text{det}})^* \pi(t), \quad \pi(0) = \pi_0,$$

where the operator $(\mathbf{L}^{\text{det}})^*$ is the formal adjoint of \mathbf{L}^{det} . A tedious but straightforward application of the Green formula

$$\int_{(\mathbf{q}, \mathbf{p}) \in \bar{\Omega} \times \mathbb{R}^N} (\mathbf{p} \cdot \nabla_{\mathbf{q}} f) g d\mathbf{q} d\mathbf{p} = \int_{(\mathbf{q}, \mathbf{p}) \in \partial \bar{\Omega} \times \mathbb{R}^N} f g (\mathbf{p} \cdot \mathbf{n}) \sigma_{\mathbf{q}}(d\mathbf{q}) d\mathbf{p} - \int_{(\mathbf{q}, \mathbf{p}) \in \bar{\Omega} \times \mathbb{R}^N} f (\mathbf{p} \cdot \nabla_{\mathbf{q}} g) d\mathbf{q} d\mathbf{p},$$

where $\sigma_{\mathbf{q}}$ refers to the surface measure on $\partial \bar{\Omega}$ while \mathbf{n} denotes the outward normal vector to $\partial \bar{\Omega}$, yields

$$(\mathbf{L}^{\text{det}})^* = L^{*,f} + L^{*,\text{dr}} + L^{*,i},$$

where

$$L^{*,f} g(\mathbf{q}, \mathbf{p}) := -\mathbf{p} \cdot \nabla_{\mathbf{q}} g(\mathbf{q}, \mathbf{p}), \\ L^{*,\text{dr}} g(\mathbf{q}, \mathbf{p}) := \sum_{i=1}^N \left\{ [p_i]^+ \delta_{q_i=0} + [p_i]^- \delta_{q_i=1} \right\} (g(\mathbf{q}, \mathbf{p}_{-i}) - g(\mathbf{q}, \mathbf{p})), \\ L^{*,i} g(\mathbf{q}, \mathbf{p}) := \sum_{i=1}^{N-1} \left\{ [p_i - p_{i+1}]^+ \delta_{q_{i+1}-q_i=1-a} + [p_{i+1} - p_i]^+ \delta_{q_{i+1}-q_i=-(1-a)} \right\} \\ \times (g(\mathbf{q}, \mathbf{p}_{i \leftrightarrow i+1}) - g(\mathbf{q}, \mathbf{p})).$$

Note that $L^{*,f}$, $L^{*,\text{dr}}$ and $L^{*,i}$ are not the respective formal adjoints of L^f , L^{dr} and L^i since the boundary terms produced by the application of the Green formula to L^f have been included in $L^{*,\text{dr}}$ and $L^{*,i}$ rather than in $L^{*,f}$. Besides, since the evolution is Hamiltonian, there is no surprise in observing the reversibility identity

$$((\mathbf{L}^{\text{det}})^* g) \circ \mathcal{S} = \mathbf{L}^{\text{det}}(g \circ \mathcal{S}),$$

where \mathcal{S} is the velocity reversing operator defined on $\bar{\Omega} \times \mathbb{R}^N$ by

$$\mathcal{S}(\mathbf{q}, \mathbf{p}) = (\mathbf{q}, -\mathbf{p}).$$

2.2.2 Stationary distributions

A stationary distribution for the deterministic CEM is a probability distribution π_∞ on $\bar{\Omega} \times \mathbb{R}^N$ such that

$$(\mathbf{L}^{\text{det}})^* \pi_\infty = 0,$$

so that, if the initial configuration of the system is distributed according to π_∞ , then $(\mathbf{q}(t), \mathbf{p}(t))$ remains distributed according to π_∞ for all $t \geq 0$.

A large class of stationary distributions can be easily obtained from the expression of $(\mathbf{L}^{\text{det}})^*$ derived in Subsection 2.2.1. Indeed, let $\Psi : [0, +\infty)^N \rightarrow \mathbb{R}$ be a symmetric function, *i.e.* such that, for all permutation σ of $\{1, \dots, N\}$,

$$\forall (v_1, \dots, v_N) \in [0, +\infty)^N, \quad \Psi(v_{\sigma(1)}, \dots, v_{\sigma(N)}) = \Psi(v_1, \dots, v_N),$$

and such that

$$\Psi(v_1, \dots, v_N) \geq 0, \quad \int_{(v_1, \dots, v_N) \in \mathbb{R}^N} \Psi(v_1, \dots, v_N) dv_1 \cdots dv_N = 1.$$

Then, the probability distribution with density

$$\mathbb{1}_{\{\mathbf{q} \in \bar{\Omega}\}} \frac{1}{|\bar{\Omega}|} \Psi(|q_1|, \dots, |q_N|) \quad (2.2)$$

with respect to the Lebesgue measure on the phase space $\bar{\Omega} \times \mathbb{R}^N$ is stationary.

A particular case of such a stationary distribution, which we shall consider as physically relevant, is the Maxwell-Boltzmann distribution at temperature T , defined by

$$\pi_T^{\text{MB}}(d\mathbf{q}d\mathbf{p}) := \frac{1}{Z^N(a, T)} \mathbb{1}_{\{\mathbf{q} \in \bar{\Omega}\}} \exp\left(-\frac{1}{2T} \sum_{i=1}^N p_i^2\right) d\mathbf{q}d\mathbf{p},$$

where

$$Z^N(a, T) := V^N(a) (2\pi T)^{N/2}.$$

Let us however mention that there are many stationary distributions that are not of the form (2.2). As an example, for any $\mathbf{q} \in \bar{\Omega}$, the probability distribution $\delta_{(\mathbf{q}, 0)}$ concentrates on a state where all the molecules have a null initial velocity, and therefore will always remain in the same position. As a consequence, this probability distribution is certainly stationary.

2.3 The thermalised CEM

We now put the system in contact with reservoirs as is described in Subsection 2.1.3. Then, the process $(\mathbf{q}(t), \mathbf{p}(t))_{t \geq 0}$ becomes a (piecewise deterministic) Markov process, and its infinitesimal generator writes

$$\mathbf{L}^{\text{th}} = L^{\text{f}} + L^{\text{tr}} + L^{\text{i}},$$

where L^{f} and L^{i} are defined in Section 2.2, while L^{tr} describes the action of:

- the random reflections for the first and N -th molecules,
- the deterministic reflections for the other molecules,

and is given by

$$\begin{aligned}
L^{\text{tr}} f &= [p_1]^- \delta_{q_1=0} \left(\int_{v=0}^{+\infty} f(\mathbf{q}, (v, p_2, \dots, p_N)) \phi_L(v) dv - f(\mathbf{q}, \mathbf{p}) \right) \\
&+ [p_1]^+ \delta_{q_1=1} \left(\int_{v=0}^{+\infty} f(\mathbf{q}, (-v, p_2, \dots, p_N)) \phi_L(v) dv - f(\mathbf{q}, \mathbf{p}) \right) \\
&+ [p_N]^- \delta_{q_N=0} \left(\int_{v=0}^{+\infty} f(\mathbf{q}, (p_1, \dots, p_{N-1}, v)) \phi_R(v) dv - f(\mathbf{q}, \mathbf{p}) \right) \\
&+ [p_N]^+ \delta_{q_N=1} \left(\int_{v=0}^{+\infty} f(\mathbf{q}, (p_1, \dots, p_{N-1}, -v)) \phi_R(v) dv - f(\mathbf{q}, \mathbf{p}) \right) \\
&+ \sum_{i=2}^{N-1} \{ [p_i]^- \delta_{q_i=0} + [p_i]^+ \delta_{q_i=1} \} (f(\mathbf{q}, \mathbf{p}_{-i}) - f(\mathbf{q}, \mathbf{p})).
\end{aligned}$$

The formal adjoint of \mathbf{L}^{th} now writes

$$(\mathbf{L}^{\text{th}})^* = L^{*,\text{f}} + L^{*,\text{tr}} + L^{*,\text{i}},$$

where $L^{*,\text{f}}$ and $L^{*,\text{i}}$ are defined in Section 2.2, while

$$\begin{aligned}
L^{*,\text{tr}} g &= \mathbb{1}_{\{p_1 > 0\}} \delta_{q_1=0} \left(\phi_L(p_1) \int_{v=0}^{+\infty} v g(\mathbf{q}, (-v, p_2, \dots, p_N)) dv - p_1 g(\mathbf{q}, \mathbf{p}) \right) \\
&+ \mathbb{1}_{\{p_1 < 0\}} \delta_{q_1=1} \left(\phi_L(-p_1) \int_{v=0}^{+\infty} v g(\mathbf{q}, (v, p_2, \dots, p_N)) dv + p_1 g(\mathbf{q}, \mathbf{p}) \right) \\
&+ \mathbb{1}_{\{p_N > 0\}} \delta_{q_N=0} \left(\phi_R(p_N) \int_{v=0}^{+\infty} v g(\mathbf{q}, (p_1, \dots, p_{N-1}, -v)) dv - p_N g(\mathbf{q}, \mathbf{p}) \right) \\
&+ \mathbb{1}_{\{p_N < 0\}} \delta_{q_N=1} \left(\phi_R(-p_N) \int_{v=0}^{+\infty} v g(\mathbf{q}, (p_1, \dots, p_{N-1}, v)) dv + p_N g(\mathbf{q}, \mathbf{p}) \right) \\
&+ \sum_{i=2}^{N-1} \{ [p_i]^+ \delta_{q_i=0} + [p_i]^- \delta_{q_i=1} \} (g(\mathbf{q}, \mathbf{p}_{-i}) - g(\mathbf{q}, \mathbf{p})).
\end{aligned}$$

2.3.1 Equilibrium and nonequilibrium steady states

If $T_L = T_R =: T$, then the Maxwell-Boltzmann distribution π_T^{MB} satisfies $(\mathbf{L}^{\text{th}})^* \pi_T^{\text{MB}} = 0$, therefore it remains a stationary distribution for the system. This distribution shall be referred to as the *equilibrium steady state* of the model at temperature T .

Out of equilibrium, that is to say when $T_L \neq T_R$, the existence and uniqueness of stationary distributions for the model is a nontrivial issue, see Chapter 3 for partial results in the case $N = 2$. In the present chapter, we shall work under the following assumption.

Assumption 1 (Nonequilibrium ergodicity). For all $T_L > 0$ and $T_R > 0$, there exists a unique stationary distribution π^{NESS} such that, for $d\mathbf{q}d\mathbf{p}$ -almost all initial configuration $(\mathbf{p}^0, \mathbf{q}^0)$, for all function $f : \bar{\Omega} \times \mathbb{R}^N$ integrable with respect to π^{NESS} , then

$$\lim_{t \rightarrow +\infty} \frac{1}{t} \int_{s=0}^t f(\mathbf{q}(s), \mathbf{p}(s)) ds = \int_{(\mathbf{q}, \mathbf{p}) \in \bar{\Omega} \times \mathbb{R}^N} f(\mathbf{q}, \mathbf{p}) \pi^{\text{NESS}}(d\mathbf{q}d\mathbf{p}), \quad \mathbb{P}_{(\mathbf{p}^0, \mathbf{q}^0)\text{-a.s.}}, \quad (2.3)$$

where $\mathbb{P}_{(\mathbf{p}^0, \mathbf{q}^0)}$ refers to the law of the process $(\mathbf{q}(t), \mathbf{p}(t))_{t \geq 0}$ with initial configuration $(\mathbf{p}^0, \mathbf{q}^0)$.

The probability distribution π^{NESS} shall be referred to as the *nonequilibrium steady state* of the model. For the sake of brevity, both sides of (2.3) shall simply be denoted by $\langle f \rangle$.

2.3.2 Equilibrium frequency of collisions

Let us first assume that $T_L = T_R =: T$. Since energy transfer between the i -th and $(i+1)$ -th molecules only occurs when $|q_i - q_{i+1}| = 1 - a$, which we shall refer to as a *collision* between the molecules, then in order to study thermal properties of the model, it is useful to compute the frequency of such collisions, that is to say, the average number of collisions by time unit.

Let us fix $i \in \{1, \dots, N-1\}$, and denote by $(t_n^\pm)_{n \geq 1}$ the sequence of successive instants at which $q_{i+1}(t) - q_i(t) = \pm(1-a)$. On account of the computations detailed in Appendix 2.A, the frequency of collisions between the i -th and $(i+1)$ -th molecules on a trajectory writes

$$\lim_{t \rightarrow +\infty} \frac{1}{t} \int_{s=0}^t \sum_{n=1}^{+\infty} (\delta_{t_n^+}(ds) + \delta_{t_n^-}(ds)) = \lim_{t \rightarrow +\infty} \frac{1}{t} \int_{s=0}^t ([p_{i+1}(s^-) - p_i(s^-)]^+ \delta_{q_{i+1}(s) - q_i(s) = 1-a}(ds) + [p_i(s^-) - p_{i+1}(s^-)]^+ \delta_{q_{i+1}(s) - q_i(s) = -(1-a)}(ds)).$$

Under Assumption 1, we obtain that the frequency of collisions $\nu_{i,i+1}^N(a, T)$ at temperature T between the i -th and $(i+1)$ -th molecules rewrites

$$\nu_{i,i+1}^N(a, T) = \frac{1}{Z^N(a, T)} \int_{(\mathbf{q}, \mathbf{p}) \in \bar{\Omega} \times \mathbb{R}^N} \exp\left(-\frac{1}{2T} \sum_{j=1}^N p_j^2\right) \times ([p_{i+1} - p_i]^+ \delta_{q_{i+1} - q_i = 1-a}(\mathbf{d}\mathbf{q}\mathbf{d}\mathbf{p}) + [p_i - p_{i+1}]^+ \delta_{q_{i+1} - q_i = -(1-a)}(\mathbf{d}\mathbf{q}\mathbf{d}\mathbf{p})),$$

which yields

$$\nu_{i,i+1}^N(a, T) = C_{i,i+1}^N(a) \sqrt{\frac{T}{\pi}}, \quad (2.4)$$

where $C_{i,i+1}^N(a)$ does not depend on T . The derivation of (2.4) is detailed in Subsection 2.B.2 of Appendix 2.B.

In the case $N = 2$, the constant $C_{1,2}^2(a)$ is explicit and worth

$$C_{1,2}^2(a) = \frac{2a}{1-a^2},$$

which is confirmed by numerical simulations for a two-molecule system as is shown on Figure 2.2.

For a large number of molecules and in the regime of weak and moderate interactions, numerical integration shows that:

- apart from side effects, the function $i \mapsto C_{i,i+1}^N(a)$ is flat, see the left-hand of Figure 2.3,
- its median value $C_{\lfloor N/2 \rfloor, \lfloor N/2 \rfloor + 1}^N(a)$ converges to some value $C(a)$ when N grows to infinity.

The shape of the function $a \rightarrow C(a)/\sqrt{\pi}$ is plotted on right-hand of Figure 2.3; it describes the frequency of collisions between two neighbouring molecules for a large chain of molecules. Of course, this function is increasing as the larger the interaction parameter is, the more often molecules collide.

2.3.3 Energy and current

On account of the shape of the Hamiltonian H^N , there is no potential energy in the system. Therefore, the energy of the i -th molecule at time $t \geq 0$ is nothing but its kinetic energy

$$E_i^N(t) := \frac{1}{2} p_i(t)^2.$$

The time-integrated current of energy $J_{i,i+1}^N([0, t])$ between the i -th and $(i+1)$ -th molecules must be such that

$$E_i^N(t) - E_i^N(0) = J_{i-1,i}^N([0, t]) - J_{i,i+1}^N([0, t]), \quad (2.5)$$

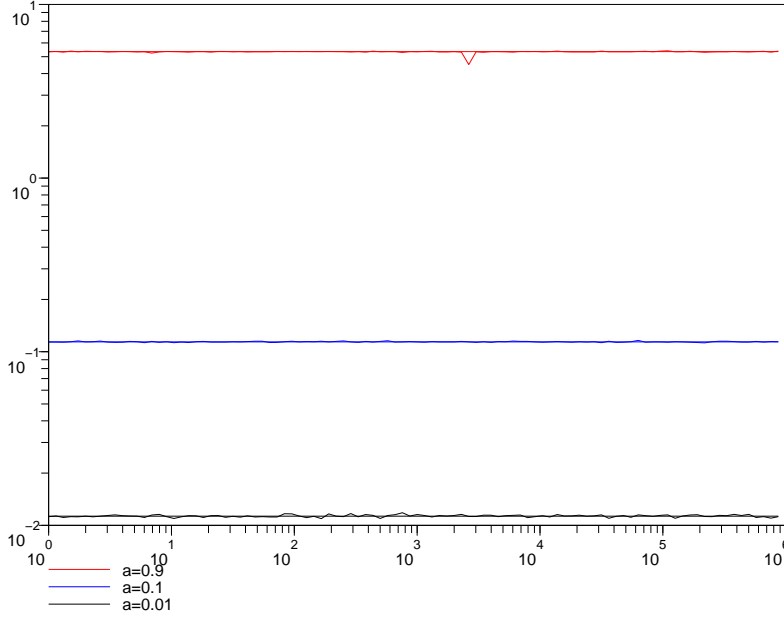

Figure 2.2: Frequency of collisions for a two-molecule system: for three values of a , namely $a = 0.01$ (weak interactions), $a = 0.1$ (moderate interactions) and $a = 0.9$ (strong interactions), the experimentally observed ratio $\nu_{1,2}^2(a, T)/\sqrt{T}$ is plotted for T ranging from 1 to 10^6 . The theoretically expected value $2a/(\sqrt{\pi}(1-a^2))$ of this ratio is superposed to the experimental results.

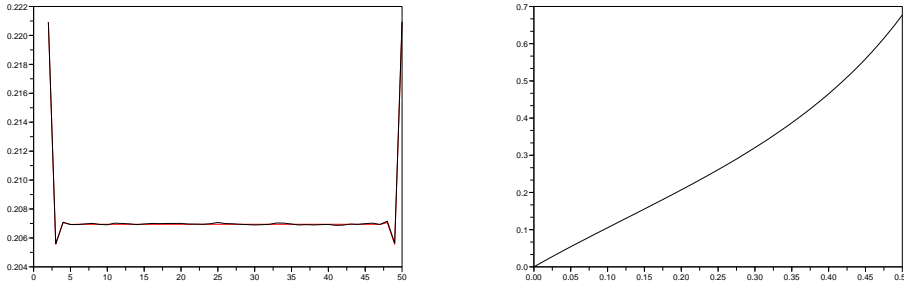

Figure 2.3: Left-hand figure: for a chain of $N = 50$ molecules and a moderate interaction parameter $a = 0.2$, the theoretical values of $C_{i,i+1}^N(a)/\sqrt{\pi}$ along the chain is plotted in red. The superposed black graph corresponds to experimental observations of the ratio $\nu_{i,i+1}^N(a, T)/\sqrt{T}$ at a fixed temperature $T = 1$. Right-hand figure: theoretical value of $C(a)/\sqrt{\pi}$ for a ranging from 0 to $1/2$. For small values of the interaction parameter, $C(a)$ exhibits a linear growth with respect to a .

where $J_{0,1}^N([0, t])$ denotes the time-integrated current of energy from the left-hand reservoir to the first molecule, and $-J_{N,N+1}^N([0, t])$ denotes the time-integrated current of energy from the right-hand reservoir to the N -th molecule. Therefore, we define, for all $i \in \{1, \dots, N-1\}$,

$$J_{i,i+1}^N([0, t]) := \frac{1}{2} \sum_{t_n^{i,i+1} \leq t} p_{i+1}(t_n^{i,i+1})^2 - p_i(t_n^{i,i+1})^2,$$

where $(t_n^{i,i+1})_{n \geq 1}$ refers to the sequence of successive instants at which $|q_{i+1}(t) - q_i(t)| = 1 - a$; and

$$J_{0,1}^N([0, t]) := \frac{1}{2} \sum_{t_n^{0,1} \leq t} (v_n^L)^2 - p_1((t_n^{0,1})^-)^2,$$

where $(t_n^{0,1})_{n \geq 1}$ refers to the sequence of successive instants at which $q_1(t) \in \{0, 1\}$, v_n^L is the velocity randomly drawn at the instant $t_n^{0,1}$ and $p_1((t_n^{0,1})^-)$ is the velocity of the first molecule immediately before the update; finally, $J_{N,N+1}^N([0, t])$ is defined similarly.

2.3.4 Steady state quantities

Let us recall that, under Assumption (1), the kinetic temperature T is usually defined by the formula

$$\langle E \rangle = \frac{d}{2} k_B T,$$

where d is the number of degrees of freedom for each molecule and k_B is the Boltzmann constant. Here, the point molecules move in a one-dimensional cell, therefore $d = 1$, and the Boltzmann constant is set to 1. As a consequence, the steady state temperature of the i -th molecule is defined by

$$T_i^N := 2\langle E_i^N \rangle = \langle p_i^2 \rangle.$$

Note that, under the equilibrium steady state π_T^{MB} , the steady state temperature of each molecule effectively coincides with T .

Let us now define the steady state energy current $j_{i,i+1}^N$ by

$$j_{i,i+1}^N := \lim_{t \rightarrow +\infty} \frac{1}{t} J_{i,i+1}^N([0, t]). \quad (2.6)$$

Owing to (2.5), the gradient of the current is the time derivative of the energy. In the steady state, this time derivative vanishes, so that $j_{i,i+1}^N$ does not depend on i and we shall refer to its value as j^N .

2.3.5 Influence of the interaction parameter a

For a finite system of N molecules and $a > 0$, there is always an exchange of energy between the reservoirs in the steady state, and therefore we cannot expect the steady state temperatures T_1^N and T_N^N to be equal to the temperatures T_L and T_R of the reservoirs.

This fact is illustrated on the left-hand of Figure 2.4, where the steady state temperatures for a two-molecule system are experimentally computed while a ranges from 0 to 1. As is expected, in the noninteracting case $a = 0$, the molecules are thermalised by their respective reservoirs; while for $a > 0$, the steady state temperatures of the molecules tend to equilibrate. The value $a = 1/2$ seems to have a peculiar role as for strong interactions, both molecules seem to have the same steady state temperature. Quite surprisingly, this common steady state temperature exhibits an oscillatory behaviour for $a > 1/2$. This fact, that we are not able to explain, is also observed on the experimental value of the current j^2 , which is plotted on the right-hand of Figure 2.4.

In the sequel of the chapter, we shall describe the temperature profile for systems with a large but finite number N of molecules. In order to keep the temperatures T_1^N and T_N^N close to the temperature of the reservoirs, it will therefore be necessary to work in the weak interaction regime.

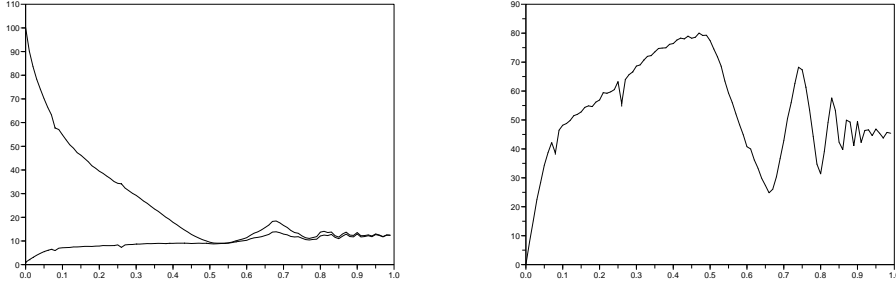

Figure 2.4: Left-hand: experimental values of $\langle p_1^2 \rangle$ and $\langle p_2^2 \rangle$ for $T_L = 100$, $T_R = 1$ and a ranging from 0 to 1. When a grows to $1/2$ (moderate interactions), the steady state temperatures of both molecules equilibrate. For $a \geq 1/2$ (strong interactions), the common temperature of the molecules exhibits an unexpected oscillatory behaviour. Right-hand: experimental value of the current j^2 for $T_L = 100$, $T_R = 1$ and a ranging from 0 to 1. In the moderate interaction regime, the intensity of the current increases. In the strong interaction regime, the same oscillatory behaviour as for the temperatures is observed.

2.3.6 Fourier law and temperature profile

We now address the energy current j^N for large values of N . Arguing as in the computation of the frequency of collisions in Subsection 2.3.2, we write

$$\begin{aligned} J_{i,i+1}^N([0, t]) &= \frac{1}{2} \int_{s=0}^t (p_{i+1}^2(s) - p_i^2(s)) \sum_{n=1}^{+\infty} (\delta_{t_n^+}(ds) + \delta_{t_n^-}(ds)) \\ &= \frac{1}{2} \int_{s=0}^t (p_i^2(s^-) - p_{i+1}^2(s^-)) \\ &\quad \times ([p_{i+1}(s^-) - p_i(s^-)]^+ \delta_{q_{i+1}(s) - q_i(s) = 1-a}(ds) + [p_i(s^-) - p_{i+1}(s^-)]^+ \delta_{q_{i+1}(s) - q_i(s) = -(1-a)}(ds)) \end{aligned}$$

so that

$$\begin{aligned} j_{i,i+1}^N &= \frac{1}{2} \int_{(\mathbf{q}, \mathbf{p}) \in \bar{\Omega} \times \mathbb{R}^N} (p_i^2 - p_{i+1}^2) \pi^{\text{NESS}}(d\mathbf{p}d\mathbf{p}) \\ &\quad \times ([p_{i+1} - p_i]^+ \delta_{q_{i+1} - q_i = 1-a} + [p_i - p_{i+1}]^+ \delta_{q_{i+1} - q_i = -(1-a)}). \end{aligned} \quad (2.7)$$

Of course, the expression of π^{NESS} is unknown. We therefore have to perform an approximation of the nonequilibrium steady state. This is the purpose of the following *local thermal equilibrium* assumption (see [71]).

Assumption 2 (Local equilibrium). We assume that, for large values of N , for all $i \in \{1, \dots, N-1\}$, under the nonequilibrium steady state,

- the positions are uniformly distributed in $\bar{\Omega}$, independently of the velocities,
- the marginal distribution of (p_i, p_{i+1}) is the product measure

$$\frac{1}{2\pi \sqrt{T_i^N T_{i+1}^N}} \exp\left(-\frac{p_i^2}{2T_i^N} - \frac{p_{i+1}^2}{2T_{i+1}^N}\right).$$

Note that Assumption 2 is very rough: in particular, it does not take the correlation between molecules i and $i+1$ into account; besides, it postulates a Gaussian distribution for the steady state velocity of the molecules.

Then, the right-hand side of (2.7) can be computed and rewrites

$$j_{i,i+1}^N = -\frac{C_{i,i+1}^N(a)}{\sqrt{\pi}} \sqrt{\frac{T_i^N + T_{i+1}^N}{2}} (T_{i+1}^N - T_i^N) = -\nu_{i,i+1}^N \left(a, \frac{T_i^N + T_{i+1}^N}{2}\right) (T_{i+1}^N - T_i^N), \quad (2.8)$$

where $\nu_{i,i+1}^N(a, T)$ is the frequency of collisions computed in Subsection 2.3.2. The derivation of (2.8) is explicated in Subsection 2.B.3 of Appendix 2.B.

Let us highlight the fact that (2.8) is the microscopic expression of the Fourier law, as it relates the energy current with the discrete gradient of the temperature. The *thermal conductivity* is given by the frequency of collisions, which is natural since collisions are the only mechanism of energy transfer.

Let us now derive a macroscopic temperature profile. To this aim, we define the distribution \mathcal{T}_N on $[0, 1]$ by

$$\mathcal{T}_N := \frac{1}{N} \sum_{i=1}^N T_i \delta_{i/N},$$

and we denote by $\mathcal{T} : [0, 1] \rightarrow [0, +\infty)$ the limit of \mathcal{T}_N when N grows to infinity. On the other hand, we define

$$\mathcal{J} := \lim_{N \rightarrow +\infty} j^N,$$

where we recall that the value j^N of $j_{i,i+1}^N$ does actually not depend on $i \in \{1, \dots, N-1\}$, see Subsection 2.3.4. Then, by (2.8), \mathcal{T} and \mathcal{J} are expected to satisfy the macroscopic Fourier law

$$\mathcal{J} = -\nu(a, \mathcal{T}) \partial_x \mathcal{T},$$

where the macroscopic conductivity is given by the frequency of collisions

$$\nu(a, T) = C(a) \sqrt{\frac{T}{\pi}},$$

and the function $a \mapsto C(a)/\sqrt{\pi}$ is plotted on the left-hand of Figure 2.3. The boundary conditions are given by the reservoirs and write

$$\mathcal{T}(0) = T_L, \quad \mathcal{T}(1) = T_R.$$

The macroscopic Fourier law can be integrated and yields the macroscopic temperature profile

$$\forall x \in [0, 1], \quad \mathcal{T}(x) = \left((1-x)T_L^{3/2} + xT_R^{3/2} \right)^{2/3}, \quad (2.9)$$

as well as the value of the macroscopic current

$$\mathcal{J} = \frac{2C(a)}{3\sqrt{\pi}} \left(T_L^{3/2} - T_R^{3/2} \right).$$

Let us point out the fact that the theoretical temperature profile does not depend on the interaction parameter a . Both the theoretical shape (2.9) and the experimental observation of the temperature profile in the weak interaction regime are plotted on Figure 2.5. We observe that the experimental profile does not match theoretical expectations and is rather linear. This fact is discussed in the conclusive Section 2.4 below.

2.4 Conclusions

Under Assumptions 1 and 2, we derived a nonlinear macroscopic temperature profile (2.9), which was already obtained in similar contexts by Dhar [49], Eckmann and Young [54], Gilbert and Lefevre [71] and Gaspard and Gilbert [70, 69], and does not depend on the physical characteristics of the material.

Numerical simulations however show that, at least in the weak interaction regime, the temperature profile is linear. Such a linear profile was also observed by Prosen and Campbell [119] and especially Ryals and Young [124] for a similar model. There, it was noted that the Gaussian shape of the marginal distributions of the velocities under local thermal equilibrium formulated in Assumption 2 is not correct. As a conclusion, we claim that this local thermal equilibrium assumption does not actually capture the correct behaviour of the material, and therefore should be refined.

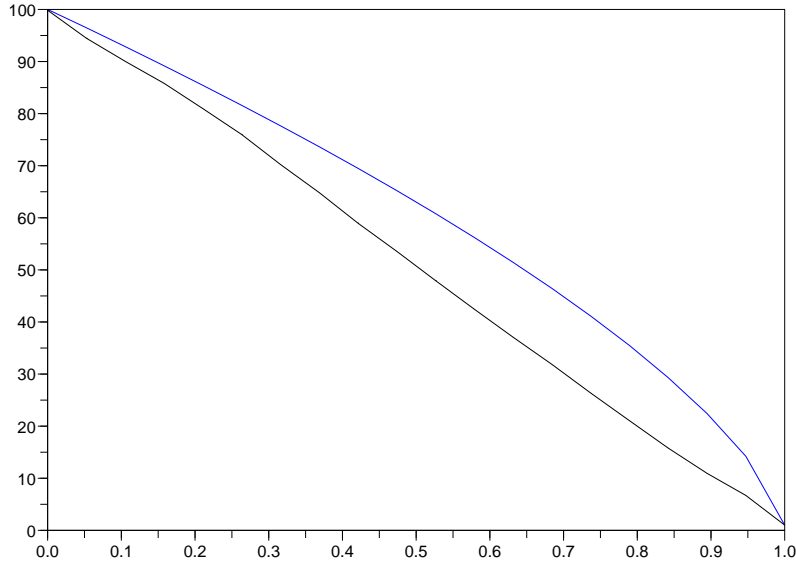

Figure 2.5: Experimental profile of \mathcal{T} for $N = 20$ molecules, in the weak interaction regime $a = 0.001$. The theoretical profile (2.9) is plotted in blue. The experimentally observed profile is plotted in black and is linear.

2.A Derivation of the expression of L^f , L^{dr} and L^i

2.A.1 Derivation of the expression of L^f and L^{dr}

To derive the expressions of L^f and L^{dr} used in Subsection 2.2.1, it is sufficient to consider a single molecule evolving in the one-dimensional cell $[0, 1]$ with ballistic motion in the bulk and specular reflection at the boundaries. Let us denote by $(q(t), p(t))$ the coordinates of the molecule at time $t \geq 0$, and assume for instance that

$$q(0) = q_0 \in (0, 1), \quad p(0) = p_0 > 0.$$

Then, for all $t \geq 0$,

$$\begin{aligned} q(t) &= q_0 + tp_0, & p(t) &= p_0, & \text{if } t < t_0^{\leftarrow}, \\ q(t) &= 1 - (t - t_{n-1}^{\leftarrow})p_0, & p(t) &= -p_0, & \text{if } t_{n-1}^{\leftarrow} \leq t < t_n^{\leftarrow}, \\ q(t) &= (t - t_n^{\leftarrow})p_0, & p(t) &= p_0, & \text{if } t_n^{\leftarrow} \leq t \leq t_n^{\rightarrow}, \end{aligned}$$

where we define $t_0^{\leftarrow} := (1 - q_0)/p_0$ and, for all $n \geq 1$,

$$t_n^{\leftarrow} := t_{n-1}^{\leftarrow} + 1/p_0, \quad t_n^{\rightarrow} := t_n^{\leftarrow} + 1/p_0.$$

In the sense of distributions on $[0, +\infty)$, we easily obtain, for $f : [0, 1] \times \mathbb{R} \rightarrow \mathbb{R}$,

$$\begin{aligned} \frac{d}{dt}f(q(t), p(t)) &= p(t)\partial_q f(q(t), p(t)) \\ &+ \sum_{n=1}^{+\infty} \left\{ (f(1, -p_0) - f(1, p_0)) \delta_{t_{n-1}^+} + (f(0, p_0) - f(0, -p_0)) \delta_{t_n^-} \right\} \\ &= p(t)\partial_q f(q(t), p(t)) + \sum_{n=1}^{+\infty} \left\{ \delta_{t_{n-1}^+} + \delta_{t_n^-} \right\} (f(q(t), -p(t^-)) - f(q(t), p(t^-))). \end{aligned} \quad (2.10)$$

As soon as $\partial_q f \in L^1_{\text{loc}}([0, 1] \times \mathbb{R})$, there is no difficulty in interpreting the term $p(t)\partial_q f(q(t), p(t))$, which is a distribution on $[0, +\infty)$, as the *pullback* (or composition) of

$$L^f f(q, p) := p\partial_q f(q, p),$$

which is a distribution on $[0, 1] \times \mathbb{R}$, along the function $t \mapsto (q(t), p(t))$.

We can similarly interpret the second term in the right-hand side of (2.10) as the pullback of the distribution

$$L^{\text{dr}} f := \{[p]^- \delta_{q=0} + [p]^+ \delta_{q=1}\} (f(q, -p) - f(q, p))$$

on $[0, 1] \times \mathbb{R}$ along the function $t \mapsto (q(t), p(t^-))$. Indeed, a (nonrigorous) application of the composition formula for distributions (see e.g. [73, Exemple 4.3.4]) allows us to define the pullback of the distribution $\delta_{q=0}$ on $[0, 1] \times \mathbb{R}$ along $t \mapsto (q(t), p(t^-))$ as

$$\delta_{q(t)=0} := p_0^{-1} \sum_{n=1}^{+\infty} \delta_{t_n^+} = ([p(t^-)]^-)^{-1} \sum_{n=1}^{+\infty} \delta_{t_n^+},$$

and the pullback of the distribution $\delta_{q=1}$ on $[0, 1] \times \mathbb{R}$ along $t \mapsto (q(t), p(t^-))$ as

$$\delta_{q(t)=1} := p_0^{-1} \sum_{n=1}^{+\infty} \delta_{t_{n-1}^+} = ([p(t^-)]^+)^{-1} \sum_{n=1}^{+\infty} \delta_{t_{n-1}^+}.$$

We deduce that

$$\sum_{n=1}^{+\infty} \delta_{t_n^+} = [p(t^-)]^- \delta_{q(t)=0} \quad \text{and} \quad \sum_{n=1}^{+\infty} \delta_{t_{n-1}^+} = [p(t^-)]^+ \delta_{q(t)=1},$$

which provides the expected expression for $L^{\text{dr}} f$.

2.A.2 Derivation of the expression of L^i

The expression of L^i is obtained by similar arguments for a two molecule system. In this case, let us denote by $(t_n^\pm)_{n \geq 1}$ the sequence of successive instants at which $q_2(t) - q_1(t) = \pm(1 - a)$. Then, the pullback $\delta_{q_2(t) - q_1(t) = 1 - a}$ of the distribution $\delta_{q_2 - q_1 = 1 - a}$ on $[0, 1]^2 \times \mathbb{R}^2$ along $(q_1(t), q_2(t), p_1(t^-), p_2(t^-))_{t \geq 0}$ satisfies

$$\sum_{n=1}^{+\infty} \delta_{t_n^+} = [p_2(t^-) - p_1(t^-)]^+ \delta_{q_2(t) - q_1(t) = 1 - a};$$

similarly, the pullback $\delta_{q_2(t) - q_1(t) = -(1 - a)}$ of the distribution $\delta_{q_2 - q_1 = -(1 - a)}$ on $[0, 1]^2 \times \mathbb{R}^2$ along $(q_1(t), q_2(t), p_1(t^-), p_2(t^-))_{t \geq 0}$ satisfies

$$\sum_{n=1}^{+\infty} \delta_{t_n^-} = [p_1(t^-) - p_2(t^-)]^+ \delta_{q_2(t) - q_1(t) = -(1 - a)}.$$

2.B Computation of pairwise marginal statistics

2.B.1 Generical computation of pairwise marginal statistics

In this subsection, we explain how to compute expressions of the form

$$\frac{1}{V^N(a)} \int_{\mathbf{q} \in \bar{\Omega}} f(q_i, q_{i+1}) d\mathbf{q},$$

for $i \in \{1, \dots, N-1\}$. To this aim, it is useful to define the sequence of auxiliary functions g_n on $[0, 1]$ by the recursive relation

$$g_0 \equiv 1, \quad g_{n+1}(q) = \int_{q'=0}^1 \mathbb{1}_{\{|q-q'| \leq 1-a\}} g_n(q') dq'.$$

Indeed, for all $n \geq 1$, $g_n(q)$ rewrites

$$g_n(q) = \int_{q_1, \dots, q_n \in [0,1]} \mathbb{1}_{\{|q-q_n| \leq 1-a, |q_n-q_{n-1}| \leq 1-a, \dots, |q_2-q_1| \leq 1-a\}} dq_1 \cdots dq_n,$$

therefore

$$V^N(a) = \int_{q=0}^1 g_{N-1}(q) dq$$

on the one hand, while

$$\int_{\mathbf{q} \in \bar{\Omega}} f(q_i, q_{i+1}) d\mathbf{q} = \int_{(q_i, q_{i+1}) \in [0,1]^2} \mathbb{1}_{\{|q_i-q_{i+1}| \leq 1-a\}} f(q_i, q_{i+1}) g_{i-1}(q_i) g_{N-i-1}(q_{i+1}) dq_i dq_{i+1}$$

on the other hand.

Remarking that

$$\begin{aligned} \forall q \in [0, a], & \quad \mathbb{1}_{\{|q-q'| \leq 1-a\}} = \mathbb{1}_{\{q' \leq q+1-a\}}, \\ \forall q \in [a, 1-a], & \quad \mathbb{1}_{\{|q-q'| \leq 1-a\}} = 1, \\ \forall q \in [1-a, 1], & \quad \mathbb{1}_{\{|q-q'| \leq 1-a\}} = \mathbb{1}_{\{q' \geq q-1+a\}}, \end{aligned}$$

we easily deduce from the construction of g_n that there exists a sequence of polynomials $P_n(a, q)$ such that, for all $n \geq 0$,

$$g_n(q) = \begin{cases} P_n(a, q) & \text{if } q \in [0, a], \\ P_n(a, a) & \text{if } q \in [a, 1-a], \\ P_n(a, 1-q) & \text{if } q \in [1-a, 1]. \end{cases}$$

Besides, the sequence $P_n(a, q)$ satisfies the recursive relation, for all $a \in [0, 1/2]$, for all $q \in [0, a]$,

$$\begin{aligned} P_0(a, q) & \equiv 1, \\ P_{n+1}(a, q) & = \int_{q'=0}^a P_n(a, q') dq' + (1-2a)P_n(a, a) + \int_{q'=1-a}^{q+1-a} P_n(a, 1-q') dq'. \end{aligned}$$

Although we did not find an explicit expression for the polynomials $P_n(a, q)$, the recursive relation can be implemented and therefore numerical integration can yield exact values for the coefficients of the polynomials, for all $n \geq 0$.

2.B.2 Computation of the frequency of collisions

Let us now apply the results of Subsection 2.B.1 above to derive the value of the frequency of collisions $\nu_{i,i+1}^N(a, T)$ stated in (2.4).

Let us first recall that

$$\begin{aligned} \nu_{i,i+1}^N(a, T) &= \frac{1}{Z^N(a, T)} \int_{(\mathbf{q}, \mathbf{p}) \in \bar{\Omega} \times \mathbb{R}^N} \exp\left(-\frac{1}{2T} \sum_{j=1}^N p_j^2\right) [p_{i+1} - p_i]^+ \delta_{q_{i+1}-q_i=1-a}(\mathbf{d}\mathbf{q}\mathbf{d}\mathbf{p}) \\ &\quad + \frac{1}{Z^N(a, T)} \int_{(\mathbf{q}, \mathbf{p}) \in \bar{\Omega} \times \mathbb{R}^N} \exp\left(-\frac{1}{2T} \sum_{j=1}^N p_j^2\right) [p_i - p_{i+1}]^+ \delta_{q_{i+1}-q_i=-(1-a)}(\mathbf{d}\mathbf{q}\mathbf{d}\mathbf{p}), \end{aligned}$$

and

$$\begin{aligned} &\frac{1}{Z^N(a, T)} \int_{(\mathbf{q}, \mathbf{p}) \in \bar{\Omega} \times \mathbb{R}^N} \exp\left(-\frac{1}{2T} \sum_{j=1}^N p_j^2\right) [p_{i+1} - p_i]^+ \delta_{q_{i+1}-q_i=1-a}(\mathbf{d}\mathbf{q}\mathbf{d}\mathbf{p}) \\ &= \frac{1}{2\pi T} \int_{(p_i, p_{i+1}) \in \mathbb{R}^2} \exp\left(-\frac{1}{2T}(p_i^2 + p_{i+1}^2)\right) [p_{i+1} - p_i]^+ dp_i dp_{i+1} \\ &\quad \times \frac{1}{V^N(a)} \int_{\mathbf{q} \in \bar{\Omega}} \delta_{q_{i+1}-q_i=1-a}(\mathbf{d}\mathbf{q}); \end{aligned}$$

similarly,

$$\begin{aligned} &\frac{1}{Z^N(a, T)} \int_{(\mathbf{q}, \mathbf{p}) \in \bar{\Omega} \times \mathbb{R}^N} \exp\left(-\frac{1}{2T} \sum_{j=1}^N p_j^2\right) [p_i - p_{i+1}]^+ \delta_{q_{i+1}-q_i=-(1-a)}(\mathbf{d}\mathbf{q}\mathbf{d}\mathbf{p}) \\ &= \frac{1}{2\pi T} \int_{(p_i, p_{i+1}) \in \mathbb{R}^2} \exp\left(-\frac{1}{2T}(p_i^2 + p_{i+1}^2)\right) [p_i - p_{i+1}]^+ dp_i dp_{i+1} \\ &\quad \times \frac{1}{V^N(a)} \int_{\mathbf{q} \in \bar{\Omega}} \delta_{q_{i+1}-q_i=-(1-a)}(\mathbf{d}\mathbf{q}). \end{aligned}$$

On the one hand,

$$\frac{1}{2\pi T} \int_{(p_i, p_{i+1}) \in \mathbb{R}^2} \exp\left(-\frac{1}{2T}(p_i^2 + p_{i+1}^2)\right) [p_{i+1} - p_i]^+ dp_i dp_{i+1} = \sqrt{\frac{T}{\pi}};$$

while, on the other hand, Subsection 2.B.1 yields

$$\begin{aligned} \frac{1}{V^N(a)} \int_{\mathbf{q} \in \bar{\Omega}} \delta_{q_{i+1}-q_i=1-a}(\mathbf{d}\mathbf{q}) &= \frac{1}{V^N(a)} \int_{q=0}^a g_{i-1}(q) g_{N-i-1}(q+1-a) dq \\ &= \frac{1}{V^N(a)} \int_{q=0}^a P_{i-1}(a, q) P_{N-i-1}(a, a-q) dq, \\ \frac{1}{V^N(a)} \int_{\mathbf{q} \in \bar{\Omega}} \delta_{q_{i+1}-q_i=-(1-a)}(\mathbf{d}\mathbf{q}) &= \frac{1}{V^N(a)} \int_{q=1-a}^1 g_{i-1}(q) g_{N-i-1}(q-(1-a)) dq \\ &= \frac{1}{V^N(a)} \int_{q=0}^a P_{i-1}(a, q) P_{N-i-1}(a, a-q) dq, \end{aligned}$$

and

$$V^N(a) = \int_{q=0}^1 g_{N-1}(q) dq = 2 \int_{q=0}^a P_{N-1}(a, q) dq + (1-2a) P_{N-1}(a, a).$$

As a conclusion, $\nu_{i,i+1}^N(a, T) = C_{i,i+1}^N(a) \sqrt{T/\pi}$, where $C_{i,i+1}^N(a)$ writes

$$C_{i,i+1}^N(a) = \frac{2 \int_{q=0}^a P_{i-1}(a, q) P_{N-i-1}(a, a-q) dq}{2 \int_{q=0}^a P_{N-1}(a, q) dq + (1-2a) P_{N-1}(a, a)}, \quad (2.11)$$

and can be computed by numerical integration for all values of $a \in [0, 1/2]$ and $N \geq 2$.

2.B.3 Computation of the current

Under Assumptions 1 and 2, the current $j_{i,i+1}^N$ writes

$$j_{i,i+1}^N = \frac{1}{2V^N(a)} \cdot \frac{1}{2\pi\sqrt{T_i^N T_{i+1}^N}} \int_{(p_i, p_{i+1}) \in \mathbb{R}^2} \exp\left(-\frac{p_i^2}{2T_i^N} - \frac{p_{i+1}^2}{2T_{i+1}^N}\right) dp_i dp_{i+1} (p_i^2 - p_{i+1}^2) \\ \times \int_{\mathbf{q} \in \Omega} ([p_{i+1} - p_i]^+ \delta_{q_{i+1}-q_i=1-a}(\mathbf{dq}) + [p_i - p_{i+1}]^+ \delta_{q_{i+1}-q_i=-(1-a)}(\mathbf{dq})),$$

see (2.7). Let us first compute

$$\frac{1}{2\pi\sqrt{T_i^N T_{i+1}^N}} \int_{(p_i, p_{i+1}) \in \mathbb{R}^2} (p_i^2 - p_{i+1}^2) [p_{i+1} - p_i]^+ \exp\left(-\frac{p_i^2}{2T_i^N} - \frac{p_{i+1}^2}{2T_{i+1}^N}\right) dp_i dp_{i+1} \\ = \frac{1}{2\pi} \left(-(T_i^N)^{3/2} I_{3,0} + T_i^N (T_{i+1}^N)^{1/2} I_{2,1} + (T_i^N)^{1/2} T_{i+1}^N I_{1,2} - (T_{i+1}^N)^{3/2} I_{0,3} \right),$$

where

$$I_{i,j} := \int_{u \in \mathbb{R}} \int_{v = \alpha u}^{+\infty} u^i v^j \exp\left(-\frac{u^2 + v^2}{2}\right) dv du, \quad \alpha := \sqrt{\frac{T_i^N}{T_{i+1}^N}}.$$

Direct integration yields

$$I_{3,0} = -\sqrt{\frac{2\pi}{1 + \alpha^{-2}}} \left(2 + \frac{1}{1 + \alpha^2}\right) = -\sqrt{2\pi} \frac{(T_i^N)^{1/2}}{(2T_{i,i+1}^N)^{1/2}} \left(2 + \frac{T_i^N}{2T_{i,i+1}^N}\right), \\ I_{2,1} = \frac{\sqrt{2\pi}}{(1 + \alpha^2)^{3/2}} = \sqrt{2\pi} \frac{(T_{i+1}^N)^{3/2}}{(2T_{i,i+1}^N)^{3/2}}, \\ I_{1,2} = -\frac{\sqrt{2\pi}}{(1 + \alpha^{-2})^{3/2}} = -\sqrt{2\pi} \frac{(T_i^N)^{3/2}}{(2T_{i,i+1}^N)^{3/2}}, \\ I_{0,3} = \sqrt{\frac{2\pi}{1 + \alpha^2}} \left(2 + \frac{\alpha^2}{1 + \alpha^2}\right) = \sqrt{2\pi} \frac{(T_{i+1}^N)^{1/2}}{(2T_{i,i+1}^N)^{1/2}} \left(2 + \frac{T_i^N}{2T_{i,i+1}^N}\right),$$

where we have defined

$$T_{i,i+1}^N := \frac{T_i^N + T_{i+1}^N}{2}.$$

As a consequence,

$$\frac{1}{2\pi\sqrt{T_i^N T_{i+1}^N}} \int_{(p_i, p_{i+1}) \in \mathbb{R}^2} (p_i^2 - p_{i+1}^2) [p_{i+1} - p_i]^+ \exp\left(-\frac{p_i^2}{2T_i^N} - \frac{p_{i+1}^2}{2T_{i+1}^N}\right) dp_i dp_{i+1} \\ = -\frac{2}{\sqrt{\pi}} \sqrt{T_{i,i+1}^N} (T_{i+1}^N - T_i^N).$$

Similarly,

$$\frac{1}{2\pi\sqrt{T_i^N T_{i+1}^N}} \int_{(p_i, p_{i+1}) \in \mathbb{R}^2} (p_i^2 - p_{i+1}^2) [p_i - p_{i+1}]^+ \exp\left(-\frac{p_i^2}{2T_i^N} - \frac{p_{i+1}^2}{2T_{i+1}^N}\right) dp_i dp_{i+1} \\ = -\frac{2}{\sqrt{\pi}} \sqrt{T_{i,i+1}^N} (T_{i+1}^N - T_i^N).$$

We deduce that

$$j_{i,i+1}^N = -\frac{1}{2V^N(a)} \int_{\mathbf{q} \in \Omega} (\delta_{q_{i+1}-q_i=1-a}(\mathbf{dq}) + \delta_{q_{i+1}-q_i=-(1-a)}(\mathbf{dq})) \frac{2}{\sqrt{\pi}} \sqrt{T_{i,i+1}^N} (T_{i+1}^N - T_i^N) \\ - C_{i,i+1}^N(a) \sqrt{\frac{T_{i,i+1}^N}{\pi}} (T_{i+1}^N - T_i^N),$$

where the value of $C_{i,i+1}^N(a)$ is given in (2.11). This yields (2.8).

Chapitre 3

États stationnaires hors de l'équilibre du modèle d'échange complet

3.1 Introduction

In this chapter, we develop an adequate setting allowing to derive rigorous ergodicity results on the thermalised Complete Exchange Model introduced in Chapter 2. It is a general rule in nonequilibrium statistical mechanics that the less randomness there is in a model, the more difficult it is to establish ergodicity results [24, 67]. Here, thermal baths are the only source of randomness, there is no additional noise. Therefore, approximations or simplifications have to be introduced.

On the one hand, approximated models were introduced in the series of articles by Lefevre, Mariani and Zambotti [103, 101, 99], where the deterministic interaction between two neighbouring particles was replaced with the interaction with an array of thermalised scatterers. Then, the emphasis was put on the macroscopic fluctuation theory of these approximated models. We refer to Lefevre [98] for a short review of results and conjectures in this direction, and mention that this also led to theoretical developments regarding the large deviations of renewal processes, see [102, 100] by the same authors.

On the other hand, the purpose of the present chapter is to provide a detailed study of the model in the particular case of a two-molecule system, from which rigorous ergodicity results can be derived. The reduction to the two particle case is a drastic simplification and allows to introduce notions that are easy to handle. We nonetheless expect that most of these notions can naturally be extended to the general case, although this extension may require a substantial amount of technical developments.

The main result of this chapter, namely Theorem 3.2.5, is not entirely proved and we left two conditions, that we were not able to prove, as technical assumptions. On the one hand, we however prove that these assumptions are satisfied in the case of thermal equilibrium, which provides a complete convergence proof for this case. On the other hand, the author is still working on these assumptions and expects to complete this work in a forthcoming future.

3.1.1 A stochastic billiard representation

Throughout this chapter, we consider a two-molecule instance of the thermalised Complete Exchange Model, so that there is no bulk molecule. For all $t \geq 0$, we denote by

$$X(t) := (q^1(t), q^2(t); p^1(t), p^2(t))$$

the process of positions and velocities of the molecules. The interaction parameter a is generally assumed to belong to $(0, 1/2)$, although we shall sometimes also consider the case $a = 0$, to which

we will refer as the *case without interaction*. When the molecule $i \in \{1, 2\}$ is such that $q^i = 0$ (resp. $q^i = 1$), the norm of its velocity is randomly drawn according to the update density $\phi^{i,+}$ (resp. $\phi^{i,-}$). We address generical update densities, and not only Maxwellian reservoirs as in Chapter 2.

Our analysis relies on the interpretation of $(X(t))_{t \geq 0}$ in terms of a stochastic billiard, which was introduced in [119, 101]: the process $(X(t))_{t \geq 0}$ describes the motion of a point particle evolving in the polygonal billiard table $\bar{\Omega}$, which refers to the closure of

$$\Omega := \{(q^1, q^2) \in (0, 1)^2 : |q^1 - q^2| < 1 - a\},$$

see Figure 3.1. The polygon $\bar{\Omega}$ is an hexagon. The facets $\{q^1 - q^2 = 1 - a\}$ and $\{q^2 - q^1 = 1 - a\}$ are called *oblique facets*. A reflection of the billiard particle on one of these facets corresponds to an interaction between the two molecules, therefore the reflection of the billiard particle on the oblique facets is specular. On the contrary, a reflection of the billiard particle on one of the four other facets corresponds to a stochastic update of the velocity of one of the molecules. Therefore, these four facets shall be called *thermalised walls*. When the billiard particle hits one of these walls, the normal component of the velocity is randomly updated according to the corresponding update density, while the tangential component of the velocity is preserved. The update densities associated with each thermalised wall are indicated on Figure 3.1.

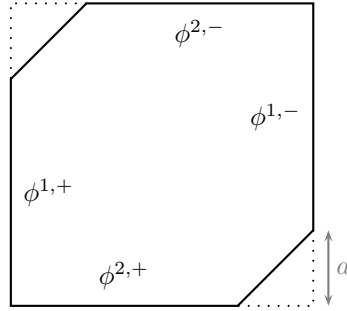

Figure 3.1: The billiard table $\bar{\Omega}$. The update densities associated with each thermalised wall are indicated.

The interpretation in terms of the motion of a particle in a billiard table in higher dimensions is a classical means to describe one dimensional gases of hard molecules; see, for instance, the so-called *mechanical models* in Chernov and Markarian [42, Sections IV.1 and IV.2] or the examples in Tabachnikov [131, Chapter 1]. As far as billiards with stochastic reflection rules are concerned, we mention recent results by Cook and Feres [45] and Chumley, Cook and Feres [43], in which the authors deal with a local description of the state of the billiard particle after each reflection, and the reflections are assumed to be identically distributed and independent. For general results on the classical theory of stochastic billiards, we refer to the article by Comets, Popov, Schütz and Vachkovskaia [44], in which the norm of the velocity vector is preserved at each reflection, while the angle of the reflection is randomly updated. In our model though, the norm of the velocity is not preserved. A similar phenomenon occurs in the random billiard models introduced and studied by Konstantin and Yarmola [95, 140], see also systems with *particle-disk interactions* [139, 138]. There, compactness issues related with existence properties of bounded stationary distributions are highlighted, similarly to our technical assumptions (T1) and (T2).

3.1.2 Organisation of the chapter and notations

3.1.2.1 Organisation of the chapter

This chapter is organised as follows.

We give the main definitions of the model in Section 3.2. There, we also state our main result, namely Theorem 3.2.5, which asserts that the billiard process is *typically ergodic*, i.e. for generical initial configurations, $X(t)$ converges in distribution to some (nonequilibrium) steady state π_{nd} .

Our proof relies on a time discretisation of the process along a sequence of observation times, such that the extracted chain have nice ergodic features. We explain this general sketch in Section 3.3. We address to seemingly auxiliary problems in Section 3.4, which provides us with a precise description of the billiard process. We finally give a proper definition of our sequence of observation times in Section 3.5, and obtain ergodicity results on both the billiard process and its discretisation in Section 3.6, thereby completing the proof of Theorem 3.2.5.

A formal construction of the billiard process is provided in Appendix 3.A, while Appendix 3.B contains the proof of a technical result.

3.1.2.2 Notations

The billiard table is the closure $\bar{\Omega}$ of the open subset Ω of $[0, 1]^2$. The polygon $\bar{\Omega}$ is an hexagon, the facets $\{q^1 - q^2 = 1 - a\}$ and $\{q^2 - q^1 = 1 - a\}$ are called *oblique facets*. The four other facets are called *thermalised walls*. For all $(i, \epsilon) \in \{1, 2\} \times \{+, -\}$, we denote by $W^{i, \epsilon}$ the set of $(q^1, q^2) \in \partial\Omega$ such that $q^i = 0$ (resp. $q^i = 1$) and $q^{i'} \in (0, 1 - a)$ (resp. $q^{i'} \in (a, 1)$) if $\epsilon = +$ (resp. $\epsilon = -$), where $i' = 2$ if $i = 1$ and $i' = 1$ if $i = 2$. The closure of the union of $W^{1, +}, \dots, W^{2, -}$ is denoted by \bar{W} .

Typical configurations of the billiard process are denoted $x = (q^1, q^2; p^1, p^2) \in \bar{\Omega} \times \mathbb{R}^2$. The Lebesgue measure on $\bar{\Omega} \times \mathbb{R}^2$ is indifferently denoted by dx or $dq^1 dq^2 dp^1 dp^2$. The use of the tensor product symbol \otimes shall be understood as follows: for any positive measures $\rho^1(dqdp)$ and $\rho^2(dqdp)$ on $[0, 1] \times \mathbb{R}$, the measure $\rho^1 \otimes \rho^2$ is the product measure $\rho^1(dq^1 dp^1) \rho^2(dq^2 dp^2)$ on $[0, 1]^2 \times \mathbb{R}$.

Given a measurable space (E, \mathcal{E}) , the *canonical random variable* on E is the measurable application X mapping E onto itself, defined by $X(\omega) = \omega$. Given a probability distribution \mathbb{P} on E , we shall refer to the probability space $(E, \mathcal{E}, \mathbb{P})$ as the probability space E endowed with the probability distribution \mathbb{P} under which the law of the canonical random variable X is \mathbb{P} .

Finally, let us mention that the symbol \mathbb{N} refers to the set of positive integers $\{1, 2, \dots\}$.

3.2 Model and results

In this section, we give a short presentation of the properties of the billiard process, an extended construction of which is detailed in Appendix 3.A. We then state our main ergodicity result, and discuss the particular case of thermal equilibrium in the context of the billiard process.

3.2.1 The billiard process

3.2.1.1 Construction and properties of the billiard process

A precise construction of the billiard process $(X(t))_{t \geq 0}$ is detailed in Appendix 3.A. In particular, we introduce a subset \mathcal{X} of $\bar{\Omega} \times \mathbb{R}^2$, that we call the space of *admissible configurations*, having the following properties.

Proposition 3.2.1 (Definition of the billiard process). *For all $x \in \mathcal{X}$, the process $(X^x(t))_{t \geq 0}$ describing the motion of the point particle in the billiard table $\bar{\Omega} \times \mathbb{R}^2$ with initial configuration x is such that, almost surely, for all $t \geq 0$, $X^x(t)$ is well-defined and belongs to \mathcal{X} . The process $(X^x(t))_{t \geq 0}$ is a Markov process with right continuous and left limited sample-paths, and it has the strong Markov property.*

Proposition 3.2.1 is obtained as a consequence of general results on Piecewise Deterministic Markov Processes [46].

For all $x \in \mathcal{X}$, the law of $(X^x(t))_{t \geq 0}$ in the Skorohod space $D([0, +\infty), \mathcal{X})$ is denoted by \mathbf{P}_x , and the expectation under \mathbf{P}_x is denoted by \mathbf{E}_x . In the sequel, we shall denote by $(X(t))_{t \geq 0}$ the canonical variable on the Skorohod space $D([0, +\infty), \mathcal{X})$ and endow the latter with the collection of probability distributions $\{\mathbf{P}_x, x \in \mathcal{X}\}$. From now on, we therefore refer to the canonical process $(X(t))_{t \geq 0}$ under the probability distribution \mathbf{P}_x as the *billiard process* with initial configuration $x \in \mathcal{X}$.

Definition 3.2.2 (Transition kernel and semigroup). *The transition kernel of the billiard process is defined by, for all $t \geq 0$, for all $x \in \mathcal{X}$,*

$$P_t(x; \cdot) := \mathbf{P}_x(X(t) \in \cdot).$$

The semigroup of the billiard process is defined on the set of continuous and bounded functions $f : \bar{\Omega} \times \mathbb{R}^2 \rightarrow \mathbb{R}$ by, for all $t \geq 0$, for all $x \in \mathcal{X}$,

$$P_t f(x) := \mathbf{E}_x(f(X(t))).$$

3.2.1.2 Symmetries of the table

The space $\bar{\Omega} \times \mathbb{R}^2$, and the space of admissible configurations \mathcal{X} , are naturally invariant under the following transformations.

Definition 3.2.3 (Symmetries of the billiard table). *The symmetries of the billiard are the following transformations:*

- the identity $\mathfrak{S}^{1,+} : (q^1, q^2; p^1, p^2) \mapsto (q^1, q^2; p^1, p^2)$;
- the point symmetry $\mathfrak{S}^{1,-} : (q^1, q^2; p^1, p^2) \mapsto (1 - q^1, 1 - q^2; -p^1, -p^2)$;
- the axial symmetry $\mathfrak{S}^{2,+} : (q^1, q^2; p^1, p^2) \mapsto (q^2, q^1; p^2, p^1)$;
- the axial symmetry $\mathfrak{S}^{2,-} : (q^1, q^2; p^1, p^2) \mapsto (1 - q^2, 1 - q^1; -p^2, -p^1)$.

Note that, for all $(i, \epsilon) \in \{1, 2\} \times \{+, -\}$, the process $(\mathfrak{S}^{i,\epsilon} X^x(t))_{t \geq 0}$ has the same law as the process $(X^{\mathfrak{S}^{i,\epsilon} x}(t))_{t \geq 0}$ constructed on the table $\bar{\Omega}$, where the update densities associated with each thermalised wall have been repositioned according to $\mathfrak{S}^{i,\epsilon}$. As a consequence, in situations in which the behaviour of the configuration x with respect to the wall $W^{i,\epsilon}$ plays a role, the symmetry $\mathfrak{S}^{i,\epsilon}$ shall be used to reduce the study to the behaviour of the configuration $\mathfrak{S}^{i,\epsilon} x$ with respect to the wall $W^{1,+}$.

3.2.2 Ergodicity of the billiard process

We now state our main result concerning the long time behaviour of the billiard process. To this aim, we first remark that many trivial stationary distributions of the billiard process can be exhibited. Indeed, depending on the initial configuration $x = (q^1, q^2; p^1, p^2) \in \mathcal{X}$,

- if $p^1 = p^2 = 0$, then under \mathbf{P}_x , for all $t \geq 0$, $X(t) = x$ and the distribution δ_x is obviously stationary;
- if either $p^1 = 0$ or $p^2 = 0$ then the trajectory of the billiard particle is stuck in a periodic orbit, to which a stationary distribution can easily be associated;
- if $1 - a < q^1 + q^2 < 1 + a$ and $p^1 + p^2 = 0$, then the trajectory of the billiard particle is also stuck in a periodic orbit.

The last two cases are illustrated on Figure 3.2.

To avoid such pathologic situations, we introduce the following set of *nondegenerate* initial configurations.

Definition 3.2.4 (Nondegenerate initial configurations). *The subset $\mathcal{X}_{\text{nd}} \subset \mathcal{X}$ is defined by $x = (q^1, q^2; p^1, p^2) \in \mathcal{X}_{\text{nd}}$ if and only if $p^1 \neq 0$, $p^2 \neq 0$ and, if $1 - a < q^1 + q^2 < 1 + a$, then $p^1 \neq -p^2$.*

Let us note that the Lebesgue measure of the set $\mathcal{X} \setminus \mathcal{X}_{\text{nd}}$ is null.

The main result of this chapter is Theorem 3.2.5 below, which describes the long time behaviour of the billiard process starting from any configuration $x \in \mathcal{X}_{\text{nd}}$. This result holds under a set of assumptions on the update densities $\phi^{i,\epsilon}$, $(i, \epsilon) \in \{1, 2\} \times \{+, -\}$, that we now introduce.

Let ψ be a probability density on $[0, +\infty)$. We introduce the following assumptions on ψ :

(H1) The probability density ψ has a finite first order moment.

(H2) The probability density ψ is bounded and continuous dr -almost everywhere in $[0, +\infty)$.

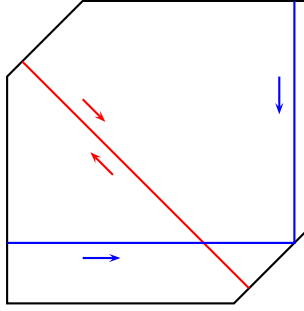

Figure 3.2: Two periodic orbits, corresponding to initial configuration such that one of the velocity components is null (blue trajectory) or $1 - a < q^1 + q^2 < 1 + a$ and $p^1 + p^2 = 0$ (red trajectory).

(H3) For all $T > 0$,

$$\int_{r=T}^{+\infty} \psi(r) dr > 0.$$

For all $(i, \epsilon) \in \{1, 2\} \times \{+, -\}$, we denote by $\psi^{i, \epsilon}$ the probability density defined on $[0, +\infty)$ by

$$\psi^{i, \epsilon}(r) := \frac{1}{r^2} \phi^{i, \epsilon} \left(\frac{1}{r} \right).$$

If $\psi^{i, \epsilon}$ satisfies the assumption (H1), we denote by $\mu^{i, \epsilon}$ its first order moment. In other words,

$$\mu^{i, \epsilon} := \int_{p=0}^{+\infty} \frac{\phi^{i, \epsilon}(p)}{p} dp.$$

Theorem 3.2.5 (Ergodicity). *Let us assume that the probability densities $\psi^{1,+}$, $\psi^{1,-}$, $\psi^{2,+}$ and $\psi^{2,-}$ satisfy assumptions (H1), (H2) and (H3). Under the technical assumptions (T1) and (T2) introduced below, there exists a probability distribution π_{nd} on \mathcal{X} such that, for all continuous and bounded function $f : \bar{\Omega} \times \mathbb{R}^2 \rightarrow \mathbb{R}$, for all $x \in \mathcal{X}_{\text{nd}}$,*

$$\lim_{t \rightarrow +\infty} \mathbf{E}_x(f(X(t))) = \int_{\bar{\Omega} \times \mathbb{R}^2} f d\pi_{\text{nd}}.$$

Proof. The proof of Theorem 3.2.5 is developed in Section 3.6. □

The technical assumptions (T1) and (T2) are explicated at the beginning of Section 3.6.

In the case of Maxwellian reservoirs [24], that is to say update densities of the form

$$\phi^{1,+}(p) = \phi^{1,-}(p) = \beta^1 p \exp\left(-\frac{\beta^1 p^2}{2}\right), \quad \phi^{2,+}(p) = \phi^{2,-}(p) = \beta^2 p \exp\left(-\frac{\beta^2 p^2}{2}\right), \quad (3.1)$$

with $\beta^1, \beta^2 > 0$, it is easily checked that assumptions (H1), (H2) and (H3) are satisfied. In particular,

$$\mu^{1,+} = \mu^{1,-} = \sqrt{\pi\beta^1/2}, \quad \mu^{2,+} = \mu^{2,-} = \sqrt{\pi\beta^2/2}.$$

The importance of small velocities in the transfer of energy in aerogels was already pointed out in [68, 71] as they imply low rates of interaction between neighbouring particles. From the mathematical point of view, the fact that the update densities (or, more precisely, the densities $\psi^{1,+}$, $\psi^{1,-}$, $\psi^{2,+}$ and $\psi^{2,-}$) satisfy the condition (H3) brings forth a very unusual shape for the thermodynamic potential describing the macroscopic fluctuation of the current of the approximated models addressed in [99], see also [102, 100].

Therefore, our proof is especially designed to address small velocities, and the condition (H3) plays a crucial role here. In particular, it allows us to use the Renewal Theorem in Subsection 3.3.1 to quantify the marginal action of the thermal baths on the molecules, see Remark 3.6.4 there.

3.2.3 Thermal equilibrium

In the case of Maxwellian reservoirs (3.1), the choice $\beta^1 = \beta^2$ was called *thermal equilibrium* in Chapter 2.

Definition 3.2.6 (Thermal equilibrium). *For general density updates, we call thermal equilibrium the case*

$$\phi^{1,+} = \phi^{2,+} =: \phi^+, \quad \phi^{1,-} = \phi^{2,-} =: \phi^-,$$

i.e. both cells are physically identical.

Remark 3.2.7. At thermal equilibrium, and if

$$\mu^+ := \int_0^{+\infty} \frac{\phi^+(p)}{p} dp < +\infty, \quad \mu^- := \int_0^{+\infty} \frac{\phi^-(p)}{p} dp < +\infty,$$

then in the absence of interactions (i.e. if $a = 0$), it is known (see Subsection 3.4.1) that the probability measure $\Phi(p)dqdp$, where

$$\Phi(p) := \frac{1}{\mu^+ + \mu^-} \left(\mathbf{1}_{\{p>0\}} \frac{\phi^+(p)}{p} + \mathbf{1}_{\{p<0\}} \frac{\phi^-(-p)}{-p} \right),$$

is stationary for both (q^1, p^1) and (q^2, p^2) .

Adding interactions, one can observe that the function $g : \bar{\Omega} \times \mathbb{R}^2 \rightarrow \mathbb{R}$ defined by

$$g(q^1, q^2; p^1, p^2) = \frac{1}{1-a^2} \Phi(p^1) \Phi(p^2)$$

is a probability density on $\bar{\Omega} \times \mathbb{R}^2$ and satisfies the relation $L^*g = 0$, where L^* refers to the formal adjoint of the infinitesimal generator of the thermalised Complete Exchange Model in Chapter 2. Therefore, it is a steady state of the billiard process, at least at the formal level.

Our proof of Theorem 3.2.5 does not rely on the use of the infinitesimal generator of the billiard process, therefore we do not provide Remark 3.2.7 with a rigorous meaning. However, we shall observe in Remark 3.6.10 that, at thermal equilibrium, Theorem 3.2.5 applies and the ergodic measure π_{nd} is the probability distribution with density g defined above with respect to the Lebesgue measure on $\bar{\Omega} \times \mathbb{R}^2$.

3.3 General sketch of the proof

We now describe the general sketch of our proof of Theorem 3.2.5. It consists in introducing a time discretisation of the billiard process along a sequence of stopping times $(\tau_n)_{n \geq 0}$, that we call *observation times*, such that the discrete time process $(X(\tau_n), \tau_n)_{n \geq 0}$ be a Markov renewal process. We then derive convergence results for the billiard process from ergodicity results on the discrete time process $(X(\tau_n), \tau_n)_{n \geq 0}$, which is done thanks to the Markov Renewal Theorem.

We first recall a few results on Harris recurrence and Markov renewal theory. We refer for instance to Asmussen [7, Section VII.3] for details.

3.3.1 Harris recurrence

Throughout Subsections 3.3.1 and 3.3.2, we let \mathcal{Y} be a measurable space. The stochastic processes we address are built on an abstract probability space, that we do not precise, which is endowed with the probability distribution P . The expectation under P is denoted by E .

Definition 3.3.1 (Harris recurrence). *A time homogeneous Markov chain $(Y_n)_{n \geq 0}$ with values in \mathcal{Y} is Harris recurrent if there exists a subset $R \subset \mathcal{Y}$, an integer $r \geq 1$, an $\epsilon > 0$ and a probability distribution λ on \mathcal{Y} such that:*

(i) the chain is recurrent in the set R , that is to say, for all $y \in \mathcal{Y}$,

$$P_y(\exists n \geq 1 : Y_n \in R) = 1;$$

(ii) the local Doeblin condition is satisfied in R , that is to say, for all $y \in R$, for all measurable subset $B \subset \mathcal{Y}$,

$$P_y(Y_r \in B) \geq \epsilon \lambda(B);$$

where $P_y(\cdot) := P(\cdot | Y_0 = y)$.

Definition 3.3.1 is *a priori* different from the classical definition of Harris recurrence as given by Meyn and Tweedie [109], the equivalence between both definitions is discussed in Asmussen [7, Corollary 3.12, p. 205].

Harris recurrence classically implies existence and uniqueness of stationary distributions defined as follows.

Definition 3.3.2 (Stationary distributions). *Let $(Y_n)_{n \geq 0}$ be time homogeneous Markov chain with values in \mathcal{Y} . A positive and σ -finite Borel measure $\bar{\nu}$ on \mathcal{Y} is called a stationary σ -finite distribution for $(Y_n)_{n \geq 0}$ if, for all measurable $B \subset \mathcal{Y}$,*

$$\int_{y \in \mathcal{Y}} P_y(Y_1 \in B) \bar{\nu}(dy) = \bar{\nu}(B).$$

Of course, if $\bar{\nu}$ is a stationary σ -finite distribution in the sense of Definition 3.3.2, then any multiple of $\bar{\nu}$ is also a stationary σ -finite distribution.

Proposition 3.3.3. *If the Markov chain $(Y_n)_{n \geq 0}$ is Harris recurrent, then it admits a unique stationary σ -finite distribution, up to a multiplicative constant.*

The proof of Proposition 3.3.3 can be found in [7, Theorems 3.2 and 3.5, pp. 200-201].

If the stationary σ -finite distributions $\bar{\nu}$ of a Harris recurrent Markov chain are actually bounded measures, then they can be normalised to a probability distribution ν , which consequently is the unique stationary probability distribution for the Markov chain $(Y_n)_{n \geq 0}$. The latter is said to be *positive Harris recurrent*, and we denote by P_ν the probability distribution

$$P_\nu(\cdot) := \int_{y \in \mathcal{Y}} P_y(\cdot) \nu(dy). \quad (3.2)$$

The expectation under P_ν is naturally denoted by E_ν .

3.3.2 Markov renewal theory

We now give a few definitions and results of Markov renewal theory.

Definition 3.3.4 (Markov renewal process). *A Markov renewal process is a random sequence $(Y_n, \tau_n)_{n \geq 0}$ taking its values in $\mathcal{Y} \times [0, +\infty)$, such that the sequence $(Y_n, \tau_{n+1} - \tau_n)_{n \geq 0}$ is a time homogeneous Markov chain taking its values in $\mathcal{Y} \times (0, +\infty)$, with a transition kernel*

$$P(Y_1 \in dz, \tau_2 - \tau_1 \in ds | Y_0 = y, \tau_1 - \tau_0 = t)$$

which does not depend on t .

It is easily checked that if $(Y_n, \tau_n)_{n \geq 0}$ is a Markov renewal process, then the marginal sequence $(Y_n)_{n \geq 0}$ is a time homogeneous Markov chain in \mathcal{Y} .

Definition 3.3.5 (Completed semi-Markov process). *Let $(Y_n, \tau_n)_{n \geq 0}$ be a Markov renewal process in $\mathcal{Y} \times [0, +\infty)$. If*

$$\sup_{n \geq 0} \tau_n = +\infty$$

almost surely, then for all $t \geq \tau_0$, there exists a unique $M(t) := m \geq 0$ such that $\tau_m \leq t < \tau_{m+1}$. The completed semi-Markov process associated with $(Y_n, \tau_n)_{n \geq 0}$ is the process

$$(Y_{M(t)}, t - \tau_{M(t)})_{t \geq \tau_0}.$$

Given a Markov renewal process satisfying the assumptions of Definition 3.3.5, the long time behaviour of the corresponding completed semi-Markov process is described by the Markov Renewal Theorem. We first need to introduce yet another definition, see Alsmeyer [2].

Definition 3.3.6 (Nonarithmeticity). *Let $(Y_n, \tau_n)_{n \geq 0}$ be a Markov renewal process such that the marginal Markov chain $(Y_n)_{n \geq 0}$ possesses a unique stationary probability distribution ν . This Markov renewal process is called d -arithmetic if $d \geq 0$ refers to the largest number for which there exists a measurable function $\gamma : \mathcal{Y} \rightarrow [0, d)$ such that*

$$P_\nu(\tau_1 - \tau_0 \in \gamma(Y_0) - \gamma(Y_1) + d\mathbb{Z}) = 1,$$

where P_ν is defined in (3.2).

If there is no such $d \geq 0$, then the Markov renewal process is said to be nonarithmetic.

There are several versions of the Markov Renewal Theorem, depending on the setup (see for instance Asmussen [7, Section VII.4] for a simple proof in the case of a Markov chain $(Y_n)_{n \geq 0}$ with discrete state space). Our version is due to Alsmeyer [2, Corollary 1] and covers the case of Markov chain with a continuous state space.

Theorem 3.3.7 (Markov Renewal Theorem). *Let $(Y_n, \tau_n)_{n \geq 0}$ be a Markov renewal process, satisfying the assumptions of Definition 3.3.5, and let $(Y_{M(t)}, t - \tau_{M(t)})_{t \geq \tau_0}$ refer to the associated completed semi-Markov process. Let us assume that:*

- the Markov chain $(Y_n)_{n \geq 0}$ is positive Harris recurrent, in which case we denote by ν its unique stationary probability distribution,
- the Markov renewal process $(Y_n, \tau_n)_{n \geq 0}$ is nonarithmetic,
- the drift of the Markov renewal process defined by

$$\bar{\mu} := E_\nu(\tau_1 - \tau_0)$$

is finite.

Then, for all bounded function $g : \mathcal{Y} \times [0, +\infty) \rightarrow \mathbb{R}$ such that, for ν -almost all $y \in \mathcal{Y}$, the function $t \mapsto g(y, t)P_y(\tau_1 - \tau_0 > t)$ is continuous dt-almost everywhere, then

$$\lim_{t \rightarrow +\infty} E_y(g(Y_{M(t)}, t - \tau_{M(t)})) = \frac{1}{\bar{\mu}} \int_{z \in \mathcal{Y}} \int_{s=0}^{+\infty} g(z, s) P_z(\tau_1 - \tau_0 > s) ds \nu(dz),$$

for ν -almost all $y \in \mathcal{Y}$.

3.3.3 Sequence of observation times and factorisation of the billiard process

We now consider the billiard process $(X(t))_{t \geq 0}$. In order to construct our sequence of observation times, we first introduce the following condition.

Definition 3.3.8 (Stability condition). *A subset $\mathcal{Y} \subset \mathcal{X}_{\text{nd}}$ and a function $\tau_{\text{obs}} : \mathcal{Y} \rightarrow (0, +\infty)$ are said to satisfy the stability condition if:*

- (i) for all $x \in \mathcal{X}_{\text{nd}}$, $\tau_0 := \inf\{t \geq 0 : X(t) \in \mathcal{Y}\} < +\infty$, \mathbf{P}_x -almost surely,
- (ii) for all $x \in \mathcal{X}_{\text{nd}}$, $\mathbf{P}_x(X(\tau_0) \in \mathcal{Y}) = 1$,
- (iii) for all $y \in \mathcal{Y}$, then $\mathbf{P}_y(X(\tau_{\text{obs}}(y)) \in \mathcal{Y}) = 1$.

Given a subset $\mathcal{Y} \subset \mathcal{X}_{\text{nd}}$ and a function $\tau_{\text{obs}} : \mathcal{Y} \rightarrow (0, +\infty)$ satisfying this stability condition, let us define the associated sequence of observation times $(\tau_n)_{n \geq 0}$ by, for all $n \geq 0$, $\tau_{n+1} := \tau_n + \tau_{\text{obs}}(X(\tau_n))$.

Proposition 3.3.9 (Sequence of observation times). *For all subset $\mathcal{Y} \subset \mathcal{X}_{\text{nd}}$ and function $\tau_{\text{obs}} : \mathcal{Y} \rightarrow (0, +\infty)$ satisfying the stability condition of Definition 3.3.8, the sequence $(Y_n, \tau_n)_{n \geq 0}$ defined by $Y_n := X(\tau_n)$ is a Markov renewal process with values in $\mathcal{Y} \times [0, +\infty)$.*

Proof. Let $x \in \mathcal{X}_{\text{nd}}$. First, it is clear from Definition 3.3.8 that, \mathbf{P}_x -almost surely, for all $n \geq 0$, $Y_n \in \mathcal{Y}$ while $\tau_{n+1} - \tau_n \in (0, +\infty)$. Besides, for all $n \geq 0$, τ_n is a stopping time for the process $(X(t))_{t \geq 0}$. As a consequence, the strong Markov property for $(X(t))_{t \geq 0}$ and the definition of the sequence $(\tau_n)_{n \geq 0}$ ensures that $(Y_n)_{n \geq 0}$ is a Markov chain. Since $\tau_{n+1} - \tau_n$ is a deterministic function of Y_n , we conclude that the sequence $(Y_n, \tau_{n+1} - \tau_n)_{n \geq 0}$ is a time homogeneous Markov chain, with a transition kernel that does not depend on the time coordinate. This completes the proof. \square

The sequence of observation times allows us to provide the following factorisation of the billiard process by the Markov renewal process.

Proposition 3.3.10 (Factorisation). *Let \mathcal{Y} be a subset of \mathcal{X}_{nd} and $\tau_{\text{obs}} : \mathcal{Y} \rightarrow (0, +\infty)$ be a function, satisfying the stability condition of Definition 3.3.8. For $x \in \mathcal{X}_{\text{nd}}$, let us denote by $(Y_n, \tau_n)_{n \geq 0}$ the Markov renewal process defined by Proposition 3.3.9, and let us assume that, \mathbf{P}_x -almost surely,*

$$\sup_{n \geq 0} \tau_n = +\infty,$$

so that the associated completed semi-Markov process $(Y_{M(t)}, t - \tau_{M(t)})_{t \geq \tau_0}$ is well-defined. Then, for all continuous and bounded function $f : \bar{\Omega} \times \mathbb{R}^2 \rightarrow \mathbb{R}$, we have

$$\forall t \geq 0, \quad \mathbf{E}_x(f(X(t))) = \mathbf{E}_x(f(X(t))\mathbf{1}_{\{t < \tau_0\}}) + \mathbf{E}_x(P_{t - \tau_{M(t)}}f(Y_{M(t)})\mathbf{1}_{\{t \geq \tau_0\}}),$$

where we recall that P_t refers to the semigroup of $(X(t))_{t \geq 0}$.

Proof. For all $t \geq 0$,

$$\mathbf{E}_x(f(X(t))) = \mathbf{E}_x(f(X(t))\mathbf{1}_{\{t < \tau_0\}}) + \sum_{m=0}^{+\infty} \mathbf{E}_x(f(X(t))\mathbf{1}_{\{\tau_m \leq t < \tau_{m+1}\}}),$$

and for all $m \geq 0$,

$$\begin{aligned} \mathbf{E}_x(f(X(t))\mathbf{1}_{\{\tau_m \leq t < \tau_{m+1}\}}) &= \mathbf{E}_x(\mathbf{E}_x(f(X(t))\mathbf{1}_{\{\tau_m \leq t < \tau_m + \tau_{\text{obs}}(X(\tau_m))\}} | X(\tau_m))) \\ &= \mathbf{E}_x(\mathbf{1}_{\{\tau_m \leq t < \tau_{m+1}\}} P_{t - \tau_m} f(X(\tau_m))), \end{aligned}$$

thanks to the strong Markov property. Taking the sum of the right-hand side above for all the values of $m \geq 0$, we obtain the expected equality. \square

3.4 Two useful auxiliary considerations

In this section, we leave the study of the ergodicity of the billiard process apart and establish auxiliary results regarding two objects:

- the evolution of a single particle in contact with thermal baths in Subsection 3.4.1,
- the evolution of the *unfolded version* of the billiard process in Subsection 3.4.2.

3.4.1 Marginal action of the thermal baths on a single particle

In order to quantify the marginal action of the thermal baths on the molecules, this subsection addresses the motion of a single molecule in the interval $[0, b]$, with $b > 0$. The molecule travels at constant velocity in the interior of the interval. When it reaches the leftmost boundary, it is reflected with a random velocity drawn according to the density $\phi^{i_+, +}(p)$ on $[0, +\infty)$, with $i_+ \in \{1, 2\}$. When it reaches the rightmost boundary, it is reflected with a random velocity, drawn according to the density $\phi^{i_-, -}(-p)$ on $(-\infty, 0]$, with $i_- \in \{1, 2\}$. The position of the molecule is denoted by $q(t) \in [0, b]$, and its velocity is denoted by $p(t) \in \mathbb{R}$, see Figure 3.3.

The time taken by the particle to cross the interval after a velocity update is distributed according to the densities $\psi^{b; i_+, +}(r)$ and $\psi^{b; i_-, -}(r)$, defined as follows.

Definition 3.4.1 (Crossing time densities). *The probability densities $\psi^{b;i_+,+}(r)$ and $\psi^{b;i_-,-}(r)$ are defined on $[0, +\infty)$ by*

$$\psi^{b;i_+,+}(r) := \frac{b}{r^2} \phi^{i_+,+} \left(\frac{b}{r} \right), \quad \psi^{b;i_-,-}(r) := \frac{b}{r^2} \phi^{i_-,-} \left(\frac{b}{r} \right).$$

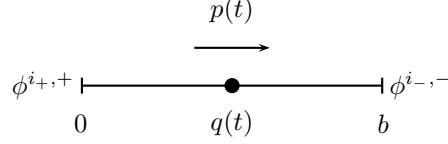

Figure 3.3: The motion of a single molecule in the interval $[0, b]$.

Definition 3.4.2 (Law of the process). *For all (q_0, p_0) , for all $t \geq 0$, the joint law of $(q(t), p(t))$ when the initial configuration of the particle is (q_0, p_0) is denoted by*

$$\rho_t^{b;i_+,i_-}(q_0, p_0; dqdp),$$

it is a probability distribution on $[0, b] \times \mathbb{R}$.

We also denote by

$$\rho_t^{b;i_+,i_-}(+; dqdp)$$

the law of $(q(t), p(t))$ when the initial position is distributed according to $\delta_0(dq)\phi^{i_+,+}(p)dp$, and by

$$\rho_t^{b;i_+,i_-}(-; dqdp)$$

the law of $(q(t), p(t))$ when the initial position is distributed according to $\delta_1(dq)\phi^{i_-,-}(-p)dp$.

Exact expression for $\rho_t^{b;i_+,i_-}(q_0, p_0; dqdp)$, $\rho_t^{b;i_+,i_-}(+; dqdp)$ and $\rho_t^{b;i_+,i_-}(-; dqdp)$ are derived in Lemma 3.4.4.

If the probability densities $\psi^{b;i_+,+}(r)$ and $\psi^{b;i_-,-}(r)$ satisfy the assumption (H1), then it is known that the long time behaviour of $(q(t), p(t))$ is described by the probability distribution

$$\rho_\infty^{b;i_+,i_-}(dqdp) := \frac{1}{b(\mu^{i_+} + \mu^{i_-})} \left(\mathbb{1}_{\{p>0\}} \frac{\phi^{i_+,+}(p)}{p} + \mathbb{1}_{\{p<0\}} \frac{\phi^{i_-,-}(-p)}{-p} \right) dqdp \quad (3.3)$$

on $[0, b] \times \mathbb{R}$, where

$$\mu^{i_+} := \int_{p=0}^{+\infty} \frac{\phi^{i_+,+}(p)}{p} dp, \quad \mu^{i_-} := \int_{p=0}^{+\infty} \frac{\phi^{i_-,-}(p)}{p} dp$$

see Lefevre and Zambotti [103, Proposition 3.1], where it was also proved that this measure is a steady state of the process $(q(t), p(t))_{t \geq 0}$. In Lemma 3.4.5, we use this fact to provide quantitative bounds on the law of $(q(t), p(t))$, for large times.

We shall work on the probability space $(\mathbb{R}_+^2)^\mathbb{N}$ endowed with the probability distribution \mathbb{P} under which the canonical variable $(v_j^+, v_j^-)_{j \geq 1}$ is an i.i.d. sequence, with marginal distribution given by the product density $\phi^{i_+,+}(v^+) \phi^{i_-,-}(v^-)$. The expectation under \mathbb{P} is denoted by \mathbb{E} .

3.4.1.1 Exact expression for the time marginals

Definition 3.4.3 (Time to reach the end of the interval). *For all $(q, p) \in [0, b] \times \mathbb{R}$, let define $\tau_{\text{end}}^b(q, p) \in (0, +\infty]$ by:*

- $\tau_{\text{end}}^b(q, p) = +\infty$ if $p = 0$;
- $\tau_{\text{end}}^b(q, p) = (b - q)/p$ if $p > 0$;
- $\tau_{\text{end}}^b(q, p) = -q/p$ if $p < 0$.

Note that $\tau_{\text{end}}^b(q, p) \in (0, +\infty]$ is the time needed by a molecule in the configuration (q, p) to reach the boundary of the interval toward which it is directed.

We denote by $U^{b;i_+,i_-}(ds)$ the renewal measure associated with the probability density $\psi^{b;i_+,i_-}$ on $[0, +\infty)$. It writes $U^{b;i_+,i_-}(ds) = \delta_0(ds) + u^{b;i_+,i_-}(s)ds$, where $u^{b;i_+,i_-}(s)$ is the associated renewal density. We refer to Asmussen [7, Chapter V] for an introduction to renewal theory. For $s \geq 0$, we also define

$$\begin{aligned} U^{b;*i_+,i_-}(s) &:= \int_{c=0}^s \psi^{b;i_+,i_-}(s-c) U^{b;i_+,i_-}(dc), \\ U^{b;i_+,*i_-}(s) &:= \int_{c=0}^s \psi^{b;i_+,*i_-}(s-c) U^{b;i_+,*i_-}(dc). \end{aligned} \quad (3.4)$$

Lemma 3.4.4 (Expression of the law of the process). *For all $t \geq 0$, the probability distribution $\rho_t^{b;i_+,i_-}(q_0, p_0; dqdp)$ on $[0, b] \times \mathbb{R}$ is given by*

$$\rho_t^{b;i_+,i_-}(q_0, p_0; dqdp) = \begin{cases} \delta_{(q_0+t p_0, p_0)}(dqdp) & \text{if } t < \tau_{\text{end}}^b(q_0, p_0), \\ \rho_{t-\tau_{\text{end}}^b(q_0; p_0)}^{b;i_+,i_-}(-\text{sgn}(p_0); dqdp) & \text{otherwise.} \end{cases} \quad (3.5)$$

Besides,

$$\begin{aligned} \rho_t^{b;i_+,i_-}(+; dqdp) &= \mathbb{1}_{\{p>0, q \leq tp\}} \phi^{i_+,i_-}(p) \left(\delta_{tp}(dq) + \frac{1}{p} u^{b;i_+,i_-} \left(t - \frac{q}{p} \right) dq \right) dp \\ &\quad + \mathbb{1}_{\{p<0, b-q \leq -tp\}} \frac{\phi^{i_+,*i_-}(-p)}{-p} U^{b;*i_+,i_-} \left(t - \frac{b-q}{-p} \right) dqdp; \end{aligned} \quad (3.6)$$

and, similarly,

$$\begin{aligned} \rho_t^{b;i_+,i_-}(-; dqdp) &= \mathbb{1}_{\{p<0, b-q \leq -tp\}} \phi^{i_+,*i_-}(-p) \left(\delta_{b+tp}(dq) + \frac{1}{-p} u^{b;i_+,*i_-} \left(t - \frac{b-q}{-p} \right) dq \right) dp \\ &\quad + \mathbb{1}_{\{p>0, q \leq tp\}} \frac{\phi^{i_+,i_-}(p)}{p} U^{b;i_+,i_-} \left(t - \frac{q}{p} \right) dqdp. \end{aligned} \quad (3.7)$$

Proof. The equality (3.5) is an obvious consequence of the Markov property. We prove (3.6); clearly, (3.7) works similarly. Let us assume that $q(0) = 0$, $p(0) = v_1^+$. Let $(v_{2j-1}^+)_{j \geq 1}$ be the sequence of successive moment updates at the leftmost boundary and let $(v_{2j}^-)_{j \geq 1}$ be the sequence of successive moment updates at the rightmost boundary. Let $\sigma_{2j-1}^+ := b/v_{2j-1}^+$, $\sigma_{2j}^- := b/v_{2j}^-$ and $S_0 := 0$, $S_j := \sigma_1^+ + \sigma_2^- + \dots + \sigma_{2j-1}^+ + \sigma_{2j}^-$, so that $(q(t), p(t))$ writes

$$q(t) = b \frac{t - S_{j-1}}{\sigma_{2j-1}^+}, \quad p(t) = \frac{b}{\sigma_{2j-1}^+} \quad \text{if } S_{j-1} \leq t < S_{j-1} + \sigma_{2j-1}^+,$$

and

$$q(t) = b \left(1 - \frac{t - (S_{j-1} + \sigma_{2j-1}^+)}{\sigma_{2j}^-} \right), \quad p(t) = -\frac{b}{\sigma_{2j}^-} \quad \text{if } S_{j-1} + \sigma_{2j-1}^+ \leq t < S_j.$$

Hence, for all continuous and bounded function $f : [0, b] \times \mathbb{R} \rightarrow \mathbb{R}$,

$$\begin{aligned} \mathbb{E}(f(q(t), p(t))) &= \sum_{j=1}^{+\infty} \mathbb{E} \left(f \left(b \frac{t - S_{j-1}}{\sigma_{2j-1}^+}, \frac{b}{\sigma_{2j-1}^+} \right) \mathbb{1}_{\{S_{j-1} \leq t < S_{j-1} + \sigma_{2j-1}^+\}} \right) \\ &\quad + \sum_{j=1}^{+\infty} \mathbb{E} \left(f \left(b \left(1 - \frac{t - (S_{j-1} + \sigma_{2j-1}^+)}{\sigma_{2j}^-} \right), -\frac{b}{\sigma_{2j}^-} \right) \mathbb{1}_{\{S_{j-1} + \sigma_{2j-1}^+ \leq t < S_j\}} \right) \\ &= \int_{s=0}^t \int_{r=t-s}^{+\infty} f \left(b \frac{t-s}{r}, \frac{b}{r} \right) \psi^{b;i_+,i_-}(r) dr U^{b;i_+,i_-}(ds) \\ &\quad + \int_{s=0}^t \int_{r=t-s}^{+\infty} f \left(b \left(1 - \frac{t-s}{r} \right), -\frac{b}{r} \right) \psi^{b;i_+,*i_-}(r) dr U^{b;i_+,*i_-}(s) ds. \end{aligned} \quad (3.8)$$

Now, the changes of variables $(q, p) = (b(t - s)/r, b/r)$ in the first integral and $(q, p) = (b(1 - (t - s)/r), -b/r)$ in the second integral yield

$$\begin{aligned} \mathbb{E}(f(q(t), p(t))) &= \int_{q=0}^b \int_{p=0}^{+\infty} f(q, p) \mathbb{1}_{\{q \leq tp\}} \phi^{i_+, +}(p) \left(\delta_{tp}(dq) + \frac{1}{p} u^{b; i_+, i_-} \left(t - \frac{q}{p} \right) dq \right) dp \\ &+ \int_{q=0}^b \int_{p=-\infty}^0 f(q, p) \mathbb{1}_{\{b-q \leq -tp\}} \frac{\phi^{i_-, -}(-p)}{-p} U^{b; *i_+, i_-} \left(t - \frac{b-q}{-p} \right) dq dp, \end{aligned}$$

which leads to (3.6). \square

3.4.1.2 Long time behaviour

We are now interested in the long time behaviour of the process $(q(t), p(t))_{t \geq 0}$. Let us first note that the probability density $\psi^{b; i_+, +}$ or $\psi^{b; i_-, -}$ satisfies assumption (H1) (resp. (H2)) for a given $b > 0$ if and only if it satisfies assumption (H1) (resp. (H2)) for all $b > 0$. As a consequence, in the following lemma, it is assumed that $\psi^{1; i_+, +}$ and $\psi^{1; i_-, -}$ satisfy assumption (H1) (resp. (H2)) for the sake of coherence with Theorem 3.2.5, but it certainly implies that $\psi^{b; i_+, +}$ and $\psi^{b; i_-, -}$ satisfy assumption (H1) (resp. (H2)) for all $b > 0$.

Lemma 3.4.5 (Long time behaviour). *If both $\psi^{1; i_+, +}$ and $\psi^{1; i_-, -}$ satisfy the assumption (H1), then for all $(p_0, q_0) \in [0, b] \times \mathbb{R}$ such that $p_0 \neq 0$, the probability distribution $\rho_t^{b; i_+, i_-}(q_0, p_0; dq dp)$ converges weakly to the probability distribution $\rho_\infty^{b; i_+, i_-}(dq dp)$ defined in (3.3). Furthermore, if $\psi^{1; i_+, +}$ and $\psi^{1; i_-, -}$ also satisfy the assumption (H2), then there exists $M^{b; i_+, i_-} \geq 0$ such that, for all $\eta > M^{b; i_+, i_-}$, for all $(q_0, p_0) \in [0, b] \times \mathbb{R}$ such that $p_0 \neq 0$, for all $t \geq \tau_{\text{end}}^b(q_0, p_0) + \eta$,*

$$\rho_t^{b; i_+, i_-}(q_0, p_0; dq dp) \geq \ell_\eta^{b; i_+, i_-}(dq dp), \quad (3.9)$$

where $\ell_\eta^{b; i_+, i_-}(dq dp)$ is the positive bounded measure on $[0, b] \times \mathbb{R}$ defined by

$$\begin{aligned} \ell_\eta^{b; i_+, i_-}(dq dp) &:= \frac{1}{2b(\mu^{i_+} + \mu^{i_-})} \left(\mathbb{1}_{\{p > 0, q \leq (\eta - M^{b; i_+, i_-})p\}} \frac{\phi^{i_+, +}(p)}{p} \right. \\ &\quad \left. + \mathbb{1}_{\{p < 0, b - q \leq -(\eta - M^{b; i_+, i_-})p\}} \frac{\phi^{i_-, -}(-p)}{-p} \right) dq dp. \end{aligned} \quad (3.10)$$

Proof. As is mentioned above, the first part of the lemma is a classical result. We now assume that $\psi^{1; i_+, +}$ and $\psi^{1; i_-, -}$ also satisfy (H2) and prove the second part of the lemma. We first claim that there exists $M^{b; i_+, i_-} \geq 0$ such that, for all $s \geq M^{b; i_+, i_-}$, if v refer to any of the functions $u^{b; i_+, i_-}$, $U^{b; *i_+, i_-}$ or $U^{b; i_+, *i_-}$, then

$$v(s) \geq \frac{1}{2b(\mu^{i_+} + \mu^{i_-})}. \quad (3.11)$$

Then, given $\eta > M^{b; i_+, i_-}$, for all $t \geq \eta$, (3.11) yields

$$\forall s \leq t, \quad v(t - s) \geq \mathbb{1}_{\{t-s \geq M^{b; i_+, i_-}\}} \frac{1}{2b(\mu^{i_+} + \mu^{i_-})} \geq \mathbb{1}_{\{s \leq \eta - M^{b; i_+, i_-}\}} \frac{1}{2b(\mu^{i_+} + \mu^{i_-})}. \quad (3.12)$$

Now (3.9) follows from (3.12) and Lemma 3.4.4.

It remains prove the existence of $M^{b; i_+, i_-}$. If $\psi^{1; i_+, +}$ and $\psi^{1; i_-, -}$ satisfy (H2), then by Lemma 3.4.6 below, the probability density $\psi^{b; i_+, +} * \psi^{b; i_-, -}$ is directly Riemann integrable. Therefore, it is a consequence of the key Renewal Theorem that $\lim_{s \rightarrow +\infty} u^{b; i_+, i_-}(s) = 1/b(\mu^{i_+} + \mu^{i_-})$, see [7, Exercise 4.2, p. 157]. Thus, there exists $M_0 \geq 0$ such that, for all $s \geq M_0$, $u^{b; i_+, i_-}(s)$ satisfies (3.11). Similarly, there exists $M_1 \geq 0$ such that, for all $s \geq M_1$, $u^{b; i_+, i_-}(s) \geq 1/(\sqrt{2}b(\mu^{i_+} +$

μ^{i-}). Hence, for all $s \geq M_1$,

$$\begin{aligned} U^{b; *i_+, i-}(s) &= \int_{c=0}^s \psi^{b; i_+, +}(s-c) U^{b; i_+, i-}(dc) \\ &\geq \int_{c=M_1}^s \psi^{b; i_+, +}(s-c) u^{b; i_+, i-}(c) dc \\ &\geq \frac{1}{\sqrt{2}b(\mu^{i_+} + \mu^{i-})} \int_{c=0}^{s-M_1} \psi^{b; i_+, +}(c) dc. \end{aligned}$$

Since $\psi^{b; i_+, +}$ is a probability density, there exists $M_2 \geq 0$ such that, as soon as $s - M_1 \geq M_2$, $\int_{c=0}^{s-M_1} \psi^{b; i_+, +}(c) dc \geq 1/\sqrt{2}$ and $U^{b; *i_+, i-}(s)$ satisfies (3.11). We similarly build $M'_2 \geq 0$ such that, for all $s \geq M_1 + M'_2$, $\int_{c=0}^{s-M_1} \psi^{b; i_-, -}(c) dc \geq 1/\sqrt{2}$, so that $U^{b; i_+, *i-}(s)$ satisfies (3.11). We conclude by taking $M^{b; i_+, i-}$ as the maximum of M_0 , $M_1 + M_2$ and $M_1 + M'_2$. \square

Lemma 3.4.6. *Let ψ^1 and ψ^2 be probability densities on $[0, +\infty)$ satisfying assumptions (H1) and (H2). Then the probability density $\psi^1 * \psi^2$ is directly Riemann integrable on $[0, +\infty)$.*

Proof. Let us first note that, under the assumption that the probability densities ψ^1 and ψ^2 satisfy (H2), then it is straightforward to check that the probability density $\psi^1 * \psi^2$ is bounded and continuous on $[0, +\infty)$. Following Asmussen [7, Proposition 4.1, p. 154], it is now enough to exhibit a nonincreasing and Lebesgue integrable function F on $[0, +\infty)$ such that, for all $t \geq 0$, $\psi^1 * \psi^2(t) \leq F(t)$.

To this aim, we slightly adapt the argument by Feller [57, Theorem 2a, p. 367] and write, for all $t \geq 0$,

$$\begin{aligned} \psi^1 * \psi^2(t) &= \int_{s=0}^{t/2} \psi^1(s) \psi^2(t-s) ds + \int_{s=t/2}^t \psi^1(s) \psi^2(t-s) ds \\ &\leq \sup_{r \geq 0} \psi^1(r) \int_{s=t/2}^{+\infty} \psi^2(s) ds + \sup_{r \geq 0} \psi^2(r) \int_{s=t/2}^{+\infty} \psi^1(s) ds. \end{aligned}$$

Let us denote by $F(t)$ the right-hand side above. On the one hand, F is certainly nonincreasing. On the other hand, the fact that F is Lebesgue integrable on $[0, +\infty)$ follows from the assumption that the probability densities ψ^1 and ψ^2 satisfy (H1), and the proof is completed. \square

3.4.2 Unfolding the trajectories

A classical trick in the study of deterministic polygonal billiards is the *unfolding procedure*, which can roughly be described as follows: when the billiard particle hits a boundary of the polygon, instead of reflecting the trajectory specularly, we rather reflect the polygon with respect to the boundary and let the billiard particle keep on moving in straight line. Repeating the procedure at each reflection, the trajectory of the billiard particle becomes a half line, evolving across a sequence of iterated copies of the original billiard table. We refer to the textbook by Tabachnikov [131] or the review article by Gutkin [75] for more precisions regarding the unfolding of polygonal billiards.

Clearly, the unfolding procedure is well adapted to specular reflections, but not to stochastic reflections. Therefore, we use a partial unfolding procedure and define the *unfolded billiard process* as follows.

Definition 3.4.7 (Unfolded billiard process). *We denote by $(\tilde{X}(t))_{t \geq 0}$ and call unfolded billiard process the process obtained by unfolding the trajectory of the billiard process at each reflection on the oblique facets. It describes the motion of a billiard particle in the set $\tilde{\Omega}$ defined as the union of the iterated reflections of Ω with respect to its oblique facets, with reflections at the boundary of $\tilde{\Omega}$ of the same nature as for the original billiard process.*

The infinite unfolded table $\tilde{\Omega}$ is depicted on Figure 3.4.

For all $t \geq 0$, we denote

$$\tilde{X}(t) = (\tilde{q}^1(t), \tilde{q}^2(t); \tilde{p}^1(t), \tilde{p}^2(t)).$$

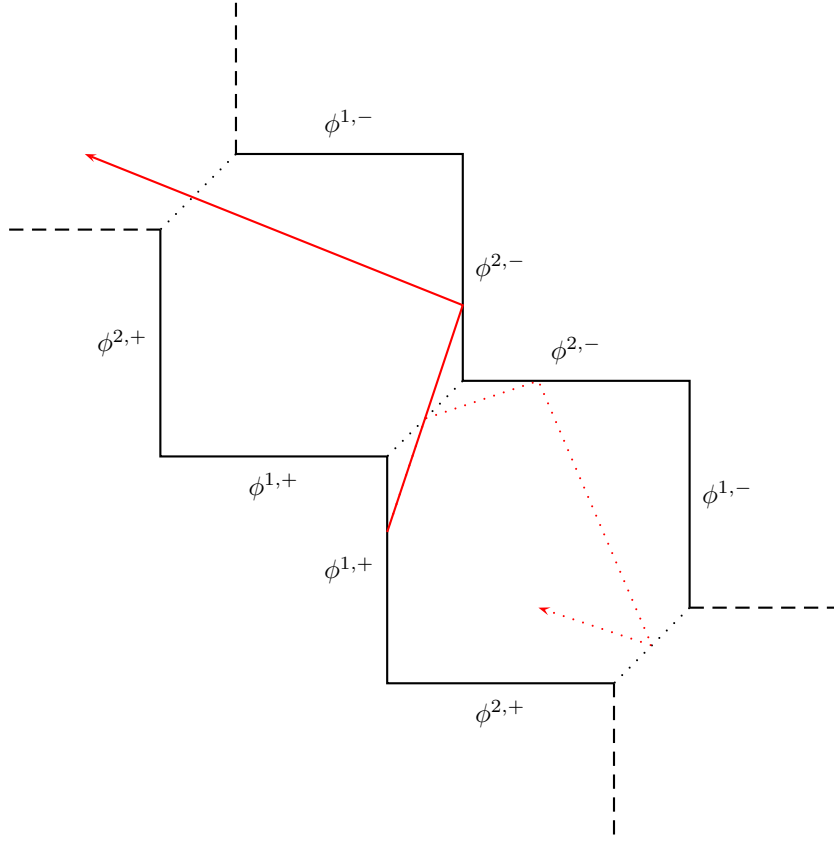

Figure 3.4: A part of the unfolded billiard table $\tilde{\Omega}$. The update densities associated with each thermalised wall are indicated. The reminiscent oblique facets are drawn in dotted line, but are no longer seen by the unfolded process. A trajectory of the unfolded process is plotted in red, the corresponding original trajectory is plotted in dotted line.

The processes $(\tilde{q}^1(t), \tilde{p}^1(t))_{t \geq 0}$ and $(\tilde{q}^2(t), \tilde{p}^2(t))_{t \geq 0}$ are respectively called *horizontal* and *vertical* components of the unfolded billiard process.

The original billiard process $X(t)$ is recovered from the unfolded process by applying the *folding map*

$$\mathfrak{F} : \tilde{\Omega} \times \mathbb{R}^2 \rightarrow \bar{\Omega} \times \mathbb{R}^2,$$

which we construct as follows. For all $k \in \mathbb{Z}$, we let U_k denote the axial symmetry of $\mathbb{R}^2 \times \mathbb{R}^2$ with respect to the line $\{(\tilde{q}^1, \tilde{q}^2) \in \mathbb{R}^2 : \tilde{q}^2 - \tilde{q}^1 = (1-a)(2k+1)\}$, that is to say

$$U_k : (\tilde{q}^1, \tilde{q}^2; \tilde{p}^1, \tilde{p}^2) \mapsto (\tilde{q}^2 + (1-a)(2k+1), \tilde{q}^1 - (1-a)(2k+1); \tilde{p}^2, \tilde{p}^1).$$

Let us define:

- \mathfrak{U}^0 as the identity of $\mathbb{R}^2 \times \mathbb{R}^2$,
- for all $k \geq 1$, $\mathfrak{U}^k := U_{k-1} \circ \dots \circ U_0$,
- for all $k \leq -1$, $\mathfrak{U}^k := U_k \circ \dots \circ U_{-1}$.

For all $k \in \mathbb{Z}$, the image of $\tilde{\Omega} \times \mathbb{R}^2$ by \mathfrak{U}^k is $\tilde{\Omega}^k \times \mathbb{R}^2$, where the polygon $\tilde{\Omega}^k$ writes

$$\begin{aligned} \tilde{\Omega}^k := \{(\tilde{q}^1, \tilde{q}^2) \in [k(1-a), k(1-a)+1] \times [-k(1-a), -k(1-a)+1] : \\ (2k-1)(1-a) \leq \tilde{q}^1 - \tilde{q}^2 \leq (2k+1)(1-a)\}. \end{aligned}$$

Besides, the unfolded table $\tilde{\Omega}$ partially depicted on Figure 3.4 writes

$$\tilde{\Omega} = \bigcup_{k \in \mathbb{Z}} \tilde{\Omega}^k.$$

Definition 3.4.8 (Folding map). *The folding map $\mathfrak{F} : \tilde{\Omega} \times \mathbb{R}^2 \rightarrow \bar{\Omega} \times \mathbb{R}^2$ is defined, for all $k \in \mathbb{Z}$, for all $\tilde{x} = (\tilde{q}^1, \tilde{q}^2; \tilde{p}^1, \tilde{p}^2) \in \tilde{\Omega}^k \times \mathbb{R}^2$, by:*

- if k is even, then $\mathfrak{F}\tilde{x} = (\tilde{q}^1 - k(1-a), \tilde{q}^2 + k(1-a); \tilde{p}^1, \tilde{p}^2)$;
- if k is odd, then $\mathfrak{F}\tilde{x} = (\tilde{q}^2 + k(1-a), \tilde{q}^1 - k(1-a); \tilde{p}^2, \tilde{p}^1)$.

Then we have, for all $t \geq 0$, $X(t) = \mathfrak{F}\tilde{X}(t)$.

Remark 3.4.9. Let us note that \mathfrak{F} is not well-defined for configurations in the intersection of $\tilde{\Omega}^k \times \mathbb{R}^2$ and $\tilde{\Omega}^{k+1} \times \mathbb{R}^2$. However, it can be checked that the images $\tilde{\mathcal{X}}^k$ of the space of admissible configurations \mathcal{X} by the applications \mathfrak{U}^k are pairwise disjoint; besides, for all $x \in \mathcal{X}$, \mathbf{P}_x -almost surely, for all $t \geq 0$, $\tilde{X}(t)$ belongs to exactly one of these images. As a consequence, it is actually sufficient to define \mathfrak{F} on $\cup_{k \in \mathbb{Z}} \tilde{\mathcal{X}}^k$ instead of on $\tilde{\Omega} \times \mathbb{R}^2$, in which case there is no more ambiguity.

3.5 The sequence of observation times

In this section, we explain how to construct a subset $\mathcal{Y} \subset \mathcal{X}_{\text{nd}}$ of and a function $\tau_{\text{obs}} : \mathcal{Y} \rightarrow (0, +\infty)$ satisfying the stability condition of Definition 3.3.8 and such that the associated Markov renewal process $(Y_n, \tau_n)_{n \geq 0}$ hopefully satisfies the assumptions of the Markov Renewal Theorem 3.3.7.

The definition of the sequence of observation times is detailed in Subsection 3.5.1. A precise description of the Markov renewal process thus obtained is made in Subsection 3.5.2. We finally give a few properties of the stationary distributions of the Markov chain in Subsection 3.5.3.

3.5.1 Definition of the sequence of observation times

3.5.1.1 Heuristic explanation

Recall that, for all $t \geq 0$, we denote by $\tilde{X}(t) = (\tilde{q}^1(t), \tilde{q}^2(t); \tilde{p}^1(t), \tilde{p}^2(t)) \in \tilde{\Omega} \times \mathbb{R}^2$ the unfolded billiard process introduced in Subsection 3.4.2. Let us now observe that the space $\tilde{\Omega}$ can be divided into bands, inside of which the horizontal and vertical components evolve independently. This fact is illustrated on Figure 3.5.

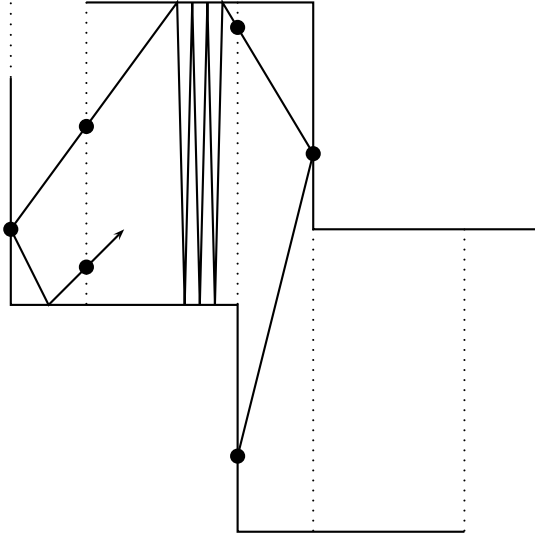

Figure 3.5: The boundaries of the bands are drawn in dotted lines. An example of a trajectory of the unfolded process is drawn in solid line. Each dot stands for an observation time. Between two consecutive observation times, the horizontal and vertical components evolve independently.

As a consequence, defining the sequence of observation times $(\tau_n)_{n \geq 0}$ as the sequence of consecutive instants at which the unfolded process hits the boundary of such a band, and letting \mathcal{Y} be the image by the folding map of these boundaries, we obtain a Markov renewal process $(X(\tau_n), \tau_n)_{n \geq 0}$ with an explicit transition kernel.

The formal construction of the set \mathcal{Y} and the corresponding function τ_{obs} are detailed in the following paragraph.

3.5.1.2 Construction of \mathcal{Y} and τ_{obs}

Elementary sections. Let us define the subsets $\mathcal{Y}'_{\text{bo}}{}^{1,+}$, $\mathcal{Y}'_{\text{in}}{}^{1,+}$ and $\mathcal{Y}'_{\text{ou}}{}^{1,+}$ of \mathcal{X}_{nd} by

$$\begin{aligned}\mathcal{Y}'_{\text{bo}}{}^{1,+} &:= \{(q^1, q^2; p^1, p^2) \in \mathcal{X}_{\text{nd}} : q^1 = 0\}, \\ \mathcal{Y}'_{\text{in}}{}^{1,+} &:= \{(q^1, q^2; p^1, p^2) \in \mathcal{X}_{\text{nd}} : q^1 = a, p^1 > 0\}, \\ \mathcal{Y}'_{\text{ou}}{}^{1,+} &:= \{(q^1, q^2; p^1, p^2) \in \mathcal{X}_{\text{nd}} : q^1 = a, p^1 < 0\},\end{aligned}$$

and, for all (i, ϵ, \star) in the set of indices

$$\Pi := \{1, 2\} \times \{+, -\} \times \{\text{bo}, \text{in}, \text{ou}\},$$

the subset $\mathcal{Y}'_{\star}{}^{i,\epsilon}$ of \mathcal{X}_{nd} is defined by $\mathfrak{S}^{i,\epsilon}(\mathcal{Y}'_{\star}{}^{1,+})$, where $\mathfrak{S}^{i,\epsilon}$ is the symmetry of \mathcal{X} introduced in §3.2.1.2. The twelve sets $\{\mathcal{Y}'_{\star}{}^{i,\epsilon} : (i, \epsilon, \star) \in \Pi\}$ are not pairwise disjoint, since the configurations $(q^1, q^2; p^1, p^2) \in \mathcal{X}_{\text{nd}}$ such that (q^1, q^2) belongs to the set

$$\mathcal{N} := \{(0, a), (a, 0), (a, a), (a, 1-a), (1-a, a), (1-a, 1-a), (1-a, 1), (1, 1-a)\}$$

necessarily belong to exactly two of these sets. To circumvent this subtlety, we define \mathcal{X}'_{nd} as the set of configurations $x \in \mathcal{X}_{\text{nd}}$ such that, \mathbf{P}_x -almost surely, for all $t \in [0, t_{\text{hit}}(x)]$, $X(t) \notin \mathcal{N}$. Certainly, if $x \in \mathcal{X}'_{\text{nd}}$, then \mathbf{P}_x -almost surely, for all $t \geq 0$, $X(t) \in \mathcal{X}'_{\text{nd}}$.

Definition 3.5.1 (Elementary sections, section). *The elementary sections $\{\mathcal{Y}'_{\star}{}^{i,\epsilon} : (i, \epsilon, \star) \in \Pi\}$ are defined by*

$$\forall (i, \epsilon, \star) \in \Pi, \quad \mathcal{Y}'_{\star}{}^{i,\epsilon} := \mathcal{Y}'_{\star}{}^{i,\epsilon} \cap \mathcal{X}'_{\text{nd}}.$$

The section of Ω is the union

$$\mathcal{Y} := \bigcup_{(i, \epsilon, \star) \in \Pi} \mathcal{Y}'_{\star}{}^{i,\epsilon}.$$

The elementary sections are drawn on Figure 3.6. The sets $\mathcal{Y}'_{\text{bo}}{}^{i,\epsilon}$ are located on the boundary of the billiard table, therefore they shall be called *boundary* sections. The sets $\mathcal{Y}'_{\text{in}}{}^{i,\epsilon}$ are located inside the billiard table and the normal component of the velocity of configurations in these sets points toward the center of the table, therefore they shall be called *inward* sections. The sets $\mathcal{Y}'_{\text{ou}}{}^{i,\epsilon}$ are located inside the billiard table and the normal component of the velocity of configurations in these sets points toward the boundary of the table, therefore they shall be called *outward* sections.

Observation time. The heuristic description of the observation time in introduction leads to defining $\tau_{\text{obs}}(y)$ as the time that the unfolded process takes to cross the band it is entering at the configuration y . Therefore, it is the quotient of the width of the band by the normal component of the velocity in y .

Definition 3.5.2 (Observation time). *For all $y = (q^1, q^2; p^1, p^2) \in \mathcal{Y}$, we define $\tau_{\text{obs}}(y)$ by:*

- $\tau_{\text{obs}}(y) := a/(\epsilon p^i)$ if $y \in \mathcal{Y}'_{\text{bo}}{}^{i,\epsilon}$,
- $\tau_{\text{obs}}(y) := (1-2a)/(\epsilon p^i)$ if $y \in \mathcal{Y}'_{\text{in}}{}^{i,\epsilon}$,
- $\tau_{\text{obs}}(y) := -a/(\epsilon p^i)$ if $y \in \mathcal{Y}'_{\text{ou}}{}^{i,\epsilon}$.

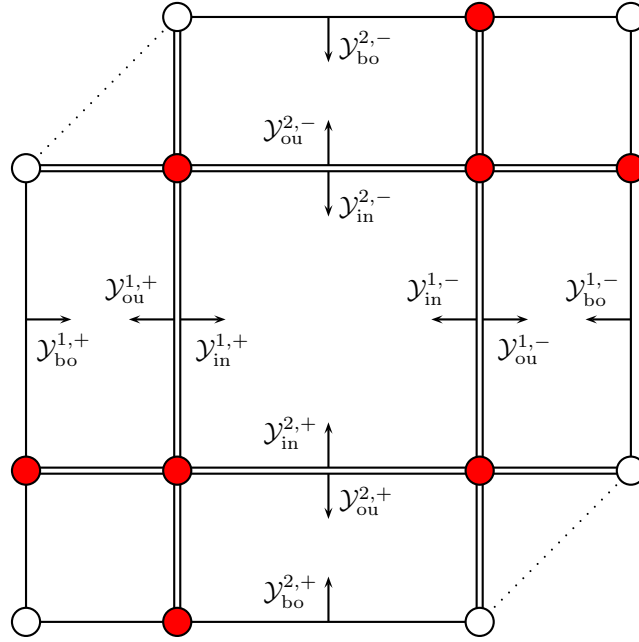

Figure 3.6: The solid lines represent the elementary sections $\{\mathcal{Y}_*^{i,\epsilon} : (i, \epsilon, \star) \in \Pi\}$. Arrows stand for the sign of the normal component of the velocity of configurations in a given elementary section. White dots are excluded from \mathcal{X}_{nd} , while red dots correspond to the set \mathcal{N} .

3.5.1.3 The stability condition

By construction, $\mathcal{Y} \subset \mathcal{X}_{\text{nd}}$ and $\tau_{\text{obs}} : \mathcal{Y} \rightarrow (0, +\infty)$. We now check that the stability condition of Definition 3.3.8 is satisfied.

Proof of (i) in Definition 3.3.8. Let us fix $x \in \mathcal{X}_{\text{nd}}$ and check that, \mathbf{P}_x -almost surely, $\tau_0 < +\infty$. Certainly,

$$\tau_0 \leq \inf\{t \geq 0 : X(t) \in \cup_{(i,\epsilon) \in \{1,2\} \times \{+,-\}} \mathcal{Y}_{\text{bo}}^{i,\epsilon}\},$$

and it follows from the definition of the boundary sections that

$$\cup_{(i,\epsilon) \in \{1,2\} \times \{+,-\}} \mathcal{Y}_{\text{bo}}^{i,\epsilon} = \mathcal{X}'_{\text{nd}} \cap (\bar{W} \times \mathbb{R}^2).$$

Since, \mathbf{P}_x -almost surely, $X(t) \in \mathcal{X}'_{\text{nd}}$, for all $t \geq 0$, we deduce that

$$\tau_0 \leq \inf\{t \geq 0 : X(t) \in \bar{W} \times \mathbb{R}^2\} = t_{\text{hit}}(x),$$

where $t_{\text{hit}}(x)$ is defined in Definition 3.A.4 and is such that $t_{\text{hit}}(x) < +\infty$ as $\mathcal{X}'_{\text{nd}} \subset \mathcal{X}_{\text{nd}}$. \square

Proof of (ii) in Definition 3.3.8. The point (ii) in Definition 3.3.8 is clearly satisfied. \square

Proof of (iii) in Definition 3.3.8. It is an easy observation on the unfolded process that, for all $y \in \mathcal{Y}$, $X(\tau_{\text{obs}}(y))$ belongs to at least one of the sets $\{\mathcal{Y}_*^{i,\epsilon} : (i, \epsilon, \star) \in \Pi\}$, \mathbf{P}_y -almost surely. On the other hand, by the definition of \mathcal{X}'_{nd} , $X(\tau_{\text{obs}}(y)) \in \mathcal{X}'_{\text{nd}}$, \mathbf{P}_y -almost surely. Therefore, $\mathbf{P}_y(X(\tau_{\text{obs}}(y)) \in \mathcal{Y}) = 1$. \square

3.5.2 Description of the Markov renewal process $(Y_n, \tau_n)_{n \geq 0}$

We now define the sequence $(\tau_n)_{n \geq 0}$ as in Proposition 3.3.9 and let $Y_n := X(\tau_n)$.

3.5.2.1 The transition kernel of the Markov chain $(Y_n)_{n \geq 0}$

Let us note that, for all $y \in \mathcal{Y}$, $\tau_0 = 0$ under \mathbf{P}_y .

Definition 3.5.3 (Transition kernel of $(Y_n)_{n \geq 0}$). *For all $y \in \mathcal{Y}$, we denote by $Q(y; \cdot)$ the law of $Y_1 = X(\tau_1)$ under \mathbf{P}_y .*

Thanks to the heuristic explanation detailed in §3.5.1.1, the transition kernel $Q(y; \cdot)$ can be explicitly computed for all $y \in \mathcal{Y}$. Let us assume for instance that $y = (0, q_0^2; p_0^1, p_0^2) \in \mathcal{Y}_{\text{bo}}^{1,+}$. Then $\tau_{\text{obs}}(y) = a/p_0^1$, and under \mathbf{P}_y , on the time interval $[0, \tau_{\text{obs}}(y))$, the horizontal component $(\tilde{q}^1(t), \tilde{p}^1(t))$ and the vertical component $(\tilde{q}^2(t), \tilde{p}^2(t))$ of the unfolded process evolve independently and have respective marginal distribution $\delta_{(q_0^1 + t p_0^1, p_0^1)}(d\tilde{q}^1 d\tilde{p}^1)$ and $\rho_t^{2-a;2,1}(q_0^2, p_0^2; d\tilde{q}^2 d\tilde{p}^2)$, where we recall the Definition 3.4.2 of the latter probability distribution. As a consequence, $P_t(y; \cdot)$ is given by the pushforward measure of

$$\delta_{(q_0^1 + t p_0^1, p_0^1)}(d\tilde{q}^1 d\tilde{p}^1) \otimes \rho_t^{2-a;2,1}(q_0^2, p_0^2; d\tilde{q}^2 d\tilde{p}^2) \quad (3.13)$$

by the folding map \mathfrak{F} .

At the observation time, by the definition of \mathcal{X} , $\tilde{q}^2(\tau_{\text{obs}}(y)) \neq 1$. If $\tilde{q}^2(\tau_{\text{obs}}(y)) > 1$, then the unfolded process is at the boundary of its domain and the component $(\tilde{q}^1, \tilde{p}^1)$ is updated according to the probability distribution $\delta_a(dq^1)\phi^{2,-}(-p)dp$. If $\tilde{q}^2(\tau_{\text{obs}}(y)) < 1$, then the unfolded process is in the interior of its domain and the component $(\tilde{q}^1, \tilde{p}^1)$ is not updated, so that its value remains (a, p_0^1) . As a consequence, the law of $\tilde{X}(\tau_{\text{obs}}(y))$ under \mathbf{P}_y writes

$$\begin{aligned} & \delta_a(d\tilde{q}^1)\phi^{2,-}(-\tilde{p}^1)d\tilde{p}^1 \otimes \mathbb{1}_{\{1 < \tilde{q}^2 < 2-a\}}\rho_{\tau_{\text{obs}}(y)}^{2-a;2,1}(q_0^2, p_0^2; d\tilde{q}^2 d\tilde{p}^2) \\ & + \delta_{(a, p_0^1)}(d\tilde{q}^1 d\tilde{p}^1) \otimes \mathbb{1}_{\{0 < \tilde{q}^2 < 1\}}\rho_{\tau_{\text{obs}}(y)}^{2-a;2,1}(q_0^2, p_0^2; d\tilde{q}^2 d\tilde{p}^2). \end{aligned}$$

Taking the pushforward measure of these two terms by \mathfrak{F} , we obtain the following expression for $Q(y; \cdot)$:

$$Q(y; \cdot) = Q_{(1,+,\text{bo}) \rightarrow (2,-,\text{bo})}(y; \cdot) + Q_{(1,+,\text{bo}) \rightarrow (1,+,\text{in})}(y; \cdot),$$

where

$$\begin{aligned} Q_{(1,+,\text{bo}) \rightarrow (2,-,\text{bo})}(y; \cdot) & := \mathbb{1}_{\{a < q^1 < 1\}}\rho_{a/p_0^1}^{2-a;2,1}(q_0^2, p_0^2; dq^1 dp^1) \otimes \delta_1(dq^2)\phi^{2,-}(-p^2)dp^2, \\ Q_{(1,+,\text{bo}) \rightarrow (1,+,\text{in})}(y; \cdot) & := \delta_{(a, p_0^1)}(dq^1 dp^1) \otimes \mathbb{1}_{\{0 < q^2 < 1\}}\rho_{a/p_0^1}^{2-a;2,1}(q_0^2, p_0^2; dq^2 dp^2), \end{aligned}$$

and $\rho_t^{2-a;2,1}(q_0, p_0; dqdp)$ refers to the pushforward measure of $\rho_t^{2-a;2,1}(q_0, p_0; dqdp)$ by the application $(q, p) \mapsto (q-1+a, p)$.

On the other elementary sections, we similarly obtain:

- for all $y = (a, q_0^2; p_0^1, p_0^2) \in \mathcal{Y}_{\text{in}}^{1,+}$,

$$Q(y; \cdot) = Q_{(1,+,\text{in}) \rightarrow (1,-,\text{ou})}(y; \cdot),$$

where

$$Q_{(1,+,\text{in}) \rightarrow (1,-,\text{ou})}(y; \cdot) := \delta_{(1-a, p_0^1)}(dq^1 dp^1) \otimes \rho_{(1-2a)/p_0^1}^{1;2,2}(q_0^2, p_0^2; dq^2 dp^2),$$

- for all $y = (1-a, q_0^2; p_0^1, p_0^2) \in \mathcal{Y}_{\text{ou}}^{1,+}$,

$$Q(y; \cdot) = Q_{(1,+,\text{ou}) \rightarrow (1,+,\text{bo})}(y; \cdot) + Q_{(1,+,\text{ou}) \rightarrow (2,-,\text{in})}(y; \cdot),$$

where

$$\begin{aligned} Q_{(1,+,\text{ou}) \rightarrow (1,+,\text{bo})}(y; \cdot) & := \delta_0(dq^1)\phi^{1,+}(p^1)dp^1 \otimes \mathbb{1}_{\{0 < q^2 < 1-a\}}\rho_{-a/p_0^1}^{2-a;2,1}(q_0^2, p_0^2; dq^2 dp^2), \\ Q_{(1,+,\text{ou}) \rightarrow (2,-,\text{in})}(y; \cdot) & := \mathbb{1}_{\{0 < q^1 < 1\}}\rho_{-a/p_0^1}^{2-a;2,1}(q_0^2, p_0^2; dq^1 dp^1) \otimes \delta_{(1-a, p_0^1)}(dq^2 dp^2), \end{aligned}$$

- on the other elementary sections, the expression of $Q(y; \cdot)$ is obtained using the symmetries of the table introduced in §3.2.1.2.

We thus obtain a collection of components $Q_{(i,\epsilon,\star)\rightarrow(i',\epsilon',\star')}(y;\cdot)$, for $(i,\epsilon,\star),(i',\epsilon',\star') \in \Pi$. Aggregating the states of the Markov chain $(Y_n)_{n \geq 0}$ into elementary sections, we can introduce the graph depicted in Figure 3.7, where:

- the vertices are the elementary sections,
- an oriented edge $\mathcal{Y}_{\star}^{i,\epsilon} \rightarrow \mathcal{Y}_{\star'}^{i',\epsilon'}$ is in the graph if and only if there exists $y \in \mathcal{Y}_{\star}^{i,\epsilon}$ such that $Q(y, \mathcal{Y}_{\star'}^{i',\epsilon'}) > 0$.

Then, associating each edge $\mathcal{Y}_{\star}^{i,\epsilon} \rightarrow \mathcal{Y}_{\star'}^{i',\epsilon'}$ with the kernel $Q_{(i,\epsilon,\star)\rightarrow(i',\epsilon',\star')}(y;\cdot)$ actually provides a complete description of the law of the Markov chain $(Y_n)_{n \geq 0}$.

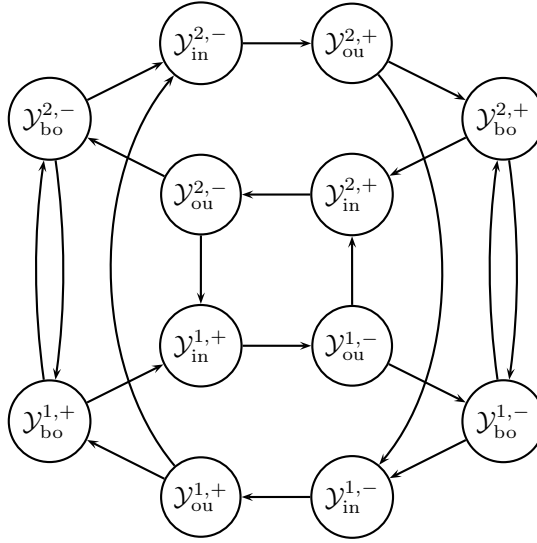

Figure 3.7: The representation of the Markov kernel $Q(y;\cdot)$ when the states are aggregated into elementary sections.

3.5.2.2 Regularity along the semigroup

The analysis carried out in the previous paragraph also yields exact expressions for the quantity $P_t(y;\cdot)$ for $y \in \mathcal{Y}$ and $t \in [0, \tau_{\text{obs}}(y))$. This allows to derive the following regularity property, the proof of which is tedious but straightforward — therefore we omit it.

Lemma 3.5.4. *Let $f : \bar{\Omega} \times \mathbb{R}^2 \rightarrow \mathbb{R}$ be continuous and bounded. For all $y \in \mathcal{Y}$, the function $t \mapsto P_t f(y)$ is continuous dt-almost everywhere on $[0, \tau_{\text{obs}}(y))$.*

3.5.2.3 Further properties of the Markov renewal process $(Y_n, \tau_n)_{n \geq 0}$

Normal component of the velocity. For all $n \geq 0$, the *normal component of the velocity* of Y_n is understood with respect to the elementary section in which Y_n lies.

Definition 3.5.5 (Normal component). *For all $(i,\epsilon,\star) \in \Pi$, for all $y = (q^1, q^2; p^1, p^2) \in \mathcal{Y}_{\star}^{i,\epsilon}$, we call normal component of the velocity in y the component p^i .*

The following lemma shows that the normal component of the velocity is only updated on the boundary sections.

Lemma 3.5.6. *Let $0 \leq n'_1 < \dots < n'_l < \dots$ refer to the increasing sequence of indices $n' \geq 0$ such that there exists $(i,\epsilon) \in \{1,2\} \times \{+,-\}$ for which $Y_{n'} \in \mathcal{Y}_{\text{bo}}^{i,\epsilon}$. Then, for all $l \geq 1$, n'_l is a stopping time for the Markov chain $(Y_n)_{n \geq 0}$.*

Furthermore, let $p^{i'} = \epsilon' v'_l$ refer to the normal component of the velocity of $Y_{n'_l} \in \mathcal{Y}_{\text{bo}}^{i', \epsilon'}$, with $v'_l > 0$. Then, for all $l \geq 1$, for all $n \in \{n'_l, \dots, n'_{l+1} - 1\}$, the normal component of the velocity of Y_n is $p^{i'}$.

Finally, on a possibly enlarged probability space, there exists i.i.d. sequences $(m'_l)_{l \geq 1}$ and $(M'_l)_{l \geq 1}$ such that, for all $l \geq 1$, $m'_l \leq v'_l \leq M'_l$.

Proof. For all $l \geq 1$, the random variable n'_l is the l -th instant of return of the Markov chain $(Y_n)_{n \geq 0}$ in a boundary section. Therefore it is a stopping time for the Markov chain $(Y_n)_{n \geq 0}$. Let us emphasise the fact that at this stage, n'_l is not necessarily almost surely finite — this fact will be proved in Subsection 3.6.1 below.

It follows from a straightforward analysis of the measures $Q_{(i, \epsilon, \star) \rightarrow (i', \epsilon', \star')}(y; \cdot)$ constructed in §3.5.2.1 above that, if $\star' \in \{\text{in}, \text{ou}\}$, then the marginal distribution of the normal component of the velocity under $Q_{(i, \epsilon, \star) \rightarrow (i', \epsilon', \star')}(y; \cdot)$ is $\delta_{p^{i'}}(dp^{i'})$, where $p^{i'}$ refers to the normal component of the velocity of $y \in \mathcal{Y}_{\star'}^{i', \epsilon'}$. Thus, for all $l \geq 1$, for all $n \in \{n'_l, \dots, n'_{l+1} - 1\}$, the normal component of the velocity of Y_n is the normal component of the velocity of $Y_{n'_l}$.

Finally, if $\star' = \text{bo}$, then the marginal distribution of the normal component of the velocity under $Q_{(i, \epsilon, \star) \rightarrow (i', \epsilon', \star')}(y; \cdot)$ is $\phi^{i', \epsilon'}(\epsilon' p^{i'}) dp^{i'}$, independently of y . As a consequence, one can realise a version of the Markov chain $(Y_n)_{n \geq 0}$ such that, at the l -th return in a boundary section $\mathcal{Y}_{\text{bo}}^{i', \epsilon'}$, the normal component of the velocity $p_{n'_l}^{i'}$ is set to $\epsilon v_l^{i', \epsilon}$, where the sequence $(v_l^{1,+}, v_l^{1,-}, v_l^{2,+}, v_l^{2,-})_{l \geq 1}$ is i.i.d. with marginal distribution given by the product density $\phi^{1,+}(v^{1,+})\phi^{1,-}(v^{1,-})\phi^{2,+}(v^{2,+})\phi^{2,-}(v^{2,-})$. Therefore, $v'_l = v_l^{i', \epsilon}$ satisfies

$$m'_l := \min(v_l^{1,+}, v_l^{1,-}, v_l^{2,+}, v_l^{2,-}) \leq v'_l \leq \max(v_l^{1,+}, v_l^{1,-}, v_l^{2,+}, v_l^{2,-}) =: M'_l,$$

and the proof is completed. \square

The sequence of observation times. We now address the following property of the sequence of observation times $(\tau_n)_{n \geq 0}$.

Lemma 3.5.7. *For all $x \in \mathcal{X}_{\text{nd}}$, \mathbf{P}_x -almost surely,*

$$\sup_{n \geq 0} \tau_n = +\infty.$$

Proof. We use the sequence of indices $\{n'_1, \dots, n'_l, \dots\}$ introduced in Lemma 3.5.6 above. If this sequence is finite, then there exists $n'_L < +\infty$ such that, for all $n \geq n'_L$, the modulus of the normal component of the velocity of Y_n is v'_L , and therefore $\tau_{\text{obs}}(Y_n) \geq (a \wedge (1 - 2a))/v'_L$. As a consequence, for all $n > n'_L$,

$$\tau_n = \tau_{n'_L} + \tau_{\text{obs}}(Y_{n'_L}) + \dots + \tau_{\text{obs}}(Y_{n-1}) \geq \tau_{n'_L} + (n - n'_L) \frac{a \wedge (1 - 2a)}{v'_L},$$

and the right-hand side above easily goes to $+\infty$ with n . Now if the sequence $\{n'_1, \dots, n'_l, \dots\}$ is infinite, it suffices to prove that $\sup_{l \geq 1} \tau_{n'_l} = +\infty$, and by the definition of the sequence $(\tau_n)_{n \geq 0}$,

$$\forall l \geq 1, \quad \tau_{n'_l} \geq \sum_{k=1}^{l-1} \tau_{\text{obs}}(Y_{n'_k}) = \sum_{k=1}^{l-1} \frac{a}{v'_k}.$$

Following Lemma 3.5.6, the right-hand side above is stochastically larger than $\sum_{k=1}^{l-1} a/M'_k$, where $(M'_k)_{k \geq 1}$ is a sequence of i.i.d. and almost surely finite random variables. As a consequence,

$$\lim_{l \rightarrow +\infty} \sum_{k=1}^{l-1} \frac{a}{M'_k} = +\infty, \quad \text{almost surely,}$$

and therefore $\sup_{n \geq 0} \tau_n = +\infty$, \mathbf{P}_x -almost surely. \square

Lemma 3.5.7 implies that the Markov renewal process $(Y_n, \tau_n)_{n \geq 0}$ satisfies the assumptions of Definition 3.3.5, which shall allow us to define the completed semi-Markov process associated with $(Y_n, \tau_n)_{n \geq 0}$.

3.5.3 On the stationary distributions of $(Y_n)_{n \geq 0}$

Recall that stationary σ -finite distributions for the Markov chain $(Y_n)_{n \geq 0}$ were introduced in Definition 3.3.2. Without addressing the issue of the existence such a distribution yet, we already derive necessary conditions. For all $(i, \epsilon, \star) \in \Pi$, let us denote by $\bar{\nu}_{|\mathcal{Y}_\star^{i,\epsilon}}$ the restriction of a stationary σ -finite distribution $\bar{\nu}$ to the elementary section $\mathcal{Y}_\star^{i,\epsilon}$.

3.5.3.1 Marginal distribution of the normal component of the velocity

The following remark on the shape of $\bar{\nu}$ on the boundary sections can immediately be formulated.

Lemma 3.5.8. *For all stationary σ -finite distribution $\bar{\nu}$, for all $(i, \epsilon) \in \{1, 2\} \times \{+, -\}$, there exist positive and σ -finite measures $\bar{\nu}_{|\mathcal{Y}_{\text{bo}}^{i,\epsilon}}^1(dq^1 dp^1)$ and $\bar{\nu}_{|\mathcal{Y}_{\text{bo}}^{i,\epsilon}}^2(dq^2 dp^2)$ such that*

$$\bar{\nu}_{|\mathcal{Y}_{\text{bo}}^{i,\epsilon}} = \bar{\nu}_{|\mathcal{Y}_{\text{bo}}^{i,\epsilon}}^1(dq^1 dp^1) \otimes \bar{\nu}_{|\mathcal{Y}_{\text{bo}}^{i,\epsilon}}^2(dq^2 dp^2).$$

Besides, the marginal distribution of the normal component (q^i, p^i) writes

$$\bar{\nu}_{|\mathcal{Y}_{\text{bo}}^{i,\epsilon}}^i(dq^i dp^i) = \delta_{q_0^i}(dq^i) \phi^{i,\epsilon}(\epsilon p^i) dp^i,$$

where $q_0^i = 0$ if $\epsilon = +$ and $q_0^i = 1$ if $\epsilon = -$, up to a multiplicative constant.

Proof. The proof for the four boundary sections being the same, we only address the case $(i, \epsilon) = (1, +)$. Then, by §3.5.2.1,

$$\begin{aligned} & \bar{\nu}_{|\mathcal{Y}_{\text{bo}}^{1,+}}(dq^1 dq^2 dp^1 dp^2) \\ &= \int_{y_0 \in \mathcal{Y}_{\text{ou}}^{1,+}} Q_{(1,+,\text{ou}) \rightarrow (1,+,\text{bo})}(y_0; dq^1 dq^2 dp^1 dp^2) \bar{\nu}_{|\mathcal{Y}_{\text{ou}}^{1,+}}(dy_0) \\ & \quad + \int_{y_0 \in \mathcal{Y}_{\text{bo}}^{2,-}} Q_{(2,-,\text{bo}) \rightarrow (1,+,\text{bo})}(y_0; dq^1 dq^2 dp^1 dp^2) \bar{\nu}_{|\mathcal{Y}_{\text{bo}}^{2,-}}(dy_0) \\ &= \int_{y_0 \in \mathcal{Y}_{\text{ou}}^{1,+}} \delta_0(dq^1) \phi^{1,+}(p^1) dp^1 \otimes \mathbf{1}_{\{0 < q^2 < 1-a\}} \rho_{-a/p_0^1}^{2-a;2,1}(q_0^2, p_0^2; dq^2 dp^2) \bar{\nu}_{|\mathcal{Y}_{\text{ou}}^{1,+}}(dy_0) \\ & \quad + \int_{y_0 \in \mathcal{Y}_{\text{bo}}^{2,-}} \delta_0(dq^1) \phi^{1,+}(p^1) dp^1 \otimes \mathbf{1}_{\{0 < q^2 < 1-a\}} \rho_{-a/p_0^2}^{2-a;2,1}(q_0^1 + 1 - a, p_0^1; dq^2 dp^2) \bar{\nu}_{|\mathcal{Y}_{\text{bo}}^{2,-}}(dy_0) \\ &= \delta_0(dq^1) \phi^{1,+}(p^1) dp^1 \otimes \bar{\nu}_{|\mathcal{Y}_{\text{bo}}^{1,+}}^2(dq^2 dp^2), \end{aligned}$$

where

$$\begin{aligned} \bar{\nu}_{|\mathcal{Y}_{\text{bo}}^{1,+}}^2(dq^2 dp^2) &:= \mathbf{1}_{\{0 < q^2 < 1-a\}} \left(\int_{y_0 \in \mathcal{Y}_{\text{ou}}^{1,+}} \rho_{-a/p_0^1}^{2-a;2,1}(q_0^2, p_0^2; dq^2 dp^2) \bar{\nu}_{|\mathcal{Y}_{\text{ou}}^{1,+}}(dy_0) \right. \\ & \quad \left. + \int_{y_0 \in \mathcal{Y}_{\text{bo}}^{2,-}} \rho_{-a/p_0^2}^{2-a;2,1}(q_0^1 + 1 - a, p_0^1; dq^2 dp^2) \bar{\nu}_{|\mathcal{Y}_{\text{bo}}^{2,-}}(dy_0) \right). \end{aligned}$$

The proof is completed. \square

3.5.3.2 Thermal equilibrium

We now assume that the system is at thermal equilibrium, *i.e.* $\phi^{1,+} = \phi^{2,+} = \phi^+$ and $\phi^{1,-} = \phi^{2,-} = \phi^-$, see Subsection 3.2.3. Let us assume that ψ^+ and ψ^- defined by $\psi^\epsilon(r) = r^{-2} \phi^\epsilon(r^{-1})$ satisfy the condition (H1), and let μ^+ and μ^- refer to the respective first order moments of ψ^+ and ψ^- . Then, a bounded stationary distribution $\bar{\nu}$ can be explicitly derived. Indeed, let us first note that the probability distributions $\rho_t^{b;i_+,i_-}(q^0, p^0; dq dp)$ and $\rho_\infty^{b;i_+,i_-}(dq dp)$ introduced in Definition 3.4.2 no longer depend on i_+ and i_- , and therefore can be denoted by $\rho_t^b(q^0, p^0; dq dp)$

and $\rho_\infty^b(dqdp)$. Furthermore, for all $b > 0$, $\rho_\infty^b(dqdp) = b^{-1} \mathbb{1}_{\{0 < q < b\}} \bar{\rho}_\infty(dqdp)$, where $\bar{\rho}_\infty(dqdp)$ refers to the positive and σ -finite measure

$$\bar{\rho}_\infty(dqdp) := \frac{1}{\mu^+ + \mu^-} \left(\mathbb{1}_{\{p > 0\}} \frac{\phi^+(p)}{p} + \mathbb{1}_{\{p < 0\}} \frac{\phi^-(-p)}{-p} \right) dqdp$$

on $\mathbb{R} \times \mathbb{R}$. Besides, the stationarity of $\rho_\infty^b(dqdp)$ reads, for all $b > 0$,

$$\forall t > 0, \quad \bar{\rho}_\infty(dqdp) = \int_{(q_0, p_0) \in [0, b] \times \mathbb{R}} \rho_t^b(q_0, p_0; dqdp) \bar{\rho}_\infty(dqdp).$$

Let us now define $\bar{\nu}$ as follows:

$$\begin{aligned} \bar{\nu}_{|\mathcal{Y}_{\text{bo}}^{1,+}} &= \delta_0(dq^1) \phi^+(p^1) dp^1 \otimes \mathbb{1}_{\{0 < q^2 < 1-a\}} \bar{\rho}_\infty(dq^2 dp^2), \\ \bar{\nu}_{|\mathcal{Y}_{\text{in}}^{1,+}} &= \delta_a(dq^1) \phi^+(p^1) dp^1 \otimes \mathbb{1}_{\{0 < q^2 < 1\}} \bar{\rho}_\infty(dq^2 dp^2), \\ \bar{\nu}_{|\mathcal{Y}_{\text{ou}}^{1,+}} &= \delta_a(dq^1) \phi^-(-p^1) dp^1 \otimes \mathbb{1}_{\{0 < q^2 < 1\}} \bar{\rho}_\infty(dq^2 dp^2), \end{aligned}$$

and the restriction of $\bar{\nu}$ to the other elementary sections is defined similarly.

Proposition 3.5.9 (Existence of a stationary probability distribution at equilibrium). *At thermal equilibrium and under the assumption that ψ^+ and ψ^- satisfy the condition (H1), the measure $\bar{\nu}$ defined above is a bounded stationary distribution for the Markov chain $(Y_n)_{n \geq 0}$.*

Proof. The fact that $\bar{\nu}$ is bounded under the assumption (H1) is straightforward. To prove that it is a stationary distribution, we have to check that, for all $(i', \epsilon', \star') \in \Pi$,

$$\bar{\nu}_{|\mathcal{Y}_{i', \epsilon', \star'}^{i', \epsilon', \star'}}(dy) = \sum_{y_0 \in \mathcal{Y}_{i, \epsilon, \star}^{i, \epsilon, \star}} Q_{(i, \epsilon, \star) \rightarrow (i', \epsilon', \star')}(y_0; dy) \bar{\nu}_{|\mathcal{Y}_{i, \epsilon, \star}^{i, \epsilon, \star}}(dy_0),$$

where the sum is taken over all the indices (i, ϵ, \star) such that the edge $(i, \epsilon, \star) \rightarrow (i', \epsilon', \star')$ belongs to the graph of Figure 3.7. The arguments are the same for all the indices (i', ϵ', \star') in Π , as an illustration we only detail the case $(i', \epsilon', \star') = (1, +, \text{in})$. Then, the only indices (i, ϵ, \star) such that the edge $(i, \epsilon, \star) \rightarrow (1, +, \text{in})$ belongs to the graph of Figure 3.7 are $(1, +, \text{bo})$ and $(2, -, \text{ou})$.

On the one hand,

$$\begin{aligned} & \int_{y_0 \in \mathcal{Y}_{\text{bo}}^{1,+}} Q_{(1,+, \text{bo}) \rightarrow (1,+, \text{in})}(y_0; dy) \bar{\nu}_{|\mathcal{Y}_{\text{bo}}^{1,+}}(dy_0) \\ &= \int_{y_0 \in \mathcal{Y}_{\text{bo}}^{1,+}} \left(\delta_{(a, p_0^1)}(dq^1 dp^1) \otimes \mathbb{1}_{\{0 < q^2 < 1\}} \rho_{a/p_0^1}^{2-a}(q_0^2, p_0^2; dq^2 dp^2) \right) \\ & \quad \cdot \delta_0(dq_0^1) \phi^+(p_0^1) dp_0^1 \mathbb{1}_{\{0 < q_0^2 < 1-a\}} \bar{\rho}_\infty(dq_0^2 dp_0^2) \\ &= \mathbb{1}_{\{0 < q^2 < 1\}} \int_{p_0^1=0}^{+\infty} \delta_{(a, p_0^1)}(dq^1 dp^1) \\ & \quad \cdot \left\{ \int_{(q_0^2, p_0^2) \in [0, 1-a] \times \mathbb{R}} \rho_{a/p_0^1}^{2-a}(q_0^2, p_0^2; dq^2 dp^2) \bar{\rho}_\infty(dq_0^2 dp_0^2) \right\} \phi^+(p_0^1) dp_0^1. \end{aligned}$$

On the other hand,

$$\begin{aligned} & \int_{y_0 \in \mathcal{Y}_{\text{ou}}^{2,-}} Q_{(2,-, \text{ou}) \rightarrow (1,+, \text{in})}(y_0; dy) \bar{\nu}_{|\mathcal{Y}_{\text{ou}}^{2,-}}(dy_0) \\ &= \int_{y_0 \in \mathcal{Y}_{\text{ou}}^{2,-}} \left(\delta_{(a, p_0^2)}(dq^1 dp^1) \otimes \mathbb{1}_{\{0 < q^2 < 1\}} \rho_{a/p_0^2}^{2-a}(q_0^1 + 1 - a, p_0^1; dq^2 dp^2) \right) \\ & \quad \cdot \mathbb{1}_{\{0 < q_0^1 < 1\}} \bar{\rho}_\infty(dq_0^1 dp_0^1) \delta_{1-a}(dq_0^2) \phi^+(p_0^2) dp_0^2 \\ &= \mathbb{1}_{\{0 < q^2 < 1\}} \int_{p_0^2=0}^{+\infty} \delta_{(a, p_0^2)}(dq^1 dp^1) \\ & \quad \cdot \left\{ \int_{(q_0^1, p_0^1) \in [0, 1] \times \mathbb{R}} \rho_{a/p_0^2}^{2-a}(q_0^1 + 1 - a, p_0^1; dq^2 dp^2) \bar{\rho}_\infty(dq_0^1 dp_0^1) \right\} \phi^+(p_0^2) dp_0^2. \end{aligned}$$

Putting the last two equalities together, we obtain

$$\begin{aligned} & \int_{y_0 \in \mathcal{Y}_{\text{bo}}^{1,+}} Q_{(1,+,\text{bo}) \rightarrow (1,+,\text{in})}(y_0; \text{d}y) \bar{\nu}_{|\mathcal{Y}_{\text{bo}}^{1,+}}(\text{d}y_0) + \int_{y_0 \in \mathcal{Y}_{\text{ou}}^{2,-}} Q_{(2,-,\text{ou}) \rightarrow (1,+,\text{in})}(y_0; \text{d}y) \bar{\nu}_{|\mathcal{Y}_{\text{ou}}^{2,-}}(\text{d}y_0) \\ &= \mathbb{1}_{\{0 < q^2 < 1\}} \int_{p_0^1=0}^{+\infty} \delta_{(a,p_0^1)}(\text{d}q^1 \text{d}p^1) \\ & \quad \cdot \left\{ \int_{(q_0^2, p_0^2) \in [0, 2-a] \times \mathbb{R}} \rho_{a/p_0^1}^{2-a}(q_0^2, p_0^2; \text{d}q^2 \text{d}p^2) \bar{\rho}_\infty(\text{d}q_0^2 \text{d}p_0^2) \right\} \phi^+(p_0^1) \text{d}p_0^1. \end{aligned}$$

By stationarity, for all $p_0^1 > 0$, the braced term above writes

$$\int_{(q_0^2, p_0^2) \in [0, 2-a] \times \mathbb{R}} \rho_{a/p_0^1}^{2-a}(q_0^2, p_0^2; \text{d}q^2 \text{d}p^2) \bar{\rho}_\infty(\text{d}q_0^2 \text{d}p_0^2) = \bar{\rho}_\infty(\text{d}q^2 \text{d}p^2),$$

so that

$$\begin{aligned} & \int_{y_0 \in \mathcal{Y}_{\text{bo}}^{1,+}} Q_{(1,+,\text{bo}) \rightarrow (1,+,\text{in})}(y_0; \text{d}y) \bar{\nu}_{|\mathcal{Y}_{\text{bo}}^{1,+}}(\text{d}y_0) + \int_{y_0 \in \mathcal{Y}_{\text{ou}}^{2,-}} Q_{(2,-,\text{ou}) \rightarrow (1,+,\text{in})}(y_0; \text{d}y) \bar{\nu}_{|\mathcal{Y}_{\text{ou}}^{2,-}}(\text{d}y_0) \\ &= \mathbb{1}_{\{0 < q^2 < 1\}} \bar{\rho}_\infty(\text{d}q^2 \text{d}p^2) \int_{p_0^1=0}^{+\infty} \delta_{(a,p_0^1)}(\text{d}q^1 \text{d}p^1) \phi^+(p_0^1) \text{d}p_0^1 \\ &= \delta_a(\text{d}q^1) \phi^+(p^1) \text{d}p^1 \otimes \mathbb{1}_{\{0 < q^2 < 1\}} \bar{\rho}_\infty(\text{d}q^1 \text{d}p^2), \end{aligned}$$

which is exactly the claimed expression for $\bar{\nu}_{|\mathcal{Y}_{\text{in}}^{1,+}}$. \square

3.6 Proof of Theorem 3.2.5

In this section, we show that, under the assumptions of Theorem 3.2.5, the Markov renewal process $(Y_n, \tau_n)_{n \geq 0}$ constructed in Section 3.5 satisfies the assumptions of the Markov Renewal Theorem 3.3.7. We then complete the proof of Theorem 3.2.5.

We first check in Subsection 3.6.1 that the Markov chain $(Y_n)_{n \geq 0}$ is Harris recurrent, which implies that it possesses a unique stationary σ -finite distribution, up to a multiplicative constant, thanks to Proposition 3.3.3. At thermal equilibrium, Proposition 3.5.9 provides a bounded stationary distribution, which implies that the Markov chain $(Y_n)_{n \geq 0}$ is positive recurrent. Out of equilibrium, we were not able to obtain such a result and therefore have to formulate the first technical assumption

(T1) The stationary distributions of the Markov chain $(Y_n)_{n \geq 0}$ are bounded.

In Subsection 3.6.2, we address the remaining assumptions of the Markov Renewal Theorem; namely, the nonarithmeticity and the finiteness of the drift. Out of equilibrium, we have to formulate the second technical assumption

(T2) With the notations of Theorem 3.3.7, $\bar{\mu} < +\infty$.

Under these technical assumptions, we complete the proof of Theorem 3.2.5 in Subsection 3.6.3.

3.6.1 Harris recurrence of the Markov chain $(Y_n)_{n \geq 0}$

This subsection is dedicated to the proof of the following proposition.

Proposition 3.6.1 (Harris recurrence). *Under the assumptions of Theorem 3.2.5 on the update densities, the Markov chain $(Y_n)_{n \geq 0}$ introduced in Section 3.5 is Harris recurrent.*

The proof is detailed in the paragraphs below. In §3.6.1.1, a family of sets R_η , indexed by some parameter η , is provided, together with $\epsilon_\eta, \lambda_\eta$ such that the local Doeblin condition is satisfied in the set R_η , with $r = 1$ and $\epsilon_\eta, \lambda_\eta$. In §3.6.1.2, a value of η is fixed in order to ensure that the set R_η is recurrent, which is proved in §3.6.1.3.

3.6.1.1 The local Doeblin condition

The local Doeblin condition expresses the fact that the Markov chain $(Y_n)_{n \geq 0}$ has good mixing properties, in the sense that it somehow forgets the initial condition after r steps, as long as this initial condition lies in R . Let us first explain how to derive a natural set R for the Markov chain $(Y_n)_{n \geq 0}$.

The transition measures of the form $Q_{(i,\epsilon,\star) \rightarrow (i',\epsilon',\text{bo})}(y; \cdot)$ correspond to an update of the normal component, so that at least this component has totally forgotten the initial condition. On the other hand, the marginal distribution of the nonupdated component is the pushforward measure by the folding map of some measure $\rho_{\tau_{\text{obs}}(y)}^{2-a; i_+, i_-}(\tilde{q}_0, \tilde{p}_0; d\tilde{q}d\tilde{p})$ for some $i_+, i_-, \tilde{q}_0, \tilde{p}_0$ depending on y . By Lemma 3.4.5, if $\tau_{\text{obs}}(y)$ is large, then $\rho_{\tau_{\text{obs}}(y)}^{2-a; i_+, i_-}(\tilde{q}_0, \tilde{p}_0; d\tilde{q}d\tilde{p})$ is close to the steady state $\rho_{\infty}^{2-a; i_+, i_-}(d\tilde{q}d\tilde{p})$ and therefore weakly depends on y .

These ideas are made precise in Lemma 3.6.3 below. It is first necessary to introduce the following notation.

Definition 3.6.2 (Function Γ). *For all $y = (q^1, q^2; p^1, p^2) \in \mathcal{Y}$, let us define $\Gamma(y)$ by*

- $\Gamma(y) := \tau_{\text{obs}}(y) - \tau_{\text{end}}^{2-a}(q^2, p^2)$ if $y \in \mathcal{Y}_{\text{bo}}^{1,+} \cup \mathcal{Y}_{\text{ou}}^{1,+}$,
- $\Gamma(y) := \tau_{\text{obs}}(y) - \tau_{\text{end}}^1(q^2, p^2)$ if $y \in \mathcal{Y}_{\text{in}}^{1,+}$,
- $\Gamma(y) := \Gamma(\mathfrak{S}^{i,\epsilon}(y))$ if $y \in \mathcal{Y}_{\star}^{i,\epsilon}$ with $(i, \epsilon) \neq (1, +)$,

where $\tau_{\text{end}}^b(q, p)$ is defined in Definition 3.4.3.

The quantity $\Gamma(y)$ denotes to the difference between the time needed by the normal component of the unfolded process to reach the elementary section toward which it is directed, and the time needed by the tangential component of the unfolded process to reach the boundary of the domain toward which it is directed. Therefore, the larger $\Gamma(y)$ is, the closer the marginal distribution of the nonupdated component of the unfolded process is to its steady state.

Lemma 3.6.3 (Local Doeblin condition). *Under the assumptions of Theorem 3.2.5, there exists $M \geq 0$ such that, for all $\eta > M$, the set*

$$R_{\eta} := \{y \in \mathcal{Y}_{\text{bo}}^{1,+} : \Gamma(y) \geq \eta\}$$

satisfies the local Doeblin condition with $r = 1$ and suitable $\epsilon_{\eta}, \lambda_{\eta}$.

Proof. Under the assumptions of Theorem 3.2.5, Lemma 3.4.5 can be applied to the probability densities $\psi^{2-a; 2, +}(r)$ and $\psi^{2-a; 1, -}(r)$ defined in Subsection 3.4.1. As a consequence, there exists $M^{2-a; 2, 1} \geq 0$, that we denote by M in the sequel of the proof, such that, for all $\eta > M$, for all $(q_0, p_0) \in [0, 2-a] \times \mathbb{R}$ such that $p_0 \neq 0$,

$$\forall t \geq \tau_{\text{end}}^{2-a}(q_0, p_0) + \eta, \quad \rho_t^{2-a, 2, 1}(q_0, p_0; dqdp) \geq \ell_{\eta}^{2-a, 2, 1}(dqdp),$$

where the positive and bounded measure $\ell_{\eta}^{2-a, 2, 1}(dqdp)$ is defined in (3.10).

Let $\eta > M$, let us define

$$R_{\eta} := \{y \in \mathcal{Y}_{\text{bo}}^{1,+} : \Gamma(y) \geq \eta\}.$$

Then, for all $y = (q_0^1, q_0^2; p_0^1, p_0^2) \in R_{\eta}$, $\tau_{\text{obs}}(y) = \tau_{\text{end}}^{2-a}(y) + \Gamma(y) \geq \tau_{\text{end}}^{2-a}(y) + \eta$. Therefore, according to §3.5.2.1,

$$\begin{aligned} Q(y; \cdot) &\geq Q_{(1,+, \text{bo}) \rightarrow (2, -, \text{bo})}(y; \cdot) \\ &= \mathbb{1}_{\{a < q^1 < 1\}} \rho_{\tau_{\text{obs}}(y)}^{1, 2-a; 2, 1}(q_0^2, p_0^2; dq^1 dp^1) \otimes \delta_1(dq^2) \phi^{2, -}(-p^2) dp^2 \\ &\geq \mathbb{1}_{\{a < q^1 < 1\}} \ell_{\eta}^{1, 2-a; 2, 1}(dq^1 dp^1) \otimes \delta_1(dq^2) \phi^{2, -}(-p^2) dp^2, \end{aligned}$$

where we denote by $\ell_{\eta}^{1, 2-a; 2, 1}(dq^1 dp^1)$ the pushforward measure of $\ell_{\eta}^{2-a; 2, 1}(dq^1 dp^1)$ by the application $(q, p) \mapsto (q-1+a, p)$. The right hand side above no longer depends on y , we denote it by $\tilde{\lambda}_{\eta}(\cdot)$. It is a positive bounded measure on $\mathcal{Y}_{\text{bo}}^{2, -}$. To complete the proof, we now check that

$\epsilon_\eta := \tilde{\lambda}_\eta(\mathcal{Y}_{\text{bo}}^{2,-}) > 0$. Certainly, it is sufficient to prove that $\ell_\eta^{1,2-a;2,1}((a,1) \times \mathbb{R}) > 0$, that is to say $\ell_\eta^{2-a;2,1}((1,2-a) \times \mathbb{R}) > 0$. Owing to (3.10),

$$\ell_\eta^{2-a;2,1}(dqdp) \geq \frac{1}{2(2-a)(\mu^{2,+} + \mu^{1,-})} \mathbb{1}_{\{p < 0, 2-a-q \leq -(\eta-M)p\}} \frac{\phi^{1,-}(-p)}{-p} dpdq,$$

and for all $p \in (-\infty, 0)$, the marginal distribution in q above gives positive weight to $(1, 2-a)$. Therefore $\epsilon_\eta > 0$ and the proof is completed by letting $\lambda_\eta(\cdot) := \tilde{\lambda}_\eta/\epsilon_\eta$. \square

Remark 3.6.4. The role of the condition (H3) is now clear: the set R_η is characterised by the fact that the normal component of the velocity is slow with respect to the tangential component of the velocity, so that the tangential component of the unfolded process has enough time to mix and get close to its steady state before the next observation time. If the normal component of the velocity is not small, then at the observation time, the tangential component has not mixed enough.

3.6.1.2 The sequence $(\Gamma(Y_n))_{n \geq 0}$

The function Γ plays a key role in the derivation of nice mixing properties for the Markov chain $(Y_n)_{n \geq 0}$, therefore it is natural to try to reduce the dimension of the problem by studying the sequence $(\Gamma(Y_n))_{n \geq 0}$. Of course, this is *not* a Markov chain. However, following the line of the proof of Lemma 3.6.3, one can obtain the following result.

Lemma 3.6.5. *Under the assumptions of Theorem 3.2.5, for all edge $(i, \epsilon, \star) \rightarrow (i', \epsilon', \star')$ in the graph of Figure 3.7, for all $\eta' \geq 0$, there exists $\underline{\eta} > 0$ such that, for all $\eta > \underline{\eta}$,*

$$\inf_{y \in \mathcal{Y}_{\star}^{i,\epsilon} : \Gamma(y) \geq \eta} \mathbf{P}_y(Y_1 \in \mathcal{Y}_{\star'}^{i',\epsilon'}, \Gamma(Y_1) \geq \eta') > 0. \quad (3.14)$$

Proof. We prove the statement for $y \in \mathcal{Y}_{\text{bo}}^{1,+} \cup \mathcal{Y}_{\text{in}}^{1,+} \cup \mathcal{Y}_{\text{ou}}^{1,+}$ and use the symmetries of §3.2.1.2 to conclude. Let us first introduce, for all $(i, \epsilon) \in \{1, 2\} \times \{+, -\}$,

$$S^{i,\epsilon} := \sup \left\{ v > 0 : \int_0^v \phi^{i,\epsilon}(p) dp < 1 \right\} \in (0, +\infty],$$

and recall the definition of $M^{b;i+,i-}$ from Lemma 3.4.5. Depending on the edge $(i, \epsilon, \star) \rightarrow (i', \epsilon', \star')$, we shall prove below that, given $\eta' \geq 0$, (3.14) holds for the following choices of $\underline{\eta}$:

- $(1, +, \text{bo}) \rightarrow (2, -, \text{bo})$: $\underline{\eta} = M^{2-a;2,1}$.
- $(1, +, \text{bo}) \rightarrow (1, +, \text{in})$: $\underline{\eta} = (M^{2-a;2,1} + 1/S^{2,+}) \vee a\eta'/(1-2a)$.
- $(1, +, \text{in}) \rightarrow (1, -, \text{ou})$: $\underline{\eta} = (M^{1;2,2} + 1/S^{2,+}) \vee (1-2a)\eta'/a$.
- $(1, +, \text{ou}) \rightarrow (2, -, \text{in})$: $\underline{\eta} = (M^{2-a;2,1} + 1/S^{1,-}) \vee a\eta'/(1-2a)$.
- $(1, +, \text{ou}) \rightarrow (1, +, \text{bo})$: $\underline{\eta} = M^{2-a;2,1}$.

Case $(1, +, \text{bo}) \rightarrow (2, -, \text{bo})$: let $\eta' \geq 0$, and let $\eta > \underline{\eta} := M^{2-a;2,1}$. Let $y \in \mathcal{Y}_{\text{bo}}^{1,+}$ such that $\Gamma(y) \geq \eta$. By Lemma 3.6.3,

$$\begin{aligned} \mathbf{P}_y(Y_1 \in \mathcal{Y}_{\text{bo}}^{2,-}, \Gamma(Y_1) \geq \eta') &\geq \epsilon_\eta \lambda_\eta(\{y' \in \mathcal{Y}_{\text{bo}}^{2,-}, \Gamma(y') \geq \eta'\}) \\ &= \frac{1}{2(2-a)(\mu^{2,+} + \mu^{1,-})} \int_{\mathcal{Y}_{2,-}} \delta_1(dq^2) \phi^{2,-}(-p^2) dp^2 \\ &\quad \left\{ \mathbb{1}_{\{p^1 < 0, (1-q^1)/(-p^1) \leq \eta - M^{2-a;2,1}, a/(-p^2) - (q^1+1-a)/(-p^1) \geq \eta'\}} \frac{\phi^{1,-}(-p^1)}{-p^1} \right. \\ &\quad \left. + \mathbb{1}_{\{p^1 > 0, (q^1+1-a)/p^1 \leq \eta - M^{2-a;2,1}, a/(-p^2) - (1-q^1)/p^1 \geq \eta'\}} \frac{\phi^{2,+}(p^1)}{p^1} \right\} dq^1 dp^1. \end{aligned} \quad (3.15)$$

The right hand side above does not depend on y . Besides, for all $p^1 < 0$, the set $\{q^1 \in [a, 1) : (1 - q^1)/(-p^1) \leq \eta - M^{2-a;2,1}\}$ has positive Lebesgue measure, and for all q^1 in this set, the assumption that $\psi^{2,-}$ satisfies (H3) ensures that

$$\int_{p^2=-\infty}^0 \mathbb{1}_{\{a/(-p^2)-(q^1+1-a)/(-p^1) \geq \eta'\}} \phi^{2,-}(-p^2) dp^2 > 0.$$

The proof of the case $(1, +, \text{ou}) \rightarrow (1, +, \text{bo})$ is similar.

Case $(1, +, \text{bo}) \rightarrow (1, +, \text{in})$: let $\eta' \geq 0$, and let $\eta > \underline{\eta} := (M^{2-a;2,1} + 1/S^{2,+}) \vee a\eta'/(1-2a)$.

Then, for all $y = (0, q_0^2; p_0^1, p_0^2) \in \mathcal{Y}_{\text{bo}}^{1,+}$ such that $\Gamma(Y) \geq \eta$, the same proof as for Lemma 3.6.3 yields

$$\begin{aligned} \mathbf{P}_y(Y_1 \in \mathcal{Y}_{\text{in}}^{1,+}, \Gamma(Y_1) \geq \eta') &\geq \frac{1}{2(2-a)(\mu^{2,+} + \mu^{1,-})} \int_{\mathcal{Y}_{\text{in}}^{1,+}} \delta_{(a,p_0^1)}(dq^1 dp^1) \\ &\left\{ \mathbb{1}_{\{p^2 < 0, (2-a-q^2)/(-p^2) \leq \eta - M^{2-a;2,1}, (1-2a)/p^1 - q^2/(-p^2) \geq \eta'\}} \frac{\phi^{1,-}(-p^2)}{-p^2} \right. \\ &\left. + \mathbb{1}_{\{p^2 > 0, q^2/p^2 \leq \eta - M^{2-a;2,1}, (1-2a)/p^1 - (1-q^2)/p^2 \geq \eta'\}} \frac{\phi^{2,+}(p^2)}{p^2} \right\} dq^2 dp^2. \end{aligned}$$

The measure with density $\phi^{2,+}(p^2)$ gives positive weight to the set $\{1/(\eta - M^{2-a;2,1}) \leq p^2 \leq S^{2,+}\}$, and for all p^2 in this set,

$$\begin{aligned} &\int_{q^2=0}^1 \mathbb{1}_{\{q^2/p^2 \leq \eta - M^{2-a;2,1}, (1-2a)/p_0^1 - (1-q^2)/p^2 \geq \eta'\}} dq^2 \\ &\geq \int_{q^2=0}^1 \mathbb{1}_{\{q^2/p^2 \leq \eta - M^{2-a;2,1}, (1-q^2)/p^2 \leq \eta(1-2a)/a - \eta'\}} dq^2 \end{aligned}$$

owing to the fact that $\Gamma(y) = a/p_0^1 - \tau_{\text{end}}^{2-a}(q_0^2, p_0^2) \geq \eta$. Now, it is a consequence of our choice of η that the right hand side above is positive. The proofs of the cases $(1, +, \text{in}) \rightarrow (1, -, \text{ou})$ and $(1, +, \text{ou}) \rightarrow (2, -, \text{in})$ are similar. \square

We now would like to introduce a collection of positive numbers $\{\eta_{\star}^{i,\epsilon} : (i, \epsilon, \star) \in \Pi\}$ such that, for all edge $(i, \epsilon, \star) \rightarrow (i', \epsilon', \star')$ of the graph,

$$\inf_{y \in \mathcal{Y}_{\star}^{i,\epsilon} : \Gamma(y) \geq \eta_{\star}^{i,\epsilon}} \mathbf{P}_y(Y_1 \in \mathcal{Y}_{\star'}^{i',\epsilon'}, \Gamma(Y_1) \geq \eta_{\star'}^{i',\epsilon'}) > 0.$$

However, some of the relations between η' and $\underline{\eta}$ introduced in the proof of Lemma 3.6.5 are not compatible, therefore we have to restrict ourselves to a subset of edges, that however preserves the connectedness of the graph. More precisely, we shall remove the edge $(1, +, \text{ou}) \rightarrow (2, -, \text{in})$ and its symmetrically associated edges.

Using the notations of the proof of Lemma 3.6.5, we define $\{\eta_{\star}^{i,\epsilon} : (i, \epsilon, \star) \in \Pi\}$ as follows:

- We first fix the values of $\eta_{\text{ou}}^{i,\epsilon}$ such that

$$\begin{aligned} \eta_{\text{ou}}^{1,+} &> M^{2-a;2,1}, \\ \eta_{\text{ou}}^{1,-} &> M^{2-a;1,2}, \\ \eta_{\text{ou}}^{2,+} &> M^{2-a;1,2}, \\ \eta_{\text{ou}}^{2,-} &> M^{2-a;2,1}. \end{aligned}$$

- We then fix the values of $\eta_{\text{in}}^{i,\epsilon}$ such that

$$\begin{aligned} \eta_{\text{in}}^{1,+} &> (\eta_{\text{ou}}^{1,-}(1-2a)/a) \vee (M^{1;2,2} + 1/S^{2,+}), \\ \eta_{\text{in}}^{1,-} &> (\eta_{\text{ou}}^{1,+}(1-2a)/a) \vee (M^{1;2,2} + 1/S^{2,+}), \\ \eta_{\text{in}}^{2,+} &> (\eta_{\text{ou}}^{2,-}(1-2a)/a) \vee (M^{1;1,1} + 1/S^{1,+}), \\ \eta_{\text{in}}^{2,-} &> (\eta_{\text{ou}}^{2,+}(1-2a)/a) \vee (M^{1;1,1} + 1/S^{1,+}). \end{aligned}$$

- We finally fix the values of $\eta_{\text{bo}}^{i,\epsilon}$ such that

$$\begin{aligned}\eta_{\text{bo}}^{1,+} &> (\eta_{\text{in}}^{1,+} a / (1 - 2a)) \vee (M^{2-a;2,1} + 1/S^{2,+}), \\ \eta_{\text{bo}}^{1,-} &> (\eta_{\text{in}}^{1,-} a / (1 - 2a)) \vee (M^{2-a;1,2} + 1/S^{2,-}), \\ \eta_{\text{bo}}^{2,+} &> (\eta_{\text{in}}^{2,+} a / (1 - 2a)) \vee (M^{2-a;2,1} + 1/S^{1,+}), \\ \eta_{\text{bo}}^{2,-} &> (\eta_{\text{in}}^{2,-} a / (1 - 2a)) \vee (M^{2-a;1,2} + 1/S^{1,-}).\end{aligned}$$

Definition 3.6.6 (The set Θ). For all $(i, \epsilon, \star) \in \Pi$, let us denote by $\Theta_{\star}^{i,\epsilon}$ the set $\{y \in \mathcal{Y}_{\star}^{i,\epsilon} : \Gamma(y) \geq \eta_{\star}^{i,\epsilon}\}$, and let Θ refer to the union of the twelve sets of the collection $\{\Theta_{\star}^{i,\epsilon} : (i, \epsilon, \star) \in \Pi\}$.

The proof of Lemma 3.6.5 ensures that, for all edge $(i, \epsilon, \star) \rightarrow (i', \epsilon', \star')$ in the (reduced) graph of Figure 3.8,

$$\alpha((i, \epsilon, \star) \rightarrow (i', \epsilon', \star')) := \inf_{y \in \Theta_{\star}^{i,\epsilon}} \mathbf{P}_y(Y_1 \in \Theta_{\star'}^{i',\epsilon'}) > 0.$$

The matrix indexed by $\Pi \times \Pi$ with coefficients $\alpha((i, \epsilon, \star) \rightarrow (i', \epsilon', \star'))$, completed with null coefficients whenever the edge $\Theta_{\star}^{i,\epsilon} \rightarrow \Theta_{\star'}^{i',\epsilon'}$ does not belong to the reduced graph of Figure 3.8, is substochastic: at each transition, some mass is lost, which corresponds to the probability for Y to leave Θ . However, it remains irreducible in the sense that the reduced graph is connected. In particular, this implies that, for all $(i, \epsilon, \star) \in \Pi$, there exists $\alpha_{\star}^{i,\epsilon} > 0$ such that, for all $y \in \Theta$, there exists a deterministic $N(y) \in \mathbb{N}$ depending only on the elementary section in which y lies, such that $\mathbf{P}_y(Y_{N(y)} \in \Theta_{\star}^{i,\epsilon}) \geq \alpha_{\star}^{i,\epsilon}$. For instance, $N(y)$ can be chosen as the minimal length of a path connecting the vertex corresponding to the elementary section in which y lies with the vertex $\Theta_{\star}^{i,\epsilon}$ in the graph of Figure 3.8. In this case, $N(y) \in \{1, \dots, 6\}$, since 6 is obviously the diameter of the graph.

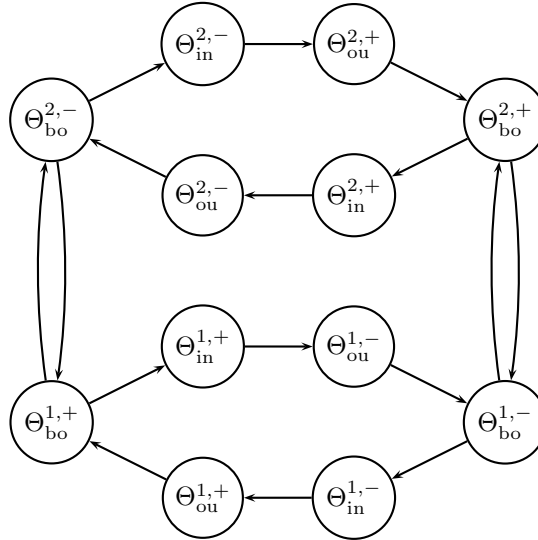

Figure 3.8: The reduced graph. Each edge is associated with the positive weight $\alpha((i, \epsilon, \star) \rightarrow (i', \epsilon', \star'))$.

According to Lemma 3.6.3 and the choice of $\eta_{\text{bo}}^{1,+}$, the local Doeblin condition is satisfied in the set

$$R := \Theta_{\text{bo}}^{1,+} = \{y \in \mathcal{Y}_{\text{bo}}^{1,+} : \Gamma(y) \geq \eta_{\text{bo}}^{1,+}\}, \quad (3.16)$$

with $r = 1$ and

$$\lambda(\cdot) := \lambda_{\eta_{\text{bo}}^{1,+}}(\cdot) = \frac{1}{\epsilon} \mathbf{1}_{\{a < q^1 < 1\}} \ell_{\eta_{\text{bo}}^{1,+}}^{\downarrow 2-a;2,1}(dq^1 dp^1) \otimes \delta_1(dq^2) \phi^{2,-}(-p^2) dp^2,$$

where $\epsilon \in (0, 1)$ is chosen such that $\lambda(\mathcal{Y}) = 1$ (see the proof of Lemma 3.6.3 above). Note that the probability distribution $\lambda(\cdot)$ is concentrated on the elementary section $\mathcal{Y}_{\text{bo}}^{2,+}$.

3.6.1.3 Recurrence

Let us now prove that the set R defined in (3.16) is recurrent, through the two following steps:

Step 1. There exists a stopping time N_1 for the Markov chain $(Y_n)_{n \geq 0}$ and $\beta > 0$ such that, for all $y \in \mathcal{Y}$, $\mathbf{P}_y(N_1 < +\infty) = 1$ and $\mathbf{P}_y(Y_{N_1} \in \Theta) \geq \beta$.

Step 2. There exists a bounded function N_2 on Θ and $\alpha > 0$ such that, for all $y \in \Theta$, $\mathbf{P}_y(Y_{N_2(y)} \in R) \geq \alpha$.

Step 1 is proved in Appendix 3.B. Following the arguments at the end of §3.6.1.2 above, Step 2 is achieved by taking $\alpha = \alpha_{\text{bo}}^{1,+}$. Combining Steps 1 and 2 and using the strong Markov property, we deduce that $N := N_1 + N_2(Y_{N_1}) \geq 1$ is a stopping time for the Markov chain $(Y_n)_{n \geq 0}$, such that, for all $y \in \mathcal{Y}$, $\mathbf{P}_y(N < +\infty) = 1$ and $\mathbf{P}_y(Y_N \in R) \geq \alpha\beta > 0$. This easily leads to the following result.

Lemma 3.6.7 (Recurrence). *For all $y \in \mathcal{Y}$, $\mathbf{P}_y(\exists n \geq 1 : Y_n \in R) = 1$.*

Proof. By the construction of N , there exists a measurable functional Φ on the space of sequences $(y_n)_{n \geq 0}$ in \mathcal{Y} such that $N = \Phi((Y_n)_{n \geq 0})$. Let us define inductively $N^{(0)} = 0$ and $N^{(i+1)} = N^{(i)} + \Phi((Y_{N^{(i)}+n})_{n \geq 0})$.

Let $y \in \mathcal{Y}$. Then, \mathbf{P}_y -almost surely, for all $i \geq 0$, $N^{(i)} < +\infty$. For $i \geq 1$, let $A^{(i)}$ refer to the event $\{Y_{N^{(1)}} \notin R, \dots, Y_{N^{(i)}} \notin R\}$. Then $\mathbf{P}_y(A^{(1)}) \leq 1 - \alpha\beta$, and, for all $i \geq 1$,

$$\mathbf{P}_y(A^{(i)}) = \mathbf{P}_y(A^{(i+1)}) + \mathbf{P}_y(A^{(i)}, Y_{N^{(i+1)}} \in R).$$

By the strong Markov property,

$$\begin{aligned} \mathbf{P}_y(A^{(i)}, Y_{N^{(i+1)}} \in R) &= \mathbf{E}_y(\mathbf{P}_y(A^{(i)}, Y_{N^{(i+1)}} \in R | Y_1, \dots, Y_{N^{(i)}})) \\ &= \mathbf{E}_y(\mathbb{1}_{\{A^{(i)}\}} \mathbf{P}_y(Y_{N^{(i+1)}} \in R | Y_1, \dots, Y_{N^{(i)}})) \\ &= \mathbf{E}_y(\mathbb{1}_{\{A^{(i)}\}} \mathbf{P}_{Y_{N^{(i)}}}(Y_{N^{(1)}} \in R)) \\ &\geq \alpha\beta \mathbf{P}_y(A^{(i)}). \end{aligned}$$

As a consequence, for all $i \geq 1$, $\mathbf{P}_y(A^{(i)}) \leq (1 - \alpha\beta)^i$. By the Borel-Cantelli lemma, there exists a \mathbf{P}_y -almost surely finite random variable I such that $\mathbf{P}_y(Y_{N^{(I)}} \in R) = 1$, which completes the proof. \square

3.6.2 Assumptions of the Markov Renewal Theorem

Under the assumptions of Proposition 3.6.1, completed by the technical assumption (T1), the Markov chain $(Y_n)_{n \geq 0}$ is positive Harris recurrent. Let us denote by ν its unique stationary probability distribution. Let us denote by \mathbf{P}_ν the probability distribution

$$\mathbf{P}_\nu(\cdot) := \int_{y \in \mathcal{Y}} \mathbf{P}_y(\cdot) \nu(dy)$$

on the Skorohod space $D([0, +\infty), \mathcal{X})$. The expectation under \mathbf{P}_ν is denoted by \mathbf{E}_ν .

By Lemma 3.5.7, the Markov renewal process satisfies the assumptions of Definition 3.3.5. To apply the Markov Renewal Theorem 3.3.7, we furthermore need to check that it is nonarithmetic, and that the drift

$$\mathbf{E}_\nu(\tau_1 - \tau_0) = \int_{y \in \mathcal{Y}} \tau_{\text{obs}}(y) \nu(dy) \quad (3.17)$$

is finite.

3.6.2.1 Nonarithmeticity

Let us recall the Definition 3.3.6 of a nonarithmetic Markov renewal process.

Lemma 3.6.8. *Under the assumptions of Theorem 3.2.5, the Markov renewal process $(Y_n, \tau_n)_{n \geq 0}$ is nonarithmetic.*

Proof. Let us assume that there exist $d \geq 0$ and a measurable function $\gamma : \mathcal{Y} \rightarrow [0, d)$ satisfying $\mathbf{P}_\nu(\tau_{\text{obs}}(Y_0) \in \gamma(Y_0) - \gamma(Y_1) + d\mathbb{Z}) = 1$. Our proof is in three steps: in Step 1, we prove that there exists a measurable function $\tilde{\gamma} : \mathcal{Y} \rightarrow [0, d)$ such that $\mathbf{P}_\nu(\gamma(Y_1) = \tilde{\gamma}(Y_0)) = 1$. In Step 2, we combine this result with the fact that the Markov chain $(Y_n)_{n \geq 0}$ satisfies the local Doeblin condition in the set R to prove that, ν -almost everywhere in R , $\tilde{\gamma}$ is constant. As a consequence, ν -almost everywhere in R , $\tau_{\text{obs}}(y) - \gamma(y)$ belongs to the shifted lattice $-\tilde{\gamma} + d\mathbb{Z}$. Finally, in Step 3, we prove that the pushforward measure of the restriction of ν to R by the application $y \mapsto \tau_{\text{obs}}(y) - \gamma(y)$ admits a density, which is a contradiction with the conclusion of Step 2.

Step 1. For all $y \in \mathcal{Y}$, there exists a unique $\tilde{\gamma}(y) \in [0, d)$ such that $\tau_{\text{obs}}(y) \in \gamma(y) - \tilde{\gamma}(y) + d\mathbb{Z}$, and the function $\tilde{\gamma} : \mathcal{Y} \rightarrow [0, d)$ is easily measurable. As a consequence, for all $z \in \mathcal{Y}$ such that $\tau_{\text{obs}}(y) \in \gamma(y) - \gamma(z) + d\mathbb{Z}$, then $\gamma(z) = \tilde{\gamma}(y)$. Therefore, $\mathbf{P}_\nu(\gamma(Y_1) = \tilde{\gamma}(Y_0)) = 1$.

Step 2. The conclusion of Step 1 rewrites

$$\mathbf{P}_\nu(\gamma(Y_1) = \tilde{\gamma}(Y_0)) = \int_{y \in \mathcal{Y}} \int_{z \in \mathcal{Y}} \mathbb{1}_{\{\gamma(z) = \tilde{\gamma}(y)\}} Q(y; dz) \nu(dy) = \int_{y \in \mathcal{Y}} \mathbf{P}_y(\gamma(Y_1) = \tilde{\gamma}(Y_0)) \nu(dy) = 1,$$

so that, for ν -almost all $y \in \mathcal{Y}$, $\mathbf{P}_y(\gamma(Y_1) = \tilde{\gamma}(Y_0)) = 1$. Now, for ν -almost all $y \in R$, for all measurable $B \subset \mathcal{Y}$,

$$\mathbb{1}_{\{\tilde{\gamma}(y) \in B\}} = \mathbf{P}_y(\tilde{\gamma}(Y_0) \in B) = \mathbf{P}_y(\gamma(Y_1) \in B) \geq \epsilon \int_{z \in \mathcal{Y}} \mathbb{1}_{\{\gamma(z) \in B\}} \lambda(dz),$$

i.e. the pushforward measure of λ by γ is absolutely continuous with respect to the Dirac distribution in $\tilde{\gamma}(y)$. Since this pushforward measure is non null and does not depend on y , we deduce that $\tilde{\gamma}$ is constant, ν -almost everywhere in R . As a conclusion,

$$\mathbf{P}_\nu(Y_0 \in R, \tau_{\text{obs}}(Y_0) - \gamma(Y_0) \in -\tilde{\gamma} + d\mathbb{Z}) = \nu(R) > 0.$$

Step 3. Let $f : [0, d) \rightarrow \mathbb{R}$ and $g : [0, +\infty) \rightarrow \mathbb{R}$ be continuous and bounded. Then, by stationarity,

$$\begin{aligned} \mathbf{E}_\nu \left(f(\gamma(Y_0)) g(\tau_{\text{obs}}(Y_0)) \mathbb{1}_{\{Y_0 \in \mathcal{Y}_{\text{bo}}^{1,+}\}} \right) &= \mathbf{E}_\nu \left(f(\gamma(Y_1)) g(\tau_{\text{obs}}(Y_1)) \mathbb{1}_{\{Y_1 \in \mathcal{Y}_{\text{bo}}^{1,+}\}} \right) \\ &= \mathbf{E}_\nu \left(f(\tilde{\gamma}(Y_0)) g(a/v) \mathbb{1}_{\{Y_1 \in \mathcal{Y}_{\text{bo}}^{1,+}\}} \right), \end{aligned}$$

where v is a random variable with density $\phi^{1,+}(p)$ and independent of both Y_0 and the event $\{Y_1 \in \mathcal{Y}_{\text{bo}}^{1,+}\}$. Then,

$$\begin{aligned} \mathbf{E}_\nu \left(f(\tilde{\gamma}(Y_0)) g(a/v) \mathbb{1}_{\{Y_1 \in \mathcal{Y}_{\text{bo}}^{1,+}\}} \right) &= \mathbf{E}_\nu \left(f(\tilde{\gamma}(Y_0)) \mathbb{1}_{\{Y_1 \in \mathcal{Y}_{\text{bo}}^{1,+}\}} \right) \int_{p=0}^{+\infty} g(a/p) \phi^{1,+}(p) dp \\ &= \mathbf{E}_\nu \left(f(\gamma(Y_1)) \mathbb{1}_{\{Y_1 \in \mathcal{Y}_{\text{bo}}^{1,+}\}} \right) \frac{\mathbf{E}_\nu \left(g(\tau_{\text{obs}}(Y_1)) \mathbb{1}_{\{Y_1 \in \mathcal{Y}_{\text{bo}}^{1,+}\}} \right)}{\mathbf{P}_\nu(Y_1 \in \mathcal{Y}_{\text{bo}}^{1,+})}, \end{aligned}$$

so that

$$\mathbf{E}_\nu \left(f(\gamma(Y_0)) g(\tau_{\text{obs}}(Y_0)) | Y_0 \in \mathcal{Y}_{\text{bo}}^{1,+} \right) = \mathbf{E}_\nu \left(f(\gamma(Y_0)) | Y_0 \in \mathcal{Y}_{\text{bo}}^{1,+} \right) \mathbf{E}_\nu \left(g(\tau_{\text{obs}}(Y_0)) | Y_0 \in \mathcal{Y}_{\text{bo}}^{1,+} \right),$$

i.e. $\gamma(Y_0)$ and $\tau_{\text{obs}}(Y_0)$ are independent under $\mathbf{P}_\nu(\cdot | Y_0 \in \mathcal{Y}_{\text{bo}}^{1,+})$. Since $\tau_{\text{obs}}(Y_0)$ admits a density under this probability distribution, then so does $\tau_{\text{obs}}(Y_0) - \gamma(Y_0)$. As a conclusion, and since $R \subset \mathcal{Y}_{\text{bo}}^{1,+}$,

$$\begin{aligned} \mathbf{P}_\nu(Y_0 \in R, \tau_{\text{obs}}(Y_0) - \gamma(Y_0) \in -\tilde{\gamma} + d\mathbb{Z}) &= \mathbf{P}_\nu(Y_0 \in R, \tau_{\text{obs}}(Y_0) - \gamma(Y_0) \in -\tilde{\gamma} + d\mathbb{Z} | Y_0 \in \mathcal{Y}_{\text{bo}}^{1,+}) \nu(\mathcal{Y}_{\text{bo}}^{1,+}) \\ &\leq \mathbf{P}_\nu(\tau_{\text{obs}}(Y_0) - \gamma(Y_0) \in -\tilde{\gamma} + d\mathbb{Z} | Y_0 \in \mathcal{Y}_{\text{bo}}^{1,+}) = 0, \end{aligned}$$

which is a contradiction with the conclusion of Step 2 and therefore completes the proof. \square

3.6.2.2 Finiteness of the drift

The drift $\bar{\mu}$ of the Markov renewal process $(Y_n, \tau_n)_{n \geq 0}$ is defined by (3.17).

Lemma 3.6.9. *At thermal equilibrium and if the probability densities ψ^+ and ψ^- satisfy the assumptions (H1), (H2) and (H3), then $\bar{\mu} < +\infty$.*

Proof. Let $y = (q^1, q^2; p^1, p^2) \in \mathcal{Y}$. Under \mathbf{P}_y , $\tau_1 = \tau_{\text{obs}}(y) \leq (a \wedge (1 - 2a))/|p^i|$, where p^i is the normal component of the velocity in y . At thermal equilibrium, Proposition 3.5.9 provides an explicit expression of ν , and the marginal distribution of $|p^i|$ under ν is proportional to either $\phi^-(p)dp$ or $\phi^+(p)dp$, depending on the elementary section in which y lies. As a consequence, the assumption (H1) ensures that $\mathbf{E}_\nu(\tau_1) < +\infty$. \square

Out of thermal equilibrium, we were not able to obtain a similar control on the marginal distribution of the normal component of the velocities, therefore we have to resort to the technical assumption (T2).

3.6.3 Conclusion of the proof of Theorem 3.2.5

We now complete the proof of Theorem 3.2.5. We recall that under the assumptions of Theorem 3.2.5, the combination of Lemma 3.5.7, Proposition 3.6.1, Lemma 3.6.8 and the technical assumptions (T1) and (T2) ensures that the Markov Renewal Theorem 3.3.7 can be applied to the Markov renewal process $(Y_n, \tau_n)_{n \geq 0}$.

Proof of Theorem 3.2.5. Let $f : \bar{\Omega} \times \mathbb{R}^2 \rightarrow \mathbb{R}$ be continuous and bounded. For all $(y, s) \in \mathcal{Y} \times [0, +\infty)$, let us define $g(y, s) := P_s f(y)$. Then, according to Lemma 3.5.4, the function g satisfies the assumptions of the Markov Renewal Theorem 3.3.7, therefore there exists a measurable subset $\mathcal{Z} \subset \mathcal{Y}$ such that $\nu(\mathcal{Z}) = 1$ and, for all $z \in \mathcal{Z}$,

$$\lim_{t \rightarrow +\infty} \mathbf{E}_z(g(Y_{M(t)}, t - \tau_{M(t)})) = \frac{1}{\bar{\mu}} \int_{y \in \mathcal{Y}} \int_{s=0}^{\tau_{\text{obs}}(y)} g(y, s) ds \nu(dy) = \int_{x \in \bar{\Omega} \times \mathbb{R}^2} f(x) \pi_{\text{nd}}(dx),$$

where the probability distribution π_{nd} is defined by

$$\int_{x \in \bar{\Omega} \times \mathbb{R}^2} f(x) \pi_{\text{nd}}(dx) := \frac{1}{\bar{\mu}} \int_{y \in \mathcal{Y}} \int_{s=0}^{\tau_{\text{obs}}(y)} P_s f(y) ds \nu(dy). \quad (3.18)$$

But by Proposition 3.3.10, we have, for all $t \geq 0$,

$$\mathbf{E}_z(g(Y_{M(t)}, t - \tau_{M(t)})) = \mathbf{E}_z(P_{t - \tau_{M(t)}} f(Y_{M(t)})) = \mathbf{E}_z(f(X(t))),$$

where we have used the fact that $\mathbf{P}_z(\tau_0 = 0) = 1$ since $\mathcal{Z} \subset \mathcal{Y}$.

As a consequence, Theorem 3.2.5 at least holds for all initial configurations $z \in \mathcal{Z}$. To complete the proof, we construct a stopping time $\tau^{\mathcal{Z}}$ for the process $(X(t))_{t \geq 0}$ such that, for all $x \in \mathcal{X}_{\text{nd}}$,

$$\mathbf{P}_x(\tau^{\mathcal{Z}} < +\infty, X(\tau^{\mathcal{Z}}) \in \mathcal{Z}) = 1. \quad (3.19)$$

For all $x \in \mathcal{X}_{\text{nd}}$, it is clear from the definition of the set \mathcal{X}'_{nd} in Subsection 3.5.1.2 that there exists a stopping time τ_{nd} for the billiard process such that $\mathbf{P}_x(\tau_{\text{nd}} < +\infty, X(\tau_{\text{nd}}) \in \mathcal{X}'_{\text{nd}}) = 1$. As a consequence, it is sufficient to obtain (3.19) for initial configurations $x \in \mathcal{X}'_{\text{nd}}$.

We now let $n(\mathcal{Z}) := \inf\{n \geq 0 : Y_n \in \mathcal{Z}\}$ and $\tau^{\mathcal{Z}} := \tau_{n(\mathcal{Z})}$. Certainly, $\tau^{\mathcal{Z}}$ is a stopping time for the Markov process $(X(t))_{t \geq 0}$. Furthermore, since $\nu(\mathcal{Z}) > 0$, the Markov chain $(Y_n)_{n \geq 0}$ is recurrent in the set \mathcal{Z} [7, Corollary 3.3, p. 200], therefore, for all $x \in \mathcal{X}'_{\text{nd}}$, $\mathbf{P}_x(\tau^{\mathcal{Z}} < +\infty) = 1$. This completes the proof. \square

Remark 3.6.10. Since the expression of $P_s f(y)$, for $s < \tau_{\text{obs}}(y)$, can be explicitly written as in §3.5.2.1, it is *a priori* possible to derive an explicit expression for the probability distribution π_{nd} whenever an explicit expression of the probability distribution ν is available. This is in particular the case at thermal equilibrium, see §3.5.3.2. We leave the detailed computation to the courageous reader but claim that in this case, one actually recovers the expression for the equilibrium steady state that was announced in Remark 3.2.7.

3.A A formal construction of the billiard process

In this appendix, we provide a formal construction of the billiard process $(X(t))_{t \geq 0}$ as a Piecewise Deterministic Markov Process (PDMP) by following step by step the general and standard methodology introduced by Davis [46, Section 26].

3.A.1 State space and billiard flow

The following definition of the state space for the billiard is classical in the theory of billiards [42, Section IV.1].

Definition 3.A.1 (State space). *The natural state space for the billiard process is the subspace \mathcal{X}' of $\Omega \times \mathbb{R}^2$ given by the union of $\Omega \times \mathbb{R}^2$, which describes the set of configurations located in the interior of the billiard table, and the subset of $\partial\Omega \times \mathbb{R}^2$ composed by configurations $(q^1, q^2; p^1, p^2)$ located at the boundary of the billiard table such that the velocity vector (p^1, p^2) points inward the billiard table Ω .*

The deterministic billiard flow with specular reflection of $\partial\Omega$ is denoted by $(\varphi_t(\cdot))$.

3.A.2 Local characteristics of the PDMP

As a PDMP, the process $(X(t))_{t \geq 0}$ is characterised by the following *local characteristics* [46, Section 26]:

- The deterministic evolution of the process is driven by the billiard flow $(\varphi_t(\cdot))$ on \mathcal{X}' , with specular reflection on the oblique facets. This flow stops being defined when it hits $\bar{W} \times \mathbb{R}^2$ (see Remark 3.A.3 below), but it is certainly nonexplosive.
- The jump rate is identically null, see Remark 3.A.2 below.
- The transition measure is defined on the set of configurations $x = (q^1, q^2; p^1, p^2) \in \bar{W} \times \mathbb{R}^2$, such that there exists $x_0 \in \Omega \times \mathbb{R}^2$ and $t > 0$ such that $\varphi_t(x_0) = x$, as follows:
 - if (q^1, q^2) is located on a singular point of $\partial\Omega$, the process is killed, see Remark 3.A.3;
 - otherwise, there exists a unique $(i, \epsilon) \in \{1, 2\} \times \{+, -\}$ such that $x \in W^{i, \epsilon} \times \mathbb{R}^2$ and the corresponding transition measure is obtained by updating the i -th velocity component according to the density $\phi^{i, \epsilon}(\epsilon p)$.

Remark 3.A.2. The jump rate of a PDMP describes the rate, possibly depending on the current state of the process, at which stochastic updates of the system spontaneously occur. The fact that the jump rate is identically null in our model is typical of stochastic billiards. On the other hand, PDMP models with positive jump rate have been introduced in the context of thermodynamical systems, and in particular for chains of oscillators: in this context, the positive jump rate stands for a stochastic noise that improves on the ergodic properties of the genuine Hamiltonian dynamics [67].

Remark 3.A.3. Killing the process when it hits a singular point of $\partial\Omega$ is a usual convention in the theory of billiards in polygons [131, 75, 42], although this does not appear explicitly in PDMP literature [46]. However, it can be taken into account by adding a cemetery state to the state space. Still, we rule out killed processes by introducing the space of *admissible configurations* in Subsection 3.A.3 below.

3.A.3 The space of admissible configurations

The author is a nice people and does not actually want the billiard process to be killed. Therefore, we define the hitting time of thermalised walls as follows.

Definition 3.A.4 (Hitting time). *The hitting time of thermalised walls $t_{\text{hit}} : \mathcal{X}' \rightarrow (0, +\infty]$ is defined by*

$$t_{\text{hit}}(x) := \inf\{t > 0 : \varphi_t(x) \in \bar{W} \times \mathbb{R}^2\}.$$

Note that, since the singular points of $\partial\Omega$ are contained in \bar{W} , the billiard flow cannot be killed before it reaches $\bar{W} \times \mathbb{R}^2$, so that $t_{\text{hit}}(x)$ is well defined in $(0, +\infty]$.

We now define the space of *admissible configurations*.

Definition 3.A.5 (Admissible configurations). *The space of admissible configurations is denoted by \mathcal{X} and composed by the configurations $x \in \mathcal{X}'$ such that:*

- x is not located on a singular point of $\partial\Omega$;
- if $t_{\text{hit}}(x) < +\infty$, then $\varphi_{t_{\text{hit}}(x)}(x)$ is not located on a singular point of $\partial\Omega$.

It can be checked that the Lebesgue measure of the space $\mathcal{X}' \setminus \mathcal{X}$ is null. In Subsection 3.A.5 below, we check that, if the billiard process starts in an admissible configuration $x \in \mathcal{X}$, then it remains in the space of admissible configurations at all times, almost surely.

3.A.4 Hitting the thermalised walls

This short paragraph is dedicated to the study of admissible configurations $x = (q^1, q^2; p^1, p^2) \in \mathcal{X}$ such that $t_{\text{hit}}(x) = +\infty$. One easily checks that there are actually two possible types of such configurations:

- $p^1 = p^2 = 0$, in which case $\varphi_t(x) = x$, for all $t \geq 0$;
- $1 - a < q^1 + q^2 < 1 + a$ and $p^1 = -p^2$, in which case the billiard flow performs roundtrips along a periodic orbit between the oblique facets, with orthogonal reflection at each facet.

Note that, in both cases, $X(t) = \varphi_t(x)$, for all $t \geq 0$; the process is never killed; and it always remains in the space of admissible configurations.

3.A.5 The sequence of stochastic updates

We now give a practical way to construct the billiard process, on the probability space $(\mathbb{R}_+^4)^{\mathbb{N}}$ endowed with the probability distribution \mathbb{P} under which the canonical variable

$$(v_j^{1,+}, v_j^{1,-}, v_j^{2,+}, v_j^{2,-})_{j \geq 1}$$

is an i.i.d. sequence, with marginal distribution given by the product density

$$\phi^{1,+}(v^{1,+})\phi^{1,-}(v^{1,-})\phi^{2,+}(v^{2,+})\phi^{2,-}(v^{2,-}).$$

In particular, this enables us to introduce the sequence of *stochastic updates* $(x_j, t_j)_{j \geq 1}$, which plays a key role in the sequel.

Let $x \in \mathcal{X}$. Since the case $t_{\text{hit}}(x) = +\infty$ has been addressed in Subsection 3.A.4 above, we can assume that $t_{\text{hit}}(x) < +\infty$. Then we let $x_0 = x$, $t_0 = 0$ and define $(x_j, t_j)_{j \geq 1}$ by induction:

- if $t_{\text{hit}}(x_{j-1}) < +\infty$, then $t_j = t_{j-1} + t_{\text{hit}}(x_{j-1})$;
- if $x_{j-1} \in \mathcal{X}$, then there exists a unique $(i, \epsilon) \in \{1, 2\} \times \{+, -\}$ such that $\varphi_{t_{\text{hit}}(x_{j-1})}(x_{j-1})$ is located on $W^{i,\epsilon}$. Then, x_j defined by replacing the i -th component of the velocity in $\varphi_{t_{\text{hit}}(x_{j-1})}(x_{j-1})$ with $v_j^{i,\epsilon}$.

By the fact that the law of $v_j^{i,\epsilon}$ has a density, it is straightforward that, if $t_{\text{hit}}(x_{j-1}) < +\infty$ and $x_{j-1} \in \mathcal{X}$, then $t_{\text{hit}}(x_j) < +\infty$ and $x_j \in \mathcal{X}$, \mathbb{P} -almost surely. Therefore, the sequence of stochastic updates $(x_j, t_j)_{j \geq 1}$ is well defined, \mathbb{P} -almost surely.

We are now able to define the billiard process.

Definition 3.A.6 (Billiard process). *For all $x \in \mathcal{X}$, we define the billiard process started at x by $X^x(t) = \varphi_{t-t_j}(x_j)$, for all $j \geq 0$, for all $t \in [t_j, t_{j+1})$.*

Then $(X^x(t))_{t \geq 0}$ is defined on the time interval $[0, \sup_{j \geq 0} t_j)$, and \mathbb{P} -almost surely, it takes its values in \mathcal{X} .

3.A.6 Standard conditions

In order to ensure that the billiard process $(X^x(t))_{t \geq 0}$ is well defined, we finally have to check the *standard conditions* [46, (24.8), p. 62]. The only nontrivial point there is the following: for all $t \geq 0$, let $N(t)$ denote the number of stochastic updates on $[0, t]$, namely

$$N(t) := \sum_{j=0}^{+\infty} \mathbf{1}_{\{t_j \leq t\}}.$$

Then we have the following result.

Lemma 3.A.7. *For all initial configuration $x \in \mathcal{X}$, then $\mathbb{E}(N(t)) < +\infty$.*

Proof. Although it is not necessary, the framework of the unfolded process introduced in Subsection 3.4.2 turns out to be convenient for this proof. Let $x = (q^1, q^2; p^1, p^2) \in \mathcal{X}$. Following Subsection 3.A.5, if $t_{\text{hit}}(x) = +\infty$, then $N(t) = 0$, for all $t \geq 0$. Now if $t_{\text{hit}}(x) < +\infty$, then observe that between four consecutive stochastic updates t_j, t_{j+1}, t_{j+2} and t_{j+3} , at least one of the two components $(\tilde{q}^1, \tilde{p}^1)$ or $(\tilde{q}^2, \tilde{p}^2)$ is updated and travels on a distance larger than $a \wedge (1 - 2a)$. As a consequence, for all $j' \geq 1$,

$$t_{3j'+1} - t_{3j'-2} \geq \frac{a \wedge (1 - 2a)}{M_{j'}},$$

where $M_{j'} := \max\{v_j^{i,\epsilon}, (i, \epsilon) \in \{1, 2\} \times \{+, -\}, 3j' - 2 \leq j \leq 3j'\}$.

Let $t'_0 := t_{\text{hit}}(x)$, $t'_{j'} := t'_0 + (a \wedge (1 - 2a)) / M_1 + \dots + (a \wedge (1 - 2a)) / M_{j'}$ and $N'(t) := \sum_{j'=0}^{+\infty} \mathbf{1}_{\{t'_{j'} \leq t\}}$. Certainly, $N(t) \leq 3N'(t)$, for all $t \geq 0$. On the other hand, since the sequence $(M_{j'})_{j \geq 1}$ is i.i.d. under \mathbb{P} , then $\mathbb{E}(N'(t)) < +\infty$, for all $t \geq 0$, see Asmussen [7, Theorem 2.4, p. 146]. This concludes the proof. \square

Lemma 3.A.7 ensures in particular that, \mathbb{P} -almost surely, the sequence of instants of stochastic updates has no accumulation point, *i.e.* $\sup_{j \geq 0} t_j = +\infty$. The properties of the process $(X^x(t))_{t \geq 0}$ stated in Proposition 3.2.1 now follow from Davis [46, Sections 24 and 25].

3.A.7 Probability spaces

The original probability space on which the billiard process $(X^x(t))_{t \geq 0}$ is constructed in Subsection 3.A.5 is the space $(\mathbb{R}_+^4)^{\mathbb{N}}$ endowed with the probability distribution \mathbb{P} , the expectation under which is denoted by \mathbb{E} . In the body of the chapter, we rather used the law \mathbf{P}_x of the process $(X^x(t))_{t \geq 0}$ in the Skorohod space $D([0, +\infty), \mathcal{X})$. However, in Appendix 3.B below, we will deal with situations in which the original sequence $(v_j^{1,+}, v_j^{1,-}, v_j^{2,+}, v_j^{2,-})_{j \geq 1}$ plays a particular role, which we shall emphasise by using the probability distribution \mathbb{P} .

3.B Recurrence of the set Θ

This appendix is dedicated to the proof of Step 1 in §3.6.1.3, namely that there exists a stopping time N_1 for the Markov chain $(Y_n)_{n \geq 0}$ and $\beta > 0$ such that, for all $y \in \mathcal{Y}$, $\mathbf{P}_y(N_1 < +\infty) = 1$ and $\mathbf{P}_y(Y_{N_1} \in \Theta) \geq \beta$, where we recall that Θ is defined in §3.6.1.2. For the sake of convenience, we shall simply use the notation N instead of N_1 .

Let $y \in \mathcal{Y}$. Then $t_{\text{hit}}(y) < +\infty$, where we recall the Definition 3.A.4 of $t_{\text{hit}}(y)$, and we let $n_0 := \sup\{n \geq 0 : \tau_n \leq t_{\text{hit}}(y)\}$. Note that n_0 is a deterministic function of y , therefore it is a stopping time for the Markov chain $(Y_n)_{n \geq 0}$. Then either $\tau_{n_0} < t_{\text{hit}}(y)$, that is to say there is a stochastic update of a component of the velocity between two observation times, or $\tau_{n_0} = t_{\text{hit}}(y)$ and the first stochastic update of a component of the velocity occurs at an observation time.

3.B.1 Stochastic update between two observation times

Let us first address the case $\tau_{n_0} < t_{\text{hit}}(y)$. Then Y_{n_0} can belong to any elementary section, including the boundary sections in the case $n_0 = 0$. We first assume that $Y_{n_0} := (q^1, q^2; p^1, p^2) \in \mathcal{Y}_\star^{1,+}$ for some $\star \in \{\text{bo}, \text{in}, \text{ou}\}$, and then extend our results to any elementary section thanks to the symmetries introduced in §3.2.1.2.

3.B.1.1 Boundary section

Let us assume that $Y_{n_0} \in \mathcal{Y}_{\text{bo}}^{1,+}$; in particular, $n_0 = 0$ and $Y_{n_0} = y$. Since $\mathcal{Y} \subset \mathcal{X}_{\text{nd}}$, then either $p^2 > 0$ or $p^2 < 0$.

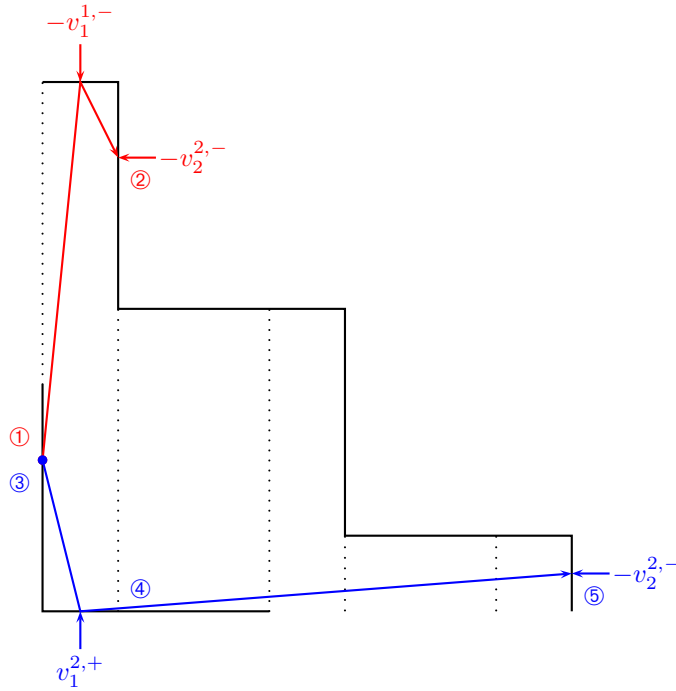

Figure 3.9: The possible cases for $Y_{n_0} \in \mathcal{Y}_{\text{bo}}^{1,+}$. The red trajectory describes the case $p^2 > 0$, while the blue trajectory describes the case $p^2 < 0$. The circled digits indicate the situation dealt with: in situations ① and ③, $\gamma \geq \eta_{\text{bo}}^{1,+}$ and $N = 0$. In situation ②, $\gamma < \eta_{\text{bo}}^{1,+}$ and $N = 1$. In situation ④, $\gamma < \eta_{\text{bo}}^{1,+}$, $\gamma' \geq \theta$ and $N = 1$. In situation ⑤, $\gamma < \eta_{\text{bo}}^{1,+}$, $\gamma' < \theta$ and $N = 5$.

Case $p^2 > 0$. Due to the definition of n_0 , $\gamma := \Gamma(Y_{n_0}) = a/p^1 - (2 - a - q^2)/p^2 > 0$. If $\gamma \geq \eta_{\text{bo}}^{1,+}$, then we let $N = 0$ and

$$\mathbf{P}_y(Y_N \in \mathcal{Y}_{\text{bo}}^{1,+}, \Gamma(Y_N) \geq \eta_{\text{bo}}^{1,+}) = 1 =: \beta_{\text{bo},\textcircled{1}}^{1,+}.$$

Now, if $\gamma < \eta_{\text{bo}}^{1,+}$, let us exhibit $\beta_{\text{bo},\textcircled{2}}^{1,+} > 0$ independent of y and such that $\mathbf{P}_y(Y_1 \in \Theta) \geq \beta_{\text{bo},\textcircled{2}}^{1,+}$. In this purpose, let us note that $t_{\text{hit}}(y) = \tau_{\text{end}}^{2-a}(q^2, p^2) = (2 - a - q^2)/p^2$. Besides,

$$\tilde{X}^y(\tau_{\text{end}}^{2-a}(q^2, p^2)) = \left(p^1 \frac{2 - a - q^2}{p^2}, 2 - a; p^1, -v_1^{1,-} \right),$$

and, on the event $\{v_1^{1,-} < (1-a)/\gamma\}$,

$$\begin{aligned}\tilde{X}^y(\tau_{\text{obs}}(y)) &= \left(a, 2-a-\gamma v_1^{1,-}; -v_2^{2,-}, -v_1^{1,-}\right), \\ Y_1 &= \mathfrak{F}\tilde{X}^y(\tau_{\text{obs}}(y)) = \left(1-\gamma v_1^{1,-}, 1; -v_1^{1,-}, -v_2^{2,-}\right) \in \mathcal{Y}_{\text{bo}}^{2,-}, \\ \Gamma(Y_1) &= \frac{a}{v_2^{2,-}} - \frac{2-a}{v_1^{1,-}} + \gamma \geq \frac{a}{v_2^{2,-}} - \frac{2-a}{v_1^{1,-}}.\end{aligned}$$

As a consequence, letting $N = 1$, we obtain

$$\begin{aligned}\mathbf{P}_y(Y_N \in \mathcal{Y}_{\text{bo}}^{2,-}, \Gamma(Y_N) \geq \eta_{\text{bo}}^{2,-}) &\geq \mathbb{P}\left(v_1^{1,-} < \frac{1-a}{\gamma}, \frac{a}{v_2^{2,-}} - \frac{2-a}{v_1^{1,-}} + \gamma \geq \eta_{\text{bo}}^{2,-}\right) \\ &\geq \mathbb{P}\left(\frac{1-a}{v_1^{1,-}} > \eta_{\text{bo}}^{1,+}, \frac{a}{v_2^{2,-}} \geq \frac{2-a}{v_1^{1,-}} + \eta_{\text{bo}}^{2,-}\right) =: \beta_{\text{bo},\textcircled{2}}^{1,+},\end{aligned}$$

and $\beta_{\text{bo},\textcircled{2}}^{1,+} > 0$ due to the assumption that $\psi^{1,-}$ and $\psi^{2,-}$ satisfy condition **(H3)**.

Case $p^2 < 0$. Similarly to the case above, $\gamma := \Gamma(Y_{n_0}) = a/p^1 - q^2/(-p^2) > 0$. If $\gamma \geq \eta_{\text{bo}}^{1,+}$, then we let $N = 0$ and

$$\mathbf{P}_y(Y_N \in \mathcal{Y}_{\text{bo}}^{1,+}, \Gamma(Y_N) \geq \eta_{\text{bo}}^{1,+}) = 1 =: \beta_{\text{bo},\textcircled{3}}^{1,+}.$$

Let us now assume that $\gamma < \eta_{\text{bo}}^{1,+}$. The situation is more intricate than in the case above due to the fact that $\tau_{\text{obs}}(y)$ does not correspond to a stochastic update of a component of the velocity. More precisely, on the event $\{v_1^{2,+} < 1/\gamma\}$,

$$\begin{aligned}Y_1 &= X^y(\tau_{\text{obs}}(y)) = \left(a, \gamma v_1^{2,+}; p^1, v_1^{2,+}\right) \in \mathcal{Y}_{\text{in}}^{1,+}, \\ \Gamma(Y_1) &= \frac{1-2a}{p^1} - \frac{1-\gamma v_1^{2,+}}{v_1^{2,+}} = \gamma' - \frac{1}{v_1^{2,+}},\end{aligned}$$

where γ' is defined by

$$\gamma' := \frac{1-a}{p^1} - \frac{q^2}{-p^2} > \gamma > 0.$$

We deduce that if γ' is not too small, then the probability that $\Gamma(Y_1)$ be large is uniformly bounded away from 0. To give a precise statement, let us fix $\theta > \eta_{\text{in}}^{1,+}$ large enough for the inequality

$$\beta_{\text{bo},\textcircled{4}}^{1,+} := \mathbb{P}\left(\frac{1}{\theta - \eta_{\text{in}}^{1,+}} \leq v_1^{2,+} < \frac{1}{\eta_{\text{bo}}^{1,+}}\right) > 0$$

to hold. Note that the existence of θ is ensured by the fact that $\psi^{2,+}$ satisfies the condition **(H3)**. Now, if $\gamma' \geq \theta$, then we let $N = 1$ and

$$\begin{aligned}\mathbf{P}_y(Y_N \in \mathcal{Y}_{\text{in}}^{1,+}, \Gamma(Y_N) \geq \eta_{\text{in}}^{1,+}) &\geq \mathbb{P}\left(v_1^{2,+} < \frac{1}{\gamma}, \gamma' - \frac{1}{v_1^{2,+}} \geq \eta_{\text{in}}^{1,+}\right) \\ &\geq \mathbb{P}\left(v_1^{2,+} < \frac{1}{\eta_{\text{bo}}^{1,+}}, \theta - \frac{1}{v_1^{2,+}} \geq \eta_{\text{in}}^{1,+}\right) = \beta_{\text{bo},\textcircled{4}}^{1,+}.\end{aligned}$$

It remains to address the case $\gamma < \eta_{\text{bo}}^{1,+}$, $\gamma' < \theta$, which has to be understood as the case in which the component p^1 is large. Then the first update of this fast component for the unfolded process typically occurs at the 5-th observation time (see Figure 3.9). More precisely, let us define $\gamma'' > 0$ by

$$\gamma'' := \frac{2-a}{p^1} - \frac{q^2}{-p^2} > \gamma > 0.$$

Then, on the event $\{v_1^{2,+} < 1/\gamma''\}$,

$$Y_5 = \left(1 - a + \gamma'' v_1^{2,+}, 1; v_1^{2,+}, -v_2^{2,-}\right) \in \mathcal{Y}_{\text{bo}}^{2,-},$$

$$\Gamma(Y_5) = \frac{a}{v_2^{2,-}} - \frac{a - \gamma'' v_1^{2,+}}{v_1^{2,+}} = \frac{a}{v_2^{2,-}} - \frac{a}{v_1^{2,+}} + \gamma''.$$

Let us now check that the conditions $\gamma \geq 0$ and $\gamma' < \theta$ prevent γ'' from being large. Writing

$$\gamma'' = -\frac{1}{1-2a}\gamma + \frac{2(1-a)}{1-2a}\gamma' < \frac{2(1-a)}{1-2a}\theta,$$

we deduce that letting $N = 5$ yields

$$\begin{aligned} \mathbf{P}_y(Y_N \in \mathcal{Y}_{\text{bo}}^{2,-}, \Gamma(Y_5) \geq \eta_{\text{bo}}^{2,-}) &\geq \mathbb{P}\left(v_1^{2,+} < \frac{1}{\gamma''}, \frac{a}{v_2^{2,-}} - \frac{a}{v_1^{2,+}} + \gamma'' \geq \eta_{\text{bo}}^{2,-}\right) \\ &\geq \mathbb{P}\left(v_1^{2,+} < \frac{1-2a}{2(1-a)\theta}, \frac{a}{v_2^{2,-}} - \frac{a}{v_1^{2,+}} \geq \eta_{\text{bo}}^{2,-}\right) =: \beta_{\text{bo},\textcircled{5}}^{1,+}, \end{aligned}$$

and $\beta_{\text{bo},\textcircled{5}}^{1,+} > 0$ due to the fact that both $\psi^{2,+}$ and $\psi^{2,-}$ satisfy the condition (H3).

Symmetries. If $Y_{n_0} \in \mathcal{Y}_{\text{bo}}^{i,\epsilon}$ for some $(i, \epsilon) \in \{1, 2\} \times \{+, -\}$, we define N and $\beta_{\text{bo},\textcircled{1}}^{i,\epsilon}, \dots, \beta_{\text{bo},\textcircled{5}}^{i,\epsilon}$ applying the argument above starting from $\mathfrak{S}^{i,\epsilon}(Y_{n_0})$. We finally define

$$\beta_{\text{3.B.1.1}} := \min_{(i,\epsilon) \in \{1,2\} \times \{+,-\}} (\beta_{\text{bo},\textcircled{1}}^{i,\epsilon}, \dots, \beta_{\text{bo},\textcircled{5}}^{i,\epsilon}) > 0.$$

3.B.1.2 Inward section

We now assume that $Y_{n_0} \in \mathcal{Y}_{\text{in}}^{1,+}$. Once again, either $p^2 > 0$ or $p^2 < 0$. The arguments are roughly the same as in the case of boundary sections and we refer to Figure 3.10 for an overview of the different cases dealt with.

Case $p^2 > 0$. Due to the definition of n_0 , $\gamma := \Gamma(Y_{n_0}) = (1-2a)/p^1 - (1-q^2)/p^2 > 0$. If $\gamma \geq \eta_{\text{in}}^{1,+}$, then we let $N = n_0$ and

$$\mathbf{P}_y(Y_N \in \mathcal{Y}_{\text{in}}^{1,+}, \Gamma(Y_N) \geq \eta_{\text{in}}^{1,+}) = 1 =: \beta_{\text{in},\textcircled{0}}^{1,+}.$$

Let us now assume that $\gamma < \eta_{\text{in}}^{1,+}$ and introduce $\gamma' := 1/p^1 - (1-q^2)/p^2 > \gamma > 0$ and $\theta > \eta_{\text{ou}}^{1,-}$ large enough for the inequality

$$\beta_{\text{in},\textcircled{2}}^{1,+} := \mathbb{P}\left(\frac{2-a}{\theta - \eta_{\text{ou}}^{1,-}} \leq v_1^{2,-} < \frac{1}{\eta_{\text{in}}^{1,+}}\right) > 0$$

to hold. If $\gamma' \geq \theta$, then we let $N = n_0 + 1$ and

$$\mathbf{P}_y(Y_N \in \mathcal{Y}_{\text{ou}}^{1,-}, \Gamma(Y_N) \geq \eta_{\text{ou}}^{1,-}) \geq \beta_{\text{in},\textcircled{2}}^{1,+};$$

while, if $\gamma' < \theta$, then we let $N = n_0 + 2$ and

$$\mathbf{P}_y(Y_N \in \mathcal{Y}_{\text{bo}}^{1,-}, \Gamma(Y_N) \geq \eta_{\text{bo}}^{1,-}) \geq \mathbb{P}\left(v_1^{2,-} < \frac{1-a}{\theta}, \frac{a}{v_2^{1,-}} - \frac{2-a}{v_1^{2,-}} \geq \eta_{\text{bo}}^{1,-}\right) =: \beta_{\text{in},\textcircled{3}}^{1,+} > 0.$$

Case $p^2 < 0$. If $\gamma := \Gamma(Y_{n_0}) = (1-2a)/p^1 - q^2/(-p^2) \geq \eta_{\text{in}}^{1,+}$, then we let $N = n_0$ and

$$\mathbf{P}_y(Y_N \in \mathcal{Y}_{\text{in}}^{1,+}, \Gamma(Y_N) \geq \eta_{\text{in}}^{1,+}) = 1 =: \beta_{\text{in},\textcircled{4}}^{1,+}.$$

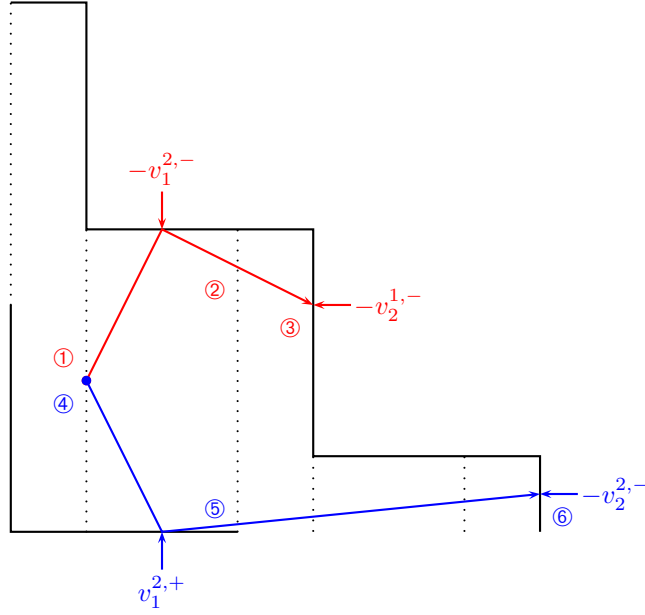

Figure 3.10: The possible cases for $Y_{n_0} \in \mathcal{Y}_{\text{in}}^{1,+}$. The red trajectory describes the case $p^2 > 0$, while the blue trajectory describes the case $p^2 < 0$. The circled digits indicate the situation dealt with: in situations ① and ④, $\gamma \geq \eta_{\text{bo}}^{1,+}$ and $N = n_0$. In situations ② and ⑤, $\gamma < \eta_{\text{bo}}^{1,+}$, $\gamma' \geq \theta$ and $N = n_0 + 1$. In situations ③ and ⑥, $\gamma < \eta_{\text{bo}}^{1,+}$, $\gamma' < \theta$ and $N = n_0 + 2$ in the red case, $N = n_0 + 4$ in the blue case.

If $\gamma < \eta_{\text{in}}^{1,+}$, we introduce $\gamma' := 1/p^1 - q^2/(-p^2) > \gamma > 0$ and $\theta > \eta_{\text{ou}}^{1,-}$ large enough for the inequality

$$\beta_{\text{in},\textcircled{6}}^{1,+} := \mathbb{P} \left(\frac{1}{\theta - \eta_{\text{ou}}^{1,-}} \leq v_1^{2,+} < \frac{1}{\eta_{\text{in}}^{1,+}} \right) > 0$$

to hold. If $\gamma' \geq \theta$, then we let $N = n_0 + 1$ and

$$\mathbf{P}_y(Y_N \in \mathcal{Y}_{\text{ou}}^{1,-}, \Gamma(Y_N) \geq \eta_{\text{ou}}^{1,-}) \geq \beta_{\text{in},\textcircled{6}}^{1,+};$$

while, if $\gamma' < \theta$, then we let $N = n_0 + 4$ and

$$\mathbf{P}_y(Y_N \in \mathcal{Y}_{\text{bo}}^{2,-}, \Gamma(Y_N) \geq \eta_{\text{bo}}^{2,-}) \geq \mathbb{P} \left(v_1^{2,+} < \frac{1}{\gamma''}, \frac{a}{v_2^{2,-}} - \frac{a}{v_1^{2,+}} + \gamma'' \geq \eta_{\text{bo}}^{2,-} \right),$$

where

$$0 < \gamma'' := \frac{2-a}{p^1} - \frac{q^2}{-p^2} < \frac{\theta}{a}.$$

As a consequence,

$$\mathbf{P}_y(Y_N \in \mathcal{Y}_{\text{bo}}^{2,-}, \Gamma(Y_N) \geq \eta_{\text{bo}}^{2,-}) \geq \mathbb{P} \left(v_1^{2,+} < \frac{a}{\theta}, \frac{a}{v_2^{2,-}} - \frac{a}{v_1^{2,+}} \geq \eta_{\text{bo}}^{2,-} \right) =: \beta_{\text{in},\textcircled{6}}^{1,+} > 0.$$

Symmetries. If $Y_{n_0} \in \mathcal{Y}_{\text{in}}^{i,\epsilon}$ for some $(i, \epsilon) \in \{1, 2\} \times \{+, -\}$, we define N and $\beta_{\text{in},\textcircled{1}}^{i,\epsilon}, \dots, \beta_{\text{in},\textcircled{6}}^{i,\epsilon}$ applying the argument above starting from $\mathfrak{S}^{i,\epsilon}(Y_{n_0})$. We finally define

$$\beta_{3.B.1.2} := \min_{(i,\epsilon) \in \{1,2\} \times \{+,-\}} (\beta_{\text{in},\textcircled{1}}^{i,\epsilon}, \dots, \beta_{\text{in},\textcircled{6}}^{i,\epsilon}) > 0.$$

3.B.1.3 Outward section

It is clear from Figure 3.9 that the argument developed in §3.B.1.1 remains valid if $Y_{n_0} \in \mathcal{Y}_{\text{ou}}^{2,-}$. This enables us to define N and $\beta_{\text{ou},\text{①}}^{2,-}, \dots, \beta_{\text{ou},\text{⑥}}^{2,-}$ in this case, and then in all the cases $Y_{n_0} \in \mathcal{Y}_{\text{ou}}^{i,\epsilon}$, $(i, \epsilon) \in \{1, 2\} \times \{+, -\}$ by symmetry. For notational convenience, we finally define

$$\beta_{3.B.1.3} := \min_{(i,\epsilon) \in \{1,2\} \times \{+,-\}} (\beta_{\text{ou},\text{①}}^{i,\epsilon}, \dots, \beta_{\text{ou},\text{⑥}}^{i,\epsilon}) > 0,$$

even though $\beta_{3.B.1.3} = \beta_{3.B.1.1}$ obviously.

3.B.1.4 Conclusion

Putting together §3.B.1.1, §3.B.1.2 and §3.B.1.3, we conclude that if $y \in \mathcal{Y}$ is such that $\tau_{n_0} < t_{\text{hit}}(y)$, then there is a *deterministic function* N of y and a positive number

$$\beta_{3.B.1} := \min(\beta_{3.B.1.1}, \beta_{3.B.1.2}, \beta_{3.B.1.3}),$$

such that $\mathbf{P}_y(Y_N \in \Theta) \geq \beta_{3.B.1}$. Besides, \mathbf{P}_y -almost surely, $N - n_0 \leq 5$.

3.B.2 Stochastic update at an observation time

Let us now address the case $\tau_{n_0} = t_{\text{hit}}(y)$. Then $n_0 \geq 1$ and Y_{n_0} lies in a boundary elementary section. Due to the symmetries introduced in §3.2.1.2, there is no loss of generality in assuming that $Y_{n_0} \in \mathcal{Y}_{\text{bo}}^{1,+}$, in which case $Y_{n_0} = (0, q^2; v_1^{1,+}, p^2)$ where (q^2, p^2) is a deterministic function of y . By the definition of \mathcal{Y} , $q^2 \in (0, a) \cup (a, 1-a)$ and $p^2 \in (-\infty, 0) \cup (0, +\infty)$. Let us mention that, in this subsection, we use the notions of renewal theory and the associated notations introduced in Subsection 3.4.1.

3.B.2.1 Case $q^2 \in (0, a)$, $p^2 < 0$

For all $k \geq 1$, let $\sigma_k := (2-a)(1/v_{2k-1}^{1,+} + 1/v_{2k}^{2,-})$, and let $S_0 := 0$, $S_k := \sigma_1 + \dots + \sigma_k$, $S_k^* := S_k + (2-a)/v_{2k+1}^{1,+}$. Let us write $t := q^2/(-p^2) > 0$ and introduce the following random variables:

$$K := \sup\{k \geq 0 : S_k < t\}, \quad K^* := \sup\{k \geq 0 : S_k^* < t\},$$

with the convention that $K^* = -1$ whenever $S_0^* > t$. Clearly, \mathbb{P} -almost surely, $K < +\infty$ and $K^* < +\infty$. Besides, for all $k \in \{0, \dots, K\}$,

$$Y_{n_0+10k} = \left(0, q^2 + p^2 S_k; v_{2k+1}^{1,+}, p^2\right) \in \mathcal{Y}_{\text{bo}}^{1,+},$$

while, as soon as $K^* \geq 0$, for all $k \in \{0, \dots, K^*\}$,

$$Y_{n_0+10k+5} = \left(1-a + q^2 + p^2 S_k^*, 1; p^2, -v_{2k+2}^{2,-}\right) \in \mathcal{Y}_{\text{bo}}^{2,-},$$

see Figure 3.11.

Certainly, $n_0 + 10K$ is *not* a stopping time for the Markov chain $(Y_n)_{n \geq 0}$. Indeed, for $k \in \{0, \dots, K^*\}$ such that $S_k < t$, deciding whether $S_{k+1} < t$ or $S_{k+1} > t$ requires the knowledge of S_k and $v_{2k+1}^{1,+}$, that can be expressed as functions of Y_{n_0+10k} , but also of $v_{2k+2}^{2,-}$, that is independent of Y_{n_0+10k} (but is a function of $Y_{n_0+10k+5}$). For the same reason, $n_0 + 10K^* + 5$ is not a stopping time for the Markov chain $(Y_n)_{n \geq 0}$ either. However, a stopping time for the Markov chain $(Y_n)_{n \geq 0}$ is recovered by considering the random time $N := (n_0 + 10K) \vee (n_0 + 10K^* + 5)$.

Then N is finite \mathbf{P}_y -almost surely, and $Y_N \in \Theta$ in particular if $N = n_0 + 10K$ and

$$\Gamma(Y_{n_0+10K}) = \frac{a}{v_{2K+1}^{1,+}} - \frac{q^2 + p^2 S_K}{-p^2} \geq \eta_{\text{bo}}^{1,+},$$

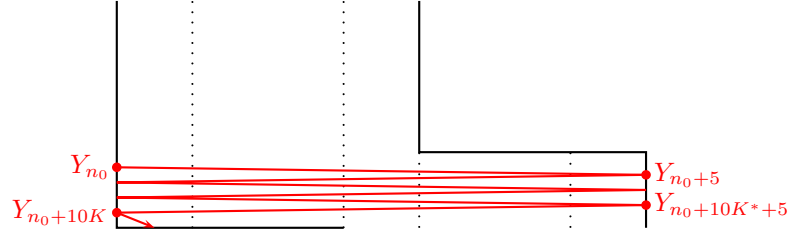

Figure 3.11: Case $q^2 \in (0, a)$, $p^2 < 0$ on the unfolded process. At the k -th reflection on the boundary on the left, the updated value of the normal velocity is $v_{2k-1}^{1,+}$. At the k -th reflection on the boundary on the right, the updated value of the normal velocity is $v_{2k}^{2,-}$. The situation depicted on the picture corresponds to $N = n_0 + 10K$, i.e. $K = K^* + 1$.

that is to say

$$\begin{aligned} \mathbf{P}_y(Y_N \in \Theta) &\geq \mathbb{P}\left(K = K^* + 1, \frac{a}{v_{2K+1}^{1,+}} - \frac{q^2 + p^2 S_K}{-p^2} \geq \eta_{\text{bo}}^{1,+}\right) \\ &= \sum_{k=0}^{+\infty} \mathbb{P}\left(S_k < t, S_k^* \geq t, \frac{a}{v_{2k+1}^{1,+}} + S_k \geq t + \eta_{\text{bo}}^{1,+}\right) \\ &= \int_{s=0}^{+\infty} \int_{r=0}^{+\infty} \mathbb{1}_{\{s < t, s + (2-a)r \geq t, s + ar \geq t + \eta_{\text{bo}}^{1,+}\}} \psi^{1,+}(r) dr U^{2-a;1,2}(ds) \\ &= \int_{s=0}^t \Psi(t-s) U^{2-a;1,2}(ds) = \Psi(t) + \int_{s=0}^t \Psi(s) u^{2-a;1,2}(t-s) ds, \end{aligned}$$

where the function Ψ is defined on $[0, +\infty)$ by

$$\forall c \geq 0, \quad \Psi(c) := \int_{r=0}^{+\infty} \mathbb{1}_{\{c \leq (2-a)r, c \leq ar - \eta_{\text{bo}}^{1,+}\}} \psi^{1,+}(r) dr.$$

Note that Ψ is nonincreasing and, due to the fact that $\psi^{1,+}$ satisfies the condition (H3), $\Psi(c) > 0$ for all $c \geq 0$.

Let $\eta' > M^{2-a;1,2}$, where $M^{2-a;1,2}$ is defined as in Lemma 3.4.5. Then, proceeding as in the proof of Lemma 3.4.5, we obtain that if $t \geq \eta'$,

$$\int_{s=0}^t \Psi(s) u^{2-a;1,2}(t-s) ds \geq \frac{1}{2(2-a)(\mu^{1,+} + \mu^{2,-})} \int_{s=0}^{\eta' - M^{2-a;1,2}} \Psi(s) ds;$$

while, if $t < \eta'$, then $\Psi(t) \geq \Psi(\eta') > 0$. As a conclusion,

$$\mathbf{P}_y(Y_N \in \Theta) \geq \left(\frac{1}{2(2-a)(\mu^{1,+} + \mu^{2,-})} \int_{s=0}^{\eta' - M^{2-a;1,2}} \Psi(s) ds \right) \wedge \Psi(\eta') > 0.$$

Using the symmetries introduced in §3.2.1.2, one can now define $\beta_{3.B.2.1} > 0$ such that, as soon as $\tau_{n_0} = t_{\text{hit}}(y)$ and $Y_{n_0} \in \mathcal{Y}_{\text{bo}}^{i,\epsilon}$ is such that $\mathfrak{G}^{i,\epsilon}(Y_{n_0}) = (0, q^2; v, p^2)$ satisfies $q^2 \in (0, a)$ and $p^2 < 0$,

$$\mathbf{P}_y(Y_N \in \Theta) \geq \beta_{3.B.2.1}.$$

3.B.2.2 Case $q^2 \in (a, 1-a)$, $p^2 < 0$

For all $k \geq 1$, let $\bar{\sigma}_k := 1/v_{2k-1}^{1,+} + 1/v_{2k}^{2,-}$, and let $\bar{S}_0 := 0$, $\bar{S}_k := \bar{\sigma}_1 + \dots + \bar{\sigma}_k$, $\bar{S}_k^* := \bar{S}_k + 1/v_{2k+1}^{1,+}$. Let us write $\bar{t} := (q^2 - a)/(-p^2) > 0$ and introduce the following random variables:

$$\bar{K} := \sup\{k \geq 0 : \bar{S}_k < \bar{t}\}, \quad \bar{K}^* := \sup\{k \geq 0 : \bar{S}_k^* < \bar{t}\},$$

with the convention that $\bar{K}^* = -1$ whenever $\bar{S}_0^* > \bar{t}$. Clearly, \mathbb{P} -almost surely, $\bar{K} < +\infty$ and $\bar{K}^* < +\infty$. Besides, for all $k \in \{0, \dots, \bar{K}\}$,

$$Y_{n_0+6k} = \left(0, q^2 + p^2 \bar{S}_k; v_{2k+1}^{1,+}, p^2\right) \in \mathcal{Y}_{\text{bo}}^{1,+},$$

while, as soon as $K^* \geq 0$, for all $k \in \{0, \dots, K^*\}$,

$$Y_{n_0+6k+3} = \left(1, q^2 + p^2 \bar{S}_k^*; -v_{2k+2}^{1,-}, p^2\right) \in \mathcal{Y}_{\text{bo}}^{1,-},$$

see Figure 3.12.

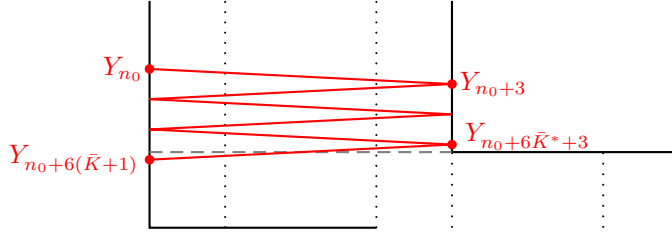

Figure 3.12: Case $q^2 \in (a, 1-a)$, $p^2 < 0$ on the unfolded process. At the k -th reflection on the boundary on the left, the updated value of the normal velocity is $v_{2k-1}^{1,+}$. At the k -th reflection on the boundary on the right, the updated value of the normal velocity is $v_{2k}^{2,-}$. The situation depicted on the picture corresponds to the event E^1 .

For the same reasons as in §3.B.2.1, $\bar{N} := (n_0 + 6\bar{K}) \vee (n_0 + 6\bar{K}^* + 3)$ is a stopping time for the Markov chain $(Y_n)_{n \geq 0}$. Let $\bar{t}' := q^2/(-p^2) > \bar{t}$, and let us define the following events:

$$\begin{aligned} E^1 &:= \{\bar{K} = \bar{K}^*, \bar{S}_{\bar{K}+1} < \bar{t}'\}, \\ E^2 &:= \{1/v_1^{1,+} > \bar{t}, 1/v_1^{1,+} + 1/v_2^{2,-} < \bar{t}'/(2-a)\}, \\ E^3 &:= \{a/v_1^{1,+} > \bar{t}'\}, \end{aligned}$$

see Figures 3.12, 3.13 and 3.14.

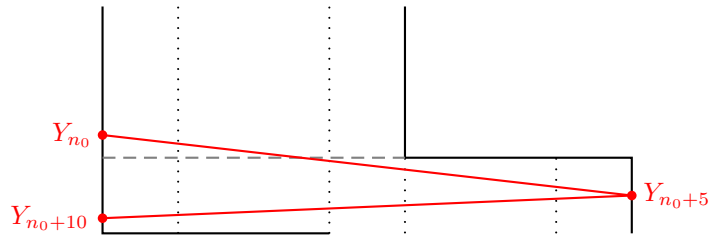
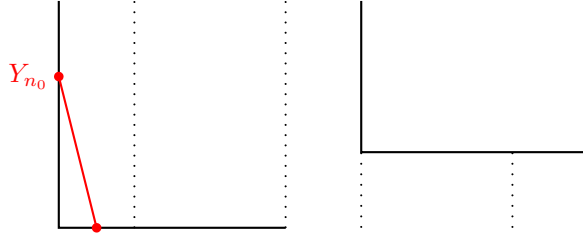

Figure 3.13: The event E^2 in the case $q^2 \in (a, 1-a)$, $p^2 < 0$.

On the event E^1 , $Y_{\bar{N}+6} = (0, q^2 + p^2 \bar{S}_{\bar{K}+1}; v_{2\bar{K}+3}^{1,+}, p^2) \in \mathcal{Y}_{\text{bo}}^{1,+}$ and one can apply the results of §3.B.2.1 to define N starting from $Y_{\bar{N}+6}$. On the event E^2 , $Y_{\bar{N}+10} = Y_{n_0+10} = (0, q^2 + p^2(2-a)(1/v_1^{1,+} + 1/v_2^{2,-}); v_3^{1,+}, p^2) \in \mathcal{Y}_{\text{bo}}^{1,+}$ and one can apply the results of §3.B.2.1 to define N starting from Y_{n_0+10} . On the complementary event $(E^1 \cup E^2)^c$, one simply lets $N = n_0$. Then, the strong

Figure 3.14: The event E^3 in the case $q^2 \in (a, 1-a)$, $p^2 < 0$.

Markov property applied with the stopping time $\bar{N} + 6$ ensures that N remains a stopping time for the Markov chain $(Y_n)_{n \geq 0}$. Besides,

$$\mathbf{P}_y(Y_N \in \Theta) = \mathbf{P}_y(Y_N \in \Theta, E^1) + \mathbf{P}_y(Y_N \in \Theta, E^2) + \mathbf{P}_y(Y_N \in \Theta, (E^1 \cup E^2)^c),$$

and we now give a lower bound uniform in y for each of the three terms of the right hand side above.

First, $\mathbf{P}_y(Y_N \in \Theta, E^1) = \mathbf{P}_y(Y_N \in \Theta | E^1) \mathbf{P}_y(E^1) \geq \beta_{3.B.2.1} \mathbf{P}_y(E^1)$, and

$$\begin{aligned} \mathbf{P}_y(E^1) &= \mathbb{P}(\bar{K} = \bar{K}^*, \bar{S}_{\bar{K}+1} < \bar{t}') \\ &= \sum_{k=0}^{+\infty} \mathbb{P}\left(\bar{S}_k^* < \bar{t}, \bar{t} \leq \bar{S}_k^* + \frac{1}{v_{2k+2}^{1,-}} < \bar{t}'\right) \\ &= \int_{s=0}^{+\infty} \int_{r=0}^{+\infty} \mathbb{1}_{\{s < \bar{t}, \bar{t} \leq s+r < \bar{t}'\}} \psi^{1,-}(r) dr U^{1;*,1}(s) ds \\ &= \int_{s=0}^{\bar{t}} \bar{\Psi}(\bar{t}' - \bar{t}; s) U^{1;*,1}(\bar{t} - s) ds, \end{aligned}$$

where the function $\bar{\Psi}$ is defined on $(0, +\infty) \times [0, +\infty)$ by

$$\forall c \geq 0, \quad \forall t > 0, \quad \bar{\Psi}(t; c) := \int_{r=0}^{+\infty} \mathbb{1}_{\{c \leq r < t+c\}} \psi^{1,-}(r) dr.$$

Note that, for all $c \geq 0$, the function $\bar{\Psi}(\cdot; c)$ is nondecreasing.

Recall that $1/S^{1,-} \in [0, +\infty)$ refers to the lower bound of the support of the density $\psi^{1,-}$, and let us fix η' large enough for the inequality

$$\frac{1}{S^{1,-}} + M^{1;1,1} < \left(1 + \frac{a}{1-2a}\right) \eta' \quad (3.20)$$

to hold. In particular, $\eta' > M^{1;1,1}$. Assume that $\bar{t} = (q^2 - a)/(-p^2) \geq \eta'$. Since $q^2 \leq 1-a$, one deduces that $\bar{t}' - \bar{t} = a/(-p^2) \geq a\eta'/(1-2a)$. Proceeding as in the proof of Lemma 3.4.5 and using the monotonicity of $\bar{\Psi}(\cdot; c)$, one gets

$$\int_{s=0}^{\bar{t}} \bar{\Psi}(\bar{t}' - \bar{t}; s) U^{1;*,1}(\bar{t} - s) ds \geq \frac{1}{2(\mu^{1,+} + \mu^{1,-})} \int_{s=0}^{\eta' - M^{1;1,1}} \Psi\left(\frac{a}{1-2a} \eta'; s\right) ds =: \beta^{(1)},$$

and $\beta^{(1)}$ no longer depends on y , while (3.20) ensures that it is positive. As a consequence,

$$\mathbf{P}_y(Y_N \in \Theta, E^1) \geq \mathbb{1}_{\{\bar{t} \geq \eta'\}} \beta^{(1)} \beta_{3.B.2.1}.$$

Let us now fix η'' such that

$$\eta'' > (2-a) \left(\eta' \vee \left(\frac{1}{S^{1,+}} + \frac{1}{S^{2,-}} \right) \right).$$

If $\bar{t} < \eta'$ and $\bar{t}' \geq \eta''$, then $\mathbf{P}_y(Y_N \in \Theta, E^2) = \mathbf{P}_y(Y_N \in \Theta | E^2) \mathbf{P}_y(E^2) \geq \beta_{3.B.2.1} \mathbf{P}_y(E^2)$, and

$$\begin{aligned} \mathbf{P}_y(E^2) &= \mathbb{P} \left(\frac{1}{v_1^{1,+}} > \bar{t}, \frac{1}{v_1^{1,+}} + \frac{1}{v_2^{2,-}} < \frac{\bar{t}'}{2-a} \right) \\ &\geq \mathbb{P} \left(\frac{1}{v_1^{1,+}} > \eta', \frac{1}{v_1^{1,+}} + \frac{1}{v_2^{2,-}} < \frac{\eta''}{2-a} \right) =: \beta^{(2)}, \end{aligned}$$

and the choice of η'' as well as the assumption that $\psi^{1,+}$ satisfies (H3) ensure that $\beta^{(2)} > 0$. As a consequence,

$$\mathbf{P}_y(Y_N \in \Theta, E^2) \geq \mathbb{1}_{\{\bar{t} < \eta', \bar{t}' \geq \eta''\}} \beta^{(2)} \beta_{3.B.2.1}.$$

Finally, let us assume that $\bar{t} < \eta'$ and $\bar{t}' < \eta''$. Then, on the event $E^3 \subset (E^1 \cup E^2)^c$, $\Gamma(Y_N) = \Gamma(Y_{n_0}) = a/v_1^{1,+} - \bar{t}'$ and then,

$$\begin{aligned} \mathbf{P}_y(Y_N \in \Theta, (E^1 \cup E^2)^c) &\geq \mathbf{P}_y(Y_N \in \Theta, E^3) \\ &= \mathbb{P} \left(\frac{a}{v_1^{1,+}} - \bar{t}' \geq \eta_{\text{bo}}^{1,+} \right) \\ &\geq \mathbb{P} \left(\frac{a}{v_1^{1,+}} \geq \eta'' + \eta_{\text{bo}}^{1,+} \right) =: \beta^{(3)}, \end{aligned}$$

and $\beta^{(3)} > 0$ thanks to the assumption that $\psi^{1,+}$ satisfies the condition (H3). As a consequence,

$$\mathbf{P}_y(Y_N \in \Theta, (E^1 \cup E^2)^c) \geq \mathbb{1}_{\{\bar{t} < \eta', \bar{t}' < \eta''\}} \beta^{(3)};$$

and putting all together we conclude

$$\mathbf{P}_y(Y_N \in \Theta) \geq \min \left(\beta^{(1)} \beta_{3.B.2.1}, \beta^{(2)} \beta_{3.B.2.1}, \beta^{(3)} \right) > 0.$$

Using the symmetries introduced in §3.2.1.2, one can now define $\beta_{3.B.2.2} > 0$ such that, as soon as $\tau_{n_0} = t_{\text{hit}}(y)$ and $Y_{n_0} \in \mathcal{Y}_{\text{bo}}^{i,\epsilon}$ is such that $\mathfrak{S}^{i,\epsilon}(Y_{n_0}) = (0, q^2; v, p^2)$ satisfies $q^2 \in (a, 1-a)$ and $p^2 < 0$,

$$\mathbf{P}_y(Y_N \in \Theta) \geq \beta_{3.B.2.2}.$$

3.B.2.3 Case $p^2 > 0$

Let us finally assume that $p^2 > 0$. Then Y_{n_0} is in one of the six situations depicted on Figure 3.15.

In situations A, C and E, one can restart the construction of N as in Subsection 3.B.1 starting from Y_{n_0} . In situations B, (resp. D, F), one can restart the construction of N as in §3.B.2.1 and §3.B.2.2 starting from $\mathfrak{S}^{2,-}(Y_{n_0+1})$ (resp. $\mathfrak{S}^{1,-}(Y_{n_0+3})$, $\mathfrak{S}^{2,-}(Y_{n_0+5})$). In any case,

$$\mathbf{P}_y(Y_N \in \Theta) \geq \beta_{3.B.2.1} \wedge \beta_{3.B.2.2} =: \beta_{3.B.2} > 0.$$

3.B.3 Conclusion

The stopping time N has been defined for all choice of y , and the proof of Step 1 in §3.6.1.3 is completed by defining $\beta := \beta_{3.B.1} \wedge \beta_{3.B.2} > 0$.

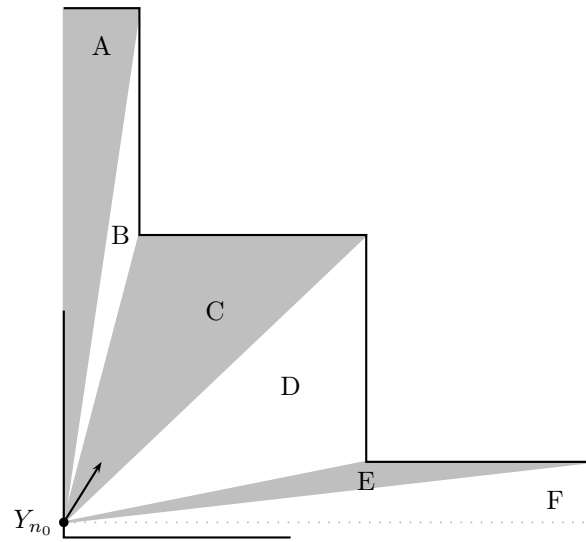

Figure 3.15: The possible situations in the case $p^2 > 0$.

Deuxième partie

**Systemes de particules interagissant
à travers leur rang**

Chapitre 4

Propagation du chaos pour les systèmes de particules interagissant à travers leur rang, et comportement en temps long de leur limite de champ moyen

Ce chapitre reprend le contenu de l'article [91], écrit avec Benjamin Jourdain et paru dans *Stochastic Partial Differential Equations: Analysis and Computations*. En plus de l'harmonisation des notations et références avec le reste du manuscrit, les modifications suivantes ont été apportées dans la version ici présentée :

- les remarques 4.3.2 et 4.4.7 ont été ajoutées ;
- l'hypothèse (D2) a été symétrisée de sorte que le coefficient de diffusion σ^2 puisse s'annuler en 0 et en 1, ce qui a entraîné une légère modification de la preuve du Lemme 4.2.10 et de l'énoncé du Lemme 4.2.12.

4.1 Introduction

Let $a, b : [0, 1] \rightarrow \mathbb{R}$ be continuous functions, with $a \geq 0$. For all $u \in [0, 1]$, let us define $A(u) = \int_0^u a(v)dv$ and $B(u) = \int_0^u b(v)dv$. Let m be a probability distribution on \mathbb{R} . We are interested in the nonlinear Cauchy problem on $[0, +\infty) \times \mathbb{R}$:

$$\begin{cases} \partial_t F_t(x) = \frac{1}{2} \partial_x^2 (A(F_t(x))) - \partial_x (B(F_t(x))), \\ F_0(x) = H * m(x), \end{cases} \quad (4.1)$$

where $H * \cdot$ refers to the spatial convolution with the Heaviside function.

The partial differential equation in (4.1) is called a scalar *quasilinear parabolic* equation. It is a model for several usual nonlinear evolution equations, such as the porous medium equation, for which $B(u) = 0$ and the diffusion term has the particular form $A(u) = u^q$, $q > 1$; or conservation laws, in which the diffusion term is linear, i.e. $A(u) = \sigma^2 u$ with $\sigma^2 \geq 0$. A conservation law is said to be *viscous* if $\sigma^2 > 0$ and *inviscid* if $\sigma^2 = 0$. A particular case of a conservation law is the Burgers equation, for which $B(u) = u^2$.

In this chapter, we introduce a probabilistic approximation of the Cauchy problem by means of a system of scalar diffusion processes, interacting through their ranking. We then use this probabilistic representation to study the long time behaviour of the solution.

A *weak solution* to the Cauchy problem (4.1) is a family of functions $(F_t)_{t \geq 0}$, such that the mapping

$$\begin{cases} [0, +\infty) & \rightarrow L^1_{\text{loc}}(\mathbb{R}) \\ t & \mapsto F_t \end{cases}$$

be continuous and such that, for all $t \geq 0$, F_t takes its values in $[0, 1]$ and for all $g \in C_c^\infty([0, +\infty) \times \mathbb{R})$,

$$\begin{aligned} & \int_{\mathbb{R}} g(t, x) F_t(x) dx - \int_{\mathbb{R}} g(0, x) H * m(x) dx \\ &= \int_{\mathbb{R}} \int_0^t \left\{ \frac{1}{2} A(F_s(x)) \partial_x^2 g(s, x) + B(F_s(x)) \partial_x g(s, x) + F_s(x) \partial_s g(s, x) \right\} ds dx, \end{aligned} \quad (4.2)$$

where $C_c^\infty([0, +\infty) \times \mathbb{R})$ refers to the space of real-valued C^∞ functions with compact support in $[0, +\infty) \times \mathbb{R}$.

When A is C^2 on $[0, 1]$, we say that $(F_t)_{t \geq 0}$ has the *classical regularity* if $(t, x) \mapsto F_t(x)$ is $C^{1,2}$ on $(0, +\infty) \times \mathbb{R}$ and solves (4.1) in the classical sense. The space derivatives $(p_t)_{t \geq 0}$ of a solution $(F_t)_{t \geq 0}$ with classical regularity satisfies the nonlinear Fokker-Planck equation

$$\partial_t p_t(x) = \frac{1}{2} \partial_x^2 (a(H * p_t(x)) p_t(x)) - \partial_x (b(H * p_t(x)) p_t(x)), \quad (4.3)$$

therefore it is natural to consider the associated *nonlinear* stochastic differential equation

$$\begin{cases} X_t = X_0 + \int_0^t b(H * P_s(X_s)) ds + \int_0^t \sigma(H * P_s(X_s)) dW_s, \\ P_t \text{ is the distribution of } X_t, \end{cases} \quad (4.4)$$

where $\sigma(u) := a(u)^{1/2}$, X_0 has distribution m and is independent of the Brownian motion W . Due to the discontinuity of the Heaviside function, a direct study of this equation by classical techniques, such as the use of fixed-point theorems [130], seems out of reach (except when the diffusion coefficient σ is constant, see [82]); therefore we introduce a linearized approximation of (4.4).

In Section 4.2, we call *particle system* a solution $X^n \in C([0, +\infty), \mathbb{R}^n)$ to the stochastic differential equation in \mathbb{R}^n

$$\begin{cases} X_t^{i,n} = X_0^i + \int_0^t b(H * \mu_s^n(X_s^{i,n})) ds + \int_0^t (c_n + \sigma(H * \mu_s^n(X_s^{i,n}))) dW_s^i, \\ \mu_t^n = \frac{1}{n} \sum_{i=1}^n \delta_{X_t^{i,n}}, \end{cases} \quad (4.5)$$

where $(X_0^i)_{i \geq 1}$ is a sequence of i.i.d. random variables with marginal distribution m , independent of the \mathbb{R}^n -valued Brownian motion (W^1, \dots, W^n) . Here, the term $c_n > 0$ has been added in the diffusion in order to ensure the well definition of solutions, and it is only required to vanish when $n \rightarrow +\infty$. In Proposition 4.2.1, we prove that as soon as the function A is increasing and m has a finite first order moment, the flow of time marginals $t \mapsto \mu_t^n$ of the empirical distribution of the particle system converges in probability to the unique mapping $t \mapsto P(t)$ such that $(H * P(t))_{t \geq 0}$ is a weak solution to the Cauchy problem (4.1). This function will be referred to as the *probabilistic solution* of the Cauchy problem. Our analysis is essentially based on results obtained for the particular case of the porous medium equation [84]. A crucial argument in the extension of this work is the uniqueness of weak solutions to the Cauchy problem stated in Proposition 4.2.2, the proof of which is adapted from works by Wu, Zhao, Yin and Lin [137] and Liu and Wang [105] (see Appendix 4.A). Proposition 4.2.1 has strong connections with recent results by Shkolnikov [127], see Remark 4.2.6.

We then give two representations of the mapping $t \mapsto P(t)$ as the flow of time marginals of a probability distribution on the space of sample-paths $C([0, +\infty), \mathbb{R})$. More precisely, in Subsection 4.2.2, we give necessary and sufficient conditions on the coefficients of the Cauchy problem for the empirical distribution $\mu^n = (1/n) \sum_{i=1}^n \delta_{X^{i,n}}$ of the particle system in $C([0, +\infty), \mathbb{R})$ to converge in probability to the law P of a weak solution to (4.4). In Subsection 4.2.3, we define the *reordered particle system* as the reflected diffusion process obtained by increasingly reordering the positions $(X_t^{1,n}, \dots, X_t^{n,n})$ of the particles. We prove in Proposition 4.2.15 that the associated empirical distribution $\tilde{\mu}^n$ converges in probability to a probability distribution \tilde{P} on $C([0, +\infty), \mathbb{R})$ with time marginals $P(t)$.

Our motivation for introducing the particle system (4.5) is the study of nonlinear evolution problems, as it has been done for particular equations by Jourdain [83, 84, 85]. However, such systems of so-called *rank-based interacting particles* also arise in several contexts (see the introduction of [80] for references), and have received much attention lately. In particular, motivated by the study of the Atlas model of equity markets introduced by Fernholz [58] (see also Banner, Fernholz and Karatzas [11]), much work has been done about the rank-based stochastic differential equation

$$dX_t^i = \sum_{j=1}^n \mathbb{1}_{\{X_t^i = Y_t^j\}} b_j dt + \sum_{j=1}^n \mathbb{1}_{\{X_t^i = Y_t^j\}} \sigma_j dW_t^i, \quad (4.6)$$

where (Y_t^1, \dots, Y_t^n) refers to the increasing reordering of (X_t^1, \dots, X_t^n) . The case $n = 2$ is exhaustively studied by Fernholz, Ichiba, Karatzas and Prokaj [61]. For $n \geq 3$, Ichiba, Karatzas and Shkolnikov [79] show that strong solutions can be defined as long as there is no triple collision. Triple collisions are studied in [78]. Concentration of measure bounds for the local time at collisions and statistics related to this system are given by Pal and Shkolnikov in [116].

As far as the long time behaviour of solutions to (4.6) is concerned, Ichiba, Papathanakos, Banner, Karatzas and Fernholz [81] prove that under some convexity assumption on the sequence of drift coefficients (b_j) , the process of spacings $(Y_t^2 - Y_t^1, \dots, Y_t^n - Y_t^{n-1})$ converges in total variation to its unique stationary distribution when $t \rightarrow +\infty$. When the sequence of diffusion coefficients is such that $\sigma_2^2 - \sigma_1^2 = \dots = \sigma_n^2 - \sigma_{n-1}^2$, this stationary distribution is the product of exponential distributions. These results extend the work by Pal and Pitman [115], in which $\sigma_j = 1$ for all j . In this case, the particle system solution to (4.6) does not have any equilibrium, as the process of its center of mass is a drifted Brownian motion. However, the convergence to equilibrium in total variation of its projection on the hyperplane $\{x_1 + \dots + x_n = 0\}$ can be deduced from the long time behaviour of the process of spacings [115]. Convergence rates are provided by Ichiba, Pal and Shkolnikov [80] using Lyapounov functionals. Based on the Poincaré inequality satisfied by the stationary distribution, Jourdain and Malrieu [89] prove the convergence to equilibrium in χ^2 distance with an exponential rate, which is uniform in n . However, due to the lack of scaling property in the dimension n for the χ^2 distance, one cannot deduce from their result the convergence to equilibrium of the probabilistic solution $(F_t)_{t \geq 0}$ to the Cauchy problem (4.1), which is the purpose of Sections 4.3 and 4.4 of this chapter.

In many cases, transport metrics, and the Wasserstein distance in particular, are contractive for the flow of solutions to parabolic equations: see von Renesse and Sturm [136] for the linear Fokker-Planck equation, Carrillo, McCann and Villani [37], Cattiaux, Guillin and Malrieu [40] and the recent work by Bolley, Gentil and Guillin [22] for the granular media equation and Bolley, Guillin and Malrieu [23] for the kinetic Vlasov-Fokker-Planck equation. We will prove such a contractivity property by a probabilistic argument and without further regularity assumption, and then take advantage of it to state the convergence to equilibrium of the solutions.

Let us first recall some useful properties of the one-dimensional Wasserstein distance (see Villani [135] for a complete introduction). Let $p \geq 1$. For all probability distributions μ and ν on \mathbb{R} , we define

$$W_p(\mu, \nu) := \inf_{(X, Y) \in \Pi(\mu, \nu)} \mathbb{E}(|X - Y|^p)^{1/p},$$

where $\Pi(\mu, \nu)$ refers to the set of random couples (X, Y) such that X has marginal distribution μ

and Y has marginal distribution ν . As soon as both μ and ν have a finite moment of order p , then $W_p(\mu, \nu) < +\infty$.

Given a right-continuous nondecreasing function F , we define its pseudo-inverse as $F^{-1}(u) := \inf\{x \in \mathbb{R} : F(x) > u\}$. Then it is a remarkable feature of the one-dimensional case that the Wasserstein distance $W_p(\mu, \nu)$ can be expressed in terms of the pseudo-inverses of the cumulative distribution functions $F_\mu := H * \mu$ and $F_\nu := H * \nu$ as

$$W_p^p(\mu, \nu) = \int_0^1 |F_\mu^{-1}(u) - F_\nu^{-1}(u)|^p du. \quad (4.7)$$

This leads to the following useful expressions: let $(x_1, \dots, x_n) \in \mathbb{R}^n$, we denote by (y_1, \dots, y_n) its increasing reordering and by μ^n its empirical distribution. Then for all probability distribution μ ,

$$W_p^p(\mu^n, \mu) = \sum_{i=1}^n \int_{(i-1)/n}^{i/n} |y_i - F_\mu^{-1}(u)|^p du \leq \sum_{i=1}^n \int_{(i-1)/n}^{i/n} |x_i - F_\mu^{-1}(u)|^p du. \quad (4.8)$$

In particular when μ is the empirical distribution μ'^n of some vector (x'_1, \dots, x'_n) with increasing reordering (y'_1, \dots, y'_n) ,

$$W_p^p(\mu^n, \mu'^n) = \frac{1}{n} \sum_{i=1}^n |y_i - y'_i|^p \leq \frac{1}{n} \sum_{i=1}^n |x_i - x'_i|^p. \quad (4.9)$$

We finally point out the fact that we will indifferently refer to the Wasserstein distance between μ and ν as $W_p(\mu, \nu)$ or $W_p(F_\mu, F_\nu)$.

In Section 4.3 we study the evolution of the Wasserstein distance between two probabilistic solutions $(F_t)_{t \geq 0}$ and $(G_t)_{t \geq 0}$ of the Cauchy problem (4.1) with different initial conditions F_0 and G_0 . We use the contractivity of the reordered particle system in Proposition 4.3.1 to prove that the flow $t \mapsto W_p(F_t, G_t)$ is nonincreasing. Then we provide an explicit expression of the time derivative of the flow in Proposition 4.3.4. Our work is related to results exposed in the review papers by Carrillo and Toscani [38] and Carrillo, Di Francesco and Lattanzio [35]; a further review is given in Remark 4.3.6.

Section 4.4 is dedicated to the convergence to equilibrium of the solutions. We call *stationary solution* the cumulative function F_∞ of a probability distribution m_∞ with a finite first order moment, such that if $(F_t)_{t \geq 0}$ is the probabilistic solution of the Cauchy problem (4.1) with $F_0 = F_\infty$, then for all $t \geq 0$, $F_t = F_\infty$. It is clear from (4.2) that F_∞ is a stationary solution if and only if it solves the *stationary equation* $(1/2)\partial^2(A(F_\infty)) - \partial(B(F_\infty)) = 0$, in the sense of distributions.

We solve the stationary equation in Proposition 4.4.1, extending the results of Jourdain and Malrieu [89] who deal with the viscous conservation law. Using the results of Section 4.3 as well as the probabilistic approximation built in Section 4.2, we then prove in Theorem 4.4.6 that the probabilistic solutions converge to the stationary solutions in Wasserstein distance.

In [89], the solutions of the viscous conservation law are proven to converge exponentially fast to equilibrium in χ^2 distance, under the condition that the initial measure m be close enough to the stationary solution m_∞ . Theorem 4.4.6 does not involve such a condition, but the proof does not provide any indication on the rate of convergence of $(F_t)_{t \geq 0}$ to the equilibrium. As we remark in Subsection 4.4.3, one can recover an exponential rate of convergence in (quadratic) Wasserstein distance in the setting of [89].

Notations

Given a separable metric space S , we denote by $P(S)$ the set of Borel probability distributions on S , equipped with the topology of weak convergence. The space $C([0, +\infty), S)$ of continuous functions from $[0, +\infty)$ to S is provided with the topology of the uniform convergence on the compact sets of $[0, +\infty)$. Besides, for all probability distribution $\mu \in P(C([0, +\infty), S))$, the marginal distribution at time $t \geq 0$ is denoted by $\mu_t \in P(S)$. The *canonical application*

$P(C([0, +\infty), S)) \rightarrow C([0, +\infty), P(S))$ associates the distribution μ with the flow of its time marginals $t \mapsto \mu_t$. Finally, if f is a real-valued bounded function then $\|f\|_\infty$ refers to the supremum of the function $|f|$.

Assumptions

Our results are valid under various assumptions on the degeneracy of the parabolic equation. Let us introduce the following conditions:

(D1) The function A is increasing.

(D2) For all $u \in (0, 1)$, $a(u) > 0$.

(D3) There exists $\underline{a} > 0$ such that, for all $u \in [0, 1]$, $a(u) \geq \underline{a}$.

Obviously, (D1) is weaker than (D2), which is weaker than (D3).

We also introduce the two following conditions on the regularity of the coefficients:

(R1) The function a is C^1 on $[0, 1]$.

(R2) The function a is C^2 on $[0, 1]$, the function b is C^1 on $[0, 1]$ and there exists $\beta > 0$ such that the functions a'' and b' are β -Hölder continuous.

The condition (R1) is a natural necessary condition for the Cauchy problem (4.1) to admit classical solutions. The stronger condition (R2) will be used in Lemma 4.2.7 to ensure the existence of classical solutions to the Fokker-Planck equation (4.3).

Finally, the existence and integrability of stationary solutions will depend on the two following equilibrium conditions:

(E1) For all $u \in (0, 1)$, $B(u) > 0$, $B(1) = 0$ and the function $a/2B$ is locally integrable on $(0, 1)$.

(E2) The function $a/2B$ is such that

$$\int_0^{1/2} \frac{a(u)u}{2|B(u)|} du + \int_{1/2}^1 \frac{a(u)(1-u)}{2|B(u)|} du < +\infty.$$

4.2 Probabilistic approximation of the solution

4.2.1 Existence and uniqueness of the probabilistic solution

Following [13], for all $n \geq 1$ there exists a unique weak solution $X^n = (X_t^{1,n}, \dots, X_t^{n,n})_{t \geq 0}$ to the stochastic differential equation (4.5). We call it the *particle system* and denote by μ^n the random variable in $P(C([0, +\infty), \mathbb{R}))$ defined by $\mu^n := (1/n) \sum_{i=1}^n \delta_{X^{i,n}}$.

Let $T > 0$, possibly $T = +\infty$. We denote by $P_1(T)$ the set of continuous mappings $t \in [0, T) \mapsto P(t) \in P(\mathbb{R})$ such that for all $t \in [0, T)$, the probability distribution $P(t)$ has a finite first order moment and the function $t \mapsto \int_{\mathbb{R}} |x|P(t)(dx)$ is locally integrable on $[0, T)$. Let $\mathcal{F}(T) := \{(H * P(t))_{t \in [0, T)}; P \in P_1(T)\}$; note that $\mathcal{F}(T) \subset C([0, T), L_{\text{loc}}^1(\mathbb{R}))$. The particular sets $P_1(+\infty)$ and $\mathcal{F}(+\infty)$ are simply denoted by P_1 and \mathcal{F} .

Throughout this chapter, we will call *probabilistic solution* the solution to the Cauchy problem (4.1) given by the following proposition.

Proposition 4.2.1. *Under the nondegeneracy condition (D1) and the assumption that m has a finite first order moment, there exists a unique weak solution $(F_t)_{t \geq 0}$ to the Cauchy problem (4.1) in \mathcal{F} , and it writes $(H * P(t))_{t \geq 0}$ where the mapping $t \mapsto P(t)$ is the limit in probability, in $C([0, +\infty), P(\mathbb{R}))$, of the sequence of mappings $t \mapsto \mu_t^n$.*

The proof of Proposition 4.2.1 relies on Proposition 4.2.2 and Lemmas 4.2.3 and 4.2.4. For all $n \geq 1$, let π^n denote the distribution of μ^n in $P(C([0, +\infty), \mathbb{R}))$. In Lemma 4.2.3, we prove that the sequence $(\pi^n)_{n \geq 1}$ is tight. Since the canonical application $P(C([0, +\infty), \mathbb{R})) \rightarrow C([0, +\infty), P(\mathbb{R}))$ is continuous, then the sequence $(\pi^n)_{n \geq 1}$ of the distributions of the random mappings $t \mapsto \mu_t^n$ in $C([0, +\infty), P(\mathbb{R}))$ is tight. Let π^∞ be the limit of a converging subsequence, that we still index by n for convenience. Lemma 4.2.4 combined with Proposition 4.2.2 proves that π^∞ concentrates on a single point $P \in P_1$, which is such that the function $(t, x) \mapsto (H * P(t))(x)$ is a weak solution of (4.1).

Proposition 4.2.2. *Assume that the nondegeneracy condition (D1) holds.*

1. *Let $T > 0$, possibly $T = +\infty$. Let $(F_t^1)_{t \in [0, T]}$ and $(F_t^2)_{t \in [0, T]} \in \mathcal{F}(T)$, such that for all $g \in C_c^\infty([0, T] \times \mathbb{R})$, $(F_t^1)_{t \in [0, T]}$ and $(F_t^2)_{t \in [0, T]}$ satisfy (4.2). Then, for all $t \in [0, T]$, $F_t^1 = F_t^2$.*
2. *There is at most one weak solution to the Cauchy problem (4.1) in \mathcal{F} .*

Proof. The second point of the proposition clearly follows from the first point, and the first point is proved in Appendix 4.A. \square

Lemma 4.2.3. *The sequence $(\pi^n)_{n \geq 1}$ is tight.*

Proof. Since the distribution of $(X^{1, n}, \dots, X^{n, n})$ in $C([0, +\infty), \mathbb{R}^n)$ is symmetric, according to Sznitman [130, Proposition 2.2, p. 177], $(\pi^n)_{n \geq 1}$ is tight if and only if the sequence of the distributions of the variables $X^{1, n} \in C([0, +\infty), \mathbb{R})$ is tight. This latter fact classically follows from the fact that for all $n \geq 1$, $X_0^{1, n} = X_0^1$ has distribution m on the one hand, and from the Kolmogorov criterion as well as the boundedness of the coefficients a and b and the sequence $(c_n)_{n \geq 1}$ on the other hand. \square

Lemma 4.2.4. *Under the assumption that m has a finite first order moment, the distribution π^∞ is concentrated on the set of mappings $P \in \mathcal{P}_1$ such that the function $(t, x) \mapsto (H * P(t))(x)$ is a weak solution to the Cauchy problem (4.1).*

Proof. We first prove that π^∞ concentrates on \mathcal{P}_1 . Let μ^∞ be a variable in $C([0, +\infty), \mathcal{P}(\mathbb{R}))$ with distribution π^∞ . We will prove that for all $t \geq 0$,

$$\sup_{s \in [0, t]} \int_{\mathbb{R}} |x| \mu^\infty(s)(dx) < +\infty \quad \text{a.s.},$$

so that taking t in a countable unbounded subset of $[0, +\infty)$ yields $\mu^\infty \in \mathcal{P}_1$ almost surely.

Let $t \geq 0$. For all $M \geq 0$, the function $f_M : \mu \mapsto \sup_{s \in [0, t]} \int_{\mathbb{R}} (|x| \wedge M) \mu(s)(dx)$ is continuous and bounded on $C([0, +\infty), \mathcal{P}(\mathbb{R}))$. For fixed n ,

$$\begin{aligned} \mathbb{E}(f_M(\mu^n)) &\leq \frac{1}{n} \sum_{i=1}^n \mathbb{E} \left(\sup_{s \in [0, t]} |X_s^{i, n}| \right) \\ &\leq \int_{\mathbb{R}} |x| m(dx) + t \|b\|_\infty + \frac{1}{n} \sum_{i=1}^n \left[\mathbb{E} \left(\sup_{s \in [0, t]} \left| \int_0^s (c_n + \sigma(H * \mu_r^n(X_r^{i, n}))) dW_r^i \right|^2 \right) \right]^{1/2} \\ &\leq C, \end{aligned}$$

where we have used the Cauchy-Schwarz inequality in the second line and the Doob inequality as well as the fact that m has a finite first order moment in the third line. The constant C depends neither on M nor on n . As a consequence, $\liminf_{M \rightarrow +\infty} \mathbb{E}(f_M(\mu^\infty)) \leq C$ and by Fatou's lemma,

$$C \geq \mathbb{E} \left(\liminf_{M \rightarrow +\infty} f_M(\mu^\infty) \right) \geq \mathbb{E} \left(\sup_{s \in [0, t]} \liminf_{M \rightarrow +\infty} \int_{\mathbb{R}} (|x| \wedge M) \mu^\infty(s)(dx) \right).$$

By the monotone convergence theorem,

$$\liminf_{M \rightarrow +\infty} \int_{\mathbb{R}} (|x| \wedge M) \mu^\infty(s)(dx) = \lim_{M \rightarrow +\infty} \int_{\mathbb{R}} (|x| \wedge M) \mu^\infty(s)(dx) = \int_{\mathbb{R}} |x| \mu^\infty(s)(dx),$$

so that $\mathbb{E} \left(\sup_{s \in [0, t]} \int_{\mathbb{R}} |x| \mu^\infty(s)(dx) \right) \leq C$, which yields the expected result.

It now remains to prove that $(t, x) \mapsto (H * \mu^\infty(t))(x)$ is almost surely a weak solution of the Cauchy problem (4.1). The computation is made for the porous medium equation in [84, Lemma 1.5] and can be straightforwardly extended; it relies on the uniform continuity of a and b on $[0, 1]$ and the fact that $c_n \rightarrow 0$. \square

Remark 4.2.5. Without assuming neither (D1) nor the existence of a first order moment for m , one can still prove that the sequence $(\pi^n)_{n \geq 1}$ is tight and that the limit of any converging subsequence concentrates on weak solutions to the Cauchy problem (4.1), that of course not necessarily belong to \mathcal{F} . Thus, the existence of weak solutions holds under very weak assumptions.

Remark 4.2.6. The law of large numbers for the sequence of mappings $t \mapsto \mu_t^n$ stated in Proposition 4.2.1 has recently been addressed under more restrictive conditions on the initial condition m and the coefficients a and b . In [127], Shkolnikov studies the particle system (4.5) with the specific condition that the process of spacings between two particles with consecutive positions in \mathbb{R} be stationary (the description of the stationary distribution is given in [81]). Then in the case where a is affine and b is C^1 , with b' uniformly negative, the sequence of mappings $t \mapsto \mu_t^n$ is proven to converge in probability, in $C([0, +\infty), \mathbb{P}(\mathbb{R}))$, to the unique mapping $t \mapsto P(t)$ such that $(t, x) \mapsto (H * P(t))(x)$ is a weak solution to the Cauchy problem (4.1) for a specified initial condition F_0 . In place of our Proposition 4.2.2, the author uses Gilding's theorem for uniqueness [72, Theorem 4] and therefore needs to assume that any weak solution to the Cauchy problem is continuous on $[0, +\infty) \times \mathbb{R}$ when m does not weight points.

In the more recent article by Dembo, Shkolnikov, Varadhan and Zeitouni [48], the stationarity assumption is removed and the continuity of $(F_t)_{t \geq 0}$ is obtained as a consequence of mild regularity and nondegeneracy assumptions on the coefficients of the Cauchy problem (4.1). More precisely, the authors establish a large deviation principle for the sequence $(\pi^n)_{n \geq 1}$, with a rate function that is infinite on the set of mappings $t \mapsto P(t)$ such that the function $(t, x) \mapsto (H * P(t))(x)$ is discontinuous. They also prove that a zero of the rate function is a mapping $t \mapsto P(t)$ such that the function $(t, x) \mapsto (H * P(t))(x)$ is a continuous weak solution to (4.1), and deduce the law of large numbers as a consequence of Gilding's uniqueness theorem.

Both approaches heavily rely on the continuity of the solution $(F_t)_{t \geq 0}$ to (4.1), as it is a crucial condition to use Gilding's uniqueness theorem. While we address the regularity of $(F_t)_{t \geq 0}$ in Lemma 4.2.7 below, we insist on the fact that our proof of Proposition 4.2.1 does not require that $(F_t)_{t \geq 0}$ be continuous, which allows us to relax the regularity and nondegeneracy assumptions on m , a and b with respect to [127, 48]. However, the regularity of $(F_t)_{t \geq 0}$ plays a more important role in establishing the law of large numbers for the sequence of empirical distributions $\mu^n \in \mathbb{P}(C([0, +\infty), \mathbb{R}))$ in Subsection 4.2.2. Therefore, in the proof of Lemma 4.2.10, we prove that, under the nondegeneracy condition (D2), the function F_t is continuous on \mathbb{R} , dt -almost everywhere.

We conclude this subsection by discussing the regularity of the probabilistic solution $(F_t)_{t \geq 0}$. For all finite $T > 0$, we denote by $C_b^{1,2}([0, T] \times \mathbb{R})$ the set of $C^{1,2}$ functions on $[0, T] \times \mathbb{R}$ that are bounded together with their derivatives. For all $l > 0$, the Hölder spaces $H^l(\mathbb{R})$ and $H^{l/2, l}([0, T] \times \mathbb{R})$ are defined as in [97, p. 7].

Lemma 4.2.7. *Assume that the uniform ellipticity condition (D3) and the regularity condition (R2) hold, that m has a finite first order moment and that $H * m$ is in the Hölder space $H^l(\mathbb{R})$, with $l = 3 + \beta$. Then for all finite $T > 0$, the probabilistic solution $(F_t)_{t \geq 0}$ to (4.1) is in $C_b^{1,2}([0, T] \times \mathbb{R})$. In particular, it is a classical solution to (4.1).*

Proof. Fix a finite $T > 0$. Then owing to the assumptions (D3), (R2) and on the regularity of $H * m$, the classical result of Ladyženskaja, Solonnikov and Ural'ceva [97, Theorem 8.1, p. 495] ensures that the Cauchy problem in divergence form

$$\begin{cases} \partial_t \tilde{F}_t(x) = \partial_x \left(\frac{1}{2} a(\tilde{F}_t(x)) \partial_x \tilde{F}_t(x) - B(\tilde{F}_t(x)) \right), \\ \tilde{F}_0(x) = H * m(x), \end{cases} \quad (4.10)$$

admits a classical bounded solution \tilde{F} , which belongs to the Hölder space $H^{l/2, l}([0, T] \times \mathbb{R})$, with $l = 3 + \beta$. Certainly, \tilde{F} satisfies (4.2) for all $g \in C_c^\infty([0, T] \times \mathbb{R})$. Let us now prove that $\tilde{F} \in \mathcal{F}(T)$. On the one hand, by the maximum principle [97, Theorem 2.5, p. 18], for all $t \in [0, T]$, $\|\tilde{F}_t\|_\infty \leq 1$. On the other hand, the space derivative $\tilde{p} := \partial_x \tilde{F}$ is $C^{1,2}$ on $[0, T] \times \mathbb{R}$ and satisfies the linear parabolic equation

$$\partial_t \tilde{p}_t(x) = \tilde{a}(t, x) \partial_x^2 \tilde{p}_t(x) + \tilde{b}(t, x) \partial_x \tilde{p}_t(x) + \tilde{c}(t, x) \tilde{p}_t(x),$$

where

$$\begin{aligned}\tilde{a}(t, x) &:= \frac{1}{2}a(\tilde{F}_t(x)), \\ \tilde{b}(t, x) &:= \frac{3}{2}a'(\tilde{F}_t(x))\partial_x\tilde{F}_t(x) - b(\tilde{F}_t(x)), \\ \tilde{c}(t, x) &:= \frac{1}{2}a''(\tilde{F}_t(x))(\partial_x\tilde{F}_t(x))^2 - b'(\tilde{F}_t(x))\partial_x\tilde{F}_t(x).\end{aligned}$$

The coefficients \tilde{a} , \tilde{b} and \tilde{c} are continuous and bounded in $[0, T] \times \mathbb{R}$ and, due to the condition (D3), the operator is parabolic. By the maximum principle [66, Theorem 9, p. 43], and since $\tilde{p}_0 \geq 0$, then $\tilde{p}_t(x) \geq 0$ for all $(t, x) \in [0, T] \times \mathbb{R}$.

As a consequence, for all $t \in [0, T]$, \tilde{p}_t is the density of a nonnegative bounded measure on \mathbb{R} , with total mass lower than 1. Let us now prove that the mapping $t \mapsto \tilde{p}_t(x)dx$ is continuous for the topology of weak convergence. Since \tilde{p} is continuous on $[0, T] \times \mathbb{R}$, the mapping $t \mapsto \tilde{p}_t(x)dx$ is continuous for the topology of vague convergence. Besides, as, for all $s, t \in [0, T]$, $\sup_{x \in \mathbb{R}} |F_t(x) - F_s(x)| \leq \|\partial_t F\|_\infty |t - s|$, the total mass $t \mapsto \int_{\mathbb{R}} \tilde{p}_t(x)dx$ is continuous.

Hence, the continuous mapping $t \mapsto \tilde{p}_t(x)dx$ is a measure-valued solution to the linear Fokker-Planck equation

$$\partial_t \mu_t = \frac{1}{2} \partial_x^2 (a(\tilde{F}_t(x)) \mu_t) - \partial_x (b(\tilde{F}_t(x)) \mu_t),$$

the coefficients of which are measurable and bounded functions on $[0, T] \times \mathbb{R}$. Therefore by Fi-galli [63, Theorem 2.6], and since \tilde{p}_0 is a probability density, then for all $t \in [0, T]$, \tilde{p}_t is the density of the distribution of \tilde{X}_t , where $(\tilde{X}_t)_{t \in [0, T]}$ is a weak solution to the stochastic differential equation

$$\tilde{X}_t = \tilde{X}_0 + \int_0^t b(\tilde{F}_s(\tilde{X}_s)) ds + \int_0^t \sigma(\tilde{F}_s(\tilde{X}_s)) d\tilde{W}_s,$$

where \tilde{X}_0 has distribution m and is independent of the Brownian motion \tilde{W} . Now one easily deduces from the assumption that m has a finite first order moment and from the boundedness of σ and b that $\tilde{F} \in \mathcal{F}(T)$. Therefore, by the first part of Proposition 4.2.2, \tilde{F} is the restriction to $[0, T]$ of the probabilistic solution $(F_t)_{t \geq 0}$ to (4.1) given by Proposition 4.2.1. Hence, $(F_t)_{t \geq 0} \in C_b^{1,2}([0, T] \times \mathbb{R})$ and the fact that $(F_t)_{t \geq 0}$ is a classical solution to (4.1) now follows from the fact that T is arbitrarily large. \square

Remark 4.2.8. The regularity assumption on the initial condition $H * m$ is far from being necessary for the probabilistic solution $(F_t)_{t \geq 0}$ to have the classical regularity. For instance, it is known for the case of the viscous conservation law that $(F_t)_{t \geq 0}$ has the classical regularity even for a discontinuous initial condition $H * m$ (see [89, Corollary 1.2]).

4.2.2 The nonlinear martingale problem

The propagation of chaos result of Proposition 4.2.1 only deals with the flow of time marginals of the empirical distribution μ^n . A natural further question is the convergence in $P(C([0, +\infty), \mathbb{R}))$ towards the solution to a proper *nonlinear martingale problem*.

Recall that the distribution of the random variable μ^n in $P(C([0, +\infty), \mathbb{R}))$ is denoted by π^n , and by Lemma 4.2.3, it is tight. Let X refer to the canonical process on the probability space $C([0, +\infty), \mathbb{R})$, namely $X_t(\omega) := \omega_t$ for all $\omega \in C([0, +\infty), \mathbb{R})$. We shall also denote by $C_b^2(\mathbb{R})$ the space of C^2 functions $\phi : \mathbb{R} \rightarrow \mathbb{R}$ such that ϕ , ϕ' and ϕ'' are bounded.

Definition 4.2.9. A probability distribution $P \in P(C([0, +\infty), \mathbb{R}))$ is called a solution to the nonlinear martingale problem if:

- $P_0 = m$;
- for all $\phi \in C_b^2(\mathbb{R})$, the process M^ϕ defined by $M_t^\phi := \phi(X_t) - \phi(X_0) - \int_0^t L(P_s)\phi(X_s) ds$ is a P -martingale, where, for all $\mu \in P(\mathbb{R})$, $L(\mu)\phi(x) := b(H * \mu(x))\phi'(x) + (1/2)a(H * \mu(x))\phi''(x)$;
- dt-almost everywhere, P_t does not weight points.

Following [84, Lemma 1.2], if P is a solution to the nonlinear martingale problem, then the function $(t, x) \mapsto H * P_t(x)$ is a weak solution to the Cauchy problem (4.1). Besides, since the coefficients a and b are bounded, it is easily seen that if m has a finite first order moment, then this solution belongs to \mathcal{F} , therefore it coincides with the probabilistic solution $(F_t)_{t \geq 0}$ given by Proposition 4.2.1.

Owing to Lévy's characterization of the Brownian motion, a probability distribution solving the nonlinear martingale problem is the distribution of a weak solution to the nonlinear stochastic differential equation (4.4). Reciprocally, the distribution P of a weak solution to (4.4) is a solution to the nonlinear martingale problem if and only if, dt -almost everywhere, P_t does not weight points. When there exists a unique solution to the nonlinear martingale problem, we will refer to the associated weak solution X of (4.4) as the *nonlinear diffusion process*.

Let us first investigate the existence of a solution to the nonlinear martingale problem.

Lemma 4.2.10. *Under the nondegeneracy condition (D2) and the assumption that m has a finite first order moment, the limit of any converging subsequence of $(\pi^n)_{n \geq 1}$ concentrates on the set of solutions to the nonlinear martingale problem.*

Proof. By Lemma 4.2.3, the sequence $(\pi^n)_{n \geq 1}$ is tight. Let π^∞ denote the limit of a converging subsequence, that we still index by n for convenience. Let Q refer to the canonical variable in the probability space $P(C([0, +\infty), \mathbb{R}))$. Since the variables X_0^i are i.i.d. with marginal distribution m , then π^∞ -a.s., $Q_0 = m$. Let us now prove that π^∞ -a.s., dt -almost everywhere, Q_t does not weight points. By Proposition 4.2.1, π^∞ -a.s., for all $t \geq 0$ one has $H * Q_t = F_t$ where $(F_t)_{t \geq 0}$ is the probabilistic solution to the Cauchy problem (4.1). Therefore it is enough to prove that, dt -almost everywhere, the function F_t is continuous on \mathbb{R} . In this purpose, we first remark that the mapping $t \mapsto P(t)$ solves a linear Fokker-Planck equation. Indeed, since A and B are C^1 on $[0, 1]$, the functions $(t, x) \mapsto A(F_t(x))$, $(t, x) \mapsto B(F_t(x))$ are of finite variation and the associated Stieltjes measures write $d(A(F_t(x))) = \bar{a}(t, x)P(t)(dx)$, $d(B(F_t(x))) = \bar{b}(t, x)P(t)(dx)$, where

$$\bar{a}(t, x) := \begin{cases} a(F_t(x)) & \text{if } F_t \text{ is continuous in } x, \\ \frac{A(F_t(x)) - A(F_t(x^-))}{F_t(x) - F_t(x^-)} & \text{otherwise,} \end{cases}$$

and $\bar{b}(t, x)$ is similarly defined. Remark that the functions \bar{a} and \bar{b} are bounded, and $\|\bar{a}\|_\infty \leq \|a\|_\infty$, $\|\bar{b}\|_\infty \leq \|b\|_\infty$. As a consequence, the continuous mapping $t \mapsto P(t)$ is a measure-valued solution on $[0, +\infty)$ to the Fokker-Planck equation with measurable and bounded coefficients

$$\partial_t P(t) = \frac{1}{2} \partial_x^2 (\bar{a}(t, x)P(t)) - \partial_x (\bar{b}(t, x)P(t)).$$

Fix a finite $T > 0$. Then by Figalli [63, Theorem 2.6], there exists a probability distribution $\bar{P} \in P(C([0, T], \mathbb{R}))$ such that, for all $t \in [0, T]$, $\bar{P}_t = P(t)$ and \bar{P} is the distribution of a weak solution $(\bar{X}_t)_{t \in [0, T]}$ on $[0, T]$ to the stochastic differential equation

$$\bar{X}_t = \bar{X}_0 + \int_0^t \bar{b}(s, \bar{X}_s) ds + \int_0^t \bar{\sigma}(s, \bar{X}_s) d\bar{W}_s,$$

where $\bar{\sigma}(t, x) := \bar{a}(t, x)^{1/2}$. The process $(\bar{X}_t)_{t \in [0, T]}$ satisfies the condition of Bogachev, Krylov and Röckner [19, Remark 2.2.3, p. 63]. Hence the positive measure $\bar{\sigma}(t, x) \bar{P}_t(dx) dt$ admits a density $\rho(t, x) \in L_{\text{loc}}^2([0, T] \times \mathbb{R})$. Recall that, by (D2), $\sigma^2(u)$ can only vanish for $u = 0$ or $u = 1$. As a consequence, $\bar{\sigma}(t, x)$ can only vanish if F_t is continuous at x and $F_t(x) = 0$ or $F_t(x) = 1$. But since F_t is the cumulative distribution function of \bar{P}_t , the set of such points x is \bar{P}_t -negligible. As a consequence, \bar{P}_t -almost everywhere, $\bar{\sigma}(t, x) > 0$, therefore

$$\bar{P}_t(dx) dt = \mathbb{1}_{\{\bar{\sigma}(t, x) > 0\}} \frac{\rho(t, x)}{\bar{\sigma}(t, x)} dx dt$$

and consequently, $\bar{P}_t(dx)$ admits a density dt -almost everywhere in $[0, T]$. Since T is arbitrary, we conclude that F_t is continuous on \mathbb{R} , dt -almost everywhere.

We finally prove that π'^∞ -a.s., for all $\phi \in C_b^2(\mathbb{R})$, the process M^ϕ defined by $M_t^\phi := \phi(X_t) - \phi(X_0) - \int_0^t L(Q_s)\phi(X_s)ds$ is a Q -martingale. We will proceed as in the proof of [84, Lemma 1.6]. Let $\phi \in C_b^2(\mathbb{R})$, $k \geq 1$, $0 \leq s_1 \leq \dots \leq s_k \leq s \leq t$ and $g : \mathbb{R}^k \rightarrow \mathbb{R}$ continuous and bounded. For all $Q \in P(C([0, +\infty), \mathbb{R}))$, we define

$$\mathcal{G}(Q) := \left\langle Q, g(X_{s_1}, \dots, X_{s_k}) \left(\phi(X_t) - \phi(X_s) - \int_s^t L(Q_r)\phi(X_r)dr \right) \right\rangle.$$

By Itô's formula, for all $n \geq 1$,

$$\begin{aligned} \mathcal{G}(\mu^n) &= \frac{1}{n} \sum_{i=1}^n g(X_{s_1}, \dots, X_{s_k}) \left(\int_s^t \phi'(X_r^{i,n}) (c_n + \sigma(H * \mu_t^n(X_r^{i,n}))) dW_r^i \right. \\ &\quad \left. + \int_s^t \phi''(X_r^{i,n}) \left(c_n \sigma(H * \mu_t^n(X_r^{i,n})) + \frac{c_n^2}{2} \right) dr \right), \end{aligned}$$

so that, since $(c_n)_{n \geq 1}$, σ , g , ϕ' and ϕ'' are bounded, $\lim_{n \rightarrow +\infty} \mathbb{E}(\mathcal{G}(\mu^n)^2) = 0$. We now check that the functional \mathcal{G} is continuous at all $P \in P(C([0, +\infty), \mathbb{R}))$ such that, dr -almost everywhere, P_r does not weight points. Let $(P^q)_{q \geq 1}$ be a sequence of probability distributions on $C([0, +\infty), \mathbb{R})$ weakly converging to $P \in P(C([0, +\infty), \mathbb{R}))$ such that, dr -almost everywhere, P_r does not weight points. Then, for all $q \geq 1$,

$$\begin{aligned} \mathcal{G}(P^q) &= \left\langle P^q, g(X_{s_1}, \dots, X_{s_k}) \int_s^t (L(P_r^q) - L(P_r))\phi(X_r)dr \right\rangle \\ &\quad + \left\langle P^q, g(X_{s_1}, \dots, X_{s_k}) \left(\phi(X_t) - \phi(X_s) - \int_s^t L(P_r)\phi(X_r)dr \right) \right\rangle. \end{aligned} \tag{4.11}$$

On the one hand, as g and the derivatives of ϕ are bounded, there exists $C > 0$ independent of q such that, for all $q \geq 1$,

$$\begin{aligned} &\left| \left\langle P^q, g(X_{s_1}, \dots, X_{s_k}) \int_s^t (L(P_r^q) - L(P_r))\phi(X_r)dr \right\rangle \right| \\ &\leq C \int_s^t \left(\sup_{x \in \mathbb{R}} |b(H * P_r^q(x)) - b(H * P_r(x))| + \sup_{x \in \mathbb{R}} |a(H * P_r^q(x)) - a(H * P_r(x))| \right) dr. \end{aligned}$$

By Dini's theorem, dr -almost everywhere in $[s, t]$, $H * P_r^q$ converges uniformly to $H * P_r$ on \mathbb{R} when $q \rightarrow +\infty$. As the functions b and a are bounded and uniformly continuous on $[0, 1]$, by Lebesgue's theorem, the right-hand side above goes to 0 when $q \rightarrow +\infty$.

On the other hand, dr -almost everywhere in $[s, t]$, the function $x \mapsto L(P_r)\phi(x)$ is continuous on \mathbb{R} and uniformly bounded in r , therefore by Lebesgue's theorem again, the function $(x_r)_{r \geq 0} \mapsto g(x_{s_1}, \dots, x_{s_k})(\phi(x_t) - \phi(x_s) - \int_s^t L(P_r)\phi(x_r)dr)$ is continuous on $C([0, +\infty), \mathbb{R})$. As a consequence, the second term in the right-hand side of (4.11) converges to $\mathcal{G}(P)$ and we conclude that $\lim_{q \rightarrow +\infty} \mathcal{G}(P^q) = \mathcal{G}(P)$.

Since we have proved that π'^∞ -a.s., dr -almost everywhere, Q_r does not weight points, then

$$\lim_{n \rightarrow +\infty} \mathbb{E}^{\pi'^n}(\mathcal{G}(Q)^2) = \mathbb{E}^{\pi'^\infty}(\mathcal{G}(Q)^2),$$

which rewrites

$$\mathbb{E}^{\pi'^\infty}(\mathcal{G}(Q)^2) = \lim_{n \rightarrow +\infty} \mathbb{E}(\mathcal{G}(\mu^n)^2) = 0.$$

As a consequence, taking ϕ , (s_1, \dots, s_k, s, t) , g in countable subsets leads to the conclusion that π'^∞ -a.s., Q solves the nonlinear martingale problem. \square

We now address the uniqueness of solutions to the nonlinear martingale problem. The following criterion is due to Stroock and Varadhan [129].

Lemma 4.2.11. *Under the assumptions of Proposition 4.2.1, if the function $(t, x) \mapsto a(F_t(x))$ is uniformly positive on the compact sets of $[0, +\infty) \times \mathbb{R}$, then there is at most one solution to the nonlinear martingale problem.*

Proof. Let P and Q denote two solutions to the nonlinear martingale problem. Then they both solve the following linear martingale problem in $R \in \mathcal{P}(C([0, +\infty), \mathbb{R}))$:

- $R_0 = m$;
- for all $\phi \in C_b^2(\mathbb{R})$, the process \widetilde{M}^ϕ defined by

$$\widetilde{M}_t^\phi := \phi(X_t) - \phi(X_0) - \int_0^t \left\{ \phi'(X_s) b(F_s(X_s)) + \frac{1}{2} \phi''(X_s) a(F_s(X_s)) \right\} ds$$

is a R -martingale.

The functions $a(F_s(x))$ and $b(F_s(x))$ are measurable and bounded, and $a(F_s(x))$ is uniformly positive on the compact sets of $[0, +\infty) \times \mathbb{R}$. By [129, Exercise 7.3.3, p. 192], $P = Q$. \square

Lemma 4.2.12. *Assume that m has a finite first order moment, and either the uniform ellipticity condition (D3) holds, or the nondegeneracy condition (D2) holds and:*

- if $\sigma^2(0) = 0$, then $F_0(x) > 0$ for all $x \in \mathbb{R}$,
- if $\sigma^2(1) = 0$, then $F_0(x) < 1$ for all $x \in \mathbb{R}$.

Then the function $(t, x) \mapsto a(F_t(x))$ is uniformly positive on the compact sets of $[0, +\infty) \times \mathbb{R}$.

Proof. If (D3) holds, the result is obvious. Now if $F_0(x) > 0$, for all compact subset $K \in [0, +\infty) \times \mathbb{R}$, by the first part of Lemma 4.B.1 in Appendix 4.B, there exists $u_0 > 0$ such that for all $(t, x) \in K$, $F_t(x) \geq u_0$. If (D2) holds in addition, for all $(t, x) \in K$, $a(F_t(x)) \geq \inf_{u \geq u_0} a(u) > 0$. The same arguments hold for the symmetric case $F_0(x) < 1$. \square

We conclude this subsection by stating a propagation of chaos result for the empirical distribution μ^n of the particle system in $\mathcal{P}(C([0, +\infty), \mathbb{R}))$.

Corollary 4.2.13. *Under the assumptions of Lemma 4.2.12, there exists a unique solution P to the nonlinear martingale problem, and it is the limit in probability, in $\mathcal{P}(C([0, +\infty), \mathbb{R}))$, of the sequence of empirical distributions μ^n .*

4.2.3 The reordered particle system

For all $t \geq 0$, let $Y_t^n := (Y_t^{1,n}, \dots, Y_t^{n,n})$ denote the increasing reordering of the vector $(X_t^{1,n}, \dots, X_t^{n,n})$. Then the sample-paths of the process Y^n are in $C([0, +\infty), D_n)$, where D_n refers to the polyhedron $\{(y_1, \dots, y_n) \in \mathbb{R}^n : y_1 \leq \dots \leq y_n\}$.

It is well known that Y^n is a normally reflected Brownian motion on ∂D_n , with constant drift vector and constant diagonal diffusion matrix. More precisely, according to [84], the process $(\beta^1, \dots, \beta^n)$ defined by $\beta_t^i = \sum_{j=1}^n \int_0^t \mathbf{1}_{\{X_s^{j,n} = X_s^{i,n}\}} dW_s^j$ is a Brownian motion. By the Itô-Tanaka formula,

$$Y_t^{i,n} = Y_0^{i,n} + b(i/n)t + (c_n + \sigma(i/n))\beta_t^i + V_t^i, \quad (4.12)$$

where V is a \mathbb{R}^n -valued continuous process with finite variation $|V|$ which writes $V_t^i = \int_0^t (\gamma_s^i - \gamma_s^{i+1}) d|V|_s$ with $d|V|_t$ -a.e., $\gamma_t^1 = \gamma_t^{n+1} = 0$, $\gamma_t^i \geq 0$ and $\gamma_t^i (Y_t^{i,n} - Y_t^{i-1,n}) = 0$. We shall now refer to the process Y^n as the *reordered particle system* and denote by $\tilde{\mu}^n \in \mathcal{P}(C([0, +\infty), \mathbb{R}))$ its empirical distribution.

Lemma 4.2.14 (Tanaka [132]). *For a given random variable $Y_0^n \in D_n$ and an independent \mathbb{R}^n -valued Brownian motion $(\beta^1, \dots, \beta^n)$, there exists a unique process $(Y^n, V) \in C([0, +\infty), D_n \times \mathbb{R}^n)$ satisfying all the above conditions.*

For $Q \in \mathcal{P}(C([0, +\infty), \mathbb{R}))$ and $t_1, \dots, t_k \geq 0$, let us denote by $Q_{t_1, \dots, t_k} \in \mathcal{P}(\mathbb{R}^k)$ the finite-dimensional marginal distribution of Q . Let us define \mathcal{A} as the set of probability distributions $Q \in \mathcal{P}(C([0, +\infty), \mathbb{R}))$ such that, for all $0 \leq t_1 < \dots < t_k$, Q_{t_1, \dots, t_k} is the distribution of $(H * Q_{t_1})^{-1}(U), \dots, (H * Q_{t_k})^{-1}(U)$ where U is a uniform random variable on $[0, 1]$. Remark that any $Q \in \mathcal{A}$ is exactly determined by the flow of its one-dimensional marginals $t \mapsto Q_t$.

Proposition 4.2.15. *Under the assumptions of Proposition 4.2.1, the empirical distribution $\tilde{\mu}^n$ of the reordered particle system converges in probability, in $\mathcal{P}(C([0, +\infty), \mathbb{R}))$, to the unique $\tilde{P} \in \mathcal{A}$ such that for all $t \geq 0$, $\tilde{P}_t = P(t)$, where the mapping $t \mapsto P(t)$ is given by Proposition 4.2.1. In particular, for all $t \geq 0$, $H * \tilde{P}_t = F_t$ where $(F_t)_{t \geq 0}$ is the probabilistic solution to the Cauchy problem (4.1).*

Proof. Let $\tilde{\pi}^n$ refer to the distribution of $\tilde{\mu}^n$ in $\mathcal{P}(C([0, +\infty), \mathbb{R}))$. According to Sznitman [130], the tightness of $(\tilde{\pi}^n)_{n \geq 1}$ is equivalent to the tightness of the sequence of the distributions of the variables $Y^{\theta_n, n} \in C([0, +\infty), \mathbb{R})$ where θ_n is a uniform random variable in the set $\{1, \dots, n\}$, independent of Y^n . For all $n \geq 1$, $Y_0^{\theta_n, n}$ has distribution m . Besides, for $s \leq t$ and $p \geq 1$,

$$\mathbb{E} \left(|Y_s^{\theta_n, n} - Y_t^{\theta_n, n}|^p \right) = \frac{1}{n} \sum_{i=1}^n \mathbb{E} \left(|Y_s^{i, n} - Y_t^{i, n}|^p \right) = \mathbb{E} \left(W_p^p(\tilde{\mu}_s^n, \tilde{\mu}_t^n) \right).$$

Now, by (4.9) and exchangeability of $(X_t^{1, n})_{t \geq 0}, \dots, (X_t^{n, n})_{t \geq 0}$,

$$\mathbb{E} \left(W_p^p(\tilde{\mu}_s^n, \tilde{\mu}_t^n) \right) \leq \frac{1}{n} \sum_{i=1}^n \mathbb{E} \left(|X_s^{i, n} - X_t^{i, n}|^p \right) = \mathbb{E} \left(|X_s^{1, n} - X_t^{1, n}|^p \right),$$

so that, by the proof of Lemma 4.2.3 and the Kolmogorov criterion, the sequence $(\tilde{\pi}^n)_{n \geq 1}$ is tight.

It is clear from the definition of the reordered particle system that for all $t \geq 0$, $\mu_t^n = \tilde{\mu}_t^n$, therefore it is already known from Proposition 4.2.1 that $\tilde{\mu}_t^n$ converges in distribution to $P(t)$. Consequently, the proof of Proposition 4.2.15 requires nothing but a uniqueness result for the support of any limit point of $(\tilde{\pi}^n)_{n \geq 1}$.

The latter is a consequence of the following remark. Certainly, $\tilde{\mu}^n \in \mathcal{A}$, and the set \mathcal{A} is closed in $\mathcal{P}(C([0, +\infty), \mathbb{R}))$ by [85, Lemma 3.5]. Hence, any limit point of $(\tilde{\pi}^n)_{n \geq 1}$ is concentrated on the unique probability distribution $\tilde{P} \in \mathcal{A}$ such that for all $t \geq 0$, $\tilde{P}_t = P(t)$. \square

4.2.4 Propagation of chaos in Wasserstein distance

The original particle system defined by (4.5) is exchangeable, therefore the propagation of chaos result stated in Proposition 4.2.1 implies that the distribution $P_t^{1, n}$ of $X_t^{1, n}$ converges weakly to $P(t)$ in $\mathcal{P}(\mathbb{R})$. This convergence result can be strengthened in Wasserstein distance.

Corollary 4.2.16. *Under the nondegeneracy condition (D1) and the assumption that m has a finite moment of order $p \geq 1$, then $P_t^{1, n}$ and $P(t)$ have a finite moment of order p , and*

$$\lim_{n \rightarrow +\infty} W_p(P_t^{1, n}, P(t)) = 0, \quad \lim_{n \rightarrow +\infty} \mathbb{E}[W_p^p(\mu_t^n, P(t))] = 0.$$

Proof. Let $t \geq 0$. As just seen before the corollary, $P_t^{1, n}$ converges weakly to $P(t)$. To prove that this convergence holds in the Wasserstein distance of order p , it is sufficient to prove that the sequence $(|X_t^{1, n}|^p)_{n \geq 1}$ is uniformly integrable (see Villani [135, Theorem 6.9]). For all $q \geq 1$,

$$\mathbb{E} \left(|X_t^{1, n} - X_0^1|^q \right) \leq 2^{q-1} \left((t \|b\|_\infty)^q + \mathbb{E} \left(\left| \int_0^t (c_n + \sigma(H * \mu_s^n(X_s^{1, n}))) dW_s^1 \right|^q \right) \right) \leq C, \quad (4.13)$$

where C does not depend on n . Thus, the sequence $(|X_t^{1, n} - X_0^1|^p)_{n \geq 1}$ is uniformly integrable, and since $|X_t^{1, n}|^p \leq 2^{p-1}(|X_t^{1, n} - X_0^1|^p + |X_0^1|^p)$ then the sequence $(|X_t^{1, n}|^p)_{n \geq 1}$ is uniformly integrable. Therefore $P_t^{1, n}$ and $P(t)$ have a finite moment of order p and $W_p(P_t^{1, n}, P(t)) \rightarrow 0$.

Let $M \geq 0$. Then, by (4.8),

$$\begin{aligned} W_p^p(\mu_t^n, P(t)) &= \sum_{i=1}^n \int_{(i-1)/n}^{i/n} (|Y_t^{i,n} - F_t^{-1}(u)|^p - M)^+ du + \sum_{i=1}^n \int_{(i-1)/n}^{i/n} (|Y_t^{i,n} - F_t^{-1}(u)|^p \wedge M) du \\ &\leq \sum_{i=1}^n \int_{(i-1)/n}^{i/n} |Y_t^{i,n} - F_t^{-1}(u)|^p \mathbb{1}_{\{|Y_t^{i,n} - F_t^{-1}(u)|^p \geq M\}} du + \sum_{i=1}^n \int_{(i-1)/n}^{i/n} (|Y_t^{i,n} - F_t^{-1}(u)|^p \wedge M) du. \end{aligned}$$

On the one hand,

$$\sum_{i=1}^n \int_{(i-1)/n}^{i/n} (|Y_t^{i,n} - F_t^{-1}(u)|^p \wedge M) du = \int_0^1 (|(H * \mu_t^n)^{-1}(u) - F_t^{-1}(u)|^p \wedge M) du,$$

and the function $\mu \in \mathcal{P}(\mathbb{R}) \mapsto \int_0^1 (|(H * \mu)^{-1}(u) - F_t^{-1}(u)|^p \wedge M) du$ is continuous and bounded. Therefore, by Proposition 4.2.1,

$$\lim_{n \rightarrow +\infty} \mathbb{E} \left(\sum_{i=1}^n \int_{(i-1)/n}^{i/n} (|Y_t^{i,n} - F_t^{-1}(u)|^p \wedge M) du \right) = 0.$$

On the other hand, remarking that for all $x, y \in \mathbb{R}$,

$$\begin{aligned} |x - y|^p \mathbb{1}_{\{|x-y| \geq M\}} &\leq |x - y|^p \mathbb{1}_{\{|x| \geq |y| \vee M^{1/p}/2\}} + |x - y|^p \mathbb{1}_{\{|y| \geq |x| \vee M^{1/p}/2\}} \\ &\leq 2^p |x|^p \mathbb{1}_{\{|x| \geq M/2^p\}} + 2^p |y|^p \mathbb{1}_{\{|y| \geq M/2^p\}}, \end{aligned} \quad (4.14)$$

we write

$$\begin{aligned} &\sum_{i=1}^n \int_{(i-1)/n}^{i/n} |Y_t^{i,n} - F_t^{-1}(u)|^p \mathbb{1}_{\{|Y_t^{i,n} - F_t^{-1}(u)|^p \geq M\}} du \\ &\leq \frac{2^p}{n} \sum_{i=1}^n |Y_t^{i,n}|^p \mathbb{1}_{\{|Y_t^{i,n}|^p \geq M/2^p\}} + 2^p \int_0^1 |F_t^{-1}(u)|^p \mathbb{1}_{\{|F_t^{-1}(u)|^p \geq M/2^p\}} du \\ &= \frac{2^p}{n} \sum_{i=1}^n |X_t^{i,n}|^p \mathbb{1}_{\{|X_t^{i,n}|^p \geq M/2^p\}} + 2^p \int_0^1 |F_t^{-1}(u)|^p \mathbb{1}_{\{|F_t^{-1}(u)|^p \geq M/2^p\}} du. \end{aligned}$$

We deduce from the exchangeability of the variables $X_t^{1,n}, \dots, X_t^{n,n}$, the uniform integrability of $(|X_t^{1,n}|^p)_{n \geq 1}$ and the finiteness of $\int_0^1 |F_t^{-1}(u)|^p du = \int_{\mathbb{R}} |x|^p P(t)(dx)$ that

$$\lim_{M \rightarrow +\infty} \sup_{n \geq 1} \mathbb{E} \left(\sum_{i=1}^n \int_{(i-1)/n}^{i/n} |Y_t^{i,n} - F_t^{-1}(u)|^p \mathbb{1}_{\{|Y_t^{i,n} - F_t^{-1}(u)|^p \geq M\}} du \right) = 0,$$

so that $\mathbb{E}[W_p^p(\mu_t^n, P(t))] \rightarrow 0$. \square

4.3 Contraction of the Wasserstein distance between two solutions

Let F_0 and G_0 be the cumulative functions of two probability distributions with a finite first order moment. Under the condition (D1), by Proposition 4.2.1 there exist a unique probabilistic solution $(F_t)_{t \geq 0}$ to the Cauchy problem (4.1) with initial condition F_0 , and a unique probabilistic solution $(G_t)_{t \geq 0}$ to the Cauchy problem (4.1) with initial condition G_0 . This section addresses the behaviour of the flow $t \mapsto W_p(F_t, G_t)$. In Proposition 4.3.1 we prove that it is nonincreasing if $W_p(F_0, G_0) < +\infty$, using only the contractivity of the reordered particle system. Then, assuming the classical regularity of $(F_t)_{t \geq 0}$ and $(G_t)_{t \geq 0}$, we provide an explicit expression of the time derivative of the flow $t \mapsto W_p(F_t, G_t)$.

We point out the fact that we will sometimes call *expectation* or *moment* of a cumulative distribution function the expectation or the moment of the derivated probability distribution.

4.3.1 Monotonicity of the flow

We first deduce from a natural coupling between two versions of the reordered particle system that the flow $t \mapsto W_p(F_t, G_t)$ is nonincreasing.

Proposition 4.3.1. *Assume that the nondegeneracy condition (D1) holds and that F_0 and G_0 have a finite first order moment. Then, for all $p \geq 1$,*

- if $W_p(F_0, G_0) < +\infty$, then the flow $t \mapsto W_p(F_t, G_t)$ is nonincreasing;
- if $W_p(F_0, G_0) = +\infty$, then for all $t \geq 0$, $W_p(F_t, G_t) = +\infty$.

Proof. We deduce the monotonicity property from the contractive behaviour of the reordered particle system. Let $(\beta^1, \dots, \beta^n)$ be a \mathbb{R}^n -valued Brownian motion and let U^1, \dots, U^n be independent uniform variables on $[0, 1]$. Let us denote by $(U^{(1)}, \dots, U^{(n)})$ the increasing reordering of (U^1, \dots, U^n) . For all $1 \leq i \leq n$, let $Y_0^{F,i} := F_0^{-1}(U^{(i)})$ and $Y_0^{G,i} := G_0^{-1}(U^{(i)})$. By Lemma 4.2.14, there exists a unique strong solution $(Y^F, V^F) \in C([0, +\infty), D_n \times \mathbb{R}^n)$ to the reflected stochastic differential equation

$$Y_t^{F,i,n} = Y_0^{F,i} + b(i/n)t + (c_n + \sigma(i/n))\beta_t^i + V_t^{F,i},$$

and similarly, we denote by (Y^G, V^G) the unique strong solution in $C([0, +\infty), D_n \times \mathbb{R}^n)$ to the reflected stochastic differential equation

$$Y_t^{G,i,n} = Y_0^{G,i} + b(i/n)t + (c_n + \sigma(i/n))\beta_t^i + V_t^{G,i}.$$

By the beginning of Subsection 4.2.3 and the Yamada-Watanabe theorem, the process $Y^{F,n}$ (resp. $Y^{G,n}$) has the same distribution as the increasing reordering of the particle system $X^{F,n}$ (resp. $X^{G,n}$) solution to (4.5) with initial conditions i.i.d. according to the cumulative distribution function F_0 (resp. G_0). In particular, the propagation of chaos result of Proposition 4.2.15 applies to the empirical distributions $\tilde{\mu}^{F,n} := (1/n) \sum_{i=1}^n \delta_{Y^{F,i,n}}$ and $\tilde{\mu}^{G,n} := (1/n) \sum_{i=1}^n \delta_{Y^{G,i,n}}$.

Now, for all $t \geq 0$, (4.9) yields $W_p^p(\tilde{\mu}_t^{F,n}, \tilde{\mu}_t^{G,n}) = (1/n) \sum_{i=1}^n |Y_t^{F,i,n} - Y_t^{G,i,n}|^p$. The following inequality, the proof of which is postponed below, is crucial:

$$\forall 0 \leq s \leq t, \quad W_p^p(\tilde{\mu}_t^{F,n}, \tilde{\mu}_t^{G,n}) \leq W_p^p(\tilde{\mu}_s^{F,n}, \tilde{\mu}_s^{G,n}). \quad (4.15)$$

Case $W_p(F_0, G_0) < +\infty$. If both F_0 and G_0 have a finite moment of order p , then owing to Corollary 4.2.16, one can extract a subsequence along which $W_p^p(\tilde{\mu}_t^{F,n}, \tilde{\mu}_t^{G,n})$ goes to $W_p^p(F_t, G_t)$ and $W_p^p(\tilde{\mu}_s^{F,n}, \tilde{\mu}_s^{G,n})$ goes to $W_p^p(F_s, G_s)$ almost surely, then conclude by using (4.15).

Assuming only $W_p(F_0, G_0) < +\infty$, we shall now proceed as in the proof of Corollary 4.2.16 to show that for all $t \geq 0$,

$$\lim_{n \rightarrow +\infty} \mathbb{E}(W_p^p(\tilde{\mu}_t^{F,n}, \tilde{\mu}_t^{G,n})) = W_p^p(F_t, G_t),$$

which results in the claimed assertion thanks to (4.15).

For all $M \geq 0$, by (4.9) we write

$$\begin{aligned} W_p^p(\tilde{\mu}_t^{F,n}, \tilde{\mu}_t^{G,n}) &= \frac{1}{n} \sum_{i=1}^n |Y_t^{F,i,n} - Y_t^{G,i,n}|^p \\ &= \frac{1}{n} \sum_{i=1}^n (|Y_t^{F,i,n} - Y_t^{G,i,n}|^p \wedge M) + \left(|Y_t^{F,i,n} - Y_t^{G,i,n}|^p - M \right)^+. \end{aligned}$$

By Proposition 4.2.1, $\tilde{\mu}_t^{F,n}$ converges in probability to the probability distribution dF_t with cumulative distribution function F_t , and similarly $\tilde{\mu}_t^{G,n}$ converges in probability to dG_t . Therefore, the couple $(\tilde{\mu}_t^{F,n}, \tilde{\mu}_t^{G,n})$ converges in probability to (dF_t, dG_t) and

$$\lim_{n \rightarrow +\infty} \mathbb{E} \left(\frac{1}{n} \sum_{i=1}^n (|Y_t^{F,i,n} - Y_t^{G,i,n}|^p \wedge M) \right) = \int_0^1 (|F_t^{-1}(u) - G_t^{-1}(u)|^p \wedge M) du.$$

By the monotone convergence theorem and (4.7),

$$\lim_{M \rightarrow +\infty} \lim_{n \rightarrow +\infty} \mathbb{E} \left(\frac{1}{n} \sum_{i=1}^n (|Y_t^{F,i,n} - Y_t^{G,i,n}|^p \wedge M) \right) = W_p^p(F_t, G_t) \in [0, +\infty].$$

It now remains to check that

$$\lim_{n \rightarrow +\infty} \mathbb{E} \left(\frac{1}{n} \sum_{i=1}^n (|Y_t^{F,i,n} - Y_t^{G,i,n}|^p - M)^+ \right) = 0. \quad (4.16)$$

Using (4.14) twice results in

$$\begin{aligned} \frac{1}{n} \sum_{i=1}^n (|Y_t^{F,i,n} - Y_t^{G,i,n}|^p - M)^+ &\leq \frac{1}{n} \sum_{i=1}^n |Y_t^{F,i,n} - Y_t^{G,i,n}|^p \mathbf{1}_{\{|Y_t^{F,i,n} - Y_t^{G,i,n}|^p \geq M\}} \\ &\leq \frac{4^p}{n} \sum_{i=1}^n |Y_t^{F,i,n} - Y_0^{F,i}|^p \mathbf{1}_{\{|Y_t^{F,i,n} - Y_0^{F,i}|^p \geq M/4^p\}} \\ &\quad + \frac{4^p}{n} \sum_{i=1}^n |Y_t^{G,i,n} - Y_0^{G,i}|^p \mathbf{1}_{\{|Y_t^{G,i,n} - Y_0^{G,i}|^p \geq M/4^p\}} \\ &\quad + \frac{2^p}{n} \sum_{i=1}^n |Y_0^{F,i} - Y_0^{G,i}|^p \mathbf{1}_{\{|Y_0^{F,i} - Y_0^{G,i}|^p \geq M/2^p\}}. \end{aligned}$$

On the one hand, by the construction of $Y_0^{F,i}$ and $Y_0^{G,i}$,

$$\begin{aligned} &\mathbb{E} \left(\frac{1}{n} \sum_{i=1}^n |Y_0^{F,i} - Y_0^{G,i}|^p \mathbf{1}_{\{|Y_0^{F,i} - Y_0^{G,i}|^p \geq M/2^p\}} \right) \\ &= \mathbb{E} \left(\frac{1}{n} \sum_{i=1}^n |F_0^{-1}(U^{(i)}) - G_0^{-1}(U^{(i)})|^p \mathbf{1}_{\{|F_0^{-1}(U^{(i)}) - G_0^{-1}(U^{(i)})|^p \geq M/2^p\}} \right) \\ &= \mathbb{E} \left(\frac{1}{n} \sum_{i=1}^n |F_0^{-1}(U^i) - G_0^{-1}(U^i)|^p \mathbf{1}_{\{|F_0^{-1}(U^i) - G_0^{-1}(U^i)|^p \geq M/2^p\}} \right) \\ &= \int_0^1 |F_0^{-1}(u) - G_0^{-1}(u)|^p \mathbf{1}_{\{|F_0^{-1}(u) - G_0^{-1}(u)|^p \geq M/2^p\}} du, \end{aligned}$$

and the right-hand side does not depend on n . Since $W_p(F_0, G_0) < +\infty$, it goes to 0 when $M \rightarrow +\infty$. On the other hand,

$$\begin{aligned} \mathbb{E} \left(\frac{1}{n} \sum_{i=1}^n |Y_t^{F,i,n} - Y_0^{F,i}|^p \mathbf{1}_{\{|Y_t^{F,i,n} - Y_0^{F,i}|^p \geq M/4^p\}} \right) &\leq \frac{4^p}{M} \mathbb{E} \left(\frac{1}{n} \sum_{i=1}^n |Y_t^{F,i,n} - Y_0^{F,i}|^{p+1} \right) \\ &\leq \frac{4^p}{M} \mathbb{E} \left(\frac{1}{n} \sum_{i=1}^n |X_t^{F,i,n} - X_0^{F,i}|^{p+1} \right), \end{aligned}$$

where we have used the inequality (4.9) in the last line. By (4.13), there exists $C > 0$ independent of n such that $\mathbb{E}(|X_t^{F,i,n} - X_0^{F,i}|^{p+1}) \leq C$. Then

$$\lim_{M \rightarrow +\infty} \limsup_{n \rightarrow +\infty} \mathbb{E} \left(\frac{1}{n} \sum_{i=1}^n |Y_t^{F,i,n} - Y_0^{F,i}|^p \mathbf{1}_{\{|Y_t^{F,i,n} - Y_0^{F,i}|^p \geq M/4^p\}} \right) = 0;$$

and likewise,

$$\lim_{M \rightarrow +\infty} \limsup_{n \rightarrow +\infty} \mathbb{E} \left(\frac{1}{n} \sum_{i=1}^n |Y_t^{G,i,n} - Y_0^{G,i}|^p \mathbf{1}_{\{|Y_t^{G,i,n} - Y_0^{G,i}|^p \geq M/4^p\}} \right) = 0,$$

which completes the proof of (4.16).

Case $W_p(F_0, G_0) = +\infty$. By the triangle inequality,

$$W_p(F_0, G_0) \leq W_p(F_0, F_t) + W_p(G_0, G_t) + W_p(F_t, G_t).$$

According to Proposition 4.2.15, there exists a subsequence (that we still index by n for convenience) along which $\tilde{\mu}_0^{F,n}$ converges to the distribution with cumulative function F_0 almost surely in $\mathbb{P}(\mathbb{R})$, and $\tilde{\mu}_t^{F,n}$ converges to the distribution with cumulative function F_t almost surely in $\mathbb{P}(\mathbb{R})$. Recalling that the Wasserstein distance is lower semicontinuous on $\mathbb{P}(\mathbb{R})$ (see [135, Remark 6.12]), we get $W_p(F_0, F_t) \leq \liminf_{n \rightarrow +\infty} W_p(\tilde{\mu}_0^{F,n}, \tilde{\mu}_t^{F,n})$ so that by Fatou's lemma, (4.9) and (4.13),

$$W_p^p(F_0, F_t) \leq \liminf_{n \rightarrow +\infty} \mathbb{E} \left(\frac{1}{n} \sum_{i=1}^n |Y_t^{F,i,n} - Y_0^{F,i}|^p \right) < +\infty,$$

and similarly $W_p(G_0, G_t) < +\infty$. As a consequence, if $W_p(F_0, G_0) = +\infty$ then $W_p(F_t, G_t) = +\infty$.

Proof of (4.15). Recall that

$$\begin{aligned} Y_t^{F,i,n} &= Y_0^{F,i} + b(i/n)t + (c_n + \sigma(i/n))\beta_t^i + V_t^{F,i}, \\ Y_t^{G,i,n} &= Y_0^{G,i} + b(i/n)t + (c_n + \sigma(i/n))\beta_t^i + V_t^{G,i}, \end{aligned}$$

with $dV_t^{F,i} = (\gamma_t^{F,i} - \gamma_t^{F,i+1})d|V^F|_t$, $dV_t^{G,i} = (\gamma_t^{G,i} - \gamma_t^{G,i+1})d|V^G|_t$. Thus, for all $1 \leq i \leq n$, the process $Y^{F,i,n} - Y^{G,i,n}$ is of finite variation, hence

$$\begin{aligned} d \sum_{i=1}^n |Y_t^{F,i,n} - Y_t^{G,i,n}|^p &= p \sum_{i=1}^n |Y_t^{F,i,n} - Y_t^{G,i,n}|^{p-2} (Y_t^{F,i,n} - Y_t^{G,i,n}) d(Y_t^{F,i,n} - Y_t^{G,i,n}) \\ &= p \sum_{i=1}^n |Y_t^{F,i,n} - Y_t^{G,i,n}|^{p-2} (Y_t^{F,i,n} - Y_t^{G,i,n}) (\gamma_t^{F,i} - \gamma_t^{F,i+1}) d|V^F|_t \\ &\quad + p \sum_{i=1}^n |Y_t^{G,i,n} - Y_t^{F,i,n}|^{p-2} (Y_t^{G,i,n} - Y_t^{F,i,n}) (\gamma_t^{G,i} - \gamma_t^{G,i+1}) d|V^G|_t, \end{aligned}$$

where, for all $p \geq 1$, we take the convention that $|z|^{p-2}z = 0$ when $z = 0$. The two terms of the last member above are symmetric; we only deal with the first one, which we rewrite $S_t d|V^F|_t$. By the Abel transform, $S_t = p \sum_{i=2}^n \gamma_t^{F,i} u(Y_t^{F,i-1,n}, Y_t^{G,i-1,n}, Y_t^{F,i,n}, Y_t^{G,i,n})$, where $u(x_1, y_1, x_2, y_2) := |x_2 - y_2|^{p-2}(x_2 - y_2) - |x_1 - y_1|^{p-2}(x_1 - y_1)$. Recall that $d|V^F|_t$ -a.e., $\gamma_t^{F,i} \geq 0$ and $\gamma_t^{F,i}(Y_t^{F,i,n} - Y_t^{F,i-1,n}) = 0$, and remark that for fixed $y_1 \leq y_2$, the expression $u(x, y_1, x, y_2)$ remains nonpositive when $x \in \mathbb{R}$. Then $d|V^F|_t$ -a.e., $S_t \leq 0$ and the proof of (4.15) is completed. \square

Remark 4.3.2. For the viscous conservation law with a concave transport coefficient B as studied in [89], one can recover the contractivity result of Proposition 4.3.1 from an elementary coupling argument on the solutions to the nonlinear stochastic differential equation (4.4), following the idea of Cattiaux and Guillin [39, Theorem 4.9]. Indeed, assume that $a(u) = \sigma^2 > 0$ and b is nonincreasing on $[0, 1]$. Then (4.4) rewrites

$$\begin{cases} X_t = X_0 + \int_0^t b(H * P_s(X_s)) ds + \sigma W_t, \\ P_t \text{ is the distribution of } X_t, \end{cases} \quad (4.17)$$

and by [89, Theorem 1.1], this equation admits a unique strong solution, and for all $t > 0$, its distribution P_t admits a density with respect to the Lebesgue measure on \mathbb{R} .

Let us assume that $W_2(F_0, G_0) < +\infty$, let U be a uniform random variable on $[0, 1]$, $X_0^F := F_0^{-1}(U)$, $X_0^G := G_0^{-1}(U)$ and let W be a Brownian motion independent of (X_0^F, X_0^G) . We denote by X^F and X^G the strong solutions to (4.17) with respective initial conditions X_0^F and X_0^G , driven

by *the same* Brownian motion W . Then, for all $t \geq 0$, the cumulative distribution function of X_t^F is F_t and the cumulative distribution function of X_t^G is G_t . As a consequence,

$$\mathbb{E}((X_t^F - X_t^G)^2) = \mathbb{E}((X_0^F - X_0^G)^2) + 2 \int_0^t \mathbb{E}((X_s^F - X_s^G)(b(F_s(X_s^F)) - b(G_s(X_s^G)))) ds. \quad (4.18)$$

For all $s \in (0, t]$, the random variables $U_s := F_s(X_s^F)$ and $V_s := G_s(X_s^G)$ are uniformly distributed on $[0, 1]$. Interpreting the nondecreasing function $-b : [0, 1] \rightarrow \mathbb{R}$ as the inverse of a cumulative distribution function, we deduce from the optimal coupling (4.7) that

$$\begin{aligned} \mathbb{E}((F_s^{-1}(U_s) + b(U_s))^2) &\leq \mathbb{E}((F_s^{-1}(U_s) + b(V_s))^2), \\ \mathbb{E}((G_s^{-1}(V_s) + b(V_s))^2) &\leq \mathbb{E}((G_s^{-1}(V_s) + b(U_s))^2). \end{aligned}$$

Developing the products and using the fact that U_s and V_s have the same distribution yields

$$\begin{aligned} \mathbb{E}(X_s^F b(F_s(X_s^F))) &= \mathbb{E}(F_s^{-1}(U_s) b(U_s)) \leq \mathbb{E}(F_s^{-1}(U_s) b(V_s)) = \mathbb{E}(X_s^F b(G_s(X_s^G))), \\ \mathbb{E}(X_s^G b(G_s(X_s^G))) &= \mathbb{E}(G_s^{-1}(V_s) b(V_s)) \leq \mathbb{E}(G_s^{-1}(V_s) b(U_s)) = \mathbb{E}(X_s^G b(F_s(X_s^F))), \end{aligned} \quad (4.19)$$

so that the integral in (4.18) is nonpositive. Note that the inequalities in (4.19) can also be obtained using [120, Theorem 3.1.2, p. 109]. Thanks to our optimal choice for (X_0^F, X_0^G) , we now conclude that

$$\forall t \geq 0, \quad W_2^2(F_t, G_t) \leq \mathbb{E}((X_t^F - X_t^G)^2) \leq \mathbb{E}((X_0^F - X_0^G)^2) = W_2^2(F_0, G_0).$$

4.3.2 Derivative of the flow

We will now compute the time derivative of the flow $t \mapsto W_p^p(F_t, G_t)$ when $(F_t)_{t \geq 0}$ and $(G_t)_{t \geq 0}$ have the classical regularity. We first derive a nonlinear evolution equation for the pseudo-inverse function F_t^{-1} . Of course, the same holds for G_t^{-1} .

Lemma 4.3.3. *Assume that the uniform ellipticity condition (D3) and the regularity condition (R1) hold, that F_0 has a finite first order moment, that the probabilistic solution $(F_t)_{t \geq 0}$ to the Cauchy problem (4.1) with initial condition F_0 has the classical regularity and that for all $0 < t_1 < t_2$, the function $(t, x) \mapsto \partial_x F_t(x)$ is bounded on $[t_1, t_2] \times \mathbb{R}$. Then the pseudo-inverse function $(t, u) \mapsto F_t^{-1}(u)$ is $C^{1,2}$ on $(0, +\infty) \times (0, 1)$ and satisfies*

$$\partial_t F_t^{-1}(u) = b(u) - \frac{1}{2} \partial_u \left(\frac{a(u)}{\partial_u F_t^{-1}(u)} \right). \quad (4.20)$$

Proof. On the one hand, since $(F_t)_{t \geq 0}$ is a classical solution to (4.1), then

$$\partial_t F_t(x) = \frac{1}{2} (a'(F_t(x)) (\partial_x F_t(x))^2 + a(F_t(x)) \partial_x^2 F_t(x)) - b(F_t(x)) \partial_x F_t(x). \quad (4.21)$$

On the other hand, the lower bound in the Aronson estimate (4.50) allows to apply the implicit functions theorem to $(t, x, u) \mapsto F_t(x) - u$ and deduce that $(t, u) \mapsto F_t^{-1}(u)$ is $C^{1,2}$ on $(0, +\infty) \times \mathbb{R}$. Besides,

$$\partial_u F_t^{-1}(u) = \frac{1}{\partial_x F_t(F_t^{-1}(u))} \quad \text{and} \quad \partial_u^2 F_t^{-1}(u) = -\frac{\partial_x^2 F_t(F_t^{-1}(u))}{[\partial_x F_t(F_t^{-1}(u))]^3}. \quad (4.22)$$

For all $t > 0$, since F_t is a continuous function then $F_t(F_t^{-1}(u)) = u$, so that derivating with respect to t yields $0 = \partial_t F_t(F_t^{-1}(u)) + \partial_x F_t(F_t^{-1}(u)) \partial_t F_t^{-1}(u)$. Using (4.21) and (4.22), we write

$$\partial_t F_t^{-1}(u) = b(u) - \frac{1}{2} \left(\frac{a'(u)}{\partial_u F_t^{-1}(u)} - \frac{a(u) \partial_u^2 F_t^{-1}(u)}{[\partial_u F_t^{-1}(u)]^2} \right),$$

from which we deduce (4.20). \square

For all function $f : \mathbb{R} \rightarrow [0, 1]$, we define the function $\text{tl}(f, \cdot) : \mathbb{R} \rightarrow [0, 1]$ by

$$\text{tl}(f, x) := \mathbf{1}_{\{x \geq 0\}}(1 - f(x)) + \mathbf{1}_{\{x \leq 0\}}f(x).$$

Then the main result of this subsection is the following.

Proposition 4.3.4. *Assume that the conditions of Lemma 4.3.3 are satisfied with both $(F_t)_{t \geq 0}$ and $(G_t)_{t \geq 0}$. Let $p \geq 2$ such that $W_p(F_0, G_0) < +\infty$ and $|x|^{p-1}(\text{tl}(F_0, x) + \text{tl}(G_0, x)) \rightarrow 0$ when $x \rightarrow \pm\infty$. Then for all $0 < t_1 < t_2$,*

$$\begin{aligned} & W_p^p(F_{t_2}, G_{t_2}) - W_p^p(F_{t_1}, G_{t_1}) \\ &= -\frac{p(p-1)}{2} \int_{t_1}^{t_2} \int_0^1 a(u) |F_t^{-1}(u) - G_t^{-1}(u)|^{p-2} \frac{(\partial_u F_t^{-1}(u) - \partial_u G_t^{-1}(u))^2}{\partial_u F_t^{-1}(u) \partial_u G_t^{-1}(u)} du dt. \end{aligned}$$

Proof. See Appendix 4.B. □

Remark 4.3.5. A straightforward strategy to prove Proposition 4.3.4 is the following: for $\epsilon_1, \epsilon_2 \in (0, 1/2)$, let

$$W_{p, \epsilon_1, \epsilon_2}^p(F_t, G_t) := \int_{\epsilon_1}^{1-\epsilon_2} |F_t^{-1}(u) - G_t^{-1}(u)|^p du,$$

then certainly $W_{p, \epsilon_1, \epsilon_2}^p(F_t, G_t) \rightarrow W_p^p(F_t, G_t)$ when $\epsilon_1, \epsilon_2 \rightarrow 0$. Now,

$$\begin{aligned} & \frac{d}{dt} W_{p, \epsilon_1, \epsilon_2}^p(F_t, G_t) \\ &= p \int_{\epsilon_1}^{1-\epsilon_2} (F_t^{-1}(u) - G_t^{-1}(u)) |F_t^{-1}(u) - G_t^{-1}(u)|^{p-2} (\partial_t F_t^{-1}(u) - \partial_t G_t^{-1}(u)) du \\ &= \frac{p}{2} \int_{\epsilon_1}^{1-\epsilon_2} (F_t^{-1}(u) - G_t^{-1}(u)) |F_t^{-1}(u) - G_t^{-1}(u)|^{p-2} \partial_u \left(\frac{a(u)}{\partial_u G_t^{-1}(u)} - \frac{a(u)}{\partial_u F_t^{-1}(u)} \right) du \\ &= \frac{p}{2} \left[a(u) (F_t^{-1}(u) - G_t^{-1}(u)) |F_t^{-1}(u) - G_t^{-1}(u)|^{p-2} \left(\frac{1}{\partial_u G_t^{-1}(u)} - \frac{1}{\partial_u F_t^{-1}(u)} \right) \right]_{\epsilon_1}^{1-\epsilon_2} \\ &\quad - \frac{p(p-1)}{2} \int_{\epsilon_1}^{1-\epsilon_2} a(u) |F_t^{-1}(u) - G_t^{-1}(u)|^{p-2} \frac{(\partial_u F_t^{-1}(u) - \partial_u G_t^{-1}(u))^2}{\partial_u F_t^{-1}(u) \partial_u G_t^{-1}(u)} du, \end{aligned}$$

where we have used (4.20) at the second line and integrated by parts in the last line. Hence, Proposition 4.3.4 holds as soon as the boundary terms vanish, i.e.

$$\liminf_{\epsilon_1, \epsilon_2 \rightarrow 0} \int_{t_1}^{t_2} \left[a(F_t^{-1} - G_t^{-1}) |F_t^{-1} - G_t^{-1}|^{p-2} \left(\frac{1}{\partial_u G_t^{-1}} - \frac{1}{\partial_u F_t^{-1}} \right) \right]_{\epsilon_1}^{1-\epsilon_2} dt = 0.$$

However, we were not able to provide a rigorous account of this statement. In Appendix 4.B, we use a different expression of $W_p^p(F_t, G_t)$ in terms of F_t, G_t to compute the time derivative of the flow.

Remark 4.3.6. Although the setting is different, the result of Proposition 4.3.1 obtained by a probabilistic approximation is comparable to the result of Carrillo, Di Francesco and Lattanzio [35, Theorem 5.1], the proof of which relies on the deterministic operator splitting method. In Lemma 4.3.3, the nonlinear evolution equation for the pseudo-inverse of the solution to the Cauchy problem generalizes in a rigorous way the proposed extensions of the work by Carrillo and Toscani [38, Section 3]. In Carrillo, Gualdani and Toscani [36], the time derivative of the flow of the Wasserstein distance between two solutions is computed by the method described in Remark 4.3.5 for the case of compactly supported solutions at all times, therefore the boundary terms necessarily vanish in the integration by parts.

The same method is also applied by Alfonsi, Jourdain and Kohatsu-Higa [1], where the authors get rid of the boundary terms using Gaussian estimates on the density. As Lemma 4.B.2 shows,

under the uniform ellipticity condition (D3), such estimates still hold in our case as soon as the tails of F_0 or G_0 are not heavier than Gaussian. Since we are willing to use Proposition 4.3.4 to compare F_t with the stationary solution F_∞ , we would therefore need the tails of F_∞ not to be heavier than Gaussian. But according to Remark 4.4.5 below, under the condition (D3), the tails of F_∞ cannot be lighter than exponential.

4.4 Convergence to equilibrium

This section is divided into three parts. In Subsection 4.4.1, we solve the stationary equation. In Subsection 4.4.2, we prove the convergence of solutions to stationary solutions. In Subsection 4.4.3, we discuss the (lack of) rate of convergence to equilibrium.

4.4.1 The stationary equation

We recall that the *stationary equation* is the following:

$$\frac{1}{2}\partial_x^2(A(F_\infty(x))) - \partial_x(B(F_\infty(x))) = 0 \quad (4.23)$$

As mentioned in the introduction, the stationary solutions for the Cauchy problem are the cumulative distribution functions, with a finite first order moment, solving (4.23) in the sense of distributions. In Proposition 4.4.1, we solve the stationary equation, and we give a criterion for integrability in Corollary 4.4.4.

Proposition 4.4.1. *Under the nondegeneracy condition (D1), a necessary and sufficient condition for the existence of cumulative distribution functions solving the stationary equation is $B(1) = 0$, $B(u) \geq 0$ and the local integrability of the function $a/2B$ on $(0, 1)$. Then all the solutions are continuous.*

If in addition $B(u) > 0$ for all $u \in (0, 1)$, which corresponds to the equilibrium condition (E1), then F_∞ is a solution if and only if there exists $\bar{x} \in \mathbb{R}$ such that for all $x \in \mathbb{R}$, $F_\infty(x) = \Psi^{-1}(x + \bar{x})$, where the function Ψ is defined by

$$\forall u \in (0, 1), \quad \Psi(u) := \int_{1/2}^u \frac{a(v)}{2B(v)} dv. \quad (4.24)$$

In this case, $\bar{x} = \Psi(F_\infty(0))$.

Proof of Proposition 4.4.1. We first prove the necessary condition. Let F be a cumulative distribution function (we shall write F instead of F_∞ in the proof), solving (4.23) in the sense of distributions. Then there exists $c \in \mathbb{R}$ such that the function $x \mapsto (1/2)A(F(x))$ is absolutely continuous with respect to the Lebesgue measure, with density $B(F(x)) + c$. Since by the condition (D1), A is increasing, then F is continuous. Hence, $B(F(x)) + c$ is a nonnegative, continuous and integrable function, so that taking the limit $x \rightarrow -\infty$ yields $B(0) + c = c = 0$. We deduce $B(u) \geq 0$ and $B(1) = 0$ by taking the limit $x \rightarrow +\infty$.

It remains to prove that $a(u)/2B(u)$ is locally integrable in $(0, 1)$. We use the convention that $a(u)/2B(u) = 0$ when $a(u) = B(u) = 0$, and we define $U := \{u \in (0, 1) : B(u) = 0 \text{ and } a(u) \neq 0\}$. Let $0 < \alpha < \beta < 1$ and $x_- := F^{-1}(\alpha)$, $x_+ := F^{-1}(\beta)$. We denote by $dF(x)$ the Stieltjes measure associated with the continuous function F of finite variation. Then by the chain rule formula [121, (4.6) p. 6], the Radon measure $(1/2)a(F(x))dF(x)$ has the density $B(F(x))$ with respect to the Lebesgue measure. Therefore $dF(x)$ -a.e., $F(x) \notin U$. By the change of variable formula [121, (4.9) p. 8],

$$\int_{x_-}^{x_+} \frac{a(F(x))}{2B(F(x))} \mathbf{1}_{\{F(x) \notin U\}} dF(x) = \int_{x_-}^{x_+} \frac{a(F(x))}{2B(F(x))} dF(x) = \int_\alpha^\beta \frac{a(u)}{2B(u)} du,$$

and the left-hand side is bounded by $x_+ - x_- < +\infty$.

We now prove that the condition is sufficient. For $u \in (0, 1)$, let us define $\Psi(u)$ as in (4.24). Then Ψ is absolutely continuous and since A is increasing, so is Ψ . Thus Ψ^{-1} is continuous, with

finite variation. In case Ψ has a finite limit in 1 (resp. 0), we write $\Psi^{-1}(x) = 1$ (resp. 0) for $x \in [\Psi(1), +\infty)$ (resp. $(-\infty, \Psi(0)]$) so that Ψ^{-1} is a cumulative distribution function on \mathbb{R} . We now check that Ψ^{-1} is a solution, in the sense of distributions, of the stationary equation. Let $\phi \in C_c^\infty(\mathbb{R})$ be a test function. Then by the integration by parts formula [121, (4.5) p. 6] and the chain rule formula applied to $A(\Psi^{-1}(x))$,

$$-\frac{1}{2} \int_{\mathbb{R}} \phi'(x) A(\Psi^{-1}(x)) dx = \frac{1}{2} \int_{\mathbb{R}} \phi(x) a(\Psi^{-1}(x)) d\Psi^{-1}(x).$$

By the change of variable formula and the definition of Ψ ,

$$\frac{1}{2} \int_{\mathbb{R}} \phi(x) a(\Psi^{-1}(x)) d\Psi^{-1}(x) = \frac{1}{2} \int_0^1 \phi(\Psi(u)) a(u) du = \int_0^1 \phi(\Psi(u)) B(u) \Psi'(u) du,$$

and performing a new change of variables in the last member above yields

$$-\frac{1}{2} \int_{\mathbb{R}} \phi'(x) A(\Psi^{-1}(x)) dx = \int_{\mathbb{R}} \phi(x) B(\Psi^{-1}(x)) dx,$$

i.e. Ψ^{-1} is a solution in the sense of distributions of the stationary equation.

We finally assume that $B(u) > 0$ for all $u \in (0, 1)$ and prove that F is a solution if and only if it is a translation of Ψ^{-1} . If F is a solution, since $B(u) > 0$ then Ψ is C^1 on $(0, 1)$ so that the chain rule formula gives

$$d(\Psi(F(x))) = \Psi'(F(x)) dF(x) = \frac{a(F(x))}{2B(F(x))} dF(x) = dx,$$

where the last equality holds due to $B(u) > 0$. Then $\Psi(F(x)) - \Psi(F(0)) = x$ and $F(x) = \Psi^{-1}(x + \bar{x})$ with $\bar{x} = \Psi(F(0))$. Reciprocally it is immediate that all the translations of Ψ^{-1} solve the stationary equation. \square

Remark 4.4.2. When the condition that $B(u) > 0$ on $(0, 1)$ is not fulfilled, then one can exhibit solutions that are not translations of each other. For instance, let $a(u) = u(1-u)|u-1/2|^{3/2}$ and $B(u) = u(1-u)(u-1/2)^2$. Then a is continuous on $[0, 1]$, its antiderivative satisfies (D1), B is C^1 on $[0, 1]$, $B(0) = B(1) = 0$ and $B(u) \geq 0$. Besides, $\Psi(u) = \text{sgn}(u-1/2)|u-1/2|^{1/2}$. For all $h \geq 0$, let us define

$$F_{\infty, h}(x) := \begin{cases} 0 & x < -1/\sqrt{2}, \\ 1/2 - x^2 & -1/\sqrt{2} \leq x < 0, \\ 1/2 & 0 \leq x < h, \\ 1/2 + (x-h)^2 & h \leq x < h + 1/\sqrt{2}, \\ 1 & x \geq h + 1/\sqrt{2}. \end{cases}$$

Then $F_{\infty, 0} = \Psi^{-1}$ and for all $h > 0$, $F_{\infty, h}$ solves the stationary equation although it is not a translation of Ψ^{-1} .

In order to apply the results of Section 4.3, we need criteria ensuring the existence of a first order moment as well as the classical regularity for a stationary solution F_∞ . They come as corollaries to Proposition 4.4.1.

Corollary 4.4.3. *Under the nondegeneracy condition (D2), the regularity condition (R1) and the equilibrium condition (E1), all the stationary solutions F_∞ are C^2 on \mathbb{R} .*

Proof. By Proposition 4.4.1 and the condition (E1), it is enough to prove that Ψ^{-1} is C^2 on \mathbb{R} , which follows from the inverse function theorem, since Ψ is C^2 on $(0, 1)$ by (R1) and (E1), and $\Psi'(u) > 0$ for all $u \in (0, 1)$ by (D2). \square

Corollary 4.4.4. *Under the nondegeneracy condition (D1) and the equilibrium condition (E1), the solutions to the stationary equation have a finite first order moment if and only if (E2) holds.*

Proof. According to Proposition 4.4.1, it is enough to prove the statement for the solution Ψ^{-1} , the first order moment of which is given by

$$\int_{1/2}^1 \Psi(u) du - \int_0^{1/2} \Psi(u) du = \int_0^{1/2} \frac{a(u)u}{2B(u)} du + \int_{1/2}^1 \frac{a(u)(1-u)}{2B(u)} du$$

by the Fubini-Tonelli theorem. The finiteness of the right-hand side is the condition (E2). \square

Remark 4.4.5. In the case of the viscous conservation law and under the condition (E1), it is sufficient that $b(0) > 0$ and $b(1) < 0$ for (E2) to hold, and in this case the probability distributions derived from the stationary solutions have exponential tails and satisfy a Poincaré inequality (see [89, Lemma 2.1]). In the general case of the stationary equation (4.23), and under the equilibrium condition (E1), these results extend as follows.

- Under the uniform ellipticity condition (D3), if $b(0) > 0$ and $b(1) < 0$ then it is clear from the expression of Ψ that the stationary solutions still have exponential tails, and they consequently satisfy a Poincaré inequality. If $b(0) = 0$ (resp. $b(1) = 0$), then the left (resp. the right) tail is heavier than exponential.
- Under the nondegeneracy condition (D1), as soon as the cumulative distribution function Ψ^{-1} admits a positive density p , then it satisfies a Poincaré inequality if and only if it satisfies the Hardy criterion (see [5, Theorem 6.2.2, p. 99]), namely

$$\sup_{x \geq 0} \int_x^{+\infty} p(y) dy \int_0^x \frac{dy}{p(y)} < +\infty, \quad \sup_{x \leq 0} \int_{-\infty}^x p(y) dy \int_x^0 \frac{dy}{p(y)} < +\infty.$$

Letting $y = \Psi(v)$, we rewrite

$$\int_0^x \frac{dy}{p(y)} = \int_{1/2}^{\Psi^{-1}(x)} (\Psi'(v))^2 dv,$$

so that that the stationary solutions satisfy a Poincaré inequality if and only if

$$\sup_{u \geq 1/2} (1-u) \int_{1/2}^u \left(\frac{a(v)}{2B(v)} \right)^2 dv < +\infty, \quad \sup_{u \leq 1/2} u \int_u^{1/2} \left(\frac{a(v)}{2B(v)} \right)^2 dv < +\infty.$$

4.4.2 Convergence in Wasserstein distance

We now state the main result of the chapter, namely the convergence to equilibrium of the probabilistic solutions in Wasserstein distance.

Theorem 4.4.6. *Let us assume that:*

- *the coefficients of the Cauchy problem (4.1) satisfy the uniform ellipticity condition (D3), the regularity condition (R2) and the equilibrium conditions (E1) and (E2);*
- *the probability distribution m has a finite first order moment;*
- $W_2(H * m, \Psi^{-1}) < +\infty$.

*Let $(F_t)_{t \geq 0}$ be the probabilistic solution the Cauchy problem (4.1) with initial condition $H * m$. Then there exists a unique stationary solution F_∞ such that F_0 and F_∞ have the same expectation, and for all $p \geq 2$ such that $W_p(H * m, \Psi^{-1}) < +\infty$,*

$$\forall 1 \leq q < p, \quad \lim_{t \rightarrow +\infty} W_q(F_t, F_\infty) = 0.$$

Proof. The proof is in 6 steps.

Step 1. We first prove the existence and uniqueness of a stationary solution F_∞ such that F_0 and F_∞ have the same expectation. By the condition (E2), the integral $\int_0^1 \Psi(u) du$ is defined. Owing to the condition (E1) and according to Proposition 4.4.1, the stationary solutions are the

functions of the form $F_\infty(x) = \Psi^{-1}(x + \bar{x})$, $\bar{x} \in \mathbb{R}$. By Corollary 4.4.4, the expectation of such a cumulative distribution function exists and it is given by

$$\int_0^1 F_\infty^{-1}(u)du = \int_0^1 \Psi(u)du - \bar{x}.$$

Thus, the unique stationary solution with the same expectation as F_0 is given by $F_\infty(x) = \Psi^{-1}(x + \bar{x})$, with $\bar{x} = \int_0^1 (\Psi(u) - F_0^{-1}(u))du$.

Step 2. We now introduce a smooth approximation of the initial condition F_0 in order to use Lemma 4.2.7. Let ζ be a C^∞ probability density on \mathbb{R} with compact support and such that $\int_{\mathbb{R}} x\zeta(x)dx = 0$. For all $\alpha > 0$ and $x \in \mathbb{R}$, we define $\zeta_\alpha(x) := \alpha^{-1}\zeta(\alpha^{-1}x)$ and $F_0^\alpha(x) := F_0 * \zeta_\alpha(x)$. Then F_0^α is C^∞ on \mathbb{R} and it is the cumulative distribution function of $X_0 + \alpha Z$, where X_0 has distribution m , Z has density ζ and X_0 and Z are independent. As a consequence, F_0^α has a finite first order moment and it has the same expectation as F_0 and F_∞ due to Step 1. By Lemma 4.2.7, the probabilistic solution $(F_t^\alpha)_{t \geq 0}$ to the Cauchy problem (4.1) with initial condition F_0^α has the classical regularity and for all finite $T > 0$, it belongs to $C_b^{1,2}([0, T] \times \mathbb{R})$.

Using the obvious coupling $(X_0, X_0 + \alpha Z)$ of F_0 and F_0^α , we note that for all $q \geq 1$,

$$W_q(F_0, F_0^\alpha) \leq \alpha \mathbb{E}(|Z|^q)^{1/q} < +\infty.$$

This leads to the following remarks:

- As F_∞ is a translation of Ψ^{-1} , by the triangle inequality, $W_q(H * m, \Psi^{-1})$ and $W_q(F_0^\alpha, F_\infty)$ are simultaneously finite or infinite.
- Using the triangle inequality again and Proposition 4.3.1, we get

$$W_q(F_t, F_\infty) \leq W_q(F_t, F_t^\alpha) + W_q(F_t^\alpha, F_\infty) \leq \alpha \mathbb{E}(|Z|^q)^{1/q} + W_q(F_t^\alpha, F_\infty).$$

Hence, as soon as, for all $\alpha > 0$, $\limsup_{t \rightarrow +\infty} W_q(F_t^\alpha, F_\infty) = 0$, then taking α arbitrarily small yields $\lim_{t \rightarrow +\infty} W_q(F_t, F_\infty) = 0$.

We now fix $\alpha > 0$. The remaining steps are dedicated to the proof of the fact that, for all $p \geq 2$ such that $W_p(H * m, \Psi^{-1}) < +\infty$, for all $1 \leq q < p$, $\lim_{t \rightarrow +\infty} W_q(F_t^\alpha, F_\infty) = 0$.

Step 3. We prove that for all $t \geq 0$, the expectation of F_t^α remains constant. By Corollary 4.2.13, for all $t \geq 0$, F_t^α is the marginal cumulative distribution function of the nonlinear diffusion process X^α solution to (4.4) with initial condition having cumulative distribution function F_0^α . Since σ and b are bounded,

$$\forall t \geq 0, \quad \mathbb{E}(X_t^\alpha) = \mathbb{E}(X_0^\alpha) + \int_0^t \mathbb{E}[b(F_s^\alpha(X_s^\alpha))]ds.$$

But for all $s > 0$, F_s^α is continuous so that $\mathbb{E}[b(F_s^\alpha(X_s^\alpha))] = \int_0^1 b(u)du = B(1)$. By (E1), we conclude that $\mathbb{E}(X_t^\alpha) = \mathbb{E}(X_0^\alpha)$.

Step 4. We now describe the evolution of the Wasserstein distance $W_2(F_t^\alpha, F_\infty)$. We are willing to use Proposition 4.3.4, therefore we need to check that $(F_t^\alpha)_{t \geq 0}$ and F_∞ satisfy the assumptions of Lemma 4.3.3. It is the case for $(F_t^\alpha)_{t \geq 0}$ thanks to Lemma 4.2.7. The stationary solution F_∞ has a finite first order moment owing to the condition (E2) and Corollary 4.4.4, it is C^2 on \mathbb{R} by the condition (R2) and Corollary 4.4.3, and from the definition of Ψ^{-1} and condition (D3) it follows that the derivative of F_∞ is bounded by $2\|B\|_\infty/\underline{a}$.

Moreover, by the assumption that $W_2(H * m, \Psi^{-1}) < +\infty$ and Step 2, $W_2(F_0^\alpha, F_\infty) < +\infty$; and since both F_0^α and F_∞ have a finite first order moment, $|x|(\text{tl}(F_0^\alpha, x) + \text{tl}(F_\infty, x))$ vanishes when $x \rightarrow \pm\infty$. Thus, Proposition 4.3.4 applies to $(F_t^\alpha)_{t \geq 0}$ and F_∞ with $p = 2$ and yields, for all $0 < t_1 < t_2$,

$$W_2^2(F_{t_2}^\alpha, F_\infty) - W_2^2(F_{t_1}^\alpha, F_\infty) = - \int_{t_1}^{t_2} \int_0^1 a(u) \frac{(\partial_u(F_t^\alpha)^{-1}(u) - \partial_u F_\infty^{-1}(u))^2}{\partial_u(F_t^\alpha)^{-1}(u)\partial_u F_\infty^{-1}(u)} dudt \leq 0.$$

Using the uniform ellipticity condition (D3), we can then assert that

$$\liminf_{t \rightarrow +\infty} \int_0^1 \frac{(\partial_u(F_t^\alpha)^{-1}(u) - \partial_u F_\infty^{-1}(u))^2}{\partial_u(F_t^\alpha)^{-1}(u)\partial_u F_\infty^{-1}(u)} du = 0,$$

and extract a sequence $(t_n)_{n \geq 1}$ growing to $+\infty$ such that the integral above goes to 0 along $(t_n)_{n \geq 1}$. Let us prove that for all $u \in (0, 1)$,

$$\lim_{n \rightarrow +\infty} \int_{1/2}^u |\partial_u(F_{t_n}^\alpha)^{-1}(v) - \partial_u F_\infty^{-1}(v)| dv = 0. \quad (4.25)$$

Let $0 < \epsilon < 1/2$. By the Cauchy-Schwarz inequality and the condition (E1),

$$\begin{aligned} \int_\epsilon^{1-\epsilon} |\partial_u(F_{t_n}^\alpha)^{-1} - \partial_u F_\infty^{-1}| dv &\leq \left(\int_\epsilon^{1-\epsilon} \partial_u(F_{t_n}^\alpha)^{-1} \partial_u F_\infty^{-1} dv \int_\epsilon^{1-\epsilon} \frac{(\partial_u(F_{t_n}^\alpha)^{-1} - \partial_u F_\infty^{-1})^2}{\partial_u(F_{t_n}^\alpha)^{-1} \partial_u F_\infty^{-1}} dv \right)^{1/2} \\ &\leq \left(\sup_{v \in [\epsilon, 1-\epsilon]} \frac{a(v)}{2B(v)} \int_\epsilon^{1-\epsilon} \partial_u(F_{t_n}^\alpha)^{-1} dv \int_\epsilon^{1-\epsilon} \frac{(\partial_u(F_{t_n}^\alpha)^{-1} - \partial_u F_\infty^{-1})^2}{\partial_u(F_{t_n}^\alpha)^{-1} \partial_u F_\infty^{-1}} dv \right)^{1/2}. \end{aligned} \quad (4.26)$$

The first integral can be bounded uniformly in n as follows:

$$\begin{aligned} \int_\epsilon^{1-\epsilon} \partial_u(F_{t_n}^\alpha)^{-1}(v) dv &= (F_{t_n}^\alpha)^{-1}(1-\epsilon) - (F_{t_n}^\alpha)^{-1}(\epsilon) \\ &\leq \frac{2}{\epsilon} \int_0^{\epsilon/2} ((F_{t_n}^\alpha)^{-1}(1-\epsilon+v) - (F_{t_n}^\alpha)^{-1}(\epsilon-v)) dv \\ &\leq \frac{2}{\epsilon} \left(\int_0^{\epsilon/2} (F_\infty^{-1}(1-\epsilon+v) - F_\infty^{-1}(\epsilon-v)) dv + \int_0^1 |(F_{t_n}^\alpha)^{-1}(v) - F_\infty^{-1}(v)| dv \right) \\ &\leq \frac{2}{\epsilon} \left(\int_0^{\epsilon/2} (F_\infty^{-1}(1-\epsilon+v) - F_\infty^{-1}(\epsilon-v)) dv + \int_0^1 |(F_0^\alpha)^{-1}(v) - F_\infty^{-1}(v)| dv \right), \end{aligned}$$

where the last inequality is due to Proposition 4.3.1. We deduce that the right-hand side of (4.26) goes to 0, so that taking $\epsilon \leq u \wedge (1-u)$ yields (4.25).

Step 5. We extract a subsequence of $(t_n)_{n \geq 1}$, that we still index by n for convenience, such that $\lim_{n \rightarrow +\infty} (F_{t_n}^\alpha)^{-1}(1/2) - F_\infty^{-1}(1/2) = \ell \in [-\infty, +\infty]$. Then using Step 4, for all $u \in (0, 1)$ one has $(F_{t_n}^\alpha)^{-1}(u) - F_\infty^{-1}(u) \rightarrow \ell$. Besides, since by Proposition 4.3.1,

$$\sup_{t \geq 0} \int_0^1 |(F_t^\alpha)^{-1}(u) - F_\infty^{-1}(u)|^2 du = W_2^2(F_0^\alpha, F_\infty) < +\infty,$$

then the functions $(u \mapsto (F_{t_n}^\alpha)^{-1}(u) - F_\infty^{-1}(u))_{n \geq 1}$ are uniformly integrable. We deduce using Step 3 that

$$\ell = \lim_{n \rightarrow +\infty} \int_0^1 ((F_{t_n}^\alpha)^{-1}(u) - F_\infty^{-1}(u)) du = 0.$$

Step 6. Let $p \geq 2$ such that $W_p(F_0^\alpha, \Psi^{-1}) < +\infty$. Then by Step 2, $W_p(F_0^\alpha, F_\infty) < +\infty$; therefore, for all $1 \leq q < p$, the functions $(u \mapsto |(F_{t_n}^\alpha)^{-1}(u) - F_\infty^{-1}(u)|^q)_{n \geq 1}$ are uniformly integrable, and using Step 5 we have

$$\lim_{n \rightarrow +\infty} \int_0^1 |(F_{t_n}^\alpha)^{-1}(u) - F_\infty^{-1}(u)|^q du = 0.$$

But according to Proposition 4.3.1, the flow $t \mapsto W_q(F_t^\alpha, F_\infty)$ is nonincreasing. As a consequence $\lim_{t \rightarrow +\infty} W_q(F_t^\alpha, F_\infty) = 0$ and the proof is completed by virtue of Step 2. \square

Remark 4.4.7. In view of the contraction results for the flow of Wasserstein distance between two solutions of Fokker-Planck equations obtained in [21, 22], one can wonder whether the formula of Proposition 4.3.4 can be used to compare the dissipation of the Wasserstein distance to the Wasserstein distance itself; that is to say, whether one can derive a differential inequality of the form

$$\frac{d}{dt} W_p^p(F_t, G_t) \leq -C W_p^p(F_0, G_0), \quad C > 0,$$

at least for initial data F_0, G_0 having the same expectation. By the Gronwall lemma, this would imply exponential contraction

$$\forall t \geq 0, \quad W_p^p(F_t, G_t) \leq \exp(-Ct) W_p^p(F_0, G_0),$$

and Theorem 4.4.6 would easily follow from the existence of a stationary solution with the same expectation of F_0 . In addition, one would obtain an exponential rate of convergence to equilibrium (this issue is discussed in Subsection 4.4.3 below).

Unfortunately, there is no hope to derive such a differential inequality from the formula of Proposition 4.3.4. Indeed, let us observe that the latter does not depend on the function b . As a consequence, if σ^2 is constant, then it is the same formula as for the heat equation, for which no such exponential contraction can be expected.

4.4.3 Rate of convergence

We first recall the result of convergence to equilibrium stated in [89], where $A(u) = \sigma^2 u$ with $\sigma^2 > 0$. Then it is easily checked that the conditions (R1), (E1) and (E2) are satisfied if B is C^2 on $[0, 1]$, with $B(1) = 0$, $b(0) > 0$, $b(1) < 0$ and $B(u) > 0$ on $(0, 1)$. Then according to Remark 4.4.5, all the stationary solutions F_∞ admit a positive density p_∞ and satisfy a Poincaré inequality. Under these assumptions, we have the following convergence result.

Lemma 4.4.8. [89, Lemma 2.8] *There exist $\eta > 0$ and $c > 0$ depending on A and B such that for all cumulative distribution function F_0 with a finite first order moment, calling F_∞ the stationary solution with the same expectation as F_0 , as soon as $\int (F_0 - F_\infty)^2 / p_\infty dx \leq \eta$ then*

$$\forall t \geq 0, \quad \int_{\mathbb{R}} \frac{(F_t(x) - F_\infty(x))^2}{p_\infty(x)} dx \leq \frac{\exp(-ct)}{c} \int_{\mathbb{R}} \frac{(F_0(x) - F_\infty(x))^2}{p_\infty(x)} dx.$$

According to [88, Proposition 1.4], the quadratic Wasserstein distance between two probability distributions μ and ν on \mathbb{R} such that μ admits a positive density p satisfies the inequality

$$W_2^2(\mu, \nu) \leq 4 \int_{\mathbb{R}} \frac{(H * \mu(x) - H * \nu(x))^2}{p(x)} dx.$$

Hence, the convergence result of Lemma 4.4.8 can be translated in terms of the Wasserstein distance.

Corollary 4.4.9. *Under the assumptions of Lemma 4.4.8, as soon as $\int (F_0 - F_\infty)^2 / p_\infty dx$ is small enough, then $W_2(F_t, F_\infty)$ converges to 0 exponentially fast.*

4.A Proof of Proposition 4.2.2

This appendix is dedicated to the proof of the first point of Proposition 4.2.2, which states that there is at most one weak solution to the Cauchy problem (4.1) in the set $\mathcal{F}(T)$, for all $T > 0$, possibly $T = +\infty$. The proof is adapted from Wu, Zhao, Yin and Lin [137, Section 3.2] as well as Liu and Wang [105], who provide uniqueness of bounded weak solutions to the *initial-boundary value* problem, namely the Cauchy problem (4.1) in the strip $[0, T] \times (0, 1)$ with boundary conditions at $x = 0$ and $x = 1$. At an intuitive level, one can see our restriction to the set $\mathcal{F}(T)$ as some boundary conditions at $x = -\infty$ and $x = +\infty$.

We shall follow the so-called Holmgren's approach which consists in turning the proof of uniqueness for (4.1) into a proof of existence for an *adjoint problem*. Recall that we make the following nondegeneracy assumption:

(D1) The function A is increasing.

Let $T > 0$, possibly $T = +\infty$, and let $(F_t^1)_{t \in [0, T]}, (F_t^2)_{t \in [0, T]} \in \mathcal{F}(T)$ such that for all $g \in C_c^\infty([0, T] \times \mathbb{R})$, both $(F_t^1)_{t \in [0, T]}$ and $(F_t^2)_{t \in [0, T]}$ satisfy (4.2). Then, for all $t \in [0, T]$, the function $F_t^2 - F_t^1$ is integrable on \mathbb{R} and the function $(s, x) \mapsto F_s^2(x) - F_s^1(x)$ is integrable on $Q_t := (0, t) \times \mathbb{R}$. Therefore, for all $t \in [0, T]$ and for all $g \in C_c^\infty([0, T] \times \mathbb{R})$, (4.2) yields

$$\int_{Q_t} (F_s^2 - F_s^1) \left\{ \frac{1}{2} \tilde{A} \partial_x^2 g + \tilde{B} \partial_x g + \partial_s g \right\} ds dx = \int_{\mathbb{R}} (F_t^2(x) - F_t^1(x)) g(t, x) dx; \quad (4.27)$$

where

$$\tilde{A}(s, x) = \int_0^1 a((1 - \theta)F_s^1(x) + \theta F_s^2(x)) d\theta,$$

and

$$\tilde{B}(s, x) = \int_0^1 b((1 - \theta)F_s^1(x) + \theta F_s^2(x)) d\theta.$$

Remark 4.A.1. For all $t \in [0, T]$, by a classical regularization argument the integral equality (4.27) holds true for all function g in the space $C_b^{1,2}([0, t] \times \mathbb{R})$ of real-valued $C^{1,2}$ functions bounded together with their derivatives.

Let $f \in C_c^\infty([0, T] \times \mathbb{R})$. Then there exists $t \in [0, T]$ such that $\text{Supp } f \subset [0, t) \times \mathbb{R}$. Let us introduce the *adjoint problem* to (4.1) as

$$\begin{cases} \frac{1}{2} \tilde{A} \partial_x^2 g + \tilde{B} \partial_x g + \partial_s g = f & (s, x) \in [0, t) \times \mathbb{R}, \\ g(t, x) = 0 & x \in \mathbb{R}. \end{cases} \quad (4.28)$$

The coefficients \tilde{A} and \tilde{B} may not be smooth enough to allow the adjoint problem to admit classical solutions. Therefore we introduce a suitable approximation of (4.28). For small $\delta, \eta > 0$, let

$$\begin{aligned} G_\delta &:= \{(s, x) \in [0, t] \times \mathbb{R} : |F_s^1(x) - F_s^2(x)| < \delta\}, \\ F_\delta &:= \{(s, x) \in [0, t] \times \mathbb{R} : |F_s^1(x) - F_s^2(x)| \geq \delta\}, \end{aligned} \quad (4.29)$$

and let us define

$$\lambda_\eta^\delta(s, x) = \begin{cases} 0 & \text{on } G_\delta, \\ \left[\frac{1}{2} (\eta + \tilde{A}(s, x)) \right]^{-1/2} \tilde{B}(s, x) & \text{on } F_\delta. \end{cases}$$

Since A is increasing and $(F_t^1)_{t \in [0, T]}, (F_t^2)_{t \in [0, T]}$ are bounded, there exist $L(\delta) > 0$ and $K(\delta) > 0$ independent of η such that

$$\begin{aligned} \tilde{A}(s, x) &\geq L(\delta) & (s, x) \in F_\delta, \\ |\lambda_\eta^\delta(s, x)| &\leq K(\delta) & (s, x) \in [0, t] \times \mathbb{R}. \end{aligned}$$

Let ξ be a C^∞ probability density on \mathbb{R}^2 such that $\text{Supp } \xi \subset [-1, 1] \times [-1, 1]$. For all $\epsilon > 0$, let $\xi_\epsilon := \epsilon^{-2} \xi(\epsilon^{-1} s, \epsilon^{-1} x)$ and define $\tilde{A}_\epsilon = \tilde{A} * \xi_\epsilon$ and $\lambda_{\eta, \epsilon}^\delta = \lambda_\eta^\delta * \xi_\epsilon$. Then \tilde{A}_ϵ and $\lambda_{\eta, \epsilon}^\delta$ are C^∞ functions and all their derivatives are bounded on $[0, t] \times \mathbb{R}$. Besides,

$$\begin{aligned} \lim_{\epsilon \rightarrow 0} \tilde{A}_\epsilon(s, x) &= \tilde{A}(s, x) & \text{a.e. in } [0, t] \times \mathbb{R}, \\ \lim_{\epsilon \rightarrow 0} \lambda_{\eta, \epsilon}^\delta(s, x) &= \lambda_\eta^\delta(s, x) & \text{a.e. in } [0, t] \times \mathbb{R}, \\ \tilde{A}_\epsilon(s, x) &\leq C & (s, x) \in [0, t] \times \mathbb{R}, \\ |\lambda_{\eta, \epsilon}^\delta(s, x)| &\leq K(\delta) & (s, x) \in [0, t] \times \mathbb{R}, \end{aligned} \quad (4.30)$$

where C refers to a positive constant independent of ϵ , δ and η , and $K(\delta)$ refers to a positive constant depending only on δ . In the sequel, the values of C and $K(\delta)$ can change from one line to another.

We finally define

$$\tilde{B}_{\eta,\epsilon}^\delta(s, x) = \lambda_{\eta,\epsilon}^\delta(s, x) \left[\frac{1}{2}(\eta + \tilde{A}_\epsilon(s, x)) \right]^{1/2},$$

and emphasize the fact that

$$\|\tilde{B}_{\eta,\epsilon}^\delta\|_\infty \leq K(\delta). \quad (4.31)$$

We are now able to introduce the *approximate adjoint problem*

$$\begin{cases} \frac{1}{2}(\eta + \tilde{A}_\epsilon)\partial_x^2 g + \tilde{B}_{\eta,\epsilon}^\delta\partial_x g + \partial_s g = f & (s, x) \in [0, t] \times \mathbb{R}, \\ g(t, x) = 0 & x \in \mathbb{R}. \end{cases} \quad (4.32)$$

The coefficients of the equation are bounded, globally Lipschitz continuous, the operator is uniformly parabolic, and the right-hand side f is continuous and bounded. Therefore the Cauchy problem (4.32) admits a unique classical bounded solution $g_{\eta,\epsilon}^\delta$ (see [94, p. 369]). Since the coefficients of the equation and f are C^∞ on $[0, t] \times \mathbb{R}$, then so is $g_{\eta,\epsilon}^\delta$ (see [66, p. 263]). Owing to the Feynman-Kac formula, $g_{\eta,\epsilon}^\delta$ has the following probabilistic representation:

$$\forall (s, x) \in [0, t] \times \mathbb{R}, \quad g_{\eta,\epsilon}^\delta(s, x) = -\mathbb{E} \left[\int_s^t f(r, Z_r^{s,x}) dr \right] \quad (4.33)$$

where, for a given standard Brownian motion W , $(Z_r^{s,x})_{r \in [0,t]}$ is the unique strong solution of the stochastic differential equation

$$Z_r^{s,x} = x + \int_s^r \tilde{B}_{\eta,\epsilon}^\delta(u, Z_u^{s,x}) du + \int_s^r (\eta + \tilde{A}_\epsilon(u, Z_u^{s,x}))^{1/2} dW_u. \quad (4.34)$$

Lemma 4.A.2. *The functions $g_{\eta,\epsilon}^\delta$, $\partial_x g_{\eta,\epsilon}^\delta$ and $\partial_x^2 g_{\eta,\epsilon}^\delta$ are such that:*

$$\sup_{[0,t] \times \mathbb{R}} |g_{\eta,\epsilon}^\delta(s, x)| \leq C, \quad (4.35)$$

$$\sup_{s \in [0,t]} \int_{\mathbb{R}} |g_{\eta,\epsilon}^\delta(s, x)| dx \leq K(\delta), \quad (4.36)$$

$$\sup_{s \in [0,t]} |\partial_x g_{\eta,\epsilon}^\delta(s, x)| \leq \kappa(\epsilon, \delta, \eta) \exp(-x^2/\kappa(\epsilon, \delta, \eta)), \quad (4.37)$$

$$\sup_{s \in [0,t]} |\partial_x^2 g_{\eta,\epsilon}^\delta(s, x)| \leq \kappa(\epsilon, \delta, \eta) \exp(-x^2/\kappa(\epsilon, \delta, \eta)), \quad (4.38)$$

where the value of $\kappa(\epsilon, \delta, \eta)$ can change from one line to another.

Proof. The inequality (4.35) directly follows from the Feynman-Kac formula (4.33). Besides, since f has a compact support in $[0, t] \times \mathbb{R}$, say $\text{Supp } f \subset [0, t] \times [x_-, x_+]$, one has

$$|g_{\eta,\epsilon}^\delta(s, x)| \leq \|f\|_\infty \int_s^t \mathbb{P}(Z_r^{s,x} \in [x_-, x_+]) dr,$$

and for $x > x_+$,

$$\mathbb{P}(Z_r^{s,x} \in [x_-, x_+]) \leq \mathbb{P}(x - Z_r^{s,x} \geq x - x_+) \leq \frac{\mathbb{E}[(x - Z_r^{s,x})^2]}{(x - x_+)^2}.$$

Owing to (4.34) and (4.31),

$$\mathbb{E}[(x - Z_r^{s,x})^2] \leq 2 \left((r - s)^2 \|\tilde{B}_{\eta,\epsilon}^\delta\|_\infty^2 + (r - s) \|\eta + \tilde{A}_\epsilon\|_\infty \right) \leq K(\delta),$$

and similar arguments for $x < x_-$ yield (4.36).

In order to prove (4.37) and (4.38), let us take the derivative with respect to x of the problem (4.32). Then the function $\partial_x g_{\eta,\epsilon}^\delta$ is the unique classical solution of the Cauchy problem

$$\begin{cases} \frac{1}{2}(\eta + \tilde{A}_\epsilon)\partial_x^2 g^1 + \left(\frac{1}{2}\partial_x \tilde{A}_\epsilon + \tilde{B}_{\eta,\epsilon}^\delta\right)\partial_x g^1 + \partial_x \tilde{B}_{\eta,\epsilon}^\delta g^1 + \partial_s g^1 = \partial_x f, \\ g^1(t, x) = 0, \end{cases} \quad (4.39)$$

and the Feynman-Kac formula now writes

$$\begin{aligned} \partial_x g_{\eta,\epsilon}^\delta(s, x) &= -\mathbb{E} \left[\int_s^t \partial_x f(r, Z_r^{1,s,x}) \exp \left(\int_s^r \partial_x \tilde{B}_{\eta,\epsilon}^\delta(u, Z_u^{1,s,x}) du \right) dr \right] \\ &= - \int_s^t \int_{\mathbb{R}} \partial_x f(r, z) G^1(s, x; r, z) dz dr \end{aligned} \quad (4.40)$$

where $(Z_r^{1,s,x})_{r \in [0,t]}$ is the associated diffusion process and $G^1(s, x; r, z)$ is the *fundamental solution* of (4.39). Following Friedman [66, p. 24], there exists some constant $\kappa > 0$ depending on the coefficients of (4.39) (therefore, on ϵ, δ and η) such that, for all $s < r$,

$$|G^1(s, x; r, z)| \leq \frac{\kappa}{(r-s)^{1/2}} \exp \left(-\frac{(z-x)^2}{\kappa(r-s)} \right), \quad (4.41)$$

$$|\partial_x G^1(s, x; r, z)| \leq \frac{\kappa}{r-s} \exp \left(-\frac{(z-x)^2}{\kappa(r-s)} \right). \quad (4.42)$$

For $x > x_+$, (4.40) combined with (4.41) yields

$$\begin{aligned} |\partial_x g_{\eta,\epsilon}^\delta(s, x)| &\leq \int_s^t \int_{z=x_-}^{x_+} \|\partial_x f\|_\infty \frac{\kappa}{(r-s)^{1/2}} \exp \left(-\frac{(z-x_+)^2}{\kappa(r-s)} \right) dz dr \\ &\leq \kappa \|\partial_x f\|_\infty (x_+ - x_-) \exp \left(-\frac{(x-x_+)^2}{\kappa(t-s)} \right) \int_s^t \frac{dr}{(r-s)^{1/2}} \\ &\leq 2(t-s)^{1/2} \kappa \|\partial_x f\|_\infty (x_+ - x_-) \exp \left(-\frac{(x-x_+)^2}{\kappa(t-s)} \right), \end{aligned}$$

and similar arguments for $x < x_-$ lead to (4.37). Likewise, for $x > x_+$, using (4.42) one gets

$$\begin{aligned} |\partial_x^2 g_{\eta,\epsilon}^\delta(s, x)| &\leq \int_s^t \int_{z=x_-}^{x_+} \|\partial_x f\|_\infty \frac{\kappa}{r-s} \exp \left(-\frac{(z-x_+)^2}{\kappa(r-s)} \right) dz dr \\ &\leq \kappa \|\partial_x f\|_\infty (x_+ - x_-) \int_s^t \frac{1}{r-s} \exp \left(-\frac{(x-x_+)^2}{\kappa(r-s)} \right) dr. \end{aligned}$$

Writing, thanks to the change of variable $v = (x-x_+)/(\kappa(r-s))^{1/2}$

$$\int_s^t \frac{1}{r-s} \exp \left(-\frac{(x-x_+)^2}{\kappa(r-s)} \right) dr = \int_{(x-x_+)/(\kappa(t-s))^{1/2}}^{+\infty} \frac{2}{v} \exp(-v^2) dv,$$

and using the fact that, as soon as $x \geq x_+ + (t\kappa)^{1/2}$,

$$\forall v \geq \frac{x-x_+}{(\kappa(t-s))^{1/2}}, \quad \frac{1}{v} \leq \frac{\kappa(t-s)}{(x-x_+)^2} v,$$

we deduce that for $x \geq x_+ + (t\kappa)^{1/2}$,

$$\int_{(x-x_+)/(\kappa(t-s))^{1/2}}^{+\infty} \frac{2}{v} \exp(-v^2) dv \leq \frac{\kappa(t-s)}{(x-x_+)^2} \exp \left(-\frac{(x-x_+)^2}{\kappa(t-s)} \right) \leq \exp \left(-\frac{(x-x_+)^2}{\kappa(t-s)} \right).$$

By similar arguments for $x < x_-$, one finally concludes to (4.38). \square

By the definition of $g_{\eta,\epsilon}^\delta$,

$$\begin{aligned} \int_{[0,+\infty) \times \mathbb{R}} (F_s^2(x) - F_s^1(x))f(s,x)dsdx &= \int_{Q_t} (F_s^2(x) - F_s^1(x))f(s,x)dsdx \\ &= \int_{Q_t} (F_s^2 - F_s^1) \left\{ \frac{1}{2}(\eta + \tilde{A}_\epsilon) \partial_x^2 g_{\eta,\epsilon}^\delta + \tilde{B}_{\eta,\epsilon}^\delta \partial_x g_{\eta,\epsilon}^\delta + \partial_s g_{\eta,\epsilon}^\delta \right\} dsdx. \end{aligned} \quad (4.43)$$

It follows from the boundedness of \tilde{A}_ϵ and $\tilde{B}_{\eta,\epsilon}^\delta$ and from Lemma 4.A.2 that

$$\sup_{s \in [0,t]} |\partial_s g_{\eta,\epsilon}^\delta(s,x)| \leq \kappa(\epsilon, \delta, \eta) \exp(-\kappa(\epsilon, \delta, \eta)x^2).$$

Consequently, $g_{\eta,\epsilon}^\delta \in C_b^{1,2}([0,t] \times \mathbb{R})$, therefore due to remark 4.A.1,

$$\int_{Q_t} (F_s^2 - F_s^1) \left\{ \frac{1}{2} \tilde{A} \partial_x^2 g_{\eta,\epsilon}^\delta + \tilde{B} \partial_x g_{\eta,\epsilon}^\delta + \partial_s g_{\eta,\epsilon}^\delta \right\} dsdx = 0. \quad (4.44)$$

As a conclusion, subtracting (4.44) to (4.43),

$$\begin{aligned} \int_{[0,+\infty) \times \mathbb{R}} (F_s^2(x) - F_s^1(x))f(s,x)dsdx \\ = \int_{Q_t} (F_s^2 - F_s^1) \left\{ \frac{1}{2}(\eta + \tilde{A}_\epsilon - \tilde{A}) \partial_x^2 g_{\eta,\epsilon}^\delta + (\tilde{B}_{\eta,\epsilon}^\delta - \tilde{B}) \partial_x g_{\eta,\epsilon}^\delta \right\} dsdx. \end{aligned} \quad (4.45)$$

We now have to prove that the right-hand side of (4.45) goes to 0 as $\epsilon, \delta, \eta \rightarrow 0$. In this purpose, we closely follow the line of [105]. In particular, the proofs of our Lemmas 4.A.3 and 4.A.4 are nothing but transcriptions of the proofs of Lemmas 1 and 3 in [105] to the framework of an unbounded domain Q_t and weak solutions in $\mathcal{F}(T)$. Then the estimates (4.35)–(4.38) ensure that the computations still make sense.

Recall that C refers to a positive constant that does not depend on ϵ, η or δ .

Lemma 4.A.3. [105, Lemma 1] *The functions $\partial_x g_{\eta,\epsilon}^\delta$ and $\partial_x^2 g_{\eta,\epsilon}^\delta$ are such that:*

$$\int_{Q_t} \frac{1}{2}(\eta + \tilde{A}_\epsilon) (\partial_x^2 g_{\eta,\epsilon}^\delta)^2 dsdx \leq \frac{K(\delta)}{\eta} + C, \quad (4.46)$$

$$\int_{Q_t} (\partial_x g_{\eta,\epsilon}^\delta)^2 dsdx \leq \frac{K(\delta)}{\eta} + C. \quad (4.47)$$

Lemma 4.A.4. [105, Lemma 3] *The function $\partial_x g_{\eta,\epsilon}^\delta$ is such that:*

$$\sup_{s \in [0,t]} \int_{\mathbb{R}} |\partial_x g_{\eta,\epsilon}^\delta(s,x)| dx \leq C. \quad (4.48)$$

The estimates of Lemmas 4.A.2, 4.A.3 and 4.A.4 give sufficient uniformity over the derivatives of $g_{\eta,\epsilon}^\delta$ to conclude.

Proposition 4.A.5. *The right-hand side of (4.45) is arbitrarily small when $\epsilon, \eta, \delta \rightarrow 0$.*

Proof. For lighter notations, let us denote $\bar{F}(s,x) = F_s^2(x) - F_s^1(x)$, and

$$\begin{aligned} I &:= \int_{Q_t} \bar{F} \frac{1}{2} (\tilde{A}_\epsilon - \tilde{A}) \partial_x^2 g_{\eta,\epsilon}^\delta dsdx + \int_{Q_t} \bar{F} \frac{\eta}{2} \partial_x^2 g_{\eta,\epsilon}^\delta dsdx + \int_{Q_t} \bar{F} (\tilde{B}_{\eta,\epsilon}^\delta - \tilde{B}) \partial_x g_{\eta,\epsilon}^\delta dsdx \\ &=: I_1 + I_2 + I_3. \end{aligned}$$

Recall that since $(F_t^1)_{t \in [0,T]}, (F_t^2)_{t \in [0,T]} \in \mathcal{F}(T)$, then $\bar{F} \in (L^1 \cap L^\infty)(Q_t)$.

Owing to the Cauchy-Schwarz inequality,

$$|I_1| \leq \left(\int_{Q_t} |\bar{F}| \frac{(\tilde{A}_\epsilon - \tilde{A})^2}{2(\eta + \tilde{A}_\epsilon)} dsdx \right)^{1/2} \left(\int_{Q_t} |\bar{F}| \frac{1}{2} (\eta + \tilde{A}_\epsilon) (\partial_x^2 g_{\eta,\epsilon}^\delta)^2 dsdx \right)^{1/2}. \quad (4.49)$$

Using (4.30), by dominated convergence the first integral in the right-hand side of (4.49) goes to 0 as $\epsilon \rightarrow 0$ for fixed η and δ . According to Lemma 4.A.3, the second integral in (4.49) is bounded by $C + K(\delta)/\eta$. Therefore, for fixed η and δ , $\lim_{\epsilon \rightarrow 0} I_1 = 0$.

Let $\alpha > 0$. Recalling the definition (4.29) of F_α and G_α , let us write

$$|I_2| \leq \frac{\eta}{2} \int_{F_\alpha} |\bar{F} \partial_x^2 g_{\eta,\epsilon}^\delta| dsdx + \frac{\eta}{2} \int_{G_\alpha} |\bar{F} \partial_x^2 g_{\eta,\epsilon}^\delta| dsdx.$$

By the Cauchy-Schwarz inequality,

$$\begin{aligned} \int_{F_\alpha} |\bar{F} \partial_x^2 g_{\eta,\epsilon}^\delta| dsdx &\leq \left(\int_{F_\alpha} |\bar{F}| \frac{dsdx}{(1/2)(\eta + \tilde{A}_\epsilon)} \right)^{1/2} \left(\int_{F_\alpha} |\bar{F}| \frac{1}{2} (\eta + \tilde{A}_\epsilon) (\partial_x^2 g_{\eta,\epsilon}^\delta)^2 dsdx \right)^{1/2} \\ &\leq C \left(\sup_{F_\alpha} \frac{1}{(1/2)(\eta + \tilde{A}_\epsilon)} \right)^{1/2} \left(C + \frac{K(\delta)}{\eta} \right)^{1/2} \\ &\leq \frac{C}{L(\alpha)} \left(C + \frac{K(\delta)}{\eta} \right)^{1/2}, \end{aligned}$$

where $L(\alpha)$ only depends on α . Likewise,

$$\begin{aligned} \int_{G_\alpha} |\bar{F} \partial_x^2 g_{\eta,\epsilon}^\delta| dsdx &\leq \left(\int_{G_\alpha} |\bar{F}| \frac{dsdx}{(1/2)(\eta + \tilde{A}_\epsilon)} \right)^{1/2} \left(\int_{G_\alpha} |\bar{F}| \frac{1}{2} (\eta + \tilde{A}_\epsilon) (\partial_x^2 g_{\eta,\epsilon}^\delta)^2 dsdx \right)^{1/2} \\ &\leq \frac{C}{\eta^{1/2}} \left(\alpha \left(C + \frac{K(\delta)}{\eta} \right) \right)^{1/2}; \end{aligned}$$

so that for fixed η , α ,

$$\limsup_{\epsilon \rightarrow 0} |I_2| \leq C\eta \left(C + \frac{K(\delta)}{\eta} \right)^{1/2} \left(\frac{1}{L(\alpha)} + \left(\frac{\alpha}{\eta} \right)^{1/2} \right).$$

Finally, let us write

$$|I_3| \leq \int_{F_\delta} |\bar{F}(\tilde{B}_{\eta,\epsilon}^\delta - \tilde{B}) \partial_x g_{\eta,\epsilon}^\delta| dsdx + \int_{G_\delta} |\bar{F}(\tilde{B}_{\eta,\epsilon}^\delta - \tilde{B}) \partial_x g_{\eta,\epsilon}^\delta| dsdx.$$

We first deal with the integral on G_δ . On account of Lemma 4.A.3, for given δ and η the family $(|\partial_x g_{\eta,\epsilon}^\delta|)_{\epsilon > 0}$ is bounded in $L^2(Q_t)$. Therefore there exists a sequence $(\epsilon_k)_{k \geq 1}$ decreasing to 0, such that $|\partial_x g_{\eta,\epsilon_k}^\delta|$ converges weakly in $L^2(Q_t)$ to a function $h \geq 0$ when $k \rightarrow +\infty$. From now on, the convergence $\epsilon \rightarrow 0$ will always be understood along the sequence $(\epsilon_k)_{k \geq 1}$. According to Lemma 4.A.4, for all compact subset $D \subset Q_t$,

$$\int_D h dsdx = \lim_{\epsilon \rightarrow 0} \int_D |\partial_x g_{\eta,\epsilon}^\delta| dsdx \leq C$$

so that

$$\int_{Q_t} h dsdx \leq C.$$

Furthermore, on G_δ one has $\tilde{B}_{\eta,\epsilon}^\delta \rightarrow 0$ a.e. when $\epsilon \rightarrow 0$, and $\|\tilde{B}_{\eta,\epsilon}^\delta\|_\infty \leq K(\delta)$. Since $\bar{F} \in (L^1 \cap L^\infty)(Q_t) \subset L^2(Q_t)$, by dominated convergence one deduces that $\mathbf{1}_{G_\delta} |\bar{F}(\tilde{B}_{\eta,\epsilon}^\delta - \tilde{B})|$ converges strongly in $L^2(Q_t)$ to $\mathbf{1}_{G_\delta} |\bar{F}\tilde{B}|$. Finally,

$$\lim_{\epsilon \rightarrow 0} \int_{G_\delta} |\bar{F}(\tilde{B}_{\eta,\epsilon}^\delta - \tilde{B}) \partial_x g_{\eta,\epsilon}^\delta| dsdx = \int_{G_\delta} |\bar{F}\tilde{B}| h dsdx \leq C\delta.$$

We now turn to the integral on F_δ . By the Cauchy-Schwarz inequality,

$$\int_{F_\delta} |\bar{F}(\tilde{B}_{\eta,\epsilon}^\delta - \tilde{B})\partial_x g_{\eta,\epsilon}^\delta| ds dx \leq \left(\int_{F_\delta} |\bar{F}(\tilde{B}_{\eta,\epsilon}^\delta - \tilde{B})|^2 ds dx \right)^{1/2} \left(\int_{F_\delta} |\bar{F}(\partial_x g_{\eta,\epsilon}^\delta)^2| ds dx \right)^{1/2}.$$

Owing to Lemma 4.A.3 and the boundedness of \bar{F} ,

$$\int_{F_\delta} |\bar{F}(\partial_x g_{\eta,\epsilon}^\delta)^2| ds dx \leq C + \frac{K(\delta)}{\eta}$$

and by construction, $\tilde{B}_{\eta,\epsilon}^\delta \rightarrow \tilde{B}$ a.e. in F_δ when $\epsilon \rightarrow 0$, while $\|\tilde{B}_{\eta,\epsilon}^\delta\|_\infty \leq K(\delta)$. By dominated convergence, one concludes that for fixed η and δ , $\limsup_{\epsilon \rightarrow 0} |I_3| \leq C\delta$.

Combining the previous estimates, let us now write

$$\limsup_{\epsilon \rightarrow 0} |I| \leq C\eta \left(C + \frac{K(\delta)}{\eta} \right)^{1/2} \left(\frac{1}{L(\alpha)} + \left(\frac{\alpha}{\eta} \right)^{1/2} \right) + C\delta$$

and conclude by taking consecutively $\eta \rightarrow 0$, $\alpha \rightarrow 0$ and $\delta \rightarrow 0$. \square

It follows from Proposition 4.A.5 and (4.45) that

$$\int_{[0,T] \times \mathbb{R}} (F_s^2(x) - F_s^1(x)) f(s, x) ds dx = 0.$$

Since f is arbitrary, $F_s^1(x) = F_s^2(x)$ a.e. in Q_t , and this holds for all $t \in [0, T]$. As a consequence, for all $t \in [0, T]$, $F_t^1 = F_t^2$.

4.B Proof of Proposition 4.3.4

This appendix is dedicated to the computation of the time derivative of the flow $t \mapsto W_p^p(F_t, G_t)$ of the Wasserstein distance between two solutions $(F_t)_{t \geq 0}$ and $(G_t)_{t \geq 0}$ of the Cauchy problem (4.1) with respective initial conditions F_0 and G_0 and classical regularity. In Subsection 4.B.1, we gather some tail estimates on the solutions F_t and G_t as well as their space derivatives. In Subsection 4.B.2, we use a new expression of $W_p^p(F_t, G_t)$ in terms of F_t and G_t to prove Proposition 4.3.4.

4.B.1 Tail estimates

In this subsection we are concerned with the asymptotic behaviour of $F_t(x)$ and $\partial_x F_t(x)$ when $|x|$ is large.

Lemma 4.B.1. *Under the assumptions of Proposition 4.2.1, for all $t > 0$, there exists a finite constant $C(t) > 0$ such that the function $t \mapsto C(t)$ is nondecreasing and:*

$$\begin{aligned} \forall x \leq -C(t), \quad & \frac{1}{2} F_0(2x - C(t)) \leq F_t(x) \leq F_0 \left(\frac{x}{2} + C(t) \right) + \exp \left(-\frac{x^2}{C(t)} \right), \\ \forall x \geq C(t), \quad & \frac{1}{2} [1 - F_0(2x + C(t))] \leq 1 - F_t(x) \leq 1 - F_0 \left(\frac{x}{2} - C(t) \right) + \exp \left(-\frac{x^2}{C(t)} \right). \end{aligned}$$

Proof. Fix a finite $T > 0$.

We will use the process $(\bar{X}_t)_{t \in [0, T]}$ introduced in the proof of Lemma 4.2.10. Let $t \in [0, T]$ and

define $C_1(t) := t\|\bar{b}\|_\infty$. If $x \leq -C_1(t)$, then

$$\begin{aligned} F_t(x) &= \mathbb{P}\left(\bar{X}_0 + \int_0^t \bar{b}(r, \bar{X}_r)dr + \int_0^t \bar{\sigma}(r, \bar{X}_r)d\bar{W}_r \leq x\right) \\ &\geq \mathbb{P}\left(\bar{X}_0 + \int_0^t \bar{\sigma}(r, \bar{X}_r)d\bar{W}_r \leq x - t\|\bar{b}\|_\infty\right) \\ &\geq \mathbb{P}\left(\bar{X}_0 \leq 2(x - t\|\bar{b}\|_\infty), \quad \left|\int_0^t \bar{\sigma}(r, \bar{X}_r)d\bar{W}_r\right| \leq t\|\bar{b}\|_\infty - x\right) \\ &= \mathbb{P}\left(\left|\int_0^t \bar{\sigma}(r, \bar{X}_r)d\bar{W}_r\right| \leq t\|\bar{b}\|_\infty - x \quad \mid \quad \bar{X}_0 \leq 2x - C_2(t)\right) \mathbb{P}(\bar{X}_0 \leq 2x - C_2(t)), \end{aligned}$$

where $C_2(t) := 2C_1(t) = 2t\|\bar{b}\|_\infty$. By Chebyshev's inequality,

$$\begin{aligned} &\mathbb{P}\left(\left|\int_0^t \bar{\sigma}(r, \bar{X}_r)d\bar{W}_r\right| \leq t\|\bar{b}\|_\infty - x \quad \mid \quad \bar{X}_0 \leq 2x - C_2(t)\right) \\ &\geq 1 - \frac{\mathbb{E}\left(\left|\int_0^t \bar{\sigma}(r, \bar{X}_r)d\bar{W}_r\right|^2 \quad \mid \quad \bar{X}_0 \leq 2x - C_2(t)\right)}{(t\|\bar{b}\|_\infty - x)^2} \\ &\geq 1 - \frac{t\|\bar{\sigma}^2\|_\infty}{(t\|\bar{b}\|_\infty - x)^2}, \end{aligned}$$

and the right-hand side is larger than $1/2$ as soon as $x \leq -C_3(t) := -(2t\|\bar{\sigma}^2\|_\infty)^{1/2}$.

As far as the upper bound is concerned, for $x \leq -C_1(t)$,

$$\begin{aligned} F_t(x) &= \mathbb{P}\left(\bar{X}_0 + \int_0^t \bar{b}(r, \bar{X}_r)dr + \int_0^t \bar{\sigma}(r, \bar{X}_r)d\bar{W}_r \leq x\right) \\ &\leq \mathbb{P}\left(\bar{X}_0 + \int_0^t \bar{\sigma}(r, \bar{X}_r)d\bar{W}_r \leq x + t\|\bar{b}\|_\infty\right) \\ &= \int_{\mathbb{R}} \mathbb{P}\left(\int_0^t \bar{\sigma}(r, \bar{X}_r)d\bar{W}_r \leq x - y + t\|\bar{b}\|_\infty \quad \mid \quad \bar{X}_0 = y\right) m(dy). \end{aligned}$$

Let us fix $x \leq -C_1(t)$. For $x_0 \in \mathbb{R}$, let us split the integral in the right-hand side above in two parts, integrating respectively on $(-\infty, x_0]$ and $(x_0, +\infty)$. Then the first part can be bounded by $F_0(x_0)$, whereas for the second part the exponential Markov inequality yields, for all $\lambda > 0$,

$$\mathbb{P}\left(\int_0^t \bar{\sigma}(r, \bar{X}_r)d\bar{W}_r \leq x - y + t\|\bar{b}\|_\infty \quad \mid \quad \bar{X}_0 = y\right) \leq \exp\left(\lambda(x - y + t\|\bar{b}\|_\infty) + t\lambda^2 \frac{\|\bar{\sigma}^2\|_\infty}{2}\right);$$

and finally, $F_t(x) \leq F_0(x_0) + \exp(\lambda(x - x_0 + t\|\bar{b}\|_\infty) + t\lambda^2\|\bar{\sigma}^2\|_\infty/2)$. As soon as $x_0 > x + t\|\bar{b}\|_\infty$, optimizing this expression in $\lambda > 0$ yields

$$F_t(x) \leq F_0(x_0) + \exp\left(-\frac{(x - x_0 + t\|\bar{b}\|_\infty)^2}{2t\|\bar{\sigma}^2\|_\infty}\right).$$

We now choose $x_0 = (x + t\|\bar{b}\|_\infty)/2$, then $x_0 < 0$ and $F_0(x_0) = F_0((x + t\|\bar{b}\|_\infty)/2) = F_0(x/2 + C_4(t))$ with $C_4(t) := t\|\bar{b}\|_\infty/2$. Moreover, for $x \leq -C_2(t) = -2t\|\bar{b}\|_\infty$,

$$\exp\left(-\frac{(x - x_0 + t\|\bar{b}\|_\infty)^2}{2t\|\bar{\sigma}^2\|_\infty}\right) = \exp\left(-x^2 \frac{(1 + t\|\bar{b}\|_\infty/x)^2}{8t\|\bar{\sigma}^2\|_\infty}\right) \leq \exp\left(-\frac{x^2}{C_5(t)}\right),$$

where $C_5(t) := 32t\|\bar{\sigma}^2\|_\infty$. We get the first part of the lemma by taking $C(t)$ as the maximum of $C_1(t), \dots, C_5(t)$, and the second part follows similarly. \square

Assuming the classical regularity of $(F_t)_{t \geq 0}$, we now derive some estimates on the probability density $\partial_x F_t$ from the celebrated Aronson inequalities on the fundamental solution of a parabolic equation with divergence form operator [6]. Due to the possible dispersion of the initial condition, our upper bound contains an extra tail term in addition to the classical Gaussian term.

Lemma 4.B.2. *Under the assumptions of Lemma 4.3.3, for all $0 < t_1 < t_2$, there exists a positive constant $K > 0$, depending on t_1 and t_2 , such that for all $(t, x) \in (t_1, t_2] \times \mathbb{R}$,*

$$\frac{1}{K(t-t_1)^{1/2}} \exp\left(-\frac{Kx^2}{t-t_1}\right) \leq \partial_x F_t(x) \leq \frac{K}{(t-t_1)^{1/2}} \left(\exp\left(-\frac{x^2}{K(t-t_1)}\right) + \text{tl}\left(F_{t_1}, \frac{x}{2}\right) \right). \quad (4.50)$$

Proof. The assumptions of Lemma 4.3.3 together with Corollary 4.2.13 ensure that the nonlinear martingale problem of Subsection 4.2.2 has a unique weak solution P . We denote by X the associated nonlinear diffusion process. Let $\Gamma(s, y; t, dx) = \mathbb{P}(X_t \in dx | X_s = y)$ be the transition probability of X . The generator

$$Lf := \frac{1}{2}a(F_t(x))\partial_x^2 f + b(F_t(x))\partial_x f$$

is uniformly elliptic, and by the regularity assumptions on A , B and $(F_t)_{t \geq 0}$, it rewrites in the divergence form

$$Lf = \frac{1}{2}\partial_x(a(F_t(x))\partial_x f) - \left(\frac{1}{2}a'(F_t(x))\partial_x F_t(x) - b(F_t(x))\right)\partial_x f.$$

Let $0 < t_1 < t_2$. The assumption of boundedness of $\partial_x F_t(x)$ on $[t_1, t_2] \times \mathbb{R}$ ensures that the coefficients of the latter form are bounded. Thus, owing to [6], $\Gamma(s, y; t, dx)$ admits a density $g(s, y; t, x)$ and there exist some positive constants γ_i, κ_i , $i \in \{1, 2\}$, depending on t_1 and t_2 , such that for all $t \in (t_1, t_2]$,

$$\frac{\kappa_1}{(t-t_1)^{1/2}} \exp\left(-\frac{(x-y)^2}{\gamma_1(t-t_1)}\right) \leq g(t_1, y; t, x) \leq \frac{\kappa_2}{(t-t_1)^{1/2}} \exp\left(-\frac{(x-y)^2}{\gamma_2(t-t_1)}\right).$$

Hence, $p_t^1(x) \leq \partial_x F_t(x) \leq p_t^2(x)$, where

$$p_t^i(x) := \frac{\kappa_i}{(t-t_1)^{1/2}} \int_{\mathbb{R}} \exp\left(-\frac{(x-y)^2}{\gamma_i(t-t_1)}\right) P_{t_1}(dy).$$

For all $x \geq 0$,

$$\int_{-\infty}^{x/2} \exp\left(-\frac{(x-y)^2}{\gamma_2(t-t_1)}\right) P_{t_1}(dy) \leq \exp\left(-\frac{x^2}{4\gamma_2(t-t_1)}\right)$$

while

$$\int_{x/2}^{+\infty} \exp\left(-\frac{(x-y)^2}{\gamma_2(t-t_1)}\right) P_{t_1}(dy) \leq 1 - F_{t_1}(x/2).$$

Likewise, for $x \leq 0$,

$$\int_{x/2}^{+\infty} \exp\left(-\frac{(x-y)^2}{\gamma_2(t-t_1)}\right) P_{t_1}(dy) \leq \exp\left(-\frac{x^2}{4\gamma_2(t-t_1)}\right)$$

while

$$\int_{-\infty}^{x/2} \exp\left(-\frac{(x-y)^2}{\gamma_2(t-t_1)}\right) P_{t_1}(dy) \leq F_{t_1}(x/2),$$

so that the upper bound of (4.50) holds for any $K \geq \kappa_2 \vee (4\gamma_2)$.

As far as the lower bound is concerned, there exist $x_- < 0 < x_+$ such that $F_{t_1}(x_+) - F_{t_1}(x_-) \geq 1/2$. Then for all $x \in \mathbb{R}$,

$$\begin{aligned} p_t^1(x) &\geq \frac{\kappa_1}{(t-t_1)^{1/2}} \int_{x_-}^{x_+} \exp\left(-\frac{(x-y)^2}{\gamma_1(t-t_1)}\right) P_{t_1}(dy) \\ &\geq \frac{\kappa_1}{2(t-t_1)^{1/2}} \exp\left(-\frac{((x_+ \vee -x_-) + |x|)^2}{\gamma_1(t-t_1)}\right). \end{aligned}$$

Now there exists $K > 0$ large enough, depending on κ_1 , γ_1 and $x_+ \vee -x_-$, such that for all $x \in \mathbb{R}$,

$$\frac{\kappa_1}{2} \exp\left(-\frac{((x_+ \vee -x_-) + |x|)^2}{\gamma_1(t-t_1)}\right) \geq \frac{1}{K} \exp\left(-\frac{Kx^2}{t-t_1}\right),$$

which results in the lower bound of (4.50). \square

4.B.2 Proof of Proposition 4.3.4

We first give a general formula for the Wasserstein distance $W_p(F, G)$ between two cumulative distribution functions F and G .

Lemma 4.B.3. *Let F and G be two cumulative distribution functions on \mathbb{R} . Then, for all $p > 1$,*

$$W_p^p(F, G) = p(p-1) \int_{\mathbb{R}^2} \mathbb{1}_{\{x < y\}} ([G(x) - F(y)]^+ + [F(x) - G(y)]^+) (y-x)^{p-2} dx dy. \quad (4.51)$$

Proof. Let us split the right-hand side of (4.51) into two symmetric integrals in F and G . Thanks to the Fubini-Tonelli theorem, the first integral writes:

$$\begin{aligned} &\int_{\mathbb{R}^2} \mathbb{1}_{\{x < y\}} [G(x) - F(y)]^+ p(p-1)(y-x)^{p-2} dx dy \\ &= \int_{\mathbb{R}^2} \mathbb{1}_{\{x < y; G(x) \geq F(y)\}} \left(\int_0^1 \mathbb{1}_{\{F(y) < u \leq G(x)\}} du \right) p(p-1)(y-x)^{p-2} dx dy \\ &= \int_0^1 \int_{\mathbb{R}^2} \mathbb{1}_{\{x < y; F(y) < u \leq G(x)\}} p(p-1)(y-x)^{p-2} dx dy du. \end{aligned}$$

By the definition of the pseudo-inverse functions F^{-1} and G^{-1} , note that for all $x, y \in \mathbb{R}$ and $u \in (0, 1)$, $F(y) < u$ if and only if $y < F^{-1}(u)$ and $G(x) \geq u$ if and only if $x \geq G^{-1}(u)$. Thus, the right-hand side above rewrites

$$\begin{aligned} &\int_0^1 \int_{\mathbb{R}^2} \mathbb{1}_{\{G^{-1}(u) \leq x < y < F^{-1}(u)\}} p(p-1)(y-x)^{p-2} dx dy du \\ &= \int_0^1 \mathbb{1}_{\{G^{-1}(u) < F^{-1}(u)\}} \int_{x=G^{-1}(u)}^{F^{-1}(u)} \int_{y=x}^{F^{-1}(u)} p(p-1)(y-x)^{p-2} dy dx du \\ &= \int_0^1 \mathbb{1}_{\{G^{-1}(u) < F^{-1}(u)\}} (F^{-1}(u) - G^{-1}(u))^p du, \end{aligned}$$

and we conclude using the symmetry in F and G of the two integrals in the right-hand side of (4.51). \square

We are now ready to complete the proof of Proposition 4.3.4.

Proof of Proposition 4.3.4. For all $t > 0$, (4.51) yields

$$W_p^p(F_t, G_t) = p(p-1)(I(F_t, G_t) + I(G_t, F_t)), \quad (4.52)$$

where we define $I(F_t, G_t) := \int_{\mathbb{R}^2} \mathbb{1}_{\{x < y\}} [G_t(x) - F_t(y)]^+ (y-x)^{p-2} dx dy$. The assumption that $W_p(F_0, G_0) < +\infty$ combined with Proposition 4.3.1 ensures that both $I(F_t, G_t)$ and $I(G_t, F_t)$ are finite.

For all $M \geq 0$, let us denote

$$I_M(F_t, G_t) := \int_{\mathbb{R}^2} \mathbf{1}_{\{-M \leq x < y \leq M\}} [G_t(x) - F_t(y)]^+ (y - x)^{p-2} dx dy,$$

then by the monotone convergence theorem, $\lim_{M \rightarrow +\infty} I_M(F_t, G_t) = I(F_t, G_t) < +\infty$. Owing to the assumption of classical regularity on $(F_t)_{t \geq 0}$ and $(G_t)_{t \geq 0}$, the function $t \mapsto I_M(F_t, G_t)$ is C^1 on $(0, +\infty)$ and for all $t > 0$,

$$\begin{aligned} \frac{d}{dt} I_M(F_t, G_t) &= \int_{\mathbb{R}^2} \mathbf{1}_{\{-M \leq x < y \leq M\}} \mathbf{1}_{\{G_t(x) \geq F_t(y)\}} (\partial_t G_t(x) - \partial_t F_t(y)) (y - x)^{p-2} dx dy \\ &= \int_{\mathbb{R}^2} \mathbf{1}_{\{-M \leq x < y \leq M; G_t(x) \geq F_t(y)\}} \partial_x \left(\frac{1}{2} a(G_t(x)) \partial_x G_t(x) - B(G_t(x)) \right) (y - x)^{p-2} dx dy \\ &\quad - \int_{\mathbb{R}^2} \mathbf{1}_{\{-M \leq x < y \leq M; G_t(x) \geq F_t(y)\}} \partial_x \left(\frac{1}{2} a(F_t(y)) \partial_x F_t(y) - B(F_t(y)) \right) (y - x)^{p-2} dx dy. \end{aligned} \tag{4.53}$$

Let us define $\varphi_M^+(x) := M \wedge F_t^{-1}(G_t(x))$ and $\varphi_M^-(x) := (-M) \vee G_t^{-1}(F_t(x))$. Then the first integral in the right-hand side of (4.53) rewrites

$$\int_{y=-M}^M \mathbf{1}_{\{F_t(y) \leq G_t(y)\}} \int_{x=\varphi_M^-(y)}^y (y - x)^{p-2} \partial_x \left(\frac{1}{2} a(G_t(x)) \partial_x G_t(x) - B(G_t(x)) \right) dx dy$$

and integrating by parts, we get

$$\begin{aligned} &\int_{x=\varphi_M^-(y)}^y (y - x)^{p-2} \partial_x \left(\frac{1}{2} a(G_t(x)) \partial_x G_t(x) - B(G_t(x)) \right) dx \\ &= -(y - \varphi_M^-(y))^{p-2} \left(\frac{1}{2} a(G_t(-M) \vee F_t(y)) \partial_x G_t(\varphi_M^-(y)) - B(G_t(-M) \vee F_t(y)) \right) \\ &\quad + \int_{x=\varphi_M^-(y)}^y (p-2)(y-x)^{p-3} \left(\frac{1}{2} a(G_t(x)) \partial_x G_t(x) - B(G_t(x)) \right) dx. \end{aligned}$$

Now

$$\begin{aligned} &\int_{y=-M}^M \mathbf{1}_{\{F_t(y) \leq G_t(y)\}} \int_{x=\varphi_M^-(y)}^y (p-2)(y-x)^{p-3} \left(\frac{1}{2} a(G_t(x)) \partial_x G_t(x) - B(G_t(x)) \right) dx dy \\ &= \int_{x=-M}^M \mathbf{1}_{\{F_t(x) \leq G_t(x)\}} \left(\frac{1}{2} a(G_t(x)) \partial_x G_t(x) - B(G_t(x)) \right) \int_{y=x}^{\varphi_M^+(x)} (p-2)(y-x)^{p-3} dy dx \\ &= \int_{x=-M}^M \mathbf{1}_{\{F_t(x) \leq G_t(x)\}} \left(\frac{1}{2} a(G_t(x)) \partial_x G_t(x) - B(G_t(x)) \right) (\varphi_M^+(x) - x)^{p-2} dy dx, \end{aligned}$$

so that the first integral in the right-hand side of (4.53) finally writes

$$\begin{aligned} &\int_{-M}^M \mathbf{1}_{\{F_t(x) \leq G_t(x)\}} \left\{ (\varphi_M^+(x) - x)^{p-2} \left(\frac{1}{2} a(G_t(x)) \partial_x G_t(x) - B(G_t(x)) \right) \right. \\ &\quad \left. - (x - \varphi_M^-(x))^{p-2} \left(\frac{1}{2} a(G_t(-M) \vee F_t(x)) \partial_x G_t(\varphi_M^-(x)) - B(G_t(-M) \vee F_t(x)) \right) \right\} dx \end{aligned}$$

whereas the second integral similarly writes

$$\begin{aligned} &\int_{-M}^M \mathbf{1}_{\{F_t(x) \leq G_t(x)\}} \left\{ (\varphi_M^+(x) - x)^{p-2} \left(\frac{1}{2} a(F_t(M) \wedge G_t(x)) \partial_x F_t(\varphi_M^+(x)) - B(F_t(M) \wedge G_t(x)) \right) \right. \\ &\quad \left. - (x - \varphi_M^-(x))^{p-2} \left(\frac{1}{2} a(F_t(x)) \partial_x F_t(x) - B(F_t(x)) \right) \right\} dx. \end{aligned}$$

Hence, we deduce that for all $0 < t_1 \leq t_2$,

$$I_M(F_{t_2}, G_{t_2}) - I_M(F_{t_1}, G_{t_1}) = \int_{t_1}^{t_2} \frac{d}{dt} I_M(F_t, G_t) dt = J_M^1 + J_M^2 + J_M^3,$$

where

$$\begin{aligned}
J_M^1 &:= \int_{t_1}^{t_2} \int_{-M}^M \mathbb{1}_{\{F_t(x) \leq G_t(x)\}} \{(\varphi_M^+(x) - x)^{p-2} [B(F_t(M) \wedge G_t(x)) - B(G_t(x))] \\
&\quad + (x - \varphi_M^-(x))^{p-2} [B(G_t(-M) \vee F_t(x)) - B(F_t(x))]\} dx dt; \\
J_M^2 &:= \frac{1}{2} \int_{t_1}^{t_2} \int_{-M}^M \mathbb{1}_{\{F_t(x) \leq G_t(x)\}} \{(\varphi_M^+(x) - x)^{p-2} a(G_t(x)) \partial_x G_t(x) \\
&\quad + (x - \varphi_M^-(x))^{p-2} a(F_t(x)) \partial_x F_t(x)\} dx dt; \\
J_M^3 &:= -\frac{1}{2} \int_{t_1}^{t_2} \int_{-M}^M \mathbb{1}_{\{F_t(x) \leq G_t(x)\}} \{(\varphi_M^+(x) - x)^{p-2} a(F_t(M) \wedge G_t(x)) \partial_x F_t(\varphi_M^+(x)) \\
&\quad + (x - \varphi_M^-(x))^{p-2} a(G_t(-M) \vee F_t(x)) \partial_x G_t(\varphi_M^-(x))\} dx dt.
\end{aligned}$$

Integral term J_M^1 . Since B is C^1 on $[0, 1]$,

$$\begin{aligned}
|J_M^1| &\leq \int_{t_1}^{t_2} \int_{-M}^M \mathbb{1}_{\{F_t(x) \leq G_t(x)\}} \|b\|_\infty \{(\varphi_M^+(x) - x)^{p-2} |F_t(M) \wedge G_t(x) - G_t(x)| \\
&\quad + (x - \varphi_M^-(x))^{p-2} |G_t(-M) \vee F_t(x) - F_t(x)|\} dx dt \\
&\leq \int_{t_1}^{t_2} \int_{-M}^M \|b\|_\infty (2M)^{p-2} \{[G_t(x) - F_t(M)]^+ + [G_t(-M) - F_t(x)]^+\} dx dt \\
&\leq \int_{t_1}^{t_2} \|b\|_\infty (2M)^{p-1} \{\text{tl}(F_t, M) + \text{tl}(G_t, -M)\} dt.
\end{aligned}$$

By Lemma 4.B.1, for all $M \geq 2C(t_2)$, for all $t \in [t_1, t_2]$,

$$\begin{aligned}
\text{tl}(F_t, M) &\leq \text{tl}(F_0, M/2 - C(t_2)) + \exp(-M^2/C(t_2)), \\
\text{tl}(G_t, -M) &\leq \text{tl}(G_0, -M/2 + C(t_2)) + \exp(-M^2/C(t_2)),
\end{aligned}$$

so that $|J_M^1| \rightarrow 0$ when $M \rightarrow +\infty$ due to the tail assumption on F_0 and G_0 .

Integral term J_M^2 . By the monotone convergence theorem,

$$\begin{aligned}
\lim_{M \rightarrow +\infty} J_M^2 &= \frac{1}{2} \int_{t_1}^{t_2} \int_{\mathbb{R}} \mathbb{1}_{\{F_t(x) \leq G_t(x)\}} \{(F_t^{-1}(G_t(x)) - x)^{p-2} a(G_t(x)) \partial_x G_t(x) \\
&\quad + (x - G_t^{-1}(F_t(x)))^{p-2} a(F_t(x)) \partial_x F_t(x)\} dx dt,
\end{aligned}$$

and the limit is finite as

$$\begin{aligned}
&\int_{t_1}^{t_2} \int_{\mathbb{R}} \mathbb{1}_{\{F_t(x) \leq G_t(x)\}} (F_t^{-1}(G_t(x)) - x)^{p-2} a(G_t(x)) \partial_x G_t(x) dx dt \\
&\leq \|a\|_\infty \int_{t_1}^{t_2} \int_{\mathbb{R}} |F_t^{-1}(G_t(x)) - x|^{p-2} \partial_x G_t(x) dx dt \\
&= \|a\|_\infty \int_{t_1}^{t_2} W_{p-2}^{p-2}(F_t, G_t) dt \\
&\leq \|a\|_\infty (t_2 - t_1) W_{p-2}^{p-2}(F_0, G_0) < +\infty,
\end{aligned}$$

due to Proposition 4.3.1 (we take the convention that $W_0^0(F_t, G_t) = 1$).

Integral term J_M^3 . Note that

$$\begin{aligned}
& \int_{t_1}^{t_2} \int_{-M}^M \mathbb{1}_{\{F_t(x) \leq G_t(x)\}} (\varphi_M^+(x) - x)^{p-2} a(F_t(M) \wedge G_t(x)) \partial_x F_t(\varphi_M^+(x)) dx dt \\
&= \int_{t_1}^{t_2} \int_{-M}^M \mathbb{1}_{\{F_t(x) \leq G_t(x); F_t(M) \leq G_t(x)\}} (M - x)^{p-2} a(F_t(M)) \partial_x F_t(M) dx dt + \\
& \int_{t_1}^{t_2} \int_{-M}^M \mathbb{1}_{\{F_t(x) \leq G_t(x); F_t(M) > G_t(x)\}} (F_t^{-1}(G_t(x)) - x)^{p-2} a(G_t(x)) \partial_x F_t(F_t^{-1}(G_t(x))) dx dt.
\end{aligned} \tag{4.54}$$

According to Lemmas 4.B.1 and 4.B.2, letting $C := C(t_1/2)$, for $M \geq 4C$, the first integral in the right-hand side of (4.54) is bounded by

$$\begin{aligned}
& \|a\|_\infty \int_{t_1}^{t_2} (2M)^{p-1} \partial_x F_t(M) dt \\
& \leq \|a\|_\infty (2M)^{p-1} \int_{t_1}^{t_2} \frac{K}{(t - t_1/2)^{1/2}} \left(\exp\left(-\frac{M^2}{K(t - t_1/2)}\right) + \text{tl}\left(F_{t_1/2}, \frac{M}{2}\right) \right) dt \\
& \leq K \|a\|_\infty (2M)^{p-1} \frac{(t_2 - t_1)}{(t_1/2)^{1/2}} \left(\exp\left(-\frac{M^2}{K(t_2 - t_1/2)}\right) + \text{tl}\left(F_0, \frac{M}{4} - C\right) + \exp\left(-\frac{M^2}{C}\right) \right),
\end{aligned}$$

and the right-hand side of the last inequality vanishes when $M \rightarrow +\infty$, whereas the second integral in the right-hand side of (4.54) converges monotonically to

$$\int_{t_1}^{t_2} \int_{\mathbb{R}} \mathbb{1}_{\{F_t(x) \leq G_t(x)\}} (F_t^{-1}(G_t(x)) - x)^{p-2} a(G_t(x)) \partial_x F_t(F_t^{-1}(G_t(x))) dx dt.$$

The second term in J_M^3 is similar.

Conclusion. Taking the limit $M \rightarrow +\infty$ in the equality $I_M(F_{t_2}, G_{t_2}) - I_M(F_{t_1}, G_{t_1}) - (J_M^1 + J_M^2) = J_M^3$ now yields

$$\begin{aligned}
& I(F_{t_2}, G_{t_2}) - I(F_{t_1}, G_{t_1}) - \frac{1}{2} \int_{t_1}^{t_2} \int_{\mathbb{R}} \mathbb{1}_{\{F_t(x) \leq G_t(x)\}} \{ (F_t^{-1}(G_t(x)) - x)^{p-2} a(G_t(x)) \partial_x G_t(x) \\
& + (x - G_t^{-1}(F_t(x)))^{p-2} a(F_t(x)) \partial_x F_t(x) \} dx dt \\
& = -\frac{1}{2} \left(\int_{t_1}^{t_2} \int_{\mathbb{R}} \mathbb{1}_{\{F_t(x) \leq G_t(x)\}} (F_t^{-1}(G_t(x)) - x)^{p-2} a(G_t(x)) \partial_x F_t(F_t^{-1}(G_t(x))) dx dt \right. \\
& \quad \left. + \int_{t_1}^{t_2} \int_{\mathbb{R}} \mathbb{1}_{\{F_t(x) \leq G_t(x)\}} (x - G_t^{-1}(F_t(x)))^{p-2} a(F_t(x)) \partial_x G_t(G_t^{-1}(F_t(x))) dx dt \right).
\end{aligned}$$

The left-hand side of the equality above is finite and the integrands in both integrals of the right-hand side are nonnegative. Hence, all the integrals involved are absolutely convergent, and we deduce

$$\begin{aligned}
& I(F_{t_2}, G_{t_2}) - I(F_{t_1}, G_{t_1}) \\
& = \frac{1}{2} \int_{t_1}^{t_2} \int_{\mathbb{R}} \mathbb{1}_{\{F_t(x) \leq G_t(x)\}} \{ (F_t^{-1}(G_t(x)) - x)^{p-2} (a(G_t(x)) (\partial_x G_t(x) - \partial_x F_t(F_t^{-1}(G_t(x)))) \\
& \quad + (x - G_t^{-1}(F_t(x)))^{p-2} (a(F_t(x)) (\partial_x F_t(x) - \partial_x G_t(G_t^{-1}(F_t(x)))) \} dx dt.
\end{aligned}$$

By symmetry and using (4.52), we now conclude

$$\begin{aligned}
& W_p^p(F_{t_2}, G_{t_2}) - W_p^p(F_{t_1}, G_{t_1}) \\
&= \frac{p(p-1)}{2} \int_{t_1}^{t_2} \int_{\mathbb{R}} \{ |F_t^{-1}(G_t(x)) - x|^{p-2} (a(G_t(x))(\partial_x G_t(x) - \partial_x F_t(F_t^{-1}(G_t(x)))) \\
&\quad + |x - G_t^{-1}(F_t(x))|^{p-2} (a(F_t(x))(\partial_x F_t(x) - \partial_x G_t(G_t^{-1}(F_t(x)))) \} dx dt \\
&= \frac{p(p-1)}{2} \int_{t_1}^{t_2} \left\{ \int_0^1 |F_t^{-1}(u) - G_t^{-1}(u)|^{p-2} a(u) \left(\frac{1}{\partial_u G_t^{-1}(u)} - \frac{1}{\partial_u F_t^{-1}(u)} \right) \partial_u G_t^{-1}(u) du \right. \\
&\quad \left. + \int_0^1 |F_t^{-1}(u) - G_t^{-1}(u)|^{p-2} a(u) \left(\frac{1}{\partial_u F_t^{-1}(u)} - \frac{1}{\partial_u G_t^{-1}(u)} \right) \partial_u F_t^{-1}(u) du \right\} dt \\
&= -\frac{p(p-1)}{2} \int_{t_1}^{t_2} \int_0^1 a(u) |F_t^{-1}(u) - G_t^{-1}(u)|^{p-2} \frac{(\partial_u F_t^{-1}(u) - \partial_u G_t^{-1}(u))^2}{\partial_u F_t^{-1}(u) \partial_u G_t^{-1}(u)} du dt;
\end{aligned}$$

which completes the proof. \square

Chapitre 5

Grands systèmes stationnaires de particules interagissant à travers leur rang

Les résultats de ce chapitre ont été repris et étendus dans l'article [123].

5.1 Introduction

5.1.1 Nonlinear process

Let m be a probability distribution on the real line, $b : [0, 1] \rightarrow \mathbb{R}$ be a continuous function and $\sigma^2 > 0$. This chapter is concerned with the long time behaviour of the viscous scalar conservation law

$$\begin{cases} \partial_t F_t = \frac{\sigma^2}{2} \partial_x^2 F_t - \partial_x (B(F_t)), \\ F_0 = H * m, \end{cases} \quad (5.1)$$

where

$$\forall u \in [0, 1], \quad B(u) := \int_{v=0}^1 b(v) dv,$$

and $H * \cdot$ refers to the convolution with the Heaviside function, so that $H * m$ is the cumulative distribution function of m . Following [83, 89, 91], the equation (5.1) possesses a unique weak solution $(F_t)_{t \geq 0}$, which describes the flow of marginal cumulative distribution functions of the nonlinear diffusion process

$$\begin{cases} dX_t = b(F_t(X_t)) dt + \sigma dW_t, \\ F_t \text{ is the CDF of } X_t, \end{cases}$$

where X_0 is distributed according to m and is independent of the standard Brownian motion $(W_t)_{t \geq 0}$ in \mathbb{R} . Let P refer to the law of the process $(X_t)_{t \geq 0}$ in the space of continuous sample-paths $C([0, +\infty), \mathbb{R})$, then for all $t > 0$, the marginal distribution P_t of X_t possesses a density p_t with respect to the Lebesgue measure on \mathbb{R} .

The two following conditions are natural in order to ensure ergodicity: first, taking the expectation of X_t yields, for all $t \geq 0$,

$$\mathbb{E}[X_t] = \mathbb{E}[X_0] + \int_{s=0}^t \mathbb{E}[b(F_s(X_s))] ds = \mathbb{E}[X_0] + tB(1),$$

therefore one has to assume that $B(1) = 0$ so as to prevent X_t from drifting away to infinity. Second, since the cumulative distribution function F_t is nondecreasing, the flux function B should be (strictly) concave so as to provide confinement. These conditions are summed up in the following Assumption (E):

(E) $B(1) = 0$ and the function b is decreasing on $[0, 1]$.

Under Assumption (E), the set of stationary distributions for the nonlinear process $(X_t)_{t \geq 0}$ is explicitly described in Proposition 5.2.2 below. In particular, there is a unique centered stationary distribution, and it possesses a density p_∞ with respect to the Lebesgue measure on \mathbb{R} .

5.1.2 Rank-based particle system

Following the propagation of chaos results of [83, 89, 91], P is the limit, in probability, of the empirical distribution

$$\mu^n := \frac{1}{n} \sum_{i=1}^n \delta_{(X_t^{i,n})_{t \geq 0}}$$

of the system of *rank-based interacting particles* defined by

$$\forall i \in \{1, \dots, n\}, \quad dX_t^{i,n} = b \left(\frac{1}{n} \sum_{j=1}^n \mathbb{1}_{\{X_t^{j,n} \leq X_t^{i,n}\}} \right) dt + \sigma dW_t^i, \quad (5.2)$$

where $X_0^{1,n}, \dots, X_0^{n,n}$ are i.i.d. according to m and independent of the standard Brownian motion $(W_t^1, \dots, W_t^n)_{t \geq 0}$ in \mathbb{R}^n .

For all $j \in \{1, \dots, n\}$, it shall actually be convenient to replace the derivative $b(j/n) = B'(j/n)$ appearing in (5.2) with its finite difference approximation

$$b_n(j) := n \left(B \left(\frac{j}{n} \right) - B \left(\frac{j-1}{n} \right) \right),$$

which does not affect the asymptotic behaviour of the system when the number of particles is large. We still denote by $(X_t^{1,n}, \dots, X_t^{n,n})_{t \geq 0}$ the resulting system of particles.

As was remarked by Jourdain and Malrieu [89], this particle system cannot converge to an equilibrium, since its projection along the direction $(1, \dots, 1)$ is a drifted Brownian motion. For all $t \geq 0$, let us denote by $(Z_t^{1,n}, \dots, Z_t^{n,n})$ the orthogonal projection of the vector $(X_t^{1,n}, \dots, X_t^{n,n})$ onto the hyperplane

$$M_n := \{(z_1, \dots, z_n) \in \mathbb{R}^n : z_1 + \dots + z_n = 0\},$$

which is orthogonal to the singular direction $(1, \dots, 1)$.

The *projected particle system* $(Z_t^{1,n}, \dots, Z_t^{n,n})_{t \geq 0}$ is a diffusion process in the hyperplane M_n , which writes

$$dZ_t^{i,n} = \left(b_n \left(\sum_{j=1}^n \mathbb{1}_{\{Z_t^{j,n} \leq Z_t^{i,n}\}} \right) - \frac{1}{n} \sum_{j=1}^n b_n(j) \right) dt + \sigma \frac{n-1}{n} dW_t^i - \frac{\sigma}{n} \sum_{j \neq i} dW_t^j. \quad (5.3)$$

Besides, by exchangeability, for all $t \geq 0$,

$$\mathbb{E}[Z_t^{1,n}] = \frac{1}{n} \mathbb{E}[Z_t^{1,n} + \dots + Z_t^{n,n}] = 0.$$

Under Assumption (E),

$$\sum_{j=1}^n b_n(j) = n(B(1) - B(0)) = 0 \quad (5.4)$$

and the projected particle system has a unique stationary distribution described in Proposition 5.2.4 below. This stationary distribution possesses a density p_∞^n with respect to the surface measure on M_n ; see Remark 5.2.5 for details on the surface measure of M_n .

5.1.3 Main results

Before stating the main result of this chapter, let us first recall the definition of the Wasserstein distance on \mathbb{R} .

Definition 5.1.1. Let $r \geq 1$ and let μ and ν be two probability distributions on \mathbb{R} . The Wasserstein distance of order r between μ and ν is defined by

$$W_r(\mu, \nu) := \inf_{(X, Y) \in \Pi(\mu, \nu)} (\mathbb{E}[|X - Y|^r])^{1/r},$$

where $\Pi(\mu, \nu)$ refers to the set of random couples (X, Y) with respective marginal distributions μ and ν .

Jourdain and Malrieu [89, Proposition 2.11] proved that under Assumption (E) and as soon as b is Lipschitz continuous and m has a finite second order moment, then for all $t \geq 0$, there exists $K(t) \in (0, +\infty)$ such that the marginal distribution $p_t^{1,n}$ of $Z_t^{1,n}$ (or $Z_t^{i,n}$ for any $i \in \{1, \dots, n\}$ by exchangeability) satisfies

$$W_2(p_t^{1,n}, p_t) \leq \frac{K(t)}{\sqrt{n}}.$$

Since the result above is not uniform in time, one cannot derive a convergence result for the marginal density $p_\infty^{1,n}$ of the first coordinate under p_∞^n towards the stationary density p_∞ of the nonlinear process. This is the purpose of our following theorem.

Theorem 5.1.2. Under Assumption (E), let $p_\infty^{1,n}$ refer to the marginal density of the first coordinate under p_∞^n . Then, for all $r \geq 1$,

$$\lim_{n \rightarrow +\infty} W_r(p_\infty^{1,n}, p_\infty) = 0.$$

Theorem 5.1.2 follows from the convergence of the Laplace transform of $p_\infty^{1,n}$ stated in Theorem 5.1.3.

Theorem 5.1.3. Let Assumption (E) hold.

Then $b(0) > 0 > b(1)$, and for all $t \in (-2b(0)/\sigma^2, -2b(1)/\sigma^2)$,

(i) the Laplace transform

$$L_\infty(t) := \int_{x \in \mathbb{R}} \exp(tx) p_\infty(x) dx$$

of p_∞ is finite,

(ii) for n large enough, the Laplace transform

$$L_\infty^n(t) := \int_{x \in \mathbb{R}} \exp(tx) p_\infty^{1,n}(x) dx$$

of $p_\infty^{1,n}$ is finite,

(iii) $\lim_{n \rightarrow +\infty} L_\infty^n(t) = L_\infty(t)$.

Let us note that $b(0) > 0 > b(1)$ is a straightforward consequence of Assumption (E).

The outline of the chapter is as follows. The stationary distributions p_∞ and p_∞^n are described in Section 5.2. The Laplace transforms of p_∞ and $p_\infty^{1,n}$ are computed, and the proof of Theorem 5.1.3 is completed, in Section 5.3. We finally explain how to derive Theorem 5.1.2 in Section 5.4.

5.2 Stationary distributions

5.2.1 Nonlinear process

We first describe the set of stationary distributions of the nonlinear process. This heavily relies on the function Φ introduced in Lemma 5.2.1 below.

Lemma 5.2.1. *Under Assumption (E),*

- (i) *for all $u \in (0, 1)$, $B(u) > 0$,*
- (ii) *the function $\Phi : (0, 1) \rightarrow \mathbb{R}$ defined by*

$$\forall u \in (0, 1), \quad \Phi(u) := \int_{v=0}^u \frac{v\sigma^2}{2B(v)} dv - \int_{v=u}^1 \frac{(1-v)\sigma^2}{2B(v)} dv \quad (5.5)$$

is C^2 and increasing on $(0, 1)$, and satisfies

$$\Phi(u) \sim \frac{\sigma^2}{2b(0)} \log(u) \quad \text{when } u \downarrow 0, \quad \Phi(u) \sim \frac{\sigma^2}{2b(1)} \log(1-u) \quad \text{when } u \uparrow 1. \quad (5.6)$$

Besides, it is integrable on $[0, 1]$ and such that

$$\int_{u=0}^1 \Phi(u) du = 0. \quad (5.7)$$

Proof. Under Assumption (E), for all $u \in (0, 1)$,

$$\frac{1}{u} \int_{v=0}^u b(v) dv > b(u) > \frac{1}{1-u} \int_{v=u}^1 b(v) dv,$$

that is to say $(1-u)B(u) > u(B(1) - B(u))$ and finally $B(u) > uB(1) = 0$, whence the first point.

Assumption (E) also implies that

- when $u \downarrow 0$, $B(u) \sim b(0)u$, with $b(0) > 0$,
- when $u \uparrow 1$, $B(u) \sim -b(1)(1-u)$, with $b(1) < 0$,

therefore the integrals in the right-hand side of (5.5) are finite, and the function Φ is C^2 and increasing on $(0, 1)$, and satisfies (5.6). The integrability of Φ on $[0, 1]$ follows from (5.6), and by the Fubini-Tonelli theorem,

$$\int_{u=0}^1 \int_{v=0}^u \frac{v\sigma^2}{2B(v)} dv du = \int_{v=0}^1 \frac{v(1-v)\sigma^2}{2B(v)} dv = \int_{u=0}^1 \int_{v=u}^1 \frac{(1-v)\sigma^2}{2B(v)} dv du,$$

whence (5.7). □

Note that the inverse function Φ^{-1} of the function Φ defined in Lemma 5.2.1 is the cumulative distribution function F_∞ of a probability distribution P_∞ on \mathbb{R} , which is such that

$$\int_{x \in \mathbb{R}} |x| P_\infty(dx) = \int_{u=0}^1 |\Phi(u)| du < +\infty, \quad \int_{x \in \mathbb{R}} x P_\infty(dx) = \int_{u=0}^1 \Phi(u) du = 0.$$

Besides, since Φ is C^2 and $\Phi'(u) > 0$ for all $u \in (0, 1)$, we deduce that F_∞ possesses a density p_∞ with respect to the Lebesgue measure on \mathbb{R} , which writes $p_\infty(x) = 2B(F_\infty(x))/\sigma^2$.

We can now recall the description of the set of stationary distributions of the nonlinear process, which is detailed in Proposition 4.4.1 of Chapter 4.

Proposition 5.2.2. *Under Assumption (E), the stationary probability distributions for the nonlinear process $(X_t)_{t \geq 0}$ are the translations of the probability distribution P_∞ ; that is to say, the probability distributions with cumulative distribution function $x \mapsto F_\infty(x + \bar{x})$ for some $\bar{x} \in \mathbb{R}$.*

As a consequence of Proposition 5.2.2, a stationary distribution for the nonlinear process is characterised by its expectation. In particular, P_∞ is the unique centered stationary distribution of the nonlinear process.

Remark 5.2.3. In Chapter 4, the stationary distributions are proven to be the translations of the function Ψ defined on $(0, 1)$ by

$$\forall u \in (0, 1), \quad \Psi(u) := \int_{v=1/2}^u \frac{\sigma^2}{2B(v)} dv.$$

Since Φ and Ψ have the same derivative, it is clear that the set of translations of Φ^{-1} coincides with the set of translations of Ψ^{-1} .

5.2.2 Projected particle system

We now address the projected particle system. In this purpose, we first introduce the following notation: for all $z = (z_1, \dots, z_n) \in M_n$, we denote by

$$z_{(1)} \leq \dots \leq z_{(n)}$$

the increasing reordering of (z_1, \dots, z_n) .

Under Assumption **(E)**, (5.3) rewrites

$$dZ_t^{i,n} = -\nabla V(Z_t^{1,n}, \dots, Z_t^{n,n})dt + \sigma \frac{n-1}{n} dW_t^i - \frac{\sigma}{n} \sum_{j \neq i} dW_t^j,$$

where the continuous function $V : M_n \rightarrow \mathbb{R}$ is defined by

$$V(z_1, \dots, z_n) := - \sum_{j=1}^n b_n(j) z_{(j)}.$$

We are now ready to describe the stationary distribution of the projected particle system, which is due to Pal and Pitman [115, Theorem 8].

Proposition 5.2.4. *Under Assumption **(E)**,*

$$\mathcal{Z}_n := \int_{z \in M_n} \exp \left(\frac{2}{\sigma^2} \sum_{j=1}^n b_n(j) z_{(j)} \right) dz < +\infty,$$

and the probability distribution with density

$$p_\infty^n(z) := \frac{1}{\mathcal{Z}_n} \exp \left(\frac{2}{\sigma^2} \sum_{j=1}^n b_n(j) z_{(j)} \right)$$

with respect to the surface measure on M_n is the unique stationary distribution of the process $(Z_t^{1,n}, \dots, Z_t^{n,n})_{t \geq 0}$.

Remark 5.2.5. A function $f : M_n \rightarrow \mathbb{R}$ is said to be symmetric if the value of $f(z_1, \dots, z_n)$ is invariant by permutation of the coordinates of (z_1, \dots, z_n) . Clearly, p_∞^n is symmetric. Therefore, it is straightforward to show that, for all measurable and symmetric function $f : M_n \rightarrow \mathbb{R}$,

$$\int_{z \in M_n} f(z) p_\infty^n(z) dz = \int_{z \in M_n} f(z) \tilde{p}_\infty^n(z) dz,$$

where the probability density \tilde{p}_∞^n is defined by

$$\begin{aligned} \tilde{p}_\infty^n(z_1, \dots, z_n) &= n! \mathbf{1}_{\{z_1 \leq \dots \leq z_n\}} p_\infty^n(z_1, \dots, z_n) \\ &= n! \mathbf{1}_{\{z_1 \leq \dots \leq z_n\}} \frac{1}{\mathcal{Z}_n} \exp \left(\frac{2}{\sigma^2} \sum_{i=1}^n b_n(i) z_i \right). \end{aligned}$$

In particular, if one is interested in the marginal distribution $p_\infty^{1,n}$, one can use exchangeability and write, for all measurable $f : \mathbb{R} \rightarrow \mathbb{R}$,

$$\begin{aligned} \int_{x \in \mathbb{R}} f(x) p_\infty^{1,n}(x) dx &= \int_{z \in M_n} f(z_1) p_\infty^n(z) dz \\ &= \int_{z \in M_n} \frac{1}{n} \sum_{i=1}^n f(z_i) p_\infty^n(z) dz \\ &= \int_{z \in M_n} \frac{1}{n} \sum_{i=1}^n f(z_i) \tilde{p}_\infty^n(z) dz. \end{aligned}$$

For all $i \in \{1, \dots, n\}$, the integral

$$\int_{z \in M_n} f(z_i) \tilde{p}_\infty^n(z) dz$$

can now be explicitated as follows. Rewriting M_n as the hypersurface $\{x \in \mathbb{R}^n : \phi(x) = 0\}$, where $\phi(x) = x_1 + \dots + x_n$, it follows from [73, Exemple 4.3.4] that the distribution

$$\delta_0 \circ \phi = dx_1 \cdots dx_{i-1} \delta_{-(x_1 + \dots + x_{i-1} + x_{i+1} + \dots + x_n)}(dx_i) dx_{i+1} \cdots dx_n$$

is well defined on \mathbb{R}^n , and such that

$$\delta_0 \circ \phi = |\nabla \phi|^{-1} dz = \sqrt{n}^{-1} dz.$$

As a consequence, we obtain the formula

$$\begin{aligned} \int_{z \in M_n} f(z_i) \tilde{p}_\infty^n(z) dz &= \frac{\sqrt{nn!}}{\mathcal{Z}_n} \int_{(x_1, \dots, x_{i-1}, x_{i+1}, \dots, x_n) \in \mathbb{R}^{n-1}} dx_1 \cdots dx_{i-1} dx_{i+1} \cdots dx_n \\ &\quad \times \mathbb{1}_{\{x_1 \leq \dots \leq x_{i-1} \leq -(x_1 + \dots + x_{i-1} + x_{i+1} + \dots + x_n) \leq x_{i+1} \leq \dots \leq x_n\}} \\ &\quad \times f(-(x_1 + \dots + x_{i-1} + x_{i+1} + \dots + x_n)) \exp\left(\frac{2}{\sigma^2} \sum_{j \neq i} (b_n(j) - b_n(i)) x_j\right). \end{aligned}$$

5.3 Expression and convergence of the Laplace transforms

In this section, we give explicit expressions of the Laplace transforms of $p_\infty^{1,n}$ and p_∞ , and we complete the proof of Theorem 5.1.3.

5.3.1 Laplace transforms

We first give explicit expressions for the Laplace transforms of p_∞ and $p_\infty^{1,n}$.

Lemma 5.3.1. *Let Assumption (E) hold, and let $t \in (-2b(0)/\sigma^2, -2b(1)/\sigma^2)$.*

(i) *The Laplace transform*

$$L_\infty(t) := \int_{x \in \mathbb{R}} \exp(tx) p_\infty(x) dx$$

of p_∞ is finite and writes

$$L_\infty(t) = \int_{u=0}^1 \exp\left(t \int_{v=0}^u \frac{v\sigma^2}{2B(v)} dv - t \int_{v=u}^1 \frac{(1-v)\sigma^2}{2B(v)} dv\right) du.$$

(ii) *There exists $n_0 \geq 1$, depending on t , such that, for all $n \geq n_0$, the Laplace transform*

$$L_\infty^n(t) := \int_{x \in \mathbb{R}} \exp(tx) p_\infty^{1,n}(x) dx$$

of $p_\infty^{1,n}$ is finite and writes

$$L_\infty^n(t) = \frac{1}{n} \sum_{i=1}^n \prod_{j=1}^{i-1} \frac{1}{1 - \frac{t\sigma^2}{2n} \frac{j/n}{B(j/n)}} \times \prod_{j=i}^{n-1} \frac{1}{1 + \frac{t\sigma^2}{2n} \frac{1-j/n}{B(j/n)}},$$

where we take the convention that a product over an empty set of indices is worth 1.

Proof. The point (i) follows from the expression of Φ given in (5.5) combined with the estimates (5.6). Let us now address (ii). For all $t \in \mathbb{R}$, Remark 5.2.5 allows us write

$$L_\infty^n(t) = \frac{1}{n} \sum_{i=1}^n I_i(t),$$

where

$$I_i(t) := \frac{\sqrt{nn!}}{\mathcal{Z}_n} \int_{(x_1, \dots, x_{i-1}, x_{i+1}, \dots, x_n) \in \mathbb{R}^{n-1}} dx_1 \cdots dx_{i-1} dx_{i+1} \cdots dx_n \\ \times \mathbb{1}_{\{x_1 \leq \dots \leq x_{i-1} \leq -(x_1 + \dots + x_{i-1} + x_{i+1} + \dots + x_n) \leq x_{i+1} \leq \dots \leq x_n\}} \exp \left(\sum_{j \neq i} \left(-t + \frac{2}{\sigma^2} (b_n(j) - b_n(i)) \right) x_j \right).$$

Note that, at this stage, nothing prevents $I_i(t)$ from being infinite.

Let us fix $i \in \{1, \dots, n\}$. Then, for all $j \neq i$, we let

$$y_j := x_j + (x_1 + \dots + x_{i-1} + x_{i+1} + \dots + x_n),$$

so that

$$dy_1 \cdots dy_{i-1} dy_{i+1} \cdots dy_n = n dx_1 \cdots dx_{i-1} dx_{i+1} \cdots dx_n,$$

while

$$\mathbb{1}_{\{x_1 \leq \dots \leq x_{i-1} \leq -(x_1 + \dots + x_{i-1} + x_{i+1} + \dots + x_n) \leq x_{i+1} \leq \dots \leq x_n\}} = \mathbb{1}_{\{y_1 \leq \dots \leq y_{i-1} \leq 0 \leq y_{i+1} \leq \dots \leq y_n\}}.$$

Besides, the quantity $\Sigma_i := x_1 + \dots + x_{i-1} + x_{i+1} + \dots + x_n$ satisfies

$$\Sigma_i = \sum_{j \neq i} x_j = \sum_{j \neq i} (y_j + \Sigma_i),$$

therefore

$$\Sigma_i = \frac{1}{n} \sum_{j \neq i} y_j.$$

As a consequence,

$$\sum_{j \neq i} \left(-t + \frac{2}{\sigma^2} (b_n(j) - b_n(i)) \right) x_j = \sum_{j \neq i} \left(-t + \frac{2}{\sigma^2} (b_n(j) - b_n(i)) \right) (y_j + \Sigma_i) \\ = \sum_{j \neq i} \left(-t + \frac{2}{\sigma^2} (b_n(j) - b_n(i)) \right) y_j + \Sigma_i \left(-(n-1)t - \frac{2n}{\sigma^2} b_n(i) \right) \\ = \sum_{j \neq i} \left(-\frac{t}{n} + \frac{2}{\sigma^2} b_n(j) \right) y_j,$$

where we have used (5.4) at the second line. Letting

$$\gamma_n(j, t) := -\frac{t}{n} + \frac{2}{\sigma^2} b_n(j),$$

we conclude that

$$I_i(t) := \frac{\sqrt{nn!}}{\mathcal{Z}_n} \int_{(y_1, \dots, y_{i-1}, y_{i+1}, \dots, y_n) \in \mathbb{R}^{n-1}} \frac{dy_1 \cdots dy_{i-1} dy_{i+1} \cdots dy_n}{n} \\ \times \mathbb{1}_{\{y_1 \leq \dots \leq y_{i-1} \leq 0 \leq y_{i+1} \leq \dots \leq y_n\}} \exp \left(\sum_{j \neq i} \gamma_n(j, t) y_j \right).$$

We can now split the integral and write

$$I_i(t) := \frac{\sqrt{n}(n-1)!}{\mathcal{Z}_n} I_i^-(t) I_i^+(t),$$

where

$$I_i^-(t) := \int_{y_{i-1}=-\infty}^0 \int_{y_{i-2}=-\infty}^{y_{i-1}} \cdots \int_{y_1=-\infty}^{y_2} \exp\left(\sum_{j=1}^{i-1} \gamma_n(j,t) y_j\right) dy_1 \cdots dy_{i-2} dy_{i-1},$$

$$I_i^+(t) := \int_{y_{i+1}=0}^{+\infty} \int_{y_{i+2}=y_{i+1}}^{+\infty} \cdots \int_{y_n=y_{n-1}}^{+\infty} \exp\left(\sum_{j=i+1}^n \gamma_n(j,t) y_j\right) dy_n \cdots dy_{i+2} dy_{i+1}.$$

Let us remark that, under Assumption (E), for all $\delta > 0$,

$$\inf_{u \in [0, 1-\delta]} \frac{B(u)}{u} > 0, \quad \inf_{u \in [\delta, 1]} \frac{B(u)}{1-u} > 0,$$

therefore

$$\liminf_{n \rightarrow +\infty} \min_{1 \leq j \leq n-1} \frac{2n B(j/n)}{\sigma^2 j/n} = -\frac{2b(1)}{\sigma^2}, \quad \limsup_{n \rightarrow +\infty} \max_{2 \leq j \leq n} -\frac{2n B(j/n)}{\sigma^2 (1-j/n)} = -\frac{2b(0)}{\sigma^2}.$$

Owing to the choice of t , there exists $n_0 \geq 1$ such that, for all $n \geq n_0$,

$$\max_{2 \leq j \leq n} -\frac{2n B(j/n)}{\sigma^2 (1-j/n)} < t < \min_{1 \leq j \leq n-1} \frac{2n B(j/n)}{\sigma^2 j/n}. \quad (5.8)$$

For $n \geq n_0$ and under Assumption (E), successive integrations yield

$$I_i^-(t) = \prod_{j=1}^{i-1} \frac{1}{\gamma_n(1,t) + \cdots + \gamma_n(j,t)} = \prod_{j=1}^{i-1} \frac{1}{-\frac{j}{n}t + \frac{2n}{\sigma^2} B\left(\frac{j}{n}\right)},$$

$$I_i^+(t) = \prod_{j=i+1}^n \frac{-1}{\gamma_n(j,t) + \cdots + \gamma_n(n,t)} = (-1)^{n-i} \prod_{j=i+1}^n \frac{1}{-\frac{n-j+1}{n}t - \frac{2n}{\sigma^2} B\left(\frac{j-1}{n}\right)},$$

and the right-hand sides of both lines are well defined on account of (5.8).

As a consequence, $L_\infty^n(t)$ writes

$$L_\infty^n(t) = \frac{1}{n} \sum_{i=1}^n (-1)^{n-i} \frac{\sqrt{n}(n-1)!}{\mathcal{Z}_n} \times \prod_{j=1}^{i-1} \frac{1}{-\frac{j}{n}t + \frac{2n}{\sigma^2} B\left(\frac{j}{n}\right)} \times \prod_{j=i+1}^n \frac{1}{-\frac{n-j+1}{n}t - \frac{2n}{\sigma^2} B\left(\frac{j-1}{n}\right)}.$$

Finally, using the fact that $L_\infty^n(0) = 1$, we deduce that

$$\mathcal{Z}_n = \sqrt{n}(n-1)! \prod_{j=1}^{n-1} \frac{\sigma^2}{2nB(j/n)},$$

whence the expected expression for $L_\infty^n(t)$. \square

5.3.2 Convergence of the Laplace transforms

Before proving Theorem 5.1.3, let us introduce the following properties, that are trivial consequences of the Taylor-Lagrange inequality.

(TL1) For all $\eta \in (0, 1)$, there exists $\kappa_\eta \in (0, +\infty)$ such that, for all $x \in [-(1 - \eta), +\infty)$,

$$|\log(1 + x) - x| \leq \kappa_\eta |x|^2.$$

One can take $\kappa_\eta = 1/(2\eta^2)$.

(TL2) For all $x, y \in \mathbb{R}$,

$$|\exp(x) - \exp(y)| \leq \exp(y) (|x - y| + |R(x - y)|),$$

where the function $R : z \mapsto \exp(z) - 1 - z$ is such that, for all $z \in [-1, 1]$,

$$|R(z)| \leq \bar{\kappa} |z|^2,$$

with $\bar{\kappa} = \exp(1)/2$.

We are now ready to prove Theorem 5.1.3.

Proof of Theorem 5.1.3. Let us fix $t \in (-2b(0)/\sigma^2, -2b(1)/\sigma^2)$ and $n \geq n_0$, where n_0 is given by Lemma 5.3.1. Let $\epsilon > 0$ such that $\epsilon < b(0) \wedge (-b(1))$, and

$$-\frac{2}{\sigma^2}(b(0) - \epsilon) < t < \frac{2}{\sigma^2}(-b(1) - \epsilon).$$

Then there exists $\delta \in (0, 1/2)$ such that:

- for all $u \in [0, \delta]$, $B(u) \geq u(b(0) - \epsilon)$,
- for all $u \in [1 - \delta, 1]$, $B(u) \geq (1 - u)(-b(1) - \epsilon)$,

and Assumption (E) allows us to define

$$s_-(\delta) := \inf_{u \in (0, 1-\delta)} \frac{B(u)}{u} > 0, \quad s_+(\delta) := \inf_{u \in (\delta, 1)} \frac{B(u)}{1-u} > 0.$$

For all $u \in (0, 1)$, let

$$f(u) := \exp(t\Phi(u)) = \exp\left(t \int_{v=0}^u \frac{v\sigma^2}{2B(v)} dv - t \int_{v=u}^1 \frac{(1-v)\sigma^2}{2B(v)} dv\right),$$

and for all $i \in \{1, \dots, n\}$, let

$$f_n(i) := \prod_{j=1}^{i-1} \frac{1}{1 - \frac{t\sigma^2}{2n} \frac{j/n}{B(j/n)}} \times \prod_{j=i}^{n-1} \frac{1}{1 + \frac{t\sigma^2}{2n} \frac{1-j/n}{B(j/n)}},$$

so that

$$|L_\infty^n(t) - L_\infty(t)| \leq \sum_{i=1}^n \int_{u=(i-1)/n}^{i/n} |f_n(i) - f(u)| du.$$

We split the sum above as follows

$$\begin{aligned} \sum_{i=1}^n \int_{v=(i-1)/n}^{i/n} |f_n(i) - f(u)| du &= \sum_{i=1}^n \mathbb{1}_{\{i \leq n\delta\}} \int_{u=(i-1)/n}^{i/n} |f_n(i) - f(u)| du \\ &\quad + \sum_{i=1}^n \mathbb{1}_{\{n\delta < i < n(1-\delta)\}} \int_{u=(i-1)/n}^{i/n} |f_n(i) - f(u)| du \\ &\quad + \sum_{i=1}^n \mathbb{1}_{\{i \geq n(1-\delta)\}} \int_{u=(i-1)/n}^{i/n} |f_n(i) - f(u)| du. \end{aligned} \quad (5.9)$$

and address the boundary terms and the central terms separately.

Boundary terms. Let us write

$$\sum_{i=1}^n \mathbb{1}_{\{i \leq n\delta\}} \int_{u=(i-1)/n}^{i/n} |f_n(i) - f(u)| du \leq \frac{1}{n} \sum_{i=1}^n \mathbb{1}_{\{i \leq n\delta\}} f_n(i) + \int_{u=0}^{\delta} f(u) du.$$

On the one hand, it follows from (5.6) that

$$\lim_{\delta \downarrow 0} \int_{u=0}^{\delta} f(u) du = 0.$$

On the other hand, we show that

$$\lim_{\delta \downarrow 0} \limsup_{n \rightarrow +\infty} \frac{1}{n} \sum_{i=1}^n \mathbb{1}_{\{i \leq n\delta\}} f_n(i) = 0, \quad (5.10)$$

so that

$$\lim_{\delta \downarrow 0} \limsup_{n \rightarrow +\infty} \sum_{i=1}^n \mathbb{1}_{\{i \leq n\delta\}} \int_{u=(i-1)/n}^{i/n} |f_n(i) - f(u)| du = 0,$$

and symmetric arguments yield the same result for the other boundary term in (5.9).

If $t \geq 0$, then for $i \leq n\delta$,

$$\prod_{j=i}^{n-1} \frac{1}{1 + \frac{t\sigma^2}{2n} \frac{1-j/n}{B(j/n)}} \leq 1,$$

while

$$\prod_{j=1}^{i-1} \frac{1}{1 - \frac{t\sigma^2}{2n} \frac{j/n}{B(j/n)}} \leq \left(1 - \frac{t\sigma^2}{2n} \frac{1}{b(0) - \epsilon}\right)^{-(i-1)} \leq \left(1 - \frac{t\sigma^2}{2n} \frac{1}{b(0) - \epsilon}\right)^{-n\delta}.$$

The right-hand side above is uniformly bounded with respect to $n \geq n_0$ and $\delta < 1/2$ by a constant $C \in (0, +\infty)$. As a consequence,

$$\frac{1}{n} \sum_{i=1}^n \mathbb{1}_{\{i \leq n\delta\}} f_n(i) \leq C\delta,$$

whence (5.10).

Let us now assume that $t < 0$. Then, for all $i \in \{1, \dots, n\}$,

$$\prod_{j=1}^{i-1} \frac{1}{1 - \frac{t\sigma^2}{2n} \frac{j/n}{B(j/n)}} \leq 1.$$

Controlling the remaining term

$$\prod_{j=i}^{n-1} \frac{1}{1 + \frac{t\sigma^2}{2n} \frac{1-j/n}{B(j/n)}}$$

for $i \leq n\delta$ is now much more delicate: indeed, for small values of j , the fraction $(1-j/n)/B(j/n)$ is no longer bounded, and the prefactor $1/n$ has to be absorbed to balance this growth. As a consequence, the geometric bound obtained above is too inaccurate. We shall therefore proceed as follows.

On the one hand,

$$\log \left(\prod_{j=\lfloor n\delta \rfloor + 1}^{n-1} \frac{1}{1 + t \frac{\sigma^2}{2n} \frac{1-j/n}{B(j/n)}} \right) = - \sum_{j=\lfloor n\delta \rfloor + 1}^{n-1} \log \left(1 + \frac{t\sigma^2}{2n} \frac{1-j/n}{B(j/n)} \right),$$

and for all $j \in \{\lfloor n\delta \rfloor + 1, \dots, n-1\}$,

$$\frac{1-j/n}{B(j/n)} \leq \frac{1}{s_+(\delta)}.$$

As a consequence, for n large enough to ensure that $t\sigma^2/(2ns_+(\delta)) \geq -1/2$, the inequality (TL1) yields

$$-\sum_{j=\lfloor n\delta \rfloor + 1}^{n-1} \log \left(1 + \frac{t\sigma^2}{2n} \frac{1-j/n}{B(j/n)} \right) \leq -\frac{t\sigma^2}{2n} \sum_{j=\lfloor n\delta \rfloor + 1}^{n-1} \frac{1-j/n}{B(j/n)} + \frac{\kappa_{1/2}}{n} \left(\frac{t\sigma^2}{s_+(\delta)} \right)^2,$$

which converges to

$$-\frac{t\sigma^2}{2} \int_{v=\delta}^1 \frac{1-v}{B(v)} dv.$$

On the other hand,

$$\prod_{j=i}^{\lfloor n\delta \rfloor} \frac{1}{1 + t \frac{\sigma^2}{2n} \frac{1-j/n}{B(j/n)}} \leq \prod_{j=i}^{\lfloor n\delta \rfloor} \frac{1}{1 - \alpha/j},$$

where

$$\alpha := -\frac{t\sigma^2}{2(b(0) - \epsilon)} \in (0, 1)$$

thanks to the choice of ϵ . Using (TL1) again, we write

$$\begin{aligned} \log \prod_{j=i}^{\lfloor n\delta \rfloor} \frac{1}{1 - \alpha/j} &= -\sum_{j=i}^{\lfloor n\delta \rfloor} \log \left(1 - \frac{\alpha}{j} \right) \\ &\leq \sum_{j=i}^{\lfloor n\delta \rfloor} \left(\frac{\alpha}{j} + \kappa_\alpha \frac{\alpha^2}{j^2} \right) \\ &\leq \alpha \sum_{j=i}^{\lfloor n\delta \rfloor} \frac{1}{j} + \kappa_\alpha \alpha^2 \frac{\pi^2}{6} \\ &\leq \alpha (1 + \log(n\delta) - \log(i)) + \kappa_\alpha \alpha^2 \frac{\pi^2}{6}, \end{aligned}$$

so that

$$\prod_{j=i}^{\lfloor n\delta \rfloor} \frac{1}{1 + t \frac{\sigma^2}{2n} \frac{1-j/n}{B(j/n)}} \leq K_\alpha \delta^\alpha \frac{1}{(i/n)^\alpha},$$

where $K_\alpha := \exp(\alpha + \kappa_\alpha \alpha^2 \pi^2/6)$. Since

$$\lim_{n \rightarrow +\infty} \frac{1}{n} \sum_{i=1}^{\lfloor n\delta \rfloor} \frac{1}{(i/n)^\alpha} = \int_{v=0}^{\delta} \frac{dv}{v^\alpha} = \frac{\delta^{1-\alpha}}{1-\alpha},$$

we conclude that

$$\limsup_{n \rightarrow +\infty} \frac{1}{n} \sum_{i=1}^{\lfloor n\delta \rfloor} f_n(i) \leq \frac{K_\alpha}{1-\alpha} \delta \exp \left(-\frac{t\sigma^2}{2} \int_{v=\delta}^1 \frac{1-v}{B(v)} dv \right) =: M(\delta).$$

To obtain (5.10), we now have to check that $M(\delta)$ vanishes with δ . To this aim, we fix $0 < \eta < b(0) \wedge (-b(1))$ such that $-2(b(0) - \eta)/\sigma^2 < t$. Then, for δ small enough, we have

$$\int_{v=\delta}^1 \frac{1-v}{B(v)} dv \leq \frac{-\log \delta}{b(0) - \eta},$$

so that

$$\exp\left(-\frac{t\sigma^2}{2} \int_{v=\delta}^1 \frac{1-v}{B(v)} dv\right) \leq \delta^{-\beta},$$

with

$$\beta := \frac{-t\sigma^2}{2(b(0) - \eta)} \in (0, 1).$$

As a conclusion, $M(\delta)$ is of order $\delta^{1-\beta}$ when δ is small, whence (5.10).

Central term. We now want to prove that

$$\lim_{\delta \downarrow 0} \limsup_{n \rightarrow +\infty} \sum_{i=1}^n \mathbb{1}_{\{n\delta < i < n(1-\delta)\}} \int_{u=(i-1)/n}^{i/n} |f_n(i) - f(u)| du = 0. \quad (5.11)$$

In this purpose, we fix $i \in \{1, \dots, n\}$ such that $n\delta < i < n(1-\delta)$, and let $u \in [(i-1)/n, i/n]$. Then, by (TL2),

$$|f_n(i) - f(u)| \leq \exp(t\Phi(u))(|\Delta| + |R(\Delta)|),$$

where $\Delta := \Delta_1 + \Delta_2$, with

$$\begin{aligned} \Delta_1 &:= -\sum_{j=1}^{i-1} \log\left(1 - \frac{t\sigma^2}{2n} \frac{j/n}{B(j/n)}\right) - t \int_{v=0}^u \frac{v\sigma^2}{2B(v)} dv, \\ \Delta_2 &:= -\sum_{j=i}^{n-1} \log\left(1 + \frac{t\sigma^2}{2n} \frac{1-j/n}{B(j/n)}\right) + t \int_{v=u}^1 \frac{(1-v)\sigma^2}{2B(v)} dv. \end{aligned}$$

The construction of n_0 ensures that there exists $\eta \in (0, 1)$ such that, for all $n \geq n_0$, for all $j \in \{1, \dots, n-1\}$,

$$-\frac{t\sigma^2}{2n} \frac{j/n}{B(j/n)} \geq -(1-\eta), \quad \frac{t\sigma^2}{2n} \frac{1-j/n}{B(j/n)} \geq -(1-\eta).$$

Then using (TL1), we write

$$\begin{aligned} |\Delta_1| &\leq \left| \sum_{j=1}^{i-1} \frac{t\sigma^2}{2n} \frac{j/n}{B(j/n)} - t \int_{v=0}^u \frac{v\sigma^2}{2B(v)} dv \right| + \kappa_\eta \sum_{j=1}^{i-1} \left| \frac{t\sigma^2}{2n} \frac{j/n}{B(j/n)} \right|^2 \\ &\leq \frac{|t|\sigma^2}{2} \sum_{j=1}^{i-1} \int_{v=(j-1)/n}^{j/n} \left| \frac{j/n}{B(j/n)} - \frac{v}{B(v)} \right| dv + \frac{|t|\sigma^2}{2} \int_{v=(i-1)/n}^u \frac{v}{B(v)} dv + \kappa_\eta \sum_{j=1}^{i-1} \left| \frac{t\sigma^2}{2n} \frac{j/n}{B(j/n)} \right|^2. \end{aligned}$$

Now

$$\frac{|t|\sigma^2}{2} \int_{v=(i-1)/n}^u \frac{v}{B(v)} dv + \kappa_\eta \sum_{j=1}^{i-1} \left| \frac{t\sigma^2}{2n} \frac{j/n}{B(j/n)} \right|^2 \leq \frac{1}{n} \left(\frac{|t|\sigma^2}{2s_-(\delta)} + \kappa_\eta \frac{t^2\sigma^4}{4s_-(\delta)^2} \right),$$

while the uniform continuity of $v/B(v)$ on $[0, 1-\delta]$ implies that, for n large enough,

$$\frac{|t|\sigma^2}{2} \sum_{j=1}^{i-1} \int_{v=(j-1)/n}^{j/n} \left| \frac{j/n}{B(j/n)} - \frac{v}{B(v)} \right| dv \leq \delta.$$

Using the same arguments for Δ_2 , we conclude that there exists a constant $\bar{S}(\delta) \in (0, +\infty)$, that does not depend on n , u and i but grows to infinity when δ vanishes, such that, for n large enough,

$$|\Delta| \leq \delta + \frac{\bar{S}(\delta)}{n}.$$

Taking n large enough to ensure that the right-hand side above be lower than 1, we deduce from (TL2) that

$$|R(\Delta)| \leq \bar{\kappa} \left(\delta + \frac{\bar{S}(\delta)}{n} \right)^2,$$

therefore

$$|f_n(i) - f(u)| \leq \exp(t\Phi(u)) \left(\delta + \frac{\bar{S}(\delta)}{n} + \bar{\kappa} \left(\delta + \frac{\bar{S}(\delta)}{n} \right)^2 \right),$$

and finally

$$\sum_{i=1}^n \mathbb{1}_{\{n\delta < i < n(1-\delta)\}} \int_{u=(i-1)/n}^{i/n} |f_n(i) - f(u)| du \leq L_\infty(t) \left(\delta + \frac{\bar{S}(\delta)}{n} + \bar{\kappa} \left(\delta + \frac{\bar{S}(\delta)}{n} \right)^2 \right).$$

Letting n grow to infinity, then δ vanish, in the right-hand side above, we obtain (5.11) and thereby complete the proof. \square

5.4 Completion of the proof of Theorem 5.1.2

The proof of Theorem 5.1.2 is based on the following lemma.

Lemma 5.4.1. *Let $(\mu_n)_{n \geq 1}$ be a sequence of probability distributions on \mathbb{R} , and let μ be a probability distribution on \mathbb{R} . Let us assume that there exists $\rho > 0$ such that, for all $t \in [-\rho, \rho]$,*

$$\lim_{n \rightarrow +\infty} \int_{x \in \mathbb{R}} \exp(tx) \mu_n(dx) = \int_{x \in \mathbb{R}} \exp(tx) \mu(dx) < +\infty.$$

Then, for all $r \geq 1$,

$$\lim_{n \rightarrow +\infty} W_r(\mu_n, \mu) = 0.$$

Before proving Lemma 5.4.1, let us explain how it allows to derive Theorem 5.1.2 from Theorem 5.1.3. To this aim, let us fix $\rho > 0$ such that

$$\rho < \frac{2}{\sigma^2} (b(0) \wedge -b(1)).$$

Then, by Theorem 5.1.3, there exists $n_0^+ \geq 1$ such that $L_\infty^n(\rho) < +\infty$ for $n \geq n_0^+$, and there exists $n_0^- \geq 1$ such that $L_\infty^n(-\rho) < +\infty$ for $n \geq n_0^-$. Clearly, this implies that, for all $t \in [-\rho, \rho]$, $L_\infty^n(t) < +\infty$ as soon as $n \geq n_0^+ \vee n_0^-$, and the assumptions of Lemma 5.4.1 are satisfied and Theorem 5.1.2 follows.

Proof of Lemma 5.4.1. The convergence of Laplace transforms on the interval $[-\rho, \rho]$ implies that μ_n converges weakly to μ . Following [135, Theorem 6.9], to obtain the convergence in Wasserstein distance of order r , it now suffices to prove that

$$\lim_{n \rightarrow +\infty} \int_{x \in \mathbb{R}} |x|^r \mu_n(dx) = \int_{x \in \mathbb{R}} |x|^r \mu(dx).$$

But since μ_n converges weakly to μ , the convergence above follows from the uniform integrability property

$$\lim_{a \rightarrow +\infty} \sup_{n \geq 1} \int_{|x| \geq a} |x|^r \mu_n(dx) = 0,$$

which can be obtained by proving that, for some $r' > r$,

$$\limsup_{n \rightarrow +\infty} \int_{x \in \mathbb{R}} |x|^{r'} \mu_n(dx) < +\infty.$$

Therefore, we now fix $r' > r$. Then, there exists a constant $M \geq 0$ such that, for all $x \in \mathbb{R}$, if $|x| \geq M$, then

$$|x|^{r'} \leq \exp(\rho|x|) \leq \exp(\rho x) + \exp(-\rho x).$$

As a consequence,

$$\limsup_{n \rightarrow +\infty} \int_{x \in \mathbb{R}} |x|^{r'} \mu_n(dx) \leq M^{r'} + \int_{x \in \mathbb{R}} (\exp(\rho x) + \exp(-\rho x)) \mu(dx) < +\infty,$$

which completes the proof. \square

Chapitre 6

Distribution du capital et performance de portefeuilles dans le modèle d'Atlas en champ moyen

Ce chapitre reprend le contenu de l'article [90], écrit avec Benjamin Jourdain. La version prépubliée de cet article comporte un appendice C, qui présente l'extension des résultats de l'article [91] à des hypothèses de non-dégénérescence un peu plus générales. Dans ce manuscrit, cet appendice a été incorporé au Chapitre 4. Par souci de cohérence avec la littérature de la théorie des portefeuilles stochastiques, les conventions de notation diffèrent légèrement des Chapitres 4 et 5 : en particulier, le « système de particules », qui représente ici les log-capitalisations des prix des actifs, est noté $(Y_n^1(t), \dots, Y_n^n(t))_{t \geq 0}$ plutôt que $(X_t^{1,n}, \dots, X_t^{n,n})_{t \geq 0}$, et les coefficients de dérive de ces processus sont donnés par la fonction $\gamma : [0, 1] \rightarrow \mathbb{R}$ plutôt que b .

6.1 Introduction

6.1.1 Rank-based models

Rank-based models of equity markets were introduced by Fernholz within the framework of *Stochastic Portfolio Theory* [58, 62] as first-order approximations of asymptotically stable markets. In such models, the capitalization of a stock is described by the exponential of a diffusion process, the drift and variance of which depend only on the rank of the stock among the whole market. A simple but celebrated instance of such a model is the *Atlas model* [58, 11, 62, 81], where all the stocks have the same variance and the smallest stock is responsible for the growth of the whole market.

In the long-term, the Atlas model was proven to capture the actual distribution of the total capital [58]. This gave rise to a large amount of mathematical studies on rank-based models [78, 79, 61, 60]; in particular, concerning the shape of capital distribution curves [11, 41, 62, 125] as well as the selection of optimal investment strategies (portfolios) on the market [11, 62]. Both the capital distribution and the performance of portfolios depend on the long time behaviour of the market, which was described in [11, 115, 89, 80, 81]. In order to study large markets, asymptotic properties, when the number of stocks grows to infinity, of long-term rank-based models were derived in [11, 41, 125].

In this chapter, we introduce a rank-based model that we call the *mean-field Atlas model*, where the drift and variance of the capitalization processes depend on empirical quantiles. This particular shape for the characteristics of the market, that we shall discuss below, allows us to:

1. derive an asymptotic description of the evolution of the market when its size grows to infinity, through a functional law of large numbers;
2. obtain closed form expressions for the long time behaviour of this asymptotic market;

3. recover capital distribution curves similar to those empirically observed;
4. carry out a detailed analysis of the performance of a portfolio rule.

Before providing more insight into these issues in Subsection 6.1.2 and giving a proper definition of our model in Subsection 6.1.3, let us insist on the following particularity of our approach. In all the works cited above, the authors first address the long time behaviour of market models with a fixed number of stocks, then possibly study the large size limit of the market under its steady state. The latter is not so easy to handle as the underlying stationary distribution is generically not known, see §6.1.2.1 below for a more detailed review. As a consequence, the asymptotic behaviour of these steady states for large markets is all the more difficult to understand, although there have been remarkable results in this direction [11, 41].

In the present chapter, we somehow take the opposite path and first obtain an asymptotic description of the evolution of the whole market when the number of stocks grows to infinity. This limit shall be referred to as the *asymptotic market*. Then, we address the long time behaviour of this asymptotic market and get an explicit description of the steady states of large markets, which is widely based on the theoretical results of Chapter 4. To our knowledge, this is the first study proceeding in this way. Reassuringly, we essentially observe the same phenomena as in previous works, which gives an *a posteriori* account for this novel approach.

6.1.2 Context and motivations

We now provide a general introduction to the issues we shall address in the context of the mean-field Atlas model; namely, the long-term stability of rank-based models, the description of capital distribution curves and the analysis of portfolio performance.

6.1.2.1 Long-term stability of rank-based models

The framework of Stochastic Portfolio Theory [58, 62] is described as follows. For a market containing a fixed number $n \geq 1$ of stocks, with respective capitalizations $X_n^1(t), \dots, X_n^n(t) > 0$ at time t , the log-capitalizations $Y_n^i(t) := \log X_n^i(t)$ are assumed to satisfy the relation

$$\forall i \in \{1, \dots, n\}, \quad dY_n^i(t) = \gamma_n^i(t)dt + \sigma_n^i(t)dB^i(t), \quad (6.1)$$

where the *growth rate* process $(\gamma_n^1(t), \dots, \gamma_n^n(t))_{t \geq 0}$ and the *volatility* process $(\sigma_n^1(t), \dots, \sigma_n^n(t))_{t \geq 0}$ in \mathbb{R}^n are adapted to a given filtration $(\mathcal{F}(t))_{t \geq 0}$ on some probability space $(\Omega, \mathcal{F}, \mathbb{P})$, and the processes $(B^i(t))_{t \geq 0}$, $i \geq 1$ are independent $(\mathcal{F}(t))_{t \geq 0}$ -Brownian motions.

The model is said to be *rank-based* whenever the growth rate process and volatility process write

$$\gamma_n^i(t) = \sum_{j=1}^n \mathbb{1}_{\{Y_n^i(t)=Y_n^{(j)}(t)\}} \gamma_n^j, \quad \sigma_n^i(t) = \sum_{j=1}^n \mathbb{1}_{\{Y_n^i(t)=Y_n^{(j)}(t)\}} \sigma_n^j, \quad (6.2)$$

for given growth rate coefficients $\gamma_n^1, \dots, \gamma_n^n \in \mathbb{R}$ and volatility coefficients $\sigma_n^1, \dots, \sigma_n^n \in \mathbb{R}$, where $Y_n^{(1)}(t) \leq \dots \leq Y_n^{(n)}(t)$ refer to the increasing reordering of $Y_n^1(t), \dots, Y_n^n(t)$. In other words, the dynamics of each stock is determined by its rank among the whole market. As is explained below, we shall work under assumptions ensuring that almost surely, dt -almost everywhere, the random variables $Y_n^1(t), \dots, Y_n^n(t)$ are pairwise distinct. Therefore there is no need to take a specific convention to resolve ties.

Let us emphasize the fact that we use the notation (j) to refer to the *increasing reordering*, following the usual convention for order statistics. However it is sometimes convenient to use the decreasing reordering [58, 62, 115, 41]. In such situations, we shall use the notation $[k]$. In other words, if $(y^1, \dots, y^n) \in \mathbb{R}^n$, then $((1), \dots, (n))$ is a permutation of $(1, \dots, n)$ such that $y^{(1)} \leq \dots \leq y^{(n)}$, while $([1], \dots, [n])$ is a permutation of $(1, \dots, n)$ such that $y^{[1]} \geq \dots \geq y^{[n]}$. Note that one may always choose $[k] = (n - k + 1)$.

As soon as, for all $j \in \{1, \dots, n\}$, $(\sigma_n^j)^2 > 0$, then the stochastic differential equation (6.1, 6.2) admits a unique weak solution [13], and almost surely, dt -almost everywhere, the random variables $Y_n^1(t), \dots, Y_n^n(t)$ are pairwise distinct. Then, we define the capitalization of the i -th stock by $X_n^i(t) := \exp Y_n^i(t)$.

A first mathematical study of rank-based models was carried out by Banner, Fernholz and Karatzas [11]. There, the emphasis was laid on the particular choice for the growth rate coefficients

$$\gamma_n^1 = ng, \quad \gamma_n^2 = \dots = \gamma_n^n = 0, \quad (6.3)$$

where $g > 0$. With this choice of coefficients, the smallest stock is responsible for the growth of the whole market, therefore, analogically to the ancient Greek myth, this model is called the *Atlas model*. Various generalizations of this model were introduced later, such as *hybrid Atlas models* by Ichiba, Papathanakos, Banner, Karatzas and Fernholz [81] (see also Fernholz, Ichiba and Karatzas [59]), in which the growth rate and volatility processes depend both on the rank and on the index i of a stock.

As far as the long time behaviour of the solution to (6.1, 6.2) is concerned, Banner, Fernholz and Karatzas [11] described the marginal distribution of each stock in the long-term. Pal and Pitman [115] and Jourdain and Malrieu [89] described their joint distribution in the long-term for models in which all the stocks are assigned the same variance, and Ichiba, Papathanakos, Banner, Karatzas and Fernholz [81] extended these results to the case of a linearly decreasing variance coefficient with respect to the rank. Rates of convergence were provided by Ichiba, Pal and Shkolnikov [80].

Generically, a necessary and sufficient condition ensuring the long-term stability of rank-based models (6.1, 6.2) is that

$$\forall k \in \{1, \dots, n-1\}, \quad \sum_{j=1}^k (\gamma_n^j - g_n) > 0, \quad (6.4)$$

where $g_n := (1/n) \sum_{j=1}^n \gamma_n^j$ is the mean growth rate of the processes $(Y_n^1(t))_{t \geq 0}, \dots, (Y_n^n(t))_{t \geq 0}$. This condition somehow expresses the fact that the growth rate of small stocks is larger than the mean growth rate of the market, while the growth rate of large stocks is smaller than the mean growth rate of the market. This is known as the *size effect*, see [58, p. 86]. From the economic point of view, this effect is a natural consequence of *rebalancing*, that is, the fact that investors buy stocks when their prices are low and sell stocks with large prices.

Similarly to the size effect on growth rates, the variance of small stocks is also empirically observed to be larger than the variance of large stocks. Throughout this chapter, we shall refer to this phenomenon as the *volatility size effect*. As an example, in [62, Figure 13.6], the variance is observed to be linearly decreasing with respect to the rank, which motivates the stability result of [81].

Several models have been introduced to capture the growth rate and volatility size effects, see for instance the so-called *Volatility-Stabilized Model* by Fernholz and Karatzas [62, Section 12], which was later on discussed by Pal [114], Shkolnikov [128] and Sarantsev [126]. As we shall see below, both rebalancing and the volatility size effect play a key role in the analysis of portfolio performance.

6.1.2.2 Capital distribution curves

For all $i \in \{1, \dots, n\}$, the market weight at time $t \geq 0$ of the i -th stock is defined by

$$\mu_n^i(t) := \frac{X_n^i(t)}{X_n^1(t) + \dots + X_n^n(t)}.$$

The *capital distribution curve* is the logarithmic representation of the market weights rearranged by decreasing order, namely the curve $\log k \mapsto \log \mu_n^{[k]}(t)$, where we recall that $[k]$ refers to the index of the stock with k -th largest capitalization at time t ; that is to say, $X_n^{[1]}(t) \geq \dots \geq X_n^{[n]}(t)$.

The actual capital distribution curves for the stocks traded on the NYSE, the AMEX and the NASDAQ stock market between 1929 and 1999 were described by Fernholz [58, Figure 5.1, p. 95]. They exhibit a remarkable stability over time, and indicate, at least for the largest stocks, a Pareto-like distribution of the capital, which is a common observation in the economic literature [58, Section 5.6].

This Pareto-like distribution was recovered for the Atlas model (6.3) by Fernholz [58, Example 5.3.3, pp. 103-104]. In the case of rank-based models (6.1, 6.2) with constant variance coefficients, Chatterjee and Pal [41] addressed the asymptotic behaviour, when n grows to infinity, of the stationary distribution of $(\mu_n^{[1]}(t), \dots, \mu_n^{[n]}(t))_{t \geq 0}$. They observed the following *phase transition* phenomenon: depending on the growth rate coefficients,

- either the largest stock dominates the market and monopolizes all the capital,
- or most of the capital is spread among a few leading stocks,
- or the market weight of every stock vanishes.

In the second case above, the distribution of the capital between the few leading stocks was also proven to exhibit a Pareto-like distribution.

6.1.2.3 Portfolio performance

A portfolio rule on an equity market is a strategy prescribing the proportion of wealth to be invested in each stock. In particular, the *equally weighted portfolio* assigns the same weight to all stocks, while the *market portfolio* is given by market weights. Due to the fact that these two strategies can easily be implemented, they are of importance for practitioners and have aroused many empirical and theoretical studies.

From the empirical point of view, it has been observed that the equally weighted portfolio generally outperforms the market portfolio ('beats the market') under various indicators; we refer to the work by Plyakha, Uppal and Vilkov [118] for a study of the major U.S. equity indices over the last four decades. From the theoretical point of view, it is commonly believed that the equally weighted portfolio beating the market is due to rebalancing: indeed, the market portfolio tends to invest more capital in large stocks, while the equally weighted portfolio is insensitive to this effect; see the preprint by Pal and Wong [117] and the references therein. As far as the Atlas model is concerned, the performance of the equally weighted portfolio and the market portfolio was addressed by Banner, Fernholz and Karatzas [11], who essentially confirmed that the equally weighted portfolio beats the market.

6.1.3 Model and results

We complete this introduction by giving a proper definition of the mean-field Atlas model and providing an overview of our results.

6.1.3.1 The mean-field Atlas model

Let $\gamma, \sigma : [0, 1] \rightarrow \mathbb{R}$ be continuous functions; γ is the *growth rate function*, σ is the *volatility function*. The function σ^2 shall be called the *variance function*. The mean-field Atlas model consists of the rank-based model (6.1, 6.2), with growth rate and volatility coefficients given by, for all $n \geq 1$,

$$\forall j \in \{1, \dots, n\}, \quad \gamma_n^j = \gamma(j/n), \quad \sigma_n^j = \sigma(j/n); \quad (6.5)$$

and initial log-capitalizations $Y_n^1(0), \dots, Y_n^n(0)$ i.i.d. according to a given probability distribution m on \mathbb{R} . It is well defined as soon as $\sigma^2(u) > 0$ for all $u \in [0, 1]$, which we shall refer to as the uniform ellipticity assumption (UE) in the sequel.

For all $j \in \{1, \dots, n\}$, for all $t \geq 0$, $Y_n^{(j)}(t)$ is the empirical quantile of order j/n of the vector $(Y_n^1(t), \dots, Y_n^n(t))$, so that the growth rate and volatility of the log-capitalization process $Y_n^{(j)}$ is a function of j/n . From the point of view of economical modelling, we argue that mean-field coefficients (6.5) are reasonable choices for large rank-based models as they describe *weak interactions* between the stocks, in the sense that the larger the market is, the smaller the individual influence of a stock on another is.

Remark 6.1.1. Let us emphasize that the mean-field Atlas model is not a generalization of the genuine Atlas model (6.3): formally, to recover (in the large size limit) the growth rate coefficients (6.3) from the mean-field coefficients (6.5), one should replace the growth rate function γ

with $g\delta_0$, where δ_0 is the Dirac distribution in 0. Of course, this is not a function and therefore the Atlas model cannot be rigorously described in terms of mean-field coefficients. However, mean-field approximations of the Atlas model can be introduced by using the growth rate function

$$\gamma_\alpha(u) := g(\alpha + 1)(1 - u)^\alpha, \quad g > 0,$$

where $\alpha > 0$ is the *Atlas index*: the larger it is, the more the growth rate concentrates on small stocks. This mean-field approximation of the Atlas model is used in Example 6.5.7 below.

6.1.3.2 Results and outline of the chapter

Section 6.2 is dedicated to the description of the asymptotic behaviour of the mean-field Atlas model in the large size limit. This issue was first addressed by Shkolnikov [127] for stationary initial distributions, and then by the author [91] for general initial distributions (see also the recent article by Dembo, Shkolnikov, Varadhan and Zeitouni [48]). The following *propagation of chaos* phenomenon was observed: when n grows to infinity, the log-capitalization processes asymptotically behave like independent copies of a stochastic process $(Y(t))_{t \geq 0}$, such that, for all $t \geq 0$,

$$\mathbb{E}(Y(t)) = \mathbb{E}(Y(0)) + gt, \quad (6.6)$$

where

$$g := \int_{u=0}^1 \gamma(u) du \quad (6.7)$$

is the *market mean growth rate*. In other words, the chaoticity of the i.i.d. initial conditions is asymptotically propagated to the log-capitalization processes when their number is large. We first recall this result, and then describe the long time behaviour of the fluctuation $\tilde{Y}(t)$ of $Y(t)$ around gt . Under a size effect assumption of the same nature as (6.4), we prove that the law of $\tilde{Y}(t)$ converges toward an explicit equilibrium distribution. We also discuss the shape of the tails of this equilibrium distribution in $-\infty$ and $+\infty$.

In Section 6.3, we define the *weighted capital measure* $\Pi_n^p(t)$ by

$$\Pi_n^p(t) := \sum_{j=1}^n \frac{(X_n^{(j)}(t))^p}{(X_n^1(t))^p + \dots + (X_n^n(t))^p} \delta_{j/n}, \quad (6.8)$$

for all *diversity indices* $p \geq 0$. When $p = 1$, we drop the superscript notation and only refer to $\Pi_n(t)$ as the *capital measure*.

The weighted capital measure is a random probability measure on $[0, 1]$. Our study of capital distribution curves and portfolio performance is based on the analysis of $\Pi_n^p(t)$ when $n \rightarrow +\infty$ and $t \rightarrow +\infty$. We first use our propagation of chaos result to derive a law of large numbers for $\Pi_n^p(t)$; namely, we prove that

$$\lim_{n \rightarrow +\infty} \Pi_n^p(t) = \Pi^p(t),$$

where the *asymptotic weighted capital measure* $\Pi^p(t)$ is a deterministic probability distribution on $[0, 1]$, with an explicit expression in terms of the law of $Y(t)$. Then, we address the long time behaviour of $\Pi^p(t)$, and prove that there exists a *critical diversity index* $p_c \geq 0$ such that:

- if $p \in [0, p_c)$, then

$$\lim_{t \rightarrow +\infty} \Pi^p(t) = \bar{\Pi}^p,$$

where the *long-term asymptotic weighted capital measure* $\bar{\Pi}^p$ is a probability distribution on $[0, 1]$, with an explicit expression in terms of the equilibrium distribution introduced above,

- if $p > p_c$, then

$$\lim_{t \rightarrow +\infty} \Pi^p(t) = \delta_1.$$

We shall refer to the fact that the model behave differently whether $p \in [0, p_c)$ or $p > p_c$ as a *phase transition* phenomenon, and the case $p \in [0, p_c)$ (resp. $p = p_c$ and $p > p_c$) shall be called the *subcritical phase* (resp. *criticality* and the *supercritical phase*).

In Section 6.4, we study the distribution of the capital for the long-term asymptotic market. This relies on the analysis of the capital measure as follows. Recall from §6.1.2.2 that the capital distribution curve describes the repartition of capital with respect to the rank of companies, ordered by size. For the sake of coherence with the works by Fernholz [58] and Chatterjee and Pal [41], the companies are ranked with respect to the decreasing order of their size: $\mu_n^{[1]}(t) \geq \dots \geq \mu_n^{[n]}(t)$. We recall that one can choose $[k] = (n - k + 1)$.

For $u, v \in [0, 1]$ with $u \leq v$, the proportion of capital held by companies ranked between nu and nv is roughly

$$\sum_{nu \leq k \leq nv} \mu_n^{[k]}(t) = \sum_{nu \leq k \leq nv} \mu_n^{(n-k+1)}(t) \simeq \sum_{n(1-v) \leq j \leq n(1-u)} \mu_n^{(j)}(t) = \langle \mathbb{1}_{\{1-v \leq \cdot \leq 1-u\}}, \Pi_n(t) \rangle,$$

which explicits the link between the capital distribution curves and the capital measure $\Pi_n(t)$. In order to describe the long-term capital distribution on large markets, we use the results of Section 6.3 on the long time behaviour of the asymptotic capital measure $\Pi(t)$.

Interestingly, the phase transition for the asymptotic weighted capital measure derived in Section 6.3 results in the same phenomenon as was observed by Chatterjee and Pal [41] (see §6.1.2.2 above). Yet we provide a different, and complementary, description. In particular, in the case where the market weight of every stock vanishes, we introduce the capital density $\bar{\mu} : [0, 1] \rightarrow [0, +\infty)$ such that the proportion of capital held by the companies ranked between nu and $n(u + du)$ is given by $\bar{\mu}(u)du$ in the long-term asymptotic market. The study of the capital density allows us to recover the Pareto-like shape of capital distribution curves, similar to the ones obtained by Fernholz.

We finally address the performance of portfolio rules in Section 6.5. We first introduce a family of portfolio rules, called *p-diversity weighted portfolios*, interpolating between the equally weighted and the market portfolio. The performance of such portfolios is described in terms of the weighted capital measures. Therefore, based on the results of Section 6.3, we obtain a law of large numbers for the growth rates of these portfolios. Then, we analyse the long time behaviour of these asymptotic growth rates.

As far as the discussion led in §6.1.2.3 is concerned, we draw the following conclusions: in the limit of a large market, the relative performance of the equally weighted portfolio with respect to the market portfolio only depends on the volatility structure of the market model, and no longer on the growth rate. In particular, if the variance of a stock is a nonincreasing function of its capitalization, which matches the volatility size effect described in §6.1.2.1, then we recover the fact that the equally weighted portfolio beats the market. However, we also provide an example of a model, where large stocks have large variance, in which the market portfolio outperforms the equally weighted portfolio, in spite of rebalancing.

6.2 The mean-field Atlas model

In this section, we give a general description of the limit of the mean-field Atlas model when the number of companies n grows to infinity, laying particular emphasis on the long time behaviour of the market. Our analysis is based on the theoretical study of Chapter 4, the main results of which shall be recalled whenever needed. Notations and conventions are set up in Subsection 6.2.1. The description of the large market asymptotics is made in Subsection 6.2.2, and its long time behaviour is discussed in Subsection 6.2.3.

6.2.1 Preliminaries

We first set up some notations and conventions.

6.2.1.1 Assumptions

Let us introduce and discuss the various assumptions that we shall use on the initial distribution m and the coefficients γ and σ of the mean-field Atlas model.

Following [13], a sufficient condition for the system (6.1) to be defined in the mean-field Atlas model is the following *uniform ellipticity* assumption

$$\forall u \in [0, 1], \quad \sigma^2(u) > 0. \quad (\text{UE})$$

A weakening of this assumption, allowing degeneracies in 0 and 1, is discussed in §6.3.2.3.

The law of large numbers for the weighted capital measure requires integrability conditions on the powers of the capitalization processes. These conditions are propagated from integrability conditions on the powers of initial capitalizations, therefore we shall assume that the common probability distribution m of the initial log-capitalizations $Y_n^1(0), \dots, Y_n^n(0)$ satisfies

$$\forall p \geq 0, \quad \int_{y \in \mathbb{R}} e^{py} m(dy) < +\infty. \quad (\text{H})$$

We now define the function Γ on $[0, 1]$ by, for all $u \in [0, 1]$,

$$\Gamma(u) := \int_{v=0}^u \gamma(v) dv.$$

Then, the long-term stability of large markets is ensured by the following equilibrium assumptions (E1) and (E2). The first one is the continuous equivalent of (6.4), namely

$$\forall u \in (0, 1), \quad \Gamma(u) - gu > 0, \quad (\text{E1})$$

where we recall that g is the market mean growth rate defined in (6.7). Note that (E1) together with the continuity of γ imply that $\gamma(0) \geq g \geq \gamma(1)$, which is the continuous translation of the size effect: in average, small stocks grow faster than the market, while large stocks grow slower than the market. In particular, if the growth rate function γ is decreasing on $[0, 1]$, then Assumption (E1) is satisfied.

The second equilibrium condition writes

$$\int_{u=0}^{1/2} \frac{u}{|\Gamma(u) - gu|} du + \int_{u=1/2}^1 \frac{1-u}{|\Gamma(u) - gu|} du < +\infty, \quad (\text{E2})$$

and ensures integrability properties for the equilibrium distribution. Note that under Assumption (E1) and because of the continuity of γ , a sufficient condition for (E2) to hold is $\gamma(0) > g > \gamma(1)$.

Let us finally note that the growth rate function corresponding to the mean-field approximation of the Atlas model introduced in Remark 6.1.1 satisfies the equilibrium conditions (E1) and (E2) for all $\alpha > 0$.

6.2.1.2 Notations

For all $T > 0$, the space of continuous sample-paths $C([0, T], \mathbb{R})$ is endowed with the sup norm $\|\cdot\|_\infty$, and the space $C([0, +\infty), \mathbb{R})$ is provided with the topology of the locally uniform convergence. For all $k \geq 1$, the set of probability distributions on $C([0, +\infty), \mathbb{R}^k)$ is denoted by $P(C([0, +\infty), \mathbb{R}^k))$. The marginal distribution of $P \in P(C([0, +\infty), \mathbb{R}))$ at time $t \geq 0$ is denoted by P_t . The cumulative distribution function of P_t is denoted by $F_t := H * P_t$, where $H * \cdot$ refers to the convolution with the Heaviside function $H(y) := \mathbf{1}_{\{y \geq 0\}}$. For all nonincreasing function $a : \mathbb{R} \rightarrow \mathbb{R}$, the pseudo-inverse of a is defined by $a^{-1}(u) := \inf\{y \in \mathbb{R} : a(y) > u\}$.

For all $q \in [1, +\infty)$, the q -Wasserstein distance between two cumulative distribution functions F and G on \mathbb{R} is defined by

$$W_q(F, G) := \inf_{(X, Y) \in \text{Coup}(F, G)} (\mathbb{E}(|X - Y|^q))^{1/q}, \quad (6.9)$$

where $\text{Coupl}(F, G)$ refers to the set of random pairs (X, Y) with marginal cumulative distribution functions F and G , see Rachev and Rüschendorf [120]. The right-hand side above can actually be rewritten in terms of the pseudo-inverse functions F^{-1} and G^{-1} as follows: given a uniform random variable U on $[0, 1]$, an optimal coupling is provided by the random pair $(F^{-1}(U), G^{-1}(U)) \in \text{Coupl}(F, G)$ [120, Theorem 3.1.2, p. 109], so that

$$W_q(F, G) = \left(\int_{u=0}^1 |F^{-1}(u) - G^{-1}(u)|^q du \right)^{1/q}. \quad (6.10)$$

Finally, if Π refers to a probability distribution on $[0, 1]$, for all measurable and bounded function $f : [0, 1] \rightarrow \mathbb{R}$, we denote

$$\langle f, \Pi \rangle := \int_{u=0}^1 f(u) \Pi(du).$$

6.2.2 Propagation of chaos and nonlinear log-capitalization process

We first recall the following propagation of chaos result from Corollary 4.2.13 in Chapter 4. For an introduction to the propagation of chaos phenomenon, we refer to the lecture notes by Sznitman [130].

Theorem 6.2.1. *Let us assume that the variance function σ^2 satisfies the uniform ellipticity condition (UE), and that the probability distribution m admits a finite first order moment. Recall that $Y_n^1(0), \dots, Y_n^n(0)$ are i.i.d. according to m .*

- There exists a unique weak solution $(Y(t))_{t \geq 0}$ to the stochastic differential equation, nonlinear in the sense of McKean,

$$\begin{cases} dY(t) = \gamma(F_t(Y(t)))dt + \sigma(F_t(Y(t)))dB(t), \\ F_t = H * P_t \text{ is the cumulative distribution function of } Y(t), \end{cases} \quad (6.11)$$

where $Y(0)$ is distributed according to m and $(B(t))_{t \geq 0}$ is a standard brownian motion in \mathbb{R} independent of $Y(0)$. Let $P \in \mathcal{P}(\mathcal{C}([0, +\infty), \mathbb{R}))$ denote the law of $(Y(t))_{t \geq 0}$.

- For any finite set $\{i_1, \dots, i_k\}$ of distinct indices, the joint law of $(Y_n^{i_1}(t), \dots, Y_n^{i_k}(t))_{t \geq 0}$ converges weakly, in $\mathcal{P}(\mathcal{C}([0, +\infty), \mathbb{R}^k))$, to the law $P^{\otimes k}$ of k independent copies of the process $(Y(t))_{t \geq 0}$.
- Finally, dt-almost everywhere, the probability distribution P_t is absolutely continuous with respect to the Lebesgue measure on \mathbb{R} .

Nonlinearity in the sense of McKean has to be understood as the fact that the coefficients in the stochastic differential equation (6.11) depend on the entire law of the random variable $Y(t)$ through its cumulative distribution function F_t . Therefore, the process $(Y(t))_{t \geq 0}$ shall be called the *nonlinear log-capitalization process*.

Remark 6.2.2. The following remarks on the nonlinear log-capitalization process can be formulated.

- The equality (6.11) rewrites

$$Y(t) = Y(0) + \int_{s=0}^t \gamma(F_s(Y(s)))ds + \int_{s=0}^t \sigma(F_s(Y(s)))dB(s).$$

On the one hand, since σ is bounded, then the stochastic integral is a centered martingale. On the other hand, by Theorem 6.2.1, ds-almost everywhere, the probability distribution P_s does not weight points so that $F_s(Y(s))$ has a uniform distribution on $[0, 1]$. As a consequence, taking the expectation of the equality above yields (6.6), i.e. $\mathbb{E}(Y(t)) = \mathbb{E}(Y(0)) + gt$.

- Theorem 6.2.1 rewrites as a law of large numbers for the empirical distribution ν^n of the process $(Y_n^1(t), \dots, Y_n^n(t))_{t \geq 0}$, defined as a random variable in $P(C([0, +\infty), \mathbb{R}))$ by

$$\nu^n := \frac{1}{n} \sum_{i=1}^n \delta_{(Y_n^i(t))_{t \geq 0}}.$$

Indeed, following [130, Proposition 2.2, p. 177], the statement of Theorem 6.2.1 combined with the exchangeability of the processes $(Y_n^1(t))_{t \geq 0}, \dots, (Y_n^n(t))_{t \geq 0}$ imply that ν^n converges in probability, in $P(C([0, +\infty), \mathbb{R}))$, to P .

6.2.3 Long time behaviour of the nonlinear log-capitalization process

We now describe the long time behaviour of the nonlinear log-capitalization process $(Y(t))_{t \geq 0}$. Because of (6.6), it is necessary to introduce a shift by defining $\tilde{Y}(t) := Y(t) - gt$, for all $t \geq 0$. The process $(\tilde{Y}(t))_{t \geq 0}$ is called the *fluctuation* process. We first note that $(\tilde{Y}(t))_{t \geq 0}$ satisfies the same nonlinear stochastic differential equation (6.11) as $(Y(t))_{t \geq 0}$, with shifted growth rate $\tilde{\gamma}(u) := \gamma(u) - g$.

Lemma 6.2.3. *Under the assumptions of Theorem 6.2.1, the fluctuation $(\tilde{Y}(t))_{t \geq 0}$ solves the nonlinear stochastic differential equation*

$$\begin{cases} d\tilde{Y}(t) = \tilde{\gamma}(\tilde{F}_t(\tilde{Y}(t)))dt + \sigma(\tilde{F}_t(\tilde{Y}(t)))dB(t), \\ \tilde{F}_t \text{ is the cumulative distribution function of } \tilde{Y}(t), \end{cases}$$

where $\tilde{Y}(0)$ is distributed according to m and $(B(t))_{t \geq 0}$ is a standard brownian motion in \mathbb{R} independent of $\tilde{Y}(0)$. Moreover, weak uniqueness holds for this nonlinear stochastic differential equation.

Proof. Weak uniqueness for the nonlinear stochastic differential equation follows from the application of Theorem 6.2.1 with γ replaced with $\tilde{\gamma}$. We now check that $(\tilde{Y}(t))_{t \geq 0}$ is a solution. By definition,

$$\begin{aligned} d\tilde{Y}(t) &= dY(t) - gdt \\ &= \gamma(F_t(Y(t)))dt + \sigma(F_t(Y(t)))dB(t) - gdt \\ &= \tilde{\gamma}(F_t(\tilde{Y}(t) + gt))dt + \sigma(F_t(\tilde{Y}(t) + gt))dB(t). \end{aligned}$$

Moreover, since, for all $y \in \mathbb{R}$, $F_t(y) = \mathbb{P}(Y(t) \leq y)$, then $F_t(y + gt) = \mathbb{P}(Y(t) - gt \leq y) = \tilde{F}_t(y)$, where \tilde{F}_t is the cumulative distribution function of $\tilde{Y}(t)$. As a consequence,

$$d\tilde{Y}(t) = \tilde{\gamma}(\tilde{F}_t(\tilde{Y}(t)))dt + \sigma(\tilde{F}_t(\tilde{Y}(t)))dB(t),$$

and the proof is completed. \square

To describe the long time behaviour of the fluctuation $(\tilde{Y}(t))_{t \geq 0}$, we now assume that the uniform ellipticity condition (UE) and the equilibrium condition (E1) hold. This enables us to define the continuous, increasing function Ψ on $(0, 1)$ by

$$\forall u \in (0, 1), \quad \Psi(u) := \int_{v=1/2}^u \frac{\sigma^2(v)}{2(\Gamma(v) - gv)} dv.$$

Note that the pseudo-inverse function Ψ^{-1} is a cumulative distribution function on \mathbb{R} . Its first order moment writes

$$\int_{y=-\infty}^0 \Psi^{-1}(y)dy + \int_{y=0}^{+\infty} (1 - \Psi^{-1}(y))dy = \int_{u=0}^{1/2} u \frac{\sigma^2(u)}{2(\Gamma(u) - gu)} du + \int_{u=1/2}^1 (1-u) \frac{\sigma^2(u)}{2(\Gamma(u) - gu)} du,$$

and, because of Assumption (UE), it is finite if and only if Assumption (E2) holds.

The cumulative distribution function Ψ^{-1} describes the equilibrium of the fluctuation process, which is made precise in the following theorem from Section 4.4 in Chapter 4.

Theorem 6.2.4. *Let us assume that:*

- the function σ^2 satisfies the uniform ellipticity condition (UE),
- the function γ satisfies the equilibrium conditions (E1) and (E2),
- the function σ^2 is C^2 on $[0, 1]$, the function γ is C^1 on $[0, 1]$ and there exists $\beta > 0$ such that the functions $(\sigma^2)''$ and γ' are β -Hölder continuous,
- the probability distribution m has a finite first order moment, and, for all $p \geq 0$, $W_p(H * m, \Psi^{-1}) < +\infty$.

Then, the pseudo-inverse Ψ^{-1} of the function Ψ introduced above is the cumulative distribution function of a probability distribution with positive density on \mathbb{R} .

Let us now write \tilde{F}_t for the cumulative distribution function of $\tilde{Y}(t)$, and define \tilde{F}_∞ by $\tilde{F}_\infty(y) = \Psi^{-1}(y + \bar{y})$, where \bar{y} is chosen so that

$$\int_{y \in \mathbb{R}} y \tilde{F}'_\infty(y) dy = \int_{y \in \mathbb{R}} y m(dy).$$

Then, for all $p \geq 1$,

$$\lim_{t \rightarrow +\infty} W_p(\tilde{F}_t, \tilde{F}_\infty) = 0.$$

The probability distribution with density $(\Psi^{-1})'$ shall be referred to as the *equilibrium distribution*. We discuss the shape of its tails in the following remark.

Remark 6.2.5. Describing the tail of the equilibrium distribution in $+\infty$ amounts to describing the behaviour of $\Psi(u)$ when $u \uparrow 1$. Let us recall that, under Assumptions (UE), (E1) and (E2), $\gamma(1) \leq g$; so that the *critical diversity index* p_c defined by

$$p_c := \frac{2(g - \gamma(1))}{\sigma^2(1)} \tag{6.12}$$

is nonnegative.

- If $\gamma(1) < g$, that is to say $p_c > 0$, then writing

$$\Gamma(v) - gv = g(1 - v) - \int_{w=v}^1 \gamma(w) dw$$

yields

$$\Psi(u) = \int_{v=1/2}^u \frac{\sigma^2(v)}{2(\Gamma(v) - gv)} dv \sim_{u \uparrow 1} \frac{\sigma^2(1)}{2(g - \gamma(1))} \int_{v=1/2}^u \frac{dv}{1 - v} \sim_{u \uparrow 1} -\frac{1}{p_c} \log(1 - u),$$

so that the tail of the equilibrium distribution in $+\infty$ is expected to be exponential with parameter p_c , that is to say, $1 - \Psi^{-1}(y)$ is expected to decay to 0 at an exponential rate of order p_c .

- If $\gamma(1) = g$, that is to say $p_c = 0$, then the tail of the equilibrium distribution in $+\infty$ is expected to be heavy, that is to say, $1 - \Psi^{-1}(y)$ is expected to decay to 0 slower than any exponential rate.

Likewise, a symmetric phenomenon is observed for the tail of the equilibrium distribution in $-\infty$. The critical index q_c defined by $q_c := 2(\gamma(0) - g)/\sigma^2(0)$ is nonnegative, and if $q_c > 0$, then

$$\Psi(u) \sim_{u \downarrow 0} \frac{1}{q_c} \log(u),$$

so that, when $y \rightarrow -\infty$, $\Psi^{-1}(y)$ is expected to decay to 0 at an exponential rate of order q_c . If $q_c = 0$, then the tail of the equilibrium distribution in $-\infty$ is expected to be heavy.

6.3 The weighted capital measure

For all $p \geq 0$, $t \geq 0$, the weighted capital measure $\Pi_n^p(t)$ is defined by (6.8). Recall that for $p = 1$, we write $\Pi_n(t)$ instead of $\Pi_n^1(t)$, and refer to this measure as the capital measure. For all measurable and bounded function $f : [0, 1] \rightarrow \mathbb{R}$,

$$\langle f, \Pi_n^p(t) \rangle = \sum_{j=1}^n \frac{(X_n^{(j)}(t))^p}{(X_n^1(t))^p + \dots + (X_n^n(t))^p} f\left(\frac{j}{n}\right) = \sum_{j=1}^n \frac{e^{pY_n^{(j)}(t)}}{e^{pY_n^1(t)} + \dots + e^{pY_n^n(t)}} f\left(\frac{j}{n}\right).$$

As is explained in Section 6.1, the capital measure is strongly related to the capital distribution curves. Likewise, we shall describe in Section 6.5 below the link between the weighted capital measures and the performance of a family of portfolio rules. Therefore, it is of interest to describe the asymptotic behaviour of the weighted capital measure when the size of the market grows to infinity. This task is carried out in Subsection 6.3.1 by deriving a law of large numbers for $\Pi_n^p(t)$. The corresponding limit $\Pi^p(t)$ is referred to as the asymptotic weighted capital measure, and its long time behaviour is addressed in Subsection 6.3.2.

6.3.1 Law of large numbers

We first address the limit, when n grows to infinity, of $\Pi_n^p(t)$.

Proposition 6.3.1. *Let us assume that the conditions of Theorem 6.2.1 are satisfied, and that the probability distribution m satisfies the condition (H). Let us fix $T > 0$ and $q \in [1, +\infty)$. Then, for all $p \geq 0$,*

- *there exists $C_T^p < +\infty$ such that*

$$\forall t \in [0, T], \quad \mathcal{Z}^p(t) := \int_{u=0}^1 e^{pF_t^{-1}(u)} du = \mathbb{E} \left(e^{pY(t)} \right) \leq C_T^p, \quad (6.13)$$

- *for all continuous function $f : [0, 1] \rightarrow \mathbb{R}$, the process $(\langle f, \Pi_n^p(t) \rangle)_{t \in [0, T]}$ converges, in $L^q(C([0, T], \mathbb{R}))$, to the deterministic process $(\langle f, \Pi^p(t) \rangle)_{t \in [0, T]}$, where $\Pi^p(t)$ is the probability distribution with density $\exp(pF_t^{-1}(u))/\mathcal{Z}^p(t)$ with respect to the Lebesgue measure on $[0, 1]$.*

The proof of Proposition 6.3.1 is detailed in Appendix 6.A. The probability distribution $\Pi^p(t)$ shall be called the *asymptotic weighted capital measure*.

6.3.2 Long-term asymptotic capital measure

We now address the long time behaviour of the asymptotic weighted capital measure $\Pi^p(t)$.

6.3.2.1 Heuristic derivation

Let us recall that the cumulative distribution function \tilde{F}_t of the fluctuation $\tilde{Y}(t) = Y(t) - gt$ writes $\tilde{F}_t(y) = F_t(y + gt)$. As a consequence, the density of the asymptotic weighted capital measure $\Pi^p(t)$ with respect to the Lebesgue measure on $[0, 1]$ rewrites

$$\frac{e^{pF_t^{-1}(u)}}{\int_{u=0}^1 e^{pF_t^{-1}(u)} du} = \frac{e^{p(\tilde{F}_t^{-1}(u) + gt)}}{\int_{u=0}^1 e^{p(\tilde{F}_t^{-1}(u) + gt)} du} = \frac{e^{p\tilde{F}_t^{-1}(u)}}{\int_{u=0}^1 e^{p\tilde{F}_t^{-1}(u)} du}.$$

Under appropriate assumptions, Theorem 6.2.4 asserts that \tilde{F}_t converges, in Wasserstein distance, to \tilde{F}_∞ defined by $\tilde{F}_\infty(y) = \Psi^{-1}(y + \bar{y})$, where \bar{y} is chosen so that \tilde{F}_∞ and m have the same

expectation. As a consequence, the asymptotic weighted capital measure $\Pi^p(t)$ is expected to converge to the probability distribution $\bar{\Pi}^p$ with density

$$\frac{e^{p\tilde{F}_\infty^{-1}(u)}}{\int_{u=0}^1 e^{p\tilde{F}_\infty^{-1}(u)} du} = \frac{e^{p(\Psi(u)-\bar{y})}}{\int_{u=0}^1 e^{p(\Psi(u)-\bar{y})} du} = \frac{e^{p\Psi(u)}}{\int_{u=0}^1 e^{p\Psi(u)} du},$$

as long as

$$\bar{Z}^p := \int_{u=0}^1 e^{p\Psi(u)} du < +\infty.$$

Following the first-order analysis of the equilibrium distribution carried out in Remark 6.2.5, this should be the case for $p \in [0, p_c)$. On the contrary, if $p > p_c$, then \bar{Z}^p is expected to be infinite, and all the mass of $\Pi^p(t)$ should concentrate around 1 when t grows to infinity, so that $\Pi^p(t)$ is rather expected to converge to the Dirac distribution δ_1 . This *phase transition phenomenon* is made precise in §6.3.2.2 below.

6.3.2.2 Phase transition

Let us recall that the critical diversity index $p_c \geq 0$ was defined in (6.12).

Lemma 6.3.2. *Let us assume that the uniform ellipticity condition (UE), that the equilibrium condition (E1) hold, and that the critical diversity index p_c is positive. Then, for all $p \in [0, p_c)$, $\bar{Z}^p < +\infty$, and we denote by $\bar{\Pi}^p$ the probability distribution with density $\exp(p\Psi(u))/\bar{Z}^p$ with respect to the Lebesgue measure on $[0, 1]$.*

Moreover, for all continuous function $f : [0, 1] \rightarrow \mathbb{R}$, the function $p \mapsto \langle f, \bar{\Pi}^p \rangle$ is continuous on $[0, p_c)$, and:

- if $\bar{Z}^{p_c} = +\infty$, then $\lim_{p \uparrow p_c} \langle f, \bar{\Pi}^p \rangle = f(1)$,
- if $\bar{Z}^{p_c} < +\infty$, we denote by $\bar{\Pi}^{p_c}$ the probability distribution with density $\exp(p_c\Psi(u))/\bar{Z}^{p_c}$ with respect to the Lebesgue measure on $[0, 1]$, and then $\lim_{p \uparrow p_c} \langle f, \bar{\Pi}^p \rangle = \langle f, \bar{\Pi}^{p_c} \rangle$.

The proof of Lemma 6.3.2 is postponed to Appendix 6.B. The probability distribution $\bar{\Pi}^p$ shall be called the *long-term asymptotic weighted capital measure*.

Example 6.3.3. We explicit the long-term asymptotic weighted capital measure for a constant variance function σ^2 and for $\gamma(u) = 1 - 2u$. For these coefficients, $g = 0$ and the equilibrium distribution was computed in [89, Example 2.3]. In particular, the function Ψ writes

$$\Psi(u) = \int_{v=1/2}^u \frac{\sigma^2}{2v(1-v)} dv = \frac{1}{p_c} \log \left(\frac{u}{1-u} \right),$$

so that, for $p \in [0, p_c)$, $\bar{\Pi}^p$ is the Beta($1 + p/p_c, 1 - p/p_c$) distribution. In addition, it is easily checked that $\bar{Z}^{p_c} = +\infty$, so that $\bar{\Pi}^p$ converges to the Dirac distribution in 1 when p approaches the critical diversity index p_c .

We now explicit the link between $\bar{\Pi}^p$ and the long time behaviour of $\Pi^p(t)$.

Proposition 6.3.4. *Let us assume that the conditions of Theorem 6.2.4 hold, and that the probability distribution m satisfies the condition (H). Let $p_c \geq 0$ be defined by (6.12). Let $f : [0, 1] \rightarrow \mathbb{R}$ be a continuous function, and $p \geq 0$.*

- Subcritical phase: if $p \in [0, p_c)$, then

$$\lim_{t \rightarrow +\infty} \langle f, \Pi^p(t) \rangle = \langle f, \bar{\Pi}^p \rangle,$$

where the probability distribution $\bar{\Pi}^p$ is defined in Lemma 6.3.2.

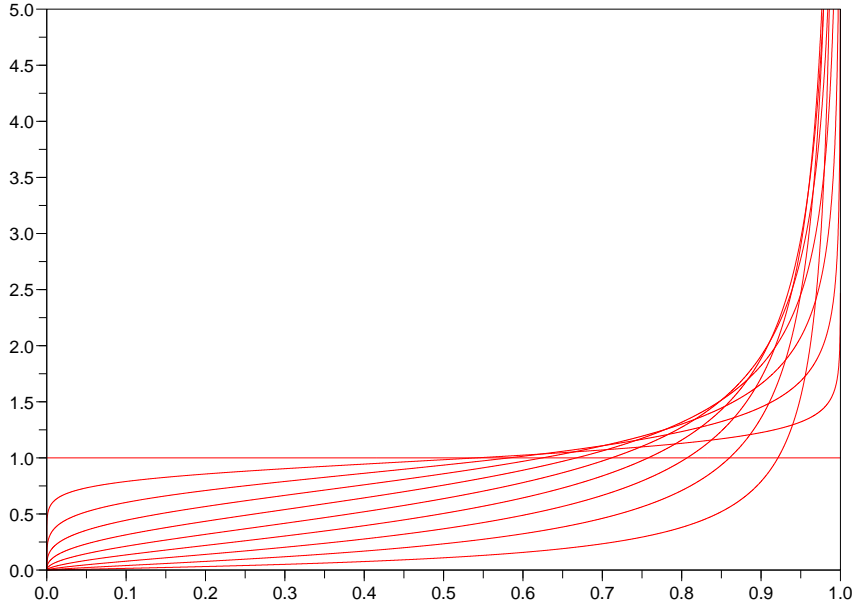

Figure 6.1: The density of $\bar{\Pi}^p$ for a constant variance function σ^2 and $\gamma(u) = 1 - 2u$. The diversity index p varies between 0 and p_c . The uniform density is recovered for $p = 0$, while the mass concentrates on the point $u = 1$ when p approaches the critical diversity index p_c .

- Supercritical phase: *if $p > p_c$, then*

$$\lim_{t \rightarrow +\infty} \langle f, \Pi^p(t) \rangle = f(1).$$

- Criticality: *the long time behaviour of $\langle f, \Pi^{p_c}(t) \rangle$ is described as follows:*
 - *if $\bar{Z}^{p_c} = +\infty$, by Lemma 6.3.2, $\lim_{p \uparrow p_c} \langle f, \bar{\Pi}^p \rangle = f(1)$, and then*

$$\lim_{t \rightarrow +\infty} \langle f, \Pi^{p_c}(t) \rangle = f(1),$$

- *if $\bar{Z}^{p_c} < +\infty$, by Lemma 6.3.2, $\lim_{p \uparrow p_c} \langle f, \bar{\Pi}^p \rangle = \langle f, \bar{\Pi}^{p_c} \rangle$, and then*

$$f(1) \wedge \langle f, \bar{\Pi}^{p_c} \rangle \leq \liminf_{t \rightarrow +\infty} \langle f, \Pi^{p_c}(t) \rangle \leq \limsup_{t \rightarrow +\infty} \langle f, \Pi^{p_c}(t) \rangle \leq f(1) \vee \langle f, \bar{\Pi}^{p_c} \rangle. \quad (6.14)$$

The proof of Proposition 6.3.4 is postponed to Appendix 6.B. The description of the long time behaviour of $\Pi^p(t)$ is summarized on Figure 6.2. Note that, in the case $\bar{Z}^{p_c} = +\infty$, the function $p \mapsto \lim_{t \rightarrow +\infty} \langle f, \Pi^p(t) \rangle$ is defined and continuous on $[0, +\infty)$.

6.3.2.3 Removing the phase transition

In order to describe all the possible situations for the equilibrium distribution, it is natural to look for functions γ and σ such that $p_c = +\infty$, that is to say, for which there is no phase transition and the tail in $+\infty$ of the equilibrium distribution is lighter than exponential. Partial results in this direction are provided in Chapter 4.

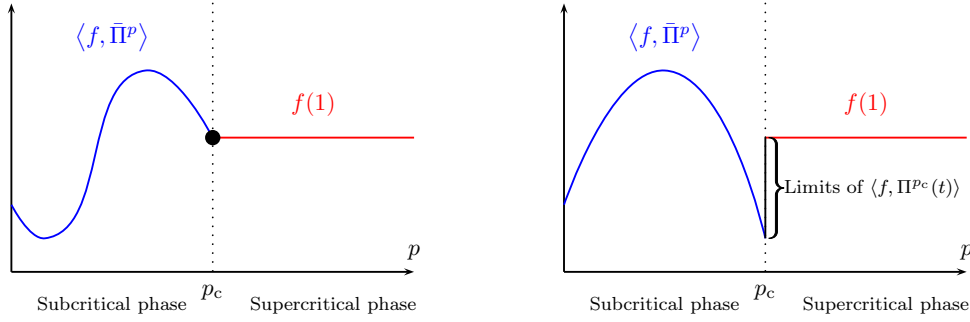

Figure 6.2: A schematic representation of the long time behaviour of $\langle f, \Pi^p(t) \rangle$ according to Proposition 6.3.4. On the left-hand figure, $\lim_{p \uparrow p_c} \langle f, \bar{\Pi}^p \rangle = f(1)$, so that $\lim_{t \rightarrow +\infty} \langle f, \Pi^{p_c}(t) \rangle$ exists and its value is represented by the black dot. On the right-hand figure, $\lim_{p \uparrow p_c} \langle f, \bar{\Pi}^p \rangle \neq f(1)$ and the limit points of $\langle f, \Pi^{p_c}(t) \rangle$ are located inside the gap between $\lim_{p \uparrow p_c} \langle f, \bar{\Pi}^p \rangle = \langle f, \bar{\Pi}^{p_c} \rangle$ and $f(1)$.

To obtain $p_c = +\infty$, one can for instance remove the uniform ellipticity assumption (UE) on the variance function σ^2 and allow the latter to vanish in 1. Our analysis shall actually cover both the tails in $-\infty$ and $+\infty$ of the equilibrium distribution, therefore we introduce the following *nondegeneracy assumption*

$$\forall u \in (0, 1), \quad \sigma^2(u) > 0, \quad (\text{ND})$$

which allows the variance to vanish in 0 and 1, in contrast with Assumption (UE). Under this assumption and suitable further assumptions on the initial distribution m , the propagation of chaos result of Theorem 6.2.1 can be recovered, see Chapter 4. We still denote by $(Y(t))_{t \geq 0}$ the corresponding nonlinear log-capitalization process. Adding the condition (H), we easily extend the laws of large numbers obtained in Proposition 6.3.1.

Let us now address the equilibrium distribution of the fluctuation $(\tilde{Y}(t))_{t \geq 0}$ defined by $\tilde{Y}(t) = Y(t) - gt$. Under Assumptions (ND) and (E1), the function Ψ can still be defined and the stationary distributions of the fluctuation $(\tilde{Y}(t))_{t \geq 0}$ are exactly the translations of the probability distribution with cumulative distribution function Ψ^{-1} , see Proposition 4.4.1 in Chapter 4. However, the tails of the equilibrium distribution can now exhibit a wide range of behaviours. For instance, if $\sigma^2(u) = (1 - u)^\alpha$ and $\Gamma(u) - gu \sim_{u \uparrow 1} (1 - u)^\beta$, with $\alpha \geq 0$ and $\beta \geq 1$, then the tail of the equilibrium distribution in $+\infty$ now depends on $\alpha - \beta$ as follows:

- if $\alpha - \beta > -1$, then $\limsup_{u \uparrow 1} \Psi(u) < +\infty$, so that the support of the equilibrium distribution is bounded from above,
- if $\alpha - \beta = -1$, then the tail of the equilibrium distribution in $+\infty$ is exponential,
- if $\alpha - \beta < -1$, then the tail of the equilibrium distribution in $+\infty$ is polynomial.

Thus, the stationary distributions of the fluctuation can be rigorously described without the uniform ellipticity assumption (UE).

However, extending the results of Proposition 6.3.4 concerning the long time behaviour of $\Pi^p(t)$ requires to establish convergence results for the fluctuation in the same way as Theorem 6.2.4. In the proof of the latter (see Theorem 4.4.6 in Chapter 4), the uniform ellipticity assumption (UE) ensured the regularity of the function $(t, y) \mapsto \tilde{F}_t(y)$, which was a crucial technical point. Replacing Assumption (UE) with the nondegeneracy assumption (ND), we were not able to obtain a similar result, and therefore our proof could not be adapted. As a consequence, in the absence of convergence results for the fluctuation, the conclusions of Proposition 6.3.4 can only be recovered at the heuristic level, based on the analysis of the equilibrium distribution described above.

6.4 Capital distribution curves

We pursue the discussion of §6.1.3.2 in order to describe the capital distribution in the long-term asymptotic mean-field Atlas model. If $[k]$ refers to the index of the company with k -th largest capitalization, we define the *relative rank* of this company by $k/n \in [0, 1]$. In the limit of large markets, we shall be interested by the proportion of capital held by companies with relative rank between u and $u + du$, for $u \in [0, 1]$.

6.4.1 Phase transition for the long-term asymptotic capital measure

We first recall the following technical lemma, which is a straightforward consequence of the Portmanteau theorem [18, Theorem 2.1, p. 16].

Lemma 6.4.1. *Let $(\Pi_n)_{n \geq 1}$ be a sequence of probability distributions on \mathbb{R} , such that Π_n converges weakly to a probability distribution Π on $[0, 1]$. If Π is absolutely continuous with respect to the Lebesgue measure on $[0, 1]$, then for all interval $I \subset [0, 1]$, $\Pi_n(I)$ converges to $\Pi(I)$.*

We deduce from §6.1.3.2, Proposition 6.3.1 and Lemma 6.4.1, that for all $t \geq 0$ and $u, v \in [0, 1]$ with $u \leq v$, the proportion of capital held by the companies with relative rank between u and v converges in probability to

$$\langle \mathbb{1}_{\{1-v \leq \cdot \leq 1-u\}}, \Pi(t) \rangle = \frac{1}{\mathcal{Z}(t)} \int_{w=u}^v e^{F_t^{-1}(1-w)} dw.$$

In particular, the proportion of capital held by the companies with relative rank between u and $u+du$ in a large market is roughly $\exp(F_t^{-1}(1-u))du/\mathcal{Z}(t)$. Then, the phase transition phenomenon derived in Section 6.3 translates as follows.

- (i) If $p_c > 1$, then the asymptotic capital measure (with index $p = 1$) is subcritical, so that in the long-term, the proportion of capital held by the companies with relative rank between u and $u + du$ is roughly $\bar{\mu}(u)du$, where

$$\bar{\mu}(u) := \frac{e^{\Psi(1-u)}}{\bar{\mathcal{Z}}}$$

is the *capital density*.

- (ii) If $p_c < 1$, the asymptotic capital measure is supercritical, therefore $\Pi(t)$ converges weakly to the Dirac distribution δ_1 . As a consequence, all the capital concentrates on the relative rank 0.

A detailed study of the capital density $\bar{\mu}$ is carried out in Subsection 6.4.2, and the Pareto-like distribution empirically observed is recovered. We establish a comparison between our results and the article by Chatterjee and Pal [41] in Subsection 6.4.3.

6.4.2 Capital distribution curve in the subcritical case

Let us assume that $p_c > 1$. Similarly to Fernholz [58, Section 5], we call *capital distribution curve* the logarithmic plot of the function $u \mapsto \bar{\mu}(u)$. For the coefficients introduced in Example 6.3.3, we draw the capital distribution curve on Figure 6.3.

Figure 6.3 has to be compared with the shape of the empirical curves obtained by Fernholz [58, Figure 5.1, p. 95], which exhibit the following characteristics:

- they are almost linear for stocks with small ranks, which indicates a Pareto-like distribution of the capital,
- they become concave for stocks with large ranks.

This behaviour is easily recovered for the long-term asymptotic capital measure.

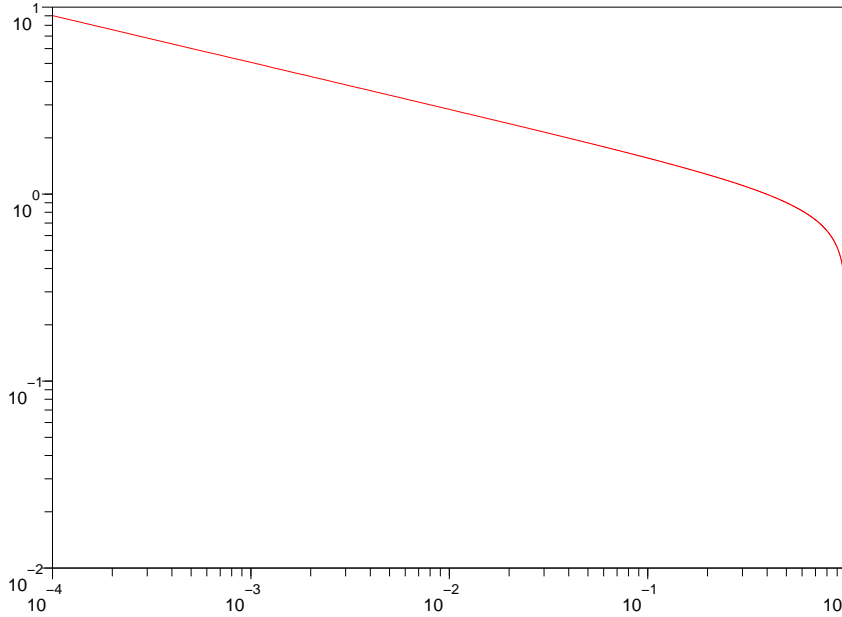

Figure 6.3: The logarithmic plot of the capital density $\bar{\mu}(u)$ for the coefficients of Example 6.3.3, with $p_c = 4$.

Proposition 6.4.2. *Let us assume that the conditions of Proposition 6.3.4 hold, with $p_c > 1$. Then:*

- for $u \downarrow 0$, $\log \bar{\mu}(u) \sim (-1/p_c) \log u$, therefore the capital distribution curve is linear with slope $-1/p_c \in (-1, 0)$,
- for $u \uparrow 1$, $\log \bar{\mu}(u) \rightarrow -\infty$ and, if the parameter q_c defined in Remark 6.2.5 is positive, then $\log \bar{\mu}(u) \sim (1/q_c) \log(1 - u)$.

Proof. By the definition of the capital density, $\log \bar{\mu}(u) = \Psi(1 - u) - \log \bar{Z}$. Therefore, the asymptotic behaviour of $\log \bar{\mu}(u)$ in 0 and 1 is a straightforward consequence of Remark 6.2.5. \square

6.4.3 The Chatterjee-Pal phase transition

We now describe the phase transition observed by Chatterjee and Pal in [41], and discuss the relation with the long time behaviour of our asymptotic capital measure.

Let us assume that, for all $u \in [0, 1]$, $\sigma(u) = 1$, and that γ is decreasing (so that it satisfies the equilibrium assumption (E1)). Then, following [115], the process of market weights $(\mu_n^1(t), \dots, \mu_n^n(t))_{t \geq 0}$, defined by

$$\mu_n^i(t) = \frac{X_n^i(t)}{X_n^1(t) + \dots + X_n^n(t)},$$

admits a unique stationary distribution. Let us sample $(\mu_n^1, \dots, \mu_n^n)$ from this distribution, and denote by $(\mu_n^{[1]}, \dots, \mu_n^{[n]})$ the decreasing reordering of $(\mu_n^1, \dots, \mu_n^n)$.

The set of sequences $(m_k)_{k \geq 1}$ such that $1 \geq m_1 \geq m_2 \geq \dots \geq 0$ is endowed with the distance $d(m, m') := \sum_{k=1}^{+\infty} 2^{-k} (|m_k - m'_k| \wedge 1)$. Then, Theorem 2 in [41] writes as follows:

- if $p_c = 0$, then the sequence $(\mu_n^{[1]}, \dots, \mu_n^{[n]})$ converges in probability to $(1, 0, \dots)$,

- if $p_c \in (0, 1)$, then the sequence $(\mu_n^{[1]}, \dots, \mu_n^{[n]})$ converges in distribution to a Poisson-Dirichlet process with parameter p_c ,
- if $p_c \geq 1$, then the sequence $(\mu_n^{[1]}, \dots, \mu_n^{[n]})$ converges in probability to $(0, 0, \dots)$.

The Poisson-Dirichlet process, introduced by Kingman [96], is a random sequence $(m_k)_{k \geq 1}$ such that, almost surely, $1 > m_1 > m_2 > \dots > 0$ and $\sum_{k=1}^{+\infty} m_k = 1$. In particular, m_k converges to 0.

In the case $p_c < 1$, let $(m_k)_{k \geq 1}$ refer to the limit, when $n \rightarrow +\infty$, of the sequence $(\mu_n^{[1]}, \dots, \mu_n^{[n]})$. It is either $(1, 0, \dots)$ or a Poisson-Dirichlet process. Let us explain how to recover our conclusion of the supercritical case (ii) in Subsection 6.4.1 from the result of Chatterjee and Pal. To this aim, we fix $u \in (0, 1]$. For all $\epsilon > 0$, there exists $K \geq 1$ such that $\sum_{k=1}^K m_k \geq 1 - \epsilon/2$. Therefore, for n large enough, $\sum_{k=1}^K \mu_n^{[k]} \geq 1 - \epsilon$. As a consequence, for n large enough and such that $K/n \leq u$, we obtain that the companies with rank $k \leq nu$ hold at least a proportion $1 - \epsilon$ of the total capital. Since u and ϵ are arbitrary, we conclude that, in the large market limit, the whole capital is held by companies with relative rank around 0.

In the case $p_c \geq 1$, all the market weights vanish. This is coherent with (i) in Subsection 6.4.1, since the measure $\bar{\mu}(u)du$ does not weight points, so that no company holds a positive proportion of capital when n grows to infinity. However, our study of the capital density $\bar{\mu}$ provides informations on the capital distribution that are not available from Chatterjee and Pal's results.

As a conclusion, although we observe the very same phenomenon as Chatterjee and Pal, we depict it differently. In particular, they give detailed informations on the supercritical phase that our study cannot recover, while we provide a more precise description the capital distribution in the subcritical phase.

6.5 Performance of diversity weighted portfolios

We finally address the analysis of the performance of diversity weighted portfolios. The mathematical framework of Stochastic Portfolio Theory is briefly recalled in Subsection 6.5.1, where we also introduce a family of portfolios, called diversity weighted portfolios. This family is indexed by a diversity index and interpolates between the equally weighted portfolio and the market portfolio.

The performance of a portfolio rule is measured by its long-term asymptotic growth rate and excess growth rate, that we define in Subsection 6.5.2. The monotonicity of these quantities with respect to the diversity index is addressed in Subsection 6.5.3, and a reduction formula providing simple expressions is derived in Subsection 6.5.4.

We use these results to explicit the long-term asymptotic growth rate of the equally weighted portfolio and the market portfolio in Subsection 6.5.5, and state global conclusions in Subsection 6.5.6.

6.5.1 Stochastic portfolio theory in a nutshell

We first provide a short overview of Stochastic Portfolio Theory [58, 62].

6.5.1.1 Portfolio

A *portfolio rule*, or *portfolio* for short, is an adapted process

$$\pi_n = (\pi_n^1(t), \dots, \pi_n^n(t))_{t \geq 0}$$

such that, for all $t \geq 0$, for all $i \in \{1, \dots, n\}$, $\pi_n^i(t) \geq 0$ and $\pi_n^1(t) + \dots + \pi_n^n(t) = 1$. It describes the proportion of wealth that one invests in each stock. We assume that portfolios are self-financing, that is to say, there is no exogenous infusion or withdrawal of money after the initial time. Then, the *wealth process* $(Z_n^{\pi_n}(t))_{t \geq 0}$ associated with a portfolio π_n satisfies

$$\frac{dZ_n^{\pi_n}(t)}{Z_n^{\pi_n}(t)} = \sum_{i=1}^n \pi_n^i(t) \frac{dX_n^i(t)}{X_n^i(t)},$$

and the initial wealth is normalized to $Z_n^{\pi_n}(0) = 1$. By Itô's formula,

$$d(\log Z_n^{\pi_n}(t)) = \gamma_n^{\pi_n}(t)dt + \sum_{i=1}^n \pi_n^i(t)\sigma_n^i(t)dB^i(t),$$

where the processes

$$\gamma_n^{\pi_n}(t) := \sum_{i=1}^n \pi_n^i(t)\gamma_n^i(t) + \gamma_{*,n}^{\pi_n}(t), \quad \gamma_{*,n}^{\pi_n}(t) := \frac{1}{2} \sum_{i=1}^n \pi_n^i(t)(1 - \pi_n^i(t))(\sigma_n^i(t))^2,$$

are respectively called the *growth rate* and the *excess growth rate* of the portfolio.

Clearly, the growth rate of the portfolio writes as the average of the growth rates of the stocks contained in the portfolio, with weights given by the portfolio, plus the excess growth rate. The latter rewrites as the average of the variances of the stocks contained in the portfolio, minus the variance of the wealth process. Since $\gamma_{*,n}^{\pi_n}(t) \geq 0$, the variance of the wealth process is lower than the average of the variances of the stocks contained in the portfolio. Thus, the variance reduction due to diversification in the portfolio is exactly measured by the excess growth rate.

6.5.1.2 Diversity weighted portfolios

For all $p \geq 0$, we now define the p -diversity weighted portfolio $\pi_n^p = (\pi_n^{p,1}(t), \dots, \pi_n^{p,n}(t))_{t \geq 0}$ by

$$\forall t \geq 0, \quad \forall i \in \{1, \dots, n\}, \quad \pi_n^{p,i}(t) := \frac{(X_n^i(t))^p}{(X_n^1(t))^p + \dots + (X_n^n(t))^p}.$$

The associated wealth process is denoted by $(Z_n^p(t))_{t \geq 0}$ and the growth rate and excess growth rate processes of the portfolio are respectively denoted by $(\gamma_n^p(t))_{t \geq 0}$, $(\gamma_{*,n}^p(t))_{t \geq 0}$. The parameter p is called the *diversity index*.

Certainly, the choice $p = 0$ corresponds to the equally weighted portfolio, while the choice $p = 1$ is the market portfolio. For $0 < p < 1$, the p -diversity weighted portfolio interpolates between the equally weighted portfolio and the market portfolio, and it is *functionally generated* by a *measure of diversity* in the sense of Fernholz [58, Section 3.4]. Let us also mention that diversity weighted portfolios, with $p = 0.76$, were used in actual portfolio managing strategies for the S&P 500 Index [58, Section 7.2].

6.5.1.3 Long-term growth rate and performance

Following [58, Section 1.3], the growth rate of a portfolio measures its long-term performance, in the sense that

$$\lim_{T \rightarrow +\infty} \frac{1}{T} \left(\log Z_n^{\pi_n}(T) - \int_{t=0}^T \gamma_n^{\pi_n}(t)dt \right) = 0, \quad \text{almost surely.}$$

As a consequence, the study of the long time behaviour of the processes $(\gamma_n^{\pi_n}(t))_{t \geq 0}$ and $(\gamma_{*,n}^{\pi_n}(t))_{t \geq 0}$ arises as a natural question with respect to practical situations. As far as the asymptotic behaviour of portfolio rules in large markets is concerned, previous studies such as [11] measured the performance of a sequence of portfolio rules $\{(\pi_n(t))_{t \geq 0}, n \geq 1\}$ by analyzing the asymptotic long-term growth rate

$$\Gamma := \lim_{n \rightarrow +\infty} \lim_{t \rightarrow +\infty} \gamma_n^{\pi_n}(t).$$

The latter was computed for the Atlas model (6.3), with constant variance coefficients $(\sigma_n^1)^2 = \dots = (\sigma_n^n)^2 > 0$, or linearly decreasing coefficients $(\sigma_n^j)^2 = \underline{a} + s^2(n - j)$, $\underline{a} > 0$, $s^2 > 0$, which matches the empirical observation of [62, Figure 13.6]. For the equally weighted portfolio and the market portfolio, exact expressions were derived. For p -diversity weighted portfolios with $p \in (0, 1)$, the long-term growth rate and excess growth rate were explicated in terms of the stationary distribution of the market portfolio. At that time, very little was known about this stationary distribution, so

that the authors had to resort to the so-called *certainty-equivalent approximation* to describe the large market limit of the long-term growth rate and excess growth rate. Still, in all cases, it was observed that, for large markets, the equally weighted portfolio outperforms diversity weighted portfolios, and in particular, beats the market.

6.5.1.4 Growth rates and capital measure

Unlike [11], we shall rather provide a detailed study of the long-term asymptotic growth rate

$$G^p := \lim_{t \rightarrow +\infty} \lim_{n \rightarrow +\infty} \gamma_n^p(t)$$

for p -diversity weighted portfolios. This brings forth results in a more synthetic fashion. To do so, we remark that, by the definition of p -diversity weighted portfolios and due to (6.5) and (6.8), for all $p \geq 0$, the growth rate and excess growth rate of p -diversity weighted portfolios write

$$\begin{aligned} \gamma_n^p(t) &= \langle \gamma, \Pi_n^p(t) \rangle + \gamma_{*,n}^p(t), \\ \gamma_{*,n}^p(t) &= \frac{1}{2} \langle \sigma^2, \Pi_n^p(t) \rangle - \frac{1}{2} \sum_{j=1}^n \left(\frac{e^{pY_n^{(j)}(t)}}{e^{pY_n^1(t)} + \dots + e^{pY_n^n(t)}} \right)^2 \sigma^2 \left(\frac{j}{n} \right), \end{aligned} \quad (6.15)$$

while the quadratic variation of $(\log Z_n^p(t))_{t \geq 0}$ writes

$$\langle \log Z_n^p \rangle(t) = \sum_{j=1}^n \sigma^2 \left(\frac{j}{n} \right) \int_{s=0}^t \left(\frac{e^{pY_n^{(j)}(s)}}{e^{pY_n^1(s)} + \dots + e^{pY_n^n(s)}} \right)^2 ds. \quad (6.16)$$

We shall prove below that the quantity

$$\sum_{j=1}^n \left(\frac{e^{pY_n^{(j)}(t)}}{e^{pY_n^1(t)} + \dots + e^{pY_n^n(t)}} \right)^2 \sigma^2 \left(\frac{j}{n} \right)$$

is of order $1/n$, so that the analysis of the long-term asymptotic portfolio performance only relies on the analysis of the long-term asymptotic weighted capital measure.

6.5.2 Long-term asymptotic growth rates

We first derive laws of large numbers for the processes $(\gamma_n^p(t))_{t \geq 0}$, $(\gamma_{*,n}^p(t))_{t \geq 0}$ and $(Z_n^p(t))_{t \geq 0}$, based on Proposition 6.3.1.

Lemma 6.5.1. *Let us assume that the conditions of Proposition 6.3.1 are satisfied. Let us fix $T > 0$ and $q \in [1, +\infty)$. Then, for all $p \geq 0$, when n grows to infinity,*

- *the growth rate $(\gamma_n^p(t))_{t \in [0, T]}$ and excess growth rate $(\gamma_{*,n}^p(t))_{t \in [0, T]}$ respectively converge, in $L^q(C([0, T], \mathbb{R}))$, to the deterministic processes $(\gamma^p(t))_{t \in [0, T]}$ and $(\gamma_*^p(t))_{t \in [0, T]}$ defined by*

$$\forall t \geq 0, \quad \gamma^p(t) = \langle b, \Pi^p(t) \rangle, \quad \gamma_*^p(t) = \frac{1}{2} \langle \sigma^2, \Pi^p(t) \rangle, \quad (6.17)$$

where b is the rate of return function defined by

$$b(u) := \gamma(u) + \frac{1}{2} \sigma^2(u);$$

- *the wealth process $(Z_n^p(t))_{t \in [0, T]}$ converges, in $L^q(C([0, T], \mathbb{R}))$, to the deterministic process $(Z^p(t))_{t \in [0, T]}$ defined by*

$$\forall t \geq 0, \quad \log Z^p(t) = \int_{s=0}^t \gamma^p(s) ds. \quad (6.18)$$

Proof. We first address the laws of large numbers (6.17) for the growth rate and excess growth rate. On account of (6.15) and Proposition 6.3.1, it suffices to prove that

$$\sum_{j=1}^n \left(\frac{e^{pY_n^{(j)}(t)}}{e^{pY_n^1(t)} + \dots + e^{pY_n^n(t)}} \right)^2 \sigma^2 \left(\frac{j}{n} \right)$$

converges to 0 in $L^q(C([0, T], \mathbb{R}))$. To this aim, we remark that, using the notations of Lemma 6.A.1 in Appendix 6.A, for all $t \geq 0$,

$$\sum_{j=1}^n \left(\frac{e^{pY_n^{(j)}(t)}}{e^{pY_n^1(t)} + \dots + e^{pY_n^n(t)}} \right)^2 \sigma^2 \left(\frac{j}{n} \right) = \frac{1}{n} \frac{\widehat{\sigma}_n^{(2p)}(t)}{(\widehat{\mathbf{1}}_n^p(t))^2},$$

where $\mathbf{1}$ refers to the the constant function equal to 1. By the same arguments as in Appendix 6.A and with the notations of Lemma 6.A.1, we obtain that $\widehat{\sigma}_n^{(2p)}(t)/(\widehat{\mathbf{1}}_n^p(t))^2$ converges, in $L^q(C([0, T], \mathbb{R}))$, to $\widehat{\sigma}^{(2p)}(t)/(\widehat{\mathbf{1}}^p(t))^2$, therefore the right-hand side above converges to 0 and (6.17) follows.

In addition, we deduce from the argument above and (6.16) that the process $(\langle \log Z_n^p \rangle(t))_{t \in [0, T]}$ converges in probability, in $C([0, T], \mathbb{R})$, to 0, and that the process $(\log Z_n^p(t))_{t \in [0, T]}$ converges in probability, in $C([0, T], \mathbb{R})$, to the process $(\log Z^p(t))_{t \in [0, T]}$ defined by (6.18). Using the continuity of the mapping

$$(y(t))_{t \in [0, T]} \mapsto \left(e^{y(t)} \right)_{t \in [0, T]}$$

on $C([0, T], \mathbb{R})$, we deduce that the process $(Z_n^p(t))_{t \in [0, T]}$ converges in probability, in $C([0, T], \mathbb{R})$, to the process $(Z^p(t))_{t \in [0, T]}$. Let $q \in [1, +\infty)$. To conclude that the convergence also holds in $L^q(C([0, T], \mathbb{R}))$ we prove that, for $r > q$,

$$\sup_{n \geq 1} \mathbb{E} \left(\sup_{t \in [0, T]} |Z_n^p(t)|^r \right) < +\infty.$$

This proof of this latter fact is based on Doob's inequality in a similar fashion as at the end of the proof of Lemma 6.A.1. Uniformity in n follows from the fact that

$$\langle \log Z_n^p \rangle(t) \leq \|\sigma^2\|_\infty \int_{s=0}^t \frac{\sum_{i=1}^n e^{2pY_n^i(s)}}{(\sum_{i=1}^n e^{pY_n^i(s)})^2} ds \leq \|\sigma^2\|_\infty t.$$

This completes the proof. \square

The deterministic processes $(\gamma^p(t))_{t \geq 0}$, $(\gamma_*^p(t))_{t \geq 0}$ and $(Z^p(t))_{t \geq 0}$ shall be respectively called the asymptotic growth rate, the asymptotic excess growth rate and the asymptotic wealth process associated with p -diversity weighted portfolios. Their long time behaviour is determined by Proposition 6.3.4 as follows.

Lemma 6.5.2. *Let us assume that the conditions of Proposition 6.3.4 hold, and recall the definition (6.12) of the critical diversity index $p_c \geq 0$.*

- For all $p \in [0, p_c)$,

$$G^p := \lim_{t \rightarrow +\infty} \gamma^p(t) = \langle b, \bar{\Pi}^p \rangle, \quad G_*^p := \lim_{t \rightarrow +\infty} \gamma_*^p(t) = \frac{1}{2} \langle \sigma^2, \bar{\Pi}^p \rangle.$$

- For all $p > p_c$,

$$G^p := \lim_{t \rightarrow +\infty} \gamma^p(t) = b(1), \quad G_*^p := \lim_{t \rightarrow +\infty} \gamma_*^p(t) = \frac{1}{2} \sigma^2(1).$$

Proof. This result follows from a straightforward application of Proposition 6.3.4 and Lemma 6.5.1. \square

The quantities G^p and G_*^p shall be respectively called the long-term asymptotic growth rate and the long-term asymptotic excess growth rates. When $p = p_c$, the limits of $\gamma^{p_c}(t)$ and $\gamma_*^{p_c}(t)$ when $t \rightarrow +\infty$ may not exist, therefore we define

$$G^{p_c} := \limsup_{t \rightarrow +\infty} \gamma^{p_c}(t), \quad G_*^{p_c} := \limsup_{t \rightarrow +\infty} \gamma_*^{p_c}(t).$$

Proposition 6.3.4 ensures that the functions $p \mapsto G^p$ and $p \mapsto G_*^p$ are continuous on $[0, p_c)$, constant on $(p_c, +\infty)$, and satisfy

$$\liminf_{p \rightarrow p_c} G^p \leq G^{p_c} \leq \limsup_{p \rightarrow p_c} G^p, \quad \liminf_{p \rightarrow p_c} G_*^p \leq G_*^{p_c} \leq \limsup_{p \rightarrow p_c} G_*^p.$$

Following Subsection 6.5.1, the performance of the p -diversity weighted portfolio is measured by its long-term asymptotic growth rate G^p , therefore we shall look for optimal values of the diversity index p for which G^p is maximal.

6.5.3 Monotonicity criterion

We first address the monotonicity of the functions $p \mapsto G^p$ and $p \mapsto G_*^p$, based on the following lemma.

Lemma 6.5.3. *Let us assume that the conditions of Proposition 6.3.1 hold and fix a continuous function $f : [0, 1] \rightarrow \mathbb{R}$. If f is monotonic on $[0, 1]$, then, for all $t \geq 0$, the function $p \mapsto \langle f, \Pi^p(t) \rangle$ has the same monotonicity on $[0, +\infty)$.*

Proof. Let us fix a continuous function $f : [0, 1] \rightarrow \mathbb{R}$. By (6.6) and the Leibniz integral rule, for all $t \geq 0$, the function

$$p \mapsto \int_{u=0}^1 e^{pF_t^{-1}(u)} f(u) du$$

is C^1 on $[0, +\infty)$, and its derivative writes

$$\frac{d}{dp} \int_{u=0}^1 e^{pF_t^{-1}(u)} f(u) du = \int_{u=0}^1 F_t^{-1}(u) e^{pF_t^{-1}(u)} f(u) du,$$

from which it easily follows that the function $p \mapsto \langle f, \Pi^p(t) \rangle$ is C^1 on $[0, +\infty)$ and

$$\frac{d}{dp} \langle f, \Pi^p(t) \rangle = \langle F_t^{-1} f, \Pi^p(t) \rangle - \langle F_t^{-1}, \Pi^p(t) \rangle \langle f, \Pi^p(t) \rangle = \text{Cov}(F_t^{-1}(U), f(U)),$$

where the random variable $U \in [0, 1]$ is distributed according to $\Pi^p(t)$.

Let us now assume that f is nondecreasing, and let U, V be independent random variables in $[0, 1]$ distributed according to $\Pi^p(t)$. Since both F_t^{-1} and f are nondecreasing, then

$$(F_t^{-1}(U) - F_t^{-1}(V))(f(U) - f(V)) \geq 0,$$

and taking the expectation of this inequality yields

$$\frac{d}{dp} \langle f, \Pi^p(t) \rangle = \text{Cov}(F_t^{-1}(U), f(U)) \geq 0,$$

so that the function $p \mapsto \langle f, \Pi^p(t) \rangle$ is nondecreasing on $[0, +\infty)$.

If f is nonincreasing, then we replace f with $-f$ in the argument above and the proof is completed. \square

We can now derive the following monotonicity criterion for the long-term asymptotic growth rate and excess growth rate.

Corollary 6.5.4. *Let us assume that the conditions of Proposition 6.3.4 hold.*

- *If the rate of return function b is monotonic on $[0, 1]$, then the function $p \mapsto G^p$ has the same monotonicity on $[0, +\infty)$.*
- *If the variance function σ^2 is monotonic on $[0, 1]$, then the function $p \mapsto G_*^p$ has the same monotonicity on $[0, +\infty)$.*

6.5.4 The reduction formula

We complete the monotonicity criterion of Corollary 6.5.4 by the following reduction formula expressing the long-term asymptotic growth rate in terms of the long-term asymptotic excess growth rate in the subcritical phase.

Proposition 6.5.5. *Let us assume that the conditions of Proposition 6.3.4 hold, and that $p_c > 0$. Then, for all $p \in [0, p_c)$,*

$$G^p = (1 - p)G_*^p + g.$$

Proof. Let us assume that $p_c > 0$ and fix $p \in [0, p_c)$. Using Lemma 6.5.2, we first write

$$G^p = \langle \gamma, \bar{\Pi}^p \rangle + \frac{1}{2} \langle \sigma^2, \bar{\Pi}^p \rangle = \langle \tilde{\gamma}, \bar{\Pi}^p \rangle + g + G_*^p,$$

where we recall that $\tilde{\gamma}(u) = \gamma(u) - g$. Thanks to the first-order analysis of Ψ carried out in Remark 6.2.5,

$$\lim_{u \downarrow 0} e^{p\Psi(u)}(\Gamma(u) - gu) = 0, \quad \lim_{u \uparrow 1} e^{p\Psi(u)}(\Gamma(u) - gu) = \lim_{u \uparrow 1} (g - \gamma(1))(1 - u)^{1-p/p_c} = 0,$$

so that integrating by parts yields

$$\int_{u=0}^1 e^{p\Psi(u)} \tilde{\gamma}(u) du = - \int_{u=0}^1 p\Psi'(u) e^{p\Psi(u)} (\Gamma(u) - gu) du = -\frac{p}{2} \int_{u=0}^1 e^{p\Psi(u)} \sigma^2(u) du,$$

hence $\langle \tilde{\gamma}, \bar{\Pi}^p \rangle = -pG_*^p$. □

Remark 6.5.6. In the supercritical phase, elementary algebra allows to derive a similar reduction formula, where p has to be replaced with p_c , namely $G^p = (1 - p_c)G_*^p + g$, for all $p > p_c$. Both formulas rewrite in a compact form as

$$\forall p \neq p_c, \quad G^p = (1 - p \wedge p_c)G_*^p + g,$$

and this also holds true for $p = p_c$ as soon as at least one of the functions $p \mapsto G^p$ or $p \mapsto G_*^p$ is continuous at p_c .

6.5.5 Performance of the equally weighted and the market portfolio

Let us apply the results of Proposition 6.5.5 to describe the performance of the equally weighted and the market portfolio.

Equally weighted portfolio: the long-term asymptotic growth rate writes

$$G^{(0)} = G_*^{(0)} + g = \frac{1}{2} \int_{u=0}^1 \sigma^2(u) du + g > g,$$

so that the equally weighted portfolio grows faster than the market mean growth rate g , by a factor depending only on the volatility structure of the market.

Market portfolio: if $p_c > 1$, then the long-term asymptotic growth rate writes $G^{(1)} = g$, so that the market portfolio grows at the market mean growth rate. If $p_c < 1$, then

$$G^{(1)} = (1 - p_c) \frac{\sigma^2(1)}{2} + g > g,$$

so that the market portfolio grows faster than the market mean growth rate, by a factor depending on both the growth rate function and the variance function of the market.

6.5.6 Optimal selection of portfolios and volatility structure

We now combine the results of Corollary 6.5.4 and Proposition 6.5.5 to select the portfolio rule with best performance, depending on the volatility structure of the market. We sum up our results in Conclusions (C1), (C2) and (C3).

Let us first assume that the variance function σ^2 is nonincreasing, which matches the volatility size effect. Then, Corollary 6.5.4 implies that the long-term asymptotic excess growth rate G_*^p is nonincreasing on $[0, +\infty)$. Using the reduction formula of Proposition 6.5.5, we deduce that the long-term asymptotic growth rate G^p is nonincreasing on $[0, +\infty)$, therefore it is maximal for $p = 0$.

(C1) If the variance function is nonincreasing, then the equally weighted portfolio is optimal among p -diversity weighted portfolios.

A particular case of a nonincreasing variance function is the case of a constant variance function. Then, by Remark 6.5.6, for all $p \neq p_c$,

$$G^p = (1 - p \wedge p_c) \frac{\sigma^2}{2} + g. \quad (6.19)$$

The expression above has the same right and left limits in p_c , so that, by Remark 6.5.6, the formula (6.19) is actually valid for all $p \in [0, +\infty)$.

(C2) If the variance function is constant, then, for all $p \geq 0$, the long-term asymptotic growth rate of the p -diversity weighted portfolio is given by the formula (6.19).

We finally look for conditions on the market model to produce a situation in which the equally weighted portfolio is *not* optimal among p -diversity weighted portfolios. On account of Corollary 6.5.4, this is the case if the rate of return function b is increasing on $[0, 1]$. In such a situation, and under Assumptions (UE) and (E1),

$$b(1) = \gamma(1) + \frac{1}{2}\sigma^2(1) > \gamma(0) + \frac{1}{2}\sigma^2(0) > g,$$

so that $p_c < 1$. Then, using the results of Subsection 6.5.5,

$$G^{(0)} = \int_{u=0}^1 b(u)du < b(1) = G^{(1)},$$

that is to say, the market portfolio outperforms the equally weighted portfolio — and it is actually optimal among all p -diversity weighted portfolios.

Example 6.5.7. Let us specify an example of a model where the market portfolio is optimal. We use the growth rate function introduced in the mean-field approximation of the Atlas model of Remark 6.1.1, $\gamma(u) = \gamma_\alpha(u) = g(\alpha + 1)(1 - u)^\alpha$, with $\alpha > 0$ to be specified below. Recall that this growth rate function satisfies Assumptions (E1) and (E2). We now choose the variance function σ^2 in order to satisfy the uniform ellipticity assumption (UE) and to ensure that the rate of return function $b = \gamma + \sigma^2/2$ is increasing; for instance, we let

$$\sigma^2(u) = 2(C + u - \gamma_\alpha(u)),$$

with $C = 1 + g(\alpha + 1)$, see Figure 6.4. Then, for all $\alpha > 0$, $b(u) = C + u$ is increasing and σ^2 satisfies the uniform ellipticity assumption (UE). We now take $\alpha > 2$ to ensure that the regularity assumptions on γ and σ^2 required in Theorem 6.2.4 are fulfilled. This completes the construction of our model, and effectively provides an instance of a mean-field Atlas market model where the market portfolio outperforms the equally weighted portfolio.

Example 6.5.7 leads to the following conclusion.

(C3) One can exhibit an example of a model where the market portfolio is optimal among all p -diversity weighted portfolios. It is necessary that, in such a model, small stocks have a smaller variance than large stocks, so that the volatility size effect is violated.

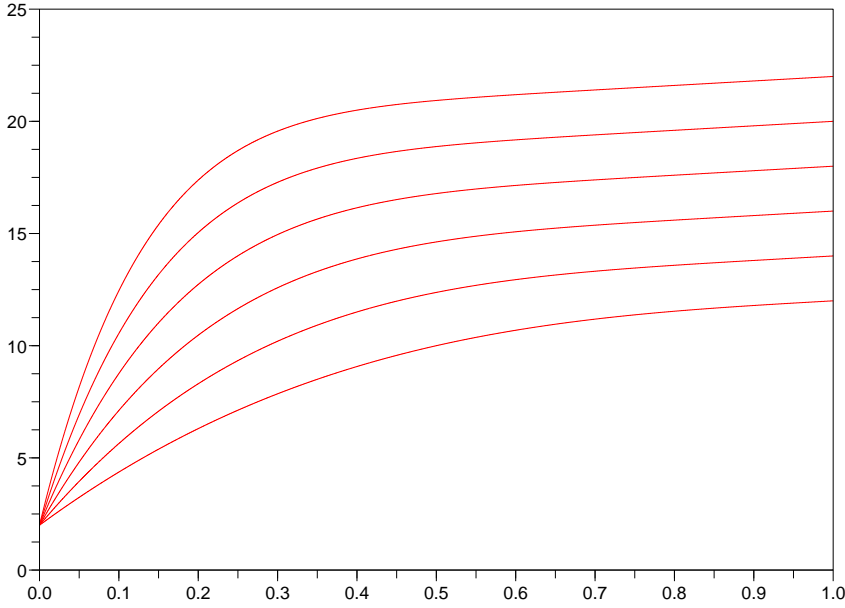

Figure 6.4: The variance function σ^2 for $g = 1$ and α taking integer values ranging from 3 (lowest curve) to 8 (highest curve).

6.A Proof of Proposition 6.3.1

This appendix is dedicated to the proof of Proposition 6.3.1. We first prove (6.13).

Proof of (6.13). Let us fix $T > 0$ and $p \geq 0$. By Theorem 6.2.1, for all $t \in [0, T]$,

$$\begin{aligned} \mathcal{Z}^p(t) &:= \int_{u=0}^1 e^{pF_t^{-1}(u)} du = \mathbb{E} \left(e^{pY(t)} \right) = \mathbb{E} \left(e^{pY(0) + p \int_{s=0}^t \gamma(F_s(Y(s))) ds + p \int_{s=0}^t \sigma(F_s(Y(s))) dB(s)} \right) \\ &\leq e^{p\|\gamma\|_\infty T} \mathbb{E} \left(e^{pY(0)} \mathbb{E} \left(e^{p \int_{s=0}^t \sigma(F_s(Y(s))) dB(s)} \middle| Y(0) \right) \right) \\ &\leq e^{p\|\gamma\|_\infty T + (p^2/2)\|\sigma^2\|_\infty T} \int_{y \in \mathbb{R}} e^{py} m(dy) =: C_T^p, \end{aligned}$$

and Assumption (H) ensures that the right-hand side above is finite. \square

We now address the second part of Proposition 6.3.1. In this purpose, we first state the following auxiliary lemma.

Lemma 6.A.1. *Under the assumptions of Proposition 6.3.1, for all $T > 0$ and $p \geq 0$, for all continuous function $f : [0, 1] \rightarrow \mathbb{R}$,*

$$\lim_{n \rightarrow +\infty} \mathbb{E} \left(\sup_{t \in [0, T]} \left| \widehat{f}_n^p(t) - \widehat{f}^p(t) \right| \right) = 0,$$

where, for all $t \geq 0$,

$$\widehat{f}_n^p(t) := \frac{1}{n} \sum_{j=1}^n e^{pY_n^{(j)}(t)} f\left(\frac{j}{n}\right), \quad \widehat{f}^p(t) := \int_{u=0}^1 e^{pF_t^{-1}(u)} f(u) du.$$

Before giving the proof of Lemma 6.A.1, let us explain how to complete the proof of Proposition 6.3.1: let us fix a continuous function $f : [0, 1] \rightarrow \mathbb{R}$, $p \geq 0$ and $T > 0$. Then, for all $t \in [0, T]$,

$$\langle f, \Pi_n^p(t) \rangle = \frac{\widehat{f}_n^p(t)}{\widehat{\mathbf{1}}_n^p(t)},$$

where we denote by $\mathbf{1}$ the constant function equal to 1. Combining Lemma 6.A.1 with the Slutsky theorem, and using the continuity of the mapping

$$((x(t))_{t \in [0, T]}, (y(t))_{t \in [0, T]}) \mapsto \left(\frac{x(t)}{y(t)} \right)_{t \in [0, T]}$$

at all point $((x(t))_{t \in [0, T]}, (y(t))_{t \in [0, T]}) \in (C([0, T], \mathbb{R}))^2$ such that, for all $t \in [0, T]$, $y(t) \neq 0$, we deduce that the sequence of processes $(\langle f, \Pi_n^p(t) \rangle)_{t \in [0, T]}$ converges in probability, in $C([0, T], \mathbb{R})$, to the process $(\langle f, \Pi^p(t) \rangle)_{t \in [0, T]}$ introduced in Proposition 6.3.1. Thanks to the elementary bound

$$\forall t \geq 0, \quad |\langle f, \Pi_n^p(t) \rangle| \leq \|f\|_\infty,$$

we conclude that the convergences above also hold in $L^q(C([0, T], \mathbb{R}))$, for all $q \in [1, +\infty)$.

Proof of Lemma 6.A.1. Let us fix $T > 0$ and $p \geq 0$. The key observation is that, for all $t \in [0, T]$, the reordered vector $(Y_n^{(1)}(t), \dots, Y_n^{(n)}(t))$ writes

$$\forall j \in \{1, \dots, n\}, \quad \forall u \in [(j-1)/n, j/n], \quad Y_n^{(j)}(t) = (H * \nu_t^n)^{-1}(u),$$

where $(H * \nu_t^n)^{-1}$ refers to the pseudo-inverse of the empirical cumulative distribution function of $Y_n^{(1)}(t), \dots, Y_n^{(n)}(t)$. Therefore, for all continuous function $f : [0, 1] \rightarrow \mathbb{R}$, for all $t \in [0, T]$,

$$\begin{aligned} \left| \widehat{f}_n^p(t) - \widehat{f}^p(t) \right| &= \left| \sum_{j=1}^n \int_{u=(j-1)/n}^{j/n} \left(e^{p(H * \nu_t^n)^{-1}(u)} f\left(\frac{j}{n}\right) - e^{pF_t^{-1}(u)} f(u) \right) du \right| \\ &\leq \|f\|_\infty \int_{u=0}^1 \left| e^{p(H * \nu_t^n)^{-1}(u)} - e^{pF_t^{-1}(u)} \right| du + \sum_{j=1}^n \int_{u=(j-1)/n}^{j/n} e^{pF_t^{-1}(u)} \left| f\left(\frac{j}{n}\right) - f(u) \right| du. \end{aligned}$$

Combining the uniform continuity of f with (6.13) yields

$$\lim_{n \rightarrow +\infty} \sup_{t \in [0, T]} \sum_{j=1}^n \int_{u=(j-1)/n}^{j/n} e^{pF_t^{-1}(u)} \left| f\left(\frac{j}{n}\right) - f(u) \right| du = 0. \quad (6.20)$$

We now fix $M > 0$ and write

$$\int_{u=0}^1 \left| e^{p(H * \nu_t^n)^{-1}(u)} - e^{pF_t^{-1}(u)} \right| du = I_n^M(t) + J_n^M(t),$$

where

$$\begin{aligned} I_n^M(t) &:= \int_{u=0}^1 \left(\left| e^{p(H * \nu_t^n)^{-1}(u)} - e^{pF_t^{-1}(u)} \right| \wedge M \right) du, \\ J_n^M(t) &:= \int_{u=0}^1 \left[\left| e^{p(H * \nu_t^n)^{-1}(u)} - e^{pF_t^{-1}(u)} \right| - M \right]^+ du, \end{aligned}$$

with $[x]^+ := x \vee 0$. In Step 1 below, we shall establish that

$$\forall M > 0, \quad \lim_{n \rightarrow +\infty} \mathbb{E} \left(\sup_{t \in [0, T]} I_n^M(t) \right) = 0, \quad (6.21)$$

while Step 2 is dedicated to the proof of

$$\lim_{M \rightarrow +\infty} \sup_{n \geq 1} \mathbb{E} \left(\sup_{t \in [0, T]} J_n^M(t) \right) = 0. \quad (6.22)$$

Then, it follows from (6.20) and (6.21) that, for all $M > 0$,

$$\limsup_{n \rightarrow +\infty} \mathbb{E} \left(\sup_{t \in [0, T]} \left| \widehat{f}_n^p(t) - \widehat{f}^p(t) \right| \right) \leq \|f\|_\infty \sup_{n \geq 1} \mathbb{E} \left(\sup_{t \in [0, T]} J_n^M(t) \right),$$

and the conclusion stems from (6.22).

Step 1. Let us first note that, by Remark 6.2.2, for all $t \in [0, T]$,

$$\lim_{n \rightarrow +\infty} \mathbb{E} (I_n^M(t)) = 0,$$

so that, by the Slutsky theorem, the continuous process $(I_n^M(t))_{t \in [0, T]}$ converges, in finite dimensional distribution, to 0. Taking for granted that the sequence of the laws of the processes $(I_n^M(t))_{t \in [0, T]}$, $n \geq 1$ is tight, [18, Theorem 7.1, p. 80] implies that this sequence converges to 0 in probability in $C([0, T], \mathbb{R})$. Then, (6.21) follows from the uniform boundedness of the process $(I_n^M(t))_{t \in [0, T]}$ with respect to n .

To complete this step, it remains to prove that the sequence of the laws of the processes $(I_n^M(t))_{t \in [0, T]}$, $n \geq 1$ is tight. First, the sequence $\{I_n^M(0), n \geq 1\}$ is bounded by M , and therefore the sequence of the laws of $I_n^M(0)$, $n \geq 1$ is tight. Thus, by the Kolmogorov criterion, it now suffices to exhibit $\alpha \geq 0$, $\delta > 0$ and $C \geq 0$ such that, for all $t, s \in [0, T]$,

$$\forall n \geq 1, \quad \mathbb{E} (|I_n^M(t) - I_n^M(s)|^\alpha) \leq C|t - s|^{1+\delta}.$$

We first use the chain of elementary inequalities

$$\forall x_1, x_2, y_1, y_2 \in \mathbb{R}, \quad \begin{aligned} \left| |x_1 - y_1| \wedge M - |x_2 - y_2| \wedge M \right| &\leq \left| |x_1 - y_1| - |x_2 - y_2| \right| \\ &\leq |x_1 - x_2| + |y_1 - y_2| \end{aligned}$$

to rewrite, for all $t, s \in [0, T]$ such that $s \leq t$,

$$|I_n^M(t) - I_n^M(s)| \leq \int_{u=0}^1 \left| e^{p(H*\nu_t^n)^{-1}(u)} - e^{p(H*\nu_s^n)^{-1}(u)} \right| du + \int_{u=0}^1 \left| e^{pF_t^{-1}(u)} - e^{pF_s^{-1}(u)} \right| du.$$

Let us now fix $\alpha > 2$. By the Jensen inequality, the inequality above yields

$$\begin{aligned} &|I_n^M(t) - I_n^M(s)|^\alpha \\ &\leq 2^{\alpha-1} \left(\int_{u=0}^1 \left| e^{p(H*\nu_t^n)^{-1}(u)} - e^{p(H*\nu_s^n)^{-1}(u)} \right|^\alpha du + \int_{u=0}^1 \left| e^{pF_t^{-1}(u)} - e^{pF_s^{-1}(u)} \right|^\alpha du \right). \end{aligned} \tag{6.23}$$

Let us address the first term in the right-hand side of (6.23). Using the Jensen inequality again,

$$\begin{aligned} &\int_{u=0}^1 \left| e^{p(H*\nu_t^n)^{-1}(u)} - e^{p(H*\nu_s^n)^{-1}(u)} \right|^\alpha du = \frac{1}{n} \sum_{i=1}^n \left| e^{pY_n^i(t)} - e^{pY_n^i(s)} \right|^\alpha \\ &\leq 2^{\alpha-1} \left(\frac{1}{n} \sum_{i=1}^n \left| \int_{r=s}^t e^{pY_n^i(r)} \left(p\gamma_n^i(r) + \frac{p^2}{2}(\sigma_n^i(r))^2 \right) dr \right|^\alpha + \frac{1}{n} \sum_{i=1}^n \left| \int_{r=s}^t p e^{pY_n^i(r)} \sigma_n^i(r) dB^i(r) \right|^\alpha \right). \end{aligned}$$

On the one hand,

$$\begin{aligned} &\mathbb{E} \left(\left| \int_{r=s}^t e^{pY_n^i(r)} \left(p\gamma_n^i(r) + \frac{p^2}{2}(\sigma_n^i(r))^2 \right) dr \right|^\alpha \right) \\ &\leq \left(p\|\gamma\|_\infty + \frac{p^2}{2}\|\sigma^2\|_\infty \right)^\alpha (t-s)^{\alpha-1} \int_{r=s}^t \mathbb{E} \left(e^{\alpha p Y_n^i(r)} \right) dr, \end{aligned}$$

and by the same arguments as in the proof of (6.13),

$$\forall r \in [0, T], \quad \mathbb{E} \left(e^{\alpha p Y_n^i(r)} \right) \leq C_T^{\alpha p},$$

where the constant $C_T^{\alpha p}$ does not depend on n . As a consequence,

$$\mathbb{E} \left(\frac{1}{n} \sum_{i=1}^n \left| \int_{r=s}^t e^{pY_n^i(r)} \left(p\gamma_n^i(r) + \frac{p^2}{2} (\sigma_n^i(r))^2 \right) dr \right|^\alpha \right) \leq C_T^{\alpha p} \left(p\|\gamma\|_\infty + \frac{p^2}{2}\|\sigma^2\|_\infty \right)^\alpha (t-s)^\alpha.$$

On the other hand, the Burkholder-Davis-Gundy inequality implies that there exists $K \geq 0$ depending only on α such that

$$\begin{aligned} \mathbb{E} \left(\left| \int_{r=s}^t p e^{pY_n^i(r)} \sigma_n^i(r) dB^i(r) \right|^\alpha \right) &\leq K \mathbb{E} \left(\left| \int_{r=s}^t p^2 e^{2pY_n^i(r)} (\sigma_n^i(r))^2 dr \right|^{\alpha/2} \right) \\ &\leq K p^2 \|\sigma^2\|_\infty (t-s)^{\alpha/2-1} \int_{r=s}^t \mathbb{E} \left(e^{\alpha p Y_n^i(r)} \right) dr \\ &\leq K p^2 \|\sigma^2\|_\infty (t-s)^{\alpha/2} C_T^{\alpha p}. \end{aligned}$$

As a conclusion, there exists $C' \geq 0$ such that

$$\mathbb{E} \left(\int_{u=0}^1 \left| e^{p(H*\nu_t^n)^{-1}(u)} - e^{p(H*\nu_s^n)^{-1}(u)} \right|^\alpha du \right) \leq C' |t-s|^{\alpha/2}.$$

The second term of (6.23) rewrites

$$\int_{u=0}^1 \left| e^{pF_t^{-1}(u)} - e^{pF_s^{-1}(u)} \right|^\alpha du = \mathbb{E} \left(\left| e^{pF_t^{-1}(U)} - e^{pF_s^{-1}(U)} \right|^\alpha \right),$$

where U is a uniform random variable on $[0, 1]$. Note that $e^{pF_t^{-1}(U)}$ has the same marginal distribution as $e^{pY(t)}$, and $e^{pF_s^{-1}(U)}$ has the same marginal distribution as $e^{pY(s)}$. By (6.9) and (6.10),

$$\int_{u=0}^1 \left| e^{pF_t^{-1}(u)} - e^{pF_s^{-1}(u)} \right|^\alpha du \leq \mathbb{E} \left(\left| e^{pY(t)} - e^{pY(s)} \right|^\alpha \right),$$

and the same arguments as for the first term in the right-hand side of (6.23) allow us to conclude that the right-hand side above is bounded by $C'(t-s)^{\alpha/2}$. As a conclusion,

$$\mathbb{E} \left(|I_n^M(t) - I_n^M(s)|^\alpha \right) \leq 2^{\alpha-1} C' (t-s)^{\alpha/2},$$

therefore the sequence of the laws of $(I_n^M(t))_{t \geq 0}$, $n \geq 1$ is tight.

Step 2. Using the chain of elementary inequalities

$$\begin{aligned} \forall x, x' \in \mathbb{R}, \quad [|x - x'| - M]^+ &\leq |x - x'| \mathbb{1}_{\{|x-x'| \geq M\}} \\ &\leq |x - x'| \mathbb{1}_{\{|x| \geq |x'| \vee M/2\}} + |x - x'| \mathbb{1}_{\{|x'| \geq |x| \vee M/2\}} \\ &\leq 2|x| \mathbb{1}_{\{|x| \geq M/2\}} + 2|x'| \mathbb{1}_{\{|x'| \geq M/2\}}, \end{aligned}$$

we obtain

$$J_n^M(t) \leq 2 \int_{u=0}^1 e^{p(H*\nu_t^n)^{-1}(u)} \mathbb{1}_{\{e^{p(H*\nu_t^n)^{-1}(u)} \geq M/2\}} du + 2 \int_{u=0}^1 e^{pF_t^{-1}(u)} \mathbb{1}_{\{e^{pF_t^{-1}(u)} \geq M/2\}} du.$$

By the Markov inequality,

$$\int_{u=0}^1 e^{pF_t^{-1}(u)} \mathbb{1}_{\{e^{pF_t^{-1}(u)} \geq M/2\}} du \leq \frac{2}{M} \int_{u=0}^1 e^{2pF_t^{-1}(u)} du,$$

so that (6.13) applied with $2p$ leads to

$$\lim_{M \rightarrow +\infty} \sup_{t \in [0, T]} \int_{u=0}^1 e^{pF_t^{-1}(u)} \mathbb{1}_{\{e^{pF_t^{-1}(u)} \geq M/2\}} du = 0.$$

We complete this step by proving that

$$\lim_{M \rightarrow +\infty} \sup_{n \geq 1} \mathbb{E} \left(\sup_{t \in [0, T]} \int_{u=0}^1 e^{p(H * \nu_t^n)^{-1}(u)} \mathbb{1}_{\{e^{p(H * \nu_t^n)^{-1}(u)} \geq M/2\}} du \right) = 0. \quad (6.24)$$

To this aim, we first write

$$\begin{aligned} \sup_{t \in [0, T]} \int_{u=0}^1 e^{p(H * \nu_t^n)^{-1}(u)} \mathbb{1}_{\{e^{p(H * \nu_t^n)^{-1}(u)} \geq M/2\}} du &= \sup_{t \in [0, T]} \frac{1}{n} \sum_{j=1}^n e^{pY_n^j(t)} \mathbb{1}_{\{e^{pY_n^j(t)} \geq M/2\}} \\ &= \sup_{t \in [0, T]} \frac{1}{n} \sum_{i=1}^n e^{pY_n^i(t)} \mathbb{1}_{\{e^{pY_n^i(t)} \geq M/2\}} \\ &\leq \frac{1}{n} \sum_{i=1}^n \sup_{t \in [0, T]} e^{pY_n^i(t)} \mathbb{1}_{\{e^{pY_n^i(t)} \geq M/2\}}, \end{aligned}$$

so that, owing to the exchangeability of the processes $(Y_n^1(t))_{t \in [0, T]}, \dots, (Y_n^n(t))_{t \in [0, T]}$,

$$\begin{aligned} \mathbb{E} \left(\sup_{t \in [0, T]} \int_{u=0}^1 e^{p(H * \nu_t^n)^{-1}(u)} \mathbb{1}_{\{e^{p(H * \nu_t^n)^{-1}(u)} \geq M/2\}} du \right) &\leq \mathbb{E} \left(\sup_{t \in [0, T]} e^{pY_n^1(t)} \mathbb{1}_{\{e^{pY_n^1(t)} \geq M/2\}} \right) \\ &\leq \mathbb{E} (M_n(T) \mathbb{1}_{\{M_n(T) \geq M/2\}}), \end{aligned}$$

where $M_n(T) := \sup_{t \in [0, T]} e^{pY_n^1(t)}$. Hence, to obtain (6.24), it suffices to prove the uniform integrability of the sequence of random variables $(M_n(T))_{n \geq 1}$; thus, it suffices to exhibit $q > p$ such that

$$\sup_{n \geq 1} \mathbb{E} \left(\sup_{t \in [0, T]} e^{qY_n^1(t)} \right) < +\infty. \quad (6.25)$$

To carry this task out, we fix $q > p$. Proceeding as in the proof (6.13), we write

$$\begin{aligned} \mathbb{E} \left(\sup_{t \in [0, T]} e^{qY_n^1(t)} \right) &\leq e^{q\|\gamma\|_\infty T} \mathbb{E} \left(e^{qY_n^1(0)} \sup_{t \in [0, T]} e^{q \int_{s=0}^t \sigma_n^1(s) dB^1(s)} \right) \\ &= e^{q\|\gamma\|_\infty T} \mathbb{E} \left(e^{qY_n^1(0)} \mathbb{E} \left(\sup_{t \in [0, T]} e^{q \int_{s=0}^t \sigma_n^1(s) dB^1(s)} \middle| Y^1(0) \right) \right). \end{aligned}$$

For all $t \in [0, T]$,

$$e^{q \int_{s=0}^t \sigma_n^1(s) dB^1(s)} \leq E(t)^2 e^{(q^2/4)\|\sigma^2\|_\infty T},$$

where $(E(t))_{t \geq 0}$ is the exponential martingale defined by

$$\forall t \geq 0, \quad E(t) := e^{(q/2) \int_{s=0}^t \sigma_n^1(s) dB^1(s) - (q^2/8) \int_{s=0}^t (\sigma_n^1(s))^2 ds}.$$

By Doob's inequality,

$$\begin{aligned} \mathbb{E} \left(\sup_{t \in [0, T]} E(t)^2 \middle| Y^1(0) \right) &\leq 4\mathbb{E} \left(E(T)^2 \middle| Y^1(0) \right) \\ &= 4\mathbb{E} \left(e^{q \int_{s=0}^T \sigma_n^1(s) dB^1(s) - (q^2/4) \int_{s=0}^T (\sigma_n^1(s))^2 ds} \middle| Y^1(0) \right) \\ &\leq 4\mathbb{E} \left(e^{q \int_{s=0}^T \sigma_n^1(s) dB^1(s) - (q^2/2) \int_{s=0}^T (\sigma_n^1(s))^2 ds} \middle| Y^1(0) \right) e^{(q^2/4)\|\sigma^2\|_\infty T} \\ &= 4e^{(q^2/4)\|\sigma^2\|_\infty T}. \end{aligned}$$

As a consequence,

$$\mathbb{E} \left(\sup_{t \in [0, T]} e^{q \int_{s=0}^t \sigma_n^1(s) dB^1(s)} \middle| Y^1(0) \right) \leq 4e^{(q^2/2)\|\sigma^2\|_\infty T},$$

so that, finally,

$$\begin{aligned} \mathbb{E} \left(\sup_{t \in [0, T]} e^{qY_n^1(t)} \right) &\leq 4e^{q\|\gamma\|_\infty T + (q^2/2)\|\sigma^2\|_\infty T} \mathbb{E} \left(e^{qY_n^1(0)} \right) \\ &= 4e^{q\|\gamma\|_\infty T + (q^2/2)\|\sigma^2\|_\infty T} \int_{y \in \mathbb{R}} e^{qy} m(dy). \end{aligned}$$

By Assumption (H), the right-hand side above is finite and does not depend on n . Therefore, (6.25) is satisfied and the proof of (6.22) is completed. \square

6.B Long time behaviour of the asymptotic capital measure

This appendix is dedicated to the proof of Lemma 6.3.2 and Proposition 6.3.4. We first discuss the finiteness of

$$\bar{Z}^p = \int_{u=0}^1 e^{p\Psi(u)} du.$$

Lemma 6.B.1. *Let us assume that the uniform ellipticity condition (UE) and the equilibrium condition (E1) hold, and recall the definition (6.12) of the critical diversity index $p_c \geq 0$.*

- if $p_c > 0$, then for all $p \in [0, p_c)$, $\bar{Z}^p < +\infty$;
- for all $p \in (p_c, +\infty)$, $\bar{Z}^p = +\infty$.

Proof. We shall distinguish between the exponential case $p_c > 0$ and the heavy-tailed case $p_c = 0$. *Exponential case, $p_c > 0$:* then $\gamma(1) < g$. Let $\eta > 0$ be small enough for the inequalities $\sigma^2(1) > \eta$ and $g - \gamma(1) > \eta$ to hold. Recall that $\sigma^2(1) > 0$ due to Assumption (UE). Then, there exists $u^* \in [0, 1)$ such that, for all $v \in [u^*, 1]$,

$$\begin{aligned} \sigma^2(1) - \eta &\leq \sigma^2(v) \leq \sigma^2(1) + \eta, \\ g - \gamma(1) - \eta &\leq \frac{\Gamma(v) - gv}{1-v} \leq g - \gamma(1) + \eta, \end{aligned}$$

so that, for all $u \in [u^*, 1)$,

$$\frac{\sigma^2(1) - \eta}{2(g - \gamma(1) + \eta)} \log \left(\frac{1 - u^*}{1 - u} \right) \leq \Psi(u) - \Psi(u^*) \leq \frac{\sigma^2(1) + \eta}{2(g - \gamma(1) - \eta)} \log \left(\frac{1 - u^*}{1 - u} \right).$$

As a consequence, for all $p \geq 0$, for all $u \in [u^*, 1)$,

$$C_-(\eta) \int_{v=u^*}^u (1-v)^{-\beta_-(\eta)} dv \leq \int_{v=u^*}^u e^{p\Psi(v)} dv \leq C_+(\eta) \int_{v=u^*}^u (1-v)^{-\beta_+(\eta)} dv, \quad (6.26)$$

where

$$\begin{aligned} \beta_-(\eta) &:= p \frac{\sigma^2(1) - \eta}{2(g - \gamma(1) + \eta)}, & C_-(\eta) &:= e^{p\Psi(u^*)} (1 - u^*)^{\beta_-(\eta)}, \\ \beta_+(\eta) &:= p \frac{\sigma^2(1) + \eta}{2(g - \gamma(1) - \eta)}, & C_+(\eta) &:= e^{p\Psi(u^*)} (1 - u^*)^{\beta_+(\eta)}. \end{aligned}$$

Certainly, \bar{Z}^p is finite if and only if the limit when $u \uparrow 1$ of the central term in the inequality (6.26) is finite.

- If $p \in [0, p_c)$, then for η small enough, $\beta_+(\eta) < 1$, so that the right-hand side of (6.26) admits a finite limit when $u \uparrow 1$.
- If $p > p_c$, then for η small enough, $\beta_-(\eta) > 1$, so that the left-hand side of (6.26) grows to $+\infty$ when $u \uparrow 1$.

This completes the proof in the case $p_c > 0$.

Heavy-tailed case, $p_c = 0$: then $\gamma(1) = g$. Note that we only have to address the case $p > p_c$. Let $p > 0$ and let $\eta > 0$ small enough for the inequality $\underline{ap}/(2\eta) \geq 1$ to hold, where $\underline{a} := \inf_{u \in [0,1]} \sigma^2(u) > 0$ due to Assumption (UE). Then, there exists $u^* \in [0, 1)$ such that, for all $v \in [u^*, 1]$,

$$\Gamma(v) - gv \leq \eta(1 - v),$$

so that, for all $u \in [u^*, 1)$,

$$\Psi(u) = \Psi(u^*) + \int_{v=u^*}^u \frac{\sigma^2(v)}{2(\Gamma(v) - gv)} dv \geq \Psi(u^*) + \frac{\underline{a}}{2\eta} (\log(1 - u^*) - \log(1 - u)).$$

As a consequence,

$$e^{p\Psi(u)} \geq e^{p\Psi(u^*) + \underline{a} \log(1-u^*)/(2\eta)} (1 - u)^{-\underline{ap}/(2\eta)},$$

and the choice of η ensures that the integral of the right-hand side above diverges to $+\infty$ in 1. This completes the proof in the case $p_c = 0$. \square

Remark 6.B.2. At the criticality, whether $\bar{Z}^{p_c} = +\infty$ or $\bar{Z}^{p_c} < +\infty$ cannot be *a priori* determined. Indeed, on the one hand, for the choice of coefficients introduced in Example 6.3.3, it is easily checked that $\bar{Z}^{p_c} = +\infty$. On the other hand, assume that $p_c > 0$ and the coefficients γ and σ are chosen so that the asymptotic expansion of Ψ writes

$$\Psi(u) = \frac{1}{p_c} (-\log(1 - u) - \beta \log(-\log(1 - u))) + \underset{u \uparrow 1}{O}(1), \quad \beta > 1.$$

Then, it is straightforward to check that $\bar{Z}^{p_c} < +\infty$.

We now complete the proof of Lemma 6.3.2.

Proof of Lemma 6.3.2. By Lemma 6.B.1, $\bar{Z}^p < +\infty$ for all $p \in [0, p_c)$, so that the probability distribution $\bar{\Pi}^p$ is well-defined. We now fix a continuous function $f : [0, 1] \rightarrow \mathbb{R}$ and prove that the function $p \mapsto \langle f, \bar{\Pi}^p \rangle$ is continuous on $[0, p_c)$. Certainly, it suffices to prove that, for all $p \in [0, p_c)$,

$$\lim_{p' \rightarrow p} \int_{u=0}^1 e^{p'\Psi(u)} f(u) du = \int_{u=0}^1 e^{p\Psi(u)} f(u) du. \tag{6.27}$$

Let us fix $p \in [0, +\infty)$. Then, for all $u \in (0, 1)$,

$$\lim_{p' \rightarrow p} e^{p'\Psi(u)} f(u) = e^{p\Psi(u)} f(u),$$

while, taking $q \in (p, p_c)$, we write

$$\forall p' \in [0, q], \quad \left| e^{p'\Psi(u)} f(u) \right| \leq e^{q\Psi(u)} \|f\|_\infty,$$

where we recall that $[\psi]^+ := \psi \vee 0$. It easily follows from Lemma 6.B.1 that the right-hand side above is integrable on $[0, 1]$, so that (6.27) stems from the dominated convergence theorem. Note that the same arguments allow to prove that, if $\bar{Z}^{p_c} < +\infty$, then the function $p \mapsto \langle f, \bar{\Pi}^p \rangle$ is continuous on $[0, p_c]$.

To complete the proof, it remains to show that, if $\bar{Z}^{p_c} = +\infty$, then $\lim_{p \uparrow p_c} \langle f, \bar{\Pi}^p \rangle = f(1)$. In this purpose, we assume that $\bar{Z}^{p_c} = +\infty$. Then, Fatou's lemma immediately yields

$$\lim_{p \uparrow p_c} \int_{u=0}^1 e^{p\Psi(u)} du = +\infty.$$

Let $\eta > 0$, then by the continuity of f , there exists $u^* \in [0, 1)$ such that, for all $u \in [u^*, 1]$, $f(1) - \eta \leq f(u) \leq f(1) + \eta$. Let us define, for all $p \in [0, p_c)$,

$$I_f(p) := \frac{\int_{u=0}^{u^*} e^{p\Psi(u)} f(u) du}{\int_{u=0}^1 e^{p\Psi(u)} du}, \quad I(p) := \frac{\int_{u=0}^{u^*} e^{p\Psi(u)} du}{\int_{u=0}^1 e^{p\Psi(u)} du},$$

and write

$$\langle f, \bar{\Pi}^p \rangle = I_f(p) + \frac{\int_{u=u^*}^1 e^{p\Psi(u)} f(u) du}{\int_{u=0}^1 e^{p\Psi(u)} du},$$

so that

$$I_f(p) + (f(1) - \eta)(1 - I(p)) \leq \langle f, \bar{\Pi}^p \rangle \leq I_f(p) + (f(1) + \eta)(1 - I(p)).$$

Observing that

$$\limsup_{p \uparrow p_c} \left| \int_{u=0}^{u^*} e^{p\Psi(u)} f(u) du \right| \leq \|f\|_\infty \int_{u=0}^{u^*} e^{p_c \Psi(u)} du < +\infty,$$

we deduce that $I_f(p)$ and $I(p)$ vanish when $p \uparrow p_c$. The conclusion is straightforward. \square

We now prove Proposition 6.3.4. We shall use the following result regarding the convergence in Wasserstein distance.

Lemma 6.B.3. *Let $(G_t)_{t \geq 0}$ be a family of cumulative distribution functions on \mathbb{R} and G_∞ be a cumulative distribution function on \mathbb{R} , such that:*

- *there exists $q \geq 1$ such that $\lim_{t \rightarrow +\infty} W_q(G_t, G_\infty) = 0$,*
- *the probability distribution with cumulative distribution function G_∞ admits a positive density with respect to the Lebesgue measure on \mathbb{R} , so that both G_∞ and G_∞^{-1} are continuous, respectively on \mathbb{R} and $(0, 1)$.*

Then, for all $y \in \mathbb{R}$, $\lim_{t \rightarrow +\infty} G_t(y) = G_\infty(y)$, and for all $u \in (0, 1)$, $\lim_{t \rightarrow +\infty} G_t^{-1}(u) = G_\infty^{-1}(u)$.

Proof. Since the Wasserstein distance metrizes the weak convergence, G_t converges weakly to G_∞ . This classically implies that $G_t(y)$ converges to $G_\infty(y)$ for all continuity point $y \in \mathbb{R}$ of G_∞ [50, Theorem 2.2, p. 86], and $G_t^{-1}(u)$ converges to $G_\infty^{-1}(u)$ for all continuity point $u \in (0, 1)$ of G_∞^{-1} [50, Theorem 2.1, p. 85]. Since G_∞ is continuous on \mathbb{R} and G_∞^{-1} is continuous on $(0, 1)$, then the proof is completed. \square

Proof of Proposition 6.3.4. Let us assume that the conditions of Theorem 6.2.4 and Proposition 6.3.1 are satisfied. Recall that the critical diversity index $p_c \geq 0$ is defined in (6.12).

Subcritical case. Let us assume that $p_c > 0$ and let $p \in [0, p_c)$. Following §6.3.2.1, it suffices to prove that, for all continuous function $f : [0, 1] \rightarrow \mathbb{R}$,

$$\lim_{t \rightarrow +\infty} \int_{u=0}^1 e^{p\tilde{F}_t^{-1}(u)} f(u) du = \int_{u=0}^1 e^{p\tilde{F}_\infty^{-1}(u)} f(u) du, \quad (6.28)$$

where the cumulative distribution function \tilde{F}_∞ is defined by Theorem 6.2.4. Combining the latter with Lemma 6.B.3, it is already known that, for all $u \in (0, 1)$, $\lim_{t \rightarrow +\infty} \tilde{F}_t^{-1}(u) = \tilde{F}_\infty^{-1}(u)$. As a consequence, and since f is bounded, (6.28) follows if we exhibit $q > p$ such that

$$\sup_{t \geq 0} \int_{u=0}^1 e^{q\tilde{F}_t^{-1}(u)} du < +\infty. \quad (6.29)$$

In this purpose, let us fix $q \geq 0$ such that $p < q < p_c$ and remark that

$$\int_{u=0}^1 e^{q\tilde{F}_t^{-1}(u)} du = \mathbb{E} \left(e^{q\tilde{Y}(t)} \right).$$

By Itô's formula and (6.13),

$$\frac{d}{dt} \mathbb{E} \left(e^{q\tilde{Y}(t)} \right) = \mathbb{E} \left(e^{q\tilde{Y}(t)} \tilde{b}_q(\tilde{F}_t(\tilde{Y}(t))) \right),$$

where $\tilde{b}_q(u) := q\tilde{\gamma}(u) + q^2\sigma^2(u)/2$. It follows from a straightforward analysis of the function $q \mapsto \tilde{b}_q(1)$ that, since $q < p_c$, then $\tilde{b}_q(1) < 0$. Therefore, by the continuity of \tilde{b}_q , there exist $\eta > 0$ and $u^* \in [0, 1)$ such that, for all $u \in [u^*, 1]$, $\tilde{b}_q(u) \leq -\eta$. As a consequence, for all $t \geq 0$,

$$\begin{aligned} & \mathbb{E} \left(e^{q\tilde{Y}(t)} \tilde{b}_q(\tilde{F}_t(\tilde{Y}(t))) \right) \\ &= \mathbb{E} \left(e^{q\tilde{Y}(t)} \tilde{b}_q(\tilde{F}_t(\tilde{Y}(t))) \mathbb{1}_{\{\tilde{F}_t(\tilde{Y}(t)) < u^*\}} \right) + \mathbb{E} \left(e^{q\tilde{Y}(t)} \tilde{b}_q(\tilde{F}_t(\tilde{Y}(t))) \mathbb{1}_{\{\tilde{F}_t(\tilde{Y}(t)) \geq u^*\}} \right) \\ &\leq \mathbb{E} \left(e^{q\tilde{Y}(t)} \tilde{b}_q(\tilde{F}_t(\tilde{Y}(t))) \mathbb{1}_{\{\tilde{F}_t(\tilde{Y}(t)) < u^*\}} \right) - \eta \mathbb{E} \left(e^{q\tilde{Y}(t)} \mathbb{1}_{\{\tilde{F}_t(\tilde{Y}(t)) \geq u^*\}} \right) \\ &\leq (\|\tilde{b}_q\|_\infty + \eta) \mathbb{E} \left(e^{q\tilde{Y}(t)} \mathbb{1}_{\{\tilde{F}_t(\tilde{Y}(t)) < u^*\}} \right) - \eta \mathbb{E} \left(e^{q\tilde{Y}(t)} \right). \end{aligned}$$

For all $t \geq 0$, the definition of \tilde{F}_t^{-1} and the right continuity of \tilde{F}_t yield, for all $u \in (0, 1)$, $\tilde{F}_t(\tilde{F}_t^{-1}(u)) \geq u$. As a consequence,

$$\mathbb{E} \left(e^{q\tilde{Y}(t)} \mathbb{1}_{\{\tilde{F}_t(\tilde{Y}(t)) < u^*\}} \right) = \int_{u=0}^1 e^{q\tilde{F}_t^{-1}(u)} \mathbb{1}_{\{\tilde{F}_t(\tilde{F}_t^{-1}(u)) < u^*\}} du \leq \int_{u=0}^{u^*} e^{q\tilde{F}_t^{-1}(u)} du \leq u^* e^{q\tilde{F}_t^{-1}(u^*)},$$

and the right-hand side converges to $u^* e^{q\tilde{F}_\infty^{-1}(u^*)} < +\infty$ when $t \rightarrow +\infty$. As a consequence, there exists $C < +\infty$ such that

$$\frac{d}{dt} \mathbb{E} \left(e^{q\tilde{Y}(t)} \right) \leq C - \eta \mathbb{E} \left(e^{q\tilde{Y}(t)} \right),$$

and (6.29) follows from Gronwall's lemma.

Supercritical case. For $p > p_c \geq 0$, Theorem 6.2.4, Fatou's lemma and Lemma 6.B.1 yield

$$\lim_{t \rightarrow +\infty} \int_{u=0}^1 e^{p\tilde{F}_t^{-1}(u)} du = +\infty. \quad (6.30)$$

Let $\eta > 0$. By the continuity of f , there exists $u^* \in [0, 1)$ such that, for all $u \in [u^*, 1]$, $f(1) - \eta \leq f(u) \leq f(1) + \eta$. Besides, there exists $M > 0$ such that $\tilde{F}_\infty(M) > u^*$. Then, for all $t \geq 0$,

$$\begin{aligned} \int_{u=0}^1 e^{p\tilde{F}_t^{-1}(u)} f(u) du &= \mathbb{E} \left(e^{p\tilde{Y}(t)} f(\tilde{F}_t(\tilde{Y}(t))) \right) \\ &= \mathbb{E} \left(e^{p\tilde{Y}(t)} f(\tilde{F}_t(\tilde{Y}(t))) \mathbb{1}_{\{\tilde{Y}(t) < M\}} \right) + \mathbb{E} \left(e^{p\tilde{Y}(t)} f(\tilde{F}_t(\tilde{Y}(t))) \mathbb{1}_{\{\tilde{Y}(t) \geq M\}} \right). \end{aligned}$$

On the one hand,

$$\mathbb{E} \left(e^{p\tilde{Y}(t)} f(\tilde{F}_t(\tilde{Y}(t))) \mathbb{1}_{\{\tilde{Y}(t) < M\}} \right) \leq \|f\|_\infty e^{pM},$$

so that

$$\lim_{t \rightarrow +\infty} \frac{\mathbb{E} \left(e^{p\tilde{Y}(t)} f(\tilde{F}_t(\tilde{Y}(t))) \mathbb{1}_{\{\tilde{Y}(t) < M\}} \right)}{\mathbb{E} \left(e^{p\tilde{Y}(t)} \right)} = 0.$$

On the other hand, since Lemma 6.B.3 implies that $\lim_{t \rightarrow +\infty} \tilde{F}_t(M) = \tilde{F}_\infty(M)$, then for t large enough one has, for all $y \geq M$, $\tilde{F}_t(y) \geq \tilde{F}_t(M) \geq u^*$. Therefore, for t large enough,

$$f(1) - \eta \leq \frac{\mathbb{E} \left(e^{p\tilde{Y}(t)} f(\tilde{F}_t(\tilde{Y}(t))) \mathbb{1}_{\{\tilde{Y}(t) \geq M\}} \right)}{\mathbb{E} \left(e^{p\tilde{Y}(t)} \mathbb{1}_{\{\tilde{Y}(t) \geq M\}} \right)} \leq f(1) + \eta,$$

while $\mathbb{E} \left(e^{p\tilde{Y}(t)} \mathbb{1}_{\{\tilde{Y}(t) \geq M\}} \right) / \mathbb{E} \left(e^{p\tilde{Y}(t)} \right)$ converges to 1. As a conclusion,

$$f(1) - \eta \leq \liminf_{t \rightarrow +\infty} \frac{\int_{u=0}^1 e^{p\tilde{F}_t^{-1}(u)} f(u) du}{\int_{u=0}^1 e^{p\tilde{F}_t^{-1}(u)} du} \leq \limsup_{t \rightarrow +\infty} \frac{\int_{u=0}^1 e^{p\tilde{F}_t^{-1}(u)} f(u) du}{\int_{u=0}^1 e^{p\tilde{F}_t^{-1}(u)} du} \leq f(1) + \eta,$$

and the proof of the supercritical case is completed.

Criticality, case $\bar{\mathcal{Z}}^{p_c} = +\infty$. Note that the proof in the supercritical case above only requires that p be such that (6.30) holds. As soon as $\bar{\mathcal{Z}}^{p_c} = +\infty$, Fatou's lemma implies that (6.30) holds with $p = p_c$, so that we similarly obtain that $\lim_{t \rightarrow +\infty} \langle f, \Pi^{p_c}(t) \rangle = f(1)$.

Criticality, case $\bar{\mathcal{Z}}^{p_c} < +\infty$. We finally assume that $\bar{\mathcal{Z}}^{p_c} < +\infty$ and prove (6.14). In this purpose, we let $\ell \in [-\|f\|_\infty, \|f\|_\infty]$ be the limit of a converging sequence $(\langle f, \Pi^{p_c}(t_k) \rangle)_{k \geq 1}$, where t_k grows to infinity with k . We shall prove that

$$f(1) \wedge \langle f, \bar{\Pi}^{p_c} \rangle \leq \ell \leq f(1) \vee \langle f, \bar{\Pi}^{p_c} \rangle. \quad (6.31)$$

First, we deduce from Fatou's lemma that there exists a subsequence of $(t_k)_{k \geq 1}$, that we still index by k for convenience, such that

$$\lim_{k \rightarrow +\infty} \int_{u=0}^1 e^{p_c \tilde{F}_{t_k}^{-1}(u)} du = I \in [J, +\infty],$$

where

$$J := \int_{u=0}^1 e^{p_c \tilde{F}_\infty^{-1}(u)} du < +\infty.$$

Let us now fix $\eta > 0$. By the continuity of f , there exists $u^* \in [0, 1)$ such that, for all $u \in [u^*, 1]$, $f(1) - \eta \leq f(u) \leq f(1) + \eta$. Now let $M \geq 0$ be large enough for the inequality $\tilde{F}_\infty(M) > u^*$ to hold. Then, for all $k \geq 1$,

$$\langle f, \Pi^{p_c}(t_k) \rangle = \frac{\int_{u=0}^1 e^{p_c \tilde{F}_{t_k}^{-1}(u)} f(u) \mathbb{1}_{\{\tilde{F}_{t_k}^{-1}(u) \leq M\}} du}{\int_{u=0}^1 e^{p_c \tilde{F}_{t_k}^{-1}(u)} du} + \frac{\int_{u=0}^1 e^{p_c \tilde{F}_{t_k}^{-1}(u)} f(u) \mathbb{1}_{\{\tilde{F}_{t_k}^{-1}(u) > M\}} du}{\int_{u=0}^1 e^{p_c \tilde{F}_{t_k}^{-1}(u)} du}.$$

On the one hand, since the equilibrium distribution does not weight points,

$$\lim_{k \rightarrow +\infty} \int_{u=0}^1 e^{p_c \tilde{F}_{t_k}^{-1}(u)} f(u) \mathbb{1}_{\{\tilde{F}_{t_k}^{-1}(u) \leq M\}} du = \int_{u=0}^1 e^{p_c \tilde{F}_\infty^{-1}(u)} f(u) \mathbb{1}_{\{\tilde{F}_\infty^{-1}(u) \leq M\}} du =: J_f^M,$$

and the limit is finite. As a consequence,

$$\lim_{k \rightarrow +\infty} \frac{\int_{u=0}^1 e^{p_c \tilde{F}_{t_k}^{-1}(u)} f(u) \mathbb{1}_{\{\tilde{F}_{t_k}^{-1}(u) \leq M\}} du}{\int_{u=0}^1 e^{p_c \tilde{F}_{t_k}^{-1}(u)} du} = \frac{J_f^M}{I},$$

where it is understood that the limit is null whenever $I = +\infty$.

On the other hand, by Lemma 6.B.3, for k large enough, $F_{t_k}(M) \geq u^*$ so that

$$\begin{aligned} & (f(1) - \eta) \int_{u=0}^1 e^{p_c \tilde{F}_{t_k}^{-1}(u)} \mathbb{1}_{\{\tilde{F}_{t_k}^{-1}(u) > M\}} du \\ & \leq \int_{u=0}^1 e^{p_c \tilde{F}_{t_k}^{-1}(u)} f(u) \mathbb{1}_{\{\tilde{F}_{t_k}^{-1}(u) > M\}} du \leq (f(1) + \eta) \int_{u=0}^1 e^{p_c \tilde{F}_{t_k}^{-1}(u)} \mathbb{1}_{\{\tilde{F}_{t_k}^{-1}(u) > M\}} du, \end{aligned}$$

therefore

$$\begin{aligned} & (f(1) - \eta) \left(1 - \frac{\int_{u=0}^1 e^{p_c \tilde{F}_{t_k}^{-1}(u)} \mathbb{1}_{\{\tilde{F}_{t_k}^{-1}(u) \leq M\}} du}{\int_{u=0}^1 e^{p_c \tilde{F}_{t_k}^{-1}(u)} du} \right) \\ & \leq \frac{\int_{u=0}^1 e^{p_c \tilde{F}_{t_k}^{-1}(u)} f(u) \mathbb{1}_{\{\tilde{F}_{t_k}^{-1}(u) > M\}} du}{\int_{u=0}^1 e^{p_c \tilde{F}_{t_k}^{-1}(u)} du} \leq (f(1) + \eta) \left(1 - \frac{\int_{u=0}^1 e^{p_c \tilde{F}_{t_k}^{-1}(u)} \mathbb{1}_{\{\tilde{F}_{t_k}^{-1}(u) \leq M\}} du}{\int_{u=0}^1 e^{p_c \tilde{F}_{t_k}^{-1}(u)} du} \right), \end{aligned}$$

As a consequence,

$$\frac{J_f^M}{I} + (f(1) - \eta) \left(1 - \frac{J^M}{I}\right) \leq \ell \leq \frac{J_f^M}{I} + (f(1) + \eta) \left(1 - \frac{J^M}{I}\right)$$

where

$$J^M := \lim_{k \rightarrow +\infty} \int_{u=0}^1 e^{p_c \tilde{F}_{t_k}^{-1}(u)} \mathbb{1}_{\{\tilde{F}_{t_k}^{-1}(u) \leq M\}} du = \int_{u=0}^1 e^{p_c \tilde{F}_\infty^{-1}(u)} \mathbb{1}_{\{\tilde{F}_\infty^{-1}(u) \leq M\}} du.$$

By the dominated convergence theorem,

$$\lim_{M \rightarrow +\infty} J_f^M = J_f := \int_{u=0}^1 e^{p_c \tilde{F}_\infty^{-1}(u)} f(u) du, \quad \lim_{M \rightarrow +\infty} J^M = J,$$

so that

$$\frac{J_f}{I} + (f(1) - \eta) \left(1 - \frac{J}{I}\right) \leq \ell \leq \frac{J_f}{I} + (f(1) + \eta) \left(1 - \frac{J}{I}\right),$$

and letting η vanish yields

$$\ell = \frac{J_f}{I} + f(1) \left(1 - \frac{J}{I}\right).$$

We conclude by remarking that $J/I \in [0, 1]$, while

$$\frac{J_f}{I} = \frac{J_f}{J} \frac{J}{I} = \langle f, \bar{\Pi}^{p_c} \rangle \frac{J}{I},$$

so that ℓ writes as a convex combination of $\langle f, \bar{\Pi}^{p_c} \rangle$ and $f(1)$ and therefore satisfies (6.31). \square

Troisième partie

**La dynamique des particules
collantes multitype**

Chapitre 7

Interprétation probabiliste de systèmes diagonaux paraboliques

7.1 Introduction

7.1.1 Parabolic system of nonlinear equations

Let $d \geq 1$ and $\lambda = (\lambda^1, \dots, \lambda^d) : [0, 1]^d \rightarrow \mathbb{R}^d$. This chapter is dedicated to the study of solutions

$$\mathbf{u} = (u^1, \dots, u^d) : [0, +\infty) \times \mathbb{R} \rightarrow [0, 1]^d$$

to the *diagonal* parabolic system of nonlinear equations

$$\forall \gamma \in \{1, \dots, d\}, \quad \begin{cases} \partial_t u^\gamma + \lambda^\gamma(\mathbf{u}) \partial_x u^\gamma = \frac{1}{2} \partial_x^2 u^\gamma, \\ u^\gamma(0, x) = u_0^\gamma(x), \end{cases} \quad (7.1)$$

where, for all $\gamma \in \{1, \dots, d\}$, u_0^γ is the cumulative distribution function (CDF) of a probability distribution m^γ on \mathbb{R} , which we shall write $u_0^\gamma = H * m^\gamma$ where $H * \cdot$ refers to the convolution with the Heaviside function H .

Let us begin by giving a precise definition of the notion of *weak solution* to the system (7.1).

Definition 7.1.1 (Weak solution to (7.1)). *A weak solution to the system (7.1) is a function*

$$\mathbf{u} = (u^1, \dots, u^d) : [0, +\infty) \times \mathbb{R} \rightarrow [0, 1]^d$$

such that, for all $\gamma \in \{1, \dots, d\}$, $\partial_x u^\gamma \in L^1_{\text{loc}}([0, +\infty) \times \mathbb{R})$ and, for all $\phi \in C_c^\infty([0, +\infty) \times \mathbb{R})$,

$$\begin{aligned} & \int_{t=0}^{+\infty} \int_{x \in \mathbb{R}} \lambda^\gamma(\mathbf{u}(t, x)) \partial_x u^\gamma(t, x) \phi(t, x) dx dt \\ &= \int_{t=0}^{+\infty} \int_{x \in \mathbb{R}} u^\gamma(t, x) \left(\frac{1}{2} \partial_x^2 \phi(t, x) + \partial_t \phi(t, x) \right) dx dt + \int_{x \in \mathbb{R}} u_0^\gamma(x) \phi(0, x) dx. \end{aligned} \quad (7.2)$$

Throughout this chapter, we shall assume that λ satisfies the following Lipschitz Continuity assumption:

(LC) There exists $L_{LC} \in [0, +\infty)$ such that

$$\forall \gamma \in \{1, \dots, d\}, \quad \forall \mathbf{u}, \mathbf{v} \in [0, 1]^d, \quad |\lambda^\gamma(\mathbf{u}) - \lambda^\gamma(\mathbf{v})| \leq L_{LC} \sum_{\gamma'=1}^d |u^{\gamma'} - v^{\gamma'}|.$$

Of course, under Assumption (LC), the functions $\lambda^1, \dots, \lambda^d$ are bounded on $[0, 1]^d$, and we denote

$$L_B := \max_{1 \leq \gamma \leq d} \sup_{\mathbf{u} \in [0, 1]^d} |\lambda^\gamma(\mathbf{u})|.$$

In the purpose of addressing hyperbolic systems, which we shall do with a completely different approach in Chapter 9, El-Hajj and Monneau established the following existence and uniqueness result for the system (7.1).

Theorem 7.1.2. [55, Theorem 2.1] *Assume that λ satisfies (LC), and that, for all $\gamma \in \{1, \dots, d\}$, the probability distribution m^γ admits a bounded density with respect to the Lebesgue measure on \mathbb{R} . Then, the system (7.1) admits a unique weak solution in the space*

$$\bigcap_{T>0} (W^{1,\infty}([0, T] \times \mathbb{R}))^d,$$

and such that, for all $\gamma \in \{1, \dots, d\}$,

$$\|u^\gamma\|_{L^\infty((0, +\infty) \times \mathbb{R})} \leq \|u_0^\gamma\|_{L^\infty(\mathbb{R})}.$$

In this chapter, we remove the assumption on the initial data and establish existence and uniqueness of a solution in a different class of functions. Besides, we provide a probabilistic representation of the solution. To this aim, we look for solutions \mathbf{u} such that, for all $t \geq 0$, for all $\gamma \in \{1, \dots, d\}$, the function $u^\gamma(t, \cdot)$ remains the CDF of a probability distribution p_t^γ on \mathbb{R} . Taking the formal space derivative of (7.1), the family of probability distributions

$$\mathbf{p}_t = (p_t^1, \dots, p_t^d), \quad t \geq 0,$$

is expected to solve, in the distributional sense, the system of nonlinear evolution equations

$$\forall \gamma \in \{1, \dots, d\}, \quad \begin{cases} \partial_t p_t^\gamma = \frac{1}{2} \partial_x^2 p_t^\gamma + \partial_x (\lambda^\gamma(H * p_t^1(x), \dots, H * p_t^d(x)) p_t^\gamma), \\ p_0^\gamma = m^\gamma. \end{cases} \quad (7.3)$$

We shall look for *mild solutions* to the system (7.3), defined as follows. For all $t > 0$, let us denote by Γ_t the heat kernel

$$\Gamma_t(x) := \frac{1}{\sqrt{2\pi t}} \exp\left(-\frac{x^2}{2t}\right),$$

and recall that

$$\|\partial_x \Gamma_t\|_{L^1(\mathbb{R})} = \frac{2}{\sqrt{2\pi t}}. \quad (7.4)$$

We furthermore denote by $P_{\text{Leb}}(\mathbb{R})$ the space of probability densities with respect to the Lebesgue measure on \mathbb{R} .

Definition 7.1.3 (Mild solutions to (7.3)). *A mild solution to the system (7.3) is a function*

$$\mathbf{p} = (p^1, \dots, p^d) : (0, +\infty) \rightarrow (P_{\text{Leb}}(\mathbb{R}))^d$$

such that, for all $t > 0$, for all $\gamma \in \{1, \dots, d\}$,

$$p_t^\gamma(x) = \Gamma_t * m^\gamma(x) - \int_{s=0}^t \partial_x \Gamma_{t-s} * (\ell^\gamma[\mathbf{p}_s] p_s^\gamma)(x) ds, \quad dx\text{-a.e.},$$

where, for all $\gamma \in \{1, \dots, d\}$, the function $\ell^\gamma[\mathbf{p}_s]$ is defined by

$$\ell^\gamma[\mathbf{p}_s](x) := \lambda^\gamma(H * p_s^1(x), \dots, H * p_s^d(x)).$$

7.1.2 Multitype rank-based system of particles

The system (7.3) is the system of Fokker-Planck equations satisfied by the marginal distributions of the diffusion process

$$\mathbf{X} = (X^1(t), \dots, X^d(t))_{t \geq 0}$$

solving the stochastic differential equation (SDE) in \mathbb{R}^d

$$\forall \gamma \in \{1, \dots, d\}, \quad \begin{cases} dX^\gamma(t) = \lambda^\gamma (H * p_t^1(X^\gamma(t)), \dots, H * p_t^d(X^\gamma(t))) dt + dW^\gamma(t), \\ p_t^\gamma \text{ is the law of } X^\gamma(t), \end{cases} \quad (7.5)$$

where $\mathbf{W} = (W^1(t), \dots, W^d(t))_{t \geq 0}$ is a standard Brownian motion in \mathbb{R}^d , and $\mathbf{X}(0)$ is a random variable in \mathbb{R}^d , independent of \mathbf{W} , such that, for all $\gamma \in \{1, \dots, d\}$, the coordinate $X^\gamma(0)$ has marginal distribution m^γ on \mathbb{R} .

The SDE (7.5) is said to be *nonlinear in McKean's sense* as the coefficients of the diffusion depend on the law of the random variable $\mathbf{X}(t)$ in \mathbb{R}^d . A classical linearisation procedure [108, 130] to address such SDEs consists in introducing n copies $\mathbf{X}_{1,n}, \dots, \mathbf{X}_{n,n}$ of the process \mathbf{X} , driven by independent Brownian motions $\mathbf{W}_1, \dots, \mathbf{W}_n$, and replacing the law of \mathbf{X} in the coefficients of the diffusion with the empirical distribution of the copies. Applying this procedure to the SDE (7.5), one obtains n processes

$$\mathbf{X}_{k,n} = (X_{k,n}^1(t), \dots, X_{k,n}^d(t))_{t \geq 0}, \quad k \in \{1, \dots, n\},$$

in \mathbb{R}^d , satisfying, for all $k \in \{1, \dots, n\}$, for all $\gamma \in \{1, \dots, d\}$,

$$dX_{k,n}^\gamma(t) = \lambda^\gamma \left(\frac{1}{n} \sum_{j=1}^n \mathbb{1}_{\{X_{j,n}^1(t) \leq X_{k,n}^\gamma(t)\}}, \dots, \frac{1}{n} \sum_{j=1}^n \mathbb{1}_{\{X_{j,n}^d(t) \leq X_{k,n}^\gamma(t)\}} \right) dt + dW_k^\gamma(t), \quad (7.6)$$

where the processes

$$\mathbf{W}_k = (W_k^1(t), \dots, W_k^d(t))_{t \geq 0}, \quad k \in \{1, \dots, n\},$$

are independent standard Brownian motions in \mathbb{R}^d , and the random variables $\mathbf{X}_{1,n}(0), \dots, \mathbf{X}_{n,n}(0)$ are independent from each other and independent of $\mathbf{W}_1, \dots, \mathbf{W}_n$. For the sake of simplicity, we shall assume that, for all $k \in \{1, \dots, n\}$,

$$\mathbf{X}_{k,n}(0) = (X_{k,n}^1(0), \dots, X_{k,n}^d(0)) \sim m^1 \otimes \dots \otimes m^d, \quad (7.7)$$

although any initial law for the $\mathbf{X}_{k,n}(0)$'s with marginal distributions m^1, \dots, m^d would lead to the same results. By the Girsanov theorem, weak existence and uniqueness hold for this system of SDEs, while strong existence and uniqueness are due to Veretennikov [133].

The processes $X_{k,n}^\gamma$ describe the behaviour of a system of $d \times n$ Brownian particles evolving on the real line according to the following rules:

- each particle has a *label* $k \in \{1, \dots, n\}$ and a *type* $\gamma \in \{1, \dots, d\}$,
- the drift of each particle depends on the proportion of particles of each type located below the particle.

In the scalar case $d = 1$, where there is only one type of particle, the system is called *rank-based* as the drift of each particle only depends on its rank among the whole system [83, 84, 85]. In the general case $d \geq 1$, the system shall be called *multitype rank-based*.

Let us finally define the *empirical distribution* of the particle system as the random probability distribution

$$\mu_n := \frac{1}{n} \sum_{k=1}^n \delta_{\mathbf{X}_{k,n}}$$

on the space $C([0, +\infty), \mathbb{R}^d)$ of continuous sample-paths in \mathbb{R}^d endowed with the topology of locally uniform convergence. For any probability distribution P on this space, the marginal distribution of P at time $t \geq 0$ is denoted by P_t , and the marginal distribution of the γ -th coordinate at time $t \geq 0$ is denoted by P_t^γ . The space of probability distributions on $C([0, +\infty), \mathbb{R}^d)$ is endowed with the topology of weak convergence.

7.1.3 Results and outline

We can now state the main result of this chapter.

Theorem 7.1.4. *Let us assume that the function $\lambda = (\lambda^1, \dots, \lambda^d)$ satisfies (LC).*

- (i) *The sequence μ_n converges in probability to the law P of the unique weak solution to the nonlinear SDE (7.5) in \mathbb{R}^d .*
- (ii) *The function $\mathbf{u} = (u^1, \dots, u^d)$ defined on $[0, +\infty) \times \mathbb{R}$ by, for all $(t, x) \in [0, +\infty) \times \mathbb{R}$,*

$$\forall \gamma \in \{1, \dots, d\}, \quad u^\gamma(t, x) := H * P_t^\gamma(x),$$

is the unique weak solution to the system (7.1) such that $(\partial_x u^1, \dots, \partial_x u^d)$ is a mild solution to the system of Fokker-Planck equations (7.3).

Remark 7.1.5. Under the assumptions of Theorem 7.1.2, let $\mathbf{u} = (u^1, \dots, u^d)$ refer to the weak solution to the system (7.1) obtained in Theorem 7.1.2. Then, following [55, Equation (3.3)], $(\partial_x u^1, \dots, \partial_x u^d)$ is a mild solution to the system of Fokker-Planck equations (7.3), therefore the function \mathbf{u} coincides with the solution that we obtain in Theorem 7.1.4.

Theorem 7.1.4 can be completed by the following convergence result for the empirical CDFs of the particle system: for all $n \geq 1$, let us define the random function $\mathbf{u}_n = (u_n^1, \dots, u_n^d)$ by, for all $(t, x) \in [0, +\infty) \times \mathbb{R}$,

$$\forall \gamma \in \{1, \dots, d\}, \quad u_n^\gamma(t, x) := H * (\mu_n)^\gamma_t(x) = \frac{1}{n} \sum_{k=1}^n \mathbb{1}_{\{X_{k,n}^\gamma(t) \leq x\}}.$$

Proposition 7.1.6. *Under the assumptions of Theorem 7.1.4, let $T > 0$. Then, for all $\tau \in (0, T)$, for all $\gamma \in \{1, \dots, d\}$,*

$$\lim_{n \rightarrow +\infty} \mathbb{E} \left(\sup_{(t,x) \in [\tau, T] \times \mathbb{R}} |u_n^\gamma(t, x) - u^\gamma(t, x)| \right) = 0,$$

and this limit holds true with $\tau = 0$ if m^γ does not weight points.

The chapter is organised as follows. We prove in Section 7.2 that mild solutions to the system of Fokker-Planck equations (7.3) are unique and provide weak solutions to the system (7.1). The nonlinear SDE (7.5) is addressed in Section 7.3, where it is formulated as a nonlinear martingale problem. We check in Proposition 7.3.2 that the marginal distributions of the solutions to this martingale problem are mild solutions to the system of Fokker-Planck equations (7.3), which allows us to derive uniqueness of the nonlinear martingale problem. Finally, existence for the martingale problem is obtained in Proposition 7.4.1 of Section 7.4 as the limit of the empirical distribution of the particle system. This completes the proof of Theorem 7.1.4, and the proof of Proposition 7.1.6 is detailed in Subsection 7.4.2.

7.2 Mild solutions to the system of Fokker-Planck equations

This section is dedicated to the study of mild solutions to the system of Fokker-Planck equations (7.3).

Proposition 7.2.1. *Assume that the function $\lambda = (\lambda^1, \dots, \lambda^d)$ satisfies (LC).*

- (i) *If $\mathbf{p} = (p^1, \dots, p^d)$ and $\mathbf{q} = (q^1, \dots, q^d)$ are mild solutions to (7.3), then for all $t > 0$, for all $\gamma \in \{1, \dots, d\}$,*

$$p_t^\gamma(x) = q_t^\gamma(x), \quad dx\text{-a.e.}$$

- (ii) *Let $\mathbf{p} = (p^1, \dots, p^d)$ be a mild solution to (7.3), and define the function $\mathbf{u} = (u^1, \dots, u^d) : [0, +\infty) \times \mathbb{R} \rightarrow [0, 1]^d$ by, for all $\gamma \in \{1, \dots, d\}$,*

$$u^\gamma(0, x) := H * m^\gamma(x), \quad u^\gamma(t, x) := H * p_t^\gamma(x).$$

Then \mathbf{u} is a weak solution to the system (7.1).

Proof. Let us first address (i). The proof follows the lines of Jourdain [82, Lemma 2.3, p. 342]. Let $\mathbf{p} = (p^1, \dots, p^d)$ and $\mathbf{q} = (q^1, \dots, q^d)$ be mild solutions to (7.3). For all $t > 0$, for all $\gamma \in \{1, \dots, d\}$,

$$\|p_t^\gamma - q_t^\gamma\|_{L^1(\mathbb{R})} \leq \int_{s=0}^t \|\partial_x \Gamma_{t-s}\|_{L^1(\mathbb{R})} \|\ell^\gamma[\mathbf{p}_s]p_s^\gamma - \ell^\gamma[\mathbf{q}_s]q_s^\gamma\|_{L^1(\mathbb{R})} ds,$$

thanks to the Fubini-Tonelli theorem and the Hausdorff-Young inequality.

By Assumption (LC), for all $s > 0$,

$$\begin{aligned} \|\ell^\gamma[\mathbf{p}_s]p_s^\gamma - \ell^\gamma[\mathbf{q}_s]q_s^\gamma\|_{L^1(\mathbb{R})} &\leq \|\ell^\gamma[\mathbf{p}_s]p_s^\gamma - \ell^\gamma[\mathbf{p}_s]q_s^\gamma\|_{L^1(\mathbb{R})} + \|\ell^\gamma[\mathbf{p}_s]q_s^\gamma - \ell^\gamma[\mathbf{q}_s]q_s^\gamma\|_{L^1(\mathbb{R})} \\ &\leq L_B \|p_s^\gamma - q_s^\gamma\|_{L^1(\mathbb{R})} + L_{LC} \sum_{\gamma'=1}^d \|(H * (p_s^{\gamma'} - q_s^{\gamma'}))q_s^\gamma\|_{L^1(\mathbb{R})} \end{aligned}$$

and

$$\begin{aligned} \sum_{\gamma'=1}^d \|(H * (p_s^{\gamma'} - q_s^{\gamma'}))q_s^\gamma\|_{L^1(\mathbb{R})} &\leq \sum_{\gamma'=1}^d \|H * (p_s^{\gamma'} - q_s^{\gamma'})\|_{L^\infty(\mathbb{R})} \|q_s^\gamma\|_{L^1(\mathbb{R})} \\ &\leq \sum_{\gamma'=1}^d \|p_s^{\gamma'} - q_s^{\gamma'}\|_{L^1(\mathbb{R})}, \end{aligned}$$

since $\|q_s^\gamma\|_{L^1(\mathbb{R})} = 1$ as $q_s^\gamma \in \text{P}_{\text{Leb}}(\mathbb{R})$. Thanks to (7.4), we obtain

$$\sum_{\gamma=1}^d \|p_t^\gamma - q_t^\gamma\|_{L^1(\mathbb{R})} \leq (L_B + dL_{LC}) \int_{s=0}^t \frac{2}{\sqrt{2\pi(t-s)}} \sum_{\gamma=1}^d \|p_s^\gamma - q_s^\gamma\|_{L^1(\mathbb{R})} ds.$$

Iterating the inequality yields

$$\begin{aligned} \sum_{\gamma=1}^d \|p_t^\gamma - q_t^\gamma\|_{L^1(\mathbb{R})} &\leq (L_B + dL_{LC})^2 \int_{s=0}^t \frac{2}{\sqrt{2\pi(t-s)}} \int_{r=0}^s \frac{2}{\sqrt{2\pi(s-r)}} \sum_{\gamma=1}^d \|p_r^\gamma - q_r^\gamma\|_{L^1(\mathbb{R})} dr ds \\ &= \frac{2}{\pi} (L_B + dL_{LC})^2 \int_{r=0}^t \sum_{\gamma=1}^d \|p_r^\gamma - q_r^\gamma\|_{L^1(\mathbb{R})} \int_{s=r}^t \frac{1}{\sqrt{(t-s)(s-r)}} ds dr \\ &= 2(L_B + dL_{LC})^2 \int_{r=0}^t \sum_{\gamma=1}^d \|p_r^\gamma - q_r^\gamma\|_{L^1(\mathbb{R})} dr, \end{aligned}$$

so that the Gronwall lemma ensures that, for all $t > 0$,

$$\sum_{\gamma=1}^d \|p_t^\gamma - q_t^\gamma\|_{L^1(\mathbb{R})} = 0,$$

hence the result.

Let us now address (ii). We fix $\gamma \in \{1, \dots, d\}$. First, it is obvious that $\partial_x u^\gamma \in L^1_{\text{loc}}([0, +\infty) \times \mathbb{R})$. Now let $\phi \in C_c^\infty([0, +\infty) \times \mathbb{R})$ and check that (7.2) holds. To this aim, we first note that, by the Fubini-Tonelli theorem, for all $t > 0$,

$$H * (\Gamma_t * m^\gamma) = \Gamma_t * (H * m^\gamma) = \Gamma_t * u_0^\gamma,$$

while the Fubini-Tonelli theorem combined with the Hausdorff-Young inequality and (7.4) yield

$$\begin{aligned} H * \int_{s=0}^t |\partial_x \Gamma_{t-s}| * |\ell^\gamma[\mathbf{p}_s]p_s^\gamma| ds &\leq L_B \int_{s=0}^t |\partial_x \Gamma_{t-s}| * (H * p_s^\gamma) ds \\ &\leq L_B \int_{s=0}^t \frac{2}{\sqrt{2\pi(t-s)}} ds < +\infty, \end{aligned}$$

therefore one can apply the Fubini theorem and get, for all $x \in \mathbb{R}$,

$$\left(H * \int_{s=0}^t \partial_x \Gamma_{t-s} * (\ell^\gamma[\mathbf{p}_s] p_s^\gamma) ds \right) (x) = \int_{s=0}^t \Gamma_{t-s} * (\ell^\gamma[\mathbf{p}_s] p_s^\gamma)(x) ds.$$

As a consequence, for all $t > 0$,

$$u^\gamma(t, x) = \Gamma_t * u_0^\gamma(x) - \int_{s=0}^t \Gamma_{t-s} * (\ell^\gamma[\mathbf{p}_s] p_s^\gamma)(x) ds.$$

Since $\partial_t \Gamma_t = (1/2) \partial_x^2 \Gamma_t$, then

$$\begin{aligned} & \int_{t=0}^{+\infty} \int_{x \in \mathbb{R}} \Gamma_t * u_0^\gamma(x) \left(\frac{1}{2} \partial_x^2 \phi(t, x) + \partial_t \phi(t, x) \right) dx dt \\ &= \int_{t=0}^{+\infty} \int_{x \in \mathbb{R}} \left(\frac{1}{2} \partial_x^2 \Gamma_t - \partial_t \Gamma_t \right) * u_0^\gamma(x) \phi(t, x) dx dt - \int_{x \in \mathbb{R}} u_0^\gamma(x) \phi(0, x) dx \\ &= - \int_{x \in \mathbb{R}} u_0^\gamma(x) \phi(0, x) dx, \end{aligned}$$

where the use of the Fubini theorem is still allowed by (7.4). Similarly,

$$\begin{aligned} & \int_{t=0}^{+\infty} \int_{x \in \mathbb{R}} \int_{s=0}^t \Gamma_{t-s} * (\ell^\gamma[\mathbf{p}_s] p_s^\gamma)(x) ds \left(\frac{1}{2} \partial_x^2 \phi(t, x) + \partial_t \phi(t, x) \right) dx dt \\ &= \int_{t=0}^{+\infty} \int_{x \in \mathbb{R}} \int_{s=0}^t \left(\frac{1}{2} \partial_x^2 \Gamma_{t-s} - \partial_t \Gamma_{t-s} \right) * (\ell^\gamma[\mathbf{p}_s] p_s^\gamma)(x) ds \phi(t, x) dx dt \\ &+ \int_{t=0}^{+\infty} \int_{x \in \mathbb{R}} \ell^\gamma[\mathbf{p}_t](x) p_t^\gamma(x) \phi(t, x) dx dt \\ &= \int_{t=0}^{+\infty} \int_{x \in \mathbb{R}} \lambda^\gamma(\mathbf{u}(t, x)) \partial_x u^\gamma(t, x) \phi(t, x) dx dt, \end{aligned}$$

which completes the proof. \square

7.3 The nonlinear martingale problem

We now formulate the nonlinear SDE (7.5) under the form of a nonlinear martingale problem. In this purpose, we denote by

$$\mathbb{X} = (\mathbf{X}^1(t), \dots, \mathbf{X}^d(t))_{t \geq 0}$$

the canonical process on $C([0, +\infty), \mathbb{R}^d)$.

Definition 7.3.1. A probability distribution P on $C([0, +\infty), \mathbb{R}^d)$ is a solution to the nonlinear martingale problem if:

- (i) $P_0 = m^1 \otimes \dots \otimes m^d$,
- (ii) for all $\varphi \in C_b^2(\mathbb{R}^d)$, the process $M^{P, \varphi}$ defined by, for all $t \geq 0$,

$$M^{P, \varphi}(t) := \varphi(\mathbb{X}(t)) - \varphi(\mathbb{X}(0)) - \int_{s=0}^t \sum_{\gamma=1}^d \left\{ \ell^\gamma[P_s](\mathbf{X}^\gamma(s)) \partial_\gamma \varphi(\mathbb{X}(s)) + \frac{1}{2} \partial_\gamma^2 \varphi(\mathbb{X}(s)) \right\} ds,$$

where $\ell^\gamma[P_s](x) := \lambda^\gamma(H * P_s^1(x), \dots, H * P_s^d(x))$, is a martingale under P .

The link between the nonlinear martingale problem and the system (7.1) is made in the following proposition.

Proposition 7.3.2. Assume that the function $\lambda = (\lambda^1, \dots, \lambda^d)$ satisfies (LC).

- (i) If P is a solution to the nonlinear martingale problem, then, for all $t > 0$, for all $\gamma \in \{1, \dots, d\}$, the probability distribution P_t^γ admits a density p_t^γ with respect to the Lebesgue measure on \mathbb{R} , and the mapping $t \mapsto (p_t^1, \dots, p_t^d)$ is a mild solution to the system of Fokker-Planck equations (7.3).
- (ii) There is at most one solution to the nonlinear martingale problem.

Proof. Let us first prove (i). The proof follows the lines of Jourdain [82, Lemma 2.3, p. 342]. Let P be a solution to the martingale problem. Following the classical argument exposed for example in [94, Remark 4.12, p. 318], we obtain that, under P , the process

$$\mathbb{X}(t) - \mathbb{X}(0) - \sum_{\gamma=1}^d \int_{s=0}^t \ell[P_s](\mathbb{X}(s)) ds,$$

where $\ell[P_s](\mathbf{x}) := (\ell^1[P_s](x^1), \dots, \ell^d[P_s](x^d)) \in \mathbb{R}^d$ for all $\mathbf{x} = (x^1, \dots, x^d) \in \mathbb{R}^d$, is a standard Brownian motion in \mathbb{R}^d . As a consequence, for all $t > 0$, the boundedness of $\ell[P_s](\mathbf{x})$ together with the Girsanov theorem imply that the probability distribution P_t admits a density p_t with respect to the Lebesgue measure on \mathbb{R}^d . For all $\gamma \in \{1, \dots, d\}$, the marginal density p_t^γ is obtained by

$$p_t^\gamma(x) := \int_{(x^1, \dots, x^{\gamma-1}, x^{\gamma+1}, \dots, x^d) \in \mathbb{R}^{d-1}} p_t(x^1, \dots, x^{\gamma-1}, x, x^{\gamma+1}, \dots, x^d) dx^1 \cdots dx^{\gamma-1} dx^{\gamma+1} \cdots dx^d.$$

We deduce from Itô's formula that, for all $t > 0$, for all $\phi \in C_b^{1,2}([0, t] \times \mathbb{R}^d)$,

$$\begin{aligned} & \int_{\mathbf{x} \in \mathbb{R}^d} \phi(t, \mathbf{x}) p_t(\mathbf{x}) d\mathbf{x} \\ &= \int_{\mathbf{x} \in \mathbb{R}^d} \phi(0, \mathbf{x}) m^1 \otimes \cdots \otimes m^d(d\mathbf{x}) \\ &+ \int_{s=0}^t \int_{\mathbf{x} \in \mathbb{R}^d} \left(\partial_s \phi(s, \mathbf{x}) + \sum_{\gamma=1}^d \left\{ \ell^\gamma[P_s](x^\gamma) \partial_\gamma \phi(s, \mathbf{x}) + \frac{1}{2} \partial_\gamma^2 \phi(s, \mathbf{x}) \right\} \right) p_s(\mathbf{x}) ds d\mathbf{x}. \end{aligned}$$

Let us now fix $\gamma \in \{1, \dots, d\}$, $\psi \in C_c^\infty(\mathbb{R})$, $t > 0$ and define $\phi \in C_b^2([0, t] \times \mathbb{R}^d)$ by

$$\phi(t, \mathbf{x}) := \psi(x^\gamma), \quad \phi(s, \mathbf{x}) := \Gamma_{t-s} * \psi(x^\gamma), \quad s < t.$$

Since, for all $\gamma' \neq \gamma$,

$$\partial_{\gamma'} \phi(s, \mathbf{x}) = 0, \quad \partial_{\gamma'}^2 \phi(s, \mathbf{x}) = 0,$$

and

$$\partial_\gamma \phi(s, \mathbf{x}) = \partial_x \Gamma_{t-s} * \psi(x^\gamma), \quad \partial_s \phi(s, \mathbf{x}) + \frac{1}{2} \partial_\gamma^2 \phi(s, \mathbf{x}) = 0,$$

then Itô's formula rewrites

$$\begin{aligned} \int_{x \in \mathbb{R}} \psi(x) p_t^\gamma(x) dx &= \int_{x \in \mathbb{R}^d} \Gamma_t * \psi(x) m^\gamma(dx) + \int_{s=0}^t \int_{x \in \mathbb{R}} \ell^\gamma[P_s](x) \partial_x \Gamma_{t-s} * \psi(x) p_s^\gamma(x) ds dx \\ &= \int_{x \in \mathbb{R}^d} \Gamma_t * m^\gamma(x) \psi(x) dx - \int_{x \in \mathbb{R}} \int_{s=0}^t \partial_x \Gamma_{t-s} * (\ell^\gamma[P_s] p_s^\gamma)(x) ds \psi(x) dx, \end{aligned}$$

where we have used the Fubini theorem at the second line. We conclude that, dx -almost everywhere,

$$p_t^\gamma(x) = \Gamma_t * m^\gamma(x) - \int_{s=0}^t \partial_x \Gamma_{t-s} * (\ell^\gamma[P_s] p_s^\gamma)(x) ds,$$

which completes the proof of (i).

Let us now give a proof of the uniqueness result (ii). To this aim, let us take two solutions P and Q to the nonlinear martingale problem. Then, by (i), for all $t > 0$, for all $\gamma \in \{1, \dots, d\}$, the probability distribution P_t^γ (resp. Q_t^γ) admits a density p_t^γ (resp. q_t^γ) with respect to the Lebesgue

measure on \mathbb{R} , and the mapping $t \mapsto (p_t^1, \dots, p_t^d)$ (resp. $t \mapsto (q_t^1, \dots, q_t^d)$) is a mild solution to the system of Fokker-Planck equations (7.3). By the uniqueness result (i) in Proposition 7.2.1, then, for all $\gamma \in \{1, \dots, d\}$, for all $t > 0$,

$$p_t^\gamma(x) = q_t^\gamma(x), \quad dx\text{-a.e.},$$

and we define

$$u^\gamma(t, x) := H * p_t^\gamma(x) = H * q_t^\gamma(x).$$

Both P and Q solve the following linear martingale problem: find a probability distribution R on $C([0, +\infty), \mathbb{R}^d)$ such that

- (i) $R_0 = m^1 \otimes \dots \otimes m^d$,
- (ii) for all $\varphi \in C_b^2(\mathbb{R}^d)$, the process N^φ defined by, for all $t \geq 0$,

$$N^\varphi(t) := \varphi(\mathbb{X}(t)) - \varphi(\mathbb{X}(0)) - \int_{s=0}^t \sum_{\gamma=1}^d \left\{ \ell_s^\gamma(\mathbb{X}^\gamma(s)) \partial_\gamma \varphi(\mathbb{X}(s)) + \frac{1}{2} \partial_\gamma^2 \varphi(\mathbb{X}(s)) \right\} ds,$$

where $\ell_s^\gamma(x) := \lambda^\gamma(u^1(s, x), \dots, u^d(s, x))$, is a martingale under R .

The solutions to this linear martingale problem are unique [129, Theorem 7.2.1, p. 187], therefore $P = Q$ and the proof of (ii) is completed. \square

Remark 7.3.3. If P is a solution to the nonlinear martingale problem, then combining Propositions 7.2.1 and 7.3.2, we deduce that the function $\mathbf{u} = (u^1, \dots, u^d)$ defined by, for all $\gamma \in \{1, \dots, d\}$, for all $(t, x) \in [0, +\infty) \times \mathbb{R}$,

$$u^\gamma(t, x) := H * P_t^\gamma(x),$$

is a weak solution to the system (7.1). Besides, by (i) in Proposition 7.3.2, for all $\gamma \in \{1, \dots, d\}$, for all $t > 0$ (resp. $t \geq 0$ if m^γ does not weight points), the function $u^\gamma(t, \cdot)$ is continuous on \mathbb{R} , and

$$\forall x \in \mathbb{R}, \quad \lim_{s \rightarrow t} u^\gamma(s, x) = u^\gamma(t, x).$$

By the Dini theorem, we deduce that u^γ is continuous on $(0, +\infty) \times \mathbb{R}$ (resp. $[0, +\infty) \times \mathbb{R}$).

7.4 The multitype rank-based particle system

In Subsection 7.4.1, we prove a law of large numbers for the empirical distribution of the particle system, which provides us with a solution to the nonlinear martingale problem. Subsection 7.4.2 is dedicated to the proof of Proposition 7.1.6.

7.4.1 Law of large numbers for the particle system

Recall that the empirical distribution of the particle system is the random probability distribution μ_n on $C([0, +\infty), \mathbb{R}^d)$ defined by

$$\mu_n = \frac{1}{n} \sum_{k=1}^n \delta_{\mathbf{X}_{k,n}},$$

where the family of processes $\mathbf{X}_{k,n} = (X_{k,n}^1(t), \dots, X_{k,n}^d(t))_{t \geq 0}$, $k \in \{1, \dots, n\}$, is the unique weak solution to the SDE (7.6)-(7.7) in $\mathbb{R}^{d \times n}$.

Proposition 7.4.1. *Under Assumption (LC), μ_n converges in probability to the unique solution P to the nonlinear martingale problem.*

Proof. The proof is similar to Jourdain [82, (ii), Proposition 2.4, p. 346]. For all $n \geq 1$, let π_n refer to the law of μ_n : π_n is a probability distribution on the space of probability distributions on $C([0, +\infty), \mathbb{R}^d)$. The proof is in two steps: in Step 1, we prove that the sequence $(\pi_n)_{n \geq 1}$ is tight; while in Step 2, we show that any limit π_∞ of a converging subsequence gives full measure to the set of solutions to the nonlinear martingale problem. Then, the conclusion of the proof follows from the uniqueness result for the martingale problem obtained in Proposition 7.3.2.

Step 1. Clearly, the processes $\mathbf{X}_{1,n}, \dots, \mathbf{X}_{n,n}$ are exchangeable, in the sense that, for all permutation σ of $\{1, \dots, n\}$, the processes $(\mathbf{X}_{\sigma(1),n}, \dots, \mathbf{X}_{\sigma(n),n})$ and $(\mathbf{X}_{1,n}, \dots, \mathbf{X}_{n,n})$ have the same law. As a consequence, by [130, Proposition 2.2, p. 177], the tightness of the sequence $(\pi_n)_{n \geq 1}$ is equivalent to the tightness of the sequence of the laws of $\mathbf{X}_{1,n}$ in $C([0, +\infty), \mathbb{R}^d)$. The latter point easily follows from the boundedness of the functions $\lambda^1, \dots, \lambda^d$.

Step 2. Let π_∞ be the limit of a converging subsequence of $(\pi_n)_{n \geq 1}$, that we still index by n for convenience. Let μ_∞ be a random variable with law π_∞ , so that μ_n converges to μ_∞ in distribution.

Clearly, π_∞ -almost surely, the marginal distribution of μ_∞ at time 0 is $m^1 \otimes \dots \otimes m^d$.

For $l \geq 1$, $0 \leq s_1 < \dots < s_l \leq s < t$, $\varphi \in C_b^2(\mathbb{R}^d)$ and $g : (\mathbb{R}^d)^l \rightarrow \mathbb{R}$ continuous and bounded, let us denote

$$\theta := \{l, (s_1, \dots, s_l, s, t), \varphi, g\},$$

and define the functional \mathcal{G}_θ on the set of probability distributions on $C([0, +\infty), \mathbb{R}^d)$ by

$$\mathcal{G}_\theta(Q) := \langle Q, g(\mathbb{X}(s_1), \dots, \mathbb{X}(s_l))(\mathbb{M}^{Q,\varphi}(t) - \mathbb{M}^{Q,\varphi}(s)) \rangle,$$

where:

- \mathbb{X} still refers to the canonical process on $C([0, +\infty), \mathbb{R}^d)$,
- the process $\mathbb{M}^{Q,\varphi}$ is introduced in Definition 7.3.1,
- for all measurable functional $G : C([0, +\infty), \mathbb{R}^d) \rightarrow \mathbb{R}$, $\langle Q, G(\mathbb{X}) \rangle$ denotes the expectation of $G(\mathbb{X})$ under Q .

If a probability distribution Q on $C([0, +\infty), \mathbb{R}^d)$ satisfies $\mathcal{G}_\theta(Q) = 0$ for all choice of θ , then it is a solution to the nonlinear martingale problem. The remainder of the proof consists in proving that, π_∞ -almost surely, for all choice of θ , $\mathcal{G}_\theta(\mu_\infty) = 0$. We shall actually prove that, for all choice of θ , π_∞ -almost surely, $\mathcal{G}_\theta(\mu_\infty) = 0$, and conclude by taking θ in a countable dense subset.

Therefore, we now fix $\theta = \{l, (s_1, \dots, s_l, s, t), \varphi, g\}$, and prove that

$$\mathbb{E} |\mathcal{G}_\theta(\mu_\infty)| = 0,$$

where we recall that the law of μ_∞ is π_∞ . To this aim, for all $i \geq 1$, we first define the continuous approximation H^i of the Heaviside function H by

$$\forall x \in \mathbb{R}, \quad H^i(x) := (1 + ix)\mathbb{1}_{\{-1/i \leq x \leq 0\}} + \mathbb{1}_{\{x > 0\}},$$

and denote by \mathcal{G}_θ^i the functional defined like \mathcal{G}_θ but with H^i instead of H in the definition of the process $\mathbb{M}^{Q,\varphi}$. Then, \mathcal{G}_θ^i is continuous on the set of probability distributions on $C([0, +\infty), \mathbb{R}^d)$, therefore

$$\forall i \geq 1, \quad \lim_{n \rightarrow +\infty} \mathbb{E} (\mathcal{G}_\theta^i(\mu_n)) = \mathbb{E} (\mathcal{G}_\theta^i(\mu_\infty)).$$

As a consequence, $\mathbb{E} |\mathcal{G}_\theta(\mu_\infty)|$ is lower than

$$\limsup_{i \rightarrow +\infty} \mathbb{E} |\mathcal{G}_\theta(\mu_\infty) - \mathcal{G}_\theta^i(\mu_\infty)| + \limsup_{n \rightarrow +\infty} \mathbb{E} |\mathcal{G}_\theta(\mu_n)| + \limsup_{i \rightarrow +\infty} \limsup_{n \rightarrow +\infty} \mathbb{E} |\mathcal{G}_\theta^i(\mu_n) - \mathcal{G}_\theta(\mu_n)|, \quad (7.8)$$

and we shall now prove that these three terms vanish.

First, Assumption (LC) allows to write, for all $i \geq 1$,

$$|\mathcal{G}_\theta(\mu_\infty) - \mathcal{G}_\theta^i(\mu_\infty)| \leq \|g\|_\infty L_{LC} \sum_{\gamma, \gamma' = 1}^d \|\partial_\gamma \varphi\|_\infty \left\langle \mu_\infty, \int_{t=s}^t |H - H^i| * (\mu_\infty)_{\gamma'}^\gamma (X^\gamma(r)) dr \right\rangle.$$

Since $|H - H^i|$ converges pointwise to 0, the dominated convergence theorem implies that the right-hand side above converges to 0, π_∞ -almost surely, and applying the dominated convergence again we deduce that

$$\limsup_{i \rightarrow +\infty} \mathbb{E} |\mathcal{G}_\theta(\mu_\infty) - \mathcal{G}_\theta^i(\mu_\infty)| = 0.$$

Second, for all $n \geq 1$,

$$\begin{aligned} \mathcal{G}_\theta(\mu_n) &= \frac{1}{n} \sum_{k=1}^n g(\mathbf{X}_k(s_1), \dots, \mathbf{X}_k(s_l)) \left(\varphi(\mathbf{X}_{k,n}(t)) - \varphi(\mathbf{X}_{k,n}(s)) \right. \\ &\quad \left. - \int_{r=s}^t \sum_{\gamma=1}^d \left\{ \ell^\gamma[(\mu_n)_r](X_{k,n}^\gamma(r)) \partial_\gamma \varphi(\mathbf{X}_{k,n}(r)) + \frac{1}{2} \partial_\gamma^2 \varphi(\mathbf{X}_{k,n}(r)) \right\} dr \right), \end{aligned}$$

and Itô's formula yields

$$\begin{aligned} &\varphi(\mathbf{X}_{k,n}(t)) - \varphi(\mathbf{X}_{k,n}(s)) - \int_{r=s}^t \sum_{\gamma=1}^d \left\{ \ell^\gamma[(\mu_n)_r](X_{k,n}^\gamma(r)) \partial_\gamma \varphi(\mathbf{X}_{k,n}(r)) + \frac{1}{2} \partial_\gamma^2 \varphi(\mathbf{X}_{k,n}(r)) \right\} dr \\ &= \sum_{\gamma=1}^d \int_{r=s}^t \partial_\gamma \varphi(\mathbf{X}_{k,n}(r)) dW_k^\gamma(r), \end{aligned}$$

so that

$$\mathbb{E} |\mathcal{G}_\theta(\mu_n)| \leq \sqrt{\mathbb{E} |\mathcal{G}_\theta(\mu_n)|^2} \leq \|g\|_\infty \sqrt{\frac{t-s}{n} \sum_{\gamma=1}^d \|\partial_\gamma \varphi\|_\infty^2},$$

hence the second term in (7.8) vanishes.

Third, the same computations as for the first term yield

$$\begin{aligned} |\mathcal{G}_\theta^i(\mu_n) - \mathcal{G}_\theta(\mu_n)| &\leq \|g\|_\infty L_{LC} \sum_{\gamma, \gamma'=1}^d \|\partial_\gamma \varphi\|_\infty \left\langle \mu_n, \int_{r=s}^t |H - H^i| * (\mu_n)_{r'}^{\gamma'}(X^\gamma(r)) dr \right\rangle \\ &\leq \|g\|_\infty L_{LC} \sum_{\gamma, \gamma'=1}^d \|\partial_\gamma \varphi\|_\infty \frac{1}{n^2} \sum_{k, k'=1}^n \int_{r=s}^t \mathbf{1}_{\{|X_{k',n}^{\gamma'}(r) - X_{k,n}^\gamma(r)| \leq 1/i\}} dr, \end{aligned}$$

where we have used the fact that, for all $x \in \mathbb{R}$,

$$|H(x) - H^i(x)| \leq \mathbf{1}_{\{|x| \leq 1/i\}}.$$

By exchangeability of the processes $\mathbf{X}_{1,n}, \dots, \mathbf{X}_{n,n}$, we deduce that

$$\begin{aligned} \mathbb{E} |\mathcal{G}_\theta^i(\mu_n) - \mathcal{G}_\theta(\mu_n)| &\leq \|g\|_\infty L_{LC} \sum_{\gamma, \gamma'=1}^d \|\partial_\gamma \varphi\|_\infty \int_{r=s}^t \left(\frac{1}{n} \mathbb{P}(|X_{1,n}^{\gamma'}(r) - X_{1,n}^\gamma(r)| \leq 1/i) \right. \\ &\quad \left. + \frac{n-1}{n} \mathbb{P}(|X_{1,n}^{\gamma'}(r) - X_{2,n}^\gamma(r)| \leq 1/i) \right) dr, \end{aligned}$$

so that

$$\begin{aligned} &\limsup_{n \rightarrow +\infty} \mathbb{E} |\mathcal{G}_\theta^i(\mu_n) - \mathcal{G}_\theta(\mu_n)| \\ &\leq \|g\|_\infty L_{LC} \sum_{\gamma, \gamma'=1}^d \|\partial_\gamma \varphi\|_\infty \limsup_{n \rightarrow +\infty} \int_{r=s}^t \mathbb{P}(|X_{1,n}^{\gamma'}(r) - X_{2,n}^\gamma(r)| \leq 1/i) dr. \end{aligned}$$

Now, for all $n \geq 1$, $\gamma, \gamma' \in \{1, \dots, d\}$ and $r \in [s, t]$,

$$\begin{aligned} \mathbb{P}(|X_{1,n}^{\gamma'}(r) - X_{2,n}^\gamma(r)| \leq 1/i) &\leq \mathbb{P}(|X_{1,n}^{\gamma'}(r) - X_{2,n}^\gamma(r)| \leq 1/i, |X_{1,n}^{\gamma'}(r)| \leq \sqrt{i}) \\ &\quad + \mathbb{P}(|X_{1,n}^{\gamma'}(r)| > \sqrt{i}). \end{aligned}$$

On the one hand,

$$\mathbb{P}(|X_{1,n}^{\gamma'}(r)| > \sqrt{i}) \leq \mathbb{P}(X_{1,n}^{\gamma'}(0) + rL_B + W_1^{\gamma'}(r) > \sqrt{i}) + \mathbb{P}(X_{1,n}^{\gamma'}(0) - rL_B + W_1^{\gamma'}(r) < -\sqrt{i}),$$

and the right-hand side does not depend on n since $X_{1,n}^{\gamma'}(0)$ has distribution $m^{\gamma'}$ and is independent of the Brownian motion $W_1^{\gamma'}$. Besides, for all $r \in [s, t]$,

$$\lim_{i \rightarrow +\infty} \mathbb{P}(X_{1,n}^{\gamma'}(0) + rL_B + W_1^{\gamma'}(r) > \sqrt{i}) + \mathbb{P}(X_{1,n}^{\gamma'}(0) - rL_B + W_1^{\gamma'}(r) < -\sqrt{i}) = 0,$$

therefore, by the dominated convergence theorem,

$$\limsup_{i \rightarrow +\infty} \limsup_{n \rightarrow +\infty} \int_{r=s}^t \mathbb{P}(|X_{1,n}^{\gamma'}(r)| > \sqrt{i}) dr = 0.$$

On the other hand, the Girsanov theorem combined with the Cauchy-Schwarz inequality yield, for all $r \in [s, t]$,

$$\begin{aligned} & \mathbb{P}(|X_{1,n}^{\gamma'}(r) - X_{2,n}^{\gamma}(r)| \leq 1/i, |X_{1,n}^{\gamma'}(r)| \leq \sqrt{i}) \\ & \leq \exp(rL_B^2) \mathbb{P}(|\tilde{X}_{1,n}^{\gamma'}(r) - \tilde{X}_{2,n}^{\gamma}(r)| \leq 1/i, |\tilde{X}_{1,n}^{\gamma'}(r)| \leq \sqrt{i})^{1/2}, \end{aligned}$$

where $\tilde{X}_{1,n}^{\gamma'}(r) := X_{1,n}^{\gamma'}(0) + \tilde{W}_1^{\gamma'}(r)$, $\tilde{X}_{2,n}^{\gamma}(r) := X_{2,n}^{\gamma}(0) + \tilde{W}_2^{\gamma}(r)$ for a standard Brownian motion $(\tilde{W}_1^{\gamma'}, \tilde{W}_2^{\gamma})$ in \mathbb{R}^2 , independent of $(X_{1,n}^{\gamma'}(0), X_{2,n}^{\gamma}(0))$. Using the trivial bound of the joint density of $(\tilde{W}_1^{\gamma'}(r), \tilde{W}_2^{\gamma}(r))$ by $1/(2\pi r)$, we obtain

$$\mathbb{P}(|\tilde{X}_{1,n}^{\gamma'}(r) - \tilde{X}_{2,n}^{\gamma}(r)| \leq 1/i, |\tilde{X}_{1,n}^{\gamma'}(r)| \leq \sqrt{i}) \leq \frac{2}{\pi r \sqrt{i}},$$

therefore

$$\mathbb{P}(|X_{1,n}^{\gamma'}(r) - X_{2,n}^{\gamma}(r)| \leq 1/i, |X_{1,n}^{\gamma'}(r)| \leq \sqrt{i}) \leq \sqrt{\frac{2}{\pi r}} \exp(rL_B) i^{-1/4}.$$

As a consequence,

$$\limsup_{i \rightarrow +\infty} \limsup_{n \rightarrow +\infty} \int_{r=s}^t \mathbb{P}(|X_{1,n}^{\gamma'}(r) - X_{2,n}^{\gamma}(r)| \leq 1/i, |X_{1,n}^{\gamma'}(r)| \leq \sqrt{i}) dr = 0,$$

so that the third term in (7.8) vanishes and the proof is completed. \square

7.4.2 Proof of Proposition 7.1.6

The proof of Proposition 7.1.6 relies on the following lemma, the proof of which can be found in Jourdain [84, Corollary 1.7].

Lemma 7.4.2. *Let P be a probability distribution on $C([0, +\infty), \mathbb{R})$ and $0 \leq \tau < T$ be such that, for all $t \in [\tau, T]$, the probability distribution P_t on \mathbb{R} does not weight points. Then the mapping*

$$Q \mapsto \sup_{(t,x) \in [\tau, T] \times \mathbb{R}} |H * Q_t(x) - H * P_t(x)|$$

is bounded and continuous at P .

Since, by Proposition 7.4.1, μ_n converges in distribution to P , we deduce from Lemma 7.4.2 that, for all $\gamma \in \{1, \dots, d\}$, for all $0 \leq \tau < T$ such that, for all $t \in [\tau, T]$, the probability distribution P_t^γ on \mathbb{R} does not weight points, then

$$\lim_{n \rightarrow +\infty} \mathbb{E} \left(\sup_{(t,x) \in [\tau, T] \times \mathbb{R}} |u_n^\gamma(t, x) - u^\gamma(t, x)| \right) = 0.$$

By Proposition 7.3.2, the fact that the probability distribution P_t^γ does not weight points holds true for all $t > 0$, and of course for all $t \geq 0$ if m^γ does not weight points. This completes the proof of Proposition 7.1.6.

Chapitre 8

La limite petit bruit de processus de diffusion interagissant à travers leur ordre

Ce chapitre reprend le contenu de l'article [92], écrit avec Benjamin Jourdain et paru dans *Electronic Journal of Probability*.

8.1 Introduction

8.1.1 Diffusions with small noise

The theory of ordinary differential equations (ODEs) with a regular drift coefficient and perturbed by a small stochastic noise was well developed by Freidlin and Wentzell [65]. For a Lipschitz continuous function $b : \mathbb{R}^n \rightarrow \mathbb{R}^n$, they stated a large deviations principle for the laws of the solutions X^ϵ to the stochastic differential equations $dX^\epsilon(t) = b(X^\epsilon(t))dt + \sqrt{2\epsilon}dW(t)$, from which it can be easily deduced that X^ϵ converges to the unique solution to the ODE $\dot{x} = b(x)$ when ϵ vanishes. When the ODE $\dot{x} = b(x)$ is not well-posed, the behaviour of X^ϵ in the small noise limit is far less well understood.

In one dimension of space, Veretennikov [134] and Bafico and Baldi [9] considered ODEs exhibiting a Peano phenomenon, *i.e.* such that $b(0) = 0$ and the ODE admits two continuous solutions x^+ and x^- such that $x^+(0) = x^-(0) = 0$, $x^+(t) > 0$ and $x^-(t) < 0$ for $t > 0$. Other solutions are easily obtained for the ODE: as an example, for all $T > 0$, the function x_T^+ defined by $x_T^+(t) = 0$ if $t < T$ and $x_T^+(t) = x^+(t - T)$ if $t \geq T$ is also a continuous solution to the ODE. The solutions x^+ and x^- are called *extremal* in the sense that they leave the origin instantaneously. For particular examples of such ODEs, it was proved in [134] and [9] that the small noise limit of the law of X^ϵ concentrates on the set of extremal solutions $\{x^+, x^-\}$ and the weights associated with each such solution was explicitly computed. In this case, large deviations principles were also proved by Herrmann [77] and Gradinaru, Herrmann and Roynette [74].

In higher dimensions of space, very few results are available. Buckdahn, Ouknine and Quincampoix [33] proved that the limit points of the law of X^ϵ concentrate on the set of solutions to the ODE $\dot{x} = b(x)$ in the so-called Filippov generalized sense. However, an explicit description of this set is not easily provided in general. Let us also mention the work by Delarue, Flandoli and Vincenzi [47] in the specific setting of the Vlasov-Poisson equation on the real line for two electrostatic particles. For a particular choice of the electric field and of the initial conditions, they showed that the particles collapse in a finite time $T > 0$, so that the ODE describing the Lagrangian dynamics of the two particles is singular at this time. After the singularity, the ODE exhibits a Peano-like phenomenon in the sense that it admits several extremal solutions, *i.e.* leaving the singular point instantaneously. Similarly to the one-dimensional examples addressed in [134, 9], the trajectory

obtained as the small noise limit of a stochastic perturbation is random among these extremal solutions.

8.1.2 Order-based processes

In this chapter, we are interested in the small noise limit of the solution X^ϵ to the stochastic differential equation

$$\forall t \geq 0, \quad X^\epsilon(t) = x^0 + \int_{s=0}^t b(\Sigma X^\epsilon(s)) ds + \sqrt{2\epsilon} W(t), \tag{8.1}$$

where $x^0 \in \mathbb{R}^n$, b is a function from the symmetric group S_n to \mathbb{R}^n , W is a standard Brownian motion in \mathbb{R}^n and, for $x = (x_1, \dots, x_n) \in \mathbb{R}^n$, Σx is a permutation $\sigma \in S_n$ such that $x_{\sigma(1)} \leq \dots \leq x_{\sigma(n)}$. A permutation $\sigma \in S_n$ shall sometimes be represented by the word $(\sigma(1) \dots \sigma(n))$, especially for small values of n . As an example, the permutation $\sigma \in S_3$ defined by $\sigma(1) = 2$, $\sigma(2) = 1$ and $\sigma(3) = 3$ is denoted by (213).

On the set $O_n := \{x = (x_1, \dots, x_n) \in \mathbb{R}^n : \exists i \neq j, x_i = x_j\}$ of vectors with non pairwise distinct coordinates, the permutation Σx is not uniquely defined. For the sake of precision, a convention to define Σx in this case is given below, although we prove in Proposition 8.1.1 that the solution X^ϵ to (8.1) does not depend on the definition of the quantity $b(\Sigma x)$ on O_n .

The solution $X^\epsilon = (X_1^\epsilon(t), \dots, X_n^\epsilon(t))_{t \geq 0}$ to (8.1) shall generically be called *order-based diffusion process*, as it describes the evolution of a system of n particles moving on the real line with piecewise constant drift depending on their ordering. Note that, in such a system, the interactions can be nonlocal in the sense that a collision between two particles can modify the instantaneous drifts of all the particles in the system.

Section 8.2 is dedicated to the complete description of the case $n = 2$. Unsurprisingly, if the particles have distinct initial positions $x^0 = (x_1^0, x_2^0)$, then in the small noise limit they first travel with constant velocity vector $b(\Sigma x^0)$.

At a collision, or equivalently when the particles start from the same initial position, various behaviours are observed, depending on b . To describe these situations, a configuration $\sigma \in S_2$ is said to be *converging* if $b_{\sigma(1)}(\sigma) \geq b_{\sigma(2)}(\sigma)$, that is to say, the velocity of the leftmost particle is larger than the velocity of the rightmost particle, and *diverging* otherwise. If both configurations are converging, which writes

$$b_1(12) \geq b_2(12), \quad b_2(21) \geq b_1(21),$$

and shall be referred to as the *converging/converging case*, then, in the small noise limit, the particles stick together and form a cluster. The velocity of the cluster can be explicitly computed by elementary arguments. Except in some degenerate situations, it is deterministic and constant. If one of the configuration is converging while the other is diverging, which shall be referred to as the *converging/diverging case*, then, in the small noise limit, the particles drift away from each other with constant velocity vector $b(\sigma)$, where σ is the diverging configuration. Finally, if both configurations are diverging, which writes

$$b_1(12) < b_2(12), \quad b_2(21) < b_1(21),$$

and shall be referred to as the *diverging/diverging case*, then the particles drift away from each other with constant velocity vector $b(\sigma)$, where σ is a random permutation in S_2 with an explicit distribution.

The study of the two-particle case is made possible by the fact that most results actually stem from the study of the scalar process $Z^\epsilon := X_1^\epsilon - X_2^\epsilon$. In particular, our result in the diverging/diverging case is similar to the situation of [134, 9], in the sense that the zero noise equation for Z^ϵ admits exactly two extremal solutions and exhibits a Peano phenomenon.

In higher dimensions, providing a general description of the small noise limit of X^ϵ seems to be a very challenging issue. As a first step, Sections 8.3 and 8.4 address two cases in which the

function b satisfies particular conditions. In Section 8.3, we assume that there exists a vector $b = (b_1, \dots, b_n) \in \mathbb{R}^n$ such that, for all $\sigma \in S_n$, for all $i \in \{1, \dots, n\}$, $b_{\sigma(i)}(\sigma) = b_i$. In other words, the instantaneous drift of the i -th particle does not depend on the whole ordering of $(X_1^\epsilon(t), \dots, X_n^\epsilon(t))$, but only on the rank of $X_i^\epsilon(t)$ among $X_1^\epsilon(t), \dots, X_n^\epsilon(t)$. In particular, the interactions are local in the sense that a collision between two particles does not affect the instantaneous drifts of the particles not involved in the collision. Such particle systems are generally called systems of *rank-based* interacting diffusions. They are of interest in the study of equity market models [58, 11, 115, 62, 78, 81, 80, 61, 59, 79] or in the probabilistic interpretation of nonlinear evolution equations [25, 84, 89, 91, 48].

A remarkable property of such systems is that the *reordered* particle system, defined as the process $Y^\epsilon = (Y_1^\epsilon(t), \dots, Y_n^\epsilon(t))_{t \geq 0}$ such that, for all $t \geq 0$, $(Y_1^\epsilon(t), \dots, Y_n^\epsilon(t))$ is the increasing reordering of $(X_1^\epsilon(t), \dots, X_n^\epsilon(t))$, is a Brownian motion with constant drift vector b , normally reflected at the boundary of the polyhedron $D_n = \{(y_1, \dots, y_n) \in \mathbb{R}^n : y_1 \leq \dots \leq y_n\}$. By a simple convexity argument, we prove that the limit of Y^ϵ when ϵ vanishes is the deterministic process ξ with the same drift b , normally reflected at the boundary of D_n .

The small noise limit ξ turns out to coincide with the sticky particle dynamics introduced by Brenier and Grenier [29], which describes the evolution of a system of particles with unit mass, travelling at constant velocity between collisions, and such that, at each collision, the colliding particles stick together and form a cluster, the velocity of which is determined by the global conservation of momentum. This provides an effective description of the small noise limit of X^ϵ .

An important fact in the rank-based case is that, whenever some particles form a cluster in the small noise limit, then for any partition of the cluster into a group of leftmost particles and a group of rightmost particles, the average velocity of the leftmost group is larger than the average velocity of the rightmost group. In Section 8.4 we provide an extension of this stability condition to the general case of order-based diffusions. We prove that, when all the particles have the same initial position, this condition ensures that in the small noise limit, all the particles aggregate into a single cluster. However the condition is no longer necessary and we give a counterexample with $n = 3$ particles.

To determine the motion of the cluster, we reinterpret the study of the small noise limit of X^ϵ as a problem of long time behaviour for the process X^1 , thanks to an adequate change in the space and time scales. In the rank-based case, it is well known that X^1 does not have an equilibrium [115, 89] as its projection along the direction $(1, \dots, 1)$ is a Brownian motion with constant drift. However, under a stronger version of the stability condition, the orthogonal projection Z^1 of X^1 on the hyperplane $M_n = \{(z_1, \dots, z_n) \in \mathbb{R}^n : z_1 + \dots + z_n = 0\}$ admits a unique stationary distribution μ . We extend both the strong stability condition and the existence and uniqueness result for μ to the order-based case, and thereby express the velocity of the cluster in terms of μ .

In the conclusive Section 8.5, we state some conjectures as regards the general small noise limit of X^ϵ , and we discuss the link between our results and the notion of *generalized flow* introduced by E and Vanden-Eijnden [51].

8.1.3 Preliminary results and conventions

8.1.3.1 Definition of Σ

For all $x \in \mathbb{R}^n$, we denote by $\bar{\Sigma}x$ the set of permutations $\sigma \in S_n$ such that $x_{\sigma(1)} \leq \dots \leq x_{\sigma(n)}$. The set $\bar{\Sigma}x$ is nonempty, and it contains a unique element if and only if $x \notin O_n$. The permutation Σx is defined as the lowest element of $\bar{\Sigma}x$ for the lexicographical order on the associated words.

8.1.3.2 Well-posedness of (8.1)

Throughout this chapter, $x^0 \in \mathbb{R}^n$ refers to the initial positions of the particles, and a standard Brownian motion W in \mathbb{R}^n is defined on a given probability space $(\Omega, \mathcal{F}, \mathbb{P}_{x^0})$. The filtration generated by W is denoted by $(\mathcal{F}_t)_{t \geq 0}$. The expectation under \mathbb{P}_{x^0} is denoted by \mathbb{E}_{x^0} .

Proposition 8.1.1. *For all $\epsilon > 0$, for all $x^0 \in \mathbb{R}^n$, the stochastic differential equation (8.1) admits a unique strong solution on the probability space $(\Omega, \mathcal{F}, \mathbb{P}_{x^0})$ provided with the filtration $(\mathcal{F}_t)_{t \geq 0}$. Besides, \mathbb{P}_{x^0} -almost surely,*

$$\forall t \geq 0, \quad \int_{s=0}^t \mathbb{1}_{\{X^\epsilon(s) \in O_n\}} ds = 0.$$

Proof. The strong existence and pathwise uniqueness follow from Veretennikov [133], as the drift function $x \mapsto b(\Sigma x)$ is measurable and bounded, while the diffusion matrix is diagonal. The second part of the proposition is a consequence of the occupation time formula [121, p. 224] applied to the semimartingales $X_i^\epsilon - X_j^\epsilon$, $i \neq j$. \square

8.1.3.3 Convergence of processes

Let $d \geq 1$. For all $T > 0$, the space of continuous functions $C([0, T], \mathbb{R}^d)$ is endowed with the sup norm in time associated with the L^1 norm on \mathbb{R}^d . Let $A^\epsilon = (A_1^\epsilon(t), \dots, A_d^\epsilon(t))_{t \geq 0}$ be a continuous process in \mathbb{R}^d defined on the probability space $(\Omega, \mathcal{F}, \mathbb{P}_{x^0})$.

- If $a = (a_1(t), \dots, a_d(t))_{t \geq 0}$ is a continuous process in \mathbb{R}^d defined on the probability space $(\Omega, \mathcal{F}, \mathbb{P}_{x^0})$, then for all $p \in [1, +\infty)$, A^ϵ is said to converge to a in $L^p_{loc}(\mathbb{P}_{x^0})$ if

$$\forall T > 0, \quad \lim_{\epsilon \downarrow 0} \mathbb{E}_{x^0} \left(\sup_{t \in [0, T]} \sum_{i=1}^d |A_i^\epsilon(t) - a_i(t)|^p \right) = 0.$$

- If $a = (a_1(t), \dots, a_d(t))_{t \geq 0}$ is a continuous process in \mathbb{R}^d defined on some probability space $(\Omega', \mathcal{F}', \mathbb{P}')$, the process A^ϵ is said to converge in distribution to a if, for all $T > 0$, for all bounded continuous function $F : C([0, T], \mathbb{R}^d) \rightarrow \mathbb{R}$,

$$\lim_{\epsilon \downarrow 0} \mathbb{E}_{x^0}(F(A^\epsilon)) = \mathbb{E}'(F(a)),$$

where \mathbb{E}' denotes the expectation under \mathbb{P}' , and, for the sake of brevity, the respective restrictions of A^ϵ and a to $[0, T]$ are simply denoted by A^ϵ and a .

Finally, the deterministic process $(t)_{t \geq 0}$ shall simply be denoted by t .

8.2 The two-particle case

In this section, we assume that $n = 2$. Then, (8.1) rewrites

$$X^\epsilon(t) = x^0 + b(12) \int_{s=0}^t \mathbb{1}_{\{X_1^\epsilon(s) \leq X_2^\epsilon(s)\}} ds + b(21) \int_{s=0}^t \mathbb{1}_{\{X_1^\epsilon(s) > X_2^\epsilon(s)\}} ds + \sqrt{2\epsilon} W(t). \quad (8.2)$$

In the configuration (12), that is to say whenever $X_1^\epsilon(t) \leq X_2^\epsilon(t)$, the instantaneous drift of the i -th particle is $b_i(12)$. Thus, in the small noise limit, the particles tend to get closer to each other if $b_1(12) \geq b_2(12)$, and to drift away from each other else. As a consequence, the configuration (12) is said to be *converging* if $b^- := b_1(12) - b_2(12) \geq 0$ and *diverging* if $b^- < 0$. Similarly, the configuration (21) is said to be *converging* if $b^+ := b_1(21) - b_2(21) \leq 0$ and *diverging* if $b^+ > 0$. The introduction of the quantities b^- and b^+ is motivated by the fact that the reduced process $Z^\epsilon := X_1^\epsilon - X_2^\epsilon$ satisfies the scalar stochastic differential equation

$$Z^\epsilon(t) = z^0 + \int_{s=0}^t \ell(Z^\epsilon(s)) ds + 2\sqrt{\epsilon} B(t), \quad (8.3)$$

where $z^0 := x_1^0 - x_2^0$, $\ell(z) := b^- \mathbb{1}_{\{z \leq 0\}} + b^+ \mathbb{1}_{\{z > 0\}}$ and $B := (W_1 - W_2)/\sqrt{2}$ is a standard Brownian motion in \mathbb{R} defined on $(\Omega, \mathcal{F}, \mathbb{P}_x)$, adapted to the filtration $(\mathcal{F}_t)_{t \geq 0}$.

The description of the small noise limit of X^ϵ is exhaustively made in Subsection 8.2.1. Some proofs are postponed to Appendix 8.A. In Subsection 8.2.2, the small noise limit of Z^ϵ is discussed.

In the sequel, we use the terminology of [9] and call *extremal solution* to the zero noise version of (8.2) a continuous function $x = (x(t))_{t \geq 0}$ such that

$$\forall t \geq 0, \quad x(t) = x^0 + \int_{s=0}^t b(\Sigma x(s)) ds,$$

and, for all $t > 0$, $x(t) \notin O_2$.

8.2.1 Small noise limit of the system of particles

To describe the small noise limit of X^ϵ , we first address the case in which both particles have the same initial position, *i.e.* $x^0 \in O_2$. The zero noise version of (8.2) rewrites

$$\forall t \geq 0, \quad x(t) = x^0 + b(12) \int_{s=0}^t \mathbb{1}_{\{x_1(s) \leq x_2(s)\}} ds + b(21) \int_{s=0}^t \mathbb{1}_{\{x_1(s) > x_2(s)\}} ds.$$

In the diverging/diverging case $b^- < 0$, $b^+ > 0$, the equation above admits two extremal solutions x^- and x^+ defined by $x^-(t) = x^0 + b(12)t$ and $x^+(t) = x^0 + b(21)t$. In the converging/diverging case $b^- \geq 0$, $b^+ > 0$, the only extremal solution is x^+ , and symmetrically, in the case $b^- < 0$, $b^+ \leq 0$, the only extremal solution is x^- . In all these cases, the small noise limit of X^ϵ concentrates on the set of extremal solutions to the zero noise equation, similarly to the situations addressed in [134, 9].

Proposition 8.2.1. *Assume that $x^0 \in O_2$, and recall that $x^-(t) = x^0 + b(12)t$, $x^+(t) = x^0 + b(21)t$.*

- (i) *If $b^- < 0$, $b^+ > 0$, the process X^ϵ converges in distribution to $\rho x^+ + (1 - \rho)x^-$ where ρ is a Bernoulli variable with parameter $-b^-(b^+ - b^-)$.*
- (ii) *If $b^- \geq 0$, $b^+ > 0$, the process X^ϵ converges in $L^1_{\text{loc}}(\mathbb{P}_{x^0})$ to x^+ .*
- (iii) *If $b^- < 0$, $b^+ \leq 0$, the process X^ϵ converges in $L^1_{\text{loc}}(\mathbb{P}_{x^0})$ to x^- .*

In the converging/converging case $b^- \geq 0$, $b^+ \leq 0$, there is no extremal solution to the zero noise version of (8.2). Informally, in both configurations the instantaneous drifts of each particle tend to bring the particles closer to each other. Therefore, in the small noise limit, the particles are expected to stick together and form a cluster; that is to say, the limit of the distribution of X^ϵ is expected to concentrate on O_2 . The motion of the cluster is described in the following proposition.

Proposition 8.2.2. *Assume that $x^0 \in O_2$, and that $b^- \geq 0$, $b^+ \leq 0$.*

- (iv) *If $b^- - b^+ > 0$, the process X^ϵ converges in $L^2_{\text{loc}}(\mathbb{P}_{x^0})$ to $\rho x^- + (1 - \rho)x^+$, where $\rho = -b^+/(b^- - b^+)$ is the unique deterministic constant in $(0, 1)$ such that, for all $t \geq 0$, $\rho x^-(t) + (1 - \rho)x^+(t) \in O_2$.*
- (v) *If $b^- = b^+ = 0$, the process X^ϵ converges in $L^2_{\text{loc}}(\mathbb{P}_{x^0})$ to $\rho x^- + (1 - \rho)x^+$, where ρ is the random process in $(0, 1)$ defined by*

$$\forall t > 0, \quad \rho(t) := \frac{1}{t} \int_{s=0}^t \mathbb{1}_{\{W_1(s) \leq W_2(s)\}} ds.$$

Note that, in both cases, the small noise limit of X^ϵ takes its values in O_2 .

In other words, in case (iv), the cluster has a deterministic and constant velocity v given by

$$v = \rho b_1(12) + (1 - \rho)b_1(21) = \frac{b_2(21)b_1(12) - b_2(12)b_1(21)}{b_1(12) - b_2(12) - b_1(21) + b_2(21)}.$$

In case (v), both particles have the same instantaneous drift in each of the two configurations, and the instantaneous drift of the cluster is a random linear interpolation of these drifts, with a coefficient $\rho(t)$ distributed according to the Arcsine law.

A common feature of Propositions 8.2.1 and 8.2.2 is that, in all cases, the small noise limit of $X^\epsilon(t)$ is a linear interpolation of $x^-(t)$ and $x^+(t)$ with coefficients $\rho(t), 1 - \rho(t) \in [0, 1]$. Depending

on the case at stake, $\rho(t)$ exhibits a wide range of various behaviours: in case (i), it is random in $\{0, 1\}$ and constant in time, in cases (ii) and (iii) it is deterministic in $\{0, 1\}$ and constant in time, in case (iv) it is deterministic in $(0, 1)$ and constant in time, and in case (v) it is random in $(0, 1)$ and nonconstant in time.

In view of (8.2), $\rho(t)$ appears as the natural small noise limit of the quantity $\zeta^\epsilon(t)/t$, where ζ^ϵ denotes the occupation time of X^ϵ in the configuration (12):

$$\forall t \geq 0, \quad \zeta^\epsilon(t) := \int_{s=0}^t \mathbb{1}_{\{X_1^\epsilon(s) \leq X_2^\epsilon(s)\}} ds = \int_{s=0}^t \mathbb{1}_{\{Z^\epsilon(s) \leq 0\}} ds,$$

where we recall that $Z^\epsilon = X_1^\epsilon - X_2^\epsilon$ solves (8.3). Indeed, Propositions 8.2.1 and 8.2.2 easily stem from the following description of the small noise limit of the continuous process ζ^ϵ .

Lemma 8.2.3. *Assume that $x^0 \in O_2$.*

- (i) *If $b^- < 0, b^+ > 0$, then ζ^ϵ converges in distribution to the process ρt , where ρ is a Bernoulli variable with parameter $-b^-/(b^+ - b^-)$.*
- (ii) *If $b^- \geq 0, b^+ > 0$, then ζ^ϵ converges in $L^1_{\text{loc}}(\mathbb{P}_{x^0})$ to 0.*
- (iii) *If $b^- < 0, b^+ \leq 0$, then ζ^ϵ converges in $L^1_{\text{loc}}(\mathbb{P}_{x^0})$ to t .*
- (iv) *If $b^- \geq 0, b^+ \leq 0$ and $b^- - b^+ > 0$, then ζ^ϵ converges in $L^2_{\text{loc}}(\mathbb{P}_{x^0})$ to ρt , where $\rho = -b^+/(b^- - b^+)$.*
- (v) *If $b^- = b^+ = 0$, then for all $t \geq 0$,*

$$\zeta^\epsilon(t) = \int_{s=0}^t \mathbb{1}_{\{W_1(s) \leq W_2(s)\}} ds.$$

Proof. The proofs of cases (i), (ii) and (iii) are given in Appendix 8.A. The proof of case (iv) is an elementary computation and is given in Subsection 8.2.2 below. In case (v), there is nothing to prove. □

Remark 8.2.4. In cases (ii), (iii), and (iv) above, the convergence is stated either in $L^1_{\text{loc}}(\mathbb{P}_{x^0})$ or in $L^2_{\text{loc}}(\mathbb{P}_{x^0})$ as these modes of convergence appear most naturally in the proof. However, all our arguments can easily be extended to show that all the convergences hold in $L^p_{\text{loc}}(\mathbb{P}_{x^0})$, for all $p \in [1, +\infty)$. As a consequence, all the convergences in Proposition 8.2.1 and 8.2.2, except in case (i), actually hold in $L^p_{\text{loc}}(\mathbb{P}_{x^0})$, for all $p \in [1, +\infty)$.

On the contrary, the convergence in the diverging/diverging case (i) cannot hold in probability. Indeed, let us assume by contradiction that there exists $T > 0$ such that the convergence in case (i) of Lemma 8.2.3 holds in probability in $C([0, T], \mathbb{R})$. Then, for all $t \in [0, T]$, $\zeta^\epsilon(t)$ converges in probability to ρt . Let us fix $t \in (0, T]$. By Proposition 8.1.1, for all $\epsilon > 0$, the random variable $\zeta^\epsilon(t)$ is measurable with respect to the σ -field \mathcal{F}_t generated by $(W(s))_{s \in [0, t]}$. Thus, we deduce that the random variable ρ is measurable with respect to \mathcal{F}_t . As a consequence, ρ is measurable with respect to $\mathcal{F}_{0+} := \bigcap_{t>0} \mathcal{F}_t$, which is contradictory with the Blumenthal zero-one law for the Brownian motion W .

We finally mention that in cases (i), (ii), (iii) and (iv), the small noise limit of the process ζ^ϵ is a Markov process, which is not the case for the process ζ^ϵ itself.

Let us now address the case $x^0 \notin O_2$ of particles with distinct initial positions. Let $\sigma = \Sigma x^0$. If $b_{\sigma(1)}(\sigma) \leq b_{\sigma(2)}(\sigma)$, a pair of particles travelling at constant velocity vector $b(\sigma)$ with initial positions x^0 never collides, and the natural small noise limit of X^ϵ is given by $x(t) = x^0 + b(\sigma)t$, for all $t \geq 0$.

If $b_{\sigma(1)}(\sigma) > b_{\sigma(2)}(\sigma)$, a pair of particles travelling at constant velocity vector $b(\sigma)$ with initial positions x^0 collides at time $t^*(x^0) := -(x_1^0 - x_2^0)/(b_1(\sigma) - b_2(\sigma)) \in (0, +\infty)$. The natural small noise limit of X^ϵ is now described by $x(t) = x^0 + b(\sigma)t$ for $t < t^*(x^0)$, and for $t \geq t^*(x^0)$, $x(t)$ is the small noise limit of $X^{\epsilon'}(t - t^*(x^0))$, where $X^{\epsilon'}$ is a copy of X^ϵ started at $x^0 + b(\sigma)t^*(x^0) \in O_2$. In that case, at least the configuration σ is converging, therefore there is neither random selection of a trajectory as in case (i), nor random and nonconstant velocity of the cluster as in case (v).

These statements are straightforward consequences of the description of the small noise limit of the process Z^ϵ with $z^0 \neq 0$ carried out in Corollary 8.2.6 below.

8.2.2 The reduced process

By Veretennikov [133], strong existence and pathwise uniqueness hold for (8.3); therefore, for all $\epsilon > 0$, Z^ϵ is adapted to the filtration generated by the Brownian motion B . As a consequence, the probability of a measurable event A with respect to the σ -field generated by $(B(s))_{s \in [0, t]}$ for some $t \geq 0$ shall be abusively denoted by $\mathbb{P}_{z^0}(A)$ instead of $\mathbb{P}_{x^0}(A)$.

To describe the small noise limit of Z^ϵ , we define $z^-(t) = b^-t$ and $z^+(t) = b^+t$. Let us begin with the case $z^0 = 0$, which corresponds to $x^0 \in O_2$.

Proposition 8.2.5. *Assume that $z^0 = 0$. Then,*

- (i) *if $b^- < 0$ and $b^+ > 0$, then Z^ϵ converges in distribution to $\rho z^- + (1 - \rho)z^+$, where ρ is a Bernoulli variable of parameter $-b^-/(b^+ - b^-)$;*
- (ii) *if $b^- \geq 0$ and $b^+ > 0$, then Z^ϵ converges to z^+ in $L^1_{\text{loc}}(\mathbb{P}_0)$;*
- (iii) *if $b^- < 0$ and $b^+ \leq 0$, then Z^ϵ converges to z^- in $L^1_{\text{loc}}(\mathbb{P}_0)$;*
- (iv) *if $b^- \geq 0$ and $b^+ \leq 0$, then Z^ϵ converges to 0 in $L^2_{\text{loc}}(\mathbb{P}_0)$; more precisely,*

$$\forall T > 0, \quad \mathbb{E}_0 \left(\sup_{t \in [0, T]} |Z^\epsilon(t)|^2 \right) \leq (8\sqrt{2} + 4)\epsilon T.$$

Proof. Since $Z^\epsilon(t) = b^- \zeta^\epsilon(t) + b^+(t - \zeta^\epsilon(t)) + 2\sqrt{\epsilon}B(t)$, cases (i), (ii) and (iii) are straightforward consequences of the corresponding statements in Lemma 8.2.3, the proofs of which are given in Appendix 8.A.

We now give a direct proof of case (iv). By the Itô formula, for all $t \geq 0$,

$$|Z^\epsilon(t)|^2 = 2 \int_{s=0}^t Z^\epsilon(s) \ell(Z^\epsilon(s)) ds + 4\sqrt{\epsilon} \int_{s=0}^t Z^\epsilon(s) dB(s) + 4\epsilon t.$$

If $b^+ \leq 0$ and $b^- \geq 0$, then for all $z \in \mathbb{R}$ one has $z\ell(z) \leq 0$, therefore

$$|Z^\epsilon(t)|^2 \leq 4\sqrt{\epsilon} \int_{s=0}^t Z^\epsilon(s) dB(s) + 4\epsilon t.$$

For all $t \geq 0$, let us define

$$M^\epsilon(t) = \int_{s=0}^t Z^\epsilon(s) dB(s);$$

and for all $L > 0$, let $\tau_L := \inf\{t \geq 0 : |Z^\epsilon(t)| \geq L\}$. The process $(M^\epsilon(t \wedge \tau_L))_{t \geq 0}$ is a martingale, therefore, for all $t \geq 0$, $\mathbb{E}_0(|Z^\epsilon(t \wedge \tau_L)|^2) \leq 4\epsilon \mathbb{E}_0(t \wedge \tau_L) \leq 4\epsilon t$, and by the Fatou lemma, $\mathbb{E}_0(|Z^\epsilon(t)|^2) \leq 4\epsilon t$. As a consequence, $(M^\epsilon(t))_{t \geq 0}$ is a martingale. For all $T > 0$,

$$\begin{aligned} \mathbb{E}_0 \left(\sup_{t \in [0, T]} |Z^\epsilon(t)|^2 \right) &\leq 4\sqrt{\epsilon} \mathbb{E}_0 \left(\sup_{t \in [0, T]} M^\epsilon(t) \right) + 4\epsilon T \\ &\leq 4\sqrt{\epsilon} \sqrt{\mathbb{E}_0 \left(\sup_{t \in [0, T]} M^\epsilon(t)^2 \right)} + 4\epsilon T \\ &\leq 8\sqrt{\epsilon} \sqrt{\mathbb{E}_0 (M^\epsilon(T)^2)} + 4\epsilon T \\ &= 8\sqrt{\epsilon} \sqrt{\mathbb{E}_0 \left(\int_0^T Z^\epsilon(s)^2 ds \right)} + 4\epsilon T \\ &\leq 8\sqrt{\epsilon} \sqrt{\int_0^T 4\epsilon s ds} + 4\epsilon T = (8\sqrt{2} + 4)\epsilon T, \end{aligned}$$

where we have used the Cauchy-Schwarz inequality at the second line, the Doob inequality at the third line and the Itô isometry at the fourth line. This completes the proof of case (iv). \square

In case (iv) of Lemma 8.2.3, the computation of the small noise limit of ζ^ϵ is straightforward.

Proof of case (iv) in Lemma 8.2.3. Let $T > 0$. By case (iv) in Proposition 8.2.5, if $x^0 \in O_2$ and $b^- \geq 0, b^+ \leq 0$, then $\lim_{\epsilon \downarrow 0} b^- \zeta^\epsilon + b^+(t - \zeta^\epsilon) = 0$ in $L^2_{\text{loc}}(\mathbb{P}_{x^0})$. If $b^- - b^+ > 0$ in addition, then this relation yields $\lim_{\epsilon \downarrow 0} \zeta^\epsilon = \rho t$ in $L^2_{\text{loc}}(\mathbb{P}_{x^0})$, with $\rho = -b^+/(b^- - b^+)$. \square

We now describe the small noise limit of Z^ϵ in the case $z^0 \neq 0$. Due to the same reasons as in Remark 8.2.4, all the convergences below are stated in $L^1_{\text{loc}}(\mathbb{P}_0)$ but can easily be extended to $L^p_{\text{loc}}(\mathbb{P}_0)$ for all $p \in [1, +\infty)$. The proof of Corollary 8.2.6 is postponed to Appendix 8.A.

Corollary 8.2.6. *Assume that $z^0 > 0$. Let us define $t^* = +\infty$ if $b^+ \geq 0$, and $t^* := z^0/(-b^+)$ if $b^+ < 0$. Then Z^ϵ converges in $L^1_{\text{loc}}(\mathbb{P}_{z^0})$ to the process z^\downarrow defined by:*

$$\forall t \geq 0, \quad z^\downarrow(t) := \begin{cases} z^0 + b^+t & \text{if } t < t^*, \\ 0 & \text{if } t \geq t^* \text{ and } b^- \geq 0, \\ b^-(t - t^*) & \text{if } t \geq t^* \text{ and } b^- < 0. \end{cases}$$

A symmetric statement holds if $z^0 < 0$.

Remark 8.2.7. For a given continuous and bounded function u_0 on \mathbb{R} , the function u^ϵ defined by

$$\forall (t, z) \in [0, +\infty) \times \mathbb{R}, \quad u^\epsilon(t, z) := \mathbb{E}_z(u_0(Z^\epsilon(t)))$$

is continuous on $[0, +\infty) \times \mathbb{R}$ owing to the Girsanov theorem and the boundedness of ℓ . Following [64, Chapter II], it is a viscosity solution to the parabolic Cauchy problem

$$\begin{cases} \partial_t u^\epsilon - \ell(z)\partial_z u^\epsilon = 2\epsilon \partial_{zz} u^\epsilon, \\ u^\epsilon(0, \cdot) = u_0(\cdot). \end{cases}$$

Atanasio and Flandoli [8] addressed the limit of u^ϵ when ϵ vanishes, for a particular function ℓ such that the corresponding hyperbolic Cauchy problem

$$\begin{cases} \partial_t u^\epsilon - \ell(z)\partial_z u^\epsilon = 0, \\ u^\epsilon(0, \cdot) = u_0(\cdot), \end{cases}$$

admits several solutions. In the diverging/diverging case $b^+ > 0, b^- < 0$, we recover their result of [8, Theorem 2.4] as u^ϵ converges pointwise to the function u defined by

$$u(t, z) = \begin{cases} u_0(z + b^+t) & \text{if } z > 0, \\ u_0(z + b^-t) & \text{if } z < 0, \\ \frac{b^+}{b^+ - b^-}u_0(b^+t) + \frac{-b^-}{b^+ - b^-}u_0(b^-t) & \text{if } z = 0. \end{cases}$$

Note that, in general, u is discontinuous on the half line $z = 0$.

In the converging/converging case $b^+ \leq 0, b^- \geq 0$, u^ϵ converges pointwise to the function u defined by

$$u(t, z) = \begin{cases} u_0(z + b^+t) & \text{if } z > -b^+t, \\ u_0(z + b^-t) & \text{if } z < -b^-t, \\ u_0(0) & \text{if } -b^-t \leq z \leq -b^+t. \end{cases}$$

Note that u is continuous on $[0, +\infty) \times \mathbb{R}$, and constant on the cone $-b^-t \leq z \leq -b^+t$.

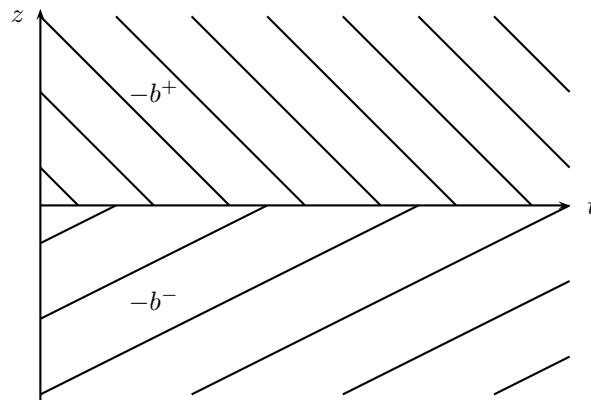

Figure 8.1: The characteristics of the conservation law in the diverging/diverging case. On the half line $z = 0$, the value of u is a linear interpolation of the values given by the upward characteristic and the downward characteristic.

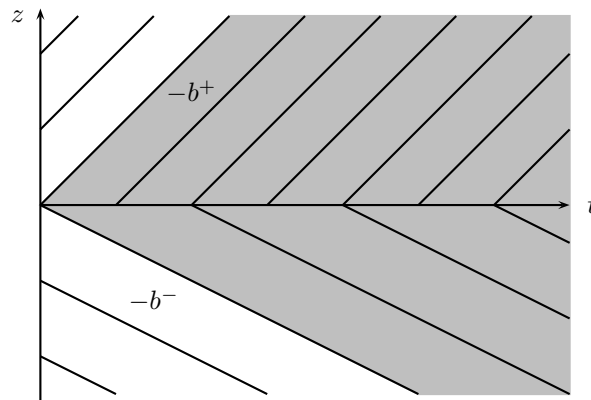

Figure 8.2: The characteristics in the converging/converging case. In the gray area, the value of u is constant.

8.3 The rank-based case

In this section, we assume that there exists a vector $b = (b_1, \dots, b_n) \in \mathbb{R}^n$ such that, for all $\sigma \in S_n$, for all $i \in \{1, \dots, n\}$, $b_{\sigma(i)}(\sigma) = b_i$. In other words, the instantaneous drift of the i -th particle at time t only depends on the rank of $X_i^\epsilon(t)$ among $X_1^\epsilon(t), \dots, X_n^\epsilon(t)$. We recall in Subsection 8.3.1 that, in this case, the increasing reordering of the particle system is a Brownian motion with constant drift, normally reflected at the boundary of the polyhedron $D_n := \{(y_1, \dots, y_n) \in \mathbb{R}^n : y_1 \leq \dots \leq y_n\}$. Its small noise limit is obtained through a simple convexity argument, and identified as the sticky particle dynamics in Subsection 8.3.2. The description of the small noise limit of the original particle system is then derived in Subsection 8.3.3.

8.3.1 The reordered particle system

For all $t \geq 0$, let

$$(Y_1^\epsilon(t), \dots, Y_n^\epsilon(t)) \in D_n$$

refer to the increasing reordering of

$$(X_1^\epsilon(t), \dots, X_n^\epsilon(t)) \in \mathbb{R}^n,$$

i.e. $Y_i^\epsilon(t) = X_{\sigma(i)}^\epsilon(t)$ with $\sigma = \Sigma X^\epsilon(t)$. The increasing reordering of the initial positions x^0 is denoted by y^0 . The process $Y^\epsilon = (Y_1^\epsilon(t), \dots, Y_n^\epsilon(t))_{t \geq 0}$ shall be referred to as the *reordered particle system*. It is continuous and takes its values in the polyhedron D_n . The following lemma is an easy adaptation of [84, Lemma 2.1, p. 91].

Lemma 8.3.1. *For all $\epsilon > 0$, there exists a standard Brownian motion*

$$\beta^\epsilon = (\beta_1^\epsilon(t), \dots, \beta_n^\epsilon(t))_{t \geq 0}$$

in \mathbb{R}^n , defined on $(\Omega, \mathcal{F}, \mathbb{P}_{x^0})$, such that

$$\forall t \geq 0, \quad Y^\epsilon(t) = y^0 + bt + \sqrt{2\epsilon}\beta^\epsilon(t) + K^\epsilon(t), \tag{8.4}$$

where the continuous process $K^\epsilon = (K_1^\epsilon(t), \dots, K_n^\epsilon(t))_{t \geq 0}$ in \mathbb{R}^n is associated with Y^ϵ in D_n in the sense of Tanaka [132, p. 165]. In other words, Y^ϵ is a Brownian motion with constant drift vector b and constant diffusion matrix $2\epsilon I_n$, normally reflected at the boundary of the polyhedron D_n ; where I_n refers to the identity matrix.

By Tanaka [132, Theorem 2.1, p. 170], there exists a unique solution

$$\xi = (\xi_1(t), \dots, \xi_n(t))_{t \geq 0}$$

to the zero noise version of the reflected equation (8.4) given by

$$\forall t \geq 0, \quad \xi(t) = y^0 + bt + \kappa(t), \tag{8.5}$$

where κ is associated with ξ in D_n . An explicit description of ξ as the sticky particle dynamics started at y with initial velocity vector b is provided in Subsection 8.3.2 below.

Proposition 8.3.2. *For all $T > 0$,*

$$\mathbb{E}_{x^0} \left(\sup_{t \in [0, T]} \sum_{i=1}^n |Y_i^\epsilon(t) - \xi_i(t)|^2 \right) \leq (4\sqrt{2n} + 2n)\epsilon T.$$

Proof. By the Itô formula,

$$\begin{aligned} \forall t \geq 0, \quad \sum_{i=1}^n |Y_i^\epsilon(t) - \xi_i(t)|^2 &= 2 \sum_{i=1}^n \int_{s=0}^t (Y_i^\epsilon(s) - \xi_i(s)) dK_i^\epsilon(s) \\ &\quad + 2 \sum_{i=1}^n \int_{s=0}^t (\xi_i(s) - Y_i^\epsilon(s)) d\kappa_i(s) \\ &\quad + 2\sqrt{2\epsilon}M^\epsilon(t) + 2n\epsilon t, \end{aligned}$$

where

$$\forall t \geq 0, \quad M^\epsilon(t) := \sum_{i=1}^n \int_{s=0}^t (Y_i^\epsilon(s) - \xi_i(s)) d\beta_i^\epsilon(s).$$

Let $|K^\epsilon|(t)$ refer to the total variation of K^ϵ on $[0, t]$. Then, by the definition of K^ϵ (see [132, p. 165]), $d|K^\epsilon|(t)$ -almost everywhere, $Y^\epsilon(t) \in \partial D_n$ and the unit vector $k^\epsilon(t) = (k_1^\epsilon(t), \dots, k_n^\epsilon(t))$ defined by $dK_i^\epsilon(t) = k_i^\epsilon(t) d|K^\epsilon|(t)$ belongs to the cone of inward normal vectors to D_n at $Y^\epsilon(t)$. Since $\xi(t) \in D_n$ and the set D_n is convex, this yields

$$\sum_{i=1}^n \int_{s=0}^t (Y_i^\epsilon(s) - \xi_i(s)) dK_i^\epsilon(s) = \int_{s=0}^t \sum_{i=1}^n (Y_i^\epsilon(s) - \xi_i(s)) k_i^\epsilon(s) d|K^\epsilon|(s) \leq 0,$$

and by the same arguments,

$$\sum_{i=1}^n \int_{s=0}^t (\xi_i(s) - Y_i^\epsilon(s)) d\kappa_i(s) \leq 0,$$

so that $\sum_{i=1}^n |Y_i^\epsilon(t) - \xi_i(t)|^2 \leq 2\sqrt{2\epsilon}M^\epsilon(t) + 2n\epsilon t$. The result now follows from the same localization procedure as in the proof of Proposition 8.2.5, case (iv). \square

8.3.2 The sticky particle dynamics

Following Brenier and Grenier [29], the *sticky particle dynamics* started at $y^0 \in D_n$ with initial velocity vector $b \in \mathbb{R}^n$ is defined as the continuous process

$$\xi = (\xi_1(t), \dots, \xi_n(t))_{t \geq 0}$$

in D_n satisfying the following conditions.

- For all $i \in \{1, \dots, n\}$, the i -th particle has initial position $\xi_i(0) = y_i^0$, initial velocity b_i and unit mass.
- A particle travels with constant velocity until it collides with another particle. Then both particles stick together and form a cluster traveling at constant velocity given by the average velocity of the two colliding particles.
- More generally, when two clusters collide, they form a single cluster, the velocity of which is determined by the conservation of global momentum.

Certainly, particles with the same initial position can collide instantaneously and form one or several clusters, each cluster being composed by particles with consecutive indices. The determination of these instantaneous clusters is made explicit in [86, Remarque 1, p. 235].

Since the particles stick together after each collision, there is only a finite number $M \geq 0$ of collisions. Let us denote by $0 = t^0 < t^1 < \dots < t^M < t^{M+1} = +\infty$ the instants of collisions. For all $m \in \{0, \dots, M\}$, we define the equivalence relation \sim_m by $i \sim_m j$ if the i -th particle and the j -th particle travel in the same cluster on $[t^m, t^{m+1})$. Note that if $i \sim_m j$, then $i \sim_{m'} j$ for all $m' \geq m$. For all $m \in \{0, \dots, M\}$, we denote by v_i^m the velocity of the i -th particle after the m -th collision. As a consequence, for all $t \in [t^m, t^{m+1})$,

$$\forall i \in \{1, \dots, n\}, \quad \xi_i(t) = \xi_i(t^m) + v_i^m(t - t^m),$$

and

$$v_i^m = \frac{1}{i_2 - i_1 + 1} \sum_{j=i_1}^{i_2} b_j,$$

where $\{i_1, \dots, i_2\}$ is the set of the consecutive indices j such that $j \sim_m i$. The clusters are characterized by the following *stability condition* due to Brenier and Grenier [29, Lemma 2.2, p. 2322].

Lemma 8.3.3. *For all $t \in [t^m, t^{m+1})$, for all $i \in \{1, \dots, n\}$, let i_1, \dots, i_2 refer to the set of consecutive indices j such that $j \sim_m i$. Then, either $i_1 = i_2$ or*

$$\forall i' \in \{i_1, \dots, i_2 - 1\}, \quad \frac{1}{i' - i_1 + 1} \sum_{j=i_1}^{i'} b_j \geq \frac{1}{i_2 - i'} \sum_{j=i'+1}^{i_2} b_j.$$

The fact that ξ describes the small noise limit of the reordered particle system Y^ϵ introduced in Subsection 8.3.1 is a consequence of Proposition 8.3.2 combined with the following lemma.

Lemma 8.3.4. *The process ξ satisfies the reflected equation (8.5) in D_n .*

Proof. The proof is constructive, namely we build a process κ associated with ξ in D_n such that, for all $t \geq 0$, $\xi(t) = y^0 + bt + \kappa(t)$. Following [84, Remark 2.3, p. 91], $\kappa : [0, +\infty) \rightarrow \mathbb{R}^n$ is associated with ξ in D_n if and only if:

- κ is continuous, with bounded variation $|\kappa| = |\kappa_1| + \dots + |\kappa_n|$ and $\kappa(0) = 0$;
- there exist functions $\gamma_1, \dots, \gamma_{n+1} : [0, +\infty) \rightarrow \mathbb{R}$ such that, for all $i \in \{1, \dots, n\}$, $d\kappa_i(t) = (\gamma_i(t) - \gamma_{i+1}(t))d|\kappa|(t)$; and, $d|\kappa|(t)$ -almost everywhere,

$$\begin{aligned} \gamma_1(t) &= \gamma_{n+1}(t) = 0, \\ \forall i \in \{2, \dots, n\}, \quad \gamma_i(t) &\geq 0, \quad \gamma_i(t)(\xi_i(t) - \xi_{i-1}(t)) = 0. \end{aligned}$$

Let $\kappa(0) = 0$ and let us define $\kappa_i(t) = \kappa_i(t^m) + (t - t^m)(v_i^m - b_i)$ for all $t \in [t^m, t^{m+1})$. Then one easily checks that (8.5) holds. Besides, κ is absolutely continuous with respect to the Lebesgue measure on $[0, +\infty)$, and its total variation $|\kappa|$ admits the Radon-Nikodym derivative $\ell_m := \sum_{i=1}^n |v_i^m - b_i|$ on $[t^m, t^{m+1})$. As a consequence, κ satisfies (i).

It remains to prove that κ satisfies (ii). For all $m \in \{0, \dots, M\}$, for all $t \in [t^m, t^{m+1})$, we define $\gamma_1(t) = \gamma_{n+1}(t) = 0$ and:

- if $\ell_m = 0$, for all $i \in \{2, \dots, n\}$, $\gamma_i(t) = 0$;
- if $\ell_m > 0$, for all $i \in \{2, \dots, n\}$,

$$\gamma_i(t) = \frac{1}{\ell_m} \sum_{j=i_1}^{i-1} (b_j - v_i^m),$$

where i_1, \dots, i_2 is the set of the consecutive indices j such that $j \sim_m i$, and we take the convention that a sum over an empty set of indices is null.

Note that, in the latter case, $\gamma_{i_1}(t) = \gamma_{i_2+1}(t) = 0$. This immediately yields $d\kappa_i(t) = (\gamma_i(t) - \gamma_{i+1}(t))d|\kappa|(t)$ as well as $\gamma_i(t)(\xi_i(t) - \xi_{i-1}(t)) = 0$. It remains to prove that $\gamma_i(t) \geq 0$. If $\gamma_i(t) = 0$ this is trivial. Else, by the construction above, the i -th particle belongs to the cluster composed by the i_1 -th, \dots , i_2 -th particles, and $i_1 < i \leq i_2$. By Lemma 8.3.3 applied with $i' = i - 1$,

$$\frac{1}{i - i_1} \sum_{j=i_1}^{i-1} b_j \geq \frac{1}{i_2 - i + 1} \sum_{j=i}^{i_2} b_j.$$

As a consequence,

$$\begin{aligned} \gamma_i(t) &= \frac{1}{\ell_m} \sum_{j=i_1}^{i-1} (b_j - v_i^m) = \frac{1}{\ell_m} \left(\sum_{j=i_1}^{i-1} b_j - \frac{i - i_1}{i_2 - i_1 + 1} \sum_{j=i_1}^{i_2} b_j \right) \\ &= \frac{1}{\ell_m} \left(\frac{i_2 - i + 1}{i_2 - i_1 + 1} \sum_{j=i_1}^{i-1} b_j - \frac{i - i_1}{i_2 - i_1 + 1} \sum_{j=i}^{i_2} b_j \right) \geq 0, \end{aligned}$$

and the proof is completed. □

In the proof of Corollary 8.3.6, we shall use the following properties of the sticky particle dynamics.

Lemma 8.3.5. *The sticky particle dynamics has the following properties.*

- Flow: Let $y^0 \in D_n$ and let us denote by $(\xi(t))_{t \geq 0}$ the sticky particle process started at y^0 , with initial velocity vector b . For a given $\delta \geq 0$, let us denote by $(\xi'(s))_{s \geq 0}$ the sticky particle process started at $\xi(\delta)$, with initial velocity vector b . Then, for all $s \geq 0$, $\xi(\delta + s) = \xi'(s)$.
- Contractivity: Let $y^0, y'^0 \in D_n$ and let us denote by $(\xi(t))_{t \geq 0}$ and $(\xi'(t))_{t \geq 0}$ the sticky particle processes respectively started at y^0 and y'^0 , with the same initial velocity vector b . Then, for all $t \geq 0$,

$$\sum_{i=1}^n |\xi_i(t) - \xi'_i(t)| \leq \sum_{i=1}^n |y_i^0 - y'^0_i|.$$

Proof. The flow property is a straightforward consequence of the definition of the sticky particle dynamics. Let us address the contractivity property. In this purpose, we write

$$\forall t \geq 0, \quad \xi(t) = y^0 + bt + \kappa(t), \quad \xi'(t) = y'^0 + bt + \kappa'(t),$$

so that, for all $t \geq 0$,

$$\begin{aligned} \sum_{i=1}^n |\xi_i(t) - \xi'_i(t)| &= \sum_{i=1}^n |y_i^0 - y'^0_i| \\ &\quad + \sum_{i=1}^n \int_{s=0}^t \operatorname{sgn}(\xi_i(s) - \xi'_i(s)) d\kappa_i(s) + \sum_{i=1}^n \int_{s=0}^t \operatorname{sgn}(\xi'_i(s) - \xi_i(s)) d\kappa'_i(s), \end{aligned}$$

where $\text{sgn}(\cdot)$ is defined by

$$\text{sgn}(x) = \begin{cases} 1 & \text{if } x > 0, \\ 0 & \text{if } x = 0, \\ -1 & \text{if } x < 0. \end{cases}$$

We prove that

$$\sum_{i=1}^n \int_{s=0}^t \text{sgn}(\xi_i(s) - \xi'_i(s)) d\kappa_i(s) \leq 0,$$

and the same arguments also yield

$$\sum_{i=1}^n \int_{s=0}^t \text{sgn}(\xi'_i(s) - \xi_i(s)) d\kappa'_i(s) \leq 0,$$

which completes the proof.

With the notations of Lemma 8.3.4,

$$\begin{aligned} \sum_{i=1}^n \int_{s=0}^t \text{sgn}(\xi_i(s) - \xi'_i(s)) d\kappa_i(s) &= \int_{s=0}^t \left(\sum_{i=1}^n \text{sgn}(\xi_i(s) - \xi'_i(s)) (\gamma_i(s) - \gamma_{i+1}(s)) \right) d|\kappa|(s) \\ &= \int_{s=0}^t \left(\sum_{i=2}^n (\text{sgn}(\xi_i(s) - \xi'_i(s)) - \text{sgn}(\xi_{i-1}(s) - \xi'_{i-1}(s))) \gamma_i(s) \right) d|\kappa|(s), \end{aligned}$$

where we have used Abel's transform as well as the fact that, $d|\kappa|(s)$ -almost everywhere, $\gamma_1(s) = \gamma_{n+1}(s) = 0$. Now, $d|\kappa|(s)$ -almost everywhere, either $\gamma_i(s) = 0$ or $\gamma_i(s) > 0$, in which case $\xi_i(s) = \xi_{i-1}(s)$ and therefore $\text{sgn}(\xi_i(s) - \xi'_i(s)) - \text{sgn}(\xi_{i-1}(s) - \xi'_{i-1}(s)) \leq 0$ since $\xi'_{i-1}(s) \leq \xi'_i(s)$. As a conclusion,

$$\int_{s=0}^t \left(\sum_{i=2}^n (\text{sgn}(\xi_i(s) - \xi'_i(s)) - \text{sgn}(\xi_{i-1}(s) - \xi'_{i-1}(s))) \gamma_i(s) \right) d|\kappa|(s) \leq 0,$$

and the proof is completed. □

8.3.3 Small noise limit of the original particle system

Proposition 8.3.2 describes the small noise limit of the reordered particle system Y^ϵ . We now describe the small noise limit of the original particle system X^ϵ . For all $\sigma \in S_n$, we denote by $\xi_{\sigma^{-1}}$ the process $(\xi_{\sigma^{-1}(1)}(t), \dots, \xi_{\sigma^{-1}(n)}(t))_{t \geq 0}$.

Recall that, for all $x \in \mathbb{R}^n$, $\bar{\Sigma}x$ refers to the set of permutations $\sigma \in S_n$ such that $x_{\sigma(1)} \leq \dots \leq x_{\sigma(n)}$. When at least two particles have the same initial position, *i.e.* $x^0 \in O_n$, $\bar{\Sigma}x^0$ contains more than one element. However, if each group of particles sharing the same initial position forms a single cluster in the sticky particle dynamics, then, for all $\sigma, \sigma' \in \bar{\Sigma}x^0$, the processes $\xi_{\sigma^{-1}}$ and $\xi_{\sigma'^{-1}}$ are equal.

Corollary 8.3.6. *The small noise limit of the original particle system is described as follows.*

1. If $\bar{\Sigma}x^0$ contains a single element, or if, for all $\sigma, \sigma' \in \bar{\Sigma}x^0$, the processes $\xi_{\sigma^{-1}}$ and $\xi_{\sigma'^{-1}}$ are equal, then X^ϵ converges in $L^2_{\text{loc}}(\mathbb{P}_{x^0})$ to $\xi_{\sigma^{-1}}$ for any $\sigma \in \bar{\Sigma}x^0$.
2. In general, X^ϵ converges in distribution to the process $\xi_{\sigma^{-1}}$, where σ is a uniform random variable among $\bar{\Sigma}x^0$.

Once again, by the same arguments as in Remark 8.2.4, in the first case above, the convergence can be stated in $L^p_{\text{loc}}(\mathbb{P}_{x^0})$, for all $p \in [1, +\infty)$, while if there exist at least $\sigma, \sigma' \in \bar{\Sigma}x^0$ such that $\xi_{\sigma^{-1}} \neq \xi_{\sigma'^{-1}}$, then in the second case above, the convergence cannot hold in probability.

Proof of Corollary 8.3.6. For all $T > 0$ and $\alpha > 0$, let $B_T(\xi, \alpha)$ refer to the set of continuous paths $y \in C([0, T], D_n)$ such that $\sup_{t \in [0, T]} \max_{1 \leq i \leq n} |y_i(t) - \xi_i(t)| < \alpha$. Owing to Proposition 8.3.2, for all $\alpha > 0$, $\lim_{\epsilon \downarrow 0} \mathbb{P}_{x^0}(Y^\epsilon \in B_T(\xi, \alpha)) = 1$.

Let us address the first part of the corollary. Let σ be a fixed permutation in $\bar{\Sigma}x^0$. Note that, for all $i \in \{1, \dots, n\}$, $X_{\sigma(i)}^\epsilon(0) = Y_i^\epsilon(0) = y_i^0$. Besides, for all $t \geq 0$, the definition of $X^\epsilon(t)$ yields

$$\forall i \in \{1, \dots, n\}, \quad |X_{\sigma(i)}^\epsilon(t) - y_i^0| \leq \max_{1 \leq k \leq n} |b_k|t + \sqrt{2\epsilon}|W_{\sigma(i)}(t)|,$$

while the definition of $\xi(t)$ yields

$$\forall i \in \{1, \dots, n\}, \quad |\xi_i(t) - y_i^0| \leq \max_{1 \leq k \leq n} |b_k|t.$$

As a consequence, for all $i \in \{1, \dots, n\}$,

$$\begin{aligned} |X_{\sigma(i)}^\epsilon(t) - \xi_i(t)|^2 &\leq 2 \left(\left(\max_{1 \leq k \leq n} |b_k|t + \sqrt{2\epsilon}|W_{\sigma(i)}(t)| \right)^2 + \left(\max_{1 \leq k \leq n} |b_k|t \right)^2 \right) \\ &\leq 6 \max_{1 \leq k \leq n} (b_k t)^2 + 8\epsilon (W_{\sigma(i)}(t))^2. \end{aligned}$$

Therefore, for a fixed $T > 0$,

$$\sup_{t \in [0, T]} \sum_{i=1}^n |X_{\sigma(i)}^\epsilon(t) - \xi_i(t)|^2 \leq \sum_{i=1}^n \left(6 \max_{1 \leq k \leq n} (b_k T)^2 + 8\epsilon \sup_{t \in [0, T]} (W_{\sigma(i)}(t))^2 \right),$$

so that

$$\begin{aligned} \mathbb{E}_{x^0} \left(\sup_{t \in [0, T]} \sum_{i=1}^n |X_{\sigma(i)}^\epsilon(t) - \xi_i(t)|^2 \mathbf{1}_{\{Y^\epsilon \notin B_T(\xi, \alpha)\}} \right) \\ \leq 6n \max_{1 \leq k \leq n} (b_k T)^2 \mathbb{P}_{x^0}(Y^\epsilon \notin B_T(\xi, \alpha)) + 8n\epsilon \mathbb{E}_{x^0} \left(\sup_{t \in [0, T]} |W_1(t)|^2 \right), \end{aligned}$$

therefore

$$\forall \alpha > 0, \quad \lim_{\epsilon \downarrow 0} \mathbb{E}_{x^0} \left(\sup_{t \in [0, T]} \sum_{i=1}^n |X_{\sigma(i)}^\epsilon(t) - \xi_i(t)|^2 \mathbf{1}_{\{Y^\epsilon \notin B_T(\xi, \alpha)\}} \right) = 0. \quad (8.6)$$

We now fix $\eta > 0$ such that, for all $m \in \{0, \dots, M-1\}$, $t^m < t^{m+1} - \eta$, and for all $m \in \{0, \dots, M\}$, we denote by I_η^m the interval $[0 \vee (t^m - \eta), (t^{m+1} - \eta) \wedge T]$. Then, one can choose $\alpha > 0$ small enough such that, for all $m \in \{0, \dots, M\}$, for all $i, j \in \{1, \dots, n\}$ such that $i < j$ and $i \not\sim_m j$,

$$\sup_{t \in I_\eta^m} \xi_i(t) + \alpha < \inf_{t \in I_\eta^m} \xi_j(t) - \alpha, \quad (8.7)$$

see Figure 8.3. In particular, if $y = (y_1, \dots, y_n) \in B_T(\xi, \alpha)$ and $t \in I_\eta^m$ is such that $y_i(t) = y_j(t)$, then $i \sim_m j$. Here, it is crucial that either all the particles have pairwise distinct initial positions, or that each group of particles sharing the same initial position forms a single cluster in the sticky particle dynamics. Otherwise, for all $\alpha > 0$, (8.7) would fail for $m = 0$.

Such a choice for α ensures the following assertion:

- (*) If $\alpha > 0$ satisfies (8.7), then on the event $\{Y^\epsilon \in B_T(\xi, \alpha)\}$, for all $m \in \{0, \dots, M\}$, for all $t \in I_\eta^m$, for all $i, j \in \{1, \dots, n\}$ such that $X_{\sigma(i)}^\epsilon(t) = Y_j^\epsilon(t)$, then $i \sim_m j$.

Before proving (*), let us show how this assertion allows to conclude: for all $t \in [0, T]$, there exists $m \in \{0, \dots, M\}$ such that $t \in I_\eta^m$. Let us fix $i \in \{1, \dots, n\}$ and j such that $X_{\sigma(i)}^\epsilon(t) = Y_j^\epsilon(t)$. Then, by (*), $j \sim_m i$. On the event $\{Y^\epsilon \in B_T(\xi, \alpha)\}$,

- if $t \in [t^m, (t^{m+1} - \eta) \wedge T]$, then $\xi_j(t) = \xi_i(t)$, so that $|X_{\sigma(i)}^\epsilon - \xi_i(t)| = |Y_j^\epsilon(t) - \xi_j(t)| < \alpha$;

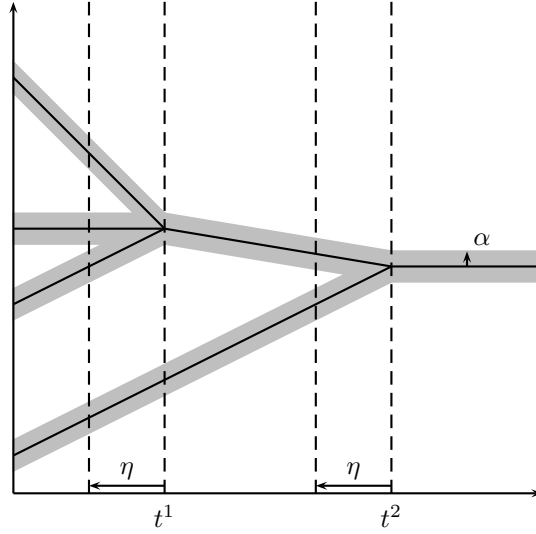

Figure 8.3: A trajectory of the sticky particle dynamics ξ for $n = 4$ particles, with $M = 2$ collisions. The initial positions of the particles are pairwise distinct. For $\eta > 0$ such that $0 < t^1 - \eta < t^1 < t^2 - \eta$, $\alpha > 0$ is chosen small enough for the set $B_T(\xi, \alpha)$ to satisfy the condition (8.7). A path y in $B_T(\xi, \alpha)$ is necessarily contained in the gray area.

- if $m \geq 1$ and $t \in [t^m - \eta, t^m \wedge T]$, then $|\xi_j(t) - \xi_i(t)| = |\xi_j(t^m) - v_j^m(t^m - t) - \xi_i(t^m) + v_i^m(t^m - t)| \leq 2 \max_{1 \leq k \leq n} |b_k| \eta$, so that $|X_{\sigma(i)}^\epsilon(t) - \xi_i(t)| \leq |Y_j^\epsilon(t) - \xi_j(t)| + |\xi_j(t) - \xi_i(t)| < \alpha + 2 \max_{1 \leq k \leq n} |b_k| \eta$.

As a conclusion,

$$\sup_{t \in [0, T]} \sum_{i=1}^n |X_{\sigma(i)}^\epsilon(t) - \xi_i(t)|^2 \mathbb{1}_{\{Y^\epsilon \in B_T(\xi, \alpha)\}} \leq n \left(\alpha + 2 \max_{1 \leq k \leq n} |b_k| \eta \right)^2.$$

Taking the expectation of both sides above, recalling (8.6), letting $\epsilon \downarrow 0$, $\alpha \downarrow 0$ and finally $\eta \downarrow 0$, we conclude that

$$\lim_{\epsilon \downarrow 0} \mathbb{E}_{x^0} \left(\sup_{t \in [0, T]} \sum_{i=1}^n |X_{\sigma(i)}^\epsilon(t) - \xi_i(t)|^2 \right) = 0.$$

Before addressing the second part of the corollary, let us prove the assertion (*). Let us assume that $\alpha > 0$ satisfies (8.7) and that $Y^\epsilon \in B_T(\xi, \alpha)$. Let $m \in \{0, \dots, M\}$, $t \in I_\eta^m$ and $i, j \in \{1, \dots, n\}$ such that $X_{\sigma(i)}^\epsilon(t) = Y_j^\epsilon(t)$. If $i = j$, then there is nothing to prove. Let us assume that $i < j$, the arguments for the case $i > j$ being symmetric. By the continuity of the trajectories of $X_1^\epsilon, \dots, X_n^\epsilon$ and the fact that $X_{\sigma(i)}^\epsilon(0) = Y_i^\epsilon(0)$, there exists a nondecreasing sequence of times $0 \leq t_{i, i+1} \leq \dots \leq t_{j-1, j} \leq t$ such that, for all $k \in \{i, \dots, j-1\}$, $X_{\sigma(i)}^\epsilon(t_{k, k+1}) = Y_k^\epsilon(t_{k, k+1}) = Y_{k+1}^\epsilon(t_{k, k+1})$. Certainly, there is an associated nondecreasing sequence of integers $0 \leq m_{i, i+1} \leq \dots \leq m_{j-1, j} \leq m$ such that, for all $k \in \{i, \dots, j-1\}$, $t_{k, k+1} \in I_\eta^{m_{k, k+1}}$. By (8.7), for all $k \in \{i, \dots, j-1\}$, $k \sim_{m_{k, k+1}} k+1$, and since $m_{k, k+1} \leq m$, then $k \sim_m k+1$. Due to the transitivity of the relation \sim_m , we conclude that $i \sim_m i+1 \sim_m \dots \sim_m j$.

Let us now address the second part of the corollary. Let us fix $T > 0$, $\delta > 0$ such that $\delta < t^1 \wedge T$ and $\eta > 0$ such that $\delta < t^1 - \eta$, and for $m \in \{1, \dots, M-1\}$, $t^m < t^{m+1} - \eta$. We slightly modify (8.7) as, for all $m \in \{0, \dots, M\}$, we denote by $I_{\eta, \delta}^m$ the interval $[\delta \vee (t^m - \eta), (t^{m+1} - \eta) \wedge T]$ and we choose $\alpha > 0$ small enough such that, for all $m \in \{0, \dots, M\}$, for all $i, j \in \{1, \dots, n\}$ such that $i < j$ and $i \not\sim_m j$,

$$\sup_{t \in I_{\eta, \delta}^m} \xi_i(t) + \alpha < \inf_{t \in I_{\eta, \delta}^m} \xi_j(t) - \alpha, \quad (8.8)$$

see Figure 8.4. In particular, if $y = (y_1, \dots, y_n) \in B_T(\xi, \alpha)$ and $t \in I_{\eta, \delta}^m$ is such that $y_i(t) = y_j(t)$, then $i \sim_m j$; while, if $t \in [0, \delta]$ is such that $y_i(t) = y_j(t)$, then $\xi_i(0) = \xi_j(0)$ although the relation $i \sim_0 j$ does not necessarily hold.

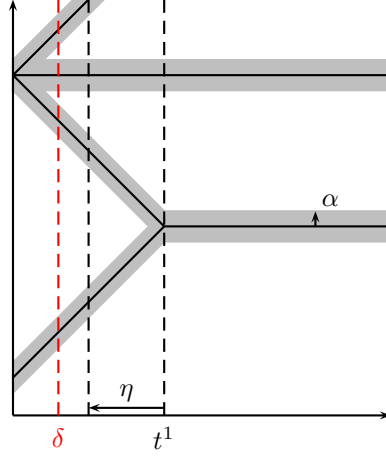

Figure 8.4: If some particles share the same initial position but instantaneously split into several clusters, δ is fixed in $(0, t^1 \wedge T)$ and η, α are taken small enough for (8.8) to hold.

Now let $F : C([0, T], \mathbb{R}^n) \rightarrow \mathbb{R}$ be a bounded and Lipschitz continuous function, with unit Lipschitz norm. We shall prove that

$$\lim_{\epsilon \downarrow 0} \mathbb{E}_{x^0} (F(X^\epsilon)) = \frac{1}{|\bar{\Sigma}x^0|} \sum_{\sigma \in \bar{\Sigma}x^0} F(\xi_{\sigma^{-1}}),$$

which leads to the second part of the lemma on account of the Portmanteau theorem [18, Theorem 2.1, p. 16].

First, by the boundedness of F , $\lim_{\epsilon \downarrow 0} \mathbb{E}_{x^0} (F(X^\epsilon) \mathbf{1}_{\{Y^\epsilon \notin B_T(\xi, \alpha)\}}) = 0$. Second,

$$\begin{aligned} \mathbb{E}_{x^0} (F(X^\epsilon) \mathbf{1}_{\{Y^\epsilon \in B_T(\xi, \alpha)\}}) &= \sum_{\sigma \in S_n} \mathbb{E}_{x^0} (F(X^\epsilon) \mathbf{1}_{\{Y^\epsilon \in B_T(\xi, \alpha), \Sigma X^\epsilon(\delta) = \sigma\}}) \\ &= \sum_{\sigma \in \bar{\Sigma}x^0} \mathbb{E}_{x^0} (F(X^\epsilon) \mathbf{1}_{\{Y^\epsilon \in B_T(\xi, \alpha), \Sigma X^\epsilon(\delta) = \sigma\}}), \end{aligned}$$

as, on the event $\{Y^\epsilon \in B_T(\xi, \alpha)\}$, the continuity of the trajectories of $X_1^\epsilon, \dots, X_n^\epsilon$ as well as the choice of δ and α imply that $\Sigma X^\epsilon(\delta) \in \bar{\Sigma}x^0$. As a consequence,

$$\begin{aligned} &\left| \mathbb{E}_{x^0} (F(X^\epsilon) \mathbf{1}_{\{Y^\epsilon \in B_T(\xi, \alpha)\}}) - \frac{1}{|\bar{\Sigma}x^0|} \sum_{\sigma \in \bar{\Sigma}x^0} F(\xi_{\sigma^{-1}}) \right| \\ &\leq \sum_{\sigma \in \bar{\Sigma}x^0} \left| \mathbb{E}_{x^0} \left(F(X^\epsilon) \mathbf{1}_{\{Y^\epsilon \in B_T(\xi, \alpha), \Sigma X^\epsilon(\delta) = \sigma\}} - \frac{1}{|\bar{\Sigma}x^0|} F(\xi_{\sigma^{-1}}) \right) \right|, \end{aligned}$$

and, for all $\sigma \in \bar{\Sigma}x^0$,

$$\begin{aligned} &\left| \mathbb{E}_{x^0} \left(F(X^\epsilon) \mathbf{1}_{\{Y^\epsilon \in B_T(\xi, \alpha), \Sigma X^\epsilon(\delta) = \sigma\}} - \frac{1}{|\bar{\Sigma}x^0|} F(\xi_{\sigma^{-1}}) \right) \right| \\ &\leq \mathbb{E}_{x^0} (|F(X^\epsilon) - F(\xi_{\sigma^{-1}})| \mathbf{1}_{\{Y^\epsilon \in B_T(\xi, \alpha), \Sigma X^\epsilon(\delta) = \sigma\}}) \\ &\quad + \|F\|_\infty \left| \mathbb{P}_{x^0}(Y^\epsilon \in B_T(\xi, \alpha), \Sigma X^\epsilon(\delta) = \sigma) - \frac{1}{|\bar{\Sigma}x^0|} \right|. \end{aligned} \tag{8.9}$$

Let us prove that the first term in the right-hand side of (8.9) vanishes. The Lipschitz continuity of F yields

$$\begin{aligned} & \mathbb{E}_{x^0} \left(|F(X^\epsilon) - F(\xi_{\sigma^{-1}})| \mathbf{1}_{\{Y^\epsilon \in B_T(\xi, \alpha), \Sigma X^\epsilon(\delta) = \sigma\}} \right) \\ & \leq \mathbb{E}_{x^0} \left(\sup_{t \in [0, T]} \sum_{i=1}^n |X_{\sigma(i)}^\epsilon(t) - \xi_i(t)| \mathbf{1}_{\{Y^\epsilon \in B_T(\xi, \alpha), \Sigma X^\epsilon(\delta) = \sigma\}} \right). \end{aligned}$$

By (8.8), for all $t \in [0, \delta]$, for all $i, j \in \{1, \dots, n\}$ such that $X_{\sigma(i)}^\epsilon(t) = Y_j^\epsilon(t)$, then $|X_{\sigma(i)}^\epsilon(t) - \xi_i(t)| \leq |Y_j^\epsilon(t) - \xi_j(t)| + |\xi_j(t) - \xi_i(t)| < \alpha + 2 \max_{1 \leq k \leq n} |b_k| \delta$ if $Y^\epsilon \in B_T(\xi, \alpha)$. As a consequence,

$$\mathbb{E}_{x^0} \left(\sup_{t \in [0, \delta]} \sum_{i=1}^n |X_{\sigma(i)}^\epsilon(t) - \xi_i(t)|^2 \mathbf{1}_{\{Y^\epsilon \in B_T(\xi, \alpha), \Sigma X^\epsilon(\delta) = \sigma\}} \right) \leq n(\alpha + 2 \max_{1 \leq k \leq n} |b_k| \delta)^2,$$

which vanishes when $\alpha \downarrow 0$ and $\delta \downarrow 0$.

Besides,

$$\begin{aligned} & \mathbb{E}_{x^0} \left(\sup_{t \in [\delta, T]} \sum_{i=1}^n |X_{\sigma(i)}^\epsilon(t) - \xi_i(t)| \mathbf{1}_{\{Y^\epsilon \in B_T(\xi, \alpha), \Sigma X^\epsilon(\delta) = \sigma\}} \right) \\ & = \mathbb{E}_{x^0} \left(\mathbf{1}_{\{\Sigma X^\epsilon(\delta) = \sigma\}} \mathbb{E}_{x^0} \left(\sup_{s \in [0, T-\delta]} \sum_{i=1}^n |X_{\sigma(i)}^\epsilon(\delta + s) - \xi_i(\delta + s)| \mathbf{1}_{\{Y^\epsilon \in B_T(\xi, \alpha)\}} \middle| \mathcal{F}_\delta \right) \right) \\ & \leq \mathbb{E}_{x^0} \left(\mathbf{1}_{\{\Sigma X^\epsilon(\delta) = \sigma\}} \mathbb{E}_{x^0} \left(\sup_{s \in [0, T-\delta]} \sum_{i=1}^n |X_{\sigma(i)}^\epsilon(\delta + s) - \xi'_i(s)| \mathbf{1}_{\{Y^\epsilon \in B_T(\xi, \alpha)\}} \middle| \mathcal{F}_\delta \right) \right) \\ & \quad + \mathbb{E}_{x^0} \left(\mathbf{1}_{\{\Sigma X^\epsilon(\delta) = \sigma\}} \mathbb{E}_{x^0} \left(\sup_{s \in [0, T-\delta]} \sum_{i=1}^n |\xi'_i(s) - \xi_i(\delta + s)| \mathbf{1}_{\{Y^\epsilon \in B_T(\xi, \alpha)\}} \middle| \mathcal{F}_\delta \right) \right), \end{aligned}$$

where, on the event $\{\Sigma X^\epsilon(\delta) = \sigma\} \in \mathcal{F}_\delta$, $(\xi'(s))_{s \geq 0}$ refers to the sticky particle process started at $(X_{\sigma(1)}^\epsilon(\delta), \dots, X_{\sigma(n)}^\epsilon(\delta)) \in D_n$, with initial velocity vector b . On the one hand, on the event $\{\Sigma X^\epsilon(\delta) = \sigma\}$, Lemma 8.3.5 yields

$$\begin{aligned} & \mathbb{E}_{x^0} \left(\sup_{s \in [0, T-\delta]} \sum_{i=1}^n |\xi'_i(s) - \xi_i(\delta + s)| \mathbf{1}_{\{Y^\epsilon \in B_T(\xi, \alpha)\}} \middle| \mathcal{F}_\delta \right) \\ & \leq \mathbb{E}_{x^0} \left(\sum_{i=1}^n |X_{\sigma(i)}^\epsilon(\delta) - \xi_i(\delta)| \mathbf{1}_{\{Y^\epsilon \in B_T(\xi, \alpha)\}} \middle| \mathcal{F}_\delta \right) \\ & \leq \mathbb{E}_{x^0} \left(\sum_{i=1}^n |Y_i^\epsilon(\delta) - \xi_i(\delta)| \mathbf{1}_{\{Y^\epsilon \in B_T(\xi, \alpha)\}} \middle| \mathcal{F}_\delta \right) \\ & \leq n\alpha, \end{aligned}$$

since the choice of δ ensures that, on the event $\{Y^\epsilon \in B_T(\xi, \alpha), \Sigma X^\epsilon(\delta) = \sigma\}$, $X_{\sigma(i)}^\epsilon(\delta) = Y_i^\epsilon(\delta)$ for all $i \in \{1, \dots, n\}$. On the other hand, let $X'^\epsilon(s) := X^\epsilon(\delta + s)$ for all $s \geq 0$, and let Y'^ϵ be defined accordingly. Then

$$\begin{aligned} & \mathbf{1}_{\{\Sigma X^\epsilon(\delta) = \sigma\}} \mathbb{E}_{x^0} \left(\sup_{s \in [0, T-\delta]} \sum_{i=1}^n |X_{\sigma(i)}^\epsilon(\delta + s) - \xi'_i(s)| \mathbf{1}_{\{Y^\epsilon \in B_T(\xi, \alpha)\}} \middle| \mathcal{F}_\delta \right) \\ & \leq \mathbf{1}_{\{\Sigma X'^\epsilon(0) = \sigma\}} \mathbb{E}_{x^0} \left(\sup_{s \in [0, T-\delta]} \sum_{i=1}^n |X_{\sigma(i)}'^\epsilon(s) - \xi'_i(s)| \mathbf{1}_{\{Y'^\epsilon \in B_{T-\delta}(\xi, \alpha)\}} \middle| \mathcal{F}_\delta \right). \end{aligned}$$

By Proposition 8.1.1, \mathbb{P}_{x^0} -almost surely on the event $\{\Sigma X^\epsilon(\delta) = \sigma\}$, σ is the only element of $\bar{\Sigma} X^\epsilon(\delta) = \bar{\Sigma} X'^\epsilon(0)$. Therefore, combining the Markov property with the first part of the proof, we

obtain that

$$\begin{aligned} & \mathbb{1}_{\{\Sigma X'^\epsilon(0)=\sigma\}} \mathbb{E}_{x^0} \left(\sup_{s \in [0, T-\delta]} \sum_{i=1}^n |X'_{\sigma(i)}{}^\epsilon(s) - \xi'_i(s)| \mathbb{1}_{\{Y'^\epsilon \in B_{T-\delta}(\xi, \alpha)\}} \middle| \mathcal{F}_\delta \right) \\ & \leq n \left(\alpha + 2 \max_{1 \leq k \leq n} |b_k| \eta \right)^2. \end{aligned}$$

As a conclusion, the right-hand side of (8.9) vanishes when $\epsilon \downarrow 0$, $\alpha \downarrow 0$ and $\eta \downarrow 0$.

We now address the second term in the right-hand side of (8.9). For all $\sigma \in \bar{\Sigma}x^0$, the process $(X_{\sigma(1)}^\epsilon, \dots, X_{\sigma(n)}^\epsilon)$ solves the stochastic differential equation

$$\forall t \geq 0, \quad X_{\sigma(i)}^\epsilon(t) = y_i^0 + \sum_{j=1}^n \int_{s=0}^t \mathbb{1}_{\{X_{\sigma(i)}^\epsilon(s)=Y_j^\epsilon(s)\}} b_j ds + \sqrt{2\epsilon} W_{\sigma(i)}(t).$$

Since, for all $\sigma \in \bar{\Sigma}x^0$, $(W_{\sigma(1)}, \dots, W_{\sigma(n)})$ is a standard Brownian motion, the uniqueness in law for the solutions to the equation above (due to the Girsanov theorem or as a consequence of Proposition 8.1.1 combined with the Yamada-Watanabe theorem) implies that the processes $(X_{\sigma(1)}^\epsilon, \dots, X_{\sigma(n)}^\epsilon)$ have the same distribution, for all $\sigma \in \bar{\Sigma}x^0$. As a consequence,

$$\forall \sigma \in \bar{\Sigma}x^0, \quad \mathbb{P}_{x^0}(Y^\epsilon \in B_T(\xi, \alpha), \Sigma X^\epsilon(\delta) = \sigma) = \frac{1}{|\bar{\Sigma}x^0|} \mathbb{P}_{x^0}(Y^\epsilon \in B_T(\xi, \alpha)),$$

therefore

$$\lim_{\epsilon \downarrow 0} \mathbb{P}_{x^0}(Y^\epsilon \in B_T(\xi, \alpha), \Sigma X^\epsilon(\delta) = \sigma) = \frac{1}{|\bar{\Sigma}x^0|},$$

and the second term in the right-hand side of (8.9) vanishes when $\epsilon \downarrow 0$. Letting $\epsilon \downarrow 0$, $\alpha \downarrow 0$, $\eta \downarrow 0$ and, finally, $\delta \downarrow 0$, we conclude that

$$\lim_{\epsilon \downarrow 0} \mathbb{E}_{x^0}(F(X^\epsilon)) = \frac{1}{|\bar{\Sigma}x^0|} \sum_{\sigma \in \bar{\Sigma}x^0} F(\xi_{\sigma^{-1}}),$$

which completes the proof. □

8.4 The order-based case

We now address the general case of order-based processes. If the initial condition $x^0 \in \mathbb{R}^n$ is such that the particles have pairwise distinct initial positions, *i.e.* $x^0 \notin O_n$, by the same arguments as in the two-particle case of Section 8.2, in the small noise limit the i -th particle travels at constant velocity $b_i(\Sigma x^0)$ until the first collision in the system. Thus, the problem is reduced to the case of initial conditions $x^0 \in O_n$ for which several particles have the same position. In this case, the isolated particles have no influence on the instantaneous behaviour of the system, as they cannot immediately collide with other particles. Up to decreasing the number of particles, the problem can be reduced to the case of initial conditions where there are no isolated particles. Still, the interactions inside each group of particles with the same initial position are likely to modify the drifts of the particles in the other groups. In this section, we avoid such situations and assume that all the particles in the system share the same initial position. Since the function Σ is invariant by translation, there is no loss of generality in taking $x^0 = 0$.

In Subsection 8.4.1, we provide an extension of the stability condition of Lemma 8.3.3 for the rank-based case, which ensures that the particles aggregate into a single cluster in the small noise limit. We describe the motion of this cluster under a slightly stronger stability condition in Subsection 8.4.2. Finally, in Subsection 8.4.3, we exhibit the example of a system with three particles for which the particles aggregate into a single cluster in the small noise limit, although the stability condition is not satisfied.

8.4.1 The stability condition

In the rank-based case addressed in Section 8.3, it is observed that, in the small noise limit, if all the particles stick into a single cluster, then the velocities satisfy the *stability condition* that for any partition of the set $\{1, \dots, n\}$ into a leftmost subset $\{1, \dots, i\}$ and a rightmost subset $\{i+1, \dots, n\}$, the average velocity of the group of leftmost particles is larger than the average velocity of the group of rightmost particles (see Lemma 8.3.3).

The purpose of this subsection is to extend this stability condition to general order-based drift functions b . More precisely, the function $b : S_n \rightarrow \mathbb{R}^n$ is said to satisfy the stability condition (SC) if

$$\forall \sigma \in S_n, \quad \forall i \in \{1, \dots, n-1\}, \quad \frac{1}{i} \sum_{j=1}^i b_{\sigma(j)}(\sigma) \geq \frac{1}{n-i} \sum_{j=i+1}^n b_{\sigma(j)}(\sigma), \quad (\text{SC})$$

which has to be understood as the extension of the stability condition of Lemma 8.3.3 in Section 8.3.

8.4.1.1 The projected system

Similarly to the two-particle case addressed in Section 8.2, in which the behaviour of $(X_1^\epsilon, X_2^\epsilon)$ heavily depends on the behaviour of the scalar process $Z^\epsilon = X_1^\epsilon - X_2^\epsilon$, the dimensionality of the problem can be reduced by subtracting the center of mass of the system to the positions of the particles. This amounts to considering the orthogonal projection $Z^\epsilon = (Z_1^\epsilon(t), \dots, Z_n^\epsilon(t))_{t \geq 0}$ of X^ϵ on the hyperplane $M_n := \{(z_1, \dots, z_n) \in \mathbb{R}^n : z_1 + \dots + z_n = 0\}$. The orthogonal projection of \mathbb{R}^n on M_n is denoted by Π and writes $\Pi = I_n - (1/n)J_n$, where I_n is the identity matrix and J_n refers to the matrix with all coefficients equal to 1. Then, Z^ϵ is a diffusion on the hyperplane M_n and satisfies

$$\forall t \geq 0, \quad Z^\epsilon(t) = \int_{s=0}^t b^\Pi(\Sigma Z^\epsilon(s)) ds + \sqrt{2\epsilon} \Pi W(t),$$

where $b^\Pi := \Pi b$. Note that the stability condition (SC) rewrites

$$\forall \sigma \in S_n, \quad \forall i \in \{1, \dots, n-1\}, \quad \sum_{j=1}^i b_{\sigma(j)}^\Pi(\sigma) \geq 0. \quad (8.10)$$

8.4.1.2 Aggregation into a single cluster

In the small noise limit, all the particles $X_1^\epsilon, \dots, X_n^\epsilon$ stick together into a single cluster if and only if Z^ϵ converges to 0. This is ensured by the stability condition (SC).

Proposition 8.4.1. *Under the stability condition (SC), for all $T > 0$,*

$$\mathbb{E}_0 \left(\sup_{t \in [0, T]} \sum_{i=1}^n |Z_i^\epsilon(t)|^2 \right) \leq (4\sqrt{2} + 2)(n-1)\epsilon T.$$

Proof. By the Itô formula, for all $t \geq 0$,

$$\sum_{i=1}^n |Z_i^\epsilon(t)|^2 = 2 \int_{s=0}^t \sum_{i=1}^n Z_i^\epsilon(s) b_i^\Pi(\Sigma Z^\epsilon(s)) ds + 2\sqrt{2\epsilon} M^\epsilon(t) + 2\epsilon(n-1)t,$$

where

$$M^\epsilon(t) := \sum_{i=1}^n \int_{s=0}^t Z_i^\epsilon(s) dW_i^\Pi(s), \quad W_i^\Pi(t) := \left(1 - \frac{1}{n}\right) W_i(t) - \frac{1}{n} \sum_{j \neq i} W_j(t).$$

Under the stability condition (SC), let us fix $z = (z_1, \dots, z_n) \in M_n$, $\sigma = \Sigma z$ and compute

$$\begin{aligned} \sum_{i=1}^n z_i b_i^\Pi(\sigma) &= \sum_{i=1}^n z_{\sigma(i)} b_{\sigma(i)}^\Pi(\sigma) = \sum_{i=1}^{n-1} b_{\sigma(i)}^\Pi(\sigma) \sum_{j=i}^{n-1} (z_{\sigma(j)} - z_{\sigma(j+1)}) \\ &= \sum_{j=1}^{n-1} (z_{\sigma(j)} - z_{\sigma(j+1)}) \sum_{i=1}^j b_{\sigma(i)}^\Pi(\sigma), \end{aligned} \quad (8.11)$$

where we have used the fact that $\sum_{j=1}^n b_{\sigma(j)}^\Pi(\sigma) = 0$ as $b^\Pi(\sigma) \in M_n$. For all $j \in \{1, \dots, n-1\}$, the definition of $\sigma = \Sigma z$ yields $z_{\sigma(j)} - z_{\sigma(j+1)} \leq 0$ while $\sum_{i=1}^j b_{\sigma(i)}^\Pi(\sigma) \geq 0$ by (8.10). As a conclusion,

$$\forall z \in M_n, \quad \sum_{i=1}^n z_i b_i^\Pi(\Sigma z) \leq 0.$$

As a consequence, for all $t \geq 0$, $\sum_{i=1}^n |Z_i^\epsilon(t)|^2 \leq 2\sqrt{2\epsilon}M^\epsilon(t) + 2\epsilon(n-1)t$, and the result follows from the same localization procedure as in the proof of Proposition 8.2.5, case (iv) and the use of the Kunita-Watanabe inequality to estimate

$$\begin{aligned} \mathbb{E}_0(M^\epsilon(T)^2) &= \mathbb{E}_0(\langle M^\epsilon \rangle(T)) = \sum_{i,j=1}^n \mathbb{E}_0 \left(\int_{s=0}^T Z_i^\epsilon(s) Z_j^\epsilon(s) d\langle W_i^\Pi, W_j^\Pi \rangle(s) \right) \\ &\leq \sum_{i,j=1}^n \mathbb{E}_0 \left(\sqrt{\int_{s=0}^T Z_i^\epsilon(s)^2 d\langle W_i^\Pi \rangle(s)} \sqrt{\int_{s=0}^T Z_j^\epsilon(s)^2 d\langle W_j^\Pi \rangle(s)} \right) \\ &\leq \sum_{i,j=1}^n \sqrt{\mathbb{E}_0 \left(\int_{s=0}^T Z_i^\epsilon(s)^2 d\langle W_i^\Pi \rangle(s) \right)} \sqrt{\mathbb{E}_0 \left(\int_{s=0}^T Z_j^\epsilon(s)^2 d\langle W_j^\Pi \rangle(s) \right)} \\ &= \left(1 - \frac{1}{n}\right) \left(\sum_{i=1}^n \sqrt{\mathbb{E}_0 \left(\int_{s=0}^T Z_i^\epsilon(s)^2 ds \right)} \right)^2 \\ &\leq (n-1) \mathbb{E}_0 \left(\int_{s=0}^T \sum_{i=1}^n Z_i^\epsilon(s)^2 ds \right), \end{aligned}$$

where we have used the Cauchy-Schwarz inequality at the third line. □

8.4.2 Velocity of the cluster

According to Proposition 8.4.1, under the stability condition (SC), the particles stick together and form a cluster in the small noise limit. The purpose of this subsection is to determine the motion of the cluster.

8.4.2.1 The strong stability condition

In the two-particle case of Section 8.2, the stability condition (SC) corresponds to the case of converging/converging configurations (iv) and (v) in Proposition 8.2.2. In order to rule out degenerate situations such as case (v), in which the velocity of the two-particle cluster is random and nonconstant, we introduce the following *strong stability condition*:

$$\forall \sigma \in S_n, \quad \forall i \in \{1, \dots, n-1\}, \quad \frac{1}{i} \sum_{j=1}^i b_{\sigma(j)}(\sigma) > \frac{1}{n-i} \sum_{j=i+1}^n b_{\sigma(j)}(\sigma). \quad (\text{SSC})$$

Similarly to (8.10), the strong stability condition (SSC) rewrites

$$\bar{b} := \inf_{\sigma \in S_n} \inf_{1 \leq i \leq n-1} \sum_{j=1}^i b_{\sigma(j)}^\Pi(\sigma) > 0. \quad (8.12)$$

Lemma 8.4.2. *Under the strong stability condition (SSC), for all $z = (z_1, \dots, z_n) \in M_n$,*

$$\sum_{i=1}^n z_i b_i^\Pi(\Sigma z) \leq -\bar{b} \max_{1 \leq i \leq n} |z_i|.$$

Proof. By (8.11) and (8.12), $\sum_{i=1}^n z_i b_i^\Pi(\sigma) \leq -\bar{b}(z_{\sigma(n)} - z_{\sigma(1)})$, where $\sigma = \Sigma z$. Since $z_{\sigma(1)} \leq \dots \leq z_{\sigma(n)}$ and $z_1 + \dots + z_n = 0$, it is an easy barycentric inequality that $z_{\sigma(n)} - z_{\sigma(1)} \geq \max_{1 \leq i \leq n} |z_i|$, and the proof is completed. □

8.4.2.2 Changing the space-time scale

Let X^1 refer to the solution to

$$\forall t \geq 0, \quad \widetilde{X}^1(t) = \int_{s=0}^t b(\Sigma X^1(s)) ds + \sqrt{2}W(t).$$

In the rank-based case, the strong stability condition (SSC) was identified by Pal and Pitman [115, Remark, p. 2187] as a necessary and sufficient condition for the law of process $Z^1 = \Pi X^1$ to converge in total variation to its unique stationary distribution. In the order-based case, the interpretation of the small noise limit of Z^ϵ in terms of the long time behaviour of the process Z^1 can be made explicit through the following space-time scale change.

For all $\epsilon > 0$, let us define $\widetilde{X}^\epsilon(t) := \epsilon X^1(t/\epsilon)$. Then it is straightforward to check that there exists a standard Brownian motion \widetilde{W}^ϵ in \mathbb{R}^n on $(\Omega, \mathcal{F}, \mathbb{P}_0)$ such that

$$\forall t \geq 0, \quad \widetilde{X}^\epsilon(t) = \int_{s=0}^t b(\Sigma \widetilde{X}^\epsilon(s)) ds + \sqrt{2\epsilon} \widetilde{W}^\epsilon(t).$$

Since the solutions to the equation above are unique in law (as a consequence of the Girsanov theorem, or by Proposition 8.1.1 combined with the Yamada-Watanabe theorem), we deduce that the processes \widetilde{X}^ϵ and X^ϵ have the same distribution. As a consequence, the process Z^ϵ has the same distribution as the process \widetilde{Z}^ϵ defined by $\widetilde{Z}^\epsilon(t) = \epsilon Z^1(t/\epsilon)$.

8.4.2.3 Long time behaviour of Z^1

This paragraph is dedicated to the study of the stochastic differential equation

$$\forall t \geq 0, \quad Z(t) = z^0 + \int_{s=0}^t b^\Pi(\Sigma Z(s)) ds + \sqrt{2}\Pi W(t), \quad (8.13)$$

where $z^0 \in M_n$. When $z^0 = 0$, the process Z^1 introduced above solves (8.13).

Lemma 8.4.3. *For all $z^0 \in M_n$, the stochastic differential equation (8.13) admits a unique weak solution in M_n , defined on some probability space endowed with the probability distribution P_{z^0} and the expectation E_{z^0} . It generates a Feller semigroup in M_n , in the sense that, for all continuous and bounded function $f : M_n \rightarrow \mathbb{R}$, the function $z \mapsto E_z(f(Z(t)))$ is continuous and bounded on M_n .*

Proof. Any point $z = (z_1, \dots, z_n) \in M_n$ is parametrized by the vector of its first $n-1$ coordinates $z' = (z_1, \dots, z_{n-1}) \in \mathbb{R}^{n-1}$ through the continuous mapping $\varphi : z' \in \mathbb{R}^{n-1} \mapsto (z_1, \dots, z_{n-1}, -(z_1 + \dots + z_{n-1})) \in M_n$. Therefore, it is equivalent to prove weak existence and uniqueness and the Feller property for the stochastic differential equation

$$\forall t \geq 0, \quad Z'(t) = z^{0'} + \int_{s=0}^t (b^\Pi)'(\Sigma \varphi(Z'(s))) ds + \sqrt{2}\Pi' W(t), \quad (8.14)$$

in \mathbb{R}^{n-1} , where $(b^\Pi)'(\sigma) = (b_1^\Pi(\sigma), \dots, b_{n-1}^\Pi(\sigma))$ and Π' is the rectangular matrix obtained by removing the n -th line from Π . Little algebra yields $\Pi'(\Pi')^* = I_{n-1} - (1/n)J_{n-1}$ which is positive definite. As a consequence, weak existence and uniqueness as well as the Feller property for (8.14) follow from the Girsanov theorem. \square

Proposition 8.4.4. *Under the strong stability condition (SSC), the solution to (8.13) admits a unique stationary probability distribution μ , and it is positive recurrent in the sense that, for all measurable and bounded function $f : M_n \rightarrow \mathbb{R}$,*

$$\forall z^0 \in M_n, \quad \lim_{t \rightarrow +\infty} \frac{1}{t} \int_{s=0}^t f(Z(s)) ds = \int_{M_n} f d\mu, \quad P_{z^0}\text{-almost surely.}$$

Proof. The proof closely follows the lines of Pagès [113, Théorème 1, p. 148], and we prove existence, uniqueness and positive recurrence separately.

Proof of existence. The existence of a stationary probability distribution relies on the fact that the function V defined on M_n by $V(z) = \sum_{i=1}^n |z_i|^2$ is a Lyapunov function for (8.13). Indeed, let L refer to the infinitesimal generator of Z . By the Itô formula,

$$\forall z \in M_n, \quad LV(z) = 2 \sum_{i=1}^n z_i b_i^\Pi(\Sigma z) + 2(n-1).$$

By Lemma 8.4.2, under the strong stability condition (SSC),

$$LV(z) \leq -\bar{b} \max_{1 \leq i \leq n} |z_i| + 2(n-1),$$

and the conclusion follows from Ethier and Kurtz [56, Theorem 9.9, p. 243].

Proof of uniqueness. The uniqueness of a stationary probability distribution is a consequence of the regularity of the semigroup associated with the diffusion process Z' in \mathbb{R}^{n-1} introduced in the proof of Lemma 8.4.3. More precisely, since $\Pi'(\Pi')^*$ is positive definite, it follows from the Girsanov theorem that, for all $z^0 \in \mathbb{R}^{n-1}$, for all $t > 0$, the distribution of $Z'(t)$ is equivalent to the Lebesgue measure on \mathbb{R}^{n-1} . By the same arguments as in the proof of [122, Proposition 8.1, p. 29], this implies that the process Z' does not admit more than one stationary probability distribution. The conclusion follows from the fact that the pushforward by the mapping φ induces a one-to-one correspondance between the stationary distributions of Z' and the stationary distributions of Z .

Proof of positive recurrence. Since μ is the unique stationary probability distribution for the Feller process Z , it is ergodic [122, Proposition 3.5, p. 8]; therefore the pointwise ergodic theorem [122, Theorem 3.4, p. 8] ensures that, for all measurable and bounded function $f : M_n \rightarrow \mathbb{R}$,

$$\text{for } \mu\text{-almost all } z^0 \in M_n, \quad P_{z^0}\text{-almost surely,} \quad \lim_{t \rightarrow +\infty} \frac{1}{t} \int_{s=0}^t f(Z(s)) ds = \int_{M_n} f d\mu.$$

The extension of this statement to *all* initial condition $z^0 \in M_n$ relies on the regularity of the semigroup associated with Z , and we refer to Pagès [113, Théorème 1, (b), p. 149] for a proof. \square

8.4.2.4 Velocity of the cluster

The description of the small noise limit can now be completed under the strong stability condition (SSC).

Proposition 8.4.5. *Under the strong stability condition (SSC), the quantity*

$$v := \int_{z \in M_n} b_i(\Sigma z) \mu(dz), \tag{8.15}$$

with μ given by Proposition 8.4.4, does not depend on $i \in \{1, \dots, n\}$. Besides, X^ϵ converges in $L^2_{\text{loc}}(\mathbb{P}_0)$ to $(vt, \dots, vt)_{t \geq 0}$.

Proof. For all $\sigma \in S_n$, let ζ_σ^ϵ refer to the occupation time of the process ΣX^ϵ in σ defined by

$$\forall t \geq 0, \quad \zeta_\sigma^\epsilon(t) := \int_{s=0}^t \mathbb{1}_{\{\Sigma X^\epsilon(s) = \sigma\}} ds.$$

Certainly, for all $i \in \{1, \dots, n\}$,

$$\forall t \geq 0, \quad X_i^\epsilon(t) = \sum_{\sigma \in S_n} b_i(\sigma) \zeta_\sigma^\epsilon(t) + \sqrt{2\epsilon} W_i(t).$$

On the other hand, for a fixed $t > 0$,

$$\frac{\zeta_\sigma^\epsilon(t)}{t} = \frac{1}{t} \int_{s=0}^t \mathbb{1}_{\{\Sigma Z^\epsilon(s) = \sigma\}} ds$$

has the same distribution as

$$\frac{1}{t} \int_{s=0}^t \mathbb{1}_{\{\Sigma \tilde{Z}^\epsilon(s) = \sigma\}} ds = \frac{1}{t} \int_{s=0}^t \mathbb{1}_{\{\Sigma(\epsilon Z^1(s/\epsilon)) = \sigma\}} ds = \frac{\epsilon}{t} \int_{u=0}^{t/\epsilon} \mathbb{1}_{\{\Sigma Z^1(u) = \sigma\}} du.$$

By the weak uniqueness for the solution to (8.13), Proposition 8.4.4 can be applied to Z^1 and yields

$$\lim_{\epsilon \downarrow 0} \frac{\epsilon}{t} \int_{u=0}^{t/\epsilon} \mathbb{1}_{\{\Sigma Z^1(u) = \sigma\}} du = \int_{z \in M_n} \mathbb{1}_{\{\Sigma z = \sigma\}} d\mu, \quad \mathbb{P}_0\text{-almost surely.}$$

Thus, for all $t \geq 0$, the random variable $R_i^\epsilon(t) := \sum_{\sigma \in S_n} b_i(\sigma) \zeta_\sigma^\epsilon(t)$ converges in probability, in \mathbb{R} , to the deterministic limit $v_i t$ where v_i is the right-hand side of (8.15). As a consequence, the process R_i^ϵ converges in finite-dimensional distribution to the process $v_i t$. On the other hand, since

$$\forall 0 \leq s \leq t, \quad |R_i^\epsilon(t) - R_i^\epsilon(s)| = \left| \int_{r=s}^t b_i(\Sigma X^\epsilon(r)) dr \right| \leq \max_{\sigma \in S_n} |b_i(\sigma)| (t - s),$$

the modulus of continuity of R_i^ϵ is uniformly bounded with respect to ϵ . Therefore, by the Arzelà-Ascoli theorem, the family of the laws of R_i^ϵ is tight and, for all $T > 0$, R_i^ϵ converges in probability, in $C([0, T], \mathbb{R})$, to the deterministic process $v_i t$. Finally, since

$$\forall t \in [0, T], \quad |R_i^\epsilon(t)| \leq \max_{\sigma \in S_n} |b_i(\sigma)| T,$$

then R_i^ϵ is bounded on $[0, T]$ uniformly in ϵ , therefore the convergence of R_i^ϵ to $v_i t$ also holds in $L^2_{\text{loc}}(\mathbb{P}_0)$. As a consequence, $X_i^\epsilon = R_i^\epsilon + \sqrt{2\epsilon} W_i$ converges to $v_i t$ in $L^2_{\text{loc}}(\mathbb{P}_0)$, so that X^ϵ converges to $(v_1 t, \dots, v_n t)$ in $L^2_{\text{loc}}(\mathbb{P}_0)$. The fact that v_i does not depend on i finally follows from Proposition 8.4.1. \square

Remark 8.4.6. In the two-particle case addressed in Section 8.2, the explicit computation of the velocity of the cluster as a function of b was made possible by the fact that the two quantities $\zeta_{(12)}^\epsilon(t)$ and $\zeta_{(21)}^\epsilon(t)$ satisfy the two independent relations

$$\begin{aligned} \zeta_{(12)}^\epsilon(t) + \zeta_{(21)}^\epsilon(t) &= t, \\ \lim_{\epsilon \downarrow 0} b_1(12) \zeta_{(12)}^\epsilon(t) + b_1(21) \zeta_{(21)}^\epsilon(t) &= \lim_{\epsilon \downarrow 0} b_2(12) \zeta_{(12)}^\epsilon(t) + b_2(21) \zeta_{(21)}^\epsilon(t). \end{aligned}$$

As soon as $n \geq 3$, under the stability condition (SC), the $n!$ unknown quantities $\zeta_\sigma^\epsilon(t)$, $\sigma \in S_n$ satisfy the n independent relations

$$\begin{aligned} \sum_{\sigma \in S_n} \zeta_\sigma^\epsilon(t) &= t, \\ \text{for all } i \in \{1, \dots, n\}, \quad \lim_{\epsilon \downarrow 0} \sum_{\sigma \in S_n} b_i(\sigma) \zeta_\sigma^\epsilon(t) &\text{ does not depend on } i, \end{aligned}$$

which is not enough to determine the small noise limit of the quantities $\zeta_\sigma^\epsilon(t)$, $\sigma \in S_n$.

Under the strong stability condition (SSC), another strategy to compute the velocity v of the cluster consists in a straightforward application of the formula (8.15), which requires to compute μ by solving the elliptic problem $L^* \mu = 0$ on M_n , where the infinitesimal generator L of the solution to (8.13) is constant on each cone $\{z = (z_1, \dots, z_n) \in M_n : \Sigma z = \sigma\}$, $\sigma \in S_n$. This task can be carried out in the rank-based case [115, Theorem 8, p. 2187], and can easily be extended to perturbations of this case where, letting $b = (b_1, \dots, b_n) \in \mathbb{R}^n$ as in Section 8.3 and $b' : S_n \rightarrow \mathbb{R}$, the drift of the i -th particle in the configuration σ is given by $b_{\sigma^{-1}(i)} + b'(\sigma)$. However, we were not able to extend this approach to the general order-based case.

8.4.3 A counterexample to necessariness

Unlike in the rank-based case, the stability condition (SC) and *a fortiori* the strong stability condition (SSC) are not necessary for all the particles to aggregate into a single cluster in the small noise limit. Indeed, consider the following example with $n = 3$: let $b(123) = (\lambda_1, \lambda_2, \lambda_3)$, $b(132) = (\eta_1, \eta_3, \eta_2)$ and $b_{\sigma(1)}(\sigma) = 1$, $b_{\sigma(2)}(\sigma) = 0$, $b_{\sigma(3)}(\sigma) = -1$ for all $\sigma \in S_3 \setminus \{(123), (132)\}$. We choose $(\lambda_1, \lambda_2, \lambda_3)$ and (η_1, η_2, η_3) in such a way that the configuration (123) does not satisfy the stability condition (SC), which is the case if for instance $\lambda_1 < (\lambda_2 + \lambda_3)/2$, but the particles still aggregate into a single cluster in the small noise limit.

We only give the main idea of the counterexample, the details of the proof are of the same nature as in Appendix 8.A. When X^ϵ is not in the configurations $\{(123), (132)\}$, the instantaneous drifts of the particles tend to keep them close to each other. During an excursion of X^ϵ in the configurations $\{(123), (132)\}$, *i.e.* an excursion of the first particle on the left of the two other particles, the average velocity of the first particle writes $v^1 = \rho\lambda_1 + (1 - \rho)\eta_1$, where ρ is the relative amount of time spent in the configuration (123) during the excursion.

If the configurations (123) and (132) are such that $\lambda_2 > \lambda_3$ and $\eta_3 > \eta_2$, then in both configurations (123) and (132), the subsystem composed by the second and the third particles is converging/converging in the sense of Section 8.2. As a consequence, the relative amount of time ρ spent in the configuration (123) during the excursion approximately writes $\rho = (\eta_3 - \eta_2)/(\lambda_2 - \lambda_3 + \eta_3 - \eta_2)$. Therefore, during the excursion, the average velocity of the subsystem composed by the second and the third particles approximately writes

$$v^{23} = \frac{\eta_3\lambda_2 - \eta_2\lambda_3}{\lambda_2 - \lambda_3 + \eta_3 - \eta_2}.$$

Note that, by the definition of ρ ,

$$v^{23} = \rho\lambda_2 + (1 - \rho)\eta_2 = \rho\lambda_3 + (1 - \rho)\eta_3 = \rho\frac{\lambda_2 + \lambda_3}{2} + (1 - \rho)\frac{\eta_2 + \eta_3}{2}.$$

The particles tend to get closer to each other if $v^1 \geq v^{23}$.

Let us fix some arbitrary values of $\lambda_2, \lambda_3, \eta_2, \eta_3$ such that $\lambda_2 > \lambda_3$ and $\eta_3 > \eta_2$. This prescribes a given value for $\rho \in (0, 1)$. The key observation is that ρ does not depend on the values of λ_1 and η_1 . Of course, if λ_1 and η_1 are chosen so that both (123) and (132) satisfy the stability condition (SC), then $\lambda_1 \geq (\lambda_2 + \lambda_3)/2$ and $\eta_1 \geq (\eta_2 + \eta_3)/2$, and the inequality $v^1 \geq v^{23}$ is straightforward. Let us now fix $\lambda_1 < (\lambda_2 + \lambda_3)/2$, so that the configuration (123) does not satisfy the stability condition (SC): in this configuration, the first particle drifts away to the left of the second and the third particles. But, since ρ and v^{23} do not depend on the value of η_1 , the latter can be taken large enough for the inequality $\rho\lambda_1 + (1 - \rho)\eta_1 \geq v^{23}$ to hold, and therefore we recover $v^1 \geq v^{23}$. To sum up, the configuration (132) can be chosen ‘converging enough’ to balance the ‘diverging tendency’ of the configuration (123). As a consequence, the particles still aggregate into a single cluster in the small noise limit, while the stability condition (SC) is not satisfied.

8.5 Conclusion

Let us conclude this chapter by stating a few conjectures as regards the general behaviour of the process X^ϵ in the small noise limit. Excluding the degenerate situations such as the case $b^+ = b^- = 0$ in Section 8.2 and recalling that, for all $\sigma \in S_n$, $\zeta_\sigma^\epsilon(t)$ is the occupation time of ΣX^ϵ in the configuration σ , we expect that the quantity

$$\rho_\sigma := \lim_{\epsilon \downarrow 0} \frac{1}{t} \zeta_\sigma^\epsilon(t)$$

does not depend on t for $t < t^*$, where t^* should be thought of as the smallest possible instant of collision between two particles with distinct initial position in the small noise limit. Note that $\rho = (\rho_\sigma)_{\sigma \in S_n}$ is a probability distribution on S_n . It is either random, in which case the particle system in the small noise limit randomly selects a trajectory among several possible ones, or deterministic,

in which case the motion of the particle system in the small noise limit is deterministic. For a given realization of ρ , the particles travel with constant velocity vector $b^\rho := \sum_{\sigma \in S_n} \rho_\sigma b(\sigma)$ on $[0, t^*]$.

Let us fix a realization of ρ . Then either all the particles drift away from each other without aggregating into clusters, or several groups of particles aggregate into clusters. This is observed on ρ as follows: in the first case, $\rho = \delta_\sigma$, where δ_σ is the Dirac measure in the configuration σ corresponding to the order in which the particles drift away from each other. Then, $b^\rho = b(\sigma)$ and $b_{\sigma(1)}(\sigma) < \dots < b_{\sigma(n)}(\sigma)$. In the second case, let $\{i_1, \dots, j_1\}, \dots, \{i_k, \dots, j_k\}$ refer to the sets of indices composing each of the k clusters, with $k \geq 1$, $i_1 < j_1 < \dots < i_k < j_k$. Then, the support of ρ , *i.e.* the set of $\sigma \in S_n$ such that $\rho_\sigma > 0$, is exactly described by the set of products $\sigma^1 \dots \sigma^k$, where $(\sigma^1, \dots, \sigma^k)$ is such that, for all $l \in \{1, \dots, k\}$, σ^l leaves the set $\{1, \dots, n\} \setminus \{i_l, \dots, j_l\}$ invariant. As is noted in Remark 8.4.6, the detailed computation of the weights ρ_σ associated with such permutations remains an open question.

As far as the law of the random probability distribution ρ is concerned, if there exists $\sigma \in S_n$ such that $b_{\sigma(1)}(\sigma) < \dots < b_{\sigma(n)}(\sigma)$, then the support of the law of ρ is given by the set of the Dirac distributions in each such σ . The weights associated with each such σ can be computed by solving an elliptic problem similar to the one introduced in the proof of Lemma 8.A.1 in Appendix 8.A, in higher dimensions. To our knowledge, there is no explicit solution to such a multidimensional problem.

If there is no permutation $\sigma \in S_n$ such that $b_{\sigma(1)}(\sigma) < \dots < b_{\sigma(n)}(\sigma)$, then determining the law of ρ in terms of b amounts to determining the sets of particles that can form clusters with positive probability. This requires a combinatorial analysis of b that remains unclear to us.

The analysis of collisions above allows us to provide a global description of the small noise limit of X^ϵ : excluding again the degenerate situations such as the case $b^+ = b^- = 0$ in Section 8.2, then between two collisions, the particles travel with a constant velocity, either alone or into clusters, depending on the outcome of the latest collision. At each collision, the velocity of all the particles are modified, possibly randomly. The colliding particles can stick into clusters, and clusters of particles not involved in the collision can be splitted.

The small noise limit of X^ϵ somehow behaves like the *generalized flows* introduced by E and Vanden-Eijnden [51]. Indeed, it follows a deterministic trajectory, that has to be interpreted as a solution to the zero noise ODE $\dot{x} = b(\Sigma x)$ in an appropriate sense, then randomly selects a new trajectory at each collision, *i.e.* at each new singularity for the ODE. But whereas E and Vanden-Eijnden observed a loss of the Markov property for some particular examples of generalized flows, which was also the case in the work by Delarue, Flandoli and Vincenzi discussed in introduction [47], we conjecture that in the order-based case, the small noise limit remains a (piecewise deterministic) Markov process. Indeed, the strong Markov property for the process X^ϵ induces a loss of memory at the collision (see the proof of Corollary 8.2.6 in Appendix 8.A below), so that the law of the small noise limit at a collision is the same as if the process restarts in the current position.

8.A Proofs in the two-particle case

This appendix contains the remaining proofs in the two-particle case of Section 8.2; namely the proofs of cases (i), (ii) and (iii) in Lemma 8.2.3 and the proof of Corollary 8.2.6.

When the particles have the same initial position, cases (i), (ii) and (iii) in Lemma 8.2.3 correspond to situations in which the small noise limit of X^ϵ concentrates on the extremal solutions x^- and x^+ associated with diverging configurations. Similarly to [9], the computation of the weights associated with x^- and x^+ in the diverging/diverging situation relies on the resolution of a one-dimensional elliptic problem. This task is carried out in Subsection 8.A.1, in a slightly more general framework, independent of the remainder of this chapter. The proofs of cases (i), (ii) and (iii) in Lemma 8.2.3 are provided in Subsection 8.A.2.

The proof of Corollary 8.2.6, which addresses the small noise limit of Z^ϵ when $z^0 \neq 0$, is given in Subsection 8.A.3.

8.A.1 Auxiliary results in the diverging/diverging case

Let $a^+ : [0, +\infty) \rightarrow \mathbb{R}$, $a^- : (-\infty, 0] \rightarrow \mathbb{R}$ be bounded and continuous functions, such that $a^-(0) < 0$ and $a^+(0) > 0$. We define the function $a : \mathbb{R} \rightarrow \mathbb{R}$ by $a(z) := a^+(z)$ if $z > 0$, and $a(z) := a^-(z)$ if $z \leq 0$. By the Girsanov theorem, for all $z^0 \in \mathbb{R}$, the stochastic differential equation

$$\forall t \geq 0, \quad Z^\epsilon(t) = z^0 + \int_{s=0}^t a(Z^\epsilon(s))ds + 2\sqrt{\epsilon}B(t), \tag{8.16}$$

admits a unique weak solution defined on some probability space endowed with the probability distribution P_{z^0} . The expectation under P_{z^0} is denoted by E_{z^0} .

Lemma 8.A.1. *Let $\bar{\delta} := 1 \wedge \inf\{\delta \geq 0 : a^+(\delta) = 0 \text{ or } a^-(-\delta) = 0\} > 0$. For all $\delta \in (0, \bar{\delta})$, let $\tau_\delta := \inf\{t \geq 0 : |Z^\epsilon(t)| = \delta\}$. Then, for all $z^0 \in [-\delta, \delta]$, τ_δ is finite P_{z^0} -almost surely, and*

$$P_0(Z^\epsilon(\tau_\delta) = \delta) = \left(\frac{\int_{y=0}^{\delta} \exp\left(-\frac{1}{2\epsilon} \int_{x=0}^y a^+(x)dx\right) dy}{\int_{y=-\delta}^0 \exp\left(\frac{1}{2\epsilon} \int_{x=y}^0 a^-(x)dx\right) dy} \right)^{-1}.$$

The limit of the quantity above when ϵ goes to 0 is given by the following corollary.

Corollary 8.A.2. *Under the assumptions of Lemma 8.A.1, for any $\bar{\epsilon} > 0$ and any function $\delta : (0, \bar{\epsilon}) \rightarrow (0, \bar{\delta})$ such that $\epsilon/\delta(\epsilon)$ vanishes with ϵ , then*

$$\lim_{\epsilon \downarrow 0} P_0(Z^\epsilon(\tau_{\delta(\epsilon)}) = \delta(\epsilon)) = \frac{a^+(0)}{a^+(0) - a^-(0)}.$$

Proof of Lemma 8.A.1. Let $z^0 \in \mathbb{R}$. Under P_{z^0} , for all $t \geq 0$, the Itô-Tanaka formula writes

$$|Z^\epsilon(t)| = |z^0| + \int_{s=0}^t \text{sgn}(Z^\epsilon(s))a(Z^\epsilon(s))ds + 2\sqrt{\epsilon}\tilde{B}(t) + L^\epsilon(t),$$

where the local time L^ϵ at 0 of the semimartingale Z^ϵ is a nonnegative process, and the process \tilde{B} defined by

$$\forall t \geq 0, \quad \tilde{B}(t) := \int_{s=0}^t \text{sgn}(Z^\epsilon(s))dB(s)$$

is a Brownian motion, due to Lévy’s characterization. Since $\delta < \bar{\delta}$, for all $t \leq \tau_\delta$, $a^+(|Z^\epsilon(t)|) > 0$ and $a^-(-|Z^\epsilon(t)|) < 0$, so that $\text{sgn}(Z^\epsilon(t))a(Z^\epsilon(t)) \geq 0$ and $|Z^\epsilon(t)| \geq |z^0| + 2\sqrt{\epsilon}\tilde{B}(t)$. As a consequence, if $|z^0| \leq \delta$ then $\tau_\delta \leq \inf\{t > 0 : |z^0| + 2\sqrt{\epsilon}\tilde{B}(t) = \delta\}$, which is known to be finite P_{z^0} -almost surely [94, Remark 8.3, p. 96]. Hence, τ_δ is finite almost surely.

Let u be the solution to the elliptic problem on $[-\delta, \delta]$:

$$\begin{cases} 2\epsilon u''(z) + a(z)u'(z) = 0, \\ u(-\delta) = 0, \quad u(\delta) = 1, \end{cases}$$

given by

$$\forall z \in [-\delta, \delta], \quad u(z) = \frac{\int_{y=-\delta}^z \exp(-A(y)/2\epsilon)dy}{\int_{y=-\delta}^{\delta} \exp(-A(y)/2\epsilon)dy},$$

where $A(y) := \int_{x=0}^y a(x)dx$. Then u is C^1 on $[-\delta, \delta]$, and u' is absolutely continuous with respect to the Lebesgue measure, so that, under P_{z^0} , $u(Z^\epsilon(\cdot \wedge \tau_\delta))$ is a martingale. By the martingale stopping theorem, for all $t \geq 0$, $E_{z^0}(u(Z^\epsilon(t \wedge \tau_\delta))) = u(z^0)$ and the dominated convergence theorem now yields $E_{z^0}(u(Z^\epsilon(\tau_\delta))) = P_{z^0}(Z^\epsilon(\tau_\delta) = \delta) = u(z^0)$. The conclusion follows from taking $z^0 = 0$. \square

Proof of Corollary 8.A.2. The proof is based on the Laplace method. More precisely, we prove that

$$\int_{y=0}^{\delta(\epsilon)} \exp\left(-\frac{1}{2\epsilon} \int_{x=0}^y a^+(x) dx\right) dy \underset{\epsilon \downarrow 0}{\sim} \frac{2\epsilon}{a^+(0)},$$

and the same arguments lead to

$$\int_{y=-\delta(\epsilon)}^0 \exp\left(\frac{1}{2\epsilon} \int_{x=y}^0 a^-(x) dx\right) dy \underset{\epsilon \downarrow 0}{\sim} -\frac{2\epsilon}{a^-(0)},$$

which yields the expected result. Let us fix $\eta \in (0, 1)$. Then by the right continuity of a^+ in 0, there exists $x_0 > 0$ such that, for all $x \in [0, x_0]$, $(1 - \eta)a^+(0) \leq a^+(x) \leq (1 + \eta)a^+(0)$. As a consequence,

$$\begin{aligned} \int_{y=0}^{\delta(\epsilon) \wedge x_0} \exp\left(-\frac{(1 + \eta)a^+(0)}{2\epsilon} y\right) dy &\leq \int_{y=0}^{\delta(\epsilon) \wedge x_0} \exp\left(-\frac{1}{2\epsilon} \int_{x=0}^y a^+(x) dx\right) dy \\ &\leq \int_{y=0}^{\delta(\epsilon) \wedge x_0} \exp\left(-\frac{(1 - \eta)a^+(0)}{2\epsilon} y\right) dy. \end{aligned}$$

Computing both the left- and the right-hand side above and using the facts that $a^+(0) > 0$ and $\delta(\epsilon)/\epsilon$ goes to $+\infty$ when ϵ goes to 0, we deduce that

$$\begin{aligned} \liminf_{\epsilon \downarrow 0} \frac{a^+(0)}{2\epsilon} \int_{y=0}^{\delta(\epsilon) \wedge x_0} \exp\left(-\frac{1}{2\epsilon} \int_{x=0}^y a^+(x) dx\right) dy &\geq \frac{1}{1 + \eta}, \\ \limsup_{\epsilon \downarrow 0} \frac{a^+(0)}{2\epsilon} \int_{y=0}^{\delta(\epsilon) \wedge x_0} \exp\left(-\frac{1}{2\epsilon} \int_{x=0}^y a^+(x) dx\right) dy &\leq \frac{1}{1 - \eta}. \end{aligned}$$

Furthermore,

$$\begin{aligned} \frac{a^+(0)}{2\epsilon} \int_{y=\delta(\epsilon) \wedge x_0}^{\delta(\epsilon)} \exp\left(-\frac{1}{2\epsilon} \int_{x=0}^y a^+(x) dx\right) dy \\ \leq \mathbf{1}_{\{\delta(\epsilon) > x_0\}} \frac{a^+(0)}{2\epsilon} \int_{y=x_0}^{\delta(\epsilon)} \exp\left(-\frac{1}{2\epsilon} \int_{x=0}^{x_0} a^+(x) dx\right) dy \\ \leq \mathbf{1}_{\{\delta(\epsilon) > x_0\}} \frac{a^+(0)}{2\epsilon} \exp\left(-\frac{1}{2\epsilon} \int_{x=0}^{x_0} a^+(x) dx\right), \end{aligned}$$

where we used the fact that $\delta(\epsilon) \leq \bar{\delta} \leq 1$ by definition. The right-hand side above certainly vanishes when ϵ goes to 0. Since η is arbitrary, the proof is completed. \square

8.A.2 Remaining proofs in Lemma 8.2.3

Since, for all $t \geq 0$,

$$\zeta^\epsilon(t) = \int_{s=0}^t \mathbf{1}_{\{Z^\epsilon(s) \leq 0\}} ds,$$

the process ζ^ϵ is measurable with respect to the filtration generated by the Brownian motion $B = (W_1 - W_2)/\sqrt{2}$. Therefore, the convergences of cases (i), (ii) and (iii) Lemma 8.2.3 are stated in $L_{\text{loc}}^1(\mathbb{P}_0)$, where the index 0 stands for the value of z^0 .

Let us begin with the proof of case (ii). Since case (iii) is symmetric, the proof is the same.

Proof of (ii). Let us assume that $b^+ > 0$, $b^- \geq 0$ and fix $T > 0$. For all $t \in [0, T]$,

$$\mathbb{E}_0 \left(\sup_{t \in [0, T]} \zeta^\epsilon(t) \right) \leq \int_{s=0}^T \mathbb{P}_0(Z^\epsilon(s) \leq 0) ds.$$

Before proving that, for all $s \in [0, T]$, $\mathbb{P}_0(Z^\epsilon(s) \leq 0)$ vanishes with ϵ and concluding thanks to the dominated convergence theorem, let us make the two following remarks.

- Certainly, for all $s \geq 0$, $Z^\epsilon(s) \geq (b^+ \wedge b^-)t + 2\sqrt{\epsilon}B(s)$. Then, as soon as $b^- > 0$,

$$\forall s \in [0, T], \quad \mathbb{P}_0(Z^\epsilon(s) \leq 0) \leq \mathbb{P}_0\left(B(s) \leq -\frac{(b^+ \wedge b^-)s}{2\sqrt{\epsilon}}\right)$$

and the right-hand side vanishes with ϵ .

- In the general case, the density of $Z^\epsilon(s)$ was derived by Karatzas and Shreve [93] but its integration over the half line $(-\infty, 0]$ is not an easy computation.

We provide a rather elementary proof, based on the use of hitting times of the Brownian motion and the strong Markov property for Z^ϵ [129, Theorem 6.2.2, p. 146]. For all $\delta > 0$, let us define $\tau_\delta := \inf\{t > 0 : Z^\epsilon = \delta\}$. Then, for all $s \in [0, T]$,

$$\begin{aligned} \mathbb{P}_0(Z^\epsilon(s) \leq 0) &= \mathbb{P}_0(Z^\epsilon(s) \leq 0, \tau_\delta > s) + \mathbb{P}_0(Z^\epsilon(s) \leq 0, \tau_\delta \leq s) \\ &\leq \mathbb{P}_0(\tau_\delta > s) + \int_{t=0}^s \mathbb{P}_0(Z^\epsilon(s) \leq 0, \tau_\delta \in dt). \end{aligned} \tag{8.17}$$

In the sequel, we shall choose δ as a function of ϵ , going to 0 with ϵ , at a rate ensuring that both terms in the right-hand side above vanish.

Let us address the first of these terms. For all $t \geq 0$, $Z^\epsilon(t) \geq 2\sqrt{\epsilon}B(t)$, therefore $\tau_\delta \leq \sigma_\delta := \inf\{t > 0 : 2\sqrt{\epsilon}B(t) = \delta\}$. Following [94, Remark 8.3, p. 96], σ_δ converges in probability to 0 as soon as $\delta/\sqrt{\epsilon}$ goes to 0. Under this condition, $\mathbb{P}_0(\tau_\delta > s)$ vanishes for all $s > 0$.

Let us now address the second term in the right-hand side of (8.17). By the strong Markov property,

$$\begin{aligned} \int_{t=0}^s \mathbb{P}_0(Z^\epsilon(s) \leq 0, \tau_\delta \in dt) &= \int_{t=0}^s \mathbb{P}_0(Z^\epsilon(s) \leq 0 | \tau_\delta = t) \mathbb{P}_0(\tau_\delta \in dt) \\ &\leq \int_{t=0}^s \mathbb{P}_0(\inf\{r \geq t : Z^\epsilon(r) = 0\} < +\infty | \tau_\delta = t) \mathbb{P}_0(\tau_\delta \in dt) \\ &= \int_{t=0}^s \mathbb{P}_0(\inf\{r \geq t : \delta + b^+(r-t) + 2\sqrt{\epsilon}(B(r) - B(t)) = 0\} < +\infty | \tau_\delta = t) \mathbb{P}_0(\tau_\delta \in dt) \\ &= \int_{t=0}^s \mathbb{P}_0(\inf\{r \geq 0 : \delta + b^+r + 2\sqrt{\epsilon}B(r) = 0\} < +\infty) \mathbb{P}_0(\tau_\delta \in dt) \\ &\leq \mathbb{P}_0(\inf\{r \geq 0 : \delta + b^+r + 2\sqrt{\epsilon}B(r) = 0\} < +\infty). \end{aligned}$$

By [94, pp. 196-197], $\mathbb{P}_0(\inf\{r \geq 0 : \delta + b^+r + 2\sqrt{\epsilon}B(r) = 0\} < +\infty) = \exp(-b^+\delta/2\epsilon)$, and the latter vanishes as soon as ϵ/δ goes to 0. As a conclusion, taking $\delta = \epsilon^{3/4}$ allows to prove that the right-hand side of (8.17) vanishes with ϵ , and the proof is completed. \square

We now address case (i).

Proof of case (i). Let us assume that $b^+ > 0$, $b^- < 0$ and fix $T > 0$. Let $F : C([0, T], \mathbb{R}) \rightarrow \mathbb{R}$ be bounded and Lipschitz continuous, with unit Lipschitz norm. Our purpose is to prove that

$$\lim_{\epsilon \downarrow 0} \mathbb{E}_0(F(\zeta^\epsilon)) = \frac{b^+}{b^+ - b^-} F(0) + \frac{-b^-}{b^+ - b^-} F(t),$$

where we recall that t denotes the process $(t)_{t \geq 0}$. Then the conclusion follows from the Portmanteau theorem [18, Theorem 2.1, p. 16].

For $\delta > 0$, let $\tau_\delta := \inf\{t > 0 : |Z^\epsilon(t)| = \delta\}$. Note that the definition of τ_δ is not the same as in the proof of case (ii) because of the absolute value. Then

$$\begin{aligned} &\left| \mathbb{E}_0(F(\zeta^\epsilon)) - \frac{b^+}{b^+ - b^-} F(0) - \frac{-b^-}{b^+ - b^-} F(t) \right| \\ &\leq \left| \mathbb{E}_0(F(\zeta^\epsilon) \mathbb{1}_{\{Z^\epsilon(\tau_\delta) = \delta\}}) - \frac{b^+}{b^+ - b^-} F(0) \right| + \left| \mathbb{E}_0(F(\zeta^\epsilon) \mathbb{1}_{\{Z^\epsilon(\tau_\delta) = -\delta\}}) - \frac{-b^-}{b^+ - b^-} F(t) \right|, \end{aligned}$$

and we prove that the first term of the right-hand side above vanishes with ϵ . The same arguments work for the second term.

By the Lipschitz continuity of F ,

$$\begin{aligned} & \left| \mathbb{E}_0 \left(F(\zeta^\epsilon) \mathbb{1}_{\{Z^\epsilon(\tau_\delta) = \delta\}} \right) - \frac{b^+}{b^+ - b^-} F(0) \right| \\ & \leq \left| \mathbb{E}_0 \left((F(\zeta^\epsilon) - F(0)) \mathbb{1}_{\{Z^\epsilon(\tau_\delta) = \delta\}} \right) \right| + \left| F(0) \left(\mathbb{P}_0(Z^\epsilon(\tau_\delta) = \delta) - \frac{b^+}{b^+ - b^-} \right) \right| \\ & \leq \mathbb{E}_0 \left(\mathbb{1}_{\{Z^\epsilon(\tau_\delta) = \delta\}} \sup_{t \in [0, T]} \zeta^\epsilon(t) \right) + \left| F(0) \left(\mathbb{P}_0(Z^\epsilon(\tau_\delta) = \delta) - \frac{b^+}{b^+ - b^-} \right) \right|. \end{aligned}$$

Owing to the uniqueness in law of solutions to (8.16) above, Corollary 8.A.2 ensures that the second term in the right-hand side above vanishes as soon as ϵ/δ goes to 0. The first term satisfies

$$\begin{aligned} \mathbb{E}_0 \left(\mathbb{1}_{\{Z^\epsilon(\tau_\delta) = \delta\}} \sup_{t \in [0, T]} \zeta^\epsilon(t) \right) &= \mathbb{E}_0 \left(\mathbb{1}_{\{Z^\epsilon(\tau_\delta) = \delta\}} \int_{s=0}^T \mathbb{1}_{\{Z^\epsilon(s) \leq 0\}} ds \right) \\ &= \int_{s=0}^T \mathbb{P}_0(Z^\epsilon(\tau_\delta) = \delta, Z^\epsilon(s) \leq 0) ds. \end{aligned}$$

We now prove that, for all $s \in [0, T]$, $\mathbb{P}_0(Z^\epsilon(\tau_\delta) = \delta, Z^\epsilon(s) \leq 0)$ vanishes for a suitable choice of δ depending on ϵ . By the same arguments as in the proof of (ii),

$$\begin{aligned} & \mathbb{P}_0(Z^\epsilon(\tau_\delta) = \delta, Z^\epsilon(s) \leq 0) \\ &= \mathbb{P}_0(Z^\epsilon(\tau_\delta) = \delta, Z^\epsilon(s) \leq 0, \tau_\delta > s) + \mathbb{P}_0(Z^\epsilon(\tau_\delta) = \delta, Z^\epsilon(s) \leq 0, \tau_\delta \leq s) \\ &\leq \mathbb{P}_0(\tau_\delta > s) + \mathbb{P}_0(\inf\{r \geq 0 : \delta + b^+ r + 2\sqrt{\epsilon} \tilde{B}(r) = 0\} < +\infty) \\ &= \mathbb{P}_0(\tau_\delta > s) + \exp(-b^+ \delta / 2\epsilon). \end{aligned}$$

The second term in the right-hand side above vanishes as soon as ϵ/δ goes to 0. To control the first term, let us use the Itô-Tanaka formula and compute

$$|Z^\epsilon(t)| = \int_{s=0}^t \operatorname{sgn}(Z^\epsilon(s)) \ell(Z^\epsilon(s)) ds + 2\sqrt{\epsilon} \int_{s=0}^t \operatorname{sgn}(Z^\epsilon(s)) dB(s) + L^\epsilon(t),$$

where the local time L^ϵ at 0 of the semimartingale Z^ϵ is a nonnegative process. Besides, for all $z \in \mathbb{R}$, $\operatorname{sgn}(z)\ell(z) \geq 0$ and the process \tilde{B} defined by

$$\tilde{B}(t) = \int_{s=0}^t \operatorname{sgn}(Z^\epsilon(s)) dB(s)$$

is a Brownian motion, due to Lévy's characterization. As a consequence, $|Z^\epsilon(t)| \geq 2\sqrt{\epsilon}\tilde{B}(t)$, therefore $\tau_\delta \leq \sigma_\delta := \inf\{t \geq 0 : 2\sqrt{\epsilon}\tilde{B}(t) = \delta\}$. By the same argument as in the proof of (ii), $\mathbb{P}_0(\tau_\delta > s)$ vanishes as soon as $\delta/\sqrt{\epsilon}$ goes to 0. We complete the proof by letting $\delta = \epsilon^{3/4}$. \square

8.A.3 Proof of Corollary 8.2.6

Certainly, the cases $z^0 > 0$ and $z^0 < 0$ are symmetric, therefore we only address the case $z^0 > 0$. Recall that, in this case, the process z^\downarrow is defined by:

- if $b^+ \geq 0$, $z^\downarrow(t) = z^0 + b^+ t$ for all $t \geq 0$;
- if $b^+ < 0$ and $b^- \geq 0$, $z^\downarrow(t) = z^0 + b^+ t$ if $t < t^* := z^0/(-b^+)$ and $z^\downarrow(t) = 0$ for $t \geq t^*$;
- if $b^+ < 0$ and $b^- < 0$, $z^\downarrow(t) = z^0 + b^+ t$ if $t < t^*$ and $z^\downarrow(t) = b^-(t - t^*)$ for $t \geq t^*$.

Proof of Corollary 8.2.6. Let us assume that $z^0 > 0$. Let $\tau_\epsilon := \inf\{t \geq 0 : Z^\epsilon(t) = 0\} = \inf\{t \geq 0 : z^0 + b^+t + 2\sqrt{\epsilon}B(t) = 0\}$. Following Karatzas and Shreve [94, Exercise 5.10, p. 197], the Laplace transform of τ_ϵ writes

$$\forall \alpha > 0, \quad \mathbb{E}_{z^0}(\exp(-\alpha\tau_\epsilon)) = \exp\left(-\frac{b^+z^0}{4\epsilon} - \frac{z^0}{2\sqrt{\epsilon}}\sqrt{\frac{(b^+)^2}{4\epsilon} + 2\alpha}\right),$$

so that one easily deduces that:

- if $b^+ \geq 0$, then for all $T > 0$, $\lim_{\epsilon \downarrow 0} \mathbb{P}_{z^0}(\tau_\epsilon \leq T) = 0$,
- if $b^+ < 0$, then τ_ϵ converges in probability to $t^* = z^0/(-b^+)$.

We first address the case $b^+ \geq 0$. Then, for all $T > 0$,

$$\begin{aligned} & \mathbb{E}_{z^0} \left(\sup_{t \in [0, T]} |Z^\epsilon(t) - z^\downarrow(t)| \right) \\ &= \mathbb{E}_{z^0} \left(\sup_{t \in [0, T]} |Z^\epsilon(t) - z^\downarrow(t)| \mathbf{1}_{\{\tau_\epsilon \leq T\}} \right) + \mathbb{E}_{z^0} \left(\sup_{t \in [0, T]} |Z^\epsilon(t) - z^\downarrow(t)| \mathbf{1}_{\{\tau_\epsilon > T\}} \right), \end{aligned}$$

and

$$\begin{aligned} \mathbb{E}_{z^0} \left(\sup_{t \in [0, T]} |Z^\epsilon(t) - z^\downarrow(t)| \mathbf{1}_{\{\tau_\epsilon \leq T\}} \right) &= \mathbb{E}_{z^0} \left(\sup_{t \in [0, T]} |(b^- - b^+)\zeta^\epsilon(t) + 2\sqrt{\epsilon}B(t)| \mathbf{1}_{\{\tau_\epsilon \leq T\}} \right) \\ &\leq |b^- - b^+|T\mathbb{P}(\tau_\epsilon \leq T) + 2\sqrt{\epsilon}\mathbb{E}_{z^0} \left(\sup_{t \in [0, T]} |B(t)| \mathbf{1}_{\{\tau_\epsilon \leq T\}} \right), \end{aligned}$$

while

$$\mathbb{E}_{z^0} \left(\sup_{t \in [0, T]} |Z^\epsilon(t) - z^\downarrow(t)| \mathbf{1}_{\{\tau_\epsilon > T\}} \right) = 2\sqrt{\epsilon}\mathbb{E}_{z^0} \left(\sup_{t \in [0, T]} |B(t)| \mathbf{1}_{\{\tau_\epsilon > T\}} \right).$$

As a consequence,

$$\mathbb{E}_{z^0} \left(\sup_{t \in [0, T]} |Z^\epsilon(t) - z^\downarrow(t)| \right) \leq |b^- - b^+|T\mathbb{P}(\tau_\epsilon \leq T) + 2\sqrt{\epsilon}\mathbb{E}_{z^0} \left(\sup_{t \in [0, T]} |B(t)| \right),$$

and the right-hand side above easily vanishes with ϵ .

We now address the case $b^+ < 0$. Let us first define the random process z_ϵ^\downarrow by

$$\forall t \geq 0, \quad z_\epsilon^\downarrow(t) := \begin{cases} z^0 + b^+t & \text{if } t < \tau_\epsilon, \\ 0 & \text{if } t \geq \tau_\epsilon \text{ and } b^- \geq 0, \\ b^-(t - \tau_\epsilon) & \text{if } t \geq \tau_\epsilon \text{ and } b^- < 0. \end{cases}$$

Note that, for $t \geq \tau_\epsilon$, $z_\epsilon^\downarrow(t)$ writes $b'(t - \tau_\epsilon)$, where $b' := b^- \wedge 0$. We now prove that, for all $T > 0$,

$$\lim_{\epsilon \downarrow 0} \mathbb{E}_{z^0} \left(\sup_{t \in [0, T]} |Z^\epsilon(t) - z_\epsilon^\downarrow(t)| \right) = 0.$$

In this purpose, we fix $T > 0$ and write, on the one hand,

$$\mathbb{E}_{z^0} \left(\sup_{t \in [0, \tau_\epsilon \wedge T]} |Z^\epsilon(t) - z_\epsilon^\downarrow(t)| \right) = \mathbb{E}_{z^0} \left(\sup_{t \in [0, \tau_\epsilon \wedge T]} |2\sqrt{\epsilon}B(t)| \right) \leq 2\sqrt{\epsilon}\mathbb{E}_{z^0} \left(\sup_{t \in [0, T]} |B(t)| \right).$$

On the other hand,

$$\begin{aligned}
\mathbb{E}_{z^0} \left(\sup_{t \in [\tau_\epsilon \wedge T, T]} |Z^\epsilon(t) - z_\epsilon^\downarrow(t)| \right) &= \mathbb{E}_{z^0} \left(\mathbf{1}_{\{\tau_\epsilon \leq T\}} \sup_{t \in [\tau_\epsilon, T]} |Z^\epsilon(t) - b'(t - \tau_\epsilon)| \right) \\
&\leq \mathbb{E}_{z^0} \left(\sup_{s \in [0, T]} |Z^\epsilon(s + \tau_\epsilon) - b's| \right) \\
&= \mathbb{E}_{z^0} \left(\mathbb{E}_{z^0} \left(\sup_{s \in [0, T]} |Z^\epsilon(s + \tau_\epsilon) - b's| \middle| \mathcal{F}_{\tau_\epsilon} \right) \right) \\
&= \mathbb{E}_0 \left(\sup_{s \in [0, T]} |Z^\epsilon(s) - b's| \right),
\end{aligned}$$

where we have used the strong Markov property for the process $(Z^\epsilon(t))_{t \geq 0}$ and the fact that $Z^\epsilon(\tau_\epsilon) = 0$. It now follows from Proposition 8.2.5 that the right-hand side above vanishes with ϵ .

To complete the proof, we finally check that

$$\lim_{\epsilon \downarrow 0} \mathbb{E}_{z^0} \left(\sup_{t \in [0, T]} |z_\epsilon^\downarrow(t) - z^\downarrow(t)| \right) = 0. \tag{8.18}$$

It follows from a straightforward analysis of $|z_\epsilon^\downarrow(t) - z^\downarrow(t)|$ that there exists $C > 0$, depending on b^+ and b' , such that, for all $t \in [0, T]$, $|z_\epsilon^\downarrow(t) - z^\downarrow(t)| \leq C(T \wedge |\tau_\epsilon - t^*|)$. Since τ_ϵ converges in probability to t^* and the function $t \mapsto C(T \wedge |t - t^*|)$ is continuous and bounded, we obtain (8.18) and the proof is completed. \square

Chapitre 9

Une dynamique des particules collantes multitype approchant les systèmes diagonaux hyperboliques

Ce chapitre est issu d'un travail en collaboration avec Benjamin Jourdain et Régis Monneau.

9.1 Introduction

9.1.1 Diagonal hyperbolic systems

Let $d \geq 1$. This chapter is dedicated to the study of solutions

$$\mathbf{u} = (u^1, \dots, u^d) : [0, +\infty) \times \mathbb{R} \rightarrow \mathbb{R}^d$$

to the *diagonal* hyperbolic system

$$\forall \gamma \in \{1, \dots, d\}, \quad \begin{cases} \partial_t u^\gamma + \lambda^\gamma(\mathbf{u}) \partial_x u^\gamma = 0, \\ u^\gamma(0, x) = u_0^\gamma(x), \end{cases} \quad (9.1)$$

where, for all $\gamma \in \{1, \dots, d\}$, u_0^γ is a nonconstant, monotonic, and bounded function on \mathbb{R} . Such initial data can then be interpreted as cumulative distribution functions of bounded positive measures on the real line, and up to rescaling, there is no loss of generality in assuming that these measures are probability measures on the real line. We shall therefore assume that there exist probability measures m^1, \dots, m^d on \mathbb{R} such that

$$\forall \gamma \in \{1, \dots, d\}, \quad u_0^\gamma = H * m^\gamma,$$

where $H * \cdot$ refers to the convolution with the Heaviside function H . Then, it is sufficient to assume that the functions $\lambda^1, \dots, \lambda^d$ are only defined on $[0, 1]^d$.

The purpose of this chapter is to construct solutions \mathbf{u} such that, for all time $t \geq 0$, for all $\gamma \in \{1, \dots, d\}$, the function $u^\gamma(t, \cdot)$ remains the cumulative distribution function of a probability measure on the real line. Such solutions will be called *probabilistic solutions*. In the scalar case $d = 1$, Brenier and Grenier [29] introduced a system of *sticky particles* allowing to approximate the entropy solution to the conservative form of (9.1). Our construction of probabilistic solutions is based on the introduction and detailed analysis of a multitype version of this particle system, that we call the Multitype Sticky Particle Dynamics.

9.1.2 Contents and outline of the chapter

The main achievements of the chapter are:

1. the introduction, in Definition 9.2.12, of a notion of probabilistic solution to (9.1), which is consistent with the notion of entropy solution of the conservative form of (9.1) in the scalar case,
2. the construction of the Multitype Sticky Particle Dynamics and the derivation of an existence result for the hyperbolic system (9.1), in Theorem 9.2.17, based on an approximation by this particle system,
3. the derivation of uniform L^p stability estimates on the particle system, that translate into Wasserstein stability estimates for the semigroup of probabilistic solutions to the hyperbolic system (9.1), in Theorem 9.2.25.

The Wasserstein distance arises from the theory of optimal transport, but turns out to be very well adapted to our probabilistic approach for the hyperbolic system (9.1). Note that estimations in Wasserstein distance have been obtained for the scalar case in [20], without relying on a particle approximation though.

The chapter is organised as follows. The main definitions and results are stated in Section 9.2. The Multitype Sticky Particle Dynamics is introduced in Section 9.3 and uniform L^p stability estimates are obtained in Section 9.4. Probabilistic solutions are finally constructed and described in Section 9.5. Furthermore, Appendix 9.A contains the proofs of some technical results.

9.1.3 Notations and conventions

We introduce a few notations and conventions that we shall use throughout the chapter.

9.1.3.1 Bold symbols

Generically, bold symbols, such as \mathbf{u} in (9.1), refer to objects of size d . Their coordinates, such as u^1, \dots, u^d , are written with thin characters, and labelled with a superscript Greek letter. This letter is usually $\gamma \in \{1, \dots, d\}$ or α, β when two distinct coordinates are at stake, in which case we take the convention that $\alpha < \beta$.

9.1.3.2 Algebraic notations

For all $x, y \in \mathbb{R}$, we let $x \wedge y := \min\{x, y\}$ and $x \vee y := \max\{x, y\}$. Given two sets A and B , the union set $A \cup B$ shall be denoted by $A \sqcup B$ whenever $A \cap B = \emptyset$.

9.1.3.3 Set of probability measures

Given a metric space E , the set of Borel probability measures on E is denoted by $\mathcal{P}(E)$. It is endowed with the topology of weak convergence, which is defined with respect to the set $C_b(E)$ of continuous and bounded functions from E to \mathbb{R} .

Given two metric spaces E, F , a measurable function $g : E \rightarrow F$, and $\mu \in \mathcal{P}(E)$, the *pushforward measure* of μ by the function g , denoted by $\mu \circ g^{-1} \in \mathcal{P}(F)$, is defined by $(\mu \circ g^{-1})(B) = \mu(g^{-1}(B))$ for all Borel set $B \subset F$.

9.2 Main definitions and results

This section contains the main definitions and results of the chapter. The various assumptions we shall make on the velocity field λ are gathered in Subsection 9.2.1. A short presentation of the scalar case, by which both our definition of solutions to the system (9.1) and our particle system are inspired, is made in Subsection 9.2.2. The Multitype Sticky Particle Dynamics that we introduce to approximate the solutions to (9.1) is described in Subsection 9.2.3.

The notion of *probabilistic solution* to the hyperbolic system (9.1) is defined in Subsection 9.2.4. A first existence theorem is stated. Further stability properties of both the particle system and the probabilistic solutions to (9.1) are detailed in Subsection 9.2.5.

A discussion of the links between our method and results and previous works is provided in Subsection 9.2.6.

9.2.1 Assumptions on the velocity field

Our results are stated under various assumptions on the function

$$\boldsymbol{\lambda} = (\lambda^1, \dots, \lambda^d) : [0, 1]^d \rightarrow \mathbb{R}^d,$$

that we now list.

We first introduce continuity conditions.

(C) Continuity: for all $\gamma \in \{1, \dots, d\}$, the function λ^γ is continuous on $[0, 1]^d$.

Under Assumption (C), the functions $\lambda^1, \dots, \lambda^d$ are bounded and we define the family of finite constants $L_{C,p}$, $p \in [1, +\infty]$, by

$$\forall p \in [1, +\infty), \quad L_{C,p} := \left(\sum_{\gamma=1}^d \sup_{\mathbf{u} \in [0,1]^d} |\lambda^\gamma(\mathbf{u})|^p \right)^{1/p}, \quad L_{C,\infty} := \sup_{1 \leq \gamma \leq d} \sup_{\mathbf{u} \in [0,1]^d} |\lambda^\gamma(\mathbf{u})|. \quad (9.2)$$

(LC) Lipschitz Continuity: there exists $L_{LC} \in [0, +\infty)$ such that

$$\forall \gamma \in \{1, \dots, d\}, \quad \forall \mathbf{u}, \mathbf{v} \in [0, 1]^d, \quad |\lambda^\gamma(\mathbf{u}) - \lambda^\gamma(\mathbf{v})| \leq L_{LC} \sum_{\gamma'=1}^d |u^{\gamma'} - v^{\gamma'}|.$$

Of course, Assumption (LC) is stronger than Assumption (C).

The following Uniform Strict Hyperbolicity condition enables us to define the Multitype Sticky Particle Dynamics.

(USH) Uniform Strict Hyperbolicity: there exists $L_{USH} \in (0, +\infty)$ such that

$$\forall \gamma \in \{1, \dots, d-1\}, \quad \inf_{\mathbf{u} \in [0,1]^d} \lambda^\gamma(\mathbf{u}) - \sup_{\mathbf{u} \in [0,1]^d} \lambda^{\gamma+1}(\mathbf{u}) \geq L_{USH}.$$

Note that, under Assumptions (C) and (USH), the triangle inequality implies that $L_{USH} \leq L_{C,1}$.

Our stability estimates are finally obtained under the following Genuine Nonlinearity assumption.

(GNL) For all $\gamma \in \{1, \dots, d\}$, λ^γ is C^1 on $[0, 1]^d$ and

$$\begin{cases} \text{either} & \forall \mathbf{u} \in [0, 1]^d, \quad \partial_\gamma \lambda^\gamma(\mathbf{u}) > 0, \\ \text{or} & \forall \mathbf{u} \in [0, 1]^d, \quad \partial_\gamma \lambda^\gamma(\mathbf{u}) < 0, \end{cases}$$

where $\partial_\gamma \lambda^\gamma$ refers to the partial derivative of λ^γ with respect to u^γ .

Of course, Assumption (GNL) implies Assumption (LC). However, we shall state our results under both assumptions whenever needed, although this is redundant. There are two reasons for this distinction: first, these assumptions play very different roles in our proofs; in particular, our quantitative stability estimates depend on the value of the constant L_{LC} but not on the suprema of the functions $|\partial_\gamma \lambda^\gamma|$. Second, Assumption (GNL) can actually be relaxed to the Diagonal Monotonicity assumption (DM) below, that no longer implies Assumption (LC). This relaxation is discussed in Remark 9.5.12.

(DM) In the sense of distributions,

$$\forall \gamma \in \{1, \dots, d\}, \quad \begin{cases} \text{either} & \forall \mathbf{u} \in [0, 1]^d, \quad \partial_\gamma \lambda^\gamma(\mathbf{u}) \geq 0, \\ \text{or} & \forall \mathbf{u} \in [0, 1]^d, \quad \partial_\gamma \lambda^\gamma(\mathbf{u}) \leq 0. \end{cases}$$

9.2.2 The scalar case

In the *scalar case* $d = 1$, we drop the superscript notation and (9.1) rewrites

$$\begin{cases} \partial_t u + \lambda(u) \partial_x u = 0, \\ u(0, x) = u_0(x), \end{cases}$$

where $u : [0, +\infty) \times \mathbb{R} \rightarrow \mathbb{R}$, $\lambda : [0, 1] \rightarrow \mathbb{R}$ and $u_0 = H * m$ is the cumulative distribution function of the probability measure m on \mathbb{R} . For smooth solutions, this equation is equivalent to the scalar conservation law

$$\begin{cases} \partial_t u + \partial_x (\Lambda(u)) = 0, \\ u(0, x) = u_0(x), \end{cases} \quad (9.3)$$

where the *flux function* $\Lambda : [0, 1] \rightarrow \mathbb{R}$ is defined by

$$\forall u \in [0, 1], \quad \Lambda(u) := \int_{v=0}^u \lambda(v) dv.$$

Brenier and Grenier [29] introduced a space discretisation of the latter equation based on the following Sticky Particle Dynamics: for all $n \geq 1$, consider a system of n particles evolving on the real line, and such that

- the particle in k -th position has initial position $x_k(0) \in \mathbb{R}$, initial velocity $\lambda(k/n)$ and mass $1/n$, where $x_1(0) \leq \dots \leq x_n(0)$,
- between collisions, the particles travel at constant velocity,
- at collisions, the particles stick into clusters, the velocity of which is determined by the conservation of mass and momentum.

This dynamics was introduced by Zel'dovitch [141] as a model of gravitational interaction, and we refer to Subsection 9.3.1 for a detailed introduction.

The Sticky Particle Dynamics defines a continuous flow taking its values in the polyhedron

$$D_n := \{(x_1, \dots, x_n) \in \mathbb{R}^n : x_1 \leq \dots \leq x_n\},$$

a generical element of which shall be denoted by $x = (x_1, \dots, x_n)$. The link between this particle system and the scalar conservation law (9.3) was established by Brenier and Grenier [29, Theorem 2.1] and Jourdain [86, Theorem 1].

Theorem 9.2.1 (Convergence of the Sticky Particle Dynamics). *Let us assume that the function λ is continuous on $[0, 1]$ and that the initial positions of the Sticky Particle Dynamics introduced above are chosen so that the empirical distribution*

$$\frac{1}{n} \sum_{k=1}^n \delta_{x_k(0)}$$

converges weakly to m . Then, for all $t \geq 0$, denoting by $(x_1(t), \dots, x_n(t)) \in D_n$ the positions of the sticky particles at time t , the empirical distribution

$$\frac{1}{n} \sum_{k=1}^n \delta_{x_k(t)}$$

converges weakly to the probability measure $\mu(t)$ on \mathbb{R} , the cumulative distribution function of which is the unique entropy solution to the scalar conservation law (9.3).

Remark 9.2.2. In [86], arbitrary initial data u_0 of bounded variation are considered, while in the present chapter, we restrict our choice of initial data to monotonic and bounded functions. Besides, we do not provide our notion of probabilistic solution to (9.1) with an entropy condition, therefore we do not expect these solutions to be unique. We shall in fact observe in §9.5.3.1 that, in general, uniqueness of probabilistic solutions does not hold.

9.2.3 The Multitype Sticky Particle Dynamics

Sections 9.3 and 9.4 are dedicated to the introduction and study of a *multitype* system of particles that extends the Sticky Particle Dynamics introduced above and allows to approximate solutions to the hyperbolic system (9.1). It describes the evolution of d systems of n particles evolving on the real line, each system being associated with a certain *type* of particle, such that:

- within each system, the particles evolve according to the Sticky Particle Dynamics with initial velocities determined by the global ordering of the particles,
- at collisions between particles of different types, the velocities of the particles are modified in order to take the new ordering into account.

This dynamics is called the Multitype Sticky Particle Dynamics (MSPD). A typical trajectory of the MSPD is plotted on Figure 9.1.

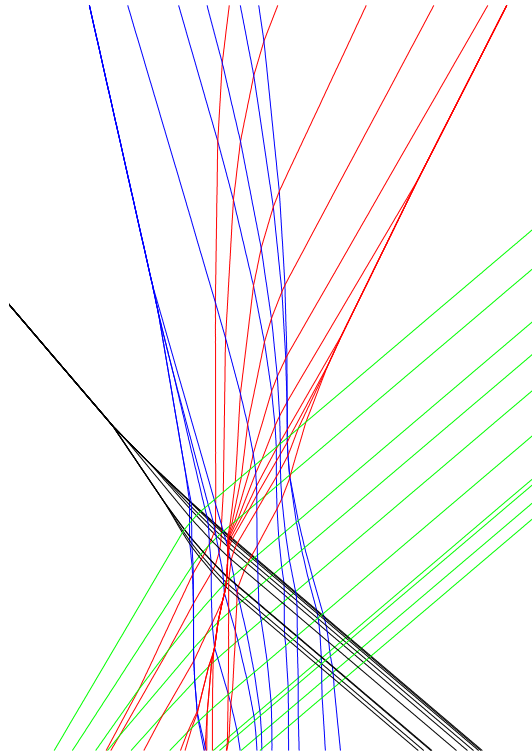

Figure 9.1: A typical trajectory of the MSPD with $d = 4$ types and $n = 10$ particles per type. The horizontal coordinate refers to the physical positions of the particles, while the vertical coordinate describes the time. Each color is associated with a type of particle. Particles of the same type stick together at collisions, and the velocities may be modified at collisions with clusters of different types.

As in the Sticky Particle Dynamics described above, the particles remain ordered within each system, therefore the MSPD takes its values in the Cartesian product $D_n^d := (D_n)^d$, a generical element of which is called a *configuration* and denoted by $\mathbf{x} = (x^1, \dots, x^d)$, where, for all $\gamma \in \{1, \dots, d\}$,

$$\mathbf{x}^\gamma = (x_1^\gamma, \dots, x_n^\gamma) \in D_n.$$

In the configuration \mathbf{x} , the number x_k^γ refers to the position of the k -th particle of type γ . The set of indices $(\gamma, k) \in \{1, \dots, d\} \times \{1, \dots, n\}$ is denoted by P_n^d , and the pair (γ, k) is rather denoted by $\gamma : k \in P_n^d$.

In Section 9.3, we give a detailed construction of this dynamics under Assumption (USH). For all initial configuration $\mathbf{x} \in D_n^d$, we denote by

$$\Phi(\mathbf{x}; t) := (\Phi_k^\gamma(\mathbf{x}; t))_{\gamma: k \in P_n^d} \in D_n^d$$

the positions of the particles at time $t \geq 0$ in the MSPD started at \mathbf{x} . Then we prove that $(\Phi(\cdot; t))_{t \geq 0}$ defines a continuous flow in D_n^d .

Remark 9.2.3. In Chapter 7, a probabilistic system of Brownian particles is introduced to approximate the solution to the parabolic system

$$\forall \gamma \in \{1, \dots, d\}, \quad \begin{cases} \partial_t u^\gamma + \lambda^\gamma(\mathbf{u}) \partial_x u^\gamma = \epsilon \partial_x^2 u^\gamma, \\ u^\gamma(0, x) = u_0^\gamma(x), \end{cases}$$

where $\epsilon > 0$. This system is called *multitype system of particles interacting through their rank*. Using the arguments introduced in Chapter 8 for the scalar case, the MSPD can be shown to describe the limit, when the intensity ϵ of the stochastic noise vanishes, of this system.

9.2.4 Probabilistic solutions to the system (9.1)

Our definition of a probabilistic solution heavily relies of the notion of cumulative distribution function on the real line, the definition and a few properties of which are recalled in §9.2.4.1. The definition of probabilistic solutions is given in §9.2.4.2, and a closedness property of the set of probabilistic solutions is stated in §9.2.4.3. Theorem 9.2.17, which is an existence result for probabilistic solutions, is detailed in §9.2.4.4.

9.2.4.1 Cumulative distribution functions

We first define and state a few properties of cumulative distribution functions (CDFs) on the real line.

Definition 9.2.4 (Cumulative distribution function). *A cumulative distribution function on the real line is a nondecreasing and right continuous function $F : \mathbb{R} \rightarrow [0, 1]$ such that*

$$\lim_{x \rightarrow -\infty} F(x) = 0, \quad \lim_{x \rightarrow +\infty} F(x) = 1.$$

CDFs are generically discontinuous and therefore can have *jumps*, defined as follows.

Definition 9.2.5 (Jumps). *Let F be a CDF on the real line. For all $x \in \mathbb{R}$, the jump of F at x is defined by*

$$\Delta F(x) := F(x) - F(x^-),$$

where

$$F(x^-) := \lim_{y \uparrow x} F(y).$$

The following characterisation of CDFs is fundamental.

Lemma 9.2.6 (CDFs are actual cumulative distribution functions). *The function F is a CDF on the real line if and only if there exists a probability measure $m \in \mathcal{P}(\mathbb{R})$ such that, for all $x \in \mathbb{R}$, then $F(x) = m((-\infty, x])$. In this case, F is said to be the CDF of m , and we denote $F = H * m$, where H refers to the Heaviside function $H(x) := \mathbb{1}_{\{x \geq 0\}}$.*

Certainly, for all $x \in \mathbb{R}$, $\Delta F(x) = m(\{x\})$, and whenever the latter quantity is positive, then x is called an *atom* of m . Note that the set of atoms of m is at most countable, therefore dx -almost everywhere, $\Delta F(x) = 0$.

We now address the *expectation* of a measurable function f in the space $L^1(m)$ of integrable functions with respect to m .

Definition 9.2.7 (Expectation). *If F is the CDF of m , then, for all $f \in L^1(m)$, the expectation of f under m is indifferently denoted*

$$\int_{x \in \mathbb{R}} f(x)m(dx) = \int_{x \in \mathbb{R}} f(x)dF(x).$$

The expectation of f under m can also be expressed in terms of the *pseudo-inverse* of F , defined as follows.

Definition 9.2.8 (Pseudo-inverse). *Let F be a CDF on the real line. Then the pseudo-inverse of F is the function $F^{-1} : (0, 1) \rightarrow \mathbb{R}$ defined by*

$$F^{-1}(v) := \inf\{x \in \mathbb{R} : F(x) \geq v\}. \tag{9.4}$$

The following properties of the pseudo-inverse are straightforward.

Lemma 9.2.9 (Properties of the pseudo-inverse). *Let F be a CDF on the real line.*

- (i) *The function $F^{-1} : (0, 1) \rightarrow \mathbb{R}$ is nondecreasing, left continuous with right limits; in particular, it is continuous dv -almost everywhere on $(0, 1)$.*
- (ii) *For all $v \in (0, 1)$, $F(F^{-1}(v)^-) \leq v \leq F(F^{-1}(v))$.*
- (iii) *For all $x \in \mathbb{R}$, for all $v \in (0, 1)$, then $F^{-1}(v) \leq x$ if and only if $v \leq F(x)$.*

The expectation of f under m satisfies the following *pseudo-inverse function formula*.

Lemma 9.2.10 (Pseudo-inverse function formula). *Let F be the CDF of the probability measure m on \mathbb{R} . Then, for all $f \in L^1(m)$,*

$$\int_{x \in \mathbb{R}} f(x)dF(x) = \int_{v=0}^1 f(F^{-1}(v))dv.$$

Let us point out the fact that, with the notations introduced in Subsection 9.1.3 above, a reformulation of Lemma 9.2.10 is $m = U \circ (F^{-1})^{-1}$, where U refers to the Lebesgue measure on $[0, 1]$.

Weak convergence of probability measures is characterised by CDFs as follows.

Lemma 9.2.11 (Weak convergence and CDFs). *Let $(m_n)_{n \geq 1}$ be a sequence of probability measures on \mathbb{R} and $m \in P(\mathbb{R})$. Let $F_n := H * m_n$ and $F := H * m$. Then m_n converges weakly to m if and only if, for all $x \in \mathbb{R}$ such that $\Delta F(x) = 0$, then $F_n(x)$ converges to $F(x)$. In this case, $F_n^{-1}(v)$ converges to $F^{-1}(v)$ for all continuity point v of F^{-1} , therefore dv -almost everywhere in $(0, 1)$.*

The equivalence between weak convergence and convergence of the CDFs outside of the atoms of the limit is a classical result, see for instance [50, Theorem 2.2, p. 86]. The almost everywhere convergence of pseudo-inverses is often used as a proof of the Skorokhod Representation Theorem on the real line, see [50, Theorem 2.1, p. 85].

We finally introduce a few notations for functions $u : [0, +\infty) \times \mathbb{R} \rightarrow [0, 1]$ such that, for all $t \geq 0$, $u(t, \cdot)$ is a CDF on the real line. For such a function, for all $t \geq 0$,

- the jump of $u(t, \cdot)$ at $x \in \mathbb{R}$ is denoted by $\Delta_x u(t, x)$ and worth $\Delta_x u(t, x) := u(t, x) - u(t, x^-)$, where $u(t, x^-) := \lim_{y \uparrow x} u(t, y)$,
- if $m \in P(\mathbb{R})$ is such that $u(t, \cdot) = H * m$, then for all $f \in L^1(m)$, the expectation of f under m is denoted

$$\int_{x \in \mathbb{R}} f(x)m(dx) = \int_{x \in \mathbb{R}} f(x)d_x u(t, x),$$

and we have

$$\int_{x \in \mathbb{R}} f(x)d_x u(t, x) = \int_{v=0}^1 f(u(t, \cdot)^{-1}(v))dv,$$

where $u(t, \cdot)^{-1}(v)$ refers to the pseudo-inverse of the CDF $u(t, \cdot)$.

9.2.4.2 Definition of probabilistic solutions

In order to define the notion of probabilistic solution to the system (9.1), we let $C_c^{1,0}([0, +\infty) \times \mathbb{R}, \mathbb{R}^d)$ refer to the set of continuous functions

$$\varphi = (\varphi^1, \dots, \varphi^d) : [0, +\infty) \times \mathbb{R} \rightarrow \mathbb{R}^d,$$

with compact support, such that, for all $\gamma \in \{1, \dots, d\}$, the partial derivative $\partial_t \varphi^\gamma$ with respect to the time variable is a continuous function on $[0, +\infty) \times \mathbb{R}$. The functions φ in this set shall be used as test functions in the definition of probabilistic solutions to (9.1).

The main difficulty in defining a notion of solution to the system (9.1) is to make sense of the product $\lambda^\gamma(\mathbf{u}) \partial_x u^\gamma$. Indeed, since we expect $u^\gamma(t, \cdot)$ to be a CDF on the real line for all $t \geq 0$, the function $\lambda^\gamma(\mathbf{u})$ is generically discontinuous at the atoms of the measure $\partial_x u^\gamma$, and therefore this product cannot be defined in the distributional sense.

In the scalar case, it is easily checked that, if $u(t, \cdot)$ is a CDF for all $t \geq 0$, then, for all function $\varphi \in C_c^{1,0}([0, +\infty) \times \mathbb{R}, \mathbb{R})$,

$$-\int_{t=0}^{+\infty} \int_{x \in \mathbb{R}} \partial_x \varphi(t, x) \Lambda(u(t, x)) dx dt = \int_{t=0}^{+\infty} \int_{x \in \mathbb{R}} \varphi(t, x) \lambda\{u\}(t, x) d_x u(t, x) dt, \tag{9.5}$$

where

$$\lambda\{u\}(t, x) := \int_{\theta=0}^1 \lambda((1 - \theta)u(t, x^-) + \theta u(t, x)) d\theta$$

is the average value of $\lambda(u(t, x))$ on the jumps of $u(t, \cdot)$. In other words, replacing $\lambda(u)$ with $\lambda\{u\}$ and then interpreting the product $\lambda\{u\} \partial_x u$ as the bounded measure with density $\lambda\{u\}$ with respect to the mesure $d_x u(t, \cdot)$ on \mathbb{R} , we obtain an equivalent formulation of the scalar conservation law (9.3), which by Theorem 9.2.1 naturally captures the asymptotic behaviour of the Sticky Particle Dynamics.

We proceed similarly for $d \geq 2$ and first take the convention that, at a space-time point (t, x) at which u^γ is discontinuous, then the quantity

$$\lambda^\gamma(\mathbf{u}(t, x)) = \lambda^\gamma(u^1(t, x), \dots, u^{\gamma-1}(t, x), u^\gamma(t, x), u^{\gamma+1}(t, x), \dots, u^d(t, x))$$

should take the average value of

$$\lambda^\gamma(u^1(t, x), \dots, u^{\gamma-1}(t, x), w, u^{\gamma+1}(t, x), \dots, u^d(t, x))$$

for $w \in [u^\gamma(t, x^-), u^\gamma(t, x)]$. Of course, this quantity can no longer be expressed as a function of $u^\gamma(t, x)$, and we introduce the following notation

$$\lambda^\gamma\{\mathbf{u}\}(t, x) := \int_{\theta=0}^1 \lambda^\gamma(u^1(t, x), \dots, (1 - \theta)u^\gamma(t, x^-) + \theta u^\gamma(t, x), \dots, u^d(t, x)) d\theta \tag{9.6}$$

as a substitute for $\lambda^\gamma(\mathbf{u}(t, x))$ in (9.1). Note that the function $\lambda^\gamma\{\mathbf{u}\}$ can be rewritten under the more explicit form

$$\lambda^\gamma\{\mathbf{u}\}(t, x) = \lambda^\gamma(\mathbf{u}(t, x))$$

if $\Delta_x u^\gamma(t, x) = 0$, and

$$\lambda^\gamma\{\mathbf{u}\}(t, x) = \frac{1}{\Delta_x u^\gamma(t, x)} \int_{w=u^\gamma(t, x^-)}^{u^\gamma(t, x)} \lambda^\gamma(u^1(t, x), \dots, u^{\gamma-1}(t, x), w, u^{\gamma+1}(t, x), \dots, u^d(t, x)) dw$$

otherwise.

We are now ready to introduce our notion of probabilistic solution.

Definition 9.2.12 (Probabilistic solution to (9.1)). *Under Assumption (C), a probabilistic solution to the hyperbolic system (9.1) is a measurable function*

$$\mathbf{u} = (u^1, \dots, u^d) : [0, +\infty) \times \mathbb{R} \rightarrow [0, 1]^d,$$

such that:

- (i) for all $t \geq 0$, for all $\gamma \in \{1, \dots, d\}$, then $u^\gamma(t, \cdot)$ is a CDF on the real line,
- (ii) for all test function $\varphi = (\varphi^1, \dots, \varphi^d) \in C_c^{1,0}([0, +\infty) \times \mathbb{R}, \mathbb{R}^d)$,

$$\begin{aligned} & \sum_{\gamma=1}^d \left(\int_{t=0}^{+\infty} \int_{x \in \mathbb{R}} \partial_t \varphi^\gamma(t, x) u^\gamma(t, x) dx dt + \int_{x \in \mathbb{R}} \varphi^\gamma(0, x) u_0^\gamma(x) dx \right) \\ &= \sum_{\gamma=1}^d \int_{t=0}^{+\infty} \int_{x \in \mathbb{R}} \varphi^\gamma(t, x) \lambda^\gamma \{\mathbf{u}\}(t, x) d_x u^\gamma(t, x) dt, \end{aligned}$$

where $\lambda^\gamma \{\mathbf{u}\}$ is defined by (9.6) above.

Remark 9.2.13. In the point (ii) of Definition 9.2.12, the integral term

$$\int_{x \in \mathbb{R}} \varphi^\gamma(t, x) \lambda^\gamma \{\mathbf{u}\}(t, x) d_x u^\gamma(t, x)$$

has to be understood as the expectation of the bounded function $\varphi^\gamma(t, \cdot) \lambda^\gamma \{\mathbf{u}\}(t, \cdot)$ under the probability measure with CDF $u^\gamma(t, \cdot)$. In addition, the point (ii) only makes sense if the function

$$t \mapsto \int_{x \in \mathbb{R}} \varphi^\gamma(t, x) \lambda^\gamma \{\mathbf{u}\}(t, x) d_x u^\gamma(t, x)$$

is measurable on $[0, +\infty)$. This property is obtained by first applying Lemma 9.2.10 to rewrite

$$\int_{x \in \mathbb{R}} \varphi^\gamma(t, x) \lambda^\gamma \{\mathbf{u}\}(t, x) d_x u^\gamma(t, x) = \int_{v=0}^1 \varphi^\gamma(t, u^\gamma(t, \cdot)^{-1}(v)) \lambda^\gamma \{\mathbf{u}\}(t, u^\gamma(t, \cdot)^{-1}(v)) dv.$$

Now it is easily checked that the function

$$(t, v) \mapsto \varphi^\gamma(t, u^\gamma(t, \cdot)^{-1}(v)) \lambda^\gamma \{\mathbf{u}\}(t, u^\gamma(t, \cdot)^{-1}(v))$$

is measurable and bounded on the product space $[0, +\infty) \times (0, 1)$, so that the conclusion follows from the Fubini Theorem.

9.2.4.3 A closedness property

We now state an important closeness property for the set of probabilistic solutions to (9.1), that shall allow us to construct solutions by approximation.

Proposition 9.2.14 (Closedness). *Under Assumption (C), let $(\mathbf{u}_n)_{n \geq 1}$ be a sequence of functions*

$$\mathbf{u}_n = (u_n^1, \dots, u_n^d) : [0, +\infty) \times \mathbb{R} \rightarrow [0, 1]^d$$

such that:

- for all $n \geq 1$, the function \mathbf{u}_n is a probabilistic solution to the system (9.1) with initial data $(u_{0,n}^1, \dots, u_{0,n}^d)$,
- for all $t \geq 0$, for all $\gamma \in \{1, \dots, d\}$, there exists a CDF $u^\gamma(t, \cdot)$ on the real line such that, for all $x \in \mathbb{R}$ for which $\Delta_x u^\gamma(t, x) = 0$, then

$$\lim_{n \rightarrow +\infty} u_n^\gamma(t, x) = u^\gamma(t, x),$$

- for all $\gamma, \gamma' \in \{1, \dots, d\}$ such that $\gamma \neq \gamma'$, dt-almost everywhere, then

$$\forall x \in \mathbb{R}, \quad \Delta_x u^\gamma(t, x) \Delta_x u^{\gamma'}(t, x) = 0. \tag{9.7}$$

Then the function $\mathbf{u} = (u^1, \dots, u^d) : [0, +\infty) \times \mathbb{R} \rightarrow [0, 1]^d$ is a probabilistic solution to the system (9.1) with initial data (u_0^1, \dots, u_0^d) defined by, for all $\gamma \in \{1, \dots, d\}$, for all $x \in \mathbb{R}$, $u_0^\gamma(x) = u^\gamma(0, x)$.

The proof of Proposition 9.2.14 is postponed to Subsection 9.A.1 in Appendix 9.A.

9.2.4.4 Existence of a probabilistic solution

In this paragraph we establish a first existence result of probabilistic solutions to the system (9.1). Of course, it is based on an approximation procedure by the MSPD. Therefore, we first state the following proposition, the proof of which is detailed in Subsection 9.5.2.

Proposition 9.2.15 (The MSPD provides an exact solution). *Let Assumptions (C) and (USH) hold, and let us fix $\mathbf{x} \in D_n^d$. For all $\gamma \in \{1, \dots, d\}$, let us denote by u_0^γ the empirical cumulative distribution function of the system of particles of type γ in the configuration \mathbf{x} ; that is to say,*

$$\forall x \in \mathbb{R}, \quad u_0^\gamma(x) := \frac{1}{n} \sum_{k=1}^n \mathbb{1}_{\{x_k^\gamma \leq x\}}.$$

For all $t \geq 0$, let us denote by $u^\gamma(t, \cdot)$ the empirical cumulative distribution function of the system of particles of type γ in the configuration $\Phi(\mathbf{x}; t)$; that is to say,

$$\forall x \in \mathbb{R}, \quad u^\gamma(t, x) := \frac{1}{n} \sum_{k=1}^n \mathbb{1}_{\{\Phi_k^\gamma(\mathbf{x}; t) \leq x\}}.$$

Then the function $\mathbf{u} = (u^1, \dots, u^d)$ is a probabilistic solution to the system (9.1) with initial data (u_0^1, \dots, u_0^d) .

We now want to combine Propositions 9.2.14 and 9.2.15 to construct probabilistic solutions to systems (9.1) with arbitrary initial data. To this aim, we fix a vector $\mathbf{m} = (m^1, \dots, m^d)$ of probability measures, and introduce a discretisation of \mathbf{m} as follows.

Definition 9.2.16 (Discretisation operator). *For all $n \geq 1$, we define the discretisation operator $\chi_n : P(\mathbb{R})^d \rightarrow D_n^d$ by, for all $\mathbf{m} = (m^1, \dots, m^d) \in P(\mathbb{R})^d$, $\chi_n \mathbf{m} = \mathbf{x}$, where, for all $\gamma : k \in P_n^d$,*

$$x_k^\gamma := (n+1) \int_{w=(2k-1)/(2(n+1))}^{(2k+1)/(2(n+1))} (H * m^\gamma)^{-1}(w) dw.$$

Then we prove in Subsection 9.5.2 the following approximation result.

Theorem 9.2.17 (Convergence of the MSPD). *Let Assumptions (C) and (USH) hold, and let us fix $\mathbf{m} = (m^1, \dots, m^d) \in P(\mathbb{R})^d$. For all $\gamma \in \{1, \dots, d\}$, let us define*

$$\forall x \in \mathbb{R}, \quad u_0^\gamma(x) := H * m^\gamma(x).$$

For all $n \geq 1$, let \mathbf{u}_n refer to the probabilistic solution to the system (9.1) derived in Proposition 9.2.15 from the MSPD started at $\chi_n \mathbf{m}$.

Then, there exists an increasing sequence of integers $(n_\ell)_{\ell \geq 1}$ and a function $\mathbf{u} = (u^1, \dots, u^d) : [0, +\infty) \times \mathbb{R} \rightarrow [0, 1]^d$ such that:

- (i) the function \mathbf{u} is a probabilistic solution to the system (9.1) with initial data (u_0^1, \dots, u_0^d) ,
- (ii) for all $t \geq 0$, for all $\gamma \in \{1, \dots, d\}$, for all $x \in \mathbb{R}$ such that $\Delta_x u^\gamma(t, x) = 0$, then

$$\lim_{\ell \rightarrow +\infty} u_{n_\ell}^\gamma(t, x) = u^\gamma(t, x).$$

In particular, under the assumptions of Theorem 9.2.17, for all CDFs u_0^1, \dots, u_0^d on the real line, there exists a probabilistic solution to the system (9.1) with initial data (u_0^1, \dots, u_0^d) .

9.2.5 Stability and semigroup properties

In this subsection, we address further properties of the probabilistic solutions obtained from Theorem 9.2.17. A key ingredient is the L^p stability result for the MSPD stated in Theorem 9.2.22 below, which naturally provides stability estimates in Wasserstein distance for the probabilistic solutions to the system (9.1), and from which the semigroup property can also be deduced.

We begin by introducing the Wasserstein distances in §9.2.5.1. Then, Theorem 9.2.22 is stated in §9.2.5.2. Finally, the Wasserstein stability estimates and the semigroup property are detailed in Theorem 9.2.25 in §9.2.5.3.

9.2.5.1 The Wasserstein distance

Our stability estimates are stated in Wasserstein distance, an introduction to which can be found in Rachev and Rüschendorf [120] or Villani [135].

Definition 9.2.18 (Wasserstein distance). *Let $m, m' \in P(\mathbb{R})$. Then, for all $p \in [1, +\infty)$, we define the Wasserstein distance of order p between m and m' by*

$$W_p(m, m') := \inf_{\mathbf{m} \ll_{m, m'}} \left(\int_{(x, x') \in \mathbb{R}^2} |x - x'|^p \mathbf{m}(dx dx') \right)^{1/p},$$

where the infimum runs over all the probability measures $\mathbf{m} \in P(\mathbb{R}^2)$ such that, for all Borel sets $A, A' \subset \mathbb{R}$,

$$\mathbf{m}(A \times \mathbb{R}) = m(A), \quad \mathbf{m}(\mathbb{R} \times A') = m'(A').$$

The Wasserstein distance of order ∞ is defined by

$$W_\infty(m, m') := \lim_{p \rightarrow +\infty} W_p(m, m').$$

Note that we allow the Wasserstein distances to take the value $+\infty$, therefore they should rather be referred to as *pseudo-distances* [135]. For the sake of simplicity, we shall keep the denomination *distance*.

The Cartesian product $P(\mathbb{R})^d$ is endowed with the family of distances $W_p^{(d)}$, $p \in [1, +\infty]$, defined by, for all $\mathbf{m} = (m^1, \dots, m^d)$, $\mathbf{m}' = (m'^1, \dots, m'^d) \in P(\mathbb{R})^d$,

$$\begin{aligned} \forall p \in [1, +\infty), \quad W_p^{(d)}(\mathbf{m}, \mathbf{m}') &:= \left(\sum_{\gamma=1}^d W_p(m^\gamma, m'^\gamma)^p \right)^{1/p}, \\ W_\infty^{(d)}(\mathbf{m}, \mathbf{m}') &:= \sup_{1 \leq \gamma \leq d} W_\infty(m^\gamma, m'^\gamma). \end{aligned} \tag{9.8}$$

It is a peculiar feature of the dimension 1 that a measure \mathbf{m} realising the infimum in Definition 9.2.18 is explicitly known, and independent of p . It is given by

$$\mathbf{m} = U \circ ((H * m)^{-1}, (H * m')^{-1})^{-1},$$

where U refers to the Lebesgue measure on $[0, 1]$ [120]. We deduce the following characterisation of the Wasserstein distance.

Lemma 9.2.19 (Optimal coupling). *Let $m, m' \in P(\mathbb{R})$ and denote $F := H * m$, $G := H * m'$. Then, for all $p \in [1, +\infty)$,*

$$W_p(m, m') = \left(\int_{v=0}^1 |F^{-1}(v) - G^{-1}(v)|^p dv \right)^{1/p},$$

while

$$W_\infty(m, m') = \sup_{v \in (0, 1)} |F^{-1}(v) - G^{-1}(v)|.$$

Note that, in particular,

$$W_1(m, m') = \|F - G\|_{L^1(\mathbb{R})}. \tag{9.9}$$

Remark 9.2.20. In the case of empirical distributions, Lemma 9.2.19 provides a very convenient expression of the Wasserstein distances. More precisely, let $\mathbf{x} = (x_1, \dots, x_n)$ and $\mathbf{x}' = (x'_1, \dots, x'_n) \in D_n$, and let us define

$$m := \frac{1}{n} \sum_{k=1}^n \delta_{x_k}, \quad m' := \frac{1}{n} \sum_{k=1}^n \delta_{x'_k}.$$

Then, for all $p \in [1, +\infty)$,

$$W_p(m, m') = \left(\frac{1}{n} \sum_{k=1}^n |x_k - x'_k|^p \right)^{1/p},$$

and

$$W_\infty(m, m') = \sup_{1 \leq k \leq n} |x_k - x'_k|.$$

Following Remark 9.2.20, we introduce the following (normalised) L^p distances on D_n^d .

Definition 9.2.21 (L^p distances on D_n^d). For all $\mathbf{x}, \mathbf{y} \in D_n^d$, we define

$$\begin{aligned} \forall p \in [1, +\infty), \quad \|\mathbf{x} - \mathbf{y}\|_p &:= \left(\frac{1}{n} \sum_{\gamma: k \in P_n^d} |x_k^\gamma - y_k^\gamma|^p \right)^{1/p}, \\ \|\mathbf{x} - \mathbf{y}\|_\infty &:= \sup_{\gamma: k \in P_n^d} |x_k^\gamma - y_k^\gamma|, \end{aligned} \quad (9.10)$$

and, for $p \in [1, +\infty]$, we denote

$$B_p(\mathbf{x}, \delta) := \{\mathbf{y} \in D_n^d : \|\mathbf{x} - \mathbf{y}\|_p < \delta\}, \quad \bar{B}_p(\mathbf{x}, \delta) := \{\mathbf{y} \in D_n^d : \|\mathbf{x} - \mathbf{y}\|_p \leq \delta\}.$$

Given $\mathbf{x}, \mathbf{y} \in D_n^d$, and defining

$$\mathbf{m} := \left(\frac{1}{n} \sum_{k=1}^n \delta_{x_k^1}, \dots, \frac{1}{n} \sum_{k=1}^n \delta_{x_k^d} \right), \quad \mathbf{m}' := \left(\frac{1}{n} \sum_{k=1}^n \delta_{y_k^1}, \dots, \frac{1}{n} \sum_{k=1}^n \delta_{y_k^d} \right),$$

then it is straightforward that, for all $p \in [1, +\infty]$,

$$\|\mathbf{x} - \mathbf{y}\|_p = W_p^{(d)}(\mathbf{m}, \mathbf{m}'). \quad (9.11)$$

9.2.5.2 Discrete stability estimates

Section 9.4 is dedicated to the proof of the following uniform stability estimates.

Theorem 9.2.22 (Uniform L^p stability estimates for the MSPD). Under Assumptions (LC), (USH) and (GNL), then for all $p \in [1, +\infty]$, there exists $\mathcal{L}_p \in [1, +\infty)$ such that, for all $\mathbf{x}, \mathbf{y} \in D_n^d$, for all $s, t \geq 0$,

$$\|\Phi(\mathbf{x}; s) - \Phi(\mathbf{y}; t)\|_p \leq \mathcal{L}_p \|\mathbf{x} - \mathbf{y}\|_p + |t - s| L_{C,p},$$

where we recall that $L_{C,p}$ is defined in (9.2), while \mathcal{L}_p is an explicit function of d , L_{LC} and L_{USH} but does not depend on n .

The value of \mathcal{L}_p is given in (9.42).

9.2.5.3 Construction of a stable semigroup

We now describe some properties of the probabilistic solutions obtained at Theorem 9.2.17, namely stability estimates and the semigroup property. Of course, our stability estimates are derived from the discrete estimates of Theorem 9.2.22. On account of (9.11), they are naturally expressed in Wasserstein distance. We first need to introduce the following subset of $\mathcal{P}(\mathbb{R}^d)$.

Definition 9.2.23 (W_1 stability class). For all $\mathbf{m}^* \in \mathcal{P}(\mathbb{R}^d)$, we denote by $\mathcal{P}_{\mathbf{m}^*}$ the W_1 stability class of \mathbf{m}^* defined as the set of $\mathbf{m} \in \mathcal{P}(\mathbb{R}^d)$ such that

$$W_1^{(d)}(\mathbf{m}^*, \mathbf{m}) < +\infty,$$

where we recall the definition (9.8) of the distance $W_1^{(d)}$.

We shall prove in Subsection 9.5.4 the following property of the set $\mathcal{P}_{\mathbf{m}^*}$.

Lemma 9.2.24 (Properties of $\mathcal{P}_{\mathbf{m}^*}$). *For all $\mathbf{m}^* \in \mathcal{P}(\mathbb{R})^d$, the set $\mathcal{P}_{\mathbf{m}^*}$ is closed and separable for the $W_1^{(d)}$ topology.*

We can now state the main result of this work. Its proof is detailed in Subsection 9.5.4.

Theorem 9.2.25 (Semigroup and stability properties of probabilistic solutions). *Let Assumptions (LC), (USH) and (GNL) hold, and let $\mathbf{m}^* \in \mathcal{P}(\mathbb{R})^d$. Then, there exists a family $(\mathbf{S}_t)_{t \geq 0}$ of operators*

$$\mathbf{S}_t : \begin{cases} \mathcal{P}_{\mathbf{m}^*} & \rightarrow \\ \mathbf{m} = (m^1, \dots, m^d) & \mapsto \mathbf{S}_t \mathbf{m} = (S_t^1 \mathbf{m}, \dots, S_t^d \mathbf{m}) \end{cases}$$

satisfying the following properties.

(i) For all $\mathbf{m} \in \mathcal{P}_{\mathbf{m}^*}$, the function

$$\mathbf{u} = (u^1, \dots, u^d) : [0, +\infty) \times \mathbb{R} \rightarrow [0, 1]^d,$$

defined by

$$\forall \gamma \in \{1, \dots, d\}, \quad u^\gamma(t, x) := H * (S_t^\gamma \mathbf{m})(x),$$

is a probabilistic solution to the hyperbolic system (9.1) with initial data (u_0^1, \dots, u_0^d) defined by

$$\forall \gamma \in \{1, \dots, d\}, \quad u_0^\gamma := H * m^\gamma.$$

(ii) For all $p \in [1, +\infty]$, for all $\mathbf{m}, \mathbf{m}' \in \mathcal{P}_{\mathbf{m}^*}$, for all $s, t \geq 0$, then

$$W_p^{(d)}(\mathbf{S}_s \mathbf{m}, \mathbf{S}_t \mathbf{m}') \leq \mathcal{L}_p W_p^{(d)}(\mathbf{m}, \mathbf{m}') + |t - s| L_{C,p}.$$

Of course, for $p > 1$, both sides of the inequality may be infinite.

(iii) The family $(\mathbf{S}_t)_{t \geq 0}$ is a semigroup on $\mathcal{P}_{\mathbf{m}^*}$.

Let us highlight the fact that on account of (9.9), then for $p = 1$, the point (ii) of Theorem 9.2.25 rewrites as a classical L^1 stability estimate

$$\sum_{\gamma=1}^d \|u^\gamma(s, \cdot) - v^\gamma(t, \cdot)\|_{L^1(\mathbb{R})} \leq \mathcal{L}_1 \sum_{\gamma=1}^d \|u^\gamma(0, \cdot) - v^\gamma(0, \cdot)\|_{L^1(\mathbb{R})} + |t - s| L_{C,1},$$

on the probabilistic solutions $\mathbf{u} = (u^1, \dots, u^d)$ and $\mathbf{v} = (v^1, \dots, v^d)$ to the hyperbolic system (9.1) defined by

$$u^\gamma(t, x) := H * (S_t^\gamma \mathbf{m})(x), \quad v^\gamma(t, x) := H * (S_t^\gamma \mathbf{m}')(x).$$

9.2.6 Discussion

Following the seminal work by Brenier and Grenier [29], see also Bouchut [27], the links between sticky particles and scalar conservation laws have received much attention, see in particular Natile and Savaré [110] and Brenier, Gangbo, Savaré and Westdickenberg [28]; also Bressan and Nguyen [31] for a study in higher dimensions. To our knowledge though, our study provides the first instance of a sticky particle dynamics aimed at approximating hyperbolic systems of equations.

On the other hand, many similarities can be underlined between our Multitype Sticky Particle Dynamics and the classical Wave Front Tracking method, for an introduction to which we refer to Bressan [30], and which turns out to be very powerful in the study of conservative hyperbolic systems, see *e.g.* Bianchini [17], which is also related with the further references [16, 10]. Stability estimates are also obtained in [10, 17] for data of arbitrary total variation, which is in contrast with the recent work by Ancona and Marson [4].

As far as monotone initial data are concerned, let us finally mention the article by Bolley, Brenier and Loeper [20], in which Wasserstein stability estimates of the very same nature as our Theorem 9.2.25 are obtained for the scalar case, but without relying on the approximation by a particle system.

9.3 The Multitype Sticky Particle Dynamics

In this section, we give a formal construction of the Multitype Sticky Particle Dynamics (MSPD). We first recall some useful facts on the Sticky Particle Dynamics in Subsection 9.3.1. The proper definition of the MSPD is given in Subsection 9.3.2, where a few elementary properties of this dynamics are also stated.

9.3.1 The Sticky Particle Dynamics

In this subsection, we give a detailed introduction of the Sticky Particle Dynamics and state a few properties of this dynamics.

9.3.1.1 Definition of the Sticky Particle Dynamics

Let us fix $\bar{\lambda} = (\bar{\lambda}_1, \dots, \bar{\lambda}_n) \in \mathbb{R}^n$. For all $x = (x_1, \dots, x_n) \in D_n$, the *Sticky Particle Dynamics started at x with initial velocity vector $\bar{\lambda}$* is described as follows.

First, the k -th particle has initial position x_k and initial velocity $\bar{\lambda}_k$, while its *initial cluster* is determined by Definition 9.3.1.

Definition 9.3.1 (Initial clusters). *The initial cluster of the k -th particle in the Sticky Particle Dynamics started at x with initial velocity $\bar{\lambda}$ is the largest set of consecutive indices $\{\underline{k}, \dots, \bar{k}\} \subset \{1, \dots, n\}$ such that:*

- $\underline{k} \leq k \leq \bar{k}$,
- $x_{\underline{k}} = \dots = x_{\bar{k}}$,
- either $\underline{k} = \bar{k}$, or for all $j \in \{\underline{k}, \dots, \bar{k} - 1\}$,

$$\frac{1}{j - \underline{k} + 1} \sum_{k'=\underline{k}}^j \bar{\lambda}_{k'} \geq \frac{1}{\bar{k} - j} \sum_{k'=j+1}^{\bar{k}} \bar{\lambda}_{k'}. \quad (9.12)$$

Clusters of particles then travel at constant velocity between collisions, and stick together at collisions. The velocity of a cluster between two collisions is given by the average of the initial velocities of the particles composing the cluster. Denoting by

$$\phi[\bar{\lambda}](x; t) = (\phi_1[\bar{\lambda}](x; t), \dots, \phi_n[\bar{\lambda}](x; t)) \in D_n$$

the positions of the particles at time $t \geq 0$, we obtain a continuous process $(\phi[\bar{\lambda}](x; t))_{t \geq 0}$ taking its values in D_n , that we call the *Sticky Particle Dynamics started at x with initial velocity vector $\bar{\lambda}$* . Clearly, this process has the flow property that, for all $s, t \geq 0$,

$$\phi[\bar{\lambda}](x; t + s) = \phi[\bar{\lambda}](\phi[\bar{\lambda}](x; t); s).$$

Remark 9.3.2. It follows from a tedious but straightforward barycentric computation that if $\{\underline{k}, \dots, \bar{k}\}$ and $\{\underline{k}', \dots, \bar{k}'\}$ are two sets of consecutive indices in $\{1, \dots, n\}$ satisfying the three conditions of Definition 9.3.1, then $\{\underline{k}, \dots, \bar{k}\} \cup \{\underline{k}', \dots, \bar{k}'\}$ also satisfies these conditions. Therefore there is no ambiguity in the definition of the initial cluster of the k -th particle.

Definition 9.3.3 (Clusters and their velocity). *We denote by $\text{clu}_k[\bar{\lambda}](x; 0)$ the initial cluster of the k -th particle, and for $t > 0$, we denote by $\text{clu}_k[\bar{\lambda}](x; t)$ the largest set of indices $\{\underline{k}, \dots, \bar{k}\}$ of the particles sharing the same position as the k -th particle at time t , that is, such that*

$$\phi_{\underline{k}}[\bar{\lambda}](x; t) = \dots = \phi_k[\bar{\lambda}](x; t) = \dots = \phi_{\bar{k}}[\bar{\lambda}](x; t).$$

For all $t \geq 0$, the set $\text{clu}_k[\bar{\lambda}](x; t)$ is called the cluster at time t of the k -th particle in the Sticky Particle Dynamics started at x with initial velocity $\bar{\lambda}$.

Finally, the velocity of the cluster of the k -th particle at time $t \geq 0$ is defined by

$$v_k[\bar{\lambda}](\mathbf{x}; t) = \frac{1}{|\text{clu}_k[\bar{\lambda}](\mathbf{x}; t)|} \sum_{k' \in \text{clu}_k[\bar{\lambda}](\mathbf{x}; t)} \bar{\lambda}_{k'},$$

where $|c|$ refers to the cardinality of the set c , so that

$$\forall t \geq 0, \quad \phi_k[\bar{\lambda}](\mathbf{x}; t) = x_k + \int_{s=0}^t v_k[\bar{\lambda}](\mathbf{x}; s) ds. \quad (9.13)$$

Remark 9.3.4. Definition 9.3.3 can be completed by the following remarks.

- (i) As is shown in [29, Lemma 2.2], in the case $t > 0$, the set $\text{clu}_k[\bar{\lambda}](\mathbf{x}; t)$ necessarily satisfies the condition (9.12). The latter is called the *stability condition*.
- (ii) As a consequence of the definition of the velocity of a cluster, we have, for all $t \geq 0$,

$$\forall k \in \{1, \dots, n\}, \quad \min_{1 \leq j \leq n} \bar{\lambda}_j \leq v_k[\bar{\lambda}](\mathbf{x}; t) \leq \max_{1 \leq j \leq n} \bar{\lambda}_j. \quad (9.14)$$

- (iii) For all $\mathbf{x} \in D_n$ and $s, t \geq 0$ such that $s \leq t$, for all $k \in \{1, \dots, n\}$,

$$\text{clu}_k[\bar{\lambda}](\mathbf{x}; s) \subset \text{clu}_k[\bar{\lambda}](\mathbf{x}; t).$$

We finally give a representation of the process $(v_1[\bar{\lambda}](\mathbf{x}; t), \dots, v_n[\bar{\lambda}](\mathbf{x}; t))_{t \geq 0}$, the proof of which follows from Lemma 8.3.4 of Chapter 8.

Lemma 9.3.5 (Representation of the velocities). *For all $\bar{\lambda} \in \mathbb{R}^n$, for all $\mathbf{x} \in D_n$, there exist right continuous processes $(\gamma_1[\bar{\lambda}](\mathbf{x}; t))_{t \geq 0}, \dots, (\gamma_{n+1}[\bar{\lambda}](\mathbf{x}; t))_{t \geq 0}$ with values in \mathbb{R} such that, for all $t \geq 0$,*

- $\gamma_1[\bar{\lambda}](\mathbf{x}; t) = \gamma_{n+1}[\bar{\lambda}](\mathbf{x}; t) = 0$,
- for all $k \in \{2, \dots, n\}$, $\gamma_k[\bar{\lambda}](\mathbf{x}; t) \geq 0$ and $\gamma_k[\bar{\lambda}](\mathbf{x}; t)(\phi_k[\bar{\lambda}](\mathbf{x}; t) - \phi_{k-1}[\bar{\lambda}](\mathbf{x}; t)) = 0$,

and, for all $k \in \{1, \dots, n\}$,

$$v_k[\bar{\lambda}](\mathbf{x}; t) = \bar{\lambda}_k + \gamma_k[\bar{\lambda}](\mathbf{x}; t) - \gamma_{k+1}[\bar{\lambda}](\mathbf{x}; t).$$

Remark 9.3.6. The processes $(\gamma_1[\bar{\lambda}](\mathbf{x}; t))_{t \geq 0}, \dots, (\gamma_{n+1}[\bar{\lambda}](\mathbf{x}; t))_{t \geq 0}$ introduced in Lemma 9.3.5 can be interpreted as Lagrange multipliers associated with the constraint that $\phi[\bar{\lambda}](\mathbf{x}; t)$ remain in the polyhedron D_n . More precisely, it is shown in Lemma 8.3.4 of Chapter 8 that the process $(\phi[\bar{\lambda}](\mathbf{x}; t))_{t \geq 0}$ is the unique solution, in the sense of Tanaka [132], to the *normally reflected equation*

$$\forall t \geq 0, \quad \mathbf{x}(t) = \mathbf{x} + \bar{\lambda}t + \kappa(t)$$

at the boundary of D_n , where $\kappa(t)$ is a reflection term, the total variation of which only grows when $\mathbf{x}(t)$ is at the boundary of D_n .

9.3.1.2 Local Sticky Particle Dynamics

Let us fix $T > 0$, $\mathbf{x} \in D_n$, and take a set $K \subset \{1, \dots, n\}$ having the property that

$$\forall k \in K, \quad \text{clu}_k[\bar{\lambda}](\mathbf{x}; T) \subset K. \quad (9.15)$$

In other words, K is the union of a certain number of clusters at time T . By (iii) in Remark 9.3.4, for all $t \in [0, T]$, all the particles of K belong to clusters contained in K . Writing $K = \{k_1, \dots, k_{|K|}\}$, it is clear that the process

$$(\phi_{k_1}[\bar{\lambda}](\mathbf{x}; t), \dots, \phi_{k_{|K|}}[\bar{\lambda}](\mathbf{x}; t))_{t \geq 0}$$

follows the Sticky Particle Dynamics in $D_{|K|}$, with initial position vector $(x_{k_1}, \dots, x_{k_{|K|}})$ and initial velocity vector $(\bar{\lambda}_{k_1}, \dots, \bar{\lambda}_{k_{|K|}})$. This is a consequence of the fact that, in the Sticky Particle Dynamics, the interactions between particles are local: when some particles collide and stick together, this does not affect the motion of the other particles.

Definition 9.3.7 (Local Sticky Particle Dynamics). *As soon as $T > 0$, $x \in D_n$ and $K \subset \{1, \dots, n\}$ satisfy the condition (9.15), the process $(\phi_{k_1}[\bar{\lambda}](x; t), \dots, \phi_{k_{|K|}}[\bar{\lambda}](x; t))$ is said to follow the Local Sticky Particle Dynamics on $[0, T]$, in the set*

$$D_K := \{(x_{k_1}, \dots, x_{k_{|K|}}) \in \mathbb{R}^K : x_{k_1} \leq \dots \leq x_{k_{|K|}}\},$$

with initial velocity vector $\bar{\lambda}_K := (\bar{\lambda}_{k_1}, \dots, \bar{\lambda}_{k_{|K|}}) \in \mathbb{R}^K$.

For $0 \leq t_1 \leq t_2$, we shall also say that $(\phi_{k_1}[\bar{\lambda}](x; t), \dots, \phi_{k_{|K|}}[\bar{\lambda}](x; t))$ follows the Local Sticky Particle Dynamics on $[t_1, t_2]$ if

$$(\phi_{k_1}[\bar{\lambda}](\phi[\bar{\lambda}](x; t_1); t - t_1), \dots, \phi_{k_{|K|}}[\bar{\lambda}](\phi[\bar{\lambda}](x; t_1); t - t_1))$$

follows the Local Sticky Particle Dynamics on $[0, t_2 - t_1]$.

For all $p \in [1, +\infty]$, we now give an estimation on the growth of the L^p distance between two realisations of the (Local) Sticky Particle Dynamics, with possibly distinct initial velocity vectors.

Proposition 9.3.8 (L^p stability for the Local Sticky Particle Dynamics). *Let $x, y \in D_n$ and $\bar{\lambda}, \bar{\mu} \in \mathbb{R}^n$. Let $T > 0$ and $K = \{k_1, \dots, k_{|K|}\} \subset \{1, \dots, n\}$ such that the processes*

$$(\phi_{k_1}[\bar{\lambda}](x; t), \dots, \phi_{k_{|K|}}[\bar{\lambda}](x; t))_{t \in [0, T]}$$

and

$$(\phi_{k_1}[\bar{\mu}](y; t), \dots, \phi_{k_{|K|}}[\bar{\mu}](y; t))_{t \in [0, T]}$$

follow the Local Sticky Particle Dynamics on $[0, T]$, with respective initial velocity vectors $\bar{\lambda}_K$ and $\bar{\mu}_K$ defined as above.

(i) For all $t \in [0, T]$,

$$\sum_{k \in K} |\phi_k[\bar{\lambda}](x; T) - \phi_k[\bar{\mu}](y; T)| \leq \sum_{k \in K} |\phi_k[\bar{\lambda}](x; t) - \phi_k[\bar{\mu}](y; t)| + (T - t) \sum_{k \in K} |\bar{\lambda}_k - \bar{\mu}_k|,$$

(ii) If $\bar{\lambda} = \bar{\mu}$, then for all $t \in [0, T]$, for all $p \in [1, +\infty)$,

$$\sum_{k \in K} |\phi_k[\bar{\lambda}](x; T) - \phi_k[\bar{\mu}](y; T)|^p \leq \sum_{k \in K} |\phi_k[\bar{\lambda}](x; t) - \phi_k[\bar{\mu}](y; t)|^p,$$

and

$$\sup_{k \in K} |\phi_k[\bar{\lambda}](x; T) - \phi_k[\bar{\mu}](y; T)| \leq \sup_{k \in K} |\phi_k[\bar{\lambda}](x; t) - \phi_k[\bar{\mu}](y; t)|.$$

Proof. Without loss of generality, we assume that $K = \{1, \dots, n\}$, so that $\bar{\lambda}_K = \bar{\lambda}$ and $\bar{\mu}_K = \bar{\mu}$. Now, by (9.13), for all $p \in [1, +\infty)$,

$$\begin{aligned} \sum_{k=1}^n |\phi_k[\bar{\lambda}](x; T) - \phi_k[\bar{\mu}](y; T)|^p &= \sum_{k=1}^n |\phi_k[\bar{\lambda}](x; t) - \phi_k[\bar{\mu}](y; t)|^p \\ &+ \sum_{k=1}^n \int_{s=t}^T p |\phi_k[\bar{\lambda}](x; s) - \phi_k[\bar{\mu}](y; s)|^{p-2} (\phi_k[\bar{\lambda}](x; s) - \phi_k[\bar{\mu}](y; s)) \{v_k[\bar{\lambda}](x; s) - v_k[\bar{\mu}](y; s)\} ds, \end{aligned}$$

where we take the convention that $|z|^{p-2}z = 0$ for $p \in [1, 2]$.

Using Lemma 9.3.5, we write, for all $k \in \{1, \dots, n\}$,

$$v_k[\bar{\lambda}](x; s) - v_k[\bar{\mu}](y; s) = \bar{\lambda}_k - \bar{\mu}_k + \gamma_k[\bar{\lambda}](x; s) - \gamma_{k+1}[\bar{\lambda}](x; s) - \gamma_k[\bar{\mu}](y; s) + \gamma_{k+1}[\bar{\mu}](y; s).$$

We shall prove below that, for all $s \in (t, T]$,

$$\sum_{k=1}^n |\phi_k[\bar{\lambda}](x; s) - \phi_k[\bar{\mu}](y; s)|^{p-2} (\phi_k[\bar{\lambda}](x; s) - \phi_k[\bar{\mu}](y; s)) \{\gamma_k[\bar{\lambda}](x; s) - \gamma_{k+1}[\bar{\lambda}](x; s)\} \leq 0; \quad (9.16)$$

then, by symmetry, the contribution of $-\{\gamma_k[\bar{\mu}](y; s) - \gamma_{k+1}[\bar{\mu}](y; s)\}$ is also nonpositive, so that we obtain

$$\begin{aligned} \sum_{k=1}^n |\phi_k[\bar{\lambda}](x; T) - \phi_k[\bar{\mu}](y; T)|^p &\leq \sum_{k=1}^n |\phi_k[\bar{\lambda}](x; t) - \phi_k[\bar{\mu}](y; t)|^p \\ &+ \sum_{k=1}^n \{\bar{\lambda}_k - \bar{\mu}_k\} \int_{s=t}^T p |\phi_k[\bar{\lambda}](x; s) - \phi_k[\bar{\mu}](y; s)|^{p-2} (\phi_k[\bar{\lambda}](x; s) - \phi_k[\bar{\mu}](y; s)) ds, \end{aligned}$$

from which (i) and the first part of (ii) easily follow. We derive the second part of (ii) by letting p grow to infinity after having taken the power $1/p$ of both sides of the inequality above.

Let us now prove (9.16). To this aim, we fix $s \in (t, T]$ and perform an Abel's transform to write

$$\begin{aligned} &\sum_{k=1}^n |\phi_k[\bar{\lambda}](x; s) - \phi_k[\bar{\mu}](y; s)|^{p-2} (\phi_k[\bar{\lambda}](x; s) - \phi_k[\bar{\mu}](y; s)) \{\gamma_k[\bar{\lambda}](x; s) - \gamma_{k+1}[\bar{\lambda}](x; s)\} \\ &= \sum_{k=2}^n \gamma_k[\bar{\lambda}](x; s) \vartheta(\phi_{k-1}[\bar{\lambda}](x; s), \phi_{k-1}[\bar{\mu}](y; s), \phi_k[\bar{\lambda}](x; s), \phi_k[\bar{\mu}](y; s)), \end{aligned}$$

where

$$\vartheta(\xi', \zeta', \xi, \zeta) := |\xi - \zeta|^{p-2} (\xi - \zeta) - |\xi' - \zeta'|^{p-2} (\xi' - \zeta'),$$

and we have applied Lemma 9.3.5 to remove $\gamma_1[\bar{\lambda}](x; s)$ and $\gamma_{n+1}[\bar{\lambda}](x; s)$. Using Lemma 9.3.5 again, we recall that $\gamma_k[\bar{\lambda}](x; s) \geq 0$ and if $\gamma_k[\bar{\lambda}](x; s) > 0$, then $\phi_{k-1}[\bar{\lambda}](x; s) = \phi_k[\bar{\lambda}](x; s)$, while we still have $\phi_{k-1}[\bar{\mu}](y; s) \leq \phi_k[\bar{\mu}](y; s)$. The conclusion of the proof now follows from the elementary observation that if $\xi' = \xi$ and $\zeta' \leq \zeta$, then $\vartheta(\xi', \zeta', \xi, \zeta) \leq 0$. \square

9.3.2 Definition of the MSPD

Let us now give a proper construction of the MSPD. First, in order to define the initial velocities of the particles, we encode the global ordering of a configuration $\mathbf{x} \in D_n^d$ in the set $\mathbf{R}(\mathbf{x})$ defined by

$$\mathbf{R}(\mathbf{x}) := \{(\alpha : i, \beta : j) \in (P_n^d)^2 : \alpha < \beta, x_i^\alpha < x_j^\beta\},$$

and we let $N(\mathbf{x})$ refer to the cardinality of $\mathbf{R}(\mathbf{x})$.

Let us fix $\gamma : k \in P_n^d$ and, for all $\gamma' \neq \gamma$, define $\omega_{\gamma':k}^{\gamma'}(\mathbf{x}) \in [0, 1]$ by

$$\omega_{\gamma':k}^{\gamma'}(\mathbf{x}) := \begin{cases} \frac{1}{n} \sum_{k'=1}^n \mathbb{1}_{\{(\gamma':k', \gamma:k) \in \mathbf{R}(\mathbf{x})\}} & \text{if } \gamma' < \gamma, \\ \frac{1}{n} \sum_{k'=1}^n \mathbb{1}_{\{(\gamma:k, \gamma':k') \notin \mathbf{R}(\mathbf{x})\}} & \text{if } \gamma' > \gamma. \end{cases}$$

We can now define the initial velocity of the particle $\gamma : k$ in the MSPD started at \mathbf{x} by

$$\tilde{\lambda}_k^\gamma(\mathbf{x}) := n \int_{w=(k-1)/n}^{k/n} \lambda^\gamma \left(\omega_{\gamma:k}^1(\mathbf{x}), \dots, \omega_{\gamma:k}^{\gamma-1}(\mathbf{x}), w, \omega_{\gamma:k}^{\gamma+1}(\mathbf{x}), \dots, \omega_{\gamma:k}^d(\mathbf{x}) \right) dw, \quad (9.17)$$

and we denote

$$\tilde{\lambda}^\gamma(\mathbf{x}) := (\tilde{\lambda}_1^\gamma(\mathbf{x}), \dots, \tilde{\lambda}_n^\gamma(\mathbf{x})) \in \mathbb{R}^n, \quad \tilde{\lambda}(\mathbf{x}) := (\tilde{\lambda}^1(\mathbf{x}), \dots, \tilde{\lambda}^d(\mathbf{x})) \in (\mathbb{R}^n)^d. \quad (9.18)$$

Then, for all $\mathbf{x} \in D_n^d$, we define the *Multitype Sticky Particle Dynamics started at \mathbf{x}* , and denote by $(\Phi(\mathbf{x}; t))_{t \geq 0}$, the continuous process taking its values in D_n^d and constructed as follows: as long as there is no collision between particles of different types, each system evolves according to the Sticky Particle Dynamics with initial velocities given by (9.17) above. When particles or clusters

of different types collide, say at time $t^* > 0$, then the initial velocity of the particle $\gamma : k$ is updated to the value $\bar{\lambda}_k^\gamma(\Phi(\mathbf{x}; t^*))$.

Under Assumption (USH), and whatever the composition of the clusters in each system, the velocity of a cluster of type α is always larger than the velocity of a cluster of type β if $\alpha < \beta$. Therefore, the set $\mathbf{R}(\mathbf{x})$ contains the pairs of particles $(\alpha : i, \beta : j)$ that will collide at a positive and finite time in the MSPD started at \mathbf{x} . At the first collision, say at time $t^* > 0$, between clusters of different types, then the fastest clusters cross the slowest clusters and the systems restart with initial velocities determined by the set $\mathbf{R}(\mathbf{x})$ to which the pairs of particles $(\alpha : i, \beta : j)$ involved in the collision have been removed.

The outline of this subsection is as follows: in §9.3.2.1, we introduce and state a few properties of the *Typewise Sticky Particle Dynamics*, which simply describes the joint evolution of d systems of sticky particles, that do not interact with each other. A proper construction of the actual MSPD is made in §9.3.2.2. Continuity properties of this dynamics are stated in §9.3.2.3 and a peculiar formalism to describe collisions is introduced in §9.3.2.4. Finally, we emphasise the fact that interactions remain local in the MSPD in §9.3.2.5.

9.3.2.1 The Typewise Sticky Particle Dynamics

This paragraph is dedicated to the study of the *Typewise Sticky Particle Dynamics*, which is defined as follows.

Definition 9.3.9 (Typewise Sticky Particle Dynamics). *Let $\bar{\lambda} = (\bar{\lambda}^1, \dots, \bar{\lambda}^d)$ be a family of d vectors*

$$\bar{\lambda}^\gamma = (\bar{\lambda}_1^\gamma, \dots, \bar{\lambda}_n^\gamma) \in \mathbb{R}^n.$$

The Typewise Sticky Particle Dynamics with initial velocity vector $\bar{\lambda}$ is the flow $(\tilde{\Phi}[\bar{\lambda}](\cdot; t))_{t \geq 0}$ defined on D_n^d by, for all $\mathbf{x} = (x^1, \dots, x^d) \in D_n^d$,

$$\forall t \geq 0, \quad \tilde{\Phi}[\bar{\lambda}](\mathbf{x}; t) = (\phi[\bar{\lambda}^1](x^1; t), \dots, \phi[\bar{\lambda}^d](x^d; t)).$$

In other words, $(\tilde{\Phi}[\bar{\lambda}](\cdot; t))_{t \geq 0}$ describes the joint evolution of d systems of n particles, where the system of particles of type γ follows the Sticky Particle Dynamics in D_n with initial position vector $\mathbf{x}^\gamma := (x_1^\gamma, \dots, x_n^\gamma) \in D_n$ and initial velocity vector $\bar{\lambda}^\gamma \in \mathbb{R}^n$, independently of the other systems.

Applying (i) in Proposition 9.3.8 with $K = \{1, \dots, n\}$ to each system already yields the following contraction property for the Typewise Sticky Particle Dynamics. Let us recall that $\|\cdot\|_1$ refers to the (normalised) L^1 distance in D_n^d , see (9.10).

Lemma 9.3.10 (L^1 contraction). *For all $\bar{\lambda} \in (\mathbb{R}^n)^d$, for all $\mathbf{x}, \mathbf{y} \in D_n^d$, for all $s, t \geq 0$ such that $s \leq t$,*

$$\|\tilde{\Phi}[\bar{\lambda}](\mathbf{x}; t) - \tilde{\Phi}[\bar{\lambda}](\mathbf{y}; t)\|_1 \leq \|\tilde{\Phi}[\bar{\lambda}](\mathbf{x}; s) - \tilde{\Phi}[\bar{\lambda}](\mathbf{y}; s)\|_1.$$

Let $\mathbf{x} \in D_n^d$. In order to define the MSPD started at \mathbf{x} in §9.3.2.2 below, we shall of course be concerned with the Typewise Sticky Particle Dynamics with initial velocity vector $\tilde{\lambda}(\mathbf{x})$ given by (9.18), up to the first collision between particles of different types. Therefore, we introduce the *collision time* $\tilde{\tau}_{\alpha:i, \beta:j}^{\text{coll}}(\mathbf{x})$ associated with a pair $(\alpha : i, \beta : j) \in \mathbf{R}(\mathbf{x})$ as the time at which the particles $\alpha : i$ and $\beta : j$ collide in the Typewise Sticky Particle Dynamics started at \mathbf{x} . The following lemma is a straightforward consequence of Assumption (USH) combined with (9.17), and we do not give a proof.

Lemma 9.3.11 (Collision times). *Under Assumption (USH), let $\mathbf{x} \in D_n^d$ and $(\alpha : i, \beta : j) \in (P_n^d)^2$ such that $\alpha < \beta$.*

(i) *If $(\alpha : i, \beta : j) \notin \mathbf{R}(\mathbf{x})$, then, for all $t \geq 0$,*

$$\tilde{\Phi}_i^\alpha[\tilde{\lambda}(\mathbf{x})](\mathbf{x}; t) \geq \tilde{\Phi}_j^\beta[\tilde{\lambda}(\mathbf{x})](\mathbf{x}; t) + L_{\text{USH}}t.$$

(ii) If $(\alpha : i, \beta : j) \in R(\mathbf{x})$, then there exists a unique $t =: \tilde{\tau}_{\alpha:i, \beta:j}^{\text{coll}}(\mathbf{x}) > 0$ such that

$$\tilde{\Phi}_i^\alpha[\tilde{\lambda}(\mathbf{x})](\mathbf{x}; t) = \tilde{\Phi}_j^\beta[\tilde{\lambda}(\mathbf{x})](\mathbf{x}; t).$$

Then, for all $s \in [0, \tilde{\tau}_{\alpha:i, \beta:j}^{\text{coll}}(\mathbf{x})]$,

$$\tilde{\Phi}_j^\beta[\tilde{\lambda}(\mathbf{x})](\mathbf{x}; s) - \tilde{\Phi}_i^\alpha[\tilde{\lambda}(\mathbf{x})](\mathbf{x}; s) \geq L_{\text{USH}}(\tilde{\tau}_{\alpha:i, \beta:j}^{\text{coll}}(\mathbf{x}) - s),$$

while, for all $s \geq \tilde{\tau}_{\alpha:i, \beta:j}^{\text{coll}}(\mathbf{x})$,

$$\tilde{\Phi}_i^\alpha[\tilde{\lambda}(\mathbf{x})](\mathbf{x}; s) - \tilde{\Phi}_j^\beta[\tilde{\lambda}(\mathbf{x})](\mathbf{x}; s) \geq L_{\text{USH}}(s - \tilde{\tau}_{\alpha:i, \beta:j}^{\text{coll}}(\mathbf{x})).$$

For all $\mathbf{x} \in D_n^d$, we now define $t^*(\mathbf{x})$ by

$$t^*(\mathbf{x}) := \begin{cases} +\infty & \text{if } N(\mathbf{x}) = 0, \\ \min\{\tilde{\tau}_{\alpha:i, \beta:j}^{\text{coll}}(\mathbf{x}), (\alpha : i, \beta : j) \in R(\mathbf{x})\} \in (0, +\infty) & \text{otherwise.} \end{cases} \quad (9.19)$$

For all $\mathbf{x} \in D_n^d$ such that $N(\mathbf{x}) \geq 1$, we let $\mathbf{x}^* := \tilde{\Phi}[\tilde{\lambda}(\mathbf{x})](\mathbf{x}; t^*(\mathbf{x}))$. The following corollary of Lemma 9.3.11 is a straightforward consequence of the flow property and the continuity of the trajectories for the Typewise Sticky Particle Dynamics, therefore we do not give a proof.

Corollary 9.3.12 (Evolution up to $t^*(\mathbf{x})$). *Under the assumptions of Lemma 9.3.11, let $\mathbf{x} \in D_n^d$, $t < t^*(\mathbf{x})$ and let us denote $\mathbf{x}' := \tilde{\Phi}[\tilde{\lambda}(\mathbf{x})](\mathbf{x}; t)$. Then $R(\mathbf{x}') = R(\mathbf{x})$, $\tilde{\lambda}(\mathbf{x}') = \tilde{\lambda}(\mathbf{x})$ and $t^*(\mathbf{x}') = t^*(\mathbf{x}) - t$. In addition, if $N(\mathbf{x}) \geq 1$, then $\mathbf{x}^* = \mathbf{x}^*$ and $R(\mathbf{x}^*)$ is a strict subset of $R(\mathbf{x})$, so that $N(\mathbf{x}^*) < N(\mathbf{x})$.*

9.3.2.2 Construction of the MSPD

We are now ready to define the MSPD started at $\mathbf{x} \in D_n^d$.

Definition 9.3.13 (Multitype Sticky Particle Dynamics). *Under Assumption (USH), for all $\mathbf{x} \in D_n^d$, the Multitype Sticky Particle Dynamics started at \mathbf{x} is the process $(\Phi(\mathbf{x}; t))_{t \geq 0}$, with values in D_n^d , defined by*

$$\forall t \geq 0, \quad \Phi(\mathbf{x}; t) := \begin{cases} \tilde{\Phi}[\tilde{\lambda}(\mathbf{x})](\mathbf{x}; t) & \text{if } t < t^*(\mathbf{x}), \\ \Phi(\mathbf{x}^*; t - t^*(\mathbf{x})) & \text{if } t \geq t^*(\mathbf{x}). \end{cases}$$

Since $N(\mathbf{x})$ is finite and Corollary 9.3.12 asserts that, for all $\mathbf{x} \in D_n^d$ such that $t^*(\mathbf{x}) < +\infty$, $N(\mathbf{x}^*) < N(\mathbf{x})$, then the process $(\Phi(\mathbf{x}; t))_{t \geq 0}$ is well defined on $[0, +\infty)$.

Let us recall that, for the Sticky Particle Dynamics with initial position vector $\mathbf{x} \in D_n$ and initial velocity vector $\bar{\lambda} \in \mathbb{R}^n$, for all $k \in \{1, \dots, n\}$, the process $(v_k[\bar{\lambda}](\mathbf{x}; s))_{s \geq 0}$ satisfies

$$\forall t \geq 0, \quad \phi_k[\bar{\lambda}](\mathbf{x}; t) = x_k + \int_{s=0}^t v_k[\bar{\lambda}](\mathbf{x}; s) ds,$$

see Definition 9.3.3. Now, for all $\mathbf{x} \in D_n^d$, for all $\gamma : k \in P_n^d$, we define the process $(v_k^\gamma(\mathbf{x}; s))_{s \geq 0}$ by

$$v_k^\gamma(\mathbf{x}; s) := \begin{cases} v_k[\tilde{\lambda}^\gamma(\mathbf{x})](\mathbf{x}^\gamma; s) & \text{if } s < t^*(\mathbf{x}), \\ v_k^\gamma(\mathbf{x}^*; s - t^*(\mathbf{x})) & \text{if } s \geq t^*(\mathbf{x}), \end{cases} \quad (9.20)$$

so that

$$\forall t \geq 0, \quad \Phi_k^\gamma(\mathbf{x}; t) = x_k^\gamma + \int_{s=0}^t v_k^\gamma(\mathbf{x}; s) ds.$$

We easily deduce from this definition and (9.14)-(9.17) that, for all $\mathbf{x} \in D_n^d$, for all $t \geq 0$,

$$\inf_{u \in [0, 1]^d} \lambda^\gamma(u) \leq v_k^\gamma(\mathbf{x}; t) \leq \sup_{u \in [0, 1]^d} \lambda^\gamma(u). \quad (9.21)$$

We are now willing to define the *cluster* of a particle in the MSPD started at \mathbf{x} , similarly to Definition 9.3.3 above. In this purpose, we first introduce the notion of *generical cluster*.

Definition 9.3.14 (Generical clusters). A generic cluster is a pair $(\gamma, \{\underline{k}, \dots, \bar{k}\})$, where $\gamma \in \{1, \dots, d\}$ is the type of the generic cluster and $\{\underline{k}, \dots, \bar{k}\}$ is a set of consecutive indices in $\{1, \dots, n\}$. To refer to the generic cluster $c := (\gamma, \{\underline{k}, \dots, \bar{k}\})$, we shall rather use the notation $c = \gamma : \underline{k} \cdots \bar{k}$.

Let us give a few rules to manipulate generic clusters.

- The type of a generic cluster c is denoted by $\text{type}(c) \in \{1, \dots, d\}$.
- The cardinality of a generic cluster $c = \gamma : \underline{k} \cdots \bar{k}$ is denoted by $|c|$ and worth $\bar{k} - \underline{k} + 1$.
- For $\gamma' : k' \in P_n^d$ and $c = \gamma : \underline{k} \cdots \bar{k}$, we shall write

$$\gamma' : k' \in c$$

if and only if $\gamma' = \gamma$ and $k' \in \{\underline{k}, \dots, \bar{k}\}$. This set membership relation allows us to define the inclusion relation $a \subset b$ between generic clusters a and b as well as the union set $a \cup b$ and the Cartesian product $a \times b$ of two generic clusters a and b .

- A generic cluster $\gamma : k \cdots k$ with a single element $\gamma : k$ shall rather be denoted by $\gamma : k$. It will always be clear from the context whether the notation $\gamma : k$ refers to a particle (that is, an element of P_n^d) or to a cluster containing a single particle.

We can now define the *cluster* of a particle in the MSPD started at $\mathbf{x} \in D_n^d$.

Definition 9.3.15 (Cluster). The cluster of the particle $\gamma : k$ in the configuration $\Phi(\mathbf{x}; t)$ is the generic cluster defined by

$$\text{clu}_k^\gamma(\mathbf{x}; t) := \begin{cases} \gamma : \text{clu}_k[\tilde{\lambda}^\gamma(\mathbf{x})](\mathbf{x}^\gamma; t) & \text{if } t < t^*(\mathbf{x}), \\ \text{clu}_k^\gamma(\mathbf{x}^*; t - t^*(\mathbf{x})) & \text{if } t \geq t^*(\mathbf{x}), \end{cases}$$

where we recall that $\text{clu}_k[\tilde{\lambda}^\gamma(\mathbf{x})](\mathbf{x}^\gamma; t)$ was defined in Definition 9.3.3.

9.3.2.3 Continuity properties of the MSPD

In this paragraph, we state some continuity properties for the MSPD in Propositions 9.3.16 and 9.3.17, the proofs of which are postponed to Subsection 9.A.2 in Appendix 9.A.

Proposition 9.3.16 (Time continuity and flow). For all $\mathbf{x} \in D_n^d$, the process $(\Phi(\mathbf{x}; t))_{t \geq 0}$ has continuous trajectories in D_n^d . Besides, $(\Phi(\cdot; t))_{t \geq 0}$ defines a flow in D_n^d .

Proposition 9.3.17 (Continuity with respect to the initial configuration). Let $\mathbf{x} \in D_n^d$. Then, for all $\epsilon > 0$, there exists $\delta > 0$ such that, for all $\mathbf{y} \in \bar{B}_1(\mathbf{x}, \delta)$,

$$\sup_{t \geq 0} \|\Phi(\mathbf{x}; t) - \Phi(\mathbf{y}; t)\|_1 \leq \epsilon.$$

9.3.2.4 Collisions

We now introduce some notations to describe the collisions between particles of different type in the MSPD. For all $\mathbf{x} \in D_n^d$, for all $(\alpha : i, \beta : j) \in (P_n^d)^2$ such that $\alpha < \beta$, let us define

$$\tau_{\alpha:i, \beta:j}^{\text{coll}}(\mathbf{x}) := \inf\{t \geq 0 : \Phi_i^\alpha(\mathbf{x}; t) \geq \Phi_j^\beta(\mathbf{x}; t)\}.$$

Certainly, Assumption (USH) ensures that $\tau_{\alpha:i, \beta:j}^{\text{coll}}(\mathbf{x}) < +\infty$; while $\tau_{\alpha:i, \beta:j}^{\text{coll}}(\mathbf{x}) > 0$ if and only if $(\alpha : i, \beta : j) \in \text{R}(\mathbf{x})$. Besides, it is easily checked that

$$t^*(\mathbf{x}) = \begin{cases} +\infty & \text{if } \text{N}(\mathbf{x}) = 0, \\ \min\{\tau_{\alpha:i, \beta:j}^{\text{coll}}(\mathbf{x}), (\alpha : i, \beta : j) \in \text{R}(\mathbf{x})\} & \text{if } \text{N}(\mathbf{x}) \geq 1. \end{cases}$$

For all $(\alpha : i, \beta : j) \in \text{R}(\mathbf{x})$, $\tau_{\alpha:i, \beta:j}^{\text{coll}}(\mathbf{x})$ is nothing but the time at which the particles $\alpha : i$ and $\beta : j$ collide in the MSPD started at \mathbf{x} . This collision takes place at the location

$$\xi_{\alpha:i, \beta:j}^{\text{coll}}(\mathbf{x}) := \Phi_i^\alpha(\mathbf{x}; \tau_{\alpha:i, \beta:j}^{\text{coll}}(\mathbf{x})) = \Phi_j^\beta(\mathbf{x}; \tau_{\alpha:i, \beta:j}^{\text{coll}}(\mathbf{x})) \in \mathbb{R},$$

and in the sequel, we shall denote by

$$\Xi_{\alpha:i, \beta:j}^{\text{coll}}(\mathbf{x}) := (\xi_{\alpha:i, \beta:j}^{\text{coll}}(\mathbf{x}), \tau_{\alpha:i, \beta:j}^{\text{coll}}(\mathbf{x})) \in \mathbb{R} \times (0, +\infty)$$

the space-time point of collision between $\alpha : i$ and $\beta : j$.

Note that, if $(\alpha : i, \beta : j) \notin R(\mathbf{x})$, then $\tau_{\alpha:i, \beta:j}^{\text{coll}}(\mathbf{x}) = 0$, which is somehow consistent with the intuitive idea that the collision between $\alpha : i$ and $\beta : j$ happened ‘before the origin of times’, which we shall refer to as the *virtual past*.

Assumption (USH) implies that the collision times $\tau_{\alpha:i, \beta:j}^{\text{coll}}(\mathbf{x})$ have properties similar to those described in Lemma 9.3.11 for the collision times $\tilde{\tau}_{\alpha:i, \beta:j}^{\text{coll}}(\mathbf{x})$ in the Typewise Sticky Particle Dynamics. As a consequence, we state the following lemma without a demonstration.

Lemma 9.3.18 (Collision times in the MSPD). *Let $\mathbf{x} \in D_n^d$ and $(\alpha : i, \beta : j) \in R(\mathbf{x})$. Then $\tau_{\alpha:i, \beta:j}^{\text{coll}}(\mathbf{x}) > 0$, and:*

- for all $s \in [0, \tau_{\alpha:i, \beta:j}^{\text{coll}}(\mathbf{x})]$,

$$\Phi_j^\beta(\mathbf{x}; s) - \Phi_i^\alpha(\mathbf{x}; s) \geq L_{\text{USH}}(\tau_{\alpha:i, \beta:j}^{\text{coll}}(\mathbf{x}) - s),$$

- for all $s \geq \tau_{\alpha:i, \beta:j}^{\text{coll}}(\mathbf{x})$,

$$\Phi_i^\alpha(\mathbf{x}; s) - \Phi_j^\beta(\mathbf{x}; s) \geq L_{\text{USH}}(s - \tau_{\alpha:i, \beta:j}^{\text{coll}}(\mathbf{x})).$$

9.3.2.5 Local interactions

We finally explain why the interactions in the MSPD remain local, in the sense of §9.3.1.2. Indeed, according to Definition 9.3.13, if $N(\mathbf{x}) \geq 1$, then at the first instant $t^*(\mathbf{x})$ of a collision between two particles of different type, the whole system restarts with new initial velocities determined by $\tilde{\lambda}(\mathbf{x}^*)$. Therefore, the velocities of all the particles could be modified.

The following lemma ensures that only the velocities of the particles involved in a collision with particles of another type at time $t^*(\mathbf{x})$ are actually modified. It is first useful to define the set

$$\mathcal{T}_{\gamma:k}(\mathbf{x}) := \{\tau_{\alpha:i, \beta:j}^{\text{coll}}(\mathbf{x}) : (\alpha : i, \beta : j) \in R(\mathbf{x}), \gamma : k \in \{\alpha : i, \beta : j\}\} \quad (9.22)$$

of instants at which the particle $\gamma : k$ collides with particles of different type in the MSPD started at \mathbf{x} . For all $T \geq 0$, we also let

$$T^- \wedge \mathcal{T}_{\gamma:k}(\mathbf{x}) := \begin{cases} 0 & \text{if the set } \mathcal{T}_{\gamma:k}(\mathbf{x}) \cap [0, T) \text{ is empty,} \\ \max(\mathcal{T}_{\gamma:k}(\mathbf{x}) \cap [0, T)) & \text{otherwise.} \end{cases} \quad (9.23)$$

Note that $0 \leq T^- \wedge \mathcal{T}_{\gamma:k}(\mathbf{x}) < T$.

Lemma 9.3.19 (Locality of the interactions in the MSPD). *Let $\mathcal{T}_{\gamma:k}(\mathbf{x})$ be defined as above.*

- (i) *For all $\gamma : k \in P_n^d$, if $t^*(\mathbf{x}) \notin \mathcal{T}_{\gamma:k}(\mathbf{x})$, then*

$$\tilde{\lambda}_k^\gamma(\mathbf{x}^*) = \tilde{\lambda}_k^\gamma(\mathbf{x}).$$

- (ii) *For all $T > 0$, for all $\gamma \in \{1, \dots, d\}$, if $K \subset \{1, \dots, n\}$ is such that, for all $k \in K$,*

$$\text{clu}_k^\gamma(\mathbf{x}; T) \subset \gamma : K$$

(with an obvious notation for $\gamma : K$), then the process $\{\Phi_k^\gamma(\mathbf{x}; t) : k \in K\}$ follows the Local Sticky Particle Dynamics, in the sense of Definition 9.3.7, on the interval $[t_0, T]$ with

$$t_0 := \max_{k \in K} T^- \wedge \mathcal{T}_{\gamma:k}(\mathbf{x}),$$

with initial velocity vector $\bar{\lambda}_K := (\bar{\lambda}_k)_{k \in K}$ defined by

$$\forall k \in K, \quad \bar{\lambda}_k := \tilde{\lambda}_k^\gamma(\Phi(\mathbf{x}; t_0)).$$

Proof. We first address (i) and let $\gamma : k \in P_n^d$ such that $t^*(\mathbf{x}) \notin \mathcal{T}_{\gamma:k}(\mathbf{x})$. Then, due to the definition of $\tilde{\lambda}_k^\gamma(\mathbf{x}^*)$, it suffices to check that, for all $\gamma' \neq \gamma$,

$$\omega_{\gamma:k}^{\gamma'}(\mathbf{x}^*) = \omega_{\gamma:k}^\gamma(\mathbf{x}).$$

We describe the case $\gamma' < \gamma$, the reverse case is symmetric. The equality above holds if and only if, for all $k' \in \{1, \dots, n\}$,

$$(\gamma' : k', \gamma : k) \in R(\mathbf{x}) \quad \text{if and only if} \quad (\gamma' : k', \gamma : k) \in R(\mathbf{x}^*),$$

that is to say

$$x_{k'}^{\gamma'} < x_k^\gamma \quad \text{if and only if} \quad \Phi_{k'}^{\gamma'}(\mathbf{x}; t^*(\mathbf{x})) < \Phi_k^\gamma(\mathbf{x}; t^*(\mathbf{x})),$$

which obviously holds true since $t^*(\mathbf{x}) \notin \mathcal{T}_{\gamma:k}(\mathbf{x})$ implies that the particle $\gamma : k$ does not collide with any particle $\gamma' : k'$ on $[0, t^*(\mathbf{x})]$.

The point (ii) is now an easy consequence of the choice of t_0 , which ensures that, for all $k \in K$, the particle $\gamma : k$ does not collide with a particle of another type in the time interval (t_0, T) . \square

9.4 The uniform L^p stability estimates

This section is dedicated to the proof of Theorem 9.2.22, and contains four subsections.

The preliminary Subsection 9.4.1 exposes some useful consequences of the Genuine Nonlinearity assumption (GNL). In Subsection 9.4.2, we introduce the notion of *locally homeomorphic* configurations, which describes pairs of configurations \mathbf{x}, \mathbf{y} such that the trajectories of the MSPD started at \mathbf{x} and \mathbf{y} locally look alike, and we prove uniform L^1 and L^∞ stability estimates for such locally homeomorphic pairs of configurations. This provides us with *local* stability results in Proposition 9.4.7. We derive *global* stability results in Subsection 9.4.3, thanks to an interpolation procedure allowing to integrate our local stability estimates along a continuous path joining arbitrary configurations \mathbf{x} and \mathbf{y} and containing enough locally homeomorphic pairs of configurations, see Proposition 9.4.11. We complete the proof of Theorem 9.2.22 in Subsection 9.4.4 by using a classical interpolation argument between L^1 and L^∞ .

9.4.1 A few consequences of Assumption (GNL)

In this paragraph, we discuss some consequences of Assumption (GNL) on the behaviour of the MSPD.

Lemma 9.4.1 below addresses the time evolution of the composition of clusters. Without Assumption (GNL), the properties of the Typewise Sticky Particle Dynamics (see (iii) in Remark 9.3.4) ensure that, between collisions with clusters of another type, clusters can only grow. However, at collisions with clusters of a different type, nothing prevents clusters from splitting.

Assumption (GNL) provides us with a better control of the behaviour of the clusters at collisions: denoting by γ the type of the cluster, then either $\partial_\gamma \lambda^\gamma > 0$, in which case the cluster will always contain a single particle (even if several particles share the same initial position, they instantaneously drift away from each other after time 0); or $\partial_\gamma \lambda^\gamma < 0$ and clusters never split at collisions.

Lemma 9.4.1 (Growth of the clusters). *Let $\mathbf{x} \in D_n^d$ and $\gamma : k \in P_n^d$. Under Assumptions (USH) and (GNL),*

- for all $s, t \geq 0$ with $s \leq t$, $\text{clu}_k^\gamma(\mathbf{x}; s) \subset \text{clu}_k^\gamma(\mathbf{x}; t)$,
- if $\partial_\gamma \lambda^\gamma > 0$, then, for all $t \geq 0$, $\text{clu}_k^\gamma(\mathbf{x}; t) = \gamma : k$.

Before proving Lemma 9.4.1 below, we need to define the notion of *left limit* for clusters.

Definition 9.4.2 (Left limit of clusters). *Let $\mathbf{x} \in D_n^d$ and $\gamma : k \in P_n^d$. For all $t > 0$, let*

$$t_0 := \inf\{s \in [0, t] : \forall r \in [s, t), N(\Phi(\mathbf{x}; r)) = N(\Phi(\mathbf{x}; s))\}.$$

Then we define the left limit in t of the cluster $\text{clu}_k^\gamma(\mathbf{x}; t)$ by

$$\text{clu}_k^\gamma(\mathbf{x}; t^-) := \bigcup_{s \in [t_0, t)} \text{clu}_k^\gamma(\mathbf{x}; s).$$

The quantity t_0 introduced in Definition 9.4.2 is nothing but the largest time before t at which a collision between clusters of different types occur in the MSPD started at \mathbf{x} , or 0 if no such collisions occurs; so that, on the time interval $[t_0, t)$, the evolution of the particles is only governed by the Typewise Sticky Particle Dynamics. The cluster $\text{clu}_k^\gamma(\mathbf{x}; t^-)$ can differ from $\text{clu}_k^\gamma(\mathbf{x}; t)$ for two reasons:

- the particle $\gamma : k$ collides with another particle of type γ , which increases the size of the cluster,
- the particle $\gamma : k$ collides with particles of another type, which changes the velocity of the particles.

It is a property of the Typewise Sticky Particle Dynamics that, if the particle $\gamma : k$ does not collide with a particle of another type at time t , then $\text{clu}_k^\gamma(\mathbf{x}; t^-) \subset \text{clu}_k^\gamma(\mathbf{x}; t)$. The proof of Lemma 9.4.1 essentially consists in checking that, under Assumption (GNL), this property remains true at collisions with particles of another type.

Proof of Lemma 9.4.1. We first remark that, for all $\mathbf{x} \in D_n^d$, for all generical cluster $\gamma : \underline{k} \cdots \bar{k}$ such that $x_{\underline{k}}^\gamma = \cdots = x_{\bar{k}}^\gamma$ and $\bar{k} > \underline{k}$, we have, for all $k, k' \in \{\underline{k}, \dots, \bar{k}\}$ such that $k < k'$,

- if $\partial_\gamma \lambda^\gamma > 0$ then $\tilde{\lambda}_{k'}^\gamma(\mathbf{x}) > \tilde{\lambda}_k^\gamma(\mathbf{x})$,
- if $\partial_\gamma \lambda^\gamma < 0$ then $\tilde{\lambda}_{k'}^\gamma(\mathbf{x}) < \tilde{\lambda}_k^\gamma(\mathbf{x})$.

Indeed, let us assume for instance that $\partial_\gamma \lambda^\gamma > 0$, then

$$\begin{aligned} \tilde{\lambda}_{k'}^\gamma(\mathbf{x}) - \tilde{\lambda}_k^\gamma(\mathbf{x}) &= n \int_{w=(k'-1)/n}^{k'/n} \lambda^\gamma(\omega_{\gamma:k'}^1(\mathbf{x}), \dots, \omega_{\gamma:k'}^{\gamma-1}(\mathbf{x}), w, \omega_{\gamma:k'}^{\gamma+1}(\mathbf{x}), \dots, \omega_{\gamma:k'}^d(\mathbf{x})) dw \\ &\quad - n \int_{w=(k-1)/n}^{k/n} \lambda^\gamma(\omega_{\gamma:k}^1(\mathbf{x}), \dots, \omega_{\gamma:k}^{\gamma-1}(\mathbf{x}), w, \omega_{\gamma:k}^{\gamma+1}(\mathbf{x}), \dots, \omega_{\gamma:k}^d(\mathbf{x})) dw \\ &= n \int_{w=(k-1)/n}^{k/n} (\lambda^\gamma(\omega_{\gamma:k}^1(\mathbf{x}), \dots, w + (k' - k)/n, \dots, \omega_{\gamma:k}^d(\mathbf{x})) \\ &\quad - \lambda^\gamma(\omega_{\gamma:k}^1(\mathbf{x}), \dots, w, \dots, \omega_{\gamma:k}^d(\mathbf{x}))) dw \\ &= n \int_{w=(k-1)/n}^{k/n} \int_{w'=w}^{w+(k'-k)/n} \partial_\gamma \lambda^\gamma(\omega_{\gamma:k}^1(\mathbf{x}), \dots, w', \dots, \omega_{\gamma:k}^d(\mathbf{x})) dw' dw > 0, \end{aligned}$$

where we have used the fact that, since $x_{k'}^\gamma = x_k^\gamma$, then $\omega_{\gamma:k'}^{\gamma'}(\mathbf{x}) = \omega_{\gamma:k}^{\gamma'}(\mathbf{x})$ for all $\gamma' \neq \gamma$.

Let us now prove Lemma 9.4.1 by induction on $N(\mathbf{x})$. First, let $\mathbf{x} \in D_n^d$ such that $N(\mathbf{x}) = 0$. Then, for all $t \geq 0$, $\Phi(\mathbf{x}; t) = \tilde{\Phi}[\tilde{\lambda}(\mathbf{x})](\mathbf{x}; t)$, therefore the first part of the lemma is a straightforward consequence of (iii) in Remark 9.3.4. Let $\gamma \in \{1, \dots, d\}$ such that $\partial_\gamma \lambda^\gamma > 0$. Let $t \geq 0$ and $\underline{k}, \dots, \bar{k}$ be a set of consecutive indices in $\{1, \dots, n\}$ such that

$$\Phi_{\underline{k}}^\gamma(\mathbf{x}; t) = \cdots = \Phi_{\bar{k}}^\gamma(\mathbf{x}; t).$$

If $\bar{k} > \underline{k}$, then the stability condition in Definition 9.3.3 fails: indeed, in this case, for all $j \in \{\underline{k}, \dots, \bar{k} - 1\}$, the remark at the beginning of the proof yields

$$\frac{1}{j - \underline{k} + 1} \sum_{k'=\underline{k}}^j \tilde{\lambda}_{k'}^\gamma(\mathbf{x}) \leq \tilde{\lambda}_j^\gamma(\mathbf{x}) < \tilde{\lambda}_{j+1}^\gamma(\mathbf{x}) \leq \frac{1}{\bar{k} - j} \sum_{k'=j+1}^{\bar{k}} \tilde{\lambda}_{k'}^\gamma(\mathbf{x}).$$

As a consequence, $\text{clu}_k^\gamma(\mathbf{x}; t) = \gamma : k$.

We now let $N \geq 0$ such that the lemma holds for all $\mathbf{x} \in D_n^d$ with $N(\mathbf{x}) \leq N$, and fix $\mathbf{x} \in D_n^d$ such that $N(\mathbf{x}) = N + 1$. For all $t \in [0, t^*(\mathbf{x}))$, $\Phi(\mathbf{x}; t) = \tilde{\Phi}[\tilde{\lambda}(\mathbf{x})](\mathbf{x}; t)$, therefore applying the argument above already yields

- for all $s, t \in [0, t^*(\mathbf{x}))$ with $s \leq t$, $\text{clu}_k^\gamma(\mathbf{x}; s) \subset \text{clu}_k^\gamma(\mathbf{x}; t)$,
- if $\partial_\gamma \lambda^\gamma > 0$, then, for all $t \in [0, t^*(\mathbf{x}))$, $\text{clu}_k^\gamma(\mathbf{x}; t) = \gamma : k$.

Besides, since $N(\mathbf{x}^*) \leq N$, where we recall that $\mathbf{x}^* = \Phi(\mathbf{x}; t^*(\mathbf{x}))$, then

- for all $s, t \in [t^*(\mathbf{x}), +\infty)$ with $s \leq t$, $\text{clu}_k^\gamma(\mathbf{x}; s) \subset \text{clu}_k^\gamma(\mathbf{x}; t)$,
- if $\partial_\gamma \lambda^\gamma > 0$, then, for all $t \in [t^*(\mathbf{x}), +\infty)$, $\text{clu}_k^\gamma(\mathbf{x}; t) = \gamma : k$.

As a consequence, if $\partial_\gamma \lambda^\gamma > 0$, then, for all $t \geq 0$, $\text{clu}_k^\gamma(\mathbf{x}; t) = \gamma : k$, and, to complete the proof, it remains to check that for $\partial_\gamma \lambda^\gamma < 0$,

$$\text{clu}_k^\gamma(\mathbf{x}; t^*(\mathbf{x})^-) \subset \text{clu}_k^\gamma(\mathbf{x}; t^*(\mathbf{x})),$$

where $\text{clu}_k^\gamma(\mathbf{x}; t^*(\mathbf{x})^-)$ is defined in Definition 9.4.2. Let $\gamma : \underline{k} \cdots \bar{k} := \text{clu}_k^\gamma(\mathbf{x}; t^*(\mathbf{x})^-)$. By Definition 9.3.3, since

$$\Phi_{\underline{k}}^\gamma(\mathbf{x}; t^*(\mathbf{x})) = \cdots = \Phi_{\bar{k}}^\gamma(\mathbf{x}; t^*(\mathbf{x})),$$

it suffices to check that the stability condition is satisfied by the quantities $\tilde{\lambda}_{\underline{k}}^\gamma(\mathbf{x}^*), \dots, \tilde{\lambda}_{\bar{k}}^\gamma(\mathbf{x}^*)$. If $\underline{k} = \bar{k}$ this is trivial, else let $j \in \{\underline{k}, \dots, \bar{k} - 1\}$. Then, by the remark at the beginning of the proof,

$$\frac{1}{j - \underline{k} + 1} \sum_{k'=\underline{k}}^j \tilde{\lambda}_{k'}^\gamma(\mathbf{x}^*) \geq \tilde{\lambda}_j^\gamma(\mathbf{x}^*) > \tilde{\lambda}_{j+1}^\gamma(\mathbf{x}^*) \geq \frac{1}{\bar{k} - j} \sum_{k'=j+1}^{\bar{k}} \tilde{\lambda}_{k'}^\gamma(\mathbf{x}^*),$$

therefore the stability condition is satisfied and $\text{clu}_k^\gamma(\mathbf{x}; t^*(\mathbf{x})^-) \subset \text{clu}_k^\gamma(\mathbf{x}; t^*(\mathbf{x}))$. The proof is completed. \square

Let $\gamma \in \{1, \dots, d\}$ and $k, k' \in \{1, \dots, n\}$ with $k \neq k'$. Under Assumption (GNL), Lemma 9.4.1 implies that, for all $\mathbf{x} \in D_n^d$, for all $\gamma : k \in P_n^d$, the set

$$\{t \in (0, +\infty) : \text{clu}_k^\gamma(\mathbf{x}; t^-) \neq \text{clu}_k^\gamma(\mathbf{x}; t)\}$$

is finite (it is actually empty if $\partial_\gamma \lambda^\gamma < 0$), and each element of this set corresponds to a collision between (the cluster containing) the particle $\gamma : k$ and another cluster of type γ .

In the sequel of this section, collisions between clusters of the same type shall be referred to as *self-interactions*. The space-time point of a self-interaction between particles $\gamma : k$ and $\gamma : k'$ shall be denoted by

$$\Xi_{\gamma:k, \gamma:k'}^{\text{self}}(\mathbf{x}) \in \mathbb{R} \times (0, +\infty).$$

The following technical result shall be used in Subsection 9.4.3.

Lemma 9.4.3 (Continuity of the composition of clusters). *Under Assumptions (USH) and (GNL), for all $\mathbf{x} \in D_n^d$, for all $t \in (0, t^*(\mathbf{x}))$ such that*

$$\forall \gamma : k \in P_n^d, \quad \text{clu}_k^\gamma(\mathbf{x}; t^-) = \text{clu}_k^\gamma(\mathbf{x}; t),$$

then there exists $\eta > 0$ such that, for all $\mathbf{y} \in \bar{B}_1(\mathbf{x}, \eta)$,

$$\forall \gamma : k \in P_n^d, \quad \text{clu}_k^\gamma(\mathbf{y}; t) = \text{clu}_k^\gamma(\mathbf{x}; t).$$

Proof. Let us first fix $t' \in (0, t)$ such that, for all $s \in [t', t]$, for all $\gamma : k \in P_n^d$, $\text{clu}_k^\gamma(\mathbf{x}; s) = \text{clu}_k^\gamma(\mathbf{x}; t)$. For $\eta' > 0$ small enough, for all $\gamma : k$ and $\gamma' : k'$ such that $\text{clu}_k^\gamma(\mathbf{x}; t) \neq \text{clu}_{k'}^{\gamma'}(\mathbf{x}; t)$,

$$\forall s \in [t', t], \quad [\Phi_k^\gamma(\mathbf{x}; s) - \eta', \Phi_k^\gamma(\mathbf{x}; s) + \eta'] \cap [\Phi_{k'}^{\gamma'}(\mathbf{x}; s) - \eta', \Phi_{k'}^{\gamma'}(\mathbf{x}; s) + \eta'] = \emptyset;$$

besides; by Lemma 9.A.4, one can also choose η' small enough to ensure that, for all $\mathbf{y}' \in \bar{B}_1(\Phi(\mathbf{x}; t'), \eta')$, then $\mathbf{y}' \in \mathcal{D}$, $R(\mathbf{y}') = R(\Phi(\mathbf{x}; t'))$ and $t^*(\mathbf{y}') > t' - t$ (we refer to 9.A.4 for a recall of the definition of the set \mathcal{D}).

By Lemma 9.3.10 combined with the flow property of Proposition 9.3.16, these conditions imply that, for all $\mathbf{y}' \in \bar{B}_1(\Phi(\mathbf{x}; t'), \eta')$,

$$\forall s \in [t', t], \quad \|\Phi(\mathbf{y}'; s - t') - \Phi(\mathbf{x}; s)\|_1 \leq \|\mathbf{y}' - \Phi(\mathbf{x}; t')\|_1 \leq \eta'.$$

We now want to fix η' small enough to satisfy the conditions above, and such that, for all $\gamma : k \in P_n^d$, if $\mathbf{y}' \in \bar{B}_1(\Phi(\mathbf{x}; t'), \eta')$, then $\text{clu}_k^\gamma(\mathbf{y}', t - t') = \text{clu}_k^\gamma(\mathbf{x}; t)$. If $\partial_\gamma \lambda^\gamma > 0$, then by Lemma 9.4.1, for all $k \in \{1, \dots, n\}$, $\text{clu}_k^\gamma(\mathbf{y}', t - t') = \text{clu}_k^\gamma(\mathbf{x}; t) = \gamma : k$ and there is nothing to prove. Let us assume that $\partial_\gamma \lambda^\gamma < 0$. Let $k \in \{1, \dots, n\}$ and denote $\gamma : \underline{k} \cdots \bar{k} = \text{clu}_k^\gamma(\mathbf{x}; t)$. For η' small enough, for all $\mathbf{y}' \in \bar{B}_1(\Phi(\mathbf{x}; t'), \eta')$, for all $s \in [t', t]$, $\text{clu}_k^\gamma(\mathbf{y}'; s - t') \subset \gamma : \underline{k} \cdots \bar{k}$ and this inclusion is an equality as soon as $\Phi_{\underline{k}}^\gamma(\mathbf{y}'; s - t') = \Phi_{\underline{k}}^\gamma(\mathbf{y}'; s - t')$. Let us write

$$\begin{aligned} \Phi_{\underline{k}}^\gamma(\mathbf{y}'; s - t') &= y_{\underline{k}}^{\prime\gamma} + \int_{r=0}^{s-t'} v_{\underline{k}}^\gamma(\mathbf{y}'; r) dr, \\ \Phi_{\bar{k}}^\gamma(\mathbf{y}'; s - t') &= y_{\bar{k}}^{\prime\gamma} + \int_{r=0}^{s-t'} v_{\bar{k}}^\gamma(\mathbf{y}'; r) dr, \end{aligned}$$

and note that, by the same computation as at the beginning of the proof of Lemma 9.4.1, as long as $\Phi_{\underline{k}}^\gamma(\mathbf{y}'; s - t') < \Phi_{\bar{k}}^\gamma(\mathbf{y}'; s - t')$, then for all $r \in [0, s - t']$,

$$v_{\underline{k}}^\gamma(\mathbf{y}'; r) - v_{\bar{k}}^\gamma(\mathbf{y}'; r) \geq \frac{1}{n} \inf(-\partial_\gamma \lambda^\gamma) =: \rho^\gamma > 0.$$

Taking $\eta' \leq \rho^\gamma(t - t')$, for all γ such that $\partial_\gamma \lambda^\gamma < 0$, therefore ensures that for all $\gamma : k$, $\text{clu}_k^\gamma(\mathbf{y}'; t - t') = \gamma : \underline{k} \cdots \bar{k}$ with the same notations as above. By Proposition 9.3.17, there exists $\eta > 0$ such that, for all $\mathbf{y} \in \bar{B}_1(\mathbf{x}, \eta)$, then $\Phi(\mathbf{y}; t') \in \bar{B}_1(\Phi(\mathbf{x}; t'), \eta')$; which completes the proof. \square

9.4.2 Local stability estimates

In this subsection, we establish local L^1 and L^∞ stability estimates on the trajectory of the MSPD started at configurations \mathbf{x} and \mathbf{y} satisfying a certain local homeomorphic property. These local stability results are stated in Proposition 9.4.7.

Let us give a brief overview of our argument. Given arbitrary configurations \mathbf{x} and \mathbf{y} in D_n^d , the properties of the Typewise Sticky Particle Dynamics described in Section 9.3 allow to derive estimates on the distances $\|\Phi(\mathbf{x}; t) - \Phi(\mathbf{y}; t)\|_1$ and $\|\Phi(\mathbf{x}; t) - \Phi(\mathbf{y}; t)\|_\infty$ under the condition that, at all time $t \geq 0$, either $R(\Phi(\mathbf{x}; t)) = R(\Phi(\mathbf{y}; t))$, *i.e.* the global ordering of the particles is the same in both systems, or there exist two clusters a and b , with $\text{type}(a) < \text{type}(b)$, such that the sets $R(\Phi(\mathbf{x}; t))$ and $R(\Phi(\mathbf{y}; t))$ only differ by the subset $a \times b$, *i.e.* the clusters a and b have collided in one of the two systems but not yet in the other, while all the other particles are in the same order in both systems.

This condition is introduced in §9.4.2.2 and called Local Homeomorphic condition (LHM). A necessary condition for this property to hold is that, in both the MSPD started at \mathbf{x} and \mathbf{y} , collisions between clusters of different type be *binary*, that is to say, do not involve more than two types of particles. Such configurations are said *binary colliding*, and are studied in §9.4.2.1. In particular, we introduce the notion of *collision graph* for a binary colliding configuration, which is the natural structure encoding the geometric properties of the trajectory of the MSPD started at this configuration.

Then, for two configurations \mathbf{x}, \mathbf{y} satisfying Condition (LHM), we prove in §9.4.2.3 and §9.4.2.4 that the study of both $\|\Phi(\mathbf{x}; t) - \Phi(\mathbf{y}; t)\|_1$ and $\|\Phi(\mathbf{x}; t) - \Phi(\mathbf{y}; t)\|_\infty$ reduces to the resolution of a system of recursive inequations, set on the common collision graph of \mathbf{x} and \mathbf{y} . This system is solved in §9.4.2.5.

9.4.2.1 Binary colliding configurations

Let us first denote by \mathcal{D} the set of configurations $\mathbf{x} \in D_n^d$ such that, for all $(\alpha : i, \beta : j) \in (P_n^d)^2$ with $\alpha < \beta$, then $x_i^\alpha \neq x_j^\beta$. Certainly, \mathcal{D} is a dense open subset of D_n^d . The set \mathcal{B} of *binary colliding configurations* is defined as follows.

Definition 9.4.4 (Binary colliding configurations). *The set of binary colliding configurations $\mathcal{B} \subset D_n^d$ is defined by $\mathbf{x} \in \mathcal{B}$ if and only if $\mathbf{x} \in \mathcal{D}$ and either $N(\mathbf{x}) = 0$, or $N(\mathbf{x}) \geq 1$ and, for all $(\alpha : i, \beta : j), (\alpha' : i', \beta' : j') \in R(\mathbf{x})$, then $\Xi_{\alpha:i, \beta:j}^{\text{coll}}(\mathbf{x}) = \Xi_{\alpha':i', \beta':j'}^{\text{coll}}(\mathbf{x})$ implies $\alpha' = \alpha$ and $\beta' = \beta$.*

We recall that the space-time collision points $\Xi_{\alpha:i, \beta:j}^{\text{coll}}(\mathbf{x})$ are defined in §9.3.2.4. Note that if $d \leq 2$, then $\mathcal{B} = \mathcal{D}$.

We now introduce a few notions to describe binary colliding configurations.

9.4.2.1.1 Collisions Let $\mathbf{x} \in \mathcal{B}$, with $N(\mathbf{x}) \geq 1$. We define the equivalence relation \sim on $R(\mathbf{x})$ by, for all $(\alpha : i, \beta : j), (\alpha' : i', \beta' : j') \in R(\mathbf{x})$,

$$(\alpha : i, \beta : j) \sim (\alpha' : i', \beta' : j') \quad \text{if and only if} \quad \Xi_{\alpha:i, \beta:j}^{\text{coll}}(\mathbf{x}) = \Xi_{\alpha':i', \beta':j'}^{\text{coll}}(\mathbf{x}).$$

Let $C(\mathbf{x}) := R(\mathbf{x}) / \sim$ refer to the set of equivalence classes and $M(\mathbf{x}) \geq 1$ denote the cardinality of $C(\mathbf{x})$. Each equivalence class $\mathbf{c} \in C(\mathbf{x})$ is naturally associated with a space-time point

$$\Xi(\mathbf{x}; \mathbf{c}) = (\xi(\mathbf{x}; \mathbf{c}), T(\mathbf{x}; \mathbf{c})) \in \mathbb{R} \times (0, +\infty),$$

defined by

$$\Xi(\mathbf{x}; \mathbf{c}) := \Xi_{\alpha:i, \beta:j}^{\text{coll}}(\mathbf{x}) \quad \text{for any } (\alpha : i, \beta : j) \in \mathbf{c}.$$

In addition, Definition 9.4.4 implies that, for all $\mathbf{c} \in C(\mathbf{x})$, there exist $\alpha, \beta \in \{1, \dots, d\}$ such that $\alpha < \beta$ and, for all $(\alpha' : i', \beta' : j') \in \mathbf{c}$, $\alpha' = \alpha$ and $\beta' = \beta$. Letting

$$\begin{aligned} a &:= \{\alpha : i \in P_n^d : \exists \beta : j \in P_n^d, (\alpha : i, \beta : j) \in \mathbf{c}\}, \\ b &:= \{\beta : j \in P_n^d : \exists \alpha : i \in P_n^d, (\alpha : i, \beta : j) \in \mathbf{c}\}, \end{aligned}$$

it is easily checked that $\mathbf{c} = a \times b$. Note that some of the clusters $\text{clu}_i^\alpha(\mathbf{x}; T(\mathbf{x}; \mathbf{c})^-)$ for $\alpha : i \in a$ (or $\text{clu}_j^\beta(\mathbf{x}; T(\mathbf{x}; \mathbf{c})^-)$ for $\beta : j \in b$) can be distinct when self-interactions occur at the same space-time point as the collision. However, after the collision, Lemma 9.4.1 ensures that the clusters remain formed and therefore

$$\forall (\alpha : i, \beta : j) \in \mathbf{c}, \quad \text{clu}_i^\alpha(\mathbf{x}; T(\mathbf{x}; \mathbf{c})) = a, \quad \text{clu}_j^\beta(\mathbf{x}; T(\mathbf{x}; \mathbf{c})) = b.$$

In the sequel, we shall simply refer to the equivalence classes as *collisions*, and say that a cluster c is *involved* in the collision $\mathbf{c} = a \times b$ if $c \in \{a, b\}$.

If $\mathbf{x} \in \mathcal{B}$ and $N(\mathbf{x}) = 0$, we simply define $M(\mathbf{x}) = 0$.

9.4.2.1.2 Collision graph Let $\mathbf{x} \in \mathcal{B}$. For all $\gamma : k \in P_n^d$, we denote by $C_{\gamma:k}(\mathbf{x})$ the subset of $C(\mathbf{x})$ composed by the collisions $\mathbf{c} = a \times b$ such that $\gamma : k \in a \cup b$. Note that $C_{\gamma:k}(\mathbf{x})$ is empty if the particle $\gamma : k$ does not collide with a particle of another type in the MSPD started at \mathbf{x} . Clearly, two distinct collisions $\mathbf{c}', \mathbf{c} \in C_{\gamma:k}(\mathbf{x})$ have distinct instants of collision $T(\mathbf{x}; \mathbf{c}') \neq T(\mathbf{x}; \mathbf{c})$, since two distinct collisions involving the same particle $\gamma : k$ cannot occur at the same time. As a consequence, the increasing order of instants of collisions induces a total order on the set $C_{\gamma:k}(\mathbf{x})$, to which we shall only refer as the *order of collisions*.

For all $\gamma \in \{1, \dots, d\}$, for all $\mathbf{c}', \mathbf{c} \in C(\mathbf{x})$, we shall write

$$\mathbf{c}' \xrightarrow{\gamma} \mathbf{c}$$

whenever there exists $k \in \{1, \dots, n\}$ such that $\mathbf{c}', \mathbf{c} \in C_{\gamma:k}(\mathbf{x})$ and \mathbf{c} is the next element after \mathbf{c}' for the order of collisions on $C_{\gamma:k}(\mathbf{x})$. Note that Lemma 9.4.1 ensures that if $\mathbf{c}' \xrightarrow{\gamma} \mathbf{c}$, then for all $k \in \{1, \dots, n\}$ such that $\mathbf{c}', \mathbf{c} \in C_{\gamma:k}(\mathbf{x})$, \mathbf{c} is the next element after \mathbf{c}' for the order of collisions on $C_{\gamma:k}(\mathbf{x})$.

The *collision graph* of a binary colliding configuration \mathbf{x} is now defined as the oriented graph with set of vertices $C(\mathbf{x})$, and set of arcs induced by the relations $\mathbf{c}' \xrightarrow{\gamma} \mathbf{c}$. If $N(\mathbf{x}) = 0$ then the collision graph of \mathbf{x} is nothing but the empty graph.

By construction, an arc is naturally associated with at least a type $\gamma \in \{1, \dots, d\}$, and since Assumption (USH) ensures that two particles of distinct type can only collide once, each arc actually has a unique type. Besides, since $\mathbf{c}' \xrightarrow{\gamma} \mathbf{c}$ implies that $T(\mathbf{x}; \mathbf{c}') < T(\mathbf{x}; \mathbf{c})$, there is no oriented cycle in the collision graph.

9.4.2.1.3 Numbering the collisions Let us now explain how to number the collisions $\mathbf{c} \in C(\mathbf{x})$ in a consistent fashion with the partial order induced by the orientation of the collision graph.

Lemma 9.4.5 (Numbering the collisions). *Under Assumptions (USH) and (GNL), let $\mathbf{x} \in \mathcal{B}$, with $M := M(\mathbf{x}) \geq 1$. Then the set of collisions $C(\mathbf{x})$ can be numbered in such a fashion $\mathbf{c}_1, \dots, \mathbf{c}_M$ that, for all $m', m \in \{1, \dots, M\}$ satisfying*

$$\mathbf{c}_{m'} \xrightarrow{\gamma} \mathbf{c}_m$$

for some $\gamma \in \{1, \dots, d\}$, then $m' < m$.

Proof. Let us call *leaves* the collisions $\mathbf{c} \in C(\mathbf{x})$ such that there is no $\mathbf{c}' \in C(\mathbf{x})$ pointing toward \mathbf{c} in the collision graph. Clearly, \mathbf{c} is a leaf if and only if, for all $\gamma : k \in P_n^d$ such that $\mathbf{c} \in C_{\gamma:k}(\mathbf{x})$, \mathbf{c} is the minimal element of $C_{\gamma:k}(\mathbf{x})$ for the order of collisions. Since there is no oriented cycle in the collision graph, the set of leaves is nonempty, and this property remains true for all nonempty subgraph of the collision graph obtained by removing a leaf and its adjacent arcs.

We now proceed as follows: we choose one leaf, call it \mathbf{c}_1 , remove it from the graph together with all the adjacent arcs, and restart the construction as long as the graph is nonempty. At the m -th step, the selected collision \mathbf{c}_m is minimal among the remaining elements of all the sets $C_{\gamma:k}$ to which it belongs for the order of collisions. This ensures that the numbering is consistent with the partial order induced by the orientation of the collision graph. \square

Remark 9.4.6. An effective way to proceed as in the proof of Lemma 9.4.5 is to number the collisions in the increasing order of collision times. If two distinct collisions \mathbf{c}' , \mathbf{c} have the same collision time, then they cannot involve the same particle; therefore, any sort of such ties leads to a numbering satisfying the conclusion of Lemma 9.4.5.

9.4.2.1.4 Last collision time For all $\gamma : k \in P_n^d$, we finally define $T_{\gamma:k}^{\max}(\mathbf{x})$ by

$$T_{\gamma:k}^{\max}(\mathbf{x}) := 0$$

if $C_{\gamma:k}(\mathbf{x})$ is empty, and

$$T_{\gamma:k}^{\max}(\mathbf{x}) := \max_{\mathbf{c} \in C_{\gamma:k}(\mathbf{x})} T(\mathbf{x}; \mathbf{c})$$

otherwise.

9.4.2.2 Statement of the local stability estimates

Two configurations $\mathbf{x}, \mathbf{y} \in D_n^d$ are said to satisfy the Local Homeomorphic condition (LHM) if:

(LHM-1) $\mathbf{x}, \mathbf{y} \in \mathcal{B}$ and $R(\mathbf{x}) = R(\mathbf{y}) =: R$,

(LHM-2) \mathbf{x} and \mathbf{y} have the same collision graph, which in particular implies $C(\mathbf{x}) = C(\mathbf{y}) =: C$,

(LHM-3) for all $\mathbf{c} \in C$, letting $T^-(\mathbf{c}) := T(\mathbf{x}; \mathbf{c}) \wedge T(\mathbf{y}; \mathbf{c})$ and $T^+(\mathbf{c}) := T(\mathbf{x}; \mathbf{c}) \vee T(\mathbf{y}; \mathbf{c})$,

(a) for all arc $\mathbf{c}' \xrightarrow{\gamma} \mathbf{c}$, $T^+(\mathbf{c}') < T^-(\mathbf{c})$,

(b) for all $(\alpha : i, \beta : j) \in \mathbf{c} = a \times b$,

$$\forall t \in [T^-(\mathbf{c}), T^+(\mathbf{c})], \quad \text{clu}_i^\alpha(\mathbf{x}; t) = \text{clu}_i^\alpha(\mathbf{y}; t) = a, \quad \text{clu}_j^\beta(\mathbf{x}; t) = \text{clu}_j^\beta(\mathbf{y}; t) = b.$$

The time intervals $[T^-(\mathbf{c}), T^+(\mathbf{c})]$ shall be referred to as *collision intervals*.

We are now able to state our local stability estimates.

Proposition 9.4.7 (Local stability estimates). *Under Assumptions (LC), (USH) and (GNL), for all $\mathbf{x}, \mathbf{y} \in D_n^d$ satisfying Condition (LHM), then*

$$\sup_{t \geq 0} \|\Phi(\mathbf{x}; t) - \Phi(\mathbf{y}; t)\|_1 \leq \mathcal{L}_1 \|\mathbf{x} - \mathbf{y}\|_1,$$

$$\sup_{t \geq 0} \|\Phi(\mathbf{x}; t) - \Phi(\mathbf{y}; t)\|_\infty \leq \mathcal{L}_\infty \|\mathbf{x} - \mathbf{y}\|_\infty,$$

where

$$\begin{aligned} \mathcal{L}_1 &:= (1 + 4\Theta(d - 1) \exp(\Theta(d - 1))) \exp(2\Theta^2 d(d - 1) \exp(\Theta(d - 1))), \\ \mathcal{L}_\infty &:= (1 + \Theta d \mathcal{L}_1) \exp(\Theta(d - 1)), \end{aligned} \tag{9.24}$$

and

$$\Theta := \frac{L_{LC}}{L_{USH}}.$$

The proof of Proposition 9.4.7 is detailed in §9.4.2.3, §9.4.2.4 and §9.4.2.5 below. Throughout these paragraphs, we fix $\mathbf{x}, \mathbf{y} \in D_n^d$ satisfying Condition (LHM) and adopt the notations of Condition (LHM) by denoting by R the set $R(\mathbf{x}) = R(\mathbf{y})$, by $N = N(\mathbf{x}) = N(\mathbf{y})$ its cardinality, by C the set of collisions $C(\mathbf{x}) = C(\mathbf{y})$ and by $M = M(\mathbf{x}) = M(\mathbf{y})$ its cardinality. Besides, Condition (LHM-2) ensures that, for all $\gamma : k \in P_n^d$, the sets $C_{\gamma:k}(\mathbf{x})$ and $C_{\gamma:k}(\mathbf{y})$ are the same, with the same order of collisions. These sets are denoted by $C_{\gamma:k}$. We finally denote

$$T_{\gamma:k}^{\max} := T_{\gamma:k}^{\max}(\mathbf{x}) \vee T_{\gamma:k}^{\max}(\mathbf{y}).$$

For all $t \geq 0$ and $\gamma : k \in P_n^d$, we define

$$d_k^\gamma(t) := |\Phi_k^\gamma(\mathbf{x}; t) - \Phi_k^\gamma(\mathbf{y}; t)|,$$

so that

$$\|\Phi(\mathbf{x}; t) - \Phi(\mathbf{y}; t)\|_1 = \frac{1}{n} \sum_{\gamma:k \in P_n^d} d_k^\gamma(t), \quad \|\Phi(\mathbf{x}; t) - \Phi(\mathbf{y}; t)\|_\infty = \sup_{\gamma:k \in P_n^d} d_k^\gamma(t).$$

In §9.4.2.3 we provide local (in time) estimates on the growth of $d_k^\gamma(t)$ inside and outside collision intervals. In §9.4.2.4, we introduce an *auxiliary system* that shall allow us to integrate these estimates along the whole sequence of collisions, and we explain how this auxiliary system can be coupled with the family of processes $\{(d_k^\gamma(t))_{t \geq 0}, \gamma : k \in P_n^d\}$. In §9.4.2.5, we obtain a bound on the auxiliary system that is transferred to the original processes $\|\Phi(\mathbf{x}; t) - \Phi(\mathbf{y}; t)\|_1$ and $\|\Phi(\mathbf{x}; t) - \Phi(\mathbf{y}; t)\|_\infty$ thanks to the coupling argument developed in §9.4.2.4.

9.4.2.3 Preliminary estimates

Let us first collect the following preliminary estimates on the joint evolution of the family of processes $\{(d_k^\gamma(t))_{t \geq 0}, \gamma : k \in P_n^d\}$.

Lemma 9.4.8 (Preliminary estimates). *Let the assumptions of Proposition 9.4.7 hold.*

(i) For all $\mathbf{c} = a \times b \in C$, for all $t \in [T^-(\mathbf{c}), T^+(\mathbf{c})]$,

$$\begin{aligned} \sum_{\alpha:i \in a} d_i^\alpha(t) &\leq \left(1 + \frac{\Theta}{n}|b|\right) \sum_{\alpha:i \in a} d_i^\alpha(T^-(\mathbf{c})) + \frac{\Theta}{n}|a| \sum_{\beta:j \in b} d_j^\beta(T^-(\mathbf{c})), \\ \sum_{\beta:j \in b} d_j^\beta(t) &\leq \left(1 + \frac{\Theta}{n}|a|\right) \sum_{\beta:j \in b} d_j^\beta(T^-(\mathbf{c})) + \frac{\Theta}{n}|b| \sum_{\alpha:i \in a} d_i^\alpha(T^-(\mathbf{c})), \end{aligned}$$

where we recall that $\Theta = L_{LC}/L_{USH}$.

(ii) Let $\mathbf{c} = a \times b \in C$, $c \in \{a, b\}$ and $\gamma := \text{type}(c)$. For all $\gamma : k \in c$, let us define $t'_{\gamma:k} := T^+(\mathbf{c}')$ if there exists $\mathbf{c}' \in C_{\gamma:k}$ such that $\mathbf{c}' \xrightarrow{\gamma} \mathbf{c}$, and $t'_{\gamma:k} := 0$ otherwise. Then, for all $t \leq T^-(\mathbf{c})$,

$$\begin{aligned} \sum_{\gamma:k \in c} \mathbb{1}_{\{t \geq t'_{\gamma:k}\}} d_k^\gamma(t) &\leq \sum_{\gamma:k \in c} \mathbb{1}_{\{t \geq t'_{\gamma:k}\}} d_k^\gamma(t'_{\gamma:k}), \\ \sup_{\gamma:k \in c} \mathbb{1}_{\{t \geq t'_{\gamma:k}\}} d_k^\gamma(t) &\leq \sup_{\gamma:k \in c} \mathbb{1}_{\{t \geq t'_{\gamma:k}\}} d_k^\gamma(t'_{\gamma:k}). \end{aligned}$$

(iii) For all $t \geq 0$, for all γ in $\{1, \dots, d\}$,

$$\begin{aligned} \sum_{k=1}^n \mathbb{1}_{\{t \geq T_{\gamma:k}^{\max}\}} d_k^\gamma(t) &\leq \sum_{k=1}^n \mathbb{1}_{\{t \geq T_{\gamma:k}^{\max}\}} d_k^\gamma(T_{\gamma:k}^{\max}), \\ \sup_{1 \leq k \leq n} \mathbb{1}_{\{t \geq T_{\gamma:k}^{\max}\}} d_k^\gamma(t) &\leq \sup_{1 \leq k \leq n} \mathbb{1}_{\{t \geq T_{\gamma:k}^{\max}\}} d_k^\gamma(T_{\gamma:k}^{\max}). \end{aligned}$$

Let us highlight the fact that $t'_{\gamma:k}$ and $T_{\gamma:k}^{\max}$ play similar roles in the respective cases (ii) and (iii). Besides, owing to Condition (LHM-3b), in case (i), for all $t \in [T^-(\mathbf{c}), T^+(\mathbf{c})]$, all the quantities $d_i^\alpha(t)$, $\alpha : i \in a_m$, have the same value; similarly, all the quantities $d_j^\beta(t)$, $\beta : j \in b_m$, have the same value. Hence, we also have

$$\begin{aligned} \sup_{\alpha:i \in a} d_i^\alpha(t) &\leq \left(1 + \frac{\Theta}{n}|b|\right) \sup_{\alpha:i \in a} d_i^\alpha(T^-(\mathbf{c})) + \frac{\Theta}{n}|a| \sup_{\beta:j \in b} d_j^\beta(T^-(\mathbf{c})), \\ \sup_{\beta:j \in b} d_j^\beta(t) &\leq \left(1 + \frac{\Theta}{n}|a|\right) \sup_{\beta:j \in b} d_j^\beta(T^-(\mathbf{c})) + \frac{\Theta}{n}|b| \sup_{\alpha:i \in a} d_i^\alpha(T^-(\mathbf{c})). \end{aligned}$$

Proof of Lemma 9.4.8. We first address (i) and fix $\mathbf{c} = a \times b \in C$. Let us use (ii) in Lemma 9.3.19 to prove that the process $\{\Phi_i^\alpha(\mathbf{x}; t) : \alpha : i \in a\}$ follows the Local Sticky Particle Dynamics on $[T^-(\mathbf{c}), T^+(\mathbf{c})]$. By Condition (LHM-3b), for all $\alpha : i \in a$, $\text{clu}_i^\alpha(\mathbf{x}; T^+(\mathbf{c})) = a$. Besides, it follows from Condition (LHM-3a) that the set $\mathcal{T}_{\alpha:i}(\mathbf{x})$ as is defined in (9.22) has an empty intersection with $(T^-(\mathbf{c}), T^+(\mathbf{c}))$. As a consequence, Lemma 9.3.19 asserts that the process $\{\Phi_i^\alpha(\mathbf{x}; t) : \alpha : i \in a\}$ follows the Local Sticky Particle Dynamics on $[T^-(\mathbf{c}), T^+(\mathbf{c})]$, with initial velocity vector $(\tilde{\lambda}_i^\alpha(\mathbf{x}'))_{\alpha:i \in a}$, where $\mathbf{x}' := \Phi(\mathbf{x}; T^-(\mathbf{c}))$; similarly, the process $\{\Phi_i^\alpha(\mathbf{y}; t) : \alpha : i \in a\}$ follows the Local Sticky Particle Dynamics on $[T^-(\mathbf{c}), T^+(\mathbf{c})]$, with initial velocity vector $(\tilde{\lambda}_i^\alpha(\mathbf{y}'))_{\alpha:i \in a}$, where $\mathbf{y}' := \Phi(\mathbf{y}; T^-(\mathbf{c}))$. We now apply (i) in Proposition 9.3.8 and obtain, for all $t \in [T^-(\mathbf{c}), T^+(\mathbf{c})]$,

$$\begin{aligned} \sum_{\alpha:i \in a} d_i^\alpha(t) &\leq \sum_{\alpha:i \in a} d_i^\alpha(T^-(\mathbf{c})) + (t - T^-(\mathbf{c})) \sum_{\alpha:i \in a} \left| \tilde{\lambda}_i^\alpha(\mathbf{x}') - \tilde{\lambda}_i^\alpha(\mathbf{y}') \right|, \\ &\leq \sum_{\alpha:i \in a} d_i^\alpha(T^-(\mathbf{c})) + (T^+(\mathbf{c}) - T^-(\mathbf{c})) \sum_{\alpha:i \in a} \left| \tilde{\lambda}_i^\alpha(\mathbf{x}') - \tilde{\lambda}_i^\alpha(\mathbf{y}') \right|. \end{aligned}$$

We shall estimate $T^+(\mathbf{c}) - T^-(\mathbf{c})$ and the distance between initial velocity vectors separately.

On the one hand, let us fix $(\alpha : i, \beta : j) \in a \times b$ and assume for instance that $T^-(\mathbf{c}) = T(\mathbf{x}; \mathbf{c}) \leq T(\mathbf{y}; \mathbf{c}) = T^+(\mathbf{c})$. Then $\Phi_i^\alpha(\mathbf{y}; T^+(\mathbf{c})) = \Phi_j^\beta(\mathbf{y}; T^+(\mathbf{c}))$, which rewrites

$$\Phi_j^\beta(\mathbf{y}; T^-(\mathbf{c})) - \Phi_i^\alpha(\mathbf{y}; T^-(\mathbf{c})) = \int_{s=T^-(\mathbf{c})}^{T^+(\mathbf{c})} (v_i^\alpha(\mathbf{y}; s) - v_j^\beta(\mathbf{y}; s)) ds$$

owing to (9.13). On account of (9.21), the right-hand side above is larger than $L_{\text{USH}}(T^+(\mathbf{c}) - T^-(\mathbf{c}))$, so that

$$\begin{aligned} T^+(\mathbf{c}) - T^-(\mathbf{c}) &\leq \frac{1}{L_{\text{USH}}} \left(\Phi_j^\beta(\mathbf{y}; T^-(\mathbf{c})) - \Phi_i^\alpha(\mathbf{y}; T^-(\mathbf{c})) \right) \\ &= \frac{1}{L_{\text{USH}}} \left(\Phi_j^\beta(\mathbf{y}; T^-(\mathbf{c})) - \Phi_j^\beta(\mathbf{x}; T^-(\mathbf{c})) + \Phi_i^\alpha(\mathbf{x}; T^-(\mathbf{c})) - \Phi_i^\alpha(\mathbf{y}; T^-(\mathbf{c})) \right) \\ &\leq \frac{1}{L_{\text{USH}}} \left(|\Phi_j^\beta(\mathbf{y}; T^-(\mathbf{c})) - \Phi_j^\beta(\mathbf{x}; T^-(\mathbf{c}))| + |\Phi_i^\alpha(\mathbf{x}; T^-(\mathbf{c})) - \Phi_i^\alpha(\mathbf{y}; T^-(\mathbf{c}))| \right) \\ &= \frac{1}{L_{\text{USH}}} \left(d_j^\beta(T^-(\mathbf{c})) + d_i^\alpha(T^-(\mathbf{c})) \right), \end{aligned}$$

where we have used the fact that $\Phi_j^\beta(\mathbf{x}; T^-(\mathbf{c})) = \Phi_i^\alpha(\mathbf{x}; T^-(\mathbf{c}))$ since $T^-(\mathbf{c}) = T(\mathbf{x}; \mathbf{c})$. Note that the right-hand side above does not actually depend on the choice of $(\alpha : i, \beta : j) \in a \times b$. Indeed,

owing to Condition **(LHM-3b)**, all the quantities $d_i^\alpha(T^-(\mathbf{c}))$, $\alpha : i \in a$ are equal, and all the quantities $d_j^\beta(T^-(\mathbf{c}))$, $\beta : j \in b$ are equal. Therefore, we rather write

$$T^+(\mathbf{c}) - T^-(\mathbf{c}) \leq \frac{1}{L_{\text{USH}}} \left(\frac{1}{|b|} \sum_{\beta:j \in b} d_j^\beta(T^-(\mathbf{c})) + \frac{1}{|a|} \sum_{\alpha:i \in a} d_i^\alpha(T^-(\mathbf{c})) \right).$$

On the other hand, let us remark that, for all $\alpha : i \in a$,

- for all $\gamma \notin \{\alpha, \beta\}$, $\omega_{\alpha:i}^\gamma(\mathbf{x}') = \omega_{\alpha:i}^\gamma(\mathbf{y}')$,
- $|\omega_{\alpha:i}^\beta(\mathbf{x}') - \omega_{\alpha:i}^\beta(\mathbf{y}')| \leq |b|/n$.

Indeed, by the definition of $\omega_{\alpha:i}^\gamma(\mathbf{x}')$ and $\omega_{\alpha:i}^\gamma(\mathbf{y}')$, the first item above easily follows if we check that, for all $\gamma : k \in P_n^d$ such that $\gamma \notin \{\alpha, \beta\}$ (say $\gamma < \alpha$),

$$x_k'^\gamma < x_i'^\alpha \quad \text{if and only if} \quad y_k'^\gamma < y_i'^\alpha.$$

But let us assume for instance that $x_k'^\gamma < x_i'^\alpha$ and $y_k'^\gamma \geq y_i'^\alpha$. Then, the collision with $\gamma : k$ comes after \mathbf{c} in $C_{\alpha:i}(\mathbf{x})$, while it is either not in $C_{\alpha:i}(\mathbf{y})$, or it comes before \mathbf{c} . This is a contradiction with Condition **(LHM-2)**. As far as the second point above is concerned, the same argument shows that the particles $\beta : j$ that do not belong to b have the same contribution in

$$\omega_{\alpha:i}^\beta(\mathbf{x}') = \frac{1}{n} \sum_{j=1}^n \mathbb{1}_{\{x_i'^\alpha \geq x_j'^\beta\}}$$

and in

$$\omega_{\alpha:i}^\beta(\mathbf{y}') = \frac{1}{n} \sum_{j=1}^n \mathbb{1}_{\{y_i'^\alpha \geq y_j'^\beta\}},$$

which is enough for the expected inequality to hold.

As a consequence, it follows from the definition of $\tilde{\lambda}$ and Assumption **(LC)** that, for all $\alpha : i \in a$,

$$\left| \tilde{\lambda}_i^\alpha(\mathbf{x}') - \tilde{\lambda}_i^\alpha(\mathbf{y}') \right| \leq \frac{L_{\text{LC}}}{n} |b|,$$

so that we finally obtain

$$\sum_{\alpha:i \in a} d_i^\alpha(t) \leq \sum_{\alpha:i \in a} d_i^\alpha(T^-(\mathbf{c})) + \frac{\Theta}{n} |a||b| \left(\frac{1}{|b|} \sum_{\beta:j \in b} d_j^\beta(T^-(\mathbf{c})) + \frac{1}{|a|} \sum_{\alpha:i \in a} d_i^\alpha(T^-(\mathbf{c})) \right),$$

whence the first inequality in the statement of **(i)** above. The second inequality follows by symmetry.

Let us now address **(ii)** and fix $\mathbf{c} = a \times b \in C$, $c \in \{a, b\}$ and $\gamma := \text{type}(c)$. As a preliminary step, let us point out the fact that, for all $\gamma : k \in c$, the quantity $t'_{\gamma:k}$ defined above easily rewrites

$$t'_{\gamma:k} = \max\{(T^-(\mathbf{c}))^- \wedge \mathcal{T}_{\gamma:k}(\mathbf{x}), (T^-(\mathbf{c}))^- \wedge \mathcal{T}_{\gamma:k}(\mathbf{y})\},$$

where we recall the definition **(9.23)** of $T^- \wedge \mathcal{T}_{\gamma:k}(\mathbf{x})$ and $T^- \wedge \mathcal{T}_{\gamma:k}(\mathbf{y})$. As a consequence, on the time interval $(t'_{\gamma:k}, T^-(\mathbf{c}))$, the particle $\gamma : k$ does not collide with any particle of another type, neither in the MSPD started at \mathbf{x} nor in the MSPD started at \mathbf{y} .

Let us denote by $t'_1 < \dots < t'_r$ the ordered elements of the set $\{t'_{\gamma:k}, \gamma : k \in c\}$. For all $l \in \{1, \dots, r\}$, we denote by c_l the set of particles $\gamma : k$ such that $t'_{\gamma:k} = t'_l$. We also define $t'_{r+1} := T^-(\mathbf{c}) > t'_r$. Thanks to Condition **(LHM-3b)**, for all $l \in \{1, \dots, r\}$, the processes

$$\{\Phi_k^\gamma(\mathbf{x}; t) : \gamma : k \in c_1 \sqcup \dots \sqcup c_l\} \quad \text{and} \quad \{\Phi_k^\gamma(\mathbf{y}; t) : \gamma : k \in c_1 \sqcup \dots \sqcup c_l\}$$

follow the Local Sticky Particle Dynamics on $[t'_l, t'_{l+1}]$, with the same initial velocity vectors. As a consequence, (i) in Proposition 9.3.8 yields, for all $t \in [t'_l, t'_{l+1}]$,

$$\begin{aligned} \sum_{\gamma:k \in c} \mathbb{1}_{\{t \geq t'_{\gamma:k}\}} d_k^\gamma(t) &= \sum_{\gamma:k \in c_1 \sqcup \dots \sqcup c_l} d_k^\gamma(t) \\ &\leq \sum_{\gamma:k \in c_1 \sqcup \dots \sqcup c_l} d_k^\gamma(t'_l) = \sum_{\gamma:k \in c_1 \sqcup \dots \sqcup c_{l-1}} d_k^\gamma(t'_l) + \sum_{\gamma:k \in c_l} d_k^\gamma(t'_{\gamma:k}), \end{aligned}$$

therefore we obtain by induction that, for all $t \leq T^-(c)$,

$$\sum_{\gamma:k \in c} \mathbb{1}_{\{t \geq t'_{\gamma:k}\}} d_k^\gamma(t) \leq \sum_{l=1}^r \sum_{\gamma:k \in c_l} d_k^\gamma(t'_{\gamma:k}) = \sum_{\gamma:k \in c} d_k^\gamma(t'_{\gamma:k}).$$

Applying (ii) in Proposition 9.3.8 instead of (i), we similarly obtain

$$\sup_{\gamma:k \in c} \mathbb{1}_{\{t \geq t'_{\gamma:k}\}} d_k^\gamma(t) \leq \sup_{\gamma:k \in c} d_k^\gamma(t'_{\gamma:k}).$$

Finally, (iii) is obtained by the same arguments as (ii): fixing $\gamma \in \{1, \dots, d\}$ and denoting by $T_1 < \dots < T_r$ the ordered elements of the set $\{T_{\gamma:k}^{\max}, k \in \{1, \dots, n\}\}$, we obtain that, for all $l \in \{1, \dots, r\}$, the processes $\{\Phi_k^\gamma(\mathbf{x}; t) : T_{\gamma:k}^{\max} \leq T_l\}$ and $\{\Phi_k^\gamma(\mathbf{y}; t) : T_{\gamma:k}^{\max} \leq T_l\}$ follow the Local Sticky Particle Dynamics on $[T_l, T_{l+1}]$ (where we take the convention that $T_{r+1} = +\infty$), with the same initial velocity vector. The conclusion follows in the same fashion as for (ii). \square

9.4.2.4 Coupling with an auxiliary system

We first give a heuristic description of our argument.

Let $\mathbf{c} = a \times b \in C$. Applying the point (i) of Lemma 9.4.8 with $t = T^+(\mathbf{c})$, we obtain

$$\begin{aligned} \sum_{\alpha:i \in a} d_i^\alpha(T^+(\mathbf{c})) &\leq \left(1 + \frac{\Theta}{n}|b|\right) \sum_{\alpha:i \in a} d_i^\alpha(T^-(\mathbf{c})) + \frac{\Theta}{n}|a| \sum_{\beta:j \in b} d_j^\beta(T^-(\mathbf{c})), \\ \sum_{\beta:j \in b} d_j^\beta(T^+(\mathbf{c})) &\leq \left(1 + \frac{\Theta}{n}|a|\right) \sum_{\beta:j \in b} d_j^\beta(T^-(\mathbf{c})) + \frac{\Theta}{n}|b| \sum_{\alpha:i \in a} d_i^\alpha(T^-(\mathbf{c})), \end{aligned} \tag{9.25}$$

and applying the point (ii) of Lemma 9.4.8 with $t = T^-(\mathbf{c})$ yields

$$\begin{aligned} \sum_{\alpha:i \in a} d_i^\alpha(T^-(\mathbf{c})) &\leq \sum_{c' \xrightarrow{\alpha} \mathbf{c}} \sum_{\alpha:i \in a'} d_i^\alpha(T^+(c')) + \sum_{\alpha:i \in a, t'_{\alpha,i}=0} d_i^\alpha(0), \\ \sum_{\beta:j \in b} d_j^\beta(T^-(\mathbf{c})) &\leq \sum_{c' \xrightarrow{\beta} \mathbf{c}} \sum_{\beta:j \in b'} d_j^\beta(T^+(c')) + \sum_{\beta:j \in b, t'_{\beta,j}=0} d_j^\beta(0), \end{aligned} \tag{9.26}$$

where a' (resp. b') in the right-hand side refers to the cluster of type α (resp. β) involved in the collision c' .

For all $c', \mathbf{c} \in C$ such that $c' \xrightarrow{\gamma} \mathbf{c}$, we denote $(c', c) \xrightarrow{\gamma} (\mathbf{c}, c)$ where c' is the cluster of type γ involved in the collision c' , and c is the cluster of type γ involved in the collision \mathbf{c} . Besides, for all $\gamma : k \in P_n^d$ such that $C_{\gamma:k}$ is nonempty, we denote $(\bullet, \gamma : k) \xrightarrow{\gamma} (\mathbf{c}, c)$, where c is the cluster of type γ involved in the minimal collision \mathbf{c} of $C_{\gamma:k}$ for the order of collisions, and \bullet is a *phantom collision*.

For all the pairs (\mathbf{c}, c) (including the pairs $(\bullet, \gamma : k)$) defined above, let us denote

$$D(\mathbf{c}, c) := \sum_{\gamma:k \in c} d_k^\gamma(T^+(\mathbf{c})),$$

where we take the convention that $T^+(\bullet) = 0$. Then the right-hand side of both lines of (9.26) rewrites under the more compact form

$$\begin{aligned} \sum_{\mathfrak{c}' \xrightarrow{\alpha} \mathfrak{c}} \sum_{\alpha:i \in a'} d_i^\alpha(T^+(\mathfrak{c}')) + \sum_{\alpha:i \in a, t'_{\alpha,i}=0} d_i^\alpha(0) &= \sum_{(\mathfrak{c}', a') \xrightarrow{\alpha} (\mathfrak{c}, a)} D(\mathfrak{c}', a'), \\ \sum_{\mathfrak{c}' \xrightarrow{\beta} \mathfrak{c}} \sum_{\beta:j \in b'} d_j^\beta(T^+(\mathfrak{c}')) + \sum_{\beta:j \in b, t'_{\beta,j}=0} d_j^\beta(0) &= \sum_{(\mathfrak{c}', b') \xrightarrow{\beta} (\mathfrak{c}, b)} D(\mathfrak{c}', b'), \end{aligned}$$

and (9.25) now writes as the system of recursive inequations

$$\begin{aligned} D(\mathfrak{c}, a) &\leq \left(1 + \frac{\Theta}{n}|b|\right) \sum_{(\mathfrak{c}', a') \xrightarrow{\alpha} (\mathfrak{c}, a)} D(\mathfrak{c}', a') + \frac{\Theta}{n}|a| \sum_{(\mathfrak{c}', b') \xrightarrow{\beta} (\mathfrak{c}, b)} D(\mathfrak{c}', b'), \\ D(\mathfrak{c}, b) &\leq \left(1 + \frac{\Theta}{n}|a|\right) \sum_{(\mathfrak{c}', b') \xrightarrow{\beta} (\mathfrak{c}, b)} D(\mathfrak{c}', b') + \frac{\Theta}{n}|b| \sum_{(\mathfrak{c}', a') \xrightarrow{\alpha} (\mathfrak{c}, a)} D(\mathfrak{c}', a'), \end{aligned} \tag{9.27}$$

on the quantities $D(\mathfrak{c}, a)$ and $D(\mathfrak{c}, b)$, with the recursive structure of the collision graph completed with the phantom collisions.

The *auxiliary system* that we introduce in this paragraph solves the system of recursive equations corresponding to (9.27), and therefore is expected to provide upper bounds on the quantities $D(\mathfrak{c}, c)$, from which we shall finally obtain bounds on the evolution of $\|\Phi(\mathbf{x}; t) - \Phi(\mathbf{y}; t)\|_1$ and $\|\Phi(\mathbf{x}; t) - \Phi(\mathbf{y}; t)\|_\infty$. This auxiliary system should naturally be defined as a sequence of positive numbers (that we shall understand as *masses*) indexed by the pairs (\mathfrak{c}, c) such that either $\mathfrak{c} = \bullet$ and c is a cluster containing a single particle, or $\mathfrak{c} \in C$ and c is a cluster involved in the collision \mathfrak{c} .

It is however more convenient to encode the structure of the collision graph through the numbering of collisions provided by Lemma 9.4.5, and therefore we let $C = \{\mathfrak{c}_1, \dots, \mathfrak{c}_M\}$ be such a numbering. The index 0 refers to phantom collisions. Then, the auxiliary system takes the form of a sequence of functions E_0, \dots, E_M respectively defined on the sets $\mathcal{U}_0, \dots, \mathcal{U}_M$ of *useful generical clusters* such that, at each step $m \in \{1, \dots, M\}$, $a_m, b_m \in \mathcal{U}_m$ and $E_m(a_m), E_m(b_m)$ are defined by the recursive equations corresponding to (9.27), while the other elements of \mathcal{U}_m are:

- either clusters c such that there exists $m' \in \{1, \dots, m-1\}$ such that $c \in \{a_{m'}, b_{m'}\}$ and c is not involved in the collisions $\mathfrak{c}_{m'+1}, \dots, \mathfrak{c}_{m-1}$, in which case $E_m(c) = E_{m'}(c)$ records the mass of the cluster at its latest collision,
- or clusters containing a single particle $\gamma : k$ which is not involved in any of the collisions $\mathfrak{c}_1, \dots, \mathfrak{c}_m$, in which case $E_m(\gamma : k) = d_k^\gamma(0)$.

Let us insist on the fact that the set of useful generical clusters \mathcal{U}_m does generally *not* describe the set of actual clusters in the MSPD started at \mathbf{x} and \mathbf{y} on the collision interval $[T^-(\mathfrak{c}_m), T^+(\mathfrak{c}_m)]$; on this interval, Condition (LHM-3b) ensures that a_m and b_m are actual clusters in both the MSPD started at \mathbf{x} and \mathbf{y} , but the other particles may belong to clusters of distinct compositions in the MSPD started at \mathbf{x} and in the MSPD started at \mathbf{y} . Therefore \mathcal{U}_m records clusters as they were at their latest collision before \mathfrak{c}_m .

A formal construction of both the set of useful clusters and the auxiliary system is detailed below.

9.4.2.4.1 The set of useful generical clusters \mathcal{U}_m For all $m \in \{0, \dots, M\}$, we define the partition \mathcal{U}_m of P_n^d into *useful generical clusters* as follows: \mathcal{U}_0 is the set of all single particles $\gamma : k \in P_n^d$, and for all $m \in \{1, \dots, M\}$, \mathcal{U}_m is derived from \mathcal{U}_{m-1} by aggregating the generical clusters composing a_m together and the generical clusters composing b_m together. Formally,

- $\mathcal{U}_0 = P_n^d$,
- for all $m \in \{1, \dots, M\}$, we define

$$\overleftarrow{a}_m := \{a' \in \mathcal{U}_{m-1} : a' \subset a_m\}, \quad \overleftarrow{b}_m := \{b' \in \mathcal{U}_{m-1} : b' \subset b_m\},$$

and let

$$\mathcal{U}_m = \left(\mathcal{U}_{m-1} \setminus (\overleftarrow{a}_m \cup \overleftarrow{b}_m) \right) \cup \{a_m, b_m\}.$$

It is straightforward to check that, for all $m \in \{1, \dots, M\}$, if $c \in \mathcal{U}_m \setminus \{a_m, b_m\}$, then $c \in \mathcal{U}_{m-1}$. Then we also define

$$\overleftarrow{c} := \{c\},$$

so that $\overleftarrow{\cdot}$ is well defined on \mathcal{U}_m and takes its values in the set of subsets of \mathcal{U}_{m-1} . Note that, for all $m', m \in \{1, \dots, M\}$ such that $\mathbf{c}_{m'} \xrightarrow{\gamma} \mathbf{c}_m$ for some $\gamma \in \{1, \dots, d\}$, denoting by c' the cluster of type γ involved in the collision $\mathbf{c}_{m'}$ and by c the cluster of type γ involved in the collision \mathbf{c}_m , then $c' \in \mathcal{U}_{m'}, \mathcal{U}_{m'+1}, \dots, \mathcal{U}_{m-1}$ and $c' \in \overleftarrow{c}$.

9.4.2.4.2 Definition of the auxiliary system We are now ready to introduce our auxiliary system. It is the sequence of functions $(E_m)_{0 \leq m \leq M}$ such that E_m is defined on \mathcal{U}_m as follows:

- for all $c = \gamma : k \in \mathcal{U}_0$, $E_0(c) = d_k^\gamma(0)$,
- for all $m \in \{1, \dots, M\}$,

$$\begin{aligned} E_m(a_m) &:= \left(1 + \frac{\Theta}{n} |b_m| \right) \sum_{a' \in \overleftarrow{a}_m} E_{m-1}(a') + \frac{\Theta}{n} |a_m| \sum_{b' \in \overleftarrow{b}_m} E_{m-1}(b'), \\ E_m(b_m) &:= \left(1 + \frac{\Theta}{n} |a_m| \right) \sum_{b' \in \overleftarrow{b}_m} E_{m-1}(b') + \frac{\Theta}{n} |b_m| \sum_{a' \in \overleftarrow{a}_m} E_{m-1}(a'), \end{aligned}$$

and, for all $c \in \mathcal{U}_m \setminus \{a_m, b_m\}$, $E_m(c) = E_{m-1}(c)$.

Note that, for all $m \in \{0, \dots, M\}$, for all $c \in \mathcal{U}_m$, $E_m(c) \geq 0$, and for $m \in \{1, \dots, M\}$, then

$$E_m(c) \geq \sum_{c' \in \overleftarrow{c}} E_{m-1}(c'). \quad (9.28)$$

The *total mass* of the auxiliary system is defined, for all $m \in \{0, \dots, M\}$, by

$$\mathcal{E}_m := \sum_{c \in \mathcal{U}_m} E_m(c).$$

In particular,

$$\|\mathbf{x} - \mathbf{y}\|_1 = \frac{\mathcal{E}_0}{n}. \quad (9.29)$$

Besides, as a straightforward consequence of (9.28), for all $m \in \{1, \dots, M\}$, $\mathcal{E}_m \geq \mathcal{E}_{m-1}$.

The coupling between the auxiliary system and the family of processes $\{(d_k^\gamma(t))_{t \geq 0}, \gamma : k \in P_n^d\}$ works as follows.

Lemma 9.4.9 (Coupling with the auxiliary system). *Let us assume that the conditions of Proposition 9.4.7 hold.*

(i) For all $m \in \{1, \dots, M\}$,

$$\sup_{t \in [T^-(\mathbf{c}_m), T^+(\mathbf{c}_m)]} \sum_{\alpha : i \in a_m} d_i^\alpha(t) \leq E_m(a_m), \quad \sup_{t \in [T^-(\mathbf{c}_m), T^+(\mathbf{c}_m)]} \sum_{\beta : j \in b_m} d_j^\beta(t) \leq E_m(b_m).$$

(ii) For all $t \geq 0$,

$$\|\Phi(\mathbf{x}; t) - \Phi(\mathbf{y}; t)\|_1 = \frac{1}{n} \sum_{\gamma : k \in P_n^d} d_k^\gamma(t) \leq \sup_{0 \leq m \leq M} \frac{\mathcal{E}_m}{n} = \frac{\mathcal{E}_M}{n}.$$

(iii) For all $t \geq 0$,

$$\|\Phi(\mathbf{x}; t) - \Phi(\mathbf{y}; t)\|_\infty = \sup_{\gamma : k \in P_n^d} d_k^\gamma(t) \leq \sup_{0 \leq m \leq M} \sup_{c \in \mathcal{U}_m} \frac{1}{|c|} E_m(c).$$

Proof. The proof of (i) works by induction on $m \in \{1, \dots, M\}$. Let $m \in \{1, \dots, M\}$ such that, if $m \geq 2$, then

$$\sum_{\alpha:i \in a_{m'}} d_i^\alpha(T^+(\mathbf{c}_{m'})) \leq E_{m'}(a_{m'}), \quad \sum_{\beta:j \in b_{m'}} d_j^\beta(T^+(\mathbf{c}_{m'})) \leq E_{m'}(b_{m'}),$$

for all $m' \in \{1, \dots, m-1\}$. By (i) in Lemma 9.4.8,

$$\sup_{t \in [T^-(\mathbf{c}_m), T^+(\mathbf{c}_m)]} \sum_{\alpha:i \in a_m} d_i^\alpha(t) \leq \left(1 + \frac{\Theta}{n} |b_m|\right) \sum_{\alpha:i \in a_m} d_i^\alpha(T^-(\mathbf{c}_m)) + \frac{\Theta}{n} |a_m| \sum_{\beta:j \in b_m} d_j^\beta(T^-(\mathbf{c}_m)),$$

and by (ii) in Lemma 9.4.8,

$$\sum_{\alpha:i \in a_m} d_i^\alpha(T^-(\mathbf{c}_m)) \leq \sum_{\alpha:i \in a_m} d_i^\alpha(t'_{\alpha:i}), \quad \sum_{\beta:j \in b_m} d_j^\beta(T^-(\mathbf{c}_m)) \leq \sum_{\beta:j \in b_m} d_j^\beta(t'_{\beta:j}),$$

where $t'_{\alpha:i}$ is $T^+(\mathbf{c}')$ if there exists $\mathbf{c}' \in C_{\alpha:i}$ such that $\mathbf{c}' \xrightarrow{\alpha} \mathbf{c}_m$ and 0 otherwise; $t'_{\beta:j}$ in the second inequality is defined similarly.

Let $m_1, \dots, m_K \leq m-1$ be the indices of all the collisions \mathbf{c}' such that $\mathbf{c}' \xrightarrow{\alpha} \mathbf{c}_m$, and for all $k \in \{1, \dots, K\}$, let us denote by a'_{m_k} the cluster of type α involved in the collision \mathbf{c}_{m_k} . Then

$$\sum_{\alpha:i \in a_m} d_i^\alpha(t'_{\alpha:i}) = \sum_{k=1}^K \sum_{\alpha:i \in a'_{m_k}} d_i^\alpha(T^+(\mathbf{c}_{m_k})) + \sum_{\alpha:i \in a_m: t'_{\alpha:i}=0} d_i^\alpha(0).$$

For all $k \in \{1, \dots, K\}$, $m_k \leq m-1$ so that

$$\sum_{\alpha:i \in a'_{m_k}} d_i^\alpha(T^+(\mathbf{c}_{m_k})) \leq E_{m_k}(a'_{m_k}) = \dots = E_{m-1}(a'_{m_k}),$$

while, for all $\alpha : i$ such that $t'_{\alpha:i} = 0$,

$$d_i^\alpha(0) = E_0(\alpha : i) = \dots = E_{m-1}(\alpha : i).$$

Clearly,

$$\overleftarrow{a}_m = \{a'_{m_1}, \dots, a'_{m_K}\} \cup \{\alpha : i \in a_m : t'_{\alpha:i} = 0\},$$

therefore

$$\sum_{\alpha:i \in a_m} d_i^\alpha(t'_{\alpha:i}) \leq \sum_{a' \in \overleftarrow{a}_m} E_{m-1}(a').$$

Similarly,

$$\sum_{\beta:j \in b_m} d_j^\beta(t'_{\beta:j}) \leq \sum_{b' \in \overleftarrow{b}_m} E_{m-1}(b'),$$

and the conclusion follows from the definition of the auxiliary system.

We now address (ii) and (iii). Let us fix $t \geq 0$ and note that, at time t , a particle $\gamma : k \in P_n^d$ is in exactly one of the following cases:

1. there exists $\mathbf{c} \in C_{\gamma:k}$ such that $T^-(\mathbf{c}) \leq t \leq T^+(\mathbf{c})$,
2. $t \leq T_{\gamma:k}^{\max}$ and, for all $\mathbf{c} \in C_{\gamma:k}$, $t \notin [T^-(\mathbf{c}), T^+(\mathbf{c})]$.
3. $t > T_{\gamma:k}^{\max}$.

If the particle $\gamma : k$ is in case (1), let us note that, by Condition (LHM-3a), there is only one $\mathbf{c} \in C_{\gamma:k}$ such that $T^-(\mathbf{c}) \leq t \leq T^+(\mathbf{c})$. Let c denote the cluster of type γ involved in this collision, and $\mu(c)$ denote the number of the collision \mathbf{c} . Then, every particle $\gamma : k' \in c$ is also in case (1), and by (i),

$$\sum_{\gamma:k' \in c} d_{k'}^\gamma(t) \leq E_{\mu(c)}(c), \quad \sup_{\gamma:k' \in c} d_{k'}^\gamma(t) \leq \frac{1}{|c|} E_{\mu(c)}(c),$$

where the second inequality follows from the fact that all the quantities $d_{k'}^\gamma(t)$ have the same value for $\gamma : k' \in c$. Let us denote by $\mathcal{U}^{(1)}$ the set of clusters c obtained from all the particles $\gamma : k$ in case (1). Then

$$\sum_{\gamma : k \text{ in case (1)}} d_k^\gamma(t) \leq \sum_{c \in \mathcal{U}^{(1)}} E_{\mu(c)}(c), \quad \sup_{\gamma : k \text{ in case (1)}} d_k^\gamma(t) \leq \sup_{c \in \mathcal{U}^{(1)}} \frac{1}{|c|} E_{\mu(c)}(c).$$

In case (2), let us denote by \mathfrak{c} the smallest collision $\mathfrak{c} \in C_{\gamma:k}$ (for the order of collisions) such that $t < T^-(\mathfrak{c})$. Let c refer to the cluster of type γ involved in this collision, and, for all $\gamma : k' \in c$, let us define $t'_{\gamma:k'}$ as in Lemma 9.4.8. Then, by (ii) in Lemma 9.4.8,

$$\begin{aligned} \sum_{\gamma:k' \in c} \mathbf{1}_{\{t'_{\gamma:k'} \leq t\}} d_{k'}^\gamma(t) &\leq \sum_{\gamma:k' \in c} \mathbf{1}_{\{t'_{\gamma:k'} \leq t\}} d_{k'}^\gamma(t'_{\gamma:k'}), \\ \sup_{\gamma:k' \in c} \mathbf{1}_{\{t'_{\gamma:k'} \leq t\}} d_{k'}^\gamma(t) &\leq \sup_{\gamma:k' \in c} \mathbf{1}_{\{t'_{\gamma:k'} \leq t\}} d_{k'}^\gamma(t'_{\gamma:k'}), \end{aligned}$$

where the indicator functions allow to retain only the particles of c that do not undergo collisions on the time interval $[t, T^-(\mathfrak{c})]$. For all such particle, that is, for all $\gamma : k' \in c$ such that $t'_{\gamma:k'} \leq t$,

- if $t'_{\gamma:k'} = 0$, then we let $c' = \gamma : k'$ and $\mu(c') = 0$,
- otherwise there exists $\mathfrak{c}' \in C_{\gamma:k'}$ such that $\mathfrak{c}' \xrightarrow{\gamma} \mathfrak{c}$, in this case we denote by c' the cluster of type γ involved in the collision \mathfrak{c}' and let $\mu(c')$ refer to the number of the collision \mathfrak{c}' .

In all cases, $c' \in \mathcal{U}_{\mu(c')}$, and by (i),

$$\sum_{\gamma:k' \in c'} d_{k'}^\gamma(t'_{\gamma:k'}) \leq E_{\mu(c')}(c'), \quad \sup_{\gamma:k' \in c'} d_{k'}^\gamma(t'_{\gamma:k'}) \leq \frac{1}{|c'|} E_{\mu(c')}(c').$$

Denoting by $\mathcal{U}^{(2)}$ the set of clusters c' obtained as above from particles $\gamma : k$ in case (2), we conclude that

$$\sum_{\gamma : k \text{ in case (2)}} d_k^\gamma(t) \leq \sum_{c' \in \mathcal{U}^{(2)}} E_{\mu(c')}(c'), \quad \sup_{\gamma : k \text{ in case (2)}} d_k^\gamma(t) \leq \sup_{c' \in \mathcal{U}^{(2)}} \frac{1}{|c'|} E_{\mu(c')}(c').$$

In case (3),

- if $C_{\gamma:k}$ is empty, we define $c = \gamma : k$ and $\mu(c) = 0$,
- otherwise, we let \mathfrak{c} be the largest collision in $C_{\gamma:k}$ and denote by c the cluster of type γ involved in the collision \mathfrak{c} , while $\mu(c)$ refers to the number of the collision \mathfrak{c} .

Then $c \in \mathcal{U}_{\mu(c)}$ and, by (i),

$$\sum_{\gamma:k' \in c} d_{k'}^\gamma(T_{\gamma:k'}^{\max}) \leq E_{\mu(c)}(c), \quad \sup_{\gamma:k' \in c} d_{k'}^\gamma(T_{\gamma:k'}^{\max}) \leq \frac{1}{|c|} E_{\mu(c)}(c).$$

Denoting by $\mathcal{U}^{(3)}$ the set of clusters c obtained as above from particles $\gamma : k$ in case (3), we use (iii) in Lemma 9.4.8 to conclude that

$$\begin{aligned} \sum_{\gamma : k \text{ in case (3)}} d_k^\gamma(t) &\leq \sum_{\gamma : k \text{ in case (3)}} d_k^\gamma(T_{\gamma:k}^{\max}) \leq \sum_{c \in \mathcal{U}^{(3)}} E_{\mu(c)}(c), \\ \sup_{\gamma : k \text{ in case (3)}} d_k^\gamma(t) &\leq \sup_{\gamma : k \text{ in case (3)}} d_k^\gamma(T_{\gamma:k}^{\max}) \leq \sup_{c \in \mathcal{U}^{(3)}} \frac{1}{|c|} E_{\mu(c)}(c). \end{aligned}$$

Let us assemble the results obtained for cases (1), (2) and (3). Defining $\mathcal{U}^* := \mathcal{U}^{(1)} \cup \mathcal{U}^{(2)} \cup \mathcal{U}^{(3)}$, we have shown that

$$\sum_{\gamma:k \in P_n^d} d_k^\gamma(t) \leq \sum_{c \in \mathcal{U}^*} E_{\mu(c)}(c), \quad \sup_{\gamma:k \in P_n^d} d_k^\gamma(t) \leq \sup_{c \in \mathcal{U}^*} \frac{1}{|c|} E_{\mu(c)}(c),$$

and we now want to bound the right-hand sides of both inequalities by above. For the second inequality, it is trivial that

$$\sup_{c \in \mathcal{U}^*} \frac{1}{|c|} E_{\mu(c)}(c) \leq \sup_{0 \leq m \leq M} \sup_{c \in \mathcal{U}_m} \frac{1}{|c|} E_m(c),$$

and therefore the proof of (iii) is completed.

As far as (ii) is concerned, let us first note that, by the construction of $\mathcal{U}^{(1)}$, $\mathcal{U}^{(2)}$ and $\mathcal{U}^{(3)}$, \mathcal{U}^* induces a partition of P_n^d . Then the conclusion of the proof stems from the following remark: for all set \mathcal{U}^* of generalised clusters inducing a partition of P_n^d and such that there exists a function

$$\mu : \mathcal{U}^* \rightarrow \{0, \dots, M\}$$

satisfying the property that

$$\forall c \in \mathcal{U}^*, \quad c \in \mathcal{U}_{\mu(c)},$$

then

$$\sum_{c \in \mathcal{U}^*} E_{\mu(c)}(c) \leq \mathcal{E}_M.$$

The latter remark easily follows from the construction of the sequence $\mathcal{U}_0, \dots, \mathcal{U}_M$ combined with (9.28). This yields (ii) and completes the proof. \square

9.4.2.5 Bounding the total mass

As a consequence of Lemma 9.4.9, the local stability estimates of Proposition 9.4.7 are derived from the following estimation on the total mass of the auxiliary system.

Lemma 9.4.10 (Estimation on the total mass). *Under the assumptions of Proposition 9.4.7, the total mass of the auxiliary system satisfies*

$$\mathcal{E}_M \leq \mathcal{L}_1 \mathcal{E}_0,$$

where \mathcal{L}_1 is defined by (9.24). Besides,

$$\sup_{0 \leq m \leq M} \sup_{c \in \mathcal{U}_m} \frac{1}{|c|} E_m(c) \leq \mathcal{L}_\infty \sup_{\gamma: k \in P_n^d} d_k^\gamma(0),$$

where \mathcal{L}_∞ is defined by (9.24).

The conclusion of Proposition 9.4.7 easily follows from the combination of Lemma 9.4.10 and (9.29).

Before proving Lemma 9.4.10, we introduce the notion of *history* of a cluster $c \in \mathcal{U}_m$ as the set $\mathcal{H}_m(c)$ of general clusters c' in \mathcal{U}_m with a different type from c and such that, for all pair of particles in $c \times c'$, if these particles collide in the MSPD started at \mathbf{x} (or, equivalently, \mathbf{y}), then the number of the collision belongs to $\{1, \dots, m\}$. If these particles do not collide in the MSPD started at \mathbf{x} (or, equivalently, \mathbf{y}), then we think of this collision as having occurred in the virtual past, and therefore include the cluster c' in the history of c as well.

Formally, we first define the sets R_0, \dots, R_M by

$$\begin{aligned} R_0 &:= R = \mathbf{c}_1 \sqcup \dots \sqcup \mathbf{c}_M, \\ R_1 &:= R_0 \setminus \mathbf{c}_1 = \mathbf{c}_2 \sqcup \dots \sqcup \mathbf{c}_M, \\ &\vdots \\ R_M &:= \emptyset, \end{aligned}$$

so that R_m contains the pairs of particles that will collide during the $(m+1)$ -th, \dots , M -th collisions. Certainly, for $a, b \in \mathcal{U}_m$ with $\alpha = \text{type}(a) < \text{type}(b) = \beta$, then whether $(\alpha : i, \beta : i) \in R_m$ or

$(\alpha : i, \beta : i) \notin R_m$ does not depend on the choice of $(\alpha : i, \beta : j) \in a \times b$, and therefore we shall commit a slight abuse of notation and write either $a \times b \in R_m$ or $a \times b \notin R_m$.

For all $m \in \{0, \dots, M\}$, for all $c \in \mathcal{U}_m$, we can now define

$$\mathcal{H}_m(c) := \{a \in \mathcal{U}_m : \text{type}(a) < \text{type}(c), a \times c \notin R_m\} \cup \{b \in \mathcal{U}_m : \text{type}(c) < \text{type}(b), c \times b \notin R_m\}.$$

It is easily checked that, for all $m \in \{1, \dots, M\}$, if $c \in \mathcal{U}_m \setminus \{a_m, b_m\}$, then

$$\mathcal{H}_{m-1}(c) = \bigsqcup_{b \in \mathcal{H}_m(c)} \overleftarrow{b}, \quad (9.30)$$

while $b_m \in \mathcal{H}_m(a_m)$, $a_m \in \mathcal{H}_m(b_m)$ and

$$\forall a' \in \overleftarrow{a_m}, \quad \mathcal{H}_{m-1}(a') = \mathcal{H}_m(a_m) \setminus \{b_m\}, \quad \forall b' \in \overleftarrow{b_m}, \quad \mathcal{H}_{m-1}(b') = \mathcal{H}_m(b_m) \setminus \{a_m\}. \quad (9.31)$$

We are now able to prove Lemma 9.4.10.

Proof of Lemma 9.4.10. We first prove the following key estimation: for all $m \in \{0, \dots, M\}$, for all $c \in \mathcal{U}_m$,

$$E_m(c) \leq \left(1 + \frac{\Theta}{n}\right)^{\sum_{b \in \mathcal{H}_m(c)} |b|} \left(\sum_{\gamma: k \in c} d_k^\gamma(0) + \frac{\Theta}{n} |c| \sum_{b \in \mathcal{H}_m(c)} E_m(b) \right). \quad (9.32)$$

The proof works by induction on $m \in \{0, \dots, M\}$. For $m = 0$, the inequality is trivial. Now let $m \in \{1, \dots, M\}$ such that, for all $c' \in \mathcal{U}_{m-1}$,

$$E_{m-1}(c') \leq \left(1 + \frac{\Theta}{n}\right)^{\sum_{b' \in \mathcal{H}_{m-1}(c')} |b'|} \left(\sum_{\gamma: k \in c'} d_k^\gamma(0) + \frac{\Theta}{n} |c'| \sum_{b' \in \mathcal{H}_{m-1}(c')} E_{m-1}(b') \right).$$

Let us fix $c \in \mathcal{U}_m$. On the one hand, if $c \notin \{a_m, b_m\}$,

$$E_m(c) = E_{m-1}(c) \leq \left(1 + \frac{\Theta}{n}\right)^{\sum_{b' \in \mathcal{H}_{m-1}(c)} |b'|} \left(\sum_{\gamma: k \in c} d_k^\gamma(0) + \frac{\Theta}{n} |c| \sum_{b' \in \mathcal{H}_{m-1}(c)} E_{m-1}(b') \right).$$

By (9.30),

$$\sum_{b' \in \mathcal{H}_{m-1}(c)} |b'| = \sum_{b \in \mathcal{H}_m(c)} \sum_{b' \in \overleftarrow{b}} |b'| = \sum_{b \in \mathcal{H}_m(c)} |b|,$$

and similarly,

$$\sum_{b' \in \mathcal{H}_{m-1}(c)} E_{m-1}(b') = \sum_{b \in \mathcal{H}_m(c)} \sum_{b' \in \overleftarrow{b}} E_{m-1}(b') \leq \sum_{b \in \mathcal{H}_m(c)} E_m(b),$$

thanks to (9.28). This yields (9.32).

On the other hand, if $c = a_m$, we recall that

$$E_m(a_m) = \left(1 + \frac{\Theta}{n} |b_m|\right) \sum_{a' \in \overleftarrow{a_m}} E_{m-1}(a') + \frac{\Theta}{n} |a_m| \sum_{b' \in \overleftarrow{b_m}} E_{m-1}(b'),$$

and write

$$\sum_{a' \in \overleftarrow{a_m}} E_{m-1}(a') \leq \sum_{a' \in \overleftarrow{a_m}} \left(1 + \frac{\Theta}{n}\right)^{\sum_{b' \in \mathcal{H}_{m-1}(a')} |b'|} \left(\sum_{\alpha: i \in a'} d_i^\alpha(0) + \frac{\Theta}{n} |a'| \sum_{b' \in \mathcal{H}_{m-1}(a')} E_{m-1}(b') \right).$$

By (9.31), for all $a' \in \overleftarrow{a}_m$,

$$\sum_{b' \in \mathcal{H}_{m-1}(a')} |b'| = \sum_{\substack{b \in \mathcal{H}_m(a_m) \\ b \neq b_m}} |b|,$$

and similarly,

$$\sum_{b' \in \mathcal{H}_{m-1}(a')} E_{m-1}(b') = \sum_{b' \in \mathcal{H}_m(a_m) \setminus \{b_m\}} E_{m-1}(b').$$

But, by the definition of $\mathcal{H}_m(a_m)$, if $b' \in \mathcal{H}_m(a_m) \setminus \{b_m\}$ then $b' \notin \{a_m, b_m\}$, therefore $E_m(b') = E_{m-1}(b')$. As a consequence,

$$\sum_{b' \in \mathcal{H}_{m-1}(a')} E_{m-1}(b') = \sum_{\substack{b \in \mathcal{H}_m(a_m) \\ b \neq b_m}} E_m(b).$$

The elementary inequality

$$\forall x \geq 0, \quad \forall k \geq 1, \quad 1 + kx \leq (1 + x)^k,$$

yields

$$\left(1 + \frac{\Theta}{n} |b_m|\right) \leq \left(1 + \frac{\Theta}{n}\right)^{|b_m|},$$

while using (9.28) again leads to $\sum_{b' \in \overleftarrow{b}_m} E_{m-1}(b') \leq E_m(b_m)$. We deduce that

$$E_m(a_m) \leq \left(1 + \frac{\Theta}{n}\right)^{\sum_{b \in \mathcal{H}_m(a_m)} |b|} \left(\sum_{\alpha: i \in a_m} d_i^\alpha(0) + \frac{\Theta}{n} |a_m| \sum_{\substack{b \in \mathcal{H}_m(a_m) \\ b \neq b_m}} E_m(b) \right) + \frac{\Theta}{n} |a_m| E_m(b_m),$$

and obtain (9.32) easily.

We now note that, for all $m \in \{0, \dots, M\}$, for all $c \in \mathcal{U}_m$,

$$\sum_{b \in \mathcal{H}_m(c)} |b| \leq |\{\beta : i \in P_n^d : \beta \neq \text{type}(c)\}| = n(d-1),$$

therefore

$$\left(1 + \frac{\Theta}{n}\right)^{\sum_{b \in \mathcal{H}_m(c)} |b|} \leq \left(1 + \frac{\Theta}{n}\right)^{n(d-1)} \leq \exp(\Theta(d-1)).$$

Besides,

$$\sum_{b \in \mathcal{H}_m(c)} E_m(b) \leq \mathcal{E}_m,$$

so that (9.32) implies the crucial $L^\infty - L^1$ estimate

$$E_m(c) \leq \exp(\Theta(d-1)) \left(\sum_{\gamma: k \in c} d_k^\gamma(0) + \frac{\Theta}{n} |c| \mathcal{E}_m \right), \tag{9.33}$$

which allows to derive both the L^1 estimate and the L^∞ estimate.

Derivation of the L^1 estimate. It is a straightforward consequence of the definition of E_m that, for all $m \in \{1, \dots, M\}$,

$$\mathcal{E}_m = \mathcal{E}_{m-1} + \frac{2\Theta}{n} \left(|b_m| \sum_{a' \in \overleftarrow{a}_m} E_{m-1}(a') + |a_m| \sum_{b' \in \overleftarrow{b}_m} E_{m-1}(b') \right).$$

By (9.33),

$$\sum_{a' \in \overleftarrow{a_m}} E_{m-1}(a') \leq \exp(\Theta(d-1)) \left(\sum_{\alpha: i \in a_m} d_i^\alpha(0) + \frac{\Theta}{n} |a_m| \mathcal{E}_{m-1} \right),$$

and similarly,

$$\sum_{b' \in \overleftarrow{b_m}} E_{m-1}(b') \leq \exp(\Theta(d-1)) \left(\sum_{\beta: j \in b_m} d_j^\beta(0) + \frac{\Theta}{n} |b_m| \mathcal{E}_{m-1} \right),$$

so that

$$\begin{aligned} \mathcal{E}_m &\leq \left(1 + \frac{4\Theta^2}{n^2} \exp(\Theta(d-1)) |a_m| |b_m| \right) \mathcal{E}_{m-1} \\ &\quad + \frac{2\Theta}{n} \exp(\Theta(d-1)) \left(|b_m| \sum_{\alpha: i \in a_m} d_i^\alpha(0) + |a_m| \sum_{\beta: j \in b_m} d_j^\beta(0) \right) \\ &\leq \left(1 + \frac{4\Theta^2}{n^2} \exp(\Theta(d-1)) \right)^{|a_m| |b_m|} \mathcal{E}_{m-1} \\ &\quad + \frac{2\Theta}{n} \exp(\Theta(d-1)) \left(|b_m| \sum_{\alpha: i \in a_m} d_i^\alpha(0) + |a_m| \sum_{\beta: j \in b_m} d_j^\beta(0) \right), \end{aligned}$$

whence

$$\begin{aligned} \mathcal{E}_M &\leq \left(1 + \frac{4\Theta^2}{n^2} \exp(\Theta(d-1)) \right)^{\sum_{m=1}^M |a_m| |b_m|} \\ &\quad \times \left(\mathcal{E}_0 + \frac{2\Theta}{n} \exp(\Theta(d-1)) \sum_{m=1}^M \left(|b_m| \sum_{\alpha: i \in a_m} d_i^\alpha(0) + |a_m| \sum_{\beta: j \in b_m} d_j^\beta(0) \right) \right). \end{aligned}$$

For all $m \in \{1, \dots, M\}$, $a_m \times b_m$ is a subset of R with cardinality $|a_m| |b_m|$, and for $m' < m$, the subsets $a_{m'} \times b_{m'} = \mathbf{c}_{m'}$ and $a_m \times b_m = \mathbf{c}_m$ are disjoint. As a consequence, for all $m \in \{1, \dots, M\}$,

$$\sum_{m=1}^M |a_m| |b_m| \leq |R| \leq |\{(\alpha: i, \beta: j) \in (P_n^d)^2 : \alpha < \beta\}| = n^2 \frac{d(d-1)}{2},$$

therefore

$$\left(1 + \frac{4\Theta^2}{n^2} \exp(\Theta(d-1)) \right)^{\sum_{m=1}^M |a_m| |b_m|} \leq \exp(2\Theta^2 d(d-1) \exp(\Theta(d-1))).$$

Furthermore, for all $\alpha: i \in P_n^d$,

$$\sum_{m=1}^M \mathbf{1}_{\{\alpha: i \in a_m\}} |b_m| = \sum_{\beta \neq \alpha} \sum_{j=1}^n \sum_{m=1}^M \mathbf{1}_{\{(\alpha: i, \beta: j) \in \mathbf{c}_m\}} \leq n(d-1),$$

so that

$$\sum_{m=1}^M |b_m| \sum_{\alpha: i \in a_m} d_i^\alpha(0) \leq n(d-1) \sum_{\alpha: i \in P_n^d} d_i^\alpha(0) = n(d-1) \mathcal{E}_0,$$

and similarly,

$$\sum_{m=1}^M |a_m| \sum_{\beta: j \in b_m} d_j^\beta(0) \leq n(d-1) \sum_{\beta: j \in b_m} d_j^\beta(0) = n(d-1) \mathcal{E}_0,$$

which finally results in $\mathcal{E}_M \leq \mathcal{L}_1 \mathcal{E}_0$, with

$$\mathcal{L}_1 := (1 + 4\Theta(d-1) \exp(\Theta(d-1))) \exp(2\Theta^2 d(d-1) \exp(\Theta(d-1))).$$

Derivation of the L^∞ estimate. Let us divide both terms of (9.33) by $|c|$ to obtain

$$\frac{1}{|c|} E_m(c) \leq \exp(\Theta(d-1)) \left(\frac{1}{|c|} \sum_{\gamma:k \in c} d_k^\gamma(0) + \frac{\Theta}{n} \mathcal{E}_m \right).$$

Owing to the L^1 bound obtained above, we write

$$\frac{1}{|c|} \sum_{\gamma:k \in c} d_k^\gamma(0) + \frac{\Theta}{n} \mathcal{E}_m \leq (1 + \Theta d \mathcal{L}_1) \sup_{\gamma:k \in P_n^d} d_k^\gamma(0),$$

the right-hand side of which no longer depends neither on m nor on c . As a consequence,

$$\sup_{0 \leq m \leq M} \sup_{c \in \mathcal{U}_m} \frac{1}{|c|} E_m(c) \leq \mathcal{L}_\infty \sup_{\gamma:k \in P_n^d} d_k^\gamma(0),$$

where $\mathcal{L}_\infty := (1 + \Theta d \mathcal{L}_1) \exp(\Theta(d-1))$. □

9.4.3 From local to global stability estimates

In this subsection, we explain how to remove Condition (LHM) from Proposition 9.4.7; namely, we prove the following result.

Proposition 9.4.11 (Global stability estimate). *Under Assumptions (LC), (USH) and (GNL), for all $\mathbf{x}, \mathbf{y} \in D_n^d$,*

$$\begin{aligned} \sup_{t \geq 0} \|\Phi(\mathbf{x}; t) - \Phi(\mathbf{y}; t)\|_1 &\leq \mathcal{L}_1 \|\mathbf{x} - \mathbf{y}\|_1, \\ \sup_{t \geq 0} \|\Phi(\mathbf{x}; t) - \Phi(\mathbf{y}; t)\|_\infty &\leq \mathcal{L}_\infty \|\mathbf{x} - \mathbf{y}\|_\infty, \end{aligned}$$

where \mathcal{L}_1 and \mathcal{L}_∞ are given in Proposition 9.4.7.

Let us give a brief overview of the proof of Proposition 9.4.11. Since the arguments does not depend on whether we work with the L^1 or the L^∞ distance, we only denote $\|\cdot\|$. Given $\mathbf{x}, \mathbf{y} \in D_n^d$, we roughly construct a continuous path joining \mathbf{x} to \mathbf{y} in D_n^d , with a length close to $\|\mathbf{x} - \mathbf{y}\|$, which can be decomposed into *small* portions on which the local stability estimate of Proposition 9.4.7 can be applied. Then, it suffices to integrate these local stability estimates along the path.

This interpolation procedure is described at the end of the proof, namely in §9.4.3.3. To apply it, we need to find a set of *good configurations* such that:

- good configurations can be found in the neighbourhood of the segment $\{(1-\rho)\mathbf{x} + \rho\mathbf{y}, \rho \in [0, 1]\}$, which is a density property and will allow us to construct a path joining \mathbf{x} to \mathbf{y} with a length close to $\|\mathbf{x} - \mathbf{y}\|$,
- if $\mathbf{z} \in D_n^d$ and \mathbf{z}' is a good configuration close to \mathbf{z} , then there exists a continuous path joining \mathbf{z} to \mathbf{z}' that can be decomposed into small portions, both extremities of which satisfy Condition (LHM), which will allow us to use the local stability estimate of Proposition 9.4.7 on each portion.

The set of good configurations is introduced in §9.4.3.1. It is composed by binary colliding configurations \mathbf{x} such that, in the MSPD started at \mathbf{x} , space-time points of self-interactions are distinct from space-time points of collisions. The proof of the density of this set is postponed to Subsection 9.A.3 of Appendix 9.A. The second property above relies on the *radial blow-up of singularities property*, which is described in §9.4.3.2.

9.4.3.1 Good configurations

We begin by introducing the set of *good configurations* $\mathcal{G} \subset D_n^d$.

Definition 9.4.12 (Good configurations). *A configuration $\mathbf{x} \in D_n^d$ belongs to the set of good configurations \mathcal{G} if:*

- (i) \mathbf{x} belongs to the set \mathcal{B} of binary colliding configurations,
- (ii) for all $\mathbf{c} = a \times b \in C(\mathbf{x})$, for all $c \in \{a, b\}$, for all $\gamma : k \in c$, $\text{clu}_k^\gamma(\mathbf{x}; T(\mathbf{x}; \mathbf{c})^-) = c$, where $\text{clu}_k^\gamma(\mathbf{x}; t^-)$ is defined in Definition 9.4.2.

In other words, a good configuration is such that, at each collision between clusters of different type in the MSPD started at \mathbf{x} , the colliding clusters are already formed when they collide, see Figure 9.2.

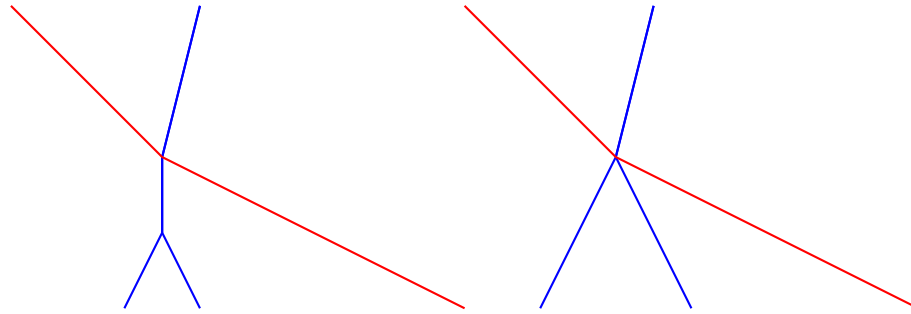

Figure 9.2: The left-hand side of the picture shows the trajectory of the MSPD started at a *good configuration*, since self-interaction space-time points are separated from collisions. On the contrary, the right-hand side of the picture shows the trajectory of the MSPD started at a configuration that cannot be good, since two distinct clusters of the same type have a self-interaction at the same time as they collide with a cluster of another type.

Lemma 9.4.13 (Density of \mathcal{G}). *Under Assumptions (USH) and (GNL), the set \mathcal{G} is dense in D_n^d .*

The proof of Lemma 9.4.13 is postponed to Subsection 9.A.3 in Appendix 9.A.

9.4.3.2 Radial blow-up of singularities

Given a configuration $\mathbf{x} \in D_n^d$ and a good configuration \mathbf{y} in the neighbourhood of \mathbf{x} , we now want to construct a path joining \mathbf{x} to \mathbf{y} that can be decomposed into small portions on which Proposition 9.4.7 can be applied. To this aim, we call *singularity* a space-time point at which a non binary collision, or both a collision and a self-interaction, occur in the MSPD started at \mathbf{x} . Note that a configuration $\mathbf{y} \in \mathcal{D}$ is good if and only there is no singularity in the MSPD started at \mathbf{y} . Then we remark that, if $\mathbf{y} \in \mathcal{G}$ is close enough to \mathbf{x} , singularities in the MSPD started at \mathbf{x} are *radially blown up* in the MSPD started at \mathbf{y} , in the sense that if one shrinks the trajectory of the MSPD started at \mathbf{y} around the singularity, one obtains the trajectory of the MSPD started at \mathbf{x} .

In this paragraph, we first give a proper definition of the notion of *locally homothetic configurations* \mathbf{x} and \mathbf{y} corresponding to the description above, then we use the radial blow-up of singularities property to construct paths joining \mathbf{x} to \mathbf{y} with the expected properties.

For all $\mathbf{x} \in \mathcal{D}$, let us first denote by

$$I(\mathbf{x}) := \{\Xi_{\alpha:i, \beta:j}^{\text{coll}}(\mathbf{x}) : (\alpha : i, \beta : j) \in R(\mathbf{x})\}$$

the set of space-time points of collisions in the MSPD started at \mathbf{x} . Of course, $I(\mathbf{x})$ is the empty set if $N(\mathbf{x}) = 0$.

For all space-time point $\Xi = (\xi_0, \tau_0) \in \mathbb{R} \times (0, +\infty)$, for all $\delta_\xi \in \mathbb{R}$, $\delta_\tau \in (0, \tau_0)$, we shall denote by

$$\Xi^{\delta_\xi, \delta_\tau} := [\xi_0 - \delta_\xi, \xi_0 + \delta_\xi] \times [\tau_0 - \delta_\tau, \tau_0 + \delta_\tau] \subset \mathbb{R} \times (0, +\infty)$$

the $(\delta_\xi, \delta_\tau)$ -box around Ξ . The open segments $(\xi_0 - \delta_\xi, \xi_0 + \delta_\xi) \times \{\tau_0 - \delta_\tau\}$ and $(\xi_0 - \delta_\xi, \xi_0 + \delta_\xi) \times \{\tau_0 + \delta_\tau\}$ shall be referred to as the *horizontal sides* of the box.

Definition 9.4.14 (Proper covering of $I(\mathbf{x})$). *Let $\mathbf{x} \in \mathcal{D}$, with $N(\mathbf{x}) \geq 1$. A proper covering of $I(\mathbf{x})$ is a pair $(\delta_\xi, \delta_\tau)$ such that:*

- $\delta_\xi > 0$, $\delta_\tau \in (0, t^*(\mathbf{x}))$,
- for all $\Xi, \Xi' \in I(\mathbf{x})$ such that $\Xi \neq \Xi'$, then the intersection $\Xi^{\delta_\xi, \delta_\tau} \cap \Xi'^{\delta_\xi, \delta_\tau}$ of the $(\delta_\xi, \delta_\tau)$ -boxes around Ξ and Ξ' is empty,
- for all $\Xi = (\xi_0, \tau_0) \in I(\mathbf{x})$,
 - for all $\gamma : k \in P_n^d$ such that there exists $t \in [\tau_0 - \delta_\tau, \tau_0 + \delta_\tau]$ such that $\Phi_k^\gamma(\mathbf{x}; t) \in [\xi_0 - \delta_\xi, \xi_0 + \delta_\xi]$, then

$$\Phi_k^\gamma(\mathbf{x}; \tau_0) = \xi_0,$$

i.e. all the particles passing in the box are involved in the collision associated with Ξ ,

– for all particle $\gamma : k$ in the box,

$$\Phi_k^\gamma(\mathbf{x}; \tau_0 - \delta_\tau) \in (\xi_0 - \delta_\xi, \xi_0 + \delta_\xi) \quad \text{and} \quad \Phi_k^\gamma(\mathbf{x}; \tau_0 + \delta_\tau) \in (\xi_0 - \delta_\xi, \xi_0 + \delta_\xi),$$

i.e. the particle enters and exits the box by the horizontal side; besides,

$$\forall t \in [\tau_0 - \delta_\tau, \tau_0), \quad \text{clu}_k^\gamma(\mathbf{x}; t) = \text{clu}_k^\gamma(\mathbf{x}; (\tau_0 - \delta_\tau)^-)$$

and

$$\forall t \in [\tau_0, \tau_0 + \delta_\tau], \quad \text{clu}_k^\gamma(\mathbf{x}; t) = \text{clu}_k^\gamma(\mathbf{x}; \tau_0),$$

i.e. self-interactions in the box can only occur at the space-time point Ξ .

Given a proper covering $(\delta_\xi, \delta_\tau)$ of $I(\mathbf{x})$, the set of $(\delta_\xi, \delta_\tau)$ -boxes around the points of $I(\mathbf{x})$ is drawn on Figure 9.3. Examples of boxes around space-time points of collisions, with dimensions that do not define a proper covering, are shown on Figure 9.4.

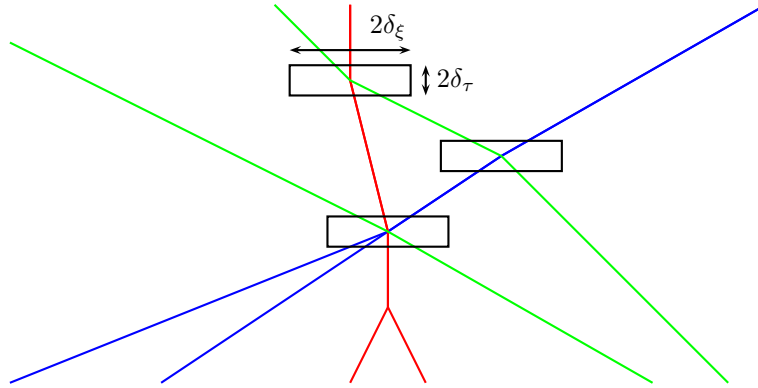

Figure 9.3: An example of set of $(\delta_\xi, \delta_\tau)$ -boxes around the points of $I(\mathbf{x})$.

Let us note that, under Assumption (GNL), a proper covering of $I(\mathbf{x})$ always exists. Indeed, since there is a finite number of self-interactions in the MSPD started at \mathbf{x} , one can construct $\delta_\tau \in (0, t^*(\mathbf{x}))$ small enough to ensure that, for all $\Xi = (\xi_0, \tau_0) \in I(\mathbf{x})$, the particles involved in the collision associated with Ξ do not have self-interactions on the time interval $[\tau_0 - \delta_\tau, \tau_0 + \delta_\tau]$ (except possibly at time τ_0). Besides, since the velocities are bounded, given a choice of δ_τ , any choice of δ_ξ such that

$$\delta_\xi > \delta_\tau L_{C, \infty} \tag{9.34}$$

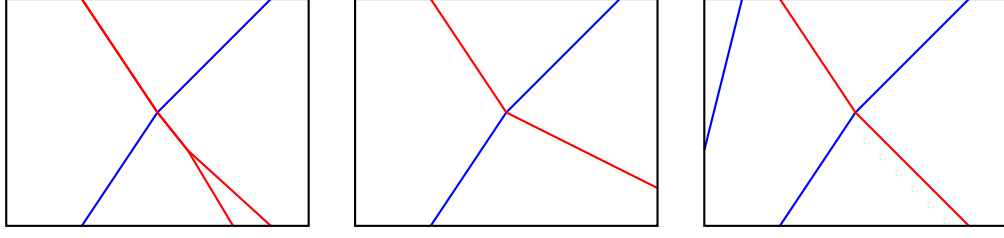

Figure 9.4: The box on the left-hand figure contains a self-interaction at a distinct space-time point from the collision. On the central figure, a particle enters the box by a vertical side. The box on the right-hand figure is crossed by a particle that is not involved in the collision.

ensures that particles enter and leave the box by the horizontal sides. Finally, one can shrink δ_τ and keep δ_ξ satisfying (9.34) accordingly to obtain boxes small enough for being disjoint and not being crossed by particles not involved in the corresponding collision.

We can now give a definition of locally homothetic configurations.

Definition 9.4.15 (Locally homothetic configurations). *Let $\mathbf{x} \in \mathcal{D}$. A configuration $\mathbf{y} \in D_n^d$ is said to be locally homothetic to \mathbf{x} if $\mathbf{y} \in \mathcal{D}$ and either $N(\mathbf{x}) = N(\mathbf{y}) = 0$, or $R(\mathbf{x}) = R(\mathbf{y})$ and there exists a proper covering $(\delta_\xi, \delta_\tau)$ of $I(\mathbf{x})$ such that, for all $\Xi_0 = (\xi_0, \tau_0) \in I(\mathbf{x})$,*

- for all $\gamma : k \in P_n^d$ such that $\Phi_k^\gamma(\mathbf{x}; \tau_0) = \xi_0$, then

$$\begin{aligned} \Phi_k^\gamma(\mathbf{y}; \tau_0 - \delta_\tau) &\in (\xi_0 - \delta_\xi, \xi_0 + \delta_\xi), & \text{clu}_k^\gamma(\mathbf{y}; \tau_0 - \delta_\tau) &= \text{clu}_k^\gamma(\mathbf{x}; \tau_0 - \delta_\tau), \\ \Phi_k^\gamma(\mathbf{y}; \tau_0 + \delta_\tau) &\in (\xi_0 - \delta_\xi, \xi_0 + \delta_\xi), & \text{clu}_k^\gamma(\mathbf{y}; \tau_0 + \delta_\tau) &= \text{clu}_k^\gamma(\mathbf{x}; \tau_0 + \delta_\tau), \end{aligned}$$

- for all $(\alpha : i, \beta : j) \in R(\mathbf{x})$ such that $\Xi_{\alpha:i, \beta:j}^{\text{coll}}(\mathbf{x}) = \Xi_0$, then the space-time point of collision $\Xi_{\alpha:i, \beta:j}^{\text{coll}}(\mathbf{y})$ belongs to the $(\delta_\xi, \delta_\tau)$ -box around Ξ_0 , and for all $\rho \in [0, 1]$, then

$$\Xi_{\alpha:i, \beta:j}^{\text{coll}}((1 - \rho)\mathbf{x} + \rho\mathbf{y}) = (1 - \rho)\Xi_0 + \rho\Xi_{\alpha:i, \beta:j}^{\text{coll}}(\mathbf{y}), \quad (9.35)$$

- for all $\gamma \in \{1, \dots, d\}$, for all $k, k' \in \{1, \dots, n\}$ such that $\Xi_{\gamma:k, \gamma:k'}^{\text{self}}(\mathbf{x}) = \Xi_0$, then the space-time point $\Xi_{\gamma:k, \gamma:k'}^{\text{self}}(\mathbf{y})$ of the self-interaction belongs to the $(\delta_\xi, \delta_\tau)$ -box around Ξ_0 , and for all $\rho \in [0, 1]$, then

$$\Xi_{\gamma:k, \gamma:k'}^{\text{self}}((1 - \rho)\mathbf{x} + \rho\mathbf{y}) = (1 - \rho)\Xi_0 + \rho\Xi_{\gamma:k, \gamma:k'}^{\text{self}}(\mathbf{y}). \quad (9.36)$$

We shall sometimes precise that \mathbf{y} locally homothetic to \mathbf{x} with respect to the proper covering $(\delta_\xi, \delta_\tau)$.

Let us remark that if $N(\mathbf{x}) = 0$ then any configuration $\mathbf{y} \in \mathcal{D}$ such that $N(\mathbf{y}) = 0$ is locally homothetic to \mathbf{x} .

Lemma 9.4.16 (Radial blow-up of singularities). *Under Assumptions (USH) and (GNL), let $\mathbf{x} \in \mathcal{D}$.*

- If $N(\mathbf{x}) = 0$, there exists $\kappa > 0$ such that, for all $\mathbf{y} \in B_1(\mathbf{x}, \kappa)$, $\mathbf{y} \in \mathcal{D}$ and $N(\mathbf{y}) = 0$ so that \mathbf{y} is locally homothetic to \mathbf{x} .
- If $N(\mathbf{x}) \geq 1$, then for all proper covering $(\delta_\tau, \delta_\xi)$ of $I(\mathbf{x})$, there exists $\kappa > 0$ such that, for all $\mathbf{y} \in B_1(\mathbf{x}, \kappa)$, \mathbf{y} is locally homothetic to \mathbf{y} with respect to $(\delta_\tau, \delta_\xi)$.

Proof. The point (i) is a straightforward consequence of (i) in Lemma 9.A.4.

The proof of (ii) works by induction on $N(\mathbf{x}) \geq 1$. Let us fix $N \geq 0$ such that the lemma is satisfied for all $\mathbf{x} \in \mathcal{D}$ such that $N(\mathbf{x}) \leq N$. Let $\mathbf{x} \in \mathcal{D}$ with $N(\mathbf{x}) = N + 1$; in particular, $t^*(\mathbf{x}) < +\infty$. Let $(\delta_\xi, \delta_\tau)$ be a proper covering of $I(\mathbf{x})$.

Using Lemma 9.A.4 again, we first obtain $\kappa_1 > 0$ such that, for all $\mathbf{y} \in B_1(\mathbf{x}, \kappa_1)$, $\mathbf{y} \in \mathcal{D}$ and $R(\mathbf{x}) = R(\mathbf{y})$.

Without loss of generality, let us assume that δ_τ is small enough to satisfy

$$t' := t^*(\mathbf{x}) + \delta_\tau < t^*(\mathbf{x}) + t^*(\mathbf{x}^*) - \delta_\tau,$$

and take δ_ξ small enough to satisfy (9.34), so that $(\delta_\xi, \delta_\tau)$ remains a proper covering of $I(\mathbf{x})$. Then, on the time interval $[0, t^*(\mathbf{x}) + \delta_\tau]$, the only collisions in the MSPD started at \mathbf{x} occur at time $t^*(\mathbf{x})$, possibly at different locations. Besides, $\Phi(\mathbf{x}; t') \in \mathcal{D}$, $N(\Phi(\mathbf{x}; t')) \leq N$, and if $N(\Phi(\mathbf{x}; t')) \geq 1$, then $(\delta_\xi, \delta_\tau)$ remains a proper covering of $I(\Phi(\mathbf{x}; t'))$. As a consequence, there exists $\kappa' > 0$ such that, for all $\mathbf{y}' \in \bar{B}_1(\Phi(\mathbf{x}; t'), \kappa')$, then \mathbf{y}' is locally homothetic to $\Phi(\mathbf{x}; t')$ (with respect to $(\delta_\xi, \delta_\tau)$ if $N(\Phi(\mathbf{x}; t')) \geq 1$). By Proposition 9.3.17, there exists $\kappa_2 > 0$ such that, for all $\mathbf{y} \in B_1(\mathbf{x}, \kappa_2)$, $\Phi(\mathbf{y}; t') \in B_1(\Phi(\mathbf{x}; t'), \kappa')$.

Combining Proposition 9.3.17 and Lemma 9.A.4, we obtain $\kappa_3 > 0$ such that, for all $\mathbf{y} \in \bar{B}_1(\mathbf{x}, \kappa_3)$,

- $\Phi(\mathbf{y}; t^*(\mathbf{x}) - \delta_\tau) \in \mathcal{D}$ and $R(\Phi(\mathbf{y}; t^*(\mathbf{x}) - \delta_\tau)) = R(\Phi(\mathbf{x}; t^*(\mathbf{x}) - \delta_\tau))$,
- $\Phi(\mathbf{y}; t^*(\mathbf{x}) + \delta_\tau) \in \mathcal{D}$ and $R(\Phi(\mathbf{y}; t^*(\mathbf{x}) + \delta_\tau)) = R(\Phi(\mathbf{x}; t^*(\mathbf{x}) + \delta_\tau))$,

and, for all $\gamma : k \in P_n^d$,

- if the particle $\gamma : k$ is involved in a collision at the space-time point $(\xi_0, t^*(\mathbf{x}))$ in the MSPD started at \mathbf{x} , then for all $t \in [t^*(\mathbf{x}) - \delta_\tau, t^*(\mathbf{x}) + \delta_\tau]$, $\Phi_k^\gamma(\mathbf{y}; t) \in (\xi_0 - \delta_\xi, \xi_0 + \delta_\xi)$,
- if the particle $\gamma : k$ is not involved in a collision at time $t^*(\mathbf{x})$ in the MSPD started at \mathbf{x} , then in the MSPD started at \mathbf{y} , the particle $\gamma : k$ does not cross any of the $(\delta_\xi, \delta_\tau)$ -boxes around points of $I(\mathbf{x})$ on the time interval $[0, t']$.

These conditions ensure that, for all particle $\gamma : k$ involved in a collision at time $t^*(\mathbf{x})$ in the MSPD started at \mathbf{x} , then the corresponding particle enters and exits the $(\delta_\xi, \delta_\tau)$ -box around $(\Phi_k^\gamma(\mathbf{x}; t^*(\mathbf{x})), t^*(\mathbf{x}))$ by horizontal sides in the MSPD started at \mathbf{y} ; besides, all the collision and self-interaction space-time points in which it is involved remain in the box.

Combining Proposition 9.3.17, Lemma 9.A.4 and Lemma 9.4.3, we finally construct $\kappa_4 > 0$ such that, for all $\mathbf{y} \in \bar{B}_1(\mathbf{x}, \kappa_4)$, for all $\gamma : k \in P_n^d$,

$$\text{clu}_k^\gamma(\mathbf{y}; t^*(\mathbf{x}) - \delta_\tau) = \text{clu}_k^\gamma(\mathbf{x}; t^*(\mathbf{x}) - \delta_\tau), \quad \text{clu}_k^\gamma(\mathbf{y}; t^*(\mathbf{x}) + \delta_\tau) = \text{clu}_k^\gamma(\mathbf{x}; t^*(\mathbf{x}) + \delta_\tau).$$

Note that Lemma 9.4.3 can be applied since the fact that $(\delta_\xi, \delta_\tau)$ is a proper covering of $I(\mathbf{x})$ implies that, on the time interval $(t^*(\mathbf{x}), t^*(\mathbf{x}) + \delta_\tau]$, there is no self-interaction in the MSPD started at \mathbf{x} .

We can now define $\kappa := \min\{\kappa_1, \dots, \kappa_4\}$ and fix $\mathbf{y} \in B_1(\mathbf{x}, \kappa)$ and $\rho \in [0, 1]$. To complete the proof, we first have to check that the homothetic relations (9.35) and (9.36) are satisfied for all $\Xi_0 = (\xi_0, \tau_0) \in I(\mathbf{x})$. We address the cases $\tau_0 = t^*(\mathbf{x})$ and $\tau_0 > t^*(\mathbf{x})$ separately, and shall proceed in three steps. In Step 1, we prove that

$$\Phi((1 - \rho)\mathbf{x} + \rho\mathbf{y}; t^*(\mathbf{x}) - \delta_\tau) = (1 - \rho)\Phi(\mathbf{x}; t^*(\mathbf{x}) - \delta_\tau) + \rho\Phi(\mathbf{y}; t^*(\mathbf{x}) - \delta_\tau).$$

In Step 2, we establish the homothetic relations (9.35) and (9.36) for $\tau_0 = t^*(\mathbf{x})$, and we check that

$$\Phi((1 - \rho)\mathbf{x} + \rho\mathbf{y}; t^*(\mathbf{x}) + \delta_\tau) = (1 - \rho)\Phi(\mathbf{x}; t^*(\mathbf{x}) + \delta_\tau) + \rho\Phi(\mathbf{y}; t^*(\mathbf{x}) + \delta_\tau). \quad (9.37)$$

Finally, we apply an inductive argument to address the case $\tau_0 > t^*(\mathbf{x})$ in Step 3.

Step 1. Since $t^*(\mathbf{y}) > t^*(\mathbf{x}) - \delta_\tau$, then for all $t \in [0, t^*(\mathbf{x}) - \delta_\tau]$, $\Phi(\mathbf{x}; t) = \tilde{\Phi}[\tilde{\lambda}(\mathbf{x})](\mathbf{x}; t)$ and $\Phi(\mathbf{y}; t) = \tilde{\Phi}[\tilde{\lambda}(\mathbf{y})](\mathbf{y}; t)$. Besides, $R(\mathbf{x}) = R(\mathbf{y})$ so that $\tilde{\lambda}(\mathbf{x}) = \tilde{\lambda}(\mathbf{y})$. Let $\gamma : k \in P_n^d$ and let us denote

$$c := \text{clu}_k^\gamma(\mathbf{x}; t^*(\mathbf{x}) - \delta_\tau) = \text{clu}_k^\gamma(\mathbf{y}; t^*(\mathbf{x}) - \delta_\tau).$$

Note that $\|\mathbf{x} - ((1 - \rho)\mathbf{x} + \rho\mathbf{y})\|_1 = \rho\|\mathbf{x} - \mathbf{y}\|_1 \leq \kappa_4$, therefore $c = \text{clu}_k^\gamma((1 - \rho)\mathbf{x} + \rho\mathbf{y}; t^*(\mathbf{x}) - \delta_\tau)$.

Let us now remark that the processes $\{\Phi_k^\gamma(\mathbf{x}; t) : \gamma : k \in c\}$, $\{\Phi_k^\gamma(\mathbf{y}; t) : \gamma : k \in c\}$ and $\{\Phi_k^\gamma((1-\rho)\mathbf{x} + \rho\mathbf{y}; t) : \gamma : k \in c\}$ follow the Local Sticky Particle Dynamics on $[0, t^*(\mathbf{x}) - \delta_\tau]$, with the same initial velocity vector. As a consequence, the center of masses

$$\frac{1}{|c|} \sum_{\gamma:k \in c} \Phi_k^\gamma(\mathbf{x}; t), \quad \frac{1}{|c|} \sum_{\gamma:k \in c} \Phi_k^\gamma(\mathbf{y}; t), \quad \frac{1}{|c|} \sum_{\gamma:k \in c} \Phi_k^\gamma((1-\rho)\mathbf{x} + \rho\mathbf{y}; t),$$

travel at the same constant velocity

$$\frac{1}{|c|} \sum_{\gamma:k \in c} \tilde{\lambda}_k^\gamma(\mathbf{x})$$

on $[0, t^*(\mathbf{x}) - \delta_\tau]$. Thus,

$$\begin{aligned} \frac{1}{|c|} \sum_{\gamma:k \in c} \Phi_k^\gamma((1-\rho)\mathbf{x} + \rho\mathbf{y}; t^*(\mathbf{x}) - \delta_\tau) &= \frac{1}{|c|} \sum_{\gamma:k \in c} \left((1-\rho)x_k^\gamma + \rho y_k^\gamma + (t^*(\mathbf{x}) - \delta_\tau) \tilde{\lambda}_k^\gamma(\mathbf{x}) \right) \\ &= (1-\rho) \frac{1}{|c|} \sum_{\gamma:k \in c} \Phi_k^\gamma(\mathbf{x}; t^*(\mathbf{x}) - \delta_\tau) + \rho \frac{1}{|c|} \sum_{\gamma:k \in c} \Phi_k^\gamma(\mathbf{y}; t^*(\mathbf{x}) - \delta_\tau), \end{aligned}$$

which of courses rewrites, for all $\gamma : k \in c$,

$$\Phi_k^\gamma((1-\rho)\mathbf{x} + \rho\mathbf{y}; t^*(\mathbf{x}) - \delta_\tau) = (1-\rho)\Phi_k^\gamma(\mathbf{x}; t^*(\mathbf{x}) - \delta_\tau) + \rho\Phi_k^\gamma(\mathbf{y}; t^*(\mathbf{x}) - \delta_\tau)$$

and completes Step 1.

Step 2. Let $\gamma : k \in P_n^d$. If the particle $\gamma : k$ does not collide with a particle of another type between times $t^*(\mathbf{x}) - \delta_\tau$ and $t^*(\mathbf{x}) + \delta_\tau =: t'$ in the MSPD started at \mathbf{x} (or equivalently \mathbf{y} or $(1-\rho)\mathbf{x} + \mathbf{y}$), then the same arguments as in Step 1 using the Local Sticky Particle Dynamics ensure that

$$\Phi_k^\gamma((1-\rho)\mathbf{x} + \rho\mathbf{y}; t') = (1-\rho)\Phi_k^\gamma(\mathbf{x}; t') + \rho\Phi_k^\gamma(\mathbf{y}; t').$$

Otherwise, there exists a unique space-time point

$$\Xi_0 \in \{\Xi_{\alpha:i, \beta:j}^{\text{coll}}(\mathbf{x}) : (\alpha : i, \beta : j) \in R(\mathbf{x}), \tau_{\alpha:i, \beta:j}^{\text{coll}}(\mathbf{x}) \in [t^*(\mathbf{x}) - \delta_\tau, t^*(\mathbf{x}) + \delta_\tau]\},$$

such that all the collisions with particles of another type and all the self-interactions of the particle $\gamma : k$ between times $t^*(\mathbf{x}) - \delta_\tau$ and $t^*(\mathbf{x}) + \delta_\tau$ in the MSPD started at \mathbf{x} occur at the space-time point Ξ_0 . By the definition of κ , the particle $\gamma : k$ collides with the same particles of another type and have the same self-interactions in the MSPD started at \mathbf{y} , and the corresponding space-time points of collisions and self-interactions belong to the $(\delta_\xi, \delta_\tau)$ -box around Ξ_0 ; but of course, they can be distinct. Let us denote by $\Xi_{(1)}, \dots, \Xi_{(L)}$ the sequence of these distinct space-time points of collisions and self-interactions, ranked by the increasing order of the times of collisions or self-interactions. For all $l \in \{1, \dots, L\}$, we write $\Xi_{(l)} = (\xi_{(l)}, \tau_{(l)})$, so that

$$t^*(\mathbf{x}) - \delta_\tau < \tau_{(1)} < \dots < \tau_{(L)} < t^*(\mathbf{x}) + \delta_\tau.$$

For all $l \in \{1, \dots, L\}$, we finally denote by $S_{l, l+1}$ the space-time segment connecting $\Xi_{(l)}$ to $\Xi_{(l+1)}$, and let $S_{0,1}$ refer to the space-time segment connecting $(\Phi_k^\gamma(\mathbf{y}; t^*(\mathbf{x}) - \delta_\tau), t^*(\mathbf{x}) - \delta_\tau)$ to $\Xi_{(1)}$, and $S_{L, L+1}$ refer to the space-time segment connecting $\Xi_{(L)}$ to $(\Phi_k^\gamma(\mathbf{y}; t^*(\mathbf{x}) + \delta_\tau), t^*(\mathbf{x}) + \delta_\tau)$.

We now define, for all $l \in \{1, \dots, L\}$,

$$\Xi'_{(l)} = (\xi'_{(l)}, \tau'_{(l)}) := (1-\rho)\Xi_0 + \rho\Xi_{(l)},$$

and similarly denote by $S'_{l, l+1}$ the space-time segment connecting $\Xi'_{(l)}$ to $\Xi'_{(l+1)}$ while $S'_{0,1}$ refers to the space-time segment connecting $((1-\rho)\Phi_k^\gamma(\mathbf{x}; t^*(\mathbf{x}) - \delta_\tau) + \rho\Phi_k^\gamma(\mathbf{y}; t^*(\mathbf{x}) - \delta_\tau), t^*(\mathbf{x}) - \delta_\tau)$ to $\Xi'_{(1)}$ and $S'_{L, L+1}$ refers to the space-time segment connecting $\Xi'_{(L)}$ to $((1-\rho)\Phi_k^\gamma(\mathbf{x}; t^*(\mathbf{x}) + \delta_\tau) + \rho\Phi_k^\gamma(\mathbf{y}; t^*(\mathbf{x}) + \delta_\tau), t^*(\mathbf{x}) + \delta_\tau)$.

Elementary geometric properties of the homothetic transform imply that, if $\rho \in (0, 1]$, then for all $l \in \{0, \dots, L\}$, the segments $S_{l,l+1}$ and $S'_{l,l+1}$ are parallel. As a consequence, if $\rho \in (0, 1]$, then the process Φ_k^γ defined on $[t^*(\mathbf{x}) - \delta_\tau, t^*(\mathbf{x}) + \delta_\tau]$ by

$$\forall l \in \{0, \dots, L\}, \quad S'_{l,l+1} = \{(\Phi_k^\gamma(t), t), t \in [\tau'_{(l)}, \tau'_{(l+1)}]\}$$

(where $\tau'_{(0)} := t^*(\mathbf{x}) - \delta_\tau$, $\tau'_{(L+1)} := t^*(\mathbf{x}) + \delta_\tau$), has the same slope as the process $\Phi_k^\gamma(\mathbf{y}; \cdot)$ on each corresponding linear part, see Figure 9.5. Besides, if two particles $\gamma : k$ and $\gamma : k'$ are in the same cluster on some linear part in the MSPD started at \mathbf{y} , then it is clear that the corresponding trajectories $\Phi_k^\gamma, \Phi_{k'}^\gamma$ coincide on the corresponding linear part.

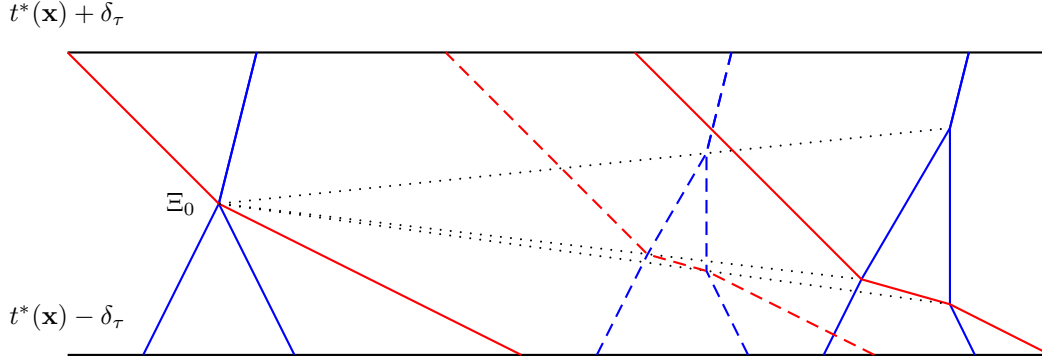

Figure 9.5: The trajectory of the MSPD started at \mathbf{x} is plotted on the left-hand side of the figure, while the trajectory of the MSPD started at \mathbf{y} is plotted on the right-hand side. The trajectory of the process Φ' is plotted in dashed lines. Each linear part is parallel to the corresponding part in the trajectory of the MSPD started at \mathbf{y} . The black lines represent the horizontal sides of the box.

As a conclusion, the processes $\Phi_k^\gamma(t - (t^*(\mathbf{x}) - \delta_\tau))$, $t \in [t^*(\mathbf{x}) - \delta_\tau, t^*(\mathbf{x}) + \delta_\tau]$, for all $\gamma : k$ such that

$$(\Phi_k^\gamma(\mathbf{x}; t^*(\mathbf{x})), t^*(\mathbf{x})) = \Xi_0,$$

exactly describe the motion of the particles in the MSPD started at $(1 - \rho)\Phi(\mathbf{x}; t^*(\mathbf{x}) - \delta_\tau) + \rho\Phi(\mathbf{y}; t^*(\mathbf{x}) - \delta_\tau)$. Thanks to Step 1, we conclude that

$$\forall t \in [t^*(\mathbf{x}) - \delta_\tau, t^*(\mathbf{x}) + \delta_\tau], \quad \Phi_k^\gamma(t) = \Phi_k^\gamma((1 - \rho)\mathbf{x} + \rho\mathbf{y}; t),$$

which yields (9.35), (9.36) for all the collision and self-interaction space-time points for the particle $\gamma : k$ on the time interval $[0, t']$; besides,

$$\Phi_k^\gamma((1 - \rho)\mathbf{x} + \rho\mathbf{y}; t') = \Phi_k^\gamma(t') = (1 - \rho)\Phi_k^\gamma(\mathbf{x}; t') + \rho\Phi_k^\gamma(\mathbf{y}; t').$$

This completes the proof of Step 2.

Step 3. Let $(\alpha : i, \beta : j) \in \mathbf{R}(\Phi(\mathbf{y}; t')) = \mathbf{R}(\Phi(\mathbf{x}; t'))$, so that

$$\tau_{\alpha:i, \beta:j}^{\text{coll}}(\mathbf{x}), \tau_{\alpha:i, \beta:j}^{\text{coll}}(\mathbf{y}), \tau_{\alpha:i, \beta:j}^{\text{coll}}((1 - \rho)\mathbf{x} + \rho\mathbf{y}) > t'.$$

Then, by the flow property of the MSPD,

$$\begin{aligned} \xi_{\alpha:i, \beta:j}^{\text{coll}}((1 - \rho)\mathbf{x} + \rho\mathbf{y}) &= \xi_{\alpha:i, \beta:j}^{\text{coll}}(\Phi((1 - \rho)\mathbf{x} + \rho\mathbf{y}; t')) \\ &= \xi_{\alpha:i, \beta:j}^{\text{coll}}((1 - \rho)\Phi(\mathbf{x}; t') + \rho\Phi(\mathbf{y}; t')) \\ &= (1 - \rho)\xi_{\alpha:i, \beta:j}^{\text{coll}}(\Phi(\mathbf{x}; t')) + \rho\xi_{\alpha:i, \beta:j}^{\text{coll}}(\Phi(\mathbf{y}; t')), \end{aligned}$$

where we used Step 2 at the second line and the fact that $\Phi(\mathbf{y}; t') \in B_1(\Phi(\mathbf{x}; t'), \kappa')$ at the third line. Using the flow property for the MSPD again, we conclude that the right-hand side above

rewrites $(1 - \rho)\xi_{\alpha:i,\beta:j}^{\text{coll}}(\mathbf{x}) + \rho\xi_{\alpha:i,\beta:j}^{\text{coll}}(\mathbf{y})$. The very same arguments allow to address self-interactions as well, and also yield

$$\begin{aligned}\tau_{\alpha:i,\beta:j}^{\text{coll}}((1 - \rho)\mathbf{x} + \rho\mathbf{y}) &= \tau_{\alpha:i,\beta:j}^{\text{coll}}(\Phi((1 - \rho)\mathbf{x} + \rho\mathbf{y}; t')) - t' \\ &= (1 - \rho) (\tau_{\alpha:i,\beta:j}^{\text{coll}}(\Phi(\mathbf{x}; t')) - t') + \rho (\tau_{\alpha:i,\beta:j}^{\text{coll}}(\Phi(\mathbf{y}; t')) - t') \\ &= (1 - \rho)\tau_{\alpha:i,\beta:j}^{\text{coll}}(\mathbf{x}) + \rho\tau_{\alpha:i,\beta:j}^{\text{coll}}(\mathbf{y}),\end{aligned}$$

which completes the proof. \square

We now explain how to construct a path joining a configuration \mathbf{x} to a good configuration \mathbf{y} close to \mathbf{x} , along which pairs of configurations satisfy the Local Homeomorphic Condition (LHM). For the sake of understandability, we first describe the case $\mathbf{x} \in \mathcal{G}$ in Lemma 9.4.17 below. Then, the situation is actually very simple as, for \mathbf{y} close enough to \mathbf{x} , the locally homothetic property implies that $\mathbf{y} \in \mathcal{G}$ and \mathbf{x}, \mathbf{y} satisfy Condition (LHM). The case of an arbitrary configuration $\mathbf{x} \in D_n^d$ (more precisely, \mathbf{x} is taken in the dense subset \mathcal{D} of D_n^d) is addressed in Lemma 9.4.18.

Lemma 9.4.17 (Construction of locally homeomorphic configurations, good case). *Under the assumptions of Lemma 9.4.16, let $\mathbf{x} \in \mathcal{G}$, and if $N(\mathbf{x}) \geq 1$, let $(\delta_\xi, \delta_\tau)$ be a proper covering of $I(\mathbf{x})$. Let $\kappa > 0$ be given by Lemma 9.4.16. Then, for all $\mathbf{y} \in \bar{B}_1(\mathbf{x}, \kappa)$, the configuration \mathbf{y} belongs to the set \mathcal{G} and the configurations \mathbf{x} and \mathbf{y} satisfy Condition (LHM).*

Proof. If $N(\mathbf{x}) = 0$, then there is nothing to prove. Let us assume that $N(\mathbf{x}) \geq 0$, let $(\delta_\xi, \delta_\tau)$ be a proper covering of $I(\mathbf{x})$ and let $\kappa > 0$ be given by Lemma 9.4.16, so that \mathbf{y} is locally homothetic to \mathbf{x} with respect to $(\delta_\xi, \delta_\tau)$. In particular, $R(\mathbf{x}) = R(\mathbf{y})$ and if $(\alpha : i, \beta : j), (\alpha' : i', \beta' : j') \in R(\mathbf{y})$ are such that

$$\Xi_{\alpha:i,\beta:j}^{\text{coll}}(\mathbf{y}) = \Xi_{\alpha':i',\beta':j'}^{\text{coll}}(\mathbf{y}),$$

then it necessarily holds

$$\Xi_{\alpha:i,\beta:j}^{\text{coll}}(\mathbf{x}) = \Xi_{\alpha':i',\beta':j'}^{\text{coll}}(\mathbf{x}),$$

Since $\mathbf{x} \in \mathcal{G} \subset \mathcal{B}$, this implies that $\mathbf{y} \in \mathcal{B}$. Besides, on account of the definitions of proper coverings and good configurations, in the MSPD started at \mathbf{x} , there is no self-interaction in the $(\delta_\xi, \delta_\tau)$ -boxes around space-time points of collisions. Since the clusters at entry and exit of these boxes have the same composition in the MSPD started at \mathbf{y} , we deduce that self-interactions are separated from collisions in the MSPD started at \mathbf{y} . As a consequence, $\mathbf{y} \in \mathcal{G}$.

We have already checked that \mathbf{x} and \mathbf{y} satisfy Condition (LHM-1). Condition (LHM-2), which asserts that \mathbf{x} and \mathbf{y} have the same collision graph, is a trivial consequence of the equality of clusters at entry and exit of boxes. Now if two collisions \mathbf{c}' and \mathbf{c} are such that $\mathbf{c}' \xrightarrow{\gamma} \mathbf{c}$, then the fact that

$$(\Xi(\mathbf{x}; \mathbf{c}'))^{\delta_\xi, \delta_\tau} \cap (\Xi(\mathbf{x}; \mathbf{c}))^{\delta_\xi, \delta_\tau} = \emptyset, \quad \Xi(\mathbf{y}; \mathbf{c}') \in (\Xi(\mathbf{x}; \mathbf{c}'))^{\delta_\xi, \delta_\tau}, \quad \Xi(\mathbf{y}; \mathbf{c}) \in (\Xi(\mathbf{x}; \mathbf{c}))^{\delta_\xi, \delta_\tau},$$

implies that

$$T^+(\mathbf{c}') = T(\mathbf{x}; \mathbf{c}') \vee T(\mathbf{y}; \mathbf{c}') \leq T(\mathbf{x}; \mathbf{c}') + \delta_\tau < T(\mathbf{x}; \mathbf{c}) - \delta_\tau < T(\mathbf{x}; \mathbf{c}) \wedge T(\mathbf{y}; \mathbf{c}) = T^-(\mathbf{c}),$$

which yields Condition (LHM-3a). Finally, Condition (LHM-3b) is also a straightforward consequence of the identity of the compositions of clusters at entry and exit of boxes. \square

When \mathbf{x} is not a good configuration, say even not a binary colliding configuration, then one can obviously not expect Condition (LHM) to hold for \mathbf{x} and \mathbf{y} chosen as in Lemma 9.4.17. As is plotted on Figure 9.6, singularities can lead this condition to fail even for the locally homothetic good configurations \mathbf{y} and $(1 - \rho)\mathbf{x} + \rho\mathbf{y}$ when ρ is too far from 1. However, based on the radial blow-up of singularities property described in §9.4.3.2, we prove in Lemma 9.4.18 below that, for $\rho^* < 1$, ρ^* close to 1, then \mathbf{y} and $(1 - \rho^*)\mathbf{x} + \rho^*\mathbf{y}$ actually satisfy the Local Homeomorphic Condition (LHM). Iterating the argument starting from $(1 - \rho^*)\mathbf{x} + \rho^*\mathbf{y}$ instead of \mathbf{y} , we obtain that the geometric sequence $(\rho^{*m})_{m \geq 0}$ has the property that, for all $m \geq 1$, the configurations $(1 - \rho^{*m-1})\mathbf{x} + \rho^{*m-1}\mathbf{y}$ and $(1 - \rho^{*m})\mathbf{x} + \rho^{*m}\mathbf{y}$ satisfy Condition (LHM).

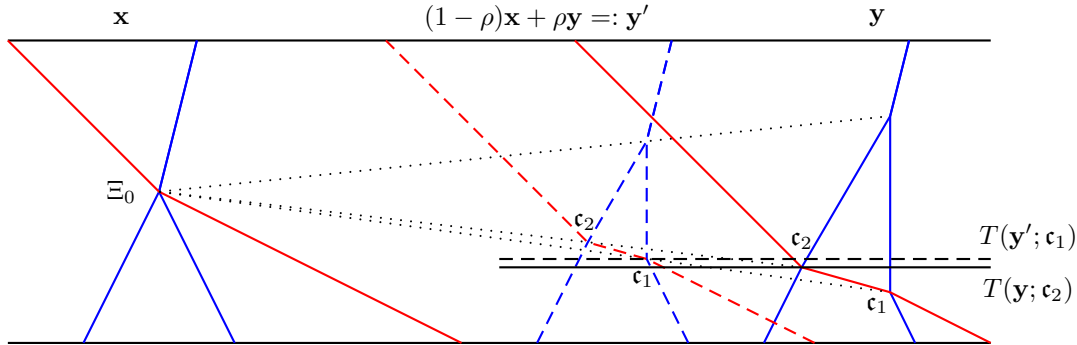

Figure 9.6: The configurations \mathbf{y} and $\mathbf{y}' := (1 - \rho)\mathbf{x} + \rho\mathbf{y}$ are both good configurations and they are locally homothetic to \mathbf{x} . In their collision graph, $\mathbf{c}_1 \rightarrow \mathbf{c}_2$; however, for the choice of ρ on the figure, then $T(\mathbf{y}'; \mathbf{c}_1) > T(\mathbf{y}; \mathbf{c}_2)$, therefore Condition (LHM-3a) is not satisfied by the pair \mathbf{y}, \mathbf{y}' .

Lemma 9.4.18 (Construction of locally homeomorphic configurations, bad case). *Under the assumptions of Lemma 9.4.16, let $\mathbf{x} \in \mathcal{D}$, and if $N(\mathbf{x}) \geq 1$, let $(\delta_\xi, \delta_\tau)$ be a proper covering of $I(\mathbf{x})$. Let $\kappa > 0$ be given by Lemma 9.4.16. Then, for all $\mathbf{y} \in B_1(\mathbf{x}, \kappa) \cap \mathcal{G}$, there exist $\rho_* \in (0, 1)$ such that, for all $m \geq 1$, the configurations $(1 - \rho_*^{m-1})\mathbf{y} + \rho_*^{m-1}\mathbf{x}$ and $(1 - \rho_*^m)\mathbf{y} + \rho_*^m\mathbf{x}$ satisfy Condition (LHM).*

Proof. Let $\mathbf{y} \in B_1(\mathbf{x}, \kappa) \cap \mathcal{G}$. For all $\rho \in (0, 1]$, it follows from Lemma 9.4.16 that the collisions locally look alike in the MSPD started at \mathbf{y} and at $(1 - \rho)\mathbf{x} + \rho\mathbf{y}$. This implies that $(1 - \rho)\mathbf{x} + \rho\mathbf{y} \in \mathcal{G}$; and, for all $\rho, \rho' \in (0, 1]$, $R((1 - \rho)\mathbf{x} + \rho\mathbf{y}) = R((1 - \rho')\mathbf{x} + \rho'\mathbf{y})$ and $(1 - \rho)\mathbf{x} + \rho\mathbf{y}, (1 - \rho')\mathbf{x} + \rho'\mathbf{y}$ have the same collision graph, so that they satisfy Conditions (LHM-1) and (LHM-2).

Let us now explain how to construct $\rho_* \in (0, 1)$ in such a way that, for all $m \geq 1$, the configurations $(1 - \rho_*^{m-1})\mathbf{y} + \rho_*^{m-1}\mathbf{x}$ and $(1 - \rho_*^m)\mathbf{y} + \rho_*^m\mathbf{x}$ satisfy Conditions (LHM-3a) and (LHM-3b). Let us denote $C := C(\mathbf{y})$. For all $\mathbf{c} \in C$, it follows from Lemma 9.4.16 that there exists a space-time point $\Xi_0(\mathbf{c})$ such that

$$\forall \rho \in (0, 1], \quad \Xi((1 - \rho)\mathbf{x} + \rho\mathbf{y}; \mathbf{c}) = (1 - \rho)\Xi_0(\mathbf{c}) + \rho\Xi(\mathbf{y}; \mathbf{c}),$$

and in particular, the collision times satisfy

$$\forall \rho \in (0, 1], \quad T((1 - \rho)\mathbf{x} + \rho\mathbf{y}; \mathbf{c}) = (1 - \rho)T_0(\mathbf{c}) + \rho T(\mathbf{y}; \mathbf{c}),$$

where we denote $\Xi_0(\mathbf{c}) = (\xi_0(\mathbf{c}), T_0(\mathbf{c}))$. Therefore, for all $\rho \in (0, 1]$, $(1 - \rho)\mathbf{x} + \rho\mathbf{y}$ and \mathbf{y} satisfy Condition (LHM-3a) as soon as, for all $\mathbf{c}', \mathbf{c} \in C$ such that $\mathbf{c}' \xrightarrow{\gamma} \mathbf{c}$,

$$((1 - \rho)T_0(\mathbf{c}') + \rho T(\mathbf{y}; \mathbf{c}')) \vee T(\mathbf{y}; \mathbf{c}') < ((1 - \rho)T_0(\mathbf{c}) + \rho T(\mathbf{y}; \mathbf{c})) \wedge T(\mathbf{y}; \mathbf{c}),$$

which is always the case if $\Xi_0(\mathbf{c}') \neq \Xi_0(\mathbf{c})$ and reduces to

$$\rho > \frac{T_0(\mathbf{c}) - T(\mathbf{y}; \mathbf{c})}{T_0(\mathbf{c}) - T(\mathbf{y}; \mathbf{c}')}$$

if $\Xi_0(\mathbf{c}') = \Xi_0(\mathbf{c})$ and either $T(\mathbf{y}; \mathbf{c}') < T(\mathbf{y}; \mathbf{c}) < T_0(\mathbf{c})$ or $T_0(\mathbf{c}) < T(\mathbf{y}; \mathbf{c}') < T(\mathbf{y}; \mathbf{c})$. We denote by $\rho_{*,1}$ the infimum of the set of $\rho \in (0, 1)$ satisfying these conditions; then, for all $\rho > \rho_{*,1}$, $(1 - \rho)\mathbf{x} + \rho\mathbf{y}$ and \mathbf{y} satisfy Condition (LHM-3a). Very similar arguments combined with the fact that $\mathbf{y} \in \mathcal{G}$ allow us to construct $\rho_{*,2} \in (0, 1)$ such that, for all $\rho > \rho_{*,2}$, $(1 - \rho)\mathbf{x} + \rho\mathbf{y}$ and \mathbf{y} satisfy Condition (LHM-3b).

As a conclusion, let us define ρ_* to be any number such that

$$\rho_{*,1} \vee \rho_{*,2} < \rho_* < 1.$$

Then we have proved that the pair of configurations \mathbf{y} and $(1 - \rho_*)\mathbf{x} + \rho_*\mathbf{y}$ satisfies Condition (LHM). To complete the proof, we apply the same arguments starting from $(1 - \rho_*)\mathbf{x} + \rho_*\mathbf{y}$ instead of \mathbf{y} . We obtain that, for all $\rho \in (0, 1]$, the configurations

$$(1 - \rho)\mathbf{x} + \rho((1 - \rho_*)\mathbf{x} + \rho_*\mathbf{y}) = (1 - \rho\rho_*)\mathbf{x} + \rho\rho_*\mathbf{y} \quad \text{and} \quad (1 - \rho_*)\mathbf{x} + \rho_*\mathbf{y}$$

satisfy Condition (LHM-1) and (LHM-2). Besides, Condition (LHM-3a) holds as soon as

$$\rho > \frac{T_0(\mathbf{c}) - T((1 - \rho_*)\mathbf{x} + \rho_*\mathbf{y}; \mathbf{c})}{T_0(\mathbf{c}) - T((1 - \rho_*)\mathbf{x} + \rho_*\mathbf{y}; \mathbf{c}')} = \frac{T_0(\mathbf{c}) - T(\mathbf{y}; \mathbf{c})}{T_0(\mathbf{c}) - T(\mathbf{y}; \mathbf{c}'')}$$

for all $\mathbf{c}', \mathbf{c} \in C((1 - \rho_*)\mathbf{x} + \rho_*\mathbf{y}) = C(\mathbf{y})$ such that $\mathbf{c}' \xrightarrow{\gamma} \mathbf{c}$, $\Xi_0(\mathbf{c}') = \Xi_0(\mathbf{c})$ and either

$$T((1 - \rho_*)\mathbf{x} + \rho_*\mathbf{y}; \mathbf{c}') < T((1 - \rho_*)\mathbf{x} + \rho_*\mathbf{y}; \mathbf{c}) < T_0(\mathbf{c}),$$

which reduces to $T(\mathbf{y}; \mathbf{c}') < T(\mathbf{y}; \mathbf{c}) < T_0(\mathbf{c})$, or

$$T_0(\mathbf{c}) < T((1 - \rho_*)\mathbf{x} + \rho_*\mathbf{y}; \mathbf{c}') < T((1 - \rho_*)\mathbf{x} + \rho_*\mathbf{y}; \mathbf{c}),$$

which reduces to $T_0(\mathbf{c}) < T(\mathbf{y}; \mathbf{c}') < T(\mathbf{y}; \mathbf{c})$. As a consequence, the conditions on ρ are the same as above and taking the infimum over the admissible values of ρ yields the same quantity $\rho_{*,1}$. Likewise, to ensure that $(1 - \rho_*^2)\mathbf{x} + \rho_*^2\mathbf{y}$ and $(1 - \rho_*)\mathbf{x} + \rho_*\mathbf{y}$ satisfy Condition (LHM-3b), we obtain the same quantity $\rho_{*,2}$ as above, therefore taking $\rho = \rho_*$ again, we conclude that the configurations $(1 - \rho_*^2)\mathbf{x} + \rho_*^2\mathbf{y}$ and $(1 - \rho_*)\mathbf{x} + \rho_*\mathbf{y}$ satisfy Condition (LHM). The proof is completed by induction. \square

9.4.3.3 Interpolation procedure

In this paragraph, we describe the interpolation procedure allowing to complete the proof of Proposition 9.4.11.

Proof of Proposition 9.4.11. Let us begin by mentioning that the arguments of the proof do not depend on the choice of the distance; in particular, continuity and density results are valid whatever the choice of the distance since these distances are equivalent. Therefore, the notation $\|\cdot\|$ shall indifferently refer to $\|\cdot\|_1$ or $\|\cdot\|_\infty$. The corresponding stability constant shall simply be denoted \mathcal{L} .

We first recall that \mathcal{D} is dense in D_n^d and, by Proposition 9.3.17, for all $t \geq 0$, the mapping $(\mathbf{x}, \mathbf{y}) \mapsto \|\Phi(\mathbf{x}; t) - \Phi(\mathbf{y}; t)\|$ is continuous on $(D_n^d)^2$. As a consequence, it suffices to prove that, for all $t \geq 0$, for all $(\mathbf{x}, \mathbf{y}) \in (\mathcal{D})^2$, $\|\Phi(\mathbf{x}; t) - \Phi(\mathbf{y}; t)\| \leq \mathcal{L}\|\mathbf{x} - \mathbf{y}\|$.

We fix $\mathbf{x}, \mathbf{y} \in \mathcal{D}$ and proceed by interpolation as follows. In Step 1, we split the segment

$$S := \{(1 - s)\mathbf{x} + s\mathbf{y}, s \in [0, 1]\} \tag{9.38}$$

into a finite number of segments

$$S_k := \{(1 - s)\mathbf{x} + s\mathbf{y}, s \in [s_k, s_{k+1}]\}, \quad k \in \{0, \dots, K\}, \tag{9.39}$$

where $0 =: s_0 < s_1 < \dots < s_K < s_{K+1} := 1$ are such that, for all $k \in \{0, \dots, K\}$, for all $s \in (s_k, s_{k+1})$, $(1 - s)\mathbf{x} + s\mathbf{y} \in \mathcal{D}$. In Step 2, for all $k \in \{0, \dots, K\}$ and $\epsilon > 0$ small enough, we define the segment S_k^ϵ by

$$S_k^\epsilon := \{(1 - s)\mathbf{x} + s\mathbf{y}, s \in [s_k + \epsilon, s_{k+1} - \epsilon]\}, \tag{9.40}$$

and construct a piecewise linear and continuous path joining the extreme points of S_k^ϵ , with length arbitrarily close to the length of S_k^ϵ , and allowing to apply Lemma 9.4.18 on a finite number of linear parts of the path in Step 3. We let ϵ vanish and complete the interpolation procedure in Step 4.

Step 1. Let S be defined by (9.38). For all $s \in [0, 1]$, $(1 - s)\mathbf{x} + s\mathbf{y} \notin \mathcal{D}$ if and only if there exists $(\alpha : i, \beta : j) \in (P_n^d)^2$ such that $\alpha < \beta$ and

$$(1 - s)x_i^\alpha + sy_i^\alpha = (1 - s)x_j^\beta + sy_j^\beta,$$

which rewrites

$$s(x_j^\beta - x_i^\alpha + y_i^\alpha - y_j^\beta) = x_j^\beta - x_i^\alpha,$$

where we recall that $x_j^\beta - x_i^\alpha \neq 0$ since $\mathbf{x} \in \mathcal{D}$. As a consequence, either $x_j^\beta - x_i^\alpha + y_i^\alpha - y_j^\beta \neq 0$ in which case there is at most one solution $s \in [0, 1]$ to the equation above, or $x_j^\beta - x_i^\alpha + y_i^\alpha - y_j^\beta = 0$ in which case there is no solution. We deduce that there is a finite number $K \geq 0$ of points $s \in [0, 1]$ such that $(1 - s)\mathbf{x} + s\mathbf{y} \notin \mathcal{D}$ and we index these points by their increasing ordering: $0 < s_1 < \dots < s_K < 1$. For the convenience of notation in the sequel of the proof, we define $s_0 := 0$ and $s_{K+1} := 1$, so that for all $k \in \{0, \dots, K\}$, for all $s \in (s_k, s_{k+1})$, $(1 - s)\mathbf{x} + s\mathbf{y} \in \mathcal{D}$. We finally define the segments $(S_k)_{0 \leq k \leq K}$ as in (9.39).

Step 2. In this step we fix $k \in \{0, \dots, K\}$ and $\epsilon > 0$ such that $s_k + \epsilon < s_{k+1} - \epsilon$. Then, the segment S_k^ϵ defined by (9.40) is a compact subset of \mathcal{D} . Its length is worth

$$\|(1 - (s_{k+1} - \epsilon))\mathbf{x} + (s_{k+1} - \epsilon)\mathbf{y} - (1 - (s_k + \epsilon))\mathbf{x} - (s_k + \epsilon)\mathbf{y}\| = (s_{k+1} - s_k - 2\epsilon)\|\mathbf{x} - \mathbf{y}\|.$$

Let us write

$$S_k^\epsilon \subset \bigcup_{\mathbf{z} \in S_k^\epsilon} B_1(\mathbf{z}, \kappa(\mathbf{z})),$$

where, for all $\mathbf{z} \in S_k^\epsilon$, we fix a proper covering of $I(\mathbf{z})$ if $N(\mathbf{z}) \geq 1$ and let $\kappa(\mathbf{z})$ be given by Lemma 9.4.16. Let us extract a finite subcover $B_1(\mathbf{z}_1, \kappa(\mathbf{z}_1)), \dots, B_1(\mathbf{z}_L, \kappa(\mathbf{z}_L))$ of S_k^ϵ where, for all $l \in \{1, \dots, L\}$, $\mathbf{z}_l \in S_k^\epsilon$ writes $(1 - \sigma_l)\mathbf{x} + \sigma_l\mathbf{y}$ with $s_k + \epsilon \leq \sigma_1 < \dots < \sigma_L \leq s_{k+1} - \epsilon$. We also define $\sigma_0 := s_k + \epsilon$, $\sigma_{L+1} := s_{k+1} - \epsilon$ and $\mathbf{z}_0 := (1 - \sigma_0)\mathbf{x} + \sigma_0\mathbf{y}$, $\mathbf{z}_{L+1} := (1 - \sigma_{L+1})\mathbf{x} + \sigma_{L+1}\mathbf{y}$. Note that, for all $l \in \{0, \dots, L\}$, the intersection of $B_1(\mathbf{z}_l, \kappa(\mathbf{z}_l))$ and $B_1(\mathbf{z}_{l+1}, \kappa(\mathbf{z}_{l+1}))$ is nonempty and contains the set

$$\{(1 - s)\mathbf{x} + s\mathbf{y}, s \in (\sigma_l + \kappa(\mathbf{z}_l), \sigma_{l+1} - \kappa(\mathbf{z}_{l+1}))\}.$$

We finally fix $\eta > 0$ and use the density of the set \mathcal{G} (see Lemma 9.4.13) to construct

$$\mathbf{z}'_{0,1}, \dots, \mathbf{z}'_{L,L+1} \in \mathcal{G}$$

such that, for all $l \in \{0, \dots, L\}$, $\mathbf{z}'_{l,l+1} \in B_1(\mathbf{z}_l, \kappa(\mathbf{z}_l)) \cap B_1(\mathbf{z}_{l+1}, \kappa(\mathbf{z}_{l+1}))$, and in addition,

$$\sum_{l=0}^L \|\mathbf{z}_l - \mathbf{z}'_{l,l+1}\| + \|\mathbf{z}'_{l,l+1} - \mathbf{z}_{l+1}\| \leq (s_{k+1} - s_k - 2\epsilon)\|\mathbf{x} - \mathbf{y}\| + \eta.$$

The quantities introduced in Step 2 are summarised on Figure 9.7.

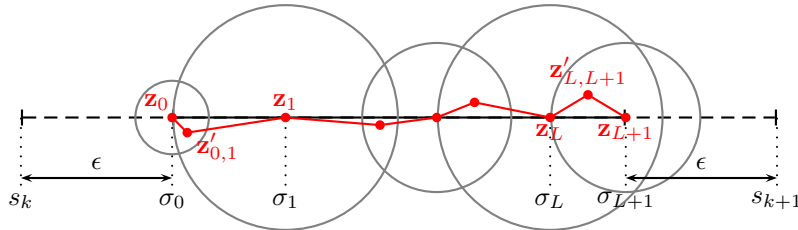

Figure 9.7: The segment S_k is drawn in dashed line, while the segment S_k^ϵ is drawn in solid line. Gray circles stand for the open balls $B_1(\mathbf{z}_l, \kappa(\mathbf{z}_l))$. The points $\mathbf{z}'_{0,1}, \dots, \mathbf{z}'_{L,L+1}$ are chosen in the dense set \mathcal{G} in order to ensure that the difference between the length of the red path and the length $(s_{k+1} - s_k - 2\epsilon)\|\mathbf{x} - \mathbf{y}\|$ of S_k^ϵ be smaller than η .

Step 3. As a continuation of Step 2, let us fix $l \in \{0, \dots, L\}$. We now prove

$$\sup_{t \geq 0} \|\Phi(\mathbf{z}_l; t) - \Phi(\mathbf{z}'_{l,l+1}; t)\| \leq \mathcal{L} \|\mathbf{z}_l - \mathbf{z}'_{l,l+1}\|,$$

and similar arguments shall also yield

$$\sup_{t \geq 0} \|\Phi(\mathbf{z}_{l+1}; t) - \Phi(\mathbf{z}'_{l,l+1}; t)\| \leq \mathcal{L} \|\mathbf{z}_{l+1} - \mathbf{z}'_{l,l+1}\|.$$

By Step 2, $\mathbf{z}_l \in \mathcal{D}$ and $\mathbf{z}'_{l,l+1} \in B_1(\mathbf{z}_l, \kappa(\mathbf{z}_l)) \cap \mathcal{G}$. As a consequence, Lemma 9.4.18 implies that there exists $\rho_* \in (0, 1)$ such that, for all $m \geq 1$, $(1 - \rho_*^{m-1})\mathbf{z}_l + \rho_*^{m-1}\mathbf{z}'_{l,l+1}$ and $(1 - \rho_*^m)\mathbf{z}_l + \rho_*^m\mathbf{z}'_{l,l+1}$ satisfy Condition (LHM). Therefore, for all $m \geq 1$, Proposition 9.4.7 yields, for all $t \geq 0$,

$$\|\Phi((1 - \rho_*^m)\mathbf{z}_l + \rho_*^m\mathbf{z}'_{l,l+1}; t) - \Phi((1 - \rho_*^{m-1})\mathbf{z}_l + \rho_*^{m-1}\mathbf{z}'_{l,l+1}; t)\| \leq \mathcal{L}(\rho_*^{m-1} - \rho_*^m) \|\mathbf{z}_l - \mathbf{z}'_{l,l+1}\|.$$

We finally deduce from the triangle inequality that, for all $M \geq 1$,

$$\begin{aligned} & \|\Phi((1 - \rho_*^M)\mathbf{z}_l + \rho_*^M\mathbf{z}'_{l,l+1}; t) - \Phi(\mathbf{z}'_{l,l+1}; t)\| \\ & \leq \sum_{m=1}^M \|\Phi((1 - \rho_*^m)\mathbf{z}_l + \rho_*^m\mathbf{z}'_{l,l+1}; t) - \Phi((1 - \rho_*^{m-1})\mathbf{z}_l + \rho_*^{m-1}\mathbf{z}'_{l,l+1}; t)\| \\ & \leq \sum_{m=1}^M \mathcal{L}(\rho_*^{m-1} - \rho_*^m) \|\mathbf{z}_l - \mathbf{z}'_{l,l+1}\| = \mathcal{L}(1 - \rho_*^M) \|\mathbf{z}_l - \mathbf{z}'_{l,l+1}\|, \end{aligned}$$

and use Proposition 9.3.17 to conclude that

$$\sup_{t \geq 0} \|\Phi(\mathbf{z}_l; t) - \Phi(\mathbf{z}'_{l,l+1}; t)\| \leq \mathcal{L} \|\mathbf{z}_l - \mathbf{z}'_{l,l+1}\|.$$

Step 4. We finally complete the interpolation procedure described in the introduction of the proof. First, it follows from Step 3 that

$$\begin{aligned} \sup_{t \geq 0} \|\Phi(\mathbf{z}_0; t) - \Phi(\mathbf{z}_{L+1}; t)\| & \leq \sum_{l=0}^L \sup_{t \geq 0} (\|\Phi(\mathbf{z}_l; t) - \Phi(\mathbf{z}'_{l,l+1}; t)\| + \|\Phi(\mathbf{z}'_{l,l+1}; t) - \Phi(\mathbf{z}_{l+1}; t)\|) \\ & \leq \mathcal{L} \sum_{l=0}^L \|\mathbf{z}_l - \mathbf{z}'_{l,l+1}\| + \|\mathbf{z}'_{l,l+1} - \mathbf{z}_{l+1}\| \\ & \leq \mathcal{L}((s_{k+1} - s_k - 2\epsilon) \|\mathbf{x} - \mathbf{y}\| + \eta). \end{aligned}$$

Recalling that $\mathbf{z}_0 = (1 - (s_k + \epsilon))\mathbf{x} + (s_k + \epsilon)\mathbf{y}$ and $\mathbf{z}_{L+1} = (1 - (s_{k+1} - \epsilon))\mathbf{x} + (s_{k+1} - \epsilon)\mathbf{y}$, and letting η vanish, we obtain

$$\sup_{t \geq 0} \|\Phi((1 - (s_k + \epsilon))\mathbf{x} + (s_k + \epsilon)\mathbf{y}; t) - \Phi((1 - (s_{k+1} - \epsilon))\mathbf{x} + (s_{k+1} - \epsilon)\mathbf{y}; t)\| \leq \mathcal{L}(s_{k+1} - s_k - 2\epsilon) \|\mathbf{x} - \mathbf{y}\|.$$

Taking the limit of both sides when ϵ vanishes and using Proposition 9.3.17, we finally write

$$\sup_{t \geq 0} \|\Phi((1 - s_k)\mathbf{x} + s_k\mathbf{y}; t) - \Phi((1 - s_{k+1})\mathbf{x} + s_{k+1}\mathbf{y}; t)\| \leq \mathcal{L}(s_{k+1} - s_k) \|\mathbf{x} - \mathbf{y}\|$$

and complete the proof thanks to the triangle inequality again. \square

9.4.4 Proof of Theorem 9.2.22

Theorem 9.2.22 is obtained by interpolating the L^1 and L^∞ estimates of Proposition 9.4.11 thanks to the Riesz-Thorin Theorem.

Proof of Theorem 9.2.22. Let us fix $\mathbf{x}, \mathbf{y} \in D_n^d$ and $s, t \geq 0$. Then, for all $p \in [1, +\infty]$,

$$\|\Phi(\mathbf{x}; s) - \Phi(\mathbf{y}; t)\|_p \leq \|\Phi(\mathbf{x}; s) - \Phi(\mathbf{y}; s)\|_p + \|\Phi(\mathbf{y}; s) - \Phi(\mathbf{y}; t)\|_p,$$

and by (9.20-9.21), for all $p \in [1, +\infty)$,

$$\|\Phi(\mathbf{y}; s) - \Phi(\mathbf{y}; t)\|_p^p = \frac{1}{n} \sum_{\gamma=1}^d \sum_{k=1}^n \left| \int_{r=s}^t v_k^\gamma(\mathbf{y}; r) dr \right|^p \leq |t-s|^p (L_{C,p})^p;$$

similarly,

$$\|\Phi(\mathbf{y}; s) - \Phi(\mathbf{y}; t)\|_\infty \leq |t-s| L_{C,\infty}.$$

It now remains to prove that

$$\|\Phi(\mathbf{x}; s) - \Phi(\mathbf{y}; s)\|_p \leq \mathcal{L}_p \|\mathbf{x} - \mathbf{y}\|_p,$$

for some \mathcal{L}_p that depends neither on n nor on s . By Proposition 9.4.11, this is already the case for $p \in \{1, +\infty\}$.

We first extend $\Phi(\cdot; s)$ into a nonlinear operator of the vector space $\mathbb{R}^{d \times n}$ by defining, for all $\bar{\mathbf{x}} \in \mathbb{R}^{d \times n}$,

$$\bar{\Phi}(\bar{\mathbf{x}}) =: \Phi(\pi(\bar{\mathbf{x}}); s),$$

where

$$\pi : \begin{cases} \mathbb{R}^{d \times n} & \rightarrow D_n^d \\ (\bar{x}_j^\gamma)_{1 \leq \gamma \leq d, 1 \leq j \leq n} & \mapsto (\bar{x}_{(k)}^\gamma)_{1 \leq \gamma \leq d, 1 \leq k \leq n} \end{cases}$$

and, for all $\gamma \in \{1, \dots, d\}$, then $\bar{x}_{(1)}^\gamma \leq \dots \leq \bar{x}_{(n)}^\gamma$ refers to the increasing reordering of $\bar{x}_1^\gamma, \dots, \bar{x}_n^\gamma$.

Then, by Proposition 9.4.11, we have, for all $\bar{\mathbf{x}}, \bar{\mathbf{y}} \in \mathbb{R}^{d \times n}$,

$$\begin{aligned} \|\bar{\Phi}(\bar{\mathbf{x}}) - \bar{\Phi}(\bar{\mathbf{y}})\|_{\ell^1} &\leq \mathcal{L}_1 \|\pi(\bar{\mathbf{x}}) - \pi(\bar{\mathbf{y}})\|_{\ell^1} \leq \|\bar{\mathbf{x}} - \bar{\mathbf{y}}\|_{\ell^1}, \\ \|\bar{\Phi}(\bar{\mathbf{x}}) - \bar{\Phi}(\bar{\mathbf{y}})\|_{\ell^\infty} &\leq \mathcal{L}_\infty \|\pi(\bar{\mathbf{x}}) - \pi(\bar{\mathbf{y}})\|_{\ell^\infty} \leq \|\bar{\mathbf{x}} - \bar{\mathbf{y}}\|_{\ell^\infty}, \end{aligned}$$

where $\|\cdot\|_{\ell^1}$ and $\|\cdot\|_{\ell^\infty}$ refer to the usual ℓ^1 and ℓ^∞ norms on the vector space $\mathbb{R}^{d \times n}$. The second inequality of both lines follows from the observation that, for all $\gamma \in \{1, \dots, d\}$, if we define

$$m := \frac{1}{n} \sum_{j=1}^n \delta_{\bar{x}_j^\gamma}, \quad m' := \frac{1}{n} \sum_{j=1}^n \delta_{\bar{y}_j^\gamma} \quad \in \mathcal{P}(\mathbb{R}),$$

and

$$\mathbf{m} := \frac{1}{n} \sum_{j=1}^n \delta_{(\bar{x}_j^\gamma, \bar{y}_j^\gamma)} \in \mathcal{P}(\mathbb{R}^2),$$

then, with the notations of Definition 9.2.18, $\mathbf{m} <_{m'}^m$ and

$$\int_{(x,x') \in \mathbb{R}^2} |x - x'|^p \mathbf{m}(dx dx') = \frac{1}{n} \sum_{j=1}^n |\bar{x}_j^\gamma - \bar{y}_j^\gamma|^p,$$

while Remark 9.2.20 yields

$$W_p(m, m') = \frac{1}{n} \sum_{k=1}^n |\bar{x}_{(k)}^\gamma - \bar{y}_{(k)}^\gamma|^p,$$

with the notations of the definition of π . The conclusion follows from the minimality of the Wasserstein distance.

We deduce that

$$\bar{\Phi}(\bar{\mathbf{x}}) - \bar{\Phi}(\bar{\mathbf{y}}) = \int_{\theta=0}^1 D\bar{\Phi}((1-\theta)\bar{\mathbf{x}} + \theta\bar{\mathbf{y}})(\bar{\mathbf{x}} - \bar{\mathbf{y}}) d\theta, \quad (9.41)$$

where the matrix $D\bar{\Phi}(\bar{\mathbf{z}})$ is defined $d\bar{\mathbf{z}}$ -almost everywhere and satisfies

$$\| \|D\bar{\Phi}(\bar{\mathbf{z}})\| \|_1 \leq \mathcal{L}_1, \quad \| \|D\bar{\Phi}(\bar{\mathbf{z}})\| \|_\infty \leq \mathcal{L}_\infty,$$

and $\| \cdot \|_p$ refers to the norm of operators on $(\mathbb{R}^{d \times n}, \| \cdot \|_{\ell^p})$. Applying the Riesz-Thorin Theorem [32, Théorème IV.29], we obtain that, $d\bar{\mathbf{z}}$ -almost everywhere,

$$\| \|D\bar{\Phi}(\bar{\mathbf{z}})\| \|_p \leq \mathcal{L}_p,$$

with

$$\mathcal{L}_p := \mathcal{L}_1^{1/p} \mathcal{L}_\infty^{1-1/p}. \tag{9.42}$$

Injecting this relation in (9.41), we conclude that

$$\| \bar{\Phi}(\bar{\mathbf{x}}) - \bar{\Phi}(\bar{\mathbf{y}}) \|_{\ell^p} \leq \mathcal{L}_p \| \bar{\mathbf{x}} - \bar{\mathbf{y}} \|_{\ell^p}.$$

Taking $\bar{\mathbf{x}} = \mathbf{x}, \bar{\mathbf{y}} = \mathbf{y}$ in D_n^d , and $p \in (1, +\infty)$, we rewrite the inequality above as

$$\sum_{\gamma=1}^d \sum_{k=1}^n | \Phi_k^\gamma(\mathbf{x}; s) - \Phi_k^\gamma(\mathbf{y}; s) |^p \leq (\mathcal{L}_p)^p \sum_{\gamma=1}^d \sum_{k=1}^n | x^\gamma - y_k^\gamma |^p,$$

and we conclude by dividing both parts of the inequality by n and taking the power $1/p$. □

9.5 Construction of solutions

This section is dedicated to the construction of probabilistic solutions to the hyperbolic system (9.1), based on the approximation by the MSPD. In particular, we prove Theorems 9.2.17 and 9.2.25. The outline of the section is as follows.

Subsection 9.5.1 contains preliminary definitions and results.

In Subsection 9.5.2, we prove the two following major results: on the one hand, the MSPD for a fixed number of particles provides an *exact* solution to the problem (9.1), with *discrete* initial data; this is the contents of Proposition 9.2.15. On the other hand, when the number of particles grows to infinity and the initial configurations are chosen according to a suitable discretisation procedure, then the set of the trajectories of the MSPD is precompact. A precise statement is given in Proposition 9.5.6. The proof of Theorem 9.2.17 then follows from these two results.

We discuss two properties of the probabilistic solutions thus obtained in Subsection 9.5.3. More precisely, we show that probabilistic solutions to the hyperbolic system (9.1) are generally not unique, and we describe the solution obtained by the limit of the MSPD in the case of the Riemann problem.

The construction of the operators $(\mathbf{S}_t)_{t \geq 0}$ introduced in Theorem 9.2.25 and the proof of their properties is finally detailed in Subsection 9.5.4.

9.5.1 Preliminary definitions

This subsection contains preliminary definitions and results concerning the set of probability measures on the space of continuous trajectories in \mathbb{R}^d .

Definition 9.5.1 (Probability measures on the space of continuous trajectories). *Let us denote by $C([0, +\infty), \mathbb{R}^d)$ the set of continuous trajectories from $[0, +\infty)$ to \mathbb{R}^d . It is endowed with the topology of the uniform convergence on the compact sets of $[0, +\infty)$, which makes it a metric space.*

The set of Borel probability measures on $C([0, +\infty), \mathbb{R}^d)$ is denoted

$$\mathbb{M} := \mathbb{P}(C([0, +\infty), \mathbb{R}^d)).$$

We recall that it is endowed with the topology of weak convergence.

For all $t \geq 0$ and $\gamma \in \{1, \dots, d\}$, let us introduce the *projection operator*

$$\pi_t^\gamma : \begin{cases} C([0, +\infty), \mathbb{R}^d) & \rightarrow \mathbb{R} \\ (X^1(s), \dots, X^d(s))_{s \geq 0} & \mapsto X^\gamma(t) \end{cases}$$

Then π_t^γ is clearly continuous, therefore the following lemma is straightforward.

Lemma 9.5.2 (Continuity of marginal distribution). *For all $t \geq 0$ and $\gamma \in \{1, \dots, d\}$, for all $\mu \in \mathbb{M}$, let us denote by*

$$\mu_t^\gamma := \mu \circ (\pi_t^\gamma)^{-1}$$

the marginal distribution of the γ -th coordinate at time t of μ . Then, the mapping

$$\mu \in \mathbb{M} \mapsto \mu_t^\gamma \in P(\mathbb{R})$$

is continuous.

9.5.2 Convergence of the MSPD

In this section, we establish a convergence result for the empirical distribution of the MSPD which shall play a crucial role in the proofs of Theorems 9.2.17 and 9.2.25.

Definition 9.5.3 (Empirical distribution of the MSPD). *Under Assumption (USH), for all $\mathbf{x} \in D_n^d$, the empirical distribution of the MSPD started at \mathbf{x} is the probability measure*

$$\mu[\mathbf{x}] := \frac{1}{n} \sum_{k=1}^n \delta_{(\Phi_k^1(\mathbf{x}; t), \dots, \Phi_k^d(\mathbf{x}; t))_{t \geq 0}} \in \mathbb{M},$$

where we recall the Definition 9.5.1 of the space \mathbb{M} .

The marginal distribution of the γ -th coordinate at time t of $\mu[\mathbf{x}]$ is denoted by $\mu_t^\gamma[\mathbf{x}]$.

9.5.2.1 Proof of Proposition 9.2.15

Let us fix $\mathbf{x} \in D_n^d$, and recall that Proposition 9.2.15 asserts that the function $\mathbf{u} = (u^1, \dots, u^d)$ defined by

$$u^\gamma(t, x) := \frac{1}{n} \sum_{k=1}^n \mathbb{1}_{\{\Phi_k^\gamma(\mathbf{x}; t) \leq x\}}$$

is a probabilistic solution to (9.1). Let us note that, with Definition 9.5.3, this function rewrites

$$u^\gamma(t, x) = (H * \mu_t^\gamma[\mathbf{x}])(x).$$

By construction, for all $t \geq 0$, for all $\gamma \in \{1, \dots, d\}$, $u^\gamma(t, \cdot)$ is a CDF on the real line. In order to prove that it is a probabilistic solution to the system (9.1), we have to check that, for all $\gamma \in \{1, \dots, d\}$, the function u^γ is measurable on $[0, +\infty) \times \mathbb{R}$. This is a consequence of the following lemma.

Lemma 9.5.4 (Measurability). *Let $\mu \in P(C([0, +\infty), \mathbb{R}))$, and for all $(t, x) \in [0, +\infty) \times \mathbb{R}$, let us define $u(t, x) := H * \mu_t(x)$. Then u is measurable on $[0, +\infty) \times \mathbb{R}$.*

Proof. If, for all $t \geq 0$, the probability measure μ_t on \mathbb{R} does not weight points, then $H * \mu_t$ is continuous on \mathbb{R} and by the Dini Theorem, u is continuous therefore measurable on $[0, +\infty) \times \mathbb{R}$. In the general case, we replace H with its continuous approximation H_l defined by, for all $l \geq 1$,

$$H_l(x) = \begin{cases} 0 & \text{if } x \leq -1/l, \\ 1 + lx & \text{if } -1/l < x < 0, \\ 1 & \text{if } x \geq 0, \end{cases}$$

and define $u_l(t, x) := H_l * \mu_t(x)$. Then, on the one hand, for all $t \geq 0$, the function $x \mapsto u_l(t, x)$ is continuous and nondecreasing on \mathbb{R} , hence the Dini Theorem still implies that u_l is continuous therefore measurable on $[0, +\infty) \times \mathbb{R}$. On the other hand, $H_l(x)$ converges to $H(x)$ for all $x \in \mathbb{R}$, therefore u is the pointwise limit of u_l . This completes the proof. \square

We can now complete the proof of Proposition 9.2.15.

Completion of the proof of Proposition 9.2.15. On account of the discussion above, it remains to check that \mathbf{u} satisfies (ii) in Definition 9.2.12. We first write the function $\lambda^\gamma\{\mathbf{u}\}$, defined by (9.6), in terms of the velocities of the particles. Let us fix

$$t \in [0, +\infty) \setminus \{\tau_{\alpha:i,\beta:j}^{\text{coll}}(\mathbf{x}), (\alpha : i, \beta : j) \in \mathbf{R}(\mathbf{x})\}.$$

Then, we claim that, for all $\gamma : k \in P_n^d$,

$$\lambda^\gamma\{\mathbf{u}\}(t, \Phi_k^\gamma(\mathbf{x}; t)) = v_k^\gamma(\mathbf{x}; t). \tag{9.43}$$

where we recall the definition (9.20) of the right-hand side. Indeed, let $\gamma : k \in P_n^d$. Let us write $x := \Phi_k^\gamma(\mathbf{x}, t)$ and $\gamma : \underline{k} \cdots \bar{k} := \text{clu}_k^\gamma(\mathbf{x}; t)$. Then

$$u^\gamma(t, x^-) = \frac{\underline{k} - 1}{n}, \quad u^\gamma(t, x) = \frac{\bar{k}}{n} \quad \text{and} \quad \Delta_x u^\gamma(t, x) = \frac{\bar{k} - \underline{k} + 1}{n} > 0.$$

As a consequence,

$$\lambda^\gamma\{\mathbf{u}\}(t, x) = \frac{n}{\bar{k} - \underline{k} + 1} \int_{w=(\underline{k}-1)/n}^{\bar{k}/n} \lambda^\gamma(u^1(t, x), \dots, u^{\gamma-1}(t, x), w, u^{\gamma+1}(t, x), \dots, u^d(t, x)) dw.$$

The choice of t implies that, for all $\gamma' \in \{1, \dots, d\}$ such that $\gamma \neq \gamma'$,

$$\Delta_x u^{\gamma'}(t, x) = 0,$$

therefore, for all $k' \in \{\underline{k}, \dots, \bar{k}\}$,

$$u^{\gamma'}(t, x) = \omega_{\gamma:k'}^{\gamma'}(\Phi(\mathbf{x}; t)).$$

As a conclusion,

$$\lambda^\gamma\{\mathbf{u}\}(t, x) = \frac{1}{\bar{k} - \underline{k} + 1} \sum_{k'=\underline{k}}^{\bar{k}} \tilde{\lambda}_{k'}^\gamma(\Phi(\mathbf{x}; t)) = v_k^\gamma(\mathbf{x}; t),$$

hence (9.43) holds dt -almost everywhere; therefore, for all $\gamma : k \in P_n^d$,

$$\forall t \geq 0, \quad \Phi_k^\gamma(\mathbf{x}; t) = x_k^\gamma + \int_{s=0}^t \lambda^\gamma\{\mathbf{u}\}(s, \Phi_k^\gamma(\mathbf{x}; s)) ds.$$

We now fix $\varphi = (\varphi^1, \dots, \varphi^d) \in C_c^{1,0}([0, +\infty) \times \mathbb{R}, \mathbb{R}^d)$ and, for all $\gamma \in \{1, \dots, d\}$, define ψ^γ by

$$\forall (t, x) \in [0, +\infty) \times \mathbb{R}, \quad \psi^\gamma(t, x) := \int_{y=x}^{+\infty} \varphi^\gamma(t, y) dy.$$

The chain rule formula for functions of finite variation [121, Proposition (4.6), p. 6] yields, for all $T \geq 0$, for all $\gamma : k \in P_n^d$,

$$\begin{aligned} \psi^\gamma(T, \Phi_k^\gamma(\mathbf{x}; T)) &= \psi^\gamma(0, x_k^\gamma) + \int_{t=0}^T (\partial_t \psi^\gamma(t, \Phi_k^\gamma(\mathbf{x}; t)) + \partial_x \psi^\gamma(t, \Phi_k^\gamma(\mathbf{x}; t)) \lambda^\gamma\{\mathbf{u}\}(t, \Phi_k^\gamma(\mathbf{x}; t))) dt \\ &= \psi^\gamma(0, x_k^\gamma) + \int_{t=0}^T (\partial_t \psi^\gamma(t, \Phi_k^\gamma(\mathbf{x}; t)) - \varphi^\gamma(t, \Phi_k^\gamma(\mathbf{x}; t)) \lambda^\gamma\{\mathbf{u}\}(t, \Phi_k^\gamma(\mathbf{x}; t))) dt. \end{aligned}$$

Since φ^γ has a compact support, the left-hand side above vanishes when T grows to infinity, and taking the average of both sides for $k \in \{1, \dots, n\}$ yields

$$0 = \int_{x \in \mathbb{R}} \psi^\gamma(0, x) du_0^\gamma(x) + \int_{t=0}^{+\infty} \int_{x \in \mathbb{R}} (\partial_t \psi^\gamma(t, x) - \varphi^\gamma(t, x) \lambda^\gamma\{\mathbf{u}\}(t, x)) dx u^\gamma(t, x) dt.$$

By the Fubini Theorem,

$$\int_{x \in \mathbb{R}} \psi^\gamma(0, x) du_0^\gamma(x) = \int_{(x, y) \in \mathbb{R}^2} \mathbb{1}_{\{x \leq y\}} \varphi^\gamma(0, y) du_0^\gamma(x) dy = \int_{y \in \mathbb{R}} \varphi^\gamma(0, y) u_0^\gamma(y) dy,$$

and we similarly obtain, for all $t \geq 0$,

$$\int_{x \in \mathbb{R}} \partial_t \psi^\gamma(t, x) d_x u^\gamma(t, x) = \int_{y \in \mathbb{R}} \partial_t \varphi^\gamma(t, y) u^\gamma(t, y) dy.$$

As a consequence,

$$\begin{aligned} & \int_{t=0}^{+\infty} \int_{y \in \mathbb{R}} \partial_t \varphi^\gamma(t, y) u^\gamma(t, y) dy dt + \int_{y \in \mathbb{R}} \varphi^\gamma(0, y) u_0^\gamma(y) dy \\ &= \int_{t=0}^{+\infty} \int_{x \in \mathbb{R}} \varphi^\gamma(t, x) \lambda^\gamma\{\mathbf{u}\}(t, x) d_x u^\gamma(t, x) dt, \end{aligned}$$

and we complete the proof by taking the sum of both sides for $\gamma \in \{1, \dots, d\}$. \square

9.5.2.2 Weak convergence of the initial discretisation

We now fix a vector $\mathbf{m} = (m^1, \dots, m^d) \in \mathbb{P}(\mathbb{R}^d)$, and recall the Definition 9.2.16 of the discretisation operator χ_n . The convergence of this discretisation operator is ensured by the following lemma.

Lemma 9.5.5 (Weak convergence of the initial discretisation). *Let $\mathbf{m} = (m^1, \dots, m^d) \in \mathbb{P}(\mathbb{R}^d)$. For all $n \geq 1$, let us denote $\mathbf{x}(n) := \chi_n \mathbf{m}$. Then, the sequence of empirical distributions*

$$\bar{m}_n := \frac{1}{n} \sum_{k=1}^n \delta_{(x_k^1(n), \dots, x_k^d(n))} \in \mathbb{P}(\mathbb{R}^d)$$

converges weakly to the probability measure $\bar{m} \in \mathbb{P}(\mathbb{R}^d)$ defined by

$$\bar{m} := \mathbb{U} \circ \left((H * m^1)^{-1}, \dots, (H * m^d)^{-1} \right)^{-1},$$

where \mathbb{U} refers to the Lebesgue measure on $[0, 1]$.

Proof. For all $n \geq 1$, for all $\gamma : k \in P_n^d$, let us define

$$x_k^{\gamma, -}(n) := (H * m^\gamma)^{-1} \left(\frac{2k-1}{2(n+1)} \right), \quad x_k^{\gamma, +}(n) := (H * m^\gamma)^{-1} \left(\frac{2k+1}{2(n+1)} \right),$$

so that $x_k^{\gamma, -}(n) \leq x_k^\gamma(n) \leq x_k^{\gamma, +}(n)$. The probability measures \bar{m}_n^- and \bar{m}_n^+ on \mathbb{R}^d are defined by

$$\bar{m}_n^\pm := \frac{1}{n} \sum_{k=1}^n \delta_{(x_k^{1, \pm}(n), \dots, x_k^{d, \pm}(n))}.$$

For all $(x^1, \dots, x^d) \in \mathbb{R}^d$, let us define

$$Q_{x^1, \dots, x^d} := (-\infty, x^1] \times \dots \times (-\infty, x^d] \subset \mathbb{R}^d.$$

Then we have, for all $(x^1, \dots, x^d) \in \mathbb{R}^d$,

$$\bar{m}_n^-(Q_{x^1, \dots, x^d}) \geq \bar{m}_n(Q_{x^1, \dots, x^d}) \geq \bar{m}_n^+(Q_{x^1, \dots, x^d}).$$

Let us prove that, as soon as $\bar{m}(\partial Q_{x^1, \dots, x^d}) = 0$, then both extremal sides above converge to $\bar{m}(Q_{x^1, \dots, x^d})$. To this aim, we observe that

$$\bar{m}_n^\pm = \mathbb{U}_n^\pm \circ \left((H * m^1)^{-1}, \dots, (H * m^d)^{-1} \right)^{-1},$$

where

$$U_n^\pm := \frac{1}{n} \sum_{k=1}^n \delta_{(2k\pm 1)/(2(n+1))} \in P([0, 1]).$$

By an elementary Riemann sum argument, we obtain that both U_n^- and U_n^+ converge weakly to U . Besides, the function

$$((H * m^1)^{-1}, \dots, (H * m^d)^{-1}) : (0, 1) \rightarrow \mathbb{R}^d$$

is continuous U -almost everywhere. Therefore, by the Continuous Mapping Theorem [50, (2.3), p. 87], both \bar{m}_n^- and \bar{m}_n^+ converge weakly to

$$U \circ ((H * m^1)^{-1}, \dots, (H * m^d)^{-1})^{-1} = \bar{m}.$$

It now follows from the Portmanteau Theorem [18, (v), Theorem 2.1, p. 16] that, as soon as $\bar{m}(\partial Q_{x^1, \dots, x^d}) = 0$, then

$$\lim_{n \rightarrow +\infty} \bar{m}_n^\pm(Q_{x^1, \dots, x^d}) = \bar{m}(Q_{x^1, \dots, x^d}),$$

therefore by the squeeze lemma,

$$\lim_{n \rightarrow +\infty} \bar{m}_n(Q_{x^1, \dots, x^d}) = \bar{m}(Q_{x^1, \dots, x^d}).$$

Following the second example in [18, Example 2.3, p. 18], this ensures that \bar{m}_n converges weakly to \bar{m} . \square

9.5.2.3 Weak convergence of the MSPD

We now prove the convergence of the whole MSPD when started at a discretisation of \mathbf{m} . For all $\mathbf{x} \in D_n^d$, we recall the Definition 9.5.3 of $\mu[\mathbf{x}] \in \mathbb{M}$.

Proposition 9.5.6 (Convergence of the MSPD). *Under Assumptions (C) and (USH), let $\mathbf{m} = (m^1, \dots, m^d) \in P(\mathbb{R})^d$ and, for all $n \geq 1$, let us denote $\mathbf{x}(n) := \chi_n \mathbf{m}$. Then there exists an increasing sequence of integers $(n_\ell)_{\ell \geq 1}$ and $\bar{\mu}[\mathbf{m}] \in \mathbb{M}$ such that*

$$\lim_{\ell \rightarrow +\infty} \mu[\mathbf{x}(n_\ell)] = \bar{\mu}[\mathbf{m}] \quad \text{in } \mathbb{M}.$$

In addition, for all $\gamma, \gamma' \in \{1, \dots, d\}$ such that $\gamma \neq \gamma'$, dt-almost everywhere, the marginal probability measures $\bar{\mu}_t^\gamma[\mathbf{m}]$ and $\bar{\mu}_t^{\gamma'}[\mathbf{m}]$ have distinct atoms.

Proof. Let $\mathbf{m} = (m^1, \dots, m^d) \in P(\mathbb{R})^d$. For all $n \geq 1$, let us define $\mathbf{x}(n)$ as above. We first prove that there exists a converging subsequence of $(\mu[\mathbf{x}(n)])_{n \geq 1}$ in \mathbb{M} . In this purpose, we fix $T > 0$ and denote by

$$\mu_{[0, T]}[\mathbf{x}(n)] := \frac{1}{n} \sum_{k=1}^n \delta_{(\Phi_k^\gamma(\mathbf{x}(n); t))_{t \in [0, T]}} \in P(C([0, T], \mathbb{R}^d))$$

the empirical distribution of the restriction of the MSPD started at $\mathbf{x}(n)$ to $[0, T]$. Let us prove that the sequence $(\mu_{[0, T]}[\mathbf{x}(n)])_{n \geq 1}$ is tight on $C([0, T], \mathbb{R}^d)$ (see [18, pp. 8-9] for an introduction to tightness). By [18, Theorem 7.3, p. 82], which is a consequence of the Arzelà-Ascoli Theorem, this follows from:

- the tightness of the sequence of initial distributions

$$\frac{1}{n} \sum_{k=1}^n \delta_{(x_k^1(n), \dots, x_k^d(n))} \in P(\mathbb{R}^d)$$

which stems from Lemma 9.5.5,

- the fact that, by (9.21), for all $n \geq 1$, for all $k \in \{1, \dots, n\}$, the process

$$(\Phi_k^1(\mathbf{x}(n); t), \dots, \Phi_k^d(\mathbf{x}(n); t))_{t \in [0, T]}$$

satisfies the Lipschitz continuity condition

$$\sum_{\gamma=1}^d |\Phi_k^\gamma(\mathbf{x}(n); t) - \Phi_k^\gamma(\mathbf{x}(n); s)| \leq |t - s| L_{C,1},$$

with a constant that does not depend on n .

As a consequence, owing to the Prohorov Theorem [18, Theorem 5.1, p. 59], there exists a subsequence of $(\mu_{[0, T]}[\mathbf{x}(n)])_{n \geq 1}$ converging weakly to some probability measure $\bar{\mu}_{[0, T]}[\mathbf{m}]$ on $C([0, T], \mathbb{R}^d)$. Letting T grow to infinity along some countable set and using a diagonal extraction procedure, we deduce that there exists an increasing sequence of integers $(n_\ell)_{\ell \geq 1}$ and $\bar{\mu}[\mathbf{m}] \in \mathbb{M}$ such that $\mu[\mathbf{x}(n_\ell)]$ converges weakly to some probability measure $\bar{\mu}[\mathbf{m}] \in \mathbb{M}$.

Let us now check that, for all $\gamma, \gamma' \in \{1, \dots, d\}$ such that $\gamma \neq \gamma'$, dt -almost everywhere, then the probability measures $\bar{\mu}_t^\gamma[\mathbf{m}]$ and $\bar{\mu}_t^{\gamma'}[\mathbf{m}]$ have distinct atoms. We note that this amounts to proving that

$$\int_{t=0}^{+\infty} \bar{\mu}_t^\gamma[\mathbf{m}] \otimes \bar{\mu}_t^{\gamma'}[\mathbf{m}] (\{(x, x') \in \mathbb{R}^2 : x = x'\}) dt = 0,$$

where $\bar{\mu}_t^\gamma[\mathbf{m}] \otimes \bar{\mu}_t^{\gamma'}[\mathbf{m}]$ denotes the product measure of $\bar{\mu}_t^\gamma[\mathbf{m}]$ and $\bar{\mu}_t^{\gamma'}[\mathbf{m}]$ on \mathbb{R}^2 . Following Lemma 9.5.2 and [18, (ii), Theorem 2.8, p. 23], then for all $t \geq 0$, the probability measure $\mu_t^\gamma[\mathbf{x}(n_\ell)] \otimes \mu_t^{\gamma'}[\mathbf{x}(n_\ell)]$ converges weakly to $\bar{\mu}_t^\gamma[\mathbf{m}] \otimes \bar{\mu}_t^{\gamma'}[\mathbf{m}]$ on \mathbb{R}^2 . Hence, for all $\epsilon > 0$, the Portmanteau Theorem [18, (iv), Theorem 2.1, p. 16] yields

$$\begin{aligned} & \bar{\mu}_t^\gamma[\mathbf{m}] \otimes \bar{\mu}_t^{\gamma'}[\mathbf{m}] (\{(x, x') \in \mathbb{R}^2 : |x - x'| < \epsilon\}) \\ & \leq \liminf_{\ell \rightarrow +\infty} \mu_t^\gamma[\mathbf{x}(n_\ell)] \otimes \mu_t^{\gamma'}[\mathbf{x}(n_\ell)] (\{(x, x') \in \mathbb{R}^2 : |x - x'| < \epsilon\}), \end{aligned}$$

therefore by the Fatou lemma,

$$\begin{aligned} & \int_{t=0}^{+\infty} \bar{\mu}_t^\gamma[\mathbf{m}] \otimes \bar{\mu}_t^{\gamma'}[\mathbf{m}] (\{(x, x') \in \mathbb{R}^2 : |x - x'| < \epsilon\}) dt \\ & \leq \liminf_{\ell \rightarrow +\infty} \int_{t=0}^{+\infty} \mu_t^\gamma[\mathbf{x}(n_\ell)] \otimes \mu_t^{\gamma'}[\mathbf{x}(n_\ell)] (\{(x, x') \in \mathbb{R}^2 : |x - x'| < \epsilon\}) dt. \end{aligned}$$

Now, for all $\ell \geq 1$, by the Fubini Theorem,

$$\begin{aligned} & \int_{t=0}^{+\infty} \mu_t^\gamma[\mathbf{x}(n_\ell)] \otimes \mu_t^{\gamma'}[\mathbf{x}(n_\ell)] (\{(x, x') \in \mathbb{R}^2 : |x - x'| < \epsilon\}) dt \\ & = \int_{(x, x') \in \mathbb{R}^2} \int_{t=0}^{+\infty} dt \mathbb{1}_{\{|x - x'| < \epsilon\}} \mu_t^\gamma[\mathbf{x}(n_\ell)](dx) \mu_t^{\gamma'}[\mathbf{x}(n_\ell)](dx') \\ & = \frac{1}{n^2} \sum_{k=1}^n \sum_{k'=1}^n \int_{t=0}^{+\infty} \mathbb{1}_{\{|\Phi_k^\gamma(\mathbf{x}(n); t) - \Phi_{k'}^{\gamma'}(\mathbf{x}(n); t)| < \epsilon\}} dt. \end{aligned}$$

By Lemma 9.3.18, for all $\gamma : k, \gamma' : k' \in P_n^d$ with $\gamma \neq \gamma'$,

$$\int_{t=0}^{+\infty} \mathbb{1}_{\{|\Phi_k^\gamma(\mathbf{x}(n); t) - \Phi_{k'}^{\gamma'}(\mathbf{x}(n); t)| < \epsilon\}} dt \leq \frac{2\epsilon}{L_{\text{USH}}}.$$

As a consequence,

$$\begin{aligned} & \int_{t=0}^{+\infty} \bar{\mu}_t^\gamma[\mathbf{m}] \otimes \bar{\mu}_t^{\gamma'}[\mathbf{m}] (\{(x, x') \in \mathbb{R}^2 : x = x'\}) dt \\ & \leq \int_{t=0}^{+\infty} \bar{\mu}_t^\gamma[\mathbf{m}] \otimes \bar{\mu}_t^{\gamma'}[\mathbf{m}] (\{(x, x') \in \mathbb{R}^2 : |x - x'| < \epsilon\}) dt \\ & \leq \frac{2\epsilon}{L_{\text{USH}}}, \end{aligned}$$

and we complete the proof by letting ϵ vanish. □

9.5.2.4 Proof of Theorem 9.2.17

We can now complete the proof of Theorem 9.2.17, which is a straightforward consequence of Proposition 9.5.6 and does not rely on the stability estimates of Section 9.4.

Proof of Theorem 9.2.17. For all $n \geq 1$, let us denote by \mathbf{u}_n the probabilistic solution to the system (9.1) obtained from the MSPD started at $\chi_n \mathbf{m}$, with $\mathbf{m} = (m^1, \dots, m^d) \in P(\mathbb{R}^d)$. On the other hand, let us define the function $\mathbf{u} = (u^1, \dots, u^d) : [0, +\infty) \times \mathbb{R} \rightarrow [0, 1]^d$ by

$$\forall t \geq 0, \quad \forall \gamma \in \{1, \dots, d\}, \quad u^\gamma(t, x) := (H * \bar{\mu}_t^\gamma[\mathbf{m}])(x),$$

where $\bar{\mu}[\mathbf{m}]$ is given by Proposition 9.5.6. Then, combining Proposition 9.5.6, Lemma 9.5.2 and Lemma 9.2.11, we obtain that the function \mathbf{u} satisfies the assumptions of Proposition 9.2.14. As a consequence, \mathbf{u} is a probabilistic solution to the system (9.1), with initial data (u_0^1, \dots, u_0^d) defined by $u_0^\gamma := H * m^\gamma$, and it is the limit, in the sense of (ii) in Theorem 9.2.17, of the sequence $(\mathbf{u}_{n_\ell})_{\ell \geq 1}$. This completes the proof of Theorem 9.2.17. □

9.5.3 Two remarks on the notion of probabilistic solution

We discuss the (non)uniqueness of probabilistic solutions to the hyperbolic system (9.1), as well as the Riemann problem.

9.5.3.1 Nonuniqueness of probabilistic solutions

Let us fix $\mathbf{x} \in D_n^d$ and define $\hat{\mathbf{x}} \in D_{2n}^d$ by, for all $\gamma \in \{1, \dots, d\}$, for all $k \in \{1, \dots, n\}$,

$$\hat{x}_{2k-1}^\gamma = \hat{x}_{2k}^\gamma := x_k^\gamma.$$

Then the empirical distributions

$$\mu_0[\mathbf{x}] := \frac{1}{n} \sum_{k=1}^n \delta_{(x_k^1, \dots, x_k^d)} \quad \text{and} \quad \mu_0[\hat{\mathbf{x}}] := \frac{1}{2n} \sum_{k=1}^{2n} \delta_{(\hat{x}_k^1, \dots, \hat{x}_k^d)}$$

are the same in $P(\mathbb{R}^d)$. As a consequence, by Proposition 9.2.15, the flows of marginal CDFs of $\mu[\mathbf{x}]$ and $\mu[\hat{\mathbf{x}}]$ are probabilistic solutions to the system (9.1) with *the same* initial data.

But let us assume that there exists $\gamma \in \{1, \dots, d\}$ such that $\partial_\gamma \lambda^\gamma > 0$. Then, by Lemma 9.4.1, in the MSPD started at $\hat{\mathbf{x}}$, the particles of type γ instantaneously drift away from each other. As a consequence, for all $t \in (0, t^*(\hat{\mathbf{x}}))$, the marginal distribution $\mu_t^\gamma[\hat{\mathbf{x}}]$ has exactly $2n$ atoms, while the marginal distribution $\mu_t^\gamma[\mathbf{x}]$ possesses at most n atoms. Therefore, the corresponding solutions to the system (9.1) do not coincide.

As a conclusion, probabilistic solutions to the system (9.1) are generally *not* unique.

9.5.3.2 The Riemann problem

Let us assume that $\mathbf{m} = (\delta_0, \dots, \delta_0)$, that is to say, the initial data of the hyperbolic problem (9.1) write

$$u_0^1(x) = \dots = u_0^d(x) = \begin{cases} 0 & \text{if } x < 0, \\ 1 & \text{if } x \geq 0. \end{cases}$$

This choice of initial data is referred to as the *Riemann problem*.

For all $n \geq 1$, the configuration $\mathbf{x}(n) := \chi_n \mathbf{m}$ writes $x_k^\gamma(n) = 0$, for all $\gamma : k \in P_n^d$. Then $N(\mathbf{x}(n)) = 0$, and, for all $t \geq 0$,

$$\Phi(\mathbf{x}(n); t) = \tilde{\Phi}[\tilde{\lambda}(\mathbf{x}(n))](\mathbf{x}(n); t),$$

where

$$\tilde{\lambda}_k^\gamma(\mathbf{x}(n)) = n \int_{w=(k-1)/n}^{k/n} \lambda^\gamma(0, \dots, 0, w, 1, \dots, 1) dw.$$

In other words, the system of particles of type γ follows the Sticky Particle Dynamics with initial position vector $(0, \dots, 0)$ and initial velocity vector derived from the function $\lambda^\gamma(0, \dots, 0, \cdot, 1, \dots, 1)$. Of course, by Assumption (USH), there is no collision between particles of different type.

Then, by Theorem 9.2.1, the probabilistic solution obtained in Theorem 9.2.17 can be described as follows: it is the function $\mathbf{u} = (u^1, \dots, u^d)$, where, for all $\gamma \in \{1, \dots, d\}$, u^γ is the unique entropy solution of the scalar conservation law

$$\begin{cases} \partial_t u^\gamma + \partial_x (\Lambda^\gamma(u^\gamma)) = 0, \\ u^\gamma(0, x) = H(x), \end{cases}$$

where H is the Heaviside function and

$$\Lambda^\gamma(u) := \int_{v=0}^u \lambda^\gamma(0, \dots, 0, v, 1, \dots, 1) dv.$$

The Riemann problem for the system (9.1) is therefore uncoupled into d independent scalar conservation laws.

9.5.4 Stability and semigroup properties

We finally address the proof of Theorem 9.2.25.

Throughout this subsection, we fix $\mathbf{m}^* \in \mathcal{P}(\mathbb{R})^d$ and work in the W_1 stability class $\mathcal{P}_{\mathbf{m}^*}$ introduced in Definition 9.2.23.

9.5.4.1 Further properties of the Wasserstein distance

We first prove Lemma 9.2.24.

Proof of Lemma 9.2.24. Let $\mathbf{m}^* \in \mathcal{P}(\mathbb{R})^d$ and recall the Definition 9.2.23 of the W_1 stability class $\mathcal{P}_{\mathbf{m}^*}$. If $\mathbf{m}^* = (m^{*,1}, \dots, m^{*,d})$ is such that

$$\sum_{\gamma=1}^d \int_{x \in \mathbb{R}} |x| m^{*,\gamma}(dx) < +\infty,$$

then $\mathcal{P}_{\mathbf{m}^*}$ is the space of all vectors of probability measures $\mathbf{m} \in \mathcal{P}(\mathbb{R})^d$ satisfying the same integrability condition, and Lemma 9.2.24 follows from [135, Theorem 6.18].

In the general case, it is clear from the definition of $\mathcal{P}_{\mathbf{m}^*}$ that it is sufficient to address the case $d = 1$, therefore we now fix $m^* \in \mathcal{P}(\mathbb{R})$ and prove that the set \mathcal{P}_{m^*} of probability measures $m \in \mathcal{P}(\mathbb{R})$ such that $W_1(m, m^*) < +\infty$ is closed for the W_1 topology and contains a countable and dense subset. Closedness is obvious; let us address separability.

For all integer $M \geq 2$, let us denote by $\mathcal{P}_{m^*}^{0,M}$ the set of probability measures on \mathbb{R} equal to the sum of the image m_M^* of the Lebesgue measure on $[0, 1/M] \cup [1 - 1/M, 1]$ by $(H * m^*)^{-1}$ and a finite linear combination of Dirac masses at rational points with rational coefficients. We prove that the countable set

$$\mathcal{P}_{m^*}^0 := \bigcup_{M \geq 2} \mathcal{P}_{m^*}^{0,M}$$

is dense in \mathcal{P}_{m^*} . To this aim, we fix $m \in \mathcal{P}_{m^*}$ and $\epsilon > 0$. For M large enough,

$$\int_{u=0}^{1/M} |(H * m)^{-1}(u) - (H * m^*)^{-1}(u)| du + \int_{u=1-1/M}^1 |(H * m)^{-1}(u) - (H * m^*)^{-1}(u)| du \leq \frac{\epsilon}{2}.$$

It follows from the proof of [135, Theorem 6.18] that the image m^M of the uniform probability measure on $[1/M, 1 - 1/M]$ by $(H * m)^{-1}$ may be approximated by a finite linear combination $\sum_{j=1}^J a_j \delta_{x_j}$

of Dirac masses at rational points with rational coefficients such that $W_1(m^M, \sum_{j=1}^J a_j \delta_{x_j}) \leq \epsilon/2$. Now

$$\begin{aligned} W_1\left(m, m_M^* + \sum_{j=1}^J \frac{(M-2)a_j}{M} \delta_{x_j}\right) &\leq \int_{u=0}^{1/M} |(H * m)^{-1}(u) - (H * m^*)^{-1}(u)| du \\ &\quad + \frac{M-2}{M} W_1\left(m^M, \sum_{j=1}^J a_j \delta_{x_j}\right) \\ &\quad + \int_{u=1-1/M}^1 |(H * m)^{-1}(u) - (H * m^*)^{-1}(u)| du \\ &\leq \epsilon, \end{aligned}$$

which concludes the proof. □

The convergence in Wasserstein distance of order $p \in [1, +\infty)$ implies the weak convergence on $P(\mathbb{R})$ [135, Theorem 6.9]. The converse is not true, but the Wasserstein distance however enjoys the following lower semicontinuity property.

Lemma 9.5.7 (Lower semicontinuity of the Wasserstein distance). *Let $(m_n)_{n \geq 1}$ and $(m'_n)_{n \geq 1}$ be two sequences of probability measures on \mathbb{R} converging weakly to the respective limits m and m' in $P(\mathbb{R})$. Then, for all $p \in [1, +\infty]$,*

$$W_p(m, m') \leq \liminf_{n \rightarrow +\infty} W_p(m_n, m'_n).$$

Of course, both terms of the inequality above can be infinite.

Proof. For $p \in [1, +\infty)$, the result is proved in [135, Remark 6.12]. If $p = +\infty$, then letting $F_n := H * m_n$, $G_n := H * m'_n$, $F := H * m$, $G := H * m'$, Lemma 9.2.11 yields, for all continuity point v of $|F^{-1} - G^{-1}|$,

$$\begin{aligned} |F^{-1}(v) - G^{-1}(v)| &= \lim_{n \rightarrow +\infty} |F_n^{-1}(v) - G_n^{-1}(v)| \\ &\leq \liminf_{n \rightarrow +\infty} \sup_{v' \in (0,1)} |F_n^{-1}(v') - G_n^{-1}(v')| = \liminf_{n \rightarrow +\infty} W_\infty(m_n, m'_n). \end{aligned}$$

Since the function $|F^{-1} - G^{-1}|$ is left continuous with right limits, we deduce that the bound above holds for all $v \in (0, 1)$, hence the expected result. □

In order to work with a distance on $P(\mathbb{R})$ that can be compared with the Wasserstein distance of order 1, but is weaker and only metrises weak convergence, we introduce the following *modified Wasserstein distance*.

Definition 9.5.8 (Modified Wasserstein distance). *For all $m, m' \in P(\mathbb{R})$, let us define the modified Wasserstein distance $\widetilde{W}_1(m, m')$ by*

$$\widetilde{W}_1(m, m') := \inf_{m < m'} \int_{(x, x') \in \mathbb{R}^2} (|x - x'| \wedge 1) \mathbf{m}(dx dx'),$$

with the same notations as in the Definition 9.2.18 of the Wasserstein distance.

Then it is obvious that, for all $m, m' \in P(\mathbb{R})$,

$$\widetilde{W}_1(m, m') \leq W_1(m, m').$$

Besides, a sequence $(m_n)_{n \geq 1}$ converges weakly to $m \in P(\mathbb{R})$ if and only if $\widetilde{W}_1(m_n, m)$ converges to 0; this follows from [135, Corollary 6.13] since the distances $|x - x'|$ and $|x - x'| \wedge 1$ induce the same topology on \mathbb{R} .

9.5.4.2 W_p convergence of the initial discretisation

We now address the convergence in Wasserstein distance of order 1 for the initial discretisation.

Lemma 9.5.9 (Wasserstein convergence of the initial discretisation). *Let $\mathbf{m}, \mathbf{m}' \in \mathcal{P}_{\mathbf{m}^*}$. Then, for all $p \in [1, +\infty]$,*

$$\lim_{n \rightarrow +\infty} \|\chi_n \mathbf{m} - \chi_n \mathbf{m}'\|_p = W_p^{(d)}(\mathbf{m}, \mathbf{m}').$$

Proof. Let us fix $\mathbf{m} = (m^1, \dots, m^d)$, $\mathbf{m}' = (m'^1, \dots, m'^d) \in \mathcal{P}$ and $\gamma \in \{1, \dots, d\}$.

On the one hand, recall that by Remark 9.2.20, $\|\chi_n \mathbf{m} - \chi_n \mathbf{m}'\|_p$ is the $W_p^{(d)}$ distance between the empirical distributions of $\chi_n \mathbf{m}$ and $\chi_n \mathbf{m}'$, therefore by Lemma 9.5.5 and Lemma 9.5.7, we deduce that

$$\liminf_{n \rightarrow +\infty} \|\chi_n \mathbf{m} - \chi_n \mathbf{m}'\|_p \geq W_p^{(d)}(\mathbf{m}, \mathbf{m}'),$$

for all $p \in [1, +\infty]$.

On the other hand, for all $p \in [1, +\infty)$, the Jensen inequality yields

$$\begin{aligned} \|\chi_n \mathbf{m} - \chi_n \mathbf{m}'\|_p^p &= \frac{1}{n} \sum_{\gamma=1}^d \sum_{k=1}^n \left| (n+1) \int_{v=(2k-1)/(2(n+1))}^{(2k+1)/(2(n+1))} ((H * m^\gamma)^{-1}(v) - (H * m'^\gamma)^{-1}(v)) dv \right|^p \\ &\leq \frac{n+1}{n} \sum_{\gamma=1}^d \int_{v=1/(2(n+1))}^{1-1/(2(n+1))} |(H * m^\gamma)^{-1}(v) - (H * m'^\gamma)^{-1}(v)|^p dv \\ &\leq \frac{n+1}{n} (W_p^{(d)}(\mathbf{m}, \mathbf{m}'))^p, \end{aligned}$$

therefore

$$\limsup_{n \rightarrow +\infty} \|\chi_n \mathbf{m} - \chi_n \mathbf{m}'\|_p \leq W_p^{(d)}(\mathbf{m}, \mathbf{m}'),$$

which completes the proof for $p < +\infty$. The case $p = +\infty$ is similar — actually easier. \square

9.5.4.3 Construction of the operators $(\mathbf{S}_t)_{t \geq 0}$

Following Lemma 9.2.24, the space $\mathcal{P}_{\mathbf{m}^*}$ metrised by the $W_1^{(d)}$ distance contains a countable and dense subset $\mathcal{P}_{\mathbf{m}^*}^0$. Applying Proposition 9.5.6 to all $\mathbf{m} \in \mathcal{P}_{\mathbf{m}^*}^0$ and using a diagonal extraction procedure, we obtain that there exists a sequence of increasing integers $(n_\ell)_{\ell \geq 1}$ such that, for all $\mathbf{m} \in \mathcal{P}_{\mathbf{m}^*}^0$, $\mu[\chi_{n_\ell} \mathbf{m}]$ converges weakly to a probability measure $\bar{\mu}[\mathbf{m}]$ in \mathbb{M} .

Lemma 9.5.10 (W_1 stability of $\bar{\mu}$). *Under the assumptions of Proposition 9.5.6, then for all $\mathbf{m} \in \mathcal{P}_{\mathbf{m}^*}^0$, for all $t \geq 0$, we have $(\bar{\mu}_t^1[\mathbf{m}], \dots, \bar{\mu}_t^d[\mathbf{m}]) \in \mathcal{P}_{\mathbf{m}^*}$.*

Proof. Let $\mathbf{m} = (m^1, \dots, m^d) \in \mathcal{P}_{\mathbf{m}^*}^0$. Following Definition 9.2.23, since $W^{(d)}(\mathbf{m}^*, \mathbf{m}) < +\infty$, it suffices to check that, for all $t \geq 0$,

$$\sum_{\gamma=1}^d W_1(m^\gamma, \bar{\mu}_t^\gamma[\mathbf{m}]) < +\infty.$$

Combining Proposition 9.5.6, Lemma 9.5.2 and Lemma 9.5.7, we have

$$\sum_{\gamma=1}^d W_1(m^\gamma, \bar{\mu}_t^\gamma[\mathbf{m}]) \leq \liminf_{\ell \rightarrow +\infty} \sum_{\gamma=1}^d W_1(\mu_0^\gamma[\chi_{n_\ell} \mathbf{m}], \mu_t^\gamma[\chi_{n_\ell} \mathbf{m}]).$$

But using Remark 9.2.20 and Theorem 9.2.22, we rewrite

$$\sum_{\gamma=1}^d W_1(\mu_0^\gamma[\chi_{n_\ell} \mathbf{m}], \mu_t^\gamma[\chi_{n_\ell} \mathbf{m}]) = \|\chi_{n_\ell} \mathbf{m} - \Phi(\chi_{n_\ell} \mathbf{m}; t)\|_1 \leq t L_{C,1},$$

which completes the proof. \square

We can now define $(\mathbf{S}_t)_{t \geq 0}$ as follows.

Proposition 9.5.11 (Construction of $(\mathbf{S}_t)_{t \geq 0}$). *Let the assumptions of Theorem 9.2.25 hold. Then, for all $\mathbf{m} \in \mathcal{P}_{\mathbf{m}^*}$, for all $t \geq 0$, for all $\gamma \in \{1, \dots, d\}$, there exists a probability measure $S_t^\gamma \mathbf{m} \in \mathcal{P}(\mathbb{R})$ such that $\mu_t^\gamma[\chi_{n_\ell} \mathbf{m}]$ converges weakly to $S_t^\gamma \mathbf{m}$. Besides, for all $t \geq 0$,*

$$\mathbf{S}_t \mathbf{m} := (S_t^1 \mathbf{m}, \dots, S_t^d \mathbf{m}) \in \mathcal{P}_{\mathbf{m}^*}, \quad (9.44)$$

and for all $\mathbf{m}' \in \mathcal{P}_{\mathbf{m}^*}$,

$$\sup_{t \geq 0} W_1^{(d)}(\mathbf{S}_t \mathbf{m}, \mathbf{S}_t \mathbf{m}') \leq \mathcal{L}_1 W_1^{(d)}(\mathbf{m}, \mathbf{m}'). \quad (9.45)$$

Proof. We first prove the proposition in the case $\mathbf{m} \in \mathcal{P}_{\mathbf{m}^*}^0$. Then, letting $S_t^\gamma \mathbf{m} := \bar{\mu}_t^\gamma[\mathbf{m}]$, (9.44) follows from Lemma 9.5.10. Taking in addition $\mathbf{m}' \in \mathcal{P}_{\mathbf{m}^*}^0$, and combining Proposition 9.5.6, Lemma 9.5.2 and Lemma 9.5.7, we have

$$W_1^{(d)}(\mathbf{S}_t \mathbf{m}, \mathbf{S}_t \mathbf{m}') \leq \liminf_{\ell \rightarrow +\infty} \sum_{\gamma=1}^d W_1(\mu_t^\gamma[\chi_{n_\ell} \mathbf{m}], \mu_t^\gamma[\chi_{n_\ell} \mathbf{m}']).$$

By Theorem 9.2.22,

$$\sum_{\gamma=1}^d W_1(\mu_t^\gamma[\chi_{n_\ell} \mathbf{m}], \mu_t^\gamma[\chi_{n_\ell} \mathbf{m}']) = \|\Phi(\chi_{n_\ell} \mathbf{m}; t) - \Phi(\chi_{n_\ell} \mathbf{m}'; t)\|_1 \leq \mathcal{L}_1 \|\chi_{n_\ell} \mathbf{m} - \chi_{n_\ell} \mathbf{m}'\|_1,$$

and by Lemma 9.5.9,

$$\lim_{\ell \rightarrow +\infty} \|\chi_{n_\ell} \mathbf{m} - \chi_{n_\ell} \mathbf{m}'\|_1 = W_1^{(d)}(\mathbf{m}, \mathbf{m}'),$$

which completes the proof of (9.45) for $\mathbf{m}, \mathbf{m}' \in \mathcal{P}_{\mathbf{m}^*}^0$.

Since the set $\mathcal{P}_{\mathbf{m}^*}^0$ is dense in $\mathcal{P}_{\mathbf{m}^*}$ and the latter is closed for the $W_1^{(d)}$ distance, we deduce that the operator \mathbf{S}_t possesses a unique continuous extension to $\mathcal{P}_{\mathbf{m}^*}$, which satisfies the same stability estimate (9.45), for all $\mathbf{m}, \mathbf{m}' \in \mathcal{P}_{\mathbf{m}^*}$. To complete the proof, it remains to identify the abstract object $\mathbf{S}_t \mathbf{m}$ with the weak limit, when ℓ grows to infinity, of $(\mu_t^1[\chi_{n_\ell} \mathbf{m}], \dots, \mu_t^d[\chi_{n_\ell} \mathbf{m}])$. Following the properties of the modified Wasserstein distance \widetilde{W}_1 introduced in Definition 9.5.8, this can be done by proving that

$$\lim_{\ell \rightarrow +\infty} \sum_{\gamma=1}^d \widetilde{W}_1(S_t^\gamma \mathbf{m}, \mu_t^\gamma[\chi_{n_\ell} \mathbf{m}]) = 0. \quad (9.46)$$

To this aim, let us fix $\mathbf{m} = (m^1, \dots, m^d) \in \mathcal{P}_{\mathbf{m}^*}$, $\epsilon > 0$ and $\mathbf{m}' = (m'^1, \dots, m'^d) \in \mathcal{P}_{\mathbf{m}^*}^0$ such that

$$W_1^{(d)}(\mathbf{m}, \mathbf{m}') \leq \epsilon.$$

Then, for all $t \geq 0$, for all $\ell \geq 1$,

$$\begin{aligned} & \sum_{\gamma=1}^d \widetilde{W}_1(S_t^\gamma \mathbf{m}, \mu_t^\gamma[\chi_{n_\ell} \mathbf{m}]) \\ & \leq \sum_{\gamma=1}^d \widetilde{W}_1(S_t^\gamma \mathbf{m}, S_t^\gamma \mathbf{m}') + \sum_{\gamma=1}^d \widetilde{W}_1(S_t^\gamma \mathbf{m}', \mu_t^\gamma[\chi_{n_\ell} \mathbf{m}']) + \sum_{\gamma=1}^d \widetilde{W}_1(\mu_t^\gamma[\chi_{n_\ell} \mathbf{m}'], \mu_t^\gamma[\chi_{n_\ell} \mathbf{m}]). \end{aligned}$$

By the properties of \widetilde{W}_1 and (9.45),

$$\sum_{\gamma=1}^d \widetilde{W}_1(S_t^\gamma \mathbf{m}, S_t^\gamma \mathbf{m}') \leq \sum_{\gamma=1}^d W_1(S_t^\gamma \mathbf{m}, S_t^\gamma \mathbf{m}') \leq \mathcal{L}_1 \sum_{\gamma=1}^d W_1(m^\gamma, m'^\gamma) \leq \mathcal{L}_1 \epsilon.$$

By the properties of \widetilde{W}_1 and the construction of the sequence $(n_\ell)_{\ell \geq 1}$,

$$\lim_{\ell \rightarrow +\infty} \sum_{\gamma=1}^d \widetilde{W}_1(S_t^\gamma \mathbf{m}', \mu_t^\gamma[\chi_{n_\ell} \mathbf{m}']) = 0.$$

By the properties of \widetilde{W}_1 and Theorem 9.2.22,

$$\begin{aligned} \sum_{\gamma=1}^d \widetilde{W}_1(\mu_t^\gamma[\chi_{n_\ell} \mathbf{m}'], \mu_t^\gamma[\chi_{n_\ell} \mathbf{m}]) &\leq \sum_{\gamma=1}^d W_1(\mu_t^\gamma[\chi_{n_\ell} \mathbf{m}'], \mu_t^\gamma[\chi_{n_\ell} \mathbf{m}]) \\ &\leq \mathcal{L}_1 \sum_{\gamma=1}^d W_1(\mu_0^\gamma[\chi_{n_\ell} \mathbf{m}'], \mu_0^\gamma[\chi_{n_\ell} \mathbf{m}]), \end{aligned}$$

and it follows from Lemma 9.5.9 that

$$\lim_{\ell \rightarrow +\infty} \sum_{\gamma=1}^d W_1(\mu_0^\gamma[\chi_{n_\ell} \mathbf{m}'], \mu_0^\gamma[\chi_{n_\ell} \mathbf{m}]) = \sum_{\gamma=1}^d W_1(m^\gamma, m'^\gamma) \leq \epsilon.$$

As a consequence, we have

$$\limsup_{\ell \rightarrow +\infty} \sum_{\gamma=1}^d \widetilde{W}_1(S_t^\gamma \mathbf{m}, \mu_t^\gamma[\chi_{n_\ell} \mathbf{m}]) \leq 2\mathcal{L}_1 \epsilon,$$

and we obtain (9.46) by letting ϵ vanish. \square

9.5.4.4 Proof of Theorem 9.2.25

Proposition 9.5.11 provides a family $(\mathbf{S}_t)_{t \geq 0}$ of operators on the W_1 stability class $\mathcal{P}_{\mathbf{m}^*}$. In this paragraph, we check that this family of operators satisfies the conclusions of Theorem 9.2.25.

Proof of Theorem 9.2.25. Let $(\mathbf{S}_t)_{t \geq 0}$ be given by Proposition 9.5.11 on $\mathcal{P}_{\mathbf{m}^*}$.

Proof of (i) in Theorem 9.2.25. Let us fix $\mathbf{m} = (m^1, \dots, m^d) \in \mathcal{P}_{\mathbf{m}^*}$. By Proposition 9.5.11, for all $t \geq 0$, for all $\gamma \in \{1, \dots, d\}$, the probability measure $\mu_t^\gamma[\chi_{n_\ell} \mathbf{m}]$ on \mathbb{R} converges weakly to $S_t^\gamma \mathbf{m}$. Therefore, the very same arguments as in the proof of Theorem 9.2.17 show that the function $\mathbf{u} = (u^1, \dots, u^d) : [0, +\infty) \times \mathbb{R} \rightarrow [0, 1]^d$ defined by $u^\gamma(t, x) := H * (S_t^\gamma \mathbf{m})(x)$ is a probabilistic solution to the system (9.1) with initial data u_0^1, \dots, u_0^d given by $u_0^\gamma := H * m^\gamma$.

Proof of (ii) in Theorem 9.2.25. Let $\mathbf{m}, \mathbf{m}' \in \mathcal{P}_{\mathbf{m}^*}$ and $s, t \geq 0$. By Theorem 9.2.22, for all $\ell \geq 1$, then

$$W_p^{(d)}(\mu_s^\gamma[\chi_{n_\ell} \mathbf{m}], \mu_t^\gamma[\chi_{n_\ell} \mathbf{m}']) \leq \mathcal{L}_p W_p^{(d)}(\mu_0^\gamma[\chi_{n_\ell} \mathbf{m}], \mu_0^\gamma[\chi_{n_\ell} \mathbf{m}']) + |t - s| L_{C,p}.$$

We obtain (ii) in Theorem 9.2.25 by applying the lower semicontinuity property of the Wasserstein distance of Lemma 9.5.7 and the convergence result of the initial discretisation of Lemma 9.5.9, which completes the proof.

Proof of (iii) in Theorem 9.2.25. Let $\mathbf{m} \in \mathcal{P}_{\mathbf{m}^*}$ and let $s, t \geq 0$. We shall prove that

$$\sum_{\gamma=1}^d \widetilde{W}_1(S_{t+s}^\gamma \mathbf{m}, S_t^\gamma \mathbf{S}_s \mathbf{m}) = 0,$$

where the modified Wasserstein distance \widetilde{W}_1 was introduced in Definition 9.5.8. In this purpose, we first remark that, by the flow property for the MSPD, for all $\ell \geq 1$,

$$\forall \gamma \in \{1, \dots, d\}, \quad \mu_{t+s}^\gamma[\chi_{n_\ell} \mathbf{m}] = \mu_t^\gamma[\Phi(\chi_{n_\ell} \mathbf{m}; s)]$$

therefore we write

$$\sum_{\gamma=1}^d \widetilde{W}_1(S_{t+s}^\gamma \mathbf{m}, S_t^\gamma \mathbf{S}_s \mathbf{m}) \leq \sum_{\gamma=1}^d \widetilde{W}_1(S_{t+s}^\gamma \mathbf{m}, \mu_{t+s}^\gamma[\chi_{n_\ell} \mathbf{m}]) + \sum_{\gamma=1}^d \widetilde{W}_1(\mu_t^\gamma[\Phi(\chi_{n_\ell} \mathbf{m}; s)], S_t^\gamma \mathbf{S}_s \mathbf{m}).$$

On the one hand, Proposition 9.5.11 yields

$$\lim_{\ell \rightarrow +\infty} \sum_{\gamma=1}^d \widetilde{W}_1(S_{t+s}^\gamma \mathbf{m}, \mu_{t+s}^\gamma[\chi_{n_\ell} \mathbf{m}]) = 0.$$

On the other hand,

$$\begin{aligned} & \sum_{\gamma=1}^d \widetilde{W}_1(\mu_t^\gamma[\Phi(\chi_{n_\ell} \mathbf{m}; s)], S_t^\gamma \mathbf{S}_s \mathbf{m}) \\ & \leq \sum_{\gamma=1}^d \widetilde{W}_1(\mu_t^\gamma[\Phi(\chi_{n_\ell} \mathbf{m}; s)], \mu_t^\gamma[\chi_{n_\ell} \mathbf{S}_s \mathbf{m}]) + \sum_{\gamma=1}^d \widetilde{W}_1(\mu_t^\gamma[\chi_{n_\ell} \mathbf{S}_s \mathbf{m}], S_t^\gamma \mathbf{S}_s \mathbf{m}), \end{aligned}$$

and using Proposition 9.5.11 again, we have

$$\lim_{\ell \rightarrow +\infty} \sum_{\gamma=1}^d \widetilde{W}_1(\mu_t^\gamma[\chi_{n_\ell} \mathbf{S}_s \mathbf{m}], S_t^\gamma \mathbf{S}_s \mathbf{m}) = 0.$$

It therefore remains to prove that

$$\lim_{\ell \rightarrow +\infty} \sum_{\gamma=1}^d \widetilde{W}_1(\mu_t^\gamma[\Phi(\chi_{n_\ell} \mathbf{m}; s)], \mu_t^\gamma[\chi_{n_\ell} \mathbf{S}_s \mathbf{m}]) = 0.$$

In this purpose, we use the control of \widetilde{W}_1 by W_1 and Theorem 9.2.22 to obtain

$$\begin{aligned} \sum_{\gamma=1}^d \widetilde{W}_1(\mu_t^\gamma[\Phi(\chi_{n_\ell} \mathbf{m}; s)], \mu_t^\gamma[\chi_{n_\ell} \mathbf{S}_s \mathbf{m}]) & \leq \mathcal{L}_1 \sum_{\gamma=1}^d W_1(\mu_0^\gamma[\Phi(\chi_{n_\ell} \mathbf{m}; s)], \mu_0^\gamma[\chi_{n_\ell} \mathbf{S}_s \mathbf{m}]) \\ & \leq \mathcal{L}_1 \|\Phi(\chi_{n_\ell} \mathbf{m}; s) - \chi_{n_\ell} \mathbf{S}_s \mathbf{m}\|_1. \end{aligned}$$

We somehow have to prove that the evolution along the MSPD for a time s asymptotically commutes with the discretisation operation when measured in $W_1^{(d)}$ distance. Let us first note that this is the case for the weak convergence: by Lemma 9.5.5, the empirical distribution of $\chi_{n_\ell} \mathbf{S}_s \mathbf{m}$ converges weakly to $\mathbf{S}_s \mathbf{m}$; while it follows from Proposition 9.5.11 that the empirical distribution of $\Phi(\chi_{n_\ell} \mathbf{m}; s)$ converges weakly to the same limit $\mathbf{S}_s \mathbf{m} \in \mathcal{P}(\mathbb{R}^d)$.

Let us now remark that by Theorem 9.2.22 and Lemma 9.5.9,

$$\begin{aligned} \|\Phi(\chi_{n_\ell} \mathbf{m}; s) - \chi_{n_\ell} \mathbf{S}_s \mathbf{m}\|_\infty & \leq \|\Phi(\chi_{n_\ell} \mathbf{m}; s) - \chi_{n_\ell} \mathbf{m}\|_\infty + \|\chi_{n_\ell} \mathbf{m} - \chi_{n_\ell} \mathbf{S}_s \mathbf{m}\|_\infty \\ & \leq sL_{C,\infty} + W_\infty^{(d)}(\mathbf{m}, \mathbf{S}_s \mathbf{m}), \end{aligned}$$

and it follows from (ii) that $W_\infty^{(d)}(\mathbf{m}, \mathbf{S}_s \mathbf{m}) \leq sL_{C,\infty}$. As a consequence, the right-hand side above is lower than $2sL_{C,\infty}$, therefore, letting $\mathbf{x}(n_\ell) := \Phi(\chi_{n_\ell} \mathbf{m}; s)$ and $\mathbf{y}(n_\ell) := \chi_{n_\ell} \mathbf{S}_s \mathbf{m}$,

$$\begin{aligned} \|\Phi(\chi_{n_\ell} \mathbf{m}; s) - \chi_{n_\ell} \mathbf{S}_s \mathbf{m}\|_1 & = \frac{1}{n_\ell} \sum_{\gamma=1}^d \sum_{k=1}^{n_\ell} |x_k^\gamma(n_\ell) - y_k^\gamma(n_\ell)| \\ & = \frac{1}{n_\ell} \sum_{\gamma=1}^d \sum_{k=1}^{n_\ell} (|x_k^\gamma(n_\ell) - y_k^\gamma(n_\ell)| \wedge (2sL_{C,\infty})) \\ & = \sum_{\gamma=1}^d \int_{(x,y) \in \mathbb{R}^2} |x - y| \wedge (2sL_{C,\infty}) \mathbf{m}_{n_\ell}^\gamma(dx dy), \end{aligned}$$

where, for all $\gamma \in \{1, \dots, d\}$, the probability measure $\mathbf{m}_{n_\ell}^\gamma$ on \mathbb{R}^2 is defined by

$$\mathbf{m}_{n_\ell}^\gamma = \frac{1}{n_\ell} \sum_{k=1}^{n_\ell} \delta_{(x_k^\gamma(n_\ell), y_k^\gamma(n_\ell))} = \mathbf{U} \circ \left((H * \mu_0^\gamma[\Phi(\chi_{n_\ell} \mathbf{m}; s)])^{-1}, (H * \mu_0^\gamma[\chi_{n_\ell} \mathbf{S}_s \mathbf{m}])^{-1} \right)^{-1}.$$

Since both $\mu_0^\gamma[\Phi(\chi_{n_\ell} \mathbf{m}; s)]$ and $\mu_0^\gamma[\chi_{n_\ell} \mathbf{S}_s \mathbf{m}]$ converge weakly to $S_s^\gamma \mathbf{m} \in \mathbf{P}(\mathbb{R})$, one deduces from Lemma 9.2.11 that $\mathbf{m}_{n_\ell}^\gamma$ converges weakly to $\mathbf{U} \circ \left((H * S_s^\gamma \mathbf{m})^{-1}, (H * S_s^\gamma \mathbf{m})^{-1} \right)^{-1}$, which is a probability measure concentrated on the diagonal in \mathbb{R}^2 . Since $(x, y) \mapsto |x - y| \wedge (2sL_{C, \infty})$ is continuous and bounded, one concludes that $\|\Phi(\chi_{n_\ell} \mathbf{m}; s) - \chi_{n_\ell} \mathbf{S}_s \mathbf{m}\|_1$ vanishes when ℓ grows to infinity. \square

Remark 9.5.12. Assumption (GNL) plays a crucial role in the proof of the discrete stability estimates of Theorem 9.2.22. However, it can be relaxed to Assumption (DM) in the statement of Theorem 9.2.25 according to the following idea: assume that λ only satisfies Assumption (DM), and in the Definition 9.5.3 of the empirical distribution of the MSPD on D_n^d , replace the velocity field λ with some approximation λ^n satisfying Assumption (GNL) but having the same Lipschitz and Uniformly Strict Hyperbolicity constants L_{LC} and L_{USH} as λ . Then the proof of Proposition 9.5.6 can be adapted to yield the same tightness result, and the sequence of MSPD trajectories thus obtained satisfies Theorem 9.2.22 with stability constants \mathcal{L}_p that only depend on d , L_{LC} and L_{USH} , while converging to a probabilistic solution to the system (9.1) with velocity field λ . The proof of Theorem 9.2.25 now works exactly the same.

9.A Proofs of technical results

9.A.1 Proof of Proposition 9.2.14

Before proving Proposition 9.2.14, we state and prove the technical Lemmas 9.A.1 and 9.A.2.

Lemma 9.A.1 (An extended pseudo-inverse function formula). *Let $\ell : [0, 1] \times \mathbb{R} \rightarrow \mathbb{R}$ be a measurable and bounded function, and F be a CDF on the real line. Then*

$$\int_{x \in \mathbb{R}} \int_{\theta=0}^1 \ell((1-\theta)F(x^-) + \theta F(x), x) d\theta dF(x) = \int_{v=0}^1 \ell(v, F^{-1}(v)) dv. \quad (9.47)$$

Proof. Let us split the integral in the left-hand side of (9.47) in two parts, depending on whether $\Delta F(x) = 0$ or $\Delta F(x) > 0$. On the one hand, using Lemma 9.2.10,

$$\begin{aligned} \int_{x \in \mathbb{R}} \int_{\theta=0}^1 \mathbb{1}_{\{\Delta F(x)=0\}} \ell((1-\theta)F(x^-) + \theta F(x), x) d\theta dF(x) &= \int_{x \in \mathbb{R}} \mathbb{1}_{\{\Delta F(x)=0\}} \ell(F(x), x) dF(x) \\ &= \int_{v=0}^1 \mathbb{1}_{\{\Delta F(F^{-1}(v))=0\}} \ell(F(F^{-1}(v)), F^{-1}(v)) dv, \end{aligned}$$

and it follows from (ii) in Lemma 9.2.9 that, if $\Delta F(F^{-1}(v)) = 0$, then $F(F^{-1}(v)) = v$. As a consequence,

$$\int_{x \in \mathbb{R}} \int_{\theta=0}^1 \mathbb{1}_{\{\Delta F(x)=0\}} \ell((1-\theta)F(x^-) + \theta F(x), x) d\theta dF(x) = \int_{v=0}^1 \mathbb{1}_{\{\Delta F(F^{-1}(v))=0\}} \ell(v, F^{-1}(v)) dv.$$

On the other hand,

$$\begin{aligned} \int_{x \in \mathbb{R}} \int_{\theta=0}^1 \mathbb{1}_{\{\Delta F(x)>0\}} \ell((1-\theta)F(x^-) + \theta F(x), x) d\theta dF(x) &= \int_{v=0}^1 \mathbb{1}_{\{\Delta F(F^{-1}(v))>0\}} \int_{\theta=0}^1 \ell((1-\theta)F(F^{-1}(v)^-) + \theta F(F^{-1}(v)), F^{-1}(v)) dv d\theta \\ &= \int_{v=0}^1 \mathbb{1}_{\{\Delta F(F^{-1}(v))>0\}} \frac{1}{\Delta F(F^{-1}(v))} \int_{w=F(F^{-1}(v)^-)}^{F(F^{-1}(v))} \ell(w, F^{-1}(v)) dw dv \\ &= \int_{v=0}^1 \int_{w=0}^1 \mathbb{1}_{\{\Delta F(F^{-1}(v))>0, F(F^{-1}(v)^-) < w \leq F(F^{-1}(v))\}} \frac{\ell(w, F^{-1}(v))}{\Delta F(F^{-1}(v))} dw dv. \end{aligned}$$

The key observation here is that, if $v \in (0, 1)$ is such that $\Delta F(F^{-1}(v)) > 0$, then, for all w such that

$$F(F^{-1}(v)^-) < w \leq F(F^{-1}(v)),$$

one has $F^{-1}(w) = F^{-1}(v)$. As a consequence, the right-hand side above rewrites

$$\begin{aligned} & \int_{v=0}^1 \int_{w=0}^1 \mathbb{1}_{\{\Delta F(F^{-1}(v)) > 0, F(F^{-1}(v)^-) < w \leq F(F^{-1}(v))\}} \frac{\ell(w, F^{-1}(v))}{\Delta F(F^{-1}(v))} dw dv \\ &= \int_{v=0}^1 \int_{w=0}^1 \mathbb{1}_{\{\Delta F(F^{-1}(w)) > 0, F(F^{-1}(v)^-) < w \leq F(F^{-1}(v))\}} \frac{\ell(w, F^{-1}(w))}{\Delta F(F^{-1}(w))} dw dv \\ &= \int_{w=0}^1 \mathbb{1}_{\{\Delta F(F^{-1}(w)) > 0\}} \frac{\ell(w, F^{-1}(w))}{\Delta F(F^{-1}(w))} \int_{v=0}^1 \mathbb{1}_{\{F(F^{-1}(v)^-) < w \leq F(F^{-1}(v))\}} dv dw. \end{aligned}$$

We now complete the proof by checking that, dw -almost everywhere, if $\Delta F(F^{-1}(w)) > 0$ then

$$\int_{v=0}^1 \mathbb{1}_{\{F(F^{-1}(v)^-) < w \leq F(F^{-1}(v))\}} dv = \Delta F(F^{-1}(w)).$$

To this aim, we note that for all $w \in (0, 1)$ such that $\Delta F(F^{-1}(w)) > 0$,

$$\begin{aligned} \int_{v=0}^1 \mathbb{1}_{\{F(F^{-1}(v)^-) < w \leq F(F^{-1}(v))\}} dv &= \int_{x \in \mathbb{R}} \mathbb{1}_{\{F(x^-) < w \leq F(x)\}} dF(x) \\ &= \sum_{x: \Delta F(x) > 0} \mathbb{1}_{\{F(x^-) < w \leq F(x)\}} \Delta F(x), \end{aligned}$$

where we have used Lemma 9.2.10 at the first line.

Recall that, by (ii) in Lemma 9.2.9, $F(F^{-1}(w)^-) \leq w \leq F(F^{-1}(w))$. As a consequence, if w is not taken from the countable set of values of $F(x^-)$ when x is an atom of dF , then the sum above contains exactly one positive term, which corresponds to $x = F^{-1}(w)$ and therefore writes $\Delta F(F^{-1}(w))$. \square

Lemma 9.A.2 (Convergence of composed CDFs). *Let $(F_n)_{n \geq 1}$ and $(G_n)_{n \geq 1}$ be two sequences of CDFs on \mathbb{R} and F and G be two CDFs on \mathbb{R} , such that:*

- for all $x \in \mathbb{R}$ such that $\Delta F(x) = 0$, then $\lim_{n \rightarrow +\infty} F_n(x) = F(x)$,
- for all $x \in \mathbb{R}$ such that $\Delta G(x) = 0$, then $\lim_{n \rightarrow +\infty} G_n(x) = G(x)$,
- for all $x \in \mathbb{R}$, $\Delta F(x) \Delta G(x) = 0$.

Then, dv -almost everywhere,

$$\lim_{n \rightarrow +\infty} F_n^{-1}(v) = F^{-1}(v) \quad \text{and} \quad \lim_{n \rightarrow +\infty} G_n(F_n^{-1}(v)) = G(F^{-1}(v)).$$

Proof. By Lemma 9.2.11, $F_n^{-1}(v)$ converges to $F^{-1}(v)$, dv -almost everywhere in $(0, 1)$. We now check that, for all $x \in \mathbb{R}$ such that $\Delta G(x) > 0$, then the set

$$\{v \in (0, 1) : F^{-1}(v) = x\}$$

is negligible with respect to the Lebesgue measure on $(0, 1)$. Since the function F^{-1} is nondecreasing, this set is an interval, and if there exists $\underline{v} < \bar{v}$ such that $F^{-1}(\underline{v}) = F^{-1}(\bar{v}) = x$, then $F(x^-) \leq \underline{v} < \bar{v} \leq F(x)$, which is a contradiction with the fact that $\Delta F(x) \Delta G(x) = 0$.

As a consequence, dv -almost everywhere,

- $F_n^{-1}(v)$ converges to $F^{-1}(v)$,
- $\Delta G(F^{-1}(v)) = 0$.

Let us fix $v \in (0, 1)$ satisfying these two conditions, and write $G_n(F_n^{-1}(v)) = G_n(F^{-1}(v)) + G_n(F_n^{-1}(v)) - G_n(F^{-1}(v))$. On the one hand,

$$\lim_{n \rightarrow +\infty} G_n(F^{-1}(v)) = G(F^{-1}(v)),$$

since $\Delta G(F^{-1}(v)) = 0$. On the other hand, by the Dominated Convergence Theorem, for all $\epsilon > 0$, there exists $\delta > 0$ such that

$$\int_{x \in \mathbb{R}} \mathbf{1}_{\{F^{-1}(v) - \delta \leq x \leq F^{-1}(v) + \delta\}} dG(x) \leq \epsilon.$$

Besides, for n large enough, $F_n^{-1}(v) \in [F^{-1}(v) - \delta, F^{-1}(v) + \delta]$, so that

$$|G_n(F_n^{-1}(v)) - G_n(F^{-1}(v))| \leq \int_{x \in \mathbb{R}} \mathbf{1}_{\{F^{-1}(v) - \delta \leq x \leq F^{-1}(v) + \delta\}} dG_n(x).$$

We now deduce from the characterisation of weak convergence on closed sets in the Portmanteau Theorem [18, Theorem 2.1, p. 16] that

$$\limsup_{n \rightarrow +\infty} |G_n(F_n^{-1}(v)) - G_n(F^{-1}(v))| \leq \epsilon,$$

which completes the proof. \square

We are now ready to prove Proposition 9.2.14.

Proof of Proposition 9.2.14. Let $(\mathbf{u}_n)_{n \geq 1}$ and \mathbf{u} satisfy the assumptions of Proposition 9.2.14. Let us fix $\varphi = (\varphi^1, \dots, \varphi^d) \in C_c^{1,0}([0, +\infty) \times \mathbb{R}, \mathbb{R}^d)$ and $\gamma \in \{1, \dots, d\}$. For all $t \geq 0$, the set of points $x \in \mathbb{R}$ such that $\Delta_x u^\gamma(t, x) > 0$ is at most countable, therefore dx -almost everywhere, $u_n^\gamma(t, x)$ converges to $u^\gamma(t, x)$. By the Dominated Convergence Theorem, we deduce that

$$\begin{aligned} & \lim_{n \rightarrow +\infty} \int_{t=0}^{+\infty} \int_{x \in \mathbb{R}} \partial_t \varphi^\gamma(t, x) u_n^\gamma(t, x) dx dt + \int_{x \in \mathbb{R}} \varphi^\gamma(0, x) u_{n,0}^\gamma(x) dx \\ &= \int_{t=0}^{+\infty} \int_{x \in \mathbb{R}} \partial_t \varphi^\gamma(t, x) u^\gamma(t, x) dx dt + \int_{x \in \mathbb{R}} \varphi^\gamma(0, x) u_0^\gamma(x) dx. \end{aligned}$$

The main difficulty of the proof actually lies in checking that

$$\lim_{n \rightarrow +\infty} \int_{t=0}^{+\infty} \int_{x \in \mathbb{R}} \varphi^\gamma(t, x) \lambda^\gamma \{\mathbf{u}_n\}(t, x) d_x u_n^\gamma(t, x) dt = \int_{t=0}^{+\infty} \int_{x \in \mathbb{R}} \varphi^\gamma(t, x) \lambda^\gamma \{\mathbf{u}\}(t, x) d_x u^\gamma(t, x) dt. \quad (9.48)$$

In the scalar case, (9.5) yields, for all $t \geq 0$,

$$\int_{x \in \mathbb{R}} \varphi(t, x) \lambda \{u_n\}(t, x) d_x u_n(t, x) = - \int_{x \in \mathbb{R}} \partial_x \varphi(t, x) \Lambda(u_n(t, x)) dx$$

and, similarly,

$$\int_{x \in \mathbb{R}} \varphi(t, x) \lambda \{u\}(t, x) d_x u(t, x) = - \int_{x \in \mathbb{R}} \partial_x \varphi(t, x) \Lambda(u(t, x)) dx,$$

so that the limit (9.48) is easy to obtain — at least for test functions having a continuous partial derivative $\partial_x \varphi$.

In the general case, Lemma 9.A.1 above allows us to rewrite (9.48) under the following equivalent form:

$$\begin{aligned} & \lim_{n \rightarrow +\infty} \int_{t=0}^{+\infty} \int_{v=0}^1 \varphi^\gamma(t, u_n^\gamma(t, \cdot)^{-1}(v)) \lambda^\gamma (u_n^1(t, u_n^\gamma(t, \cdot)^{-1}(v)), \dots, v, \dots, u_n^d(t, u_n^\gamma(t, \cdot)^{-1}(v))) dv dt \\ &= \int_{t=0}^{+\infty} \int_{v=0}^1 \varphi^\gamma(t, u^\gamma(t, \cdot)^{-1}(v)) \lambda^\gamma (u^1(t, u^\gamma(t, \cdot)^{-1}(v)), \dots, v, \dots, u^d(t, u^\gamma(t, \cdot)^{-1}(v))) dv dt. \end{aligned}$$

By the Dominated Convergence Theorem and thanks to the continuity of the functions $\varphi^\gamma(t, \cdot)$ and λ^γ , this identity follows if we first prove that, dt -almost everywhere, dv -almost everywhere, for all $\gamma, \gamma' \in \{1, \dots, d\}$ with $\gamma \neq \gamma'$,

$$\lim_{n \rightarrow +\infty} u_n^\gamma(t, \cdot)^{-1}(v) = u^\gamma(t, \cdot)^{-1}(v), \quad \lim_{n \rightarrow +\infty} u_n^{\gamma'}(t, u_n^\gamma(t, \cdot)^{-1}(v)) = u^{\gamma'}(t, u^\gamma(t, \cdot)^{-1}(v)).$$

These equalities are obtained by applying Lemma 9.A.2 above at all times t such that

$$\forall x \in \mathbb{R}, \quad \Delta_x u_n^\gamma(t, x) \Delta_x u_n^{\gamma'}(t, x) = 0.$$

On account of Condition (9.7), this is the case dt -almost everywhere, which completes the proof. \square

9.A.2 Proofs of Propositions 9.3.16 and 9.3.17

This subsection contains the proofs of Propositions 9.3.16 and 9.3.17, which were stated in §9.3.2.3 and describe some continuity properties of the trajectories of the MSPD.

Proof of Proposition 9.3.16. We prove by induction on $N(\mathbf{x})$ that

- (i) the process $(\Phi(\mathbf{x}; t))_{t \geq 0}$ has continuous trajectories in D_n^d ,
- (ii) for all $s, t \geq 0$, $\Phi(\mathbf{x}; s + t) = \Phi(\Phi(\mathbf{x}; s); t)$.

Let $\mathbf{x} \in D_n^d$ such that $N(\mathbf{x}) = 0$. Then, by Definition 9.3.13,

$$\forall t \geq 0, \quad \Phi(\mathbf{x}; t) = \tilde{\Phi}[\tilde{\lambda}(\mathbf{x})](\mathbf{x}; t),$$

and (i) follows from the continuity of the trajectories of $(\tilde{\Phi}[\tilde{\lambda}(\mathbf{x})](\mathbf{x}; t))_{t \geq 0}$. Now, for all $s, t \geq 0$, $\Phi(\mathbf{x}; s + t) = \tilde{\Phi}[\tilde{\lambda}(\mathbf{x})](\mathbf{x}; s + t)$ and $\Phi(\mathbf{x}; s) = \tilde{\Phi}[\tilde{\lambda}(\mathbf{x})](\mathbf{x}; s) =: \mathbf{x}'$. By Corollary 9.3.12, $N(\mathbf{x}') = 0$ and $\tilde{\lambda}(\mathbf{x}') = \tilde{\lambda}(\mathbf{x})$. Hence,

$$\Phi(\Phi(\mathbf{x}; s); t) = \Phi(\mathbf{x}'; t) = \tilde{\Phi}[\tilde{\lambda}(\mathbf{x}')](\mathbf{x}'; t) = \tilde{\Phi}[\tilde{\lambda}(\mathbf{x})](\tilde{\Phi}[\tilde{\lambda}(\mathbf{x})](\mathbf{x}; s); t),$$

and the flow property for $(\tilde{\Phi}[\tilde{\lambda}(\mathbf{x})](\cdot; t))_{t \geq 0}$ yields

$$\tilde{\Phi}[\tilde{\lambda}(\mathbf{x})](\tilde{\Phi}[\tilde{\lambda}(\mathbf{x})](\mathbf{x}; s); t) = \tilde{\Phi}[\tilde{\lambda}(\mathbf{x})](\mathbf{x}; s + t) = \Phi(\mathbf{x}; s + t),$$

which results in (ii).

Now let $N \geq 0$ such that, for all $\mathbf{x} \in D_n^d$ with $N(\mathbf{x}) \leq N$, then (i) and (ii) are satisfied. Let $\mathbf{x} \in D_n^d$ with $N(\mathbf{x}) = N + 1$. In particular, $N(\mathbf{x}) \geq 1$ so that $t^*(\mathbf{x}) < +\infty$, and for all $t \in [0, t^*(\mathbf{x}))$, $\Phi(\mathbf{x}; t) = \tilde{\Phi}[\tilde{\lambda}(\mathbf{x})](\mathbf{x}; t)$. As a consequence, the function $t \mapsto \Phi(\mathbf{x}; t)$ is continuous on $[0, t^*(\mathbf{x}))$. On the other hand, since $N(\mathbf{x}^*) < N(\mathbf{x}) = N + 1$, the function $t \mapsto \Phi(\mathbf{x}; t)$ is continuous on $[t^*(\mathbf{x}), +\infty)$. Therefore it remains to prove that the function $t \mapsto \Phi(\mathbf{x}; t)$ is left continuous at the point $t^*(\mathbf{x})$, where, by definition, it takes the value

$$\Phi(\mathbf{x}; t^*(\mathbf{x})) = \Phi(\mathbf{x}^*; t^*(\mathbf{x}) - t^*(\mathbf{x})) = \mathbf{x}^*,$$

and we recall that, by definition, $\mathbf{x}^* = \tilde{\Phi}[\tilde{\lambda}(\mathbf{x})](\mathbf{x}; t^*(\mathbf{x}))$. As a consequence, the continuity of the trajectories of $(\tilde{\Phi}[\tilde{\lambda}(\mathbf{x})](\mathbf{x}; t))_{t \geq 0}$ yields

$$\lim_{t \uparrow t^*(\mathbf{x})} \Phi(\mathbf{x}; t) = \lim_{t \uparrow t^*(\mathbf{x})} \tilde{\Phi}[\tilde{\lambda}(\mathbf{x})](\mathbf{x}; t) = \mathbf{x}^* = \Phi(\mathbf{x}; t^*(\mathbf{x})),$$

which is the expected result.

We finally address (ii). Let $s, t \geq 0$.

Case $s \geq t^(\mathbf{x})$.* Then $s + t \geq t^*(\mathbf{x})$, so that, by Definition 9.3.13,

$$\Phi(\mathbf{x}; s + t) = \Phi(\mathbf{x}^*; s + t - t^*(\mathbf{x})) = \Phi(\mathbf{x}^*; s' + t),$$

where $s' := s - t^*(\mathbf{x}) \geq 0$. Since, by Corollary 9.3.12, $N(\mathbf{x}^*) < N(\mathbf{x})$, then the flow property for $(\Phi(\mathbf{x}^*; t))_{t \geq 0}$ yields $\Phi(\mathbf{x}^*; s' + t) = \Phi(\Phi(\mathbf{x}^*; s'); t) = \Phi(\Phi(\mathbf{x}^*; s - t^*(\mathbf{x})); t)$ and, using Definition 9.3.13 again, $\Phi(\mathbf{x}^*; s - t^*(\mathbf{x})) = \Phi(\mathbf{x}; s)$. As a conclusion, $\Phi(\mathbf{x}; s + t) = \Phi(\Phi(\mathbf{x}; s); t)$.

Case $s < t^*(\mathbf{x})$. Then we write $\mathbf{x}' := \Phi(\mathbf{x}; s) = \tilde{\Phi}[\tilde{\lambda}(\mathbf{x})](\mathbf{x}; s)$, and recall that, by Corollary 9.3.12, $\tilde{\lambda}(\mathbf{x}') = \tilde{\lambda}(\mathbf{x})$ and $t^*(\mathbf{x}') = t^*(\mathbf{x}) - s$. By Definition 9.3.13,

$$\Phi(\mathbf{x}'; t) = \begin{cases} \tilde{\Phi}[\tilde{\lambda}(\mathbf{x}')](\mathbf{x}'; t) & \text{if } t < t^*(\mathbf{x}'), \\ \Phi(\mathbf{x}'; t - t^*(\mathbf{x}')) & \text{if } t \geq t^*(\mathbf{x}'). \end{cases}$$

If $t < t^*(\mathbf{x}') = t^*(\mathbf{x}) - s$, then combining the flow property for $(\tilde{\Phi}[\tilde{\lambda}(\mathbf{x})](\cdot; t))_{t \geq 0}$ with the equality $\tilde{\lambda}(\mathbf{x}') = \tilde{\lambda}(\mathbf{x})$, we obtain

$$\tilde{\Phi}[\tilde{\lambda}(\mathbf{x}')](\mathbf{x}'; t) = \tilde{\Phi}[\tilde{\lambda}(\mathbf{x})](\tilde{\Phi}[\tilde{\lambda}(\mathbf{x})](\mathbf{x}; s); t) = \tilde{\Phi}[\tilde{\lambda}(\mathbf{x})](\mathbf{x}; s + t),$$

and, since $s + t < t^*(\mathbf{x})$, the right-hand side above is worth $\Phi(\mathbf{x}; s + t)$.

If $t \geq t^*(\mathbf{x}') = t^*(\mathbf{x}) - s$, then by Corollary 9.3.12, $\mathbf{x}^* = \mathbf{x}'$, therefore it is straightforward that

$$\Phi(\mathbf{x}'; t) = \Phi(\mathbf{x}^*; t - t^*(\mathbf{x}')) = \Phi(\mathbf{x}^*; s + t - t^*(\mathbf{x})) = \Phi(\mathbf{x}; s + t).$$

In both cases, we conclude that $\Phi(\Phi(\mathbf{x}; s); t) = \Phi(\mathbf{x}'; t) = \Phi(\mathbf{x}; s + t)$, which is (ii). \square

Before detailing the proof of Proposition 9.3.17, we first define

$$\bar{t}(\mathbf{x}) := \inf\{t \geq 0 : N(\Phi(\mathbf{x}; t)) = 0\}.$$

Certainly, if $N(\mathbf{x}) = 0$ then $\bar{t}(\mathbf{x}) = 0$, otherwise $\bar{t}(\mathbf{x}) > 0$, and an upper bound on $\bar{t}(\mathbf{x})$ can be derived as follows.

Lemma 9.A.3 (Bound on $\bar{t}(\mathbf{x})$). *Under Assumption (USH), for all $\mathbf{x} \in D_n^d$ such that $N(\mathbf{x}) > 0$,*

$$\bar{t}(\mathbf{x}) \leq \frac{1}{L_{\text{USH}}} \sup\{x_j^\beta - x_i^\alpha, (\alpha : i, \beta : j) \in R(\mathbf{x})\} < +\infty. \quad (9.49)$$

Proof. Let $\mathbf{x} \in D_n^d$. Then, for all $t \geq 0$, we have $t \geq \bar{t}(\mathbf{x})$ if and only if $N(\Phi(\mathbf{x}; t)) = 0$, which is equivalent to the fact that, for all $(\alpha : i, \beta : j) \in (P_n^d)^2$ with $\alpha < \beta$,

$$\Phi_i^\alpha(\mathbf{x}; t) \geq \Phi_j^\beta(\mathbf{x}; t),$$

that is to say,

$$\int_{s=0}^t (v_i^\alpha(\mathbf{x}; s) - v_j^\beta(\mathbf{x}; s)) ds \geq x_j^\beta - x_i^\alpha.$$

Recall that, by (9.21) and Assumption (USH), since the left-hand side above is larger than tL_{USH} , then a sufficient condition for this inequality to hold is that $t \geq (x_j^\beta - x_i^\alpha)/L_{\text{USH}}$, which yields the bound (9.49). \square

Let us now recall that the dense open set $\mathcal{D} \subset D_n^d$ is defined in §9.4.2.1 as the set of configurations $\mathbf{x} \in D_n^d$ such that, for all $(\alpha : i, \beta : j) \in (P_n^d)^2$ with $\alpha < \beta$, then $x_i^\alpha \neq x_j^\beta$.

Lemma 9.A.4 (Properties of \mathcal{D}). *The set \mathcal{D} has the following properties.*

(i) *For all $\mathbf{x} \in \mathcal{D}$, there exists $\eta > 0$ such that, for all $\mathbf{y} \in \bar{B}_1(\mathbf{x}, \eta)$, we have $\mathbf{y} \in \mathcal{D}$ and $R(\mathbf{x}) = R(\mathbf{y})$.*

(ii) *The function t^* defined in (9.19) is continuous on the set $\{\mathbf{x} \in \mathcal{D} : N(\mathbf{x}) \geq 1\}$.*

Proof. Let $\mathbf{x} \in \mathcal{D}$. Let

$$\eta := \frac{1}{3n} \min\{|x_i^\alpha - x_j^\beta|, (\alpha : i, \beta : j) \in (P_n^d)^2, \alpha < \beta\} > 0.$$

Let $\mathbf{y} \in \bar{B}_1(\mathbf{x}, \eta)$. Then, in particular, for all $\alpha : i \in P_n^d$, $|x_i^\alpha - y_i^\alpha| \leq n\eta$. Let $(\alpha : i, \beta : j) \in (P_n^d)^2$ with $\alpha < \beta$.

If $(\alpha : i, \beta : j) \in \mathbf{R}(\mathbf{x})$, then $x_j^\beta - x_i^\alpha \geq 3n\eta$. Since $|x_j^\beta - y_j^\beta| \leq n\eta$ and $|x_i^\alpha - y_i^\alpha| \leq n\eta$, we deduce that $y_j^\beta - y_i^\alpha \geq n\eta$ so that $y_j^\beta > y_i^\alpha$ and $(\alpha : i, \beta : j) \in \mathbf{R}(\mathbf{y})$.

Likewise, if $(\alpha : i, \beta : j) \notin \mathbf{R}(\mathbf{x})$, then $x_i^\alpha - x_j^\beta \geq 3n\eta$ and $y_i^\alpha - y_j^\beta \geq n\eta$ so that $(\alpha : i, \beta : j) \notin \mathbf{R}(\mathbf{y})$.

As a conclusion, $\mathbf{R}(\mathbf{x}) = \mathbf{R}(\mathbf{y})$ and $\mathbf{y} \in \mathcal{D}$.

We now prove that the function t^* is continuous on the set $\{\mathbf{x} \in \mathcal{D} : \mathbf{N}(\mathbf{x}) \geq 1\}$. Let us fix a configuration \mathbf{x} in this set. Let $(\mathbf{y}_k)_{k \geq 1}$ be a sequence converging to \mathbf{x} in D_n^d . By the first part of the lemma, there is no loss of generality in assuming that, for all $k \geq 1$, $\|\mathbf{x} - \mathbf{y}_k\|_1 \leq \eta$, where η is defined in the first part of the proof, so that $\mathbf{R}(\mathbf{y}_k) = \mathbf{R}(\mathbf{x})$. This allows us to write

$$t^*(\mathbf{y}_k) = \min\{\tilde{\tau}_{\alpha:i, \beta:j}^{\text{coll}}(\mathbf{y}_k), (\alpha : i, \beta : j) \in \mathbf{R}(\mathbf{x})\}.$$

Let us fix $(\alpha : i, \beta : j) \in \mathbf{R}(\mathbf{x})$. We denote $\tau_k := \tilde{\tau}_{\alpha:i, \beta:j}^{\text{coll}}(\mathbf{y}_k)$ and prove that $\lim_{k \rightarrow +\infty} \tau_k = \tilde{\tau}_{\alpha:i, \beta:j}^{\text{coll}}(\mathbf{x})$. On the one hand, the sequence $(\tau_k)_{k \geq 1}$ is bounded. Indeed, combining Lemma 9.A.3 with the fact that $\mathbf{R}(\mathbf{y}_k) = \mathbf{R}(\mathbf{x})$ and $\|\mathbf{x} - \mathbf{y}_k\|_1 \leq \eta$, we obtain

$$\tau_k \leq \frac{1}{L_{\text{USH}}} (|x_i^\alpha - x_j^\beta| + n\eta).$$

On the other hand, let $\tau \geq 0$ refer to the limit of a converging subsequence of $(\tau_k)_{k \geq 1}$, that we still index by k for convenience. For all $\mathbf{y} \in D_n^d$ and $t \geq 0$, let

$$g(\mathbf{y}, t) := \tilde{\Phi}_j^\beta[\tilde{\lambda}(\mathbf{x})](\mathbf{y}; t) - \tilde{\Phi}_i^\alpha[\tilde{\lambda}(\mathbf{x})](\mathbf{y}; t),$$

so that, for all $\mathbf{y} \in \bar{B}_1(\mathbf{x}, \eta)$, $\tilde{\tau}_{\alpha:i, \beta:j}^{\text{coll}}(\mathbf{y}) = t$ if and only if $g(\mathbf{y}, t) = 0$. In particular, for all $k \geq 1$, $g(\mathbf{y}_k, \tau_k) = 0$, therefore

$$|g(\mathbf{x}, \tau)| = |g(\mathbf{x}, \tau) - g(\mathbf{y}_k, \tau_k)| \leq |g(\mathbf{x}, \tau) - g(\mathbf{x}, \tau_k)| + |g(\mathbf{x}, \tau_k) - g(\mathbf{y}_k, \tau_k)|.$$

By the continuity of the trajectories of the flow $(\tilde{\Phi}[\tilde{\lambda}(\mathbf{x})](\cdot; t))_{t \geq 0}$, $|g(\mathbf{x}, \tau) - g(\mathbf{x}, \tau_k)|$ vanishes when k grows to infinity. Furthermore, Lemma 9.3.10 yields

$$\begin{aligned} \frac{1}{n} |g(\mathbf{x}, \tau_k) - g(\mathbf{y}_k, \tau_k)| &\leq \frac{1}{n} |\tilde{\Phi}_i^\alpha[\tilde{\lambda}(\mathbf{x})](\mathbf{x}; \tau_k) - \tilde{\Phi}_i^\alpha[\tilde{\lambda}(\mathbf{x})](\mathbf{y}_k; \tau_k)| \\ &\quad + \frac{1}{n} |\tilde{\Phi}_j^\beta[\tilde{\lambda}(\mathbf{x})](\mathbf{x}; \tau_k) - \tilde{\Phi}_j^\beta[\tilde{\lambda}(\mathbf{x})](\mathbf{y}_k; \tau_k)| \\ &\leq \|\tilde{\Phi}[\tilde{\lambda}(\mathbf{x})](\mathbf{x}; \tau_k) - \tilde{\Phi}[\tilde{\lambda}(\mathbf{x})](\mathbf{y}_k; \tau_k)\|_1 \\ &\leq \|\mathbf{x} - \mathbf{y}_k\|_1, \end{aligned}$$

and the right-hand side also vanishes when k grows to infinity. As a conclusion, $g(\mathbf{x}, \tau) = 0$ so that $\tau = \tilde{\tau}_{\alpha:i, \beta:j}^{\text{coll}}(\mathbf{x})$.

Thus, for all $(\alpha : i, \beta : j) \in \mathbf{R}(\mathbf{x})$, the function $\tilde{\tau}_{\alpha:i, \beta:j}^{\text{coll}}$ is continuous at \mathbf{x} , and we complete the proof by recalling that the minimum of a finite number of continuous functions remains a continuous function. \square

For initial configurations $\mathbf{x} \notin \mathcal{D}$, Lemma 9.A.4 can be completed by the following lemma.

Lemma 9.A.5 (Estimates on the collision times). *Under Assumption (USH), for all $\mathbf{x} \in D_n^d$, let*

$$\mathbf{R}'(\mathbf{x}) := \{(\alpha : i, \beta : j) \in (P_n^d)^2 : \alpha < \beta, x_i^\alpha = y_j^\beta\},$$

and let us define $\eta' > 0$ by

$$\eta' := \frac{1}{3n} \min\{|x_i^\alpha - x_j^\beta| : (\alpha : i, \beta : j) \in (P_n^d)^2, \alpha < \beta, (\alpha : i, \beta : j) \notin R'(\mathbf{x})\},$$

where we take the convention that $\eta' = +\infty$ whenever the minimum above is taken over an empty set. Then, for all $\mathbf{y} \in D_n^d$ such that $\|\mathbf{x} - \mathbf{y}\|_1 \leq \eta' L_{\text{USH}}/L_{C,1}$,

$$\inf\{t \geq 0 : R(\Phi(\mathbf{y}; t)) = R(\mathbf{x})\} \leq \frac{n}{L_{\text{USH}}} \|\mathbf{x} - \mathbf{y}\|_1,$$

while

$$\sup\{t \geq 0 : R(\Phi(\mathbf{y}; t)) = R(\mathbf{x})\} \geq \frac{2n\eta'}{L_{C,1}}.$$

Proof. Let $\mathbf{y} \in D_n^d$ such that $\|\mathbf{x} - \mathbf{y}\|_1 \leq \eta' L_{\text{USH}}/L_{C,1}$. Recall that $L_{\text{USH}} \leq L_{C,1}$, so that $\|\mathbf{x} - \mathbf{y}\|_1 \leq \eta'$, which implies that

$$R(\mathbf{y}) \subset R(\mathbf{x}) \cup R'(\mathbf{x}).$$

Let $(\alpha : i, \beta : j) \in R(\mathbf{y})$.

- If $(\alpha : i, \beta : j) \in R'(\mathbf{x})$, then by Assumption (USH),

$$\tau_{\alpha:i, \beta:j}^{\text{coll}}(\mathbf{y}) \leq \frac{1}{L_{\text{USH}}}(y_j^\beta - y_i^\alpha) = \frac{1}{L_{\text{USH}}}(y_j^\beta - x_j^\beta + x_i^\alpha - y_i^\alpha) \leq \frac{n}{L_{\text{USH}}} \|\mathbf{x} - \mathbf{y}\|_1.$$

- If $(\alpha : i, \beta : j) \in R(\mathbf{x})$, then by the boundedness of the velocities,

$$\tau_{\alpha:i, \beta:j}^{\text{coll}}(\mathbf{y}) \geq \frac{1}{L_{C,1}}(y_j^\beta - y_i^\alpha) \geq \frac{1}{L_{C,1}}(|x_j^\beta - x_i^\alpha| - n\eta') \geq \frac{2n\eta'}{L_{C,1}}.$$

Since the choice of \mathbf{y} ensures that $\|\mathbf{x} - \mathbf{y}\|_1/L_{\text{USH}} < 2\eta'/L_{C,1}$, we conclude that, on the time interval $[n\|\mathbf{x} - \mathbf{y}\|_1/L_{\text{USH}}, 2n\eta'/L_{C,1}]$, then $R(\Phi(\mathbf{y}; t)) = R(\mathbf{x})$. \square

We are now ready to prove Proposition 9.3.17.

Proof of Proposition 9.3.17. The proof works by induction on $N(\mathbf{x})$.

Let us first fix $\epsilon > 0$ and $\mathbf{x} \in D_n^d$ such that $N(\mathbf{x}) = 0$. Let $\delta > 0$, and let $\mathbf{y} \in \bar{B}_1(\mathbf{x}, \delta)$. Then, in particular, for all $\gamma : k \in P_n^d$, $|x_k^\gamma - y_k^\gamma| \leq n\delta$. We shall study separately $\|\Phi(\mathbf{x}; t) - \Phi(\mathbf{y}; t)\|_1$ on the intervals $[0, \bar{t}(\mathbf{y}))$ and $[\bar{t}(\mathbf{y}), +\infty)$.

If $\bar{t}(\mathbf{y}) = 0$ then the interval $[0, \bar{t}(\mathbf{y}))$ is empty. If $\bar{t}(\mathbf{y}) > 0$, that is to say $N(\mathbf{y}) \geq 1$, then we let $t \in [0, \bar{t}(\mathbf{y}))$. Then

$$\|\Phi(\mathbf{x}; t) - \Phi(\mathbf{y}; t)\|_1 \leq \|\mathbf{x} - \mathbf{y}\|_1 + \frac{1}{n} \sum_{\gamma=1}^d \sum_{k=1}^n \int_{s=0}^t |v_k^\gamma(\mathbf{x}; s) - v_k^\gamma(\mathbf{y}; s)| ds \leq \delta + 2L_{C,1}t.$$

Following Lemma 9.A.3,

$$\bar{t}(\mathbf{y}) \leq \frac{1}{L_{\text{USH}}} \sup\{y_j^\beta - y_i^\alpha, (\alpha : i, \beta : j) \in R(\mathbf{y})\}.$$

and, for all $(\alpha : i, \beta : j) \in R(\mathbf{y})$,

$$y_j^\beta - y_i^\alpha = y_j^\beta - x_j^\beta + x_j^\beta - x_j^\alpha + x_i^\alpha - y_i^\alpha \leq |x_j^\beta - y_j^\beta| + |x_i^\alpha - y_i^\alpha| \leq n\delta,$$

where we have used the fact that $N(\mathbf{x}) = 0$ so that $x_j^\beta \leq x_i^\alpha$. As a consequence,

$$\sup_{t \in [0, \bar{t}(\mathbf{y}))} \|\Phi(\mathbf{x}; t) - \Phi(\mathbf{y}; t)\|_1 \leq \left(1 + \frac{2n}{L_{\text{USH}}} L_{C,1}\right) \delta.$$

We now study $\|\Phi(\mathbf{x}; t) - \Phi(\mathbf{y}; t)\|_1$ for $t \geq \bar{t}(\mathbf{y})$. Letting $\mathbf{x}' := \Phi(\mathbf{x}; \bar{t}(\mathbf{y}))$, $\mathbf{y}' := \Phi(\mathbf{y}; \bar{t}(\mathbf{y}))$ and using Proposition 9.3.16, this amounts to studying $\|\Phi(\mathbf{x}'; t) - \Phi(\mathbf{y}'; t)\|_1$ for $t \geq 0$. By the definition of \bar{t} , $N(\mathbf{x}') = N(\mathbf{y}') = 0$, so that $\tilde{\lambda}(\mathbf{x}') = \tilde{\lambda}(\mathbf{y}')$. Hence, for all $t \geq 0$, Lemma 9.3.10 yields

$$\|\Phi(\mathbf{x}'; t) - \Phi(\mathbf{y}'; t)\|_1 = \|\tilde{\Phi}[\tilde{\lambda}(\mathbf{x}')](\mathbf{x}'; t) - \tilde{\Phi}[\tilde{\lambda}(\mathbf{x}')](\mathbf{y}'; t)\|_1 \leq \|\mathbf{x}' - \mathbf{y}'\|_1.$$

Using the bound obtained on $\|\mathbf{x}' - \mathbf{y}'\|_1$ above, we finally deduce that

$$\sup_{t \geq 0} \|\Phi(\mathbf{x}; t) - \Phi(\mathbf{y}; t)\|_1 \leq \left(1 + \frac{2n}{L_{\text{USH}}} L_{C,1}\right) \delta,$$

so that the conclusion follows from taking δ small enough for the inequality

$$\left(1 + \frac{2n}{L_{\text{USH}}} L_{C,1}\right) \delta \leq \epsilon$$

to hold.

We now let $N \geq 0$ such that, for all $\mathbf{x} \in D_n^d$ such that $N(\mathbf{x}) \leq N$, the conclusion of Proposition 9.3.17 holds. Let us fix $\epsilon > 0$ and $\mathbf{x} \in D_n^d$, such that $N(\mathbf{x}) = N + 1$. We are willing to construct $\delta > 0$ such that, for all $\mathbf{y} \in \bar{B}_1(\mathbf{x}, \delta)$,

$$\sup_{t \geq 0} \|\Phi(\mathbf{x}; t) - \Phi(\mathbf{y}; t)\|_1 \leq \epsilon.$$

First, by Corollary 9.3.12, $N(\mathbf{x}^*) \leq N$, therefore there exists $\delta^* > 0$ such that, for all $\mathbf{y} \in D_n^d$, if $\|\mathbf{x}^* - \Phi(\mathbf{y}; t^*(\mathbf{x}))\|_1 \leq \delta^*$, then

$$\sup_{t \geq 0} \|\Phi(\mathbf{x}^*; t) - \Phi(\Phi(\mathbf{y}; t^*(\mathbf{x})); t)\|_1 \leq \epsilon,$$

that is to say, thanks to the flow property stated in Proposition 9.3.16,

$$\sup_{t \geq t^*(\mathbf{x})} \|\Phi(\mathbf{x}; t) - \Phi(\mathbf{y}; t)\|_1 \leq \epsilon.$$

We now prove that there exists $\delta > 0$ such that, for all $\mathbf{y} \in \bar{B}_1(\mathbf{x}, \delta)$, then $\sup_{t \in [0, t^*(\mathbf{x})]} \|\Phi(\mathbf{x}; t) - \Phi(\mathbf{y}; t)\|_1 \leq \epsilon$ and $\|\mathbf{x}^* - \Phi(\mathbf{y}; t^*(\mathbf{x}))\|_1 \leq \delta^*$; which we shall actually do at once by constructing $\delta > 0$ such that, for all $\mathbf{y} \in \bar{B}_1(\mathbf{x}, \delta)$,

$$\sup_{t \in [0, t^*(\mathbf{x})]} \|\Phi(\mathbf{x}; t) - \Phi(\mathbf{y}; t)\|_1 \leq \epsilon \wedge \delta^*.$$

To this aim, we first assume that $\mathbf{x} \in \mathcal{D}$. Then, by (i) in Lemma 9.A.4, there exists $\eta > 0$ such that, for all $\mathbf{y} \in \bar{B}_1(\mathbf{x}, \eta)$, then $R(\mathbf{x}) = R(\mathbf{y})$, and therefore $\tilde{\lambda}(\mathbf{x}) = \tilde{\lambda}(\mathbf{y}) =: \bar{\lambda}$. As a consequence, for all $t \in [0, t^*(\mathbf{x}) \wedge t^*(\mathbf{y})]$,

$$\Phi(\mathbf{x}; t) = \tilde{\Phi}[\bar{\lambda}](\mathbf{x}; t), \quad \Phi(\mathbf{y}; t) = \tilde{\Phi}[\bar{\lambda}](\mathbf{y}; t),$$

so that Lemma 9.3.10 yields

$$\forall t \in [0, t^*(\mathbf{x}) \wedge t^*(\mathbf{y})], \quad \|\Phi(\mathbf{x}; t) - \Phi(\mathbf{y}; t)\|_1 \leq \|\mathbf{x} - \mathbf{y}\|_1.$$

Letting $\mathbf{x}' := \Phi(\mathbf{x}; t^*(\mathbf{x}) \wedge t^*(\mathbf{y}))$, $\mathbf{y}' := \Phi(\mathbf{y}; t^*(\mathbf{x}) \wedge t^*(\mathbf{y}))$, one still has the trivial bound, for all $t \in [t^*(\mathbf{x}) \wedge t^*(\mathbf{y}), t^*(\mathbf{x})]$,

$$\begin{aligned} \|\Phi(\mathbf{x}; t) - \Phi(\mathbf{y}; t)\|_1 &\leq \|\mathbf{x}' - \mathbf{y}'\|_1 + 2L_{C,1}(t - t^*(\mathbf{x}) \wedge t^*(\mathbf{y})) \\ &\leq \|\mathbf{x} - \mathbf{y}\|_1 + 2L_{C,1}|t^*(\mathbf{x}) - t^*(\mathbf{y})|. \end{aligned}$$

As a conclusion, for $\mathbf{y} \in D_n^d$ such that $\|\mathbf{x} - \mathbf{y}\|_1 \leq \eta$,

$$\sup_{t \in [0, t^*(\mathbf{x})]} \|\Phi(\mathbf{x}; t) - \Phi(\mathbf{y}; t)\|_1 \leq \|\mathbf{x} - \mathbf{y}\|_1 + 2L_{C,1}|t^*(\mathbf{x}) - t^*(\mathbf{y})|.$$

By Lemma 9.A.4, there exists $\delta > 0$ such that, for all $\mathbf{y} \in D_n^d$ such that $\|\mathbf{x} - \mathbf{y}\|_1 \leq \delta$, the right-hand side above is lower than $\epsilon \wedge \delta^*$. This completes the proof of the case $\mathbf{x} \in \mathcal{D}$.

Without assuming that $\mathbf{x} \in \mathcal{D}$, we proceed as follows. Let $\eta' > 0$ be given by Lemma 9.A.5. Let us note that, since $N(\mathbf{x}) \geq 1$, then $\eta' < +\infty$. Besides, the proof of Lemma 9.A.5 shows that $t^*(\mathbf{x}) \geq 3n\eta'/L_{C,1}$. Let us denote

$$t' := \frac{2n\eta'}{L_{C,1}} \in (0, t^*(\mathbf{x})).$$

Then $\Phi(\mathbf{x}; t') \in \mathcal{D}$, and $R(\Phi(\mathbf{x}; t')) = R(\mathbf{x})$. As a consequence, using the argument above, we obtain that there exists $\delta' > 0$ such that, for all $\mathbf{y} \in D_n^d$ such that $\Phi(\mathbf{y}; t') \in \bar{B}_1(\Phi(\mathbf{x}; t'), \delta')$, then

$$\sup_{t \in [t', t^*(\mathbf{x})]} \|\Phi(\mathbf{x}; t) - \Phi(\mathbf{y}; t)\|_1 \leq \epsilon \wedge \delta^*.$$

Now, for all $\mathbf{y} \in D_n^d$ such that $\|\mathbf{x} - \mathbf{y}\|_1 \leq n\eta' L_{\text{USH}}/L_{C,1}$, then

$$t'' := \inf\{t \geq 0 : R(\Phi(\mathbf{y}; t)) = R(\mathbf{x})\} \leq t',$$

and

$$\sup_{t \in [0, t'']} \|\Phi(\mathbf{x}; t) - \Phi(\mathbf{y}; t)\|_1 \leq \|\mathbf{x} - \mathbf{y}\|_1 + 2L_{C,1}t'' \leq \left(1 + 2n\frac{L_{C,1}}{L_{\text{USH}}}\right) \|\mathbf{x} - \mathbf{y}\|_1,$$

where the bound on t'' follows from Lemma 9.A.5. On the other hand, using Lemma 9.A.5 again, we obtain that, on the time interval $[t'', t']$, $R(\Phi(\mathbf{y}; t)) = R(\mathbf{x}) = R(\Phi(\mathbf{x}; t))$, therefore by Lemma 9.3.10,

$$\sup_{t \in [t'', t']} \|\Phi(\mathbf{x}; t) - \Phi(\mathbf{y}; t)\|_1 \leq \|\Phi(\mathbf{x}; t'') - \Phi(\mathbf{y}; t'')\|_1 \leq \left(1 + 2n\frac{L_{C,1}}{L_{\text{USH}}}\right) \|\mathbf{x} - \mathbf{y}\|_1.$$

As a consequence, letting

$$\delta := \min\left(n\eta' \frac{L_{\text{USH}}}{L_{C,1}}, \frac{\epsilon \wedge \delta'}{1 + 2nL_{C,1}/L_{\text{USH}}}\right),$$

we conclude that, for all $\mathbf{y} \in \bar{B}_1(\mathbf{x}, \delta)$,

$$\|\Phi(\mathbf{x}; t') - \Phi(\mathbf{y}; t')\|_1 \leq \delta',$$

while

$$\sup_{t \in [0, t']} \|\Phi(\mathbf{x}; t) - \Phi(\mathbf{y}; t)\|_1 \leq \epsilon,$$

which completes the proof. \square

9.A.3 Proof of Lemma 9.4.13

We now detail the proof of Lemma 9.4.13, which asserts that the set of good configurations \mathcal{G} is dense in D_n^d .

Proof of Lemma 9.4.13. Let us begin the proof by recalling the chain of inclusions

$$\mathcal{G} \subset \mathcal{B} \subset \mathcal{D} \subset D_n^d,$$

and that \mathcal{D} is dense in D_n^d . As a consequence, it suffices to prove that, for all $\mathbf{x} \in \mathcal{D}$, for all $\epsilon > 0$, there exists $\mathbf{y} \in \mathcal{G}$ such that $\|\mathbf{x} - \mathbf{y}\|_1 \leq \epsilon$. The reader will not be surprised that the proof works by induction on $N(\mathbf{x})$.

If $\mathbf{x} \in \mathcal{D}$ and $N(\mathbf{x}) = 0$, then $\mathbf{x} \in \mathcal{G}$ and there is nothing to prove. Now let $N \geq 0$ such that any $\mathbf{x} \in \mathcal{D}$ with $N(\mathbf{x}) \leq N$ belongs to the closure of \mathcal{G} . Let $\mathbf{x} \in \mathcal{D}$ with $N(\mathbf{x}) = N + 1$; in particular, $t^*(\mathbf{x}) < +\infty$. Let us fix

$$t^*(\mathbf{x}) < t' < t'' < t^*(\mathbf{x}) + t^*(\mathbf{x}^*),$$

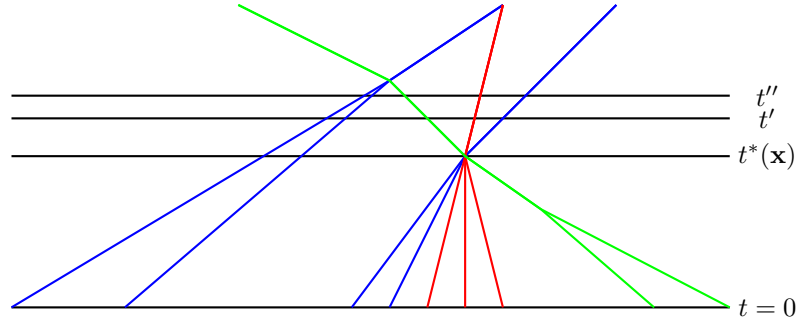

Figure 9.8: The choices of t' and t'' to ensure that, on the time interval $(t^*(\mathbf{x}), t'']$, there is neither self-interaction nor collision in the MSPD started at \mathbf{x} .

such that, in the MSPD started at \mathbf{x} , there is no self-interaction on the time interval $(t^*(\mathbf{x}), t'']$, see Figure 9.8.

We shall prove in Step 1 below that, for all $\epsilon > 0$, there exists $\mathbf{x}' \in \bar{B}_1(\mathbf{x}, \epsilon)$ and $s' \in (0, t^*(\mathbf{x}))$ such that:

- in the MSPD started at \mathbf{x}' , there is no self-interaction on the time interval $[s', t^*(\mathbf{x})]$,
- for all $t \geq t^*(\mathbf{x})$, $\Phi(\mathbf{x}; t) = \Phi(\mathbf{x}'; t)$.

As a consequence, we shall assume, without loss of generality, that \mathbf{x} satisfies the following property: there exists $s' \in (0, t^*(\mathbf{x}))$ such that, in the MSPD started at \mathbf{x} , there is no self-interaction on the time interval $[s', t^*(\mathbf{x})]$, see Figure 9.9.

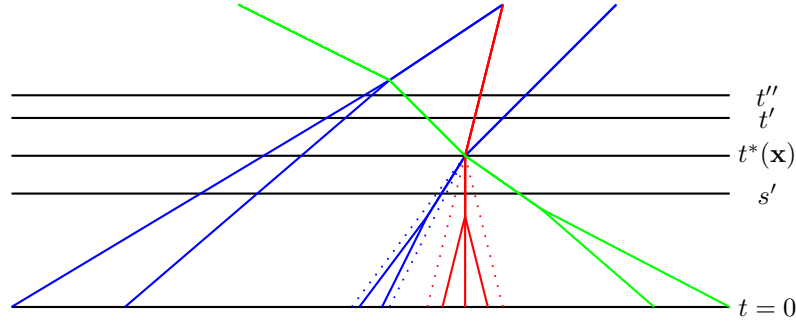

Figure 9.9: The shrinking of particles having a self-interaction at time $t^*(\mathbf{x})$ allows to select $s' < t^*(\mathbf{x})$ such that there is no self-interaction on the time interval $[s', t'']$.

Then, arguing as in the proof of Lemma 9.4.16, there exists $\epsilon_0 > 0$ such that, for all $\mathbf{y} \in \bar{B}_1(\mathbf{x}, \epsilon_0)$,

1. $\mathbf{y} \in \mathcal{D}$ and $R(\mathbf{y}) = R(\mathbf{x})$,
2. $\Phi(\mathbf{y}; s') \in \mathcal{D}$ and $R(\Phi(\mathbf{y}; s')) = R(\Phi(\mathbf{x}; s'))$, which implies that, in the MSPD started at \mathbf{y} , there is no collision on the time interval $[0, s']$,
3. for all $\gamma : k \in P_n^d$, $\text{clu}_k^\gamma(\mathbf{y}; s') = \text{clu}_k^\gamma(\mathbf{x}; s')$,
4. $\Phi(\mathbf{y}; t') \in \mathcal{D}$ and $R(\Phi(\mathbf{y}; t')) = R(\Phi(\mathbf{x}; t'))$, which implies that

$$\{(\alpha : i, \beta : j) \in R(\mathbf{x}) : \tau_{\alpha:i, \beta:j}^{\text{coll}}(\mathbf{x}) \in [t^*(\mathbf{x}), t']\} = \{(\alpha : i, \beta : j) \in R(\mathbf{y}) : \tau_{\alpha:i, \beta:j}^{\text{coll}}(\mathbf{y}) \in (s', t')\}$$

i.e. the collisions in the MSPD started at \mathbf{x} on the time interval $[t^*(\mathbf{x}), t']$ (or, equivalently, (s', t')) involve the same pairs of particles as the collisions in the MSPD started at \mathbf{y} on the time interval (s', t') ,

5. $\Phi(\mathbf{y}; t'') \in \mathcal{D}$ and $R(\Phi(\mathbf{y}; t'')) = R(\Phi(\mathbf{x}; t''))$, which implies that, in the MSPD started at \mathbf{y} , there is no collision on the time interval $[t', t'']$,

6. for all $\gamma : k \in P_n^d$, $\text{clu}_k^\gamma(\mathbf{y}; t'') = \text{clu}_k^\gamma(\mathbf{x}; t'')$, which implies that, in the MSPD started at \mathbf{y} , there is no self-interaction on the time interval $[s', t'']$.

Let us fix $\epsilon \in (0, \epsilon_0]$. The sequel of the proof is as follows: in Step 2, we construct $\mathbf{y}_0 \in \bar{B}_1(\mathbf{x}, \epsilon/2)$ such that, in the MSPD started at \mathbf{y}_0 , the collisions on the time interval $[0, t']$ (or, equivalently, (s', t')), are binary. Of course, $\|\mathbf{x} - \mathbf{y}_0\|_1 \leq \epsilon_0$, therefore \mathbf{y}_0 satisfies all the conditions above; in particular, in the MSPD started at \mathbf{y}_0 , the self-interactions are separated from collisions on the time interval $[0, t']$. In Step 3, we show that there exists $\eta \in (0, \epsilon/2]$ such that, for all $\mathbf{y} \in \bar{B}_1(\mathbf{y}_0, \eta)$, the collisions on the time interval $[0, t']$ in the MSPD started at \mathbf{y} remain binary. In Step 4, we construct $\eta' > 0$ such that, for all $\mathbf{y}' \in \bar{B}_1(\Phi(\mathbf{y}_0; t'), \eta')$, there exists $\mathbf{y} \in \bar{B}_1(\mathbf{y}_0, \eta)$ such that $\Phi(\mathbf{y}'; t'' - t') = \Phi(\mathbf{y}; t'')$.

Taking the result of these four steps for granted, let us explain how to complete the proof. By construction, the collisions in the time interval $[0, t']$ in the MSPD started at \mathbf{y}_0 are binary and separated from self-interactions. Besides, $N(\Phi(\mathbf{y}_0; t')) = N(\Phi(\mathbf{x}; t')) \leq N$, therefore there exists $\mathbf{y}' \in \bar{B}_1(\Phi(\mathbf{y}_0; t'), \eta')$ such that $\mathbf{y}' \in \mathcal{G}$. Let $\mathbf{y} \in \bar{B}_1(\mathbf{y}_0, \eta)$ be given by Step 4. Then, on the one hand,

$$\|\mathbf{x} - \mathbf{y}\|_1 \leq \|\mathbf{x} - \mathbf{y}_0\|_1 + \|\mathbf{y}_0 - \mathbf{y}\|_1 \leq \frac{\epsilon}{2} + \eta \leq \epsilon,$$

while, on the other hand,

- since $\mathbf{y} \in \bar{B}_1(\mathbf{y}_0, \eta)$, the collisions are binary and separated from self-interactions on the time interval $[0, t']$ in the MSPD started at \mathbf{y} ,
- since $\mathbf{y}' \in \mathcal{G}$, the collisions are binary and separated from self-interactions in the MSPD started at $\Phi(\mathbf{y}'; t'' - t') = \Phi(\mathbf{y}; t'')$.

As a consequence of the flow property for the MSPD, $\mathbf{y} \in \mathcal{G}$ and the proof is completed.

Let us now give a detailed proof of Steps 1 to 4.

Step 1. We separate self-interactions from collisions by shrinking groups of particles involved in self-interactions at time $t^*(\mathbf{x})$ around their center of mass, as is depicted on Figure 9.9. Let us fix $\epsilon > 0$ and assume that there exist $\gamma \in \{1, \dots, d\}$ and $\underline{k} < \bar{k}$ such that

$$\text{clu}_{\underline{k}}^\gamma(\mathbf{x}; t^*(\mathbf{x})) = \text{clu}_{\bar{k}}^\gamma(\mathbf{x}; t^*(\mathbf{x})) = \gamma : \underline{k} \cdots \bar{k}, \quad \text{clu}_{\underline{k}}^\gamma(\mathbf{x}; t^*(\mathbf{x})^-) \neq \text{clu}_{\bar{k}}^\gamma(\mathbf{x}; t^*(\mathbf{x})^-),$$

that is to say, a self-interaction occurs at time $t^*(\mathbf{x})$ between the particles $\gamma : \underline{k}, \dots, \gamma : \bar{k}$. Note that this implies that $\partial_\gamma \lambda^\gamma < 0$. Let us define

$$\xi := \frac{1}{\bar{k} - \underline{k} + 1} \sum_{k=\underline{k}}^{\bar{k}} x_k^\gamma,$$

and denote by \mathbf{x}^ρ the configuration in D_n^d such that, for all $\gamma' : k' \in P_n^d$,

$$(x^\rho)_{k'}^{\gamma'} := \begin{cases} x_{k'}^{\gamma'} & \text{if } \gamma' : k' \notin \gamma : \underline{k} \cdots \bar{k}, \\ (1 - \rho)\xi + \rho x_{k'}^{\gamma'} & \text{otherwise,} \end{cases}$$

for all $\rho \in [0, 1]$. Then, it is easily seen that, for all $\gamma' : k' \notin \gamma : \underline{k} \cdots \bar{k}$,

$$\forall t \in [0, t'], \quad \Phi_{k'}^{\gamma'}(\mathbf{x}^\rho; t) = \Phi_{k'}^{\gamma'}(\mathbf{x}; t).$$

Besides, we claim that

1. $\inf\{t \geq 0 : \Phi_{\underline{k}}^\gamma(\mathbf{x}^\rho; t) = \Phi_{\bar{k}}^\gamma(\mathbf{x}^\rho; t)\} = \rho t^*(\mathbf{x})$,
2. for all $k \in \{\underline{k}, \dots, \bar{k}\}$, for all $t \geq \rho t^*(\mathbf{x})$, $\Phi_k^\gamma(\mathbf{x}^\rho; t) = \Phi_k^\gamma(\mathbf{x}^0; t)$,
3. for all $k \in \{\underline{k}, \dots, \bar{k}\}$, for all $t \geq t^*(\mathbf{x})$, $\Phi_k^\gamma(\mathbf{x}^\rho; t) = \Phi_k^\gamma(\mathbf{x}; t)$.

The first point is obtained by elementary geometry if there is no self-interaction between times 0 and $t^*(\mathbf{x})$. Otherwise, let c_1, \dots, c_r denote the distinct elements of the set

$$\{\text{clu}_k^\gamma(\mathbf{x}; t^*(\mathbf{x})^-), k \in \{\underline{k}, \dots, \bar{k}\}\}.$$

Let us recall that in the proof of Lemma 9.4.16, we made the observation that, in the Local Sticky Particle Dynamics, the center of mass travels at constant velocity whatever the composition of the clusters. Applying this remark to each generical cluster c_i , we write

$$t^*(\mathbf{x}) = \inf\{t \geq 0 : \Phi_{\underline{k}}^\gamma(\tilde{\mathbf{x}}; t) = \Phi_{\bar{k}}^\gamma(\tilde{\mathbf{x}}; t)\},$$

where $\tilde{\mathbf{x}}$ is derived from \mathbf{x} by the following procedure: for all $i \in \{1, \dots, r\}$, for all $\gamma : k \in c_i$, replace the coordinate x_k^γ in \mathbf{x} with

$$\tilde{x}_k^\gamma := \frac{1}{|c_i|} \sum_{\gamma: k' \in c_i} x_{k'}^\gamma.$$

Then, in the MSPD started at $\tilde{\mathbf{x}}$, the particles $\gamma : \underline{k}, \dots, \gamma : \bar{k}$ do not have self-interactions between times 0 and $t^*(\mathbf{x})$, so that the argument above yields

$$\inf\{t \geq 0 : \Phi_{\underline{k}}^\gamma(\tilde{\mathbf{x}}^\rho; t) = \Phi_{\bar{k}}^\gamma(\tilde{\mathbf{x}}^\rho; t)\} = \rho \inf\{t \geq 0 : \Phi_{\underline{k}}^\gamma(\tilde{\mathbf{x}}; t) = \Phi_{\bar{k}}^\gamma(\tilde{\mathbf{x}}; t)\} = \rho t^*(\mathbf{x}),$$

where $\tilde{\mathbf{x}}^\rho$ is derived from $\tilde{\mathbf{x}}$ in the same fashion as \mathbf{x}^ρ is derived from \mathbf{x} . To complete the argument, we now have to check that

$$\inf\{t \geq 0 : \Phi_{\underline{k}}^\gamma(\mathbf{x}^\rho; t) = \Phi_{\bar{k}}^\gamma(\mathbf{x}^\rho; t)\} = \inf\{t \geq 0 : \Phi_{\underline{k}}^\gamma(\tilde{\mathbf{x}}^\rho; t) = \Phi_{\bar{k}}^\gamma(\tilde{\mathbf{x}}^\rho; t)\}.$$

This follows from the fact that the operations mapping \mathbf{x} to $\tilde{\mathbf{x}}$ and \mathbf{x} to \mathbf{x}^ρ are commutative; therefore the equality above is obtained by the same geometric arguments as in the case $\rho = 1$.

The second and third points above easily follow.

Finally, the configuration \mathbf{x}^ρ satisfies

$$\|\mathbf{x} - \mathbf{x}^\rho\|_1 = \frac{1-\rho}{n} \sum_{k=\underline{k}}^{\bar{k}} |\xi - x_k^\gamma|,$$

so that for ρ close enough to 1, $\|\mathbf{x} - \mathbf{x}^\rho\|_1 \leq \epsilon$ while the self-interactions between the particles $\gamma : \underline{k}, \dots, \gamma : \bar{k}$ in the MSPD started at \mathbf{x}^ρ occur before $\rho t^*(\mathbf{x}) < t^*(\mathbf{x})$, without modifying neither the trajectories of the other particles on $[0, t^*(\mathbf{x})]$, nor the trajectories of all the particles after $t^*(\mathbf{x})$ with respect to the MSPD started at \mathbf{x} . Applying the argument to the finite number of groups of particles having a self-interaction at time $t^*(\mathbf{x})$, we conclude that there exists $\mathbf{x}' \in \bar{B}_1(\mathbf{x}, \epsilon)$ and $s' \in (0, t^*(\mathbf{x}))$ such that, in the MSPD started at \mathbf{x}' , there is no self-interaction in the time interval $[s', t^*(\mathbf{x})]$.

Step 2. We now blow up the non-binary collisions by shifting the initial positions, as is described on Figure 9.10. Let us assume that there exist

$$\gamma_1 < \dots < \gamma_r, \quad r \geq 3,$$

such that, in the MSPD started at \mathbf{x} , a collision occurs at the space-time point $(\xi^*, t^*(\mathbf{x}))$ between clusters of type $\gamma_1, \dots, \gamma_r$. For all $i \in \{1, \dots, r\}$, let us denote by c_i the cluster of type γ_i involved in the collision. For $\theta > 0$, let us define the configuration $\mathbf{x}^{\theta,1}$ as follows: for all $\gamma : k \in P_n^d$,

$$(x^{\theta,1})_k^\gamma := \begin{cases} x_k^\gamma & \text{if } \gamma : k \notin c_3 \cup \dots \cup c_r, \\ x_k^\gamma + \theta & \text{if } \gamma : k \in c_3 \cup \dots \cup c_r. \end{cases}$$

Note that

$$\|\mathbf{x} - \mathbf{x}^{\theta,1}\|_1 \leq \frac{\theta}{n} (|c_3| + \dots + |c_r|),$$

so that θ can be chosen small enough to ensure that $\mathbf{x}^{\theta,1} \in \bar{B}_1(\mathbf{x}, \epsilon_0)$, and therefore satisfies all the conditions stated in the introduction of the proof. In particular, on the time interval $[s', t']$, the collisions in the MSPD started at $\mathbf{x}^{\theta,1}$ remain the same as in the MSPD started at \mathbf{x} .

Then, it is straightforwardly checked that, in the MSPD started at $\mathbf{x}^{\theta,1}$,

- there is a binary collision between c_1 and c_2 at the space-time point $(\xi^*, t^*(\mathbf{x}))$,
- there is a collision between c_3, \dots, c_r at the space-time point $(\xi^* + \theta, t^*(\mathbf{x}))$,
- if $\tau_{i,j}$ refers to the instant of collision between the clusters c_i and c_j , then

$$\forall j \in \{3, \dots, r\}, \quad t^*(\mathbf{x}) < \tau_{1,j} < \tau_{2,j}.$$

More precisely, the boundedness of the velocities yields

$$\tau_{1,j} \geq t^*(\mathbf{x}) + \frac{\theta}{2L_{C,1}},$$

while Assumption (USH) yields

$$\tau_{2,j} \leq t^*(\mathbf{x}) + \frac{\theta}{L_{\text{USH}}}.$$

Let us now define the configuration $\mathbf{x}^{\theta,2}$ by, for all $\gamma : k \in P_n^d$,

$$(x^{\theta,2})_k^\gamma := \begin{cases} (x^{\theta,1})_k^\gamma & \text{if } \gamma : k \notin c_4 \cup \dots \cup c_r, \\ (x^{\theta,1})_k^\gamma + \theta \left(\frac{2L_{C,1}}{L_{\text{USH}}} - 1 \right) & \text{if } \gamma : k \in c_4 \cup \dots \cup c_r. \end{cases}$$

Then, the same arguments as above ensure that, for θ small enough, in the MSPD started at $\mathbf{x}^{\theta,2}$,

- there is a binary collision between c_1 and c_2 at time $t^*(\mathbf{x})$,
- there are binary collisions between c_3 and c_1 , then between c_3 and c_2 , at respective times $\tau_{1,3}$ and $\tau_{2,3}$ such that

$$t^*(\mathbf{x}) < \tau_{1,3} < \tau_{2,3} \leq t^*(\mathbf{x}) + \frac{\theta}{L_{\text{USH}}},$$

- all the collisions between clusters c_1, c_2, c_3 on the one hand and c_4, \dots, c_r on the other hand occur after the time $t^*(\mathbf{x}) + \theta/L_{\text{USH}}$.

Iterating the argument, we finally construct a configuration $\mathbf{x}^{\theta,r-2}$ such that

$$\|\mathbf{x} - \mathbf{x}^{\theta,r-2}\|_1 \leq C\theta$$

for some constant C depending only on $L_{C,1}$, L_{USH} , n and d , and, for θ small enough, in the MSPD started at $\mathbf{x}^{\theta,r-2}$, if $\tau_{i,j}$ refers to the instant of collision between c_i and c_j , then, for all $j \in \{3, \dots, r\}$,

$$\tau_{j-2,j-1} \leq \tau_{1,j} < \tau_{2,j} < \dots < \tau_{j-1,j}.$$

We complete Step 2 by applying the argument to blow-up all the non-binary collisions, and finally take θ small enough for the resulting configuration \mathbf{y}_0 to be such that $\|\mathbf{x} - \mathbf{y}_0\|_1 \leq \epsilon/2$.

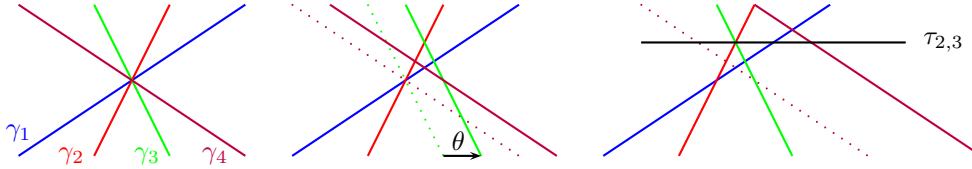

Figure 9.10: Blowing up the non-binary collisions: the left-hand figure represents a collision involving four clusters $\gamma_1, \dots, \gamma_4$. In the central figure, the clusters γ_3 and γ_4 are shifted on the right of a distance θ . In the right-hand figure, the cluster γ_4 is shifted on the right in order to ensure that its first collision with one of the three other clusters occurs after $\tau_{2,3}$, therefore after all the collisions between the clusters γ_1, γ_2 and γ_3 . The minimal shift distance remains proportional to θ .

Step 3. We begin by noting that, for all $\eta \in (0, \epsilon/2]$, for all $\mathbf{y} \in \bar{B}_1(\mathbf{y}_0, \eta)$, $\|\mathbf{x} - \mathbf{y}\|_1 \leq \epsilon_0$, therefore \mathbf{y} satisfies all the conditions stated in the introduction of the proof. In particular, in the

MSPD started at \mathbf{y} , there is no self-interaction on the time interval $[s', t'']$, while all the collisions occurring on the time interval $[0, t'']$ actually occur on the time interval (s', t') , and they involve the same pairs of clusters than in the MSPD started at \mathbf{y}_0 . By Step 2, it is known that the corresponding collisions are binary in the MSPD started at \mathbf{y}_0 . Let R refer to the subset of $\mathbf{R}(\mathbf{y}_0)$ defined by

$$R := \{(\alpha : i, \beta : j) \in \mathbf{R}(\mathbf{y}_0) : \tau_{\alpha:i, \beta:j}^{\text{coll}}(\mathbf{y}_0) \in (s', t')\} = \mathbf{R}(\mathbf{y}_0) \setminus \mathbf{R}(\Phi(\mathbf{y}_0; t')).$$

By Proposition 9.3.17, one can construct $\eta \in (0, \epsilon/2]$ such that, for all $\mathbf{y} \in \bar{B}_1(\mathbf{y}_0, \eta)$, for all $(\alpha : i, \beta : j)$ and $(\alpha' : i', \beta' : j') \in R$, if $\Xi_{\alpha:i, \beta:j}^{\text{coll}}(\mathbf{y}_0) \neq \Xi_{\alpha':i', \beta':j'}^{\text{coll}}(\mathbf{y}_0)$, then $\Xi_{\alpha:i, \beta:j}^{\text{coll}}(\mathbf{y}) \neq \Xi_{\alpha':i', \beta':j'}^{\text{coll}}(\mathbf{y})$. This implies that, in the MSPD started at \mathbf{y} , the collisions on $[0, t']$ are binary.

Step 4. By Lemma 9.4.3, there exists $\eta'_1 > 0$ such that, for all $\mathbf{y}' \in \bar{B}_1(\Phi(\mathbf{y}_0; t'), \eta'_1)$, for all $\gamma : k \in P_n^d$,

$$\text{clu}_k^\gamma(\mathbf{y}'; t'' - t') = \text{clu}_k^\gamma(\mathbf{y}_0; t'').$$

Besides, by Lemma 9.A.4, there exists $\eta'_2 > 0$ such that, for all $\mathbf{y}' \in \bar{B}_1(\Phi(\mathbf{y}_0; t'), \eta'_2)$, $\mathbf{R}(\mathbf{y}') = \mathbf{R}(\Phi(\mathbf{y}_0; t'))$ and $t^*(\mathbf{y}') > t'' - t'$, which implies

$$\|\Phi(\mathbf{y}'; t'' - t') - \Phi(\mathbf{y}_0; t'')\|_1 \leq \|\mathbf{y}' - \Phi(\mathbf{y}_0; t')\|_1, \quad (9.50)$$

thanks to Lemma 9.3.10.

For $\mathbf{y}' \in \bar{B}_1(\Phi(\mathbf{y}_0; t'), \eta'_1 \wedge \eta'_2)$ and $\mathbf{y}'' := \Phi(\mathbf{y}'; t'' - t')$, we are willing to construct \mathbf{y} , close to \mathbf{y}_0 , such that $\Phi(\mathbf{y}; t'') = \mathbf{y}''$. It is therefore necessary to describe how to follow the MSPD flow *backward*, and we shall construct a process $(\Psi(\mathbf{y}''; s))_{s \in [0, t'' - s']}$ such that

$$\forall s \in [0, t'' - s'], \quad \Phi(\Psi(\mathbf{y}''; s); t'' - s) = \mathbf{y}''.$$

Of course, there is generically not a unique fashion to do so; since clusters containing several particles in \mathbf{y}'' could split at any time $s \geq 0$. In order to ensure that $\Psi(\mathbf{y}''; s)$ remains as close as possible to $\Phi(\mathbf{y}_0; t'' - s)$, we define the backward dynamics $(\Psi(\mathbf{y}''; s))_{s \in [0, t'' - s']}$ so that clusters never split.

Let us carry this task out by defining the *backward frozen dynamics* independently of the setting of the proof. Let $\mathbf{z} \in D_n^d$, and let c_1, \dots, c_L refer to the partition of P_n^d into generical clusters such that, for all $\gamma : k \in P_n^d$, the generical cluster c_l containing $\gamma : k$ is the largest set of particles of type γ having the same position as $\gamma : k$ in the configuration \mathbf{z} . The generical cluster c_l shall be called the *frozen cluster* of the particle $\gamma : k$.

For all $s \geq 0$, we define the process $(\Psi(\mathbf{z}; s))_{s \geq 0}$ as follows. For all $l \in \{1, \dots, L\}$, the initial velocity of all the particles in the frozen cluster c_l is set to

$$-\frac{1}{|c_l|} \sum_{\gamma: k \in c_l} \tilde{\lambda}_k^\gamma(\mathbf{z}). \quad (9.51)$$

Then, frozen clusters travel at constant velocity. When two frozen clusters of the same type collide, they stick together and form a frozen cluster with velocity determined by conservation of mass and momentum. When clusters of different type collide, say at time s^* , they remain formed and the new velocity of each cluster is given by (9.51), where \mathbf{z} is replaced with $\Psi(\mathbf{z}; s^*)$ instead.

This backward frozen dynamics is generally *not* the MSPD with reverse velocity function $-\lambda$; since, in the latter dynamics, frozen clusters of a type γ such that $-\partial_\gamma \lambda^\gamma > 0$ would instantaneously split. However, it can be interpreted as a variant of the MSPD, where the initial velocity of the particle $\gamma : k$ in the frozen cluster c_l is defined by (9.51) instead of $-\tilde{\lambda}_k^\gamma(\mathbf{z})$. This ensures that frozen clusters do not split, and stick together at collisions with frozen clusters of the same type — which we shall refer to as *self-interactions* for the backward frozen dynamics.

As a consequence, the proof of Proposition 9.3.17 can be slightly adapted to yield the following statement: if $\mathbf{z} \in D_n^d$ and $s \geq 0$ are such that, in the backward dynamics started at \mathbf{z} , there is no self-interaction on the time interval $[0, s]$, then for all $\epsilon > 0$, there exists $\delta > 0$ such that, for all $\mathbf{z}' \in \bar{B}_1(\mathbf{z}, \delta)$ having the property that the frozen clusters are the same in the configurations \mathbf{z} and \mathbf{z}' , we have:

- there is no self-interaction in the backward frozen dynamics started at \mathbf{z}' on the time interval $[0, s]$, which implies that the frozen clusters are the same in the configurations $\Psi(\mathbf{z}; r)$ and $\Psi(\mathbf{z}'; r)$ for all $r \in [0, s]$,
- the following continuity property holds:

$$\sup_{r \in [0, s]} \|\Psi(\mathbf{z}; r) - \Psi(\mathbf{z}'; r)\|_1 \leq \epsilon.$$

We shall refer to these two points as Property (*).

Let us now come back to the construction of \mathbf{y} , close to \mathbf{y}_0 , and such that $\Phi(\mathbf{y}; t'') = \mathbf{y}''$. Let $\mathbf{y}_0'' := \Phi(\mathbf{y}_0; t'')$. Since there is no self-interaction in the MSPD started at \mathbf{y}_0 on the time interval $[s', t'']$, then it is straightforwardly checked that, for all $s \in [0, t'' - s']$,

$$\Psi(\mathbf{y}_0''; s) = \Phi(\mathbf{y}_0; t'' - s).$$

Let $\epsilon > 0$ to be precised below. Let $\delta > 0$ associated to ϵ by Property (*), and let us define

$$\eta' := \eta'_1 \wedge \eta'_2 \wedge \delta.$$

Let us now fix $\mathbf{y}' \in \bar{B}_1(\Phi(\mathbf{y}_0; t'), \eta')$ and denote $\mathbf{y}'' := \Phi(\mathbf{y}'; t'' - t')$. Then the fact that $\eta' \leq \eta'_1 \wedge \eta'_2$ implies that the frozen clusters are the same in the configurations \mathbf{y}'' and \mathbf{y}_0'' , and (9.50) combined with $\eta' \leq \delta'$ yield $\mathbf{y}'' \in \bar{B}_1(\mathbf{y}_0'', \delta)$. As a consequence, Property (*) ensures that: one the hand, there is no self-interaction in the backward frozen dynamics started at \mathbf{y}'' on the time interval $[0, t'' - s']$, therefore

$$\forall s \in [0, t'' - s'], \quad \Phi(\Psi(\mathbf{y}''; s); t'' - s) = \mathbf{y}'';$$

on the other hand,

$$\sup_{s \in [0, t'' - s']} \|\Psi(\mathbf{y}''; s) - \Psi(\mathbf{y}_0''; s)\|_1 \leq \epsilon,$$

which in particular implies that

$$\|\Psi(\mathbf{y}''; t'' - s') - \Phi(\mathbf{y}_0; s')\|_1 \leq \epsilon.$$

Besides, the frozen clusters are the same in the configurations $\Psi(\mathbf{y}''; t'' - s')$ and $\Phi(\mathbf{y}_0; s')$.

Recall the construction of $\eta > 0$ carried out in Step 3. To complete the proof, it remains to fix a value of ϵ ensuring that, for all $\mathbf{z} \in \bar{B}_1(\Phi(\mathbf{y}_0; s'), \epsilon)$ having the same frozen clusters as $\Phi(\mathbf{y}_0; s')$, one can construct a configuration $\mathbf{y} \in \bar{B}_1(\mathbf{y}_0, \eta)$ such that $\Phi(\mathbf{y}; s') = \mathbf{z}$, and apply the result to $\mathbf{z} = \Psi(\mathbf{y}''; t'' - s')$. In other words, we now have to take self-interactions into account, which was not the case for the backward frozen dynamics. On the other hand, since $s' < t^*(\mathbf{y}_0)$, we do not have to care about collisions between clusters of different type, therefore the problem can be addressed cluster by cluster. This enables us to use the following trick: for all frozen cluster c in $\Phi(\mathbf{y}_0; s')$, for all $\gamma : k \in c$, let us define

$$y_k^\gamma := (y_0)_k^\gamma + h_c,$$

where

$$h_c := z_k^\gamma - \Phi_k^\gamma(\mathbf{y}_0; s')$$

does not depend on the choice of $\gamma : k$ in c . Then

$$\|\mathbf{y} - \mathbf{y}_0\|_1 \leq \epsilon,$$

and by Proposition 9.3.17, ϵ can be chosen small enough to prevent particles belonging to different frozen clusters in $\Phi(\mathbf{y}_0; s')$ from colliding in the MSPD started at \mathbf{y} . Under this condition, it is easily checked that, for all $s \in [0, s']$, for all frozen cluster c in $\Phi(\mathbf{y}_0; s')$,

$$\forall \gamma : k \in c, \quad \Phi_k^\gamma(\mathbf{y}; s) = \Phi_k^\gamma(\mathbf{y}_0; s) + h_c.$$

In particular, $\Phi(\mathbf{y}; s') = \mathbf{z}$ and we complete the proof by taking $\epsilon \leq \eta$. □

Bibliographie

- [1] A. Alfonsi, B. Jourdain et A. Kohatsu-Higa : Pathwise optimal transport bounds between a one-dimensional diffusion and its Euler scheme. *Ann. Appl. Probab.*, 24(3):1049–1080, 2014.
- [2] G. Alsmeyer : The Markov renewal theorem and related results. *Markov Process. Related Fields*, 3(1):103–127, 1997.
- [3] L. Ambrosio, N. Gigli et G. Savaré : *Gradient flows in metric spaces and in the space of probability measures*. Lectures in Mathematics ETH Zürich. Birkhäuser Verlag, Basel, seconde édition, 2008.
- [4] F. Ancona et A. Marson : Existence theory by front tracking for general nonlinear hyperbolic systems. *Arch. Ration. Mech. Anal.*, 185(2):287–340, 2007.
- [5] C. Ané, S. Blachère, D. Chafaï, P. Fougères, I. Gentil, F. Malrieu, C. Roberto et G. Scheffer : *Sur les inégalités de Sobolev logarithmiques*, volume 10 de *Panoramas et Synthèses*. Société Mathématique de France, Paris, 2000. Avec une préface de D. Bakry et M. Ledoux.
- [6] D. G. Aronson : Bounds for the fundamental solution of a parabolic equation. *Bull. Amer. Math. Soc.*, 73:890–896, 1967.
- [7] S. Asmussen : *Applied probability and queues*, volume 51 de *Applications of Mathematics*. Springer-Verlag, New York, seconde édition, 2003. Stochastic Modelling and Applied Probability.
- [8] S. Attanasio et F. Flandoli : Zero-noise solutions of linear transport equations without uniqueness : an example. *C. R. Math. Acad. Sci. Paris*, 347(13-14):753–756, 2009.
- [9] R. Bafico et P. Baldi : Small random perturbations of Peano phenomena. *Stochastics*, 6(3-4):279–292, 1981/82.
- [10] P. Baiti et A. Bressan : The semigroup generated by a temple class system with large data. *Differential Integral Equations*, 10(3):401–418, 1997.
- [11] A. D. Banner, R. Fernholz et I. Karatzas : Atlas models of equity markets. *Ann. Appl. Probab.*, 15(4):2296–2330, 2005.
- [12] G. Basile, C. Bernardin et S. Olla : Thermal conductivity for a momentum conservative model. *Comm. Math. Phys.*, 287(1):67–98, 2009.
- [13] R. F. Bass et É. Pardoux : Uniqueness for diffusions with piecewise constant coefficients. *Probab. Theory Related Fields*, 76(4):557–572, 1987.
- [14] C. Bernardin et S. Olla : Fourier’s law for a microscopic model of heat conduction. *J. Stat. Phys.*, 121(3-4):271–289, 2005.
- [15] L. Bertini, A. De Sole, D. Gabrielli, G. Jona-Lasinio et C. Landim : Stochastic interacting particle systems out of equilibrium. *J. Stat. Mech. Theory Exp.*, P07014(7), 2007.
- [16] S. Bianchini : The semigroup generated by a temple class system with non-convex flux function. *Differential Integral Equations*, 13(10-12):1529–1550, 2000.
- [17] S. Bianchini : Stability of L^∞ solutions for hyperbolic systems with coinciding shocks and rarefactions. *SIAM J. Math. Anal.*, 33(4):959–981, 2001.
- [18] P. Billingsley : *Convergence of probability measures*. Wiley Series in Probability and Statistics : Probability and Statistics. John Wiley & Sons Inc., New York, seconde édition, 1999. A Wiley-Interscience Publication.

- [19] V. I. Bogachev, N. V. Krylov et M. Röckner : Elliptic and parabolic equations for measures. *Uspekhi Mat. Nauk*, 64(6(390)):5–116, 2009.
- [20] F. Bolley, Y. Brenier et G. Loeper : Contractive metrics for scalar conservation laws. *J. Hyperbolic Differ. Equ.*, 2(1):91–107, 2005.
- [21] F. Bolley, I. Gentil et A. Guillin : Convergence to equilibrium in Wasserstein distance for Fokker-Planck equations. *J. Funct. Anal.*, 263(8):2430–2457, 2012.
- [22] F. Bolley, I. Gentil et A. Guillin : Uniform convergence to equilibrium for granular media. *Arch. Ration. Mech. Anal.*, 208(2):429–445, 2013.
- [23] F. Bolley, A. Guillin et F. Malrieu : Trend to equilibrium and particle approximation for a weakly selfconsistent Vlasov-Fokker-Planck equation. *M2AN Math. Model. Numer. Anal.*, 44(5):867–884, 2010.
- [24] F. Bonetto, J. L. Lebowitz et L. Rey-Bellet : Fourier’s law : a challenge to theorists. *In Mathematical physics 2000*, pages 128–150. Imp. Coll. Press, London, 2000.
- [25] M. Bossy et D. Talay : Convergence rate for the approximation of the limit law of weakly interacting particles : application to the Burgers equation. *Ann. Appl. Probab.*, 6(3):818–861, 1996.
- [26] M. Bossy et D. Talay : A stochastic particle method for the McKean-Vlasov and the Burgers equation. *Math. Comp.*, 66(217):157–192, 1997.
- [27] F. Bouchut : *On zero pressure gas dynamics*, pages 171–190. Numéro 22 de Series on Advances in Mathematics for Applied Sciences. World Scientific, 1994.
- [28] Y. Brenier, W. Gangbo, G. Savaré et M. Westdickenberg : Sticky particle dynamics with interactions. *J. Math. Pures Appl. (9)*, 99(5):577–617, 2013.
- [29] Y. Brenier et E. Grenier : Sticky particles and scalar conservation laws. *SIAM J. Numer. Anal.*, 35(6):2317–2328 (électronique), 1998.
- [30] A. Bressan : *Hyperbolic systems of conservation laws*, volume 20 de *Oxford Lecture Series in Mathematics and its Applications*. Oxford University Press, Oxford, 2000. The one-dimensional Cauchy problem.
- [31] A. Bressan et T. Nguyen : Non-existence and non-uniqueness for multidimensional sticky particle systems. *Kinet. Relat. Models*, 7(2):205–218, 2014.
- [32] H. Brezis : *Analyse fonctionnelle*. Collection Mathématiques Appliquées pour la Maîtrise. Masson, Paris, 1983. Théorie et applications.
- [33] R. Buckdahn, Y. Ouknine et M. Quincampoix : On limiting values of stochastic differential equations with small noise intensity tending to zero. *Bull. Sci. Math.*, 133(3):229–237, 2009.
- [34] L. Bunimovich, C. Liverani, A. Pellegrinotti et Y. Suhov : Ergodic systems of n balls in a billiard table. *Comm. Math. Phys.*, 146(2):357–396, 1992.
- [35] J. A. Carrillo, M. Di Francesco et C. Lattanzio : Contractivity and asymptotics in Wasserstein metrics for viscous nonlinear scalar conservation laws. *Boll. Unione Mat. Ital. Sez. B Artic. Ric. Mat. (8)*, 10(2):277–292, 2007.
- [36] J. A. Carrillo, M. P. Gualdani et G. Toscani : Finite speed of propagation in porous media by mass transportation methods. *C. R. Math. Acad. Sci. Paris*, 338(10):815–818, 2004.
- [37] J. A. Carrillo, R. J. McCann et C. Villani : Contractions in the 2-Wasserstein length space and thermalization of granular media. *Arch. Ration. Mech. Anal.*, 179(2):217–263, 2006.
- [38] J. A. Carrillo et G. Toscani : Wasserstein metric and large-time asymptotics of nonlinear diffusion equations. *In New trends in mathematical physics*, pages 234–244. World Sci. Publ., Hackensack, NJ, 2004.
- [39] P. Cattiaux et A. Guillin : Semi log-concave Markov diffusions.
À paraître dans *Séminaire de Probabilités*.
Preprint accessible à l’adresse <http://arxiv.org/abs/1303.6884>.
- [40] P. Cattiaux, A. Guillin et F. Malrieu : Probabilistic approach for granular media equations in the non-uniformly convex case. *Probab. Theory Related Fields*, 140(1-2):19–40, 2008.

- [41] S. Chatterjee et S. Pal : A phase transition behavior for Brownian motions interacting through their ranks. *Probab. Theory Related Fields*, 147(1-2):123–159, 2010.
- [42] N. Chernov et R. Markarian : *Introduction to the ergodic theory of chaotic billiards*. Publicações Matemáticas do IMPA. [IMPA Mathematical Publications]. Instituto de Matemática Pura e Aplicada (IMPA), Rio de Janeiro, seconde édition, 2003. 24o Colóquio Brasileiro de Matemática. [24th Brazilian Mathematics Colloquium].
- [43] T. Chumley, S. Cook et R. Feres : From billiards to thermodynamics. *Comput. Math. Appl.*, 65(10):1596–1613, 2013.
- [44] F. Comets, S. Popov, G. M. Schütz et M. Vachkovskaia : Billiards in a general domain with random reflections. *Arch. Ration. Mech. Anal.*, 191(3):497–537, 2009.
- [45] S. Cook et R. Feres : Random billiards with wall temperature and associated Markov chains. *Nonlinearity*, 25(9):2503, 2012.
- [46] M. H. A. Davis : *Markov models and optimization*, volume 49 de *Monographs on Statistics and Applied Probability*. Chapman & Hall, London, 1993.
- [47] F. Delarue, F. Flandoli et D. Vincenzi : Noise prevents collapse of Vlasov-Poisson point charges. *Comm. Pure Appl. Math.*, 67(10):1700–1736, 2014.
- [48] A. Dembo, M. Shkolnikov, S.R.S. Varadhan et O. Zeitouni : Large deviations for diffusions interacting through their ranks.
À paraître dans *Comm. Pure Appl. Math.*
Preprint accessible à l'adresse <http://arxiv.org/abs/1211.5223>.
- [49] A. Dhar : Heat conduction in a one-dimensional gas of elastically colliding particles of unequal masses. *Phys. Rev. Lett.*, 86(16):3554–3557, 2001.
- [50] R. Durrett : *Probability : theory and examples*. Duxbury Press, Belmont, CA, seconde édition, 1996.
- [51] W. E et E. Vanden-Eijnden : A note on generalized flows. *Phys. D*, 183(3-4):159–174, 2003.
- [52] A. Eberle : Reflection coupling and Wasserstein contractivity without convexity. *C. R. Math. Acad. Sci. Paris*, 349(19-20):1101–1104, 2011.
- [53] J.-P. Eckmann : Non-equilibrium steady states. In *Proceedings of the International Congress of Mathematicians, Beijing*, volume III, pages 409–418. Higher Education Press, 2002.
- [54] J.-P. Eckmann et L.-S. Young : Temperature profiles in Hamiltonian heat conduction. *Europhys. Lett.*, 68(6):790–796, 2004.
- [55] A. El Hajj et R. Monneau : Uniqueness results for diagonal hyperbolic systems with large and monotone data. *J. Hyperbolic Differ. Equ.*, 10(3):461–494, 2013.
- [56] S. N. Ethier et T. G. Kurtz : *Markov processes*. Wiley Series in Probability and Mathematical Statistics : Probability and Mathematical Statistics. John Wiley & Sons Inc., New York, 1986. Characterization and convergence.
- [57] W. Feller : *An introduction to probability theory and its applications. Vol. II*. John Wiley & Sons Inc., New York, seconde édition, 1971.
- [58] E. R. Fernholz : *Stochastic portfolio theory*, volume 48 de *Applications of Mathematics (New York)*. Springer-Verlag, New York, 2002. Stochastic Modelling and Applied Probability.
- [59] E. R. Fernholz, T. Ichiba et I. Karatzas : A second-order stock market model. *Ann. Finance*, 9(3):439–454, 2013.
- [60] E. R. Fernholz, T. Ichiba et I. Karatzas : Two Brownian particles with rank-based characteristics and skew-elastic collisions. *Stochastic Process. Appl.*, 123(8):2999–3026, 2013.
- [61] E. R. Fernholz, T. Ichiba, I. Karatzas et V. Prokaj : Planar diffusions with rank-based characteristics and perturbed Tanaka equations. *Probab. Theory Related Fields*, 156(1-2): 343–374, 2013.
- [62] E. R. Fernholz et I. Karatzas : Stochastic portfolio theory : A survey. In *Handbook of Numerical Analysis. Mathematical Modeling and Numerical Methods in Finance*, 2009.

- [63] A. Figalli : Existence and uniqueness of martingale solutions for SDEs with rough or degenerate coefficients. *J. Funct. Anal.*, 254(1):109–153, 2008.
- [64] W. H. Fleming et H. M. Soner : *Controlled Markov processes and viscosity solutions*, volume 25 de *Stochastic Modelling and Applied Probability*. Springer, New York, seconde édition, 2006.
- [65] M. I. Freidlin et A. D. Wentzell : *Random perturbations of dynamical systems*, volume 260 de *Grundlehren der Mathematischen Wissenschaften [Fundamental Principles of Mathematical Sciences]*. Springer-Verlag, New York, seconde édition, 1998. Traduit de l'édition originale en russe de 1979 par Joseph Szücs.
- [66] A. Friedman : *Partial differential equations of parabolic type*. Prentice-Hall Inc., Englewood Cliffs, N.J., 1964.
- [67] J. Fritz, T. Funaki et J. L. Lebowitz : Stationary states of random Hamiltonian systems. *Probab. Theory Related Fields*, 99(2):211–236, 1994.
- [68] P. Gaspard et T. Gilbert : Heat conduction and Fourier's law by consecutive local mixing and thermalization. *Phys. Rev. Lett.*, 101:020601, Jul 2008.
- [69] P. Gaspard et T. Gilbert : Heat conduction and Fourier's law in a class of many particle dispersing billiards. *New J. Phys.*, 10(10):103004, 2008.
- [70] P. Gaspard et T. Gilbert : On the derivation of Fourier's law in stochastic energy exchange systems. *J. Stat. Mech. Theory Exp.*, 2008(11):P11021, 2008.
- [71] T. Gilbert et R. Lefevre : Heat conductivity from molecular chaos hypothesis in locally confined billiard systems. *Phys. Rev. Lett.*, 101:200601, Nov 2008.
- [72] B. H. Gilding : Improved theory for a nonlinear degenerate parabolic equation. *Ann. Scuola Norm. Sup. Pisa Cl. Sci. (4)*, 16(2):165–224, 1989.
- [73] F. Golse : Distributions, analyse de Fourier, équations aux dérivées partielles. Cours de l'École Polytechnique. Accessible à l'adresse <http://www.math.polytechnique.fr/~golse/mat431.html>.
- [74] M. Gradinaru, S. Herrmann et B. Roynette : A singular large deviations phenomenon. *Ann. Inst. H. Poincaré Probab. Statist.*, 37(5):555–580, 2001.
- [75] E. Gutkin : Billiards in polygons. *Phys. D*, 19(3):311–333, 1986.
- [76] M. Hairer et J. C. Mattingly : Yet another look at Harris' ergodic theorem for Markov chains. In *Seminar on Stochastic Analysis, Random Fields and Applications VI*, volume 63 de *Progr. Probab.*, pages 109–117. Birkhäuser/Springer Basel AG, Basel, 2011.
- [77] S. Herrmann : Phénomène de Peano et grandes déviations. *C. R. Acad. Sci. Paris Sér. I Math.*, 332(11):1019–1024, 2001.
- [78] T. Ichiba et I. Karatzas : On collisions of Brownian particles. *Ann. Appl. Probab.*, 20(3):951–977, 2010.
- [79] T. Ichiba, I. Karatzas et M. Shkolnikov : Strong solutions of stochastic equations with rank-based coefficients. *Probab. Theory Related Fields*, 156(1-2):229–248, 2013.
- [80] T. Ichiba, S. Pal et M. Shkolnikov : Convergence rates for rank-based models with applications to portfolio theory. *Probab. Theory Related Fields*, 156(1-2):415–448, 2013.
- [81] T. Ichiba, V. Papathanakos, A. Banner, I. Karatzas et E. R. Fernholz : Hybrid atlas models. *Ann. Appl. Probab.*, 21(2):609–644, 2011.
- [82] B. Jourdain : Diffusions with a nonlinear irregular drift coefficient and probabilistic interpretation of generalized Burgers' equations. *ESAIM Probab. Statist.*, 1:339–355 (électronique), 1995/97.
- [83] B. Jourdain : Diffusion processes associated with nonlinear evolution equations for signed measures. *Methodol. Comput. Appl. Probab.*, 2(1):69–91, 2000.
- [84] B. Jourdain : Probabilistic approximation for a porous medium equation. *Stochastic Process. Appl.*, 89(1):81–99, 2000.

- [85] B. Jourdain : Probabilistic characteristics method for a one-dimensional inviscid scalar conservation law. *Ann. Appl. Probab.*, 12(1):334–360, 2002.
- [86] B. Jourdain : Signed sticky particles and 1D scalar conservation laws. *C. R. Math. Acad. Sci. Paris*, 334(3):233–238, 2002.
- [87] B. Jourdain : Probabilistic approximation via spatial derivation of some nonlinear parabolic evolution equations. In *Monte Carlo and quasi-Monte Carlo methods 2004*, pages 197–216. Springer, Berlin, 2006.
- [88] B. Jourdain : Equivalence of the Poincaré inequality with a transport-chi-square inequality in dimension one. *Electron. Commun. Probab.*, 17(43):1–12, 2012.
- [89] B. Jourdain et F. Malrieu : Propagation of chaos and Poincaré inequalities for a system of particles interacting through their CDF. *Ann. Appl. Probab.*, 18(5):1706–1736, 2008.
- [90] B. Jourdain et J. Reygner : Capital distribution and portfolio performance for rank-based models of equity market.
À paraître dans *Annals of Finance*.
Preprint accessible à l'adresse <http://arxiv.org/abs/1312.5660>.
- [91] B. Jourdain et J. Reygner : Propagation of chaos for rank-based interacting diffusions and long time behaviour of a scalar quasilinear parabolic equation. *Stoch. PDE : Anal. Comp.*, 1(3):455–506, 2013.
- [92] B. Jourdain et J. Reygner : The small noise limit of order-based diffusion processes. *Electron. J. Probab.*, 19(29):1–36, 2014.
- [93] I. Karatzas et S. E. Shreve : Trivariate density of Brownian motion, its local and occupation times, with application to stochastic control. *Ann. Probab.*, 12(3):819–828, 1984.
- [94] I. Karatzas et S. E. Shreve : *Brownian motion and stochastic calculus*, volume 113 de *Graduate Texts in Mathematics*. Springer-Verlag, New York, seconde édition, 1991.
- [95] K. Khanin et T. Yarmola : Ergodic properties of random billiards driven by thermostats. *Comm. Math. Phys.*, 320(1):121–147, 2013.
- [96] J. F. C. Kingman : Random discrete distribution. *J. Roy. Statist. Soc. Ser. B*, 37:1–22, 1975. Avec une discussion par S. J. Taylor, A. G. Hawkes, A. M. Walker, D. R. Cox, A. F. M. Smith, B. M. Hill, P. J. Burville, T. Leonard et une réponse de l'auteur.
- [97] O. A. Ladyženskaja, V. A. Solonnikov et N. N. Ural'ceva : *Linear and quasilinear equations of parabolic type*. Traduit du russe par S. Smith. Translations of Mathematical Monographs, Vol. 23. American Mathematical Society, Providence, R.I., 1967.
- [98] R. Lefevre : Macroscopic fluctuation theory of local collisional dynamics. *Physica Scripta*, 86(5):058506, 2012.
- [99] R. Lefevre, M. Mariani et L. Zambotti : Macroscopic fluctuation theory of aerogel dynamics. *J. Stat. Mech. Theory Exp.*, 2010(12):L12004, 2010.
- [100] R. Lefevre, M. Mariani et L. Zambotti : Large deviations for renewal processes. *Stochastic Process. Appl.*, 121(10):2243–2271, 2011.
- [101] R. Lefevre, M. Mariani et L. Zambotti : Large deviations of the current in stochastic collisional dynamics. *J. Math. Phys.*, 52(3):033302, 22, 2011.
- [102] R. Lefevre, M. Mariani et L. Zambotti : Large deviations for a random speed particle. *ALEA Lat. Am. J. Probab. Math. Stat.*, 9(2):739–760, 2012.
- [103] R. Lefevre et L. Zambotti : Hot scatterers and tracers for the transfer of heat in collisional dynamics. *J. Stat. Phys.*, 139(4):686–713, 2010.
- [104] S. Lepri, R. Livi et A. Politi : Thermal conduction in classical low-dimensional lattices. *Phys. Rep.*, 377(1):1–80, 2003.
- [105] Q. Liu et C. Wang : Uniqueness of the bounded solution to a strongly degenerate parabolic problem. *Nonlinear Anal.*, 67(11):2993–3002, 2007.
- [106] F. Malrieu : Logarithmic Sobolev inequalities for some nonlinear PDE's. *Stochastic Process. Appl.*, 95(1):109–132, 2001.

- [107] F. Malrieu : Convergence to equilibrium for granular media equations and their Euler schemes. *Ann. Appl. Probab.*, 13(2):540–560, 2003.
- [108] H. P. McKean, Jr. : Propagation of chaos for a class of non-linear parabolic equations. *In Stochastic Differential Equations (Lecture Series in Differential Equations, Session 7, Catholic Univ., 1967)*, pages 41–57. Air Force Office Sci. Res., Arlington, Va., 1967.
- [109] S. Meyn et R. L. Tweedie : *Markov chains and stochastic stability*. Cambridge University Press, Cambridge, seconde édition, 2009. Prologue de Peter W. Glynn.
- [110] L. Natile et G. Savaré : A Wasserstein approach to the one-dimensional sticky particle system. *SIAM J. Math. Anal.*, 41(4):1340–1365, 2009.
- [111] S. Olla, S. R. S. Varadhan et H.-T. Yau : Hydrodynamical limit for a Hamiltonian system with weak noise. *Comm. Math. Phys.*, 155(3):523–560, 1993.
- [112] F. Otto : The geometry of dissipative evolution equations : the porous medium equation. *Comm. Partial Differential Equations*, 26(1-2):101–174, 2001.
- [113] G. Pagès : Sur quelques algorithmes récursifs pour les probabilités numériques. *ESAIM Probab. Statist.*, 5:141–170 (électronique), 2001.
- [114] S. Pal : Analysis of market weights under volatility-stabilized market models. *Ann. Appl. Probab.*, 21(3):1180–1213, 2011.
- [115] S. Pal et J. Pitman : One-dimensional Brownian particle systems with rank-dependent drifts. *Ann. Appl. Probab.*, 18(6):2179–2207, 2008.
- [116] S. Pal et M. Shkolnikov : Concentration of measure for systems of Brownian particles interacting through their ranks.
À paraître dans *Ann. Appl. Probab.*
Preprint accessible à l'adresse <http://arxiv.org/abs/1011.2443>.
- [117] S. Pal et T.-K. L. Wong : Energy, entropy, and arbitrage.
Preprint accessible à l'adresse <http://arxiv.org/abs/1308.5376>.
- [118] Y. Plyakha, R. Uppal et G. Vilkov : Equal or Value Weighting? Implications for Asset-Pricing Tests.
Preprint accessible à l'adresse <http://dx.doi.org/10.2139/ssrn.1787045>.
- [119] T. Prosen et D. K. Campbell : Normal and anomalous heat transport in one-dimensional classical lattices. *Chaos*, 15(1):015117, 2005.
- [120] S. T. Rachev et L. Rüschendorf : *Mass transportation problems. Vol. I*. Probability and its Applications (New York). Springer-Verlag, New York, 1998. Theory.
- [121] D. Revuz et M. Yor : *Continuous martingales and Brownian motion*, volume 293 de *Grundlehren der Mathematischen Wissenschaften [Fundamental Principles of Mathematical Sciences]*. Springer-Verlag, Berlin, troisième édition, 1999.
- [122] L. Rey-Bellet : Ergodic properties of Markov processes. *In Open quantum systems. II*, volume 1881 de *Lecture Notes in Math.*, pages 1–39. Springer, Berlin, 2006.
- [123] J. Reygner : Chaoticity of the stationary distribution of rank-based interacting diffusions.
Preprint accessible à l'adresse <http://arxiv.org/abs/1408.4103>.
- [124] B. Ryals et L.-S. Young : Nonequilibrium steady states of some simple 1-D mechanical chains. *J. Stat. Phys.*, 146:1089–1103, 2012.
- [125] A. Sarantsev : Infinite-dimensional reflected brownian motion and competing particle systems.
Preprint accessible à l'adresse <http://arxiv.org/abs/1309.2621>.
- [126] A. Sarantsev : On a class of diverse market models. *Ann. Finance*, 10(2):291–314, 2014.
- [127] M. Shkolnikov : Large systems of diffusions interacting through their ranks. *Stochastic Process. Appl.*, 122(4):1730–1747, 2012.
- [128] M. Shkolnikov : Large volatility-stabilized markets. *Stochastic Process. Appl.*, 123(1):212–228, 2013.

- [129] D. W. Stroock et S. R. S. Varadhan : *Multidimensional diffusion processes*. Classics in Mathematics. Springer-Verlag, Berlin, 2006. Réimpression de l'édition de 1997.
- [130] A.-S. Sznitman : Topics in propagation of chaos. In *École d'Été de Probabilités de Saint-Flour XIX—1989*, volume 1464 de *Lecture Notes in Math.*, pages 165–251. Springer, Berlin, 1991.
- [131] S. Tabachnikov : *Geometry and billiards*, volume 30 de *Student Mathematical Library*. American Mathematical Society, Providence, RI, 2005.
- [132] H. Tanaka : Stochastic differential equations with reflecting boundary condition in convex regions. *Hiroshima Math. J.*, 9(1):163–177, 1979.
- [133] A. Ju. Veretennikov : Strong solutions and explicit formulas for solutions of stochastic integral equations. *Mat. Sb. (N.S.)*, 111(153)(3):434–452, 480, 1980.
- [134] A. Ju. Veretennikov : Approximation of ordinary differential equations by stochastic ones. *Mat. Zametki*, 33(6):929–932, 1983.
- [135] C. Villani : *Optimal transport*, volume 338 de *Grundlehren der Mathematischen Wissenschaften [Fundamental Principles of Mathematical Sciences]*. Springer-Verlag, Berlin, 2009. Old and new.
- [136] M.-K. von Renesse et K.-T. Sturm : Transport inequalities, gradient estimates, entropy, and Ricci curvature. *Comm. Pure Appl. Math.*, 58(7):923–940, 2005.
- [137] Z. Wu, J. Zhao, J. Yin et H. Li : *Nonlinear diffusion equations*. World Scientific Publishing Co. Inc., River Edge, NJ, 2001. Traduit de l'édition originale en chinois de 1996 et révisé par les auteurs.
- [138] T. Yarmola : Sub-exponential mixing of open systems with particle-disk interactions. Preprint accessible à l'adresse <http://arxiv.org/abs/1302.6083>.
- [139] T. Yarmola : Ergodicity of some open systems with particle-disk interactions. *Comm. Math. Phys.*, 304(3):665–688, 2011.
- [140] T. Yarmola : Sub-exponential mixing of random billiards driven by thermostats. *Nonlinearity*, 26(7):1825–1837, 2013.
- [141] Ya. B. Zel'dovitch : Gravitational instability : An approximate theory for large density perturbations. *Astronomy and Astrophysics*, 5:84–89, 1970.