



HAL
open science

Nouveaux fluorophosphates de métaux de transition utilisés comme matériaux d'électrode positive pour batteries li-ion

Jean-Marcel Ateba Mba Ateba Mba

► **To cite this version:**

Jean-Marcel Ateba Mba Ateba Mba. Nouveaux fluorophosphates de métaux de transition utilisés comme matériaux d'électrode positive pour batteries li-ion. Matériaux. Université Sciences et Technologies - Bordeaux I, 2013. Français. NNT: 2013BOR14862 . tel-01118715

HAL Id: tel-01118715

<https://theses.hal.science/tel-01118715>

Submitted on 19 Feb 2015

HAL is a multi-disciplinary open access archive for the deposit and dissemination of scientific research documents, whether they are published or not. The documents may come from teaching and research institutions in France or abroad, or from public or private research centers.

L'archive ouverte pluridisciplinaire **HAL**, est destinée au dépôt et à la diffusion de documents scientifiques de niveau recherche, publiés ou non, émanant des établissements d'enseignement et de recherche français ou étrangers, des laboratoires publics ou privés.



Distributed under a Creative Commons Attribution - NonCommercial - NoDerivatives 4.0
International License

N d'ordre : 4862

THÈSE

PRÉSENTÉE A

L'UNIVERSITÉ BORDEAUX I

ÉCOLE DOCTORALE DES SCIENCES CHIMIQUES

Par

Jean-Marcel ATEBA MBA

POUR OBTENIR LE GRADE DE

DOCTEUR

SPÉCIALITÉ : PHYSICO-CHIMIE DE LA MATIÈRE CONDENSÉE

New Transition Metal Fluorophosphates as Positive Electrode Materials for Li-ion Batteries

Thèse dirigée par :

Mme **Laurence CROGUENNEC** Chargée de Recherche CNRS HDR, ICMCB – CNRS, Pessac
M. **Christian MASQUELIER** Professeur, LRCS - Université Picardie Jules Verne (UPJV), Amiens

Soutenue le 4 octobre 2013 devant la commission d'examen formée par :

Mme Laurence CROGUENNEC	Chargée de Recherche CNRS HDR, ICMCB - CNRS	Examineur
Mme Marie-Liesse DOUBLET	Directrice de recherche CNRS, ICG - Université de Montpellier	Rapporteur
M. Helmut EHRENBERG	Professeur Dr, KIT - Karlsruhe Institute of Technology	Examineur
M. Eric LE FUR	Maître de Conférences HDR, ENSCR, Rennes	Rapporteur
M. Mario MAGLIONE	Directeur de Recherche CNRS, ICMCB - CNRS	Président
M. Christian MASQUELIER	Professeur, LRCS - UPJV, Amiens	Examineur
Mme Maria-Rosa PALACIN	Directrice de recherche, ICMAB - CSIC, Barcelone	Examineur
M. Nadir RECHAM	Maître de Conférences, LRCS - UPJV, Amiens	Examineur



RESUME DE LA THESE

Synthèses de LiMPO_4X

La voie céramique a été utilisée pour synthétiser les matériaux LiMPO_4X (avec $M = \text{V, Fe, Ti}$ et $X = \text{O}$ ou F) dont les diagrammes de diffraction des rayons X sont donnés à la figure 1. LiVPO_4O a été obtenu pour la première fois par une voie céramique en une seule étape. LiVPO_4F a été quant à lui obtenu par une voie céramique en deux étapes, la première étape consiste en la synthèse de VPO_4 tandis que la seconde étape consiste en un traitement à haute température du mélange $\text{VPO}_4 : \text{LiF}$, dans un tube d'or scellé pour éviter toute sublimation et ainsi la formation de la phase $\alpha\text{-Li}_3\text{V}_2(\text{PO}_4)_3$. Les deux phases LiFePO_4F et LiTiPO_4F ont été obtenues en présence de LiF , qui est ensuite éliminée par un lavage de la poudre à l'eau froide.

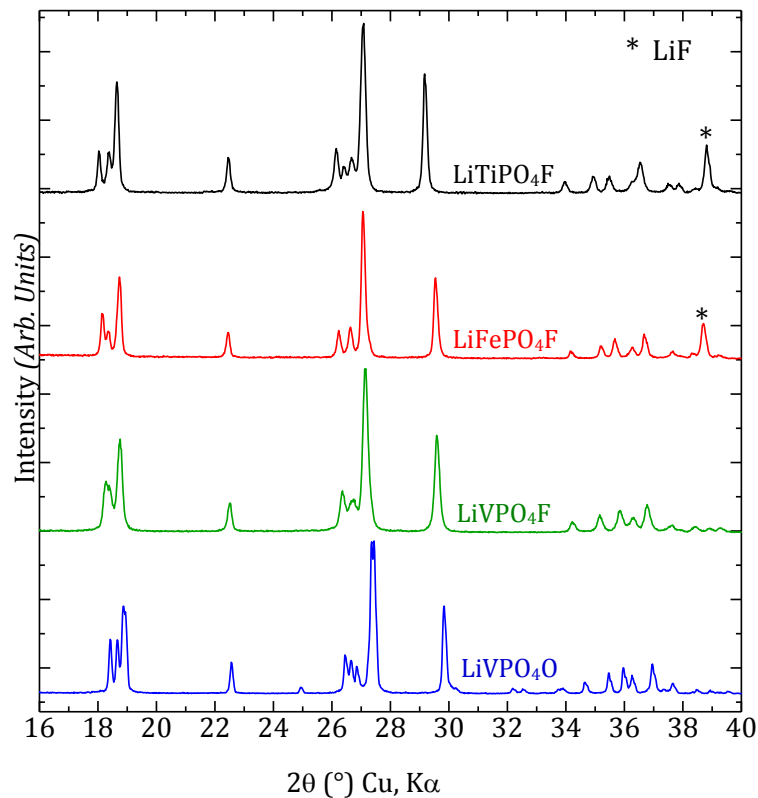

Figure 1: Diagrammes de diffraction des rayons X des phases étudiées

Nous avons observé la dégradation de LiTiPO_4F durant un vieillissement à l'air et un lavage à l'eau. Cette dégradation conduit à la formation de deux nouvelles phases: l'une cristallise dans le groupe d'espace $P\bar{1}$ tandis que la seconde cristallise dans le groupe d'espace Cc .

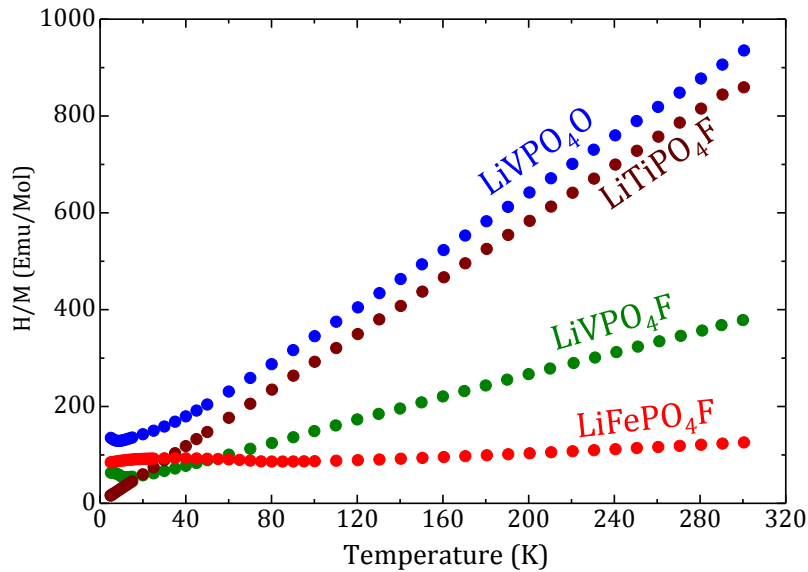

Figure 2: Dépendance du rapport H/M avec la température pour $LiMPO_4X$

La composition chimique et plus particulièrement les teneurs en Li, M (avec $M = Ti, V$ et Fe) et P dans $LiMPO_4F$ ont été confirmées par des dosages ICP. Des analyses CHNS ont montré que la teneur en H était négligeable dans les deux matériaux $LiFePO_4F$ et $LiTiPO_4F$. La variation de la susceptibilité magnétique à basse température (Figure 2) indique un comportement antiferromagnétique avec des températures de Néel respectivement de 9 K, 13 K et 80 K pour $LiVPO_4F$, $LiVPO_4O$ et $LiFePO_4F$. De plus, la susceptibilité à haute température a permis de confirmer le degré d'oxydation de chaque métal de transition (Fe^{3+} , V^{3+} , V^{4+} , dont les configurations électroniques sont respectivement $t_{2g}^3e_g^2$, $t_{2g}^2e_g^0$ et $t_{2g}^1e_g^0$). Sur la base des analyses menées en spectroscopie Mössbauer nous avons également pu confirmer le degré d'oxydation et l'environnement octaédrique des ions Fe^{3+} dans $LiFePO_4F$.

Structures de $LiMPO_4X$ (avec $X = O$ et F)

La caractérisation structurale complète des phases $LiMPO_4X$ a pu être réalisée en combinant des études en diffraction des rayons X et des neutrons ainsi qu'en spectroscopie RMN. Les phases $LiMPO_4X$ cristallisent dans une structure de type Tavorite et sont iso-structurales au minéral $LiFePO_4OH$. La figure 3 représente les longueurs de liaisons le long des chaînes dans chacune des structures. Le volume de la maille élémentaire de $LiVPO_4O$ est deux fois plus grand que celui de $LiMPO_4F$. Nous avons ainsi observé alternativement une liaison longue (2.21 Å et 2.17 Å) et une liaison courte (1.62 Å et 1.71 Å) le long des chaînes de $LiVPO_4O$ (les liaisons longues étant de type vanadyle) alors que pour $LiFePO_4F$ et $LiVPO_4F$, nous avons observé des distances M-F de

1.98 Å. Dans la structure de LiTiPO₄F, nous avons observé des distances de 2.01 Å et 1.94 Å telles que la distance moyenne est de 1.98 Å.

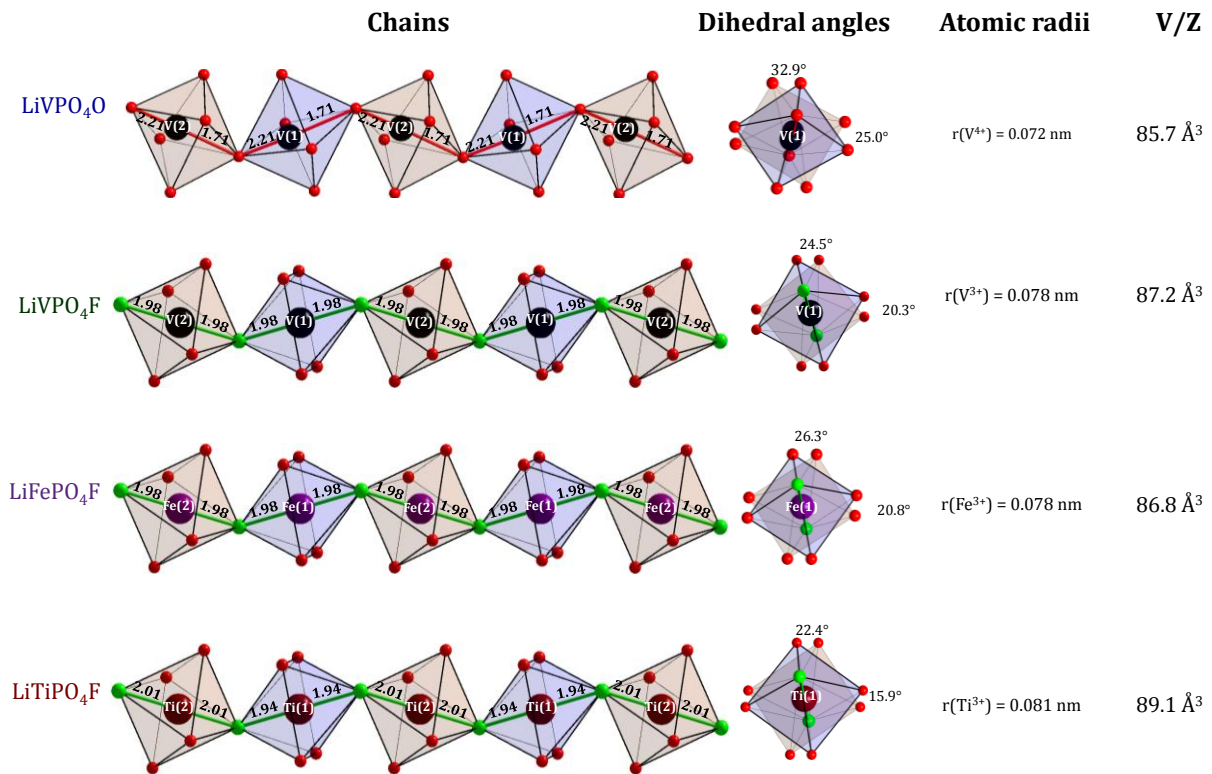

Figure 3: comparaison des chaînes [MO₄X₂], des angles diédraux, des rayons ioniques des métaux de transition et des rapports V/Z dans LiMPO₄X (M = V, Fe, Ti et X = O ou F)

L'évolution du ratio V/Z est en bon accord avec celle des rayons ioniques des métaux de transition. En effet, V/Z augmente avec le rayon ionique. Les contraintes stériques induites par la présence des ions Li⁺ dans les tunnels sont illustrées par les angles diédraux.

Un seul site de lithium est observé dans les structures LiVPO₄F et LiFePO₄F, les ions Li⁺ sont coordonnés par 4 atomes d'oxygène et 1 atome de fluor, formant un pentaèdre distordu très similaire dans les deux structures ($\delta = 6.00 \cdot 10^{-3}$ dans LiVPO₄F et $\delta = 6.51 \cdot 10^{-3}$ dans LiFePO₄F). La spectroscopie RMN MAS du ⁷Li réalisées pour les deux échantillons révèle un signal fin déplacé de 117 ppm pour LiVPO₄F et de 203 ppm pour LiFePO₄F, ces déplacements sont en bon accord avec l'augmentation du nombre d'électrons non-appariés dans les orbitales t_{2g} (2 pour V³⁺ et 3 pour Fe³⁺). Le signal RMN MAS du ⁷Li de LiVPO₄F présente un épaulement qui n'a pas été attribué à une impureté mais à des défauts structuraux qui ne sont pas détectés par diffraction des rayons X et des neutrons.

Les deux sites du Li présents dans la structure de LiVPO_4O sont entourés de cinq atomes d'oxygènes (formant des pentaèdres distordus) et sont séparés de 3.44 Å. Étonnamment, le spectre de RMN MAS du ^7Li montre un seul signal centré à 71 ppm. Les deux sites du Li sont significativement différents (*i.e.* avec des distances V-O et angles O-V-O différents), l'observation d'un signal unique n'était pas attendue. Néanmoins, des calculs réalisés en DFT ont montré que les deux signaux sont en fait attendus proches, du fait d'un transfert très similaire de densité de spins des ions vanadium paramagnétiques vers les deux types de noyaux Li. Par conséquent, dans les conditions de mesures utilisées, les deux contributions ne peuvent pas être séparées. Une autre explication pour ce signal unique pourrait être une grande mobilité entre les deux sites du Li bien qu'ils sont séparés de 3.44 Å. Des mesures à haut champ et à grande vitesse de rotation permettraient très certainement de séparer ces deux signaux. La localisation du Li dans LiTiPO_4F n'a pas pu être effectuée car les données de diffraction des neutrons n'étaient pas de qualité suffisante. Néanmoins, la RMN MAS du ^7Li NMR a montré qu'il a trois signaux de RMN suggérant la présence de trois sites/environnement du lithium dans la structure.

Un signal fortement déplacé est observé pour le fluor en RMN MAS du ^{19}F (à -1500 ppm) pour LiVPO_4F . Aucun signal n'est observé pour LiFePO_4F car il est probablement fortement déplacé en ppm, les ions Fe^{3+} possèdent en effet plus d'électrons non appariés que les ions V^{3+} . Néanmoins, (étonnamment) aucun signal n'est observé pour LiTiPO_4F alors que Ti^{3+} possède moins de spins que V^{3+} .

La structure magnétique de LiVPO_4F et LiFePO_4F a été déterminée par un affinement Rietveld des données de diffraction des neutrons enregistrées à basse température. Les moments magnétiques portés par les métaux dans chacun de ces matériaux sont anti-parallèles le long des chaînes et anti-parallèles entre les chaînes. Les moments magnétiques résultants sont respectivement $1.22 \mu_B$ et $3.92 \mu_B$ pour LiVPO_4F et LiFePO_4F .

Pour LiVPO_4O , les mesures magnétiques révèlent une transition magnétique à une température de 9 K entre un ordre paramagnétique et un ordre antiferromagnétique. Pourtant, aucune transition magnétique n'est observée en diffraction des neutrons à basse température, probablement du fait de la transparence du vanadium aux neutrons et de la configuration électronique de V^{4+} ($t_{2g}^1 e_g^0$) qui possède uniquement un électron célibataire. Dans le cas de LiVPO_4F , seulement deux pics supplémentaires de très faibles intensités sont observés. Il n'est donc pas étonnant que la transition magnétique ne soit pas observée pour LiVPO_4O .

Comportement électrochimique de LiMPO₄X

Le comportement électrochimique de LiMPO₄X a été étudié vs. Li⁺/Li et comparé à celui d'autres phosphates. Nous avons toujours observé des potentiels relativement élevés pour les couples redox mis en jeu. A titre d'exemple, LiVPO₄F présente un potentiel de 4.22 V, le plus élevé jamais observé pour le couple redox V⁴⁺/V³⁺ dans les phosphates de vanadium. Lors de l'extraction du Li⁺ de LiVPO₄F (qui conduit à la formation de VPO₄F) une phase intermédiaire a été mise en évidence pour la composition Li_{0.67}VPO₄F. Celle-ci est clairement observée par diffraction des rayons X et cristallise dans le groupe d'espace $P\bar{1}$. La désintercalation du lithium de Li_{0.67}VPO₄F conduit ensuite à la formation de VPO₄F qui cristallise dans le groupe d'espace $C2/c$. Par contre, lors de la réintercalation de lithium dans VPO₄F la formation de la phase intermédiaire Li_{0.67}VPO₄F n'est pas observée, comme montré par diffraction des rayons X *in situ*, mais seules les deux phases VPO₄F et LiVPO₄F sont présentes. Tous les processus mis en jeu reposent sur des mécanismes biphasés.

LiVPO₄F peut également intercaler un autre lithium dans sa structure hôte et conduire ainsi à la formation de Li₂VPO₄F via un mécanisme biphasé. Li₂VPO₄F cristallise dans le groupe d'espace $C2/c$ et s'est révélée être très instable. Les deux phases VPO₄F et Li₂VPO₄F sont homéotypes de LiVPO₄F. Les états d'oxydation des ions vanadium dans ces phases ont été confirmés par des mesures magnétiques. La structure de Li_{0.67}VPO₄F n'a pas pu être déterminée.

Les mauvaises performances électrochimiques de LiVPO₄O (cyclabilité limitée, grande polarisation...) ont été attribuées à des particules de grandes tailles et fortement agglomérées. L'extraction du Li⁺ de LiVPO₄O conduit à la formation de VPO₄O via un processus biphasé, et le couple redox V⁵⁺/V⁴⁺ est observé à 3.95 V vs. Li⁺/Li. Nous avons démontré pour la première fois que LiVPO₄O peut accepter un ion lithium supplémentaire dans sa structure et conduire ainsi à la formation de Li₂VPO₄O dans laquelle le degré d'oxydation du vanadium est +3. Le couple redox V⁴⁺/V³⁺ est observé à un potentiel moyen de 2.3 V vs. Li⁺/Li pour le système LiVPO₄O ⇌ Li₂VPO₄O alors qu'il est observé à 4.2 V vs. Li⁺/Li pour le système LiVPO₄F ⇌ VPO₄F. Cette différence peut être le résultat de la présence alternée de liaisons longues V–O et courtes V=O dans la structure de LiVPO₄O.

L'insertion/extraction de Li⁺ dans la structure de LiVPO₄O a lieu réversiblement via la formation de deux phases intermédiaires, Li_{1.5}VPO₄O et Li_{1.75}VPO₄O, jamais rapportées précédemment dans la littérature.

La courbe électrochimique de LiFePO_4F est caractérisée par un potentiel de l'ordre de 2.8 V vs. Li^+/Li . Une oxydation du Fe^{3+} en Fe^{4+} est suggérée par celle-ci, mais ceci n'est clairement pas possible à un potentiel aussi bas. Cette signature particulière a été attribuée à une dégradation de la phase lors de son broyage à l'air à l'aide d'un broyeur Spex.

L'étude des propriétés électrochimiques de LiTiPO_4F a montré que le potentiel observé pour le couple redox $\text{Ti}^{4+}/\text{Ti}^{3+}$ est de l'ordre de 3 V vs. Li^+/Li . La désintercalation/intercalation de Li^+ de la structure de LiTiPO_4F démontre une bonne rétention de capacité et une faible polarisation tandis que l'intercalation/désintercalation du Li^+ se traduit par une perte rapide de capacité et une forte polarisation.

L'étude des propriétés électrochimiques du matériau LiTiPO_4F lavé à l'eau froide révèle des propriétés complètement différentes de celle de LiTiPO_4F non lavé, avec l'apparition de deux pseudo-plateaux de potentiel : l'un à 3.0 V et l'autre à 1.7 V vs. Li^+/Li . Dans chaque domaine de potentiel, seulement 0.5 Li peuvent être échangés en bon accord avec un degré d'oxydation moyen pour le titane proche de 3.5 (*i.e.* $\text{Ti}^{3+}/\text{Ti}^{4+} \sim 1/1$). La signature électrochimique de l'échantillon vieilli un an à l'air ne démontre pas de capacité lors de la première extraction du Li, en bon accord avec la seule présence de titane tétravalent dans le matériau.

Contents

General Introduction

1. General Introduction.....	5
2. Rechargeable Li-ion Batteries.....	8
3. Positive Electrode Materials.....	10
4. Tavorite Materials.....	12
5. The Aim of This Thesis.....	15

Chapter I : SYNTHESIS AND CRYSTAL STRUCTURE OF LiVPO₄F AND LiVPO₄O

I-1. Introduction.....	23
I-2. CERAMIC SYNTHESIS OF LiVPO ₄ F AND LiVPO ₄ O.....	24
I-2a. One-step Ceramic Synthesis of LiVPO ₄ F.....	24
I-2b. Two-Step Ceramic Route for the Synthesis of LiVPO ₄ F.....	26
<i>i- Synthesis of the intermediate phase: C-VPO₄</i>	26
<i>ii- Synthesis of LiVPO₄F</i>	28
I-2c. Synthesis of LiVPO ₄ O.....	30
I-2d. Morphology and Magnetic Behavior of LiVPO ₄ X (X = O/F).....	31
I-2e. Summary and Conclusion.....	34
I-3. CRYSTAL AND MAGNETIC STRUCTURES OF LiVPO ₄ F.....	34
I-3a. The Crystal structure of LiVPO ₄ F.....	35
I-3b. NMR Study of LiVPO ₄ F.....	40
I-3c. Magnetic structure of LiVPO ₄ F.....	44
I-3d. Conclusion and Summary.....	46
I-4. CRYSTAL STRUCTURE AND NMR STUDY OF LiVPO ₄ O.....	47
I-4a. Crystal structure of LiVPO ₄ O.....	47
I-4b. NMR Study of LiVPO ₄ O.....	51
I-5. Conclusion and summary of this chapter.....	53

Chapter II : ELECTROCHEMICAL BEHAVIOR OF LiVPO_4X (X = O or F)

II-1. Introduction	61
II-2. ELECTRODES PREPARATION AND BATTERIES CONFIGURATION	64
II-3. ELECTROCHEMICAL BEHAVIOR OF LiVPO_4F	66
II-3a. Reversible Li^+ insertion into LiVPO_4F ($\text{V}^{3+}/\text{V}^{2+}$ couple)	66
II-3b. Reversible Li^+ extraction from LiVPO_4F ($\text{V}^{4+}/\text{V}^{3+}$ couple)	69
II-3c. Crystal Structures of $\text{Li}_x\text{VPO}_4\text{F}$ ($x = 2, 0.67, 0$)	77
<i>i- Crystal Structure of VPO_4F</i>	78
<i>ii- Hypothesis on the structure of $\text{Li}_{0.67}\text{VPO}_4\text{F}$</i>	80
<i>iii- Structure of $\text{Li}_2\text{VPO}_4\text{F}$</i>	81
<i>iv- Comparative NMR Study of $\text{Li}_x\text{VPO}_4\text{F}$ phases (with $x = 1, 0.67$ and 0)</i>	84
II-3d. Conclusion	86
II-4. ELECTROCHEMICAL BEHAVIOR OF LiVPO_4O	88
II-4a. Reversible Li^+ insertion into LiVPO_4O ($\text{V}^{3+}/\text{V}^{4+}$ couple)	89
II-4b. Reversible Li^+ extraction from LiVPO_4O ($\text{V}^{4+}/\text{V}^{5+}$ couple)	92
II-5. Conclusions and summary of this chapter	97

Chapter III : SYNTHESIS, CRYSTAL STRUCTURE AND ELECTROCHEMICAL PROPERTIES OF LiFePO_4F

III-1. Introduction	107
III-2. SYNTHESIS OF LiFePO_4F	109
III-2a. Iono-thermal Synthesis	110
III-2b. One-step Ceramic Synthesis	112
III-2c. Mössbauer spectroscopy and Magnetic properties of LiFePO_4F	113
III-2d. Conclusion	115
III-3. CRYSTAL AND MAGNETIC STRUCTURES OF LiFePO_4F	116
III-3a. Crystal structure of LiFePO_4F	116
III-3b. NMR measurements	121

III-3c. Magnetic structure of LiFePO_4F	124
III-4. ELECTROCHEMICAL PROPERTIES OF LiFePO_4F	127
III-5. Conclusion and summary of this chapter	134

Chapter IV : SYNTHESIS, CRYSTAL STRUCTURE AND ELECTROCHEMICAL PROPERTIES OF LiTiPO_4F

IV-1. Introduction	143
IV-2. STUDY OF THE PHASE LiTiPO_4F	144
IV-2a. Synthesis of LiTiPO_4F	144
IV-2b. Chemical composition and magnetic behavior of LiTiPO_4F	145
IV-2c. Crystal Structure of LiTiPO_4F	146
IV-3. WASHING AND AGING EFFECT ON LiTiPO_4F	150
IV-3a. Effect of aging in air on LiTiPO_4F	150
IV-3b. Effect of washing on LiTiPO_4F	154
IV-3c. Conclusion and summary	157
IV-4. ELECTROCHEMICAL BEHAVIOR OF LiTiPO_4F	157
IV-5. Conclusion and summary of this chapter	160

GENERAL CONCLUSION, SUMMARY AND PERSPECTIVES

GENERAL CONCLUSION, SUMMARY AND PERSPECTIVES	165
--	-----

ANNEXE	177
--------------	-----

Figures Captions	189
------------------------	-----

Tables Captions	201
-----------------------	-----

INTRODUCTION

Contents

1. General Introduction	5
2. Rechargeable Li-ion Batteries	8
3. Positive Electrode Materials	10
4. Tavorite Materials	12
5. The Aim of This Thesis	15

1. General Introduction

A country's energy consumption is directly related to both its economic output and the individual well-being of its citizens. Both the growth of population and the desire to maintain growth while raising standards of living result in increased energy consumption as a society develops. In 2008, the world population of 6.7 billion inhabitants consumed a total amount of energy of 132,000 TWh¹. This energy consumption is steadily increasing from 74,000 TWh in 1973 to 137,000 TWh in 2010 (Figure 1). The recent projections estimate that our energy consumption will reach 160,000 TWh in 2040 with a world population of 9 billion². Another important factor that deeply influences the increase of energy consumption is the quality of life. Indeed due to their development, the so call "third world countries" now aspire to live in the same way as the so call "developed countries".

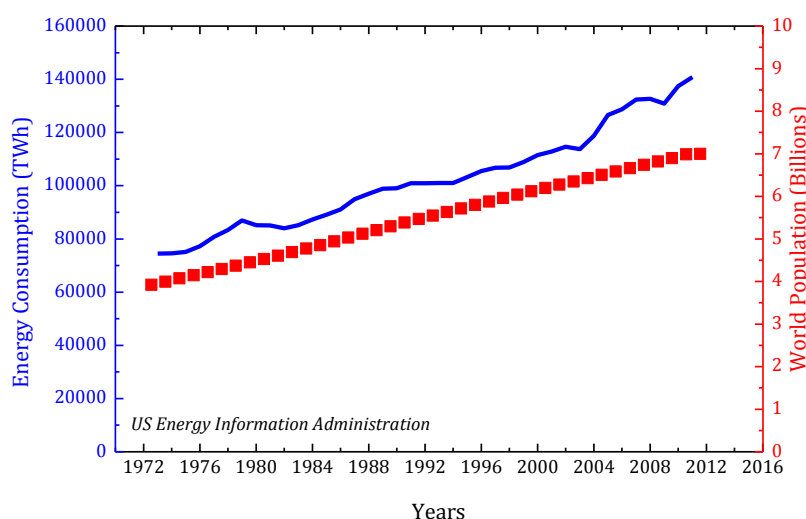

Figure 1 : World total final consumption and world population from 1973 to 2011

In order to satisfy our energetic demand, we are using two kinds of energy sources: *non-renewable energy* (energy produced once by nature which cannot be reproduced or generated but can only be depleted) and *renewable energy* (energy top up by nature which can be reproduced or regenerated only by nature and which is considered as being infinite). Non-renewable energy represents 95% of energy consumed nowadays (Nuclear power included). However, non-renewable energies present two main drawbacks:

- It gets inevitably exhausted, and regarding its definition it is consumed faster than its generation. Current state of the non-renewable energies confirmed its depleting. As an example, the current reserve of oil (which represents 48% of energy now consumed

¹ International Energy Agency, *Key World Energy Statistic 2012*

² US Energy Information Administration

mainly for transportation) remaining is 54 years (this is an average value which deeply depends on the region see Figure 2)³. The second most consumed non-renewable energy is natural gas (20% of total energy consumed in 2010), but according to the specialists the natural gas in our disposition cannot stand over 60 years if the production trend is maintained. Another example can be seen through the coal reserve which can stand for 110 years. In the light of the foregoing, it becomes clear that most of the non-renewable energies mostly used as energy resources today will probably disappear in the next century.

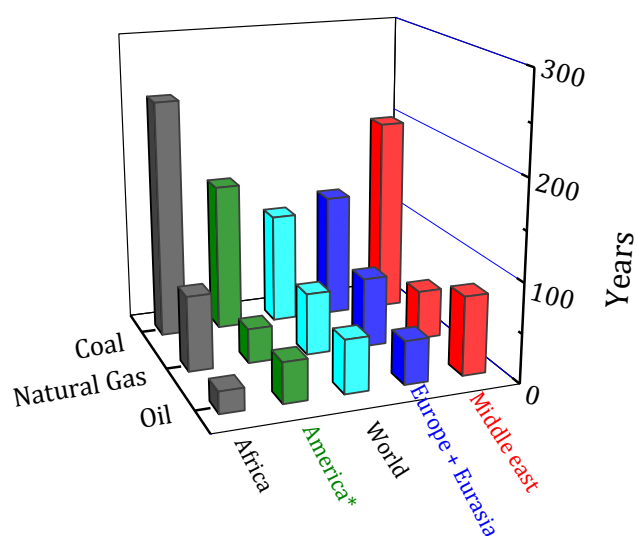

Figure 2: Primary Energy reserves by regions (America referred to North and Latin America). The values are given in R/P ratio i.e. amount of known resource/amount used per year

- Another major drawback of the non-renewable energies is their impact on the climate changes. Indeed despite the Kyoto Protocol and a wealth of good intentions, emissions of greenhouse gases continued to increase in recent years. We face a global environmental crisis that is expected to include the increase of temperatures over lands and in oceans, rising sea levels, more acidification of the oceans, increased floodings as well as droughts, and as a result the extinction of many species. The climate-energy crisis could cause major disruptions to ecosystems, the availability of fresh water, farming ... Even nuclear power which has been considered as a reliable source of electricity in many countries for decades (an essential point for the mix of energy sources) has to face serious ecological problems as encountered in Fukushima in 2010.

With regard to what follows, it becomes obvious that *i)* we cannot continue to use exceedingly non-renewable energies while they are limited; *ii)* we cannot continue to pollute environment

³ BP Statistical Review of World Energy, June 2012 ; bp.com/statisticalreview

through an intensive use of non-renewable energies. To overcome the limitations of non-renewable energies, many countries have turned to renewable energies which are:

- Hydroelectric power: in terms of renewable resources, the share of hydroelectric power has remained constant, as concerns have grown about its social and environmental consequences. This energy represents 80-90 % of the renewable energy consumed today.
- Solar energy: utilization of solar energy on a terawatt can be a cost effective solution in large-scale, environmental friendly and a solution to the growing global demand for energy. Solar technologies can contribute to significant reductions of carbon emissions and pollution of the environment and includes conventional photovoltaic solar cells and solar thermal concentration...
- Wind energy: Wind energy has evolved significantly in the last decades. In 2010, the installed capacity was 0.2 terawatts and is expected to reach 1.5 terawatts by 2020. In addition, the cost of production is now nearly comparable to that of conventional electricity generation technologies.

Most of renewable energy sources are dependent to short-term weather conditions (geothermal, hydro, biomass, wind ...), and are therefore variable (vary over relatively short time period) and uncertain (there are not completely predictable). Thus, renewable energy is not often correlated with normal demand patterns for electricity and large-scale deployment of renewable energy creates challenges for grid operators to maintain reliable service. To prevent blackout particularly during peak energy demand, a storage system is required to balance and to regulate electricity production and consumption.

Although other options are available, the most flexible energy-storage schemes are batteries and capacitors, since they can be located almost everywhere and often are maintenance-free, readily, scalable and portable.

The batteries are well above other forms of electrical energy storage system and their size is flexible into different formats varying from coin cell to megawatt load-leveling applications. Alessandro Volta is well known as being the first who developed in 1800 the first battery, a cell consisting of alternate disks of zinc and copper separated by cardboard with an electrolyte of a brine solution.

With the invention of lead-acid battery by Gaston Planté in 1859, the secondary batteries well known as rechargeable batteries, began to be attractive. In 1899, Waldermar Jungner developed the nickel cadmium battery and a year later, Thomas Edison invented nickel-iron battery as energy source for electric vehicles.

In 2000, a quarter of batteries sold were Li-ion batteries and almost half were Ni-MH batteries. Last year, those statistics were inverted. Indeed the secondary battery sales statistics by volume indicates that almost 60% of the batteries sold were Li-ion⁴. This attractiveness of Li-ion batteries are due to higher volumetric energy storage capability (see Figure 3) and lower cost of Li-ion batteries. As an example, higher-energy and lower-cost Li-ion batteries are already operational in hybrid electric buses, in electric cars and in fully electric vehicles.

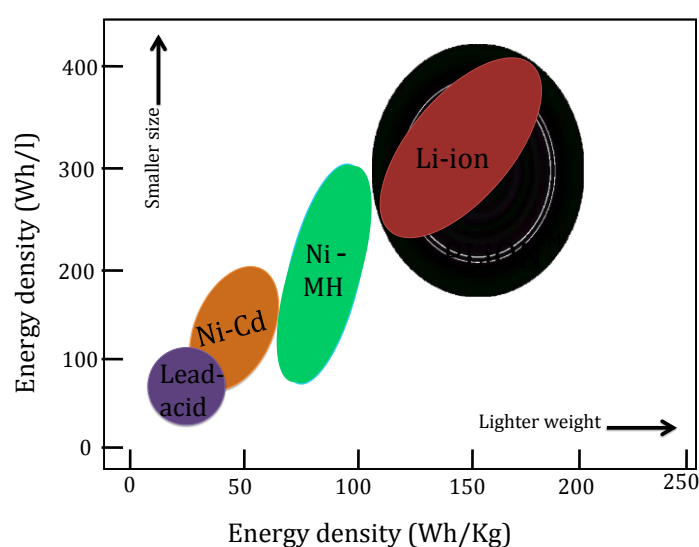

Figure 3: Energy densities of different well-known electrochemical batteries

2. Rechargeable Li-ion Batteries

A rechargeable Li-ion battery is an electrochemical storage device composed of a “negative” host electrode and a “positive” host electrode. Both electrodes are immersed in an ionic conductor (electrical insulator), the electrolyte. As the battery is being **charged**, lithium ions (positively charged lithium atoms, illustrated in Figure 4 as green balls) migrate from the “positive” electrode through the electrolyte towards the “negative” electrode. The reverse process takes place upon the **discharge** process. Thus lithium ions shuttle back and forth between the two electrodes.

⁴ Machinery statistics released by the Japan Ministry of Economy, Trade and Industry

Simultaneously with the migration of Li^+ ion, electrons migrate through an external circuit and consequently can be “recuperated” through electrical energy during discharge. Note that the “negative” electrode is also call **anode** (electrode in which chemical oxidation occurred during discharge) and the “positive” electrode **cathode** (electrode in which chemical reduction occurred during discharge).

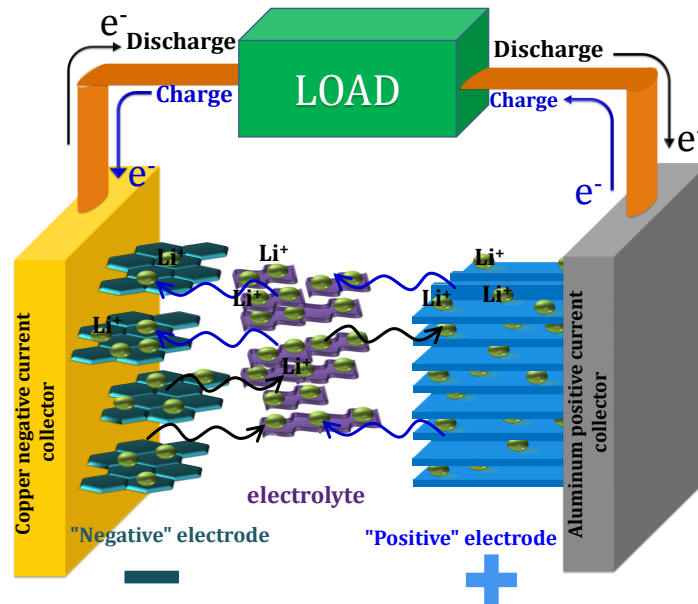
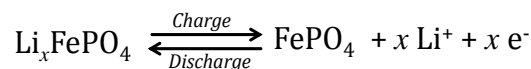

Figure 4: A schematic representation of a Li-ion battery with graphite as negative insertion electrode material and an insertion compound as positive electrode material.

The chemical reaction, **insertion reaction**, occurring at the positive electrode can be summarized as shown here as an example for the well known intercalation compound LiFePO_4 :



The two main feature of the Li-ion battery are: *i)* the **potential**: which depends on the nature of the two redox couples involved and on the difference in potential between them, but also on the advancement of the reactions; *ii)* the **capacity** which depends on the number of Li exchanged per metal.

According to the above equation, the electric charge transferred (linked to the mole of Li) during the charge or discharge process is $(96500/3600) \times x$ in A·h/mol. For the active material this leads to a specific capacity of $(26.8/M) \times x$ A·h/g (M being the molar mass of the active material). Therefore, the specific capacity can also be reported as the energy stored in the chemical reaction, expressed in volumetric basis by using the density or in gravimetric by using molar mass according to the followings:

Specific energy in gravimetric units: $E \times (26.8 \times x / M)$ in W·h/g

Specific energy in volumetric units: $E \times (26.8 \times x / M) \times d$ in W·h/l

With **E** the potential and *d* the density of the active material.

The energy of a Li-ion battery can consequently be improved by increasing the number of moles of Li exchanged which is usually below 1 per transition metal ion (but that can reach 3 for conversion reactions, not discussed here [1, 2]), by choosing an active material with a low molar mass and/or by choosing a positive electrode material which can operated at higher potential *E*.

3. Positive Electrode Materials

The choice of the positive electrode material is important for the optimization of the Li-ion battery. The ions-electrons duality is mandatory for the positive electrode used in the intercalation chemistry. Indeed the active material should possess both stable crystallographic structure which allows an intercalation/extraction of the Li^+ ions and a transition metal stable at different oxidation states (ability to be oxidized and/or reduced reversibly). There are varieties of active materials which can be classified according to their framework structure (Figure 5):

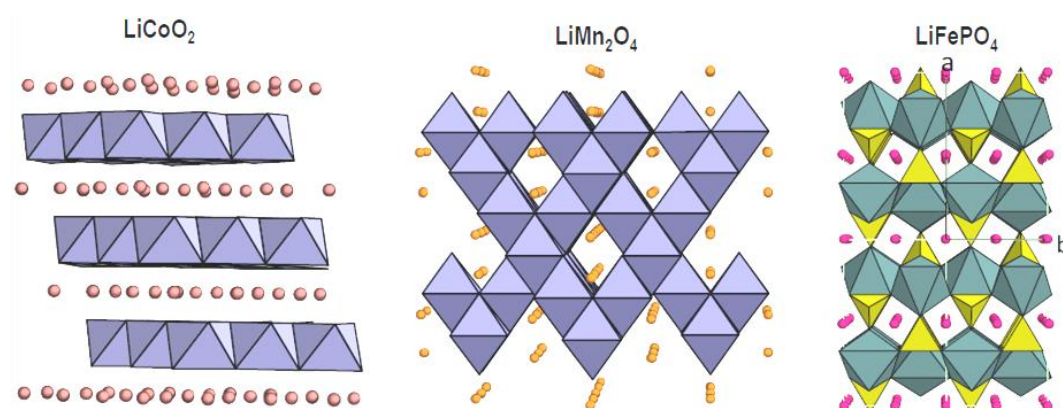

Figure 5: Schematic representation of the crystal structures of 2D LiCoO_2 (left), 3D LiMn_2O_4 (center) and polyanionic (here triphylite LiFePO_4) (right) [3]

Layered structures: The compounds are built up by layers of lithium lying between slabs of close-packed octahedra formed by the transition metal and oxygens. Their structure is therefore a bi-dimensional crystal structure from which lithium ions may be easily intercalated or extracted in a reversible manner. As an example one can mention LiCoO_2 , first introduced by J.B. Goodenough [4], that remains the main material used as positive electrode in commercial lithium-ion batteries. We can also enumerate $\text{LiNi}_{1-y-z}\text{Co}_y\text{Al}_z\text{O}_2$, [5] and $\text{LiCo}_{1/3}\text{Ni}_{1/3}\text{Mn}_{1/3}\text{O}_2$ [6]. Overlithiated layered oxides (such as $\text{Li}_{1+x}\text{Mn}_{1-x}\text{O}_2$ with M being mainly Mn) exhibit high

reversible capacities (> 200 mAh/g) after an “activation” process at high voltage (> 4.5 V vs. Li) [7, 8]. Due to irreversible structural instabilities (when the number of extracted lithium ions is high at the end of the charge process), irreversible migration of transition metals within the lithium layers may occur and lead to important capacity loss upon cycling. Moreover, a more dramatic effect is that in the charged state the transition metal ions, such as Ni or Co, are at the tetravalent state, an instable oxidation state so that any heating leads to metal reduction through oxygen loss.

Spinel structures: In order to overcome the drawbacks of the layered structures, J.B. Goodenough [9] and M.M. Thackeray [9-11] had envisioned the possibility to use a three-dimensional oxides such as the Spinel LiMn_2O_4 . In such Spinel structure, MnO_6 octahedra are connected to each other through edge-sharing and define a three-dimensional network of conduction paths for lithium motion (Figure 5). Spinel LiMn_2O_4 exhibits an operating voltage of 4.1 V vs. Li^+/Li , and its high potential analogue, $\text{Li}[\text{Ni}_{1/2}\text{Mn}_{3/2}]\text{O}_4$, lies at about 4.7 V vs. Li^+/Li . Coupled with an elevated-potential negative electrode such as the Spinel $\text{Li}_4\text{Ti}_5\text{O}_{12}$, that latter system provides a route to develop a promising new generation of 12 V batteries [12]. These oxides (layered oxides and Spinel oxides) are reasonably good ionic and electronic conductors and lithium insertion/extraction proceeds while operating on the $\text{M}^{4+}/\text{M}^{3+}$ redox couple, located between 4V and 5V vs. Li^+/Li .

Polyanionic frameworks: Besides those “simple” oxides (which may lead actually to quite complicated mixed cation arrangements and properties), three-dimensional frameworks built of transition metals and polyanions $(\text{XO}_4)^{n-}$ have become in the last fifteen years the subject of very intensive research worldwide since the discovery of the electrochemically active LiFePO_4 [13, 14]. Despite the “weight penalty” (smaller theoretical gravimetric capacity) arising from the presence of polyanion groups such as $(\text{PO}_4)^{3-}$, $(\text{SiO}_4)^{4-}$, $(\text{SO}_4)^{2-}$ etc. the positive attributes of such materials are as follows:

- ✓ Very stable frameworks provide long term structural stability, essential for extensive cycling and safety issues
- ✓ The chemical nature of the polyanion allows the monitoring of a given $\text{M}^{n+}/\text{M}^{(n-1)+}$ redox couple, through the **inductive effect** introduced by Goodenough [15, 16] and gives rise to higher values vs. Li than in oxides

- ✓ An immense variety of atomic arrangements and crystal structures adopted with an extreme versatility towards cation and anion substitutions for a given structural type

Among polyanionic-based materials, one might enumerate: NASICON structure $(A_xMM'(XO_4)_3)$; Olivine structure $LiMPO_4$; more “exotic” structures such as hydrated phosphates, diphosphates, alluaudites, silicates, borates... and new promising materials derived from the Tavorite structure $A_xM(XO_4)Y$.

4. Tavorite Materials

The name Tavorite was known 67 years ago since the first discovery of this mineral by Dr. Elysiário Távora Filho (Brazilian professor of Mineralogy at the Federal University of Rio de Janeiro) [17]. The first study of the Tavorite mineral was performed by M.L. Lindberg et al. [18] who proposed the chemical formula of $LiFePO_4OH$ (with Fe ion at the trivalent state), similar to the Montebasite $LiAlPO_4OH$ (which was discovered in Montebas in ~1870, (Creuse, France) [19]). Note that the description of the Tavorite structure ($LiFePO_4OH$) is exactly the same as that of the Amblygonite structure (first described by Prof. Johann Friedrich August Breithaupt – German mineralogist), which chemical formula consisted of $LiAlPO_4F$. Amblygonite and Tavorite are therefore isostructural and both differ from the Montebasite structure. Indeed Montebasite mineral crystallizes in the monoclinic system with the space group of $C2/c$, on the contrary to the Tavorite structure which crystallizes in the triclinic system with the space group $P-1$ (Figure 6).

The general chemical formula of Tavorite family is A_xMXO_4Y with A as alkaline ion, M as a transition metal or earth-alkaline metal, X as phosphorus or sulfur and Y as halide, hydroxide, oxygen, or a mixed of halide and hydroxide ... V.I. Simonov and N.V. Belov [20] first described the crystal structure of the Tavorite compound. The structure is built up by $[MO_4Y_2]$ octahedra and $[PO_4]$ tetrahedra connected to each other through their corners by oxygen atoms. The octahedra chains of $-\cdots YO_4MY-YO_4MY\cdots-$ (Figure 6) are connected through the ligand Y and the chains are connected to each other through $[PO_4]$ tetrahedra by oxygen atoms. Two crystallographic sites were observed for the transition metal M (both at special Wyckoff position) and one crystallographic site for X (phosphorus or sulfur). The structure generates 3 tunnels (in three directions) within which the atom A lies. The number of Li sites and their precise localization were hypothetical in the Tavorite-type structure. Indeed V.I. Simonov and N.V. Belov [20], through their studies of the $LiAlPO_4(F_x,OH_{1-x})$ series, reported a large and extremely anisotropic

displacement parameter for the Li atom and suggested that the site was split into two fractionally occupied positions. Note that Baur et al. [21] found no such splitting in the structure of Montebrasite LiAlPO_4OH . Later, during the study of the $\text{LiAlPO}_4(\text{F}_x\text{OH}_{1-x})$ series (performed using single crystals), L.A. Groat et al. [22] confirmed the distribution of Li between two sites highly dependent on the amount of fluorine in the sample.

Note that the Montebrasite structure is very similar with the Tavorite / Amblygonite one, but slightly more distorted with only one site for the transition metal (Figure 6).

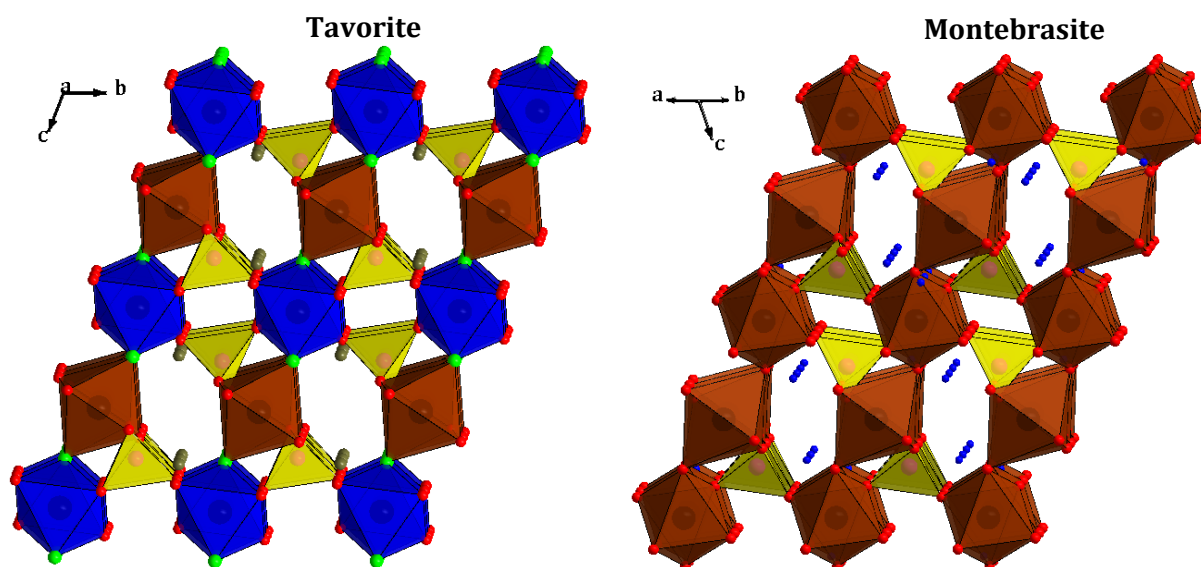

Figure 6: Representation of the Tavorite (left) and Montebrasite (right) crystal structures. The blue and brown polyhedra are MO_4Y_2 octahedra and the yellow are XO_4 tetrahedra.

Four models of unit cells describing the Tavorite structure are reported in literature and gathered in Table 1. Figure 7 illustrates how these models are related to each other. The feature of model I, the most commonly used, is that $a_I < b_I < c_I$, $(\alpha_I, \beta_I) > 100^\circ$, and $\gamma_I < 100^\circ$. Model II derives from Model I through a simple permutation of the lattice parameters and angles: in other words, the generated “boxes” are identical. The volume of the unit-cell of Model III is twice bigger than those of Models I and II with complex transformation from one to the other ($a_{\text{III}} = a_I + b_I$, $b_{\text{III}} = c_I$, and $c_{\text{III}} = b_I - a_I$). One peculiar feature of Model IV, rarely used, is that at least one of the angles is lower than 70° , that is, far from a conventional description of a triclinic system. In this thesis the structure of the Tavorite will always be described in Model I so that the octahedra chains are running along the c axis. Note however that J. Barker et al. described the Tavorite-like LiVPO_4F in Model I, but with the chains running along the longest diagonal of the primitive cell.

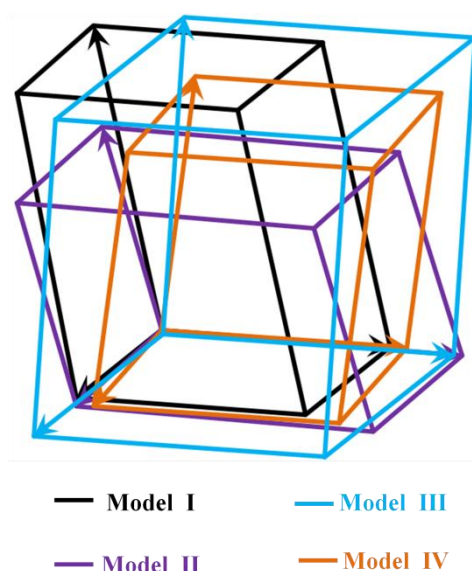

Figure 7: Illustration of geometrical relationships between the four models used in the literature to describe Tavorite-type structures.

Table 1 : Tavorite-like structures reported in the literature that adopt the space group $P\bar{1}$

	<i>A</i>	<i>b</i>	<i>c</i>	α	<i>B</i>	γ	<i>V</i> (Å ³)	References	MODEL
FeSO ₄ ·H ₂ O	5.176	5.176	7.608	107.57	107.57	93.65	182.55	ICSD# 79162	I
LiMgSO ₄ F	5.162	5.388	7.073	106.68	107.4	97.50	174.72	ICSD# 281119	I
LiFeSO ₄ F	5.174	5.494	7.222	106.52	107.21	97.791	182.44	[23, 24]	I
LiCoSO ₄ F	5.172	5.421	7.184	106.85	107.78	97.98	177.77	ICSD# 167202	I
LiAlPO ₄ ·OH _{0.5} F _{0.5}	5.060	5.160	7.080	109.87	107.5	97.9	159.78	ICSD# 20577	I
LiAlPO ₄ F	5.060	5.160	7.080	109.87	107.5	97.9	159.78	ICSD# 48012	I
LiTiPO ₄ F	5.199	5.314	7.243	106.97	108.26	97.655	176.09	[20]	I
LiVPO ₄ F	5.170	5.308	7.263	107.59	107.97	98.39	174.36	This Work	I
LiFePO ₄ F	5.155	5.304	7.261	107.35	107.85	98.618	174.24	[20, 21]	I
LiFePO ₄ OH	5.347	7.284	5.132	109.15	97.90	106.52	175.05	ICSD# 167608	II
Li ₂ FePO ₄ F	5.374	7.443	5.325	109.03	94.423	108.26	187.41	[21]	II
LiTiPO ₄ O	6.904	7.197	7.903	90.45	91.31	117.19	349.13	ICSD# 39761	III
LiVPO ₄ O	6.748	7.206	7.922	89.84	91.32	116.99	343.16	ICSD# 20537	III
LiAlPO ₄ ·OH _{0.5} F _{0.5}	5.184	7.155	5.040	112.12	97.80	67.88	160.43	ICSD# 26513	IV
LiFePO ₄ ·(OH _{0.5} ,F _{0.5})	5.138	5.307	7.422	67.48	67.72	81.98	172.99	ICSD# 20808	IV
LiGaPO ₄ ·OH	5.085	5.297	7.301	67.830	67.839	82.027	168.67	ICSD# 250410	IV

Tavorite based materials are becoming the subject of studies as positive materials for Li-ion batteries. Indeed the combination of “Tavorite” and “battery” introduced in “web of knowledge” gave a result of 30 articles, with 18 publications for only the year of 2012 (Figure 8). The tremendous increase of the number of citations also shows the huge interest of researchers for this new type of materials which was almost unknown 5 years ago as materials for Li-ion

batteries. Note that ICMCB and LRCS published their first results on Tavorite-type materials for Li-ion batteries in 2010 [23-27].

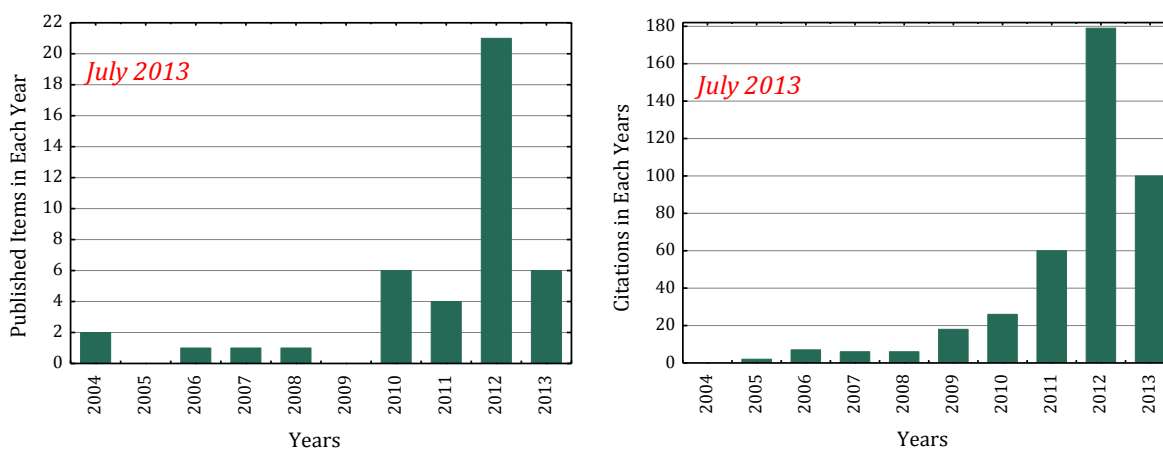

Figure 8: (left) Evolution of the number of articles published based on Tavorite system. (right) Evolution of the citations in each year. (Data recorded for the past 10 years in “web of knowledge”)

5. The Aim of This Thesis

Fluoro-phosphate (and fluoro-sulphate) materials benefit in particular from the inductive effect of both phosphate (respectively sulphate) and F anions, which lowers the energy of a given M^n/M^{n-1} redox couple, therefore leading to the increase of its potential vs. Li. As a result, lithium transition metal fluorophosphates is an appealing class of materials for Li-ion batteries as these Tavorite-type structures are capable to operate at very high potential compared to other phosphates ($\text{Li}_3\text{V}_2(\text{PO}_4)_3$, LiFePO_4 ...), hydroxyl phosphates (LiFePO_4OH ...), oxyphosphates (LiVPO_4O , VPO_4O ...) ... Few (only 4 to our knowledge) structural families of lithium and sodium transition metal fluorophosphates have been reported before in the literature: AMPO_4F (Figure 9), $\text{A}_3\text{M}_2(\text{PO}_4)_2\text{F}_3$ [28, 29] $\text{A}_2\text{MPO}_4\text{F}$ [30, 31] and $\text{A}_5\text{M}(\text{PO}_4)_2\text{F}_2$ [32]. Note that the so-called fluorophosphates should be actually called fluoride phosphates as they combine phosphate and fluoride anions in the same framework and do not contain P-F type bonds.

Since the potential of a redox couple depend on the combination of the nature of the metal, the nature of the ligand and the nature of the crystalline structure, a large variety of Tavorite type material operate in a large range potential including 1.2 V to ~4.3 V vs. Li^+ (see Figure 9).

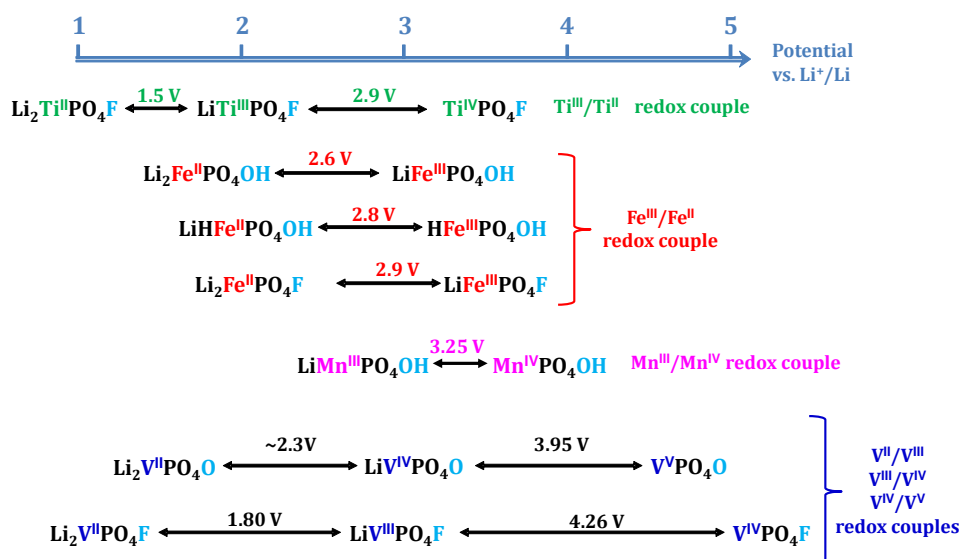

Figure 9: Overview of redox couple potentials for the transition metal in Tavorite A_xMPO_4Y [3]

The crystal chemistry of Tavorite fluorophosphates, particularly the localization of the Li atom, was very ambiguous at the beginning of this work, due to the difficulty in obtaining single-phase samples exempt of impurities. Therefore, optimization of synthesis procedure and clarification of the crystal structures of $LiMPO_4F$ ($M = V, Fe, Ti$) were our priority. The prime focuses in this thesis are highlighted as follows:

- Preparation of high purity $LiMPO_4F$ via solid-state routes.
- Structural studies of $LiMPO_4F$ using X-ray and neutron diffraction, 7Li , ^{31}P and ^{19}F MAS NMR.
- Magnetic behaviour and magnetic structure of $LiVPO_4F$ and $LiFePO_4F$ through the evolution of the magnetic susceptibility with temperature and neutron diffraction experiments performed at low temperature.
- Understanding the Li^+ extraction/insertion and insertion/extraction mechanism from/into $LiMPO_4F$.

References

- Poizot, P.; Laruelle, S.; Grugeon, S.; Dupont, L. and Tarascon, J.M.; *From the Vanadates to 3d-Metal Oxides Negative Electrodes*, Ionics, **2000**, 6(5-6): p. 321-330.
- Poizot, P.; Laruelle, S.; Grugeon, S.; Dupont, L. and Tarascon, J.M.; *Nano-sized transition-metaloxides as negative-electrode materials for lithium-ion batteries*, Nature, **2000**, 407(6803): p. 496-499.
- Masquelier, C. and Croguennec, L.; *Polyanionic (Phosphates, Silicates, Sulfates) Frameworks as Electrode Materials for Rechargeable Li (or Na) Batteries*, Chemical Reviews, **2013**, 10.1021/cr3001862.
- Mizushima, K.; Jones, P.C.; Wiseman, P.J. and Goodenough, J.B.; *LiXCO₂ "(O-less-Than-X-less-Than-Or-Equal-To-1) - A New Cathode Material for Batteries of High-Energy density* Materials Research Bulletin, **1980**, 15(6): p. 783-789.
- Guilmard, M.; Pouillier, C.; Croguennec, L. and Delmas, C.; *Structural and electrochemical properties of LiNi_{0.70}Co_{0.15}Al_{0.15}O₂*, Solid State Ionics, **2003**, 160(1-2): p. 39-50.
- Ohzuku, T. and Makimura, Y.; *Layered lithium insertion material of LiCo_{1/3}Ni_{1/3}Mn_{1/3}O₂ for lithium-ion batteries*, Chemistry Letters, **2001**(7): p. 642-643.
- Kropf, A.J.; Johnson, C.S.; Vaughey, J.T. and Thackeray, M.M.; *XAFS analysis of layered Li(x)Ni(0.5)Mn(0.5)O(2) (0 < x <= 2) electrodes for lithium batteries*, Physica Scripta, **2005**, T115: p. 274-277.
- Lu, Z.H.; MacNeil, D.D. and Dahn, J.R.; *Layered cathode materials Li NixLi(1/3-2x/3)Mn(2/3-x/3) O-2 for lithium-ion batteries*, Electrochemical and Solid State Letters, **2001**, 4(11): p. A191-A194.
- Goodenough, J.B.; Thackeray, M.M.; David, W.I.F. and Bruce, P.G.; *Lithium Insertion Extraction Reactions with Manganese Oxides*, Revue De Chimie Minerale, **1984**, 21(4): p. 435-455.
- Thackeray, M.M.; David, W.I.F. and Goodenough, J.B.; *Structural Characterization of the Lithiated Iron-Oxides LiXFe₃O₄ and LiXFe₂O₃ (0-Less-Than-X-Less-Than-2)*, Materials Research Bulletin, **1982**, 17(6): p. 785-793.
- Thackeray, M.M.; Depicciotto, L.A.; David, W.I.F.; Bruce, P.G. and Goodenough, J.B.; *Structural Refinement of Delithiated LiVO₂ by Neutron-Diffraction*, Journal of Solid State Chemistry, **1987**, 67(2): p. 285-290.
- Imazaki, M.; Ariyoshi, K. and Ohzuku, T.; *An Approach to 12 V "Lead-Free" Batteries: Tolerance toward Overcharge of 2.5 V Battery Consisting of LTO and LAMO Batteries and Energy Storage:*, J. Electrochem. Soc., **2009**, 156(10): p. A780-A786.
- Padhi, A.K.; Nanjundaswamy, K.S. and Goodenough, J.B.; *Phospho-olivines as positive-electrode materials for rechargeable lithium batteries*, Journal of the Electrochemical Society, **1997**, 144(4): p. 1188-1194.
- Padhi, A.K.; Nanjundaswamy, K.S.; Masquelier, C.; Okada, S. and Goodenough, J.B.; *Effect of structure on the Fe³⁺/Fe²⁺ redox couple in iron phosphates*, Journal of the Electrochemical Society, **1997**, 144(5): p. 1609-1613.
- Manthiram, A. and Goodenough, J.B.; *Lithium Insertion into Fe₂(Mo₄)₃ Frameworks - Comparison of M = W with M = Mo*, Journal of Solid State Chemistry, **1987**, 71(2): p. 349-360.
- Manthiram, A. and Goodenough, J.B.; *Lithium Insertion into Fe₂(SO₄)₃ Frameworks*, Journal of Power Sources, **1989**, 26(3-4): p. 403-408.
- Filho, E.T., *Estudos brasileiros de geologia*. 1946: Fundação Getrílio Vargas.
- Lindberg, M.L. and Pecora, W.T.; *Tavorite and Barbozalite, 2 New Phostate Minerals from Minas-Gerais, Brazil*, American Mineralogist, **1955**, 40(11-2): p. 952-966.
- Cloizeaux, A.D., *On a New Locality of Amblygonite and on Montebasite, A new Hydrated Aluminium and Lithium Phosphate*. 1874.

20. Simonov, V.I. and Belov, N.V.; *The Crystal Structure of Amblygonite*, Doklady Akademii Nauk Sssr, **1958**, 119(2): p. 354-356.
21. Baur, W.H.; *Die Kristallstruktur des Edelamblygonits $\text{LiAlPO}_4(\text{OH},\text{F})$* , Acta Crystallographica, **1959**, 12(12): p. 988-994.
22. Groat, L.A.; Chakoumakos, B.C.; Brouwer, D.H.; Hoffman, C.M.; Fyfe, C.A.; Morell, H. and Schultz, A.J.; *The amblygonite (LiAlPO_4F)-montebrasite (LiAlPO_4OH) solid solution: A combined powder and single-crystal neutron diffraction and solid-state ^6Li MAS, CP MAS, and REDOR NMR study*, American Mineralogist, **2003**, 88(1): p. 195-210.
23. Marx, N.; *Synthèse et Caractérisation de Nouveaux Phosphates Utilisés Comme Matériaux d'Electrode Positive pour Batteries au Lithium*, Universtité de Bordeaux 1, **2010**.
24. Marx, N.; Croguennec, L.; Carlier, D.; Bourgeois, L.; Kubiak, P.; Le Cras, F. and Delmas, C.; *Structural and Electrochemical Study of a New Crystalline Hydrated Iron(III) Phosphate $\text{FePO}_4 \cdot \text{H}_2\text{O}$ Obtained from $\text{LiFePO}_4(\text{OH})$ by Ion Exchange*, Chemistry of Materials, **2010**, 22(5): p. 1854-1861.
25. Marx, N.; Croguennec, L.; Carlier, D.; Wattiaux, A.; Le Cras, F.; Suard, E. and Delmas, C.; *The structure of tavorite $\text{LiFePO}_4(\text{OH})$ from diffraction and GGA plus U studies and its preliminary electrochemical characterization*, Dalton Transactions, **2010**, 39(21): p. 5108-5116.
26. Recham, N.; Chotard, J.N.; Dupont, L.; Delacourt, C.; Walker, W.; Armand, M. and Tarascon, J.M.; *A 3.6 V lithium-based fluorosulphate insertion positive electrode for lithium-ion batteries*, Nature Materials, **2010**, 9(1): p. 68-74.
27. Recham, N.; Chotard, J.N.; Jumas, J.C.; Laffont, L.; Armand, M. and Tarascon, J.M.; *Ionothermal Synthesis of Li-Based Fluorophosphates Electrodes*, Chemistry of Materials, **2010**, 22(3): p. 1142-1148.
28. Le Meins, J.M.; Bohnke, O. and Courbion, G.; *Ionic conductivity of crystalline and amorphous $\text{Na}_3\text{Al}_2(\text{PO}_4)_2\text{F}_3$* , Solid State Ionics, **1998**, 111(1-2): p. 67-75.
29. Le Meins, J.M.; Courbion, G. and Greneche, J.M.; *Structural phase transitions evidenced by Mossbauer spectrometry in a ferric fluorophosphate: $\text{Na}_3\text{Fe}_2(\text{PO}_4)_2\text{F}_3$* , Hyperfine Interactions, **1999**, 122(3-4): p. 365-369.
30. Yakubovich, O.V.; Karimova, O.V. and Melnikov, O.K.; *The mixed anionic framework in the structure of $\text{Na}_2\{\text{MnF PO}_4\}$* , Acta Crystallographica Section C-Crystal Structure Communications, **1997**, 53: p. 395-397.
31. Dutreilh, M.; Chevalier, C.; El-Ghozzi, M.; Avignat, D. and Montel, J.M.; *Synthesis and crystal structure of a new lithium nickel fluorophosphate $\text{Li}_2\text{NiF}(\text{PO}_4)$ with an ordered mixed anionic framework*, Journal of Solid State Chemistry, **1999**, 142(1): p. 1-5.
32. Yin, S.C.; Herle, P.S.; Higgins, A.; Taylor, N.J.; Makimura, Y. and Nazar, L.F.; *Dimensional reduction: Synthesis and structure of layered $\text{Li}_5\text{M}(\text{PO}_4)_2\text{F}_2$ ($\text{M} = \text{V}, \text{Cr}$)*, Chemistry of Materials, **2006**, 18(7): p. 1745-1752.

Chapter I
SYNTHESIS AND CRYSTAL
STRUCTURE OF
 LiVPO_4F AND LiVPO_4O

Contents

I-1. Introduction	23
I-2. CERAMIC SYNTHESIS OF LiVPO_4F AND LiVPO_4O	24
I-2a. One-step Ceramic Synthesis of LiVPO_4F	24
I-2b. Two-Step Ceramic Route for the Synthesis of LiVPO_4F	26
<i>i- Synthesis of the intermediate phase: C-VPO_4</i>	26
<i>ii- Synthesis of LiVPO_4F</i>	28
I-2c. Synthesis of LiVPO_4O	30
I-2d. Morphology and Magnetic Behavior of LiVPO_4X (X = O/F)	31
I-2e. Summary and Conclusion	34
I-3. CRYSTAL AND MAGNETIC STRUCTURES OF LiVPO_4F	34
I-3a. The Crystal structure of LiVPO_4F	35
I-3b. NMR Study of LiVPO_4F	40
I-3c. Magnetic structure of LiVPO_4F	44
I-3d. Conclusion and Summary	46
I-4. CRYSTAL STRUCTURE AND NMR STUDY OF LiVPO_4O	47
I-4a. Crystal structure of LiVPO_4O	47
I-4b. NMR Study of LiVPO_4O	51
I-5. Conclusion and summary of this chapter	53

I-1. Introduction

The lithium vanadium fluorophosphate LiVPO_4F was first synthesized by J. Barker et al. [1, 2] through a two-step ceramic process, the first step being a carbothermal reduction (CTR) process which leads to the formation of VPO_4 . An excess of carbon was used over stoichiometric proportions in order to ensure a complete reduction of vanadium. Y. Li et al. [3] and Q. Zhang et al. [4] reported the synthesis of LiVPO_4F using a two-step sol-gel process with the synthesis of $\text{V}_2\text{O}_5 \cdot n\text{H}_2\text{O}$ as an intermediate phase. A pure phase of LiVPO_4F , as mentioned by several authors [4-8], is quite difficult to obtain.

J. Barker et al. [1, 2, 9, 10] had proposed that LiVPO_4F crystallized in the same space group as LiAlPO_4F which is a member of Tavorite (refer to the general introduction) type structure. Based on the analogy with LiAlPO_4F , J. Barker proposed that the Li atoms were located within 2 crystallographic sites with 50% occupancy in each. However, the position of one of the Li sites is highly hypothetical as we will discuss later.

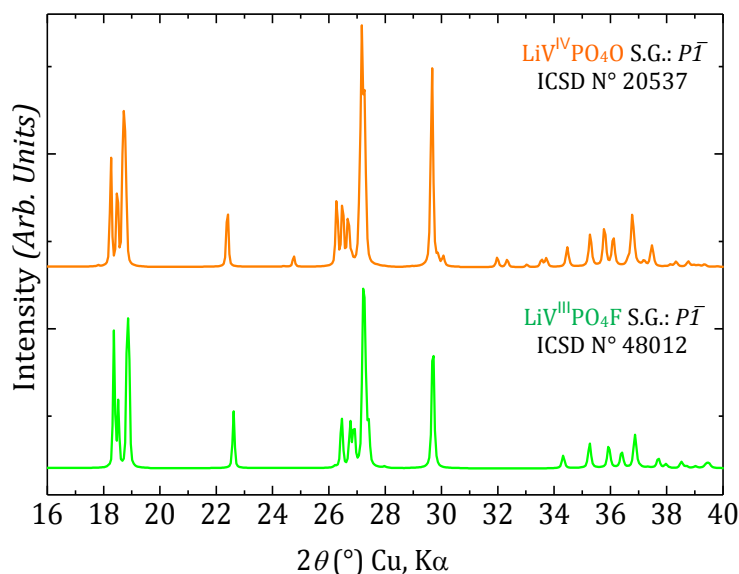

Figure I-1: Simulated XRD patterns of LiVPO_4O (orange) and LiVPO_4F (green) from ICSD N° 20537 and LiAlPO_4F (ICSD N° 48012, where Al was replaced by V) respectively.

In the two following chapters, we will compare LiVPO_4F with the triclinic lithium vanadium oxyphosphate LiVPO_4O which is often obtained by a sol-gel process [8, 11, 12]. The only structural studies of LiVPO_4O were carried out by a Russian group 30 years ago [13] and no other structural determination was done so far!!! The tavorite phases LiVPO_4O and LiVPO_4F are homeotypic, their X-ray Diffraction (XRD) patterns being very similar (Figure I-1) but in fact differ. A closer inspection shows additional diffraction peaks for LiVPO_4O displayed at 25° , 32.2° ,

and 32.5° in 2θ ($d = 3.56 \text{ \AA}$, 2.78 \AA , and 2.75 \AA , respectively) compared to the simulated XRD pattern of LiVPO_4F (simulation obtained from LiAlPO_4F (ICSD N° 48012) where Al was replaced by V).

In this chapter we present our results in defining a reliable procedure for the ceramic synthesis of pure phases of LiVPO_4F and LiVPO_4O . Their crystal structure as well as their magnetic structure will be presented, as a result of refinements of both X-Ray and neutron diffraction data.

I-2. CERAMIC SYNTHESIS OF LiVPO_4F AND LiVPO_4O

I-2a. One-step Ceramic Synthesis of LiVPO_4F

We attempted to synthesize LiVPO_4F through a one-step ceramic route using either V_2O_3 or V_2O_5 as vanadium precursors. Stoichiometric amounts of V_2O_3 vanadium (III) oxide (99.9%, from CERAC), $\text{NH}_4\text{H}_2\text{PO}_4$ ammonium phosphate monobasic, and LiF lithium fluoride (both from Aldrich) were mixed in a planetary ball milling machine and then pressed as a pellet. A first thermal treatment was undertaken at 300°C during 5 hours under argon flow so as to remove ammonia [14]. After grinding the obtained powder for homogenization, new pellets were heated up to 800°C for 10 h under argon flow.

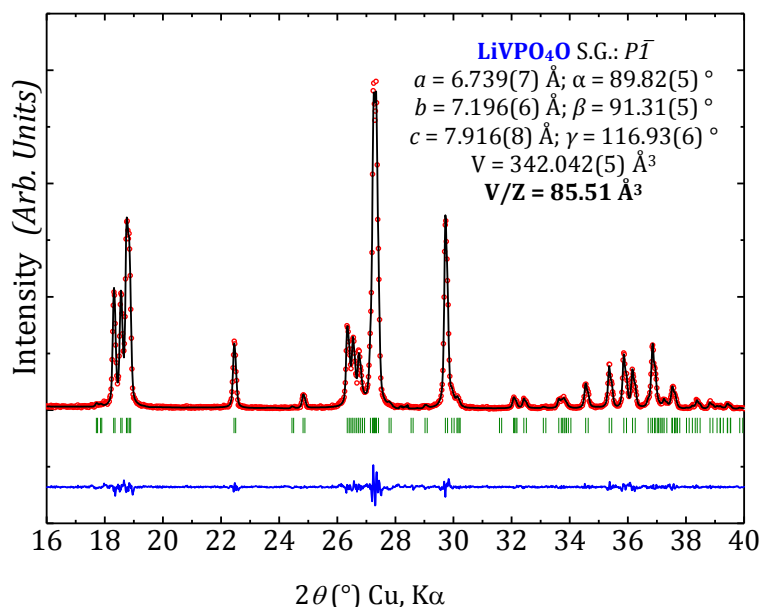
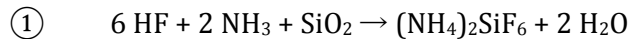

Figure I-2: XRD pattern refinement of LVPO_4O obtained through a one-step reaction using LiF as lithium precursor

The recovered powder was “pale green” in color, and its X-ray diffraction (XRD) pattern was successfully refined using the lattice parameters of LiVPO₄O (Figure I-2) instead of those reported for LiVPO₄F. To the best of our knowledge, this triclinic phase of LiVPO₄O had never been synthesized directly by a ceramic route as only a sol-gel procedure had been reported previously [11, 12]. The obtention of LiVPO₄O using LiF as a precursor (so as to obtain LiVPO₄F) raised two main observations:

✚ *The absence of fluorine in the final product whereas LiF was used as lithium precursor.* This was also observed by C. Allen et al. [8] who mixed VPO₄ and LiF in stoichiometric proportions together with CH₃(CH₂)₄COOH and ended up with the monoclinic α-Li₃V₂(PO₄)₃ in which the vanadium oxidation state is +3. The absence of fluorine in the final product was due to the formation of HF which reacted together with NH₃ on the quartz tube to form (NH₄)₂SiF₆ (NH₃ which is generated from both NH₄VO₃ and NH₄H₂PO₄ precursors, can react with SiO₂ and form H₂NSiOOH as established by M. Zhou et al. [15]). We therefore believe that during the synthesis of LiVPO₄F, C. Allen obtained a decomposition of the complex H₂NSiOOH and formed (NH₄)₂SiF₆ according to the reaction ①:



As it will be discussed later based on XRD data refinement, we also did not observe the presence of fluorine in the final product as would have been the case in the solid solution LiVPO₄O_xF_y.

✚ *The oxidation of vanadium from V³⁺ to V⁴⁺ whereas the synthesis was performed in argon.* It appeared that the tubular furnace used was not well hermetic and hence favored this vanadium oxidation, which allowed us, by the way, to discover the direct synthesis of pure LiVPO₄O. In order to avoid the oxidation of vanadium which leads to the formation of LiVPO₄O instead of LiVPO₄F, we have performed the direct synthesis in a hermetic furnace. We ended up with the monoclinic α-Li₃V₂(PO₄)₃ as a main phase together with small amounts of unknown impurities.

The second attempt of the synthesis of LiVPO₄F through a one-step ceramic route was done using V₂O₅ as the vanadium precursor instead of V₂O₃. Just as previously, we mixed stoichiometric proportions of vanadium oxide (V) with ammonium phosphate (NH₄H₂PO₄) and lithium fluoride (LiF). In order to reduce the oxidation state of vanadium, we added in a stoichiometric proportion highly divided carbon source (C_{sp}). Carbon favors the formation of carbon monoxide (CO) at high temperature and thus leads to the reduction of the oxidation state of vanadium. This type of reaction is called carbothermal reduction (CTR). Using V₂O₅ as a

vanadium source led to the formation of the α -Li₃V₂(PO₄)₃ and V₂O₃ as final products. We did not succeed to synthesize LiVPO₄F through a one-step ceramic route and hence developed a different two-step ceramic route.

I-2b. Two-Step Ceramic Route for the Synthesis of LiVPO₄F

As presented in the introduction of this chapter, J. Barker et al. reported the synthesis of LiVPO₄F through an intermediate phase VPO₄ which had been obtained by carbothermal reduction (CTR) [1, 16]. CTR is a solid-state synthesis method using a highly divided carbon which reacts with a transition metal oxide in order to reduce the oxidation state of the corresponding metal. The CTR method is widely used in industry in order to reduce a metal oxide to a metal state and relies on two reactions:

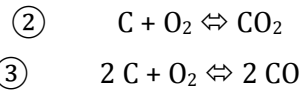

While the formation enthalpy of CO₂ is lower than the one of CO (-394 kJ·mol⁻¹ vs. -220 kJ·mol⁻¹), the formation entropy of CO₂ is much more lower (2 J·mol⁻¹·K⁻¹ for CO₂ vs. 177 J·mol⁻¹·K⁻¹ for CO). Consequently, according to the Ellingham diagram, the overall free energy of formation for CO₂ by oxidation of carbon is almost constant and independent of the temperature, while the CO free energy formation is a decreasing line (negative slope). Carbon is unique in the sense of having an oxide (CO) whose free energy of formation becomes increasingly negative as the temperature increases. CO is therefore more stable at higher temperatures. This means that providing a higher enough reaction temperature, carbon can reduce any metal oxide so as to form CO and a metal [16].

i- Synthesis of the intermediate phase: C-VPO₄

To synthesize VPO₄, we mixed (according to the reaction $\textcircled{4}$) stoichiometric proportions of vanadium oxide (V₂O₅, 99.9% from Aldrich), ammonium phosphate (NH₄H₂PO₄ from Aldrich) and carbon according to the equation $\textcircled{4}$.

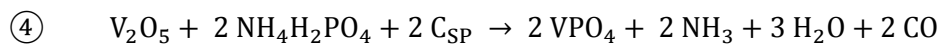

To enable complete vanadium reduction and to ensure the presence of residual carbon in the final product, 5% mass excess of carbon was used, therefore producing a C-VPO₄ composite. The choice of carbon is important since highly divided carbon yields better reduction of the metal

oxide and we therefore choose carbon super P (C_{sp}) which XRD diffraction pattern (Figure I-3) exhibits broad lines at $(002)_{P6_3mc}$ and $(101)_{P6_3mc}$.

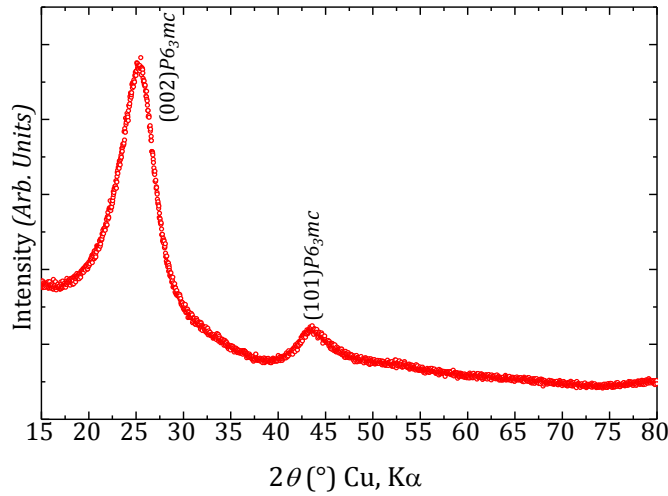

Figure I-3: XRD pattern of C_{SP} used for carbothermal synthesis of VPO_4

The precursors were ball milled in a Spex grinder for 90 min. (or in a planetary grinder for 12 hours). We observed that during milling, the powder color changed from orange for a small milling time, to green for a medium milling time and black for a long milling time (90 min in Spex or 12 hours in planetary grinder). The milled powder was pressed into a pellet and then heated up to 300 $^\circ\text{C}$ during 8 hours under argon flow (pretreatment) prior to a grinding and a final treatment at 800 $^\circ\text{C}$ during 10 hours under argon flow. Figure I-4 shows the result obtained from a full-pattern matching refinement of VPO_4 XRD data based on a structural model described in a monoclinic unit cell in the space group Cmcm ($N^\circ 63$). The lattice parameters obtained (insert in Figure I-4) are close to those reported in ICSD $N^\circ 36521$.

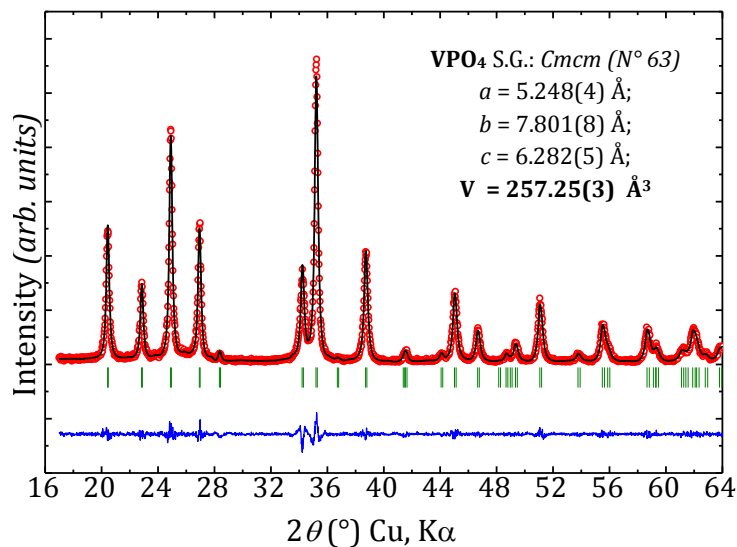

Figure I-4: XRD pattern refinement of C-VPO_4 obtained through a CTR process

ii- Synthesis of LiVPO_4F

VPO_4 was mixed with lithium fluoride in stoichiometric proportions (according to the reaction ⑤) and the obtained powder was pressed into a pellet, subsequently heated up to 750°C under argon flow in a crucible during one hour.

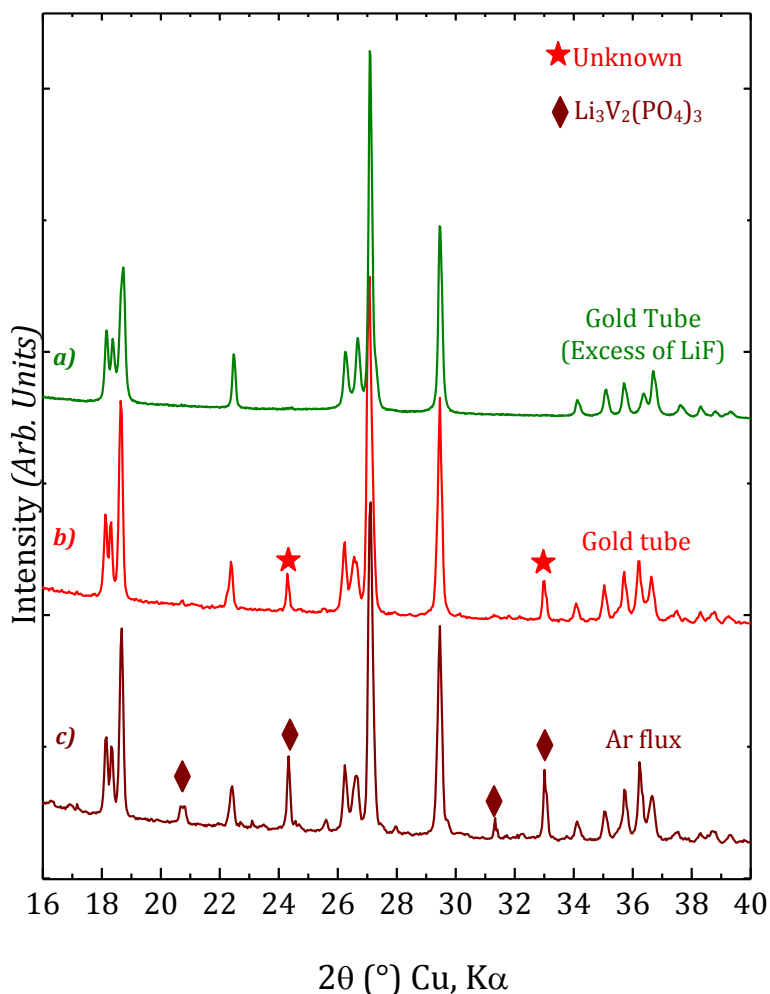
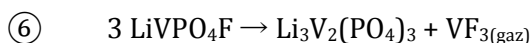

Figure I-5: X-ray diffraction patterns of different powders prepared in this work
a) pellet under Ar flux in crucible, b) pellet in a gold sealed tube, c) stoichiometric proportions of VPO_4/LiF in a gold sealed tube.

The XRD data of the “dark grey” product obtained (Figure I-5a) is comparable to the simulated XRD pattern of LiVPO_4F . Nevertheless, careful analysis showed the presence of $\alpha\text{-Li}_3\text{V}_2(\text{PO}_4)_3$ as an impurity. This impurity, containing a V/P ratio of 2/3, was produced by the sublimation of VF_3 from the reaction mixture, as mentioned also by F. Zhou et al. [7], according to the reaction scheme:



To bypass the sublimation of VF_3 , we decided to perform the synthesis by placing the VPO_4/LiF mixture in a gold tube sealed in an argon-filled glove box, so as to avoid the argon flow. The tube was then heated up to 750°C during 1 h and quenched in liquid nitrogen. The XRD pattern (Figure I-5b) shows that the two first peaks of the impurity obtained are similar to the previous $\alpha\text{-Li}_3\text{V}_2(\text{PO}_4)_3$. However, the full-pattern matching refinement revealed that the lattice parameters of that impurity did not converge to those of $\alpha\text{-Li}_3\text{V}_2(\text{PO}_4)_3$. Moreover, we observed that this unknown impurity is soluble in water, the solution becoming green after 12 hours of stirring. After filtration and drying, pure LiVPO_4F was obtained. Q. Zhang et al. [4] reported the synthesis of LiVPO_4F and claimed to observe Li_3PO_4 as an impurity. This impurity was not encountered during our many attempts of synthesis of LiVPO_4F .

In order to obtain Li/V/P/F proportions as close as possible to the ideal stoichiometry, thermal gravimetric analysis experiments (TGA) of C- VPO_4 have been performed so as to determine the exact amount of remaining carbon in the synthesized C- VPO_4 composite. Figure I-6a displays the TGA and DSC data of C- VPO_4 heated under O_2 flow, the final product being VPO_4O (XRD pattern displayed in Figure I-6b) according to the reaction (7):

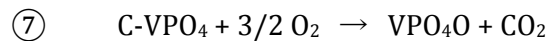

The percentage of carbon found in C- VPO_4 (7.68 %) has then been taken into account for the subsequent synthesis of LiVPO_4F so as to ensure the best stoichiometric proportions between VPO_4 and LiF . A highly pure LiVPO_4F powder was obtained by this procedure (Figure I-5c) which was used successfully several times with excellent reproducibility.

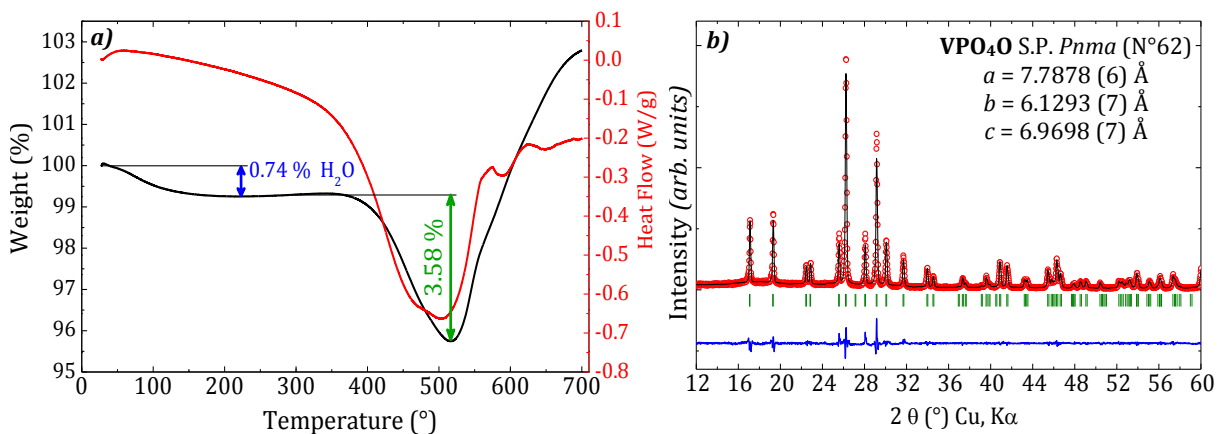
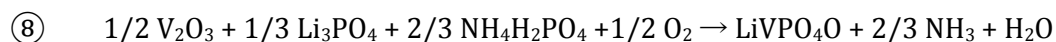

Figure I-6: a) TGA (black line) and DSC (red line) of VPO_4 performed under O_2 flow
b) Full-pattern refinement of the XRD data of VPO_4O obtained after TGA in air.

I-2c. Synthesis of LiVPO₄O

As described previously (I-1a) we succeeded in the synthesis of LiVPO₄O via a one-step ceramic route, using V₂O₃ as a vanadium precursor together with NH₄H₂PO₄ and LiF. The presence (or not) of LiF raised some questions which we attempted to answer. We tried to synthesize LiVPO₄O using Li₃PO₄ instead of LiF according to the reaction ⑧.



The exact same procedure as described above (one-step ceramic synthesis of LiVPO₄O using LiF) was used. In Table I-1 we gathered the lattice parameters of LiVPO₄O from literature (ICSD N° 20537) which are compared with LiVPO₄O obtained from LiF and from Li₃PO₄. As one can notice there is almost no difference of lattice parameters between the three materials.

Table I-1 Comparison of the published LiVPO₄O lattice parameters (ICSD N°20537) with those obtained in this study

Space Group $P\bar{1}$ (N° 2); Z = 4								
LiVPO ₄ O from	<i>a</i> (Å)	<i>b</i> (Å)	<i>c</i> (Å)	α (°)	β (°)	γ (°)	Volume (Å ³)	V/Z (Å ³)
ICSD N° 20537	6.748	7.206	7.922	89.84	91.32	116.99	343.16	85.79
"LiF"	6.747(2)	7.195(7)	7.918(9)	89.84(3)	91.33(2)	116.93(6)	343.18(6)	85.79
"Li ₃ PO ₄ "	6.748(6)	7.199(8)	7.923(3)	89.86(8)	91.34(8)	116.98(8)	343.20(6)	85.80

It is worth to notice at this stage that the above mentioned LiVPO₄O which crystallizes in the triclinic system differs from the well known α -LiVPO₄O and β -LiVPO₄O polymorphs reported in literature:

- **α -LiVPO₄O** crystallizes in tetragonal symmetry ($P4/nmm$ (N° 129)) and can be obtained by dehydration of LiVPO₄O·2H₂O [17] or by electrochemical lithiation of α_1 - and α_{II} -VPO₄O [18, 19]. The structure of α -LiVPO₄O (Figure I-7a) is built up by vanadate (VO₅) and phosphate (PO₄) layers of [VPO₄O]_∞ as proposed by A.S. Hameed et al. [17]. The long V-O bond length (1.93 Å) led A.S. Hameed to consider a penta-coordinated vanadium. The layers of [VPO₄O]_∞ are stacked along the *c* direction and are symmetrically bridged by lithium ions in octahedra.

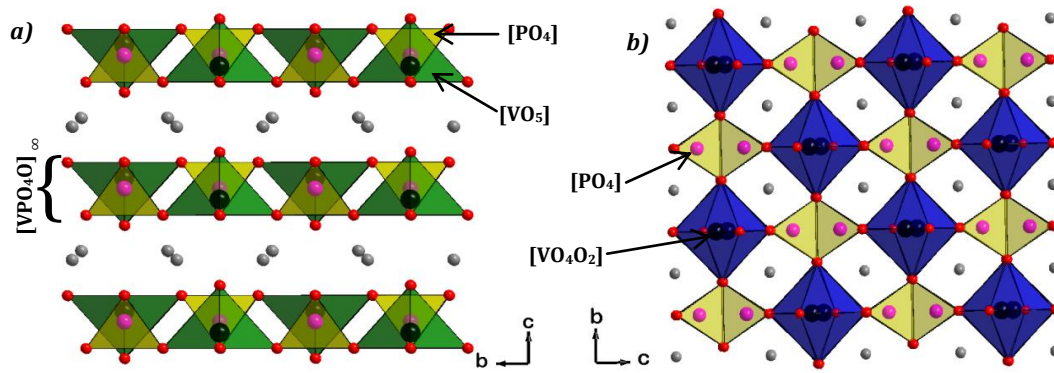

Figure I-7: Skeleton representation of a) $\alpha\text{-LiVPO}_4\text{O}$ and b) $\beta\text{-LiVPO}_4\text{O}$ along the a direction

- **$\beta\text{-LiVPO}_4\text{O}$** crystallizes in orthorhombic symmetry ($Pnma$ ($N^\circ 62$)) and can be obtained by a ceramic CTR route using VPO_4O and Li_2CO_3 (mixed with carbon and heated at 450°C) [20] or by electrochemical lithiation of $\beta\text{-VPO}_4\text{O}$ [21]. The $\beta\text{-LiVPO}_4\text{O}$ framework structure is closely related to that found in $\beta\text{-VPO}_4\text{O}$ and comprises infinite chains of corner-shared VO_6 octahedra, cross-linked by corner-sharing PO_4 tetrahedra. Just as for $\alpha\text{-LiVPO}_4\text{O}$, alternative short (1.63 \AA) and long (2.43 \AA) V–O bonds are observed.

One should note that the notation for the different polymorphs of LiVPO_4O in the literature is confusing. For instance T.A. Kerr et al. [22] and C. Allen et al. [8] referred to the triclinic phase when designated $\alpha\text{-LiVPO}_4\text{O}$, but Y. Yang et al. [12] and B.M. Azmi et al. [11] did not put any symbol in front of LiVPO_4O to designate the same triclinic phase. For homogenization with LiVPO_4F notation, we decided to put no symbol in front of LiVPO_4O .

I-2d. Morphology and Magnetic Behavior of LiVPO_4X ($\text{X} = \text{O}/\text{F}$)

As gathered in Figure I-8, we succeeded in preparing phase-pure LiVPO_4F and LiVPO_4O for which the XRD patterns can be fully indexed in the $P\bar{1}$ triclinic space group. The unit-cell used to describe LiVPO_4O (343.2 \AA^3) is nearly twice bigger than that used to describe LiVPO_4F (174.4 \AA^3), as will be detailed further in the next section. An interesting and useful observation is that the V/Z ratio is significantly smaller in $\text{LiV}^{\text{IV}}\text{PO}_4\text{O}$ (85.8 \AA^3) than in $\text{LiV}^{\text{III}}\text{PO}_4\text{F}$ (87.2 \AA^3) as a result of different oxidation states of vanadium (with ionic radii of 0.063 nm for V^{4+} and of 0.074 nm for V^{3+}).

High resolution scanning electron microscopy (SEM) analysis of metalized samples (*i.e.* Pd plating on particles) was performed using a Hitachi S-4500 microscope. The SEM micrographs (inset of Figure I-8) of LiVPO_4F indicate a particle size of about $1\text{--}2 \text{ }\mu\text{m}$ surrounded by particles

of carbon (80–60 nm), whereas the primary particles size of LiVPO_4O is about 1 μm with agglomerates of about 5–6 μm .

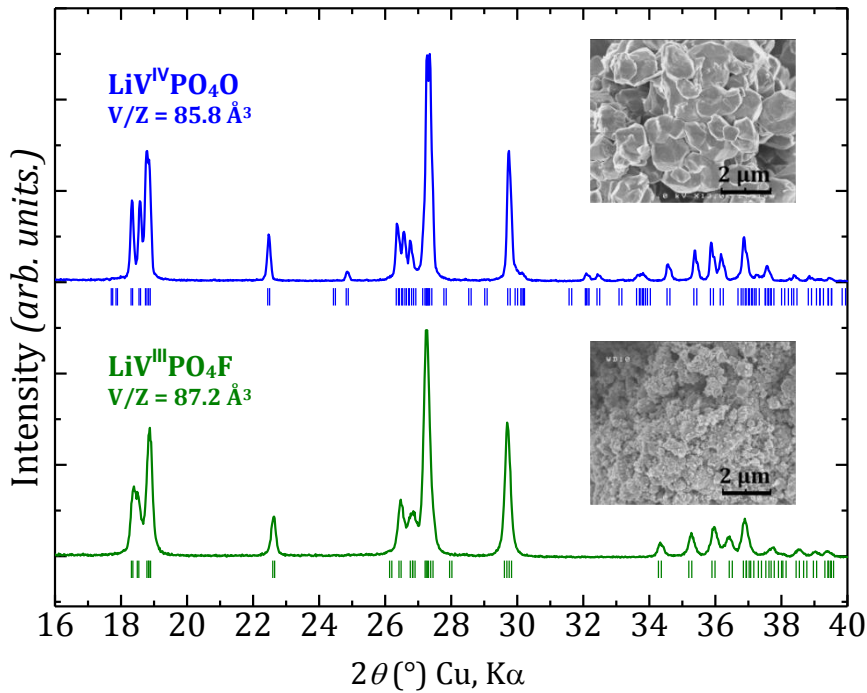

Figure I-8: XRD patterns of phase-pure LiVPO_4F and LiVPO_4O with calculated Bragg positions. SEM images are included in the insets

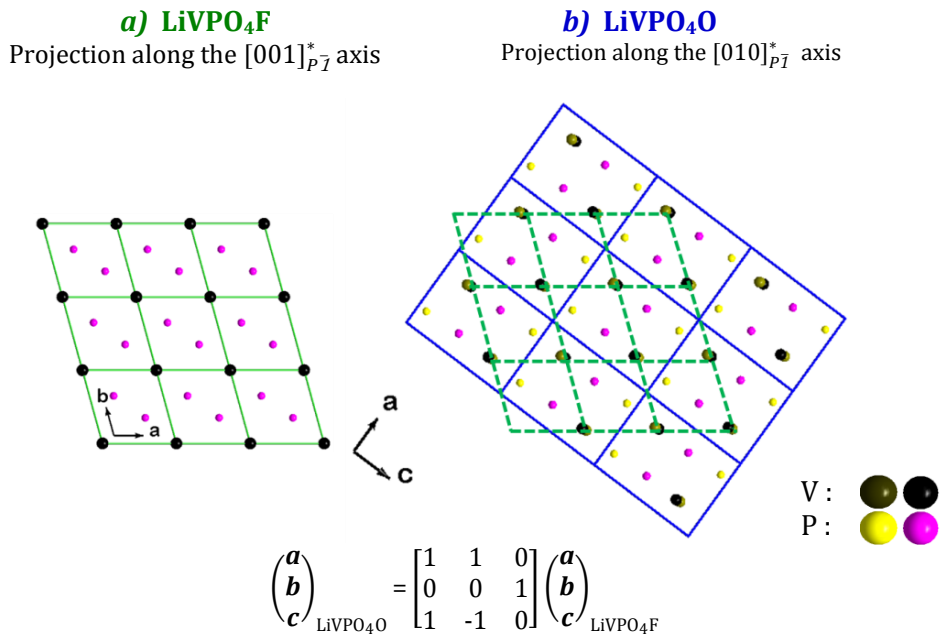

Figure I-9: Illustration of the transformation matrix from LiVPO_4O to LiVPO_4F unit cells.

The unit cell of LiVPO_4O is almost two times bigger than that of LiVPO_4F through a transformation matrix from LiVPO_4F to LiVPO_4O , illustrated in

Figure I-9. The transformation matrix M is $\begin{bmatrix} 1 & 1 & 0 \\ 0 & 0 & 1 \\ 1 & -1 & 0 \end{bmatrix}$.

In order to confirm the chemical compositions of the samples, the Li, V, and P contents were determined using an ICP-OES spectrometer (Varian 720-ES Optical Emission Spectrometer) after complete dissolution of the powders into a hydrochloric acid solution. Stoichiometries of $\text{Li}_{1.13}/\text{V}_{1.04}/\text{P}_{1.00}$ and $\text{Li}_{1.05}/\text{V}_{0.97}/\text{P}_{1.00}$ were found for LiVPO_4F and LiVPO_4O , respectively, which agree reasonably well with the formulas expected.

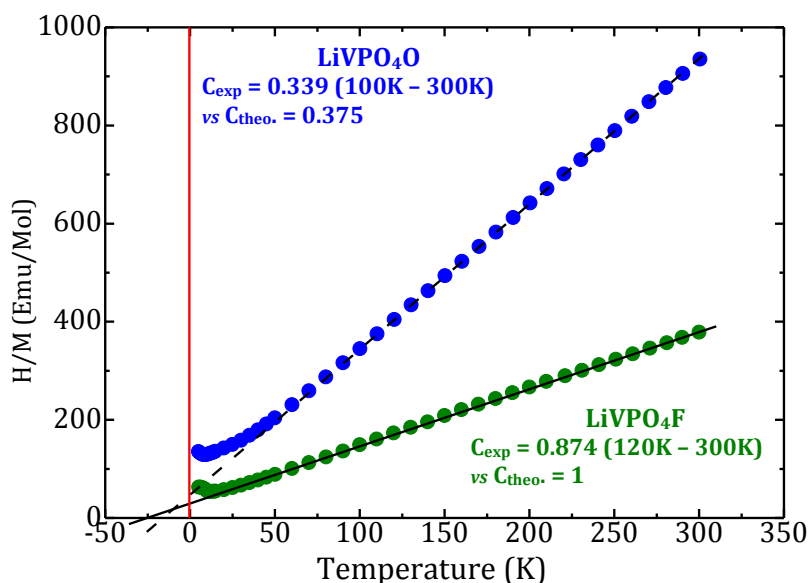

Figure I-10: Temperature dependence of the H/M ratio for LiVPO_4F and LiVPO_4O . Comparison of experimental and theoretical Curie constants is given for the two phases with, for information, the temperature range used for their calculation.

The static molar magnetic susceptibilities of the two materials ($\chi(T) = M(T)/H$ ($H = 1$ T) with H as the magnetic field and M as the magnetization) were measured between 5 and 300 K using a SQUID magnetometer (Quantum Design) for the two materials. The zero field cooled χ values were obtained by cooling the sample in zero field down to 5 K and then heating them under the measuring field. The diamagnetic contributions were corrected using the atomic values from G.A. Bain and J.F. Berry [23] yielding the χ_{M} paramagnetic susceptibility contribution. The temperature dependence of the H/M ratio for both LiVPO_4F and LiVPO_4O is shown in Figure I-10. Both compounds show curvatures indicative of onsets of antiferromagnetic ordering, with Néel temperatures of 13 and 9 K for LiVPO_4F and LiVPO_4O , respectively. Curie-Weiss type paramagnetism appears for temperatures higher than 50 K for LiVPO_4F and 100 K for LiVPO_4O . The obtained Curie constants of 0.874 and 0.339 are close to the theoretical values for octahedral V^{3+} and V^{4+} ($C_{\text{theo.}}(\text{LiV}^{\text{III}}\text{PO}_4\text{F}) = 1$ and $C_{\text{theo.}}(\text{LiV}^{\text{IV}}\text{PO}_4\text{O}) = 0.375$). Further confirmation of the different oxidation states of vanadium in these two samples is given through bond

valence calculations within the crystal structures. The magnetic structure will be described in a next paragraph based on the neutron diffraction data recorded at low temperature (below Néel temperature).

I-2e. Summary and Conclusion

In this section, we reported on the reproducible synthesis of pure LiVPO_4F and LiVPO_4O , summarized as follows:

- LiVPO_4O can be synthesized by a direct ceramic route using V_2O_3 as the vanadium precursor and LiF. In presence of O_2 , we ended up with LiVPO_4O for which the oxidation state of vanadium is +4 instead of +3. This lithium vanadium oxyphosphate was also successfully synthesized using Li_3PO_4 instead of LiF.
- LiVPO_4F was obtained through a two-step ceramic route using a carbon coated VPO_4 (C- VPO_4) and LiF. In a gold-sealed tube, C- VPO_4 was mixed in a stoichiometric proportion with LiF. All our (many) attempts to prepare LiVPO_4F through a single-step reaction using V_2O_3 (or V_2O_5) as the vanadium precursors generated mixtures of powders containing variable amounts of $\text{Li}_3\text{V}_2(\text{PO}_4)_3$ and others unknown impurities.
- The oxidation state of vanadium in both compounds was confirmed through a Curie constant determined based on magnetic susceptibility measurement vs. temperature. The unit cell of LiVPO_4O is almost two times bigger than the one of LiVPO_4F .

I-3. CRYSTAL AND MAGNETIC STRUCTURES OF LiVPO_4F

As presented in the introduction, LiVPO_4F and the triclinic LiVPO_4O crystallize in the Tavorite structure. Simonov et al. [24] had published the crystal structure of LiAlPO_4F where two sites of lithium were proposed, each site being occupied at 50% and separated from the other by a distance of 0.5 Å. To the best of our knowledge, no neutron diffraction study had been performed to localize the Li sites so that the two positions of Li in LiAlPO_4F were questionable.

During the submission of our paper reporting the structural determination of LiVPO_4F [25], we became aware of a structure determination just published by B.L. Ellis et al. [26] which had been

determined using synchrotron XRD. The differences between the model proposed by B.L. Ellis et al. and ours will be presented in this section.

X-Ray diffraction data were collected from a Panalytical diffractometer (X'Pert PRO MPD) with a $\text{Cu K}\alpha_1$ radiation (Germanium monochromator), by using counting steps of 700 sec. per 0.008° between $2\theta = 10^\circ$ and $2\theta = 130^\circ$. Neutron diffraction was performed at the Institute Laue Langevin (Grenoble, France) in collaboration with E. Suard on the high-resolution diffractometer D2B. The sample was contained in an 8 mm diameter vanadium tube and the diffraction pattern was collected in transmission mode at room temperature with a wavelength of $1.59355(3) \text{ \AA}$ (refined by fixing the cell parameters to the values determined from the X-ray diffraction data) between $[0-140^\circ]$ angular ranges using a 0.05° (2θ) step with an accumulation time of 9 hours. Correction of the absorption was necessary in order to take into account a decrease of the experimental diffracted intensity compared to the expected one. The calculated absorption correction coefficient (μR factor in the FullProf program with μ being the absorption of the sample and R the radius of the vanadium tube [27]) was found to be equal to 0.290 for LiVPO_4F and 0.295 for LiVPO_4O .

I-3a. The Crystal structure of LiVPO_4F

The combined Rietveld refinements of neutron and XRD data for LiVPO_4F were carried out using the structural model of Tavorite-type LiAlPO_4F reported by Simonov et al. [24] [ICSD N° 48012]. The different steps used for the refinement were as follows:

1. We first refined the positions of the heaviest atoms (since Li is almost “transparent” to X-rays) with the structural model $[\text{V}(1)_{1a}\text{V}(2)_{1b}]\text{P}_{2i}(\text{O}_{2i})_4\text{F}_{2i}$: in this model vanadium atoms occupy special $1a$ (0, 0, 0) and $1b$ (0, 0, 1/2) positions, contrary to the $1a$ (0, 0, 0) and $1h$ (1/2, 1/2, 1/2) positions mentioned by Barker through analogy with the crystal structure of LiAlPO_4F [1, 2, 9, 10]. B.L. Ellis et al. [26] mentioned positions of $1a$ (0, 0, 0) and $1b$ (0, 1/2, 1/2) but the Wyckoff position of $1b$ is actually (0, 0, 1/2) for $P\bar{1}$ space group.
2. The Rietveld refinements were then conducted by using the structural model $[\text{Li}(1)_{2i}\text{Li}(2)_{2i}][\text{V}(1)_{1a}\text{V}(2)_{1b}]\text{P}_{2i}(\text{O}_{2i})_4\text{F}_{2i}$ of LiAlPO_4F where the two atomic positions for Li are $2i(0.98, 0.64, 0.26)$ and $2i(0.18, 0.56, 0.50)$ *i.e.* distant of 1.94 \AA and partially occupied at 50% each.

3. The structural model obtained at this stage showed large standard deviations of atomic coordinates for Li(2) when compared to all other atomic positions of the structure (10 times higher). Additionally, a very short Li(2)-O(2) distance of 1.23 Å was spotted with occupancies of 0.9 and 0.2 for Li(1) and Li(2), respectively.

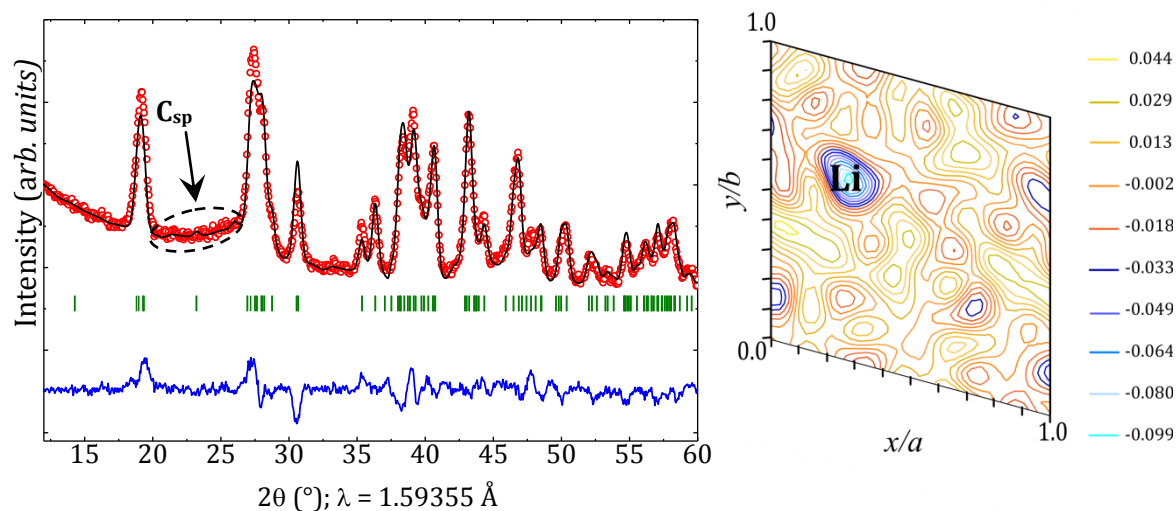

Figure I-11: a) Rietveld refinement of neutron diffraction data (only heaviest atoms are considered) b) 2D section of 3D difference Fourier maps at $y = 0.68$ with the maxima corresponding to the Li(1) site for the crystal structure of LiVPO_4F

4. As this questioned the existence of two independent crystallographic sites for Li, we then calculated Fourier difference maps using the GFourier software within the FullProf_suite program considering only the host structure $[\text{V}(1)_{1a}\text{V}(2)_{1b}]\text{P}_{2i}(\text{O}_{2i})_4\text{F}_{2i}$ determined previously from XRD data and thus without the two Li ions. As illustrated in Figure I-11a, the refinement of the neutron diffraction data showed very bad minimization of the intensity difference (the blue line representing the difference between the data recorded and the calculated pattern) with very poor reliability factors. Since Li is the only atom in LiVPO_4F composition with a negative coherent diffusion wavelength ($-0.19 \cdot 10^{-4}$ Å [28] in natural $^6\text{Li}/^7\text{Li}$ abundance) it was therefore possible to localize lithium in the LiVPO_4F unit cell. The calculated Fourier (Figure I-11b) differential map showed a maximum negative residual nuclear density located in $2i$ position at (~ 0.29 , ~ 0.62 , ~ 0.28). The presence of carbon in LiVPO_4F (resulting from the reaction between C-VPO_4 and LiF) is visible in the neutron diffraction pattern where the background is high.

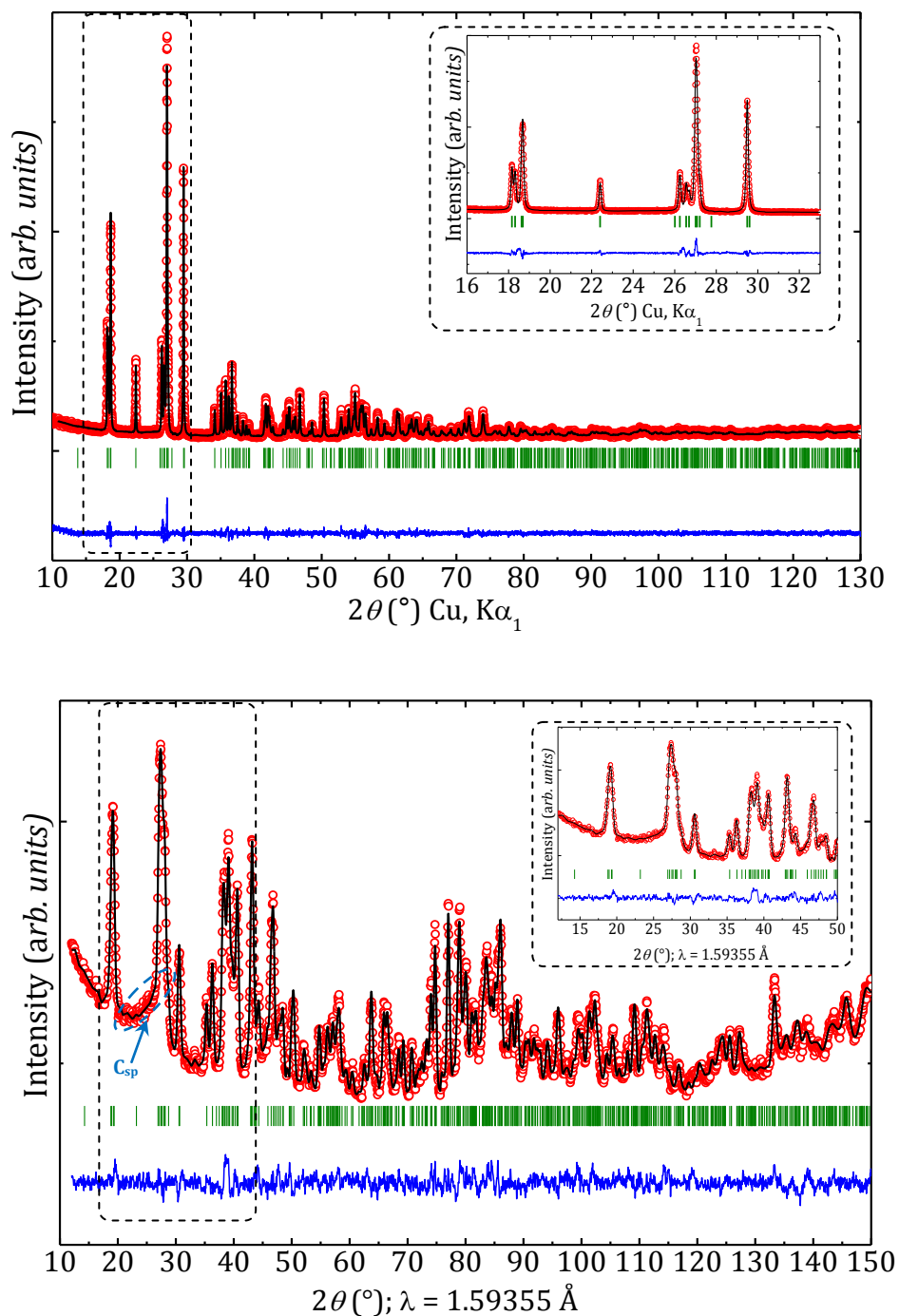

Figure I-12: Observed (red dots), calculated (black line), and difference (blue line) plots obtained for the Rietveld refinement of (a) X-ray diffraction data and (b) neutron diffraction data for LiVPO_4F

5. This position was hence included in the atomic coordinates list so as to refine properly the neutron diffraction data. Subsequent Fourier difference maps showed non residual nuclear densities and we thus adopted a structural model with only one Li(1) crystallographic site at $2i(0.371(1), 0.703(1), 0.233(1))$. Separate refinements of thermal motion factors and occupancies led to satisfactory reliability factors (ANNEX I, Table I-1) and good minimization of the intensity difference ($I_{obs} - I_{calc}$), for X-rays and neutron data refinements, as shown in Figure

I-12. The lattice parameters as well as the atomic positions are gathered in table I-1 of the ANNEX I. The resulting inter-atomic distances are recorded in Table I-2 of ANNEX I.

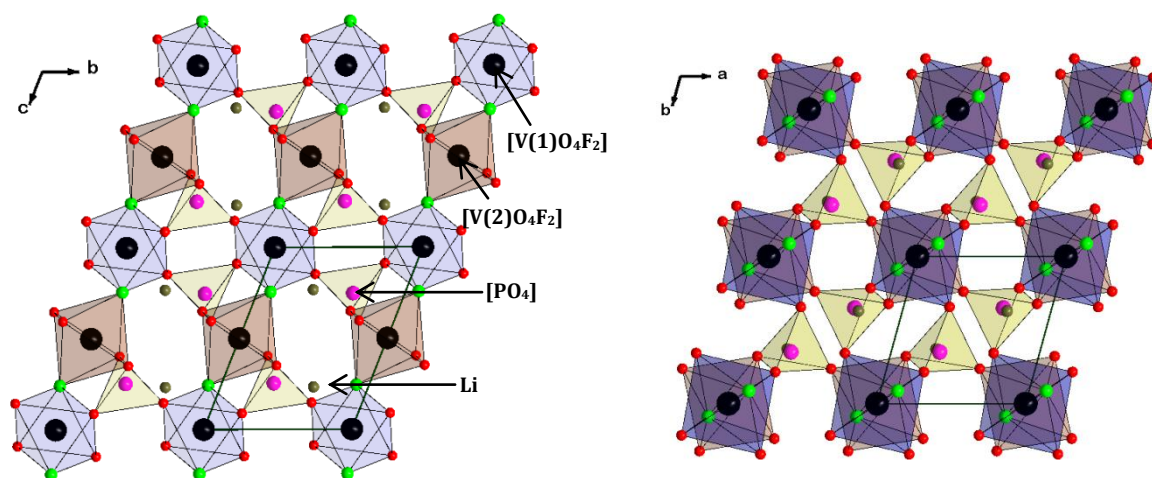

Figure I-13: Representations of the crystal structure of LiVPO_4F

As mentioned earlier, LiVPO_4F crystallizes in the Tavorite structure, built up by $[\text{VO}_4\text{F}_2]$ octahedra which share common fluorine atoms so as to form $\cdots\text{V}\cdots\text{F}\cdots\text{V}\cdots\text{F}\cdots\text{V}\cdots$ infinite chains running along the $[001]_{p\bar{1}}$ direction (Figure I-13 and Figure I-14). The chains are connected to each other via isolated (with respect to each other) $[\text{PO}_4]$ tetrahedra through $\cdots\text{V}\cdots\text{O}\cdots\text{P}\cdots\text{O}\cdots\text{V}\cdots$ sequences. Vanadium lies in two octahedral sites with a very narrow range of V–O distances, 1.96–1.99 Å (ANNEX I table I-2).

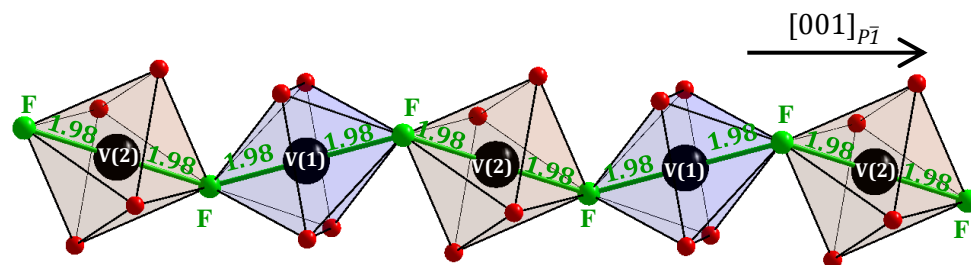

Figure I-14: Representation of chains along the c axis in the structure of LiVPO_4F

The V–F distances along the chain of $[-\text{F}-\text{VO}_4-\text{F}-\text{VO}_4-\text{F}-]$ are very homogeneous with a value of 1.98 Å (Figure I-14). This value is quite small compared to those encountered in $\text{VPO}_4\cdot\text{H}_2\text{O}$ [29, 30] another Tavorite-like structure (which crystallizes in $C2/c$ space group) containing V^{III} where the distances V–(OH₂) (running along the chain) are 2.17 Å. The $[\text{V}(1)\text{O}_4\text{F}_2]$ octahedron is slightly more distorted than the $[\text{V}(2)\text{O}_4\text{F}_2]$ octahedron ($\Delta = 3.98\times 10^{-5}$ and $\Delta = 2.28\times 10^{-5}$, respectively). The phosphorus atom lies within a regular tetrahedron ($\Delta = 2.22\times 10^{-4}$) with P–O distances in the range of 1.50–1.55 Å (Figure I-15a).

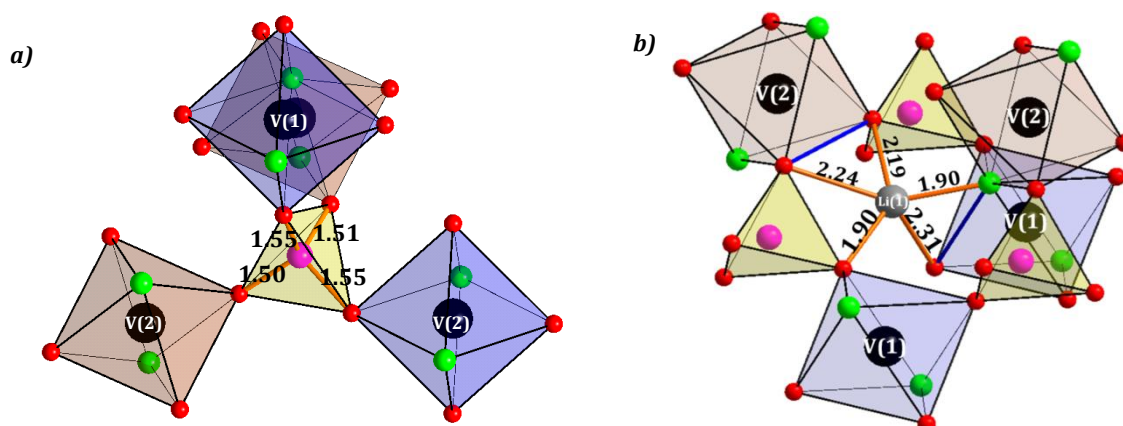

Figure I-15: Schematic representation of tetrahedra PO_4 (a) and pentahedra LiO_4F (b) local environment in the structure of LiVPO_4F

The unique Li(1) site (Figure I-15b) is surrounded by four oxygen atoms and one fluorine, forming a very distorted five-vertex polyhedron ($d = 1.90\text{--}2.24 \text{ \AA}$; $\Delta = 6.83 \times 10^{-3}$; see table I-2 of ANNEX I). This pentahedron shares one edge with one $[\text{V}(2)\text{O}_4\text{F}_2]$ and one edge with one $[\text{V}(1)\text{O}_4\text{F}_2]$ octahedron. The corner-sharing polyhedra of LiVPO_4F generate a three-dimensional framework with tunnels running along $[100]_{P\bar{1}}$, $[010]_{P\bar{1}}$, and $[101]_{P\bar{1}}$. The calculated valence bond sums (BVS) for the cations using “Bond_Str” software in FullProf_suite matched remarkably well with expected values and gave respectively $\text{BVS}_{\text{V}(1)} = 3.02$, $\text{BVS}_{\text{V}(2)} = 3.01$, $\text{BVS}_{\text{P}} = 4.99$, and $\text{BVS}_{\text{Li}} = 0.90$ in reasonably good agreement with expectations.

Two observations had been previously reported concerning the lithium site in LiVPO_4F :

- In analogy with LiAlPO_4F [24], J. Barker proposed the existence of two crystallographic sites for lithium for the structure of LiVPO_4F , each site being occupied at 50%. Let us recall that in LiAlPO_4F , the two Li sites are separated by 0.5 \AA . The fractional coordinates for the single lithium site observed in our study is at the barycenter of the two Li sites proposed for LiAlPO_4F (Figure I-16a).
- B.L. Ellis et al. [26] reported on the crystal structure of LiVPO_4F using 2 sites for Li occupied at 18 % for Li(1) and 82 % for Li(2). The structural determination was performed from the analysis of synchrotron X-ray diffraction data. In order to check for the adequacy of their structural description with our data, we decided to refine our neutron diffraction data using B.L. Ellis structural model. The obtained refinement converged to only one lithium site: the first site Li(1) was refined as empty and the coordinates of the second Li(2) converged to a position very close to the unique Li site we had found [25]. The schematic representation of both Li sites in

B.L. Ellis structure ($\text{Li}(1)_{\text{Ellis}}$ and $\text{Li}(2)_{\text{Ellis}}$) and Li site (Li_{Ateba}) in our structure (Figure I-16b) revealed that $\text{Li}(2)_{\text{Ellis}} = \text{Li}_{\text{Ateba}}$.

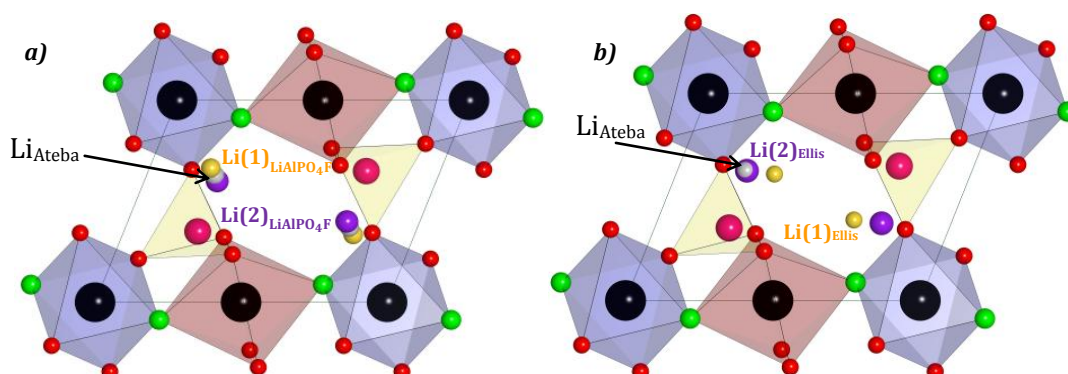

Figure I-16: Skeleton representation of LiVPO_4F structure along the c direction presenting: a) 2 sites of Li as suggested by J. Barker et al. [25] based on the analogy with LiAlPO_4F , represented as $\text{Li}(1)_{\text{LiAlPO}_4\text{F}}$ and $\text{Li}(2)_{\text{LiAlPO}_4\text{F}}$ b) 2 sites of Li as observed by B.L. Ellis et al. [26], represented by $\text{Li}(1)_{\text{Ellis}}$ and $\text{Li}(2)_{\text{Ellis}}$
In both cases the Li's position found in this work is presented as Li_{Ateba}

I-3b. NMR Study of LiVPO_4F

In order to confirm (or infirm) the presence of only one lithium site in the structure of LiVPO_4F , we have performed in collaboration with M. Ménétrier and M. Duttine (ICMCB-Bordeaux), ^7Li MAS NMR as part of a large NMR study currently performed on Tavorite type systems in our laboratory. In this section (and only in this section) two samples of LiVPO_4F are used and labeled as follows:

- *GEN II* refers to a second generation of LiVPO_4F samples (see Figure I-5b) which contains an unknown impurity.
- *GEN III* refers to a pure sample of LiVPO_4F (see Figure I-5c) obtained by adjusting the stoichiometry (1:1) in LiF/C-VPO_4 mixture

The ^7Li MAS NMR spectra were recorded on a Bruker Advance spectrometer with a 7T magnet (116 MHz resonance frequency for ^7Li), using a standard Bruker 2.5 MAS probe at a 30 kHz typical spinning speed. A Hahn echo sequence was applied with a 90° pulse of 1.4 microsecond. A recycle delay was typically 2s. The 0 ppm external reference was a 1M LiCl aqueous solution.

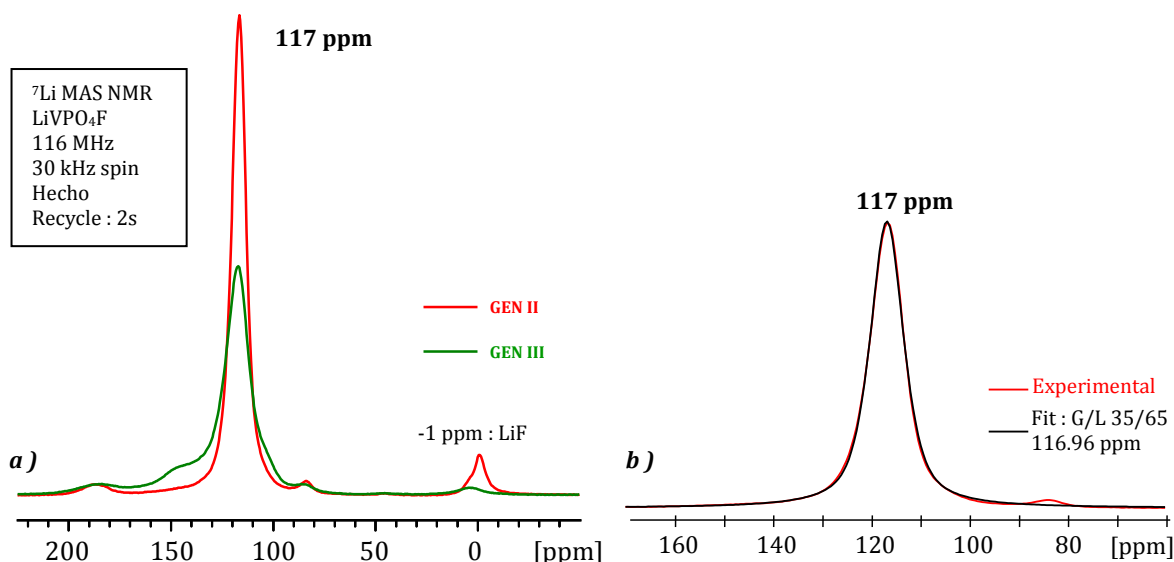

Figure I-17: ${}^7\text{Li}$ MAS NMR spectra *a)* of GEN II (red line) and GEN III (green line). The magnitude is scaled to the mass of active material in the NMR rotor. *b)* An example of the fit is given for the signal at 117 ppm.

Figure I-17a shows the isotropic signals (*i.e.* without spinning site band) of the ${}^7\text{Li}$ NMR spectra recorded for two samples of LiVPO_4F corresponding (see Figure I-5) respectively to GEN II (red trace) and to GEN III (green trace). A rather sharp peak centered at 117 ppm is observed in both cases, which agrees well with the unique Li site determined by diffraction. A fit of this line with a single Gaussian/Lorentzian contribution is given for the sample GEN II in Figure I-17b, showing indeed no hint of several components in this signal. The observed NMR shift (117 ppm) is close to the one published by B.L. Ellis et al. [26] (112 ppm). Note that B.L. Ellis et al. proposed a decomposition of their Li NMR signal into two components, but specified that this was not the unique decomposition possible. The spectrum for the GEN II sample also exhibits a weak signal at -1 ppm assigned to the presence of residual LiF which is absent for the GEN III sample prepared with exact stoichiometry of LiF and C-VPO₄.

Both spectra also exhibit additional signals at 4, 84 and 186 ppm and the spectrum for the pure sample exhibits two additional components seen as shoulders of the main peak at 102 and 147 ppm. Since no other compound was detected by diffraction, these may correspond either to Li in undetected impurities or to Li in the material with different environments (about 5% in GEN II and 25% in GEN III). Indeed, recent 2D dipolar homonuclear correlation NMR experiments have been performed on the GEN II by the NMR platform of the RS2E network¹ (Rob Messinger and Michael Deschamps at CEMHTI Orléans) which show that all these additional signals are correlated to the main one. It therefore appears that these signals correspond to Li in the same material, but in environments modified by defects in the structure (this is supported by the

¹ RS2E: Réseau sur le Stockage Electrochimique de l'Energie – French network for electrochemical energy storage. Web site: <http://www.energie-rs2e.com/fr>

presence of Gaussian contribution in the fit of the signal as shown in Figure I-17b). It is important to note that these NMR shifts are governed by the influence of the electron spins from the V ions on the Li nuclei, mostly from the Fermi contact interaction. The electron spin transfer mechanisms at the origin of this interaction are under investigation in the group at ICMCB by D. Carlier, in a similar strategy as applied to other Li-transition metal phosphates [31, 32]. A consequence of the magnitude of this Fermi contact interaction is that subtle changes in the electronic configuration of the vanadium ions can give rise to very different Li NMR shifts even with relatively minor structural distortions, which can therefore remain unnoticed by diffraction.

^{31}P MAS NMR spectra (Figure I-18) were recorded on a Bruker Avance III spectrometer with a 2.35T magnet (40.6 MHz resonance frequency for ^{31}P), a standard Bruker 2.5 MAS probe at a 30 kHz typical spinning speed. A Hahn echo sequence was used with a 90° pulse of 1.1 microsecond. A recycle delay was 1s. A secondary external reference was $\text{Al}(\text{PO}_3)_3(\text{solid})$ (-50.8 ppm vs. H_3PO_4 85%).

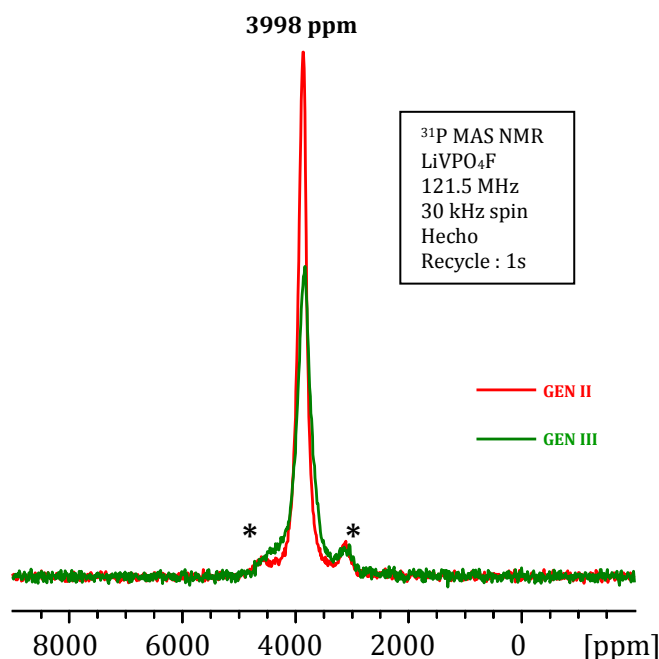

Figure I-18: ^{31}P MAS NMR spectra of GEN II (red line) and GEN III (green line). The magnitude is scaled to the mass of active material in the NMR rotor and the spinning sidebands are marked with asterisks.

Both samples of LiVPO_4F exhibit (Figure I-18) a single relatively sharp ^{31}P MAS NMR signal at 3998 ppm with its spinning sidebands marked by asterisks in agreement with the unique phosphorous site present in the structure determined by Rietveld refinement. The shoulder at around 4500 ppm most probably corresponds to the presence of defects with different magnitude/nature for the two samples as observed previously for Li. The shift in LiVPO_4F is less pronounced than in $\text{VPO}_4\cdot\text{H}_2\text{O}$ for which A. Castets et al. [29, 32] observed a shift of 5535 ppm

for ^{31}P . Since the two structures lead to relatively similar V–O–P configurations and contain the same V^{3+} paramagnetic cation, it is tempting to elaborate a discussion about this difference in shift. However, there is a strong difference between the two compounds in the elongation of their respective octahedra (bond length V–(OH₂) is 2.17 Å for [VO₆] octahedron and bond length V–F is 1.98 Å for [VO₄F₂] octahedron). In $\text{VPO}_4\cdot\text{H}_2\text{O}$ a strong elongation exists along the bridging O direction, which lifts the degeneracy of the t_{2g} orbitals, and leads to occupation of the d_{xz} and d_{yz} orbitals by the two electron spins [32]. In LiVPO_4F however, there is no clear elongation, and the change in the nature of the bridging anion (F for O) obviously changes the nature of the bonds. It would therefore be hazardous to comment further on the NMR shift difference in the two compounds. An analysis of the DOS from DFT calculations is currently in progress in the group at ICMCB to this aim.

^{19}F MAS NMR spectra were recorded on a Bruker Avance III spectrometer with a 2.35T magnet (94.3 MHz resonance frequency for ^{19}F), using a standard Bruker 2.5 MAS probe at a 30 kHz typical spinning speed. A Hahn echo sequence was used with a 90° pulse of 1 microsecond. A recycle delay of 1s was applied. The 0 ppm external reference was CFCl_3 .

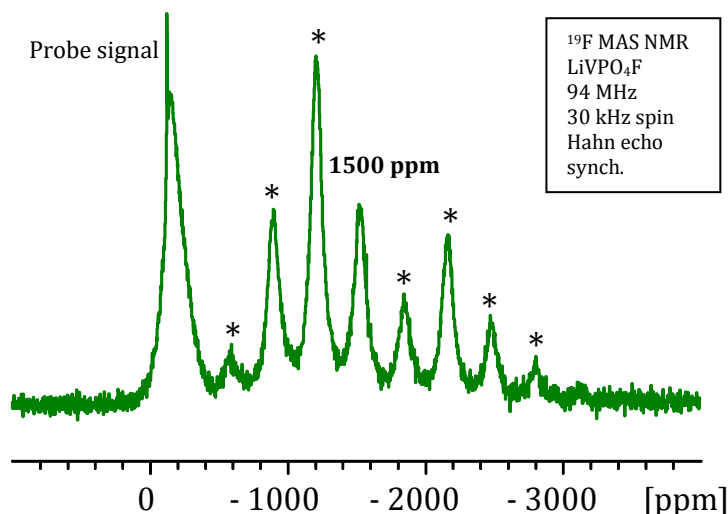

Figure I-19: ^{19}F MAS NMR spectrum for GEN III sample. The spinning sidebands are marked with asterisks.

The complete ^{19}F MAS NMR spectrum for the GEN III sample (Figure I-19) exhibits a strong parasitic contribution from the probe around -150 ppm, and a broad spinning sidebands manifold corresponding to fluorine in the material, again strongly shifted by Fermi contact type interactions with the electron spins from the V ions. Determining the isotropic contribution is not trivial, since the temperature change induced by changes of the spinning speed leads to strong changes in these shifts. Using DFT calculations D. Carrier succeeded in determining that

the isotropic signal was the -1500 ppm one [33]. This is to our knowledge the first report and analysis of the ^{19}F NMR signal in such a paramagnetic sample.

Although pure LiVPO_4F was obtained based on the X-ray/neutron diffraction (GEN III; Figure I-5c), this NMR study has enlightened the existence of defects in the LiVPO_4F structure. Therefore, other techniques (such as EPR), sensitive to the local and to the electronic configuration of the transition metal ion, have to be used to characterize each generation of LiVPO_4F sample (GEN II and GEN III) to check for the possible presence of V^{IV} in these materials as the existence of $\text{LiVPO}_4\text{F}_x\text{O}_y$ cannot be totally ruled out.

I-3c. Magnetic structure of LiVPO_4F

In collaboration with E. Suard (ILL–Grenoble) and G. Rousse (UPMC–Paris), we performed neutron powder diffraction at low temperature, on LiVPO_4F , in order to determine a possible magnetic ordering below $T_N = 13$ K. This has been done on the diffractometer D20 of ILL with a wavelength of $\lambda = 2.40$ Å. The neutron diffraction pattern indeed presents extra peaks below 13 K in accordance with the temperature obtained from magnetic susceptibility data recorded vs. temperature (Figure I-10). Although vanadium is transparent to neutrons, we can see its presence through the ordering of its magnetic moment at low temperature. Indeed, some tiny peaks are seen in the diffraction pattern at 2K, that were absent at 50K, as pictured in Figure I-20a. Those peaks increase significantly from 13 K down to 2K (Figure I-20b) and are however very small because of the small number of electrons on the vanadium (V^{3+} , $3d^2$) and of the small resulting magnetic moment.

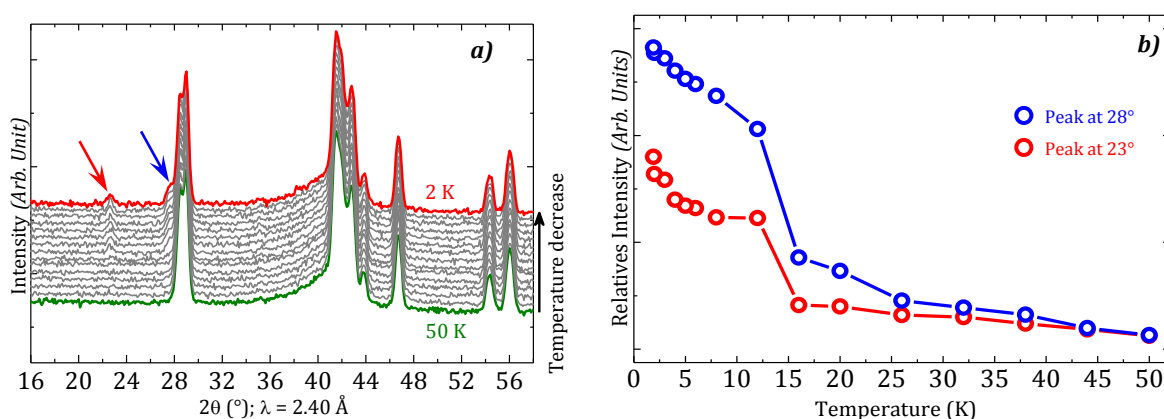

Figure I-20: a) Low temperature neutron diffraction experiment (on D20) carried out on LiVPO_4F ;
b) The change in intensities versus time of the magnetic superstructure peaks

The magnetic peaks can be indexed using a $\mathbf{k} = (\frac{1}{2} \frac{1}{2} 0)$ propagation vector, so that the magnetic cell is 4 times larger than the nuclear cell. The latter being of triclinic ($P\bar{1}$) symmetry, there is no constraint to be added between the magnetic moments due to the symmetry analysis: indeed the

2 metal atoms of the nuclear cell are distributed on the $1a$ and $1b$ Wyckoff positions. We had therefore considered two possible cases: the moment on metal sitting in the two Wyckoff sites are parallel or antiparallel, so that the resulting magnetic structure would be collinear.

The preliminary refinements of the 2K structure using these two different models, and allowing the magnetic moment to orient in any direction, led to a much better refinement when the two moments were antiparallel. It appeared that it was rather difficult to fully solve the magnetic structure since vanadium was transparent to neutrons, and V^{3+} presents a d^2 , $t_{2g}^2 e_g^0$, $S=1$, $L=3$ configuration, so that the magnetic moment is expected to be weak (lower than theoretical $2 \mu_B$ expected). We therefore ended up with a model that could properly fit the data, and for which the magnetic moment of V^{3+} is refined to $1.22(5)\mu_B$.

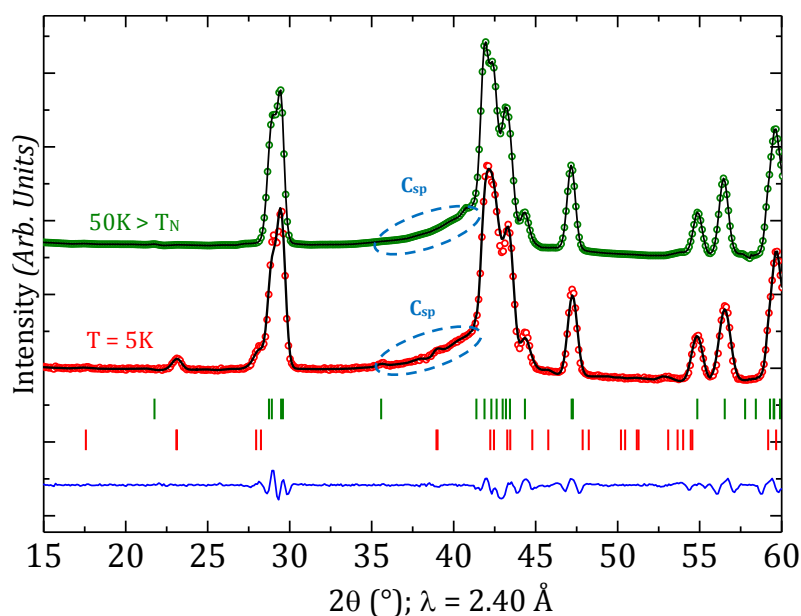

Figure I-21: Magnetic Rietveld Refinements of LiVPO_4F : Observed versus calculated (black line) powder neutron diffraction patterns of LiVPO_4F collected on D20 with $\lambda = 2.40 \text{ \AA}$, at 2K (red dots) and 50K (green dots). The difference pattern (blue line) of the 2K pattern is displayed at the panel bottom. The positions of the Bragg reflections are shown as vertical bars below.

The result of the Rietveld refinement is given in Figure I-21 and compared to that of the pattern recorded above T_N to highlight the presence of the magnetic peaks. The resulting magnetic structure is presented in Table I-2, and shown in Figure I-22a where the magnetic moments that are along the chains are oriented antiparallel, and the chains are also antiparallel through the propagation vector \mathbf{k} confirming the antiferromagnetic behavior observed with magnetic measurements. Figure I-22b exhibits the orientation of the magnetic moment in both $[\text{V}(1)\text{O}_4\text{F}_2]$ and $[\text{V}(2)\text{O}_4\text{F}_2]$ octahedra which are oriented so that the equatorial plane of oxygen atoms is perpendicular to fluorine vertices. The magnetic moment of V(1) is almost perpendicular to the equatorial plane of oxygen and almost oriented toward fluorine atoms. In the case of V(2) the

magnetic moment is slightly tilted out of the oxygen equatorial plane and oriented through the O(1)–O(2) edge.

Table I-2: Magnetic moments (in μ_B) at 2 K, the components are given along the a, b and c axes. Propagation vector $k = (\frac{1}{2}, \frac{1}{2}, 0)$, Magnetic R-factor=19.5%

LiVPO_4F				
Atom	m_a	m_b	m_c	$M_{\text{Total}} (\mu_B)$
V (0 0 0)	0.9(2)	-0.2(1)	-0.5(2)	1.22(5)
V (0 0 $\frac{1}{2}$)	-0.9(2)	0.2(1)	0.5(2)	1.22(5)

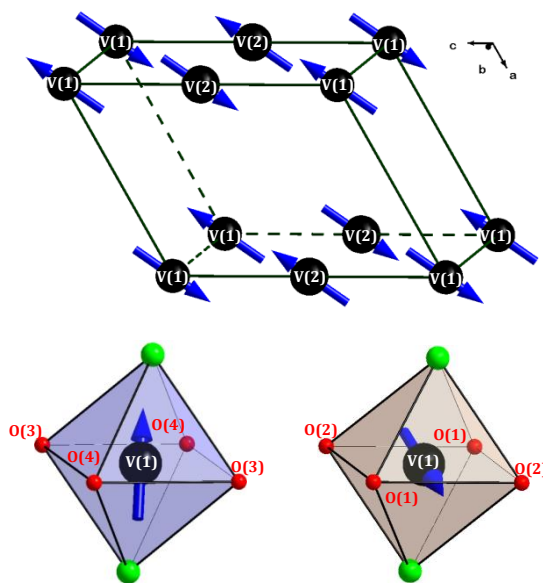

Figure I-22: Illustration of the proposed magnetic structure of LiVPO_4F : a) 3D view of the magnetic moments borne by vanadium atoms b) 3D view of isolated octahedra.

A comparative analysis and discussion of magnetic structures in Tavorite-type materials will be given in chapter III through the study of the magnetic structure of LiFePO_4F .

I-3d. Conclusion and Summary

Based on simultaneous Rietveld refinements carried out from XRD and neutron diffraction data, we demonstrated that there is only one lithium site in the structure of LiVPO_4F . This atomic position for Li happens to be the barycenter of the two Li sites proposed by J. Barker and fits well with one of the two positions of lithium published (the one occupied at 82%) by B.L. Ellis. An unique ^7Li NMR signal shifted at 117 ppm was observed in agreement with the unique lithium site obtained after Rietveld refinement of both XRD and neutron diffraction data. Although not detected in XRD and neutron diffraction data, ^7Li NMR revealed the existence of some defects. These defects were also present in ^{31}P NMR which exhibited a unique signal (in

good agreement with the unique phosphorous site present in the structure of LiVPO_4F) strongly shifted at 3998 ppm. Interestingly, we observed a ^{19}F NMR signal for the LiVPO_4F , shifted at -1500 ppm and this is the first time that such an observation could be done on a paramagnetic sample.

Neutron diffraction data performed at low temperature (at 2 K) revealed the existence of magnetic moment ordering and confirmed the antiferromagnetic behavior observed by magnetic measurements. The magnetic moments that lie along the chain are oriented antiparallel and the chains are antiparallel. The magnetic moment found was $1.22(5) \mu_{\text{B}}$.

I-4. CRYSTAL STRUCTURE AND NMR STUDY OF LiVPO_4O

I-4a. Crystal structure of LiVPO_4O

As mentioned previously, the only known structural determination for the triclinic LiVPO_4O was carried out by A.V. Lavrov et al. [13]. For a better comparison with LiVPO_4F , we have decided to re-investigate the structure of LiVPO_4O using both X-ray and neutron diffraction. The full-pattern matching refinement of LiVPO_4O was done starting from the published lattice parameters of LiVPO_4O (ICSD N° 20537). Simultaneous Rietveld refinements of both neutron and X-ray diffraction data were done using the same sequence of refinements than that used for LiVPO_4F .

1. The positions of the heaviest atoms were refined using the published structure of LiVPO_4O . Contrary to LiVPO_4F , each vanadium atom is not occupying a special position but is in $2i$ general Wyckoff position for $P\bar{1}$ space group. The structural model we used is therefore $[\text{V}(1)_{2i}\text{V}(2)_{2i}][\text{P}(1)_{2i}\text{P}(2)_{2i}][\text{O}_{2i}]_{10}$.

2. As presented in Figure I-24, the refinement of neutron diffraction data showed very bad minimization of the intensity difference and reliability factors, and high Chi (χ) value. The calculated Fourier differential map shows two maximum negative residual nuclear density located in $2i$ position at (~ 0.22 , ~ 0.160 , ~ 0.087) for Li(1) and (~ 0.703 , ~ 0.156 , ~ 0.576) for Li(2). It is worth noticing a flat background in the neutron diffraction pattern of LiVPO_4O contrary to LiVPO_4F where the background was “domed” at around 24-25° as a consequence of the presence of carbon.

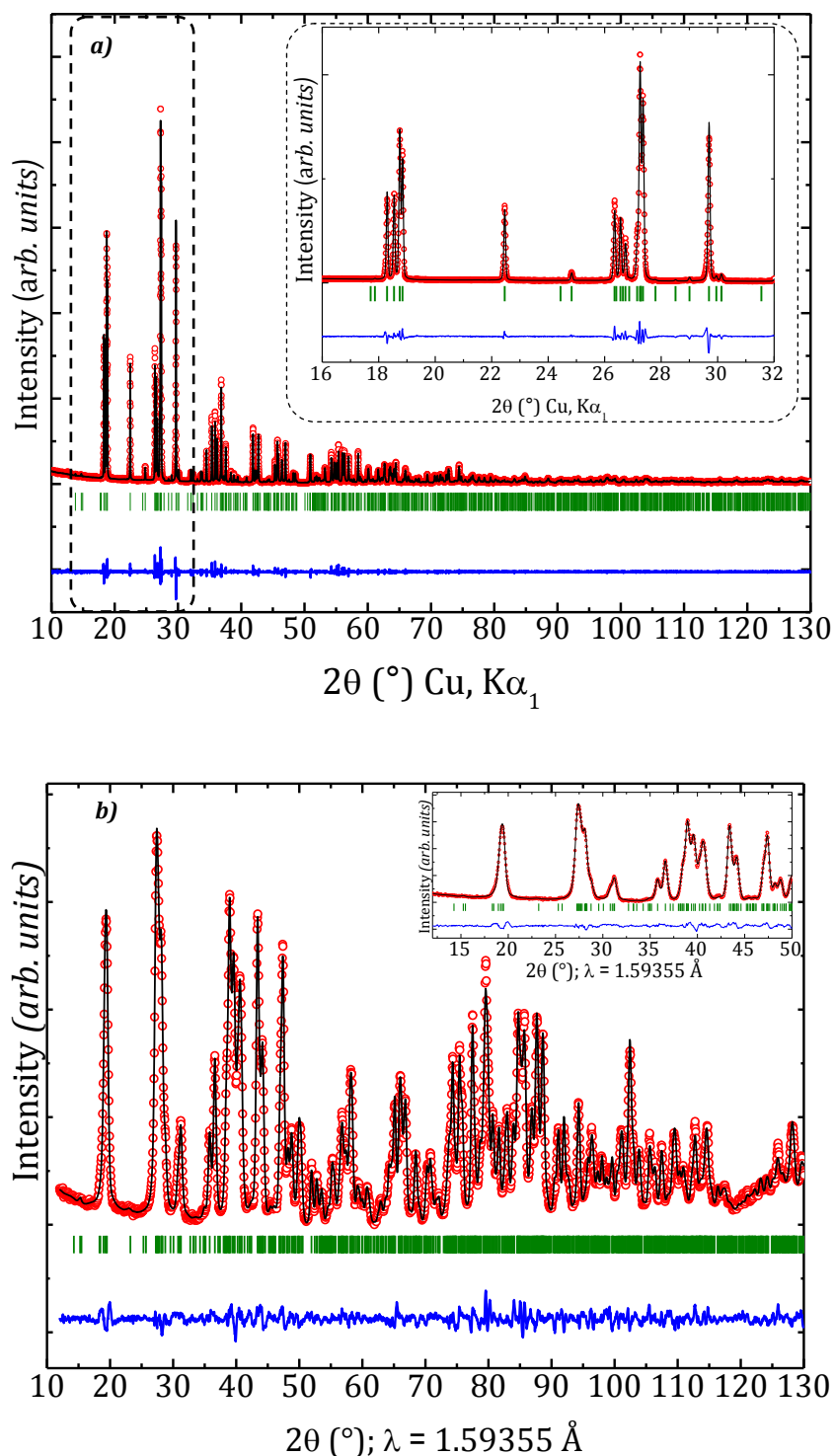

Figure I-23: Observed (red dots), calculated (black line), and difference (blue line) plots obtained for the Rietveld refinement of (a) X-ray diffraction and (b) neutron diffraction data for LiVPO_4O

3. Two independent positions for lithium were then included in the Rietveld refinements of both neutron and X-ray diffraction data. The refinement of neutron and X-ray diffraction data showed good minimization of the difference between the experiment and calculated patterns as can be seen in Figure I-23. The subsequent Fourier Difference maps showed no residual nuclear densities and we therefore adopted a structural model with two crystallographic sites for

lithium at $(0.204(5), -0.688(5), 0.075(4))$ and $(0.273(5), -0.207(5), 0.409(4))$ for Li(1) and Li(2) respectively. Separate refinements of thermal motion factors and occupancies led to satisfactory reliability factors (Table I-3 in ANNEX I). The lattice parameters as well as the atomic positions are gathered in Table I-3 of ANNEX I. The resulting inter-atomic distances and angles are recorded in Table I-4 of ANNEX I.

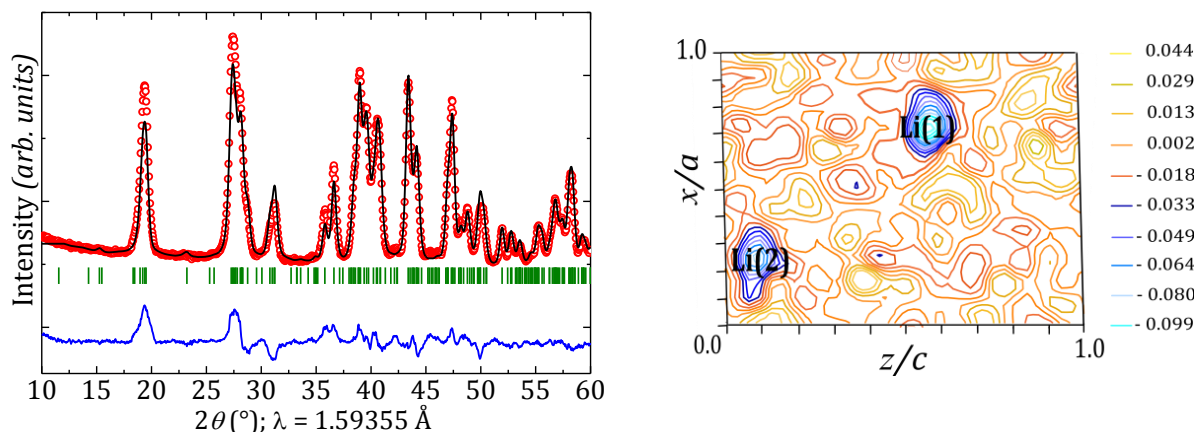

Figure I-24: (Left) Rietveld refinement of neutron diffraction data (only heaviest atoms are considered); (Right) 2D section of 3D Fourier difference map at $y = 0.156$ with the maxima corresponding to the Li(1) and Li(2) sites for the crystal structure of LiVPO_4O

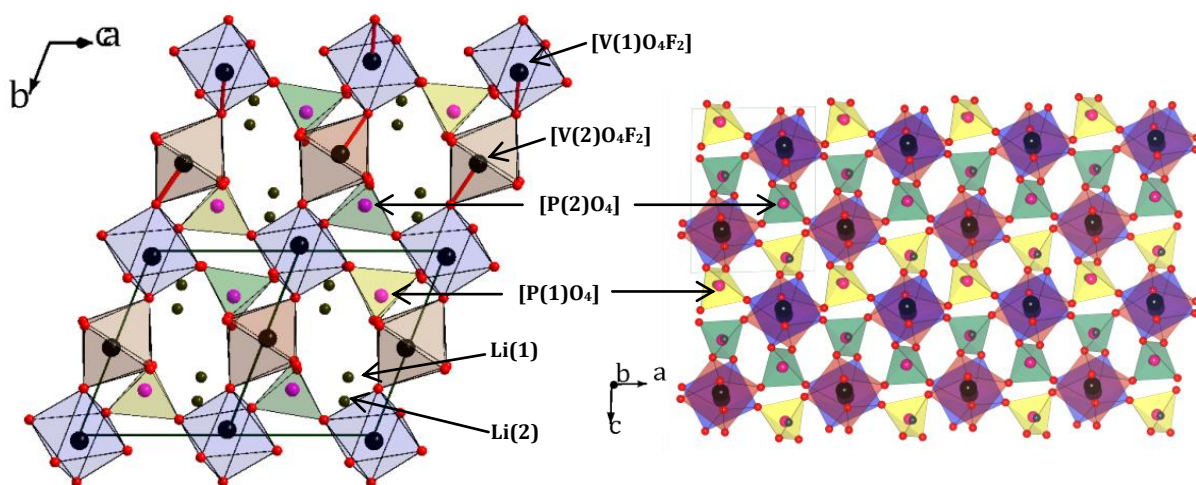

Figure I-25: (Left) Representation of the crystal structure of LiVPO_4O (Right) Octahedra chains connected alternatively by different tetrahedra along the c direction

The 3D structure of LiVPO_4O (Figure I-25) is basically similar to that of LiVPO_4F and is built up by chains of $[\text{V}(1)\text{O}_6]$ and $[\text{V}(2)\text{O}_6]$ octahedra connected alternatively through their corners by the O(6) and O(5) oxygen sites. These chains run along $[010]_{P\bar{1}}$ and are connected to each other by $[\text{P}(1)\text{O}_4]$ and $[\text{P}(2)\text{O}_4]$ tetrahedra characterized by P–O distances in between 1.50 and 1.58 Å (Figure I-26). The two different tetrahedra connect the vanadium chains alternatively along the $[001]_{P\bar{1}}$ as presented in Figure I-25b. The vanadium cations lie within two octahedral sites with a wide range of V–O distances: 1.62–2.17 Å for V(1) and of 1.71–2.21 Å for V(2), as a typical

example of alternate short and long distances in vanadyl-containing compounds (Table I-3). The short and long V–O distances in $[\text{VO}_4\text{O}_2]$ octahedra chains are alternated along the $[101]_{P\bar{1}}$ direction. One notes that the $[\text{V}(2)\text{O}_4\text{O}_2]$ octahedron is slightly more symmetrical than the $[\text{V}(1)\text{O}_4\text{O}_2]$ octahedron ($\Delta = 5.51 \times 10^{-3}$ and $\Delta = 7.63 \times 10^{-3}$ respectively). The tunnels generated by these polyhedra run along the $[\bar{1}10]_{P\bar{1}}$, $[101]_{P\bar{1}}$, and $[10\bar{1}]_{P\bar{1}}$ directions.

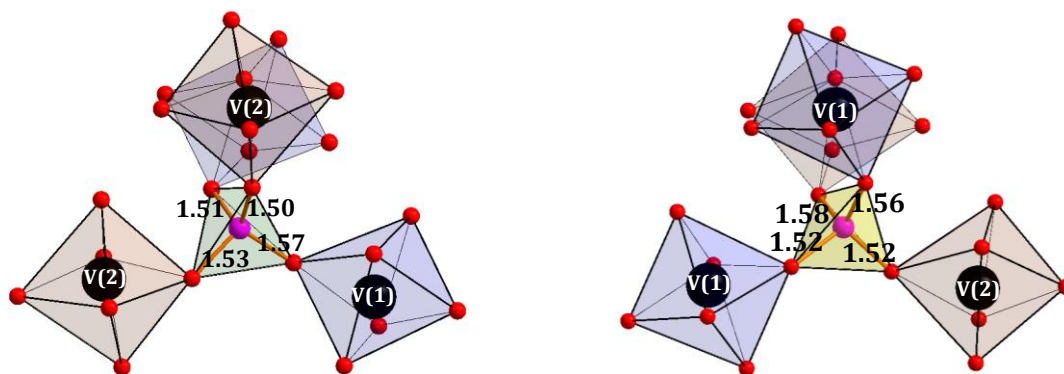

Figure I-26: Schematic representation of $[\text{P}(1)\text{O}_4]$ (left) and $[\text{P}(2)\text{O}_4]$ (right) local environments in LiVPO_4O

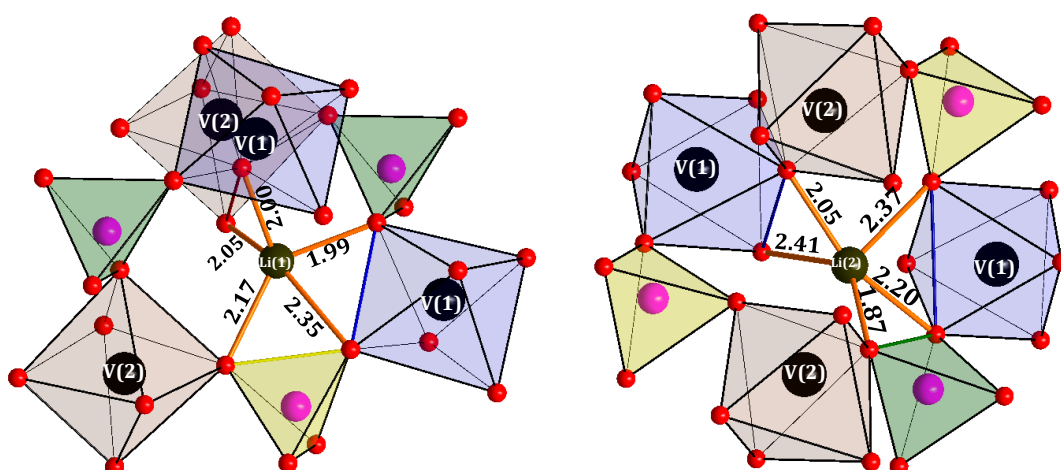

Figure I-27: Schematic representation of $\text{Li}(1)\text{O}_5$ (left) and $\text{Li}(2)\text{O}_5$ (right) local environments in LiVPO_4O

The lithium ions are distributed over two fully occupied distinct crystallographic sites, $\text{Li}(1)$ and $\text{Li}(2)$, due to the doubling of the unit-cell, at a distance from each other of 3.44 \AA . They lie in two very distorted pentahedral sites ($\Delta = 3.96 \times 10^{-3}$ and $\Delta = 8.52 \times 10^{-3}$; Figure I-27). The shortest Li–P distances are along the $[100]_{P\bar{1}}$ direction, so that each type of Li sites lies perpendicular to one type of phosphorous site. This can be seen in Figure I-25b where $\text{Li}(1)$ is above (seen in figure) or under (hidden in the figure) $\text{P}(2)$ and $\text{Li}(2)$ is above or under $\text{P}(1)$ with the distances of 2.77 \AA for $\text{Li}(1)\text{--P}(2)$ and 2.61 \AA for $\text{Li}(2)\text{--P}(1)$.

The cations BVS values calculated for V(1), V(2), P(1), P(2), Li(1), and Li(2) are respectively $\text{BVS}_{\text{V}(1)} = 4.02$, $\text{BVS}_{\text{V}(2)} = 3.98$, $\text{BVS}_{\text{P}(1)} = 5.01$, $\text{BVS}_{\text{P}(2)} = 5.03$, $\text{BVS}_{\text{Li}(1)} = 0.94$, and $\text{BVS}_{\text{Li}(2)} = 1.03$, in very good agreement with expectations.

Table I-3: long (V-O) and short (V=O) distances (in Å) in LiVPO_4O and VPO_4O polymorphs.

	V=O (Å)	V-O (Å)	S.G	Symmetry
δ - VPO_4O (ICSD N° 420073)	1.62	1.84	$P4_2/mbc$	Tetragonal
ε - VPO_4O (ICSD N° 415924)	1.57	2.56	Cc	Monoclinic
γ - VPO_4O (ICSD N° 415213)	1.50	2.70	$Pnam$	Orthorhombic
	1.62	1.81		
β - VPO_4O (ICSD N° 9413)	1.56	2.59	$Pnma$	Orthorhombic
α_{II} - VPO_4O (ICSD N° 2889)	1.58	2.86	$P4/n$	Tetragonal
α_I - VPO_4O (ICSD N° 108983)	1.63	2.48	$P4/n$	Tetragonal
β - LiVPO_4O (ICSD N° 80613)	1.63	2.34	$Pnma$	Orthorhombic
α - LiVPO_4O (ICSD N° 99618)	1.58	1.95	$P4/nmm$	Tetragonal
LiVPO_4O (in this work)	1.71	2.21	$P\bar{1}$	Triclinic
	1.62	2.17		

I-4b. NMR Study of LiVPO_4O

To the best of our knowledge, no NMR investigation of LiVPO_4O had been previously reported. ^7Li and ^{31}P MAS NMR measurements for LiVPO_4O were carried out in the same conditions as for LiVPO_4F . ^7Li MAS NMR shows a rather sharp peak at 79 ppm (Figure I-28) less shifted than in LiVPO_4F (116 ppm) due to the change in oxidation state of vanadium. Indeed V^{4+} ($t_{2g}^1 e_g^0$) should provide less spin transfer toward the Li nuclei than V^{3+} ($t_{2g}^2 e_g^0$). In LiVPO_4O two peaks corresponding to each crystallographic site of lithium might be expected to be observed, which is obviously not the case as shown by the fit of the spectrum by a single Gaussian/Lorentzian contribution. Although the two crystallographic sites for Li are different (the pentahedron of Li(1) shares two edges, one with $[\text{V}(1)\text{O}_4\text{O}_2]$ octahedron and another one with $[\text{V}(2)\text{O}_4\text{O}_2]$ whereas the Li(2) shares two edges with two $[\text{V}(1)\text{O}_4\text{O}_2]$ octahedra), one has again to remember that the interaction governing the shift is governed by the electron spin transfer, in other words by the relative arrangement of the d orbitals of the V ions carrying the spins and the Li atoms (via the O possibly). In this respect, the two lithiums do not appear to differ strongly, as confirmed by D. Carrier through DFT calculations. Therefore the two contributions might be included in the single signal identified (in agreement with its strong Gaussian character). Another possible explanation of the observation of one single signal can be found in the mobility of the two Li atoms between the two crystallographic sites but the two sites are separated by 3.44 Å so that the mobility between them is unlikely but possible, and no hint of motion was detected by the NMR. Very high field and fast MAS measurement are planned at the Orleans NMR platform in order to discriminate between these effects.

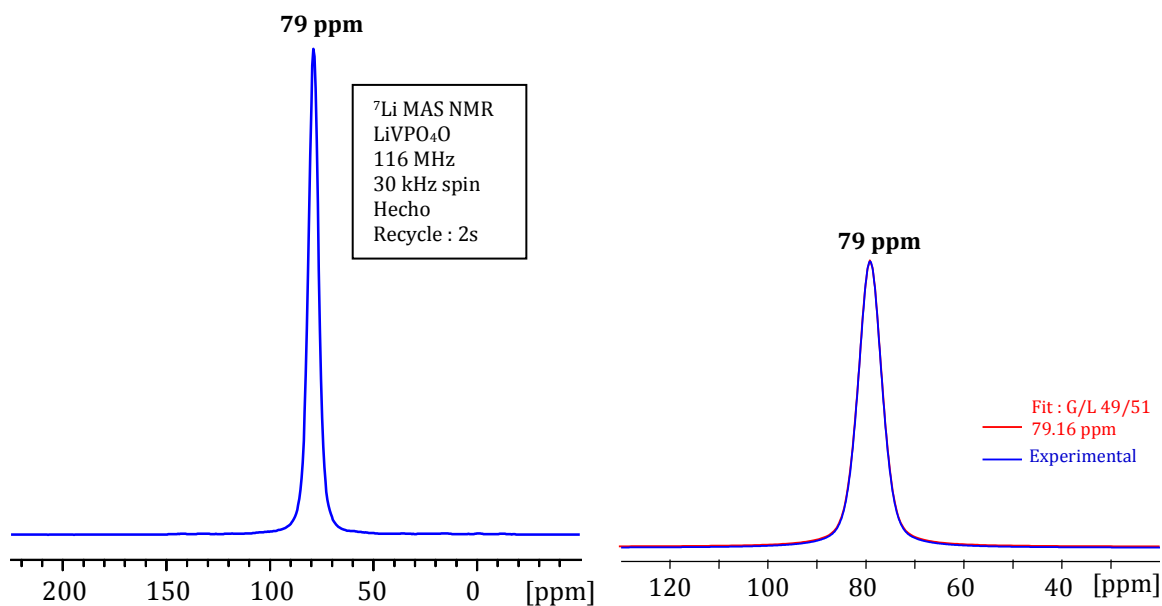

Figure I-28: ${}^7\text{Li}$ MAS NMR spectrum of LiVPO_4O (left) and a fit of ${}^7\text{Li}$ MAS NMR spectrum (right). The result is given in the insert

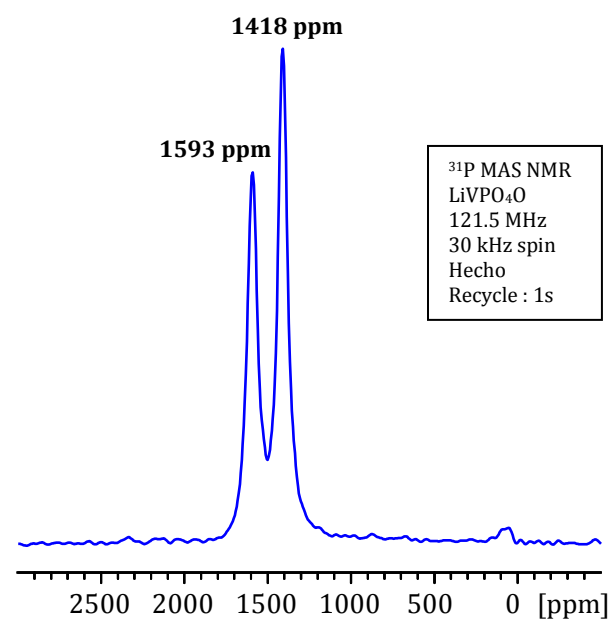

Figure I-29: ${}^{31}\text{P}$ MAS NMR spectrum (Hahn echo) of LiVPO_4O (spinning 30 kHz)..

LiVPO_4O was also analyzed by ${}^{31}\text{P}$ NMR, the spectrum of which is presented in Figure I-29. The two signals at 1593 ppm and 1418 ppm confirm the existence of two different types of P in agreement with the two crystallographic sites (less shifted than in LiVPO_4F for the same reason as for ${}^7\text{Li}$ signals). The relative magnitude (*i.e.* area) of the two signals is not strongly different from 1.

Powder neutron diffraction was performed at low temperature on D20 diffractometer in collaboration with E. Suard (ILL–Grenoble). Though the magnetic measurement revealed a

magnetic transition at a temperature of 9 K from paramagnetic to antiferromagnetic ordering, no magnetic transition was observed using low temperature neutron diffraction. This is probably due to the transparency of vanadium in neutron diffraction with in addition the electronic configuration of V^{4+} ($t_{2g}^1 e_g^0$) which displays only one single electron. In the case of LiVPO_4F , two tiny peaks were observed at 2 K and the Rietveld refinement led to a small magnetic moment ($1.22 \mu_B$). It was therefore not surprising that no magnetic transition appeared for LiVPO_4O .

I-5. Conclusion and summary of this chapter

It was possible to synthesize LiVPO_4O in one-step ceramic route using stoichiometric amounts of V_2O_3 , $\text{NH}_4\text{H}_2\text{PO}_4$ and LiF or Li_3PO_4 under O_2 atmosphere. We paid significant efforts in trying to obtain LiVPO_4F through a one step ceramic route using either V_2O_3 or V_2O_5 as vanadium precursors under inert atmosphere and always ended up with the monoclinic $\alpha\text{-Li}_3\text{V}_2(\text{PO}_4)_3$ and V_2O_3 as main impurities. Nevertheless, LiVPO_4F was obtained through a two-step ceramic route which consisted first on the synthesis of carbon coated VPO_4 (C-VPO_4) by CTR process then on the reaction between LiF and the C-VPO_4 . SEM images of LiVPO_4O showed particles size of about $1 \mu\text{m}$ highly agglomerated at $5\text{-}6 \mu\text{m}$ and the particles size of LiVPO_4F as about $1\text{-}2 \mu\text{m}$. The oxidation state of vanadium in both LiVPO_4O and LiVPO_4F was confirmed by magnetism and Bond Valence Sum (BVS).

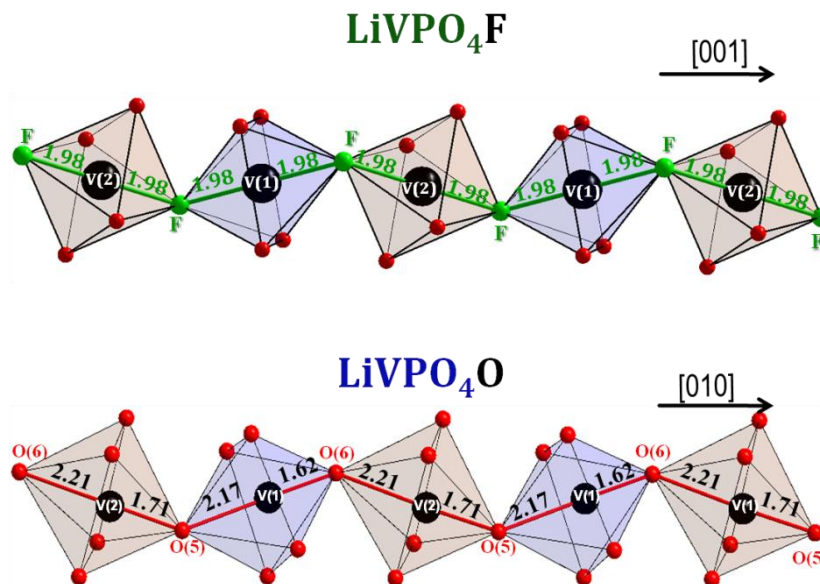

Figure I-30: Comparison of $[\text{VO}_4\text{X}_2]$ chains in LiVPO_4X ($\text{X} = \text{F}, \text{O}$).

Both LiVPO_4O and LiVPO_4F crystallize in a Tavorite-like structure with the unit cell volume of LiVPO_4O being two times bigger than the one of LiVPO_4F . While one lithium site was found for LiVPO_4F (as shown by Rietveld refinement of neutron diffraction data), two independent sites of lithium fully occupied were observed in the case of LiVPO_4O . ^7Li NMR exhibited one sharp single signal for LiVPO_4F consistent with the unique site of Li observed. Surprisingly, one single sharp signal was also observed for the ^7Li NMR of LiVPO_4O indicating that the two Li sites are similar. ^{31}P NMR confirmed the presence of one site of phosphorous in LiVPO_4F with a signal observed at 3998 ppm. In the same way, two signals of ^{31}P NMR were observed (at 1593 ppm and 1418 ppm) for LiVPO_4O corresponding to the two sites of phosphorous present in the structure of LiVPO_4O .

One of the main distinctive characteristic between the two structures is found along their respective chains where two independent vanadium sites are encountered with very regular V–F distances in LiVPO_4F (1.98 Å) compared with alternate long and short V–O distances in LiVPO_4O (Figure I-30-30). Noteworthy, the V(1)–F–V(2) angle in LiVPO_4F (132.5°) which is smaller than the corresponding angles V(1)–O(5)–V(2) and V(2)–O(6)–V(1) in LiVPO_4O (138.6° and 137.1°, respectively). We also observed a difference of the dihedral angle in both compounds since LiVPO_4F exhibited a dihedral angle of 25.05° and LiVPO_4O possess a dihedral angle of 24.53°.

References

1. Barker, J.; Saidi, M.Y. and Swoyer, J.; *Lithium Metal Fluorophosphate and Preparation Thereof*, US Patent **2005**, 0142056 A1(US 2005).
2. Barker, J.; Saidi, M.Y. and Swoyer, J.L.; *Electrochemical insertion properties of the novel lithium vanadium fluorophosphate, LiVPO_4F* , Journal of the Electrochemical Society, **2003**, 150(10): p. A1394-A1398.
3. Li, Y.; Zhou, Z.; Gao, X.P. and Yan, J.; *A Novel Sol-gel Method to Synthesize Nanocrystalline LiVPO_4F and its Electrochemical Li Intercalation Performances*, **2006**, 160: p. 633-637.
4. Zhang, Q.; Zhong, S.K.; Liu, L.T.; Liu, J.Q.; Jiang, J.Q.; Wang, J. and Li, Y.H.; *A novel method to synthesize $\text{LiVPO}_4\text{F}/\text{C}$ composite materials and its electrochemical Li-intercalation performances*, Journal of Physics and Chemistry of Solids, **2009**, 70(7): p. 1080-1082.
5. Zheng, J.C.; Zhang, B. and Yang, Z.H.; *Novel synthesis of LiVPO_4F cathode material by chemical lithiation and postannealing*, Journal of Power Sources, **2012**, 202: p. 380-383.
6. Plashnitsa, L.S.; Kobayashi, E.; Okada, S. and Yamaki, J.; *Symmetric lithium-ion cell based on lithium vanadium fluorophosphate with ionic liquid electrolyte*, Electrochimica Acta, **2011**, 56(3): p. 1344-1351.
7. Zhou, F.; Zhao, X.M. and Dahn, J.R.; *Reactivity of charged LiVPO_4F with 1 M LiPF_6 EC:DEC electrolyte at high temperature as studied by accelerating rate calorimetry*, Electrochemistry Communications, **2009**, 11(3): p. 589-591.
8. Allen, C.J.; Jia, Q.Y.; Chinnasamy, C.N.; Mukerjee, S. and Abraham, K.M.; *Synthesis, Structure and Electrochemistry of Lithium Vanadium Phosphate Cathode Materials*, Journal of the Electrochemical Society, **2011**, 158(12): p. A1250-A1259.
9. Barker, J.; Gover, R.K.B.; Burns, P.; Bryan, A.; Saidi, M.Y. and Swoyer, J.L.; *Performance evaluation of lithium vanadium fluorophosphate in lithium metal and lithium-ion cells*, Journal of the Electrochemical Society, **2005**, 152(9): p. A1776-A1779.
10. Barker, J.; Gover, R.K.B.; Burns, P.; Bryan, A.; Saidi, M.Y. and Swoyer, J.L.; *Structural and electrochemical properties of lithium vanadium fluorophosphate, LiVPO_4F* , Journal of Power Sources, **2005**, 146(1-2): p. 516-520.
11. Azmi, B.M.; Ishihara, T.; Nishiguchi, H. and Takita, Y.; *Cathodic performance of LiVOPO_4 prepared by impregnation method for Li ion secondary battery*, Electrochemistry, **2003**, 71(12): p. 1108-1110.
12. Yang, Y.; Fang, H.S.; Zheng, J.; Li, L.P.; Li, G.S. and Yan, G.F.; *Towards the understanding of poor electrochemical activity of triclinic LiVOPO_4 : Experimental characterization and theoretical investigations*, Solid State Sciences, **2008**, 10(10): p. 1292-1298.
13. Lavrov, A.V.; Nikolaev, V.P.; Sadikov, G.G. and Poraikoshits, M.A.; *Synthesis and Crystal-Structure of Mixed Vanadyl and Lithium Otho-Phosphate, LiVOPO_4* , Doklady Akademii Nauk Sssr, **1982**, 266(2): p. 343-346.
14. Viswanath, R.S. and Miller, P.J.; *High-Temperature Phase-Transition in $\text{NH}_4\text{H}_2\text{PO}_4$* , Solid State Communications, **1979**, 32(8): p. 703-706.
15. Zhou, M.F. and Chen, M.H.; *Reactions of silicon dioxide with ammonia molecules: formation and characterization of the $\text{SiO}_2\text{-NH}_3$ complex and the H_2NSiOOH molecule*, Chemical Physics Letters, **2001**, 349(1-2): p. 64-70.
16. Barker, J.; Saidi, M.Y. and Swoyer, J.L.; *A carbothermal reduction method for the preparation of electroactive materials for lithium ion applications*, Journal of the Electrochemical Society, **2003**, 150(6): p. A684-A688.
17. Hameed, A.S.; Nagarathinam, M.; Reddy, M.V.; Chowdari, B.V.R. and Vittal, J.J.; *Synthesis and electrochemical studies of layer-structured metastable $\alpha(1)\text{-LiVOPO}_4$* , Journal of Materials Chemistry, **2012**, 22(15): p. 7206-7213.
18. Dupre, N.; Gaubicher, J.; Angenault, J. and Querton, M.; *Electrochemical study of intercalated vanadyl phosphate*, Journal of Solid State Electrochemistry, **2004**, 8(5): p. 322-329.

19. Dupre, N.; Wallez, G.; Gaubicher, J. and Quarton, M.; *Phase transition induced by lithium insertion in alpha(I)- and alpha(II)-VOPO(4)*, Journal of Solid State Chemistry, **2004**, 177(8): p. 2896-2902.
20. Barker, J.; Saidi, M.Y. and Swoyer, J.L.; *Electrochemical properties of beta-LiVOPO(4) prepared by carbothermal reduction*, Journal of the Electrochemical Society, **2004**, 151(6): p. A796-A800.
21. Gaubicher, J.; Le Mercier, T.; Chabre, Y.; Angenault, J. and Quarton, M.; *Li/beta-VOPO4: A new 4 V system for lithium batteries*, Journal of the Electrochemical Society, **1999**, 146(12): p. 4375-4379.
22. Kerr, T.A.; Gaubicher, J. and Nazar, L.F.; *Highly reversible Li insertion at 4 V in epsilon-VOPO(4)/alpha-LiVOPO(4) cathodes*, Electrochemical and Solid State Letters, **2000**, 3(10): p. 460-462.
23. Bain, G.A. and Berry, J.F.; *Diamagnetic corrections and Pascal's constants*, Journal of Chemical Education, **2008**, 85(4): p. 532-536.
24. Simonov, V.I. and Belov, N.V.; *The Crystal Structure of Amblygonite*, Doklady Akademii Nauk Sssr, **1958**, 119(2): p. 354-356.
25. Ateba Mba, J.M.; Masquelier, C.; Suard, E. and Croguennec, L.; *Synthesis and Crystallographic Study of Homeotypic LiVPO(4)F and LiVPO(4)O*, Chemistry of Materials, **2012**, 24(6): p. 1223-1234.
26. Ellis, B.L.; Ramesh, T.N.; Davis, L.J.M.; Goward, G.R. and Nazar, L.F.; *Structure and Electrochemistry of Two-Electron Redox Couples in Lithium Metal Fluorophosphates Based on the Tavorite Structure*, Chemistry of Materials, **2011**, 23(23): p. 5138-5148.
27. Rinard, P.M.; *Neutron Interactions with Matter.*, Passive Nondestructive Assay of Nuclear Materials, **1991**, NUREG/CR-5550 /LA-UR-90-732(Edited by Reilly, D, N.Ensslin, H. Smith, Jr, and S. Kreiner.): p. Chapter 12.
28. Sears, V.F.; *Neutron scattering lengths and cross section*, Neutron News, **1992**, 3(3): p. 26-37.
29. Castets, A.; *RMN de matériaux paramagnétiques: mesures et modélisation*, Bordeaux 1 University, **2012**.
30. Vaughey, J.T.; Harrison, W.T.A.; Jacobson, A.J.; Goshorn, D.P. and Johnson, J.W.; *Synthesis, Structure, and Properties of 3 New Vanadium (III) Phosphates - VPO(4) Center Dot H2O and V1.23(PO4)(OH)0.69(H2O)0.31 Center Dot 0.33H2O*, Inorganic Chemistry, **1994**, 33(11): p. 2481-2487.
31. Castets, A.; Carlier, D.; Zhang, Y.; Boucher, F.; Marx, N.; Croguennec, L. and Menetrier, M.; *Multinuclear NMR and DFT Calculations on the LiFePO(4)center dot OH and FePO(4)center dot H(2)O Homeotypic Phases*, Journal of Physical Chemistry C, **2011**, 115(32): p. 16234-16241.
32. Castets, A.; Carlier, D.; Zhang, Y.; Boucher, F.; Marx, N.; Gautier, R.; Le Fur, E.; Le Polles, L.; Croguennec, L. and Menetrier, M.; *NMR study of the LiMnPO(4)center dot OH and MPO(4)center dot H(2)O (M=Mn, V) homeotypic phases and DFT calculations*, Solid State Nuclear Magnetic Resonance, **2012**, 42: p. 42-50.
33. Duttine, M.; Carlier, D.; Ateba Mba, J.M.; Croguennec, L.; Masquelier, C. and M., M.; *19F, 7Li and 31P MAS NMR Characterization and DFT Calculations for the Tavorite-Type LiVPO4F*, Journal of Physical Chemistry C, **2013**, SUBMITTED.

Chapter II
ELECTROCHEMICAL BEHAVIOR OF
 LiVPO_4X ($\text{X} = \text{O}$ or F)

Contents

II-1. Introduction	61
II-2. ELECTRODE PREPARATION AND BATTERY CONFIGURATION	64
II-3. ELECTROCHEMICAL BEHAVIOR OF LiVPO_4F	66
II-3a. Reversible Li^+ insertion into LiVPO_4F ($\text{V}^{3+}/\text{V}^{2+}$ couple)	66
II-3b. Reversible Li^+ extraction from LiVPO_4F ($\text{V}^{4+}/\text{V}^{3+}$ couple)	69
II-3c. Crystal Structures of $\text{Li}_x\text{VPO}_4\text{F}$ ($x = 2, 0.67, 0$)	77
<i>i- Crystal Structure of VPO_4F</i>	<i>78</i>
<i>ii- Hypothesis on the structure of $\text{Li}_{0.67}\text{VPO}_4\text{F}$</i>	<i>80</i>
<i>iii- Structure of $\text{Li}_2\text{VPO}_4\text{F}$</i>	<i>81</i>
<i>iv- Comparative NMR Study of $\text{Li}_x\text{VPO}_4\text{F}$ phases (with $x = 1, 0.67$ and 0)</i>	<i>84</i>
II-3d. Conclusion.....	86
II-4. ELECTROCHEMICAL BEHAVIOR OF LiVPO_4O	88
II-4a. Reversible Li^+ insertion into LiVPO_4O ($\text{V}^{3+}/\text{V}^{4+}$ couple)	89
II-4b. Reversible Li^+ extraction from LiVPO_4O ($\text{V}^{4+}/\text{V}^{5+}$ couple)	92
II-5. Conclusions and summary of this chapter.....	97

II-1. Introduction

LiVPO_4F is an attractive material as a positive electrode in Li-ion battery as it displays one of the highest $\text{V}^{4+}/\text{V}^{3+}$ redox couple among known polyanionic compositions (Table II-1). As an example, the average redox potential of the $\text{V}^{4+}/\text{V}^{3+}$ couple in LiVPO_4F is 4.2 V vs. Li^+/Li , much higher than for the well-known $\alpha\text{-Li}_3\text{V}_2(\text{PO}_4)_3$ [1-5] (Figure II-1). It is worth noticing that both LiVP_2O_7 and LiVPO_4F have the same average potential [6-9] (Figure II-1) but the advantage of LiVPO_4F is that the total energy is higher (655 Wh/Kg) than that of LiVP_2O_7 (486 Wh/Kg).

Table II-1: Average potentials, capacities and energy densities of vanadium phosphates reported in the literature.

	Initial/final Active material	Average Potential (V vs. Li)	Theoretical Capacity (mAh/g)	Energy density (Wh/g)
Li batteries	$\text{V}^{\text{V}}\text{PO}_4\cdot 2\text{H}_2\text{O} / \text{Li}_x\text{V}^{\text{IV}}\text{PO}_4\cdot 2\text{H}_2\text{O}$ [10, 11]	3.7	135	499
	$\text{V}^{\text{V}}\text{PO}_4\cdot \text{H}_2\text{O} / \text{Li}_x\text{V}^{\text{IV}}\text{PO}_4\cdot \text{H}_2\text{O}$ [10]	3.6	149	536
	$\text{V}^{\text{V}}\text{PO}_4\text{O} / \text{LiV}^{\text{IV}}\text{PO}_4\text{O}$ [11-16]	3.9	165	643
	$\text{V}^{\text{IV}}\text{O}(\text{H}_2\text{PO}_4)_2 / \text{LiV}^{\text{III}}\text{O}(\text{H}_2\text{PO}_4)_2$ [17]	4.2	103	433
	$\text{LiV}^{\text{III}}\text{PO}_4\text{F} / \text{V}^{\text{IV}}\text{PO}_4\text{F}$ [18-28]	4.2	156	655
	$\text{LiV}^{\text{IV}}\text{PO}_4\text{O} / \text{V}^{\text{V}}\text{PO}_4$ [11-16, 27, 29-42]	3.9	159	620
	$\text{LiV}^{\text{III}}\text{P}_2\text{O}_7 / \text{V}^{\text{IV}}\text{P}_2\text{O}_7$ [6-8, 43]	4.2	116	487
	$\text{Li}_2\text{V}^{\text{IV}}\text{P}_2\text{O}_7 / \text{V}^{\text{V}}\text{P}_2\text{O}_7$ [44]	4.2	105	441
	$\text{Li}_2\text{V}^{\text{IV}}\text{O}(\text{HPO}_4)_2 / \text{LiV}^{\text{V}}\text{O}(\text{HPO}_4)_2$ [17]	4.2	98	412
	$\text{Li}_3\text{V}^{\text{III}}_2(\text{PO}_4)_3 / \text{LiV}^{\text{IV}}_2(\text{PO}_4)_3$ [1-5]	3.7	131	485
	$\text{Li}_4\text{V}^{\text{IV}}\text{O}(\text{PO}_4)_2 / \text{Li}_5\text{V}^{\text{V}}\text{O}(\text{PO}_4)_2$ [17, 45]	4.1	94	385
$\text{Li}_5\text{V}^{\text{III}}(\text{PO}_4)_2\text{F}_2 / \text{Li}_4\text{V}^{\text{IV}}(\text{PO}_4)_2\text{F}_2$ [46]	4.1	171	701	
Na batteries	$\text{Li}_{1.1}\text{Na}_{0.4}\text{V}^{3.7}\text{PO}_{4.8}\text{F}_{0.7} / \text{V}^{\text{V}}\text{PO}_{4.8}\text{F}_{0.7}$ [47]	4.0	140	560
	$\text{NaV}^{\text{III}}\text{PO}_4\text{F} / \text{V}^{\text{III}}\text{PO}_4\text{F}$ [48-50]	4.0	143	572
	$\text{Na}_3\text{V}^{\text{III}}_2(\text{PO}_4)_2\text{F}_3 / \text{NaV}^{\text{IV}}_2(\text{PO}_4)_2\text{F}_3$ [51-55]	3.9	192	749

The electrochemical performances of LiVPO_4F had been widely studied by J. Barker et al. [19-21, 49, 56-60]. During the charge of LiVPO_4F (electrochemical extraction of Li^+ from LiVPO_4F), two plateaus were observed and located at 4.24 V vs. Li^+/Li for the first one and at 4.28 V vs. Li^+/Li for the second one. Surprisingly, during the subsequent discharge (electrochemical insertion of Li^+ in VPO_4F) only one plateau was observed at a potential of 4.2 V vs. Li^+/Li .

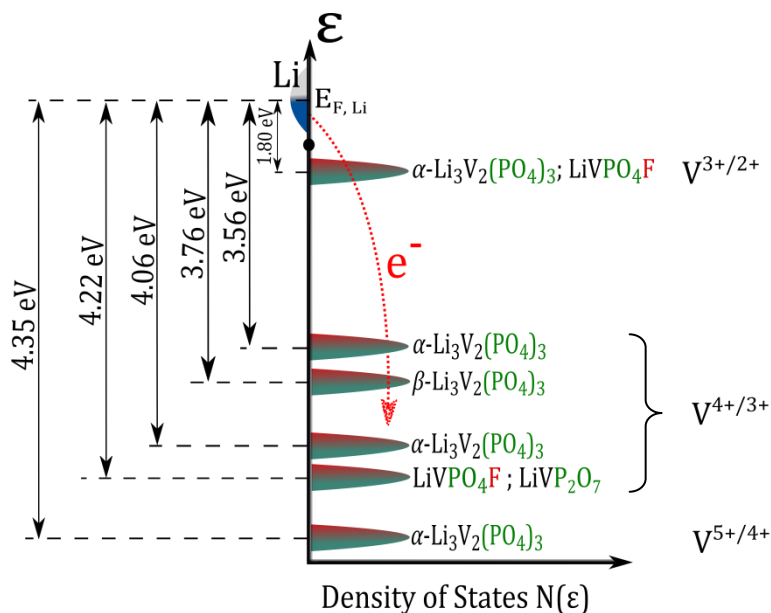

Figure II-1: Respective positions of $\text{V}^{n+}/\text{V}^{(n-1)+}$ redox couples in phosphate, diphosphate and NASICON-like polyanionic structures. α - and β - $\text{Li}_3\text{V}_2(\text{PO}_4)_3$ refer to Anti-NASICON (monoclinic) and NASICON (rhombohedral) forms respectively.

J. Barker also showed that it was possible to insert lithium into LiVPO_4F electrochemically at a potential of 1.80 V vs. Li^+/Li leading to $\text{Li}_2\text{VPO}_4\text{F}$ [60]. Based on the two redox potentials involved during first charge ($\text{V}^{4+}/\text{V}^{3+}$) and during first discharge ($\text{V}^{3+}/\text{V}^{2+}$), J. Barker envisioned the preliminary performance of a symmetrical Li-ion cell $\text{LiVPO}_4\text{F}||\text{LiVPO}_4\text{F}$ (EC/DMC in 2:1, by weight proportion, was used as electrolyte) which can operate with an average voltage of 2.4 V vs. Li^+/Li (Figure II-2)

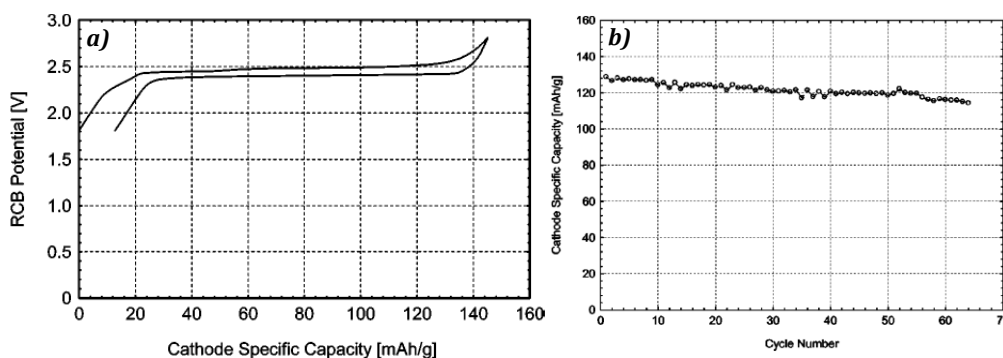

Figure II-2: a) Electrochemical behavior of a typical symmetrical $\text{LiVPO}_4\text{F}||\text{LiVPO}_4\text{F}$ cell cycled between 1.80 V and 2.80 V as reported by J. Barker together with b) the corresponding capacity vs. cycles number [60].

The initial active specific capacity reported at a rate of C/5 by J. Barker was 128 mAh/g for both electrodes, which dropped down to 116 mAh/g after 65 cycles (corresponding to 9% of capacity fade). L.S. Plashnitsa et al. [61] studied the performance of $\text{LiVPO}_4\text{F}||\text{LiVPO}_4\text{F}$ cells using either LiPF_6 in EC-DMC (with proportion of 1:1 by weight) or $\text{LiBF}_4/\text{EMIBF}_4$ in ionic liquid (IL). For the first case, the symmetrical cell operated at 2.4 V vs. Li^+/Li with an initial capacity of 120 mAh/g

which dramatically decreased (Figure II-3) reaching 20 mAh/g after only 9 cycles. Interestingly, less capacity fade was observed for the symmetrical battery of LiVPO_4F using the IL-based electrolyte, with a capacity retention of 60 mAh/g after 19 cycles (Figure II-3c and 3d).

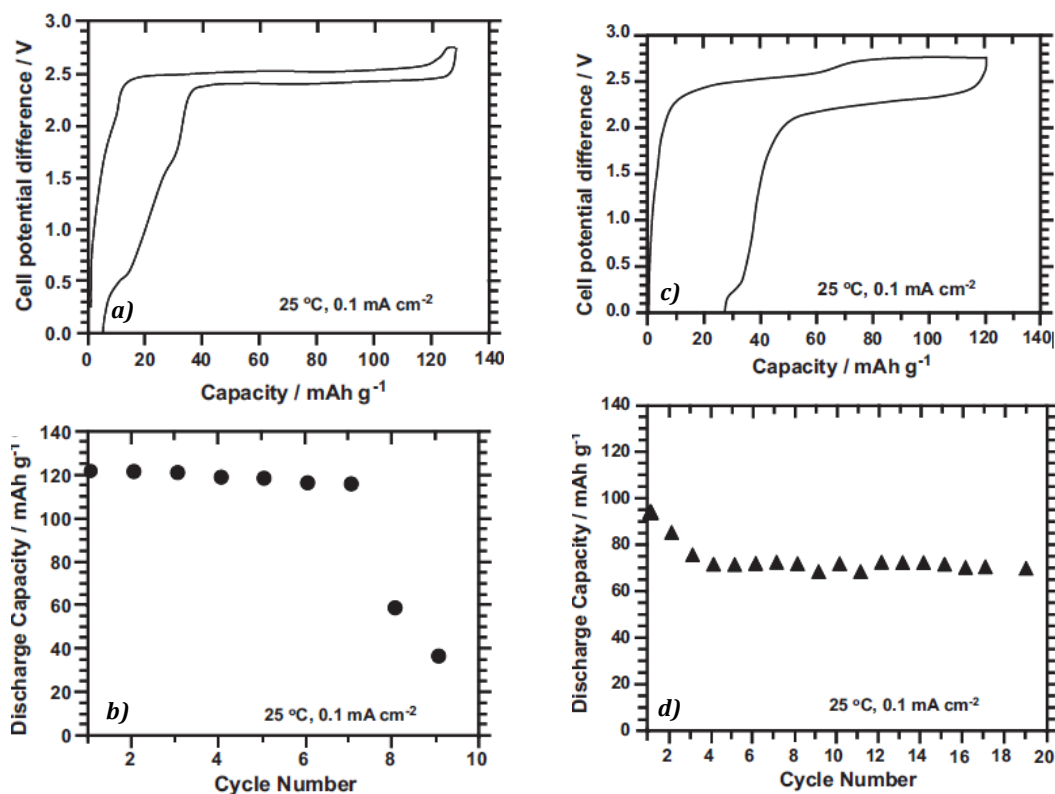

Figure II-3: a) The first charge/discharge galvanostatic data for the $\text{LiVPO}_4\text{F}/[1\text{M}] \text{LiPF}_6/\text{EC-DMC}$ (1:1)/ LiVPO_4F cell and b) the corresponding capacity vs. cycles number. c) The first charge/discharge galvanostatic data for the $\text{LiVPO}_4\text{F}/[1\text{M}] \text{LiBF}_4/\text{EMIBF}_4/\text{LiVPO}_4\text{F}$ cell and d) the corresponding capacity vs. cycles number [61].

T.A. Kerr et al. [13] reported on the first electrochemical signature of the triclinic LiVPO_4O which had been obtained by chemical lithiation of $\epsilon\text{-VPO}_4\text{O}$. The obtained LiVPO_4O exhibited a capacity of ~110 mAh/g (theoretical specific capacity of LiVPO_4O is 159 mAh/g) with an operating potential of 3.9 V vs. Li^+/Li . T.A. Kerr also showed that $\epsilon\text{-VPO}_4\text{O}$ can accommodate Li^+ leading to the formation of the triclinic phase LiVPO_4O . B.M. Azmi et al. [29] reported for the first time the electrochemical behavior of the “as-prepared” LiVPO_4O . The obtained electrochemical signature presented very small capacity retention (~10 mAh/g at C/50). Y. Yang et al. [36] investigated the poor electrochemical performances of the triclinic LiVPO_4O and associated it to the very low intrinsic electronic conductivity. Recently, during this thesis, C. Allen et al. [39] demonstrated that Li^+ can be extracted from LiVPO_4O with a relatively good reversible capacity of 120 mAh/g. Note that C. Allen reported particles size of 2-5 μm for the “as-prepared” LiVPO_4O and found a discharge capacity of the triclinic LiVPO_4O higher than the one of the orthorhombic LiVPO_4O (both described in Chapter I, Figure I-7).

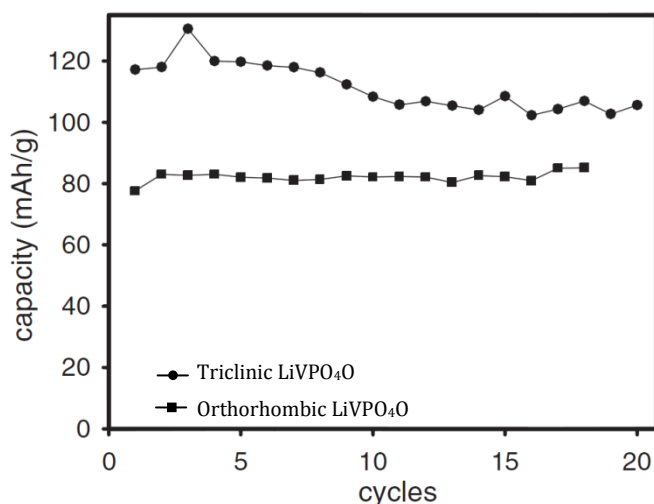

Figure II-4: Discharge capacities vs. cycle number of triclinic LiVPO_4O (dots) and orthorhombic LiVPO_4O (squares) phases. The cycling rate was C/10. [39]

In this chapter, we are reporting on the electrochemical behavior of both LiVPO_4F and LiVPO_4O used as positive electrode materials in Li-ion batteries. Structural changes associated with the reversible insertion/extraction of Li^+ out of/in these structures will be presented, as investigated by both *ex situ* and *in situ* X-Ray diffraction.

II-2. ELECTRODE PREPARATION AND BATTERY CONFIGURATION

We have performed electrochemical tests in coin cells assembled in an argon-filled dry glove box. Prior to be used as positive electrodes, the active materials were ball milled with 12 wt % of C_{SP} when LiVPO_4F was concerned and 15 wt % of C_{SP} when LiVPO_4O was used. In both cases, 12 wt % of PVdF binder was added. In order to ensure porosity and rapid electrolyte uptake within the electrodes, 33 wt % of Dibutylphthalate (DBP) was used. Finally some drops of acetone were added and the slurry was stirred for 1-2 hours prior to be casted (thickness $\sim 150 \mu\text{m}$) on a glass plate. After drying, electrodes of 1 cm in diameter were cut and soaked in ether in order to get rid of DBP. The electrodes loading were about $3\text{-}4 \text{ mg/cm}^2$.

The cells consisted of the positive electrode (as described above), 1 cm^2 Li disk as negative electrode and 1 M of LiPF_6 in a mixture of EC-DMC (1:1) as the electrolyte (LP30). The assembled cells were cycled between 3 V and 4.55 V vs. Li^+/Li when attention was given to Li^+ extracted from LiVPO_4X ($\text{X} = \text{F}, \text{O}$) first and between 3 V and 1.50 V vs. Li^+/Li when attention was given to Li^+ inserted into LiVPO_4X ($\text{X} = \text{F}, \text{O}$) first.

For *in situ* XRD, the synthesized LiVPO_4F powder was mixed with 12 wt % C_{SP} (15 wt % of C_{SP} was used in the case of LiVPO_4O) and subsequently mixed/ground under argon using a Spex grinder for 15 minutes. The XRD patterns were recorded, during battery operation, with a Bruker D8 Advance diffractometer operating in Bragg-Brentano geometry with the $\text{CuK}\alpha$ radiation. A special stainless steel *in situ* cell designed by J.B. Leriche et al. [62] (see Figure II-5) was assembled in an argon-filled dry box. Li metal was used as the negative electrode pasted on a Whatman glass fiber sheet separator saturated with a 1M LiPF_6 in ethylene carbonate (EC) and dimethyl carbonate (DMC) (1:1 in wt%) electrolyte. The positive electrodes were prepared by directly depositing ~ 15 mg of powder behind a thin aluminum sheet (thickness of $3 \mu\text{m}$) used to protect the beryllium window from possible oxidation at high voltage. The cell was connected to a Mac-Pile system operating in galvanostatic cycling mode. Typically, each electrochemical cell was charged (or discharged) at a current equivalent to a C/50 rate during which the XRD patterns were collected, every hour, between $2\theta = 13^\circ$ and $2\theta = 45^\circ$. After 45° , high-intensity diffraction peaks of Be (51°) tend to “screen” those of the studied phase. At 38.6° in 2θ ($d_{\text{(hkl)}} = 2.33 \text{ \AA}$), the diffraction peak of Aluminum was present and used as a position-reference peak for successive experiments.

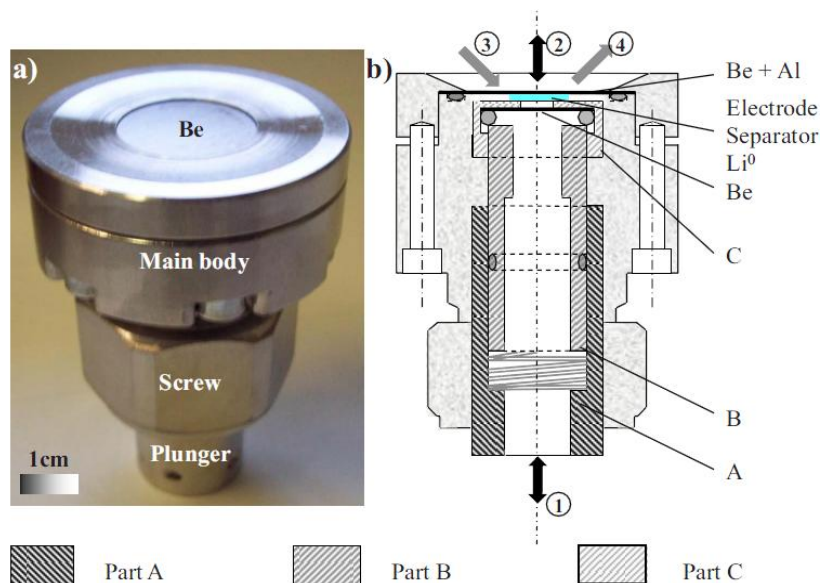
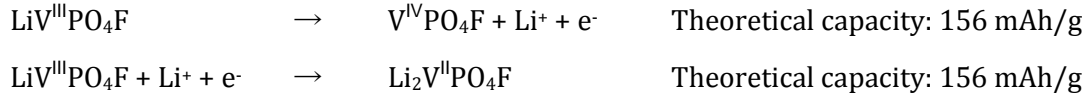

Figure II-5: a) Photography and b) detailed description of the Leriche's *in situ* cell used for *in situ* XRD experiments [62]

II-3. ELECTROCHEMICAL BEHAVIOR OF LiVPO_4F

The lithium-ion extraction/insertion reaction from LiVPO_4F , in the upper voltage range, relies on the reversibility of the $\text{V}^{4+}/\text{V}^{3+}$ redox couple, and the lithium insertion/extraction reaction in the lower voltage range relies on the reversibility of the $\text{V}^{3+}/\text{V}^{2+}$ redox couple. The two electrochemical reactions associated can be summarized as:



II-3a. Reversible Li^+ insertion into LiVPO_4F ($\text{V}^{3+}/\text{V}^{2+}$ couple)

As established by J. Barker et al. [60], LiVPO_4F can accommodate electrochemically one Li that leads to the formation of $\text{Li}_2\text{VPO}_4\text{F}$ at a potential of 1.80 V vs. Li^+/Li . We have performed a GITT experiment (Galvanostatic Intermittent Titration Technique) in order to determine the mechanism of Li insertion/extraction between 1.50–3.00 V as well as the exact position of the plateau previously observed by J. Barker. The GITT (Figure II-6a) measurements consisted of a series of current-pulses applied at a rate of $C/100$ during 1 hour, followed by a long relaxation time for which the condition was set to $dV/dt < 4$ mV/h *i.e.* the variation of the potential is lower than 4 mV per 1 hour. The relaxation condition was reached within about 4 hours on the plateau as witnessed by the zoom-in (Figure II-6b) of time vs. potential. We therefore confirmed that the electrochemical insertion of Li into LiVPO_4F occurred at the exact potential of 1.81 V vs. Li^+/Li (Figure II-6b) and the very flat plateau suggested a biphasic mechanism of Li insertion into LiVPO_4F .

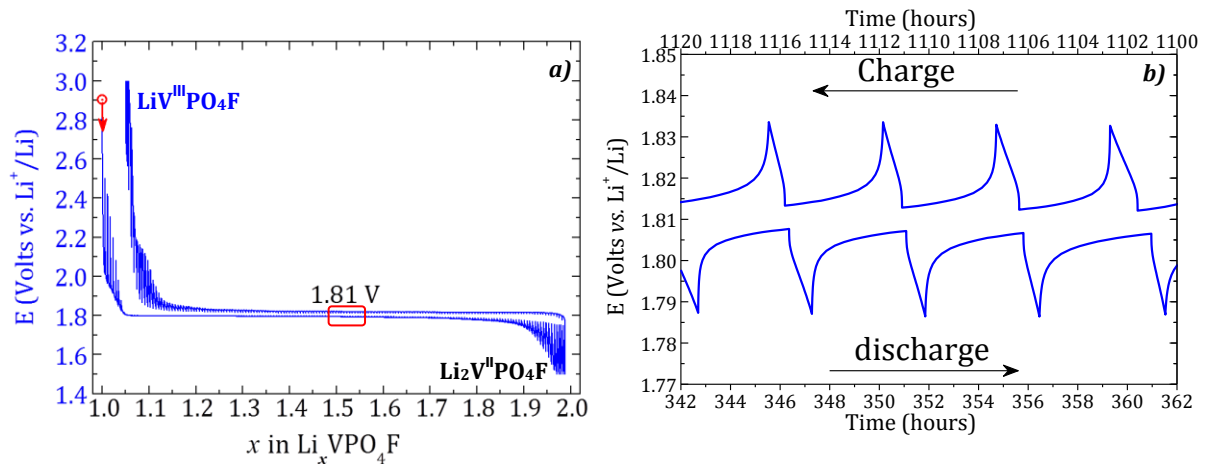

Figure II-6: GITT measurement of LiVPO_4F between 1.5–3 V vs. Li. a) Potential vs. $\text{Li}_x\text{VPO}_4\text{F}$ and b) in the region of $\text{Li}_{0.5}\text{VPO}_4\text{F}$, potential vs. time.

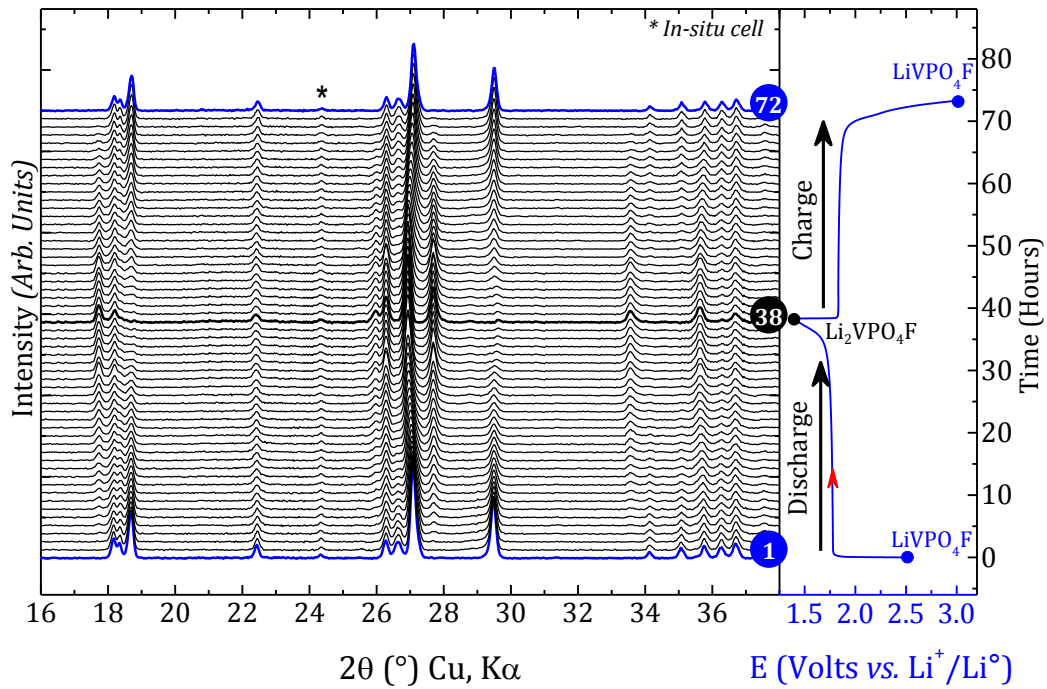

Figure II-7: 2D View of collected in-situ XRD patterns for the global electrochemical reaction $\text{LiVPO}_4\text{F} \rightleftharpoons \text{Li}_2\text{VPO}_4\text{F}$ (left) and corresponding galvanostatic cycling data (right). The XRD patterns highlighted in blue refer to LiVPO_4F and the dark black one to $\text{Li}_2\text{VPO}_4\text{F}$

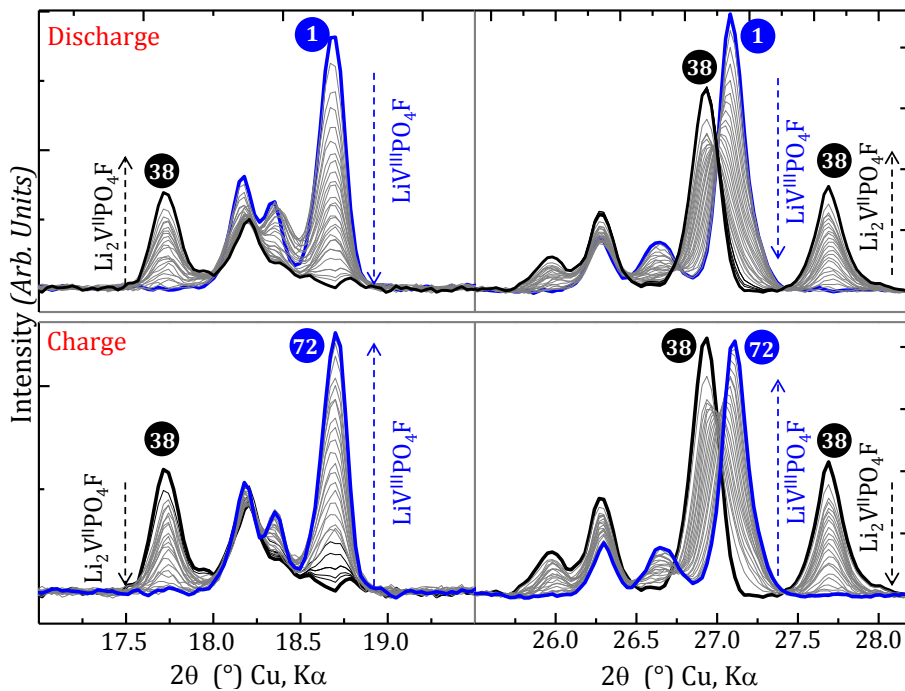

Figure II-8: Selected 2θ regions showing the respective growths and disappearances of the phases involved in the $\text{LiVPO}_4\text{F} \rightleftharpoons \text{Li}_2\text{VPO}_4\text{F}$ reaction.

A detailed *In situ* XRD experiment was performed in order to follow the mechanism of Li insertion/extraction into LiVPO_4F . As presented in Figure II-7 during the discharge of LiVPO_4F from 2.5 V down to 1.5 V, all the diffraction peaks of the starting LiVPO_4F phase, progressively vanish in a continuous manner. The diffraction peaks selected in the $17^\circ \leq 2\theta \leq 19.5^\circ$ and $25.5^\circ \leq$

$2\theta \leq 28^\circ$ regions (Figure II-8) clearly illustrate the two-phase mechanism as none of them are shifted towards higher or lower 2θ diffraction angles.

Figure II-9 illustrates the appearance of the $(200)_{c2/c}$ peak of $\text{Li}_2\text{VPO}_4\text{F}$ as a function of $x\text{Li}^+$ overall content. It shows an experimental (black dots line) deviation from the theoretical (dash-red line) increase intensity at midcharge. The decrease in the intensity of the $(110)_{p\bar{1}}$ peak of LiVPO_4F (blue dots lines) fit with the theoretical.

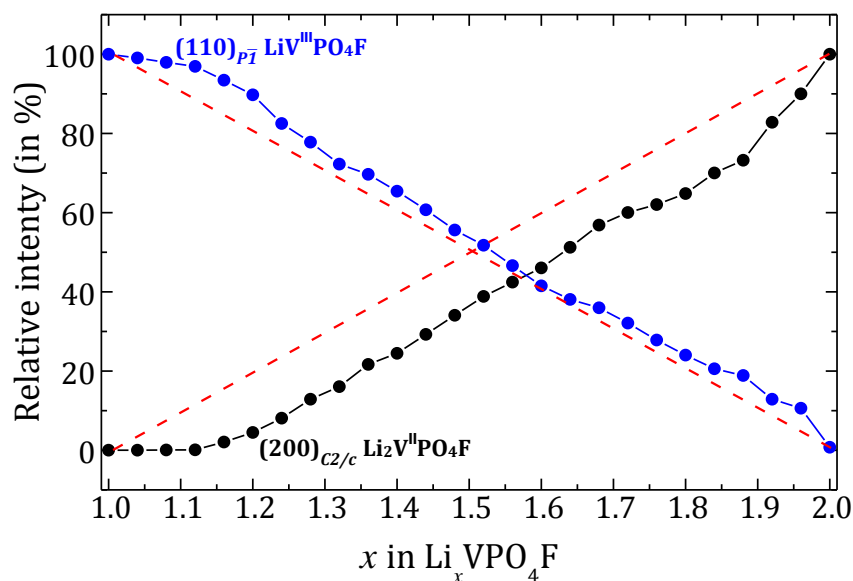

Figure II-9: variations of normalized intensities of the $(110)_{p\bar{1}}$ peak of LiVPO_4F (blue) and the $(200)_{c2/c}$ peak of $\text{Li}_2\text{VPO}_4\text{F}$ (red) as a function of $x \text{Li}^+$.

A possible occurrence of an amorphous phase might explain the apparent delay in the $\text{Li}_2\text{VPO}_4\text{F}$ formation as also observed in the $\text{LiFePO}_4\text{-FePO}_4$ system [62, 63].

The refined lattice parameters of LiVPO_4F before and after a full electrochemical cycle and the refined lattice parameters of $\text{Li}_2\text{VPO}_4\text{F}$ are gathered in Figure II-10. The lattice parameters of the two LiVPO_4F (the initial one and the fully charged one after a complete electrochemical cycling) are very similar and as expected, exhibit a V/Z lower than the one of $\text{Li}_2\text{VPO}_4\text{F}$ ($\sim 87.5 \text{ \AA}^3$ for LiVPO_4F vs. $\sim 93.8 \text{ \AA}^3$ for $\text{Li}_2\text{VPO}_4\text{F}$). This is a consequence of the V^{2+} ionic radii (0.088 nm) which is bigger than the one of V^{3+} (0.074 nm).

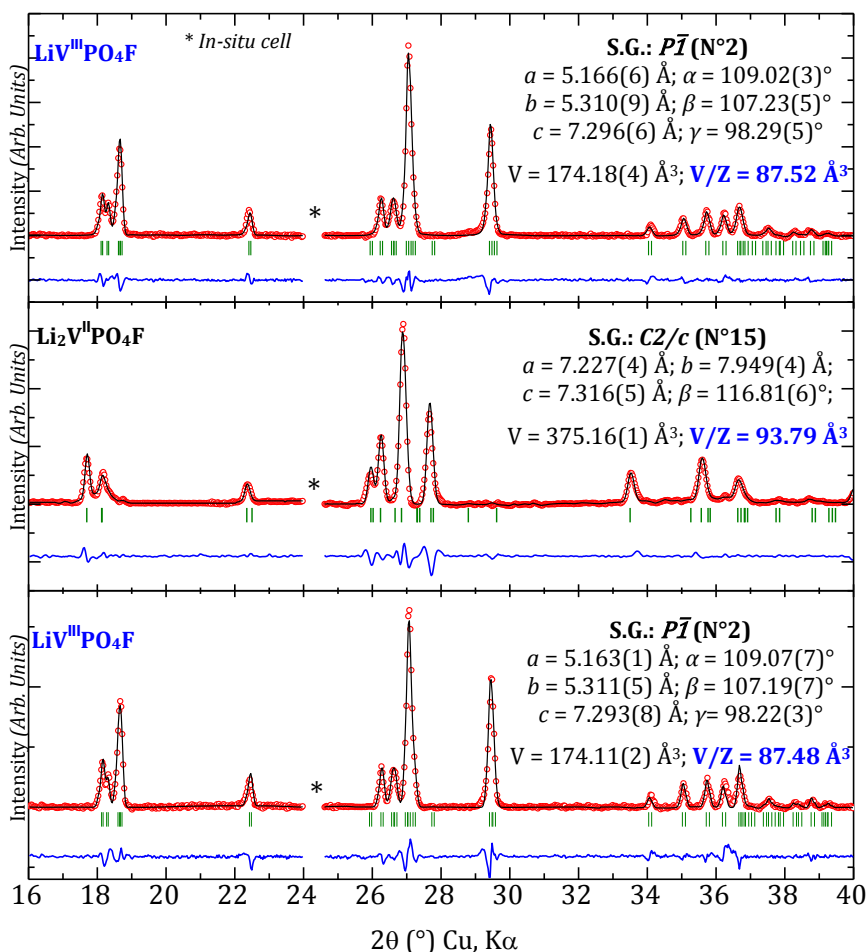

Figure II-10: XRD patterns and full-pattern matching refinements of initial LiVPO_4F , reduced $\text{Li}_2\text{VPO}_4\text{F}$ and fully charge LiVPO_4F . The space groups, the lattice parameters and the volumes are inserted for each XRD pattern.

II-3b. Reversible Li^+ extraction from LiVPO_4F ($\text{V}^{4+}/\text{V}^{3+}$ couple)

Galvanostatic data of LiVPO_4F have been recorded between 3 and 4.55 V at a rate of C/50 for 4 different samples (see Figure I-5 in chapter I), and presented in Figure II-11. LiVPO_4F containing small amounts of $\alpha\text{-Li}_3\text{V}_2(\text{PO}_4)_3$ as impurity, exhibited three small plateaus at potentials of 3.57 V, 3.65 V and 4.04 V vs. Li^+/Li (Figure II-11a), barely seen in the differential capacity curve. Those plateaus are located at the same potentials as those observed for $\alpha\text{-Li}_3\text{V}_2(\text{PO}_4)_3$ [1, 3-5, 64]. F. Zhou et al. [24] who also obtained the $\alpha\text{-Li}_3\text{V}_2(\text{PO}_4)_3$ as impurity during the synthesis of LiVPO_4F also observed the same plateaus located at the same potentials.

Figure II-11b shows two galvanostatic electrochemical data: the blue one corresponds to LiVPO_4F containing an unknown impurity (see Figure I-5b in chapter I) and the red one is the galvanostatic data of a material that had been washed with water (as described in chapter I). We note the absence of the three small plateaus previously observed, and a similarity between the two electrochemical data. Figure II-11c shows the electrochemical data of a pure LiVPO_4F

sample where the capacity at the end of charge (full Li extraction from LiVPO_4F) was 154 mAh/g. Note that pure LiVPO_4F exhibited higher capacity on charge, but lower capacity on discharge. However the capacity retention recorded was the highest compared with other non-pure LiVPO_4F powders.

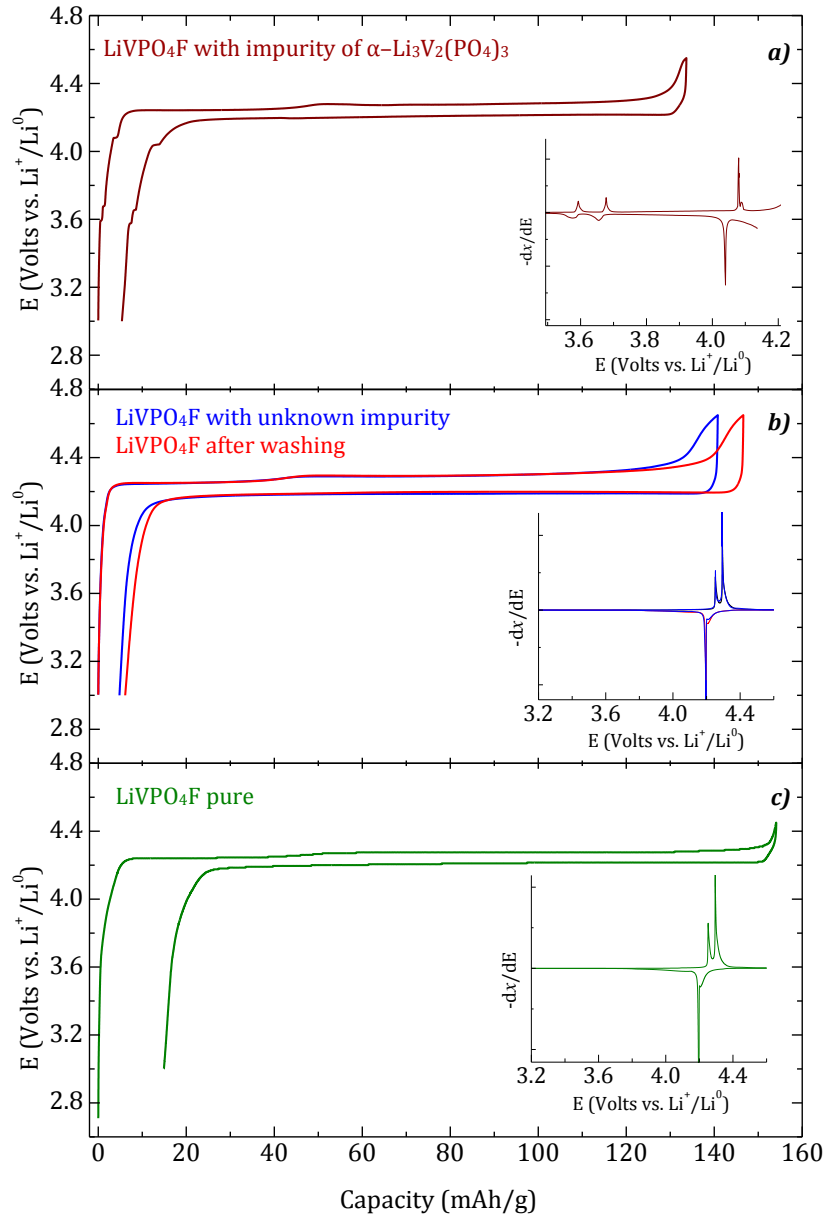

Figure II-11: Electrochemical behavior of different LiVPO_4F samples cycled between 3.00–4.60 V vs. Li^+/Li at $C/50$: a) LiVPO_4F samples containing $\alpha\text{-Li}_3\text{V}_2(\text{PO}_4)_3$ as impurity, b) LiVPO_4F sample containing an unknown impurity before (red) and after washing (blue), and c) pure LiVPO_4F

Figure II-12 exhibits the GITT measurement recorded during Li^+ extraction first from LiVPO_4F performed in the same conditions as previously (for Li^+ insertion first into LiVPO_4F). Close inspection of the data indicated the presence of a small inflection at a relaxed potential of 4.25 V vs. Li^+/Li between two plateaus: a shorter one (1/3 Li) at 4.24 V and a longer one (2/3 Li) at 4.26 V vs. Li. J. Barker et. al. interpreted this inflection in the charge profile as the extraction of Li^+

from two energetically non-equivalent crystallographic sites within the LiVPO_4F framework structure. Indeed, as the inflection point is observed at the composition $\text{Li}_{0.67}\text{VPO}_4\text{F}$, we could have expected the distribution of Lithium in two sites in the pristine material, with 1/3 Li in one site and 2/3 Li in the other site, and thus the preferential deintercalation of the first versus the second. Nevertheless, as discussed in Chapter I our structural study has shown that lithium occupies a single site in LiVPO_4F , which thus tends to rule out the interpretation proposed by J. Barker to explain that peculiar composition $\text{Li}_{0.67}\text{VPO}_4\text{F}$.

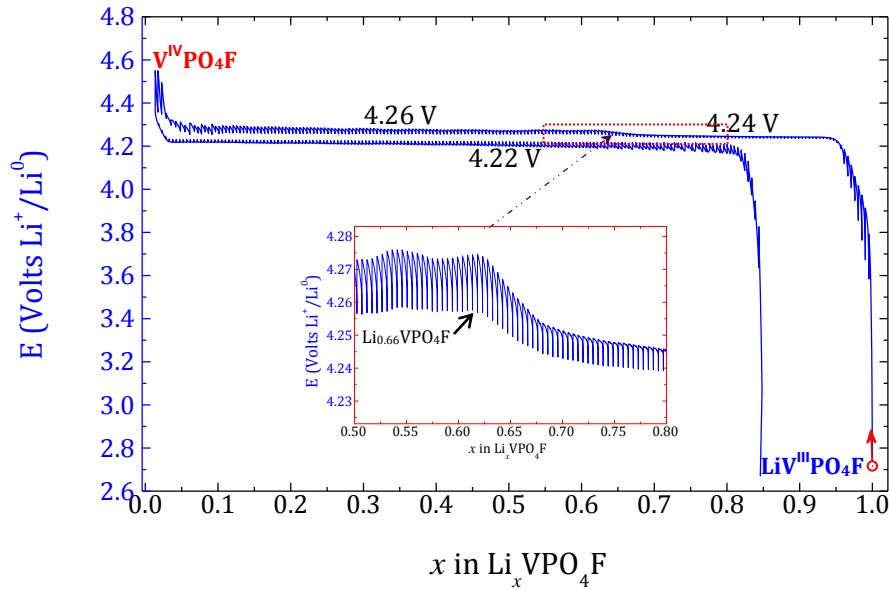
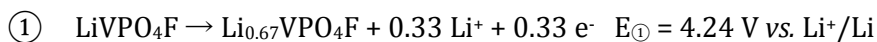

Figure II-12: GITT measurement of LiVPO_4F between 2.7–4.55 V with a current rate of $C/100$. The relaxation condition was $dV/dt < 4 \text{ mV/h}$

Several *in situ* XRD experiments were conducted in order to follow carefully the phase formations in the $\text{LiVPO}_4\text{F} \Leftrightarrow \text{VPO}_4\text{F}$ system. The *in situ* XRD and electrochemistry data related to a full charge/discharge cycle were gathered in Figure II-13 and Figure II-14. All phenomena are related to two-phase reactions:

- During the first part of the charge, the diffraction peaks of the starting LiVPO_4F phase progressively vanish and new Bragg positions that cannot be indexed with the unit-cell parameters of the fully de-lithiated phase VPO_4F progressively grow. The XRD pattern, recorded at 1/3 of the charge (*i.e.* corresponding to a global composition of $\text{Li}_{0.67}\text{VPO}_4\text{F}$) is highlighted in green in Figure II-13 and Figure II-14 and can be fully indexed as a single phase. At this composition, the pristine phase LiVPO_4F has completely disappeared. From LiVPO_4F to $\text{Li}_{0.67}\text{VPO}_4\text{F}$, a two-phase mechanism is clearly demonstrated here.



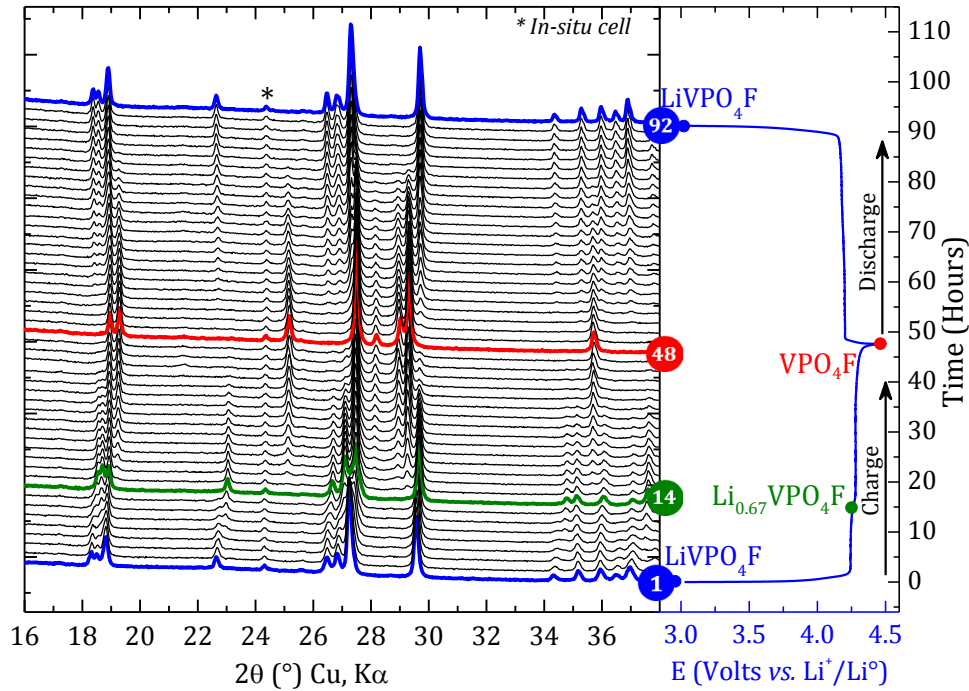
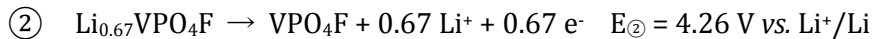
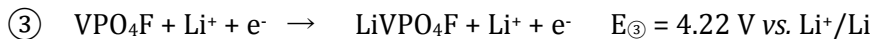

Figure II-13: 2D View of collected in-situ XRD patterns for the global electrochemical reaction $\text{LiVPO}_4\text{F} \rightleftharpoons \text{VPO}_4\text{F}$ (left) and corresponding galvanostatic cycling data (right). The XRD patterns highlighted refer to LiVPO_4F (#1 and #92, blue), $\text{Li}_{0.67}\text{VPO}_4\text{F}$ (#14, green) and VPO_4F (#48, red).

- Upon further Li^+ extraction, a similar two-phase process occurs, this time between $\text{Li}_{0.67}\text{VPO}_4\text{F}$ and VPO_4F . The XRD data of the end-member (fully-oxidized VPO_4F phase) were refined in the $C2/c$ space group (Figure II-15) and with a unit-cell per formula unit (V/Z) contraction of $\sim 8\%$ vs. LiVPO_4F , in good agreement with B.L. Ellis [25]. This V/Z contraction is $\sim 5\%$ for the $\text{LiFeSO}_4\text{F}/\text{FeSO}_4\text{F}$ system that belongs to the Tavorite family as well [65, 66].



- The Li^+ insertion into VPO_4F does not take the same reaction path as the Li^+ extraction from LiVPO_4F . Indeed, upon discharge, a single two-phase reaction takes place between VPO_4F and LiVPO_4F with no occurrence (as clearly seen in Figure II-14) of the intermediate phase $\text{Li}_{0.67}\text{VPO}_4\text{F}$.



At the end of the full cycle, the diffraction pattern of the pristine LiVPO_4F is fully re-covered apart from small global intensity changes.

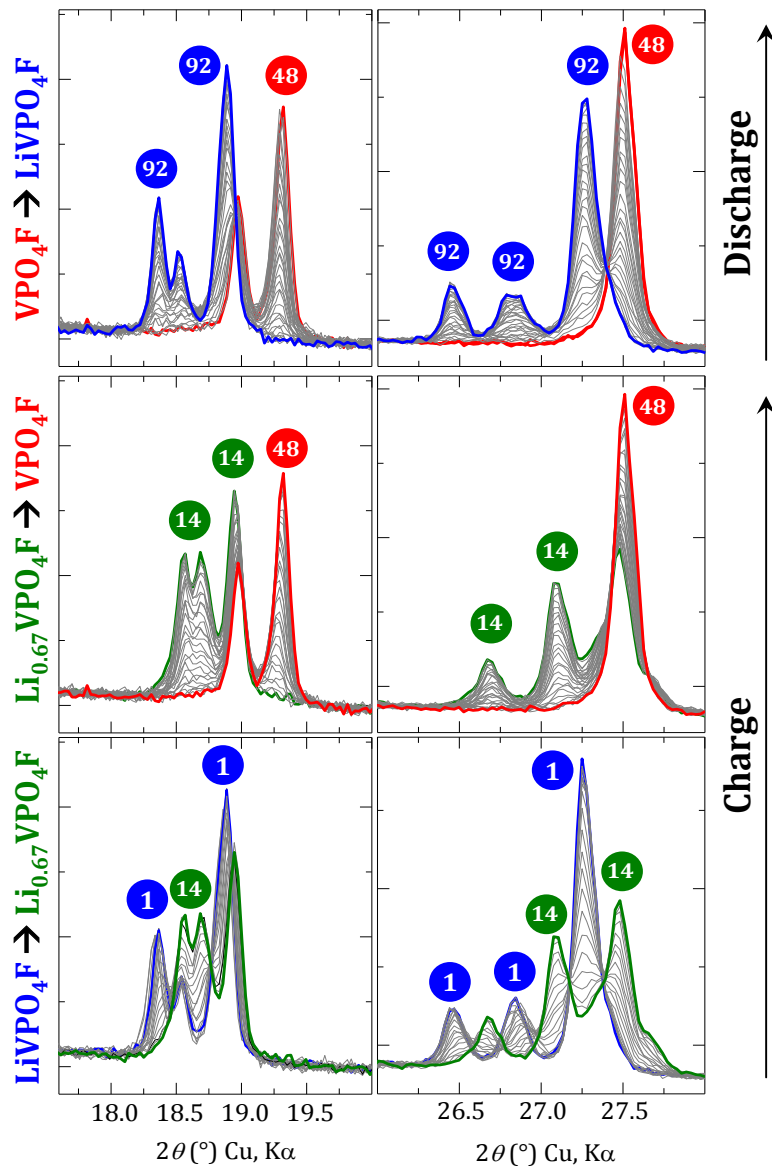

Figure II-14: Selected 2θ regions showing the respective growths and disappearance of the phases involved in the $\text{LiVPO}_4\text{F} \rightleftharpoons \text{VPO}_4\text{F}$ reaction. The XRD patterns highlighted refer to LiVPO_4F (#1 and #92, blue), $\text{Li}_{0.67}\text{VPO}_4\text{F}$ (#14, green) and VPO_4F (#48, red).

Figure II-15 presents the full-pattern matching refinement of the phases LiVPO_4F , $\text{Li}_{0.67}\text{VPO}_4\text{F}$ and VPO_4F together with their space group and lattice parameters.

The overall reaction is pictured in Figure II-15 which includes the unit-cell volumes obtained by refinement of the two-phase XRD patterns. The unit-cell contraction of $\sim 1.5\%$ between LiVPO_4F and $\text{Li}_{0.67}\text{VPO}_4\text{F}$ is sufficient to trigger a well-defined two-phase reaction upon electrochemical oxidation. As a major result of this study, the peculiar composition “ $\text{Li}_{0.67}\text{VPO}_4\text{F}$ ” pops up as a single phase during charge and as a two-phase mixture $0.33 \times \text{VPO}_4\text{F} + 0.67 \times \text{LiVPO}_4\text{F}$ during discharge.

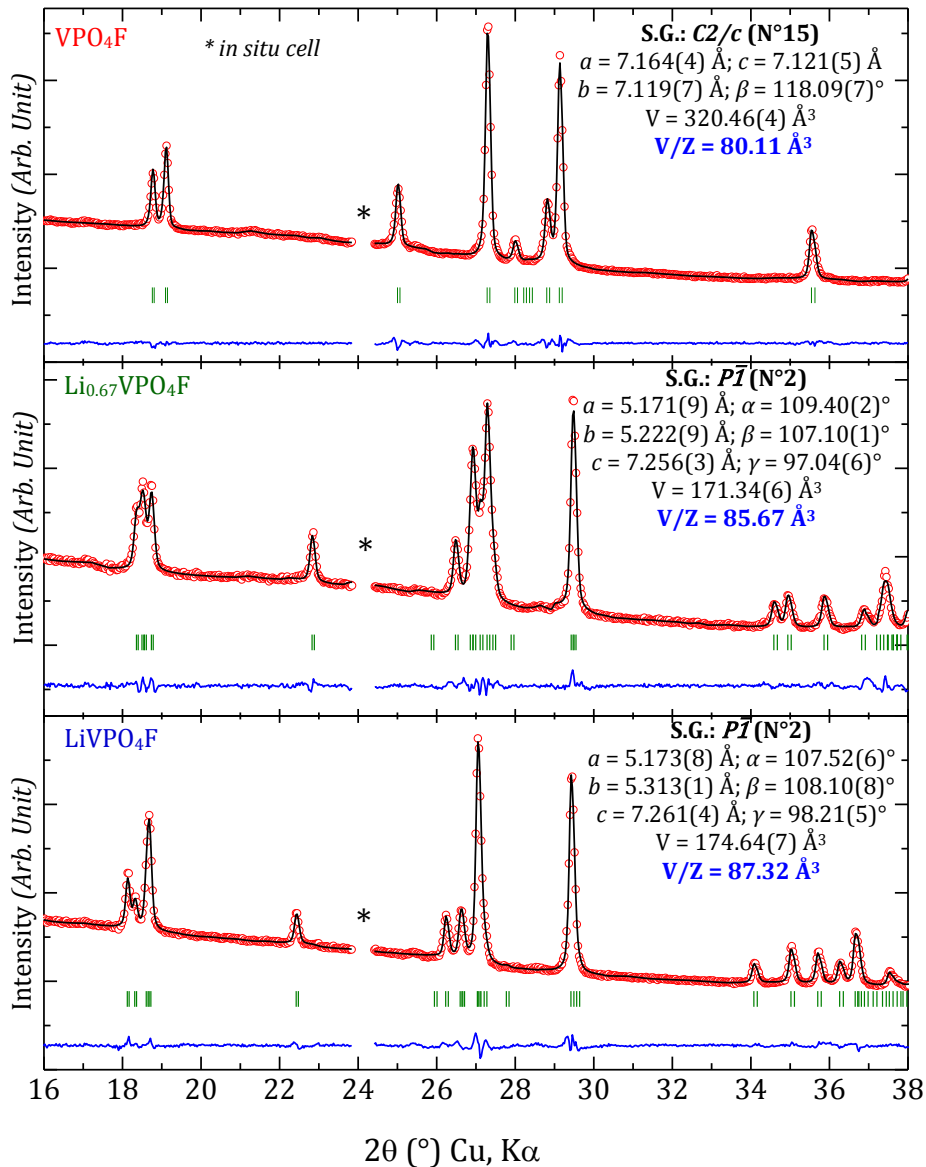

Figure II-15: Full-pattern matching refinements of LiVPO_4F , $\text{Li}_{0.67}\text{VPO}_4\text{F}$ and VPO_4F . The lattice parameters as well as the volumes are inserted in each XRD pattern.

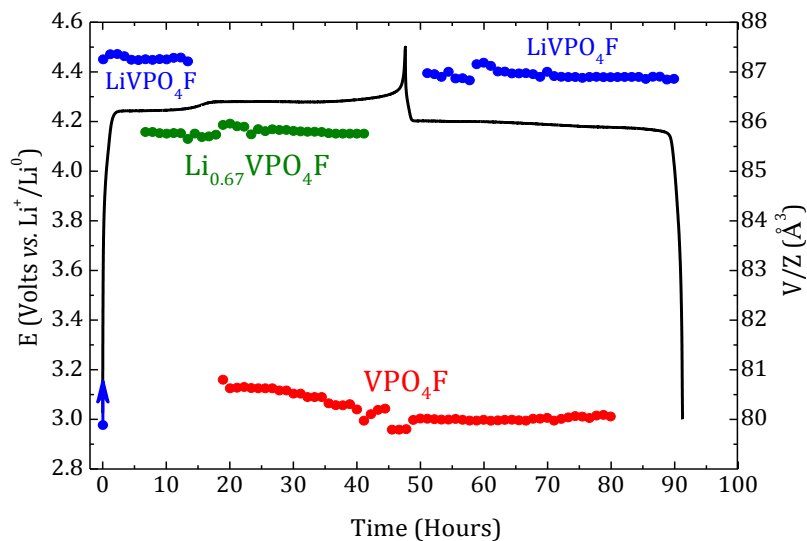

Figure II-16: Unit-cell volume changes during the global electrochemical reaction $\text{LiVPO}_4\text{F} \rightleftharpoons \text{VPO}_4\text{F}$ involving successive two-phase reactions.

This phenomenon of 2 plateaus in charge and 1 plateau in discharge was observed for all the further cycles of LiVPO_4F , as for the olivine NaFePO_4 [67, 68], for which two plateaus were observed in charge at a potential of 2.87 V and 2.97 V vs. Na^+/Na (with the formation of the intermediate phase $\text{Na}_{0.7}\text{FePO}_4$) and only one plateau in discharge. According to M. Casas-Cabanas, the formation of the intermediate phase would allow buffering the internal stresses due to a large cell mismatch between NaFePO_4 and FePO_4 ($\sim 18\%$ in volume) contrary to LiFePO_4 where no intermediate phase is formed as the contraction is only $\sim 7\%$ between LiFePO_4 and FePO_4 . Note that for the $\text{LiVPO}_4\text{F} \rightleftharpoons \text{VPO}_4\text{F}$ system, the contraction is only $\sim 8\%$ (close to the one of $\text{LiFePO}_4 \rightleftharpoons \text{FePO}_4$ system), but yet an intermediate phase was observed.

Although a close inspection of the XRD pattern of $\text{Li}_{0.67}\text{VPO}_4\text{F}$ did not reveal visible superstructure reflections, we may suggest the existence of an ordered (charge ordering on vanadium sites and/or Li/vacancy) in this composition that will need further investigation, through e-diffraction at low temperature for instance.

A second series of *in situ* XRD experiments were undertaken to further check on the relative stabilities of the $\text{Li}_x\text{VPO}_4\text{F}$ compositions.

- Upon charge for instance from LiVPO_4F up to $\text{Li}_{0.67}\text{VPO}_4\text{F}$, the insertion of Li^+ into $\text{Li}_{0.67}\text{VPO}_4\text{F}$ led to the formation of LiVPO_4F so that the reaction $\text{Li}_{0.67}\text{VPO}_4\text{F} \rightleftharpoons \text{LiVPO}_4\text{F}$ is fully reversible (Figure II-17).

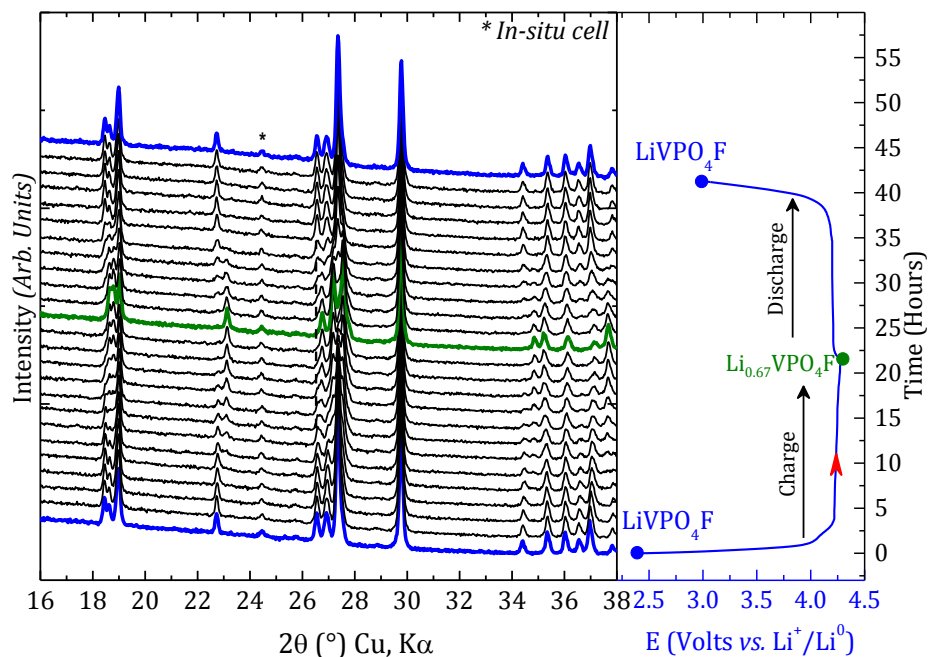

Figure II-17: Galvanostatic cycling of a $\text{Li}/\text{LP30}/\text{LiVPO}_4\text{F}$ cell cycled at $C/75$ (right) and *in situ* XRD recorded upon oxidation up to the global composition $\text{Li}_{0.67}\text{VPO}_4\text{F}$ and then back to LiVPO_4F (left).

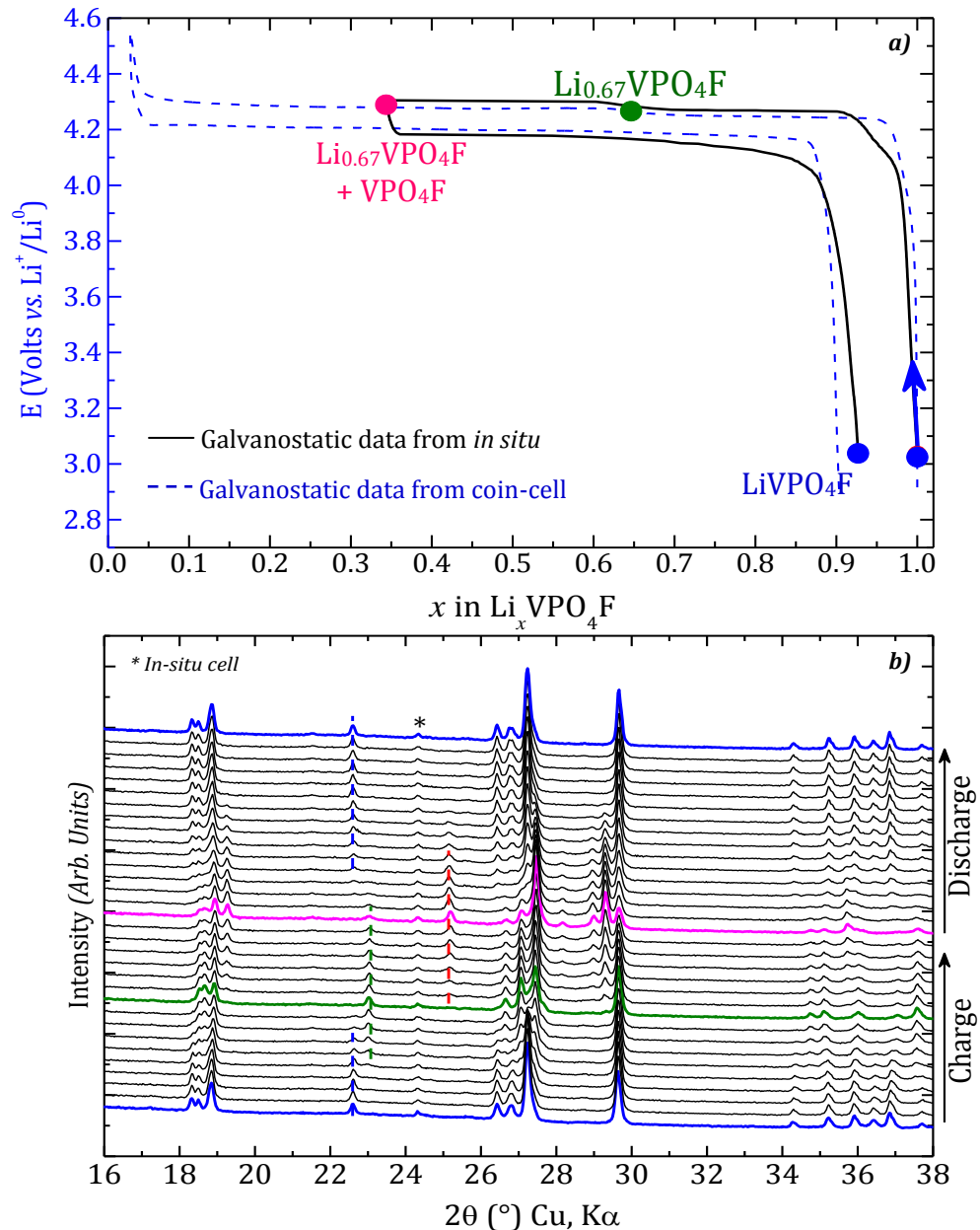

Figure II-18: a) Electrochemical data of a $\text{Li/LP30/LiVPO}_4\text{F}$ cell cycled at $C/50$ for the present *in situ* (black line) and galvanostatic data recorded in coin cell (dash blue) b) *in situ* XRD patterns recorded upon oxidation up to the global composition $\text{Li}_{0.33}\text{VPO}_4\text{F}$ and then back to LiVPO_4F .

- Upon charge from LiVPO_4F up to the middle of the second voltage plateau, *i.e.* up to a global composition “ $\text{Li}_{0.33}\text{VPO}_4\text{F}$ ”, the two phases $\text{Li}_{0.67}\text{VPO}_4\text{F}$ and VPO_4F were present in equal proportions (pink XRD pattern in Figure II-18). Upon subsequent discharge from this two phase mixture, we found a puzzling mechanism that involves the progressive apparition of LiVPO_4F and the concomitant disappearance (at different paces) of both $\text{Li}_{0.67}\text{VPO}_4\text{F}$ and VPO_4F . Even under the low discharge rate used for this *in situ* experiment, the consequence is that several XRD patterns actually revealed the presence of the three distinct phases of the system.

II-3c. Crystal Structures of $\text{Li}_x\text{VPO}_4\text{F}$ ($x = 2, 0.67, 0$)

The $\text{Li}_x\text{VPO}_4\text{F}$ compositions were obtained electrochemically in large battery cells in which ~ 600 mg of active material were casted on an aluminum foil. All along the charge (*resp.* discharge) process an intermittent galvanostatic experiment was performed with successive 1 hour charge (*resp.* discharge) periods at a rate of $C/200$ (*resp.* $D/200$) and 10 hour relaxation periods. Before stopping the batteries a chrono-amperometry was performed during 10 hours at potentials of 4.55 V, 4.25 V and 1.6 V corresponding to the formation of VPO_4F , $\text{Li}_{0.67}\text{VPO}_4\text{F}$ and $\text{Li}_2\text{VPO}_4\text{F}$ respectively. Afterwards, the cycled powder was gently scratched from the aluminum foil current collector, washed with Dimethyl Carbonate (DMC) to get rid of the electrolyte and dried under vacuum. The obtained powder of $\text{Li}_x\text{VPO}_4\text{F}$ was measured by XRD on a Panalytical diffractometer (X'Pert PRO MPD) and on the high resolution powder neutron diffractometer D2B of ILL-Grenoble in collaboration with E. Suard.

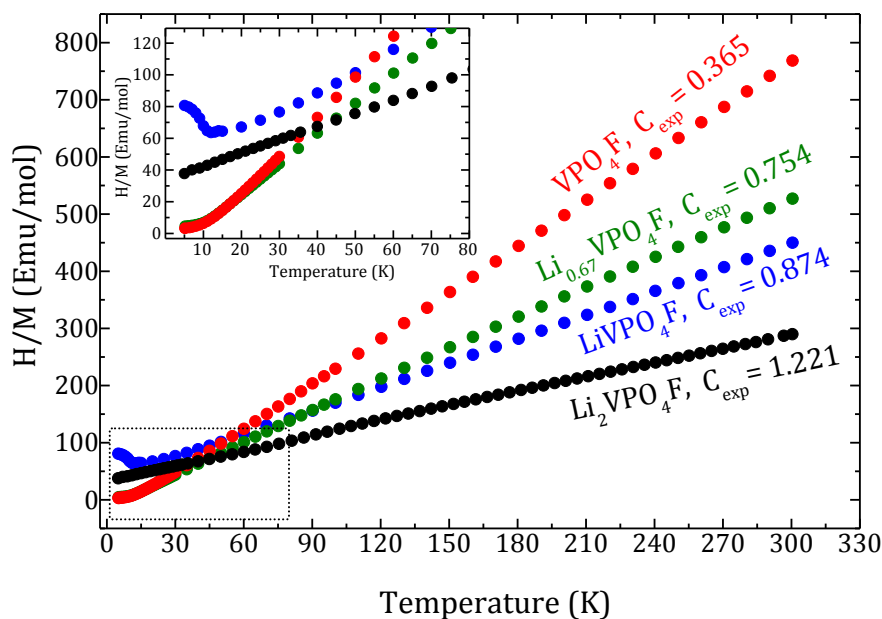

Figure II-19: Temperature dependence of the H/M ratio for $\text{Li}_x\text{VPO}_4\text{F}$ (with $x = 2, 1, 0.67$ and 0)

The static molar magnetic susceptibilities of $\text{Li}_x\text{VPO}_4\text{F}$ ($\chi(T) = M(T)/H$ ($H = 1$ T) with H as the magnetic field and M as the magnetization) were measured between 5 and 300 K using a SQUID magnetometer (Quantum Design). The zero field cooled χ values were obtained by cooling the sample in zero field down to 5 K and then heating them under the measuring field. The diamagnetic contributions were corrected using the atomic values from G.A. Bain and J.F. Berry [69] yielding the χ_m paramagnetic susceptibility contribution. The temperature dependence of the H/M ratio is displayed in Figure II-19 for $\text{Li}_x\text{VPO}_4\text{F}$ (with $x = 2, 1, 0.67$ and 0). Contrary to LiVPO_4F where a significant curvature was observed around 9 K indicating an antiferromagnetic

behavior, no indication of the onset of antiferromagnetic ordering was observed for $\text{Li}_2\text{VPO}_4\text{F}$, $\text{Li}_{0.67}\text{VPO}_4\text{F}$ and VPO_4F so that the phases remained paramagnetic until very low temperature. The calculated Curie constants of $\text{Li}_{0.67}\text{VPO}_4\text{F}$ and VPO_4F were 0.754 and 0.365 respectively. Those values are close to the theoretical Curie values of $\text{V}^{3.33+}$ and V^{4+} which are 0.792 and 0.375 respectively. However, the experimental Curie constant of $\text{Li}_2\text{VPO}_4\text{F}$ ($C_{\text{exp}} = 1.221$) was significantly different from the theoretical Curie values of V^{2+} ($C_{\text{theo}} = 1.875$) indicative of an oxidation of $\text{Li}_2\text{VPO}_4\text{F}$. Note that B.L. Ellis et al. [25] isolated $\text{Li}_2\text{VPO}_4\text{F}$ and VPO_4F by chemical reduction and oxidation respectively. However, B.L. Ellis did not identify the intermediate $\text{Li}_{0.67}\text{VPO}_4\text{F}$.

***i*- Crystal Structure of VPO_4F**

The simultaneous refinements of XRD and neutron diffraction data were carried out based on the published structure of FeSO_4F [70] (Figure II-20).

The recorded lattice parameters and atomic positions are gathered in ANNEX I table II-1. Neutron diffraction data were not relevant for the Rietveld refinement of VPO_4F due to the same coherent diffusion wavelength of oxygen ($\lambda_{\text{coh,O}} = 0.58 \cdot 10^{-4}$ Å [71]) and fluorine ($\lambda_{\text{coh,F}} = 0.56 \cdot 10^{-4}$ Å [71]) and to the transparency of vanadium towards neutron diffraction. Moreover, the ratio of signal intensity over background for our recorded neutron diffraction data is 1.6, that is much lower than for LiVPO_4F (2.7) and LiVPO_4O (4.5). Nevertheless, the XRD data were suitable for the determination of the structure of VPO_4F which is related to the LiVPO_4F parent. The unique site of vanadium lies within a $[\text{VO}_4\text{F}_2]$ octahedron which is more distorted than the octahedra in LiVPO_4F ($3.98 \cdot 10^{-5}$ and $2.28 \cdot 10^{-5}$ for LiVPO_4F vs. $6.23 \cdot 10^{-4}$ for VPO_4F). The V-F distances along the chain of $[\text{VO}_4\text{F}_2]$ octahedra are 1.96 Å longer than in the structure of VPO_4F , reported by B.L. Ellis (1.92 Å). The average P-O distances in $[\text{PO}_4]$ tetrahedra is shorter in VPO_4F (1.48 Å) than in LiVPO_4F (1.53 Å) and the tetrahedron $[\text{PO}_4]$ in VPO_4F is more symmetric than in LiVPO_4F ($\Delta = 1.02 \cdot 10^{-4}$ in VPO_4F vs. $\Delta = 2.22 \cdot 10^{-4}$ in LiVPO_4F).

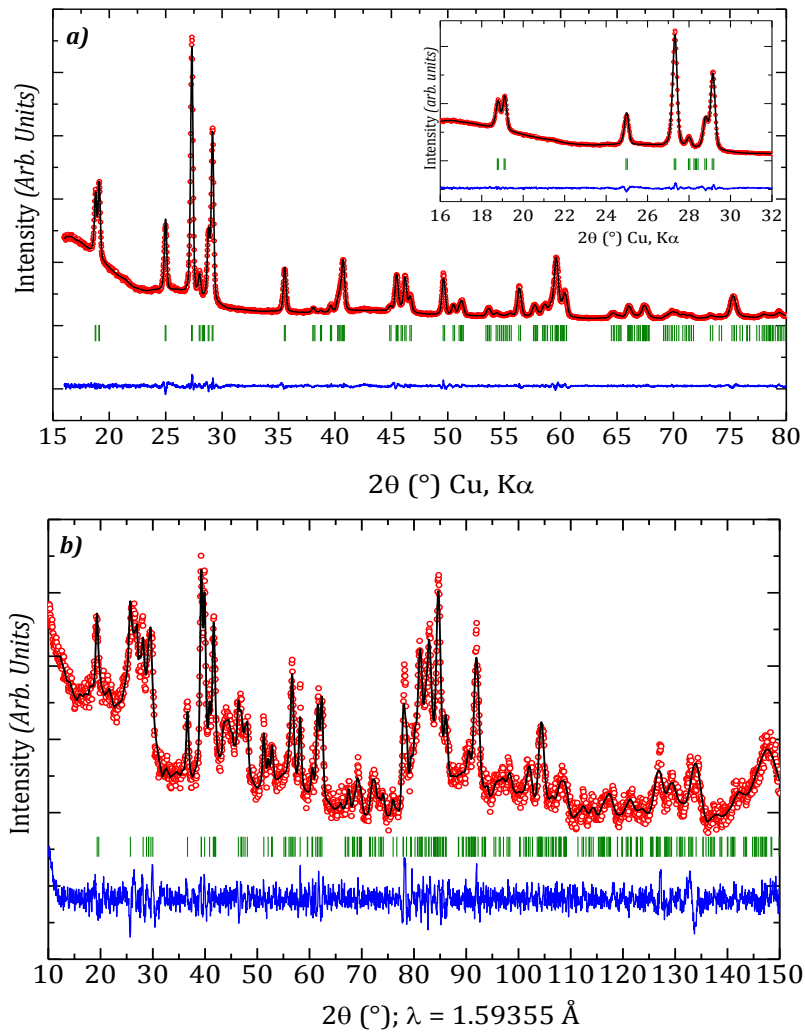

Figure II-20: Observed (red dots), calculated (black line), and difference (blue line) plots obtained for the Rietveld refinement of X-ray diffraction data (a) and neutron diffraction data for VPO_4F (b)

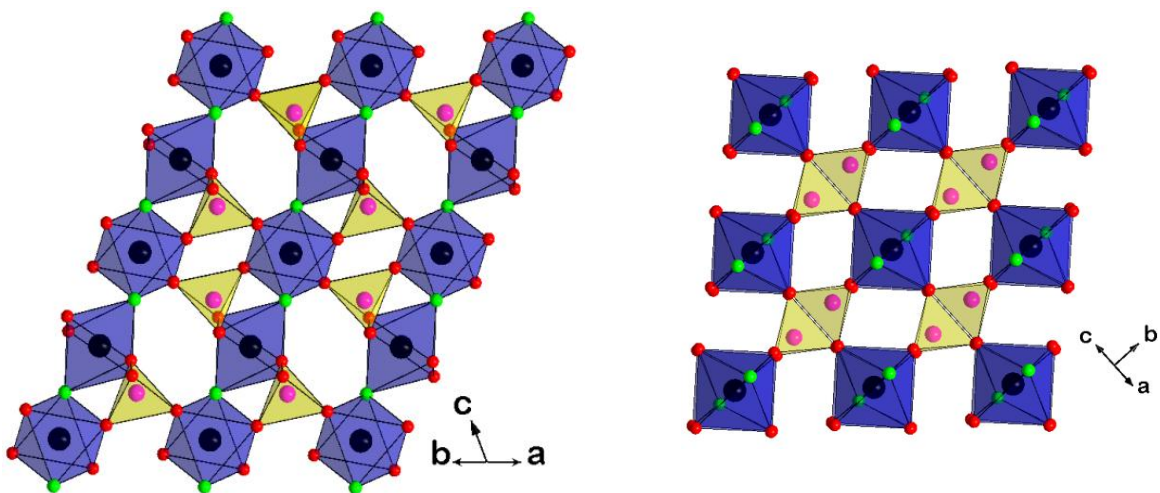

Figure II-21: Representation of VPO_4F skeleton framework structure in the $[001]_{c2/c}$ (left) and $[101]_{c2/c}$ (right) directions

ii- Hypothesis on the structure of $\text{Li}_{0.67}\text{VPO}_4\text{F}$

Both XRD and neutron diffraction data were successfully refined in full-pattern matching (Figure II-) in the $P\bar{1}$ space group. The obtained lattice parameters were: $a = 5.240(8)$ Å; $b = 5.192(6)$ Å; $c = 7.273(1)$ Å; $\alpha = 109.156(9)^\circ$; $\beta = 107.294(7)^\circ$; $\gamma = 96.999(2)^\circ$, with a volume $V = 173.15(1)$ Å³. $\text{Li}_{0.67}\text{VPO}_4\text{F}$ had never been reported before in the literature. Electron diffraction experiments were performed (in collaboration with F. Weill from ICMCB) on a JEOL JEM 2100 on a sample prepared by milling the powder sample in ethanol. A drop of the resulting suspension was cast onto a copper grid covered with carbon films. Figure II-22 gives representative electron diffraction patterns of $\text{Li}_{0.67}\text{VPO}_4\text{F}$ which are indexed in $P\bar{1}$. The obtained parameters are consistent with those found with full-pattern matching refinement of XRD and neutron diffraction data. No super-lattice reflections were observed.

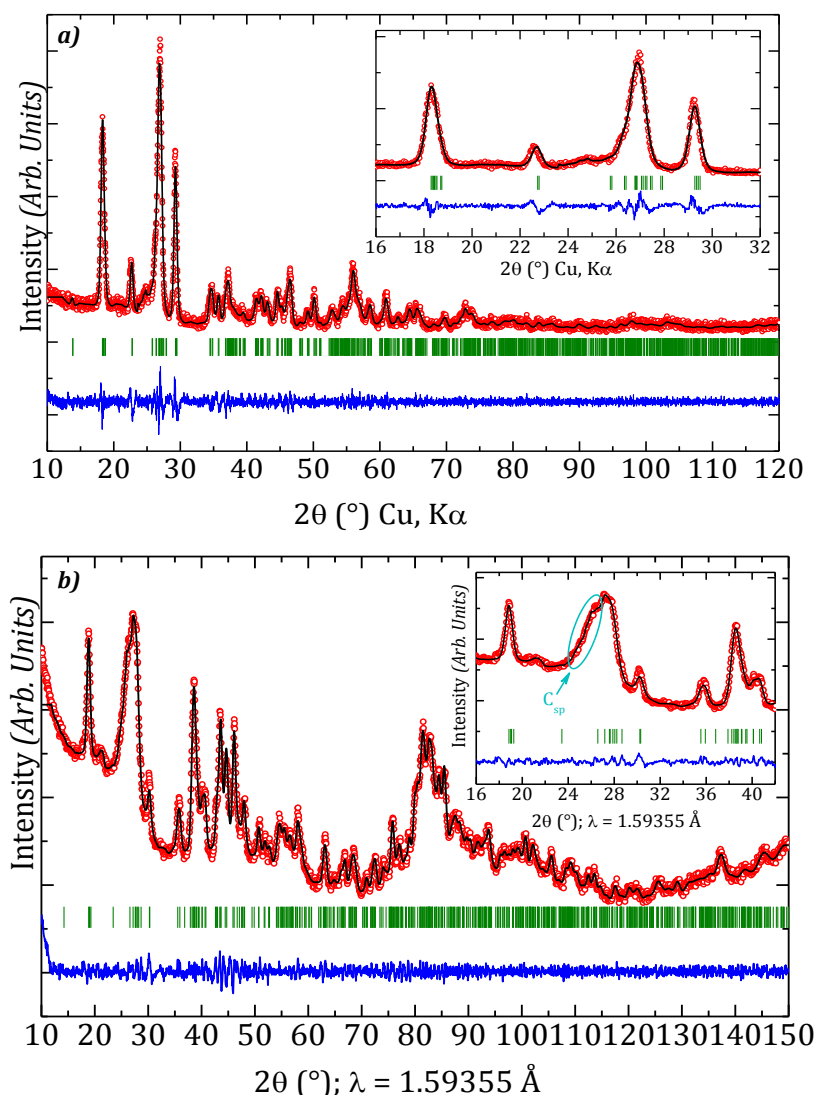

Figure II-22: Observed (red dots), calculated (black line), and difference (blue line) plots obtained for the Rietveld refinement of (a) X-ray diffraction data and (b) neutron diffraction data for $\text{Li}_{0.67}\text{VPO}_4\text{F}$

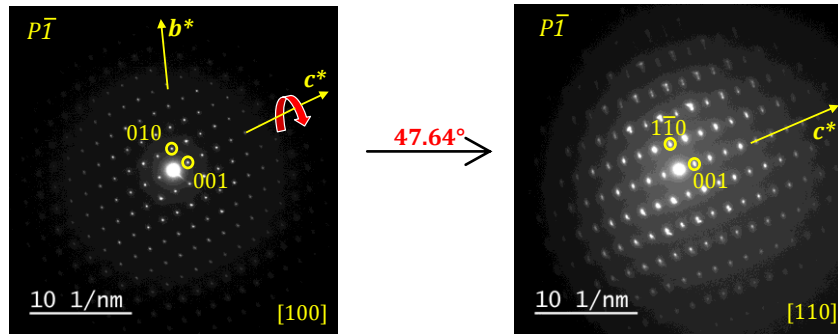

Figure II-22: Electron diffraction patterns of LiVPO_4F obtained by rotation around a common direction

iii- Structure of $\text{Li}_2\text{VPO}_4\text{F}$

It was difficult to solve the structure of $\text{Li}_2\text{VPO}_4\text{F}$ due to its high air sensitivity. Indeed, we observed an evolution of the XRD pattern (Figure II-23) even though the material was stored in a dry glove box filled with Ar. The lattice parameters obtained at the end of “oxidation” of $\text{Li}_2\text{VPO}_4\text{F}$ were very close to those of the pristine LiVPO_4F (insert in Figure II-23).

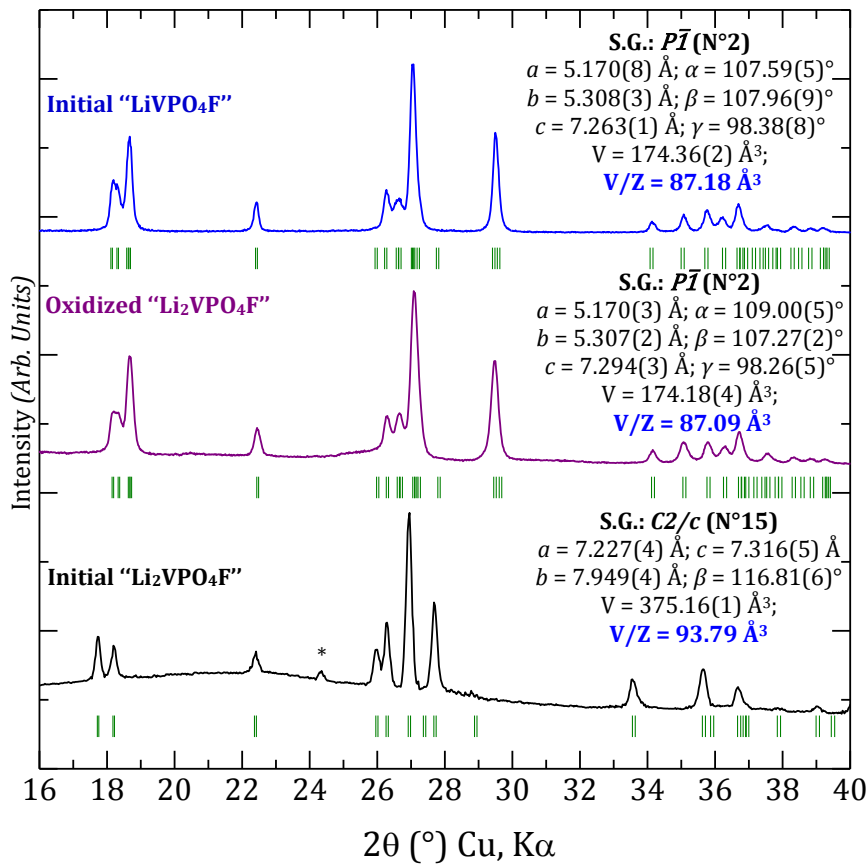
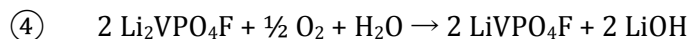

Figure II-23: XRD of $\text{Li}_2\text{VPO}_4\text{F}$ obtained by chemical lithiation (black) and the product of oxidation of $\text{Li}_2\text{VPO}_4\text{F}$ (purple) compared with the pristine LiVPO_4F (blue). The corresponding Bragg positions are given under each peak.

As the reduction potential of H_2O is higher (~ 3.45 vs. Li^+/Li) than the one of $\text{Li}_2\text{VPO}_4\text{F}$ (1.81 V vs. Li^+/Li), it is thermodynamically favorable to withdraw Li^+ from the host structure when it is exposed to air, leading to LiOH and/or Li_2O which further react with CO_2 to yield Li_2CO_3 . The corresponding reaction can be written as:



To the best of our knowledge, the stability of $\text{Li}_2\text{VPO}_4\text{F}$ had never been reported before. Our second attempt to obtain $\text{Li}_2\text{VPO}_4\text{F}$ was done by chemical lithiation using LiAlH_4 as the reducing agent, dissolved in tetrahydrofuran (THF). To this end, stoichiometric proportions of LiVPO_4F and LiAlH_4 were mixed in THF. To enable complete LiVPO_4F reduction, a 5 wt % mass excess of LiAlH_4 was used. The reaction was stirred during 24 hours, rinsed with THF and dried under vacuum. The XRD pattern of the obtained powder has been successfully indexed in the $C2/c$ space group (with the lattice parameters of $a = 7.225(4)$ Å; $b = 7.945(2)$ Å; $c = 7.304(5)$ Å; $\beta = 116.771(1)^\circ$ and $V = 374.381(3)$ Å³) contrary to the pristine Tavorite-type LiVPO_4F (which crystallizes in the space group $P\bar{1}$) and in agreement with B.L. Ellis et al. [25] (Figure II-24). Note that no residual peaks of pristine LiVPO_4F were present and therefore, the obtained $\text{Li}_2\text{VPO}_4\text{F}$ was found pure.

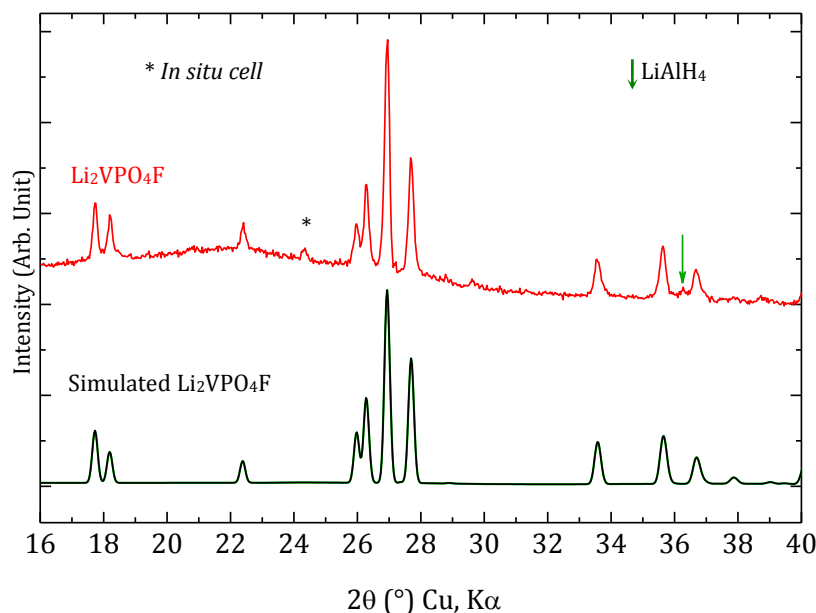

Figure II-24: XRD pattern of $\text{Li}_2\text{VPO}_4\text{F}$ obtained by chemical lithiation in comparison with the simulated pattern of $\text{Li}_2\text{VPO}_4\text{F}$ as published by B.L. Ellis et al. [25].

The refinement revealed an expansion of 7.58 % for the V/Z value, slightly lower than for the $\text{LiFePO}_4\text{F}/\text{Li}_2\text{FePO}_4\text{F}$ system (8.84 %). Contrary to LiVPO_4F , $\text{Li}_2\text{VPO}_4\text{F}$ exhibits only one crystallographic site for vanadium and two distinct crystallographic sites for Li. Similar transitions from triclinic to monoclinic system had been reported for Tavorite-like structure such as LiFePO_4F ($P\bar{1}$) vs. $\text{Li}_2\text{FePO}_4\text{F}$ ($C2/c$) [72].

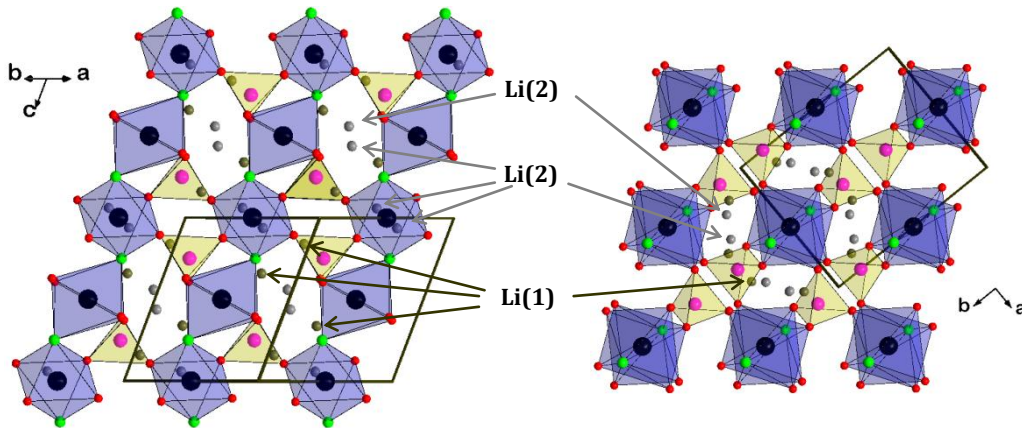

Figure II-25: Skeleton representation of $\text{Li}_2\text{VPO}_4\text{F}$ structure.

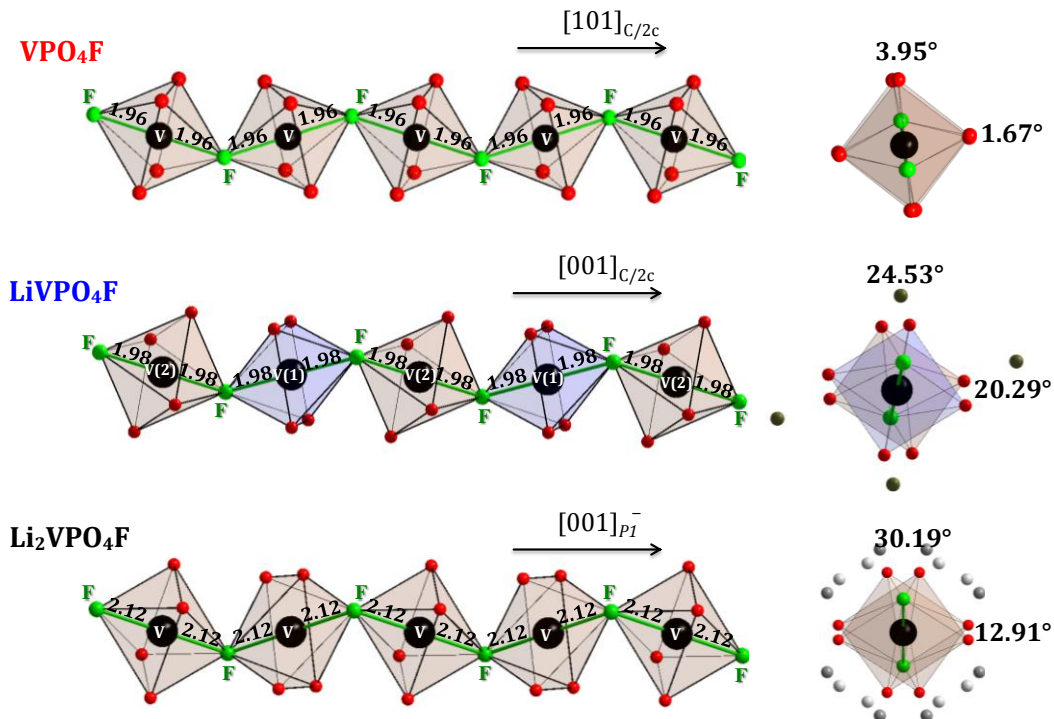

Figure II-26: Comparative distances and dihedral angles in the structure of $\text{Li}_2\text{VPO}_4\text{F}$, LiVPO_4F and VPO_4F .

As mentioned above, both structures of $\text{Li}_2\text{VPO}_4\text{F}$ and VPO_4F (and in a larger extend $\text{Li}_{0.67}\text{VPO}_4\text{F}$) are related to the Tavorite LiVPO_4F but some differences are spotted such as the V-F distances along their respective chains. Indeed V-F distances in $\text{Li}_2\text{VPO}_4\text{F}$ are 2.12 Å, which move down to 1.98 Å in LiVPO_4F and finally shrink to 1.96 Å for VPO_4F . This evolution is consistent with that of

the vanadium ionic radius which decreases from V^{2+} (0.088 nm) in $\text{Li}_2\text{VPO}_4\text{F}$ to V^{3+} (0.074 nm) in LiVPO_4F and being smaller for V^{4+} (0.063 nm) VPO_4F . Interestingly, the dihedral angles along the octahedra $[\text{VO}_4\text{F}_2]$ chains increase with the presence of Li, so that the presence of Li in the host structure leads to a higher tilt of dihedral angles (Figure II-26). This is not surprising since the presence of lithium induces steric constraints in the host structure and electrostatic repulsions.

iv- Comparative NMR Study of $\text{Li}_x\text{VPO}_4\text{F}$ phases (with $x = 1, 0.67$ and 0)

^7Li MAS NMR, ^{31}P MAS NMR and ^{19}F MAS NMR experiments were performed in the same conditions as in chapter I. The sample holder (rotor) was filled in an Ar filled glove box in order to avoid a possible air and/or humidity contamination.

Although VPO_4F was supposed to be fully delithiated, the ^7Li MAS NMR spectrum of VPO_4F exhibits 3 tiny signals (red in Figure II-27). The signal at around -2 ppm is assigned to the “SEI” layer and is also present in $\text{Li}_{0.67}\text{VPO}_4\text{F}$ (green in Figure II-27). The small signal at around 116 ppm is similar to that of the pristine LiVPO_4F (blue in Figure II-27) probably due to the presence of some unreacted LiVPO_4F . For $\text{Li}_{0.67}\text{VPO}_4\text{F}$, the ^7Li MAS NMR spectrum shows at least 4 signals in addition to a 116 ppm contribution, arising most probably again from unreacted LiVPO_4F , and the SEI signal. The 4 signals show the existence of different types of environment for Li. It is very likely that this corresponds to some kind of charge ordering in the material, and further NMR experiments are in progress to investigate this.

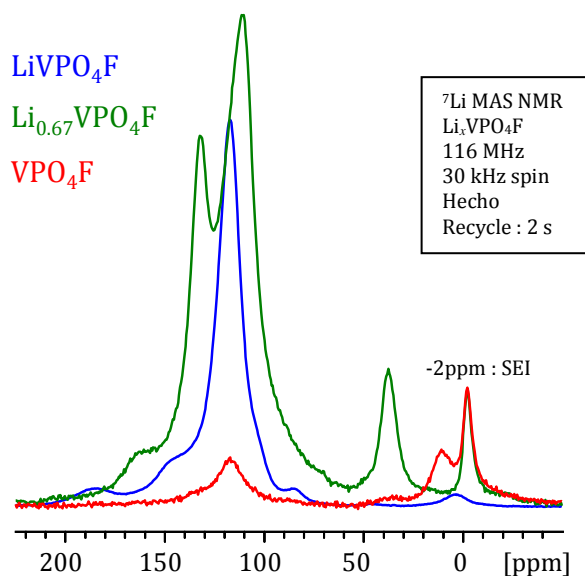

Figure II-27: ^7Li MAS NMR spectra of pristine LiVPO_4F (blue), intermediate $\text{Li}_{0.67}\text{VPO}_4\text{F}$ (green) and fully delithiated VPO_4F (red) The magnitude is scaled to the mass of active material in the NMR rotor.

The ^{31}P MAS NMR spectra of the deintercalated compounds show a narrow contribution close to (-2.6 ppm), due to traces of the LiPF_6 salt from the electrolytes and/or decomposition products of the anion in the “SEI”. VPO_4F (red Figure II-28) shows a major signal at around 2225 ppm in agreement with the unique site of phosphorous in the VPO_4F structure. This signal is less shifted compared to the one of LiVPO_4F (4000 ppm, blue in Figure II-28) due in first approximation to the higher oxidation state of vanadium which provides less spin transfer to the phosphorous site. In the case of $\text{Li}_{0.67}\text{VPO}_4\text{F}$ (green in Figure II-28), 3 signals are observed, two of which are reminiscent of the extreme LiVPO_4F and VPO_4F compositions. The analysis of these signals indeed requires further investigations, but it seems that the P nuclei feel environments (again, mostly in terms of electronic configuration of the neighboring V ions) similar to those of the extreme compositions plus one kind of intermediate environment. In first approximation, this is also consistent with the picture of a –at least local– charge ordering.

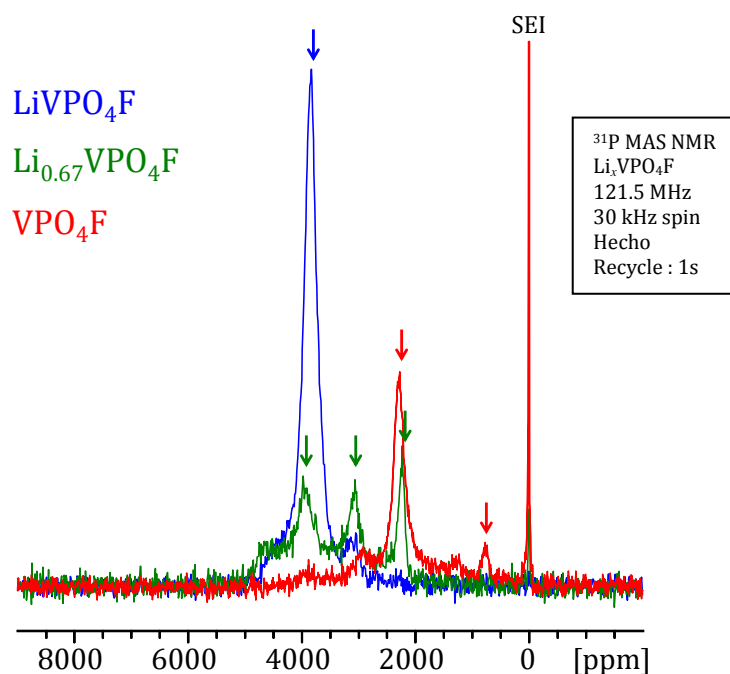

Figure II-28: ^{31}P MAS NMR spectra of pure LiVPO_4F (blue), intermediate $\text{Li}_{0.67}\text{VPO}_4\text{F}$ (green) and fully delithiated VPO_4F (red). Due to the existence of spinning side bands for each contribution, the main isotropic contributions are marked by arrows.

^1H MAS NMR spectra were recorded on a Bruker Avance III spectrometer with a 2.35 T magnet (100 MHz resonance frequency for ^1H), using a standard Bruker 2.5 MAS probe at a 30 kHz typical spinning speed. A Hahn echo sequence was used with a 90° pulse of 1.1 microsecond. A recycle delay was 1s. The 0 ppm external reference used was tetramethylsilane (TMS).

The ^1H MAS NMR spectra of the charged materials are compared to that of the pristine LiVPO_4F in Figure II-29. The signal for the pristine compound is virtually negligible in magnitude, whereas distinct contributions appear for the two deintercalated compounds. It is therefore

likely that, during the charge process, some electrolyte decomposition occurs and generates H^+ ions that can exchange with Li^+ in the material. This parasitic electrochemical process also explains why some Li remained in the “fully” charged material.

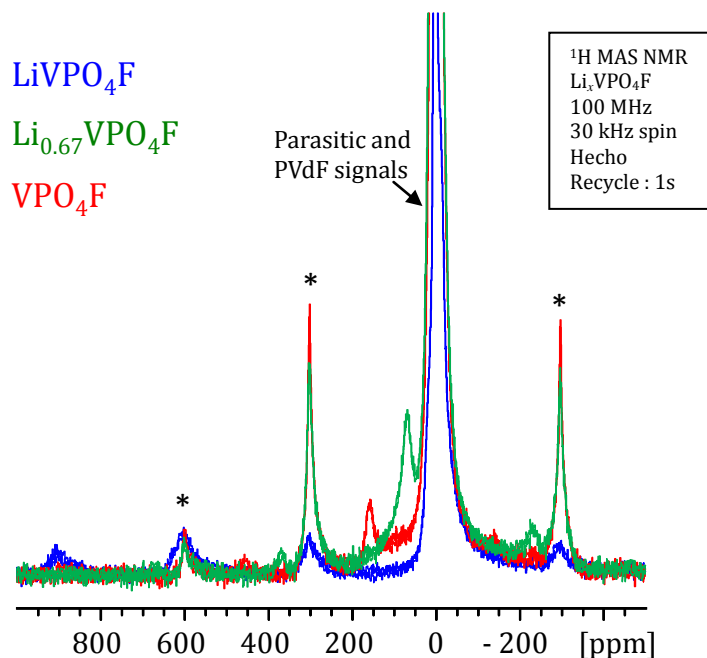

Figure II-29: ^1H MAS NMR spectra of pure LiVPO_4F (blue), intermediate $\text{Li}_{0.67}\text{VPO}_4\text{F}$ (green) and fully delithiated VPO_4F (red) (spinning sidebands are marked by asterisks)

II-3d. Conclusion

This electrochemical study of LiVPO_4F provides a first complete visualization of phases formed during Li^+ electrochemical extraction/insertion at ~ 4.25 V and 1.8 V vs. Li into/from the LiVPO_4F structure.

Between 1.5–3.0 V vs. Li^+/Li , LiVPO_4F can accommodate Li^+ in its host structure through a biphasic mechanism which leads to the formation of $\text{Li}_2\text{VPO}_4\text{F}$. The reduction of V^{3+} to V^{2+} occurs at a potential of 1.81 V vs. Li^+/Li with a very small polarization of ~ 15 mV. The obtained $\text{Li}_2\text{VPO}_4\text{F}$ crystallizes in the $C2/c$ space group and was found to be highly sensitive to moisture.

The extraction of Li^+ from LiVPO_4F proceeds through two plateaus and reveals the formation of an intermediate $\text{Li}_{0.67}\text{VPO}_4\text{F}$ which XRD is completely different from those of LiVPO_4F and VPO_4F . The two associated electrochemical oxidation plateaus are extremely close to each other, located at 4.24 V and 4.26 V vs. Li^+/Li . Surprisingly, subsequent lithium insertion in VPO_4F proceeds without any intermediate but at the composition of “ $\text{Li}_{0.67}\text{VPO}_4\text{F}$ ” we observed 2 phases instead of one single phase (Figure II-30). This overall mechanism (two phases during charge and one

during subsequent discharge) has to be tackled by DFT calculation in order to model the activation energies in both cases. Low temperature e-diffraction for both $\text{Li}_{0.67}\text{VPO}_4\text{F}$ and “ $\text{Li}_{0.67}\text{VPO}_4\text{F}$ ” are planned in our group.

In all the reactions involved, two-phase mechanisms were systematically encountered, without noticeable modifications of the $[\text{VPO}_4\text{F}]$ framework besides significant unit-cell contractions/expansions and overall shifts in symmetry from triclinic $P\bar{1}$ to monoclinic $C2/c$. The overall electrochemical reactions are topotactic and are associated with very small polarization.

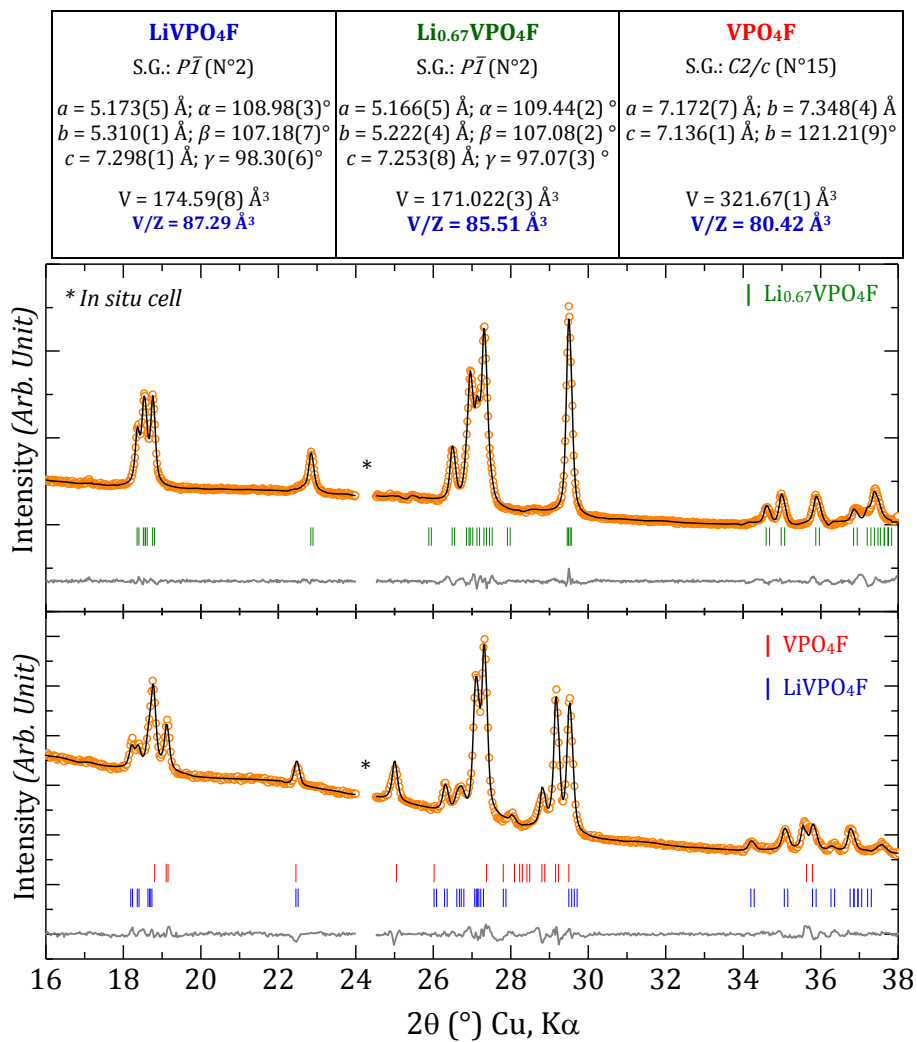

Figure II-30: X-Ray diffraction patterns and full-pattern matching refinements of the global composition “ $\text{Li}_{0.67}\text{VPO}_4\text{F}$ ” obtained as a single phase during oxidation (top) and as a two-phase mixture during reduction (bottom)

II-4. ELECTROCHEMICAL BEHAVIOR OF LiVPO_4O

The lithium-ion extraction/insertion reaction from LiVPO_4O , in the upper voltage range, relies on the reversibility of the $\text{V}^{5+}/\text{V}^{4+}$ redox couple, and the lithium insertion/extraction reaction in the lower voltage range relies on the reversibility of the $\text{V}^{4+}/\text{V}^{3+}$ redox couple. The two electrochemical reactions associated can be summarized as:



LiVPO_4O was cycled between 1.6 V and 4.5 V (Figure II-31) so as to involve the two redox couples of $\text{V}^{5+}/\text{V}^{4+}$ and $\text{V}^{4+}/\text{V}^{3+}$. Although a good reproducibility of each galvanostatic cycling was obtained, one can notice that only 0.5 Li^+ was exchanged between 3.0–4.55 V (Li^+ extraction from LiVPO_4O). Nevertheless, between 3.0–1.6 V (Li^+ insertion into LiVPO_4O), one Li was inserted in the LiVPO_4O framework leading to a composition close to $\text{Li}_2\text{VPO}_4\text{O}$.

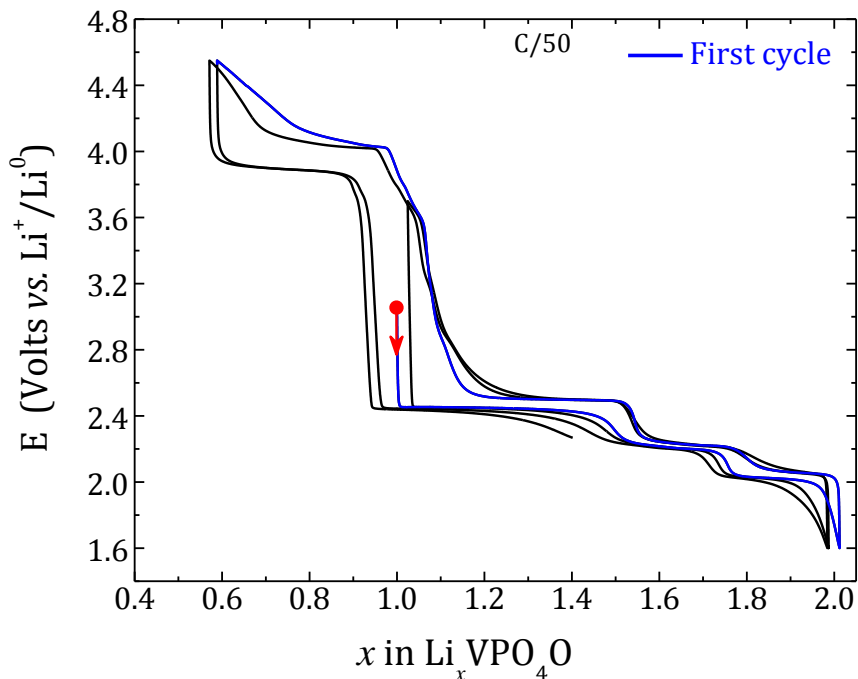

Figure II-31: Galvanostatic cycling from 1.6 V–4.5 V vs. Li^+/Li at $\text{C}/50$ of $\text{LiVPO}_4\text{O}/\text{LP30}/\text{Li}$ cell.

The understanding of the mechanisms of Li^+ insertion/extraction (between 3.0–1.6 V) and Li extraction/insertion (between 3.0–4.55 V) in LiVPO_4O will be discussed in this section.

II-4a. Reversible Li^+ insertion into LiVPO_4O ($\text{V}^{3+}/\text{V}^{4+}$ couple)

We have shown for the first time that the framework structure of LiVPO_4O can accommodate up to one Li with a capacity very close to the theoretical one (158 mAh/g). The electrochemical formation of $\text{Li}_2\text{VPO}_4\text{O}$ from LiVPO_4O was possible through 2 intermediate phases of compositions $\text{Li}_{1.5}\text{VPO}_4\text{O}$ and $\text{Li}_{1.75}\text{VPO}_4\text{O}$ leading to three reversible reactions summarized as:

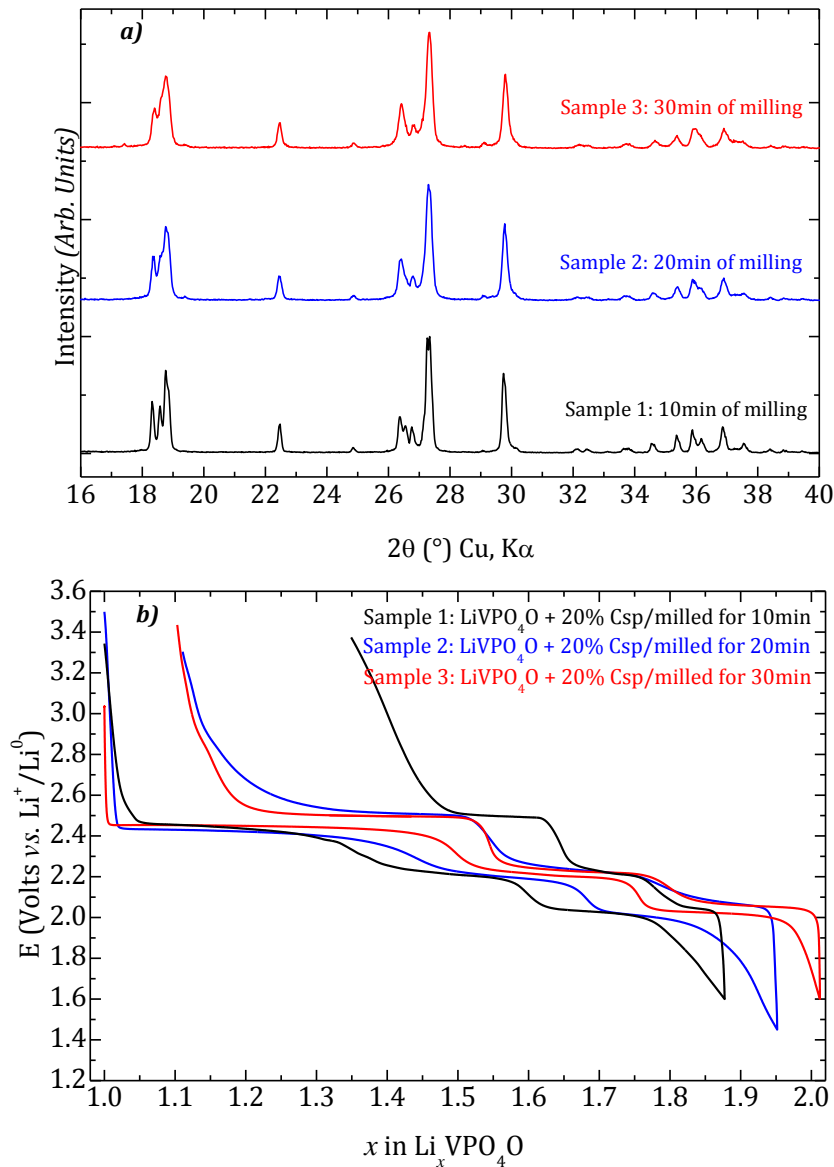
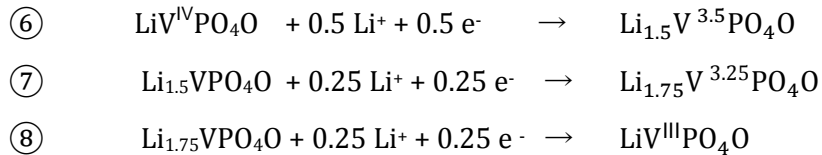

Figure II-32: a) Three different milling durations of a mixture of LiVPO_4O and 20% of C_{sp} . b) Corresponding electrochemical Li insertion/extraction at $\text{C}/50$

As shown in Chapter I, the synthesis of LiVPO_4O leads to the formation of particles (2-3 μm in size) highly agglomerated (5-6 μm). SPEX grinding has been performed so as to decrease the particle size, as it is well illustrated in Figure II-32 with the observation of a diffraction line broadening with an increasing milling time. Thin electrodes, with 150 μm of thickness, were made by a mixture of LiVPO_4O and 15 wt % of C_{SP} (grinded at different time durations). We added 12 wt % of PVdF as binder. The obtained electrodes were cycled in coin-cells. Figure II-32b displays the galvanostatic data (between 1.4 V and 3 V vs. Li) of different samples of LiVPO_4O (Figure II-32a). For a sample milled for a long time (sample 3), the capacity was improved and was very close to the theoretical capacity. The electrochemical data of sample 3 displayed a well defined plateau and a small polarization. One can notice a stronger irreversibility for sample 1, probably due to limited diffusion within these larger particles.

GITT measurements (Figure II-33) show a flat plateau between LiVPO_4O and $\text{Li}_{1.5}\text{VPO}_4\text{O}$ at a potential of 2.45 V vs. Li^+/Li , indicating a biphasic mechanism for reaction (6). Further Li^+ insertion into $\text{Li}_{1.5}\text{VPO}_4\text{O}$ (reaction (7)) occurred at a potential close to 2.21 V vs. Li^+/Li with a pseudo plateau which indicates that the mechanism might be of second order. Only 0.25 Li^+ can be inserted into $\text{Li}_{1.5}\text{VPO}_4\text{O}$, ending up with a composition of $\text{Li}_{1.75}\text{VPO}_4\text{O}$. Reaction (8) is the insertion of Li^+ in $\text{Li}_{1.75}\text{VPO}_4\text{O}$ which occurs at a potential of 2.04 V vs. Li^+/Li possibly also through a second order mechanism so as to form $\text{Li}_2\text{VPO}_4\text{O}$ after the insertion of 0.25 Li.

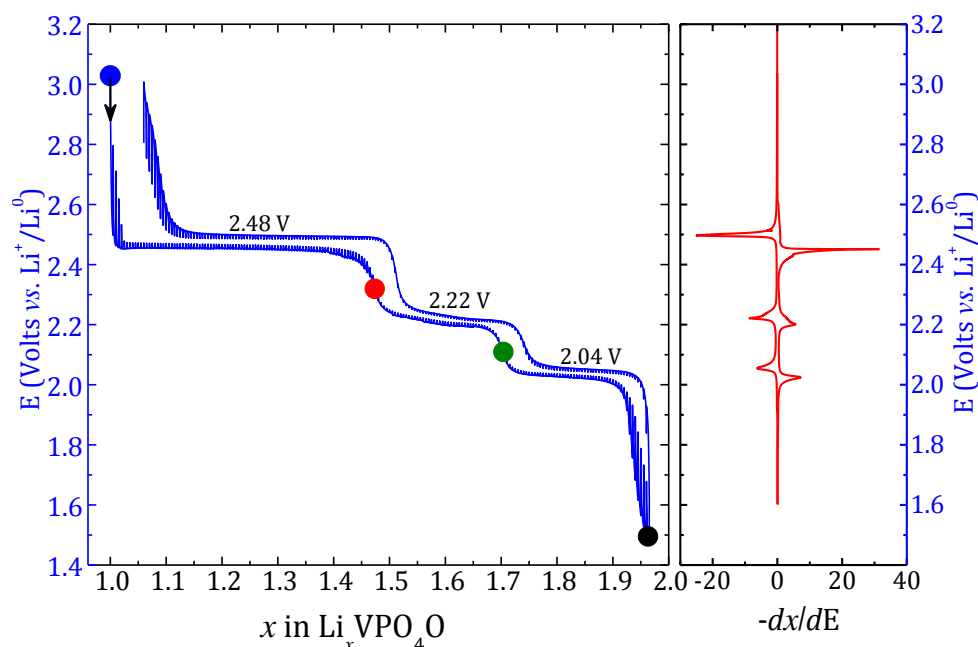

Figure II-33: GITT measurement of LiVPO_4O (left): a current corresponding to a rate of $C/200$ was applied during one hour with a relaxation time condition of $dV/dt < 4\text{mV/h}$. Derivative curve calculated (right) from GITT.

The very narrow and sharp peak in the derivative curve (Figure II-33) at potential around 2.5 V vs. Li^+/Li indicates a biphasic mechanism between LiVPO_4O and $\text{Li}_{1.5}\text{VPO}_4\text{O}$. The peaks at around

2.2 V and 2 V vs. Li^+/Li are much broader so that the determination of the mechanism of Li^+ insertion in both $\text{Li}_{1.5}\text{VPO}_4\text{O}$ and $\text{Li}_{1.75}\text{VPO}_4\text{O}$ appears to be not straightforward.

The mechanisms of Li^+ insertion in LiVPO_4O were followed by *in situ* XRD and the recorded XRD data were gathered in Figure II-34 together with the electrochemistry. The *in situ* experiment had been performed on sample 3 (Figure II-32b) with an acquisition time of 2 hours for each different XRD pattern.

- During the first part of the discharge corresponding to the reaction ⑥, the diffraction peaks of the starting LiVPO_4O phase progressively disappeared (Figure II-35) and new Bragg positions located at 28° and 28.27° in 2θ progressively grew. The XRD pattern, recorded after 15 hours of discharge (red in Figure II-34) corresponds to the pure phase of $\text{Li}_{1.5}\text{VPO}_4\text{O}$, formed at a potential of 2.46 V vs. Li^+/Li .

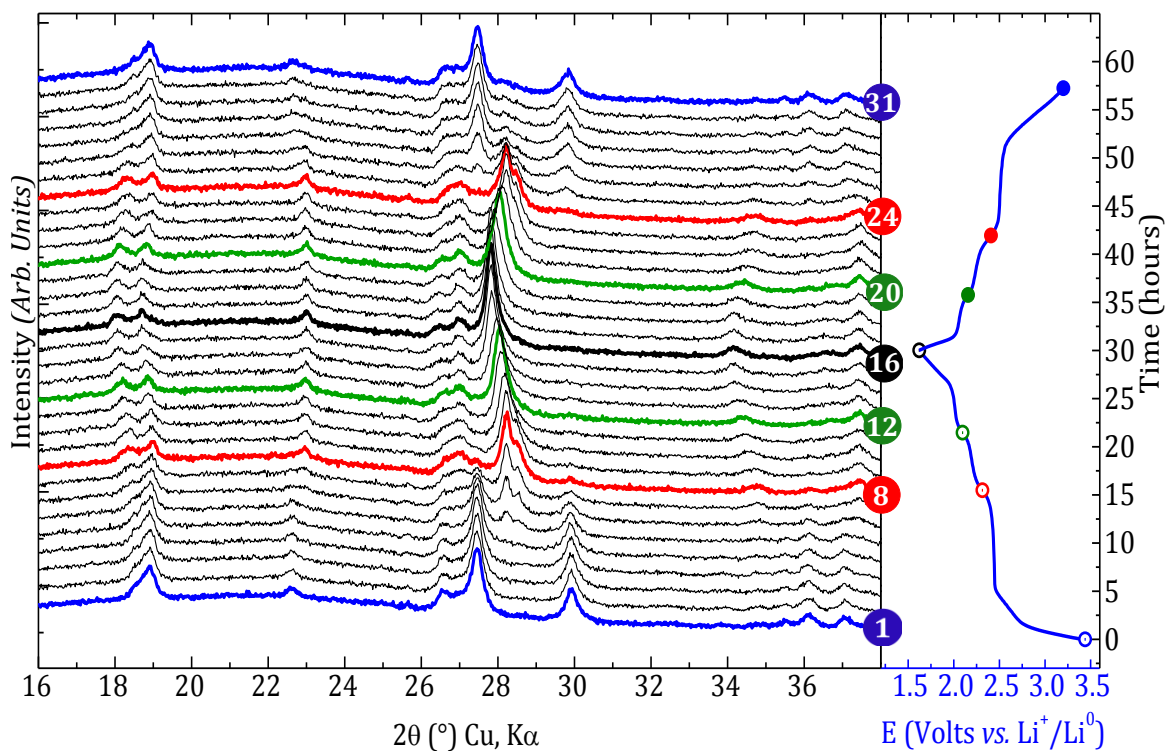

Figure II-34: 2D View of collected *in-situ* XRD patterns for the global electrochemical reaction $\text{LiVPO}_4\text{O} \rightleftharpoons \text{Li}_2\text{VPO}_4\text{O}$ (left) and corresponding galvanostatic cycling data (right). The XRD patterns highlighted refer to LiVPO_4O (blue), $\text{Li}_{1.5}\text{VPO}_4\text{O}$ (red), $\text{Li}_{1.75}\text{VPO}_4\text{O}$ (green) and $\text{Li}_2\text{VPO}_4\text{O}$ (black).

- Upon further Li^+ insertion into $\text{Li}_{1.5}\text{VPO}_4\text{O}$, the position of the peaks between 17° and 18° and the peak at 28° in 2θ (Figure II-34 and Figure II-35) seems shifted to lower angles, suggesting a solid solution mechanism. The insertion of Li in $\text{Li}_{1.5}\text{VPO}_4\text{O}$ occurred at the average potential of 2.21 V vs. Li^+/Li and leads to $\text{Li}_{1.75}\text{VPO}_4\text{O}$.

- The mechanism of lithium insertion into $\text{Li}_{1.75}\text{VPO}_4\text{O}$ seems also to proceed through a second order mechanism since peaks seem to be shifted to lower 2θ angles (Figure II-35) indicative of a volume increase. The new phase $\text{Li}_2\text{VPO}_4\text{O}$ is formed at the average potential of 2.04 V vs. Li^+/Li .

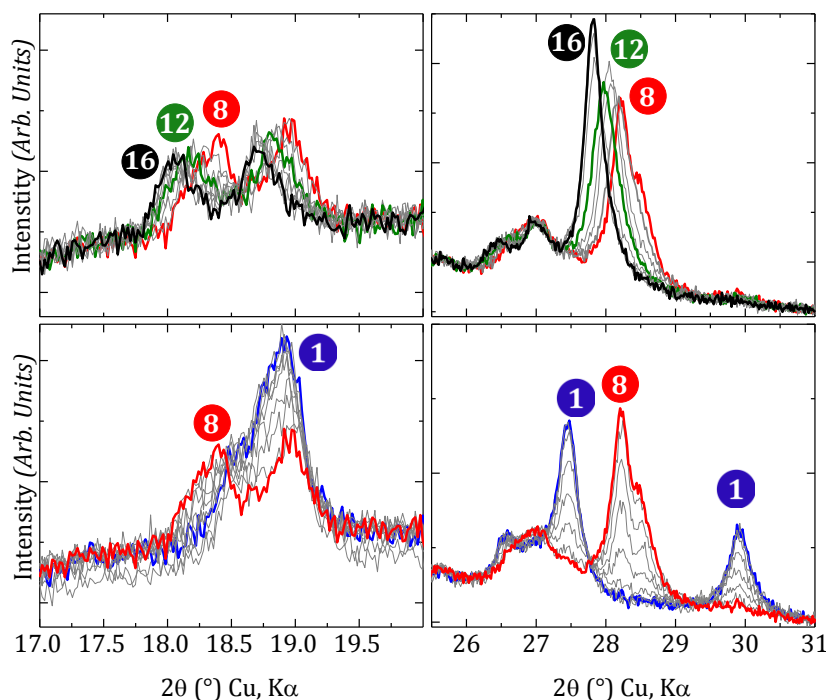

Figure II-35: Selected 2θ regions showing the respective growths and disappearance of the phases involved in the $\text{LiVPO}_4\text{O} \rightleftharpoons \text{Li}_2\text{VPO}_4\text{O}$ reaction. The XRD patterns highlighted refer to $\text{Li}_{1.5}\text{VPO}_4\text{O}$ (red), $\text{Li}_{1.75}\text{VPO}_4\text{O}$ (green) and $\text{Li}_2\text{VPO}_4\text{O}$ (black).

These *in situ* XRD experiments fully support the occurrence of a biphasic reaction between LiVPO_4O and $\text{Li}_{1.50}\text{VPO}_4\text{O}$ and also strongly suggest the occurrence of two successive solid solution reactions between $\text{Li}_{1.50}\text{VPO}_4\text{O}$, $\text{Li}_{1.75}\text{VPO}_4\text{O}$ and $\text{Li}_2\text{VPO}_4\text{O}$. Nevertheless, based on XRD patterns with very limited angular ranges ($16\text{-}38^\circ$ (2θ)), it was not possible to determine with a high degree of reliability the unit cells describing the structures of these three phases $\text{Li}_x\text{VPO}_4\text{O}$ ($x = 1.50, 1.75$ and 2). In the frame of Matteo Bianchini PhD thesis the preparation of these three compositions is in progress *ex situ*, through chemical lithium intercalation. Their XRD patterns are recorded in transmission mode from a capillary sealed under argon in order to get a wide angular range.

II-4b. Reversible Li^+ extraction from LiVPO_4O ($\text{V}^{4+}/\text{V}^{5+}$ couple)

We have performed electrochemical cycling of LiVPO_4O (from 3 V to 4.6 V at a rate of C/50) in coin cell configuration, as displayed in Figure II-36. The data suggested that only 0.5 Li was

extracted at an average potential of 3.95 V vs. Li^+/Li . This first, reproducible, result raised two questions:

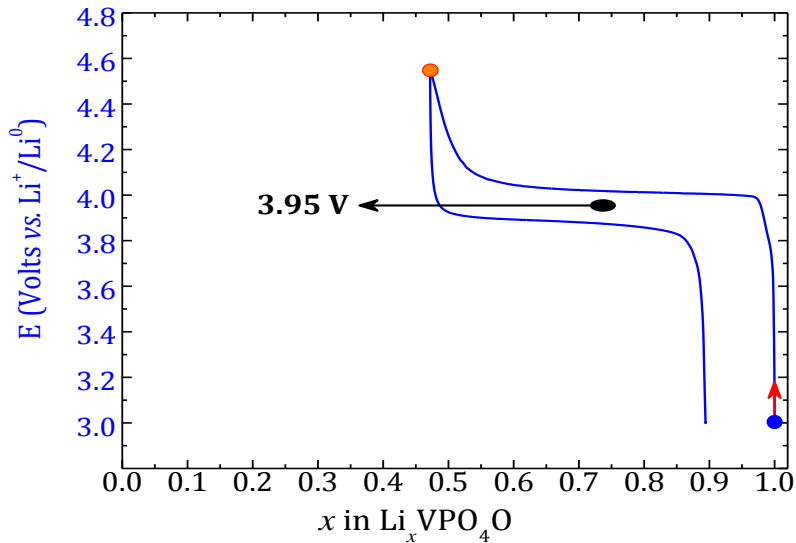
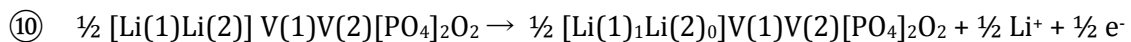

Figure II-36: Galvanostatic cycling of Li/LiPF_6 [1M] in $\text{EC}:\text{DMC}$ (1:1)/ LiVPO_4O cell at $\text{C}/50$ from 3 V to 4.6 V

➤ Previous observations about the poor electrochemical activity of LiVPO_4O were confirmed. The electrochemical activity is significantly improved by ball-milling of the electrode with carbon and big particles of LiVPO_4O gave poor rate capability during Li^+ extraction. The data reported in figure II-37 might therefore be related with the reaction:



➤ It could also be envisaged that only one (out of two) Li site was emptied from the LiVPO_4O framework structure thus giving rise to the phase of composition $\text{Li}_{0.5}\text{VPO}_4\text{O}$.



^7Li MAS NMR tends to prove that the two sites of Li are equivalent at least in terms of spin transfer from V^{4+} to Li^+ . The DFT calculations performed in our group by E. Bogdan and D. Carlier showed that the $\text{Li}_{0.5}\text{VPO}_4\text{O}$ phase is not stable versus LiVPO_4O and VPO_4O , indicating that full extraction of Li^+ from LiVPO_4O is possible.

XRD *in situ* performed between 3 and 4.55 V (Figure II-37) evidenced the two-phase mechanism since no peak was shifted to lower or higher 2θ angles but rather, the appearance of new peaks are visible at 19.5° and 29° . One can notice the presence of the peaks belonging to the initial phase at the end of the charge, showing that the reaction was not complete. The FWHM of initial

XRD patterns of LiVPO_4O is widened as illustrated by the continuous increase of the $(200)_{P\bar{1}}$ peak (Figure II-38) from charge to discharge so that the total increase of FWHM is about 40 %. The shrinkage of the crystallite coherent domain size can be linked to the decrease of the particle size, and therefore enhance the capacity of LiVPO_4O .

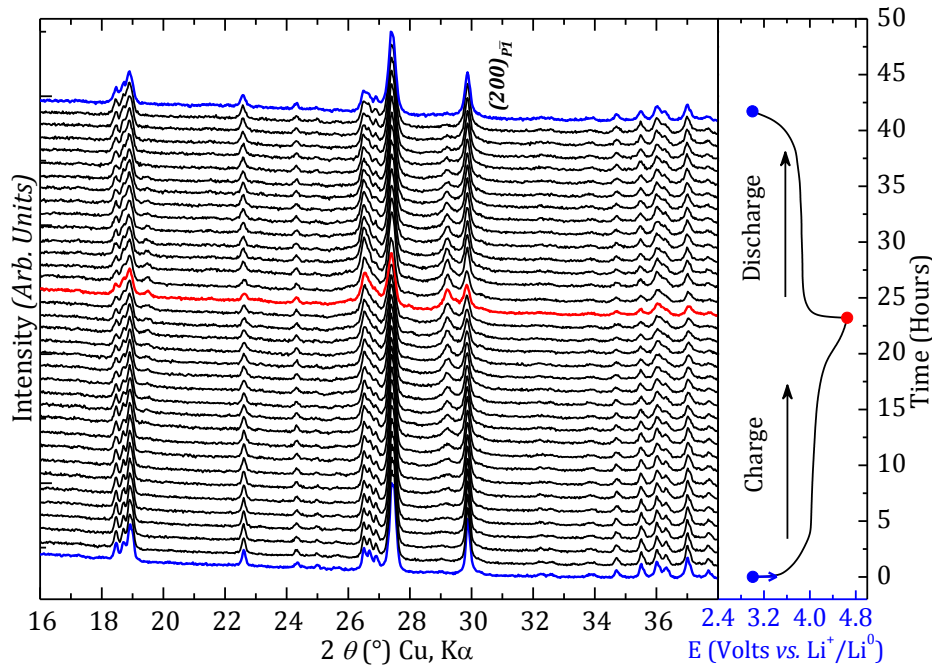

Figure II-37: Galvanostatic cycling of a $\text{Li/LP30/LiVPO}_4\text{O}$ cell cycled at $C/50$ up to 4.5 V (right) and in situ XRD patterns (left)

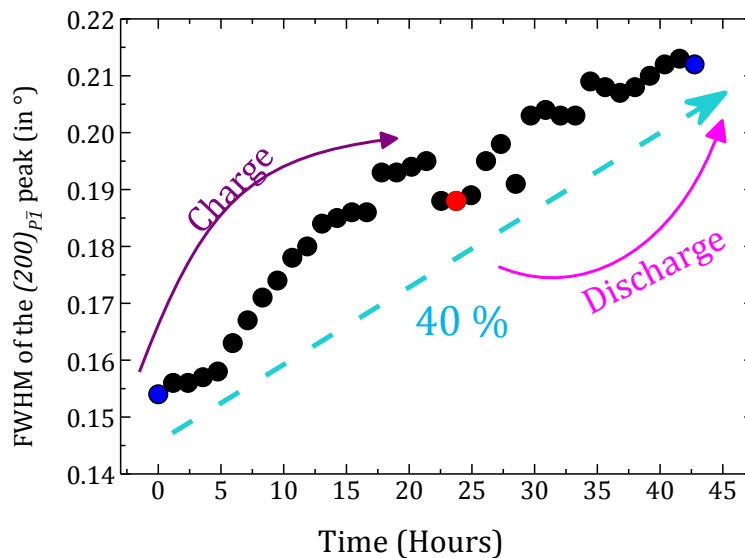

Figure II-38: Evolution (from charge to discharge) of the FWHM for $(200)_{P\bar{1}}$ peaks of LiVPO_4O .

This observation suggested that the large agglomerated particles of LiVPO_4O did not fully contribute to the electrochemical cycling and more interestingly, that the kinetics can be improved. As a consequence of particle size shrinkage, an increase of columbic efficiency was observed, as illustrated in Figure II-39 in which the number of Li^+ exchanged from 3 V to 4.55 V

increases with the cycles number. This is also illustrated in Figure II-40a which displays the capacity increase with the numbers of cycling reaching 130 mAh/g after 20 cycles and being then stabilized at a capacity around 134 mAh/g. More interestingly, the polarization decreases with the number of cycles as pictured in Figure II-40b.

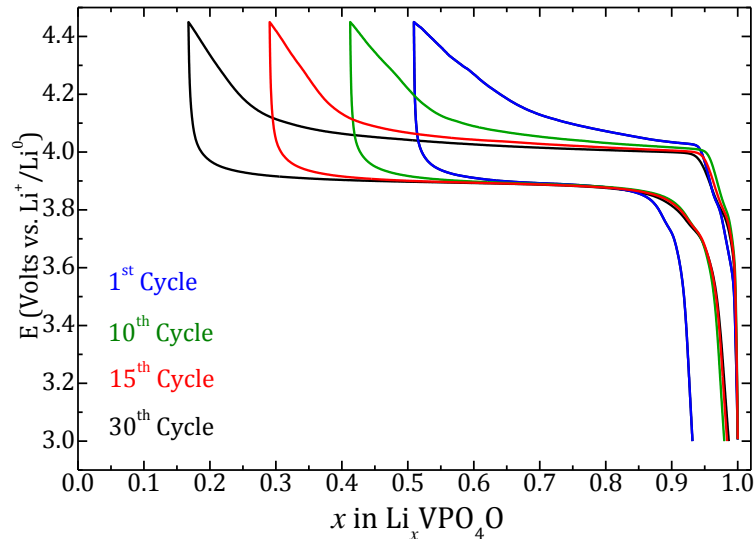

Figure II-39: Different cycles (at a rate of $C/20$) for $\text{Li}||\text{LiVPO}_4\text{O}$ cell

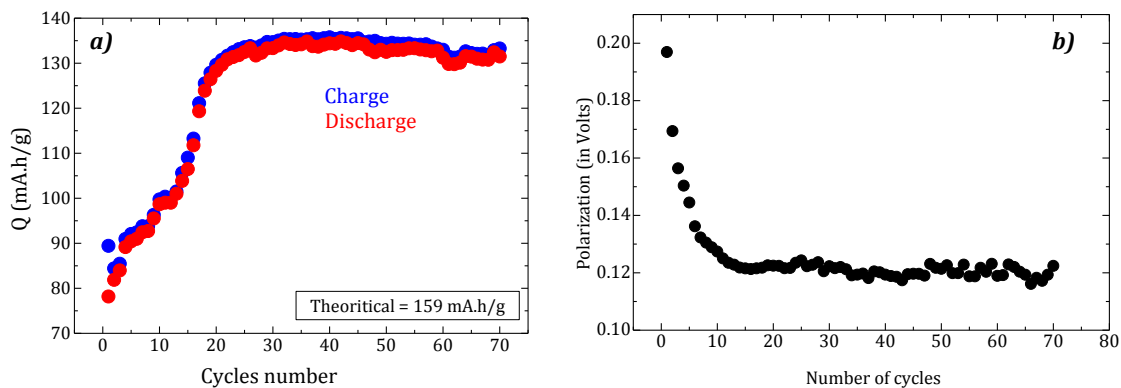

Figure II-40: a) charge and discharge capacity of $\text{Li}||\text{LiVPO}_4\text{O}$ cell versus number of cycles
b) polarization of each cycle

Since the electrochemical preparation of VPO_4O was not straightforward, we succeeded in isolating VPO_4O by chemical oxidation using a very powerful oxidant, nitronium tetrafluoroborate (NO_2BF_4). The redox couple implied from the use of NO_2BF_4 is $\text{NO}_2^+/\text{NO}_2$ which redox potential is ~ 5.1 V vs. Li^+/Li in acetonitrile media. The powder of LiVPO_4O had been added to a solution of NO_2BF_4 in acetonitrile, in excess of 5 wt %, to ensure the total oxidation of V^{4+} to V^{5+} . The greenish initial powder of LiVPO_4O became yellowish after 12 hours of stirring. The reaction was maintained under stirring during 24 hours and the recovered yellowish powder was separated by centrifugation and washed with acetonitrile. The XRD data were successfully refined in both Cc and $C2/c$ space groups (but could not be refined within the orthorhombic unit

cell of $\beta\text{-VPO}_4\text{O}$). They are displayed in Figure II-41 together with the corresponding lattice parameters. The crystallization of VPO_4O in $C2/c$ is unlikely since this will require the presence of vanadium at the center of the VO_6 octahedra with similar V–O distances along the chains as observed in $\text{VPO}_4\cdot\text{H}_2\text{O}$ instead of alternate long and short distances as observed in VPO_4O . Another example is VPO_4F which crystallizes in $C2/c$ and within which V–F distances are symmetric along the vanadium-centered octahedra. Note however that the oxidation states in $\text{VPO}_4\cdot\text{H}_2\text{O}$ and VPO_4F are +3 and +4 respectively, rather than +5 as for VPO_4O [73]. The V/Z obtained after the refinement was 81.9 \AA^3 (in C/c space group) lower than for the V/Z obtained for LiVPO_4O (85.8 \AA^3), in good agreement with an oxidation of V^{4+} to V^{5+} .

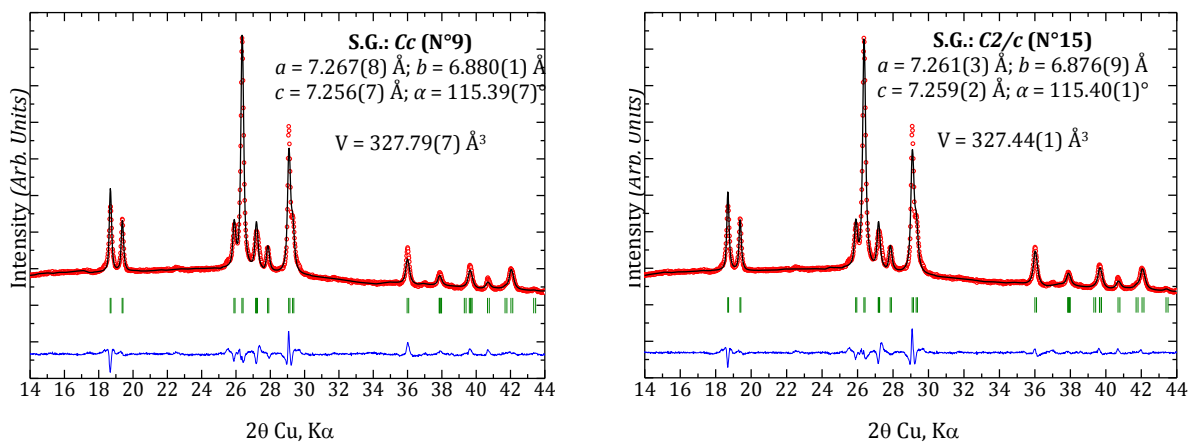

Figure II-41: Full pattern matching refinements of XRD data in Cc (left) and $C2/c$ (right) space groups of VPO_4O obtained by chemical delithiation

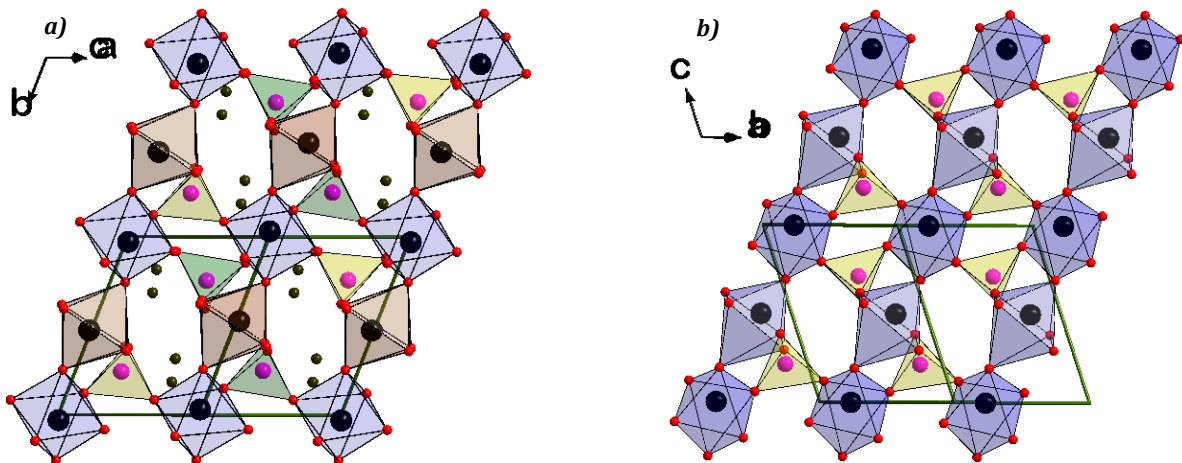

Figure II-42: Representation of the structure of: a) LiVPO_4O and b) $\epsilon\text{-VPO}_4\text{O}$ along the $(1\bar{1}0)_{C/c}$ and $(10\bar{1})_{P\bar{1}}$ directions.

T.A. Kerr et al. [13] had shown that the insertion of Li^+ in $\epsilon\text{-VPO}_4\text{O}$ led to the formation of the triclinic LiVPO_4O . Figure II-42 illustrates the similitude between the $\epsilon\text{-VPO}_4\text{O}$ and LiVPO_4O framework structures. Indeed octahedral $[\text{VO}_4\text{O}_2]$ chains are connected by tetrahedra $[\text{PO}_4]$ in the same way for both structures. The extraction of Li^+ from LiVPO_4O is therefore topotactic.

II-5. Conclusions and summary of this chapter

The mechanisms of Li^+ insertion/extraction and extraction/insertion in both LiVPO_4F and LiVPO_4O were studied in order to understand the relationships between crystallographic and electrochemical properties. For LiVPO_4F , the insertion of Li^+ leads to the formation of $\text{Li}_2\text{VPO}_4\text{F}$ at a potential of 1.81 V vs. Li^+/Li through a biphasic mechanism. Li^+ extraction from LiVPO_4F undergoes a first intermediate phase which composition is $\text{Li}_{0.67}\text{VPO}_4\text{F}$ at a potential of 4.25 V vs. Li^+/Li . The fully delithiated phase VPO_4F is obtained by a biphasic mechanism of Li^+ extraction from $\text{Li}_{0.67}\text{VPO}_4\text{F}$ at a potential of 4.26 V vs. Li^+/Li . Surprisingly, the subsequent insertion of Li^+ in VPO_4F to LiVPO_4F occurs through a single discharge plateau without occurrence of $\text{Li}_{0.67}\text{VPO}_4\text{F}$. The thermodynamic or kinetic origin of these findings is not fully understood yet and we are tackling it through T-controlled XRD, e^- diffraction, MAS NMR... Besides DFT calculations that could address the relative stabilities of the phases encountered in the VPO_4F - $\text{Li}_2\text{VPO}_4\text{F}$ system, further experiments have to be performed in order to evaluate the stability of the new intermediate phase of $\text{Li}_{0.67}\text{VPO}_4\text{F}$ which has never been reported before.

Despite the unknown structure of the new phase $\text{Li}_{0.67}\text{VPO}_4\text{F}$, the structure of $\text{Li}_x\text{VPO}_4\text{F}$ are related to the parent LiVPO_4F with the same packing of the $[\text{VPO}_4\text{F}_2]$ unit framework besides significant unit-cell contractions/expansions and overall shifts in symmetry from triclinic $P\bar{1}$ to monoclinic $C2/c$. The overall electrochemical reactions are topotactic and associated with very small polarization. Some features were pointed out just like the increase of V-F distance when one moves from VPO_4F to $\text{Li}_2\text{VPO}_4\text{F}$ and in the same way, the increase of tilted angles along octahedral chains.

The ^7Li MAS NMR signal of VPO_4F displayed a tiny signal at 116 ppm most probably due to unreacted LiVPO_4F . The ^7Li MAS NMR signal of $\text{Li}_{0.67}\text{VPO}_4\text{F}$ presented at least 4 signals which show the existence of different types of environment for Li. This result might probably due to charge ordering, which has to be confirmed by further NMR experiments and DFT calculations.

Li^+ insertion into LiVPO_4O undergoes through 3 reversible reactions (the first one being biphasic and the two others most probably solid solutions) and leads to the formation of $\text{Li}_{1.5}\text{VPO}_4\text{O}$, $\text{Li}_{1.75}\text{VPO}_4\text{O}$ and $\text{Li}_2\text{VPO}_4\text{O}$ at potentials of 2.46, 2.2 and 2.02 V vs. Li^+/Li respectively. Li^+ extraction from LiVPO_4O emphasized, with a reaction limited to the exchange of 0.5 Li during the first cycle, the poor electronic conductivity of LiVPO_4O which has to be improved by carbon coating and/or particles size decrease.

It is worth to notice that the $\text{V}^{4+}/\text{V}^{3+}$ redox couple is located at different potentials in LiVPO_4X : around 4.25 V vs. Li^+/Li for LiVPO_4F and at around 2.3 V vs. Li^+/Li in LiVPO_4O . As shown in Figure II-43 the difference between the upper voltage redox couple ($\text{V}^{3+}/\text{V}^{2+}$) and lower voltage redox couple ($\text{V}^{4+}/\text{V}^{3+}$) in LiVPO_4F is 2.45 V whereas the upper voltage redox couple ($\text{V}^{5+}/\text{V}^{4+}$) and lower voltage redox couple ($\text{V}^{4+}/\text{V}^{3+}$) in LiVPO_4O is 1.65 V. This difference might come from the presence of vanadyl bonds in LiVPO_4O . Indeed the p_y orbitals of oxygen are oriented through d_{yz} vanadium anti-bonding orbitals inducing the increase of $\text{V}^{4+}/\text{V}^{3+}$ density of state.

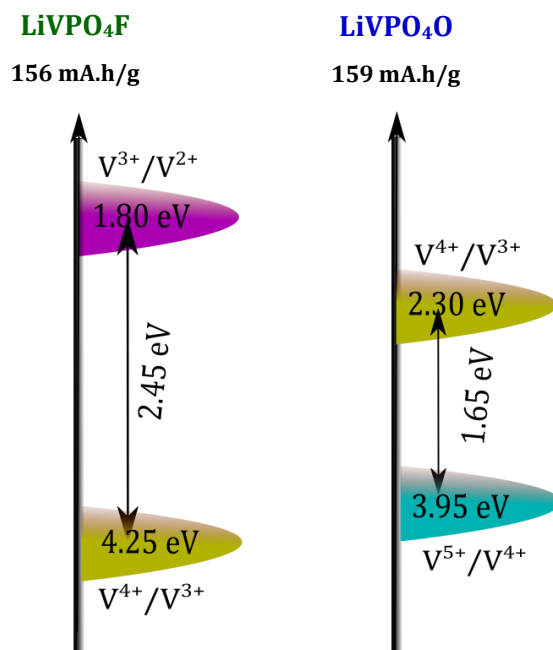

Figure II-43: Different schematic densities of state of $\text{V}^n/\text{V}^{n-1}$ encountered in LiVPO_4F (left) and LiVPO_4O (right)

References

- Gaubicher, J.; Wurm, C.; Goward, G.; Masquelier, C. and Nazar, L.; *Rhombohedral form of $\text{Li}_3\text{V}_2(\text{PO}_4)_3$ as a cathode in Li-ion batteries*, Chemistry of Materials, **2000**, 12(11): p. 3240-+.
- Huang, H.; Yin, S.C.; Kerr, T.; Taylor, N. and Nazar, L.F.; *Nanostructured composites: A high capacity, fast rate $\text{Li}_3\text{V}_2(\text{PO}_4)_3$ /carbon cathode for rechargeable lithium batteries*, Advanced Materials, **2002**, 14(21): p. 1525-+.
- Morgan, D.; Ceder, G.; Saidi, M.Y.; Barker, J.; Swoyer, J.; Huang, H. and Adamson, G.; *Experimental and computational study of the structure and electrochemical properties of $\text{Li}_x\text{M}_2(\text{PO}_4)_3$ compounds with the monoclinic and rhombohedral structure*, Chemistry of Materials, **2002**, 14(11): p. 4684-4693.
- Morcrette, M.; Leriche, J.B.; Patoux, S.; Wurm, C. and Masquelier, C.; *In situ X-ray diffraction during lithium extraction from rhombohedral and monoclinic $\text{Li}_3\text{V}_2(\text{PO}_4)_3$* , Electrochemical and Solid State Letters, **2003**, 6(5): p. A80-A84.
- Patoux, S.; Wurm, C.; Morcrette, M.; Rousse, G. and Masquelier, C.; *A comparative structural and electrochemical study of monoclinic $\text{Li}_3\text{Fe}_2(\text{PO}_4)_3$ and $\text{Li}_3\text{V}_2(\text{PO}_4)_3$* , JOURNAL OF POWER SOURCES, **2003**, 119: p. 278-284.
- Barker, J.; Gover, R.K.B.; Burns, P. and Bryan, A.; *LiVP_2O_7 : A viable lithium-ion cathode material?*, Electrochemical and Solid State Letters, **2005**, 8(9): p. A446-A448.
- Wurm, C.; Morcrette, M.; Rousse, G.; Dupont, L. and Masquelier, C.; *Lithium insertion/extraction into/from LiMX_2O_7 compositions ($\text{M} = \text{Fe}, \text{V}$; $\text{X} = \text{P}, \text{As}$) prepared via a solution method*, Chemistry of Materials, **2002**, 14(6): p. 2701-2710.
- Uebou, Y.; Okada, S.; Egashira, M. and Yamaki, J.I.; *Cathode properties of pyrophosphates for rechargeable lithium batteries*, Solid State Ionics, **2002**, 148(3-4): p. 323-328.
- Rousse, G.; Wurm, C.; Morcrette, M.; Rodriguez-Carvajal, J.; Gaubicher, J. and Masquelier, C.; *Crystal structure of a new vanadium(IV) diphosphate: VP_2O_7 , prepared by lithium extraction from LiVP_2O_7* , International Journal of Inorganic Materials, **2001**, 3(7): p. 881-887.
- Dupre, N.; Gaubicher, J.; Angenault, J. and Quarton, M.; *Electrochemical study of intercalated vanadyl phosphate*, Journal of Solid State Electrochemistry, **2004**, 8(5): p. 322-329.
- Dupre, N.; Gaubicher, J.; Le Mercier, T.; Wallez, G.; Angenault, J. and Quarton, M.; *Positive electrode materials for lithium batteries based on VOPO_4* , Solid State Ionics, **2001**, 140(3-4): p. 209-221.
- Gaubicher, J.; Le Mercier, T.; Chabre, Y.; Angenault, J. and Quarton, M.; *Li/beta- VOPO_4 : A new 4 V system for lithium batteries*, Journal of the Electrochemical Society, **1999**, 146(12): p. 4375-4379.
- Kerr, T.A.; Gaubicher, J. and Nazar, L.F.; *Highly reversible Li insertion at 4 V in epsilon- VOPO_4 /alpha- LiVOPO_4 cathodes*, Electrochemical and Solid State Letters, **2000**, 3(10): p. 460-462.
- Dupre, N.; Gaubicher, J.; Angenault, J.; Wallez, G. and Quarton, M.; *Electrochemical performance of different Li- VOPO_4 systems*, JOURNAL OF POWER SOURCES, **2001**, 97-8: p. 532-534.
- Azmi, B.A.; Ishihara, T.; Nishiguchi, H. and Takita, Y.; *Vanadyl phosphates Of VOPO_4 as a cathode of Li-ion rechargeable batteries*, Journal of Power Sources, **2003**, 119: p. 273-277.
- Dupre, N.; Wallez, G.; Gaubicher, J. and Quarton, M.; *Phase transition induced by lithium insertion in alpha(I)- and alpha(II)- VOPO_4* , Journal of Solid State Chemistry, **2004**, 177(8): p. 2896-2902.
- Dubarry, M.; Gaubicher, J.; Guyomard, D.; Wallez, G.; Quarton, M. and Baehtz, C.; *Uncommon potential hysteresis in the $\text{Li}/\text{Li}_x\text{VO}(\text{H}_{2-x}\text{PO}_4)_2$ ($0 \leq x \leq 2$) system*, Electrochimica Acta, **2008**, 53(13): p. 4564-4572.
- Barker, J.; Saidi, M.Y. and Swoyer, J.L.; *Electrochemical insertion properties of the novel lithium vanadium fluorophosphate, LiVPO_4F* , Journal of the Electrochemical Society, **2003**, 150(10): p. A1394-A1398.

19. Barker, J.; Gover, R.K.B.; Burns, P.; Bryan, A.; Saidi, M.Y. and Swoyer, J.L.; *Structural and electrochemical properties of lithium vanadium fluorophosphate, LiVPO_4F* , Journal of Power Sources, **2005**, 146(1-2): p. 516-520.
20. Barker, J.; Gover, R.K.B.; Burns, P.; Bryan, A.; Saidi, M.Y. and Swoyer, J.L.; *Performance evaluation of lithium vanadium fluorophosphate in lithium metal and lithium-ion cells*, Journal of the Electrochemical Society, **2005**, 152(9): p. A1776-A1779.
21. Gover, R.K.B.; Burns, P.; Bryan, A.; Saidi, M.Y.; Swoyer, J.L. and Barker, J.; *LiVPO_4F : A new active material for safe lithium-ion batteries*, Solid State Ionics, **2006**, 177(26-32): p. 2635-2638.
22. Li, Y.; Zhou, Z.; Gao, X.P. and Yan, J.; *A Novel Sol-gel Method to Synthesize Nanocrystalline LiVPO_4F and its Electrochemical Li Intercalation Performances*, **2006**, 160: p. 633-637.
23. Zhang, Q.; Zhong, S.K.; Liu, L.T.; Liu, J.Q.; Jiang, J.Q.; Wang, J. and Li, Y.H.; *A novel method to synthesize $\text{LiVPO}_4\text{F}/\text{C}$ composite materials and its electrochemical Li-intercalation performances*, Journal of Physics and Chemistry of Solids, **2009**, 70(7): p. 1080-1082.
24. Zhou, F.; Zhao, X.M. and Dahn, J.R.; *Reactivity of charged LiVPO_4F with 1 M LiPF_6 EC:DEC electrolyte at high temperature as studied by accelerating rate calorimetry*, Electrochemistry Communications, **2009**, 11(3): p. 589-591.
25. Ellis, B.L.; Ramesh, T.N.; Davis, L.J.M.; Goward, G.R. and Nazar, L.F.; *Structure and Electrochemistry of Two-Electron Redox Couples in Lithium Metal Fluorophosphates Based on the Tavorite Structure*, Chemistry of Materials, **2011**, 23(23): p. 5138-5148.
26. Ateba Mba, J.M.; Croguennec, L.; Basir, N.I.; Barker, J. and Masquelier, C.; *Lithium Insertion or Extraction from/into Tavorite-Type LiVPO_4F : An In Situ X-ray Diffraction Study*, Journal of the Electrochemical Society, **2012**, 159(8): p. A1171-A1175.
27. Ateba Mba, J.M.; Masquelier, C.; Suard, E. and Croguennec, L.; *Synthesis and Crystallographic Study of Homeotypic LiVPO_4F and LiVPO_4O* , Chemistry of Materials, **2012**, 24(6): p. 1223-1234.
28. Zheng, J.C.; Zhang, B. and Yang, Z.H.; *Novel synthesis of LiVPO_4F cathode material by chemical lithiation and postannealing*, Journal of Power Sources, **2012**, 202: p. 380-383.
29. Azmi, B.M.; Ishihara, T.; Nishiguchi, H. and Takita, Y.; *Cathodic performance of LiVOPO_4 prepared by impregnation method for Li ion secondary battery*, Electrochemistry, **2003**, 71(12): p. 1108-1110.
30. Barker, J.; Saidi, M.Y. and Swoyer, J.L.; *Electrochemical properties of beta- LiVOPO_4 prepared by carbothermal reduction*, Journal of the Electrochemical Society, **2004**, 151(6): p. A796-A800.
31. Azmi, B.M.; Ishihara, T.; Nishiguchi, H. and Takita, Y.; *LiVOPO_4 as a new cathode materials for Li-ion rechargeable battery*, JOURNAL OF POWER SOURCES, **2005**, 146(1-2): p. 525-528.
32. Song, Y.N.; Zavalij, P.Y. and Whittingham, M.S.; *epsilon- VOPO_4 : Electrochemical synthesis and enhanced cathode behavior*, Journal of the Electrochemical Society, **2005**, 152(4): p. A721-A728.
33. Kuo, H.T.; Bagkar, N.C.; Liu, R.S.; Shen, C.H.; Shy, D.S.; Xing, X.K.; Lee, J.F. and Chen, J.M.; *Structural transformation of LiVOPO_4 to $\text{Li}_3\text{V}_2(\text{PO}_4)_3$ with enhanced capacity*, Journal of Physical Chemistry B, **2008**, 112(36): p. 11250-11257.
34. Nagamine, K.; Honma, T. and Komatsu, T.; *Selective Synthesis of Lithium Ion-Conductive beta- LiVOPO_4 Crystals via Glass-Ceramic Processing*, Journal of the American Ceramic Society, **2008**, 91(12): p. 3920-3925.
35. Ren, M.M.; Zhou, Z.; Gao, X.P.; Liu, L. and Peng, W.X.; *LiVOPO_4 hollow microspheres: One-pot hydrothermal synthesis with reactants as self-sacrifice templates and lithium intercalation performances*, Journal of Physical Chemistry C, **2008**, 112(33): p. 13043-13046.
36. Yang, Y.; Fang, H.S.; Zheng, J.; Li, L.P.; Li, G.S. and Yan, G.F.; *Towards the understanding of poor electrochemical activity of triclinic LiVOPO_4 : Experimental characterization and theoretical investigations*, Solid State Sciences, **2008**, 10(10): p. 1292-1298.
37. Ren, M.M.; Zhou, Z.; Su, L.W. and Gao, X.P.; *LiVOPO_4 : A cathode material for 4 V lithium ion batteries*, JOURNAL OF POWER SOURCES, **2009**, 189(1): p. 786-789.
38. Ren, M.M.; Zhou, Z. and Gao, X.P.; *LiVOPO_4 as an anode material for lithium ion batteries*, Journal of Applied Electrochemistry, **2010**, 40(1): p. 209-213.

39. Allen, C.J.; Jia, Q.Y.; Chinnasamy, C.N.; Mukerjee, S. and Abraham, K.M.; *Synthesis, Structure and Electrochemistry of Lithium Vanadium Phosphate Cathode Materials*, Journal of the Electrochemical Society, **2011**, 158(12): p. A1250-A1259.
40. Saravanan, K.; Lee, H.S.; Kuezma, M.; Vittal, J.J. and Balaya, P.; *Hollow alpha-LiVOPO(4) sphere cathodes for high energy Li-ion battery application*, Journal of Materials Chemistry, **2011**, 21(27): p. 10042-10050.
41. Wang, L.; Yang, L.B.; Gong, L.; Jiang, X.Q.; Yuan, K. and Hu, Z.B.; *Synthesis of LiVOPO(4) for cathode materials by coordination and microwave sintering*, Electrochimica Acta, **2011**, 56(20): p. 6906-6911.
42. Hameed, A.S.; Nagarathinam, M.; Reddy, M.V.; Chowdari, B.V.R. and Vittal, J.J.; *Synthesis and electrochemical studies of layer-structured metastable alpha(1)-LiVOPO(4)*, Journal of Materials Chemistry, **2012**, 22(15): p. 7206-7213.
43. Rouse, G.; Rodriguez-Carvajal, J.; Wurm, C. and Masquelier, C.; *Magnetic structure of two lithium iron phosphates: A- and B-Li(3)Fe(2)(PO(4))(3)*, Applied Physics a-Materials Science & Processing, **2002**, 74: p. S704-S706.
44. Kishore, A.S.; Pralong, V.; Caignaert, V.; Varadaraju, U.V. and Raveau, B.; *A new lithium vanadyl diphosphate Li(2)VOP(2)O(7): Synthesis and electrochemical study*, Solid State Sciences, **2008**, 10(10): p. 1285-1291.
45. Kishore, M.S.; Pralong, V.; Caignaert, V.; Varadaraju, U.V. and Raveau, B.; *Synthesis and electrochemical properties of a new vanadyl phosphate: Li(4)VO(PO(4))(2)*, Electrochemistry Communications, **2006**, 8(10): p. 1558-1562.
46. Makimura, Y.; Cahill, L.S.; Iriyama, Y.; Goward, G.R. and Nazar, L.F.; *Layered lithium vanadium fluorophosphate, Li(5)V(PO(4))(2)F(2): A 4 V class positive electrode material for lithium-ion batteries*, Chemistry of Materials, **2008**, 20(13): p. 4240-4248.
47. Park, Y.-U.; Seo, D.-H.; Kim, B.; Hong, K.-P.; Kim, H.; Lee, S.; Shakoor, R.A.; Miyasaka, K.; Tarascon, J.-M. and Kang, K.; *Tailoring a fluorophosphate as a novel 4 V cathode for lithium-ion batteries*, Sci. Rep., **2012**, 2.
48. Barker, J.; Saidi, M.Y. and Swoyer, J.L.; *A sodium-ion cell based on the fluorophosphate compound NaVPO(4)F*, Electrochemical and Solid State Letters, **2003**, 6(1): p. A1-A4.
49. Barker, J.; Saidi, M.Y. and Swoyer, J.L.; *A comparative investigation of the Li insertion properties of the novel fluorophosphate phases, NaVPO(4)(4)(FandLiVPO)F*, Journal of the Electrochemical Society, **2004**, 151(10): p. A1670-A1677.
50. Zhao, J.Q.; He, J.P.; Ding, X.C.; Zhou, J.H.; Ma, Y.O.; Wu, S.C. and Huang, R.M.; *A novel sol-gel synthesis route to NaVPO(4)F as cathode material for hybrid lithium ion batteries*, JOURNAL OF POWER SOURCES, **2010**, 195(19): p. 6854-6859.
51. Barker, J.; Gover, R.K.B.; Burns, P. and Bryan, A.J.; *Hybrid-ion - A lithium-ion cell based on a sodium insertion material*, Electrochemical and Solid State Letters, **2006**, 9(4): p. A190-A192.
52. Gover, R.K.B.; Bryan, A.; Burns, P. and Barker, J.; *The electrochemical insertion properties of sodium vanadium fluorophosphate, Na(3)V(2)(PO(4))(2)F(3)*, Solid State Ionics, **2006**, 177(17-18): p. 1495-1500.
53. Barker, J.; Gover, R.K.B.; Burns, P. and Bryan, A.J.; *Li(4/3)Ti(5/3)O(4) parallel to Na(3)V(2),(PO(4))(2)F(3): An example of a hybrid-ion cell using a non-graphitic anode*, Journal of the Electrochemical Society, **2007**, 154(9): p. A882-A887.
54. Jiang, T.; Chen, G.; Li, A.; Wang, C.Z. and Wei, Y.J.; *Sol-gel preparation and electrochemical properties of Na(3)V(2)(PO(4))(2)F(3)/C composite cathode material for lithium ion batteries*, Journal of Alloys and Compounds, **2009**, 478(1-2): p. 604-607.
55. Shakoor, R.A.; Seo, D.H.; Kim, H.; Park, Y.U.; Kim, J.; Kim, S.W.; Gwon, H.; Lee, S. and Kang, K.; *A combined first principles and experimental study on Na(3)V(2)(PO(4))(2)F(3) for rechargeable Na batteries (vol 22, pg 20535, 2012)*, Journal of Materials Chemistry, **2012**, 22(48): p. 25498-25498.
56. Huang, H.; Faulkner, T.; Barker, J. and Saidi, M.Y.; *Lithium metal phosphates, power and automotive applications*, Journal of Power Sources, **2009**, 189(1): p. 748-751.
57. Barker, J.; Saidi, M.Y.; Gover, R.K.B.; Burns, P. and Bryan, A.; *The effect of Al substitution on the lithium insertion properties of lithium vanadium fluorophosphate, LiVPO(4)F*, Journal of Power Sources, **2007**, 174(2): p. 927-931.

58. Barker, J.; Gover, R.K.B.; Burns, P. and Bryan, A.J.; *A lithium-ion cell based on $\text{Li}(4/3)\text{Ti}(5/3)\text{O}(4)$ and $\text{LiVPO}(4)\text{F}$* , *Electrochemical and Solid State Letters*, **2007**, 10(5): p. A130-A133.
59. Barker, J.; Saidi, M.Y. and Swoyer, J.; *Lithium Metal Fluorophosphate and Preparation Thereof*, US Patent **2005**, 0142056 A1(US 2005).
60. Barker, J.; Gover, R.K.B.; Burns, P. and Bryan, A.; *A symmetrical lithium-ion cell based on lithium vanadium fluorophosphate, $\text{LiVPO}(4)\text{F}$* , *Electrochemical and Solid State Letters*, **2005**, 8(6): p. A285-A287.
61. Plashnitsa, L.S.; Kobayashi, E.; Okada, S. and Yamaki, J.; *Symmetric lithium-ion cell based on lithium vanadium fluorophosphate with ionic liquid electrolyte*, *Electrochimica Acta*, **2011**, 56(3): p. 1344-1351.
62. Leriche, J.B.; Hamelet, S.; Shu, J.; Morcrette, M.; Masquelier, C.; Ouvrard, G.; Zerrouki, M.; Soudan, P.; Belin, S.; Elkaim, E. and Baudalet, F.; *An Electrochemical Cell for Operando Study of Lithium Batteries Using Synchrotron Radiation*, *Journal of the Electrochemical Society*, **2010**, 157(5): p. A606-A610.
63. Ouvrard, G.; Zerrouki, M.; Soudan, P.; Lestriez, B.; Masquelier, C.; Morcrette, M.; Hamelet, S.; Belin, S.; Flank, A.M. and Baudalet, F.; *Heterogeneous behaviour of the lithium battery composite electrode LiFePO_4* , *JOURNAL OF POWER SOURCES*, **2013**, 229(0): p. 16-21.
64. Morgan, D.; Ceder, G.; Saidi, M.Y.; Barker, J.; Swoyer, J.; Huang, H. and Adamson, G.; *Experimental and computational study of the structure and electrochemical properties of monoclinic $\text{Li}(x)\text{M}(2)(\text{PO}(4))(3)$ compounds*, *JOURNAL OF POWER SOURCES*, **2003**, 119: p. 755-759.
65. Recham, N.; Chotard, J.N.; Dupont, L.; Delacourt, C.; Walker, W.; Armand, M. and Tarascon, J.M.; *A 3.6 V lithium-based fluorosulphate insertion positive electrode for lithium-ion batteries*, *Nature Materials*, **2010**, 9(1): p. 68-74.
66. Tripathi, R.; Ramesh, T.N.; Ellis, B.L. and Nazar, L.F.; *Scalable Synthesis of Tavorite $\text{LiFeSO}(4)\text{F}$ and $\text{NaFeSO}(4)\text{F}$ Cathode Materials*, *Angewandte Chemie-International Edition*, **2010**, 49(46): p. 8738-8742.
67. Moreau, P.; Guyomard, D.; Gaubicher, J. and Boucher, F.; *Structure and Stability of Sodium Intercalated Phases in Olivine $\text{FePO}(4)$* , *Chemistry of Materials*, **2010**, 22(14): p. 4126-4128.
68. Casas-Cabanas, M.; Roddatis, V.V.; Saurel, D.; Kubiak, P.; Carretero-Gonzalez, J.; Palomares, V.; Serras, P. and Rojo, T.; *Crystal chemistry of Na insertion/deinsertion in $\text{FePO}(4)$ - $\text{NaFePO}(4)$* , *Journal of Materials Chemistry*, **2012**, 22(34): p. 17421-17423.
69. Bain, G.A. and Berry, J.F.; *Diamagnetic corrections and Pascal's constants*, *Journal of Chemical Education*, **2008**, 85(4): p. 532-536.
70. Melot, B.C.; Rouse, G.; Chotard, J.N.; Ati, M.; Rodriguez-Carvajal, J.; Kemei, M.C. and Tarascon, J.M.; *Magnetic Structure and Properties of the Li-Ion Battery Materials $\text{FeSO}(4)\text{F}$ and $\text{LiFeSO}(4)\text{F}$* , *Chemistry of Materials*, **2011**, 23(11): p. 2922-2930.
71. Sears, V.F.; *Neutron scattering lengths and cross section*, *Neutron News*, **1992**, 3(3): p. 26-37.
72. Ramesh, T.N.; Lee, K.T.; Ellis, B.L. and Nazar, L.F.; *Tavorite Lithium Iron Fluorophosphate Cathode Materials: Phase Transition and Electrochemistry of $\text{LiFePO}(4)\text{F}$ - $\text{Li}(2)\text{FePO}(4)\text{F}$* , *Electrochemical and Solid State Letters*, **2010**, 13(4): p. A43-A47.
73. Girgsdies, F.; Dong, W.S.; Bartley, J.K.; Hutchings, G.J.; Schlogl, R. and Ressler, T.; *The crystal structure of epsilon- $\text{VOPO}(4)$* , *Solid State Sciences*, **2006**, 8(7): p. 807-812.

Chapter III
SYNTHESIS, CRYSTAL STRUCTURE
AND ELECTROCHEMICAL
PROPERTIES OF LiFePO_4F

Contents

III-1. Introduction.....	107
III-2. SYNTHESIS OF LiFePO_4F	109
III-2a. Iono-thermal Synthesis.....	110
III-2b. One-step Ceramic Synthesis.....	112
III-2c. Mössbauer spectroscopy and Magnetic properties of LiFePO_4F	113
III-2d. Conclusion	115
III-3. CRYSTAL AND MAGNETIC STRUCTURES OF LiFePO_4F	116
III-3a. Crystal structure of LiFePO_4F	116
III-3b. NMR measurements.....	121
III-3c. Magnetic structure of LiFePO_4F	124
III-4. ELECTROCHEMICAL PROPERTIES OF LiFePO_4F	127
III-5. Conclusion and summary of this chapter	134

III-1. Introduction

As established by J.B. Goodenough and coworkers [1, 2] for NASICON-type compositions, it is possible to increase the average operating potential of the Fe³⁺/Fe²⁺ redox couple by shifting from PO₄ to XO₄ groups (with X = W or S). This could be well established for the Tavorite-type structure AFeXO₄Y as well (with A = Li or H, X = P or S, Y = OH or F) in which the average potential of the redox couple Fe³⁺/Fe²⁺ increases when substituting SO₄ for PO₄ (illustrated in Table III-1 and Figure III-1). As described previously in this manuscript for vanadium-containing compositions, the presence of fluorine increases the average potential vs. Li of the Fe³⁺/Fe²⁺ redox couple.

Table III-1: recorded potential vs. Li of the Fe³⁺/Fe²⁺ redox couple, theoretical capacity, and energy density for reported Tavorite type compositions AFeXO₄Y (with A= Li or H, X=P or S, Y = OH or F)

		Average potentials (V vs. Li ⁺ /Li)	Theoretical capacities (mAh/g)	Energy densities (Wh/g)
FePO ₄ ·H ₂ O	[3]	3.0	159	445
FeSO ₄ OH _x F _y	[4]	3.4	158	537
FeSO ₄ F	[4]	3.6	157	565
LiFePO ₄ OH	[5]	2.6	153	413
LiFePO ₄ OH _{0.6} F _{0.4}	[6]	2.7	168	437
LiFePO ₄ F	[7, 8]	2.8	152	426
LiFeSO ₄ F _(Tavorite)	[9, 10]	3.6	151	544
LiFeSO ₄ F _(Triplite)	[11, 12]	3.9	151	589

The increase of the electronegativity difference between M and Y leads to a higher ionic character of the M–Y bond, which stabilizes the anti-bonding orbital of the metal M and thus increases the energy difference with the negative Li electrode.

Figure III-1 illustrates that lithium iron sulfates exhibit higher potential vs. Li⁺/Li compared to lithium iron phosphates. For both sulfates and phosphates, the presence of fluorine widens the potential windows. One can therefore notice that the potential of the Tavorite LiFeSO₄·OH is 0.35 V higher than the potential of the Tavorite LiFeSO₄F [9, 10, 13, 14]. In the same way, the potential of LiFePO₄F is 0.20 V higher than the potential of LiFePO₄·OH [3, 8, 9, 15]. The best illustrations of the fluorine effect can be seen in the operating potential of the Tavorite LiFePO₄OH_{0.4}F_{0.6} [6] which appeared to be 2.7 V vs. Li⁺/Li just in between the operating potential of LiFePO₄F (2.8 V) and LiFePO₄OH (2.6 V). It is worth to notice that the operating potential of

the Triplite phase LiFeSO_4F is 3.9 V vs. Li^+/Li , known as the highest potential recorded for the redox couple $\text{Fe}^{3+}/\text{Fe}^{2+}$.

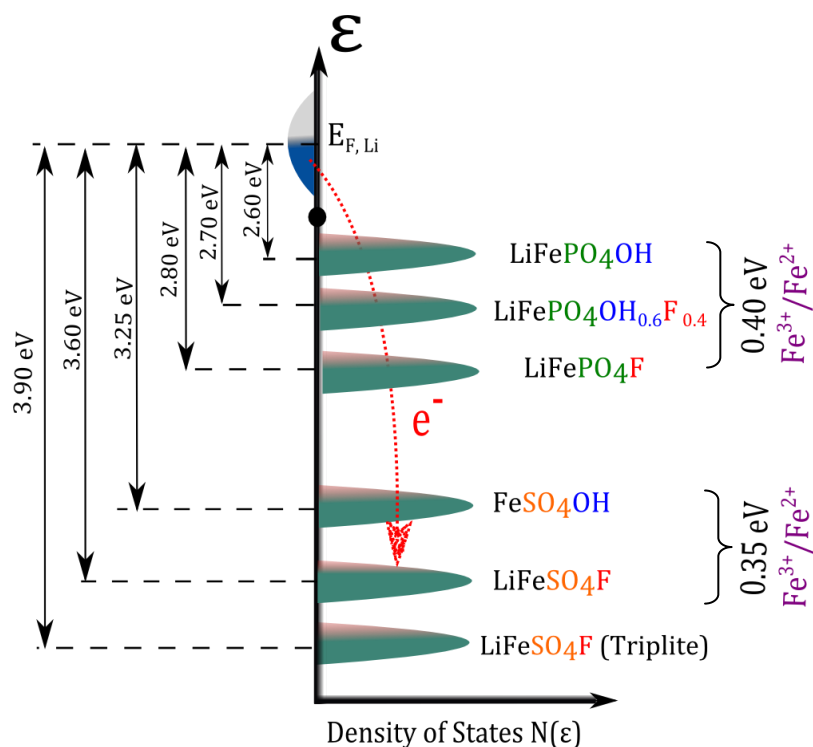

Figure III-1: Respective positions of the $\text{Fe}^{3+}/\text{Fe}^{2+}$ redox couple in iron phosphates/sulfates

As part of our study on Tavorite-type fluorophosphate materials, we have studied the lithium iron fluorophosphate LiFePO_4F which had been synthesized for the first time by N. Recham et al. [7, 16] using ceramic or iono-thermal synthesis routes. T.N. Ramesh et al. [8] and M. Prabu et al. [15] reported the synthesis of LiFePO_4F through a two-step ceramic synthesis with FePO_4 used as an intermediate. In this chapter, we are presenting both iono-thermal and ceramic synthesis routes as well as the advantages and drawbacks of each technique.

N. Recham et al. [7] and T.N. Ramesh et al. [8] published the crystal structure of LiFePO_4F based on laboratory X-Ray diffraction. They both proposed that LiFePO_4F crystallizes in the Tavorite structure with two crystallographic sites for lithium. We will present in this chapter our structural study of LiFePO_4F , based on Rietveld refinements of both X-Ray and neutron diffraction data, both being supported by NMR measurements.

Although the two reported electrochemical signatures in literature [7,8] are significantly different, their operating potentials are roughly the same, i.e. ~ 2.80 V vs. Li^+/Li . We are presenting here the electrochemical signature of LiFePO_4F performed at different cycling rates as well as in situ X-Ray diffraction during the charge / discharge processes.

III-2. SYNTHESIS OF LiFePO_4F

J. Barker et al. [17] patented the synthesis of LiFePO_4F through a two-step ceramic route using FePO_4 as an intermediate. N. Recham et al. [7] reported for the first time the synthesis of LiFePO_4F using iono-thermal or ceramic routes. Iono-thermal synthesis was carried out by using ionic liquid (IL) which is constituted by an association of organic cations and anions. This is the reason why ILs are also sometimes referred to as molten salts. The parallel can be established with inorganic salts (such as NaI), which are used for high temperature syntheses. On contrary, the iono-thermal synthesis generally operates at much lower temperatures. Due to their advantages such as non-flammability, low-vapor pressure, high thermal stability, good electrochemical stability, low toxicity, material compatibility, high ions content..., ILs have been widely studied as agents for extraction and separation processes, organic syntheses and catalysis, as well as potential electrolytes for energy storage devices and electroplating [18-22] and as electrolytes in lithium-ion batteries [23]. However the use of ILs are limited since they are expensive.

For the synthesis of LiFePO_4F , N. Recham et al. [7] used 1-butyl-3-methylimidazolium triflate as IL and the synthesis was done at 260 °C for 48 hours using Li_3PO_4 and FeF_3 precursors. The reaction yielded nano-particles of LiFePO_4F as well as the formation of LiF. This is one of the advantages of the iono-thermal synthesis which produces nanometric particles at very low temperatures. Moreover, because of the flexible nature of the cationic/anionic pairs, they present, as solvents, great opportunities to purposely promote nucleation, influencing material properties and allowing the synthesis of materials with specific structure and morphology. The drawback of iono-thermal synthesis is its cost. However, N. Recham et al. [24] mentioned that it was possible to recover and regenerate the IL.

N. Recham et al. [7] also succeeded in the synthesis of LiFePO_4F through a one-step ceramic route by using FeF_3 and Li_3PO_4 , which had been ball-milled and placed in a platinum sealed tube. The tube was heated up to 700 °C for 24 hours. As expected, the particles size obtained was bigger compared with those from iono-thermal synthesis (3-6 μm for the ceramic synthesis vs. 30-60 nm for the iono-thermal synthesis). The drawback of those syntheses (iono-thermal and ceramic) was the formation of LiF obtained at the end of the reaction which was further removed by washing. This therefore raised the question of LiFePO_4F stability upon moisture.

T.N. Ramesh et al. [8] reported the synthesis of LiFePO_4F through a two-step reaction using FePO_4 as an intermediate phase mixed in stoichiometric proportions with LiF . The preparation of FePO_4 was carried out by mixing Fe_2O_3 and $\text{NH}_4\text{H}_2\text{PO}_4$ in stoichiometric proportions and heated up to $870\text{ }^\circ\text{C}$ during 6-10 hours. The obtained FePO_4 was ball-milled with stoichiometric amounts of LiF heated at $575\text{ }^\circ\text{C}$ for 1.25 hours under N_2 flow. The SEM indicated that the obtained particle size of LiFePO_4F was 2-5 μm .

M. Prabu et al. [15] published the synthesis of LiFePO_4F through a two-step reaction using FePO_4 as an intermediate and further mixed with LiF . The synthesis route of FePO_4 differs from the one of T.N. Ramesh since FePO_4 was obtained via a co-precipitation of both $\text{FeCl}_3\cdot 6\text{H}_2\text{O}$ and $\text{Na}_3\text{PO}_4\cdot 12\text{H}_2\text{O}$ which led to FePO_4 . The obtained FePO_4 was dried and further mixed with LiF in stoichiometric proportion prior to be heated up to $575\text{ }^\circ\text{C}$ during one hour.

We are describing here the iono-thermal synthesis, which had been done using two different ILs, and the ceramic synthesis. For both synthesis techniques, the lattice parameters of the obtained phases were compared with those from Tavorite hydroxyl/fluoro-phosphate.

III-2a. Iono-thermal Synthesis

The iono-thermal synthesis of LiFePO_4F was carried out using a protocol similar to the patented route described by Recham et al. [16] in which stoichiometric proportions of Li_3PO_4 and FeF_3 (typically 57.9 mg of Li_3PO_4 and 56.4 mg of FeF_3) were ball-milled under inert Ar gas. The powder was recovered in a glove box filled with Ar prior to be introduced in the Teflon beaker of a Bomb Parr® together with 10 ml of IL. The reaction mixture was stirred for 1 hour in order to solubilize faster both Li_3PO_4 and FeF_3 . For this experiment, two different ILs were used: i) 1-ethyl-3-methylimidazolium bis-(trifluoromethanesulfonyl imide) commercially well known as EMI-TFSI and ii) trifluoromethanesulfonate which will be named as Triflate for commodity. The Teflon beaker was capped and tightened in a stainless steel Bomb PARR® under Ar atmosphere, prior to be heated for 10 hours up to $260\text{ }^\circ\text{C}$ when EMI-TFSI was used and $280\text{ }^\circ\text{C}$ when Triflate was used. The synthesis temperatures were lower than the decomposition temperatures of each IL since EMI-TFSI decomposed at around $300\text{ }^\circ\text{C}$ whereas Triflate decomposed at $310\text{ }^\circ\text{C}$.

The recovered powders were rinsed with acetone to get rid of IL, washed with a large excess of cold water (Temperature below $10\text{ }^\circ\text{C}$) during ~ 1 hour in order to remove LiF which was formed during the synthesis. Finally, the powder was dried in the oven at $60\text{ }^\circ\text{C}$ overnight. Figure III-2a and Figure III-2b present the full-pattern matching refinement of the XRD data of the grey

powder recovered after the synthesis in EMI-TFSI and of the obtained dark green powder obtained when Triflate was used as IL. The use of Triflate yields the formation of “ LiFePO_4F ” accompanied with the triphylite LiFePO_4 as an impurity.

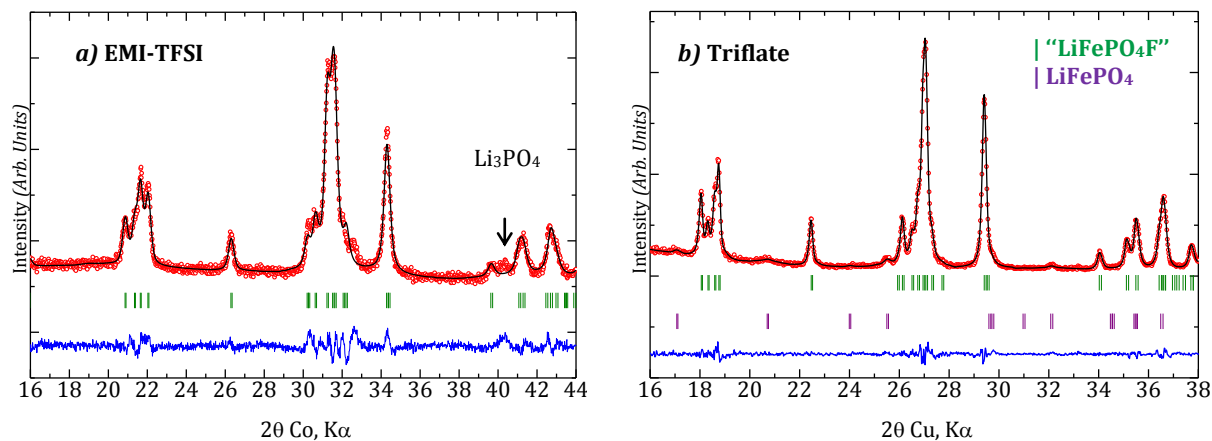

Figure III-2: Full-pattern matching refinements of LiFePO_4F synthesized using a) EMI-TFSI and b) Triflate

Table III-2: Lattice parameters and angles of different LiFePO_4X ($\text{X} = \text{OH}, \text{F}$) obtained by iono-thermal syntheses and compared with those reported in literature

LiFePO_4X $\text{X} = \text{OH}, \text{F}$	a (Å)	b (Å)	c (Å)	α (Å)	β (Å)	γ (Å)	V (Å ³)	V/Z (Å ³)
Iono-thermal synthesis								
From: EMI-TFSI	5.124(7)	5.330(8)	7.301(6)	106.58(3)	109.17(1)	97.82(1)	174.66(1)	87.33
From: Triflate	5.159(4)	5.320(6)	7.277(1)	107.17(8)	108.49(3)	98.10(2)	174.80(5)	87.37
Reported LiFePO_4X from literature ¹								
LiFePO_4F Recham [7]	5.155	5.304	7.261	107.36	107.86	98.62	173.91	86.96
LiFePO_4F Ramesh [8]	5.152	5.300	7.260	107.34	107.88	98.56	173.67	86.84
$\text{LiFePO}_4\text{OH}_{0.4}\text{F}_{0.6}$ Ellis [6]	5.133	5.323	7.288	106.80	109.00	97.82	174.31	87.15
LiFePO_4OH Marx [3]	5.119	5.353	7.290	106.36	109.36	97.73	174.98	87.49
Ceramic synthesis								
Before washing	5.154(2)	5.305(6)	7.258(5)	107.35(4)	107.95(1)	98.47(5)	173.86(5)	86.93
After washing	5.153(8)	5.304(8)	7.257(6)	107.35(2)	107.95(4)	98.47(3)	173.80(3)	86.90

The obtained lattice parameters are gathered in Table III-2 together with the reported lattice parameters of LiFePO_4F [7, 8], $\text{LiFePO}_4(\text{OH})_{0.4}\text{F}_{0.6}$ [6] and LiFePO_4OH [3]. The table indicates that the OH/F content (ligands which bridge the iron octahedra chains) affects the lattice parameters, particularly the unit cell volume. The ionic radii of OH^- is indeed significantly bigger than the

¹ The lattice parameters from T.N. Ramesh, B.L. Ellis and N. Marx have been put in the proper unit cell as described in the General Introduction.

one of F^- (0.152 nm for OH^- vs. 0.119 nm for F^-) and the close inspection of the V/Z ratios in the powders we obtained from iono-thermal synthesis suggests $\text{LiFePO}_4\text{OH}_{1-x}\text{F}_x$ compositions. One can observe from the XRD patterns of the sample prepared by EMI-TFSI, a low crystallinity of the particles. Contrary to the ceramic route, we observed poor reproducibility of the iono-thermal synthesis route.

III-2b. One-step Ceramic Synthesis

The synthesis of LiFePO_4F through a ceramic route was carried out using the patented protocol of N. Recham et al. [16] in which Li_3PO_4 and FeF_3 were chosen as precursors which led to the formation of LiF and LiFePO_4F according to the equation ①:

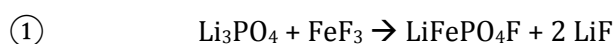

Stoichiometric amounts of Li_3PO_4 and FeF_3 were ball-milled under inert Ar atmosphere. The recovered powder was pressed into a pellet in a glove box filled with Ar and placed in a gold tube sealed under Ar and heated up to 700 °C for 1 hour prior to be quenched in liquid nitrogen.

The obtained yellowish (recalling the color of LiFePO_4OH [3]) pellet was ground and the XRD was performed using a Panalytical diffractometer (X'Pert PRO MPD) with a $\text{Cu K}\alpha_1$ radiation. As presented in Figure III-3a, LiFePO_4F was obtained together with LiF (peak at 38.7°) in the non-washed sample as expected from reaction ①. The peaks of the X-ray diffraction patterns are very sharp compared with those issued from the sample obtained from iono-thermal synthesis (see Figure III-2). The SEM image (insert Figure III-3) indicates highly agglomerated particles with particles size around 5-7 μm .

It is possible, using cold water, to get rid of LiF formed during the synthesis. As shown in Figure III-3b LiF disappeared when the sample had been rinsed in cold water. This raised the question of the stability of LiFePO_4F . According to the unit cell parameter obtained by full-pattern matching refinement of the XRD data, both washed and non-washed LiFePO_4F exhibited very similar unit cell parameters (Table III-2) and the volumes per formula group unit are in agreement with the presence of F^- ligand instead of mixed OH/F . Since well-crystallized and large amounts of pure LiFePO_4F (~500 mg) can be obtained through a one step-ceramic process, we therefore adopted that method for further study of Tavorite LiFePO_4F . The chemical composition of the samples was confirmed by using an ICP-OES spectrometer. The obtained

ratio is $\text{Li}_{1.01}/\text{Fe}_{1.00}/\text{P}_{1.04}$ and no residual H (as one might expect regarding the washed sample) was present which agrees well with the expected formula of LiFePO_4F .

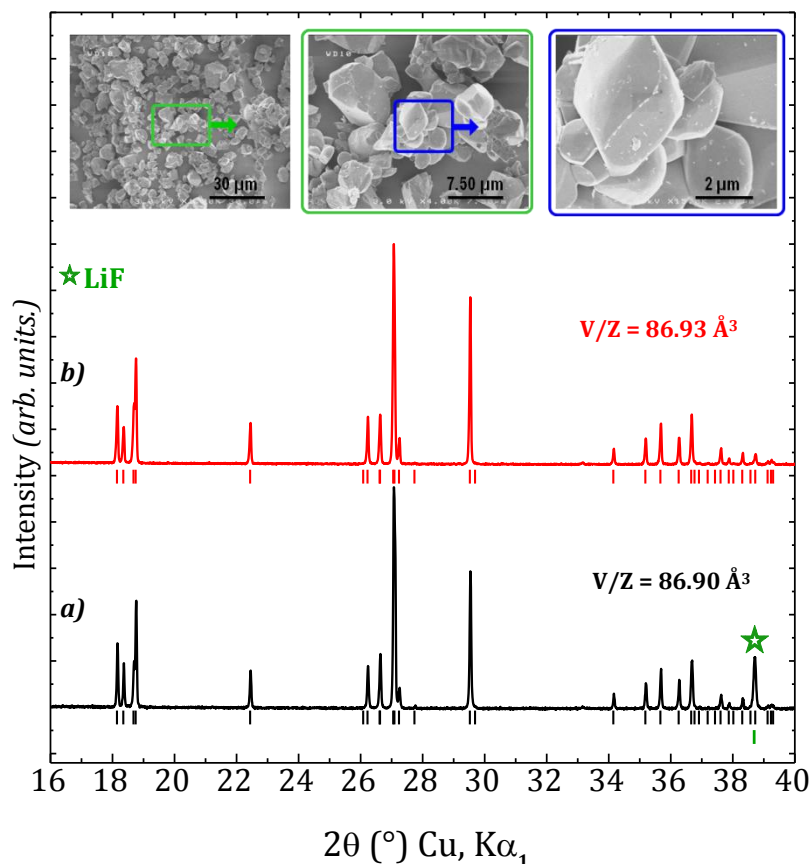

Figure III-3: XRD patterns of LiFePO_4F preparations obtained after ceramic synthesis a) before washing and b) after washing with calculated Bragg positions. SEM images are included in the inserts.

III-2c. Mössbauer spectroscopy and Magnetic properties of LiFePO_4F

Both samples (washed and non-washed) have been studied by Mössbauer spectroscopy in collaboration with A. Wattiaux (ICMCB–Bordeaux). The samples were prepared as finely ground powders. The sample holder was formed by a tight stacking of two nylon disks between which the powders were inserted. The samples were analyzed with a constant acceleration Halder-type spectrometer at room temperature using ^{57}Co source (Rh matrix) in transmission geometry. Polycrystalline absorbers containing about 10 mg/cm^2 of iron were used to avoid the experimental widening of the lines. The velocity was calibrated using pure iron metal as the standard material. The calculation of the spectra was performed in two steps using two computer programs. Preliminary calculations adjust the spectra using Lorentzian profile lines, position, amplitude and width of each line are parameters that can be refined. The obtained Mössbauer parameters of isomer shift δ , quadrupole splitting Δ , and half width of peak Γ , are inserted in Figure III-4. For both (washed and non-washed) samples, the value of the isomer

shift (δ) and of the quadrupolar splitting (Δ) confirmed the presence of Fe^{3+} lying in octahedral sites, indicating that the washing procedure we used had no impact on the recovered LiFePO_4F phase.

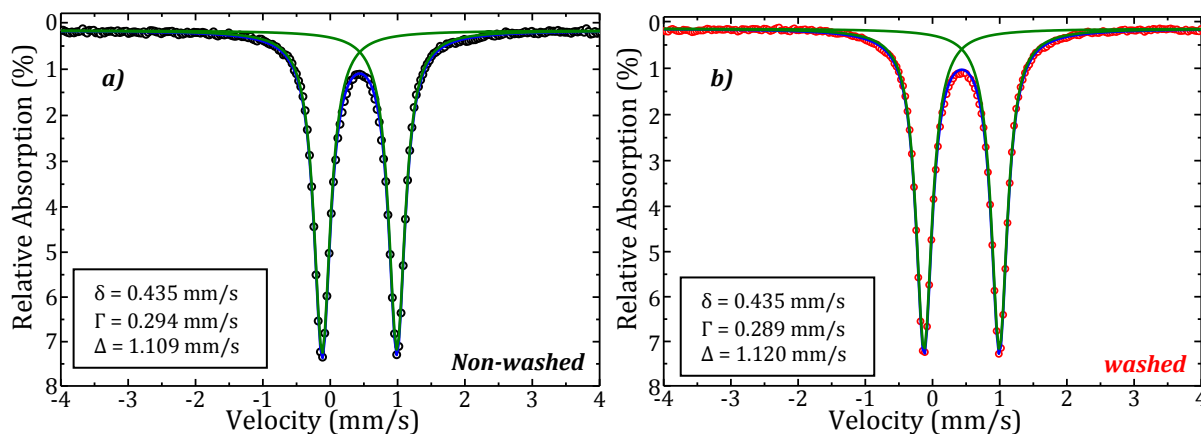

Figure III-4: Calculated spectrum (blue line) and deconvolution (green line) of experimental data obtained a) before washing (black dots) and b) after washing (red dots) for the LiFePO_4F phase obtained by ceramic route

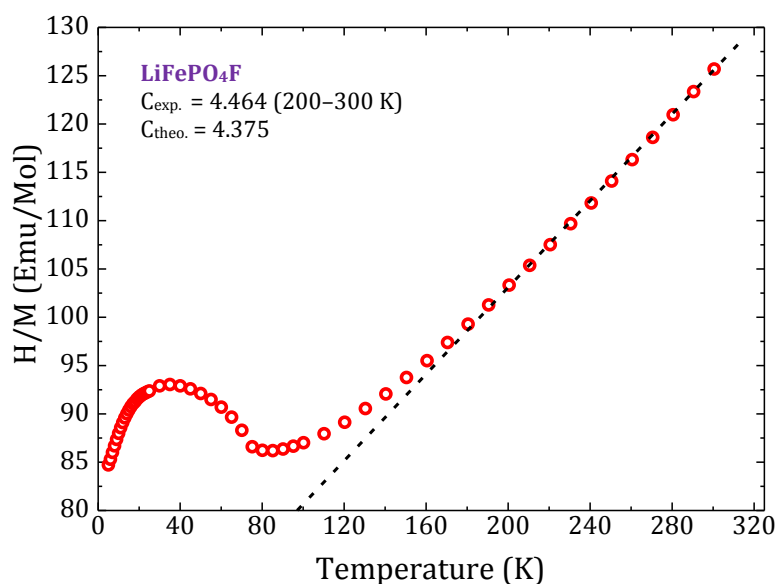

Figure III-5: Temperature dependence of the H/M ratio for the washed LiFePO_4F . Comparison of experimental and theoretical Curie constants is given and the temperature range used for its calculation.

The oxidation state of Fe was also confirmed by the measurement of the static molar magnetic susceptibility of a washed sample. The measurement was made between 5 and 300 K using a SQUID magnetometer (Quantum Design). The zero-field cooled χ value was obtained by cooling the sample in zero-field down to 5 K and then heating it under the applied field. The diamagnetic contributions were corrected using the atomic values from Bain and Berry [25] yielding the χ_M paramagnetic susceptibility contribution. The temperature dependence of the H/M ratio for LiFePO_4F is pictured in Figure III-5. A curvature at around 90 K indicates an antiferromagnetic

behavior and the Néel temperature was determined as being 80 K. A similar antiferromagnetic behavior was also observed for Tavorite LiFeSO_4F and FeSO_4F [26] within which the oxidation state of Fe is +2 and +3 respectively. Note that the Néel temperature determined for LiFeSO_4F is 25 K and 50 K for the delithiated FeSO_4F . In LiFePO_4F , Curie–Weiss type paramagnetism appears for temperatures higher than 200 K. The obtained Curie constant of 4.464 is close to the theoretical value expected for HS Fe^{3+} ($C_{\text{theo}}(\text{LiFe}^{\text{III}}\text{PO}_4\text{F}) = 4.375$). Further confirmation of the different oxidation states of cations (Fe, P and Li) will be given through bond valence calculations within the crystal structures and the magnetic structure at low temperatures will be determined by Rietveld refinement of neutron diffraction data.

III-2d. Conclusion

The iono-thermal synthesis as well as the ceramic synthesis led to the formation of LiF when Li_3PO_4 and FeF_3 were chosen as precursors, so that LiFePO_4F was obtained indirectly. The use of EMI-TFSI and Triflate as solvent for iono-thermal synthesis, led to the formation of $\text{LiFePO}_4\text{OH}_x\text{F}_{(1-x)}$ within which the ligand (bridging two octahedra) is a mix OH/F instead of F. Particles obtained after using Triflate presented higher crystallinity compared with those from EMI-TFSI. The poor reproducibility and the small amounts of powder obtained led us to use a ceramic route for the syntheses of LiFePO_4F .

Ceramic syntheses yielded pure LiFePO_4F powders, free of OH groups and with large and well crystallized particles. ICP analysis confirmed the stoichiometric composition of LiFePO_4F . The experimental Curie constant ($C_{\text{exp.}} = 4.464$) of the obtained powder was in good agreement with the theoretical Curie constant ($C_{\text{theo.}} = 4.375$) confirming the oxidation state of iron (Fe^{3+}). LiF was successfully removed from the final product when the sample had been washed with cold water. Mössbauer spectroscopy indicated no changes of the LiFePO_4F phase after washing (iron oxidation state remained +3).

III-3. CRYSTAL AND MAGNETIC STRUCTURES OF LiFePO_4F

III-3a. Crystal structure of LiFePO_4F

Several proposed crystal structures of LiFePO_4F were published recently, basically with similar descriptions but differing from the occupancies of the Li crystallographic sites. N. Recham et al. [7] described the structure of LiFePO_4F with two crystallographic sites of Li which occupancies had been fixed to 50% for each, separated by a distance of 0.8 Å. T.N. Ramesh et al. [8] described the structure of LiFePO_4F with the occupancies of the two sites of Li being 77% and 23% each and separated by 0.7 Å. In both cases, only lab XRD data were used. We extended this crystallographic study using neutron diffraction data, especially suited for the determination of Li's sites. The structure will be compared with the Tavorite-like analogous $\text{FePO}_4\cdot\text{H}_2\text{O}$ and LiFePO_4OH and the Li positions will be compared with the published position of N. Recham and T.N Ramesh.

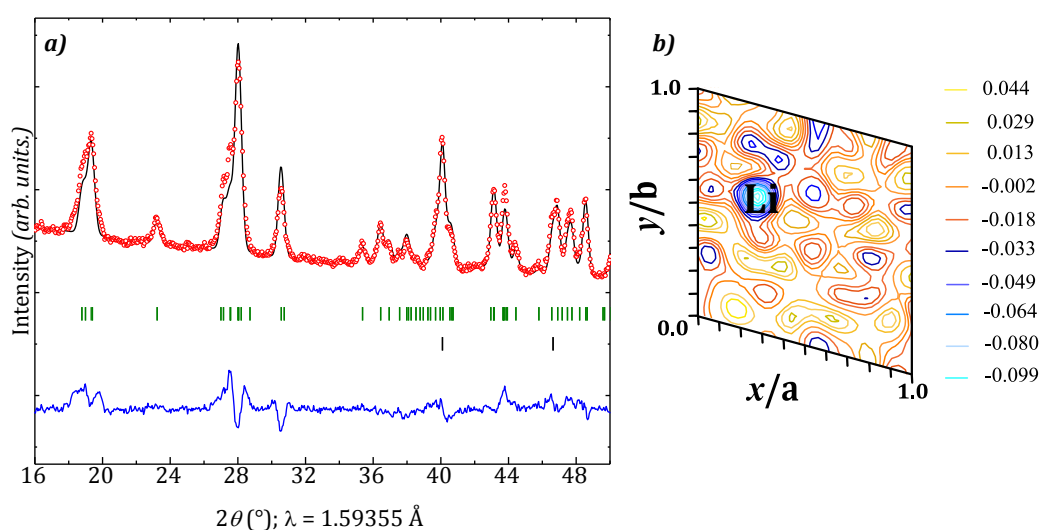

Figure III-6: a) Rietveld refinement of neutron diffraction data (only Fe, P, O and F atoms are considered); b) 2D section of 3D Fourier difference maps at $y = 0.278$ with the maximum corresponding to the Li site in the crystal structure of LiFePO_4F

Just as for LiVPO_4O and LiVPO_4F , (chapter I), the XRD data were collected from a Panalytical diffractometer (X'Pert PRO MPD) equipped with a $\text{Cu K}\alpha_1$ radiation (thanks to a Ge monochromator), and neutron diffraction was performed at the Institute Laue Langevin (Grenoble, France) on the high-resolution diffractometer D2B. For both XRD and neutron diffraction data, the measurements were carried out on the non-washed sample of LiFePO_4F .

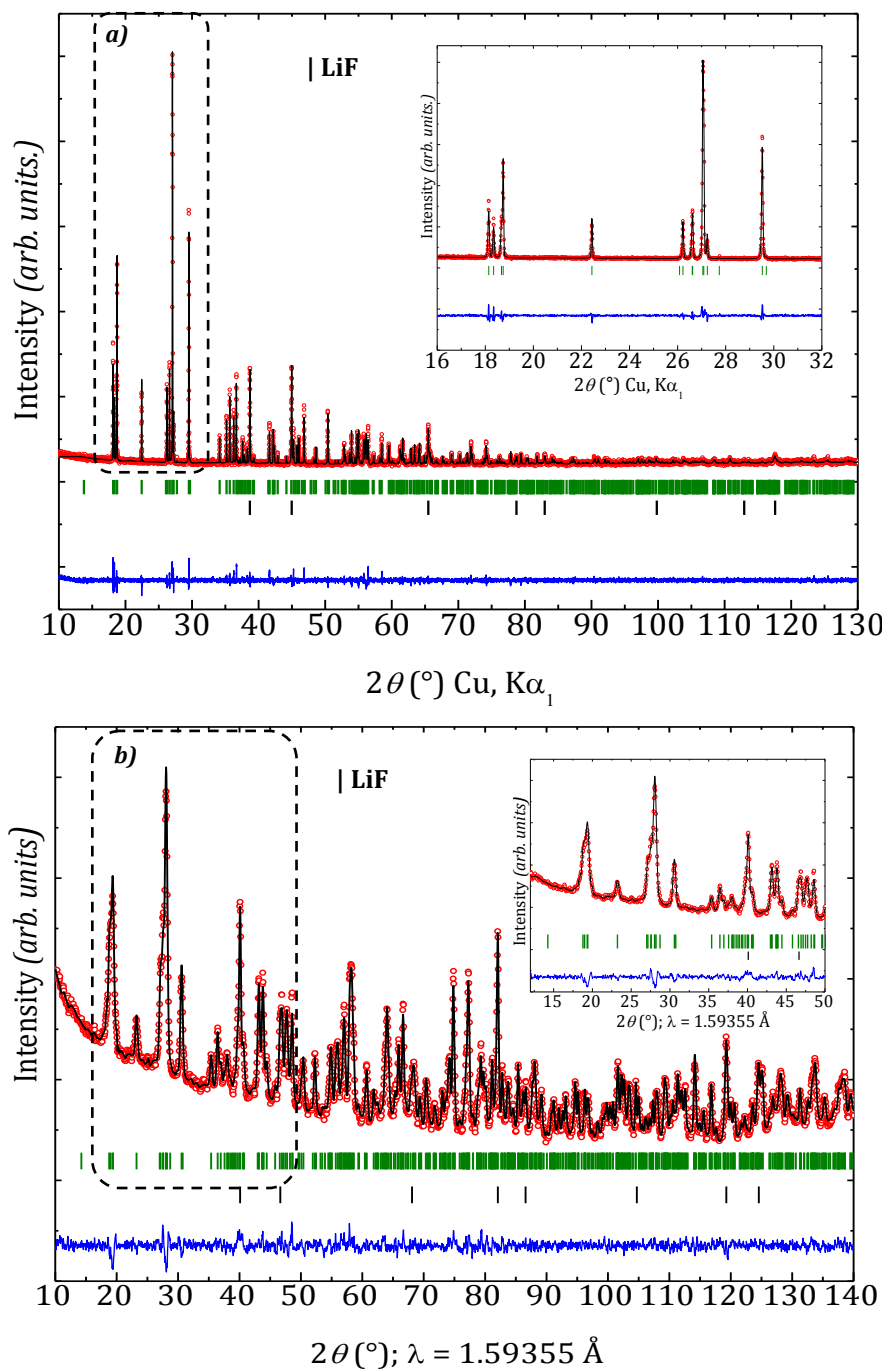

Figure III-7: Observed (red dots), calculated (black line), and difference (blue line) plots obtained for the Rietveld refinement of (a) X-ray diffraction data and (b) neutron diffraction data for LiFePO_4F

The absorption coefficient μ_R is 0.28 [27]. The Rietveld refinements were carried out using the structural model of LiVPO_4F (see Chapter I). The different steps of refinement were as follow:

1. The structural model $\text{Fe}(1)_{1a}\text{Fe}(2)_{1b}\text{P}_{2i}[\text{O}_{2i}]_4\text{F}_{2i}$ free of Li was first refined: in our model, Fe(1) and Fe(2) atoms occupy special $1a$ (0, 0, 0) and $1b$ (0, 0, 1/2) positions respectively. Figure

III-6a shows, in this case, the poor quality of the refinement with bad minimization of the intensity difference.

2. We then calculated Fourier difference maps considering only the host structure $\text{Fe}(1)_{1a}\text{Fe}(2)_{1b}\text{P}_{2i}[\text{O}_{2i}]_4\text{F}_{2i}$. The calculated Fourier (Figure III-6b) differential map shows a maximum negative residual nuclear density located in $2i$ position at $(\sim 0.251, \sim 0.602, \sim 0.281)$.

3. This position was hence included in the atomic coordinates list in order to refine properly the neutron diffraction data. Subsequent Fourier Difference maps showed non residual nuclear densities and we thus adopted a structural model with only one Li(1) crystallographic site at $2i(0.7198(1), 0.3783(7), 0.233(1))$. Separate refinements of thermal motion factors and occupancies led to satisfactory reliability factors (Table III-1 of the ANNEXE I) and good minimization of the difference intensity for X-rays and neutron data refinements, as shown in Figure III-7. The lattice parameters as well as the atomic positions are gathered in Table III-1 of the ANNEX I. The resulting inter-atomic distances are recorded in Table III-2 of the ANNEX I.

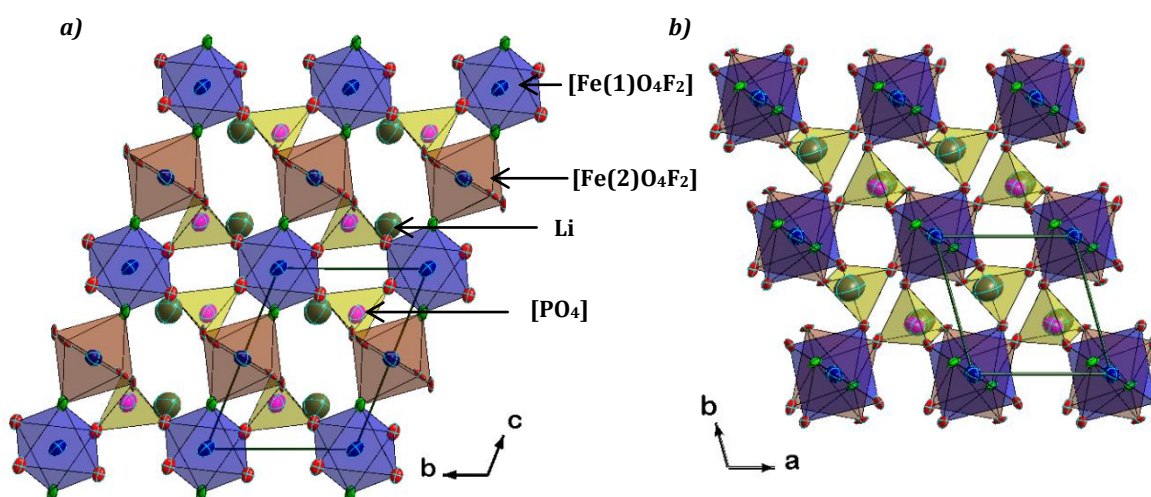

Figure III-8: Skeleton framework structure of Tavorite LiFePO_4F with ellipsoid representation of atoms as obtained after thermal motion refinements

It is well-established that lithium iron (III) fluorophosphate belongs to the Tavorite system so that the crystal structure is built up by $[\text{FeO}_4\text{F}_2]$ octahedra which share common fluorine atoms. The resulting chains are running along $[001]_{p\bar{1}}$ direction. Fe lies within two octahedral sites with Fe–O distances range of 1.95–2.01 Å (Table III-2 of the ANNEX I). The value of the Fe–F distance (1.98 Å), is the same as the V–F one observed along the chains of $[\text{VO}_4\text{F}_2]$ octahedra in the structure of LiVPO_4F . Based on the good quality of the XRD and neutron diffraction data, we were able to refine the anisotropic parameters for all atoms (Table III-3). The anisotropic displacement of Fe is oriented in the equatorial plane of oxygen atoms (Figure III-8).

Table III-3: Anisotropic thermal motion parameters U_{ij} (in \AA^2) for LiFePO_4F

Atoms	U_{11}	U_{22}	U_{33}	U_{12}	U_{13}	U_{23}
Fe(1)	0.01225	0.01155	0.01373	0.00032	0.00531	0.00029
Fe(2)	0.01465	0.01647	0.01392	0.00234	0.00534	0.00668
P	0.01841	0.01377	0.01825	-0.00085	0.00690	0.00347
O(1)	0.01000	0.01600	0.00900	0.00780	0.00490	0.01040
O(2)	0.01272	0.00393	0.01467	0.00433	0.00373	0.00523
O(3)	0.00821	0.00932	0.01431	0.00358	0.00664	0.00374
O(4)	0.00586	0.01018	0.01689	-0.00032	0.00408	0.00385
F	0.01104	0.00556	0.01220	0.00509	0.00045	0.00291
Li	0.07060	0.04885	0.05152	0.02137	0.01270	0.01366

The Fe–F distance in $\text{LiFe}^{\text{III}}\text{PO}_4\text{F}$ is very small compared with the Fe–(OH_2) distance (2.17 \AA) observed in the $\text{Fe}^{\text{III}}\text{PO}_4\cdot\text{H}_2\text{O}$ structure [3]. For $\text{LiFe}^{\text{III}}\text{PO}_4\text{OH}$, it was established that the Fe–(OH) bond lengths were close to 2.02 \AA . The length of the Fe–X bond ($X = \text{F}, \text{OH}, \text{OH}_2$) increases significantly with the presence of OH and OH_2 (see Figure III-9) due to the high covalency of the O–H bond which further weakens the Fe–X bond through the inductive effect.

$$d_{(\text{Fe-F})}\text{LiFePO}_4\text{F} = 1.98 \text{ \AA} < d_{(\text{Fe-OH})}\text{LiFePO}_4\text{OH} = 2.02 \text{ \AA} < d_{(\text{Fe-OH}_2)}\text{HFePO}_4\text{OH} = 2.17 \text{ \AA}$$

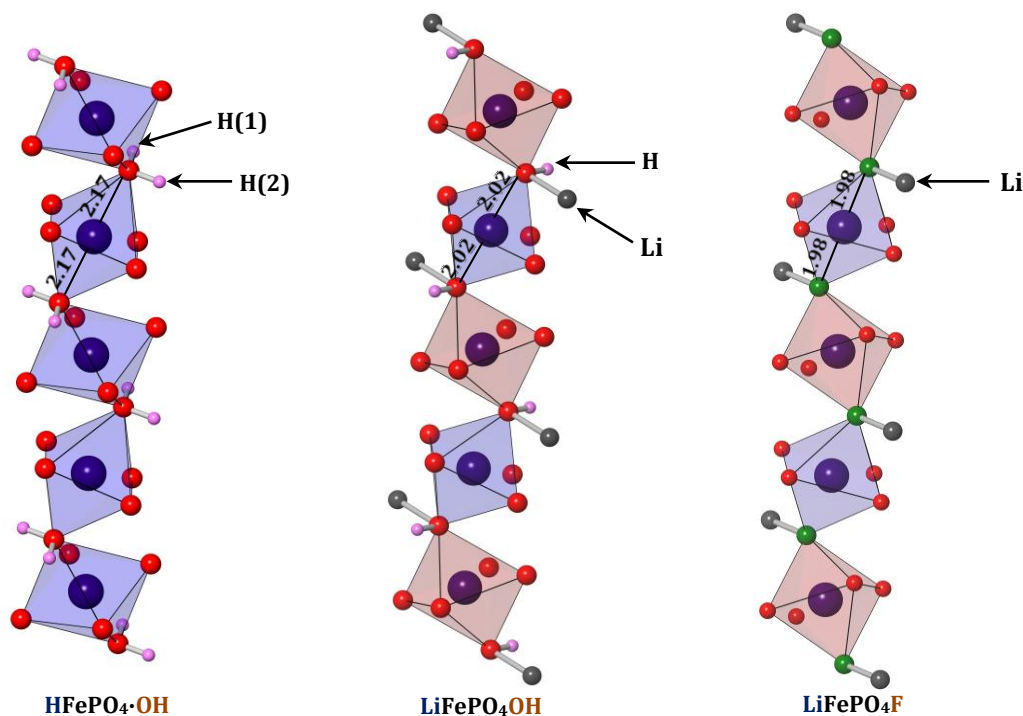
Figure III-9: Octahedral chains of FeO_4X_2 in AFePO_4X (with $A = \text{H}$ or Li and $X = \text{OH}$ or F)

In comparison with LiFePO₄OH, the distortions of the octahedra in the structure of LiFePO₄F are very close to each other ($\Delta_{\text{Fe}(1)\text{O}_4\text{F}_2} = 3.45 \cdot 10^{-5}$ and $\Delta_{\text{Fe}(2)\text{O}_4\text{F}_2} = 1.68 \cdot 10^{-5}$ in LiFePO₄F vs. $\Delta_{\text{Fe}(1)\text{O}_4\text{O}_2} = 1.7 \cdot 10^{-5}$ and $\Delta_{\text{Fe}(2)\text{O}_4\text{O}_2} = 2.7 \cdot 10^{-4}$ in LiFePO₄OH). N. Marx et al. [5] had shown that the difference of the distortion of the two iron octahedral sites was visible in Mössbauer spectroscopy data of LiFePO₄OH through the asymmetric doublet of the observed line. This asymmetry of the doublet together with the broadness of the lines led N. Marx to consider and to refine the Mössbauer spectrum with two different sites of Fe. We first considered N. Marx's approach (two different crystallographic sites of Fe) for the refinement of the Mössbauer data. The obtained χ^2 value was very poor although we had a very good data resolution. Based on the very similar distortion of the two iron octahedra sites and to the sharpness of the lines, we successfully refined the Mössbauer data considering one distribution site of Fe. The obtained Mössbauer parameters are listed in Table III-4.

Table III-4: Mössbauer parameters, distortions and Fe-X distances of the washed LiFePO₄F (LiFePO₄F_w) and the non-washed LiFePO₄F (LiFePO₄F_{nw}) in this study compared with the reported LiFePO₄OH and HFePO₄OH [3].

Sites	LiFePO ₄ F _{nw}		LiFePO ₄ F _w		LiFePO ₄ OH		HFePO ₄ OH
	Fe ³⁺ (1)	Fe ³⁺ (2)	Fe ³⁺ (1)	Fe ³⁺ (2)	Fe ³⁺ (1)	Fe ³⁺ (2)	Fe ³⁺
Distortion of [FeO ₄ X ₂]	3.45·10 ⁻⁵	1.68·10 ⁻⁵	3.45·10 ⁻⁵	1.68·10 ⁻⁵	1.7·10 ⁻⁵	2.7·10 ⁻⁴	2.8·10 ⁻³
Fe-X (Å)	1.98	1.98	1.98	1.98	2.02	2.02	2.17
δ (mm/s)	0.435		0.435		0.405	0.415	0.407
Γ (mm/s)	0.294		0.289		0.3	0.3	0.3
Δ (mm/s)	1.109		1.120		0.67	0.57	1.58
%	100		100		49.6	50.4	100

The values of the isomer shifts (δ) are typical for the oxidation state +3 of Fe [28] and the quadrupolar splitting (Δ) fits well with Fe³⁺ in octahedral environment [28]. The isomer shift depends on the oxidation state of Fe and also on the ligand, as illustrated in Table III-4. The FWHM (Γ) were fixed to 0.3 for both LiFePO₄OH and FePO₄·H₂O [29], whereas for LiFePO₄F, this value was refined and converged to 0.294 and 0.289 for non-washed and washed samples respectively. N. Marx et al. [29] had linked the quadrupolar splitting with the distortion of [FeO₄X₂] claiming that the quadrupolar splitting decreases when octahedral site of Fe is more symmetrical. This argument does not apply to LiFePO₄F which presents a higher quadrupolar splitting despite less distorted octahedral sites of Fe.

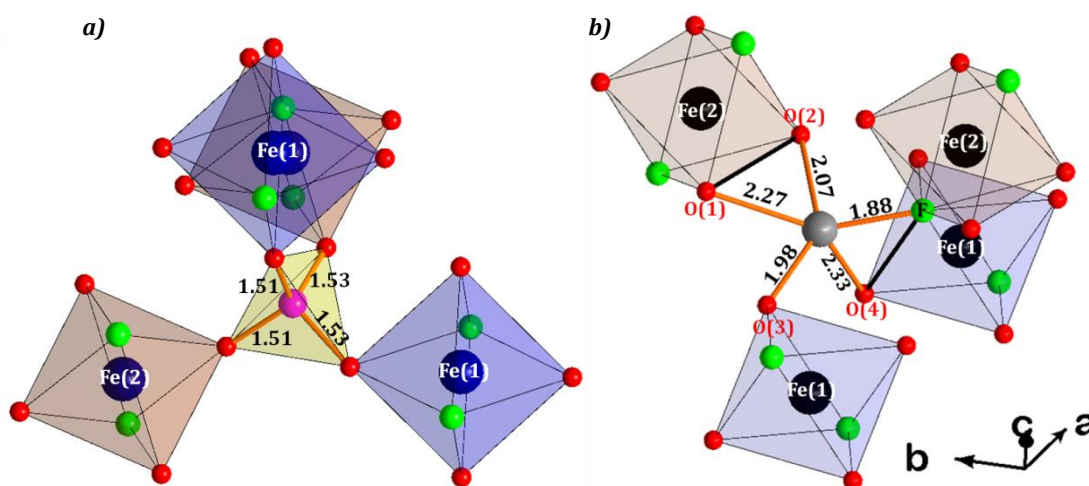

Figure III-10: a) Schematic representation of $[\text{PO}_4]$ tetrahedron local environment in LiFePO_4F
 b) Schematic representation of LiO_4F local environment in LiFePO_4F .

The P–O distances in LiFePO_4F are in a very narrow range of 1.50–1.55 Å (Figure III-10a). This unique phosphorus atom lies within a tetrahedron which distortion is $\Delta = 4.14 \cdot 10^{-5}$, very similar to the distortion of the $[\text{PO}_4]$ tetrahedron in LiFePO_4OH ($\Delta = 4.2 \cdot 10^{-5}$) and different compared with the one from $\text{FePO}_4 \cdot \text{H}_2\text{O}$ ($\Delta = 3.8 \cdot 10^{-4}$).

As seen in Figure III-10b, the unique Li(1) site is surrounded by four oxygen and one fluorine atoms, forming a very distorted five-vertex polyhedron ($\Delta = 6.51 \cdot 10^{-3}$). Just like in the case of LiVPO_4F , the pentahedral site around Li^+ shares one edge with one $[\text{Fe}(2)\text{O}_4\text{F}_2]$ and $[\text{Fe}(1)\text{O}_4\text{F}_2]$ respectively. As illustrated in Figure III.9 the Li position is in the ligand's neighborhood for both LiFePO_4OH and LiFePO_4F . In both structures, Li is oriented in the same direction as H(2) in $\text{FePO}_4 \cdot \text{H}_2\text{O}$. The calculated valence bond sums (BVS) for the cations using “Bond_Str” software in Fullprof_suite matched well with expected values and gave respectively $\text{BVS}_{\text{Fe}(1)}=3.04$, $\text{BVS}_{\text{Fe}(2)}=3.02$, $\text{BVS}_{\text{P}(1)}=5.10$, and $\text{BVS}_{\text{Li}(1)}=0.95$ in reasonably good agreement with expectations.

III-3b. NMR measurements

The ^7Li , ^{31}P , and ^{19}F MAS NMR spectra were recorded (in collaboration with M. Ménétrier and M. Duttine) at 100MHz in the same conditions as previously reported (Chapter I) using a Bruker Avance III spectrometer equipped with a 2.35 T magnet.

The ^7Li MAS NMR (Figure III-11a) exhibits two sharp isotropic signals located at 203 ppm and -1 ppm corresponding to the unique lithium site in the LiFePO_4F structure and to LiF respectively. This result is in a good agreement with Rietveld refinements of neutron diffraction data which established only one Li site in LiFePO_4F structure. The unique site of lithium in

LiFePO_4F is consistent with previous observations in fluorophosphate/sulphate Tavorite compositions where one lithium site has been found [5, 10, 29, 30]. One can notice a tiny shoulder at 150 ppm associated with an impurity which could not be detected by X-ray diffraction. Further NMR studies have to be performed in order to know whether this signal is an impurity or is correlated to the signal at 203 ppm *i.e.* associated to some structural defects in the LiFePO_4F structure. The shift in LiFePO_4F is stronger than in LiVPO_4F , since HS Fe^{3+} contains much more electron spins with a $t_{2g}^3 e_g^2$ electronic configuration.

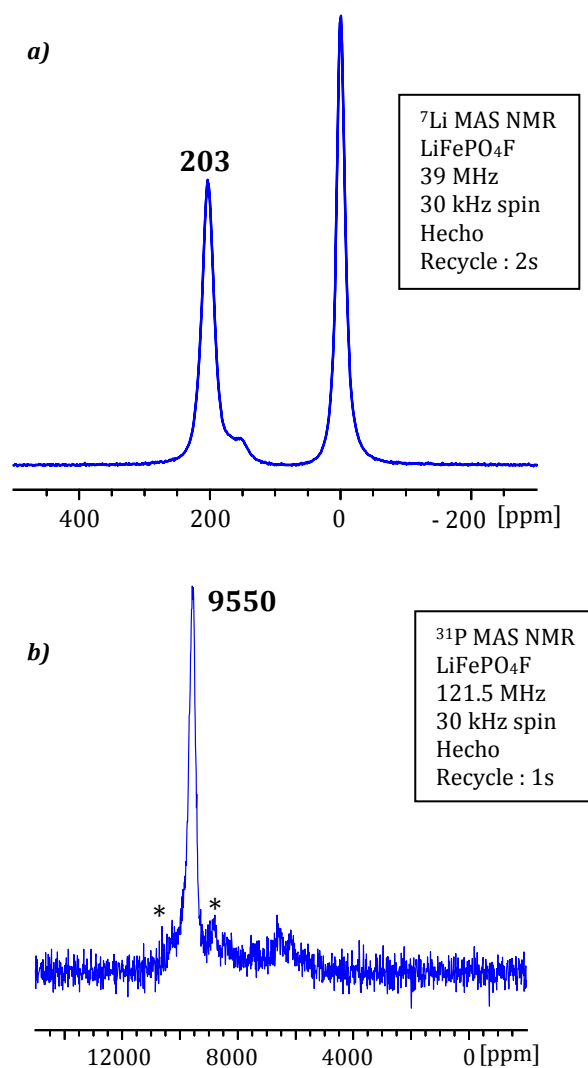

Figure III-11: a) ${}^7\text{Li}$ MAS NMR and b) ${}^{31}\text{P}$ MAS NMR spectrum of LiFePO_4F (spinning sidebands are shown by asterisks).

As expected regarding the above-described structure, ${}^{31}\text{P}$ MAS NMR exhibits one sharp signal, which is highly shifted at 9550 ppm, a logically higher value again than in the V compound (Figure III-11b). Additional weaker contributions are also present around 6500 ppm, which can be due to impurities and/or defects (like the additional ${}^7\text{Li}$ NMR signal).

No signal was observed by ^{19}F MAS NMR, which is not a surprise since Fe^{3+} with high spin configuration $t_{2g}^3 e_g^2$ should exert a very strong electron-nucleus dipolar interaction and contribute to a very high electron spin transfer. The ^{19}F NMR signal is therefore expected to be much broader and more shifted (Fermi contact) than the signal in LiVPO_4F (-1500 ppm) where the configuration of V^{3+} is $t_{2g}^2 e_g^0$.

Since LiFePO_4OH , $\text{FePO}_4 \cdot \text{H}_2\text{O}$ and LiFePO_4F all contain HS Fe^{3+} with all d orbitals containing one electron spin, the situation is a priori simpler than in the V case (see chapter I), and it is tempting to discuss the comparison of the Li and P shifts in the three compounds. In $\text{FePO}_4 \cdot \text{H}_2\text{O}$, the (H₂-)O—Fe bond is weakened (and lengthened) by the two antagonistic strongly covalent O—H bonds compared to LiFePO_4OH . This leads to shorter and stronger Fe—O—P bonds and consequently to a stronger hyperfine interaction causing a stronger ^{31}P NMR shift in $\text{FePO}_4 \cdot \text{H}_2\text{O}$ than in LiFePO_4OH as discussed by Castets et al. [31]. In the LiFePO_4F case, one cannot compare the Fe—F distance to that of Fe—O(—H or H₂) in order to compare bond strengths or covalency with the oxide compounds, and to discuss the antagonistic (P—)O—Fe bond. However, the latter bond distance in LiFePO_4F is somehow intermediate between those in the two oxides, and so is the ^{31}P NMR shift (9550 ppm compared to 7498 ppm for LiFePO_4OH and 11 066 ppm for $\text{FePO}_4 \cdot \text{H}_2\text{O}$). On the contrary, the Li NMR shifts are rather close in LiFePO_4F (203 ppm) and LiFePO_4OH (214 ppm).

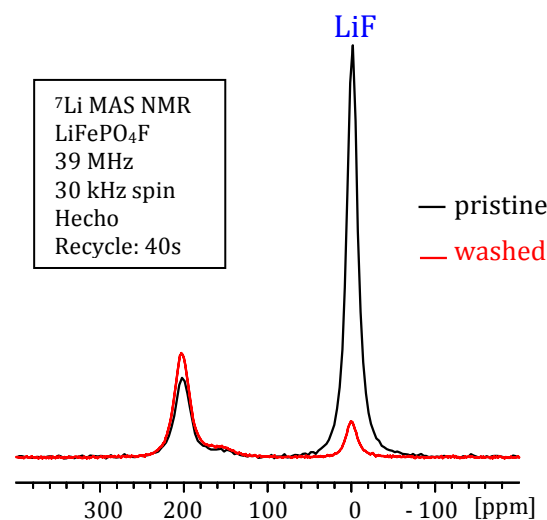

Figure III-12: ^{7}Li MAS NMR spectrum of LiFePO_4F before (black) and after (red) washing.

Figure III-12, illustrates the effect of the “washing” procedure we used for $\text{LiFePO}_4\text{F}/\text{LiF}$ mixtures: a very small quantity of LiF can be observed in the MAS NMR spectrum of the washed sample indicating that we have not totally removed LiF contrary to what X-ray diffraction data suggested. Note that the relative ratio between the Li in the material and in LiF is different in this

figure from above (Figure III-11b). This is due to a longer recycle delay used for the spectra in the present figure, required for a quantitative observation of the Li from LiF due to its longer T1 relaxation time. Besides, the peak at 203 ppm associated to the unique lithium site in LiFePO_4F as well as the peak at 150 ppm has not changed after washing, emphasizing the stability of LiFePO_4F .

Further confirmation of the stability of LiFePO_4F has been made using ^1H MAS NMR which shows no significant proton signal in Figure III-13 (the signals present are due to artifacts from the probe and rotor, since they are also observed without a sample), stressing the absence of proton in the washed LiFePO_4F , and in particular, the absence of the LiFePO_4OH phase whose spectrum has been added to the figure for comparison [31-33].

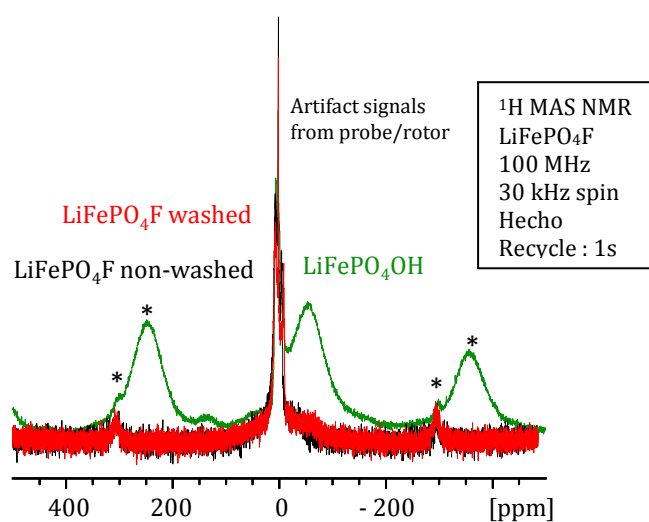

Figure III-13: ^1H MAS NMR spectrum of LiFePO_4F before (black) and after (red) washing compared to the signal for LiFePO_4OH (green). Spinning sidebands are marked by asterisks.

III-3c. Magnetic structure of LiFePO_4F

In collaboration with E. Suard (from ILL-Grenoble) and G. Rousse (from UPMC-Paris), we performed neutron powder diffraction at low temperature, on LiFePO_4F , in order to determine its possible magnetic structure below $T_N = 90$ K using the D2B diffractometer. The non-washed LiFePO_4F sample presents extra peak at 2 K that are a consequence of the long range ordering of the magnetic moments. Those peaks are more intense for LiFePO_4F compared to LiVPO_4F where only two tiny extra peaks appeared resulting from the number of electron spins present in both transition metals.

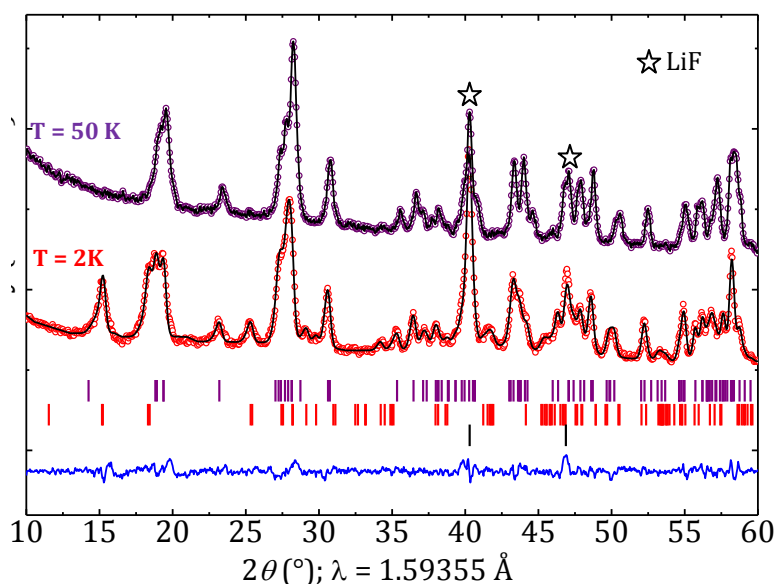

Figure III-14: Rietveld Refinements of neutron diffraction data of the non-washed LiFePO_4F : Observed versus calculated (black line) powder neutron diffraction patterns collected at 2K (red dots) and 50 K (purple dots). The difference pattern (blue line) is displayed at the panel bottom. The positions of the Bragg reflections are shown as vertical bars below

The magnetic peaks can be indexed using the $\mathbf{k} = (\frac{1}{2} \frac{1}{2} 0)$ propagation vector, so that the magnetic cell is 4 times larger than the nuclear cell. The latter being of triclinic symmetry ($P\bar{1}$), there is no constraint to be added between the magnetic moments due to the symmetry analysis: indeed the 2 Fe atoms of the nuclear cell are distributed on the $1a$ and $1b$ Wyckoff positions. We have therefore considered (just as for LiVPO_4F) two possible cases: either the magnetic moments of metals present on the two Wyckoff sites are parallel or antiparallel, so that the resulting magnetic structure will be collinear. The refinement of the 2K structure using these two different models, and allowing the magnetic moment to orient in any direction, leads to a much better refinement when the two magnetic moments of the metals are antiparallel. The refinement leads to a total magnetic moment of $3.92(4) \mu_B$. This value is lower than the $5 \mu_B$ expected for Fe^{3+} in high spin configuration: d^5 , $t_{2g}^3 e_g^2$, $\mathbf{S} = 5/2$, $\mathbf{L} = 0$. B. C. Melot et al. [26] reported a magnetic moment of $4.32 \mu_B$ for $\text{Fe}^{\text{III}}\text{SO}_4\text{F}$.

Figure III-14 presents the refinement of neutron data for both temperatures (above and below T_N) where better evidence of the magnetic peaks is shown on the pattern recorded below T_N . The resulting magnetic structure is presented in Table III-5, and illustrated in Figure III-15. The reliability factor was 4.80% better (lower) than for LiVPO_4F (19.5%) probably due to high intensity magnetic peaks observed for LiFePO_4F contrary to LiVPO_4F in which two tiny peaks were present.

Table III-5: Magnetic moments (μ_B) at 2 K, the components (in μ_B) are given along the a , b and c axes. Propagation vector $k = (\frac{1}{2}, \frac{1}{2}, 0)$, G-type magnetic structure, Magnetic R-factor=4.80%

LiFePO ₄ F					
Atom		m_a	m_b	m_c	$M_{Total} (\mu_B)$
Fe(1)	Fe (0 0 0)	3.4(1)	-1.6(2)	0.7(2)	3.92(4)
Fe(2)	Fe (0 0 $\frac{1}{2}$)	-3.4(1)	1.6(2)	-0.7(2)	3.92(4)

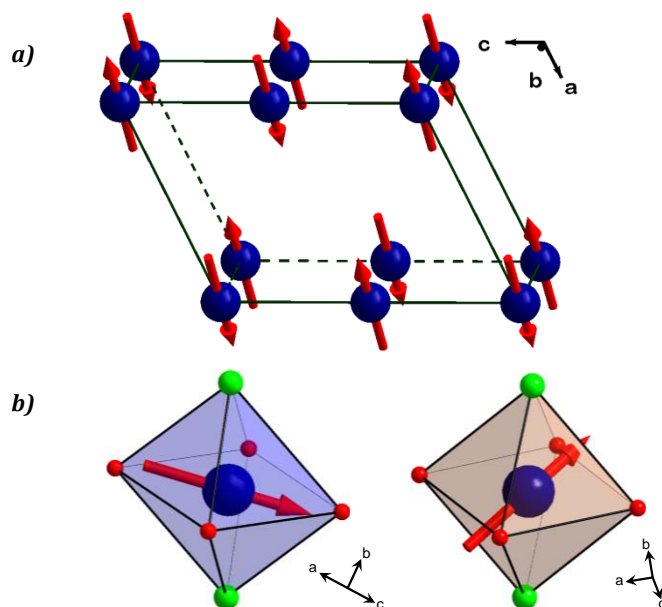

Figure III-15: Illustration of the proposed magnetic structure of LiFePO_4F : a) 3D view of the magnetic structure b) 3D view of moment in isolated octahedra: $[\text{Fe}(1)\text{O}_4\text{F}_2]$ octahedra (blue) and $[\text{Fe}(2)\text{O}_4\text{F}_2]$ octahedra (red)

The magnetic moments that are along the chains are oriented antiparallel, and the chains are also antiparallel through the propagation vector \mathbf{k} . The magnetic structure of LiFePO_4F corresponds to magnetic structures analogous in the G-type antiferromagnetic order of perovskites where all nearest neighbors are antiferromagnetically coupled. The spin sequence is the same as for LiVPO_4F but the orientations of the moments are different. The moments are collinear, and almost lying in the oxygen equatorial plane of the $[\text{FeO}_4\text{F}_2]$ octahedra similar to the orientation of the magnetic moment supported by V(2) in the case of LiVPO_4F . Careful inspection of the moment orientation shows that the moment supported by Fe(1) is oriented throughout oxygen atoms whereas the moment supported by Fe(2) is oriented through opposite octahedral faces. The two moments are perpendicular to the direction of the $[\text{FeO}_4\text{F}_2]$ octahedra chains.

These different orientations of magnetic moments in both LiVPO_4F and LiFePO_4F may be due to the strong spin-orbit coupling observed for Fe^{3+} , but caution has to be exercised concerning the spin orientation of moments, due to the small number of observed magnetic reflections in LiVPO_4F .

When comparing these magnetic structures with the one of the sulfate analog LiFeSO_4F and FeSO_4F [26], we can note the following feature: in terms of spin sequence, the magnetic structure we have here is the same as the one observed for LiFeSO_4F (G-type: all nearest neighbors are antiferromagnetically coupled), although in this latter compound the oxidation state of iron is 2+. In contrary, FeSO_4F (that contains Fe^{3+} like LiFePO_4F , but presents a monoclinic $C2/c$ space group) presents a magnetic structure that differs since the antiferromagnetic chains are coupled ferromagnetically (A-type: ferromagnetic planes of spins that are coupled antiferromagnetically to each other) in FeSO_4F . The magnetic structure of these fluorosulfates and phosphates seems to depend strongly on the geometrical characteristics of the structure, in particular to the Fe-O-O-Fe super-super exchange paths that govern the coupling between adjacent chains. The oxidation state of iron is therefore not the only parameter as FeSO_4F and LiFePO_4F present distinct magnetic structures.

III-4. ELECTROCHEMICAL PROPERTIES OF LiFePO_4F

J. Barker et al. [17] reported the synthesis of LiFePO_4F but not, surprisingly, its electrochemical signature. N. Recham et al. [7] reported for the first time the galvanostatic signature of LiFePO_4F (see Figure III-16a) with a capacity of 128 mAh/g for the first cycle (85% of the theoretical) at C/15 in the potential window of 1.2 V–4.2 V. The electrochemical signature presented a pseudo plateau at a potential around 1.5 V vs. Li^+/Li which was attributed to a possible conversion reaction. A flat plateau was observed during discharge and charge within the composition range for $\text{Li}_{(1+x)}\text{FePO}_4\text{F}$ ($x = 0.05\text{--}0.45$), and $\text{Li}_{(1+x)}\text{FePO}_4\text{F}$ ($x = 0.85\text{--}0.45$) respectively.

The description of the electrochemical signature of LiFePO_4F as published by N. Recham differs from that of T.N. Ramesh et al. [8] (see Figure III-16b). The latter performed a galvanostatic test at a rate of C/10 leading to a capacity of 145 mAh/g within a potential window of 1.5 V–4.0 V. The composition range of $\text{Li}_{(1+x)}\text{FePO}_4\text{F}$ ($x = 0\text{--}0.35$) exhibited a sloping curve centered around 3.1 V, indicative of a single-phase behavior, followed by a two-phase plateau in the region of $\text{Li}_{(1+x)}\text{FePO}_4\text{F}$ ($x = 0.35\text{--}0.75$). The subsequent charge was similar to the discharge, contrary to the electrochemical curve reported by N. Recham.

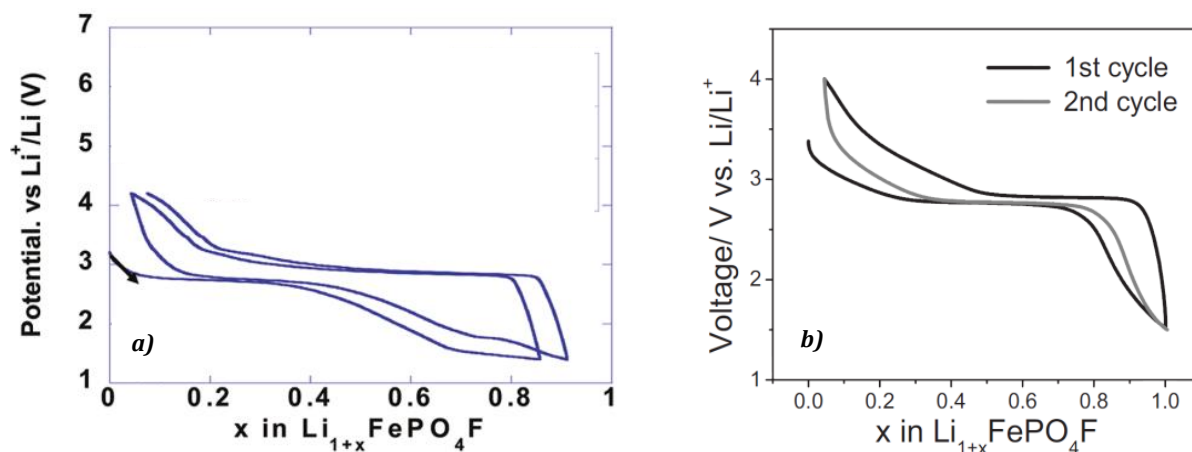

Figure III-16: The electrochemical signature of LiFePO_4F as presented in literature by a) N. Recham et al. [7]; b) T.N. Ramesh et al. [8]

We have performed galvanostatic tests in coin cells assembled in an Ar filled dry glove box. Prior to be used as positive electrodes, the active materials were ball milled with 16 wt% of C_{sp} and 5 wt % of PTFE. The cells consisted of the positive electrode (loading was about $5\text{-}7\text{ mg/cm}^2$), 1 cm^2 Li disks as negative electrode, and LiPF_6 (1 M) in a mixture of EC-DMC (1:1) as electrolyte. The lithium insertion/extraction relies on the reversibility of the $\text{Fe}^{3+}/\text{Fe}^{2+}$ redox couple, so that the electrochemical reaction associated can be summarized as:



The galvanostatic cycling was performed at different current rates and our data are gathered in Figure III-17a-b. Figure III-17a presents the electrochemical performances of LiFePO_4F at a rate of C/10 similar to the one reported in literature. Surprisingly, the reversible capacity was of 83 mAh/g, lower than those reported, but at C/100 the capacity increased up to 143 mAh/g with significantly lower polarization as well. Those results are a consequence of the low kinetics of the obtained phase due to the large particles size of the powders we prepared. The electrochemical signature at C/100 is similar to the one reported by T.N. Ramesh et al [8]. However, at a potential around 3.2 V vs. Li^+/Li (and a composition close to LiFePO_4F), one can notice a small inflection point, also presents within the data recorded at C/10.

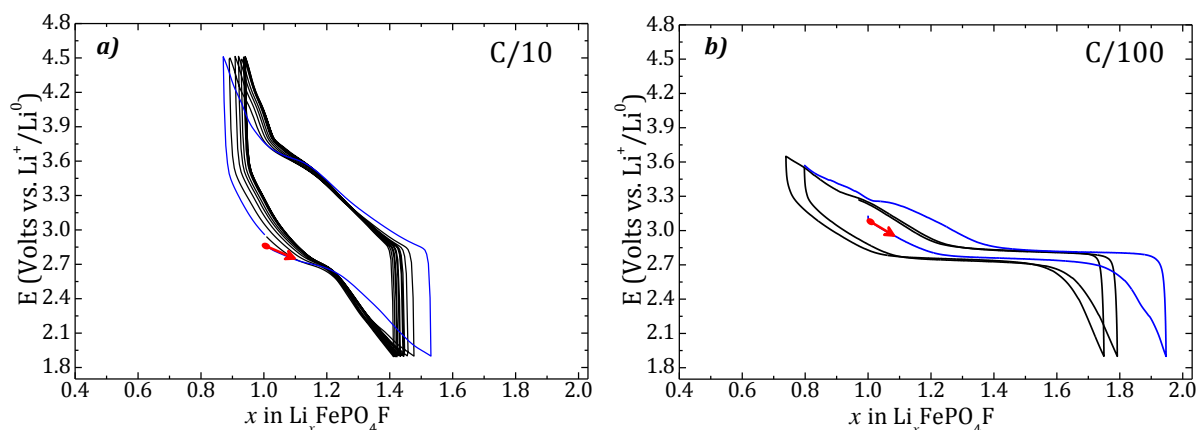

Figure III-17: Electrochemical behavior of LiFePO_4F performed at different C rates a) C/10; b) C/100. The blue line is the first cycle.

More interestingly is that during charge, the electrochemical data presented a sloping outgrowth curve beyond the composition of LiFePO_4F , so that the end of the charge process would represent the formation of the $\text{Li}_{0.7}\text{FePO}_4\text{F}$ composition at C/100. This result would suggest an oxidation of LiFePO_4F , i.e. implying the rarely encountered oxidation of Fe^{3+} into Fe^{4+} . However the $\text{Fe}^{4+}/\text{Fe}^{3+}$ couple cannot be present at such low potential. This particular electrochemical signature can be due to the degradation of the LiFePO_4F sample. The XRD pattern of a mixture of LiFePO_4F and C_{sp} (in the weight proportion of 85:15) presented broad peaks (Figure III-18b) after 15 min of Spex milling. After 3 months, the XRD pattern of the previous sample presented extremely broad diffraction peaks probably induced either by an amorphization or a degradation of the sample. The corresponding Mössbauer data tends to suggest that LiFePO_4F get degraded after air exposure of the milled sample: additional lines suggest the presence of iron oxide.

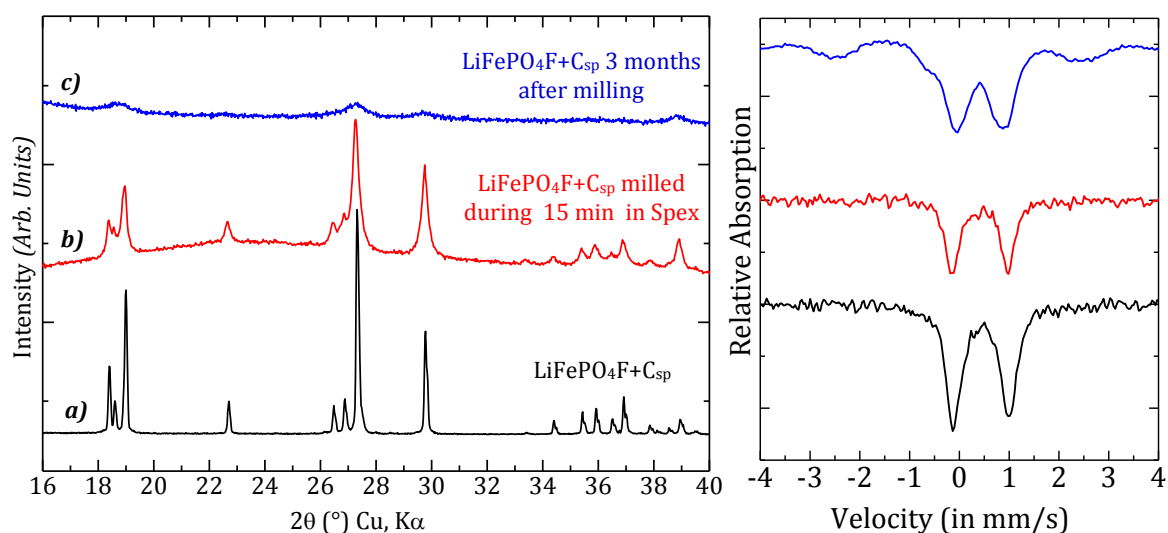

Figure III-18: XRD patterns (left) and the corresponding Mössbauer spectra (right) showing the degradation of a mixture of LiFePO_4F and C_{sp} (85:15 wt %) after Spex milling and air exposure: a) initial LiFePO_4F and C_{sp} , b) 15 min of Spex milling, c) air exposure during 3 months.

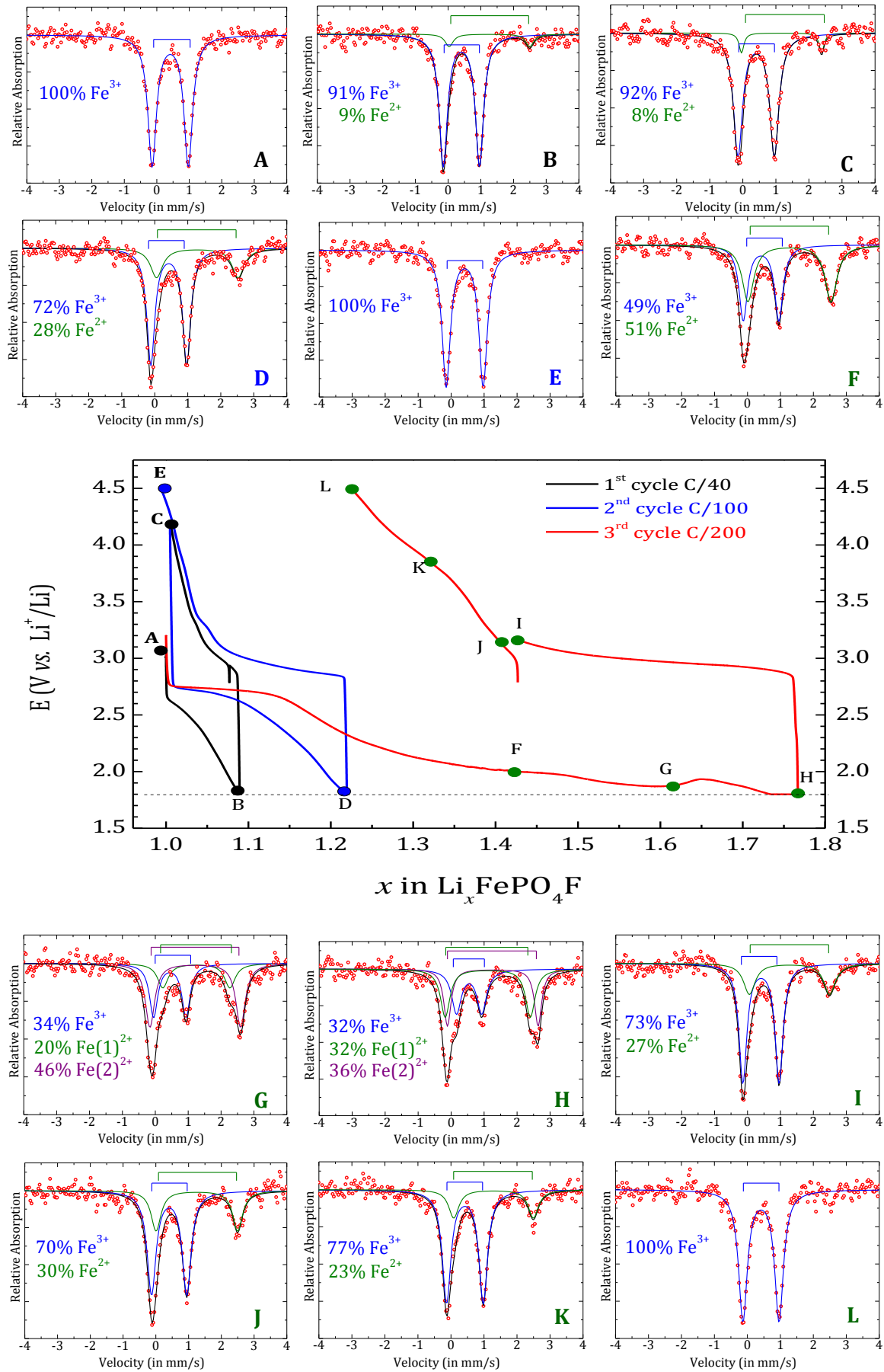

Figure III-19: Mössbauer in situ study of LiFePO_4F : the galvanostatic data are surrounded by the spectra (from A to M)

We have performed, in collaboration with M. Sougrati (ICG Montpellier), an *in situ* Mössbauer spectroscopy experiment upon discharge and charge using a stainless steel Swagelok-type cell similar to the one described in Chapter II, with a special plunger which enabled the γ rays to pass throughout the electrode and the Swagelok cell. The powder was prepared from a hand milled (in mortar instead of Spex milled in order to avoid possible degradation) mixture of LiFePO_4F and C_{sp} (85:15 wt %). All the spectra have been recorded at room temperature in transmission geometry using a 0.55 Gbq source of $^{57}\text{CoRh}$ in constant acceleration mode. The velocity range was reduced to ± 2.5 mm/s for a better resolution data. For the electrochemical tests, the galvanostatic data were recorded between 1.8 V and 4.5 V vs. Li^+/Li . Three successive rates were performed: at C/40 for the first cycle then at C/100 for the second cycle and finally at C/200 for the third cycle. The capacity retention was very poor probably due to the milling conditions.

The first Mössbauer spectroscopy data (recorded at point A, before discharge) confirmed the presence of Fe^{3+} only in the pristine sample. At the end of the first discharge (for C/40), the capacity delivered was about 15 mAh/g and the Mössbauer spectroscopy (at the point B) exhibited 91% of Fe^{3+} indicating a presence of unreacted initial LiFePO_4F . At the end of the second discharge (point D), the presence of Fe^{3+} decreased down to 72 % for C/100 and to 32 % for C/200.

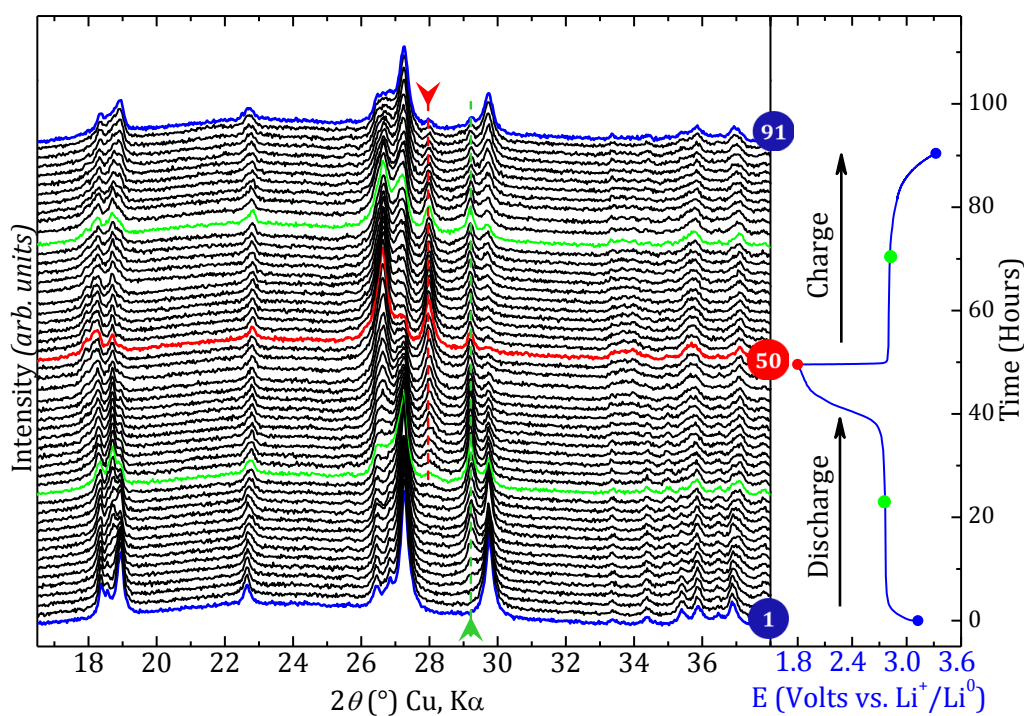

Figure III-20: 2D View of collected *in situ* XRD patterns for the global electrochemical reaction $\text{LiFePO}_4\text{F} \rightleftharpoons \text{Li}_2\text{FePO}_4\text{F}$ (left) and corresponding galvanostatic cycling (right). The XRD patterns highlighted in blue refer to LiFePO_4F and the red one to $\text{Li}_2\text{FePO}_4\text{F}$. The XRD pattern of the intermediate phase is presented in green.

In order to investigate the phase transformation mechanism upon discharge from LiFePO_4F to $\text{Li}_2\text{FePO}_4\text{F}$, an *in situ* XRD experiment was performed using the same conditions as in Chapter II. The recorded XRD patterns and the associated galvanostatic data are gathered in Figure III-20 and Figure III-21. No solid solution was observed, as suggested by Ramesh, since no XRD peaks were shifted to higher or lower 2θ angles (Figure III-21). The XRD data showed the appearance of a new phase at a composition of $\text{Li}_{1.5}\text{FePO}_4\text{F}$ as witnessed by the appearance of the peak at around 29.5° in 2θ . At first sight, one might have thought that this new phase corresponded to $\text{Li}_2\text{FePO}_4\text{F}$ but surprisingly, at the middle of the plateau, the fraction of that new phase is maximum (Figure III-22). However, no intermediate phase ($\text{Li}_{1.5}\text{FePO}_4\text{F}$) was observed by Mössbauer. The peak at 29.5° (corresponding to the intermediate phase) did not completely disappear at the end of the discharge (Figure III-22).

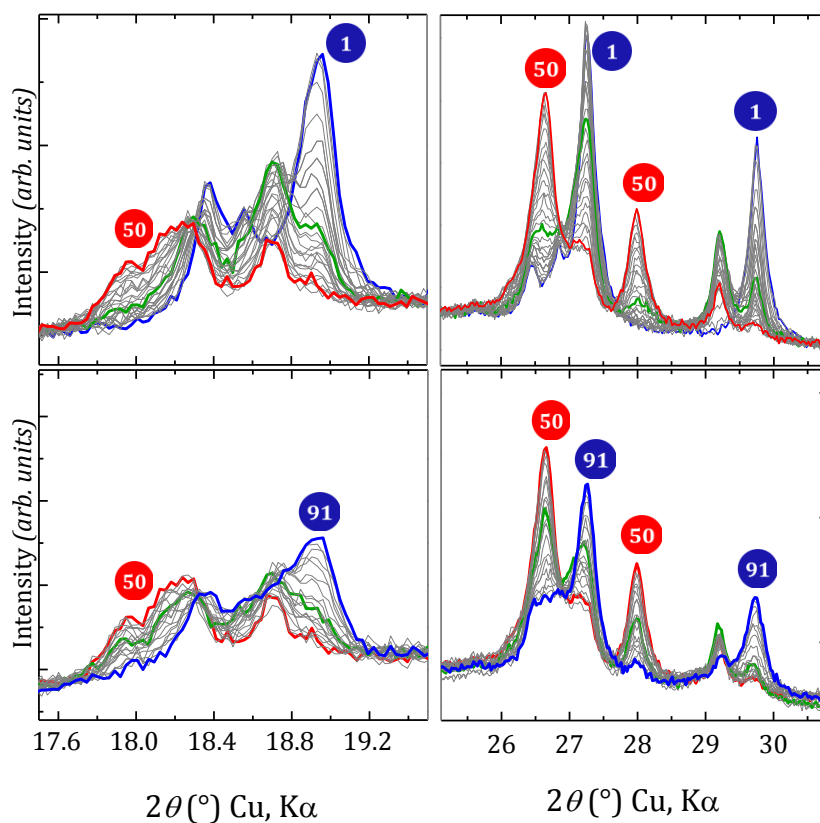

Figure III-21: Selected 2θ regions showing the respective growth and disappearance of the phases involved in the LiFePO_4F (blue) \rightleftharpoons $\text{Li}_2\text{FePO}_4\text{F}$ (red) reaction. The XRD pattern of the intermediate phase is presented in green.

Additionally, from the composition of $\text{Li}_{1.5}\text{FePO}_4\text{F}$, a new diffraction peak at 28° appeared which reached a maximum intensity at the end of discharge. This new peak can be ascribed to $\text{Li}_2\text{FePO}_4\text{F}$, as shown in Figure III-23 which presents the XRD patterns at the end of discharge together with the simulated $\text{Li}_2\text{FePO}_4\text{F}$ XRD patterns (simulated from the published $\text{Li}_2\text{FePO}_4\text{F}$ [8]). The diffraction peaks at 29.5° and 18.7° do not belong to the $\text{Li}_2\text{FePO}_4\text{F}$ phase.

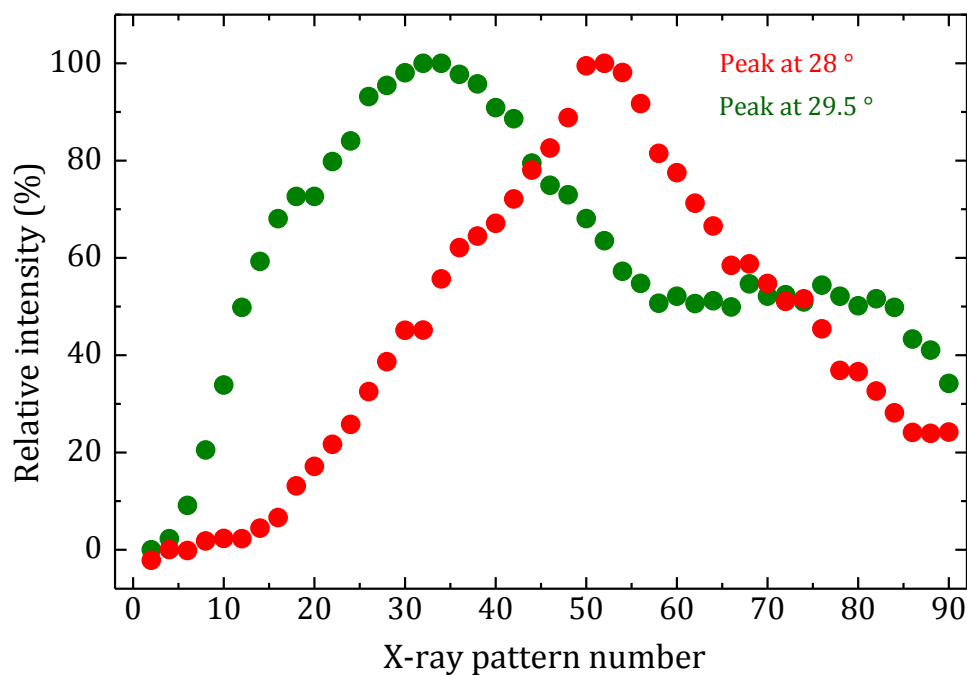

Figure III-22: Relative peak intensities for the peak corresponding to an intermediate phase (green) and a fully lithiated phase $\text{Li}_2\text{FePO}_4\text{F}$ (red)

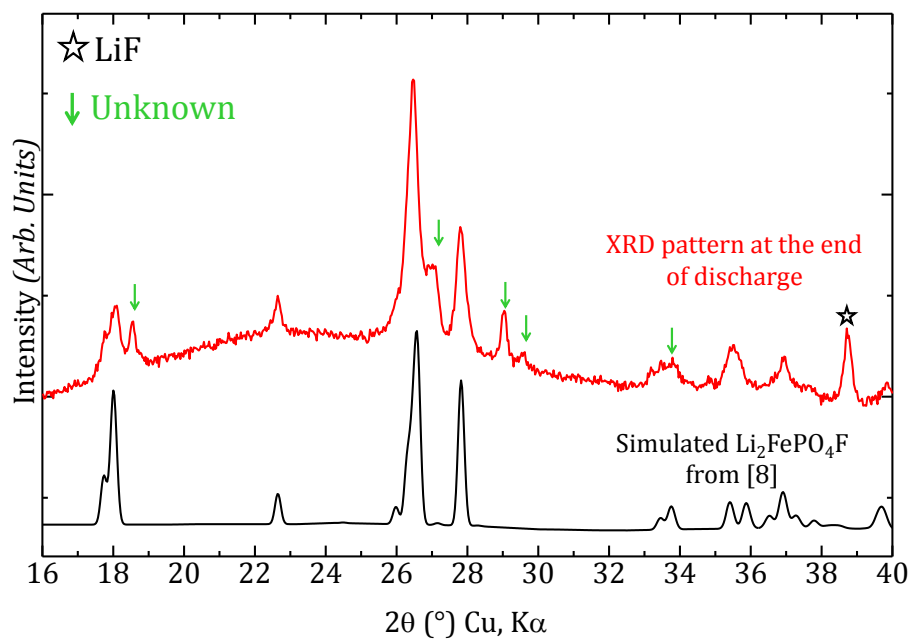

Figure III-23: Fullpattern refinement of the XRD data n° 50 corresponding to a fully lithiated phase. Bragg positions are those taken from Ramesh et al. [8]

III-5. Conclusion and summary of this chapter

Two synthesis routes have been performed for the synthesis of LiFePO_4F : the iono-thermal synthesis yielded the formation of a mixed OH/F LiFePO_4X powder, as shown by the lattice parameters. Moreover we observed low crystallinity and bad reproducibility of the obtained phase so that the synthesis of LiFePO_4F by iono-thermal synthesis was not straightforward. During the ceramic synthesis routes, we ended up with high crystallinity of LiFePO_4F . The particles size obtained through ceramic route were about 5-7 μm . Both ceramic and iono-thermal routes can be considered as indirect synthesis of LiFePO_4F since LiF was formed as the main phase. Nevertheless, LiF can be removed using a cold-water washing. Based on Mössbauer spectroscopy and NMR, we have shown that LiFePO_4F is stable upon moisture. The Curie constant obtained (based on the susceptibility measurement vs. temperature) confirmed the oxidation state of 3+ for Fe. Moreover, the magnetic data indicated an antiferromagnetic behavior with a Néel temperature of 80 K.

The favorite structure of LiFePO_4F was determined by simultaneous Rietveld refinements of both X-ray and neutron diffraction data. The resolved structure of LiFePO_4F was compared with those of $\text{FePO}_4\cdot\text{H}_2\text{O}$ and LiFePO_4OH in which the Fe-X distance along the octahedra chain is 2.17 Å and 2.02 Å, longer than the Fe-F distance (1.98 Å) in LiFePO_4F . The two sites of Fe are very close to each other, so that we could not distinguish them while refining the Mössbauer data. Contrary to previous publications from Ramesh et al. [8] and Recham et al. [7], we observed only one Li site in the structure of LiFePO_4F . This result was supported by ^7Li MAS NMR which exhibited a sharp signal shifted at 203 ppm, stronger than in LiVPO_4F (117 ppm) compound since Fe^{3+} contains much more electron spins with a $t_{2g}^3 e_g^2$ electronic configuration. In similar way the ^{31}P MAS NMR exhibited a stronger Fermi shift in LiFePO_4F than in LiVPO_4F (9550 ppm vs. 3998 ppm).

The magnetic structure of LiFePO_4F was determined by Rietveld refinement of neutron diffraction data performed at low temperature. All nearest neighbors magnetic moments present in the Fe atoms are antiferromagnetically coupled (G-type) and the magnetic moment was 3.92 μ_B .

LiFePO_4F exhibited an operating potential around 2.8 V vs. Li^+/Li . The electrochemical data presented a sloping outgrowth curve beyond the composition of LiFePO_4F so that the end of the charge suggested an oxidation of Fe^{3+} to Fe^{4+} , which is clearly not possible at such low potential.

This particular and surprising signature can be ascribed to a possible air degradation of a Spex milled mixture of LiFePO_4F and C_{sp} . The *in situ* XRD displayed no solid solution during Li insertion into LiFePO_4F but revealed two biphasic mechanisms with an intermediate which formation is still unknown. Note worthy that this intermediate phase was neither detected in Mössbauer nor noticed in galvanostatic data.

References

1. Goodenough, J.B.; *Mapping of Redox Energies*, Molecular Crystals and Liquid Crystals Science and Technology Section a-Molecular Crystals and Liquid Crystals, **1998**, 311: p. 1-14.
2. Padhi, A.K.; Manivannan, V. and Goodenough, J.B.; *Tuning the position of the redox couples in materials with NASICON structure by anionic substitution*, Journal of the Electrochemical Society, **1998**, 145(5): p. 1518-1520.
3. Marx, N.; Croguennec, L.; Carlier, D.; Bourgeois, L.; Kubiak, P.; Le Cras, F. and Delmas, C.; *Structural and Electrochemical Study of a New Crystalline Hydrated Iron(III) Phosphate $\text{FePO}_4 \cdot x\text{H}_2\text{O}$ Obtained from $\text{LiFePO}_4(\text{OH})$ by Ion Exchange*, Chemistry of Materials, **2010**, 22(5): p. 1854-1861.
4. Ati, M.; Sougrati, M.T.; Rouse, G.; Recham, N.; Doublet, M.L.; Jumas, J.C. and Tarascon, J.M.; *Single-Step Synthesis of $\text{FeSO}_4\text{F}_{1-y}\text{OH}_y$ ($0 \leq y \leq 1$) Positive Electrodes for Li-Based Batteries*, Chemistry of Materials, **2012**, 24(8): p. 1472-1485.
5. Marx, N.; Croguennec, L.; Carlier, D.; Wattiaux, A.; Le Cras, F.; Suard, E. and Delmas, C.; *The structure of tavorite $\text{LiFePO}_4(\text{OH})$ from diffraction and GGA plus U studies and its preliminary electrochemical characterization*, Dalton Transactions, **2010**, 39(21): p. 5108-5116.
6. Ellis, B.L. and Nazar, L.F.; *Anion-Induced Solid Solution Electrochemical Behavior in Iron Tavorite Phosphates*, Chemistry of Materials, **2012**, 24(6): p. 966-968.
7. Recham, N.; Chotard, J.N.; Jumas, J.C.; Laffont, L.; Armand, M. and Tarascon, J.M.; *Ionothermal Synthesis of Li-Based Fluorophosphates Electrodes*, Chemistry of Materials, **2010**, 22(3): p. 1142-1148.
8. Ramesh, T.N.; Lee, K.T.; Ellis, B.L. and Nazar, L.F.; *Tavorite Lithium Iron Fluorophosphate Cathode Materials: Phase Transition and Electrochemistry of LiFePO_4F - $\text{Li}_2\text{FePO}_4\text{F}$* , Electrochemical and Solid State Letters, **2010**, 13(4): p. A43-A47.
9. Recham, N.; Chotard, J.N.; Dupont, L.; Delacourt, C.; Walker, W.; Armand, M. and Tarascon, J.M.; *A 3.6 V lithium-based fluorosulphate insertion positive electrode for lithium-ion batteries*, Nature Materials, **2010**, 9(1): p. 68-74.
10. Tripathi, R.; Ramesh, T.N.; Ellis, B.L. and Nazar, L.F.; *Scalable Synthesis of Tavorite LiFeSO_4F and NaFeSO_4F Cathode Materials*, Angewandte Chemie-International Edition, **2010**, 49(46): p. 8738-8742.
11. Barpanda, P.; Ati, M.; Melot, B.C.; Rouse, G.; Chotard, J.N.; Doublet, M.L.; Sougrati, M.T.; Corr, S.A.; Jumas, J.C. and Tarascon, J.M.; *A 3.90 V iron-based fluorosulphate material for lithium-ion batteries crystallizing in the triplite structure*, Nature Materials, **2011**, 10(10): p. 772-779.
12. Ben Yahia, M.; Lemoigno, F.; Rouse, G.; Boucher, F.; Tarascon, J.M. and Doublet, M.L.; *Origin of the 3.6 V to 3.9 V voltage increase in the LiFeSO_4F cathodes for Li-ion batteries*, Energy & Environmental Science, **2012**, 5(11): p. 9584-9594.
13. Reddy, M.A.; Pralong, V.; Caignaert, V.; Varadaraju, U.V. and Raveau, B.; *Monoclinic iron hydroxy sulphate: A new route to electrode materials*, Electrochemistry Communications, **2009**, 11(9): p. 1807-1810.
14. Delacourt, C.; Ati, M. and Tarascon, J.M.; *Measurement of Lithium Diffusion Coefficient in $\text{Li}_y\text{FeSO}_4\text{F}$* , Journal of the Electrochemical Society, **2011**, 158(6): p. A741-A749.
15. Prabu, M.; Reddy, M.V.; Selvasekarapandian, S.; Rao, G.V.S. and Chowdari, B.V.R.; *Synthesis, impedance and electrochemical studies of lithium iron fluorophosphate, LiFePO_4F cathode*, Electrochimica Acta, **2012**, 85(0): p. 572-578.
16. Tarascon, J.M.; Recham, N. and Armand, M.; *Method for Producing Inorganic Compounds*, FR20090055233, **2009**.
17. Barker, J.; Saidi, M.Y. and Swoyer, J.; *Lithium Metal Fluorophosphate and Preparation Thereof*, US Patent **2005**, 0142056 A1(US 2005).

18. Seddon, K.R.; *Ionic liquids for clean technology*, Journal of Chemical Technology and Biotechnology, **1997**, 68(4): p. 351-356.
19. Welton, T.; *Room-temperature ionic liquids. Solvents for synthesis and catalysis*, Chemical Reviews, **1999**, 99(8): p. 2071-2083.
20. Wasserscheid, P. and Keim, W.; *Ionic liquids - New "solutions" for transition metal catalysis*, Angewandte Chemie-International Edition, **2000**, 39(21): p. 3772-3789.
21. Hagiwara, R.; *Electrochemistry using ionic liquid 2. Room temperature alkylimizadolum molten salts containing fluoroanions*, Electrochemistry, **2002**, 70(2): p. 130-136.
22. Ohno, H.; *Electrochemical Aspects of Ionic Liquids*, John Wiley & Sons, **2005**.
23. Devynck, J.; Messina, R.; Pingarron, J.; Tremillon, B. and Trichet, L.; *Electrochemical Intercalation of Lithium into Transition-Metal Compounds in Low-Temperature Chloroaluminate Melts*, Journal of the Electrochemical Society, **1984**, 131(10): p. 2274-2279.
24. Recham, N.; Dupont, L.; Courty, M.; Djellab, K.; Larcher, D.; Armand, M. and Tarascon, J.M.; *Ionothermal Synthesis of Tailor-Made LiFePO_4 Powders for Li-Ion Battery Applications*, Chemistry of Materials, **2009**, 21(6): p. 1096-1107.
25. Bain, G.A. and Berry, J.F.; *Diamagnetic corrections and Pascal's constants*, Journal of Chemical Education, **2008**, 85(4): p. 532-536.
26. Melot, B.C.; Rousse, G.; Chotard, J.N.; Ati, M.; Rodriguez-Carvajal, J.; Kemei, M.C. and Tarascon, J.M.; *Magnetic Structure and Properties of the Li-Ion Battery Materials FeSO_4 and LiFeSO_4* , Chemistry of Materials, **2011**, 23(11): p. 2922-2930.
27. Rinard, P.M.; *Neutron Interactions with Matter*. , Passive Nondestructive Assay of Nuclear Materials, **1991**, NUREG/CR-5550 /LA-UR-90-732(Edited by Reilly, D, N.Ensslin, H. Smith, Jr, and S. Kreiner.): p. Chapter 12.
28. Menil, F.; *Systematic Trends of the Fe-57 Mössbauer Isomer-Shifts in (FEON) and (FEFN) Polyhedra - Evidence of a New Correlation Between the Isomer-Shift and the Inductive Effect of the Competing Bond T-X(-Fe) (Where X is O or F and T any Element with a Formal Positive Charge)*, Journal of Physics and Chemistry of Solids, **1985**, 46(7): p. 763-789.
29. Marx, N.; *Synthèse et Caractérisation de Nouveaux Phosphates Utilisés Comme Matériaux d'Electrode Positive pour Batteries au Lithium*, Université de Bordeaux 1, **2010**.
30. Ateba Mba, J.M.; Masquelier, C.; Suard, E. and Croguennec, L.; *Synthesis and Crystallographic Study of Homeotypic LiVPO_4 and LiVPO_4O* , Chemistry of Materials, **2012**, 24(6): p. 1223-1234.
31. Castets, A.; Carlier, D.; Zhang, Y.; Boucher, F.; Marx, N.; Croguennec, L. and Menetrier, M.; *Multinuclear NMR and DFT Calculations on the LiFePO_4 center dot OH and FePO_4 center dot H(2)O Homeotypic Phases*, Journal of Physical Chemistry C, **2011**, 115(32): p. 16234-16241.
32. Castets, A.; *RMN de matériaux paramagnétiques: mesures et modélisation*, Bordeaux 1 University, **2012**.
33. Castets, A.; Carlier, D.; Zhang, Y.; Boucher, F.; Marx, N.; Gautier, R.; Le Fur, E.; Le Polles, L.; Croguennec, L. and Menetrier, M.; *NMR study of the LiMnPO_4 center dot OH and MnPO_4 center dot H(2)O (M=Mn, V) homeotypic phases and DFT calculations*, Solid State Nuclear Magnetic Resonance, **2012**, 42: p. 42-50.

Chapter IV
SYNTHESIS, CRYSTAL STRUCTURE
AND ELECTROCHEMICAL
PROPERTIES OF LiTiPO_4F

Contents

IV-1. Introduction	143
IV-2. STUDY OF THE PHASE LiTiPO_4F	144
IV-2a. Synthesis of LiTiPO_4F.....	144
IV-2b. Chemical composition and magnetic behavior of LiTiPO_4F.....	145
IV-2c. Crystal Structure of LiTiPO_4F	146
IV-3. WASHING AND AGING EFFECT ON LiTiPO_4F	150
IV-3a. Effect of aging in air on LiTiPO_4F	150
IV-3b. Effect of washing on LiTiPO_4F	154
IV-3c. Conclusion and summary	157
IV-4. ELECTROCHEMICAL BEHAVIOR OF LiTiPO_4F	157
IV-5. Conclusion and summary of this chapter.....	160

IV-1. Introduction

In the field of Li and Na-ion batteries there is a large panel of Tavorite-like structures reported in literature. The transition metals mainly encountered are: vanadium as in $\text{Li}_x\text{VPO}_4\text{X}$ ($x = 1$ or 0 ; $\text{X} = \text{O}, \text{F}$ or H_2O), iron as in $\text{Li}_x\text{FeYO}_4\text{X}$ ($x = 0$ or 1 ; $\text{Y} = \text{P}$ or S ; $\text{X} = \text{F}, \text{OH}$ or H_2O) and manganese as in AMnPO_4OH ($\text{A} = \text{Li}$ or H). Yet, there are only two reported Tavorite-like structures within which titanium is used as transition metal: LiTiPO_4O [1] and NaTiPO_4O [2-5], none of them had been used in Li-ion batteries so far. On the contrary titanium-rich NASICON-like structures were widely explored in Li and Na-ion batteries as positive and negative electrode materials: $\text{LiTi}_2(\text{PO}_4)_3$ and $\text{NaTi}_2(\text{PO}_4)_3$ [6-11], $\text{A}_{x<1}\text{TiPO}_4\text{O}$ (with $\text{A} = \text{Ni}$ [12, 13] or Co [14]), $\text{Mg}_{0.5}\text{Ti}_2(\text{PO}_4)_3$ [15]...

It is worth to notice that LiTiPO_4O and NaTiPO_4O are isostructural to LiVPO_4O (which structure has been described in details in chapter I and is doubled versus that of LiVPO_4F) and possess titanium ions at the tetravalent state. The Tavorite-like LiTiPO_4F (with titanium ions at the trivalent state) was first reported by N. Recham et al [16]. N. Recham had noticed that two voltage domains were involved upon cycling of $\text{Li}/\text{LiTiPO}_4\text{F}$ cells, one at lower voltages (2–1.3 V vs. Li) and the other at higher voltages (2–4.2 vs. Li), with for both of them the exchange of only 0.5 Li^+ . Instead of forming $\text{Li}_2\text{Ti}^{\text{II}}\text{PO}_4\text{F}$ in discharge and $\text{Ti}^{\text{IV}}\text{PO}_4\text{F}$ in charge, the phases of compositions $\text{Li}_{1.5}\text{Ti}^{\text{III/II}}\text{PO}_4\text{F}$ and $\text{Li}_{0.5}\text{Ti}^{\text{IV/III}}\text{PO}_4\text{F}$ were obtained.

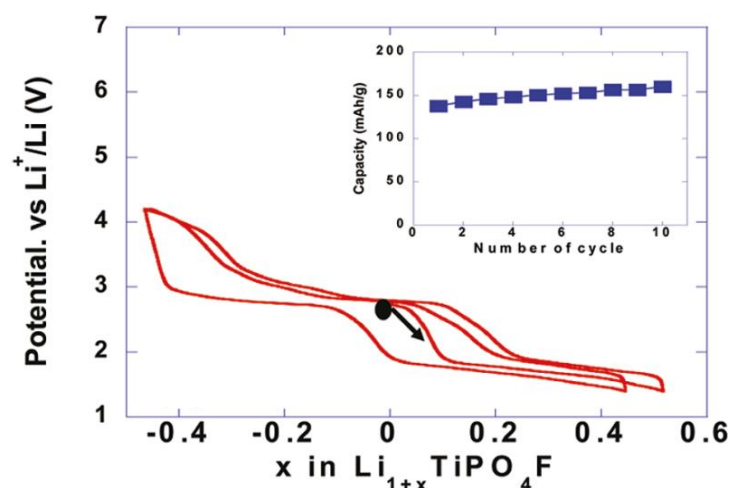

Figure IV-1: Electrochemical cycling of LiTiPO_4F as reported by N. Recham et al. [16]. The inset shows the evolution of the capacity with the cycle numbers.

Those electrochemical limitations can be related to poor electronic conductivity of LiTiPO_4F , but cannot be ascribed to a limited diffusion due to the particles size (as discussed in the second part

of chapter II for LiVPO₄O) since N. Recham prepared nano-particles of LiTiPO₄F (50-70 nm). As it will be discussed in details in the following, we did the hypothesis considering that instead of forming LiTi^{III}PO₄F N. Recham obtained LiTi^{+4/+3}PO₄F_{1-x}O_x ($x \sim 0.5$) or Li_{1-x}Ti^{+4/+3}PO₄F ($x \sim 0.5$). For such compositions, the intercalation of ~ 0.5 Li⁺ at low voltage would be associated to the reduction of all Ti⁴⁺ ions to the trivalent state. Likewise, at high potential the deintercalation of ~ 0.5 Li would be associated to the oxidation of all Ti⁺³ ions to the tetravalent state.

This phase LiTiPO₄F was thus included in our extended study of Tavorite-like fluorophosphates as positive electrode materials for Li-ion batteries. We are reporting in this chapter the synthesis of LiTiPO₄F, its crystal structure and its electrochemical behavior. We will also discuss about the aging of LiTiPO₄F at room temperature in air or after its washing in water.

IV-2. STUDY OF THE PHASE LiTiPO₄F

IV-2a. Synthesis of LiTiPO₄F

LiTiPO₄F was synthesized by N. Recham et al. [17, 18] following the same protocol as for the synthesis of LiFePO₄F. Li₃PO₄ was used as both lithium and phosphate precursor whereas TiF₃ was used as titanium and fluoride precursor. The reaction scheme is described as follow:

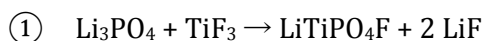

The reaction was performed by Iono-thermal synthesis as well as by ceramic synthesis. For the iono-thermal syntheses, 1,2-dimethyl-3-(3-hydroxypropyl)imidazolium bis(trifluoromethane sulfonyl)imide was used as ionic liquid and the reaction yielded to the formation of LiTiPO₄F as nanoparticles (30-70 nm in diameter). Despite the same precursors and duration time were used as for iono-thermal syntheses, ceramic synthesis led as expected to the formation of bigger particles (3-4 μm) because it was performed at higher temperature. For both reaction routes LiF was removed by washing the sample with water.

In our case, LiTiPO₄F was obtained through ceramic route. Li₃PO₄ (from Aldrich) and TiF₃ (from Alfa Aesar) were ground/mixed in stoichiometric proportions in an Ar-filled glove box. The mixed powder was then pressed into a pellet, placed in a gold tube which was sealed in the glove box, and heated up to 750 °C for 1 hour prior to be quenched in liquid nitrogen.

The obtained violet powder was recovered in an Ar-filled glove box and placed in a tight sample-holder to prevent its exposure to air during the measure of its XRD pattern on a Siemens D5000 powder diffractometer with the Cu K α radiation. As depicted in Figure IV-2, the XRD pattern of that (non-washed) sample was successfully refined considering a Tavorite-type structure described in the space group $P\bar{1}$ with lattice parameters larger than those reported by N. Recham for LiTiPO₄F. N. Recham et al. [16] reported a unit cell volume of 176.10 Å³ whereas we observed 178.31 Å³. The higher V/Z value obtained in our case, for a non-washed sample, would be consistent with the formation of a mixed valence titanium fluorophosphate by N. Recham as the ionic radii of Ti³⁺ (0.076 nm) is larger than that of Ti⁴⁺ (0.068 nm). The sample of N. Recham would have been oxidized during the washing process used to remove LiF.

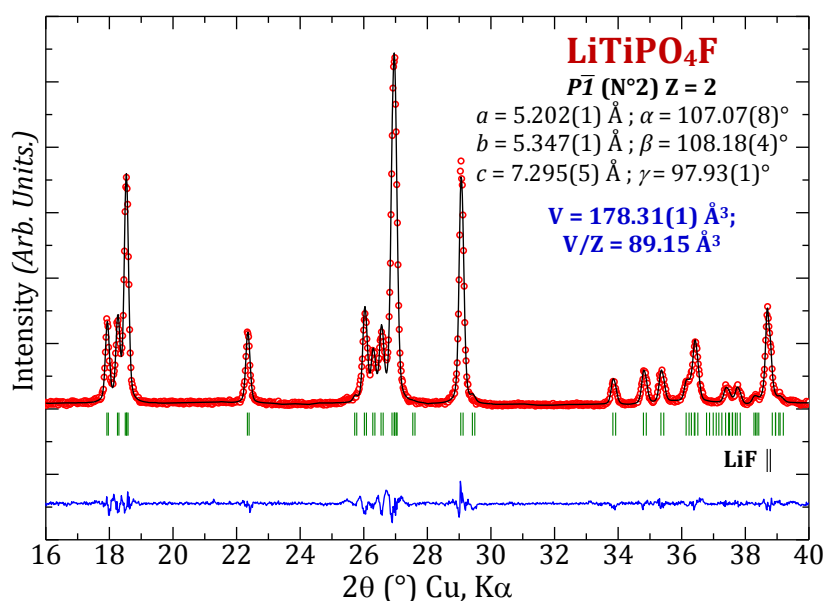

Figure IV-2: Full-pattern matching refinement of the XRD pattern recorded for the pristine (non-washed) LiTiPO₄F.

IV-2b. Chemical composition and magnetic behavior of LiTiPO₄F

The Li, Ti and P contents were determined using an ICP-OES spectrometer (Varian 720-ES Optical Emission Spectrometer) after complete dissolution of the powder (which contains in fact a mixture of LiTiPO₄F and LiF) into a solution of HCl/H₂O. We observed that this dissolution was more difficult than for LiVPO₄F, LiVPO₄O and LiFePO₄F. A stoichiometry of Li_{2.95}/Ti_{1.00}/P_{0.96} was determined in rather good agreement with the presence of 2 moles of LiF and 1 mole of LiTiPO₄F. More interestingly is the absence of protons which has been checked using CHNS elemental analyzer based on combustion and gas chromatography analysis.

The static molar magnetic susceptibility of the LiTiPO₄F/LiF mixture was measured between 5 and 300 K using a SQUID magnetometer (Quantum Design). The zero-field cooled susceptibility (χ) values were obtained by cooling the sample in zero-field down to 5 K and then heating it under the measuring field of 10 000 Oe. The values reported here are given per mol of titanium, which was determined by chemical analyses. The diamagnetic contributions were corrected using the atomic values from G.A. Bain and J.F. Berry [19] yielding the χ_m paramagnetic susceptibility contribution. Contrary to LiVPO₄F, LiVPO₄O and LiFePO₄F no curvature indicative of the antiferromagnetic behavior was present for LiTiPO₄F so that the paramagnetic behavior remained all over the temperature range (Figure IV-3). The obtained Curie constant was 0.365 (in the temperature range 3–290 K) very close to the theoretical value of 0.375 for Ti³⁺ which electronic configuration is $t_{2g}^1 e_g^0$.

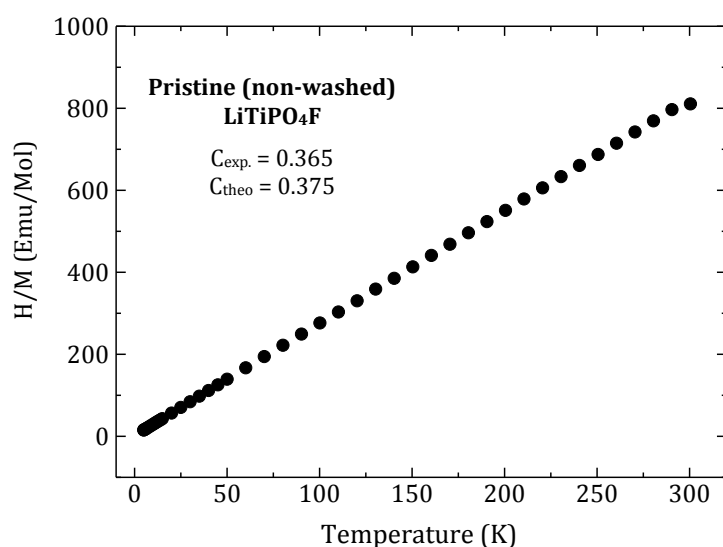

Figure IV-3: Temperature dependence of the H/M ratio for the pristine LiTiPO₄F/LiF mixture. The calculated Curie constant is given in insert in comparison with the theoretical one considering a Ti³⁺-only material.

From these analyses we can thus consider that the material LiTiPO₄F containing only Ti³⁺ was effectively formed in the mixture obtained with LiF.

IV-2c. Crystal Structure of LiTiPO₄F

Based only on laboratory XRD data, N. Recham et al. [1] determined the structure of LiTiPO₄F and did the hypothesis that Lithium ions were distributed equally on two sites, only half occupied and separated by 1.13 Å. Our structural determination however, was based on both laboratory XRD and neutron diffraction. For the determination of the structure of LiTiPO₄F, the same methodology as described in chapters I and III was used. We choose to perform this in-depth structural characterization for the pristine (non-washed) material despite it is a mixture

of LiTiPO₄F and LiF. Indeed, we wanted to prevent any evolution of the original Tavorite-like phase formed and to study actually LiTi^{III}PO₄F. The presence of LiF was taken into account considering a second phase for the refinement. Its unit cell was described in the space group *Fm-3m* (N° 225); its cell parameter was refined whereas the atomic positions were fixed to those reported in the ICSD N° 18012.

1. Only Ti, P, O and F atoms were first considered according to the structural model [Ti(1)_{1a}Ti(2)_{1b}](P_{2i})(O_{2i})₄F_{2i}; in this model Ti(1) and Ti(2) atoms occupy special *1a* (0, 0, 0) and *1b* (0, 0, 1/2) positions respectively, as also defined by N. Recham. Surprisingly, already at this stage (*i.e.* without considering the Lithium atoms), the refinement of neutron diffraction data (Figure IV-4) seemed to converge with reasonably good reliability factors ($R_{wp} = 2.63\%$; $R_{Bragg} = 0.60\%$; $\chi^2 = 1.66\%$) compared to the results obtained previously for the homeotypic phases LiVPO₄F ($R_{wp} = 5.40\%$; $R_{Bragg} = 6.95\%$; $\chi^2 = 4.54\%$), LiVPO₄O ($R_{wp} = 3.38\%$; $R_{Bragg} = 4.52\%$; $\chi^2 = 3.63\%$) and LiFePO₄F ($R_{wp} = 3.81\%$; $R_{Bragg} = 5.28\%$; $\chi^2 = 3.68\%$).

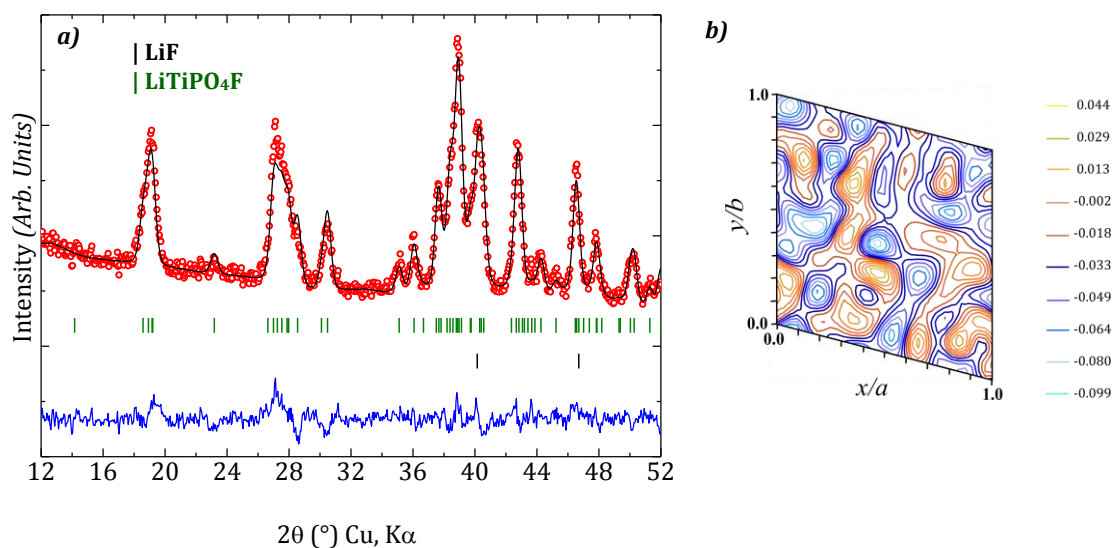

Figure IV-4: a) Neutron diffraction data refinement considering only heaviest atoms (*i.e.* without Li) and b) Corresponding Fourier difference map.

2. The localization of Li was much more difficult as depicted in Figure IV-4b in which several negative nuclear densities (blue lines) were observed very close to positive nuclear densities (red lines). The difficulty to localize Lithium atoms in this structure is probably due to the coherent scattering length of Ti (which is $-0.34 \cdot 10^{-4}$ Å [20]) higher compared with the Li coherent scattering length ($-0.19 \cdot 10^{-4}$ Å [20]) but with similar sign and magnitude. In addition, the neutron diffraction data were obtained on small amounts of powders and were thus not of optimized quality (signal over noise ratio for instance). The Li positions and the number of Li sites were therefore not determined and the structure of LiTiPO₄F is going to be described in the

following without considering the position of Li and based on the analysis of the X-ray diffraction data (which is not affected by the light element Li). Figure IV-5 presents the Rietveld refinement of XRD data performed with two phases: LiTiPO_4F and LiF . The obtained lattice parameters as well as the atomic positions are gathered in Table IV-1 in ANNEX I and the resulting inter-atomic distances are recorded in Table IV-2 of the same annex.

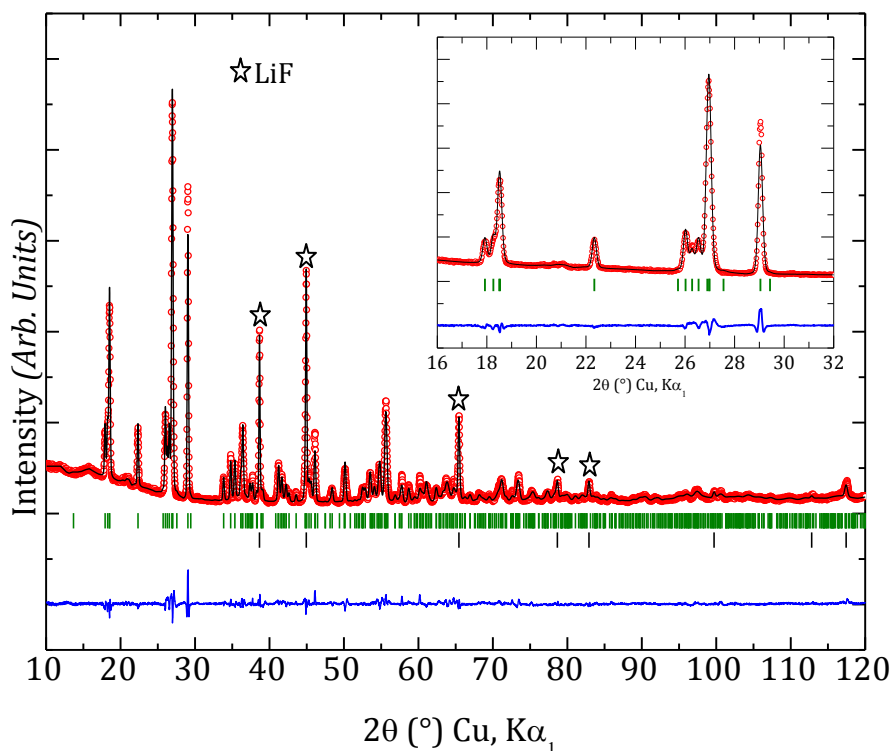

Figure IV-5: Observed (red dots), calculated (black line), and difference (blue line) plots obtained for the Rietveld refinement of X-ray diffraction data for LiTiPO_4F . The presence of LiF is indicated by stars.

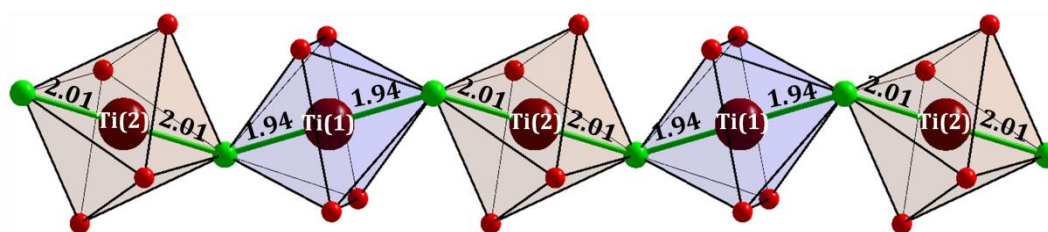

Figure IV-6: Representation of chains along the c axis in LiTiPO_4F structure

We observed that the Ti-F distances along the chains in $[\text{Ti}(1)\text{O}_4\text{F}_2]$ and $[\text{Ti}(2)\text{O}_4\text{F}_2]$ octahedra are 2.01 Å and 1.94 Å respectively (Figure IV-6). Note that N. Recham et al. reported smaller Ti-F distances of 1.91 Å and 2.00 Å for Ti(1)-F and Ti(2)-F respectively, suggesting a larger average oxidation for titanium in their sample. Successive short and long Ti-F distances are observed along the chains for LiTiPO_4F whereas regular M-F distances (of 1.98 Å) were obtained along the chains in the other fluorophosphates LiVPO_4F and LiFePO_4F . We also observed that the

octahedra in LiTiPO_4F are more distorted than in LiVPO_4F and LiFePO_4F . Similarly, the unique phosphorous site encountered in the structure of LiTiPO_4F lies in a more distorted tetrahedral site than those of LiVPO_4F and LiFePO_4F (see ANNEX I).

Although the localization of Li in the LiTiPO_4F structure was not straightforward from diffraction data, the study performed by ^7Li MAS NMR revealed the presence of at least 4 signals at -1, 8, 32 and 63 ppm as shown in Figure IV-7. As previously demonstrated (see Chapter III), the peak at -1 ppm corresponds to the presence of LiF. The three others could be ascribed to 3 different environments for Li in the structure of LiTiPO_4F .

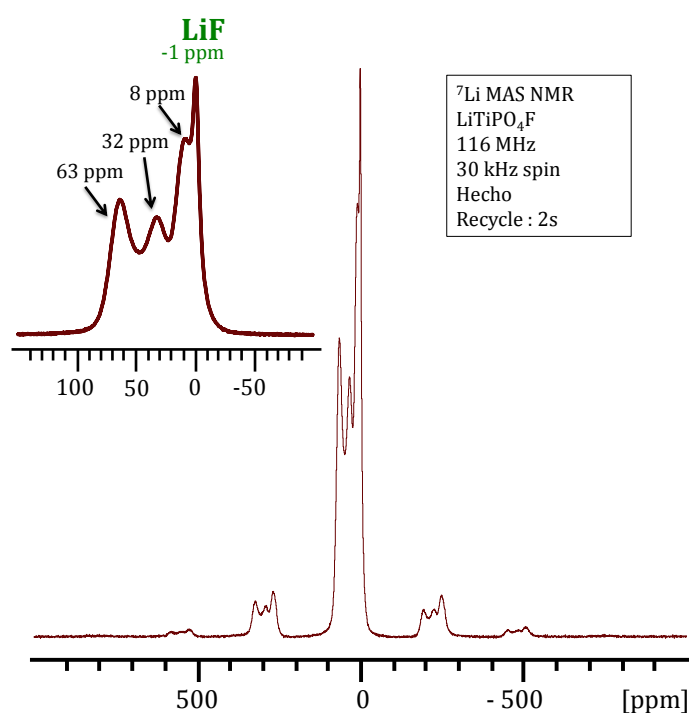

Figure IV-7: ^7Li MAS NMR spectrum of LiTiPO_4F

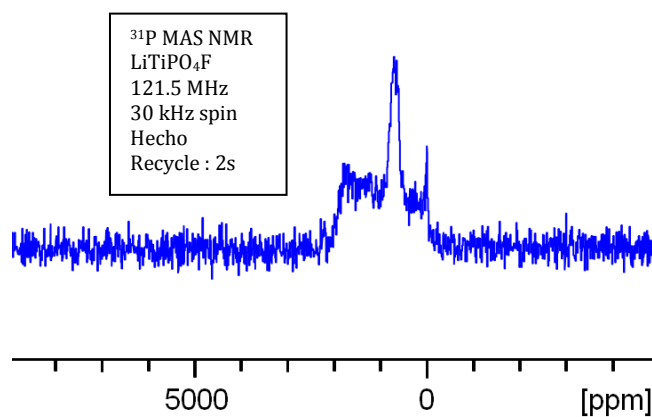

Figure IV-8: ^{31}P MAS NMR spectrum of LiTiPO_4F

The ³¹P MAS NMR shift (see Figure IV-8) is less strong for LiTiPO₄F (800 ppm) compared with LiVPO₄F (4000 ppm) and LiFePO₄F (9550 ppm). One can notice that the intensity of the ³¹P NMR signal is smaller than those previously observed for LiVPO₄F, LiVPO₄O and LiFePO₄F. Just as for LiFePO₄F, we did not observe any ¹⁹F NMR signal, in contradiction with our expectation. Indeed, with only one electron spin for Ti³⁺ ($t_{2g}^1 e_g^0$), we were expecting to observe a ¹⁹F NMR signal for LiTiPO₄F less shifted than for V³⁺ in LiVPO₄F which possesses two electron spins ($t_{2g}^2 e_g^0$) and a ¹⁹F NMR signal shifted at 1500 ppm. In the general conclusion, we will present a detailed comparison of all LiMPO₄F structures.

IV-3. WASHING AND AGING EFFECT ON LiTiPO₄F

IV-3a. Effect of aging in air on LiTiPO₄F

The obtained LiTi^{III}PO₄F/LiF mixture has been exposed to air during 15 hours, 9 months and 1 year in order to check for the stability of LiTi^{III}PO₄F in air. We observed that the color of the powder changed from violet to whitish with aging which could be consistent with an oxidation of Ti³⁺ to Ti⁴⁺ which electronic configuration is $t_{2g}^0 e_g^0$. That oxidation can be associated to a partial substitution of oxygen for fluorine (the Tavorite-like phase LiTi^{IV}PO₄O is white whereas LiTi^{III}PO₄F is obviously violet) and/or to a partial lithium deintercalation according to reactions ② and ③ respectively, but also to the combination of both according to the reaction ④:

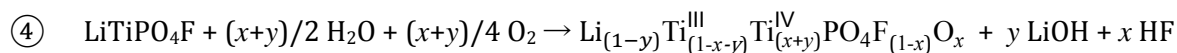
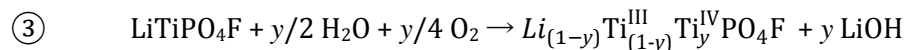
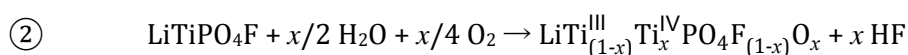

The recorded XRD patterns are gathered in Figure IV-9. An evolution of the XRD patterns is observed between the non-washed sample (initial mixture of LiTi^{III}PO₄F and LiF) and the sample exposed to air for 15 hours, 9 months and one year. Note that the intensity of the peak associated to LiF at about 39° (2θ) progressively decreases with the increasing time of storage in air. Furthermore, all the diffraction peaks of the starting LiTiPO₄F progressively vanish whereas those of a new phase progressively grow. The material obtained after an aging in air during one year contains almost only this new phase, with small residual amounts of a Tavorite-like phase

described in the space group $P-1$ and of LiF (as revealed especially by the peaks at 22.5° and 38.5° respectively).

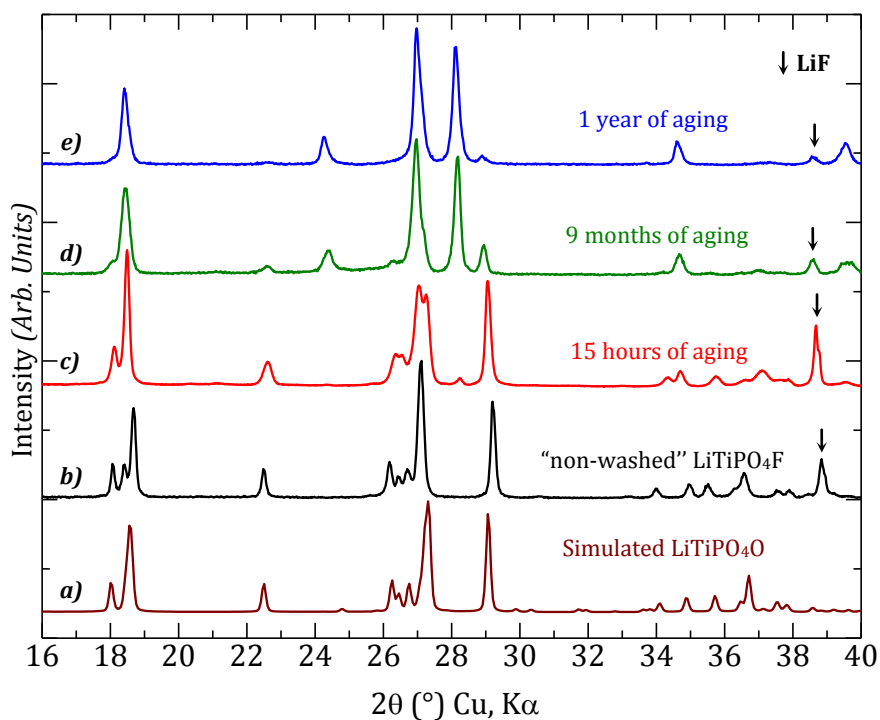

Figure IV-9: The XRD patterns of the “non-washed” sample (a) and the XRD patterns of the samples exposed to air during b) 15 hours, c) 9 months and d) 1 year. The simulated XRD pattern of LiTiPO_4O is also given for comparison.

The XRD pattern of the sample obtained after 1 year of aging in air is completely different from that of $\text{LiTi}^{\text{III}}\text{PO}_4\text{F}$ and $\text{LiTi}^{\text{IV}}\text{PO}_4\text{O}$ (Figure IV-9), showing immediately that the oxidation process involved upon aging in air is not described (or not only described) by the reaction of oxygen substitution for fluorine (reaction ②). All the diffraction lines associated with the new phase were successfully indexed considering a unit cell described in the space group Cc or $C2/c$. Nevertheless, as clearly shown in Figure IV-10 a significantly better refinement was obtained considering the first unit cell and led us to adopt it in the following. The V/Z value obtained for this new phase was found to be around 83.78 \AA^3 which is significantly smaller than that determined for $\text{LiTi}^{\text{III}}\text{PO}_4\text{F}$ (89.15 \AA^3), suggesting again an oxidation of the pristine $\text{LiTi}^{\text{III}}\text{PO}_4\text{F}$, but also from that of $\text{LiTi}^{\text{IV}}\text{PO}_4\text{O}$. At this step information are not sufficient to propose a chemical formula for this new phase.

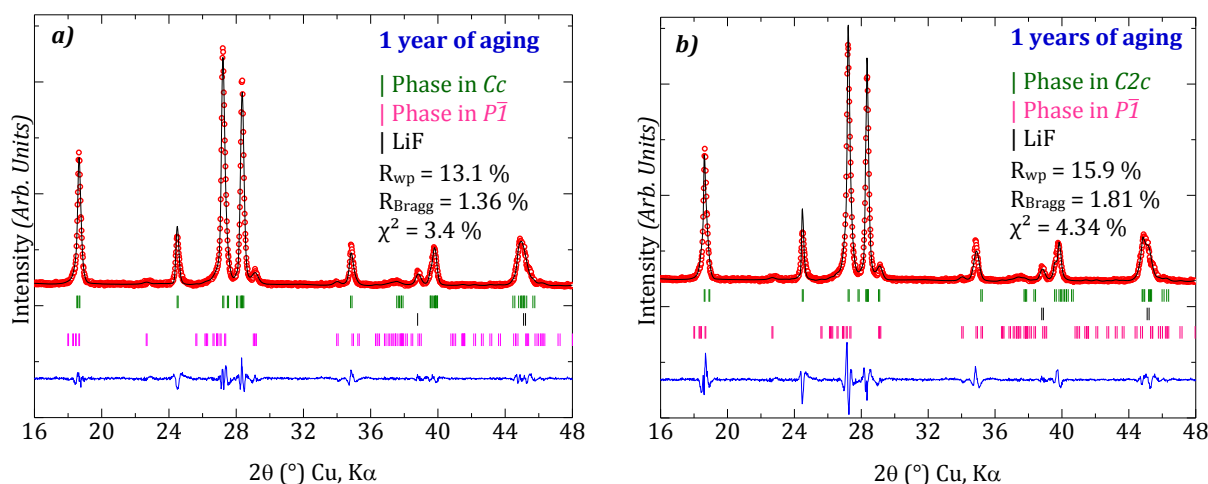

Figure IV-10: Full-pattern matching refinement of the XRD pattern obtained for the sample aged during 1 year in air, considering a) a unit cell described in the Cc space group for the main phase and b) a unit cell described in the $C/2c$ space group for the main phase. The reliability factors are given in inserts.

The XRD patterns obtained for the two other samples aged for 15 hours and during 9 months in air could be refined considering again this new phase, a Tavorite-like phase described in $P-1$ and LiF (see Figure IV-11). The lattice parameters, unit cell volumes and V/Z values are compared in Table IV-1 for $\text{LiTi}^{\text{III}}\text{PO}_4\text{F}$, $\text{LiTi}^{\text{IV}}\text{PO}_4\text{O}$ and the three different samples obtained after their aging in air. Note that already after 15 hours in air the material is modified in depth, with the formation in small amount of the new phase described in Cc , but also with a modification of the Tavorite-like phase described in $P-1$ whose unit cell volume is significantly decreased, in good agreement also with an oxidation. The refinement of the XRD data is not that satisfactory, particularly in the region of $25\text{--}28^\circ$ in 2θ , for the sample aged during 9 months. Note that it can be explained by the fact that we consider the presence of two phases only whereas a distribution of phases close in compositions is actually present. This is probably due to a gradient in composition for the phases.

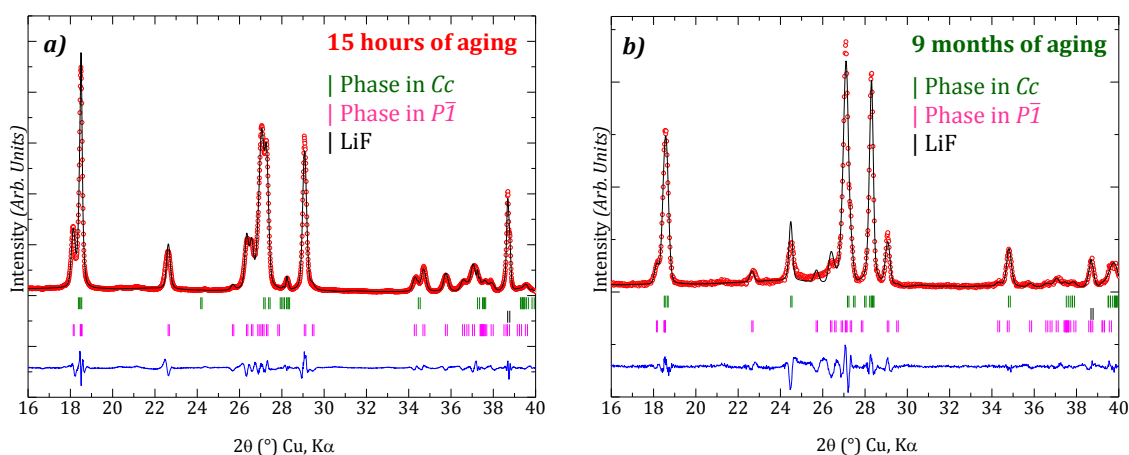
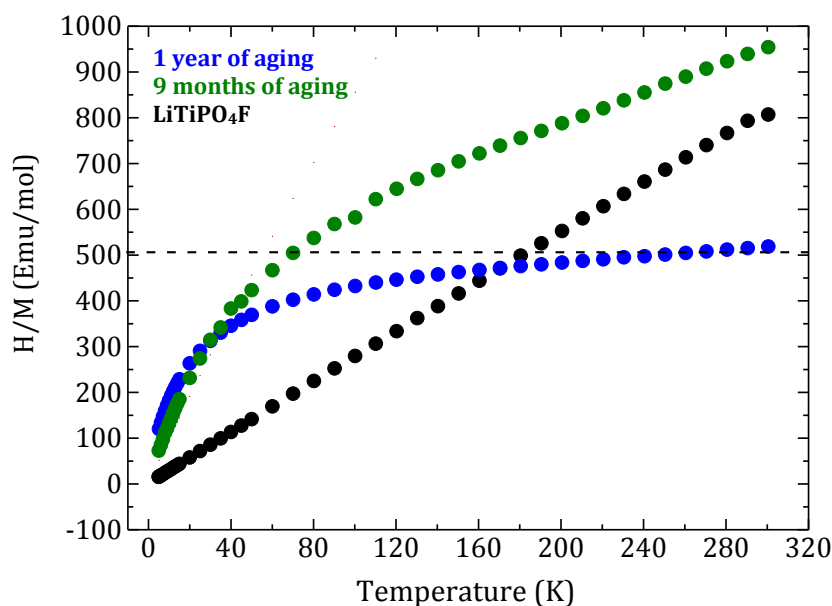

Figure IV-11: Full-pattern matching refinement of the XRD patterns obtained for the samples aged in air during a) 15 hours and b) 9 months.

Table IV-1: Lattice parameters, unit cell volumes and V/Z values obtained after different aging time of LiTiPO_4F in air. Comparison with those of LiTiPO_4F and LiTiPO_4O .

	a (Å)	b (Å)	c (Å)	α (°)	β (°)	γ (°)	V (Å ³)	V/Z (Å ³)
LiTiPO_4F ($P\bar{1}$)	5.202(1)	5.347(1)	7.295(5)	107.07(8)	108.18(4)	97.93(1)	178.31(1)	89.15
LiTiPO_4O ($P\bar{1}$)	6.904	7.197	7.903	90.45	91.31	117.19	349.13	87.28
15 hours of aging								
Phase $P\bar{1}$	5.210(3)	5.271(8)	7.243(1)	107.19(3)	108.68(2)	97.11(1)	174.71(7)	87.36
New phase Cc	7.353(7)	7.359(9)	7.335(8)	90	120.76(8)	90	341.14(8)	85.29
9 months of aging								
Phase $P\bar{1}$	5.201(9)	5.269(9)	7.231(1)	107.18(8)	108.54(5)	97.09(5)	174.28(9)	87.14
New phase Cc	7.315(2)	7.264(4)	7.350(2)	90	120.70(3)	90	335.84(4)	83.96
1 year of aging								
Phase $P\bar{1}$	5.194(4)	5.278(3)	7.244(1)	107.22(1)	108.65(4)	97.04(4)	174.47(3)	87.23
New phase Cc	7.305(5)	7.264(4)	7.341(3)	90	120.66(3)	90	335.13(3)	83.78

**Figure IV-12: Temperature dependence of the H/M ratio for $\text{LiTi}^{\text{III}}\text{PO}_4\text{F}/\text{LiF}$ mixture (black), sample aged for 9 months (green) and the sample aged for 1 year (blue). The molar weight used for the calculation of the H/M ratio for both 9 months and 1 year aged samples was that of TiPO_4F**

In order to get more insight into the oxidation state of titanium in these aged samples, a magnetic study was performed. The evolution of the curves that give the static molar magnetic susceptibility versus temperature appears rather continuous (based on three samples only), between the pristine sample containing $\text{LiTi}^{\text{III}}\text{PO}_4\text{F}$ and LiF , the sample aged for 9 months and the sample aged for 1 year. As discussed previously the first shows a paramagnetic behavior in the overall temperature range with titanium ions only at the trivalent state, whereas the third interestingly shows a magnetic susceptibility practically independent from temperature from

160 K up to room temperature (Figure IV-12). This observation indicates a diamagnetic behavior for the sample aged during one year in air and reveals the presence of titanium ions almost all at the tetravalent state in that sample. As expected also from the XRD analysis, the sample aged during 9 months is intermediate between the two.

Considering that the new phase contains only titanium ions at the tetravalent state and is not $\text{LiTi}^{\text{IV}}\text{PO}_4\text{O}$, all the compositions $\text{Li}_{1-y}\text{Ti}^{\text{IV}}\text{PO}_4\text{F}_{1-x}\text{O}_x$ such as $(x+y) = 1$ and $y \neq 0$ could be considered. At this step, it is interesting to mention that the description of the Tavorite-like structure was performed in the space group Cc for $\text{V}^{\text{V}}\text{PO}_4\text{O}$ that is characterized by successive long and short V-O distances along the chains (see Chapter II). Note that for a mixed oxy-fluorophosphate and especially for the composition $\text{Li}_{1/2}\text{Ti}^{\text{IV}}\text{PO}_4\text{F}_{1/2}\text{O}_{1/2}$, such a sequence of long (Ti-F) and short (Ti-O) distances would be expected with an off-centered position of Ti in the octahedral sites.

IV-3b. Effect of washing on LiTiPO_4F

Just as described in Chapter III, it was possible to remove LiF from the mixture of $\text{LiTi}^{\text{III}}\text{PO}_4\text{F}/\text{LiF}$ through its washing with cold water. The corresponding XRD pattern is given in Figure IV-13 in comparison with those obtained for the pristine (non-washed) sample, the sample washed with room temperature water (labeled “RT-washed”) and the sample non-washed but aged in air during 15 hours. The peak at around 38.7° in 2θ , characteristic of LiF, disappeared only when a washing in cold water (labeled “CW-washed”) was performed. More interestingly is that we observed an evolution of the XRD pattern during the washing, the pattern obtained being then very similar to that observed after 15 hours of aging in air.

As well illustrated in Figure IV-14 (through the observation of the intensity difference) the XRD patterns of both “RT-washed” and “CW-washed” samples have been fully explained considering for the first one (in addition to LiF), the presence of a Tavorite-like phase indexed in the space group $P-1$ and for the second one, the presence of two Tavorite-like phases, described for the major one in $P-1$ and for the minor one in Cc . As previously discussed for the samples aged in air (paragraph IV-3a), whatever the washing conditions the phases were oxidized as they show unit cell volumes and V/Z values smaller than that observed for $\text{LiTi}^{\text{III}}\text{PO}_4\text{F}$ (see Table IV-2). As already explained for the sample aged during 9 months in air to the quality of the refinements is not that satisfactory for the two samples “RT-washed” and “CW-washed”, considering the only presence of two phases described in Cc and $P\bar{1}$. Indeed, each sample is in fact a distribution of

phases between the two end members (described in Cc and $P\bar{1}$) showing a gradient of compositions.

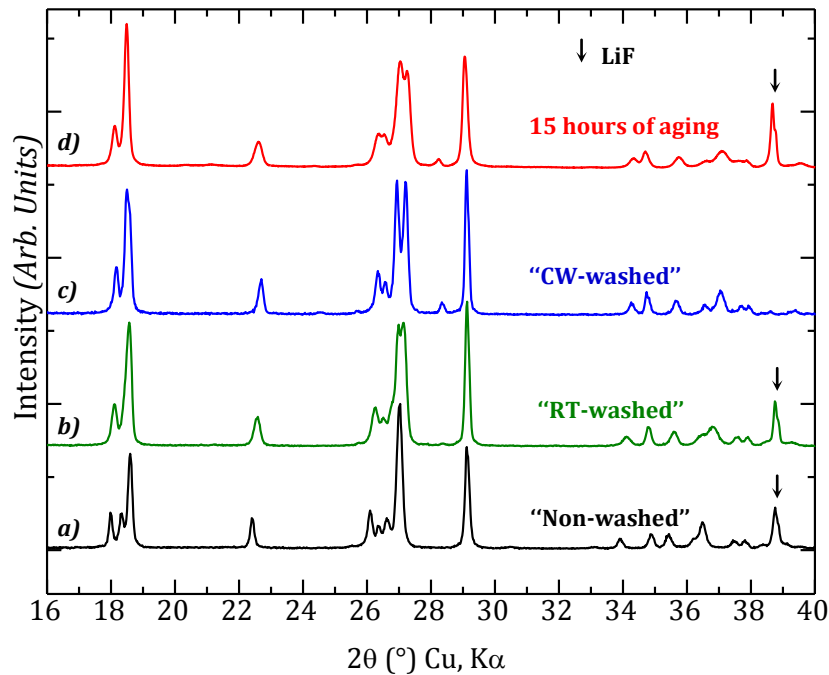

Figure IV-13: XRD patterns of different samples of LiTiPO_4F : a) “non-washed”, b) “RT-washed” c) “CW-washed” and d) the “non-washed” aged during 15 hours in air

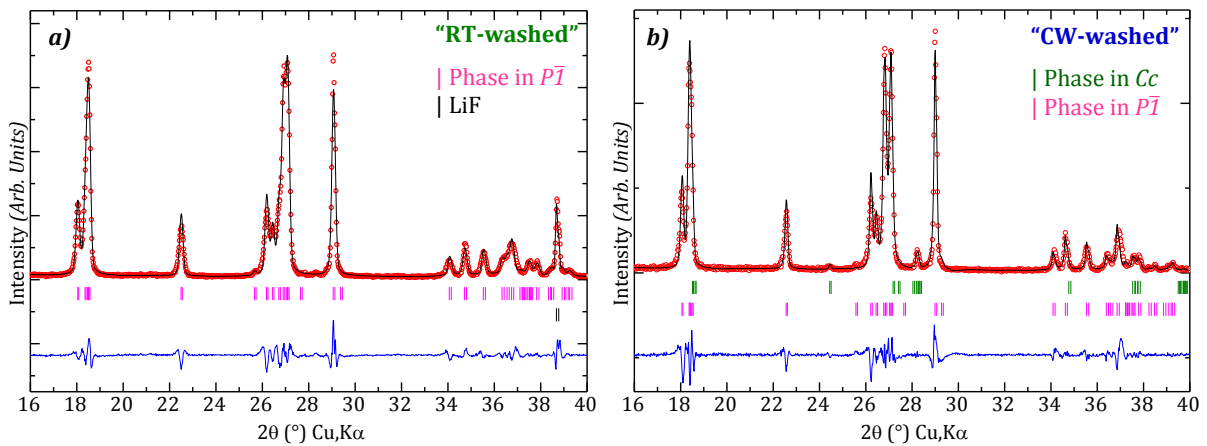

Figure IV-14: Full-pattern matching refinement of the XRD patterns collected for the samples washed with a) room temperature water: the XRD data were refined considering only one phase ($P\bar{1}$) and with b) cold water: the XRD data were refined considering two phases ($P\bar{1}$ and Cc).

Table IV-2: Lattice parameters, unit cell volumes and V/Z values determined for the different phases observed in samples washed with room temperature water and cold water. Comparison with those of $\text{LiTi}^{\text{III}}\text{PO}_4\text{F}$.

	a (Å)	b (Å)	c (Å)	α (°)	β (°)	γ (°)	V (Å ³)	V/Z (Å ³)
LiTiPO_4F ($P\bar{1}$)	5.202(1)	5.347(1)	7.295(5)	107.07(8)	108.18(4)	97.93(1)	178.31(1)	89.15
“RT-washed”								
Phase $P\bar{1}$	5.210(7)	5.303(1)	7.275(6)	107.07(2)	108.64(3)	97.41(3)	176.50(7)	88.25
“CW-washed”								
Phase $P\bar{1}$	5.221(2)	5.298(4)	7.287(2)	107.25(8)	108.79(3)	97.09(4)	176.83(1)	88.41
New phase Cc	7.314(6)	7.267(4)	7.345(2)	90	120.54(1)	90	336.29(3)	84.07

The static molar magnetic susceptibilities of “CW-washed” sample was measured between 5 and 300 K, and compared with the “non-washed” sample, and with the samples aged in air during 9 months and 1 year (Figure IV-15). The Curie constant obtained for the “CW-washed” sample was found to be 0.175 (calculated between 120–300 K), *i.e.* smaller than that of the “non-washed” sample (0.365), confirming a partial oxidation of the “CW-washed” sample. This Curie constant suggests a distribution of 48%: 52% (*i.e.* close to 1:1) for Ti^{3+} : Ti^{4+} . This result leads us to assume a composition close to $\text{Li}_{(1-y)}\text{Ti}_{(1-x-y)}^{\text{III}}\text{Ti}_{(x+y)}^{\text{IV}}\text{PO}_4\text{F}_{(1-x)}\text{O}_x$ with $(x+y) = 1/2$ for “CW-washed” sample.

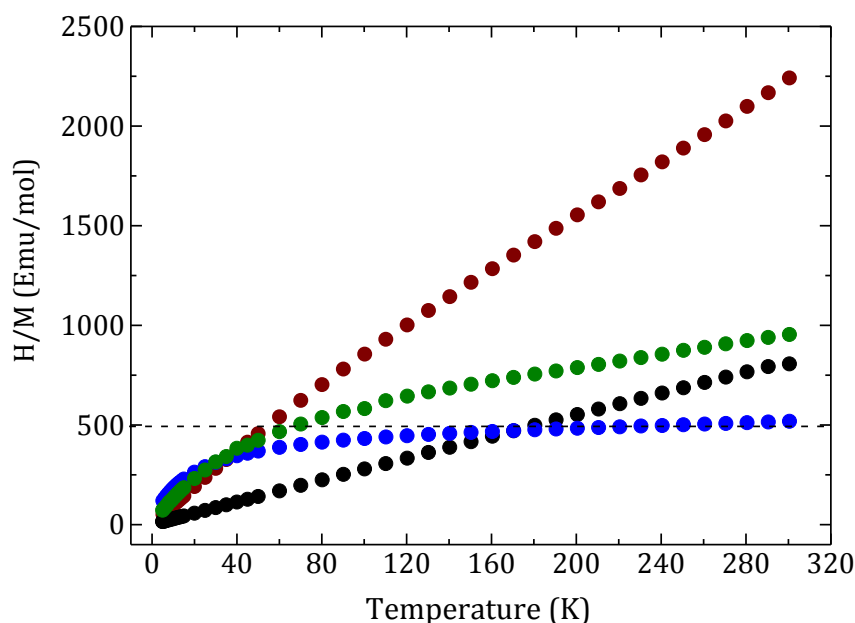

Figure IV-15: Temperature dependence of the H/M ratio for $\text{LiTiPO}_4\text{F}/\text{LiF}$ mixture (black), sample aged for 9 months (green), the sample aged for 1 year (blue) and the sample washed with cold water (brown). The molar weight used for the calculation of the H/M ratio for the “CW-washed” sample was that of TiPO_4F .

IV-3c. Conclusion and summary

We have succeeded in the synthesis of LiTiPO₄F material obtained together with LiF. The magnetic susceptibility exhibited a paramagnetic behavior all over the temperature range, with a Curie constant of 0.365 consistent with the presence of titanium at the trivalent state only. Due to poor resolution of the neutron diffraction data we were not able to localize the Li⁺ ions in the structure of LiTiPO₄F. However, ⁷Li MAS NMR suggests the presence of three different environments for Li. On the contrary to observations made for LiVPO₄F and LiFePO₄F within which a regular M–F distance of 1.98 Å was observed along the chains, successive short and long distances of 1.94 Å and 2.01 Å were observed for Ti(1)–F and Ti(2)–F respectively.

The LiTiPO₄F phase was shown to be instable in air and during washing in water. Oxidation of titanium was proved from magnetic measurements. The phase formed was shown to be different from LiTiPO₄O. Indeed during ageing in air, we have shown the appearance of a new phase which crystallizes in *Cc* space group. We suggest that oxidation of titanium is induced by both oxygen substitution for fluorine and lithium deintercalation with the formation of $\text{Li}_{(1-y)}\text{Ti}_{(1-x-y)}^{\text{III}}\text{Ti}_{(x+y)}^{\text{IV}}\text{PO}_4\text{F}_{(1-x)}\text{O}_x$.

IV-4. ELECTROCHEMICAL BEHAVIOR OF LiTiPO₄F

The two redox couples which can be involved during Li deintercalation and intercalation from/in LiTiPO₄F are Ti^{III}/Ti^{IV} and Ti^{II}/Ti^{III} respectively. The corresponding electrochemical reactions are:

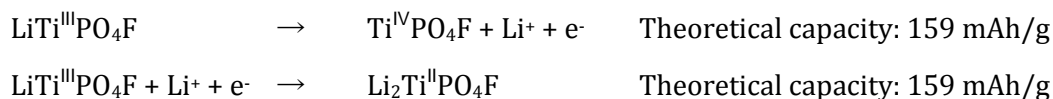

We have performed electrochemical tests of the “non-washed” and “CW-washed” samples in Swagelok cells, assembled in an argon-filled glove box. Prior to be used as positive electrodes, the active materials were ball milled under Ar with 16 wt % of SP carbon and 5 wt % of PTFE. The cells consisted of 1 cm² Li disks as negative electrode, LiPF₆ (1 M) in a mixture of EC-DMC (1:1) as electrolyte and the positive electrode with a loading in active material of approximately 8 mg/cm². The galvanostatic curves were recorded starting either in discharge first (first

insertion of Li^+) or in charge first (first extraction of Li^+) with the current rate corresponding to C/50.

0.5 Li^+ were deintercalated from the “non-washed” sample (Figure IV-16a) during the first charge. That reaction is reversible: a capacity of 111 mAh/g is observed after 6 cycles, *i.e.* about 70 % of the theoretical capacity. The average operating potential associated to that reaction and thus to the redox couple $\text{Ti}^{4+}/\text{Ti}^{3+}$ in this sample was 3 V vs. Li^+/Li . It is as expected higher than in other phosphate compounds such as the NASICON $\text{LiTi}_2(\text{PO}_4)_3$ (2.5 V vs. Li^+/Li) [6-8, 10, 21], due to the inductive effect of fluorine. Note that a difference of ~ 0.7 V is observed between the average potential in charge and that in discharge. It can be most probably mainly ascribed to the presence of a large amount of LiF in the positive electrode (2 mol. LiF vs. 1 mol “non-washed” sample).

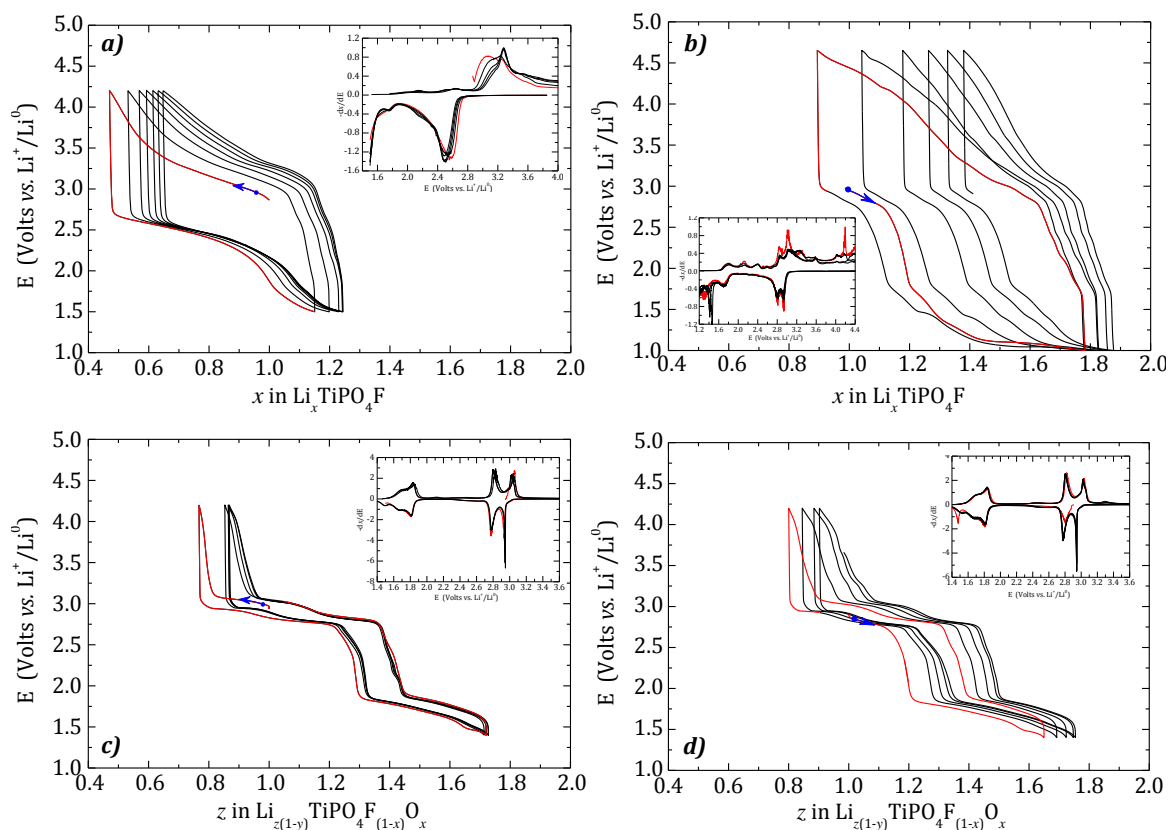

Figure IV-16: Electrochemical behavior of:
a-b) “non-washed” sample starting either by a) the extraction of Li^+ or b) the insertion of Li^+
c-d) “CW-washed” sample starting either by c) the extraction of Li^+ or d) the insertion of Li^+
The derivative curves are given in the inserts.

Using the same sample, we have performed an electrochemical cycling starting this time by the insertion of Li^+ (Figure IV-16b). Note that in that case the redox couple $\text{Ti}^{2+}/\text{Ti}^{3+}$ is expected to be involved. A very large polarization was observed that led us to increase the potential window down to 1 V vs. Li^+/Li . As highlighted by the derivative curve given in insert the reaction

occurring in discharge at low potential around 1.4 V vs. Li^+/Li is irreversible, as not observed in charge. No obvious reversible reaction occurs at low voltage, suggesting that Li^+ cannot be intercalated in $\text{LiTi}^{\text{III}}\text{PO}_4\text{F}$ and thus that no reduction of Ti^{3+} to Ti^{2+} occurs as it would have been expected with the formation of $\text{Li}_2\text{Ti}^{\text{II}}\text{PO}_4\text{F}$.

It is interesting to mention that the electrochemical signature obtained for the “non-washed” sample ($\text{LiTiPO}_4\text{F}/2\text{LiF}$) is significantly different from that observed by N. Recham for a sample announced to be $\text{LiTi}^{\text{III}}\text{PO}_4\text{F}$ [16] with the absence of a pseudo-plateau at lower potential (below 2 V vs. Li^+/Li).

Both electrochemical signatures (charge first and discharge first) of the “CW-washed” samples (Figure IV-16c-d) were found significantly different from those of the “non-washed” sample just previously described and similar to that reported by N. Recham [16]. That first result reveals thus that the sample reported by N. Recham was in fact not LiTiPO_4F . Indeed, as discussed previously, LiTiPO_4F evolved during its washing in water to a mixture of phases with an average composition $\text{Li}_{(1-y)}\text{Ti}_{(1-x-y)}^{\text{III}}\text{Ti}_{(x+y)}^{\text{IV}}\text{PO}_4\text{F}_{(1-x)}\text{O}_x$. Two voltage domains were observed and located at 3.0 and 1.7 V vs. Li^+/Li . Two pseudo-plateaus are in fact observed around 3.0 V, separated by an inflection point corresponding to the composition $\text{Li}_{1.1}\text{TiPO}_4\text{F}_{(1-x)}\text{O}_x$. At high voltages (2.3–4.2 V vs. Li^+/Li), the two electrochemical curves exhibited smaller polarizations (~ 0.2 mV) compared with previous electrochemical cycling curves obtained for the “non-washed” sample (~ 0.7 V), and only 0.5 Li was reversibly exchanged. At low voltages (2.3–1.4 V vs. Li^+/Li) similar amount of Li was also exchanged. Those galvanostatic behaviors are in good agreement with the presence of both Ti^{3+} and Ti^{4+} in the sample, as revealed by the magnetic measurements. At high voltage all the Ti^{3+} ions are oxidized to Ti^{4+} , whereas at low voltage all the Ti^{4+} ions are reduced to Ti^{3+} .

A very good reversibility of the electrochemical cycles was observed when a charge was performed first for the “CW-washed” sample (Figure IV-16c), on the contrary to the results obtained when a discharge was carried out first (Figure IV-16d): in that latter case all the cycles are shifted to higher x values in good agreement with the observations made by N. Recham. Both electrochemical curves, always started in the middle of the voltage domain located around 3 V vs. Li^+/Li , confirming the partial oxidation of the “CW-washed” sample.

We have also performed electrochemical tests on the sample aged for one year (Figure IV-17). During the first charge, almost no Li could be extracted in good agreement with the full oxidation of Titanium to the tetravalent state, as well demonstrated by magnetic measurements. On the contrary, lithium could be intercalated upon discharge. Good reversibility and capacity retention

were observed. The larger polarization observed again in that case can be ascribed to the presence of LiF or of $\text{Li}_2\text{CO}_3/\text{LiOH}$ as discussed previously (§ IV-3).

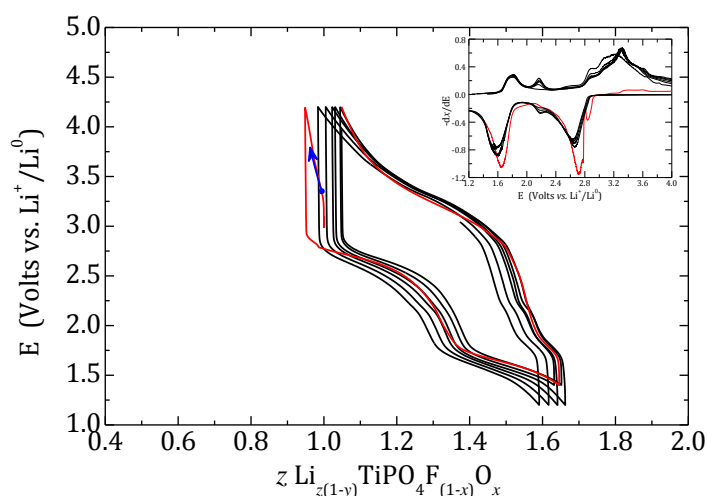

Figure IV-17: Electrochemical signature (starting in charge) of the $\text{LiTiPO}_4\text{F}/\text{LiF}$ sample aged during one year

The galvanostatic behavior of “CW-washed” sample was in good agreement with the possible formation of the phase $\text{LiTiPO}_4\text{F}_{0.5}\text{O}_{0.5}$ during washing, whereas the galvanostatic behavior of the sample aged during one year showed no activity during first charge, in a good agreement with the possible formation of the phase $\text{Li}_{0.5}\text{TiPO}_4\text{F}_{0.5}\text{O}_{0.5}$.

IV-5. Conclusion and summary of this chapter

We had succeeded in the ceramic synthesis of LiTiPO_4F through a one step ceramic synthesis which involved the use of Li_3PO_4 and TiF_3 as precursors. The chemical composition of LiTiPO_4F was confirmed by ICP and the Curie constant calculated based on the evolution of the magnetic susceptibility with temperature was in good agreement with the oxidation state of Ti^{3+} . The crystal structure was determined based only on XRD data and exhibited a V/Z larger than the one previously reported by N. Recham (89.15 Å vs. 88.05 Å). Interestingly we observed, along the chains of $[\text{TiO}_4\text{F}_2]$ octahedra, distances of 1.94 Å and 2.01 Å in $[\text{Ti}(1)\text{O}_4\text{F}_2]$ and $[\text{Ti}(2)\text{O}_4\text{F}_2]$ respectively. Although we could not localize Li based on poor resolution of neutron diffraction data, we observed three ^7Li NMR signals suggesting 3 different environments for Li in the LiTiPO_4F host structure.

LiTiPO_4F proved to be highly air sensitive and was easily oxidized according to two reactions: the first reactions led to the formation of a phase which can be described in $P\bar{1}$ space group and

the second reaction led to a phase which can be described in Cc space group. The magnetic susceptibility recorded versus temperature indicates a paramagnetic behavior for the “CW-washed” phase within which two oxidation states of Ti are present ($\text{Ti}^{3+}/\text{Ti}^{4+}$) and a diamagnetic behavior for the sample aged during one year imputable to the only presence of Ti^{4+} .

The average operating potential associated to first Li^+ extraction from LiTiPO_4F (electrochemical oxidation first) and thus to the redox couple $\text{Ti}^{4+}/\text{Ti}^{3+}$ was 3 V vs. Li^+/Li . It is as expected higher than in other phosphate compounds such as the NASICON $\text{LiTi}_2(\text{PO}_4)_3$ (2.5 V vs. Li^+/Li), due to the inductive effect of fluorine. A relatively good capacity retention was obtained contrary to the first Li^+ insertion into LiTiPO_4F (electrochemical reduction first) in which the redox couple $\text{Ti}^{4+}/\text{Ti}^{3+}$ was involved.

The galvanostatic cycling of the cold-water washed sample of LiTiPO_4F was completely different from that of the pure LiTiPO_4F and exhibited two pseudo-plateaus:

- The upper one located at 3.0 V vs. Li^+/Li which can be assigned to $\text{Ti}^{4+}/\text{Ti}^{3+}$ redox couple. More interestingly is that whether we started by oxidation (Li^+ extraction first) or by reduction (Li^+ insertion first), we were always in the middle of the high voltage domain. The polarization in the upper voltage region was significantly smaller than that observed for the “non-washed” sample ($\text{LiTiPO}_4\text{F}/2\text{LiF}$). This was probably due to the presence of a mixed valence oxidation state for Ti ($\text{Ti}^{4+}/\text{Ti}^{3+}$) in the sample. Operating potential of the $\text{Ti}^{4+}/\text{Ti}^{3+}$ redox couple is higher in that sample than that observed in the NASICON $\text{LiTi}_2(\text{PO}_4)_3$ which exhibited an average potential of 2.5 V vs. Li^+/Li .
- The lower one located at 1.7 V vs. Li^+/Li which can be also assigned to the redox couple $\text{Ti}^{4+}/\text{Ti}^{3+}$.

In both cases, only 0.5 Li was exchanged clearly indicated the proportion of 50% for each oxidation state of titanium.

References

1. Geifman, I.N.; Furmanova, N.G.; Nagorny, P.G.; Yun, L.D. and Rotenfeld, M.V.; *Crystalline-Structure and EPR V(+4) in Lithium-Titanium Binary Hydroxyorthophosphate, Alpha-LiTiOPO(4)*, Kristallografiya, **1993**, 38(6): p. 88-94.
2. Geifman, I.N.; Nagorny, P.G. and Rotenfeld, M.V.; *V4+ EPR, dielectric characteristics and superionic conductivity in monocrystalline NaTiOPO₄*, Fizika Tverdogo Tela, **1994**, 36(12): p. 3550-3555.
3. Stus, N.V.; Slobodyanik, M.S.; Straitiychuk, D.A. and Lisnyak, V.V.; *Pressure induced gamma ->alpha-NaTiOPO₄ phase transition*, Journal of Alloys and Compounds, **2005**, 393(1-2): p. 66-69.
4. Bamberger, C.E.; Begun, G.M. and Cavin, O.B.; *SYNTHESIS AND CHARACTERIZATION OF SODIUM TITANIUM PHOSPHATES, NA₄(TiO)(PO₄)₂, NA(TiO)PO₄, AND NA₂Ti₂(PO₄)₃*, Journal of Solid State Chemistry, **1988**, 73(2): p. 317-324.
5. Dahaoui, S.; Hansen, N.K. and Menaert, B.; *NaTiOPO₄ and KTiOPO₄ at 110 K*, Acta Crystallographica Section C-Crystal Structure Communications, **1997**, 53: p. 1173-1176.
6. Delmas, C.; Cherkaoui, F.; Nadiri, A. and Hagemmuller, P.; *A nasicon-type phase as intercalation electrode: NaTi₂(PO₄)₃*, Materials Research Bulletin, **1987**, 22(5): p. 631-639.
7. Delmas, C.; Nadiri, A. and Soubeyroux, J.L.; *The NASICON-Type Titanium Phosphates LiTi₂(PO₄)₃, NaTi₂(PO₄)₃ as Electrode Materials*, Solid State Ionics, **1988**, 28: p. 419-423.
8. Aatiq, A.; Menetrier, M.; Croguennec, L.; Suard, E. and Delmas, C.; *On the structure of Li(3)Ti(2)(PO(4))(3)*, Journal of Materials Chemistry, **2002**, 12(10): p. 2971-2978.
9. Aravindan, V.; Chuilin, W.; Reddy, M.V.; Rao, G.V.S.; Chowdari, B.V.R. and Madhavi, S.; *Carbon coated nano-LiTi(2)(PO(4))(3) electrodes for non-aqueous hybrid supercapacitors*, Physical Chemistry Chemical Physics, **2012**, 14(16): p. 5808-5814.
10. Delmas, C. and Nadiri, A.; *The Chemical Short-Circuit Method - An Improvement in the Intercalation in the Intercalation-Deintercalation Techniques*, Materials Research Bulletin, **1988**, 23(1): p. 65-72.
11. Eljazouli, A.; Nadiri, A.; Dance, J.M.; Delmas, C. and Leflem, G.; *RELATIONSHIPS BETWEEN STRUCTURE AND MAGNETIC-PROPERTIES OF TITANIUM(III) NASICON-TYPE PHOSPHATES*, Journal of Physics and Chemistry of Solids, **1988**, 49(7): p. 779-783.
12. Belharouak, I. and Amine, K.; *New active titanium oxyphosphate material for lithium batteries*, Electrochemistry Communications, **2005**, 7(7): p. 648-651.
13. Godbole, V.A.; Villeveille, C.; Sommer, H.H.; Colin, J.F. and Novak, P.; *A structural and electrochemical study of Ni(0.5)TiOPO(4) synthesized via modified solution route*, Electrochimica Acta, **2012**, 77: p. 244-249.
14. Essehli, R.; El Bali, B.; Ehrenberg, H.; Svoboda, I.; Bramnik, N. and Fues, H.; *Co(0.5)TiOPO(4): Crystal structure, magnetic and electrochemical properties*, Materials Research Bulletin, **2009**, 44(4): p. 817-821.
15. Vidal-Abarca, C.; Mba, J.M.A.; Masquelier, C.; Tirado, J.L. and Lavela, P.; *In Situ X-ray Diffraction Study of Electrochemical Insertion in Mg(0.5)Ti(2)(PO(4))(3): An Electrode Material for Lithium or Sodium Batteries*, Journal of the Electrochemical Society, **2012**, 159(10): p. A1716-A1721.
16. Recham, N.; Chotard, J.N.; Jumas, J.C.; Laffont, L.; Armand, M. and Tarascon, J.M.; *Ionothermal Synthesis of Li-Based Fluorophosphates Electrodes*, Chemistry of Materials, **2010**, 22(3): p. 1142-1148.
17. Recham, N.; Chotard, J.N.; Dupont, L.; Djellab, K.; Armand, M. and Tarascon, J.M.; *Ionothermal Synthesis of Sodium-Based Fluorophosphate Cathode Materials*, Journal of the Electrochemical Society, **2009**, 156(12): p. A993-A999.
18. Tarascon, J.M.; Recham, N. and Armand, M.; *Method for Producing Inorganic Compounds*, FR20090055233, **2009**.

19. Bain, G.A. and Berry, J.F.; *Diamagnetic corrections and Pascal's constants*, Journal of Chemical Education, **2008**, 85(4): p. 532-536.
20. Sears, V.F.; *Neutron scattering lengths and cross section*, Neutron News, **1992**, 3(3): p. 26-37.
21. Patoux, S. and Masquelier, C.; *Lithium insertion into titanium phosphates, silicates, and sulfates*, Chemistry of Materials, **2002**, 14(12): p. 5057-5068.



**GENERAL CONCLUSION,
SUMMARY AND PERSPECTIVES**

Syntheses of LiMPO₄X

Ceramic route was useful for the synthesis of LiMPO₄X (with M = V, Fe, Ti and X = O or F) whose XRD patterns are displayed in Figure 1. LiVPO₄O was synthesized through a one-step reaction route for the first time. LiVPO₄F was obtained by a two-step ceramic route, the first step being the formation of a carbon coated VPO₄ mixed in rigorous stoichiometric proportions with LiF. The second step of the synthesis of LiVPO₄F was carried out in a sealed gold tube to avoid possible sublimation which leads to the formation of α -Li₃V₂(PO₄)₃. Both LiFePO₄F and LiTiPO₄F were obtained together with the formation of LiF which was removed by a washing with cold water.

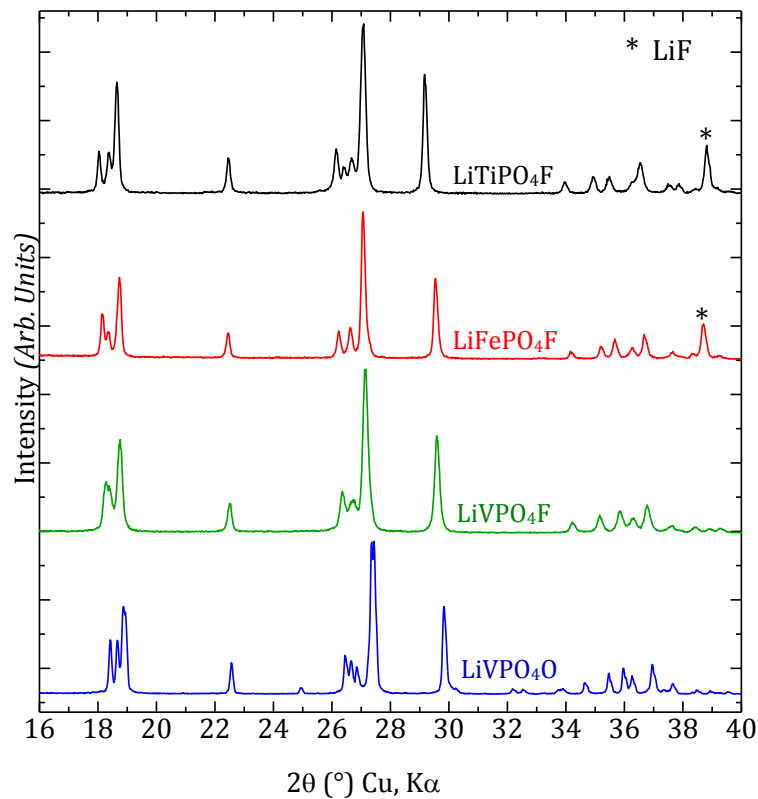
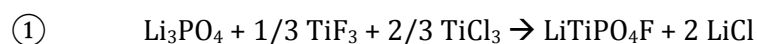

Figure 1: XRD patterns of different LiMPO₄X obtained in this work

We observed a degradation of LiTiPO₄F during aging and/or washing with water. This degradation led to the appearance of two new phases: one crystallizes in $P\bar{1}$ space group and another one crystallizes in Cc space group.

We are planning to bypass the effect of washing, by using an additional precursor as TiCl₃, we therefore expect to end up with the formation of LiTiPO₄F and LiCl according to the equation ①:



The choice of those precursors will favor the formation of LiCl which is expected to be removed by a washing with most of the common organic solvents (such as Acetonitrile, Dimethylfurane, acetone...) in Ar-filled glove box.

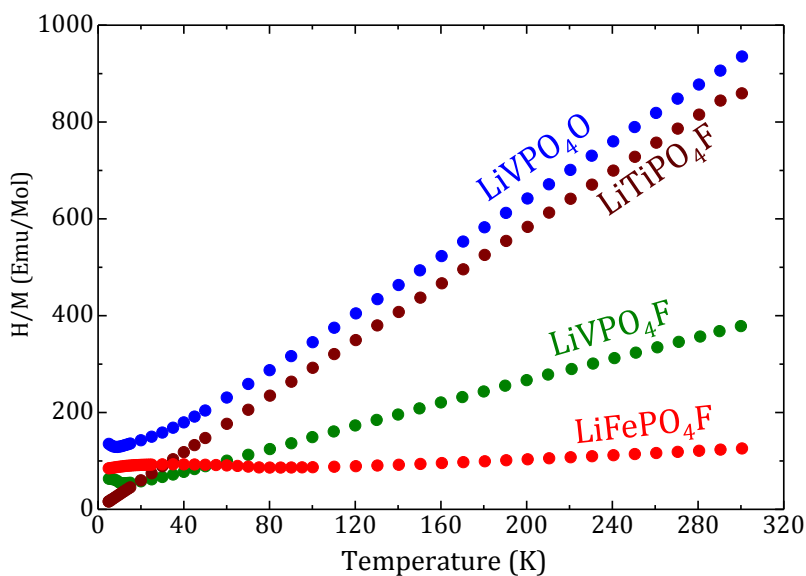

Figure 2: Temperature dependence of the H/M ratio for LiMPO_4X

The chemical composition and particularly the Li, M (with M = Ti, V and Fe) and P contents in LiMPO_4F were confirmed by ICP titrations. Based on the CHNS analyses, no H was observed in both LiFePO_4F and LiTiPO_4F . The variation of the susceptibility at low temperature range (Figure 2) indicates an antiferromagnetic behavior with Néel temperature of 9 K, 13 K and 80 K for LiVPO_4F , LiVPO_4O and LiFePO_4F respectively. Moreover, the susceptibility at high temperature range confirmed the oxidation state of each transition metal (Fe^{3+} , V^{3+} , V^{4+} , whose electronic configurations are $t_{2g}^3e_g^2$, $t_{2g}^2e_g^0$ and $t_{2g}^1e_g^0$ respectively). Based on Mössbauer spectroscopy analysis, we could confirm the oxidation state of Fe^{3+} lying in octahedral environment.

Structures of LiMPO_4X (with X = O or F)

Complete structural characterization of LiMPO_4X was performed using XRD and neutron diffraction data with the support of NMR studies. LiMPO_4X crystallizes in Tavorite-type structures and are iso-structural to the mineral LiFePO_4OH . Figure 3 displays the bond length along the chains in each structure. The unit cell volume of LiVPO_4O is two times bigger than those of LiMPO_4F . We observed an alternative long (2.21 Å and 2.17 Å) and short (1.62 Å and 1.71 Å) distances along the LiVPO_4O chains (the short distances being vanadyl-type) whereas for LiFePO_4F and LiVPO_4F , we observed the same and regular M–F distances of 1.98 Å. In the

structure of LiTiPO_4F , we observed distances of 2.01 Å and 1.94 Å so that the average distance is 1.98 Å.

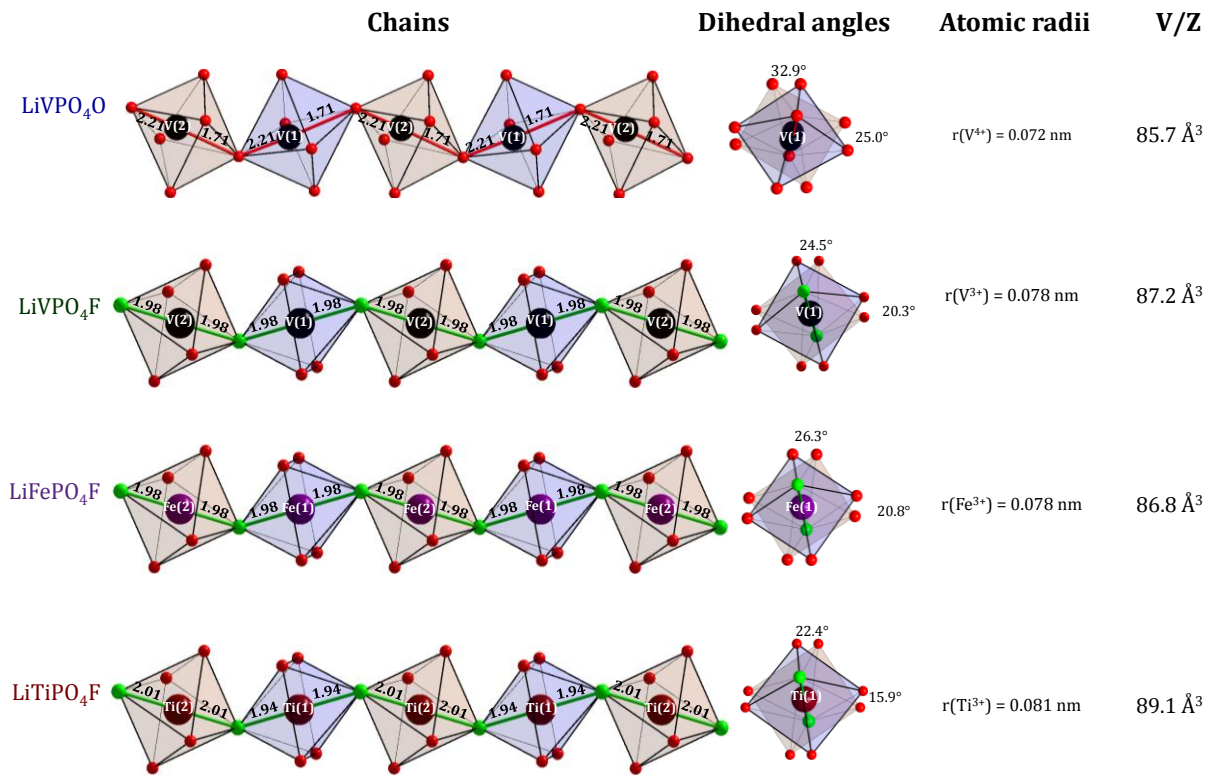

Figure 3: Comparison of $[\text{MO}_4\text{X}_2]$ chains, dihedral angles, atomic radii of transition metal and V/Z in LiMPO_4X ($M = \text{V}, \text{Fe}, \text{Ti}$ and $X = \text{O}$ or F)

The evolution of V/Z is consistent with the atomic radii of the transition metal. Indeed V/Z increases with the increase of atomic radii. The Li steric constraints in each structure is illustrated by larger dihedral angles (as encountered in LiVPO_4O). In order to localize precisely the Li site(s) an acquisition of neutron diffraction data with very good resolution has to be performed for LiTiPO_4F (by increasing the acquisition time or the amount of powder).

The unique Li site observed in the structure of LiVPO_4F and LiFePO_4F is coordinated by 4 oxygen atoms and one fluorine, forming a distorted pentahedron which distortion is very similar in both structures with values of $6.00 \cdot 10^{-3}$ in LiVPO_4F and $6.51 \cdot 10^{-3}$ in LiFePO_4F . ^7Li MAS NMR performed in both samples exhibited a sharp signal shifted at 117 ppm for LiVPO_4F and 203 ppm for LiFePO_4F , those shift being in good agreement with the increasing number of single spins in t_{2g} orbitals (2 for V^{3+} and 3 for Fe^{3+}). The ^7Li MAS NMR of LiVPO_4F presented a shoulder which can be assigned not to the impurity but to structural defects which were not detected by XRD and neutron diffraction.

The two Li sites present in the structure of LiVPO_4O are surrounded by 5 oxygen atoms (forming distorted pentahedra) and are separated by 3.44 Å. Surprisingly, the ^7Li MAS NMR spectrum shows a single signal shifted at 71 ppm. The two Li sites being significantly different (*i.e.* with different V-O distances and O-V-O angles), the observation of a unique signal was not expected. Nevertheless DFT calculations have shown that the two Li sites are in fact not so different, with a rather similar spin transfer from the vanadium paramagnetic ion to the Li nucleus. Therefore, the two contributions might not be separated in the spectrum. Another explanation for this single ^7Li NMR signal could be the mobility between the two Li sites although they are separated by 3.44 Å. Very high field and fast MAS measurements might possibly help discriminate between these two hypotheses. The localization of Li in LiTiPO_4F structure was not successful using both XRD and neutron diffraction data probably due to low resolution data. However ^7Li NMR exhibited 3 signals suggesting at least 3 Lithium sites in the structures.

A highly shifted ^{19}F NMR signal (shifted at -1500 ppm) was observed only for LiVPO_4F . No signal was observed for LiFePO_4F probably shifted at a very higher ppm value compared to LiVPO_4F as Fe^{3+} possesses more spins than V^{3+} . Surprisingly no signal was also observed for LiTiPO_4F while Ti^{3+} possesses less spins than V^{3+} .

The magnetic structure of LiVPO_4F and LiFePO_4F was determined by a Rietveld refinement of neutron diffraction data performed at low temperature. The antiferromagnetism of both LiVPO_4F and LiFePO_4F was consistent with the evolution of the static magnetic susceptibility with temperature. The magnetic moment bear by the metal in each compound are antiparallel along the chain and the chains are also antiparallel through the propagation vector. Therefore LiVPO_4F and LiFePO_4F adopt a magnetic structure analogous to a G-type AFM where all nearest neighbors are antiferromagnetically coupled. The resulting magnetic moments were 1.22 μ_{B} and 3.92 μ_{B} for LiVPO_4F and LiFePO_4F respectively.

For LiVPO_4O , the magnetic measurement revealed a magnetic transition at a temperature of 9 K from paramagnetic to antiferromagnetic ordering. However, no magnetic transition was observed using low temperature neutron diffraction, probably due to the transparency of vanadium in neutron diffraction with in addition the electronic configuration of V^{4+} ($t_{2g}^1 e_g^0$) which displays only one single electron. Let us recall that in the case of LiVPO_4F , two tiny peaks were observed. It was therefore not surprising that no magnetic transition was detected for LiVPO_4O .

Electrochemical behavior of LiMPO₄X

The electrochemical behavior of LiMPO₄X was followed vs. Li⁺/Li and compared with other phosphates. We always observed a relatively high potential of the redox couples involved. As an example, LiVPO₄F present an operating potential of 4.22 V, higher than any other vanadium phosphate in which the couple V⁴⁺/V³⁺ is present. During the Li⁺ extraction from LiVPO₄F (which leads to the formation of VPO₄F) an intermediate phase was spotted at a composition of Li_{0.67}VPO₄F. This intermediate was clearly visible by *in situ* XRD and crystallizes in $P\bar{1}$ space group as confirmed by electron diffraction. Further Li⁺ extraction from Li_{0.67}VPO₄F results in the formation of VPO₄F which crystallizes in $C2/c$ space group. Interestingly, during subsequent Li⁺ insertion in VPO₄F the formation of the intermediate Li_{0.67}VPO₄F was not observed as well demonstrated by *in situ* XRD, but only two phases of VPO₄F and LiVPO₄F were present. All those processes rely on biphasic mechanisms as also well demonstrated by *in situ* XRD. We also planned to study the mechanism of Na⁺ insertion/extraction into VPO₄F in order to follow the possible formation of Na_{0.67}VPO₄F.

LiVPO₄F can also accommodate one Li in its host structure leading to the formation of Li₂VPO₄F through a biphasic mechanism. Li₂VPO₄F crystallizes in $C2/c$ space group and proved to be highly air sensitive. Both VPO₄F and Li₂VPO₄F crystallize in $C2/c$ space group and are related to the parent phase LiVPO₄F. Their oxidation state as well as the one of Li_{0.67}VPO₄F was confirmed by the measurement of the magnetic susceptibility with temperature and contrary to LiVPO₄F, the paramagnetism remained all along the temperature range. The structure of Li_{0.67}VPO₄F is still unknown but might probably be related to the parent LiVPO₄F. ⁷Li MAS NMR of Li_{0.67}VPO₄F shows 4 signals ascribed to different types of environments for Li and corresponding to some kind of charge ordering in the material. Further NMR experiments are in progress to investigate this.

The poor electrochemical performances of LiVPO₄O (small capacity retention, high polarization...) was ascribed to the big sized and highly agglomerated particles. The Li⁺ extraction from LiVPO₄O leads to the formation of VPO₄O through a biphasic process, and the V⁵⁺/V⁴⁺ redox couple operates at a potential of 3.95 V vs. Li⁺/Li. We have demonstrated for the first time that LiVPO₄O can accommodate one Li in his host structure and leads to the formation of Li₂VPO₄O in which vanadium oxidation state is +3. The V⁴⁺/V³⁺ redox couple involved in this process is the same as the one involve in the LiVPO₄F \rightleftharpoons VPO₄F system, but with an average potential located at 2.3 V vs. Li⁺/Li for LiVPO₄O \rightleftharpoons Li₂VPO₄O system and 4.2 V vs. Li⁺/Li for the LiVPO₄F \rightleftharpoons VPO₄F system. This difference can be the result of the presence of the alternative long

V–O and short V=O distances in the structure of LiVPO_4O . A possible reduction of V^{3+} present in $\text{Li}_2\text{VPO}_4\text{O}$ has to be investigated through Li^+ insertion in the structure (chemically or electrochemically).

The insertion/extraction of Li^+ in the structure of LiVPO_4O undergoes reversibly through two intermediate phases of $\text{Li}_{1.5}\text{VPO}_4\text{O}$ and $\text{Li}_{1.75}\text{VPO}_4\text{O}$ never reported before in the literature. Their obtention by chemical lithiation of LiVPO_4O is under process in our laboratory in order to determine their respective structure.

The galvanostatic behavior of LiFePO_4F exhibited an operating potential around 2.8 V vs. Li^+/Li . A sloping outgrowth curve was observed beyond the composition of LiFePO_4F so that the end of the charge suggested an improbable oxidation of Fe^{3+} , which is clearly not possible at such low potential. This particular and surprising signature can be ascribed to a possible air degradation of a Spex milled mixture of LiFePO_4F and C_{sp} . The poor electrochemical performances of LiFePO_4F (huge polarization and small amount of Li^+ exchanged) could be by-passed through a sol-gel synthesis of LiFePO_4F expected to end up with the formation of small particles and through a carbon coating of LiFePO_4F particles.

The *in situ* XRD displayed no solid solution during Li insertion into LiFePO_4F but revealed two biphasic mechanisms with an intermediate still unknown. However, we did not observe any intermediate phase using Mössbauer technique and the galvanostatic cycling.

The galvanostatic signature of LiTiPO_4F presented an average redox potential around 3 V vs. Li^+/Li for the $\text{Ti}^{4+}/\text{Ti}^{3+}$ redox couple. The first galvanostatic extraction of Li^+ from the structure of LiTiPO_4F presented a relatively good capacity retention and smaller polarization compared with the first galvanostatic insertion of Li^+ which presented a fast capacity fading and higher polarization.

The galvanostatic cycling of the cold-water washed sample of LiTiPO_4F was completely different from that of the LiTiPO_4F and exhibited two pseudo-plateaus: the upper one located at 3.0 V and 1.7 V vs. Li^+/Li . In each voltage domain, only 0.5 Li was exchanged in good agreement with the average oxidation state of Titanium in that sample which is close to 3.5 (*i.e.* $\text{Ti}^{3+}/\text{Ti}^{4+} \sim 1/1$). The galvanostatic signature of the sample aged for one year exhibited no capacity during the first Li extraction in good agreement with the presence of tetravalent titanium ions only in the material.

$\text{Na}_3\text{V}_2(\text{PO}_4)_2\text{F}_3$: Another vanadium fluorophosphate material

More recently, in the frame of Atif Emre DEMET Master Thesis, we focused our interest on $\text{Na}_3\text{V}_2(\text{PO}_4)_2\text{F}_3$ as a positive electrode material for Li and Na-ion batteries as more than one electron per transition metal are expected to be reversibly exchanged and at a high voltage. This composition is with no doubt one of the most attractive candidates for positive electrode for the development of Na-ion batteries. Figure 4 describes the three-dimensional framework of $\text{Na}_3\text{V}_2(\text{PO}_4)_2\text{F}_3$ which is built up of $[\text{V}_2\text{O}_8\text{F}_3]$ bi-octahedra and $[\text{PO}_4]$ tetrahedra. Each bi-octahedron shares its oxygen atoms with eight $[\text{PO}_4]$ tetrahedra, building thus rather large cavities in which Na^+ cations are located. Two types of fluorine exist, the F(1) atoms bridging the two VO_4F_2 octahedra of each $[\text{V}_2\text{O}_8\text{F}_3]$ unit and the two terminal F(2) atoms pointing along the c direction. We observed a V-F(1) distance (F(1) being the bridging atom between two octahedra) of 1.98 Å, same as for the M-F distances along the chains of the Tavorite-like structure of LiFePO_4F and LiVPO_4F . The terminal V-F(2) distance is 1.93 Å.

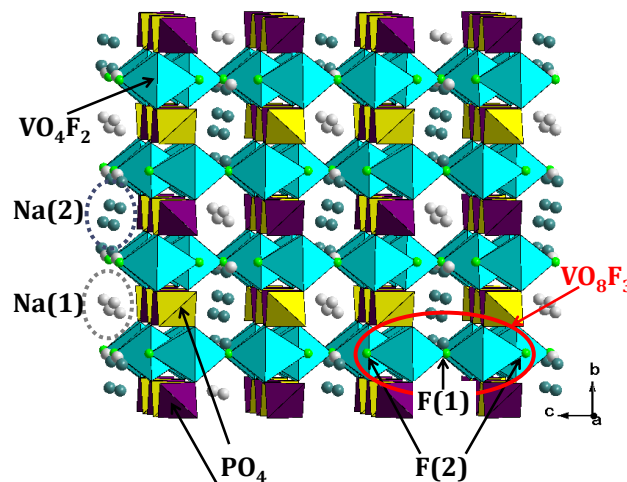

Figure 4: Description of the three-dimensional structure of $\text{Na}_3\text{V}_2(\text{PO}_4)_2\text{F}_3$

Figure 5 gives the electrochemical curves obtained for $\text{Li}||\text{Na}_3\text{V}_2(\text{PO}_4)_2\text{F}_3$ cells cycled in the 2.7–4.5 V potential window. They support the occurrence of several phase transitions upon cycling and reveal the complexity of the phase diagram that is dependent on the potential window used. During the first charge in the 2.7–4.5 V potential window, Na^+ ions are deintercalated from $\text{Na}_3\text{V}_2^{\text{III}}(\text{PO}_4)_2\text{F}_3$ to form (theoretically) $\text{Na}_{3-x}\text{V}_2^{\text{III,IV}}(\text{PO}_4)_2\text{F}_3$ ($x \leq 2$) through the oxidation of V^{III} to V^{IV} for charge compensation.

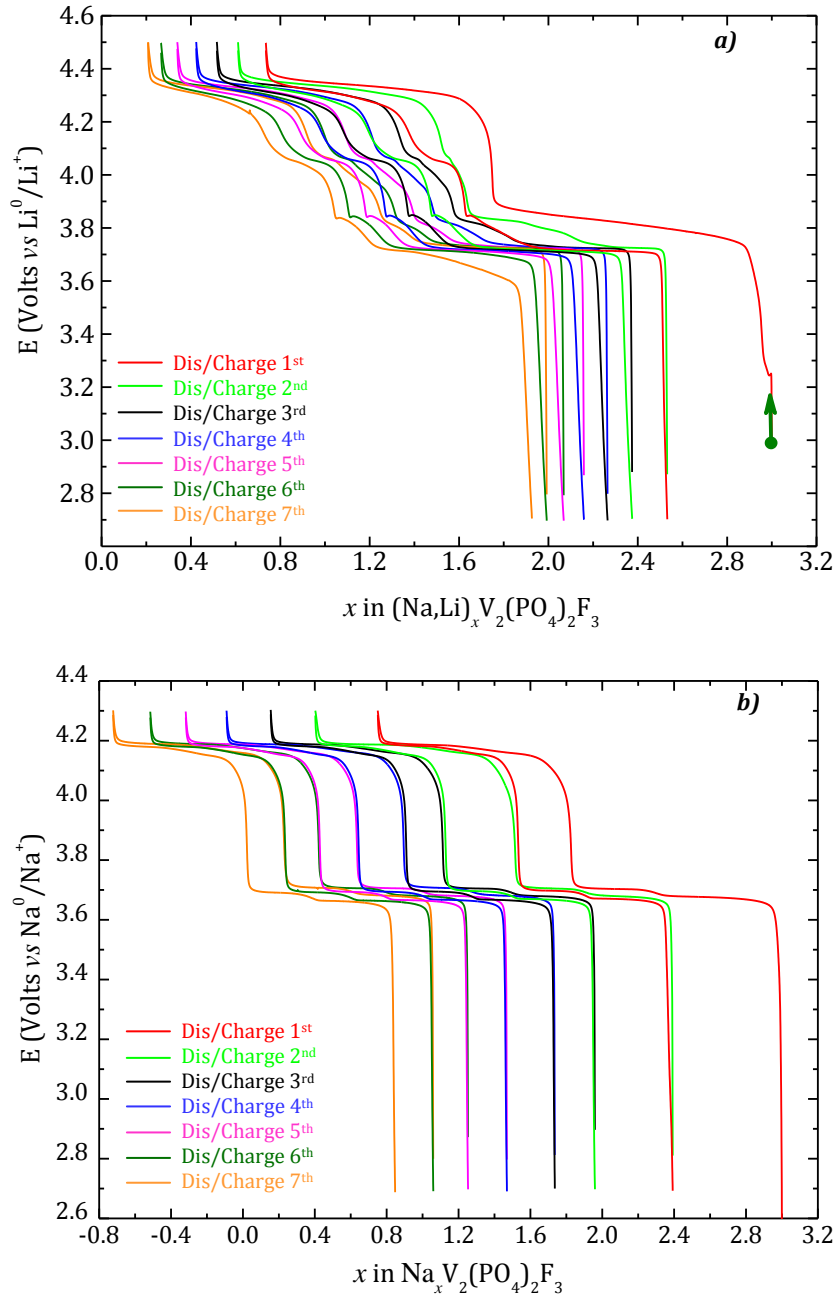

Figure 5 a) Electrochemical curves obtained for $\text{Li}|\text{LP30}|\text{Na}_3\text{V}_2(\text{PO}_4)_2\text{F}_3$ cells cycled between 2.7–4.5 V vs. Li^+/Li at C/50 b) Electrochemical curves obtained for $\text{Na}|\text{NaPF}_6$ in PC $|\text{Na}_3\text{V}_2(\text{PO}_4)_2\text{F}_3$ cells cycled between 2.7–4.3 V vs. Na^+/Na .

In fact, in parallel to Na^+ deintercalation, a Na^+/Li^+ ion exchange occurs and $(\text{Li,Na})_{3-x}\text{V}_2^{\text{III,IV}}(\text{PO}_4)_2\text{F}_3$ ($x \leq 2$) is formed. The continuous change during the first two cycles is due to a continuous change in the composition of the material $(\text{Na,Li})_x\text{V}_2(\text{PO}_4)_2\text{F}_3$ ($x \leq 2$) from a Na-rich material to a Li-rich one. Note that depending on the OCV period prior to cycling of the $\text{Li}||\text{Na}_3\text{V}_2(\text{PO}_4)_2\text{F}_3$ battery and on the cycling rate, the electrochemical signature appears slightly different due to a more or less extended Na^+/Li^+ ion exchange in the pristine or deintercalated material. During the first charge up to 5 V $\text{Na}_3\text{V}_2^{\text{III}}(\text{PO}_4)_2\text{F}_3$ is fully deintercalated with the exchange of three electrons (*i.e.* the deintercalation of three alkali ions) and the oxidation of

vanadium up to the average oxidation state $V^{4.5+}$ (V^{IV}/V^V). Interestingly, an irreversible phase transition occurs and then, the cycling takes place between the compositions $V_2(PO_4)_2F_3$ and $Li_{-1.5}V_2(PO_4)_2F_3$.

ANNEXE I: CRYSTALLOGRAPHIC DATA

Table I-1: Structural parameters obtained after Rietveld refinement of XRD and neutron diffraction data from phase pure LiVPO₄F

LiVPO₄F						
S.G. : $P\bar{2}_1$; Z = 2						
$a = 5.1708(3) \text{ \AA}; \alpha = 107.595(3)^\circ$ $b = 5.3083(3) \text{ \AA}; \beta = 107.969(2)^\circ$ $c = 7.2631(4) \text{ \AA}; \gamma = 98.388(2)^\circ$			XRD: $R_{wp} = 15.2 \%$; $R_{bragg} = 1.88 \%$; $\chi^2 = 1.73$			
$V = 174.36(2) \text{ \AA}^3; V/Z = 87.18 \text{ \AA}^3$			Neutrons: $R_{wp} = 13.0\%$; $R_{bragg} = 5.11\%$; $\chi^2 = 3.93$			
Atomic parameters						
Atoms	Wyckoff position	Atomic position			Occ	B _{iso}
		x/a	y/b	z/c		
V(1)	1a	0	0	0	1	0.404(1)
V(2)	1c	0	0	1/2	1	0.306(1)
P	2i	0.3264(1)	0.6494(1)	0.2533(1)	1	0.557(4)
O(1)	2i	0.3737(3)	0.2374(2)	0.5962(2)	1	0.417(3)
O(2)	2i	0.1072(2)	-0.3218(2)	0.3508(2)	1	0.425(3)
O(3)	2i	0.6906(2)	0.6567(2)	-0.1471(2)	1	0.752(3)
O(4)	2i	0.2567(2)	0.7848(2)	0.0885(2)	1	0.299(2)
F	2i	-0.1135(2)	0.0873(2)	0.2438(2)	1	0.842(3)
Li(1)	2i	0.703(1)	0.371(1)	0.233(1)	1	2.635(2)

Table 0-2: Selected bond lengths (Å) and angles (°) in the structure of LiVPO_4F .
Numbers in the diagonals (bold) are V-X distances (X = F or O).
Numbers below the diagonals are X-V-X angles.
Numbers above the diagonals are X-X distances

V(1)O₄F₂	O(4)a	O(4)b	F(1)a	F(1)b	O(3)a	O(3)b
O(4)a	1.96(3)	3.92(2)	2.62(2)	2.94(2)	2.75(3)	2.82(3)
O(4)b	180	1.96(3)	2.94(2)	2.62(2)	2.82(3)	2.75(3)
F(1)a	83.40(2)	95.60(2)	1.98(2)	3.96(2)	2.79(3)	2.82(2)
F(1)b	95.60(2)	83.40(2)	180	1.98(2)	2.82(2)	2.79(3)
O(3)a	88.56(2)	91.43(3)	89.42(2)	90.58(2)	1.99(2)	3.97(2)
O(3)b	91.43(3)	88.56(2)	90.58(2)	89.42(2)	180	1.99(2)
Distortion: $\Delta = 3.98 \cdot 10^{-5}$						

V(2)O₄F₂	O(1)a	O(1)b	F(1)a	F(1)b	O(2)a	O(2)b
O(1)a	1.96(3)	3.86(3)	2.76(2)	2.78(2)	2.71(2)	2.82(3)
O(1)b	180	1.96(3)	2.78(2)	2.76(2)	2.82(3)	2.71(2)
F(1)a	89.61(3)	90.38(3)	1.98(3)	3.97(3)	2.79(3)	2.82(2)
F(1)b	90.38(3)	89.61(3)	180	1.98(3)	2.82(2)	2.79(3)
O(2)a	87.62(2)	92.38(2)	89.58(2)	90.41(3)	1.98(2)	3.97(2)
O(2)b	92.38(2)	87.62(2)	90.41(3)	89.58(2)	180	1.98(2)
Distortion: $\Delta = 2.28 \cdot 10^{-5}$						

PO₄	O(1)	O(2)	O(3)	O(4)
O(1)	1.50(2)	2.54(3)	2.38(2)	2.54(2)
O(2)	115.11(3)	1.51(3)	2.52(2)	2.44(3)
O(3)	102.54(3)	110.69(3)	1.55(3)	2.54(3)
O(4)	112.57(2)	105.86(3)	110.13(2)	1.55(2)
Distortion: $\Delta = 2.22 \cdot 10^{-4}$				

LiO₄F	O(1)	O(2)	O(3)	O(4)	F
O(1)	2.24(3)	2.71(2)	2.37(3)	4.14(2)	3.98(2)
O(2)	75.39(2)	2.19(3)	3.96(2)	3.15(3)	2.94(3)
O(3)	69.58(3)	140.23(3)	1.90(2)	3.24(3)	3.42(2)
O(4)	131.00(2)	88.79(2)	100.09(2)	2.31(3)	2.62(2)
F	148.37(3)	91.68(2)	128.08(3)	76.18(3)	1.90(2)
Distortion: $\Delta = 6.00 \cdot 10^{-3}$					

Table 0-3: Structural parameters obtained after Rietveld refinement of XRD and Neutron diffraction data of phase pure LiVPO_4O

LiVPO_4O						
S.G. : $P\bar{1}$; Z = 4						
$a = 6.7320(1) \text{ \AA}$; $\alpha = 89.843(1)^\circ$			XRD: $R_{\text{wp}} = 13.2 \%$;			
$b = 7.1942(1) \text{ \AA}$; $\beta = 91.272(1)^\circ$			$R_{\text{bragg}} = 1.73 \%$ $\chi^2 = 1.92$			
$c = 7.9204(1) \text{ \AA}$; $\gamma = 116.886(4)^\circ$			Neutron $R_{\text{wp}} = 10.1 \%$;			
$V = 342.92(1) \text{ \AA}^3$; $V/Z = 85.73 \text{ \AA}^3$			$R_{\text{bragg}} = 3.61 \%$ $\chi^2 = 2.23$			
Atomic parameters						
Atoms	Wyckoff position	Atomic position			Occ	B_{iso}
		x/a	y/b	z/c		
V(1)	$2i$	0.2534(9)	0.0332(8)	0.7704(6)	1	0.498(6)
V(2)	$2i$	0.2440(9)	-0.4742(8)	0.7350(7)	1	0.974(1)
P (1)	$2i$	0.2317(1)	-0.2507(9)	0.0815(9)	1	0.397(3)
P(2)	$2i$	0.2548(1)	-0.7591(1)	0.4142(1)	1	0.584(2)
O(1)	$2i$	0.5460(5)	0.0936(4)	0.8274(1)	1	0.630(3)
O(2)	$2i$	0.1226(5)	-0.1535(4)	0.9700(3)	1	0.609(7)
O(3)	$2i$	-0.0680(4)	-0.0812(4)	0.6968(1)	1	0.430(8)
O(4)	$2i$	0.3476(5)	0.1237(3)	0.5345(1)	1	0.341(2)
O(5)	$2i$	0.2390(7)	-0.2514(5)	0.6654(4)	1	0.685(9)
O(6)	$2i$	0.2702(6)	0.2524(4)	0.8410(3)	1	0.469(3)
O(7)	$2i$	0.0779(6)	-0.3521(3)	0.2300(1)	1	0.516(1)
O(8)	$2i$	0.2819(4)	-0.3981(5)	-0.0210(2)	1	0.550(1)
O(9)	$2i$	0.4303(8)	-0.6167(14)	0.2921(2)	1	0.837(1)
O(10)	$2i$	0.1796(4)	-0.6160(5)	0.5194(3)	1	0.638(3)
Li(1)	$2i$	0.204(5)	-0.688(5)	0.075(4)	1	2.636(3)
Li(2)	$2i$	0.273(5)	-0.207(5)	0.409(4)	1	2.612(1)

Table 0-4: Selected bond lengths (Å) and angles (°) in the structure of LiVPO₄O. Numbers in the diagonals (bold) are V-O distances. Numbers below the diagonals are O-V-O angles. Numbers above the diagonals are O-O distances.

V(1)O₆	O(6)	O(1)	O(4)	O(3)	O(2)	O(5)
O(6)	1.62(8)	2.58(7)	2.74(3)	2.87(2)	2.82(1)	3.80(3)
O(1)	95.48(2)	1.86(1)	2.70(8)	3.85(3)	2.84(7)	2.90(8)
O(4)	97.81(1)	89.10(7)	1.99(7)	2.84(3)	3.85(3)	2.66(9)
O(3)	94.53(9)	169.94(5)	90.34(4)	2.00(8)	2.66(3)	2.77(2)
O(2)	100.98(5)	94.51(5)	160.41(2)	82.75(7)	2.01(4)	2.85(4)
O(5)	177.25(3)	84.02(5)	79.48(7)	86.00(3)	81.75 (3)	2.17(2)
Distortion: $\Delta = 7.63 \cdot 10^{-3}$						

V(2)O₆	O(5)	O(10)	O(7)	O(8)	O(9)	O(6)
O(5)	1.71(1)	2.72(5)	2.81(7)	2.75(6)	2.80(1)	3.92(1)
O(10)	96.85(1)	1.93(5)	2.60(5)	3.89(1)	2.79(1)	2.86(3)
O(7)	99.44(6)	83.65(1)	1.98(4)	2.78(2)	3.93(1)	2.79(6)
O(8)	96.09(5)	166.02(6)	89.06(1)	1.99(2)	2.89(3)	2.71(2)
O(9)	97.76(7)	90.48(8)	162.35(5)	92.95(7)	2.00(2)	2.71(1)
O(6)	175.40(3)	87.13(3)	83.24(1)	80.16(4)	79.84(8)	2.21(4)
Distortion: $\Delta = 5.51 \cdot 10^{-3}$						

P(1)O₄	O(8)	O(2)	O(7)	O(1)
O(8)	1.50(2)	2.44(1)	2.54(6)	2.47(7)
O(2)	109.22(4)	1.51(1)	2.44(8)	2.59(1)
O(7)	114.32(3)	107.75(5)	1.53(4)	2.42(1)
O(1)	107.76(1)	115.30(1)	102.53(4)	1.57(1)
Distortion: $\Delta = 3.08 \cdot 10^{-4}$				

P(2)O₄	O(3)	O(9)	O(4)	O(10)
O(3)	1.52(4)	2.42(8)	2.51(4)	2.59(3)
O(9)	105.43(4)	1.52(6)	2.56(3)	2.49(6)
O(4)	108.85(1)	111.91(3)	1.56(6)	2.59(1)
O(10)	113.13(4)	106.78(5)	110.64(6)	1.58(2)
Distortion: $\Delta = 2.83 \cdot 10^{-4}$				

Li(1)O₄O	O(2)	O(6)	O(8)	O(9)	O(3)
O(2)	1.99(1)	2.86(5)	3.17(5)	3.87(4)	2.65(9)
O(6)	91.54(3)	2.00(7)	2.71(2)	3.70(7)	3.93(1)
O(8)	103.41(3)	83.74(6)	2.05(5)	3.30(3)	4.23(4)
O(9)	136.96(9)	124.87(5)	102.71(3)	2.17(3)	2.42(8)
O(3)	74.96(1)	128.42(3)	147.54(6)	64.70(6)	2.35(4)
Distortion: $\Delta = 4.00 \cdot 10^{-3}$					

Li(2)O₄	O(7)	O(5)	O(1)	O(4)a	O(4)b
O(7)	1.87(3)	3.56(8)	2.42(1)	3.88(4)	3.88(1)
O(5)	130.36(4)	2.05(6)	4.16(6)	2.99(5)	2.66(9)
O(1)	72.39(1)	156.06(8)	2.20(2)	2.71(1)	3.50(7)
O(4)a	131.71(4)	84.67(3)	72.401(2)	2.37(7)	3.321(9)
O(4)b	129.44(8)	72.90(4)	98.89(2)	87.87(5)	2.41(1)
Distortion: $\Delta = 8.52 \cdot 10^{-3}$					

Table 10-1: Structural parameters obtained after Rietveld refinement of XRD and neutron diffraction data from phase pure VPO₄F

VPO₄F						
S.G. : C2/c; Z = 4						
$a = 7.1662(4) \text{ \AA}; b = 7.1267(3) \text{ \AA}$ $c = 7.1285(4) \text{ \AA}; \beta = 118.077(2)^\circ$			XRD: $R_{wp} = 18.9 \%$; $R_{bragg} = 2.98 \%$ $\chi^2 = 3.43$			
$V = 321.22(3) \text{ \AA}^3; V/Z = 80.30 \text{ \AA}^3$			Neutrons: $R_{wp} = 20.8 \%$; $R_{bragg} = 0.61 \%$ $\chi^2 = 1.43$			
Atomic parameters						
Atoms	Wyckoff position	Atomic position			Occ	B _{iso}
		x/a	y/b	z/c		
V	4d	1/4	1/4	1/2	1	0.284(8)
P	4e	0	0.6280(5)	1/4	1	0.918(4)
O(1)	8f	0.3374(9)	0.0087(6)	0.0770(9)	2	1.146(1)
O(2)	8f	0.3961(5)	0.2465(7)	0.3430(1)	2	1.007(4)
F	4e	0	0.1530(9)	1/4	1	3.515(4)

Table 10-2: Selected bond lengths (Å) and angles (°) in the structure of VPO_4F .
Numbers in the diagonals (bold) are V-X distances (X = F or O).
Numbers below the diagonals are X-V-X angles.
Numbers above the diagonals are X-X distances

V(1)O₄F₂	O(2)a	O(2)b	O(1)a	O(1)b	Fa	Fb
O(2)a	1.85(8)	3.71(2)	2.74(1)	2.63(3)	2.72(9)	2.67(7)
O(2)b	180	1.85(8)	2.63(3)	2.74(1)	2.67(7)	2.72(9)
O(1)a	92.33(3)	87.66(7)	1.94(1)	3.88(2)	2.70(2)	2.81(9)
O(1)b	87.66(7)	92.33(3)	180	1.94(1)	2.81(9)	2.70(2)
Fa	91.10(7)	88.89(3)	87.55(9)	92.44(1)	1.96(4)	3.92(8)
Fb	88.89(3)	91.10(7)	92.44(1)	87.55(9)	180	1.96(4)
Distortion: $\Delta = 6.23 \cdot 10^{-4}$						

PO₄	O(2)a	O(2)b	O(1)a	O(1)b
O(2)a	1.47(3)	2.41(5)	2.42(7)	2.41(2)
O(2)b	110.07(2)	1.47(3)	2.41(2)	2.42(7)
O(1)a	109.47(1)	108.45(1)	1.50(1)	2.47(1)
O(1)b	108.45(1)	109.47(1)	110.92(3)	1.50(1)
Distortion: $\Delta = 1.02 \cdot 10^{-4}$				

Table II0-1: Structural parameters obtained after Rietveld refinement of XRD and neutron diffraction data from phase LiFePO₄F

LiFePO₄F						
S.G. : $P\bar{1}$; Z = 2						
$a = 5.1525(5) \text{ \AA}$; $\alpha = 107.352(4)^\circ$			X-Ray: $R_{wp} = 14.3 \%$;			
$b = 5.3037(9) \text{ \AA}$; $\beta = 107.949(7)^\circ$			$R_{bragg} = 3.97 \%$ $\chi^2 = 1.71$			
$c = 7.2557(9) \text{ \AA}$; $\gamma = 98.467(6)^\circ$			Neutrons: $R_{wp} = 12.3 \%$;			
$V = 173.69(3) \text{ \AA}^3$; $V/Z = 86.84 \text{ \AA}^3$			$R_{bragg} = 6.22 \%$ $\chi^2 = 2.00$			
Atomic parameters						
Atoms	Wyckoff position	Atomic position			Occ	B _{iso}
		x/a	y/b	z/c		
Fe(1)	$1a$	0	0	0	1	0.907(2)
Fe(2)	$1c$	0	0	1/2	1	0.954(1)
P	$2i$	0.3219(9)	0.6483(1)	0.2519(7)	1	0.969(3)
O(1)	$2i$	0.3774(8)	0.2387(8)	0.5898(8)	1	0.668(3)
O(2)	$2i$	0.1078(7)	-0.3348(3)	0.3595(3)	1	0.669(9)
O(3)	$2i$	0.6906(3)	0.6529(4)	-0.1437(4)	1	0.698(3)
O(4)	$2i$	0.2636(5)	0.7925(2)	0.0975(2)	1	0.910(5)
F	$2i$	-0.1153(9)	0.0855(6)	0.2435(2)	1	0.878(3)
Li	$2i$	0.7198(1)	0.3783(7)	0.2330(1)	1	2.193(2)

Table II0-2: Selected bond lengths (Å) and angles (°) in the structure of LiFePO₄F.
Numbers in the diagonals (yellow) are Fe-X distances (X = F or O).
Numbers below the diagonals are X-Fe-X angles.
Numbers above the diagonals are X-X distances

Fe(1)O₄F₂	O(3)a	O(3)b	O(4)a	O(4)b	F(1)a	F(1)b
O(3)a	1.99(6)	3.99(2)	2.78(1)	2.82(5)	2.81(2)	2.81(4)
O(3)b	180	1.99(6)	2.82(5)	2.78(1)	2.81(4)	2.81(2)
O(4)a	89.08(6)	90.91(4)	1.96(7)	3.93(5)	2.92(7)	2.65(7)
O(4)b	90.91(4)	89.08(6)	180	1.96(7)	2.65(7)	2.92(7)
F(1)a	89.95(3)	90.04(7)	95.44(6)	84.55(4)	1.98(3)	3.96(6)
F(1)b	90.04(7)	89.95(3)	84.55(4)	95.44(6)	180	1.98(3)

Distortion $\Delta = 3.45 \cdot 10^{-5}$

Fe(2)O₄F₂	O(1)a	O(1)b	O(2)a	O(2)b	F(1)a	F(1)b
O(1)a	1.95(2)	3.90(5)	2.87(6)	2.73(5)	2.76(9)	2.79(4)
O(1)b	180	1.95(2)	2.73(5)	2.87(6)	2.79(4)	2.76(9)
O(2)a	92.87(4)	87.12(6)	2.01(5)	4.03(1)	2.87(8)	2.77(3)
O(2)b	87.12(6)	92.87(4)	180	2.01(5)	2.77(3)	2.87(8)
F(1)a	89.47(8)	90.52(2)	92.12(2)	87.87(8)	1.98(1)	3.96(2)
F(1)b	90.52(2)	89.47(8)	87.87(8)	92.12(2)	180	1.98(1)

Distortion $\Delta = 1.68 \cdot 10^{-5}$

PO₄	O(1)	O(2)	O(3)	O(4)
O(1)	1.51(5)	2.51(3)	2.38(1)	2.51(4)
O(2)	111.05(1)	1.53(4)	2.51(4)	2.50(4)
O(3)	102.49(5)	109.87(4)	1.53(7)	2.51(8)
O(4)	112.01(1)	110.18(9)	110.99(8)	1.51(7)

Distortion $\Delta = 4.14 \cdot 10^{-5}$

LiO₄F	O(1)	O(2)	O(3)	O(4)	F
O(1)	2.27(3)	2.73(5)	2.38(1)	4.23(4)	3.99(9)
O(2)	77.85(2)	2.07(2)	3.82(6)	3.23(6)	2.88(1)
O(3)	67.70(6)	141.73(5)	1.97(7)	3.24(6)	3.42(6)
O(4)	133.72(9)	94.41(5)	100.09(2)	2.33(1)	2.65(7)
F	147.73(2)	93.28(1)	128.08(3)	77.31(5)	1.88(6)

Distortion $\Delta = 6.51 \cdot 10^{-3}$

Table 0V-1: Structural parameters obtained after Rietveld refinement of XRD and neutron diffraction data from phase LiTiPO₄F

LiTiPO₄F						
S.G. : $P\bar{1}$; Z = 2						
$a = 5.203(9) \text{ \AA}; \alpha = 107.015(4)^\circ$			XRD: $R_{wp} = 15.2 \%$;			
$b = 5.345(1) \text{ \AA}; \beta = 108.183(1)^\circ$			$R_{bragg} = 1.88 \%$; $\chi^2 = 1.73$			
$c = 7.287(9) \text{ \AA}; \gamma = 97.93(4)^\circ$			Neutrons: $R_{wp} = 13.0 \%$;			
$V = 178.20(1) \text{ \AA}^3; V/Z = 89.1 \text{ \AA}^3$			$R_{bragg} = 5.11 \%$; $\chi^2 = 3.93$			
Atomic parameters						
Atoms	Wyckoff position	Atomic position			Occ	B _{iso}
		x/a	y/b	z/c		
Ti(1)	$1a$	0	0	0	1	1.003(1)
Ti(2)	$1b$	0	0	1/2	1	0.079(1)
P	$2i$	0.3230(1)	0.6494(1)	0.2511(6)	1	0.062(4)
O(1)	$2i$	0.3754(1)	0.2529(2)	0.6069(1)	1	0.219(3)
O(2)	$2i$	0.1312(1)	-0.3310(8)	0.3648(1)	1	0.512(3)
O(3)	$2i$	0.6720(9)	0.6559(7)	-0.1524(4)	1	1.086(3)
O(4)	$2i$	0.2561(1)	0.7808(4)	0.0978(1)	1	0.361(2)
F	$2i$	-0.1141(1)	0.0784(1)	0.2711(9)	1	0.226(3)

Table II0-2: Selected bond lengths (Å) and angles (°) in the structure of LiTiPO₄F.
Numbers in the diagonals (yellow) are Ti-X distances (X = F or O).
Numbers below the diagonals are X-Ti-X angles.
Numbers above the diagonals are X-X distances

Ti(1)O₄F₂	O(3)a	O(3)b	O(4)a	O(4)b	Fa	Fb
O(3)a	2.07(2)	3.99(2)	2.88(5)	2.87(3)	2.86(2)	2.82(4)
O(3)b	180	2.07(2)	2.87(3)	2.88(5)	2.82(4)	2.86(2)
O(4)a	90.60(1)	89.94(1)	1.99(5)	4.13(8)	2.67(1)	2.89(2)
O(4)b	89.94(1)	90.60(1)	180	1.99(5)	2.89(2)	2.67(1)
F(1)a	90.75(5)	89.24(7)	85.43(2)	94.56(8)	1.94(1)	3.88(2)
F(1)b	89.24(7)	90.75(5)	94.56(8)	85.43(2)	180	1.94(1)
Distortion		$\Delta = 7.17 \cdot 10^{-4}$				

Ti(2)O₄F₂	O(1)a	O(1)b	O(2)a	O(2)b	Fa	Fb
O(1)a	1.98(8)	3.97(7)	2.95(8)	2.78(5)	2.87(1)	2.79(2)
O(1)b	180	1.98(8)	2.78(5)	2.95(8)	2.79(2)	2.87(1)
O(2)a	89.54(9)	93.45(1)	2.07(4)	4.14(2)	2.86(3)	2.92(1)
O(2)b	93.45(1)	89.54(9)	180	2.07(4)	2.92(1)	2.86(3)
Fa	91.58(1)	88.41(9)	88.84(2)	91.15(8)	2.01(1)	4.03(2)
Fb	88.41(9)	91.58(1)	91.15(8)	88.84(2)	180	2.01(1)
Distortion		$\Delta = 3.43 \cdot 10^{-4}$				

PO₄	O(1)	O(2)	O(3)	O(4)
O(1)	1.51(5)	2.51(3)	2.38(1)	2.51(4)
O(2)	111.05(1)	1.53(4)	2.51(4)	2.50(4)
O(3)	102.49(5)	109.87(4)	1.53(7)	2.51(8)
O(4)	112.01(1)	110.18(9)	110.99(8)	1.51(7)
Distortion		$\Delta = 4.14 \cdot 10^{-5}$		

Figures Captions

General Introduction

Figure 1: World total final consumption and world population from 1973 to 2011

Figure 2: Primary Energy reserves by regions (America referred to North and Latin America). The values are given in R/P ratio i.e. amount of known resource/amount used per year

Figure 3: Energy densities of different well-known electrochemical batteries

Figure 4: A schematic representation of a Li-ion battery with graphite as negative insertion electrode material and an insertion compound as positive electrode material.

Figure 5: Schematic representation of the crystal structures of 2D LiCoO_2 (left), 3D LiMn_2O_4 (center) and polyanionic (here triphylite LiFePO_4) (right) [3]

Figure 6: Representation of the Tavorite (left) and Montebasite (right) crystal structures. The blue and brown polyhedra are MO_4Y_2 octahedra and the yellow are XO_4 tetrahedra.

Figure 7: Illustration of geometrical relationships between the four models used in the literature to describe Tavorite-type structures.

Figure 8: (left) Evolution of the number of articles published based on Tavorite system. (right) Evolution of the citations in each year. (Data recorded for the past 10 years in “web of knowledge”)

Figure 9: Overview of redox couple potentials for the transition metal in Tavorite AxMPO_4Y [3]

Chapter I : SYNTHESIS AND CRYSTAL STRUCTURE OF LiVPO₄F AND LiVPO₄O

Figure I-1: Simulated XRD patterns of LiVPO₄O (orange) and LiVPO₄F (green) from ICSD N° 20537 and LiAlPO₄F (ICSD N° 48012, where Al was replaced by V) respectively.

Figure I-2: XRD pattern refinement of LVPO₄O obtained through a one-step reaction using LiF as lithium precursor

Figure I-3: XRD pattern of C_{SP} used for carbothermal synthesis of VPO₄

Figure I-4: XRD pattern refinement of C-VPO₄ obtained through a CTR process

Figure I-5: X-ray diffraction patterns of different powders prepared in this work a) pellet under Ar flux in crucible, b) pellet in a gold sealed tube, c) stoichiometric proportions of VPO₄/LiF in a gold sealed tube.

Figure I-6: a) TGA (black line) and DSC (red line) of VPO₄ performed under O₂ flow b) Full-pattern refinement of the XRD data of VPO₄O obtained after TGA in air.

Figure I-7: Skeleton representation of a) α-LiVPO₄O and b) β-LiVPO₄O along the a direction

Figure I-8: XRD patterns of phase-pure LiVPO₄F and LiVPO₄O with calculated Bragg positions. SEM images are included in the insets

Figure I-9: Illustration of the transformation matrix from LiVPO₄O to LiVPO₄F unit cells.

Figure I-10: Temperature dependence of the H/M ratio for LiVPO₄F and LiVPO₄O. Comparison of experimental and theoretical Curie constants is given for the two phases with, for information, the temperature range used for their calculation.

Figure I-11: a) Rietveld refinement of neutron diffraction data (only heaviest atoms are considered) b) 2D section of 3D difference Fourier maps at y = 0.68 with the maxima corresponding to the Li(1) site for the crystal structure of LiVPO₄F

Figure I-12: Observed (red dots), calculated (black line), and difference (blue line) plots obtained for the Rietveld refinement of (a) X-ray diffraction data and (b) neutron diffraction data for LiVPO₄F

Figure I-13: Representations of the crystal structure of LiVPO₄F

Figure I-14: Representation of chains along the c axis in the structure of LiVPO₄F

Figure I-15: Schematic representation of tetrahedra PO₄ (a) and pentahedra LiO₄F (b) local environment in the structure of LiVPO₄F

Figure I-16: Skeleton representation of LiVPO_4F structure along the c direction presenting: a) 2 sites of Li as suggested by J. Barker et al. [25] based on the analogy with LiAlPO_4F , represented as $\text{Li}(1)_{\text{LiAlPO}_4\text{F}}$ and $\text{Li}(2)_{\text{LiAlPO}_4\text{F}}$ b) 2 sites of Li as observed by B.L. Ellis et al. [26], represented by $\text{Li}(1)_{\text{Ellis}}$ and $\text{Li}(2)_{\text{Ellis}}$ In both cases the Li's position found in this work is presented as Li_{Ateba}

Figure I-17: ^7Li MAS NMR spectra a) of GEN II (red line) and GEN III (green line). The magnitude is scaled to the mass of active material in the NMR rotor. b) An example of the fit is given for the signal at 117 ppm.

Figure I-18: ^{31}P MAS NMR spectra of GEN II (red line) and GEN III (green line). The magnitude is scaled to the mass of active material in the NMR rotor and the spinning sidebands are marked with asterisks.

Figure I-19: ^{19}F MAS NMR spectrum for GEN III sample. The spinning sidebands are marked with asterisks.

Figure I-20: a) Low temperature neutron diffraction experiment (on D20) carried out on LiVPO_4F ; b) The change in intensities versus time of the magnetic superstructure peaks

Figure I-21: Magnetic Rietveld Refinements of LiVPO_4F : Observed versus calculated (black line) powder neutron diffraction patterns of LiVPO_4F collected on D20 with $\lambda = 2.40 \text{ \AA}$, at 2K (red dots) and 50K (green dots). The difference pattern (blue line) of the 2K pattern is displayed at the panel bottom. The positions of the Bragg reflections are shown as vertical bars below.

Figure I-22: Illustration of the proposed magnetic structure of LiVPO_4F : a) 3D view of the magnetic moments bore by vanadium atoms b) 3D view of isolated octahedra.

Figure I-23: Observed (red dots), calculated (black line), and difference (blue line) plots obtained for the Rietveld refinement of (a) X-ray diffraction and (b) neutron diffraction data for LiVPO_4O

Figure I-24: (Left) Rietveld refinement of neutron diffraction data (only heaviest atoms are considered); (Right) 2D section of 3D Fourier difference map at $y = 0.156$ with the maxima corresponding to the $\text{Li}(1)$ and $\text{Li}(2)$ sites for the crystal structure of LiVPO_4O

Figure I-25: (Left) Representation of the crystal structure of LiVPO_4O (Right) Octahedra chains connected alternatively by different tetrahedra along the c direction

Figure I-26: Schematic representation of $[\text{P}(1)\text{O}_4]$ (left) and $[\text{P}(2)\text{O}_4]$ (right) local environments in LiVPO_4O

Figure I-27: Schematic representation of $\text{Li}(1)\text{O}_5$ (left) and $\text{Li}(2)\text{O}_5$ (right) local environments in LiVPO_4O

Figure I-28: ${}^7\text{Li}$ MAS NMR spectrum of LiVPO_4O (left) and a fit of ${}^7\text{Li}$ MAS NMR spectrum (right). The result is given in the insert

Figure I-29: ${}^{31}\text{P}$ MAS NMR spectrum (Hahn echo) of LiVPO_4O (spinning 30 kHz)..

Figure I-30: Comparison of $[\text{VO}_4\text{X}_2]$ chains in LiVPO_4X ($\text{X} = \text{F}, \text{O}$).

Chapter II ELECTROCHEMICAL BEHAVIOR OF LiVPO_4X (X = O or F)

Figure II-1: Respective positions of $\text{V}^{n+}/\text{V}^{(n-1)+}$ redox couples in phosphate, diphosphate and NASICON-like polyanionic structures. α - and β - $\text{Li}_3\text{V}_2(\text{PO}_4)_3$ refer to Anti-NASICON (monoclinic) and NASICON (rhombohedral) forms respectively.

Figure II-2: a) Electrochemical behavior of a typical symmetrical $\text{LiVPO}_4\text{F}||\text{LiVPO}_4\text{F}$ cell cycled between 1.80 V and 2.80 V as reported by J. Barker together with b) the corresponding capacity vs. cycles number [60].

Figure II-3: a) The first charge/discharge galvanostatic data for the $\text{LiVPO}_4\text{F}/[1\text{M}] \text{LiPF}_6/\text{EC-DMC (1:1)}/\text{LiVPO}_4\text{F}$ cell and b) the corresponding capacity vs. cycles number. c) The first charge/discharge galvanostatic data for the $\text{LiVPO}_4\text{F}/[1\text{M}] \text{LiBF}_4/\text{EMIBF}_4/\text{LiVPO}_4\text{F}$ cell and d) the corresponding capacity vs. cycles number [61].

Figure II-4: Discharge capacities vs. cycle number of triclinic LiVPO_4O (dots) and orthorhombic LiVPO_4O (squares) phases. The cycling rate was C/10. [39]

Figure II-5: a) Photography and b) detailed description of the Leriche's in situ cell used for in situ XRD experiments [62]

Figure II-6: GITT measurement of LiVPO_4F between 1.5–3 V vs. Li. a) Potential vs. $\text{Li}_x\text{VPO}_4\text{F}$ and b) in the region of $\text{Li}_{0.5}\text{VPO}_4\text{F}$, potential vs. time.

Figure II-7: 2D View of collected in-situ XRD patterns for the global electrochemical reaction $\text{LiVPO}_4\text{F} \rightleftharpoons \text{Li}_2\text{VPO}_4\text{F}$ (left) and corresponding galvanostatic cycling data (right). The XRD patterns highlighted in blue refer to LiVPO_4F and the dark black one to $\text{Li}_2\text{VPO}_4\text{F}$

Figure II-8: Selected 2θ regions showing the respective growths and disappearances of the phases involved in the $\text{LiVPO}_4\text{F} \rightleftharpoons \text{Li}_2\text{VPO}_4\text{F}$ reaction.

Figure II-9: variations of normalized intensities of the $(110)_{P\bar{1}}$ peak of LiVPO_4F (blue) and the $(200)_{C2/c}$ peak of $\text{Li}_2\text{VPO}_4\text{F}$ (red) as a function of x Li⁺.

Figure II-10: XRD patterns and full-pattern matching refinements of initial LiVPO_4F , reduced $\text{Li}_2\text{VPO}_4\text{F}$ and fully charge LiVPO_4F . The space groups, the lattice parameters and the volumes are inserted for each XRD pattern.

Figure II-11: Electrochemical behavior of different LiVPO_4F samples cycled between 3.00–4.60 V vs. Li^+/Li at C/50: a) LiVPO_4F samples containing α - $\text{Li}_3\text{V}_2(\text{PO}_4)_3$ as impurity, b) LiVPO_4F sample containing an unknown impurity before (red) and after washing (blue), and c) pure LiVPO_4F

Figure II-12: GITT measurement of LiVPO_4F between 2.7–4.55 V with a current rate of C/100. The relaxation condition was $dV/dt < 4 \text{ mV/h}$

Figure II-13: 2D View of collected in-situ XRD patterns for the global electrochemical reaction $\text{LiVPO}_4\text{F} \rightleftharpoons \text{VPO}_4\text{F}$ (left) and corresponding galvanostatic cycling data (right). The XRD patterns highlighted refer to LiVPO_4F (#1 and #92, blue), $\text{Li}_{0.67}\text{VPO}_4\text{F}$ (#14, green) and VPO_4F (#48, red).

Figure II-14: Selected 2θ regions showing the respective growths and disappearance of the phases involved in the $\text{LiVPO}_4\text{F} \rightleftharpoons \text{VPO}_4\text{F}$ reaction. The XRD patterns highlighted refer to LiVPO_4F (#1 and #92, blue), $\text{Li}_{0.67}\text{VPO}_4\text{F}$ (#14, green) and VPO_4F (#48, red).

Figure II-15: Full-pattern matching refinements of LiVPO_4F , $\text{Li}_{0.67}\text{VPO}_4\text{F}$ and VPO_4F . The lattice parameters as well as the volumes are inserted in each XRD pattern.

Figure II-16: Unit-cell volume changes during the global electrochemical reaction $\text{LiVPO}_4\text{F} \rightleftharpoons \text{VPO}_4\text{F}$ involving successive two-phase reactions.

Figure II-17: Galvanostatic cycling of a $\text{Li/LP30/LiVPO}_4\text{F}$ cell cycled at C/75 (right) and in situ XRD recorded upon oxidation up to the global composition $\text{Li}_{0.67}\text{VPO}_4\text{F}$ and then back to LiVPO_4F (left).

Figure II-18: a) Electrochemical data of a $\text{Li/LP30/LiVPO}_4\text{F}$ cell cycled at C/50 for the present in situ (black line) and galvanostatic data recorded in coin cell (dash blue) b) in situ XRD patterns recorded upon oxidation up to the global composition $\text{Li}_{0.33}\text{VPO}_4\text{F}$ and then back to LiVPO_4F .

Figure II-19: Temperature dependence of the H/M ratio for $\text{Li}_x\text{VPO}_4\text{F}$ (with $x = 2, 1, 0.67$ and 0)

Figure II-20: Observed (red dots), calculated (black line), and difference (blue line) plots obtained for the Rietveld refinement of X-ray diffraction data (a) and neutron diffraction data for VPO_4F (b)

Figure II-21: Representation of VPO_4F skeleton framework structure in the $[001]_{c2/c}$ (left) and $[101]_{c2/c}$ (right) directions

Figure II-22: Observed (red dots), calculated (black line), and difference (blue line) plots obtained for the Rietveld refinement of (a) X-ray diffraction data and (b) neutron diffraction data for $\text{Li}_{0.67}\text{VPO}_4\text{F}$

Figure II-23: Electron diffraction patterns of LiVPO_4F obtained by rotation around a common direction

Figure II-24: XRD of $\text{Li}_2\text{VPO}_4\text{F}$ obtained by chemical lithiation (black) and the product of oxidation of $\text{Li}_2\text{VPO}_4\text{F}$ (purple) compared with the pristine LiVPO_4F (blue). The corresponding Bragg positions are given under each peak.

Figure II-25: XRD pattern of $\text{Li}_2\text{VPO}_4\text{F}$ obtained by chemical lithiation in comparison with the simulated pattern of $\text{Li}_2\text{VPO}_4\text{F}$ as published by B.L. Ellis et al. [25].

Figure II-26: Skeleton representation of $\text{Li}_2\text{VPO}_4\text{F}$ structure.

Figure II-27: Comparative distances and dihedral angles in the structure of $\text{Li}_2\text{VPO}_4\text{F}$, LiVPO_4F and VPO_4F .

Figure II-28: ^7Li MAS NMR spectra of pristine LiVPO_4F (blue), intermediate $\text{Li}_{0.67}\text{VPO}_4\text{F}$ (green) and fully delithiated VPO_4F (red) The magnitude is scaled to the mass of active material in the NMR rotor.

Figure II-29: ^{31}P MAS NMR spectra of pure LiVPO_4F (blue), intermediate $\text{Li}_{0.67}\text{VPO}_4\text{F}$ (green) and fully delithiated VPO_4F (red). Due to the existence of spinning side bands for each contribution, the main isotropic contributions are marked by arrows.

Figure II-30: ^1H MAS NMR spectra of pure LiVPO_4F (blue), intermediate $\text{Li}_{0.67}\text{VPO}_4\text{F}$ (green) and fully delithiated VPO_4F (red) (spinning sidebands are marked by asterisks)

Figure II-31: X-Ray diffraction patterns and full-pattern matching refinements of the global composition " $\text{Li}_{0.67}\text{VPO}_4\text{F}$ " obtained as a single phase during oxidation (top) and as a two-phase mixture during reduction (bottom)

Figure II-32: Galvanostatic cycling from 1.6 V–4.5 V vs. Li^+/Li at C/50 of $\text{LiVPO}_4\text{O}/\text{LP30}/\text{Li}$ cell.

Figure II-33: a) Three different milling durations of a mixture of LiVPO_4O and 20% of C_{sp} . b) Corresponding electrochemical Li insertion/extraction at C/50

Figure II-34: GITT measurement of LiVPO_4O (left): a current corresponding to a rate of C/200 was applied during one hour with a relaxation time condition of $dV/dt < 4\text{mV/h}$. Derivative curve calculated (right) from GITT.

Figure II-35: 2D View of collected in-situ XRD patterns for the global electrochemical reaction $\text{LiVPO}_4\text{O} \rightleftharpoons \text{Li}_2\text{VPO}_4\text{O}$ (left) and corresponding galvanostatic cycling data (right). The XRD patterns highlighted refer to LiVPO_4O (blue), $\text{Li}_{1.5}\text{VPO}_4\text{O}$ (red), $\text{Li}_{1.75}\text{VPO}_4\text{O}$ (green) and $\text{Li}_2\text{VPO}_4\text{O}$ (black).

Figure II-36: Selected 2θ regions showing the respective growths and disappearance of the phases involved in the $\text{LiVPO}_4\text{O} \rightleftharpoons \text{Li}_2\text{VPO}_4\text{O}$ reaction. The XRD patterns highlighted refer to $\text{Li}_{1.5}\text{VPO}_4\text{O}$ (red), $\text{Li}_{1.75}\text{VPO}_4\text{O}$ (green) and $\text{Li}_2\text{VPO}_4\text{O}$ (black).

Figure II-37: Galvanostatic cycling of Li/LiPF_6 [1M] in EC:DMC (1:1)/ LiVPO_4O cell at C/50 from 3 V to 4.6 V

Figure II-38: Galvanostatic cycling of a $\text{Li}/\text{LP30}/\text{LiVPO}_4\text{O}$ cell cycled at C/50 up to 4.5 V (right) and in situ XRD patterns (left)

Figure II-39: Evolution (from charge to discharge) of the FWHM for $(200)_{\text{P1}}$ peaks of LiVPO_4O .

Figure II-40: Different cycles (at a rate of C/20) for Li//LiVPO₄O cell

**Figure II-41: a) charge and discharge capacity of Li//LiVPO₄O cell versus number of cycles
b) polarization of each cycle**

Figure II-42: Full pattern matching refinements of XRD data in Cc (left) and C2/c (right) space groups of VPO₄O obtained by chemical delithiation

Figure II-43: Representation of the structure of: a) LiVPO₄O and b) ε-VPO₄O along the $(\bar{1}\bar{1}0)_{C/c}$ and $(10\bar{1})_{P\bar{1}}$ directions.

Figure II-44: Different schematic densities of state of V^n/V^{n-1} encountered in LiVPO₄F (left) and LiVPO₄O (right)

Chapter III SYNTHESIS, CRYSTAL STRUCTURE AND ELECTROCHEMICAL PROPERTIES OF LiFePO_4F

Figure III-1: Respective positions of the $\text{Fe}^{3+}/\text{Fe}^{2+}$ redox couple in iron phosphates/sulfates

Figure III-2: Full-pattern matching refinements of LiFePO_4F synthesized using a) EMI-TFSI and b) Triflate

Figure III-3: XRD patterns of LiFePO_4F preparations obtained after ceramic synthesis a) before washing and b) after washing with calculated Bragg positions. SEM images are included in the inserts.

Figure III-4: Calculated spectrum (blue line) and deconvolution (green line) of experimental data obtained a) before washing (black dots) and b) after washing (red dots) for the LiFePO_4F phase obtained by ceramic route

Figure III-5: Temperature dependence of the H/M ratio for the washed LiFePO_4F . Comparison of experimental and theoretical Curie constants is given and the temperature range used for its calculation.

Figure III-6: a) Rietveld refinement of neutron diffraction data (only Fe, P, O and F atoms are considered); b) 2D section of 3D Fourier difference maps at $y = 0.278$ with the maximum corresponding to the Li site in the crystal structure of LiFePO_4F

Figure III-7: Observed (red dots), calculated (black line), and difference (blue line) plots obtained for the Rietveld refinement of (a) X-ray diffraction data and (b) neutron diffraction data for LiFePO_4F

Figure III-8: Skeleton framework structure of Tavorite LiFePO_4F with ellipsoid representation of atoms as obtained after thermal motion refinements

Figure III-9: Octahedral chains of FeO_4X_2 in AFePO_4X (with A = H or Li and X = OH or F)

Figure III-10: a) Schematic representation of $[\text{PO}_4]$ tetrahedron local environment in LiFePO_4F b) Schematic representation of LiO_4F local environment in LiFePO_4F .

Figure III-11: a) ^7Li MAS NMR and b) ^{31}P MAS NMR spectrum of LiFePO_4F (spinning sidebands are shown by asterisks).

Figure III-12: ^7Li MAS NMR spectrum of LiFePO_4F before (black) and after (red) washing.

Figure III-13: ^1H MAS NMR spectrum of LiFePO_4F before (black) and after (red) washing compared to the signal for LiFePO_4OH (green). Spinning sidebands are marked by asterisks.

Figure III-14: Rietveld Refinements of neutron diffraction data of the non-washed LiFePO_4F : Observed versus calculated (black line) powder neutron diffraction patterns collected at 2K (red dots) and 50 K (purple dots). The difference pattern (blue line) is displayed at the panel bottom. The positions of the Bragg reflections are shown as vertical bars below

Figure III-15: Illustration of the proposed magnetic structure of LiFePO_4F : a) 3D view of the magnetic structure b) 3D view of moment in isolated octahedra: $[\text{Fe}(1)\text{O}_4\text{F}_2]$ octahedra (blue) and $[\text{Fe}(2)\text{O}_4\text{F}_2]$ octahedra (red)

Figure III-16: The electrochemical signature of LiFePO_4F as presented in literature by a) N. Recham et al. [7]; b) T.N. Ramesh et al. [8]

Figure III-17: Electrochemical behavior of LiFePO_4F performed at different C rates a) C/10; b) C/100. The blue line is the first cycle.

Figure III-18: XRD patterns (left) and the corresponding Mössbauer spectra (right) showing the degradation of a mixture of LiFePO_4F and C_{sp} (85:15 wt %) after Spex milling and air exposure: a) initial LiFePO_4F and C_{sp} , b) 15 min of Spex milling, c) air exposure during 3 months.

Figure III-19: Mössbauer in situ study of LiFePO_4F : the galvanostatic data are surrounded by the spectra (from A to M)

Figure III-20: 2D View of collected in situ XRD patterns for the global electrochemical reaction $\text{LiFePO}_4\text{F} \rightleftharpoons \text{Li}_2\text{FePO}_4\text{F}$ (left) and corresponding galvanostatic cycling (right). The XRD patterns highlighted in blue refer to LiFePO_4F and the red one to $\text{Li}_2\text{FePO}_4\text{F}$. The XRD pattern of the intermediate phase is presented in green.

Figure III-21: Selected 2θ regions showing the respective growth and disappearance of the phases involved in the LiFePO_4F (blue) \rightleftharpoons $\text{Li}_2\text{FePO}_4\text{F}$ (red) reaction. The XRD pattern of the intermediate phase is presented in green.

Figure III-22: Relative peak intensities for the peak corresponding to an intermediate phase (green) and a fully lithiated phase $\text{Li}_2\text{FePO}_4\text{F}$ (red)

Figure III-23: Fullpattern refinement of the XRD data n° 50 corresponding to a fully lithiated phase. Bragg positions are those taken from Ramesh et al. [8]

Chapter IV SYNTHESIS, CRYSTAL STRUCTURE AND ELECTROCHEMICAL PROPERTIES OF LiTiPO_4F

Figure IV-1: Electrochemical cycling of LiTiPO_4F as reported by N. Recham et al. [16]. The inset shows the evolution of the capacity with the cycle numbers.

Figure IV-2: Full-pattern matching refinement of the XRD pattern recorded for the pristine (non-washed) LiTiPO_4F .

Figure IV-3: Temperature dependence of the H/M ratio for the pristine $\text{LiTiPO}_4\text{F}/\text{LiF}$ mixture. The calculated Curie constant is given in insert in comparison with the theoretical one considering a Ti^{3+} -only material.

Figure IV-4: a) Neutron diffraction data refinement considering only heaviest atoms (i.e. without Li) and b) Corresponding Fourier difference map.

Figure IV-5: Observed (red dots), calculated (black line), and difference (blue line) plots obtained for the Rietveld refinement of X-ray diffraction data for LiTiPO_4F . The presence of LiF is indicated by stars.

Figure IV-6: Representation of chains along the c axis in LiTiPO_4F structure

Figure IV-7: ^7Li MAS NMR spectrum of LiTiPO_4F

Figure IV-8: ^{31}P MAS NMR spectrum of LiTiPO_4F

Figure IV-9: The XRD patterns of the “non-washed” sample (a) and the XRD patterns of the samples exposed to air during b) 15 hours, c) 9 months and d) 1 year. The simulated XRD pattern of LiTiPO_4O is also given for comparison.

Figure IV-10: Full-pattern matching refinement of the XRD pattern obtained for the sample aged during 1 year in air, considering a) a unit cell described in the Cc space group for the main phase and b) a unit cell described in the $C/2c$ space group for the main phase. The reliability factors are given in inserts.

Figure IV-11: Full-pattern matching refinement of the XRD patterns obtained for the samples aged in air during a) 15 hours and b) 9 months.

Figure IV-12: Temperature dependence of the H/M ratio for $\text{LiTi}^{\text{III}}\text{PO}_4\text{F}/\text{LiF}$ mixture (black), sample aged for 9 months (green) and the sample aged for 1 year (blue). The molar weight used for the calculation of the H/M ratio for both 9 months and 1 year aged samples was that of TiPO_4F

Figure IV-13: XRD patterns of different samples of “ LiTiPO_4F ”: a) “non-washed”, b) “RT-washed” c) “CW-washed” and d) the “non-washed” aged during 15 hours in air

Figure IV-14: Full-pattern matching refinement of the XRD patterns collected for the samples washed with a) room temperature water: the XRD data were refined considering only one phase ($P\bar{1}$) and with b) cold water: the XRD data were refined considering two phases ($P\bar{1}$ and Cc).

Figure IV-15: Temperature dependence of the H/M ratio for $\text{LiTiPO}_4\text{F}/\text{LiF}$ mixture (black), sample aged for 9 months (green), the sample aged for 1 year (blue) and the sample washed with cold water (brown). The molar weight used for the calculation of the H/M ratio for the “CW-washed” sample was that of TiPO_4F .

Figure IV-16: Electrochemical behavior of: a-b) “non-washed” sample starting either by a) the extraction of Li^+ or b) the insertion of Li^+ c-d) “CW-washed” sample starting either by c) the extraction of Li^+ or d) the insertion of Li^+ The derivative curves are given in the inserts.

Figure IV-17: Electrochemical signature (starting in charge) of the $\text{LiTiPO}_4\text{F}/\text{LiF}$ sample aged during one year

GENERAL CONCLUSION, SUMMARY AND PERSPECTIVES

Figure 1: XRD patterns of different LiMPO_4X obtained in this work

Figure 2: Temperature dependence of the H/M ratio for LiMPO_4X

Figure 3: Comparison of $[\text{MO}_4\text{X}_2]$ chains, dihedral angles, atomic radii of transition metal and V/Z in LiMPO_4X ($M = \text{V, Fe, Ti}$ and $X = \text{O or F}$)

Figure 4: Description of the three-dimensional structure of $\text{Na}_3\text{V}_2(\text{PO}_4)_2\text{F}_3$

Figure 5 a) Electrochemical curves obtained for $\text{Li}/\text{LP30}/\text{Na}_3\text{V}_2(\text{PO}_4)_2\text{F}_3$ cells cycled between 2.7–4.5 V vs. Li^+/Li at C/50 b) Electrochemical curves obtained for Na/NaPF_6 in PC $|\text{Na}_3\text{V}_2(\text{PO}_4)_2\text{F}_3$ cells cycled between 2.7–4.3 V vs. Na^+/Na .

Table Captions

General Introduction

Table1: Tavorite-like structures reported in the literature that adopt the space group $P\bar{1}$

Chapter I : SYNTHESIS AND CRYSTAL STRUCTURE OF LiVPO₄F AND LiVPO₄O

Table I-1: Comparison of the published LiVPO₄O lattice parameters (ICSD N°20537) with those obtained in this study

Table I-2: Magnetic moments (in μ_B) at 2 K, the components are given along the a, b and c axes. Propagation vector $k = (\frac{1}{2}, \frac{1}{2}, 0)$, Magnetic R-factor=19.5%

Table I-3: long (V-O) and short (V=O) distances (in Å) in LiVPO₄O and VPO₄O polymorphs.

Chapter II ELECTROCHEMICAL BEHAVIOR OF LiVPO₄X (X = O or F)

Table II-1: Average potentials, capacities and energy densities of vanadium phosphates reported in the literature.

Chapter III SYNTHESIS, CRYSTAL STRUCTURE AND ELECTROCHEMICAL PROPERTIES OF LiFePO_4F

Table III-1: recorded potential vs. Li of the $\text{Fe}^{3+}/\text{Fe}^{2+}$ redox couple, theoretical capacity, and energy density for reported Tavorite type compositions AFeXO_4Y (with $\text{A} = \text{Li}$ or H , $\text{X} = \text{P}$ or S , $\text{Y} = \text{OH}$ or F)

Table III-2: Lattice parameters and angles of different LiFePO_4X ($\text{X} = \text{OH}$, F) obtained by iono-thermal syntheses and compared with those reported in literature

Table III-3: Anisotropic thermal motion parameters U_{ij} (in \AA^2) for LiFePO_4F

Table III-4: Mössbauer parameters, distortions and Fe-X distances of the washed LiFePO_4F ($\text{LiFePO}_4\text{F}_w$) and the non-washed LiFePO_4F ($\text{LiFePO}_4\text{F}_{nw}$) in this study compared with the reported LiFePO_4OH and $\text{HFePO}_4\cdot\text{OH}$ [3].

Table III-5: Magnetic moments (μ_B) at 2 K, the components (in μ_B) are given along the a, b and c axes. Propagation vector $k = (\frac{1}{2}, \frac{1}{2}, 0)$, G-type magnetic structure, Magnetic R-factor=4.80%

Chapter IV SYNTHESIS, CRYSTAL STRUCTURE AND ELECTROCHEMICAL PROPERTIES OF LiTiPO_4F

TableIV-1: Lattice parameters, unit cell volumes and V/Z values obtained after different aging time of LiTiPO_4F in air. Comparison with those of LiTiPO_4F and LiTiPO_4O .

TableIV-2: Lattice parameters, unit cell volumes and V/Z values determined for the different phases observed in samples washed with room temperature water and cold water. Comparison with those of $\text{LiTi}^{\text{III}}\text{PO}_4\text{F}$.

Résumé :

Nos efforts se sont portés sur des fluorophosphates de structure TAVORITE de formule LiMPO_4F ($\text{M} = \text{V}, \text{Fe}, \text{Ti}$) et LiVPO_4O qui, comparés à d'autres familles structurales de phosphates tels que $\text{Li}_3\text{M}_2(\text{PO}_4)_3$ (NASICON) ou $\text{LiFePO}_4(\text{OH})$ (Tavorite) possèdent d'excellentes densités d'énergie théorique comme matériaux d'électrodes dans des accumulateurs au Li. Des méthodes de synthèse reproductibles, par voie céramique en tubes scellés et/ou ionothermale (synthèse à basse température), ont été mises au point dans ce travail. Les matériaux ainsi préparés ont été caractérisés en détail par magnétométrie, par RMN et surtout par diffraction des rayons X et des neutrons. Les structures cristallines ont ainsi pu être déterminées ainsi que les mécanismes d'insertion/extraction du Li^+ , via de nombreuses études par diffraction X *in situ* lors de la charge/décharge des accumulateurs.

Mots-clés :

- Électrode positive pour batteries Li-ion
 - Fluorophosphates
 - Tavorite
 - Diffraction des rayons X et des neutrons
 - Diffraction X *in situ*
 - Densités d'énergie
-

Abstract:

This work focused on TAVORITE-based fluorophosphates LiMPO_4F ($\text{M} = \text{V}, \text{Fe}, \text{Ti}$) and LiVPO_4O which, when compared with other phosphate structural families such as $\text{Li}_3\text{V}_2(\text{PO}_4)_3$ (NASICON) or $\text{LiFePO}_4(\text{OH})$ (Tavorite), possess superior energy density as electrode materials for Li batteries. Reproducible synthesis procedures were developed through “classical” ceramic routes in sealed containers and/or low temperature ionothermal reaction. The obtained materials were characterized by magnetometry, solid state NMR and heavily by X-Ray and Neutron diffraction. The crystal structures of all the materials were determined, as well as the mechanisms of Li^+ insertion/extraction through *in situ* X-Ray diffraction during electrochemical charge/discharge of the batteries.

Keywords :

- Positive electrode for Li-ion batteries
 - Fluorophosphate
 - Tavorite
 - X-ray and neutron diffraction
 - In-situ X-ray diffraction
 - Energy density
-