



**HAL**  
open science

# Percolation sur les groupes et modèles dirigés

Sébastien Martineau

► **To cite this version:**

Sébastien Martineau. Percolation sur les groupes et modèles dirigés. Mathématiques générales [math.GM]. Ecole normale supérieure de lyon - ENS LYON, 2014. Français. NNT : 2014ENSL0959 . tel-01127079

**HAL Id: tel-01127079**

**<https://theses.hal.science/tel-01127079>**

Submitted on 6 Mar 2015

**HAL** is a multi-disciplinary open access archive for the deposit and dissemination of scientific research documents, whether they are published or not. The documents may come from teaching and research institutions in France or abroad, or from public or private research centers.

L'archive ouverte pluridisciplinaire **HAL**, est destinée au dépôt et à la diffusion de documents scientifiques de niveau recherche, publiés ou non, émanant des établissements d'enseignement et de recherche français ou étrangers, des laboratoires publics ou privés.

# THÈSE

en vue d'obtenir le grade de  
Docteur de l'Université de Lyon  
délivré par l'École Normale Supérieure de Lyon

**Discipline : Mathématiques**

Unité de Mathématiques Pures et Appliquées - UMR 5669  
École doctorale Infomaths

présentée et soutenue publiquement le 10 décembre 2014 par

Sébastien MARTINEAU

---

## Percolation sur les groupes et modèles dirigés

---

**Directeur de thèse :** Vincent BEFFARA

**Après avis de :** Itai BENJAMINI  
Gábor PETE  
Tatiana SMIRNOVA-NAGNIBEDA

**Devant la commission d'examen formée de :**

Vincent BEFFARA	<i>Directeur</i>
Damien GABORIAU	<i>Membre</i>
Gábor PETE	<i>Rapporteur</i>
Tatiana SMIRNOVA-NAGNIBEDA	<i>Rapporteuse</i>
Ariel YADIN	<i>Membre</i>



# Remerciements

En premier lieu, je tiens à exprimer ma gratitude à l'égard de mon directeur de thèse. Vincent, tu m'as accordé une grande liberté tout en sachant rester disponible ; tu m'as incité à aller voir ce qu'il se passait hors de Lyon ; tu as toujours été bienveillant et patient envers moi ; et ton impressionnante répartie mathématique (ou autre) a été un excellent terreau pour mon esprit en germe. Pour cela et tant d'autres choses, merci !

I would like to thank Itai Benjamini, Gábor Pete and Tatiana Smirnova-Nagnibeda for having reviewed this thesis. Their work has been inspirational to me and I am both pleased and honoured that they accepted to read my modest contributions. I acknowledge their valuable comments.

I am indebted to Damien Gaboriau, Gábor Pete, Tatiana Smirnova-Nagnibeda and Ariel Yadin for being members of my jury; through discussions, articles or talks, each of them has influenced my mathematical life.

Damien and Itai, I am also grateful to you for having carefully followed my evolution since the very start of my doctorate.

Je suis également reconnaissant vis-à-vis de l'Unité de Mathématiques Pures et Appliquées et du département de mathématiques de l'ENS Lyon. Y enseigner et faire de la recherche a été un véritable plaisir, grâce à vous tous (élèves évidemment inclus). J'adresse des remerciements tous particuliers aux membres (et anciens membres) de l'équipe de probabilité et du groupe de travail de dynamique mesurable : votre présence mathématique et votre affabilité ont été capitales pour moi, ces dernières années.

Merci bien sûr à Magalie et Virginia, sans qui la vie serait impossible ! Merci aux probabilistes du jeudi après-midi (et vendredi matin au temps jadis). Merci à Hugo et Grégory pour leur clairvoyance humaine et mathématique. Quant à Vincent Tassion... « Bah voilà ! » Pour toutes ces années d'enrichissement mutuel (mathématique et autre), je te remercie profondément. Puisse l'aventure mathématique se poursuivre !

Je suis redevable à Damien Gaboriau et François Le Maître pour leurs commentaires et suggestions concernant le chapitre 1. As for Chapter 2, I must of course thank Vincent Tassion for the collaboration, but also Hugo Duminil-Copin for initiating the project, Mikael de la Salle for pointing out the compactness argument of Lemma 2.1.4, and Itai Benjamini and the anonymous referee of [MT] for useful remarks.

Je suis reconnaissant envers tous ceux qui m'ont aidé à préparer cette journée de soutenance, ainsi que Grand Chef, Damien, Mohamed, Loïc, Daniel, Juhan, Anne-Laure, maman et papa pour leurs relectures attentives.

Enfin, à titre personnel, je tiens à remercier tous ceux avec qui j'ai eu la joie de partager

un sourire, un fourire,  
une vigie Dame Annie,  
une randonnée, un randori,  
une sortie ski,  
une escapade chilienne,  
un directeur de thèse,  
un bureau, un enseignement,  
des années, mon enfance,  
des géniteurs, des chromosomes,  
de la chaleur familiale,  
des poèmes,  
des instants à cœur ouvert,  
de l'amitié, de l'amour,  
des références humoristiques à répéter à outrance<sup>0</sup>,  
des bonjours enjoués ou théâtraux,  
des nietzscherries ou autres méditations métaphysiques,  
des pensées sur les maths ou la vie,  
un nouvel an,  
une soirée,  
une partie de magic ou dominion,  
une technique de prestidigitatation,  
un dinosaure en chocolat, un goûthé,  
une soupe à l'oignon,  
un intérêt pour les mangas,  
une balade en bord de Rhône,  
une vision du tri sélectif et des tatouages,  
une conception du billet de vingt euros,  
une semaine à Luminy,  
une conf en Russie,  
un plan Martinique, un after hour indien,  
une séance d'arts martiaux  
ou une maison pendant près de vingt ans.

Bref... aux amis/frangin/père/mère/grands-pères/grands-mères/uncles/tantes/cousins/cousines, merci du fond du cœur !

---

0. « J'aimerais remercier Jean Castel qui fut indispensable, Ernest Prouch et tous ceux que j'oublie.

— Et voici notre invité surprise...

— Ernest Prouch ?

— Non, tous-ceux-que-j'oublie ! »

# Table des matières

<b>0</b>	<b>Introduction (en français)</b>	<b>1</b>
0.1	Percolations générales . . . . .	4
0.1.1	Vocabulaire de théorie des graphes . . . . .	4
0.1.2	Percolation : définition et premiers exemples . . . . .	9
0.1.3	Un premier argument . . . . .	12
0.2	Graphes transitifs . . . . .	17
0.2.1	Graphes de Cayley . . . . .	17
0.2.2	Unimodularité et transport de masse . . . . .	29
0.2.3	Un mot sur les graphes rotatoirement transitifs . . . . .	34
0.3	Etat de l'art en percolation de Bernoulli . . . . .	35
0.3.0	Préambule sur la planarité . . . . .	36
0.3.1	Le cas planaire euclidien . . . . .	39
0.3.2	Hors du plan euclidien . . . . .	43
0.4	Percolations invariantes . . . . .	52
0.4.1	Premières définitions et propriétés . . . . .	52
0.4.2	Le paramètre d'unicité . . . . .	54
0.4.3	Moyennabilité et percolation . . . . .	56
0.4.4	Le principe de transport de masse en percolation . . . . .	58
0.4.5	Le théorème d'indistinguabilité . . . . .	64
0.5	Résultats de cette thèse . . . . .	68
<b>0</b>	<b>Introduction (in English)</b>	<b>1</b>
0.1	General percolations . . . . .	4
0.1.1	The vocabulary of graph theory . . . . .	4
0.1.2	Percolation: definition and first examples . . . . .	8
0.1.3	A first argument . . . . .	11
0.2	Transitive graphs . . . . .	16
0.2.1	Cayley graphs . . . . .	16
0.2.2	Unimodularity and the Mass Transport Principle . . . . .	27
0.2.3	Rotarily transitive graphs . . . . .	32
0.3	A short survey of Bernoulli percolation . . . . .	33
0.3.0	Planar graphs . . . . .	34
0.3.1	Discretising the Euclidean plane . . . . .	36

0.3.2	Beyond the Euclidean plane . . . . .	40
0.4	Invariant percolations . . . . .	49
0.4.1	First definitions and properties . . . . .	49
0.4.2	The uniqueness parameter . . . . .	50
0.4.3	Amenability and percolation . . . . .	53
0.4.4	The Mass Transport Principle in percolation . . . . .	55
0.4.5	The Indistinguishability Theorem . . . . .	61
0.5	Results of this thesis . . . . .	64
<b>1</b>	<b>Orbit equivalence and strong indistinguishability</b>	<b>71</b>
1.1	Orbit equivalence theory . . . . .	72
1.1.0	Generalities on the standard Borel space . . . . .	72
1.1.1	Countable Borel equivalence relations . . . . .	73
1.1.2	Measure invariance . . . . .	73
1.1.3	Amenability and hyperfiniteness . . . . .	75
1.1.4	Ergodicity . . . . .	76
1.1.5	Strong ergodicity . . . . .	77
1.1.6	Graphings . . . . .	78
1.2	Percolation . . . . .	79
1.2.1	General definitions . . . . .	80
1.2.2	Independent percolation . . . . .	80
1.2.3	Generalized percolation . . . . .	82
1.2.4	Cluster indistinguishability . . . . .	83
1.2.5	Insertion-tolerance . . . . .	84
1.2.6	Percolation and orbit equivalence . . . . .	85
1.3	Ergodicity and indistinguishability . . . . .	85
1.3.0	The dictionary . . . . .	85
1.3.1	Classic connection . . . . .	86
1.3.2	Two lemmas on asymptotic invariance . . . . .	88
1.3.3	Strong version . . . . .	90
1.3.4	Classic and strong indistinguishability do not coincide . . . . .	93
1.3.5	Complements on asymptotic cluster properties . . . . .	100
<b>2</b>	<b>Locality of percolation for abelian Cayley graphs</b>	<b>103</b>
2.0	Introduction . . . . .	103
2.0.1	Statement of Schramm's Conjecture . . . . .	104
2.0.2	The Grimmett-Marstrand Theorem . . . . .	105
2.0.3	Main result . . . . .	106
2.0.4	Questions . . . . .	107
2.0.5	Organization of the chapter . . . . .	107
2.1	Marked abelian groups and locality . . . . .	107
2.1.1	The space of marked abelian groups . . . . .	108
2.1.2	Percolation on marked abelian groups . . . . .	110
2.1.3	A first continuity result . . . . .	111

2.1.4	Proof of Theorem 2.1.3 . . . . .	112
2.2	Proof of Lemma 2.1.8 . . . . .	113
2.2.1	Setting and notation . . . . .	114
2.2.2	Geometric constructions . . . . .	117
2.2.3	Construction of Good Blocks . . . . .	123
2.2.4	Construction of a finite-size criterion . . . . .	125
2.3	Proof of Lemma 2.1.9 . . . . .	126
2.3.1	Hypotheses and notation . . . . .	126
2.3.2	Sketch of proof . . . . .	127
2.3.3	Geometric setting: boxes and corridors . . . . .	127
2.3.4	Probabilistic setting . . . . .	131
<b>3</b>	<b>Directed Diffusion-Limited Aggregation</b>	<b>135</b>
3.0	Introduction . . . . .	135
3.1	Presentation of DDLA . . . . .	138
3.1.1	Some notation . . . . .	138
3.1.2	Definition in discrete time . . . . .	139
3.1.3	Definition in continuous time . . . . .	140
3.1.4	Some general heuristics . . . . .	140
3.2	DDLA in Infinite Volume . . . . .	142
3.3	Transport of information . . . . .	147
3.4	Bounds on the height and width of the cluster . . . . .	152
3.5	The infinite cluster . . . . .	157





# Chapitre 0

## Introduction (en français)

La percolation est un modèle de mécanique statistique qui a été introduit en 1957 par Broadbent et Hammersley [HB57]. En quoi consiste la mécanique statistique ? Il s'agit de la branche de la physique à laquelle il incombe d'expliquer les phénomènes observés à notre échelle à partir d'un modèle microscopique simple. Quand le modèle microscopique est déterministe, l'étude est le plus souvent inextricable, la résolution d'un système de  $10^{24}$  équations différentielles étant difficile — et inutile si on n'a pas accès par la mesure aux conditions initiales. Aussi, on emploie des modèles probabilistes : les effets de moyenne sont parfois d'un plus grand secours au physicien qu'une description déterministe précise mais complexe. Parmi les succès de cette approche, on compte, entre autres, le modèle du ferromagnétisme d'Ising [Len20] et la percolation.

Afin d'introduire naturellement la percolation de Bernoulli, partons du problème concret suivant [Gri99]. On dispose d'une pierre poreuse qu'on immerge dans une bassine d'eau. On aimerait savoir si l'eau s'est infiltrée en profondeur dans la pierre sans avoir à la briser. Comment procéder ? La stratégie type de la mécanique statistique consiste à

1. mesurer un petit nombre de paramètres de la pierre, parmi lesquels on espère que se trouvent tous les paramètres pertinents,
2. proposer un modèle aléatoire de la pierre à échelle microscopique où ces paramètres sont imposés,
3. puis étudier théoriquement ce modèle.

Si la réponse théorique à la question posée est oui avec probabilité très proche de 0 ou de 1, on postulera que la pierre réelle se range du côté de la majorité. Si la réponse à la question posée demeure véritablement non-déterministe, on se mettra en quête de paramètres pertinents supplémentaires.

Dans le cas précis du problème d'infiltration dans la pierre poreuse, on retiendra comme paramètre pertinent la porosité de la pierre, c'est-à-dire la proportion de trous dans cette dernière. Il s'agit d'un nombre  $p$  entre 0 et 1 qu'il est aisé de mesurer par pesée. On adoptera le modèle aléatoire

suivant. On part d'une pierre sans trou qu'on tronçonne en minuscules cubes — plus précisément, on prend une largeur de cube égale à la largeur du plus petit trou qu'on trouve à la surface de la pierre. Chaque cube est retiré avec probabilité  $p$  et laissé sur place sinon<sup>1</sup>, le tout indépendamment les uns des autres. L'eau s'insinue alors depuis l'extérieur de la pierre : un trou est inondé si et seulement si un chemin de trous le raccorde à l'extérieur.

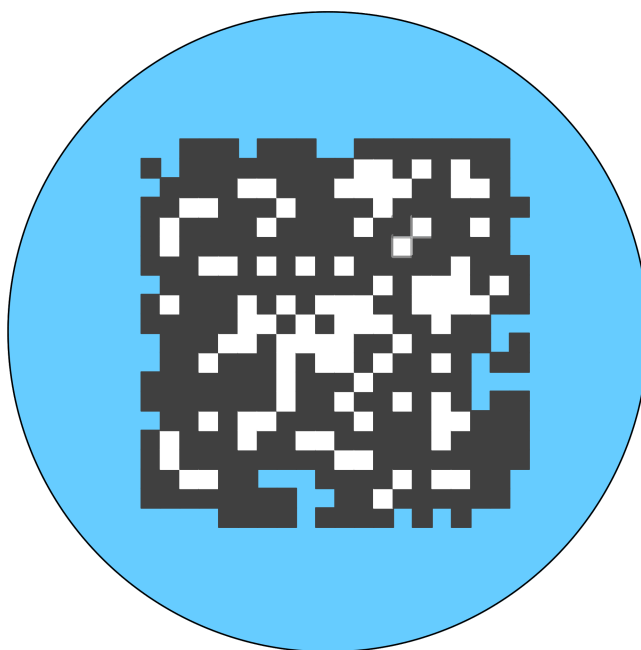

FIGURE 1 – Illustration du modèle dans le cas 2D.

Idéalisant la situation, on peut imaginer que les minuscules cubes sont de taille véritablement infime par rapport à celle de la pierre. Vue depuis le centre de la pierre et à cette échelle infime, la situation est la suivante : l'espace tridimensionnel est décomposé selon un réseau cubique et chaque cube est un trou avec probabilité  $p$  et occupé par de la roche sinon — ce indépendamment les uns des autres. L'extérieur de la pierre ayant été rejeté à l'infini et tous les sites de l'espace correspondant à des points proches du centre dans la situation physique macroscopique, l'événement d'infiltration en profondeur s'exprime mathématiquement comme l'existence d'un chemin

---

1. On ignorera des « détails physiques » tels que « comment fait un cube pour rester en l'air s'il est entouré de trous », l'objectif étant ici d'avoir un modèle mathématique le plus simple possible.

infini constitué exclusivement de trous.

Le modèle qu'on vient d'introduire est la percolation de Bernoulli par sites sur  $\mathbb{Z}^3$ . On sait démontrer, pour ce modèle, qu'il existe un nombre  $p_c$  strictement compris entre 0 et 1 tel que :

- si  $p < p_c$ , alors, presque sûrement, l'infiltration n'a pas lieu,
- si  $p > p_c$ , alors, presque sûrement, l'infiltration a lieu.

Le nombre  $p_c$  est qualifié de paramètre ou probabilité **critique**.

Le fait que la réponse dépende véritablement de  $p$  — autrement dit le fait que  $p_c$  soit différent de 0 et 1 — indique que le paramètre de porosité était effectivement pertinent ; et le fait que, à  $p$  fixé, la réponse soit presque déterministe indique qu'on n'a oublié aucun autre paramètre pertinent. On n'a plus qu'à estimer numériquement  $p_c$ , comparer sa valeur à la porosité mesurée et on « sait » si l'infiltration a lieu dans notre pierre ou non, sans avoir à la briser. Telle quelle, l'approche est simpliste à bien des égards. La tâche du physicien est alors d'affiner cette méthode pour accroître sa pertinence physique tandis que celle du mathématicien est d'analyser rigoureusement le modèle simple (duquel il n'exige qu'une adéquation *qualitative* avec la réalité).

Dans la situation précédente, il existe un paramètre critique marquant une frontière nette entre deux régimes bien différents. C'est ce qu'on appelle une **transition de phase**. Pour d'autres exemples, on pourra penser à la transition glace/eau liquide qui s'opère à  $0^\circ\text{C}$  ou au phénomène de perte d'aimantation spontanée qui a lieu à la température de Curie.

Cette thèse porte sur *deux* types de problèmes de mécanique statistique : on y traite de *percolation sur les graphes de Cayley* et de *modèles dirigés*. Que signifient les expressions « graphes de Cayley » et « modèles dirigés » ? Introduits section 0.2.1, les graphes de Cayley généralisent aux groupes de type fini la procédure associant le réseau cubique au groupe  $\mathbb{Z}^3$ . Les modèles dirigés, quant à eux, sont les modèles de mécanique statistique où « haut et bas jouent des rôles différents ». On verra que les modèles dirigés peuvent servir à mettre en évidence des phénomènes intéressants (cf. section 1.3.4) ou à rendre accessibles à l'étude rigoureuse certaines questions qui sont hors de portée dans le cas non-dirigé (cf. chapitre 3).

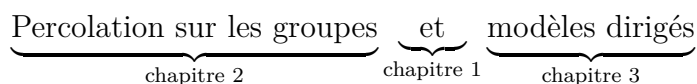

FIGURE 2 – Représentation schématique du contenu de la thèse.

Les modèles dirigés intervenant dans cette thèse font l'objet d'un examen au cas par cas tandis que les problèmes de percolation qui y sont abordés s'inscrivent dans un vaste édifice théorique. On se concentrera donc, dans cette introduction, sur la théorie de la percolation, cette composante de la thèse appelant plus que l'autre à être mise en contexte. Cette introduction sera également l'occasion de formuler un certain nombre de définitions importantes pour la suite.

## 0.1 Percolations générales

Comme le suggère le début de cette introduction, cette thèse se place dans le cadre de la géométrie discrète. Rappelons donc quelques définitions de théorie des graphes.

### 0.1.1 Vocabulaire de théorie des graphes

Un **graphe** est la donnée d'une paire  $\mathcal{G} = (V, E)$  vérifiant la condition  $E \subset \binom{V}{2}$ , c'est-à-dire telle que  $E$  soit une partie de l'ensemble des paires d'éléments de  $V$ . On appelle  $V = V(\mathcal{G})$  l'ensemble des **sommets** (ou **sites**) de  $\mathcal{G}$  et  $E = E(\mathcal{G})$  l'ensemble des **arêtes** de  $\mathcal{G}$ . Si  $u$  et  $v$  vérifient  $\{u, v\} \in E$ , on dit que  $u$  et  $v$  sont **voisins** (ou **adjacents**) et que ce sont les **extrémités** de l'arête  $\{u, v\}$ .

Visuellement, on pense souvent l'ensemble des sommets comme un ensemble de points reliés par des lignes courbes ou droites, dans le plan ou dans l'espace. Les sommets sont parfois représentés par des disques ou des croix ; quand ce n'est pas le cas, c'est généralement que l'ensemble des sommets est l'ensemble des points d'où partent soit une unique ligne, soit au moins trois lignes. Deux exemples de représentations visuelles d'un graphe sont fournis par la figure 3 où, quand deux lignes devraient se croiser dans le dessin en un point qui n'est pas un sommet, l'une des deux lignes est interrompue au niveau du croisement.

Un **sous-graphe** d'un graphe  $\mathcal{G}_1$  est un graphe  $\mathcal{G}_2$  vérifiant  $V(\mathcal{G}_2) \subset V(\mathcal{G}_1)$  et  $E(\mathcal{G}_2) \subset E(\mathcal{G}_1)$ . Si  $V'$  est une partie de l'ensemble des sommets d'un graphe  $\mathcal{G}$ , la **restriction** de  $\mathcal{G}$  à  $V'$  est le graphe  $(V', \binom{V'}{2} \cap E(\mathcal{G}))$ . On dit également que  $\mathcal{G}$  **induit** sur  $V'$  la structure de graphe  $(V', \binom{V'}{2} \cap E(\mathcal{G}))$ .

Un **morphisme** de graphes d'un graphe  $\mathcal{G}_1$  vers un graphe  $\mathcal{G}_2$  est une application  $\varphi$  de  $V(\mathcal{G}_1)$  vers  $V(\mathcal{G}_2)$  telle que l'image directe de toute arête de  $\mathcal{G}_1$  soit une arête de  $\mathcal{G}_2$ . Autrement dit, c'est une application envoyant des sommets voisins à la source sur des sommets voisins au but. Un **isomorphisme** de graphes est un morphisme bijectif dont la réciproque est un morphisme. Un **automorphisme** de graphes est un isomorphisme d'un graphe vers lui-même.

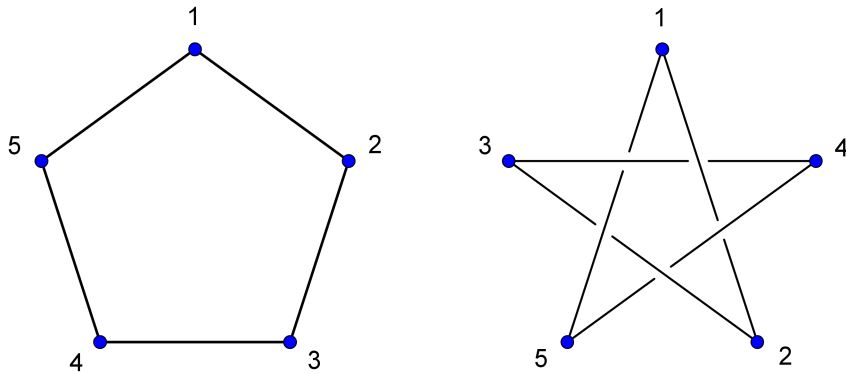

FIGURE 3 – Deux représentations du graphe  $(\{1, 2, 3, 4, 5\}, \{\{1, 2\}, \{2, 3\}, \{3, 4\}, \{4, 5\}, \{5, 1\}\})$ .

*Exemple.* On appellera **ligne** un graphe  $(V, E)$  défini comme suit,  $a$  et  $b$  désignant deux éléments de  $\mathbb{Z} \cup \{\pm\infty\}$  tels que  $a \in \{-\infty, 0, +\infty\}$  et  $a \leq b$  :

$$V := \{n \in \mathbb{Z} : a \leq n \leq b\} \quad \text{et} \quad E := \{\{m, n\} \subset V : |m - n| = 1\}.$$

Lorsqu'un des éléments de  $\{a, b\}$  est fini, on le qualifie d'**extrémité** de cette ligne. La **longueur** d'une ligne est le cardinal de son ensemble d'arêtes, c'est-à-dire  $b - a$  si on exclut le cas  $a = b = \pm\infty$ . La ligne définie par  $(a, b) = (-\infty, +\infty)$  est notée  $\mathcal{Z}$ . Il arrivera parfois que le rôle spécial joué par la valeur  $a = 0$  le soit par la valeur  $a = 1$ .

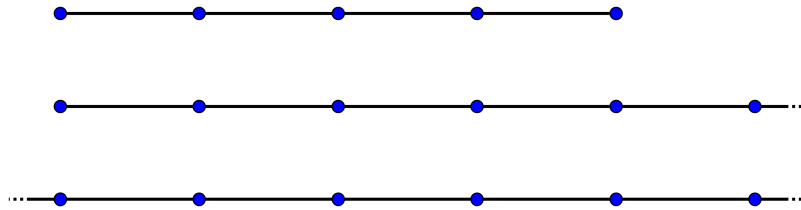

FIGURE 4 – Trois exemples de lignes.

Le **produit (direct)** de deux graphes  $\mathcal{G}_1 = (V_1, E_1)$  et  $\mathcal{G}_2 = (V_2, E_2)$  est le graphe

$$(V_1 \times V_2, (E_1 \times V_2) \cup (V_1 \times E_2)).$$

*Exemples.* Le produit direct de  $d$  copies de  $\mathcal{Z}$ , noté  $\mathcal{Z}^d$ , est le **réseau hypercubique** de dimension  $d$ . Quand  $d = 2$ , on parle de **réseau carré** et quand  $d = 3$  de **réseau cubique**. Le **réseau triangulaire** est le graphe  $\mathcal{L}_\Delta = (V, E)$  défini par

$$V := \mathbb{Z}[e^{i\pi/3}] \quad \text{et} \quad E := \{\{u, v\} \subset V : |u - v| = 1\}.$$

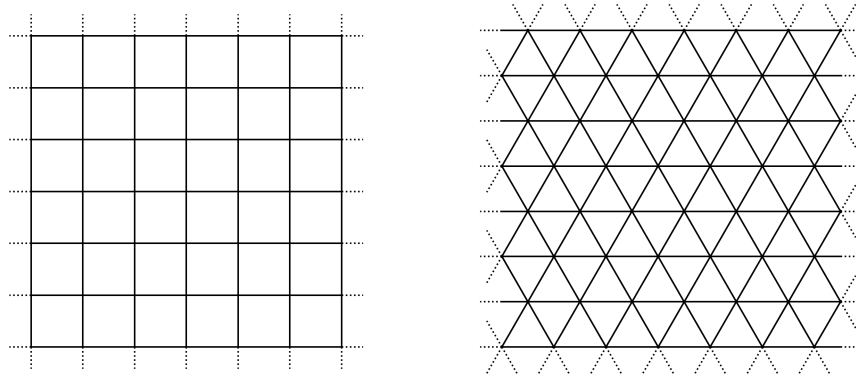

FIGURE 5 – Des portions finies de  $\mathcal{Z}^2$  et  $\mathcal{L}_\Delta$ .

On appelle **chemin** un morphisme de graphes d'une ligne vers un graphe. Un chemin est qualifié de **fini** si sa source est une ligne finie. Il est dit **auto-évitant** s'il est injectif. L'image par un chemin d'une arête de la ligne est qualifiée d'arête **empruntée** par le chemin. On dit qu'un chemin fini  $\kappa$  partant d'une ligne d'extrémités  $a$  et  $b$  **relie**  $\kappa(a)$  et  $\kappa(b)$ , et que  $\kappa(a)$  et  $\kappa(b)$  sont les **extrémités** de  $\kappa$ . Si  $A$  et  $B$  sont des ensembles de sommets, on dit qu'un chemin **relie**  $A$  et  $B$  si une extrémité de ce chemin appartient à  $A$  et l'autre à  $B$ .

Un graphe est **connexe** si deux sommets quelconques de ce graphe sont toujours reliés par un chemin. La **longueur** d'un chemin est celle de la ligne à sa source. La **distance**  $d(u, v)$  entre deux sommets  $u$  et  $v$  d'un graphe connexe est la longueur minimale d'un chemin les reliant. Un chemin  $\kappa$  est **géodésique** si

$$\forall m, n, \quad d(\kappa(m), \kappa(n)) = |m - n|.$$

Etant donnés deux sommets d'un graphe connexe, il existe toujours un chemin géodésique les reliant (prendre un chemin de longueur minimale).

Un **graphe cyclique** est un graphe de la forme suivante :

$$V_n := \mathbb{Z}/n\mathbb{Z} \quad \text{et} \quad E_n := \{\{k, k'\} \subset \mathbb{Z}/n\mathbb{Z} : k - k' \in \{-1, 1\}\},$$

où  $n$  désigne un entier supérieur ou égal à 3, appelé **longueur** du graphe cyclique  $(V_n, E_n)$ . Un **cycle** est un morphisme injectif d'un graphe cyclique

vers un graphe. La **longueur** d'un cycle est la longueur du graphe cyclique à sa source.

Un graphe n'admettant aucun cycle est appelé une **forêt**. Un sommet d'une forêt qui a un unique voisin est appelé une **feuille**. Un **arbre** est une forêt connexe. L'arbre **engendré** par une famille de sommets d'un arbre est la restriction de cet arbre à l'union des (images des) chemins géodésiques reliant des sommets de cette famille. Lorsque la famille de sommets est un triplet, on parle de **tripode**.

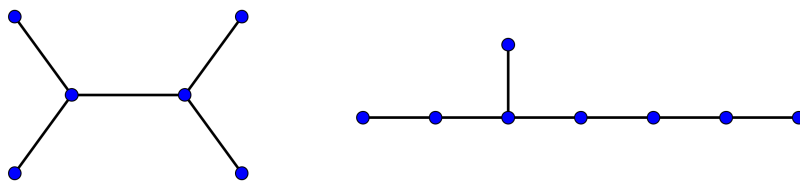

FIGURE 6 – Deux arbres.

Un **graphe enraciné** est la donnée d'un graphe et d'un sommet de ce graphe, appelé **racine**. Un **morphisme de graphes enracinés** (resp. **isomorphisme**, **automorphisme**) de  $(\mathcal{G}_1, v_1)$  vers  $(\mathcal{G}_2, v_2)$  est un morphisme (resp. isomorphisme, automorphisme) de graphes de  $\mathcal{G}_1$  vers  $\mathcal{G}_2$  envoyant  $v_1$  sur  $v_2$ .

Un **revêtement** de  $\mathcal{G}_2$  par  $\mathcal{G}_1$  est un morphisme de graphes  $\varphi : \mathcal{G}_1 \rightarrow \mathcal{G}_2$  tel que pour tout  $u \in V(\mathcal{G}_1)$ , pour tout voisin  $w$  de  $\varphi(u)$ , il existe un unique voisin  $v$  de  $u$  tel que  $\varphi(v) = w$ .

*Exemple.* Pour tout  $n \geq 3$ , la réduction modulo  $n$  définit un revêtement du graphe cyclique de longueur  $n$  par la ligne  $\mathcal{Z}$ .

Enfin, le **degré** (ou la **valence**) d'un sommet est le nombre de voisins de ce sommet. Un graphe est qualifié de **localement fini** si chacun de ses sommets est de degré fini, de  **$d$ -régulier** si chacun de ses sommets est de degré  $d$  et de **régulier** s'il existe  $d \in \mathbb{N}$  tel qu'il soit  $d$ -régulier. Un graphe dont la fonction degré est bornée est dit **de degré borné**.

*Exemple.* Etant donné un entier naturel  $d$ , il existe à isomorphisme près un unique arbre  $d$ -régulier ayant au moins un sommet. Dans la suite, on notera  $\mathcal{T}_d$  un représentant de cette classe d'isomorphisme.

DORÉNAVANT, TOUS LES GRAPHS SERONT IMPLICITEMENT PRIS CONNEXES, LOCALEMENT FINIS ET D'ENSEMBLE DE SOMMETS NON-VIDE. L'HYPOTHÈSE DE CONNEXITÉ NE SERA PAS IMPOSÉE LORSQU'ON S'INTÉRESSERA À UN SOUS-GRAPHE DU GRAPHE EN CONSIDÉRATION.



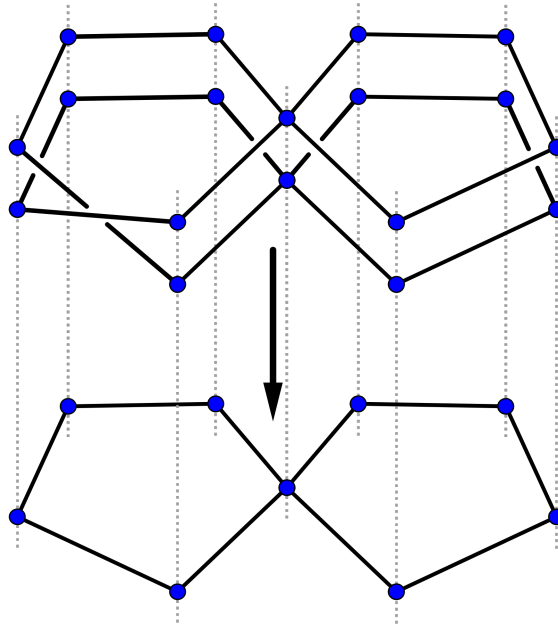
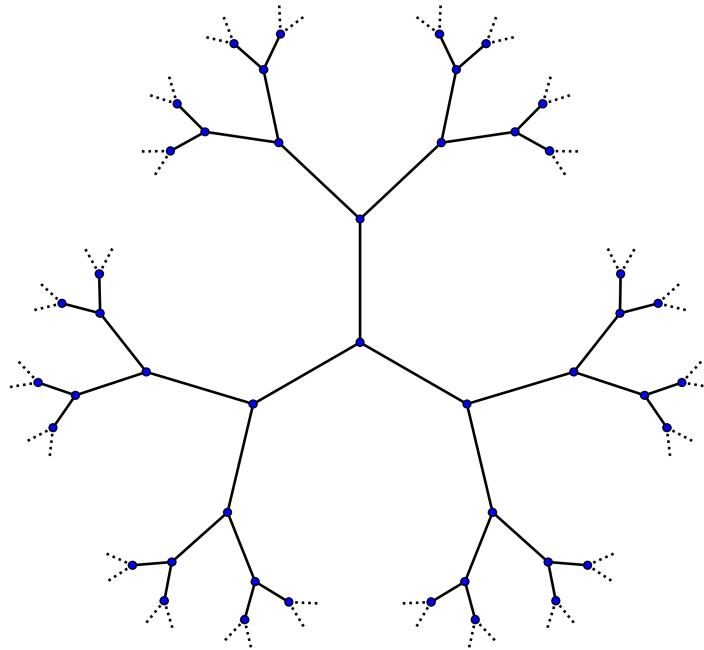

FIGURE 7 – Un exemple de revêtement.

FIGURE 8 – Une portion finie de  $\mathcal{T}_3$ .

### 0.1.2 Percolation : définition et premiers exemples

Soit  $\mathcal{G} = (V, E)$  un graphe. Une **percolation** (ou **percolation par arêtes**) sur  $\mathcal{G}$  est la donnée d'une mesure de probabilité sur  $2^E$ , l'ensemble des parties de  $E$ . Une **percolation par sites** est la donnée d'une mesure de probabilité sur  $2^V$ . Lorsque  $X$  désignera  $E$  ou  $V$ , on identifiera  $2^X$  et  $\{0, 1\}^X$ , via l'opérateur « fonction indicatrice ». Un élément de  $2^E$  ou  $2^V$  sera génériquement noté  $\omega$ .

On pense une percolation (par sites ou par arêtes) comme encodant un sous-graphe aléatoire de  $\mathcal{G}$ . Dans le cas d'une percolation par arêtes, on associe à  $\omega \in 2^E$  le graphe  $\mathcal{G}_\omega$  ayant pour ensemble de sommets  $V$  et pour ensemble d'arêtes  $\omega$ . Une arête dans  $\omega$  est dite **ouverte** tandis qu'une arête dans  $E \setminus \omega$  est dite **fermée**, et un chemin n'empruntant que des arêtes ouvertes est dit **ouvert**. Dans le cas d'une percolation par sites, le graphe associé à  $\omega \in 2^V$  est  $(V, \binom{\omega}{2} \cap E)$ . Un site dans  $\omega$  est dit **ouvert** tandis qu'un site dans  $V \setminus \omega$  est dit **fermé**, et un chemin dont l'image est incluse dans  $\omega$  est dit **ouvert**.

A toute percolation par sites on peut associer une percolation par arêtes. Soit  $\psi : 2^V \rightarrow 2^E$  l'application définie par  $\psi(\omega) := \binom{\omega}{2} \cap E$ . Pousser en avant par  $\psi$  une percolation par sites donne une percolation par arêtes. Elles ne sont pas toutes obtenues de la sorte : dans une configuration de percolation par arêtes provenant d'une configuration de percolation par sites, si deux arêtes d'un cycle de longueur 3 sont ouvertes, la troisième l'est automatiquement.

A l'inverse, à toute percolation par arêtes on peut associer une percolation par sites, mais sur un autre graphe. On définit  $\mathcal{G}^* = (V^*, E^*)$  par

$$V^* := E \quad \text{et} \quad E^* := \{\{e, e'\} \subset E : |e \cap e'| = 1\},$$

où  $|X|$  désigne le cardinal de  $X$ . On a alors  $2^E = 2^{V^*}$ , si bien qu'une percolation par arêtes sur  $\mathcal{G}$  est une percolation par sites sur  $\mathcal{G}^*$ . L'intérêt de la définition de  $E^*$  est que les chemins de longueur  $\ell \geq 2$  dans  $\mathcal{G}$  correspondent naturellement aux chemins de longueur  $\ell - 1$  dans  $\mathcal{G}^*$  : il suffit d'associer à un chemin la succession des arêtes qu'il emprunte.

*Remarque.* On peut définir un modèle de percolation plus général, qui englobe les deux précédents. Une **percolation par sites et arêtes** est une mesure de probabilité sur  $2^E \times 2^V$ . Un chemin est alors déclaré ouvert lorsqu'il ne passe que par des arêtes et des sommets conservés dans  $(\omega, \omega') \in 2^E \times 2^V$ .

Dans cette thèse, on se concentre sur la percolation par arêtes, mais bien des résultats s'adaptent directement au cas de la percolation par sites.

*Exemple.* Etant donné un paramètre  $p \in [0, 1]$  et un graphe  $\mathcal{G} = (V, E)$ , on peut définir la percolation dite **de Bernoulli** comme

$$\mathbb{P}_p := \text{Ber}(p)^{\otimes E} = (p\delta_1 + (1-p)\delta_0)^{\otimes E}.$$

Il s'agit tout simplement d'effacer chaque arête avec probabilité  $1 - p$  (et de la conserver sinon), ce indépendamment pour toutes les arêtes. On peut également définir la percolation par sites de Bernoulli, comme  $\text{Ber}(p)^{\otimes V}$ . La figure 9 représente une configuration de percolation de Bernoulli par arêtes sur une portion du réseau carré pour  $p = 0,5$ .

*Remarque.* En physique, comme dans les tous premiers paragraphes de cette introduction, la percolation est parfois entendue au sens restreint de percolation de Bernoulli. Ce ne sera pas le cas dans le reste de cette thèse.

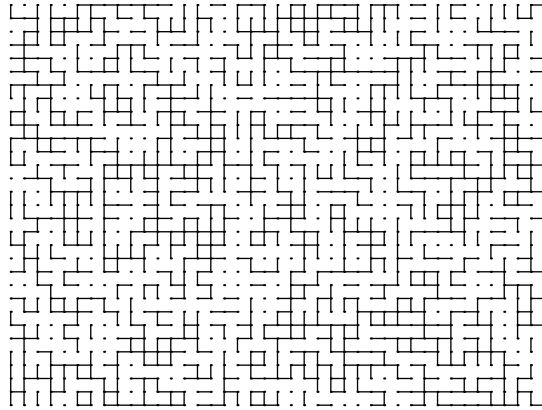

FIGURE 9 – Percolation de Bernoulli de paramètre  $p = 0,5$  sur une portion finie de  $\mathcal{Z}^2$ . Illustration due à Vincent Beffara.

Les questions qui se posent devant une telle figure se formulent, en grande partie, en termes de clusters. Etant donné un élément  $\omega$  de  $2^E$ , un **cluster** est une composante connexe de  $\mathcal{G}_\omega$ , c'est-à-dire une classe d'équivalence pour la relation « être relié par un chemin dans  $\mathcal{G}_\omega$  ». Si le graphe  $\mathcal{G}$  est infini, on peut s'intéresser au nombre de clusters infinis ainsi qu'à leur géométrie.

*Autre exemple.* Soit  $\mathcal{G} = (V, E)$  un graphe fini. Le **modèle d'Ising** sur  $\mathcal{G}$  de température inverse  $\beta$  est une mesure de probabilité sur  $\{-1, +1\}^V$  définie par

$$\mathbb{P}^{(\beta)}(\{\omega\}) := \frac{1}{Z^{(\beta)}} \exp \left( \beta \sum_{\{u,v\} \in E} \omega_u \omega_v \right).$$

Dans la formule ci-dessus, la constante de renormalisation  $Z^{(\beta)}$  — dite « fonction de partition » — est déterminée de façon univoque par le fait que la masse totale de l'espace pour une mesure de probabilité vaut 1. On peut penser  $\mathbb{P}^{(\beta)}$  comme une percolation par sites. Si on interprète le « spin »

$\pm 1$  en chaque site comme une aimantation, on dispose là d'un modèle du ferromagnétisme. Plus une configuration comporte d'arêtes dont les extrémités ont même spin, plus elle sera probable : les aimants en deux sites voisins ont tendance à s'aligner. L'amplitude de ce phénomène s'affaiblit à mesure que la température  $T = 1/\beta$  augmente, l'agitation thermique devenant de plus en plus prépondérante par rapport au phénomène magnétique. Lorsque  $\beta = 0$ , on retrouve la percolation de Bernoulli (par sites) de paramètre  $1/2$ . Quand  $\beta$  tend vers l'infini,  $\mathbb{P}^{(\beta)}(\{v \mapsto +1\})$  et  $\mathbb{P}^{(\beta)}(\{v \mapsto -1\})$  tendent vers  $1/2$ . Pour s'initier au modèle d'Ising, on pourra se référer à [Vel09].

Etudier tous les types de percolations sur tous les types de graphes est un trop vaste programme : sans hypothèse, il est difficile de dire quoi que ce soit de très intéressant. En effet, même en se restreignant à la percolation de Bernoulli, sans hypothèse sur le graphe d'étude, « tout peut arriver ». Par exemple, le nombre de clusters infinis peut<sup>2</sup> ne pas avoir de valeur presque sûre. Quand le nombre de clusters infinis est infini avec probabilité strictement positive, c'est automatiquement le cas avec probabilité 1 (d'après la loi du 0-1 de Kolmogorov), mais l'ensemble des  $p \in [0, 1]$  vérifiant cette propriété peut<sup>3</sup> ne pas être un intervalle. Pour les graphes transitifs (ou homogènes) — introduits en section 0.2 —, ces deux « pathologies » sont exclues (par la proposition 0.4.1 et le théorème 0.4.4). Dans cette thèse, on s'intéresse aux percolations sur les graphes transitifs qui respectent les symétries du graphe (les percolations invariantes, voir section 0.4), avec un intérêt tout particulier pour la percolation de Bernoulli.

*Remarque.* Pour pouvoir étudier *finement* la percolation de Bernoulli, il est nécessaire de s'intéresser à une classe de graphes *restreinte* ; toutefois, on peut se restreindre à d'autres classes que celle des graphes transitifs. Par exemple, un beau théorème de Lyons [Lyo90] stipule que le point critique pour la percolation de Bernoulli sur un arbre est l'inverse du branchement de

---

2. On verra au cours de la section 0.3 que la percolation de Bernoulli de paramètre  $0,6$  sur  $\mathcal{Z}^2$  fournit presque sûrement un unique cluster infini, et que l'appartenance de l'origine à ce cluster infini est de probabilité un certain réel  $\theta(0,6) \in ]0, 1[$ . On considère le graphe constitué de deux copies de  $\mathcal{Z}^2$  raccordées par une unique arête. Pour la percolation de Bernoulli de paramètre  $0,6$  sur ce graphe, la probabilité qu'il existe un unique cluster infini vaut  $0,6 \times \theta(0,6)^2 \in ]0, 1[$  tandis que celle qu'il en existe exactement deux vaut 1 moins cette quantité.

3. On suppose acquis les notations et résultats de la page 54. Soit  $\mathcal{G}$  un graphe transitif vérifiant  $p_c(\mathcal{G}) < p_u(\mathcal{G}) < 1$ , par exemple le produit de  $\mathcal{Z}$  par un arbre régulier de grand degré. On considère  $\mathcal{T}$  l'arbre régulier de valence 3 où chaque arête a été remplacée par une ligne de longueur  $\ell$  telle que  $p_u(\mathcal{G})^\ell < 1/2$ . L'union disjointe de  $\mathcal{G}$  et  $\mathcal{T}$  fournit un exemple de graphe où l'ensemble des  $p$  fournissant une infinité de clusters infinis n'est pas un intervalle. En effet, cet ensemble est compris entre  $]p_c(\mathcal{G}), p_u(\mathcal{G})[ \cup ]p_c(\mathcal{T}), 1[$  et son adhérence, et l'hypothèse sur  $\ell$  donne l'inégalité  $p_c(\mathcal{T}) > p_u(\mathcal{G})$ . Pour rendre cet exemple connexe, il suffit d'y ajouter une arête, entre un sommet quelconque de  $\mathcal{G}$  et un sommet quelconque de  $\mathcal{T}$  : cela ne change pas l'ensemble des paramètres fournissant une infinité de clusters infinis.

cet arbre. Sans entrer dans les détails, cela signifie que, si le graphe d'étude est un arbre, les transitions de phase pour la percolation de Bernoulli et pour une certaine marche aléatoire biaisée s'opèrent au *même* paramètre. La percolation de Bernoulli peut également être bien comprise sur certains graphes aléatoires : c'est le cas pour la triangulation planaire infinie uniforme d'Angel et Schramm (UIPT, voir [AS03]).

### 0.1.3 Un premier argument

En 1894, dans le premier numéro de *The American Mathematical Monthly*, Wood a posé la question suivante.

QUESTION 0.1.1 (WOOD, [WOO94]). *Des boules blanches et des boules noires — en nombre égales — étant disposées au hasard dans une boîte, quelle est la probabilité que celle-ci soit traversée de gauche à droite par un chemin ininterrompu de boules blanches ?*

Plus précisément, il s'agissait d'étudier le cas d'une boîte rectangulaire remplie sur plusieurs étages. Obtenir une solution exacte à ce problème semble difficile ; c'est pourquoi on préférera le cadre de travail suivant :

- on suppose la boîte rhombique de petit angle  $\pi/3$ ,
- on postule les boules disposées sur un unique étage de cette boîte, qu'elles remplissent parfaitement,
- on estime que toutes les configurations possibles sont équiprobables.

Sous ces hypothèses, on va déterminer la valeur exacte de la probabilité recherchée. L'argument que l'on présente est classique [Wer09].

A un tirage, on peut faire correspondre une configuration de percolation par sites sur une portion de réseau triangulaire. Cela est illustré par la figure 11.

Formellement, on choisit un entier naturel impair  $k$  et l'on considère le graphe  $\mathcal{G} = (V, E)$  obtenu par restriction du réseau triangulaire à

$$V = \{m + ne^{i\pi/3} : 0 \leq m \leq k \text{ et } 0 \leq n \leq k\}.$$

Le nombre  $k$  représente la largeur de la boîte moins 1. Sur les figures, ce nombre vaut 9. On pose

- Gauche :=  $\{ne^{i\pi/3} : 0 \leq n \leq k\}$ ,
- Droite :=  $\{k + ne^{i\pi/3} : 0 \leq n \leq k\}$ ,
- Bas :=  $\{m : 0 \leq m \leq k\}$ ,
- Haut :=  $\{m + ke^{i\pi/3} : 0 \leq m \leq k\}$ .

Comme  $k$  est impair, le nombre de sommets de  $\mathcal{G}$  est pair. On considère la percolation par sites consistant à conserver un ensemble de sommets tiré uniformément parmi ceux de cardinal  $\frac{|V|}{2}$  et l'on cherche à calculer la probabilité de l'événement  $A$  suivant : « il existe un chemin reliant Gauche et Droite et ne passant que par des sites ouverts ».

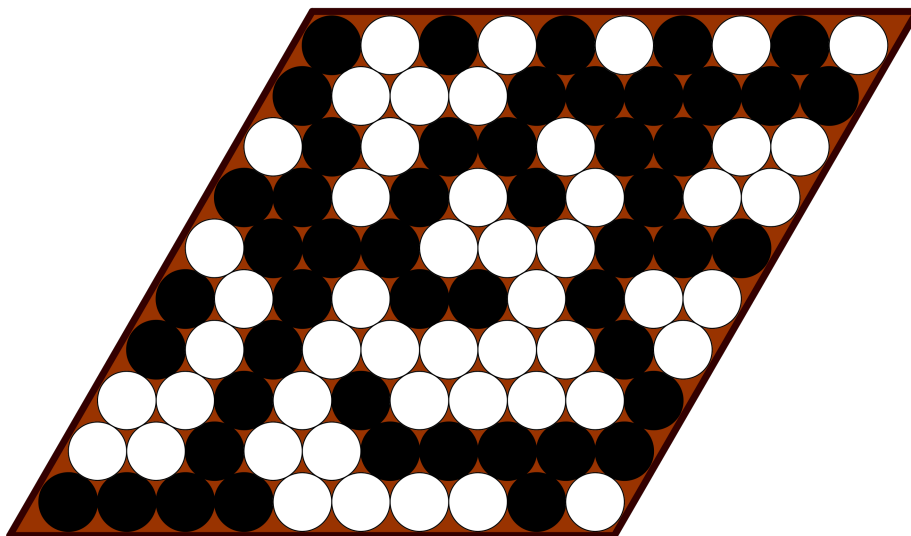

FIGURE 10 – Vue de dessus schématique d’une boîte rhombique remplie sur un étage de boules blanches et noires.

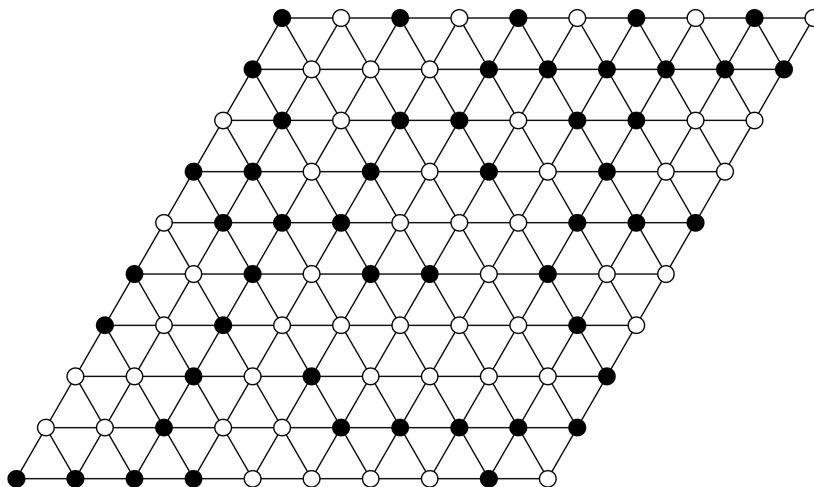

FIGURE 11 – La configuration de percolation par sites encodant la situation présentée figure 10.

Il est visuellement intuitif que l’occurrence de  $A$  est équivalente à la non-occurrence de l’événement  $B$  suivant : « il existe un chemin reliant Haut et Bas et ne passant que par des sites fermés ». Pour une démonstration rigoureuse de ce fait, le lecteur pourra consulter [Gal79, Hun14]. Notant  $\mathbb{P}$  la percolation étudiée, on a donc  $\mathbb{P}[A] + \mathbb{P}[B] = 1$ . Or, par symétrie,

$$\mathbb{P}[A] = \mathbb{P}[B].$$

En effet, la réflexion par rapport à la droite de pente  $\tan(\pi/6) = \frac{\sqrt{3}}{3}$  passant par l'origine induit un automorphisme de graphes de  $\mathcal{G}$  qui échange Gauche et Bas, ainsi que Droite et Haut. L'égalité  $\mathbb{P}[A] = \mathbb{P}[B]$  découle alors du fait que la mesure  $\mathbb{P}$  jouit des deux propriétés de stabilité suivantes. Si  $\mathbf{w}$  est de loi  $\mathbb{P}$ , alors

- pour tout automorphisme  $\varphi$  de  $\mathcal{G}$ , la loi de  $\varphi(\mathbf{w})$  est  $\mathbb{P}$ ,
- $V \setminus \mathbf{w}$  est de loi  $\mathbb{P}$ .

Des relations  $\mathbb{P}[A] + \mathbb{P}[B] = 1$  et  $\mathbb{P}[A] = \mathbb{P}[B]$  il découle que la probabilité  $\mathbb{P}[A]$  recherchée vaut  $1/2$ .

*Remarque.* La percolation de Bernoulli par sites de paramètre  $1/2$  vérifiant les deux propriétés de stabilité sus-évoquées, cette percolation donne également probabilité  $1/2$  à l'événement  $A$ .

Un tel argument peut-il être appliqué dans le cadre de la percolation par arêtes ? Il s'avère que oui, comme nous allons le voir maintenant.

Soit  $k$  un entier naturel non-nul. On considère l'ensemble

$$R := \{(m, n) \in \mathbb{Z}^2 : 0 \leq m \leq k \text{ et } 1 \leq n \leq k\}.$$

On le munit de la structure de graphe induite par restriction de celle de  $\mathbb{Z}^2$ , à laquelle on retranche les arêtes reliant entre eux deux sommets de premières coordonnées égales et valant 0 ou  $k$ . Le graphe ainsi formé est noté  $\mathcal{R}$ .

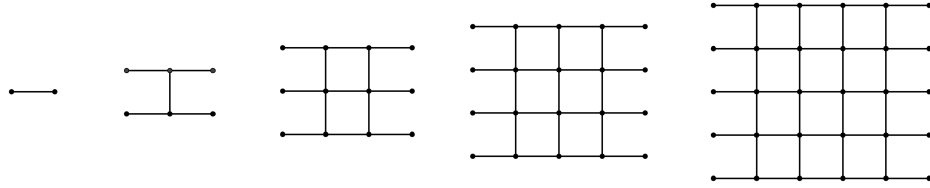

FIGURE 12 – Le graphe  $\mathcal{R}$  pour  $k$  entre 1 et 5.

On pose Gauche  $:= \{0\} \times \{1, \dots, k\}$  et Droite  $:= \{k\} \times \{1, \dots, k\}$ . Soit  $A$  l'événement « il existe un chemin d'arêtes ouvertes reliant Gauche à Droite ». On va démontrer que, pour la percolation de Bernoulli par arêtes de paramètre  $1/2$ , la probabilité de  $A$  vaut  $1/2$ .

Pour cela, on pose :

- $R_{\text{dual}} := \{(m, n) \in (\mathbb{Z}^2 + (1/2, 1/2)) : 0 < m < k \text{ et } 0 < n < k + 1\}$ ,
- Bas  $:= \{(m, n) \in R_{\text{dual}} : n = 1/2\}$ ,
- Haut  $:= \{(m, n) \in R_{\text{dual}} : n = k + 1/2\}$ .

Deux sommets de  $\mathcal{R}_{\text{dual}}$  sont déclarés adjacents s'ils satisfont aux trois conditions suivantes :

- ils n'appartiennent pas tous les deux à **Bas**,
- ils n'appartiennent pas tous les deux à **Haut**,
- ils diffèrent selon exactement une coordonnée, et de précisément 1.

Cela définit un graphe noté  $\mathcal{R}_{\text{dual}}$ .

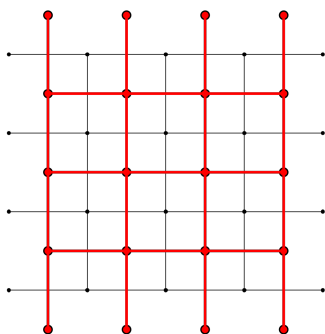

FIGURE 13 – Le graphe  $\mathcal{R}_{\text{dual}}$  pour  $k = 4$ .

A une configuration  $\omega$  de percolation par arêtes sur  $\mathcal{R}$  on peut associer une configuration  $\omega_{\text{dual}}$  de percolation par arêtes sur  $\mathcal{R}_{\text{dual}}$  : si on réalise les arêtes comme des segments dans le plan, chaque arête de  $\mathcal{R}$  intersecte une unique arête de  $\mathcal{R}_{\text{dual}}$ , et inversement ; on déclare une arête duale ouverte si et seulement si l'arête qu'elle croise est fermée. Voir figure 14.

Il est intuitif que l'occurrence de l'événement  $A$  est équivalente à la non-occurrence de l'événement  $B$  suivant : « il existe un chemin  $\omega_{\text{dual}}$ -ouvert reliant **Haut** et **Bas** ». (Pour une démonstration rigoureuse de ce fait, consulter [BR06] ou [Kes82].) On a donc  $\mathbb{P}_{1/2}[A] + \mathbb{P}_{1/2}[B] = 1$ . Les deux observations suivantes garantissent que  $\mathbb{P}_{1/2}[A] = \mathbb{P}_{1/2}[B]$ .

*Observations.* La rotation de centre  $(k/2, (k+1)/2)$  et d'angle  $\pi/2$  induit un isomorphisme de  $\mathcal{R}$  vers  $\mathcal{R}_{\text{dual}}$  qui envoie **Gauche** sur **Bas** et **Droite** sur **Haut**.

L'opérateur  $\omega \mapsto \omega_{\text{dual}}$  pousse en avant la percolation de Bernoulli de paramètre  $1/2$  sur  $\mathcal{R}$  sur la percolation de Bernoulli de paramètre  $1 - 1/2 = 1/2$  sur  $\mathcal{R}_{\text{dual}}$ .

Encore une fois, il découle des relations  $\mathbb{P}_{1/2}[A] + \mathbb{P}_{1/2}[B] = 1$  et  $\mathbb{P}_{1/2}[A] = \mathbb{P}_{1/2}[B]$  que  $\mathbb{P}_{1/2}[A] = \mathbb{P}_{1/2}[B] = 1/2$ .



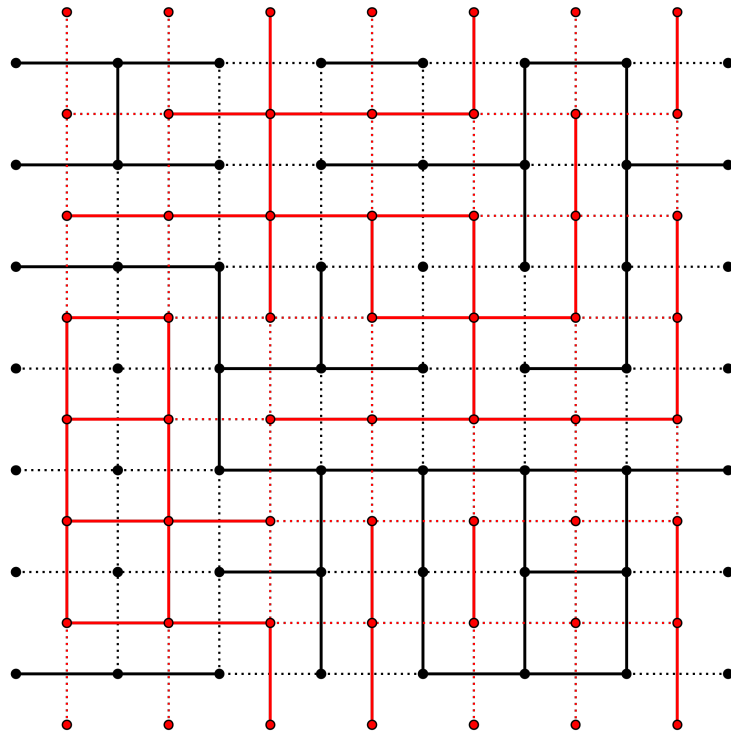

FIGURE 14 – Une configuration de percolation vue simultanément dans  $\mathcal{R}$  et  $\mathcal{R}_{\text{dual}}$ .

## 0.2 Graphes transitifs

Un graphe est dit **transitif** (ou **transitif au sens des sommets**, ou encore **homogène**) si le groupe de ses automorphismes agit transitivement sur l'ensemble de ses sommets. Il s'agit précisément des graphes où « tous les sommets jouent le même rôle ». Les graphes transitifs constituent un excellent cadre dans lequel étudier la percolation.

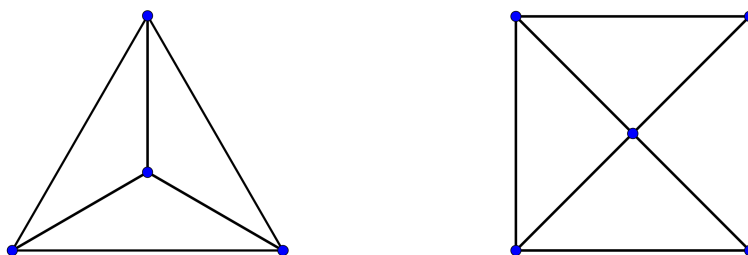

FIGURE 15 – Le graphe de gauche est transitif mais pas celui de droite.

Une classe particulière de graphes transitifs est celle des graphes de Cayley, qui nous fournira nos premiers exemples.

### 0.2.1 Graphes de Cayley

Soient  $G$  un groupe de type fini et  $S = \{s_1, \dots, s_n\}$  une partie génératrice finie de  $G$ . Le **graphe de Cayley**  $\mathcal{G} = \text{Cay}(G; S) = \text{Cay}(G; s_1, \dots, s_n)$  associé à  $(G, S)$  est défini par

$$V(\mathcal{G}) = G \quad \text{et} \quad E(\mathcal{G}) = \{\{g, g'\} \subset G : g^{-1}g' \in S \cup S^{-1} \setminus \{1_G\}\}.$$

En d'autres termes, on relie chaque  $g$  à  $gs$ , l'élément  $g$  étant pris quelconque et  $s$  dans  $S$ . Ce graphe est connexe car la partie  $S$  engendre  $G$  et localement fini car  $S$  est fini. Par associativité de la loi de composition interne de  $G$ , l'action de  $G$  sur  $G = V$  par multiplication à gauche définit une action par automorphismes de graphes. Cette action est simplement transitive, c'est-à-dire libre et transitive. En fait, tout graphe (connexe, non-vide et localement fini) sur lequel un groupe admet une action simplement transitive par automorphismes de graphes est un graphe de Cayley de ce groupe (qui est automatiquement de type fini). Voir [Sab58].

Munir un groupe d'une structure de graphe permet de se poser des questions géométriques sur ce groupe. Les mathématiques développées dans ce contexte sont regroupées sous le nom de « théorie géométrique des groupes ». Elles sont particulièrement fructueuses en interactions avec le corps principal de la théorie des groupes et donnent naissance à des questions nouvelles.

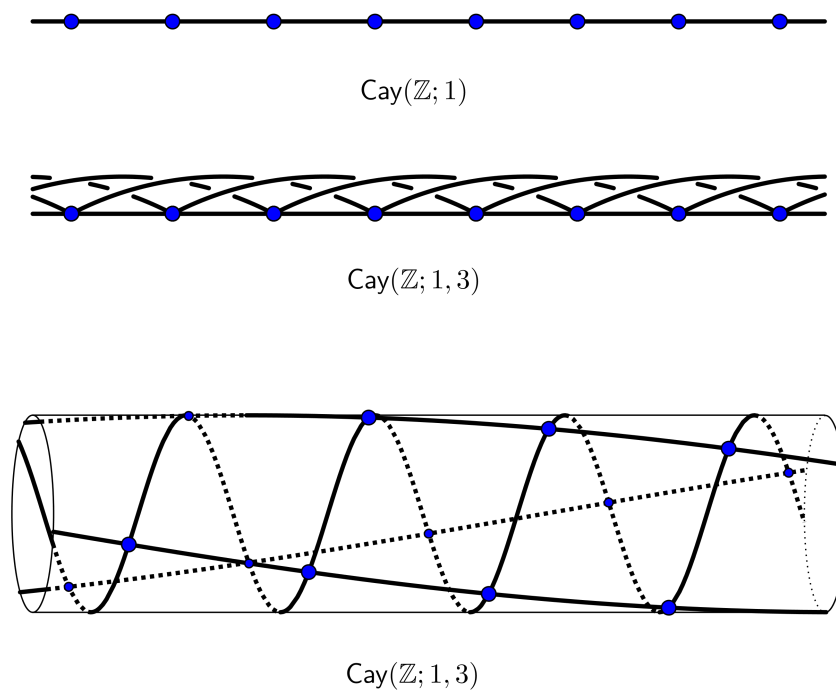
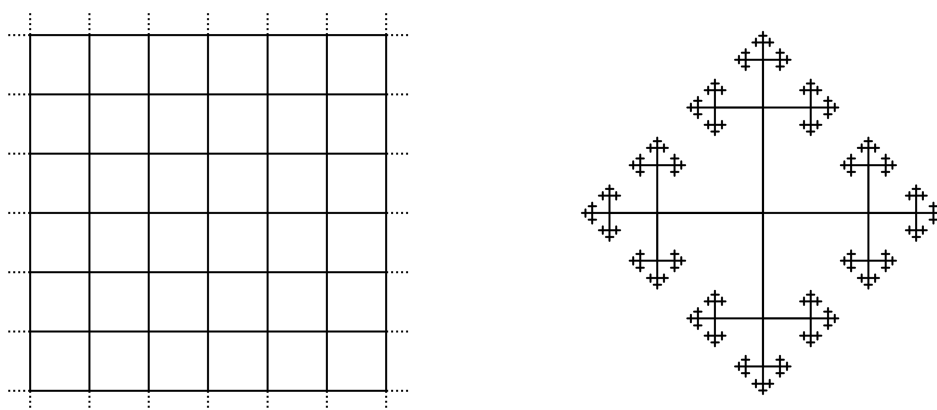
FIGURE 16 – Des graphes de Cayley de  $\mathbb{Z}$ .FIGURE 17 – Cay( $\mathbb{Z}^2; (1, 0), (0, 1)$ )  $\simeq \mathbb{Z}^2$  et Cay( $\langle a, b \rangle; a, b$ )  $\simeq \mathcal{T}_4$ .

Cette approche consistant à considérer un groupe comme un *objet* géométrique était déjà connue de Cayley et Dehn, et a été remise au goût du jour par Gromov [Gro81, Gro84].

Les paragraphes qui suivent présentent sommairement quelques proprié-

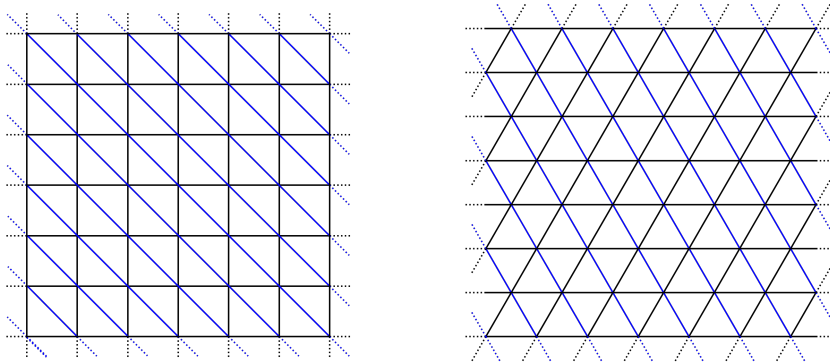

FIGURE 18 –  $\text{Cay}(\mathbb{Z}^2; (1, 0), (0, 1), (1, -1)) \simeq \mathcal{L}_\Delta$ .

tés géométriques qui s'avèrent reliées aux propriétés algébriques des groupes, ainsi qu'à leurs actions. Le lecteur intéressé pourra consulter [dlH00, Gro96].

**Interactions entre la géométrie d'un groupe, les propriétés algébriques de ce dernier et ses actions**

Avant de pouvoir énoncer quelques liens entre géométrie et théorie usuelle des groupes, étoifons notre vocabulaire. Un **bout** d'un graphe connexe localement fini  $\mathcal{G} = (V, E)$  est une application  $\xi$  qui associe à toute partie finie  $F$  de  $V$  une composante connexe infinie de son complémentaire, avec la condition de compatibilité suivante :

$$\forall F, F', F \subset F' \implies \xi(F') \subset \xi(F).$$

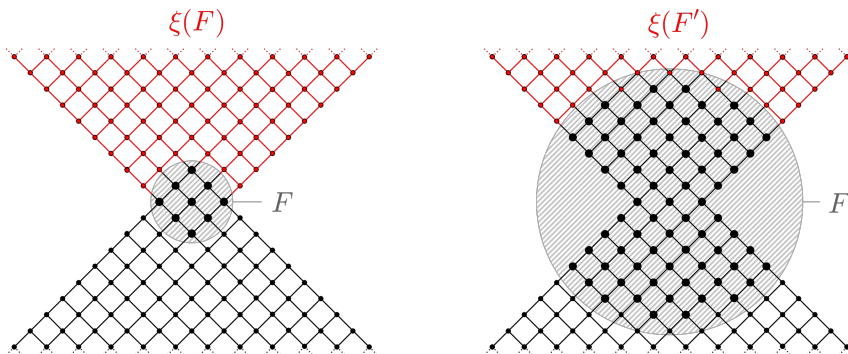

FIGURE 19 – Etant donnée une partie finie  $F$  de  $V$ , un bout  $\xi$  sélectionne une composante connexe infinie de  $V \setminus F$ .

Tout bout est réalisé par un chemin géodésique  $\kappa : \mathbb{N} \rightarrow V$ . Cela signifie que, pour tout bout  $\xi$ , il existe un chemin géodésique  $\kappa : \mathbb{N} \rightarrow V$  tel que

$$\forall F, \exists n_F, \forall n \geq n_F, \kappa(n) \in \xi(F).$$

*Démonstration.* Les graphes finis n'ayant pas de bout, on peut supposer le graphe considéré infini. Soient  $\xi$  un bout et  $o$  un sommet du graphe. Par locale finitude du graphe, pour tout  $n \in \mathbb{N}$ , la boule  $B(o, n)$  de centre  $o$  et de rayon  $n$  est finie. Etant donné un entier naturel  $n$ , il existe un sommet  $v_n$  qui appartient à  $\xi(B(o, n))$ , et on note  $\kappa_n : \{0, \dots, d(o, v_n)\} \rightarrow V$  un chemin géodésique reliant  $o = \kappa_n(0)$  et  $v_n$ . Le graphe à l'étude étant localement fini, par extraction diagonale, il existe un chemin  $\kappa : \mathbb{N} \rightarrow V$  qui est limite simple de  $\kappa_{n(k)}$ , pour une certaine extractrice  $(n(k))$ . Ce chemin convient.  $\square$

*Remarque.* On peut penser un bout comme une classe d'équivalence de chemins géodésiques, deux chemins étant déclarés équivalents lorsqu'ils réalisent le même bout.

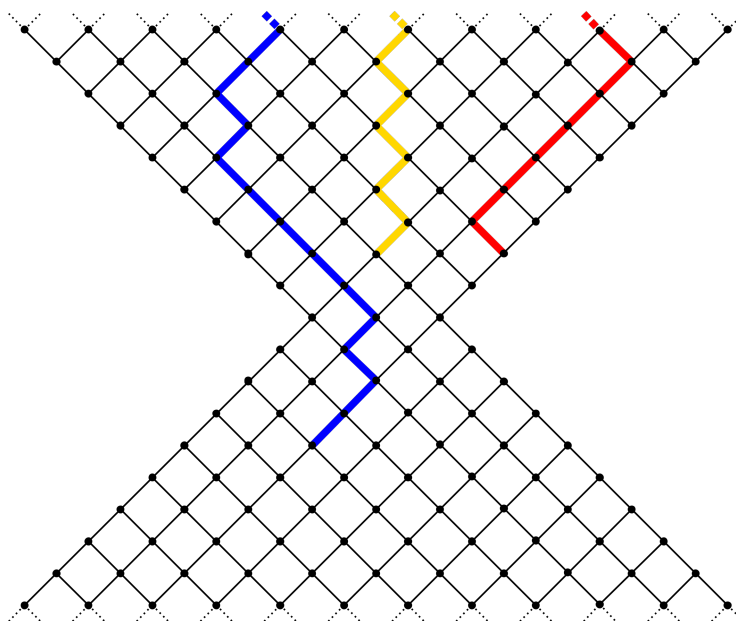

FIGURE 20 – Les images de trois chemins géodésiques réalisant le bout représenté figure 19.

L'espace des bouts d'un graphe est muni de la topologie prodiscrète, c'est-à-dire de la topologie de la convergence simple pour la topologie discrète au but. On peut démontrer que tout graphe transitif a 0, 1, 2 ou un espace de Cantor de bouts (cf. [Hal73, Jun81]). Quand on dit qu'un espace **a**  $x$  **bouts** ou **est à**  $x$  **bouts**, cela signifie que son nombre de bouts vaut *exactement*  $x$ .

*Exemples.* Tout produit de deux graphes infinis a 1 bout ; c'est en particulier le cas de  $\mathcal{Z}^d$  dès que  $d \geq 2$ . Le graphe  $\mathcal{Z}$  a 2 bouts. Pour tout  $d \geq 3$ , l'arbre  $d$ -régulier a une infinité de bouts. Enfin, un graphe (connexe localement fini) a 0 bout si et seulement s'il est fini.

Une autre notion qui sera utile est celle de virtualité. On dit qu'un groupe vérifie **virtuellement** une propriété s'il contient un sous-groupe d'indice fini vérifiant cette propriété.

**THÉORÈME 0.2.1 (HOPF).** *Un groupe est virtuellement  $\mathbb{Z}$  si et seulement si un (chacun) de ses graphes de Cayley a deux bouts.*

Un graphe est à **croissance polynomiale** si pour un (tout) choix de sommet  $o$ , le cardinal de la boule de centre  $o$  et de rayon  $n$  est majoré par une fonction polynomiale de  $n$ .

**THÉORÈME 0.2.2 (GROMOV, [GRO81, KLE10, ST10]).** *Un groupe de type fini est virtuellement nilpotent si et seulement si un (chacun) de ses graphes de Cayley est à croissance polynomiale.*

On remarque que, dans les deux théorèmes précédents, les propriétés algébriques ne dépendent que du groupe considéré alors que les propriétés géométriques dépendent a priori également du choix de la partie génératrice définissant le graphe de Cayley d'étude. En fait, ces propriétés ne dépendent pas du choix de la partie génératrice car, étant donnés deux graphes de Cayley d'un même groupe  $G$ , l'identité de  $G$  induit une application bilipschitzienne entre ces graphes. Plus précisément, si  $S$  et  $S'$  dénotent deux parties génératrices finies de  $G$  et si  $d_S$  (resp.  $d_{S'}$ ) dénote la distance induite sur  $G$  par la structure de graphe  $\text{Cay}(G; S)$  (resp.  $\text{Cay}(G; S')$ ), alors on a l'inégalité suivante<sup>4</sup> :

$$\forall (g, g') \in G^2, d_S(g, g') \leq \max\{d_S(1, s'); s' \in S'\} \times d_{S'}(g, g').$$

La géométrie à grande échelle du groupe est indépendante du choix d'une partie génératrice : de même que les normes sont équivalentes en dimension finie, les métriques de Cayley sont équivalentes sur un groupe de type fini.

On peut déduire de cette remarque le fait que le nombre de bouts d'un groupe est bien défini, en ce sens qu'il ne dépend pas du graphe de Cayley considéré. On a vu que ce nombre valait nécessairement 0, 1, 2 ou  $\infty$ . Le théorème 0.2.1 caractérise algébriquement les groupes à 2 bouts. Les groupes à 0 bout ne sont rien d'autre que les groupes finis. Un théorème de Stallings caractérise également de façon algébrique les groupes ayant une infinité de bouts (en termes de produits amalgamés, voir [DK, Sta68]). L'existence d'un

---

4. ainsi que, par corollaire, celle où  $S$  et  $S'$  voient leurs rôles échangés, d'où le caractère bilipschitzien de l'identité de  $G$

unique bout étant la négation du fait d'avoir 0, 2 ou  $\infty$  bouts, chaque nombre de bouts — donnée géométrique — s'interprète algébriquement.

Une autre notion d'importance en théorie géométrique des groupes est celle de moyennabilité. Un groupe discret  $G$  est dit **moyennable** s'il existe une mesure de probabilité finiment additive sur  $(G, 2^G)$  qui est invariante par multiplication à gauche, c'est-à-dire s'il existe une fonction  $m : 2^G \rightarrow [0, 1]$  telle que :

- si  $A$  et  $B$  sont deux parties disjointes de  $G$ , alors  $m(A \cup B) = m(A) + m(B)$ ,
- si  $A$  est une partie de  $G$  et  $g$  un élément de  $G$ , alors  $m(A) = m(gA)$ ,
- $m(G) = 1$ .

Les groupes finis sont évidemment moyennables. Dès lors que  $G$  est infini, il est impossible de démontrer l'existence d'une telle mesure finiment additive dans la théorie des ensembles sans axiome du choix — voir [Bla77, PS77]. Toutefois, en ayant recours à l'axiome du choix, on peut démontrer que de nombreux groupes infinis sont moyennables (par exemple les groupes abéliens). Cette notion a été introduite par von Neumann [vN29] dans le but d'améliorer notre compréhension du paradoxe de Banach-Tarski<sup>5</sup> [BT24] : la non-moyennabilité d'un groupe de transformations est en un sens équivalente au fait que ce groupe permette l'apparition d'un paradoxe à la Banach-Tarski (voir l'alternative de Tarski dans [dlH04]). Dans ce qui suit, on ne s'intéressera qu'aux groupes de type fini, puisque c'est le cadre naturel d'étude des graphes de Cayley.

**THÉORÈME 0.2.3** (FØLNER, [FØL55]). *Un groupe de type fini  $G$  est moyennable si et seulement si un (chacun) de ses graphes de Cayley  $\mathcal{G} = (V, E)$  vérifie la **condition de Følner** :*

$$\inf_{F \in V} \frac{|\partial F|}{|F|} = 0,$$

où  $F \in V$  signifie «  $F$  est une partie finie non-vide de  $V$  » et  $\partial F$  dénote  $\{e \in E : |e \cap F| = 1\}$ , la **frontière** de  $F$ .

*Remarque.* Ce théorème nous invite à définir la **constante de Cheeger** — ou **constante isopérimétrique** — d'un graphe de degré borné  $\mathcal{G} = (V, E)$  comme

$$h(\mathcal{G}) = \inf_{F \in V} \frac{|\partial F|}{|F|}$$

et à qualifier de **moyennable** un graphe dont la constante isopérimétrique est nulle.

---

5. Si on accepte l'axiome du choix, il est possible de partitionner la boule euclidienne unité  $B$  de  $\mathbb{R}^3$  en un nombre fini de parts  $A_1, \dots, A_k$  et de trouver des déplacements affines  $\varphi_1, \dots, \varphi_k$  tels que les  $\varphi_i(A_i)$  partitionnent l'union disjointe de deux boules euclidiennes unités!

*Exemples.* Les groupes  $\mathbb{Z}^d$  sont moyennables. En effet, les boules du réseau hypercubique de dimension  $d$  ont un cardinal croissant en la  $d^{\text{ème}}$  puissance du rayon tandis que les sphères croissent en la  $(d - 1)^{\text{ème}}$  puissance de ce dernier. Le groupe libre à deux générateurs  $\mathbb{F}_2$  n'est pas moyennable. Au sens de Følner, ceci découle du fait que le nombre de feuilles d'un arbre fini non-vide excède toujours son nombre de sommets de degré 3 ou plus, et du fait que la borne inférieure du théorème 0.2.3 peut être prise sur les parties connexes sans briser l'équivalence. On peut également démontrer directement qu'il n'existe pas sur  $\mathbb{F}_2 = \langle a, b \rangle$  de mesure de probabilité finiment additive invariante en constatant que si  $m$  désigne une telle fonction et  $A$  l'ensemble des éléments de  $\mathbb{F}_2$  dont la forme réduite commence par  $a$  ou  $a^{-1}$ , les deux faits suivants entrent en contradiction :

- $2m(A) = m(A) + m(aA) \geq m(\mathbb{F}_2) = 1$ ,
- $3m(A) = m(A) + m(bA) + m(b^2A) \leq m(\mathbb{F}_2) = 1$ .

Outre celle isopérimétrique de Følner, on peut mentionner les caractérisations suivantes de la moyennabilité. Cet échantillon ne représente qu'une faible proportion des nombreuses caractérisations de la moyennabilité d'un groupe de type fini (voir [Pie84]).

**THÉORÈME 0.2.4.** *Un groupe de type fini  $G$  est moyennable si et seulement si l'une (chacune) des conditions suivantes est satisfaite :*

- pour un (chacun) de ses graphes de Cayley, les probabilités  $p_n$  de retour au point de départ de la marche aléatoire simple tendent vers 0 exponentiellement vite en le nombre de pas — i.e.  $\limsup \frac{\log p_n}{n} < 0$  ;
- pour toute action de  $G$  par homéomorphismes sur un espace compact  $X$  non-vide, il existe une mesure de probabilité borélienne  $\mu$  sur  $X$  invariante sous l'action de  $G$ .

*Remarque.* Les théorèmes 0.2.3 et 0.2.4 reposent sur l'axiome du choix. On peut néanmoins démontrer sans ce dernier que la condition de Følner est équivalente à celle d'évanouissement exponentiel des probabilités de retour de la marche aléatoire simple (voir par exemple [Woe00]).

La classe des groupes discrets moyennables est stable par passage à un sous-groupe<sup>6</sup>, par quotient et par extension (par exemple par produit direct ou semi-direct). En particulier, tout groupe discret contenant un groupe libre à deux générateurs est non-moyennable.<sup>7</sup> Le problème de Day-von Neumann consiste à déterminer si la réciproque est vraie.<sup>8</sup> En 1980, Ol'Shanskii a

6. Pour établir cette propriété de stabilité, on utilise l'axiome du choix. L'usage de cet axiome peut être évité si on ne s'intéresse qu'aux groupes dénombrables.

7. On démontre usuellement le paradoxe de Banach-Tarski en établissant que  $\text{SO}(3)$  contient un groupe libre à deux générateurs.

8. Il est équivalent de poser ce problème pour un groupe discret quelconque ou en restriction aux groupes de type fini. En effet, un groupe discret est moyennable si et seulement si tous ses sous-groupes de type fini sont moyennables.



démontré que ce n'était pas le cas [Ol'80]. Il est toutefois possible de formuler des réponses positives à ce problème (voir l'alternative de Tits page 27 et le théorème 1.2.5).

### La notion de quasi-isométrie

Il existe une notion de géométrie à grande échelle plus lâche que l'équivalence bilipschitzienne : celle de quasi-isométrie, qui — comme la notion de moyennabilité — permet de relier la géométrie d'un groupe aux propriétés de ses actions.

Une application  $\varphi$  d'un espace métrique  $(X, d)$  vers un autre espace métrique  $(X', d')$  est une **quasi-isométrie** s'il existe deux constantes  $A \geq 1$  et  $B \geq 0$  telles que

- $\forall (x, y) \in X^2, A^{-1}d'(\varphi(x), \varphi(y)) - B \leq d(x, y) \leq Ad'(\varphi(x), \varphi(y)) + B,$
- tout point de  $X'$  est à distance au plus  $B$  d'un point de  $\varphi(X)$ .

S'il existe un tel  $\varphi$ , on dit que  $(X, d)$  et  $(X', d')$  sont **quasi-isométriques**. « Etre quasi-isométrique » définit bien une relation d'équivalence. Cette notion étant un affaiblissement de l'équivalence bilipschitzienne, on peut parler de la classe de quasi-isométrie d'un groupe de type fini.

Contrairement à l'équivalence bilipschitzienne, l'équivalence par quasi-isométrie identifie un groupe de type fini à ses sous-groupes d'indice fini.<sup>9</sup> Elle permet également d'identifier des groupes de type fini et des groupes continus. Ainsi,  $\mathbb{Z}$  et  $\mathbb{R}$  sont quasi-isométriques. Plus généralement, un réseau (sous-groupe discret cocompact) d'un groupe de Lie est toujours de type fini et quasi-isométrique à ce groupe de Lie. Tout cela, et plus encore<sup>10</sup>, est contenu dans le théorème 0.2.5. Pour énoncer ce théorème, on doit introduire quelques notions.

Un espace métrique  $(X, d)$  est dit **géodésique** si, pour tous points  $x$  et  $y$  de  $X$ , il existe une isométrie  $\varphi : [0, d(x, y)] \rightarrow X$  envoyant 0 sur  $x$  et  $d(x, y)$  sur  $y$ . Un espace métrique est **propre** si ses boules fermées sont compactes. Enfin, on dit qu'un groupe discret agissant par homéomorphismes sur un espace topologique non-vide agit **proprement** sur ce dernier si l'application  $(g, x) \mapsto (g \cdot x, x)$  est propre au sens où l'image réciproque de tout compact par elle est compacte.

**THÉORÈME 0.2.5** ([EFR53, ŠVA55, M<sup>+</sup>68]). *Soient  $X$  un espace métrique géodésique propre et  $x$  un point de  $X$ . Soit  $G$  un groupe agissant par isométries sur  $X$  de façon propre et de telle sorte que le quotient  $G \backslash X$  soit compact. Alors  $G$  est de type fini et  $g \mapsto g \cdot x$  est une quasi-isométrie.*

9. Elle induit aussi d'autres identifications entre groupes de type fini : il existe des groupes de type fini qui sont quasi-isométriques sans qu'ils soient commensurables, c'est-à-dire sans qu'ils contiennent chacun un même groupe comme sous-groupe d'indice fini.

10. par exemple le fait que le groupe fondamental d'une variété riemannienne est quasi-isométrique au revêtement universel de cette dernière

*Remarque.* Ce théorème est à rapprocher de la remarque selon laquelle tout graphe (connexe, non-vide et localement fini) muni d'une action simplement transitive d'un groupe est un graphe de Cayley de ce groupe (qui est automatiquement de type fini). En effet,

- les espaces métriques géodésiques sont aux espaces métriques ce que les graphes connexes sont aux espaces métriques à distance à valeurs dans  $\mathbb{N}$  ;
- la propriété d'un espace métrique est un analogue continu de l'hypothèse de locale finitude<sup>11</sup> en théorie des graphes ;
- la propriété est une forme lâche et continue d'injectivité ;
- la compacité du quotient est une forme lâche et continue de surjectivité.

La notion de quasi-isométrie permet non seulement d'aborder des questions de géométrie — c'est-à-dire portant sur des actions de groupes par isométries — mais aussi des questions de topologie — c'est-à-dire relatives à des actions par homéomorphismes.

**THÉORÈME 0.2.6 (GROMOV).** *Deux groupes de type fini sont quasi-isométriques si et seulement s'ils admettent chacun une action propre sur un même espace localement compact non-vide de telle sorte que les deux quotients associés soient compacts et que ces deux actions commutent.*

*Éléments de démonstration.* On suppose que les deux groupes considérés  $G$  et  $H$  sont quasi-isométriques. On note  $(A, B)$  un couple de réels tel qu'il existe une  $(A, B)$ -quasi-isométrie de  $G$  vers  $H$ . On prend pour espace localement compact l'espace des  $(A, B)$ -quasi-isométries de  $G$  vers  $H$  muni de la topologie de la convergence simple. Le groupe  $G$  agit naturellement à la source des quasi-isométries et  $H$  naturellement à leur but. On vérifie que ces actions satisfont aux conditions du théorème.

Réciproquement, s'il existe de telles actions sur un espace localement compact non-vide  $X$ , on prend  $K$  un compact de  $X$  suffisamment grand pour qu'il se surjecte sur chacun des quotients par projection canonique. Pour tout  $g \in G$ , il existe un élément  $h(g)$  de  $H$  tel que  $gK \cap h(g)K \neq \emptyset$ . Ce  $h(g)$  n'est pas unique : on le fixe de façon arbitraire et vérifie que  $g \mapsto h(g)$  est une quasi-isométrie de  $G$  vers  $H$ .  $\square$

### Quelques exemples et classes de groupes intéressants

Outre cette compréhension conceptuelle, on dispose d'une liste d'exemples et de classes de groupes relativement bien compris. Les premiers exemples sont les groupes abéliens et les groupes libres. Algébriquement, ils sont l'objet de théorèmes de structure assez fins. Mais qu'en est-il géométriquement ?

---

11. Un graphe est localement fini si et seulement s'il est propre.

Tout groupe abélien de type fini est quasi-isométrique à sa partie sans torsion, c'est-à-dire à un réseau hypercubique de dimension le rang de cette partie sans torsion. Cette dimension est invariante par quasi-isométrie, en tant qu'exposant de croissance du cardinal des boules. Les groupes libres  $\mathbb{F}_d$  pour  $d \geq 2$  se réalisent tous comme sous-groupes d'indice fini de  $\mathbb{F}_2$  : ils appartiennent donc à la même classe de quasi-isométrie. Leur géométrie à quasi-isométrie près est celle d'un arbre régulier de valence au moins 3.

Un autre exemple d'importance est celui du **groupe de l'allumeur de réverbères**. On pense à  $\mathbb{Z}$  comme à une rue bi-infinie et place un réverbère en face de chaque maison. L'état de chaque réverbère — « allumé » ou « éteint » — est un élément de  $\mathbb{Z}/2\mathbb{Z}$ . Une configuration est la donnée de la position de l'allumeur et de l'état des réverbères, c'est-à-dire un élément de  $\mathbb{Z} \times \prod_{\mathbb{Z}} \mathbb{Z}/2\mathbb{Z}$ . Le groupe de l'allumeur de réverbères  $\text{LL}(\mathbb{Z})$  est le groupe engendré par les deux transformations suivantes :

— « l'allumeur fait un pas » —  $S : (n, x) \mapsto (n + 1, x)$  ;

— « il actionne l'interrupteur sur place » —  $T : (n, x) \mapsto (n, x + \mathbf{1}_{\{n\}})$ .

Algébriquement, ce groupe s'écrit  $\mathbb{Z} \rtimes \bigoplus_{\mathbb{Z}} \mathbb{Z}/2\mathbb{Z}$ , le groupe  $\mathbb{Z}$  agissant par décalage des coordonnées. Il s'agit d'un groupe à croissance exponentielle qui est moyennable ; on ne rencontre pas tel comportement chez les groupes libres ou abéliens.

Un graphe transitif est dit à **croissance exponentielle** si,  $b_n$  dénotant le cardinal d'une boule de rayon  $n$ , la limite de  $\frac{\log b_n}{n}$  est strictement positive, cette limite existant par sous-additivité et étant finie parce que le graphe est de degré borné. Un groupe est à **croissance exponentielle** si un (donc chacun) de ses graphes de Cayley est à croissance exponentielle.

La croissance exponentielle du groupe  $\text{LL}(\mathbb{Z})$  résulte de ce que les éléments  $S$  et  $ST$  engendrent un monoïde libre à deux générateurs. La moyennabilité de  $\text{LL}(\mathbb{Z})$ , quant à elle, peut s'établir en prenant pour  $N^{\text{ème}}$  ensemble de Følner

$$\{(n, x) : |n| \leq N \text{ et } \forall i, |i| > N \implies x_i = 0\}.$$

Le graphe de Cayley de  $\text{LL}(\mathbb{Z})$  pour la partie génératrice  $\{S, ST\}$  est le graphe de Diestel-Leader de paramètre  $(2, 2)$ , introduit page 32 (voir [Woe05]).

Il existe bien sûr d'autres exemples et classes de groupes d'intérêt. Une classe remarquable est celle des groupes de Kazhdan [BdLHV08]. Soit  $G$  un groupe dénombrable discret. Une **représentation unitaire** de  $G$  est la donnée d'un espace de Hilbert complexe  $H$  et d'un morphisme de groupes de  $G$  vers le groupe des automorphismes unitaires de  $H$ . Une représentation unitaire  $\pi$  de  $G$  sur  $H$  **admet un vecteur invariant non-nul** s'il existe  $\xi \in H \setminus \{0\}$  tel que  $\forall g \in G, \pi(g)\xi = \xi$ . On dit que  $\pi$  **admet presque un vecteur invariant** si, pour tout  $\epsilon > 0$  et toute partie finie  $F$  de  $G$ , il

existe  $\xi \in H$  tel que  $\forall g \in F, \|\pi(g)\xi - \xi\| < \epsilon\|\xi\|$ . On dit que  $G$  vérifie la **propriété (T)** — ou **propriété de Kazhdan**, ou encore **propriété (T) de Kazhdan** — si toute représentation unitaire de  $G$  admettant presque un vecteur invariant admet un vecteur invariant non-nul.

*Quelques faits.* Tout groupe fini vérifie la propriété (T).

Tout quotient d'un groupe vérifiant la propriété (T) la vérifie aussi.

Tout groupe dénombrable discret ayant la propriété (T) est de type fini.

Le groupe  $\mathrm{SL}_n(\mathbb{Z})$  vérifie la propriété (T) si et seulement si  $n \geq 3$ .

**PROPOSITION 0.2.7.** *Tout groupe de type fini qui est moyennable et vérifie la propriété (T) est fini.*

*Démonstration.* Soit  $G$  un groupe de type fini, moyennable et vérifiant la propriété de Kazhdan. On pose  $H := \ell^2(G)$  et  $\pi$  la représentation définie par

$$\pi(g)f : h \mapsto f(g^{-1}h).$$

On déduit aisément de la condition de Følner que  $\pi$  a presque un vecteur invariant. Comme  $G$  a la propriété (T), cette représentation a un vecteur invariant  $f$  non-nul. Par invariance,  $f$  doit être constante. Comme  $f$  est constante, non-nulle et de carré sommable,  $G$  est fini.  $\square$

*Remarque.* La propriété (T) n'est pas géométrique en ce sens qu'elle n'est pas invariante par quasi-isométrie. Voir [BdLHV08].

Une autre classe est celle des groupes nilpotents, dont l'exemple-type est le **groupe de Heisenberg** que forment les matrices  $3 \times 3$  triangulaires supérieures à coefficients entiers et avec des 1 sur la diagonale.

On peut également mentionner les groupes hyperboliques au sens de Gromov [GdlH90]. Bien que l'hyperbolicité soit définie de façon géométrique, cette qualité implique pour les groupes qui en jouissent de notables propriétés de calculabilité : les groupes hyperboliques sont automatiques, si bien qu'ils sont de présentation finie et que le problème du mot est résoluble pour ces groupes. Les groupes libres de type fini — de même que, par exemple, le groupe fondamental de la surface (compacte orientable sans bord) de genre 2 — sont hyperboliques.

Les **groupes linéaires** forment aussi une classe de groupes remarquable. Il s'agit des groupes pouvant se réaliser comme sous-groupe de  $\mathrm{GL}_n(\mathbb{K})$  pour un certain entier  $n$  et un certain corps commutatif  $\mathbb{K}$ . L'alternative de Tits répond positivement au problème de Day-von Neumann (voir page 23) dans le cas des groupes linéaires de type fini : tout groupe linéaire de type fini est soit virtuellement résoluble, soit un sur-groupe de  $\mathbb{F}_2$ .

Enfin, on peut évoquer la classe des groupes **à croissance intermédiaire**, c'est-à-dire dont le cardinal des boules d'un (donc tout) graphe de

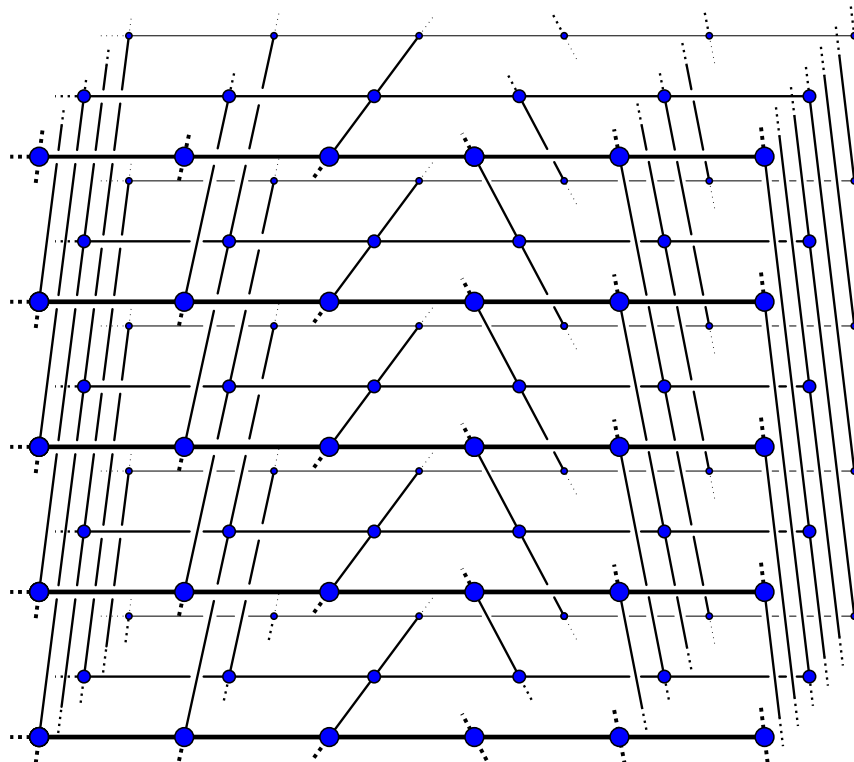

FIGURE 21 – Une portion du graphe de Cayley du groupe de Heisenberg pour les générateurs  $\begin{pmatrix} 1 & 1 & 0 \\ 0 & 1 & 0 \\ 0 & 0 & 1 \end{pmatrix}$  et  $\begin{pmatrix} 1 & 0 & 0 \\ 0 & 1 & 1 \\ 0 & 0 & 1 \end{pmatrix}$ .

Cayley croît plus vite que tout polynôme en  $n$  mais moins vite que tout  $\exp(en)$ , plus ou moins vite étant pris au sens des « petits o » de Landau et  $n$  désignant le rayon de boule. Grigorchuk a construit dans [Gri83] un exemple de tel groupe comme sous-groupe du groupe des automorphismes de l'arbre binaire enraciné infini vers le bas. Pour une démonstration détaillée, consulter [dlH00].

L'étude des groupes de type fini par restriction à des classes d'intérêt est une approche évidemment naturelle : plus on a d'hypothèses à exploiter, plus on peut démontrer de théorèmes. Gromov en a fait un leitmotiv à prendre avec légèreté : « Un théorème valable pour tous les groupes est soit trivial soit faux ». S'il est périlleux d'essayer de formaliser et prouver une telle assertion, on peut bien démontrer qu'il est impossible de classer les groupes de type fini — voir le premier théorème de la section 4 de [Ghy04].

Aussi vaste le monde des groupes de type fini soit-il, il ne recouvre pas tout entier celui des graphes transitifs. Le reste de cette partie vise à explorer ce territoire au delà des graphes de Cayley.

### 0.2.2 Unimodularité et transport de masse

Soit  $\mathcal{G} = (V, E)$  un graphe transitif et  $o$  un sommet quelconque de  $\mathcal{G}$ . Soit  $G$  un sous-groupe du groupe d'automorphismes de  $\mathcal{G}$  agissant transitivement sur  $V$ . On dit que le couple  $(\mathcal{G}, G)$  vérifie le **principe de transport de masse** si, pour toute fonction  $f : V \times V \rightarrow [0, +\infty]$  invariante sous l'action diagonale<sup>12</sup> de  $G$ , l'égalité suivante a lieu :

$$\sum_{v \in V} f(o, v) = \sum_{v \in V} f(v, o).$$

Cette égalité ne dépend pas du choix de  $o$  par invariance des fonctions  $f$  considérées et par transitivité de l'action de  $G$  sur  $\mathcal{G}$ .

On pense à  $f(u, v)$  comme à la masse envoyée par le sommet  $u$  au sommet  $v$ . Le principe de transport de masse stipule alors que lorsque la procédure d'envoi de masse  $f$  est  $G$ -invariante, l'origine  $o$  reçoit autant de masse qu'elle en envoie. Ce principe constitue un puissant outil en théorie de la percolation [Hag97, BLPS99b], comme en témoigne la section 0.4.

Il peut également être énoncé en utilisant le vocabulaire des groupes localement compacts. Un **groupe localement compact** est un groupe topologique<sup>13</sup> dont la topologie est localement compacte. Le groupe  $\text{Aut}(\mathcal{G})$  des automorphismes de  $\mathcal{G}$  peut être vu comme une partie de  $V^V$  ; on le munit de la topologie induite par la topologie prodiscrète sur  $V^V$  — c'est-à-dire la topologie produit de topologies discrètes. Ceci fait de  $\text{Aut}(\mathcal{G})$  un groupe topologique séparé. Ce groupe est localement compact car  $\mathcal{G}$  est tacitement supposé connexe et localement fini. En effet, si  $g \in G$ , alors l'ensemble  $\{h \in G : h \cdot o = g \cdot o\}$  est un voisinage de  $g$  ; cette partie est également compacte en tant que partie fermée du compact  $\prod_{v \in V} B(g \cdot o, d(o, v))$ . Il découle de la locale compacité de  $\text{Aut}(\mathcal{G})$  que tout sous-groupe fermé de  $\text{Aut}(\mathcal{G})$  est localement compact.

Etant donné un groupe localement compact  $G$ , il existe, à multiplication scalaire près, une unique mesure de Radon sur  $G$  qui est non-nulle et invariante par multiplication à gauche — i.e. telle que, pour tout  $g \in G$ , l'application  $h \mapsto gh$  préserve la mesure considérée (voir [Car40]). L'une quelconque de ces mesures est qualifiée de **mesure de Haar**. Soit  $\mu$  une telle mesure. Pour tout  $g \in G$ , la mesure  $\mu_g : A \mapsto \mu(Ag)$  est invariante par multiplication à gauche. Elle s'écrit donc, de façon unique, sous la forme

12. Cela signifie que, pour tout  $g \in G$  et tout couple de sommets  $(u, v)$ , on a  $f(g \cdot u, g \cdot v) = f(u, v)$ .

13. Un groupe topologique est un groupe muni d'une topologie rendant  $(g, h) \mapsto gh^{-1}$  continue.

$m(g)\mu$ . La fonction  $m$  ainsi définie est la **fonction modulaire**. Elle ne dépend pas du choix de  $\mu$ . Si la fonction modulaire est constante égale à 1, on dit que le groupe topologique  $G$  est **unimodulaire** : ceci revient à dire que le groupe  $G$  admet une mesure de Radon non-nulle qui est invariante par multiplication à gauche et à droite.

PROPOSITION 0.2.8 ([BLPS99B, SCH79, TRO85]). *Soit  $G$  un sous-groupe fermé de  $\text{Aut}(\mathcal{G})$  agissant transitivement sur  $V$ . Les propositions suivantes s'équivalent :*

- le couple  $(\mathcal{G}, G)$  vérifie le principe de transport de masse ;
- le groupe  $G$  est unimodulaire ;
- pour tous sommets  $u$  et  $v$ , les ensembles  $\text{Stab}_G(u) \cdot v$  et  $\text{Stab}_G(v) \cdot u$  ont même cardinal.

PROPOSITION 0.2.9. *Si  $\mathcal{G}$  est un graphe de Cayley de  $G$ , alors  $(\mathcal{G}, G)$  vérifie le principe de transport de masse.*

*Démonstration.* Soit  $f : V \times V \rightarrow [0, +\infty]$  une fonction  $G$ -invariante. Alors

$$\sum_{v \in V} f(o, v) = \sum_{g \in G} f(o, g \cdot o) = \sum_{g \in G} f(g^{-1} \cdot o, o) = \sum_{g \in G} f(g \cdot o, o) = \sum_{v \in V} f(v, o).$$

□

*Remarque.* Pour démontrer la proposition 0.2.9, il eût été tout aussi facile d'établir l'unimodularité de  $G$  : ce groupe est discret, si bien que la mesure de comptage est invariante à gauche et à droite, et vérifie les autres conditions requises.

Un graphe transitif  $\mathcal{G}$  est dit **unimodulaire** si  $(\mathcal{G}, \text{Aut}(\mathcal{G}))$  vérifie le principe de transport de masse. Les graphes de Cayley sont unimodulaires, d'après la proposition précédente et parce que si  $G$  est un sous-groupe de  $H$ , alors le principe de transport de masse pour  $(\mathcal{G}, G)$  l'implique pour  $(\mathcal{G}, H)$ . En fait, il s'avère que si  $G$  et  $H$  sont deux sous-groupes fermés de  $\text{Aut}(\mathcal{G})$  agissant transitivement sur les sommets, alors  $(\mathcal{G}, G)$  vérifie le principe de transport de masse si et seulement si  $(\mathcal{G}, H)$  le vérifie. La démonstration de ce fait utilise la théorie des percolations invariantes [BLPS99b].

Outre les graphes de Cayley, les graphes transitifs moyennables sont également des exemples de graphes unimodulaires [SW90]. Un exemple de graphe transitif moyennable qui n'est pas de Cayley est le graphe de Petersen, un graphe fini à dix sommets représenté figure 22.

Voici maintenant un exemple de couple  $(\mathcal{G}, G)$  ne vérifiant pas le principe de transport de masse. Soient  $d \geq 3$  et  $\xi$  un bout de l'arbre  $d$ -régulier  $\mathcal{T}_d$ . Le groupe  $\text{Aut}(\mathcal{T}_d)$  agit sur les bouts de  $\mathcal{T}_d$ . On note  $G_\xi$  le stabilisateur de  $\xi$ . Ce groupe agit transitivement sur les sommets de  $\mathcal{T}_d$ .

PROPOSITION 0.2.10. *Le couple  $(\mathcal{T}_d, G_\xi)$  construit ci-dessus ne vérifie pas le principe de transport de masse.*

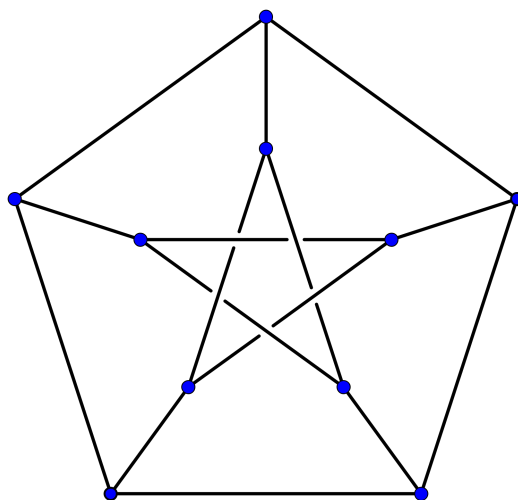

FIGURE 22 – Le graphe de Petersen.

*Démonstration.* On envoie masse 1 de  $u$  vers  $v$  si  $v$  est un voisin de  $u$  tel que  $v \notin \xi(\{u\})$  et masse 0 sinon. L'origine reçoit alors masse 1 mais envoie masse  $d - 1 \geq 2$ .  $\square$

*Remarque.* L'arbre  $\mathcal{T}_d$  est unimodulaire en tant que graphe de Cayley du produit libre de  $d$  copies de  $\mathbb{Z}/2\mathbb{Z}$ . Il résulte de cela et de la proposition 0.2.10 que le groupe  $G_\xi$  n'est pas fermé dans  $\text{Aut}(\mathcal{T}_d)$ .

Pour obtenir à partir de la proposition 0.2.10 un exemple de *graphe* non-unimodulaire, on ajoute à  $\mathcal{T}_d$  certaines arêtes. Etant donnés deux sommets  $u$  et  $v$  de  $\mathcal{T}_d$ , on dit que  $u$  est le père de  $v$  si  $f(u, v) = 1$  dans le transport de masse de la démonstration ci-dessus. Chaque sommet de  $\mathcal{T}_d$  a un unique père. Cette définition étant posée, le graphe  $\mathcal{T}_d^\xi$  est défini comme suit :

- l'ensemble des sommets de  $\mathcal{T}_d^\xi$  est l'ensemble des sommets de  $\mathcal{T}_d$ ;
- deux sommets de  $\mathcal{T}_d^\xi$  sont reliés si et seulement si soit ils le sont dans  $\mathcal{T}_d$ , soit l'un d'entre eux est le père de l'autre.

Ce graphe est appelé le **graphe des grands-parents** à  $d - 1$  enfants. Le groupe  $G_\xi$  agit sur  $\mathcal{T}_d^\xi$  car la fonction  $f$  ayant servi à définir la notion de parenté est  $G_\xi$ -invariante. Cette action est transitive car, en tant qu'action sur les sommets, c'est la même action que celle sur  $\mathcal{T}_d$ . En fait, on a même la proposition suivante.

**PROPOSITION 0.2.11.** *Le groupe  $G_\xi$  est exactement le groupe des automorphismes de  $\mathcal{T}_d^\xi$ .*



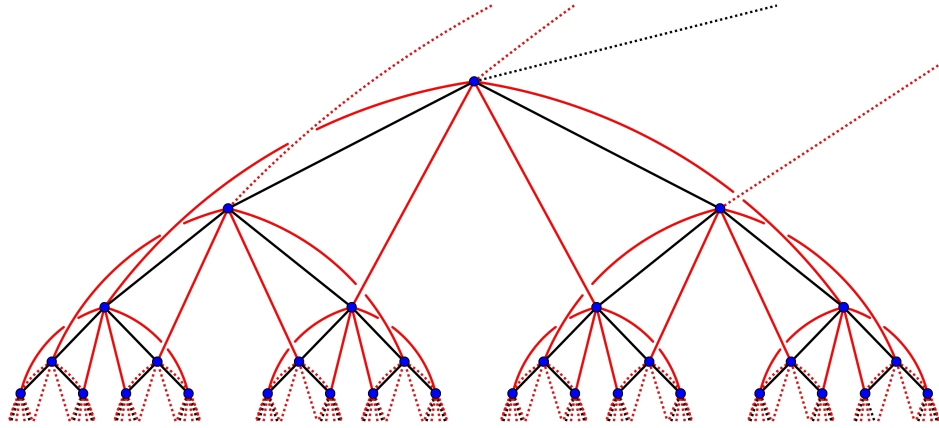

FIGURE 23 – Une portion du graphe des grands-parents à 2 enfants.

*Démonstration.* On a vu que  $G_\xi$  était un sous-groupe de  $\text{Aut}(\mathcal{T}_d^\xi)$ . Il s'agit maintenant de démontrer que tout automorphisme de  $\mathcal{T}_d^\xi$  préserve la structure de graphe de  $\mathcal{T}_d$  et le bout  $\xi$ . Le premier point résulte du fait que deux sommets voisins dans  $\mathcal{T}_d^\xi$  le sont dans  $\mathcal{T}_d$  si et seulement si il existe  $d+1$  chemins de longueur 2 les reliant dans  $\mathcal{T}_d^\xi$ . Le second point découle quant à lui de ce que la notion de parenté suffit à retrouver  $\xi$ , et que  $u$  est le père de  $v$  si et seulement si  $u$  et  $v$  sont voisins dans  $\mathcal{T}_d$  et il existe un unique  $\mathcal{T}_d$ -voisin de  $u$  qui est voisin de  $v$  dans  $\mathcal{T}_d^\xi$ .  $\square$

On déduit des propositions 0.2.10 et 0.2.11 que le graphe des grands-parents à  $d-1$  enfants n'est pas unimodulaire. En particulier, ce n'est pas un graphe de Cayley.

*Remarque.* Le fait d'être unimodulaire (ou de Cayley) n'est pas préservé par équivalence bilipschitzienne, et ce même au sein de la classe des graphes transitifs. Il suffit pour s'en apercevoir de comparer un graphe de Cayley de  $\mathbb{Z}/2\mathbb{Z} \star \mathbb{Z}/2\mathbb{Z} \star \mathbb{Z}/2\mathbb{Z}$  au graphe des grands-parents à 2 enfants. On ne sait pas si tout graphe transitif unimodulaire est quasi-isométrique à un graphe de Cayley. Cependant, on sait qu'il existe des graphes transitifs qui ne sont pas quasi-isométriques à un graphe de Cayley [EFW12].

De même que les graphes de grands-parents, les graphes de Diestel-Leader constituent des exemples importants de graphes transitifs. Etant donné deux nombres entiers  $m$  et  $n$  supérieurs ou égaux à 2, on construit le **graphe de Diestel-Leader** de paramètres  $m$  et  $n$  — noté  $\mathcal{DL}(m, n)$  — comme suit. Soient  $\xi$  un bout de  $\mathcal{T}_{m+1}$  et  $\chi$  un bout de  $\mathcal{T}_{n+1}$ . Soient  $o$  un sommet privilégié de  $\mathcal{T}_{m+1}$  et  $o'$  un sommet de  $\mathcal{T}_{n+1}$ . On définit ainsi les fonctions de génération :

- $f$  est l'unique fonction des sommets de  $\mathcal{T}_{m+1}$  vers  $\mathbb{Z}$  telle que  $f(o) = 0$  et «  $u'$  est le  $\xi$ -père de  $u \implies f(u) = f(u') + 1$  » ;
- $g$  est l'unique fonction des sommets de  $\mathcal{T}_{n+1}$  vers  $\mathbb{Z}$  telle que  $g(o') = 0$  et «  $v'$  est le  $\chi$ -père de  $v \implies g(v) = g(v') + 1$  ».

L'ensemble des sommets de  $\mathcal{DL}(m, n)$  est

$$\{(u, v) \in \mathcal{T}_{m+1} \times \mathcal{T}_{n+1} : f(u) + g(v) = 0\}.$$

Deux sommets  $(u, v)$  et  $(u', v')$  sont joints par une arête si et seulement si  $u$  est voisin de  $u'$  dans  $\mathcal{T}_{m+1}$  et  $v$  voisin de  $v'$  dans  $\mathcal{T}_{n+1}$ . A isomorphisme de graphes près, ce graphe ne dépend pas des choix de  $o, o', \xi$  et  $\chi$ . Il est connexe et transitif.

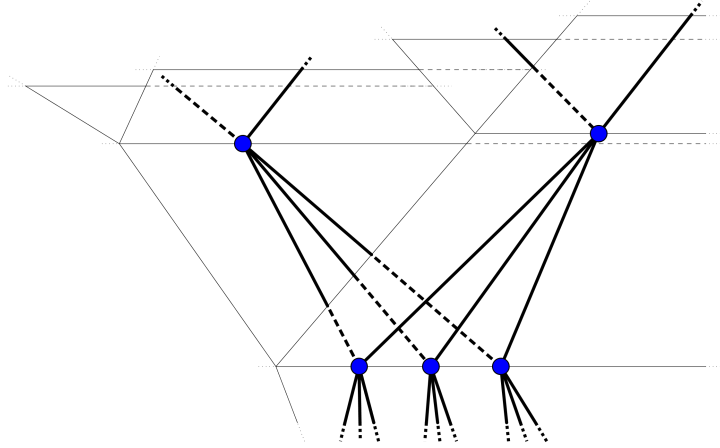

FIGURE 24 – Une portion finie du graphe  $\mathcal{DL}(2, 3)$ .

**PROPOSITION 0.2.12.** *Le graphe  $\mathcal{DL}(m, n)$  est unimodulaire si et seulement si  $m = n$ .*

*Démonstration.* On suppose tout d'abord que  $m = n$ . Le graphe  $\mathcal{DL}(n, n)$  est un graphe de Cayley de  $\mathbb{Z} \times \bigoplus_{\mathbb{Z}} \mathbb{Z}/n\mathbb{Z}$ , le groupe  $\mathbb{Z}$  agissant par décalage. La partie génératrice est formée des  $(ST_a)_{a \in \mathbb{Z}/n\mathbb{Z}}$ , où

- $S = 1 \in \mathbb{Z} \subset \mathbb{Z} \times \bigoplus_{\mathbb{Z}} \mathbb{Z}/n\mathbb{Z}$ ,
- $T_a$  est l'élément de  $\bigoplus_{\mathbb{Z}} \mathbb{Z}/n\mathbb{Z} \subset \mathbb{Z} \times \bigoplus_{\mathbb{Z}} \mathbb{Z}/n\mathbb{Z}$  valant  $a$  en 0 et 0 partout ailleurs.

Pour les détails, voir [Woe05].

On suppose désormais que  $m$  est différent de  $n$ . Soient  $(u, v)$  et  $(u', v')$  deux sommets voisins de  $\mathcal{DL}(m, n)$ . On considère le graphe obtenu à partir de  $\mathcal{DL}(m, n)$  en retirant le sommet  $(u', v')$  et les arêtes dont une extrémité est ce sommet. On s'interroge sur la valeur du nombre  $N(u, v, u', v')$  de voisins de  $(u', v')$  qui sont dans la composante connexe de  $(u, v)$ . Utilisant le fait que  $m$  et  $n$  sont supérieurs ou égaux à 2, on peut montrer que

- si  $f(u) = f(u') + 1$ , alors  $N(u, v, u', v') = m$ ,
- si  $f(u) = f(u') - 1$ , alors  $N(u, v, u', v') = n$ .

Comme  $m \neq n$ , il résulte de cela que l'action diagonale de  $\text{Aut}(\mathcal{DL}(m, n))$  sur les couples de sommets préserve la fonction

$$\Phi : ((u, v), (u', v')) \mapsto f(u) - f(u').$$

En d'autres termes, un automorphisme de  $\mathcal{DL}(m, n)$ , dès lors que  $\min(m, n) \geq 2$  et  $m \neq n$ , ne peut que traduire les générations. On considère la fonction d'envoi de masse suivante :  $(u, v)$  envoie masse 1 à  $(u', v')$  si ces sommets sont voisins et vérifient  $\Phi((u, v), (u', v')) = 1$  ; sinon, la masse envoyée est 0. Cette fonction est bien invariante sous l'action de  $\text{Aut}(\mathcal{DL}(m, n))$ . L'origine reçoit masse  $m$  et envoie masse  $n \neq m$ , d'où la non-unimodularité de  $\mathcal{DL}(m, n)$ .  $\square$

D'un point de vue plus structurel, la classe des graphes transitifs unimodulaires est close par produit direct. La classe des graphes transitifs non-unimodulaires jouit également de certaines propriétés de stabilité par produit (direct ou libre) : voir [Tim06]. Cet article de Timár présente en outre une construction intéressante de graphe transitif non-unimodulaire « auto-similaire ».

### 0.2.3 Un mot sur les graphes rotatoirement transitifs

Pensant à l'action de  $\mathbb{Z}^2$  sur un de ses graphes de Cayley, on qualifie volontiers l'action d'un groupe de type fini sur l'un de ses graphes de Cayley d'action par *translation* ; ces actions sont libres. Pour d'autres actions transitives, à l'inverse, tout élément agit avec au moins un point fixe : c'est le cas de l'action par *rotation* de  $\text{SO}(3)$  sur la sphère  $\mathbb{S}^2$ . Il est légitime de se demander si ce phénomène est possible en théorie des graphes. On pose donc la définition suivante : un groupe  $G$  agit sur un ensemble de façon **rotatoirement transitive** si cette action est transitive et de telle sorte que tout élément de  $G$  agisse avec au moins un point fixe. Si  $\mathcal{G}$  est un graphe tel que  $\text{Aut}(\mathcal{G})$  agisse sur  $\mathcal{G}$  de façon rotatoirement transitive, on dira que  $\mathcal{G}$  est **rotatoirement transitif**. Ces graphes ne peuvent pas être de Cayley mais...

QUESTION 0.2.13. *Existe-t-il un graphe rotatoirement transitif à au moins deux sommets ?*

QUESTION 0.2.14. *Existe-t-il une action d'un groupe sur un graphe à au moins deux sommets qui est rotatoirement transitive ?*

Si  $\mathcal{G}$  est un graphe fini ayant au moins deux sommets, aucun groupe ne peut agir dessus de façon rotatoirement transitive.

*Démonstration.* Puisque  $\text{Aut}(\mathcal{G})$  est fini, on peut supposer que le groupe  $G$  agissant est fini. On suppose que  $G$  agit transitivement sur  $\mathcal{G}$ . D'après la formule dite de Burnside, le nombre moyen de points fixes d'un élément uniformément tiré dans  $G$  est égal à 1. On déduit du fait que l'identité a au moins 2 points fixes qu'il existe un élément de  $G$  sans point fixe.  $\square$

A l'inverse, il est aisé de construire un graphe rotatoirement transitif qui n'est *pas* localement fini (ce qui sort du cadre indiqué page 7). On part pour cela de notre premier exemple d'action rotatoirement transitive :

$\mathrm{SO}(3) \curvearrowright \mathbb{S}^2$ . On munit  $\mathbb{S}^2$  de sa métrique ronde. Toute isométrie<sup>14</sup> de  $\mathbb{S}^2$  provient d'un élément de  $\mathrm{O}(3)$ . Malheureusement, ce groupe n'agit pas de façon rotatoirement transitive sur  $\mathbb{S}^2$ , à cause de l'antipodie  $-\mathrm{id}$ . Passant au quotient par antipodie, on obtient le plan projectif  $\mathbb{RP}^2$  muni d'une métrique riemannienne. Le groupe de ses isométries agit sur lui de façon rotatoirement transitive, car toute isométrie de  $\mathbb{RP}^2$  provient d'un élément de  $\mathrm{O}(3)$  — qui agit de façon rotatoirement transitive sur  $\mathbb{RP}^2$ . Un paramètre  $a \in \mathbb{R}$  étant donné, on peut construire le graphe suivant : l'ensemble des sommets est  $\mathbb{RP}^2$  et deux sommets sont reliés s'ils sont à distance exactement  $a$  au sens de la métrique riemannienne. Pour de convenables valeurs du paramètre  $a$ , tout automorphisme de graphes de  $\mathbb{RP}^2$  est une isométrie de  $\mathbb{RP}^2$  au sens de la distance induite par la métrique riemannienne — la réciproque étant immédiate et indépendante de la valeur de  $a$ . Il résulte de cela que, hors du monde des graphes localement finis, il existe bien un graphe rotatoirement transitif.

Dans le cadre des graphes infinis localement finis, les questions 0.2.13 et 0.2.14 restent — à ma connaissance — ouvertes.

### 0.3 Etat de l'art en percolation de Bernoulli

Cette section vise à présenter l'état de l'art en percolation de Bernoulli. C'est mon intérêt pour ce modèle qui m'a amené à m'intéresser à d'autres percolations, notamment aux percolations invariantes abstraites dont il sera question dans la section 0.4. Il existe bien entendu d'autres percolations étudiées pour elles-mêmes : le modèle d'Ising [Vel09], le random cluster [Gri06], les forêts couvrantes uniformes ou minimales [LP] et le Divide and Color [Häg01] ; elles ne seront quasiment pas abordées dans cette thèse.

La percolation de Bernoulli a été introduite section 0.1.2.

Etant donné un graphe  $\mathcal{G} = (V, E)$  et un sommet  $o$  de  $\mathcal{G}$ , on définit la fonction  $\theta : p \mapsto \mathbb{P}_p[o \leftrightarrow \infty]$ , où  $\mathbb{P}_p$  désigne la mesure  $\mathrm{Ber}(p)^{\otimes E}$  sur  $2^E$  et  $o \leftrightarrow \infty$  l'événement « le cluster de  $o$  est infini ». Une définition analogue peut être formulée pour la percolation de Bernoulli par sites. On remarque que si  $\mathcal{G}$  est transitif, alors  $\theta$  ne dépend pas du choix du sommet  $o$ .

Soit  $(U_e)_{e \in E}$  une suite de variables aléatoires indépendantes de loi uniforme sur  $[0, 1]$ . Pour  $p \in [0, 1]$ , une arête  $e$  est déclarée  $p$ -ouverte si et seulement si  $U_e < p$ . Pour tout  $p$ , l'ensemble des arêtes  $p$ -ouvertes forme une percolation de Bernoulli de paramètre  $p$ . Or, à aléa fixé, si  $p < q$ , le  $p$ -cluster d'un sommet est inclus dans le  $q$ -cluster de ce sommet ; en particulier, le second est infini dès que le premier l'est. D'où la croissance de la fonction  $\theta$ .

---

14. Dans ce paragraphe, « isométrie » est pris au sens métrique, la distance considérée provenant de la structure riemannienne de la variété considérée.

Un argument consistant à réaliser plusieurs processus — en l’occurrence des percolations de Bernoulli de paramètres différents — dans un même univers de façon judicieuse est appelé un argument de **couplage**. Ce couplage particulier est qualifié de **couplage standard**.

De la croissance de  $\theta$ , on déduit l’existence d’un unique réel  $p_c \in [0, 1]$  tel que :

- pour tout  $p < p_c$ ,  $\theta(p) = 0$  ;
- pour tout  $p > p_c$ ,  $\theta(p) > 0$ .

Ce réel  $p_c$  est appelé le **paramètre critique** (ou **probabilité critique**, ou encore **point critique**) du graphe  $\mathcal{G}$  pour la percolation de Bernoulli. On va voir que ces objets —  $\theta$  et  $p_c$  — suffisent à formuler une importante partie des grandes questions du domaine.

Les théorèmes portant sur la percolation de Bernoulli se répartissent en deux catégories : ceux où le graphe d’étude est une discrétisation du plan euclidien et les autres. Pour une présentation détaillée de la percolation de Bernoulli sur les discrétisations du plan euclidien et sur  $\mathcal{Z}^d$ , le lecteur pourra se référer à [BR06, Gri99, Kes82, Wer09]. Pour ce qui est des graphes plus généraux, il pourra consulter [Ben13, LP, Pet13].

### 0.3.0 Préambule sur la planarité

A un graphe  $\mathcal{G} = (V, E)$  on peut associer un espace topologique, appelé son **squelette** ou son **CW-complexe**. Intuitivement, il s’agit de l’espace obtenu en considérant chaque arête comme un segment joignant ses extrémités. Pour définir proprement ce squelette, on pose

$$X := V \times \{-1\} \cup \{(u, v) \in V^2 : \{u, v\} \in E\} \times [0, 1].$$

On munit  $X$  de la topologie produit de la topologie discrète et de la topologie usuelle de  $\mathbb{R}$ . Soit  $\sim$  la relation d’équivalence engendrée par « pour tout  $(u, v) \in V^2$  vérifiant  $\{u, v\} \in E$  :

- $(u, -1) \sim ((u, v), 0)$ ,
- $\forall t \in [0, 1], ((u, v), t) \sim ((v, u), 1 - t)$  ».

Le squelette de  $\mathcal{G}$  est l’espace  $X/\sim$  muni de la topologie quotient.

*Remarque.* Un graphe est localement fini si et seulement si son squelette est localement compact. Un graphe est connexe si et seulement si son squelette est connexe.

Un **plongement** d’un graphe dans un espace topologique est un plongement de son squelette dans cet espace. (On rappelle qu’un plongement d’un espace topologique dans un autre espace topologique est une application continue du premier vers le second qui induit un homéomorphisme vers son image.) Un graphe est dit **planaire** s’il admet un plongement propre dans le plan  $\mathbb{R}^2$ . Un **graphe plongé dans le plan** est la donnée simultanée d’un graphe

dont tout sommet est de degré au moins 3 et d'un plongement propre de ce dernier dans le plan.

Etant donné un graphe infini  $\mathcal{G}$  plongé dans le plan, on définit son **graphe dual**  $\mathcal{G}_{\text{dual}}$  comme suit. L'image du plongement morcelle le plan en composantes connexes homéomorphes à un disque ouvert. Ces composantes sont appelées **faces** et forment l'ensemble des sommets de  $\mathcal{G}_{\text{dual}}$ . Deux faces distinctes sont déclarées adjacentes s'il existe une arête qui les borde toutes les deux, c'est-à-dire s'il existe une arête dont l'image par le plongement est incluse dans l'intersection des frontières des deux faces considérées. Les arêtes de  $\mathcal{G}_{\text{dual}}$  correspondent naturellement à celles de  $\mathcal{G}$ . Le graphe  $\mathcal{G}_{\text{dual}}$  peut ne pas être localement fini mais tous ses sommets sont nécessairement de degré au moins 3.

*Exemples.* Le **réseau hexagonal** est le dual du réseau triangulaire plongé en réalisant ses arêtes par des segments (voir figure 25). Le réseau carré plongé comme indiqué figure 26 est isomorphe à son dual.

*Remarques.* Quand il est localement fini, le graphe dual se plonge proprement dans le plan de façon canonique à homéomorphisme du plan près. Cette classe de plongements de  $\mathcal{G}_{\text{dual}}$  ne dépend que de la classe de plongements de  $\mathcal{G}$ . La procédure de dualité est involutive sur les classes de plongements telles que  $\mathcal{G}_{\text{dual}}$  soit localement fini, d'où l'appellation « dualité ».

Lorsqu'on s'intéresse à des graphes *finis* plongés dans le plan, les éventuelles conditions au bord appellent des définitions différentes. La construction de  $\mathcal{R}_{\text{dual}}$  présentée page 15 illustre cela. Noter également que, dans le cas des graphes finis, il existe une unique « face » non-bornée et que celle-ci est homéomorphe à un plan épointé.

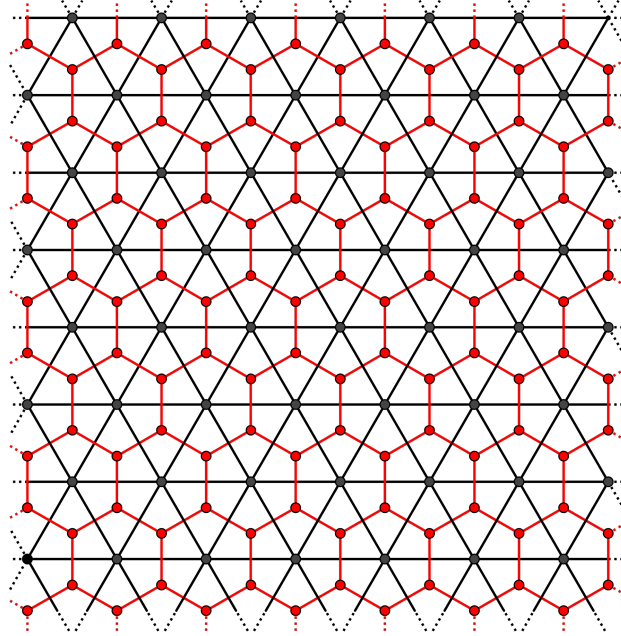

FIGURE 25 – Les réseaux hexagonal et triangulaire sont duaux.

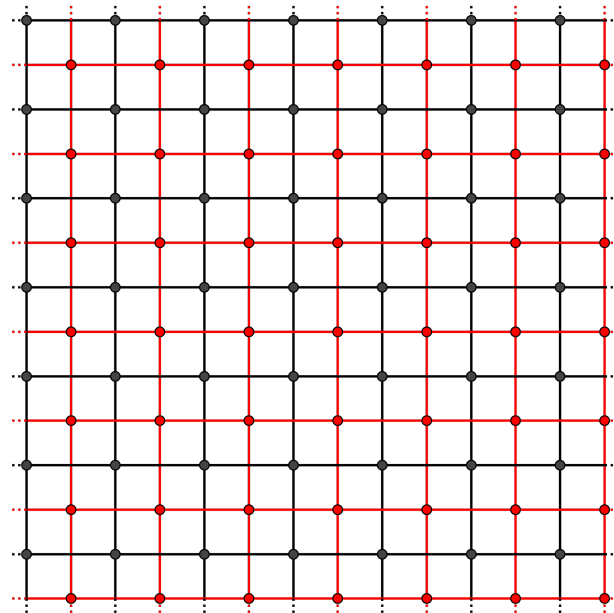

FIGURE 26 – Le réseau carré est isomorphe à son dual.

### 0.3.1 Le cas planaire euclidien

L'argument d'« auto-dualité » de la section 0.1.3 suggère que le paramètre  $p = 1/2$  joue un rôle particulier quand il s'agit de percolation de Bernoulli par arêtes sur le réseau carré. Il s'avère en fait, mais ce n'est pas facile à démontrer, que le réseau carré a un paramètre critique égal à  $1/2$ . De même, le paramètre critique de la percolation de Bernoulli par sites sur le réseau triangulaire ou l'UIPT vaut  $1/2$ . Voir [Kes80, Ang03].

Par des arguments de dualité plus élaborés, on peut démontrer que, pour la percolation par arêtes

- sur le réseau triangulaire,  $p_c = 2 \sin(\pi/18)$ ,
- sur le réseau hexagonal,  $p_c = 1 - 2 \sin(\pi/18)$ ,
- sur le réseau en nœud papillon,  $p_c$  est l'unique racine dans  $[0, 1]$  du polynôme  $1 - X - 6X^2 + 6X^3 - X^5$ .

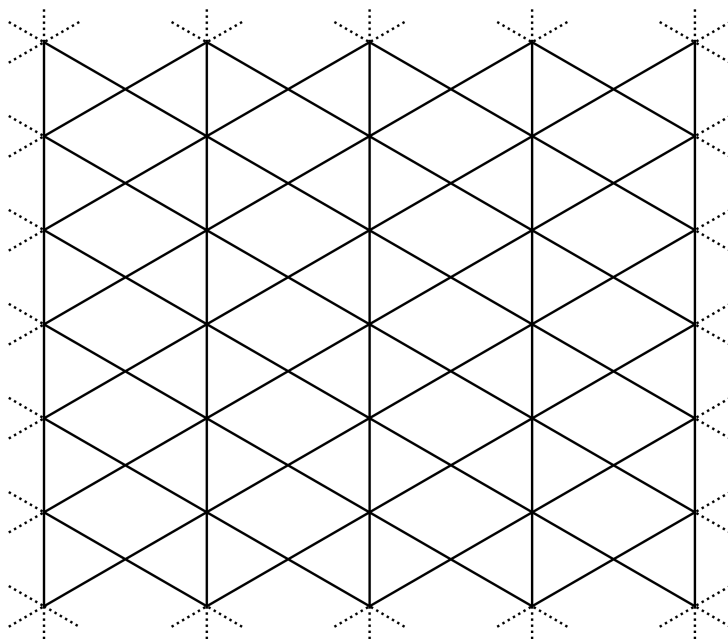

FIGURE 27 – Une portion finie du réseau en nœud papillon.

On peut également mentionner le théorème suivant (voir [BR06]).

**THÉORÈME 0.3.1.** *Soit  $\mathcal{G}$  un graphe infini plongé dans le plan euclidien  $\mathbb{R}^2$ . On suppose l'image du plongement laissée invariante par deux translations du plan linéairement indépendantes ainsi que par  $x \mapsto -x$ . Alors, le graphe  $\mathcal{G}_{\text{dual}}$  est localement fini et on a la relation  $p_c(\mathcal{G}) + p_c(\mathcal{G}_{\text{dual}}) = 1$ .*

Sur tous ces graphes, on sait montrer que  $\theta(p_c) = 0$  — voir [Har60, Ang03].



Dans le cas de la percolation par sites sur le réseau triangulaire, des liens forts avec l'analyse complexe permettent de comprendre finement les propriétés fractales de la percolation de Bernoulli au point critique. Ces liens sont conjecturés valides pour la percolation par arêtes sur le réseau carré. Faire de ces conjectures des théorèmes est un problème de premier plan.

Le théorème 0.3.2 est un résultat d'invariance conforme représentatif du champ d'étude. L'énoncer requiert l'introduction de certaines notations.

NOTATION. Soient  $C_1$  et  $C_2$  deux courbes de Jordan polygonales dans le plan réel (qui sera identifié à la droite complexe). Chacune borde un unique domaine borné simplement connexe ; on note ces domaines  $D_1$  et  $D_2$ . Soient  $a_1, b_1, c_1$  et  $d_1$  quatre points distincts de  $C_1$  qu'on peut parcourir dans cet ordre dans le sens trigonométrique. Soient également  $a_2, b_2$  et  $c_2$  trois points distincts de  $C_2$  pouvant être parcourus dans cet ordre dans le sens trigonométrique. D'après le théorème d'uniformisation de Riemann, il existe un unique biholomorphisme  $f$  de  $D_1$  vers  $D_2$  qui se prolonge continûment au bord en envoyant  $a_1$  sur  $a_2$ ,  $b_1$  sur  $b_2$  et  $c_1$  sur  $c_2$ . On note  $d_2 := f(d_1)$ . Etant donné un réel  $\delta > 0$ , on peut définir le graphe  $\mathcal{G}_i^\delta$  comme la plus grande composante connexe du graphe défini par

$$V_i^\delta := \{z \in D_i : z/\delta \in \mathbb{Z}[e^{i\pi/3}]\} \quad \text{et} \quad E_i^\delta := \{\{z, z'\} \subset V_i^\delta : |z - z'| = \delta\}.$$

Cette composante est unique dès que  $\delta$  est pris suffisamment petit.

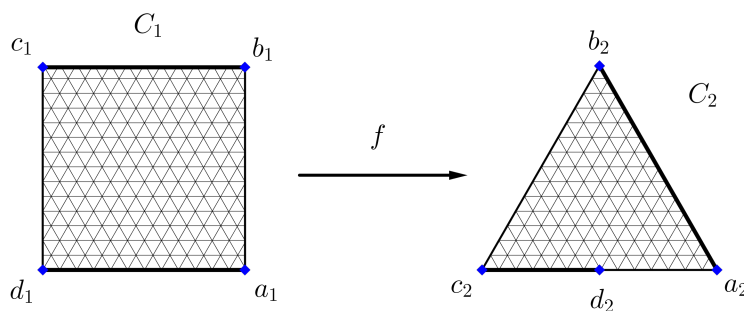

FIGURE 28 – Visualisation des notations intervenant dans le théorème de Smirnov.

THÉORÈME 0.3.2 (SMIRNOV, [SMI01]). *Pour la percolation par sites sur  $\mathcal{G}_i^\delta$  de paramètre  $1/2$ , la probabilité qu'il existe un chemin ouvert reliant un sommet à distance inférieure à  $\delta$  de l'arc  $(a_i, b_i) \subset C_i$  à un sommet à distance inférieure à  $\delta$  de l'arc  $(c_i, d_i)$  converge quand  $\delta$  tend vers 0 vers une limite indépendante de  $i \in \{1, 2\}$ . Dans le cas où  $C_2$  est un triangle équilatéral de sommets  $a_2, b_2$  et  $c_2$ , cette limite vaut  $\frac{|d_2 - c_2|}{|a_2 - c_2|}$ .*

Il est remarquable que la seule façon connue de prouver la convergence ci-dessus (seulement pour  $i = 1$ ) soit de prouver ce résultat plus fort de « convergence et invariance conforme » : on ne sait pas établir l'unicité des sous-limites sans avoir recours à la rigidité de l'analyse complexe, et ce même si on suppose que  $C_1$  est un triangle équilatéral de sommets  $a_1$ ,  $b_1$  et  $c_1$ .

L'objet mathématique permettant de décrire les limites d'échelle de modèles planaires euclidiens critiques est le SLE — pour Schramm-Loewner Evolution, voir [BN14]. Les processus SLE sont des modèles de courbes aléatoires. Ils sont définis de manière concrète (en termes de mouvements browniens et de chaînes de Loewner) et paramétrés par un réel  $\kappa \in \mathbb{R}_+$ . Ils sont également caractérisés de manière abstraite comme les seules courbes aléatoires vérifiant une certaine forme de « propriété de Markov conforme ». On sait démontrer des théorèmes de convergence vers un SLE pour un certain nombre de modèles de mécanique statistique : la marche aléatoire à boucles effacées, le modèle d'Ising sur les graphes isoradiaux, certains modèles de dimères, la percolation de Bernoulli par sites critique sur réseau triangulaire et la courbe d'exploration d'un arbre couvrant uniforme. Un tel lien reste conjectural pour la marche aléatoire auto-évitante, la percolation de Bernoulli critique par arêtes sur réseau carré, le random cluster et le modèle  $O(n)$ . Voir [DC13].

*Remarque.* Le SLE étant un modèle de courbe aléatoire, on peut se demander comment il peut intervenir en tant que limite d'un modèle de percolation. La procédure d'interface illustrée figure 29 donne la réponse.

De résultats de convergence vers des SLE, il est possible de déduire des résultats portant sur les modèles discrets. Voici un théorème ainsi obtenu (voir [BDC13]).

**THÉORÈME 0.3.3.** *Pour la percolation par sites sur le réseau triangulaire, lorsque  $p$  tend vers  $1/2$  par valeurs supérieures, on a*

$$\theta(p) = (p - 1/2)^{5/36+o(1)}.$$

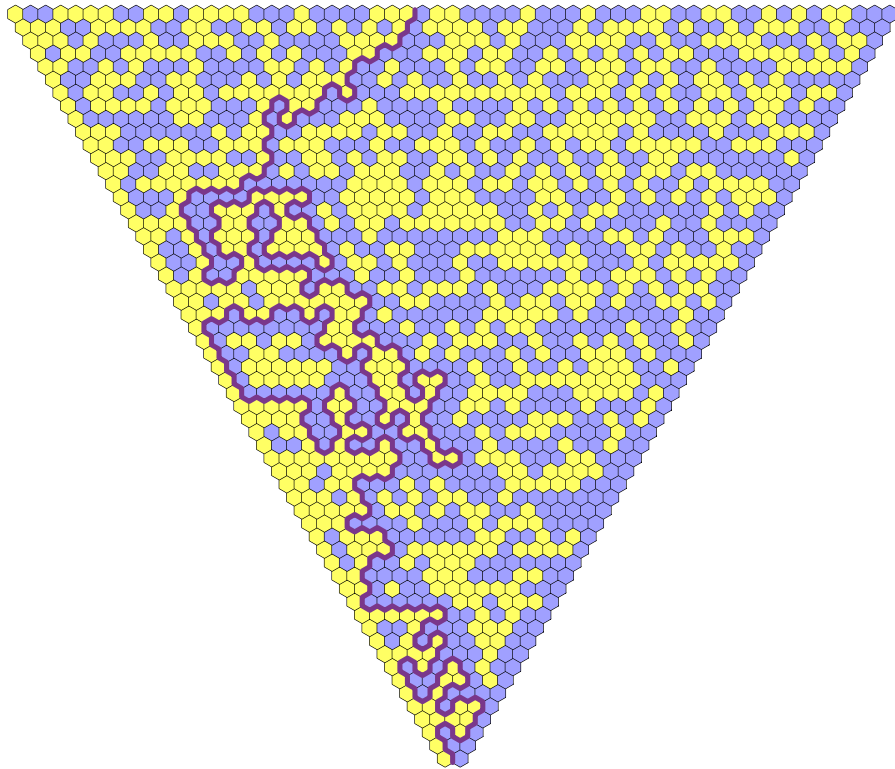

FIGURE 29 – Cette illustration de la procédure d’interface est due à Vincent Beffara. Notez qu’une percolation par sites sur  $\mathcal{L}_\Delta$  revient à une percolation par faces sur le réseau hexagonal.

### 0.3.2 Hors du plan euclidien

Il existe évidemment des graphes dignes d'intérêt qui ne discrétisent pas le plan euclidien. Une des questions majeures du domaine est de savoir si  $\theta(p_c) = 0$  pour le réseau cubique : en effet,  $p_c$  est la seule valeur où la réponse à la question d'infiltration posée page 1 demeure inconnue. Les simulations et les théorèmes présentés ci-après suggèrent une réponse affirmative.

#### Percolation au point critique

Dans leur article fondateur [BS96], Benjamini et Schramm ont formulé la conjecture suivante.

**CONJECTURE 0.3.4 (BENJAMINI ET SCHRAMM).** *Tout graphe transitif vérifiant  $p_c < 1$  vérifie également  $\theta(p_c) = 0$ .*

*Remarque.* Dans la conjecture 0.3.4, on ne peut pas lever la condition de transitivité. Un contre-exemple est le graphe représenté figure 30, la suite  $(a_n) \in (\mathbb{N}^*)^{\mathbb{N}}$  étant prise telle que  $a_n = \lfloor \log_2(n \log(n)^2) \rfloor$  à partir d'un certain rang. En effet, pour la mesure  $\mathbb{P}_p$ , la probabilité de l'événement «  $v_n$  et  $v_{n+1}$  sont reliés » vaut  $1 - (1 - p^2)^{a_n}$ . Par indépendance, si  $\theta$  est défini relativement à la racine  $v_0$ , on a  $\theta(p) = \prod_{n=0}^{\infty} (1 - (1 - p^2)^{a_n})$ . Un simple calcul donne  $\theta(p) = 0 \Leftrightarrow p < \frac{1}{\sqrt{2}}$ . Le graphe considéré vérifie donc  $p_c = \frac{1}{\sqrt{2}} < 1$  et  $\theta(p_c) > 0$ .

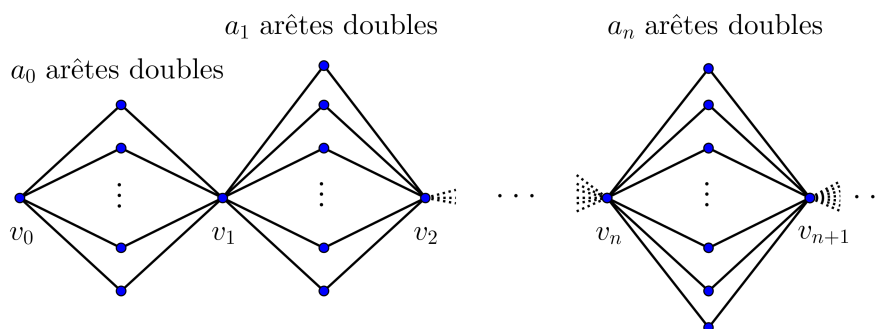

FIGURE 30 – Un graphe vérifiant  $\theta(p_c) > 0$  si la suite  $(a_n)$  est bien choisie.

*Remarque d'ordre physique.* Une autre façon d'exprimer la nullité de  $\theta(p_c)$  est « la fonction  $\theta$  est continue en  $p_c$  », la continuité à droite de  $\theta$  étant automatique. En physique, on la formule en disant que la transition de phase est du second ordre, tandis que le cas discontinu est qualifié de transition de phase du premier ordre. La discontinuité, le saut caractéristique des transitions de phase du premier ordre correspond à une énergie qui doit être

échangée pour passer d'une phase à l'autre. Quand une casserole d'eau est sur le feu, elle demeure longtemps à  $100^\circ\text{C}$ , pour effectuer ce transfert d'énergie : la transition liquide/gaz est du premier ordre. La transition ferromagnétique, quant à elle, fournit un exemple physique de transition de phase du second ordre : si on chauffe un matériau magnétisé, il perdra son aimantation spontanée à la température de Curie mais ne fera aucune halte à cette température.

On sait que  $\theta(p_c) = 0$  pour les graphes quasi-« planaires euclidiens » car les contraintes topologiques imposées par la planarité permettent de forcer des chemins à se croiser (voir [DCST14]). À l'inverse, quand le graphe est suffisamment foisonnant, il est peu coûteux d'obtenir des disjonctions d'ensembles, et ceci peut également être mis à profit pour établir que  $\theta(p_c) = 0$ . Ainsi, on sait démontrer que  $\theta(p_c) = 0$  sur

- le réseau hypercubique de dimension  $d \geq 15$  — voir [HS90, Fit13],
- le graphe d'ensemble de sommets  $\mathbb{Z}^d$  où  $u$  et  $v$  sont reliés si

$$0 < \|u - v\|_1 \leq L$$

pour  $d > 6$  et  $L > L(d)$  — consulter [HS90],

- les graphes transitifs unimodulaires non-moyennables — se référer à [BLPS99a].

Le cas du réseau  $\mathcal{Z}^d$  reste ouvert quand  $3 \leq d \leq 14$ .

Surprenamment, le cas des demi-espaces est résolu en toute dimension : on sait démontrer que la restriction du réseau hypercubique de dimension  $d$  à  $\mathbb{N} \times \mathbb{Z}^{d-1}$  a le même  $p_c$  que  $\mathcal{Z}^d$  et vérifie  $\theta(p_c) = 0$  dès que  $d \geq 2$ . (Voir [Har60, Kes80] pour le cas où  $d = 2$  et [BGN91a, BGN91b, GM90] pour celui où  $d \geq 3$ .) Ce qui rend le cas du demi-espace plus accessible que celui de  $\mathcal{Z}^d$  est l'existence d'une direction disposant d'une orientation privilégiée. L'utilisation d'orientations privilégiées a aussi été exploitée dans [PPS06] et [Tim06] pour établir que  $\theta(p_c) = 0$  sur certains graphes transitifs non-unimodulaires.

### Valeur du paramètre critique

Pour nombre de graphes planaires euclidiens, non seulement on savait que  $\theta(p_c) = 0$  mais on avait également accès à la valeur de  $p_c$ . Pour les graphes plus généraux, la détermination exacte de la valeur de  $p_c$  semble impossible, à quelques exceptions près :

- on s'attend à être capable de déterminer quand  $p_c = 1$  ;
- pour les arbres, le paramètre critique est égal à l'inverse du branchement [Lyo90] ;
- la géométrie de certains graphes peut parfois être ramenée à celle d'un arbre d'une façon permettant de déterminer la valeur de  $p_c$  ; voir [Špa09].

A défaut d'expliciter la valeur de  $p_c$ , on peut essayer de comprendre comment cette dernière dépend du graphe étudié. On va ici s'intéresser aux graphes vérifiant  $p_c < 1$ . En particulier, les réseaux hypercubiques considérés seront de dimension au moins 2. La question de savoir quand un graphe vérifie  $p_c = 1$  est abordée page 47.

En ce qui concerne les réseaux hypercubiques, on sait que, pour tout entier  $d \geq 2$  :

- $\mathbb{Z}^d$  vérifie  $p_c^{\text{arête}} < p_c^{\text{site}}$ ,
- si  $p_c(d)$  dénote la probabilité critique par arêtes de  $\mathbb{Z}^d$ , alors

$$p_c(d) = \frac{1}{2d} + \frac{1}{(2d)^2} + \frac{7/2}{(2d)^3} + O\left(\frac{1}{(2d)^4}\right),$$

- si on ajoute convenablement des arêtes à un graphe représentant  $\mathbb{Z}^d$ , alors sa probabilité critique décroît strictement.

On se référera respectivement à [GS<sup>+</sup>98], [HS95] et [AG91, BR06].

Dans [BS96], Benjamini et Schramm ont demandé si un énoncé analogue au dernier ci-dessus était valide pour les revêtements de graphes transitifs. Voir définition page 7.

**QUESTION 0.3.5 (BENJAMINI ET SCHRAMM).** *Est-il toujours vrai que si un graphe transitif  $\mathcal{G}_2$  vérifiant  $p_c(\mathcal{G}_2) < 1$  admet un revêtement non-injectif par un graphe transitif  $\mathcal{G}_1$ , alors  $p_c(\mathcal{G}_1) < p_c(\mathcal{G}_2)$  ?*

Une preuve par couplage de l'inégalité large est présentée dans [BS96].

Une autre catégorie de résultats concerne la question dite de localité. Pour l'énoncer, on a besoin d'un peu de vocabulaire. On note  $\mathfrak{G}$  l'espace des classes d'isomorphisme de graphes transitifs. Par abus de langage, on confondra parfois un graphe transitif  $\mathcal{G}$  et sa classe d'isomorphisme  $[\mathcal{G}]$ . Soient  $\mathcal{G} \in \mathfrak{G}$  et  $o$  un sommet quelconque de  $\mathcal{G}$ . On considère la boule de rayon  $k$  centrée en  $o$ , munie de sa structure de graphe enraciné en  $o$ . A isomorphisme de graphes enracinés près, cette boule ne dépend pas du choix de  $o$ , et on la dénote par  $\mathcal{B}_{\mathcal{G}}(k)$ . Si  $(\mathcal{G}_1, \mathcal{G}_2) \in \mathfrak{G}^2$ , on définit la distance entre  $\mathcal{G}_1$  et  $\mathcal{G}_2$  comme valant  $2^{-n}$ , où

$$n := \max\{k : B_{\mathcal{G}_1}(k) \simeq B_{\mathcal{G}_2}(k)\} \in \mathbb{N} \cup \{\infty\}.$$

Cela définit la **distance de Benjamini-Schramm** — ou **distance locale** — sur  $\mathfrak{G}$  (voir [BS01b, BNP11]). La conjecture suivante, due à Schramm [BNP11], formalise l'idée selon laquelle la valeur de  $p_c$  ne dépendrait essentiellement que de la structure locale du graphe transitif considéré.

**CONJECTURE 0.3.6 (SCHRAMM).** *Si  $\epsilon > 0$ , alors  $p_c$  est continue vu comme fonction de  $\{\mathcal{G} \in \mathfrak{G} : p_c(\mathcal{G}) < 1 - \epsilon\}$  vers  $[0, 1]$ .*

Il est nécessaire dans cette conjecture d'imposer une condition de non-trivialité à  $p_c$ , afin d'éviter les situations suivantes :

$$\begin{aligned} & \text{— Cay}(\mathbb{Z}/n\mathbb{Z} \times \mathbb{Z}/n\mathbb{Z}; (0, 1), (1, 0)) \xrightarrow[n \rightarrow \infty]{} \text{Cay}(\mathbb{Z}^2; (0, 1), (1, 0)) \\ & \text{— et Cay}(\mathbb{Z} \times \mathbb{Z}/n\mathbb{Z}; (0, 1), (1, 0)) \xrightarrow[n \rightarrow \infty]{} \text{Cay}(\mathbb{Z}^2; (0, 1), (1, 0)) \end{aligned}$$

où des graphes de  $p_c$  égal à 1 convergent vers un graphe de  $p_c$  égal à  $1/2$ . On ne connaît pas de telle suite discréditant la conjecture pour  $\epsilon = 0$ . Plus précisément, on ne sait pas si 1 est un point d'accumulation de l'ensemble des points critiques de graphes transitifs.

Les trois théorèmes suivants corroborent cette conjecture. Leurs preuves se trouvent respectivement dans [GM90], [Pet13, Tas14] et [BNP11].

**THÉORÈME 0.3.7 (GRIMMETT ET MARSTRAND).** *Si  $d \geq 2$ , alors le paramètre critique du graphe défini par restriction de  $\mathcal{Z}^d$  à  $\{0, \dots, n\}^{d-2} \times \mathbb{Z}^2$  converge vers celui de  $\mathcal{Z}^d$  quand  $n$  tend vers l'infini.*

**THÉORÈME 0.3.8.** *Si  $\mathcal{G}_n \xrightarrow[n \rightarrow \infty]{} \mathcal{G}$  désigne une suite convergente d'éléments de  $\mathfrak{G}$ , alors  $\liminf p_c(\mathcal{G}_n) \geq p_c(\mathcal{G})$ .*

**THÉORÈME 0.3.9.** *Soit  $(\mathcal{G}_n)$  une suite d'éléments de  $\mathfrak{G}$  convergeant vers un arbre régulier  $\mathcal{T}_d$ . Si les constantes de Cheeger des  $\mathcal{G}_n$  sont uniformément minorées, alors  $d$  est supérieur ou égal à 3 et  $p_c(\mathcal{G}_n)$  converge vers  $p_c(\mathcal{T}_d)$ .*

A ces trois théorèmes, on peut ajouter le suivant, que j'ai obtenu en collaboration avec Vincent Tassion [MT].

**THÉORÈME 0.3.10.** *La fonction  $p_c$  est continue en restriction à l'espace des graphes de Cayley de groupes abéliens vérifiant  $p_c < 1$ .*

Ce théorème fera l'objet du chapitre 2.

*Remarque.* Le fait que  $p_c$  semble dépendre de la structure locale d'un graphe transitif plutôt que de sa structure globale (disons sa classe de quasi-isométrie) apporte un bémol à la résolution du problème de la pierre poreuse présentée page 3 : selon qu'on modélise le milieu tridimensionnel par un réseau cubique ou par  $\mathcal{L}_\Delta \times \mathcal{Z}$ , on n'aura *pas* les mêmes réponses. Le physicien aura donc besoin d'informations plus fines que « le problème se pose en dimension 3 » pour concevoir son modèle.

### Existence d'une transition de phase

Il est impropre de parler de transition de phase si l'une des phases est inexistante ou presque. Quand  $p_c$  vaut-il 0? Quand vaut-il 1? L'argument de Peierls garantit que  $p_c$  est strictement positif pour tout graphe transitif. Voir [Pei36].

PROPOSITION 0.3.11 (PEIERLS). *Soit  $d \geq 2$ . Tout graphe de degré partout majoré par  $d$  a un paramètre critique supérieur ou égal à  $\frac{1}{d-1}$ .*

*Démonstration.* Soit  $p < \frac{1}{d-1}$  et  $o$  un sommet du graphe d'étude. Pour  $n \geq 1$ , il y a au plus  $d(d-1)^{n-1}$  chemins auto-évitant de longueur  $n$  issus de  $o$ . Ainsi, la probabilité, pour la percolation de Bernoulli de paramètre  $p$ , qu'il existe un chemin ouvert auto-évitant issu de  $o$  de longueur  $n$  est majorée par  $d(p(d-1))^{n-1}$ . Cette probabilité tend donc vers 0 quand  $n$  tend vers l'infini et on a  $p \leq p_c$ .  $\square$

*Remarques.* Un argument analogue permet de démontrer facilement que le point critique de  $\mathcal{Z}^2$  est différent de 1. Il s'agit non plus de majorer le nombre de chemins issus de l'origine mais le nombre de cycles duaux entourant l'origine ; voir [HB57, Ham57, Ham59]. Une fois l'inégalité  $p_c(\mathcal{Z}^d) < 1$  établie pour  $d = 2$ , on en dispose pour tout  $d \geq 2$ . En effet, si  $d$  est supérieur ou égal à 2, le graphe  $\mathcal{Z}^d$  contient  $\mathcal{Z}^2$  comme sous-graphe si bien que  $p_c(\mathcal{Z}^d) \leq p_c(\mathcal{Z}^2)$ . On notera également que l'arbre  $d$ -régulier réalise un cas d'égalité de la proposition 0.3.11.

Quand  $p_c$  est-il égal à 1 ? Un exemple de graphe transitif infini vérifiant  $p_c = 1$  est  $\mathcal{Z}$  : ôter une proportion  $\epsilon > 0$  d'arêtes suffit à morceler la ligne bi-infinie en composantes toutes finies. Généraliser ce constat aux graphes transitifs à deux bouts ne présente pas de difficulté.

PROPOSITION 0.3.12. *Tout graphe transitif à zéro ou deux bouts a un paramètre critique égal à 1.*

Benjamini et Schramm ont conjecturé dans [BS96] que la réciproque était vraie pour les graphes de Cayley.

CONJECTURE 0.3.13 (BENJAMINI ET SCHRAMM). *Un graphe de Cayley vérifie  $p_c = 1$  si et seulement s'il a zéro ou deux bouts.*

Le théorème suivant étai cette conjecture (voir [LP, Tim07]).

THÉORÈME 0.3.14. *Un graphe de Cayley qui n'est pas à croissance intermédiaire vérifie  $p_c = 1$  si et seulement s'il a zéro ou deux bouts.*

*Remarque.* Muchnik et Pak ont établi dans [MP01] que les groupes de Grigorchuk (les exemples standards de groupes à croissance intermédiaire) vérifient  $p_c < 1$ .

Le théorème suivant indique que la condition «  $p_c = 1$  » est géométrique. Il est démontré par couplage dans [LP].

THÉORÈME 0.3.15. *Soient  $\mathcal{G}_1$  et  $\mathcal{G}_2$  deux graphes transitifs quasi-isométriques. Alors  $p_c(\mathcal{G}_1) = 1$  équivaut à  $p_c(\mathcal{G}_2) = 1$ .*

Enfin, Teixeira a démontré très récemment que tout graphe à croissance polynomiale dont la dimension isopérimétrique locale excède strictement 1 vérifie  $p_c < 1$  ; voir [Tex] pour un énoncé précis.



### Existence d'une seconde transition de phase

D'autres questions portent sur l'existence d'une *seconde* transition de phase. Avant d'aborder cette seconde transition, il s'agit d'étudier plus en détail les régimes délimités par  $p_c$ . Cette étude fera usage d'un outil puissant, l'inégalité de Harris (voir [Har60]).

Une partie borélienne de  $2^E = \{0, 1\}^E$  est dite **croissante** si sa fonction indicatrice est croissante de  $\{0, 1\}^E$  muni de l'ordre produit vers  $\{0, 1\}$ . Plus concrètement, est croissant un événement qui, s'il a lieu, aura toujours lieu si on ouvre des arêtes supplémentaires.

**INÉGALITÉ DE HARRIS.** *Si  $A$  et  $B$  désignent deux événements croissants, alors  $\mathbb{P}_p[A \cap B] \geq \mathbb{P}_p[A]\mathbb{P}_p[B]$ .*

*Remarque.* Oubliant le cas vide où  $B$  est de probabilité nulle, on peut interpréter cette inégalité en termes de probabilités conditionnelles :

$$\mathbb{P}_p[A|B] \geq \mathbb{P}_p[A].$$

Cette inégalité est assez intuitive d'un point de vue bayésien : « comme  $B$  est croissant, conditionner cet événement à avoir lieu incite les arêtes à être plus ouvertes que si elles étaient tirées sans conditionnement, ce qui augmente la probabilité d'occurrence de  $A$  (ce dernier événement étant croissant) ».

Si  $\mathcal{G} = (V, E)$  est un graphe connexe et  $o$  le sommet intervenant dans la définition de la fonction  $\theta$ , alors, d'après l'inégalité de Harris, pour tout sommet  $v$ ,

$$\theta(p) \geq \mathbb{P}_p[v \leftrightarrow \infty \text{ et } o \leftrightarrow v] \geq \mathbb{P}_p[o \leftrightarrow v]\mathbb{P}_p[v \leftrightarrow \infty] \geq p^{d(o,v)}\mathbb{P}_p[v \leftrightarrow \infty],$$

l'événement  $o \leftrightarrow v$  se lisant «  $o$  et  $v$  sont dans le même cluster ». Ainsi, quand  $\theta(p) = 0$ , chaque sommet a probabilité nulle d'appartenir à un cluster infini. On en déduit que si  $\theta(p) = 0$ , alors il n'y a  $\mathbb{P}_p$ -presque sûrement aucun cluster infini. A l'inverse, quand  $\theta(p) > 0$ , la loi du 0-1 de Kolmogorov implique l'existence presque sûre d'au moins un cluster infini.

Pour les graphes transitifs, le bilan peut être raffiné en étudiant la question non plus de l'existence d'un cluster infini mais du nombre de tels clusters. On va voir au cours de la section 0.4 que si  $\mathcal{G}$  désigne un graphe transitif, alors

- pour tout  $p$ , le nombre de clusters infinis a une valeur  $\mathbb{P}_p$ -presque sûre  $N_\infty^{\mathcal{G}}(p)$  qui est 0, 1 ou  $\infty$ ,
- pour tout  $x \in \{0, 1, \infty\}$ , l'ensemble des  $p$  où  $N_\infty^{\mathcal{G}}$  vaut  $x$  est un intervalle.

On note  $p_u$  et appelle **paramètre d'unicité** la borne inférieure de l'intervalle des  $p$  fournissant presque sûrement un unique cluster infini.

$$\begin{array}{ccccccc}
 0 & & p_c & & p_u & & 1 \\
 | & \xrightarrow{N_\infty^{\mathcal{G}}(p) = 0} & | & \xrightarrow{N_\infty^{\mathcal{G}}(p) = \infty} & | & \xrightarrow{N_\infty^{\mathcal{G}}(p) = 1} & | \\
 \hline
 \end{array}$$

*Remarque.* L'intervalle correspondant à  $x = 1$  contient 1, si bien que les  $p$  éventuels vérifiant  $N_\infty^{\mathcal{G}}(p) = \infty$  sont inférieurs ou égaux à  $p_u$ . On pourrait naïvement imaginer qu'ouvrir plus d'arêtes permette à plus de composantes infinies d'émerger, ce qui n'est pas compatible avec la vraie monotonie. En réalité, la situation est la suivante :

- lorsque les clusters infinis sont en nombre infini, ils sont suffisamment petits pour pouvoir coexister sans fusionner,
- un cluster infini unique occupe une si grande proportion de l'espace que son complémentaire ne peut contenir que des composantes finies.

Ceci en tête, on conçoit aisément que les  $p$  correspondant à  $x = \infty$  soient inférieurs à ceux correspondant à  $x = 1$ .

Dans [BS96], Benjamini et Schramm ont formulé la conjecture suivante.

**CONJECTURE 0.3.16 (BENJAMINI ET SCHRAMM).** *Un graphe transitif est non-moyennable si et seulement s'il vérifie  $p_c < p_u$ .*

Cette conjecture est validée à plusieurs égards. On démontrera que, dès que le graphe transitif considéré est moyennable, le nombre de clusters infinis ne peut prendre pour valeur que 0 ou 1, si bien que  $p_c = p_u$ . Voir théorème 0.4.8. Par ailleurs, si  $G$  est un groupe de type fini non-moyennable, on sait qu'il existe une partie génératrice finie telle que le graphe de Cayley associé vérifie  $p_c < p_u$ . Voir [PSN00, Tho]. Ce fait est utilisé dans la démonstration du théorème 1.2.5 qui répond affirmativement au « problème de Day-von Neumann mesurable » — voir [GL09].

La stabilité de la propriété  $p_c < p_u$  par équivalence bilipschitzienne sur les graphes de Cayley étant inconnue, les résultats de [PSN00, Tho] ne suffisent pas à établir la validité de la conjecture dans le cas des graphes de Cayley. On peut toutefois déduire des affirmations précédentes la caractérisation suivante de la moyennabilité d'un groupe de type fini.

**THÉORÈME 0.3.17.** *Un groupe de type fini est moyennable si et seulement si tous ses graphes de Cayley vérifient  $p_c = p_u$ .*

### Percolation sur le plan hyperbolique

Dans [BS01a], Benjamini et Schramm ont démontré le théorème suivant.

**THÉORÈME 0.3.18.** *Soit  $\mathcal{G}$  un graphe non-moyennable à un bout plongé dans le plan. Soit  $G$  un groupe d'homéomorphismes du plan. On suppose que  $G$  préserve l'image du plongement. On suppose également que  $G$  agit*

sur  $V(\mathcal{G})$  de façon transitive. Alors, le graphe  $\mathcal{G}_{\text{dual}}$  est localement fini et on a les relations

$$p_c(\mathcal{G}) < p_u(\mathcal{G}) < 1 \quad \text{et} \quad p_u(\mathcal{G}) + p_c(\mathcal{G}_{\text{dual}}) = 1.$$

De plus, il existe presque sûrement un unique cluster infini à  $p_u$ .

Le théorème 0.3.19 indique qu'on peut remplacer ci-dessus la condition « non-moyennable et à un bout » par « quasi-isométrique au plan hyperbolique » sans changer la validité ni la portée de l'énoncé.

**THÉORÈME 0.3.19** (BABAI, [BAB97]). *Soit  $\mathcal{G}$  un graphe infini plongé dans le plan. Soit  $G$  un groupe d'homéomorphismes du plan. On suppose que  $G$  préserve l'image du plongement. On suppose également que  $G$  agit sur  $V(\mathcal{G})$  de façon transitive.*

*Alors, le graphe  $\mathcal{G}$  est quasi-isométrique à un et un seul des espaces suivants : la droite  $\mathbb{R}$ , le plan euclidien  $\mathbb{R}^2$ , l'arbre trivalent  $\mathcal{T}_3$  ou le plan hyperbolique  $\mathbb{H}^2$ .*

### Résultats portant sur $p_u$

Au paramètre  $p_u$ , le nombre de clusters infinis peut prendre n'importe quelle valeur parmi  $\{0, 1, \infty\}$ . Evidemment, lorsque cette valeur est nulle, on a  $p_c = p_u$ . Le réseau carré vérifie  $N_{\infty}^{\mathbb{Z}^2}(p_u) = 0$ . L'unicité à  $p_u$  est observée sur les arbres réguliers (qui vérifient  $p_u = 1$ ) et les discrétisations du plan hyperbolique (théorème 0.3.18). Dans ce dernier cas, on a  $p_u < 1$ . Enfin, les résultats suivants permettent de construire des graphes transitifs vérifiant  $N_{\infty}^{\mathcal{G}}(p_u) = \infty$ .

**THÉORÈME 0.3.20** (LYONS ET SCHRAMM, [LS11]). *Si  $\mathcal{G}$  est un graphe de Cayley d'un groupe ayant la propriété (T), alors  $N_{\infty}^{\mathcal{G}}(p_u) \neq 1$ . En particulier,  $p_u(\mathcal{G}) < 1$ .*

**THÉORÈME 0.3.21** (PERES, [PER00]). *Si  $\mathcal{G}$  est le produit d'un graphe transitif infini et d'un graphe transitif non-moyennable, alors  $N_{\infty}^{\mathcal{G}}(p_u) \neq 1$ . En particulier,  $p_u(\mathcal{G}) < 1$ .*

Quand  $p_u$  est-il égal à 1 ? Benjamini et Schramm ont posé dans [BS96] la question ci-dessous.

**QUESTION 0.3.22** (BENJAMINI ET SCHRAMM). *Un graphe transitif vérifie-t-il  $p_u < 1$  si et seulement s'il a un bout ?*

Les résultats qui suivent suggèrent une réponse affirmative à cette question. Voir respectivement [LP] et [BB99].

THÉORÈME 0.3.23. *Tout graphe transitif dont le nombre de bouts est différent de 1 vérifie  $p_u = 1$ .*

THÉORÈME 0.3.24 (BABSON ET BENJAMINI). *Soit  $G$  un groupe de présentation finie. Si  $G$  a un bout, alors tout graphe de Cayley de  $G$  vérifie  $p_u < 1$ .*

Le résultat suivant garantit que la propriété «  $p_u = 1$  » est géométrique. Cet analogue pour  $p_u$  du théorème 0.3.15 est démontré dans [LS11].

THÉORÈME 0.3.25. *Soient  $\mathcal{G}_1$  et  $\mathcal{G}_2$  deux graphes transitifs quasi-isométriques. Alors  $p_u(\mathcal{G}_1) = 1$  équivaut à  $p_u(\mathcal{G}_2) = 1$ .*

Enfin, il paraît légitime de se demander si la conjecture 0.3.6 est valable si on remplace  $p_c$  par  $p_u$ .

QUESTION 0.3.26. *Est-il vrai que si  $\epsilon$  désigne un réel strictement positif, alors  $p_u$  est continu vu comme fonction de  $\{\mathcal{G} \in \mathfrak{G} : p_u(\mathcal{G}) < 1 - \epsilon\}$  vers  $[0, 1]$  ?*

### Récapitulons.

Voici un tableau synthétisant la situation quant aux questions portant sur les valeurs de  $p_c$  et  $p_u$ . La colonne « Local » rassemble les résultats et conjectures de type “continuité au sens de Benjamini-Schramm”. La colonne « Global » recueille les problèmes (conjecturalement) invariants par quasi-isométrie.

Local	Global
valeur de $p_c$ sachant $p_c < 1 - \epsilon$ conjecture 0.3.6, théorèmes 0.3.7, 0.3.8, 0.3.9 et 0.3.10	$p_c < 1$ conjecture 0.3.13, théorèmes 0.3.14 et 0.3.15
valeur de $p_u$ sachant $p_u < 1 - \epsilon$ ? question 0.3.26, théorèmes 0.3.7 et 0.3.10	$p_c < p_u$ conjecture 0.3.16, théorèmes 0.3.17 et 0.3.18
	$p_u < 1$ question 0.3.22, théorèmes 0.3.18, 0.3.20, 0.3.21, 0.3.23, 0.3.24 et 0.3.25

En ce qui concerne les comportements aux points  $p_c$  et  $p_u$ , le bilan est le suivant. Il semble que  $N_\infty^{\mathcal{G}}(p_c)$  soit égal à 0 pour tout graphe transitif  $\mathcal{G}$  vérifiant  $p_c < 1$ . Sur les graphes transitifs vérifiant  $p_c < p_u < 1$ , le nombre  $N_\infty^{\mathcal{G}}(p_u)$  peut aussi bien valoir 1 que  $\infty$ .

## 0.4 Percolations invariantes

La section 0.3 proposait une vue d'ensemble de la théorie de la percolation de Bernoulli. On va ici tâcher d'aborder ce sujet plus en détail. On démontrera plusieurs résultats évoqués dans les sections précédentes, en présentant les arguments employés dans leur cadre de généralité naturel ; cela nous amènera à considérer des classes de percolations très étendues. Le lecteur désireux d'approfondir le contenu de cette section est invité à consulter [Ben13, BLPS99b, LP, Pet13].

### 0.4.1 Premières définitions et propriétés

Soit  $\mathcal{G} = (V, E)$  un graphe, qui n'est pas encore supposé transitif. Son groupe d'automorphismes  $\text{Aut}(\mathcal{G})$  agit sur  $E$ , donc sur  $\{0, 1\}^E$ , donc sur les percolations sur  $\mathcal{G}$ . Si  $G$  est un sous-groupe de  $\text{Aut}(\mathcal{G})$ , on dit qu'une percolation sur  $\mathcal{G}$  est  $G$ -invariante si

$$\forall g \in G, g \cdot \mathbb{P} = \mathbb{P}.$$

Pour tout  $p \in [0, 1]$ , la percolation de Bernoulli de paramètre  $p$  sur  $\mathcal{G}$  est  $\text{Aut}(\mathcal{G})$ -invariante. La percolation de Bernoulli vérifie deux autres propriétés importantes : l'ergodicité et la propriété d'ajout (voir définitions et énoncés ci-après).

Une percolation  $\mathbb{P}$  est dite  $G$ -ergodique si elle attribue à tout borélien  $G$ -invariant de  $\{0, 1\}^E$  une probabilité dans  $\{0, 1\}$ . Lorsque le groupe agissant sera univoquement suggéré par le contexte<sup>15</sup>, on pourra écrire « ergodique » au lieu de «  $G$ -ergodique ».

**PROPOSITION 0.4.1.** *On suppose qu'il existe un sommet de  $\mathcal{G}$  dont la  $G$ -orbite est infinie. Alors, pour tout  $p \in [0, 1]$ , la percolation de Bernoulli de paramètre  $p$  sur  $\mathcal{G}$  est  $G$ -ergodique.*

*Démonstration.* Soit  $B$  un borélien  $G$ -invariant de  $\{0, 1\}^E$ . Soit  $\epsilon > 0$ . Soit  $C \subset \{0, 1\}^E$  tel que

- $C$  soit de la forme  $\mathfrak{C} \times \{0, 1\}^{E \setminus F}$ , pour une partie  $F$  finie de  $E$  et  $\mathfrak{C}$  une partie de  $\{0, 1\}^F$ ,
- $\mathbb{P}_p[B \Delta C] \leq \epsilon$ , ce qu'on note également  $B \stackrel{\epsilon}{\simeq} C$ .

Puisque l'action de  $G$  sur le graphe connexe localement fini  $\mathcal{G}$  admet une orbite infinie, il existe un élément  $g$  de  $G$  tel que  $g \cdot F$  et  $F$  soient disjoints. Par  $G$ -invariance de  $B$  et  $\mathbb{P}_p$ , on a

$$B = B \cap (g \cdot B) \stackrel{2\epsilon}{\simeq} C \cap (g \cdot C).$$

---

15. Quand un graphe sera introduit comme graphe de Cayley d'un groupe  $G$ , ce sera ce groupe qui agira ; quand aucun groupe ne sera clairement suggéré par le contexte, il s'agira par défaut de  $\text{Aut}(\mathcal{G})$ .

Comme  $F$  et  $g \cdot F$  sont disjoints, il résulte de l'indépendance des états des arêtes que

$$\mathbb{P}_p[C \cap g \cdot C] = \mathbb{P}_p[C] \times \mathbb{P}_p[g \cdot C] = \mathbb{P}_p[C]^2.$$

Il découle de  $\mathbb{P}_p[B \Delta C] \leq \epsilon$  que  $|\mathbb{P}_p[B] - \mathbb{P}_p[B]^2| \leq 4\epsilon$ . On conclut en faisant tendre  $\epsilon$  vers 0.  $\square$

Si  $(\omega, e) \in \{0, 1\}^E \times E$ , on dénote par  $\omega^e$  l'unique élément de  $\{0, 1\}^E$  coïncidant avec  $\omega$  sur  $E \setminus \{e\}$  et valant 1 en  $e$ . On définit l'opérateur d'ajout comme  $\Pi^e : \omega \mapsto \omega^e$ . On dit qu'une percolation  $\mathbb{P}$  vérifie la **propriété d'ajout** si, pour tout borélien  $B \subset \{0, 1\}^E$ , pour toute arête  $e$ ,

$$\mathbb{P}[B] > 0 \implies \mathbb{P}[\Pi^e(B)] > 0.$$

De même, on définit  $\omega_e$  comme l'unique élément de  $\{0, 1\}^E$  coïncidant avec  $\omega$  sur  $E \setminus \{e\}$  et valant 0 en  $e$ ; l'opérateur d'effaçage est  $\Pi_e : \omega \mapsto \omega_e$ ; et une percolation  $\mathbb{P}$  vérifie la **propriété d'effaçage** si, pour tout borélien  $B \subset \{0, 1\}^E$ , pour toute arête  $e$ ,

$$\mathbb{P}[B] > 0 \implies \mathbb{P}[\Pi_e(B)] > 0.$$

**PROPOSITION 0.4.2.** *Soit  $p \in [0, 1]$ . Si  $p > 0$ , alors la percolation de Bernoulli de paramètre  $p$  sur  $\mathcal{G}$  vérifie la propriété d'ajout. Si  $p < 1$ , alors la percolation de Bernoulli de paramètre  $p$  sur  $\mathcal{G}$  vérifie la propriété d'effaçage.*

DANS LE RESTE DE LA SECTION 0.4, ON SUPPOSE QUE  $G$  EST UN SOUS-GROUPE FERMÉ DE  $\text{Aut}(\mathcal{G})$  AGISSANT TRANSITIVEMENT SUR  $\mathcal{G}$ . ON SUPPOSE EN OUTRE LE GRAPHE  $\mathcal{G}$  INFINI.

Par ergodicité, pour tout  $p \in [0, 1]$ , il existe un certain  $N_\infty^{\mathcal{G}}(p) \in \mathbb{N} \cup \{\infty\}$  tel que,  $\mathbb{P}_p$ -presque sûrement, le nombre de clusters infinis soit égal à  $N_\infty^{\mathcal{G}}(p)$ .

**PROPOSITION 0.4.3.** *Soit  $\mathbb{P}$  une percolation ergodique sur  $\mathcal{G}$  vérifiant la propriété d'ajout. Alors, il existe une constante  $x \in \{0, 1, \infty\}$  telle que le nombre de clusters infinis soit  $\mathbb{P}$ -presque sûrement égal à  $x$ . En particulier, pour tout  $p \in ]0, 1]$ , la quantité  $N_\infty^{\mathcal{G}}(p)$  appartient à  $\{0, 1, \infty\}$ .*

*Démonstration.* L'existence d'un  $x \in \mathbb{N} \cup \{\infty\}$  tel que le nombre de clusters infinis soit  $\mathbb{P}$ -presque sûrement égal à  $x$  résulte de l'ergodicité de  $\mathbb{P}$ . Supposons que  $x \notin \{0, \infty\}$ . Il existe  $\mathbb{P}$ -presque sûrement une partie finie  $F \subset V$  intersectant tous les clusters infinis. Par dénombrabilité, il existe donc une partie  $F$  telle que cette partie intersecte avec probabilité non-nulle tous les clusters infinis. En utilisant la propriété d'ajout un nombre fini de fois afin de relier entre eux tous les sommets de  $F$ , on constate que, avec probabilité non-nulle, il existe un unique cluster infini. Ainsi,  $x$  vaut 1 et la preuve s'achève.  $\square$

### 0.4.2 Le paramètre d'unicité

Le théorème suivant complète la proposition 0.4.3. Consulter [HP99] pour une démonstration dans le cas des graphes de Cayley et [Sch99] pour un traitement du cas général.

**THÉORÈME 0.4.4 (HÄGGSTRÖM, PERES ET SCHONMANN).** *Si  $p \in [0, 1]$  vérifie  $N_\infty^{\mathcal{G}}(p) = 1$ , alors tout  $q > p$  vérifie  $N_\infty^{\mathcal{G}}(q) = 1$ .*

Ce résultat appelle la définition de  $p_u$  — le **paramètre d'unicité** — comme la borne inférieure de l'ensemble des  $p$  vérifiant  $N_\infty^{\mathcal{G}}(p) = 1$ .

*Exemples.* L'étude des graphes suivants permet de constater que tous les cas d'égalité entre  $p_c$ ,  $p_u$  et 1 sont possibles, pourvu qu'ils soient compatibles avec la relation  $p_c \leq p_u \leq 1$ .

Le graphe  $\mathcal{Z}$  vérifie  $p_c = p_u = 1$  : ôter une proportion  $\epsilon > 0$  d'arêtes suffit à morceler la ligne bi-infinie en composantes toutes finies.

Le réseau carré vérifie  $p_c = p_u = 1/2$ . Voir la page 39 et le théorème 0.4.8.

Tout graphe de Cayley d'un groupe abélien de rang au moins 2 vérifie  $p_c = p_u \leq 1/2$ . Pour l'inégalité sur  $p_c$ , il suffit de remarquer que tout tel graphe de Cayley contient le réseau carré comme sous-graphe. L'égalité de  $p_c$  et  $p_u$ , quant à elle, résulte encore du théorème 0.4.8.

Pour tout  $d \geq 3$ , l'arbre  $d$ -régulier vérifie  $p_c = \frac{1}{d-1} < p_u = 1$ . La valeur de  $p_c$  découle de ce que l'étude de la percolation de Bernoulli de paramètre  $p$  sur l'arbre  $\mathcal{T}_d$  se ramène à celle du processus de Bienaymé-Galton-Watson de loi de reproduction binomiale de paramètre  $(d-1, p)$ .

Pour tout  $d$  suffisamment grand, le graphe  $\mathcal{T}_d \times \mathcal{Z}$  vérifie  $p_c < p_u < 1$ . Voir le théorème 0.4.5 pour l'inégalité  $p_c < p_u$  et le théorème 0.4.6 pour l'inégalité  $p_u < 1$ , laquelle est valable dès que  $d \geq 2$ . Pour établir cette dernière inégalité, on peut également invoquer le théorème 0.3.24.

**THÉORÈME 0.4.5 ([BS96, GN90]).** *Pour tout  $d$  suffisamment grand, le graphe  $\mathcal{T}_d \times \mathcal{Z}$  vérifie  $p_c < p_u$ .*

*Démonstration.* On note  $\mathcal{G}_d$  le graphe  $\mathcal{T}_d \times \mathcal{Z}$ . On désigne par  $p_c(d)$  son paramètre critique et  $p_u(d)$  son paramètre d'unicité. Puisque  $\mathcal{G}_d$  contient  $\mathcal{T}_d$  comme sous-graphe, on a  $p_c(d) \leq \frac{1}{d-1}$ .

Soit  $(o, o') \in V(\mathcal{T}_d) \times V(\mathcal{Z})$ . On appelle « bon chemin » un chemin fini de  $\mathcal{G}_d$  partant de  $(o, o')$  et s'arrêtant dans la fibre de  $o$ , c'est-à-dire en un point de  $\{o\} \times V(\mathcal{Z})$ . On note  $c_n$  le nombre de bons chemins de longueur  $n$ .

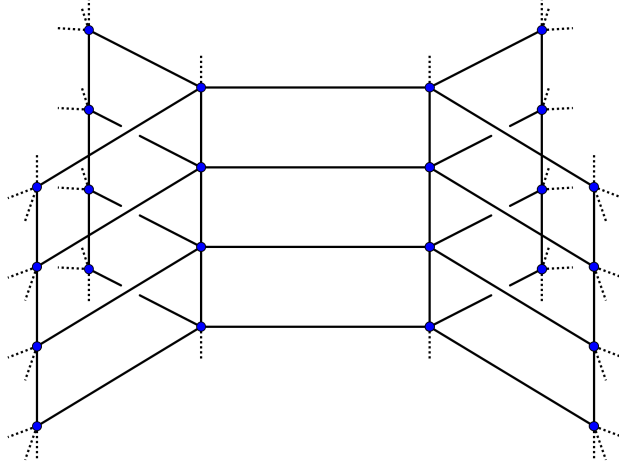
FIGURE 31 – Une portion finie de  $\mathcal{T}_3 \times \mathcal{Z}$ .

FAIT. Pour tout  $n \in \mathbb{N}$ , on dispose de l'inégalité  $c_n \leq (4\sqrt{d})^n$ .

*Démonstration.* Tout bon chemin de longueur  $n$  doit faire un nombre pair  $2k$  de pas dans le facteur  $\mathcal{T}_d$  et  $n - 2k$  autres pas dans le facteur  $\mathcal{Z}$ . Parmi les  $2k$  pas, exactement  $k$  s'éloignent de  $o$ , de telle sorte que

$$\begin{aligned}
 c_n &\leq \sum_{k=0}^{\lfloor \frac{n}{2} \rfloor} \binom{n}{n-2k, k, k} \times 2^{n-2k} \times d^k \times 1^k \\
 &\leq d^{n/2} \sum_{k=0}^{\lfloor \frac{n}{2} \rfloor} \binom{n}{n-2k, k, k} \times 2^{n-2k} \\
 c_n &\leq d^{n/2} \sum_{i+j+k=n} \binom{n}{i, j, k} \times 2^i \times 1^j \times 1^k \\
 &\leq (4\sqrt{d})^n.
 \end{aligned}$$

□

On suppose désormais  $d$  supérieur ou égal à 18, si bien que  $4\sqrt{d} < d - 1$ . Soit  $p \in \left] \frac{1}{d-1}, \frac{1}{4\sqrt{d}} \right[ \neq \emptyset$ . La quantité  $c_n p^n$  tend vers 0 exponentiellement vite en  $n$ . Notant  $\mathfrak{N}$  l'ensemble des bons chemins auto-évitant, on dispose des inégalités suivantes :

$$\mathbb{E}_p [ |\text{cluster}(o, o') \cap (\{o\} \times V(\mathcal{Z}))| ] \leq \sum_{\kappa \in \mathfrak{N}} p^{\text{longueur}(\kappa)} \leq \sum_{n \geq 0} c_n p^n < +\infty.$$



Ainsi, au paramètre  $p$ , la probabilité que deux sommets de la fibre de  $o$  soient reliés tend vers 0 quand leur distance tend vers l'infini. On conclut en remarquant que

- $N_\infty^{\mathcal{G}_d}(p) = 0$  est exclu car  $p > \frac{1}{d-1} \geq p_c(\mathcal{G}_d)$ ,
- $N_\infty^{\mathcal{G}_d}(p) = 1$  est exclu car impliquerait, d'après l'inégalité que Harris, que  $\inf_{u,v \in V} \mathbb{P}_p[u \xleftrightarrow{\omega} v] \geq \theta(p)^2 > 0$ , ce qu'on vient de contredire.

□

THÉORÈME 0.4.6 ([HPS99]). *Pour tout  $d \geq 2$ , on a  $p_u(\mathcal{T}_d \times \mathcal{Z}) \leq 1/2$ .*

On va démontrer le théorème 0.4.6 en admettant le théorème suivant.

THÉORÈME 0.4.7 ([SCH99]). *Soit  $p \in [0, 1]$  tel que*

$$\lim_{R \rightarrow \infty} \inf_{u,v \in V} \mathbb{P}_p \left[ \exists u' \in B(u, R), \exists v' \in B(v, R), u' \xleftrightarrow{\omega} v' \right] = 1.$$

Alors, on a  $p \geq p_u(\mathcal{G})$ .

*Démonstration du théorème 0.4.6.* Soient  $d \geq 2$  et  $p > 1/2$ . Sur  $\mathcal{Z}^2$ , le fait que  $N_p^{\mathcal{Z}^2} = 1$  et l'inégalité de Harris donnent :

$$\lim_{R \rightarrow \infty} \inf_{u,v \in V(\mathcal{Z}^2)} \mathbb{P}_p \left[ \exists u' \in B(u, R), \exists v' \in B(v, R), u' \xleftrightarrow{\omega} v' \right] = 1.$$

Comme pour tous  $u$  et  $v$  dans  $V(\mathcal{T}_d \times \mathcal{Z})$ , il existe un morphisme de graphes injectif de  $\mathcal{Z}^2$  vers  $\mathcal{T}_d \times \mathcal{Z}$  dont l'image contient  $u$  et  $v$ , la relation suivante vaut dans  $\mathcal{T}_d \times \mathcal{Z}$  :

$$\lim_{R \rightarrow \infty} \inf_{u,v \in V} \mathbb{P}_p \left[ \exists u' \in B(u, R), \exists v' \in B(v, R), u' \xleftrightarrow{\omega} v' \right] = 1.$$

D'après le théorème 0.4.7,  $p$  est supérieur ou égal à  $p_u(\mathcal{T}_d \times \mathcal{Z})$ , si bien que le paramètre d'unicité de  $\mathcal{T}_d \times \mathcal{Z}$  est inférieur ou égal à  $1/2$ . □

### 0.4.3 Moyennabilité et percolation

Les deux théorèmes suivants apportent une validation partielle de la conjecture 0.3.16, selon laquelle la moyennabilité de  $\mathcal{G}$  serait équivalente à l'égalité de  $p_c(\mathcal{G})$  et  $p_u(\mathcal{G})$ .

THÉORÈME 0.4.8 (BURTON ET KEANE, [BK89]). *Si le graphe transitif  $\mathcal{G}$  est moyennable, alors toute percolation  $G$ -invariante sur  $\mathcal{G}$  qui vérifie la propriété d'ajout fournit presque sûrement au plus un cluster infini. En particulier, tout graphe transitif moyennable vérifie  $p_c = p_u$ .*

*Éléments de démonstration.* Pour simplifier l'exposition, on va commencer par présenter les idées de la preuve dans le cas d'une percolation de Bernoulli de paramètre  $p \in ]0, 1[$ . D'après la proposition 0.4.3, il suffit d'établir la non-moyennabilité du graphe étudié en supposant qu'avec probabilité non-nulle, il existe au moins trois clusters infinis. Sous cette hypothèse, en utilisant convenablement les propriétés d'ajout et d'effaçage de la percolation de Bernoulli, on peut démontrer qu'il existe,

avec une certaine probabilité  $p_0$  strictement positive, un point de branchement — c'est-à-dire un point qui, si on l'enlève du graphe, suffit à morceler un cluster infini en au moins trois clusters infinis. Si  $F$  désigne une partie finie de  $V(\mathcal{G})$ , l'espérance du nombre de points de branchement dans  $F$  vaut  $p_0 \times |F|$ .

On ajoute à l'ensemble aléatoire des points de branchement dans  $F$  un point par cluster infini qui résulterait du retrait de tous les points de branchement de  $F$  et serait voisin d'un tel point de branchement ; on dira que ces points correspondent chacun à un « pseudo-cluster infini ». On munit cet ensemble aléatoire d'une structure de graphe, de la façon suivante :

- deux points de branchement sont déclarés adjacents s'il existe un chemin d'arêtes ouvertes les reliant sans quitter  $F$  ni toucher d'autre point de branchement,
- deux points correspondant à des pseudo-clusters infinis ne sont jamais adjacents
- et un point correspondant à un pseudo-cluster infini est adjacent à l'unique point de branchement duquel le pseudo-cluster est voisin par une arête ouverte.

Ce graphe est une forêt aléatoire finie dont chaque sommet est soit de degré 1 (c'est-à-dire une feuille), soit de degré au moins 3. Un tel graphe a nécessairement plus de feuilles que de sommets de degré au moins 3. Cela signifie que la forêt aléatoire considérée comporte toujours plus de sommets correspondant à des pseudo-clusters infinis que de points de branchement. Or chaque pseudo-cluster infini rencontre la frontière de  $F$  en au moins un point : deux pseudo-clusters distincts ne pouvant passer par un même point de  $\partial F$ , le nombre de points de branchement est toujours majoré par  $|\partial F|$ . En prenant l'espérance, il résulte de cela que  $p_0 \times |F| \leq |\partial F|$ , ce qui établit la non-moyennabilité du graphe considéré.

Dans cette preuve, on a utilisé deux propriétés de la percolation de Bernoulli qui ne figuraient pas parmi les hypothèses du théorème à établir : l'ergodicité et la propriété d'effaçage. Pour s'affranchir de l'hypothèse d'ergodicité, on peut faire appel à un théorème de décomposition ergodique (voir le lemme 3.6 de [LS11]). Pour ce qui est de la propriété d'effaçage, on peut, en s'y prenant correctement, remplacer les points de branchement par les points dont le  $R$ -voisinage suffit, une fois effacé, à morceler un cluster infini en au moins trois clusters infinis. Le nombre  $R$  est alors choisi suffisamment grand pour qu'un tel point existe avec probabilité non-nulle, puis est fixé une fois pour toutes.  $\square$

**THÉORÈME 0.4.9** ([PSN00, THO]). *Si  $G$  est un groupe de type fini non-moyennable, alors il existe une partie génératrice finie  $S$  de  $G$  telle que  $\text{Cay}(G; S)$  vérifie  $p_c < p_u$ .*

*Aperçu de la démonstration.* Soit  $G$  un groupe de type fini qui n'est pas moyennable et soit  $S$  une partie génératrice finie de  $G$  stable par l'opérateur d'inversion. En couplant une percolation de Bernoulli de paramètre bien choisi à un processus de marche aléatoire branchante, Benjamini et Schramm ont démontré dans [BS96] que si  $d$  dénote le degré d'un sommet quelconque de  $\text{Cay}(G; S)$  et  $\rho$  son rayon spectral — c'est-à-dire, en les termes du théorème 0.2.4, la quantité  $\exp(\limsup \frac{\log p_n}{n})$  —, alors

$$d\rho p_c < 1 \implies p_c < p_u.$$

Comme  $G$  n'est pas moyennable, le théorème 0.2.4 garantit que  $\rho < 1$ . Ainsi, quitte à remplacer  $S$  par  $S^{(k)}$  — le multi-ensemble comptant chaque élément de  $G$  avec multiplicité le nombre de façons dont il peut s'écrire comme produit de  $k$  éléments de  $S$  —, le rayon spectral peut être rendu arbitrairement petit. En effet, le rayon spectral de  $\text{Cay}(G; S^{(k)})$  vaut  $\rho^k$ .

En utilisant d'autres inégalités pour contrôler les facteurs en  $d$  et  $p_c$ , on peut, quitte à remplacer  $S$  par  $S^{(k)}$  pour  $k$  assez grand, supposer que la condition  $dpp_c < 1$  est satisfaite, d'où le théorème 0.4.9.  $\square$

*Remarque.* Le lecteur est invité à consulter [PSN00] pour une présentation précise des inégalités en jeu et [Tho] pour remplacer le multi-ensemble  $S^{(k)}$  par une partie génératrice sans multiplicité.

On peut également mentionner la caractérisation suivante de la moyennabilité en termes de percolations invariantes.

**THÉORÈME 0.4.10** ([BLPS99B]). *On suppose que  $\mathcal{G}$  est un graphe de Cayley d'un groupe de type fini  $G$ . Alors, le groupe  $G$  est moyennable si et seulement si, pour tout  $\alpha < 1$ , il existe une percolation par sites  $G$ -invariante sur  $\mathcal{G}$  ne fournissant presque sûrement que des clusters finis mais telle que, pour tout sommet  $v$ , le sommet  $v$  soit ouvert avec probabilité au moins  $\alpha$ .*

#### 0.4.4 Le principe de transport de masse en percolation

Le principe de transport de masse, introduit page 29, sera généralement employé sous sa forme suivante.

**PROPOSITION 0.4.11.** *Soit  $\mathbb{P}$  une percolation  $G$ -invariante sur  $\mathcal{G}$ . Soit  $f : V \times V \times 2^E \rightarrow [0, +\infty]$  une fonction borélienne invariante sous l'action diagonale de  $G$ . Soit  $o$  un sommet de  $\mathcal{G}$ . Si  $G$  est unimodulaire, alors l'égalité ci-dessous a lieu :*

$$\sum_{v \in V} \mathbb{E}[f(o, v, \omega)] = \sum_{v \in V} \mathbb{E}[f(v, o, \omega)].$$

*Démonstration.* Comme  $\mathbb{P}$  est  $G$ -invariante, la fonction  $F : (u, v) \mapsto \mathbb{E}[f(u, v, \omega)]$  est invariante sous l'action diagonale de  $G$ . D'après la proposition 0.2.8, le couple  $(\mathcal{G}, G)$  vérifie le principe de transport de masse : appliquer ce dernier à  $F$  donne l'égalité recherchée.  $\square$

#### Quelques résultats classiques

On présente ici trois démonstrations faisant intervenir le principe de transport de masse, puis un théorème utilisant deux des résultats ainsi établis. Ces quatre preuves constituent une (petite) partie de la démonstration du théorème 0.4.18 ; voir [LS11]. On peut également signaler que la proposition 0.4.13 et une variante de la proposition 0.4.12 sont mises à profit

dans [BLPS99a] pour établir que tout graphe transitif unimodulaire non-moyennable vérifie  $\theta(p_c) = 0$ .

Lorsqu'on considère un cluster d'une configuration  $\omega \in 2^E$  comme un graphe, il est implicitement muni de la structure induite par  $\mathcal{G}_\omega = (V, \omega)$ .

**PROPOSITION 0.4.12** ([LS11]). *Soit  $\mathbb{P}$  une percolation  $G$ -invariante sur  $\mathcal{G}$ . Si  $G$  est unimodulaire, alors,  $\mathbb{P}$ -presque sûrement, tout cluster infini a 1 bout, 2 bouts ou aucun bout isolé.*

*Remarque.* Souvent, comme c'est le cas ici, le principe de transport de masse permet de démontrer que, presque sûrement, les clusters infinis sont en un certain sens « homogènes » ; dans ce cas précis, si on se restreint au cas des percolations ne chargeant que les forêts, la proposition 0.4.12 affirme que, presque sûrement, tout cluster contenant un point de branchement en contient « partout ».

*Démonstration.* On note  $\hat{A}_n$  la partie aléatoire formée de l'union des parties connexes  $A \subset V$  qui sont

- connexes,
- de cardinal au plus  $n$ ,
- incluses dans un cluster infini
- et telles que le retrait de  $A$  morcelle le cluster contenant  $A$  en au moins trois composantes connexes infinies.

Tout cluster à au moins trois bouts intersecte  $\bigcup_n \hat{A}_n$ . Si  $C$  est un tel cluster et  $\xi$  un bout isolé de  $C$ , alors, pour un certain  $n$ , la partie  $\hat{A}_n$  isole  $\xi$ , en ce sens que  $\xi(\hat{A}_n)$  n'a qu'un bout.

Pour  $n \in \mathbb{N}$ , on peut définir le transport de masse suivant :  $u$  répartit uniformément une masse unité parmi les points de  $\hat{A}_n \cap \text{cluster}(u)$  qui sont les plus proches de lui pour la distance de graphe de  $\mathcal{G}_\omega$ , si de tels points existent ; sinon,  $u$  n'envoie pas de masse. La masse reçue doit, d'après le principe de transport de masse, être intégrable d'intégrale au plus 1 ; elle est donc presque sûrement finie pour toutes les valeurs de  $n$ . Or, quand il existe un cluster ayant au moins trois bouts dont un isolé, pour un certain  $n$ , ce transport de masse fait recevoir à un point une masse infinie : cela arrive donc avec probabilité nulle.  $\square$

**NOTATION.** Un sous-graphe fini non-vide  $\mathcal{K}$  de  $\mathcal{G}$  étant donné, on pose

$$\alpha(\mathcal{K}) := \frac{2|E(\mathcal{K})|}{|V(\mathcal{K})|}.$$

Si  $\mathfrak{T}$  désigne un ensemble de sous-graphes de  $\mathcal{G}$ , on pose

$$\alpha(\mathfrak{T}) := \sup\{\alpha(\mathcal{K}) ; \mathcal{K} \in \mathfrak{T} \text{ et } 0 < |V(\mathcal{K})| < \infty\}.$$

**PROPOSITION 0.4.13** ([BLPS99B]). *Soit  $\mathbb{P}$  une percolation sur  $\mathcal{G}$  qui est  $G$ -invariante et telle que,  $\mathbb{P}$ -presque sûrement, tout cluster fini appartienne*

à un certain ensemble  $\mathfrak{T}$  de sous-graphes de  $\mathcal{G}$ . Soit  $o$  un sommet de  $\mathcal{G}$ . On note  $D$  le nombre d'arêtes ouvertes contenant  $o$ . On suppose que  $G$  est unimodulaire et que  $\mathbb{E}[D] > \alpha(\mathfrak{T})$ .

Alors, on a  $\mathbb{P}[p_c(\mathcal{G}_\omega) < 1] > 0$ .

*Démonstration.* On définit le transport de masse suivant : chaque sommet répartit uniformément une masse égale à son degré dans  $\mathcal{G}_\omega$  sur tout son cluster si ce dernier est fini et ne transfère aucune masse sinon. Par principe de transport de masse,

$$\mathbb{E}[D\mathbb{1}_{|\text{cluster}(o)| < \infty}] = \mathbb{E}[\alpha(\text{cluster}(o))\mathbb{1}_{|\text{cluster}(o)| < \infty}].$$

Si,  $\mathbb{P}$ -presque sûrement, tous les clusters étaient finis, on aurait donc  $\mathbb{E}[D] \leq \alpha(\mathfrak{T})$ . Ayant supposé le contraire, il existe un cluster infini avec probabilité strictement positive.

Si on intersepte cette percolation avec une percolation de Bernoulli indépendante de paramètre  $p$  suffisamment proche de 1, l'inégalité  $\mathbb{E}[D] > \alpha(\mathfrak{T})$  perdure pour la nouvelle percolation, laquelle fournit donc également un cluster infini avec probabilité strictement positive.<sup>16</sup> On déduit de cela et du théorème de Fubini-Tonelli que le graphe  $\mathcal{G}_\omega$  vérifie  $p_c < 1$  avec probabilité non-nulle.  $\square$

*Remarque.* Si  $\mathfrak{T}$  ne contient que des arbres, alors  $\alpha(\mathfrak{T}) \leq 2$ .

PROPOSITION 0.4.14 ([BLPS99B]). *Si  $\mathbb{P}$  est une percolation  $G$ -invariante sur  $\mathcal{G}$  et si  $G$  est unimodulaire, alors, avec les notations de la proposition précédente,*

$$\mathbb{E}[D|o \xrightarrow{\omega} \infty] \geq 2.$$

*Démonstration.* On considère le transport de masse suivant :  $u$  envoie masse unité à  $v$  si

- le  $\omega$ -cluster de  $u$  est infini
- $u$  et  $v$  sont reliés par une arête ouverte,
- et le  $\omega_{\{u,v\}}$ -cluster de  $u$  est fini

et masse 0 sinon. On vérifie que la masse donnée par  $o$  moins la masse reçue par  $o$  est nulle si  $o$  est dans un cluster fini et minorée par  $2 - D$  sinon. On conclut en invoquant le principe de transport de masse.  $\square$

THÉORÈME 0.4.15 ([BLPS99B]). *Si  $\mathbb{P}$  est une percolation  $G$ -invariante sur  $\mathcal{G}$  dont presque toute configuration est une forêt et si  $G$  est unimodulaire, alors,  $\mathbb{P}$ -presque sûrement, tout cluster ayant au moins trois bouts vérifie  $p_c < 1$ .*

*Éléments de démonstration.* On va démontrer que si la probabilité qu'il existe un cluster à au moins trois bouts est non-nulle, alors  $\mathbb{P}[p_c(\mathcal{G}_\omega) < 1] > 0$ . On peut ramener la démonstration du théorème à celle de ce fait en considérant la percolation formée de l'ensemble des clusters à au moins trois bouts vérifiant  $p_c = 1$ .

<sup>16</sup> Il arrive qu'on qualifie de percolation une variable aléatoire dont la loi est une percolation.

En enlevant convenablement<sup>17</sup> des arêtes au niveau des points de branchement, on définit une percolation  $G$ -invariante avec moins d'arêtes mais dont les sommets  $v$  vérifiant  $v \xleftrightarrow{\omega} \infty$  sont les mêmes que dans la percolation de départ. Ainsi, l'inégalité de la proposition 0.4.14 valant pour cette percolation, elle vaut en tant qu'inégalité stricte pour la percolation initiale :

$$\mathbb{E}[D|o \xleftrightarrow{\omega} \infty] > 2.$$

D'après la proposition 0.4.13 et comme  $\alpha(\mathcal{K}) \leq 2$  dès que  $\mathcal{K}$  est un arbre fini non-vide, la forêt couvrante vérifie  $p_c < 1$  avec probabilité non-nulle.  $\square$

### Transport de masse et modèles dirigés

Le principe de transport de masse permet également d'étudier des modèles dirigés de percolation, « dirigés » étant pris au sens informel évoqué page 3. Il convient de préciser que, dans cette thèse, il sera question non pas de modèles de « percolation dirigée » mais de « modèles dirigés » de percolation : cela signifie que la définition de ce qu'est un chemin ouvert sera la même tout au long de cette thèse, et que chaque fois qu'on voudra restreindre son attention à des « chemins dirigés », cela fera l'objet d'une mention explicite.

NOTATION. Si  $d$  désigne un entier naturel, on note  $(e_1, \dots, e_d)$  le système de générateurs canonique de  $\mathbb{Z}^d$ . Plus précisément, pour tout  $i \in \{1, \dots, d\}$ , on pose  $e_i = (\mathbb{1}_{i=j})_{1 \leq j \leq d}$ .

PROPOSITION 0.4.16. *Soit  $\mathbb{P}$  une percolation  $\mathbb{Z}^2$ -invariante sur le graphe  $\text{Cay}(\mathbb{Z}^2; e_1, e_2)$  telle que,  $\mathbb{P}$ -presque sûrement, pour tout  $v \in \mathbb{Z}^2$ , au moins une des arêtes  $\{v, v - e_1\}$  et  $\{v, v - e_2\}$  soit ouverte. Soit  $h$  le morphisme de groupes de  $\mathbb{Z}^2$  vers  $\mathbb{Z}$  envoyant  $e_1$  et  $e_2$  sur 1. Alors,  $\mathbb{P}$ -presque sûrement, la fonction  $h$  est surjective en restriction à n'importe quel cluster.*

*Remarque.* Le cadre de cette proposition fournit une généralisation du modèle de marches coalescentes présenté dans [Arr79, TW98] — pourvu qu'on considère ce modèle en temps positifs et négatifs.

*Démonstration.* Etant donnée une configuration de percolation, on étiquette  $\infty$  tout sommet dont le cluster se surjecte sur  $\mathbb{Z}$  via  $h$ ; tout autre sommet  $v$  est étiqueté  $m(v) := \max h_{|\text{cluster}(v)} - h(v) < \infty$ . On note  $p_n$  la probabilité que l'origine  $(0, 0)$  soit étiquetée  $n$ . Pour  $n \in \mathbb{N}$ , on définit le transport de masse suivant : si le sommet  $u$  est d'étiquette 0, le sommet  $v$  d'étiquette  $n$ , et si  $u$  et  $v$  sont reliés par un chemin de  $n$  arêtes ouvertes,  $u$  envoie masse 1 à  $v$ ; sinon,  $u$  envoie masse 0 à  $v$ . L'origine ne pouvant recevoir de masse que de  $\{(a, b) \in \mathbb{N}^2 : a + b = n\}$ , on a, par principe de transport de masse,  $(n + 1)p_n \geq p_0$ . Puisque  $\sum_{n < \infty} p_n \leq 1$  et comme la série harmonique diverge,  $p_0$  est nul et la proposition est établie.  $\square$

---

17. de façon  $G$ -invariante et de telle sorte que la probabilité qu'au moins une arête soit ôtée soit strictement positive

*Contre-exemple.* En général, lorsqu'on a un morphisme de groupes  $h$  de  $\mathbb{Z}^d$  vers  $\mathbb{Z}$  et une percolation  $\mathbb{Z}^d$ -invariante sur  $\text{Cay}(\mathbb{Z}^d; e_1, \dots, e_d)$ , il est possible que chaque cluster soit envoyé par  $h$  sur une demi-droite. Un exemple simple est le suivant. Soit  $\mathbf{b}$  une variable aléatoire uniforme à valeurs dans  $\mathbb{Z}/2\mathbb{Z}$ . Soit  $\mu$  une mesure de probabilité sur  $\mathbb{N}$  chargeant tous les points. Soit  $(n_{i,j})$  une variable de loi  $\mu^{\otimes \mathbb{Z}^2}$  indépendante de  $\mathbf{b}$ . On prendra  $d = 3$  et  $h$  qui envoie  $e_1$  et  $e_2$  sur 0 et  $e_3$  sur 1. Une arête de la forme  $\{v, v + e_i\}$  pour  $i \in \{1, 2\}$  est conservée si et seulement si  $h(v) + i \in \mathbf{b}$ . Une arête de la forme  $\{v, v + e_3\}$  est ouverte si et seulement si  $n_{c(\mathbf{b}, v)} = n_{c(\mathbf{b}, v + e_3)} + 1$ , le couple  $c(\mathbf{b}, v)$  étant défini comme égal à  $(v_1, v_3)$  si  $h(v) \in \mathbf{b}$  et à  $(v_2, v_3)$  sinon.

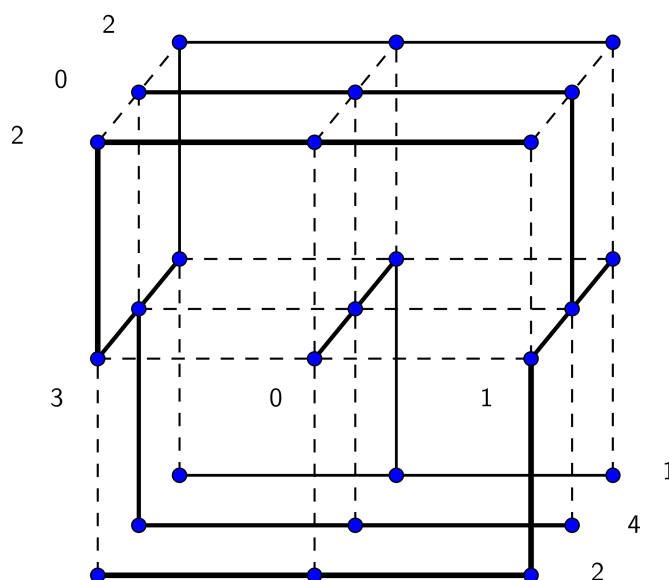

FIGURE 32 – Une percolation sur  $\mathbb{Z}^3$  fournissant des clusters de coordonnée verticale majorée mais non minorée.

Sous des hypothèses additionnelles, on peut raffiner la proposition 0.4.16 comme suit.

**PROPOSITION 0.4.17.** *Soit  $\mathbb{P}$  une percolation  $\mathbb{Z}^2$ -invariante sur le graphe  $\text{Cay}(\mathbb{Z}^2; e_1, e_2)$  telle que,  $\mathbb{P}$ -presque sûrement, pour tout  $v \in \mathbb{Z}^2$ , une et une seule des arêtes  $\{v, v - e_1\}$  et  $\{v, v - e_2\}$  soit ouverte. Soit  $h$  le morphisme de groupes de  $\mathbb{Z}^2$  vers  $\mathbb{Z}$  envoyant  $e_1$  et  $e_2$  sur 1. Alors,  $\mathbb{P}$ -presque sûrement, un et un seul des deux événements suivants a lieu :*

- tout cluster contient un chemin auto-évitant bi-infini;
- tous les sommets sont dans le même cluster.

*Démonstration.* On commence par introduire un peu de vocabulaire. Pour  $v \in V$  et  $\omega \in 2^E$ , on note  $\Phi(v, \omega)$  le sommet  $u$  de  $\{v - e_1, v - e_2\}$  tel que l'arête  $\{u, v\}$  soit  $\omega$ -ouverte lorsque ce sommet existe et est unique, et  $v - e_1$  sinon. Le « chemin dirigé » issu d'un sommet  $v$  est le chemin semi-infini  $\kappa$  uniquement déterminé par  $\kappa(0) = v$  et  $\forall n \in \mathbb{N}, \kappa(n+1) = \Phi(\kappa(n), \omega)$ . On appelle « niveau » un ensemble de la forme  $h^{-1}(\{n\})$ , où  $n$  désigne un entier relatif. Enfin, la « hauteur » d'un sommet  $v$  est l'entier  $h(v)$ .

Soit  $\omega$  une configuration telle que, pour tout  $v$ , une et une seule des arêtes  $\{v, v - e_1\}$  et  $\{v, v - e_2\}$  soit ouverte. Soient trois points  $u_1 = (x_1, y_1)$ ,  $u_2 = (x_2, y_2)$  et  $u_3 = (x_3, y_3)$  de  $h^{-1}(\{n\})$  vérifiant  $x_1 < x_2 < x_3$  et  $u_1 \xleftrightarrow{\omega} u_3$ . Il résulte de  $u_1 \xleftrightarrow{\omega} u_3$  et la forme particulière de  $\omega$  que les chemins dirigés issus de  $u_1$  et  $u_3$  se rencontrent. Puisque les trois points considérés appartiennent au même niveau et satisfont à la relation  $x_1 < x_2 < x_3$ , le chemin dirigé issu de  $u_2$  rencontre également l'un des chemins dirigés issus de  $u_1$  et  $u_3$  (donc les deux, avec lesquels il coïncide à partir d'un certain rang). Voir la figure 33.

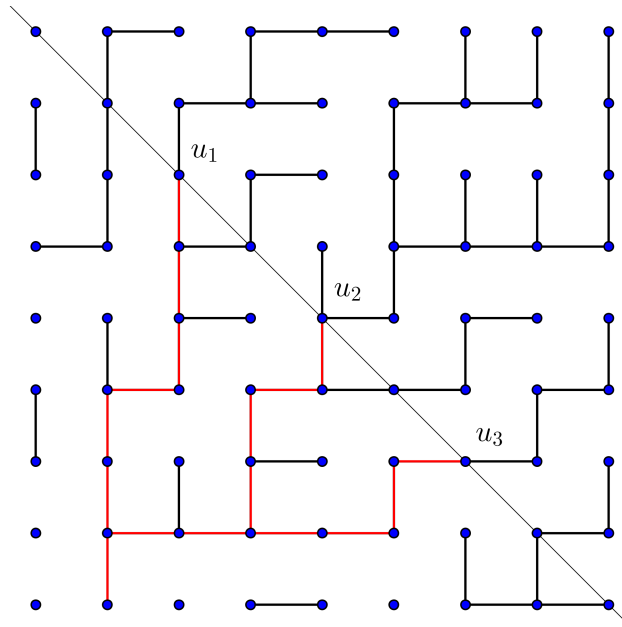

FIGURE 33 – En noir, une configuration de percolation vérifiant l'hypothèse de travail. En rouge, l'union des images de trois chemins dirigés.

On déduit de cela que, presque sûrement, tout cluster intersecte  $h^{-1}(\{n\})$  selon un ensemble de la forme

$$\{a + (-m, m) ; m \in I\},$$

où  $a$  désigne un élément de  $\mathbb{Z}^2$  et  $I$  un intervalle entier de  $\mathbb{Z}$ . Cette intersection est donc soit finie, soit une demi-droite, soit le niveau tout entier. On va montrer que le cas de la demi-droite est presque sûrement exclu. Supposons que l'événement  $E_n$  défini comme « il existe un cluster intersectant  $h^{-1}(\{n\})$  selon une demi-droite d'abs-



cisse bornée supérieurement (resp. inférieurement) » a une probabilité non-nulle. On remarque que, sur cet événement, il existe un unique point  $u(\omega) \in h^{-1}(\{n\})$  qui vérifie :

- $u(\omega)$  appartient à un cluster intersectant  $h^{-1}(\{n\})$  selon une demi-droite d'abscisse bornée supérieurement (resp. inférieurement)
- et  $u(\omega)$  est le point d'abscisse maximale (resp. minimale) parmi les points de son cluster qui sont de hauteur  $n$ .

Ainsi, conditionnant à l'occurrence de  $E_n$  et considérant l'abscisse de  $u(\omega)$ , on définit une variable aléatoire uniforme sur  $\mathbb{Z}$ . Cela étant absurde, l'événement  $E_n$  a bien probabilité nulle, et c'est également le cas de  $\bigcup_n E_n$ .

Avec probabilité 1, s'il existe un  $n$  tel que le niveau  $h^{-1}(\{n\})$  soit inclus dans un cluster, alors ce cluster contient tous les sommets de  $\mathbb{Z}^2$ . En effet, dans ce cas, tous les sommets de hauteur supérieure ont un chemin qui mène à ce niveau, et l'existence d'un niveau où ce ne serait pas le cas conduirait encore, en conditionnant et considérant la plus grande hauteur d'un tel niveau, à l'existence d'une variable aléatoire uniforme sur  $\mathbb{Z}$ .

Pour démontrer l'alternative (sans établir son caractère exclusif), il ne reste donc plus à traiter que le cas où tous les clusters intersectent finiment chaque niveau. Tout cluster, dès lors qu'il intersecte le niveau  $h^{-1}(\{n\})$ , intersecte les niveaux  $h^{-1}(\{m\})$  pour  $m < n$ . Si tout cluster intersecte tous les niveaux, alors tous les clusters contiennent un chemin auto-évitant bi-infini : appliquer l'astuce d'extraction diagonale rencontrée page 20. Le cas où un cluster n'intersecte pas tous les niveaux est exclu par le transport de masse où chaque sommet répartit équitablement une masse unité parmi tous les sommets les plus hauts de son cluster pourvu que ceux-ci existent et soient en nombre fini.

Enfin, on montre que cette alternative est bien exclusive. Soit  $\omega$  configuration telle que, pour tout  $v$ , une et une seule des arêtes  $\{v, v-e_1\}$  et  $\{v, v-e_2\}$  soit ouverte. La structure particulière de  $\omega$  garantit que tout chemin auto-évitant  $\kappa : \mathbb{Z} \rightarrow V(\mathcal{G})$  qui est  $\omega$ -ouvert vérifie au moins l'une des deux propriétés suivantes :

- $\exists n_0 \in \mathbb{Z}, \forall n \geq n_0, h(\kappa(n+1)) = h(\kappa(n)) + 1$  ;
- $\exists n_0 \in \mathbb{Z}, \forall n \leq n_0, h(\kappa(n+1)) = h(\kappa(n)) - 1$ .

Si un tel chemin existe, quitte à le tronquer, changer son orientation et le concaténer avec le chemin dirigé issu de son extrémité, on peut supposer que  $h$  induit une bijection de l'image de  $\kappa$  vers  $\mathbb{Z}$  ; on dira également que  $\kappa$  est « monotone ». Presque sûrement, tout cluster qui contient un chemin bi-infini monotone en contient un seul<sup>18</sup> ; en effet, le cas contraire donnerait lieu à des points de branchement, ce qu'exclut la démonstration du théorème 0.4.8. Si la probabilité d'occurrence simultanée des deux événements de l'alternative était strictement positive, en conditionnant par rapport à ce double événement et considérant l'abscisse du point de hauteur nulle de l'unique chemin bi-infini monotone  $\omega$ -ouvert, on définirait une variable aléatoire uniforme sur  $\mathbb{Z}$ , ce qui n'est pas.  $\square$

### 0.4.5 Le théorème d'indistinguabilité

On va maintenant traiter du théorème d'indistinguabilité de Lyons et Schramm. Ce théorème stipule que si  $G$  est unimodulaire, alors pour toute percolation  $G$ -invariante sur  $\mathcal{G}$  vérifiant la propriété d'ajout, « les clusters

18. à égalité des images près

infinis ont presque sûrement tous la même allure ». Pour rendre cet énoncé précis, il s'agit d'introduire un peu de vocabulaire.

Une **propriété de sommets** est une fonction borélienne, booléenne et  $G$ -invariante définie sur  $\{0, 1\}^E \times V$ , c'est-à-dire une fonction borélienne

$$P : \{0, 1\}^E \times V \rightarrow \{\text{vrai, faux}\}$$

qui est invariante sous l'action diagonale de  $G$ . Si  $W \subset V$ , on écrira  $P^+(\omega, W)$  au lieu de « tous les sommets de  $W$  vérifient  $P(\omega, \cdot)$  ». Plus formellement, on pose

$$P^+(\omega, W) := \text{«}\forall v \in W, P(\omega, v)\text{»}.$$

On pose également

- $P^-(\omega, W) := \text{«}\forall v \in W, \neg P(\omega, v)\text{»}$ ,
- $P^\pm(\omega, W) := \text{«}P^+(\omega, W) \vee P^-(\omega, W)\text{»}$ .

L'expression  $P^\pm(\omega, W)$  signifie « tous les sommets de  $W$  s'accordent sur  $P(\omega, \cdot)$  ».

Une **propriété de clusters** est une propriété de sommets  $P$  telle que  $P(\omega, v) \iff P(\omega, u)$  dès que  $u \xleftrightarrow{\omega} v$ . En d'autres termes, il s'agit d'une propriété de sommets telle que, pour tout  $\omega$ , la fonction  $P(\omega, \cdot)$  soit constante sur les  $\omega$ -clusters.

Pour formaliser la notion d'indistinguabilité des clusters infinis, il faut bien parler de clusters infinis. Aussi pose-t-on

$$V_\infty(\omega) := \{v \in V : v \xleftrightarrow{\omega} \infty\}.$$

On dit qu'une percolation  $\mathbb{P}$  vérifie la propriété d'**indistinguabilité** (des clusters infinis) si, pour toute propriété de clusters  $P$ , on a

$$\mathbb{P}[P^\pm(\omega, V_\infty(\omega))] = 1.$$

**THÉORÈME 0.4.18 (LYONS ET SCHRAMM, [LS11]).** *Si  $G$  est unimodulaire, toute percolation  $G$ -invariante sur  $\mathcal{G}$  vérifiant la propriété d'ajout vérifie également la propriété d'indistinguabilité.*

*Remarque.* On ne peut retirer, dans le théorème 0.4.18, ni l'hypothèse d'unimodularité, ni celle sur la propriété d'ajout. Etant donnée une percolation de Bernoulli fournissant une infinité de clusters infinis sur un graphe de grands-parents, on peut distinguer les clusters infinis par la structure locale du cluster au voisinage de son point le plus proche du bout distingué. Quant à la propriété d'ajout, elle est nécessaire pour éviter la situation suivante : on réalise une percolation de Bernoulli de paramètre  $p$  puis, pour chaque cluster infini, tire à pile ou face pour déterminer si elle sera morcelée par une seconde percolation de Bernoulli indépendante de paramètre  $q$  (choisir  $(p, q)$  de telle sorte que  $p > p_u$  et  $pq > p_c$ ).

*Aperçu de la démonstration du théorème 0.4.18.* On commence par se ramener à montrer que,  $\mathbb{P}$ -presque sûrement, tous les clusters infinis sont transients pour la marche aléatoire simple. Supposons donc cette transience acquise et terminons la preuve. On considère une propriété de clusters  $P$  sur laquelle, avec probabilité strictement positive, les clusters infinis ne s'accordent pas tous. Soit  $o$  un sommet de  $\mathcal{G}$ . On dit qu'une arête  $e$  est « pivot » pour la configuration  $\omega$  si  $P(\omega_e, o) \neq P(\omega^e, o)$  et le  $\omega_e$ -cluster de  $o$  est infini. En utilisant la propriété d'ajout « pour relier deux clusters infinis en désaccord quant à  $P$  », on démontre que la probabilité qu'il existe une arête pivot est non-nulle ; on peut trouver un nombre  $R$  tel qu'une telle arête se trouve avec probabilité strictement positive à distance au plus  $R$  de l'origine  $o$ . On définit ensuite une marche aléatoire sur le cluster de l'origine jouissant de suffisamment de propriétés d'invariance pour permettre l'utilisation d'un principe de transport de masse. Ce principe garantissant une forme d'homogénéité, presque sûrement, si le marcheur passe une fois à distance au plus  $R$  d'une arête pivot (ce qui arrive avec probabilité non-nulle), il passera une infinité de fois à distance au plus  $R$  d'arêtes pivots. Si la marche est transiente, aucun  $R$ -voisinage d'arête pivot ne peut être visité une infinité de fois, si bien que la probabilité qu'il existe une infinité d'arêtes pivots est strictement positive. Ceci signifie que l'événement  $\{\omega : P(\omega, o)\}$  ne peut pas être approché cylindriquement, ce qui contredit le caractère borélien de  $P$ .

Il reste donc à établir la transience presque sûre de tous les clusters infinis : si les clusters s'accordent sur la question de la transience, ils s'accorderont sur toutes les questions. On considère la forêt minimale couvrante libre<sup>19</sup> du graphe  $\mathcal{G}_\omega = (V, \omega)$ . On peut démontrer que, presque sûrement, tout cluster infini de la percolation d'origine contient un arbre infini de la forêt minimale couvrante libre. D'après le principe de monotonie de Rayleigh<sup>20</sup>, il suffit de montrer que, presque sûrement, tous les arbres infinis de la forêt couvrante sont transients. Or, d'après la théorie du branchement de Lyons (voir [Lyo90]), tout arbre vérifiant  $p_c < 1$  est transient pour la marche aléatoire simple<sup>21</sup>. Il suffit donc de montrer que, presque sûrement, tous les clusters infinis de la forêt couvrante vérifient  $p_c < 1$ .

Le lemme 3.6 de [LS11] garantit qu'on ne perd pas en généralité à supposer  $\mathbb{P}$  ergodique. D'après la proposition 0.4.3, le nombre de clusters infinis a une valeur  $\mathbb{P}$ -presque sûre  $x \in \{0, 1, \infty\}$ . L'indistinguabilité étant évidente si  $x \leq 1$ , on suppose que  $x = \infty$ . Presque sûrement, les clusters infinis n'ont aucun bout isolé : en effet, dans le cas contraire, on pourrait employer la propriété d'ajout pour créer un cluster avec au moins trois bouts dont un bout isolé, ce qui contredirait la proposition 0.4.12. En particulier,  $\mathbb{P}$ -presque sûrement, tous les clusters infinis ont au moins trois bouts. Il est possible d'en déduire que, presque sûrement, les clusters infinis de la forêt minimale couvrante libre ont au moins trois bouts. D'après le théorème 0.4.15, ils vérifient donc presque sûrement  $p_c < 1$ , ce qui achève la preuve du théorème d'indistinguabilité.  $\square$

On peut formuler un autre théorème d'indistinguabilité, dont la conclu-

19. La **forêt minimale couvrante libre** d'un graphe  $\mathcal{G}$  est définie comme suit. On tire pour chaque arête  $e$  du graphe une variable aléatoire uniforme sur  $[0, 1]$ , ces variables étant prises indépendantes les unes des autres. On garde les arêtes qui ne sont pas d'étiquette maximale dans un cycle.

20. Tout graphe connexe admettant un sous-graphe transient est transient.

21. Noter que cela est faux pour des graphes quelconques : en témoigne le cas du réseau carré.

sion est moins puissante mais qui s'applique pour tout graphe transitif (même non-unimodulaire). A cette fin, on définit la notion de propriété robuste.

Une propriété de clusters  $P$  est dite **robuste** si, pour toute arête  $e = \{u, v\}$ , pour toute configuration  $\omega \in 2^E$  vérifiant  $\omega(e) = 1$ , les deux affirmations suivantes sont équivalentes :

- le  $\omega$ -cluster de  $u$  est infini et  $P(u, \omega)$  est vérifiée,
- un élément  $v'$  de  $\{u, v\}$  satisfait à  $P(v', \omega_e)$  et appartient à un  $\omega_e$ -cluster infini.

On dit qu'une percolation  $\mathbb{P}$  vérifie la propriété d'**indistinguabilité par propriétés robustes** si, pour toute propriété de clusters  $P$  qui est robuste, on a  $\mathbb{P}[P^\pm(\omega, V_\infty(\omega))] = 1$ .

**THÉORÈME 0.4.19** (HÄGGSTRÖM, PERES ET SCHONMANN, [HPS99]). *La percolation de Bernoulli de paramètre  $p$  sur le graphe transitif  $\mathcal{G}$  vérifie la propriété d'indistinguabilité par propriétés robustes dès que  $p > p_c(\mathcal{G})$ .*

Forts de ces théorèmes d'indistinguabilité, on peut démontrer (ou redémontrer) de nombreux résultats portant sur la percolation de Bernoulli. Le théorème 0.4.19 permet de démontrer rapidement le théorème 0.4.4. En effet, si  $p$  est un paramètre où il existe un unique cluster infini et si  $q > p \geq p_c(\mathcal{G})$ , il suffit de considérer la propriété robuste « le cluster du sommet considéré vérifie  $\theta(p/q) > 0$  » qui est  $\mathbb{P}_q$ -presque-sûrement satisfaite par un cluster infini (par couplage standard) et ne peut l'être par plusieurs (par unicité au paramètre  $p$ ). De façon analogue, on peut démontrer la version faible du théorème suivant. La version forte demande un peu plus de travail.

**THÉORÈME 0.4.20** ([HPS99]). *Soit  $(U_e)_{e \in E(\mathcal{G})}$  une suite de variables aléatoires indépendantes de loi uniforme sur  $[0, 1]$ . Pour tout  $p \in [0, 1]$ , on définit le  $p$ -cluster d'un sommet comme son cluster pour la configuration  $\omega_p := (\mathbb{1}_{U_e < p})$ . Alors, les clusters infinis naissent simultanément : cela signifie que*

- pour tout  $(p_1, p_2)$  vérifiant  $p_c(\mathcal{G}) < p_1 < p_2 \leq 1$ , presque sûrement, tout  $p_2$ -cluster infini contient un  $p_1$ -cluster infini (version faible),
- presque sûrement, pour tout  $(p_1, p_2)$  vérifiant  $p_c(\mathcal{G}) < p_1 < p_2 \leq 1$ , tout  $p_2$ -cluster infini contient un  $p_1$ -cluster infini (version forte).

*En fait, entre  $p_c$  et  $p_u$ , les clusters infinis fusionnent incessamment :*

- pour tout  $(p_1, p_2)$  vérifiant  $p_c(\mathcal{G}) < p_1 < p_2 < p_u(\mathcal{G})$ , presque sûrement, tout  $p_2$ -cluster infini contient une infinité de  $p_1$ -clusters infinis (version faible),
- presque sûrement, pour tout  $(p_1, p_2)$  vérifiant  $p_c(\mathcal{G}) < p_1 < p_2 < p_u(\mathcal{G})$ , tout  $p_2$ -cluster infini contient une infinité de  $p_1$ -clusters infinis (version forte).

Le théorème 0.4.18 permet également de démontrer que, dès que  $G$  est unimodulaire, il y a évanouissement des corrélations dans la phase  $N_\infty^{\mathcal{G}} = \infty$ . Cela est exprimé par le théorème suivant.

**THÉORÈME 0.4.21 (LYONS ET SCHRAMM, [LS11]).** *On suppose que  $G$  est unimodulaire. Soit  $\mathbb{P}$  une percolation  $G$ -invariante sur  $\mathcal{G}$  qui vérifie la propriété d'ajout. On suppose que  $\mathbb{P}$ -presque toute configuration donne lieu à une infinité de clusters infinis.*

*Alors, on a  $\inf_{u,v \in V} \mathbb{P}[u \overset{\omega}{\longleftrightarrow} v] = 0$ . Cela est en particulier le cas dès que  $\mathbb{P} = \mathbb{P}_p$  pour  $p$  vérifiant  $N_\infty^{\mathcal{G}}(p) = \infty$  —  $G$  étant encore supposé unimodulaire.*

*Remarque.* D'après l'inégalité de Harris, si  $N_\infty^{\mathcal{G}}(p) = 1$ , alors

$$\inf_{u,v \in V} \mathbb{P}_p[u \overset{\omega}{\longleftrightarrow} v] \geq \theta(p)^2 > 0.$$

Le théorème 0.4.21 peut être reformulé en termes métriques. Définissons  $d_p : V \times V \rightarrow \mathbb{R}_+$  par

$$d_p(u, v) := -\ln \mathbb{P}_p[u \overset{\omega}{\longleftrightarrow} v].$$

L'inégalité de Harris garantit que, pour tout  $p \in ]0, 1[$ , la fonction  $d_p$  définit une distance ( $\text{Aut}(\mathcal{G})$ -invariante) sur  $V$ . Cette distance permet d'énoncer de façon concise un certain nombre de faits et conjectures concernant la percolation de Bernoulli.

- Pour  $p > p_u$ , l'espace  $V$  est  $d_p$ -borné ; pour  $p < p_u$ , il ne l'est pas. Voir le théorème 0.4.21.
- Pour  $p > p_c$ , la quantité  $\sum_v e^{-d_p(o,x)}$  est finie ; pour  $p < p_c$ , elle ne l'est pas. Voir [AV08].
- Pour  $p < p_c$ , la distance  $d_p$  est bilipschitziennement équivalente à la distance de graphe. Voir [AV08].
- Il est conjecturé que, pour tout  $p < p_u$ , toute  $d_p$ -boule de rayon fini ne contient qu'un nombre fini de points. Voir [LS11].

## 0.5 Résultats de cette thèse

C'est dans ce vaste paysage que s'inscrit cette thèse. Mes contributions, évidemment, se placent à une échelle bien plus modeste. Elles sont réparties en trois chapitres indépendants.

Les chapitres 1 et 2 ont ceci de commun qu'ils utilisent des outils de théorie des *groupes* et actions de groupes pour étudier la *percolation* de Bernoulli. Dans le premier cas, on travaille sur des graphes de Cayley non-moyennables en utilisant la théorie de l'équivalence orbitale — en particulier le théorème 1.1.11, dû à Chifan et Ioana — pour renforcer le théorème d'indistinguabilité de Lyons et Schramm dans le cas de la percolation de Bernoulli. Dans le second cas, on établit la validité de la conjecture de localité de Schramm pour les graphes de Cayley de groupes abéliens, et ce en utilisant l'espace des groupes marqués.

Le point commun entre les chapitres 1 et 3 est la présence dans chacun d'eux d'un *modèle dirigé*, c'est-à-dire d'un modèle où « haut et bas jouent des rôles différents ».

Voici une brève présentation de ces trois chapitres.

### Equivalence orbitale et indistinguabilité forte

Dans le premier chapitre, on définit une propriété d'indistinguabilité renforcée (section 1.3.3) et établit que cette dernière est vérifiée par la percolation de Bernoulli (corollaire 1.3.11). La non-trivialité de cette notion est illustrée par un modèle dirigé (section 1.3.4) pour lequel on démontre un théorème d'indistinguabilité tout en montrant que la propriété renforcée n'est pas satisfaite. Ce modèle dirigé ne vérifie pas la propriété d'ajout.

Ce chapitre a donné lieu à la prépublication [Marb].

### Localité de la percolation pour les graphes de Cayley abéliens

Le deuxième chapitre rend compte d'un travail réalisé en collaboration avec Vincent Tassion [MT]. On y établit la localité de la percolation dans le cas abélien (théorème 0.3.10). Les nouveautés principales de [MT] sont l'introduction en percolation de l'espace des groupes marqués, la gestion de l'anisotropie<sup>22</sup> et l'utilisation du chemin exploré comme grain au lieu d'une boîte totalement ouverte (section 2.2.3).

### DLA dirigé

Le DLA — Diffusion-Limited Aggregation — est un modèle important<sup>23</sup> de physique statistique qui a été introduit en 1981 par Witten et Sander dans [WS81]. Il est défini comme suit. Une première particule — un site de  $\mathbb{Z}^2$  — est fixé. Ensuite, une particule est relâchée « de l'infini » et effectue une marche aléatoire simple. Dès qu'elle entre en contact avec la première particule, elle s'immobilise définitivement. Puis, une autre particule est libérée, qui s'arrêtera dès qu'elle touchera l'agrégat, etc.

Les simulations révèlent que cette dynamique donne lieu à une structure fractale, mais l'étude rigoureuse de ce modèle reste en majeure partie hors de portée des techniques probabilistes actuelles.

Dans le troisième et dernier chapitre de cette thèse (qui correspond à [Mara]), on étudie une variante plus accessible de ce modèle, où les marches aléatoires définissant le processus sont dirigées : les pas des marcheurs aléatoires sont de loi uniforme sur  $\{(0, -1), (-1, 0)\}$ . L'étude de ce processus — dit de **DLA dirigé**, ou **DDLA** — se heurte aux mêmes difficultés que celle du processus DLA (non-localité et non-monotonie de la dynamique)

22. c'est-à-dire de l'absence de réflexions laissant le graphe étudié invariant

23. DLA modélise les phénomènes de croissance dendritique [Vic92], de claquage au sein d'un diélectrique [BB84] et de digitation visqueuse en cellule de Hele-Shaw [SB84].

mais est facilitée par le caractère dirigé des marches, qui rend ces dernières moins erratiques. A terme, on espère que le DDLA servira de laboratoire pour développer des techniques à même d'améliorer notre compréhension rigoureuse de DLA.

A ce jour, on dispose sur le DDLA d'une dynamique en volume infini (section 3.2), d'un théorème de contrôle de la propagation d'information (section 3.3), d'inégalités asymptotiques sur la hauteur et la largeur de l'agrégat (section 3.4) ainsi que d'un résultat faible sur la géométrie de l'agrégat infini (section 3.5).

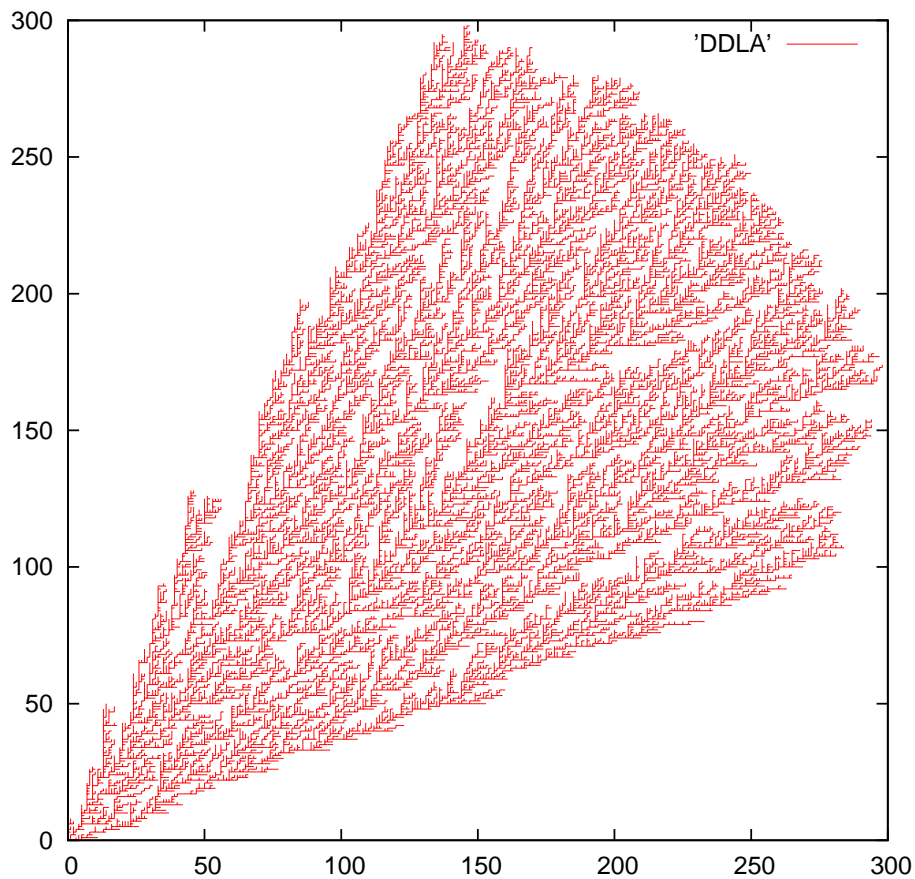

FIGURE 34 – Agrégat de DDLA. Simulation de Vincent Beffara.

# Chapter 0

## Introduction (in English)

Percolation is a model of statistical mechanics that was introduced in 1957 by Broadbent and Hammersley [HB57]. What is statistical mechanics? This branch of physics is devoted to explaining microscopically the macroscopic world. To do so, it is convenient to use probabilistic models: a simple probabilistic distribution is more tractable than a system of  $10^{24}$  differential equations with initial conditions inaccessible to measurement. Among the success of this approach, one finds Ising's model of ferromagnetism [Len20] and percolation.

In order to introduce Bernoulli percolation in a natural way, let us start with the following concrete problem [Gri99]. Take a porous stone and plunge it into water. We would like to know whether the water penetrates deeply into the stone or only superficially. How can it be done without breaking the stone? The general strategy of statistical mechanics goes as follows:

1. measure a few macroscopic parameters of the stone (hoping not to forget a relevant one),
2. propose a stochastic model of the stone (from the microscopic viewpoint) where the measured parameters are imposed,
3. and then study this model theoretically.

If the theoretical answer to our question is affirmative with probability very close to 0 or 1, we postulate that the real stone agrees with the majority. Otherwise, we look for other relevant parameters.

In the case of the porous stone, we measure its porosity, that is to say the proportion of holes. This number  $p$  lies between 0 and 1, and is easily measured by weighing. We adopt the following model. Start with a stone without holes and cut it into tiny cubes. Each cube is thrown away with probability  $p$  and kept otherwise, in an independent way.<sup>1</sup>

---

1. We will ignore “physical details” such as “how a cube can stay in mid-air if it is not in contact with another cube”. The purpose here is to have a mathematical model that is as simple as possible.



The water then infiltrates the stone: a hole is wet if and only if a path of holes goes from it to the outside of the stone.

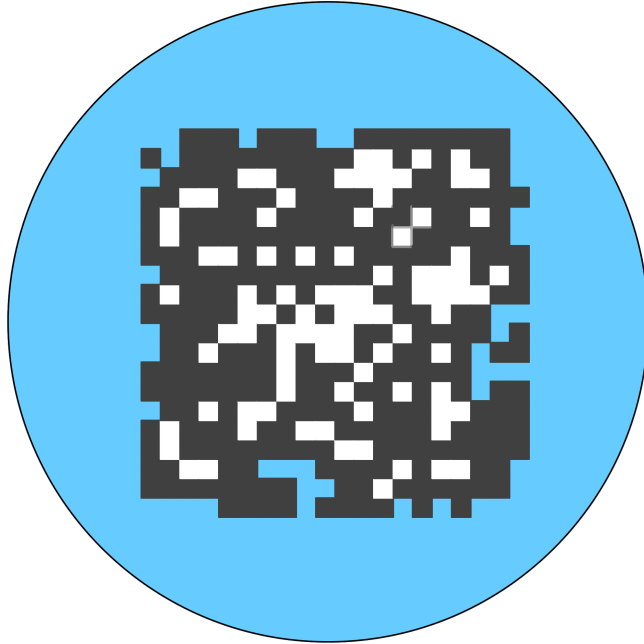

Figure 1 – Illustration of the model in 2D.

Idealising the situation, we can imagine that the minuscule cubes have a size that is infinitely smaller than that of the stone. Seen from the centre of the stone and at this infinitesimal scale, the situation is as follows: the three-dimensional space is decomposed along a cubic lattice and each cube is a hole with probability  $p$  and occupied by rock otherwise, independently. The exterior of the stone having been displaced to infinity and the sites of the space corresponding to points close to the centre in the macroscopic picture, the event of deep infiltration is mathematically formalised as the existence of an infinite path consisting exclusively of holes.

The model we have just introduced is Bernoulli site-percolation on  $\mathbb{Z}^3$ . One can show, for this model, that there is a real number  $p_c$  lying strictly between 0 and 1 such that:

- if  $p < p_c$ , then, almost surely, infiltration does not occur,
- if  $p > p_c$ , then, almost surely, infiltration occurs.

The number  $p_c$  is called the **critical** parameter, or critical probability.

The fact that the answer to the question does depend on the value of  $p$ —

that is the fact that  $p_c$  is different from 0 and 1 — indicates that the porosity is indeed a relevant parameter. The fact that, at fixed  $p$ , the answer is almost deterministic indicates that we have not forgotten any other relevant parameter. Now, we just have to numerically estimate  $p_c$ , compare its value with the measured porosity and we “know” if infiltration occurs or not in our stone, without having to break it. As such, this approach is simplistic. The task of the physicist is then to refine this method to increase its physical relevance while the one of the mathematician is to analyse rigourously the simple model (the adequation of which with the reality is only *qualitative*).

In the previous situation, there is a critical parameter that marks a neat boundary between two different regimes. This is what is called a **phase transition**. For other examples, one may think of the transition between ice and liquid water that takes place at  $0^\circ\text{C}$ , or of the appearance/disappearance of the spontaneous magnetisation at the Curie temperature.

This thesis is about *two* kinds of problems of statistical mechanics: we deal with *percolation on Cayley graphs* and *directed models*. What do the expressions “Cayley graphs” and “directed models” mean? Introduced in Section 0.2.1, Cayley graphs generalise to finitely generated groups the procedure that associates the cubic lattice with the group  $\mathbb{Z}^3$ . As for directed models, they are models of statistical mechanics where “up and down play different roles”. We will see that directed models exhibit interesting features (cf. Section 1.3.4) and are often easier to study than undirected models (cf. Chapter 3).

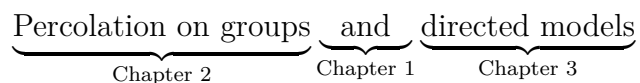

Figure 2 – Schematic representation of the content of this thesis.

The directed models considered in this thesis are investigated on a case by case basis whereas the percolation problems that are addressed belong to a vast theoretical landscape. Since the latter demands more than the former to be put into context, this introduction will mainly concentrate on percolation theory. This introduction will also be an opportunity to formulate a few definitions that will be useful in the next chapters.

## 0.1 General percolations

This thesis takes place in the framework of discrete geometry. Let us thus recall a few definitions from graph theory.

### 0.1.1 The vocabulary of graph theory

A **graph** is a pair  $\mathcal{G} = (V, E)$  that satisfies the condition  $E \subset \binom{V}{2}$ , where  $\binom{V}{2}$  denotes the set of pairs of elements of  $V$ . The elements of  $V = V(\mathcal{G})$  are called the **vertices** (or **sites**) of  $\mathcal{G}$ . The elements of  $E = E(\mathcal{G})$  are the **edges** (or **bonds**) of  $\mathcal{G}$ . If  $u$  and  $v$  satisfy  $\{u, v\} \in E$ , we say that  $u$  and  $v$  are **neighbours** (or **adjacent**), and that they are the **endpoints** of the edge  $\{u, v\}$ . One also says that the edge  $\{u, v\}$  connects  $u$  and  $v$ .

Visually, we often think of the vertices as points of the plane or the space that are connected by lines according to the edge-set. On pictures, vertices are sometimes represented by discs or crosses; when it is not the case, the vertex-set is generally the set of the points from which depart a unique line or at least three lines. Figure 3 provides two visual representations of a same graph.<sup>2</sup>

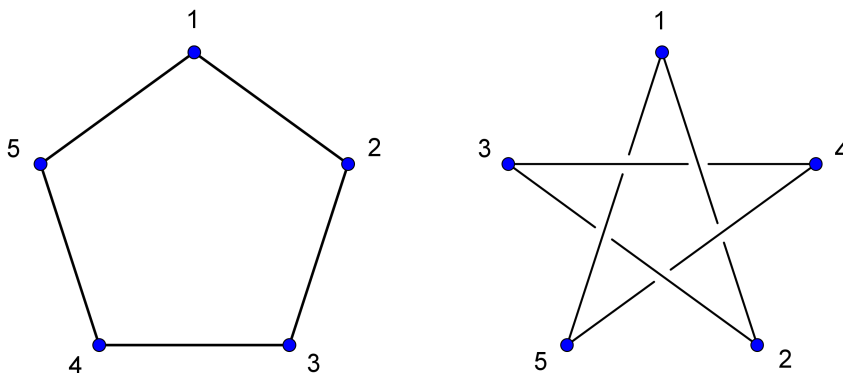

Figure 3 – Two representations of the graph  $(\{1, 2, 3, 4, 5\}, \{\{1, 2\}, \{2, 3\}, \{3, 4\}, \{4, 5\}, \{5, 1\}\})$ .

A **subgraph** of a graph  $\mathcal{G}_1$  is a graph  $\mathcal{G}_2$  such that  $V(\mathcal{G}_2) \subset V(\mathcal{G}_1)$  and  $E(\mathcal{G}_2) \subset E(\mathcal{G}_1)$ . If  $V'$  is a subset of  $V(\mathcal{G})$ , the **restriction** of  $\mathcal{G}$  to  $V'$  is the graph  $(V', \binom{V'}{2} \cap E(\mathcal{G}))$ . We also say that  $\mathcal{G}$  **induces** the graph structure  $(V', \binom{V'}{2} \cap E(\mathcal{G}))$  on  $V'$ .

A graph **morphism** from a graph  $\mathcal{G}_1$  to a graph  $\mathcal{G}_2$  is a mapping  $\varphi$  from  $V(\mathcal{G}_1)$  to  $V(\mathcal{G}_2)$  such that the image of any edge of  $\mathcal{G}_1$  is an edge of  $\mathcal{G}_2$ . In

<sup>2</sup> When two lines should intersect in the picture at a point that is not a vertex, one of the two lines is interrupted at the intersection point.

other words, it is a function that maps adjacent vertices to adjacent vertices. A graph **isomorphism** is a bijective morphism  $\varphi$  such that  $\varphi^{-1}$  is a graph homomorphism. A graph **automorphism** is a graph isomorphism from a graph to itself.

*Example.* We call **line** a graph  $(V, E)$  defined as follows,  $a$  and  $b$  denoting two elements of  $\mathbb{Z} \cup \{\pm\infty\}$  such that  $a \in \{-\infty, 0, +\infty\}$  and  $a \leq b$ :

$$V := \{n \in \mathbb{Z} : a \leq n \leq b\} \quad \text{and} \quad E := \{\{m, n\} \subset V : |m - n| = 1\}.$$

When one of the elements of  $\{a, b\}$  is finite, it is said to be an **endpoint** of this line. The **length** of a line is its number of edges, i.e.  $b - a$  if one excludes the (uninteresting) cases where  $a = b = \pm\infty$ . The line defined by  $(a, b) = (-\infty, +\infty)$  is denoted by  $\mathcal{Z}$ . The special role played by  $a = 0$  may sometimes be played by  $a = 1$ .

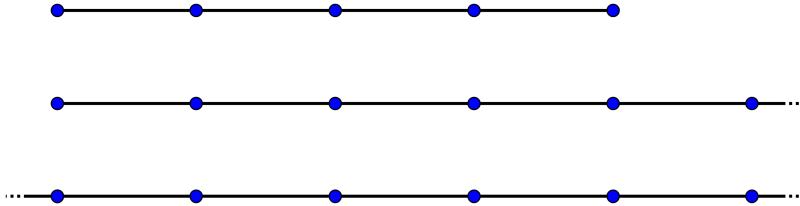

Figure 4 – Three examples of lines.

The **(direct) product** of two graphs  $\mathcal{G}_1 = (V_1, E_1)$  and  $\mathcal{G}_2 = (V_2, E_2)$  is the graph

$$(V_1 \times V_2, (E_1 \times V_2) \cup (V_1 \times E_2)).$$

*Examples.* The direct product of  $d$  copies of  $\mathcal{Z}$ , denoted by  $\mathcal{Z}^d$ , is the **hypercubic lattice** of dimension  $d$ . When  $d = 2$ , we speak of **square lattice** and, when  $d = 3$ , of **cubic lattice**. The **triangular lattice** is the graph  $\mathcal{L}_\Delta = (V, E)$  defined by

$$V := \mathbb{Z}[e^{i\pi/3}] \quad \text{and} \quad E := \{\{u, v\} \subset V : |u - v| = 1\}.$$

A **path** is a graph homomorphism from a line to a graph. A path is **finite** if its domain of definition is a finite line. It is **self-avoiding** if it is injective. The image of an edge by a path is said to be **visited** by this path. We say that a finite path  $\kappa$  whose domain of definition is the  $(a, b)$ -line **connects**  $\kappa(a)$  and  $\kappa(b)$ , and that  $\kappa(a)$  and  $\kappa(b)$  are the **endpoints** of  $\kappa$ . If

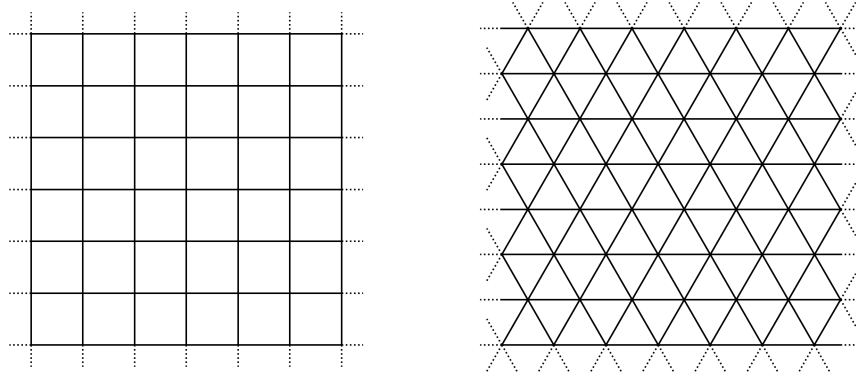
Figure 5 – Finite portions of  $\mathcal{Z}^2$  and  $\mathcal{L}_\Delta$ .

$A$  and  $B$  are subsets of  $V(\mathcal{G})$ , a path **connects**  $A$  and  $B$  if one endpoint of this path belongs to  $A$  and the other to  $B$ .

A graph is **connected** if any two vertices of this graph are connected by a path. The **length** of a path is the length of the line that constitutes its domain of definition. The **distance**  $d(u, v)$  between two vertices  $u$  and  $v$  of a connected graph is the minimal length of a path connecting them. A path  $\kappa$  is **geodesic** if

$$\forall m, n, d(\kappa(m), \kappa(n)) = |m - n|.$$

If  $u$  and  $v$  are two vertices of a connected graph, there is a geodesic path connecting them (take a path of minimal length).

A **cyclic graph** is a graph of the following form:

$$V_n := \mathbb{Z}/n\mathbb{Z} \quad \text{and} \quad E_n := \{\{k, k'\} \subset \mathbb{Z}/n\mathbb{Z} : k - k' \in \{-1, 1\}\},$$

where  $n \geq 3$ . The number  $n$  is called the **length** of the cyclic graph  $(V_n, E_n)$ . A **cycle** is an injective morphism from a cyclic graph to a graph. The **length** of a cycle is the length of the cyclic graph that constitutes its domain of definition.

A graph that admits no cycle is called a **forest**. A vertex of a forest that has a unique neighbour is called a **leaf**. A **tree** is a connected forest. The tree **spanned** by a family of vertices of a tree is the restriction of this tree to the union of the (images of the) geodesic paths connecting vertices of this family. When this family is a triplet, we speak of **tripod**.

A **rooted graph** is the data of a graph and a vertex of this graph, called the **root**. A **morphism of rooted graphs** (resp. **isomorphism, automorphism**) from  $(\mathcal{G}_1, v_1)$  to  $(\mathcal{G}_2, v_2)$  is a graph homomorphism (resp. isomorphism, automorphism) from  $\mathcal{G}_1$  to  $\mathcal{G}_2$  that maps  $v_1$  to  $v_2$ .

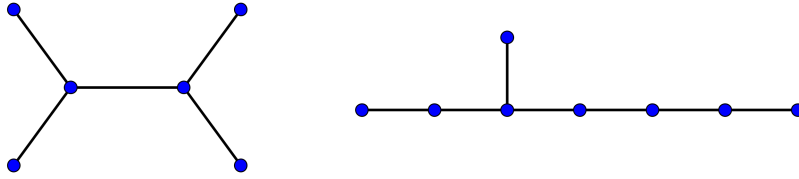

Figure 6 – Two trees.

A **covering map** of  $\mathcal{G}_2$  by  $\mathcal{G}_1$  is a graph homomorphism  $\varphi : \mathcal{G}_1 \rightarrow \mathcal{G}_2$  such that for every  $u \in V(\mathcal{G}_1)$  and every neighbour  $w$  of  $\varphi(u)$ , there is a unique neighbour  $v$  of  $u$  such that  $\varphi(v) = w$ .

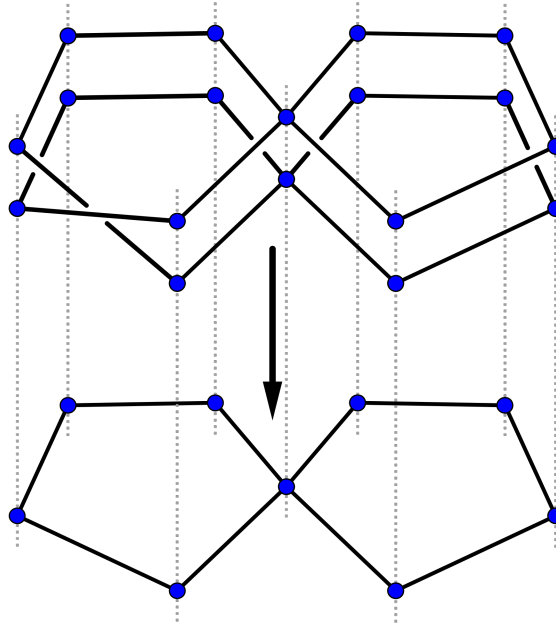

Figure 7 – An example of a covering map.

*Example.* For every  $n \geq 3$ , the reduction modulo  $n$  defines a covering map of the cyclic graph of length  $n$  by the line  $\mathcal{Z}$ .

Finally, the **degree** (or **valency**) of a vertex is its number of neighbours. A graph is **locally finite** if each of its vertices has finite degree. It is  **$d$ -regular** if all of its vertices have degree  $d$ . It is **regular** if there exists  $d \in \mathbb{N}$  such that it is  $d$ -regular. A graph whose degree function is bounded is said to have **bounded degree**.

*Example.* For every  $d \in \mathbb{N}$ , there exists a  $d$ -regular tree having at least one vertex, and it is unique up to isomorphism. In this introduction, we will denote by  $\mathcal{T}_d$  an element of this isomorphism class.

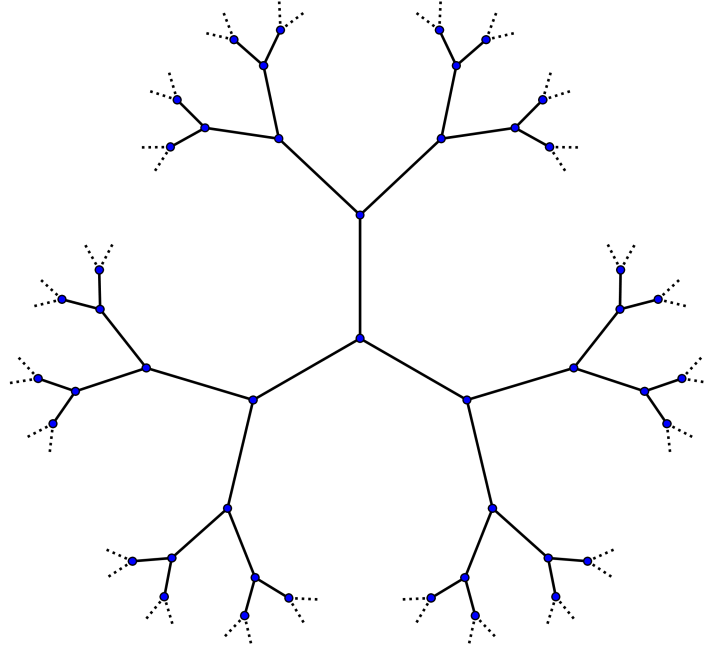

Figure 8 – A finite portion of  $\mathcal{T}_3$ .

FROM NOW ON, ALL THE GRAPHS WILL IMPLICITLY BE TAKEN CONNECTED, LOCALLY FINITE AND WITH AT LEAST ONE VERTEX. WE WILL NOT IMPOSE THE CONNECTEDNESS HYPOTHESIS WHEN WE WILL BE INTERESTED IN SUBGRAPHS OF THE GRAPH UNDER CONSIDERATION.

### 0.1.2 Percolation: definition and first examples

Let  $\mathcal{G} = (V, E)$  be a graph. A **percolation** (or **edge-percolation**) on  $\mathcal{G}$  is a probability measure on  $2^E$ , the set of subsets of  $E$ . A **site-percolation** is a probability measure on  $2^V$ . For any set  $X$ , we will identify  $2^X$  and  $\{0, 1\}^X$ , via the “indicator function” operator. An element of  $2^E$  or  $2^V$  will generically be denoted by  $\omega$ .

We think of a (site- or edge-)percolation as encoding a random subgraph of  $\mathcal{G}$ . In the case of an edge-percolation, an element  $\omega \in 2^E$  has an associated graph  $\mathcal{G}_\omega = (V, \omega)$ . An edge in  $\omega$  is said to be **open** while an edge in  $E \setminus \omega$  is said to be **closed**, and a path that visits only open edges is **open**. For a site-percolation, the graph associated with  $\omega \in 2^V$  is  $(V, \binom{\omega}{2} \cap E)$ . A site of

$\omega$  is said to be **open** while a site in  $V \setminus \omega$  is said to be **closed**, and a path the image of which is a subset of  $\omega$  is **open**.

From any site-percolation, one can build an edge-percolation. Let  $\psi : 2^V \rightarrow 2^E$  be the mapping defined by  $\psi(\omega) := \binom{\omega}{2} \cap E$ . Pushing forward a site-percolation by  $\psi$  gives an edge-percolation. Not every edge-percolation is obtained this way: in an edge-percolation configuration that comes from a site-percolation configuration, if two edges of a cycle of length 3 are open, then so is the third one.

In the opposite, from any edge-percolation, one can build a site-percolation, but on a different graph. Define  $\mathcal{G}^* = (V^*, E^*)$  by

$$V^* := E \quad \text{and} \quad E^* := \{\{e, e'\} \subset E : |e \cap e'| = 1\},$$

where  $|X|$  stands for the cardinality of  $X$ . Since  $2^E = 2^{V^*}$ , an edge-percolation on  $\mathcal{G}$  is a site-percolation on  $\mathcal{G}^*$ . The definition of  $E^*$  is such that the paths of length  $\ell \geq 2$  in  $\mathcal{G}$  correspond naturally to the paths of length  $\ell - 1$  in  $\mathcal{G}^*$ : map a path to the sequence of the edges it visits.

*Remark.* One can define a more general percolation model, which encompasses both site- and edge-percolations: a **percolation by sites and edges** is a probability measure on  $2^E \times 2^V$ . A path is then declared open if it visits only vertices and edges that are retained in  $(\omega, \omega') \in 2^E \times 2^V$ .

In this thesis, we focus on edge-percolation, but a lot of results adapt to site-percolation.

*Example.* Given a parameter  $p \in [0, 1]$  and a graph  $\mathcal{G} = (V, E)$ , we define **Bernoulli** percolation as

$$\mathbb{P}_p := \text{Ber}(p)^{\otimes E} = (p\delta_1 + (1-p)\delta_0)^{\otimes E}.$$

Concretely, this definition means that each edge is retained with probability  $p$ , and that this is done independently for all edges. We can also define Bernoulli site-percolation as  $\text{Ber}(p)^{\otimes V}$ . Figure 9 represents a configuration of Bernoulli percolation on a portion of the square lattice for  $p = 0,5$ .

*Remark.* In physics, as in the very first paragraphs of this introduction, percolation is sometimes understood in the restricted sense of Bernoulli percolation. This will not be the case in the remaining of this thesis.

Most of the questions Figure 9 suggests involve the notion of cluster. Given an element  $\omega$  of  $2^E$ , a **cluster** is a connected component of  $\mathcal{G}_\omega$ , i.e. an equivalence class for the relation “being connected by a path of  $\mathcal{G}_\omega$ ”. If the graph  $\mathcal{G}$  is infinite, one may be interested in studying the number of infinite clusters and their geometry.



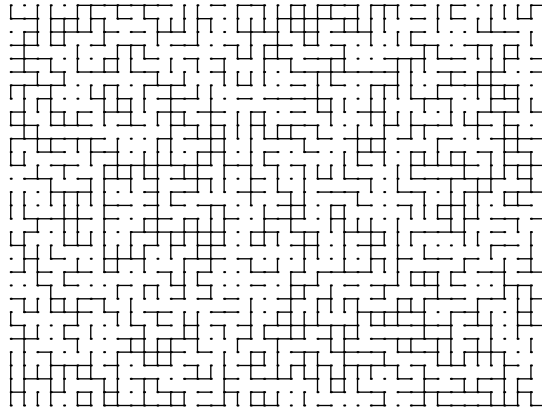

Figure 9 – Bernoulli percolation of parameter  $p = 0,5$  on a finite portion of  $\mathcal{Z}^2$ . Illustration due to Vincent Beffara.

*Another example.* Let  $\mathcal{G} = (V, E)$  be a finite graph. The **Ising model** on  $\mathcal{G}$  of inverse temperature  $\beta$  is a probability measure on  $\{-1, +1\}^V$  defined by

$$\mathbb{P}^{(\beta)}(\{\omega\}) := \frac{1}{Z^{(\beta)}} \exp \left( \beta \sum_{\{u,v\} \in E} \omega_u \omega_v \right).$$

In the formula above, the renormalization constant  $Z^{(\beta)}$  — called the “partition function” — is univocally determined by the fact that the total mass of a probability measure is 1. One can think of  $\mathbb{P}^{(\beta)}$  as a site-percolation. The Ising model is used as a model of ferromagnetism: interpret the spin  $\pm 1$  at each site as a magnetization. The more a configuration contains edges the endpoints of which have the same spin, the more it is likely — two adjacent magnets tend to align. The magnitude of this phenomenon decreases when the temperature  $T = 1/\beta$  increases; the effects of thermal fluctuations dominate more and more the influence of microscopic magnetization. When  $\beta = 0$ , this model coincides with Bernoulli site-percolation of parameter  $p = 1/2$ . When  $\beta$  goes to infinity,  $\mathbb{P}^{(\beta)}(\{v \mapsto +1\})$  and  $\mathbb{P}^{(\beta)}(\{v \mapsto -1\})$  tend to  $1/2$ . For an initiation to Ising model, one may refer to [Vel09].

Studying all types of percolations on all kinds of graphs is too ambitious a program: without hypotheses, it is difficult to say anything interesting. Indeed, even if one restricts to Bernoulli percolation, without any assumption on the graph, “anything can happen”. For instance, the number of infinite clusters can have no almost-certain value.<sup>3</sup> When the number of infinite

---

3. We will see in Section 0.3 that Bernoulli percolation of parameter 0,6 on  $\mathcal{Z}^2$  produces almost surely a unique infinite cluster, and that the probability that the origin belongs to it is a certain real number  $\theta(0,6) \in (0, 1)$ . We consider the graph built by connecting

clusters is infinite with positive probability, it is the case with probability 1 (according to Kolmogorov’s zero-one law), but the set of the parameters  $p \in [0, 1]$  satisfying this property is not always an interval.<sup>4</sup> For transitive (or homogeneous) graphs — introduced in Section 0.2 —, these two “pathologies” are excluded (by Proposition 0.4.1 and Theorem 0.4.4). In this thesis, we are interested in percolations on transitive graphs that respect the symmetries of the graph (the so-called “invariant percolations”, see Section 0.4), with a particular interest in Bernoulli percolation.

*Remark.* To study *finely* Bernoulli percolation, it is necessary to consider a *restricted* class of graphs. However, it is possible to focus on other classes than the one of transitive graphs. For example, a beautiful theorem of Lyons [Lyo90] states that the critical parameter for Bernoulli percolation on a tree is the inverse of the branching number of this tree. Without getting into details, this means that, if the graph under study is a tree, then the phase transitions for Bernoulli percolation and some biased random walk model occur at the *same* value of the parameter. Bernoulli percolation is also well understood on several random graphs: it is for example the case for the Uniform Infinite Planar Triangulation of Angel and Schramm (UIPT, see [AS03]).

### 0.1.3 A first argument

In 1894, in the first volume of *The American Mathematical Monthly*, Wood asked the following question.

QUESTION 0.1.1 (WOOD, [Woo94]). *Put as many white balls as black balls randomly in a box. What is the probability that the latter is crossed from left to right by an uninterrupted path of white balls?*

More precisely, he considered the case of a rectangular box filled with several layers of balls. Solving exactly this problem seems difficult; that is why we will work in the following framework:

- we assume the box to be rhombic, with a little angle equal to  $\pi/3$ ;

---

two copies of  $\mathcal{Z}^2$  by a unique edge connecting their origins. For Bernoulli percolation of parameter 0,6 on this graph, the probability that there is a unique infinite cluster is  $0,6 \times \theta(0,6)^2 \in (0, 1)$  while the probability to have exactly two infinite clusters is  $1 - 0,6 \times \theta(0,6)$ .

4. We assume granted the notation and results of page 51. Let  $\mathcal{G}$  be a transitive graph such that  $p_c(\mathcal{G}) < p_u(\mathcal{G}) < 1$ , for example the product of  $\mathcal{Z}$  by a regular tree of large degree. We consider  $\mathcal{T}$  the 3-regular tree where each edge has been replaced with a line of length  $\ell$  such that  $p_u(\mathcal{G})^\ell < 1/2$ . The disjoint union of  $\mathcal{G}$  and  $\mathcal{T}$  is an example of a graph such that the set of the  $p$ ’s providing infinitely many infinite clusters is not an interval. Indeed, this set lies between  $(p_c(\mathcal{G}), p_u(\mathcal{G})) \cup (p_c(\mathcal{T}), 1)$  and its closure, and the hypothesis on  $\ell$  guarantees that  $p_c(\mathcal{T}) > p_u(\mathcal{G})$ . To make this example connected, add an edge between any vertex of  $\mathcal{G}$  and any vertex of  $\mathcal{T}$ : this does not change the set of the parameters that produce infinitely many infinite clusters.

- we postulate that the balls are placed on the first layer of the box, and that they perfectly fill this layer;

- we deem all the possible configurations equiprobable.

Under these hypotheses, we will determine the exact value of the crossing probability. The argument we present here is a classical one [BR06].

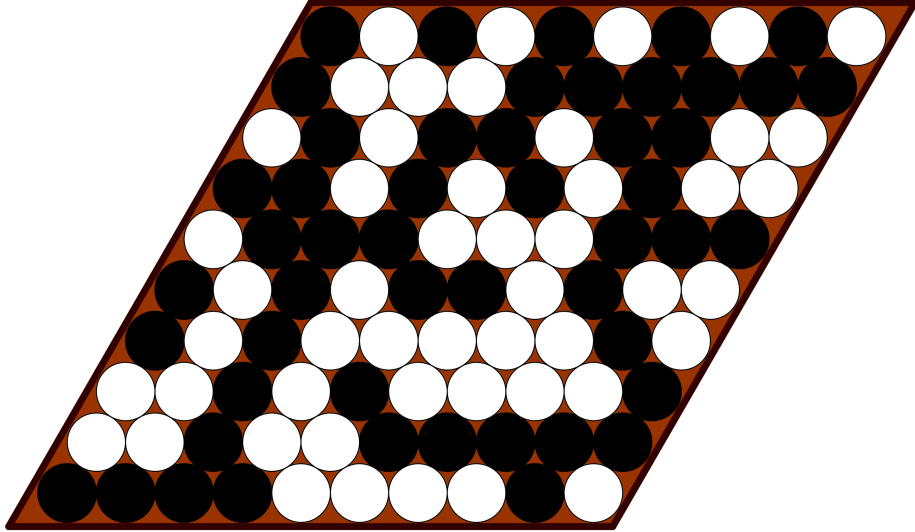

Figure 10 – A rhombic box whose first layer is filled with white and black balls, seen from above.

To each admissible configuration of balls corresponds a configuration of site-percolation on a portion of the triangular lattice, as depicted by Figure 11.

Formally, we choose an odd natural number  $k$  and consider the graph  $\mathcal{G} = (V, E)$  defined by restricting the triangular lattice to

$$V = \{m + ne^{i\pi/3} : 0 \leq m \leq k \text{ and } 0 \leq n \leq k\}.$$

The number  $k + 1$  represents the width of the box. In Figure 10 and Figure 11, this number is 9. We set

- Left :=  $\{ne^{i\pi/3} : 0 \leq n \leq k\}$ ,
- Right :=  $\{k + ne^{i\pi/3} : 0 \leq n \leq k\}$ ,
- Bottom :=  $\{m : 0 \leq m \leq k\}$ ,
- Top :=  $\{m + ke^{i\pi/3} : 0 \leq m \leq k\}$ .

Since  $k$  is odd, the number of vertices of  $\mathcal{G}$  is even. We consider the site-percolation consisting in keeping a vertex-set chosen uniformly among all those of cardinality  $\frac{|V|}{2}$ . We want to compute the probability of the following event: “there is a path that connects Left and Right, and goes exclusively through open sites”. This event is denoted by  $A$ .

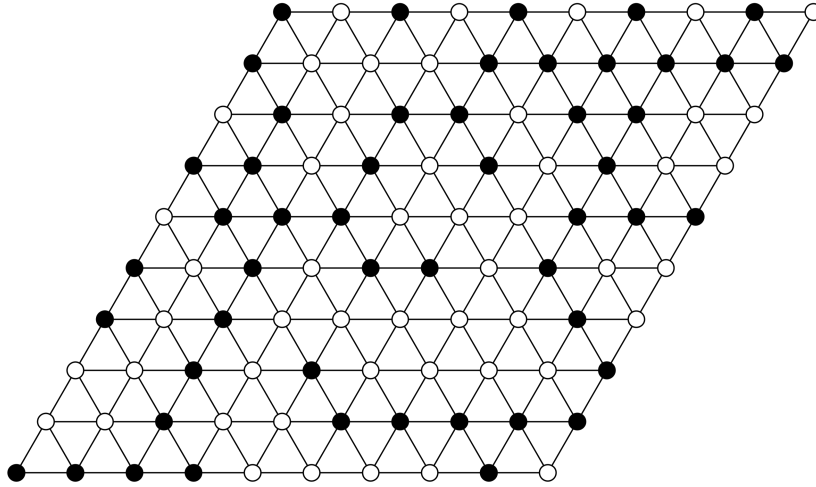

Figure 11 – The site-percolation configuration encoding the situation presented Figure 10.

It is visually intuitive that  $A$  occurs if and only if the following event (denoted by  $B$ ) does not occur: “there is a path that connects **Top** and **Bottom** and goes exclusively through closed sites”. For a rigorous proof of this fact, the reader may consult [Gal79, Hun14]. Denoting by  $\mathbb{P}$  the percolation under study, we thus have  $\mathbb{P}[A] + \mathbb{P}[B] = 1$ . It also holds that  $\mathbb{P}[A] = \mathbb{P}[B]$ .

Indeed, the reflection relative to the straight line of slope  $\tan(\pi/6) = \frac{\sqrt{3}}{3}$  passing through the origin induces a graph automorphism of  $\mathcal{G}$  that exchanges **Left** and **Bottom**, as well as **Right** and **Top**. The equality  $\mathbb{P}[A] = \mathbb{P}[B]$  then follows from the fact that the measure  $\mathbb{P}$  satisfies the following stability properties. If the distribution of  $\mathbf{w}$  is  $\mathbb{P}$ , then

- for every automorphism  $\varphi$  of  $\mathcal{G}$ , the distribution of  $\varphi(\mathbf{w})$  is  $\mathbb{P}$ ,
- the distribution of  $V \setminus \mathbf{w}$  is  $\mathbb{P}$ .

The relations  $\mathbb{P}[A] + \mathbb{P}[B] = 1$  and  $\mathbb{P}[A] = \mathbb{P}[B]$  imply that the probability we are interested in —  $\mathbb{P}[A]$  — is equal to  $1/2$ .

*Remark.* Bernoulli site-percolation of parameter  $1/2$  satisfies the two aforementioned stability properties. As a result, this percolation also gives probability  $1/2$  to the event  $A$ .

Can one apply such an argument in the context of edge-percolation? It turns out that this is the case, as we shall now see.

Let  $k$  be a positive integer. Consider the set

$$R := \{(m, n) \in \mathbb{Z}^2 : 0 \leq m \leq k \text{ and } 1 \leq n \leq k\}.$$

We endow it with a graph structure by restricting to it the one of  $\mathbb{Z}^2$ , and then removing the edges  $\{u, v\}$  such that  $u = (m, n)$  and  $v = (m', n')$  satisfy  $m = m' \in \{0, k\}$ . This graph is denoted by  $\mathcal{R}$  and depicted Figure 12

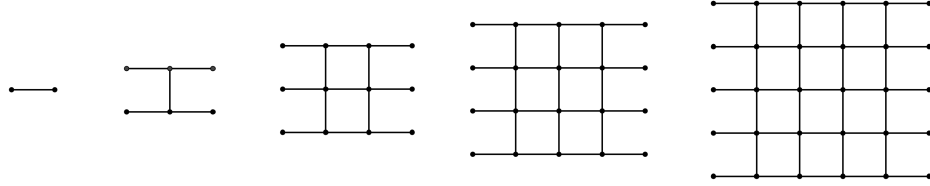

Figure 12 – The graph  $\mathcal{R}$  for  $k$  between 1 and 5.

Set  $\text{Left} := \{0\} \times \{1, \dots, k\}$  and  $\text{Right} := \{k\} \times \{1, \dots, k\}$ . Let  $A$  be the event “there is an open path connecting **Left** and **Right**”. We shall prove that, for Bernoulli site-percolation of parameter  $1/2$ , the probability of  $A$  is  $1/2$ .

To this end, we set:

- $R_{\text{dual}} := \{(m, n) \in (\mathbb{Z}^2 + (1/2, 1/2)) : 0 < m < k \text{ and } 0 < n < k + 1\}$ ,
- $\text{Bottom} := \{(m, n) \in R_{\text{dual}} : n = 1/2\}$ ,
- $\text{Top} := \{(m, n) \in R_{\text{dual}} : n = k + 1/2\}$ .

Two vertices of  $R_{\text{dual}}$  are declared to be adjacent if they satisfy the following three conditions:

- at most one of them belongs to **Bottom**,
- at most one of them belongs to **Top**,
- they differ along exactly one coordinate, and of precisely 1.

This defines a graph denoted by  $\mathcal{R}_{\text{dual}}$ . See Figure 13.

Given a configuration  $\omega$  of edge-percolation on  $\mathcal{R}$ , one can build a configuration  $\omega_{\text{dual}}$  of edge-percolation on  $\mathcal{R}_{\text{dual}}$ : if one realises the edges as segments in the plane, each edge of  $\mathcal{R}$  intersects a unique edge of  $\mathcal{R}_{\text{dual}}$ , and conversely; we declare a dual edge to be open if and only if the edge it crosses is closed. See Figure 14.

It is intuitive that the occurrence of the event  $A$  is equivalent to the non-occurrence of the event  $B$  defined as follows: “there is an  $\omega_{\text{dual}}$ -open path connecting **Top** and **Bottom**”. (For a rigorous proof of this fact, consult [BR06] or [Kes82].) As a consequence, we have  $\mathbb{P}_{1/2}[A] + \mathbb{P}_{1/2}[B] = 1$ . Moreover, the following two observations guarantee that  $\mathbb{P}_{1/2}[A] = \mathbb{P}_{1/2}[B]$ .

*Observations.* The rotation of centre  $(k/2, (k + 1)/2)$  and angle  $\pi/2$  induces an isomorphism from  $\mathcal{R}$  to  $\mathcal{R}_{\text{dual}}$  that maps **Left** onto **Bottom** and **Right** onto **Top**.

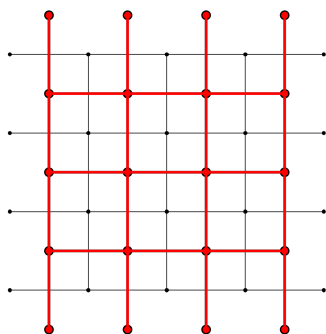

Figure 13 – The graph  $\mathcal{R}_{\text{dual}}$  for  $k = 4$ .

The operator  $\omega \mapsto \omega_{\text{dual}}$  pushes forward Bernoulli percolation of parameter  $1/2$  on  $\mathcal{R}$  to Bernoulli percolation of parameter  $1 - 1/2 = 1/2$  on  $\mathcal{R}_{\text{dual}}$ .

Once again, it results from the relations  $\mathbb{P}_{1/2}[A] + \mathbb{P}_{1/2}[B] = 1$  and  $\mathbb{P}_{1/2}[A] = \mathbb{P}_{1/2}[B]$  that  $\mathbb{P}_{1/2}[A] = \mathbb{P}_{1/2}[B] = 1/2$ .

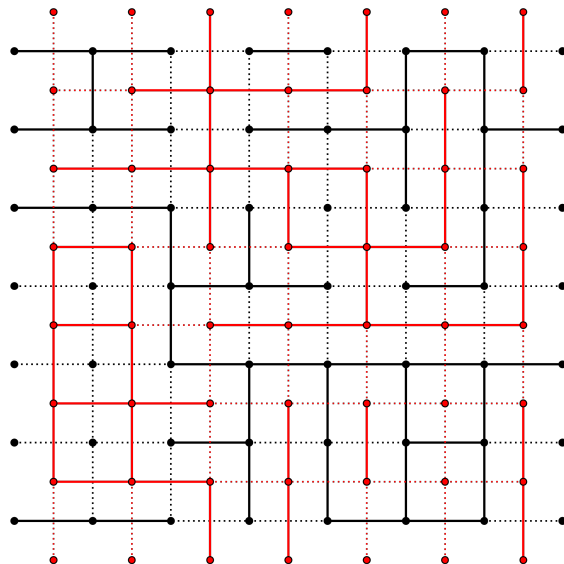

Figure 14 – A percolation configuration seen simultaneously in  $\mathcal{R}$  and  $\mathcal{R}_{\text{dual}}$ .

## 0.2 Transitive graphs

A graph is called **transitive** (or **vertex-transitive**, or **homogeneous**) if its automorphism group acts transitively on its vertex-set. Informally, a graph is transitive if “all its vertices play the same role”. Transitive graphs constitute an excellent framework for percolation theory.

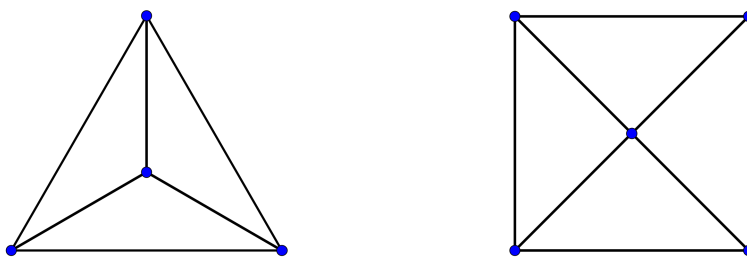

Figure 15 – The graph on the left is transitive but not the one on the right.

A particular class of transitive graphs is the one of Cayley graphs, which will provide us with our first examples.

### 0.2.1 Cayley graphs

Let  $G$  be a finitely generated group and  $S = \{s_1, \dots, s_n\}$  a finite generating subset of  $G$ . The **Cayley graph**  $\mathcal{G} = \text{Cay}(G; S) = \text{Cay}(G; s_1, \dots, s_n)$  associated with  $(G, S)$  is defined by

$$V(\mathcal{G}) = G \quad \text{and} \quad E(\mathcal{G}) = \{\{g, g'\} \subset G : g^{-1}g' \in S \cup S^{-1} \setminus \{1_G\}\}.$$

In other words, we connect  $g$  to  $gs$  by an edge for every  $g \in G$  and  $s \in S$ . This graph is connected because  $S$  generates  $G$ , and locally finite because  $S$  is finite. By associativity of the group law, the action of  $G$  on  $G = V$  by left-multiplication induces an action by graph automorphisms. This action is simply transitive, i.e. free and transitive. In fact, every (non-empty, connected, locally finite) graph on which a group acts simply transitively by graph automorphisms is a Cayley graph of this group (which is automatically finitely generated). See [Sab58].

Endowing a group with a graph structure allows us to ask geometric questions about this group. The mathematics developed in this context forms the so-called “geometric group theory”. It yields a plethora of interactions with the main body of group theory, and gives birth to new questions. This approach consisting in considering a group as a geometric *object* was

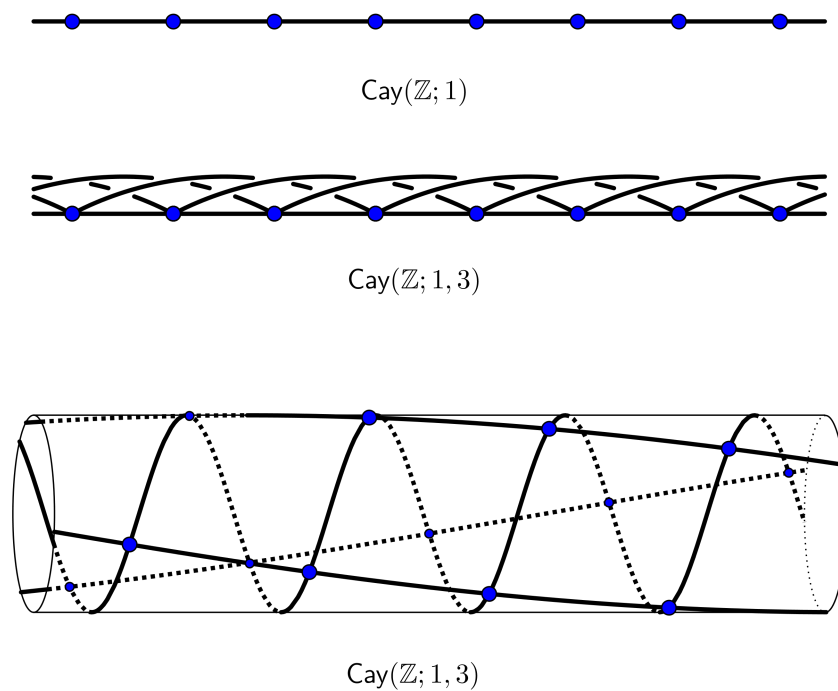

Figure 16 – Cayley graphs of  $\mathbb{Z}$ .

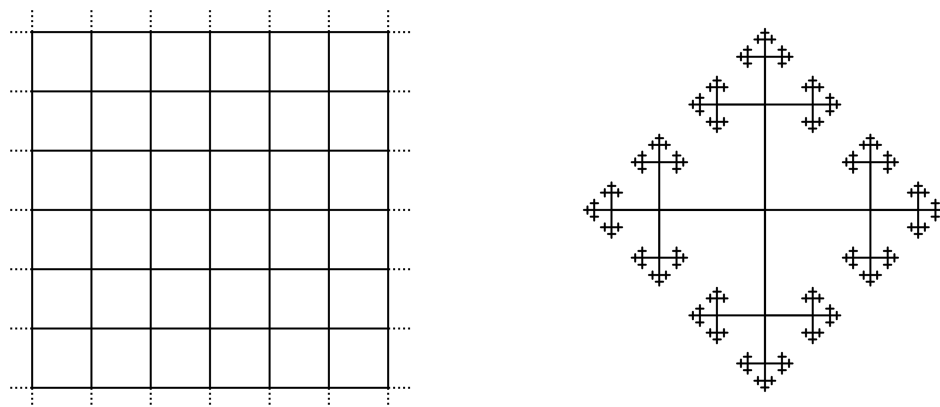
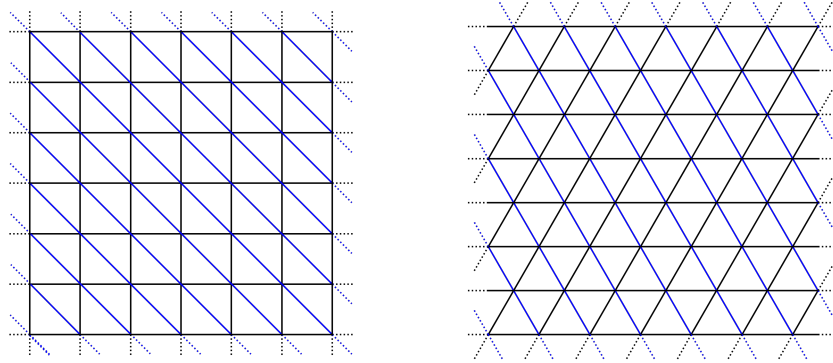

Figure 17 –  $\text{Cay}(\mathbb{Z}^2; (1, 0), (0, 1)) \simeq \mathbb{Z}^2$  and  $\text{Cay}(\langle a, b \rangle; a, b) \simeq \mathcal{T}_4$ .

known to Cayley and Dehn, and has been brought back to the front scene by Gromov [Gro81, Gro84].

The following paragraphs present concisely some geometric properties that turn out to be related to algebraic properties of groups, and to their



Figure 18 –  $\text{Cay}(\mathbb{Z}^2; (1, 0), (0, 1), (1, -1)) \simeq \mathcal{L}_\Delta$ .

actions. The interested reader may want to consult [dlH00, Gro96].

### Interactions between the geometry of a group, its algebraic properties and its actions

In order to enunciate several links between geometry and usual group theory, we need to expand our vocabulary. An **end** of a locally finite connected graph  $\mathcal{G} = (V, E)$  is a mapping  $\xi$  that sends every finite subset  $F$  of  $V$  to an infinite connected component of its complement, with the following monotonicity condition:

$$\forall F, F', F \subset F' \implies \xi(F') \subset \xi(F).$$

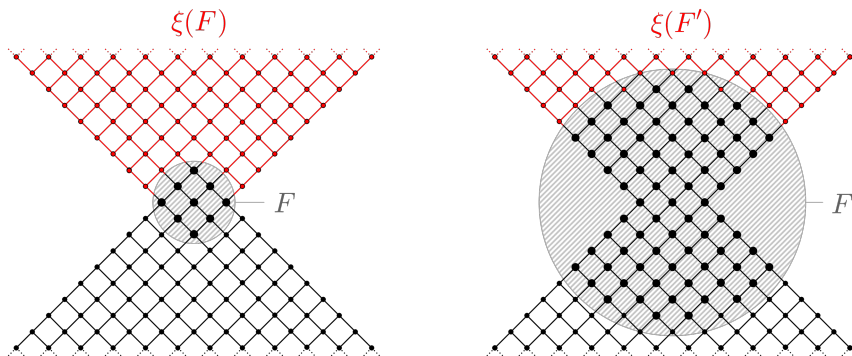
Figure 19 – Given a finite subset  $F$  of  $V$ , an end  $\xi$  selects an infinite connected component of  $V \setminus F$ .

Every end is realised by a geodesic path  $\kappa : \mathbb{N} \rightarrow V$ . This means that for

every end  $\xi$ , there is a geodesic path  $\kappa : \mathbb{N} \rightarrow V$  such that

$$\forall F, \exists n_F, \forall n \geq n_F, \kappa(n) \in \xi(F).$$

*Proof.* Finite graphs have no end: we can thus assume the considered graph to be infinite. Let  $\xi$  be an end of the graph and  $o$  one of its vertices. By local finiteness of the graph, for every  $n \in \mathbb{N}$ , the ball  $B(o, n)$  of centre  $o$  and radius  $n$  is finite. Given a natural number  $n$ , there is a vertex  $v_n$  that belongs to  $\xi(B(o, n))$ , and we denote by  $\kappa_n : \{0, \dots, d(o, v_n)\} \rightarrow V$  a geodesic path that connects  $o = \kappa_n(0)$  and  $v_n$ . Since the graph under study is locally finite, by diagonal extraction, there is a path  $\kappa : \mathbb{N} \rightarrow V$  that is the pointwise limit of a subsequence of  $(\kappa_n)$ . This path satisfies the desired properties.  $\square$

*Remark.* We can think of an end as an equivalence class of geodesic paths, two paths being declared equivalent if they realise the same end.

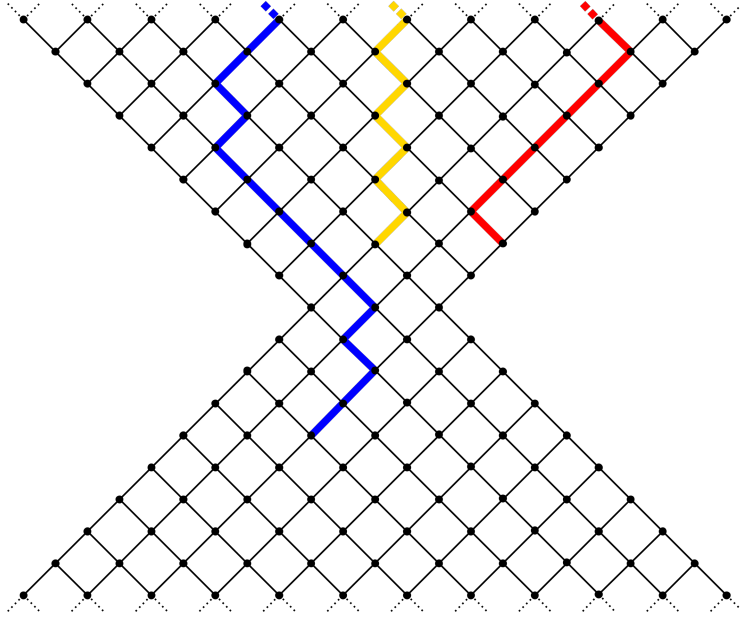

Figure 20 – The images of three geodesic paths realising the end represented on Figure 19.

The space of the ends of a graph is endowed with the prodiscrete topology, that is the topology of pointwise convergence for the discrete topology on the target space. It can be proved that every transitive graph has 0, 1, 2 or a Cantor space of ends (cf. [Hal73, Jun81]). When we say that a space **has**  $x$  **ends**, or **is**  $x$ -**ended**, we mean that its number of ends is *exactly*  $x$ .

*Examples.* The product of two infinite graphs has 1 end; in particular, this is the case of  $\mathbb{Z}^d$  as soon as  $d \geq 2$ . The graph  $\mathbb{Z}$  has 2 ends. For every

$d \geq 3$ , the  $d$ -regular tree has infinitely many ends. At last, a (connected, locally finite) graph has 0 ends if and only if it is finite.

Another notion that will prove to be useful is the one of virtuality. We say that a group **virtually** satisfies a property if it contains a finite index subgroup that satisfies this property.

**THEOREM 0.2.1 (HOPF).** *A group is virtually  $\mathbb{Z}$  if and only if one (each) of its Cayley graphs has two ends.*

A graph has **polynomial growth** if for one (every) vertex  $o$ , the cardinality of the ball of centre  $o$  and radius  $n$  is dominated by a polynomial function of  $n$ .

**THEOREM 0.2.2 (GROMOV, [GRO81, KLE10, ST10]).** *A finitely generated group is virtually nilpotent if and only if one (each) of its Cayley graphs has polynomial growth.*

Notice that, in the previous two theorems, algebraic properties only depend on the considered group whereas geometric properties depend a priori also on the generating subset used to define the Cayley graph. In fact, these geometric properties do not depend on the choice of the generating subset because, given two Cayley graphs of a same finitely generated group  $G$ , the identity of  $G$  induces a bi-Lipschitz mapping between these graphs. More precisely, if  $S$  and  $S'$  denote two finite generating subsets of  $G$  and if  $d_S$  (resp.  $d_{S'}$ ) denotes the metric induced by the graph structure  $\text{Cay}(G; S)$  (resp.  $\text{Cay}(G; S')$ ) on  $G$ , then we have the following inequality<sup>5</sup>:

$$\forall (g, g') \in G^2, d_S(g, g') \leq \max\{d_S(1, s'); s' \in S'\} \times d_{S'}(g, g').$$

The large scale geometry of a group is independent of its generating system: as well as all norms are equivalent in finite dimension, all Cayley metrics are equivalent on a finitely generated group.

One can deduce from this remark that the number of ends of a finitely generated group is well defined: it does not depend on the considered Cayley graph. We have seen that this number is necessarily 0, 1, 2 or  $\infty$ . Theorem 0.2.1 characterises algebraically the groups that have 2 ends. Groups with 0 ends are exactly the finite groups. A theorem of Stallings also characterises algebraically groups with infinitely many ends (in terms of amalgamated products, see [DK, Sta68]). The existence of a unique end being, for a group, the negation of having 0, 2 or  $\infty$  ends, every possible number of ends — geometric data — can be interpreted algebraically.

---

5. as well as, by symmetry, the inequality where  $S$  and  $S'$  are exchanged, entailing that the identity of  $G$  is bi-Lipschitz

Another important notion in geometric group theory is that of amenability. A discrete group  $G$  is said to be **amenable** if there is a finitely additive probability measure on  $(G, 2^G)$  that is invariant under left-multiplication, that is to say if there is a function  $m : 2^G \rightarrow [0, 1]$  such that:

- if  $A$  and  $B$  are disjoint subsets of  $G$ , then  $m(A \cup B) = m(A) + m(B)$ ,
- if  $A$  is a subset of  $G$  and  $g$  an element of  $G$ , then  $m(A) = m(gA)$ ,
- $m(G) = 1$ .

Finite groups are clearly amenable. As soon as  $G$  is infinite, it is impossible to prove the existence of such a finitely additive measure in set theory without the axiom of choice — see [Bla77, PS77]. However, by using the axiom of choice, one can establish that a lot of infinite groups are amenable (e.g. abelian groups). This notion was introduced by von Neumann [vN29] in order to improve our understanding of the Banach-Tarski Paradox<sup>6</sup> [BT24]: the non-amenability of a group of transformations turns out to be equivalent to the fact that this group permits the occurrence of a paradox *à la* Banach-Tarski (see Tarski’s Alternative in [dlH04]). In what follows, we will concentrate on finitely generated groups, since it is the natural framework for the study of Cayley graphs.

**THEOREM 0.2.3** (FØLNER, [FØL55]). *A finitely generated group  $G$  is amenable if and only if one (each) of its Cayley graphs  $\mathcal{G} = (V, E)$  satisfies **Følner’s condition**:*

$$\inf_{F \in V} \frac{|\partial F|}{|F|} = 0,$$

where  $F \in V$  means that  $F$  is a non-empty finite subset of  $V$  and  $\partial F$  denotes  $\{e \in E : |e \cap F| = 1\}$ , the **boundary** of  $F$ .

*Remark.* This theorem prompts us to define the **Cheeger constant** — or **isoperimetric constant** — of a graph  $\mathcal{G} = (V, E)$  of bounded degree as

$$h(\mathcal{G}) = \inf_{F \in V} \frac{|\partial F|}{|F|},$$

and to say that a graph the isoperimetric constant of which is zero is **amenable**.

*Examples.* For every  $d$ , the group  $\mathbb{Z}^d$  is amenable. Indeed, the balls of the  $d$ -dimensional hypercubic lattice have a cardinality that goes as the  $d^{\text{th}}$  power of the radius while the spheres grow in its  $(d - 1)^{\text{th}}$  power. The free group with two generators  $\mathbb{F}_2$  is not amenable. In Følner’s sense, it follows from the fact that the number of leaves of a non-empty finite tree is always at least its number of vertices of degree 3 or more, and from the fact that the infimum taken in Theorem 0.2.3 may be taken on finite non-empty *connected* subsets without breaking the equivalence. One can also show

---

6. With the axiom of choice, it is possible to decompose the unit Euclidean ball  $B$  of  $\mathbb{R}^3$  into a finite number of pieces  $A_1, \dots, A_k$  and to find a finite number of elements  $\varphi_1, \dots, \varphi_k$  of  $\text{SO}(3)$  such that the  $\varphi_i(A_i)$  partition the disjoint union of *two unit* Euclidean balls!

directly that  $\mathbb{F}_2 = \langle a, b \rangle$  admits no invariant finitely additive probability measure; if  $m$  denotes such a function and if  $A$  is the set of the elements of  $\mathbb{F}_2$  whose reduced form starts with  $a$  or  $a^{-1}$ , the following two facts lead to a contradiction:

- $2m(A) = m(A) + m(aA) \geq m(\mathbb{F}_2) = 1$ ,
- $3m(A) = m(A) + m(bA) + m(b^2A) \leq m(\mathbb{F}_2) = 1$ .

Amenability of a group can be characterised in a lot of different ways [Pie84]; here are two of them.

**THEOREM 0.2.4.** *A finitely generated group  $G$  is amenable if and only if one (each) of the following conditions is satisfied:*

- for one (each) of its Cayley graphs, the probability  $p_n$  that the simple random walk comes back to its starting point in  $n$  steps decays exponentially fast — which means that  $\limsup \frac{\log p_n}{n} < 0$  ;
- for every action of  $G$  by homeomorphisms on a non-empty compact Hausdorff space  $X$ , there is a Borel probability measure  $\mu$  on  $X$  that is invariant under the action of  $G$ .

*Remark.* Theorems 0.2.3 and 0.2.4 rest on the axiom of choice. Nevertheless, one can prove without this axiom the equivalence of Følner's condition and the exponential decay of the return probabilities (see e.g. [Woe00]).

The class of amenable discrete groups is closed under taking subgroups<sup>7</sup>, quotients and extensions (it is thus closed under direct and semidirect products). In particular, every discrete group that contains a free group with two generators is non-amenable.<sup>8</sup> The problem of Day-von Neumann consists in determining if the reciprocal holds.<sup>9</sup> In 1980, Ol'Shanskii proved that it was *not* the case [Ol'80]. Nevertheless, it is possible to formulate affirmative answers to this problem (see Tits' Alternative on page 27 and Theorem 1.2.5).

### The notion of quasi-isometry

There exists a notion of large scale geometry that is coarser than the bi-Lipschitz equivalence: the one of quasi-isometry, which — as the notion of amenability — builds a bridge between the geometry of a group and the properties of its actions.

A mapping  $\varphi$  from a metric space  $(X, d)$  to another metric space  $(X', d')$  is a **quasi-isometry** if there are two constants  $A \geq 1$  and  $B \geq 0$  such that

<sup>7</sup>. To establish this property of stability, one uses the axiom of choice. The use of this axiom can be avoided if one restricts to countable groups.

<sup>8</sup>. Usually, one establishes the Banach-Tarski Paradox by showing that  $\text{SO}(3)$  contains a free group with two generators.

<sup>9</sup>. The problem of Day-von Neumann for discrete groups is equivalent to that for finitely generated groups because a discrete group is amenable if and only if all its finitely generated subgroups are amenable.

- $\forall(x, y) \in X^2, A^{-1}d'(\varphi(x), \varphi(y)) - B \leq d(x, y) \leq Ad'(\varphi(x), \varphi(y)) + B,$
- and every point of  $X'$  is at distance at most  $B$  from a point of  $\varphi(X)$ .

If such a  $\varphi$  exists, we say that  $(X, d)$  and  $(X', d')$  are **quasi-isometric**. “Being quasi-isometric” defines an equivalence relation. Since being quasi-isometric is a condition that is more easily satisfied than being bi-Lipschitz equivalent, one can speak of the class of quasi-isometry of a finitely generated group.

Contrarily to bi-Lipschitz equivalence, the equivalence by quasi-isometry identifies a finitely generated group with its finite index subgroups.<sup>10</sup> It also allows us to identify finitely generated groups with continuous groups. For instance,  $\mathbb{Z}$  and  $\mathbb{R}$  are quasi-isometric. More generally, a lattice (or cocompact discrete subgroup) in a Lie group is always finitely generated and quasi-isometric to this Lie group. This fact, as well as others<sup>11</sup>, is contained in Theorem 0.2.5. To state it, we need to introduce a few notions.

A metric space  $(X, d)$  is **geodesic** if, for all points  $x$  and  $y$  of  $X$ , there exists an isometry  $\varphi : [0, d(x, y)] \rightarrow X$  mapping 0 to  $x$  and  $d(x, y)$  to  $y$ . A metric space is **proper** if its closed balls are compact. Finally, we say that a discrete group acting by homeomorphisms on a non-empty Hausdorff topological space acts **properly** if the mapping  $(g, x) \mapsto (g \cdot x, x)$  is proper (in the sense that the pre-image of any compact set is compact).

**THEOREM 0.2.5** ([EFR53, ŠVA55, M<sup>+</sup>68]). *Let  $X$  be a proper geodesic metric space and let  $x$  be a point of  $X$ . Let  $G$  be a group that acts by isometries on  $X$  in a proper way. Assume that the quotient  $G \backslash X$  is compact and Hausdorff. Then  $G$  is finitely generated and  $g \mapsto g \cdot x$  is a quasi-isometry.*

*Remark.* This theorem is related to the remark according to which every (non-empty, connected, locally finite) graph endowed with a simply transitive action of a group is a Cayley graph of this group (which turns out to be finitely generated). Indeed,

- geodesic metric spaces are to metric spaces what connected graphs are to metric spaces with a  $\mathbb{N}$ -valued distance;
- the properness of a metric space is a continuous analog of local finiteness in graph theory;<sup>12</sup>
- properness is a weak and continuous form of faithfulness;
- compactness of the quotient is a weak and continuous form of surjectivity.

The notion of quasi-isometry allows us not only to tackle geometric questions — i.e. questions about actions by isometries — but also problems of

---

10. It also induces other identifications between finitely generated groups: there are finitely generated groups that are quasi-isometric but not commensurable, which means that they do not contain a same group as a finite index subgroup.

11. for example, the fact that the fundamental group of a Riemannian manifold is quasi-isometric to its universal cover

12. A graph is locally finite if and only if it is proper.

topology — that is to say relative to actions by homeomorphisms.

**THEOREM 0.2.6 (GROMOV).** *Two finitely generated groups are quasi-isometric if and only if both of them admit a proper action on a same non-empty locally compact Hausdorff space such that:*

- both associated quotients are compact Hausdorff,
- and these two actions commute.

*Sketch of proof.* Assume that the two considered groups —  $G$  and  $H$  — are quasi-isometric. Denote by  $(A, B)$  a couple of real numbers such that there exists an  $(A, B)$ -quasi-isometry from  $G$  to  $H$ . Take as the locally compact space the space of the  $(A, B)$ -quasi-isometries from  $G$  to  $H$ , endowed with the topology of point-wise convergence. The group  $G$  acts naturally by pre-composition and  $H$  by post-composition. It can be checked that these actions fulfil the requirements.

Conversely, if there are such actions on a non-empty locally compact Hausdorff space  $X$ , take a compact  $K$  of  $X$  that is large enough to surject on both quotients by the canonical projections. For every  $g \in G$ , there is an element  $h(g)$  of  $H$  such that  $gK \cap h(g)K \neq \emptyset$ . This  $h(g)$  is not unique: fix it arbitrarily and check that  $g \mapsto h(g)$  is a quasi-isometry from  $G$  to  $H$ .  $\square$

### Several examples and classes of interesting groups

Apart from this conceptual understanding, we have at our disposal a list of examples and classes of groups that are pretty well understood. The first examples are free abelian groups and free groups. Their algebraic structure is well known. What about their geometric structure?

Every finitely generated abelian group is quasi-isometric to its torsion-free part, that is to a hypercubic lattice of dimension equal to the rank of this torsion-free part. This dimension is preserved by quasi-isometry, as the exponent of growth of the balls. For every  $d \geq 2$ , the free group  $\mathbb{F}_d$  can be realised as a finite index subgroup of  $\mathbb{F}_2$ : these free groups thus belong to the same quasi-isometry class. Their geometry up to quasi-isometry is that of any regular tree of valency at least 3.

Another important example is the **lamplighter group**. Think of  $\mathbb{Z}$  as a bi-infinite street and put a lamp in front of each house. The state of each lamp — “on” or “off” — is an element of  $\mathbb{Z}/2\mathbb{Z}$ . A configuration is the data of the position of the lamplighter and the states of the lamps, that is to say an element of  $\mathbb{Z} \times \prod_{\mathbb{Z}} \mathbb{Z}/2\mathbb{Z}$ . The lamplighter group  $\text{LL}(\mathbb{Z})$  is the group generated by the following two transformations:

- “the lamplighter takes a step” —  $S : (n, x) \mapsto (n + 1, x)$ ;
- “the lamplighter switches the state of the lamp where he stands” —  $T : (n, x) \mapsto (n, x + \mathbf{1}_{\{n\}})$ .

Algebraically, this group is  $\mathbb{Z} \times \bigoplus_{\mathbb{Z}} \mathbb{Z}/2\mathbb{Z}$ , the group  $\mathbb{Z}$  acting by shifting the coordinates. It is an amenable group of exponential growth; such a behaviour does not exist among free groups and free abelian groups.

A transitive graph is said to have **exponential growth** if,  $b_n$  denoting the cardinality of a ball of radius  $n$ , the limit of  $\frac{\log b_n}{n}$  is not zero; this limit exists by subadditivity and is finite because the graph has bounded degree. A group has **exponential growth** if one (hence each) of its Cayley graphs has exponential growth.

The exponential growth of  $\text{LL}(\mathbb{Z})$  results from the fact that the elements  $S$  and  $ST$  generate a free monoid. As for the amenability of  $\text{LL}(\mathbb{Z})$ , it can be established geometrically: take the  $N^{\text{th}}$  Følner set to be

$$\{(n, x) : |n| \leq N \text{ and } \forall i, |i| > N \implies x_i = 0\}.$$

The Cayley graph of  $\text{LL}(\mathbb{Z})$  relative to the generating system  $\{S, ST\}$  is the Diestel-Leader graph of parameter  $(2, 2)$ , introduced on page 31 (see [Woe05]).

Of course, there are other examples and classes of interesting groups. A remarkable class is the one of Kazhdan groups [BdLHV08]. Let  $G$  be a countable discrete group. A **unitary representation** of  $G$  is the data of a complex Hilbert space  $H$  and a group morphism from  $G$  to the group of unitary operators of  $H$ . A unitary representation  $\pi$  of  $G$  on  $H$  **admits a non-zero invariant vector** if there is  $\xi \in H \setminus \{0\}$  such that  $\forall g \in G, \pi(g)\xi = \xi$ . We say that  $\pi$  **almost admits an invariant vector** if, for every  $\epsilon > 0$  and every finite subset  $F$  of  $G$ , there is  $\xi \in H$  such that  $\forall g \in F, \|\pi(g)\xi - \xi\| < \epsilon\|\xi\|$ . The group  $G$  has **Property (T)** — or **Kazhdan's Property**, or **Kazhdan's Property (T)** — if every unitary representation of  $G$  that almost admits an invariant vector admits a non-zero invariant vector.

*A few facts.* Every finite group has Property (T).

Every quotient of a group that has Property (T) has Property (T).

Every Kazhdan discrete countable group is finitely generated.

The group  $\text{SL}_n(\mathbb{Z})$  has Property (T) if and only if  $n \geq 3$ .

**PROPOSITION 0.2.7.** *Every amenable finitely generated group that has Property (T) is finite.*

*Proof.* Let  $G$  be a finitely generated group that is amenable and has Property (T). Set  $H := \ell^2(G)$ . Let  $\pi$  be the representation defined by

$$\pi(g)f : h \mapsto f(g^{-1}h).$$

One easily deduces from Følner's condition that  $\pi$  almost has an invariant vector. Since  $G$  has Property (T), this representation admits a non-zero invariant vector  $f$ . By invariance,  $f$  is constant. Since  $f$  is constant, non-zero and in  $\ell^2(G)$ , the group  $G$  is finite.  $\square$

*Remark.* Property (T) is not geometric: this means that it is not invariant under quasi-isometry. See [BdLHV08].



Another class is the one of nilpotent groups, whose typical example is **Heisenberg's group**, constituted of the matrices of the form  $\begin{pmatrix} 1 & * & * \\ 0 & 1 & * \\ 0 & 0 & 1 \end{pmatrix}$  with integer coefficients.

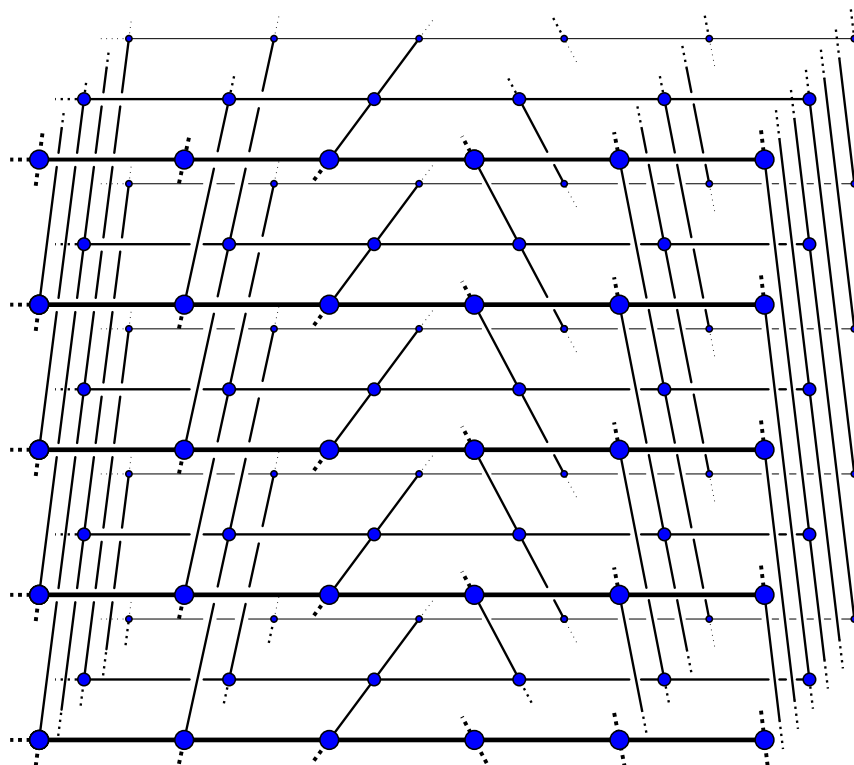

Figure 21 – A portion of the Cayley graph of Heisenberg's group relative to the generators  $\begin{pmatrix} 1 & 1 & 0 \\ 0 & 1 & 0 \\ 0 & 0 & 1 \end{pmatrix}$  and  $\begin{pmatrix} 1 & 0 & 0 \\ 0 & 1 & 1 \\ 0 & 0 & 1 \end{pmatrix}$ .

Let us also mention Gromov-hyperbolic groups [GdlH90]. Even though hyperbolicity is defined geometrically, this quality implies for the groups that enjoy it noteworthy computability properties: hyperbolic groups are automatic, so that they are finitely presented and have a solvable word problem. Finitely generated free groups — as well as, for instance, the fundamental group of the (compact, orientable) surface of genus 2 (without boundary) — are hyperbolic.

The so-called **linear groups** also form a remarkable class of groups. These are the groups that can be realised as subgroups of  $GL_n(\mathbb{K})$  for some positive integer  $n$  and some field  $\mathbb{K}$ . Tits' Alternative provides a positive

answer to the problem of Day-von Neumann (see page 22) for finitely generated linear groups: every finitely generated linear group is either virtually solvable or a group that contains  $\mathbb{F}_2$ .

At last, one can evoke the class of groups of **intermediate growth**, that is to say finitely generated groups such that the cardinality of the balls of one (hence each) of its Cayley graphs grows faster than any polynomial in  $n$  but slower than any  $\exp(\epsilon n)$ , where “faster” and “slower” are taken in the sense of the little  $o$ 's of Landau and  $n$  denotes the radius of the ball. In [Gri83], Grigorchuk built an example of a group of intermediate growth; this example is a subgroup of the automorphism group of the infinite rooted binary tree. For a detailed demonstration, consult [dlH00].

The study of finitely generated groups by restriction to interesting classes is obviously a natural approach: the more we have hypotheses at our disposal, the more we are able to prove theorems. Gromov made of this a leitmotiv, to be taken lightly: “A theorem that holds for every group is either trivial or false.” Even though it is perilous to try to formalise and prove such an assertion, one can show that it is impossible to classify finitely generated groups — see the first theorem of Section 4 in [Ghy04].

Vast though the world of finitely generated groups may be, it does not fully cover that of transitive graphs. The remaining of Section 0.2 is devoted to explore this territory beyond Cayley graphs.

### 0.2.2 Unimodularity and the Mass Transport Principle

Let  $\mathcal{G} = (V, E)$  be a transitive graph and  $o$  any vertex of  $\mathcal{G}$ . Let  $G$  be a subgroup of the automorphism group of  $\mathcal{G}$  that acts transitively on  $V$ . We say that the couple  $(\mathcal{G}, G)$  satisfies the **Mass Transport Principle** if, for every function  $f : V \times V \rightarrow [0, +\infty]$  that is invariant under the diagonal<sup>13</sup> action of  $G$ , the following equality holds:

$$\sum_{v \in V} f(o, v) = \sum_{v \in V} f(v, o).$$

The fact that this equality holds does not depend on the choice of  $o$  by invariance of the function  $f$  under consideration and by transitivity of the action of  $G$  on  $\mathcal{G}$ .

We think of  $f(u, v)$  as the mass sent by the vertex  $u$  to the vertex  $v$ . The Mass Transport Principle states that if the procedure governing how the mass is sent is  $G$ -invariant, the origin  $o$  receives as much mass as it sends. This principle constitutes a powerful tool in percolation theory [Hag97, BLPS99b], as testified by Section 0.4.

---

13. This means that, for every  $g \in G$  and every couple of vertices  $(u, v)$ , we have  $f(g \cdot u, g \cdot v) = f(u, v)$ .

This principle can also be phrased using the vocabulary of locally compact groups. A **locally compact group** is a Hausdorff topological group<sup>14</sup> the topology of which is locally compact. The automorphism group of  $\mathcal{G}$ , denoted by  $\text{Aut}(\mathcal{G})$ , can be seen as a subset of  $V^V$ ; we endow it with the topology induced by the prodiscrete topology — i.e. the product of discrete topologies. This makes of  $\text{Aut}(\mathcal{G})$  a Hausdorff topological group. This group is locally compact because  $\mathcal{G}$  is tacitly taken connected and locally finite. Indeed, if  $g \in G$ , then the set  $\{h \in G : h \cdot o = g \cdot o\}$  is a neighbourhood of  $g$ ; it is compact because it is a closed subset of the compact set  $\prod_{v \in V} B(g \cdot o, d(o, v))$ . It follows from the local compactness of  $\text{Aut}(\mathcal{G})$  that every closed subgroup of  $\text{Aut}(\mathcal{G})$  is locally compact.

Given a locally compact group  $G$ , there is, up to multiplication by a positive real number, a unique non-zero Radon measure on  $G$  that is invariant under left-multiplication — i.e. such that, for every  $g \in G$ , the map  $h \mapsto gh$  preserves the measure (see [Car40]). Any of these measures is called a **Haar measure**. Let  $\mu$  be such a measure. For every  $g \in G$ , the measure  $\mu_g : A \mapsto \mu(Ag)$  is invariant by left-multiplication. It can thus be written, in a unique way, in the form  $m(g)\mu$ . The function  $m$  is called the **modular function**. It does not depend on the choice of  $\mu$ . If the modular function takes only the value 1, we say that the topological group  $G$  is **unimodular**: this amounts to saying that the group  $G$  admits a non-zero Radon measure that is invariant under left- and right-multiplication.

**PROPOSITION 0.2.8** ([BLPS99B, SCH79, TRO85]). *Let  $G$  be a closed subgroup of  $\text{Aut}(\mathcal{G})$  that acts transitively on  $V$ . The following assertions are equivalent:*

- the couple  $(\mathcal{G}, G)$  satisfies the Mass Transport Principle;
- the group  $G$  is unimodular;
- for every couple of vertices  $(u, v)$ , the sets  $\text{Stab}_G(u) \cdot v$  and  $\text{Stab}_G(v) \cdot u$  have the same cardinality.

**PROPOSITION 0.2.9.** *If  $\mathcal{G}$  is a Cayley graph of  $G$ , then  $(\mathcal{G}, G)$  satisfies the Mass Transport Principle.*

*Proof.* Let  $f : V \times V \rightarrow [0, +\infty]$  be a  $G$ -invariant function. Then

$$\sum_{v \in V} f(o, v) = \sum_{g \in G} f(o, g \cdot o) = \sum_{g \in G} f(g^{-1} \cdot o, o) = \sum_{g \in G} f(g \cdot o, o) = \sum_{v \in V} f(v, o).$$

□

*Remark.* To establish Proposition 0.2.9, it would have been equally easy to check that  $G$  is unimodular: this group is discrete, so that the counting measure is left- and right-invariant; it also fulfils the other requirements.

---

<sup>14</sup> A topological group is a group endowed with a topology such that  $(g, h) \mapsto gh^{-1}$  is continuous.

A transitive graph  $\mathcal{G}$  is said to be **unimodular** if  $(\mathcal{G}, \text{Aut}(\mathcal{G}))$  satisfies the Mass Transport Principle. Cayley graphs are unimodular, according to the previous proposition and because if  $G$  is a subgroup of  $H$ , then the Mass Transport Principle for  $(\mathcal{G}, G)$  implies the Mass Transport Principle for  $(\mathcal{G}, H)$ . It turns out that if  $G$  and  $H$  are two closed subgroups of  $\text{Aut}(\mathcal{G})$  that act transitively on  $V(\mathcal{G})$ , then  $(\mathcal{G}, G)$  satisfies the Mass Transport Principle if and only if  $(\mathcal{G}, H)$  satisfies it. The proof of this fact uses the theory of invariant percolations [BLPS99b].

There are other unimodular transitive graphs than Cayley graphs: for instance, amenable transitive graphs are unimodular [SW90]. An example of an amenable transitive graph that is not a Cayley graph is the Petersen graph, a graph with ten vertices depicted Figure 22.

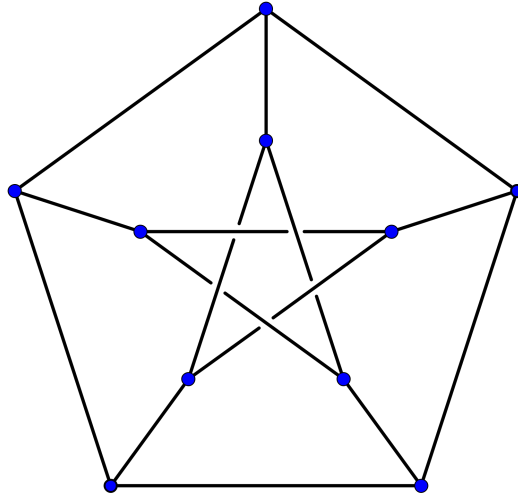

Figure 22 – The Petersen graph.

We now present an example of a couple  $(\mathcal{G}, G)$  that does *not* satisfy the Mass Transport Principle. Let  $d \geq 3$ . Let  $\xi$  be an end of the  $d$ -regular tree  $\mathcal{T}_d$ . The group  $\text{Aut}(\mathcal{T}_d)$  acts on the ends of  $\mathcal{T}_d$ . Denote by  $G_\xi$  the  $G$ -stabilizer of  $\xi$ . The group  $G_\xi$  acts transitively on the vertices of  $\mathcal{T}_d$ .

**PROPOSITION 0.2.10.** *The couple  $(\mathcal{T}_d, G_\xi)$  described above does not satisfy the Mass Transport Principle.*

*Proof.* Send mass 1 from  $u$  to  $v$  if  $v$  is a neighbour of  $u$  such that  $v \notin \xi(\{u\})$  and mass 0 otherwise. The origin receives mass 1 but sends mass  $d - 1 \geq 2$ .  $\square$

*Remark.* The tree  $\mathcal{T}_d$  is unimodular: it is a Cayley graph of the free product of  $d$  copies of  $\mathbb{Z}/2\mathbb{Z}$ . It results from this and Proposition 0.2.10 that  $G_\xi$  is not a closed subgroup of  $\text{Aut}(\mathcal{T}_d)$ .

To obtain an example of a non-unimodular *graph* from Proposition 0.2.10, we add certain edges to  $\mathcal{T}_d$ . Given two vertices  $u$  and  $v$  of  $\mathcal{T}_d$ , we say that  $u$  is the father of  $v$  if  $f(u, v) = 1$  in the mass transport of the previous demonstration. Every vertex of  $\mathcal{T}_d$  has a unique father. The graph  $\mathcal{T}_d^\xi$  is defined as follows:

- the vertex-set of  $\mathcal{T}_d^\xi$  is that of  $\mathcal{T}_d$ ;
- two vertices of  $\mathcal{T}_d^\xi$  are connected by an edge if and only if either it is the case in  $\mathcal{T}_d$  or one of them is the father of the father of the other.

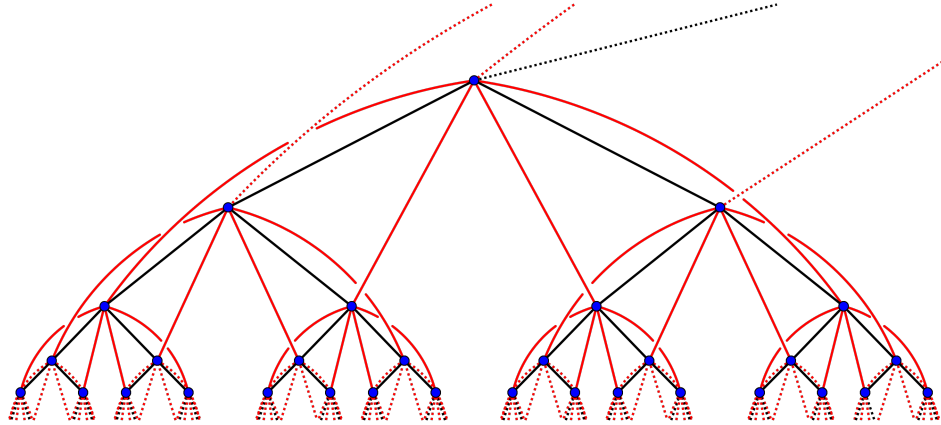

Figure 23 – A portion of the grand-parents graph with 2 children.

This graph is called the **grand-parents graph** with  $d-1$  children. The group  $G_\xi$  acts on the vertices of  $\mathcal{T}_d^\xi$  because the function  $f$  used to define the notion of fatherhood is  $G_\xi$ -invariant. This action is transitive because  $G_\xi$  acts transitively on  $\mathcal{T}_d$ . In fact, we even have the following proposition.

**PROPOSITION 0.2.11.** *The group  $G_\xi$  is exactly the automorphism group of the graph  $\mathcal{T}_d^\xi$ .*

*Proof.* We have seen that  $G_\xi$  is a subgroup of  $\text{Aut}(\mathcal{T}_d^\xi)$ . Let us show that every automorphism of  $\mathcal{T}_d^\xi$  preserves the graph structure of  $\mathcal{T}_d$  and the end  $\xi$ . The first point results from the fact that two adjacent vertices of  $\mathcal{T}_d^\xi$  are neighbours in  $\mathcal{T}_d$  if and only if there are  $d+1$  paths of length 2 that connect them in  $\mathcal{T}_d^\xi$ . As for the second point, it follows from the fact that the notion of fatherhood suffices to recover the end  $\xi$ , and the fact that  $u$  is the father of  $v$  if and only if “ $u$  and  $v$  are neighbours in  $\mathcal{T}_d$  and  $u$  has a unique  $\mathcal{T}_d$ -neighbour that is adjacent to  $v$  in  $\mathcal{T}_d^\xi$ ”.  $\square$

We deduce from Proposition 0.2.10 and Proposition 0.2.11 that the grand-parents graph with  $d-1$  children is not unimodular. In particular, it is not a Cayley graph.

*Remark.* Being unimodular (or a Cayley graph) is not preserved by bi-Lipschitz equivalence in the class of transitive graphs: compare any Cayley

graph of  $\mathbb{Z}/2\mathbb{Z} \star \mathbb{Z}/2\mathbb{Z} \star \mathbb{Z}/2\mathbb{Z}$  with the grand-parents graph with 2 children. We do not know if every unimodular transitive graph is quasi-isometric to a Cayley graph. However, we know that there are transitive graphs that are not quasi-isometric to a Cayley graph [EFW12].

As well as grand-parents graphs, Diestel-Leader graphs are important examples of transitive graphs. Given two integers  $m$  and  $n$  greater than or equal to 2, we build the **Diestel-Leader graph** of parameters  $m$  and  $n$  — denoted by  $\mathcal{DL}(m, n)$  — as follows. Let  $\xi$  be an end of  $\mathcal{T}_{m+1}$  and  $\chi$  an end of  $\mathcal{T}_{n+1}$ . Let  $o$  be any vertex of  $\mathcal{T}_{m+1}$  and  $o'$  any vertex of  $\mathcal{T}_{n+1}$ . Let us define the following “generation functions”:

- $f$  is the unique function from the vertices of  $\mathcal{T}_{m+1}$  to  $\mathbb{Z}$  such that  $f(o) = 0$  and “ $u'$  is the  $\xi$ -father of  $u \implies f(u) = f(u') + 1$ ”;
- $g$  is the unique function from the vertices of  $\mathcal{T}_{n+1}$  to  $\mathbb{Z}$  such that  $g(o') = 0$  and “ $v'$  is the  $\chi$ -father of  $v \implies g(v) = g(v') + 1$ ”.

The vertex-set of  $\mathcal{DL}(m, n)$  is

$$\{(u, v) \in \mathcal{T}_{m+1} \times \mathcal{T}_{n+1} : f(u) + g(v) = 0\}.$$

Two vertices  $(u, v)$  and  $(u', v')$  are connected by an edge if and only if  $u$  is adjacent to  $u'$  in  $\mathcal{T}_{m+1}$  and  $v$  is adjacent to  $v'$  in  $\mathcal{T}_{n+1}$ . Up to isomorphism, this graph does not depend on the choice of  $(o, o', \xi, \chi)$ . This graph is connected and transitive.

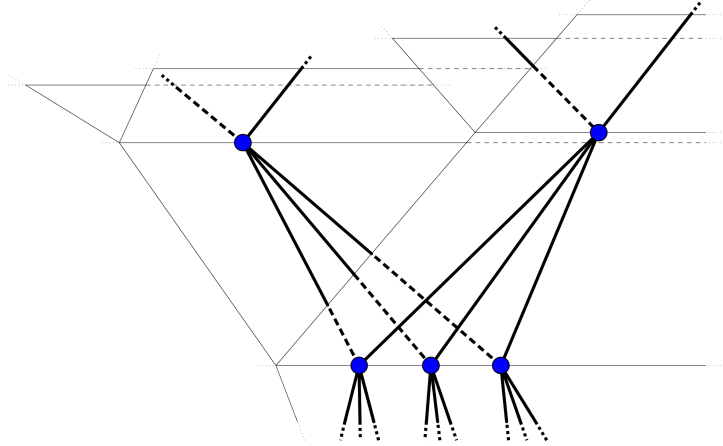

Figure 24 – A finite portion of  $\mathcal{DL}(2, 3)$ .

**PROPOSITION 0.2.12.** *The graph  $\mathcal{DL}(m, n)$  is unimodular if and only if  $m$  is equal to  $n$ .*

*Proof.* To begin with, assume that  $m = n$ . The graph  $\mathcal{DL}(n, n)$  is a Cayley graph of  $\mathbb{Z} \times \bigoplus_{\mathbb{Z}} \mathbb{Z}/n\mathbb{Z}$ , where the group  $\mathbb{Z}$  acts by shifting the coordinates. The generating system is  $\{ST_a; a \in \mathbb{Z}/n\mathbb{Z}\}$ , where

- $S = 1 \in \mathbb{Z} \subset \mathbb{Z} \times \bigoplus_{\mathbb{Z}} \mathbb{Z}/n\mathbb{Z}$ ,
- $T_a$  is the element of  $\bigoplus_{\mathbb{Z}} \mathbb{Z}/n\mathbb{Z} \subset \mathbb{Z} \times \bigoplus_{\mathbb{Z}} \mathbb{Z}/n\mathbb{Z}$  that maps 0 to  $a$  and everything else to 0.

For details, see [Woe05].

Now, assume that  $m$  is different from  $n$ . Let  $(u, v)$  and  $(u', v')$  be two adjacent vertices of  $\mathcal{DL}(m, n)$ . Consider the graph obtained by restriction of  $\mathcal{DL}(m, n)$  to the complement of  $\{(u', v')\}$ . What is the value of the number  $N(u, v, u', v')$  of neighbours of  $(u', v')$  that are in the connected component of  $(u, v)$ ? Using the fact that  $m$  and  $n$  are at least 2, one can show that

- if  $f(u) = f(u') + 1$ , then  $N(u, v, u', v') = m$ ,
- if  $f(u) = f(u') - 1$ , then  $N(u, v, u', v') = n$ .

Since  $m \neq n$ , it results from this that the diagonal action of  $\text{Aut}(\mathcal{DL}(m, n))$  on the couples of vertices preserves the function

$$\Phi : ((u, v), (u', v')) \mapsto f(u) - f(u').$$

In other words, as soon as  $\min(m, n) \geq 2$  and  $m \neq n$ , an automorphism of  $\mathcal{DL}(m, n)$  can only shift the generations. Consider the following mass transport:  $(u, v)$  sends mass 1 to  $(u', v')$  if these vertices are adjacent and satisfy  $\Phi((u, v), (u', v')) = 1$ ; otherwise, no mass is sent. This function is invariant under the diagonal action of  $\text{Aut}(\mathcal{DL}(m, n))$ . The origin receives mass  $m$  and sends mass  $n \neq m$ , which implies the non-unimodularity of  $\mathcal{DL}(m, n)$ .  $\square$

From a structural point of view, the class of unimodular transitive graphs is closed under direct product. The class of non-unimodular transitive graphs also enjoys certain properties of stability by (direct or free) product: see [Tim06]. This reference also presents an interesting “auto-similar” non-unimodular transitive graph.

### 0.2.3 Rotarily transitive graphs

Thinking of the action of  $\mathbb{Z}^2$  on one of its Cayley graphs, one naturally qualifies the action of a finitely generated group on one of its Cayley graphs of action by *translation*; these actions are free. In the opposite, for certain transitive actions, every element of the group acts with at least one fixed point: this is the case of the action of  $\text{SO}(3)$  by *rotation* on the sphere  $\mathbb{S}^2$ . It is legitimate to wonder whether this phenomenon is possible in graph theory. We thus introduce the following definition: a group  $G$  acting on a set is said to act **rotationally transitively** if this action is transitive and such that every element of  $G$  acts with at least one fixed point. If  $\mathcal{G}$  is a graph such that  $\text{Aut}(\mathcal{G})$  acts rotationally transitively on  $\mathcal{G}$ , we will say that the graph  $\mathcal{G}$  is **rotationally transitive**. These graphs cannot be Cayley graphs. But...

QUESTION 0.2.13. *Is there a rotationally transitive graph with at least two vertices?*

QUESTION 0.2.14. *Is there a rotationally transitive action of a group on a graph with at least two vertices?*

If  $\mathcal{G}$  is a finite graph with at least two vertices, then no group can act on it in a rotationally transitive way.

*Proof.* Since  $\text{Aut}(\mathcal{G})$  is finite, we may assume that the group  $G$  that acts is finite. Assume that  $G$  acts transitively on  $\mathcal{G}$ . According to Burnside's formula, the average number of fixed points for a uniformly chosen element of  $G$  is equal to 1. It results from this and the fact that the identity has at least 2 fixed points that  $G$  has an element without any fixed points.  $\square$

On the contrary, it is easy to build a rotationally transitive graph that is *not* locally finite (which does not fit in the framework defined on page 8). To do so, we start with our first example of a rotationally transitive action:  $\text{SO}(3) \curvearrowright \mathbb{S}^2$ . Endow  $\mathbb{S}^2$  with its round metric. Every isometry<sup>15</sup> of  $\mathbb{S}^2$  comes from an element of  $\text{O}(3)$ . Unfortunately, this group does not act rotationally transitively on  $\mathbb{S}^2$ , because of  $-\text{id}$ . Quotienting out by  $-\text{id}$ , we obtain the real projective plane  $\mathbb{RP}^2$  endowed with a Riemannian metric. Its isometry group acts rotationally transitively on it, because every isometry of  $\mathbb{RP}^2$  comes from an element  $\text{O}(3)$  — which acts rotationally transitively on  $\mathbb{RP}^2$ . Given a parameter  $a \in \mathbb{R}$ , we build the following graph: the vertex-set is  $\mathbb{RP}^2$  and two vertices are connected if and only if their Riemannian distance is exactly  $a$ . For suitable values of  $a$ , every graph automorphism of  $\mathbb{RP}^2$  is an isometry of  $\mathbb{RP}^2$  in the sense of the metric induced by the Riemannian structure — the converse is immediate and independent of the value of  $a$ . As a consequence, outside the world of locally finite graphs, we have an example of a rotationally transitive graph.

In the framework of infinite locally finite graphs, questions 0.2.13 and 0.2.14 are — to my knowledge — open.

### 0.3 A short survey of Bernoulli percolation

This section presents most of the main results of the theory of Bernoulli percolation. It is my interest in this model that has prompted me to study other percolations, in particular abstract invariant percolations (see Section 0.4). Of course, there are other percolations that are studied for their own sake: the Ising model [Vel09], the random cluster model [Gri06], the uniform/minimal spanning forests [LP], and the Divide and Color model [Häg01]; they will not be considered here.

Bernoulli percolation was introduced in Section 0.1.2.

Given a graph  $\mathcal{G} = (V, E)$  and a vertex  $o$  of  $\mathcal{G}$ , we define the function  $\theta : p \mapsto \mathbb{P}_p[o \leftrightarrow \infty]$ , where  $\mathbb{P}_p$  denotes the measure  $\text{Ber}(p)^{\otimes E}$  on  $2^E$  and

---

15. In this paragraph, the word “isometry” is taken in the metric sense, for the distance provided by the Riemannian structure.



$o \leftrightarrow \infty$  the event “the cluster of  $o$  is infinite”. An analogous definition can be formulated for Bernoulli site-percolation. Notice that if  $\mathcal{G}$  is transitive, then  $\theta$  does not depend on the choice of  $o$ .

Let  $(U_e)_{e \in E}$  be a sequence of independent random variables uniformly distributed on  $[0, 1]$ . For  $p \in [0, 1]$ , an edge  $e$  is declared to be  $p$ -open if  $U_e < p$ . For every  $p$ , the set of the  $p$ -open edges forms a Bernoulli percolation of parameter  $p$ . The randomness being frozen, if  $p < q$ , then the  $q$ -cluster of a vertex contains its  $p$ -cluster; in particular, the former is infinite as soon as the latter is. Hence  $\theta$  is non-decreasing.

An argument consisting in realising several processes — in this case, Bernoulli percolations of different parameters — in the same probability space is called a **coupling** argument. This particular coupling is called the **standard coupling**.

Since  $\theta$  is non-decreasing, there is a unique real number  $p_c \in [0, 1]$  such that:

- for every  $p < p_c$ ,  $\theta(p) = 0$ ;
- for every  $p > p_c$ ,  $\theta(p) > 0$ .

This real number  $p_c$  is called the **critical parameter** (or **critical probability**, or again **critical point**) of the graph  $\mathcal{G}$  for Bernoulli percolation. We will see that these objects —  $\theta$  and  $p_c$  — suffice to formulate most of the important questions in the field.

Theorems about Bernoulli percolation split into two categories: the one where the graph under study discretises the Euclidean plane and the others. For a detailed presentation of Bernoulli percolation on the discretizations of the Euclidean plane and on  $\mathcal{Z}^d$ , the reader is referred to [BR06, Gri99, Kes82, Wer09]. For more general graphs, one may consult [Ben13, LP, Pet13].

### 0.3.0 Planar graphs

Given a graph  $\mathcal{G} = (V, E)$ , one can build a topological space, called its **skeleton** or its **CW-complex**. Intuitively, it is the space obtained by considering each edge as a segment joining its endpoints. To define rigorously the skeleton, we set

$$X := V \times \{-1\} \cup \{(u, v) \in V^2 : \{u, v\} \in E\} \times [0, 1].$$

Endow  $X$  with the product of the prodiscrete topology and the usual topology of  $\mathbb{R}$ . Let  $\sim$  be the equivalence relation generated by “for every  $(u, v) \in V^2$  that satisfies  $\{u, v\} \in E$ :

- $(u, -1) \sim ((u, v), 0)$ ,
- $\forall t \in [0, 1], ((u, v), t) \sim ((v, u), 1 - t)$ ”.

The skeleton of  $\mathcal{G}$  is the space  $X/\sim$  endowed with the quotient topology.

*Remark.* A graph is locally finite if and only if its skeleton is locally compact. A graph is connected if and only if its skeleton is connected.

An **embedding** of a graph in a topological space is an embedding of its skeleton in this space. Recall that an embedding of a topological space  $X$  in another topological space  $Y$  is a continuous mapping from  $X$  to  $Y$  that induces a homeomorphism from  $X$  to  $f(X)$ . A graph is said to be **planar** if it admits a proper embedding in the plane  $\mathbb{R}^2$ . A **graph embedded in the plane** is the data of a graph all the vertices of which have degree at least 3 and of a proper embedding of it in the plane.

Given an infinite graph  $\mathcal{G}$  embedded in the plane, one defines its **dual graph** as follows. The image of the embedding disconnects the plane into connected components homeomorphic to an open disc. These components are called the **faces** of the embedded graph. They constitute the vertex-set of  $\mathcal{G}_{\text{dual}}$ . Two distinct faces are declared to be adjacent if there is an edge that borders them both, that is to say if there is an edge the image of which by the embedding is contained in the intersection of the boundaries of the considered faces. The edges of  $\mathcal{G}_{\text{dual}}$  naturally correspond to those of  $\mathcal{G}$ . The graph  $\mathcal{G}_{\text{dual}}$  may not be locally finite, but all its vertices necessarily have degree at least 3.

*Examples.* The **hexagonal lattice** is the dual of the triangular lattice embedded in the plane by realising its edges by segments (see Figure 25). The square lattice embedded as indicated on Figure 26 is isomorphic to its dual graph.

*Remarks.* When the dual graph is locally finite, it can be embedded in the plane in a way that is canonic up to homeomorphisms of the plane. The class of embeddings of  $\mathcal{G}_{\text{dual}}$  depends only on the class of embeddings of  $\mathcal{G}$ . The procedure of taking the dual graph is involutive on the classes of embeddings such that  $\mathcal{G}_{\text{dual}}$  is locally finite, hence the name “duality”.

If one is interested in *finite* graphs, possible boundary conditions call for different definitions. The construction of  $\mathcal{R}_{\text{dual}}$  presented on page 14 illustrates this. Also, notice that in the case of finite graphs, there is exactly one “face” that is unbounded, and that it is homeomorphic to a punctured plane.

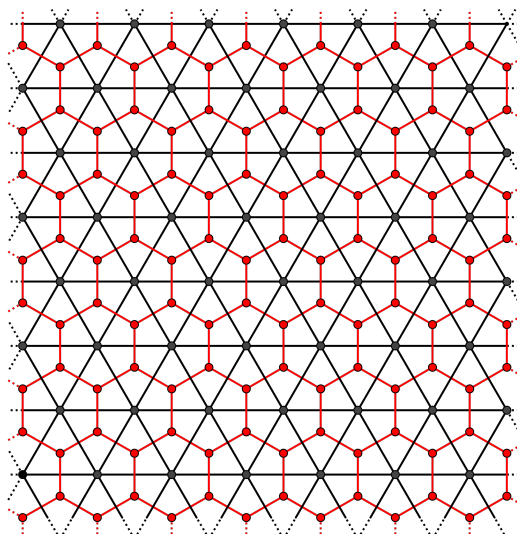

Figure 25 – The hexagonal lattice is the dual of the triangular lattice.

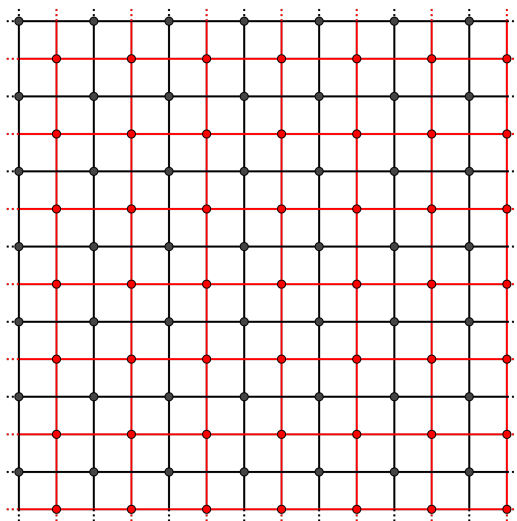

Figure 26 – The square lattice is isomorphic to its dual graph.

### 0.3.1 Discretising the Euclidean plane

The self-duality argument of Section 0.1.3 suggests that the parameter  $p = 1/2$  plays a particular role when it comes to studying Bernoulli edge-percolation on the square lattice. It turns out that the critical parameter of this graph is equal to  $1/2$ ; this is not an easy theorem. Likewise, the critical parameter of Bernoulli site-percolation on the triangular lattice or the UIPT is  $1/2$ . See [Kes80, Ang03].

By using more sophisticated duality arguments, one can show that, for Bernoulli edge-percolation

- on the triangular lattice,  $p_c = 2 \sin(\pi/18)$ ,
- on the hexagonal lattice,  $p_c = 1 - 2 \sin(\pi/18)$ ,
- on the bow-tie lattice, the critical parameter is the unique root of the polynomial  $1 - X - 6X^2 + 6X^3 - X^5$  that belongs to  $[0, 1]$ .

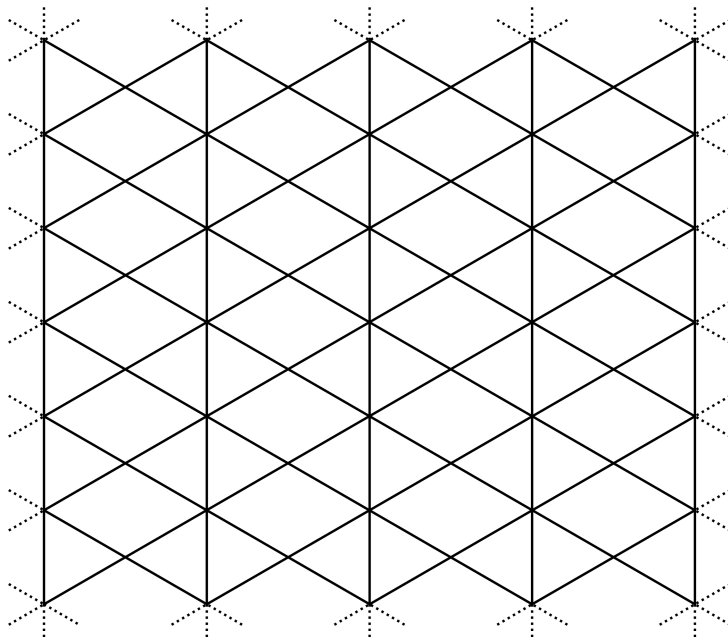

Figure 27 – A finite portion of the bow-tie lattice.

The following theorem is also worth mentioning (see [BR06]).

**THEOREM 0.3.1.** *Let  $\mathcal{G}$  be an infinite graph embedded in the Euclidean plane  $\mathbb{R}^2$ . Assume that the image of the embedding is left invariant by two independent translations of the plane, as well as by  $x \mapsto -x$ . Then, the graph  $\mathcal{G}_{\text{dual}}$  is locally finite and the following relation holds:  $p_c(\mathcal{G}) + p_c(\mathcal{G}_{\text{dual}}) = 1$ .*

On all of these graphs, it is known that  $\theta(p_c) = 0$  — see [Har60, Ang03].

In the case of the site-percolation on the triangular lattice, strong links with complex analysis enable us to understand the fractal properties of Bernoulli percolation at the critical point. These links are conjectured to hold for critical Bernoulli edge-percolation on the square lattice. To transform these conjectures into theorems is a major open problem in the field.

Theorem 0.3.2 is a result of conformal invariance that is representative of this domain. Stating it requires some notation.

NOTATION. Let  $C_1$  and  $C_2$  denote two polygonal Jordan curves in the real plane (which will be identified with the complex line). Each of them borders a unique bounded simply connected domain; these domains are denoted by  $D_1$  and  $D_2$ . Let  $a_1, b_1, c_1$  and  $d_1$  be four distinct points of  $C_1$ , ordered counterclockwise. Let  $a_2, b_2$  and  $c_2$  be three distinct points of  $C_2$ , also ordered counterclockwise. It follows from Riemann's Uniformization Theorem that there is a unique biholomorphism  $f$  from  $D_1$  to  $D_2$  that extends continuously to the boundary in such a way that  $a_1, b_1$  and  $c_1$  are respectively mapped to  $a_2, b_2$  and  $c_2$ . Set  $d_2 := f(d_1)$ . Given a positive real number  $\delta$ , define the graph  $\mathcal{G}_i^\delta$  as the largest connected component of the following graph:

$$V_i^\delta := \{z \in D_i : z/\delta \in \mathbb{Z}[e^{i\pi/3}]\} \quad \text{and} \quad E_i^\delta := \{\{z, z'\} \subset V_i^\delta : |z - z'| = \delta\}.$$

This component is unique as soon as  $\delta$  is taken small enough.

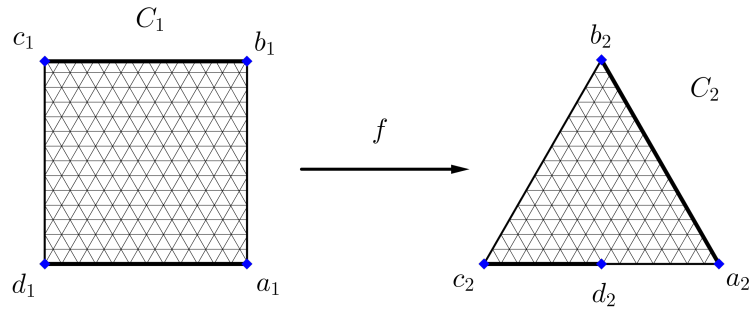

Figure 28 – Visual representation of the notation used in Theorem 0.3.2.

THEOREM 0.3.2 (SMIRNOV, [SMI01]). *For Bernoulli site-percolation on  $\mathcal{G}_i^\delta$  and of parameter  $1/2$ , consider the probability that there is an open path connecting a vertex at a distance of at most  $\delta$  from the arc  $(a_i, b_i) \subset C_i$  to a vertex at a distance of at most  $\delta$  from the arc  $(c_i, d_i) \subset C_i$ . This probability converges as  $\delta$  tends to 0, to a limit that is independent of  $i \in \{1, 2\}$ . If  $C_2$  is an equilateral triangle the vertices of which are  $a_2, b_2$  and  $c_2$ , then this limit is equal to  $\frac{|d_2 - c_2|}{|a_2 - c_2|}$ .*

It is remarkable that the only known way to establish the convergence in Theorem 0.3.2 (only for  $i = 1$ ) is to prove the stronger result of “convergence and conformal invariance”: we do not know how to establish the uniqueness of sublimits without resorting to the rigidity of complex analysis, even if we assume that  $C_1$  is an equilateral triangle with vertices  $a_1, b_1$  and  $c_1$ .

The mathematical object that describes the scaling limits of critical statistical mechanics models in the Euclidean plane is the SLE, for Schramm-Loewner Evolution (see e.g. [BN14]). SLE processes are models of random

curves. They are defined in a concrete way (in terms of Brownian motion and Loewner chains) and parametrized by a non-negative real number  $\kappa$ . They can also be characterized in an abstract way, as the only curves satisfying a form of “Conformal Markov Property”. Theorems of convergence to an SLE are known for several models: the loop-erased random walk, the Ising model on isoradial graphs, certain dimer models, Bernoulli site-percolation on the triangular lattice and the exploration curve of a uniform spanning tree. Such a link remains conjectural for the self-avoiding random walk, Bernoulli edge-percolation on the square lattice, the random cluster and the  $O(n)$  model. See [DC13].

*Remark.* Since SLE processes are models of random curves, one may wonder how can an SLE appear as a limit for a percolation model. The answer lies in the interface procedure represented on Figure 29.

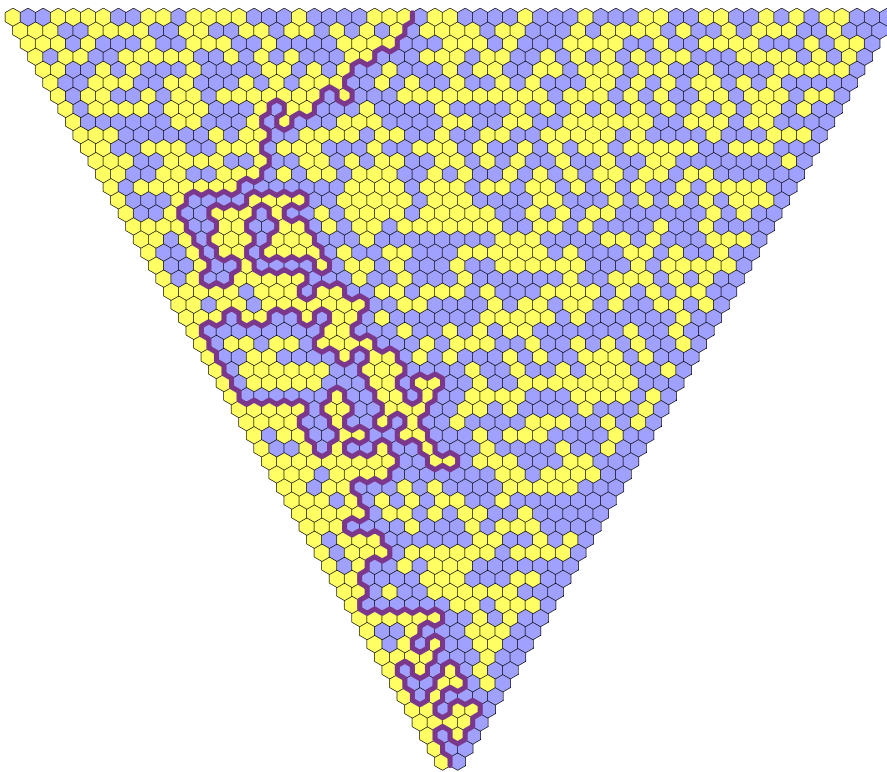

Figure 29 – This illustration of the interface procedure is due to Vincent Beffara. Notice that a site-percolation on  $\mathcal{L}_\Delta$  is the same as a face-percolation on the hexagonal lattice.

From results of convergence to an SLE, one can deduce theorems about discrete models. Here is an example of such a theorem (see [BDC13]).

**THEOREM 0.3.3.** *For site-percolation on the triangular lattice, when  $p$  tends to  $1/2$  from above, one has:*

$$\theta(p) = (p - 1/2)^{5/36+o(1)}.$$

### 0.3.2 Beyond the Euclidean plane

Of course, there are interesting graphs that do not discretise the Euclidean plane. A major question in the field is to know whether  $\theta(p_c) = 0$  for the cubic lattice: indeed,  $p_c$  is the only value of the parameter where the answer to the question of infiltration asked on page 1 remains unknown. Simulations, as well as the theorems presented here, strongly suggest that  $\theta(p_c) = 0$ .

#### Percolation at the critical point

In their foundational paper [BS96], Benjamini and Schramm formulated the following conjecture.

**CONJECTURE 0.3.4 (BENJAMINI AND SCHRAMM).** *If a transitive graph satisfies  $p_c < 1$ , then it satisfies  $\theta(p_c) = 0$ .*

*Remark.* In Conjecture 0.3.4, one cannot remove the transitivity assumption. A counter-example is the graph represented on Figure 30, the sequence  $(a_n) \in (\mathbb{N}^*)^{\mathbb{N}}$  being taken such that  $a_n = \lfloor \log_2(n \log(n)^2) \rfloor$  for  $n$  large enough. Indeed, the  $\mathbb{P}_p$ -probability of the event “ $v_n$  and  $v_{n+1}$  are connected by an open path” is  $1 - (1 - p^2)^{a_n}$ . By independence, if  $\theta$  is defined relatively to the root  $v_0$ , we have  $\theta(p) = \prod_{n=0}^{\infty} (1 - (1 - p^2)^{a_n})$ . A simple computation gives  $\theta(p) = 0 \Leftrightarrow p < \frac{1}{\sqrt{2}}$ . The considered graph thus satisfies  $p_c = \frac{1}{\sqrt{2}} < 1$  and  $\theta(p_c) > 0$ .

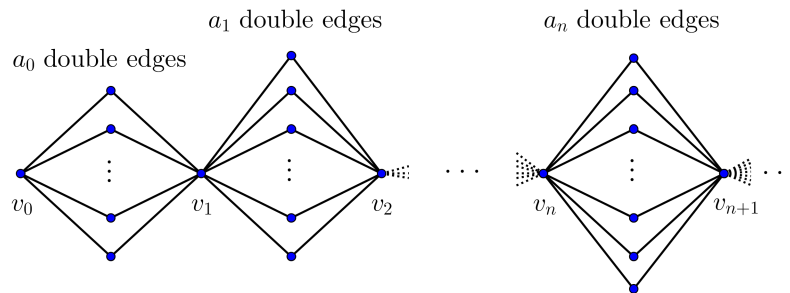

Figure 30 – A graph that satisfies  $\theta(p_c) > 0$  if the sequence  $(a_n)$  is well chosen.

*Remark of physical order.* Another way to say that  $\theta(p_c) = 0$  is “the function  $\theta$  is continuous at  $p_c$ ”; indeed  $\theta$  is automatically right-continuous. Physicists phrase this left-continuity at  $p_c$  by saying that a second-order phase transition occurs; the discontinuous case corresponds to a first-order phase transition. The discontinuity, the jump characteristic of first-order phase transitions corresponds to an energy that must be transferred to go from one state to the other. When water is heated to reach 100 °C, it stays at this temperature for some time, to transfer the afore-mentioned energy: the liquid-gas transition is a first-order phase transition. As for the ferromagnetic transition, it is a physical example of a second-order phase transition: if one heats a magnetised material, it loses its spontaneous magnetization at the Curie temperature, without halting at this temperature.

We know that  $\theta(p_c) = 0$  for graphs that “almost discretise the Euclidean plane”, because the topological constraints imposed by planarity can be used to force paths to intersect (see [DCST14]). In the opposite, when a graph expands sufficiently, it is easy to make paths disjoint, and this can be used to show that  $\theta(p_c) = 0$ . More precisely, we know that  $\theta(p_c) = 0$  on

- the hypercubic lattice of dimension  $d \geq 15$  — consult [HS90, Fit13],
- the graph with vertex-set  $\mathbb{Z}^d$  and where  $u$  are  $v$  adjacent if

$$0 < \|u - v\|_1 \leq L,$$

for  $d > 6$  and  $L > L(d)$  — refer to [HS90],

- non-amenable unimodular transitive graphs — see [BLPS99a].

The case of  $\mathcal{Z}^d$  is open for  $3 \leq d \leq 14$ .

Surprisingly, the case of half-spaces is solved in every dimension: it is known that the restriction of  $\mathcal{Z}^d$  to  $\mathbb{N} \times \mathbb{Z}^{d-1}$  has the same  $p_c$  as  $\mathcal{Z}^d$  and satisfies  $\theta(p_c) = 0$  as soon as  $d \geq 2$ . (See [Har60, Kes80] for the case  $d = 2$  and [BGN91a, BGN91b, GM90] for  $d \geq 3$ .) What makes half-spaces easier to handle than full spaces is the existence of a direction with a preferred orientation. Preferred orientations were also used in [PPS06] and [Tim06] to establish that  $\theta(p_c) = 0$  for several non-unimodular transitive graphs.

### The value of the critical parameter

For many Euclidean planar graphs, we know that  $\theta(p_c) = 0$  and what is the value of  $p_c$ . For more general graphs, determining the exact value of  $p_c$  seems impossible, up to two exceptions:

- we expect to be able to characterise when  $p_c$  is equal to 1;
- for trees, the critical point  $p_c$  is equal to the inverse of the branching number [Lyo90];
- the geometry of some graphs can be reduced to that of a tree in a way that allows us to determine the value of  $p_c$ ; see [Špa09].



Even though the explicit value of  $p_c$  seems out of reach, we can try to understand how this value depends on the graph under study. Here, we focus on the graphs that satisfy  $p_c < 1$ . In particular, we consider  $\mathcal{Z}^d$  only for  $d \geq 2$ . The question to know when a graph satisfies  $p_c = 1$  is studied on page 44.

For hypercubic lattices of dimension  $d \geq 2$ , we know that:

- $\mathcal{Z}^d$  satisfies  $p_c^{\text{edge}} < p_c^{\text{site}}$ ,
- if  $p_c(d)$  denotes the critical point for Bernoulli edge-percolation on  $\mathcal{Z}^d$ , then

$$p_c(d) = \frac{1}{2d} + \frac{1}{(2d)^2} + \frac{7/2}{(2d)^3} + O\left(\frac{1}{(2d)^4}\right),$$

- if one (suitably) adds edges to a graph that represents  $\mathcal{Z}^d$ , then its critical point strictly decreases.

Refer respectively to [GS<sup>+</sup>98], [HS95] and [AG91, BR06].

In [BS96], Benjamini and Schramm asked whether a statement analogous to the third one above is valid for covering maps between transitive graphs. See definition on page 7.

**QUESTION 0.3.5 (BENJAMINI AND SCHRAMM).** *Does it always hold that if a transitive graph  $\mathcal{G}_2$  satisfying  $p_c(\mathcal{G}_2) < 1$  is non-injectively covered by a transitive graph  $\mathcal{G}_1$ , then  $p_c(\mathcal{G}_1) < p_c(\mathcal{G}_2)$ ?*

Under the assumptions of Question 0.3.5, the inequality  $p_c(\mathcal{G}_1) \leq p_c(\mathcal{G}_2)$  can be established by a coupling argument [BS96].

Another class of results is about the question of locality. To state them, let us introduce some vocabulary. Denote by  $\mathfrak{G}$  the space of the isomorphism classes of transitive graphs. We may identify a transitive graph  $\mathcal{G}$  with its isomorphism class  $[\mathcal{G}]$ . Let  $\mathcal{G} \in \mathfrak{G}$ . Let  $o$  be any vertex of  $\mathcal{G}$ . Consider the ball of radius  $k$  centred at  $o$ , endowed with its structure of graph rooted at  $o$ . Up to isomorphism of rooted graphs, this ball does not depend on the choice of  $o$ , and we denote it by  $\mathcal{B}_{\mathcal{G}}(k)$ . If  $(\mathcal{G}_1, \mathcal{G}_2) \in \mathfrak{G}^2$ , we set the distance between  $\mathcal{G}_1$  and  $\mathcal{G}_2$  to be  $2^{-n}$ , where

$$n := \max\{k : \mathcal{B}_{\mathcal{G}_1}(k) \simeq \mathcal{B}_{\mathcal{G}_2}(k)\} \in \mathbb{N} \cup \{\infty\}.$$

This defines the **Benjamini-Schramm distance** — or **local distance** — on  $\mathfrak{G}$  (see [BS01b, BNP11]). The following conjecture, due to Schramm [BNP11], makes precise the idea that the value of  $p_c$  may be sensitive only to the local structure of the transitive graph under consideration.

**CONJECTURE 0.3.6 (SCHRAMM).** *If  $\epsilon > 0$ , then  $p_c$  is continuous seen as a function from  $\{\mathcal{G} \in \mathfrak{G} : p_c(\mathcal{G}) < 1 - \epsilon\}$  to  $[0, 1]$ .*

In the conjecture above, it is necessary to prevent the case  $p_c = 1$  from occurring, in order to avoid the following situations:

- $\text{Cay}(\mathbb{Z}/n\mathbb{Z} \times \mathbb{Z}/n\mathbb{Z}; (0, 1), (1, 0)) \xrightarrow{n \rightarrow \infty} \text{Cay}(\mathbb{Z}^2; (0, 1), (1, 0)),$
- and  $\text{Cay}(\mathbb{Z} \times \mathbb{Z}/n\mathbb{Z}; (0, 1), (1, 0)) \xrightarrow{n \rightarrow \infty} \text{Cay}(\mathbb{Z}^2; (0, 1), (1, 0)),$

where graphs with a critical point equal to 1 converge to a graph where  $p_c$  is equal to  $1/2$ . We do not know any sequence that contradicts Conjecture 0.3.6 for  $\epsilon = 0$ . More precisely, it is unknown whether 1 is an accumulation point of the set of the critical points of transitive graphs.

The three following theorems corroborate this conjecture. Their proofs can be found in [GM90], [Pet13, Tas14] and [BNP11].

**THEOREM 0.3.7 (GRIMMETT AND MARSTRAND).** *If  $d \geq 2$ , then the critical parameter of the graph defined by restriction of  $\mathcal{Z}^d$  to  $\{0, \dots, n\}^{d-2} \times \mathbb{Z}^2$  converges to that of  $\mathcal{Z}^d$  when  $n$  goes to infinity.*

**THEOREM 0.3.8.** *If  $\mathcal{G}_n \xrightarrow{n \rightarrow \infty} \mathcal{G}$  is a converging sequence of elements of  $\mathfrak{G}$ , then  $\liminf p_c(\mathcal{G}_n) \geq p_c(\mathcal{G})$ .*

**THEOREM 0.3.9.** *Let  $(\mathcal{G}_n)$  be a sequence of elements of  $\mathfrak{G}$  that converges to a regular tree  $\mathcal{T}_d$ . If the Cheeger constants of the  $\mathcal{G}_n$ 's are uniformly bounded away from 0, then  $d$  is at least 3 and  $p_c(\mathcal{G}_n)$  converges to  $p_c(\mathcal{T}_d)$ .*

To these three theorems, one can add the following, which I obtained in collaboration with Vincent Tassion [MT].

**THEOREM 0.3.10.** *The function  $p_c$  is continuous in restriction to the space of the Cayley graphs of abelian groups that satisfy  $p_c < 1$ .*

Chapter 2 is devoted to proving this theorem.

*Remark.* The fact that  $p_c$  seems to depend on the local structure of the considered transitive graph rather than on its global structure (say its class of quasi-isometry) reveals a slight flaw in the resolution of the porous stone problem presented on page 2: depending on whether we model the 3-dimensional world by a cubic lattice or  $\mathcal{L}_\Delta \times \mathcal{Z}$ , we will *not* have the same answers. The physicist will thus need information finer than “the problem takes place in dimension 3” to conceive his model.

### Existence of a phase transition

It is unsuitable to speak of a phase transition if one of the phases is empty (or almost empty). When is  $p_c$  equal to 0? When is it equal to 1? Peierls' argument guarantees that  $p_c$  is positive for every transitive graph. See [Pei36].

PROPOSITION 0.3.11 (PEIERLS). *Let  $d \geq 2$ . Let  $\mathcal{G}$  be a graph. Assume that every vertex of  $\mathcal{G}$  has degree at most  $d$ . Then, the critical parameter of  $\mathcal{G}$  is at least  $\frac{1}{d-1}$ .*

*Proof.* Let  $p < \frac{1}{d-1}$ . Let  $o$  be a vertex of  $\mathcal{G}$ . For every  $n \geq 1$ , there are at most  $d(d-1)^{n-1}$  self-avoiding paths of length  $n$  starting at  $o$ . Thus, for Bernoulli percolation of parameter  $p$ , the probability that there is an open self-avoiding path of length  $n$  starting at  $o$  is at most  $d(p(d-1))^{n-1}$ . As a result, this probability tends to 0 when  $n$  goes to infinity, and hence  $p \leq p_c$ .  $\square$

*Remarks.* One can use a similar argument to show that the critical point of  $\mathcal{Z}^2$  is not equal to 1. This time, one does not give an upper bound for the number of paths starting at the origin but for the number of dual cycles that surround the origin; see [HB57, Ham57, Ham59]. Once the inequality  $p_c(\mathcal{Z}^d) < 1$  is established for  $d = 2$ , we have it for every  $d \geq 2$ . Indeed, if  $d$  is at least 2, then the graph  $\mathcal{Z}^d$  contains  $\mathcal{Z}^2$  as a subgraph, so that  $p_c(\mathcal{Z}^d) \leq p_c(\mathcal{Z}^2)$ . Also, notice that for the  $d$ -regular tree, the inequality of Proposition 0.3.11 is an equality.

When is  $p_c$  equal to 1? The graph  $\mathcal{Z}$  is an example of an infinite transitive graph that satisfies  $p_c = 1$ : indeed, removing a proportion  $\epsilon > 0$  of edges is enough to break the bi-infinite line into components that are all finite. Generalizing this observation to two-ended transitive graphs is straightforward.

PROPOSITION 0.3.12. *Every transitive graph with 0 or 2 ends has a critical parameter equal to 1.*

Benjamini and Schramm have conjectured in [BS96] that the reciprocal holds for Cayley graphs.

CONJECTURE 0.3.13 (BENJAMINI AND SCHRAMM). *A Cayley graph satisfies  $p_c = 1$  if and only if it has 0 or 2 ends.*

The following theorem supports this conjecture (see [LP, Tim07]).

THEOREM 0.3.14. *A Cayley graph that does not have intermediate growth satisfies  $p_c = 1$  if and only if it has 0 or 2 ends.*

*Remark.* Muchnik and Pak established in [MP01] that Grigorchuk groups (the main examples of groups of intermediate growth) satisfy  $p_c < 1$ .

The following theorem states that the condition “ $p_c = 1$ ” is *geometric*. Its proof involves a coupling argument [LP].

**THEOREM 0.3.15.** *Let  $\mathcal{G}_1$  and  $\mathcal{G}_2$  be two transitive graphs that are quasi-isometric. Then  $p_c(\mathcal{G}_1) = 1$  is equivalent to  $p_c(\mathcal{G}_2) = 1$ .*

Let us also mention that Texeira recently proved that every graph with polynomial growth and local isoperimetric dimension  $d > 1$  satisfies  $p_c < 1$ ; see [Tex] for a precise statement.

### Existence of a second phase transition

Other questions deal with the existence of a *second* phase transition. Before tackling this second transition, we need to study in detail the regimes delimited by  $p_c$ . This will involve a powerful tool, the Harris inequality [Har60].

A Borel subset  $A$  of  $2^E = \{0, 1\}^E$  is said to be **increasing** if

$$\forall \omega, \eta \in 2^E, \omega \in A \implies \omega \cup \eta \in A.$$

Said in words, an event is non-decreasing if adding edges can only help making it happen.

**THE HARRIS INEQUALITY.** *Let  $A$  and  $B$  be two increasing events, then*

$$\mathbb{P}_p[A \cap B] \geq \mathbb{P}_p[A]\mathbb{P}_p[B].$$

*Remark.* Forgetting the case where  $B$  has probability 0, one can think of this inequality in terms of conditional probabilities:

$$\mathbb{P}_p[A|B] \geq \mathbb{P}_p[A].$$

This inequality is quite intuitive from a Bayesian point of view: “since  $B$  is increasing, conditioning this event to happen prompts the edges to be more open than without conditioning, which in return increases the probability of the increasing event  $A$ ”.

If  $\mathcal{G} = (V, E)$  is a connected graph and  $o$  the vertex used to define the function  $\theta$ , then the Harris inequality guarantees that for every vertex  $v$ ,

$$\theta(p) \geq \mathbb{P}_p[v \leftrightarrow \infty \text{ and } o \leftrightarrow v] \geq \mathbb{P}_p[o \leftrightarrow v]\mathbb{P}_p[v \leftrightarrow \infty] \geq p^{d(o,v)}\mathbb{P}_p[v \leftrightarrow \infty],$$

where the event  $o \leftrightarrow v$  reads “ $o$  and  $v$  belong to the same cluster”. Thus, when  $\theta(p) = 0$ , every vertex has probability zero to belong to an infinite cluster. As a consequence, if  $\theta(p) = 0$ , then there are  $\mathbb{P}_p$ -almost surely no infinite clusters. In the opposite, when  $\theta(p) > 0$ , Kolmogorov’s zero-one law implies the almost sure existence of at least one infinite cluster.

For transitive graphs, one can refine this description by studying the number of infinite clusters. We will see in Section 0.4 that if  $\mathcal{G}$  is a transitive graph, then

- for every  $p$ , the number of infinite clusters has a  $\mathbb{P}_p$ -almost deterministic value  $N_\infty^{\mathcal{G}}(p)$ , which is 0, 1 or  $\infty$ ,
- for every  $x \in \{0, 1, \infty\}$ , the set of the  $p$ 's such that  $N_\infty^{\mathcal{G}}(p)$  is equal to  $x$  is an interval.

We denote by  $p_u$  the lower bound of the  $p$ 's that yield exactly one infinite cluster. This number is called the **uniqueness parameter**.

$$\begin{array}{ccccccc}
 0 & & p_c & & p_u & & 1 \\
 & \underbrace{\hspace{1.5cm}}_{N_\infty^{\mathcal{G}}(p) = 0} & & \underbrace{\hspace{1.5cm}}_{N_\infty^{\mathcal{G}}(p) = \infty} & & \underbrace{\hspace{1.5cm}}_{N_\infty^{\mathcal{G}}(p) = 1} & \\
 & | & & | & & | & \\
 \hline
 \end{array}$$

*Remark.* The interval corresponding to  $x = 1$  contains 1. As a result, every  $p$  that satisfies  $N_\infty^{\mathcal{G}}(p) = \infty$  is smaller than or equal to  $p_u$ . Naively, we may imagine that opening more edges allows more infinite clusters to emerge, which is not compatible with the actual monotonicity. The real situation is as follows:

- when there are infinitely many infinite clusters, these clusters are small enough to co-exist without merging,
- a unique infinite cluster occupies a proportion of the graph that is so large that its complement can only contain finite clusters.

With this viewpoint, one easily figures that the  $p$ 's corresponding to  $x = \infty$  are inferior to the ones corresponding to  $x = 1$ .

In [BS96], Benjamini and Schramm formulated the following conjecture.

**CONJECTURE 0.3.16 (BENJAMINI AND SCHRAMM).** *A transitive graph  $\mathcal{G}$  is amenable if and only if  $p_c(\mathcal{G}) = p_u(\mathcal{G})$ .*

This conjecture is backed up by different results. We will see that Bernoulli percolation on an amenable transitive graph always produces at most one infinite cluster, so that all amenable transitive graphs satisfy  $p_c = p_u$ . See Theorem 0.4.8. Besides, if  $G$  is a non-amenable finitely generated group, it is known that there *is* a finite generating system such that the corresponding Cayley graph satisfies  $p_c < p_u$ . See [PSN00, Tho]. This fact is used in the proof of Theorem 1.2.5, which provides a positive answer to the “measurable Day-von Neumann Problem” — see [GL09].

It is not known whether the property  $p_c < p_u$  is preserved under bi-Lipschitz equivalence in the class of Cayley graphs. This is why the results of [PSN00, Tho] do not imply Conjecture 0.3.16, even in the case of Cayley graphs. Nevertheless, it is possible to deduce from the afore-mentioned facts the following characterization of the amenability of a finitely generated group.

**THEOREM 0.3.17.** *A finitely generated group is amenable if and only if all of its Cayley graphs satisfy  $p_c = p_u$ .*

### Percolation in the hyperbolic plane

In [BS01a], Benjamini and Schramm proved the following theorem.

**THEOREM 0.3.18.** *Let  $\mathcal{G}$  be a one-ended non-amenable graph embedded in the plane. Let  $G$  be a group of homeomorphisms of the plane. Assume that  $G$  preserves the image of the embedding and that  $G$  acts transitively on  $V(\mathcal{G})$ . Then, the graph  $\mathcal{G}_{\text{dual}}$  is locally finite and the following relations hold:*

$$p_c(\mathcal{G}) < p_u(\mathcal{G}) < 1 \quad \text{and} \quad p_u(\mathcal{G}) + p_c(\mathcal{G}_{\text{dual}}) = 1.$$

Moreover, there is almost surely a unique infinite cluster at  $p_u$ .

Theorem 0.3.19 indicates that, in Theorem 0.3.18, one can replace the condition “one-ended non-amenable” with “quasi-isometric to the hyperbolic plane” without modifying the validity or generality of the statement.

**THEOREM 0.3.19 (BABAI, [BAB97]).** *Let  $\mathcal{G}$  be an infinite graph embedded in the plane. Let  $G$  be a group of homeomorphisms of the plane. Assume that  $G$  preserves the image of the embedding and that  $G$  acts transitively on  $V(\mathcal{G})$ .*

*Then, the graph  $\mathcal{G}$  is quasi-isometric to one and exactly one of the following spaces: the line  $\mathbb{R}$ , the Euclidean plane  $\mathbb{R}^2$ , the trivalent tree  $\mathcal{T}_3$  or the hyperbolic plane  $\mathbb{H}^2$ .*

### Results on $p_u$

At the parameter  $p_u$ , the number of infinite clusters can take any value in  $\{0, 1, \infty\}$ . Of course, when this value is zero,  $p_c$  is equal to  $p_u$ . The square lattice satisfies  $N_{\infty}^{\mathbb{Z}^2}(p_u) = 0$ . Uniqueness at  $p_u$  occurs on regular trees (which satisfy  $p_u = 1$ ) and the discretizations of the hyperbolic plane (Theorem 0.3.18). In the latter case,  $p_u < 1$  holds. At last, the following results enable us to build transitive graphs that satisfy  $N_{\infty}^{\mathcal{G}}(p_u) = \infty$ .

**THEOREM 0.3.20 (LYONS AND SCHRAMM, [LS11]).** *If  $\mathcal{G}$  is a Cayley graph of a group with Property (T), then  $N_{\infty}^{\mathcal{G}}(p_u) \neq 1$ . In particular,  $p_u(\mathcal{G}) < 1$ .*

**THEOREM 0.3.21 (PERES, [PER00]).** *If  $\mathcal{G}$  is the product of an infinite transitive graph and a non-amenable transitive graph, then  $N_{\infty}^{\mathcal{G}}(p_u) \neq 1$ . In particular,  $p_u(\mathcal{G}) < 1$ .*

When is  $p_u$  equal to 1? In [BS96], Benjamini and Schramm asked the question below.

**QUESTION 0.3.22 (BENJAMINI AND SCHRAMM).** *Does a transitive graph  $\mathcal{G}$  satisfy  $p_u(\mathcal{G}) < 1$  if and only if it has one end?*

The results that follow suggest a positive answer to this question. See respectively [LP] and [BB99].

**THEOREM 0.3.23.** *Every transitive graph with a number of ends different from 1 satisfies  $p_u = 1$ .*

**THEOREM 0.3.24 (BABSON AND BENJAMINI).** *Let  $G$  be a finitely presented group. If  $G$  is one-ended, then every Cayley graph of  $G$  satisfies  $p_u < 1$ .*

The following result guarantees that the property “ $p_u = 1$ ” is geometric. This analog of Theorem 0.3.15 for  $p_u$  is proved in [LS11].

**THEOREM 0.3.25.** *Let  $\mathcal{G}_1$  and  $\mathcal{G}_2$  be two transitive graphs that are quasi-isometric. Then,  $p_u(\mathcal{G}_1) = 1$  if and only if  $p_u(\mathcal{G}_2) = 1$ .*

At last, it seems legitimate to wonder whether Conjecture 0.3.6 holds if  $p_c$  is replaced with  $p_u$ .

**QUESTION 0.3.26.** *Does it hold that if  $\epsilon$  is a positive real number, then  $p_u$  is continuous seen as a function from  $\{\mathcal{G} \in \mathfrak{G} : p_u(\mathcal{G}) < 1 - \epsilon\}$  to  $[0, 1]$ ?*

### Let us recapitulate.

Here is a table that sums up the situation relative to the questions concerning the values of  $p_c$  and  $p_u$ . The column “Local” contains the results and conjectures closely related to Benjamini-Schramm continuity. The column “Global” gathers the problems that are (conjecturally) stable under quasi-isometry.

Local	Global
value of $p_c$ knowing that $p_c < 1 - \epsilon$ <small>Conjecture 0.3.6, Theorems 0.3.7, 0.3.8, 0.3.9 and 0.3.10</small>	$p_c < 1$ <small>Conjecture 0.3.13, Theorems 0.3.14 and 0.3.15</small>
value of $p_u$ knowing that $p_u < 1 - \epsilon$ ? <small>Question 0.3.26, Theorems 0.3.7 and 0.3.10</small>	$p_c < p_u$ <small>Conjecture 0.3.16, Theorems 0.3.17 and 0.3.18</small>
	$p_u < 1$ <small>Question 0.3.22, Theorems 0.3.18, 0.3.20, 0.3.21, 0.3.23, 0.3.24 and 0.3.25</small>

As for the behaviour at the points  $p_c$  and  $p_u$ , here are the main conjectures and results in a nutshell. It seems that  $N_\infty^{\mathcal{G}}(p_c)$  is equal to 0 for every transitive graph  $\mathcal{G}$  that satisfies  $p_c < 1$ . On transitive graphs that satisfy  $p_c < p_u < 1$ , the number  $N_\infty^{\mathcal{G}}(p_u)$  can take any value in  $\{1, \infty\}$

## 0.4 Invariant percolations

Section 0.3 presented the general landscape of Bernoulli percolation. Here, we consider the topic in more detail. We establish several results that were mentioned in the previous sections and state the arguments that are used in their natural level of generality. This will prompt us to consider vast classes of percolations. The reader interested in the content of this section is referred to [Ben13, BLPS99b, LP, Pet13].

### 0.4.1 First definitions and properties

Let  $\mathcal{G} = (V, E)$  be a graph that is not yet assumed to be transitive. Its automorphism group  $\text{Aut}(\mathcal{G})$  acts on  $E$ , hence on  $\{0, 1\}^E$ , hence on the percolations on  $\mathcal{G}$ . If  $G$  is a subgroup of  $\text{Aut}(\mathcal{G})$ , we say that a percolation on  $\mathcal{G}$  is  **$G$ -invariant** if

$$\forall g \in G, g \cdot \mathbb{P} = \mathbb{P}.$$

For every  $p \in [0, 1]$ , Bernoulli percolation of parameter  $p$  on  $\mathcal{G}$  is  $\text{Aut}(\mathcal{G})$ -invariant. Bernoulli percolations satisfy two other important properties: ergodicity and insertion-tolerance.

A percolation  $\mathbb{P}$  is said to be  **$G$ -ergodic** if it gives to any  $G$ -invariant Borel subset of  $\{0, 1\}^E$  a probability that belongs to  $\{0, 1\}$ . When the group that acts is clear from the context<sup>16</sup>, we write “ergodic” instead of  $G$ -ergodic.

**PROPOSITION 0.4.1.** *Assume that there is a vertex of  $\mathcal{G}$  the  $G$ -orbit of which is infinite. Then, for every  $p \in [0, 1]$ , Bernoulli percolation of parameter  $p$  on  $\mathcal{G}$  is  $G$ -ergodic.*

*Proof.* Let  $B$  be a  $G$ -invariant Borel subset of  $\{0, 1\}^E$ . Let  $\epsilon > 0$ . Let  $C \subset \{0, 1\}^E$  be such that:

- $C = \mathfrak{C} \times \{0, 1\}^{E \setminus F}$ , for some finite subset  $F$  of  $E$  and some  $\mathfrak{C} \subset \{0, 1\}^F$ ,
- $\mathbb{P}_p[B \Delta C] \leq \epsilon$ , which we also write  $B \stackrel{\epsilon}{\simeq} C$ .

Since the action of  $G$  on the locally finite connected graph  $\mathcal{G}$  admits an infinite orbit, there is an element  $g \in G$  such that  $g \cdot F$  and  $F$  are disjoint. By  $G$ -invariance of  $B$  and  $\mathbb{P}_p$ , we have

$$B = B \cap (g \cdot B) \stackrel{2\epsilon}{\simeq} C \cap (g \cdot C).$$

As  $F$  and  $g \cdot F$  are disjoint, it follows from the independence of the states of the edges that

$$\mathbb{P}_p[C \cap g \cdot C] = \mathbb{P}_p[C] \times \mathbb{P}_p[g \cdot C] = \mathbb{P}_p[C]^2.$$

It results from  $\mathbb{P}_p[B \Delta C] \leq \epsilon$  that  $|\mathbb{P}_p[B] - \mathbb{P}_p[B]^2| \leq 4\epsilon$ . We conclude by making  $\epsilon$  go to 0.  $\square$

If  $(\omega, e) \in \{0, 1\}^E \times E$ , we denote by  $\omega^e$  the unique element of  $\{0, 1\}^E$  that is equal to  $\omega$  on  $E \setminus \{e\}$  and that maps  $e$  to 1. We define the insertion

---

16. When a graph is introduced as a Cayley graph of a group  $G$ , this group  $G$  is the one acting on  $\mathcal{G}$ . When no group is clearly suggested by the context, we take the acting group to be  $\text{Aut}(\mathcal{G})$ .



operator as  $\Pi^e : \omega \mapsto \omega^e$ . We say that a percolation  $\mathbb{P}$  is **insertion-tolerant** if for every Borel subset  $B \subset \{0, 1\}^E$  and every edge  $e$ ,

$$\mathbb{P}[B] > 0 \implies \mathbb{P}[\Pi^e(B)] > 0.$$

Likewise, we set  $\omega_e$  to be the unique element of  $\{0, 1\}^E$  that is equal to  $\omega$  on  $E \setminus \{e\}$  and that maps  $e$  to 0; the deletion operator is  $\Pi_e : \omega \mapsto \omega_e$ ; and a percolation  $\mathbb{P}$  is **deletion-tolerant** if for every Borel subset  $B \subset \{0, 1\}^E$  and every edge  $e$ ,

$$\mathbb{P}[B] > 0 \implies \mathbb{P}[\Pi_e(B)] > 0.$$

**PROPOSITION 0.4.2.** *Let  $p \in [0, 1]$ . If  $p > 0$ , then the Bernoulli percolation of parameter  $p$  on  $\mathcal{G}$  is insertion-tolerant. If  $p < 1$ , then the Bernoulli percolation of parameter  $p$  on  $\mathcal{G}$  is deletion-tolerant.*

IN THE REMAINING OF SECTION 0.4, WE ASSUME THAT  $G$  IS A CLOSED SUBGROUP OF  $\text{Aut}(\mathcal{G})$  THAT ACTS TRANSITIVELY ON  $V(\mathcal{G})$ . WE ALSO ASSUME  $\mathcal{G}$  TO BE INFINITE.

By ergodicity, for every  $p \in [0, 1]$ , there is a constant  $N_\infty^{\mathcal{G}}(p) \in \mathbb{N} \cup \{\infty\}$  such that  $\mathbb{P}_p$ -almost surely, the number of infinite clusters is equal to  $N_\infty^{\mathcal{G}}(p)$ .

**PROPOSITION 0.4.3.** *Let  $\mathbb{P}$  be an ergodic percolation on  $\mathcal{G}$  that is insertion-tolerant. Then, there is a constant  $x \in \{0, 1, \infty\}$  such that the number of infinite clusters is  $\mathbb{P}$ -almost surely equal to  $x$ . In particular, for every  $p \in ]0, 1]$ , the quantity  $N_\infty^{\mathcal{G}}(p)$  belongs to  $\{0, 1, \infty\}$ .*

*Proof.* The existence of an  $x \in \mathbb{N} \cup \{\infty\}$  such that the number of infinite clusters is  $\mathbb{P}$ -almost surely equal to  $x$  follows from the ergodicity of  $\mathbb{P}$ . Assume that  $x \notin \{0, \infty\}$ . Then,  $\mathbb{P}$ -almost surely, there is a finite subset  $F$  of  $V$  that intersects all the infinite clusters. Since the set of finite subsets of  $V$  is countable, there is a finite subset  $F$  of  $V$  such that  $F$  intersects all the infinite clusters with positive probability. By using insertion-tolerance finitely many times in order to connect all the points of  $F$ , we notice that, with positive probability, there is a unique infinite cluster. Thus  $x$  is equal to 1.  $\square$

## 0.4.2 The uniqueness parameter

The following theorem gives a more detailed picture of Bernoulli percolation than Proposition 0.4.3. See [HP99] for a proof in the case of Cayley graphs and [Sch99] for the general case.

**THEOREM 0.4.4 (HÄGGSTRÖM, PERES AND SCHONMANN).** *If  $p \in [0, 1]$  satisfies  $N_\infty^{\mathcal{G}}(p) = 1$ , then every  $q \in [p, 1]$  satisfies  $N_\infty^{\mathcal{G}}(q) = 1$ .*

This result calls for the following definition. The **uniqueness parameter**  $p_u$  of a transitive graph  $\mathcal{G}$  is the lower bound of the set of the parameters  $p$  such that  $N_\infty^{\mathcal{G}}(p) = 1$ .

*Examples.* The following graphs show that every configuration of equality/strict inequality between  $p_c$ ,  $p_u$  and 1 is possible, as soon as the relation  $p_c \leq p_u \leq 1$  is satisfied.

The graph  $\mathcal{Z}$  satisfies  $p_c = p_u = 1$ : removing a proportion  $\epsilon > 0$  of edges breaks the bi-infinite line into components that are all finite.

The square lattice satisfies  $p_c = p_u = 1/2$ . See page 36 and Theorem 0.4.8.

Every Cayley graph of an abelian group of rank at least 2 satisfies  $p_c = p_u \leq 1/2$ . For the inequality on  $p_c$ , notice that every such Cayley graph contains a square lattice as a subgraph. As for the equality of  $p_c$  and  $p_u$ , it results from Theorem 0.4.8.

For every  $d \geq 3$ , the  $d$ -regular tree satisfies  $p_c = \frac{1}{d-1} < p_u = 1$ . To compute the value of  $p_c$ , notice that the study of Bernoulli percolation of parameter  $p$  on the tree  $\mathcal{T}_d$  boils down to the study of the Bienaymé-Galton-Watson process with reproduction law  $\text{Binomial}(d-1, p)$ .

For  $d$  large enough, the graph  $\mathcal{T}_d \times \mathcal{Z}$  satisfies  $p_c < p_u < 1$ . See Theorem 0.4.5 for the inequality  $p_c < p_u$  and Theorem 0.4.6 for the inequality  $p_u < 1$ , which holds as soon as  $d \geq 2$ . To establish the latter inequality, one can also use Theorem 0.3.24.

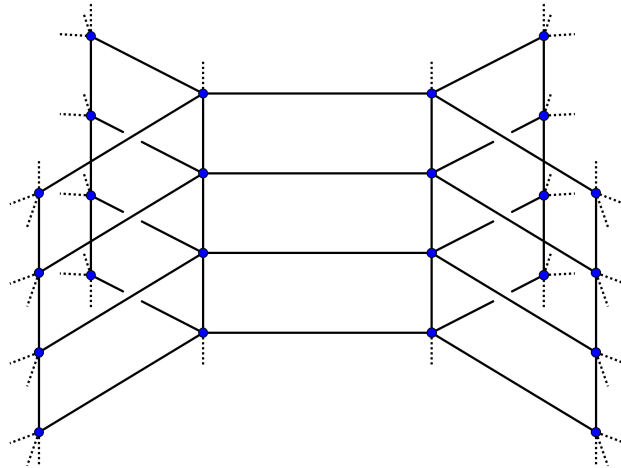

Figure 31 – A finite portion of  $\mathcal{T}_3 \times \mathcal{Z}$ .

**THEOREM 0.4.5** ([BS96, GN90]). *For  $d$  large enough, the graph  $\mathcal{T}_d \times \mathcal{Z}$  satisfies  $p_c < p_u$ .*

*Proof.* Let  $\mathcal{G}_d$  be the graph  $\mathcal{T}_d \times \mathcal{Z}$ . Denote by  $p_c(d)$  its critical parameter and by  $p_u(d)$  its uniqueness parameter. Since  $\mathcal{G}_d$  contains  $\mathcal{T}_d$  as a subgraph, we have  $p_c(d) \leq \frac{1}{d-1}$ .

Let  $(o, o') \in V(\mathcal{T}_d) \times V(\mathcal{Z})$ . A “good path” is a finite path of  $\mathcal{G}_d$  starting at  $(o, o')$  and finishing in the fibre of  $o$ , that is finishing at a point of  $\{o\} \times V(\mathcal{Z})$ . Denote by  $c_n$  the number of good paths of length  $n$ .

**FACT 0.4.5.** *For every  $n \in \mathbb{N}$ , we have  $c_n \leq (4\sqrt{d})^n$ .*

*Proof.* Every good path of length  $n$  must take an even number of steps —  $2k$  — in the factor  $\mathcal{T}_d$  and  $n-2k$  other steps in the factor  $\mathcal{Z}$ . Amidst these  $2k$  steps, exactly  $k$  go away from  $o$ , so that

$$\begin{aligned} c_n &\leq \sum_{k=0}^{\lfloor \frac{n}{2} \rfloor} \binom{n}{n-2k, k, k} \times 2^{n-2k} \times d^k \times 1^k \\ &\leq d^{n/2} \sum_{k=0}^{\lfloor \frac{n}{2} \rfloor} \binom{n}{n-2k, k, k} \times 2^{n-2k} \\ c_n &\leq d^{n/2} \sum_{i+j+k=n} \binom{n}{i, j, k} \times 2^i \times 1^j \times 1^k \\ &\leq (4\sqrt{d})^n. \end{aligned}$$

□

Assume that  $d \geq 18$ . As a consequence,  $4\sqrt{d} < d-1$ . Let  $p \in \left] \frac{1}{d-1}, \frac{1}{4\sqrt{d}} \right[ \neq \emptyset$ . The quantity  $c_n p^n$  decays exponentially fast in  $n$ . Denote by  $\aleph$  the set of the good paths that are self-avoiding. The following inequalities hold:

$$\mathbb{E}_p [ |\text{cluster}(o, o') \cap (\{o\} \times V(\mathcal{Z}))| ] \leq \sum_{\kappa \in \aleph} p^{\text{length}(\kappa)} \leq \sum_{n \geq 0} c_n p^n < +\infty.$$

At the parameter  $p$ , the probability that two vertices of the fibre of  $o$  are connected by an open path tends to 0 when their distance goes to infinity. To conclude, notice that:

- $N_\infty^{\mathcal{G}_d}(p) = 0$  cannot occur, because  $p > \frac{1}{d-1} \geq p_c(\mathcal{G}_d)$ ,
- $N_\infty^{\mathcal{G}_d}(p) = 1$  is impossible because it would imply, together with the Harris inequality, that  $\inf_{u, v \in V} \mathbb{P}_p[u \xleftrightarrow{\omega} v] \geq \theta(p)^2 > 0$ , which we have just proved not to hold.

□

THEOREM 0.4.6 ([HPS99]). *For every  $d \geq 2$ , we have  $p_u(\mathcal{T}_d \times \mathcal{Z}) \leq 1/2$ .*

We will prove Theorem 0.4.6 by using the following result, which we shall admit.

THEOREM 0.4.7 ([SCH99]). *Let  $p \in [0, 1]$  be such that*

$$\lim_{R \rightarrow \infty} \inf_{u, v \in V} \mathbb{P}_p \left[ \exists u' \in B(u, R), \exists v' \in B(v, R), u' \overset{\omega}{\longleftrightarrow} v' \right] = 1.$$

*Then, we have  $p \geq p_u(\mathcal{G})$ .*

*Proof of theorem 0.4.6.* Let  $d \geq 2$  and  $p > 1/2$ . On  $\mathcal{Z}^2$ , the fact that  $N_p^{\mathcal{Z}^2} = 1$  and the Harris inequality give:

$$\lim_{R \rightarrow \infty} \inf_{u, v \in V(\mathcal{Z}^2)} \mathbb{P}_p \left[ \exists u' \in B(u, R), \exists v' \in B(v, R), u' \overset{\omega}{\longleftrightarrow} v' \right] = 1.$$

Since for every  $(u, v)$  in  $V(\mathcal{T}_d \times \mathcal{Z})^2$ , there is an injective graph homomorphism from  $\mathcal{Z}^2$  to  $\mathcal{T}_d \times \mathcal{Z}$  the image of which contains  $u$  and  $v$ , the following equality holds in  $\mathcal{T}_d \times \mathcal{Z}$ :

$$\lim_{R \rightarrow \infty} \inf_{u, v \in V} \mathbb{P}_p \left[ \exists u' \in B(u, R), \exists v' \in B(v, R), u' \overset{\omega}{\longleftrightarrow} v' \right] = 1.$$

According to Theorem 0.4.7, we have  $p \geq p_u(\mathcal{T}_d \times \mathcal{Z})$ , hence  $p_u(\mathcal{T}_d \times \mathcal{Z}) \leq 1/2$ .  $\square$

### 0.4.3 Amenability and percolation

The following two theorems partially back up Conjecture 0.3.16, according to which  $\mathcal{G}$  is amenable if and only if  $p_c(\mathcal{G})$  and  $p_u(\mathcal{G})$  are equal.

THEOREM 0.4.8 (BURTON AND KEANE, [BK89]). *If the transitive graph  $\mathcal{G}$  is amenable, then every  $G$ -invariant percolation on  $\mathcal{G}$  that is insertion-tolerant yields almost surely at most one infinite cluster. In particular, every amenable transitive graph satisfies  $p_c = p_u$ .*

*Sketch of proof.* To simplify the exposition, we first present the proof for the case of a Bernoulli percolation of parameter  $p \in (0, 1)$ . According to Proposition 0.4.3, we only need to establish that if the  $\mathbb{P}_p$ -probability that there are at least three infinite clusters is positive, then  $\mathcal{G}$  is non-amenable. Under this assumption, by using the insertion-tolerance and deletion-tolerance of  $\mathbb{P}_p$ , one can show that the probability that there is a branching point (i.e. a point the removal of which breaks its cluster into at least three infinite clusters) is a positive number  $p_0$ . If  $F$  is a finite subset of  $V(\mathcal{G})$ , then the expected number of branching points in  $F$  is  $p_0 \times |F|$ .

Add to the random set of the branching points that belong to  $F$  one point per “infinite cluster that would result from the removal of all the branching points in  $F$  and that would be adjacent to such a branching point”; we will say that each of these points corresponds to an “infinite pseudo-cluster”. Endow this random set with a graph structure in the following way:

- two branching points are adjacent if there is an open path connecting them without getting outside  $F$  nor touching another branching point,
- two points that correspond to infinite pseudo-clusters are never adjacent,
- and a point that corresponds to an infinite pseudo-cluster is adjacent to the unique branching point to which its pseudo-cluster is adjacent by an open edge.

This graph is a random finite forest. Every vertex of this forest has degree 1 (it is a leaf) or at least 3. Such a graph necessarily has more leaves than vertices of degree at least 3. This means that the random forest under consideration always contains more vertices that correspond to infinite pseudo-clusters than branching points. But every infinite pseudo-cluster meets the boundary of  $F$  at one point at least; since two distinct pseudo-clusters cannot intersect, the number of branching points is always at most  $|\partial F|$ . By taking the expectation, one deduces from this that  $p_0 \times |F| \leq |\partial F|$ , which establishes the non-amenability of  $\mathcal{G}$ .

In this proof, we have used two properties of Bernoulli percolation that are not among the hypotheses of Theorem 0.4.8: ergodicity and deletion-tolerance. To remove the assumption of ergodicity, one can for example use an Ergodic Decomposition Theorem (see Lemma 3.6 in [LS11]). As for deletion-tolerance, with some care, one can consider, instead of branching points, the points the  $R$ -neighbourhood of which, once removed, breaks the infinite cluster into at least three infinite clusters. The number  $R$  is chosen large enough (more precisely such that such a point exists with positive probability) and then fixed.  $\square$

**THEOREM 0.4.9** ([PSN00, THO]). *If  $G$  is a non-amenable finitely generated group, then there is a finite generating subset  $S$  of  $G$  such that  $\text{Cay}(G; S)$  satisfies  $p_c < p_u$ .*

*A glimpse of the proof.* Let  $G$  be a finitely generated group that is not amenable. Let  $S$  be a finite generating system of  $G$  that is stable under inversion. By coupling a Bernoulli percolation of well chosen parameter with a branching random walk, Benjamini and Schramm proved in [BS96] that if  $d$  denotes the degree of any vertex of  $\text{Cay}(G; S)$  and  $\rho$  its spectral radius — that is to say, with the notation of Theorem 0.2.4, the quantity  $\exp(\limsup \frac{\log p_n}{n})$  —, then

$$d\rho p_c < 1 \implies p_c < p_u.$$

Since  $G$  is not amenable, Theorem 0.2.4 guarantees that  $\rho < 1$ . Thus, up to substituting  $S$  with  $S^{(k)}$  — the multi-set to which each element of  $G$  belongs with multiplicity the number of ways in which it can be written as a product of  $k$  elements of  $S$  —, the spectral radius can be made arbitrarily small. Indeed, the spectral radius of  $\text{Cay}(G; S^{(k)})$  is  $\rho^k$ .

By using other inequalities to control  $d$  and  $p_c$ , one can, up to replacing  $S$  with  $S^{(k)}$  for  $k$  large enough, assume that  $d\rho p_c < 1$ . Theorem 0.4.9 follows.  $\square$

*Remark.* The reader is invited to consult [PSN00] for a precise presentation of the inequalities involved and [Tho] to replace the multi-set  $S^{(k)}$  by a generating set without multiplicity.

We can also mention the following characterization of amenability in terms of invariant percolations.

**THEOREM 0.4.10** ([BLPS99B]). *Assume that  $\mathcal{G}$  is a Cayley graph of some finitely generated group  $G$ . Then, the group  $G$  is amenable if and only if for every  $\alpha < 1$ , there is a  $G$ -invariant site-percolation on  $\mathcal{G}$  that almost surely yields no infinite cluster and is such that for every  $v \in V(\mathcal{G})$ , the vertex  $v$  is open with probability at least  $\alpha$ .*

*Remark.* One direction of this result is essentially Proposition 0.4.13.

#### 0.4.4 The Mass Transport Principle in percolation

The Mass Transport Principle, introduced page 27, will generally be used in its following form.

**PROPOSITION 0.4.11.** *Let  $\mathbb{P}$  be a  $G$ -invariant percolation on  $\mathcal{G}$ . Let  $f : V \times V \times 2^E \rightarrow [0, +\infty]$  be a Borel function that is invariant under the diagonal action of  $G$ . Let  $o$  be a vertex of  $\mathcal{G}$ . If  $G$  is unimodular, then the following equality holds:*

$$\sum_{v \in V} \mathbb{E}[f(o, v, \omega)] = \sum_{v \in V} \mathbb{E}[f(v, o, \omega)].$$

*Proof.* Since  $\mathbb{P}$  is  $G$ -invariant, the function  $F : (u, v) \mapsto \mathbb{E}[f(u, v, \omega)]$  is invariant under the diagonal action of  $G$ . Proposition 0.2.8 guarantees that the couple  $(\mathcal{G}, G)$  satisfies the Mass Transport Principle. Applying this principle to  $F$  gives the desired equality.  $\square$

#### Several classical results

We present three proofs by Mass Transport Principle and then use two of the results established in this way to prove Theorem 0.4.15. These four demonstrations form a (small) share of the proof of Theorem 0.4.18; see [LS11]. Proposition 0.4.13 and a variation on Proposition 0.4.12 are used in the paper [BLPS99a] to show that every non-amenable unimodular transitive graph satisfies  $\theta(p_c) = 0$ .

When one considers a cluster of a configuration  $\omega \in 2^E$  as a *graph*, it is implicitly endowed with the structure induced by  $\mathcal{G}_\omega = (V, \omega)$ .

**PROPOSITION 0.4.12** ([LS11]). *Let  $\mathbb{P}$  be a  $G$ -invariant percolation on  $\mathcal{G}$ . If  $G$  is unimodular, then  $\mathbb{P}$ -almost surely, every infinite cluster has 1 end, 2 ends, or no isolated end.*

*Remark.* The Mass Transport Principle is often used to show that infinite clusters are “homogeneous” in some way; e.g. if one restricts to percolations that almost surely yield a forest, Proposition 0.4.12 states that, almost surely, every cluster that contains a branching point contains branching points “everywhere”.

*Proof.* Denote by  $\hat{A}_n$  the random set formed by the union of the connected subsets  $A \subset V$  that are

- connected,
- of cardinality at most  $n$ ,
- a subset of some infinite cluster,
- and such that the removal of  $A$  breaks the cluster that contains  $A$  into at least three infinite connected components.

Every cluster that has at least three ends intersects  $\bigcup_n \hat{A}_n$ . If  $C$  is such a cluster and  $\xi$  an isolated end of  $C$ , then for some integer  $n$ , the subset  $\hat{A}_n$  isolates  $\xi$ , which means that  $\xi(\hat{A}_n)$  is one-ended.

For every  $n \in \mathbb{N}$ , we define the following mass transport: if  $\hat{A}_n \cap \text{cluster}(u)$  is finite,  $u$  distributes uniformly a unit mass among the points of  $\hat{A}_n \cap \text{cluster}(u)$  that minimize their  $\mathcal{G}_\omega$ -distance to  $u$ ; otherwise,  $u$  sends no mass. According to the Mass Transport Principle, the expected sent mass is at most 1; in particular, it is almost surely finite for every  $n$ . But, when there is a cluster with at least three ends among which at least one is isolated, for some value of  $n$ , this mass transport sends to some point an infinite mass: this must thus happen with probability 0.  $\square$

NOTATION. Given a non-empty finite subgraph  $\mathcal{K}$  of  $\mathcal{G}$ , set

$$\alpha(\mathcal{K}) := \frac{2|E(\mathcal{K})|}{|V(\mathcal{K})|}.$$

If  $\mathfrak{T}$  is a set of subgraphs of  $\mathcal{G}$ , set

$$\alpha(\mathfrak{T}) := \sup\{\alpha(\mathcal{K}) ; \mathcal{K} \in \mathfrak{T} \text{ and } 0 < |V(\mathcal{K})| < \infty\}.$$

PROPOSITION 0.4.13 ([BLPS99B]). *Let  $\mathbb{P}$  be a  $G$ -invariant percolation on  $\mathcal{G}$  such that  $\mathbb{P}$ -almost surely, every finite cluster belongs to some set  $\mathfrak{T}$  of subgraphs of  $\mathcal{G}$ . Let  $o$  be a vertex of  $\mathcal{G}$ . Denote by  $D$  the number of open edges that contain  $o$ . Assume that  $G$  is unimodular and that  $\mathbb{E}[D] > \alpha(\mathfrak{T})$ .*

*Then, the probability that  $p_c(\mathcal{G}_\omega) < 1$  is positive.*

*Proof.* Define the following mass transport: every vertex distributes uniformly a mass equal to its  $\mathcal{G}_\omega$ -degree among the vertices of its cluster if this cluster is finite; if a vertex belongs to an infinite cluster, it sends no mass. According to the Mass Transport Principle,

$$\mathbb{E}[D\mathbb{1}_{|\text{cluster}(o)| < \infty}] = \mathbb{E}[\alpha(\text{cluster}(o))\mathbb{1}_{|\text{cluster}(o)| < \infty}].$$

If,  $\mathbb{P}$ -almost surely, every cluster was finite, then we would have  $\mathbb{E}[D] \leq \alpha(\mathfrak{T})$ . Since we have assumed the opposite, there must be an infinite cluster with positive probability.

If one intersects the percolation under study with an independent Bernoulli percolation of parameter  $p$  close enough to 1, then the inequality  $\mathbb{E}[D] > \alpha(\mathfrak{T})$  still holds for the new percolation, which thus yields an infinite cluster with positive probability.<sup>17</sup> It results from this and the Fubini-Tonelli Theorem that  $p_c(\mathcal{G}_\omega) < 1$  with positive probability.  $\square$

---

17. We may qualify of “percolation” a random variable the distribution of which is a percolation.

*Remark.* If  $\mathfrak{T}$  contains only trees, then  $\alpha(\mathfrak{T}) \leq 2$ .

PROPOSITION 0.4.14 ([BLPS99B]). *If  $\mathbb{P}$  is a  $G$ -invariant percolation on  $\mathcal{G}$  and if  $G$  is unimodular, then, with the notation of Proposition 0.4.13,*

$$\mathbb{E}[D|o \xleftrightarrow{\omega} \infty] \geq 2.$$

*Proof.* Consider the following mass transport:  $u$  sends unit mass to  $v$  if

- the  $\omega$ -cluster of  $u$  is infinite,
- $u$  and  $v$  are connected by an open edge
- and the  $\omega_{\{u,v\}}$ -cluster of  $u$  is finite,

and mass 0 otherwise. One can check that the mass sent by  $o$  minus the mass received by  $o$  is zero if  $o$  belongs to a finite cluster and bounded below by  $2 - D$  otherwise. One concludes by using the Mass Transport Principle.  $\square$

THEOREM 0.4.15 ([BLPS99B]). *If  $\mathbb{P}$  is a  $G$ -invariant percolation on  $\mathcal{G}$  almost every configuration of which is a forest and if  $G$  is unimodular, then,  $\mathbb{P}$ -almost surely, every cluster that has at least three ends satisfies  $p_c < 1$ .*

*Sketch of proof.* We will show that if the probability that there is a cluster with at least three ends is positive, then  $\mathbb{P}[p_c(\mathcal{G}_\omega) < 1] > 0$ . The demonstration of the general statement boils down to this one by considering the percolation formed of the union of the clusters with at least three ends that satisfy  $p_c = 1$ .

By suitably<sup>18</sup> removing edges around the branching points, one can define a  $G$ -invariant percolation that has less edges than the initial one, but such that the vertices  $v$  that satisfy  $v \xleftrightarrow{\omega} \infty$  are the same as in the initial percolation. Since the inequality of Proposition 0.4.14 holds for this new percolation, it holds as a strict inequality for the original percolation:

$$\mathbb{E}[D|o \xleftrightarrow{\omega} \infty] > 2.$$

By Proposition 0.4.13 and because  $\alpha(\mathcal{K}) \leq 2$  as soon as  $\mathcal{K}$  is a non-empty tree, the spanning forest satisfies  $p_c < 1$  with positive probability.  $\square$

### The Mass Transport Principle and directed models

The Mass Transport Principle is also an efficient tool to study directed models, “directed” being understood as in page 3. Notice that this thesis is about “directed models” of percolation, not models of “directed percolation”: this means that the definition of an open path will always be the same, and that when we will restrict our attention to “directed path”, this will be done explicitly.

NOTATION. If  $d$  is a positive integer, denote by  $(e_1, \dots, e_d)$  the canonical generating system of  $\mathbb{Z}^d$ . More precisely, for every  $i \in \{1, \dots, d\}$ , set  $e_i = (\mathbb{1}_{i=j})_{1 \leq j \leq d}$ .

---

<sup>18</sup> in a way that is  $G$ -invariant and such that the probability that at least one edge is removed is positive



**PROPOSITION 0.4.16.** *Let  $\mathbb{P}$  be a  $\mathbb{Z}^2$ -invariant percolation on the Cayley graph of  $\mathbb{Z}^2$  relative to  $\{e_1, e_2\}$ . Assume that,  $\mathbb{P}$ -almost surely, for every  $v \in \mathbb{Z}^2$ , at least one of the edges  $\{v, v - e_1\}$  and  $\{v, v - e_2\}$  is open. Let  $h$  be the group morphism from  $\mathbb{Z}^2$  to  $\mathbb{Z}$  that maps  $e_1$  and  $e_2$  to 1. Then,  $\mathbb{P}$ -almost surely, the function  $h$  is surjective in restriction to any cluster.*

*Remark.* The setup of this proposition generalises the model of coalescing random walks that is presented in [Arr79, TW98] — if one considers this model in positive *and* negative times.

*Proof.* Given a percolation configuration, label  $\infty$  every vertex the cluster of which surjects onto  $\mathbb{Z}$  via  $h$ ; every other vertex  $v$  is labelled  $m(v) := \max h_{|\text{cluster}(v)} - h(v) < \infty$ . Denote by  $p_n$  the probability that the origin  $(0, 0)$  is labelled  $n$ . For every  $n \in \mathbb{N}$ , define the following mass transport: if “the vertex  $u$  is labelled 0, the vertex  $v$  is labelled  $n$ , and  $u$  and  $v$  are connected by a path formed of  $n$  open edges”, then  $u$  sends mass 1 to  $v$ ; otherwise,  $u$  sends mass 0 to  $v$ . Since the origin can only receive mass from  $\{(a, b) \in \mathbb{N}^2 : a + b = n\}$ , the Mass Transport Principle gives  $(n + 1)p_n \geq p_0$ . It results from  $\sum_{n < \infty} p_n \leq 1$  and the divergence of the harmonic series that  $p_0 = 0$ , which entails Proposition 0.4.16.  $\square$

*Counter-example.* In general, when we have a group morphism  $h$  from  $\mathbb{Z}^d$  to  $\mathbb{Z}$  and a  $\mathbb{Z}^d$ -invariant percolation on  $\text{Cay}(\mathbb{Z}^d; e_1, \dots, e_d)$ , it is possible that each cluster is mapped by  $h$  onto a half-line. Such an example is as follows. Let  $\mathbf{b}$  be a random variable that is uniform in  $\mathbb{Z}/2\mathbb{Z}$ . Let  $\mu$  be a probability measure on  $\mathbb{N}$  that gives positive probability to every point. Let  $(n_{i,j})$  be a random variable of distribution  $\mu^{\otimes \mathbb{Z}^2}$  that is independent of  $\mathbf{b}$ . Take  $d = 3$  and  $h$  that maps  $e_1$  and  $e_2$  to 0, and  $e_3$  to 1. An edge of the form  $\{v, v + e_i\}$  for  $i \in \{1, 2\}$  is open if and only if  $h(v) + i \in \mathbf{b}$ . An edge of the form  $\{v, v + e_3\}$  is open if and only if  $n_{c(\mathbf{b}, v)} = n_{c(\mathbf{b}, v + e_3)} + 1$ , the couple  $c(\mathbf{b}, v)$  being defined as  $(v_1, v_3)$  if  $h(v) \in \mathbf{b}$  and  $(v_2, v_3)$  otherwise. See Figure 32.

Under additional assumptions, Proposition 0.4.16 can be refined as follows.

**PROPOSITION 0.4.17.** *Let  $\mathbb{P}$  be a  $\mathbb{Z}^2$ -invariant percolation on the Cayley graph of  $\mathbb{Z}^2$  relative to  $\{e_1, e_2\}$ . Assume that,  $\mathbb{P}$ -almost surely, for every  $v \in \mathbb{Z}^2$ , exactly one of the edges  $\{v, v - e_1\}$  and  $\{v, v - e_2\}$  is open. Let  $h$  be the group morphism from  $\mathbb{Z}^2$  to  $\mathbb{Z}$  that maps  $e_1$  and  $e_2$  to 1. Then,  $\mathbb{P}$ -almost surely, exactly one of the following events occurs:*

- every cluster contains a self-avoiding bi-infinite path;
- all the vertices belong to the same cluster.

*Proof.* Let us first introduce some vocabulary. For  $v \in V$  and  $\omega \in 2^E$ , denote by  $\Phi(v, \omega)$  the vertex  $u$  of  $\{v - e_1, v - e_2\}$  such that the edge  $\{u, v\}$  is  $\omega$ -open when this vertex exists and is unique, and  $v - e_1$  otherwise. The “directed path” launched at  $v$  is the semi-infinite path  $\kappa$  uniquely defined by  $\kappa(0) = v$  and  $\forall n \in \mathbb{N}, \kappa(n + 1) =$

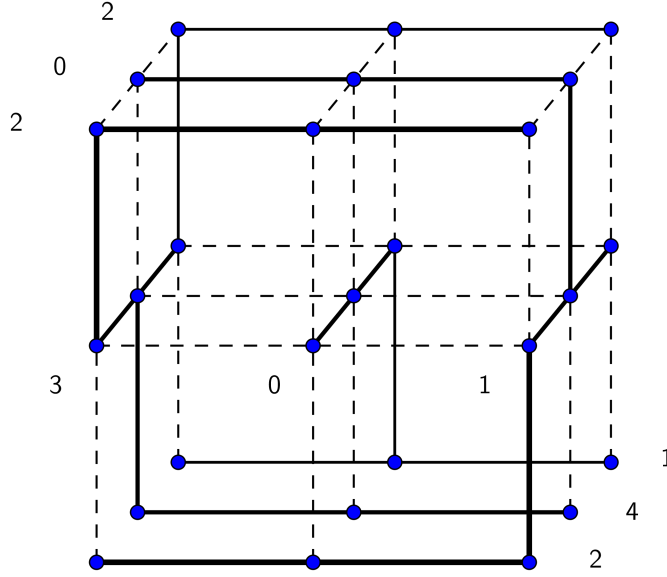

Figure 32 – A percolation on  $\mathbb{Z}^3$  that yields clusters that are vertically bounded above but not below.

$\Phi(\kappa(n), \omega)$ . A “level” is a set of the form  $h^{-1}(\{n\})$ , for some  $n \in \mathbb{Z}$ . At last, the “height” of a vertex  $v$  is the integer  $h(v)$ .

Let  $\omega$  be a configuration such that for every  $v$ , exactly one of the edges  $\{v, v - e_1\}$  and  $\{v, v - e_2\}$  is open. Let  $u_1 = (x_1, y_1)$ ,  $u_2 = (x_2, y_2)$  and  $u_3 = (x_3, y_3)$  be three points of  $h^{-1}(\{n\})$  such that  $x_1 < x_2 < x_3$  and  $u_1 \xrightarrow{\omega} u_3$ . It results from  $u_1 \xrightarrow{\omega} u_3$  and the structure of  $\omega$  that the directed paths launched at  $u_1$  and  $u_3$  coalesce. Since the three considered points belong to the same level and satisfy  $x_1 < x_2 < x_3$ , the directed path launched at  $u_2$  also meets one of the directed paths launched at  $u_1$  and  $u_3$  (hence both of them, with which it coincides at infinity). See Figure 33.

It follows from this that, almost surely, every cluster intersects  $h^{-1}(\{n\})$  along a set of the form

$$\{a + (-m, m) ; m \in I\},$$

where  $a \in \mathbb{Z}^2$  and  $I$  is an interval of  $\mathbb{Z}$ . This intersection is thus a finite set, a half-line, or the whole level. We will show that the case of the half-line holds almost never. Assume that the event  $E_n$  defined as “there is a cluster that intersects  $h^{-1}(\{n\})$  along a half-line where the first coordinate is bounded above (resp. below)” has positive probability. Notice that, on this event, there is a unique point  $u(\omega) \in h^{-1}(\{n\})$  such that:

- $u(\omega)$  belongs to a cluster that intersects  $h^{-1}(\{n\})$  along a half-line where the first coordinate is bounded above (resp. below),
- and  $u(\omega)$  is the point of maximal (resp. minimal) first coordinate among the points of its cluster that have height  $n$ .

Thus, by conditioning on  $E_n$  and considering the first coordinate of  $u(\omega)$ , we define a uniform random variable on  $\mathbb{Z}$ . Since such a random variable does not exist, the

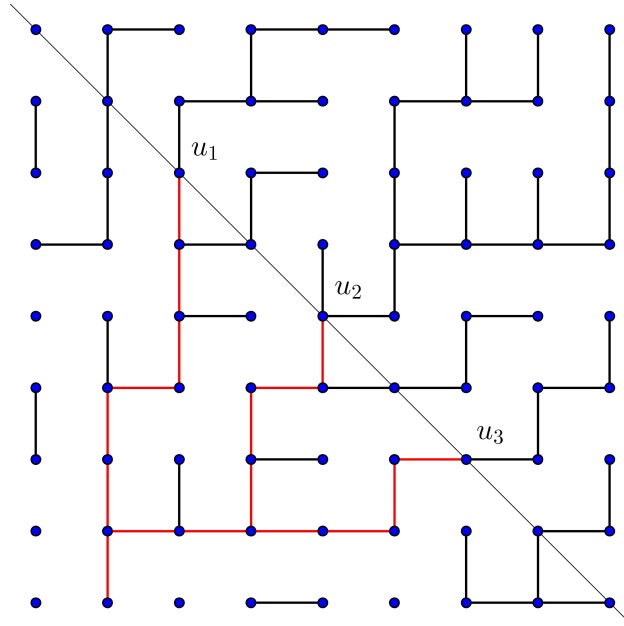

Figure 33 – In black, a percolation configuration that satisfies our assumptions. In red, the union of the images of three directed paths.

event  $E_n$  has probability zero, and this is also the case of  $\bigcup_n E_n$ .

With probability 1, if there is some integer  $n$  such that the level  $h^{-1}(\{n\})$  is a subset of *one* cluster, then this cluster contains all the vertices of  $\mathbb{Z}^2$ . Indeed, such an  $n$  exists, then all the vertices the height of which is larger than  $n$  belong to the same cluster; thus, if there is also a level that intersects several clusters, then, by conditioning and considering the maximal height of such a level, one would define a random variable that is uniform in  $\mathbb{Z}$ .

To establish the alternative (not the fact that it is exclusive), it is consequently enough to deal with the case where all the clusters intersect every level in finitely many points. Every cluster, as soon as it intersects level  $h^{-1}(\{n\})$ , intersects level  $h^{-1}(\{n-1\})$ . If every cluster intersects every level, then every cluster contains a bi-infinite self-avoiding path: proceed by diagonal extraction as on page 19. The case of a cluster that does not intersect every level is impossible, as testified by the mass transport where every vertex distributes fairly a unit mass among the highest vertices of its cluster if these vertices are in finite number, and sends mass zero otherwise.

At last, we show that this alternative is exclusive. Let  $\omega$  be a configuration such that for every  $v$ , exactly one of the edges  $\{v, v - e_1\}$  and  $\{v, v - e_2\}$  is open. The structure of  $\omega$  guarantees that every self-avoiding path  $\kappa : \mathbb{Z} \rightarrow V(\mathcal{G})$  that is  $\omega$ -open satisfies at least one of the following conditions:

- $\exists n_0 \in \mathbb{Z}, \forall n \geq n_0, h(\kappa(n+1)) = h(\kappa(n)) + 1$ ;
- $\exists n_0 \in \mathbb{Z}, \forall n \leq n_0, h(\kappa(n+1)) = h(\kappa(n)) - 1$ .

If such a path exists, up to truncating it, reversing its orientation and concatenating it with the directed path launched at its endpoint, one can assume that  $h$  induces a bijection from the image of  $\kappa$  to  $\mathbb{Z}$ ; we will say that  $\kappa$  is “monotonic”. Almost surely,

every cluster that contains a bi-infinite monotonic path contains exactly one such path (up to equality of the image); indeed, otherwise, there would be a branching point, which is excluded by the proof of Theorem 0.4.8. If the probability that the two events of the alternative occur simultaneously were positive, by conditioning on it and considering the first coordinate of the unique point that belongs to both  $h^{-1}(\{0\})$  and the unique bi-infinite monotonic  $\omega$ -open path, we would define a random variable that is uniform in  $\mathbb{Z}$ , which does not exist.  $\square$

### 0.4.5 The Indistinguishability Theorem

In this paragraph, we deal with the Indistinguishability Theorem of Lyons and Schramm. This theorem states that if  $G$  is unimodular, then for every  $G$ -invariant percolation on  $\mathcal{G}$  that is insertion-tolerant, “all infinite clusters have almost surely the same behaviour”. To make this assertion precise, we need a few definitions.

A **vertex property** is a Borel, Boolean and  $G$ -invariant function defined on  $\{0, 1\}^E \times V$ , i.e. a Borel function

$$P : \{0, 1\}^E \times V \rightarrow \{\text{true}, \text{false}\}$$

that is invariant under the diagonal action of  $G$ . If  $W \subset V$ , we write  $P^+(\omega, W)$  for “all the vertices of  $W$  satisfy  $P(\omega, \cdot)$ ”. More formally, we set:

$$P^+(\omega, W) := “\forall v \in W, P(\omega, v)”.$$

We also define:

- $P^-(\omega, W) := “\forall v \in W, \neg P(\omega, v)”$ ,
- $P^\pm(\omega, W) := “P^+(\omega, W) \vee P^-(\omega, W)”$ .

The expression  $P^\pm(\omega, W)$  means “all the vertices of  $W$  agree on  $P(\omega, \cdot)$ ”.

A **cluster property** is a vertex property  $P$  such that  $P(\omega, v) \iff P(\omega, u)$  as soon as  $u \xleftrightarrow{\omega} v$ . In other words, it is a vertex property such that, for every  $\omega$ , the function  $P(\omega, \cdot)$  is constant on  $\omega$ -clusters.

To speak of indistinguishability of infinite clusters, we need to speak of infinite clusters. Thus, we set:

$$V_\infty(\omega) := \{v \in V : v \xleftrightarrow{\omega} \infty\}.$$

A percolation  $\mathbb{P}$  is said to satisfy the **Indistinguishability Property** if for every cluster property  $P$ ,

$$\mathbb{P}[P^\pm(\omega, V_\infty(\omega))] = 1.$$

**THEOREM 0.4.18 (LYONS AND SCHRAMM, [LS11]).** *If the group  $G$  is unimodular, then every  $G$ -invariant percolation on  $\mathcal{G}$  that is insertion-tolerant satisfies the Indistinguishability Property.*

*Remark.* In Theorem 0.4.18, one can remove neither the assumption of unimodularity nor that of insertion-tolerance. Given a Bernoulli percolation yielding infinitely many infinite clusters on a grand-parents graph, one can distinguish the infinite clusters by their local structure in the neighbourhood of the point that is the closest to the marked end. As for insertion-tolerance, it is necessary to prevent the following situation from happening: perform a Bernoulli percolation of parameter  $p$  and then, for every infinite cluster, toss a coin to determine whether this cluster is broken up by an independent Bernoulli percolation of parameter  $q$  or not. (Choose  $(p, q)$  such that  $p > p_u$  and  $pq > p_c$ .)

*Glimpse of the proof of theorem 0.4.18.* First, we show that it is enough to prove that,  $\mathbb{P}$ -almost surely, every infinite cluster is transient for the simple random walk. Thus, let us assume that this transience holds and establish the Indistinguishability Property. Consider a cluster property  $P$  on which, with positive probability, two infinite clusters do not agree. Say that an edge  $e$  is “pivotal” for the configuration  $\omega$  if  $P(\omega_e, o) \neq P(\omega^e, o)$  and the  $\omega_e$ -cluster of  $o$  is infinite. By using insertion-tolerance to connect two infinite clusters that do not agree on  $P$ , one proves that the probability that there is a pivotal edge is positive; one can thus find a number  $R$  such that the probability that such an edge lies at distance less than  $R$  from  $o$  is positive. Then, one defines a random walk on the cluster of the origin that enjoys enough invariance properties to allow the use of some form of Mass Transport Principle. Since this principle guarantees some form of homogeneity, almost surely, if the walker gets at least once at distance less than  $R$  from a pivotal edge (which happens with positive probability), then this happens infinitely many times. If this random walk is transient, then no  $R$ -neighbourhood of a pivotal edge can be visited infinitely many times, so that the probability that there are infinitely many pivotal edges is positive. This means that the event  $\{\omega : P(\omega, o)\}$  cannot be well approximated by cylindrical events, which contradicts the fact that  $P$  is Borel.

It thus remains to show that every infinite cluster is almost surely transient: if all clusters agree on the question of transience, they will agree on every question. Consider the free minimal spanning forest<sup>19</sup> of the graph  $\mathcal{G}_\omega = (V, \omega)$ . One can show that, almost surely, every infinite cluster of the original percolation contains an infinite tree of this random forest. By Rayleigh’s monotonicity principle<sup>20</sup>, it is sufficient to show that, almost surely, all the infinite trees of the random forest are transient. By the theory of the branching number (see [Lyo90]), every tree that satisfies  $p_c < 1$  is transient<sup>21</sup>. It is thus enough to prove that, almost surely, every infinite cluster of the random forest satisfies  $p_c < 1$ .

Lemma 3.6 of [LS11] guarantees that there is no loss of generality in assuming  $\mathbb{P}$  to be ergodic. By Proposition 0.4.3, the number of infinite clusters has a  $\mathbb{P}$ -almost deterministic value  $x \in \{0, 1, \infty\}$ . Since the Indistinguishability Property trivially holds if  $x \leq 1$ , we can assume that  $x = \infty$ . Almost surely, no infinite cluster has an isolated end: indeed, otherwise, one could use insertion-tolerance

---

19. The **free minimal spanning forest** of a graph  $\mathcal{G}$  is defined as follows. For every edge  $e$ , toss a random variable that is uniform in  $[0, 1]$ ; these variables are taken to be independent. Open the edges the label of which is the maximal label of some cycle.

20. Every connected graph that contains a transient subgraph is transient.

21. This not the case for general graphs, as shown by the square lattice.

to build a cluster with at least three ends among which at least one is isolated, thus contradicting Proposition 0.4.12. In particular,  $\mathbb{P}$ -almost surely, every infinite cluster has at least three ends. It is possible to deduce from this that, almost surely, every infinite cluster of the free minimal spanning forest has at least three ends. By Theorem 0.4.15, they almost surely satisfy  $p_c < 1$ , which ends the proof of Theorem 0.4.18.  $\square$

There is another theorem of indistinguishability; its conclusion is less powerful, but it holds for every transitive graph. To this end, we introduce the notion of robust property.

A cluster property  $P$  is **robust** if for every edge  $e = \{u, v\}$  and every configuration  $\omega \in 2^E$  satisfying  $\omega(e) = 1$ , the following two assertions are equivalent:

- the  $\omega$ -cluster of  $u$  is infinite and  $P(u, \omega)$  holds;
- an element  $v'$  of  $\{u, v\}$  satisfies  $P(v', \omega_e)$  and belongs to an infinite  $\omega_e$ -cluster.

A percolation  $\mathbb{P}$  is said to satisfy the **property of indistinguishability by robust properties** if for every robust cluster property  $P$ ,

$$\mathbb{P}[P^\pm(\omega, V_\infty(\omega))] = 1.$$

**THEOREM 0.4.19** ([HPS99]). *Bernoulli percolation of parameter  $p$  on the transitive graph  $\mathcal{G}$  satisfies the property of indistinguishability by robust properties as soon as  $p > p_c(\mathcal{G})$ .*

With these Indistinguishability Theorems, one can prove (or re-prove) numerous results about Bernoulli percolation. Theorem 0.4.19 easily implies Theorem 0.4.4. Indeed, if  $p$  is a parameter at which there is a unique infinite cluster and if  $q > p \geq p_c(\mathcal{G})$ , the robust property “the cluster of the considered vertex satisfies  $\theta(p/q) > 0$ ” is  $\mathbb{P}_q$ -almost surely satisfied by an infinite cluster (use the standard coupling) and cannot be satisfied simultaneously by several clusters (by uniqueness at parameter  $p$ ). Likewise, one can prove the weak version of the following theorem. The strong version requires more work.

**THEOREM 0.4.20** ([HPS99]). *Let  $(U_e)_{e \in E(\mathcal{G})}$  be a sequence of independent random variables that are uniform in  $[0, 1]$ . For every  $p \in [0, 1]$ , define the  $p$ -cluster of a vertex as its cluster for the configuration  $\omega_p := (\mathbb{1}_{U_e < p})$ . Then, infinite clusters are born simultaneously, which means that:*

- for every  $(p_1, p_2)$  that satisfies  $p_c(\mathcal{G}) < p_1 < p_2 \leq 1$ , almost surely, every infinite  $p_2$ -cluster contains an infinite  $p_1$ -cluster (weak version);
- almost surely, for every  $(p_1, p_2)$  that satisfies  $p_c(\mathcal{G}) < p_1 < p_2 \leq 1$ , every infinite  $p_2$ -cluster contains an infinite  $p_1$ -cluster (strong version).

*In fact, between  $p_c$  and  $p_u$ , infinite clusters merge relentlessly:*

- for every  $(p_1, p_2)$  that satisfies  $p_c(\mathcal{G}) < p_1 < p_2 \leq 1$ , almost surely, every infinite  $p_2$ -cluster contains infinitely many infinite  $p_1$ -clusters (weak version);
- almost surely, for every  $(p_1, p_2)$  that satisfies  $p_c(\mathcal{G}) < p_1 < p_2 \leq 1$ , every infinite  $p_2$ -cluster contains infinitely many infinite  $p_1$ -clusters (strong version).

Theorem 0.4.18 can also be used to show that as soon as  $G$  is unimodular, the connectivity decays in the phase  $N_\infty^{\mathcal{G}} = \infty$ . This is made precise by the following theorem.

**THEOREM 0.4.21 (LYONS AND SCHRAMM, [LS11]).** *Assume that  $G$  is unimodular. Let  $\mathbb{P}$  be a  $G$ -invariant percolation on  $G$  that is insertion-tolerant. Assume that  $\mathbb{P}$ -almost every configuration yields infinitely many infinite clusters.*

*Then, we have  $\inf_{u, v \in V} \mathbb{P}[u \overset{\omega}{\longleftrightarrow} v] = 0$ . In particular, this conclusion holds as soon as  $\mathbb{P} = \mathbb{P}_p$  for  $p$  such that  $N_\infty^{\mathcal{G}}(p) = \infty$ ; the group  $G$  is still assumed to be unimodular.*

*Remark.* By the Harris inequality, if  $N_\infty^{\mathcal{G}}(p) = 1$ , then

$$\inf_{u, v \in V} \mathbb{P}_p[u \overset{\omega}{\longleftrightarrow} v] \geq \theta(p)^2 > 0.$$

Theorem 0.4.21 can be rephrased in metric terms. Define  $d_p : V \times V \rightarrow \mathbb{R}_+$  by

$$d_p(u, v) := -\ln \mathbb{P}_p[u \overset{\omega}{\longleftrightarrow} v].$$

The Harris inequality guarantees that for every  $p \in (0, 1)$ , the function  $d_p$  defines a distance on  $V$  (which is  $\text{Aut}(\mathcal{G})$ -invariant). This distance can be used to state geometrically several facts and conjectures about Bernoulli percolation.

- For  $p > p_u$ , the space  $V$  is  $d_p$ -bounded; for  $p < p_u$ , it is not. See Theorem 0.4.21.
- For  $p > p_c$ , the quantity  $\sum_v e^{-d_p(o, x)}$  is finite; for  $p < p_c$ , it is not. See [AV08].
- For  $p < p_c$ , the distance  $d_p$  is bi-Lipschitz equivalent to the graph distance. See [AV08].
- It is conjectured that for  $p < p_u$ , every  $d_p$ -ball of finite radius contains finitely many points. See [LS11].

## 0.5 Results of this thesis

This thesis fits into the vast landscape presented in the previous sections. My contributions, of course, take place at a much more modest scale. They are divided into three chapters.

Chapters 1 and 2 both use tools of *group* theory and group actions to study Bernoulli *percolation*. In the first case, we work on non-amenable Cayley graphs by using orbit equivalence theory (in particular Theorem 1.1.11, due to Chifan and Ioana) to strengthen the Indistinguishability Theorem of Lyons and Schramm in the case of Bernoulli percolation. In Chapter 2, we prove that Schramm’s Locality Conjecture holds for abelian Cayley graphs by using the space of marked groups.

The common feature between Chapter 1 and Chapter 3 is the presence in each of them of a *directed model*, that is to say a model where “up and down play different roles”.

Here is a brief presentation of these three chapters.

### Orbit equivalence and strong indistinguishability

In the first chapter, we define the notion of strong indistinguishability (Section 1.3.3) and establish that it holds for Bernoulli percolation (Corollary 1.3.11). The non-triviality of this strengthening is illustrated by a directed model (Section 1.3.4), for which we prove that indistinguishability holds but not strong indistinguishability. This directed model is not insertion-tolerant. This chapter gave rise to [Marb].

### Locality of percolation for abelian Cayley graphs

The second chapter is about a theorem that I established in collaboration with Vincent Tassion [MT]. We prove that Bernoulli percolation is local for abelian Cayley graphs (Theorem 0.3.10). The main innovations of [MT] are the introduction in percolation theory of the space of marked groups, the removal of any assumption of isotropy<sup>22</sup> and the use of the explored path as a seed instead of a fully open box (Section 2.2.3).

### Directed DLA

DLA — for Diffusion-Limited Aggregation — is an important<sup>23</sup> model in statistical mechanics. It was introduced in 1981 by Witten and Sander in [WS81]. To define it, fix a particle (a site of  $\mathbb{Z}^2$ ). Then, release a particle “from infinity” and let it perform a simple random walk. As soon as it touches the first particle, it sticks to it and stops. Then, release another particle, which also stops as soon as it touches the cluster, and so on. . .

Numerical simulations give rise to fractal-looking pictures, but the rigorous study of this model remains mainly out of reach of current probabilistic techniques.

---

22. We do not need the graph under study to be stable under any reflection.

23. DLA is a model for dendritic growth [Vic92], dielectric breakdown [BB84] and viscous fingering in a Hele-Shaw cell [SB84].



In the third chapter of this thesis (which corresponds to [Mara]), we study an easier version of this model, where the random walks that define the process are directed: the steps are taken according to a uniform distribution on  $\{(0, -1), (-1, 0)\}$ . Studying this process (called **directed DLA**, or **DDLA**) requires to tackle the same difficulties as for DLA (non-locality and non-monotonicity of the dynamics) but is easier as directed random walks are less erratic than undirected random walks. We hope that the study of DDLA will help developing techniques for DLA.

So far, we have proved four results on DDLA: the existence of an infinite volume dynamics (Section 3.2), an upper bound on the speed of propagation of information (Section 3.3), asymptotic inequalities on the height and width of the cluster (Section 3.4) and a weak theorem about the geometry of the infinite aggregate (Section 3.5).

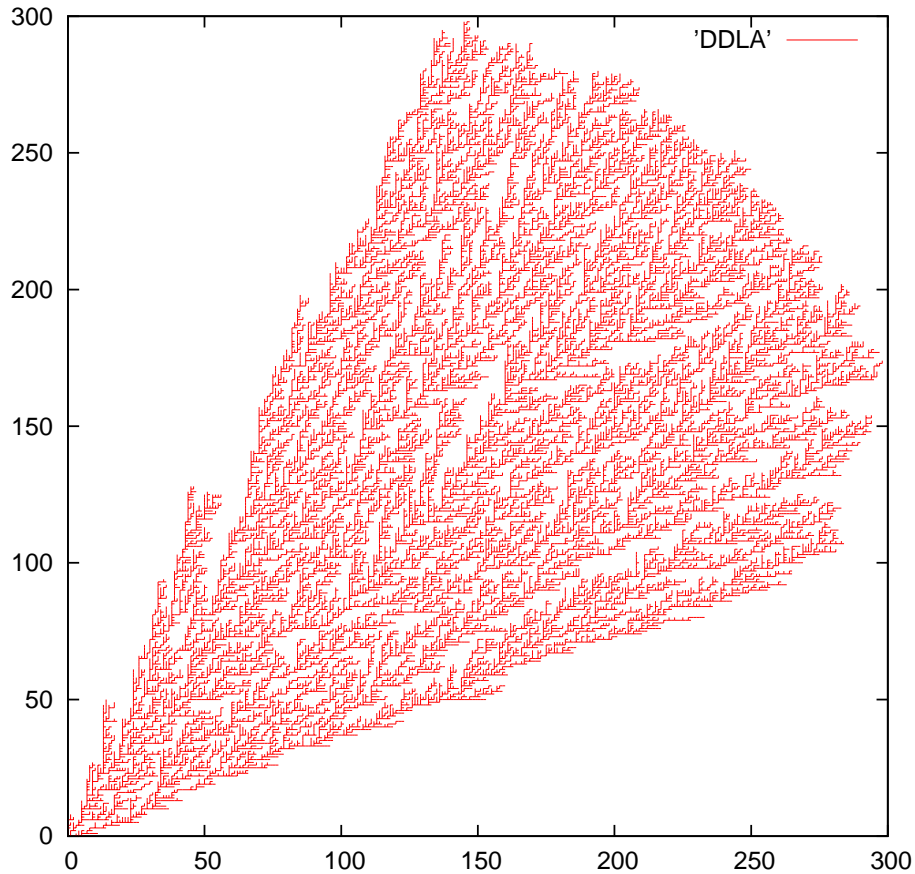

Figure 34 – DDLA cluster. Simulation due to Vincent Beffara.

# Chapter 1

## Orbit equivalence and strong indistinguishability

Orbit equivalence is a branch of ergodic theory that focuses on the dynamical properties of equivalence relations. Its fruitful interactions with other mathematical fields are numerous — e.g. operator algebra theory [MvN36, Pop07], foliation theory [Con79, Lev93], descriptive set theory [JKL02, KM04], etc. Among the many concepts of the field, a fundamental one is the notion of *ergodicity*: an equivalence relation defined on a probability space is said to be ergodic if every saturated set has measure 0 or 1. It is striking to see how a definition that is usually given in the group action context can be easily stated in the seemingly static framework of equivalence relations.

The other fundamental notion considered in this chapter, *indistinguishability*, belongs to percolation theory, a branch of statistical physics. Percolation is concerned with the study of random subgraphs of a given graph. These subgraphs are generally far from connected, and one is naturally interested in their infinite connected components — or infinite clusters. A difficult theorem due to Lyons and Schramm [LS11] states that, under some hypotheses, if several infinite clusters are produced, they all “look alike”. This is the Indistinguishability Theorem (see Theorem 1.2.10).

Its equivalence to some form of ergodicity should not be surprising: in both cases, when one asks a nice question, all the objects — in one case the points of the space lying under the relation, in the other one the infinite clusters — give the same answer. This connection is well-understood (see [Gab05, GL09] and Proposition 1.3.4). In the orbit equivalence world, a hard theorem due to Chifan and Ioana (see [CI10] and Theorem 1.1.11) allows us to get from this ergodicity a *stronger* form of ergodicity.

In this chapter, we define a notion of strong indistinguishability and prove its equivalence to strong ergodicity: this is Theorem 1.3.10. In particular, Bernoulli percolation satisfies the Strong Indistinguishability Property

(see Corollary 1.3.11). We also define an invariant percolation that is not insertion-tolerant, satisfies the Indistinguishability Property and does not satisfy the Strong Indistinguishability Property (see Subsection 1.3.4).

This chapter is self-contained, so that the orbit equivalence part can be read without prerequisite by a percolation theorist and vice versa. The first section presents what will be needed of orbit equivalence theory. The second one deals with percolation theory. The third and last section recalls the classical correspondence between ergodicity and indistinguishability and explores the correspondence between strong ergodicity and the notion of strong indistinguishability defined in this chapter. This chapter follows [Marb].

### Terminology

If  $R$  is an equivalence relation defined on a set  $X$ , the  $R$ -**class** of  $x$  is

$$[x]_R := \{y \in X : xRy\}.$$

A subset  $A$  of  $X$  is said to be  $R$ -**saturated**, or  $R$ -**invariant**, if

$$\forall x \in A, [x]_R \subset A.$$

The  $R$ -**saturation** of a subset  $A$  of  $X$  is the smallest subset  $R$ -saturated subset of  $X$  that contains  $A$ . Concretely, it is  $\bigcup_{x \in A} [x]_R$ .

## 1.1 Orbit equivalence theory

This section presents standard definitions and theorems from orbit equivalence theory. For details relative to Subsection 1.1.0, one can refer to [Kec95]. For Subsections 1.1.1 to 1.1.6, possible references are [Gab10] and [KM04].

### 1.1.0 Generalities on the standard Borel space

A measurable space  $X$  is called a **standard Borel space** if it can be endowed with a Polish topology inducing its  $\sigma$ -algebra. For instance,  $\{0, 1\}^{\mathbb{N}}$  endowed with the product  $\sigma$ -algebra is a standard Borel space. A measurable subset of a standard Borel space is called a **Borel subset**.

The following general results on standard Borel spaces will be used without explicit mention.

**THEOREM 1.1.1.** *Any Borel subset of a standard Borel space is itself a standard Borel space.*

Let  $X$  and  $Y$  be two measurable spaces. A bijection  $f : X \rightarrow Y$  is a **Borel isomorphism** if  $f$  and  $f^{-1}$  are measurable. If  $X = Y$ , we speak of **Borel automorphism**.

**THEOREM 1.1.2.** *Let  $X$  and  $Y$  be standard Borel spaces. If  $f : X \rightarrow Y$  is a measurable bijection, then  $f^{-1}$  is automatically measurable, hence a Borel isomorphism.*

**THEOREM 1.1.3.** *Every non-countable standard Borel space is isomorphic to  $[0, 1]$ . In particular, the continuum hypothesis holds for standard Borel spaces.*

### 1.1.1 Countable Borel equivalence relations

Let  $\Gamma$  be a countable group and  $\Gamma \curvearrowright X$  be a Borel action of it on a standard Borel space. By **Borel action**, we mean that every  $\gamma \in \Gamma$  induces a Borel automorphism of  $X$ . Such an action induces a partition of  $X$  into orbits. Let us consider  $R$  (or  $R_{\Gamma \curvearrowright X}$ ) the relation “being in the same orbit” and call it the **orbit equivalence relation** of  $\Gamma \curvearrowright X$ . It is a subset of  $X^2$ . Since  $\Gamma$  is countable, the following assertions hold:

- $R$  is *countable*, i.e. every  $R$ -class is (finite or) countable,
- $R$  is Borel, as a subset of  $X^2$ .

The following theorem provides the converse:

**THEOREM 1.1.4** (FELDMAN AND MOORE, [FM75]). *Every countable Borel equivalence relation on a standard Borel space is induced by a Borel action of some countable group.*

In other words, every countable Borel equivalence relation on a standard Borel space is an orbit equivalence relation. This is why the theory of “countable Borel equivalence relations” is called “orbit equivalence theory”.

### 1.1.2 Measure invariance

When dealing with a Borel action of  $\Gamma$  on a probability space, it makes sense to speak of invariance of the probability measure. The purpose of this subsection is to define this notion for countable Borel equivalence relations. To begin with, one needs to know how the standard Borel space behaves when it is endowed with a probability measure.

**DEFINITION.** A **standard probability space** is a standard Borel space endowed with a probability measure.

**THEOREM 1.1.5.** *Every atomless standard probability space  $(X, \mu)$  is isomorphic to  $[0, 1]$  endowed with its Borel  $\sigma$ -algebra and the Lebesgue measure, i.e. there is a measure-preserving Borel isomorphism between  $(X, \mu)$  and  $([0, 1], dx)$ .*

THROUGHOUT THIS PAPER, STANDARD PROBABILITY SPACES WILL IMPLICITLY BE ASSUMED TO BE ATOMLESS.

Having a nice measured space to work on is not enough to provide a notion of invariance of the measure: to do so, one needs relevant transformations, presented below.

**DEFINITION.** If  $R$  is a countable Borel equivalence relation,  $[R]$  denotes the group of the Borel automorphisms of  $X$  whose graph is included in  $R$ . A **partial Borel automorphism** of  $X$  is a Borel isomorphism between two Borel subsets of  $X$ . One denotes by  $[[R]]$  the set of partial Borel automorphisms whose graph is included in  $R$ .

*Remark.* In the literature,  $X$  is often equipped with a “nice” probability measure<sup>1</sup>, and one often uses  $[R]$  and  $[[R]]$  to denote the objects defined above quotiented out by almost everywhere agreement. In this chapter, we will stick to the definition we gave, which can be found in [KM04].

As exemplified by the theorem below, these Borel automorphisms allow us to mimic intrinsically the “group action” definitions in the “orbit equivalence” setting.

**THEOREM 1.1.6.** *Let  $R$  be a countable Borel equivalence relation on a standard probability space  $(X, \mu)$ . The following assertions are equivalent:*

- *there exist a countable group  $\Gamma$  and  $\Gamma \curvearrowright X$  a measure-preserving Borel action of it such that  $R = R_{\Gamma \curvearrowright X}$ ,*
- *every Borel action of a countable group that induces  $R$  preserves  $\mu$ ,*
- *every element of  $[R]$  preserves  $\mu$ .*

*When any of these equivalent properties is satisfied, we say that the measure  $\mu$  is **preserved** by  $R$ , or that it is  **$R$ -invariant**.*

HENCEFORTH,  $(X, \mu)$  WILL ALWAYS BE AN ATOMLESS STANDARD PROBABILITY SPACE AND THE EQUIVALENCE RELATIONS WE WILL CONSIDER ON IT WILL ALWAYS BE MEASURE-PRESERVING COUNTABLE BOREL EQUIVALENCE RELATIONS.

*Remark.* There is no uniqueness theorem (analogous to Theorem 1.1.3 or Theorem 1.1.5) for the object  $(X, \mu, R)$ . This is why orbit equivalence theory is not empty. Another fact to keep in mind is that the space  $X/R$  essentially never bears a natural standard Borel structure, even though  $R$  is Borel.

---

1. Here, “nice” means “ $R$ -invariant”, which will be defined using  $[R]$  (as defined above).

### 1.1.3 Amenability and hyperfiniteness

Amenability of a group can be defined in many equivalent ways. For our purpose, the following characterization will be enough.

**THEOREM 1.1.7.** *A countable group  $\Gamma$  is amenable if and only if there exists a **Reiter sequence**, i.e.  $f_n \in \ell^1(\Gamma)$  such that:*

- $\forall n, f_n \geq 0$  and  $\|f_n\|_1 = 1$ ,
- $\forall \gamma \in \Gamma, \|f_n - \gamma \cdot f_n\|_1 \xrightarrow{n \rightarrow \infty} 0$ .

In the theorem above,  $\Gamma$  acts on  $\ell^1(\Gamma)$  via  $\gamma \cdot f(\eta) := f(\gamma^{-1}\eta)$ . Taking the inverse of  $\gamma$  guarantees that this defines a left action. Besides, the action it induces on indicator functions corresponds to the natural action  $\Gamma \curvearrowright \text{Subsets}(\Gamma)$ , i.e. we have  $\gamma \cdot \mathbb{1}_A = \mathbb{1}_{\gamma \cdot A}$ .

This theorem in mind, the following definition of amenability for equivalence relations is natural.

**DEFINITION.** Let  $R$  be a countable Borel equivalence relation on  $(X, \mu)$ . One says that  $R$  is  **$\mu$ -amenable** if and only if there is a sequence of *Borel* functions  $f_n : R \rightarrow \mathbb{R}^+$  such that:

- $\forall x \in X, \sum_{y \in [x]_R} f_n(x, y) = 1$ ,
- there is a full-measure  $R$ -invariant Borel subset  $A \subset X$  such that

$$\forall (x, y) \in (A \times A) \cap R, \sum_{z \in [x]_R} |f_n(x, z) - f_n(y, z)| \xrightarrow{n \rightarrow \infty} 0.$$

*Comment.* In the definition above (and in others), one can indifferently impose  $A$  to be  $R$ -invariant or not. Indeed, it can be deduced from Theorem 1.1.4 that the  $R$ -saturation of a  $\mu$ -negligible set is still  $\mu$ -negligible. (Recall that all considered equivalence relations are tacitly assumed to preserve the measure.)

Proposition 1.1.8 shows that this definition is a nice extension of the classical notion of amenability (for countable groups) to equivalence relations.

**NOTATION.** Let  $\Gamma \curvearrowright X$  be a Borel action of a countable group on a standard Borel space. If  $X$  is endowed with an atomless probability measure  $\mu$  that is  $\Gamma$ -invariant, we will write  $\Gamma \curvearrowright (X, \mu)$ .

**PROPOSITION 1.1.8.** *Let  $\Gamma \curvearrowright (X, \mu)$  be a measure-preserving action of a countable group. If  $\Gamma$  is amenable, then  $R_{\Gamma \curvearrowright X}$  is  $\mu$ -amenable. Besides, if  $\Gamma \curvearrowright X$  is free, then the converse holds.*

It is easy to see that *finite* equivalence relations (i.e. whose classes are finite) are amenable: one just needs to set  $f_n(x, y) = \frac{1}{|[x]_R|} \mathbb{1}_{y \in [x]_R}$ . The proof naturally extends to hyperfinite equivalence relations, defined below.

DEFINITION. An equivalence relation  $R$  on a standard Borel space  $X$  is said to be **hyperfinite** if it is a countable increasing union of finite Borel equivalence subrelations. (No measure appears in this definition.) If  $\mu$  is an  $R$ -invariant probability measure on  $X$ , the relation  $R$  is **hyperfinite  $\mu$ -almost everywhere** if there is a full-measure Borel subset  $A \subset X$  such that  $R \cap (A \times A)$  is hyperfinite.

*Example.* The group  $\Gamma_\infty := \bigoplus_{n \in \mathbb{N}} \mathbb{Z}/2\mathbb{Z}$  is the increasing union of the subgroups  $\Gamma_N := \bigoplus_{n \leq N} \mathbb{Z}/2\mathbb{Z}$ . Hence, any  $R_{\Gamma_\infty \curvearrowright X}$  is hyperfinite. Besides,  $\Gamma_\infty$  is amenable: set  $f_n = \frac{1_{\Gamma_n}}{|\Gamma_n|}$ . Hence, any  $R_{\Gamma_\infty \curvearrowright (X, \mu)}$  is  $\mu$ -amenable.

THEOREM 1.1.9 (CONNES-FELDMAN-WEISS, [CFW81]). *Let  $R$  be a Borel countable equivalence relation on  $(X, \mu)$ . The relation  $R$  is  $\mu$ -amenable if and only if it is hyperfinite  $\mu$ -almost everywhere.*

#### 1.1.4 Ergodicity

DEFINITION. Let  $\Gamma \curvearrowright (X, \mu)$  be a measure-preserving action. It is said to be **ergodic** if, for every  $\Gamma$ -invariant Borel subset  $B$  of  $X$ , either  $\mu(B) = 0$  or  $\mu(B) = 1$ .

DEFINITION. An equivalence relation  $R$  on a standard probability space  $(X, \mu)$  is said to be **ergodic** (or  **$\mu$ -ergodic**) if, for every  $R$ -invariant Borel subset  $B$  of  $X$ , either  $\mu(B) = 0$  or  $\mu(B) = 1$ .

*Remark.* Let  $\Gamma \curvearrowright (X, \mu)$  be a measure-preserving group action. Let  $B$  be a subset of  $X$ . Notice that it is the same for  $B$  to be  $\Gamma$ -invariant or  $R_{\Gamma \curvearrowright X}$ -invariant. This means that the following assertions are equivalent:

- $\forall \gamma \in \Gamma, \gamma \cdot B = B,$
- $\forall x \in B, \forall y \in X, xR_{\Gamma \curvearrowright X}y \implies y \in B.$

In particular,  $\Gamma \curvearrowright X$  is ergodic if and only if  $R_{\Gamma \curvearrowright X}$  is ergodic.

*The Bernoulli example.* Let  $\Gamma$  be an infinite countable group and  $(\Sigma, \nu)$  denote either  $([0, 1], \text{Leb})$  or  $(\{0, 1\}, \text{Ber}(p)) = (\{0, 1\}, (1-p)\delta_0 + p\delta_1)$ . Let  $A$  denote either  $\Gamma$  or the edge-set of a Cayley graph of  $\Gamma$ . (The notion of Cayley graph is introduced in Subsection 1.2.1.) Let  $\mathcal{S}$  be the equivalence relation induced by the shift action of  $\Gamma$  on  $(\Sigma^A, \nu^{\otimes A})$  defined by

$$\gamma \cdot (\sigma_a)_{a \in A} = (\sigma_{\gamma^{-1} \cdot a})_{a \in A}.$$

This equivalence relation preserves  $\nu^{\otimes A}$  and is ergodic.

The following theorem states that the amenable world shrinks to a point from the orbital point of view.

**THEOREM 1.1.10** (DYE, [DYE59]). *Every countable Borel equivalence relation that is ergodic and hyperfinite  $\mu$ -almost everywhere is isomorphic to the orbit equivalence relation of the Bernoulli shift  $(\mathbb{Z} \curvearrowright (\{0, 1\}^{\mathbb{Z}}, \text{Ber}(1/2)^{\otimes \mathbb{Z}}))$ . This means that if  $R$  is such a relation on a standard probability space  $(X, \mu)$ , there are*

- a full-measure  $R$ -invariant Borel subset  $A$  of  $X$ ,
- a full-measure  $\mathbb{Z}$ -invariant Borel subset  $B$  of  $\{0, 1\}^{\mathbb{Z}}$ ,
- a measure-preserving Borel isomorphism  $f : A \rightarrow B$

such that  $\forall x, y \in A, xRy \iff f(x)R_{\mathbb{Z} \curvearrowright \{0, 1\}^{\mathbb{Z}}} f(y)$ .

### 1.1.5 Strong ergodicity

The notion of strong ergodicity, presented in this subsection, is due to Schmidt [Sch81].

**DEFINITION.** Let  $\Gamma \curvearrowright (X, \mu)$  be a measure-preserving action. A sequence  $(B_n)$  of Borel subsets of  $X$  is said to be **asymptotically  $\Gamma$ -invariant (with respect to  $\mu$ )** if

$$\forall \gamma \in \Gamma, \mu((\gamma \cdot B_n) \Delta B_n) \xrightarrow{n \rightarrow \infty} 0.$$

The action  $\Gamma \curvearrowright (X, \mu)$  is said to be **strongly ergodic** if, for every asymptotically  $\Gamma$ -invariant sequence of Borel sets  $(B_n)$ ,

$$\mu(B_n)(1 - \mu(B_n)) \xrightarrow{n \rightarrow \infty} 0.$$

Making use of [R], one can extend this notion to equivalence relations.

**DEFINITION.** Let  $R$  be an equivalence relation on a standard probability space  $(X, \mu)$ . A sequence  $(B_n)$  of Borel subsets of  $X$  is said to be **asymptotically  $R$ -invariant (with respect to  $\mu$ )** if

$$\forall \phi \in [R], \mu(\phi(B_n) \Delta B_n) \xrightarrow{n \rightarrow \infty} 0.$$

The equivalence relation  $R$  is said to be **strongly ergodic** if, for every asymptotically  $R$ -invariant sequence of Borel sets  $(B_n)$ ,

$$\mu(B_n)(1 - \mu(B_n)) \xrightarrow{n \rightarrow \infty} 0.$$

*Remark.* One can check that if  $\Gamma \curvearrowright (X, \mu)$  is a measure-preserving action, then  $(B_n)$  is asymptotically  $\Gamma$ -invariant if and only if it is asymptotically  $R_{\Gamma \curvearrowright X}$ -invariant. In particular,  $\Gamma \curvearrowright (X, \mu)$  is strongly ergodic if and only if  $R_{\Gamma \curvearrowright X}$  is strongly ergodic.



*Remark.* It is clear that strong ergodicity implies ergodicity: if  $B$  is invariant, set  $B_n := B$  for all  $n$  and apply strong ergodicity. What may be less clear is that the converse does not hold. In fact, the unique ergodic amenable relation is not strongly ergodic. To prove this, consider an ergodic measure-preserving action of  $\Gamma_\infty := \bigoplus_{n \in \mathbb{N}} \mathbb{Z}/2\mathbb{Z}$  on a standard probability space  $(X, \mu)$ , for example the Bernoulli shift. For  $N \in \mathbb{N}$ , set as previously  $\Gamma_N := \bigoplus_{n \leq N} \mathbb{Z}/2\mathbb{Z}$ . Since  $\Gamma_N$  is finite, the restricted action  $\Gamma_N \curvearrowright (X, \mu)$  admits a fundamental domain  $D_N$ , that is a Borel subset that intersects each orbit in exactly one point<sup>2</sup>. One can find a Borel subset of  $D_N$  of measure  $\frac{\mu(D_N)}{2}$ . Then, define  $B_N$  as the  $R_{\Gamma_N \curvearrowright X}$ -saturation of  $D_N$ . Each  $B_N$  has measure  $\frac{1}{2}$  and is  $\Gamma_M$ -invariant for  $M \leq N$ , which completes the demonstration.

The following theorem will be crucial in Section 1.3 because it allows us, under certain conditions, to deduce strong ergodicity from ergodicity. In its statement,  $\mathcal{S}$  stands for the relation introduced in the Bernoulli example of Subsection 1.1.4 and  $(X, \mu)$  for its underlying standard probability space.

**THEOREM 1.1.11** (CHIFAN-IOANA, [CI10]). *Let  $B$  be a Borel subset of  $X$  such that  $\mu(B) \neq 0$ . Any ergodic equivalence subrelation of  $(\mathcal{S}|_B, \frac{\mu}{\mu(B)})$  that is not  $\frac{\mu}{\mu(B)}$ -amenable is strongly ergodic.*

*Comment.* In fact, [CI10] proves a lot more. But since we do not need the full result of Chifan and Ioana — whose statement is more technical —, we will stick to the stated version.

### 1.1.6 Graphings

A **graphing** of a relation  $R$  on  $X$  is a countable family  $(\varphi_i)$  of partial Borel automorphisms of  $X$  that generates  $R$  as an equivalence relation: this means that the smallest equivalence relation on  $X$  that contains the graphs of the  $\varphi_i$ 's is  $R$ . In particular, the Borel partial automorphisms that appear in a graphing belong to  $[[R]]$ . The notion of graphing generalizes to relations the notion of generating system.

Notice that the data of a graphing endows each  $R$ -class with a structure of connected graph: put an edge from  $x$  to  $x'$  if there is an  $i$  such that  $x$  belongs to the domain of  $\varphi_i$  and  $x' = \varphi_i(x)$ . One can do this with multiplicity.

*Example.* Let  $\Gamma$  be a finitely generated group and  $S$  a finite generating system of  $\Gamma$ . Let  $\Gamma \curvearrowright X$  be a Borel action on a standard Borel space. For  $s \in S$ , let  $\varphi_s$  denote the Borel automorphism implementing the action of

2. To get such a fundamental domain, one can think of  $X$  as  $[0, 1]$  and keep a point if and only if it is the smallest in its orbit for the usual ordering of the interval.

$s^{-1}$ . Then,  $(\varphi_s)_{s \in S}$  is a graphing of  $R_{\Gamma \curvearrowright X}$ . Let us take a closer look at the graph structure.

Let  $\mathcal{G} = (V, E) = (\Gamma, E)$  denote the Cayley graph of  $\Gamma$  relative to  $S$  (see Subsection 1.2.1 for the definition). In this example, we will use the concrete definition of Cayley graphs and take the vertex-set to be  $\Gamma$ . If the action is free, then, for every  $x$ , the mapping  $\gamma \mapsto \gamma^{-1} \cdot x$  is a graph isomorphism between  $\mathcal{G}$  and the graphed orbit of  $x$ . The only point to check is that the graph structure is preserved: for all  $(\gamma, \eta, x) \in \Gamma \times \Gamma \times X$ ,

$$\begin{aligned} (\gamma, \eta) \in E &\iff \exists s \in S, \eta = \gamma s \\ &\iff \exists s \in S, \eta^{-1} = s^{-1} \gamma^{-1} \\ &\iff \exists s \in S, \eta^{-1} \cdot x = s^{-1} \gamma^{-1} \cdot x \\ &\iff (\eta^{-1} \cdot x, \gamma^{-1} \cdot x) \text{ is an edge.} \end{aligned}$$

The point in putting all these inverses is that, this way, we only work with Cayley graphs on which the group acts from the left.

We now have all the vocabulary needed to state the following theorem, the graph-theoretic flavor of which will allow us to travel between the world of orbit equivalence and the one of percolation.

**THEOREM 1.1.12.** *Let  $R$  be a countable Borel equivalence relation on  $X$  that preserves the atomless probability measure  $\mu$ .*

- *If it admits a graphing such that, for  $\mu$ -almost every  $x$ , the class of  $x$  has two ends (seen as a graph), then  $R$  is hyperfinite  $\mu$ -almost everywhere.*
- *If it admits a graphing such that, for  $\mu$ -almost every  $x$ , the class of  $x$  has infinitely many ends, then  $R$  is not “hyperfinite  $\mu$ -almost everywhere”.*

This theorem is corollaire IV.24 in [Gab00]. It is a statement among several of the kind (see [Ada90, Ghy95]).

## 1.2 Percolation

*Preliminary remark.* This section follows [Marb], which makes it redundant with Chapter 0. This has the advantage of making the current chapter self-contained.

Percolation is a topic coming originally from statistical mechanics (see [Gri99]). After a foundational paper by Benjamini and Schramm [BS96], strong connections with group theory have developed. This section presents the objects and theorems that will be needed in Section 1.3. For more information about this material, one can refer to [Gab05], [Lyo00] and [LP].

### 1.2.1 General definitions

FROM HERE ON,  $\Gamma$  WILL BE ASSUMED TO BE FINITELY GENERATED.

Let  $S$  be a finite generating set of  $\Gamma$ . Define a graph by taking  $\Gamma$  as vertex-set and putting, for each  $\gamma \in \Gamma$  and  $s \in S$ , an edge from  $\gamma$  to  $\gamma s$ . This defines a locally finite connected graph  $\mathcal{G} = (V, E)$  that is called the **Cayley graph** of  $\Gamma$  relative to  $S$ . The action of  $\Gamma$  on itself by multiplication from the left induces a (left) action on  $\mathcal{G}$  by graph automorphisms. It is free and transitive as an action on the vertex-set. In fact, a locally finite connected graph  $\mathcal{G}$  is a Cayley graph of  $\Gamma$  if and only if  $\Gamma$  admits an action on  $\mathcal{G}$  that is free and transitive on the vertex-set.

We have defined  $\mathcal{G}$  explicitly to prove that  $\Gamma$  admits Cayley graphs, but further reasonings shall be clearer if one forgets that  $V = \Gamma$  and just remembers that  $\mathcal{G}$  is endowed with a free vertex-transitive action of  $\Gamma$ . Thus, in order to get an element of  $\Gamma$  from a vertex, one will need a reference point. Let  $\rho$  be a vertex of  $\mathcal{G}$  that we shall use as such a reference or anchor point. Any vertex  $v \in V$  can be written uniquely in the form  $\gamma \cdot \rho$ .

The action  $\Gamma \curvearrowright E$  induces a shift action  $\Gamma \curvearrowright \Omega := \{0, 1\}^E$ . A **(bond) percolation** will be a probability measure on  $\Omega$ . It is said to be  **$\Gamma$ -invariant** if it is as a probability measure on  $\Omega$ .

IN WHAT FOLLOWS, ALL CONSIDERED PERCOLATIONS WILL BE ASSUMED TO BE  $\Gamma$ -INVARIANT. BESIDES, FOR SIMPLICITY, WE WILL WORK UNDER THE IMPLICIT ASSUMPTION THAT  $\mathbb{P}$  IS ATOMLESS, SO THAT  $(\Omega, \mathbb{P})$  WILL ALWAYS BE A STANDARD PROBABILITY SPACE.

A point  $\omega$  of  $\Omega$  is seen as a subgraph of  $\mathcal{G}$  the following way:  $V$  is its set of vertices and  $\omega^{-1}(\{1\})$  its set of edges. In words, keep all edges whose label is 1 and throw away the others — edges labeled 1 are said to be **open**, the other ones are said to be **closed**. The connected components of this graph are called the **clusters** of  $\omega$ . If  $v \in V$ , its  $\omega$ -cluster will be denoted by  $\mathcal{C}(\omega, v)$ . For  $v \in V$ , the map  $\omega \mapsto \mathcal{C}(\omega, v)$  is Borel, the set of finite paths in  $\mathcal{G}$  being countable. If  $(u, v) \in V^2$ , we will use  $u \overset{\omega}{\longleftrightarrow} v$  as an abbreviation for “ $u$  and  $v$  are in the same  $\omega$ -cluster”. The number of infinite clusters of  $\omega$  will be denoted by  $N_{\infty}^{\mathcal{G}}(\omega)$ . The function  $N_{\infty}^{\mathcal{G}}$  is Borel.

### 1.2.2 Independent percolation

The simplest interesting example of percolation is the product measure  $\text{Ber}(p)^{\otimes E}$ , for  $p \in (0, 1)$ . It will be denoted by  $\mathbb{P}_p$ . Such percolations are called **independant** or **Bernoulli** percolations. One is interested in the emergence of infinite clusters when  $p$  increases. To study this phenomenon,

introduce the **percolation function** of  $\mathcal{G}$ , defined as

$$\theta_{\mathcal{G}} : p \mapsto \mathbb{P}_p[|\mathcal{C}(\omega, \rho)| = \infty].$$

Endow  $[0, 1]^E$  with the probability measure  $\mathbb{P}_{[0,1]} := \text{Leb}([0, 1])^{\otimes E}$ . Notice that  $\mathbb{P}_p$  is the push-forward of  $\mathbb{P}_{[0,1]}$  by the following map

$$\begin{aligned} \pi_p : [0, 1]^E &\longrightarrow \{0, 1\}^E \\ x &\longmapsto (\mathbf{1}_{x(e) < p})_{e \in E}. \end{aligned}$$

Realizing probability measures as distributions of random variables suitably defined on a same probability space is called a **coupling**. A fundamental property of this coupling is that, when  $x \in [0, 1]^E$  is fixed,  $p \mapsto \pi_p(x)$  is non-decreasing for the product order. One deduces the following proposition.

**PROPOSITION 1.2.1.** *The function  $\theta_{\mathcal{G}}$  is non-decreasing.*

**COROLLARY 1.2.2.** *There is a unique real number  $p_c(\mathcal{G}) \in [0, 1]$  such that the following two conditions hold:*

- $\forall p < p_c(\mathcal{G}), \theta_{\mathcal{G}}(p) = 0,$
- $\forall p > p_c(\mathcal{G}), \theta_{\mathcal{G}}(p) > 0.$

One calls  $p_c(\mathcal{G})$  the **critical probability** of  $\mathcal{G}$ .

*Remark.* When  $p_c(\mathcal{G})$  is not trivial (neither 0 nor 1), this result establishes the existence of a *phase transition*. One cannot have  $p_c(\mathcal{G}) = 0$ , but  $p_c(\mathcal{G}) = 1$  may occur (e.g. it does for  $\mathbb{Z}$ ).

The following theorems describe almost totally the phase transitions related to the number of infinite clusters.

**PROPOSITION 1.2.3.** *For all  $p \in (0, 1)$ , the random variable  $N_{\infty}^{\mathcal{G}}$  takes a  $\mathbb{P}_p$ -almost deterministic value, which is 0, 1 or  $\infty$ . This value is 0 if  $p < p_c(\mathcal{G})$  and 1 or  $\infty$  if  $p > p_c(\mathcal{G})$ .*

**THEOREM 1.2.4** (HÄGGSTRÖM-PERES, [HP99]). *There is exactly one real number  $p_u(\mathcal{G}) \in [p_c(\mathcal{G}), 1]$  such that the following two conditions hold:*

- $\forall p < p_u(\mathcal{G}), \mathbb{P}_p[N_{\infty}^{\mathcal{G}} = 1] = 0,$
- $\forall p > p_u(\mathcal{G}), \mathbb{P}_p[N_{\infty}^{\mathcal{G}} = 1] = 1.$

One calls  $p_u(\mathcal{G})$  the **uniqueness probability** of  $\mathcal{G}$ .

If  $\Gamma$  is amenable, Proposition 1.2.8 gives  $p_c(\mathcal{G}) = p_u(\mathcal{G})$ . The converse is conjectured to hold. A weak form of the converse has been established by Pak and Smirnova-Nagnibeda [PSN00] and used in [GL09] to prove Theorem 1.2.5, which provides a positive answer to the “measurable Day-von Neumann Problem”.

**THEOREM 1.2.5.** *If  $\Gamma$  is not amenable, then there is a measurable ergodic essentially free action of  $\mathbb{F}_2$  on  $([0, 1]^{\Gamma}, \text{Leb}([0, 1])^{\otimes \Gamma})$  such that the orbit equivalence relation associated with the Bernoulli shift of  $\Gamma$  contains  $R_{\mathbb{F}_2 \curvearrowright [0, 1]^{\Gamma}}$ .*

*Comment.* Theorem 1.2.5 has important consequences. For instance, it is invoked in [IKT08] to show that if  $\Gamma$  is not amenable, then its ergodic actions cannot be classified up to isomorphism. Compare this result with Theorem 1.1.10.

PROPOSITION 1.2.6 ([BLPS99A]). *If  $\Gamma$  is non-amenable, then  $p_c(\mathcal{G}) < 1$  and there is no infinite cluster  $\mathbb{P}_{p_c(\mathcal{G})}$ -almost surely.*

CONJECTURE 1.2.7. *If  $p_c(\mathcal{G}) < 1$ , then there is no infinite cluster  $\mathbb{P}_{p_c(\mathcal{G})}$ -almost surely.*

The phase transition theorems are roughly summarized in the picture below. Remember that the quantities  $p_c$ ,  $p_u$  and 1 may coincide.

$$\begin{array}{ccccccc}
 0 & & & & & & 1 \\
 & N_{\infty}^{\mathcal{G}} = 0 & & p_c & & N_{\infty}^{\mathcal{G}} = \infty & & p_u & & N_{\infty}^{\mathcal{G}} = 1 & & 1 \\
 & \text{-----} & & | & & \text{-----} & & | & & \text{-----} & & | \\
 & & & & & & & & & & & & 
 \end{array}$$

### 1.2.3 Generalized percolation

The notion of generalized percolation that is presented in this subsection is due to Gaboriau [Gab05].

Let  $\Gamma \curvearrowright (X, \mathbb{P})$  be a Borel action on a standard probability space. Assume that it is provided together with a  $\Gamma$ -equivariant map

$$\pi : X \rightarrow \Omega = \{0, 1\}^E,$$

the space  $\{0, 1\}^E$  being endowed with the shift action. This will be called a **generalized ( $\Gamma$ -invariant) percolation**. As for percolations, we will omit the “ $\Gamma$ -invariant” part of the denomination.

To begin with, let us see how this notion is connected to the one presented in Subsection 1.2.1. If a generalized percolation is given, then  $\pi_{\star}\mathbb{P}$  — the pushforward of  $\mathbb{P}$  by  $\pi$  — is a  $\Gamma$ -invariant percolation that may have atoms. Conversely, if one is given a  $\Gamma$ -invariant atomless percolation, one can consider the Bernoulli shift action  $\Gamma \curvearrowright X = \Omega$  together with  $\pi : X \rightarrow \Omega$  the identity. Via this procedure, one can redefine in the percolation setting any notion introduced in the generalized framework.

Notice that the  $\pi_p$ ’s of the standard coupling, introduced at the beginning of Subsection 1.2.2, provide interesting examples of such generalized percolations.

This setting provides the same atomless measures on  $\Omega$  as the previous one, but it allows more flexibility in our way to speak of them. In the next subsection, we will discuss properties of clusters. The usual setting allows us to speak of properties such as “being infinite”, “having three ends”, “being transient for simple random walk”. The generalized one will allow us, if we consider  $\Gamma \curvearrowright [0, 1]^E$  together with  $\pi_{p_1}$ , to speak of “the considered  $p_1$ -cluster contains an infinite  $p_0$ -cluster”.

### 1.2.4 Cluster indistinguishability

In this subsection, we work with a given generalized percolation. The action is denoted by  $\Gamma \curvearrowright (X, \mathbb{P})$  and the equivariant map by  $\pi$ .

NOTATION. We call **vertex property** — or **property** — a Borel Boolean function on  $X \times V$  that is invariant under the diagonal action of  $\Gamma$ . If  $W \subset V$ , we write  $P^+(x, W)$  for “all the vertices in  $W$  satisfy  $P(x, \cdot)$ ”. More formally, we define

$$P^+(x, W) := “\forall v \in W, P(x, v)”.$$

We also set

$$\begin{aligned} &— P^-(x, W) := “\forall v \in W, \neg P(x, v)”, \\ &— P^\pm(x, W) := “P^+(x, W) \vee P^-(x, W)”.$$

The expression  $P^\pm(x, W)$  means “all the vertices in  $W$  agree on  $P(x, \cdot)$ ”.

*Example.* The degree of a vertex in a graph is its number of neighbors. “The vertex  $v$  has degree 4 in  $\pi(x)$  seen as a subgraph of  $\mathcal{G}$ ” is a property.

DEFINITION. We call **cluster property** a property  $P$  such that  $P(x, v) \iff P(x, u)$  as soon as  $u \xleftrightarrow{\pi(x)} v$ . In words, it is a vertex property such that, for any  $x$ , the function  $P(x, \cdot)$  is constant on  $\pi(x)$ -clusters.

*Example.* The previous example is usually not a cluster property: for most Cayley graphs  $\mathcal{G}$ , there are subgraphs of  $\mathcal{G}$  where some component has some vertices of degree 4 and others of other degree. “The  $\pi(x)$ -cluster of  $v$  is infinite”, “the  $\pi(x)$ -cluster of  $v$  is transient”, “the  $\pi(x)$ -cluster of  $v$  has a vertex of degree 4” are cluster properties.

*Counter-example.* “The  $\pi(x)$ -cluster of  $v$  contains  $\rho$ ” is *not* a cluster property, because of the lack of  $\Gamma$ -invariance. It is to avoid such “properties” that  $\Gamma$ -invariance is required in the definition of vertex properties: allowing them would automatically make any indistinguishability theorem false since they can distinguish the cluster of the origin from the others.

*Example.* Here is another example of cluster property, which can be (directly) considered only in the generalized setting. Consider  $X = [0, 1]^E$  and  $0 < p_0 < p_1 < 1$ . We take  $\pi = \pi_{p_1}$  (see Subsection 1.2.2). The property “the  $\pi_{p_1}(x)$ -cluster of  $v$  contains an infinite  $\pi_{p_0}(x)$ -cluster” is a cluster property. It has been considered by Lyons and Schramm in [LS11] to derive the Häggström-Peres Theorem from indistinguishability.

To formalize the indistinguishability of infinite clusters, one needs to speak of cluster properties and infinite clusters. Thus, we set

$$V_\infty^\pi(x) := \{v \in V : |\mathcal{C}(\pi(x), v)| = \infty\}.$$

DEFINITION. The considered generalized percolation will be said to satisfy **(infinite cluster) indistinguishability** (or one will say that its infinite clusters are indistinguishable) if, for every cluster property  $P$ ,

$$\mathbb{P}[P^\pm(x, V_\infty^\pi(x))] = 1.$$

Of course, this notion is empty as soon as  $\mathbb{P}[N_\infty^\mathcal{G}(\pi(x)) \leq 1] = 1$ , e.g. for  $\mathbb{P}_p$  when  $\Gamma$  is amenable.

*Remark.* Assume momentarily that  $\Gamma \curvearrowright (X, \mathbb{P})$  is ergodic and that the infinite clusters are indistinguishable. Then for every cluster property  $P$ , by indistinguishability,

$$\mathbb{P}[P^+(x, V_\infty^\pi(x)) \text{ or } P^-(x, V_\infty^\pi(x))] = 1.$$

Besides, by ergodicity,  $\mathbb{P}[P^+(x, V_\infty^\pi(x))]$  and  $\mathbb{P}[P^-(x, V_\infty^\pi(x))]$  are 0 or 1. Altogether, these identities guarantee that

$$\mathbb{P}[P^+(x, V_\infty^\pi(x))] = 1 \quad \text{or} \quad \mathbb{P}[P^-(x, V_\infty^\pi(x))] = 1.$$

To state the Indistinguishability Theorem in its natural form, we need to introduce the notion of insertion-tolerance.

### 1.2.5 Insertion-tolerance

In this subsection, we work with non-generalized percolations.

DEFINITION. If  $(\omega, e) \in \Omega \times E$ , one denotes by  $\omega^e$  the unique element of  $\Omega$  equal to  $\omega$  on  $E \setminus \{e\}$  and taking the value 1 at  $e$ . One sets  $\Pi^e : \omega \mapsto \omega^e$ . A percolation is said to be **insertion-tolerant** if for every Borel subset  $B \subset \Omega$ , for every edge  $e$ ,

$$\mathbb{P}[B] > 0 \implies \mathbb{P}[\Pi^e(B)] > 0.$$

*Example.* For any  $p \in (0, 1)$ , the percolation  $\mathbb{P}_p$  is insertion-tolerant.

PROPOSITION 1.2.8. *If  $\Gamma$  is amenable and if  $\mathbb{P}$  is an insertion-tolerant percolation on  $\mathcal{G}$ , then  $\mathbb{P}[N_\infty^\mathcal{G}(\omega) \leq 1] = 1$ .*

*Remark.* Proposition 1.2.8 improves results obtained in [BK89, GKN92]. For a proof of the general statement, see [LP].

PROPOSITION 1.2.9 ([LS11], PROPOSITION 3.10). *If  $\mathbb{P}$  is an insertion-tolerant percolation on  $\mathcal{G}$  that produces a.s. at least two infinite clusters, then it produces a.s. infinitely many infinite clusters and each of them has infinitely many ends.*

Now that insertion-tolerance has been introduced, we can state the Indistinguishability Theorem of Lyons and Schramm ([LS11]).

THEOREM 1.2.10 (LYONS-SCHRAMM, [LS11]). *Any insertion-tolerant percolation has indistinguishable infinite clusters.*

### 1.2.6 Percolation and orbit equivalence

In this subsection, we work with a generalized percolation, where the action is denoted by  $\Gamma \curvearrowright (X, \mathbb{P})$  and the equivariant map by  $\pi$ .

The **cluster equivalence relation** is defined as follows: two configurations  $x$  and  $x'$  in  $X$  are said to be  $R_{cl}$ -**equivalent** if there exists  $\gamma \in \Gamma$  such that  $\gamma^{-1} \cdot x = x'$  and  $\gamma \cdot \rho \xleftrightarrow{\pi(x)} \rho$ . In words, an  $R_{cl}$ -class is a configuration up to  $\Gamma$ -translation and with a distinguished cluster — the one of the root  $\rho$ .

Every generalized percolation is  $R_{cl}$ -invariant, since  $R_{cl}$  is a subrelation of  $R_{\Gamma \curvearrowright X}$ .

Let  $S$  denote the generating set associated with the choice of the Cayley graph  $\mathcal{G}$ . For  $s \in S$ , let  $\tilde{\varphi}_s$  denote the restriction of  $x \mapsto s^{-1} \cdot x$  to the  $x$ 's such that the edge  $(\rho, s \cdot \rho)$  is  $\pi(x)$ -open. If the action of  $\Gamma$  on  $X$  is free, this graphing induces on  $[x]_{R_{cl}}$  the graph structure of the  $\pi(x)$ -cluster of the anchor point  $\rho$ . This remark, together with Theorem 1.1.12 and Proposition 1.2.9, provides the following proposition.

**PROPOSITION 1.2.11.** *Let  $\mathbb{P}$  denote an insertion-tolerant classical percolation. Assume that*

- $N_\infty^{\mathcal{G}}$  is infinite  $\mathbb{P}$ -almost surely,
- for  $\mathbb{P}$ -almost every  $\omega$ , the map  $\gamma \mapsto \gamma \cdot \omega$  is injective.

*Then  $R_{cl}$  is not  $\mathbb{P}$ -amenable.*

*Remark.* This proposition applies to Bernoulli percolations that yield infinitely many infinite clusters.

## 1.3 Ergodicity and indistinguishability

Throughout this section, we will work with a generalized percolation. The underlying standard probability space will be denoted by  $(X, \mathbb{P})$  and the equivariant map by  $\pi$ .

### 1.3.0 The dictionary

The following array presents concisely the correspondence between percolation theory and orbit equivalence theory. In the following subsections, no knowledge of this array will be assumed and we will start from scratch. However, we think it may be useful to the reader to have all the data compactly presented in a single place, hence this subsection.

In the following “dictionary”, the bijection  $\psi : \Gamma \backslash (X \times V) \rightarrow X$  induced by  $(x, \gamma \cdot \rho) \mapsto \gamma^{-1} \cdot x$  is the translator.



Orbit equivalence		Percolation
$X$	$\xleftrightarrow{\psi}$	$\Gamma \backslash (X \times V)$
$\gamma^{-1} \cdot x$		$[(x, \gamma \cdot \rho)]$
$x \in X_\infty$		$\rho \xleftrightarrow{\pi(x)} \infty$
Borel subset		vertex property
$R_{cl}$ -class		cluster
$R_{cl}$ -invariant		cluster property
ergodicity of $R$	$\simeq$	indistinguishability
$\phi$ s.t. $\text{graph}(\phi) \subset R_{cl}$		rerooting
$\phi \in [R]$		vertex-bijective rerooting
asymptotically $R_{cl}$ -invariant		asymptotic cluster property
strong ergodicity of $R$	$\simeq$	strong indistinguishability
graphing		graph structure

### 1.3.1 Classic connection

The map  $P \mapsto B_P := \{x \in X : P(x, \rho)\}$  realizes a bijection from the set of properties onto the set of Borel subsets of  $X$ . Its inverse map is  $B \mapsto (P_B : (x, \gamma \cdot \rho) \mapsto “(\gamma^{-1} \cdot x, \rho) \in B”)$ . It induces a bijection between the set of cluster properties and the set of  $R_{cl}$ -invariant Borel subsets of  $X$ .

NOTATION. Set the **infinite locus** to be  $X_\infty := \{x \in X : |\mathcal{C}(\pi(x), \rho)| = \infty\}$ .

*Remark.* This definition coincides with the usual orbit-equivalence definition

$$\{x \in X : |[x]_{R_{cl}}| = \infty\}$$

as soon as  $\Gamma \curvearrowright X$  is free. Remember that if there is no  $\pi$  in the second description, it is because it is hidden in  $R_{cl}$ .

LEMMA 1.3.1. *Let  $P$  denote a property and  $\Lambda$  a subset of  $\Gamma$ . For any  $x \in X$ ,*  
 $P^\pm(x, V_\infty^\pi(x) \cap (\Lambda^{-1} \cdot \rho)) \iff \forall y, z \in X_\infty \cap (\Lambda \cdot x), (y \in B_P \iff z \in B_P)$ .

*Proof.* It results from the fact that, for any cluster property  $P$  and any  $x \in X$ , if one sets  $\Delta := \Lambda^{-1}$ ,

$$\begin{aligned} P^\pm(x, V_\infty^\pi(x) \cap (\Delta \cdot \rho)) &\iff \{\forall u, v \in V_\infty^\pi(x) \cap (\Delta \cdot \rho), P(x, u) \iff P(x, v)\} \\ &\iff \left( \forall \gamma_0, \gamma_1 \in \Delta, \left\{ \begin{array}{c} \gamma_0 \cdot \rho \xleftrightarrow{\pi(x)} \infty \\ \text{and} \\ \gamma_1 \cdot \rho \xleftrightarrow{\pi(x)} \infty \end{array} \right\} \implies (P(x, \gamma_0 \cdot \rho) \iff (P(x, \gamma_1 \cdot \rho))) \right) \\ &\iff \forall \gamma_0, \gamma_1 \in \Delta, \left\{ \begin{array}{c} \rho \xleftrightarrow{\pi(\gamma_0^{-1} \cdot x)} \infty \\ \text{and} \\ \rho \xleftrightarrow{\pi(\gamma_1^{-1} \cdot x)} \infty \end{array} \right\} \implies (P(\gamma_0^{-1} \cdot x, \rho) \iff (P(\gamma_1^{-1} \cdot x, \rho))) \\ &\iff \forall y, z \in X_\infty \cap (\Lambda \cdot x), (y \in B_P \iff z \in B_P). \end{aligned}$$

□

Taking  $\Lambda = \Gamma$  gives the following proposition.

PROPOSITION 1.3.2. *Consider a generalized percolation defined by  $\Gamma \curvearrowright (X, \mathbb{P})$  and a  $\Gamma$ -equivariant map  $\pi : X \rightarrow \Omega$ . Then the considered generalized percolation has indistinguishable infinite clusters if and only if for every Borel subset  $B$  of  $X$ , for  $\mathbb{P}$ -almost every  $x \in X$ , the following holds:*

$$\forall y \in X_\infty \cap (\Gamma \cdot x), x \in B \iff y \in B.$$

Let  $R$  denote the restriction of  $R_{cl}$  to  $X_\infty \times X_\infty$ .

PROPOSITION 1.3.3. *Consider a generalized percolation defined by  $\Gamma \curvearrowright (X, \mathbb{P})$  and a  $\Gamma$ -equivariant map  $\pi : X \rightarrow \Omega$ . Assume that  $\mathbb{P}[X_\infty] > 0$ . Then  $R$  is  $\frac{\mathbb{P}}{\mathbb{P}[X_\infty]}$ -ergodic if and only if for every cluster property  $P$ , the conditional probability  $\mathbb{P} \left[ P(x, \rho) \mid \rho \xleftrightarrow{\pi(x)} \infty \right]$  is either 0 or 1.*

*Proof.* The relation  $R$  is  $\frac{\mathbb{P}}{\mathbb{P}[X_\infty]}$ -ergodic if and only if, for every  $R_{cl}$ -invariant Borel subset  $B$  of  $X$ ,  $\mathbb{P}[B \cap X_\infty] \in \{0, \mathbb{P}[X_\infty]\}$ . The proposition results from the fact that, for any  $R_{cl}$ -invariant Borel subset of  $X$  and any  $x \in X$ ,

$$\mathbb{P}[B \cap X_\infty] \in \{0, \mathbb{P}[X_\infty]\} \iff \mathbb{P}[P_B(x, \rho) \text{ and } \rho \xleftrightarrow{\pi(x)} \infty] \in \left\{ 0, \mathbb{P} \left[ \rho \xleftrightarrow{\pi(x)} \infty \right] \right\}.$$

□

PROPOSITION 1.3.4 (GABORIAU-LYONS, [GL09]). *Consider a generalized percolation defined by  $\Gamma \curvearrowright (X, \mathbb{P})$  and a  $\Gamma$ -equivariant map  $\pi : X \rightarrow \Omega$ . Assume that  $\Gamma \curvearrowright (X, \mathbb{P})$  is ergodic and  $\mathbb{P}[X_\infty] > 0$ . Then the considered generalized percolation has indistinguishable infinite clusters if and only if  $R$  is  $\frac{\mathbb{P}}{\mathbb{P}[X_\infty]}$ -ergodic.*

As a preliminary to the next subsection, we detail the proof of this theorem, which can be found in [GL09].

*Proof.* Assume that  $R$  is ergodic. Let  $B$  be a  $R_{cl}$ -invariant Borel subset of  $X$ . Then, some  $B' \in \{B, X \setminus B\}$  satisfies  $\mathbb{P}[B' \cap X_\infty] = 0$ . Hence,  $\mathbb{P} \left[ \bigcup_{\gamma \in \Gamma} \gamma^{-1} \cdot (B' \cap X_\infty) \right] = 0$ , so that

$$\mathbb{P} \left[ \{x \in X : \forall y \in X_\infty \cap (\Gamma \cdot x), y \in X \setminus B'\} \right] = 1.$$

The first implication is thus a consequence of Proposition 1.3.2.

The converse statement follows directly from the remark at the end of Subsection 1.2.4 — which makes crucial use of the ergodicity of  $\Gamma \curvearrowright X$  — and Proposition 1.3.3. □

### 1.3.2 Two lemmas on asymptotic invariance

To translate properly the notion of strong ergodicity from orbit equivalence theory to percolation theory, we will need the following lemma. Since it holds with a high level of generality, and since the symbols  $X$  and  $R$  have a specific meaning in this section, we denote by  $(Y, \mu)$  a standard probability space and by  $R_Y$  a countable Borel equivalence relation on  $Y$  that preserves the measure  $\mu$ .

**LEMMA 1.3.5.** *A sequence  $(B_n)$  of Borel subsets of  $Y$  is  $\mu$ -asymptotically  $R_Y$ -invariant if and only if for every Borel (not necessarily bijective) map  $\phi : Y \rightarrow Y$  whose graph is included in  $R_Y$ , the  $\mu$ -measure of  $\phi^{-1}(B_n) \Delta B_n$  converges to 0 as  $n$  goes to infinity.*

*Remark.* This result is false if we replace  $\phi^{-1}(B_n)$  with  $\phi(B_n)$ . Indeed, a Borel map whose graph is included in  $R_Y$  may have a range of small measure. For instance, take the “first-return in  $[0, \epsilon[$  map” for an action of  $\mathbb{Z}$  on  $\mathbb{R}/\mathbb{Z} \simeq [0, 1[$  by irrational translation.

*Proof.* One implication is tautological. To establish the other, assume that  $(B_n)$  is asymptotically invariant and take  $\phi$  a Borel map from  $Y$  to  $Y$  whose graph is included in  $R_Y$ . There are

- a partition  $Y = \bigsqcup_{i \in \mathbb{N}} Y_i$  of  $Y$  into countably many Borel subsets
- and countably many  $\varphi_i \in [R_Y]$

such that for all  $i$ , the maps  $\phi$  and  $\varphi_i$  coincide on  $Y_i$ . (This can be proved using Theorem 1.1.4.) Let  $\epsilon$  be a positive real number. Take  $N$  such that  $\mu(\bigsqcup_{i > N} Y_i) < \epsilon$ . For every  $i$  and  $n$ , we have,

$$\begin{aligned} \phi^{-1}(B_n) \Delta B_n &\stackrel{\epsilon}{\simeq} \bigsqcup_{i \leq N} Y_i \cap (\phi^{-1}(B_n) \Delta B_n) \\ &= \bigsqcup_{i \leq N} Y_i \cap (\varphi_i^{-1}(B_n) \Delta B_n) \\ &\subset \bigcup_{i \leq N} \varphi_i^{-1}(B_n) \Delta B_n, \end{aligned}$$

where  $A \stackrel{\epsilon}{\simeq} B$  means that  $\mu(A \Delta B) \leq \epsilon$ . Since  $\mu(\bigcup_{i \leq N} \varphi_i^{-1}(B_n) \Delta B_n)$  goes, by hypothesis, to 0 as  $n$  goes to infinity, the lemma is established.  $\square$

We will also need the following lemma.

**LEMMA 1.3.6.** *If  $\Gamma \curvearrowright (Y, \mu)$  is a strongly ergodic action and if  $Z$  is a Borel subset of  $Y$  of positive measure, then  $(Z, \frac{\mu}{\mu(Z)}, (R_{\Gamma \curvearrowright Y})|_Z)$  is strongly ergodic.*

*Remark.* If one replaces “strongly ergodic” with “ergodic” in the above statement, the proof is straightforward: one just needs to take  $B$  an  $R$ -invariant set and apply ergodicity to  $\Gamma \cdot B$ . The proof gets a bit more technical in the strong case because one needs to take a *suitable*  $\Gamma$ -saturation of  $B$ .

*Proof.* Set  $R := (R_{\Gamma \curvearrowright Y})|_Z$ . Let  $(B_n)$  denote a  $\frac{\mu}{\mu(Z)}$ -asymptotically  $R$ -invariant sequence of Borel subsets of  $Z$ . It is enough to show that there is a sequence  $(B'_n)$  of  $\mu$ -asymptotically  $\Gamma$ -invariant subsets of  $Y$  satisfying the following condition:

$$\mu(B_n \Delta (B'_n \cap Z)) \xrightarrow{n \rightarrow \infty} 0.$$

Indeed, by strong ergodicity of the action, the sequence  $(\mu(B'_n))$  would then have no accumulation point other than 0 and 1, so that  $\mu(B'_n \cap Z)$  would have no accumulation point other than 0 and  $\mu(Z)$ , which ends the proof together with condition  $(\star)$ .

For any finite subset  $\Lambda$  of  $\Gamma$ , set

$$B_{n,+}^\Lambda := \bigcap_{\gamma \in \Lambda} \gamma \cdot (B_n \cup (Y \setminus Z)) \quad \text{and} \quad B_{n,-}^\Lambda := \bigcap_{\gamma \in \Lambda} \gamma \cdot ((Z \setminus B_n) \cup (Y \setminus Z)).$$

If  $\Lambda$  is fixed and finite, the measure of  $B_{n,+}^\Lambda \cup B_{n,-}^\Lambda$  converges to 1 as  $n$  goes to infinity.

Proceeding by contradiction, we assume that there exist  $\eta$  and  $\gamma$  in  $\Lambda$  such that

$$\limsup_n \mu(\{y \in Y : \eta \cdot y \in B_n \text{ and } \gamma \cdot y \in Z \setminus B_n\}) > 0.$$

The measure  $\mu$  being  $\Gamma$ -invariant, it follows that

$$\limsup_n \mu(\{y \in Y : y \in B_n \text{ and } \gamma\eta^{-1} \cdot y \in Z \setminus B_n\}) > 0$$

which contradicts the  $\frac{\mu}{\mu(Z)}$ -asymptotic  $R$ -invariance of  $(B_n)$ . More precisely, the mapping  $\varphi : Z \rightarrow Z$  that sends  $y$  to  $\gamma\eta^{-1} \cdot y$  if the latter belongs to  $Z$  and to  $y$  otherwise contradicts Lemma 1.3.5.

By a diagonal argument, one can find a sequence  $(\Lambda_n)$  of finite subsets of  $\Gamma$  such that, setting  $\Lambda_n^{(2)} := \{\gamma\eta : \gamma, \eta \in \Lambda_n\}$ , the following two conditions hold:

- the sequence  $(\Lambda_n)$  is non-decreasing and its union is  $\Gamma$ ,
- $\mu(B_{n,+}^{\Lambda_n^{(2)}} \cup B_{n,-}^{\Lambda_n^{(2)}}) \xrightarrow{n \rightarrow \infty} 1$ .

Set  $B'_n := B_{n,+}^{\Lambda_n}$ . For  $n$  large enough,  $\Lambda_n$  contains the identity element, so that

$$B_n \cap (B_{n,+}^{\Lambda_n} \cup B_{n,-}^{\Lambda_n}) = B_n \cap B_{n,+}^{\Lambda_n} = Z \cap B_{n,+}^{\Lambda_n}.$$

It follows from this and the second condition that condition  $(\star)$  is satisfied. To show that  $(B'_n)$  is  $\mu$ -asymptotically  $\Gamma$ -invariant, take  $\gamma \in \Gamma$ . Taking  $n$  large enough guarantees that  $\gamma \in \Lambda_n$ . The measure  $\mu$  being  $\Gamma$ -invariant, we only need to show that  $\mu(B'_n \setminus \gamma \cdot B'_n)$  tends to 0. To do so, it is enough to establish that the measure of  $B'_n \setminus B_{n,+}^{\Lambda_n^{(2)}}$  tends to 0. Notice that

$$B'_n \setminus B_{n,+}^{\Lambda_n^{(2)}} \subset Y \setminus \left( \left( B_{n,+}^{\Lambda_n^{(2)}} \cup B_{n,-}^{\Lambda_n^{(2)}} \right) \cap (\Lambda_n \cdot Z) \right).$$

Indeed, the sets  $B_{n,+}^{\Lambda_n} \cap (\Lambda_n \cdot Z)$  and  $B_{n,-}^{\Lambda_n} \cap (\Lambda_n \cdot Z)$  are disjoint.

Since  $Z$  has positive measure and  $\Gamma \curvearrowright (Y, \mu)$  is ergodic, the measure of  $\Lambda_n \cdot Z$  converges to 1. We conclude using the second condition.  $\square$

### 1.3.3 Strong version

Consider  $\mathbb{P}_p$  for  $p \in (p_c(\mathcal{G}), p_u(\mathcal{G}))$ . By Theorems 1.1.11, 1.2.10 and 1.2.11 and Proposition 1.3.4, its cluster equivalence relation is strongly ergodic on the infinite locus. One would like to deduce from this information a strong form of indistinguishability of  $\mathbb{P}_p$ . This idea is due to Damien Gaboriau.

Another way to describe our goal is to say that we look for a proposition similar to Proposition 1.3.4 for strong notions. This is achieved in Theorem 1.3.10.

Again, everything will be stated for a generalized percolation, with the same notation as previously.

DEFINITION. We call **re-anchoring**, or **rerooting**, a Borel map

$$\begin{aligned} \alpha : X \times V &\longrightarrow V \\ (x, v) &\longmapsto u_{x,v}^\alpha \end{aligned}$$

that is  $\Gamma$ -equivariant under the diagonal action and such that

$$\forall (x, v) \in X \times V, u_{x,v}^\alpha \xleftrightarrow{\pi(x)} v.$$

In words, a re-anchoring is a  $\Gamma$ -equivariant way of changing of position within one's cluster.

*Example.* If  $\gamma \in \Gamma$ , setting

$$u_{x,v}^{\alpha_\gamma} := \begin{cases} \gamma \cdot v & \text{if } v \xleftrightarrow{\pi(x)} \gamma \cdot v \\ v & \text{otherwise} \end{cases}$$

defines a re-anchoring.

DEFINITION. Let  $(P_n)$  be a sequence of vertex properties. Let  $\mathbb{P}$  be a percolation. We will say that  $(P_n)$  is an **asymptotic cluster property** (for  $\mathbb{P}$ ) if, for any rerooting  $\alpha$ ,

$$\forall v \in V, \mathbb{P} \left[ \left\{ x \in X : P_n(x, v) \iff P_n(x, u_{x,v}^\alpha) \right\} \right] \xrightarrow{n \rightarrow \infty} 1.$$

*Remark.* For a given rerooting, the convergence above holds for all  $v$  as soon as it holds for one, by  $\Gamma$ -invariance and -equivariance.

*Remark.* This definition of “depending asymptotically only on one’s cluster” is quite natural if one looks for a translation of strong ergodicity, but it may not be the clearest definition from a probabilistic point of view. For a probabilistically more natural definition, see Subsection 1.3.5.

NOTATION. In what follows,  $A \Subset B$  means that  $A$  is a finite subset of  $B$ .

DEFINITION. We will say that  $\mathbb{P}$  satisfies the **Strong Indistinguishability Property** if, for every  $\mathbb{P}$ -asymptotic cluster property  $(P_n)$  and every  $F \Subset V$ ,

$$\mathbb{P}[P_n^\pm(x, V_\infty^\pi(x) \cap F)] \xrightarrow{n \rightarrow \infty} 1.$$

*Remark.* Subsection 1.3.5 makes the definition of asymptotic cluster property look like the conclusion of strong indistinguishability.

LEMMA 1.3.7. *The map  $(B_n) \mapsto (P_{B_n})$  is a bijection from the set of the  $\mathbb{P}$ -asymptotically  $R_{cl}$ -invariant sequences of Borel subsets of  $X$  onto the set of  $\mathbb{P}$ -asymptotic cluster properties. Its inverse map is  $(P_n) \mapsto (B_{P_n})$ .*

*Proof.* First, let  $(B_n)$  be a  $\mathbb{P}$ -asymptotically  $R_{cl}$ -invariant sequence of Borel subsets of  $X$  and set  $P_n := B_{P_n}$ . We show that  $(P_n)$  is a  $\mathbb{P}$ -asymptotic cluster property.

Let  $\alpha$  be a rerooting. Since  $(x, v) \mapsto (x, u_{x,v}^\alpha)$  is  $\Gamma$ -equivariant, it induces a map  $\bar{\alpha} : \Gamma \backslash (X \times V) \rightarrow \Gamma \backslash (X \times V)$ . Set

$$\phi := \psi \circ \bar{\alpha} \circ \psi^{-1},$$

where  $\psi$  is the bijection introduced in Subsection 1.3.0. More explicitly, we have  $\phi : x \mapsto \gamma_x^{-1} \cdot x$ , where  $\gamma_x$  is defined by

$$u_{x,\rho}^\alpha = \gamma_x \cdot \rho.$$

The graph of this Borel map is a subset of  $R$ . By Lemma 1.3.5, the probability of  $B_n \Delta \phi^{-1}(B_n)$  goes to 0 as  $n$  goes to infinity. As a consequence,  $(P_n)$  is an asymptotic cluster property.

Now, let  $(P_n)$  be a  $\mathbb{P}$ -asymptotic cluster property and set  $B_n := B_{P_n}$ . We show that  $(B_n)$  is  $\mathbb{P}$ -asymptotically  $R_{cl}$ -invariant.

Let  $\phi \in [R]$ . Since  $R_{cl} \subset R_{\Gamma \curvearrowright X}$ , one can define a Borel map

$$\begin{array}{ccc} X_\infty & \longrightarrow & \Gamma \\ x & \longmapsto & \gamma_x \end{array}$$

such that  $\forall x \in X$ ,  $\phi(x) = \gamma_x^{-1} \cdot x$ . Define  $\alpha$  by  $u_{x,\eta \cdot \rho}^\alpha := \eta \cdot \gamma_{\eta^{-1} \cdot x}$ . This is a rerooting. We have

$$\begin{aligned} \phi^{-1}(B_n) &= \{x \in X : P_n(\phi(x), \rho)\} \\ &= \{x \in X : P_n(\gamma_x^{-1} \cdot x, \rho)\} \\ &= \{x \in X : P_n(x, \gamma_x \cdot \rho)\} && \text{by } \Gamma\text{-invariance of } P_n \\ &= \{x \in X : P_n(x, u_{x,\rho}^\alpha)\} \end{aligned}$$

Since  $(P_n)$  is a  $\mathbb{P}$ -asymptotic cluster property, we deduce from this that the probability of  $B_n \Delta \phi^{-1}(B_n)$  tends to 0. Since this holds for every  $\phi \in [R]$ , the sequence  $(B_n)$  is  $\mathbb{P}$ -asymptotically  $R_{cl}$ -invariant.  $\square$

*Remark.* In the previous proof, the use of Lemma 1.3.5 allows us to obtain the asymptotic-cluster-property condition for all rerootings, while a “literal translation” would have given it only for the vertex-bijective ones — the rerootings  $(x, v) \mapsto u_{x,v}$  such that, for every  $x$ , the map  $v \mapsto u_{x,v}$  is bijective. From the percolation point of view, vertex-bijective rerootings are absolutely non-natural objects: the use of such a lemma was unavoidable.

From Lemma 1.3.1 and Lemma 1.3.7, one deduces the following statement.

**PROPOSITION 1.3.8.** *A generalized percolation satisfies the Strong Indistinguishability Property if and only if for every  $\mathbb{P}$ -asymptotically  $R_{cl}$ -invariant sequence  $(B_n)$  of Borel subsets of  $X$ , for every  $\Lambda \in \Gamma$ ,*

$$\mathbb{P}[\{x \in X : \forall y, z \in X_\infty \cap (\Lambda \cdot x), y \in B_n \iff z \in B_n\}] \xrightarrow{n \rightarrow \infty} 1.$$

**PROPOSITION 1.3.9.** *Consider a generalized percolation such that  $\mathbb{P}[X_\infty]$  is positive. The following assertions are equivalent:*

1. *the relation  $R$  is  $\frac{\mathbb{P}}{\mathbb{P}[X_\infty]}$ -strongly ergodic,*
2. *for every asymptotic cluster property  $(P_n)$ , there exists  $(\epsilon_n) \in \{-, +\}^{\mathbb{N}}$  such that*

$$\forall F \in V, \mathbb{P}[P_n^{\epsilon_n}(x, V_\infty^\pi(x) \cap F)] \xrightarrow{n \rightarrow \infty} 1,$$

3. *for every asymptotic cluster property  $(P_n)$ , there exists  $(\epsilon_n) \in \{-, +\}^{\mathbb{N}}$  such that*

$$\mathbb{P}\left[P_n^{\epsilon_n}(x, \rho) \Big| \rho \xleftrightarrow{\pi(x)} \infty\right] \xrightarrow{n \rightarrow \infty} 1.$$

*Proof.* Assume that  $R$  is strongly ergodic. Let  $(P_n)$  be an asymptotic cluster property. Set  $B_n := B_{P_n}$ . By strong ergodicity, there exists  $(\epsilon_n) \in \{-, +\}^{\mathbb{N}}$  such that  $\mathbb{P}[B^{-\epsilon_n} \cap X_\infty]$  tends to 0. (We denote by  $B^+$  the set  $B$  and  $B^-$  its complement.) Hence, for any  $\Lambda \in \Gamma$ ,  $\mathbb{P}\left[\bigcup_{\gamma \in \Lambda} \gamma \cdot (B^{-\epsilon_n} \cap X_\infty)\right]$  tends to 0. This establishes the second statement: specifying the previous sentence for a particular  $\Lambda$  solves the case  $F = \Lambda^{-1} \cdot \rho$ .

Taking  $F = \{\rho\}$  gives (ii)  $\implies$  (iii) and (iii)  $\implies$  (i) is straightforward.  $\square$

**THEOREM 1.3.10.** *Consider a generalized percolation such that  $\Gamma \curvearrowright (X, \mathbb{P})$  is strongly ergodic and  $\mathbb{P}[X_\infty] > 0$ . It satisfies the Strong Indistinguishability Property if and only if  $R$  is  $\frac{\mathbb{P}}{\mathbb{P}[X_\infty]}$ -strongly ergodic.*

*Proof.* If  $R$  is strongly ergodic, Proposition 1.3.9 implies that strong indistinguishability holds. Conversely, assume strong indistinguishability to hold. Let  $(B_n)$  be a  $\frac{\mathbb{P}}{\mathbb{P}[X_\infty]}$ -asymptotically  $R$ -invariant sequence of Borel subsets of  $X_\infty$ . Strong indistinguishability implies that for every  $\gamma$ ,

$$\mathbb{P}[\{x \in X_\infty : \gamma \cdot x \in X_\infty \implies (x \in B_n \iff \gamma \cdot x \in B_n)\}] \xrightarrow[n \rightarrow \infty]{} \mathbb{P}[X_\infty].$$

This means that  $(B_n)$  is  $\frac{\mathbb{P}}{\mathbb{P}[X_\infty]}$ -asymptotically  $(R_{\Gamma \curvearrowright X})|_{X_\infty}$ -invariant. By Lemma 1.3.6, the strong ergodicity of  $R_{\Gamma \curvearrowright X}$  entails that the only possible accumulation points of  $(\mathbb{P}[B_n \cap X_\infty])$  are 0 and  $\mathbb{P}[X_\infty]$ . This ends the proof.  $\square$

From this theorem and the few lines at the beginning of the current subsection, we can derive the following corollary — even for  $p = p_u(\mathcal{G})$  if the assumption of the corollary is satisfied for this parameter.

**COROLLARY 1.3.11.** *As soon as  $\mathbb{P}_p$  produces infinitely many infinite clusters, it satisfies the Strong Indistinguishability Property.*

### 1.3.4 Classic and strong indistinguishability do not coincide

Obviously, strong indistinguishability implies the classical one: take  $P_n = P$  for all  $n$ . In this subsection, we study a particular percolation, and prove that it satisfies the Indistinguishability Property but not the strong one.

To define this percolation, take  $\Gamma$  to be the free group  $\langle a, b \rangle$ . Endow it with the generating system  $\{a, b\}$ . We will use the concrete definition of Cayley graphs and take the vertex set of  $\mathcal{G}$  to be  $\Gamma$ . Set

$$X := \{a, b\}^\Gamma \quad \text{and} \quad \mathbb{P} := \left( \frac{1}{2}\delta_a + \frac{1}{2}\delta_b \right)^{\otimes \Gamma}.$$

The equivariant map  $\pi$  is defined as follows: for each  $\gamma$ , among the two edges  $\{\gamma, \gamma a\}$  and  $\{\gamma, \gamma b\}$ , open the edge  $\{\gamma, \gamma x_\gamma\}$  and close the other one. The analogous model for  $\mathbb{Z}^2$  instead of  $\langle a, b \rangle$  has been extensively studied, see e.g. [FINR04] and references therein.

**THEOREM 1.3.12.** *The considered percolation satisfies the Indistinguishability Property but not the Strong Indistinguishability Property.*

*Proof.* In this proof, we will use the **height** function defined as the unique morphism

$$\begin{aligned} h : \Gamma &\longrightarrow \mathbb{Z} \\ a &\longmapsto 1 \\ b &\longmapsto -1. \end{aligned}$$



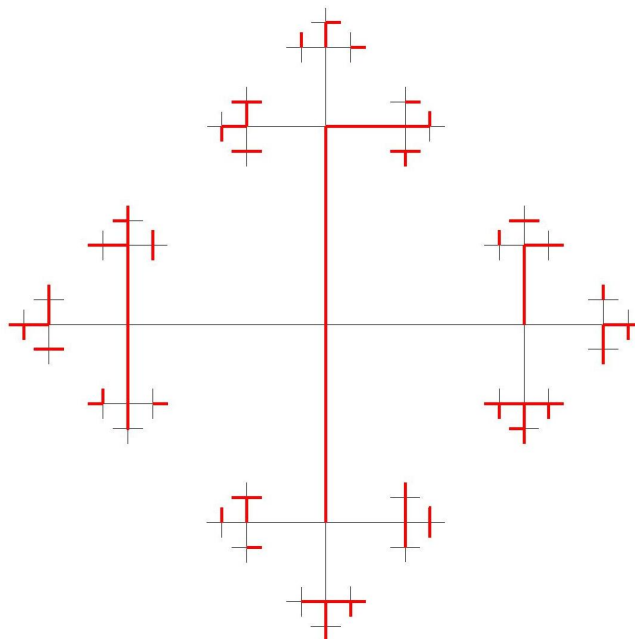

Figure 35 – A possible percolation configuration.

First, let us prove that strong indistinguishability does not hold. The  $x$ -**directed path** launched at  $\gamma$  is defined by  $\tilde{\gamma}_0 := \gamma$  and  $\tilde{\gamma}_{k+1} := \tilde{\gamma}_k x_{\tilde{\gamma}_k}$ . The elements  $x_{\tilde{\gamma}_k}$  are called the **steps** of the directed path. Set  $P_n(x, \gamma)$  to be “there are more  $a$ ’s than  $b$ ’s in the first  $2n + 1$  steps of the  $x$ -directed path launched at  $\gamma$ ”. Let  $d$  denote the graph distance on  $\mathcal{G}$ . Let  $\gamma$  and  $\eta$  denote two elements of  $\Gamma$ . Assume that there exists  $x$  such that  $\gamma$  and  $\eta$  are  $\pi(x)$ -connected. Then, along the geodesic path from  $\gamma$  to  $\eta$ , the height increases, reaches a unique maximum, and then decreases. Let  $\tau$  be the vertex where this maximum is attained. If  $\gamma$  and  $\eta$  are  $\pi(x)$ -connected, the  $x$ -directed paths launched at  $\gamma$  and  $\eta$  coincide with the one launched at  $\tau$ , up to forgetting the first  $d(\gamma, \tau)$  steps of the first path and the first  $d(\eta, \tau)$  ones of the second. Thus, the probability of the event

$$\gamma \xleftrightarrow{\pi(x)} \eta \quad \text{and} \quad P_n(x, \gamma) \neq P_n(x, \eta)$$

is less than the probability that a simple random walk on  $\mathbb{Z}$  that takes  $n - d(\gamma, \eta)$  steps ends up in  $[-d(\eta, \gamma), d(\eta, \gamma)]$ . This is known to go to zero as  $n$  goes to infinity, as  $n^{-1/2}$ . Therefore, by Proposition 1.3.13,  $(P_n)$  is an asymptotic cluster property. But  $P_n(x, a)$  and  $P_n(x, b)$  are independent of probability  $1/2$ . Since the considered percolation produces only infinite clusters, it cannot satisfy the Strong Indistinguishability Property.

Now, let us establish the Indistinguishability Property. Let us define the **contour** exploration of the cluster of the origin  $\rho = 1$ . Intuitively, we explore the cluster of the origin (and some vertices of its boundary) using a depth-first search algorithm, with the following conventions:

- vertices of negative height are ignored,
- when a vertex  $\gamma$  has its two sons  $\gamma a^{-1}$  and  $\gamma b^{-1}$  in its cluster,  $\gamma a^{-1}$  is explored first — in figures,  $\gamma a^{-1}$  will be represented to the left of  $\gamma b^{-1}$ .

Formally, the exploration is defined as follows. If  $m$  is an integer, define  $\vec{E}_{x,m}$  to be

$$\{(\gamma, \gamma s^{-1}) : \gamma \in \Gamma, s \in \{a, b\}, h(\gamma) > m\} \cup \{(\gamma, \gamma x_\gamma) : \gamma \in \Gamma, h(\gamma) \geq m\}.$$

Given a configuration  $x \in \{a, b\}^\Gamma$ , we define a bijection  $\text{next}_{x,m}$  from  $\vec{E}_{x,m}$  to itself. If  $(\gamma, \gamma') \in \vec{E}_{x,m}$ , then  $\text{next}_{x,m}(\gamma, \gamma')$  is set to be  $(\gamma', \gamma'')$ , where  $\gamma''$  is

- $\gamma' b^{-1}$  if  $\gamma' = \gamma a$ ,
- $\gamma' a^{-1}$  if  $\gamma' = \gamma' x_{\gamma'}$  and  $h(\gamma') > m$ ,
- $\gamma$  if  $\gamma' \neq \gamma' x_{\gamma'}$  and  $h(\gamma) = h(\gamma') + 1$ ,
- $\gamma' x_{\gamma'}$  otherwise.

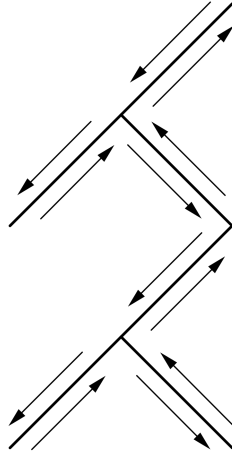

Figure 36 – The exploration process.

The **exploration** — or **exploration in positive time** — is defined by

- $\vec{e}_0 = (\gamma_0, \gamma_1) = (1, x_1)$ ,
- $\forall k > 0, \vec{e}_k = (\gamma_k, \gamma_{k+1}) = \text{next}_{x,0}(\vec{e}_{k-1})$ .

Since  $\text{next}_x$  is a bijection, one can also define the **exploration in negative time**:

- $\vec{e}_0 = (\gamma_0, \gamma_1) = (1, x_1)$ ,
- $\forall k \leq 0, \vec{e}_k = (\gamma_k, \gamma_{k+1}) = \text{next}_{x,0}(\vec{e}_{k-1})$ .

Whenever there is no explicit mention of negative times, “exploration” will always be understood as “exploration in positive time”. Define

$$k(x) := \min \left\{ k > 0 : h(\gamma_k) = 0 \text{ and } \gamma_k \xleftrightarrow{\pi(x)} 1 \right\}.$$

Notice that it is almost surely well-defined.

Indeed, for each positive height  $n$ , there is a unique couple  $(\gamma_{n,x}, \gamma'_{n,x})$  satisfying the following conditions:

- the  $x$ -directed path launched at 1 contains  $\gamma'_{n,x}$  but not  $\gamma_{n,x}$ ,
- $\gamma_{n,x}^{-1} \gamma'_{n,x} \in \{a, b\}$
- and  $h(\gamma_{n,x}) = n$ .

Denote by  $T_{n,x}$  the connected component of  $\gamma_{n,x}$  in the graph defined by  $\pi(x)$  but where the edges  $\gamma_{n,x}a$  and  $\gamma_{n,x}b$  have been removed. It is rooted at  $\gamma_{n,x}$ . The following facts hold:

- considered as rooted graphs up to isomorphism, the  $T_{n,x}$ 's are i.i.d. critical Galton-Watson trees,
- each  $T_{n,x}$  has probability  $1/4$  of being explored<sup>3</sup> by the contour exploration (it has probability  $1/2$  of belonging to the cluster of 1 and, conditioned on this, it has probability  $1/2$  of being explored in positive time rather than in negative time)
- and the events and random variables mentioned in the two facts above are independent.

Since the depth of a critical Galton-Watson tree is non-integrable, by the independent form of the Borel-Cantelli Lemma, it almost surely occurs that one of them is explored and reaches height 0.

Thus, the Borel mapping  $x \mapsto \gamma_{k(x)}^{-1} \cdot x$  coincides on a full-measure set with a Borel bijection  $T : X \rightarrow X$ .

Indeed,  $k'(x) := \min\{k < 0 : h(\gamma_k) = 0 \text{ and } \gamma_k \xleftrightarrow{\pi(x)} 1\}$  is almost surely well-defined, so that the mapping  $S : x \mapsto \gamma_{k'(x)}^{-1} \cdot x$  is almost surely well-defined. For almost every  $x$ ,  $T(S(x)) = S(T(x))$ .

For almost every  $x$ , the points  $T(x)$  and  $x$  are in the same  $\Gamma$ -orbit. By Theorem 1.1.6, the Borel bijective map  $T$  preserves the measure  $\mathbb{P}$ . By Proposition 1.3.4, it is enough to show that  $T$  is ergodic. (Indeed, for almost every  $x$ , the point  $T(x)$  and  $x$  are in the same  $R_{cl}$ -class.)

Let  $B$  denote a Borel subset of  $X$  and assume that  $B = T(B)$ . We need to show that  $\mathbb{P}[B] \in \{0, 1\}$ . Let  $\epsilon > 0$ . Let  $C$  be an event such that

- $\mathbb{P}[B \Delta C] < \epsilon$ ,

---

3. Of course, the generations of negative height are not explored.

—  $C$  is  $\sigma(x|_{\mathcal{B}})$ -measurable for some ball  $\mathcal{B}$  centered at 1.

Denote by  $R$  the radius of the ball  $\mathcal{B}$  and by  $\mathbf{C}$  the subset of  $\{a, b\}^{\mathcal{B}}$  such that

$$C = \mathbf{C} \times \prod_{\gamma \notin \mathcal{B}} \{a, b\}.$$

Set  $X_n := T^n(x)|_{\mathcal{B}}$ . We will show that  $(X_n)_{n \geq 0}$  is an irreducible aperiodic time-homogeneous Markov chain. Assuming this, we conclude the proof. Since  $\mathbb{P}$  is  $T$ -invariant, it would result from our assumption that

$$\mathbb{P}[X_0 \in \mathbf{C} \text{ and } X_n \in \mathbf{C}] \xrightarrow{n \rightarrow \infty} \mathbb{P}[X_0 \in \mathbf{C}]^2.$$

Using the notation  $A \stackrel{\epsilon}{\simeq} A'$  as a shortcut for  $\mathbb{P}[A \Delta A'] \leq \epsilon$ , we have

$$B = B \cap T^n(B) \stackrel{2\epsilon}{\simeq} C \cap T^n(C).$$

Letting  $n$  go to infinity, we get  $|\mathbb{P}[B] - \mathbb{P}[C]^2| \leq 2\epsilon$ . Since  $|\mathbb{P}[C] - \mathbb{P}[B]| < \epsilon$ , we have  $|\mathbb{P}[B] - \mathbb{P}[B]^2| < 4\epsilon$ . Letting  $\epsilon$  go to zero, one gets  $\mathbb{P}[B] = \mathbb{P}[B]^2$  and concludes.

Now, let us prove that  $(X_n)$  is an irreducible aperiodic time-homogeneous Markov chain. Since  $(X_n)$  is defined by iteration and restriction of the measure-preserving transformation  $T$ , if it is a Markov chain, it is necessarily time-homogeneous. Let us establish the Markov Property.

To define  $(X_0, \dots, X_n)$ , one needs to explore a certain set of vertices denoted by  $\text{Explo}_n(x)$ .

- Conditionally on  $(X_0, \dots, X_n)$ , the state of the vertices in  $\Gamma \setminus \text{Explo}_n(x)$  is i.i.d.  $\frac{1}{2}\delta_a + \frac{1}{2}\delta_b$ .
- Define  $\hat{\gamma}_0$  to be the point of height  $R + 1$  in the  $x$ -directed path launched at 1. Then, define an auxiliary exploration: it explores the vertices of the cluster of the origin as previously until it reaches  $\hat{\gamma}_0 x_{\hat{\gamma}_0}$  and then executes the exploration defined by  $\text{next}_{x, R+1}$ . Notice that, after  $\hat{\gamma}_0$ , the vertices explored by the auxiliary exploration are exactly the ones of height at least  $R + 1$  that are explored by the usual exploration; besides, they are explored in the same order. Denote by  $(\hat{\gamma}_k)$  the sequence of the vertices of height exactly  $R + 1$  that are visited by any of our two explorations, in the order in which they are discovered. Set  $\mathcal{P}$  to be the set of the elements of  $\Gamma$  whose expression as a reduced word starts with  $a^{-1}$  or  $b^{-1}$ . Conditionally on the data of the whole auxiliary exploration, the sequence

$$\left( (\hat{\gamma}_k^{-1} \cdot x)|_{\mathcal{P}} \right)_{k \geq 1}$$

is i.i.d., the common law of its elements being  $\left( \frac{1}{2}\delta_a + \frac{1}{2}\delta_b \right)^{\otimes \mathcal{P}}$ .

The exploration never visits a site of  $\hat{\gamma}_k \cdot \mathcal{P}$  after one of  $\hat{\gamma}_\ell \cdot \mathcal{P}$  for  $\ell > k$ . Thus, to establish the Markov Property, it is enough to show that, within some  $\hat{\gamma}_k \cdot \mathcal{P}$ , the vertices that we explore between the  $n^{\text{th}}$  and  $(n+1)^{\text{th}}$  steps of the construction (in order to define  $X_{n+1}$ ) and that have already been explored have their state written in  $X_n$ . More formally, it is enough to show that if we set

- $k_- := \min\{k \leq 0 : \gamma_k = \hat{\gamma}_0\}$ ,
- $k_+ := \max\{k \geq 0 : \gamma_k = \hat{\gamma}_0\}$ ,
- $\mathcal{L} := \{\gamma_k : k_- \leq k \leq 0\} \setminus \{\hat{\gamma}_0\}$ ,
- $\mathcal{L}' := \{\eta : \exists \gamma \in \mathcal{L}, h(\gamma) = 0 \text{ and } d(\gamma, \eta) \leq R\}$ ,
- $\mathcal{R} := \{\gamma_k : 0 \leq k \leq k_+\} \setminus \{\hat{\gamma}_0\}$ ,
- $\mathcal{R}' := \{\eta : \exists \gamma \in \mathcal{R}, h(\gamma) = 0 \text{ and } d(\gamma, \eta) \leq R\}$

then  $(\mathcal{L} \cup \mathcal{L}') \cap (\mathcal{R} \cup \mathcal{R}')$  is always included in  $\mathcal{B}$ . Since  $\mathcal{L}' \cap \mathcal{R}'$  consists in the  $1 + R$  first vertices visited by the  $x$ -directed path launched at 1, it is a subset of  $\mathcal{B}$ . To establish  $\mathcal{L} \cap \mathcal{R}' \subset \mathcal{B}$ , take  $\gamma$  in  $\mathcal{L}$  and  $\eta$  at height 0 such that  $\eta \in \mathcal{R}$  and  $d(\gamma, \eta) \leq R$ . It results from the respective definitions of  $\mathcal{L}$  and  $\mathcal{R}$  that the geodesic path connecting  $\gamma$  to the tripod  $(1, \hat{\gamma}_0, \eta)$  intersects it at a point  $\kappa$  which belongs to the geodesic  $(1, \hat{\gamma}_0)$ . Since 1 and  $\eta$  have the same height,  $d(\kappa, 1) \leq d(\kappa, \eta)$ . Thus  $d(\gamma, 1) \leq d(\gamma, \eta)$  and  $\mathcal{L} \cap \mathcal{R}' \subset \mathcal{B}$ .

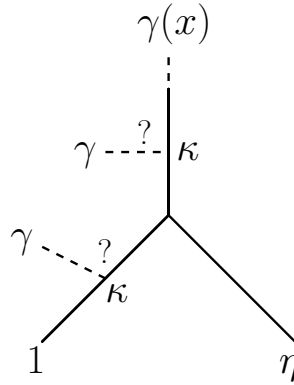

Figure 37 – Illustration of the “tripod argument”.

The inclusion  $\mathcal{L}' \cap \mathcal{R} \subset \mathcal{B}$  follows by symmetry. To have the Markov Property, it remains to show that  $\mathcal{L}' \cap \mathcal{R}' \subset \mathcal{B}$ . This results from the fact that if  $\gamma \in \mathcal{L}$  and  $\eta \in \mathcal{R}$  both have height 0, then every point  $\kappa$  of the tree spanned by  $\{\hat{\gamma}_0, \gamma, 1, \eta\}$  satisfies

$$d(\kappa, 1) \leq \max(d(\kappa, \gamma), d(\kappa, \eta)).$$

See Figure 38.

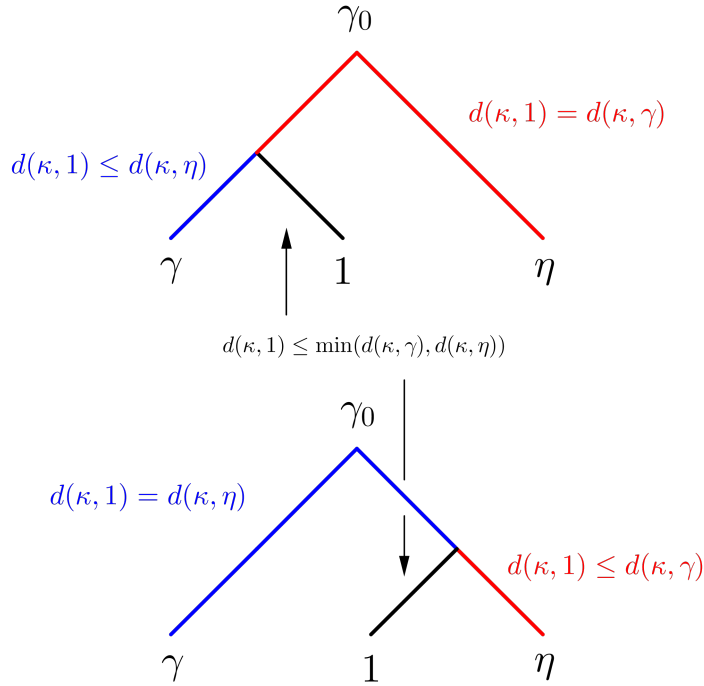

Figure 38 – This picture captures geometrically the Markov Property.

Now, let us establish the irreducibility of the considered Markov chain. Let  $\chi$  and  $\xi$  be two elements of  $\{a, b\}^{\mathcal{B}}$ . The knowledge of the restriction of  $x$  to  $\mathcal{B}$  suffices to determine the point at height  $R + 1$  in the  $x$ -directed path launched at 1. Denote it by  $\gamma(x|_{\mathcal{B}})$ . Imposing on  $x$  the following conditions (compatible since they involve disjoint areas)

- $x|_{\mathcal{B}} = \chi$ ,
- $x_{\gamma(\chi)} = a$ ,
- $x_{\gamma(\chi)ab^{-1}} = b$ ,
- $(\gamma(\xi)ba^{-1}\gamma(\chi)^{-1} \cdot x)|_{\mathcal{B}} = \xi$ .

we have  $X_0 = \chi$  and  $\exists k > 0, X_k = \xi$ . Thus, the intersection of these two events has positive probability and  $(X_n)$  is irreducible.

To establish the aperiodicity of the Markov chain  $(X_n)$ , apply the previous argument for  $\chi = \xi = (a)_{\gamma \in \mathcal{B}}$  with the additional condition  $x_{a^{n+1}b^{-1}} = a$ , which gives  $\mathbb{P}[X_0 = X_1 = (a)_{\gamma \in \mathcal{B}}] > 0$ .  $\square$

*Remark.* The previous proof does not only prove that the infinite clusters

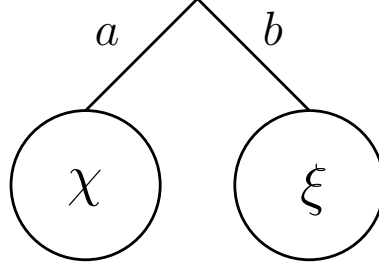

Figure 39 – This picture gives the irreducibility of  $(X_n)$ .

are indistinguishable, but also that the “height-levels of infinite clusters” are indistinguishable, which is a stronger statement.

### 1.3.5 Complements on asymptotic cluster properties

This subsection provides equivalent definitions of asymptotic cluster properties. We stick to the usual notation for generalized percolations.

NOTATION. If  $x \in X$ , denote by  $\mathfrak{C}^\pi(x)$  the set of the clusters of  $\pi(x)$ .

PROPOSITION 1.3.13. *Let  $(P_n)$  be a sequence of properties. The following assertions are equivalent*

1.  $(P_n)$  is a  $\mathbb{P}$ -asymptotic cluster property,
2.  $\forall F \Subset V, \mathbb{P}[\forall C \in \mathfrak{C}^\pi(x), P_n^\pm(x, C \cap F)] \xrightarrow[n \rightarrow \infty]{} 1$ ,
3.  $\exists u \in V, \forall v \in V, \mathbb{P}[P_n^\pm(x, \{u, v\}) | u \overset{\pi(x)}{\longleftrightarrow} v] \xrightarrow[n \rightarrow \infty]{} 1$ ,
4.  $\forall u \in V, \forall v \in V, \mathbb{P}[P_n^\pm(x, \{u, v\}) | u \overset{\pi(x)}{\longleftrightarrow} v] \xrightarrow[n \rightarrow \infty]{} 1$ .

*Remark.* Above, we set  $P[A|B] := 1$  when  $\mathbb{P}[B] = 0$ .

*Proof.* The assertions (iii) and (iv) are equivalent by  $\Gamma$ -invariance.

Rewriting (ii) as follows

$$\forall F \Subset V, \mathbb{P}\left[\forall (u, v) \in F^2, \left(u \overset{\pi(x)}{\longleftrightarrow} v\right) \implies P_n^\pm(x, \{u, v\})\right] \xrightarrow[n \rightarrow \infty]{} 1$$

clarifies its equivalence<sup>4</sup> with (iv): one way, take  $F := \{u, v\}$ ; the other way, write  $F$  as the *finite* union of the pairs it contains.

Now assume (i) and establish (iii). We will do so for  $u = \rho$ . Let  $v = \gamma \cdot \rho$  be a vertex. Applying (i) to the  $\alpha_\gamma$  introduced at the beginning of Subsection 1.3.3, one gets

$$\mathbb{P}\left[\left\{x \in X : P_n(x, \rho) = P_n\left(x, u_{x, \rho}^{\alpha_\gamma}\right)\right\}\right] \xrightarrow[n \rightarrow \infty]{} 1.$$

4. Remember that  $\mathbb{P}[Q_n|Q] \xrightarrow[n \rightarrow \infty]{} 1$  is equivalent to  $\mathbb{P}[Q \implies Q_n] \xrightarrow[n \rightarrow \infty]{} 1$ .

Hence, if  $A := \{x \in X : \rho \xleftrightarrow{\pi(x)} \gamma \cdot \rho\}$ ,

$$\mathbb{P} \left[ \left\{ x \in A : P_n(x, \rho) = P_n(x, u_{x, \rho}^{\alpha_\gamma}) \right\} \right] \xrightarrow{n \rightarrow \infty} \mathbb{P}[A].$$

But, on  $A$ , “ $P_n(x, \rho) = P_n(x, u_{x, \rho}^{\alpha_\gamma})$ ” means that “ $P_n(x, \rho) = P_n(x, v)$ ”, so that (iii) is established.

It is now enough to show that (ii) implies (i). Assume (ii). Let  $\alpha$  be a rerooting. Set  $w(x) := u_{x, \rho}^\alpha$  and take  $\epsilon > 0$ . Let  $F \subseteq V$  be such that  $\mathbb{P}[w \notin F] < \epsilon$ . We have

$$(w \in F \text{ and } \forall C \in \mathfrak{C}^\pi(x), P_n^\pm(x, F \cap C)) \implies P_n^\pm(x, \{\rho, w\}).$$

(Apply the second hypothesis to the common cluster of  $\rho$  and  $w$ .)

The condition on the left hand side being satisfied with probability asymptotically larger than  $1 - 2\epsilon$  (by (ii) and choice of  $F$ ),

$$\liminf_n \mathbb{P} [P_n^\pm(x, \{\rho, w\})] \geq 1 - 2\epsilon.$$

Since this holds for any value of  $\epsilon$ , the proof is over.  $\square$





## Chapter 2

# Locality of percolation for abelian Cayley graphs

In this chapter, we prove that the value of the critical probability for percolation on an abelian Cayley graph is determined by its local structure. This is a partial positive answer to a conjecture of Schramm: the function  $p_c$  defined on the set of Cayley graphs of abelian groups of rank at least 2 is continuous for the Benjamini-Schramm topology. The proof involves group-theoretic tools and a new block argument.

This chapter follows the paper [MT], which has been written in collaboration with Vincent Tassion.

### 2.0 Introduction

In the paper [BS96], Benjamini and Schramm launched the study of percolation in the general setting of transitive graphs. Among the numerous questions that have been studied in this setting stands the question of locality: roughly, “does the value of the critical probability depend only on the local structure of the considered transitive graph?” This question emerged in [BNP11] and is formalized in a conjecture attributed to Oded Schramm. In the same paper, the particular case of (uniformly non-amenable) tree-like graphs is treated.

In the present chapter, we study the question of locality in the context of abelian groups.

- Instead of working in the geometric setting of transitive graphs, we employ the vocabulary of groups — or more precisely of *marked groups*, as presented in Section 2.1. This allows us to use additional tools of algebraic nature, such as quotient maps, that are crucial to our approach. These tools could be useful to tackle Schramm’s Conjecture in a more general framework than the one presented in this chapter, e.g. Cayley graphs of nilpotent groups.

- We extend renormalization techniques developed in [GM90] by Grimmett and Marstrand for the study of percolation on  $\mathbb{Z}^d$  (equipped with its standard graph structure). The Grimmett-Marstrand Theorem answers positively the question of locality for the  $d$ -dimensional hypercubic lattice. With little extra effort, one can give a positive answer to Schramm’s Conjecture in the context of abelian groups, under a symmetry assumption. Our main achievement is to improve the understanding of supercritical bond percolation on general abelian Cayley graphs: such graphs do not have enough symmetry for Grimmett and Marstrand’s arguments to apply directly. The techniques we develop here may be used to extend other results of statistical mechanics from symmetric lattices to lattices which are not stable under any reflection.

### 2.0.1 Statement of Schramm’s Conjecture

The following paragraph presents the vocabulary needed to state the conjecture of Schramm (for more details, see [BNP11]).

**Transitive graphs** We recall here some standard definitions from graph theory. A graph is said to be **transitive** if its automorphism group acts transitively on its vertices. Let  $\mathfrak{G}$  denote the space of (locally finite, non-empty, connected) transitive graphs considered up to isomorphism. By abuse of notation, we will identify a graph with its isomorphism class. Take  $\mathcal{G} \in \mathfrak{G}$  and  $o$  any vertex of  $\mathcal{G}$ . Then consider the ball of radius  $k$  (for the graph distance) centered at  $o$ , equipped with its graph structure and rooted at  $o$ . Up to isomorphism of rooted graphs, it is independent of the choice of  $o$ , and we denote it by  $\mathcal{B}_{\mathcal{G}}(k)$ . If  $\mathcal{G}, \mathcal{H} \in \mathfrak{G}$ , we set the distance between them to be  $2^{-n}$ , where

$$n := \max\{k : \mathcal{B}_{\mathcal{G}}(k) \simeq \mathcal{B}_{\mathcal{H}}(k)\} \in \mathbb{N} \cup \{\infty\}.$$

This defines the **Benjamini-Schramm distance** on the set  $\mathfrak{G}$ . It was introduced in [BS01b] and [BNP11].

**Locality in percolation theory** We will use the standard definitions from percolation theory and refer to [Gri99] and [LP] for background on the subject. To any  $\mathcal{G} \in \mathfrak{G}$  corresponds a critical parameter  $p_c(\mathcal{G})$  for i.i.d. bond percolation. One can see  $p_c$  as a function from  $\mathfrak{G}$  to  $[0, 1]$ . The locality question is concerned with the continuity of this function.

QUESTION 2.0.1 (LOCALITY OF PERCOLATION). *Let  $(\mathcal{G}_n)$  be a sequence of transitive graphs that converges to a limit  $\mathcal{G}$ .*

$$\text{Does the convergence } p_c(\mathcal{G}_n) \xrightarrow[n \rightarrow \infty]{} p_c(\mathcal{G}) \text{ hold?}$$

With this formulation, the answer is negative. Indeed, for the usual graph structures, the following convergences hold:

$$\begin{aligned} & - (\mathbb{Z}/n\mathbb{Z})^2 \xrightarrow{n \rightarrow \infty} \mathbb{Z}^2, \\ & - \mathbb{Z}/n\mathbb{Z} \times \mathbb{Z} \xrightarrow{n \rightarrow \infty} \mathbb{Z}^2. \end{aligned}$$

In both cases, the critical parameter is constant equal to 1 all along the sequence and jumps to a non trivial value in the limit. The following conjecture, attributed to Schramm and formulated in [BNP11], states that Question 2.0.1 should have a positive answer whenever the previous obstruction is avoided.

**CONJECTURE 2.0.2 (SCHRAMM).** *Let  $\mathcal{G}_n \xrightarrow{n \rightarrow \infty} \mathcal{G}$  denote a converging sequence of transitive graphs. Assume that  $\sup_n p_c(\mathcal{G}_n) < 1$ . Then*

$$p_c(\mathcal{G}_n) \xrightarrow{n \rightarrow \infty} p_c(\mathcal{G}).$$

It is unknown whether  $\sup_n p_c(\mathcal{G}_n) < 1$  is equivalent or not to  $p_c(\mathcal{G}) < 1$  for all  $n$ . In other words, we do not know if 1 is an isolated point in the set of critical probabilities of transitive graphs. Besides, no geometric characterization of the probabilistic condition  $p_c(\mathcal{G}) < 1$  has been established so far, which constitutes part of the difficulty of Schramm's Conjecture.

## 2.0.2 The Grimmett-Marstrand Theorem

The following theorem, proved in [GM90], is an instance of a locality result. It was an important step in the comprehension of the supercritical phase of percolation.

**THEOREM 2.0.3 (GRIMMETT-MARSTRAND).** *Let  $d \geq 2$ . For the usual graph structures, the following convergence holds:*

$$p_c\left(\mathbb{Z}^2 \times \{-n, \dots, n\}^{d-2}\right) \xrightarrow{n \rightarrow \infty} p_c\left(\mathbb{Z}^d\right).$$

*Remark.* Grimmett and Marstrand's proof covers more generally the case of edge structures on  $\mathbb{Z}^d$  that are invariant under both translation and reflection.

The graph  $\mathbb{Z}^2 \times \{-n, \dots, n\}^{d-2}$  is not transitive, so the result does not fit exactly into the framework of the previous subsection. However, as remarked in [BNP11], one can easily deduce from it the following statement:

$$p_c\left(\mathbb{Z}^2 \times \left(\frac{\mathbb{Z}}{n\mathbb{Z}}\right)^{d-2}\right) \xrightarrow{n \rightarrow \infty} p_c\left(\mathbb{Z}^d\right). \quad (2.1)$$

Actually, after having introduced the space of marked abelian groups, we will see in Section 2.1.3 that one can deduce from the Grimmett-Marstrand

Theorem a statement that is much stronger than convergence (2.1). We will be able to prove that  $p_c(\mathbb{Z}^d) = \lim p_c(\mathcal{G}_n)$  for any sequence of abelian Cayley graphs  $\mathcal{G}_n$  converging to  $\mathbb{Z}^d$  with respect to the Benjamini-Schramm distance.

### 2.0.3 Main result

In this chapter we prove the following theorem, which provides a positive answer to Question 2.0.1 in the particular case of Cayley graphs of abelian groups (see definitions in Section 2.1).

**THEOREM 2.0.4.** *Consider a sequence  $(\mathcal{G}_n)$  of Cayley graphs of abelian groups satisfying  $p_c(\mathcal{G}_n) < 1$  for all  $n$ . If the sequence converges to a Cayley Graph  $\mathcal{G}$  of an abelian group, then*

$$p_c(\mathcal{G}_n) \xrightarrow{n \rightarrow \infty} p_c(\mathcal{G}). \quad (2.2)$$

We now give three examples of application of this theorem. Let  $d \geq 2$ , fix a generating set  $S$  of  $\mathbb{Z}^d$ , and denote by  $\mathcal{G}$  the associated Cayley graph of  $\mathbb{Z}^d$ .

**Example 1:** There exists a natural Cayley graph  $\mathcal{G}_n$  of  $\mathbb{Z}^2 \times \left(\frac{\mathbb{Z}}{n\mathbb{Z}}\right)^{d-2}$  that is covered by  $\mathcal{G}$ . For such sequence, the convergence (2.2) holds, and generalizes (2.1).

**Example 2:** Consider the generating set of  $\mathbb{Z}^d$  obtained by adding to  $S$  all the  $n \cdot s$ , for  $s \in S$ . The corresponding Cayley graph  $\mathcal{H}_n$  converges to the Cartesian product  $\mathcal{G} \times \mathcal{G}$ , and we get

$$p_c(\mathcal{H}_n) \xrightarrow{n \rightarrow \infty} p_c(\mathcal{G} \times \mathcal{G}).$$

**Example 3:** Consider a sequence of vectors  $x_n \in \mathbb{Z}^d$  such that  $\lim |x_n| = \infty$ , and write  $\mathcal{G}_n$  the Cayley graph of  $\mathbb{Z}^d$  constructed from the generating set  $S \cup \{x_n\}$ . Then the following convergence holds:

$$p_c(\mathcal{G}_n) \xrightarrow{n \rightarrow \infty} p_c(\mathcal{G} \times \mathbb{Z}).$$

The content of Example 2 was obtained in [dLSS11] when  $\mathcal{G}$  is the canonical Cayley graph of  $\mathbb{Z}^d$ , based on the Grimmett-Marstrand Theorem. In the statement above,  $\mathcal{G}$  can be any Cayley graph of  $\mathbb{Z}^d$ , and the Grimmett-Marstrand Theorem cannot be applied without additional symmetry assumption.

### 2.0.4 Questions

In this chapter, we work with abelian groups because their structure is very well understood. An additional important feature is that the net formed by large balls of an abelian Cayley graph has roughly the same geometric structure as the initial graph. Since nilpotent groups also present these characteristics, the following question appears as a natural step between Theorem 2.0.4 and Question 2.0.1.

QUESTION 2.0.5. *Is it possible to extend Theorem 2.0.4 to nilpotent groups?*

This question can also be asked for other models of statistical mechanics than Bernoulli percolation. In Question 2.0.6 and Question 2.0.7, we mention two other natural contexts where the locality question can be asked.

Theorem 2.1 of [Bod05] states that locality holds for the critical temperature of the Ising model for the hypercubic lattice. This suggests the following question.

QUESTION 2.0.6. *Is it possible to prove Theorem 2.0.4 for the critical temperature of the Ising model instead of  $p_c$ ?*

Define  $c_n$  as the number of self-avoiding walks starting from a fixed root of a transitive graph  $\mathcal{G}$ . By sub-multiplicativity, the sequence  $c_n^{1/n}$  converges to a limit called the connective constant of  $\mathcal{G}$ . In this context, the following question was raised by I. Benjamini [Ben]:

QUESTION 2.0.7. *Does the connective constant depend continuously on the considered infinite transitive graph?*

See [GLa, GLb].

### 2.0.5 Organization of the chapter

Section 2.1 presents the material on marked abelian groups that will be needed to establish Theorem 2.0.4. In Section 2.1.4, we explain the strategy of the proof, which splits into two main lemmas. Each of Sections 2.2 and 2.3 is devoted to the proof of one of these lemmas.

We draw the attention of the interested reader to Lemma 2.2.8. Together with the uniqueness of the infinite cluster, it allows us to avoid the construction of “seeds” in Grimmett and Marstrand’s approach.

## 2.1 Marked abelian groups and locality

In this section, we present the space of marked abelian groups and show how problems of Benjamini-Schramm continuity for abelian Cayley graphs can be reduced to continuity problems for marked abelian groups. Then,

we provide a first example illustrating the use of marked abelian groups in proofs of Benjamini-Schramm continuity. Finally, Section 2.1.4 presents the proof of Theorem 2.1.3, which is the marked group version of our main theorem.

General marked groups are introduced in [Gri84]. Here, we only define marked groups and Cayley graphs in the *abelian* setting, since we do not need a higher level of generality.

### 2.1.1 The space of marked abelian groups

Let  $d$  denote a positive integer. A **( $d$ -)marked abelian group** is the data of an abelian group together with a generating  $d$ -tuple  $(s_1, \dots, s_d)$ , up to isomorphism. (We say that  $(G; s_1, \dots, s_d)$  and  $(G'; s'_1, \dots, s'_d)$  are isomorphic if there is a group isomorphism from  $G$  to  $G'$  mapping  $s_i$  to  $s'_i$  for all  $i$ .) We write  $\mathbf{G}_d$  for the set of the  $d$ -marked abelian groups. Elements of  $\mathbf{G}_d$  will be denoted by  $[G; s_1, \dots, s_d]$  or  $G^\bullet$ , depending on whether we want to insist on the generating system or not. Finally, we write  $\mathbf{G}$  the set of all the marked abelian groups: it is the disjoint union of all the  $\mathbf{G}_d$ 's.

**Quotient of a marked abelian group** Given a marked abelian group  $G^\bullet = [G; s_1, \dots, s_d]$  and a subgroup  $\Lambda$  of  $G$ , we define the **quotient**  $G^\bullet/\Lambda$  by

$$G^\bullet/\Lambda = [G/\Lambda; \bar{s}_1, \dots, \bar{s}_d],$$

where  $(\bar{s}_1, \dots, \bar{s}_d)$  is the image of  $(s_1, \dots, s_d)$  by the canonical surjection from  $G$  onto  $G/\Lambda$ . Quotients of marked abelian groups will be crucial to define and understand the topology of the set of marked abelian groups. In particular, for the topology defined below, the quotients of a marked abelian group  $G^\bullet$  forms a neighbourhood of it.

**The topology** We first define the topology on  $\mathbf{G}_d$ . Let  $\delta$  denote the canonical generating system of  $\mathbb{Z}^d$ . To each subgroup  $\Gamma$  of  $\mathbb{Z}^d$  corresponds an element of  $\mathbf{G}_d$ , via the mapping

$$\Gamma \longmapsto [\mathbb{Z}^d; \delta]/\Gamma. \quad (2.3)$$

One can verify that the mapping defined by (2.3) realizes a bijection from the set of the subgroups of  $\mathbb{Z}^d$  onto  $\mathbf{G}_d$ . This way,  $\mathbf{G}_d$  can be seen as a subset of  $\{0, 1\}^{\mathbb{Z}^d}$ . We consider on  $\mathbf{G}_d$  the topology induced by the product topology on  $\{0, 1\}^{\mathbb{Z}^d}$ . This makes of  $\mathbf{G}_d$  a Hausdorff compact space. Finally, we equip  $\mathbf{G}$  with the topology generated by the open subsets of the  $\mathbf{G}_d$ 's. (In particular,  $\mathbf{G}_d$  is an open subset of  $\mathbf{G}$ .)

Let us illustrate the topology with three examples of converging sequences:

- $[\mathbb{Z}/n\mathbb{Z}; 1]$  converges to  $[\mathbb{Z}; 1]$ .

- $[\mathbb{Z}; 1, n, \dots, n^{d-1}]$  converges to  $[\mathbb{Z}^d; \delta]$ .
- $[\mathbb{Z}; 1, n, n+1]$  converges to  $[\mathbb{Z}^2; \delta_1, \delta_2, \delta_1 + \delta_2]$ .

**Cayley graphs** Let  $G^\bullet = [G; s_1, \dots, s_d]$  be a marked abelian group. Its Cayley graph, denoted  $\text{Cay}(G^\bullet)$ , is defined by taking  $G$  as vertex-set and declaring  $a$  and  $b$  to be neighbours if there exists  $i$  such that  $a = b \pm s_i$ . It is uniquely defined up to graph isomorphism. We write  $B_{G^\bullet}(k) \subset G$  the ball of radius  $k$  in  $\text{Cay}(G^\bullet)$ , centered at 0.

**Converging sequences of marked abelian groups** In the rest of the chapter, we will use the topology of  $\mathbf{G}$  through the following proposition, which gives a geometric flavour to the topology. In particular, it will allow us to do the connection with the Benjamini-Schramm topology through Corollary 2.1.2.

**PROPOSITION 2.1.1.** *Let  $(G_n^\bullet)$  be a sequence of marked abelian groups that converges to some  $G^\bullet$ . Then, for any integer  $k$ , the following holds for  $n$  large enough:*

1.  $G_n^\bullet$  is of the form  $G^\bullet/\Lambda_n$ , for some subgroup  $\Lambda_n$  of  $G$ , and
2.  $\Lambda_n \cap B_{G^\bullet}(k) = \{0\}$ .

*Proof.* Let  $d$  be such that  $G^\bullet \in \mathbf{G}_d$ . For  $n$  large enough, we also have  $G_n^\bullet \in \mathbf{G}_d$ . Let  $\Gamma$  (resp.  $\Gamma_n$ ) denote the unique subgroup of  $\mathbb{Z}^d$  that corresponds to  $G^\bullet$  (resp.  $G_n^\bullet$ ) via bijection (2.3). The group  $\Gamma$  is finitely generated: we consider  $F$  a finite generating subset of it. Taking  $n$  large enough, we can assume that  $\Gamma_n$  contains  $F$ , which implies that  $\Gamma$  is a subgroup of  $\Gamma_n$ . We have the following situation

$$\mathbb{Z}^d \xrightarrow{\varphi} \mathbb{Z}^d/\Gamma \xrightarrow{\psi_n} \mathbb{Z}^d/\Gamma_n.$$

Identifying  $G$  with  $\mathbb{Z}^d/\Gamma$  and taking  $\Lambda_n = \ker \psi_n = \Gamma_n/\Gamma$ , we obtain the first point of the proposition.

By definition of the topology, taking  $n$  large enough ensures that  $\Gamma_n \cap B_{\mathbb{Z}^d}(k) = \Gamma \cap B_{\mathbb{Z}^d}(k)$ . We have

$$\begin{aligned} B_{\mathbb{Z}^d/\Gamma}(k) \cap \Lambda_n &= \varphi(B_{\mathbb{Z}^d}(k) \cap \Gamma_n) \\ &= \varphi(B_{\mathbb{Z}^d}(k) \cap \Gamma) \\ &= \{0\}. \end{aligned}$$

This ends the proof of the second point. □

**COROLLARY 2.1.2.** *The mapping  $\text{Cay}$  from  $\mathbf{G}$  to  $\mathfrak{G}$  that sends a marked abelian group to its Cayley graph is continuous.*



*Remark.* If one defines Cayley graphs as labelled oriented multigraphs (for every  $i$  and  $g$ , put an edge from  $g$  to  $g + s_i$  with label  $i$ ), one can study them by using a topology analogous to the Benjamini-Schramm topology but where isomorphisms are imposed to preserve orientations and labels. In this framework, the mapping  $\text{Cay}$  is an embedding.<sup>1</sup> The advantage of marked groups over Cayley graphs thus lies in the fact that given two elements that are close, we know that they have the same balls of large radius *and* “how to patch these around a point”; think of the labels and orientations as gluing instructions. In fact, Proposition 2.1.1 gives even more: an abelian Cayley graph  $\mathcal{G}$  that is taken close enough to another abelian Cayley graph  $\mathcal{H}$  is covered by it, and with a large injectivity radius; this point uses crucially the fact that  $\mathcal{H}$  is a Cayley graph of a finitely presented group.

### 2.1.2 Percolation on marked abelian groups

Via the Cayley graph process, each marked abelian group  $G^\bullet$  has an associated critical parameter  $p_c^\bullet(G^\bullet) := p_c(\text{Cay}(G^\bullet))$  for bond percolation. If  $G^\bullet$  is a marked abelian group, then  $p_c^\bullet(G^\bullet) < 1$  if and only if the rank of  $G$  is at least 2. (We commit the abuse of language of calling **rank** of an abelian group the rank of its torsion-free part.) This motivates the following definition:

$$\tilde{\mathbf{G}} = \{G^\bullet \in \mathbf{G} : \text{rank}(G) \geq 2\}.$$

In the context of marked abelian groups, we will prove the following theorem:

**THEOREM 2.1.3.** *Consider  $G_n^\bullet \rightarrow G^\bullet$  a converging sequence in  $\tilde{\mathbf{G}}$ . Then,*

$$p_c^\bullet(G_n^\bullet) \xrightarrow{n \rightarrow \infty} p_c^\bullet(G^\bullet).$$

Theorem 2.1.3 above states that  $p_c^\bullet$  is continuous on  $\tilde{\mathbf{G}}$ . It seems a priori weaker than Theorem 2.0.4. Nevertheless, the following lemma allows us to deduce Theorem 2.0.4 from Theorem 2.1.3.

**LEMMA 2.1.4.** *Let  $G^\bullet$  be an element of  $\tilde{\mathbf{G}}$ . Assume it is a continuity point of the restricted function*

$$p_c^\bullet : \tilde{\mathbf{G}} \rightarrow (0, 1).$$

*Then its associated Cayley graph  $\text{Cay}(G^\bullet)$  is a continuity point of the restricted function*

$$p_c : \text{Cay}(\tilde{\mathbf{G}}) \rightarrow (0, 1).$$

*Proof.* Assume, by contradiction, that there is a sequence of marked abelian groups  $G_n^\bullet$  in  $\tilde{\mathbf{G}}$  such that  $\text{Cay}(G_n^\bullet)$  converges to some  $\text{Cay}(G^\bullet)$  and  $p_c^\bullet(G_n^\bullet)$  stays away from  $p_c^\bullet(G^\bullet)$ . Define  $d$  to be the degree of  $\text{Cay}(G^\bullet)$ . Considering

---

1. For general (i.e. not necessarily abelian) marked groups, the corresponding mapping would be a homeomorphism.

$n$  large enough, we can assume that all the  $G_n^\bullet$ 's lie in the compact set  $\bigcup_{d' \leq d} \mathbf{G}_{d'}$ . Up to extraction, one can then assume that  $G_n^\bullet$  converges to some marked abelian group  $G_\infty^\bullet$ . This group must have rank at least 2. Since  $\text{Cay}$  is continuous,  $\text{Cay}(G^\bullet) = \text{Cay}(G_\infty^\bullet)$  and Theorem 2.1.3 is contradicted by the sequence  $(G_n^\bullet)$  that converges to  $G_\infty^\bullet$ .  $\square$

We will also use the following theorem, which is a particular case of Theorem 3.1 in [BS96].

**THEOREM 2.1.5.** *Let  $G^\bullet$  be a marked abelian group and  $\Lambda$  a subgroup of  $G$ . Then*

$$p_c^\bullet(G^\bullet/\Lambda) \geq p_c^\bullet(G^\bullet).$$

### 2.1.3 A first continuity result

In this section, we will prove Proposition 2.1.6, which is a particular case of Theorem 2.0.4. We deem interesting to provide a short separate proof using the Grimmett-Marstrand Theorem. This proposition epitomizes the scope of Grimmett-Marstrand results in our context. It also illustrates how marked groups can appear as useful tools to deal with locality questions. More precisely, Lemma 2.1.4 reduces some questions of continuity in the Benjamini-Schramm space to equivalent questions in the space of marked abelian groups, where the topology allows us to employ methods of algebraic nature.

**PROPOSITION 2.1.6.** *Let  $(G_n^\bullet)$  be a sequence in  $\tilde{\mathbf{G}}$ . Assume that  $(G_n^\bullet)$  converges to  $[\mathbb{Z}^d; \delta]$ , where  $\delta$  stands for the canonical generating system of  $\mathbb{Z}^d$ . Then*

$$p_c^\bullet(G_n^\bullet) \xrightarrow{n \rightarrow \infty} p_c^\bullet([\mathbb{Z}^d; \delta]).$$

*Proof.* Since  $\mathbf{G}_d$  is open, we can assume that  $G_n^\bullet$  belongs to it. It is thus a quotient of  $[\mathbb{Z}^d; \delta]$ , and Theorem 2.1.5 gives

$$\liminf p_c^\bullet(G_n^\bullet) \geq p_c^\bullet([\mathbb{Z}^d; \delta]).$$

To establish the other semi-continuity, we will show that the Cayley graph of  $G_n^\bullet$  eventually contains  $\mathbb{Z}^2 \times \{0, \dots, K\}$  as a subgraph (for  $K$  arbitrarily large), and conclude by applying the Grimmett-Marstrand Theorem.

Let us denote by  $\Gamma_n$  the subgroup of  $\mathbb{Z}^d$  associated with  $G_n^\bullet$  via bijection (2.3). We call a subgroup of  $\mathbb{Z}^d$  generated by two different elements of the canonical generating system of  $\mathbb{Z}^d$  a **coordinate plane**.

**LEMMA 2.1.7.** *For any integer  $K$ , for  $n$  large enough, there exists a coordinate plane  $\Pi$  satisfying*

$$(\Pi + B_{\mathbb{Z}^d}(0, 2K + 1)) \cap \Gamma_n = \{0\}.$$

*Proof of Lemma 2.1.7.* To establish Lemma 2.1.7, we proceed by contradiction. Up to extraction, we can assume that there is some  $K$  such that

$$\text{for all } \Pi, \quad (\Pi + B_{\mathbb{Z}^d}(0, 2K + 1)) \cap \Gamma_n \neq \{0\}. \quad (2.4)$$

We denote by  $v_n^\Pi$  a non-zero element of  $(\Pi + B_{\mathbb{Z}^d}(0, 2K + 1)) \cap \Gamma_n$ . Up to extraction, we can assume that, for all  $\Pi$ , the sequence  $v_n^\Pi / \|v_n^\Pi\|$  converges to some  $v_\Pi$ . (The vector space  $\mathbb{R}^d$  is endowed with an arbitrary norm  $\|\cdot\|$ .) Since  $\Gamma_n$  converges pointwise to  $\{0\}$ , for any  $\Pi$ , the sequence  $\|v_n^\Pi\|$  tends to infinity. This entails, together with Equation (2.4), that  $v_\Pi$  is contained in the real plane spanned by  $\Pi$ . The Incomplete Basis Theorem implies that the vector space spanned by the  $v_\Pi$ 's has dimension at least  $d - 1$ . By continuity of the minors, for  $n$  large enough, the vector space spanned by  $\Gamma_n$  has dimension at least  $d - 1$ . This entails that, for  $n$  large enough,  $\Gamma_n$  has rank at least  $d - 1$ , which contradicts the hypothesis that  $\mathbb{Z}^d / \Gamma_n$  has rank at least 2.  $\square$

For any  $K$ , provided that  $n$  is large enough, one can see

$$\mathbb{Z}^2 \times \{-K, \dots, K\}^{d-2}$$

as a subgraph of  $\text{Cay}(G_n^\bullet)$ . (Restrict the quotient map from  $\mathbb{Z}^d$  to  $G_n^\bullet$  to the  $\Pi + B_{\mathbb{Z}^d}(0, K)$  given by Lemma 2.1.7 and notice that it becomes injective.) It results from this that

$$\limsup \text{p}_c^\bullet(G_n^\bullet) \leq \text{p}_c(\mathbb{Z}^2 \times \{-K, \dots, K\}^{d-2}).$$

The right-hand side goes to  $\text{p}_c^\bullet([\mathbb{Z}^d; \delta])$  as  $K$  goes to infinity, by the Grimmett-Marstrand Theorem. This establishes the second semi-continuity.  $\square$

*Remark.* Proposition 2.1.6 states exactly what the Grimmett-Marstrand Theorem implies in our setting. Together with Lemma 2.1.4, it entails that the hypercubic lattice is a continuity point of  $\text{p}_c$  on  $\text{Cay}(\mathring{\mathbf{G}})$ . Without additional idea, one could go a bit further: the proof of Grimmett and Marstrand adjusts directly to the case of Cayley graphs of  $\mathbb{Z}^d$  that are stable under reflections relative to coordinate hyperplanes. This statement also has a counterpart analog to Proposition 2.1.6. However, we are still far from Theorem 2.1.3, since the Grimmett-Marstrand Theorem relies heavily on the stability under reflection. In the rest of the chapter, we solve the Locality Problem for general abelian Cayley graphs. We do so directly in the marked abelian group setting, and do not use a ‘‘slab result’’ analog to the Grimmett-Marstrand Theorem.

#### 2.1.4 Proof of Theorem 2.1.3

The purpose of this section is to reduce the proof of Theorem 2.1.3 to the proof of two lemmas (Lemma 2.1.8 and Lemma 2.1.9). These are respectively established in Section 2.2 and Section 2.3.

As in Section 2.1.3, it is the upper semi-continuity of  $p_c^\bullet$  that is hard to establish: given  $G^\bullet$  and  $p > p_c^\bullet(G^\bullet)$ , we need to show that the parameter  $p$  remains supercritical for any element of  $\tilde{\mathbf{G}}$  that is close enough to  $G^\bullet$ . To do so, we will characterize supercriticality by using a **finite-size criterion**, that is a property of the type “ $\mathbb{P}_p[\mathcal{E}_N] > 1 - \eta$ ” for some event  $\mathcal{E}_N$  that depends only on the states of the edges in the ball of radius  $N$ . The finite-size criterion we use is denoted by  $\mathcal{FC}(p, N, \eta)$  and characterizes supercriticality through Lemma 2.1.8 and Lemma 2.1.9. Its definition involving heavy notation, we postpone it to Section 2.2.4.

First, we work with a fixed marked abelian group  $G^\bullet$ . Assuming that  $p > p_c^\bullet(G^\bullet)$ , we construct in its Cayley graph a box that is well-connected inside with high probability. This is formalized by Lemma 2.1.8 below, which will be proved in Section 2.2.

LEMMA 2.1.8. *Let  $G^\bullet \in \tilde{\mathbf{G}}$ . Let  $p > p_c^\bullet(G^\bullet)$  and  $\eta > 0$ . Then, there exists  $N$  such that  $G^\bullet$  satisfies the finite-size criterion  $\mathcal{FC}(p, N, \eta)$ .*

Then, take  $H^\bullet = G^\bullet/\Lambda$  a marked abelian group that is close to  $G^\bullet$ . Since  $\text{Cay}(G^\bullet)$  and  $\text{Cay}(H^\bullet)$  have the same balls of large radius, the finite criterion is also satisfied by  $H^\bullet$ . This enables us to prove that there is also percolation in  $\text{Cay}(H^\bullet)$ . As in Grimmett and Marstrand’s approach, we will not be able to prove that percolation occurs in  $\text{Cay}(H^\bullet)$  for the same parameter  $p$ , but we will have to slightly increase the parameter. Here comes a precise statement, established in Section 2.3.

LEMMA 2.1.9. *Let  $G^\bullet \in \tilde{\mathbf{G}}$ . Let  $p > p_c^\bullet(G^\bullet)$  and  $\delta > 0$ . Then there exists  $\eta > 0$  such that the following holds: if there exists  $N$  such that  $G^\bullet$  satisfies the finite-size criterion  $\mathcal{FC}(p, N, \eta)$ , then  $p_c(H^\bullet) < p + \delta$  for any marked abelian group  $H^\bullet$  close enough to  $G^\bullet$ .*

Assuming these two lemmas, let us prove Theorem 2.1.3.

*Proof of Theorem 2.1.3.* Let  $G_n^\bullet \xrightarrow[n \rightarrow \infty]{} G^\bullet$  denote a converging sequence of elements of  $\tilde{\mathbf{G}}$ . Our goal is to establish that  $p_c^\bullet(G_n^\bullet) \xrightarrow[n \rightarrow \infty]{} p_c^\bullet(G^\bullet)$ .

For  $n$  large enough,  $G_n^\bullet$  is a quotient of  $G^\bullet$ . (See Proposition 2.1.1.) By Theorem 2.1.5, for  $n$  large enough,  $p_c^\bullet(G^\bullet) \leq p_c^\bullet(G_n^\bullet)$ . Hence, we only need to prove that  $\limsup p_c^\bullet(G_n^\bullet) \leq p_c^\bullet(G^\bullet)$ .

Take  $p > p_c$  and  $\delta > 0$ . By Lemma 2.1.8, we can pick  $N$  such that  $\mathcal{FC}(p, N, \eta)$  is satisfied. Lemma 2.1.9 then guarantees that, for  $n$  large enough,  $p_c^\bullet(G_n^\bullet) \leq p + \delta$ , which ends the proof.  $\square$

## 2.2 Proof of Lemma 2.1.8

Through the entire section, we fix:

- $G^\bullet \in \tilde{\mathbf{G}}$  a marked abelian group of rank greater than two,
- $p \in (\text{pc}^\bullet(G^\bullet), 1)$ ,
- $\eta > 0$ .

We write  $G^\bullet$  in the form  $[\mathbb{Z}^r \times T; S]$ , where  $T$  is a finite abelian group. Let  $\mathcal{G} = (V, E) = (\mathbb{Z}^r \times T, E)$  denote the Cayley graph associated with  $G^\bullet$ . Paths and percolation will always be considered relative to this graph structure.

### 2.2.1 Setting and notation

#### Between continuous and discrete

An element of  $\mathbb{Z}^r \times T$  will be written

$$x = (x_{\text{free}}, x_{\text{tor}}).$$

For the geometric reasonings, we will use linear algebra tools. (The vertex set —  $\mathbb{Z}^r \times T$  — is roughly  $\mathbb{R}^r$ .) Endow  $\mathbb{R}^r$  with its canonical Euclidean structure. We denote by  $\|\cdot\|$  the associated norm and  $\mathbb{B}(v, R)$  the closed ball of radius  $R$  centered at  $v \in \mathbb{R}^r$ . If the center is 0, this ball may be denoted by  $\mathbb{B}(R)$ . Set  $R_S := \max_{s \in S} \|s_{\text{free}}\|$ . In  $\mathcal{G}$ , we define for  $k > 0$

$$\begin{aligned} B(k) &:= \{x : \|x_{\text{free}}\| \leq kR_S\} \\ &= (\mathbb{B}(kR_S) \cap \mathbb{Z}^d) \times T. \end{aligned}$$

Up to Section 2.2.4, we fix an orthonormal basis  $\mathbf{e} = (e_1, \dots, e_d)$  of  $\mathbb{R}^r$ . Define

$$\begin{aligned} \pi_{\mathbf{e}} : \quad \mathbb{R}^r &\longrightarrow \mathbb{R}^2 \\ \sum_{i=1}^r x_i e_i &\longmapsto (x_1, x_2). \end{aligned}$$

We now define the function **Graph**, which allows us to move between the continuous space  $\mathbb{R}^2$  and the discrete set  $V$ . It maps each subset  $X$  of  $\mathbb{R}^2$  to the subset of  $V$  defined by

$$\mathbf{Graph}(X) := \left( (\pi_{\mathbf{e}}^{-1}(X) + \mathbb{B}(R_S)) \cap \mathbb{Z}^r \right) \times T. \quad (2.5)$$

In Section 2.2.4, we will have to consider different bases. To make explicit the dependence on  $\mathbf{e}$ , we will write  $\mathbf{Graph}_{\mathbf{e}}$ .

If  $a$  and  $b$  belong to  $\mathbb{R}^2$ , we will consider the segment  $[a, b]$  and the parallelogram  $[a, b, -a, -b]$  spanned by  $a$  and  $b$  in  $\mathbb{R}^2$ , defined respectively by

$$\begin{aligned} [a, b] &= \{\lambda a + (1 - \lambda)b ; 0 \leq \lambda \leq 1\} \text{ and} \\ [a, b, -a, -b] &= \{\lambda a + \mu b ; |\lambda| + |\mu| \leq 1\} \end{aligned}$$

Write then  $L(a, b) := \mathbf{Graph}([a, b])$  and  $R(a, b) := \mathbf{Graph}([3a, 3b, -3a, -3b])$  the corresponding subsets of  $V$ .

The following lemma illustrates one important property of the function **Graph** connecting continuous and discrete.

LEMMA 2.2.1. *Let  $X \subset \mathbb{R}^2$ . Let  $\gamma$  be a finite path of length  $k$  in  $\mathcal{G}$ . Assume that  $\gamma_0 \in \text{Graph}(X)$  and  $\gamma_k \notin \text{Graph}(X)$ . Then the support of  $\gamma$  intersects  $\text{Graph}(\partial X)$ .*

*Proof.* It suffices to show that if  $x$  and  $y$  are two neighbours in  $\mathcal{G}$  such that  $x \in \text{Graph}(X)$  and  $y \notin \text{Graph}(X)$ , then  $x$  belongs to  $\text{Graph}(\partial X)$ . By definition of  $\text{Graph}$ , we have  $x_{\text{free}} \in \pi^{-1}(X) + \mathbb{B}(R_S)$ , which can be restated as

$$\pi(\mathbb{B}(x_{\text{free}}, R_S)) \cap X \neq \emptyset. \quad (2.6)$$

By definition of  $R_S$ , we have  $y_{\text{free}} \in \mathbb{B}(x_{\text{free}}, R_S)$  and our assumption on  $y$  implies that  $\pi(y_{\text{free}}) \notin X$ , which gives

$$\pi(\mathbb{B}(x_{\text{free}}, R_S)) \cap {}^c X \neq \emptyset. \quad (2.7)$$

Since  $\pi(\mathbb{B}(x_{\text{free}}, R_S))$  is connected, (2.6) and (2.7) implies that

$$\pi(\mathbb{B}(x_{\text{free}}, R_S)) \cap \partial X \neq \emptyset$$

which proves that  $x$  belongs to  $\text{Graph}(\partial X)$ .  $\square$

### Percolation toolbox

**Probabilistic notation** We denote by  $\mathbb{P}_p$  the law of independent bond percolation of parameter  $p \in [0, 1]$  on  $\mathcal{G}$ .

**Connections** Let  $A$ ,  $B$  and  $C$  denote three subsets of  $V$ . The event “there is an open path intersecting  $A$  and  $B$  that lies in  $C$ ” will be denoted by “ $A \xleftrightarrow{C} B$ ”. The event “restricting the configuration to  $C$ , there is a unique component that intersects  $A$  and  $B$ ” will be written “ $A \xleftrightarrow{!C} B$ ”. The event “there is an infinite open path that touches  $A$  and lies in  $C$  will be denoted by “ $A \xleftrightarrow{C} \infty$ ”. If the superscript  $C$  is omitted, it means that  $C$  is taken to be the whole vertex set.

This paragraph contains the percolation results that will be needed to prove Theorem 2.1.3. The following lemma, sometimes called “square root trick”, is a straightforward consequence of the Harris inequality.

LEMMA 2.2.2. *Let  $\mathcal{A}$  and  $\mathcal{B}$  be two increasing events. Assume that  $\mathbb{P}_p[\mathcal{A}] \geq \mathbb{P}_p[\mathcal{B}]$ . Then, the following inequality holds:*

$$\mathbb{P}_p[\mathcal{A}] \geq 1 - (1 - \mathbb{P}_p[\mathcal{A} \cup \mathcal{B}])^{1/2}.$$

The lemma above is often used when  $\mathbb{P}_p[\mathcal{A}] = \mathbb{P}_p[\mathcal{B}]$ , in a context where the equality of the two probabilities is provided by symmetries of the underlying graph (see [Gri99]). This slightly generalized version allows us to link geometric properties to probabilistic estimates without any symmetry assumption, as illustrated by the following lemma.

LEMMA 2.2.3. *Let  $a$  and  $b$  be two points in  $\mathbb{R}^2$ . Let  $A \subset V$  be a subset of vertices of  $\mathcal{G}$ . Assume that*

$$\mathbb{P}_p [A \leftrightarrow L(a, b)] > 1 - \varepsilon^2 \text{ for some } \varepsilon > 0. \quad (2.8)$$

*Then, there is  $u \in [a, b]$  such that*

$$\min \left( \mathbb{P}_p \left[ A \xrightarrow{C(n, h_{\text{opt}}, \ell_0)} L(a_0, u) \right], \mathbb{P}_p \left[ A \xrightarrow{C(n, h_{\text{opt}}, \ell_0)} L(u, b_0) \right] \right) > 1 - \varepsilon.$$

*Remark.* The same statement holds when we restrict the open paths to lie in a subset  $C$  of  $V$ .

*Proof.* We can approximate the event estimated in Inequality (2.8) and pick  $k$  large enough such that

$$\mathbb{P}_p [A \leftrightarrow L(a, b) \cap B(k)] > 1 - \varepsilon^2.$$

The set  $L(a, b) \cap B(k)$  being finite, there are only finitely many different sets of the form  $L(a, u) \cap B(k)$  for  $u \in [a, b]$ . We can thus construct  $u_1, u_2, \dots, u_n \in [a, b]$  such that  $u_1 = a$  and  $u_n = b$ , and for all  $1 \leq i < n$ ,

1.  $[a, u_i]$  is a strict subset of  $[a, u_{i+1}]$ ,
2.  $L(a, b) \cap B(k)$  is the union of  $L(a, u_i) \cap B(k)$  and  $L(u_{i+1}, b) \cap B(k)$ .

Assume that for some  $i$ , the following inequality holds:

$$\mathbb{P}_p [A \leftrightarrow L(a, u_i) \cap B(k)] \geq \mathbb{P}_p [A \leftrightarrow L(u_{i+1}, b) \cap B(k)]. \quad (2.9)$$

Lemma 2.2.2 then implies that

$$\mathbb{P}_p [A \leftrightarrow L(a, u_i) \cap B(k)] > 1 - \varepsilon.$$

If Inequality (2.9) never holds (resp. if it holds for all possible  $i$ ), then  $A$  is connected to  $L(\{a\})$  (resp. to  $L(\{b\})$ ) with probability exceeding  $1 - \varepsilon$ . In these two cases, the conclusion of the lemma is trivially true. We can assume that we are in none these two situations, and define  $j \in \{2, \dots, n-1\}$  to be the smallest possible  $i$  such that Inequality (2.9) holds. We will show the conclusion of Lemma 2.2.3 holds for  $u = u_j$ . We already have

$$\mathbb{P}_p [A \leftrightarrow L(a, u_j) \cap B(k)] > 1 - \varepsilon,$$

and inequality (2.9) does not hold for  $i = j - 1$ . Once again, Lemma 2.2.2 implies that

$$\mathbb{P}_p [A \leftrightarrow L(u_j, b) \cap B(k)] > 1 - \varepsilon.$$

□

LEMMA 2.2.4. *Bernoulli percolation on  $\mathcal{G}$  at a parameter  $p > p_c(\mathcal{G})$  produces almost surely a unique infinite component. Moreover, any fixed infinite subset of  $V$  is intersected almost surely infinitely many times by the infinite component.*

The first part of the lemma is standard (see [BK89] or [Gri99]). The second part stems from the 0-1 law of Kilogram.

### 2.2.2 Geometric constructions

In this section, we aim to prove that a set connected to infinity with high probability also has “good” local connections. To formalize this, we need a few additional definitions. We say that  $(a, b, u, v) \in (\mathbb{R}^2)^4$  is a **good quadruple** if

1.  $u = \frac{a+b}{2}$ ,
2.  $v \in [-a, b]$  and
3.  $[a, b, -a, -b]$  contains the planar ball of radius  $R_S$ .

Property 3 ensures that the parallelogram  $[a, b, -a, -b]$  is not too degenerate. Given a good quadruple  $(a, b, u, v)$ , we define the following four subsets of

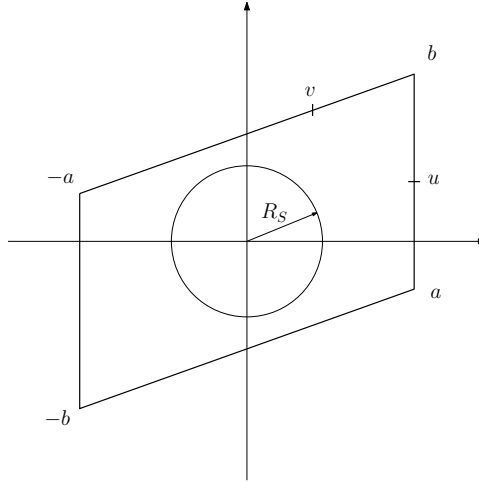

Figure 40 – A good quadruple

the graph  $\mathcal{G}$ :

$$\mathcal{Z}(a, b, u, v) = \{L(a, u), L(u, b), L(b, v), L(v, -a)\}.$$

LEMMA 2.2.5. *Let  $A$  be a finite subset of  $V$  containing 0 and such that*

$$-A := \{-x; x \in A\} = A.$$

*Let  $k \geq 1$  be such that  $B := B(k)$  contains  $A$ . Assume the following relation to hold for some  $\varepsilon \in (0, 1)$ :*

$$\mathbb{P}_p[A \leftrightarrow \infty] > 1 - \varepsilon^{24}.$$

*Then there is a good quadruple  $(a, b, u, v)$  such that for any  $Z \in \mathcal{Z}(a, b, u, v)$*

- (i)  $B \cap Z = \emptyset$ ,
- (ii)  $\mathbb{P}_p \left[ A \xleftrightarrow{R(a,b)} Z \right] > 1 - \varepsilon$ .



*Proof.* Let  $(n, h, \ell) \in \mathbb{N} \times \mathbb{R} \times \mathbb{R}_+$ . Define  $a := (n, h - \ell)$ ,  $b := (n, h + \ell)$  and the three following subsets of  $V$  illustrated on Figure 41:

$$\begin{aligned} C(n, h, \ell) &:= \text{Graph}([a, b, -a, -b]) \\ LR(n, h, \ell) &:= \text{Graph}([a, b] \cup [-a, -b]) = L(a, b) \cup L(-a, -b) \\ UD(n, h, \ell) &:= \text{Graph}([-a, b] \cup [-b, a]) = L(-a, b) \cup L(-b, a) \end{aligned}$$

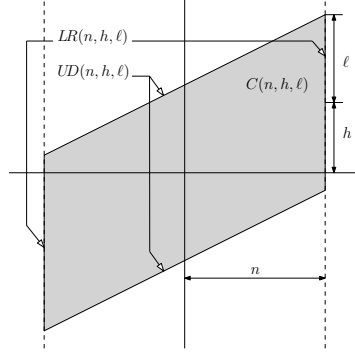

Figure 41 – Pictures of the planar sets defining  $C(n, h, \ell)$ ,  $UD(n, h, \ell)$  and  $LR(n, h, \ell)$

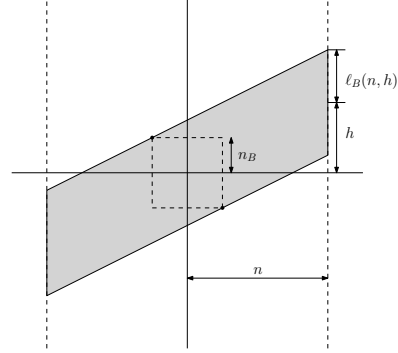

Figure 42 – Definition of  $\ell_B(n, h)$

Let us start by focusing on the geometric constraint (i), which we wish to translate into analytic conditions on the triple  $(n, h, \ell)$ . We fix  $n_B$  large enough such that

$$B \cap \text{Graph}(\mathbb{R}^2 \setminus (-n_B + 1, n_B - 1)^2) = \emptyset. \quad (2.10)$$

This way, any set defined as the image by the function  $\text{Graph}$  of a planar set in the complement of  $(-n_B + 1, n_B - 1)^2$  will not intersect  $B$ . In particular, defining for  $n > n_B$  and  $h \in \mathbb{R}$

$$\ell_B(n, h) = n_B \left( 1 + \frac{|h|}{n} \right),$$

the set  $UD(n, h, \ell)$  does not intersect  $B$  whenever  $\ell \geq \ell_B - 1$ . (See Figure 42.) Suppose that  $A$  intersects the infinite cluster. By Lemma 2.2.4,  $V \setminus C(n, h, \ell)$  — which is infinite — intersects the infinite cluster almost surely. Thus there is an open path from  $A$  to  $V \setminus C(n, h, \ell)$ . By Lemma 2.2.1,  $A$  is connected to  $UD(n, h, \ell) \cup LR(n, h, \ell)$  within  $C(n, h, \ell)$ , which gives the following inequality:

$$\mathbb{P}_p \left[ \left( A \xleftrightarrow{C(n, h, \ell)} LR(n, h, \ell) \right) \cup \left( A \xleftrightarrow{C(n, h, \ell)} UD(n, h, \ell) \right) \right] > 1 - \varepsilon^{24}. \quad (2.11)$$

The strategy of the proof is to work with some sets  $C(n, h, \ell)$  that are balanced in the sense that

$$\mathbb{P}_p \left[ A \xleftrightarrow{C(n, h, \ell)} LR(n, h, \ell) \right] \text{ and } \mathbb{P}_p \left[ A \xleftrightarrow{C(n, h, \ell)} UD(n, h, \ell) \right]$$

are close, and conclude with Lemma 2.2.2. We shall now prove two facts, which ensure that the inequality between the two afore-mentioned probabilities reverses for some  $\ell$  between  $\ell_B(n, h)$  and infinity.

**FACT 2.2.6.** *There is some  $n > n_B$  such that, for all  $h \in \mathbb{R}$ , when  $\ell = \ell_B(n, h)$*

$$\mathbb{P}_p \left[ A \xleftrightarrow{C(n, h, \ell)} LR(n, h, \ell) \right] < \mathbb{P}_p \left[ A \xleftrightarrow{C(n, h, \ell)} UD(n, h, \ell) \right].$$

*Proof of Fact 2.2.6.* For  $n > n_B + R_S$ , define the following sets, illustrated on Figure 43:

$$\begin{aligned} X &= \text{Graph} \left( ((-\infty, n_B) \times \mathbb{R}) \cup (\mathbb{R} \times [-n_B, \infty)) \right) \\ \partial X &= \text{Graph} \left( (\{n_B\} \times (-\infty, -n_B]) \cup ([n_B, \infty) \times \{-n_B\}) \right) \\ X_n &= \text{Graph} \left( ([-n, n_B) \times \mathbb{R}) \cup ([-n, n] \times [-n_B, \infty)) \right) \\ \partial_1 X_n &= \text{Graph} \left( \{-n\} \times \mathbb{R} \cup \{n\} \times [-n_B, \infty) \right) \\ \partial_2 X_n &= \text{Graph} \left( \{n_B\} \times (-\infty, -n_B] \cup [n_B, n] \times \{-n_B\} \right) \end{aligned}$$

Since the sequence of events  $\left( A \xleftrightarrow{X_n} \partial_1 X_n \right)_{n > n_B + R_S}$  is decreasing, we have

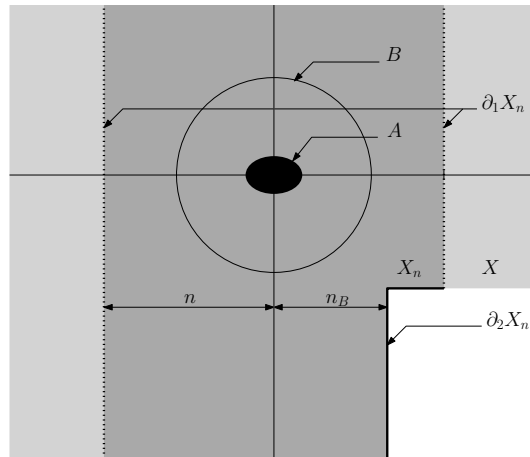

Figure 43 – Planar pictures corresponding to  $X$ ,  $X_n$ ,  $\partial_1 X_n$  and  $\partial_2 X_n$

$$\begin{aligned}
\lim_{n \rightarrow \infty} \mathbb{P}_p \left[ A \xleftrightarrow{X_n} \partial_1 X_n \right] &= \mathbb{P}_p \left[ \bigcap_{n > n_B + R_S} \left( A \xleftrightarrow{X_n} \partial_1 X_n \right) \right] \\
&\leq \mathbb{P}_p \left[ A \xleftrightarrow{X} \infty \right] \\
&= \mathbb{P}_p \left[ \left( A \xleftrightarrow{X} \infty \right) \cap \left( A \xleftrightarrow{X} \partial X \right) \right]. \quad (2.12)
\end{aligned}$$

(The last equality results from the fact that the infinite set  $V \setminus X$  intersects the infinite cluster almost surely.)

The sequence  $\left( A \xleftrightarrow{X_n} \partial_2 X_n \right)_{n > n_B + R_S}$  is increasing, hence we have

$$\begin{aligned}
\lim_{n \rightarrow \infty} \mathbb{P}_p \left[ A \xleftrightarrow{X_n} \partial_2 X_n \right] &= \mathbb{P}_p \left[ \bigcup_{n > n_B + R_S} \left( A \xleftrightarrow{X_n} \partial_2 X_n \right) \right] \\
&= \mathbb{P}_p \left[ A \leftrightarrow \partial X \right]. \quad (2.13)
\end{aligned}$$

Since  $p \in (0, 1)$  and  $A$  is finite, the probability that  $A$  is connected to  $\partial X$  but intersects only finite clusters is positive. Thus the following strict inequality holds

$$\mathbb{P}_p \left[ \left( A \xleftrightarrow{X} \infty \right) \cap \left( A \xleftrightarrow{X} \partial X \right) \right] < \mathbb{P}_p \left[ A \leftrightarrow \partial X \right]. \quad (2.14)$$

From (2.12), (2.13) and (2.14), we can pick  $n_1 > n_B + R_S$  large enough such that, for all  $n \geq n_1$ ,

$$\mathbb{P}_p \left[ A \xleftrightarrow{X_n} \partial_1 X_n \right] < \mathbb{P}_p \left[ A \xleftrightarrow{X_n} \partial_2 X_n \right].$$

Fix  $n \geq n_1$  and  $h \geq 0$ , then define  $\ell = \ell_B(n, h)$ . For these parameters, we have  $A \subset C(n, h, \ell) \subset X_n$  and  $LR(n, h, \ell) \subset \partial_1 X_n$ , which gives

$$\begin{aligned}
\mathbb{P}_p \left[ A \xleftrightarrow{C(n, h, \ell)} LR(n, h, \ell) \right] &\leq \mathbb{P}_p \left[ A \xleftrightarrow{X_n} \partial_1 X_n \right] \\
&< \mathbb{P}_p \left[ A \xleftrightarrow{X_n} \partial_2 X_n \right] \\
&\leq \mathbb{P}_p \left[ A \xleftrightarrow{C(n, h, \ell)} UD(n, h, \ell) \right].
\end{aligned}$$

The last inequality follows from the observation that each path connecting  $A$  to  $\partial_2 X_n$  inside  $X_n$  has to cross  $UD(n, h, \ell)$ .

The computation above shows that the following strict inequality holds for  $n \geq n_1$ ,  $h \geq 0$ , and  $\ell = \ell_B(n, h)$

$$\mathbb{P}_p \left[ A \xleftrightarrow{C(n, h, \ell)} LR(n, h, \ell) \right] < \mathbb{P}_p \left[ A \xleftrightarrow{C(n, h, \ell)} UD(n, h, \ell) \right]. \quad (2.15)$$

In the same way, we find  $n_2$  such that for all  $n \geq n_2$  and  $h \leq 0$ , Equation (2.15) holds for  $\ell = \ell_B(n, h)$ . Taking  $n = \max(n_1, n_2)$  ends the proof

of the fact.  $\square$

In the rest of the proof, we fix  $n$  as in the previous fact. For  $h \in \mathbb{R}$ , define

$$\ell_{\text{eq}}(h) = \sup \left\{ \ell \geq \ell_B(n, h) - 1 : \mathbb{P}_p \left[ A \xleftrightarrow{C(n, h, \ell)} UD(n, h, \ell) \right] \geq \mathbb{P}_p \left[ A \xleftrightarrow{C(n, h, \ell)} LR(n, h, \ell) \right] \right\}.$$

FACT 2.2.7. *For all  $h \in \mathbb{R}$ , the quantity  $\ell_{\text{eq}}(h)$  is finite.*

*Proof of Fact 2.2.7.* We fix  $h \in \mathbb{R}$  and use the same technique as developed in the proof of Fact 2.2.6. Define

$$\begin{aligned} Y &= \text{Graph}([-n, n] \times \mathbb{R}) \\ \partial Y &= \text{Graph}(\{-n, n\} \times \mathbb{R}) \end{aligned}$$

In the same way we proved equations (2.12) and (2.13), we have here

$$\begin{aligned} \lim_{\ell \rightarrow \infty} \mathbb{P}_p \left[ A \xleftrightarrow{C(n, h, \ell)} UD(n, h, \ell) \right] &= \mathbb{P}_p \left[ A \xleftrightarrow{Y} \infty \right] \\ \lim_{\ell \rightarrow \infty} \mathbb{P}_p \left[ A \xleftrightarrow{C(n, h, \ell)} LR(n, h, \ell) \right] &= \mathbb{P}_p \left[ A \leftrightarrow \partial Y \right] \end{aligned}$$

Thus, we can find a finite  $\ell$  large enough such that

$$\mathbb{P}_p \left[ A \xleftrightarrow{C(n, h, \ell)} UD(n, h, \ell) \right] < \mathbb{P}_p \left[ A \xleftrightarrow{C(n, h, \ell)} LR(n, h, \ell) \right].$$

$\square$

The quantity  $\ell_{\text{eq}}$  plays a central role in our proof, linking geometric and probabilistic estimates. We can apply Lemma 2.2.2 with the two events appearing in Inequality (2.11), to obtain the following alternative:

$$\text{If } \ell < \ell_{\text{eq}}(h), \quad \text{then } \mathbb{P}_p \left[ A \xleftrightarrow{C(n, h, \ell)} UD(n, h, \ell) \right] > 1 - \varepsilon^{12}. \quad (2.16a)$$

$$\text{If } \ell > \ell_{\text{eq}}(h), \quad \text{then } \mathbb{P}_p \left[ A \xleftrightarrow{C(n, h, \ell)} LR(n, h, \ell) \right] > 1 - \varepsilon^{12}. \quad (2.16b)$$

Fix  $(h_{\text{opt}}, \ell_0) \in \mathbb{R} \times \mathbb{R}_+$  such that

$$\ell_{\text{eq}}(h_{\text{opt}}) < \ell_0 < \inf_{h \in \mathbb{R}} (\ell_{\text{eq}}(h)) + \frac{1}{6}. \quad (2.17)$$

With such notation, we derive from (2.16b)

$$\mathbb{P}_p \left[ A \xleftrightarrow{C(n, h_{\text{opt}}, \ell_0)} LR(n, h_{\text{opt}}, \ell_0) \right] > 1 - \varepsilon^{12}.$$

Another application of Lemma 2.2.2 ensures then the existence of a real number  $h_0$  of the form  $h_0 = h_{\text{opt}} + \sigma\ell_0/3$  (for  $\sigma \in \{-2, 0, +2\}$ ) such that

$$\mathbb{P}_p \left[ A \xleftrightarrow{C(n, h_{\text{opt}}, \ell_0)} LR(n, h_0, \ell_0/3) \right] > 1 - \varepsilon^4.$$

Recall that  $LR(n, h_0, \ell_0/3) = L(a_0, b_0) \cup L(-a_0, -b_0)$  with  $a_0 = (n, h_0 - \ell_0/3)$  and  $b_0 = (n, h_0 + \ell_0/3)$ . By symmetry, the set  $A$  is connected inside  $C(n, h_0, \ell_0/3)$  to  $L(a_0, b_0)$  and to  $L(-a_0, -b_0)$  with equal probabilities. Applying again Lemma 2.2.2 gives

$$\mathbb{P}_p \left[ A \xleftrightarrow{C(n, h_{\text{opt}}, \ell_0)} L(a_0, b_0) \right] > 1 - \varepsilon^2.$$

Then, use Lemma 2.2.3 to split  $L(a_0, b_0)$  into two parts that both have a good probability to be connected to  $A$ : we can pick  $u = (n, h) \in [a_0, b_0]$  such that both

$$\mathbb{P}_p \left[ A \xleftrightarrow{C(n, h_{\text{opt}}, \ell_0)} L(a_0, u) \right] \quad \text{and} \quad \mathbb{P}_p \left[ A \xleftrightarrow{C(n, h_{\text{opt}}, \ell_0)} L(u, b_0) \right]$$

exceed  $1 - \varepsilon$ . Finally, pick  $\ell$  such that  $\ell_{\text{eq}}(h) - 1/6 < \ell < \ell_{\text{eq}}(h)$ . Define  $a = u + (0, -\ell)$  and  $b = u + (0, \ell)$ . In particular, we have  $u = (a+b)/2$ . Our choice of  $\ell_0$  (see Equation (2.17)) implies that  $\ell > \ell_0 - 1/3 \geq 2\ell_0/3$ , and the following inclusions hold:

$$\begin{aligned} L(a_0, u) &\subset L(a, u) \\ L(u, b_0) &\subset L(u, b) \\ C(n, h_{\text{opt}}, \ell_0) &\subset R(a, b) \end{aligned}$$

These three inclusions together with the estimates above entail the point (ii) of Lemma 2.2.5 for  $Z = L(a, u)$  and  $Z = L(u, b)$ .

Now, let us construct a suitable vector  $v \in [-a, b]$  such that the point (ii) of Lemma 2.2.5 is satisfied for  $Z = L(-a, v)$  and  $Z = L(v, b)$ . Equation (2.16a) implies that

$$\mathbb{P}_p \left[ A \xleftrightarrow{C(n, h, \ell)} UD(n, h, \ell) \right] > 1 - \varepsilon^{12}.$$

As above, using  $UD(n, h, \ell) = L(-a, b) \cup L(-b, a)$ , Lemma 2.2.2 and symmetries, we obtain

$$\mathbb{P}_p \left[ A \xleftrightarrow{C(n, h, \ell)} L(-a, b) \right] > 1 - \varepsilon^6.$$

By Lemma 2.2.3, we can pick  $v \in [-a, b]$  such that the following estimate holds for  $Z = L(-a, v)$ ,  $L(v, b)$ :

$$\mathbb{P}_p \left[ A \xleftrightarrow{C(n, h, \ell)} Z \right] > 1 - \varepsilon^3 \geq 1 - \varepsilon.$$

It remains to verify the point (i). For  $Z = L(a, u), L(u, b)$ , it follows from  $n > n_B$  and the definition of  $n_B$ , see Equation (2.10). For  $Z = L(-a, v), L(v, b)$ , it follows from  $\ell > \ell_B(n, h) - 1$  (see Fact 2.2.6) and the definition of  $\ell_B(n, h)$ .  $\square$

### 2.2.3 Construction of Good Blocks

In this section, we will define a finite block together with a local event that “characterize” supercritical percolation — in the sense that the event happening on this block with high probability will guarantee supercriticality. This block will be used in Section 2.3 for a coarse graining argument.

In Grimmett and Marstrand’s proof of Theorem 2.0.2, the coarse graining argument uses “seeds” (big balls, all the edges of which are open) in order to propagate an infinite cluster from local connections. More precisely, they define an exploration process of the infinite cluster: at each step, the exploration is successful if it creates a new seed in a suitable place, from which the process can be iterated. If the probability of success at each step is large enough, then, with positive probability, the exploration process does not stop and an infinite cluster is created.

In their proof, the seeds grow in the unexplored region. Since we cannot control this region, we use the explored region to produce seeds instead. Formally, long finite self-avoiding paths will play the role of the seeds in the proof of Grimmett and Marstrand. The idea is the following: if a point is reached at some step of the exploration process, it must be connected to a long self-avoiding path, which is enough to iterate the process.

LEMMA 2.2.8. *For all  $\varepsilon > 0$ , there exists  $m \in \mathbb{N}$  such that, for any fixed self-avoiding path  $\gamma$  of length  $m$ ,*

$$\mathbb{P}_p[\gamma \leftrightarrow \infty] > 1 - \varepsilon.$$

*Proof.* By translation invariance we can restrict ourselves to self-avoiding paths starting at the origin 0. Fix  $\varepsilon > 0$ . For all  $k \in \mathbb{N}$  we consider one self-avoiding path  $\gamma^{(k)}$  starting at the origin that minimizes the probability to intersect the infinite cluster among all the self-avoiding paths of length  $k$ :

$$\mathbb{P}_p[\gamma^{(k)} \leftrightarrow \infty] = \min_{\gamma: \text{length}(\gamma)=k} \mathbb{P}_p[\gamma \leftrightarrow \infty].$$

By diagonal extraction, we can consider an infinite self-avoiding path  $\gamma^{(\infty)}$  such that, for any  $k_0 \in \mathbb{N}$ ,  $(\gamma_0^{(\infty)}, \gamma_1^{(\infty)}, \dots, \gamma_{k_0}^{(\infty)})$  is the beginning of infinitely many  $\gamma^{(k)}$ ’s. By Lemma 2.2.4,  $\gamma^{(\infty)}$  intersects almost surely the infinite cluster of a  $p$ -percolation. Thus, there is an integer  $k_0$  such that

$$\mathbb{P}_p[\{\gamma_0^{(\infty)}, \gamma_1^{(\infty)}, \dots, \gamma_{k_0}^{(\infty)}\} \leftrightarrow \infty] > 1 - \varepsilon.$$

Finally, there exists  $m$  such that  $\gamma_m$  begins with the sequence

$$(\gamma_0^{(\infty)}, \gamma_1^{(\infty)}, \dots, \gamma_{k_0}^{(\infty)}),$$

thus it intersects the infinite cluster of a  $p$ -percolation with probability exceeding  $1 - \varepsilon$ . By choice of  $\gamma^{(m)}$ , it holds for any other self-avoiding path  $\gamma$  of length  $m$  that

$$\mathbb{P}_p[\gamma \leftrightarrow \infty] > 1 - \varepsilon.$$

□

We will focus on paths that start close to the origin. Let us define  $\mathcal{S}(m)$  to be the set of self-avoiding paths of length  $m$  that start in  $B(1)$ .

**LEMMA 2.2.9.** *For any  $\eta > 0$ , there are two integers  $m, N \in \mathbb{N}$  and a good quadruple  $(a, b, u, v)$  such that*

$$\forall \gamma \in \mathcal{S}(m), \forall Z \in \mathcal{Z}(a, b, u, v) \quad \mathbb{P}_p \left[ \gamma \xleftrightarrow{R(a,b) \cap B(N)} Z \cap B(N) \right] > 1 - 3\eta.$$

*Proof.* By Lemma 2.2.8, we can pick  $m$  such that any self-avoiding path  $\gamma \in \mathcal{S}(m)$  satisfies

$$\mathbb{P}_p[\gamma \leftrightarrow \infty] > 1 - \eta.$$

Pick  $k \geq m + 1$  such that

$$\mathbb{P}_p[B(k) \leftrightarrow \infty] > 1 - \eta^{24}.$$

The number of disjoint clusters (for the configuration restricted to  $B(n+1)$ ) connecting  $B(k)$  to  $B(n)^c$  converges when  $n$  tends to infinity to the number of infinite clusters intersecting  $B(k)$ . The infinite cluster being unique, we can pick  $n$  such that

$$\mathbb{P}_p \left[ B(k) \xleftrightarrow{!B(n+1)!} B(n)^c \right] > 1 - \eta. \quad (2.18)$$

Applying Lemma 2.2.5 with  $A = B(k)$  and  $B = B(n+1)$  provides a good quadruple  $(a, b, u, v)$  such that the following two properties hold for any  $Z \in \mathcal{Z}(a, b, u, v)$ :

- (i)  $B(n+1) \cap Z = \emptyset$ ,
- (ii)  $\mathbb{P}_p \left[ B(k) \xleftrightarrow{R(a,b)} Z \right] > 1 - \eta$ .

Note that condition (i) implies in particular that  $B(n+1)$  is a subset of  $R(a, b)$ . Equation (2.18) provides with high probability a “uniqueness zone” between  $B(k)$  and  $B(n)^c$ : any pair of open paths crossing this region must be connected inside  $B(n+1)$ . In particular, when  $\gamma$  is connected to infinity,

and  $B(k)$  is connected to  $Z$  inside  $R(a, b)$ , this “uniqueness zone” ensures that  $\gamma$  is connected to  $Z$  by an open path lying inside  $R(a, b)$ :

$$\begin{aligned} & \mathbb{P}_p \left[ \gamma \xleftrightarrow{R(a,b)} Z \right] \\ & \geq \mathbb{P}_p \left[ \{\gamma \leftrightarrow \infty\} \cap \left\{ B(k) \xleftrightarrow{!B(n+1)!} B(n)^c \right\} \cap \left\{ B(k) \xleftrightarrow{R(a,b)} Z \right\} \right] \\ & > 1 - 3\eta. \end{aligned}$$

The identity

$$\mathbb{P}_p \left[ \gamma \xleftrightarrow{R(a,b)} Z \right] = \lim_{N \rightarrow \infty} \mathbb{P}_p \left[ \gamma \xleftrightarrow{R(a,b) \cap B(N)} Z \cap B(N) \right]$$

concludes the proof of Lemma 2.2.9.  $\square$

#### 2.2.4 Construction of a finite-size criterion

In this section, we give a precise definition of the finite-size criterion  $\mathcal{FC}(p, N, \eta)$  used in Lemma 2.1.8 and Lemma 2.1.9. Its construction is based on Lemma 2.2.9.

Recall that, up to now, we worked with a fixed orthonormal basis  $\mathbf{e}$ , which was hidden in the definition of  $\mathbf{Graph} = \mathbf{Graph}_{\mathbf{e}}$ , see Equation (2.5). In order to perform the coarse graining argument in any marked group  $G^\bullet/\Lambda$  close to  $G^\bullet$ , we will need to have the conclusion of Lemma 2.2.9 for all the orthonormal bases.

Denote by  $\mathcal{B}$  the set of the orthonormal basis of  $\mathbb{R}^r$ . It is a compact subset of  $\mathbb{R}^{r \times r}$ . If we fix  $X \subset \mathbb{R}^2$ , a positive integer  $N$  and  $\mathbf{e} \in \mathcal{B}$  then the following inclusion holds for any orthonormal basis  $\mathbf{f}$  close enough to  $\mathbf{e}$  in  $\mathcal{B}$ :

$$\mathbf{Graph}_{\mathbf{e}}(X) \cap B(N) \subset (\mathbf{Graph}_{\mathbf{f}}(X) + B(1)) \cap B(N). \quad (2.19)$$

We define  $\mathcal{N}(\mathbf{e}, N) \subset \mathcal{B}$  to be the neighbourhood of  $\mathbf{e}$  formed by the orthonormal bases  $\mathbf{f}$  for which the inclusion above holds. A slight modification of the orthonormal basis in Lemma 2.2.9 keeps its conclusion with the same integer  $N$  and the same vectors  $a, b, u, v$ , but with

- $Z + B(1)$  in place of  $Z$
- and  $R(a, b) + B(1)$  instead of  $R(a, b)$ .

In order to state this result properly, let us define:

$$\begin{aligned} \mathcal{Z}_{N,\mathbf{e}}(a, b, u, v) &= \{(Z + B(1)) \cap B(N) : Z \in \mathcal{Z}_{\mathbf{e}}(a, b, u, v)\}; \\ R_{N,\mathbf{e}}(a, b) &= (R(a, b) + B(1)) \cap B(N). \end{aligned}$$

Note that we add the subscript  $\mathbf{e}$  here to insist on the dependence on the basis  $\mathbf{e}$ . This dependence was implicit for the sets  $Z$  and  $R(a, b)$  which were defined via the function  $\mathbf{Graph}$ .

We are ready to define the finite size criterion  $\mathcal{FC}(p, N, \eta)$  that appears in lemmas 2.1.8 and 2.1.9.



DEFINITION OF THE FINITE-SIZE CRITERION. Let  $N \geq 1$  and  $\eta > 0$ . We say that the finite size criterion  $\mathcal{FC}(p, N, \eta)$  is satisfied if for any  $\mathbf{e} \in \mathcal{B}$ , there exist  $m \geq 1$  and a good quadruple  $(a, b, u, v)$  such that:

$$\forall \gamma \in \mathcal{S}(m), \forall Z \in \mathcal{Z}_{N, \mathbf{e}}(a, b, u, v), \quad \mathbb{P}_p \left[ \gamma \xleftarrow{R_{N, \mathbf{e}}(a, b)} Z \right] > 1 - \eta. \quad (2.20)$$

**Proof of Lemma 2.1.8.** Let  $\eta > 0$ . Given  $\mathbf{e}$  an orthonormal basis, Lemma 2.2.9 provides  $m_{\mathbf{e}}, N_{\mathbf{e}} \in \mathbb{N}$ , and a good quadruple  $(a_{\mathbf{e}}, b_{\mathbf{e}}, u_{\mathbf{e}}, v_{\mathbf{e}})$  such that the following holds (we omit the subscript for the parameters  $m, a, b, u, v$ ):

$$\forall \gamma \in \mathcal{S}(m), \forall Z \in \mathcal{Z}_{\mathbf{e}}(a, b, u, v), \quad \mathbb{P}_p \left[ \gamma \xleftarrow{R_{\mathbf{e}}(a, b) \cap B(N_{\mathbf{e}})} Z \cap B(N_{\mathbf{e}}) \right] > 1 - \eta.$$

For any  $\mathbf{f} \in \mathcal{N}(\mathbf{e}, N_{\mathbf{e}})$ , we can use inclusion (2.19) to derive from the estimate above that for all  $\gamma \in \mathcal{S}(m)$  and  $Z \in \mathcal{Z}_{\mathbf{f}}(a, b, u, v)$ ,

$$\mathbb{P}_p \left[ \gamma \xleftarrow{(R_{\mathbf{f}}(a, b) + B(1)) \cap B(N_{\mathbf{e}})} (Z + B(1)) \cap B(N_{\mathbf{e}}) \right] > 1 - \eta.$$

By compactness of  $\mathcal{B}$ , we can find a finite subset  $\mathcal{F} \subset \mathcal{B}$  of bases such that

$$\mathcal{B} = \bigcup_{\mathbf{e} \in \mathcal{F}} \mathcal{N}(\mathbf{e}, N_{\mathbf{e}}).$$

For  $N := \max_{\mathbf{e} \in \mathcal{F}} N_{\mathbf{e}}$ , the finite-size criterion  $\mathcal{FC}(p, N, \eta)$  is satisfied. □

## 2.3 Proof of Lemma 2.1.9

Through the entire section, we fix:

- $G^\bullet \in \tilde{\mathbf{G}}$  a marked abelian group of rank greater than two,
- $p \in (\text{pc}^\bullet(G^\bullet), 1)$ ,
- $\delta > 0$ .

Let  $\mathcal{G} = (V, E)$  denote the Cayley graph associated with  $G^\bullet$ .

### 2.3.1 Hypotheses and notation

Let us start by an observation that follows from the definition of good quadruple at the beginning of Section 2.2.2: there is an absolute constant  $\kappa$  such that for any good quadruple  $(a, b, u, v)$  and any  $w \in \mathbb{R}^2$ ,

$$\text{Card} \left\{ z \in \mathbb{Z}^2 : w + z_1 u + z_2 v \in [5a, 5b, -5a, -5b] \right\} \leq \kappa.$$

We fix  $\kappa$  as above and choose  $\eta > 0$  such that

$$p_0 := \sup_{t \in \mathbb{N}} \left\{ 1 - (1 - \delta/\kappa)^t - \eta(1 - p)^{-t} \right\} > \text{pc}^{\text{site}}(\mathbb{Z}^2). \quad (2.21)$$

We will prove that this choice of  $\eta$  provides the conclusion of Lemma 2.1.9. We assume that  $G^\bullet$  satisfies  $\mathcal{FC}(p, N, \eta)$  for some positive integer  $N$  (which will be fixed throughout this section). Let us consider a marked abelian group  $H^\bullet = G^\bullet/\Lambda$  of rank at least 2 and such that

$$\Lambda \cap B(2N + 1) = \{0\}.$$

(Notice that such  $H^\bullet$ 's form a neighbourhood of  $G^\bullet$  in  $\tilde{\mathcal{G}}$  by Proposition 2.1.1.) Under these hypotheses, we will prove that  $p_c(H^\bullet) < p + \delta$ , providing the conclusion of Lemma 2.1.9.

The Cayley graph of  $H^\bullet = G^\bullet/\Lambda$  is denoted by  $\bar{\mathcal{G}} = (\bar{V}, \bar{E})$ . For  $x \in V$ , we write  $\bar{x}$  for the image of  $x$  by the quotient map  $G \rightarrow G/\Lambda$ . This quotient map naturally extends to subsets of  $V$  and we write  $\bar{A}$  for the image of a set  $A \subset V$ .

### 2.3.2 Sketch of proof

Under the hypotheses above, we show that percolation occurs in  $\bar{\mathcal{G}}$  at parameter  $p + \delta$ . The proof goes as follows.

**Step 1: Geometric construction.** We will construct a renormalized graph, that is a family of big boxes (living in  $\bar{\mathcal{G}}$ ) arranged as a square lattice. In particular, there will be a notion of neighbour boxes. The occurrence of the finite-size criterion  $\mathcal{FC}(p, N, \eta)$  will imply good connection probabilities between neighbouring boxes. This is the object of Lemma 2.3.2.

**Step 2: Construction of an infinite cluster.** The renormalized graph built in the first step will allow us to couple a  $(p + \delta)$ -percolation on  $\bar{\mathcal{G}}$  with a percolation on  $\mathbb{Z}^2$  in such a way that the existence of an infinite component in  $\mathbb{Z}^2$  would imply an infinite component in  $\bar{\mathcal{G}}$ . This event will happen with positive probability. The introduction of the parameter  $\delta$  will allow us to apply a ‘‘sprinkling’’ technique in the coupling argument developed in the proof of Lemma 2.3.4.

### 2.3.3 Geometric setting: boxes and corridors

Since  $\Lambda$  has corank at least 2, we can fix an orthonormal basis  $\mathbf{e} \in \mathcal{B}$  such that

$$\Lambda \subset \text{Ker}(\pi_{\mathbf{e}}) \times T. \quad (2.22)$$

Condition (2.22) ensures that sets defined in  $\mathcal{G}$  via the function  $\text{Graph}_{\mathbf{e}}$  have a suitable image in the quotient  $\bar{\mathcal{G}}$ . More precisely, for any  $x \in V$  and any planar set  $X \subset \mathbb{R}^2$ , we have

$$x \in \text{Graph}_{\mathbf{e}}(X) \iff \bar{x} \in \overline{\text{Graph}_{\mathbf{e}}(X)}. \quad (2.23)$$

According to  $\mathcal{FC}(p, N, \eta)$ , there is some  $m < N$  and a good quadruple  $(a, b, u, v)$  such that

$$\forall \gamma \in \mathcal{S}(m), \forall Z \in \mathcal{Z}_{N, \mathbf{e}}(a, b, u, v), \quad \mathbb{P}_p \left[ \gamma \xrightarrow{R_{N, \mathbf{e}}(a, b)} Z \right] > 1 - \eta.$$

We introduce here some subsets of  $\overline{\mathcal{G}}$ , that will play the role of vertices and edges in the renormalized graph.

**Box.** For  $z$  in  $\mathbb{Z}^2$ , define

$$B_z := \overline{\text{Graph}(z_1 u + z_2 v + [a, b, -a, -b])}.$$

When  $z$  and  $z'$  are neighbours in  $\mathbb{Z}^2$  for the standard graph structure, we write  $z \sim z'$ . In this case, we say that the two boxes  $B_z$  and  $B_{z'}$  are **neighbours**.

**Corridor.** For  $z$  in  $\mathbb{Z}^2$ , define

$$C_z := \overline{\text{Graph}(z_1 u + z_2 v + [4a, 4b, -4a, -4b])}.$$

We will explore the cluster of the origin in  $\overline{\mathcal{G}}$ . If the cluster reaches a box  $B_z$ , we will try to spread it to the neighbouring boxes ( $B_{z'}$  for  $z' \sim z$ ) by creating paths that lie in their respective corridors  $C_{z'}$ . For this strategy to work, we need the boxes to have good connection probabilities and the corridors to be “sufficiently disjoint”: if the exploration is guaranteed to visit each corridor at most  $\kappa + 1$  times, then we do not need more than  $\kappa$  “sprinkling operations”. These two properties are formalized by the following two lemmas.

LEMMA 2.3.1. *For all  $\bar{x} \in V$ ,*

$$\text{Card}\{z \in \mathbb{Z}^2 / \bar{x} \in C_z\} \leq \kappa. \quad (2.24)$$

*Proof.* By choice of the basis, equivalence (2.23) holds and implies, for any  $z = (z_1, z_2) \in \mathbb{Z}^2$ ,

$$\bar{x} \in C_z \iff x \in \text{Graph}_{\mathbf{e}}(z_1 u + z_2 v + [4a, 4b, -4a, -4b])$$

By the last condition defining a good quadruple,

$$\bar{x} \in C_z \implies \pi(x) \in z_1 u + z_2 v + [5a, 5b, -5a, -5b]$$

The choice of  $\kappa$  at the beginning of the section (see Equation (2.24)) concludes the proof.  $\square$

LEMMA 2.3.2. *For any couple of neighbouring boxes  $(B_z, B_{z'})$ ,*

$$\forall \bar{x} \in B_z, \forall \gamma \in \mathcal{S}(m) \quad \mathbb{P}_p \left[ \bar{x} + \bar{\gamma} \xrightarrow{C_{z'}} B_{z'} + \overline{B(1)} \right] > 1 - \eta. \quad (2.25)$$

*Proof.* We assume that  $z' = z + (0, 1)$ . The cases of  $z + (1, 0)$ ,  $z + (0, -1)$  and  $z + (-1, 0)$  are treated the same way.

The assumption  $\Lambda \cap B(2N+1) = \{0\}$  implies that  $\overline{R_{N,e}(a, b)}$  is isomorphic (as a graph) to  $R_{N,e}(a, b)$ . It allows us to derive from estimate (2.20) that

$$\mathbb{P}_p \left[ \overline{\gamma} \xleftrightarrow{\overline{R_{N,e}(a, b)}} \overline{Z} \right] > 1 - \eta. \quad (2.26)$$

Now let  $B_z$  and  $B_{z'}$  be two neighbouring boxes. Let  $\bar{x}$  be any vertex of  $B_z$ . By translation invariance, we get from (2.26) that

$$\mathbb{P}_p \left[ x + \overline{\gamma} \xleftrightarrow{\overline{\bar{x} + R_{N,e}(a, b)}} \bar{x} + \overline{Z} \right] > 1 - \eta.$$

Here comes the key geometric observation: there exists  $Z \in \mathcal{Z}_{N,e}(a, b, u, v)$  such that

$$\bar{x} + \overline{Z} \subset B_{z'} + \overline{B(1)}.$$

This is illustrated on Figures 44 and 45 when  $z = (0, 0)$  and  $z' = (0, 1)$ . Besides,  $\bar{x} + \overline{R_N(a, b)} \subset C_{z'}$ . Hence, by monotonicity, we obtain that

$$\mathbb{P}_p \left[ \bar{x} + \overline{\gamma} \xleftrightarrow{C_{z'}} B_{z'} + \overline{B(1)} \right] > 1 - \eta.$$

□

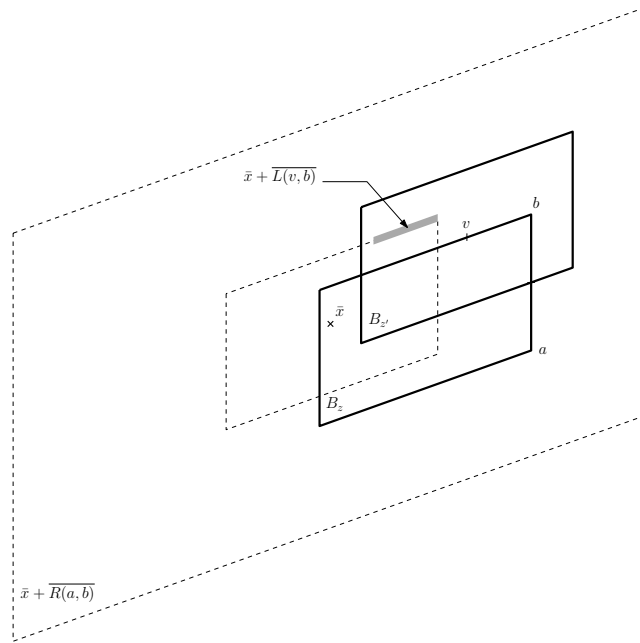

Figure 44 – If  $\bar{x}$  is in the left part of the box  $B_z$ , then  $\bar{x} + \overline{L(v, b)} \subset B_{z'}$ .

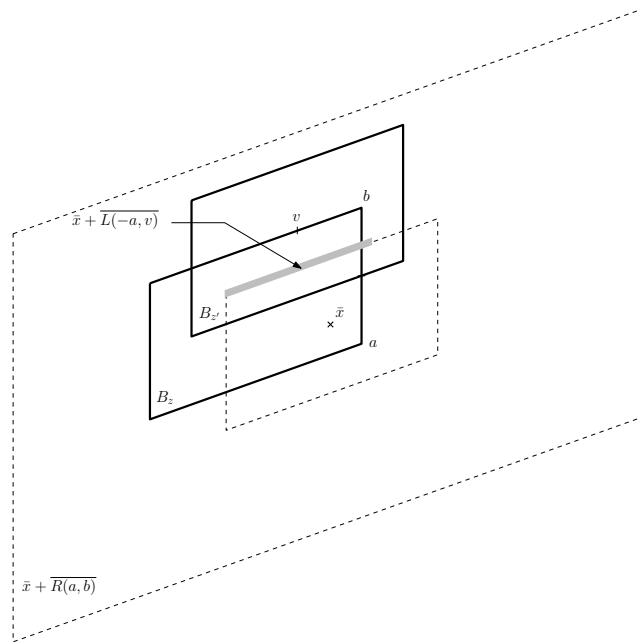

Figure 45 – If  $\bar{x}$  is in the right part of the box  $B_z$ , then  $\bar{x} + \overline{L(-a, v)} \subset B_{z'}$ .

### 2.3.4 Probabilistic setting

Let  $\omega_0$  be Bernoulli percolation of parameter  $p$  on  $\overline{\mathcal{G}}$ . In order to apply a “sprinkling argument”, define for every  $z \in \mathbb{Z}^2$  a sequence  $(\xi^z(e))_{e \text{ edges in } C_z}$  of independent Bernoulli variables of parameter  $\frac{\delta}{\kappa}$ . In other words,  $\xi^z$  is a  $\frac{\delta}{\kappa}$ -percolation on  $C_z$ . We assume that  $\omega_0$  and all the  $\xi^z$ 's are independent. Lemma 2.3.1 implies that at most  $\kappa + 1$  Bernoulli variables are associated with a given edge  $e$ :  $\omega_0(e)$  and the  $\xi^z(e)$ 's for  $z$  such that  $e \subset C_z$ .

To state Lemma 2.3.3, we also need the notion of edge-boundary. The **edge-boundary** of a set  $A$  of vertices is the set of the edges of  $\mathcal{G}$  with exactly one endpoint in  $A$ . It is denoted by  $\Delta A$ .

**LEMMA 2.3.3.** *Let  $B_z$  and  $B_{z'}$  be two neighbouring boxes. Let  $H$  be a subset of  $\overline{V}$ . Let  $(\omega(e))_{e \in E}$  be a family of independent Bernoulli variables of parameter  $\mathbb{P}[\omega(e) = 1] \in [p, 1)$  independent of  $\xi^{z'}$ . If there exists  $\bar{x} \in B_z$  and  $\bar{\gamma} \in \mathcal{S}(m)$  such that  $\bar{x} + \bar{\gamma} \subset H$ , then*

$$\mathbb{P} \left[ H \xrightarrow[\omega \vee \xi^{z'}]{C_{z'}} B_{z'} + \overline{B(1)} \mid \forall e \in \Delta H, \omega(e) = 0 \right] \geq p_0.$$

*Proof.* In all this proof, the marginals of  $\omega$  are assumed to be Bernoulli random variables of parameter  $p$ . The more general statement of Lemma 2.3.3 follows by a stochastic domination argument. The case  $H \cap (B_{z'} + \overline{B(1)}) \neq \emptyset$  being trivial, we assume that  $H \cap (B_{z'} + \overline{B(1)}) = \emptyset$ .

Let  $W \subset \Delta H$  be the (random) set of edges  $\{\bar{x}, \bar{y}\} \subset C_{z'}$  such that

- (i)  $\bar{x} \in H$ ,  $\bar{y} \in C_{z'} \setminus H$  and
- (ii) there is an  $\omega$ -open path joining  $\bar{y}$  to  $B_{z'} + \overline{B(1)}$ , lying in  $C_{z'}$ , but using no edge with an endpoint in  $H$ .

In a first step, we want to say that  $|W|$  cannot be too small. The inclusions  $\bar{x} + \bar{\gamma} \subset H \subset (B_{z'} + \overline{B(1)})^c$  imply that any  $\omega$ -open path from  $\bar{x} + \bar{\gamma}$  to  $B_{z'} + \overline{B(1)}$  must contain at least one edge of  $W$ . Thus, there is no  $\omega$ -open path connecting  $\bar{x} + \bar{\gamma}$  to  $B_{z'} + \overline{B(1)}$  in  $C_{z'}$  when all the edges of  $W$  are  $\omega$ -closed. Consequently, for any  $t \in \mathbb{N}$ , we have

$$\begin{aligned} \mathbb{P} \left[ \left( \bar{x} + \bar{\gamma} \xrightarrow[\omega]{C_{z'}} B_{z'} + \overline{B(1)} \right)^c \right] &\geq \mathbb{P}[\text{all edges in } W \text{ are } \omega\text{-closed}] \\ &\geq (1 - p)^t \mathbb{P}[|W| \leq t]. \end{aligned}$$

To get the last inequality above, remark that the random set  $W$  is independent from the  $\omega$ -state of the edges in  $\Delta H$ . Using estimate (2.25), it can be rewritten as

$$\mathbb{P}[|W| \leq t] \leq \eta(1 - p)^{-t}. \quad (2.27)$$

We distinguish two cases. Either  $W$  is small, which has a probability estimated by Equation (2.27) above; or  $W$  is large, and we use in that case that

$B_{z'} + \overline{B(1)}$  is connected to  $H$  as soon as one edge of  $W$  is  $\xi^{z'}$ -open. The following computation makes this quantitative:

$$\begin{aligned}
& \mathbb{P} \left[ H \xleftrightarrow[\omega \vee \xi^{z'}]{C_{z'}} B_{z'} + \overline{B(1)} \mid \forall e \in \Delta H, \omega(e) = 0 \right] \\
& \geq \mathbb{P} \left[ \text{at least one edge of } W \text{ is } \xi^{z'}\text{-open} \mid \forall e \in \Delta H, \omega(e) = 0 \right] \\
& = \mathbb{P} \left[ \text{at least one edge of } W \text{ is } \xi^{z'}\text{-open} \right] \\
& \geq \mathbb{P} \left[ \text{at least one edge of } W \text{ is } \xi^{z'}\text{-open and } |W| > t \right] \\
& \geq 1 - \mathbb{P} \left[ \text{all the edges of } W \text{ are } \xi^{z'}\text{-closed} \mid |W| > t \right] - \mathbb{P} [|W| \leq t].
\end{aligned}$$

Using Equation (2.27), we conclude that, for any  $t$ ,

$$\mathbb{P} \left[ H \xleftrightarrow[\omega \vee \xi^{z'}]{C_{z'}} A \mid \forall e \in \Delta H, \xi^{z'}(e) = 0 \right] \geq 1 - (1 - \delta/\kappa)^t - \eta(1 - p)^{-t}. \quad (2.28)$$

Our choice of  $\eta$  in (2.21) make the right hand side of (2.28) larger than  $p_0$ .  $\square$

LEMMA 2.3.4. *With positive probability, the origin is connected to infinity in the configuration*

$$\omega_{\text{total}} := \omega_0 \vee \bigvee_{z \in \mathbb{Z}^2} \xi^z.$$

Lemma 2.3.4 concludes the proof of Lemma 2.1.9 because  $\omega_{\text{total}}$  is stochastically dominated by a  $(p + \delta)$ -percolation. Indeed,  $(\omega_{\text{total}}(e))_e$  is an independent sequence of Bernoulli variables such that, for any edge  $e$ ,

$$\mathbb{P} [\omega_{\text{total}}(e) = 1] \leq 1 - (1 - p)(1 - \delta/\kappa)^\kappa \leq p + \delta.$$

*Proof of Lemma 2.3.4.* The strategy of the proof is similar to the one described in the original paper of Grimmett and Marstrand: we explore the Bernoulli variables one after the other in an order prescribed by the algorithm hereafter. During the exploration, we define simultaneously random variables on the graph  $\overline{\mathcal{G}}$  and on the square lattice  $\mathbb{Z}^2$ .

**Algorithm**

- (0) Set  $z(0) = (0, 0) \in \mathbb{Z}^2$ . Explore the connected component  $H_0$  of the origin in  $\mathcal{G}$  in the configuration  $\omega_0$ . Notice that only the edges of  $H_0 \cup \Delta H_0$  have been explored in order to determine  $H_0$ .
- If  $H_0$  contains a path of  $\mathcal{S}(m)$ , set  $X((0, 0)) = 1$  and  $(U_0, V_0) = (\{0\}, \emptyset)$  and move to  $(t = 1)$ .
  - Else, set  $X((0, 0)) = 0$  and  $(U_0, V_0) = (\emptyset, \{0\})$  and move to  $(t = 1)$ .
- ( $t$ ) Call **unexplored** the vertices in  $\mathbb{Z}^2 \setminus (U_t \cup V_t)$ . Examine the set of unexplored vertices neighbouring an element of  $U_t$ . If this set is empty, define  $(U_{t+1}, V_{t+1}) = (U_t, V_t)$  and move to  $(t + 1)$ . Otherwise, choose such an unexplored vertex  $z_t$ . In the configuration  $\omega_{t+1} := \omega_t \vee \xi^{z_t}$ , explore the connected component  $H_{t+1}$  of the origin.
- If  $H_{t+1} \cap B_{z_t} \neq \emptyset$ , which means in particular that  $B_{z_t}$  is connected to 0 by an  $\omega_{t+1}$ -open path, then set  $X(z_t) = 1$  and  $(U_{t+1}, V_{t+1}) = (U_t \cup \{z_t\}, V_t)$  and move to  $(t + 1)$ .
  - Else set  $X(z_t) = 0$  and  $(U_{t+1}, V_{t+1}) = (U_t, V_t \cup \{z_t\})$  and move to  $(t + 1)$ .

This algorithm defines in particular:

- a random process growing in the lattice  $\mathbb{Z}^2$ ,

$$S_0 = (U_0, V_0), S_1 = (U_1, V_1), \dots$$

- a random sequence  $(X(z_t))_{t \geq 0}$ .

Lemma 2.3.3 ensures that for all  $t \geq 1$ , whenever  $z_t$  is defined,

$$\mathbb{P}[X(z_t) = 1 | S_0, S_1, \dots, S_{t-1}] \geq p_0 > p_c^{\text{site}}(\mathbb{Z}^2). \quad (2.29)$$

Estimate (2.29) states that each time we explore a new site  $z_t$ , whatever the past of the exploration is, we have a sufficiently high probability of success: together with Lemma 1 of [GM90], it ensures that

$$\mathbb{P}[|U| = \infty] > 0,$$

where  $U := \bigcup_{t \geq 0} U_t$  is the set of  $z_t$ 's such that  $X(z_t)$  equals 1. For such  $z_t$ 's, we know that  $B_{z_t}$  is connected to the origin of  $\overline{\mathcal{G}}$  by an  $\omega_{t+1}$ -open path. Hence, when  $U$  is infinite, there must exist an infinite open connected component in the configuration

$$\omega_0 \vee \bigvee_{t \geq 0} \xi^{z_t},$$

which is a sub-configuration of  $\omega_{\text{total}}$ , and Lemma 2.3.4 is established.  $\square$





## Chapter 3

# Directed Diffusion-Limited Aggregation

In this chapter, we define a directed version of the Diffusion-Limited-Aggregation model. We present several equivalent definitions in finite volume and a definition in infinite volume. We obtain bounds on the speed of propagation of information in infinite volume and explore the geometry of the infinite cluster. We also explain how these results fit in a strategy for proving a shape theorem for this model. This chapter follows [Mara].

### 3.0 Introduction

Diffusion-Limited Aggregation (in short, DLA) is a statistical mechanics growth model that has been introduced in 1981 by Sander and Witten [WS81]. It is defined as follows. A first particle — a site of  $\mathbb{Z}^2$  — is fixed. Then, a particle is released “at infinity” and performs a symmetric random walk. As soon as it touches the first particle, it stops and sticks to it. Then, we release another particle, which will also stick to the cluster (the set of the particles of the aggregate), and so on... After a large number of iterations, one obtains a fractal-looking cluster.

DLA does not just model sticking particles, but also Hele-Shaw flow [SB84], dendritic growth [Vic92] and dielectric breakdown [BB84]. Figure 47 illustrates the viscous fingering phenomenon, which appears in Hele-Shaw flow. This phenomenon can be observed by injecting quickly a large quantity of oil into water.

This model is extremely hard to study; only two non-trivial results are rigorously known about DLA: an upper bound on the speed of growth [Kes87] and the fact that the infinite cluster has almost surely infinitely many holes, i.e. that the complement of the cluster has infinitely many finite components [EW99]. The difficulty comes from the fact that the dynamics is neither monotone nor local, and that it roughens the cluster.

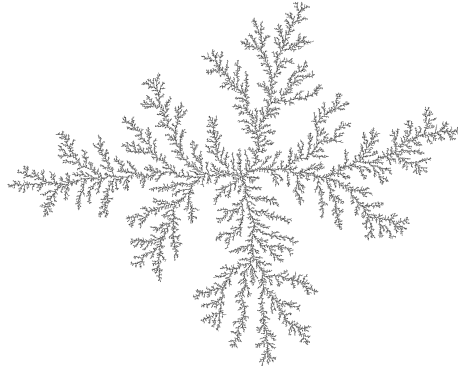

Figure 46 – DLA cluster obtained by Vincent Beffara.



Figure 47 – Viscous fingering picture obtained by Jessica Todd.

The *non-locality* is quite clear: if big arms surround  $P$ , even if they are far from it,  $P$  will never be added to the cluster.

By *non-monotonicity* (which is a more serious issue), we mean that there is no coupling between a DLA starting from a cluster  $C$  and another from a cluster  $D \subsetneq C$  such that, at each step, the inclusion of the clusters remains valid almost surely. To understand why, throw the same particles for both dynamics, i.e. use the naïve coupling. The big cluster will catch the particles

sooner than the small one: when a particle is stopped in the  $C$ -dynamics<sup>1</sup>, it may go on moving for the  $D$ -dynamics and stick somewhere that is not in the  $C$ -cluster, which would break the monotonicity. In fact, this is even a proof of the non-existence of *any* monotonic coupling, under the assumption that there exists  $(P, Q) \in D \times (C \setminus D)$  such that if  $R \in \{P, Q\}$ ,  $R$  can be connected to infinity by a  $\mathbb{Z}^2$ -path avoiding  $C \setminus \{R\}$ .

Finally, the fact that the dynamics *roughens* the cluster instead of smoothing it is what makes the difference between the usual (external) DLA and the internal DLA of [DF91], for which a shape theorem exists [LBG92]. Even though this roughening is not mathematically established, simulations such as the one of Figure 46 suggest it by the fractal nature of the picture they provide.

The rigorous study of DLA seeming, for the moment, out of reach, several toy models have been studied. These models are usually easier to study for one of the following reasons:

- either the particles are not added according to the harmonic measure of the cluster (i.e. launched at infinity) but “according to some nicer measure”<sup>2</sup>;
- or the dynamics does not occur in the plane<sup>3</sup>.

In this chapter, we prove some results on Directed Diffusion-Limited Aggregation (DDLA), which is a variant where the particles follow downward directed random walks. A large cluster is presented in Figure 48. Directed versions of DLA have already been considered by physicists [BS84, BS85, Maj03] but, to our knowledge, they have been rigorously studied only in the case of the binary tree (or Bethe lattice). The present model is defined in the plane. Simulations strongly suggest that the DDLA-cluster converges after suitable rescaling to some deterministic convex compact, delimited from below by two segments.

DDLA can be seen either as a ballistic deposition model where the falling particles fluctuate randomly or as a stretch version of DLA. See respectively [Sep00] and [BKP12].

Section 3.1 is devoted to several equivalent definitions of DLA. In Section 3.2, we define the dynamics in infinite volume. In Section 3.3, we obtain a bound on the speed of propagation of the information for a DDLA starting from a (sufficiently) horizontal interface. In Section 3.4, we adapt Kesten’s argument (see [Kes87]) to obtain bounds on the speed of horizontal growth and vertical growth. Finally, Section 3.5 explores the geometry of the infinite cluster.

---

1. and if, at the considered time, the  $C$ -cluster is still bigger than the  $D$ -one...

2. See e.g. [CM02].

3. See e.g. [BY08] for a study of DLA on cylinders  $G \times \mathbb{N}$  or [AABK09, AAK13, Ami09] for results on long-range DLA on  $\mathbb{Z}$ .

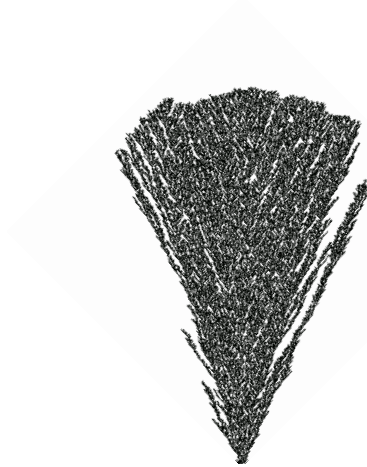

Figure 48 – Large DDLA cluster obtained by Vincent Beffara.

NOTATION. We use “a.s.e.” as an abbreviation for “almost surely, eventually”, which means either “almost surely, there exists  $n_0 \in \mathbb{N}$  such that for all  $n \geq n_0$ ” or “almost surely, there exists  $t_0 \in \mathbb{R}_+$  such that for all  $t \geq t_0$ ”.

### 3.1 Presentation of DDLA

#### 3.1.1 Some notation

In this chapter, when dealing with DDLA, we will think of  $\mathbb{Z}^2$  as rotated by an angle of  $+\frac{\pi}{4}$  (so that the particles we will throw move downward). The vertices of  $\mathbb{Z}^2$  will often be referred to as **sites**. Let

$$\mathbf{E} := \{((a, b), (c, d)) \in (\mathbb{Z}^2)^2 : (a = c \ \& \ b = d + 1) \text{ or } (a = c + 1 \ \& \ b = d)\}$$

be the set of the **(directed) edges**; it endows  $\mathbb{Z}^2$  with a structure of directed graph. We will denote by  $d$  the graph-distance on  $(\mathbb{Z}^2, \mathbf{E})$ , i.e. the  $\|\cdot\|_1$ -distance. If  $e = (P, Q)$  is an edge, we call  $P$  the **upper vertex** of  $e$  and  $Q$  its **lower vertex**. They are referred to as  $\mathbf{u}(e)$  and  $\mathbf{l}(e)$ .

A **downward directed symmetric random walk** is a Markov chain with transition probabilities

$$p(P, Q) = \mathbf{1}_{(P, Q) \in \mathbf{E}}/2.$$

An **upward directed symmetric random walk** is obtained with transition probabilities

$$p(P, Q) = \mathbf{1}_{(Q, P) \in \mathbf{E}}/2.$$

When the starting point of a directed random walk is not specified, it is tacitly taken to be  $(0, 0)$ .

The **height** of  $P = (a, b)$ , denoted by  $\mathbf{h}(P)$ , is  $a + b$ . Its **horizontal deviation (relative to 0)** is  $\mathbf{d}(P) := b - a$ . The height (resp. horizontal deviation) of  $P$  **relative to**  $Q$  is  $\mathbf{h}(P) - \mathbf{h}(Q)$  (resp.  $\mathbf{d}(P) - \mathbf{d}(Q)$ ). If  $A \subset \mathbb{Z}^2$ , we set

$$\mathbf{h}(A) := \sup_{P \in A} \mathbf{h}(P), \quad \mathbf{d}(A) := \sup_{P \in A} \mathbf{d}(P) \quad \text{and} \quad |\mathbf{d}|(A) := \sup_{P \in A} |\mathbf{d}(P)|.$$

The **line of height**  $n$  is

$$L_n := \{(x, y) \in \mathbb{Z}_+^2 : x + y = n\}.$$

We also set

$$L_{\leq n} := \{(x, y) \in \mathbb{Z}_+^2 : x + y \leq n\}.$$

A line  $L_n$  is said to be **above** a set  $S$  if  $S \subset L_{\leq n-1}$ . Finally, if one fixes a subset  $C$  of  $\mathbb{Z}^2$ , the **activity** of a site  $P \in \mathbb{Z}^2$  relative to  $C$  is

$$\mathbf{act}_C(P) := \mathbb{P}[\forall n \in \mathbb{N}, P + W_n \notin C] \cdot |\{e \in \mathbf{E} : \mathbf{l}(e) \in C \ \& \ \mathbf{u}(e) = P\}|,$$

where  $(W_n)_{n \in \mathbb{Z}_+}$  is an upward directed symmetric random walk and  $|\cdot|$  stands for the cardinality operator. In what follows, we will consider a growing subset of  $\mathbb{Z}^2$ , called **cluster**. The **current activity** (or **activity**) of a site  $P$  will then be relative to the cluster at the considered time. The **activity of the cluster** will be the sum over all sites of their activity.

### 3.1.2 Definition in discrete time

At time 0, the cluster is  $C_0 := \{(0, 0)\}$ . Assume that the cluster has been built up to time  $n$ , and that  $C_n \subset L_{\leq n}$ . To build  $C_{n+1}$ , choose any line  $L_k$  above  $C_n$ . Then, independently of all the choices made so far, choose uniformly a point in  $L_k$ , and send a downward symmetric random walk  $(W_n)$  from this point. If the walk intersects  $C_n$ , then there must be a first time  $\tau$  when the walker is on a point of the cluster: let

$$C_{n+1} := C_n \cup \{W_{\tau-1}\} \subset L_{\leq n+1}.$$

If the random walk fails to hit the cluster, we iterate the procedure {choice of a starting point + launching of a random walk} independently and with the same  $k$ , until a random walk hits the cluster, which will happen almost surely. This is obviously the same as conditioning the procedure to succeed.

The dynamics does not depend on the choices of  $k$ : indeed, choosing uniformly a point in  $L_{k+1}$  and taking a step downward give the same measure to all the points of  $L_k$  (and if a walker goes outside  $\mathbb{Z}_+^2$ , it will never hit the cluster). The dynamics is thus well-defined. We call this process **Directed Diffusion-Limited Aggregation** (or **DDLA**).

*Remark.* Since the process does not depend on the choices of  $k$ , we can take it as large as we want so that we may (informally at least) think of the particles as falling from infinity.

Here is another process, which is the same (in distribution) as DDLA. We set  $C_0 := \{(0, 0)\}$ . Assume that we have built  $C_n$ , a random set of cardinality  $n + 1$ . We condition the following procedure to succeed:

PROCEDURE. We choose, uniformly and independently of all the choices made so far, an edge  $e$  such that  $l(e) \in C_n$ . We launch an upward directed symmetric random walk from  $\mathbf{u}(e)$ . We say that the procedure succeeds if the random walk does not touch  $C_n$ .

The particle added to the cluster is the upper vertex of the edge that has been chosen. Iterating the process, we obtain a well-defined dynamics. It is the same as the first dynamics: this is easily proved by matching downward paths with the corresponding upward ones.

### 3.1.3 Definition in continuous time

We now define **DDLA in continuous time**: this is the natural continuous time version of the second definition of DDLA. Let  $((N_t^e)_{t \geq 0})_{e \in \mathbf{E}}$  be a family of independent Poisson processes of intensity 1 indexed by the set of the directed edges. The cluster  $C(0)$  is defined as  $\{(0, 0)\}$  and we set  $T(0) := 0$ .

Assume that for some (almost surely well-defined) stopping time  $T(n)$ , the cluster  $C(T(n))$  contains exactly  $n$  particles. Then, wait for an edge whose lower vertex is in  $C(T(n))$  to ring (such edges will be called **growth-edges**). When the clock on a growth-edge  $e$  rings, send an independent upward directed random walk from its upper vertex. If it does not intersect  $C(T(n))$ , add a particle at  $\mathbf{u}(e)$  and define  $T(n + 1)$  to be the current time. Otherwise, wait for another growth-edge to ring, and iterate the procedure.

This dynamics is almost surely well-defined for all times<sup>4</sup> because it is stochastically dominated by first-passage percolation [Kes86]. Markov chain theory guarantees that  $(C_n)_{n \in \mathbb{Z}_+}$  and  $(C(T(n)))_{n \in \mathbb{Z}_+}$  are identical in distribution.

*Remark.* This definition in continuous time consists in adding sites at a rate equal to their current activity.

### 3.1.4 Some general heuristics

Before going any further, it may be useful to know what is the theorem we are looking for and how the results presented in this chapter may play

---

4. i.e.  $\sup_n T(n)$  is almost surely infinite

a part in its proof. In this subsection, we present *highly informal heuristics that have not been made mathematically rigorous in any way yet*. They constitute a strategy for proving a shape theorem for DDLA.

UNPROVED ASSERTION. *There is some convex compact  $D$  of non-empty interior such that  $\frac{C(t)}{t}$  converges almost surely to  $D$  for the Hausdorff metric. Besides, the boundary of  $D$  consists in two segments and the  $(-\pi/4)$ -rotated graph of a concave function.*

To prove such a result, the step 0 may be to prove that the width and height of the cluster both grow linearly in time, so that we would know that we use the right scaling. This would result from a stronger form of Fact 3.4.5.

Provided this, one may use compactness arguments to prove that if there exists a unique “invariant non-empty compact set”  $D$ , then we have the desired convergence (to  $D$ ). By invariance, we informally mean the following: if  $t$  is large enough and if we launch a DDLA at time  $t$  from  $(tD) \cap \mathbb{Z}^2$ , then  $\frac{C(t+s)}{t+s}$  “remains close” to  $D$ .

This existence and uniqueness may be proved by finding a (maybe non-explicit) ordinary differential equation satisfied by the upper interface of  $D$ . To do so, we would proceed in two steps.

### Step 1

First of all, one needs to check that the upper interface is typically “more or less” the  $(-\pi/4)$ -rotated graph of a differentiable function. To do so, one would need to control fjords. Roughly speaking, we call **fjord** the area delimited by two long and close arms of the cluster. Fjords are the enemies of both regularity and “being the graph of a function”.

Here are some heuristics about fjords: in Figure 48, we observe that there are mesoscopic fjords far from the vertical axis and no such fjord close to it. We try to account for this.

DEFINITION. We say that a site  $P$  **shades** a second one if it can catch particles that would go to the second site if  $P$  was vacant.

Assume that we have a behaviour as suggested by Figure 48. If we are close to the vertical axis, the local slope is close to 0. We will assume that, at any time, none of the two top-points of the arms delineating the considered fjord shades the other: they will thus survive (i.e. keep moving), following more or less upward directed random walks. By recurrence of the 2-dimensional random walk, we obtain that the two top-points will collide at some time, closing the fjord. To avoid the shading phenomenon, one needs a still unknown proper and *tractable* definition of top-point. However,



it seems quite reasonable to expect this phenomenon “not to occur” if the slope is close to 0 because there is no initial shading.

When the slope gets higher, the shading phenomenon appears. If the slope is not too high, the “lower top-point” manages to survive but it is hard for it to catch up with the upper one: this creates a fjord<sup>5</sup>. If the slope is too high, the “lower top-point” stops catching particles: we are in the lower interface.

## Step 2

Now, we need to find an ODE satisfied by  $r$ , where  $\alpha \mapsto r(\alpha)$  is the angular parametrization of the upper interface of  $D$  and is defined on  $(-\alpha_0, \alpha_0)$ . We assume that  $\alpha = 0$  corresponds to what we think of as the vertical.

Assume that one can launch a DDLA from an infinite line of slope  $\tan(\alpha)$  (which is made possible by Section 3.2) and define a deterministic<sup>6</sup> speed of vertical growth  $\mathbf{v}(\alpha)$ . The set  $D$  being invariant,  $r(\alpha) \cdot \cos(\alpha)$  must be proportional to  $\mathbf{v}(\theta(\alpha))$ , where  $\tan(\theta(\alpha))$  stands for the local slope of  $D$  at the neighborhood of the point defined by  $\alpha$  and  $r(\alpha)$ .

More exactly, we have

$$\begin{cases} r(\alpha) \cdot \cos(\alpha) = c \cdot \mathbf{v}(\theta(\alpha)) \\ \tan(\alpha - \theta(\alpha)) = \frac{r'(\alpha)}{r(\alpha)}. \end{cases}$$

The knowledge of  $\theta(\alpha_0)$  due to the previous step allows us to find  $\alpha_0$ .

Simulations suggest that  $\alpha_0 < \pi/4$ ; Corollary 3.5.3 is a weak result in this direction.

The last point that has to be checked is that the lower interface consists of two segments. Assume that the points of the lower interface are of bounded local slope. From this and large deviation theory, one can deduce that it costs typically exponentially much for a particle to stick to the lower interface at large distance from the upper interface.<sup>7</sup> This might allow us to compare DDLA with ballistic deposition, for which the upper interface converges to the graph of a concave function [Sep00] and the lower interface converges to the union of two segments (use the Kesten-Hammersley Lemma [SW78]).

## 3.2 DDLA in Infinite Volume

In this section, we define Directed Diffusion-Limited Aggregation starting from a suitable infinite set. Notice that we make the trivial adjustment

---

5. Simulations suggest that this process builds fjords forming a deterministic angle with the vertical.

6. by ergodicity arguments

7. By this, we mean that, conditionally on an initial cluster, the probability that the next particle sticks to the lower interface at distance  $d$  from the upper interface is lower than  $e^{-\epsilon d}$ , for some constant  $\epsilon$ .

that the process now lives in  $\mathbb{Z}^2$  instead of  $\mathbb{N}^2$ .

Here is a very informal description of the construction. Each edge has a Poisson clock and infinitely many upward directed symmetric random walks attached to it, everything being chosen independently. When a clock rings at some edge for the  $k^{\text{th}}$  time, if its upper extremity is vacant and its lower one occupied, the  $k^{\text{th}}$  random walk is sent and we see if it hits the current cluster or not: we add a particle if and only if the walk does not hit the cluster.

In finite volume, this is not problematic because we can (almost surely) define the **first (or next) ringing time**: since we only need to know the state of the cluster just before we send the walk, the construction is done. In the case of an infinite initial cluster, in any non-trivial time interval, there are almost surely infinitely many ringing times to consider.<sup>8</sup> To define the dynamics, a solution is to show that, for all  $(P_0, T_0) \in \mathbb{Z}^2 \times \mathbb{R}_+^*$ , what happens at  $P_0$  before time  $T_0$  just depends on some random finite set of edges. Indeed, in this case, we can apply the construction in finite volume. This is the idea behind Harris-like constructions. See e.g. [Sep00] for an easy Harris-like construction of ballistic deposition, the local and monotonic version of DDLA.

Rigourously, the construction goes as follows. Let  $((N_t^e)_{t \geq 0})_{e \in \mathbf{E}}$  be a family of independent Poisson processes of intensity 1 indexed by the set of the directed edges. Let  $((W_n^{e,k})_{n \in \mathbb{N}})_{e \in \mathbf{E}, k \in \mathbb{N}^*}$  be a family of independent upward directed symmetric random walks (simply referred to as random walks in this section) indexed by  $\mathbf{E} \times \mathbb{N}^*$ .

NOTATION. Let  $r_\theta$  be the rotation of centre  $(0, 0)$  and angle  $\theta$ . For  $b \in \mathbb{R}_+^*$ , let

$$\mathcal{C}_b := r_{-\pi/4} \left( \{(x, y) \in \mathbb{R}^2 : |y| \geq b|x|\} \right)$$

be the  **$b$ -cone** and let

$$\mathcal{W}_b := r_{-\pi/4} \left( \{(x, y) \in \mathbb{R}^2 : |y| = (b+1)x\} \right)$$

be the  **$b$ -wedge**. (Remember that we think of  $\mathbb{Z}^2$  as rotated by an angle of  $+\pi/4$ .) When  $b$  is not specified, it is taken to be equal to the  $a$  introduced in the next line.

ASSUMPTION ON THE CLUSTER. There is some  $(a, K) \in \mathbb{R}_+^2$  such that for all  $P \in C$ ,

$$(P + (K, K) + \mathcal{C}_a) \cap C = \emptyset \quad \text{and} \quad (P + s((K, K) + \mathcal{C}_a)) \cap C = \emptyset,$$

where  $s$  maps  $Q \in \mathbb{Z}^2$  to  $-Q$ .

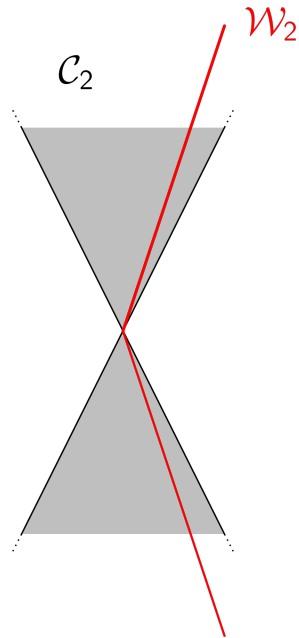

Figure 49 – The  $b$ -cone and the  $b$ -wedge for  $b = 2$ .

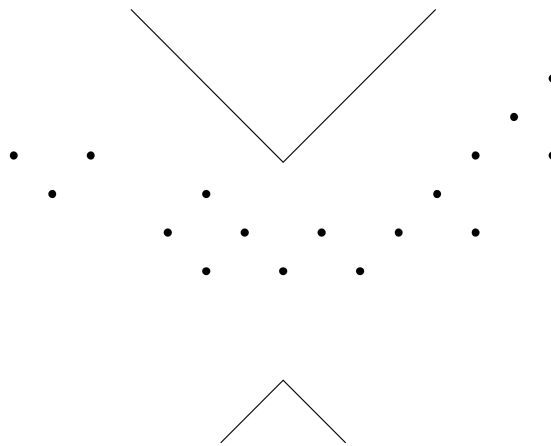

Figure 50 – A finite portion of a cluster satisfying the assumption for  $(a, K) = (1, 2)$ .

---

8. This problem is essentially the same as the one that makes impossible a discrete-time construction: we cannot throw our particles the one after the other because there is

Let us fix  $T_0 \in \mathbb{R}_+^*$ . Let us pick a site  $P_0$  in  $\mathbb{Z}^2$  and try to decide whether we add it to the cluster before time  $T_0$  or not and, if so, when. If this can be done with probability 1, then the dynamics is almost surely well-defined. Indeed, it is enough to check every  $(P_0, T_0)$  in  $\mathbb{Z}^2 \times \mathbb{N}^*$ .

DEFINITIONS. A site  $P$  is said to be **activated** if there is an upward directed path  $(Q_0, \dots, Q_n)$  such that:

- $Q_0 \in C$ ,
- $Q_n = P$ ,
- there is an increasing  $n$ -tuple  $(t_1, \dots, t_n)$  such that  $t_n \leq T_0$  and for every  $k \in \{1, \dots, n\}$ , the clock at  $(Q_{k-1}, Q_k)$  rings at time  $t_k$ .

The model consisting in adding a vertex  $P$  before time  $t$  if and only if the condition above is satisfied for  $t$  instead of  $T_0$  is called **Directed First-Passage Percolation** (or **DFPP**). We also say that a directed edge  $(P, Q)$  is **activated** if there is an upward directed path  $(Q_0, \dots, Q_n)$  such that:

- $Q_0 \in C$ ,
- $Q_{n-1} = P$
- $Q_n = Q$ ,
- there is an increasing  $n$ -tuple  $(t_1, \dots, t_n)$  such that  $t_n \leq T_0$  and for every  $k \in \{1, \dots, n\}$ , the clock at  $(Q_{k-1}, Q_k)$  rings at time  $t_k$ .

For any directed edge  $(P, Q)$ , each time the clock at  $(P, Q)$  rings, if  $(P, Q)$  belongs to the current DFPP cluster, then we **launch** a new random walk from  $Q$ ; the  $k^{\text{th}}$  random walk to be launched is  $Q + W^{(P,Q),k}$ .

FACT 3.2.1. *The probability that  $P \in \mathbb{Z}^2$  is activated decays exponentially fast in  $d(P, C)$ .*

*Remark.* Fact 3.2.1 is a direct consequence of the exponential decay of sub-critical percolation if  $T_0 < \ln 2$ ; see [AV08].

*Proof.* Let  $B(P, n)$  denote the  $\|\cdot\|_1$ -ball of centre  $P$  and radius  $n$ . Let  $k_0 \in \mathbb{N}^*$ . If the following holds for  $n = \lfloor \frac{d(P,C)}{k_0} \rfloor - 1$ :

$$\forall 0 < k \leq k_0, \\ B(P, (k_0 - k + 1)n) \text{ contains all the vertices that can be connected to} \\ B(P, (k_0 - k)n) \text{ by edges whose clock rings between } \frac{k-1}{2} \text{ and } \frac{k}{2},$$

then  $P$  cannot belong to the activation cluster of  $C$  for  $T_0 \leq k_0/2$ . But, by the exponential decay of activation percolations over a time-range equal to  $1/2 < \ln 2$ , the probability that this condition is not satisfied is lower than

$$\sum_{k=1}^{k_0} |B(P, k_0 n)| c e^{-n/c},$$

which decays exponentially fast in  $n$ . □

---

no uniform probability measure on an infinite countable set.

DEFINITIONS. Let  $P \in C$ . The **wedge based at  $P$**  is defined as  $P + \mathcal{W}$ . It divides  $\mathbb{R}^2$  into two connected components. A point of  $\mathbb{R}^2$  that belongs to the same connected component as  $P + (-1, 1)$  is said to be to the **left** of the wedge based at  $P$ . The set of the points of  $\mathbb{Z}^2$  that are to the left of the wedge based at  $P$  is denoted by  $\text{Left}(P)$ . The site  $P$  is said to be **good** if it satisfies the following conditions:

- no activated directed edge  $(P, Q)$  satisfies “ $P \in \text{Left}(P) \Leftrightarrow Q \notin \text{Left}(P)$ ”,
- every random walk launched from a activated site of  $\text{Left}(P)$  remains in  $\text{Left}(P)$ .

The site  $P$  is said to be **quasi-good** if it satisfies the following conditions:

- only finitely many activated edges satisfy “exactly one extremity of the considered edge belongs to  $\text{Left}(P)$ ”,
- only finitely many walks that are launched from an activated edge whose extremities belong to  $\text{Left}(P)$  do not stay in  $\text{Left}(P)$ , and each of them takes only finitely many steps outside  $\text{Left}(P)$ .

There is a constant  $c' = c'(a, K)$  such that for every  $P \in C$  and every  $Q \in \mathbb{Z}^2$ , the following inequality holds:

$$\max(d(Q, C), d(Q, P + \mathcal{W})) \geq c'(d(Q, P) - c').$$

For  $P \in C$ , consider the following events:

- to an edge  $(P', Q')$  such that “ $P' \in \text{Left}(P) \Leftrightarrow Q' \notin \text{Left}(P)$ ” corresponds the event “the directed edge  $(P, Q)$  is activated”,
- to  $(k, n) \in \mathbb{N}^*$  and  $e$  a directed edge the two extremities of which belong to  $\text{Left}(P)$  corresponds the event “the  $k^{\text{th}}$  random walk at  $e$  is launched and its  $n^{\text{th}}$  step lands outside  $\text{Left}(P)$ ”.

It follows from the estimate above and large deviation theory that the events under consideration have summable probability. The Borel-Cantelli Lemma implies that almost surely, only finitely many of these events occur:  $P$  is thus almost surely quasi-good. By independence, the site  $P$  has positive probability to be good. In fact, this proof being quantitative, we know that the probability that  $P$  is good can be bounded below by some positive constant  $\varepsilon = \varepsilon(a, K)$ .

FACT 3.2.2. *Assume that the horizontal deviation  $\mathbf{d}$  is not bounded above in restriction to  $C$ . Then, almost surely, there is a good site  $P$  such that  $P_0 \in \text{Left}(P)$ .*

Taking Fact 3.2.2 for granted, it is not hard to conclude. If  $\mathbf{d}$  is bounded, then the assumption on  $C$  guarantees that  $C$  is finite and the process has already been defined. We may thus assume that  $C$  is infinite. If  $\mathbf{d}$  is neither bounded above nor bounded below in restriction to  $C$ , then Fact 3.2.2 and its symmetric version (which follows from it) imply the following: almost

surely, there are a wedge to the right of  $P_0$  and a (symmetric) wedge to the left of  $P_0$  that are not crossed by the DFPP or any walk launched from between these wedges before time  $T_0$ . Since the intersection of  $C$  with the area delineated by the wedges is finite, the construction is once again reduced to finite volume. (The definition of goodness guarantees that the fate of the considered area can be defined without having to look outside it.) Finally, if  $\mathbf{d}$  is only bounded in one direction (say above), then one can find a site  $P$  that is good and such that  $P \in \text{Left}(P)$ : since  $C \cap \text{Left}(P)$  is finite, the construction in finite volume can be used.

*Proof of Fact 3.2.2.* Let  $P$  be a point in  $C$  such that  $P_0 \in \text{Left}(P)$ . (Such a point exists owing to the geometric assumption on  $C$  and because  $\mathbf{d}$  is not bounded above in restriction to  $C$ .) Explore the DFPP cluster of the 1-neighbourhood of  $P + \mathcal{W}$  in reverse time: starting at time  $T_0$  from  $P + \mathcal{W}$ , one follows the downward DFPP process associated with the same clocks. At time  $t = 0$ , this exploration has visited a random set of sites and edges. The **area explored at step 1** is this random set, together with all the vertices and edges in  $\text{Left}(P)$ . By looking at the clocks and walks lying in this area, one can see if  $P$  is good or not. If this is the case, we stop the process. Otherwise, since we know that  $P$  is *quasi-good*, up to taking  $P' \in C$  far enough to the right of  $P$ , we can assume that the information revealed so far yields no obstruction to the fact that  $P'$  is good. Since we have made irrelevant all the negative information, the probability that  $P'$  is good conditionally on the fact that  $P$  is not good is at least the  $\varepsilon$  introduced before Fact 3.2.2. Iterating this process, we find a good site  $P$  such that  $P_0 \in \text{Left}(P)$  in at most  $k$  steps with probability at least  $1 - (1 - \varepsilon)^k$ . Thus, almost surely, such a site exists.  $\square$

*Remarks.* The dynamics is measurably defined and does not depend on the choices that are made. Besides, the  $t_0$ -dynamics ( $t_0 \in \mathbb{R}_+^*$ ) are coherent. More exactly, at (typical) fixed environment, if we apply the previous construction with  $(P, t_0)$  and  $(P, s_0)$ , if the first construction says that  $P$  is added at time  $T < s_0$ , then so does the second construction.

Also notice that this dynamics defines a simple-Markov process relative to the filtration

$$\mathcal{F}_t := \sigma(N_s^e : s \leq t, e \in \mathbf{E}) \vee \sigma(W_k^{e,m} : e \in \mathbf{E}, 1 \leq m \leq N_t^e, k \geq 0).$$

### 3.3 Transport of information

In this section, we prove bounds on the speed of propagation of the information for a horizontal initial cluster. Such a control guarantees a

weak (and quantitative) form of locality, which may help studying further DDLA.

Let us consider a DDLA launched with the initial interface

$$D := \{P \in \mathbb{Z}^2 : \mathbf{h}(P) = 0\}.$$

Before stating the proposition, we need to introduce some terminology. Let  $F \Subset \mathbb{Z}^2$ , i.e. let  $F$  be a non-empty finite subset of  $\mathbb{Z}^2$ . We want to define where some information about  $F$  may be available. Formally, we want our area of potential influence (a random subset of  $\mathbb{Z}^2$  depending on time) to satisfy the following property: if we use the same clocks and walks to launch a DDLA from  $D$  and one from  $D\Delta G$  with  $G \subset F$ , the clusters will be the same outside the area of potential influence at the considered time. In fact, the way this area is defined in this section, we even know that the pair (*area, data of the particles present in the cluster outside the area*) satisfies the (say weak) Markov Property.

We define this area as follows<sup>9</sup>. Instead of saying that a site of  $\mathbb{Z}^2$  — in the cluster or not — belongs to the area of potential influence, we will say that it is **red**, which is shorter and more visual. A non-red site belonging to the cluster will be colored in **black**. Initially,

$$\mathfrak{R}_0 := F$$

is the red area. Then, a site  $P$  becomes red when one of the following events occurs:

- $P = \mathbf{u}(e)$ , the site  $\mathbf{l}(e)$  is red, the clock on  $e$  rings and the launched random walk avoids black sites;
- $P = \mathbf{u}(e)$ , the site  $\mathbf{l}(e)$  is black, the clock on  $e$  rings and the launched random walk avoids black sites and goes through at least one red site.

It is not clear that this is well-defined, for the same reason that makes the definition in infinite volume uneasy, but we will see in the proof of Proposition 3.3.1 that some larger<sup>10</sup> set is finite almost surely for all times, so that the construction boils down to finite volume, entailing proper definition of the red area.

By construction, it is clear that if it is well-defined, red is a good notion of area of potential influence.

NOTATION.  $\mathfrak{R}_t$  will denote the red area at time  $t$ . We set  $\mathfrak{h}_t := \mathbf{h}(\mathfrak{R}_t)$  and  $\mathfrak{d}_t := |\mathbf{d}|(\mathfrak{R}_t)$ . This holds only for this section.

---

9. Some looser definition may be proposed but this one is used because it is tractable.

10. Of course, as in all Harris-like constructions, this set is larger than some set that is not defined yet !

PROPOSITION 3.3.1. *If  $F \in \mathbb{Z}^2$  and if we choose  $D$  as initial cluster, then  $(\mathfrak{R}_t(F))_{t \geq 0}$  is well-defined and a.s.e.*

$$\mathfrak{h}_t \leq c_0 \cdot t \ln t \text{ and } \mathfrak{d}_t \leq c_0 \cdot t^2 \ln t$$

for some deterministic constant  $c_0$  independent of  $F$ .

*Proof.* Without loss of generality, we may assume that  $\mathfrak{R}_0 = \{(0, 0)\}$ . Indeed, if one takes  $F$  to be  $\{(0, 0)\}$ , then for any finite subset  $G$  of  $\mathbf{h}^{-1}(\mathbb{N})$ , the event  $G \subset \mathfrak{R}_1$  has positive probability.

The rough idea of the proof is the following:

1. We prove that the red area cannot be extremely wide.
2. We show that if it is not very wide, it is quite small (in height).
3. We prove that if it is small, it is narrow.
4. We initialize the process with the first step and then iterate Steps 2 and Step 3, allowing us to conclude.

**Step 1: At most exponential growth**

For  $n \in \mathbb{N}$ , we set

$$S_n := \left\{ P \in \mathbb{Z}^2 : \mathbf{h}(P) + |\mathbf{d}(P)| \leq 2n \text{ and } \mathbf{h}(P) > 0 \right\}.$$

We consider the following model.

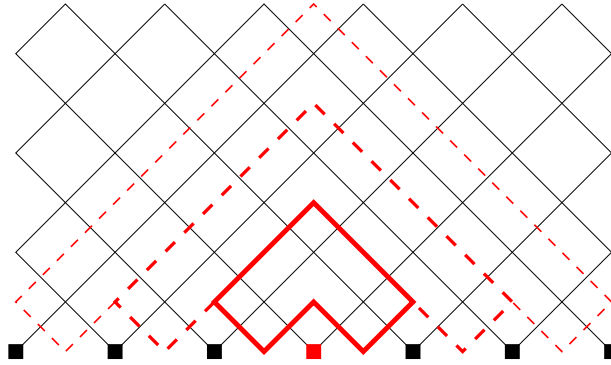

Figure 51 – Illustration of the model used in Step 1.

At time 0, the cluster is  $\mathfrak{S}_0 := S_0$ . An edge  $e$  is said to be **decisive** if  $\mathbf{l}(e) \in \mathfrak{S}_t$  and  $\mathbf{u}(e) \notin \mathfrak{S}_t$ . The cluster does not change until a clock on a decisive edge rings. When this event occurs,  $\mathfrak{S}_t$ , which was  $S_n$  for some random  $n$ , becomes  $S_{n+1}$ . The data of  $\mathfrak{S}_t$  is thus just the data of this random  $n(t)$ .



Let  $(\tau_n)_{n \geq 1}$  be a sequence of independent random variables such that  $\tau_n$  follows an exponential law of parameter  $2n$ . Let  $T_n := \sum_{k=1}^n \tau_k$ . Then, by construction,  $(T_n)_{n \in \mathbb{N}}$  has the same law as the sequence of the jumping times of the cluster from one state to another.

FACT 3.3.2. *Almost surely, eventually,*

$$T_{\lfloor e^{n^2} \rfloor} > \frac{n^2}{8}.$$

*Proof.* Consider  $f : n \mapsto \lfloor e^{n^2} \rfloor$ . By construction, one has the following estimate:

$$\mathbb{E} \left[ \sum_{k=f(n)+1}^{f(n+1)} \tau_k \right] = \sum_{k=f(n)+1}^{f(n+1)} \frac{1}{2k} \underset{n \rightarrow \infty}{\sim} n.$$

Setting  $\mathfrak{T}_n := \sum_{k=f(n)+1}^{f(n+1)} \tau_k$ , we have

$$\mathbf{Var}[\mathfrak{T}_n] \underset{\text{indep.}}{=} \sum_{k=f(n)+1}^{f(n+1)} \mathbf{Var}[\tau_k] \leq \frac{1}{4} \times \frac{\pi^2}{6}.$$

By Chebyshev's inequality and our control on the expectation, for  $n$  large enough,

$$\mathbb{P} \left[ \mathfrak{T}_n < \frac{n}{2} \right] \leq \frac{\pi^2}{3n^2}.$$

By the Borel-Cantelli Lemma, a.s.e.  $\mathfrak{T}_n > \frac{n}{2}$ . The result follows.  $\square$

Consequently, for some (explicit)  $c \in \mathbb{R}_+^*$ , a.s.e.  $\mathfrak{S}_t \subset S_{\lfloor e^{ct} \rfloor}$ . The area  $\mathfrak{A}_t$  is therefore well-defined and is a.s.e. a subset of  $S_{\lfloor e^{ct} \rfloor}$ .

## Step 2: Polynomial growth of the height

LEMMA 3.3.3. *Let  $M$  be a sequence of positive real numbers such that a.s.e.,  $\mathfrak{R}_n \subset S_{\lfloor M_n \rfloor}$ . Assume that  $M_n$  is eventually larger than  $n$ . Then for some constant  $a \in \mathbb{R}_+^*$ , a.s.e.,  $\mathfrak{h}_n \leq an \ln M_n$ .*

*Proof.* The **colored area** is the set the sites that are red or black. It is dominated by the directed first-passage percolation starting from  $D$  and using the same clocks. Let  $\mathfrak{P}_t$  be the cluster of this percolation at time  $t$ . We know that, a.s.e.  $\mathfrak{R}_n \subset S_{\lfloor M_n \rfloor} \cap \mathfrak{P}_n =: \mathfrak{A}_n^{\text{exp}(cn)}$ , where  $\mathfrak{A}_t^r := S_{\lfloor r \rfloor} \cap \mathfrak{P}_t$ . For  $n \in \mathbb{N}$  and  $a \in \mathbb{R}_+^*$ ,

$$\begin{aligned} \mathbb{P} \left[ \mathfrak{h}(\mathfrak{A}_n^{M_n}) > an \ln M_n \right] &\leq \mathbb{P} \left[ \exists k \leq 2n, \mathfrak{h} \left( \mathfrak{A}_{\frac{k+1}{2}}^{M_n} \right) - \mathfrak{h} \left( \mathfrak{A}_{\frac{k}{2}}^{M_n} \right) > a \ln M_n / 2 \right] \\ &\leq 2n \max_{k \leq 2n} \mathbb{P} \left[ \mathfrak{h} \left( \mathfrak{A}_{\frac{k+1}{2}}^{M_n} \right) - \mathfrak{h} \left( \mathfrak{A}_{\frac{k}{2}}^{M_n} \right) > a \ln M_n / 2 \right] \\ &\leq 2ne^{-\text{cst} \cdot a \ln M_n} (2M_n + 1) \\ &\leq 2n(2M_n + 1)^{1-\text{cst} \cdot a}. \end{aligned}$$

(For the last inequality, see page 145.) Since  $n = O(M_n)$ , taking  $a$  large enough implies that the probabilities  $\mathbb{P} \left[ \mathbf{h}(\mathfrak{A}_n^{M_n}) > an \ln M_n \right]$  are summable. Applying the Borel-Cantelli Lemma, we obtain that a.s.e.  $\mathfrak{h}_n \leq an \ln M_n$ .  $\square$

Applying Lemma 3.3.3 to  $(e^{cn})$  and increasing slightly the value of  $a$ , one gets that a.s.e.,  $\mathfrak{h}(t) \leq at^2$ . Indeed,  $(n+1)^2 \underset{n \rightarrow \infty}{\sim} n^2$ .

### Step 3: Polynomial lateral growth

LEMMA 3.3.4. *Let  $M$  be a sequence of real numbers greater than 1 such that a.s.e.,  $\mathfrak{h}_n \leq M_n$ . Then, for some constant  $b \in \mathbb{R}_+^*$ , a.s.e.,  $\mathfrak{d}_n \leq b \cdot nM_n$ .*

NOTATION. If  $k \in \mathbb{N}$ , let  $H_k := \{P \in \mathbb{Z}^2 : 0 \leq \mathbf{h}(P) \leq k\}$  be the  $k$ -strip.

*Proof.* Given a natural number  $k$ , we consider the dynamics defined as in Step 1, but with

$$S_n^k := S_n \cap H_k$$

instead of  $S_n$ . We denote by  $\mathfrak{S}_t^k$  the corresponding cluster at time  $t$ . As long as  $\mathfrak{h}_t \leq k$ , we have  $\mathfrak{R}_t \subset \mathfrak{S}_t^k$ .

Let  $\tau_n$  be i.i.d. random variables following an exponential law of parameter 1 and let

$$T_n := \sum_{i=1}^n \tau_i.$$

The sequence of the jumping times of the  $H_k$ -dynamics dominates stochastically  $(T_n/2k)_n$ .

Large deviation theory guarantees that there is some  $\text{cst}'$  such that for any  $n \in \mathbb{N}$ ,

$$\begin{aligned} \mathbb{P} \left[ \mathbf{d}(\mathfrak{S}_n^{M_n}) \geq \lfloor 3nM_n \rfloor \right] &\leq \mathbb{P} \left[ T_{\lfloor 3nM_n \rfloor} / (2M_n) \leq n \right] \\ &\leq \mathbb{P} \left[ T_{\lfloor 3nM_n \rfloor} \leq 2nM_n \right] \\ &\leq e^{-\text{cst}' \times nM_n}. \end{aligned}$$

The Borel-Cantelli Lemma thus gives: a.s.e.,  $\mathbf{d}(\mathfrak{S}_n^{M_n}) < \lfloor 3nM_n \rfloor$ .  $\square$

It results from Lemma 3.3.4 applied to the estimate of Step 2 that a.s.e.,  $\mathfrak{d}_t \leq bt^3$ .

### Step 4: Final bounds

Applying Lemma 3.3.3 to the polynomial estimates we now have yields the following: a.s.e.,  $\mathfrak{h}_t \leq \text{cst}'' \cdot t \ln t$ . Applying Lemma 3.3.4 to this estimate gives the almost quadratic bound on the width.  $\square$

*Remark.* The same arguments can be adapted to prove Proposition 3.3.1 for any sufficiently horizontal initial cluster. More exactly, it is enough to assume that the initial cluster satisfies the assumption of section 3.2 for  $a < 1$ . In this case, the constant  $c_0$  depends on  $a$ , the quantity  $\mathfrak{h}_t$  stands for the maximal distance from a point of  $\mathfrak{R}_t$  to  $C$  and  $\mathfrak{d}_t$  designates the diameter of  $\mathfrak{R}_t$ .

### 3.4 Bounds on the height and width of the cluster

Let us consider the discrete-time dynamics starting from  $(0, 0)$ . In this section, let  $\mathfrak{h}_n := \mathbf{h}(C_n)$  and  $\mathfrak{d}_n := |\mathbf{d}|(C_n)$ . Following [Kes87], we obtain the following bounds:

PROPOSITION 3.4.1. *For some constant  $c_1$ , almost surely, eventually,*

$$\sqrt{2n} \leq \mathfrak{h}_n \leq c_1 n^{2/3}$$

and

$$c_1^{-1} n^{1/3} \leq \mathfrak{d}_n \leq c_1 \sqrt{n}.$$

*Remark.* For DLA, Kesten has proved that the radius of the cluster is almost surely eventually lower than  $c_1 n^{2/3}$ .

*Proof.* Before applying Kesten's argument, we need some lower bound on the activity of the cluster. This is natural since a high activity of the cluster guarantees, for all  $P \in \mathbb{Z}^2$ , a low probability that this site will be the next to be added to the cluster (lower than  $1/\mathbf{act}(\text{cluster})$ ). This allows us to control the probability that a path of length  $l$  is added between times  $n_0$  and  $n_1$  and thus the probability that the height (or the width) of the cluster is increased by  $l$  between  $n_0$  and  $n_1$ .

Notice that the lower bounds are consequences of the upper bounds and the fact that  $C_n$  contains  $n + 1$  particles.

DEFINITION. An **animal** is a non-empty finite set that can be obtained by a DDLA starting from  $(0, 0)$ .

LEMMA 3.4.2. *There is a constant  $c$  such that*

$$\forall F \Subset \mathbb{N}^2, F \text{ is an animal} \implies \mathbf{act}(F) \geq c \max(|\mathbf{d}|(F), \sqrt{\mathbf{h}(F)}).$$

*Proof.* First of all, we notice that

$$\mathbf{act}(F) = \sum_{P \in L_{\mathbf{h}(F)}} 2\mathbb{P}[\exists k \in \mathbb{N}, P + W_k \in F],$$

where  $(W_k)$  is a downward directed symmetric random walk. This is a consequence of the equivalence between the two constructions of DDLA in discrete time.

We will prove that there exists  $c \in \mathbb{R}_+^*$  such that for every animal  $F$  and every  $Q \in L_{\mathbf{h}(F)}$ ,

$$\mathbf{d}(Q) \in \left[-\sqrt{\mathbf{h}(F)}, 0\right] \implies \mathbb{P}[\exists k \in \mathbb{N}, Q + W_k \in F] > c.$$

Together with the first formula of the proof, this will imply that

$$\mathbf{act}(F) \geq c\sqrt{\mathbf{h}(F)}.$$

Let  $F$  be an animal and  $P \in F$  be such that  $\mathbf{h}(P) = \mathbf{h}(F)$ . By symmetry, we can assume that  $\mathbf{d}(P) \geq 0$ . Since  $F$  is an animal, for all  $Q \in L_{\mathbf{h}(F)}$  such that  $\mathbf{d}(Q) < \mathbf{d}(P)$ , we have the following inequality:

$$\mathbb{P}[\exists k \in \mathbb{N}, Q + W_k \in F] \geq \mathbb{P}[\mathbf{d}(Q + W_{\mathbf{h}(F)}) > 0].$$

Besides, if  $\mathbf{d}(Q) > -\sqrt{\mathbf{h}(F)}$ , then

$$\mathbb{P}[\mathbf{d}(Q + W_{\mathbf{h}(F)}) > 0] \geq \mathbb{P}\left[\tilde{W}_{\mathbf{h}(F)} > \sqrt{\mathbf{h}(F)}\right],$$

where  $(\tilde{W}_k)_k$  is the symmetric 1-dimensional random walk. The quantity in the right-hand side of this inequality is bounded from below by the Central Limit Theorem, implying half of the desired inequality.

Let  $P \in F$  be such that  $|\mathbf{d}(P)| = |\mathbf{d}(F)|$ . Since  $F$  is an animal, there exists  $A \subset F$  such that  $A$  is an animal,  $\mathbf{h}(P) = \mathbf{h}(A)$  and  $P \in A$ . It follows from  $(\star)$  that

$$F \subset F' \implies \mathbf{act}(F) \leq \mathbf{act}(F').$$

Thus, we just need to prove the result for  $A$ .

By symmetry, we can assume that  $\mathbf{d}(P) > 0$ . If  $Q \in L_{\mathbf{h}(A)}$  and  $\mathbf{d}(Q) \in [0, \mathbf{d}(P)]$ ,

$$\mathbb{P}[\exists k, Q + W_k \in A] \geq \mathbb{P}[\mathbf{d}(Q + W_{\mathbf{h}(A)}) > 0] \geq \frac{1}{2}.$$

This ends the proof of the lemma.  $\square$

Let  $(\mathbf{f}, \alpha)$  be  $(n \mapsto \mathbf{h}(A_n), \frac{1}{2})$  or  $(n \mapsto |\mathbf{d}|(A_n), 1)$ . We will prove that there exists almost surely  $k_0$  such that

$$\forall k > k_0, \forall l, 2^k \leq l \leq 2^{k+1} \implies \mathbf{f}(2^{k+1}) - \mathbf{f}(l) \leq \frac{2^{k+3}}{c\mathbf{f}(l)^\alpha} + 2^{k/2}.$$

We then conclude using the following ‘‘discrete Gronwall Lemma’’.

LEMMA 3.4.3. Let  $\alpha \in (0, 1]$ ,  $c \in \mathbb{R}_+^*$  and  $(a_n)_{n \in \mathbb{N}} \in \mathbb{N}^{\mathbb{N}}$ . Assume that  $\forall n, a_{n+1} - a_n \in [0, 1]$  and that there exists  $k_0$  such that

$$\forall k > k_0, \forall l, 2^k \leq l \leq 2^{k+1} \implies \frac{a_{2^{k+1}} - a_l}{2^k} \leq \frac{8}{c \cdot a_l^\alpha} + 2^{-k/2}.$$

Then, there exists some  $c_1$  depending only on  $(\alpha, c)$  such that, eventually,

$$a_n \leq c_1 n^{1/(\alpha+1)}.$$

Its proof is postponed to the end of the section.

Let  $(k, l)$  be such that  $2^k \leq l \leq 2^{k+1}$  and let us set  $m := \lfloor \frac{2^{k+3}}{c \cdot \mathbf{f}(l)^\alpha} + 2^{k/2} \rfloor$ . We are looking for an upper bound on  $\mathbb{P}[\mathbf{f}(2^{k+1}) - \mathbf{f}(l) > m]$  in order to apply the Borel-Cantelli Lemma.

DEFINITION. The path  $(P_1, \dots, P_n) \in (\mathbb{N}^2)^n$  is said to be **filled in order** if

- it is an upward directed path:  $\forall i, P_{i+1} - P_i \in \{(0, 1), (1, 0)\}$ ;
- all the  $P_i$  belong to the considered cluster;
- if  $i < j$ ,  $P_i$  is added to the cluster before  $P_j$ .

Assume that  $\mathbf{f}(2^{k+1}) - \mathbf{f}(l) > m$ . Let  $P$  be such that

$$\mathbf{f}(P) = \max_{Q \in C_{2^{k+1}}} \mathbf{f}(Q).$$

By construction of DDLA, there exists a path filled in order linking 0 to  $P$ . Taking its  $r$  last steps for a suitable value of  $r$ , we obtain a path  $\mathbf{P} = (P_1, \dots, P_r)$  that is filled in order (relative to  $C_{2^{k+1}}$ ) and such that  $P_r = P$  and  $\mathbf{f}(P_r) - \mathbf{f}(P_1) = m$ . In particular, there exists a path of length  $m$  —  $(P_1, \dots, P_m)$  — filled in order such that its sites are added to the cluster between times  $l$  and  $2^{k+1}$ .

The number of upward directed paths of length  $m$  starting in  $L_{\leq l}$  is

$$\frac{(l+1)(l+2)}{2} \cdot 2^m.$$

We now need to control, for such a path  $\mathbf{P} = (P_1, \dots, P_m)$ , the probability that it is filled in order between times  $l$  and  $2^{k+1}$ . More precisely, we extend  $\mathbf{P}$  to an infinite upward directed path and look for an upper bound on the probability that its first  $m$  sites are successfully added between times  $l$  and  $2^{k+1}$ . For  $n \in [l+1, 2^{k+1}]$ , assume that  $i = \min\{j \in \mathbb{N} : P_j \notin C_{n-1}\}$ . Let  $I_n$  be the event that  $P_i$  is the site added at time  $n$ . The probability we want to control is lower than  $\mathbb{P}\left[\sum_{n=l+1}^{2^{k+1}} I_n \geq m\right]$ .

We know, by Lemma 3.4.2, that  $\mathbb{P}[I_n | C_{n-1}] \leq \frac{1}{c \cdot \mathbf{f}(n-1)^\alpha}$ . By monotonicity of  $\mathbf{f}$ , this implies that, almost surely,

$$\sum_{n=l+1}^{2^{k+1}} \mathbb{P}[I_n | C_{n-1}] \leq \frac{2^k}{c \cdot \mathbf{f}(l)^\alpha}.$$

We now use the following exponential bound:

THEOREM 3.4.4 (THEOREM 4.B IN [FRE73]). *Let  $(\mathcal{F}_n)$  be a filtration. Let  $\tau$  be an  $(\mathcal{F}_n)$ -stopping time. Let  $(X_n)$  be a sequence of random variables such that*

*for every  $n$ ,  $X_n \in [0, 1]$  and  $X_n$  is  $\mathcal{F}_n$ -measurable.*

*Let  $M_n := \mathbb{E}[X_n | \mathcal{F}_{n-1}]$ . Let  $(a, b)$  be such that  $0 < b \leq a$ . Then,*

$$\mathbb{P} \left[ \sum_{n=1}^{\tau} X_n \geq a \text{ and } \sum_{n=1}^{\tau} M_n \leq b \right] \leq \left( \frac{b}{a} \right)^a e^{a-b}.$$

Applying this to  $I_n$  with  $\mathcal{F}_n := \sigma(C_0, \dots, C_n)$ ,  $a := m$ ,  $b := \frac{2^k}{c \cdot \mathbf{f}(l)^\alpha} \leq \frac{m}{8}$  and a constant stopping time, we obtain that the probability that there are at least  $m$  successful fillings through  $\mathbf{P}$  between times  $l$  and  $2^{k+1}$  is lower than  $(\frac{\epsilon}{8})^m$ .

Thus,

$$\begin{aligned} \mathbb{P}[\mathbf{f}(2^{k+1}) - \mathbf{f}(l) > m] &\leq \frac{(l+1)(l+2)}{2} \cdot 2^m \cdot \left(\frac{\epsilon}{8}\right)^m \\ &\leq (2^{k+1} + 2)^2 \cdot \left(\frac{\epsilon}{4}\right)^{2^{k/2}}. \end{aligned}$$

Since  $\sum_{k \geq 1} \sum_{l=2^{k+1}}^{2^{k+1}} (2^{k+1} + 2)^2 \cdot \left(\frac{\epsilon}{4}\right)^{2^{k/2}} < \infty$ , by the Borel-Cantelli Lemma and Lemma 3.4.3, the proposition is established.  $\square$

*Proof of lemma 3.4.3.* Take  $d_0$  such that  $(2^{1/(\alpha+1)} - 1) \cdot d_0 > \frac{8}{cd_0^\alpha} + 1$  and take  $c_1 > 2^{1+1/(\alpha+1)} d_0$ . For  $k > k_0$ ,

$$\begin{aligned} a_{2^k} \geq d_0 \cdot 2^{k/(\alpha+1)} &\implies a_{2^{k+1}} - a_{2^k} \leq \frac{8}{c} \cdot \frac{2^k}{d_0^\alpha \cdot 2^{k\alpha/(\alpha+1)}} + 2^{k/2} \\ &\implies a_{2^{k+1}} - a_{2^k} \leq \left(\frac{8}{cd_0^\alpha} + 1\right) \cdot 2^{k/(\alpha+1)} \\ &\implies a_{2^{k+1}} - a_{2^k} \leq d_0 \cdot 2^{(k+1)/(\alpha+1)} - d_0 \cdot 2^{k/(\alpha+1)}, \end{aligned}$$

where the last line results from the choice of  $d_0$ . Thus, there exists  $k_1 > k_0$  such that  $a_{2^{k_1}} \leq 2d_0 \cdot 2^{k_1/(\alpha+1)}$ .

If  $\forall k \geq k_1$ ,  $a_{2^k} > d_0 \cdot 2^{k/(\alpha+1)}$ , then the implication we have just proved shows that

$$\forall k > k_1, a_{2^k} - a_{2^{k_1}} \leq d_0 \cdot 2^{k/(\alpha+1)} - d_0 \cdot 2^{k_1/(\alpha+1)},$$

which implies that  $\forall k \geq k_1$ ,  $a_{2^k} \leq 2d_0 \cdot 2^{k/(\alpha+1)}$ . Since  $(a_n)_{n \in \mathbb{N}}$  is a non-decreasing sequence, we obtain

$$\forall m > 2^{k_1}, a_m \leq 2^{1+1/(\alpha+1)} \cdot d_0 \cdot m^{1/(\alpha+1)}.$$

Thus, we can assume that  $k_1$  is such that  $a_{2^{k_1}} \leq d_0 \cdot 2^{k_1/(\alpha+1)}$ . Assume that there exists  $k_2 > k_1$  such that  $a_{2^{k_2}} > d_0 \cdot 2^{k_2/(\alpha+1)}$ . Take a minimal such  $k_2$ .

By minimality, there exists some minimal  $l$  between  $2^{k_2-1} + 1$  and  $2^{k_2}$  such that  $a_{l-1} \leq d_0 \cdot (l-1)^{1/(\alpha+1)}$  and  $a_l > d_0 \cdot l^{1/(\alpha+1)}$ . Thus,

$$a_{2^{k_2}} - a_l \leq \frac{8}{c} \cdot \frac{2^{k_2-1}}{d_0^\alpha \cdot l^{\alpha/(\alpha+1)}} + 2^{(k_2-1)/2}$$

and, since  $a_l \leq a_{l-1} + 1$ ,

$$\begin{aligned} a_{2^{k_2}} &\leq d_0 \cdot (l-1)^{1/(\alpha+1)} + 1 + \frac{8}{c} \cdot \frac{2^{k_2-1}}{d_0^\alpha \cdot l^{\alpha/(\alpha+1)}} + 2^{(k_2-1)/2} \\ &\leq 2d_0 \cdot 2^{k_2/(\alpha+1)} + 1. \end{aligned}$$

In fact, we have proved that, for  $k \geq k_1$ ,

$$a_{2^k} \leq d_0 \cdot 2^{k/(\alpha+1)} \implies a_{2^{k+1}} \leq 2d_0 \cdot 2^{(k+1)/(\alpha+1)} + 1$$

and

$$\begin{aligned} a_{2^k} > d_0 \cdot 2^{k/(\alpha+1)} &\implies a_{2^k} \leq 2d_0 \cdot 2^{k/(\alpha+1)} + 1 \\ &\implies a_{2^{k+1}} \leq 2d_0 \cdot 2^{(k+1)/(\alpha+1)} + 1. \end{aligned}$$

This implies the proposition.  $\square$

We can deduce from this a version of Proposition 3.4.1 for the continuous-time model. Of course, we set  $\mathfrak{h}_t := \mathbf{h}(C_t)$  and  $\mathfrak{d}_t := |\mathbf{d}|(C_t)$ .

**FACT 3.4.5.** *For some constant  $d_1$ , almost surely, for every positive  $\varepsilon$ , eventually,*

$$(2 - \varepsilon)t \leq \mathfrak{h}_t \leq d_1 t$$

and

$$\frac{\sqrt{t}}{d_1} \leq \mathfrak{d}_t \leq d_1 t.$$

*Proof.* The quantities  $\mathfrak{h}_t$  and  $\mathfrak{d}_t$  grow at most linearly because continuous-time DDLA is stochastically dominated by First-Passage Percolation.

If the lower extremity of an edge is a highest point of the cluster, then the activity of this edge is 1. Consequently, if  $T_k$  is the first time when the cluster is of height  $k$ , then  $(T_{k+1} - T_k)_{k \in \mathbb{N}}$  is stochastically dominated by independent exponential random variables of parameter 2 (there exist at least 2 edges of lower extremity being a highest point of the cluster). This entails the at least linear growth of the height.

It results from this, the fact that discrete- and continuous-time DDLA define the same process and Proposition 3.4.1 that the number  $N(t)$  of particles in the cluster at time  $t$  satisfies, for some deterministic constant  $a$ ,

$$N(t) \geq at^{3/2},$$

almost surely eventually<sup>11</sup>. This implies that, a.s.e.  $\mathfrak{d}_t \geq \frac{N(t)^{1/3}}{c_1} \geq \frac{a^{1/3}}{c_1} \sqrt{t}$ .  $\square$

11. because  $N(t)$  goes to infinity when  $t$  tends to infinity.

### 3.5 The infinite cluster

NOTATION. In this section, we set

$$S_n := \{P \in \mathbb{Z}^2 : \|P\|_1 = n\} \text{ and } B_n := \{P \in \mathbb{Z}^2 : \|P\|_1 \leq n\}.$$

We call **elementary loop**

$$L := \{P \in \mathbb{Z}^2 : \|P\|_\infty = 1\}.$$

We start this section with a formal definition of (undirected) DLA.

Recall that if  $F \Subset \mathbb{Z}^2$ , the **harmonic measure** of  $F$  is the unique probability measure  $\mu_F$  such that the following holds:

Take any sequence  $(\nu_n)$  of probability measures on  $\mathbb{Z}^2$  satisfying

$$\forall G \Subset \mathbb{Z}^2, \exists n_G, \forall n \geq n_G, \nu_n(G) = 0.$$

Take  $W_n$  the symmetric (non-directed) nearest-neighbor random walk in  $\mathbb{Z}^2$ , starting at 0. Choose independently a starting point  $P$  according to  $\nu_n$ . If  $G$  is a non-empty subset of  $\mathbb{Z}^2$ , let

$$\tau(G) = \min\{k : W_k \in G\},$$

which is finite almost surely. Then,

$$\forall Q \in F, \mathbb{P}_n [P + W_{\tau(-P+F)} = Q] \xrightarrow{n \rightarrow \infty} \mu_F(\{Q\}).$$

In words,  $\mu_F$  measures the probability that a site in  $F$  is the first site of  $F$  to be touched by a walk launched from very far. For more information on the harmonic measure, see [Spi76].

There are several equivalent<sup>12</sup> definitions of DLA. The setting that will be convenient in this section is the following. The first cluster is  $C_0 := \{(0,0)\} \subset B_0$ . Assume that the first  $n$  clusters have been built and are subsets of  $B_n$ . Independently of all the choices made so far, choose a point  $P$  in  $S_{n+2}$  according to  $\mu_{S_{n+2}}$ . Throw a symmetric random walk  $(P+W_k)_{k \in \mathbb{N}}$  starting at  $P$  and set

$$C_{n+1} := \{P + W_{\tau(-P+C_n)-1}\} \cup C_n \subset B_{n+1}.$$

We call this process **Diffusion-Limited Aggregation**.<sup>13</sup>

The following fact about  $C_\infty := \bigcup_n C_n$  is well-known.

12. The equivalences between the following definition and the natural definitions you may think of boil down to the definition of harmonic measure and strong Markov Property for random walks.

13. The process consisting in adding a site with probability proportional to its harmonic measure relative to  $\{P \notin C_n : \exists Q \in C_n, \|P - Q\|_1 = 1\}$  is very similar to this process, but not equal to it in distribution.



FACT 3.5.1. *There is some  $\varepsilon > 0$  such that for all  $P \in \mathbb{Z}^2$ ,  $\mathbb{P}[P \notin C_\infty] \geq \varepsilon$ .*

*Proof.* Let  $P \in \mathbb{Z}^2$ . We consider our evolution temporally: we launch the first particle, look at it step after step until it sticks, before launching the second particle. . . A step is said to be **critical** if the current particle is at distance 1 from  $P$  and  $P$  is at distance 1 from the current cluster.

We wait for a critical step (we may wait forever). Conditionally on the fact that such a step exists, with probability  $4^{-7}$ , the particle tries — immediately after the first critical step — to visit all the points of  $P + L$ , say clockwise<sup>14</sup>. Since the step is critical and  $L$  has cardinality 8, the particle must stick to some particle of the cluster and the cardinality of  $(P + L) \cap C_{\text{current time}}$  is increased by 1. Doing so at the first 8 critical steps that occur<sup>15</sup> prevents  $P$  from being added to the cluster. The fact thus holds for  $\varepsilon := 4^{-7 \times 8}$ .  $\square$

Such a proof cannot work for the directed version of DLA. Indeed, take a site  $P$  with a neighbor belonging to the cluster. Even assuming that there are enough particles coming in the neighborhood of  $P$ , one cannot always surround  $P$  by modifying a finite number of steps: for example,  $(2, 0)$  will never be added to the cluster before  $(1, 0)$  if one considers a DDLA launched from  $(0, 0)$ . The screening effect of the particles above it can be very strong, but will never reduce its activity to 0.

However, we can prove the following proposition.

PROPOSITION 3.5.2. *Consider a DDLA starting from  $\{(0, 0)\}$ . With positive probability, the site  $(1, 0)$  is never added to the cluster.*

*Proof.* With positive probability, the first vertex to be added is  $(0, 1)$ . Denote by  $X_t$  the maximal first coordinate of an element of  $\mathbb{N} \times \{1\}$  that belongs to the cluster at time  $t$ . At time  $t$ , the activity of  $(1, 0)$  is at most  $2^{1-X_t}$  times the activity of  $(X_t + 1, 1)$ . (To see this inequality, map a directed random walk  $W$  launched at  $(1, 0)$  that takes its first  $X_t$  steps to the left to the random walk launched at  $(X_t + 1, 1)$  that merges with  $W$  as soon as  $W$  enters  $\mathbb{N} \times \{1\}$ .) Thus, conditionally on the fact that  $(n, 1)$  is added to the cluster before  $(1, 0)$ , the probability that  $(1, 0)$  is added to the cluster before  $(n + 1, 1)$  is at most  $2^{-n}$ . Since  $\prod_{n \geq 1} (1 - 2^{-n})$  is positive, Proposition 3.5.2 is established.  $\square$

COROLLARY 3.5.3. *Consider a DDLA starting from  $\{(0, 0)\}$ . Almost surely, for every  $n \in \mathbb{N}$ , only finitely many points of  $\mathbb{N} \times \{n\}$  are added to the cluster.*

14. By this, we mean that the following 7 steps that the particle would take if it was not hindered by the cluster are the ones making it visit  $P + L$  clockwise.

15. which means at every critical step if there are less than 8 of them  
By “the first 8 critical steps”, we mean the first critical step (which occurs for the  $k_1^{\text{th}}$  particle), the first critical step of a particle different from the  $k_1^{\text{th}}$  one, and so on up to 8.

NOTATION. Recall that for  $b \in \mathbb{R}_+^*$ , we set  $\mathcal{C}_b := r_{-\pi/4}(\{(x, y) \in \mathbb{R}^2 : |y| \geq b|x|\})$ .

FACT 3.5.4. Consider a DDLA starting from  $C \neq \emptyset$ . Let

$$C_\infty := \bigcup_{t \geq 0} C_t.$$

Then, almost surely, for all  $P \in \mathbb{Z}^2$ , for all  $b > 0$ ,  $C_\infty \cap (P + \mathcal{C}_b)$  is infinite.

*Proof.* Notice that it is enough to prove the fact with “non-empty” instead of “infinite”.

There is an increasing path  $\mathbf{P} = (P_1, \dots, P_n)$  going from a point of  $C$  to a point in  $P + \mathcal{C}_b$ . The conic structure and the law of large numbers guarantee that the activity of  $P_n$  is bounded away from 0 (say larger than  $c > 0$ ) as long as  $P + \mathcal{C}_b = \emptyset$  (which we now assume).

Thus, if  $k(t) := \max\{i : P_i \in C_t\}$  and if  $k(t) < n$ , then  $P_{k(t)+1}$  will be added at rate at least  $2^{n-k(t)}c > 0$ . Indeed, a walk can reach  $P_n$  from  $P_{k+1}$  by using  $\mathbf{P}$ ; then, from  $P_n$ , it escapes with probability  $c$ . Consequently,  $k(t)$  will almost surely take a finite time to increase its value, as long  $k(t) < n$ . Thus  $k(\infty) = n$ , and Fact 3.5.4 is established.  $\square$

Let us conclude with a couple of questions.

QUESTION 3.5.5. For which values of  $b$  does it hold that the infinite DDLA cluster is almost surely a subset of  $\mathcal{C}_b$  up to finitely many points?

QUESTION 3.5.6. What is the distribution of the number of ends of the infinite DDLA cluster?



# Bibliographie

- [AABK09] G. AMIR, O. ANGEL, I. BENJAMINI et G. KOZMA, *One-dimensional long-range diffusion-limited aggregation I*, 2009. ArXiv : 0910.4416.
- [AAK13] G. AMIR, O. ANGEL et G. KOZMA, *One-dimensional long-range diffusion limited aggregation II: the transient case*, 2013. ArXiv : 1306.4654.
- [Ada90] S. ADAMS, *Trees and amenable equivalence relations*, Ergodic Theory Dynam Systems, 10 (1), p. 1–14, 1990.
- [AG91] M. AIZENMAN et G. GRIMMETT, *Strict monotonicity for critical points in percolation and ferromagnetic models*, Journal of Statistical Physics, 63 (5-6), p. 817–835, 1991.
- [Ami09] G. AMIR, *One-dimensional long-range diffusion-limited aggregation III: the limit aggregate*, 2009. ArXiv : 0911.0122.
- [Ang03] O. ANGEL, *Growth and percolation on the uniform infinite planar triangulation*, Geometric & Functional Analysis GAFA, 13 (5), p. 935–974, 2003.
- [Arr79] R. ARRATIA, *Brownian motion on the line*, Thèse de doctorat, PhD dissertation, Univ. Wisconsin, Madison, 1979.
- [AS03] O. ANGEL et O. SCHRAMM, *Uniform infinite planar triangulations*, Comm Math Phys, 241 (2-3), p. 191–213, 2003.
- [AV08] T. ANTUNOVIĆ et I. VESELIĆ, *Sharpness of the phase transition and exponential decay of the subcritical cluster size for percolation on quasi-transitive graphs*, Journal of Statistical Physics, 130 (5), p. 983–1009, 2008.
- [Bab97] L. BABAI, *The growth rate of vertex-transitive planar graphs*, dans *Proceedings of the eighth annual ACM-SIAM symposium on Discrete algorithms*, p. 564–573, Society for Industrial and Applied Mathematics, 1997.
- [BB84] R. BRADY et R. BALL, *Fractal growth of copper electrodeposits*, Nature, 309, p. 225–229, 1984.
- [BB99] E. BABSON et I. BENJAMINI, *Cut sets and normed cohomology with applications to percolation*, Proceedings of the American Mathematical Society, 127 (2), p. 589–597, 1999.
- [BDC13] V. BEFFARA et H. DUMINIL-COPIN, *Planar percolation with a glimpse of Schramm–Loewner evolution*, Probability Surveys, 10, p. 1–50, 2013.
- [BdLHV08] B. BEKKA, P. DE LA HARPE et A. VALETTE, *Kazhdan’s property (T)*, Cambridge University Press, 2008.

- [Ben] I. BENJAMINI, *Euclidean vs. Graph Metric*. To appear in Erdős Centennial (Bolyai Society Mathematical Studies).
- [Ben13] I. BENJAMINI, *Coarse Geometry and Randomness*, Lecture Notes in Mathematics, tome 2100, Springer, 2013.
- [BGN91a] D. BARSKY, G. GRIMMETT et C. NEWMAN, *Dynamic renormalization and continuity of the percolation transition in orthants*, dans *Spatial Stochastic Processes*, p. 37–55, Springer, 1991.
- [BGN91b] D. BARSKY, G. GRIMMETT et C. NEWMAN, *Percolation in half-spaces: equality of critical densities and continuity of the percolation probability*, *Probability Theory and Related Fields*, 90 (1), p. 111–148, 1991.
- [BK89] R. BURTON et M. KEANE, *Density and uniqueness in percolation*, *Comm Math Phys*, 121 (3), p. 501–505, 1989.
- [BKP12] N. BERGER, J. KAGAN et E. PROCACCIA, *Stretch IDLA*, 2012. ArXiv : 1209.3112.
- [Bla77] A. BLASS, *A model without ultrafilters*, *Bull Acad Polon Sci Sér Sci Math Astronom Phys*, 25 (4), p. 329–331, 1977.
- [BLPS99a] I. BENJAMINI, R. LYONS, Y. PERES et O. SCHRAMM, *Critical percolation on any nonamenable group has no infinite clusters*, *Ann Probab*, 27 (3), p. 1347–1356, 1999.
- [BLPS99b] I. BENJAMINI, R. LYONS, Y. PERES et O. SCHRAMM, *Group-invariant percolation on graphs*, *Geom Funct Anal*, 9 (1), p. 29–66, 1999.
- [BN14] N. BERESTYCKI et J. NORRIS, *Lectures on Schramm–Loewner Evolution*, 2014.
- [BNP11] I. BENJAMINI, A. NACHMIAS et Y. PERES, *Is the critical percolation probability local?*, *Probab Theory Related Fields*, 149 (1-2), p. 261–269, 2011.
- [Bod05] T. BODINEAU, *Slab percolation for the Ising model*, *Probab Theory Related Fields*, 132 (1), p. 83–118, 2005.
- [BR06] B. BOLLOBAS et O. RIORDAN, *Percolation*, Cambridge University Press, 2006.
- [BS84] R. BRADLEY et P. STRENSKI, *Directed diffusion-limited aggregation on the Bethe lattice: Exact results*, *Phys Rev B*, 30, p. 6788–6790, 1984.
- [BS85] R. BRADLEY et P. STRENSKI, *Directed aggregation on the Bethe lattice: Scaling, mappings, and universality*, *Phys Rev B*, 31, p. 4319–4328, 1985.
- [BS96] I. BENJAMINI et O. SCHRAMM, *Percolation beyond  $\mathbf{Z}^d$ , many questions and a few answers*, *Electron Comm Probab*, 1, p. 71–82, 1996.
- [BS01a] I. BENJAMINI et O. SCHRAMM, *Percolation in the hyperbolic plane*, *Journal of the American Mathematical Society*, 14 (2), p. 487–507, 2001.
- [BS01b] I. BENJAMINI et O. SCHRAMM, *Recurrence of distributional limits of finite planar graphs*, *Electron J Probab*, 6 (23), p. 1–13, 2001.
- [BT24] S. BANACH et A. TARSKI, *Sur la décomposition des ensembles de points en parties respectivement congruentes*, *Fund math*, 6 (1), p. 244–277, 1924.

- [BY08] I. BENJAMINI et A. YADIN, *Diffusion limited aggregation on a cylinder*, Comm Math Phys, 279 (1), p. 187–223, 2008.
- [Car40] H. CARTAN, *Sur la mesure de Haar*, CR Acad Sci Paris, 211, p. 759–762, 1940.
- [CFW81] A. CONNES, J. FELDMAN et B. WEISS, *An amenable equivalence relation is generated by a single transformation*, Ergodic Theory Dynamical Systems, 1 (4), p. 431–450, 1981.
- [CI10] I. CHIFAN et A. IOANA, *Ergodic subequivalence relations induced by a Bernoulli action*, Geom Funct Anal, 20 (1), p. 53–67, 2010.
- [CM02] L. CARLESON et N. MAKAROV, *Laplacian path models*, J Anal Math, 87, p. 103–150, 2002. Dedicated to the memory of Thomas H. Wolff.
- [Con79] A. CONNES, *Sur la théorie non commutative de l'intégration*, dans *Algèbres d'opérateurs (Sém., Les Plans-sur-Bex, 1978)*, Lecture Notes in Math., tome 725, p. 19–143, Springer, Berlin, 1979.
- [DC13] H. DUMINIL-COPIN, *Parafermionic observables and their applications to planar statistical physics models*, Ensaios Matemáticos, 25, p. 1–371, 2013.
- [DCST14] H. DUMINIL-COPIN, V. SIDORAVICIUS et V. TASSION, *Absence of infinite cluster for critical Bernoulli percolation on slabs*, 2014. ArXiv : 1401.7130.
- [DF91] P. DIACONIS et W. FULTON, *A growth model, a game, an algebra, Lagrange inversion, and characteristic classes*, Rend Sem Mat Univ Politec Torino, 49 (1), p. 95–119, 1991. Commutative algebra and algebraic geometry, II (Turin, 1990).
- [DK] C. DRUTU et M. KAPOVICH, *Lectures on Geometric Group Theory*. [www.math.ucdavis.edu/~kapovich/EPR/ggt.pdf](http://www.math.ucdavis.edu/~kapovich/EPR/ggt.pdf).
- [dlH00] P. DE LA HARPE, *Topics in geometric group theory*, Chicago Lectures in Mathematics, University of Chicago Press, Chicago, IL, 2000.
- [dlH04] P. DE LA HARPE, *Mesures finiment additives et paradoxes*, Panoramas et Synthèses, 18, p. 39–61, 2004.
- [dLSS11] B. DE LIMA, R. SANCHIS et R. SILVA, *Critical point and percolation probability in a long range site percolation model on  $\mathbf{Z}^d$* , Stochastic Process Appl, 121 (9), p. 2043–2048, 2011.
- [Dye59] H. DYE, *On groups of measure preserving transformation I*, Amer J Math, 81, p. 119–159, 1959.
- [Efr53] V. EFREMOVIC, *The proximity geometry of Riemannian manifolds*, Uspekhi Mat Nauk, 8 (5), p. 57, 1953.
- [EFW12] A. ESKIN, D. FISHER et K. WHYTE, *Coarse differentiation of quasi-isometries. I: Spaces not quasi-isometric to Cayley graphs*, Ann Math, 176 (1), p. 221–260, 2012.
- [EW99] D. EBERZ-WAGNER, *Discrete Growth Models*, Thèse de doctorat, University of Washington, 1999. ArXiv : math.PR/9908030.
- [FINR04] L. FONTES, M. ISOPI, C. NEWMAN et K. RAVISHANKAR, *The Brownian web: characterization and convergence*, Ann Probab, 32 (4), p. 2857–2883, 2004.

- [Fit13] R. FITZNER, *Non-backtracking lace expansion (the NoBLE project)*, Thèse de doctorat, Eindhoven University of Technology, 2013.
- [FM75] J. FELDMAN et C. MOORE, *Ergodic equivalence relations, cohomology, and von Neumann algebras*, Bull Amer Math Soc, 81 (5), p. 921–924, 1975.
- [Føl55] E. FØLNER, *On groups with full Banach mean value*, Mathematica Scandinavica, 3, p. 243–254, 1955.
- [Fre73] D. FREEDMAN, *Another note on the Borel-Cantelli lemma and the strong law, with the Poisson approximation as a by-product*, Ann Probability, 1, p. 910–925, 1973.
- [Gab00] D. GABORIAU, *Coût des relations d'équivalence et des groupes*, Invent Math, 139 (1), p. 41–98, 2000.
- [Gab05] D. GABORIAU, *Invariant percolation and harmonic Dirichlet functions*, Geom Funct Anal, 15 (5), p. 1004–1051, 2005.
- [Gab10] D. GABORIAU, *Orbit equivalence and measured group theory*, dans *Proceedings of the International Congress of Mathematicians. Volume III*, p. 1501–1527, Hindustan Book Agency, New Delhi, 2010.
- [Gal79] D. GALE, *The game of Hex and the Brouwer fixed-point theorem*, American Mathematical Monthly, p. 818–827, 1979.
- [GdlH90] E. GHYS et P. DE LA HARPE, *Sur les groupes hyperboliques d'après Mikhael Gromov, vol. 83 of Progress in Mathematics*, 1990.
- [Ghy95] E. GHYS, *Topologie des feuilles génériques*, Ann of Math (2), 141 (2), p. 387–422, 1995.
- [Ghy04] E. GHYS, *Groupes aléatoires (d'après Misha Gromov, . . .)*, Astérisque, (294), p. 173–204, 2004.
- [GKN92] A. GANDOLFI, M. KEANE et C. NEWMAN, *Uniqueness of the infinite component in a random graph with applications to percolation and spin glasses*, Probab Theory Related Fields, 92 (4), p. 511–527, 1992.
- [GLa] G. GRIMMETT et Z. LI, *Locality of connective constants, I. Transitive graphs*. ArXiv :1412.0150.
- [GLb] G. GRIMMETT et Z. LI, *Locality of connective constants, II. Cayley graphs*. ArXiv :1501.00476.
- [GL09] D. GABORIAU et R. LYONS, *A measurable-group-theoretic solution to von Neumann's problem*, Invent Math, 177 (3), p. 533–540, 2009.
- [GM90] G. GRIMMETT et J. MARSTRAND, *The supercritical phase of percolation is well behaved*, Proc Roy Soc London Ser A, 430 (1879), p. 439–457, 1990.
- [GN90] G. GRIMMETT et C. NEWMAN, *Percolation in  $\infty + 1$  dimensions*, Disorder in physical systems, p. 167–190, 1990.
- [Gri83] R. GRIGORCHUK, *On the Milnor problem of group growth*, Dokl Akad Nauk SSSR, 271 (1), p. 30–33, 1983.
- [Gri84] R. GRIGORCHUK, *Degrees of growth of finitely generated groups and the theory of invariant means*, Izv Akad Nauk SSSR Ser Mat, 48 (5), p. 939–985, 1984.

- [Gri99] G. GRIMMETT, *Percolation*, Grundlehren der Mathematischen Wissenschaften, tome 321, deuxième édition, Springer-Verlag, Berlin, 1999.
- [Gri06] G. R. GRIMMETT, *The random-cluster model*, tome 333, Springer, 2006.
- [Gro81] M. GROMOV, *Groups of polynomial growth and expanding maps*, Publications Mathématiques de l’IHES, 53 (1), p. 53–78, 1981.
- [Gro84] M. GROMOV, *Infinite groups as geometric objects*, dans *Proceedings of the International Congress of Mathematicians*, tome 1, p. 2, 1984.
- [Gro96] M. GROMOV, *Geometric group theory, Vol. 2: Asymptotic invariants of infinite groups*, Bull Amer Math Soc, 33, p. 0273–0979, 1996.
- [GS+98] G. GRIMMETT, A. STACEY ET AL., *Critical probabilities for site and bond percolation models*, The Annals of Probability, 26 (4), p. 1788–1812, 1998.
- [Hag97] O. HAGGSTROM, *Infinite clusters in dependent automorphism invariant percolation on trees*, The Annals of Probability, p. 1423–1436, 1997.
- [Häg01] O. HÄGGSTRÖM, *Coloring percolation clusters at random*, Stochastic processes and their applications, 96 (2), p. 213–242, 2001.
- [Hal73] R. HALIN, *Automorphisms and endomorphisms of infinite locally finite graphs*, dans *Abhandlungen aus dem Mathematischen Seminar der Universität Hamburg*, tome 39, p. 251–283, Springer, 1973.
- [Ham57] J. HAMMERSLEY, *Percolation processes: II. The connective constant*, dans *Proc. Cambridge Philos. Soc*, tome 53, p. 642–645, 1957.
- [Ham59] J. HAMMERSLEY, *Bornes supérieures de la probabilité critique dans un processus de filtration*, Le Calcul des Probabilités et ses Applications, CNRS, Paris, p. 17–37, 1959.
- [Har60] T. HARRIS, *A lower bound for the critical probability in a certain percolation process*, dans *Mathematical Proceedings of the Cambridge Philosophical Society*, tome 56, p. 13–20, Cambridge Univ Press, 1960.
- [HB57] J. HAMMERSLEY et S. BROADBENT, *Percolation processes: I. Crystals and mazes*, dans *Proc. Cambridge Philos. Soc*, tome 53, p. 629–641, 1957.
- [HP99] O. HÄGGSTRÖM et Y. PERES, *Monotonicity of uniqueness for percolation on Cayley graphs: all infinite clusters are born simultaneously*, Probab Theory Related Fields, 113 (2), p. 273–285, 1999.
- [HPS99] O. HÄGGSTRÖM, Y. PERES et R. SCHONMANN, *Percolation on transitive graphs as a coalescent process: Relentless merging followed by simultaneous uniqueness*, dans *Perplexing problems in probability*, p. 69–90, Springer, 1999.
- [HS90] T. HARA et G. SLADE, *Mean-field critical behaviour for percolation in high dimensions*, Comm Math Phys, 128 (2), p. 333–391, 1990.
- [HS95] T. HARA et G. SLADE, *The self-avoiding-walk and percolation critical points in high dimensions*, Combinatorics, Probability and Computing, 4 (03), p. 197–215, 1995.
- [Hun14] S. HUNEKE, *An Inductive Proof of Hex Uniqueness*, The American Mathematical Monthly, 121 (1), p. 78–80, 2014.



- [IKT08] A. IOANA, A. KECHRIS et T. TSANKOV, *Subequivalence relations and positive-definite functions*, 2008. Arxiv : 0806.0430.
- [JKL02] S. JACKSON, A. KECHRIS et A. LOUVEAU, *Countable Borel equivalence relations*, J Math Log, 2 (1), p. 1–80, 2002.
- [Jun81] H. JUNG, *A note on fragments of infinite graphs*, Combinatorica, 1 (3), p. 285–288, 1981.
- [Kec95] A. KECHRIS, *Classical descriptive set theory*, Graduate Texts in Mathematics, tome 156, Springer-Verlag, New York, 1995.
- [Kes80] H. KESTEN, *The critical probability of bond percolation on the square lattice equals 1/2*, Communications in mathematical physics, 74 (1), p. 41–59, 1980.
- [Kes82] H. KESTEN, *Percolation theory for mathematicians*, Springer, 1982.
- [Kes86] H. KESTEN, *Aspects of first passage percolation*, dans *École d'été de probabilités de Saint-Flour, XIV—1984*, Lecture Notes in Math., tome 1180, p. 125–264, Springer, Berlin, 1986.
- [Kes87] H. KESTEN, *How long are the arms in DLA?*, J Phys A, 20 (1), p. L29–L33, 1987.
- [Kle10] B. KLEINER, *A new proof of Gromov's theorem on groups of polynomial growth*, Journal of the American Mathematical Society, 23 (3), p. 815–829, 2010.
- [KM04] A. KECHRIS et B. MILLER, *Topics in orbit equivalence*, Lecture Notes in Mathematics, tome 1852, Springer-Verlag, Berlin, 2004.
- [LBG92] G. LAWLER, M. BRAMSON et D. GRIFFEATH, *Internal diffusion limited aggregation*, Ann Probab, 20 (4), p. 2117–2140, 1992.
- [Len20] W. LENZ, *Beiträge zum Verständnis der magnetischen Eigenschaften in festen Körpern*, Physikalische Zeitschrift, 21, p. 613–615, 1920.
- [Lev93] G. LEVITT, *La dynamique des pseudogroupes de rotations*, Invent Math, 113 (3), p. 633–670, 1993.
- [LS11] R. LYONS et O. SCHRAMM, *Indistinguishability of percolation clusters*, dans *Selected works of Oded Schramm. Volume 1, 2*, Sel. Works Probab. Stat., p. 701–728, Springer, New York, 2011.
- [Lyo90] R. LYONS, *Random walks and percolation on trees*, Ann Probab, 18 (3), p. 931–958, 1990.
- [Lyo00] R. LYONS, *Phase transitions on nonamenable graphs*, J Math Phys, 41 (3), p. 1099–1126, 2000. Probabilistic techniques in equilibrium and nonequilibrium statistical physics.
- [LP] R. LYONS avec Y. PERES, *Probability on trees and networks*, Cambridge University Press, en préparation. Version actuelle disponible sur la page de R. Lyons : <http://mypage.iu.edu/~rdlyons/>.
- [M<sup>+</sup>68] J. MILNOR ET AL., *A note on curvature and fundamental group*, Journal of Differential geometry, 2 (1), p. 1–7, 1968.
- [Maj03] S. MAJUMDAR, *Traveling front solutions to directed diffusion-limited aggregation, digital search trees, and the Lempel-Ziv data compression algorithm*, Physical Review E, 68 (2), p. 026 103, 2003.

- [Mara] S. MARTINEAU, *Directed Diffusion-Limited Aggregation*. ArXiv : 1411.3667.
- [Marb] S. MARTINEAU, *Ergodicity and indistinguishability in percolation theory*. ArXiv : 1210.1548.
- [MP01] R. MUCHNIK et I. PAK, *Percolation on Grigorchuk groups*, 2001.
- [MT] S. MARTINEAU et V. TASSION, *Locality of percolation for abelian Cayley graphs*. ArXiv : 1312.1946.
- [MvN36] F. MURRAY et J. VON NEUMANN, *On rings of operators*, Ann of Math (2), 37 (1), p. 116–229, 1936.
- [Ol'80] A. OL'SHANSKII, *On the problem of the existence of an invariant mean on a group*, Russian Mathematical Surveys, 35 (4), p. 180–181, 1980.
- [Pei36] R. PEIERLS, *On Ising's model of ferromagnetism*, dans *Mathematical Proceedings of the Cambridge Philosophical Society*, tome 32, p. 477–481, Cambridge Univ Press, 1936.
- [Per00] Y. PERES, *Percolation on nonamenable products at the uniqueness threshold*, dans *Annales de l'Institut Henri Poincaré (B) Probability and Statistics*, tome 36, p. 395–406, Elsevier, 2000.
- [Pet13] G. PETE, *Probability and geometry on groups*, 2013.
- [Pie84] J.-P. PIER, *Amenable locally compact groups*, Wiley New York, 1984.
- [Pop07] S. POPA, *Deformation and rigidity for group actions and von Neumann algebras*, dans *International Congress of Mathematicians. Vol. I*, p. 445–477, Eur. Math. Soc., Zürich, 2007.
- [PPS06] Y. PERES, G. PETE et A. SCOLNICOV, *Critical percolation on certain nonunimodular graphs*, New York J Math, 12, p. 1–18, 2006.
- [PS77] D. PINCUS et R. SOLOVAY, *Definability of measures and ultrafilters*, J Symbolic Logic, 42 (2), p. 179–190, 1977.
- [PSN00] I. PAK et T. SMIRNOVA-NAGNIBEDA, *On non-uniqueness of percolation on nonamenable Cayley graphs*, C R Acad Sci Paris Sér I Math, 330 (6), p. 495–500, 2000.
- [Sab58] G. SABIDUSSI, *On a class of fixed-point-free graphs*, Proceedings of the American Mathematical Society, 9 (5), p. 800–804, 1958.
- [SB84] B. SHRAIMAN et D. BENSIMON, *Singularities in nonlocal interface dynamics*, Phys Rev A, 30, p. 2840–2842, 1984.
- [Sch79] G. SCHLICHTING, *Polynomidentitäten und permutatonsdarstellungen lokalkompakter gruppen*, Inventiones mathematicae, 55 (2), p. 97–106, 1979.
- [Sch81] K. SCHMIDT, *Amenability, Kazhdan's property T, strong ergodicity and invariant means for ergodic group-actions*, Ergodic Theory Dynamical Systems, 1 (2), p. 223–236, 1981.
- [Sch99] R. SCHONMANN, *Stability of infinite clusters in supercritical percolation*, Probability Theory and Related Fields, 113 (2), p. 287–300, 1999.
- [Sep00] T. SEPPÄLÄINEN, *Strong law of large numbers for the interface in ballistic deposition*, Ann Inst H Poincaré Probab Statist, 36 (6), p. 691–736, 2000.

- [Smi01] S. SMIRNOV, *Critical percolation in the plane: Conformal invariance, Cardy's formula, scaling limits*, Comptes Rendus de l'Académie des Sciences-Series I-Mathematics, 333 (3), p. 239–244, 2001.
- [Špa09] I. ŠPAKULOVÁ, *Critical percolation of virtually free groups and other tree-like graphs*, The Annals of Probability, p. 2262–2296, 2009.
- [Spi76] F. SPITZER, *Principles of random walk*, Graduate Texts in Mathematics, tome 34, deuxième édition, Springer-Verlag, New York-Heidelberg, 1976.
- [ST10] Y. SHALOM et T. TAO, *A finitary version of Gromov's polynomial growth theorem*, Geometric and Functional Analysis, 20 (6), p. 1502–1547, 2010.
- [Sta68] J. STALLINGS, *On torsion-free groups with infinitely many ends*, Annals of Mathematics, p. 312–334, 1968.
- [Šva55] A. ŠVARC, *A volume invariant of coverings*, dans *Dokl. Akad. Nauk SSSR (NS)*, tome 105, p. 32–34, 1955.
- [SW78] R. SMYTHE et J. WIERMAN, *First-passage percolation on the square lattice*, Lecture Notes in Mathematics, tome 671, Springer, Berlin, 1978.
- [SW90] P. SOARDI et W. WOESS, *Amenability, unimodularity, and the spectral radius of random walks on infinite graphs*, Mathematische Zeitschrift, 205 (1), p. 471–486, 1990.
- [Tas14] V. TASSION, *Planarité et localité en percolation*, Thèse de doctorat, Ecole Normale supérieure de Lyon, 2014.
- [Tex] A. TEXEIRA, *Percolation and local isoperimetric inequalities*. ArXiv : 1409.5923.
- [Tho] A. THOM, *A remark about the spectral radius*. To appear in International Mathematics Research Notices. ArXiv : 1306.1767.
- [Tim06] Á. TIMÁR, *Percolation on nonunimodular transitive graphs*, Ann Probab, 34 (6), p. 2344–2364, 2006.
- [Tim07] Á. TIMÁR, *Cutsets in infinite graphs*, Combinatorics, Probability and Computing, 16 (01), p. 159–166, 2007.
- [Tro85] V. TROFIMOV, *Automorphism groups of graphs as topological groups*, Mathematical Notes, 38 (3), p. 717–720, 1985.
- [TW98] B. TÓTH et W. WERNER, *The true self-repelling motion*, Probability Theory and Related Fields, 111 (3), p. 375–452, 1998.
- [Vel09] Y. VELENIK, *Le modèle d'Ising*, 2009.
- [Vic92] T. VICSEK, *Fractal Growth Phenomena*, deuxième édition, World Scientific, 1992.
- [vN29] J. VON NEUMANN, *Zur allgemeinen Theorie der Massen*, Fundamenta Mathematicae, 13, p. 73–116, 1929.
- [Wer09] W. WERNER, *Percolation et modèle d'Ising*, Soc. Math. de France, 2009.
- [Woe00] W. WOESS, *Random walks on infinite graphs and groups*, tome 138, Cambridge university press, 2000.

- [Woe05] W. WOESS, *Lamplighters, Diestel–Leader graphs, random walks, and harmonic functions*, *Combinatorics, Probability and Computing*, 14 (03), p. 415–433, 2005.
- [Woo94] D. WOOD, *Average and probability, problem 5*, *The American Mathematical Monthly*, 1, p. 211–212, 1894.
- [WS81] T. WITTEN et L. SANDER, *Diffusion-Limited Aggregation, a Kinetic Critical Phenomenon*, *Phys Rev Lett*, 47, p. 1400–1403, 1981.