



HAL
open science

Proxemic interaction and migratable user interface : applied to smart city

Huiliang Jin

► **To cite this version:**

Huiliang Jin. Proxemic interaction and migratable user interface : applied to smart city. Other. Ecole Centrale de Lyon, 2014. English. NNT : 2014ECDL0027 . tel-01127427

HAL Id: tel-01127427

<https://theses.hal.science/tel-01127427v1>

Submitted on 7 Mar 2015

HAL is a multi-disciplinary open access archive for the deposit and dissemination of scientific research documents, whether they are published or not. The documents may come from teaching and research institutions in France or abroad, or from public or private research centers.

L'archive ouverte pluridisciplinaire **HAL**, est destinée au dépôt et à la diffusion de documents scientifiques de niveau recherche, publiés ou non, émanant des établissements d'enseignement et de recherche français ou étrangers, des laboratoires publics ou privés.

Thèse de l'Université de Lyon

Proxemic Interaction and Migratable User Interface: applied to Smart City

Pour l'obtention du titre de
Docteur de l'Ecole Centrale de Lyon

Ecole Doctorale
Informatique et Mathématique

Spécialité
Informatique

Par

JIN HUILIANG

Soutenue publiquement le 15 Octobre 2014, devant la commission d'examen :

Christophe KOLSKI	Professeur-Université de Valenciennes	Rapporteur
Patrick GIRARD	Professeur-Université de Poitiers	Rapporteur
Franck TAPPIN-BERNARD	Professeur-UJF Grenoble 1	Examineur
Bertrand DAVID	Professeur-Ecole Centrale de Lyon	Directeur
René CHALON	Maître de Conférence-Ecole Centrale de Lyon	Co-directeur

Acknowledgements

Three years ago, I came into France to begin my PhD study in laboratory LIRIS. During the three years, it's my great honor to work under the guidance of Prof. Bertrand David and Prof. René CHALON. Without them, I cannot finish my study successfully.

My supervisor Prof Bertrand DAVID gave me a chance to work in this lab when I was refused by my last application because of some procedure reasons. He saved me from the hardest time at the beginning. I have not studied the human computer interaction before the PhD, it is Bertrand introduced me to this domain, just like open a gate of new world to me. I am gradually got familiar with this domain, and at last I decided to make HCI as my future career. I owe to Prof David for his hard working for redaction of my papers, for preparing documents of my routine study and many other things. He is a very sympathetic and responsible gentleman and I am so lucky to be his student. He gave me chance to attend international conferences and broad my knowledge of the academic activities in the world.

Prof René CHALON is my co-supervisor who is also very kind and always smiles to us. He works together with Prof DAVID for reading and modifying my papers, which are always piles of pages, but he still reads carefully to pick out every mistakes. He helped me to build my prototype, to repair the equipment, and he provided me with the devices I need during the work. Besides, he also answers other problems about many other things patiently and I am really grateful for all these things.

I need also to thank the members of the SILEX team (Tao Xu, Yun Zhou, Bingxue Zhang, Florent Delomier, Olivier CHAMPALLE, Chen WANG, Ivan Dal Pio Luogo, Gaël Duperrey), they created a friendly and vivid ambient of the laboratory, they shared experiences and many other interesting things with me and these were great helpful for my life and study. Our French colleagues in lab patiently speak French with me even my French is bad, this helps me a lot to improve my French. I'd like to thank Dongming CHEN, the couples of Yuxing Tang, the couples of Wuming Zhang, Xiaofang Wang and other friends who passed the happy time with me and made me feel like home.

I would like to thank my family and my wife Xiaoxia LEI who always support me throughout my life, they gave me the power to conquer difficulties in life and they shared the most cheerful time with me.

At last, I need to thank the China Scholarship Council (CSC) that finances me to study in France, they gave me a very precious chance for my life. I wish my country can become more and more prosperous in the future.

Table of Contents

1	Introduction.....	9
1.1	Ubiquitous Computing	9
1.2	Smart City	15
1.3	Public Display and Ubiquitous Display.....	17
1.4	Research Questions	21
1.5	Organizational Overview	23
2	Background and Related Work	25
2.1	Context-aware computing.....	27
2.2	Spatial-aware interaction with large display	28
2.2.1	Distance-based interactions.....	28
2.2.2	Proxemic-aware display	30
2.3	Migratable User Interface	32
2.4	Data migration between devices	34
2.4.1	Inter-device communication	34
2.4.2	Proximity and device discovery	36
2.5	Conclusion.....	37
3	Proxemics and Large Public Displays	41
3.1	Theories of Proxemic interaction.....	41
3.1.1	Proxemics of anthropology	41
3.1.2	Proxemic interaction	42
3.1.3	Proxemic interaction dimensions	44
3.1.4	Discrete vs Continuous distance	45
3.1.5	Single User vs Multiple Users	46
3.1.6	Privacy, Priority and Occlusion	47
3.1.7	The dark patterns of proxemic interaction.....	49
3.2	Proxemic interaction design for a public display.....	49
3.3	Conclusion.....	51
4	The Prototype of Proxemic Public Displays	53
4.1	Technical installation principles.....	53
4.2	System Architecture.....	55
4.2.1	Specification of Kinect	56
4.2.2	Web Camera and Face Recognition.....	63
4.2.3	Leap Motion	63
4.3	Proxemic display interfaces.....	65
4.3.1.	Two-layer user interface	66

4.3.2.	Migratable User Interface	70
4.4	Proxemic display Interactions.....	70
4.4.1	Implicit interaction with proxemic display	71
4.4.2	Explicit interaction with proxemic display.....	73
4.5	Module for data migration	78
4.5.1	Resources Selection	79
4.5.2	Data Communication	80
4.6	System Configuration Tool	81
4.7	Conclusion.....	82
5	The Migratable User Interface	83
5.1	Current Technologies of Resource Migration	83
5.2	The Toolkit Architecture.....	86
5.3	Mobile Application	88
5.4	Service on the Side of Display.....	90
5.5	Data Communication Security	92
5.6	User Management System.....	94
5.7	User Study.....	94
5.7.1	The test procedure	95
5.7.2	Data collection	96
5.7.3	Results of the User Study.....	96
5.8	Conclusion.....	98
6	Exploring Applications of Proxemic Displays in the Smart City	99
6.1	A Proxemic Flight Information Board	101
6.1.1	Users of the flight display board.....	102
6.1.2	Positions of users related to the display board	102
6.1.3	Priority of flights	103
6.1.4	Mobile devices of Users.....	103
6.1.5	The potential issues of proxemic display board	104
6.2	An Intelligence Timetable in a Bus Shelter	106
6.3	A Shopping Guide Screen in a Shopping Mall	110
6.4	Conclusion.....	113
7	Use Study and Discussion.....	115
7.1	The Experimental Application.....	115
7.2	The User Study Protocol.....	120
7.3	Data Collection	122
7.4	User Study Results	123
7.4.1	Task completion time	123
7.4.2	Memory efficiency comparison	125

7.4.3	System usability scale result	125
7.4.4	Qualitative Analysis	127
7.5	Conclusion.....	129
8	Conclusion and Future Work	131
8.1	Conclusions and Contributions	131
8.2	Future Perspective.....	134
	Bibliography	137
	ANNEXE	149
	Publications	153

1 Introduction

- 1.1 Ubiquitous Computing
- 1.2 Smart City
- 1.3 Public Display and Ubiquitous Display
- 1.4 Research Questions
- 1.5 Organization Overview

1.1 Ubiquitous Computing

The prospect of ubiquitous computing is gradually becoming a reality. Computers, Smartphones, laptops, tablets, smart watches and many other new kinds of digital intelligent devices have constructed a ubiquitous society which increasingly resembles the descriptions of Mark Weiser (Mark Weiser, 1999): *The most profound technologies are those that disappear. They weave themselves into the fabric of everyday life until they are indistinguishable from it.* However, disappearing devices could be defined as all devices in a ubiquitous environment connecting with each other seamlessly, so that users can focus on the task they want to do, rather than focus on which devices they should use. From another point of view, ubiquitous computing is in fact a user-centric and context-aware interactive environment, based on seamless communications of various in-environment devices, to assist users in completing specific tasks more efficiently or to offer users more intelligent services.

The first UbiComp system was designed by Mark Weiser. This system integrated smart boards, pads and tabs to construct a distributed communication and collaborative system under a laboratory context, as



Figure 1.1 an ubiquitous System designed by Mark Weiser's (Mark Weiser, 1999)

shown in **Figure 1.1**. Since the advancement of Wireless network and sensors in recent decades, the principles of ubiquitous computing have already been applied to different domains in everyday life. For example, Rememberer is a tool for capturing visitors to a museum in San Francisco (Fleck et al., 2002), as shown in **Figure 1.2**. This tool helps visitors to a museum to access information and services integrated in physical objects in a “nomadic” manner. Visitors registered a RFID tag before starting the visit and he/she was given a PDA. Then when the visitor stopped in front of an exhibit, he/she was recognized by the RFID reader, and related information about the current exhibit was sent to his/her PDA for reading. Furthermore, the visit history (including the visit photos) was recorded in the personal account of the visitor, and he/she could check the history anywhere at any time. The Rememberer is a typical ubiquitous system, offering users dynamic contents in a changing environment by recognizing users’ contexts.

Ubiquitous computing is also known as pervasive computing or ambient intelligence in European countries, which all aim to build a context-aware interactive environment based on multi-devices and multi-sensors, though they emphasize some different aspects. Ubiquitous computing is more related to work environments just like the collaborative environment constructed by Mark Weiser in the laboratory. Pervasive computing was first used and supported by IBM in 1998, and emphasized that computing could be conducted everywhere and anywhere by networked digital devices. Ambient intelligence first appeared in 1999 (Ronzani, 2009). It is actually built upon the theories of ubiquitous/pervasive computing, and combines research with Human computer interaction, context-awareness etc. to construct an environment that is sensitive and responsive to the presence of



Figure 1.2 The Rememberer Infrastructures

people. The relationship of the three concepts is shown in **Figure 1.3**.

Though researchers have carried out much research into ubiquitous computing since the concept was first put forward, there are still some problems to be solved. The challenges of ubiquitous computing could be classified into three categories: technology, psychology and sociability. Ubiquitous computing normally contains several challenges from a technical point of view:

- Sensor technology is a bottle neck in constructing a ubiquitous system. Sensors normally sense the contextual information of an interactive scene

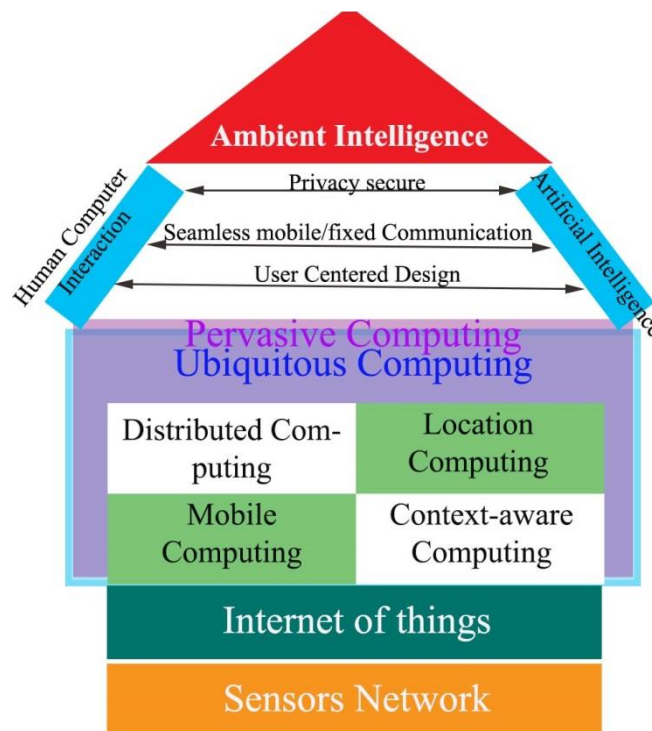

Figure 1.3 Relationship of ubiquitous computing, pervasive computing

(user's identity, location, time, etc.), and a ubiquitous system relies on this information to interact with users more intelligently. Sensors should be quick, responsive, reliable and accurate for a ubiquitous system. For example, using a RFID tag to read the user's identity is faster and more accurate than recognizing identity by camera-based face recognition. According to the types of ubiquitous system, we can select sensors such as temperature, humidity, pressure, audio, proximity, light or movement, etc. We can build a complex ubiquitous system by combining different types of sensors. However, these sensors only provide simple or binary

information, which is still not enough for a complex user-centric interactive system.

- Inter-device communication is also important for a ubiquitous system, because individual sensors or components of sensors need to communicate with each other about what information they have captured for more thorough data analysis. Bluetooth is reliable and is the most popular protocol for wireless inter-device communication. It is implemented by many ubiquitous systems. Most wearable smart devices (like smart watch, smart glass, etc.) use Bluetooth to build connections. To implement Bluetooth for inter-device communication of a ubiquitous system is a plausible way, but all the devices should be manually paired with each other before communication. This is because, as we know, the pairing process is frustrating and time-consuming, which can reduce the practicability of a ubiquitous system. In comparison with Bluetooth, Wi-Fi is another popular inter-device communication protocol, which is high speed and easy to access without a pairing process. Wi-Fi can be deployed locally or cover a large enough scale like a city. Thus all the devices within this scale can connect to the same Wi-Fi, and then are all interconnected wirelessly. Besides the communication protocol, unifying the data format for transmission is also a challenge. Each ubiquitous system always has its own data format, which is used only for its own convenience. However, with the development of ubiquitous computing, numerous ubiquitous systems or large scale ubiquitous systems will emerge. Consequently, how to organize, take advantage of and reuse data generated by sensors from everywhere will be a challenge. Unifying sensor data (such as in the JSON format) could avoid the overlapping investment of sensors, and optimize use of sensor data.
- Middleware is a critical component of a ubiquitous system. It helps to organize context data from sensors and to analyze them according to predefined logics. It also produces format data for the upper layer of the ubiquitous system (XU et al., 2014). Researchers have proposed many different middleware platforms for various ubiquitous systems, but until now there is no middleware platform which could be adapted to most ubiquitous systems. Developers have to re-develop their own middleware for specific systems, thus distracting developers from innovation of the ubiquitous system itself. The middleware always handles four steps of tasks: collect raw context data from the sensor network, context data fusion and modeling, context reasoning and rendering related contents or services to the upper level. Middleware has interfaces both to bottom sensor level and upper interface levels, so the interface should be

normalized, and middleware should be independent of applications. Developers could freely add or remove sensors from middleware, and customize the kinds of middleware output data. Furthermore, the sensor data collected by middleware might be sensitive (private data), in which case the additional issue of how to ensure data security needs to be considered carefully. As Vaskar R. et al. (Vaskar et al., 2003) pointed out, the ubiquitous environment is extremely dynamic in nature and devices frequently join and leave the environment, meaning that middleware must consider how to easily configure the newly added devices dynamically.

- Interface and interaction design is also a challenge of the ubiquitous system. The interface is what the system presents to users, it decides the user's feelings to the system, while interaction is how the system "communicates" with users, it influences the user's experience with the system. Compared with the traditional WIMP interface (Window, Icons, Menus, Pointer), interfaces for the ubiquitous system are very different, as ubiquitous systems do not have a definite device entity and are frameless. As a result, interfaces should be adaptive to different forms of "devices", to present the best interface to users on any surface. For example, an interface displayed on a wall-size display is definitely different from an interface displayed on a palm-size screen. Furthermore, input devices to ubiquitous systems are no longer the traditional keyboard and mouse, but rather new and diverse inputs, for example, speech, gesture and body language, etc. Users might interact with several different invisible devices at a time, so interaction must be consistent, and be easily understandable. Similarly, with the middleware level, ubiquitous systems might display private information to users in some situations, so the interface for displaying this sensitive message should be secure enough to avoid this message being picked up by others, especially in a public location. Besides, the interface and interaction for multiple users' collaborative work is also an important aspect of the ubiquitous system: how to distinguish one user from the others, how to coordinate interactions and interfaces of multiple users are all problems needing to be solved.

Challenges not only come from technology problems, but also from psychologies and sociability. The future ubiquitous system is an intelligent system which could communicate spontaneously with users, rather than wait for users to command or operate on it. This system could learn users' needs and help users to sort out the requirements that they currently have. As a result, the system is more like a virtual person rather than a mere machine: during the design of this system, the user's psychology should be fully considered. At present, there is still not

sufficient research about psychology issues in ubiquitous computing, because it's difficult to define what the psychology problem is, and what the criteria to judge the user's psychology are. It is obvious that user's behavior, user's expression and user's speech etc. can all be considered as indicators of user's psychology. However, this still depends on the context and type of ubiquitous system. At present, the temporary solution for handling this problem is to offer some choices for users to make decisions. However, if we were to have more knowledge on users' real thoughts, the system would be more useful.

Sociability is another potential challenge as the ubiquitous system is no more a passive machine but an active system which reacts and communicates with users. Sociability issues emerge from two aspects: one is between a system and users, and one is between the users of a system. For example, a ubiquitous system communicates with users in a socialized way, like a simulated person: it speculates on the current user's intention, and offers some relative information to him/her. During this process, the system should recognize the user's identity or other personal related information. The users must be aware that they are recognized, and they can refuse to be recognized by some simple gestures. Besides, because the interaction between users and the system is beyond the scope of Keyboard or Mouse, during interaction design, and especially for systems applied in public spaces, we should avoid any interactions appearing too weird, or avoid using voice commands in a quiet place. The second problem is between the users of a system. A ubiquitous system might be oriented at multiple users for sequence interaction or simultaneous interaction. So we should consider how to make all users feel pleasant during the whole process of interaction, and assign resources to users reasonably.

Collaboration between multiple users on a ubiquitous system is another aspect that needs to be considered. Unlike collaboration on an identified platform for a specific purpose (e.g. a private multi-touch table, a private large screen, etc.), collaboration on a ubiquitous system can happen anywhere with any people. As a result, a ubiquitous collaborative system is more complex to build than a single-purpose collaborative system. The former has to consider more aspects than the latter, such as: the number of concurrent users, the most appropriate interaction (touch input, keyboard, gestures, etc.), the purposes of collaborations, the features of users in collaboration, etc.

1.2 Smart City

The smart city is a new kind of city management concept based on advanced hardware infrastructures, data and knowledge of city and citizens, to improve the competence of a city. It highlights the importance of Information and Communication Technologies (ICTs). According to (Caragliu et al., 2009), a smart city can be defined along six dimensions: smart economy, smart mobility, smart environment, smart people, smart living and smart government. Each dimension includes some factors that can further describe the idea of them. For example, under the dimension of smart mobility, it comprises (inter-) national accessibility, availability of ICT infrastructure, and sustainable, innovative and safe transport systems. The smart city originates from the concept of “Smarter Planet” which was put forward by IBM in November 2008 (Smarter Planet, IBM, 2008). They seek to apply the new generation of information technologies into the business, government and civil society of the city. Their aim is also to install sensors in the objects in a complicated system (e.g. a grid network), to monitor its status, and connect all the sensors as an internet-of-things which meanwhile connects to an internet. Then the super computer or cloud network integrates this internet-of-things, to manage activity, status of living and production in a finer way. The smart city is not only the application of new information technology, but also the participation of the citizens in the various activities of the city with the intelligence of humans.

As a matter of fact, one of the key elements of the smart city is the internet-of-things based on sensor networks. Sensors become ubiquitous and the data generated by the sensors are integrated and analyzed by the related management departments of a city. From this point of view, the smart city is indeed a large scale ubiquitous environment composed of many varieties of ubiquitous systems. As a result, the smart city is an important field for ubiquitous computing and ambient intelligence (David et al., 2012).

At present, the smart city is still an idea under progress and experimentation. It aims at highlighting the role of Information and Communication Technologies (ICTs) in a modern city, at integrating and optimizing the resources of a city, to make city life more efficient, energy-economic and intelligent. Compared with digital cities and intelligent cities, the smart city also pays attention to the non-technological aspect, such as social activity, environment, and energy, etc., while digital or intelligent cities place more emphasis on how technologies can change the city. For example, Wang et al. (Wang et al., 2014) implemented a system of

managing road lanes dynamically in the context of the smart city. The system collects the location of vehicles and, based on the internet-of-things,

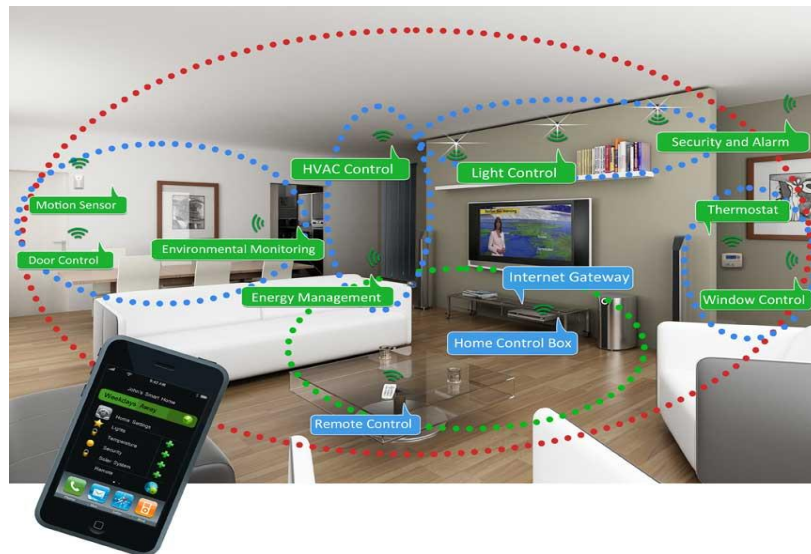

Figure 1.4 Smart Home Environment

allocates the road dynamically, especially for special vehicles such as buses or ambulances. Their demo is a subcategory of smart transportation. Similarly, David et al. described a smart bus shelter named a “Communicating bus stop” (David et al., 2012) by location-based services. The bus-stop is a system which uses a mobile network for communication between bus drivers and passengers to better serve passengers, especially those who have special requirements (handicapped, bicycle, etc.). Moreover, the bus shelter contains an electronic display board to display local related information about shopping, cultural events or sport, etc. Jacquet et al. (Jacquet et al., 2011) studied new interactive displays in stations and airports. They designed an opportunistic system for presenting information on these kinds of displays. In this case, displays can present information related to users currently in their proximity.

Besides the research about the smart city, there are already large scale projects for the smart city. For example, the smart city of Lyon (Smart city Lyon) is a project launched by the grand Lyon bureau. This project encourages the development of innovative services for the next generation of cities and is a test bed for related experiments. The blue print of smart city Lyon includes three levels: economic level, sustainability level and urban development level. The three levels cover digital and green economy, smart energy use, intelligent transport and city management, etc., to

promote the competition power of the city. Though the smart city is getting more and more attention, there are still no successful models to follow. Researchers need to design and imagine more interesting and promising scenarios of application. The challenge facing the smart city is how to bring innovative technology or concepts to the common appliances or life which citizens are already familiar with, then to gradually change their usage habits. In this process, the technology or concept is not visible to users, but users are gradually being immersed into a ubiquitous environment. Furthermore, how to capture, organize and analyze the data generated from the city is a major issue needing to be solved. According to Z.Xiong (Xiong et al., 2012), “Data Vitalization” is the main principle of the smart city. The concept of data vitalization proposes to make data have life, and to combine the separate data together, for better utilization of data.

Among the infrastructure of the city, the public display is the most common media and influences people’s life from all aspects. For a long time now, the large paper board and the negative electrical public display have been the main forms of public display. However, more and more electronic displays are replacing the traditional display board in the new century (Skin, 2011). Now it is possible to display dynamic information on the electronic display rather than display pre-edited information. In this dissertation, we choose the electronic public display as a platform for implementing smart city related applications.

1.3 Public Display and Ubiquitous Display

Though digital devices are widely involved in our daily life, we cannot say that they are fabricating into our lives . Devices are still divided from each other, their functions are definitive and we still have to perform specific tasks on specific devices. According to the usage of devices, we could divide them into personal devices and public devices. The convergence of personal devices is evolving faster than the convergence of devices under public contexts. For example, smart television or smart furniture allows users to control their domestic appliances with their mobile devices freely. Also all the smart devices belonging to the same user can communicate with each other freely, such as the smart home designed by Green Peak (**Figure 1.4**, Smart Home, 2012).

In contrast, public devices are far less converged. Public displays have long existed as media to publish something publicly, but they are now gradually changing from simple paper boards to more and more diverse ones. At present, digital public displays are gradually replacing paper notice boards, which used to be everywhere. The digital public display is a common and typical public digital device, and plays an important role in the city for public services. However, because of its simple function and low efficient interaction, users always ignore them. Public displays are constrained to their rigid role of a screen, only for displaying some information or for users to perform simple and low efficient interactions directly on screen: e.g. **Figure 1.5** contains a large public display that supports interactions of multi users. It is clear that public displays are more than media merely for displaying information. Researchers have carried out a lot of work around the subject of public displays in the future society. Davies N et al. (Davies et al., 2012) emphasized that public displays of the 21st century should become the backbone of a new global communication medium, and many innovation works about public displays could be achieved on the platform of public displays.



Figure 1.5 a large multi-touch display designed by Uma

Digital public displays are very frequent in all the locations around us, railway station, airport, shopping mall, city square, bus shelter, etc., and in some semi-public places, in university buildings, enterprises, research lab, etc. Most of these screens display some pre-edited contents, and a few of them support simple interactions by touching on screen. Though display designers are trying to make them more attractive, users still tend to just pass by them and ignore the contents. How to motivate users to interact with a public display is an active research subject., In this field, most

researchers studied interactions on public displays, to make public displays become interactive objects, thus attracting users' attention and motivating them to interact with public displays.

The research subjects about digital public displays mainly focus on the on-screen interactions (Hinrichs et al., 2013). Interactions vary according to the size of screens: normal size, large size, wall size or irregular shape (cylinder, projected, etc.) screens. Interactions on normal sized screens are already well studied: touch-sensitive screens are already widely applied on normal sized screens. However, it is still difficult and expensive to apply touch sensitive interactions on large size screens. Also it is not practical either to let users directly touch on large screens for interactions, because large-size screens are too wide to reach all the areas on the screen. As a result, at present most on-screen interaction research focuses on the large or wall sized screens, especially for public displays because these kinds of display in public spaces are mainly large size ones. We can divide research on interactions with large-sized displays into three categories:

- Direct on-screen interaction, similar to interactions on normal-sized screens. Researchers have tried to build directly on-screen interactions which can adapt to users' habits. For example, the city wall (Peltonen et al., 2008) is a large-scale multi-touch display installed in the city center of Helsinki. It displays videos or photos gathered from public sources (youtube, flickr) about the city, for citizens to watch and discuss. Several users can simultaneously interact directly on the display by gestures, just like what users usually do on a touch screen;
- Interaction from a distance and direct on-screen interaction cannot be applied on extra-large screens, for example, on a wall-sized screen, because it is too large to touch. Besides, sometimes we cannot directly touch a public display, for example if a display is covered by a window to protect it from vandalism. As a result, researchers studied interaction with a public display from a distance. Malik et al. (Malik et al., 2006) constructed a table-sized touchpad which connects with a distant large display. The touchpad recognized users' multi-fingers and whole-hand gestures, while the system allowed users to create their own workspace by hand on the distant display by some pre-defined gestures, and to interact comfortably while they were sitting in front of the touchpad. Nancel et al. (Nance et al., 2011) studied input technologies of mid-air pan and zoom navigation on a wall-sized display, as well as studying different degrees-of-freedom (DOF) of mid-air gestures (1D, 2D, 3D) and uni-manual and bi-manual gesture inputs. They found that though mid-air gestures are

promising, they tend to be more tiring and less effective compared with interaction on devices. They also found that linear-gestures are more efficient than circular-gestures.

- Interaction by mobile device is another way of interacting with a distant large display. It makes use of an additional mobile device for interacting. Compared with other additional devices, mobile devices are smaller and easier to configure. Hardy et al. (Hardy et al., 2008) studied a touch and interact prototype for users to touch a display with their mobile phones for selecting corresponding items on the display. This prototype took advantage of NFC (near field communication) tags to recognize the touch position of mobile devices with the large display, and also combined the touch events with keypad events of mobile phones, to explore more input possibilities. Earlier work such as Cheverst et al. (Cheverst et al., 2005a) explored Bluetooth based interaction with a situated display by mobile phones;

Interactive public displays are not only standalone but are also normally used to build an interactive space together with other devices. For example, construct an interactive ROOM for improving education (iRoom of Standford (Borchers et al., 2002)), or build an interactive space in the context of a museum for exhibiting artifacts (Zabulis et al., 2010). In this circumstance, the space around a large display becomes a stage rather than a space, especially if the screen is placed in a public place. People might gather in the place in front of a screen to discuss some topics or explore the interactions. As stated in the paper (Kuikkaniemi et al., 2011), framed digital displays will be replaced by walls or facades that are more motivating and also support group interactions. At the same time, framed displays will transform to displays that can be seen everywhere, that is to say, ubiquitous displays. To cope with this change, there are still many problems, and challenges need to be solved. Ubiquitous displays are not a standalone display but a display network which includes public displays and other devices, where all the devices are inter-connected. There is still no generally accepted definition of a ubiquitous display. Everyone has their own understanding of ubiquitous displays. However, generally speaking, ubiquitous displays can have the following features:

- A ubiquitous display is an interactive terminal or knot of a large scale ubiquitous display network;
- A ubiquitous display is context-aware. It can sense context information, which can be used to analyze user related data, for example, user's identity, user's location, time, etc;

- A ubiquitous display is a positive display, which can provide users with dynamic and more personalized information;
- A ubiquitous display can support multi-users interaction and collaborative work;
- The contents of a ubiquitous display can be displayed in any format of data, and the contents can adapt to different shapes of displaying area;

Ubiquitous displays are progressing. There is no all-around or systematic methodology for dealing with ubiquitous display related subjects. However, among all current research, proxemic interaction is one of the most promising research fields. Proxemic interaction is a set of interaction models taking into consideration the spatial relationship of objects as criteria of interactions.

Saul Greenberg defined proxemic interaction as a new kind of *ubiquitous computing, and it can exploit people's expectations of how they interact with their technological devices as they move toward one another* (Greenberg et al., 2011).

1.4 Research Questions

The long term goal of my thesis is to explore how proxemic interactions can be applied to smart city contexts. To achieve this goal, I identified several precise research questions as follows:

1 How to apply proxemic interaction patterns to address the problems of public displays in a smart city?

Public displays in a smart city are no longer normal screens but ubiquitous displaying media deployed in a large scope. At present, the smart city is still an open concept under development, while public displays are considered to be one of the most important roles in the smart city. It is still a problem to define what kinds of public displays can be adapted to the requirements of the smart city. We try to apply the theories of proxemics to construct such public displays in this dissertation.

Proxemic interaction was well studied under the installation of a private context. However, there are still few practices for applying proxemic interaction theories on a public display, which is also an important ubiquitous media in future smart cities. We need to figure out how

proxemic interaction can improve efficiency of public displays in a city (e.g. to display personal related information to a specific individual on a public display instead of displaying general information to all audiences)

2 What kinds of technologies can be used to build proxemic interactive public displays?

The proximity toolkit developed by Marquardt et al. (Marquardt et al., 2011) has to be installed in a specific room equipped with complicated but accurate motion tracking systems. These can generate fine-grained proxemic data. However, in a public place, it is difficult to install this complex proximity toolkit, and we need to construct a simpler and light-weight proximity tool for application with a public display in public and open locations;

3 How to coordinate interactions of multiple users for proxemic public displays?

One significant difference of public places with a private room is that in public places there can be multiple users: especially for a sufficiently large public display, there are always several users gathering in front of it to interact. At present, the interactions of multiple users are still awkward. We need to study how the principles of proxemics are helpful to coordinate the interactions of multiple users on a large public display, and facilitate the collaborative interactions as well;

4 How can we bridge the gap between public displays and ambient personal mobile devices?

A public display is currently blind to ambient personal mobile devices. It is difficult for a display to discover spontaneously the devices around it. Proxemics of inter-devices can help one device to discover another device by their relative position, such as the Micro-mobility described by Marquardt et al. (Marquardt et al., 2012a). In public places, as mobile devices are random personal devices belonging to different users, it is not appropriate to apply micro-mobility, and we need to find other ways. Secondly, even if a public display can discover ambient devices, there is still no easy way to connect it with those devices seamlessly, not to mention the process of exchanging resources with each other. We want to build an efficient tool to connect a public display with ambient mobile devices seamlessly, and simplify the process of resource exchanging.

1.5 Organizational Overview

The dissertation is structured into the following sections:

In chapter 2, we survey related works, and the major references relevant to proxemic interaction during our study. We review the previous works and put forward our research questions;

In chapter 3, we elaborate the concepts of proxemics of anthropology and proxemic interactions from the viewpoint of ubiquitous computing. We also describe patterns of proxemic interaction applied on a public display;

In chapter 4, we illustrate the process of development of a proxemic display prototype, including the system architecture, sensor modules, principles of interface design and the interaction modalities of the display;

In chapter 5, we introduce the migratable user interface, and describe the process of development of a toolkit for data migration between public display and personal mobile devices;

In chapter 6, we describe the potential application scenarios of the proxemic display in the smart city contexts;

In chapter 7, we build an experimental application, and conduct a pilot laboratory user study based on this application. We present and discuss the results of user studies based on qualitative and quantitative test data.

In chapter 8, we conclude the work of this dissertation, and describe our perspectives concerning future research of proxemic interaction in the smart city.

2 Background and Related Work

2.1 Context-aware computing

2.2 Spatial-aware interaction with large display

2.2.1 Distance-based interaction

2.2.2 Proxemic-aware display

2.3 Migratable User Interface

2.4 Data Migration between devices

2.2.3 Inter-device communication

2.2.4 Proximity and device discovery

2.5 Conclusion

To publish public information on a large public display has a long history since ancient Rome, when they published political events or social news on city walls. The paper board is always the main approach to publishing information. With the development of technology, electrical displays are replacing traditional paper boards: we can see electrical display boards in railway stations, airports, shopping malls and business centers, etc. These displays can be single display, or one terminal in a display network. Also they can be interactive or un-interactive, and the contents presented might be fixed or dynamically changed. According to these characteristics, we can classify these displays in 8 types, as shown in **Figure 2.1**. Each dot is a category of public displays: among the values, the X axis represents the content type, the Y axis delegates the attribute of displays, while the Z axis is the interactivity of displays.

Interactive displays are common in modern cities. We can expect that, in the future, interactive displays will play an increasingly important role in society. This is because they can provide users with more flexible information that they can choose rather than uniform information that cannot be changed. New challenges are arising with the large scale application of interactive displays. As we know, most of the interactive displays around us are foot-scale displays: only one user can interact with a display at a time, and all the users follow the rules of “first come first served”. As a result, if this display is placed in a crowded place, such as a shopping mall, a railway station or an airport, most of the users might give up interacting with it because of the potential waiting time. In order to keep users interested in the display by making the interface more

attractive, we can also shorten the waiting time by supporting multi-user interaction: several users can interact simultaneously on a sufficiently large public display without disturbing others. In this situation, how to coordinate users' relationships with each other continues to be a challenge.

Besides, there is another challenge for these kinds of displays. In the future ubiquitous society, various kinds of ubiquitous displays surround users, providing not only public but also relatively private information. Individuals have to face information flowing from everywhere: information might be useful, or might be spam or even intrusive information. As a result, how to distinguish this information to find the most relevant information for them, and protect themselves from harmful information is a tremendous task for common users. This is a legal problem and, meanwhile, a challenge for human computer interaction. How can we make a public display publish more personal-related information while still keeping users from being intruded on?

As we discussed in the previous, proxemic interaction is an approach for dealing with users' spatial interaction with a large display. Proxemic interaction provides possible patterns that can make sense of users' spatial relationship with a large display, as well as mediate the spatial relationship between multiple users who stand in front of a large display. Before discussing proxemic interaction, we first revisit some similar concepts.

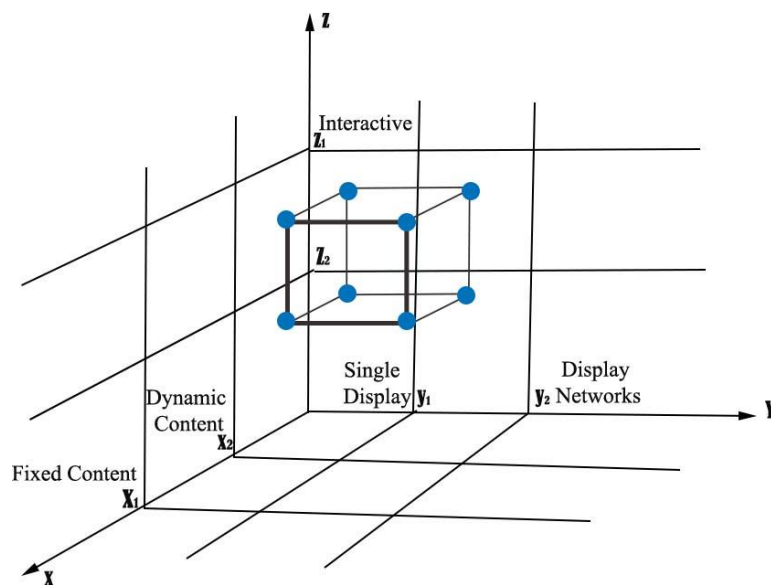

Figure 2.1 Categories of public displays

2.1 Context-aware computing

Schilit and Theimer first put forward the term “context-aware computing” (Schilit et Theimer, 1994). They described context as location, identities of nearby people, objects and changes to those objects. If a computer system can sense users’ context, surroundings, and changing environment, and make changes to adapt itself to users’ real time needs, then we can say that the computer system is a context-aware computing system. Context of a specific system is different: even for a system in different situations, the contexts are also various, and it is hard to define what is context. Dey and Abowd made a general definition about context (Dey et al., 2000):

Any information that can be used to characterize the situation of entities (i.e. whether a person, place or object) that are considered relevant to the interaction between a user and an application, including the user and the application themselves

Context is different but normally contains five elements:

- Who: user’s identity, who is using the system;
- When: time attributes of interact events, what is the time, when a user arrives? How long does the user stay?
- Where: attributes of location, where the user is?
- What: user’s activity, or what the user wants from the system;
- Why: purpose or expectation of the user with this system? This is the synthetic analysis results of the last four elements.

Compared with a passive interaction system, a context-aware system can positively help a user to finish his/her task. The systems sense user related-contexts and deduce users’ object of interactions according to these contexts, then it can provide pointed services or information. Specific to a public display, if a display is context-aware, then it is possible to display personalized information for a user, to cope with the challenges: one person for many screens. For example, in an airport, all the passengers search for their own flights from a public display board in a hurry. However, they have to find out one piece of information from hundreds of lines of flights. If we replace the display board with a context-aware display, it can sense users’ context information. If there is only one user in front of the board, then it can directly display the flight info of that specific user. However, displaying personal-related information on a public display is still disputable. We will discuss this in the following sections.

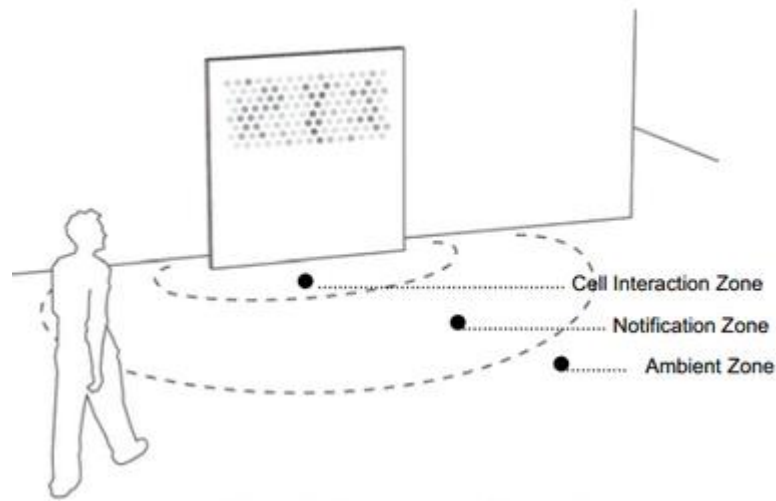

Figure 2.2 Hello Wall and the Zones of Interaction

2.2 Spatial-aware interaction with large display

A spatial-aware large display is a display that can sense the user's position relative to itself, and display some dynamic information based on the spatial relationship. Distance between a display and a user is the most fundamental dimension of spatial-aware interactions, which have also been studied for many years.

2.2.1 Distance-based interactions

Distance is the most frequently considered and fundamental factor in the study of spatial-aware interactions. The hello wall (Thorsten et al., 2003) is a wall-sized ambient display, which is also a center of a ubiquitous computing environment. As shown in **Figure 2.2**, it has three zones of interaction in front of the Hello Wall: from far to close is the *Ambient zone*, *Notification zone* and *Cell interaction zone*. This distance-based zone implies different interaction possibilities and information types shown on the Hello Wall. D.Vogel et al. (Vogel et al., 2004) built an interactive public ambient display, and also divided four zones from far to close in front of the display: *Ambient Display*, *Implicit Interaction*, *Subtle*

Interaction and Personal Interaction. The display detected both the user’s distance and the user’s position in front of the display, as well as the user’s movement inside the zones.

Ju et al. (Ju et al., 2008) developed a “Range” framework to explore implicit interactions on an electronic whiteboard. There are four interactive zones in front of the whiteboard: public, social, personal and intimate zones. Their aim is to explore implicit interaction on the “Range” platform, which was designed for informal meeting collaborative work.

From the examples mentioned above, we can conclude that distance-based interactions were a considerable improvement on traditional screens, which display uniform contents to all passengers without knowledge of their distance. However, to divide distance discontinuously has side-effects as well. First, different users might have a different sense of distance: in inter-human communication, one person prefers to stand close to an object, while another person might prefer to stand a bit further. As a result, to divide distances according to one predefined criterion is not reasonable. Secondly, interfaces displayed to users are also changing discontinuously according to the user’s distance. It’s difficult for users to read the contents that are abruptly changing. Thirdly, similar to inter-human communication that distances between two people are changing gradually according to peoples’ habits, the distance between a user and a display should preferably be transformed gradually.

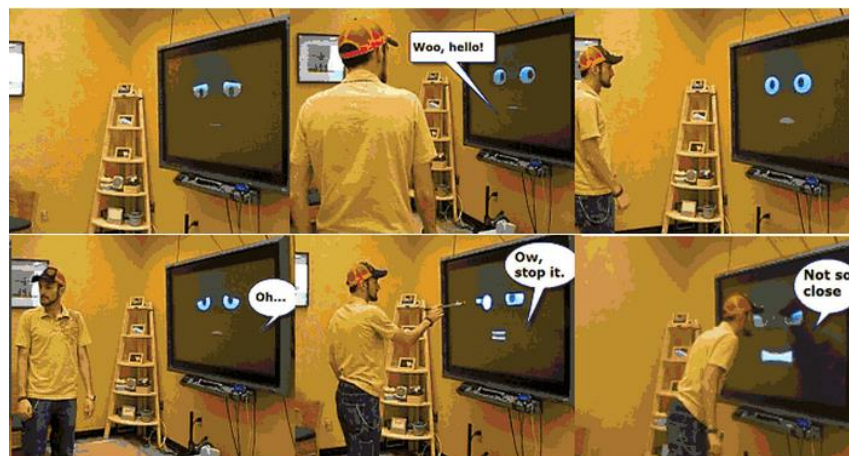

Figure 2.3 Vicon Face (Greenberg et al. 2011)

2.2.2 Proxemic-aware display

Proxemics is not an inherent terminology of computer science, but a subcategory of nonverbal communication study of anthropology. People always have a sense of space when they communicate with others. For example, one person tends to stand closer to a friend and stand away from a stranger in a crowded place. Similarly, two friends stand closer while talking than two strangers. This sense of distance is distinguished in different cultures. Edward T.Hall (Hall, 1966) first defined this term. He emphasized the impact of the user's use of space, which was equivalent to proxemic behavior in interpersonal communication. Hall's proxemic theories can be extended to the study of inter-personal communication in daily life, as well as to other aspects such as space organization in houses, buildings, or cities.

Inspired by the theory of proxemics for inter-human communication, Saul Greenberg et al. (Greenberg et al., 2011) put forward proxemic interaction as a new kind of ubiquitous computing. They pointed out that, though we all have plenty of digital devices, which seem to be ubiquitous, these devices are blind to each other's presence. Devices in ubiquitous environments are still difficult to connect seamlessly. Though users can manually connect these devices, they still need to have some knowledge of connection. What is more problematic is that these devices are also blind to people, and to fixed or semi-fixed features around them. That's



Figure 2.4 Proxemic Media Player (Greenberg et al. 2011)

where proxemic interaction can be helpful.

Proxemic interaction makes devices aware of nearby objects, including people, electrical devices and other non-electrical devices. The spatial relationship between two devices or between devices and users can be used as criteria of interactions, connection or resource exchanges. Saul Greenberg et al. concluded five proxemics dimensions for ubiquitous computing:

- Distance of a user to an entity;
- Orientation of a user to an entity;
- Movement of a user towards or away from an entity;
- Identity of users or devices in the vicinity;
- Location layout of a ubiquitous environment where an entity is.

The main difference with the previous work on distance-based interactions is that the distance, orientation, movement and identity mentioned in their theory are not only between users and devices, but also between several devices. A large display can not only sense users' position, but also get to know the position of a digital or non-digital device.

Based on this terminology, Marquardt et al. developed a proximity toolkit (Marquardt et al., 2011) for rapid prototyping of proxemic interactions. This toolkit is based on the Vicon motion tracking system, OptiTrack and Kinect to capture the position of users and other devices, while all the entities being tracked have to attach several reflective infrared markers. The toolkit was installed in an elaborate room, and a large tactile display was used as a main interactive object. The proximity toolkit can capture fine-grained relative spatial relationship among all the captured objects.

With the toolkit, developers can easily measure the above-mentioned five dimensions. They have implemented several interesting applications for proxemic interactions, for example the proxemic vicon face (**Figure 2.3**), which is an animated face reacting with different expressions to the user's relative position to it. A proxemic media player (**Figure 2.4**) is responsive to the user's spatial relationship to a large display: the media player can recognize two users at the same time to display different contents to the users in different positions. Users can control the media player with a non-digital stick by pointing it to the screen, and the proximity toolkit can measure the pointing direction of the stick to the screen. The proximity toolkit is very helpful for constructing proxemic interaction prototypes

rapidly. However, this toolkit can only be used in a semi-public or private location, which means that the layout of locations is more or less fixed and difficult to be re-arranged. Furthermore, in order to be recognized, users and other devices need to be attached to infrared reflective markers. It is apparently not appropriate in open public places to ask users to wear additional markers.

Besides this, there are also many inherent negative points about proxemic interactions, as Saul Greenberg discussed in his paper (Greenberg et al., 2014) about dark patterns of proxemic interactions: proxemic interaction might be misused. Since the proxemic interaction tries to dedicate users' needs by their proxemic attributes, this process is not always agreeable. This is because users approaching a display might only want to check some general information rather than personal-related information, and to display their personal information on a large display in a public place is possibly intruding and unexpected.

One possible solution of avoiding detriment to users is to let them make the choice: to make users decide which of their data can be collected by a proxemic system, which information should be displayed to them, to decide whether they can or cannot be recognized.

2.3 Migratable User Interface

The devices in a ubiquitous environment are various, with different sizes of screen and resolutions. Content migration between different devices is frequent in such a ubiquitous environment. As a result, for a ubiquitous display system, contents or interfaces should be able to migrate among different display mediums, and during this process, the interface should adapt to different screen sizes and resolutions. The display media can be like other ubiquitous displays, ubiquitous mobile devices, or any other kinds of display surface (cylinder, cube etc.).

We defined this process as migration of user interfaces (MUIs), which means an interface can freely transform (only parts or the whole interface) to different display media. During this process, the interface migrated to another display media can adapt itself to new display media, to ensure users can read the interface in the most appropriate format for the current media.

Migratable user interfaces can be tracked back to the migratory application studied by Krishna (Krishna et al., 1995). The migratory

application is capable of migrating from one machine to another machine over a network. During the roaming process, users' interfaces and application contexts migrate together with the application: thus users can continue their tasks in another machine. Anyway, the migration can only be implemented under the same operating system. Migratable user interfaces can remove this limitation, and transfer parts or the whole interface to any other ubiquitous media freely. Donatien et al. gave a simple description of the Migratable User interface (Donatien et al., 2004): *the migration of user interface (MUI) is the action of transferring a UI from one device to another, and a user interface is said to be migratable if it has the ability to migrate.*

Distributed User Interfaces (DUIs) form another similar area of research on interface transfer among different platforms of various devices, where they call this process "distribution". Gallud et al. defined the Distributed User Interface as: *A distributed user interface is a user interface which has been decomposed and ported* (Gallud et al., 2011). They listed as well the essential properties of DUI, decomposability (and composability), simultaneity, and continuity. The core idea of DUI is to distribute some elements of an interface among various kinds of hardware platform (devices) and different kinds of software platform. The DUI emphasized the ability of the interface to be distributed over different devices. Hosio et al. (Hosio et al., 2010) have implemented a platform for the distributed user interface on a large display, and deployed the display in a real city center. Compared with DUIs, the migratable user interface is not only the interface that can be distributed and adapted to different devices, but also the interface that automatically adapts to user's preferences. For example, if a user prefers a text-based interface to an image-based interface, the main interface migrated to the user's devices considers this preference and mainly displays the interface with texts. MUIs are more intelligent than DUIs: the former considers the interface transfer process from the user's preference point of view, while the latter rather considers the technology point of view. Furthermore, we combine interface migration with proxemics of devices, to use the spatial relationship between devices as references of interface migration. Interface migration between different devices is indeed a data-transmission process at the lower layer, and the data transmission protocols determine the efficiency of the interface migration process.

Besides, Calvary et al. (Calvary et al., 2011) put forward plasticity of user interfaces in ambient intelligence, and described the transport scenario to apply theories of plasticity of UIs. Plastic UIs can transmit among

different device platforms and self-adapt to the devices, contexts and user's proximity. Unlike MUIs, plasticity highlights the ability of UIs to adapt to the context of use while at the same time respecting the user-centered properties.

2.4 Data migration between devices

Data migration between devices is a process of communication. In this section, we discuss and compare the main inter-device communication methods.

2.4.1 Inter-device communication

The communication process includes two steps: connection and data transmission. To connect various digital devices there is a mature technology and a standardized process: Infrared, Bluetooth and Wi-Fi are all reliable ways of connecting devices. In contrast, data transmission is not a uniform process, because data types that been transferred and conditions of usage are always diverse. There is still no well-accepted method for data transmission between a public display and personal mobile devices. The Hermes photo (Cheverst et al., 2005b) display allowed users to connect and exchange photos with it by their personal

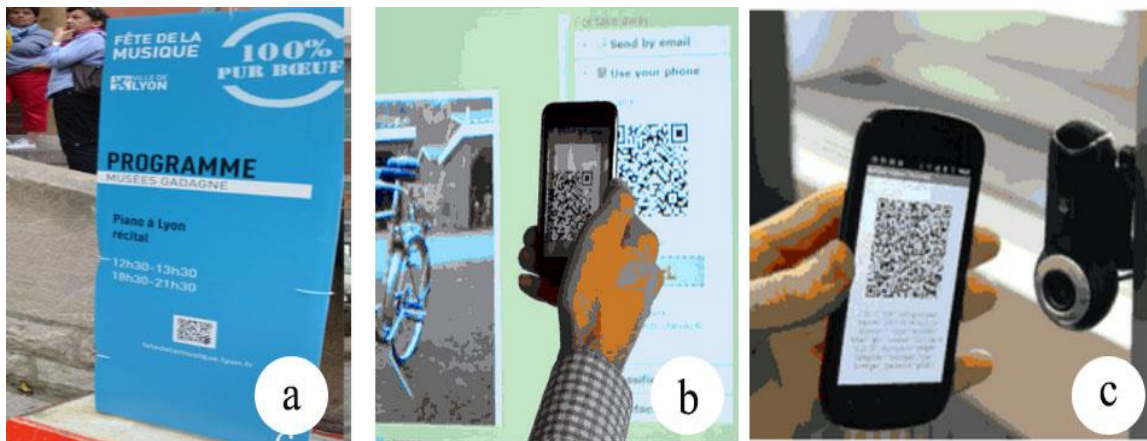

Figure 2.5 a: an advertisement board with QR code; b: download by QR code; c: upload by QR code

mobile devices through Bluetooth. It is a typical demo of exchanging information between a public display with personal mobile devices. Instant place (Rui et al., 2008) went further than mere data exchanging. It recognized the Bluetooth enabled mobile device near a public display, then published the names of those devices on the display to attract users and let them know that their devices are recognized. Their experiment results showed that Bluetooth presence of mobile devices on a public display can prompt interactions around the display. Similarly, Andrew et al. (Andrew et al., 2007) developed a photo-based method to exchange media packages between a situated display and personal mobile devices. The bidirectional data transmission also used the Bluetooth personal area networking (PAN) protocol. Most research about communication between a display and personal mobile devices is based on the Bluetooth protocol, e.g. Shoot&Copy (Boring et al., 2007), Touch&Interact (Hardy et al., 2008), DUI display (Hosio et al., 2010).

Bluetooth is widely applied in mobile devices, and connection and data communication are reliable enough. However, with the advancement of technology, the wireless network, based on IEEE 802.11 standards, is faster and more easily accepted by users. Both Bluetooth and the wireless network required users to connect devices manually through an authentication process. With regard to data communication between large public displays and personal mobile devices, this authentication process might discourage users to try to connect their devices with a public display.

As an alternative method, matrix codes are widely used as a simple means of data transmission between a large display and personal mobile devices

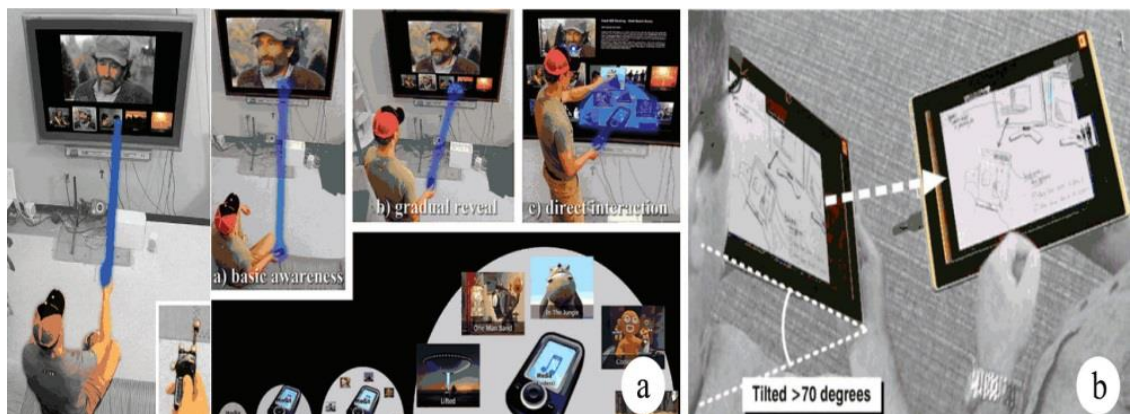

Figure 2.6 a, Proxemic media player sensed the spatial-attributes of a smartphone;
b: micro-mobility of two tablets to transmit contents

(**Figure 2.5a**) by wireless network (Wi-Fi, 3G/4G). QR code (Quick Response Code) is the most popular matrix code printed on large displays, both digital displays and paper boards. Users can scan a QR code published on a display by their smartphone, and get a link to specific resources. Then they open a website via the link to get related information. Florian A. et al. (Florian et al., 2013) have studied the downloading resource process from a display by QR codes to a smartphone, as well as the resource sending process from a smartphone to a display by QR codes (**Figure 2.5b** and **c**). The result shows that the QR code is more helpful in retrieving resources from a display rather than in posting resources to a display. As shown in **Figure 2.5c**, to make a display scan QR code displayed in a phone screen is an awkward process.

To conclude, Bluetooth is not best to apply in communication between a public display and personal mobile devices. Though Bluetooth is a reliable protocol for data transmission, the configuration and pairing process of Bluetooth is too tedious to apply in public places. It is almost impossible to ask users to manually pair their own devices with a busy public display through Bluetooth only for downloading information. The QR code is a widely accepted way of obtaining information from a public display very conveniently. However, the QR code allows users to download un-categorized information via a specific website rather than to get information directly from what users see on a public display. Besides, under some situations (dim light, crowded places or stained QR codes), it is difficult to scan QR codes. In my opinion, QR codes and other Matrix codes are only means of transition from now to the ubiquitous computing society: Matrix codes cannot really meet the requirements of ubiquitous computing. Matrix codes distribute the same information to all users, who scan the codes without considering users' usage contexts and just-in-time needs, for example, their reading history, interface preferences, etc. Users have to begin on a totally new interface instead of continuing their unfinished interactions. As a result, it is necessary to develop a tool specific for inter-communication between large displays and users' personal mobile devices.

2.4.2 Proximity and device discovery

Proxemic interaction not only studied the spatial relationship between users and devices, but also studied the spatial relationship between several devices (digital or non-digital). The spatial relationship between devices can make one device spontaneously discover and interact with other

nearby devices. The relative position of devices can also be used for controlling devices (such as when users control the proxemic media player with a non-digital stick) or exchanging information between digital devices.

Unlike the Bluetooth or Wi-Fi connection, in proxemic semantics, a mobile device can positively discover the surrounding devices by adding infrared markers to digital devices, thus allowing its position to be tracked. Once digital devices (e.g. a smartphone) are close to the screen, the screen can sense its approach and exchange resources with it. For example in the proxemic media player example, if a user standing in front of a large display takes out his/her mobile phone, the display can sense the phone and prompt a notice on the large display to remind the user to connect his/her mobile phone with the display (as shown in **Figure 2.6a**). Similarly, inter-mobile device proxemics is also used as references of connection and data transmission. For example, micro-mobility (Marquardt et al., 2012a) describes how people orient and tilt a mobile device to another mobile device held by another person. Inter-device communication regarding micro-mobility can facilitate small group collaborative work by making inter-device communication smoother and more seamless (as shown in **Figure 2.6b**).

To conclude, the proxemics between devices can act as references of control, device connection and data transmission in personal usage situation. However, there are still issues need to be studied if we apply device proxemics to data migration between public displays and personal mobile devices, due to the diversity of mobile devices in the vicinity of a public screen.

2.5 Conclusion

Ubiquitous computing is more and more a reality with the progress of technologies. However, ecologies of digital devices are still far removed from the description of disappearing technologies. Users still have to work on specific devices for specific tasks, and devices are not intelligent enough to positively interact with users. Also, the gap between users and devices is still distinct. This disadvantage can become a great burden for users in a ubiquitous society. As a result, it has become necessary to make digital devices get to know users' real time requirements. To solve this problem, context-aware computing has proposed a set of context attributes in the design of a context-aware system, where different systems should

select different attributes in the development process. Among these attributes, identity is the most common context to be considered for a context-aware system, as a system aware of users' identities is capable of offering more personalized information to users. In contrast to the popularity of identity recognition of users, spatial attributes (user to device, user to user, device to device) have rarely been considered as necessary contexts.

There are two aspects that are challenging in a ubiquitous environment. First, it is increasingly difficult for users to manage and operate on various kinds of digital devices without knowledge or training of a ubiquitous environment. Secondly, a device in a ubiquitous environment is also difficult to find and interact with nearby devices: a device is blind to its surrounding devices and also has no knowledge of its users. These two drawbacks make a ubiquitous environment difficult to use, and not as intelligent as it is expected to be. In a ubiquitous environment, users can focus on their tasks, rather than focus on the use of devices, and all devices are borderless and just act as one device. We see that many efforts have already been made to achieve this goal. However, this goal is still far from being attained. Saul Greenberg et al. proposed proxemic interaction as their understandings of a new kind of ubiquitous computing in 2011. They take proxemics into consideration while designing interactions in a room-sized ubiquitous environment. All devices (digital, non-digital) are aware of each other, as well as users, and inter-device communication is seamless. Their research had depicted the prospect of combining proximity with ubiquitous computing, and they already clearly defined the five dimensions of proxemic interaction. In any case, proxemic interaction is still a newborn semantic needing to be studied further, not only in a controlled room-sized location, but also in public places.

Proxemic interaction is an intercrossed field of ubiquitous computing, context-aware computing and psychological theories, providing a new dimension of ubiquitous computing. Currently there are few applications of proxemic interaction besides the applications based on the proximity toolkit developed by Marquardt et al. However, this is not widely applied, possibly as it is expensive and difficult to deploy the infrastructures of proximity toolkits. In my thesis, I construct a more light-weight proxemic interaction platform, and probe into proxemic interaction on a large public display in the context of the smart city.

In this chapter we have reviewed some representative works about large displays in recent decades, and we have listed them as shown in **Table 2.1**.

From the table, we can clearly find the following trends of public displays: be aware of spatial relationships with users, display more personal-related information, be open to ambient mobile devices and be available for multiple users. This progress all seeks to cope with the development of the ubiquitous computing society, where a public display is not only a single display medium, but also an intelligent human-like information hub.

In the next chapter, we continue to discuss in detail the principles of proxemics on a large public display.

Table 2.1 Comparison of Systems Related to our Research.

Name.	Capabilities			
	Aware of spatial relationship	Displaying private information	Mobile Device Awareness	Multiple User
Single Display Privacy ware (Shoemaker et al., 2001)	No	Yes	No	Yes
Dynamo (Izadi et al., 2003)	No	No	Yes (by USB slots)	Yes
Hello Wall (Thorsten et al., 2003)	Yes	Yes	Yes (by viewports)	Yes
Blue Board (Russell et al., 2004)	No	Yes (by badge)	No	Yes
Interactive Public Ambient Displays (Vogel et al., 2004)	Yes	Yes	No	Yes
Instant Place (Rui et al., 2008)	No	Yes	Yes (by Bluetooth)	Yes
Range (Ju et al., 2008)	Yes	No	No	Yes
Interactive displays in stations and airports (Jacquet et al., 2011)	Yes	Yes	No	Yes
Proximity Toolkit (Marquardt et al., 2011)	Yes	Yes	Yes	Yes

3 Proxemics and Large Public Displays

3.1 Theories of Proxemic Interaction

- 3.1.1 Proxemics of anthropology
- 3.1.2 Proxemic interaction
- 3.1.3 Proxemic interaction dimensions
- 3.1.4 Discrete vs Continuous distance
- 3.1.5 Single User vs Multiple Users
- 3.1.6 Privacy, Priority and Occlusion
- 3.1.7 The dark patterns of proxemic interaction

3.2 Proxemic interaction for a public display

3.3 Conclusion

3.1 Theories of Proxemic interaction

In this section, we first elaborate proxemics from anthropology viewpoints, and then further discuss its extensions to the domain of human-computer interactions.

3.1.1 Proxemics of anthropology

Edward T.Hall (Hall et al., 1966) coined this term Proxemics and divided it into two categories: personal space and territory. Personal space indicates the spaces around a person, while territory means the area belonging to users (e.g. a private room, a private office or even the space around their office tables). For example, in a bus passengers always prefer to sit alone rather than sit side by side with a stranger, to keep his/her sense of territory. However, people tend to be willing to sit side by side with a friend. Edward T. Hall described a territory as an area which a person may lay claim to and defend against others.

Proxemics is people's understanding of the space around them (as shown in **Figure 3.1**). All people have a sense of self-space unconsciously, but

this sense of space greatly varies according to cultures. For example, in Asian countries, strangers tend to stand further back to keep a comfortable distance with each other than in European countries. Hall has depicted a diagram to describe his understanding of the space around a person. The divided spaces from intimate to public space always move together with the person. Only close friends or families can be allowed to enter the personal or intimate spaces, while others should keep away from the personal spaces to respect his/her sense of territory.

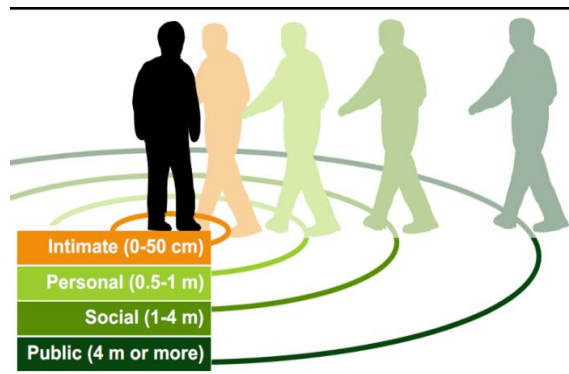

Figure 3.1 Proxemics around people (defined by Hall)

The space awareness of humans inspired the design of human computer interaction. What if a device can also be spatial-aware, for example, if a computer can sense the approach of users, and then wake up from sleeping mode? This is the origin of proxemic interaction, which makes efforts to extend the theories of proxemics to human computer interaction.

3.1.2 Proxemic interaction

Saul Greenberg proposed to apply the proxemics principles to human computer interaction by gauging the proxemics of users (distance, orientation, movement, identity and location) to interactive objects. The five dimensions of proxemics included both the personal space and territory categories. The innovative point of proxemic interaction is to make a device be aware of the user's position, to interpret the user's intentions and to provide personalized and more intelligent services. In the proximity-aware intelligent room constructed by Saul Greenberg et al., they have fully studied the different conditions of proxemic interaction. They have also applied various kinds of proxemic interaction prototypes, with a large touch-sensitive screen as the center of interactions. However, as we discussed in chapter 2, the infrastructure of the proximity toolkit is

appropriate for application in a relatively private room, but is too complicated and expensive to apply in public places. In fact proxemic interaction can have a greater effect in a public place than in a private room. It has two obvious advantages for combining the semantics of proxemic interaction with a public display installed in public places:

- Positively help users to get relevant information

At present, most public displays are passive and only publish standardized information to all users. However, with proxemic interaction, a public display can discover, attract and publish personalized information to users by getting to know users' proxemic attributes to the display. The display can propose particular contents to current users dynamically to help users get the most relevant information in a shorter time;

- Mediate multi-user interaction

The greatest difference between a public place and a private room is that in public places there might be frequent new multiple users. It is difficult for a traditional public display to handle the situation of group users, where users always wait in a queue or just gather in front of a screen to read information. The proxemic interaction theories can be used to mediate the group users' interactions on a public display, especially for a large size display. A proxemic interactive display can distribute different types of contents to users standing in different positions around the display, to make sure each user gets the contents exactly as they want without disturbing others.

Study of proxemic interaction for public spaces in a smart city has not yet been well explored. Unlike private indoor environments, there are still many problems that need to be considered and discussed. We continue to discuss the issue of proxemic interaction based on a public display installation in the remainder of this chapter.

To construct a proxemic interactive public display, we first need to make the proxemic attributes measurable. The five proxemic dimensions proposed by Saul Greenberg et al. are a general set of attributes for indoor proxemic interactions. These five dimensions can cover most of the aspects of proxemics. However, specific to concrete scenarios, we have to review these five dimensions according to the characteristics of public spaces.

3.1.3 Proxemic interaction dimensions

Among the five dimensions defined by Saul Greenberg, distance, motion, orientation, and identity are dimensions related to users, while location is the dimension related to the user's territory. When designing interaction with large public displays, we need to review these dimensions to adapt them better to the situation of public displays.

- Distance

Distance is a basic and important dimension for a proxemic interactive system, i.e. the user's distance with an object. The object can be a digital screen, fixed or semi-fixed features of a location, or other users. In a public place, it is not necessary to consider the user's distance with fixed or semi-fixed features because there are few fixed or semi-fixed features, and the setting of the space around a large display is always changing. However, the distance between users and the distance between the user and the public display have to be considered.

- Identity

Identity of an entity includes the context information about an entity, to distinguish one entity from others. Depending on the situation, identity can be simple just like an ID, or more complicated including other context information. Specific to a user, identity may be only a name, or some additional information such as age, male/female, color preference, etc.

- Orientation

The nuance of orientation change of a user can be used to speculate as to what the user focuses on. This information can help to deduce whether the user is interested in an interface, for example, to speculate whether the user is attracted by an advertisement or not. Orientation can be continuous (pitch/yaw/roll angle of objects relative to each other) or discrete (away or towards), similar to distance.

- Movement

Movement of identity is a key factor of proxemic interaction, and in particular movement of users specific to the condition of interaction with large public displays. User movement includes speed and orientation of users, e.g. movement can reflect whether a user is walking towards a public display or away from it. *The speed* of movement is the most

significant factor in this dimension. For example, if a user passes by a display quickly at a very close distance, this should not be considered as the same situation when one user stands at the same close distance to the display. If user speed is very fast, the display gives no response even if he/she is at close distance.

- Location

Location of proxemics means the “physical contexts in which the entity resides” (Saul Greenberg). However, for a public place, there are rarely fixed characteristics of a location. Location dimensions for a public place refer more to contexts of a location (e.g. bus station, airport, shopping mall, etc.) than a territorial meaning of users (a private room).

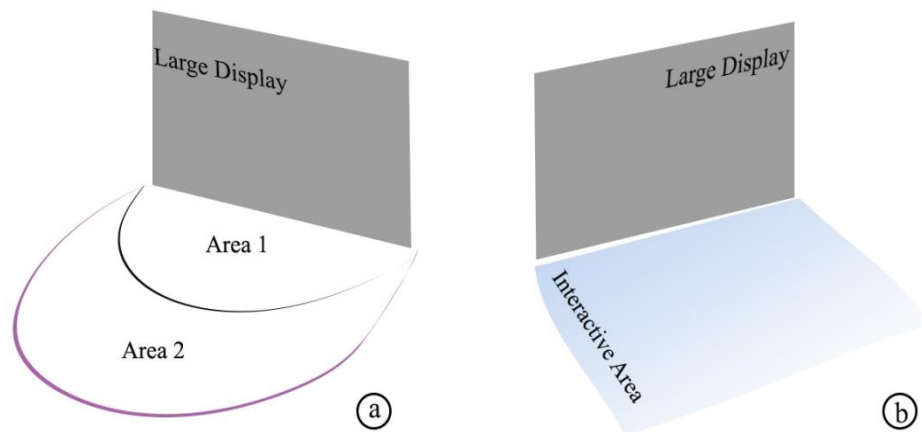

Figure 3.2 a, Discrete interactive zones; b, Continuous interactive zones

3.1.4 Discrete vs Continuous distance

Distance is the first dimension of proxemics to be considered in proxemic interaction design: to classify the spaces in front of a public display into several zones according to distance. We can divide the area by distance discretely or continuously, as shown in **Figure 3.2a** and b.

Figure 3.2a is a typical proxemic interactive display where the space in front of it is divided into Area 1 and Area 2 discretely according to distance. Users in each area can read distinct information from the display, or engage in different levels of interactions. The advantage of discrete proxemic areas is that the interactive zones are distinctly isolated, and users in closer areas cannot be disturbed by users in outer areas. However, the disadvantage is also obvious. How to decide the border line of each

zone is important: people can have different understandings of the interactive zones with a public display (i.e. users' sense of distance might be different), and if users happen to stand in the borderline of the interactive areas, how should we handle this ambiguous situation?

Figure 3.2b is an interactive display with a continuous interactive area. Saturation of color means the interaction possibilities: from far to close users can get increasingly more information and gradually engage in increasingly sophisticated interactions or take increasing control of the screen. In continuous interactive areas, we do not have to classify areas according to definitive distance, and there are no border lines. Users can gradually walk close to the display, and in the process, the display can publish interfaces gradually changing depending on the user's distance from the display. This is in accordance with people's expectation of walking closer and getting more details. However, the disadvantage of continuous proxemics is that when one user is close to the display, other users might intrude into his/her territory unconsciously. It is essential to provide some measures to make sure others respect the personal space of current users.

3.1.5 Single User vs Multiple Users

The behaviors of users in public places can be quite different from the behaviors of users in private rooms, especially when there are multiple users. Since displays are increasing in size, the main problem is how to take full advantage of the large display capability and make multiple users interact with the display simultaneously. There are two typical models of group users in front of a display: gathering or waiting in line, as shown in **Figure 3.3**.

In typical large public displays such as the departure information board in railway stations or airports, everyone gathers around the board to search for their train or flight.. For a smaller public display, audiences have to wait in a line until the current user has left. However, this situation rarely occurs in a public place, because users tend not to be willing to wait for a long time for an unimportant public display.

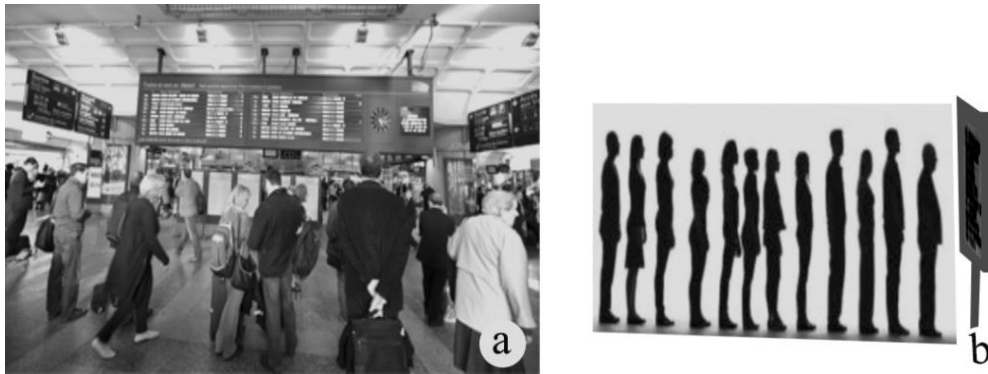

Figure 3.3 a, passengers gather around a large display; b, people wait in a line in front of a display

According to the specification of our proxemic display, it can recognize the user's identity and publish identified information instead of general public information to specific users. It is largely different from current forms of public displays, meaning that we have to reconsider the group users gathering situation. While there are not many issues if we only display general information to a group of users gathering in front of a large display, if we display personalized information to a group of users, it might be annoying and disturbing due to privacy concerns. It can be deleterious to users if his/her privacy is exposed in public places. A simple solution is to ask users to wait in a line and read information one by one. However, as we discussed above, this is a low efficiency way and wastes the display capability of a large screen. We thus need to find other solutions, which can display personalized information to specific users without jeopardizing the user's privacy, and meanwhile take the best advantages of displaying the capability of a large display.

3.1.6 Privacy, Priority and Occlusion

Proxemic interaction distinguishes users by their relative positions to a large display. It is thus possible to display personal-related information to users who stand in different positions in front of the display. In this case, one user cannot peek at the personal content of the other. For example, in the airport, a passenger walks to a display board. If there are no other people nearby, we can directly display his/her flight info instead of displaying all the flight information, or if there is another user in front of the board but standing at a distance from his/her current position, we can

also display his/her own flight info. There are several situations, as shown in **Figure 3.4**.

- Only one user in front of the display
This is the simplest situation where the display belongs to the current user. This situation occurs mostly on a small foot-sized screen. He/she can read general information or private information without concerning the privacy issue;
- Two or more users in front of the display
Two or more users stand side by side in front of a large display. If it is necessary to display personal-related information to them, we have to make sure that they cannot see each other's private information.

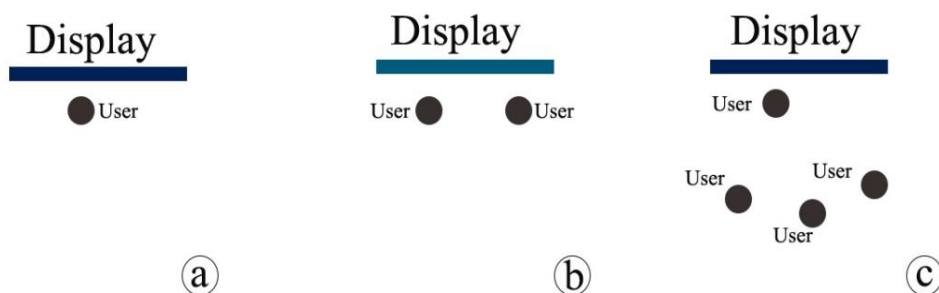

Figure 3.4 Models of Multiple Users

Furthermore, if the display is interactive, we have to handle the occlusion of interaction, and mediate the priority of interaction reasonably;

- One user is close to the display while others are waiting in an outer space
This is the most common situation, with one user interacting with the display and other users waiting. For a small display, it is only possible to accept one audience at a time. However, for a large-enough display, this is not sufficiently practical and it is necessary to search for other solutions to take full advantage of the display area of the large display. For example, this could be to divide the display into several partitions and display personal-related information to the current user while displaying general information to the users waiting in outer zones. In this way, we can retain the attention of the waiting user, while not disturbing the current user's interaction.

3.1.7 The dark patterns of proxemic interaction

Though application of proxemic interaction dimensions on a large display can improve the latter's performance, there are still dark sides of proxemic interaction, which are referred to as dark patterns by Saul Greenberg (S.Greenberg, 2014). He said it is necessary to avoid abuse of proxemic interaction systems. Proxemic interaction systems might be misused to cause detriment to users. For example, a user coming close to a display might not be willing to check out his/her personal related information, but the display imposes the personal contents to him/her, and even imposes some other unexpected information (advertisements). Also to make a public display recognize the user's identity might be rude and unacceptable. There are great risks at stake if we store users' personal information on a public display. How to prevent this information from being abused, and how to reasonably take advantage of proxemic interaction dimensions for a public display is a topic we need to consider.

Besides, we should be aware that, even in a public place, users have a territory sense. Each user, especially the current user who is interacting, has a sense of territory while he/she is checking information related to him/herself (e.g. when we withdraw money from a ATM, it is unacceptable if someone else is standing beside us). When designing interaction, personal territory should be respected.

3.2 Proxemic interaction design for a public display

From the interaction point of view, proxemic interaction is an intersection of implicit interaction and explicit interaction. The available interactions of users with the display are gradually transitioning between implicit and explicit interactions according to their spatial relationship with the display.

We can observe from communication between humans that plenty of information is expressed by implicit signs (e.g. body language, gestures, expression, voice, etc.). Though sometimes we don't express our meanings explicitly, others can understand our real meanings by these implicit body languages. At present, interactions between humans and computers are mostly explicit. Users directly input their command via the computer interfaces, and the computer gives output according to a pre-designed program, which is called explicit interaction. If the computer is

intelligent enough to understand the user's natural behaviors as inputs, then we can say that the computer supports implicit interaction.

Schmidt (Schmidt, 2000) defined implicit interaction as:

An action performed by the user that is not primarily aimed to interact with a computerized system but which such a system understands as input.

Proxemic interaction can be considered as one kind of implicit interaction. For example, if a user walks towards a public display, he/she might not be meaning to interact with the display but is just curious. However, the display recognizes the user's approach, then wakes up automatically (e.g. lights up the screen) to attract users to interact on the display. Implicit interaction can improve the performance of a public display by making it understand users' just-in-time needs through implicit signals. While it is difficult even for one person to understand others' meanings by their behavior, gestures and voice, etc., it is even more difficult for a computer system to interpret users' behaviors. Most implicit interactive systems try to understand users with some pre-defined rules, though these rules are not always correct. For explicit interactions, there is no such problem because it is the user who decides what kind of information or service a computer system should provide. The user clearly knows what he/she is interacting with, and what kinds of result he/she can get through the interactions. We can conclude as to the advantages and disadvantages of implicit and explicit interactions as follows:

- Explicit interaction is accurate, without ambiguity. However, explicit interaction is an old-fashioned pattern of interaction, and is not efficient enough to cope with the development of the ubiquitous society where interaction is no longer passive;
- Implicit interaction endeavors to make a computer system positively deduce user's intentions according to user's implicit behaviors, expressions or other signals. With this information, a computer system can propose better information to users rather than pre-edited and general information. In this way, users can focus more on their tasks when they are confronted with many digital devices rather than focus on how to use these devices and be disturbed by other irrelevant information. However, interaction accuracy greatly relies on the rules of interpretation of the user's implicit signs.

During implementation of proxemic interaction with a public display, we need to balance implicit and explicit interactions according to different application scenarios.

3.3 Conclusion

In this chapter, we discussed proxemics under the requirements of a large public display. We find that not all dimensions of proxemics can be implemented with public displays, but that it is necessary to consider the characteristics of public displays to decide which proxemics dimensions are appropriate. Besides, we compare the differences of implicit interaction and explicit interaction, and discuss how to take advantage of explicit and implicit interactions on the interactions of users with a large display, and what disadvantages should be avoided. We also describe the dark patterns of proxemic interactions, and in our work we have to avoid these dark patterns. In the next chapter, we continue to illustrate the construction of proxemic interactive public displays.

4 The Prototype of Proxemic Public Displays

4.1 Technical installation principles

4.2 System Architecture

4.2.1 Specification of Kinect

4.2.2 Web Camera and Face recognition

4.2.3 Leap motion

4.3 Proxemic display Interfaces

4.3.1 Two-layer user interface

4.3.2 Migratable user interface

4.4 Proxemic display Interactions

4.4.1 Implicit interaction with proxemic display

4.4.2 Explicit interaction with proxemic display

4.5 Module for data migration

4.5.1 Resources Selection

4.5.2 Data Communication

4.6 System Configuration Tool

4.7 Conclusion

In this chapter, we describe the architecture of a proxemic interaction prototype based on a public display: we first discuss the principles while building the architecture, and then we illustrate the components of the architecture, and finally describe how to deploy the architecture.

4.1 Technical installation principles

A proxemic interactive system is built on the proximity sensors, which can detect the position and movement of users, and even some nuances in change of position (orientation, eyesight). As a result, sensor quality determines the availability of a proxemic system. Specific to the condition of proxemic interaction, we identified several principles or challenges during installation of a proxemic interaction system.

- Simplicity

Proxemic interaction should be simple enough to use. Because the system is not designed for professional usage but for public usage, we assume that potential users are all new users rather than experienced users for this proxemic system. Simplicity includes: simple and comprehensive interface, simple interaction, etc.

- Quick response

Proxemic sensors should have a quick response to users' presence and position changing. For example, the system should act instantly once a user enters the interactive zones of the proxemic display. In this way, we can attract potential users' attention by reacting to them quickly.

- Intuitive interaction

Interactions with the proxemic display include both implicit and explicit interaction. Implicit interaction (user's movement) should be easy to understand without confusing information, and explicit interaction (e.g. gestures, postures) should be natural to use. There is no need for new users to acquire complicated training to interact with the system.

- Multiple users

A public display can cope with multiple users at the same time. Especially for a proxemic display, it should be able to detect and mediate the space

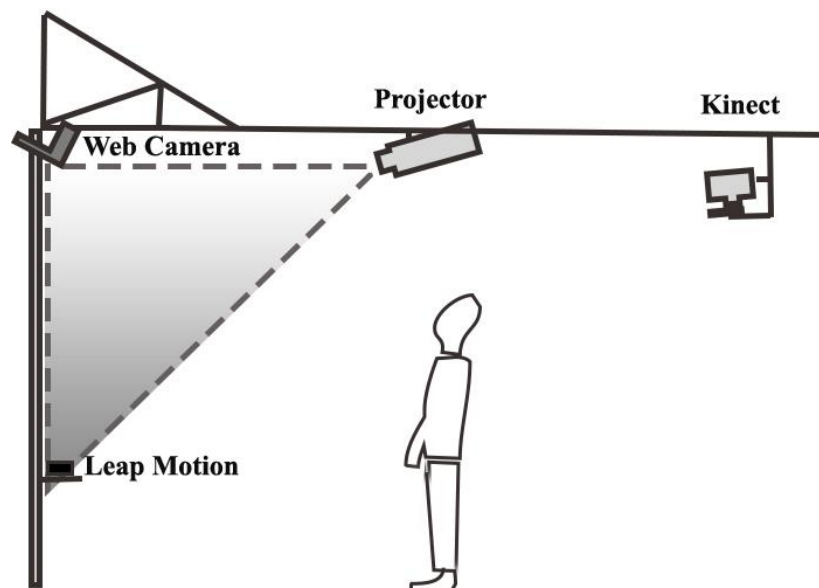

Figure 4.1 System Deployment

relationship between multiple users, and offer the optimized interface and interaction to each user.

- Two-layer interface

The interfaces we build for proxemic display are two-layer, i.e. we distinguish the interfaces according to the content displayed, where each layer displays different levels of information.

- Security of personal information

The privacy issue is always a problem when displaying personal-related information on a public display, even when personal-related information is not so strictly private. The two-layer interface can ensure security by avoiding peeps during the user's interaction with a public screen. Besides this, we should also consider data security during data migration from public displays to personal mobile devices.

4.2 System Architecture

Performance of the proxemic interaction system depends on the performance of sensors. The Vicon motion tracking system is a fine-grained and accurate sensor system for tracking users' movement by passive reflective markers. However, the Vicon system is expensive and can only be installed in an indoor location. Also, it needs sophisticated calibrations. Compared with the Vicon system, Microsoft's Kinect is a cheap and accurate sensor for tracking user's position, body postures and gestures. Kinect can measure the distance between itself and a user, and can detect six users and track the skeleton of two users at the same time. The greatest advantage of Kinect compared with the Vicon system is that it does not require users to wear markers, which is especially convenient for users in public places. Compared with Kinect, leap motion cannot capture the depth data of the whole body, but can recognize subtle movement of user's fingers, to implement more precise gesture interactions. We simulate a large public display with a projection screen, as shown in **Figure 4.1**, we install a projector on the ceiling, and a Kinect is installed facing the projection screen. A web camera is installed in front of the display to recognize the identity of users.

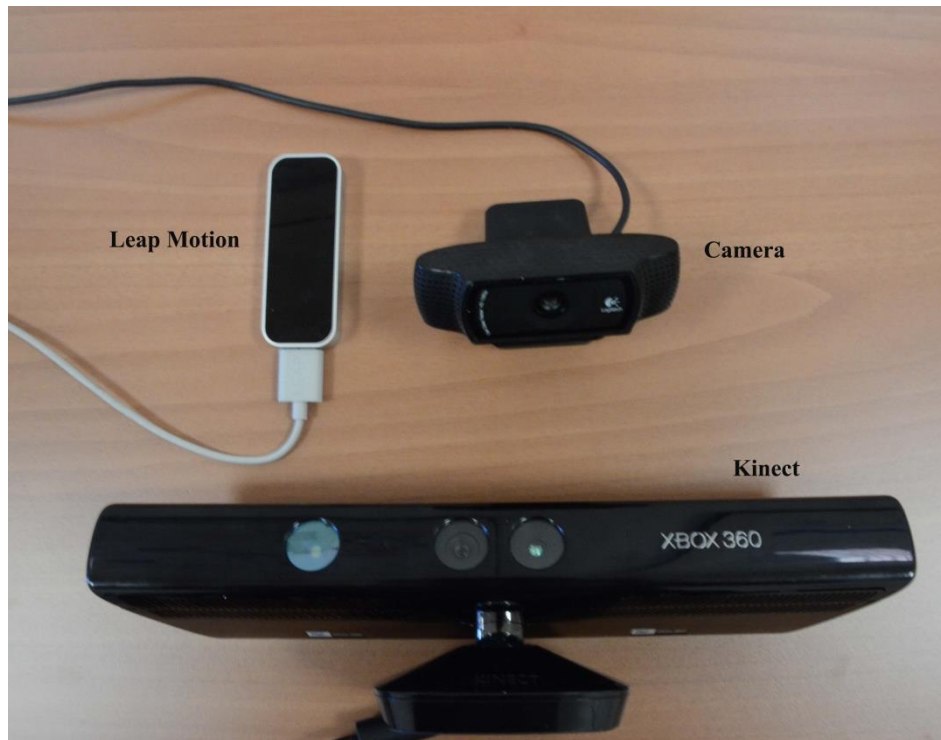

Figure 4.2 Hardware for the prototype

For the construction of our prototype, we employ three sensors:

Kinect: for detecting the proxemics of users, and supporting several coarse gestures or posture interactions;

Leap motion: to support fine-grained interactions of users;

Camera: to recognize the identity of users.

The three sensors we used are shown in **Figure 4.2**. We continue to describe the details of the three sensors in the following sections.

4.2.1 Specification of Kinect

Kinect is a device for motion sensing input, designed by Microsoft as an interaction input device for Xbox 360 and Xbox One. It can also be used on Windows 7 or higher. Kinect is capable of full-body 3D motion capture, facial recognition and voice recognition. Microsoft had released two versions of Kinect: Kinect for Xbox 360 and Xbox One. The previous is the first version of Kinect, while the second one is the most up-to-date

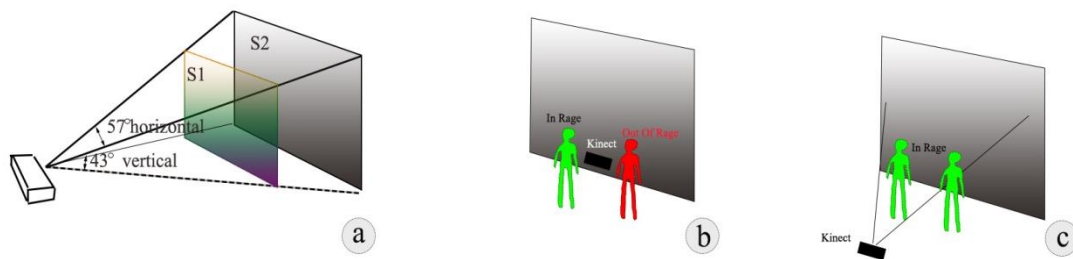

Figure 4.3 Rear-installed Kinect

version until 2014. Kinect for Xbox One has a wider working range, higher quality cameras and quicker response time. However, the technology principles are similar between the two versions. Since we use the first generation of Kinect for our system, the next sections are all based on the first generation of Kinect.

The Kinect is composed of a RGB camera and two in-depth sensors. According to the Kinect specification, the RGB camera can capture 30 frames per second with the default resolution 640×480 . Kinect is able to work from 1.2 to 3.5 meters in distance, and have an angular field of view of 57° horizontally and 43° vertically. Also, the motor inside Kinect can tilt the sensor up to 27° either up or down. As we can see from **Figure 4.3a**, the surface of S1 and S2 establishes the detectable area of the Kinect in the distance. The surface of S1 is smaller than S2, because it is closer to the Kinect. If we install the Kinect just in front of the display, it has problems detecting multiple users at the same time, as shown in **Figure 4.3b**. As a result, we install the Kinect facing the screen so that it can detect multiple users, as shown in **Figure 4.3c**. Each user in the sensing area of Kinect has a coordinate in three dimensions, as shown in **Figure 4.4**. The X axis is the horizontal position of the user, while the Y axis is the height of the user, and the Z axis is the distance of the user from the display. The origin of coordinate is the center point of Kinect.

We use the Kinect to measure the proxemic attributes of users, including:

- users entering or leaving the interactive area, whether a user is present in the interactive area, and whether he/she is leaving;

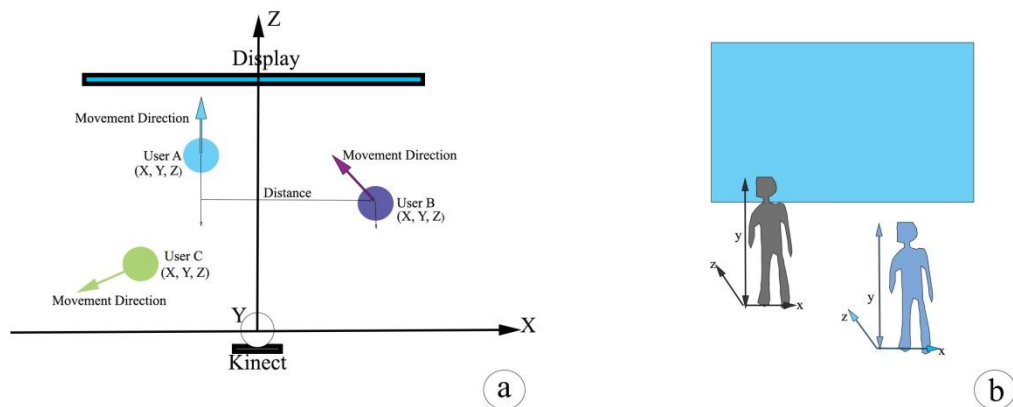

Figure 4.4 the Kinect coordinates

- User's distance from the display: the distance of a user from the display decides what kind of information they can read from the display, and what kinds of interaction they can get access to;
- User's movement: distance alone is not enough to speculate on the user's intention, because even at the same distance, users can walk towards any directions. We are not sure whether or not the user is walking towards the display. As a result, we take the user's direction of movement to decide whether the user is walking towards the display or away from it. If users walk towards the display, increasingly detailed contents are displayed, whereas if users walk away from the display, the detail contents will be replaced by general contents;
- User's position: to decide where to display the private window that belongs to a specific user. The private window is a window created temporarily for a specific user when he/she stands in front of the display. The position of the window should be set according to the position of its owner. It is unacceptable to present one private window to another user;

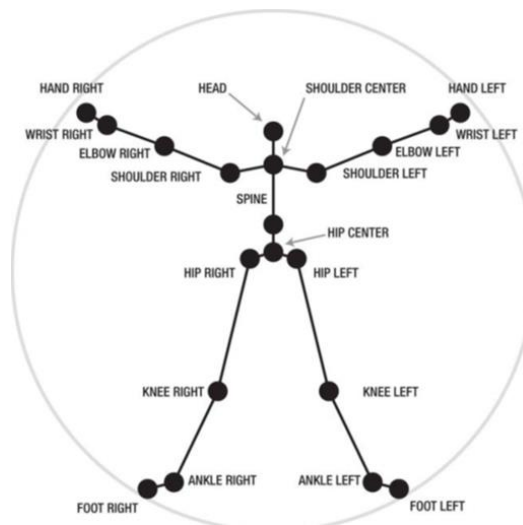

Figure 4.5 The joints recognized by Kinect

- User's speed: the speed of the movement is a factor which can tell whether the user is interested in the display or not. For example, a user passing by the display at a very close distance will be ignored by the display because he/she moves quickly. Only users standing still in front of the display are tracked;
- Total number of users in sight: to decide how many users are inside the interactive zone in order to allocate the display areas dynamically. The number of users is an important factor for deciding what kinds of interface should be presented to users;
- The relative positions between users in front of the display: to make sure the privacy information of each user is secure enough. For example, we need to measure the distance between two users who stand close to the display. If the distance is too close, which means that one user is standing too close to another, we can decide that there is a risk of exposing privacy. We thus have to remind the current user about that or take some other actions to avoid the exposure of privacy.

Kinect can recognize the skeleton of a user, and reads the skeleton frames at a frame rate of 30 FPS (Frame per second). The skeleton includes 20 joints of the whole body (as shown in **Figure 4.5**). Each joint has a value in three dimensions (X, Y, Z) to identify the position and depth information related to the position of Kinect. As a result, we can identify a user's distance between a Kinect based on the depth value of his/her joint

(e.g. Head) to the Kinect. Here we take the Head coordinate as the

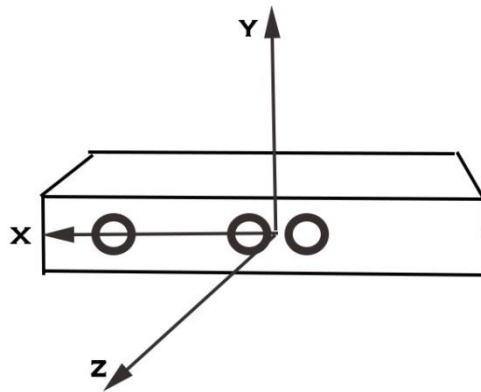

Figure 4.6 Kinect coordinate specification

reference of the user's position and movement, which means:

The user's position can be expressed by $(X_{\text{HEAD}}, Y_{\text{HEAD}}, Z_{\text{HEAD}})$. The original point is the center of Kinect, as shown in **Figure 4.6**. X_{HEAD} is the horizontal dimension of a person, Y_{HEAD} is the vertical dimension of a person, and Z_{HEAD} is the depth dimension of a person. So we use Z_{HEAD} as the reference of the distance between a user and a screen. Because we installed the Kinect facing the screen, the real distance can be calculated as:

$$\text{DIS}_{\text{user-to-screen}} = \text{DIS}_{\text{kinect-to-screen}} - \text{DIS}_{\text{user-to-kinect}}$$

Movement is a continuous change of position over a period of time. We add a dimension of time, and express the user's movement by $(X_{\text{HEAD}}, Y_{\text{HEAD}}, Z_{\text{HEAD}}, \text{Time})$. With this vector, we can calculate the user's movement in the X direction (horizontal) or the Z direction (walking towards or away from the display). The value of the Y axis is rarely changed because it is a fixed value related to the user's height.

The prototype of proxemic interaction is indeed a system of sensors. We have to collect, organize and process the sensor data and make reasonable decisions. In order to better integrate sensor data, we have classified the system into several independent sensor modules, and connected them with local networks, as shown in **Figure 4.7**. Kinect, leap motion and web camera are three sensor modules that capture related information about users and interaction contexts. They encode the raw sensor data according to standard data format (JSON, JavaScript Object Notation) and send the

formatted data to the data process center via a local network. The data process center decodes the raw data and extracts the useful information. Then, according to the principles of proxemic interaction, the interface layer displays specific contents to users. The data communication module is in charge of the resource exchange between the public display and personal mobile devices. From left to right, the user is walking closer to the display. He/she is detected by Kinect, the web camera and leap motion in order, and the contents presented on the display are more and more personal-related.

We conclude the proxemics parameters used for the proxemic interaction display prototype, as shown in **Table 4.1**.

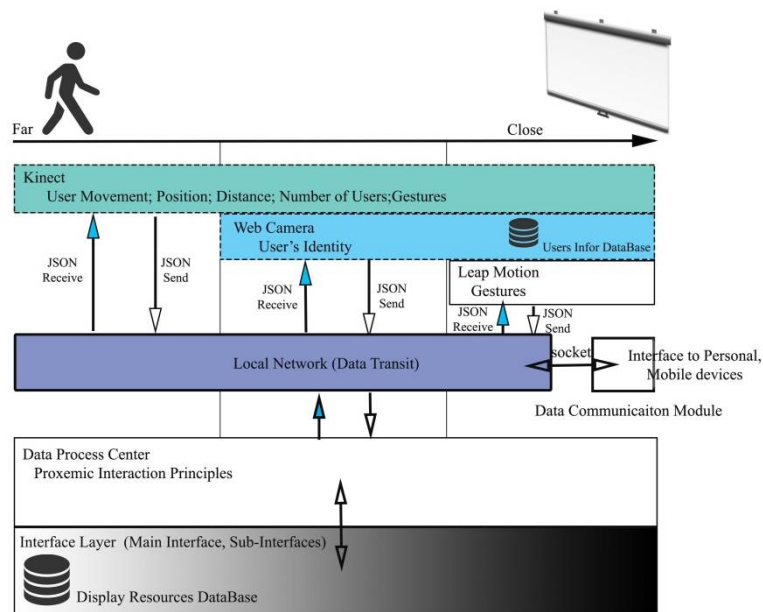

Figure 4.7 Modularized System Architectures

Table 4.1 Proxemic Parameters measured by the prototype

Type	Parameters	Properties	Description	Measured By	Data Type
One user	Presence Or Not	Binary	To mark whether one user is present in the engagement zone of display or not	Kinect	Boolean
	Distance	Continuous	The absolute distance between the current user and the display	Kinect	Double
	Movement	Continuous	The motion of the current user in the engagement zone of the display	Kinect	Double
	Speed	Continuous	Movement speed of the current user	Kinect	Double
	Height	Fixed Value	Height of user	Kinect	Double
	Identity	Fixed Value	Contexts of the current user (name, ID, etc.)	Web camera	String
	Location	Not A Value	The location contexts of current interaction	Pre-defined	Array of string
Multiple users	Relative Distance	Continuous	The relative distance among multiple users	Kinect	Double

4.2.2 Web Camera and Face Recognition

The system can recognize users' identities when users are standing close to the display, in order to provide some personal-related information. There are plenty of ways to recognize users' identities, for example, by personal identity badge such as Radio Frequency Identification (RFID) tags. RFID is wireless and has no-contact electromagnetic fields for tracking and identifying objects which are attached to the tags. While it is quick and accurate to recognize users' identities by RFID tags, RFID is not so widely spread in daily life except in professional and industrial fields. Instead, we use a web camera to recognize users' identities by computer vision algorithm Haar-like features. Haar-like features are digital image features used in object recognition. It is a type of real time face recognition detector. The most important advantage of Haar-like features is that calculation is very fast. We employ it to provide real time and quick-response identity recognition.

We have applied the haarcascade for front face which is provided by OpenCV. The haarcascade is an xml file named: haar feather-based cascade classifier for object detection. It stores the features of all recognized faces. The haarcascade xml file can be created by training the features of faces which need to be recognized. As a result, we have to get enough images of the front face and side faces of a person to be recognized. While this represents a huge amount of work if we apply it in a public scenario, it works well for an experimental object prototype.

In order to recognize a user's identity, we install a web camera just in front of the display. Face recognition is only activated when a user enters the close space of the display, and other users who stand at a distance from the display are not recognized.

4.2.3 Leap Motion

Leap motion is a peripheral hardware sensor device for recognizing the subtle motion of hand and finger, allowing users to operate on a computer screen without touching it directly. It is connected to a computer by USB cables. It is composed of two monochromatic IR cameras and three infrared LEDs, and has a frame rate of up to 300 FPS. Kinect can only detect and recognize users' whole body postures or coarse hand gestures. It is difficult for Kinect to recognize the motion of user's fingers.

Considering these differences, we use Kinect for recognizing body postures, or coarse hand gesture inputs for users standing at a distance from the display, while we use Leap motion to track the finger motion gestures of users standing close to the display.

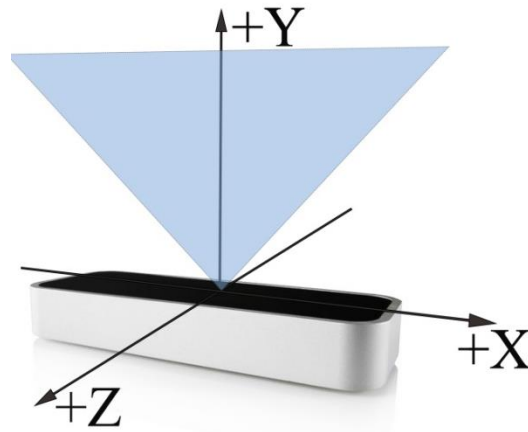

Figure 4.8 Leapmotion Coordinate

The leap motion can recognize hands, fingers and stick-like tools which are longer, thinner and straighter than a finger. The effective range of leap motion is approximately 25 to 600 millimeters above the device. Its field of view is an inverted pyramid centered above the device (as shown in **Figure 4.8**).

5.3.1 Data Communication

The Kinect, web camera and Leap motion are the core sensors of our system. They collect data individually. For a complete proxemic interactive display, individual data should be integrated together to take better advantage of the data. The data generated by raw sensors should be uniform with the same standard format. Here we make use of JSON (javascript object notation) format. JSON is a human-readable text, made up of attribute-value pairs. These pairs can be decoded by all the web applications that conform to the JSON standard. The sensors collect raw data, then encode some data with JSON format, and send them to the display server by Http protocols.

For example, a JSON object for describing a user's contexts can be decoded as follows:

```

{
  "Identity": [
    {"id": "121"},
    {"first_name": "John"},
    {"last_name": "SMITH"}
  ],
  "Coordinate": [
    {"Head": "200.05, 170000.00, 1"},
    {"Left_Hand": "200.05, 140000.00, 1.2"},
    {"Right_Hand": "200.05, 140000.00, 1.15"}
  ],
  "Gestures": [
    {"Circle": "true"},
    {"Swipe": "false"}
  ]
}

```

This JSON object contains three JSON arrays: identity of user, real time coordinate of user and real time gestures of user.

Sensors encode the raw data according to JSON format and post the data to the server. The server decodes the data, and then gets the information about current users and other contextual information, to make a decision and render specific contents to the current user.

4.3 Proxemic display interfaces

We propose to implement two-layers of interface for this prototype of proxemic interactive screen. Two-layer interfaces can be helpful to support multiple user interactions while still keeping the privacy of personal information.

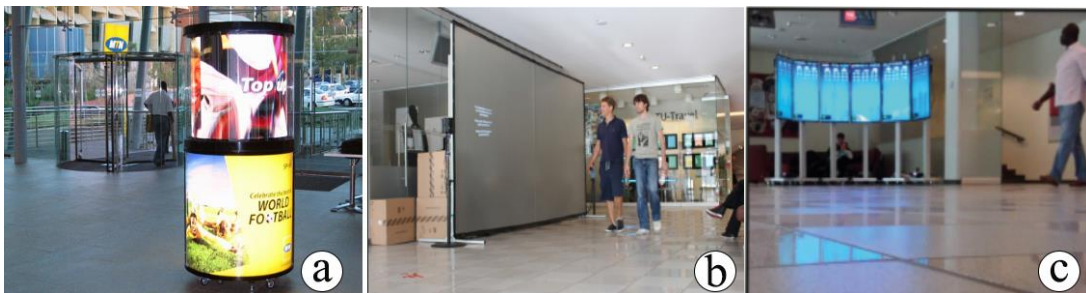

Figure 4.9 a: cylinder display of DynaScan technology; b: Screnfinity by (Schmidt, C., 2013); c: chained display by (Ten Koppel, 2012)

4.3.1. Two-layer user interface

The interface for public displays has long since been stereotyped, and the interfaces of modern electrical public displays are more or less the same as those of paper notice boards. However, with the development of ubiquitous computing, various forms of public displays are emerging. The typical kinds of interfaces for framed rectangular displays are no longer preferable. For example, there are already heterogeneous displays, large size displays, and chain displays, as shown in **Figure 4.14a,b and c**.

Display evolution trends tend to become larger, interactive and frameless. As a result, the interfaces provided by the displays need to be reconsidered to cope with the development of display media and interaction advancement.

It is especially significant to design interfaces for multiple users, as modern displays are larger and expected to handle the situation of multiple users. Several users can simultaneously interact with the same large display, while still getting the information they want individually. Specific to a proxemic display, we can display personal-related information to users, but we have to avoid these contents being peeked at by vicinity audiences.

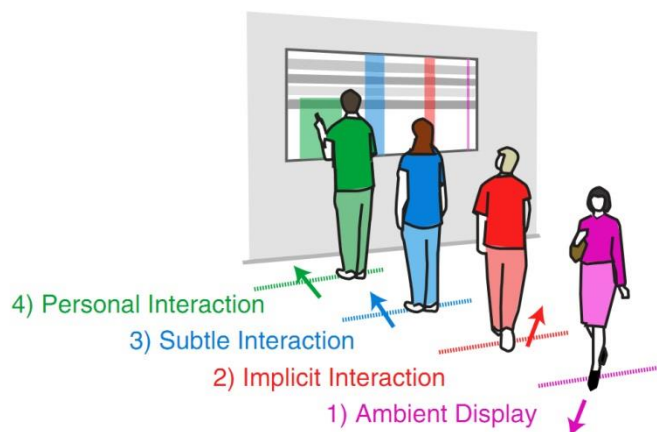

Figure 4.10 Dynamic interfaces designed by D.Vogel for different interactive phases

Some previous works have already handled this problem, for example the dynamic interfaces designed by D.Vogel (Vogel et al., 2004), shown in **Figure 4.10**. A large screen allocates identified interfaces to users at different distances, and the interface contents transform progressively along with the movement of users. This prototype can treat multiple users at different phases, but cannot accept multiple users in the same zone (e.g. two users both in the personal interaction zone). Besides, the interface transition was based on the user's discrete position, which is not as natural as continuous movement of users. However, this idea of dynamic and two-layer user interface inspires the interface design of proxemic displays. We go one step further to study the situation of multiple users at the same interaction phase.

- Two-layer interface

We divide the interface for a large enough display into two components: the main interface, and the sub-interface, as shown in **Figure 4.11**. The main interface is fixed, to display public or general information, while the sub-interface displays personal-related information in a small enough sub-window floating over the main interface (in this case the sub-window is the display carrier of the sub-interface). The sub-interface is not permanent. Only when one user is close enough to the display, can a sub-interface be created for him/her. The position of the sub-interface is moveable. The size and position of a sub-interface is decided by six factors:

- Height, Width of sub-interface;
- Rotate angle, margin to bottom, and margin to closest frame of main interface;
- The distance to the other sub-interface by side;

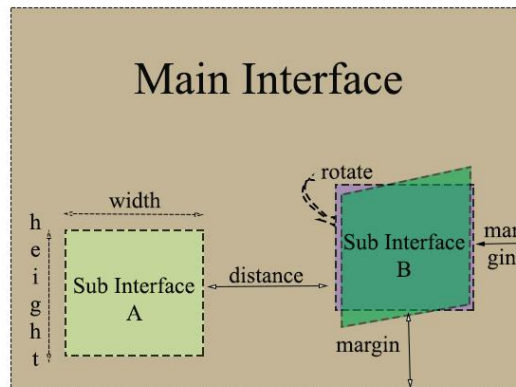

Figure 4.11 The interface components and display characteristics

These six factors can restrict the size and the position of a sub-interface. All six factors dynamically change according to proxemics of users. That means the size of a sub-interface can be manipulated by users, to make it larger or smaller. Also, the position of a sub-interface pans along with the position of users, to keep the sub-interface always within the sight of the current user. Furthermore, the position of the sub-interface in the vertical axis is decided by the user's height. A sub-interface created for an adult is not at the same height as a sub-interface created for a child. The axis of rotation can also be manipulated by users, to rotate the sub-interface to the direction of his/her eyesight.

The distance between two sub-interfaces is a factor to make sure that two sub-interfaces cannot be too close to each other. This is a trick to protect users' private information. For example, if two sub-interfaces are too close to each other (the distance is smaller than a threshold value), which means two users are standing too close to each other, we can remove both the sub-interfaces so that both of them can only read general information. Alternatively, we can also correlate distance to the opacity of sub-interfaces: opacity of the two sub-interfaces decreases as distance decreases. If the two sub-interfaces are close enough, both of them become transparent, and disappear from the main interface.

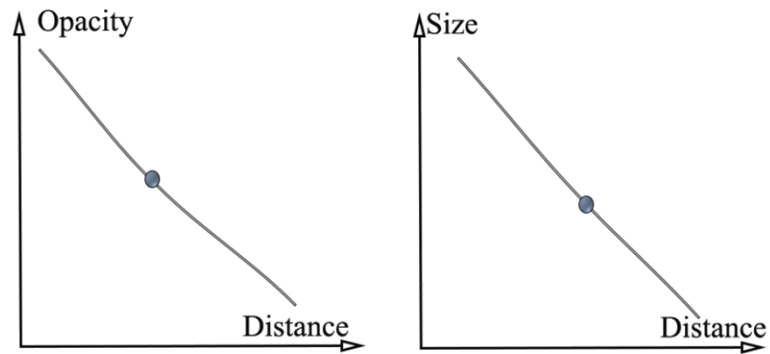

Figure 4.12 The correlation between properties of interface with distance

The numbers of sub-interfaces are still limited by the size of a display. Once a user walks away from a display, the sub-interface belonging to him/her is erased from the main interface. When there are no users standing close to the display, it only displays the main interface, in the same way as a normal public display.

- Opacity, size and distance

Opacity is a value which decides the level of transparency of a sub-interface. A large value means a sub-interface is clear, while a small value means a sub-interface is transparent. The opacity and size of a sub-interface is a function of distance between user and display, as shown in **Figure 4.12**.

$$Opacity = f(distance);$$

$$Size = g(distance);$$

According to the user's distance from the display, the opacity and size of the corresponding sub-interface gradually change. For example, if a user walks closer to the display, the opacity of the sub-interface increases, while the size of the sub-interface gets larger. In contrast, if a user walks away from the display, the opacity and size of the interface get smaller until the sub-interface becomes invisible.

For this multi-layer interface, we assume that when one user walks closer to a display, he/she is going to check his/her personal-related information. However, this assumption is not always correct. Thus it is better to give users' the ability to make choices, and users should be able to remove the sub-interface appearing by a simple gesture. We will implement this rule in the process of interaction design.

4.3.2. Migratable User Interface

The sub-interfaces are created once users are present in interactive zones. If users are out of the interactive zones, all their sub-interfaces are removed from the main interfaces. However, what if users want to keep the information on the sub-interfaces? As a matter of fact, all the sub-interfaces belonging to certain users are migratable. This means the owners of sub-interfaces can migrate the sub-interfaces to their own mobile devices easily, and the interface can re-design itself to adapt to the screen size of different mobile devices. It is essential to emphasize that only the owner of a sub-interface can download it. One user cannot download the information from another user's sub-interface. In this way we can protect users' privacy.

Users can download the whole sub-interface, or only download some content blocks of the sub-interface, according to their preference. Resource migration is bidirectional. In this way, a public display is open to users' mobile devices. This idea is inspired by the description in (Davies et al., 2012) about open display networks:

Public display systems should also be open to content from "users", i.e. non-developers. By allowing viewers to actively influence the content of their displays, we envision increased participation in, and relevance of, such systems.

Users can create contents on their own mobile devices, and send the contents to the public display to exhibit them publicly. In the next chapter, we will discuss how to make the interface migrate seamlessly among public displays and users' mobile devices.

4.4 Proxemic display Interactions

In this section, we discuss the interaction of users with the proxemic display. The differences between a proxemic display and a traditional interactive screen include three aspects: the proxemic display is large, untouchable and context-aware. As a result, the interaction applied on a proxemic display is greatly different from a traditional touch screen.

We divide the available interactions into two categories: implicit interaction and explicit interaction. As we discussed above, all direct interactions on a touch-sensitive screen are explicit interactions. In

contrast, implicit interactions are those that take users' natural behavior as inputs. Users do not have to perform some routine actions to interact. Implicit and explicit interactions are both available to users: this depends on their position related to the display.

4.4.1 Implicit interaction with proxemic display

We apply the methodology of implicit interaction in the interaction with the proxemic displays, based on users' spatial relationship related to the display. Users' movement process can be binary status or continuous status.

- Binary status:

Entering and leaving the engagement zone of the proxemic display;

If a user enters the engagement zone of the display, then the display recognizes the presence of the user and creates a sub-interface for him/her. In contrast, if a user leaves the engagement zone of the display, the sub-interface belonging to him/her is removed from the display.

- Continuous status:

Moving towards or away from the display, moving continuously inside the engagement zone;

Once a user enters the engagement zone, his/her movement is continuously captured by the Kinect. He/she moves close to the display, the sub-interface becomes clearer and larger, and more information will be presented to the user. On the contrary, if he/she moves away from the display, the sub-interface gradually shrinks and disappears from the display. The sub-interface belonging to the current user is not fixed, and the position of the sub-interface moves along with the user's movement. While the sub-interface is appearing, we display messages to users and remind them that they can engage in explicit interactions by gestures.

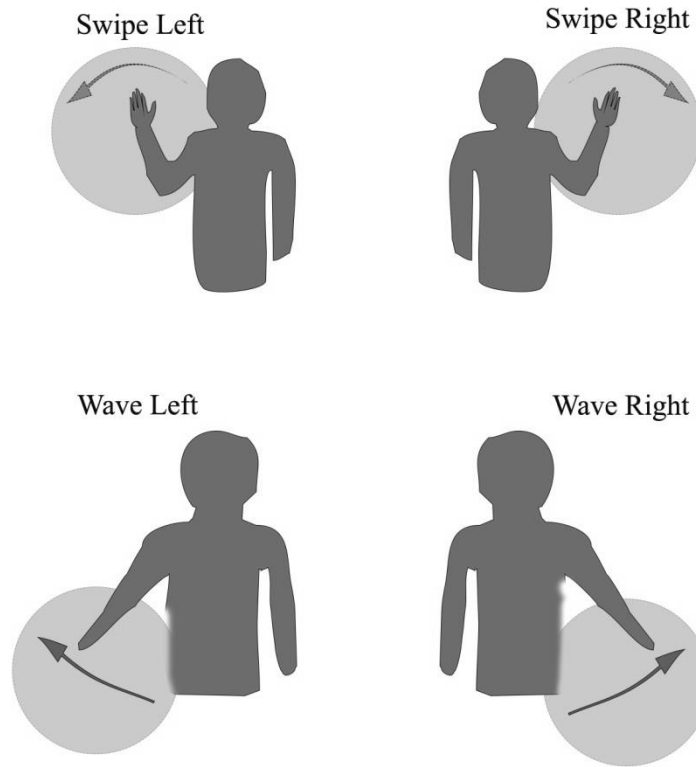

Figure 4.14 Swipe and Wave Gestures

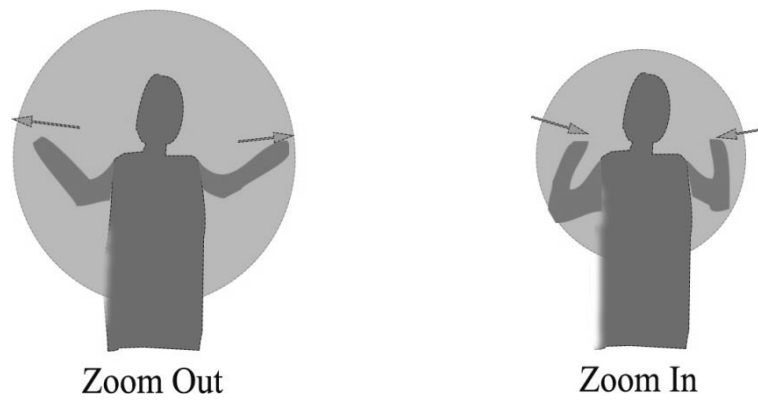

Figure 4.13 Zoom Gestures

4.4.2 Explicit interaction with proxemic display

Gesture interactions with the display are explicit interactions. Analogous with inter-human communication, the closer the user is to the display, the more explicit the available interactions are.

Interaction by coarse gestures

- **Scroll gestures by wave left or right**

Users can scroll contents of an interface to browse the details by waving their left hand or right hand, as shown in **Figure 4.14**. Content is scrolled downwards by waving the left hand, and upwards by waving the right hand. Content scrolling is as natural as scrolling a website or document with a mouse or keyboard in a computer.

- **Switch gesture by swipe left or right**

We arrange the content blocks (a content block is a page of contents with the same theme, as shown in **Figure 4.15**) on the display in a horizontal line. The switch between different blocks can be controlled by gestures, swipe left or right, as shown in **Figure 4.14**. A left hand swipe moves the blocks to the left, while a right hand swipe moves the blocks to the right. Swipe gestures are the most natural gestures and are consistent with the intuition of users. It is not necessary to learn or practice the gestures. Any users can directly switch the contents on the display naturally by swipe gestures.

- **Zoom gesture**

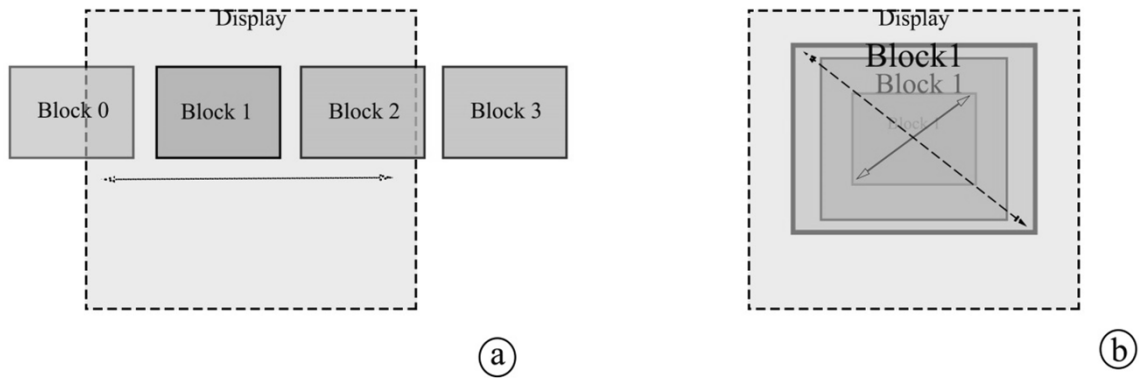

Figure 4.15 The modularized interface of a public display

By dragging hands in opposite direction or towards each other can zoom out or zoom in current contents, as shown in **Figure 4.13**. The entire current content block currently presented on the display can be zoomed by users with simple zooming gestures. More and more details will be displayed to users related to the current subject along with the enlargement of the content block's size. In contrast, if the user zooms out the current content block, only the main contents are displayed.

We have to mediate the priority of users if there are several users in front of the display. For example, if two users stand simultaneously in front of the display, deciding which user has priority to browse and zoom the content blocks can be a problem. We have created the rules for multi-user conditions. Only the user standing closer to the display can have the priority of swiping and zooming gestures. However, if there are two users standing at the same distance from the display, the gestures will be unavailable to avoid users' occlusion with each other.

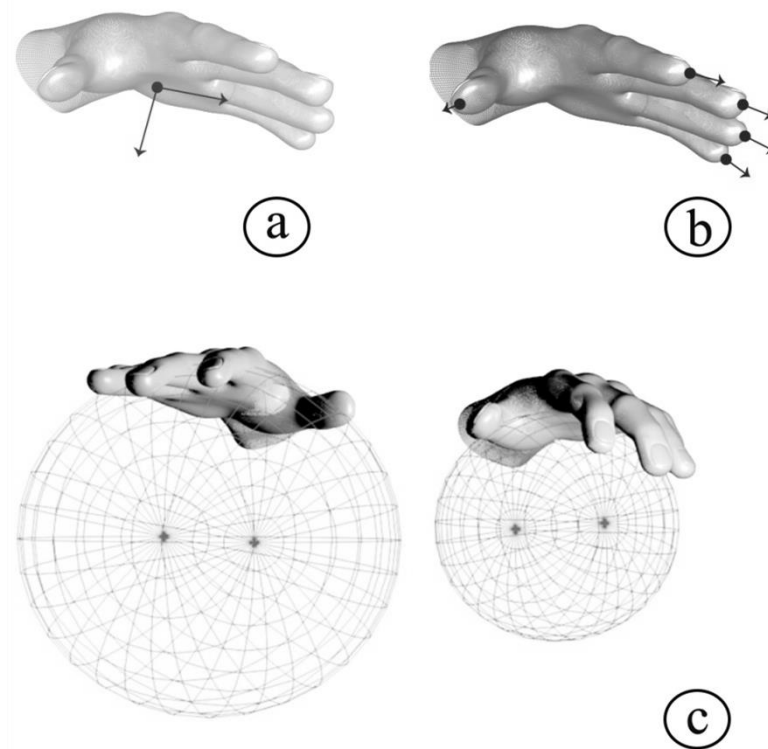

Figure 4.16 Leap motion: a, hand vector; b, finger models, c; simulated palm ball

Fine-grained gesture interaction

If users decide to check more detailed information, then they walk towards the display. Their personal sub-interfaces are enlarged and placed on the display just in front of them. Then they can operate on the sub-interfaces by mid-air gestures performed by Leap motion. Leap motion can detect the tiny movement of hand, fingers and the knuckles of a finger. We can get the direction of fingers, palm direction, sphere of palm and grab strength by the Leap motion SDK. As we can see from **Figure 4.16a** and **b**, from the direction of the palm, we can justify the palm facing up or down; in **Figure 4.16c**, leap motion simulates a ball with the diameter related to the sphere of the palm, so that we can justify the grab gestures by the size change of the palm ball.

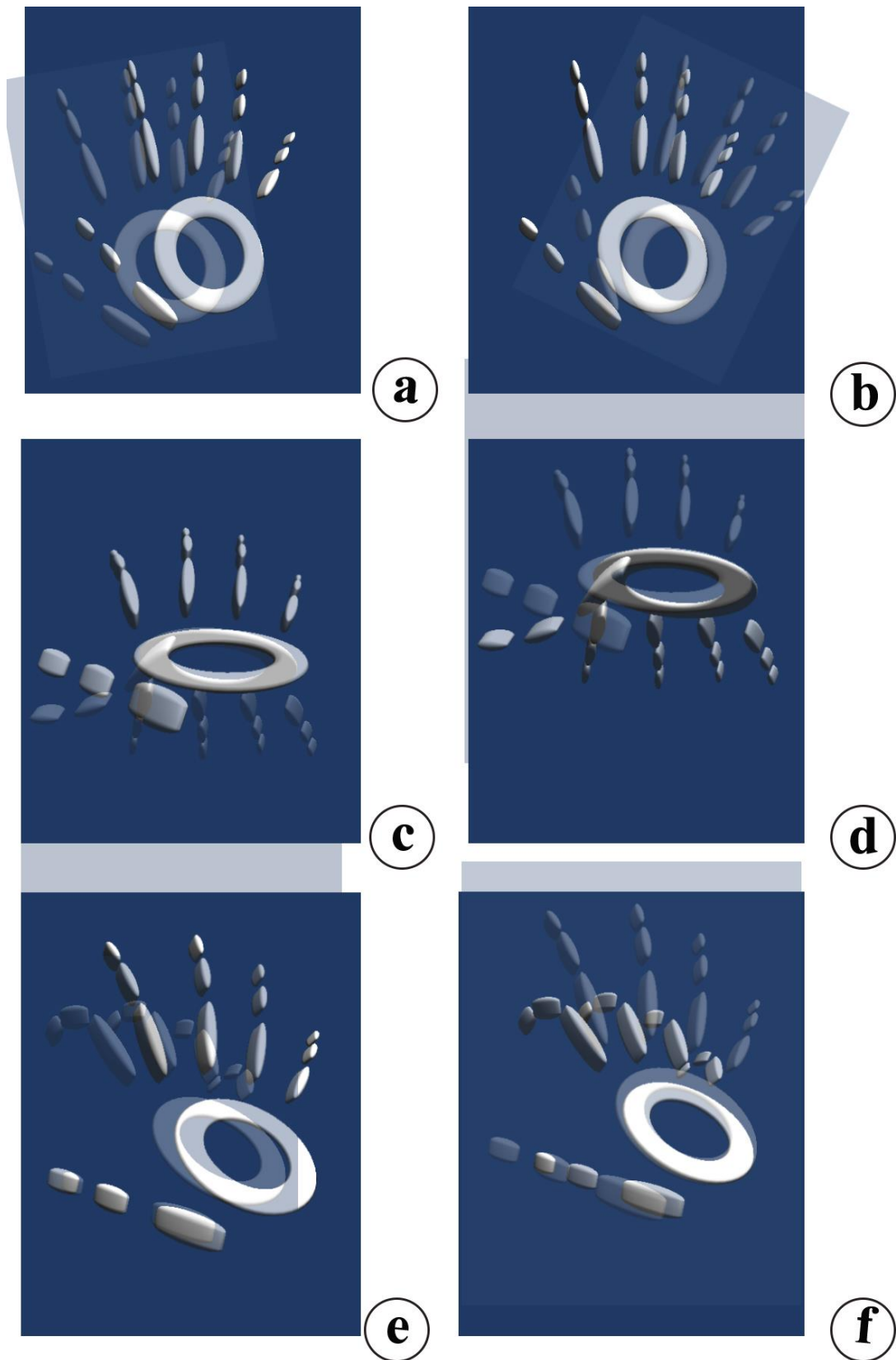

Figure 4.17 Leap Motion Gestures, a: switch left, b: switch right, c: scroll up, d: scroll down

We choose the direction attribute of the hand to determine the fine-grained gestures of hand movement in four directions: up, down, left and right. Hand.direction is a vector meaning the direction from the palm position to the fingers. The vector includes the pitch, yaw and roll angles of the palm with respect to the horizontal plane. We use the angle of pitch to decide the switch gestures in the horizontal direction, and the angle of yaw to decide the scroll gestures in the vertical direction.

```
If (hand.direction.pitch< $\mu$ ) then "switch leftwards";
Else if (hand.direction.pitch> $\alpha$ ) then "switch rightwards"
    If (hand.direction.yaw> $\beta$ ) then "scroll upwards";
    Else if (hand.direction.yaw< $\varphi$ ) then "scroll downwards"
 $\mu$ ,  $\alpha$ ,  $\beta$  and  $\varphi$  are variables decided by real conditions.
```

- **Wave hand horizontally to switch**

Users can simply swipe their hand leftwards or rightwards to switch between different interfaces. Unlike swipe gestures, wave gestures do not require users to move their hand in a wide range. Users only have to wave their hand slightly to perform the switchover action. A slight movement of the hand is comfortable, and also avoids awkward actions in public places.

- **Bend Palm Vertically to scroll**

Similarly to switch gestures, users can bend their palm in the vertical direction, to scroll the contents in the current interface. As shown in **Figure 4.17b** and **d**, bending the palm upwards scrolls up the contents, while bending the palm downwards scrolls down the contents. The bend movement is also slight, to avoid weird awkward gestures in public places.

- **Grasp hand to shrink sub-interface**

Users can also change the size of their sub-interfaces to adapt to their preference by zooming gestures, as shown in **Figure 4.17e**. The user grasps the hand to shrink (zoom in) the current sub-interface. From **Figure 4.16c**, we can see that the palm center is simulated as a ball which is held by the hand. The diameter of the ball can be calculated by the sphereRadius of Leap motion SDK. We use the diameter as the referenced value of sub-interface size. When the hand is grasped, the diameter of the virtual ball decreases. Meanwhile, the size of the sub-interface also shrinks until it disappears from the display. This grasp gesture can also allow users to quickly hide the sub-interface should other users intrude.

- **Open hand to enlarge sub-interface**

In contrast, users can open their hand to enlarge (zoom out) the sub-interface, as shown in **Figure 4.17f**. Similar to the shrinking gesture, the size of the sub-interface increases along with the hand opening (diameter of the virtual ball is getting larger).

- **Swipe to hide or open the sub-interface by Leap motion**

The sub-interface is placed over the public display. As a result, it is a critical issue of privacy if some personal-related information is displayed on the sub-interface. Users need to be able to quickly hide the sub-interface when there is another user standing next to them. Users can quickly swipe their hand downwards to hide their private sub-interfaces, and in contrast, they can swipe their hand upwards to open the sub-interface again.

- **Transparent sub-interface**

Swipe gestures can allow users to quickly hide the sub-interfaces. However, these gestures might be rude to other users, and make them feel like they have offended the current user. As a result, we provide another solution for this situation. Kinect can detect the number of users in the current situation. Thus, if we detect there is another user entering the same distance with the current user, we can change the opacity of the current sub-interface, making it somewhat transparent to remind the current user that he/she should be cautious about his/her personal-related information. In this way, we can guarantee the security of personal data without disturbing the normal interactions.

4.5 Module for data migration

The interface is not only responsive to users, but is also open to ambient devices, mainly the mobile devices of users. We have integrated a module for data communication with the display. The module is a set of software which includes two packages: one package installed on the display, and the other package installed on users' mobile devices. The software packages implement network sockets and follow the client-server structure. The network socket is the most common inter-process communication flow across a computer network. It can provide reliable connection between network endpoints and ensure secure data communication.

The server side accepts resources that are sent from the client side. The data communication process is carried out by a local Wi-Fi network. One typical download process only includes two steps:

First select the resource from the display, and then download it from the display to mobile devices.

4.5.1 Resources Selection

Users can download any resources on the display, including the resources on their sub-interfaces or the resources on the main interface of a display. The Kinect detects the user's hand movement and converts the hand movement into the cursor's position on the display. Thus the user can choose an item on the display by moving his/her hand. The item can be of various types, such as an image, a text block or a document, or even the sub-interface of the user.

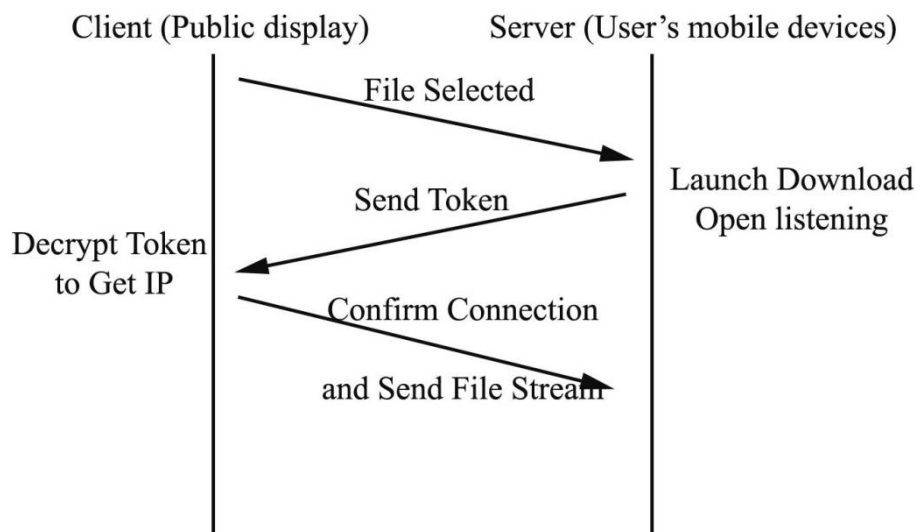

Figure 4.18 Handshake of authentication

4.5.2 Data Communication

Once the user selects an item, he/she can easily download the item to his/her mobile devices via a wireless network. During the download process, the public display is a client and the user's mobile device is a server. Once the user has selected the file he/she wants to download, he/she can launch the application in the mobile device, and click the download button. Data communication is carried out by TCP/IP protocol to ensure secure and reliable data transmission. TCP/IP uses a standard three-way handshake process between the client and server. The IP address of public display is known to the mobile devices, but the public display is not aware of the IP address of mobile devices, as users' mobile devices cannot be predicted. As a result, before data transmission begins, we also implement a handshake process to register the IP address of mobile devices with the

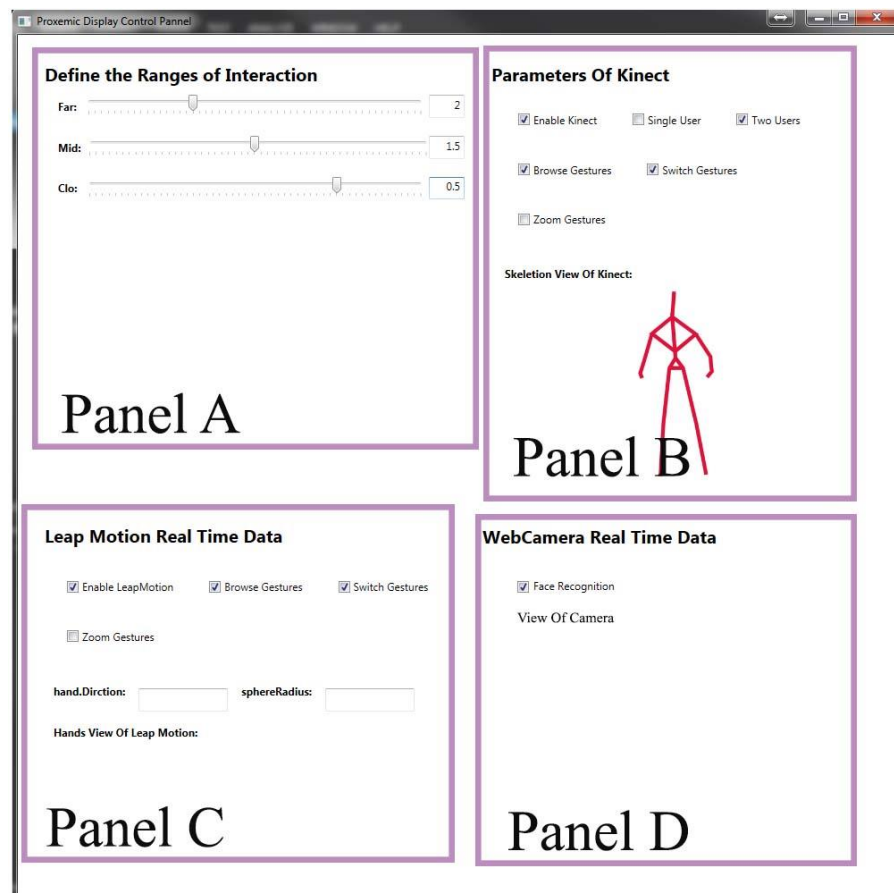

Figure 4.19 Control Panel of Proxemic Display

public display, as shown in **Figure 4.18**. Users only have to select files from the display and launch the download process on mobile applications. The authentication and communication processes are automatically completed by this software. Once the resource is downloaded, it will be opened instantly on the user's mobile device.

The software module is oriented at downloading resources from a public display by users' mobile devices. However, the process is bidirectional for exchanging resources between two entities. Users can upload the resources stored in their mobile devices to the public display as well. The resources can be any file types. In this way, we have bridged the gap between public displays and personal mobile devices, and connect the two most common and typical media seamlessly. We discuss the potential applications based on this communication module in chapter 6.

4.6 System Configuration Tool

We have provided a graphic user interface for configuring the proxemic interactive display. Users can configure the parameters of the system, the installation layout of the display, and observe the real time data of the users' proxemics.

The proxemic display control panel is shown in **Figure 4.19**. It is composed of four panels, each of which contains some parameters that can be modified.

In panel A, users can define the borders of engagement zones of a proxemic display by dragging the slides or entering numbers according to the real installation and screen size. The slide value delegates the distance of each range to the display, and the limit is from 0 to 2.5 meters approximately. Users can modify the three slides: far, middle and close to construct three different types of proxemic displays, as shown in **Table 4.2**, $2.5 > \text{value 1} > \text{value 2} > \text{value 3} > 0$.

In panel B, users can personalize the Kinect-related attributes. We have listed all the available gestures supported by our prototype. Users can enable or disable specific gestures according to the real requirements. Users can also select the numbers of users supported by the prototype, according to the size of the display, and the actual surface of a public place. There is an output window where users can see the current skeleton

view of users detected by Kinect. They can thus clearly know whether there are users to be detected and tracked.

Table 4.2 Definition of the interactive ranges

Types	Far	Middle	Close	Numbers of ranges
1	Value 1	Value 2	Value 3	3
2	Value 2	Value 2	Value 3	2
3	Value 3	Value 3	Value 3	1

In panel C, users can also personalize the Leap motion-related attributes, to enable or disable some gestures according to real situations. We have displayed the real time data of two key factors: hand direction and palm radius sphere, along with the view of hands by Leap motion. Developers of the prototype can get to know the relationship between current gestures and real time data, and can thus modify and optimize the gesture parameters.

In panel D, users can enable or disable face recognition by camera, because it is not always necessary to recognize the user's identity by the prototype.

4.7 Conclusion

In this chapter, we have illustrated the architecture of the proxemic interaction prototype, which includes the design principles of the prototype, system architectures, and the specification of different functional modules. This proxemic interaction prototype includes two main modules: the interactive module and the data communication module. We have implemented the implicit and explicit interactions based on camera, the Kinect and the Leap motion. We also discussed which kinds of interfaces are appropriate to implementation of proxemic interactions.

The communication module makes it realistic to exchange resources seamlessly between a public display and personal mobile devices. In the next chapter, we continue to elaborate the migratable user interface based on the data communication modules.

5 The Migratable User Interface

5.1 Current technologies of Resources Migration

5.2 The Toolkit Architecture

5.3 Mobile Application

5.4 Service on the Side of Display

5.5 Data Communication Security

5.6 User Management System

5.7 User Study

5.7.1 The test procedure

5.7.2 Data Collection

5.7.3 Results of the User Study

5.8 Conclusion

A large proxemic public display changes the ways of interaction between citizens and public displays, and increases the efficiency of interaction by allowing users to check the information that is related to them. However, there is the risk of privacy, to show personal-related information on a public display. As a result, we designed sub-interfaces which only belong to certain users. However, this trick does not remove personal information from public media, so the privacy risk still exists. Personal mobile devices are already widespread devices that always been taken with us every day. If we can display personal-related information on the screens of personal mobile devices, it seems be a solution for security issues. At present, individual users cannot download yet resources freely from a public display, and there is definitely a gap between public displays and personal devices. In this chapter, we discuss how to bridge this gap between the two media so that we can use the screens of users' mobile devices as extension screens of public displays.

5.1 Current Technologies of Resource Migration

At present, matrix codes (or two-dimensional barcodes) are widely used by public media as ways of transferring public resources to personal devices. QR codes (quick-response codes) are the most popular ones which can be found everywhere. The QR code contains the information related to the item it is currently attached to. The information can be

scanned by devices through cameras. Due to the cheap price and quick-response, QR codes are widely used for tracking products, identification of items and circuit management, etc. The biggest advantage of the QR code is that it can be printed on almost any surface, making it a very cheap way of conveying data. For example, QR codes are printed on all the timetables of bus stations in Lyon, as shown in **Figure 5.1**, Passengers scan the QR code with smartphones and can get a link to the website of public transportation in Lyon. They can then search for the information they want from the website. However, the information is not related to the current station where the passenger is located, but to a website of the public transportation company. So users still have to search by themselves for the exact information they want.

But are QR codes as popular as they appear to be? In order to investigate the real usage situation of QR codes, we have conducted an online investigation into the usage of inter-device communications.

The purpose of this investigation includes two aspects: the first concerns the user's preference of inter-device communications, while the second concerns the user's degree of acceptance about the usage of QR codes. In accordance with these two aspects, we have listed three questions in the questionnaire:

4 Direction > GARE DE VAISE
PERIODE NORMALE

> LUNDI AU VENDREDI 019AM

4h	5h	6h	7h	8h	9h	10h	11h	12h	13h	14h	15h	16h	17h	18h	19h	20h	21h	22h	23h	00h	
		57	02	05								15	08	11	10						
			07	22								30	21	23	30						
			12									40	34	35	50						
			18									55	47	50							
			24										59								
			29																		
			35																		
			40																		
			45																		
			55																		

> SAMEDIS, DIMANCHES ET FETES TOUTE L'ANNEE
pas de service

VACANCES DE NOEL du 23/12/2013 au 01/01/2014 inclus

> LUNDI AU DIMANCHE
pas de service

Dates des vacances scolaires :
Date d'application de cet horaire : 21/10/2013
Arrêt : Campus Lyon Ouest - 46094
17 avenue Guy De Collongue (en face) 69130 ECULLY

Obtenez les horaires d'attente des bus gratuitement avec

Figure 5.1 A bus timetable with matrix code

- If you want to send a file from your smartphone to other digital devices (smart phone, PC, etc.), which method below do you prefer to use?

A, Bluetooth; B, Email; C, Near Field Communication; D, Wi-Fi direct; E: Others (Please specify).

- How often do you scan QR codes to get information (e.g. QR codes on any surfaces of public media)?

A, frequently; B, neutral; C, occasionally; D, never

- Why do you like or dislike using QR codes?

We obtained 40 responses worldwide during a period of 15 days. The respondents were from America (2), France (19), China (18) and Pakistan (1), including 21 males and 19 females. 6 of them are between the ages 15-25 (15%), while 34 are between the ages 25-35 (85%). The investigation results are shown in **Figure 5.2**.

With regard to the preference of resource communication between devices, we found that Wi-Fi direct is the most frequently used method: up to 42.5% participants (17/40) use Wi-Fi. 12.5% of participants (5/40) choose Bluetooth, while the remainder use NFC (7.5%, 3/40), email (20%, 8/40), share by cloud (7.5%, 3/40) and USB cables (10%, 4/40). It proves that Wi-Fi is the most popular method of inter-device communication. Regarding the usage conditions of QR codes, only 5% of participants (2/40) use QR codes frequently. In contrast, up to 50% (20/40) never use QR codes, 50% of participants (16/40) use QR codes occasionally, and the remaining 2 participants are neutral (5%). The investigation results prove that Wi-Fi is more popular than Bluetooth, NFC and other methods. Not surprisingly, the QR code is not as popular as it seems to be. It is widely applied but not widely accepted by users. As is proved by the feedback we collected from the on-line survey: “I don’t know what can I get by scanning the QR code, so I always don’t scan it”, “I don’t installed an app on my smartphone to scan the QR code”, “I scanned it once, but I found some information that is not what I expected to get”, “It is said that QR code might contain virus”. Though the QR code is cheap and a fast way of allowing users to download information from other media, for electrical digital displays, the QR code is somewhat simple, as it gives static information instead of providing the dynamic information which users need.

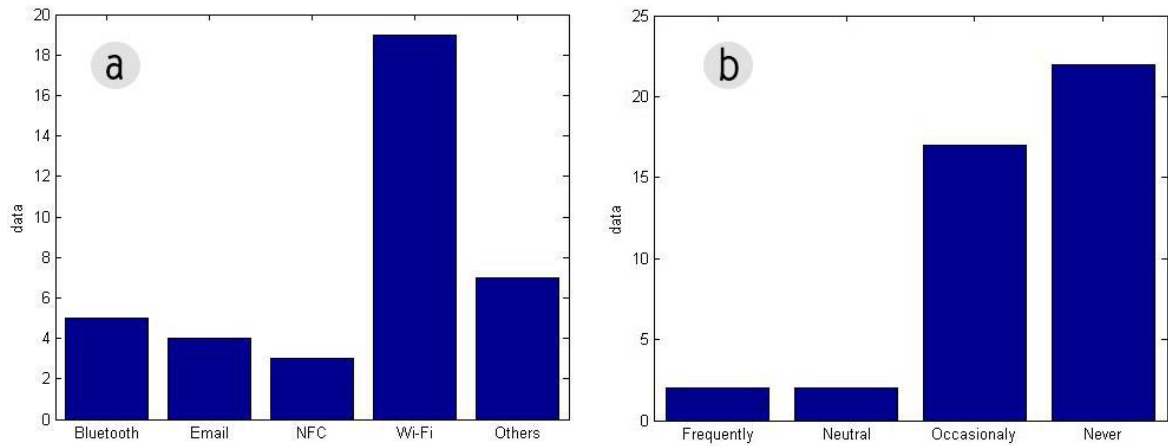

Figure 5.2 Investigation Results

QR codes are widely used due to their economy, but they are still not convenient enough. Especially for electrical displays, there should be better solutions for opening resources than only printing QR codes. This is because the QR code does not store enough dynamic information, and contains only a static link to the specific information, and the data communication process is carried out by other communication methods, for example, Bluetooth, Wi-Fi, 3G or 4G networks, etc. Users' mobile devices should connect to the internet to download information, but mobile devices do not always connect to internet.

To conclude, there is still no appropriate method of communication between public displays and users' mobile devices. It is necessary to specially design a set of tools for treating communication between these two media.

5.2 The Toolkit Architecture

Communication between public displays and personal mobile devices is different with the process of communication between personal devices. Communication between personal devices pays less attention to time efficiency, and the operation can be somewhat complicated for various kinds of functions. However, for public displays, the same steps of operation designed for personal devices might be too tedious. Normally the download or upload resource process includes two steps: select item to download or upload, and to download or upload that file. We have optimized the process and made it simpler to adapt to the public scenario. The architecture of the toolkit is shown in **Figure 5.3**.

The application includes two parts: one is the application installed in the mobile Android devices, while the other is the package installed on the display. The toolkit requires all the devices to connect to the same local wireless Wi-Fi network. The mobile application is composed of three main modules: interface, selection and the data transmission module. The interface layer allows users to check the file downloaded and browse the file system of their mobile devices. Users can select an item from the file system with the selection module. The data transmission module carries out the data communication task, and can send or receive data packets by wireless network. Unlike the mobile application, the service package installed on the public display has no interfaces. Users do not need to consider the configuration of the service package: they can freely select any item shown on the display, and the selection module detects the user's selection and prepares the selected item for migration. The transmission module carries out the data communication task, and is also able to send or receive data packets by requirements.

It should be mentioned that all data transmissions are bidirectional: both

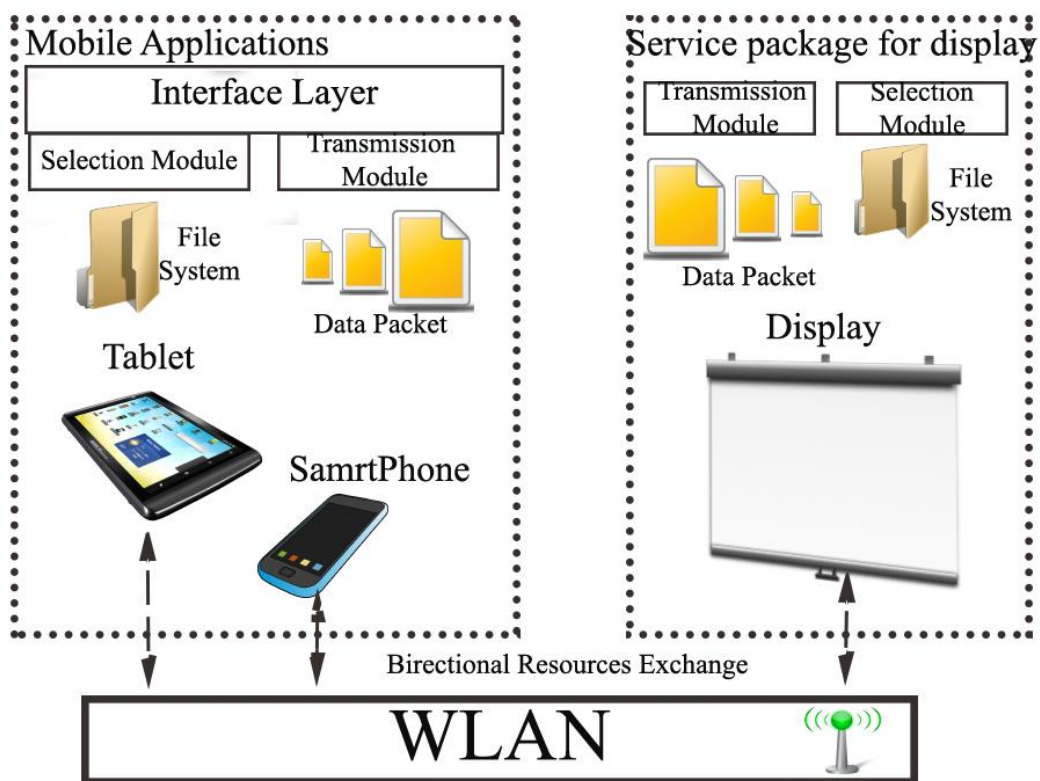

Figure 5.3 Architecture of the data migration toolkit

data transmission modules on the two sides can receive files from the other side, or send files to the other side. The direction of data communication is decided by the real requirements. Not only can users download items from the display to their mobile devices, but also users can upload some items stored in their mobile devices to the display. Furthermore, the data types supported by the toolkit are various: users can select and transmit any data types they can find from the file systems of mobile devices and on the display: document, image, video or even only several lines of text. Compared with the QR-based methods, the advantage of this toolkit is that it transmits the data that the user wants directly rather than a link to the data. Users can get the information they want instantly. It is not necessary to search again for information from another website.

5.3 Mobile Application

We developed the mobile application on an Android platform. Since the application is expected to be used together with the public display in a public place, the core idea of this application development is to keep the interface and operation as easy as possible.

The application interfaces include six android activities. The main activity is the navigation panel, shown in **Figure 5.4a**. The navigation panel is the main interface of the application, and users can quickly navigate to other functions, such as the “one-click to pick” activity, the “upload file” activity, etc. These functions are the most frequently used activities of the application. The left and right arrows at the bottom of the interface are the switch buttons between different interfaces.

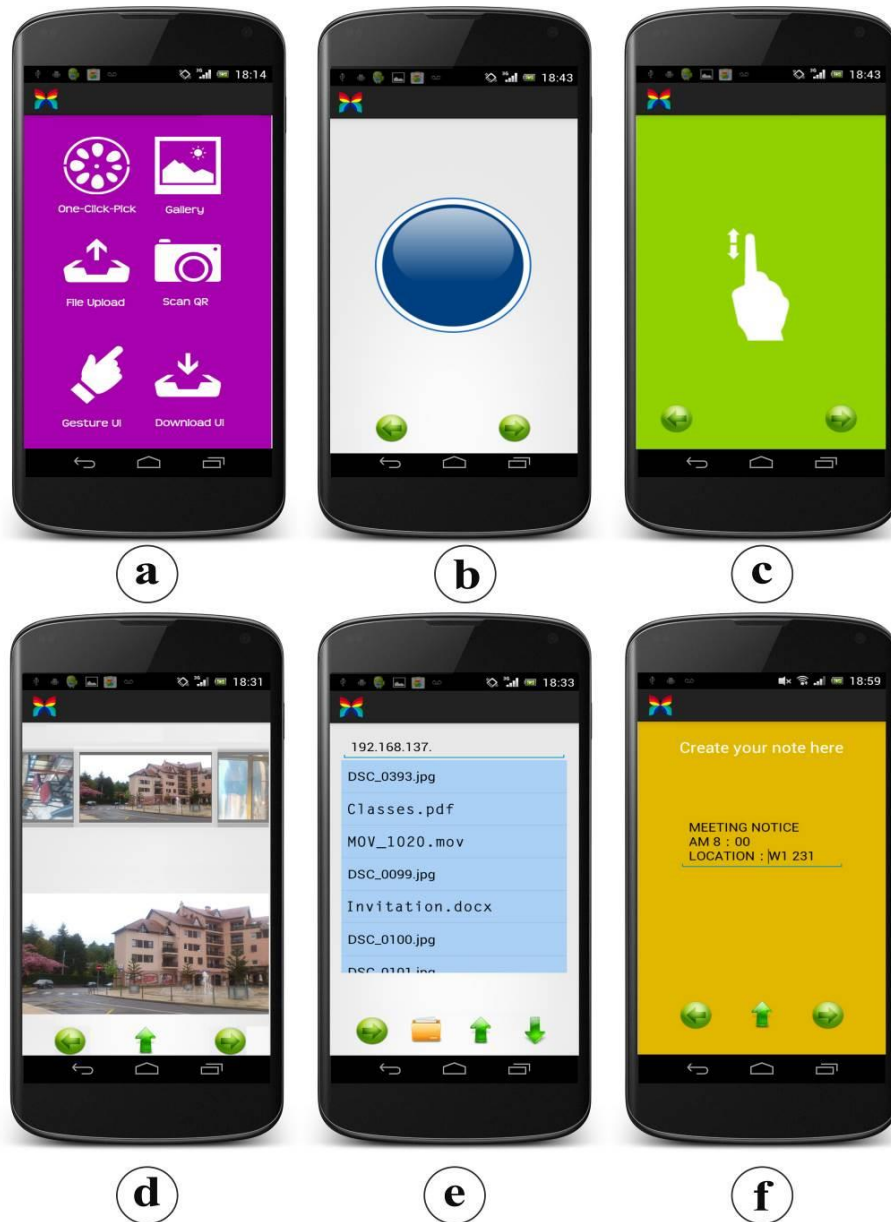

Figure 5.4 The mobile application interfaces

If the user clicks the one-click-pick icon at the top left corner, it opens the interface shown in **Figure 5.4b**. There is only one big button on the interface, which is for pick (download) items from the public display. Once the user selects the item he/she wants to download, he/she only clicks this button, and then the item is downloaded instantly to the mobile devices.

The application supports gesture interaction as well. On the navigation panel, if the user clicks the gesture UI icon at the bottom left corner, it navigates to the interface shown in **Figure 5.4c**. There are only switch arrows on this interface. However, users can interact by flick gestures, i.e. quickly brushing fingertips on the screen of mobile devices is the flick gesture. The downwards flick gesture activates the download process, which has the same effect as clicking the download button.

Users can also select files stored in the mobile device to upload them to the public display, as shown in **Figure 5.4d** and e. Users can browse the photos or other types of files of the mobile device, and briefly tap on the selected item that he/she plans to upload. They then flick their finger quickly upwards, and the item is sent to the display; or as an alternative, they can click the up arrow at the bottom of the interface to upload the file. However, it might not be so frequently used to upload personal files to public media, by contrast, to create a short note and to show it on a public display might be more needed. As a result, we have an interface for users to create a short note, as shown in **Figure 5.4f**. Users can create a short note on this interface. Then, once they have finished, they can click the up arrow or perform the flick gesture to upload the note and publish it on the public display.

5.4 Service on the Side of Display

Unlike the mobile application which is designed as a tool for individual users, the toolkit for the display is installed on the display server as a service. It runs at the background, and permanently listens to the queueing requests from the mobile devices.

- Download item from the display

As the public display we built for the prototype is simulated by a projection display, users have problems in freely selecting items on the display like on a multi-touch screen. Thanks to installation of the Kinect, we can simulate a touch-sensitive large screen with the projection display. Hand position is detected by Kinect as a vector (X, Y, Z) : among these, Z is the depth value which delegates the distance of the user's hand to Kinect. We only consider the hand position in two dimensions (X, Y) . We carry out a coordinate transform calculation between the coordinate of Kinect and coordinate of screen. Thus the hand movement is transformed to the cursor's position on the screen.

In this way, selecting an item on a display that the user wants to download is simple: the user can move his/her hand to anchor the mouse cursor over an item icon, while triggering the download command on the mobile application. The selected item is sent to the mobile devices instantly, as shown in **Figure 5.5a** and **b**. As the interface we designed for the proxemic display includes the sub-interfaces and the public interfaces, we take the sub-interface as a whole item. When the user selects the sub-interface, he/she downloads all the contents of his/her sub-interface to his/her mobile devices. However, we have to make sure that one specific device belongs to one specific person, so as to avoid sending one user's sub-interface contents to the mobile device of another user. Besides, the

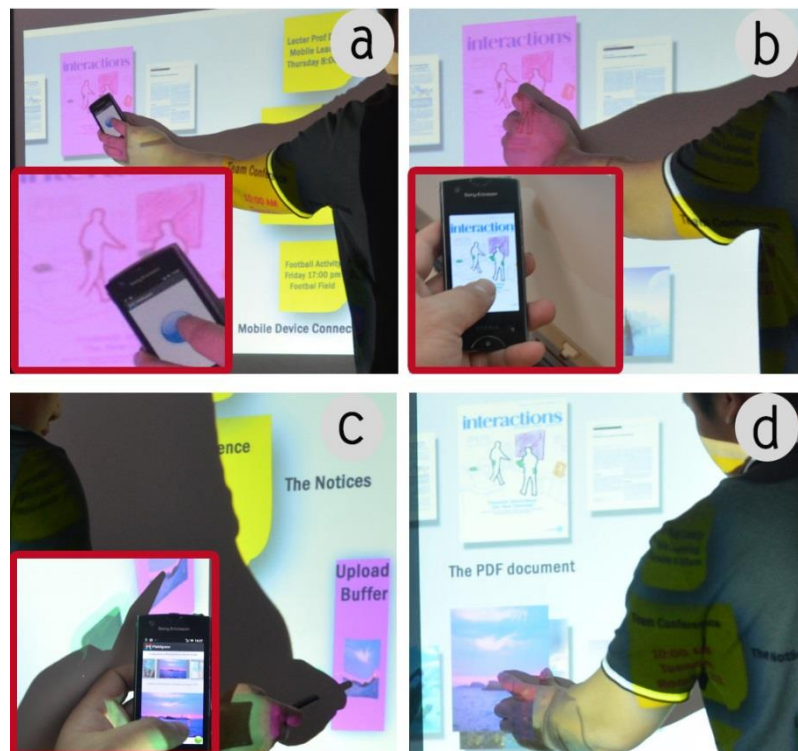

Figure 5.5 The toolkit download and upload process

contents on the public interface can also be downloaded individually.

- Upload item to the display

The display continuously listens to the upload requests from mobile devices via an individual thread. Once the user selects an item from his/her mobile device, he/she triggers the uploading process. The mobile device sends a upload request to the display, the display judges whether the request is from a device it can trust: if the device can be trusted, then it opens the accepting socket to accept the uploading data. Once all data have been accepted successfully, they are saved temporarily in the buffer zone of the display, so that the user can re-check the item, and decide whether or not to publish the file on the display. He/she can also retrieve the item if he/she finds any problem or mistakes, as shown in **Figure 5.5c** and d.

5.5 Data Communication Security

Due to the usage context of the toolkit in public places, and data communication between personal devices and public displays, it is necessary to guarantee the security of users' personal data, including the data stored in their mobile devices, and the relative personal information displayed in the sub-interface of the display. Throughout the resource exchange process, there are several steps that might cause lack of security of personal data:

- The security of the local Wi-Fi network

To use this toolkit, we require users to connect their devices under the same local Wi-Fi network with the public display. The Wi-Fi network is protected by a password, and the setting of the Wi-Fi network is standard WPA2-PSK. Users have to type in the password to connect to the local network. However, for the time being, we publish the network password on the display, and anyone who wants to connect to the network can get the password easily. As a result, the password can protect the local network from unauthorized attacks from outside, but cannot prevent the risk from inside the network. One possible solution is to frequently change the password for local hotspot. However, this might disturb users because they also have to frequently reconnect to the hotspot for each use.

- Data transmission

We employed the peer-to-peer socket communication flow to send and receive data. The destination of send and receive messages is identified by a unique IP address and port, making it impossible to transfer one user's resource to another unknown device. However, as the data sent are not encrypted, it is still possible to be intercepted by illegal users.

SSL (secure socket layer) or its successor TLS (transport layer security) are protocols that can be used to protect communication security on internet and to avoid eavesdropping. The TLS is composed of the TLS record protocol layer and the TLS handshake protocol layer. The client and server side has to exchange a symmetric key in order to certificate with each other, and only when the certification is get recognized, then they can exchange data. In our prototype toolkit, we have not employed the SSL or TLS to protect data, because in the context of this prototype, the data transmitted are not really confidential data. In particular for the downloading process, the user data downloaded are the public resources so there is no need to encrypt data as is normally required by the high-confidential systems. With regard to the upload process, as users already plan to publish the data on the public display, data are not really confidential, so there is no real concern about their security. Also, considering this is a prototype, we do not plan to employ sophisticated encryption protocols, but rather to focus on the interactions of the prototype.

However, users wishing to download their personal sub-interface to mobile devices might be concerned with whether or not other people can also obtain their personal contents. We have already taken measures from the interaction methods to avoid this problem. As we discussed in section 5.3, the sub-interface created for a specific user moves according to user movements, so only the current user can read and access his/her sub-interface. As a result, only the current user can select his/her sub-interface to download. Other users have no access to the information and cannot download the sub-interface without his/her permission.

5.6 User Management System

For the time being, we have no pre-knowledge of users' personal mobile devices. Therefore, users have to type in the password manually to connect their mobile devices with the public display. In the long run, we can build a database, which saves all users' identity information, including the mobile devices they use. Users who want to take advantage of the services of proxemic displays need to register themselves as new users in the database management system. Their identities along with their mobile devices are saved in the database of the proxemic display.

In this way, the user does not need to manually connect his/her device. Once a device with activated Wi-Fi gets close to the display, it can automatically connect to the local network. Meanwhile the local network is isolated from unauthorized users and devices, and the data transmitted inside the network are protected; Secondly, with the database management system, only registered users can connect with the network. Unregistered users are kept away from the local network. Also, the display only creates the sub-interface for registered users, while un-registered users can only read public and general information. Finally, for the current toolkit, the display cannot distinguish the ownership of a device: who owns this device or which device belongs to whom? With the user management system, we can match users with their own mobile devices. Along with user identity recognition by web camera, we can further promote some interesting resources for users' mobile devices once they are recognized by the display.

5.7 User Study

We organized a pilot user study to evaluate the toolkit, and discussed whether it can really connect seamlessly mobile devices with public display. As a comparison, we selected the QR code as the other way of uploading and downloading processes. Both data communication methods are based on the same Wi-Fi local network.

We invited 10 participants in our laboratory (8 males, 2 females) to attend the user study. The testers range in age from 22 to 30 years old (Mean = 25, Standard Deviation = 2.644). All of them have at least one smart mobile device (smartphone or tablet), and they are all familiar with the

use of smartphones, and how to scan the QR code by smartphone. We prepared an Android smartphone with our pre-installed mobile application

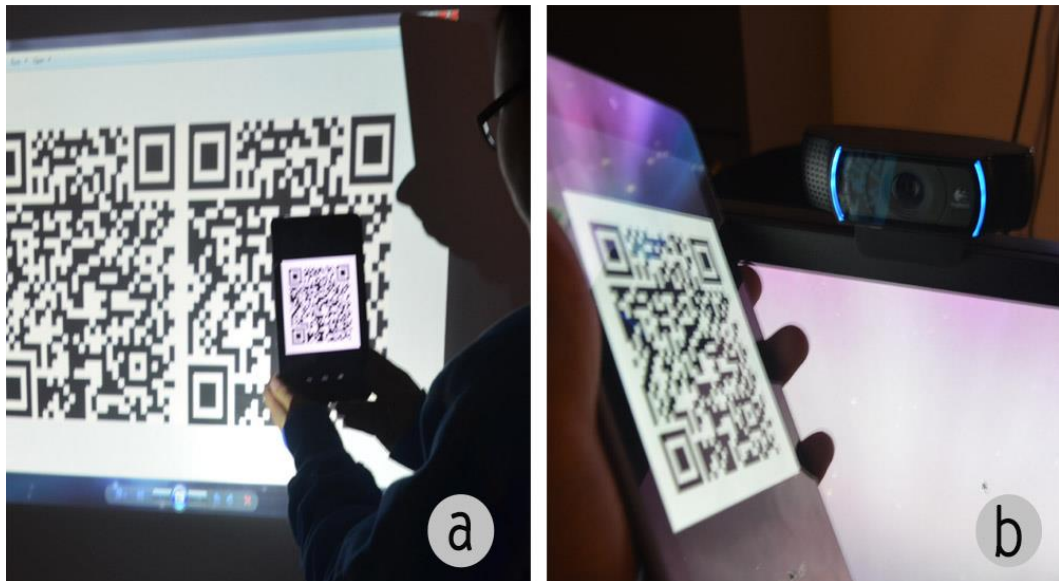

Figure 5.6 Download and Upload by QR codes

and an application for scanning the QR code. For the downloadable data, we prepared two files: one image file of 4.43 Mb and one pdf file of 8.91 Mb. We uploaded the two files to Google Drive, and encoded their links to QR codes. Before the test began, testers could practice for a while to learn how to use the QR scanner application and the mobile application we developed.

5.7.1 The test procedure

The whole test includes two tasks: download item from the public display, and upload item on the mobiles to the display. Both tasks should be carried on by QR codes and the toolkit we developed separately. Testers have to first download the image from the display, and then download the pdf file by QR code. Once the download task is completed, testers re-upload the image and pdf file one by one to the display, as shown in **Figure 5.6a** and **b**. The first round of tasks is finished by QR codes, after which the testers begin to carry out the same procedure of downloading and uploading items with the application we developed.

5.7.2 Data collection

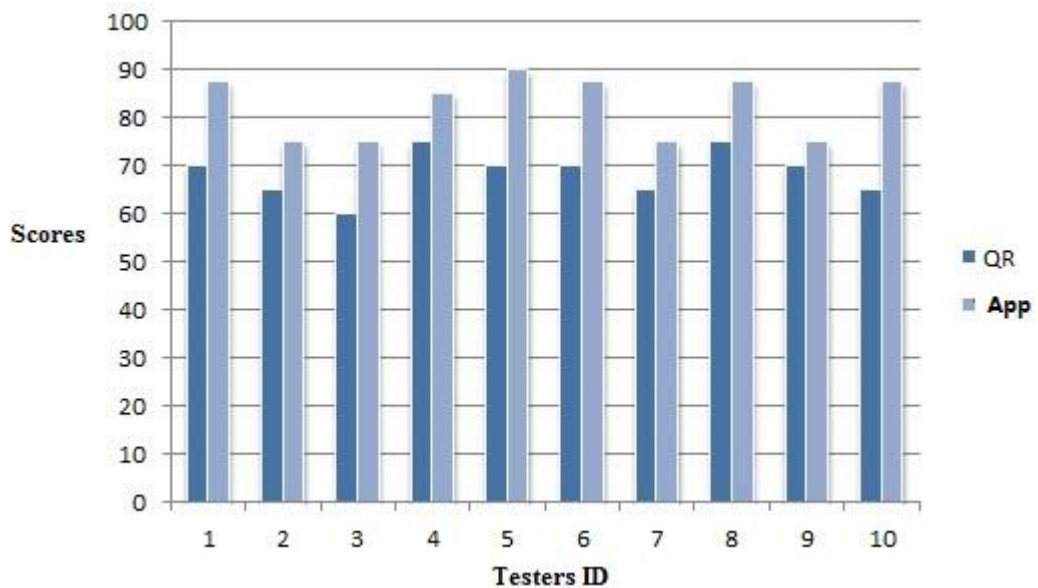

Figure 5.7 The SUS results of the user study

After each task, the testers filled out a system usability scale (SUS) questionnaire to compare the perceived usability of the three techniques. The SUS includes 10 statements, where each has a five-point Likert scale ranging from Strongly Disagree to Strongly Agree. For example, typical questions are: I think that I would like to use this product frequently, and I found the product very awkward to use, etc. (Bangol et al., 2008). SUS produces an easy-to-understand score from 0 (negative) to 100 (positive).

We also recorded the task completion time, including four values: download by application, download by scanning QR code, upload by application and upload by scanning QR code. Besides the quantitative results, we also collected qualitative feedback from testers by interviewing them.

5.7.3 Results of the User Study

The SUS scores can reflect the objective usability of a system. We calculated the SUS scores according to users' responses to the SUS questionnaire. The score for the QR code method is 68.5, which means class C according to the SUS grade, while the application we developed got a score of 82.5, which means class B. The result proved that the

application we developed is significantly better than the QR code-based means.

Alt, F. et al. (2013) obtained similar results in their lab study for resource exchange with public displays: they compared different technologies for display and mobile device inter-communication, and obtained a score for the QR code of 73.5, which was grade C as well.

With regard to task completion time, the result is shown in **Figure 5.7**. We can obviously find that our application saves more time than the QR code. In order to prove this in a statistical way, we applied the ANOVA method to compare the data of the two methods. The ANOVA result for uploading image files is $F(1,18) = 70.54$, $p < .001$, thus revealing that there is a significant time difference between the two methods for completing the upload image task. Similarly, for the pdf file, the ANOVA for downloading is $F(1,18) = 52.45$, $p < .001$, and the uploading is $F(1,18) = 112.2$, $p < .001$. The results showed that the task completion time for pdf uploading and downloading is distinctly different. In contrast, the download process for the same task is $F(1,18) = 1.128$, $p = .302$, which means that the download completion times were not obviously different.

These results are not surprising. As a matter of fact, to operate on QR codes takes up more time than the application we designed, especially for uploading a file from mobiles to public displays. It is very awkward to upload a file from mobile devices to public displays without any preparation, because users have to first upload the file to a network driver, then encode its link with QR code, so that they can scan the QR code as shown in **Figure 5.6b**, which is difficult. While the operation with our application is natural and simple, users only have to browse the file and click buttons or flick gestures to upload it. However, the pdf downloading task time is not significantly different, i.e. the application did not improve download efficiency. This is because for the large pdf file, data transmission time contributes to a large extent for the total task time, while for the two methods, data transmission time is more or less the same. The only difference is that our application saves time for the operation steps. As a result, long data transmission time might reduce the time advantages of the application.

We collected the qualitative results by interviewing the participants after the user study. Most of the participants gave positive feedback to the application: they thought it was easy to learn and very simple to use, and they were surprised to find that they can download files from a large display directly onto a personal smartphone. For the uploading task, they

thought it was very convenient to upload resources to public displays by special designed application rather than by mere QR codes. Tester 3 said that it is impossible to prepare a QR code for every file in his cellphone except when he rarely needs to upload a file, so he would not try to upload a file to a display by QR code.

However, there were also some testers who doubted the practicability of the application (Tester 2, Tester 3, Tester 9). Their main concern was how can the display detect the user's selection without Kinect, because if a public display is not equipped with Kinect, how can we detect the user's selection? Anyway, in this case we only simulated a tactile screen with Kinect: Kinect is not necessary if the display is already touch-sensitive. Tester 7 complained that this is not convenient enough if it requires users to connect manually their mobile devices to the local network of public displays. She recommended that users be allowed to scan a QR code and connect automatically to the local network. But as we discussed before, we try to avoid using the QR code because it is not really convenient enough. As an alternative choice, we can use a RFID or NFC tag to build the connection automatically, because most smartphones today have embedded NFC technology.

5.8 Conclusion

In this chapter, we have elaborated work about how to connect seamlessly a public display with personal mobile devices, and exchange resources between the two typical media seamlessly. We have specially developed a toolkit with this aim in mind. This toolkit is composed of a mobile application running on an Android device and a service package installed on the server of the public display. We have organized a lab user study to evaluate the usability of the toolkit. The results of this user study are positive. The participants generally agreed that this toolkit can improve the performance of a common public display, and that they would like to use it if it is available.

This toolkit is significant in smart city application scenarios because it connects the life of citizens with the city more closely, and turns a public display into a window between citizens and a city. The potential applications of this toolkit are depicted in the next chapter.

6 Exploring Applications of Proxemic Displays in the Smart City

6.1 A Proxemic Flight Information Board

6.1.1 Users of the flight display board

6.1.2 Positions of users related to the display board

6.1.3 Priority of flights

6.1.4 Mobile Devices of Users

6.1.5 The potential issues of proxemic display boards

6.2 An Intelligent Timetable in a Bus Shelter

6.3 A Shopping Guide Screen in a Shopping Mall

6.4 Conclusion

The smart city is still a controversial concept which is in the development process. As we discussed in section 1.2, the smart city highlights not only the importance of applying information technologies to improve the efficiency of the city's living and production activities, but also the importance of citizens' intelligence to develop and manage the city. A smart city can take advantage of the wisdom of citizens, and make them participate in the construction of the smart city process by their own knowledge. The smart city can encourage the innovation of society by providing an available interactive platform for citizens. With this platform, citizens can make their own innovative contribution to the daily activities of their cities. The public display is such a platform for information and communication. However, for a long time now, public displays only act as media for publishing information. Citizens can only read information but cannot interact with the displays. Thanks to the development of display technology, more and more public screens are being replaced by electrical display boards, which make the interaction between users and public displays more realistic. As we described in chapter 5, we have built a proxemic public display according to the theories of proxemic interaction. This display senses users' proxemic attributes, including users' identities

to provide personalized information and services to users. This proxemic public display has several advantages, making it ideal for application in the context of the smart city:

- It is an interactive display

The public display is an interactive object, and interaction is not only passive, but positive as well. Users can interact implicitly and explicitly with it. These kinds of interaction modalities can improve the efficiency of interaction between users and a public display by providing personal-related information instantly;

- It is a spatial-sensitive display

The proxemic display can recognize users' position in relation to it. In this way, the display can mediate multiple user interactions according to their spatial relationship. This capability of the display can be used to enhance the collaborative work between multiple users;

- It can recognize users' identities

The display can recognize users' identities for providing specific information to users. With knowledge of users' identities, the display can get more knowledge about users and the contexts of interaction, and thus provide more accurate information to users;

- It is open to ambient devices

The display is open to ambient users' devices. Users can download resources from the display, thus allowing normal users to freely access the resources saved on the network of public displays. Meanwhile, users can create resources by their own mobile devices and publish the resources on the public display. This lets common users contribute creative contents to public displays that are normally isolated from them. Furthermore, users can report events in the neighborhood that cannot be covered by the smart city sensors through the public display network. In this way, normal citizens participate in the management of a smart city, so that the efficiency of a smart city can be improved.

From the advantages of the proxemic display described above, we find that the proxemic display works as a platform installed in the smart city, not only for publishing information, but also for collecting the intelligences of citizens, as well as a platform to encourage citizens to

participate in the management of the city. In this chapter, we will illustrate several scenarios where the proxemic display can be valuable.



Figure 6.1 A giant flight display board in Frankfurt airport

6.1 A Proxemic Flight Information Board

The airport is one of the most modern places in a city, and provides services to passengers from different regions and countries. However, the airport infrastructures are not always modern: for example, the display boards have not changed for a long time, and are basically always the old styles. At present, the flight information board in an airport always displays all flight information together, as shown in **Figure 6.1**. Passengers have to search for their flights from hundreds of flight information, item by item. This low efficiency of time is especially annoying for passengers who have tight schedules to catch connection flights. Many passengers getting off a plane gather in front of a small flight board to look for their connection flights. This is a low efficiency way that is completely contradictory to the expectations of a smart city. In fact the display board is just a passive electrical board, and flight information is controlled by someone in the server room. The display board is blind to ambient people and ambient devices. This is where our proxemic display prototype can be helpful to build an innovative flight display board for the modern airport in a smart city. When designing proxemic flight display boards, we need to consider several key elements:

users, positions and identity of user, priority of flights and the mobile devices of users.

6.1.1 Users of the flight display board

The main users of the flight display board are passengers. We divide the situation into two categories: when there is only one user in front of the board, we call it situation A, and when there are multiple users in front of the board, we call it situation B. If there is only one user in front of the display board, the board can recognize the user's identity and display the flight information only related to him/her directly. As the display board is always large size, we add a floating sub-interface and display the personal-related information to him/her on that sub-interface. However, as situation A is rare, the most common situation is situation B: i.e. there are multiple users in front of the display board. For situation B, we have to consider the positions of users related to the display.

6.1.2 Positions of users related to the display board

If there are multiple users in front of the display, it is necessary to discern users according to the distance between them and the display board. Users at different distances should read distinguishable information from the display according to the interaction rules we designed for the proxemic display prototype. Only users standing close to the display board can be recognized. Meanwhile the sub-interface will be created for them, and they can read instantly their flight information (e.g. flight boarding gate, time of departure, status, etc.) from the sub-interface. Once they leave the close range of the display board, the sub-interface will be erased from the main interface. During this process, the other parts of the display board still display general information, so that other passengers standing at a distance from the display can get information just like on a common display board.

With regard to the user's identity recognition, in our prototype, we use a camera to recognize the user's identity. However, in the real application, especially for this kind of display board in an airport, it is difficult for now to store users' face information, and recognition might still be inaccurate. If we recognize one passenger as another one, and display the wrong information to him/her, this can be a great risk of privacy. As a result, we can recognize the user's identity by quickly scanning the matrix

code printed in their boarding pass. This can be a feasible solution before face recognition technology becomes sufficiently precise.

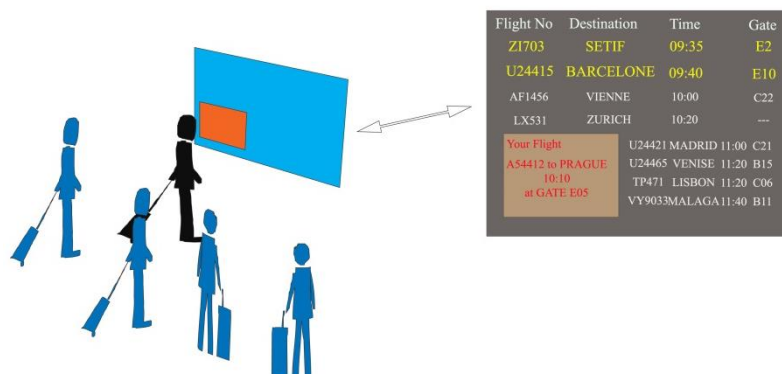

Figure 6.2 Installation of a Proxemic Display Board in an airport and the interface

6.1.3 Priority of flights

Though we can display personal-related information to specific users for him/her to get information quickly, most passengers still have to read and search for information from the main interface of the display board. At present, all flight information is displayed on a board ordered by time. All information is displayed with the same font size and color, which is not an effective way of displaying information. We suggest displaying flight information according to their priorities: priority of flight information is mainly decided by the time between now and its boarding time. Those flights which have short time intervals should be displayed in a larger font size, and in highlighted color, so that passengers who take those flights can quickly know their flight boarding gate.

6.1.4 Mobile devices of Users

The mobile devices of users are important terminals for passengers to get useful information. Via a proxemic display board which is aware of users' ambient mobile devices, we can take advantage of these devices to provide accurate information.

The modern airport is always covered by the public Wi-Fi network, thus making it easier to connect users' mobile devices with public display boards. We can merge the public Wi-Fi network with the network of

display boards, and open the resources on the display board to users' mobile devices. Passengers in an airport often connect their smartphones or other mobile devices to the public Wi-Fi network. Meanwhile we can recommend that they install the application which we developed in chapter 6, so that they can download information freely from a nearby display board.

For example, one passenger who has read the information on his/her sub-interface can also download the information to the smartphone by clicking the download button on the mobile application for checking at a later stage. We do not allow passengers to upload information from their mobile devices to the display board, because it is not appropriate to display other information on a flight information board, as this might confuse and disturb other passengers. However, for other public displays with different functions in an airport, for example a notice board, the system administrator can decide to open the uploading function according to the real situation. The simulated scenario of a proxemic display board is shown in **Figure 6.2**.

We can see from **Figure 6.2**, that one passenger is standing close to the display, and that he/she can read directly the information related to him/her from the sub-interface. Furthermore he/she can download the information to his/her smartphone easily. The interface of a display board is divided into two partitions: private sub-interface and public display area. The other passengers standing at a distance from the display board can also read the normal flight information from other angles. Once the closest passenger walks away from the board, his/her sub-interface is erased and no personal information can be peeked by others. We also personalize flight information by font size and font color according to flight priority. In this way, we can improve the efficiency of a proxemic flight display board.

This similar concept can also be implemented in other public transportation systems, for example railway stations, bus stations, etc.

6.1.5 The potential issues of proxemic display board

Though the proxemic display board has these advantages, attention still needs to be paid to some issues during real application. The most important issue is how to handle multiple users simultaneously. If several passengers gather in front of the display board and all stand at a close distance, how can we distinguish between them? Under this condition, it is

not appropriate to show many sub-interfaces at the same time. Because the sub-interfaces will be occluded with each other and take up too large a display area of the main interface, meaning that personal information security is no longer assured. We have envisaged two solutions for this situation:

- Let users decide whether or not to display the sub-interface. If they want to check the information on their sub-interfaces, they can scan a matrix code printed in their boarding pass by the camera installed along with the display board and open sub-interfaces. If they do not scan the codes, only general information is displayed;
- If the display board detects there are many users (for example, more than three users) gather closely to it, then it hides the currently shown sub-interfaces, and replaces all the personal related information with general public information, thus it can protect the current personal related information.

The second issue is the display time of a sub-interface. As a sub-interface occupies the display areas of a display board, even if it is small, it can still weaken the display capability of the board. Consequently, we should limit the display time of a sub-interface, for example, to limit it to 30 seconds. Once the time limit is close, the sub-interface will twinkle slightly to remind the user that the time limit is nearly up. The user can touch the sub-interface again to keep it displayed for another 30 seconds.



Figure 6.3 Screenshots from A day made of Glass by Corning Corporation (Corning, 2011)

6.2 An Intelligence Timetable in a Bus Shelter

Bus shelters are one of the most common public infrastructures in a city. There is always a paper timetable in the bus shelter, and the bus's route map and the timetable of the buses passing by the current stop are printed on the paper board. Just like the airport flight display board, this kind of timetable is difficult to read if there are many bus lines in one stop. At present, some timetables might print a matrix code, and passengers can scan the matrix code to read further information about buses. However, bus shelters should be more intelligent, especially in the future smart city. Paper timetables will progressively be replaced by electrical displays.

The Corning Corporation has made a video to present the future life in a city which is made of glass. They have presented a demo of a future bus-shelter, as shown in **Figure 6.3**, where a digital tactile screen made of glass is installed inside the bus shelter. A passenger walks towards the screen. Just like a normal screen, it displays the bus lines and the waiting

time, a map of the city and the name of the current stop. The passenger can select the destination from the navigation bar above the map. The route by public transportation and the estimated time is displayed on the map. The passenger can take out his/her smartphone and move the smartphone close to the map, and the route map will be downloaded to the smartphone instantly. This kind of intelligent timetable is not only used for the bus station, but acts also as a public screen which can provide more diverse information rather than merely bus-related information. However, at present, such kinds of intelligent bus timetables are not yet in operation. This is where our prototype can be helpful, and we can use it to build an intelligent timetable.

Compared with the Corning design which considers only the situation of one user, if there is one user standing in front of the screen, he/she can occlude the sight of other passengers. They thus have to wait for the current user to leave in order to read the information. As we discussed before, this wastes the display area of a big electrical screen. We can handle the multiple user situation based on the proxemic display prototype, to take better advantage of the display capability of a large enough screen.

The basic functions of the timetable are to display the bus timetable and the waiting time for the next buses. The information displayed is pre-edited and is not aware of the users. Whenever a passenger has to search for the information he/she wants, even if he/she is a frequent passenger, the screen shows the same information to all the passengers. The intelligent timetable should be able to discern the frequent passenger from the new passenger to display specific information. For example, for a frequent passenger, the timetable can display directly the information related to the bus line which he/she takes every day. However, for a new passenger, the timetable should display all the information available, ensuring that he/she can get as much information as possible.

An intelligent bus timetable can have the following advantages:

- Dynamic interfaces

We have proposed the interface design principles which include the main interface and the dynamic sub-interfaces. The sub-interface is used to display some personal-related information to passengers who are standing near the timetable, while the main interface always displays the main contents of the timetable. The appearance of sub-interfaces has no influence on the main-interface, because the content layout of the main

interfaces will be re-arranged according to the position and movement of the sub-interfaces.

- Passenger identity recognition

This function can help the timetable to distinguish frequent passengers and new passengers according to their identities. It is not practical to recognize the identities of passengers by camera. In fact, the pre-paid public transportation card is already a passenger badge. These kinds of cards store information about users' identities and maybe other information such as the history records of buses or metros. With this information we can get to know the frequent buses that a passenger always takes, and display the related information to him/her on a floating sub-interface. For example, he/she can read the detailed information about the buses he/she always takes, the balance of his/her transportation card, etc. The most useful situation is that we can display not only information about current buses or undergrounds, but that the timetable can also display the potential buses or undergrounds for connections in other stations, according to the habitual route of a passenger. In this way, a passenger can decide whether he/she can catch the connecting buses or undergrounds in advance, which can prevent them from waiting.

The types of information displayed are determined by the personal information available from the card. The more personal information we get, the more personalized information can be displayed to the passengers.

For new passengers without a badge, we can only identify their roles by the types of temporary tickets they bought. For example, most cities in the world have day tickets for tourists. Passengers who have presented a day ticket to the timetable, can be recognized as tourists. As a result, the timetable can display the bus routes from the current location to other main tourist sites. When someone is standing near the timetable and interacting with it, other parts of the timetable still display general information, so that other passengers can still get general information.

It is not necessary to display personal information on the sub-interface each time. If the timetable detects that there is only one passenger in front of it, it can display information with a larger font size at the main interface.



Figure 6.4 An intelligent bus shelter with an interactive timetable

- Accessible data on timetable

All data displayed on the timetable are accessible to passengers' personal mobile devices based on the data migration toolkit we have developed. Passengers can select any information displayed in the timetable, for example, the schedule of a bus, the map from the current location to the destination, the contents displayed on the sub-interfaces, and they can download the selected resources by operating on the mobile application. The resources downloaded automatically adjust the format which fits to the screen size of mobile devices.

With regard to resources uploading from mobile devices to the timetable, it is not necessary for a bus timetable to accept the resources from passengers' mobile devices. If resources have to be uploaded, the timetable developers have only to open the socket to accept data from users' mobile devices. The overall design of the time table for a bus shelter in the smart city is shown in **Figure 6.4**. We have put the timetable in an enhanced bus shelter designed by P3GM corporation (P3GM, 2013), as shown in **Figure 6.4d**. **Figure 6.4a** is the default situation of the bus timetable: the arrival time of the buses and the local map is displayed. **Figure 6.4b** is the situation when one passenger approaches the timetable:



Figure 6.5 A shopping guide screen in the Lyon Part Dieu shopping mall

the detailed timetable of the buses is displayed in a floating window. **Figure 6.4c** is the situation when one passenger stands close to the timetable: his/her identity is recognized, a personal sub-interface is created, and some information related to his/her is displayed in the sub-interface.

6.3 A Shopping Guide Screen in a Shopping Mall

Compared with timetables in airports or in bus shelters, the shopping mall is a place where new technologies are more easily implemented. For example, **Figure 6.5** shows a horizontal tactile screen placed in a very large shopping mall of Lyon, which displays the current location of the user, and a shopping guide map allowing users to search for the store they are interested in. The screen can display the map to guide users to a specific shop from his/her current location. The screen can also display some advertisements about the shops in this shopping mall. The screen supports only one user's interaction at a time. As there are always many customers in the shopping mall, if one user is interacting with the screen, other customers might not be willing to wait in front of the screen. Furthermore, customers who are already very familiar with the shopping mall find it unnecessary to look for something via the screen. In contrast, new customers might not be aware of how the screen can help him/her. As a result, these screens cannot be fully taken advantage of. To make the

screen more attractive and optimize its use, we have to make a lot of improvements. Compared with the outdoor environment, the indoor location is more preferable for installation of a proxemic interactive screen. The improvement work based on proxemic interaction can aim at the following aspects:

- To attract customers by sensing them

At present, most interaction screens are passive screens. They wait for users to find them rather than attract users to interact with them. This means that screens are easily ignored, especially the screens which are not necessary, e.g. screens installed in a shopping mall. In such situations, to make a screen attract the user's attention by positive reactions is a way of improving the percent of usage of the screen.

Proxemic interaction can detect the spatial relationship between users and a screen. The distance between a user and a screen is a criterion for judging whether or not a user is going to interact with the screen.. If someone is passing close to the screen, then the screen can play a short animation or quickly twinkle the interface to catch the attention of potential users. One person who has noticed the reactions of the screen might be curious to stop and stay in front of the screen. At that time, he/she is still not sure that the reaction of the screen is caused by his/her actions. However, the screen can detect that one user stop in front of it by the sudden change of speed. It can thus play a welcoming animation to tell the user that he/she is detected by the screen, and that the screen is ready to interact with him/her.

- To inspire user's interests

The basic function of a screen in a shopping mall is to guide customers, and inspire them by attractive promotion or advertisements. In a very large shopping mall, the guiding function is very important, especially for new customers, because it is hard for new customers to find how to get to the boutique they want to visit. For the guiding function, we take common measures to make users search for or select the destination they want, and display the route from current location to the destination. However, as the shopping mall is very large, it is still difficult for customers to remember the route by themselves. Using data migration mobile applications, customers can download the instant interactive guide map to their smartphones or other devices, and always keep the route map to hand as a reference.

Secondly, the screen should be able to display some advertisements or promotion activities to inspire customers, especially frequent customers. With identity recognition, either by camera or by some customer membership cards, the screen can display the latest products, or boutique coupons according to the shopping preference and history of that customer. The shops can even publish the promotion code or coupons on the screens. Customers can freely download the coupons on their smartphones and use coupons in the shops.

- Multi-user situation

The interactions we described above are for a single user. As a matter of fact, the most common situation is multiple users as the pedestrian flow of a shopping mall can be huge. Among them, some customers want to search for detailed information, while other customers might only want to quickly glimpse the latest promotions of the shopping mall. With the help of proxemic interaction, we can handle with the requirements of several customers at the same time on the same screen, as discussed in the last two scenarios. In the future smart city, screens should be larger than the current screens shown in **Figure 6.5**.

Wall sized displays could also be used to replace the current shopping guide screen in the shopping mall. Wall sized displays can not only be a shopping guide screen, but could also have many other functions, such as interactive advertisement, auto client-services, etc. As a result, it is necessary to divide interactive zones according to the rules of sub-interfaces or the main interface, to create floating sub-interfaces on the main interface. The sub-interfaces float along with the movement of users, while the customers can interact on the sub-interface, to check the information related to them. Once they leave the screen, the sub-interfaces are removed and erased. The concept of sub-interfaces makes sure that multiple users can interact with a large enough screen at the same time without occluding with each other, and that all customers can read the information they want from the screen separately.

- To accept feedback from customers

The main disadvantage of a screen designed to serve customers is that it cannot accept direct feedback from customers. It is difficult for customers to give feedback, so that they give up feedbacking advice (e.g. to send email, to make a call, etc.). As a consumer media, it is better to accept customers' feedback directly. However, with the mobile application we have developed, it is simple for users to upload contents including texts

from their personal mobile devices to the display, i.e. the screen is no longer isolated from common users, but is open to users' mobile devices.

Consumers can give feedback about an advertisement, a product or a service, etc. This feedback can be read by other consumers from the display, as well as be read by merchants, to improve their products or services. By opening the screen to consumers, we can improve the effect of the on-screen advertisements, as well as the performance of the screen.

6.4 Conclusion

In this chapter, we have discussed the potential applications of proxemic interactions on a public display in different domains of a smart city: in the airport, in the bus shelter and in the shopping mall. These three domains cover public transportation areas between cities, public transportation inside a city, and commercial media for business objects. From the description, we find that the idea of proxemic interaction and migratable user interface are promising areas for implementation in the smart city context. With the development of technology and exploration in the domains of the smart city, proxemic interactions and inter-communication between personal mobile devices and public electronic devices (especially the large scale public screens or networks of public screens) are becoming increasingly significant. Proxemics ensures that an electrical device can understand users' implicit behaviors, and based on the spatial relationships of multiple users, coordinate the simultaneous interactions between multiple users.

Public screens will not be isolated from each other but will become networked media which share resources and increase the importance of inter-device connection and communication. The concept of the migratable user interface seeks to connect seamlessly the electrical devices in a certain context, which can ensure seamless resource exchange between multiple devices. This makes it easier for citizens to take advantage of the resources on the platform of public screen networks. It also creates opportunities for citizens to share their knowledge and experience about the city or local communities through the public screen network.

Besides the applications for public services in the context of smart city, we have published an article about how to build a new kind of sociable platform with a proxemic and accessible interactive display (Jin et al.,

2013). We have applied the theory to construct a sociable screen in a neighborhood. Local residents can share the news, photos, lost-and-found, notices and other information related to their neighborhoods with other residents through the screen. Also, residents can gather in front of the screen to check and discuss the recent events that happened in the neighborhood. In this way, the interactive screen becomes a new kind of social media, which is off-line compared with online social media (Facebook, Twitter, Instagram, etc.). People have more opportunities to talk with each other face to face rather than to talk to other people through an electrical device. In any case, there are still many areas in which our proxemic interaction model can be helpful.

In the next chapter, we build an experimental application in the airport context, and organize a user study to evaluate usability of a proxemic airport display.

7 Use Study and Discussion

7.1 The Experimental Application

7.2 The Protocol of User Study

7.3 Data Collection

7.4 User Study Results

7.4.1 Task completion time

7.4.2 Memory efficiency comparison

7.4.3 System usability scale result

7.4.4 Qualitative result

To demonstrate the usability of our system, we have constructed an experimental application in our laboratory to simulate a smart city scenario. Based on this application, we have organized a user study to evaluate the usability of the system.

We invited 10 volunteers for a user study (3 females, 7 males), with an average age of 26.5, and an average height of 172.7 cm. We asked them to carry out specific tasks, and recorded the total task time. They all use smart mobile devices frequently: 7 use IOS devices, while 2 use android devices and 1 uses a windows phone.

The purpose of this user study is to demonstrate whether the idea of proxemic interaction can really help citizens to improve the efficiency of their life in a smart city. To this end, we first build an application which relates to the daily lives of a city.

7.1 The Experimental Application

We discussed in previous chapters several promising application scenarios for application in the smart city, and decided to build an experimental application simulating a flight information board in an airport. We built a database which contains 100 lines of flight information, where each data line is a standard flight including: airline, flight number, destination, scheduled departure time, gate and status. For example, a piece of flight information is as follows:

Airline	Flight no.	Destination	Departure time	Gate	Status
Air France	AF7645	Paris CDG	15:15	T2-D20	Boarding

The complete interface of the board is shown in **Figure 7.1**. All the information is listed in chronological order. We simulated the flight board with a projection screen installed on a wall. The peripheral appliances for detecting the proxemic attributes of the screen include:

- one Kinect, which is installed on the ceiling and facing the projection screen;
- one Leap motion, which is installed close to and in front of the projection screen, and facing upwards;
- one High-quality camera, which is installed on top of the screen and facing towards the screen users.

Besides, we have installed a local wireless network with a wireless router; This simulated the wireless network which is often provided in a modern airport. The projection screen is connected to the network. We have provided participants with an Android smartphone, enabling them to manually connect the smartphone to the wireless Hotspot easily.

Regarding this application scenario, we have selected several proxemic dimensions from the full set of dimensions based on the requirements of the flight information board. This includes the distance of a user from the screen, the movement of a user in front of the screen, and the identity of the user. These three factors can be used to construct a basic proxemic interactive screen. It is not essential to detect the orientation of a user in this scenario, because this is different to a commercial advertisement board. We do not have to assess the change in users' attentions by the nuance of their orientations.

Based on the proxemic interaction prototype we built in chapter 5, we quickly build this experimental application by adding specific contents to the interface, and disable the unrelated dimensions that are not considered for this application. The main interface of this application is shown in

Figure 7.1. The application is developed with WPF (windows presentation foundation) by Visual Studio 2012.

AIRLINE	FLIGHT NO.	DESTINATEION	DEPA. TIME	GATE	STATUS
KML	KL1418	AMESTERDAM	13:55	T2-D20	LAST CALL
EASY JET	U24317	BREST	13:55	T2-D30	LAST CALL
EASY JET	U24445	PORTO	14:00	T2-D30	BOARDING
LUFTHANSA	LH1077	FRANCFORT	14:40	T2-D25	
SWISS AIR	LX333	ZURICH	14:55	T2-D25	
HOP	A54516	BOLOGNE	15:15	T2-D20	
HOP	A54126	BORDEAUX	15:15	T2-D20	
HOP	A54056	MARSEILLE	15:15	T2-D20	
HOP	A54506	MILAN-MALPENSA	15:15	T2-D20	
HOP	A54006	NANTES	15:15	T2-D20	
AIR FRANCE	AF7645	PARIS C.D.G	15:15	T2-D20	
hOP	A54526	VENISE	15:15	T2-D20	
HOP	A54136	CAEN	15:20	T2-D20	
ALITALIA	AZ7285	OME FIUMICINO	15:20	T2-D20	
AIR FRANCE	AF7850	TOULOUSE	15:20	T2-D20	
HOP	A54086	BIARRITZ	15:25	T2-D20	
HOP	A54096	BREST	15:25	T2-D20	
HOP	A54046	METZ-NANCY	15:25	T2-D20	
AIR FRANCE	AF7837	NICE	15:25	T2-D20	
HOP	A54076	PAU	15:25	T2-D20	
HOP	A54066	LILLE	15:30	T2-D20	
AIR CORSIKA	CE074	LIMOGES	15:30	T2-D20	
HOP	A54316	BRUXELLES	15:35	T2-D20	
HOP	A54196	MONTPELLIER	15:35	T2-D20	
HOP	A54156	RENNES	15:35	T2-D20	
HOP	A54186	STRASBOURG	15:35	T2-D20	
AIR ONE	AF813	CATANE	15:40	T2-D15	
AER LINGUS	EI553	DUBLIN	15:45	T2-D16	
GERMANWINGS	4U9415	DUSSELDORF	15:50	T2-D25	
AIR FRANCE	AF7848	TOULOUSE	16:00	T2-D20	
EASYJET	U24417	BARCELONE	16:10	T3-D30	
HOP	50355	ANTALYA	16:15	T1-D15	
HOP	A54106	NANTES	16:20	T2-D20	
HOP	A54026	BORDEAUX	16:25	T2-D20	
EASYJET	U24325	BASTIA	16:45	T3-D30	
LUFTHANSA	LH2251	MUNICH	16:45	T2-D25	
ROYAL MAROC	AIRAT721	CASABLANCA	16:55	T1-D16	
EASYJET	U23192	LONDRE-STANSTED	17:10	T3-D30	
TURKISH AIRLINE	TK810	ISTANBUL	18:00	T1-D16	
TAR BORTUGAL	TP123	LISBONNE	18:00	T2-D16	

Figure 7.1 The flight information board interface

Kinect is used to detect the real time distance and movement of users, while the camera is used to recognize users' identity once users approach the screen.



The information board supports gesture interactions by Kinect and Leap motion. If the user stands at a distance from the information board, and there are no other users in front of the display, he/she can wave their hand to the left or right to browse the lists of information. If the user stands closer to the screen, then Leap motion is activated to recognize the fine-grained gestures for more precise gesture interactions on the screen. The details of the application specification are shown in Table 7.1. The range of distance is from 0 meter to 2 meters in front of the screen, which means that users standing closer than 2 meters in front of the screen can be detected. We applied successive zones of interactions instead of discrete

zones of interactions: users progressively approaching the screen can be gradually engaged in more and more interactions with the screen. Passengers standing very close to the screen can engage in interaction by Leap motion, i.e. fine-grained gesture interactions. Meanwhile, their identity can be recognized by the camera. A piece of information related to his/her flight is floating on the main interface of the board. Thus he/she can quickly get the flight information related to him/her instead of searching from all the flights, as shown in **Figure 7.2**. **Error! Reference source not found.** The movement of users in front of the screen is also taken into consideration, because the board is a projection screen, measuring 2.2 meter wide by 1.8 meter high which is large enough. Users can move slightly in front of the screen to avoid occluding the sight of other passengers, along with his/her movement, this sub-interface will as well move along with him/her to always keep in front of his/her eyes.

AIRLINE	FLIGHT NO.	DESTINATION	DEPA. TIME	GATE	STATUS
KLM	KL1418	AMSTERDAM	13:55	T2-D20	LAST CALL
EASYJET	U24317	BREST	13:55	T2-D30	LAST CALL
EASYJET	U24445	PORTO	14:00	T2-D30	BOARDING
LUFTHANSA	LH1077	FRANCFORT	14:40	T2-D25	
SWISS AIR	LX533	ZURICH	14:55	T2-D25	
HOP	A54516	BOLOGNE	15:15	T2-D20	
HOP	A54126	BORDEAUX	15:15	T2-D20	
HOP	A54056	MARSEILLE	15:15	T2-D20	
HOP	A54506	MILAN-MALPENSA	15:15	T2-D20	
HOP	A54006	NANTES	15:15	T2-D20	
AIR FRANCE	AF7645	PARIS C.D.G	15:15	T2-D20	
hOP	A54526	VENISE	15:15	T2-D20	
HOP	A54136	CAEN	15:20	T2-D20	
ALITALIA	AZ7285	OME FIUMICINO	15:20	T2-D20	
AIR FRANCE	AF7850	TOULOUSE	15:20	T2-D20	
HOP	A54086	BIARRITZ	15:25	T2-D20	
HOP	A54096	BREST	15:25	T2-D20	
HOP	A54046	METZ-NANCY	15:25	T2-D20	
AIR FRANCE	AF7837	NICE	15:25	T2-D20	
HOP	A54076	PAU	15:25	T2-D20	
HOP	A54066	LILLE	15:30	T2-D20	
AIR CORSICA	CE074	LIMOGES	15:30	T2-D20	
HOP	A54316	BRUXELLES	15:35	T2-D20	
HOP	A54196	MONTPELLIER	15:35	T2-D20	
HOP	A54156	RENNES	15:35	T2-D20	
HOP	A54186	STRASBOURG	15:35	T2-D20	
AIR ONE	AP813	CATANE	15:40	T2-D15	
AER LINGUS	EI553	DUBLIN	15:45	T2-D16	
GERMANWINGS	4U9415	DUSSELDORF	15:50	T2-D25	
AIR FRANCE	AF7848	TOULOUSE	16:00	T2-D20	
EASYJET	U24417	BARCELONE	16:10	T2-D20	
	50355	ANTALYA	16:15	T2-D20	
HOP	A54106	NANTES	16:20	T2-D20	
HOP	A54026	BORDEAUX	16:25	T2-D20	
EASYJET	U24325	BASTIA	16:45	T2-D30	
LUFTHANSA	LH2251	MUNICH	16:45	T2-D25	
ROYAL AIR	AT721	CASABLANCA	16:55	T2-D20	
MAROC					
EASYJET	U23192	LONDRE-STANSTED	17:10	T2-D30	
TURKISH AIRLINE	TK1810	ISTANBUL	18:00	T1-D16	
FRANCE AIR	FR100	LISBONNE	18:00	T2-D20	

Figure 7.2 A sub-interface with personal-related information

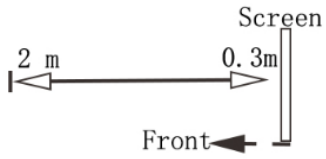
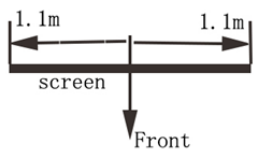
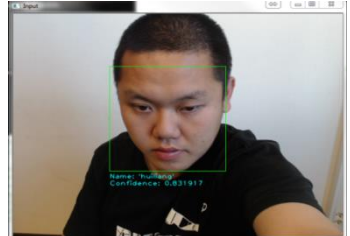
Table 7.1 The technology specification of the toy application

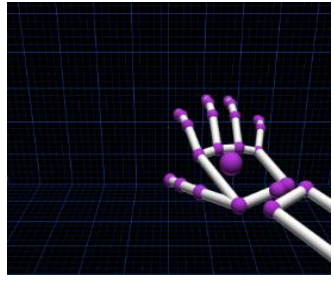
Factors	Devices			Technology Specification
	Kinect	Leap	Cam	
Distance	√			<p>The range of distance is about 0.3 meter to 2 meters in front of the screen</p> 
Movement	√			<p>The range of movement is about 1.1 meters to the left and right of the screen's center line</p> 
Identity		√		<p>The camera recognizes the identity of users who stand at a distance closer than 0.5 meter from the screen</p> 
Posture Interaction	√			<p>Kinect can recognize coarse posture interaction from a distance</p> 
Gesture Interaction			√	<p>Users close to the screen can interact by fine-grained gestures</p> 

We also consider the situation of multiple users, limited by the size of the projection screen and the capability of Kinect (Kinect can only track the skeletons of two players). At most we allow two passengers to stand at close distance from the screen. During this situation, the interaction with the Leap motion is disabled, because the leap motion supports only one user's interactions. We do not limit the number of passengers outside the close space of the screen. Also, the skeletons of other passengers cannot be detected by the Kinect, and thus have no impact on the current two users' interactions.

Passengers can download the information related to them by connecting the smartphone to the local hotspot. The local hotspot is not encrypted by password, and passengers can easily connect the smartphone to the hotspot. We have installed the application for communicating with the information board as discussed in chapter 6. Uploading information from the smartphone to the information board is not authorized considering the characteristics of the screen.



KLM Flight		KL 1418	LYS TO AMS
DEPARTURE GATE	DATE	SEAT NUMBER	
	17/JUNE/2014	10A	
BOARDING TIME	PASSENGER NAME	DEPARTURE TIME	
13:25	XXX XXX	13:55	
TERMINAL			
T-2			
			

Figure 7.3 A boarding pass for the user study

7.2 The User Study Protocol

The aim of the user study is to compare the efficiency of a common flight information board with the efficiency of a proxemic flight information board. We use time to find the information as a gauge for efficiency. The time to find the correct information is recorded by a stop watch in seconds. The time begins once a user enters the effective zone of the screen, and

until he/she finds the information he/she wants. We provide testers with a stop watch. Once he/she finds the correct flight, then he/she stops the watch and we record the task time in seconds.

Before the test, we printed out a boarding pass for the tester. The boarding pass contains the information of flight, destination and time, as shown in **Figure 7.3**. We give each tester a different boarding pass. The testers act as passengers who come to an airport to transfer to a connect flight, and the display board is installed in a public area of the airport terminal. They need to find the boarding gates of their flights as soon as possible because the flight connection time is very short. Besides, we provide an Android smartphone which installs the migration application on it. We allow participants to practice for a while to learn how to use the application.

The complete user study includes three tasks:

Task 1

A passenger walks to the front of the display board. He/she has to find the boarding gate of the flight that is shown on his/her boarding pass. We record task time with a stop watch.

Task 2

2.1 We give the current tester another different boarding pass. However, this time we change the common display board for a proxemic display board. The tester walks closer to the display board up to the close zone. The camera installed on the top of the display board recognizes the identity of the current passenger, and prompts a line of information just related to the passenger. Once the passenger reads the information, he/she stops the stop watch, and the task time is recorded.

2.2 Secondly, the passenger takes out his/her smartphone, and connects to the local Wi-Fi hotspot. He/she then launches the migration application, and clicks on the download button. The flight information related to him/herself, as well as the path from the current location to the boarding gate is downloaded instantly to the smartphone. Then he/she walks away from the screen, and the temporary flight information is removed from the display board.

2.3 After the second task, we ask users to tell us the boarding gate of the flight in task 1, to test whether he/she has remembered the boarding gate.

Task 3

The proxemic display board is also interactive by gestures., We invite participants to experience interactions in different spatial relationships with the board. The interaction includes:

Browse gestures by Kinect:

Once users enter the effective range of the display board, we play a short animation on the screen to remind them that they can browse the current contents by waving their hand upwards or downwards. We ask them to find specific flight information by browsing the current contents.

Fine-grained gestures by Leap motion:

Once the user has found a specific piece of information, he/she can step further into the screen. As he/she approaches the screen a floating window appears on the screen. This piece of information is displayed on the floating window, and more details about the flight are displayed on the window. He/she can move in front of the screen, and this window moves along at the same time, always remaining within his/her sight. He/she can wave their hand slightly only to browse information on that window, and zoom in or out the size of the window by pitch gestures.

7.3 Data Collection

We collect both qualitative data and quantitative data from the user study. Quantitative data contain the task completion time we recorded during the test, and the responses from the post-test questionnaires.

The system usability scale method is a reliable tool for measuring system usability. It yields a score between 0 and 100. This score can reflect the usability of a system objectively. As a result, we also conduct a system usability scale analysis for the user study.

To collect feedback more generally from participants, we ask each participant to fill out a questionnaire concerning the experience of the test after their tasks. This questionnaire includes a list of questions about the user study, and each question has a five Likert scale response. The participants can choose a scale according to their own experiences. Besides, for qualitative data we also have open questions for testers to write down their opinions about the proxemic display board. The questionnaire can be found in Appendix I.

7.4 User Study Results

7.4.1 Task completion time

Task completion time can reveal whether users can find the correct information more quickly on a proxemic display than on a common display. The original task completion time data are shown on **Table 7.2**.

Table 7.2 Task Completion Time for Two Tasks

Testers No. \ Time (s)	Task 1	Task 2.1
T1	10.2	5.3
T2	8.4	3.5
T3	9.7	5.6
T4	15.1	6.2
T5	12.3	6.4
T6	17.4	7.1
T7	16.5	4.8
T8	10.1	5.9
T9	9.3	6.8
T10	11.2	4.9
Mean	11.7	5.1
SD	3.03	1.14

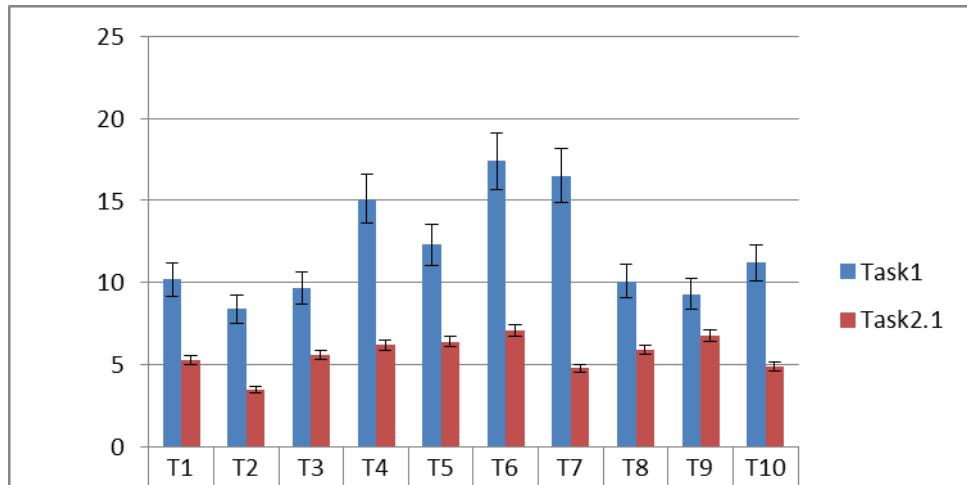

Figure 7.4 Comparison of task completion time

To reveal the difference in time more significantly, we show the task completion time in **Figure 7.4**. We observe that the task time of task 2.1 is obviously shorter than task 1 for all testers.

To prove whether this result continues to apply more generally, we also applied a one way ANOVA (analysis of variance) method to analyze the difference between the two sets of data. ANOVA is a set of statistical models designed to compare the difference between two groups of data.

We carried out the ANOVA analysis with R programming language, where R is a special language and software environment for statistical computing. We input the raw data to R and obtain the ANOVA table as shown in **Table 7.3**.

Table 7.3 Anova Result

Source	Sum of Square	Degree of Freedom	Mean Square	F ratio	P value
Task type	202.88	18	202.884	35.621	1.203e-05
Error	102.52	1	5.696		

$$F_{(1,18)} = 35.621, p = 1.203 \times 10^{-5}$$

From the ANOVA result, we find that the variation between two tasks is significant. This is because P is evidently a small value, which means that

the proxemic flight display board greatly improves efficiency of users' interaction with the screen. Standard passengers can find their flight more quickly from this new kind of screen than from a normal screen.

7.4.2 Memory efficiency comparison

In task 2.3, we ask testers to repeat the boarding gate they got from task 1, to evaluate whether they can remember the information from a normal display board after a while and given the distraction of other tasks. According to the results, 7 testers can cite the boarding gate instantly and correctly, while the other 3 testers have to think for a while to recall the boarding gate, out of which 1 tester got it wrong.

Compared to this situation, if testers download the boarding information to the smartphone, it is obvious that they can check the boarding gate at any time. Thus they can easily get to the correct boarding gate.

7.4.3 System usability scale result

Task completion time reflects only the improvement in efficiency. We also implement the system usability scale method to evaluate the usability of this new display board. The system usability scale contains the following ten questions:

- 1 *I think that I would like to use this system frequently.*
- 2 *I found the system unnecessarily complex.*
- 3 *I thought the system was easy to use.*
- 4 *I think that I would need the support of a technical person to be able to use this system.*
- 5 *I found the various functions in this system were well integrated.*
- 6 *I thought there was too much inconsistency in this system.*
- 7 *I would imagine that most people would learn to use this system very quickly.*
- 8 *I found the system very cumbersome to use.*
- 9 *I felt very confident using the system.*
- 10 *I needed to learn a lot of things before I could get going with this system.*

The ten SUS questions contain five positive sentences and five negative sentences. Users can give a score of 1 to 5 for each question, which ranges from strongly disagree to strongly agree. We calculated the scores according to SUS rules.

- For odd questions, subtract one from the user's response;
- For even questions, subtract the user's response from 5;
- Then sum all the scores for each user and multiply by 2.5. We get a score between 0 to 100.

Table 7.4 Original Scores of SUS Questions

	Q1	Q2	Q3	Q4	Q5	Q6	Q7	Q8	Q9	Q10
T1	5	1	5	1	5	1	5	1	5	1
T2	4	1	5	1	4	1	5	1	3	1
T3	5	1	4	2	5	2	4	1	5	1
T4	3	1	5	1	3	1	5	1	3	1
T5	3	2	4	2	5	1	4	2	4	1
T6	2	1	5	1	4	1	4	1	4	1
T7	5	1	3	1	3	1	3	1	3	2
T8	4	1	5	1	4	2	3	1	5	1
T9	2	2	4	1	5	1	4	1	4	2
T10	5	1	3	1	4	2	5	1	3	1

Table 7.5 Calculation Results of SUS scores

	Q1	Q2	Q3	Q4	Q5	Q6	Q7	Q8	Q9	Q10	Score
T1	4	4	4	4	4	4	4	4	4	4	100
T2	3	4	4	4	3	4	4	4	2	4	90
T3	4	4	3	3	4	3	3	4	4	4	90
T4	2	4	4	4	2	4	4	4	2	4	85
T5	2	3	3	3	4	4	3	3	3	4	80
T6	1	4	4	4	3	4	3	4	3	4	85
T7	4	4	2	4	2	4	2	4	2	3	77.5
T8	3	4	4	4	3	3	2	4	4	4	87.5
T9	1	3	3	4	4	4	3	4	3	3	82.5
T10	4	4	2	4	3	3	4	4	2	4	85
Score	70	95	82.5	95	80	92.5	80	97.5	72.5	97.5	

The original scores of the testers for the ten questions are shown in **Table 7.4**, while the calculation process and results are shown in **Table 7.5**.

From **Table 7.5**, we can calculate the average SUS score for this prototype as 86.25. According to the SUS method scales, this score is grade A and in the top 10% of usability, meaning that users are pleased with usability and might be willing to recommend this product to other friends.

7.4.4 Qualitative Analysis

From the SUS table, we can get an overall score for the proxemic display board. We find that, generally speaking, system testers are satisfied with the usage experience of the system. However, we cannot find out the answers concerning detailed information of this prototype. Using the questionnaire we designed for this prototype as shown in Appendix I, we collect more precise feedback from testers.

The overall results of the questionnaire answers are shown in **Figure 7.5**. We can clearly see users' answers to each question from the figure.

For example, the response to question 8: "it is easier to find the correct flight on a proxemic board by floating window". Six testers in ten agree with this description, and 4 testers strongly agree with this description. We can reason that, to display personal-related flight information on a floating window can really help users find their personal-related information. For negative questions like question 7: "I don't want my personal flight to be displayed on a public screen", 2 testers strongly disagree with this description, while 7 testers agree with it, and 1 tester is neutral. With this question, we try to find out whether displaying personal flight information on a public screen bothers users or not due to privacy concerns. However, the results show in this scenario that users are not particularly concerned with information privacy. Flights are not really considered as private information. This might result in that all testers for this user study are Chinese students, and that, in their opinion, personal flight info is not private information that cannot be displayed in public places.

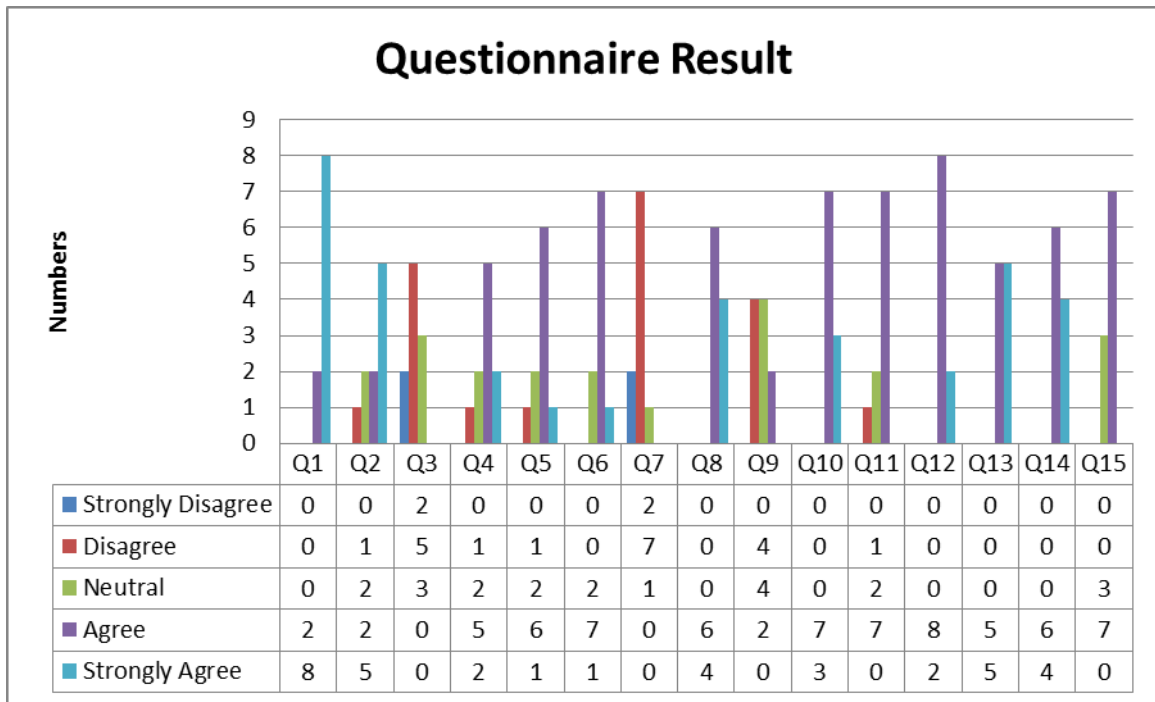

Figure 7.5 Questionnaire results of the user study

During the user study, we noted testers' opinions for this prototype. They also wrote down some comments about the prototype. For example, the precision of identity recognition is often doubted by testers, because with a normal camera, we cannot recognize a user's identity to a certainty of 100%. Some of them advised using QR code or RFID tags instead of the camera for recognizing users' identities. Some testers still have problems interacting with the screen by gestures, because they feel that mid-air gestures are not as natural and comfortable as mouse or keyboard. Also when an interaction takes a long time, their arms start to tire. Several testers also find that the interface transition from far to close is somewhat ambiguous at times. We do not present enough guided information on the screen, so new users without any training might be confused by the reaction and changing contents on screens. With respect to data migration, most testers find that downloading information from a large public screen improves the experience of interaction with a public screen, and encourages them to discover more interesting information on a public screen.

7.5 Conclusion

In this chapter, we built an experimental application to simulate a proxemic flight display board in an airport. Based on this experimental application, we conducted a tentative user study in our laboratory. We recruited ten testers, and organized two comparative tasks to validate whether proxemic interaction can really improve the efficiency of user's interactions with a normal public screen in a smart city. We also evaluate interactions according to user's experiences when they interact with the screen. Finally, we analyzed the results of the user study from a qualitative and quantitative viewpoint. We observe that although there are still some proxemic interaction problems, testers are generally content with the performance of proxemic interactive screens.

8 Conclusion and Future Work

8.1 Conclusions and Contributions 8.2 Future Perspective

8.1 Conclusions and Contributions

This dissertation investigated the proxemic interaction theories and implemented proxemic interaction towards public displays in the context of a smart city. We re-investigated the dimensions of proxemic interaction, and discussed proxemic interaction patterns by considering application scenarios together with the public. Based on these proxemic interaction patterns for public displays, we built a prototype with Kinect, web camera and Leap motion. This prototype can support development of various applications of proxemic public displays for the smart city.

The smart city is a large scale ubiquitous computing environment. Besides public displays, users' mobile devices are another major ubiquitous media in the smart city. To take better advantage of users' mobile devices, we also developed a software toolkit for data migration between a public display and personal mobile devices. With this toolkit, we built a complete toolset for a proxemic interactive public display. Compared with previous work, this prototype is an attempt to address the challenges of public screens in the smart city by proxemic interaction theories, and we provided an easy-to-setup solution for proxemic interactive public displays.

The major contributions of this dissertation can be concluded as:

- **Proxemic interaction patterns for a large public display**

Proxemic interaction is an overall concept for the user's interaction with an object. According to the characteristics of a public screen, we have re-considered the five dimensions of proxemic interaction (distance, orientation, movement, identity and location). For example, the location of a public screen is different from the concept of location for a specific room. Location refers more to the characteristics of the user's current location than to the layout of fixed or semi-fixed features of a room. A proxemic interactive public display considers not only normal contexts but

also spatial relationships with users, thus making it more intelligent than a normal context-aware system.

The major improvement in our proxemic interaction patterns compared with the Saul Greenberg's model is that we highlights more on multiple users situation. As for a public screen, there are always multiple users rather than a single user. We envisioned the interaction modalities of multiple users (two users stand side by side, one user stands close to the display while another user is waiting, etc..) Also, we have proposed the instant sub-interface within the frame of the main interface, thus displaying different levels of information to users standing in different positions.

We also discussed the differences between distinct areas of interactions, and continuous interactive areas. We compared the advantages and disadvantages of these two kinds of proxemic interaction, and proposed to apply continuous interactive areas for a public screen.

- **An easy-to-setup hardware infrastructure for a proxemic public display**

Based on proxemic interaction patterns, we built an infrastructure for a proxemic interactive public display using a projector, Microsoft Kinect, Leap motion and Web camera. We simulated a projection screen with a normal projector on the wall. The prototype used Kinect to construct proxemic interactive zones in front of the display. We can recognize the distance, movement and multi-user spatial relationship by Kinect. The Leap motion recognizes the fine-grained gesture interactions of users to convert a normal projection screen into a gestural interactive object. The camera can recognize the identity of users standing close enough to the display. In this way, we can display more and more detailed contents and enable more and more precise user interactions, as users approach the display. Because the sensors we used for this prototype can be easily bought at a low price, it is easier to build a basic proxemic interactive public screen according to our setup.

Furthermore, we provided a graphic user interface for configuring the parameters of the prototype. Developers of a proxemic display can monitor the real time data of the interaction. Also, they can access the sensor data from the network socket by reading from a specific address. This means that other applications can also take advantage of these sensor data via a network.

Limited by the capability of Kinect and Leap motion, we can only track two users at the same time, and only one user can interact by Leap motion. If we want to support more users, the infrastructure can be extended by adding more Kinect and Leap motion. Since the sensor data are integrated by JSON standard via a network, the integration process is easy to configure.

- **We proposed a migratable user interface to address the privacy issue of proxemic displays, and we developed a toolkit to support interface migration**

Privacy is a serious issue of proxemic interaction. We proposed the concept of a migratable user interface, which can migrate personal-related information to users' mobile devices.

We developed a toolkit to support interface migration from a public display to personal mobile devices. This toolkit is very simple to install and use, and bridges the gap between personal mobile devices and a public display by connecting the two typical media seamlessly. This toolkit resolves the issue of privacy but also improves the performance of proxemic public displays. Normal users can freely access the resources of a public display. Another promising vision is that users can also create contents with their mobile devices and choose to publish these creative contents to public displays. The toolkit creates a new area for the application on a public display because it closely links users and displays. It turns public displays into interactive windows between citizens and the smart city, meaning that citizens can participate in the city's activities through their own mobile devices.

Besides, **the minor contribution** of our dissertation is that we conducted a tentative User Study. We implemented a comparative laboratory user study based on an experimental application, which is a simulated airport flight display. We applied both the quantitative method (ANOVA, System Usability Scale) and the qualitative method (questionnaire) to evaluate the proxemic application. Though the user study is only a lab user study with limited numbers of users, the results of this study prove that a proxemic public display performs better than an old public display during the construction of a smart city. We also collect some potential issues that might exist in public proxemic interactions, which can be used as references for other researchers in the same field.

8.2 Future Perspective

In this dissertation, we built a proxemic interaction prototype and, based on this prototype, we implemented an experimental application and organized a lab user study for this application. In the future work, we propose to continue the study from possible directions as follows:

Install the experimental application in real situations, and observe user behaviors and collect feedback.

Until now, most user studies of proxemic interaction were performed in the laboratory. There is still no user study in real situations. The problem is that behaviors of users in a lab context can be really different from behaviors in real public places. For proxemic interaction, we seek to make the computer understand meanings of user behavior, and to pre-define meanings of behaviors according to experiences or we summarize meanings of some behaviors from small scale users. However, neither method is appropriate. Installation of a demo application in a real public place can help us to observe the real behaviors of users. Then, with this knowledge, we can design interactions that are closer to the real situation, and find out more about natural patterns of user's behaviors, which cannot occur in a controlled laboratory context;

Extend the dimensions of proxemic interaction.

Proxemics is a factor that varies according to culture, age and gender, and some other unidentified factors (Hall, 1966). In this dissertation, we have not considered factors other than the user's sense of space, but these factors might be important for proxemic interaction. For example, gender is an interesting proxemic dimension that is valuable for interaction. An electrical advertisement screen in a shopping mall can display different contents to female (cosmetics, dressing, etc.) and male (games, electrical devices, etc.) customers. In future work, we can explore how these factors impact users' behaviors and then can be used to improve proxemic interaction;

Explore interactions for the smart city.

The smart city is a concept of the future city, with intelligent management of data, more efficient life and more natural ways of interactions between citizens and the public media of a city. In the smart city, a public display or a public display network is a very important and promising interactive

object and information carrier. In this dissertation, we only considered the basic proxemic interactions with public displays for users getting visual information. However, proxemic interaction not only interacts between humans and a screen, it can also interact between humans and other digital objects, between several digital objects, etc. Besides, we can also consider audio feedback to users who have visual disabilities instead of visual feedback. These areas have still not been fully explored, and can also be promising areas for proxemic interaction.

In the future work, we can continue to find more significant scenarios in the smart city to apply proxemic interaction, e.g. proxemic retailer machine, proxemic traffic light, proxemic building, etc.

Technological improvement of the prototype

From the technological aspect, we can improve the performance of the prototype, and develop more complete APIs for development of other applications. We have used the web camera as a means of identity recognition. The most serious problem here is not the precision of face recognition, but how to get enough photos of users to train the data set, necessary for identity recognition. However, with the widespread utilization of Facebook, Instagram and Flickr, etc., huge numbers of personal photos tagged with identity are shared online. These photos can be collected to construct a face recognition training set, thus making face recognition by web camera more feasible.

Bibliography

- Andrew, M., Gary M., and Richard H., 2007. *Creating and Sharing Multi-Media Packages Using Large Situated Public Displays and Mobile Phones*. In Proceedings of the 9th International Conference on Human Computer Interaction with Mobile Devices and Services. MobileHCI '07. New York, NY, USA: ACM. pp. 222–225.
- Azad, A., Ruiz, J., Vogel, D., Hancock, M., & Lank, E., 2012. *Territoriality and behaviour on and around large vertical publicly-shared displays*. In Proceedings of the Designing Interactive Systems Conference (pp. 468–477). New York, NY, USA: ACM.
- Ballagas, R., Rohs, M., & Sheridan, J. G., 2005. *Sweep and point and shoot: phonecam-based interactions for large public displays*. In CHI '05 Extended Abstracts on Human Factors in Computing Systems. New York, NY, USA: ACM. pp. 1200–1203.
- Ballagas, R., Borchers, J., Rohs, M., & Sheridan, J. G., 2006. *The smart phone: a ubiquitous input device*. IEEE Pervasive Computing, 5(1), pp.70 – 77.
- Bangor, A., Kortum, P. T., & Miller, J. T., 2008. *An Empirical Evaluation of the System Usability Scale*. International Journal of Human-Computer Interaction, 24(6), pp.574–594.
- Bauml, B., Schmidt, F., Wimbock, T., Birbach, O., Dietrich, A., Fuchs, M., Grebenstein, M., 2011. *Catching flying balls and preparing coffee: Humanoid rollin'justin performs dynamic and sensitive tasks*. In 2011 IEEE International Conference on Robotics and Automation (ICRA) .pp. 3443–3444.
- Berti S, Paternò F, Santoro C., 2006. A taxonomy for migratory user interfaces. Interactive Systems. Design, Specification, and Verification. Springer Berlin Heidelberg, pp. 149-160.
- David, B., Yin, C., Zhou, Y., Xu T., Zhang, B., Jin, H., and Chalon, R., 2012. *SMART-CITY: Problematics, Techniques and Case Studies*. In 8th International Conference on Computing Technology and Information Management (ICCM), pp.168–174.

- Borchers, J., Ringel, M., Tyler, J., Fox, A., 2002. *Stanford Interactive Workspaces: A Framework for Physical and Graphical User Interface Prototyping*. IEEE Wireless Communications, 9, no. 6, pp.64–69.
- Boring, S., Gehring, S., Wiethoff, A., Blöckner, A. M., Schöning, J., & Butz, A., 2011. *Multi-user interaction on media facades through live video on mobile devices*. In Proceedings of the SIGCHI Conference on Human Factors in Computing Systems. New York, NY, USA: ACM, pp.2721-2724.
- Boring, S., Manuela A., Gregor B., Otmar H., and Andreas B., 2007. *Shoot & Copy: Phonecam-Based Information Transfer from Public Displays onto Mobile Phones*. In Proceedings of the 4th International Conference on Mobile Technology, Applications, and Systems and the 1st International Symposium on Computer Human Interaction in Mobile Technology, Mobility '07. New York, NY, USA: ACM, pp. 24–31.
- Brignull, H., Izadi, S., Fitzpatrick, G., Rogers, Y., & Rodden, T., 2004. *The Introduction of a Shared Interactive Surface into a Communal Space*. In Proceedings of the ACM Conference on Computer Supported Cooperative Work. New York, NY, USA: ACM, pp. 49–58.
- Calvary, G., Serna, A., Kolski, C., Coutaz, J., (2011). Transport: a fertile ground for the plasticity of user interfaces. In Kolski (Eds.), *Human-Computer Interactions in Transport*, ISTE Ltd and John Wiley & Sons Inc., pp. 343-368.
- Caragliu, A., Caragliu, A., Del Bo, C. & Nijkamp, P., 2009. *Smart cities in Europe*. Serie Research Memoranda 0048 (VU University Amsterdam, Faculty of Economics, Business Administration and Econometrics).
- Cheverst, K., Dix, A. J., Fitton, D., Kray, C., Rouncefield, M., Saslis-Lagoudakis, G., & Sheridan, J. G. (2005, May). Exploring Mobile Phone Interaction with Situated Displays. In PERMID, pp. 43-47.
- Cheverst, K., Alan D., Daniel F., Chris K., Mark R., Corina S., George S., and Jennifer G., 2005b. *Exploring Bluetooth Based Mobile Phone Interaction with the Hermes Photo Display*. In Proceedings of the 7th International Conference on Human Computer Interaction with Mobile Devices & Services, 47–54. MobileHCI '05. New York, NY, USA: ACM.

- Churchill E, Girgensohn A, Nelson L, et al. Blending digital and physical spaces for ubiquitous community participation[J]. *Communications of the ACM*, 2004, 47(2), pp.38-44.
- Corning, 2011 https://www.youtube.com/watch?v=6Cf7IL_eZ38
- Dachselt, R., & Buchholz, R., 2009. *Natural throw and tilt interaction between mobile phones and distant displays*. In CHI '09 Extended Abstracts on Human Factors in Computing Systems. New York, NY, USA: ACM, pp. 3253–3258.
- Davies, N., M. Langheinrich, R. Jose, and A. Schmidt. 2012. *Open Display Networks: A Communications Medium for the 21st Century*. *Computer* 45 (5), pp. 58–64.
- Dey, A.K. and Abowd, G.D., 2000. *Towards a better understanding of context and context-awareness*, Proceedings of the Workshop on the What, Who, Where, When and How of Context-Awareness, ACM Press, New York, pp.304-307.
- Grolaux D, Van Roy P, Vanderdonck J., 2004 Migratable user interfaces: Beyond migratory interfaces[C]//Mobile and Ubiquitous Systems: Networking and Services, MOBIQUITOUS. The First Annual International Conference on. IEEE, pp.422-430.
- Dourish, P., 2001. *Where the Action is: The foundations of Embodied Interaction*, The MIT Press.
- Hall, E.T., 1966. *The Hidden Dimension*. Anchor Books. ISBN 0-385-08476-5.
- Elhart, I., Memarovic, N., Langheinrich, M., & Rubegni, E., 2013. *Control and scheduling interface for public displays*. In Proceedings of the ACM conference on Pervasive and ubiquitous computing adjunct publication. New York, NY, USA: ACM, pp.51-54.
- Fischer, P. T., Hornecker, E., 2012. *Urban HCI: spatial aspects in the design of shared encounters for media facades*. In Proceedings of the SIGCHI Conference on Human Factors in Computing Systems. New York, NY, USA: ACM, pp.307-316.
- Fleck, M., Frid, M., Kindberg, T., O'Brien-Strain, E., Rajani, R., Spasojevic, M., 2002. *Rememberer: A Tool for Capturing Museum Visits*. In Proceedings of the 4th international conference on Ubiquitous Computing (UbiComp '02),

Gaetano Borriello and Lars Erik Holmquist (Eds.). Springer-Verlag, London, UK, pp. 48-55.

Florian, A., Alireza Sahami S., Thomas K., Albrecht S., 2013. *Interaction Techniques for Creating and Exchanging Content with Public Displays*. In Proceedings of the SIGCHI Conference on Human Factors in Computing Systems. New York, NY, USA: ACM, pp.1709-1718.

Gallud, J., Tesoriero, R., M.R. Penichet, V., 2011. *Distributed User Interfaces: Designing Interfaces for the Distributed Ecosystem*, ISBN 978-1-4471-2271-5

Gellersen H, Fischer C, Guinard D, et al. *Supporting device discovery and spontaneous interaction with spatial references*[J]. Personal and Ubiquitous Computing, 2009, 13(4), pp. 255-264.

Giffinger, R., Christian, F., Hans, K., Robert, K., Nataša, P., Evert, M., 2007. *Smart cities – Ranking of European medium-sized cities*. Smart Cities. Vienna: Centre of Regional Science.

Greenberg, S., Boring, S., Vermeulen, J. and Dostal, J., 2014. *Dark Patterns in Proxemic Interactions: A Critical Perspective*. In Proc. ACM Conference on Designing Interactive Systems. Vancouver, Canada, June, pp.21-25.

Greenberg, S., Marquardt, N., Ballendat, T., Diaz-Marino, R., Wang, M., 2011. *Proxemic Interactions: The New Ubicomp?* Interactions 18, no. 1, pp. 42–50.

Hardy, R., Rukzio, E., 2008. *Touch & Interact: Touch-Based Interaction of Mobile Phones with Displays*. In Proceedings of the 10th International Conference on Human Computer Interaction with Mobile Devices and Services, New York, NY, USA: ACM, pp. 245–254.

Harrison C, Dey A K., 2008. *Lean and zoom: proximity-aware user interface and content magnification*, in Proceedings of the SIGCHI Conference on Human Factors in Computing Systems. ACM, pp.507-510.

Hekler, E. B., Klasnja, P., Froehlich, J. E., Buman, M. P., 2013. *Mind the Theoretical Gap: Interpreting, Using, and Developing Behavioral Theory in HCI Research*. In Proceedings of the SIGCHI Conference on Human Factors in Computing Systems, New York, NY, USA: ACM, pp. 3307–3316.

- Hinrichs, U., Carpendale, S., Valkanova, N., Kuikkaniemi, K., Jacucci, G., Moere, A. V., 2013. *Interactive Public Displays*. IEEE Computer Graphics and Applications, 33(2), pp. 25–27.
- Hosio, S., Jurmu, M., Kukka, H., Rieki, J., Ojala, T., 2010. *Supporting Distributed Private and Public User Interfaces in Urban Environments*. In Proceedings of the Eleventh Workshop on Mobile Computing Systems & Applications, HotMobile'10. New York, NY, USA: ACM, pp.25-30.
- Huang, E. M., & Mynatt, E. D., 2003. *Semi-public displays for small, co-located groups*. In Proceedings of the SIGCHI Conference on Human Factors in Computing Systems. New York, NY, USA: ACM, pp.49-56.
- Huang, E. M., Koster, A., & Borchers, J., 2008. *Overcoming Assumptions and Uncovering Practices: When Does the Public Really Look at Public Displays?* In Proceedings of the 6th International Conference on Pervasive Computing , Berlin, Heidelberg: Springer-Verlag, pp. 228–243.
- Izadi, S., Brignull, H., Rodden, T., Rogers, Y., & Underwood, M., 2003. *Dynamo: a public interactive surface supporting the cooperative sharing and exchange of media*. In Proceedings of the 16th annual ACM symposium on User interface software and technology. New York, NY, USA: ACM, pp. 159–168.
- Jacquet C, Bellik Y, Bourda Y., 2011. *Towards new interactive displays in stations and airports*[J]. In Kolski (Eds.), Human-Computer Interactions in Transport, ISTE Ltd and John Wiley & Sons Inc., pp. 311-342.
- Jin, H., David, B., Chalon, R., 2013: *A Proxemic Interactive Platform for Sociable Public Zones in the Smart City*. Intelligent Environments (Workshops), pp. 617-628
- Ju W., Lee, B. A., and Klemmer, S. R., 2008. *Range: Exploring Implicit Interaction through Electronic Whiteboard Design*. In Proceedings of the ACM Conference on Computer Supported Cooperative Work, pp. 17-26.
- Kindberg, T., O'Neill, E., Bevan, C., Kostakos, V., Stanton Fraser, D., & Jay, T., 2008. *Measuring trust in wi-fi hotspots*. In Proceedings of the SIGCHI Conference on Human Factors in Computing Systems, New York, NY, USA: ACM, pp. 173–182.

- Kortuem, G., Kray, C., & Gellersen, H., 2005. *Sensing and visualizing spatial relations of mobile devices*. In Proceedings of the 18th annual ACM symposium on User interface software and technology. New York, NY, USA: ACM, pp. 93–102.
- Kostakos, V., Nicolai, T., Yoneki, E., O’Neill, E., Kenn, H., & Crowcroft, J., 2009. *Understanding and measuring the urban pervasive infrastructure*. Personal and Ubiquitous Computing, 13(5), pp. 355–364.
- Kray, C., Nesbitt, D., Dawson, J., & Rohs, M., 2010. *User-defined gestures for connecting mobile phones, public displays, and tabletops*. In Proceedings of the 12th international conference on Human computer interaction with mobile devices and services, New York, NY, USA: ACM, pp. 239–248.
- Krishna, A., Bharat and Luca C., 1995. *Migratory applications*. In Proceedings of the 8th annual ACM symposium on User interface and software technology (UIST ’95). ACM, New York, NY, USA, pp. 132-142.
- Kuikkaniemi, K., Jacucci, G., Turpeinen, M., Hoggan, E., & Müller, J., 2011. *From Space to Stage: How Interactive Screens Will Change Urban Life*. Computer, 44(6), pp.40–47.
- Ledo, D., & Greenberg, S., 2013. *Mobile proxemic awareness and control: exploring the design space for interaction with a single appliance*. In CHI ’13 Extended Abstracts on Human Factors in Computing Systems. New York, NY, USA: ACM, pp. 2831–2832.
- Malik, S., Ranjan, A., Balakrishnan, R., 2006. *Interacting with Large Displays from a Distance with Vision-Tracked Multi-Finger Gestural Input*. In ACM SIGGRAPH 2006 Sketches. SIGGRAPH ’06. New York, NY, USA: ACM, pp.43-52.
- Marquardt, N., R. Diaz-Marino, Boring, S., and Greenberg, S., 2011. *The Proximity Toolkit: Prototyping Proxemic Interactions in Ubiquitous Computing Ecologies*. In Proceedings of the 24th Annual ACM Symposium on User Interface Software and Technology, pp.315–326.
- Marquardt, N., Hinckley, K., and Greenberg, S., 2012a. *Cross-Device Interaction via Micro-Mobility and F-Formations*. In Proceedings of the 25th Annual ACM Symposium on User Interface Software and Technology. UIST ’12. New York, NY, USA: ACM, pp.13-22.

- Marquardt, N., Ballendat, T., Boring, S., Greenberg, S., & Hinckley, K., 2012b. *Gradual engagement: facilitating information exchange between digital devices as a function of proximity*. In Proceedings of the 2012 ACM international conference on Interactive tabletops and surfaces. New York, NY, USA: ACM, pp. 31–40.
- Marquardt, N., & Greenberg, S., 2012c. *Informing the design of proxemic interactions*. Pervasive Computing, IEEE, 11(2), pp.14–23.
- Mayrhofer, R., Gellersen, H., & Hazas, M., 2007. *Security by spatial reference: using relative positioning to authenticate devices for spontaneous interaction*. In Proceedings of the 9th international conference on Ubiquitous computing Berlin, Heidelberg: Springer-Verlag, pp. 199–216.
- Memarovic, N., Elhart, I., Michelotti, A., Rubegni, E., & Langheinrich, M., 2013. *Social networked displays: integrating networked public displays with social media*. In Proceedings of the 2013 ACM conference on Pervasive and ubiquitous computing adjunct publication . New York, NY, USA: ACM, pp. 55–58.
- Müller, J., Jentsch, M., Kray, C., & Krüger, A., 2008. *Exploring factors that influence the combined use of mobile devices and public displays for pedestrian navigation*. In Proceedings of the 5th Nordic conference on Human-computer interaction: building bridges. New York, NY, USA: ACM, pp. 308–317.
- Müller, J., & Krüger, A., 2009. *MobiDiC: Context Adaptive Digital Signage with Coupons*. In Proceedings of the European Conference on Ambient Intelligence, Berlin, Heidelberg: Springer-Verlag, pp. 24–33.
- Nancel, M., Wagner, J., Pietriga, E., Chapuis, O., and Mackay, W., 2011. *Mid-Air Pan-and-Zoom on Wall-Sized Displays*. In Proceedings of the SIGCHI Conference on Human Factors in Computing Systems, CHI '11. New York, NY, USA: ACM, pp. 177–186.
- Nancel, M., Chapuis, O., Pietriga, E., Yang, X.-D., Irani, P. P., & Beaudouin-Lafon, M., 2013. *High-precision Pointing on Large Wall Displays Using Small Handheld Devices*. In Proceedings of the SIGCHI Conference on Human Factors in Computing Systems. New York, NY, USA: ACM, pp. 831–840.
- P3GM. <http://p3gm.com/technology/>

- Peltonen P, Kurvinen E, Salovaara A, 2008. It's Mine, Don't Touch!: interactions at a large multi-touch display in a city centre, in Proceedings of the SIGCHI Conference on Human Factors in Computing Systems. ACM, pp. 1285-1294.
- Poslad, S., 2009. *Ubiquitous Computing: Smart Devices, Environments and Interactions* Wiley, ISBN: 978-0-470-03560-3, 2009.
- Ronzani D., 2009. *The Battle of Concepts: Ubiquitous Computing, Pervasive Computing and Ambient Intelligence in Mass Media*. Ubiquitous Computing and Communication Journal 4, no. 2, pp. 9–19.
- Ravnik R, Solina F. *Interactive and audience adaptive digital signage using real-time computer vision*[J]. International Journal of Advanced Robotic Systems, 2013, 10, pp. 1-7.
- José R, Otero N, Izadi S, et al. *Instant places: Using bluetooth for situated interaction in public displays*[J]. Pervasive Computing, IEEE, 2008, 7(4), pp. 52-57.
- Russell D M, Trimble J P, Dieberger A., 2004. *The use patterns of large, interactive display surfaces: Case studies of media design and use for BlueBoard and MERBoard*. In Proceedings of the 37th Annual Hawaii International Conference on. IEEE, 2004: pp.10-.
- Roussel, N., Evans, H., & Hansen, H., 2003. *Using distance as an interface in a video communication system*. In Proceedings of the 15th French-speaking conference on human-computer interaction on 15eme Conference Francophone sur l'Interaction Homme-Machine. New York, NY, USA: ACM, pp. 268–271.
- Schilit, B.N., and Theimer, M.M. ,1994a. *Disseminating Active Map Information to Mobile Hosts*.IEEE Network 8, no. 5, pp. 22–32.
- Schilit,B.N., Theimer,M.M.,1994b. *Context-aware computing applications*, in : Proceedings of the Workshop on Mobile Computign Systems and Applications. pp.85-90.
- Schmidt, A., 2000. *Implicit Human Computer Interaction through Context*. Personal Technologies 4, no. 2–3 , pp. 191–99.

- Schmidt, C., Constantin S., Jörg M., and Gilles B., 2013. *Screenfinity: extending the perception area of content on very large public displays*. In Proceedings of the SIGCHI Conference on Human Factors in Computing Systems (CHI '13). ACM, New York, NY, USA, pp. 1719-1728.
- Schmidt, D., Seifert, J., Rukzio, E., & Gellersen, H., 2012. *A cross-device interaction style for mobiles and surfaces*. In Proceedings of the Designing Interactive Systems Conference . New York, NY, USA: ACM, pp. 318–327.
- Seifert, J., Simeone, A., Schmidt, D., Holleis, P., Reinartz, C., Wagner, M., Rukzio, E., 2012. *MobiSurf: improving co-located collaboration through integrating mobile devices and interactive surfaces*. In Proceedings of the 2012 ACM international conference on Interactive tabletops and surfaces. New York, NY, USA: ACM, pp. 51–60.
- Shoemaker, G. B. D., & Inkpen, K. M., 2001. *Single display privacyware: augmenting public displays with private information*. In Proceedings of the SIGCHI Conference on Human Factors in Computing Systems. New York, NY, USA: ACM, pp. 522–529.
- SKIN, 2011. <http://eecatalog.com/smart-energy/2012/11/29/all-about-the-fifth-play-smart-home-and-smart-energy/>
- Smarter Planet, IBM. [http://www.ibm.com/smarterplanet/now\](http://www.ibm.com/smarterplanet/now)
- SmartCity Lyon. <http://www.economie.grandlyon.com/>
- SmartHome, 2012. <http://eecatalog.com/smart-energy/2012/11/29/all-about-the-fifth-play-smart-home-and-smart-energy/>
- Snibbe, S. S., & Raffle, H. S., 2009. *Social immersive media: pursuing best practices for multi-user interactive camera/projector exhibits*. Proceedings of the SIGCHI Conference on Human Factors in Computing Systems. ACM, pp. 1447-1456.
- Streitz, N., Siegel, J., Hartkopf, V., Konomi, S., 1999. *Cooperative Buildings: Integrating Information, Organization, and Architecture*. Springer Berlin Heidelberg, pp. 22–32.
- Ten Koppel, M., Bailly, G., Müller, J., Walter, R., 2012. *Chained Displays: Configurations of Public Displays Can Be Used to Influence Actor-, Audience-, and*

- Passer-by Behavior*. In Proceedings of the 2012 ACM Annual Conference on *Human Factors in Computing Systems*, pp.317–326.
- Thorsten P., Carsten R., Norbert S., Richard S., and Carsten M., 2003. *Hello.Wall--Beyond Ambient Displays*. In Adjunct Proceedings of UbiComp, pp. 277-278.
- Vaskar R., Vaskar R., Jiannong C., Mohan K., Daqiang Z., 2013. *Middleware for pervasive computing: A survey*, *Pervasive and Mobile Computing*, Volume 9, Issue 2, April 2013, Pages 177-200, ISSN 1574-1192.
- Vogel D., and Ravin B., 2004. *Interactive Public Ambient Displays: Transitioning from Implicit to Explicit, Public to Personal, Interaction with Multiple Users*. In Proceedings of the 17th Annual ACM Symposium on User Interface Software and Technology, UIST '04. New York, NY, USA: ACM, pp.137–146.
- Wang, C., David, B., Chalon, R., 2014. *A smart city case study : dynamic management of road lanes*. 3rd International Conference on Advanced Logistics and Transport, Hammamet, Tunisie, pp.629-640.
- Weiser, M., 1999. *The computer for the 21st century*. Scientific american 265.3, pp. 94-104.
- Wilson, A. D., & Sarin, R., 2007. *BlueTable: connecting wireless mobile devices on interactive surfaces using vision-based handshaking*. In Proceedings of Graphics Interface 2007 . New York, NY, USA: ACM, pp. 119–125.
- Wisneski, C., Ishii, H., Dahley, A., Gorbet, M., Brave, S., Ullmer, B., & Yarin, P., 1998. *Ambient Displays: Turning Architectural Space into an Interface between People and Digital Information*. In Proceedings of the First International Workshop on Cooperative Buildings, Integrating Information, Organization, and Architecture (CoBuild '98), Springer-Verlag, London, UK, pp.22-32.
- Xiong, Z., 2012. *Smart city and Data Vitalisation*. The 5th Beihang Centrale Workshop. 7th January 2012.
- Xu, T., David, B., Chalon, R., 2014. *The context-aware Middleware in Ambient Intelligence*, dissertation of Ecole Centrale de Lyon.
- Yuill, N., & Rogers, Y., 2012. *Mechanisms for collaboration: A design and evaluation framework for multi-user interfaces*. ACM Transactions on Computer-Human Interaction, 19(1), pp.1–25.

Zabulis, X., Grammenos, D., Sarmis, T., Tzevanidis, K., and Argyros, A. A., 2010.
*Exploration of Large-Scale Museum Artifacts through Non-Instrumented,
Location-Based, Multi-User Interaction.* In Proc. of VAST, pp.21–24.

ANNEXE

Post-test Questionnaire

Personal Information						
Name		Gender				
Age		Education Level				
Profession						
Are you a frequent flyer			Yes <input type="checkbox"/>	No <input type="checkbox"/>		
Do you have a smartphone			Yes <input type="checkbox"/>	No <input type="checkbox"/>		
Which operation system is your smartphone						
Questions About Test Experience						
No	Questions	Strongly Disagree	Disagree	Neutral	Agree	Strongly Agree
1	It's a bit annoying to find your flight from a normal displaying board					
Comments:						
2	It's easy to forget your boarding gate that your read from the board					
Comments:						
3	It's difficult to learn the interactions with this proxemic screen					
Comments:						
4	It's easy to adapt to the interface changing while you are approaching the					

	screen					
Comments:						
5	The gestures is natural and easy to engage in					
Comments:						
6	It's useful to browse the contents on screen by gestures					
Comments:						
7	I don't want my personal flight to be displayed on a public place					
Comments:						
8	It's easier to find out the correct flight on a proxemic board by a floating window					
Comments:						
9	Movement of the floating window is smooth					
Comments:						
10	I don't want my own flight to be displayed on the public screen					
Comments:						
11	The fine-grained gestures are easy to learn					
Comments:						
12	The fine-grained					

	gestures are easy to engage in					
Comments:						
13	It's easy to learn the mobile application					
Comments:						
14	It's easy to download the information from the screen by this app					
Comments:						
15	You are satisfied with the proxemic displaying board					
Comments:						

Publications

- H. Jin**, B. David, R. Chalon. *Proxemic interaction applied with public screen*. In HCI International 2013, 21 - 26 July 2013, Nevada, USA. pp. 378-387. LNCS 8028. Springer-Verlag Berlin Heidelberg. ISBN 978-3-642-39350-1. 2013.
- H. Jin**, B. David, R. Chalon. *Novel Proxemic Interactive Platform for Sociable Public Zone in Smart City*. In 9th International Conference on Intelligent Environments IE'13 (Sociable Smart City 2013 workshop), Juan A. Bot á, Dimitris Charitos ed. Athens, Greece. pp. 617-628. Ambient Intelligence and Smart Environments 17. IOS Press Amsterdam, The Netherlands. ISBN 978-1-61499-285-1. 2013.
- H. Jin**, T.Xu, B. David, R. Chalon: *Exploring Initiative Interactions on a Proxemic and Ambient Public Screen*. In HCI International 2014, 22-27 June 2014, Heraklion, Greece, pp. 567-577. LNCS 8511. Springer International Publishing. ISBN 978-3-319-07229-6. 2014.
- H. Jin**, T.Xu, B. David, R. Chalon: *Direct Migrator: eliminating borders between Personal Mobile Devices and Pervasive Displays*. In 5th Pervasive Computing and Communications Workshops (PERCOM Workshops), 2014 IEEE International Conference on , vol., no., pp.557-562, 24-28 March 2014
- T. Xu, **H. Jin**, B. David, R. Chalon, Y. Zhou: *A Context-Aware Middleware for Interaction Device Deployment in AmI*. In HCI International 2013, 21 - 26 July 2013, Streitz N., Stephanidis C. ed. Nevada, USA. pp. 183-192. LNCS 8028. Springer-Verlag Berlin Heidelberg. ISBN 978-3-642-39350-1. 2013.
- B. David, T. Xu, **H. Jin**, Y. Zhou, R. Chalon, B. Zhang, C. Yin, C. Wang. *User-oriented System for Smart City approaches*. In 12th IFAC/IFIP/IFORS/IEA Symposium on Analysis, Design, and Evaluation of Human-Machine Systems, August 11-15, 2013, Las Vegas, Nevada, USA. pp. 333-340. IFAC / Elsevier . ISSN 1474-6670. 2013.
- B. David, C. Yin, Y. Zhou, T. Xu, B. Zhang, **H. Jin**, R. Chalon. *SMART-CITY: Problematics, techniques and case studies*. In ICCM'2012, 8th International Conference on Computing Technology and Information Management, Seoul, Korea. pp. 168-174. Computing Technology and Information Management (ICCM) 1. IEEE Conference Publications. ISBN 978-1-4673-0893-9. 2012.

AUTORISATION DE SOUTENANCE

Vu les dispositions de l'arrêté du 7 août 2006,

Vu la demande Des Directeurs de Thèse

Monsieur B. DAVID et Monsieur R. CHALON

et les rapports de

Monsieur C. KOLSKI
Professeur - LAMIH UMR CNRS 8201 - Université de Valenciennes Hairaut Cambrésis - Le Mont Houy -
BP 311 - 59313 Valenciennes cedex 9

Et de

Monsieur P. GIRARD
Professeur - LIAS / ISAE-ENSMA - Université de Poitiers - Téléport 2 - 1 rue Clément Ader - BP 40109 -
86961 Chasseneuil Futuroscope cedex

Monsieur JIN Huiliang

est autorisé à soutenir une thèse pour l'obtention du grade de **DOCTEUR**

Ecole doctorale INFOMATHS

Fait à Ecully, le 6 octobre 2014

P/Le directeur de l'E.C.L.
La directrice des Etudes



Abstract

Ubiquitous computing is gradually coming into reality, people use various digital devices (personal computer, laptop, tablet and smartphone) in order to study, work, entertain and communicate with each other. A city is actually a ubiquitous society, citizens get practical information from digital public displays that are installed everywhere in a city: bus station, railway station, airport or commercial center, etc. It seems that we are closing to the vision of ubiquitous computing, however, it's still far from the vision what Mark Weiser described: *the most profound technologies are those that disappear, they weave themselves into the fabric of everyday life until they are indistinguishable from it*. That means in nowadays the widespread digital devices are still not intelligent enough and not well integrated, this issue is especially serious under a context of city than for personal usage condition.

Smart city is a modern concept of city that seeks to improve the efficiency and quality of life by the information and communication technologies (ICTs), it as well emphasizes the importance of citizens' knowledge for the wise management of city. The ICTs of a smart city constructs a large scale ubiquitous system, including traffic control systems, public transportation system, energy control systems, etc. In all the systems, digital public displays are one of the most important viewports that connect citizens with city. However, the public display today is only used as a screen to display information, it's blind to the presence of users and ambient devices, these result in low efficiency of interactions, and make a city unable to take use of citizen knowledge.

In this dissertation, we build an intelligent public display by the theory of proxemic interaction. Proxemic interaction is spatial related interaction patterns inspired by the psychological term: Proxemics, it studies the spatial-related interaction human to device and device to device. A proxemic interactive public display means that it is aware of user's presence, position, movement, identity and other user related attributes, and takes these attributes as implicit inputs for interactions. Besides, it can sense ambient mobile devices and act as a hub for local devices information flows. Compared with traditional public display, proxemic interactive display can provide specific users with more personal related and instant-need information rather than provide general information to all users. That means to make displays sense users instead of making users explore displays exhaustively. These advantages make a proxemic display more adapt to the prospect of smart city.

Our object is to study how to address the challenges of public display in a smart city by proxemic interaction. Towards this object, we study the dimensions of proxemic interaction, and build a prototype of proxemic interactive projected display with Kinect, Leap motion and web camera. This prototype supports implicit and explicit interaction of users to provide more personalized contents to users, as well as natural interactions. Furthermore, we developed a toolkit for data migration between public display and personal mobile devices, so that public display becomes aware of ambient users' devices, users can download resources from public displays freely, while public displays can be as a terminal to collect knowledge of citizens for smart city.

We discuss the potential applications of this prototype under smart city, and build an experimental application of proxemic airport flight information board. Based on this experimental application, we organized a systematic laboratory user study to validate whether proxemic interaction can really improve the performance of public displays.

Key words: public display, proxemic interaction, smart city, inter-device communication

Résumé

L'informatique ubiquitaire est graduellement devenue une réalité, nous utilisons divers dispositifs pour travailler et s'amuser (l'ordinateur, le portable, le smartphone). Au-delà des dispositifs personnels, les citoyens obtiennent des informations par les écrans publics qui sont présents partout dans les villes: l'abribus, l'aéroport, le centre commercial, etc. Il semble que la vision de l'informatique ubiquitaire est plus proche, cependant, l'avenir décrit par Mark Weiser est encore loin: *«des technologies les plus profondes sont celles qui disparaissent»*. Actuellement les appareils électroniques ne sont pas assez intelligents et bien intégrés dans le contexte d'une ville. La ville intelligente (smart city) est un concept émergent pour construire une ville utilisant les technologies de l'information et de la communication (TIC). Ce concept propose d'améliorer la qualité de la vie et d'augmenter l'efficacité des activités dans une ville par les TIC. Il aussi met l'accent sur les savoir-faire des citoyens pour la construction des villes. La ville intelligente est en effet un système ubiquitaire large qui comprend différents systèmes (le système de gestion trafic, le système de transport public, le système de distribution de l'énergie, etc.). Les écrans publics construisent l'une des plus importants systèmes dans une ville. Cependant, ils ne sont utilisés que pour afficher de l'information, ils sont aveugles aux utilisateurs ainsi qu'à leurs dispositifs personnels.

Dans cette thèse, nous proposons de construire des écrans publics intelligents basés sur l'interaction proxémique. L'interaction proxémique est inspirée par le terme venant de la psychologie «Proxémique». La Proxémique désigne les espaces virtuels autour des êtres humains pendant la communication. Les espaces sont différents selon la culture, les lieux où l'interaction se déroule. La Proxémique a été introduite à l'interaction homme machine par S. Greenberg en 2011 et il a créé le terme d'interaction proxémique. L'interaction proxémique étudie l'interaction en fonction de la relation spatiale entre les objets. Un écran proxémique peut connaître la distance, la position, l'identité et le mouvement de l'utilisateur. Ces dimensions proxémiques sont mesurées par l'écran comme les signaux de l'interaction implicite. Par ailleurs, il peut détecter les dispositifs mobiles des utilisateurs: il peut distribuer et échanger de l'information avec les dispositifs de l'environnement. Par rapport à un écran traditionnel, un écran proxémique offre des contenus plus personnalisés et ainsi répond aux besoins immédiats des utilisateurs. Ces avantages permettent à un écran public de bien s'adapter aux exigences de la ville intelligente.

Notre objectif est d'étudier la façon de relever les défis d'un écran public dans une ville intelligente par l'interaction proxémique. Pour atteindre cet objectif, nous étudions les dimensions de l'interaction proxémique, et puis nous concevons un prototype d'écran proxémique grâce à différents capteurs: Kinect, Leapmotion et Webcam. Ce prototype supporte l'interaction implicite et explicite des utilisateurs pour fournir un contenu plus personnalisé aux utilisateurs, ainsi que des interactions naturelles. En outre, nous avons développé une boîte à outils pour la migration des données entre l'écran public et les appareils mobiles personnels. Avec cet outil, l'utilisateur peut télécharger des ressources à partir de l'écran, et l'écran deviendra un terminal pour recueillir les connaissances des citoyens pour la ville intelligente. Nous discutons les applications potentielles de ce prototype dans la ville intelligente, et nous proposons une application expérimentale qui est un panneau d'affichage proxémique des vols dans un aéroport. Basé sur cette application, nous avons réalisé des études utilisateurs systématiques dans notre laboratoire pour vérifier si l'interaction proxémique peut vraiment améliorer les performances d'un écran public.

Mots clés: L'écran public, interaction proxémique, ville intelligente, communication inter-dispositif