



HAL
open science

Contribution to the control of nonlinear systems under aperiodic sampling

Hassan Omran

► **To cite this version:**

Hassan Omran. Contribution to the control of nonlinear systems under aperiodic sampling. Signal and Image processing. Ecole Centrale de Lille, 2014. English. NNT : 2014ECLI0005 . tel-01127625

HAL Id: tel-01127625

<https://theses.hal.science/tel-01127625>

Submitted on 7 Mar 2015

HAL is a multi-disciplinary open access archive for the deposit and dissemination of scientific research documents, whether they are published or not. The documents may come from teaching and research institutions in France or abroad, or from public or private research centers.

L'archive ouverte pluridisciplinaire **HAL**, est destinée au dépôt et à la diffusion de documents scientifiques de niveau recherche, publiés ou non, émanant des établissements d'enseignement et de recherche français ou étrangers, des laboratoires publics ou privés.

ÉCOLE CENTRALE DE LILLE

THESE

Soumise pour le grade de

DOCTEUR

Spécialité : Automatique, Génie Informatique, Traitement du Signal et Image

Par

Hassan Omran

Doctorat délivré par L'École Centrale de Lille

Titre de la thèse :

Contribution à la commande de systèmes non linéaires sous échantillonnage apériodique

Soutenue le 24 Mars 2014 devant le jury composé de :

Président :	M. J. Daafouz	Professeur à l'Université de Lorraine
Rapporteur :	M. F. Mazenc	Chargé de Recherche INRIA à l'INRIA Saclay
Rapporteur :	M. L. Zaccarian	Directeur de Recherche CNRS au LAAS
Membre :	M. W. Michiels	Professeur à la KU Leuven
Directeur de thèse :	M. J.-P. Richard	Professeur à l'École Centrale de Lille
Co-directeur de thèse :	Mme. F. Lamnabhi-Lagarrigue	Directeur de Recherche CNRS au L2S-Supélec
Co-encadrant de thèse :	M. L. Hetel	Chargé de Recherche CNRS au LAGIS

Thèse préparée au
Laboratoire d'Automatique, Génie Informatique et Signal
L.A.G.I.S.- École Centrale de Lille
Ecole Doctorale SPI 072 (Lille I, Lille II, Artois, ULCO, UVHC, EC Lille)
PRES Université Lille Nord de France

ÉCOLE CENTRALE DE LILLE

THESIS

Submitted for the degree of

DOCTOR

Specialty : Automatic Control, Computer Science, Signal Processing and Image

By

Hassan Omran

Phd awarded by ÉCOLE CENTRALE DE LILLE

Title of the thesis :

Contribution to the control of nonlinear systems under aperiodic sampling

Defended on 24 March 2014 in presence of the committee :

Chairman :	M. J. Daafouz	Professor at University of Lorraine
Reviewer :	M. F. Mazenc	INRIA Research Associate at INRIA Saclay
Reviewer :	M. L. Zaccarian	CNRS Research Director at LAAS
Examiner :	M. W. Michiels	Professor at KU Leuven
Thesis supervisor :	M. J.-P Richard	Professor at École Centrale de Lille
Thesis co-supervisor :	Mme. F. Lamnabhi-Lagarrigue	CNRS Research Director at L2S-Supélec
Thesis co-supervisor :	M. L. Hetel	CNRS Research Associate at LAGIS

Thesis prepared at

Laboratoire d'Automatique, Génie Informatique et Signal

L.A.G.I.S.- École Centrale de Lille

Ecole Doctorale SPI 072 (Lille I, Lille II, Artois, ULCO, UVHC, EC Lille)

PRES Université Lille Nord de France

Acknowledgements

It is with great emotion that I would like to thank all those who, directly or indirectly, have contributed to this work. The work of this PhD thesis has been carried on at *Laboratoire d'Automatique, Génie Informatique et Signal (LAGIS)* at *École Centrale de Lille*, from Mars 2011 to Mars 2014. It was supported by *Highly-complex and networked control systems (HYCON) 2*, which is a four-year European project coordinated by CNRS Research Director Françoise Lamnabhi-Lagarrigue.

First and foremost, I would like to express my deepest and sincere gratitude to my advisors: CNRS Research Associate Laurentiu Hetel, Professor Jean-Pierre Richard, CNRS Research Director Françoise Lamnabhi-Lagarrigue. I would like to thank you for supporting and orienting me with such patience, care and disponibility. Your knowledge, wisdom and passion for research will always be an ideal for me. Finally, I would like to thank you for your friendship, sympathy, nobleness, and human values, which are as inspiring as your scientific excellence.

Furthermore, I would like to warmly thank all the members of the PhD committee, for having accepted to examine my work, and also for the insightful comments and discussions. Namely, INRIA Research Associate Frédéric Mazenc from the *INRIA Saclay*, CNRS Research Director Luca Zaccarian from the *Laboratoire d'Analyse et d'Architecture des Systèmes (LAAS)*, Professor Jamal Daafouz from the *University of Lorraine*, Professor Wim Michiels from the *University of Leuven (KU Leuven)*.

Those three years would have never been so overwhelming without the amazing company of all the members of the team *Systèmes Non Linéaires et à Retards (SyNeR)* and other teams of LAGIS, and the team *Non-Asymptotic estimation for online systems (Non-A)* of INRIA. I would like to specify my office friends: Christophe the best 3pt basketball shooter, Manu, Romain, Bo, Qi. Also the Associate professor Alexandre Kruszewski. Thank you all for the friendly atmosphere, the interesting scientific and diverse discussions, nice activities and all the fun. During these years, I had also the amazing chance to meet my friend and guitar star Diego, Safa, Antonio, Matteo, Rosane, Jorge, Srinath, Xin, Nouha, Andrey, Sonia, Ayoub, Ma, Vincent, Karama, Ayda, and many others. And finally I would like not to forget Blaireau especially for his company during conferences, and the nice photos he brings us from all over the world.

I would like to thank all the personnel of LAGIS for their help, as well as their lovely humor and the nice atmosphere of the laboratory. I would like to mention Professor Philippe Vanheeghe, director of LAGIS, our big brother Bernard, Christine, Patrick, Gilles, Jacques, Hilaire, Brigitte, Régine.

I am also indebted to all the professors who have taught me in all the previous levels. I would like to specify the professors and colleagues in the *Higher Institute for Applied Science and Technology (HIAST)* in Damascus, where I did my engineering studies, and the professors in the *École Centrale de Nantes* where I did my Master studies.

During these years I met my sweet Widad, whom I thank for her presence, help and of course her wonderful smile. Finally, I would like to thank my family from all of my heart. My gratitude for your endless love and support is by no means measurable by any words. I would love to dedicate this work to my wonderful brother, loving parents and caring grandparents and uncles.

Hassan Omran.

Contents

Acknowledgements	i
List of Figures	vii
Abbreviations	ix
Notations	xi
Introduction	xiii
1 Sampled-data control systems	1
1.1 Introduction	1
1.2 Evolution of sampled-data control	1
1.3 Sampled-data systems with aperiodic sampling	2
1.4 Analysis and controller design approaches for sampled-data systems	5
1.5 Stability analysis of LTI sampled-data systems	6
1.5.1 Input-delay approach	9
1.5.2 Impulsive modeling approach	11
1.5.3 Robust control theory approach	13
1.5.4 Convex-embedding approach	16
1.6 Stability analysis of nonlinear sampled-data systems	18
1.6.1 Emulation approach for nonlinear systems	18
1.6.1.1 Qualitative properties of sampled-data systems under emulation	19
1.6.1.2 Stability analysis based on linearization	20
1.6.1.3 Dissipation preservation under emulation	21
1.6.1.4 Quantitative estimation of the MASP	23
1.6.1.5 Further notes and references on emulation approach	26
1.6.2 Discrete-time approach for nonlinear systems	27
1.6.2.1 Discrete-time modeling	27
1.6.2.2 Discrete-time controller design	29
1.6.2.3 Further notes on discrete-time approach	31
1.7 Conclusion	32
2 Stability of bilinear sampled-data systems - hybrid systems approach	33
2.1 Introduction	33

2.2	Bilinear systems	34
2.3	Stabilization of bilinear systems	34
2.3.1	Linear state-feedback control	35
2.4	Problem formulation	37
2.5	Hybrid system framework	38
2.6	Local stability and MASP estimation	39
2.6.1	Method 1: adaptation of a result on general nonlinear sampled- data systems	40
2.6.2	Method 2: direct Lyapunov function approach	44
2.7	Numerical example	47
2.8	Conclusion	49
3	Stability of bilinear sampled-data systems - dissipativity approach	51
3.1	Introduction	51
3.2	Technical preliminaries	52
3.2.1	The properties of the operator Δ_{sh}	52
3.2.2	Two technical lemmas	53
3.3	Stability results	54
3.3.1	Invariance property	54
3.3.2	LMI stability conditions for bilinear sampled-data systems	56
3.4	Numerical Examples	60
3.4.1	Example 1	60
3.4.2	Example 2: DC-DC Power Converter	62
3.5	Conclusion	65
4	Stability of input-affine nonlinear systems with sampled-data control	67
4.1	Introduction	67
4.2	Problem formulation	68
4.3	Robustness analysis representation	70
4.4	Main results	70
4.4.1	Stability analysis	70
4.4.2	Sum of squares stability conditions for the class of polynomial systems	73
4.5	Illustrative Examples	76
4.5.1	Example 1	76
4.5.2	Example 2	77
4.6	Conclusion	79
	General conclusion	81
	Résumé étendu en français	85
A	Dissipative dynamical systems	97
A.1	Introduction	97
A.2	Dynamical control properties via dissipativity	98
A.3	Kalman-Yakubovich-Popov Lemma	100
A.4	Exponential dissipativity	102

Bibliography

103

List of Figures

1	Sampled-data control system.	xiii
1.1	Diagram of a sampled-data control system.	3
1.2	Aperiodic sampling as a result of packet dropouts.	4
1.3	Stability of the sampled-data system in Example 1.1 with periodic sampling intervals.	8
1.4	Instability of the sampled-data system in Example 1.1 with alternating sampling intervals $T_1 \rightarrow T_2 \rightarrow T_1 \dots$	9
1.5	The piecewise-linear delay induced by sampling.	10
1.6	Equivalent representation of the sampled-data system, from a robust control theory point of view.	14
1.7	Embedding of the uncertainty set \mathcal{W} in $\bar{\mathcal{W}}$	17
2.1	Bilinear system state diagram.	35
3.1	The polytope (blue boxes) and the corresponding region of stability $\mathcal{E}_{c^*}(P)$	60
3.2	State evolution for the bilinear sampled-data system in Example 1, with a variable sampling which is bounded by $\bar{h} = 0.051$	61
3.3	State evolution for the bilinear sampled-data system in Example 1, with a constant sampling intervals $t_{k+1} - t_k = 0.09$	62
3.4	Buck-boost converter.	63
3.5	The domain of attraction $\mathcal{E}_{c^*}(P)$ for the system (3.29) when controlled with the static feedback controller, in the aperiodically sampled-data case with $h_{max} = 1.5$ ms. The curves in black are simulations of the sampled-data system, for different initial states.	64
4.1	The sampled-data feedback control of an affine nonlinear system.	68
4.2	The equivalent representation of the sampled-data system (4.3).	69
4.3	Tradeoff between α (the exponential decay rate of the storage function), and the estimation of the MASP \bar{h}	77
4.4	State trajectory evolution for two sequences of sampling intervals.	78
5	Commande du système avec retour d'état échantillonné.	85

Abbreviations

A/D	A nalog to D igital
D/A	D igital to A nalog
ZOH	Z ero- O rders H old
LTI	L inear T ime- I nvariant
LPV	L inear P arameter- V arying
BLS	B i L inear S ystems
NCS	N etworked C ontrol S ystem
LKF	L yapunov- K rasovskii F unctional
LMI	L inear M atrix I equality
IQC	I ntegral Q uadratic C onstraint
SOS	S um O f S quares
MASP	M aximum A llowable S ampling P eriod/interval
UAS	U niformly A symptotically S table
GUAS	G lobally U niformly A symptotically S table
GUES	G lobally U niformly E xponentially S table
ISS	I ntermediate- S tate S tability

Notations

\mathbb{N}	The set of natural numbers.
\mathbb{R}	The set of real numbers.
\mathbb{R}_+	The set of positive real numbers.
\mathbb{R}^n	The n -dimensional Euclidean space.
$\mathbb{R}^{n \times m}$	The matrix algebra with the coefficients in \mathbb{R} .
$\mathbb{R}[x]$	The notation $p(x) \in \mathbb{R}[x]$ with $x \in \mathbb{R}^n$, means that $p(x)$ belongs to the set of polynomials in the variables $\{x_i\}_{i=1, \dots, n}$ with coefficients in \mathbb{R} .
$\mathcal{C}([a, b], \mathbb{R}^n)$	The set of continuous functions mapping the interval $[a, b]$ to \mathbb{R}^n .
$ x $	Denotes the Euclidean norm of the vector $x \in \mathbb{R}^n$.
$[x]_i$	Denotes the i^{th} element of the vector $x \in \mathbb{R}^n$.
\dot{x}	Denotes the derivative of $x(\cdot)$ with respect to time t , i.e. $\frac{dx}{dt}$.
$x(t^-)$	The limit from below of a signal $x(t)$, i.e. $\lim_{\theta \uparrow t} x(\theta)$.
$x(t^+)$	The limit from above of a signal $x(t)$, i.e. $\lim_{\theta \downarrow t} x(\theta)$.
$\ z\ _{L_2}$	The L_2 -norm of $z \in L_2$, i.e. $\ z\ _{L_2} = \sqrt{\langle z, z \rangle}$.
$\ \Delta\ $	The L_2 -induced gain of the operator Δ .
M^T	The transpose of the matrix M .
$M > 0$	Means that the matrix M is positive definite.
$M \geq 0$	Means that the matrix M is positive semi-definite.
*	The symmetric part of a symmetric matrix.
(x_1, x_2)	Denotes $[x_1^T, x_2^T]^T$.
$\lambda_i(M)$	The i^{th} eigenvalue of the matrix M .
$\lambda_{\min}(M)$	The minimum eigenvalue of the matrix M .
$\lambda_{\max}(M)$	The maximum eigenvalue of the matrix M .

0	The zero matrix in appropriate dimensions.
I	The identity matrix in appropriate dimensions.
$\langle v, z \rangle$	The inner product. For $v, z \in \mathbb{R}^n$, $\langle v, z \rangle = z^T v$, and for $v, z \in L_2$, $\langle v, z \rangle = \int_0^\infty z^T(s)v(s)ds$.
$\nabla V(x)$	The gradient of the function $V(x)$.
\mathcal{K}	A function $\alpha : [0, a) \rightarrow [0, \infty)$ is said to belong to class \mathcal{K} if it is continuous, strictly increasing and $\alpha(0) = 0$.
\mathcal{K}_∞	A function $\alpha : [0, a) \rightarrow [0, \infty)$ is said to belong to class \mathcal{K}_∞ if it is of class \mathcal{K} , $a = \infty$, and $\alpha(r) \rightarrow \infty$ as $r \rightarrow \infty$.
\mathcal{KL}	A function $\beta : [0, a) \times [0, \infty) \rightarrow [0, \infty)$ is said to belong to class \mathcal{KL} if it is continuous and satisfies: 1) for each fixed s the mapping $\beta(r, s)$ belongs to class \mathcal{K} with respect to r , and 2) for each fixed r the mapping $\beta(r, s)$ is decreasing with respect to s , and $\beta(r, s) \rightarrow 0$ as $s \rightarrow \infty$.
<i>conv</i>	The convex hull of a set.

Introduction

The use of digital technologies has been contributing significantly to the applicability of automatic control methods. Today, a digital computer is an essential part of almost any control loop. A classical sampled-data control system is shown in Fig. 1. It is constituted of a continuous-time plant (based on power exchanges and energy transformation), interacting in a feedback loop with a digital controller (based on a discrete-time control algorithm). The continuous-time signal corresponding to the output of the system is measured at sampling instants. The controller uses the sampled-data signal to calculate a corresponding control action. The interface between the continuous-time signals and the discrete-time signals is done by means of *sample-and-hold* devices.

In many present applications (such as cars, aircrafts, robots...) all these components are embedded and the control parts are deployed on several microcontrollers, which have to schedule their various tasks (measure, actuate, compute, communicate...) regarding to real-time specifications and expected performances. The complexity in the design of control algorithms is linked to the kind of modeling hypotheses one can accept as “sufficiently realistic”. Among these, linearity of the process model and periodicity of the sampling have been supposed for a long time, mainly because sampled-data control

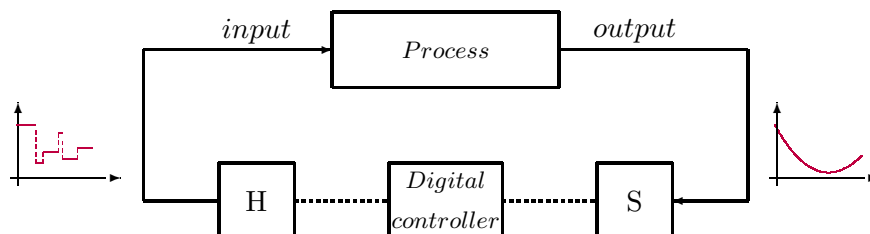

FIGURE 1: Sampled-data control system.

theory was well developed for the case of Linear-Time Invariant (LTI) systems with constant sampling intervals.

However, these hypotheses are probably more related to the kind of control one can compute under theoretical guarantees, than to the physics of the processes or the nature of the controllers. When the interval between two successive sampling instances is time-varying, sampled-data systems become much more complex: basically, even guaranteeing stability in this case is not straightforward. It is also well recognized that, despite a rich and dense effort, nonlinear systems remain complex by nature and still constitute a research topic.

Nevertheless, from the engineer's point of view, the situation of a nonlinear process with an aperiodic controller has become the standard rather than the exception. Processes are expected to reach their maximum performance of speed, low power consumption, etc., and this makes non negligible nonlinear phenomena appear. In the same time, microprocessors have to schedule more tasks, including communication with each others. This increases their practical timing constraints and unavoidably generates imperfections on the sampling rates.

Thus, already for linear systems and even more for nonlinear ones, it is of great interest to be able to determine an upper bound on the sampling intervals which guarantees the stability of a sampled-data controlled system. In the literature, this bound is referred to as the *MASP*, which acronym comes from *Maximum Allowable Sampling Period*. However, note that in the case of aperiodic sampling, the *period* does not exist anymore. Along this manuscript, we will keep this acronym but it will rather refer to a *Maximum Allowable Sampling interval*.

For the case of linear systems, several pioneering approaches exist for analyzing stability under aperiodic sampling. These approaches share the advantage of being constructive, thus quantitative estimations of the MASP may be provided. For the case of nonlinear systems, several generic methods exist. However, in practice it is not always clear how to apply them, and only few works provide a constructive tool for estimating the MASP. Providing efficient methodology for computing the MASP in the nonlinear case is a challenging, open problem.

Objectives

The work in this thesis is dedicated to the following problem:

Find stability criteria for nonlinear sampled-data control systems, which provide a computable estimate of the MASP.

A particular attention will be first given to the case of bilinear system. These systems represent an intermediate between linear and nonlinear models. Their study is relevant in theory, since they may approximate various nonlinear systems. It is also relevant in practice, since they appear naturally in several application domains. We intend to study the stability of bilinear systems with aperiodic sampled-data control. This will allow for tackling the difficulties of nonlinear systems, while using the quasi-linear structure of the considered class of systems. Our goal is to provide constructive methods for this case.

Furthermore, we will show how the methodology can be extended for the much more general case of nonlinear systems affine in the control.

Structure of the thesis

The thesis is organized as follows.

Chapter 1

In the first chapter we intend to present an overview of sampled-data control techniques. We introduce general sampled-data systems, and a very short history of using digital technology in control engineering. Then, we focus on the stability of sampled-data control systems with aperiodic sampling. Without being exhaustive, we present what we think to be the main methodologies for stability analysis in both the LTI and the nonlinear cases.

Chapter 2

The second chapter is dedicated to the local stability analysis of bilinear sampled-data systems, controlled via a linear state-feedback static controller, using a hybrid system methodology.

The proposed stability conditions are formulated as Linear Matrix Inequalities (LMIs). Two constructive methods are considered. They are based on a hybrid system approach, which has been presented in Chapter 1. The first method is a specialization of a generic result used for the nonlinear case. The contribution here is to find a constructive way to apply this generic method for the particular case of bilinear systems. The second method is based on a direct search of a Lyapunov function using LMIs. The novelty here is to avoid some conservative upper bounds on the derivative of a Lyapunov function in the first method. The results of this chapter have been published in [95].

Chapter 3

This chapter re-considers the problem of local stability of bilinear systems with aperiodic sampled-data linear state feedback control using a new approach. The method is based on the analysis of contractive invariant sets, and it is inspired by the dissipativity theory. Local stability is investigated via an invariance property of some ellipsoidal sets. State-space constraints are easily included in the analysis. The region of attraction is estimated by a certain level surface of a quadratic function, which can be interpreted as a discrete-time Lyapunov function. An LMI optimization allows for choosing, among quadratic Lyapunov functions, the one which maximizes the MASP. The results of this chapter have been published in [92, 94].

Chapter 4

This chapter generalizes the results from Chapter 3 to the case of nonlinear sampled-data systems affine in the input. Assuming that a stabilizing continuous-time controller exists and has to be implemented digitally, we intend to provide sufficient asymptotic/exponential stability conditions for the obtained sampled-data system. The main idea of the chapter is to address the stability problem using the concept of exponential dissipativity. Furthermore, the result is particularized for the class of polynomial input-affine sampled-data systems, where stability may be tested numerically using Sum Of Squares (SOS) decomposition and semi-definite programming. The SOS techniques are used to derive storage and supply functions. The results of this chapter have been published in [93, 96, 97].

Personal Publications

Journals

- [94] H. Omran, L. Hetel, J.-P. Richard, and F. Lamnabhi-Lagarrigue. “Stability analysis of bilinear systems under aperiodic sampled-data control”. *Automatica*. Accepted.
- [93] H. Omran, L. Hetel, J. P. Richard, and F. Lamnabhi-Lagarrigue. “Stabilité des systèmes non linéaires sous échantillonnage aperiodique”. *Journal Européen des Systèmes Automatisés*. Accepted.

Conferences

- [92] H. Omran, L. Hetel, and J.-P. Richard. “Local stability of bilinear systems with asynchronous sampling”. In *The 4th IFAC Conference on Analysis and Design of Hybrid Systems (ADHS)*, pages 19-24, Eindhoven, Netherlands, 2012.
- [95] H. Omran, L. Hetel, J.-P. Richard, and F. Lamnabhi-Lagarrigue. “Stability of bilinear sampled-data systems with an emulation of static state feedback”. In *IEEE 51st Annual Conference on Decision and Control (CDC)*, pages 7541-7546, Maui, USA, 2012.
- [96] H. Omran, L. Hetel, J.-P. Richard, and F. Lamnabhi-Lagarrigue. “On the stability of input-affine nonlinear systems with sampled-data control”. In *European Control Conference (ECC)*, Zurich, Switzerland, pages 2585-2590, 2013.
- [97] H. Omran, L. Hetel, J. P. Richard, and F. Lamnabhi-Lagarrigue. “Stabilité des systèmes non linéaires sous échantillonnage aperiodique”. *5èmes Journées Doctorales / Journées Nationales MACS*, Strasbourg, France, 2013.

Chapter 1

Sampled-data control systems

1.1 Introduction

In this chapter we intend to present an overview on sampled-data control. We introduce first general sampled-data systems, and a short history of using digital technology in control engineering. Then, we focus on the stability of sampled-data control systems with aperiodic sampling. We present the main methodologies for stability analysis in both the Linear Time-Invariant (LTI) and the nonlinear cases. Without being exhaustive, which would be neither possible nor useful, we try to give a structural survey of what we think to be the main results and issues in this domain.

1.2 Evolution of sampled-data control

Technological advances offer faster and wider range of innovation, yet exploiting them requires more research and engineering effort: automatic control did not escape it since digital technology appeared. The rapid development and growth of digital technologies have contributed significantly to the development of all engineering domains. Till the 1950's, control engineering was entirely depending on analog components, while today almost all control systems are digitally implemented. Making full use of the potentials of computers and networks in control needed a deep understanding of the emerging research domain. This issue has attracted the attention of researchers since the mid 20th century [56]. In 1960, Rudolph Kalman stated the following [57]:

In no small measure, the great technological progress in automatic control and communication systems during the past two decades has depended

on advances and refinements in the mathematical study of such systems. Conversely, the growth of technology brought forth many new problems (such as those related to using digital computers in control, etc.) to challenge the ingenuity and competence of research workers concerned with theoretical questions.

In the 1950's, computers were used for supervisory tasks, including scheduling, production planning and reporting. Analog control loops were needed anyway as early computers were unreliable, slow and expensive [106]. Then, in the 1960's computers began to take the place of the analog devices in some large industrial systems. The first use of a digital computer for fully direct control of a process was initiated by Imperial Chemical Industries (ICI) who began to work in 1959 with the Ferranti Company on a Direct Digital Control (DDC) scheme for a soda ash plant at Fleetwood, Lancashire [10].

Late in the 1960's and in the 1970's, technological progress made it possible to produce smaller, cheaper and more reliable computers, with enhanced computing power [106]. The development of minicomputers and microcomputers permitted to widen the domain of application of computers in control. It became possible to use them in smaller projects, and the number of computers used in control systems, has been increasing rapidly [7].

Later, innovative efforts led to the crucial use of data networks in control systems. In 1986, Bosch introduced the Control Area Network (CAN) [8], and nowadays several networks (Fieldbus, industrial Ethernet, etc) are used in control applications. The domain of application includes automotive industry, process control, teleoperation and others. The advantages of using data networks in control are numerous: low-cost, avoidance of unnecessary wiring, ease of maintenance, flexibility of adding new modules to the control loop, etc. However, networks impose many imperfections that must be taken into account [8, 107, 129]. This motivated a new domain of academic research called Networked Controlled Systems (NCSs) [47], where sampling belongs to the essential issues.

1.3 Sampled-data systems with aperiodic sampling

Most of the plants in engineering practice are continuous-time “by nature”. Speed and position of a vehicle, temperature and pressure in a chemical process, current of an electrical device are few examples. The class of sampled-data control systems combines features of both continuous-time and discrete-time systems. A sampled-data control system is formed of a continuous-time plant, controlled by a discrete-time algorithm. The mixture of two different types of signals results in a system of a hybrid nature. The

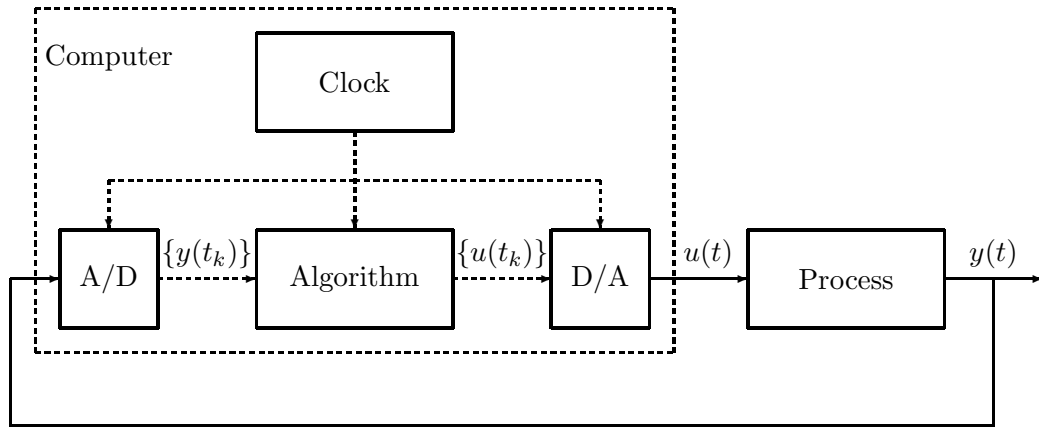

FIGURE 1.1: Diagram of a sampled-data control system.

controller is implemented using a digital computing unit, which can be a computer or a microcontroller, on-board or connected via a data network.

A schematic of a general sampled-data control system is shown in Fig. 1.1. It consists of continuous-time process with input u and output y , interconnected with a digital computing unit. The interface between the continuous-time process and the discrete-time controller is made using analog-to-digital (A/D) and digital-to-analog (D/A) converters. The output $y(t)$ which is a continuous-time signal, is converted to a discrete sequence $\{y(t_k)\}$ using an A/D converter. The computer then generates the control action which is the sequence $\{u(t_k)\}$. This sequence is converted to a continuous-time input $u(t)$ using a D/A converter. One way to do the D/A conversion is to keep the signal constant between two sampling instants, this mechanism is called *zero-order hold* (ZOH).

The digital controller must synchronize the sampling instants, receive the sampled measured value from the A/D converter, calculate the control action and send it to the D/A converter. This is commonly considered to be occurring in a periodic way, with constant sampling intervals. However, the intervals between two successive sampling instants may be varying due to practical constraints. In point-to-point digital control systems, jitter can be caused by clock inaccuracy, imperfect synchronization, computational delays, system architecture characteristics and real-time scheduling [127]. Aperiodic sampling intervals may also be encountered in NCSs, as constraints are induced by the network [107, 129]. For examples, packet dropouts are almost inevitable in NCSs, especially in the case of wireless networks, and they cause variations of the sampling intervals. As a matter of fact, the sampling interval will be a multiple of the nominal one when packets are dropped out, as it can be seen in Fig. 1.2 (here, packets containing the samples 4, 7 and 8 are lost).

Solutions to such a problem can be obtained by means of choosing a hardware with more powerful capabilities. However, these solutions are usually expensive, and they may not

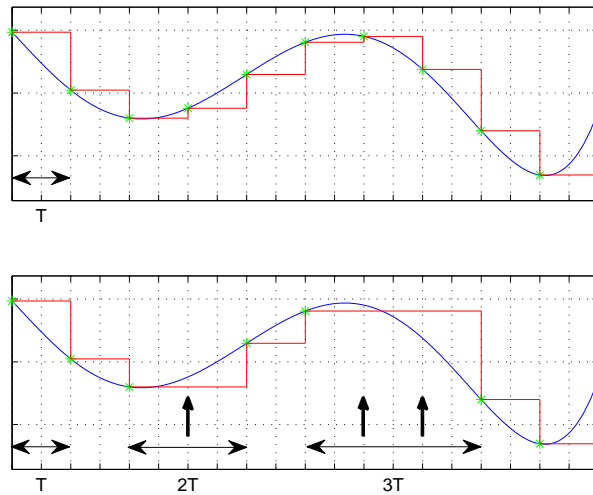

FIGURE 1.2: Aperiodic sampling as a result of packet dropouts.

always be available. One can also think of solutions from the computer science point of view, like improving the efficiency of calculations, optimizing the codes and enhancing the scheduling policies. Again, these solutions may be limited. From control theory point of view, the solution is to take the imperfections into account, and to design controllers that are less sensitive to the variations of the sampling intervals. Nevertheless, this requires studying systems with complex behaviors, and addressing challenging control problems. In fact, variations of the sampling intervals can have a major effect on stability and performance of sampled-data systems.

Besides, it must be mentioned that there exist several approaches that consider changing intentionally the sampling intervals, in order to sample as less as possible [4, 32, 45, 118]. In *event-based control* [118], the sensor measures continuously the output of the system, but it sends the information to the controller only if specific conditions are satisfied. For example, if the difference between the currently measured value and the last transmitted one exceeds some threshold. In *self-triggered control* [4], the next sampling instant is calculated as well as the control action, based on the current sampled value. The methodology in *state-dependent sampling control* [32] is like the one in self-triggered control, the difference is that in the former method the next sampling interval is pre-calculated off-line, while in the latter one the calculations are real-time.

In this thesis we focus on the robustness aspects with respect to time-varying sampling intervals. This problem will be mathematically formalized in the following sections.

1.4 Analysis and controller design approaches for sampled-data systems

Because of the hybrid nature of sampled-data systems, there exist specific methods for controller design. Two approaches have attracted most of the attention in the literature: emulation and discrete-time. These approaches will be discussed later in Section 1.6.1 and Section 1.6.2, but we give here a rough overview of their main lines.

Emulation

The principle of the emulation approach is to design a continuous-time controller using one of the methods from continuous-time control theory. This is done while completely ignoring the sampling. Then, the controller is discretized using methods such as Euler, Runge-Kutta or Tustin. Finally, the discretized control law is implemented digitally using sample-and-hold devices such as ZOH. This is a popular and easily applied approach. However, a fundamental question, which is important from both practical and academic points of view, needs to be addressed: *how to choose the sampling period so that the system with the emulated controller, will have a satisfactory performance?* Intuitively a “fast” sampling is needed, but an exact qualitative answer to this question is a very important issue.

Discrete-time

In this approach, an exact or an approximate discrete-time model of the plant is found first. Then, a discrete-time controller of the discrete-time model is designed and implemented using a ZOH. This method is straightforward for the case of LTI systems with a fixed sampling period, as an exact linear discrete-time model can be found. This case has been studied since the 1950's, leading to a mature *discrete-time control theory* for LTI systems. For other cases, it is usually harder to use this approach. For example, an exact discrete-time model of a nonlinear continuous-time plant is usually unavailable, and an approximation is often used in order to design the controller. However, in this case it is not guaranteed that the discrete-time controller, which is designed to stabilize the approximate discrete-time model of the plant, will also stabilize the sampled-data system.

Sampled-data approach

This approach is related to the emulation one. The main difference is the use of a discrete-time model of the plant. The approach takes into account the inter-sample behavior of the system, like in [25] where lifting technique is used to study linear sampled-data systems. For more information about this approach see [25, 49, 80, 128] and the references therein.

1.5 Stability analysis of LTI sampled-data systems

Consider the following LTI continuous-time plant:

$$\dot{x}(t) = A_0x(t) + B_0u(t), \quad (1.1)$$

where $x \in \mathbb{R}^n$ is the state vector, and $u \in \mathbb{R}^m$ is the input vector. Assume that the following assumptions hold:

- The state vector x is available only on a set of sampling instants $\{t_k\}_{k \in \mathbb{N}}$:

$$0 = t_0 < t_1 < \dots < t_k < \dots; \quad t_k \in \mathbb{R}_+, \forall k \in \mathbb{N}; \quad \lim_{k \rightarrow \infty} t_k = \infty. \quad (1.2)$$

- The sampling intervals are time-varying, and they are bounded in the interval $[\underline{h}, \bar{h}]$:

$$0 < \underline{h} \leq t_{k+1} - t_k \leq \bar{h}, \quad \forall k \in \mathbb{N}. \quad (1.3)$$

- The control is a piecewise-constant:

$$u(t) = Kx(t_k), \quad \forall t \in [t_k, t_{k+1}), \quad (1.4)$$

for a matrix K with appropriate dimensions.

In the literature, the value \bar{h} is often referred to as *Maximum Allowable Sampling Period (MASP)*. Note that we are supposing that there is no transmission delays and no data-processing time. Under these assumptions, we obtain the closed-loop sampled-data system:

$$\dot{x}(t) = A_0x(t) + B_0Kx(t_k), \quad \forall t \in [t_k, t_{k+1}), \quad \forall k \in \mathbb{N}. \quad (1.5)$$

The solution $x(\cdot)$ of (1.5) at any instant $t \in [t_k, t_{k+1})$ is

$$\begin{aligned} x(t) &= \Phi(t - t_k)x(t_k) + \Gamma(t - t_k)u(t_k) \\ &= (\Phi(t - t_k) + \Gamma(t - t_k)K)x(t_k), \end{aligned}$$

where

$$\begin{cases} \Phi(t - t_k) := e^{A_0(t-t_k)}, \\ \Gamma(t - t_k) := \int_0^{t-t_k} e^{A_0 s} B_0 ds. \end{cases} \quad (1.6)$$

Then,

$$x(t) = \Lambda(t - t_k)x(t_k), \quad (1.7)$$

with $\Lambda(s) = \Phi(s) + \Gamma(s)K$. Denoting $\theta_k := t_{k+1} - t_k$, $x(k) := x(t_k)$ and $u(k) := u(t_k) = Kx(k)$, we get the discrete-time model

$$x(k+1) = \Phi(\theta_k)x(k) + \Gamma(\theta_k)u(k), \quad (1.8)$$

which in closed-loop becomes

$$x(k+1) = \Lambda(\theta_k)x(k). \quad (1.9)$$

The controller is found via the emulation approach. First, the gain K is determined by classical continuous-time methods for the system (1.1). Then, it is discretized using a ZOH (1.4). Alternatively, this gain can be obtained by discrete-time methods for the model (1.8). This is called discrete-time approach.

Periodic sampling

Consider the sampled-data system (1.5) with periodic sampling, i.e. where the sampling instants satisfy

$$t_{k+1} - t_k = T, \quad \forall k \in \mathbb{N}. \quad (1.10)$$

In this case, an exact discrete-time model can be obtained from (1.9):

$$x(k+1) = \Lambda(T)x(k). \quad (1.11)$$

The system (1.11) is a *LTI discrete-time system*. Well known necessary and sufficient conditions for its asymptotic stability are called in the following theorem.

Theorem 1.1. *The discrete-time LTI system (1.11) is asymptotically stable if and only if the matrix $\Lambda(T)$ is Schur, i.e. all its eigenvalues are strictly within the unit circle.*

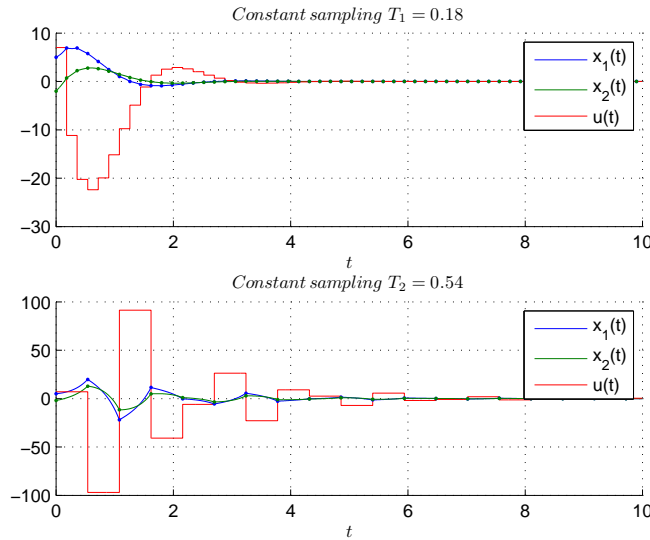

FIGURE 1.3: Stability of the sampled-data system in Example 1.1 with periodic sampling intervals.

The case of periodic sampling is well understood, since control theory is well developed for discrete-time LTI systems. See also [25, 34, 35, 106] where other advanced topics can be found, such as: optimal control, robust controller design, identification, etc.

Aperiodic sampling

Consider the sampled-data system (1.5) with aperiodic sampling, i.e. where the sampling instants satisfy (1.3). Since 1989, much attention has been given to the stability analysis of such systems [108, 123, 127]. Control systems with aperiodic sampling are more complicated to study than the periodic case, as the variations of the sampling intervals can degrade the stability and the performance of sampled-data control systems. The following motivating example from [130] shows how variations of the sampling intervals can cause instability.

Example 1.1. Consider the LTI sampled-data system (1.5), where

$$A_0 = \begin{bmatrix} 1 & 3 \\ 2 & 1 \end{bmatrix}, \quad B_0 = \begin{bmatrix} 1 \\ 0.6 \end{bmatrix}, \quad K = \begin{bmatrix} -1 & -6 \end{bmatrix}. \quad (1.12)$$

In the case of constant sampling intervals, the sampled-data system is stable for both sampling intervals $T_1 = 0.18$ and $T_2 = 0.54$. This can be seen from Theorem 1.1, as the eigenvalues of the matrices $\Lambda(T_1)$ and $\Lambda(T_2)$ defined in (1.11) satisfy

$$\begin{aligned} |\lambda_i(\Lambda(T_1))| &= 0.7761, & i = 1, 2; \\ |\lambda_i(\Lambda(T_2))| &= 0.7083, & i = 1, 2. \end{aligned}$$

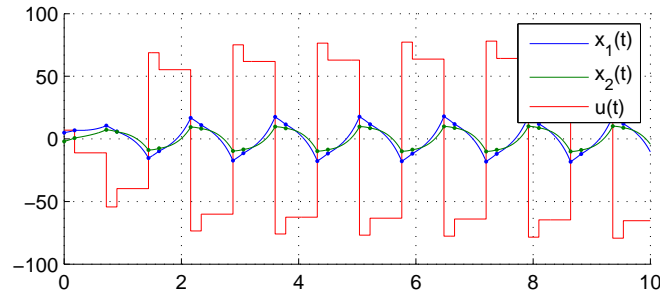

FIGURE 1.4: Instability of the sampled-data system in Example 1.1 with alternating sampling intervals $T_1 \rightarrow T_2 \rightarrow T_1 \dots$.

An illustration of the systems evolution, for both of these constant sampling intervals, is given in Fig 1.3. One may think that alternating the sampling interval between T_1 and T_2 will not affect the stability. However, the sampled-data system with periodically time-varying sampling intervals $T_1 \rightarrow T_2 \rightarrow T_1 \dots$ is unstable, as it can be seen in Fig 1.4. This example shows the importance of taking into consideration the variations of the sampling intervals, when analyzing the stability of sampled-data systems.

In what follows, we present different approaches in the literature which provide sufficient conditions for the stability of LTI sampled-data systems under aperiodic sampling.

1.5.1 Input-delay approach

This approach was first introduced in [73] and further developed in [37], and then in several other works like [36, 113, 114]. In this approach, the sampled-data system is modeled as a continuous-time system, with delayed control input. The basic idea in this approach is to write the sampled-data control (1.4) as a delayed control

$$\begin{aligned} u(t) &= Kx(t_k) = Kx(t - \tau(t)), \\ \tau(t) &= t - t_k, \quad \forall t \in [t_k, t_{k+1}), \end{aligned} \quad (1.13)$$

where the delay is piecewise-linear, and satisfies $\dot{\tau}(t) = 1$ for $t \neq t_k$, and $\tau(t_k) = 0$. This delay indicates time that has passed since the last sampling instant, see Fig. 1.5. This permits to use tools for stability of systems with time-varying delays. Time-delay are described by means of *functional differential equations*.

Definition 1.2 (Retarded Functional Differential Equations). The general form of a *retarded functional differential equation* for a maximum delay $\bar{h} > 0$ is

$$\begin{aligned} \dot{x} &= f(t, x_t), \\ x_{t_0} &= \phi(t_0 + \theta), \quad \forall \theta \in [-\bar{h}, 0], \end{aligned} \quad (1.14)$$

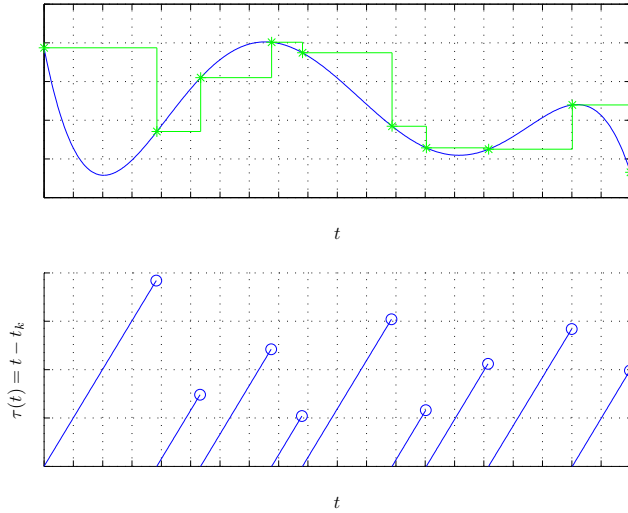

FIGURE 1.5: The piecewise-linear delay induced by sampling.

where $x(t) \in \mathbb{R}^n$ and $f : \mathbb{R} \times \mathcal{C}([-h, 0], \mathbb{R}^n) \rightarrow \mathbb{R}^n$. The notation $\mathcal{C}([a, b], \mathbb{R}^n)$ denotes the set of continuous functions mapping the interval $[a, b]$ into \mathbb{R}^n , and $x_t(\theta) = x(t + \theta)$, $\forall \theta \in [-\bar{h}, 0]$.

Lyapunov methods are an efficient tool for stability analysis. In the case of delay-free systems, stability is guaranteed via the construction of a classical Lyapunov function, which is a positive definite function $V(t, x(t))$, whose time derivative is negative definite along the system trajectories. For a time-delay system, the evolution of the state at instant t is determined by x_t , instead of $x(t)$. Thus, it is natural to study the stability using a *Lyapunov functional* $V(t, x_t)$.

Theorem 1.3 (Lyapunov-Krasovskii Stability Theorem [42]). *Consider the continuous, non-decreasing functions $\alpha, \beta, \gamma : \mathbb{R}_+ \rightarrow \mathbb{R}_+$, where $\alpha(s), \beta(s)$ are strictly positive and satisfy $\alpha(0) = \beta(0) = 0$. Suppose that the function f in (1.14) maps $\mathbb{R} \times$ bounded set in \mathcal{C} into a bounded set in \mathbb{R}^n . If there exists a differentiable functional $V : \mathbb{R} \times \mathcal{C}([a, b], \mathbb{R}^n) \rightarrow \mathbb{R}$ such that*

$$\alpha(|\phi(0)|) \leq V(t, \phi) \leq \beta(\|\phi\|_c),$$

and

$$\dot{V}(t, \phi) \leq \gamma(\|\phi\|_c),$$

where $|\cdot|$ denotes a norm over \mathbb{R}^n , and $\|\phi\|_c = \max_{a \leq \xi \leq b} |\phi(\xi)|$ is the associated continuous norm of $\phi \in \mathcal{C}([a, b], \mathbb{R}^n)$, then the origin of the system (1.14) is stable. If $\gamma(s) > 0$ for $s > 0$, then it is *Uniformly Asymptotically Stable (UAS)*. If, in addition, $\lim_{s \rightarrow \infty} \alpha(s) = \infty$, then it is *Globally Uniformly Asymptotically Stable (GUAS)*.

A functional which satisfies the hypothesis of Theorem 1.3 is called *Lyapunov-Krasovskii Functional (LKF)*. An example of such LKF is given by:

$$V(x_t) = x^T(t)Px(t) + \int_{-\bar{h}}^0 \int_{t+\theta}^t \dot{x}^T(s)U\dot{x}(s) ds d\theta, \quad (1.15)$$

where $P > 0$ and $U > 0$. This LKF has been used for several time-delay systems, and in particular for sampled-data systems [37]. We recall also the following discontinuous time-dependent Lyapunov functional from [36]:

$$V(t, x(t), \dot{x}_t) = x^T(t)Px(t) + (\bar{h} - \tau(t)) \int_{t-\tau(t)}^t e^{2\alpha(s-t)} \dot{x}^T(s)U\dot{x}(s). \quad (1.16)$$

The analysis of the derivatives of the functionals (1.15) and (1.16) leads to LMI conditions. Upper bounding techniques are usually used to ensure the negativity of their time derivatives, and the proposed LMIs are only sufficient for the existence of these LKFs. The LKF in (1.16) provides less conservative results than the one in (1.15), as it takes into account the information about the particularity of the sampling-induced saw-tooth delay. Thus, it can ensure the stability for time-varying delays which are longer than any constant delay that preserves stability. A drawback of this approach is, as usual with Lyapunov techniques, that it is not clear how to choose the Lyapunov functional. Currently, an important effort of research is dedicated to finding and exploiting better ones.

1.5.2 Impulsive modeling approach

In this approach, the sampled-data system is modeled as an impulsive system. The stability is studied in a hybrid systems framework, using Lyapunov functions with discontinuities at the impulse times [13, 82].

Definition 1.4 (Impulsive Systems [82]). Consider the system

$$\begin{aligned} \dot{x}(t) &= f_k(x(t), t), \quad t \neq t_k, \forall k \in \mathbb{N}, \\ x(t_k) &= g_k(x(t_k^-), t_k), \quad t = t_k, \forall k \in \mathbb{N}, \end{aligned} \quad (1.17)$$

where $f_k, g_k : \mathbb{R}^n \times \mathbb{R} \rightarrow \mathbb{R}$ are locally Lipschitz functions such that $f(0, t) = 0, g(0, t) = 0, \forall t \geq t_0$, with an impulse sequence t_k which is strictly increasing in $[t_0, \infty)$ for some initial time t_0 .

The stability of the impulsive system (1.17) can be ensured by using Lyapunov methods, involving Lyapunov functions that are discontinuous at impulse instants. Recall the

notation in (1.13) $\tau(t) = t - t_k, \quad \forall t \in [t_k, t_{k+1})$. We state the following stability result from [82].

Theorem 1.5 ([82]). *Assume that there exist positive scalars c_1, c_2, c_3, b and a Lyapunov function $V : \mathbb{R}^n \times \mathbb{R} \rightarrow \mathbb{R}$, such that:*

$$c_1|x|^b \leq V(x, \tau) \leq c_2|x|^b, \quad \forall x \in \mathbb{R}^n, \forall \tau \in [0, \bar{h}].$$

Suppose that for any impulse sequence $\{t_k\}_{k \in \mathbb{N}}$ such that:

$$\{t_k \mid \epsilon \leq t_{k+1} - t_k \leq \bar{h}, k \in \mathbb{N}\}, \quad (1.18)$$

with some $0 \leq \epsilon \leq \bar{h}$, the corresponding solution $x(\cdot)$ to (1.17) satisfies:

$$\frac{dV(x(t), \tau(t))}{dt} \leq -c_3 V(x(t), \tau(t)), \quad \forall t \neq t_k, \forall k \in \mathbb{N},$$

and

$$V(x(t_k), 0) \leq \lim_{t \uparrow t_k} V(x(t), \tau(t)), \quad \forall k \in \mathbb{N}.$$

Then, the equilibrium point $x = 0$ of system (1.17) is Globally Uniformly Exponentially Stable (GUES) over the class of sampling impulse instants (1.18), i.e. there exist $c, \lambda > 0$ such that for any sequence $\{t_k\}$ that belongs to the set (1.18):

$$|x(t)| \leq c|x(t_0)|e^{-\lambda(t-t_0)}, \quad \forall t \geq t_0.$$

In order to apply this method to the stability problem of sampled-data systems, system (1.5) is written as an impulsive system (1.17) with the state $\xi(t) = [x^T(t), z^T(t)]^T$, where $z(t) = x(t_k), \forall t \in [t_k, t_{k+1})$. The dynamics of the system can be written as

$$\dot{\xi}(t) = F\xi(t), \quad t \neq t_k, \forall k \in \mathbb{N},$$

$$\xi(t_k) = \begin{bmatrix} x(t_k^-) \\ x(t_k^-) \end{bmatrix}, \quad t = t_k, \forall k \in \mathbb{N},$$

with the notation $x(t^-) = \lim_{\theta \uparrow t} x(\theta)$, and

$$F := \begin{bmatrix} A_0 & B_0K \\ 0 & 0 \end{bmatrix}.$$

The stability analysis can be led in this hybrid framework, using time-varying discontinuous Lyapunov functions. For example, in [82] the following function is considered:

$$V(\xi(t)) = x^T(t)Px(t) + \xi^T(t) \left(\int_{-\tau(t)}^0 (s + \bar{h})(Fe^{Fs})^T \tilde{R}(Fe^{Fs}) ds \right) \xi(t) \\ + (\bar{h} - \tau(t))(x(t) - z(t))^T X(x(t) - z(t)),$$

where $\tilde{R} := \begin{bmatrix} R & 0 \\ 0 & 0 \end{bmatrix}$ and P, R, X are symmetric positive definite matrices. This discontinuous Lyapunov function is inspired by the Lyapunov-Krasovskii functional from the input-delay approach, like the one in [37]. Vice versa, this approach has also inspired the use of discontinuous Lyapunov functionals in the time-delay approach (see for example the functional (1.16)). Hybrid and input-delay approaches share the same advantages and drawbacks. Both of them are constructive, and LMI conditions are used to construct the Lyapunov functionals/functions. On the other hand, conservatism is added by the upper boundings introduced when studying the derivatives of Lyapunov functionals/functions.

1.5.3 Robust control theory approach

In this approach, sampling effect is seen as a perturbation, and tools from robust control theory are used to ensure stability. The main idea is to write the sampled-data system (1.5) on each interval $[t_k, t_{k+1})$ as:

$$\dot{x}(t) = \underbrace{(A_0 + B_0K)}_{:=A} x(t) + \underbrace{B_0K}_{:=B} \underbrace{(x(t_k) - x(t))}_{:=w(t)}. \quad (1.19)$$

Then, the system can be represented equivalently by the feedback interconnection of the operator $\Delta_{sh} : y \rightarrow w$ defined by:

$$w(t) = (\Delta_{sh} y)(t) = - \int_{t_k}^t y(\tau) d\tau, \quad \forall t \in [t_k, t_{k+1}), \quad (1.20)$$

with the system \mathcal{G}

$$\mathcal{G} := \begin{cases} \dot{x}(t) = Ax(t) + Bw(t), \\ y(t) = Cx(t) + Dw(t), \end{cases} \quad (1.21)$$

where $C = A = A_0 + B_0K$ and $D = B = B_0K$, which yields $y(t) = \dot{x}(t)$. Note that the nominal system (1.21) is LTI. It represents the dynamics of the continuous-time (delay-free) system with an additive input perturbation $w(\cdot)$. The operator Δ_{sh} captures both the effects of sampling and its variations. This can be seen in Fig. 1.6. The stability can then be studied by analyzing the equivalent model (1.21), (1.20). Small gain theory [42]

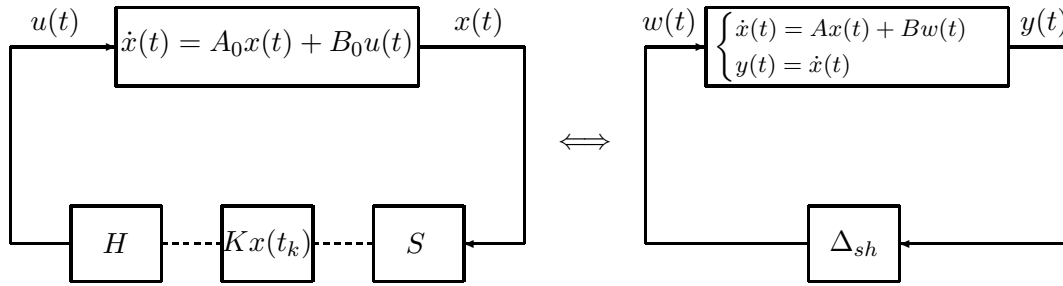

FIGURE 1.6: Equivalent representation of the sampled-data system, from a robust control theory point of view.

constitutes an interesting tool in this framework: the stability of the interconnection \mathcal{G} , Δ_{sh} is guaranteed if the following condition holds:

$$\|\Delta_{sh}\| \|\mathcal{G}\| < 1,$$

where $\|\mathcal{G}\|$ is the L_2 -induced norm of operator $\mathcal{G} : w \rightarrow y$, and it is equal to $\|\hat{G}(s)\|_\infty$ the H_∞ norm of $\hat{G}(s) = s(sI - A)^{-1}B$. $\|\Delta_{sh}\|$ is the L_2 -induced norm of operator $\Delta_{sh} : y \rightarrow w$. In order to check the small gain condition, $\|\Delta_{sh}\|$ must be estimated. An estimate of the norm has been computed in [59], with the purpose of studying the stability of single-input single-output time-delay systems, with a time-varying delay. As a matter of fact, a more general uncertain delay operator has been considered:

$$\Delta_d : y(t) \rightarrow w = (\Delta_d y)(t) = \int_{t-\tau(t)}^t y(s) ds, \quad (1.22)$$

where $\tau(t) \in [0, \bar{h}]$.

Lemma 1.6 ([59]). *The L_2 -induced norm of the operator Δ_d (1.22) is bounded by \bar{h} .*

Using this property, and the fact that the operator satisfies $M\Delta_d = \Delta_d M$ for $M \in \mathbb{R}^{n \times n}$, Mirkin [74] provided the following small gain condition

$$\exists M \in \mathbb{R}^{n \times n}, M > 0 \quad \text{such that } \|M\hat{G}(s)M^{-1}\|_\infty < \frac{1}{\bar{h}}. \quad (1.23)$$

Interestingly, it is also shown that (1.23) is related to the condition in [37] which is obtained using the input-delay approach and the Lyapunov-Krasovskii functional (1.15). The same LMI can be used to check both conditions. Mirkin then showed that the bound on the operator gain can be enhanced by exploiting the properties of Δ_{sh} .

Lemma 1.7 ([74]). *The operator Δ_{sh} defined in (1.20) is bounded on L_2 and its L_2 -induced norm is*

$$\delta_0 = \frac{2}{\pi} \bar{h}, \quad (1.24)$$

and thus

$$\langle \Delta_{sh}z, \Delta_{sh}z \rangle \leq \delta_0^2 \langle z, z \rangle,$$

for all $z \in L_2$.

This bound on the norm is actually exact, and it is attained when $t_{k+1} - t_k = \bar{h}$. This leads to the following sufficient stability condition, improving (1.23):

$$\exists M \in \mathbb{R}^{n \times n}, M > 0 \quad \text{such that } \|M\hat{G}(s)M^{-1}\|_\infty < \frac{\pi}{2\bar{h}}. \quad (1.25)$$

Note that $\frac{\pi}{2} \approx 1.57$, and thus the conservatism of (1.25) is reduced by about 57% with respect to (1.23). Fujioka [39] showed that the operator Δ_{sh} also satisfies the following passivity-like property.

Lemma 1.8 ([39]). *The operator Δ_{sh} defined in (1.20) satisfies*

$$\langle \Delta_{sh}z, z \rangle \leq 0, \quad (1.26)$$

for all $z \in L_2$.

The two above properties of Δ_{sh} are grouped into the following integral property for $0 \leq Y = Y^T \in \mathbb{R}^{n \times n}$, $0 < X = X^T \in \mathbb{R}^{n \times n}$:

$$\int_0^\infty \begin{bmatrix} y(\tau) \\ w(\tau) \end{bmatrix}^T \begin{bmatrix} \delta_0^2 X & -Y \\ -Y & -X \end{bmatrix} \begin{bmatrix} y(\tau) \\ w(\tau) \end{bmatrix} d\tau \geq 0. \quad (1.27)$$

Using the integral property (1.27), Fujioka [39] has proposed a stability condition based on Integral Quadratic Constraints (IQCs) [72].

Theorem 1.9 ([39]). *Suppose that $A = A_0 + B_0K$ (1.19) is Hurwitz. The system (1.5) is GUAS if there exist $\epsilon > 0$, $0 < X = X^T \in \mathbb{R}^{n \times n}$, $0 \leq Y = Y^T \in \mathbb{R}^{n \times n}$ satisfying*

$$\begin{bmatrix} \hat{G}(j\omega) \\ I \end{bmatrix}^T \begin{bmatrix} \delta_0^2 X & -Y \\ -Y & -X \end{bmatrix} \begin{bmatrix} \hat{G}(j\omega) \\ I \end{bmatrix} \leq -\epsilon I, \quad (1.28)$$

for all $\omega \in \mathbb{R}$.

Note that only input-output stability (L_2 -stability) is ensured under condition (1.28) in Theorem 1.9, as well as under (1.25) or (1.23). However, it has been shown in [39] that when A is Hurwitz, the input-output stability implies the asymptotic stability of the origin $x = 0$.

Checking (1.28) in Theorem 1.9 requires verifying the condition at infinite number of points. The following equivalent LMI condition has been proposed using Kalman-Yakubovich-Popov Lemma [105].

Theorem 1.10 ([39]). *The system (1.5) is UGAS if there exist $0 < P = P^T \in \mathbb{R}^{n \times n}$, $0 < X = X^T \in \mathbb{R}^{n \times n}$, $0 \leq Y = Y^T \in \mathbb{R}^{n \times n}$ satisfying*

$$\begin{bmatrix} A^T P + PA & PB \\ B^T P & 0 \end{bmatrix} + \begin{bmatrix} C & D \\ 0 & I \end{bmatrix}^T \begin{bmatrix} \delta_0^2 X & -Y \\ -Y & -X \end{bmatrix} \begin{bmatrix} C & D \\ 0 & I \end{bmatrix} < 0. \quad (1.29)$$

The approach is interesting, because condition (1.29) is simple and has few variables. It enhances the applicability, especially from an engineering point of view. Nevertheless, it is only applicable to LTI systems, and it is not clear how to extend it to systems with time-varying parametric uncertainties. In Chapter 3, we will propose an extensible alternative via dissipativity theory

1.5.4 Convex-embedding approach

With the convex-embedding approach [27, 38, 48], the stability is studied in the discrete-time domain. Denote $\theta_k = t_{k+1} - t_k$, and consider the discrete-time system (1.9)

$$x_{k+1} = \Lambda(\theta_k)x_k, \quad (1.30)$$

where, as in Section 1.5:

$$\Lambda(\eta) = e^{A_0(\eta)} + \int_0^\eta e^{A_0 s} B ds K. \quad (1.31)$$

The system (1.30) is Linear Parameter-Varying (LPV), where $\Lambda(\theta_k)$ is an exponential uncertainty with a time-varying parameter $\theta_k \in [\underline{h}, \bar{h}]$. Stability of (1.30) can be guaranteed by showing the existence of discrete-time Lyapunov functions. For example, the system is exponentially stable if one can find a quadratic Lyapunov function $V(x) = x^T P x$ such that

$$\begin{aligned} P &> 0, \\ \Lambda^T(\eta) P \Lambda(\eta) - P &< 0, \quad \forall \eta \in [\underline{h}, \bar{h}]. \end{aligned} \quad (1.32)$$

Note however that verifying the previous condition requires verifying an infinite set of inequalities. The main idea here is to find a finite set of sufficient conditions for (1.32) by embedding the set $\mathcal{W} := \{\Lambda(\eta), \eta \in [\underline{h}, \bar{h}]\}$ in a larger set $\bar{\mathcal{W}}$, defined as the following

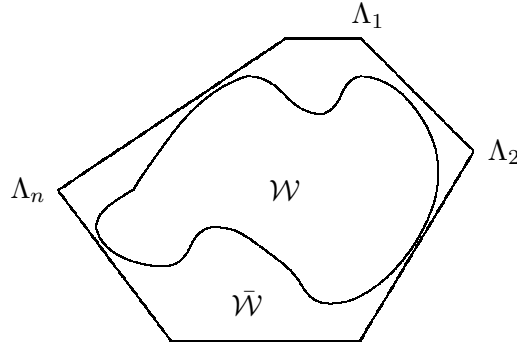
FIGURE 1.7: Embedding of the uncertainty set \mathcal{W} in $\bar{\mathcal{W}}$.

convex hull with finite number of vertices Λ_i , $i = 1, \dots, N$:

$$\begin{aligned} \mathcal{W} &:= \{\Lambda(\eta), \eta \in [\underline{h}, \bar{h}]\} \subseteq \bar{\mathcal{W}} := \text{conv}\{\Lambda_1, \Lambda_2, \dots, \Lambda_N\}, \\ &= \left\{ \sum_{i=1}^N \alpha_i \Lambda_i \mid \alpha_i \geq 0, i = 1, \dots, N, \sum_{i=1}^N \alpha_i = 1 \right\}. \end{aligned} \quad (1.33)$$

This idea is illustrated in Fig. 1.7. The main difficulty in constructing the polytope $\bar{\mathcal{W}}$ is the exponential nature of the uncertainty (1.31). Several approaches exist for the computation of the vertices Λ_i . See for example [48] for a Taylor series approximation, [38, 110] for a method using gridding and [27] for another one based on the real Jordan form.

Using the vertices in (1.33), the infinite dimensional inequality problem in (1.32) is guaranteed to be satisfied if the following LMIs are satisfied

$$\begin{aligned} P &> 0, \\ \Lambda_i^T P \Lambda_i - P &< 0, \quad i = 1, \dots, N, \end{aligned} \quad (1.34)$$

by applying twice the Schur complement lemma. Note that in the previous approaches, stability was guaranteed by means of a continuous-time Lyapunov function or functional (with or without discontinuities), while here a discrete-time Lyapunov is considered. Thus, the stability is guaranteed for the sequence $x(t_k)$, without consideration of the intersample behavior. However, in [39], the following proposition has shown that for linear sampled-data system, the stability for the convergence of the state in continuous-time and in discrete-time, is equivalent.

Proposition 1.11 ([39]). *Consider the sampled-data system (1.5) with (1.3). For a given $x(t_0)$, the following conditions are equivalent:*

1. $\lim_{t \rightarrow \infty} x(t) = 0$
2. $\lim_{k \rightarrow \infty} x(t_k) = 0$

In [49] the convex embedding approach is extended to the continuous-time case, using a quasi-quadratic Lyapunov function. This method considers intersample behavior. It provides an accurate analysis, the precision of which can be tuned according to the accuracy of the polytopic approximation (1.33). However, this may increase the number of vertices, and therefore the computational complexity of the analysis. Furthermore, it seems difficult to adapt the method to systems with time-varying parametric uncertainties.

1.6 Stability analysis of nonlinear sampled-data systems

A system which includes a nonlinear plant and a sampled-data control law is called a *nonlinear sampled-data control system*. The linearization of the nonlinear model in the neighborhood of an operating point yields a linear approximation which permits to use tools from linear control theory. Nevertheless, the approximation is only valid sufficiently near the operating point, and the nonlinearity must be taken into account in order to analyze the stability. Either for the periodic or the aperiodic sampling cases, the nonlinear sampled-data control is less understood than the linear one. In the following, an overview of methods and tools for studying nonlinear sampled-data systems is presented. The main research lines are classified according to the way the controller is obtained. There are two main approaches: the *emulation approach*, and the *discrete-time approach*. The steps of these two approaches are given in Table 1.1 from [84].

1.6.1 Emulation approach for nonlinear systems

In the emulation approach, it is assumed that some controller is designed in continuous-time. Then, this controller is discretized using one of the numerical methods, such as Euler, Runge-Kutta or Tustin [117]. Finally, it is implemented using a sample-and-hold device. Thus, the controller design is separated from the sampling issue, and several

TABLE 1.1: The steps of the discrete-time and the emulation approaches.

Emulation	Discrete-time
continuous-time plant model	continuous-time plant model
↓	↓
continuous-time controller	discretize plant model
↓	↓
discretize controller	discrete-time controller
↓	↓
implement the controller	implement the controller

classical tools from continuous-time control theory [64] can be used. On the other hand, in order to make the sampled-data system inherit the properties of the continuous-time system, fast sampling is required, and choosing the upper bound of the sampling interval is a critical question.

Consider the following plant:

$$\dot{x}_p(t) = f_p(x_p(t), u(t)), \quad y(t) = g_p(x_p(t)), \quad (1.35)$$

where x_p is the plant state, u is the control input, y is the measured output. Suppose that stability in some sense (UGAS, ISS, etc) is guaranteed by the continuous-time controller:

$$\dot{x}_c(t) = f_c(x_c(t), y(t)), \quad u(t) = g_c(x_c(t), y(t)), \quad (1.36)$$

where x_c is the controller state. The implementation of this controller using a ZOH yields:

$$t \in [t_k, t_{k+1}) : \begin{cases} \dot{x}_p(t) &= f_p(x_p(t), u(t_k)), \\ y(t) &= g_p(x_p(t)), \end{cases} \quad (1.37)$$

$$t \in [t_k, t_{k+1}) : \begin{cases} \dot{x}_c(t) &= f_c(x_c(t), y(t_k)), \\ u(t) &= g_c(x_c(t), y(t_k)). \end{cases} \quad (1.38)$$

Note that in this case, the controller is supposed to be calculated in continuous-time, as can be seen from (1.38). The values of y and u are transmitted on sampling instants t_k . When the controller is computed numerically, (1.38) is to be replaced by:

$$t_k = kT, \quad k \in \mathbb{N} : \begin{cases} x_c(k+1) &= F_T^c(x_c(k), y(k)), \\ u(k) &= g_c(x_c(k), y(k)), \end{cases} \quad (1.39)$$

where T is a constant sampling interval, $y(k) := y(t_k)$ and $u(k) := u(t_k)$. Note that in this second model, periodic sampling is supposed. Moreover, the closed-loop system is determined by a differential equation which represents the continuous-time plant, and a difference equation which represents the discrete-time controller. The term F_c^T is obtained by calculating a discrete-time model of (1.38).

1.6.1.1 Qualitative properties of sampled-data systems under emulation

The choice of sampling intervals is a critical issue in the emulation approach. Intuitively, by choosing a sufficiently fast frequency of sampling, the stability will be preserved under sampled-data implementation. This conjecture has been confirmed in [46], for the case of input-affine systems:

Theorem 1.12 ([46]). *Consider the system*

$$\dot{x}_p(t) = f(t, x_p(t)) + g(x_p(t))u(t), \quad (1.40)$$

with $x_p \in \mathbb{R}^n$, $f : \mathbb{R} \times \mathbb{R}^n \rightarrow \mathbb{R}^n$ and $g : \mathbb{R}^n \rightarrow \mathbb{R}^n$, $|g| \leq c$, $c > 0$. Suppose that a control $u^c(x_p(t))$ exists and stabilizes the system exponentially, and that $f(\cdot)$, $g(\cdot)$ and $u^c(\cdot)$ are smooth with respect to t and x_p . Furthermore, the continuous-time controlled system shall have the Lipschitz properties:

$$\begin{aligned} |f(t, x_1) - f(t, x_2)| &\leq \mathcal{K}_f |x_1 - x_2|, \\ |u^c(x_1) - u^c(x_2)| &\leq \mathcal{K}_u |x_1 - x_2|. \end{aligned}$$

Finally it is assumed that the open-loop system (1.40) has no finite escape time for any bounded input u . For discretized control let the state be available at well defined time instants $t_k = t_0 + kT$, $k = 0, 1, \dots$: $x_p(t_k) = x_p(t)|_{t=t_k}$. Consider that the control applied to (1.40) is discretized:

$$u(t) = u^c(x_p(t_k)), \quad \forall t \in (t_k, t_{k+1}], \quad u(t_0) = 0.$$

Then, there exists a sufficiently small \hat{T} such that for any $T < \hat{T}$ the discretized control for the system (1.40) is stable.

Even though Theorem 1.12 does not give an estimation of the stabilizing sampling frequency, it proves the interesting fact that the discretization of stabilizing continuous-time nonlinear control law with Lipschitz property preserves the stability of the initial nonlinear system, for constant and sufficiently small sampling intervals. This result has been generalized in [16] to the case of time-varying sampling intervals, with dynamical control laws which are discretized using Euler approximation.

In the case of ISS, a similar result is presented in [121]. It shows that when the periodic sampling is sufficiently fast, ISS property of a nonlinear system is semi-globally practically preserved. The semi-global practical stability means that for any region of initial conditions, there exists a sufficiently small sampling period that asymptotically stabilizes the origin of the system. The result is based on exploiting a Razumikhin-type theorem for ISS.

1.6.1.2 Stability analysis based on linearization

For a special class of nonlinear sampled-data systems, it is shown in [52] that stability conditions can be obtained by analyzing a linearized model.

Theorem 1.13 ([52]). *Consider the sampled-data nonlinear system with a constant sampling interval $t_{k+1} - t_k = T$:*

$$\begin{aligned} t \in [t_k, t_{k+1}) & : \dot{x}_p(t) = f(x_p(t)) + B_0 x_c(t_k), \\ k \in \mathbb{N} & : x_c(k+1) = C x_c(k) + D x_p(k), \end{aligned} \quad (1.41)$$

where B_0 , C and D are real matrices with appropriate dimensions, and $x_c(k) := x_c(t_k)$, $x_p(k) := x_p(t_k)$. The function $f : \mathbb{R}^n \rightarrow \mathbb{R}^n$ is assumed to be continuously differentiable with $f(0) = 0$. Then, the equilibrium $(x_p^T, x_c^T) = (0, 0)$ of (1.41) is uniformly asymptotically stable, if the equilibrium of the linear sampled-data system

$$\begin{aligned} t \in [t_k, t_{k+1}) & : \dot{x}_p(t) = A_0 x_p(t) + B_0 x_c(t_k), \\ k \in \mathbb{N} & : x_c(k+1) = C x_c(k) + D x_p(k), \end{aligned} \quad (1.42)$$

is exponentially stable, where $A_0 \in \mathbb{R}^{n \times n}$ denotes the Jacobian of f at $x_p = 0$

$$A_0 = \left. \frac{\partial f}{\partial x_p} \right|_{x_p=0}.$$

The nature of the result is in the spirit of the Lyapunov's First Method [64], as it permits to guarantee the stability of the equilibrium of the nonlinear system, by studying the stability of its linearization at the origin. However, in the same way, it does not provide any estimate of the domain of attraction. Note that the origin of the linear sampled-data system (1.42) is exponentially stable if and only if the matrix

$$\begin{bmatrix} \Phi(T) & \Gamma(T) \\ D & C \end{bmatrix}$$

is Schur, where $\Phi(T)$ and $\Gamma(T)$ are given in (1.6). This can be found directly from Theorem 1.1. This result has been generalized in [53] to the case of time-varying sampling intervals, with a more general class of nonlinear systems. In [69], stability conditions are given, based on an appropriate linearization of the plant and of the controller. However, here again these methods do not provide any estimate of the domain of attraction.

1.6.1.3 Dissipation preservation under emulation

In [5, 9, 68, 84], some results concerning the emulation approach were generalized and unified in a methodological framework, by considering the preservation of dissipation inequality under sampling. It is shown that if a continuous-time controller provides

some dissipation properties, then the resulting sampled-data system satisfies similar properties in a semi-global practical sense.

Consider the general nonlinear plant:

$$\dot{x}_p = f_p(x_p, u, w), \quad y = g_p(x_p), \quad (1.43)$$

where x_p is the plant state, u is the control input, y is the measured output and w is the disturbance. Suppose that stability is guaranteed by the continuous-time dynamic output feedback:

$$\dot{x}_c = f_c(x_c, y), \quad u = g_c(x_c), \quad (1.44)$$

where x_c is the controller state. Consider the emulation of this controller, with a sequence of periodic sampling instants $t_k = kT$, $k \in \mathbb{N}$. In [5], the discrete-time model of the closed-loop system with a ZOH is denoted as:

$$\begin{aligned} x_p(k+1) &= F_T^p(x_p(k), x_c(k), w[k]), \\ x_c(k+1) &= F_T^c(x_p(k), x_c(k), w[k]), \end{aligned} \quad (1.45)$$

where $x_p(k) := x_p(t_k)$, $x_c(k) := x_c(t_k)$ and $w[k] := \{w(t) : t \in [t_k, t_{k+1}]\}$.

Theorem 1.14 ([5]). *Suppose that there exists a differentiable storage function $V(x_p, x_c)$ and a continuous supply rate $\mathcal{S}(x_p, x_c, w)$ such that the following holds for all (x_p, x_c) and w along (1.43) (1.44):*

$$\dot{V} = \left\langle \frac{\partial V}{\partial x}, f \right\rangle \leq \mathcal{S}(x_p, x_c, w), \quad (1.46)$$

where $x := (x_p, x_c)$ and $f := (f_p, f_c)$. Then for any strictly positive numbers $D > \nu > 0$ there exists $T^* > 0$ such that for all $T \in (0, T^*)$, all (x_p, x_c, w) with $|(x_p(k), x_c(k))| \leq D$, $\text{ess sup}_{\theta \in [t_k, t_{k+1}]} |w(\theta)| \leq D$ we have that (1.45) satisfies:

$$\frac{\Delta V}{T} \leq \frac{1}{T} \int_{t_k}^{t_{k+1}} \mathcal{S}(x_p(k), x_c(k), w(t)) dt + \nu,$$

where $\Delta V := V(x_p(k+1), x_c(k+1)) - V(x_p(k), x_c(k))$.

The advantage of this method is that dissipation inequalities permit to study several properties of the sampled-data system with an emulated controller. These properties include stability, ISS, L_p -stability, passivity, etc. See [84] for an application of dissipation inequalities to the study of ISS and passivity. This preservation of dissipation is satisfied for sufficiently small sampling intervals upper bounded by T^* . However, the result does not provide any quantitative estimate of T^* .

1.6.1.4 Quantitative estimation of the MASP

The previous results are qualitative and prove some nice properties of sampled-data systems, for sufficiently small sampling intervals. However, they do not provide any method for estimating the maximum allowable sampling intervals, for which the stability properties are preserved. In the following, we review some works which provide such an estimation.

Hybrid system approach

In [86], L_p -stability properties have been studied for NCS with scheduling protocols. The results are based on the hybrid modeling approach and the small gain theorem, and they can be applied to the sampled-data case to calculate the MASP. In [18, 19], the bound on the MASP has been improved, using a Lyapunov-based method, which result has been particularized to the sampled-data case in [88]. Consider the plant:

$$\dot{x}_p = f_p(x_p, u), \quad y = g_p(x_p),$$

where x_p is the plant state, u is the control input, y is the measured output. Suppose that asymptotic stability is guaranteed by the continuous-time output feedback:

$$\dot{x}_c = f_c(x_c, y), \quad u = g_c(x_c),$$

where x_c is the controller state. The sampled-data implementation of the controller can be written in the following form:

$$\begin{aligned} \dot{x}_p &= f_p(x_p, \hat{u}), & t \in [t_k, t_{k+1}), \\ y &= g_p(x_p), \\ \dot{x}_c &= f_c(x_c, \hat{y}), & t \in [t_k, t_{k+1}), \\ u &= g_c(x_c), \\ \dot{\hat{y}} &= 0, & t \in [t_k, t_{k+1}), \\ \dot{\hat{u}} &= 0, & t \in [t_k, t_{k+1}), \\ \hat{y}(t_k^+) &= y(t_k), \\ \hat{u}(t_k^+) &= u(t_k), \end{aligned} \tag{1.47}$$

where x_p and x_c are respectively the states of the plant and of the controller, y is the plant output and u is the controller output; \hat{y} and \hat{u} are the most recently transmitted plant and controller output values. In between sampling instants, the values of \hat{y} and \hat{u} are held constant. Define the augmented state vector $x(t)$ and the network-induced

error $e(t)$:

$$e(t) = \begin{pmatrix} e_y(t) \\ e_u(t) \end{pmatrix} := \begin{pmatrix} \hat{y}(t) - y(t) \\ \hat{u}(t) - u(t) \end{pmatrix} \in \mathbb{R}^{n_e}, \quad x(t) := \begin{pmatrix} x_p(t) \\ x_c(t) \end{pmatrix} \in \mathbb{R}^{n_x}. \quad (1.48)$$

Note that the error vector is subject to resets at each sampling instant. The sampled-data system (1.47) can be written as a system with jumps:

$$\begin{aligned} \dot{x} &= f(x, e) & t \in [t_k, t_{k+1}), \\ \dot{e} &= g(x, e) & t \in [t_k, t_{k+1}), \\ e(t_k^+) &= 0, \end{aligned} \quad (1.49)$$

with $0 < \epsilon \leq t_{k+1} - t_k \leq \bar{h}$, for all $k \in \mathbb{N}$, $x \in \mathbb{R}^{n_x}$, $e \in \mathbb{R}^{n_e}$. The functions f and g are obtained by direct calculations from the sampled-data system (1.47) (see [88] and [86]):

$$f(x, e) := \begin{pmatrix} f_p(x_p, g_c(x_c) + e_u) \\ f_c(x_c, g_p(x_p) + e_y) \end{pmatrix}; \quad g(x, e) := \begin{pmatrix} -\frac{\partial g_p}{\partial x_p} f_p(x_p, g_c(x_c) + e_u) \\ -\frac{\partial g_c}{\partial x_c} f_c(x_c, g_p(x_p) + e_y) \end{pmatrix}.$$

It should be noted that $\dot{x} = f(x, 0)$ is the closed loop system without the sampled-data implementation. Considering a clock τ which evolves with respect to the sampling instants, system (1.49) can be written as the following hybrid system:

$$\begin{aligned} \left. \begin{aligned} \dot{x} &= f(x, e) \\ \dot{e} &= g(x, e) \\ \dot{\tau} &= 1 \end{aligned} \right\} & \tau \in [0, \bar{h}), \\ \left. \begin{aligned} x^+ &= x \\ e^+ &= 0 \\ \tau^+ &= 0 \end{aligned} \right\} & \tau \in [\epsilon, \bar{h}], \end{aligned} \quad (1.50)$$

with $x \in \mathbb{R}^{n_x}$, $e \in \mathbb{R}^{n_e}$, $\tau \in \mathbb{R}_+$, $\bar{h} \geq \epsilon > 0$. The following theorem provides a quantitative method to estimate the MASP, using the model (1.50).

Theorem 1.15 ([88]). *Suppose there exist $\tilde{\Delta}_x, \tilde{\Delta}_e > 0$, a locally Lipschitz function $W : \mathbb{R}^{n_e} \rightarrow \mathbb{R}_+$, a locally Lipschitz, positive definite, radially unbounded function $V : \mathbb{R}^{n_x} \rightarrow \mathbb{R}_+$, real numbers $L > 0$, $\gamma > 0$, functions $\underline{\alpha}_W, \bar{\alpha}_W \in \mathcal{K}_\infty$ and a continuous, positive definite function ϱ such that, $\forall e \in \mathbb{R}^{n_e}$:*

$$\underline{\alpha}_W(|e|) \leq W(e) \leq \bar{\alpha}_W(|e|),$$

and for almost all $|x| \leq \tilde{\Delta}_x$ and $|e| \leq \tilde{\Delta}_e$:

$$\left\langle \frac{\partial W(e)}{\partial e}, g(x, e) \right\rangle \leq LW(e) + H(x, e),$$

$$\langle \nabla V(x), f(x, e) \rangle < -\varrho(|x|) - \varrho(W(e)) - H^2(x, e) + \gamma^2 W^2(e).$$

Finally, consider that the MASP \bar{h} satisfies $0 < \epsilon \leq \bar{h} < \mathcal{T}(\gamma, \mathcal{L})$, given by the following function:

$$\mathcal{T}(\gamma, L) := \begin{cases} \frac{1}{Lr} \arctan(r) & \gamma > L, \\ \frac{1}{L} & \gamma = L, \\ \frac{1}{Lr} \operatorname{arctanh}(r) & \gamma < L, \end{cases} \quad \text{with } r = \sqrt{\left| \frac{\gamma^2}{L^2} - 1 \right|}.$$

Then, for all sampling intervals less than \bar{h} the set $\{(x, e, \tau) : x = 0, e = 0\}$ is UAS, i.e. there exist $\Delta > 0$ and $\beta \in \mathcal{KL}$ such that for each initial condition $\tau(t_0) \in \mathbb{R}_+$, $|(x(t_0), e(t_0))| \leq \Delta$:

$$\left| \begin{bmatrix} x(t) \\ e(t) \end{bmatrix} \right| \leq \beta \left(\left| \begin{bmatrix} x(t_0) \\ e(t_0) \end{bmatrix} \right|, t \right), \quad \forall t \geq t_0.$$

To our best knowledge, Theorem 1.15 is among the first results providing an explicit formulation of the MASP. It is applicable for both constant and variable sampling intervals. The proof is based on studying a hybrid Lyapunov function, and it addresses asymptotic/exponential stability. Moreover, it has the advantage of considering a general class of nonlinear systems. Nevertheless, it is not clear how to construct the functions $V(x)$, $W(e)$ and $H(x, e)$ which satisfy the hypotheses.

Time-delay approach

Recently, a new approach has been proposed by Mazenc et al. [71], for the case of control affine non-autonomous systems. It is based on extending the idea in [37] for the case of LTI systems. This result considers the robustness of nonlinear systems, with respect to both sampling and delay. We state as follows an adaptation where only sampling is considered. Consider the nonlinear system:

$$\dot{x}_p(t) = f(t, x_p(t)) + g(t, x_p(t))u(t), \quad (1.51)$$

with the state $x_p \in \mathbb{R}^n$ and the input $u \in \mathbb{R}^m$, and with functions f, g that are locally Lipschitz with respect to x_p and piecewise continuous in t . Assume that the \mathcal{C}^1 controller $u(t) = u_c(t, x_p)$ is designed in order to make the system (1.51) UGAS. Moreover, assume that there exist a \mathcal{C}^1 positive definite and radially unbounded function V , and

a continuous positive definite function W such that:

$$W_b(t, x_p) := - \left[\frac{\partial V}{\partial t}(t, x_p) + \frac{\partial V}{\partial x_p}(f(t, x_p) + g(t, x_p)u_c(t, x_p)) \right] \quad (1.52)$$

satisfies $W_b(t, x_p) \geq W(x_p)$, for all $t \geq t_0$ and $x_p \in \mathbb{R}^n$. Also, consider $u_c(t, 0) = 0$ for all $t \in \mathbb{R}$. Hence, V is a strict Lyapunov function for $\dot{x}_p = f(t, x_p) + g(t, x_p)u_c(t, x_p)$, and one can fix class \mathcal{K}_∞ functions α_1 and α_2 such that $\alpha_1(|x_p|) \leq V(t, x_p) \leq \alpha_2(|x_p|)$, for all $t \geq t_0$ and $x_p \in \mathbb{R}^n$. Define the function $h(\cdot)$ by:

$$h(t, x_p) = \frac{\partial u_c}{\partial t}(t, x_p) + \frac{\partial u_c}{\partial x_p}(f(t, x_p) + g(t, x_p)u_c(t, x_p)). \quad (1.53)$$

Theorem 1.16 ([71]). *Suppose that there exist constants c_1, c_2, c_3 and c_4 such that:*

$$\left| \frac{\partial u_c}{\partial x_p}(t, x_p)g(t, x_p) \right|^2 \leq c_1, \quad (1.54)$$

$$\left| \frac{\partial V}{\partial x_p}(t, x_p)g(t, x_p) \right|^2 \leq c_2, \quad (1.55)$$

$$|h(t, x_p)|^2 \leq c_3W(x_p), \quad (1.56)$$

$$\left| \frac{\partial V}{\partial x_p}(t, x_p)g(t, x_p)u_c(t, x_p) \right|^2 \leq c_4(V(t, x_p) + 1), \quad (1.57)$$

hold for all $t \geq t_0$ and $x_p \in \mathbb{R}^n$. Consider the system (1.51) in closed-loop with:

$$u(t) = u_c(t_k, x_p(t_k)), \quad t \in [t_k, t_{k+1}),$$

where the sequence $\{t_k\}$ satisfies $t_0 = 0$, $0 < \underline{h} \leq t_{k+1} - t_k \leq \bar{h}$, $\forall k \in \mathbb{N}$. Then, the closed-loop system is UGAS if:

$$\bar{h} \leq \frac{1}{\sqrt{4c_1 + 8c_2c_3}}. \quad (1.58)$$

Note that the estimate of the MASP (1.58) is given directly in terms of the system dynamics, the control and the Lyapunov function. The stability is proven by means of a Lyapunov functional. However, it is not clear how conservative the result is.

1.6.1.5 Further notes and references on emulation approach

It must be mentioned that other works can be found in the literature. In [131] an analytical relationship between sampling rates and the domains of attraction of the system is derived, for a special class of nonlinear sampled-data systems. In [60], the input-delay approach is explored on the basis of vector Lyapunov functions. In [62], stabilization of nonlinear systems is considered, with inputs that are subject to both

delays and sampling. It is shown that sampled-data feedback laws with a predictor-based delay compensation can guarantee global asymptotic stability for the closed-loop system. Results on global stabilization under sampled-data control can be found in [61] for the case of feedforward system, based on a discontinuous feedback.

1.6.2 Discrete-time approach for nonlinear systems

The main motivation for considering direct discrete-time design, is to avoid the disadvantages of the emulation approach, among which is the necessity of a relatively fast sampling. Moreover, some properties such as dead-beat control [106], can not be achieved in continuous-time. This approach has shown a promising potential to find better performing controllers, since sampling is taken into account for the design.

1.6.2.1 Discrete-time modeling

Consider the nonlinear continuous-time plant:

$$\dot{x}_p = f_p(x_p, u), \quad x_p(t_0) = x_0, \quad (1.59)$$

with a set of sampling instants $0 = t_0 < t_1 < \dots < t_k < \dots$ which satisfy:

$$t_{k+1} - t_k = T, \quad (1.60)$$

and with a sampled-data control $u(t) = u(k) := u(t_k), \forall t \in [t_k, t_{k+1})$. The relation between the states $x_p(k) := x_p(t_k)$ is given by the *exact discrete-time model* of (1.59):

$$x_p(k+1) = x_p(k) + \int_{t_{k+1}}^{t_k} f(x_p(s), u(k)) ds \quad (1.61)$$

$$= F_T^p(x_p(k), u(k)). \quad (1.62)$$

In [80], the equivalent discrete-time model of the nonlinear continuous-time system is provided, using the formalism of asymptotic expansion. It is shown that solutions to non-autonomous differential equations can be described by their asymptotic expansion in powers of the sampling period. Considering the autonomous vector field f_p , the differential equation

$$\dot{x}_p(t) = f_p(x_p(t)), \quad (1.63)$$

is transformed, under sampling, into the difference equation

$$x_p(k+1) = F_T^p(x_p(k)), \quad (1.64)$$

with

$$F_T^p(x_p) = x_p + \sum_{i \geq 1} \frac{T^i}{i!} L_{f_p}^i(x_p), \quad (1.65)$$

where the map $F_T^p(x) : (0, T] \times \mathbb{R}^n \rightarrow \mathbb{R}^n$ is deduced from the flow associated with (1.63). It is parameterized by the sampling period T , and the Lie derivatives of f_p :

$$L_{f_p}^i(x_p) = \frac{\partial L_{f_p}^{i-1}(x_p)}{\partial x_p} f(x_p) = f_p^i(x_p), \quad L_{f_p}^0(x_p) = f_p(x_p). \quad (1.66)$$

A similar result using Lie derivatives may also be established, for non-autonomous systems (see [80] for details). Several works consider that it is possible to obtain an exact discrete-time model of the plant (1.62) (see for example [66]). Nevertheless, this assumption is rarely applicable: as a matter of fact, calculating the discrete-time model of a nonlinear continuous-time plant, is a very hard problem. It requires an explicit analytic solution of a nonlinear differential equation. Alternatively, it is possible to consider a family of approximate models \tilde{F}_T^p which converge to the exact model when an approximation parameter (such as the sampling period) approaches to zero:

$$x_p(k+1) = \tilde{F}_T^p(x_p(k), u(k)). \quad (1.67)$$

Numerical approximation method permits to find such approximate discrete-time models. The Euler method is the easiest one, and it is the most popular in the literature. Using this method, the discrete-time model (1.62) can be approximated by:

$$\tilde{F}_T^p(x_p(k), u(k)) := x_p(k) + T f_p(x_p(k), u(k)) \quad (1.68)$$

Using series expansion methods is another way to find the approximate model. Consider again the system (1.63). Although the series expansion (1.65) is calculated over infinite terms to get the exact solution, it is pointed out in [81] that a truncation of the series may provide an efficient approximation. It yields an approximate model of order z in T , and with an error in $O(T^{z+1})$. [81] also gives more details about series expansion, and the relation between continuous-time dynamics under holding devices, as well as discrete-time mappings.

1.6.2.2 Discrete-time controller design

Once the family of approximates (1.67) is calculated, classical discrete-time design methods are used to calculate a controller that stabilizes \tilde{F}_T^p :

$$\begin{aligned}x_c(k+1) &= F_T^c(x_c(k), x_p(k)), \\ u(k) &= G_T^c(x_c(k), x_p(k)).\end{aligned}\tag{1.69}$$

At this stage, a critical question is whether the controller (1.69), which is designed in order to stabilize the approximate model (1.67), will also stabilize the exact one (1.62). This must be guaranteed without knowing the exact model. Several examples in [85] show that if the controller or the approximation is not chosen properly, then stability may not be preserved. The following case is taken from those examples.

Example 1.2 ([85]). *Consider the sampled-data control of a triple integrator*

$$\begin{aligned}\dot{x}_1 &= x_2, \\ \dot{x}_2 &= x_3, \\ \dot{x}_3 &= u.\end{aligned}\tag{1.70}$$

Note that the exact LTI discrete-time model of this system can be computed. Nevertheless, an approximate model is considered in order to illustrate the main problem encountered in step (1.69). The Euler approximate discrete-time model is:

$$\begin{aligned}x_1(k+1) &= x_1(k) + Tx_2(k), \\ x_2(k+1) &= x_2(k) + Tx_3(k), \\ x_3(k+1) &= x_3(k) + Tu(k).\end{aligned}\tag{1.71}$$

A minimum-time dead-beat controller for the Euler discrete-time model is given by

$$u(k) = -\frac{x_1(k)}{T^3} - \frac{3x_2(k)}{T^2} - \frac{3x_3(k)}{T}.\tag{1.72}$$

On the one hand, the closed-loop system (1.71) (1.72) has all poles equal zero for all $T > 0$, and hence the controller stabilizes asymptotically the Euler-based closed-loop system for all $T > 0$. On the other hand, the closed-loop system consisting of the exact discrete-time model of the triple integrator and the controller (1.72) is unstable for all $T > 0$.

Various conditions guaranteeing that (1.69) will stabilize (1.62) are presented in [5, 85, 89]. We present here the conditions in [5]. As stated by the authors, these conditions

are strong, but they are relatively easy to state. Consider the following properties:

Definition 1.17 (Equi-Lipschitz Lyapunov function [5]). Suppose that there exist a Lyapunov function V_T , functions $\alpha_1, \alpha_2, \alpha_3 \in \mathcal{K}_\infty$, and $T^* > 0$ such that for all $T \in (0, T^*)$ and all $\tilde{x} := (x_c, x_p)$ we have:

$$\alpha_1(|\tilde{x}|) \leq V_T(\tilde{x}) \leq \alpha_2(|\tilde{x}|), \quad (1.73)$$

$$\frac{\Delta V^a}{T} \leq -\alpha_3(|\tilde{x}|), \quad (1.74)$$

where $\Delta V^a := V_T\left(\tilde{F}_T^p(x_p(k), u(k)), F_T^c(x_c(k), x_p(k))\right) - V_T(\tilde{x}(k))$, and $u(k)$ is defined in (1.69). Moreover, suppose that there exist $L > 0$ and $T^* > 0$ such that for all $T \in (0, T^*)$, x_1, x_2 and all z we have:

$$|V_T(x_1, z) - V_T(x_2, z)| \leq L|x_1 - x_2|. \quad (1.75)$$

If V_T satisfying (1.73), (1.74), (1.75) exists, it is called an *equi-Lipschitz Lyapunov function* for the system (1.67) (1.69).

Definition 1.18 (One-step consistency [5]). Suppose that there exist T^* and $\rho, \alpha_4 \in \mathcal{K}$ such that for all $T \in (0, T^*)$ and all x_p, u we have:

$$|\tilde{F}_T^p(x_p, u) - F_T^p(x_p, u)| \leq T\rho(T)\alpha_4(|(x_p, u)|). \quad (1.76)$$

Then \tilde{F}_T^p and F_T^p are said to be *one-step consistent*.

Definition 1.19 (Boundedness of G_T^c [5]). Suppose there exist $T^* > 0$ and $\alpha_5 \in \mathcal{K}$ such that for all $T \in (0, T^*)$ and all $\tilde{x} := (x_c, x_p)$ we have:

$$|G_T^c(\tilde{x})| \leq \alpha_5(|\tilde{x}|). \quad (1.77)$$

Then G_T^c is said to be *bounded uniformly in small T* .

Theorem 1.20 ([5]). *Suppose that the following conditions hold:*

1. *There exists an equi-Lipschitz Lyapunov function for the closed-loop system (1.67), (1.69).*
2. *\tilde{F}_T^p and F_T^p are one-step consistent.*
3. *G_T^c is bounded uniformly in small T .*

Then, there exists $\beta \in \mathcal{KL}$ such that for any positive numbers $D, \nu, T^* > 0$ such that for any $T \in (0, T^*)$ and any $|\tilde{x}| \leq D$ solutions of the exact closed-loop (1.62), (1.69) satisfy:

$$|\tilde{x}(k)| \leq \beta(|\tilde{x}(0)|, kT) + \nu, \quad k \geq 0. \quad (1.78)$$

Note that even if \tilde{F}_T^p is not known explicitly, consistency can still be checked. As a matter of fact, the conditions in Theorem 1.20 can be checked when the continuous-time system (1.59), the approximate model (1.67) and the controller (1.69) are available. The theorem provides a framework for controller design, but does not tell how to construct a stabilizing controller. In some particular cases, it is possible to design a controller that satisfy the conditions: for example, a backstepping control has been investigated in [87, 103].

For the more general case, one manner for approaching the controller synthesis problem is to redesign a continuous-time controller for sampled-data implementation [83, 87, 103]. Assume that a continuous-time controller $u_c(x)$ has been designed for the closed-loop continuous-time system, together with a Lyapunov function $V(\cdot)$. Instead of a direct emulation, the following sampling period dependent controller can be implemented:

$$u_{sd}(x) = u_c(x) + \sum_{i=1}^N T^i u_i(x), \quad (1.79)$$

where T is the sampling period, and $u_i(x)$ are extra terms that are determined through the redesign process. In [87, 103], $u_i(x)$ are determined using backstepping techniques. See also [83], where Fliess series expansions of the first difference for $V(\cdot)$ along solutions of the system controlled by $u_{sd}(x)$, are used to determine $u_i(x)$. For application, see [67] where redesign methods have been considered for a jet engine, and an inverted pendulum examples.

1.6.2.3 Further notes on discrete-time approach

To end with this section, note that discrete-time approach was considered only for periodic sampling, even if it might be possible to extend it in same way to aperiodic cases. Besides, it must be noted that structural properties of a given continuous-time plant may not be inherited to its discrete-time (exact or approximate) model [63]. The affinity of the system in control and the minimum phase properties are among the properties that may be lost in the sampled-data model. However, the approach is complex, and does not have the attractive easiness of the emulation counterpart approach. At last, note that when using discrete-time methods, no inter-sample behavior is taken into account.

Consequently, the behavior of the sampled-data system, between sampling instants is not necessarily guaranteed.

1.7 Conclusion

In this chapter, an overview of results on stability and stabilization of sampled-data systems is presented. Attention has been given to robust stability analysis, with time-varying sampling intervals. It appears that robustness with respect to the time-variations of sampling intervals, is a very challenging problem for both linear and nonlinear systems.

For the case of linear systems, it is shown that several pioneering approaches exist in the literature. These approaches share the advantage of being constructive using LMIs, thus they are numerically tractable. In particular, the MASP that guarantees the stability of a given controller can be efficiently estimated. However, it is not clear how these methods can be extended to the nonlinear case.

For the case of nonlinear systems, the main results are classified into two categories: emulation approach, and discrete-time approach. This classification takes into account the way the controller is synthesized. Concerning the main challenges of the discrete-time approach, we underline the difficulty of constructing an accurate discrete-time model for a nonlinear plant. Another important challenge, is guaranteeing the stability of the closed-loop, with the limitation of using only an approximation of the discrete-time model. In the emulation approach, the main difficulty is to provide a quantitative estimation of the MASP. Only few works provide a constructive method for estimating the MASP, which shows that the problem is more challenging in the nonlinear case, than the linear one.

In the following chapters, we intend to provide a contribution to the stability analysis of nonlinear systems under time-varying sampling intervals. The main objective is to provide tractable stability criteria, which allow for estimating the MASP.

We address first the case of bilinear systems, which represents a simple class of nonlinear systems, and can be considered as an intermediate between linear and nonlinear systems. Two approaches are being considered for bilinear systems: the first one relies on the hybrid dynamical systems framework, while the second one is based on robust control theory.

After that, we will consider a more general class of nonlinear systems, with aperiodic sampled-data control.

Chapter 2

Stability of bilinear sampled-data systems - hybrid systems approach

2.1 Introduction

This chapter is dedicated to the local stability analysis of bilinear sampled-data systems, controlled via a linear state feedback static controller, using a hybrid systems methodology. When a continuous-time controller is emulated, intuitively the stability will be preserved if the sampling intervals are sufficiently small. Nevertheless, this issue has been rarely addressed in a formal quantitative study for bilinear systems. Our purpose is to find a constructive way to calculate the MASP.

Two constructive methods are considered. They are both based on the hybrid systems framework, presented in Section 1.6.1.4. The first method is a specialization of the result used for the general nonlinear case [88]. The contribution here is to find a constructive way to apply this generic method, for the particular case of bilinear systems. The second method is based on a direct search of a Lyapunov function using LMIs. The novelty here is to avoid some conservative upper bounds on the derivative of a Lyapunov function in the first method.

The chapter is organized as follows. First, bilinear systems are introduced in Section 2.2. In Section 2.4, we formulate the problem under study. Section 2.5 is dedicated to system modeling. In Section 2.6, we introduce the main results, where sufficient conditions for the local stability of sampled-data bilinear systems are provided. Finally, the results are illustrated by means of a numerical example in Section 2.7.

2.2 Bilinear systems

Bilinear systems are considered as the “simplest” class of nonlinear systems. They are linear separately with respect to the state and the control, but not to both of them jointly. Since the beginning of 1970’s, they have attracted the attention of many researchers [15, 30, 75, 101]. The associated state-space model is:

$$\dot{x}(t) = A_0x(t) + \sum_{i=1}^m [u(t)]_i N_i x(t) + B_0 u(t), \quad \forall t \geq t_0, \quad (2.1)$$

where the state vector is $x(t) \in \mathbb{R}^n$, and the control input is $u(t) \in \mathbb{R}^m$. The term A_0x is called the *drift*, B_0u is the *additive control* and $\sum_{i=1}^m [u]_i N_i x$ is the *multiplicative control* [30].

Bilinear systems have applications in various domains since many processes can be modeled by this way. Examples of these processes are found in engineering application such as power electronics [54, 116], a.c. transmission systems [78], controlled hydraulic systems [43] and chemical processes [31]. Bilinear systems can also be encountered in domains such as ecology, socio-economics, biology and immunology [75, 76], only to cite a few.

From the point of view of nonlinear systems theory, the study of bilinear systems is very interesting since such models offer a more accurate approximation to nonlinear systems than the classical linear ones. This can be seen in the added bilinear terms, in state and control, which may come from a Taylor series truncation: [79, 101] and the references therein give more insight to the approximation of more highly nonlinear systems by bilinear models. As a matter of fact, bilinear systems have also an interesting variable structure characteristic. For example, it has been shown in [75] that bilinear models have more powerful controllability properties than the linear ones. For information about structural properties, system characterization and solutions, see [77].

2.3 Stabilization of bilinear systems

Even for such “simplest” class of nonlinear systems, the feedback stabilization of bilinear systems is a challenging problem, and several controller structures can be found in the literature [1, 44, 70, 77, 109, 115]. We mention as follows some of the notable approaches. Linear state feedback $u = Kx$ has been proposed in several works [1, 77]. Quadratic controller has been considered in [44, 77, 109], and improvements have been provided in the literature (see [23, 115] for normalized quadratic control methods). In

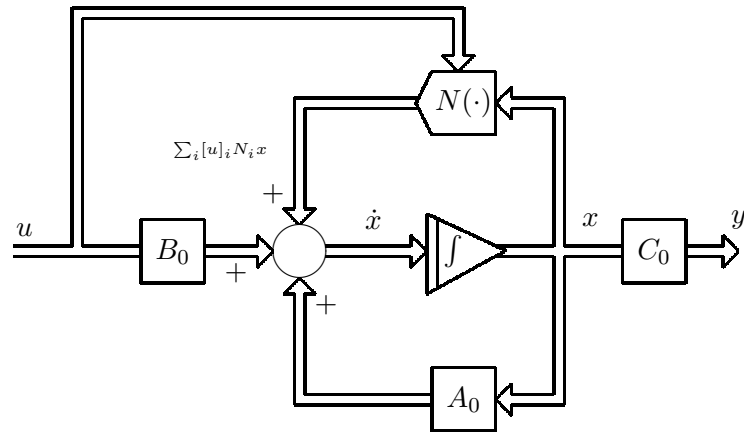

FIGURE 2.1: Bilinear system state diagram.

[70, 77] a discontinuous bang-bang controller has been proposed. In the special case of dyadic bilinear systems $\dot{x} = A_0 x + \sum_{i=1}^m b_i (c_i^T x + 1)u$, several authors have considered stabilization using the so-called division controllers [24, 44]. In [55], necessary and sufficient conditions for the global asymptotic stabilization by using a homogeneous feedback is provided for a class of bilinear systems (with scalar multiplicative control and no additive control). Sliding mode control has also been applied, see for example [119]. In [58], a polynomial static output feedback controller has been proposed, with a guaranteed upper bound of a performance index. Global asymptotic stabilization using a hybrid controller has been proposed in [3]. Finally, stabilisation of bilinear discrete-time systems using polyhedral Lyapunov functions, has been considered in [6].

2.3.1 Linear state-feedback control

The linear state feedback is an interesting solution because of its simplicity [1]. It is easily implemented, and several results address the problem of finding such controllers. Unfortunately, in nontrivial cases it has been shown that it is usually impossible to stabilize globally the bilinear systems with linear feedback control [77] (page. 39). As a matter of fact, in the scalar case ($n = 1$), it is impossible. For planar single-input systems ($n = 2, m = 1$), necessary and sufficient conditions are given in [65]. To our best knowledge, the problem is not fully analyzed yet for $n > 2$.

Recently in [1, 2, 120], numerically tractable conditions have allowed for the design of a linear state feedback controller that ensures local asymptotic stabilization.

Theorem 2.1 ([1]). *Given the system (2.1) and the polytope containing the origin:*

$$\mathcal{P}_c = \text{conv}\{x_1, x_2, \dots, x_p\} \quad (2.2)$$

$$= \{x \in \mathbb{R}^n : a_j^T x \leq 1, j = 1, 2, \dots, r\}. \quad (2.3)$$

Then, a controller:

$$u(t) = Kx(t), \quad K \in \mathbb{R}^{m \times n},$$

which guarantees the asymptotic stability of the resulting closed-loop system, can be found if there exist scalars γ and c , a symmetric matrix $P \in \mathbb{R}^{n \times n}$, and a matrix $W \in \mathbb{R}^{m \times n}$ such that

$$0 < \gamma < 1,$$

$$c > 0,$$

$$P > 0,$$

$$\begin{bmatrix} 1 & \gamma a_j^T P c \\ c P a_j \gamma & P c \end{bmatrix} \geq 0, \quad j = 1, 2, \dots, r,$$

$$\begin{bmatrix} 1 & x_i^T \\ x_i & cP \end{bmatrix} \geq 0, \quad i = 1, 2, \dots, p,$$

$$\gamma(A_0 P + P A_0^T) + \gamma(B_0 W + W^T B_0^T) + \begin{bmatrix} x_i^T N_1 \\ x_i^T N_2 \\ \vdots \\ x_i^T N_m \end{bmatrix} W$$

$$+ W^T \begin{bmatrix} N_1^T x_i & N_2^T x_i & \dots & N_m^T x_i \end{bmatrix} < 0,$$

$$i = 1, 2, \dots, p.$$

The controller is given by $K = W P^{-1}$ and \mathcal{P}_c belongs to the domain of attraction of the equilibrium.

The LMI conditions depend on the vertices of the convex polytope \mathcal{P}_c (2.2), and the dual representation (2.3) where the polytope is presented by r hyperplanes. The proposed conditions are sufficient only for the local stabilization. Note that the above LMI conditions require the pair (A_0, B_0) to be asymptotically stabilizable. However, this condition is not necessary for the stabilization of bilinear systems. This can be seen in following example.

Example 2.1.

$$\dot{x} = A_0 x + B_0 u + u N x, \quad u = K x,$$

with

$$A_0 = \begin{bmatrix} -1 & 0 \\ 0 & 0 \end{bmatrix}; B_0 = \begin{bmatrix} 0 \\ 0 \end{bmatrix}; N = \begin{bmatrix} 0 & -1 \\ 1 & 0 \end{bmatrix}; K = \begin{bmatrix} 0 & 1 \end{bmatrix}$$

is equivalent to:

$$\begin{cases} \dot{x}_1 = -x_1 - x_2^2, \\ \dot{x}_2 = x_1 x_2. \end{cases}$$

Even though the pair (A_0, B_0) is not stabilizable, the system is still shown to be asymptotically stable using center manifold method ¹.

In spite of this academic example, this state feedback design strategy has shown its interest in practical applications [1, 91]. The question now is how to guarantee the stability of the closed loop with a discrete controller implementation.

2.4 Problem formulation

Consider the bilinear system (2.1). We suppose that the following assumptions hold:

A1 The control is a piecewise-constant control law

$$u(t) = Kx(t_k), \quad \forall t \in [t_k, t_{k+1}),$$

with a set of sampling instants $\{t_k\}_{k \in \mathbb{N}}$ satisfying:

$$0 < \epsilon \leq t_{k+1} - t_k \leq \bar{h}, \quad \forall k \in \mathbb{N}, \quad (2.4)$$

where \bar{h} is a given MASP.

A2 The pair A_0, B_0 is stabilizable, and the linear feedback gain $K \in \mathbb{R}^{m \times n}$ is calculated so that the system (2.1) with the continuous state feedback $u(t) = Kx(t)$ has a locally asymptotically stable equilibrium point at $x = 0$. The actual domain of attraction (a connected neighborhood of $x = 0$, see [41]) is denoted \mathcal{D}_0 .

A3 The state variables are subject to constraints defined by a polytopic set $\mathcal{P} \subset \mathcal{D}_0$:

$$\mathcal{P} = \text{conv}\{x_1, x_2, \dots, x_p\} \quad (2.5)$$

$$= \{x \in \mathbb{R}^n : a_j^T x \leq 1, j = 1, 2, \dots, r\} \quad (2.6)$$

corresponding to an admissible set in the state-space ².

¹Jean-Pierre Richard, Lecture Notes: Systèmes Dynamiques, http://researchers.lille.inria.fr/~jrichard/pdfs/SystDynJPR2009_part3.pdf

²The equivalence between the representations in (2.5) and (2.6) is given in [26] (Theorem 1.29).

Under these assumptions, we obtain the closed-loop sampled-data system:

$$\dot{x}(t) = \left(A_0 + \sum_{i=1}^m [Kx(t_k)]_i N_i \right) x(t) + B_0 K x(t_k), \quad \forall t \in [t_k, t_{k+1}), \quad \forall k \in \mathbb{N}. \quad (2.7)$$

System (2.7) may also be written as follows

$$\dot{x}(t) = \tilde{A}[x(t), e(t)]x(t) + B e(t), \quad \forall t \in [t_k, t_{k+1}) \quad (2.8)$$

with

$$\begin{aligned} e(t) &= x(t_k) - x(t), \\ \tilde{A}[x, e] &:= A_0 + B_0 K + \sum_{i=1}^m [K(x + e)]_i N_i, \end{aligned} \quad (2.9)$$

and

$$B = B_0 K. \quad (2.10)$$

The goal of the chapter is twofold. First, we would like to ensure that the obtained sampled-data system satisfies the state-space constraints (2.5) or (2.6) for any $x_0 \in \mathcal{P}$. Secondly, we would like to provide conditions that guarantee the asymptotic convergence of the system solutions to the origin.

Problem: *Find a criterion for the local asymptotic stability of the equilibrium point $x = 0$ of the bilinear sampled-data system (2.7), together with an estimate $\mathcal{E} \subset \mathcal{P}$ of the domain of attraction, such that for any initial condition $x(t_0) \in \mathcal{E}$ the system solutions satisfy $x(t) \in \mathcal{P}$, $\forall t > t_0$, and $x(t) \rightarrow 0$.*

2.5 Hybrid system framework

Several works about sampled-data systems [19, 33, 88] adopt the hybrid systems framework [40]. A hybrid system \mathcal{H} is a tuple $(\mathcal{A}, \mathcal{B}, F, G)$, where $\mathcal{A} \subseteq \mathbb{R}^n$ and $\mathcal{B} \subseteq \mathbb{R}^n$ are, respectively, the *flow set* and the *jump set*, while $F : \mathbb{R}^n \rightarrow \mathbb{R}^n$ and $G : \mathbb{R}^n \rightarrow \mathbb{R}^n$ are, respectively, the *flow map* and *jump map*. The hybrid system is usually represented by:

$$\mathcal{H} : \begin{cases} \dot{\xi} &= F(\xi) & \xi \in \mathcal{A} \\ \xi^+ &= G(\xi) & \xi \in \mathcal{B} \end{cases}$$

The dynamics given by F , determines the continuous-time evolution (flow) of the state through \mathcal{A} , while G determines the discrete-time evolution (jumps) in \mathcal{B} . See [40] for more details about hybrid dynamical systems.

In Section 1.6.1.4, it has been shown how the sampled-data system (1.47) can be represented by a hybrid model (1.50). In a similar way, we fit the sampled-data system (2.7) into a hybrid model. The system (2.7) is formulated similarly to (1.47) as follows:

$$\begin{aligned}
\dot{x} &= A_0x(t) + \sum_{i=1}^m u_i(t)N_ix(t) + B_0u(t), & t \in [t_k, t_{k+1}), \\
y &= x, \\
u &= K\hat{y}, \\
\dot{\hat{y}} &= 0, & t \in [t_k, t_{k+1}), \\
\hat{y}(t_k^+) &= y(t_k).
\end{aligned} \tag{2.11}$$

The hybrid model for this case is determined by

$$\left. \begin{aligned}
\dot{x} &= f(x, e) = \tilde{A}[x, e]x + Be \\
\dot{e} &= g(x, e) = -\tilde{A}[x, e]x - Be \\
\dot{\tau} &= 1
\end{aligned} \right\} \tau \in [0, \bar{h})$$

$$\left. \begin{aligned}
x^+ &= x \\
e^+ &= 0 \\
\tau^+ &= 0
\end{aligned} \right\} \tau \in [\epsilon, \bar{h}] \tag{2.12}$$

with $\tilde{A}[x, e]$ and B given in (2.9) and (2.10), and ϵ given in (2.4). Note that in contrast to the general case model, there is no \hat{u} in (2.11). This is due to the fact that the considered controller is a static one. In this case, we may consider only one ZOH mechanism in the input side of the controller.

For the hybrid system (2.12), we are only interested in stability with respect to the variables x and e . We consider the following definition of stability with respect to the set $\{(x, e, \tau) : x = 0, e = 0\}$, adapted from [88].

Definition 2.2. Consider the hybrid system (2.12). The set $\{(x, e, \tau) : x = 0, e = 0\}$ is *uniformly asymptotically stable (UAS)* if there exist $\Delta > 0$ and $\beta \in \mathcal{KL}$ such that for each initial condition $\tau(t_0) \in \mathbb{R}_+$, $|(x(t_0), e(t_0))| \leq \Delta$:

$$\left\| \begin{bmatrix} x(t) \\ e(t) \end{bmatrix} \right\| \leq \beta \left(\left\| \begin{bmatrix} x(t_0) \\ e(t_0) \end{bmatrix} \right\|, t \right), \quad \forall t \geq t_0. \tag{2.13}$$

2.6 Local stability and MASP estimation

In this section, we provide sufficient stability conditions for the considered case of sampled-data bilinear systems (2.7), or equivalently (2.12). The conditions are used to estimate an upper bound on the MASP. Two methods are to be considered. First, we introduce a method that is based on the application of results for general nonlinear sampled-data systems in [88] (Method 1). Next, to avoid the use of conservative

bounds in the previous method, we look directly for an underlying Lyapunov function by formalizing the conditions as LMIs (Method 2). In both of these methods, we will be dealing with local asymptotic stability. Consider the the polytope \mathcal{P} defined in (2.5). If $x(t_k)$ is in the polytope \mathcal{P} , then

$$A[x(t_k)] := \tilde{A}[x(t), e(t)] \in \text{conv}\{A_1, A_2, \dots, A_p\},$$

with

$$A_q = A[x_q] \quad \forall q \in \{1, 2, \dots, p\}. \quad (2.14)$$

Note that the set of barycentric coordinates that determine $x(t_k)$ with respect to the vertex of the polytope \mathcal{P} , determine also $A[x(t_k)]$ with respect to the vertices in (2.14). This is due to the linearity of $A[x(t_k)]$ in $x(t_k)$, and it can be seen as follows. If $x(t_k) \in \mathcal{P}$, then there exist positive scalars

$$\{\lambda_q(t_k)\}_{q=1}^p, \quad \sum_{q=1}^p \lambda_q = 1 \quad (2.15)$$

such that

$$x(t_k) = \sum_{q=1}^p \lambda_q x_q$$

hence

$$\begin{aligned} \sum_{q=1}^p \lambda_q A_q &= \sum_{q=1}^p \lambda_q \left(A_0 + B_0 K + \sum_{i=1}^m [K x_q]_i N_i \right) \\ &= A_0 + B_0 K + \sum_{i=1}^m \left[K \left(\sum_{q=1}^p \lambda_q x_q \right) \right]_i N_i \\ &= A[x(t_k)]. \end{aligned}$$

2.6.1 Method 1: adaptation of a result on general nonlinear sampled-data systems

The following theorem proposes stability conditions using an adaptation of the results in [88] for the case of bilinear systems.

Theorem 2.3. *Consider the bilinear sampled-data system (2.12), the polytope \mathcal{P} in (2.5), the notations (2.14) and a function*

$$\mathcal{T}(\gamma, L) := \begin{cases} \frac{1}{Lr} \arctan(r) & \gamma > L \\ \frac{1}{L} & \gamma = L \\ \frac{1}{Lr} \operatorname{arctanh}(r) & \gamma < L \end{cases} \quad (2.16)$$

with

$$r = \sqrt{\left| \frac{\gamma^2}{L^2} - 1 \right|} \quad (2.17)$$

where L is given by

$$L = \frac{1}{2} \max\{-\lambda_{\min}(B^T + B), 0\} \quad (2.18)$$

and γ is the solution to the following optimization problem:

$$\gamma = \min \gamma' \quad (2.19)$$

satisfying the constraints $\exists P \in \mathbb{R}^{n \times n}$ a symmetric positive definite matrix, $\exists \gamma' > 0$ and $\exists \alpha > 0$, such that

$$M_{lj} = \begin{bmatrix} A_l^T P + P A_l + \frac{1}{2}(A_l^T A_j + A_j^T A_l) + \alpha I & P B \\ * & (\alpha - \gamma'^2) I \end{bmatrix} < 0, \quad (2.20)$$

$$\forall l, j \in \{1, 2, \dots, p\},$$

where A_l and A_j are the vertices given in (2.14). Assume that the MASP is strictly bounded by $\mathcal{T}(\gamma, L)$, i.e. $\bar{h} < \mathcal{T}(\gamma, L)$. Then, for the bilinear sampled-data system (2.12), the set $\{(x, e, \tau) : x = 0, e = 0\}$ is locally uniformly asymptotically stable.

Proof. This proof is mainly based on an adaptation of Theorem 1 in [88] to the bilinear case.

Let $\phi : [0, \tilde{T}] \rightarrow \mathbb{R}$ be the solution to

$$\dot{\phi} = -2L\phi - \gamma(\phi^2 + 1) \quad \phi(0) = \lambda^{-1} \quad (2.21)$$

where $\lambda \in (0, 1)$. We recall the following result.

Claim 2.6.1. [19] $\phi(\tau) \in [\lambda, \lambda^{-1}]$ for all $\tau \in [0, \tilde{T}]$. Moreover, we have that $\phi(\tilde{T}) = \lambda$ for \tilde{T} given by

$$\tilde{T}(\lambda, \gamma, L) := \begin{cases} \frac{1}{Lr} \arctan\left(\frac{r(1-\lambda)}{2\frac{\lambda}{1+\lambda}(\frac{\gamma}{L}-1)+1+\lambda}\right) & \gamma > L \\ \frac{1}{L} \frac{1-\lambda}{1+\lambda} & \gamma = L \\ \frac{1}{Lr} \operatorname{arctanh}\left(\frac{r(1-\lambda)}{2\frac{\lambda}{1+\lambda}(\frac{\gamma}{L}-1)+1+\lambda}\right) & \gamma < L \end{cases} \quad (2.22)$$

with r is given in (2.17).

Consider the following notations

$$\xi := [x^T, e^T, \tau]^T, \quad (2.23)$$

$$F(\xi) := [f(x, e)^T, g(x, e)^T, 1]^T. \quad (2.24)$$

Note that $\tilde{T}(\lambda, \gamma, L)$ in (2.22) and $\mathcal{T}(\gamma, L)$ in (2.16) satisfy $\mathcal{T}(\gamma, L) = \tilde{T}(0, \gamma, L)$, and for a fixed L and γ we have that $\tilde{T}(\cdot, \gamma, L)$ is strictly decreasing. Hence, since the conditions of the theorem require \bar{h} to be strictly smaller than $\mathcal{T}(\gamma, L)$, there exists $\lambda \in (0, 1)$ such that $\bar{h} = \tilde{T}(\lambda, \gamma, L)$. For the considered value of λ , define the function

$$U(\xi) = V(x) + \gamma\phi(\tau)W^2(e) \quad (2.25)$$

with a quadratic function $V(x) = x^T P x$, and $W(e) = |e|$. The function $U(\xi)$ will be used as a Lyapunov function. Note that

$$\lambda_{\min}(P)|x|^2 + \lambda\gamma|e|^2 \leq U(\xi) \leq \lambda_{\max}(P)|x|^2 + \lambda^{-1}\gamma|e|^2. \quad (2.26)$$

The Lyapunov function is non-increasing at sampling instants as it can be seen from the following

$$\begin{aligned} U(\xi^+) &= V(x^+) + \gamma\phi(\tau^+)W^2(e^+) \\ &= V(x) \\ &\leq V(x) + \gamma\phi(\tau)W^2(e) = U(\xi). \end{aligned} \quad (2.27)$$

In order to treat the quantity $\langle \nabla U(\xi), F(\xi) \rangle$ we need two inequalities that correspond to both $\langle \frac{\partial W(e)}{\partial e}, g(x, e) \rangle$ and $\langle \nabla V(x), f(x, e) \rangle$. We get the first inequality as follows:

$$\begin{aligned} \left\langle \frac{\partial W(e)}{\partial e}, g(x, e) \right\rangle &= \frac{e^T(t)}{W(e)} [-A[x(t_k)]x(t) - B e(t)] \\ &= -\frac{1}{2W(e)} e^T(t) (B^T + B) e(t) - \frac{1}{W(e)} e^T A[x(t_k)]x(t) \\ &\leq \frac{1}{2} \max\{-\lambda_{\min}(B^T + B), 0\} W(e) + |A[x(t_k)]x(t)| \end{aligned}$$

$$\left\langle \frac{\partial W(e)}{\partial e}, g(x, e) \right\rangle \leq L W(e) + H(x, e) \quad (2.28)$$

with

$$H(x(t), e(t)) = |\tilde{A}[x(t), e(t)]x(t)| = |A[x(t_k)]x(t)|. \quad (2.29)$$

and L given in (2.18).

In order to obtain the second inequality, consider

$$\begin{aligned}
\langle \nabla V(x), f(x, e) \rangle &= \dot{x}^T P x + x^T P \dot{x} \\
&= x^T A^T[x(t_k)] P x + x^T P A[x(t_k)] x \\
&\quad + x^T P B e + e^T B^T P x.
\end{aligned} \tag{2.30}$$

Note that by multiplying the LMIs in (2.20) each by the appropriate coefficients $\lambda_l(t_k)$ from (2.15), and then taking the sums over $l \in \{1, 2, \dots, p\}$ we obtain

$$\begin{bmatrix} A^T[x(t_k)]P + PA[x(t_k)] + \frac{1}{2}(A^T[x(t_k)]A_j + A_j^T A[x(t_k)]) + \alpha I & PB \\ * & (\alpha - \gamma^2)I \end{bmatrix} < 0,$$

$\forall j \in \{1, 2, \dots, p\}$. Similarly, by multiplying the resulting inequalities by $\lambda_j(t_k)$, and taking the sum we get

$$\begin{bmatrix} A^T[x(t_k)]P + PA[x(t_k)] + A^T[x(t_k)]A[x(t_k)] + \alpha I & PB \\ B^T P & (\alpha - \gamma^2)I \end{bmatrix} < 0. \tag{2.31}$$

Define the continuous, positive definite function $\varrho(s) = \alpha s^2$. From (2.31) and (2.30) the following inequality will be satisfied locally inside the addressed polytopic region

$$\langle \nabla V(x), f(x, e) \rangle < -\varrho(|x|) - \varrho(W(e)) - H^2(x, e) + \gamma^2 W^2(e). \tag{2.32}$$

From (2.28) and (2.32) we have

$$\begin{aligned}
\langle \nabla U(\xi), F(\xi) \rangle &< -\varrho(|x|) - \varrho(W(e)) - H^2(x, e) + \gamma^2 W^2(e) \\
&\quad + 2\gamma\phi(\tau)W(e)(LW(e) + H(x, e)) \\
&\quad - \gamma W^2(e)(2L\phi(\tau) + \gamma(\phi^2(\tau) + 1)) \\
&< -\varrho(|x|) - \varrho(W(e)) - H^2(x, e) \\
&\quad + 2\gamma\phi(\tau)W(e)H(x, e) - \gamma^2 W^2(e)\phi^2(\tau)
\end{aligned}$$

yielding

$$\langle \nabla U(\xi), F(\xi) \rangle < -\varrho(|x|) - \varrho(W(e)). \tag{2.33}$$

The local stability is straightforward, since $\varrho(\cdot)$ is positive definite.

□

Remark 2.4. In this method, the MASP is calculated by the expression (2.16), based on L and γ . L is calculated analytically, whereas γ is found by solving LMI conditions. The optimization problem is a minimization of γ' because for any constant L , $\mathcal{T}(\cdot, L)$ is a strictly decreasing function.

Remark 2.5. Note that since γ does not depend on L , and from the continuity of $\mathcal{T}(\gamma, \cdot)$:

$$\mathcal{T}(\gamma, 0) = \lim_{L \rightarrow 0} \mathcal{T}(\gamma, L) = \lim_{L \rightarrow 0} \frac{\arctan(\sqrt{|\frac{\gamma^2}{L^2} - 1|})}{\sqrt{|\gamma^2 - L^2|}} = \frac{\pi}{2\gamma}.$$

Remark 2.6. The stability conditions presented in this theorem are based on the generic inequalities (2.32), (2.28) for nonlinear system presented in [88]. Our contribution is to provide a constructive manner to apply this result to the case of bilinear systems. We provide explicit forms of $H(x, e)$, $W(e)$, $V(x)$, and we find L , γ that gives the upper bound on MASP. We provide as well, an LMI formulation that allows us to obtain sufficient stability condition. Note that in order to obtain LMI based stability conditions the approach has been adapted to the bilinear case: the function $H(\cdot, \cdot)$ used here has been modified to depend both on the error $e(t)$ and the state $x(t)$, while in [88] it is only a function of x .

2.6.2 Method 2: direct Lyapunov function approach

In the previous method, the stability conditions are obtained using upper estimations of the derivative of a Lyapunov function in (2.28) and (2.32). Such upper estimations may be found conservative. In order to avoid them, we provide as follows a second method which evaluates directly the derivative of the Lyapunov function.

Theorem 2.7. *Consider the bilinear sampled-data system (2.12). Suppose that MASP is bounded by a value \mathcal{T} , i.e. $\bar{h} \leq \mathcal{T}$. Assume that there exist symmetric positive definite matrices $P, Q, X, Y \in \mathbb{R}^{n \times n}$, such that the following LMIs are satisfied*

$$\begin{bmatrix} A_l^T P + P A_l + X & P B - A_l^T Q \\ * & -B^T Q - Q B - \frac{1}{\tau} Q + Y \end{bmatrix} < 0, \quad \forall l \in \{1, 2, \dots, p\}. \quad (2.34)$$

$$\begin{bmatrix} A_l^T P + P A_l + X & PB - A_l^T Q \exp(-1) \\ * & [-B^T Q - QB - \frac{1}{T} Q] \exp(-1) + Y \end{bmatrix} < 0, \\ \forall l \in \{1, 2, \dots, p\}. \end{bmatrix} \quad (2.35)$$

where A_l are the vertices in given in (2.14). Then the set $\{(x, e, \tau) : x = 0, e = 0\}$ of the bilinear sampled-data system (2.12) is locally uniformly asymptotically stable.

Proof. We consider the function

$$U'(\xi) = V'(x) + W'(\tau, e) \quad (2.36)$$

with $V'(x) = x^T P x$, and $W'(\tau, e) = \exp(\frac{-\tau}{T}) e^T Q e$. We recall the notations ξ and $F(\xi)$ defined as in (2.23), (2.24). This Lyapunov function will be used to prove the stability of the hybrid system (2.12). It is inspired by the Lyapunov functions from [88] and [19].

From the fact that $P > 0$, $Q > 0$, we have that $U'(\xi)$ satisfies

$$U'(\xi) \geq \lambda_{\min}(P)|x|^2 + \lambda_{\min}(Q) \exp(-1)|e|^2, \quad (2.37)$$

$$U'(\xi) \leq \lambda_{\max}(P)|x|^2 + \lambda_{\max}(Q)|e|^2. \quad (2.38)$$

At sampling instants, $U'(\xi)$ is non increasing

$$\begin{aligned} U'(\xi^+) &= V'(x^+) + W'(\tau^+, e^+) \\ &= x^T P x \\ &\leq x^T P x + W'(\tau, e) = U'(\xi). \end{aligned} \quad (2.39)$$

In order to study the derivative of $U'(\xi)$, we note that

$$\begin{aligned} \langle \nabla U'(\xi), F(\xi) \rangle &= \dot{x}^T P x + x^T P \dot{x} - \frac{1}{T} e^T [Q \exp(\frac{-\tau}{T})] e \\ &\quad + \dot{e}^T [Q \exp(\frac{-\tau}{T})] e + e^T [Q \exp(\frac{-\tau}{T})] \dot{e}. \end{aligned}$$

by replacing \dot{x} and \dot{e} from (2.12) we have that

$$\begin{aligned} \langle \nabla U'(\xi), F(\xi) \rangle &= x^T A^T [x(t_k)] P x + x^T P A [x(t_k)] x + e^T B^T P x + x^T P B e \\ &\quad - x^T A^T [x(t_k)] [Q \exp(\frac{-\tau}{T})] e - e^T [Q \exp(\frac{-\tau}{T})] A [x(t_k)] x \\ &\quad - e^T (B^T Q + Q B + \frac{Q}{T}) \exp(\frac{-\tau}{T}) e \end{aligned}$$

and we can write the following matrix form

$$\langle \nabla U'(\xi), F(\xi) \rangle + x^T X x + e^T Y e = \quad (2.40)$$

$$\begin{bmatrix} x \\ e \end{bmatrix}^T \begin{bmatrix} A[x(t_k)]^T P + PA[x(t_k)] + X & PB - A[x(t_k)]^T Q \exp(-\frac{\tau}{T}) \\ * & [-B^T Q - QB - \frac{Q}{T}] \exp(-\frac{\tau}{T}) + Y \end{bmatrix} \begin{bmatrix} x \\ e \end{bmatrix}. \quad (2.41)$$

By multiplying the LMIs in (2.34) and (2.35) by the appropriate coefficients $\lambda_l(t_k)$ from (2.15), and taking the sums over each of the resulting inequalities we obtain

$$M_{\mu_1} = \begin{bmatrix} A^T[x(t_k)]P + PA[x(t_k)] + X & PB - A^T[x(t_k)]Q \\ * & [-B^T Q - QB - \frac{1}{T}Q] + Y \end{bmatrix} < 0, \quad (2.42)$$

$$M_{\mu_2} = \begin{bmatrix} A^T[x(t_k)]P + PA[x(t_k)] + X & PB - A^T[x(t_k)]Q \exp(-1) \\ * & [-B^T Q - QB - \frac{1}{T}Q] \exp(-1) + Y \end{bmatrix} < 0. \quad (2.43)$$

For any $\tau \in [0, T]$, we have that $\exp(-\tau/T) \in [\exp(-1), 1]$. Finally from (2.42), (2.43) and (2.40) there exists then $\theta(\tau) \in [0, 1]$ such that

$$\langle \nabla U'(\xi), F(\xi) \rangle + x^T X x + e^T Y e = \begin{bmatrix} x \\ e \end{bmatrix}^T [\theta(\tau)M_{\mu_1} + (1 - \theta(\tau))M_{\mu_2}] \begin{bmatrix} x \\ e \end{bmatrix} < 0.$$

This yields

$$\langle \nabla U'(\xi), F(\xi) \rangle < -x^T X x - e^T Y e, \quad \forall \tau \in [0, T]. \quad (2.44)$$

From (2.38) we have that for any $\sigma > 0$,

$$-\sigma U' \geq -\sigma \lambda_{max}(P)|x|^2 - \sigma \lambda_{max}(Q)|e|^2. \quad (2.45)$$

Moreover, from the fact that $X > 0$, $Y > 0$ we have

$$-x^T X x - e^T Y e \leq -\lambda_{min}(X)|x|^2 - \lambda_{min}(Y)|e|^2. \quad (2.46)$$

If σ satisfies

$$0 < \sigma \leq \min \left\{ \frac{\lambda_{min}(Y)}{\lambda_{max}(Q)}, \frac{\lambda_{min}(X)}{\lambda_{max}(P)} \right\} \quad (2.47)$$

then from (2.44), (2.45) and (2.46),

$$\begin{aligned} \langle \nabla U'(\xi), F(\xi) \rangle &< -x^T X x - e^T Y e \\ &\leq -\sigma \lambda_{\max}(P) |x|^2 - \sigma \lambda_{\max}(Q) |e|^2 \\ &\leq -\sigma U'. \end{aligned} \tag{2.48}$$

Asymptotic stability follows using standard Lyapunov arguments. \square

Remark 2.8. In this method the MASP is found by solving a set of LMIs for the maximum value possible of \mathcal{T} . The existence of a solution to the LMI conditions, guarantees the existence of a Lyapunov function that will yield the asymptotic stability. Note that the proposed conditions directly study the derivative of the Lyapunov function. Numerical examples will show the conservatism reduction in comparison with the approach in Method 1. Note that both the approach of Method 1 and Method 2 are robust not only to the sampled-data implementation but also to variations of the sampling intervals.

Remark 2.9. Note that the local asymptotic stability of the hybrid system (2.12) implies the local asymptotic stability of (2.7). As a matter of fact, the established asymptotic stability is local in both Method 1 and Method 2, since the inequalities (2.33) and (2.48) are satisfied only inside the studied polytope \mathcal{P} . Moreover, one can find an invariant set $\mathcal{E} \in \mathcal{P}$, such that for $x(t_0) \in \mathcal{E}$ one has $|(x(t_0), e(t_0))| = |(x(t_0), 0)| \leq \Delta$ for some $\Delta > 0$, for which the inequality (2.13) is satisfied.

2.7 Numerical example

In this section we present a numerical comparison of the two proposed methods. Consider the example of bilinear systems in [2] and [120], where a continuous-time state feedback controllers has been computed in order to locally stabilize the bilinear system. The system is described by the matrices

$$A_0 = \begin{bmatrix} -0.5 & 1.5 & 4 \\ 4.3 & 6.0 & 5.0 \\ 3.2 & 6.8 & 7.2 \end{bmatrix}; \quad B_0 = \begin{bmatrix} -0.7 & -1.3 \\ 0 & -4.3 \\ 0.8 & -1.5 \end{bmatrix}$$

$$N_1 = \begin{bmatrix} -1 & 0 & 0 \\ 0 & 0 & 0 \\ 0 & 0 & 0 \end{bmatrix}; \quad N_2 = \begin{bmatrix} 0 & 1 & 0 \\ 0 & 0 & 0 \\ 0 & 0 & 0 \end{bmatrix}.$$

In [120], the linear state feedback

$$K = \begin{bmatrix} 0.0016 & 0.0035 & 0.0034 \\ 2.2404 & 3.2676 & 5.9199 \end{bmatrix}$$

was proven to establish the local stability for the bilinear system (in the continuous-time case), inside an ellipsoidal region \mathcal{D}_0 . We consider a local polytopic region $\mathcal{P} \subset \mathcal{D}_0$

$$\mathcal{P} = [-1.35, +1.35] \times [-0.75, +0.75] \times [-0.65, +0.65].$$

Using Method 1, we found that the system is locally stable if $\bar{h} < \mathcal{T} = 2.7 \times 10^{-3}$. This was calculated from (2.16) for $L = 29.79$, and $\gamma = 563.3$. The other variables in the optimization problem were $\alpha = 5.84$, and

$$P = \begin{bmatrix} 281.3 & 210.6 & 882.2 \\ 210.6 & 622 & 565.1 \\ 882.2 & 565.1 & 3688.3 \end{bmatrix}.$$

Using Method 2, we found that the sampled-data system is locally stable for a larger MASP $\bar{h} \leq \mathcal{T} = 12 \times 10^{-3}$. The LMIs in (2.34) and (2.35) have a solution for this value of MASP with

$$P = \begin{bmatrix} 1.2722 & 0.5769 & 3.8769 \\ 0.5769 & 2.4533 & 1.1283 \\ 3.8769 & 1.1283 & 16.9212 \end{bmatrix} \quad Q = \begin{bmatrix} 5.6140 & 8.1180 & 14.7162 \\ 8.1180 & 12.0092 & 21.2460 \\ 14.7162 & 21.2460 & 39.7534 \end{bmatrix}$$

$$X = \begin{bmatrix} 0.4274 & 0.7044 & 0.8281 \\ 0.7044 & 1.1646 & 1.3662 \\ 0.8281 & 1.3662 & 1.6119 \end{bmatrix} \quad Y = \begin{bmatrix} 0.0356 & -0.0081 & -0.0187 \\ -0.0081 & 0.3417 & -0.1550 \\ -0.0187 & -0.1550 & 1.0122 \end{bmatrix}$$

The results illustrate the reduction of conservatism in Method 2 with respect to Method 1. Simulations show that the system is unstable for a larger sampling intervals. However, it is not clear how to improve the method in order to obtain a larger estimate of the MASP.

2.8 Conclusion

In this chapter, we have provided sufficient conditions for the local stability of bilinear sampled-data systems, controlled via a linear state feedback controller. We presented results for estimating the MASP that guarantees the local stability of the system. Two methods which are based on a hybrid system approach were considered. The first method is an adaptation of results on the general nonlinear case, while the second one is based on a direct search of a Lyapunov function for the hybrid model. The stability conditions, in both methods, were given in the form of LMIs, which are easily computationally tractable. The results were illustrated by a numerical example.

Chapter 3

Stability of bilinear sampled-data systems - dissipativity approach

3.1 Introduction

This chapter considers the problem of local stability of bilinear systems with aperiodic sampled-data linear state feedback control. This problem has been considered in Chapter 2, and we intend to address it using a new approach in this chapter. The method is based on the analysis of contractive invariant sets, and it is inspired by the dissipativity theory.

The notion of dissipativity was introduced by [124]. Since its introduction, the dissipativity theory has been attracting an increasing attention. It can be used to study stability, passivity, robustness and other analysis and design problems. It was motivated by passivity properties of electrical circuits, and it can be seen as a generalized notion of abstract energy for dynamical systems. See the Appendix A for more details.

In this chapter, local stability of bilinear sampled-data systems will be investigated via an invariance property of some ellipsoidal sets [64], [11]. The proposed method is inspired by the results of [39] for the linear case, and by the dissipativity theory [124, 125]. State-space constraints are easily included in the analysis. It will be proven that the invariance property leads to local asymptotic stability, and the region of attraction will be estimated by a certain level surface of a quadratic function, which can be interpreted as a discrete-time Lyapunov function. An LMI optimization allows for choosing, among quadratic Lyapunov functions, the one which maximizes the MASP. The results are illustrated by means of numerical examples.

This chapter is organized as follows. Technical lemmas are presented in Section 3.2. Sufficient conditions for the invariance and the local stability are given in Section 3.3. Finally, the results are illustrated by means of two examples in Section 3.4.

3.2 Technical preliminaries

Consider again the problem formulation from Section 2.4. The bilinear system

$$\dot{x}(t) = A_0x(t) + \sum_{i=1}^m [u(t)]_i N_i x(t) + B_0 u(t), \quad \forall t > t_0, \quad x(t_0) = x_0,$$

with a sampled data state feedback $u(t) = Kx(t_k)$ from equation (2.7), can be written as follows:

$$\dot{x}(t) = \underbrace{\left(A_0 + B_0 K + \sum_{i=1}^m [Kx(t_k)]_i N_i \right)}_{:=A(x(t_k))} x(t) + \underbrace{B_0 K}_{:=B} \underbrace{(x(t_k) - x(t))}_{:=w(t)}. \quad (3.1)$$

Defining

$$C(x(t_k)) = A(x(t_k)) = A_0 + B_0 K + \sum_{i=1}^m [Kx(t_k)]_i N_i, \quad D = B = B_0 K, \quad (3.2)$$

this shows that the closed-loop bilinear sampled-data system, can be represented by the feedback connection of the system

$$\mathcal{G} := \begin{cases} \dot{x}(t) = A(x(t_k))x(t) + Bw(t), \\ y(t) = C(x(t_k))x(t) + Dw(t), \end{cases} \quad (3.3)$$

with the operator $\Delta_{sh} : y \rightarrow w$,

$$w(t) = (\Delta_{sh} y)(t) = - \int_{t_k}^t y(\tau) d\tau, \quad \forall t \in [t_k, t_{k+1}). \quad (3.4)$$

3.2.1 The properties of the operator Δ_{sh}

We recall that the operator Δ_{sh} in (3.4) has been studied in the LTI systems context, and has two important properties. The first one concerns the gain, and the second is of the passivity-type. In [74], it has been shown that the gain of the operator is bounded on L_2 and its L_2 -induced norm satisfies $\|\Delta_{sh}\| \leq \delta_0$ with $\delta_0 = \frac{2}{\pi} \bar{h}$ (see Lemma 1.7).

Moreover, it has been shown that for any $v \in L_2[0, \bar{h})$, the $L_2[0, \bar{h})$ -induced norm is also bounded by δ_0 :

$$\int_{t_k}^t (\Delta_{sh}v)^T(\tau)(\Delta_{sh}v)(\tau)d\tau \leq \delta_0^2 \int_{t_k}^t v^T(\tau)v(\tau)d\tau, \quad \forall t \in [t_k, t_{k+1}). \quad (3.5)$$

The passivity-type property is given in [39], where it is shown that for any $0 \leq Y = Y^T \in \mathbb{R}^{n \times n}$ and $v \in L_2$:

$$\langle Y \Delta_{sh}v, v \rangle = \int_0^\infty v^T(\tau)Y(\Delta_{sh}v)(\tau)d\tau \leq 0.$$

This relation is based on the fact that for any $v \in L_2[0, \bar{h})$

$$\int_{t_k}^t v^T(\tau)Y(\Delta_{sh}v)(\tau)d\tau \leq 0, \quad \forall t \in [t_k, t_{k+1}).$$

In the LTI context, the two properties lead to LMI conditions for stability, which are based on Integral Quadratic Constraints (IQC) [72], and on the Kalman-Yakubovich-Popov lemma [105]. The application of these techniques is restricted to the LTI case, and their extension to bilinear sampled-data systems is not direct. This is why we propose to use the operator's properties to define contractive invariant sets.

3.2.2 Two technical lemmas

The following technical lemmas are based on the work in [39].

Lemma 3.1. *Let Δ_{sh} be the operator defined in (3.4). Then, for any $v \in L_2[0, \bar{h})$ and $0 < X^T = X \in \mathbb{R}^{n \times n}$, the following inequality holds:*

$$\mathcal{I}_1(t) = \int_{t_k}^t \left[(\Delta_{sh}v)^T(\tau)X(\Delta_{sh}v)(\tau) - \delta_0^2 v^T(\tau)Xv(\tau) \right] d\tau \leq 0, \quad \forall t \in [t_k, t_{k+1}). \quad (3.6)$$

Proof. First of all, we note that since $X^T = X > 0$, then there exists $U \in \mathbb{R}^{n \times n}$ such that $X = U^T U$. For any $t \in [t_k, t_{k+1})$ one has

$$\mathcal{I}_1(t) = \int_{t_k}^t \left[(U(\Delta_{sh}v)(\tau))^T (U(\Delta_{sh}v)(\tau)) - \delta_0^2 (Uv(\tau))^T (Uv(\tau)) \right] d\tau.$$

From (3.4) we can see that $U(\Delta_{sh}v) = \Delta_{sh}(Uv)$, then

$$\mathcal{I}_1(t) = \int_{t_k}^t \left[((\Delta_{sh}(Uv))(\tau))^T ((\Delta_{sh}(Uv))(\tau)) - \delta_0^2 (Uv(\tau))^T (Uv(\tau)) \right] d\tau.$$

Considering the vector $z = Uv \in L_2[0, \bar{h})$, we have

$$\mathcal{I}_1(t) = \int_{t_k}^t (\Delta_{sh}z)^T(\tau)(\Delta_{sh}z)(\tau) d\tau - \delta_0^2 \int_{t_k}^t z^T(\tau)z(\tau) d\tau$$

which can be seen to be negative directly from (3.5). \square

Lemma 3.2. *Let Δ_{sh} be the operator defined in (3.4). Then, for any $v \in L_2[0, \bar{h})$ and $0 \leq Y^T = Y \in \mathbb{R}^{n \times n}$, the following inequality holds:*

$$\mathcal{I}_2(t) = \int_{t_k}^t \left[(\Delta_{sh}v)^T(\tau)Yv(\tau) + v^T(\tau)Y(\Delta_{sh}v)(\tau) \right] d\tau \leq 0, \quad \forall t \in [t_k, t_{k+1}). \quad (3.7)$$

Proof. For any $t \in (t_k, t_{k+1})$ we have $\frac{d}{dt}(\Delta_{sh}v)(t) = -v(t)$, hence

$$\begin{aligned} \mathcal{I}_2(t) &= 2 \int_{t_k}^t v^T(\tau)Y(\Delta_{sh}v)(\tau) d\tau = - \int_{t_k}^t \frac{d}{d\tau} \left((\Delta_{sh}v)^T(\tau)Y(\Delta_{sh}v)(\tau) \right) d\tau \\ &= \left[-(\Delta_{sh}v)^T(\tau)Y(\Delta_{sh}v)(\tau) \right]_{t_k}^t = -(\Delta_{sh}v)^T(t)Y(\Delta_{sh}v)(t) \leq 0. \end{aligned}$$

\square

3.3 Stability results

In this section we give first a useful generic lemma concerning the positive invariance of nonlinear sampled-data systems, controlled by a linear state feedback. Then we provide the LMI conditions for the stability of bilinear sampled-data systems.

3.3.1 Invariance property

In the following, we derive sufficient conditions for the positive invariance (see [64]) of some sub-level sets for a class of nonlinear sampled-data systems:

$$\begin{cases} \dot{x}(t) = f_k(x(t)) + g_k(x(t))Kx(t_k), & \forall t \in [t_k, t_{k+1}), \quad \forall k \in \mathbb{N}, \quad t > t_0, \\ x(t_0) = x_0, \end{cases} \quad (3.8)$$

where $K \in \mathbb{R}^{m \times n}$ is the linear feedback gain and, for any $k \in \mathbb{N}$, $f_k : \mathbb{R}^n \rightarrow \mathbb{R}^n$ and $g_k : \mathbb{R}^n \rightarrow \mathbb{R}^{n \times m}$ are Lipschitz continuous functions¹. We also suppose that the state of system (3.8) does not exhibit impulsive behaviors at the sampling instants, thus the solution is everywhere continuous. The set of sampling instants $\{t_k\}_{k \in \mathbb{N}}$ satisfies (2.4).

¹One can also consider less conservative conditions, i.e. local Lipschitz continuity, by adding boundedness conditions on the solutions of (3.8), see Theorem 3.3 in [64].

Definition 3.3 (Positively Invariant Set [64]). Let $x(t)$ be the solution of (3.8), the set $\mathcal{E} \subset \mathbb{R}^n$ is said to be *positively invariant* w.r.t. the system (3.8) if:

$$\forall t_0 \in \mathbb{R}, \quad x(t_0) \in \mathcal{E} \Rightarrow x(t) \in \mathcal{E}, \quad \forall t \geq t_0.$$

Lemma 3.4. Consider the system (3.8), a differentiable positive definite function $V : \mathbb{R}^n \rightarrow \mathbb{R}^+$, and the function $\mathcal{S}(\cdot, \cdot)$ defined by the quadratic form

$$\mathcal{S}(\dot{x}(t), x(t_k) - x(t)) = \begin{bmatrix} \dot{x}(t) \\ x(t_k) - x(t) \end{bmatrix}^T \begin{bmatrix} -\delta_0^2 X & Y \\ Y & X \end{bmatrix} \begin{bmatrix} \dot{x}(t) \\ x(t_k) - x(t) \end{bmatrix} \quad (3.9)$$

with $\delta_0 = \frac{2}{\pi} \bar{h}$, $0 < X^T = X \in \mathbb{R}^{n \times n}$, and $0 \leq Y^T = Y \in \mathbb{R}^{n \times n}$. Assume that:

$$\text{for } \dot{x}(t_k) \neq 0, \quad \frac{d}{dt}V(x(t)) < \mathcal{S}(\dot{x}(t), x(t_k) - x(t)), \quad \forall t \in [t_k, t_{k+1}). \quad (3.10)$$

For a positive scalar β , consider the sub-level set defined by:

$$\mathcal{L}_\beta := \{x \in \mathbb{R}^n : V(x) \leq \beta\}. \quad (3.11)$$

Then all the sub-level sets $\mathcal{L}_{V(x(t_k))}$ are positively invariant and

a) if $\dot{x}(t_k) \neq 0$, the sets $\mathcal{L}_{V(x(t_k))}$ are in contraction :

$$V(x(t_{k+1})) < V(x(t_k)), \quad \forall k \in \mathbb{N}, \quad \text{s.t. } \dot{x}(t_k) \neq 0. \quad (3.12)$$

b) if $\dot{x}(t_k) = 0$ then the sets $\mathcal{L}_{V(x(t_k))}$ and $\mathcal{L}_{V(x(t_{k+1}))}$ are equal.

Proof. a) Note that the system in (3.8) can be written as

$$\dot{x}(t) = \underbrace{f_k(x(t)) + g_k(x(t))Kx(t)}_{F_k(x(t))} + \underbrace{g_k(x(t))K}_{G_k(x(t))} \underbrace{(x(t_k) - x(t))}_{w(t)}$$

and thus it can be written as an interconnection of the system

$$N := \begin{cases} \dot{x}(t) = F_k(x(t)) + G_k(x(t))w(t) \\ y(t) = \dot{x}(t) \end{cases}$$

with the operator $\Delta_{sh} : y \rightarrow w$ given in (3.4). Since $\dot{x}(t_k) \neq 0$, then, for any $t \in (t_k, t_{k+1})$ and for any $k \in \mathbb{N}$, integrating (3.10) from t_k to t yields

$$V(x(t)) - V(x(t_k)) < \int_{t_k}^t \mathcal{S}(y(\tau), w(\tau)) d\tau. \quad (3.13)$$

Then, from (3.9), Lemma 3.1 and Lemma 3.2 we find directly

$$\int_{t_k}^t \mathcal{S}(y(\tau), w(\tau)) d\tau = \mathcal{I}_1(t) + \mathcal{I}_2(t) \leq 0, \quad \forall t \in [t_k, t_{k+1}) \quad (3.14)$$

with $\mathcal{I}_1(t)$ and $\mathcal{I}_2(t)$ given in (3.6) and (3.7) respectively. For $t \rightarrow t_{k+1}$, we obtain $\mathcal{I}_1(t_{k+1}) + \mathcal{I}_2(t_{k+1}) \leq 0$. Using (3.13) and (3.14) we see that $V(x(t)) < V(x(t_k))$, $\forall t \in (t_k, t_{k+1}]$, $\forall k \in \mathbb{N}$.

b) Assume that $\dot{x}(t_k) = 0$. Due to the Lipschitz continuity of the vector field, and Theorem 3.2 in [64], for any interval $[t_k, t_{k+1})$ we have

$$\exists s \in [t_k, t_{k+1}) \text{ s.t. } \dot{x}(s) = 0 \Rightarrow \dot{x}(t) = 0, \quad \forall t \in [t_k, t_{k+1}). \quad (3.15)$$

Thus, since the state $x(t)$ is continuous at the sampling instants, if $\dot{x}(t_k) = 0$, (3.15) implies that $x(t) = x(t_k)$ and $V(x(t)) = V(x(t_k))$, $\forall t \in [t_k, t_{k+1}]$.

Note that for both points a) and b) we get the positive invariance of $\mathcal{L}_{V(x(t_k))}$, which completes the proof. \square

3.3.2 LMI stability conditions for bilinear sampled-data systems

In the next theorem, sufficient conditions are provided under the form of LMIs, for (2.7) to be locally asymptotically stable at $x = 0$, inside a given polytopic region \mathcal{P} defined by (2.5) and (2.6). The result is based on the application of the Lemma 3.4.

Theorem 3.5. *Consider the system (2.7), the equivalent representation (3.3) and (3.4). Suppose there exist symmetric positive definite matrices $X, Y, P \in \mathbb{R}^{n \times n}$, matrices $P_2, P_3 \in \mathbb{R}^{n \times n}$, and a scalar $\gamma > 0$ such that the following optimization problem is feasible*

$$\gamma^* = \min \gamma, \quad \text{under the constraints:} \quad (3.16)$$

$$E_j = \begin{bmatrix} \gamma & a_j^T \\ a_j & P \end{bmatrix} \geq 0, \quad \forall j \in \{1, 2, \dots, r\}, \quad (3.17)$$

and

$$M_q = \begin{bmatrix} A_q^T P_2 + P_2^T A_q & P - P_2^T + A_q^T P_3 & P_2^T B \\ P - P_2 + P_3^T A_q & -P_3 - P_3^T + \delta_0^2 X & P_3^T B - Y \\ B^T P_2 & B^T P_3 - Y & -X \end{bmatrix} < 0, \quad (3.18)$$

$\forall q \in \{1, 2, \dots, p\}$

where the vertices $\{A_q\}_{q \in \{1, 2, \dots, p\}}$ are defined by

$$A_q := A(x_q) = A_0 + B_0 K + \sum_{i=1}^m [K x_q]_i N_i \quad (3.19)$$

with $\{x_q\}_{q \in \{1, 2, \dots, p\}}$ given in (2.5). Then the equilibrium $x = 0$ of (2.7) is locally asymptotically stable, and an estimate of its domain of attraction is given by the ellipsoid

$$\mathcal{E}_{c^*}(P) = \{x \in \mathbb{R}^n : x^T P x \leq c^*\} \subset \mathcal{P}, \quad \text{with } c^* = 1/\gamma^*. \quad (3.20)$$

Proof. The proof consists of two steps. First we show that the existence of a solution for (3.18) makes the quadratic function $V(x) = x^T P x$ satisfy the conditions of Lemma 3.4, and thus leads to the positive invariance of the sub-level sets $\mathcal{L}_{V(x(t_k))}$. In the second step, we show that this positive invariance leads to the local asymptotic stability in $\mathcal{E}_{c^*}(P)$. In the proof, we consider the more general representation \mathcal{G}' instead of \mathcal{G} in (3.3):

$$\mathcal{G}' := \begin{cases} \dot{x}(t) = A(\eta_k)x(t) + Bw(t), \\ y(t) = C(\eta_k)x(t) + Dw(t), \\ \eta_k \in \mathcal{P}, \quad \forall k \in \mathbb{N}, \end{cases} \quad (3.21)$$

$$C(\eta_k) = A(\eta_k) = A_0 + B_0 K + \sum_{i=1}^m [K \eta_k]_i N_i, \quad D = B = B_0 K$$

Obviously, system \mathcal{G} (3.3) corresponds to \mathcal{G}' (3.21) in the particular case $\eta_k = x(t_k)$. The interconnection of \mathcal{G}' with the operator $\Delta_{sh} : y \rightarrow w$ in (3.4) may also be expressed as:

$$\dot{x}(t) = \left(A_0 + \sum_{i=1}^m [K \eta_k]_i N_i \right) x(t) + B_0 K x(t_k), \quad \forall t \in [t_k, t_{k+1}), \quad \forall k \in \mathbb{N}. \quad (3.22)$$

Step 1: Assume that η_k is in the polytope \mathcal{P} . Let $\{\lambda_q(\eta_k)\}_{q \in \{1, 2, \dots, p\}}$ represent the barycentric coordinates of η_k in \mathcal{P} , i.e. $\eta_k = \sum_{q=1}^p \lambda_q x_q$. The set of barycentric coordinates that determines η_k with respect to the vertices of \mathcal{P} , also determine $A(\eta_k)$ with respect to the vertices in (3.19). This is due to the linearity of $A(\eta_k)$ in η_k . Multiplying

each of the inequalities (3.18) by the appropriate λ_q , and taking the sum over of the resulting inequalities yields:

$$\begin{bmatrix} A^T(\eta_k)P_2 + P_2^T A(\eta_k) & P - P_2^T + A^T(\eta_k)P_3 & P_2^T B \\ P - P_2 + P_3^T A(\eta_k) & -P_3 - P_3^T + \delta_0^2 X & P_3^T B - Y \\ B^T P_2 & B^T P_3 - Y & -X \end{bmatrix} < 0. \quad (3.23)$$

Recall the notations with $y(t) = \dot{x}(t)$, $w(t) = x(t_k) - x(t)$ defined in (3.3) and (3.4), and the quadratic supply rate function $\mathcal{S}(\cdot, \cdot)$ defined in (3.9). Thus, for all $[x^T(t) y^T(t) w^T(t)] \neq 0$, the LMI (3.23) implies:

$$2(x^T P_2^T + y^T P_3^T)(-y + A(\eta_k)x + Bw) + 2y^T(t)Px(t) - \mathcal{S}(y(t), w(t)) < 0, \quad (3.24)$$

where we get the first term using the descriptor method [37]:

$$2(x^T P_2^T + y^T P_3^T)(-y + A(\eta_k)x + Bw) = 0.$$

From (3.24), we see that for $\eta_k \in \mathcal{P}$ the inequality in (3.23) is equivalent to the condition:

$$\dot{V}(x(t)) < \mathcal{S}(y(t), w(t)), \text{ whenever } [x^T(t) y^T(t) w^T(t)] \neq 0. \quad (3.25)$$

Note that $\dot{x}(t_k) \neq 0$ implies that $\dot{x}(t) \neq 0$ for all $t \in [t_k, t_{k+1})$, therefore $[x(t)^T y(t)^T w(t)^T] \neq 0$, and Lemma 3.4 leads to the positive invariance of the sub-level sets $\mathcal{L}_{V(x(t_k))}$, and also

$$V(x(t_{k+1})) < V(x(t_k)) \text{ whenever } \dot{x}(t_k) \neq 0, \eta_k \in \mathcal{P}. \quad (3.26)$$

This shows the positive invariance of the sets $\mathcal{L}_{V(x(t_k))}$.

Step 2: Now we show that the positive invariance property obtained in Step 1, leads to local asymptotic stability. From (3.22), the state evolution over the interval $t \in [t_k, t_{k+1})$ is:

$$x(t) = \Lambda(\eta_k, \sigma)x(t_k), \quad (3.27)$$

with $\Lambda(\eta_k, \sigma) = e^{\tilde{A}_0(\eta_k)\sigma} + \int_0^\sigma e^{\tilde{A}_0(\eta_k)(\sigma-s)} B_0 K ds$, $\tilde{A}_0(\eta_k) = A_0 + \sum_{i=1}^m [K\eta_k]_i N_i$ and $\sigma = t - t_k$. From (3.26)

$$x^T(t_{k+1})Px(t_{k+1}) < x^T(t_k)Px(t_k), \text{ whenever } \dot{x}(t_k) \neq 0, \eta_k \in \mathcal{P}. \quad (3.28)$$

For any non-zero vector $y \in \mathbb{R}^n$, multiplying the LMI in (3.23) by $[y^T \quad y^T A^T(\eta_k) \quad 0]$ from the right, and by its transpose from the left yields:

$$y^T (A^T(\eta_k)P + PA(\eta_k) + \delta_0^2 A^T(\eta_k)XA(\eta_k))y < 0, \quad y \neq 0.$$

This shows that $A(\eta_k)$ is Hurwitz for $\eta_k \in \mathcal{P}$, thus from (3.28) we have:

$$x^T(t_k)(\Lambda^T(\eta_k, h_k)P\Lambda(\eta_k, h_k) - P)x(t_k) < 0,$$

for all $x(t_k) \neq 0, \eta_k \in \mathcal{P}$ and $0 < h_k \leq \bar{h}$. Therefore $\Lambda^T(\eta_k, h_k)P\Lambda(\eta_k, h_k) - P$ is negative definite. Given that P is positive definite, then there exists a sufficiently small $\varrho > 0$ which is independent of k , such that:

$$\Lambda^T(\eta_k, h_k)P\Lambda(\eta_k, h_k) - P \leq -\varrho P.$$

Setting $0 < \alpha = 1 - \varrho, 0 < \alpha < 1$, as a result we obtain $V(x(t_k)) \leq \alpha^k V(x(t_0))$, which leads to

$$\lim_{k \rightarrow \infty} V(x(t_k)) = 0 \quad \Rightarrow \quad \lim_{k \rightarrow \infty} x(t_k) = 0.$$

From (3.27), since η_k belongs to the compact set \mathcal{P} and σ is bounded, then by the continuity of Λ , the image of $\Lambda : \mathcal{P} \times [\epsilon, \bar{h}] \rightarrow \mathbb{R}^{n \times n}$ is compact, and $\exists \mu > 0$ such that the Euclidean norm of $x(t)$ satisfies $|x(t)| \leq \mu|x(t_k)|$ for any $t \in [t_k, t_{k+1})$. As a result one has

$$\lim_{k \rightarrow \infty} x(t_k) = 0 \quad \Rightarrow \quad \lim_{t \rightarrow \infty} x(t) = 0$$

and $x = 0$ is locally asymptotically stable for (3.22). The local asymptotic stability of (2.7) follows from the particular case $\eta_k = x(t_k)$. However, we still need to find a positive invariant set inside \mathcal{P} . The desired ellipsoid (3.20) is found, as according to [12] (page. 70). Note that $\mathcal{E}_{c^*}(P)$ is the largest sub-level set of $x^T P x$ contained in the polytope \mathcal{P} . \square

Remark 3.6. The last theorem provides sufficient, thus possibly conservative conditions for the local stability of bilinear sampled-data systems with state constraints. These conditions exploit dissipativity properties, and depend on the chosen supply rate function. Besides, the obtained MASP depends on the choice of the analytical polytope.

Remark 3.7. For given \mathcal{P}, K and \bar{h} , the provided conditions represent LMIs, thus they are numerically tractable. Note that the set of LMI conditions in (3.18) require the pair (A_0, B_0) to be stabilizable. Thus, the open-loop system can be unstable. Numerical examples of the proposed approach will be given in the following section.

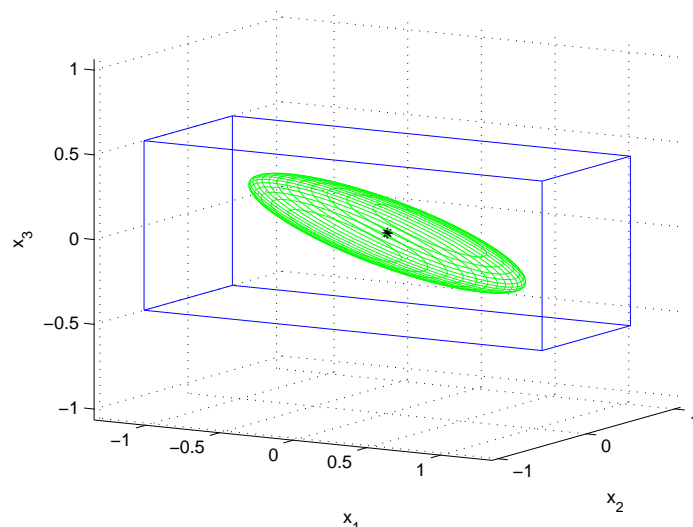

FIGURE 3.1: The polytope (blue boxes) and the corresponding region of stability $\mathcal{E}_{c^*}(P)$.

3.4 Numerical Examples

3.4.1 Example 1

Consider the bilinear sampled-data system in (2.7) defined by

$$A_0 = \begin{bmatrix} -0.5 & 1.5 & 4 \\ 4.3 & 6.0 & 5.0 \\ 3.2 & 6.8 & 7.2 \end{bmatrix}, \quad B_0 = \begin{bmatrix} -0.7 & -1.3 \\ 0 & -4.3 \\ 0.8 & -1.5 \end{bmatrix},$$

$$N_1 = \begin{bmatrix} -1 & 0 & 0 \\ 0 & 0 & 0 \\ 0 & 0 & 0 \end{bmatrix}, \quad N_2 = \begin{bmatrix} 0 & 1 & 0 \\ 0 & 0 & 0 \\ 0 & 0 & 0 \end{bmatrix}.$$

In [120], the state feedback

$$K = \begin{bmatrix} 0.0016 & 0.0035 & 0.0034 \\ 2.2404 & 3.2676 & 5.9199 \end{bmatrix}$$

was proven to locally stabilize the continuous-time bilinear system, inside an ellipsoidal region containing the box:

$$\mathcal{P} = [-1.35, +1.35] \times [-0.5, +0.5] \times [-0.5, +0.5].$$

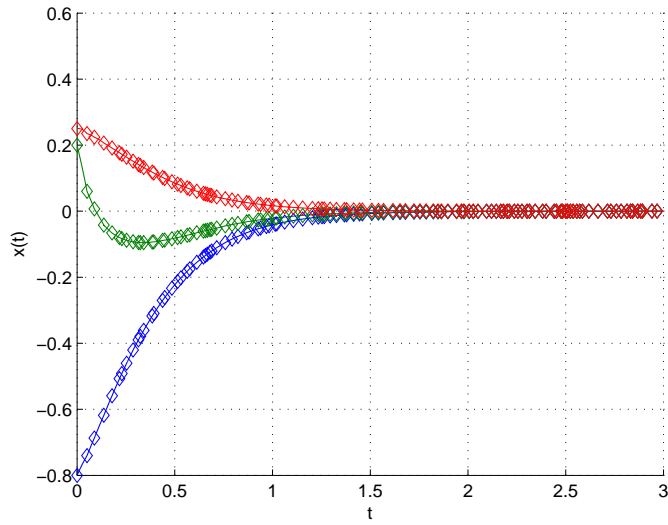

FIGURE 3.2: State evolution for the bilinear sampled-data system in Example 1, with a variable sampling which is bounded by $\bar{h} = 0.051$.

Our objective here is to find a MASP for which the local stability of the bilinear system with aperiodic sampled-data control is guaranteed, while satisfying the set constraints defined by \mathcal{P} . Using the method of Theorem 2.3, we find that the LMI conditions in (3.18) are feasible for $\bar{h} = 0.051$, with

$$P = 10^3 \begin{bmatrix} 34.27 & 10.82 & 92.73 \\ 10.82 & 50.43 & 28.41 \\ 92.73 & 28.41 & 394.23 \end{bmatrix}.$$

The domain of attraction $\mathcal{E}_{c^*}(P)$ given in (3.20) for $c^* = 10.84 \times 10^3$ (see Fig.3.1). Considering the initial state $x_0 = [-0.8 \ 0.2 \ 0.25]^T$, the time evolution of the state is shown in Fig. 3.2. The random sequence of sampling periods satisfies the hypothesis in (2.4) with $\bar{h} = 0.051$. The stability is ensured as the initial state is located inside $\mathcal{E}_{c^*}(P)$. Numerical solutions starting from the same initial conditions, show that for a uniform sampling interval $t_{k+1} - t_k = 0.09$ the solution of the system becomes unbounded (see Fig. 3.3). This gives an idea about the conservatism induced by the proposed analysis method.

Considering the same box \mathcal{P} , other methods are used to find the MASP that ensures the stability, and a comparison is given in Table 3.1. The results (a) and (b), are based on the hybrid system theory. It must be noted that [88] treats a general class of nonlinear systems, and Theorem 2.3 is its specialization for the bilinear case, with constructive LMI conditions. The results (c) and (d), are based on dissipativity theory, and the contractivity of invariant sets. The reduction of conservatism in (d) with respect to

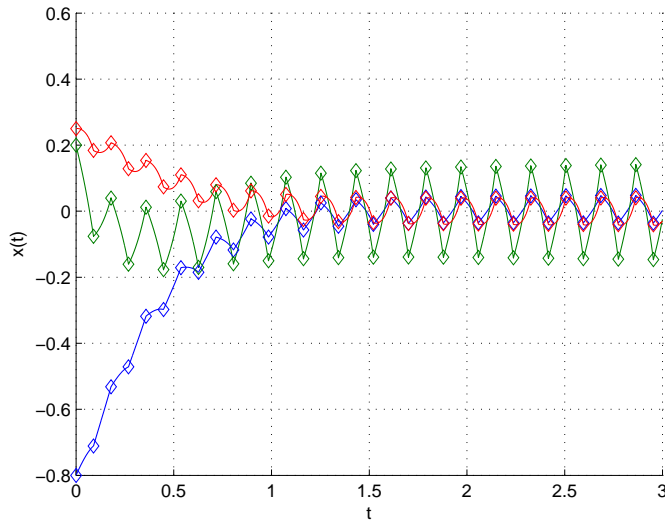

FIGURE 3.3: State evolution for the bilinear sampled-data system in Example 1, with a constant sampling intervals $t_{k+1} - t_k = 0.09$.

the preliminary results in (c) is due to the use of the descriptor method in formalizing the LMI conditions, which avoids some conservative cross products. Note that in this example, dissipativity-based techniques give better estimation than hybrid ones.

3.4.2 Example 2: DC-DC Power Converter

Consider the buck-boost converter in Fig. 3.4, where a pulse width modulator is used to adjust the duty cycle of the switching device. Consider the average-value model of the converter [54, 116]:

$$\dot{\bar{x}} = (DA_1 + (1 - D)A_2)\bar{x} + (DB_1 + (1 - D)B_2)v.$$

In the system state $\bar{x} = [i_L^- \ v_c^-]^T$, i_L^- is the average inductor current, and v_c^- the average capacitor voltage. The system matrices are

$$A_1 = \begin{bmatrix} -\frac{R_{ON}+R_L}{L} & 0 \\ 0 & -\frac{1}{RC} \end{bmatrix}; \quad A_2 = \begin{bmatrix} -\frac{R_L}{L} & \frac{1}{L} \\ -\frac{1}{C} & -\frac{1}{RC} \end{bmatrix};$$

TABLE 3.1: Estimation of the MASP that guarantees the local asymptotic stability of the system in Example 1.

	(a)	(b)	(c)	(d)
	Theorem 2.3 and [88]	Theorem 2.7	Theorem 4 [92]	Theorem 3.5
\bar{h}	5.4×10^{-3}	13.8×10^{-3}	43×10^{-3}	51×10^{-3}

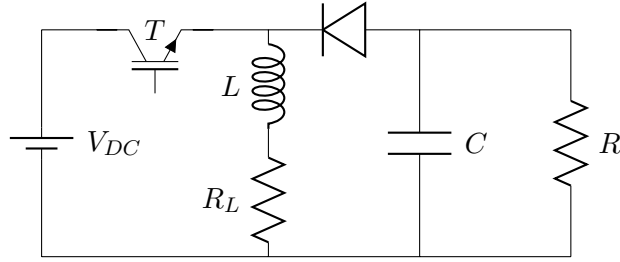

FIGURE 3.4: Buck-boost converter.

$$B_1 = \begin{bmatrix} \frac{1}{L} & 0 \\ 0 & 0 \end{bmatrix}; B_2 = \begin{bmatrix} 0 & -\frac{1}{L} \\ 0 & 0 \end{bmatrix}; v = \begin{bmatrix} V_{DC} \\ v_D \end{bmatrix}.$$

R_{ON} is the on-resistance of the switching device, v_D is the diode voltage, and V_{DC} is the source voltage. $D \in [D_1, D_2] = [0, 1]$ is system input representing the duty cycle. The system is subjected to saturation due to the hard limits on the duty cycle. Several works have dealt with stability and stabilization of DC-DC converter. Examples like in [54] and [91] consider a nonlinear systems approach to design continuous time state-feedback controller that achieves stabilization and tracking, and guarantees robustness with respect to bilinearities and saturation. However, less attention has been paid to study robustness with respect to sampled-data implementation. For a certain working point \bar{x}_0 , D_0 we have

$$0 = (D_0 A_1 + (1 - D_0) A_2) \bar{x}_0 + (D_0 B_1 + (1 - D_0) B_2) v.$$

Considering $\hat{x} = x - \bar{x}_0$, and the input signal $u = D - D_0$, we can see that

$$\dot{\hat{x}} = A_0 \hat{x} + B_0 u + N u \hat{x}, \quad (3.29)$$

where $A_0 = (D_0 A_1 + (1 - D_0) A_2)$, $B_0 = ((A_1 - A_2) \bar{x}_0 + (B_1 - B_2) v)$, and $N = (A_1 - A_2)$. Consider the following values $V_{DC} = 6V$, $R = 50\Omega$, $L = 20mH$, $C = 220\mu F$, $R_{ON} = 0.08\Omega$, $R_L = 0.34\Omega$, and $v_D = 0.67V$. From the constraints over the duty cycle we see that u must be bounded by $-D_0 + D_1 \leq u \leq D_2 - D_0$. We consider $D_0 = (D_1 + D_2)/2$, which corresponds to the equilibrium point $\bar{x}_0 = [+0.21 \ -5.17]$ and $|u| \leq u_{max} = (D_2 - D_1)/2$.

We are interested in the state-space region where a linear control $u = K \hat{x}$ is not saturated, i.e. $\{\hat{x} \in \mathbb{R}^2 : |K \hat{x}| \leq u_{max}\}$. Moreover, we assume that the errors satisfy $|\hat{i}_L| < 0.5A$, $|\hat{v}_c| < 3V$. By intersection, this leads to considering the polytope $\mathcal{P} := \{(-0.42, -3), (-0.16, +3), (+0.16, -3), (+0.42, +3)\}$. Using classical results for

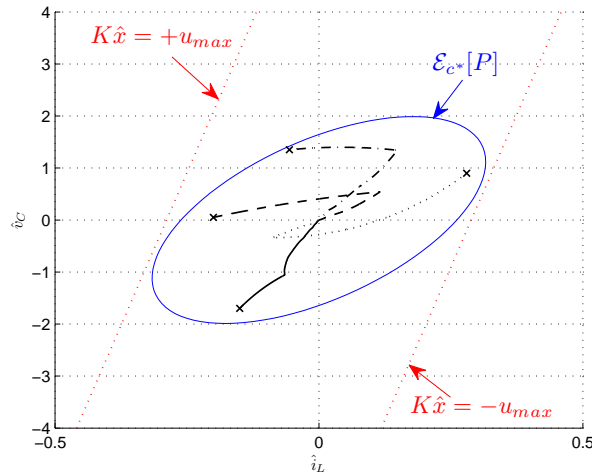

FIGURE 3.5: The domain of attraction $\mathcal{E}_{c^*}(P)$ for the system (3.29) when controlled with the static feedback controller, in the aperiodically sampled-data case with $h_{max} = 1.5$ ms. The curves in black are simulations of the sampled-data system, for different initial states.

the stabilization of the continuous-time system, we find the following controller

$$K = [-1.7329 \quad +0.0738].$$

Finally, in order to study the robustness with respect to aperiodic sampling, we apply Theorem 3.5. We find that the system is stable under sampled-data implementation of the feedback controller K with variable sampling periods bounded by $\bar{h} = 1.5$ ms. The guaranteed domain of attraction $\mathcal{E}_{c^*}(P)$ is given in (3.20), for $c^* = 37.81 \times 10^3$ and

$$P = 10^3 \begin{bmatrix} 554.9 & -49.62 \\ -49.62 & 14.01 \end{bmatrix}.$$

The domain of attraction is shown in Fig. 3.5, together with simulations of the evolutions of the state of the sampled-data system. Different initial conditions are considered, and random variable sampling periods, bounded by $\bar{h} = 1.5$ ms are used in the simulations. Simulations show that by slightly increasing the sampling interval, the system becomes unstable. For example, with the initial condition $x_0 = [-0.15 \quad -1.7]^T \in \mathcal{E}_{c^*}(P)$, we obtain an unstable behavior when choosing a constant sampling $t_{k+1} - t_k = 2.1$ ms. However, for the same initial condition the system state converges to the origin if the bound $\bar{h} = 1.5$ ms is respected (as shown in Fig. 3.5).

3.5 Conclusion

In this chapter we have provided sufficient conditions for the local stability of bilinear sampled-data systems, when controlled via a linear state feedback. Polytopic state-space constraints have been included in the analysis. The local stability is guaranteed inside an ellipsoid contained in the addressed convex hull. The conditions for the stability analysis, as well as the estimate of the domain of attraction, were given in the form of LMIs, which makes them computationally tractable. The results have been illustrated by numerical examples, and compared to the existing literature. Note that Lemma 3.8 treats a more general case of nonlinear systems. However, it only shows invariance property. In the next chapter, we intend to show how such a result can be extended in order to cover the asymptotic stability of a general class of nonlinear systems.

Chapter 4

Stability of input-affine nonlinear systems with sampled-data control

4.1 Introduction

This chapter is dedicated to the stability analysis of nonlinear sampled-data systems, which are affine in the input. Assuming that a stabilizing continuous-time controller exists and is to be implemented digitally, we intend to provide sufficient conditions for the sampled-data system to be asymptotically/exponentially stable. The main idea of the chapter is to extend the results from Chapter 3 using an approach inspired by the dissipativity theory.

In Chapter 3, local asymptotic stability of bilinear sampled-data systems controlled by a linear state feedback has been considered by using the analysis of contractive invariant sets and the dissipativity theory. The obtained results are constructive, but their extension for generic nonlinear systems does not seem to be trivial. Here we keep the objectives of Chapter 3, and enlarge them to the case of input-affine nonlinear systems. Dissipativity will constitute the keystone for the MASP estimation, and the robustness analysis with respect to the sampling jitters. The method will be applied to local and global analysis. Additionally, the particular case of polynomial systems will be studied in relation with SOS techniques. The result will be applied to a benchmark example from the literature in order to show the usefulness of the proposed stability conditions.

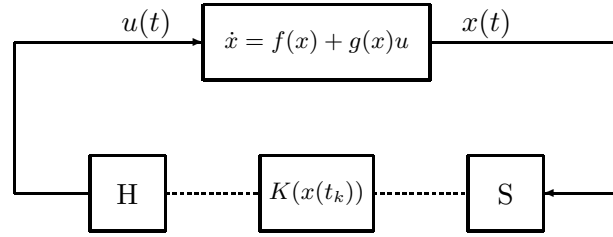

FIGURE 4.1: The sampled-data feedback control of an affine nonlinear system.

The chapter is organized as follows. The problem under study is introduced in Section 4.2. In Section 4.3 the system is represented by an equivalent model which is adopted to our dissipativity analysis. Sufficient conditions for the asymptotic/exponential stability of affine nonlinear sampled-data systems are given in Section 4.4. Finally, illustrative examples are presented in Section 4.5.

4.2 Problem formulation

Consider the affine nonlinear control system given by

$$\dot{x}(t) = f(x(t)) + g(x(t))u(t), \quad \forall t > t_0, \quad x(t_0) = x_0, \quad (4.1)$$

where $x(t) \in \mathbb{R}^n$ and $u(t) \in \mathbb{R}^m$ are the state and the input, respectively. The functions $f : \mathbb{R}^n \rightarrow \mathbb{R}^n$ with $f(0) = 0$, and $g : \mathbb{R}^n \rightarrow \mathbb{R}^{n \times m}$ are sufficiently smooth to make the system well defined, i.e. for any $x(t_0)$ and any admissible $u(\cdot)$, the existence and uniqueness of a solution is ensured on $[t_0, \infty)$. We suppose that a continuous-time controller $u(t) = K(x(t))$ stabilizes asymptotically/exponentially the equilibrium $x = 0$ of the system, where $K : \mathbb{R}^n \rightarrow \mathbb{R}^m$ is a continuously differentiable function.

We consider the emulation of the controller $u = K(x)$ with the following assumptions:

- the set of uncertain sampling instants $\{0 = t_0 < t_1, \dots < t_k < \dots\}$ satisfies

$$0 < t_{k+1} - t_k \leq \bar{h}, \quad \forall k \in \mathbb{N},$$

for a given MASP \bar{h} , and

$$\lim_{k \rightarrow \infty} t_k = \infty;$$

- the control input is then calculated based on the sampled-data version of the state:

$$u(t) = K(x(t_k)), \quad \forall t \in [t_k, t_{k+1}). \quad (4.2)$$

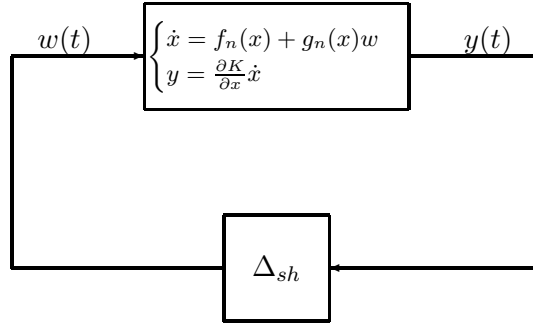

FIGURE 4.2: The equivalent representation of the sampled-data system (4.3).

Under these assumptions, we obtain a closed-loop sampled-data system (see also Fig. 4.1):

$$\begin{aligned} \dot{x}(t) &= f(x(t)) + g(x(t))K(x(t_k)), \\ \forall t \in [t_k, t_{k+1}), \quad k \in \mathbb{N}. \end{aligned} \quad (4.3)$$

We consider the following notions of stability:

Definition 4.1 ([64]). The equilibrium point $x = 0$ of the system (4.3) is *locally uniformly asymptotically stable*, if there exists a class \mathcal{KL} function $\beta(\cdot, \cdot)$, such that

$$|x(t)| \leq \beta(|x(t_0)|, t - t_0), \quad \forall t \geq t_0, \quad \forall x(t_0) \in \mathcal{D}_0. \quad (4.4)$$

In this case \mathcal{D}_0 is an estimate of the domain of attraction of $x = 0$. The equilibrium point $x = 0$ is *globally uniformly asymptotically stable* if (4.4) is satisfied for any initial state $x(t_0) \in \mathbb{R}^n$ (i.e., $\mathcal{D}_0 = \mathbb{R}^n$).

Definition 4.2 ([64]). The equilibrium point $x = 0$ of the system (4.3) is *locally uniformly exponentially stable* in a neighborhood \mathcal{D}_0 of the equilibrium, if (4.4) is satisfied with

$$\beta(s, t) = cse^{-\lambda t}, \quad c > 0, \lambda > 0.$$

In this case \mathcal{D}_0 is an estimate of the domain of attraction of $x = 0$. The equilibrium point $x = 0$ is *globally uniformly exponentially stable* if this condition is satisfied for any initial state $x(t_0) \in \mathbb{R}^n$, (i.e., $\mathcal{D}_0 = \mathbb{R}^n$).

Problem: Find a criterion for the local/global asymptotic/exponential stability of the equilibrium point $x = 0$ of the sampled-data system (4.3).

4.3 Robustness analysis representation

The system (4.3) can be written as

$$\dot{x}(t) = f_n(x(t)) + g_n(x(t))w(t), \quad \forall t \in [t_k, t_{k+1}), \quad k \in \mathbb{N}, \quad (4.5)$$

where $f_n(x) = f(x) + g(x)K(x)$, $g_n(x) = g(x)$ and $w(t) = K(x(t_k)) - K(x(t))$. Note that $f_n(x)$ represents the dynamics of the nominal, continuous-time, closed-loop system, i.e. the dynamics without the sampled-data implementation. From (4.5) the sampled-data system (4.3) can be represented by the equivalent feedback connection of

$$\mathcal{G} := \begin{cases} \dot{x} = f_n(x) + g_n(x)w, \\ y = \frac{\partial K}{\partial x} \dot{x}, \end{cases} \quad (4.6)$$

with the operator $\Delta_{sh} : y \rightarrow w$

$$w(t) = (\Delta_{sh} y)(t) = - \int_{t_k}^t y(\tau) d\tau, \quad \forall t \in [t_k, t_{k+1}). \quad (4.7)$$

This representation is shown in Fig. 4.2. Recall that the properties of the operator Δ_{sh} have been shown in Section 3.2.1.

4.4 Main results

4.4.1 Stability analysis

In the following we provide the main results of this chapter.

Theorem 4.3. *Consider the sampled-data system (4.3) and the equivalent representation (4.6), (4.7). Consider the quadratic form:*

$$\mathcal{S}(y, w) = \begin{bmatrix} y \\ w \end{bmatrix}^T \begin{bmatrix} -\delta_0^2 X & Y \\ Y & X \end{bmatrix} \begin{bmatrix} y \\ w \end{bmatrix}, \quad (4.8)$$

with $\delta_0 = \frac{2}{\pi} \bar{h}$, $0 < X^T = X \in \mathbb{R}^{m \times m}$, and $0 \leq Y^T = Y \in \mathbb{R}^{m \times m}$. Consider a neighborhood $\mathcal{D} \subset \mathbb{R}^n$ of the equilibrium point $x = 0$, and suppose that there exist a differentiable positive definite function $V : \mathcal{D} \rightarrow \mathbb{R}^+$, such that there exist $\alpha > 0$ and class \mathcal{K} functions β_1 and β_2 , verifying

$$\beta_1(|x|) \leq V(x) \leq \beta_2(|x|), \quad \forall x \in \mathcal{D}, \quad (4.9)$$

and for any $x(t) \in \mathcal{D}$:

$$\dot{V}(x(t)) + \alpha V(x(t)) \leq \mathcal{S}(y(t), w(t)), \quad (4.10)$$

$$\dot{V}(x(t)) + \alpha V(x(t)) \leq \mathcal{S}(y(t), w(t))e^{-\alpha \bar{h}}. \quad (4.11)$$

Then, the equilibrium $x = 0$ of the system (4.3) is locally uniformly asymptotically stable. Moreover, consider the sub-level set defined by $V(\cdot)$ and a scalar $c > 0$

$$\mathcal{L}_c := \{x \in \mathbb{R}^n : V(x) \leq c\}. \quad (4.12)$$

Then the set \mathcal{L}_{c^*} defined by the maximal sub-level set of V contained in \mathcal{D}

$$c^* = \max_{\mathcal{L}_c \subset \mathcal{D}} c \quad (4.13)$$

is an estimate of the domain of attraction. Finally, if all the conditions are satisfied for $\mathcal{D} = \mathbb{R}^n$, with class \mathcal{K}_∞ functions β_1 and β_2 , then the equilibrium $x = 0$ is globally uniformly asymptotically stable.

Proof. To show the stability of the sampled-data system, we define first the function

$$W(t) = V(x(t))e^{\alpha(t-t_k)} - \int_{t_k}^t \mathcal{S}(y(\tau), w(\tau)) d\tau,$$

for any $t \in [t_k, t_{k+1})$. The conditions (4.10) and (4.11) are sufficient to have

$$\dot{W}(t) \leq 0, \quad \forall t \in [t_k, t_{k+1}), \quad \forall x(t) \in \mathcal{D}. \quad (4.14)$$

The last equation yields

$$V(x(t))e^{\alpha(t-t_k)} - \int_{t_k}^t \mathcal{S}(y(\tau), w(\tau)) d\tau \leq V(x(t_k)). \quad (4.15)$$

From Lemma 3.1 and Lemma 3.2, it is easy to see that

$$V(x(t)) \leq e^{-\alpha(t-t_k)} V(x(t_k)), \quad \forall t \in [t_k, t_{k+1}), \quad \forall x(t) \in \mathcal{D}. \quad (4.16)$$

Clearly, the set \mathcal{L}_{c^*} is positively invariant [64], and it is the largest sub-level set contained in \mathcal{D} . Consider an initial condition $x_0 \in \mathcal{L}_{c^*}$. From the continuity of the solution $x(t)$, (4.16) leads to

$$V(x(t)) \leq e^{-\alpha(t-t_0)} V(x(t_0)), \quad \forall t \geq t_0, \quad \forall x_0 \in \mathcal{L}_{c^*}. \quad (4.17)$$

From (4.9) and (4.17), we see that for any solution with $x(t_0) \in \mathcal{L}_{c^*}$

$$\begin{aligned} |x(t)| &\leq \beta_1^{-1}(V(x(t_0))e^{-\alpha(t-t_0)}) \\ &\leq \beta_1^{-1}(\beta_2(|x(t_0)|)e^{-\alpha(t-t_0)}) \\ &:= \beta(|x(t_0)|, t-t_0), \quad \forall t \geq t_0, \quad \forall x(t_0) \in \mathcal{L}_{c^*}. \end{aligned}$$

The function $\beta(\cdot, \cdot)$ can be easily seen to be a class \mathcal{KL} function. This shows that $x = 0$ is locally uniformly asymptotically stable. Finally, it is trivial to see that if all the conditions are satisfied for $\mathcal{D} = \mathbb{R}^n$, with class \mathcal{K}_∞ functions β_1 and β_2 , then $x = 0$ is globally uniformly asymptotically stable. This completes the proof. \square

Corollary 4.4. *Suppose that all the conditions of Theorem 4.3 are satisfied with*

$$\beta_1(|x|) \geq k_1|x|^q, \quad \beta_2(|x|) \leq k_2|x|^q, \quad \text{for some } k_1, k_2, q > 0. \quad (4.18)$$

Then, the equilibrium $x = 0$ is locally exponentially stable. Moreover, the sub-level set \mathcal{L}_{c^} defined in (4.13) and (4.12), is an estimate of the domain of attraction. If the conditions hold for $\mathcal{D} = \mathbb{R}^n$, then $x = 0$ is globally exponentially stable.*

Proof. Following the same steps as in the proof of Theorem 4.3, we get

$$V(x(t)) \leq e^{-\alpha(t-t_0)}V(x(t_0)), \quad \forall t \geq t_0, \quad \forall x_0 \in \mathcal{L}_{c^*}.$$

Thus, from (4.9) and (4.18)

$$\begin{aligned} |x(t)| &\leq \left(\frac{V(x(t_0))e^{-\alpha(t-t_0)}}{k_1} \right)^{1/q} \leq \left(\frac{k_2|x(t_0)|^q e^{-\alpha(t-t_0)}}{k_1} \right)^{1/q} \\ &= \left(\frac{k_2}{k_1} \right)^{1/q} |x(t_0)| e^{-(\alpha/q)(t-t_0)}, \quad \forall t \geq t_0, \quad \forall x(t_0) \in \mathcal{L}_{c^*}. \end{aligned}$$

This shows that $x = 0$ locally exponentially stable. If the conditions hold for $\mathcal{D} = \mathbb{R}^n$, the proof of global exponential stability is trivial. \square

Remark 4.5. Considering the storage function $V(x(t))$, the inequalities (4.10) and (4.11) show that (4.6) is exponentially dissipative with respect to the supply rates $\mathcal{S}(y, w)$ and $e^{-\alpha\bar{h}}\mathcal{S}(y, w)$ respectively, with \mathcal{S} defined in (4.8). See Section A.4 for the definitions of exponential dissipativity.

4.4.2 Sum of squares stability conditions for the class of polynomial systems

When the linear approximation fails, the dynamics of many physical phenomena can be modeled by polynomial differential equations. They are frequently found in several domains like process control, biology, robotics, and electrical systems. For this class of systems, SOS decomposition and semi-definite programming [102], are shown to be a useful tool. It has been used in several analysis and synthesis control problems [100].

In this section we specialize the previous result for the class of affine polynomial sampled-data systems, using SOS decomposition and semi-definite programming techniques. We formulate a constructive method to find a storage function and a supply rate, which satisfy the asymptotic/exponential stability conditions proposed in the previous section.

Let us consider the stability problem defined in Section 4.2 for the particular case where the $f(x)$, $g(x)$ and $K(x)$ are polynomial functions. The system (4.6) will be defined by:

$$\begin{cases} \dot{x} = F(x, w) \\ y = G(x, w) \end{cases} \quad (4.19)$$

where

$$F(x, w) := f_n(x) + g_n(x)w,$$

and

$$G(x, w) := \frac{\partial K}{\partial x} F(x, w).$$

When looking for a polynomial storage function $V(x)$, verifying the dissipativity inequalities in Theorem 4.3 is a problem of checking the non negativity of polynomials. This can be seen from (4.8) and (4.19), as for the polynomial case (4.10) and (4.11) are, respectively, equivalent to

$$0 \leq -\frac{\partial V}{\partial x} F(x, w) - \alpha V(x) + [-\delta_0^2 G^T(x, w) X G(x, w) + 2G^T(x, w) Y w + w^T X w],$$

and

$$0 \leq -\frac{\partial V}{\partial x} F(x, w) - \alpha V(x) + [-\delta_0^2 G^T(x, w) X G(x, w) + 2G^T(x, w) Y w + w^T X w] e^{-\alpha \bar{h}},$$

for any $x \in \mathcal{D}$. In fact, the right terms in the last inequalities can be written as polynomials of the form $p(\xi) \geq 0$, with $p(\xi) \in \mathbb{R}[\xi]$, and $\xi = (x, w)$.

Checking the non negativity of a polynomial is known to be a difficult problem. Recent methods relaxed this problem using semi-definite programming and the SOS decomposition [102]. The relaxation is based on checking whether a polynomial is a SOS, which is sufficient to ensure the semi-definite positivity.

Definition 4.6. [100] A multivariate polynomial $p(x) \in \mathbb{R}[x]$ is said to be a sum of squares (SOS), if there exist some polynomials $p_i(x) \in \mathbb{R}[x]$, $i \in \{1, \dots, M\}$, such that $p(x) = \sum_{i=1}^M p_i^2(x)$.

The relaxation is only sufficient, but there are suggestions in the literature which indicate that it is not too conservative (see [100] and the references therein). However, it must be noted that the computational complexity of the algorithms testing whether a polynomial $p(x)$ is an SOS increases rapidly with the degree of $p(x)$.

SOS techniques are shown to be very useful in systems analysis [100]. In the following, we reformalize Theorem 4.3 and Corollary 4.4 using the SOS method. The local applicability of the dissipativity inequalities inside a region \mathcal{D} is ensured using a technique similar to the S-procedure [12]. Note that when looking for a Lyapunov or a storage function, we need to ensure its positive definiteness. Thus, guaranteeing that it is an SOS is not sufficient, as it only guarantees its non negativity. To overcome this problem, we use the following proposition:

Proposition 4.7. [100] *Given a polynomial $V(x) \in \mathbb{R}[x]$ of degree $2d$, let*

$$\varphi(x) = \sum_{i=1}^n \sum_{j=1}^d \epsilon_{ij} x_i^{2j}, \text{ such that } \sum_{j=1}^d \epsilon_{ij} > \gamma, \quad \forall i = 1, \dots, n \quad (4.20)$$

with γ a positive number, and $\epsilon_{ij} \geq 0$ for all i and j . Then the condition

$$V(x) - \varphi(x) \text{ is SOS,} \quad (4.21)$$

guarantees the positive definiteness of $V(x)$.

Corollary 4.8. *Assume that the functions $f(x)$, $g(x)$ and $K(x)$ in the sampled-data system (4.3) are polynomial functions. Consider the equivalent representation (4.19) and (4.7). Let $\mathcal{D} = \{x \in \mathbb{R}^n : \mu_l(x) \geq 0, l = 1, 2, \dots, s\}$ be a neighborhood of the origin $x = 0$. Suppose that there exist a polynomial function $V(x) \in \mathbb{R}[x]$, and sums of squares $\sigma_l(\xi)$ and $\varsigma_l(\xi)$, with $l \in \{1, \dots, s\}$ and $\xi = (x, w)$, such that the following polynomials are SOS*

$$\hat{V}(x) = V(x) - \varphi(x), \quad (4.22)$$

$$\begin{aligned} \rho_1(\xi) = & - \sum_{l=1}^s \sigma_l(\xi) \mu_l(x) - \frac{\partial V}{\partial x} F(x, w) - \alpha V(x) \\ & + \left[-\delta_0^2 G^T(x, w) X G(x, w) + 2G^T(x, w) Y w + w^T X w \right], \end{aligned} \quad (4.23)$$

$$\begin{aligned} \rho_2(\xi) = & - \sum_{l=1}^s \varsigma_l(\xi) \mu_l(x) - \frac{\partial V}{\partial x} F(x, w) - \alpha V(x) \\ & + \left[-\delta_0^2 G^T(x, w) X G(x, w) + 2G^T(x, w) Y w + w^T X w \right] e^{-\alpha \bar{h}}. \end{aligned} \quad (4.24)$$

with $\delta_0 = \frac{2}{\pi} \bar{h}$, $0 < X^T = X \in \mathbb{R}^{m \times m}$, $0 \leq Y^T = Y \in \mathbb{R}^{m \times m}$, and $\varphi(x)$ a positive definite polynomial defined in (4.20). Then, the equilibrium $x = 0$ of the system (4.3) is locally uniformly asymptotically stable. Moreover, the sub-level set \mathcal{L}_{c^*} defined in (4.13) and (4.12), is an estimate of the domain of attraction. Finally, if (4.23) and (4.24) are SOS while $\mu_l(x) = 0$, for all $l \in \{1, 2, \dots, s\}$, then the equilibrium is globally uniformly asymptotically stable.

Proof. First, note that from (4.22) and Proposition 4.7, the function $V(x)$ is ensured to be definite positive and radially unbounded ($V(x) \rightarrow \infty$ when $x \rightarrow \infty$). Therefore, using Lemma 4.3 from [64], there exist class \mathcal{K} functions β_1 and β_2 , such that

$$\beta_1(|x|) \leq V(x) \leq \beta_2(|x|), \quad \forall x \in \mathbb{R}^n.$$

Moreover, when $x \in \mathcal{D}$, i.e. $\mu_l(x) \geq 0$ for all $l \in \{1, 2, \dots, s\}$, then from the non negativity of the SOS polynomials $\sigma_l(\xi)$ and $\varsigma_l(\xi)$, we can see that $\rho_1(\xi) \geq 0$ (resp. $\rho_2(\xi) \geq 0$). The later implies that the dissipativity condition (4.10) (resp. (4.11)) is satisfied. Thus all the local stability conditions of Theorem 4.3 are satisfied. The case where (4.23) and (4.24) are SOS for $\mu_l(x) = 0 \forall l \in \{1, 2, \dots, s\}$ satisfies obviously the global stability conditions in Theorem 4.3. \square

Corollary 4.9. *Suppose that all the conditions of Corollary 4.8 are satisfied, and that the storage function $V(x)$ satisfies*

$$k_1 |x|^q \leq V(x) \leq k_2 |x|^q, \quad \forall x \in \mathbb{R}^n. \quad (4.25)$$

Then, the equilibrium $x = 0$ is locally exponentially stable. Moreover, the sub-level set \mathcal{L}_{c^} defined in (4.13) and (4.12), is an estimate of the domain of attraction. If the conditions hold for $\mathcal{D} = \mathbb{R}^n$, then $x = 0$ is globally exponentially stable.*

Proof. The proof follows the same steps as the one of Corollary 4.8. It is a direct result of Corollary 4.4. \square

4.5 Illustrative Examples

In the following, we apply the proposed method on two nonlinear systems. First we revisit the example in [88]. We find the MASP which guarantees the global uniform asymptotic stability of the sampled-data system. Next, we consider another example that illustrates the applicability of the results for local exponential stability.

4.5.1 Example 1

Consider the following system from [88]

$$\dot{x} = dx^2 - x^3 + u,$$

with a bounded time-varying $|d| \leq 1$, and a stabilizing control $u = K(x) = -2x$. Emulating this controller results in a sampled-data system that can be represented by the operator Δ_{sh} in (4.7), and a system (4.6) described by

$$\begin{cases} \dot{x} = dx^2 - x^3 - 2x + w, \\ y = -2(dx^2 - x^3 - 2x + w). \end{cases}$$

We apply the Corollary 4.8 in order to find a storage function of the form $V(x) = ax^2 + bx^4$, such that (4.22), (4.23) and (4.24) are SOS. We choose $\varphi(x) = 10^{-3}x^2$, $\alpha = 0.1$ and $\bar{h} = 0.72$. We intend to test the global stability of the closed-loop sampled-data system at the origin. In this case, the polynomials (4.23) and (4.24) take the form

$$\begin{aligned} \rho_1(\xi) &= -(2ax + 4bx^3)(dx^2 - x^3 - 2x + w) - \alpha(ax^2 + ax^4) \\ &\quad + [-4\delta_0^2 X(dx^2 - x^3 - 2x + w)^2 \\ &\quad - 4Y(dx^2 - x^3 - 2x + w)w + Xw^2], \end{aligned} \tag{4.26}$$

$$\begin{aligned} \rho_2(\xi) &= -(2ax + 4bx^3)(dx^2 - x^3 - 2x + w) - \alpha(ax^2 + ax^4) \\ &\quad + [-4\delta_0^2 X(dx^2 - x^3 - 2x + w)^2 \\ &\quad - 4Y(dx^2 - x^3 - 2x + w)w + Xw^2]e^{-\alpha\bar{h}}, \end{aligned} \tag{4.27}$$

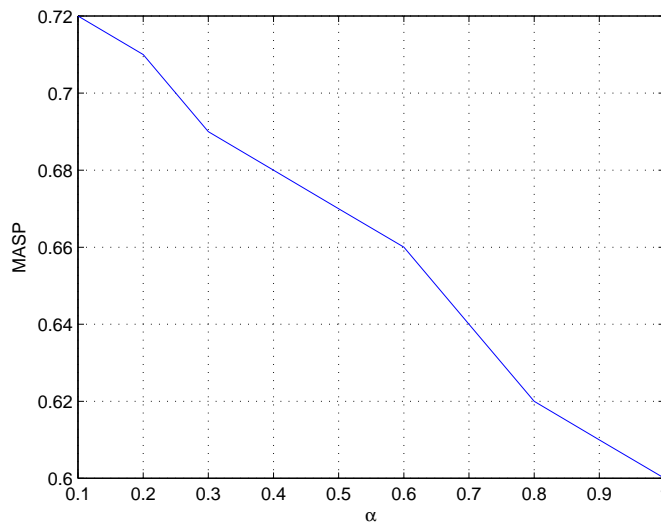

FIGURE 4.3: Tradeoff between α (the exponential decay rate of the storage function), and the estimation of the MASP \bar{h} .

where a, b, X, Y are decision variables. Note that the time-varying terms d and d^2 appear in the polynomial expressions. However, if both (4.26) and (4.27) are ensured to be SOS for all the values of $(d, d^2) \in \{(1, 0), (1, 1), (-1, 0), (-1, 1)\}$, then they will be SOS for any time-varying $|d| \leq 1$. This requirement is found to be satisfied using the SOSTOOLS software [104], for the storage function $V(x) = 0.77402x^2 + 0.19911x^4$, and the supply function (4.8) defined by $X = 0.47522$ and $Y = 0.62302 \cdot 10^{-3}$. By Corollary 4.8, we obtain the global uniform asymptotic stability of the equilibrium $x = 0$, of the sampled-data system. This result cannot be obtained when trying a quadratic storage function. Increasing α (the exponential decay rate of the storage function), results in the decrement of the maximum value of \bar{h} for which the problem is feasible. This can be seen in Fig 4.3. Previous works considered this example in the literature for estimating the MASP. In [88], a bound of $\bar{h} = 0.368$ is found. In [60], the proposed upper bound is $\bar{h} = 0.1428$. The conditions proposed in this paper are found feasible for $\bar{h} = 0.72$. State trajectory evolutions are shown in Fig 4.4. It can be seen that the state trajectory is asymptotically stable when the sampling periods are inferior to the bound $\bar{h} = 0.72$. Also, note that for a uniform sampling period of $t_{k+1} - t_k = 1.05$, asymptotic stability is no longer guaranteed.

4.5.2 Example 2

Consider the following system

$$\dot{x} = x^2 + (x - 1)u,$$

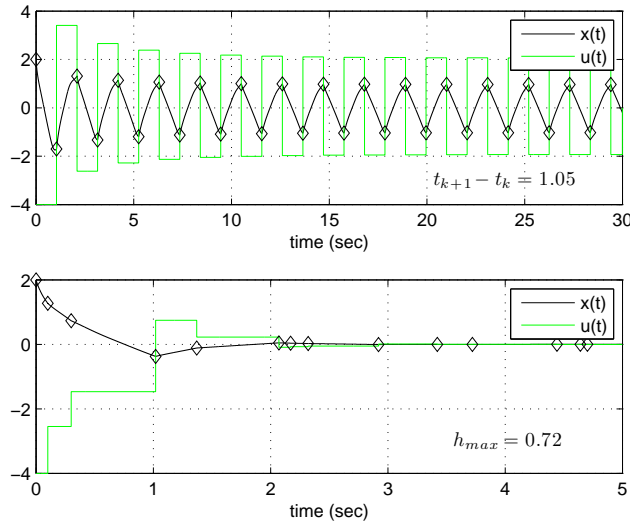

FIGURE 4.4: State trajectory evolution for two sequences of sampling intervals.

with the controller $u = K(x) = x + 2x^2$, which stabilizes the system at the equilibrium point $x = 0$. Note that, in the continuous-time case, this equilibrium is only locally stable. Our purpose is to find the maximum value of \bar{h} that guarantees the local exponential stability of $x = 0$, when the controller is emulated. We consider the neighborhood $x \in [-0.4, +0.4]$. The sampled-data system can be represented by the operator Δ_{sh} in (4.7), and a system (4.6) described by

$$\begin{cases} \dot{x} = -x + 2x^3 + (x-1)w, \\ y = (1+4x)(-x + 2x^3 + (x-1)w). \end{cases}$$

We consider applying Corollary 4.9 with a quadratic storage function $V(x) = ax^2$. Note that $V(x)$ satisfies (4.25) with $k_1 = k_2 = a$ and $q = 2$. We choose $\varphi(x) = 10^{-3}x^2$, $\alpha = 0.25$ and $\bar{h} = 0.6$. The considered domain \mathcal{D} is described by $\{x \in \mathbb{R} : \mu_1(x) \geq 0\}$ with $\mu_1(x) = (x+0.4)(0.4-x)$. The polynomials (4.23) and (4.24) are in this case

$$\begin{aligned} \rho_1(\xi) = & -\sigma_1(\xi)\mu_1(x) - (2ax)(-x + 2x^3 + (x-1)w) - \alpha(ax^2) \\ & + [-\delta_0^2 X(1+4x)^2(-x + 2x^3 + (x-1)w)^2 \\ & + 2Y(1+4x)(-x + 2x^3 + (x-1)w)w + Xw^2], \end{aligned} \quad (4.28)$$

$$\begin{aligned} \rho_2(\xi) = & -\varsigma_1(\xi)\mu_1(x) - (2ax)(-x + 2x^3 + (x-1)w) - \alpha(ax^2) \\ & + [-\delta_0^2 X(1+4x)^2(-x + 2x^3 + (x-1)w)^2 \\ & + 2Y(1+4x)(-x + 2x^3 + (x-1)w)w + Xw^2]e^{-\alpha\bar{h}}, \end{aligned} \quad (4.29)$$

where a, X, Y are decision variables, and $\sigma_1(\xi), \varsigma_1(\xi)$ are decision SOS polynomials. Using the software SOSTOOLS we find that (4.28) and (4.29) are SOS with $a = 0.12015$, $X = 0.25506$, $Y = 0.88456 \cdot 10^{-2}$. The decision SOS polynomials are

$$\begin{aligned}\sigma_1(\xi) &= 0.62335 w^2 - 0.3616 x w^2 + 1.6714 x^2 w^2 \\ &\quad - 0.67622 x^3 w + 2.0314 x^4 w + 3.228 x^6, \\ \varsigma_1(\xi) &= 0.52025 w^2 - 0.31686 x w^2 + 1.4349 x^2 w^2 \\ &\quad - 0.54824 x^3 w + 1.60754 x^4 w + 2.8846 x^6.\end{aligned}$$

Thus all the conditions of Corollary 4.9 are satisfied, and $x = 0$ is locally exponentially stable. The estimation of the domain of attraction \mathcal{L}_{c^*} can be easily seen to be equals to the studied domain $[-0.4, +0.4]$.

4.6 Conclusion

In this chapter we have provided sufficient conditions for the stability of nonlinear sampled-data systems, which are affine in the control. The main idea of the chapter is to use the dissipativity theory to provide an estimate of the MASP. The provided results can be used to analyze asymptotic/exponential stability, and can be applied locally or globally. The results are numerically tractable for the case of polynomial systems, with the use of SOS decomposition and semi-definite programming. The method is applied to a benchmark example from the literature, and it has been shown that it can provide a good estimate of the MASP. The novelty of this contribution is that it provides a quantitative estimate of the MASP using robust control tools based on the dissipativity theory.

General conclusion

This thesis has provided contributions to the stability analysis of nonlinear systems under aperiodic sampling. A continuous-time controller is supposed to be designed without taking the sampling into consideration, and it is emulated in discrete-time. The main objective was to provide tractable stability criteria which allow for estimating the Maximum Allowable Sampling Period (MASP)¹.

A particular attention has been given to the case of bilinear systems, which are a special class of nonlinear systems. They represent a challenging intermediate between linear and nonlinear systems, which is relevant in practical applications. The study of such systems allows for tackling the difficulties of nonlinear systems while exploiting their quasi-linear structure. New theoretical methods have been proposed for this class of systems. Afterwards, the results have been extended to more general classes of nonlinear systems. We describe, in what follows, the contributions of the thesis with a little more detail.

In Chapter 1, we proposed an overview of the techniques involved in sampled-data control, ranging from Lyapunov-Krasovskii functionals, impulsive modeling, small gain and convex-embedding approaches for LTI systems, to different emulation and discrete-time approaches for nonlinear systems.

In Chapter 2, we have provided sufficient conditions for the local stability of bilinear sampled-data systems, controlled via a linear state feedback controller. New results for estimating the MASP that guarantees the local stability of the system are given. Two methods were considered via the hybrid system modeling approach. The first method [95] is a constructive adaptation of a generic result for nonlinear case [88], while the second one is based on a direct search of a Lyapunov function for the hybrid model [95]. The stability conditions of both methods are given in the form of Linear Matrix Inequalities (LMIs), which are easily tractable in terms of computation.

¹Note that the term “period” is usually employed, but should rather be called “interval” since it contains the asynchronous sampling case.

In Chapter 3, the local stability of bilinear sampled-data systems has been investigated using a new approach inspired by dissipativity [92, 94]. Sufficient conditions have been provided based on the analysis of contractive invariant sets. Polytopic state-space constraints have been included in the analysis. The local stability is guaranteed inside an ellipsoidal estimate of the domain of attraction. The stability analysis criteria, as well as the conditions for estimating the domain of attraction, are given in the form of LMIs.

In Chapter 4, we have provided sufficient conditions for the stability of nonlinear sampled-data systems, affine in the control. The main idea of this contribution is to extend the dissipativity-based results developed for bilinear systems to a more general nonlinear case [93, 96, 97]. The method provides a quantitative estimate of the MASP and can be used to analyze asymptotic/exponential stability. It is shown that the results are numerically tractable for the case of polynomial systems. In this case, the tractability refers to the use of SOS decomposition and semi-definite programming.

We believe that the results of this thesis reveal several perspectives, and emerging research directions can now be considered as follows.

First, the provided results contribute to stability analysis of Networked Control Systems (NCSs), as for such systems robustness with respect to aperiodic sampling is an essential issue. However, networks impose other communication imperfections that must also be taken into account: time-varying delays, constraints on the number of nodes accessing the network, and quantization. Extending our methodology in order to include these additional network imperfections would be of great interest.

Second, although the results we provided are shown to have rather low levels of conservatism, it is still possible to improve the numerical solvability of the proposed conditions. These conditions can be enhanced by giving more insight into the mathematical model of the sampling effects. This would lead to new characterizations of supply functions used in the dissipativity-based approach. Moreover, information about the lower bound of the sampling interval could be useful in the analysis. Analyzing stability while taking into consideration both the upper and the lower bound on the sampling intervals could enhance the results.

Third, the present work addresses stability analysis for sampled-data systems with an emulated controller. It means we considered that a controller has been designed in continuous-time without taking the sampling into account. In the future, we may try to build on our progress in order to design (possibly more complex) sampled-data controllers. This constitutes a challenging issue.

Finally, the thesis was focused on the robust stability with respect to aperiodic sampling. From this point of view, the variations of the sampling intervals are seen as perturbations.

Nevertheless, there exist various approaches where the sampling intervals are supposed to be controllable. These approaches include event-based control, self-triggered control and state-dependent sampling control: the idea is to guarantee stability while sampling as less as possible. Extending our results for these controlled sampling methodologies is another interesting research direction.

Résumé étendu en français

Introduction

La technologie numérique contribue considérablement à l'implémentation des contrôleurs automatiques. De nos jours, les instruments de calcul numérique sont essentiels dans la plupart des boucles de contrôle. Une boucle de commande classique avec retour d'état échantillonné est montrée dans la Fig. 5. Elle est constituée d'un processus en temps continu, bouclé par un contrôleur numérique. Le signal de sortie y (temps continu) est mesuré aux instants d'échantillonnage. Le contrôleur utilise le signal échantillonné pour calculer le signal de commande (temps discret). L'interface, depuis les valeurs discrètes vers les signaux continus, est réalisée par un bloqueur, comme le bloqueur d'ordre zéro.

La complexité de l'algorithme de commande est liée aux hypothèses de modélisation. Parmi celles-ci, la linéarité du processus et la périodicité de l'échantillonnage ont dû être supposées pendant longtemps, principalement parce que la théorie de la commande des systèmes échantillonnés est bien développée pour le cas des systèmes linéaires invariants dans le temps, avec échantillonnage uniforme. Ces hypothèses sont considérées à cause des limites des outils développés pour synthétiser un contrôleur. Cependant, les phénomènes physiques sont fondamentalement non linéaires et les intervalles entre les instants d'échantillonnage varient dans le temps à cause des contraintes de temps réel. Ceci rend le problème d'analyse de stabilité plus difficile. En fait, la stabilité des

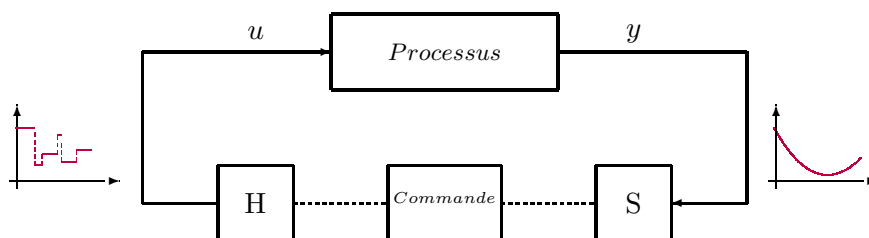

FIGURE 5: Commande du système avec retour d'état échantillonné.

systèmes non linéaires échantillonnés est un sujet complexe par nature et constitue un sujet de recherche intéressant.

L'approche de synthèse par *émulation* est souvent considérée. Dans cette approche, une commande qui stabilise le système en temps continu est implémentée en utilisant un bloqueur d'ordre zéro (BOZ). Intuitivement, on se doute que des pas d'échantillonnage "suffisamment petits" vont assurer la stabilité : au-delà de cette approche qualitative, il est concrètement important d'avoir une estimation quantitative de ce qu'on appelle le *plus grand pas d'échantillonnage permis* (MASP en anglais).

Plusieurs travaux dans la littérature se sont penchés sur ce problème. Le cas des systèmes échantillonnés linéaires a été largement étudié, et les résultats sont constructifs. Quelques travaux plus rares traitent le cas des systèmes non linéaires. Notons dès à présent qu'il n'est pas toujours évident de les appliquer et de calculer une estimation numérique du plus grand pas d'échantillonnage qui garantit la stabilité.

Le travail présenté dans cette thèse est dédié au problème suivant:

Fournir un critère de stabilité pour les systèmes non linéaires, qui permet de calculer une estimation du plus grand pas d'échantillonnage permis.

Le travail se concentre d'abord sur le cas des systèmes bilinéaires. Ces systèmes représentent un cas intermédiaire entre les modèles linéaires et les modèles non linéaires les plus généraux. Ils peuvent servir d'approximation pour les systèmes non linéaires, et modéliser des processus dans une bonne variété de domaines. L'objectif de ce travail est donc tout d'abord d'étudier le problème de stabilité des systèmes bilinéaires avec échantillonnage aperiodique. Ensuite, on généralise les résultats pour une classe plus large de systèmes non linéaires.

Structure du mémoire

Cette thèse est organisée comme suit:

Chapitre 1

Dans ce chapitre, on présente une vue d'ensemble des systèmes de commande échantillonnés. D'abord, on introduit ces systèmes et on présente un très bref historique de l'utilisation de la technologie numérique en automatique. Ensuite, on se concentre sur le problème de l'analyse de la stabilité des systèmes linéaires et non linéaires échantillonnés. Comme de nombreuses publications et plusieurs théories sont

consacrées à l'analyse de stabilité sous échantillonnage périodique ou apériodique, ce chapitre présente un aperçu bref mais structuré des principaux résultats de ce domaine.

Chapitre 2

Ce chapitre est dédié à l'analyse de la stabilité locale des systèmes bilinéaires échantillonnés, contrôlés par un retour d'état statique. La stabilité est étudiée en utilisant une formulation de type système hybride. L'objectif est de trouver un critère de stabilité et une méthode constructive pour estimer le plus grand pas d'échantillonnage permis. Ce problème a rarement été considéré pour les systèmes bilinéaires, et à notre connaissance, jamais de façon constructive.

Deux méthodes sont considérées. Elles sont développées dans le cadre des systèmes hybrides. La première méthode est une spécialisation d'un résultat concernant les systèmes non linéaires généraux. Le but est de trouver une méthode constructive afin de l'appliquer pour le cas des systèmes bilinéaires. La deuxième méthode est basée sur une recherche directe d'une fonction de Lyapunov en utilisant des inégalités matricielles linéaires (LMIs).

Formulation du problème

On considère le système bilinéaire:

$$\dot{x}(t) = A_0x(t) + \sum_{i=1}^m [u(t)]_i N_i x(t) + B_0 u(t), \quad \forall t \geq t_0. \quad (1)$$

On suppose que les hypothèses suivantes sont satisfaites:

A1 La commande est constante par morceaux

$$u(t) = Kx(t_k), \quad \forall t \in [t_k, t_{k+1}),$$

avec un ensemble des instants d'échantillonnage $\{t_k\}_{k \in \mathbb{N}}$ qui satisfait:

$$0 < \epsilon \leq t_{k+1} - t_k \leq \bar{h}, \quad \forall k \in \mathbb{N}, \quad (2)$$

où \bar{h} est un **plus grand pas d'échantillonnage permis**.

A2 La paire (A_0, B_0) est stabilisable et le retour d'état linéaire $u(t) = Kx(t)$ est calculé afin de stabiliser asymptotiquement localement l'origine du système (1). Le domaine d'attraction est \mathcal{D}_0 .

A3 Les variables d'état sont soumises à des contraintes données par un polytope $\mathcal{P} \subset \mathcal{D}_0$:

$$\mathcal{P} = \text{conv}\{x_1, x_2, \dots, x_p\}, \quad (3)$$

$$= \{x \in \mathbb{R}^n : a_j^T x \leq 1, j = 1, 2, \dots, p\}. \quad (4)$$

Sous ces hypothèses, le système en boucle fermée est:

$$\dot{x}(t) = \left(A_0 + \sum_{i=1}^m [Kx(t_k)]_i N_i \right) x(t) + B_0 K x(t_k), \quad \forall t \in [t_k, t_{k+1}), \quad \forall k \in \mathbb{N}. \quad (5)$$

Le système (5) peut être représenté par

$$\dot{x}(t) = \tilde{A}[x(t), e(t)]x(t) + B e(t), \quad \forall t \in [t_k, t_{k+1}) \quad (6)$$

avec

$$e(t) = x(t_k) - x(t),$$

$$\tilde{A}[x, e] := A_0 + B_0 K + \sum_{i=1}^m [K(x + e)]_i N_i, \quad (7)$$

et

$$B = B_0 K. \quad (8)$$

Si $x(t_k)$ est dans le polytope \mathcal{P} , alors

$$A[x(t_k)] := \tilde{A}[x(t), e(t)] \in \text{conv}\{A_1, A_2, \dots, A_p\},$$

avec

$$A_q = A[x_q] \quad \forall q \in \{1, 2, \dots, p\}. \quad (9)$$

Problème:

Trouver un critère de stabilité asymptotique locale de l'équilibre $x = 0$ du système (5), ainsi qu'une estimation du domaine d'attraction $\mathcal{E} \subset \mathcal{P}$ de telle sorte que pour tout $x(t_0) \in \mathcal{E}$ les solutions satisfont $x(t) \in \mathcal{P}, \forall t > t_0$, et $x(t) \rightarrow 0$.

Le système bilinéaire échantillonné peut être représenté par:

$$\begin{aligned}
 \dot{x} &= A_0 x(t) + \sum_{i=1}^m u_i(t) N_i x(t) + B_0 u(t), & t \in [t_k, t_{k+1}), \\
 y &= x, \\
 u &= K \hat{y}, \\
 \dot{\hat{y}} &= 0, & t \in [t_k, t_{k+1}), \\
 \hat{y}(t_k^+) &= y(t_k).
 \end{aligned} \tag{10}$$

Le système (10) peut être représenté par le modèle hybride suivant:

$$\begin{aligned}
 \left. \begin{aligned}
 \dot{x} &= f(x, e) = \tilde{A}[x, e]x + Be \\
 \dot{e} &= g(x, e) = -\tilde{A}[x, e]x - Be \\
 \dot{\tau} &= 1
 \end{aligned} \right\} & \tau \in [0, \bar{h}) \\
 \left. \begin{aligned}
 x^+ &= x \\
 e^+ &= 0 \\
 \tau^+ &= 0
 \end{aligned} \right\} & \tau \in [\epsilon, \bar{h}]
 \end{aligned} \tag{11}$$

Méthode 1:

Le théorème suivant est une adaptation du résultat de [88] pour le cas bilinéaire.

Théorème .0.1. On considère le système (11), le polytope \mathcal{P} dans (3), la notation (9) et une fonction \mathcal{T} donnée par

$$\mathcal{T}(\gamma, L) := \begin{cases} \frac{1}{Lr} \arctan(r) & \gamma > L \\ \frac{1}{L} & \gamma = L \\ \frac{1}{Lr} \operatorname{arctanh}(r) & \gamma < L \end{cases} \tag{12}$$

avec

$$r = \sqrt{\left| \frac{\gamma^2}{L^2} - 1 \right|} \tag{13}$$

où L est donné par

$$L = \frac{1}{2} \max\{-\lambda_{\min}(B^T + B), 0\} \tag{14}$$

et γ est la solution du problème d'optimisation suivant

$$\gamma = \min \gamma' \tag{15}$$

sous les contraintes $\exists P \in \mathbb{R}^{n \times n}$, une matrice symétrique définie positive, $\exists \gamma' > 0$ et $\exists \alpha > 0$, telle que

$$M_{lj} = \begin{bmatrix} A_l^T P + P A_l + \frac{1}{2}(A_l^T A_j + A_j^T A_l) + \alpha I & P B \\ * & (\alpha - \gamma'^2) I \end{bmatrix} < 0, \quad \forall l, j \in \{1, 2, \dots, p\}, \quad (16)$$

où A_l and A_j sont des sommets donnés par (9). On suppose que $\bar{h} < \mathcal{T}(\gamma, L)$. Alors, pour le système (11), l'ensemble $\{(x, e, \tau) : x = 0, e = 0\}$ est localement *uniformément asymptotiquement stable*.

Méthode 2:

Dans cette méthode, on cherche directement une fonction de Lyapunov pour le modèle hybride. L'objectif est d'éviter le conservatisme présent dans la méthode précédente, dû aux bornes supérieures sur la dérivée de la fonction de Lyapunov.

Théorème .0.2. On considère le système (11). On suppose que $\bar{h} \leq \mathcal{T}$. On suppose qu'il existe des matrices symétriques définies positives $P, Q, X, Y \in \mathbb{R}^{n \times n}$ telles que les LMIs suivantes sont satisfaites:

$$\begin{bmatrix} A_l^T P + P A_l + X & P B - A_l^T Q \\ * & -B^T Q - Q B - \frac{1}{\mathcal{T}} Q + Y \end{bmatrix} < 0, \quad \forall l \in \{1, 2, \dots, p\}, \quad (17)$$

$$\begin{bmatrix} A_l^T P + P A_l + X & P B - A_l^T Q \exp(-1) \\ * & [-B^T Q - Q B - \frac{1}{\mathcal{T}} Q] \exp(-1) + Y \end{bmatrix} < 0, \quad \forall l \in \{1, 2, \dots, p\}, \quad (18)$$

où A_l des sommets donnés par (9). Alors, pour le système (11), l'ensemble $\{(x, e, \tau) : x = 0, e = 0\}$ est localement *uniformément asymptotiquement stable*.

Chapitre 3

Ce chapitre est dédié à l'analyse de la stabilité locale des systèmes bilinéaires échantillonnés, contrôlés par un retour d'état statique. Ce problème a été considéré dans

le Chapitre 2, mais l'objectif de ce chapitre est de le traiter en utilisant une nouvelle approche. Le problème de l'analyse de stabilité est étudié via une propriété d'invariance des sous ensembles ellipsoïdaux. La méthode présentée ici est inspirée par la théorie de la dissipativité.

La notion de dissipativité a été introduite par Willems [124]. Depuis son introduction, cette approche a attiré beaucoup d'attention, car elle peut être utilisée pour étudier la stabilité, la passivité, la robustesse et d'autres problèmes d'analyse et de synthèse. Ces travaux sont inspirés par les propriétés de passivité des circuits électriques et peuvent être considérés comme la généralisation d'une notion abstraite d'énergie pour les systèmes dynamiques.

L'équation (5) peut être écrite

$$\dot{x}(t) = \underbrace{\left(A_0 + B_0K + \sum_{i=1}^m [Kx(t_k)]_i N_i \right)}_{A(x(t_k))} x(t) + \underbrace{B_0K}_{B} \underbrace{(x(t_k) - x(t))}_{w(t)}.$$

On définit

$$C(x(t_k)) = A(x(t_k)) = A_0 + B_0K + \sum_{i=1}^m [Kx(t_k)]_i N_i, \quad D = B = B_0K, \quad (19)$$

ce qui montre que le système échantillonné peut être représenté par le bouclage du système

$$G := \begin{cases} \dot{x}(t) = A(x(t_k))x(t) + Bw(t), \\ y(t) = C(x(t_k))x(t) + Dw(t), \end{cases} \quad (20)$$

avec l'opérateur $\Delta_{sh} : y \rightarrow w$,

$$w(t) = (\Delta_{sh} y)(t) = - \int_{t_k}^t y(\tau) d\tau, \quad \forall t \in [t_k, t_{k+1}). \quad (21)$$

On remarque que l'effet des variations des pas d'échantillonnage est modélisé par l'opérateur Δ_{sh} . Cette approche est considérée dans [74] et [39] avec l'objectif d'étudier la stabilité des systèmes échantillonnés linéaires. Dans [74], une limite supérieure sur le gain de l'opérateur Δ_{sh} est trouvée. Il est montré que $\|\Delta_{sh}\| \leq \delta_0$ avec $\delta_0 = \frac{2}{\pi} h_{max}$. Cette limite est atteinte ($\|\Delta_{sh}\| = \delta_0$) pour $t_{k+1} - t_k = h_{max}$. Des conditions de stabilité basées sur le théorème du petit gain sont fournies sous la forme de LMI. Dans [39], la propriété précédente est associée à une propriété de passivité pour trouver des conditions moins contraignantes. Le résultat est basé sur des techniques de commande robuste, utilisant une approche fréquentielle et le lemme de Kalman-Yakubovich-Popov.

Théorème .0.3. On considère le système (11), la représentation équivalente (21) et (20). On suppose qu'il existe des matrices symétriques définies positives $X, Y, P \in \mathbb{R}^{n \times n}$, et des matrices $P_2, P_3 \in \mathbb{R}^{n \times n}$ telles que le problème d'optimisation suivant admet une solution

$$\gamma^* = \min_{E_j \geq 0, M_q < 0} \gamma, \quad \forall j \in \{1, 2, \dots, r\}, \quad \forall q \in \{1, 2, \dots, p\} \quad (22)$$

avec

$$E_j = \begin{bmatrix} \gamma & a_j^T \\ a_j & P \end{bmatrix} \geq 0 \quad (23)$$

et

$$M_q = \begin{bmatrix} A_q^T P_2 + P_2^T A_q & P - P_2^T + A_q^T P_3 & P_2^T B \\ P - P_2 + P_3^T A_q & -P_3 - P_3^T + \delta_0^2 X & P_3^T B - Y \\ B^T P_2 & B^T P_3 - Y & -X \end{bmatrix} < 0 \quad (24)$$

avec $\delta_0 = \frac{2}{\pi} h_{max}$, et les sommets $\{A_q\}_{q \in \{1, 2, \dots, p\}}$ sont donnés par

$$A_q := A(x_q) = A_0 + B_0 K + \sum_{i=1}^m \left[K x_q \right]_i N_i \quad (25)$$

avec $\{x_q\}_{q \in \{1, 2, \dots, p\}}$ donné dans (3). Alors, l'équilibre $x = 0$ du système (11) est localement asymptotiquement stable et le domaine d'attraction est estimé par

$$\mathcal{E}_{c^*}[P] = \{x \in \mathbb{R}^n : x^T P x \leq c^*\} \subset \mathcal{P}, \quad \text{with } c^* = 1/\gamma^*. \quad (26)$$

Chapitre 4

Dans ce chapitre on généralise les résultats du Chapitre 3 pour le cas des systèmes non linéaires affines en l'entrée. Nous supposons qu'il existe une commande stabilisante en temps continu. Lors de l'implémentation numérique de cette commande, il s'agit de trouver des conditions préservant la stabilité asymptotique/exponentielle sous échantillonnage. Les conditions sont formulées à la fois pour la stabilité globale et la stabilité locale. L'idée principale est d'aborder le problème dans le cadre de la dissipativité exponentielle. Le résultat est ensuite repris dans le cas spécifique des systèmes non linéaires polynomiaux, où les conditions de stabilité sont vérifiées numériquement en utilisant la décomposition en somme des carrés (SOS) et la programmation semi-définie.

Formulation du problème

On considère le système non linéaire

$$\dot{x}(t) = f(x(t)) + g(x(t))u(t), \quad \forall t > t_0, \quad x(t_0) = x_0, \quad (27)$$

où $x(t) \in \mathbb{R}^n$ et $u(t) \in \mathbb{R}^m$ sont respectivement l'état et l'entrée. Les fonctions $f : \mathbb{R}^n \rightarrow \mathbb{R}^n$ avec $f(0) = 0$, et $g : \mathbb{R}^{n \times m} \rightarrow \mathbb{R}^n$ sont suffisamment lisses pour qu'à chaque $x(t_0)$ et $u(\cdot)$ admissible corresponde une seule solution sur $[t_0, \infty)$. On suppose qu'il existe une commande $u = K(x)$ qui stabilise l'équilibre en temps continu, où $K : \mathbb{R}^n \rightarrow \mathbb{R}^m$ est une fonction continûment différentiable. On considère l'émulation de la commande $u = K(x)$ en supposant que:

- les instants d'échantillonnage $\{0 = t_0 < t_1, \dots < t_k < \dots\}$ satisfont

$$0 < t_{k+1} - t_k \leq \bar{h}, \quad \forall k \in \mathbb{N},$$

pour une borne supérieure finie \bar{h} ,

$$\lim_{k \rightarrow \infty} t_k = \infty;$$

- le contrôle est un retour d'état constant par morceaux:

$$u(t) = K(x(t_k)), \quad \forall t \in [t_k, t_{k+1}). \quad (28)$$

On obtient alors le système en boucle fermée:

$$\begin{aligned} \dot{x}(t) &= f(x(t)) + g(x(t))K(x(t_k)), \\ \forall t &\in [t_k, t_{k+1}), \quad k \in \mathbb{N}. \end{aligned} \quad (29)$$

Problème : *Notre objectif est de trouver un critère de stabilité asymptotique et exponentielle locale/globale de l'équilibre $x = 0$ du système non linéaire échantillonné (29).*

Une représentation équivalente

On note que le système (29) s'écrit aussi :

$$\dot{x}(t) = f_n(x(t)) + g_n(x(t))w(t), \quad \forall t \in [t_k, t_{k+1}), \quad k \in \mathbb{N}, \quad (30)$$

où $f_n(x) = f(x) + g(x)K(x)$, $g_n(x) = g(x)$ et $w(t) = K(x(t_k)) - K(x(t))$. On note que $f_n(x)$ représente la dynamique de boucle fermée en temps continu. L'équation (29) montre que le système échantillonné peut être représenté par le bouclage du système:

$$\mathcal{G} := \begin{cases} \dot{x} = f_n(x) + g_n(x)w, \\ y = \frac{\partial K}{\partial x} \dot{x}, \end{cases} \quad (31)$$

avec l'opérateur $\Delta_{sh} : y \rightarrow w$

$$w(t) = (\Delta_{sh} y)(t) = - \int_{t_k}^t y(\tau) d\tau, \quad \forall t \in [t_k, t_{k+1}). \quad (32)$$

Les propriétés de l'opérateur Δ_{sh} sont présentées dans la Section 3.2.1. Nous considérons ici l'exploitation de ces propriétés afin de développer un critère de stabilité pour le contrôle échantillonné des systèmes non linéaires. L'approche s'inspire de la notion de dissipativité exponentielle.

Analyse de stabilité

On considère les définitions de stabilité suivantes.

Définition .0.1. Le point d'équilibre $x = 0$ de (29) est *localement uniformément asymptotiquement stable* dans un voisinage \mathcal{D}_0 de l'équilibre, s'il existe une fonction $\beta(\cdot, \cdot)$ de classe \mathcal{KL} , telle que

$$|x(t)| \leq \beta(|x(t_0)|, t - t_0), \quad \forall t \geq t_0, \quad \forall x(t_0) \in \mathcal{L}. \quad (33)$$

Il est *globalement uniformément asymptotiquement stable* si (33) est satisfaite pour $\mathcal{D}_0 = \mathbb{R}^n$.

Théorème .0.4. Soient le système non linéaire échantillonné (29) et sa présentation équivalente (31), (32). On considère la forme quadratique:

$$\mathcal{S}(y(t), w(t)) = \begin{bmatrix} y(t) \\ w(t) \end{bmatrix}^T \begin{bmatrix} -\delta_0^2 X & Y \\ Y & X \end{bmatrix} \begin{bmatrix} y(t) \\ w(t) \end{bmatrix}, \quad (34)$$

avec $\delta_0 = \frac{2}{\pi} \bar{h}$, $0 < X^T = X \in \mathbb{R}^{m \times m}$ et $0 \leq Y^T = Y \in \mathbb{R}^{m \times m}$. Considérons un voisinage $\mathcal{D} \subset \mathbb{R}^n$ de l'équilibre $x = 0$ et une fonction différentiable définie positive $V : \mathcal{D} \rightarrow \mathbb{R}^+$, pour laquelle il existe $\alpha > 0$ et des fonctions β_1 et β_2 de classe \mathcal{K} , telles que:

$$\beta_1(|x|) \leq V(x) \leq \beta_2(|x|), \quad \forall x \in \mathcal{D}, \quad (35)$$

et pour tout $x(t) \in \mathcal{D}$, V satisfait:

$$\dot{V}(x(t)) + \alpha V(x(t)) \leq \mathcal{S}(y(t), w(t)), \quad (36)$$

$$\dot{V}(x(t)) + \alpha V(x(t)) \leq \mathcal{S}(y(t), w(t)) e^{-\alpha \bar{h}}. \quad (37)$$

Alors, l'équilibre $x = 0$ du système (29) est localement uniformément asymptotiquement stable. De plus, considérons les ensembles définis par $V(\cdot)$ et un scalaire $c > 0$:

$$\mathcal{L}_c := \{x \in \mathbb{R}^n : V(x) \leq c\}. \quad (38)$$

Alors, l'ensemble \mathcal{L}_{c^*} défini par la surface de niveau maximal de V contenue dans \mathcal{D} :

$$c^* = \max_{\mathcal{L}_c \subset \mathcal{D}} c \quad (39)$$

est une estimation du domaine d'attraction de $x = 0$. Enfin, si toutes les conditions sont satisfaites pour $\mathcal{D} = \mathbb{R}^n$, avec des fonctions β_1 et β_2 de classe \mathcal{K}_∞ , alors $x = 0$ est globalement uniformément asymptotiquement stable.

Conclusion

Cette thèse a contribué à l'analyse de stabilité des systèmes non linéaires sous échantillonnage aperiodique. En adoptant une démarche d'émulation, un contrôleur en temps continu est tout d'abord synthétisé sans prendre l'échantillonnage en considération. Ensuite il est implémenté en temps discret. L'objectif principal est de fournir un critère de stabilité qui permet d'estimer le plus grand pas d'échantillonnage admissible.

Dans ce travail nous nous sommes essentiellement concentrés sur les systèmes bilinéaires. Ils représentent un cas particulier des systèmes non linéaires, mais aussi un cas intermédiaire entre les systèmes linéaires et non linéaires généraux. Plusieurs méthodes théoriques ont été proposées pour ce cas. Ensuite, les résultats ont été étendus au cas non linéaire général (sous l'hypothèse affine en la commande).

Nous sommes convaincus que les perspectives qui émergent des travaux présentés dans cette thèse sont multiples.

Tout d'abord, les résultats de cette thèse représentent une contribution à l'analyse de stabilité des systèmes de commande en réseau, car ils traitent le problème d'échantillonnage aperiodique. Un axe de recherche intéressant serait de considérer d'autres imperfections

du réseau: le retard variant dans le temps, les contraintes sur le nombre des capteurs/actionneurs qui ont accès au réseau, la quantification, etc.

Un autre axe de recherche serait de réduire le conservatisme des résultats. Ceci peut être réalisé en étudiant plus profondément le modèle mathématique de l'effet de l'échantillonnage. De plus, prendre en compte une borne inférieure sur les intervalles d'échantillonnage pourrait permettre d'améliorer les résultats.

Enfin, dans ce travail on considère l'analyse de stabilité pour un contrôleur donné. Le contrôleur est calculé en temps continu, sans prendre l'échantillonnage en considération. Il serait intéressant de prendre l'échantillonnage en compte afin de calculer directement un contrôleur discret.

Appendix A

Dissipative dynamical systems

A.1 Introduction

The purpose of this appendix is to provide a brief presentation of the notion of dissipativity of dynamical systems. This notion was initiated by Willems [124, 125]. It was motivated by the concept of passivity from electrical networks theory. Dissipativity extends, in an abstract sense, the notion of energy. It can be seen as a generalization of Lyapunov functions technique, for input-output systems. Since the 1970's, dissipativity has been providing several useful tools for studying dynamical systems, and several researchers have been considering it (see the references [14, 29, 50, 51, 124, 126], just to name a few). Consider the continuous-time dynamical system Σ described by the equations

$$\Sigma := \begin{cases} \dot{x} = f(x) + g(x)w, \\ y = h(x) + j(x)w, \end{cases} \quad (\text{A.1})$$

where the values of the state x , the input w and the output y lie in \mathbb{R}^n , \mathbb{R}^m and \mathbb{R}^p , respectively. The functions in (A.1) are supposed to be smooth enough to guarantee the existence of a solution for any initial condition $x(t_0) = x_0 \in \mathbb{R}^n$. Moreover, they satisfy $f(0) = 0$ and $h(0) = 0$. Suppose there exists a function $\mathcal{S}(y, w) : \mathbb{R}^p \times \mathbb{R}^m \rightarrow \mathbb{R}$ such that $\mathcal{S}(0, 0) = 0$ and for all input-output pairs $w \in \mathbb{R}^m$ and $y \in \mathbb{R}^p$, it satisfies $\int_{t_1}^{t_2} |\mathcal{S}(y(s), w(s))| ds < \infty$, for $t_2 \geq t_1 \geq t_0$. The following definition introduces the notion of dissipativity.

Definition A.1 (Dissipativity [14]). System Σ (A.1) is said to be *dissipative* with respect to the *supply rate* $\mathcal{S}(y, w)$, if there exists a *storage function* $V(x) : \mathbb{R}^n \rightarrow \mathbb{R}_+$ such that

the following *dissipation inequality* holds:

$$V(x(t_2)) - V(x(t_1)) \leq \int_{t_1}^{t_2} \mathcal{S}(y(s), w(s)) ds, \quad (\text{A.2})$$

for all $t_1 \leq t_2$ and all signals (w, y, x) which satisfy (A.1).

Definition A.1 can be interpreted as follows. The positive semi-definite, memoryless storage function $V(x)$, generalizes the notion of energy. The memoryless function $\mathcal{S}(y, w)$ represents the rate at which power flows into the system. Finally, the dissipation inequality (A.2) shows that over the time interval $[t_1, t_2]$, the change of stored energy $V(x(t_2)) - V(x(t_1))$ is bounded by the amount of supply that flows into the dissipative system Σ . Definition A.1 is sometimes referred to as *Willems dissipativity*. It is a general definition, and does not require any regularity of the storage function. When the storage function V is smooth, then (A.2) can be written as

$$\dot{V}(x(t)) \leq \mathcal{S}(y(t), w(t)), \quad t \geq t_0.$$

It must be noted that there exists a variety of definitions for dissipativity in the literature. For example, the following definition is provided by Hill and Moylan:

Definition A.2 ([50]). System Σ is dissipative with respect to the supply rate $\mathcal{S}(y, w)$, if for all admissible $w(\cdot)$ and all $t \geq t_0$ one has

$$\int_{t_0}^t \mathcal{S}(y(s), w(s)) ds \geq 0, \quad (\text{A.3})$$

with $x(t_0) = 0$, and along trajectories of Σ .

See [14] and the references therein for relationships between several types of definitions.

A.2 Dynamical control properties via dissipativity

Using dissipativity allows for considering various properties of control systems from a single point of view. These properties have a wide range of applications in control and systems theory. Here, we point out some of these properties, and provide some useful references.

Passivity:

The concept of passivity was first studied in control theory by Popov in the 1960s. It was motivated by electrical networks theory. In specific, a single input electrical circuit which

consists of resistors, capacitors, and inductors (referred to as RLC circuit), satisfies the following property:

$$E(t_2) - E(t_1) \leq \int_{t_1}^{t_2} v(s)i(s)ds, \quad t_1 \leq t_2, \quad (\text{A.4})$$

where $E(t)$ is the energy stored in the circuit at instant t , $v(t)$ is the applied input voltage, and $i(t)$ is the corresponding drawn current. The inequality (A.4) captures the fact that the energy stored in the circuit at instant t_2 , cannot exceed the sum of what was already stored in the circuit at time t_1 , and the accumulated power over the interval $[t_1, t_2]$. Definition A.4 corresponds to Definition A.2 with $E(\cdot)$ as a storage function, and the product of voltage and current as a supply function. This has motivated the general definition of passive dynamical systems:

Definition A.3 (Passivity). System Σ (A.1) with $p = m$ is said to be passive if it satisfies the Definition A.1 with the supply function $\mathcal{S}(y, w) = w^T y$.

Passive dynamical systems have several appealing properties which are used in optimal control, design, large-scale networks and others. See [17, 90, 98, 99, 112, 122] for more information about passivity and its applications.

L_2 -Gain:

Gain properties describe how a system attenuates or amplifies a class of input signals. They are given by the quotient between some measures of output and input signals. In control systems theory, Lebesgue integrable functions are often considered, and the L_2 -gain is defined based on the L_2 -norm:

Definition A.4. Consider the system Σ (A.1) with $j(\cdot) = 0$, that is:

$$\begin{cases} \dot{x} = f(x) + g(x)w, \\ y = h(x), \end{cases} \quad (\text{A.5})$$

and with $x(0) = 0$. The system (A.5) has an L_2 -gain less or equal to γ if

$$\sup_{0 < \|w\|_{L_2} < \infty} \frac{\|y\|_{L_2}}{\|w\|_{L_2}} \leq \gamma.$$

The following theorem illustrates how an estimate of the L_2 -gain of a system can be obtained using dissipation inequalities.

Theorem A.5 ([122]). *The system (A.5) has an L_2 -gain less or equal to γ if there exists a positive definite and proper storage function V , such that the system is dissipative with*

respect to the supply rate

$$\mathcal{S}(y, w) = \gamma^2 |w|^2 - |y|^2. \quad (\text{A.6})$$

Theorem A.5 provides a sufficient condition. Moreover, for linear control systems, it is shown that it is also a necessary one. L_2 -gains properties have several applications in control theory. For example, they can be used to show the stability of interconnected systems using small gain theorem [64]. Furthermore, they play an important role in H_2 theory and H_∞ theory [28, 111].

It must be noted that there exist several properties which can be studied in the framework of dissipativity. These properties include stability, ISS and minimum phase behavior. See [29] for more information and references about this issue.

A.3 Kalman-Yakubovich-Popov Lemma

The Kalman-Yakubovich-Popov (KYP) Lemma was motivated by the *absolute stability Lur'e problem*, and it has a very wide range of applications in control and systems theory including dissipativity, stability, absolute stability, optimal control, adaptive control and others [14]. The lemma originates from a stability criterion of nonlinear feedback systems given by Popov. Then, Yakubovich and Kalman introduced the celebrated lemma, which shows that the frequency condition of Popov is equivalent to the existence of a Lyapunov function of certain simple form. See [105] and references therein for more details.

The KYP lemma provide the following interesting result for LTI systems.

Theorem A.6 ([111]). *Consider the following system Σ_L defined by*

$$\Sigma_L := \begin{cases} \dot{x} = Ax + Bw, \\ y = Cx + Dw, \end{cases} \quad (\text{A.7})$$

Suppose that Σ_L is controllable, and let \mathcal{S} be the supply rate (A.10). Then, the following statements are equivalent.

1. *There exists $P^T = P \in \mathbb{R}^{n \times n}$ such that*

$$\begin{bmatrix} A^T P + PA & PB \\ B^T P & 0 \end{bmatrix} - \begin{bmatrix} C & D \\ 0 & I \end{bmatrix}^T \begin{bmatrix} Q & S \\ S^T & R \end{bmatrix} \begin{bmatrix} C & D \\ 0 & I \end{bmatrix} < 0. \quad (\text{A.8})$$

2. For all $\omega \in \mathbb{R}$ with $\det(j\omega I - A) \neq 0$, the transfer function $\hat{G}(s) := C(sI - A)^{-1}B + D$ satisfies

$$\begin{bmatrix} \hat{G}(j\omega) \\ I \end{bmatrix}^T \begin{bmatrix} Q & S \\ S^T & R \end{bmatrix} \begin{bmatrix} \hat{G}(j\omega) \\ I \end{bmatrix} > 0, \quad (\text{A.9})$$

Theorem A.6 shows the equivalence between a frequency domain condition (A.9) and an LMI condition (A.8). Note that the condition (A.9) needs to be tested at an infinite number of points. However, using Theorem A.6 it is possible to verify the equivalent condition (A.8), which can be easily tested. This has many applications in control theory, such as in the IQCs stability theorem [72].

The following theorem, which is known as the nonlinear KYP Lemma, provides necessary and sufficient conditions for the system Σ to be dissipative with respect to Definition A.2.

Theorem A.7 ([50]). *Suppose that the Σ (A.1) is reachable from the origin. More precisely given any x_1 and t_1 , there exists $t_0 \leq t_1$ and an admissible control $u(\cdot)$ such that the state can be driven from $x(t_0) = 0$ to $x(t_1) = x_1$. Consider the quadratic supply rate*

$$\mathcal{S}(y, w) = \begin{bmatrix} y \\ w \end{bmatrix}^T \begin{bmatrix} Q & S \\ S^T & R \end{bmatrix} \begin{bmatrix} y \\ w \end{bmatrix} = y^T Q y + 2y^T S w + w^T R w, \quad (\text{A.10})$$

with $Q = Q^T$, $R = R^T$. Then, the nonlinear system Σ is dissipative in the sense of Definition A.2 with respect to the supply rate (A.10) if and only if there exist functions $V : \mathbb{R}^n \rightarrow \mathbb{R}$, $L : \mathbb{R}^n \rightarrow \mathbb{R}^q$, $W : \mathbb{R}^n \rightarrow \mathbb{R}^{q \times m}$ (for some integer q), with $V(\cdot)$ differentiable, such that:

$$\begin{aligned} V(x) &\geq 0, \\ V(0) &= 0, \end{aligned}$$

$$\begin{aligned} \nabla V^T(x) f(x) &= h^T(x) Q h(x) - L^T(x) L(x), \\ \frac{1}{2} g^T(x) \nabla V(x) &= \hat{S}(x) h(x) - W^T(x) L(x), \\ \hat{R}(x) &= W^T(x) W(x), \end{aligned}$$

where

$$\begin{aligned} \hat{S}(x) &= Q j(x) + S, \\ \hat{R}(x) &= R + j^T(x) S + S^T j(x) + j^T(x) Q j(x). \end{aligned}$$

A.4 Exponential dissipativity

With the objective of generalizing the Strict Positive Real Lemma and the Strict Bounded Real Lemma to nonlinear systems, the notion of *exponential dissipativity* has been introduced in [22].

Definition A.8 (Exponential Dissipativity [22]). The system Σ (A.1) is *exponentially dissipative* with respect to the supply rate $\mathcal{S}(y, w)$, if there exists a continuous *exponential storage function* $V : \mathbb{R}^n \rightarrow \mathbb{R}_+$ and a constant $\alpha \geq 0$ satisfying:

$$e^{\alpha t_2} V(x(t_2)) - e^{\alpha t_1} V(x(t_1)) \leq \int_{t_1}^{t_2} e^{\alpha s} \mathcal{S}(y(s), w(s)) ds, \quad (\text{A.11})$$

for all $t_1 \leq t_2$ and all signals (w, y, x) which satisfy (A.1).

Note that Definition A.8 and Definition A.1 coincide when $\alpha = 0$. When the storage function V is smooth, then the integral inequality (A.11) can be written as:

$$\dot{V}(x(t)) + \alpha V(x(t)) \leq \mathcal{S}(y(t), w(t)), \quad t \geq t_0.$$

This notion has several interesting applications. In [22], exponential dissipativity has been used to provide a nonlinear analog to the classical real positivity and small gain theorems for linear feedback systems. Moreover, it has been used to provide sufficient conditions for asymptotic stability of a time delay system [20, 21]. We also use it in this work (see Theorem 4.3).

Bibliography

- [1] F. Amato, C. Cosentino, A. Fiorillo, and A. Merola. Stabilization of bilinear systems via linear state-feedback control. *IEEE Transactions on Circuits and Systems II: Express Briefs*, 56(1):76 – 80, 2009.
- [2] F. Amato, C. Cosentino, and A. Merola. Stabilization of bilinear systems via linear state feedback control. In *15th Mediterranean Conference on Control Automation, MED '07*, pages 1 – 5, 2007.
- [3] V. Andrieu and S. Tarbouriech. Global asymptotic stabilization for a class of bilinear systems by hybrid output feedback. *IEEE Transactions on Automatic Control*, 58(6):1602 – 1608, 2013.
- [4] A. Anta and P. Tabuada. To sample or not to sample: Self-triggered control for nonlinear systems. *IEEE Transactions on Automatic Control*, 55(9):2030 – 2042, 2010.
- [5] A. Astolfi, D. Nesic, and A. Teel. Trends in nonlinear control. In *47th IEEE Conference on Decision and Control*, pages 1870 – 1882, 2008.
- [6] N. Athanasopoulos and G. Bitsoris. Unconstrained and constrained stabilisation of bilinear discrete-time systems using polyhedral Lyapunov functions. *International Journal of Control*, 83(12):2483 – 2493, 2010.
- [7] D. Auslander, Y. Takahashi, and M. Tomizuka. Direct digital process control: Practice and algorithms for microprocessor application. *Proceedings of the IEEE*, 66(2):199 – 208, 1978.
- [8] J. Baillieul and P. Antsaklis. Control and communication challenges in networked real-time systems. *Proceedings of the IEEE*, 95(1):9 – 28, 2007.
- [9] H. Beikzadeh and H. J. Marquez. Dissipativity of nonlinear multirate sampled-data systems under emulation design. *Automatica*, 49(1):308 – 312, 2013.
- [10] S. Bennett. Control and the digital computer: the early years. In *15th Triennial World Congress*, 2002.

-
- [11] F. Blanchini. Set invariance in control. *Automatica*, 35(11):1747 – 1767, 1999.
- [12] S. Boyd, L. E. Ghaoui, E. Feron, and V. Balakrishnan. *Linear Matrix Inequalities in System and Control Theory*. Studies in Applied Mathematics. SIAM, 1994.
- [13] C. Briat and A. Seuret. A looped-functional approach for robust stability analysis of linear impulsive systems. *Systems & Control Letters*, 61(10):980 – 988, 2012.
- [14] B. Brogliato, R. Lozano, B. Maschke, and O. Egeland. *Dissipative Systems Analysis and Control*. Communications and Control Engineering. Springer, 2007.
- [15] C. Bruni, G. D. Pillo, and G. Koch. Bilinear systems: An appealing class of "nearly linear" systems in theory and applications. *IEEE Transactions on Automatic Control*, 19(4):334 – 348, 1974.
- [16] L. Burlion, T. Ahmed-Ali, and F. Lamnabhi-Lagarrigue. On the stability of a class of nonlinear hybrid systems. *Nonlinear Analysis: Theory, Methods & Applications*, 65(12):2236 – 2247, 2006.
- [17] C. Byrnes, A. Isidori, and J. Willems. Passivity, feedback equivalence, and the global stabilization of minimum phase nonlinear systems. *IEEE Transactions on Automatic Control*, 36(11):1228 – 1240, 1991.
- [18] D. Carnevale, A. Teel, and D. Nešić. Further results on stability of networked control systems: a Lyapunov approach. In *American Control Conference*, 2007.
- [19] D. Carnevale, A. Teel, and D. Nešić. A Lyapunov proof of an improved maximum allowable transfer interval for networked control systems. *IEEE Transactions on Automatic Control*, 52(5):892 – 897, 2007.
- [20] V. Chellaboina, W. Haddad, and A. Kamath. A dissipative dynamical systems approach to stability analysis of time delay systems. In *American Control Conference*, volume 1, pages 363 – 368, 2003.
- [21] V. Chellaboina, W. Haddad, and A. Kamath. New sufficient conditions for stability analysis of time delay systems using dissipativity theory. In *American Control Conference*, volume 5, pages 4171 – 4176, 2004.
- [22] V. Chellaboina and W. M. Haddad. Exponentially dissipative nonlinear dynamical systems a nonlinear extension of strict positive realness. *Mathematical Problems in Engineering*, 1:25 – 45, 2003.
- [23] M.-S. Chen and Y.-Z. Chen. Normalised quadratic controls for a class of bilinear systems. *IEE Proceedings Control Theory and Applications*, 149(6):520 – 524, 2002.

- [24] M.-S. Chen, Y.-R. Hwang, and Y.-J. Kuo. Exponentially stabilizing division controllers for dyadic bilinear systems. *IEEE Transactions on Automatic Control*, 48(4):106 – 110, 2003.
- [25] T. Chen and B. Francis. *Optimal sampled-data control systems*. Springer, 1994.
- [26] F. Christophersen. *Optimal Control of Constrained Piecewise Affine Systems*. Lecture Notes in Control and Information Sciences. Springer, 2007.
- [27] M. Cloosterman, L. Hetel, N. van de Wouw, W. Heemels, J. Daafouz, and H. Nijmeijer. Controller synthesis for networked control systems. *Automatica*, 46(10):1584 – 1594, 2010.
- [28] J. Doyle, K. Glover, P. Khargonekar, and B. Francis. State-space solutions to standard h_2 and h_∞ control problems. *IEEE Transactions on Automatic Control*, 34(8):831 – 847, 1989.
- [29] C. Ebenbauer, T. Raff, and F. Allgöwer. Dissipation inequalities in systems theory: An introduction and recent results. In *Invited Lectures of the 6th International Congress on Industrial and Applied Mathematics*, pages 23 – 42, 2007.
- [30] D. Elliott. *Bilinear Control Systems Matrices in Action*, volume 169 of *Applied Mathematical Sciences*. Springer, 2009.
- [31] M. Espana and I. Landau. Reduced order bilinear models for distillation columns. *Automatica*, 14(4):345 – 355, 1978.
- [32] C. Fiter, L. Hetel, W. Perruquetti, and J.-P. Richard. A state dependent sampling for linear state feedback. *Automatica*, 48(8):1860 – 1867, 2012.
- [33] F. Forni, S. Galeani, D. Nešić, and L. Zaccarian. Event-triggered transmission for linear control over communication channels. *Automatica*, 50(2):490 – 498, 2013.
- [34] B. Francis and T. Georgiou. Stability theory for linear time-invariant plants with periodic digital controllers. *IEEE Transactions on Automatic Control*, 33(9):820 – 832, 1988.
- [35] G. Franklin, D. Powell, and M. Workman. *Digital Control of Dynamic Systems*. Addison-Wesley Longman Publishing Co., Inc., 3rd edition, 1997.
- [36] E. Fridman. A refined input delay approach to sampled-data control. *Automatica*, 46(2):421 – 427, 2010.
- [37] E. Fridman, A. Seuret, and J.-P. Richard. Robust sampled-data stabilization of linear systems: an input delay approach. *Automatica*, 40(8):1441 – 1446, 2004.

- [38] H. Fujioka. Stability analysis for a class of networked/embedded control systems: A discrete-time approach. In *American Control Conference, 2008*, pages 4997 – 5002, 2008.
- [39] H. Fujioka. Stability analysis of systems with aperiodic sample-and-hold devices. *Automatica*, 45(3):771 – 775, 2009.
- [40] R. Goebel, R. Sanfelice, and A. Teel. Hybrid dynamical systems. *IEEE Control Systems*, 29(2):28 – 93, 2009.
- [41] L. Gruyitch, J.-P. Richard, P. Borne, and J.-C. Gentina. *Stability domains*. Chapman&Hall\CRC, 2004.
- [42] K. Gu, V. L. Kharitonov, and J. Chen. *Stability of Time-Delay Systems*. Control Engineering. Birkhuser, 2003.
- [43] L. Guo and H. Schwarz. A control scheme for bilinear systems and application to a secondary controlled hydraulic rotary drive. In *Proceedings of the 28th IEEE Conference on Decision and Control*, volume 1, pages 542 – 547, 1989.
- [44] P. O. Gutman. Stabilizing controllers for bilinear systems. *IEEE Transactions on Automatic Control*, 26(4):917 – 922, 1981.
- [45] W. Heemels, K. Johansson, and P. Tabuada. An introduction to event-triggered and self-triggered control. In *IEEE 51st Annual Conference on Decision and Control (CDC), 2012*, pages 3270 – 3285, 2012.
- [46] G. Herrmann, S. Spurgeon, and C. Edwards. Discretization of sliding mode based control schemes. In *Proceedings of the 38th IEEE Conference on Decision and Control*, volume 5, pages 4257 – 4262, 1999.
- [47] J. Hespanha, P. Naghshtabrizi, and Y. Xu. A survey of recent results in networked control systems. *Proceedings of the IEEE*, 95(1):138 – 162, 2007.
- [48] L. Hetel, J. Daafouz, and C. Iung. Stabilization of arbitrary switched linear systems with unknown time-varying delays. *IEEE Transactions on Automatic Control*, 51(10):1668 – 1674, 2006.
- [49] L. Hetel, A. Kruszewski, W. Perruquetti, and J. P. Richard. Discrete and intersample analysis of systems with aperiodic sampling. *IEEE Transactions on Automatic Control*, 56(7):696 – 1701, 2011.
- [50] D. Hill and P. Moylan. The stability of nonlinear dissipative systems. *IEEE Transactions on Automatic Control*, 21(5):708 – 711, 1976.

- [51] D. J. Hill and P. J. Moylan. Dissipative dynamical systems: Basic input-output and state properties. *Journal of the Franklin Institute*, 309(5):327 – 357, 1980.
- [52] L. Hou, A. Michel, and H. Ye. Some qualitative properties of sampled-data control systems. *IEEE Transactions on Automatic Control*, 42(12):1721 – 1725, 1997.
- [53] B. Hu and A. N. Michel. Stability analysis of digital feedback control systems with time-varying sampling periods. *Automatica*, 36(6):897 – 905, 2000.
- [54] T. Hu. A nonlinear-system approach to analysis and design of power-electronic converters with saturation and bilinear terms. *IEEE Transactions on Power Electronics*, 26(2):399 – 410, 2011.
- [55] H. Jerbi. Global feedback stabilization of new class of bilinear systems. *Systems & Control Letters*, 42(4):313 – 320, 2001.
- [56] I. E. Jury. Synthesis and critical study of sampled-data control systems. *Transactions of the American Institute of Electrical Engineers, Part II: Applications and Industry*, 75(3):141 – 151, 1956.
- [57] R. Kalman. On the general theory of control systems. In *Proceedings of the First International Congress on automatic Control*, volume 1, pages 481 – 492, 1960.
- [58] D. Kang, S. Won, and Y. J. Jang. Guaranteed cost control for bilinear systems by static output feedback. *Applied Mathematics and Computation*, 219(14):7398 – 7405, 2013.
- [59] C.-Y. Kao and B. Lincoln. Simple stability criteria for systems with time-varying delays. *Automatica*, 40(8):1429 – 1434, 2004.
- [60] I. Karafyllis and C. Kravaris. Global stability results for systems under sampled-data control. *International Journal of Robust and Nonlinear Control*, 19:1105 – 1128, 2009.
- [61] I. Karafyllis and M. Krstic. Global stabilization of feedforward systems under perturbations in sampling schedule. *SIAM Journal on Control and Optimization*, 50(3):1389 – 1412, 2012.
- [62] I. Karafyllis and M. Krstic. Nonlinear stabilization under sampled and delayed measurements, and with inputs subject to delay and zero-order hold. *IEEE Transactions on Automatic Control*, 57(5):1141 – 1154, 2012.
- [63] N. Kazantzis and C. Kravaris. System-theoretic properties of sampled-data representations of nonlinear systems obtained via taylor methods. In *American Control Conference*, volume 2, pages 1354 – 1360, 1994.

- [64] H. Khalil. *Nonlinear Systems*. Prentice-Hall, Upper Saddle River, 2002.
- [65] D. Koditschek and K. Narendra. Stabilizability of second-order bilinear systems. *IEEE Transactions on Automatic Control*, 28(10):987 – 989, 1983.
- [66] G. Kreisselmeier and T. Birkholzer. Numerical nonlinear regulator design. *IEEE Transactions on Automatic Control*, 39(1):33 – 46, 1994.
- [67] D. Laila, D. Nešić, and A. Astolfi. 3 sampled-data control of nonlinear systems. In A. Loría, F. Lamnabhi-Lagarrigue, and E. Panteley, editors, *Advanced Topics in Control Systems Theory*, volume 328 of *Lecture Notes in Control and Information Science*, pages 91–137. Springer London, 2006.
- [68] D. Laila, D. Nešić, and A. R. Teel. Open- and closed-loop dissipation inequalities under sampling and controller emulation. *European Journal of Control*, 8(2):109 – 125, 2002.
- [69] D. Lawrence. Proceedings of the 36th iee conference on decision and control. In *Stability analysis of nonlinear sampled-data systems*, volume 1, pages 365 – 366, 1997.
- [70] R. Longchamp. Stable feedback control of bilinear systems. *IEEE Transactions on Automatic Control*, 25(2):302 – 306, 1980.
- [71] F. Mazenc, M. Malisoff, and T. N. Dinh. Robustness of nonlinear systems with respect to delay and sampling of the controls. *Automatica*, 49(6):1925 – 1931, 2013.
- [72] A. Megretski and A. Rantzer. System analysis via integral quadratic constraints. *IEEE Transactions on Automatic Control*, 42(6):819 – 830, 1997.
- [73] Y. V. Mikheev, V. A. Sobolev, and E. M. Fridman. Asymptotic analysis of digital control systems. *Automation and Remote Control*, 49(9):1175 – 1180, 1988.
- [74] L. Mirkin. Some remarks on the use of time-varying delay to model sample-and-hold circuits. *IEEE Transactions on Automatic Control*, 52(6):1109 – 1112, 2007.
- [75] R. Mohler. Natural bilinear control processes. *IEEE Transactions on Systems Science and Cybernetics*, 6(3):192 – 197, 1970.
- [76] R. Mohler. *Bilinear control processes: with applications to engineering, ecology, and medicine*. Mathematics in Science and Engineering. Academic Press, 1974.
- [77] R. Mohler. *Nonlinear Systems, Vol. 2: Applications to Bilinear Control*. Prentice Hall, Englewood Cliffs, New Jersey, 1991.

- [78] R. Mohler and A. Khapalov. Bilinear control and application to flexible a.c. transmission systems. *Journal of Optimization Theory and Applications*, 105(3):621 – 637, 2000.
- [79] R. Mohler and W. Kolodziej. An overview of bilinear system theory and applications. *IEEE Transactions on Systems, Man and Cybernetics*, 10(10):683 – 688, Oct. 1980.
- [80] S. Monaco and D. Normand-Cyrot. Advanced tools for nonlinear sampled-data systems analysis and control. *European Journal of Control*, 13(23):221 – 241, 2007.
- [81] S. Monaco, D. Normand-Cyrot, and C. Califano. From chronological calculus to exponential representations of continuous and discrete-time dynamics: A Lie-algebraic approach. *IEEE Transactions on Automatic Control*, 52(12):2227 – 2241, 2007.
- [82] P. Naghshtabrizi, J. P. Hespanha, and A. R. Teel. Exponential stability of impulsive systems with application to uncertain sampled-data systems. *Systems & Control Letters*, 57(5):378 – 385, 2008.
- [83] D. Nešić and L. Grüne. Lyapunov-based continuous-time nonlinear controller re-design for sampled-data implementation. *Automatica*, 41(7):1143 – 1156, 2005.
- [84] D. Nešić and A. Teel. Sampled-data control of nonlinear systems: An overview of recent results. In S. Moheimani, editor, *Perspectives in robust control*, volume 268 of *Lecture Notes in Control and Information Sciences*, pages 221–239. Springer London, 2001.
- [85] D. Nešić and A. Teel. A framework for stabilization of nonlinear sampled-data systems based on their approximate discrete-time models. *IEEE Transactions on Automatic Control*, 49(7):1103 – 1122, 2004.
- [86] D. Nešić and A. Teel. Input-output stability properties of networked control systems. *IEEE Transactions on Automatic Control*, 49(10):1650 – 1667, 2004.
- [87] D. Nešić and A. Teel. Stabilization of sampled-data nonlinear systems via backstepping on their Euler approximate model. *Automatica*, 42(10):1801 – 1808, 2006.
- [88] D. Nešić, A. Teel, and D. Carnevale. Explicit computation of the sampling period in emulation of controllers for nonlinear sampled-data systems. *IEEE Transactions on Automatic Control*, 54(3):619 – 624, 2009.
- [89] D. Nešić, A. Teel, and P. Kokotović. Sufficient conditions for stabilization of sampled-data nonlinear systems via discrete-time approximations. *Systems & Control Letters*, 38(45):259 – 270, 1999.

-
- [90] E. Nuno, L. Basanz, and R. Ortega. Passivity-based control for bilateral teleoperation: A tutorial. *Automatica*, 47(3):485 – 495, 2011.
- [91] C. Olalla, I. Queinnec, R. Leyva, and A. El Aroudi. Optimal state-feedback control of bilinear dc-dc converters with guaranteed regions of stability. *Industrial Electronics, IEEE Transactions on*, 59(10):3868 – 3880, 2012.
- [92] H. Omran, L. Hetel, and J.-P. Richard. Local stability of bilinear systems with asynchronous sampling. In *The 4th IFAC Conference on Analysis and Design of Hybrid Systems*, pages 19 – 24, 2012.
- [93] H. Omran, L. Hetel, J. P. Richard, and F. Lamnabhi-Lagarigue. Stabilité des systèmes non linéaires sous échantillonnage aperiodique. *Journal Européen des Systèmes Automatisés*. Accepted.
- [94] H. Omran, L. Hetel, J.-P. Richard, and F. Lamnabhi-Lagarigue. Stability analysis of bilinear systems under aperiodic sampled-data control. *Automatica*. Accepted.
- [95] H. Omran, L. Hetel, J.-P. Richard, and F. Lamnabhi-Lagarigue. Stability of bilinear sampled-data systems with an emulation of static state feedback. In *IEEE 51st Annual Conference on Decision and Control (CDC)*, pages 7541 – 7546, 2012.
- [96] H. Omran, L. Hetel, J.-P. Richard, and F. Lamnabhi-Lagarigue. On the stability of input-affine nonlinear systems with sampled-data control. In *European Control Conference (ECC)*, pages 2585 – 2590, 2013.
- [97] H. Omran, L. Hetel, J. P. Richard, and F. Lamnabhi-Lagarigue. Stabilité des systèmes non linéaires sous échantillonnage aperiodique. In *5èmes Journées Doctorales / Journées Nationales MACS*, 2013.
- [98] R. Ortega, Z. P. Jiang, and D. Hill. American control conference. In *Passivity-based control of nonlinear systems: a tutorial*, volume 5, pages 2633 – 2637, 1997.
- [99] R. Ortega, A. Van Der Schaft, B. Maschke, and G. Escobar. Interconnection and damping assignment passivity-based control of port-controlled hamiltonian systems. *Automatica*, 38(4):585 – 596, 2002.
- [100] A. Papachristodoulou and S. Prajna. A tutorial on sum of squares techniques for systems analysis. In *American Control Conference*, volume 4, pages 2686 – 2700, 2005.
- [101] P. Pardalos and V. Yatsenko. *Optimization and Control of Bilinear Systems*, volume 11 of *Springer Optimization and Its Applications*. Springer, 2008.

- [102] P. Parrilo. *Structured semidefinite programs and semialgebraic geometry methods in robustness and optimization*. PhD thesis, California Institute of Technology, Pasadena, CA, 2000.
- [103] R. Postoyan, T. Ahmed-Ali, and F. Lamnabhi-Lagarrigue. Robust backstepping for the Euler approximate model of sampled-data strict-feedback systems. *Automatica*, 45(9):2164 – 2168, 2009.
- [104] S. Prajna, A. Papachristodoulou, and P. Parrilo. Introducing SOSTOOLS: a general purpose sum of squares programming solver. In *Proceedings of the 41st IEEE Conference on Decision and Control*, volume 1, pages 741 – 746, 2002.
- [105] A. Rantzer. On the Kalman-Yakubovich-Popov lemma. *Systems & Control Letters*, 28(1):7 – 10, 1996.
- [106] K. Åström and B. Wittenmark. *Computer-controlled systems: theory and design*. Prentice-Hall information and system sciences series. Prentice-Hall, Upper Saddle River, NJ, 1997.
- [107] J.-P. Richard and T. Divoux. *Systèmes commandés en réseau*. IC2 Systèmes Automatisés. Hermès-Lavoisier, 2007.
- [108] V. Ritzey and G. Franklin. A stability criterion for asynchronous multirate linear systems. *IEEE Transactions on Automatic Control*, 34(5):529 – 535, 1989.
- [109] E. Ryan and N. Buckingham. On asymptotically stabilizing feedback control of bilinear systems. *IEEE Transactions on Automatic Control*, 28(8):863 – 864, 1983.
- [110] A. Sala. Computer control under time-varying sampling period: An {LMI} gridding approach. *Automatica*, 41(12):2077 – 2082, 2005.
- [111] C. Scherer and S. Weiland. *Linear matrix inequalities in control*. 2005.
- [112] R. Sepulchre, M. Janković, and P. Kokotović. *Constructive Nonlinear Control*. Communications and Control Engineering. Springer, 1997.
- [113] A. Seuret, E. Fridman, and J.-P. Richard. Exponential stabilization of delay neutral systems under sampled-data control. In *Proceedings of the 2005 IEEE International Symposium on Intelligent Control, Mediterrean Conference on Control and Automation*, pages 1281–1285, 2005.
- [114] A. Seuret and J.-P. Richard. Control of a remote system over network including delays and packet dropout. In *17th IFAC World Congress*, 2008.
- [115] J. Shen and Y. Zhu. Global feedback stabilization of multi-input bilinear systems. *Applied Mathematics Letters*, 26(8):820 – 825, 2013.

- [116] H. Sira-Ramírez and R. Silva-Ortigoza. *Control Design Techniques in Power Electronics Devices*. Springer, 2006.
- [117] A. Stuart and A. Humphries. *Dynamical Systems and Numerical Analysis*. Cambridge Monographs on Applied and Computational Mathematics. Cambridge University Press, 1998.
- [118] P. Tabuada. Event-triggered real-time scheduling of stabilizing control tasks. *IEEE Transactions on Automatic Control*, 52(9):1680 – 1685, 2007.
- [119] C. W. Tao, W.-Y. Wang, and M. Chan. Design of sliding mode controllers for bilinear systems with time varying uncertainties. *IEEE Transactions on Systems, Man, and Cybernetics-Part B: Cybernetics*, 34(1):639 – 645, 2004.
- [120] S. Tarbouriech, I. Queinnec, T. Calliero, and P. L. D. Peres. Control design for bilinear systems with a guaranteed region of stability: An LMI-based approach. In *17th Mediterranean Conference on Control and Automation, MED '09.*, pages 809 – 814, 2009.
- [121] A. Teel, D. Nesic, and P. Kokotović. A note on input-to-state stability of sampled-data nonlinear systems. In *Proceedings of the 37th IEEE Conference on Decision and Control*, volume 3, pages 2473 – 2478, 1998.
- [122] A. van der Schaft. *L₂-Gain and Passivity Techniques in Nonlinear Control*. Lecture Notes in Control and Information Sciences. Springer, 1996.
- [123] P. Voulgaris. Control of asynchronous sampled data systems. *IEEE Transactions on Automatic Control*, 39(7):1451 – 1455, 1994.
- [124] J. Willems. Dissipative dynamical systems. part I: general theory. *Archive for Rational Mechanics and Analysis*, 45(5):321 – 351, 1972.
- [125] J. Willems. Dissipative dynamical systems. part II: Linear systems with quadratic supply rates. *Archive for Rational Mechanics and Analysis*, 45(5):352 – 393, 1972.
- [126] J. Willems. Dissipative dynamical systems. *European Journal of Control*, 13:134 – 151, 2007.
- [127] B. Wittenmark, J. Nilsson, and M. Torngren. Timing problems in real-time control systems. In *Proceedings of the American Control Conference*, volume 3, pages 2000 – 2004, 1995.
- [128] L. Zaccarian, A. Teel, and D. Nešić. On finite gain l_p stability of nonlinear sampled-data systems. *Systems & Control Letters*, 49(3):201 – 212, 2003.

-
- [129] L. Zhang, H. Gao, and O. Kaynak. Network-induced constraints in networked control systems—a survey. *IEEE Transactions on Industrial Informatics*, 9(1):403 – 416, 2013.
- [130] W. Zhang. *Stability analysis of networked control systems*. PhD thesis, Department of Electrical Engineering and Computer Science, Case Western Reserve University, August 2001.
- [131] Y. Zheng, D. Owens, and S. Billings. Fast sampling and stability of nonlinear sampled-data systems: Part 2. *The IMA Journal of Mathematical Control & Information*, 7:13 – 33, 1990.

Contribution to the control of nonlinear systems under aperiodic sampling

Abstract: This PhD thesis is dedicated to the stability analysis of nonlinear systems under sampled-data control, with arbitrarily time-varying sampling intervals. When a controller is designed in continuous-time, and then implemented digitally (emulation approach), it is of great interest to provide stability criteria, and to estimate the bound on the sampling intervals which guarantees the stability of the sampled-data system. Whereas several works deal with linear models, the issue has been rarely addressed in a formal quantitative study in the nonlinear case.

First, an overview on sampled-data control is presented. Challenges and main methodologies for stability analysis are presented for both the linear time-invariant and the nonlinear cases. Then, local stability of bilinear sampled-data systems controlled by a linear state feedback is considered by using two approaches: the first one is based on hybrid systems theory; the second one is based on the analysis of contractive invariant sets and is inspired by the dissipativity theory. Both approaches provide sufficient stability conditions in the form of LMI. Finally, the dissipativity-based stability conditions are extended for the more general case of nonlinear systems which are affine in the input, including the case of polynomial systems which leads to conditions in the form of sum of squares (SOS).

Keywords: Sampled-data systems, bilinear systems, nonlinear systems, hybrid dynamical systems, aperiodic sampling, stability, dissipativity, linear matrix inequalities (LMIs), sum of squares (SOS).

Contribution à la commande de systèmes non linéaires sous échantillonnage aperiodique

Résumé: Cette thèse est dédiée à l'analyse de stabilité des systèmes non linéaires sous échantillonnage variant avec le temps. Lors de l'implémentation numérique d'un contrôleur qui est calculé en temps-continu (approche par émulation), il est d'un grand intérêt de fournir des critères de stabilité et d'estimer la borne supérieure de l'intervalle d'échantillonnage qui garantit la stabilité du système en temps discret. Plusieurs travaux récents ont abordé ces questions dans le cas de modèles linéaires, mais la question a rarement été abordée dans une étude quantitative et formelle pour les systèmes non linéaires.

Tout d'abord, le mémoire présente un aperçu sur les systèmes échantillonnés. Les défis et les principales méthodes pour l'analyse de stabilité sont présentés pour le cas des systèmes linéaires invariants dans le temps et celui des systèmes non linéaires. Ensuite, l'analyse de la stabilité locale des systèmes bilinéaires échantillonnés contrôlés par un retour d'état linéaire est considérée. Deux approches sont utilisées, la première basée sur la théorie des systèmes hybrides, la seconde basée sur l'analyse des ensembles invariants contractants. Cette dernière approche est inspirée par la théorie de la dissipativité. L'ensemble de ces résultats conduit à des conditions suffisantes de stabilité exprimées sous forme LMI. Enfin, les conditions de stabilité basées sur la dissipativité sont étendues au cas des systèmes non linéaires affines en l'entrée. Les résultats sont ensuite repris dans le cas spécifique des systèmes non linéaires polynomiaux où les conditions de stabilité sont vérifiées numériquement en utilisant la décomposition en somme des carrés (SOS).

Mots-clés : Systèmes échantillonnés, systèmes bilinéaires, systèmes non linéaires, systèmes dynamiques hybrides, échantillonnage aperiodique, stabilité, dissipativité, inégalités matricielles linéaires (LMIs), somme des carrés (SOS).