



**HAL**  
open science

# Representation of thermal building simulation in virtual reality for sustainable building

Yudi Nugraha Bahar

► **To cite this version:**

Yudi Nugraha Bahar. Representation of thermal building simulation in virtual reality for sustainable building. Signal and Image processing. Université de Bourgogne, 2014. English. NNT : 2014DI-JOS016 . tel-01136697

**HAL Id: tel-01136697**

**<https://theses.hal.science/tel-01136697>**

Submitted on 27 Mar 2015

**HAL** is a multi-disciplinary open access archive for the deposit and dissemination of scientific research documents, whether they are published or not. The documents may come from teaching and research institutions in France or abroad, or from public or private research centers.

L'archive ouverte pluridisciplinaire **HAL**, est destinée au dépôt et à la diffusion de documents scientifiques de niveau recherche, publiés ou non, émanant des établissements d'enseignement et de recherche français ou étrangers, des laboratoires publics ou privés.

# SPIM

## Thèse de Doctorat



école doctorale sciences pour l'ingénieur et microtechniques  
UNIVERSITÉ DE BOURGOGNE

# **Representation of Thermal Building Simulation in Virtual Reality for Sustainable Building**

 YUDI NUGRAHA BAHAR



# SPIM

## Thèse de Doctorat



école doctorale sciences pour l'ingénieur et microtechniques  
UNIVERSITÉ DE BOURGOGNE

Présenté pour obtenir

Le grade de Docteur de l'Université de Bourgogne

Spécialité : Instrumentation et Informatique de l'Image

15 Avril 2014

**Jury :**

M. Gilles Gesquiere, Professeur, Université Lumière Lyon 2, Rapporteur

M. Livio De Luca, Ingénieur de Recherche, CNRS, Rapporteur

M. Jean-christophe Lapayre, Professeur, Université de Franche-Comté, Examineur

M. Christophe Nicolle, Professeur, Université de Bourgogne, Directeur de Thèse

M. Christian Père, Maître de conférences, ENSAM ParisTech, Invité

Doctorat préparé au sein de l'Institut Image, dans l'équipe projet Gunzo et projet CoRDOBA  
Cluny, du laboratoire LE2I, ENSAM ParisTech et l'Université de Bourgogne



Institut Image



ARTS  
ET MÉTIERS  
ParisTech

SPIM





# Acknowledgements

---

First of all I would like to thank my supervisors Christian Pere and Pr. Christophe Nicolle for giving me the possibility to conduct this research and for their continuous help, advice, encouragement, and patience. I have been extremely lucky to have Christian Pere as my supervisor in Cluny who cared so much about my work, and who responded to my questions and queries wisely. Pr. Christophe Nicolle for his continual support and useful guidance during the years of study. Their wisdom, sense of humor and kindness never ceased to impress and educate me and I am sincerely grateful to them.

I would also like to thank the staff and students at ENSAM ParisTech Cluny, Institute Image Chalon sur Saone, LE2I - UMR CNRS 6306, and Bourgogne University Dijon, they created a pleasant environment to work in. I also thank to my working mates that I had the pleasure to work with: Jeremie Landrieu and Gunzo team for their cooperation and the interesting discussions that we had all these years. This highly skillful team gave me the chance to exchange ideas and to learn a lot from their experiences. I will always remember the golden times when our working rooms were full of great people. Also particular thanks to all other colleagues, individuals and institutions who have given their have contribution to this work and cannot be mentioned one by one.

I also wish to thank the Ministry of National education and culture Republic of Indonesia (Dikti-Diknas) and Gunadarma University Jakarta for providing financial support. Pr. E.S. Margianti and Pr. Suryadi Harmanto as head of Gunadarma University that gave me a valuable support. Pr. Sarifuddin Madenda and Pr. Fabrice Meriaudeau, without their support this opportunity won't be happen.

Finally, my greatest thanks to my wife Suci for her love, unconditional support and sacrifice, parents, brothers and sisters, and friends in Indonesia (Jakarta & Makassar) and in France (Dijon, Paris, Cluny), les amis Marocains et Tunisiens, as well as Franco-Indo family who have always been supportive.



# Abstract

---

The importance of energy efficiency as well as integration of advances in sustainable building design and VR technology have lead this research to focus on thermal simulation results visualized in a virtual environment (VE). The emphasis is on the representation of thermal building simulation (TBS) results and on the perception of thermal data simulated in a VE. The current application of the design process through energy efficiency in VR systems is limited mostly to building performance predictions and design review, as the issue of the data formats and the workflow used for 3D modeling, thermal calculation and VR visualization.

Different applications and tools involved to represent TBS in VE are become the challenge of this work. Many 3D modeller, thermal simulation tools and VR tools are available and they are differ in their function and platform. Issues of data format exchange, appropriate tools and equipments from this situation require an interoperability solution that needs to be structured in a workflow method. Significances and barriers to integration design with CAD and TBS tools are also outlined in order to transfer the model to VR system. Therefore, the idea then is to use Building Information Model (BIM) extensively used in Architecture, Engineering and Construction (AEC) community. It then continued to evaluate the current trends for TBS representation in VE, to create data transfer method, and to integrate them in the workflow. After a review in thermal simulation and an evaluation of related works, we specify the application, method and tools for our objectives.

An application of a method of data transfer and presentation of data in VE are formulated and tested. This effort conduct using a specific data workflow which performed the data transfer through 3 phases. This relies on the smooth exchange of data workflow between CAD tools, thermal calculation tools and VR tools. Presentation of data in VE is conducted through immersive visualization and intuitive interaction. An experiment scenario of a thermal simulation in VR system was created to interactively visualize the results in the immersion room and tested by some respondents. The system include with friendly interface for interaction. It presents a realistic 3D model of the project (Gunzo room) in existing condition and renovated version, and their TBS results visualized in some visualization metaphor. In the experiment, the method which bundled in an application brings together within a couple of virtual scenario and a software/hardware solution. The obtained results concentrate on visualization, interaction and its feedback. Some visualization metaphor are tested and evaluated to present more informative TBS results where the user can interact and perceive the impact of their action.

Evaluation of the application prototype showed various levels of user satisfaction, and improvements in the accuracy and efficiency of data interpretation. The research has demonstrated it is possible to improve the representation and interpretation of building performance data, particularly TBS results using visualization techniques. Using specific method, the data flow that starts from the design process is completely and accurately channelled to the VR system. The method can be used with any kind of construction project and, being a flexible application, accepts new data when necessary, allowing for a comparison between the planned and the constructed.

**Keywords:** Thermal building simulation, BIM, Three-dimensional (3D), Virtual reality, Data integration, Scientific visualization



---

# Résumé

---

La sobriété énergétique du bâti devient aujourd'hui un élément clé en phase de conception. L'intégration en amont d'outils numériques, notamment la réalité virtuelle (RV). Nous a conduit, dans cette recherche, à nous concentrer sur les résultats de simulations thermiques visualisées dans un environnement virtuel. La contribution est portée sur la représentation et la perception dans un EV de ces données issues de simulation. Nous nous limitons à la caractérisation de l'efficacité énergétique en processus de conception. Cette étude vise la prédiction des performances thermiques dans des systèmes de réalité virtuelle. Les problématiques de formats de données et de flux de travail entre la modélisation classique CAO (Conception Assistée par Ordinateur), les simulations thermiques, et la visualisation immersive sont également traitées.

Il existe plusieurs outils logiciels dédiés à la représentation de simulations thermiques en EV et le premier enjeu de ces travaux fut de sélectionner l'outil approprié. De nombreux modeleurs CAO, logiciels de simulation thermique et outils de RV sont disponibles ; ils diffèrent notamment par leurs approches (fonctionnalités et environnement logiciel). La problématique d'interopérabilité (formats d'échange entre les outils logiciels) requiert de bâtir un flux de travail structuré. Les difficultés d'intégration entre outils CAO et outils de simulation, et les barrières au transfert vers des systèmes de réalité virtuelle sont également décrits. Il est apparu pertinent d'utiliser le Building Information Model (BIM) de plus en plus utilisé parmi les acteurs de l'architecture, ingénierie et construction (AIC). Puis nous avons poursuivi par l'évaluation des tendances actuelles en matière de représentation de données thermiques issues de simulation dans un EV, par la création de méthode de transfert de données de sorte à les intégrer au flux de travail. Après un état de l'art sur la simulation thermique et une évaluation des travaux connexes, nous décrivons l'application, la méthode et les outils pour parvenir à nos objectifs.

Une proposition de procédé de transfert de données et de présentation de données en EV est formulée et évaluée. Le flux d'échanges de données s'effectue en trois phases, de sorte à optimiser les passages entre la CAO, le calcul thermique et la réalité virtuelle. La représentation des données dans l'EV est réalisée grâce à une visualisation immersive et interactive. Une expérimentation a été conduite de sorte à évaluer des sujets : Le scénario consistait en une visualisation interactive de données thermiques selon 4 modalités en environnement virtuel. L'interface développée pour l'interaction a été voulue intuitive et conviviale. L'application contient un modèle 3D réaliste du projet (salle Gunzo) dans deux configurations : état actuel et état rénové. Les données thermiques sont restituées selon plusieurs métaphores de représentation. L'expérimentation développe une approche qui associe au scénario de rénovation virtuelle une configuration matérielle/logicielle. Les résultats obtenus se concentrent sur la visualisation, l'interaction et le retour subjectif des utilisateurs. Quatre métaphores de visualisation sont testées et leur évaluation porte notamment sur deux critères : leurs capacités à restituer les résultats de simulation thermique ; le degré d'interaction et la perception de l'utilisateur des impacts de ses actions.

L'évaluation subjective révèle les préférences des utilisateurs et montre que les métaphores de représentation ont une influence sur la précision et l'efficacité de l'interprétation des données. Ces travaux montrent que les techniques de représentation et de visualisation de données de simulation ont un effet sur la pertinence de leur interprétation. La méthode décrite spécifie les modalités de transfert de la donnée depuis la phase conception jusqu'aux outils et systèmes de RV. Sa souplesse lui permet d'être transposée à tout type de projet : Il est possible, si nécessaire, d'y inclure de nouvelles données permettant, par exemple, une comparaison entre les prévisions (modèle "as planned") et le réel (modèle "as built").

**Mots-clés:** Simulation thermique du bâtiment, BIM, 3D, la réalité virtuelle, l'intégration des données, la visualisation scientifique



# Contents

Acknowledgements .....	i
Abstract .....	iii
<i>Résumé</i> .....	v
Contents .....	vii
Figures .....	xi
Tables .....	xix
Equations and Scripts .....	xxi

## Chapter 1 Introduction

1.1 Sustainable Building Issues .....	3
1.2 Building Performance Optimization: Information Communications Technology (ICT) for Sustainability .....	5
1.3 Context and Objectives .....	7
1.4 Synopsis .....	10

## Chapter 2 Thermal Building Simulations

2.1 Introduction to Thermal Building Simulation .....	15
2.1.1 Basic Principles of Thermal Simulation .....	16
2.1.2 Input to energy simulation .....	18
2.1.3 Basic tool architecture .....	18
2.2 Thermal Simulation Software and the BIM Platform .....	20
2.2.1 Interoperability through BIM Platform .....	20
2.2.2 Thermal Simulation Tools and Their Interoperability .....	24
2.3 Interoperability Review of the Most Applicable TBS Tools in the AEC Community .....	27
2.3.1 Thermal Simulation Tools as BIM Application .....	27
2.3.2 Review of Data Exchange .....	31
2.4 Thermal Building Simulation in the context of this study .....	33
2.4.1 Thermographic Camera vs. Thermal Software .....	33
2.4.2 Parameters in Thermal Building Simulation Models .....	35
2.5 Summary .....	37

## Chapter 3 Virtual Reality and Scientific Visualization of Thermal Building Simulation

3.1 Virtual Reality in Scientific Visualization .....	41
3.1.1 Scientific Visualization .....	41
3.1.2 Virtual Reality .....	42
3.1.3 VR Technological Components .....	45
3.1.3.1 Display .....	45
3.1.3.2 Input Devices .....	46
3.1.3.3 Software Tools .....	48
3.2 Towards Immersive Visualization and Intuitive Interaction in VE .....	50
3.2.1 Immersive Visualization to Represent TBS Data .....	51
3.2.2 Interaction in a VE for Displaying TBS Data .....	53



3.3 VR Applications, CAD and TBS .....	56
3.3.1 VR-CAD Integration .....	57
3.3.2 Review of VR Application for Scientific Visualization of TBS .....	59
3.4 Summary .....	65

## **Chapter 4 Method of Representing Thermal Building Simulation in VR System**

4.1 Workflow toward the Virtual Environment .....	69
4.2 A 3D Model and its Thermal Analysis prepared for the VR System .....	71
4.2.1 Modeling in Revit Architecture .....	72
4.2.2 Thermal Calculation in Autodesk Ecotect .....	75
4.2.2.1 Weather Manager and Weather Data Import .....	75
4.2.2.2 3D Modeling and Import-Export of the Geometry .....	76
4.2.2.3 Material Assignment and Material Properties .....	76
4.2.2.4 Zone Settings and Occupancy Schedules .....	77
4.2.2.5 Thermal Analysis / Calculation .....	78
4.2.2.6 Visual Analysis .....	78
4.2.3 Data Treatment in VR System .....	80
4.3 Development of TBS model in VR system .....	81
4.3.1 Perl Routine (Preformat application) .....	81
4.3.2 Setting in 3DVia Studio (Virtools) .....	84
4.3.2.1 Object Geometry .....	85
4.3.2.2 Particles .....	85
4.3.2.3 Camera .....	88
4.3.2.4 Scripts and Object Behavior .....	90
4.3.2.5 Interaction Feedback .....	91
4.3.2.6 Graphical User Interface .....	92
4.4 Specifying the Visualization and Interaction of TBS in VE .....	93
4.4.1 The Visualization of TBS in VE .....	93
4.4.2 The Interaction of TBS in VE .....	96
4.5 Summary .....	99

## **Chapter 5 Case Studies: Thermal Building Simulation and Visualization in Virtual Environment**

5.1 Experiment of representing TBS in Virtual Environment .....	103
5.1.1 Object of Experiment (Gunzo Room) .....	103
5.1.2 Workflow from Revit Architecture to Ecotect Analysis .....	104
5.1.2.1 Modeling in Revit Architecture .....	104
5.1.2.1.1 Gunzo Room in Existing Condition .....	104
5.1.2.1.2 Gunzo Room Renovated Version .....	108
5.1.2.2 Thermal Calculation (Ecotect Analysis) .....	111
5.1.2.2.1 Adjacency Checks .....	112
5.1.2.2.2 Internal Loads and Schedule .....	113
5.1.2.2.3 Weather Data .....	115
5.1.2.2.4 Calculation Mode .....	117
5.1.2.2.5 Thermal Analysis .....	119

5.1.3 The TBS Results of Gunzo Room .....	121
5.1.3.1 Monthly Temperature Profile .....	121
5.1.3.2 Passive Gains Breakdown .....	122
5.1.3.3 Passive Adaptivity Index .....	123
5.1.3.4 Summary .....	125
5.1.4 Preformat Data .....	126
5.2 Experiments using PC and Tablet .....	127
5.2.1 Hardware and Software Solutions .....	127
5.2.2 Experiment Framework with PC and Tablet .....	128
5.3 Experiments in the Immersion Room .....	132
5.3.1 Details of Setting in the Visualization and Interaction .....	133
5.3.2 Experimental Setup .....	143
5.3.2.1 Hypotheses and Experimental Protocols .....	143
5.3.2.2 Test Subjects and Procedure .....	143
5.3.2.3 Technical Components and Data Supply .....	144
5.4 The Results of the experiment in Immersion Room .....	146
5.4.1. Visualization Metaphor .....	147
5.4.2. Performance on Nine Tasks .....	149
5.4.3 Task Completion Times .....	149
5.4.4 Subjective Impressions .....	153
5.5 Summary .....	156
<b>Chapter 6 Conclusion</b>	
6.1 Development of the TBS framework .....	162
6.2 Visualization and Interaction of TBS in VE .....	164
6.3 Critical Evaluation of the Research .....	166
6.4 Future Work .....	167
<b>Bibliography</b> .....	169
<b>Appendices</b>	
Appendix A: Schematic VSL Scripting (Virtools and 3DVIA Studio) .....	183
Appendix B: IFC data of Gunzo room .....	214
Appendix C: Questioner of the Experiment and Description of Menu Interface .....	222
Appendix D: Preformatted Results (Ecotect – Perl Routine) .....	227
<b>Publications</b> .....	231



# Figures

Figure 1.1. Final energy consumption prospective in the world in 2030 according to the IEA reference scenario.....	3
Figure 1.2. Life cycle energy use of residential buildings.....	4
Figure 1.3. Evolution of Energy Consumption in France.....	4
Figure 1.4. Most of household energy consumption in France is used for heating .....	4
Figure 1.5. Thermal analysis supports decision-making and problem-solving in several phases during the building process, from early design to operation and maintenance.....	8
Figure 1.6. Building stakeholders and the option of the representation of thermal building simulation used for design review or decision making during the project .....	9
Figure 2.1. General input data of thermal simulation engines .....	16
Figure 2.2. Workflow to produce a thermal simulation model .....	17
Figure 2.3. General architecture of energy simulation tools .....	19
Figure 2.4. Basic workflow of some thermal simulation tools. a). RIUSKA, b). eQuest, c). DesignBuilder .....	19
Figure 2.5. Architects' and engineers' priorities in term of interoperability of building model .....	21
Figure 2.6. Interoperability and AEC Practice .....	22
Figure 2.7. IFC is aiming to be a global standard for BIM data exchange. (a). BIM embrace all aspects of the building (planning, design, simulation, etc.) in a management-system and management-concept that sharing information among stakeholders produces a maximum benefit. (b). The IFC approach through BIM platform supports this tool-set offers significant benefits in terms of interoperability and shared data support .....	23
Figure 2.8. An ideal workflow for energy performance in thermal simulation tools .....	25
Figure 2.9. A simple model built in Revit and analyzed in eQUEST, IES, and Ecotect. The results were manually post-processed in Excel .....	26
Figure 2.10. The ThermalOpt diagram, shows the test case at each step of the multidisciplinary design optimization process, as well as the corresponding time (in hours) .....	26
Figure 2.11. Summary of data exchange between modeling tools and thermal simulation tools. The linkages include those as interface, add-on or plug-in. The data exchange is conducted in various formats, primarily by IFC and gbXML .....	32
Figure 2.12. Illustration of workflow between thermal software and thermographic camera to create thermal 3D model. There is a long workflow with the camera if the 3D model need to further processing .....	33
Figure 3.1. Virtuality continuum by Milgram and Kishino .....	43
Figure 3.2. Taxonomy of selection / manipulation techniques (Bowman, 1999) .....	55
Figure 3.3. An approach to integrate CAD design and VR. The work used a low cost 3D game engine as a VR aided design for the architectural education. Workflow of Software involved are; 3D modeling tools: Maya, 3D Studio VIZ, Micro Station, AutoCAD; 3D game engine: Unreal Engine (Tang, 2006) .....	58
Figure 3.4. A building interactive modeling for construction education in VE proposed by Ku et al., (2011). The research using the AC3D software (3D modeling software) Second Life platform (a game engine), to address the communication issues and effectively complement traditional teaching approaches and furthermore integrate with BIM to enhance construction education .....	59
Figure 3.5. General model of Thermic3D (Fricoteaux 2010) .....	60

Figure 3.6.	Visualization of the temperature modification in a living room (Fricoteaux 2010) .....	60
Figure 3.7.	Temperature distribution in a computer room (data center). Study of optimum solutions through simulations using VR simulation technology .....	61
Figure 3.8.	The concept of the proposed EPAR modeling .....	61
Figure 3.9.	Walk through the building, averaged velocity field (left). Turbulent flow, orthogonal slice planes of the averaged velocity field (right) .....	62
Figure 3.10.	Turbulent natural convection in the open carriage of a train. The buoyant flow is driven by two lines of heaters placed along the lower section of the seats next to the cabin walls ....	63
Figure 3.11.	Screenshot of online interactive simulation run of air flow inside a passenger cabin. The menu showing the integrated VR user interface is on the right .....	63
Figure 3.12.	(a). External view of a user interacting with a CFD isoplane, (b). Dynamic particle visualization as seen by the user through the HMD .....	64
Figure 3.13.	(a). Isoplane as seen by the user using AR system (in horizontal), (b). Isoplane as seen by the user through the HMD (in vertical) .....	64
Figure 3.14.	VFire running in a 6-sided CAVE-like environment. The data layers can be modified by the user using joystick .....	65
Figure 4.1.	The three steps of data workflow from design software to VR system. The first two steps are to accommodate the tools and the method that are commonly used by AEC community .....	69
Figure 4.2.	Generic workflow for visualization in a PC and tablet. This concept used the same principle of three steps data workflows toward the thermal simulation and visualization in VE (immersion room) .....	69
Figure 4.3.	Detailed Illustration of data workflow of TBS toward the VE. Main applications involved: Revit, 3DSMax, Ecotect, 3DVia Studio (or Virtools), and Perl Routine for preformat .....	70
Figure 4.4.	Illustration of management system for the visualization and interaction .....	70
Figure 4.5.	Revit Architecture User Interface.1. Ribbon Bar, 2. Contextual Bar (This tab contains options related to selected object), 3. Option Bar (only appear when a tool activated. This bar used to define how an object to be placed), 4. Project Browser (the most important feature to access the project such as the views, families, groups, and Revit links), 5. Drawing Area (The area used to interact with the model), 6. Navigation Bar (This bar contains navigation tools such as zoom, steering wheel, and view cube), 7. View Control (provides the tools for changing the drawing scale, detail level, and model graphic style), 8. Status Bar (To indicate and tell what to do) .....	73
Figure 4.6.	Revit Architecture ribbon bar used for modeling. Basic objects include: Masses (generic solids, surfaces and wires), Site (topo surface, pad, parking space), wall, opening, door, window, column, roof, floor, ceiling, stairs, railing, ramp, curtain wall, mullion .....	73
Figure 4.7.	The Parameter Properties Dialog (Family Parameters) .....	74
Figure 4.8.	Display panel of climate data to manage specific time and site location. On the right hand, display panel to load climate data file, site locations around the world are available according to the city .....	75
Figure 4.9.	Display panel to import a file (left) and Display panel to export (right) .....	76
Figure 4.10.	Display panel to modify the zones profile, HVAC system, etc. ....	77
Figure 4.11.	Display panel of schedule editor. This is to set a specific operational, for example, time of occupancy .....	78
Figure 4.12.	(a). Thermal analyses over slice thermal indicator with sun-path simulation. (b). Result of thermal calculation in the interior using 3D visualization (CFD) .....	79
Figure 4.13.	Result of thermal calculation in analysis table. It describes calculation results per- zone (i.e. outside temperature, diffuse solar, wind speed and zone temperature) .....	79

Figure 4.14. (a). Illustration of simulation scenario: People inside the 3D model act as the behavior of the camera, moving around and navigate interactively. (b). Illustration scenario to generate thermal visualization in VE using metaphor (grid of particles and transparent cubes) ..... 82

Figure 4.15. Folder arrangement used to proceed transfer data from Ecotect to 3DViaStudio/Virtools . 83

Figure 4.16. Detail arrangement of data storage. Txt file from Ecotect restored in Input data folder to be pre-format into a new Txt writing. The new Txt writing automatically generated in output data. In this figure for example, exports were made from Ecotect and we put the records of these exports in the folder "3-Input\_Data" ..... 84

Figure 4.17. The Routine program restructured the Ecotect analysis grid data in Input\_Data (Left image) into a new format on Output\_Data (Right image). This is to changing the spacing arrangement, not the value of Ecotect analysis grid data ..... 84

Figure 4.18. A 3D geometry enriched with texture mapping and exported to 3DViaStudio/Virtools. It shows 3D Model of Gunzo room before and after renovation ..... 85

Figure 4.19. Making the emitter by creating a 3D frame, Level manager > 3D Frames > Name "Emitter". The 3D frame setup position and scale are set according to the 512 parts ..... 86

Figure 4.20. Applying a Cubical Particle System BB to Emitter. The texture or color, for example Burst is set for the Emitter. Add a texture Burst.jpg. Level manager > Textures > Burst.jpg ..... 86

Figure 4.21. Schematic>Emitter Script>Edit the Cubical Particle System setup including the burst texture 87

Figure 4.22. Creating camera behavior on the "Main Camera" actor from the "Project Editor" tab ..... 88

Figure 4.23. (a). In "Target" block, add a new pointer to your "vkCamera" component, and call it "camera". (b).Call the "camera" target and apply a "Translate" function on it with the value of vkVec3 (0, 0 ,1), then compile again. This will translate the camera one meter on the Z axis (the order of a Vec3 is always X, Y, Z) every frame ..... 88

Figure 4.24. Completed parameter for camera rotation and translation ..... 89

Figure 4.25. Dialog box of active stereo. Checking the "Stereo" option will activate the stereo device ... 90

Figure 4.26. Xbox Controller Input ..... 92

Figure 4.27. (a). Illustration of thermal grid with transparent cubes to be generated inside the Gunzo room precisely arranged on the XYZ axis. (b). The cubes filled with particles, (c). The scenario to generate thermal visualization using grid transparent cubes ..... 93

Figure 4.28. Setting of cubes and particle simulation ..... 94

Figure 4.29. Flowchart of process decision program to visualize the thermal metaphors ..... 95

Figure 4.30. Kelvin color temperatures scale ..... 95

Figure 4.31. Illustration of color indicator (Kelvin color temperatures scale) implemented in our simulation ..... 96

Figure 4.32. Illustration of the instruments and system of the interface within the immersion room. The coupling is flexible between the three blocks: Model, View and Controller ..... 97

Figure 4.33. Illustration of the positioning of the speakers in the environment. The perception of 3D sound positioning can be achieved using a 3D arrangement of speakers positioned around the listener. We arranged four speakers surround the immersion room that enables listeners to perceive sounds as to come from any point in the simulation space ... 99

Figure 5.1. Photos of Interior of Gunzo room. The object is located on the historical site of Cluny ..... 103

Figure 5.2. Lay out of Gunzo room in existing condition. Length 4.45 m, width 3.87 m and height 3.92 m. Stone Wall 85 thick, doors and window of wood and floor covered by vinyl tile ..... 104

Figure 5.3. Gunzo room in existing condition: Section 1 and Section 2 ..... 105

Figure 5.4. 3D view of Gunzo room in existing condition. Stone wall interior covered by wallpaper ... 105

Figure 5.5. Detail of Gunzo Room in Existing Condition ..... 106

Figure 5.6. Rendering using lighting from the window of Gunzo room (existing condition). It combines the lighting between natural and artificial ..... 107

Figure 5.7. Rendering of material components of Gunzo room (existing condition). Wall surface finished by wallpaper and concrete floor finished by vinyl tile .....	107
Figure 5.8. Close up rendering of the window, old heater and exterior sash of Gunzo room (existing condition).....	108
Figure 5.9. Digital Mock-up of Gunzo Room, (from left to right): Existing Conditions, 1st alternative, 2nd alternative, and 3rd alternative .....	108
Figure 5.10. Comparison of window lay out between the existing condition and the renovate version (alternative 1, 2, and 3) .....	109
Figure 5.11. (a). Revit Model of Gunzo room (3D View and section) in existing conditions. (b). The chosen renovated version (alternative 3) .....	110
Figure 5.12. The chosen renovated version of Gunzo room (3D view in the day and the night .....	110
Figure 5.13. The creation of Gunzo room 3D geometry in the first step called modeling. As the Gunzo room properly modeled in Revit Architecture it is automatically respects to IFC structure. The 3D model is ready to move on the next step, thermal calculation and simulation using thermal tools (Ecotect) .....	110
Figure 5.14. Gunzo room imported data using IFC/ifcXML format (left hand). Matching the 3D model with point cloud model from laser scanner (right hand) .....	111
Figure 5.15. Gunzo room zone and its adjacency zones .....	112
Figure 5.16. Display of Zone management. This display list all zones in the model and their current settings. It shows values of Gunzo room (1 Room zone) in general setting .....	113
Figure 5.17. Zone profile of Gunzo room (1 Room zone): HVAC system and hours of operation .....	113
Figure 5.18. Specific operational of Gunzo room (time of occupancy) during the year .....	114
Figure 5.19. Display panel of climate data of Lyon and the stereographic diagram of solar position ....	116
Figure 5.20. Weather data: Location (Lyon), Climate summary, Degree hours (heating, cooling and solar) .....	116
Figure 5.21. On the Analysis Grid tab to specify various types of volumetric .....	117
Figure 5.22. Result area of color contours defined in Ecotect analysis, showing the grid of Mean Radiant Temperature .....	117
Figure 5.23. The panel that control all aspects of the current analysis grid .....	117
Figure 5.24. Analysis grid of Gunzo room aligned to the XYZ axis .....	118
Figure 5.25. An example of selected time for an analysis in the experiment .....	119
Figure 5.26. Gunzo room`s sun-path in a sky dome projection shown in 3D. To make an interactive viewing, we can turn on the daily sun-path and annual sun-path. We can drag the Sun, represented by the orange sphere in the drawing area, to affect the time of day .....	119
Figure 5.27. Internal volumes filled up by a series of sampling rays, distributed within the bounds of the zone. To account for geometry of any complexity, internal volumes are calculated by generating a series of sampling rays, pseudo-randomly distributed within the bounds of each zone. If the ray intersects two or more surfaces in that zone, the volume is taken from the distance between the farthest two intersection points. The results of comfort values displayed horizontally in flat surfaces .....	120
Figure 5.28. Gunzo room in existing condition on 06 January (upper hand), 14:15. Gunzo room renovated version on 06 January, 14:15 (lower hand). The results of temperature values displayed in horizontal grid surface (left hand). Thermal visualization with CFD blockages in Ecotect (right hand).....	120
Figure 5.29. Monthly Mean Radiant Temperature results between the two versions of the Gunzo room during the year .....	121
Figure 5.30. Breakdown of Gains and Losses, from 1st January to 31st December. (a) Results of the Gunzo room under existing conditions. (b). Results of the Gunzo room renovated version .....	122

Figure 5.31. Chart of adaptability Index of Gunzo Room Existing Condition from 1<sup>st</sup> January to 31<sup>st</sup> December. After renovation, the Adaptability Index is 0.23, better than the Gunzo Room in Existing Condition (0.26) ..... 124

Figure 5.32. Superimposed Chart of adaptability Index of Gunzo room in existing condition (green line and dots) and the renovated version (purple line and dots) ..... 124

Figure 5.33. Workflow of preformatted data of MRT to structure the value in volumetric ..... 126

Figure 5.34. The results of the thermal calculation in Txt format organized in file folder. The result contained values of temperature at selected time during the year. The eight text files contains the results of the eight layers (depends on altitude) temperature. Each text file begins with 8-8, means that each layer contains a grid of 8 rows and 8 columns. The next number is the point elevation on Z axis. In the example, each text file ends with "\_01-06\_14-15", means of the date and time selected of the simulation performed on January 6<sup>th</sup> at 14:15..... 126

Figure 5.35. Txt structure of temperature data (MRT) before and after preformatted. The data (on the right) are ready to export to 3DVia Studio/Virtools ..... 127

Figure 5.36. Detailed workflow to present TBS results on PC and Tablet ..... 128

Figure 5.37. Experiment of thermal visualization with transparence cube and particles using Virtools. It is applied for PC and tablet ..... 128

Figure 5.38. Experiment of thermal visualization with particles. The Gunzo room filled up with particles generated by cubes emitters and assign the color according to the thermal value given by Ecotect ..... 130

Figure 5.39. Gunzo room in existing condition and TBS results with visualization of particles (Sept. 6<sup>th</sup> 14:15) ..... 130

Figure 5.40. Thermographic images are create using photos taken at the beginning of each month. It is used a portable thermal camera from Flux IR FlexCam® model Ti50. Twelve parts of images, 4 vertical and 3 horizontal, are assembled using the "Hugin" software. Selected resolution is 640 x 480. The assembled image resized in Photoshop before transferred into 3DVIA Studio/Virtools ..... 130

Figure 5.41. Visualization of image of thermographic camera attached on the surface of the wall. Thermal information is only available for the window facade and has no volumetric properties. Later, this method is not include in the simulation due to the limitation of thermographic results for future planned project (renovate version) and the 3-D aspect for immersion ..... 131

Figure 5.42. Three workshops designed for the experimental study: Paper-based (Workshop A), PC (Workshop B) and Tablet /iPad (Workshop C) ..... 131

Figure 5.43. Detailed process of data workflow toward Immersion room. Main applications involved: Revit architecture, 3DSMax, Ecotect, 3DVia Studio, and Perl Routine for preformat ..... 132

Figure 5.44. Principle of system commands and menus for the user interface ..... 135

Figure 5.45. (a). 3D model of Gunzo room in existing condition visualized in immersion room. The interface equipped with some large commands and menu to help the user since the beginning of the simulation, (b). Visualization with active stereo ..... 136

Figure 5.46. Visualization metaphor of transparent cubes of Gunzo room in existing conditions simulated on November 6<sup>th</sup>, at 14:15. The grid cubes (512 parts) completely filled the room and the color indicate the temperature of the area they occupy ..... 137

Figure 5.47. Visualization cubes with transparent mode. The transparent value ranges between 0 and 8 point. Default value was set on 3 point. The transparency of the cubes can be modified by the user from a small "Transparency" menu, on the right-bottom corner of the display (plus-minus button). This icon appears automatically when simulation with cubes is conducted ..... 137



Figure 5.48. Visualization metaphor of particles of Gunzo room in existing conditions simulated on November 6<sup>th</sup>, at 14:15. The grid cubes (512 parts) act as the emitters and completely filled with the particle. The Birth rate of the particle is set to 3 point by default, and the user can modify it simple by clicking the plus-minus button on the right-bottom corner of the display. This icon appears automatically when simulation with particle is conducted ..... 138

Figure 5.49. Visualization layer particles. In normal cases, the simulation result will visualize the room completely filled with cubes or particles that indicate the temperature of the area they occupy. In order to make a better perception the both metaphors are also divided into 8 layers on each axis in the room. In this simulation, only two layers are shown at a time, a horizontal layer and a vertical layer ..... 138

Figure 5.50. Visualization metaphor of layer cubes of Gunzo room in existing conditions simulated on November 6<sup>th</sup>, at 14:15. A "slide-in" menu for the layer is provided for the both metaphors (Cubes and particles) to enable the user to choose which layer to be displayed. An option button to hide or to show the layers is also available in the bottom of the slide-in menu (Appendix C). By default, this menu is hiding and represent by with blinking arrow. The user can click the arrow to access the menu ..... 139

Figure 5.51. Visualization metaphor of layer particles of Gunzo room in current state. February 6<sup>th</sup>, at 14:15 ..... 139

Figure 5.52. The switch between vertical and horizontal layers organized in a slide-in menu. This slide-in menu activated by clicking a blinking blue arrow on the left side of the screen. Both images in the menu contains of 8 buttons: vertically and horizontally. The activated layer will turn the button red, while the other buttons remain black. If a layer is deactivated, the switching buttons are also deactivated, and will reactivate along with them ..... 140

Figure 5.53. The hide-show icons give the user options to activate or deactivate the layers vertically or horizontally, and to switch between the eight vertical layers and the eight horizontal layers. When the layers are active the buttons are colored, and when we deactivated the buttons turn grey ..... 140

Figure 5.54. A view of the immersion room (LITE) ..... 144

Figure 5.55. A participant received explanation regarding the experiment and begins a short rehearsal, examining the virtual mockup to get used to the immersive room ..... 145

Figure 5.56. The four thermal metaphors visualized in the experiment in the immersion room; (a). Simulation results of renovated version in June 6<sup>th</sup>, 14:15 using colored cubes, (b). Simulation results of the Gunzo room in existing conditions in November using particles, (c). Simulation results of the Gunzo room in existing conditions on February 6<sup>th</sup>, at 14:15, using layer particles in vertical and horizontal. (d). Simulation results of renovated version using layer cubes in vertical and horizontal on March 6<sup>th</sup>, at 14:15 ..... 147

Figure 5.57. Mean accuracy points of four visualization metaphor ..... 147

Figure 5.58. Accuracy of each type of visualization metaphor in 9 tasks (T<sub>1</sub> – to find the temperature in a particular spot in the room (Difficult 1); T<sub>2</sub> – to find the temperature in a particular spot in the room (Difficult 2); T<sub>3</sub> – to locate the spot in the room with a specific temperature (Difficult 1); T<sub>4</sub> – to locate the spot in the room with a specific temperature (Difficult 2); T<sub>5</sub> – to detect the maximum temperature (before renovation); T<sub>6</sub> – to detect the minimum temperature (before renovation); T<sub>7</sub> – to detect the maximum temperature (after renovation); T<sub>8</sub> – to detect the minimum temperature (after renovation); T<sub>9</sub> – to find the difference in temperature before and after the renovation ..... 151

Figure 5.59. Mean task completion times for all tasks with the four metaphors used in the experiment. 151

Figure 5.60. (a) Level of immersiveness among the metaphors. (b). Percentage of application usefulness of the metaphors ..... 153

Figure 5.61. User preferences concerning services through the application. (a). Preference in how to know the temperature of a room after renovation (the room is not built yet).  
 (b). preference types of information on interactive thermal representation for a room.  
 (c). Preference of temperature visibility in the span of period calculated for a room ..... 154

Figure 5.62. User experience while conducting the overall task in VEs. E1 – Comprehend the simulation task; E2 – Easiness of the VR interface; E3 – Intensity of concentration during the experiment; E4 – Level of sensation while immersed in thermal visualization ..... 154

Figure 5.63. Detail of Impression regarding the VR application ..... 155

Figure 5.64. Summary of Impression of the VR application (W – Workability; EU – Ease of use; F – Flexibility (freedom of movement); E – Effectiveness; C – Comfort; P – Precision) ... 156

Figure 6.1. Images of TBS results of Gunzo room represented in VR. The application is intended to help building stakeholders to review their project design through thermal calculation results in order to obtain a sustainable building ..... 162

Figure 6.2. Images of the two version of Gunzo room captured during the integration process of their TBS results in VE ..... 165



# Tables

Table 2.1.	Interoperability of the thermal tools investigated .....	28
Table 2.2.	Comparison between Thermographic Camera and Thermal Software .....	34
Table 2.3.	The required data at each level of the workflow to maintain seamless data exchange .....	38
Table 3.1.	Types of VR systems .....	44
Table 3.2.	The contribution of each of the five human senses (Heilig, 1992). It shows that human vision provides the most of information passed to the brain and captures most of human attention. Therefore the stimulation of the visual system plays a principal role in “fooling the senses” and has become the focus of research .....	51
Table 3.3.	The field of view of different display types for virtual reality .....	52
Table 3.4.	Relations between display types and interaction techniques .....	53
Table 4.1	Revit architecture file formats and exchange .....	72
Table 4.2.	User motions using Xbox Controller .....	92
Table 5.1.	Gunzo room zone management. Both, Gunzo room existing conditions and the renovated versions were equally processed in parallel time simulation through Ecotect .....	115
Table 5.2.	Description of scripts used to organize thermal data workflow and visualization metaphor for the simulation conducted for PC and Tablet. The schematic VSL scripting is presented in Appendix A1 .....	129
Table 5.3.	Experiment stage description .....	145
Table 5.4.	Details of Mean values of the correct answers on four metaphors .....	148
Table 5.5.	Percentage of accuracy through 9 task regarding actions in immersive room using the four metaphors .....	150
Table 5.6.	Mean values of accuracy through 9 tasks .....	150
Table 5.7.	Detail of the time spent by the participants (in second) to answer the question in 9 task with regard to the four metaphors .....	152
Table 5.8.	Comparison of accuracy and time spent for the task ( <i>TM</i> – Thermal Metaphor; <i>AT</i> – Average Time; <i>FT</i> – Fastest time; <i>A</i> – Accuracy; <i>T</i> – Time spent / task) .....	153



# Equations and Scripts

Equation 2.1	The mean radiant temperature for a person [°C]	35
Equation 2.2	Comfort temperature for free running building	36
Equation 2.3	Comfort temperature for heated or cooled building	36
Equation 2.4	The effective solar collecting area for the opaque building elements	36
Equation 2.5	The effective solar collecting areas for transparent elements	36
Equation 2.6	The heat gains, in terms of hourly heat fluxes distributed over the internal air temperature node	36
Equation 2.7	The heat gains, in terms of hourly heat fluxes distributed over the temperature node that represents the mass of the building	36
Equation 2.8	The heat gains, in terms of hourly heat fluxes distributed over the central temperature node	36
Script 4.1	Txt preformatting in Perl Routine (Credit: C. Pere)	82
Script 5.1	Thermal simulation behavior to treat Ecotect data from Txt of Perl Routine to simulation cubes or particles	133
Script 5.2	Behavior of a particle inside a cube (cube number 7 of 512)	134
Script 5.3	Reference of system commands and menus for the user interface	136
Script 5.4	Behavior of post process rendering of stereoscopic camera	141
Script 5.5	Behavior of copy frame	142
Script 5.6	Behavior of Interaction	142



# Chapter 1

## Introduction





**B**uilding simulation began in the 1960s and became the hot topic of the 1970s within the energy research community (Hong et al, 2000). Building simulation can be applied in the life cycle analysis of a building, including design, construction, operation, maintenance, and management. Its ability to deal with the resulting complexity of scale and diversity of component interactions has gained building simulation a uniquely recognized role in the prediction, assessment and verification of building performance (Augenbroe, G., et al, 2004).

In term of prediction, assessment and verification of building performance, thermal building simulation is become one of popular application (Hong et al. 2000). Thermal building simulation tool has become an integral part of the ensemble of computer applications for the design, engineering and operation of buildings. The primary objective of it use is to conduct a performance analysis that informs a design decision.

Building performance simulation becomes increasingly complex due to changing perceptions. In a competitive globalized construction market, some methods have emerged particularly to respond the sustainability issue and specific demands of building stakeholders. They bringing specific knowledge input to the building performances and its representation requirements beyond the capabilities of the conventional architectural and building engineering, especially thermal building simulation. The following subsections detailed the emerging issue as the background of this study. It begins with discussing the sustainable building issues and the use of ICT for building performance optimization. Next, the various underlying issues are discussed as the basis to formulate the context and the objective of this work.

## 1.1 Sustainable Building Issues

The concept of sustainability, the consideration of natural resources and energy conservation has become a global issue as a result of the global warming and climate change (Ghaffarian et al., 2013). The rapidly growing world energy use has already raised concerns over supply difficulties, exhaustion of energy resources and heavy environmental impacts such as ozone layer depletion, global warming, scarcity of resources, etc. (Lombard et al., 2008).

Buildings are the major source of global demand for energy and materials that produce by-product greenhouse gases (GHG), as well as the single primary contributor to anthropogenic climate change (Architecture 2030, 2011). The growing trend particularly in building energy consumption apparently will continue during the coming years due to the expansion of built area and associated energy needs.

The International Energy Agency (IEA, 2009) released a publication that estimated that existing buildings are responsible for more than 40% of the world's total primary energy consumption and for 24% of global carbon dioxide emissions. According to the reference scenario of IEA (Fig. 1.1), the building sector will remain the first consumer with in 2030 with consumption share of 32% (3639 Million Tons of Oil Equivalent). Its energy demand will grow with an average of around 1.2% per year against 1.4% for the whole final energy consumption.

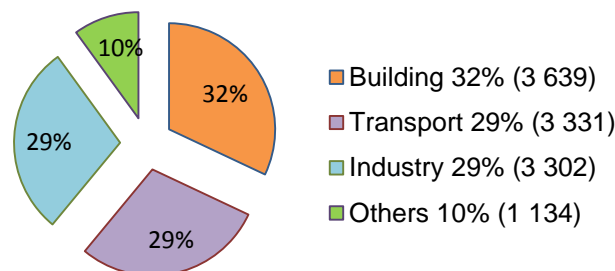

Figure 1.1. Final energy consumption prospective in the world in 2030 according to the IEA reference scenario (IEA, 2009).

It is interesting to note that, buildings would consume one-quarter to one-third of the overall energy generated globally. In addition, More than four-fifths of site energy use typically occurs in the operational phase of a building’s life, for example in residential buildings (Fig. 1.2). Energy efficiency of new buildings determines the energy consumption for far longer than in other end-use sectors (Missaoui et al., 2010).

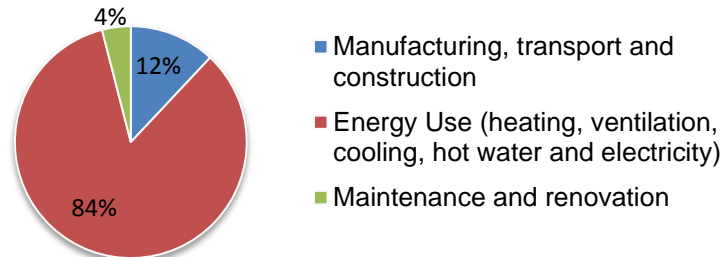

Figure 1.2. Life cycle energy use of residential buildings (International WBCSD, 2007)

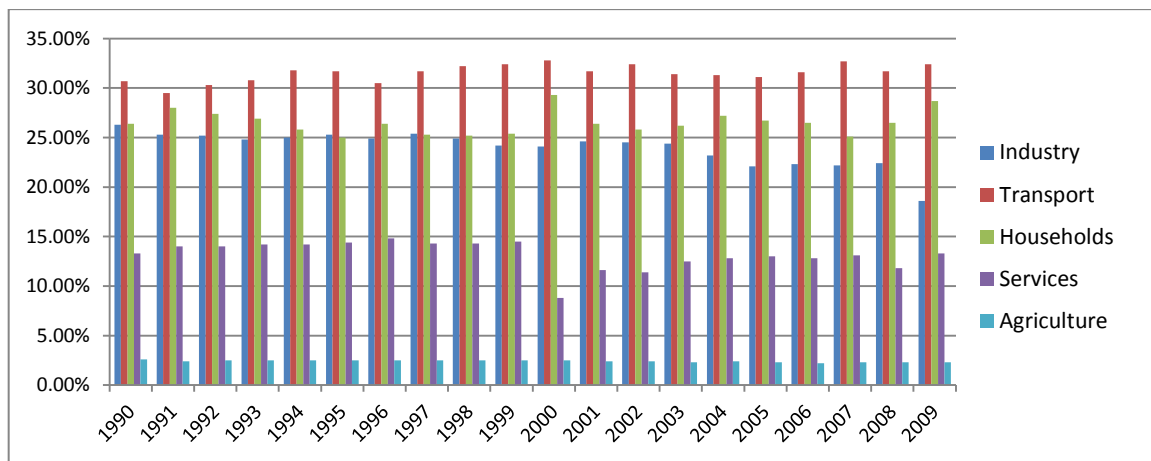

Figure 1.3. Evolution of Energy Consumption in France. (Source: Eurostat - June 2011 - COMEXT-Sirene energy data, 2011 revision of the period 1990-2009 and Targets data June 2010; EEA - June 2011 - CO2 emissions data; ECFIN - June 2011 - AMECO macro-economic data)

Figure 1.3 shows energy consumption in France in 2009 which dominated by transport (34%) and households (30%). Most of household consumption is used for heating (84%) as describe in figure 1.4.



Figure 1.4. Most of household energy consumption in France is used for heating (Quenard, 2011).

Currently, 30% of global CO2 emissions and 40% of global resource consumption result from the constructing of buildings (International WBCSD, 2009). In France, buildings are responsible for 43% of electrical consumption and 21% of CO2 emissions (CAD-magazine, 2011) and buildings responsible for at least 40% of energy use in most countries (Missaoui et al., 2010).

Every building responds according to its composition and of its design. As building growth intersects with environmental concerns and the rising cost of energy, the growing field within building design has emphasized sustainable design. Sustainable design is a practice of designing, constructing, and operating buildings in a manner that minimizes their environment impact.

Recent studies indicate that the demand for sustainable building facilities with minimal environmental impact is increasing (Azhar et al., 2011). Rising energy costs, human health and growing environmental concerns, as described previously, are the catalysts for such high demand (Holmes et al. 2007). It's no doubt the building sector has the greatest potential to reduce energy consumption. Unfortunately, many buildings are still constructed or renovated without consideration of energy conserving strategies or other sustainability aspects.

Implementing sustainability issues starts at the concept planning and project programming stage where the building feasibility and performance of alternatives should be compared in order to select the best decision in project. Sustainability decisions made at the beginning of a project life cycle have a far greater influence than those made at later stages, since design and construction decisions will influence the continuing operating costs and, in many cases, revenues over the building's lifetime.

Improving energy efficiency is the first and most important step toward achieving sustainability in buildings. Energy efficiency is a parameter that indicates the minimum level of energy usage for performing an associated task and that largely depends on the state-of-the-art technological and production processes. Energy efficiency is highly valued in almost all engineering and technological fields because of the workability of end-use product that consume less energy on long term basis (Parameshwarana et al., 2012).

Energy-efficiency measures can often be developed specifically for old buildings, which need to be refurbished, and for new buildings before the construction process. Thermal modernization of old buildings, or buildings constructed recently but in poor thermal condition, is performed to achieve significant reductions in energy consumption and to improve indoor-climate conditions (Chwieduk, 2003).

## **1.2 Building Performance Optimization: Information Communications Technology (ICT) for Sustainability**

This subsection discusses the need of technologies for building performance optimization to achieve more significant measures and detailed information regarding energy consumption in the building sector. According to Mahdieh et al. (2012), it is important to harness the ICT (Information Communications Technology) in particular the virtual architecture to optimize the design of a building in order to reduce energy consumption. Computer simulations are much more demanding in terms of input information and data processing than ordinary design work. In addition, as building codes are updated to consider building performance, there is an increasing obligation of designers to provide higher degrees of insight regarding building outcomes. Building stakeholder need to define the technology to realize opportunities for complicated project and data flexibility.

Building performance simulation offers the potential to cope adequately with building performance related concerns. In contrast to the traditional engineering methods (not considering the system dynamics), computer based modeling better approaches the reality. Increasingly, computer-based models (programs) are being employed to aid in the design, operation, or management decision making process (Hensen et al., 2002). With the realistic visual representation of buildings on the computer having reached maturity, the emphasis has now shifted to the performance simulation of buildings on the computer. The challenge of performance simulation in computer-based models of buildings lies in the post processing and integration of the simulation technique that requires different kinds of building representations.

Related to thermal building performance for example, there is more demand from building stakeholders. To be a “successful” design assessment tool, a computer program intended to evaluate design proposals must facilitate the building stakeholder’s iterative approach where initial understandings, not only of the problem, but also the way to present it.

Following are the problems with the thermal measurement today:

- Thermal tools primarily focus only on direct application of 2D thermal imagery which makes the process of data collection and analysis time-consuming (e.g. thermographic camera and thermometer). Furthermore, the current practice of thermography is not able to simulate thermal result of future building (Ham, 2013).
- The results of calculations are usually presented in 2D or text format so it is sometimes difficult to understand and the model is not interactive.
- In case of an old building, it requires a specific calculation and simulation since the structure is different with modern building.
- If the building is not exist yet (future project) it requires a simulation results between the current state and the projected state during the year to compare the both version.
- It is important to find a method and practical implementation regarding thermal building simulation (TBS) that flexible for the existing building and the future project.
- Today, the typical thermal simulation tool produces complex and enormous amounts of data. This data can be used to provide detailed answers to thermal measurement and design questions after interpret in an advanced representation which is normally by transfer it to other tools. Furthermore, there are issues remain regarding data format to overcome the data exchange.

Therefore, the specific aspect of this building performance context should give building stakeholders (architect, engineer, building owners, etc.) an immediately understandable results. The results necessarily of 3D data impression which is traditionally provide in 2D and text. These data of simulation, generated by performing an analysis of a building or its elements, may be used more efficiently and effectively by improving its visual representation.

For additional background, the following describes a reality that occurs on the field. This is a case commonly occurs in a building project which describes the routine issues that must be delivery through visual representations. A building owner has decided to build a new building or to renovate an old one. He informs an architect and a constructor of his operation requirements (functionality, space, flexibility, indoor comfort, temperature variation, etc.). The building owner also requires that the building should obtain desired indoor comfort with low energy use with the pre-calculation available during the year. The building owner would like to know earlier how much energy might be saved, or the temperature reduced to justify any additional expense or design change. Architects and engineers also need to know the relative performance of buildings to choose a suitable alternative.

The multiple stages and the involvement of various parties in a project indicate how complicated is the process to achieve a sustainable design particularly through ICT (see also Fig. 1.5). The fact that thermal simulation has become an integrated element of the design process has resulted in a diverse and growing user uptake, addressing the whole design team (Bahar et al., 2013). Building owners for example, they are often not an expert but it is highly important part. In a project, it will usually not be procurement staff who set the user’s requirements since they do not expert in modeling and simulation. Therefore, it is essential that all stakeholders work closely together to ensure that full advantage is taken of the scope available to consider sustainability issues before the subsequent development of specifications.

In addition, past research on utilization of simulation tools during the architectural design process indicates that despite the increase in number of available tools in the last decade, building stakeholders especially architects and designers find it difficult to use thermal tools, since they are not compatible with the working methods and needs, or the tools are judged as complex and cumbersome (Gratia et

al., 2002; Punjabi et al., 2005). The continuing growing number of this tool reflects a broader variety of tools abilities but it does not necessarily reflect a wider penetration within the building design community (stakeholder). Fortunately, on the other hand, there has been developed the concept of collaboration for building stakeholder to work together within the model called Building Information Modeling (BIM). It provides a method where design and analysis process can be integrated from the earliest stages of the design, and can also assist in design decision-making (Aksamija, 2010). BIM improved coordination and organization, which is the interaction depends on multi-party tools. BIM for thermal building simulations integrated with the design process. Interoperability between BIM-based design and thermal simulation tools can improve the workflow between design deliverables and analysis applications, since the information contained in the BIM models can also be reused for analysis (Haymaker, et al., 2007). Therefore, the emphasis on high-performance buildings makes it important to leverage BIM-based thermal analyses during design (Welle et al., 2011). However, the next challenge is certainly lies on how to integrate BIM data which deals with the data workflow toward the new trend application (i.e. virtual reality (VR) application).

### 1.3 Context and Objectives

The implementation of building performance optimization benefits the context of sustainable (also called green) buildings. With view to the sustainable energy performance of green buildings, this work contributes to develop a technology to complement current practices in optimizing building performance.

As describe in previous subsection, background issues on building performance and more expectation from building stakeholder ultimately lead to the context of focused sustainable building method and tools. Sustainable building (also known as green construction or green building) refers to a structure and using process that is environmentally responsible and resource-efficient throughout a building's life-cycle: from siting to design, construction, operation, maintenance, renovation, and demolition. This requires close cooperation of the design team, the architects, the engineers, and the client at all project stages (Yan et al., 2006). With respect to our work, we specify the project stages to focus on indoor thermal simulation. According to Chappells et al. (2005) fundamental principles of sustainable building on aspect of Indoor Environmental Quality is to provide a building design, which affords the best possible conditions in terms of indoor air quality, ventilation, thermal comfort and access to natural ventilation and daylighting. This effort in line with the future of comfort and the way to deal with environmental sustainability, energy consumption and the indoor environment (Chappells et al., 2005).

Sustainable buildings often include measures to reduce energy consumption. Building energy evaluation and assessment methods have evolved over the last decades towards sophisticated tools, which can support designers in minimizing building energy use. Certainly, building performance simulations are an integral part of the design process for energy efficient and high-performance buildings, since they help in investigating design options and assess the environmental and energy impacts of design decisions (Augenbroe, P., et al., 2004; Wetter, 2011). Unfortunately, the majority of building energy performance evaluation methods and tools focus mostly on the building and system level while ignoring more detailed data (Maile et al., 2012). They are most often do not consider properly to represent a more detailed engineering data which is very important for sustainable building projects. In contrast, building stakeholder expectations in terms of the data representation is higher. Their expectations on how the data is presented have shifted toward the simplicity, convenience, comprehensiveness. Building owner in particular often requires a different or additional service to support the presentation results.

As this working environment is highly collaborative and multidisciplinary, raises several issues related to the measurement, data integration and data representation (Cormier et al., 2011; Haymaker et al., 2007). A number of questions then arise, for example: how to deal with the multiple and varied models

and data formats used to represent the building; how to make those data visible and accessible to stakeholders; how ensuring building data integrity in such concurrent and collaborative workflow, and last but not least how to see all the results in real time, detail but easy to understand, and more interactive.

There are many important factors that can be measured relating to the performance of a building. However, building energy efficiency, thermal performance, and the material efficiency are considered as significant parameters of sustainable energy performance indicators to be fully taken into consideration during the performance evaluations (Ghaffarian et al. 2013). These parameters are always involved in sustainable design starts from the programming phase to the maintenance (Fig. 1.5). Therefore, this study focuses on building thermal simulation with the aim of energy efficiency. Thermal building simulation is the dynamic analysis of energy performance of buildings using computer modeling and simulation techniques.

Feasibility study	Programming	Schematic design	Detailed design	Construction	Maintenance
 Visualisations without design or preliminary geometry	 Space objects with space data input	 No definition of structures, properties (U-values etc.) by structural types (EW1 etc.)	 Structures, windows, doors etc. defined on general level without connection to manufacturers	 Building components with manufacturer data and real dimensions	 Model completed with maintenance data
Requirements, specifications and comparisons					
Energy and environmental analysis					
Comfort analysis					
Lighting visualisations					
Cost analysis					

Figure 1.5. Thermal analysis supports decision-making and problem-solving in several phases during the building process, from early design to operation and maintenance (Laine et al., 2007).

The most dominant method for modeling energy performance of existing buildings and assessing various design alternatives is the use of building thermal simulation tools. In fact, many thermal simulation tools are available today and they differ in their manner of simulating thermal energy (Fig. 1.6). Most of them produce thermal calculation simulations in 2D graphic charts (statistical values) and CFDs. However, only few products can present their calculations and simulation results in 3D which is still limited for PC use, and none of them has been satisfactory when applied for 3D data, particularly in real scale as provided in virtual reality. Woksepp et al., (2006) claimed that applications of VR have clearly been an area of increasing research and development activities in architecture and construction. The research has indicated that VR at the present time has become more accessible and more available. As it appreciated and accepted by building stakeholders, it promises broad benefits for thermal building simulation.

VR offers a large array of potential uses particularly in thermal building simulation. It has become an enabling technology in a variety of building performance applications due to its ability to present three-dimensional, complex data and information in an intuitive and interactive manner. As a visualization tool VR has many advantages for building stakeholder. By allowing them to immerse themselves in their design, VR allows a much clearer understanding of both a qualitative and quantitative nature of the space they are designing (Pilgrim, 2003). VR allows designers to evaluate proportion and scale using intuitive interactive modeling environments and so simulate the effects of thermal, as well as lighting, ventilation, acoustics, etc. As a visualization tool VR is also used to

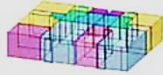
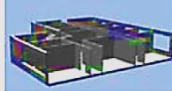
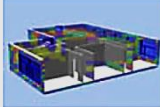
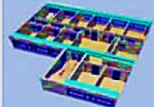
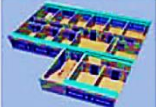

communicate ideas from designers to clients by generating walkthrough models to test the design with the clients in a more direct manner. VR can also be used to model the construction sequence in order to simulate and monitor site progress. Therefore, the research effort discussed here also focuses on the implementation of VR as a visualization tool for building thermal simulation used for building performance predictions and design review. Various simulations for building thermal performance can be optimized, not only on the calculation results, but also on the application method for visualization and interaction in virtual environment.

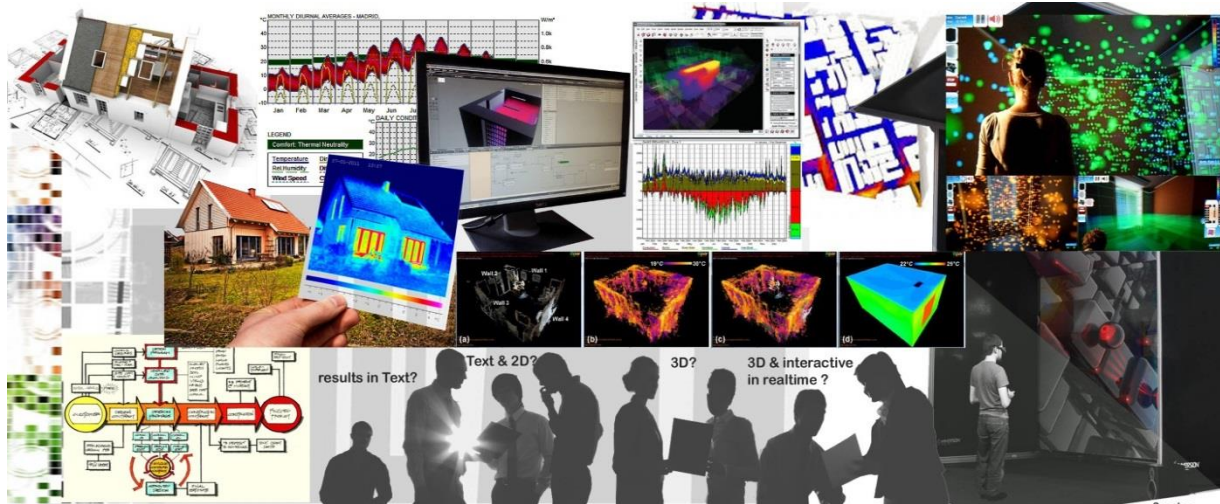

Figure 1.6. Building stakeholders and the option of the representation of thermal building simulation used for design review or decision making during the project.

However, although VR offers a high quality for simulation results, there are some aspects that important to address for representing TBS in VR. They are the basis for an engineering platform that can address a wide range of issues concurrently, including those of modeling (designing), thermal building analysis, and design review. These aspects are:

- High Performance Computing: the high fidelity numerical models coupled with experimental, thermal calculation and data workflow.
- Visualization: not only the 3D visualization of the data but the interaction allowed by displaying this data inside a virtual environment.
- Real Time Simulation: a scenario tailored to the Thermal software and VR software which formulates a dynamic simulation capability to generate physically realistic responses of the model under different interactions.

Based on these aspects and also the previous explanation, this thesis work focuses on 3D modeling, thermal calculations as well as its visualization and simulation. The objective is to carry out research on real time visualization of TBS in VR for sustainable building projects. Beyond the visualization of large database resulting from upstream computation, the experiments aim to propose a new way of data representations (surfaces, particles, graphs, etc). The experiments conducted in virtual reality rooms (CAVE-like or LITE) of the Institute Image. The work also concerns the integration (or the encapsulation) of the results computation in IFC standard for a better interoperability between CAD tools, thermal simulation software and virtual reality tools.

This thesis is part of a collaborative work of some Masters and PhD students. For the purposes of our research we had to design and implement a basic thermal building model for visualization and interaction on the virtual environment. Further, we have also studied the workflow and mode of thermal visualization represented to virtual environments. On various case studies we have improved the



concept of the representation with our method and techniques of provide an efficient visualization environment with natural three-dimensional visualization and interaction.

The scientific emphases are:

- To study the benefit brought by real time visualization on a full scale thermal building simulation for design review, in particular to facilitate building stakeholders (architects, engineering, building owner, constructor, etc.) evaluate their design decisions during the project.
- To review current practice and requirements for the representation of building performance data. Also, to define the most adapted way in representing the data in VE.
- To develop a representation of TBS in VR for energy efficiency where the users can observe and simulate the thermal results before and after renovation during a certain time.
- To present a VE that facilitates the interpretation of TBS results (immersive visualization and intuitive interaction).
- To test and to validate the TBS results through an in-depth experiment with specific scenario in virtual environment.
- To approach other potential aid for building stakeholder in building assessment. The research perspectives can be proposed to other types of simulation by extending the visualization (i.e. acoustics, aerodynamics, weather, snow, etc.).

The technological aspects are:

- To understand the results and to adapt the formats of the thermal computation software towards real time visualization tools.
- To integrate the simulation data into the building digital mock-up (BIM – IFC).
- To identify visualization techniques and technologies suitable for the representation of a building's 3D form and the interpretation of the related output data.
- To propose various representations modes (textures, particles, surface, etc.)
- To allow the visit in real time, scale 1/1 of buildings under study or existing, to interact with this model and to modify it in real time with constant geometry. This treatment is done during the stages of building process in order to make decisions without awaiting the realization of a physical model.
- To develop an application allowing the integration and the interaction in real time with the 3D full scale model. The friendly interface allowing the real time and easy request by semantics criteria and a selection of the various computation results.

## 1.4 Synopsis

The thesis is structured as follows.

Chapter one provides backgrounds of this research, stating context and objectives, and the overall structure of the thesis. It discusses the challenges and the problems faced by building stakeholder when adopting a sustainable building design approach, particularly to optimize building's energy performance. Also highlight the importance of new technologies in its measurement techniques. This chapter describes motivation of our work and outlines the research agenda of this thesis, which has been derived from the general research issues regarding sustainable building, TBS, and VR.

Chapter two describes the introduction to TBS, TBS tools and BIM platform. Based on the BIM context, it then discussed interoperability of TBS tools and TBS in the context of this study. This chapter discusses the TBS significance including its software, interoperability between the software related to BIM platform, and its specific area focused in this study. A state-of-the-art review of building performance tools and its data exchange was conducted to establish which techniques were available

to building stakeholders within existing TBS tools. Last section presents the TBS specification for this study. It allows identifying the limitations of existing TBS methods in relation to our objectives solutions.

Chapter three describes and discusses both VR and Scientific Visualization of TBS. A review of visualization and virtual reality is conducted to identify technologies suitable for the display of a building's 3D geometry and its associated data toward the representation in virtual environment. General principles of scientific visualization of TBS are described.

It also explores the context and the challenges that must be overcome to realize an effective visualization of TBS in VR. The advantages that can be achieved are highlighted. Finally it provides an overview of related work in the field of visualization of TBS in VR.

Chapter four establishes the method of representation of TBS in VR. It begins from 3D data as the basic input of VR system, the workflow and technique of visualization and interaction in VR. It describes the visualization concept of TBS toward the VE. The design phase begins from CAD Modeling (Revit Architecture), thermal calculation and simulation (Ecotect analysis) and preformatted data using Perl Routine. Finally it describes the process to integrate the data to 3DVia Studio (Virtools) and the method of specifying the TBS visualization and interaction in VE.

Chapter five describes application of the TBS representation using VR techniques and its validation. It establishes the design of the experiment (case study), the general procedural aspects and the results. It outlines hypothetical visualization metaphors to conduct in a test. It is to know the pertinence of visualization metaphors as well as its interaction scenario to building stakeholder. A user test was conducted to evaluate factors affect the successful representation of TBS in VE. Such things as the effectivity, workability, flexibility and precision of the visualizations are examined.

Chapter six lists the general conclusion and avenues for future work. Conclusions drawn about the development of the representation of the TBS in VE generated within our framework. It also reviews the concept of visualization and Interaction of TBS in VE. Then it states some critical evaluation of the research. The future work details the potential development of the method, and follow-ups to existing experiments that may be performed.

Appendices:

Appendix A contains schematic VSL Scripting (Virtools and 3DViaStudio),

Appendix B contains IFC data of Gunzo room,

Appendix C contains questioner of the experiment and description of menu interface,

Appendix D contains an example of data preformatted results (Ecotect – Perl Routine).



# Chapter 2

## Thermal Building Simulations

### Abstract

Thermal building simulation (TBS) is the dynamic analysis of the energy performance of buildings using computer modeling and simulation techniques. TBS is a powerful method for studying the thermal performance of buildings and to evaluate architectural design. In terms of sustainable building projects required by AEC community we present our approach toward optimizing thermal performance of building using TBS tools. This approach begins with reviewing the tools, their methods, data exchange and their potential interoperability with VR technology.

Chapter two describes the introduction to TBS, TBS tools and Building Information Modelling (BIM) platform. Based on the BIM context, it then discussed interoperability of TBS tools and TBS in the context of this study. This chapter discusses the TBS significance including its software, interoperability between the software related to BIM platform, and its specific area focused in this study. A state-of-the-art review of building performance tools and its data exchange was conducted to establish which techniques were available to building stakeholders within existing TBS tools. Last section presents the TBS specification for this study. It allows identifying the limitations of existing TBS methods in relation to our objectives solutions.

### Contents

2.1 Introduction to Thermal Building Simulation .....	15
2.1.1 Basic Principles of Thermal Simulation .....	16
2.1.2 Input to energy simulation .....	18
2.1.3 Basic tool architecture .....	18
2.2 Thermal Simulation Software and the BIM Platform .....	20
2.2.1 Interoperability through BIM Platform .....	20
2.2.2 Thermal Simulation Tools and Their Interoperability .....	24
2.3 Interoperability Review of the Most Applicable Building Thermal Simulation Tools in the AEC Community .....	27
2.3.1 Thermal Simulation Tools as BIM Application .....	27
2.3.2 Review of Data Exchange .....	31
2.4 Thermal Building Simulation in the context of this study .....	33
2.4.1 Thermographic Camera vs. Thermal Software .....	33
2.4.2 Parameters in Thermal Building Simulation Models .....	35
2.5 Summary .....	37



**T**hermal simulation tools are being used increasingly by all professions involved in the design of buildings. As building analysis software becomes more sophisticated, integrated, and easier to use, we are faced with the opportunity and the necessity to better our understanding of building performance especially for energy optimization. In the traditional building performance analysis process, an analysis expert collects building information from 2D drawings, photos, and so on, to construct an analysis model within a selected analysis program. This analysis process is usually too expensive and too labor intensive. It also takes more time to deliver the results than the building stakeholder expects (Moon et al., 2011).

As mentioned in chapter 1, building stakeholder which consists of various team members has diverse even more specific expectations. Recognizing the implications of design decisions made by the different team members on the energy and environmental performance of the building engages all design team members in performing simulations. As a consequence, simulation tools have become recognized as design support tools within the Architecture-Engineering-Construction (AEC) industry (Attia, 2010).

From an AEC perspective, an advanced analysis of thermal building simulation in building modeling programs has become a critical part of high-performance buildings. The conceptual design phase of thermal modeling in TBS is used to provide the designer with first order of magnitude feedback about the impact of various building configurations on annual thermal performance (US GSA, 2010).

The tools described in this chapter are a selected subset of all building thermal performance simulation tools that exist today. The tools listed were selected as those most applicable by professional users in the AEC community. Since more 3D building geometry models can be reused in thermal simulation tools, their functions and smooth process in interoperability become the issues. Hereby, their functionality, models, and the usage of data exchange possibilities are being addressed. In particular, this as a way to get solution for a proper thermal tools, which is appropriate in the context of 3D geometry, calculations and data exchange, especially for simulation with the VR application.

## 2.1 Introduction to Thermal Building Simulations

This section introduces TBS and discusses about basic principles of thermal simulation which is bundled in software. Then it explains their input to energy simulation and their basic tool architecture. Thermal building simulation is the dynamic analysis of the energy performance of buildings using computer modeling and simulation techniques. In this simulation, a calculation of building thermal loads and thermal consumption are involved in determining the thermal characteristics of the building and its building systems. TBS is a powerful method for studying the thermal performance of buildings and to evaluate architectural design. Complex design problems can be investigated and their performance can be quantified and evaluated using this method.

The thermal tool landscape for all building design professionals is diverse, ranging from research software to commercial products with thousands of users. They vary in their thermodynamic models, graphical user interfaces, purpose of use, life-cycle applicability, and ability to exchange data with other software applications. The fact that thermal simulation has become an integrated element of the design process has resulted in a diverse and growing user uptake, addressing the whole design team. On the other hand, due to the increasing importance of the decisions made early in the design process and their impact on energy performance and cost, several thermal simulation tools have been developed to perform early energy analysis independently.

Normally, these tools are developed to be used during the design phase of the building life-cycle. Recent developments lead to a broader use over all phases of a building's life. In these tools, data exchange, primarily from CAD applications, also related to other design tools such as HVAC (Heating,

Ventilation and Air Conditioning) modeling tools. Now they can provide a user-friendly and practical way of integrating these tools in the design process of a building. (Maile et al., 2007).

### 2.1.1 Basic Principles of Thermal Simulation

In general, building thermal simulation tools predict the thermal performance of a given building and the thermal comfort of its occupants. They support the understanding of how a given building operates according to certain criteria (predict the annual energy performance of a building and its HVAC system) and enable comparisons of different design alternatives (Maile et al., 2007). Evaluation of thermal comfort involves assessment of at least six factors: human activity levels, thermal resistance of clothing, air temperature, mean radiant temperature, air velocity and vapor pressure in ambient air (Fanger, 1970).

Based on the evaluation in this study of various tools, some information required for thermal simulation includes as input data such as: building geometry, including the layout and configuration of the space (surfaces and volumes), grouping of rooms in thermally homogenous zones, building orientation, building construction, including the thermal properties of all construction elements, building usage including functional use, internal loads and schedules for lighting, occupants, and equipment, heating, ventilating, and air conditioning (HVAC) system type and operating characteristics, space conditioning requirements, utility rates, and weather data.

It is not easy to measure or to elaborate all of those values at a particular location in a building to create thermal comfort. Manual calculation of those values at every point within a building is almost impossible. One way to analyze thermal performance in buildings is by using thermal simulation programs that are capable of calculating all of those values accurately.

The accuracy of a thermal simulation result is determined by the input data. This input data mainly consists of the building geometry, internal loads, HVAC systems and components, weather data, operating strategies and schedules, and simulation specific parameters (Figure 2.1).

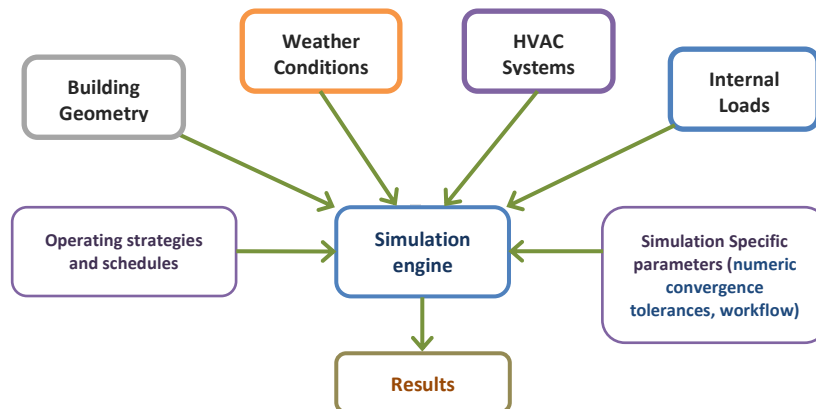

Figure 2.1. General input data of thermal simulation engines (Maile et al., 2007).

Most thermal simulation programs consist of what is referred to as an engine, which enables detailed thermal simulations based on simple text-based input and output files. These engines contain mathematical and thermodynamic algorithms that are used to calculate the thermal performance according to the underlying model of the engine. The simulation engine uses an input file (or files) of a defined format that contains a representation of the input. Based on this input the engine performs a simulation and writes its output into one or more output files (Maile et al., 2007). These engines are mainly used to support the design process of a building by comparing energy consumption of different design alternatives.

Data come from internal and external parts of the building. The external loads, for example, are strongly influenced by weather and climate; collected and statistically assembled weather data are thus used in energy performance simulation. Weather data files are being created for design purposes in an increasing number of cities and regions around the world. These weather files do not reflect a specific year, but provide a statistical reference for the typical weather parameters of a specific location. During commissioning and operation, weather information can sometimes be measured directly at the building in question or at weather stations that are located close by. Internal loads such as loads from people, lights and equipment in a space depend greatly on the actual usage of the space and the behavior of its occupants. Figure 2.2 shows the grand picture of the thermal model production.

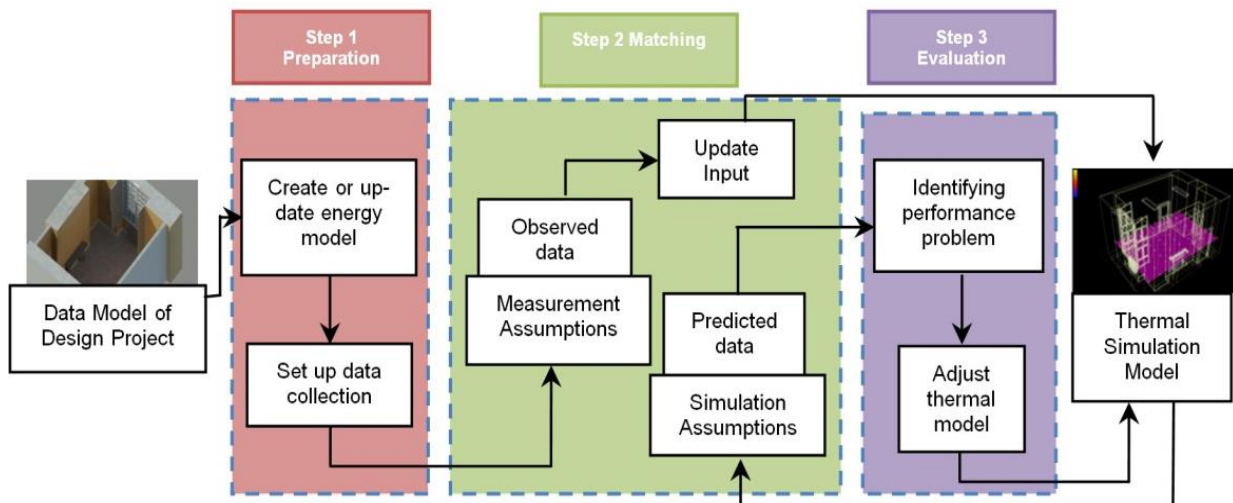

Figure 2.2. Workflow to produce a thermal simulation model.

The result of the thermal simulation engine is an integrated model or comprehensive information and it should allow another program to read or to analyze further. The output data or the simulation result may be presented in a text, graph or code.

The output results may include:

- Assessment of the space and building thermal performance for compliance with regulations and targets;
- Overall estimate of the energy used by the space and for the building and an overall estimate of the energy cost;
- Time-based simulation of the energy use of the building and time-based estimate of utility costs;
- Lifecycle estimate of the energy use and cost for the building.

Various thermal simulation tools are used to support almost all AEC design and management tasks, and the information entered into all of these tools describes the same physical project. However, this information is passed from one tool to the next by producing paper-based or electronic documents which can only be interpreted by people, who must re-enter relevant information into the next computer tool. This is because many thermal calculations and simulation software programs are part of the system of building energy performance and they generally receive geometry data from the design tool.

In addition, thermal simulation software sometimes does not present the overall results geometrically, but rather the forms of scale, charts or other notation codes. This format is sometimes not readable or hard to interpret by other software, which again creates more obstacles in the process of data exchange. This indicates that such tools are generally created as a multipurpose product or as a stand-alone tool and work independently. These kinds of applications store the building information in



a native and proprietary format. In order to make this valuable information available to other project participants, these software applications must be able to understand the native formats of the other applications.

### **2.1.2. Input to energy simulation**

Every thermal simulation particularly provided by thermal tools is based on thermodynamic equations, principles and assumptions. It depends on the context and objectives of the simulation. Since thermal processes in a building are complex, thermal simulation programs approximate their predictions with qualified equations and methods. Therefore, results can be arbitrarily incorrect, if some assumptions are not satisfied in the simulation or matched in real life.

The building geometry constitutes the basic input for thermal simulation. It is crucial to understand that, although there is usually only one model is used, which is from the architect, there are differences between a building model that was created by an architect and a building model needed for thermal simulation. The latter, often referred to as thermal building model or thermal view of the building model, which is basically a simplified view of the architectural building. Recently, with the rapid advancement in methods of data exchange, the process can be carried out automatically when the transfer data conducted between software. In fact, some of the plug-in software design enables the automatic conversion of the model.

HVAC systems and their components are a major part of the input information for thermal simulation models. These systems can be designed to reflect the actual system if the energy simulations tool (graphical user interface and the engine) provides enough flexibility. To define a realistic representation of the real HVAC system within a predefined structure can sometimes be challenging. Therefore, newer engines such as EnergyPlus and Ecotect support component-based HVAC modeling without the restriction of hardcoded predefined HVAC systems employed by older tools, such as DOE-2. Another important aspect is the possibility to model new HVAC technologies and concepts such as under-floor heating and cooling within the energy simulation tool. Besides the HVAC system configuration and HVAC component parameters, control strategies are necessary as input for thermal simulations. These strategies determine the simulated behavior of the HVAC components to act as a system and serve the building as intended. These control strategies in current simulation tools are simplistic when compared to actual control implementations (Maile et al., 2007).

### **2.1.3. Basic tool architecture**

Most building simulation tools consist of two different components, the engine and the graphical user interface. The simulation engine is usually developed by one or more academic and/or research institutions, while the user interfaces are mostly implemented by private software vendors. The general data flow principle between simulation engines and graphical user interfaces is illustrated in Figure 2.3.

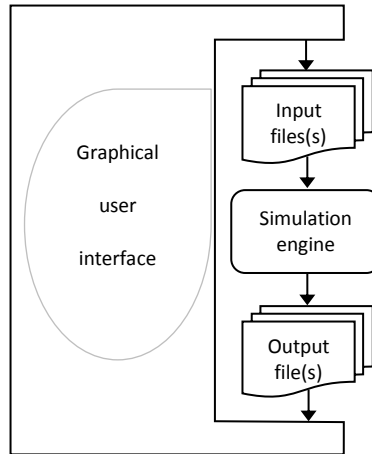

Figure 2.3. General architecture of energy simulation tools

The simulation engine uses an input file (or files) of a defined format that contains a representation of the previously described input. This input could be a text file or geometry. Based on this input the engine performs a simulation and writes its output into one or more output files. The output files contain results from the simulation, while they also contain information about the simulation run itself, such as warning messages or feedback information to evaluate the input. These processes are usually wrapped around graphical user interfaces. The interfaces enable the user an easier generation of input files and initiate the simulation with the engine, also process the output files to illustrate results in a more graphical manner (Maile et al., 2007). Figure 2.4 shows basic workflow of some thermal simulation tools.

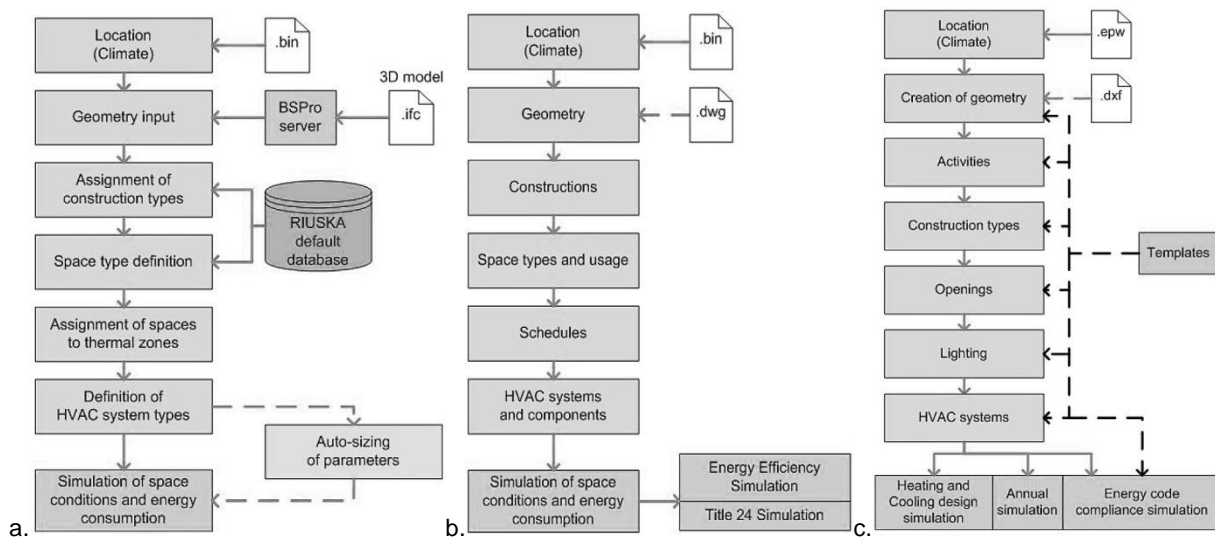

Figure 2.4. Basic workflow of some thermal simulation tools. a). RIUSKA b). eQuest c). DesignBuilder.

To sum up, the practical use of the tools is important that made them generally divided into simple parts. This concern to a graphical user interface that eases the generation of input and the analysis of output, and exposes the functionality of the engine to the user. Easy-to-use interfaces do not make thermal analysis available to everyone. The knowledge of limitations of the programs and an understanding of thermal processes are crucial to the generation and understanding of realistic and reliable simulation results. Previous examples show that these tools have a quite similar characteristic in basic workflow although came from different platforms.

## 2.2 Thermal Simulation Software and the BIM Platform

With the development of building thermal tools incorporating local weather data and provision of local building materials, construction and codes, the number of tools users is growing enormously. Currently, there are more than 400 applications that can be applied to analyzing building energy and thermal simulation (EERE, 2013). They are operated based on the manufacturers' instruction, spread all over the world and have their own standards. These various software applications need to be studied to determine which of them has performed a strong analysis of sustainable design as well as which provides a foundation for interoperability.

Today's emphasis on high-performance buildings makes it important to leverage BIM-based thermal analyses during design (Welle et al., 2011). BIM technology involves the creation and use of coordinated, consistent information about a building. It allows for better decision-making, documentation and accurate prediction of building performance. Direct links between BIM and non-BIM modeling tools are an important ramification of BIM technology, enabling the creation of deliverables that have an explicit relationship to each other, resulting in a better coordinated and seamless data exchange that saves time, resources, effort and assures quality based liability and reduces risk (Attia, 2010).

Reviewing and comparing tools in this paper will allow identification of the data exchange among the commonly used building thermal tools according to the selection criteria as regards their interoperability through the BIM platform. The following covers most of the tools widely known in thermal simulation, which have been selected based on their popularity within the AEC community.

### 2.2.1 Interoperability through BIM Platform

Interoperability refers to the ability of two separate systems or software programs to communicate and exchange data with each other. The advantage that seamless data transfer offers is that this will remove redundancy and duplicate data generation, in analytical models and ensure the incorporation of sustainable features, at an early design stage (Kumar, 2008). Interoperability is one of the major themes of research and development in information technology for architecture, engineering, construction, and facilities management (AEC/FM) industries.

Interoperability—the possibility for information to flow from one computer application to the next throughout the lifecycle of a project—relies on the development and use of common information structures throughout the AEC/FM industry (Froese, 2003). Exchanging models and other data between different software platforms remains one of the industry's biggest challenges on the way to fully integrated and collaborative project teams.

A survey of building performance tools by Attia (2010) describes the major difference between the needs and priorities of architects and engineers concerning the interoperability of the building model. Architects exchange models with 3D drawing packages and the exchange of models with CAD programs. On the other hand, engineers defined the ability to exchange models with MEP drawing packages and the ability to exchange models for multiple simulation domains.

Attia et al., 2012 summarizes a study undertaken to reveal potential challenges and opportunities for using building performance simulation tools. The findings are based on an inter-group comparison between architects and engineers. As the most important objective (39%), architects chose the ability to exchange models with 3D drawing packages, such as SketchUp and 3DS Max. The second choice was for the exchange of models with CAD programs (25%). The exchange of models for multiple simulation domains and the exchange of model with MEP drawing packages came in last with almost no difference (18.3% and 17.8%) in preference. On the other hand, engineers prioritized different sub-criteria. The most important sub-criterion was the ability to exchange model with MEP drawing packages, such as Revit and Bentley products (45%). In second place (35%), came the ability to

exchange models for multiple simulation domains. In third place (18%), engineers voted for the ability of exchanging models with CAD programs. It also found that 23% of the architects and 26% of the engineers agreed that the graphical representation of the output results is the most important feature concerning the usability and information management of interface. There was consensus among both groups that the flexible use and navigation is the second most important feature followed by the graphical representation of the results in 3D spatial analysis.

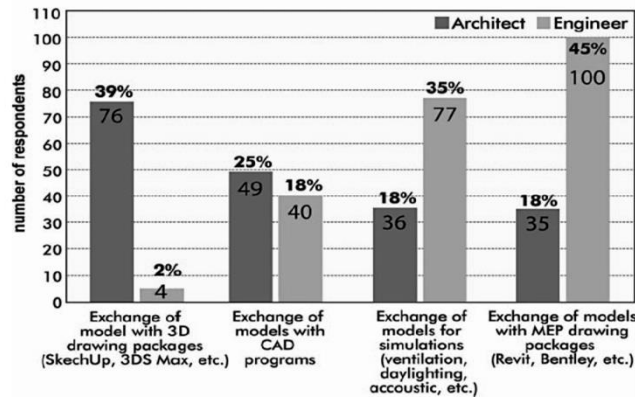

Figure 2.5. Architects' and engineers' priorities in term of interoperability of building model (Attia et al., 2012)

In a typical construction project, the basic structure organization of the team includes client, project manager, architect, civil engineer, structural engineer, mechanical engineer and electrical engineer. It is now possible for them to work together within the model in an improved coordination and organization. This interaction depends on multi party tools to success. The method is called Integrated Design Process (IDP). The IDP's purpose is to utilize a collaborative team effort to prepare design and construction documents that result in an optimized project system solution (Rossi et al., 2009; Stamp, 2012). As building codes are updated to take building performance into account, there is an increasing obligation on the part of designer to provide higher degrees of insight regarding building outcomes. The design team needs to define technology standards to encourage opportunities for increased project and data flexibility.

BIM has the real role in the IDP. BIM and web-based project management software has created a solid platform for an improved, more efficient means of collaboration between all the parties involved in project delivery (Sacks et al., 2010). BIM is a shared digital representation of the physical and functional characteristics of a building founded on open standards for interoperability. A shared knowledge resource for information about a building forming a reliable basis for decisions during its life-cycle from inception onward. The basic premise is the collaboration between different stakeholders at different phases of the life cycle of a building (Fig. 2.7). That is to insert, extract, update or modify information in the process, to support and reflect the roles of that stakeholder (BuildingSMART, 2013).

BIM is a data-rich, object-based, intelligent digital representation of a facility which includes not only 3D geometric models (which, therefore, are capable of directly generating 2D and 3D drawings), but also specific information on a wide range of building elements and systems associated with a building (e.g., wall constructions, material properties, spaces and thermal zones, heating, ventilating, and air conditioning (HVAC) systems, geospatial information, space loads, etc.). This information can be used for other building analysis purposes (Haymaker et al., 2007). In most cases, only the mechanical engineer or modeling engineer completes energy simulations. To achieve a comprehensive thermal building, this organizational structure requires excellent communication between groups, particularly at the initial design stages. However, with the BIM concept, communication

and data exchange among all parties can reach a high degree. Moreover, redundant building data can be significantly reduced by using BIM (Narowski et al., 2011).

The use of BIM as a central repository for the building project information has revolutionized information for project management. The AEC industry is constantly looking for new ways to improve collaboration and interoperability of BIM platforms through new technology and open-standards programs. This is to be more readily share information among the various design and simulation platforms that are available on the market today. A model-based approach to interoperability requires information structures that are standardized throughout the industry (Fig. 2.6).

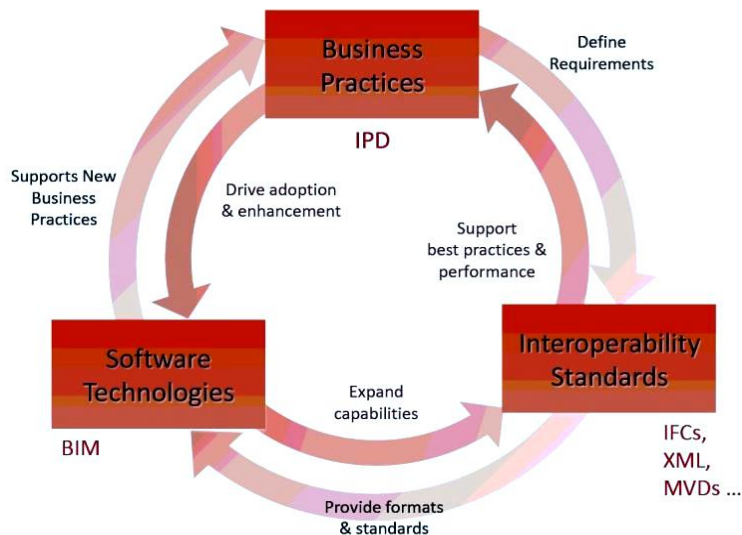

Figure 2.6. Interoperability and AEC Practice (Sullivan, 2011).

Significant progress has been made in this common data exchange, particularly in multi-platform interoperability. Currently, the Industry Foundation Class (IFC) and Green Building XML (gbXML) are two prevalent informational infrastructures in the AEC industry. IFC and gbXML are both used for common data exchange between AEC applications such as CAD and building simulation tools (Dong et al., 2007; Knight et al., 2010; Moon et al., 2011; Attia et al., 2012). Both IFC and XML create a common language to transfer BIM information between different BIM and building analyses applications while maintaining the meaning of different pieces of information in the transfer. This reduces the need to remodel the same building in each different application. It also adds transparency to the process (Haymaker, et al., 2007).

Through BIM platform, BuildingSmart International is developing the IFC standard. IFC represents a data schema for sharing construction and facility management data across various applications used in the AEC/FM industry domain. It enables service engineers to collaborate between heterogeneous disciplines, improving interoperability, reducing costs and overall design quality (Fig. 2.7). IFC is an object-oriented data schema based on class definitions representing the objects (such as building elements, spaces, properties, shapes, etc.) that are used by different software applications in the construction or facility management project. IFC has variant data file formats that facilitate exchange between applications, e.g., .ifc, which is the default IFC exchange format, .ifcXML, IFC data file using the XML document structure, and .ifcZIP, IFC data file using the PKzip 2.04 g compression algorithm (BuildingSMART, 2013). IFC has been used as solutions for integration that address not only homogeneous, fully-structured, model-based information, but also a heterogeneous mix of many forms of information (Caldas, et al., 2003; Froese, 2003).

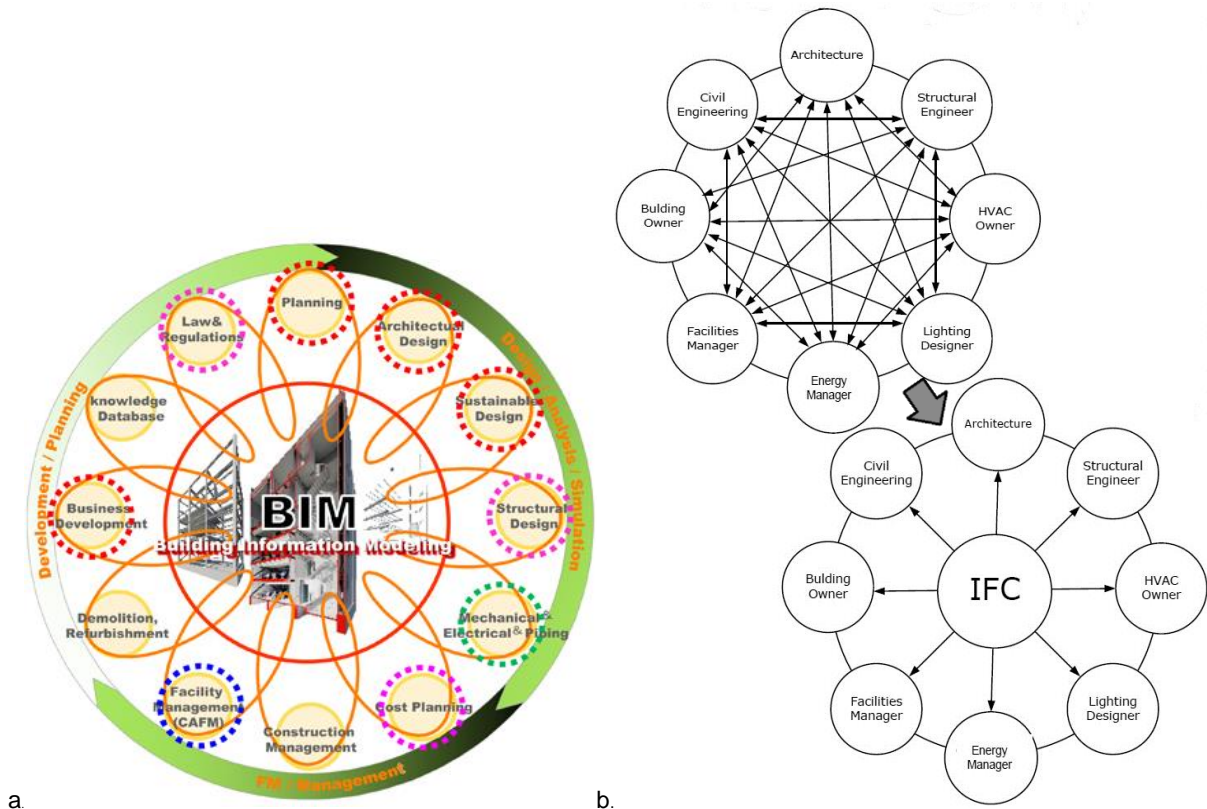

Figure 2.7. IFC is aiming to be a global standard for BIM data exchange. (a). BIM embrace all aspects of the building (planning, design, simulation, etc.) in a management-system and management-concept that sharing information among stakeholders to produces a maximum benefit. (b). The IFC approach through BIM platform supports AEC tool-set and offers significant benefits in terms of interoperability and shared data support.

The AEC Industry has yielded the proprietary development of energy export and import capabilities in several major engineering modeling tools. A number of these involve the use of gbXML. The gbXML developed by Green Building Studio (formerly GeoPraxis). With the development of integration modules inside major engineering analysis tools, gbXML has become the defacto industry standard schema (gbXML, 2013). GbXML is based on the XML (Extensible Markup Language) deployed by Green Building Studio Inc. It has the ability to carry building environmental sensing information. It also has a global “language” format, with consistent syntax and can potentially represent any computational building model through translation using appropriate mapping engines.

In terms of geometry, the generic approach of IFC has the ability to represent any shape of building geometry, while gbXML only accept the rectangular shape. CAD—magazine has claimed that the IFC format is very powerful but rather few thermal simulation tools use it. They prefer the gbXML due to its capacity to provide a satisfactory answer (CAD-magazine 2011).

IFC uses a “top-down” and relational approach, which yields a relatively complex data representation schema and a large data file size. Conversely, gbXML adopts a “bottom-up” approach, which is flexible, open source, and a relatively straight forward data schema. The “top-down” approach can trace back all the semantic changes when one value of the element in the schema is changed (Dong, et al., 2007).

The technology for exchanging information using IFC has now been established, but many areas require additional development before comprehensive interoperability solutions are reached. These areas include: extending the scope to include a broader range of project information, for more types of projects, and more types of information; developing the exchange mechanisms layer below the data standards and the formalized transactions layer above; developing the range of software applications that implement model-based interoperability; and re-examining project management practices based on new integration technologies (Froese, 2003).

### 2.2.2 Thermal Simulation Tools and Their Interoperability

A multiplatform concept is a fundamental criterion for assessing thermal tools because it allows multidisciplinary storing of information with one virtual representation. The reliability of data exchange and the straightforward nature of the tool, as well as user-friendly interfaces are major aspects of the practical use of thermal tools. In this respect, the success of interoperability is limited to the detailed design phase because it ensures access for the design team to building thermal model, only after the whole building design has been completed. In this interoperability, the amount of input data, the availability of rich 3D geometry models, as well as the effective data exchange and software interfaces are crucial to enable faster and more reliable thermal performance simulation analysis.

With the increasing complexity of the geometry of buildings, the simulation tool requires an appropriate geometric model. For the comparison of simulated results with measured data, the simulation tool requires an integrated simulation. The geometry today consists of complex spaces. This means that it requires the feedback from the HVAC system response to the space or zone (Maile, et al, 2007). Thermal zones are an agglomeration of one or more spaces with similar thermal characteristics. These characteristics can be categorized by orientation, size, HVAC system type, and internal loads.

The IFC provides the data concerning the semantics and syntax of construction elements; a comprehensive set covering tangibles and abstract entities such as windows, doors, walls, spaces, furnishing elements, etc. (Cormier, et al, 2011). Thermal characteristic is another kind of IFC product. It is included in a sub division in another concept of basic class for physical objects, along with spatial elements, structural analysis items and other physical elements. It also includes other concepts which are associated with materials, shape representations, and placement in space.

IFC and gbXML formats for thermal analysis can read as some distribution elements (HVAC, electricity, plumbing) which are organized according to the concept of ports. These elements may have specific connections for various services in the building and be connected together to form a system (Bahar et al., 2013). Since it is possible to write IFC and interfaces to HVAC design and simulation tools also cost estimation tools, it is possible to import building geometry data from design tools, which allows the exchange of thermal data (HVAC data). This includes the geometry, performance specification and construction properties.

Figure 2.8 illustrates the workflow that defines the area input of BIM in the thermal simulation process. The first step is to define the location of the building that provides a link to weather data. The second step will ideally provide information through importing data from a BIM. This information includes the needed 3D geometry information, material definitions, and space types that are typically defined by the architect.

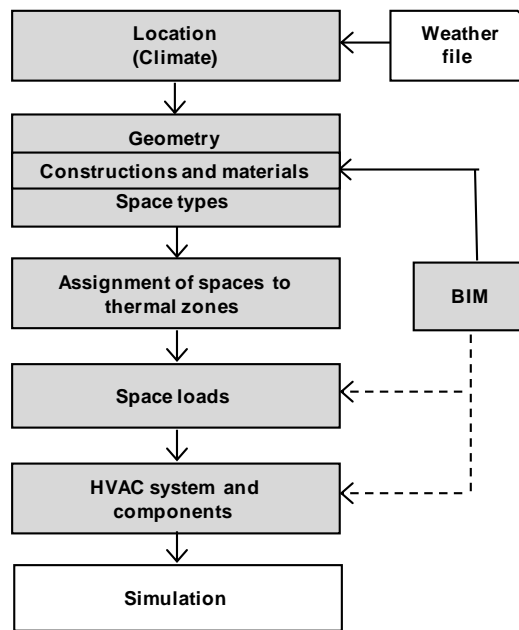

Figure 2.8. An ideal workflow for energy performance in thermal simulation tools (Maile et al, 2007).

A simplification of geometry might need to comply with the geometry definition of the relevant thermal performance simulation tool. Based on these geometry definitions, the user interface would be able to aggregate spaces into zones (as well as subdivide spaces into zones). A “thermal zone” which may cover one or more rooms, is an important basic structure for thermal simulation. In this process, the data will bind into an appropriate zone by the IFC or gbXML format, for example. In the next step, space loads (such as lighting loads) could be assigned to the specific appropriate space types that have been imported via the BIM link. However, this workflow might not immediately smooth management interoperability. The experiences of many BIM based projects show that interoperable thermal analysis software is not enough for the management of thermal performance during the building process, but also requires tools to manage different revisions of BIMs, to compare thermal performance of these revisions and to visualize this in an easy-to-understand way (Laine et al., 2007).

An advanced interoperability method was developed by Welle et al. (2011) with ThermalOpt. ThermalOpt is a methodology for automated BIM-based multidisciplinary thermal simulation that attempts to mitigate several technical barriers to BIM-based multidisciplinary thermal simulation encountered in practice today. In this method, the user can start the process by building a parametric BIM model and assigning analysis information using the BIM Application GUI (Digital Project) and the Analysis Application GUI (ThermalSim Plugin). When the user initializes the trade study (in this case an optimization), the BIM information is passed via IFC (DP Plugin) to a middleware (IFC2ThermalSim Plugin) for pre-processing. It then passes to an energy simulation environment (EnergyPlus Wrapper) and a day lighting simulation environment (Radiance Wrapper) for analysis.



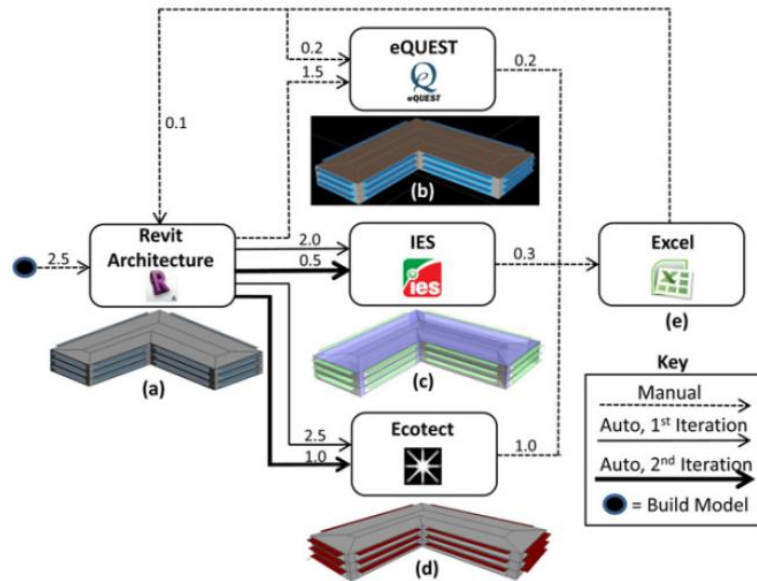

Figure 2.9. A simple model built in Revit and analyzed in eQUEST, IES, and Ecotect. The results were manually post-processed in Excel (Welle et al., 2011).

Figure 2.9 is an example of a simple interoperability method that is usually used in a common data exchange between AEC tools. As seen time requirements (in hours) for each step labeled on the arrows, this simple method is time consuming.

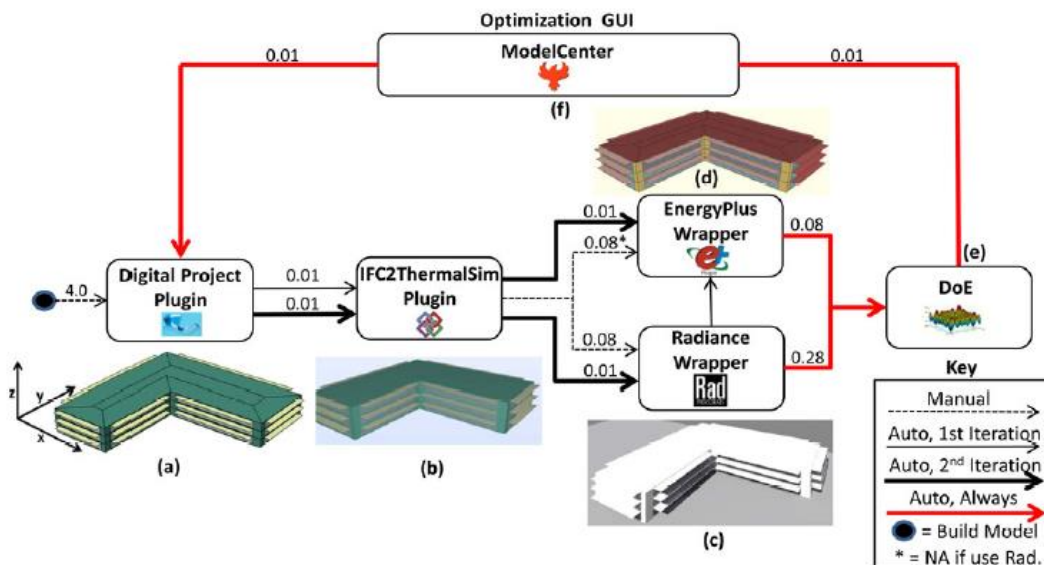

Figure 2.10. The ThermalOpt diagram, shows the test case at each step of the multidisciplinary design optimization process, as well as the corresponding time (in hours).

ThermalOpt enables an automated methodology to pre-process, configure, execute, and post-process a BIM-based multidisciplinary thermal simulation process that may be used during early design. This method is capable of significantly reducing the time to pre-process, configure, execute, and post-process this design task while improving its consistency over conventional methods (Welle et al, 2011).

## 2.3 Interoperability Review of the most Applicable TBS Tools in the AEC Community

This section discusses thermal simulation tools as BIM applications and their review of data exchange. The tools presented in this section are shortlisted of the most applicable TBS tools in the AEC Community. This is to determine the TBS selection tools used for this work. The selection parameter is focused on the character of the data exchange. The review is particularly useful to provide an overview of the real situation of data exchange between TBS tools and design tools.

### 2.3.1 Thermal Simulation Tools as BIM Application

There exist today a large number of simulation tools as BIM applications concerning thermal simulation in buildings. Crawley et al. (2008) have detailed the functionality and differences of 20 major building simulation tools. Attia (2010) described eight building performance simulation tools according to selection criteria and user surveys. Donn et al. (2012) have compared 9 tools in the Building Performance Sketch. It is a concept for sketching building performance early in building design which proposes the selection of the most expressive tool for each purpose. For the sketching 'instrument' to be the best available for the purpose, it is assumed it is likely to be a simulation model. If it is to be quick and simple and issue focused, then it is unlikely to be a comprehensive model of all building physics based on a BIM. Moon et al. (2011) studied the interoperability between a BIM-based architectural model (Revit Architecture and Revit MEP) and four performance analysis programs (EnergyPlus, eQUEST, Ecotect and IES/VE). Bagnall (2009) also has presented advanced building analysis using Autodesk, Revit, MEP, Ecotect, and IES VE. Dubois et al. (2010) reviewed the existing computer tools widely used by architects today, covering a total of 56 computer programs which were classified into three categories: CAAD (computer-aided architectural design) tools, visualization tools, and simulation tools. Based on these reports, as well as on the analysis of recent trends in thermal tools, this report reviewed certain selected tools that are most applicable to the BIM application. The present review focuses on tools that can be used at multiple stages of the life-cycle and that provide functionalities to exchange data with other tools in open standard building information models, in this case IFC and gbXML.

Thus, the goals of the review are to draw a picture of the principles of data exchange in thermal simulation software and to compare the interoperability challenges and opportunities of using selected thermal tools and building performance simulation tools that integrate thermal analysis.

All data for the identification of the tools have been gathered and shortlisted in the chart below. The tools listed were selected as those most applicable by professional users in the AEC community (whether they focus on the BIM platform or not). These applications are DPV (Design Performance Viewer), Design Builder, Ecotect, EnergyPlus, eQUEST, EcoDesigner, ESP-r, Green Building Studio, Lesosai, IDA ICE, IES VE, TRACE700, TRNSYS and Riuska.

They have also been tested on their reliability according to the basic principal of thermal simulation and data exchange. The test is to illustrate interchanged between BIM design and thermal tools. The websites of each program were visited and a database with key information was selectively built and enriched by journal updates. In addition, scientific articles about the selected programs were consulted when necessary. As a thermal simulation tool is used within a design process that involves other software (e.g. CAD, spreadsheets, presentation, etc.) the assessment of the compatibility and interoperability of each tool focuses on typical software used in the industry (Table 2.1).

Table 2.1. Interoperability of the thermal tools investigated.

Tool	Application	Input Data	Output Data	BIM Based Geometry Import
DPV (Design Performance Viewer)	Environmental design, <b>thermal design and analysis</b> , heating and cooling loads, energy cost, Energy/CO <sub>2</sub> , life cycle assessment, scheduling.	CAD-BIM, revit		The building model is directly built in the CAD-BIM environment.
DesignBuilder	Environmental design, 3D Model (3D Design), <b>thermal design and analysis</b> , heating and cooling loads, natural and artificial lighting, Internal air, mean radiant and operative temperatures, humidity, CO <sub>2</sub> emissions, solar shading, heat transmission, solar shading, scheduling.	gbXML, .dxf, .pdf, .bmp, .jpg	CAD: AutoCAD, Microstation, SketchUp using 3-D dxf, .epw, .csv, .tmy, .tmy2	Provides interoperability with BIM models through its .gbXML import capability.
Ecotect	Environmental design, 3D Model (3D Design), <b>thermal design and analysis</b> , heating and cooling loads, Validation; Solar control, overshadowing, prevailing, winds & air Flow, natural and artificial lighting, life cycle assessment, life cycle costing, scheduling, geometric and statistical acoustic analysis.	.dwg, .ifc, gbXML, .obj, 3DS, .xml, ASCII, etc.	Metafiles, Bitmaps or animations. RADIANCE, POV Ray, VRML, AutoCAD dxf, EnergyPlus, ESP-r, ASCII Mod files, XML, etc.	Imports CAD-BIM models from most CAD software
eQUEST	Energy performance, simulation, energy use analysis, conceptual design performance analysis, 3D Model (3D Design), <b>thermal design and analysis</b> , heating and cooling loads, Solar control, overshadowing, Lighting system, life cycle assessment, life cycle costing, Scheduling.	gbXML, .dwg, dxf	dxf, gbXML, .xls	Support gbXML format
EnergyPlus	Energy Simulation, <b>thermal design and analysis</b> , Heating and cooling loads, Validation; Solar control, Overshadowing, Natural and artificial lighting, Life cycle assessment, Life cycle costing, Scheduling.	ifc, gbXML, text	ASCII	.ifc compatible. (BIM Application)
EcoDesigner	Energy balance evaluation, CO <sub>2</sub> , overshadowing, <b>heating, cooling</b> , lighting, water use, Life cycle costing, Scheduling, prime energy usage (gas, energy, electricity etc.)	gbXML	gbXML, .pdf	Provides another dimension in the BIM environment for the architect in shaping his design
ESP-r	Environmental Design, 3D Design, <b>thermal design and analysis</b> , heating and cooling loads, Solar control, lighting, natural ventilation, combined heat and electrical power generation and photovoltaic facades, acoustic analysis, life cycle and environmental impacts assessments.	XML	XML, .csv, VRML	no
Green Building Studio	Environmental Design, <b>thermal analysis</b> , annual energy consumption (electric and gas), Carbon emissions, day lighting, water usage and cost, Life cycle costing, natural ventilation.	gbXML-enabled BIM or 3D-CAD	gbXML, VRML	Supports gbXML format and has easy interoperability with BIM Application
Lesosai	<b>thermal design and analysis</b> , Heating and cooling loads, Solar control, CO <sub>2</sub> , natural and artificial lighting, life cycle assessment, life cycle costing, Scheduling.	gbXML, .nbdm, .skp	.xls, .xml, .pdf, .bld, .txt files	Supports gbXML format and has easy interoperability with BIM Application
IDA ICE	Environmental design, 3D Model (3D Design), <b>thermal design and analysis</b> , heating and cooling, Solar and shading, surface transmissions, air leakage, cold bridges and furniture, lighting, Air CO <sub>2</sub> and moisture levels, Energy costing.	.ifc, .dxf, .dwf, .3ds, .cgm, .cmx, .dgn	.html, .doc, .xls, .jpeg, .jpg, .png, .tiff, .bmp	.ifc compatible. (BIM Application)

IES VE	<b>Thermal design and analysis</b> , heating and cooling loads, CO <sub>2</sub> , Validation; Solar, Shading, Lighting, Airflow, Life cycle costing, Scheduling, fire evacuation.	gbXML, .dxf, .dwg	.ve	Supports gbXML format and has easy interoperability with BIM Application
TRACE 700	Environmental design, 3D Model (3D Design), <b>thermal design and analysis</b> , heating and cooling, life cycle costing, plants system.	gbXML	pdf, rtf, .txt, .doc, .xls	Supports gbXML format and has easy interoperability with BIM Application
TRNSYS	Environmental design, 3D Model (3D Design), <b>thermal design and analysis</b> , heating and cooling loads, Solar control, overshadowing, prevailing winds & air Flow, electrical, photovoltaic, hydrogen systems, Life cycle costing.	.skp, ASCII, xml	ASCII (Simulation Studio Tool : HTML, C++)	no
Riuska	Environmental design, 3D Model, <b>thermal design and analysis</b> , heating and cooling loads, validation; Solar control, overshadowing, lighting, life cycle assessment, life cycle costing, scheduling.	ifc	ifc	.ifc compatible. (BIM Application)

This review indicates that there are many energy simulation tools that are used particularly for thermal calculation. In some cases, thermal tools are not stand-alone, but integrated into or as a part of design software. Among these thermal tools, the link with BIM applications is the most interesting possibility in terms of interoperability for energy simulations. These applications are DPV, Design Builder, Ecotect, EnergyPlus, eQUEST, EcoDesigner, Green Building Studio, IDA ICE, IES VE, and Riuska.

- The Design Performance Viewer (DPV) is an ongoing research project begun in 2007, conducted at the Institute of Technology in Architecture (ITA) at the Department of Architecture at the ETH Zurich (Design Performance, 2013). The DPV enables instantaneous energy and CO<sub>2</sub> emission calculations and the graphical visualization of the resulting performance indices of a building design focused not only on form and geometry, but also viewed in an integrated way. Relevant energy data is calculated and visualized in real time. The user can immediately see how measures concerning building geometry, construction and technical systems affect energy and exergy consumption as well as costs. DPV is directly linked to the library of the CAD-BIM environment. To deliver immediate performance feedback, the DPV is integrated into the BIM-modeling environment (Autodesk Revit).
- DesignBuilder has been specifically developed around EnergyPlus (DesignBuilder, 2013), allowing input of all of the EnergyPlus fabric and glazing data. As an interface to EnergyPlus, it builds models for energy simulation using EnergyPlus. DesignBuilder allows compliance with energy certificates in UK, alternatives comparison and parametric analysis of different design parameters. It provides a wide range of environmental performance simulations in a 3D interface, also performing daylight analysis. Design Builder allows import of 3D architectural models created in Revit, ArchiCAD or MicroStation and other 3D CAD systems supporting .gbXML, and dxf data exchange.
- Ecotect was developed by Dr. Andrew Marsh and Square One Research Ltd. that was acquired by Autodesk. Ecotect analysis offers a wide range of simulation and building energy analysis functionalities to visualize and simulate a building's performance within the context of its environment (Ecotect Community Wiki, 2013). The new Ecotect Analysis includes an expanded array of environmental analysis and simulation capabilities including shadows and reflections, shading design, solar analysis, photovoltaic array sizing and load matching, lighting design, right-to-light analysis for neighboring buildings, acoustic analysis, thermal analysis, and ventilation and airflow (Ecotect analysis, 2013).

Ecotect has added the support for IFC and gbXML schemas since the release of the newest version 5.6. Ecotect can perform more applications: daylight analysis, sound analysis and more visualization. It can import CAD-BIM models from most CAD software; Revit, AutoCad, ArchiCad and 3DsMax. Ecotect can export to a wide range of other programs and CAD formats. Export is supported to Radiance (ray-traced rendering), POV-Ray and .wrl, .dxf (compatible with most CAD software), GBS, EnergyPlus and eQUEST.

- EnergyPlus is an energy analysis and thermal load simulation program. EnergyPlus is a new-generation building energy simulation program based on DOE-2 and BLAST, with numerous added capabilities. Released in April 2001, the program was developed jointly by Lawrence Berkeley National Laboratory, the University of Illinois, the U.S. Army Construction Engineering Research Laboratory, GARD Analytics, Inc., Oklahoma State University and others, with support from the U.S. Department of Energy, Office of Building Technology, State and Community Programs (EnergyPlus, 2013).  
EnergyPlus has data exchange via IFC, gbXML, and dxf. All CAD programs linked to EnergyPlus through a plugin or export function (ArchiCAD, Google/Trimble SketchUp, MicroStation, Revit, Vectorworks) allow active solar system calculation. EnergyPlus and Green Building Studio can operate or allow performing of thermal simulations from Google/Trimble SketchUp (.skp) and Excel (.xls), the non-BIM application.
- eQUEST was developed by James J. Hirsch & Associates in collaboration with Lawrence Berkeley National Laboratory, with LBNL DOE-2 (eQUEST, 2013). eQUEST is based on DOE-2 dynamic energy simulation software and calculates heating and cooling loads during a year based on a data-entry building description. eQUEST has the ability to import .dwg files. It is also possible to export analysis results in Excel (.xls) format. eQUEST can import building geometry via gbXML but it is not as generic as the IFC format.
- EcoDesigner is bound up with archiCAD. EcoDesigner integrates the VIP web engine directly into ArchiCAD's program core, but is configured to act as a design aid rather than a simulation tool. Although not as comprehensive as Ecotect, EcoDesigner provides ArchiCAD users with basic energy- and carbon-checking functions. EcoDesigner, EnergyPlus, Green Building Studio and Ecotect can link with ArchiCAD BIM.
- Green Building Studio (GBS) is a web-based energy analysis service supplied by Autodesk (Autodesk Inc., 2013). GBS is an analysis tool, which performs whole building energy analysis but does not provide a 3D interface. The model has to be created by another software program which can export to the .gbXML format. GBS does not support the .ifc format but provides easy interoperability with BIM tools and other software; it offers a great interoperability with Autodesk Revit, ArchiCad, Ecotect, eQuest, and EnergyPlus. Various file formats are supported, such as .gbXML, VRML, and some weather files.
- IDA Indoor Climate and Energy is a simulation application for the accurate study of the thermal indoor climate of individual zones (thermal zones) within a building, as well as the energy consumption for the entire building (Korhonen et al., 2008). IDA ICE was developed by the EQUA Simulation Technology Group in Stockholm (IDA ICE, 2013). IDA ICE supports gbXML and IFC as BIM interfaces. IDA ICE can import .ifc, .dxf, .dwf, .3ds, .cgm, .cmx, .dgn, .drw, .gbr, .svg, .pcl, .prn, .prt, .pct, .plt, .wpg, .vwpg, .bmp, .jpeg, .jpg, .png, .pcx, .tiff, .tif, .pcd, .tga, .emf, .wmf and export is possible to .html, .doc, .xls, .jpeg, .jpg, .png, .tiff, .bmp and clipboard. IDA ICE imports all versions of .ifc so the program is .ifc compatible.

- VE (Virtual Environment) was developed by IES (Integrated Environmental Solutions) in Scotland (IES VE, 2013). It is an integrated system that operates all of its building simulations from a central building model. The software allows the assessment of performance and providing feedback on a building energy consumption and carbon dioxide emission. IES VE supports gbXML and dxf and it can import files from Revit, ArchiCad and as a plug-in of Google SketchUp. Vectorworks BIM software is interoperable with IES VE and Autodesk Ecotect Analysis.
- RIUSKA was developed by Granlund. The core of the software is the widely used DOE 2.1E simulation program (Granlund, 2013). It calculates indoor temperatures, occupancy, lighting, equipment gains, and the heating and cooling of individual spaces, and can be used to compare and dimension HVAC systems as well as to calculate the energy consumption of whole buildings. Riuska allows the direct transfer and reuse of digital building geometry data from IFC-compliant architectural software (Autodesk Revit, ArchiCAD, Nemetschek's Allplan and Visio). RIUSKA can also export main spatial thermal parameters to IFC to be used in other applications, such as building services system modeling or requirement management tools.

(Limitation: This test and review covers most of the tools widely known and used by the AEC community. However, a comprehensive review of all available tools world-wide is nearly impossible due to the amount of information that would need to be collected).

### 2.3.2 Review of Data Exchange

The review has indicated that there are many design or modeling tools commonly used today include some form of algorithm for the prediction of building energy simulations. These include the three CAD software programs widely used by the AEC community: Revit, Archicad, and Sketch-Up. Thus, to obtain thermal simulation results, the thermal analysis proceed either by the thermal engine that has been integrated into them (in this case the mass model is automatically converted into the energy model) or by transferring it to another thermal engine that is interoperable with BIM models. Fortunately, many manufacturers and third-party vendors are beginning to provide BIM object libraries populated with many of the physical and analytical characteristics needed to perform HVAC analysis. This review has also indicated that when the model is used to perform analysis, either an integrated analytical modeling tool within the BIM software runs the analysis, or the information in the model is exported out of the physical model in a file format that the analytical modeling software accepts. Two of the most common formats are IFC and gbXML (Figure 2.11).

Revit (Architecture and MEP) is a tool supplied by Autodesk, purposely built for BIM. Green Building Studio and Ecotect are integrated with Revit, now known as Project Vasari. Revit links with DPV (Design Performance Viewer), Design Builder, EnergyPlus, eQUEST, ESP-r, Lesosai, TRNSYS, IDA ICE, IES VE, TRACE700 and Riuska.

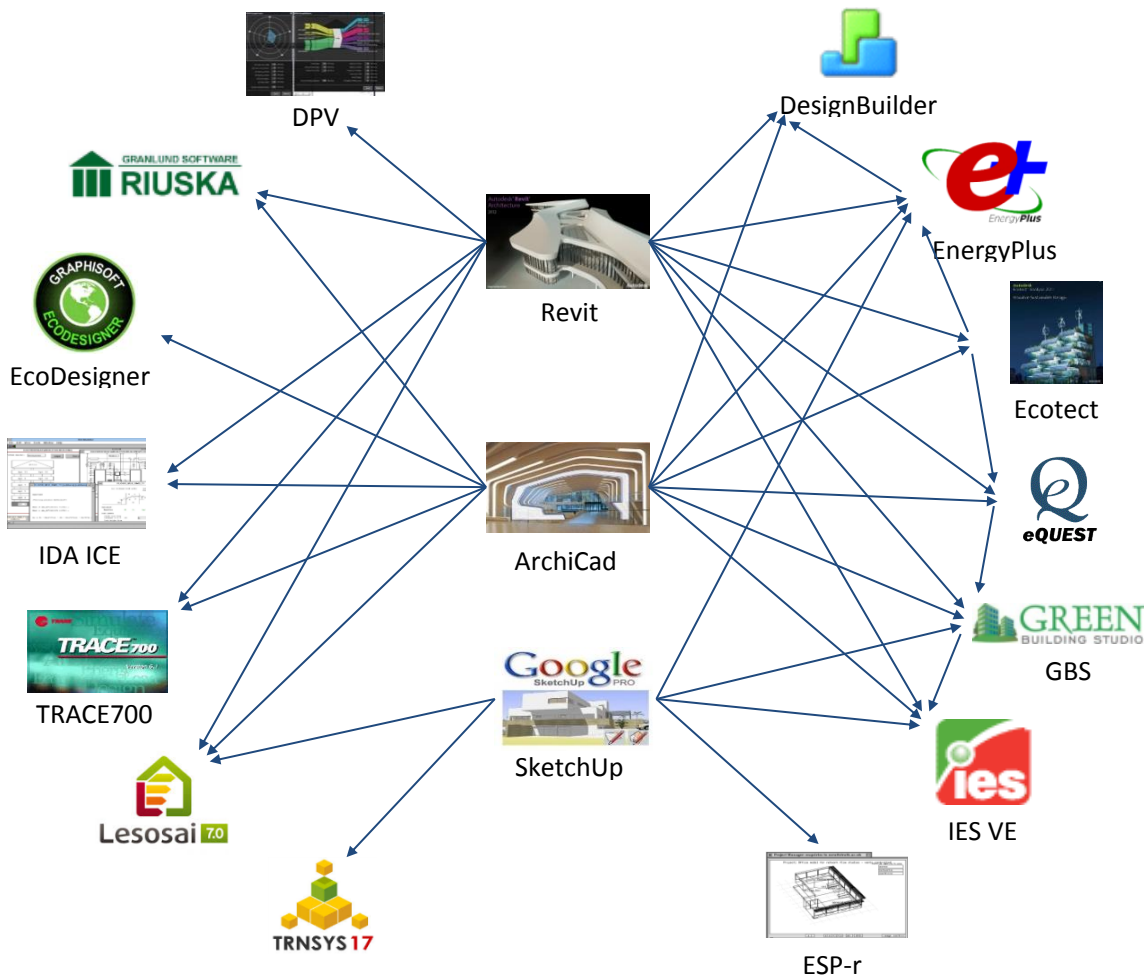

Figure 2.11. Summary of data exchange between modeling tools and thermal simulation tools. The linkages include those as interface, add-on or plug-in. The data exchange is conducted in various formats, primarily by IFC and gbXML.

ArchiCAD is an architectural BIM/CAD tool supplied by Graphisoft/Abvent. EcoDesigner is built into ArchiCAD as an interface. The ArchiCAD BIM program also links with Design Builder, Ecotect, EnergyPlus, Green Building Studio, Lesosai, TRNSYS, IDA ICE, IES VE, TRACE700, and Riuska. Within ArchiCAD, it is possible to create zones and then export the simplified energy model into Ecotect using Green Building Studio's .gbXML format, where the energy analysis and solar design can be completed.

Google/Trimble SketchUp does not offer direct support for BIM. SketchUp integrates with certain plugins: IES VE-Ware, Lesosai and Trnsys. SketchUp has links to ESP-r, and also integrates OpenStudio, a free plugin for the SketchUp 3D drawing program. OpenStudio is an open source tool to support whole building energy modeling using EnergyPlus. The OpenStudio plug-in automatically generates the input for an EnergyPlus object when the user draws a surface in SketchUp. This plugin makes it easy to create and edit building geometry in EnergyPlus input files. It allows the launching of EnergyPlus simulations and visualization of the results without leaving SketchUp. This plugin performs energy analysis on a SketchUp design by adding attributes to the geometry and then connecting it to Green Building Studio's web service, or other analysis applications that import .gbXML. With the plugin, SketchUp is able to both import and export .gbXML files.



## 2.4 Thermal Building Simulation in the context of this study

This section describes the type of TBS tools addressed to this work. The first subsection comparing thermographic camera and thermal software. They were two popular tools commonly used to measure the temperature of a room but have a different method. Thermal software has been extensively discussed in the previous sections. This section will focus on thermographic camera to have comparison between them. The second subsection detailing parameters in TBS models and calculation which is generated by thermal software.

### 2.4.1 Thermographic Camera vs. Thermal Software

It is common today for many professional building inspectors and energy auditors to use infrared imaging technology (thermographic camera) to evaluate the performance of “thermal envelope” in the process of performing energy auditing of homes and buildings (Schreyer et al., 2009). Thermography is the determination of surface temperatures of objects and bodies with the help of infrared photography (Wild, 2007). Infrared thermography is a non-invasive diagnostic technique for building that allows the user to visualize and quantify changes in skin surface temperature. A thermographic camera is used to convert infrared radiation emitted from the building surface or the facade into electrical impulses that are visualized in color on a display screen. It can measure temperature and instantly converting the image into a standard electronic format to allow further processing (FLIR, 2013). The camera also extensively used in many fields: medicine, engineering, building, military, archeology, energetics, etc.

An infrared camera or a thermal camera is a handy tool for a quick and convenient information on defects of heating and cooling area. Once the user has adjusted certain parameters, the camera calculates the temperatures of the target. It then provides the user with a map of the temperatures which is called a thermogram where each temperature is represented by a different colour. Some applications of thermal camera for building, e.g.: to search for a leak in a heating system, maintenance on air conditioning systems, optimize settings for a heated slab, wall or ceiling radiant.

The characters of this camera, which can measure the temperature on the field instantly is an interesting alternative to TBS. However, it is important to underline the method to produce 3D data and its interoperability, particularly compare to thermal software (Fig. 2.12 and Tab. 2.2)

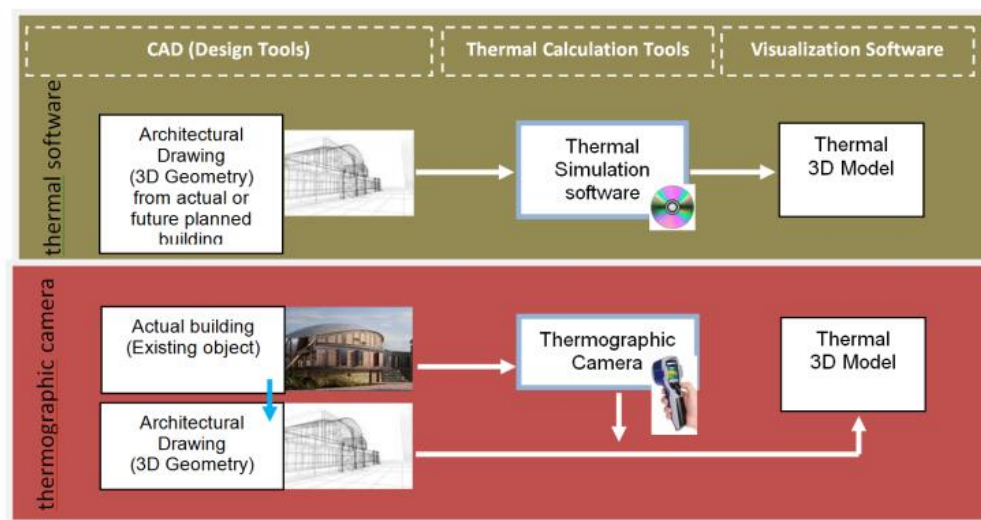

Figure 2.12. Illustration of workflow between thermal software and thermographic camera to create thermal 3D model. There is a long workflow with the camera if the 3D model needs to further processing.



	<b>Thermographic Camera</b>	<b>Thermal Software</b>
<i>Developed</i>	Since 1960's	Since 1980's
<i>Moment captured</i>	The capture recorded by time event or a specific moment.	Simulate thermal for any time session but in any moment (depend on weather data available) and in flexible moments: per month, week, hour, etc.
<i>Function</i>	Permit assessment or evaluation for one time.	<ul style="list-style-type: none"> <li>- Inform energy decisions from earliest phases of design through construction and into operation</li> <li>-Permit assessment of predicted performance with established benchmarks or project goals.</li> <li>-Inform energy decisions from earliest phases of design through construction and into operation</li> </ul>
<i>Real Timing</i>	Catching target in real time	Need time to draw the model
<i>Measurement survey</i>	Need to visit the target regularly (intensively)	Not too often (occasionally).
<i>Object/Target</i>	A building that already exist	A building that already exist as well as a building planned for future
<i>Method</i>	Capture 3D object for represented in 2D image (and then visualize to 3D image).	Generated 3D geometry to visualize in 2D and 3D.
<i>Integration with VR&amp;AR</i>	potential	potential
<i>Output</i>	Due to the low spatial resolution of consumer-level thermal cameras (typically 160 × 120 or 320 × 240 pixels), the building areas which can be represented in a single thermal image are relatively small compared to their digital counterparts. Thus, modeling the entire building energy performance requires a large number of thermal images.	The output can visualize the whole building in high resolution. The simulation results from CFD analysis that can be systematically analyzed in 3D.

Table 2.2. Comparison between Thermographic Camera and Thermal Software

Thermographic camera is a tool that works in a different method with thermal software in processing and resulting image. Its normally provide such captured thermal performance formatted in 2D graphic. This tool can result thermal calculation directly in a display screen but not provide a direct simulation as in the thermal software. The camera also can only apply for a building that already exists, and not for future planned building.

Anyway, this camera is the fastest way to gain thermal calculation directly. The camera provides a means for temperature measurement in building constructions from the inside as well as from the outside. However, a format data from thermographic camera still need to be proceed (one more step) to a visualization tool, particularly if wants to be operated for VR. Despite its practical used to visualize thermal, the themographic camera produced 2D format that need to be process further or need such post-processing to represent its 3D result. Therefore, it would be a long and complicated workflow if the resulted data from the camera need to exchange to other 3D software, compared to thermal software.

### 2.4.2 Parameters in Thermal Building Simulation Models

There are a number of different ways of measuring thermal performance. Thermal analysis is concerned with predicting the usage profile of thermal consumption and calculation within a building by means of the data from internal and external parts of the building. Comprehensive internal and external loads are necessary to provide enough information for a thermal calculation in a building. The external loads are strongly influenced by weather and climate, thus collected and statistically assembled weather data are used in energy performance simulation, while the internal loads come from people, lights and equipment in a space and depend greatly on the actual usage of a space and the behavior of its occupants.

Thermal Comfort is defined in the ISO 7730 standard as: "That condition of mind which expresses satisfaction with the thermal environment" (ASHRAE, 1993). A definition most people can agree on, but also a definition which is not easily converted into physical parameters. An established comfort criteria according to ASHRAE 55-2004 (American Society of Heating, Refrigerating and Air-Conditioning Engineers) is to support the desired quality and occupant satisfaction with building performance. Design of the building envelope and systems must exhibit with the capability to meet the comfort criteria under expected environmental and use conditions. Using information from the building envelope and systems comfort criteria could then be converted into physical parameters.

Thermal comfort standards are essentially based on a set of air and radiant temperatures and relative humidity levels that will satisfy at least 80 % of the occupants at specified metabolic rates and clothing values. As far as individual thermal sensations are concerned, there are six primary factors identified to most affect the thermal comfort. The modeling of four objective parameters (air temperature, mean radiant temperature, air velocity, and relative humidity) and two subjective parameters (metabolic rate, thermal resistance of clothing) should be ensured in a suitable way (Fanger, 1970).

Mean radiant temperature (MRT) is a primary factor and should be identified as having the strongest effect of thermal comfort. It plays an important part in calculating the operative temperature (Christensen, 2009). MRT is simply the area weighted mean temperature of all the objects surrounding the body. It will be positive when surrounding objects are warmer than the average skin temperature and negative when they are colder. The MRT is a significant factor, especially in buildings whose envelopes were exposed to a strong solar radiation, and where conventional indoor temperature and humidity control cannot guarantee indoor comfort (Atmaca et al., 2006). The radiant temperature can be calculated from measured values of the temperature of the surrounding walls and surfaces and their positions with respect to the person. If relatively small temperature differences exist between the surfaces of the enclosure, the following equation can be used (ASHRAE, 1993):

$$T_{mr} = T_i F_{p-i} + T_i F_{p-i} + \dots + T_N F_{p-N} \quad (\text{Equation 2.1})$$

where  $T_{mr}$  = the mean radiant temperature for a person [°C],  $T_i$  = the temperature of surface  $i$  [°C],  $F_{p-i}$  = the angular factor between a person and surface  $i$ .

This describes that what we feel in terms of thermal comfort comes from the influence of the surface temperatures in the space as well as the dry bulb (air) temperature (Bean, 2010).

Effects of radiant temperature on human thermal comfort of MRT are conducted for this study. After completing a long investigation, we determined the use of Autodesk Ecotect. Ecotect thermal analysis provides an optimistic method for this calculation. As perform in Ecotect, Humphreys et al. (1998) give equations for calculating the indoor comfort temperature from outdoor monthly mean temperature as follows.

*Free Running Building:*

$$T_c = 11.9 + 0.534 T_o \quad (\text{Equation 2.2})$$

*Heated or Cooled Building:*

$$T_c = 23.9 + 0.295(T_o - 22) \exp\left[-(T_o - 22)/33.941\right]^2 \quad (\text{Equation 2.3})$$

Where  $T_o$  in this case as the monthly mean of the outdoor air temperature and  $T_c$  is comfort temperature.

Some addition formulas that include to this calculation are: indirect solar loads through opaque objects, direct solar gains through transparent objects, and ventilation and infiltration gains (see also Kokogiannakis, 2008).

The effective solar collecting area for the opaque building elements is given by equation 2.4:

$$A_{sol,k} = \alpha_k \cdot R_{se} \cdot U_k \cdot A_{op} \quad (\text{Equation 2.4})$$

where,

$\alpha_k$  is the solar absorption coefficient of the opaque element  $k$  [-].

$R_{se}$  is the external surface resistance of the opaque element  $k$  [ $m^2K/W$ ]. This is suggested to be equal to  $0.04 m^2K/W$ , according to the EN ISO 6946 (2007).

$U_k$  is the thermal transmittance of the opaque element  $k$ , which is calculated according to the ISO 6946 Standard [ $W/m^2K$ ].

$A_{op}$  is the overall area of the opaque element  $k$  [ $m^2$ ].

The effective solar collecting areas for transparent elements are defined by equation 2.5:

$$A_{sol,k} = F_{sh,gl,k} \cdot g_k \cdot (1 - F_f) \cdot A_w \quad (\text{Equation 2.5})$$

where,

$F_{sh,gl,k}$  is the shading reduction factor for movable shading provisions for the glazing element  $k$  [-].

$g_k$  is the total solar energy transmittance of the transparent element  $k$  [-]. The solar energy transmittance for radiation perpendicular to the glazing is calculated according to the EN 673 Standard (1997) and then a reduction factor (usually 0.9) is applied to calculate the time-averaged value needed for this equation.

$F_f$  is the ratio of the projected frame area to the overall projected area of the glazed element (including frame area) [-].

$A_w$  is the overall area of the glazed element (including frame area) ( $m^2$ ).

The ventilation heat transfer coefficient and the heat gains (i.e. solar and internal) are determined in the same way as for the monthly method. The heat gains, in terms of hourly heat fluxes, are distributed over the internal air temperature node ( $\theta_{air}$ ), the temperature node that represents the mass of the building ( $\theta_m$ ) and the central temperature node ( $\theta_c$ ). The way that the heat gains are distributed over these nodes is described by equations 2.6 to 2.8 respectively:

$$\Phi_{air} = 0.5 \Phi_{int} \quad (\text{Equation 2.6})$$

$$\Phi_m = \frac{A_m}{A_{tot}} (0.5 \Phi_{int} + \Phi_{sol}) \quad (\text{Equation 2.7})$$

$$\Phi_c = \left(1 - \frac{A_m}{A_{tot}} - \frac{H_{tr,w}}{9.1 A_{tot}}\right) (0.5 \Phi_{int} + \Phi_{sol}) \quad (\text{Equation 2.8})$$

where,

$\Phi_{air}$  is the total heat gains on the air node during the considered hour [W].

$\Phi_m$  is the total heat gains on the node that represents the mass of the building during the considered hour [W].

$\Phi_c$  is the total heat gains on the central node during the considered hour [W].

$A_{tot}$  is the area of all surfaces facing the building zone. The Standard suggests that this can be equal to:  $4.5 \cdot A_{fl}$ , where  $A_{fl}$  is the floor area of the building.

$\Phi_{sol}$  is the total heat flux from solar sources through all building elements for which solar radiation has direct access during the considered hour [W].

$\Phi_{int}$  is the total heat flux generated from internal heat sources during the considered hour [W].

## 2.5 Summary

Thermal building simulation offers a new overview of the achievements and challenges in energy efficiency. Regarding data resulted there is a significance on its digital model representation. It also provides a glimpse into the changing “appearance” of thermal calculation and simulation tools that is brought about by the internet revolution, software solution and devices, as exemplified by new forms of ubiquitous, collaborative, and pervasive applications.

This chapter has described the recent developments for methods and interoperable software environment to manage building thermal performance using BIM tools. BIM provides an alternative solution regarding interoperability, particularly to verify and to present building thermal performance in different phases of the building process. The experiences from many BIM based projects and studies show that interoperable thermal analysis software is getting more efficient to manage thermal performance during the building process. However, it requires more tools to handle advance requirement from building stakeholder, to compare thermal performance results and to visualize this results in an easy way.

As the AEC professional integrating architectural model and thermal calculation, there were two steps to simulate the digital model and to obtain the thermal results. Firstly, the model is created using design tools and secondly, thermal analyzing is performed using thermal calculation tools.

After reviewing and testing some applications used to model and to study thermal calculation and visualization, only limited tools enable us to carry out the experiment, due to its interoperability (Cormier et al., 2011; Dubois et al., 2010; Attia, 2010; Hanam, 2010; Wagner, 2010; Crawley, 2008) . Finally, we propose to carried out the model using Autodesk Revit and Ecotect to incorporate the design process and building performance analysis in a thermal context. The combination of Ecotect and BIM model of Revit provides a convenient tool to conduct whole calculation through the easier data flow from the BIM model to Ecotect.

Effects of radiant temperature on human thermal comfort of MRT are investigated for this experiment. After completing a long investigation, we determined on the use of Autodesk Ecotect. Feasibly, any model can be constructed within the Ecotect environment using its own internal drawing commands, extrusions and other modeling features. Imported models from design tool will universally fail, unless special care is taken to establish each piece of geometry as floor, wall, window, door, and aperture. Ecotect will not interpret this on its own with an imported model (Wagner, 2010). Therefore, in the experiment we used Autodesk Revit 2012, one of the leading design tools in the AEC community due to its high interoperability. Data transfer between CAD, thermal software and visualization software required some specific items that express the successful of the exchange. That is why the selected tools should able to accommodate this requirement. Table 2.3 describes the required data at each level of the workflow to maintain seamless data exchange. Ones these items fulfilled and completed during the workflow, it will ease data process and validation of the result.

CAD Modeling	Thermal	Visualization
<ul style="list-style-type: none"> <li>- Site and building location</li> <li>- Building orientation including its relationship to the true north</li> <li>- The building story information</li> <li>- 3D Geometry of adjacent building</li> <li>- 3D Geometry of the building, including walls (exterior/interior), curtain walls, roofs, floor/slabs, ceilings, windows/skylights, doors and shading devices</li> <li>- Space objects, including those defined by virtual space boundaries</li> </ul>	<ul style="list-style-type: none"> <li>- Building Spaces</li> <li>- Spaces (Temperature value, ventilation, building elements, material)</li> <li>- Energy analysis zones</li> <li>- Annual results</li> </ul>	<ul style="list-style-type: none"> <li>- Temperature in scale, text and 2D graphics</li> <li>- Radiation value, reflectance, and its transmittance in 3D entity; particles, spray, etc.</li> <li>- Animations of thermal simulation and virtual interaction with building elements.</li> </ul>

Table 2.3. The required data at each level of the workflow to maintain seamless data exchange.

The choice of this design tool accounted for various technical considerations, in particular the ease of data organization and the flexibility of data transfer. Most Revit models are quite complicated geometrically in comparison to other CAD project model. There are two commonly used format for transferring data from Revit to Ecotect; GbXML and DXF. The IFC format also accepted in Ecotect (in beta version) as a new opportunity for seamless data exchange. IFC and gbXML are both used for common data exchange between AEC applications such as CAD and building simulation tools (Dong et al., 2007, Knight et al., 2010). Both IFC and XML create a common language to transfer BIM information between different BIM and building analyses applications while maintaining the meaning of different pieces of information in the transfer (Haymaker et al., 2007).

# Chapter 3

## Virtual Reality and Scientific Visualization of Thermal Building Simulation

### Abstract

Scientific visualization is oriented towards the informative display of abstract quantities and concepts. Further, as the phenomena being represented are abstract, a researcher can perform investigations in virtual reality which is impossible or meaningless in the real world. In this way the best aspects of computer simulation and intuitive real-world interaction are combined (Bryson, S., 1996).

The use of virtual environment (virtual reality) techniques for scientific visualization, particularly building's 3D geometry and its associated thermal data are important for TBS representation. The framework and review of developed VR application using CAD software and 3D Game Engine, shows that the integration between these technologies enables the creation and sharing of a common geometrical database. This also possible for some approaches when include thermal simulation software. By utilizing such integration method (workflow idea from BIM), a realistic VE can be created from the CAD models and to include TBS results.

Chapter Three describes and discusses both VR and Scientific Visualization of TBS. A review of visualization and virtual reality was conducted to identify technologies suitable for the display of a building's 3D geometry and its associated data particularly thermal data toward the representation in virtual environment. General principles of scientific visualization of TBS are described. It also explored in more detail in the context of the challenges that must be overcome to build an effective visualization of TBS in VR, and the advantages that can be achieved are highlighted. Finally it provides an overview of related work in the field of visualization of TBS in VR.

### Contents

3.1 Virtual Reality in Scientific Visualization .....	41
3.1.1 Scientific Visualization .....	41
3.1.2 Virtual Reality .....	42
3.1.3 VR Technological Components .....	45
3.1.3.1 Display .....	45
3.1.3.2 Input Devices .....	46
3.1.3.3 Software Tools .....	48
3.2 Towards Immersive Visualization and Intuitive Interaction in VE .....	50
3.2.1 Immersive Visualization to Represent TBS Data .....	51
3.2.2 Interaction in a VE for Displaying TBS Data .....	53

3.3 VR Applications, CAD and TBS .....	56
3.3.1 VR-CAD Integration .....	57
3.3.2 Review of VR Application for Scientific Visualization of TBS .....	59
3.4 Summary .....	65

Virtual reality (VR) is being increasingly used in the field of scientific visualization. This field is based upon using computer graphics to express complex ideas and scientific concepts. This field has developed out of experience gained in computer graphics and human-computer interaction. The basic concept is that of the immersion of the user in a computer-generated world such that the sensory information conveyed reinforces the impression that the model or synthetic world is real.

### 3.1 Virtual Reality in Scientific Visualization

Virtual reality and scientific visualization are well matched for several reasons, in addition to inherently three-dimensional display and control. Scientific visualization is oriented toward the informative display of abstract quantities and concepts, as opposed to an attempt to realistically represent objects in the real world. Thus, the graphics demands of scientific visualization can be oriented toward accurate, as opposed to realistic, representations (Bryson, 1996). This section describes the significance of virtual reality in scientific visualization that can help building stakeholders to present TBS results in VE.

Further, as the phenomena being represented are abstract, a researcher can perform investigations in virtual reality impossible or meaningless in the real world. In this way, the best aspects of computer simulation and intuitive real-world interaction are combined.

#### 3.1.1 Scientific Visualization

Card et al., (1999) is defined visualization as the use of computer-based, interactive, and visual representations of data to amplify cognition. Visualization transforms data or information into images or graphs. It is primarily aimed at one of human's most dominant senses, the eyes. In today's modern trends computers have been used for this transformation and with the use of computers other sensory representations have been included such as sound and touch. The modern visualization involves the user exploring, transforming and viewing their data as images to gain understanding and insight (John et al., 2001).

Visualization has been divided up into three main types, they are: scientific visualization, data visualization, and information visualization. These main types are different but inter-related. Scientific visualization is the formal name given by computer scientists that all inclusively covers the interaction technique, data representation and processing algorithms, visual representations and any other sensual representations. However, data visualization is a more general term than scientific visualization because it may deal with data forms outside the realms of science and may include any of data analysis techniques. Nowadays research on data visualization is undergoing principal developments in a number of different fields. These developments consist of investigating ways of applying visualization techniques and systems for efficient manipulation, interpretation and presentation of data. Information visualization is the terms for attempts to visualize abstract forms of data. For example, directory or file structures on a computer, the information content of books, or hyper-text documents on the web (John et al., 2001).

Scientific visualization is used as a means of communicating abstract concepts to an audience which also aids with understanding. According to McCormick et al. (1987), scientific visualization is the use of computer graphics to create visual images that aid in the understanding of complex (often massive) numerical representations of scientific concepts or results.

While static visualizations of environmental phenomena are still valuable for the objectives of many studies, there is an increasing demand for dynamic, interactive visualization capabilities to facilitate the analysis and understanding of complex environmental processes (Burrough, 1998). In particular, there is a strong interest in using advanced visualization techniques to involve public interests in decision making. It's obvious because it provides a powerful means through which scientists



and the general public can effectively communicate and collaborate. In this significant interest, because of its relationship to 3D geometry, building stakeholders have more pay attention to scientific visualization.

Today scientific visualization is closely associated with VR as it shares many of the same attributes. Virtual reality enables scientists to demonstrate a method or convey complex ideas in a visual format. VR and scientific visualization are converging fields. Along the interactivity, VR aims to be immersive and achieves this by having feedback on its sensory devices. In this respect, visualization is primarily aimed at vision. The system is often interactive and may use feedback but this is not vital. In many ways, the major impact of VR technology on scientific visualization is in providing a “real-time” intuitive interface for exploring data while facilitating the use of scientific visualization in the research process (Bryson, 1996).

### 3.1.2 Virtual Reality

The term "Virtual Reality" has been defined in a number of ways since it was first coined - the focus being broadened in recent years. Nowadays, VR has a very broad scope and shifting definition, meant that many computer-based simulations that would have once been categorized differently are now included in the VR fold. Although this broadening has tended to cause some confusion about what constitutes VR and what doesn't, it was beyond the scope of our research. This section specifies some key concepts and objectives of VR presented in the literature, to consider the concepts to our purpose.

In a simple way, VR means a world experienced through our sensory skills, but we do not physically exist in the actual world. VR is about creating substitutes for real-world objects, events or environments that are acceptable to humans as real or true. It creates an environment in which the human brain and sensory functions are coupled so tightly with the computer. That make the user seems to be moving around inside the computer-created virtual world in the same way he/she moves around the natural environment. The terms “virtual environments (VE)”, “artificial environments” and “synthetic environments” are often used interchangeably when the subject of VR is discussed (Lu et.al. 1999).

Gutierrez, et al., (2008) and Guttentag (2010) defined VR as the use of a computer-generated 3D environment – called a ‘virtual environment’ (VE) – that one can navigate and possibly interact with, resulting in real-time simulation of one or more of the user’s five senses. ‘Navigate’ refers to the ability to move around and explore the VE, and ‘interact’ refers to the ability to select and move objects within the VE.

Augmented Reality (AR) is a variation of the VR. AR similar to VR in the sense that both are using computer-generated data virtually. VR trying to produce a complete environment, simulated or synthetic, which surrounds or drown the subject. AR is different from the VR, it does not try to block the surrounding of the user’s real environment. It is an environment where the additional information generated by a computer is inserted into the user’s view of a real world scene. The augmenting information may consist of virtual geometric objects placed into the environment, or a display of non-geometric information about existing real objects (Wang et al., 2007). The goal is to improve the environmental conditions for a specific purpose (Sairio, 2001). AR system components are similar to the VR system. It's just that the AR system are not fully intended to immerse the users in a virtual environment but to superimpose real objects that generated by computer graphics in the actual space so that the user looking at these objects as if it exist in the real world. In addition, AR still faces technical challenges regarding for example binocular (stereo) view, field of view, high resolution, color depth, luminance, contrast, and focus depth (Krevelen et al., 2010).

VR is a technology that allows people to enter and interact with three-dimensional computer graphics worlds. Another term for these worlds is VE (as both of them are used in computer community

interchangeably). A VE can present such alternative "space" that supports many human activities, particularly to provide a specific condition at a certain time and to interact with it. VEs allow users to visually walk through, inspect and present the designs in an immersive 3D environment at the proper size and scale (Reffat et al., 2008). Virtual space offered by VR is the physical condition in a quasi-immersive atmosphere that can be perceived by the five senses. VR users who are in the virtual environment will feel the reality, he is able to sense the representation of himself in that spot and become part of the environment. Therefore, the users are difficult to distinguish between real space and the virtual worlds along the simulation.

There are several kinds of VR system, a combination or a mixture of some types of conditions as shown in virtuality continuum by Milgram et al., (1994). VR, as a system, consists of hardware and software components. The hardware generally includes a number of input and output devices. The software generally consists of separate tools to author and interactively display the 3D environment. (Pilgrim, 2003). Based on combinations of hardware/software, different degrees of realism, and modes of user interactions, VR systems can be classified into distinct types by different means. Zachmann (1998) distinguish the VR systems by examining the relationship between the VE they represent and the real world of the user (Tab. 3.1).

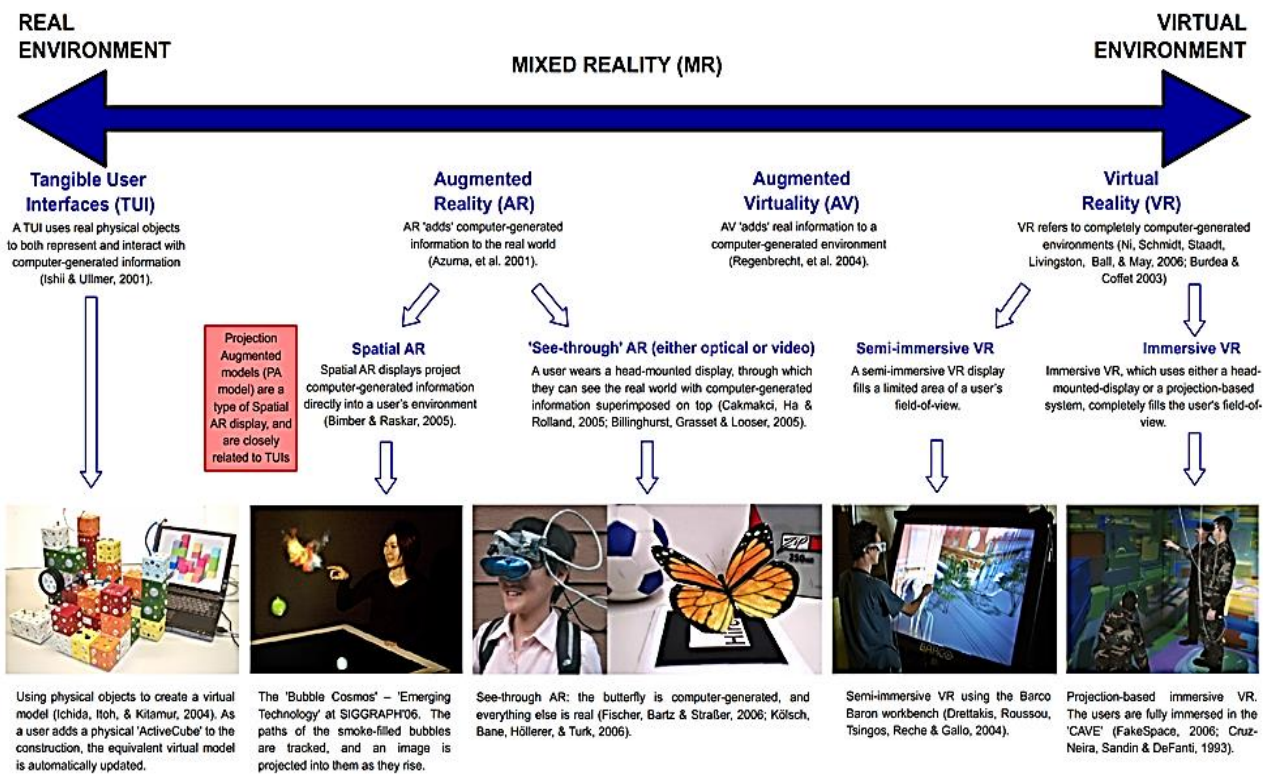

Figure 3.1. Virtuality continuum by Milgram and Kishino (Milgram et al., 1994)

	Relationships with the Real-world		
	Unreal	Not Existing	Existing
High Immersion	Entertainment	Functional Simulation	Tele-presence
In-Between		Training	
High Presence		Ergonomic	VR

Table 3.1. Types of VR systems (Zachmann, 1998)

Types of VR system according to Zachmann (1998) explained as follow.

1. The VE is actually a full projection of some real environment which might be of very different physical scales or at some distance from the users. The latter case is often described by the term tele-presence. With this type of VR systems, the user can manipulate existing real objects remotely through the aid of their corresponding virtual objects (i.e., tele-operation). Some examples are modifications of the structure of materials at atomic scale and steering a vehicle on the moon or polluted terrain.
2. The VE does not exist (i.e., does not have its real world counterpart yet), but is otherwise fairly realistic. It might have existed in the past (e.g., the re-creation of Titanic), or it might exist in the future (e.g., an automobile under design). With this type of VR systems, the user manipulates non-existent objects directly. For example, a designer can examine the interior of a future car design, and a manufacturing engineer can visualize the fabrication processes being planned.
3. The VE is quite unreal from the viewpoint of the actual physical world. This is commonly the case in creative entertainment applications that strive to provide the audience with an exciting, exotic and imaginary world. The unreal phenomena are created by so-called `cartoon-physics` which lends special effects to objects that are not possible according to physical laws. Certainly, the user can only interact with non-existent objects in this of VR system.

In this thesis, we also refer to the concept of immersive VR, which gives the user the psycho-physical experience of being present in a virtual environment consisting of interactive (virtual) objects. VR is also defined as anything that contributes to make us feel present (on all levels, not just cognitive) in a synthetic environment and the study of these factors. That's why a lot of people are now using the term Immersive VR. According to Nahon (2009) Immersive VR is a set of technologies and sciences that enables to physically immerse a user within a virtual 3D world by providing both an enhanced presence of the virtual world for the user (potentially with stereoscopic and view dependent rendering, 3D sound, haptic, etc.), and an enhanced presence of the user in the virtual world (through direct natural body-based interactions). In addition, according to Van Dam et al, (2002) immersive VR has great potential for dealing with the serious problem of exponentially growing scientific datasets. Although there are some differences concerning VR definitions, they are essentially equivalent. They all mean that VR is an interactive and immersive (with the feeling of presence) experience in a simulated (autonomous) world (Mazuryk et al., 1996). Therefore, this measure will use to optimize the presentation of TBS in VR system (section 3.2).

A VR can be used in a variety of ways, including: to provide the end user with an immersive experience for entertainment purposes; to design a new concept or product; to explore and gain insight from data in an intuitive manner; for tourism; and to train people at complex (and perhaps dangerous) tasks in a safe, convenient, and/or effective environment (Miles et al., 2012). Early adopters of VR include the aeronautics industry (flight simulators), the entertainment industry (simulator rides, videogames, and movies), medical-procedures training, oil and gas exploration, automotive design, and building and environment design. As the available hardware gets more powerful, and often less

expensive, more and more application areas are taking advantage of VR. TBS is a relatively new in VR technology. Therefore, it is necessary to discuss more specific about VR technological components, type of immersive visualization and intuitive interaction appropriate to TBS characteristics.

### 3.1.3 VR Technological Components

Before applying VR as an enabling technology for TBS, the characteristics of the technology and the application must be specified. Additional input and output hardware devices and special software are needed for enhanced user interaction and immersion. This subsection discussed these specific hardware and software to determine their function characteristic. In general: input devices are responsible for interaction, output devices for the feeling of immersion and software for a proper control and synchronization of the whole environment (Mazuryk et al., 1996, Burdea et al., 1994).

#### 3.1.3.1 Display

Visual displays are the most popular in VR systems (as output device) with other types of displays as supplements. Visual displays are the devices that present to the user's eyes the 3D computer generated world. There are six categories of display and each providing a different degree of immersion. They are: desktop displays, head-mounted displays, arm-mounted displays, single screen displays, surround screen displays, and now volumetric displays (Shneiderman, 1998; Stuart, 1996). These different display types have fundamental different characteristics. Most are capable of producing wide-angle stereoscopic views of the scene, although monoscopic vision may also be used (John et al., 2001).

Stereoscopic visual displays are used to present virtual worlds. There are two types of stereoscopic rendering developed for light projection onto a fabric screen, passive and active. Active solutions require shutter glasses; the shutters for each eye open alternatively and are coordinated with the projector. Each eye receives separate image to give the impression of stereovision. Passive solutions use polarizing or red/green glasses. Two sets of images are projected simultaneously so twice as many projectors are needed than the active solution. Each eye receives a different image because each lens of the glasses filters out one set of images. This type of passive solution does not work on desktop displays (John et al., 2001).

Generally a head tracking device coupled with the displays provides the location and direction of sight of the viewer. This is used to compute the correct perspective view of the virtual world. Head-Mounted Displays (HMDs) are also broadly used visual displays in VR systems. These devices place a pair of display screens directly in front of the user's eyes. The screens are mounted on a helmet that viewers wear while in the virtual world. However, HMD are still too clumsy not to be distracting to the user. They also have limited field of vision, can cause difficulties for users performing active tasks (Miles et al., 2012), and they usually lack in contrast and resolution for a reasonably immersive environment. The combined demands of wide field of view and high display quality and resolution are extremely difficult to put into a HMD display. The alternatives of the CRT-based Binocular Omni-Oriented Monitor (BOOM) displays (Bryson, 1996) and the projection-screen-based Cave Automatic Virtual Environment (CAVE)-type displays (Cruz-Neira et al., 1993) are proving popular for many scientific visualization applications. BOOM is look like a pair of binoculars mounted on an articulated arm. The user looks at the virtual environment through the lenses and having his movements constrained by the arm's length and motion range. However, even the images presented are typically more stable than HMD, it can be referred to as a "head-coupled" display. Another factor to be considered in selecting virtual reality visual displays for scientific visualization is the issue of user acceptance. Many researchers have expressed distaste for donning helmets or strapping displays onto their heads. The CAVE-type displays avoid many of these problems (Bryson, 1996).

Single-screen projection displays include the Immersive Workbench products. Most of these displays use a tabletop metaphor, in which virtual objects appear to lie on the table's surface. Virtual tables use projectors, hidden inside the table, to display the VR image onto a glass or plastic screen that forms the tabletop. With the aid of shutter glasses and head trackers, a user can get excellent 3D views.

The CAVE is an example of a multiple screen projection system where stereoscopic images are projected onto a cube composed of display screens that completely surround the user. The user explores the virtual world by moving around inside the cube. The CAVE blends real and virtual objects naturally in the same space so those individuals have an unoccluded view of their bodies as they interact with virtual objects (John et al., 2001). These displays have the advantage that they do not require special eye-wear thus accommodating user's eyes during focusing, and they can cover large surfaces for a wide field-of-view. Projection surfaces may range from flat, plain colored walls to complex scale models, and calibration may be needed if using cameras in e.g. a multi-walled CAVE with irregular surfaces (van Krevelen et al., 2010). Several variations of this projection setup have been developed, examples include asymmetric screens, portable CAVEs with only two walls, arrangements in "U", and spherical screens (Juarez et al., 2010). Panoramic screens also offer very large display areas and higher resolution of images. They are spherical and often used in the domes of modern simulators. They enable a group of VR users to share the same visual experience. However, it is hard to maintain a consistent image quality across the entire screen.

CAVE displays give users a much wider field of view, which helps in immersion, as it provides a better sense of presence and interaction in VE (Ohno et al., 2007; Sutcliffe et al., 2005). Sutcliffe et al. (2005) conducted an experimental study comparing presence, memory, and interaction in three different virtual environments: CAVE, Interactive WorkBench, and RealityRoom. It was found that the CAVE was remembered better to the user. It had better usability and provided a better sense of presence to its users. The main remaining advantages of the CAVE over other visual displays are that CAVEs provide "instant on", for example, wear stereo glasses, walk in the start exploring the data, also multiple people can simultaneously stand inside a CAVE.

In addition, the number of expensive methods, physical models and prototypes can be radically reduced by CAVE. CAVE creates a quite different form of communication and cooperation. Building stakeholders, for example, can deal with one issue simultaneously. As everyone is seeing the same thing, those people who have different interests in the process of development and construction can also immediately see the consequences and effects of decisions.

### 3.1.3.2. Input Devices

An input device is used to manipulate the digital information displayed over the real environment. Every VR system requires some sort of input device so that the user's actions can be interpreted and the VE can respond accordingly.

The types of input devices that VR systems utilize are quite varied, but can be as simple as a mouse, joystick, or fixed, mechanical arm with a visual display at one end (BOOM). Nevertheless, far more sophisticated devices are also used, such as interactive gloves, voice recognition software, and wands, such as those used with Nintendo's popular Wii video game console. Also, the movement of a user's body can be tracked using body suits with angle measurement devices placed on various joints, or noncontact tracking devices, which may involve the use of optical sensors, ultrasonic sound, infrared emitters, or electromagnetic fields (Gutierrez, et al., 2008).

Real-time motion capture is used with VEs to capture the user's position and movement. It allows the user to interact with the virtual world in an intuitive fashion, using natural movements. This input device in particular is used for training applications and motor-skill learning (Miles et al., 2012).

The input devices that return force information to users are called haptic devices. Haptic technology provides various forms of sensing movement and providing force and tactile feedback to a user, providing them with a means of interacting with their environment in terms of touch and to enhance their immersion in to the VE. Haptic is like tele-operation, but the remote slave system is purely computational. Through these devices, users can interact with the virtual world through hand gestures, it is possible to touch, weight and grasp virtual objects with sensation close to that of real objects. In order to create a sense of touch between the user's hand and a virtual object, contact or restoring forces are computed to prevent penetration into the virtual model. This involves specific efforts such as contact determination, penetration detection and computing the restoring forces (van Krevelen et al., 2010).

The haptic is divided into two types of return: force feedback and touch feedback (Aguerreche et al., 2009). The decision to use a system with force feedback or touch may depend on practical constraints. A feedback arm devices with specific efforts is expensive, cumbersome and often have low amplitude of movements. The tactile systems are generally lighter even there are new versions of force feedback systems. The choice of a feedback system also depends on the efforts objectives of an experiment: a tactile system appears to be better than a feedback system effort to feel the touch, while the force feedback system allows for better assessment the magnitude of a force. However, as the limitation of the haptic as mentioned earlier, many users only benefit by visual cues to help them understand the present constraints (Aguerreche et al., 2009).

Some potential interfaces method using special input devices that allow the thermal feedback have been developed to have a more realistic sensation of touching in VE. Also, intended for more realistic perception of virtual objects that might have a similar effect on haptic actuators as color has on visual displays. Jones et al. (2003) have used thermal actuators to identify materials. Citerin et al. (2006) have developed a haptic device to render both kinesthetic and thermal sensations computed from operator interaction with a 3D virtual environment. Yang et al., (2008) investigated thermo-tactile interaction using a tactile display to provide both normal vibrotactile stimulus and temperature, as Khoudja et al. (2003; 2004) presented a new vibrotactile display call Vital to transfer heat between the fingertip and different explored surface, Wettach et al., (2007) have designed a prototype of a wearable device that sends thermal impulses to the user`s elbow..

In order to transcribe data from thermal calculations, it seems natural to use the thermal feedback in addition to traditional visual feedback. As several works explained earlier, it is possible to combine multiple sensory interactions to enhance a feeling of thermal sensation more realistic. In addition, there also efforts to present real touch sensation in VE. Thermal display functions have tried to embed into tactile feeling display for satisfactory realism. However, the touch which is only using a finger certainly cannot represent the thermal sensation for the body as a whole. In addition, haptic technology is difficult to achieve convincingly because the human sense of touch is far more sensitive than the senses of sight or sound. This is related to the results in real-time. In visual systems a picture needs to be refreshed at only 30 frames per second to trick the eye into thinking it is seeing continuous motion. However, the sense of touch is more difficult as it requires that a sensation be updated 1000 times per second or more to relay a convincing tactile experience (Fisch et al., 2003).

Although the visual aspects of VR often attract the most attention, an audio element also can be very important for the creation of realistic VEs (Gutierrez et al., 2008). As an addition to the visual information, auditory information can offer several benefits such as; an additional channel of data passing, alert or focus signals that attract the user or warn him/her, spatial orientation cues and as for perception ability of information that is outside of visual display (Mazuryk et al., 1996). According to Bouvier (2009), sound immersion prevents the user to hear sounds from the physical environment. This allows the virtual environment to substitute the real environment more effectively and enhanced the sense of presence.

In VR systems, audio generally is communicated through headphones or specially located speakers. High quality audio is naturally desirable, yet giving ‘spatial’ qualities to the sound is also important because it allows the user to perceive an external ‘sound stage’ from which the sounds are emitted. Giving sound spatial qualities involves giving it directionality and accounting for the acoustic properties of the rendered VE. Directionality is important to consider because sounds must be perceived as coming from appropriate features of the VE (Guttentag, 2010). In addition, it can help provide assistance to users with visual difficulties.

The use of three-dimensional sound in scientific visualization particularly for TBS has been relatively unexplored but holds promise. Aside from the conventional uses of sound to provide user feedback as to the state of the environment, sound can be used as an additional data display channel (Bryson, 1996). Scalar quantities and temperature value for example can be mapped to the frequency, timbre, or amplitude of a sound.

To conclude, one of the aspects that make VEs unique from other interactive technologies is its ability to present the user with multiple inputs and outputs (Stanney, 1995). The recent trend regarding input devices in VE is to combine different ways of visual feedback, audio and haptic (Zhang et al., 2005; Sreng et al., 2007). Hecht et al. (2006) concludes that multiple arrangements of these devices simultaneously improve the performance of a user in VE.

### 3.1.3.3. Software Tools

According to Jubertie (2007), VR software has to contain 3 modules:

- The render, which consists in transforming information of the virtual environment into a readable image by displays.
- The interaction with the virtual world.
- The simulation, which defines the behavior and the evolution of a virtual reality application.

VR software is needed for 3D modeling, interfacing with the hardware devices, managing the VE in real time, and providing feedback and validation. However, there is no specialized software for TBS as VR applications. Also, typically it VEs are built using a variety of open source and commercial software packages. Custom software is also needed so that the full multimodal experience can be provided for the particular TBS scenario. There are various types of software and platforms available, which should be selected as we demonstrated here.

For 3D modeling, companies such as Dassault Systèmes (Paris, France) and Autodesk (San Rafael, USA) provide software specifically designed for rapid development. Such packages include Autodesk Revit (CAD), Ecotect, 3DsMax and 3DVia Studio / Virtools, provide the user with a broad range of robust tools. A problem with commercial packages is that they are often expensive and the user is confined to the specific tool set given to them, also there are issues regarding data exchange. For this reason, universities and research groups often use open-source software develop their own some times by exploiting those existing software (section 3.3).

As the TBS related to the AEC domain, the creation, the integration and storage of all necessary information for the digital model of TBS to represent in VR systems are often done through a CAD and modeling environment. The essence and core functions of this CAD modeling environment are not much different from those commonly used in traditional CAD applications. However, due to the requirement of thermal calculation, realism, and interactivity in VR systems, the information demands and integration/storage requirements of this digital model and its CAD modeling environment are very high. The BIM platform (as describe in Chapter 2) is considered as the solution for the interoperability issue. It is intended to allow data integration in efficient way when conducting energy analysis on buildings. Using this method, the geometry from design tools have to exported to the energy simulation program due to the original resource (for example from architect), and the limitation of this energy

simulation program to produce detail drawing. So that normally the process should pass through thermal calculation tools before integrate the data to VR.

In thermal software, for example, this modeling environment must support the creation, integration and storage of different geometric, physical, and functional information of a thermal data. The data must go through the conceptualization, design, and verification. This data exchange with CAD has been solved through BIM method. However, difficult tasks, such as the collaboration of thermal data management and other engineering data management of CAD product will become more complicated in VR systems (Lu et al., 1999). Data exchange and standardization efforts, such as step from CAD and thermal software, are the challenges toward the VR systems.

A number of VR software to provide insight into VE are available and offers large challenges and potential for TBS through visualizing computational results. However, it is much harder to find scientific applications of TBS that really fit particularly if we want to apply it in a high immersion system (CAVE). The idea is then how to choose the VR software and components that are best suited to represent TBS data.

Based on this issue we took the idea from the new trend in computer games. A trend that is becoming increasingly popular in building design process support are using creativity techniques, gaming principles and scenario based techniques. This method is effective because computer games provide insight into the possible consequences of real-world decisions (Tideman et al., 2008). According to Zyda (2005), VR field is transitioning into work influenced by video games and thus now influences the industry as well. Since much of the research and development being conducted in the games community parallels the Virtual Reality community's efforts.

In fact, the principal function VR software can also be applied to any real-time 3D application like 3D game engines, rendering engines and 3D modeling software (Romain et al., 2010), which today makes them popular in VR system. These software designed more compact, easy to learn and to re-develop, sometimes no cost (open source), and flexible to adjust to VR component.

Generally, real time 3D game engines and rendering engines do not provide technical thermal calculations. However, most of these programs can be used to study direct and/or diffuse heat patterns and temperature level on building facades and inside buildings, whether at one specific moment or for a sequence in time. Few of these engines provide numerical output of hot-cold intensity results which is the focus is clearly on visualization rather than numerical analysis. Most of these engines work with rendering method. In most cases, 3D rendering does not support early design phase for modeling decisions. Its rendering is thought of as a post-design rather than a design tool or simulation tool. Therefore, a part of this issue has solved in Chapter 2, which describes selected design tools and thermal simulation tool addressed for TBS with respect to their performance and interoperability.

Romain et al. (2010) distinguish two trends in the type of software used for VR. They are: Real time 3D game engines and rendering engines, and VR software.

A 3D rendering engines and rendering engines (the "all in one" 3D modeling solution software) can be an economic alternative that are really dedicated to VR. They provide VR features as it often used for other kinds of interactive applications with real-time graphical requirements such as marketing demos, architectural visualizations and training simulations. Among the most considered game engines, there are some popular example e.g. the Unreal Engine 3 made by Epic Games, Unity 3D from Unity Technologies, and Torque 3D from Garage Games. And among the "all in one" 3D modeling solution software, they are for example, 3D Studio Max, Maya and Softimage (XSI) from Autodesk, 3D Lightwave from NewTech, Cinema 4D from Maxon, Carrara made by DAZ 3D, Houdini from Side Effects and Blender, an open source software from Blender foundation.



VR software can be similar to 3D game engines, however, it contains additional tools dedicated to integration and management of VR devices such as HMD, professional haptic devices, workbenches or CAVE systems (Romain et al., 2010). The market of multi-interfaces VR software is rather limited, quality platforms are expensive and some research laboratories prefer to develop their own applications. Among the most considered game engines applied for VR, some popular examples are, 3D Via Studio, Virtools from Dassault Systèmes, Vizard made by WorldVIZ, 3D Quest from Act-3D, Eon Reality Studio from Eon Reality, TechViz XL made by TechViz, some Open Source software like OpenMask from the Institut National de Recherche en Informatique et Automatique (INRIA), and VR Juggler from the Iowa State University VRAC (Romain et al., 2010). Although less flexibility in data exchange, most of them are well established and well recognized in rendering, simulation and interaction, similar to a 3D game engine.

To conclude the section, today's VR developers are faced with a very difficult task of integrating disparate hardware and software components of VR. The current vendors of VR hardware components often provide no software for integrating these devices into a working system. Moreover, the task of integrating VR components is a difficult and time-consuming process when used to apply such special simulation. With respect to TBS, we consider to apply a reliable display, simple input tools and establish VR software, in order to have immersive visualization and intuitive interaction in VE. There are a large variety of software packages available for VE creation and development. However it is more important to note that there is no a special package for TBS integration in VE. It means the system needs to use more than one package. Each package or suite has different benefits, so we intended the systems in this work uses the best available package for the project. A combination or a collaboration of the packages is definitely should be optimized using such workflow in order to bring the TBS in VE.

### **3.2 Towards Immersive Visualization and Intuitive Interaction in VE**

This section describes the VR proportion produced by VR technological component in conducting a simulation of visualization and interaction. The integration of VE with a simulation is intended to make it closer to the real environment. A successful virtual environment is where users feel that they are truly present in the simulated world. Also, that their experience in the virtual world matches what they would experience in the environment being simulated. This sensation is referred to as engagement, immersion, or presence. So, a VR experience can be described by its capacity to provide physical immersion and psychological presence.

Bouvier (2009) defined that 'presence' is mainly concerns with immersive and interactive properties of the system. Immersion refers to the extent to which a user is isolated from the real world. In a 'fully immersive system' the user is completely encompassed by the VE and has no interaction with the real world, while in a 'semi-immersive' or 'non immersive system' (the latter includes contemporary 3D video games) the user retains some contact with the real world (Gutierrez, et al., 2008). The level of immersion offered by a VR system is one factor that may influence a user's feelings of 'presence' (Banos, et al., 2004). Both immersion and presence are enhanced by a wider field of view than is available on desktop displays. This helps to provide situation awareness, aids spatial judgments, and enhances navigation and locomotion (Koutek, 2003). This is why we need to define these experiences from input devices and output device (display). Experience to feel hot and cold temperatures through a simulated environment would require some condition. The following subsections discuss VR experiences (immersion and presence) in the context of the TBS toward the immersive visualization and intuitive Interaction.

### 3.2.1 Immersive Visualization to Represent TBS data

In a VR system, a computer generates sensory impressions that are delivered to the human senses. The type and the quality of these impressions determine the level of immersion and the feeling of presence in VR. Ideally the high-resolution, high-quality and consistent over all the displays, information should be presented to all of the user's senses (Slater et al., 1994). Which senses are most significant, what are the most important stimuli and of what quality do they have to be in order to be accepted by the user? According to Heilig (1992) the vision took a large contribution (Tab. 3.2)

Sight	70 %
Hearing	20 %
Smell	5 %
Touch	4 %
Taste	1 %

Table 3.2. The contribution of each of the five human senses (Heilig, 1992). It shows that human vision provides the most of information passed to the brain and captures most of human attention.

Therefore the stimulation of the visual system plays a principal role in “fooling the senses”. This sense becomes the focus of exploitation in this work. As explain earlier this also related to the real-timing.

Since most immersive VEs are highly visual, it is quite important that we understand human visual perception. Depth perception is crucial, since we are attempting to represent a 3D environment on 2D displays. Research has identified many visual cues that humans use to determine depth, and divide them into monocular versus binocular (using one or two eyes), and static versus dynamic (Bowman 1999). Most depth cues are static and monocular. Its including linear perspective, texture gradient, relative height, and aerial perspective.

The visualization techniques used to interpret thermal analysis data are currently limited to static, often predetermined, tables and graphs. Therefore, the geometrical component of the analytical data is not well presented to the user. Manipulation on depth perception for the data and the ways of presenting the data will affects the immersions levels. Stereo in particular is widely believed to be a very important depth cue that enhances immersive VEs. Many studies have been performed comparing human performance in stereoscopic, monocular, and biocular (the same image presented to both eyes) viewing situations and the general consensus is that stereo improves presence and can improve performance (Bowman, 1999).

Virtual Immersion is interaction with the virtual model (Mérienne et al., 2012). Particularly in modern engineering simulations, the model or data sets consist of a time series of three-dimensional volumes with many parameters at each point. Three-dimensional computer graphics allow the shape and form of objects to be presented and perceived. In this representation, the use of photo-realistic textures for color provides detailed visual information. With respect to thermal metaphor, the patterns contained in textures help to increase optic flow. This increases a user's perception of visualization and movement as they travel through a virtual world. Further, users are often interested in behavior induced by that data, such as streamlines in a vector field, rather than in the data value themselves. This should be accommodated by a display that can deliver a quality immersion and interaction.

As mentioned earlier, visual information is the most important aspect in creating the illusion of immersion in a virtual world. Ideally we should be able to generate feedback equal to or exceeding the limits of the human visual system. Kellogg et al. (2008) argue that immersive visualization does not mean that users are surrounded by imagery on all sides, but means that users perceive virtual space as real. However, they prefer to use CAVE. The benefit of CAVEs (for their project) over single-screen

immersive environments is that users are simply additionally surrounded by imagery. The surrounding is conditioned, such that user's peripheral vision improves the understanding of complex multi scale data. Also such that measured data like surface topography can be displayed up to 1:1 scale.

Full and partial immersion in virtual reality are fundamental different user experiences. Partial immersion supports the feeling of “looking at” a virtual environment while full immersion supports the feeling of “being in” that environment (Shneiderman, 1998). To apply a full immersion it should refer to the interaction scenario (UI) and the display type. The potentials for immersing the user in a virtual environment is often measured from the field of view (FoV), which describes how much of the user’s view can be covered (Kjeldskov, 2001).

Display type	Field of view (approx.)
Ordinary computer monitors	20-40°
HMDs/BOOMs	30-80°
Holobenches	80-120°
Large wall-mounted displays	100-140°
Panoramic displays	160-180°
CAVEs	up to 180°

Table 3.3. The field of view of different display types for virtual reality (Kjeldskov, 2001)

Kjeldskov (2001) found that existing virtual reality applications often have problematic UIs and often have very little in common when it comes to interaction techniques. These interaction techniques are typically applied regardless of the display type used. He suggests the notion of available field of view describing the FoV available to the user in any given viewing direction. If a display always provides an available FoV, it is considered as a full immersive display. If a display does not always provide an available FoV, it is considered as a partial immersive display. The partial immersive displays are characterized by the fact that they do not provide their optimal FoV in all directions. Kellogg et al. (2008) argue that immersive visualization does not always rely on this FoV. Therefore, conceptual frameworks for interaction (involving display type) can influence significantly on the quality of interaction techniques.

Table 3.4 describes relations between display types and interaction techniques. Interaction techniques to produce a full or partial immersion clearly bound by the type of the device. However, the reciprocal relationship between the quality of interaction and impressiveness resulted by interaction device still depends on the display device, simulation scenario and the user.

Interaction Technique		Partial Immersive Displays	Full Immersive Displays
<b>Orientating</b>	Headtracking	Problematic because the user can't orientate 360° by simply looking in the desired direction.	Very intuitive because the user can orientate simply by looking around as in the real world.
	Headtracking with active "zones"	Limits freedom of movement. Conflicts with orientating in the physical world.	n/a
	Joystick	Easy to use. Better than trackball for fast / continuous rotations.	Supports viewing the virtual environment from "odd perspectives" as addition to head tracking. Frees the user from moving physically.
	Trackball	Easy to use. Better than joystick for precise / absolute rotations.	
	Spacemouse	Supports rotating and moving the virtual world at same time. Hard to learn how to operate smoothly.	Can be used with HMDs but is <i>not</i> well designed for hand-held use in the CAVE without additional tracking.
<b>Moving</b>	Position tracking	Very intuitive to use within the limits of the physical space available. However, typically demands further support for moving the virtual world (e.g. by means of joystick, trackball or Spacemouse).	
	Joystick	Flying in the direction the stick is moved. Easy to use but not suited for both: fast and precise movements. Supporting orientating with same device is problematic – demands shifting between several modes of operation.	
	Trackball	Flying in the direction the ball is rolled. Great feeling of control over small movements. Not suited for moving long distances. Supporting orientating with same device is problematic – demands shifting between several modes of operation.	
	Spacemouse	Works fine if user remains still. Performs well along with head tracking but is hard to learn to operate smoothly.	Does not work well. Device must stay in fixed orientation in relation to the display. Is hard to learn to operate smoothly.
<b>Acting</b>	Virtual hand (using tracking)	Does not support "close-by" acting unless user stands close to the screen.	Can be projected close to physical hands but the user's body might occlude graphics.
	Virtual pointer (using tracking)	Large screens have good affordances for "pointing at" objects in a VE.	May support moving in pointing direction by indicating direction visually.

Table 3.4. Relations between display types and interaction techniques (Kjeldskov, 2001)

TBS representation is a combination of 3D visualization and interaction, thus requiring a full immersive display. Equipment used should also be qualified in all three parameters (orientation, motion, and action). The use of head tracking and virtual hand although intuitive, but they are quite burden and have real-timing issues. Trackball and space mouse are slow and hard to learn to operate smoothly.

The point is that the selection of the type of display should be adapted to the type of interaction that will be carried out in a simulation. Plus-minus of the device can be overcome through a proper interaction scenario.

### 3.2.2 Interaction in a VE for Displaying TBS Data

Interaction of VR technology means to exchange information between human and computer, which is called human-computer interaction (HCI) (Tan et al., 2010). Human-computer interaction effectively realizes human computer dialogue through computer input and output devices as described earlier. This interaction technique designates a method, a strategy, and a usage scenario. Its allowing the user to accomplish a specific task in the virtual world, for instance to browse, select objects, simulate thermal results, monitor the implementation, etc. In HCI, Norman (1990) identifies four characteristics of usable artifacts recommended for virtual environment interfaces: affordances,

constraints, good mappings, and feedback. Affordances refer to the properties of an object that inform the user of its purpose and the way it can be used. Constraints are limitations on the use of an object that guide users into proper actions. Good mappings mean that the conceptual model, or metaphor, on which an object is based, is easily understood in the specific task domain of the object. Finally, feedback is the indication given by an artifact of the state of its operation or usage, to help the user understand what has happened so that the next action can be planned and carried out.

In contrast to our applications, the user is able to interact with a given scene, using 3D input device, e.g. a joystick or pointer. Any interaction must be evaluated by the system ideally without any latency (real time system). Speed and performance were two of several desirable values - along with accuracy, ease of use, access to very large data sets, and elegance of program structure. The point here is to elevate real-time performance to the status of a requirement for interactive visualization systems.

Interaction between users and virtual environments regarding TBS is complex. Users must be able to navigate through 3D space, explore virtual objects (thermal entity) with high degrees of freedom (DoF). They also must control parameters of the simulation, and interact with the 3D GUI inside the virtual environment in a user-friendly way.

To further support an immersive impression the displayed world needs to react immediately to movements of the observer and allow direct interaction with the scene content. Immersion implies that the user has the impression of being part of the computer generated environment he sees. He should be able to touch objects, move them around and perform other interactions directly and intuitively that fit to the displayed content (Lang et al., 2004). Therefore, several images should be projected around him (e.g. CAVE). A true three-dimensional perception is achieved using stereoscopic projection techniques. Monteiro et al., 2008 is used stereoscopic three-dimensional models to simulate the relationship between the presence of objects and persons. Depending on the scenario further sensory information can be very supportive. For building stakeholder the visualization and auditory information within a larger building for example, strongly improves the sensation of being there.

An important aspect influencing the user in performing TBS in VE is the effect from their background. Building stakeholder commonly come from different background (age, gender and profession). They are for example as a building owner, general contractor, architect and engineer. Their characteristics that significantly influence VR experiences (presentation, task, etc.) need to be identified, in order to design VR systems that accommodate their uniqueness or special needs. We must be sure to consider individual differences when designing interaction techniques.

Experience level also influences the skills of the user, the abilities which predict performance, and the manner in which users understand and organize task information. This implicates that for TBS the VE interface design has to be appropriate for the level of expertise of the target user population. Technical aptitudes (e.g., spatial visualization, orientation, spatial memory, spatial scanning) are also generally significant toward the HCI performance. Some studies indicate that individuals who score low on spatial memory tests generally have longer mean execution times and more first try errors. This is particularly related to system navigation issues. A specific interaction and visualization metaphors could potentially be developed to assist with this issue (Stanney, 1995).

The TBS as a further step of design process is an iterative and multidisciplinary process. Each member of building stakeholder has its own interest, so that in otherwise the TBS objective needs to be better understood. This to ensure that an effective simulation scenario is developed better for them through VE. Simulation is used in complex dynamic problems where exact analytic and mathematical methods are problematic and not feasible. So, the process of TBS is about solving this complex dynamic problem. It should be evident that this simulation is more than just execution of calculations. This based on a scientific theory or on experience.

Computer simulation is only possible if a simulation model exist. This model can be a formal numerical or product model, can also an informal model such as a diagram, a sketch, a graph or even a written description of the behavior of the system to be simulated. TBS in this context have become an integral part of the ensemble of computer applications for the design (modeling), thermal simulation tool and VR software. The primary objective of it use is to conduct a performance analysis that informs building thermal calculation results. How effectively this is done, is as much dependent on the quality of the tools and the seamless data workflow as well as the simulation scenario. Regarding the scenario, one important aspect that will directly influence how effectively users can function in virtual worlds is the nature of the tasks being performed. Some TBS tasks may be uniquely suited to virtual representation, and some others may not be effectively performed in such environments. Therefore, it is important to determine the types of TBS tasks for which VEs will be appropriate. For example, to perform calculation task, to select the object, choosing a time calculations, to find the value of the temperatures in the room, etc. In figure 3.2, Bowman (1999) proposed taxonomy of interaction techniques for selection and manipulation based on a more formal task analysis.

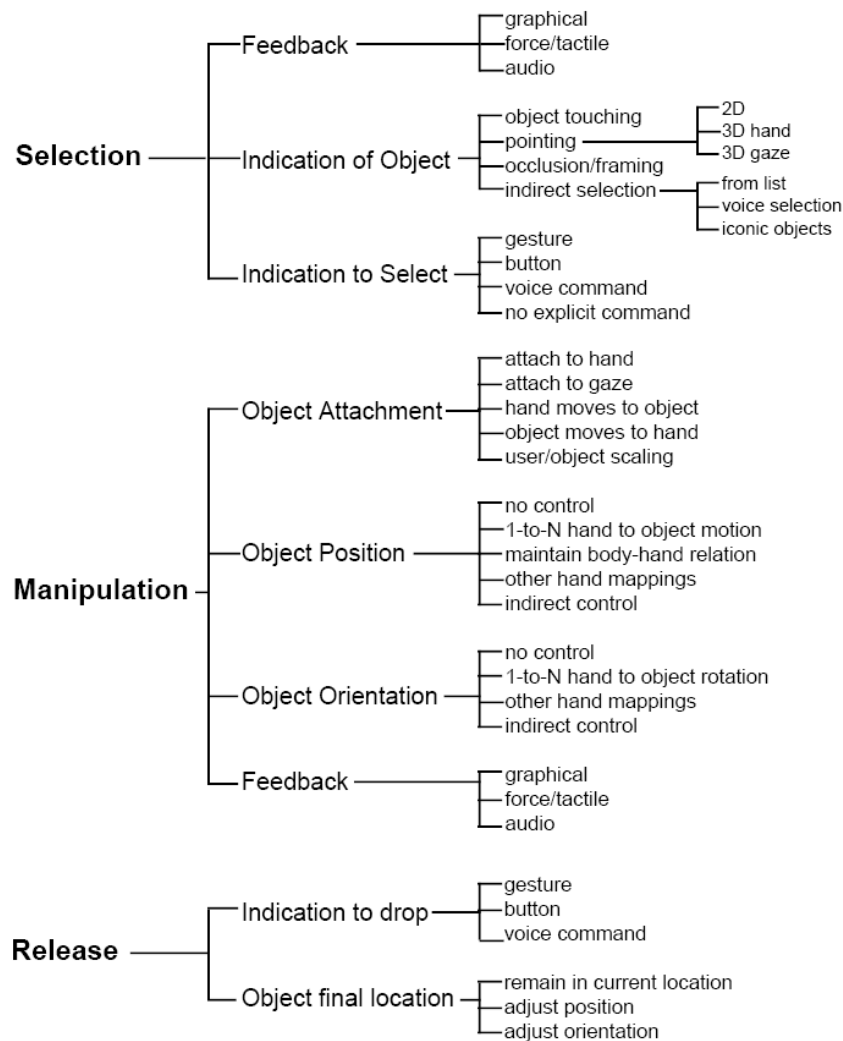

Figure 3.2. Taxonomy of selection / manipulation techniques (Bowman, 1999).

Bowman (1999) also list some performance metrics for immersive travel techniques, such as; Speed (efficient task completion), Accuracy, Spatial Awareness, Ease of Learning, Ease of Use,

Information Gathering, Presence, and User Comfort. This list will be used in our experiment to evaluate performance of our TBS application.

The development of a user interfaces with the principle that an appropriate overall interaction metaphor makes a system more usable. Therefore, better tuning of the synchronization between visualization of the simulation and interaction is needed. The tools embedded in this environment should focus on data integration and simulation interoperability. A generic data integration solution may be possible when tools are in semantically close domains. Fortunately, the IFC format reflects awareness of this fundamental issue, particularly for the AEC tools.

The integration initiative supports the view that the tools should be able to respond to explicit analysis scenarios, i.e. be able to handle a particular simulation request and produce output that is cognizant of the context of the request. This can be accomplished by defining project models that contain workflows with interactions. The challenge is therefore to develop user driven, constructive interfaces. The interface is bundled with the simulation scenario. The Scenario layer communicates with the building analysis model layer. Data instances are extracted from an analysis model to be used in scenario tasks whereas the results of an analysis are committed back to the model. The interfaces that execute these user driven simulations provide access to heterogeneous thermal results. It facilitate a quick and an accurate evaluation and comparison of design alternatives.

Of equal importance in TBS is ensuring the health and welfare of users who interact with the VE. If the human element in these systems is ignored or minimized it could result in discomfort or harm. Also, failure to meet the performance requirements will cause the immersion to fail, with consequences for the usage of such system. There are several health and safety issues which may affect users of VEs. The direct effects can be looked at from a microscopic level (e.g., individual tissue) or a macroscopic level (e.g., trauma). The indirect effects are primarily psychological (Stanney, 1995). Some individuals are susceptible to “flicker vertigo” when they are exposed to flickering lights. Another direct macroscopic effect motion sickness (i.e., cybersickness) that could prevent VR from realizing its full potential. Everything required to support the working of the virtual environment, including data management and access, user interaction, computation, and rendering, should consider these constraints.

To summarize, the real-time interactive environments can enhance the role of scientific visualization of TBS. A more realistic representation conveys more detailed and richer information to assist a human’s comprehension ability thus augmenting the cognitive process and activity. So, in order to make this visualization system easy to use, the human-computer interface should be intuitive. Such a system will clearly require interactive capabilities which allow intuitive control of the data visualization displays, avoiding as much as possible difficulties due to the arbitrariness of the interface. The interface technology aspects are including: Interaction (real-time feedback, natural interface, unobtrusive simulation actions), immersion (spatial assessment, three dimensional representation, real-time movement), simulation (calculation and rendering of (physical) properties of the design) and visualization (representing non-visual information in a visual manner to provide feedback). The most obvious need is for the ability to rapidly and precisely select a task and a location in three dimensions. There are three components to this ability: the ability to specify a space, an action at that space, and the ability to provide feedback.

### 3.3 VR Applications, CAD and TBS

As explained earlier, many people associate VR with games and the most compellingly real presentations of physical settings available with computers. On the other hand, CAD is associated with architectural and/or engineering drawings. While VR is often refer to more realistic-looking models, CAD is refer to more accurate and precise ones. CAD programs were created for site and building models. VR programs are most adept at presenting models. As describe in chapter 2, TBS tools is used to study thermal performance of buildings and to evaluate architectural design. In fact, since there is a solution for interoperability, the different function of these three technologies has not also concerned with what kinds of models may be used, but with the programs' best features.

The use of 3D Game Engines to create real-world Walkthrough-Virtual Reality (VR) applications is increasing to currently available commercial VR packages (Shiratuddin et al., 2002; Romain et al., 2010). While many VR company have developed procedures for importing data from CAD applications into VR applications, some researcher takes a different approach to integrating CAD and 3D game engine, even thermal simulation tools with VR.

This section describes the framework and the review of developed VR application utilizing a CAD software and a 3D Game Engine, as well as some approach to include thermal simulation software. The integration between the three technologies enables the creation and sharing of a common geometrical database between them. By utilizing such integration method, realistic VE can be created from the CAD models and then to include TBS results.

#### 3.3.1 VR-CAD Integration

VR techniques can be successfully used at many stages of design. VR applied to CAD allows virtual prototyping to become a significant part of the design development cycle. Nevertheless, in TBS cases, the objects are currently still created with CAD software and then exported into standard graphic object formats, such as FBX, VRML, STL, Txt, etc.

Several studies have been conducted using design tools to represent design results in VE. Studies regarding 3D CAD models and immersive environments, for example, try to focus on VR-CAD integrated systems to evaluate the design process (Toma et al., 2012; Bourdot et al., 2010; Weidlich et al., 2007; Ingrassia et al., 2009; Sampaio et al., 2012, 2010, 2008; Shiratuddin et al., 2002). These works were carried out to develop concepts, methods and tools for integrating VR as a user interface into the process of geometric modeling and detailing. They focused on CAD data workflows and design review, and became initiate concepts for the visualization of thermal building simulation in VE.

However, VR-CAD data exchange is one of the most important issues faced by the virtual prototyping community. CAD systems used by the industry to develop their product models are generally unsuitable for producing optimal representations for VR applications (Seth et al., 2010). Most VR applications take advantage of scene-graphs (e.g., Openscenegraph, OpenSG, OpenGL Performer, etc.) for visualization which are simply hierarchical data structures comprised of triangulated mesh geometry, spatial transforms, lighting, material properties, and other metadata. Scene graph renderers provide the VR application with methods to exploit this data structure to ensure interactive frame rates. Translating CAD data into a scene graph requires translation of the individual precise parametric surface, often multiple times, to produce several —level-of-detail polygonal representations of each part. During this translation process, the parametric (procedural modeling history and constraints) information of the CAD model generally does not get imported into the VR application. In addition, pre-existing texture maps may not be included in these visually optimized model representations. In virtual assembly simulations, geometric constraint-based applications that depend on parametric model definitions to define inter-part constraint relationships generally have to deal with two representations of the same model: one for visualization and another for constraint modeling algorithms for performing assembly. Similarly, physics modeling applications also use dual model



representations: high-fidelity model for visualization and a coarser representation used for interactive physics calculations (Seth et al., 2010).

After all, there is a workflow issues to process CAD models with VR techniques. This is not only because most of VR-CAD applications only manage meshed objects, but also the current VR-CAD software still needs an intuitive interface to interact with CAD meshes. There is a clear shortage of true VR-CAD integration to directly interact with native CAD models. In addition, implementing a complete VR-CAD framework requires the combination of a number of such haptic solutions. Therefore, the transition between various haptic paradigms particularly becomes a critical issue (Bourdot et al., 2010). This issue of workflow has been a challenge in the integration process from CAD to VR. Tang (2006) has tried to make a simple integration using a low cost 3D game engine (Fig. 3.3). Using a simple display, the work is approached the design as VR-CAD application. Its involving two design tools, two rendering engines (the “all in one” 3D modeling solution software), and one 3D game engine.

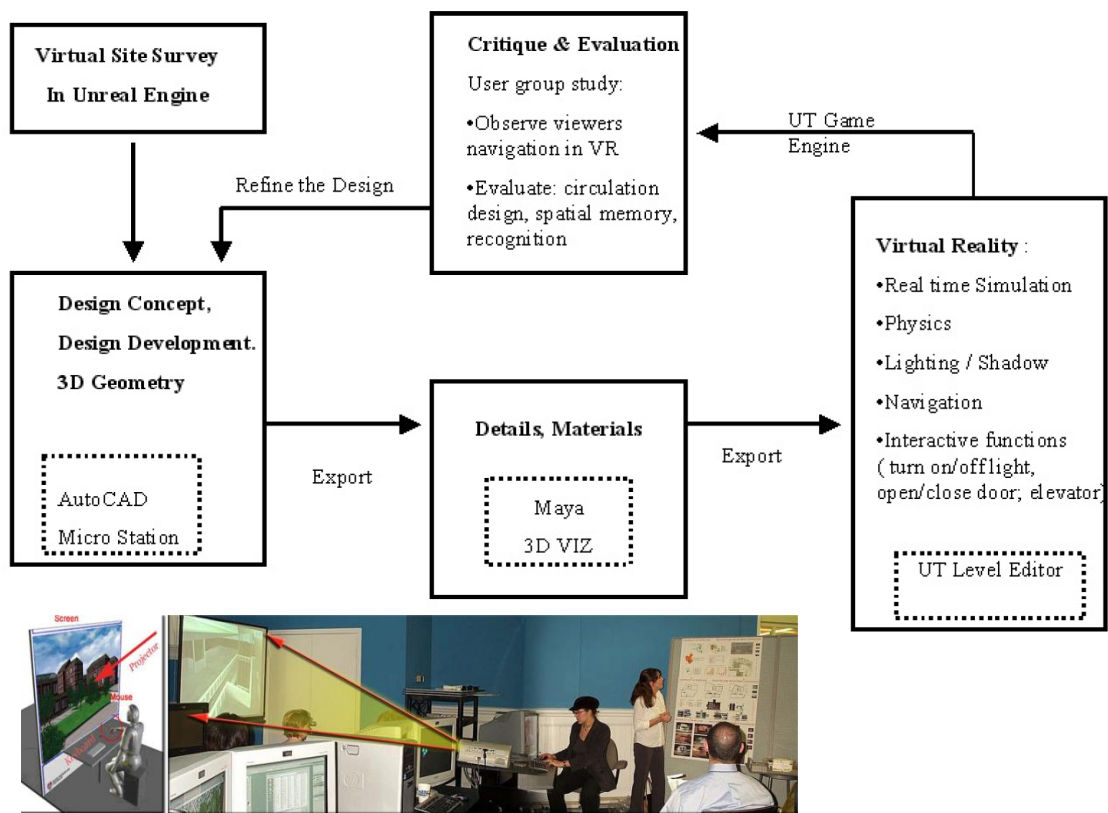

Figure 3.3. An approach to integrate CAD design and VR. The work used a low cost 3D game engine as a VR aided design for the architectural education. Workflow of Software involved are; 3D modeling tools: Maya, 3D Studio VIZ, Micro Station, AutoCAD; 3D game engine: Unreal Engine (Tang, 2006).

Similarly, Ku et al. (2011) proposed a building interactive modeling for construction education in VE (Fig. 3.4). The work is using 3D modeling software and a game engine, furthermore to integrate with BIM. Nevertheless, despite the potential benefits of virtual worlds, various obstacles exist particularly in interoperability and simultaneous review of multiple design options. The two integration techniques described are intended as a VR aided design for the architectural education (not including thermal simulation tools).



Figure 3.4. A building interactive modeling for construction education in VE proposed by Ku et al. (2011). The research using the AC3D software (3D modeling software) and Second Life platform (a game engine), to address the communication issues and effectively complement traditional teaching approaches and furthermore integrate with BIM to enhance construction education.

Commercial CAD systems (for example AutoCAD, ArchiCAD, Dassault Systems, etc.) have made various attempts to embed capabilities for immersive and desktop stereo visualization into available commercial software to some degree. Attempts have also been made by academia to provide haptic interaction and immersive visualizations for assembly/disassembly applications with commercial CAD systems. Thus, although addressed to some degree by industry and academia, there is still no general non-proprietary way to convert CAD assemblies into a representation suitable for VR. In this case, for a process of integration of CAD to VR, there is still a vast opportunity, both in terms of methods and tools (for example by using the game engine). It all depends on the creativity in selecting and integrating the methods and the tools.

### 3.3.2 Review of VR Application for Scientific Visualization of TBS

This subsection discusses the review of the application of TBS to a VE, as a continuation of the VR-CAD workflow method from the previous subsection. Several works have been conducted to represent TBS results in VE. Fricoteaux (2010) has studied the creation of thermal Information in VE called Thermic3D conducted at the Heudiasyc UTC laboratory (Université de Technologie de Compiègne) in partnership with Saint-Gobain Recherche. The systems have been developed around the issue of the scientific visualization in VE and propose different solutions to retrieve information regarding thermal data, and re-transcribes thermal calculation results in a virtual building. Thermic3D system is designed to be driven by people who are experts in thermal but did not used to deal with VR systems. After, they must explain their thermal calculation results to non-experts (engineers, marketing engineers, architects, etc.).

In the workflow: thermal calculation used TRNSYS, modeling used 3DsMax, and the simulation is realized in Virtools. The general model including input (geometry and thermal parameter), simulation (calculation and visualization) and interaction (Fig. 3.5). The interface is adopted Model-View-Controller (MVC) architecture. The user input, the modeling of the external world, and the visual feedback to the user are separated and handled by model, viewport and controller objects.

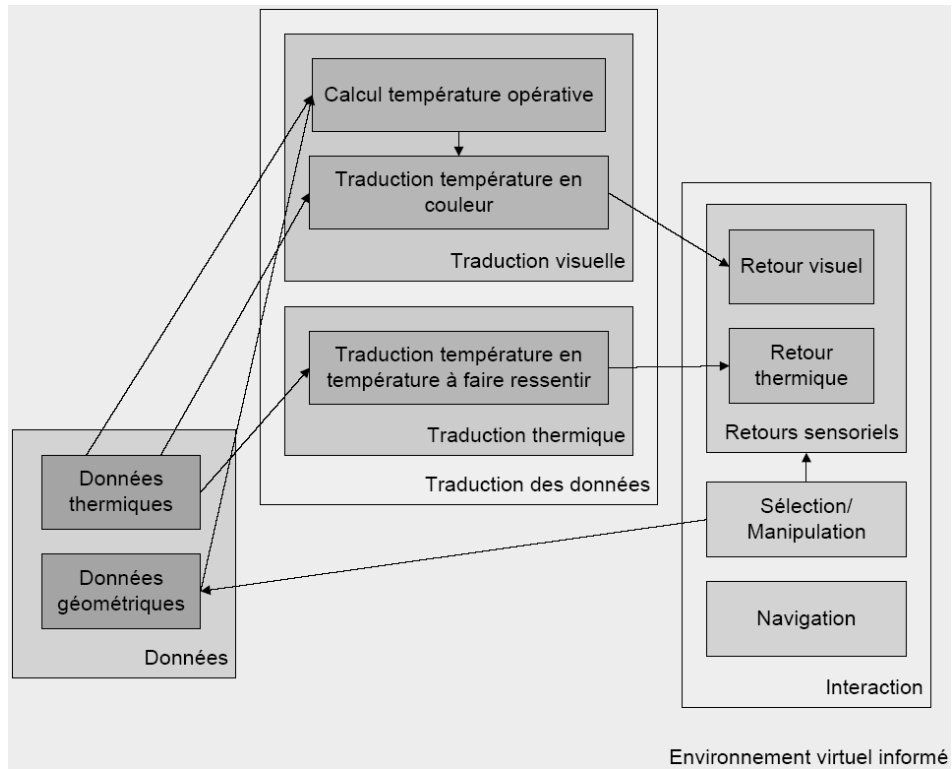

Figure 3.5. General model of Thermic3D (Fricoteaux 2010)



Figure 3.6. Visualization of the temperature modification in a living room (Fricoteaux 2010)

Thermic3D has proposed a new technique for visual representation of data, extracting 3D objects to visualize the evolution of the temperature in the objects. The system particularly deals with combining visual and thermal feedback to recreate the concept of thermal comfort in a VE (Fig. 3.6). The prototype reproduces thermal calculations results using TRNSYS integrated in a virtual building visualization in big screen and equipped with hardware such as PC, speaker, infrared camera, 3D glasses and small peltier plat. The experiment made some excellent progress concerning solution to perceptions of thermal data, especially for visual and thermal feedback in VE, but problems in representing details of the thermal calculation results in 3D volumetric with friendly interface remain.

Taisei corporation Japan (2013), the construction industry's data center thermal analysis system uses Hybridvision. Their VR technology confirms the results of full-scale simulations. Major equipment, such as server racks and air conditioners, can be created at full scale, and images of a completed data center can be previewed. The results of air flow and thermal simulations in data centers are

superimposed in a VR display that accurately recreates the data center's space. It seeks optimum solutions to thermal problems by conducting repeated simulations using the study results as input conditions.

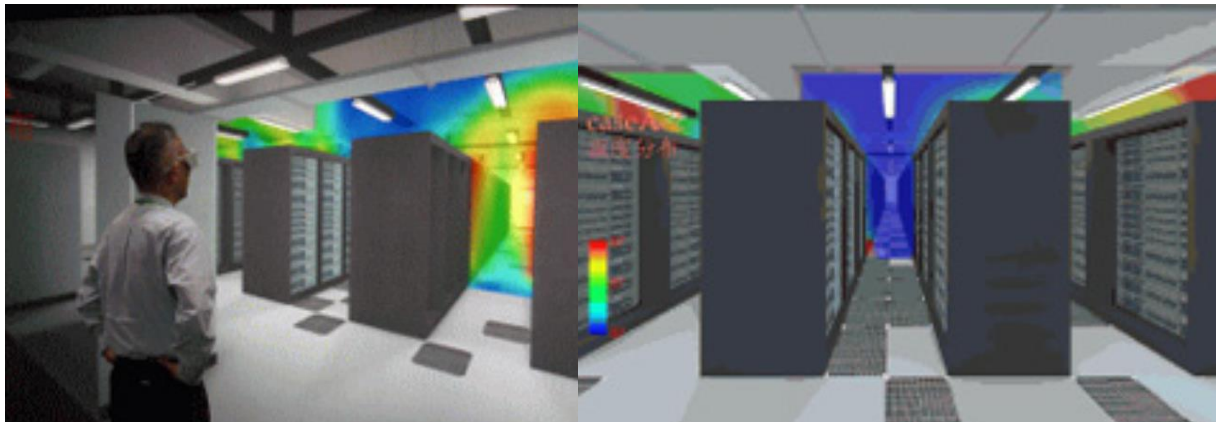

Figure 3.7. Temperature distribution in a computer room (data center). Study of optimum solutions through simulations using VR simulation technology (Taisei corporation Japan, 2013).

Ham et al. (2013) presented Energy Performance Augmented Reality (EPAR) modeling, a new methodology of using unordered digital and thermal imagery as well as CFD models to compare between actual and simulated building energy performance and identify the deviations in 3D environment.

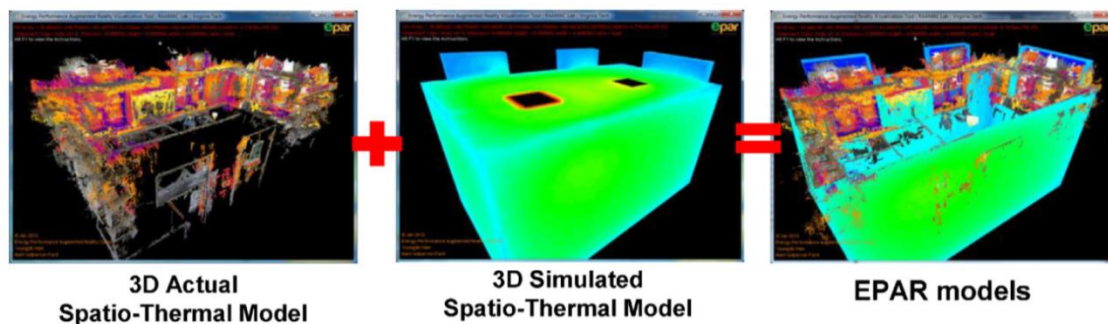

Figure 3.8. The concept of the proposed EPAR modeling.

The outcomes are EPAR models which visualize actual and expected models in a common 3D environment. The simulated energy performance is visually overlaid on the actual energy performance of the real-world in 3D, and facilitates the detailed comparison of the two results. However, the simulation only focused to facilitate the identification of potential areas for building retrofit. The data and process or the workflow in the proposed method is still complicated and the outcome is not intended to be interactive.

Crouse et al. (2002) demonstrated the modeling of convective flows based on a 3D lattice Boltzmann approach for low Mach number flows with variable density combined with a large eddy turbulence model. The visualization techniques integrate the simulation results and the CAD model in a VR environment. The workflow integrated within a CAD environment, the geometric model, based on an IFC building product data model, is discretized using a Cartesian grid based on a tree topology. These data then reading from a VRML file.



The computation was performed on a high-performance parallel vector computer, the Hitachi SR8000-F1. For preprocessing, the generation of the three-dimensional computational lattice has been integrated into the Architectural Desktop environment. Based on IFC model, a surface mesh for each mass element consisting of triangular and quadrilateral facets is generated at the interfaces between fluid and solids. For visualization purposes, the application VirtualFluids is used. This application is designed for a combined visualization of simulation data and a corresponding spatial CAD model. This technique used a moving 2D translucent in the EVE. On these plans, the temperature is represented by a color code: blue for cold and red for warm. Placed in layer composition, the plane (s) cuts into the space or object to show the temperature. These orthogonal cutting planes are used to visualize scientific data in a building to control the effective management of energy. The thermal visualization using a cutting plane was very interesting particularly for the accuracy. However, there are difficulties regarding workflow in translation of thermal data into the VE and presenting it a friendly interface.

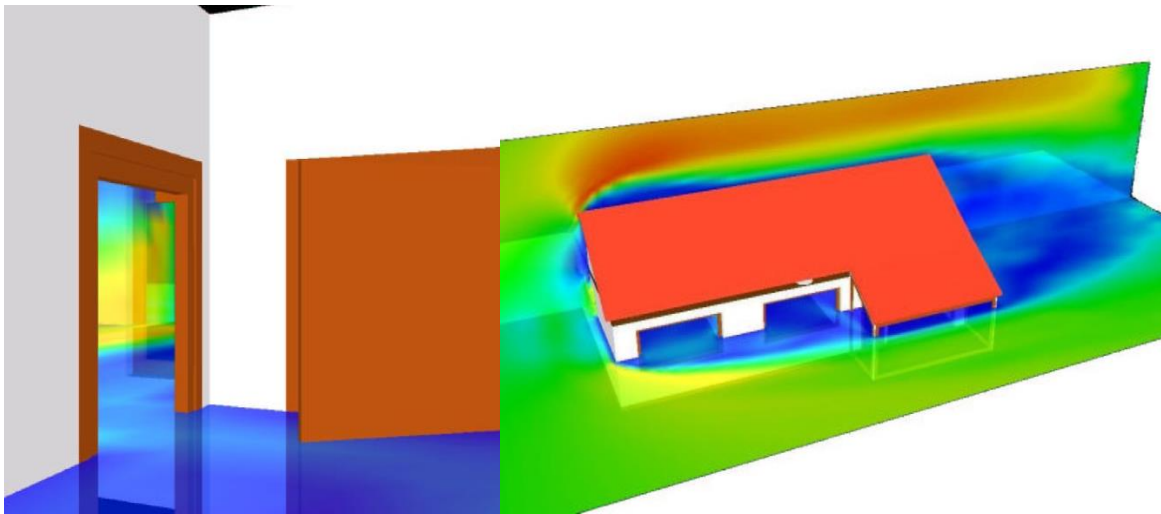

Figure 3.9. Walk through the building, averaged velocity field (left). Turbulent flow, orthogonal slice planes of the averaged velocity field (right).

Van Treeck et al. (2006) presented work on the development of an interactive Computational Steering Environment (CSE) for interactive indoor thermal comfort simulation by using high-performance supercomputing facilities. The numerical method is based on the hybrid thermal lattice Boltzmann model. The CSE allows for modifying both the geometric model and the boundary conditions during runtime with immediate visualization of changes in the results. The application is demonstrated by two industrial applications with complex geometries, turbulent natural convection in the separator room of a ferry boat, and turbulent convection in a passenger train's carriage.

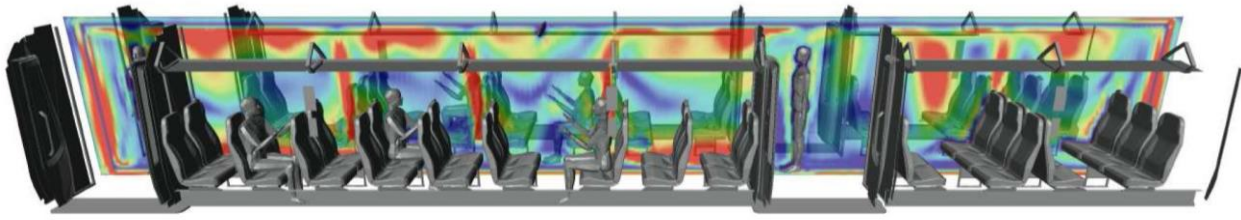

Figure 3.10. Turbulent natural convection in the open carriage of a train. The buoyant flow is driven by two lines of heaters placed along the lower section of the seats next to the cabin walls.

The work integrated an interactive user interface with a context-based 3D menu to provide an intuitive front-end in the application. It used the Mercury Open Inventor library and supports VR environments with single or multiple projection screens and head/input device tracking. Similar to Crouse et al. (2002), orthogonal cutting planes are used to visualize scientific data. The approach using thermal visualization concept for local thermal comfort analysis is very comprehensive. However, if the calculation is not focused only for single task simulation and used a numerical manikin despite a real test user, it can significantly facilitate the comparison of several results in different time calculations with immersive sensation. More research needs to be done to generate 3D models and integrate those with advance interface for the purpose of analyzing thermal performance in 3D immersive.

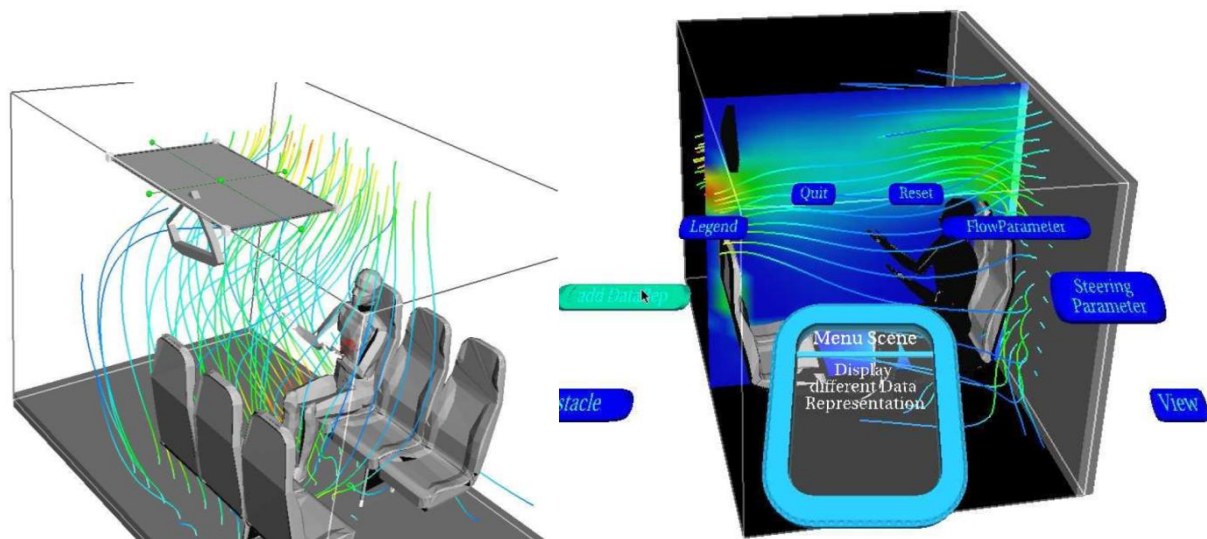

Figure 3.11. Screenshot of online interactive simulation run of air flow inside a passenger cabin. The menu showing the integrated VR user interface is on the right.

Malkawi et al. (2005) have worked on an interactive speech and gesture recognition-based, immersive Augmented Reality (AR) model designed to visualize and interact with buildings and their thermal environments. The model includes four components: wireless sensor data, CFD analysis, HCI, and AR visualization. The sensor data component tracks temperature and velocity changes that occur within a room and updates the boundary conditions for simulation. The workflow includes: design feasibility, meshing (Gambit v2.0.6), CFD analysis (Fluent v6.02), and export and store VRML models. CFD data is first converted to VRML format. This data also needs to be calibrated in order to be viewed accurately. Calibration involves mapping the VRML model to the actual space by performing geometric transformations such as scaling, rotation, and translation.

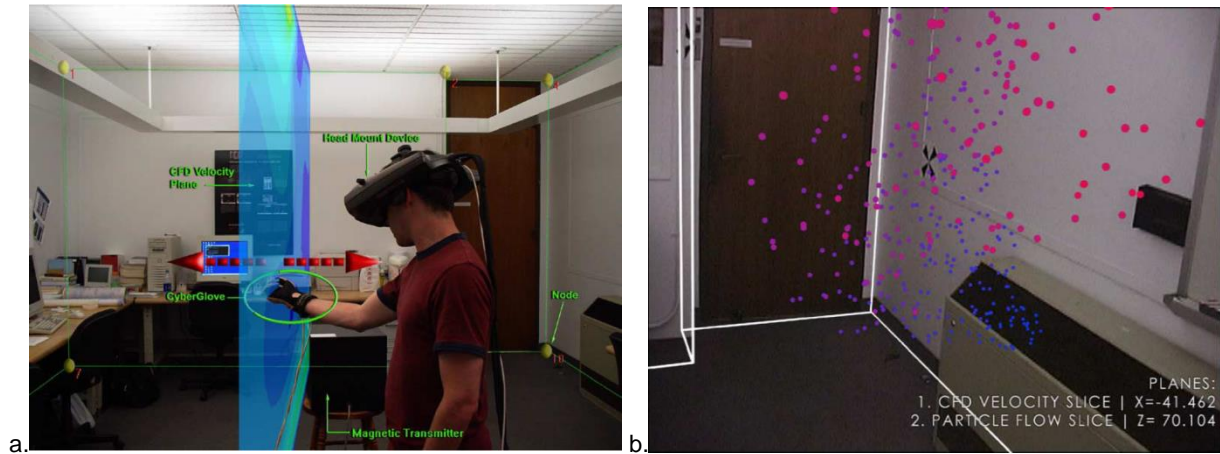

Figure 3.12. (a). External view of a user interacting with a CFD isoplane, (b). Dynamic particle visualization as seen by the user through the HMD.

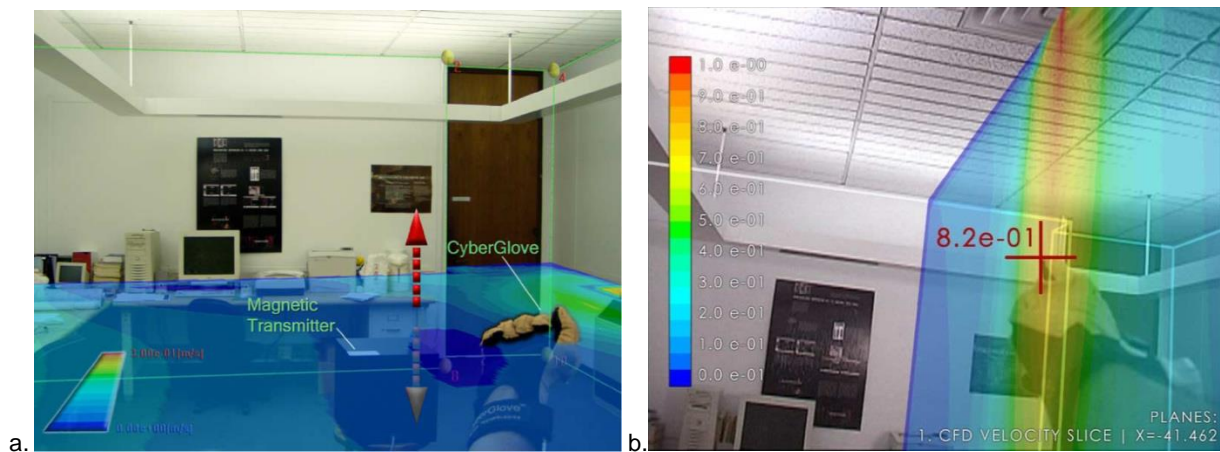

Figure 3.13. (a). Isoplane as seen by the user using AR system (in horizontal), (b). Isoplane as seen by the user through the HMD (in vertical).

The implementation of a Human Building Interaction (HBI) was used in an immersive AR environment to visualize CFD simulation results in actual space and in real time using speech and gesture recognition mechanisms. The system allowed the user to visualize the thermal behavior of a room while navigating through the space and interacting with it. The thermal metaphors presented were colored fluid dynamics and particles in isoplane through HMD. However, while projected in VE the user is still burdened with by number of sensors and other heavy equipment. The experiment did not focus on multitask simulation, for example before and after renovation and calculation results during the year. The research demonstrated that constructing an AR system is a challenge due to issues, such as the sensitivity of human eyes for detecting registration errors is extremely high, related to AR hardware.

Hoang et al., (2010) present VFire, an immersive wild fire simulation and visualization system. Users are placed in a VE generated from real-world data regarding topology and vegetation. The simulation is performed on the graphics card, which then provides visualization of the results. The system is intended to train fire chiefs in planning containment efforts and to educate fire fighters, policymakers, and the general public about wild fire behavior and the effects of preventative measures.





Figure 3.14. VFire running in a 6-sided CAVE-like environment. The data layers can be modified by the user using joystick.

VFire is a wild fire simulation and visualization tool built for an immersive virtual environment. Users are able to load data about a geographical region and then experiment on it by starting fires, manipulating fuels, and altering weather conditions. In this work, immersion is primarily achieved through visual feedback. This is accomplished through the use of depth cues (stereoscopic) and specialized hardware (CAVE). Visualization of fire behavior is achieved through the use of a particle system on the GPU. Particles are generated by streaming emitters through a geometry shader that emits particles based on the state of the emitters. The buildings are composed of a cube with a gable roof, which are drawn from a single point passed to a geometry shader (Hoang et al., 2010).

As can be seen from the previous projects, thermal visualization using a metaphor has been applied in a number of applications. However, there have been fewer examples of this being applied in a CAVE setting, and no previous work compared thermal metaphors to visual conditions in a realistic CAVE task. In addition, apart from complicated workflow, their thermal metaphor and task scenario in user interface is less resemble to the real environment which could leads to misinterpretation by the user.

### 3.4 Summary

Current state and actual requirements for 3D visualization and interaction in VR have described in order to representing TBS. The new trends in VR technological components useful for TBS representation has also described as the new possibilities. The explanation is useful in selecting approaches to define appliances and work phases, starting from the planning, modeling, calculating and presenting the TBS results in VE.

While many significant applications of virtual reality to scientific visualization may be implemented with existing technology, the current state of the technology to integrate TBS results is limited. The issues lies in the senses and the right devices needed to produce immersive visualization and intuitive interaction. However, a VR interface is reliable for visualization and interaction of TBS results, as it can provide the essence of VR experiences: immersion and presence. It can be used in as natural a way as possible, and provides as unambiguous a three-dimensional display as possible.

Interactivity is fundamental to scientific visualization of TBS. The immersive VR can provide good environments also for advance visualization. Since immersion depends on the vividness of the display, its factors are closely related to the devices that lead to realism in representation. Therefore,



the ability to visualize complex computations and simulations is absolutely essential to insure the integrity of analyses, to provoke insights and to communicate those insights with others.

Many efforts have been made, through the quality of the material representations and actions performed by users. One of the most common complaints about thermal realization in virtual world experiences is the lack of physical as well as psychical sensations in the environment. Only a few potential applications have been developed that allow the thermal sensation to have a more realistic perception of virtual objects that might have a significant effect on visual displays. A room-sized with advanced visualization solution that combines high-resolution, stereoscopic projection and 3D computer graphics should be considered, as it creates a complete sense of presence in a VE. Therefore, one of the major challenges in this research is how to use CAVE system for the translation of thermal data for a correct interpretation of the user.

As several related works have shown, the developed methods and applications offer some potential solutions for thermal representation and interaction in VE. Their thermal metaphor solutions can be classified into three categories: Visualization on cutting planes, projection on objects and limited volumetric visualization. Some works have chosen to use cutting planes and limited volumetric visualization methods that describe the thermal properties in space. Some workflows that have been described in some works are very valuable reference. It shows that the integration between the three technologies has involved developing VR application. They are: CAD software (and/or “all in one” 3D modeling solution software), thermal simulation software, and VR software (or 3D Game Engine). Relating to this work, their workflow method will be considered certainly with respect to BIM and specific technological component.

# Chapter 4

## Method of Representing Thermal Building Simulation in VR System

### Abstract

Method of representing TBS results is framed by the performance of selected application and its data formats with emphasize principle of integration for thermal calculation and scientific visualization in VR. This is to overcome the issue of the data formats and the workflow used for 3D modeling, thermal calculation and VR visualization.

This method is emphasized to deliver suitability between the framework and the application tools before test them with experiments. Some standard procedures, settings, and behavior apply in VR system are explored and determined to present the TBS result appropriately. Development of TBS model in VR system is then enriched with our specification of TBS visualization and interaction in VE.

Chapter four establishes the method of representation of TBS in VR. It begins from 3D data as the basic input of VR system, the workflow and technique of visualization and interaction in VR. It describes the visualization concept of TBS toward the VE. The design phase begins from CAD Modeling (Revit Architecture), thermal calculation and simulation (Ecotect analysis) and preformatted data using Perl Routine. Finally it describes the process to integrate the data to 3D Via Studio (Virtools) and the method of specifying the TBS Visualization and Interaction in VE.

### Contents

4.1 Workflow toward the Virtual Environment .....	69
4.2 A 3D Model and its Thermal Analysis prepared for the VR System .....	71
4.2.1 Modeling in Revit Architecture .....	72
4.2.2 Thermal Calculation in Autodesk Ecotect .....	75
4.2.2.1 Weather Manager and Weather Data Import .....	75
4.2.2.2 3D Modeling and Import-Export of the Geometry .....	76
4.2.2.3 Material Assignment and Material Properties .....	76
4.2.2.4 Zone Settings and Occupancy Schedules .....	77
4.2.2.5 Thermal Analysis / Calculation .....	78
4.2.2.6 Visual Analysis .....	78
4.2.3 Data Treatment in VR System .....	80

4.3 Development of TBS model in VR system .....	81
4.3.1 Perl Routine (Preformat application) .....	81
4.3.2 Setting in 3DVia Studio (Virtools) .....	84
4.3.2.1 Object Geometry .....	85
4.3.2.2 Particles .....	85
4.3.2.3 Camera .....	88
4.3.2.4 Scripts and Object Behavior .....	90
4.3.2.5 Interaction Feedback .....	91
4.3.2.6 Graphical User Interface .....	92
4.4 Specifying the Visualization and Interaction of TBS in VE .....	93
4.4.1 The Visualization of TBS in VE .....	93
4.4.2 The Interaction of TBS in VE .....	96
4.5 Summary .....	99

The idea of generating 3D models that can be immediately recognized and processed by thermal tools and then VR tools is the main objective. The workflow integrate data format to each application involved, so that resulting in a seamless exchange and reliable when displayed in VE. The data flow that starts from the design process strived to channel up to the VR system completely and accurately. Next sections describe the TBS data workflow toward the VE. Its detail the steps starting from the input, the integration process, and the output in VE, along with the tools used.

### 4.1 Workflow toward the Virtual Environment

The workflow is developed in three steps: planning and modeling, thermal calculation, and the integration to VE particularly to CAVE (Fig. 4.1). These steps are refers to the BIM method and using previous selected tools. The work also conducts experiments for the VR application on the PC and tablet (Fig. 4.2).

- The planning has to take into consideration the final purpose of the presentation. The definition of the tasks and their details has to be done according to this idea. The idea is then realized in modeling. The geometric modeling needs to relate correctly with the tasks defined in the planning step. We used some popular software in each field, from 3D modeling solution to rendering engine commonly used in BIM. The selected software including: Revit Architecture (a BIM software, used to design a building and its components in 3D), 3DsMax (a 3D computer graphics software for making 3D animations, models, and images).
- Thermal calculation and simulation is actually an integral part of the modeling. We used an established thermal analysis tools as well as BIM appliance, Ecotect.
- The integration into the VE makes use of two optional programs: 3DVia Studio and/or Virtools. They are VR software commonly used to integrate and manage VR devices (CAVE-like and tablet). It takes the 3D model created from Revit Architecture, 3DsMax and Ecotect. In terms of simulation and visualization, we include interactive scenario with navigation keys for the user. A true three-dimensional perception is achieved using stereoscopic projection techniques.

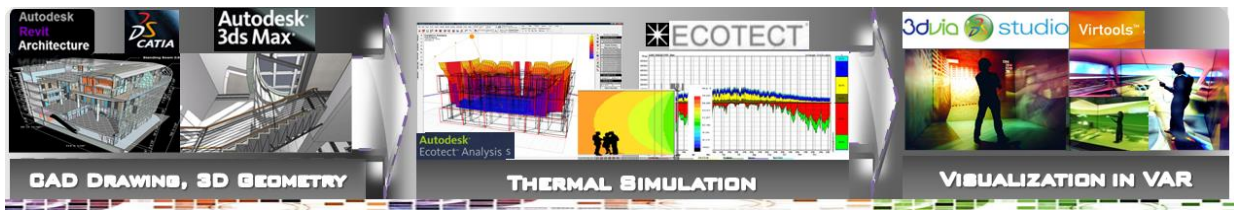

Figure 4.1. The three steps of data workflow from design software to VR system. The first two steps are to accommodate the tools and the method that are commonly used by AEC community.

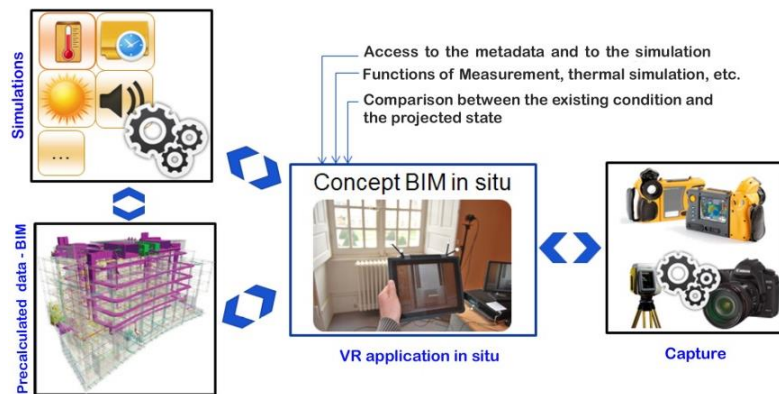

Figure 4.2. Generic workflow for visualization in a PC and tablet. This concept used the same principle of three steps data workflows toward the thermal simulation and visualization in VE (immersion room).

Figure 4.3 describes the detailed Illustration of workflow with the format of data exchange. A 3D model begins from Autodesk Revit exported in .Fbx to be read and textured in Autodesk 3DSMax. At once, the geometry is also exported to Autodesk Ecotect (ifc/gbxml) to have a thermal calculation result. Data exchange from Ecotect to 3DVia Studio can proceed with exporting Txt format.

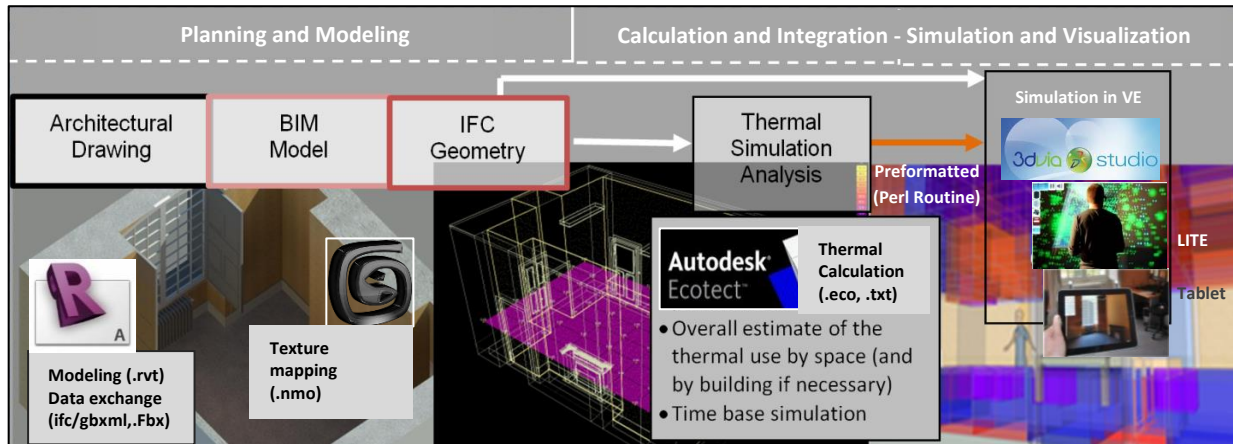

Figure 4.3. Detailed Illustration of data workflow of TBS toward the VE. Main applications involved: Revit, 3DSMax, Ecotect, 3DVia Studio (or Virtools), and Perl Routine for preformat.

In terms of visualization and interaction, we include interactive scenario with navigation keys for the user. 3D model and thermal calculations have been carried and recorded at the beginning, so that users can instantly using the button on the UI to perform the simulation. This is to achieve an efficient simulation that involves the agent and its environment to collaborate in an integrated management system (Fig. 4.4). The system is expected to have this objective including:

- Provision of 3D animation of geometrical or architectural objects from inside the virtual environment without having to import such objects from an external thermal tool system.
- Provision of simulating the thermal properties of thermal objects from inside the VE.
- Automated assembly hierarchies between architectural objects and its thermal performance using constraint-based rules that facilitate the synchronization for all changes in time and position.
- Improved interaction techniques that substitute the real world interaction, graphics rendering systems that generate high quality stereo images, and realistic behavior of objects in VEs.

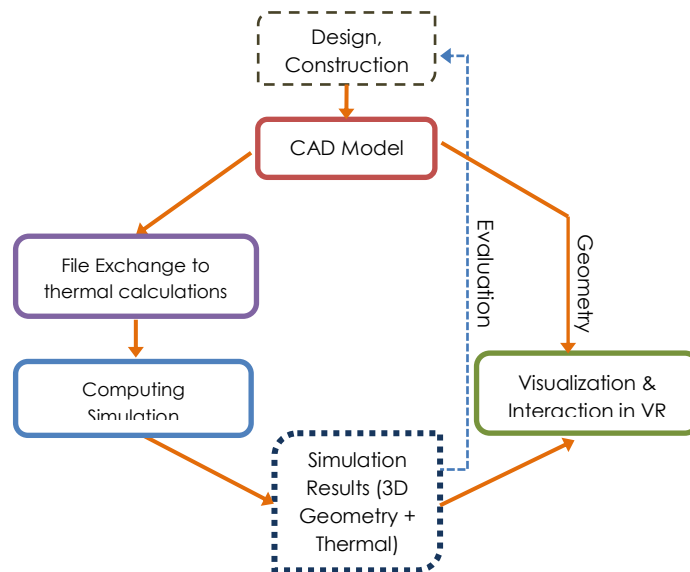

Figure 4.4. Illustration of management system for the visualization and interaction.

## 4.2 A 3D Model and its Thermal Analysis prepared for the VR System

Modeling is a crucial work of TBS toward the VE. User must be able to interact with the created model as with the real world. So it requires a model that is able to be integrated for further process. This section discusses the significance of the 3D modeled objects its thermal analysis prepared to the VR system. The object contains of required data of CAD modeling as described earlier at the end of chapter two (Tab. 2.3). The modeled objects should have natural behavior assigned to them (in some cases also autonomous behavior). The object components must be constant during the integration process. This process will perform a join action integrally or an exchange data to thermal software before proceed to VR system. Referring to the TBS output, CAD tools have to configure and parameterize each building data in an individual way. The desired geometrical data (completed 3D model) then used for thermal calculation by transferred them into thermal software. The data resulting in thermal calculation results along with the geometry. As describe earlier, the transfer operation of such data can be delivered using suitable data exchange formats (e.g the IFC-format). This format allows transfer of object of structured building models from CAD to thermal building simulation tools. It then enriches and pre-format using other added software as the VR software has different platform. By then the results should possibly transferred to VR software to have an advance presentation.

Begins in design tools, a building create as 3D CAD data (in this case we used Autodesk Revit Architecture 2012). The data contains of geometrical, topological, and common surface elements. These CAD data then exported to a thermal analysis software (in this case we used Autodesk Ecotect). The data including: Building spaces, spaces (Temperature value, ventilation, building elements, material), thermal analysis zones and annual results. In thermal software, the building will analyzed according to zones which is determined by rooms. These data has to be transferred because CAD application does not bind this entity to objects. A “thermal zone” which may cover one or more rooms, is an important basic structure for thermal simulation. In thermal application the data will bind into an appropriate zone by the IFC format.

In the next step, after thermal calculation has finished, the data is then transferred to VR software. In this case we used 3DViaStudio/Virttools. Thermal data will processed into code information (2D graphic), as well as air airflow simulation (3D particle). For instance, user can choose a time point within the simulated time period for the steady state of CFD (Computational Fluid Dynamics) simulation in Ecotect. The result of thermal calculation and the three dimensional temperature, is then transferred and visualized with 3DVia Studio/Virttools. The data including: temperature in scale, text and 2D graphics, and it metaphors in 3D entity (particles, etc.). The quantity of model presented by post processing are available as 3D simulation result and figures or graphics of hourly, daily and monthly temperature statistic.

The following subsections detailed the three phases from the steps of data workflow. Firstly, the design phase, it is regarding standard operation procedure for energy model using CAD Modeling (Revit Architecture). Secondly, thermal calculation phase. In this phase such analyses proceed to validate thermal calculation result (Ecotect). The last phase is data treatment in VR system (3DViaStudio/Virttools). This is to adjust the prepared data into the final output of the TBS representation. This last phase will more detail in the next section which is describe the development of TBS model in VR system.

### 4.2.1 Modeling in Revit Architecture

CAD geometrical data is created using architectural design method. This design proposed building layout including functional and non-functional space configuration and placement of other geometric elements. The main parts of the elements include:

- The site and building location
- The building orientation including its relationship to the true north
- The site and building elevation above the reference datum
- The building story information
- 3D Geometry of adjacent building
- 3D Geometry of the building, including walls (exterior/interior), curtain walls, roofs, floor/slabs, ceilings, windows/skylights, doors and shading devices
- Space objects, including those defined by virtual space boundaries

In Revit, these elements are structured and managed in specific manner, particularly according to BIM. Revit Architecture use .rvt files for storing BIM models. It supports export and import 3D data in various formats including the open XML-based and IFC standard (Tab. 4.1). Typically, a building is made using 3D objects to create walls, floors, roofs, structure, windows, doors, electrical systems and other objects as needed. These parametric objects- 3D building objects (such as windows or doors) or 2D drafting objects (such as fasteners) - are called "families" and are saved in .rfa files, and imported into the .rvt database as needed.

Revit Architecture Native	Import	Export
.rvt: Geometry files-- used as CENTRAL files (Database repository file), and LOCAL files (transient files). .rfa: Family files (Object libraries). These are re-usable revit objects. REVIT comes with a set of ready-made libraries, and allows for creating customized ones. .rte: Template files--where preferences can be saved (drawing units, interface parameters, etc).	dwg, dxf, dng, ifc, sat, skp.	adsk, dwg, dwf, dxf, dng, ifc, ODBC, sat, gbXML.

Table 4.1 Revit architecture file formats and exchange

Figure 4.5 describes Revit user interface. This interface accommodates working system for building planning and design, which is normally carried by building experts (architect). It comprises several screens, panels, and toolbars that facilitate project organization. For example, the Project Browser has places for structural plans, 3D views, and elevations. The Project Browser also contains more complicated aspects of Building Information Modeling (BIM) that include legends, schedules, quantities, and sheets (Autodesk 2013). The ribbon bar used for modeling (Fig. 4.6). It provides the majority of the tools necessary to create a project or a family. Each tab in the Ribbon holds a menu of different functions related to the model opened. For example, Architecture tab displays building façade components and other architectural-related items. Structure tab displays building structure components. System tab displays building mechanical and electrical components. The model mostly created using basic objects in Architecture tab. Related to our 3D model, the parameters based on the results of field measurements. How many existing facilities in the ribbon used is depends the on the detail of the model.

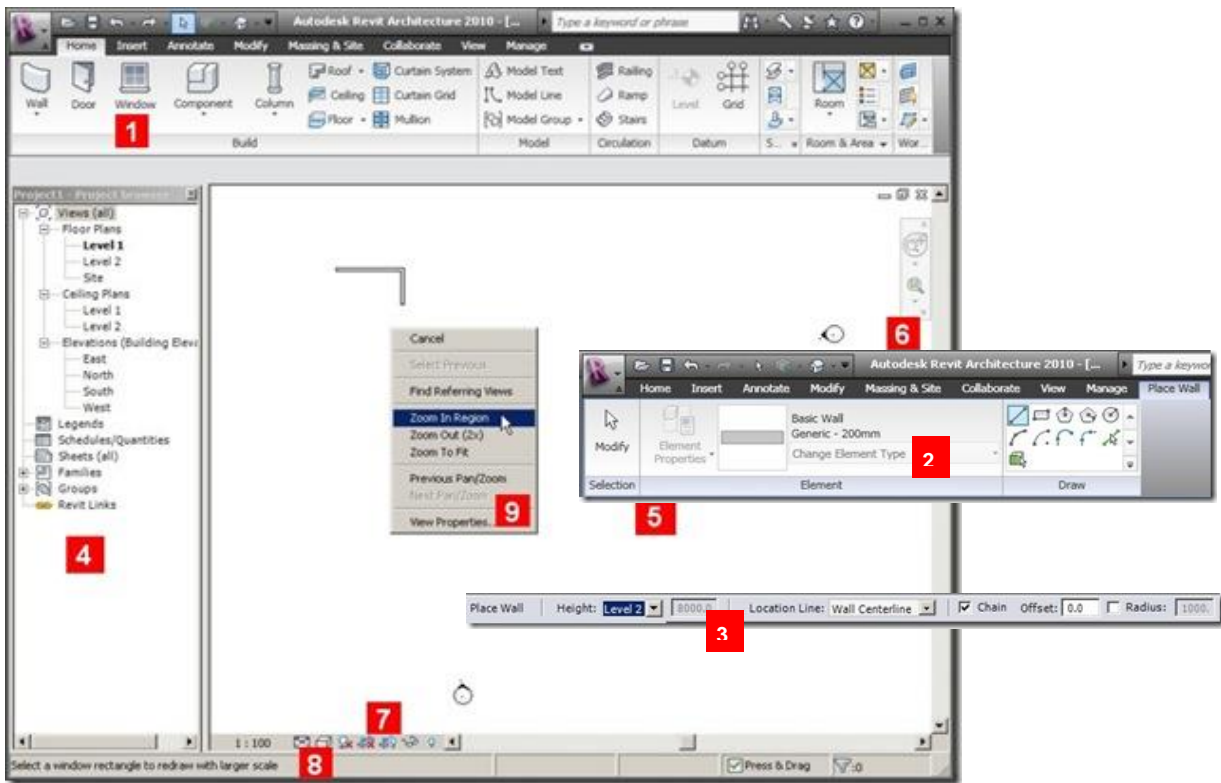

Figure 4.5. Revit Architecture User Interface. 1. Ribbon Bar, 2. Contextual Bar (This tab contains options related to selected object), 3. Option Bar (only appear when a tool activated. This bar used to define how an object to be placed), 4. Project Browser (the most important feature to access the project such as the views, families, groups, and Revit links), 5. Drawing Area (The area used to interact with the model), 6. Navigation Bar (This bar contains navigation tools such as zoom, steering wheel, and view cube), 7. View Control (provides the tools for changing the drawing scale, detail level, and model graphic style), 8. Status Bar (To indicate and tell what to do).

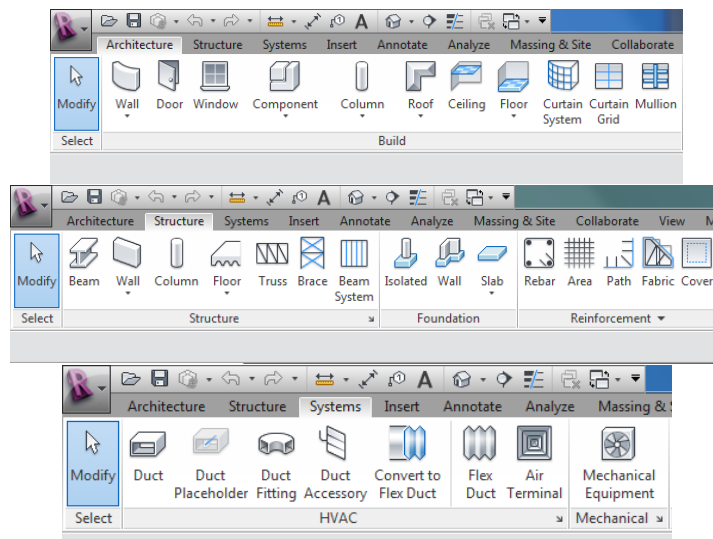

Figure 4.6. Revit Architecture ribbon bar used for modeling. Basic objects include: Masses (generic solids, surfaces and wires), Site (topo surface, pad, parking space), wall, opening, door, window, column, roof, floor, ceiling, stairs, railing, ramp, curtainwall, mullion.



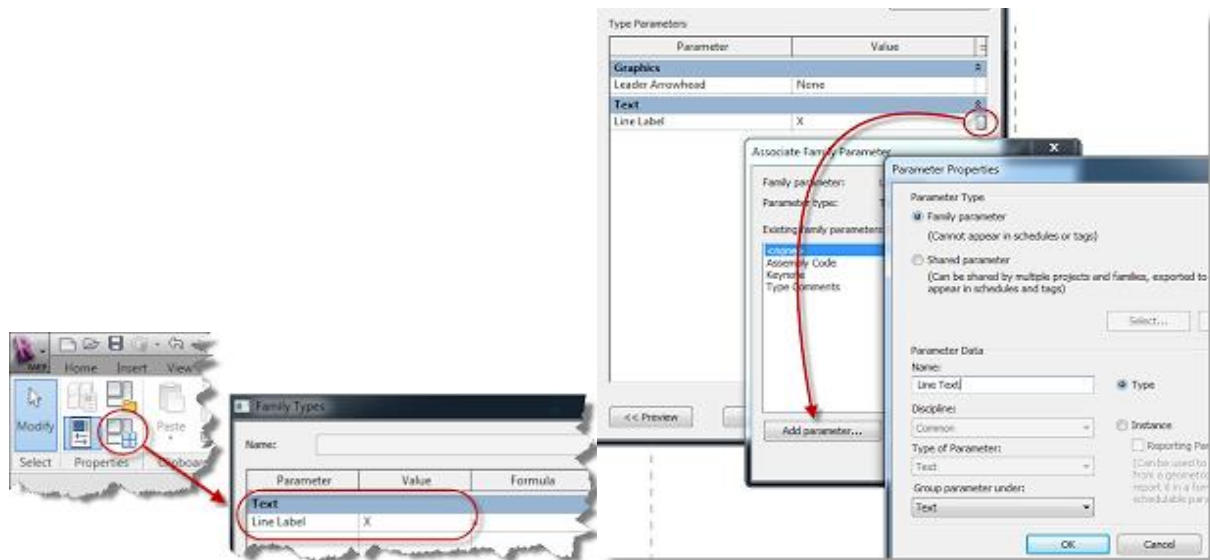

Figure 4.7. The Parameter Properties dialog (Family Parameters)

In Autodesk Revit Architecture, all model information's stored in a single, coordinated database. A Revit model is a single database file represented in the various ways. Such representations can be plans, sections, elevations, legends, and schedules.

Revisions and alterations to information are automatically updated throughout the model. Because changes to each representation of the database model are made to one central model, changes made in one representation of the model (for example a plan) are propagated to other representations of the model (for example elevations). Thus, Revit drawings and schedules are always fully coordinated in terms of the building objects shown in drawings. Changes to a schedule view are automatically reflected in all other views.

Parametric components, also known as families, are the basis for all building components designed in Revit Architecture (Fig. 4.7). These components offer an open, graphical system for design thinking and form making, while providing the opportunity to adjust and express design intent, and no programming language or coding is required.

All elements in Revit are “family based” and each family element have multiple types defined with it, each with a different size, shape, material set or parameter variables. There are many categories of objects ('families' in Revit terminology), which divide into three groups:

- System Families are pre-made by Autodesk and customization is limited
- Loadable Families / Components can be built from scratch
- In-Place Families which are like loadable families, but cannot be saved out of the project in which they are made.

Each family of a certain building object, such as a wall, is associated with parameters of two types: type parameters and instance parameters. While type parameter is common information for an element in a family, instance parameters are usually for that specific instance or model and are generally user created. A type parameter affects all instances (individual elements) of that family in the project and any future instances that are placed in the project. The value for instance parameters is generated as the user models the building. It affects only one selected element, or the element that the user is creating.

Once the model is completed in Revit, it then transferred to Autodesk Ecotect to have thermal calculation.

## 4.2.2 Thermal Calculation in Autodesk Ecotect

Ecotect is a software package with a unique approach to conceptual building design. It couples an intuitive 3D design interface with a comprehensive set of performance analysis functions and interactive information displays (Moon et al., 2011). Ecotect is quite different from other analysis tools in that it specifically targets the earliest stages of design, a time when simple decisions can have far-reaching effects on not just energy but almost every aspect of the performance of the final project. Its intuitive wizard-based approach and range of data visualization options mean that designers can engage with complex performance issues quicker, earlier and at a much higher level.

Principal operations of thermal analysis through Ecotect:

- Weather Manager / Weather Data Import
- 3D Modeling / Import-Export
- Material Assignment / Material Properties
- Zone Settings / Occupancy Schedules
- Thermal Analysis / Calculation
- Visual Analysis

In this work, the 3D model from Revit transferred to Ecotect 2011. At this second phase, the simulation run after selecting the appropriate utility, weather data, and analysis method. Next subsections describe each of principal operation of thermal analysis through Ecotect.

### 4.2.2.1 Weather Manager and Weather Data Import

The advantage with Ecotect is the simplicity of accessing weather data. A thermal data allow the user to customize the plotted environment or model based on desired time period. For example, in the thermal comfort analysis it allows user to view data based on selected months, single month, single day or single hour. A graphic data as well as an animated option is available that displays selected time periods as well as site location (Fig. 4.8). The weather data files in Ecotect are taken from the US Department of Energy. They are a statistical reference of typical weather (collected during the last 15-20 years) of site locations around the world.

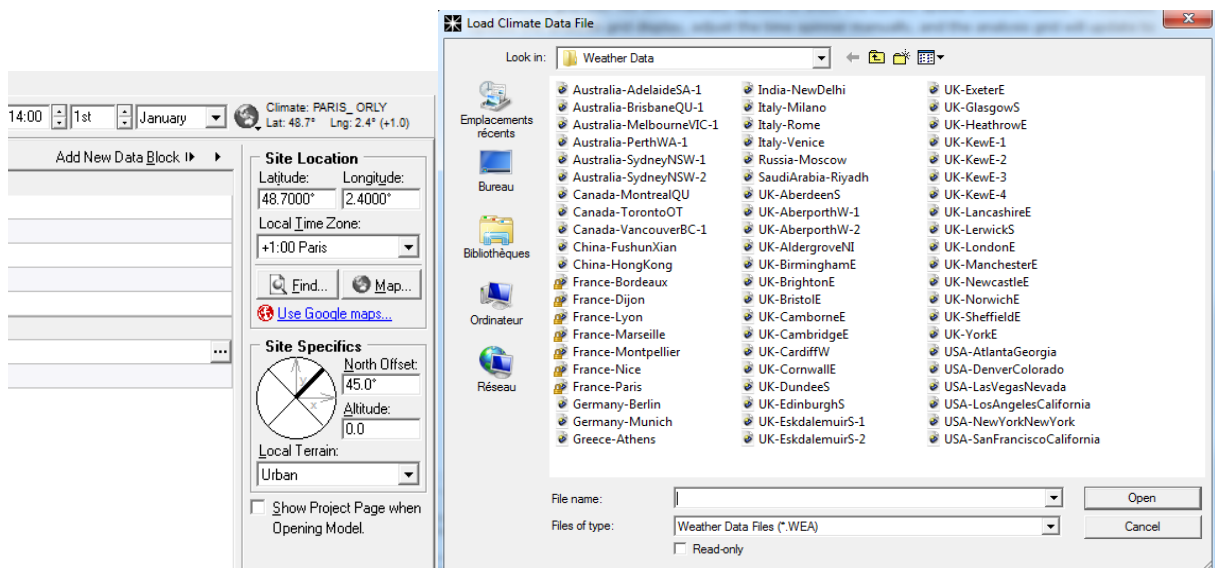

Figure 4.8. Display panel of climate data to manage specific time and site location. On the right hand, display panel to load climate data file, site locations around the world are available according to the city.

### 4.2.2.2 3D Modeling and Import-Export of the Geometry

Feasibly, any model can be constructed within the Ecotect environment using its own modeling features. Even though Ecotect has its own 3D modeling interface, it gives its users a wide range of import options. However, imported models from design tool will universally fail, unless special care is taken to establish each piece of geometry. Ecotect will not interpret this on its own with an imported model (Wagner, 2010). In addition, importing a large geometry file into Ecotect could be quite hard and may require editing. The program sometimes does not understand all the geometry being imported and different results may occur. To reduce this problem it's necessary to import a simple 3D model.

Therefore, the use of Autodesk Revit 2012 as one of the leading design tools in the AEC community greatly helps this transfer process. The choice of this design tool accounted for various technical considerations, in particular the ease of data organization and the flexibility of data transfer. There are two commonly used format for transferring data from Revit to Ecotect; IFC/GbXml and DXF. IFC and gbXML are both used for common data exchange between AEC applications such as CAD and building simulation tools (Dong et al., 2007, Knight et al., 2010). Both IFC and XML create a common language to transfer BIM information between different BIM and building analyses applications while maintaining the meaning of different pieces of information in the transfer (Haymaker et al., 2007).

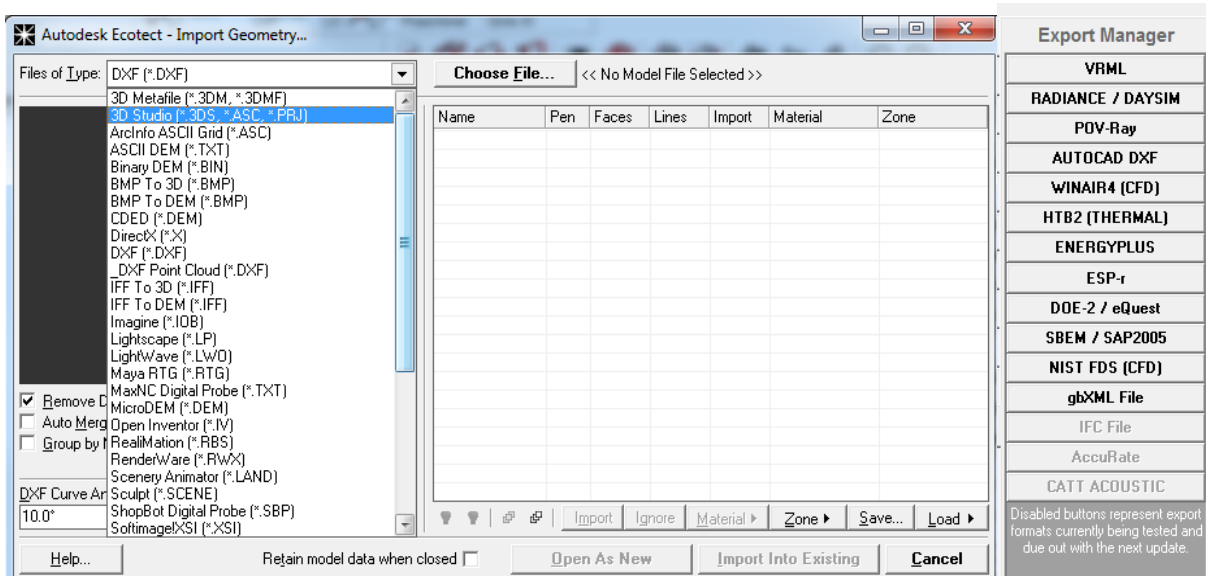

Figure 4.9. Display panel to import a file (left) and Display panel to export (right)

### 4.2.2.3 Material Assignment and Material Properties

This is to create new materials in the element library, using / to attach the material, to manage material layers, and to manage the material properties. In this work, the materials will set in according to the real condition. All components (BIM components) like floor, wall, window, door, aperture actually already assign material from Revit. This assignment automatically transferred to Ecotect material properties. However, we should re-check whether the transfer is complete. There are some small details that should be verified. For example, for a wall we can check its texture, thickness, unit, etc. Ecotect allows this process through a display panel of elements in current model. It allows to re-check or to manage material properties.

#### 4.2.2.4 Zone Settings and Occupancy Schedules

At the heart of any thermal simulation is the concept of a thermal zone. A thermal zone is a single space or group of indoor spaces that has uniform thermal load profiles and conditioning requirements. A simple way to think of a thermal zone is as a space that can effectively be conditioned using only one thermostat. A thermal zone defined the basic unit in thermal calculations for which internal temperatures and heat loads are calculated. A thermal zone is defined by a completely enclosed space, bound by its floors, walls and ceiling/roof. Once the zone is made, Ecotect assigns default values to materials of these components. By occupying these zones, Ecotect can perform various settings, such as:

- Absorptance and Emittance
- Space Loads (HVAC supply loads)
- Condensation
- Heat balance
- Thermal Design

The analysis will determine the thermal demand for the building in addition to the annual thermal consumption (Fig. 4.10). Thermal demand determined based on some items. They are: the proposed building space layout, proposed construction types assigned to building elements, HVAC system, infiltration, outside air requirements, internal loads from people, lighting and equipment, and the operating schedules for occupancy (Fig. 4.11), lighting, equipment, and HVAC. Annual thermal consumption is the energy used every year for heating, cooling, lighting, and building equipment. The thermal calculation can be determined for each space, zone, and or as the total consumption for the building (or parts of the building). If thermal data is only calculated on the zone level, it may not be possible to determine individual space profiles within the zone.

Figure 4.10. Display panel to modify the zones profile, HVAC system, etc.

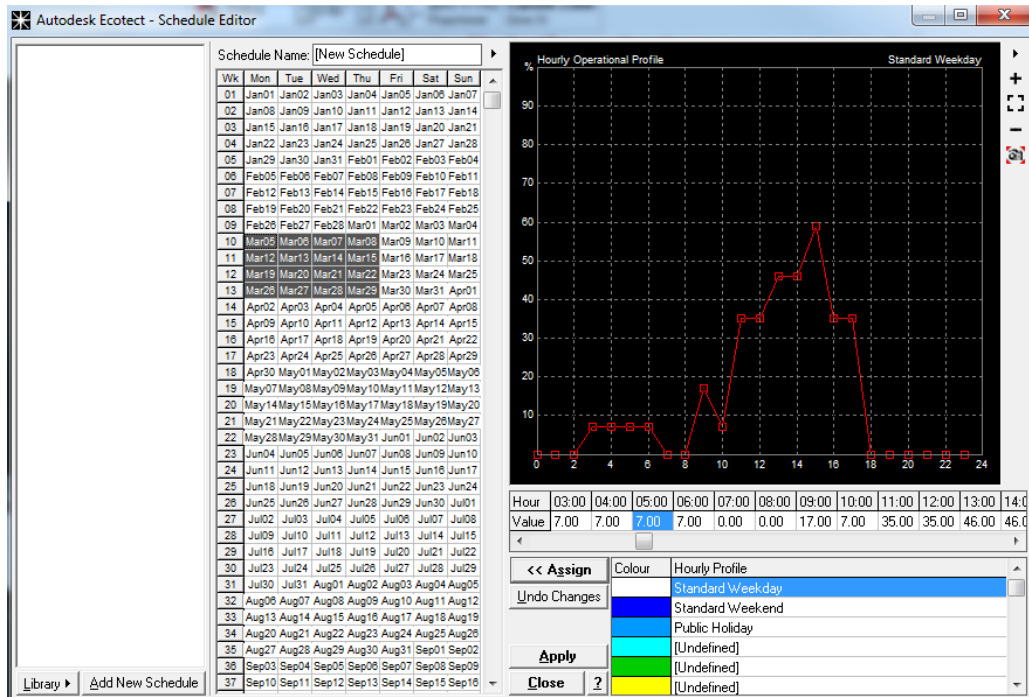

Figure 4.11. Display panel of schedule editor. This is to set a specific operational, for example, time of occupancy.

#### 4.2.2.5 Thermal Analysis / Calculation

This step implies that the following data already taking care from the previous steps:

- Building Geometry including the layout and configuration of space,
- Building Orientation,
- Weather data.
- Building usage including functional use,
- Internal loads and schedules for lighting, occupants, and equipment,
- Heating, ventilating, and air conditioning (HVAC) system type and operating characteristics,
- Space conditioning requirements,
- Utility rates

Effects of radiant temperature on human thermal comfort of MRT are investigated for this experiment. Ecotect thermal analysis provides optimistic method for this calculation including some other calculation (Subsection 2.4.2).

Mean radiant temperature (MRT) is a primary factor and should be identified as having the strongest effect of thermal comfort. The MRT in Ecotect describes in Monthly Temperature Profile that would be the priority for our calculation. In Ecotect, this calculation results can be interactively visualize in calculation mode of spatial comfort. Other calculations that will perform to support the results are Passive Gains Breakdown and Passive Adaptivity Index.

#### 4.2.2.6 Visual Analysis

In the calculation, the process can be viewed in various ways. Various options are available in the visualization settings panel for controlling the appearance of an Ecotect model when viewed using the Visualize tab. It is to appear various visualization setting, display, effects, and interactive.

The feedback received from Ecotect shows results in 3D, which help visualize the data. Many of these calculations are easily done through the calculation wizards.

In this work, the calculation is prepared to analyze the spatial comfort of MRT. After initiate the spatial comfort calculation, Ecotect calculates the range of thermal comfort values over the analysis grid in incremental time steps during the year. Once completed, spatial comfort values will be displayed for the current date and time. To see comfort values for other dates and times of the year, we can use the date/time toolbar to select the required date.

The corresponding spatial comfort values are displayed on the analysis grid. Spatial comfort values mapped over the analysis grid in any axis direction. In the following image, the analysis grid has been aligned to the XY axis, displaying comfort values horizontally in flat surfaces (Fig. 4.12a). The values also can be show with CFD (Fig. 4.12b). The calculation results also appear in analysis table (Fig. 4.13). The table indicates the calculation results of each zone in figures.

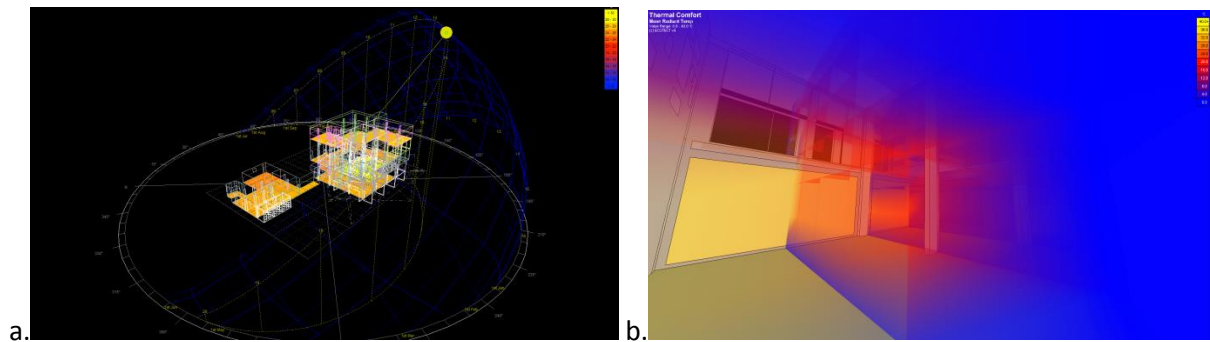

Figure 4.12 (a). Thermal analyses over slice thermal indicator with sun-path simulation. (b). Result of thermal calculation in the interior using 3D visualization (CFD).

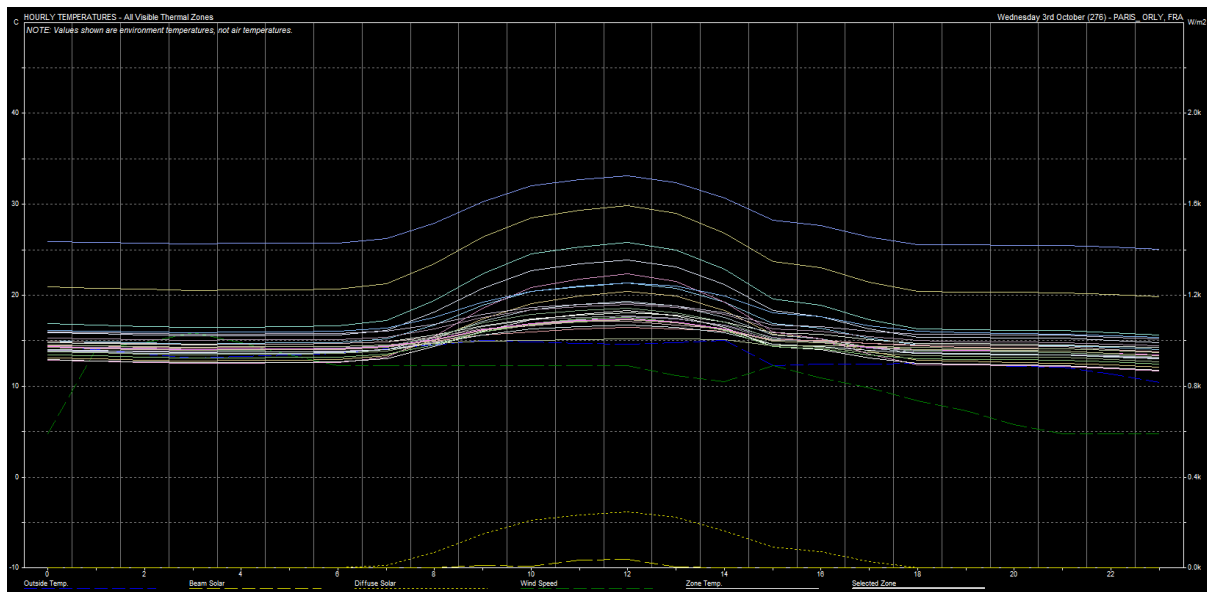

Figure 4.13. Result of thermal calculation in analysis table. It describes calculation results per-zone (i.e. outside temperature, diffuse solar, wind speed and zone temperature).

In figure 4.13, the dashed blue line represents the outside temperature, as derived from the weather data file loaded previously. The other colored lines represent the temperature graph for the various zones in the model - the colors correspond with the colors used in the Zone Management dialogue box. The dashed and dotted orange lines represent Beam and Diffuse solar radiation. Beam



Solar refers to the direct component of radiation from the Sun itself, whereas Diffuse Solar refers to radiation that occurs due to reflections from clouds, moisture vapor and other atmospheric particles.

### 4.2.3 Data Treatment in VR System

As in thermal tools, the main idea for VR software is the concept of a building zone provided from thermal analysis. A strategy for thermal zoning in fact has to be set significantly by the building type or by the rooms which desired to visualize. For example, hotels frequently have multi-perimeter and core thermal zone but small office typically have only one conditioned thermal zone plus unconditioned spaces. The building zone in this case is describing as the thermal visualization zone.

VR software (in this case 3DVia Studio or Virtools) provide such presentation of thermal performance in 3D simulation and figures or graphic. These facilities can be used to model temperature value or thermal mass effect resulted from Ecotect. This visualization constructs by 3D particle or spray element. It can be realized for a representation of thermal simulation along with building elements. However, since thermal data and VR software have different format the data will need to preformat using our software. This process will be detailed in next section (Section 4.3)

In order to represents the TBS, 3DVia Studio will be more exploit the 3D model (object geometry), texture, camera and behavioral scripts. This way, the virtual facility enabling a holistic approach addressing the model animation and the TBS process. So that in the operation, it will enables the user to:

- Walk-through a full 3-Dimensional inventory of all equipment housed within the object.
- Visualize the temperature distribution in the room.
- Interactive with visual and sound sensation.
- Evaluate the thermal / environmental simulation.

In this step, data processed focuses on visualization and interaction. As a visualization tool, VR has given users a less inhibited method of observing and interacting with data. By placing users in the same environment as the data, a better sense of shape, motion, and spatial relationship can be conveyed (Clifton et al., 1997). With respect to this work, the immersion is primarily achieved through visual feedback. This is accomplished through the use of depth cues method and intuitive interaction. This high immersion and presence can only realize by limited VR display. Therefore, we introduce this concept of delivering thermal building simulation results in VE using an immersion room (CAVE-like display). The data output will have a significant value with immersion room, as it provides a better sense of presence and interaction in VE (Ohno et al., 2007; Sutcliffe et al., 2005). The idea then is to create an application to visualize thermal data of a building in different concepts of data representation. This application can show thermal metaphor according to design condition that can be simulated during the year, where user can navigate with it. Figure 4.14 shows the illustration of how the data present in VE. The 3D model and thermal results visualize within the simulation scenario.

To provide the desired visual sensation (deep cues), we use 3D glasses to mimic critical visual information such as stereoscopic, colors, and shapes. The immersion room cut out all extraneous visual information, helping user to focus on the object to enhance the visual sensation. Audio and touch sensation is also important to enhance the immersive experiences of the users. The ability to touch virtual objects and to react to their sound, for example, is perhaps important for thermal simulation tasks. In our VR systems we also explore this type of sound sensation. It applies to sense the temperature values resulted in the simulation space.

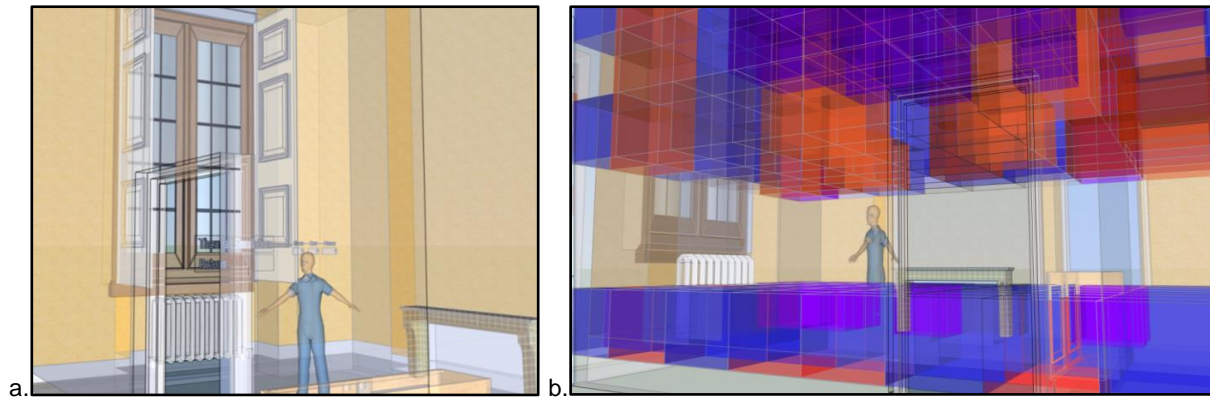

Figure 4.14. (a). Illustration of simulation scenario: People inside the 3D model act as the behavior of the camera, moving around and navigate interactively. (b). Illustration scenario to generate thermal visualization in VE using metaphor (grid of particles and transparent cubes).

### 4.3 Development of TBS model in VR system

This section describes the specific data process in order to realize the model in VR system. It can consider as the detailed version of the previous subsection (subsection 4.2.3). It describes a specific way of Revit and Ecotect data process in order to transfer to 3DViaStudio/Virtools. Also, the development of TBS model using 3DViaStudio/Virtools.

#### 4.3.1 Perl Routine (Preformat Application)

Thermal data from Ecotect cannot directly export to VR software. Data tables of temperature value from Ecotect should be preformatted so that they can be processed by 3DVia Studio. Data exchange from Ecotect to 3DViaStudio/Virtools is conducted with exporting format Txt. However, This process should pass through a program we have built called Perl Routine. This application enables syntax preformat of Txt data which automatically alters the syntax typing without changing the origin data value.

The composition of thermal visualization in 3D space as illustrated earlier is composed in XYZ axis. In the experiment, we apply the idea to divide the interior space into  $8 \times 8 \times 8 = 512$  parts which is each section contains the temperature values embodied in grid of cube. The cubes will be textured in transparent or in particle 3D, colored according to temperature value it adopt. This set of grid cubes can be advanced to be more detail, by increasing the amount of the cubes or divide it into small pieces, for example  $16 \times 16 \times 8$ ,  $20 \times 20 \times 20$ , etc. The more divided the cube the more detailed the value. We have tried to use a more detailed grid ( $16 \times 16 \times 8$  and  $32 \times 32 \times 16$ ), however these configurations reduces the speed of the visualization process.

Txt data from Ecotect is a set of values of temperature in a 3D position (XYZ axis). The data is to be attached to the 512 parts of interior space. These data are collected according to time simulation (per hour, day and month). This input can be detailed more precisely depending on the needs of the experiment. As Txt data files from Ecotect cannot directly be read by 3DViaStudio (Virtools) directly, the standard organization of this data exchange process is made. This standards organization are summarized the mechanism of directory/folder that conducted while exporting the data from Ecotect to 3DViaStudio/Virtools. Script 4.1 shows Txt preformat in Perl Routine. It's placed in folder arrangement (Fig. 4.15) used for preformat data.



```

# Directory names
$dir_input_data = "3-Input_Data";
$dir_output_data = "4-Output_Data";
# Scan the input_data directory
opendir (DIR_INPUT_DATA, $dir_input_data) || die "$dir_input_data doesn't exist";
# Read each subdirectory of input_data
while ($Export_input_dir = readdir(DIR_INPUT_DATA))
{
    # If the current subdirectory doesn't exist in output_data, create it
    unless (-e "$dir_output_data/$Export_input_dir")
    {
        print "Create the directory $dir_output_data/$Export_input_dir\n";
        mkdir("$dir_output_data/$Export_input_dir", 0777);

        # Scan the subdirectory
        opendir (FILE, "$dir_input_data/$Export_input_dir") || die
"$dir_input_data/$Export_input_dir doesn't exist";

        # Read each file of each subdirectory
        while ($file = readdir(FILE))
        {
            # Preformat sub
            if ($file =~ /\.txt/)
            {
                preformat("$dir_input_data/$Export_input_dir/$file", "$dir_output_data/$Export_input_dir
/$file");
            }
        }
    }
}
PREFORMAT
sub preformat
{
    # Get the given argument
    $file_in = $_[0];
    $file_out = $_[1];
    # Print a simple message
    print "Create the file $file_out\n";
    # Open file in for reading
    unless (open (FILE_IN, "<$file_in"))
    {
        print "Error in $script_name: Cannot open $file_in for reading \n";
        return 0;
    }
    # Open file out for writing
    open (FILE_OUT, ">$file_out");
    # Read each line
    while (<FILE_IN>)
    {
        # Remove the chariot return
        chomp;
        # If it is not header lines
        if (/COLS,\s+/ or /ROWS,\s+/)
        {
            # Write in the file out
            print FILE_OUT "$'\n";
        }
        # If it is not header lines
        unless (/\/\//i)
        {
            # Replace coma and blanks by a tab
            s/, \s+/\t/g;
            # Write in the file out
            print FILE_OUT "$_\n";
        }
    }
}
#Close the files
close FILE_IN;
close FILE_OUT;
}

```

Script 4.1. Txt preformatting in Perl Routine (Credit: C. Pere).

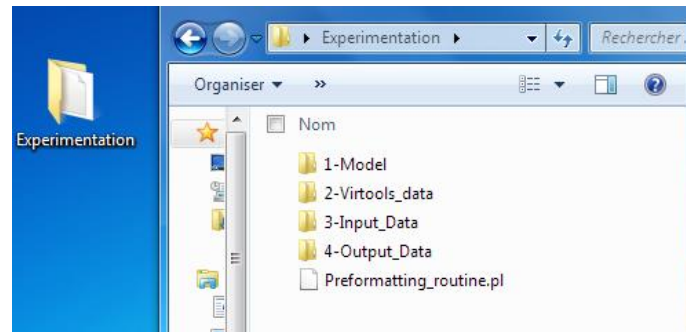

Figure 4.15. Folder arrangement used to preformat data from Ecotect to 3DViaStudio/Virtools.

In figure 4.15, the main folder called "Experimentation" built to catalyze the exchange data from Ecotect to 3DViaStudio/Virtools. It contains such comprehensive workflow to set the data transferred from Ecotect to 3DViaStudio/Virtools. Follows are the details:

- A directory named "1-Model ". It contains the Revit model, data 3DS, Revit to 3DsMax used.Fbx
- A directory named "2-Virtools data ". It contains all data related to 3DViaStudio (Virtools): (s). cmo, scripts.
- A directory named "3-Input\_Data". It contains the raw data simulation (Analysis Grid Data, Mean Radiant Temperature), exported from Ecotect.
- A directory "4-Output\_Data". It contains all of the output data, processed automatically after running `the routine program`. Its folder organization would be similar to the folder "Input data ".
- The routine program is a program to pre-format data from Ecotect (Script 4.1). Perl routine will retrieve the data in 4-Output\_Data directory. It will compare directories 3 and 4, and then conduct the appropriate pre-formats. A file contained pre-formatted data export to 4-Output\_Data directory.

Follows is arrangement to export thermal data from Ecotect and to initiate the preformat:

The Txt file from Ecotect placed in "Input\_Data" directory. Each of these files should be placed in the directory with the naming rules of the date and time of thermal calculation.

As the interior space divided into 512 parts or 8x8x8, the directory will contain 8 Txt files (Fig. 4.16).

The Txt file named according to the following rule: *X-Y-Z\_Date of the Simulation\_Time of the Simulation*

Note:

X is the quantity of rows in the table.

Y is the quantity of columns in the table.

Z is the layer on the request (Z = 0 for the layer altitude 0, Z = 1 for the first layer ...).

Date of Simulation represents the date chosen in Ecotect when calculating thermal. The format will be: MM-DD (for Month, Day).

The simulation time represents the selected time in Ecotect when calculating thermal. The format is as follows: HH-mm (Hour, minute).

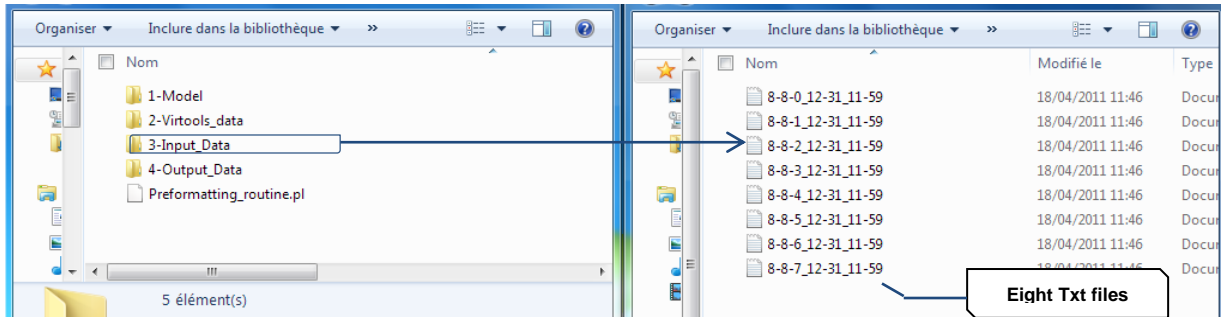

Figure 4.16. Detail arrangement of data storage. Txt file from Ecotect restored in Input data folder to be pre-format into a new Txt writing. The new Txt writing automatically generated in output data. In this figure for example, exports were made from Ecotect and we put the records of these exports in the folder "3-Input\_Data".

The eight text files contain the results of the eight layers of temperature depending on altitude. Each text file begins with 8-8, means that each layer contains a grid of 8 rows and 8 columns. In this example, each text file ends with "\_12-31\_11-59", means that the date and time selected of the simulation performed on December 31 at 11:59.

Once the Txt files from the Ecotect have placed in the directory "3-Inputdata", the preformat is ready to perform. Only by clicking the icon of Preformatting\_routine twice, the data will preformat automatically. This program is to slightly modify the syntax files from the export of Ecotect so they are readable in 3DViaStudio/Virttools. It is to remove the header of the document and change the separator between files. It changes the arrangement of the old type separator " ," (comma space) to a separator type tab (Fig. 4.17). The result (new txt file) will found in folder "4-Output\_Data".

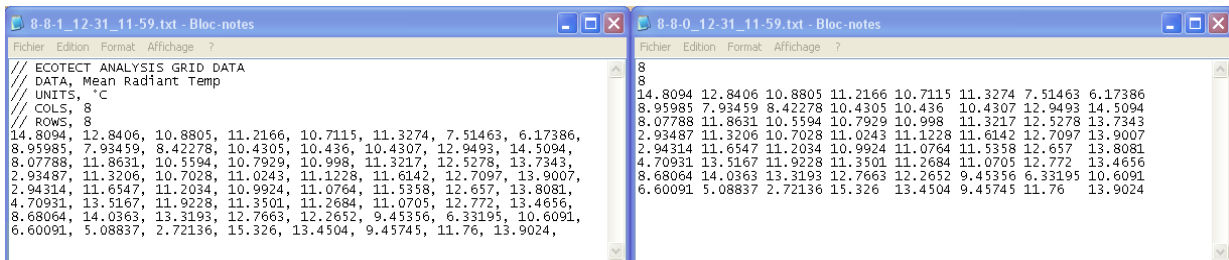

Figure 4.17. The Routine program restructured the Ecotect analysis grid data in 3-Input\_Data (Left hand) into a new format to 4-Output\_Data (Right hand). This is to change the spacing arrangement, not the value of the data.

In "4-Output\_Data", new type of arrangement of separator tab has been created between values in each row. At this stage the Txt data is ready to transfer to 3DViaStudio/Virttools.

### 4.3.2 Setting in 3DVia Studio (Virttools)

This subsection describes the setting of the model (3D geometry) and its thermal data in 3DVIA Studio. 3DVIA Studio is an interactive application authoring environment that was designed specifically to accept large CAD data assets. The application has also been used for entertainment titles within entertainment and social gaming. We choose this software to our VR system as it create compelling and realistic interactive 3D projects using advanced rendering, physics, sound, animation, video, web and asset manipulation engines. In order to set a TBS scenario, we need to set the data from the previous steps, 3D model from Revit and Txt data from Ecotect.

### 4.3.2.1 Object Geometry

The modeling of the object in 3D geometry for our VR system is done by Revit. We have modeled the 3D geometry exactly like the actual condition in the real world. However, we intended to create it in a simplified representation. Therefore, we begin this concept from the earlier step in Revit. The modeling complexity is generally inversely proportional to the rendering speed. As the model gets more complex and detail, the frame rate tend to drop. Our VR system will not sacrifice detail and exactness so we model the object in simplicity. This is important to gain rendering speed.

To address this situation we go through the following strategies:

- The object must be simple in terms of quantity, for example it is part of a large object (a building) that are representing the other parts.
- This simple object will contain detail and precision, especially in terms of material (texture) or property (standard of IFC format).
- The model criteria, as explained in the previous chapter, designed and calculated through the process of BIM modeling.
- When the model export to 3DViaStudio, the status is final (no modification at all). All we have to do is to adjust the position, scale, and behavior of the objects in VE.
- In VE, the model will furnished with thermal entities as well as navigation and simulation menus.

3DVia Studio/Virtools uses resources in the form of 3D models, textures, characters, sounds, videos, etc. This 3D model can be imported from other programs. Due to the quality of the textures provided in 3DViaStudio (Virtools) has low real impression, we take the advantage of 3DsMax for the texture mapping. This texture mapping is only to enrich the texture visualization, not the components/material items in the IFC format.



Figure 4.18. A 3D geometry enriched with texture mapping and exported to 3DViaStudio/Virtools. It shows 3D Model of Gunzo room before and after renovation.

### 4.3.2.2 Particles

Particles are a very important part of TBS in a VE. Particles in this case will be ambient (everywhere) inside the room. Located particles have position, orientation, color and intensity. These particles create with 3D frame, called cubical particle system emitters (Fig. 4.19). It applies a cubical particle system Building Block (BB) to Emitter (Fig. 4.20). The texture in the emitters is then set to embodied thermal value according to preformatted Txt data from Ecotect. VSL script in 3DViaStudio/Virtools is used to configure the cubical particle system emitters based on Txt data stored in folder "4-Output\_Data" (Fig. 4.21). Specific setting of this particle simulation is described further in subsection 4.4.1.

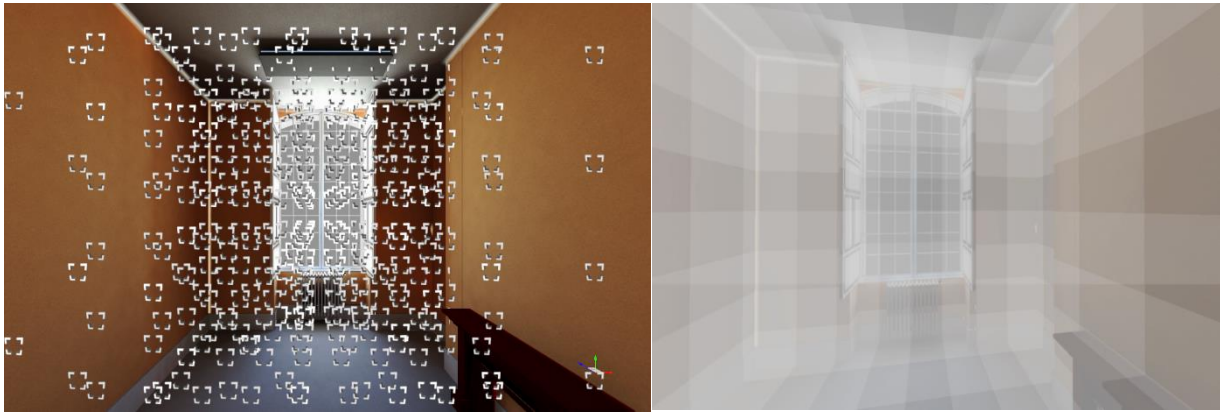

Figure 4.19. Making the emitter by creating a 3D frame. Level manager > 3D Frames > Name “Emitter”. The 3D frame setup position and scale are set according to the 512 parts.

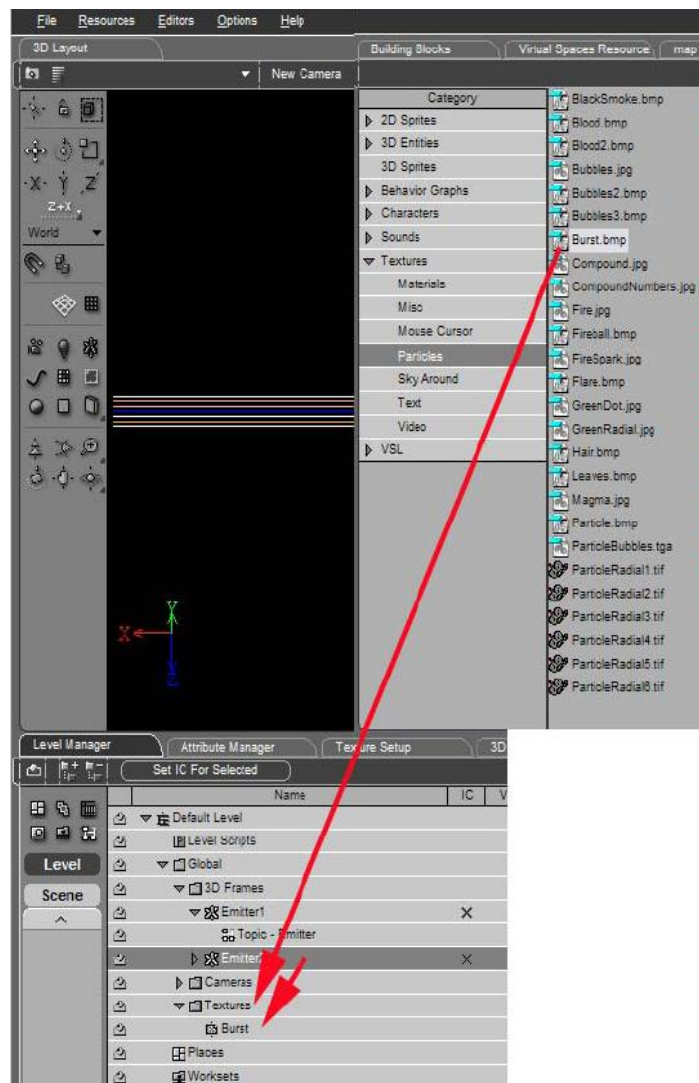

Figure 4.20. Applying a Cubical Particle System BB to Emitter. The texture or color, for example Burst is set for the Emitter. Add a texture Burst.jpg. Level manager > Textures > Burst.jpg

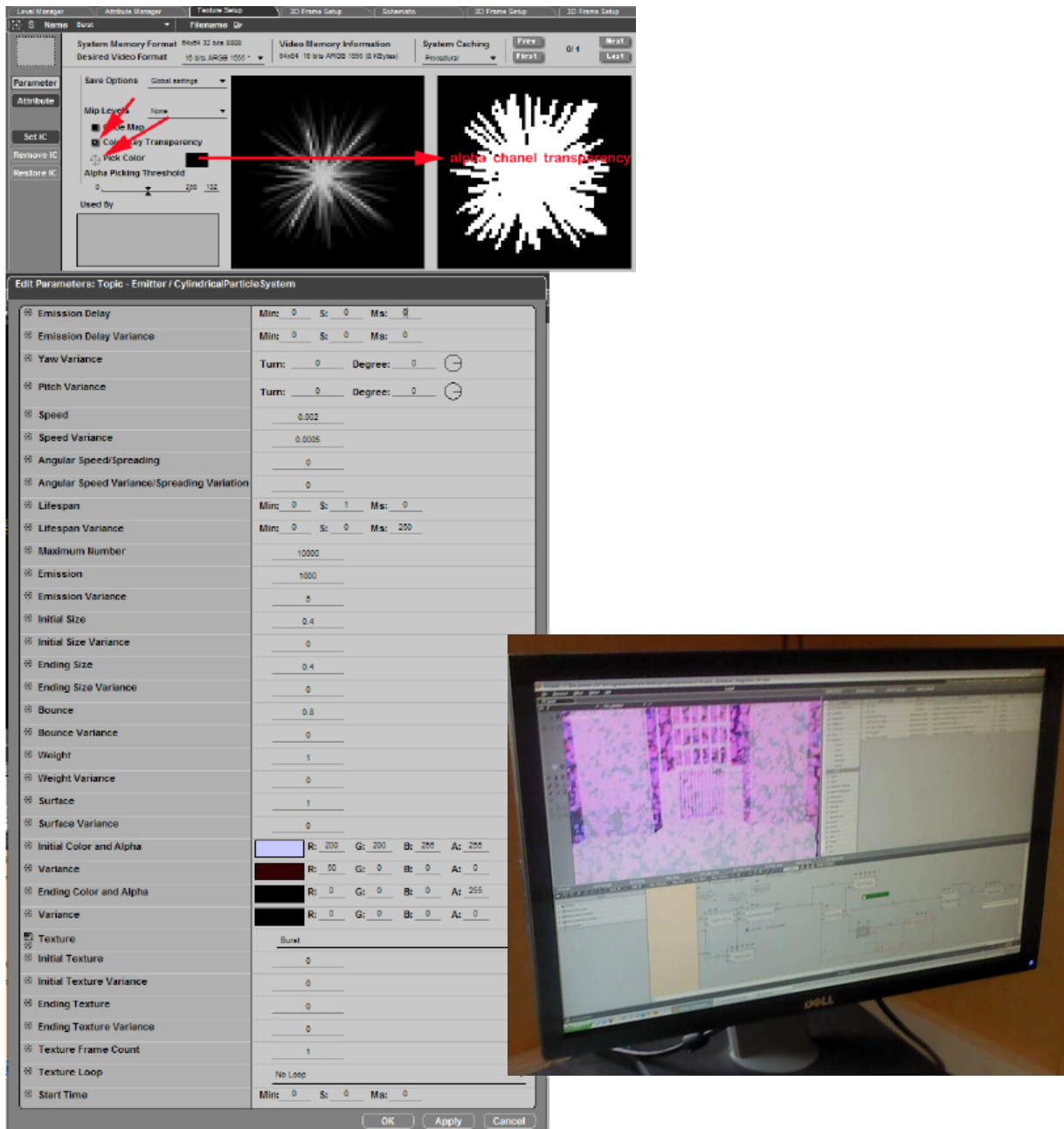

Figure 4.21. Schematic > Emitter Script > Edit the Cubical Particle System setup including the burst texture.

The method uses particle systems for visualization of TBS is using the rules such as particle fill out the surface of an object. It does not only spread out, but also describes temperature information on a color. Particularly in this particle data, we also refer to Wang et al (2010). Their worked on VR visual representation of volumetric scalar temperature data, in terms of data density, size of visualization elements, which conducted experiment using stereoscopic visualization. Density defines how many 3D points are placed in an existing in cloud point along each axis (e.g. X-axis, Y-axis and Z-axis). It is define a cubic cloud point area to attach the value of the particles. In our experiment, we put more cubic in XYZ axis. to detail their value. We also arrange their transparency, density and size as those have a significant influence on the volumetric data perception (Wang et al., 2010).



### 4.3.2.3 Camera

Follows is an example technique to create a camera and to be able to walk the camera around the environment through keyboard inputs and controllers. Camera behavior create from 3DViaStudio interface. Right click on the “Main Camera” actor from the “Project Editor” tab and select “Add New Behavior”.

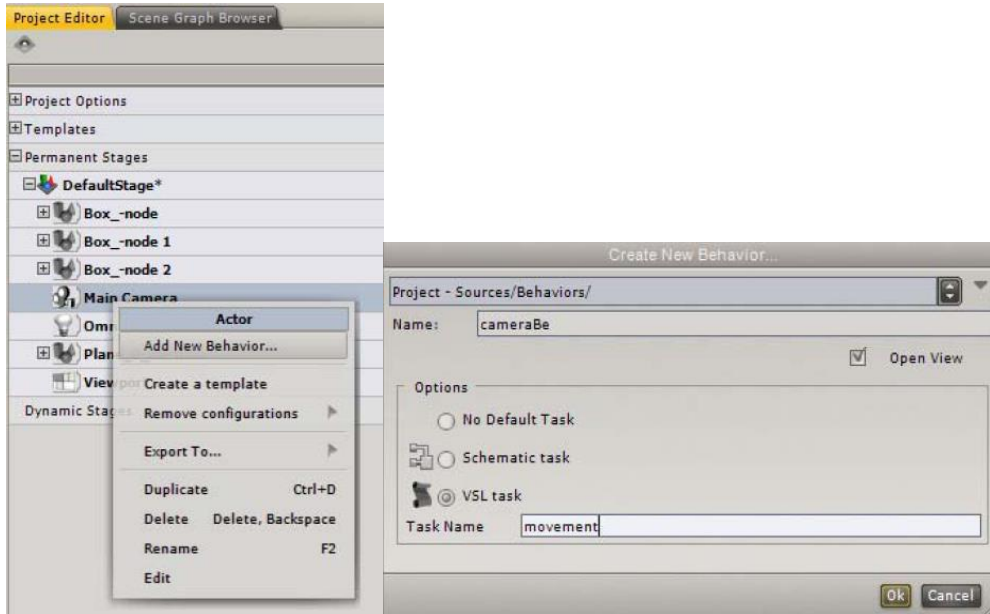

Figure 4.22. Creating camera behavior on the “Main Camera” actor from the “Project Editor” tab.

As the VSL tasks are created, all of the valid blocks are already constructed.

Following are the behavior of the blocks :

*Target* : Provides direct access to the component ring to which the behavior belongs to. By default, 3D ViaStudio will always add a pointer (Ptr) to the behavior itself with a default name of “be” (short for behavior) (Fig. 4.23).

*pLocal* : To store local variables that only this individual task has access to.

*OnStart* : Code within these brackets will be called only once, when the task is first started.

*OnStop* :Code within these brackets will only be called once, when the task is stopped.

*Execute*:Code within these brackets will be executed every frame that our project is running, unless the task has been stopped. More on the concept of frames and timing will be explained later.

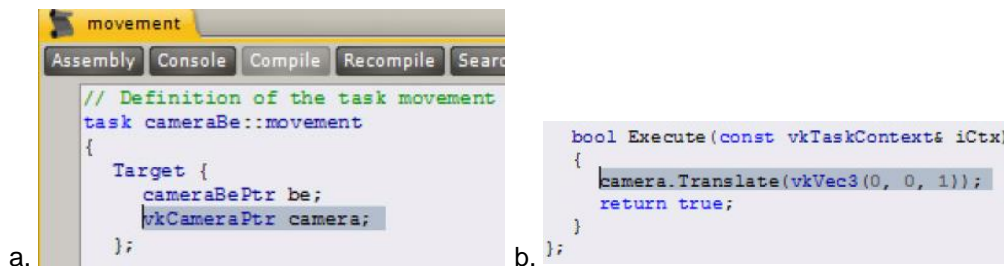

Figure 4.23. (a). In “Target” block, add a new pointer to “vkCamera” component, and call it “camera”. (b).Call the “camera” target and apply a “Translate” function on it with the value of vkVec3 (0, 0,1), then compile again. This will translate the camera one meter on the Z axis (the order of a Vec3 is always X, Y, Z) every frame.

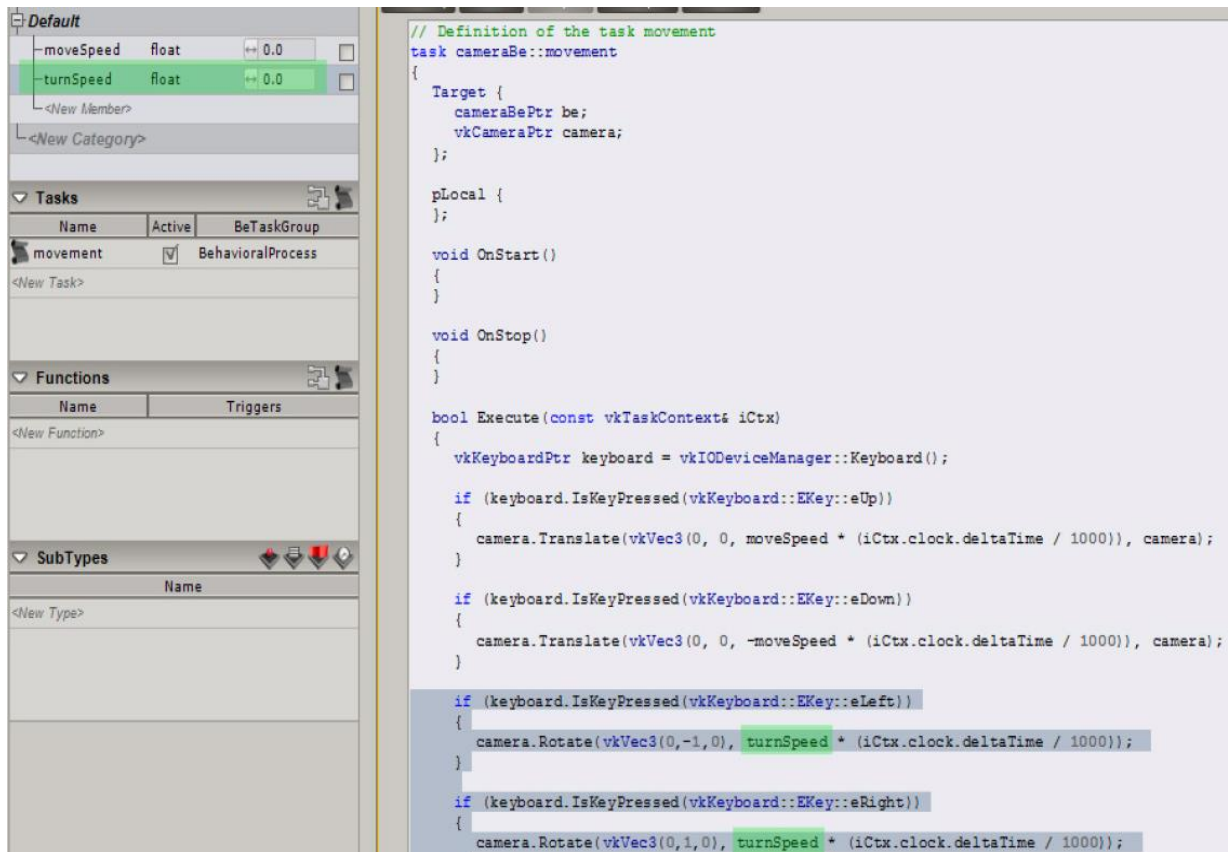

Figure 4.24. Completed parameter for camera rotation and translation

Figure 4.24 describes parameter for camera rotation and translation. The script sets the movement of the camera according to arrows buttons on keyboard. This function can also apply to a controller. The next important function is how to create stereoscopic 3D from the camera. Along with the movement, deep cues from the camera expected to produce an immersive visualization and intuitive interaction.

The stereo mechanism is arranged within the software. To activate stereoscopic 3D, it simply clicks a button within the 3DVIA Scenes application and toggle between anaglyph, side-by-side, line-by-line and checkerboard viewing cameras. As the stereo vision arranged by the software, the camera projector is just need to put in a certain distance. In this work we use active stereoscopy (frame Sequential). On the computer side, the OpenGL Stereo driver of the graphic card, manages the frame sequence. On the end-user side, we use shutter glasses that are able to occult each eye one after the other.

In 3DViaStudio, the Stereoscopic Camera component is available from the Libraries view > Cameras category. How to use it is simply by drag and drop the camera from the Libraries view to the 3D View. In the creation option tab there is "stereo" option (Fig. 4.25). We can also use it while programming in Schematic or in VSL. The Stereoscopic Camera is represented by a double cameras icon in the 3D layout (the separation between the two camera icons depends on the inter pupillar distance value). A Stereoscopic camera automatically creates and parents two asymmetric cameras, which will be used for passive or active stereoscopy (in this case we set the rendering driver for active stereo).



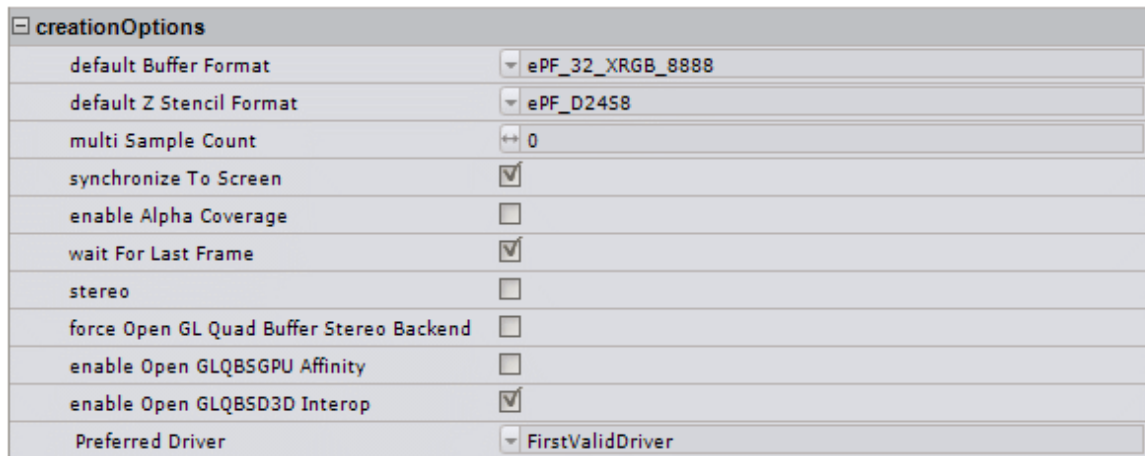

Figure 4.25. Dialog box of active stereo. Checking the “Stereo” option will activate the stereo device.

In stereo rendering mode, the display alternates between left and right images at each frame display. These images can be perceived by a user wearing shutter glasses which continuously transmit separate images to the left and right eyes. It's creating a view of computer or video-based objects that have depth, perspective and presence in three-dimensional space.

#### 4.3.2.4 Scripts and Object Behavior

Interaction is the key to a successful and interesting VE. This requires some means of defining the actions that objects take on their own and when the user (or other objects) interacts with them. This is refer to generically as the World Scripting. Scripting is an essential part of creating any kind of interactive 3D experience. Scripts may be textual or they might be actually compiled into the program structure. There is no common scripting language used in today's VR products.

In this work we used 3DVia Studio and Virtools as VR software. Virtools for visualization and interaction with tablet, and 3DVia Studio for the immersion room. They are quite similar tools since they have a similar function and have the same platform. The differences between them are only in the script management and the quality of the visualization.

3DViaStudio offers a line based coding language called Virtools Scripting Language (VSL). Schematic graph coding is a more visual style (think flow charts) of coding, and thus has more interface elements to learn, so the initial learning curve can be steeper. However, the end result can be much easier for people without a coding background to understand and work with.

A behavior is a type of component that allows the user to add interactivity to their project through scripts (or code). The primary elements of a behavior are members, tasks, and functions.

Virtools is a software program used to create interactive 3D virtual environments, which can then be exported to play on the Web via the 3DVia Player. Virtools operates in *author* or *play* mode; *author* is for setting up the world and *play* is for seeing how the environment will run. A Virtools composition is a '.cmo' file. Its 3D object or scene is an '.nmo' file, which can come from Maya or 3D Studio Max or VRML files, and a Virtools script is an '.nms' file.

3DVia Studio/Virtools consists of **objects** (seen and unseen) and **scripts** (which cause behavior and interaction). Objects can be 3D, lights, cameras, etc. Objects can have position and orientation and can be manipulated. 3D objects have geometric meshes, which can have materials, which can contain textures or colors. Meshes, materials and textures may all be shared among objects. Elements may be organized into hierarchies for ease in manipulation. Scripts are composed of Building Blocks which are linked together. Scripts include code written in VSL (Virtools Scripting Language), a C++-like language.

In our experiment, we mostly do the VSL scripts editing not using the VSL Editor but Schematic programming (Graphs). Even though, in this work we will also present some VSL scripts, in addition to Schematic programming (Graphs).

The behavior engine, CK2, processes the behaviors of how each object acts in a given environment. Behavior Building Blocks (BB's) are used to create behaviors. BB's use parameters and are represented by rectangles. BB's can be dragged onto objects or dragged into scripts. Input parameters to BB's are represented by top arrows; output parameters by bottom arrows; behavior inputs by arrows from the left; and behavior outputs by arrows to the right. The behavior inputs and outputs get connected through lines. Managers are used to support the behavior engine. Examples are the Level Manager, Resource Manager, and the Sound Manager.

Building Blocks belong to objects or to the Level. If they belong to the Level then often they need a target parameter. Array behavior for example could belong to a script for the object (for example: cube) or it could belong to a script for Level and then have the cube as its target parameter.

#### 4.3.2.5 Interaction Feedback

As describe in chapter 3, there are two important terms that must be considered before determining the characteristics of interaction (immersion and presence). Feedback can be seen for control and for learning. If the user does not feel himself in the virtual world, both physically and mentally, it is probable that he will not interact with the virtual objects regardless of their range, speed, and mapping. According to Steuer (1992), interactivity in virtual reality is composed of three elements. These are speed, range and mapping. Speed is the response time of the virtual world. If the virtual world responses to user actions as quickly as possible, it is considered an interactive simulation since immediacy of responses affect the vividness of the environment.

Range represents the number of attributes that can be manipulated by the user. If the user can change and interact with a large number of objects, the degree of interactivity is higher. Mapping defines the interconnection between the actions of the user and the actions within the virtual world. Mapping is a function of the types of controllers used to interact with the mediated environment.

The descriptions given above determine the characteristics of interaction in our virtual world. We intended the user believes that he exist in the VE. It happens if the user is immersed with virtual objects that are not static, but responsive to users' actions. The user must be given some indication of interaction feedback when the virtual cursor selects or explores an object. TBS systems can have the visual feedback of seeing the cursor choosing the menu and the users can penetrate an object. The user can then immerse and explore the objects. The selected object is then highlighted in TBS manner. The Range or the attribute that can be manipulated by the user including walk through the object, explore the TBS of the object, and interact with the visualization metaphor of the TBS results. Alternatively, an audio signal is generated to indicate a different value of temperature and its position in the object.

To have a better mapping and speed in VE we use a controller. Since haptic and tracking device have issue with real timing (speed) and difficult for new user, we adopt the gamer's method to have more speed and flexibility. There have been many different types controllers used in the computer simulation and computer games. The most popular controller has been joystick, which is simple a box with button and stick to control the motion. We choose the joystick that is configured for three-dimensional movement, signals movement along the XYZ axis. It can also completely programed and customized every axis and button.

As the technical specifications in the system (3D game engine), it is interesting to think for the effectiveness of the interaction feedback just like in video game. Since many gamers nowadays have been raised on consoles, it is important to use a controller that easy to use and compatible with the

system for better TBS experience. We use a gamepad joystick designs or two-handed gaming controllers called Xbox 360 (Fig. 4.26).The Xbox 360 Controller is the primary controller for Microsoft's Xbox 360 console. The controller is compatible with PCs and the wireless version is suitable for immersion room. We set it behavior function as the object behavior on the interface menu and the movement of the camera (subsection 4.3.2.3). This camera movement is consider as user movement in our simulation (Tab.4.2).



Figure 4.26. Xbox Controller Input.

Xbox Controller Input for TBS	User Motion
Directional pad (Used for navigating menus as well as controlling movement)	Move left / right / forward / backward
Left trigger + Right Thumbstick or Directional pad (Shift key + ↑ / ↓ key)	Rotate left / right / forward / backward
Right Thumbstick (←/→/↑/↓ key) + Right shoulder	Cursor

Table 4.2. User motions using Xbox Controller.

#### 4.3.2.6 Graphical User Interface

Our VR system intended to provide some sort of control panels available to the user. Information from the database present on these panels. There are several ways to create these panels. We apply 2D menus that display on the screen (CAVE display) and integrate the controller to the virtual world. The simulation system then notes user interaction with this controller as providing control over the system.

One primary area of user control is control of the viewpoint (moving around within the virtual world). This systems use the joystick or similar device to move. We did not use gestures from a glove or tracking camera to indicate a motion command since there is issue of real timing. Controls cause changes in the VE and displays show some measurement on it. There are four primary types of 2D controls and displays. These four types are buttons, sliders, gauges and text. Buttons will be menu items with either icons or text identifiers. Sliders are used for more analog control over various attributes. A variation of a slider is the dial, but these are harder to implement as 2D controls. Gauges are graphical depictions of the value of some attribute(s) of the world. Text may be used for both control and display. However, in this system the user will not necessary to enter text commands to some command parser. The system will use text displays to show various attributes of the virtual world.

## 4.4 Specifying the Visualization and Interaction of TBS in VE

This section describes specific works to optimize TBS visualization and Interaction in VE. Our VE system concentrates both on the simulation and the presentation. Providing enhanced visualizations can possibly help users to better interpret and understand what is happening at any point in time during the simulation. We concluded that a good visualization of the simulation would be depending on the detailed 3D geometry of the object (building) and the thermal metaphors.

The system is expected to have this objective including:

- Provision of 3D animation of geometrical or architectural objects from inside the virtual environment without having to import such objects from an external thermal tool system.
- Provision of simulating the thermal properties of thermal objects from inside the VE.
- Automated assembly hierarchies between architectural objects and its thermal performance using constraint-based rules that facilitate the synchronization for all changes in time and position.
- Improved interaction techniques that substitute the real world interaction, graphics rendering systems that generate high quality stereo images, and realistic behavior of objects in VEs.

### 4.4.1 The Visualization of TBS in VE

Along with the 3D model, thermal results bounded in visualization metaphor. As described earlier, we created a concept of dividing the 3D model (interior space of the room) into eight layers, and to fix the size of the cubic matrix. In the script it is assumed that this matrix has cubes of 8x8x8. The BB system used "ArrayLoad" parameter to fill all around of the simulation space with the cube (Fig. 4.27 and Fig. 4.28). These cubes as well enforced as emitter. We do not have to generate the grid cubes (as emitter) in the simulation space. It is sufficient to always show the existing grid cubes but in hidden mode. We just have to assigning a color to each cube.

Visualization of thermal behavior is achieved through colored cube and the use of a particle system of 3DViaStudio. The colored cube is just attaching the color particles based on the state of the emitters while the simulation ignited. Visualization particle is a rather complex. The particle system is composed of two types of objects: emitters and particles. Once the simulation has been updated to the current simulation time, the particles ignited through the emitter that is already created. The emitter is placed in cubes and hid in the simulation space. In this case we set the emitter invisible by using no color (fully transparence,  $\alpha=1.0$ ) but keep it in active mode. Particles are generated by streaming emitters through a geometry shader that emits particles based on the state of the emitters. In rendering, all particles are sorted and rendered from inside the cube. When the particle is rendered, it texture color is resulted as the output color.

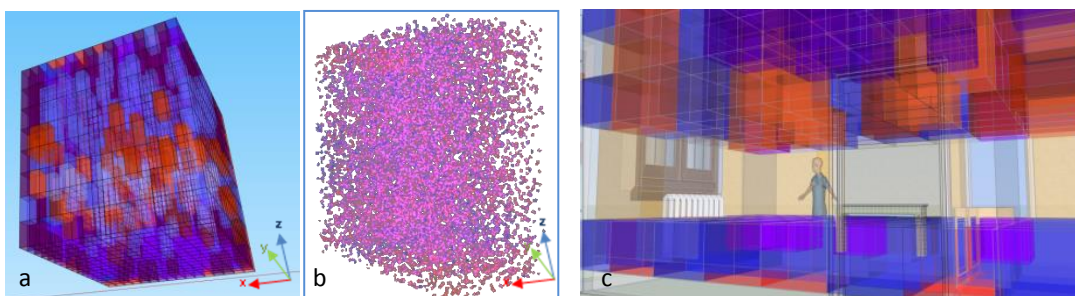

Figure 4.27. (a). Illustration of thermal grid with transparent cubes to be generated inside the interior space of a room precisely arranged on the XYZ axis. (b). The cubes filled with particles (c). The scenario to generate thermal visualization using grid transparent cubes.



Arrays		
start_array	Edit...	{ "sim_results",Text_Sim_results},{ "scene_disp",Text_scen_...
0	Edit...	"sim_results",Text_Sim_results
1	Edit...	"scene_disp",Text_scen_disp
2	Edit...	"interaction",Text_interaction
3	Edit...	"quotation",Text_quotation
4	Edit...	"nav_mode",Text_Nav_Mode
5	Edit...	"back",Text_Back_from_start
sim_results_array	Edit...	{ "ecotect",Text_ecotect},{ "cam_th",Text_cam_th}...
0	Edit...	"ecotect",Text_ecotect
1	Edit...	"cam_th",Text_cam_th
2	Edit...	"back",Text_Back_from_start
ecotect_array	Edit...	{ "cubes",Text_cubes},{ "gene_part",Text_Gene_Part}...
0	Edit...	"cubes",Text_cubes
1	Edit...	"gene_part",Text_Gene_Part
2	Edit...	"layers",Text_Layer_mode
cubes_array	Edit...	{ "search_folder",Text_Search_folder},{ "back_to_sim_result...
0	Edit...	"search_folder",Text_Search_folder
1	Edit...	"back_to_sim_results",Text_to_Sim_results_Back
gene_part_array	Edit...	{ "search_folder_part",Text_Search_folder},{ "back_to_sim_r...
0	Edit...	"search_folder_part",Text_Search_folder
1	Edit...	"back_to_sim_results",Text_to_Sim_results_Back
scene_disp_array	Edit...	{ "current",Text_current},{ "projected",Text_projected}...
0	Edit...	"current",Text_current
1	Edit...	"projected",Text_projected
2	Edit...	"back",Text_Back_from_start
begin_array	Edit...	{ "back",Text_Back_from_start}
0	Edit...	"back",Text_Back_from_start
tracker_array	Edit...	{ "start",Text_start}
mouse_keyboard_array	Edit...	{ "start",Text_start}
interaction_array	Edit...	{ "back",Text_Back_from_start}
quotation	Edit...	{ "begin",Text_Begin},{ "back",Text_Back_from_start}...
back_array	Edit...	{ "start",Text_start}
layers_array	Edit...	{ "search_folder_layers",Text_Search_folder},{ "back_to_sim...
0	Edit...	"search_folder_layers",Text_Search_folder
1	Edit...	"back_to_sim_results",Text_to_Sim_results_Back
list_info_obj		▼ null <span>Pick...</span>
Node2DPtr		
interaction_texture_table	▼ null [ :Metadata_table.Texture_table=vkNode2D]	<span>Pick...</span>
info_chart	▼ null [ :ECOTECT_Group.Information_chart=vkNode2D]	<span>Pick...</span>
transparency	▼ null [ :Transparency=vkNode2D]	<span>Pick...</span>
arrow	▼ null [ :Options_panel.Menu_arrow=vkNode2D]	<span>Pick...</span>
options_panel	▼ null [ :Options_panel=vkNode2D]	<span>Pick...</span>
horiz_layer_button	▼ null [ :Options_panel.Horizontal_L=vkNode2D]	<span>Pick...</span>
vert_layer_button	▼ null [ :Options_panel.Vertical_L=vkNode2D]	<span>Pick...</span>
cubes_or_particles	▼ null [ :Cubes_or_Particles=vkNode2D]	<span>Pick...</span>

Figure 4.28. Setting of cubes and particle simulation.

Figure 4.29 shows the flowchart to initiate the cubes and particle simulation and visualization in VE. This process decision program applied to the user interface. Colored cubes and particles are thermal metaphors that equally demonstrate the value of txt format, but not appear simultaneously.

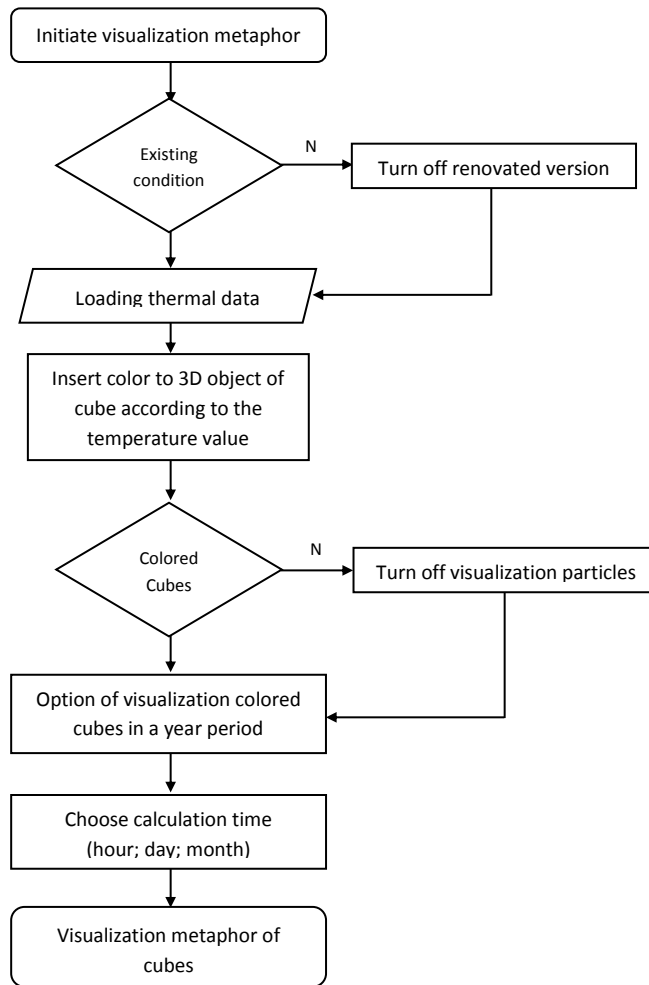

Figure 4.29. Flowchart of process decision program to visualize the thermal metaphors

In terms of thermal interpretation, we use a color attached to the cube. The value is adapting the color temperature chart called Kelvin color temperatures scale (Fig.4.30). Color temperature is a standard method of describing colors used in a range of situations and with different equipment. This concept offer a visualization of dynamic value of the temperature in the room as show within temperature scale. The color of the cube is determined in proportion to the value of the temperature. The boundaries of the interval are considered as minimum and maximum variables. Blue corresponds to the minimum temperature and red corresponds to the maximum temperature. These color behaviors are recorded in the matrix. The boundary of the interval is fixed. We decided to limit the interval between 0-40°C since the temperature of the room during the year hovering between this limit. 0°C is the lower bound indicated by blue color and 40°C the as the upper bound indicated by red color. Figure 4.31 shows the application of this color indication for our simulation.



Figure 4.30. Kelvin color temperatures scale

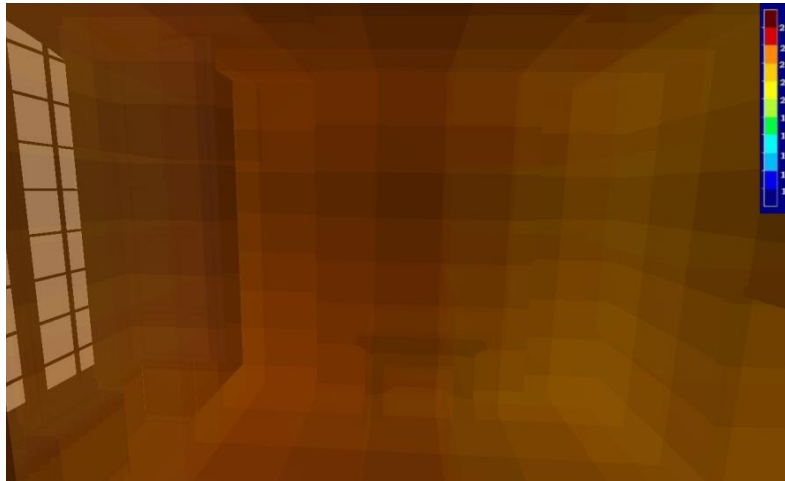

Figure 4.31. Illustration of color indication (Kelvin color temperatures scale) implemented in our simulation

In term of intensified view of data, we focus on the exploration process. We developed intuitive interaction scenarios to support interest driven exploration. Intuitive navigation and the use of simple and fast interactive visualization tools provide a useful approach to the effective exploration of volumetric data.

The visual feedback is accomplished through stereoscopic vision to provide the user with a 3D experience of datasets, allowing a quicker exploration. Stereoscopy creates the illusion of three-dimensional depth from given color cubes and particles. There are two ways to achieve stereoscopic vision: passive and active stereo. Our 3D displays are intended to use stereoscopic method to convey images, which is including an active shutter 3D system. The system works by openly presenting the image intended for the left eye while blocking the right eye's view, then presenting the right-eye image while blocking the left eye. It repeating this so rapidly that the interruptions do not interfere with the perceived fusion of the two images into a single 3D image.

This generally uses liquid crystal shutter glasses. In active shutter glasses, each eye's glass contains a liquid crystal layer which has the property of becoming opaque when voltage is applied. The glasses are controlled by a timing signal that allows the glasses to alternately block one eye, and then the other, in synchronization with the refresh rate of the screen. The projector projects frames for each eye sequentially; the shutters on the glasses are synchronized to the projector so that the correct eye is shuttered for each frame. The rate of alternation required is minimum 120 Hz to completely eliminate noticeable flicker to allowing 60 images per second per eye. As the experiment intended to perform in immersion room equipped with special projectors, it utilizes active stereo. Advantage of this active stereo is that the user can see "where" objects are in relation to his/her own body with much greater precision (in full Color), especially when those objects are moving toward or away from him/her in the depth dimension. Thus the user can perceive and measure the simulation space.

#### 4.4.2 The Interaction of TBS in VE

In the interaction between users and VE, users designed to be able to navigate through 3D space, explore virtual building, as well as control parameters of the simulation. They interact with the GUI inside the VE in a user-friendly way. The type of interaction technique depends on the task to be performed. In our case, we designed interaction techniques that would assist in visualization and simulations in fully immersive (CAVE-like systems / Immersion room). When starting the application, the user is presented with the virtual world rendered to physical scale. The user is able to navigate by simply operating the joystick to the direction he wishes to go. The speed at which the user travels is already set in moderate level. It allowing for fine navigation within the object (interior of the room).

When exploring TBS in VEs, users will be given a mechanism to enter world of object or "room" in the scene. The mechanism that allow users to freely move to other rooms, or scenes. Therefore, this application profited from the life-size display of the fully immersive CAVE-like systems. This provides a higher degree of user immersion in the virtual worlds, and to have impressive applications like architectural walkthroughs or navigation. In addition, the CAVE environment has the advantage of allowing multiple users simultaneously although only the perspective of one viewer may be displayed at a time. In our immersion room (CAVE-like environment) which is consist of two walls or without a back wall, rotation is necessary for the user to see objects behind him.

In order to interact with the world, the user must first select a tool to use. The selection technique is using the direct pointing to gain more intuitive and easy way of object selection when the user select an object with the cursor or pointer. To do so, a main menu button can be pressed to enter the simulation. Some tools can be used for TBS (comparing to some TBS tools) are thermal simulation, state of the simulated object, thermal metaphor, and time of simulation.

In terms of navigation, we maximized the use of controller in order to change the position and orientation of the user's viewpoint. We apply the navigation process into three categories: Exploration, Search tasks and Maneuvering tasks (Koutek, 2003). *Exploration* is navigation without any explicit target when the user simply explores the environment (Van Dam et al., 2000). *Search tasks* involve moving through the environment to a particular location. Finally, *maneuvering tasks* are characterized by precise movements usually done to position users better for performing other tasks. The user's movement through the VE will have some direction motion, such as: physical walking, hand directed, gaze directed, object driven and goal driven. The speed control set in constant acceleration.

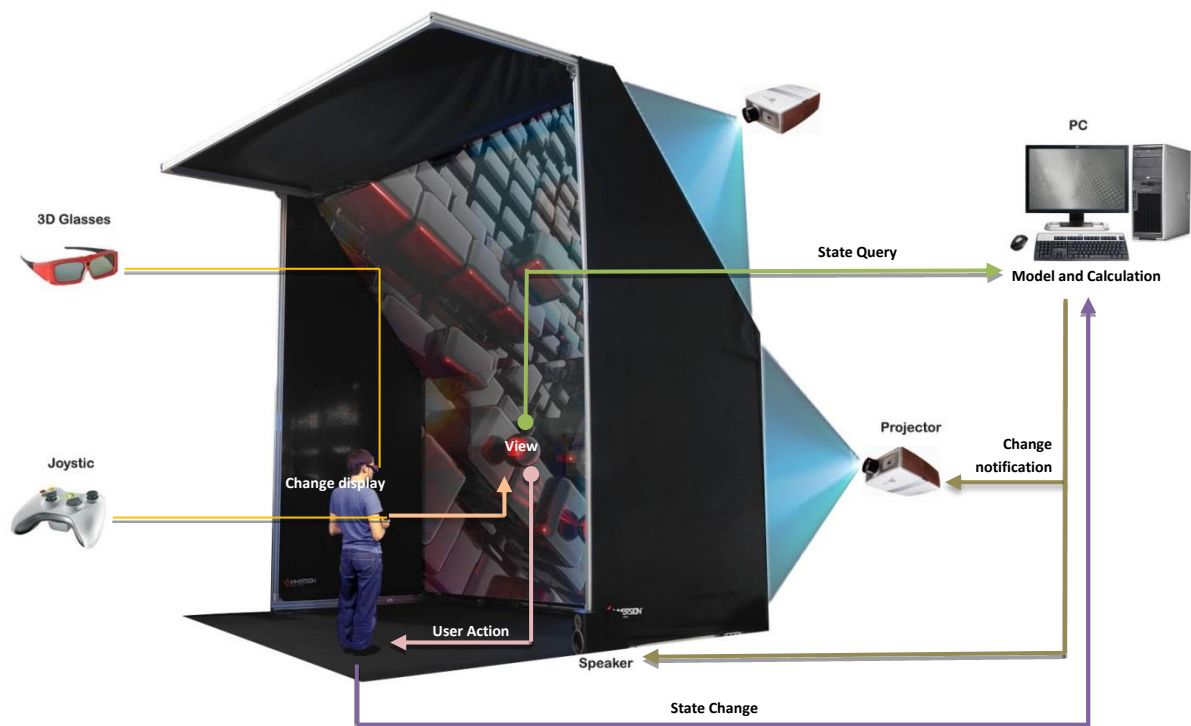

Figure 4.32. Illustration of the instruments and system of the interface within the immersion room. The coupling is flexible between the three blocks: Model, View and Controller.

In the experiment, the immersion room is set to provide visualization and interaction concerning the thermal condition in VE with friendly interface (Fig. 4.32). The interface is adopted Model-View-Controller (MVC) architecture that suited for iterative design (Reenskaug, 1979).



The advantage of the MVC is the resulting application is modular. The coupling is flexible between the three blocks: Model, View and Controller. This implies that the change of a block does not affect the overall structure, which makes changes easier.

In principal, using MVC, the system in the VE is divided into three main parts:

- Data: These data is dynamically loaded into the environment. They are: thermal and geometric data (3D model);
- Data translation: An intermediate step between the raw data and the data represented (returns in visual and in sound).
- Interaction: It is to give the user visual feedback and provide the user to have the ability to navigate in the environment as well as to manipulate the objects interactively.

Well-designed metaphors can assist users in performing tasks in HCI. Thus, designing effective VE metaphors could similarly enhance human performance in virtual worlds (Stanney, 1995). Such metaphors may also be a means of assisting in the integration of multi-modal interaction. In this application we arrange some command and menus for the user interface. The context of the interface is menu driven which allow the user to choose from a list of options. These command and menus using some icons which design to represent the function they are providing (see Appendix C).

Beyond the need for TBS visual metaphors, we also try to use auditory metaphors. It is to provide a means of effectively presenting auditory information to users. We propose the use of sound effect to complete the information and perception of the user, thus amplifies the immersive sensation. The way it works is synchronized with the real-time visualization and movement by the user. This environment supports with four speakers surround the immersion room (Fig. 4.33).

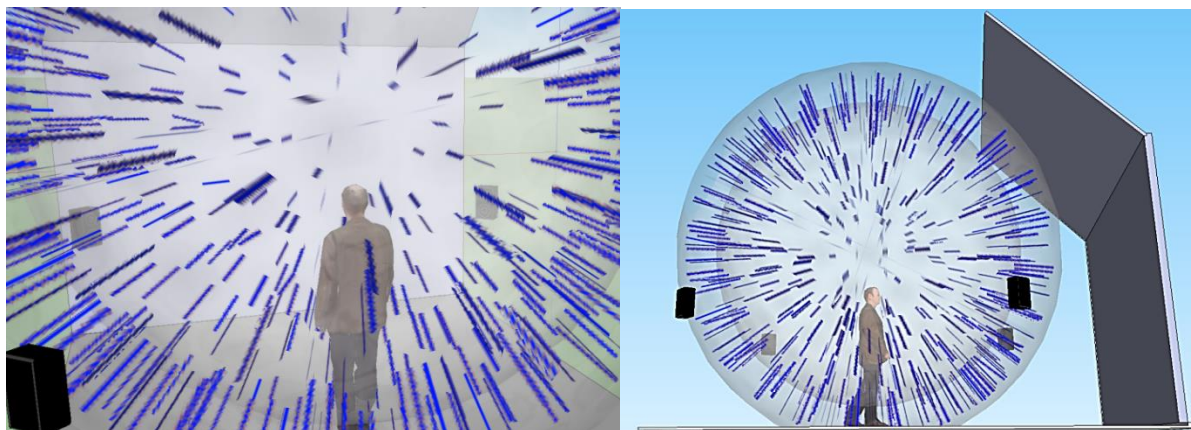

Figure 4.33. Illustration of the positioning of the speakers in the environment. The perception of 3D sound positioning can be achieved using a 3D arrangement of speakers positioned around the listener. We arranged four speakers surround the immersion room that enables listeners to perceive sounds as to come from any point in the simulation space.

A localized sound is attached to objects to enhance the sense of immersion provided by visual displays. As explained earlier, our simulation object is divided in some cubes (grid of emitters). When the simulation is initiated, each cube will contain the appropriate color according to the value of the temperature. In this concept, we also add the sound to each cube. Cube with high temperature values (red color) will generate high sound. Otherwise, cube with low temperature value (blue color) will generate low sound. Thus, when the user moves from one spot to another in the simulation space, he/she will hear the sound fluctuations depend on the value of the temperature at the spot he/she went through.

## 4.5 Summary

TBS representation in VE is a concept of the importance of thermal measurement and integration of advances in 3D design and VR technology. Data integration has become the essence of the method on thermal simulation results represented in a VE. It combines the principle of integration of 3D CAD geometry, thermal calculation and scientific visualization in VR. To conduct the method, we concept the data transfer by means of the smooth data exchange between CAD Revit, Ecotect analysis and 3DVia Studio/Virtools. The data contains geometrical, topological, surface elements, and thermal calculation results in real-time and as close as possible to the actual space.

CAD data in 3D models composed of basic geometry are usually designed and transferred to other tools for next process. It is particularly if intended to have its thermal calculation (BIM concept). Further, a specific effort can carry out in order to present all those data in VE. However, CAD and thermal data needed for the VE is not simple. They need to be structured in a workflow method. Challenges in data exchange, as well as technological component used have become an important issue. Regarding 3D modeling and thermal simulation it can optimize the methods and tools used by the AEC community. Thermal calculation and simulation using Ecotect is through a 3D mock-up from Revit. Using this model, it then followed by the generation of a thermal model in the context of TBS. In the simulation, a calculation of building thermal loads and thermal consumption are involved in determining the thermal characteristics of the building and its building systems. The MRT in Ecotect become the priority for our calculation. The calculation result focuses in monthly temperature profile. These data is then manifested to VE with a thermal visualization metaphor.

Thermal calculation result converted and coupled into the 3D model to become the virtual model. This virtual model fully processed on 3DVia Studio/Virtools. Visualization between users and objects in VE are certainly through techniques of interaction and visualization metaphors. It is to inform the user regarding thermal result interactively as well as putting them in high immersion. The application scenario is mainly created to interactively visualize this TBS results in the immersion room (CAVE).

We keep the idea to conduct the integration in VE through the concept of BIM. Processing 3D geometry and thermal data to VR software is a specific task. In this task, the methods performs in transfer data is directly associated to the visualization output on the display. This process takes place in the background, the user (building stakeholder) then expected to understand the final results. In order to accommodate this user, we developed a simulation scenario comprise of immersive visualization and intuitive interaction.

In terms of immersive visualization, we place the 3D model along with its TBS results as in reality. To provide the user with a 3D experience, the visual feedback is accomplished through stereoscopic vision. The 3D model and its thermal simulations generate in high quality stereo images to facilitate the user in interpreting the results. In terms of intuitive interaction, we provide interaction scenario as in video game. The interaction techniques provide interaction scenario that substitute the real world interaction. This support with friendly user interface and realistic behavior of objects in VEs. Mechanism of interaction and visualization in the system (immersion room) is through the MVC concept.



# Chapter 5

## Case Studies: Thermal Building Simulation and Visualization in Virtual Environment

### Abstract

---

The method implemented for representing TBS results (discussed in Chapter 4) is conducted with case studies. The workflow and the results are validated through experiments. Experiment scenario of a thermal simulation is created to interactively visualize the results in the immersion room and tested by some participants. In the experiment, the method which bundled in an application brings together within a couple of virtual scenario and a software/hardware solution. Some visualization metaphor are tested and evaluated to present more informative thermal simulation results where the user can interact and perceive the impact of the modifications generated by the system. Evaluation of the application prototype showed various levels of user satisfaction, and improvements in the accuracy and efficiency of data interpretation.

Chapter five describes application of the TBS representation using VR techniques and its validation. It establishes the design of the experiment (case study), the general procedural aspects and the results. It outlines hypothetical visualization metaphors to conduct in a test. It is to know the pertinence of visualization metaphors as well as its interaction scenario to building stakeholder. A user test was conducted to evaluate factors affect the successful representation of TBS in VE. Such things as the effectivity, workability, flexibility and precision of the visualizations are examined.

### Contents

---

5.1 Experiment of representing TBS in Virtual Environment .....	103
5.1.1 Object of Experiment (Gunzo Room) .....	103
5.1.2 Workflow from Revit Architecture to Ecotect Analysis .....	104
5.1.2.1 Modeling in Revit Architecture .....	104
5.1.2.1.1 Gunzo Room in Existing Condition .....	104
5.1.2.1.2 Gunzo Room Renovated Version .....	108
5.1.2.2 Thermal Calculation (Ecotect Analysis) .....	111
5.1.2.2.1 Adjacency Checks .....	112
5.1.2.2.2 Internal Loads and Schedule .....	113
5.1.2.2.3 Weather Data .....	115
5.1.2.2.4 Calculation Mode .....	117
5.1.2.2.5 Thermal Analysis .....	119

5.1.3 The TBS Results of Gunzo Room .....	121
5.1.3.1 Monthly Temperature Profile .....	121
5.1.3.2 Passive Gains Breakdown .....	122
5.1.3.3 Passive Adaptivity Index .....	123
5.1.3.4 Summary .....	125
5.1.4 Preformat Data .....	126
5.2 Experiments using PC and Tablet .....	127
5.2.1 Hardware and Software Solutions .....	127
5.2.2 Experiment Framework with PC and Tablet .....	128
5.3 Experiments in the Immersion Room .....	132
5.3.1 Details of Setting in the Visualization and Interaction .....	133
5.3.2 Experimental Setup .....	143
5.3.2.1 Hypotheses and Experimental Protocols .....	143
5.3.2.2 Test Subjects and Procedure .....	143
5.3.2.3 Technical Components and Data Supply .....	144
5.4 The Results of the experiment in Immersion Room .....	146
5.4.1. Visualization Metaphor .....	147
5.4.2. Performance on Nine Tasks .....	149
5.4.3 Task Completion Times .....	149
5.4.4 Subjective Impressions .....	153
5.5 Summary .....	156

The case study conducted with two types of experiment, in PC, Tablet and in immersion room. It's implementing workflow method and the tools described earlier. Each phase using the same object (3D model) which is modeled in respect of AEC standard process and BIM.

## 5.1 Experiment of representing TBS in Virtual Environment

This section describes the process of experiment of representing TBS in VE. It began with the background checking of the object, and the realization of a mock-up model of the existing conditions, followed by the exploration of some alternative models (renovated version scenario). This first step conducted the modelling, thermal calculation and data preformat using Revit, Ecotect and Perl Routine.

### 5.1.1 Object of Experiment (Gunzo Room)

The Gunzo room was chosen as the object of the experiment to represent the other rooms in the building. The room is located in an old building situated on the historical site of the Cluny Abbey which is also a part of the Arts et Métiers ParisTech (ENSAM) campus (Fig.5.1). The room volume is approximately 68.5 m<sup>3</sup>. The stone wall is 85 cm thick, and the doors and window are made of wood. The large window consists of two panels, with an interior shutter thickness of 2.5 cm. The exterior window sash has one single glass layer, with a thickness of 3 mm. The window faces south-south west. There are three doors on the other side, opposite the window.

The interior consist of two lights (double tube lamp 40-70 W for each), and one radiator. Lighting was fixed on the ceiling, and chimney was not functioned. The wall in this room classified into two kinds. Rock wall thickness of 85 cm and partition wall thickness of 15 cm. All of these walls covered by brown wallpaper in the interior. The surface of the floor covered by vinyl tile and the ceiling material is GRC board tile. As it is typical of old structures, the building consists of rooms enclosed by thick walls and large windows which have been protected. Thermal problems exist in all of the rooms, so it can be quite uncomfortable for the occupants.



Figure 5.1. Photos of Interior of Gunzo room. The object is located on the historical site of Cluny

As a historical property, changes are not allowed to the exterior façade. Therefore, renovation is limited to certain parts of the interior only. In this case, as Judkoff (2008) data, we found that the window was the most crucial factor effecting indoor energy consumption. The interior configuration is adapted to the addition of a partition fitted for a new window. This concept is used as part of interior insulation of a building (Ter Minassian, 2011) which has demonstrated its effectiveness, and is becoming common practice in window renovation especially in the Nordic countries.

The renovated version was created according to several alternatives in order to adapt to the requirements of an efficient environment. The renovated window or the new window consists of two panels; an exterior sash and an interior shutter. Due to the need to preserve the historical façade, no changes were made to the exterior sash. We operated a modification on the interior shutter in terms of its position as well as its material. The modification was effected by moving the interior shutter backwards against the exterior sash. This modification required the addition of a shelf under the window sill. The former heater was also replaced with a modern one for maximum performance. This change was made to optimize the thermal calculation result, and to provide the room with optimum conditions.

### 5.1.2 Workflow from Revit Architecture to Ecotect Analysis

This subsection details the 3D model and its workflow from Revit to Ecotect.

#### 5.1.2.1 Modeling in Revit Architecture

We create the 3D geometry in a digital mock-up in two conditions; actual condition and renovate version. The renovate version are created in several alternatives to adapted the needs of an efficient environment. This is to optimize thermal calculation and to deliver the room into a proper environment for the experiment. Several alternatives made to be discussed among the team to specified which one of them is the most efficient to be proceed for the experiment. Renovate version performed on window changes, especially on placement of interior shutters including its material. The digital model was developed with Autodesk Revit and exported in Fbx and IFC format (Appendix B). These formats later on will be transfer and process in Ecotect, 3DMax, and 3DViaStudio/Virtools.

##### 5.1.2.1.1 Gunzo Room in Existing Condition

This subsection describes final results of the 3D model of Gunzo room in existing condition. It presents in lay out, section, and details.

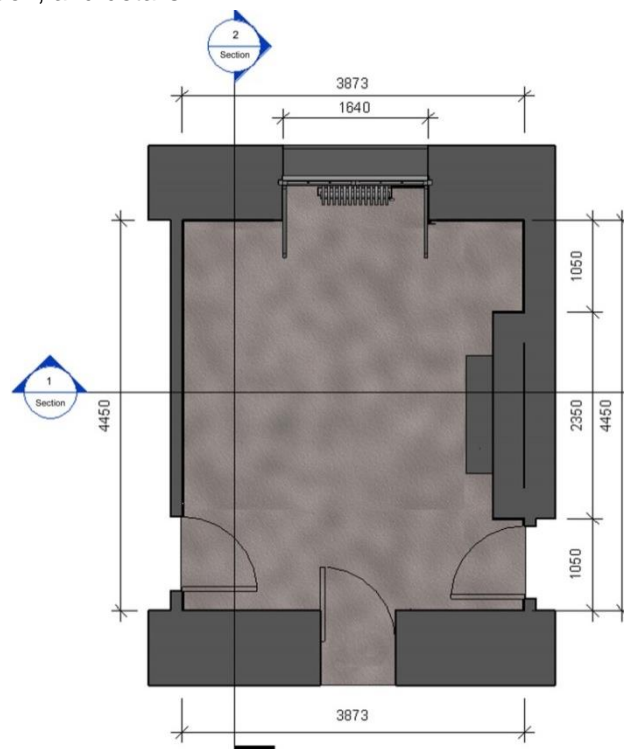

Figure 5.2. Lay out of Gunzo room in existing condition. Length 4.45 m, width 3.87 m and height 3.92 m. Stone wall 85 thick, doors and window of wood and floor covered by vinyl tile.



Figure 5.3 shows two sections of Gunzo room in existing condition. The section cutting lines is taken from the lay out (Fig. 5.2). The upper and the lower figure are actually the same. The lower figure is in transparent mode.



Figure 5.3. Gunzo room in existing condition: Section 1 and Section 2.

Figure 5.4 shows 3D view of Gunzo room in existing condition. It shows the thickness of the wall including its material.



Figure 5.4. 3D view of Gunzo room in existing condition. Stone wall interior covered by wallpaper.



Figure 5.5 shows the building material of Gunzo room in existing condition. It describes the material components and the furniture. All of these items will use as a parameter of thermal calculation and visualization in VR.

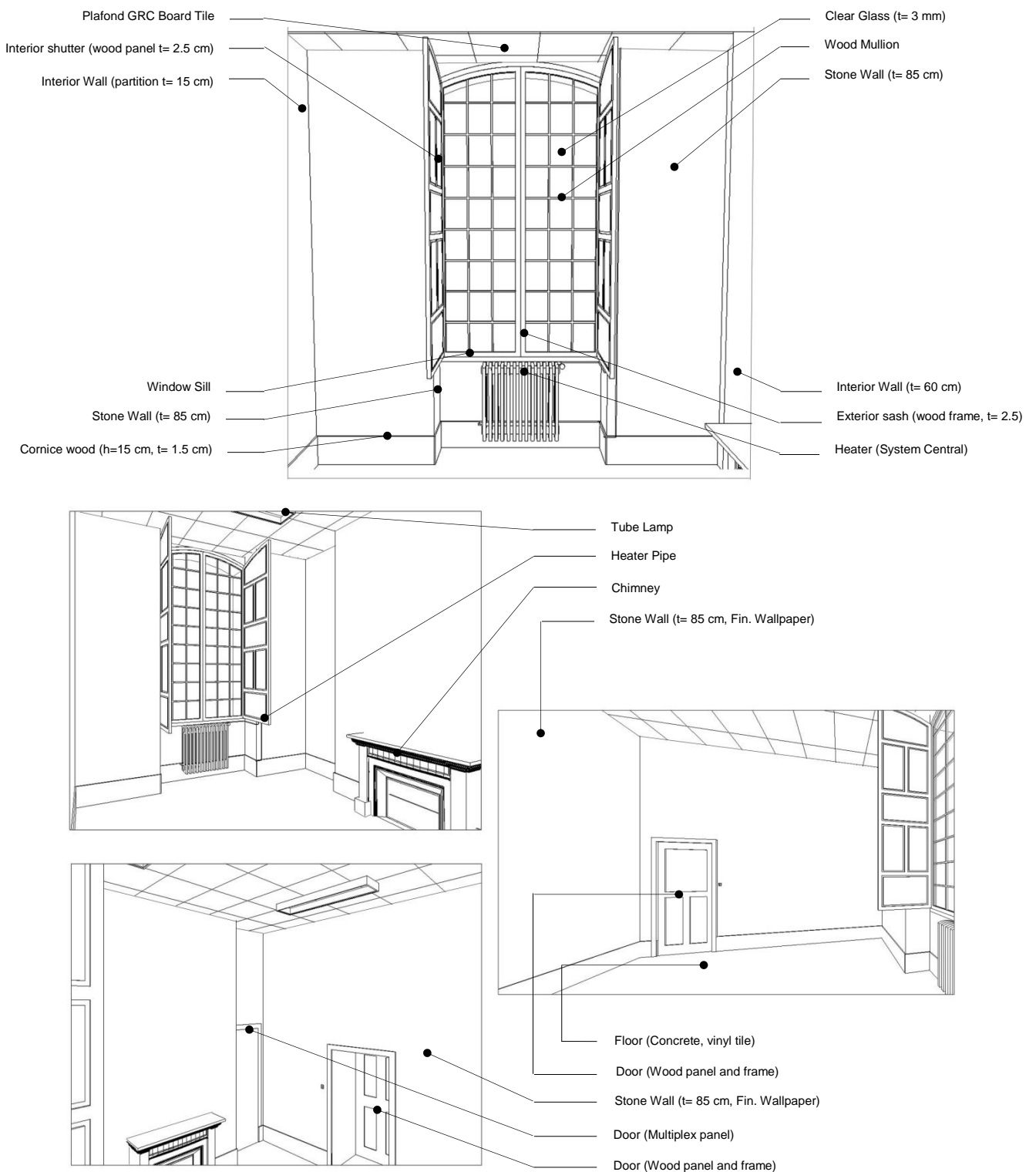

Figure 5.5. Detail of Gunzo Room in Existing Condition

Figure 5.6 and figure 5.7 show rendering of the interior of Gunzo room in existing condition. This is to show the material components and furniture as in real conditions.



Figure 5.6. Rendering using lighting from the window of Gunzo room (existing condition). It combines the lighting between natural and artificial.



Figure 5.7. Rendering of material components of Gunzo room (existing condition). Wall surface finished by wallpaper and concrete floor finished by vinyl tile

Figure 5.8 shows close up rendering of the window and old heater of Gunzo room (existing condition). The window consist panels and exterior sash as it real condition in real world. The exterior sash composed of frames to hold the glass.

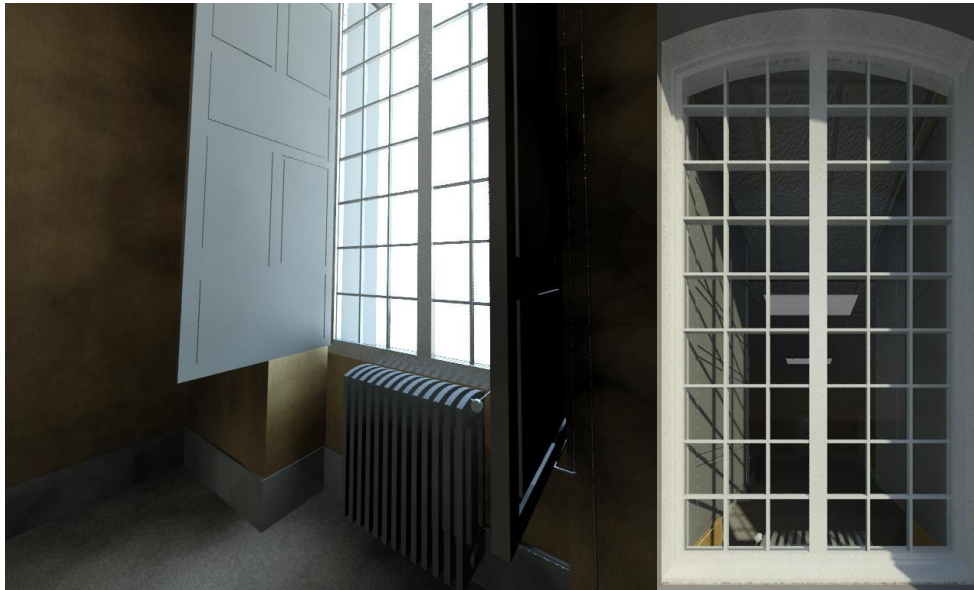

Figure 5.8. Close up rendering of the window, old heater and exterior sash of Gunzo room (existing condition).

#### 5.1.2.1.2 Gunzo Room Renovated Version

The 3D modelling continues to design the Gunzo room renovated version. Several alternatives of renovated version were considered (Fig. 5.9). It then discussed in terms of their design efficiency and energy characteristics. The third alternative was selected for the most efficient before proceed on experiment. In the third alternative of the renovated version, changes made to the wall and window components. The wall under the window is filled up leaving only a space for the heater. The interior shutter is changed for a new model with an aluminum frame and clear glass, and moved against the sash so that its position is parallel to the interior surface of the stone wall.



Figure 5.9. Digital Mock-up of Gunzo Room, (from left to right): Existing Conditions, 1<sup>st</sup> alternative, 2<sup>nd</sup> alternative, and 3<sup>rd</sup> alternative.

Figure 5.10 shows the modification (particularly window lay out) in Gunzo room renovated version (alternative 1, 2, and 3). It also compares to the existing condition.

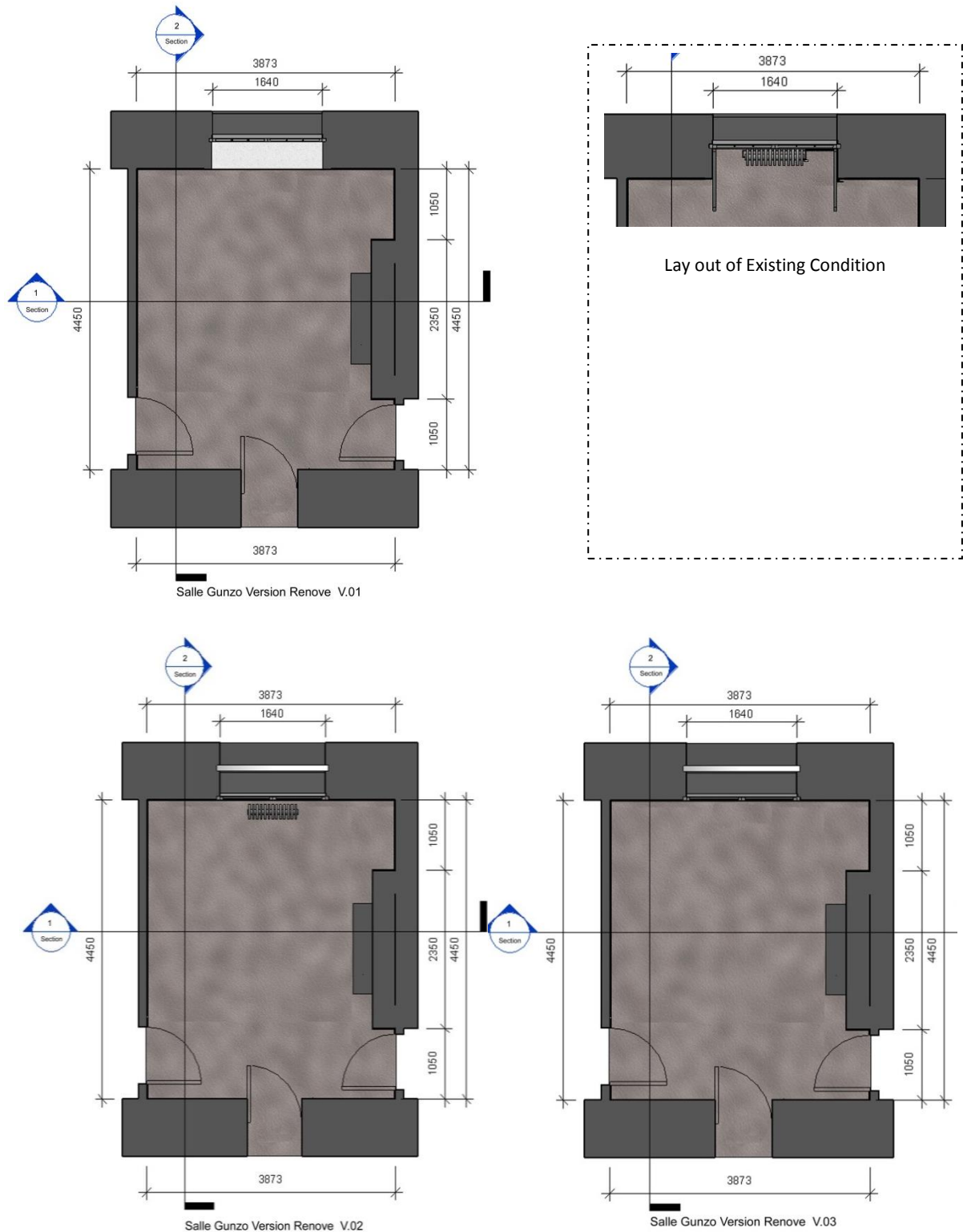

Figure 5.10. Comparison of window lay out between the existing condition and the renovate version (alternative 1, 2, and 3).



Figure 5.11 shows the comparison between Gunzo room in existing conditions and the chosen alternative of renovated version. The images show in 3D View and section. The change made significantly to the window and the heather. Figure 5.12 shows the detail condition of the renovated version alternative 3. It shows rendering in realistic view in the day and in the night.

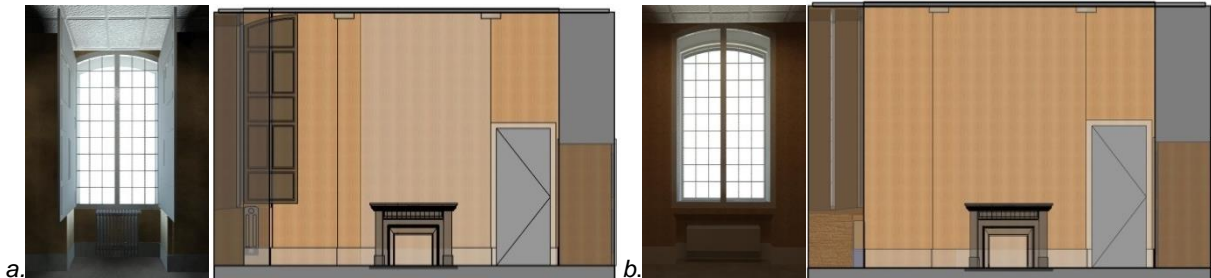

Figure 5.11. (a). Revit Model of Gunzo room (3D View and section) in existing conditions (b). The chosen renovated version (alternative 3).



Figure 5.12. The chosen renovated version of Gunzo room (3D view in the day and the night).

The completion of the 3D model (existing conditions and renovated version) is the end of the first step (modeling). The 3D model and its IFC data are ready for the next process (Fig. 5.13). At this point, these 3D models of Gunzo room are ready to transfer to Ecotect.

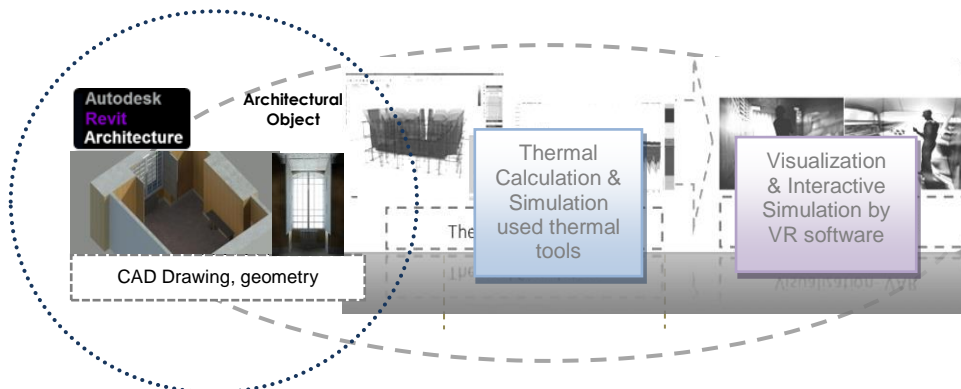

Figure 5.13. The creation of Gunzo room 3D geometry in the first step called modeling. As the Gunzo room properly modeled in Revit Architecture it is automatically respects to IFC structure. The 3D model is ready to move on the next step, thermal calculation and simulation using thermal tools (Ecotect).

### 5.1.2.2 Thermal Calculation (Ecotect Analysis)

Data exchange from Revit to Ecotect is used IFC/ifcXML format (Fig. 5.14). The 3D model is transferred in simplicity and direct usability. In this geometrically clean model, it typically requires little to no additional work within Ecotect. We have also done modeling using laser scanning. It's to obtain 3D model of Gunzo room in existing condition with 3D point cloud. This model is only used to compare and to match Revit 3D model. It is not used for thermal calculation in Ecotect, but to assist in terms of precision when the 3D model imported from Revit.

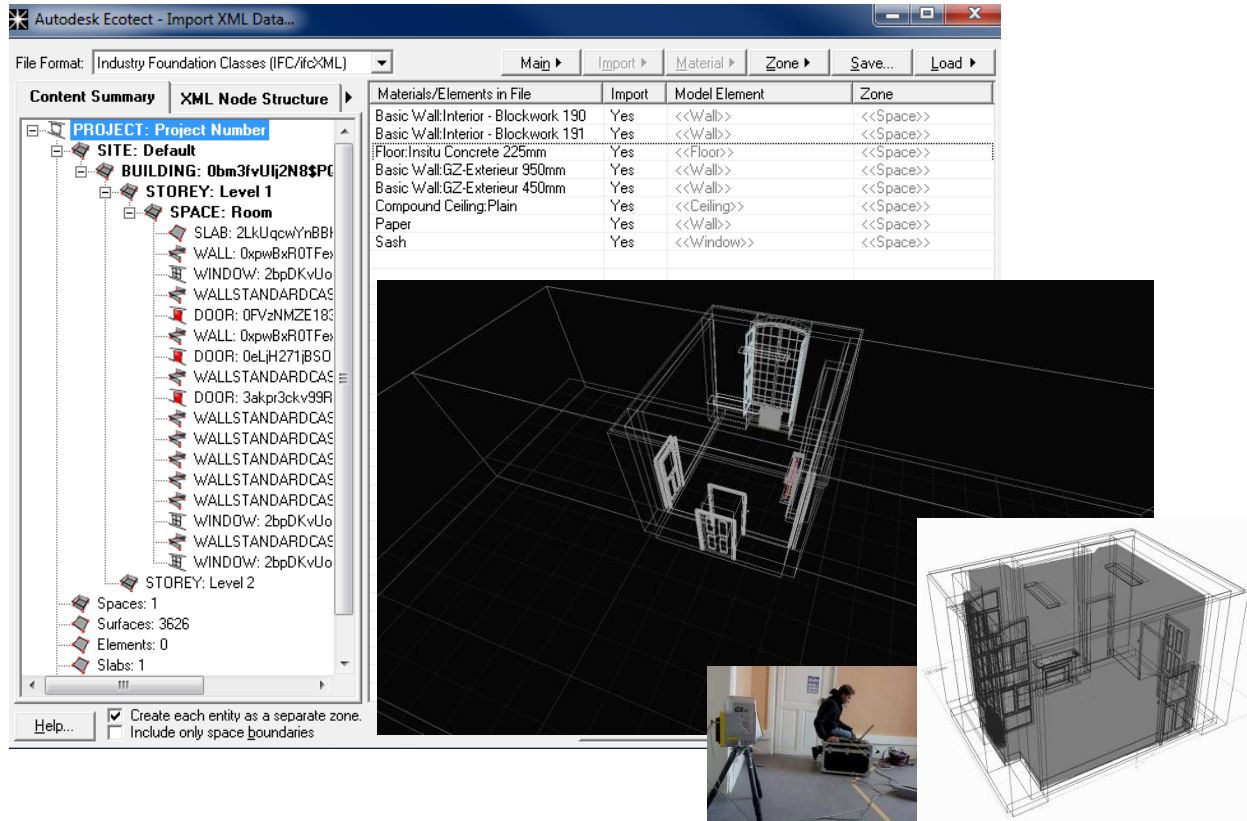

Figure 5.14. Gunzo room imported data using IFC/ifcXML format (left hand). Matching the 3D model with point cloud model from laser scanner (right hand).

In the Gunzo room of IFC/ifcXML format, we have a rather simple model that is the best choice for thermal analysis. Simplicity of volumes allows Ecotect to understand general volumes, and most importantly shared adjacent surfaces. So that the geometry is kept simple to gain a fast calculations. Since workflow from Revit to Ecotect done properly we don't need to create any models or to add any detail in Ecotect. We only need to add some adjacent zones.

Once the object engages to start simulation and analysis in Ecotect, the geometry should set to an ideal adjustment. This setting is to be eligible as an import file. The geometry should pass through two kinds of operating principles, Environmental Setting and Calculation Mode.

Following are some points of these principal operations (these points are detailed in next subsections) :

- 3D Modeling, Adjacency Checks
- Zone Settings / Internal Load and Schedules
- Weather Manager / Weather Data Import
- Thermal Analysis / Calculation Mode

### 5.1.2.2.1 Adjacency Checks

The main focus when preparing the environment in Ecotect is the existence of Thermal Zone. Each building must comprise one or more fully enclosed thermal zones (see Chapter 2). The thermal zone is the basic unit in thermal calculations for which internal temperatures and heat loads are calculated. A thermal zone is a single space or group of indoor spaces that has uniform thermal load profiles and conditioning requirements

In order to determine the spatial relationships between different zones, Ecotect performs an Inter-Zonal Adjacency calculation prior to any detailed thermal analysis. This works out the areas of each material through which each zone will likely exchange heat, air, sound and potential overshadowing with other zones. Gunzo room zone is the main volume to calculate but there were some rooms surround it as neighbor. Obviously these neighbor rooms have influence for thermal calculation, means that while focusing the result to Gunzo room the model have more than a single zone to calculate. As a part of office room, it is surrounded by corridor and other office rooms. Ecotect will understand how it touches the other zone - it will use the calculations to base simple thermal analysis equations.

While checking for adjacency we set the *Inter Zonal Adjacencies* accuracy to high level and adjust the surface adjacency tolerance to close. Then, enabled the feature of *Perform Detailed Shading Calculations* to calculate radiation impact from the sun.

To avoid such errors, we created other zones of neighbor rooms constructed from closed objects. Eventually the model being overlaid with a series of sample points. So, we ensure that shared faces are double-counted and that they are well-modeled (facing outwards, in the same plane, and extremely close together). So that, when the calculation starts, Ecotect will analyze all zones with focus to Gunzo room zone, while others zones counted as spaces that affects the Gunzo room zone.

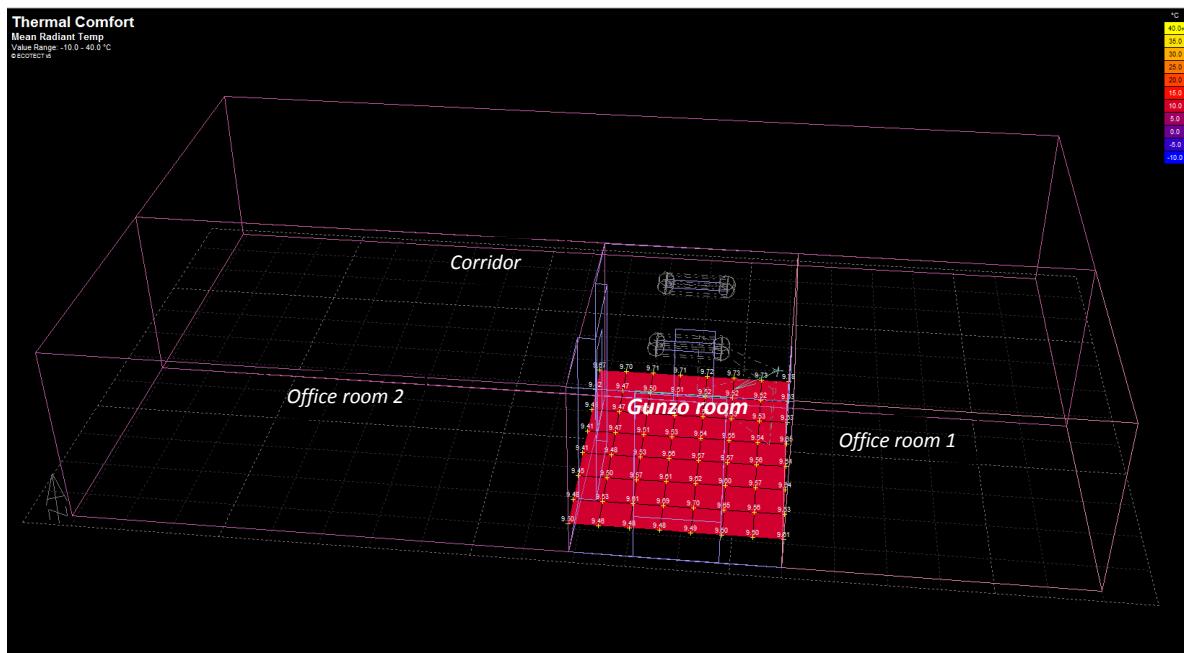

Figure 5.15. Gunzo room zone and its adjacency zones

### 5.1.2.2.2 Internal Loads and Schedule

Internal loads and schedule are set through zone management (Fig. 5.16). Values used in calculations are: internal design condition (the clothing, humidity and air speed), occupancy and operation. It contains design values and conditions of each zone.

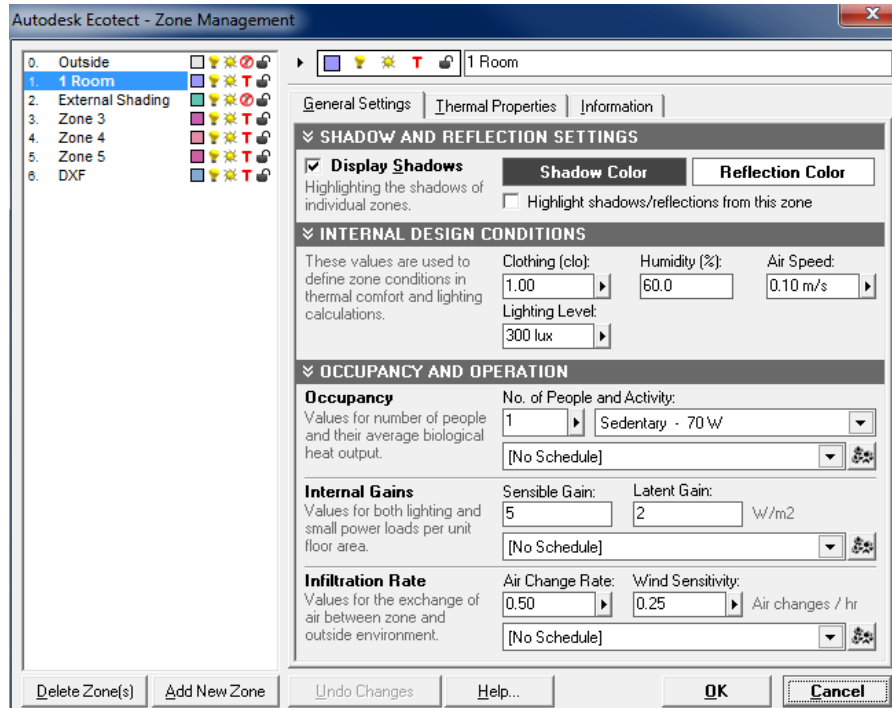

Figure 5.16. Display of Zone management. This display list all zones in the model and their current settings. It shows values of Gunzo room (1 Room zone) in general setting.

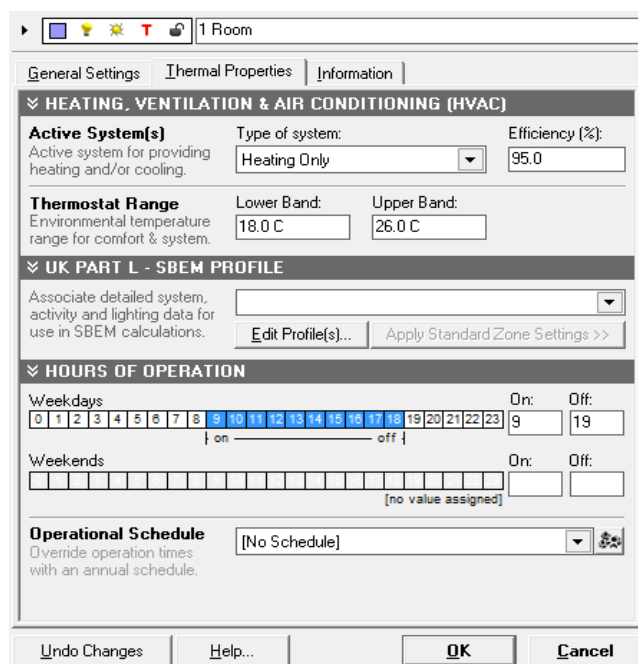

Figure 5.17. Zone profile of Gunzo room (1 Room zone): HVAC system and hours of operation.



Gunzo room did not use air conditioning (AC) system but a heater (Fig. 5.17). This means that heating systems run as required to maintain the zone air temperature between the thermostat settings at all times during the operational period. Windows are considered to not open so the only ventilation and infiltration is set in the Air Change Rate settings for the zone. We set the heating system in high efficiency (95%). Also, set the environment temperature range for comfort and system, 18°C for lower band and 26°C for upper band.

Times of operation and room occupancy are representing in hours of occupancy. These values used to limit the times over which the degree hour temperature distribution graph is calculated, restricting it to occupied hours only. We set the same occupancy value for the two version of Gunzo room.

Occupancy schedule or Daily profile of the room operation of Gunzo room (Fig. 5.18):

- Person : 1
- Work day : Monday - Friday
- Work hour : 09.00 – 18.00
- Weekend : Saturday-Sunday

Table 5.1 summarizes all of conditions and settings of Gunzo room zone (actual and renovated version).

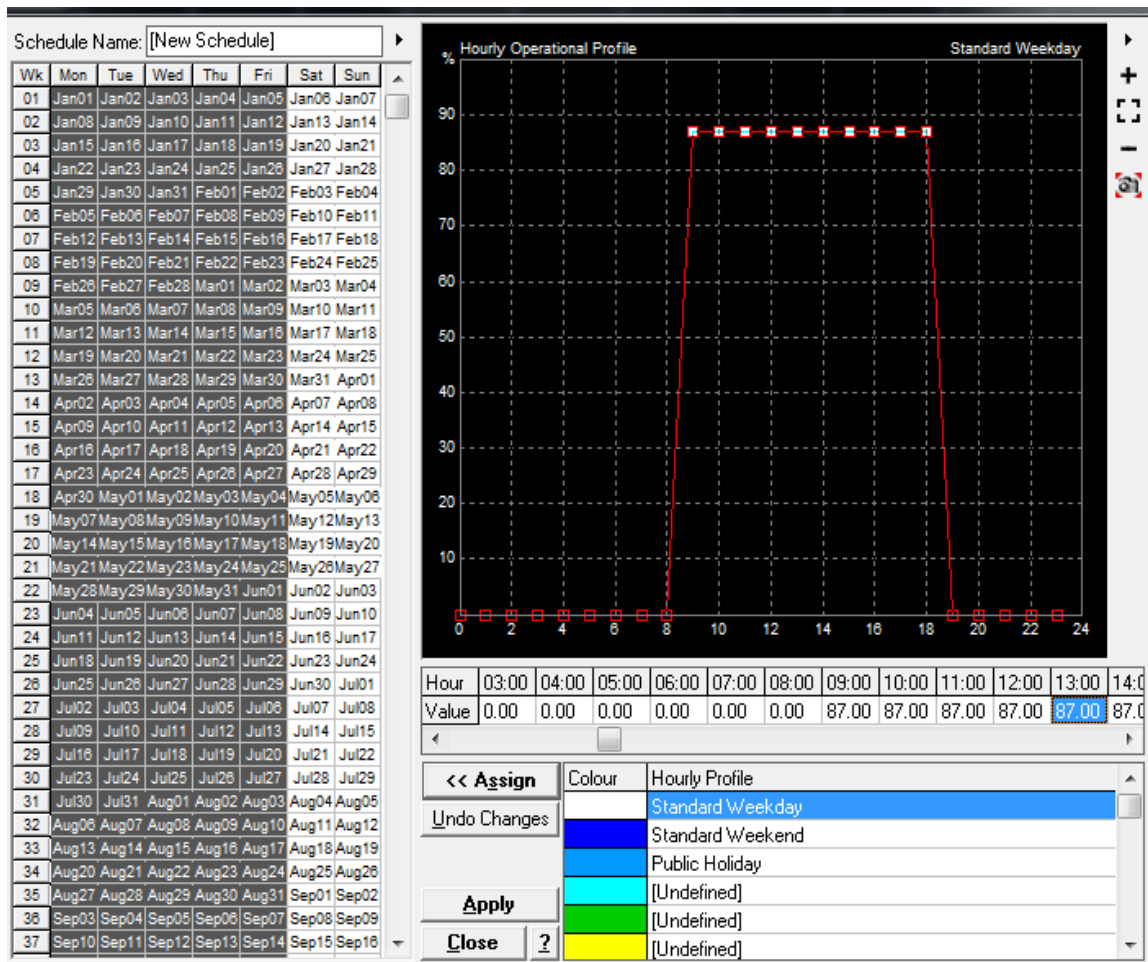

Figure 5.18. Specific operational of Gunzo room (time of occupancy) during the year.

Gunzo Room Zone Management			
	Existing Condition	Renovated Version	Notes
<b>General Setting</b>			
<u>Internal Design Condition :</u>			
• Clothing	Light Business Suit	Light Business Suit	
• Humidity	10% ~ 30%	10% ~ 30%	
• Air Speed	Still (0 m/s)	Still (0 m/s)	
• Lighting Level	office room (300 lux)	office room (300 lux)	
<u>Occupancy and Operation :</u>			
• Number of people and Activity	1 P, Activity : Reading, Typing	1 P, Activity : Reading, Typing	
• Internal Gain			Values for both lighting and small power loads per unit floor area
- Sensible Gain	5 W/m2	5 W/m2	
- Latent Gain	2 W/m2	2 W/m2	
• Infiltration Rate			Values for the exchange of air between zone and outside environment
- Air Change Rate	Average (1.0 ach)	Well Sealed (0.5 ach)	
- Wind Sinsitivity	Reasonably Protected (0.25 ach)	Well Protected (0.1 ach)	
<b>Thermal Properties</b>			
• Thermostat Range			Environment temperature range for comfort and system
- Lower band	18°C	18°C	
- Upper band	26°C	26°C	
• Active System	Heating Only (Efficiency : 95%)	Heating Only (Efficiency : 95%)	
• Hours of Operation			
- Year	Jan - Apr, Oct - Dec	Jan - Apr, Oct - Dec	May - Sep. No Heating
- Week	Monday - Friday	Monday - Friday	Weekend. No Heating
- Day	09.00 - 18.00	09.00 - 18.00	Work-hour

Table 5.1. Gunzo room zone management. Using this setting, the both version of Gunzo room are equally processed in parallel time simulation.

### 5.1.2.2.3 Weather Data

In this calculation, the weather data files in Ecotect are taken from the US Department of Energy (EERE, 2012), arranged by World Meteorological Organization region and Country. It provides data based on weather factors (solar, wind, temperature, etc.) referenced per year. These weather files do not reflect a specific year, but provide a statistical reference for the typical weather parameters of a specific location.

A thermal data allow us to customize the plotted environment or model based on desired time period. For example, in this experiment we conduct the thermal comfort analysis. The thermal comfort analysis allows us to view data based on selected months, day and hour. A graphic data as well as an animated option is available that displays selected time periods. Object Gunzo room has been set to use weather data in Lyon which is closest to Cluny (Fig. 5.19). Its general assumption of thermal factor has been setting up in a certain condition in Cluny to conduct the analysis.

The Climate data (Weather data file) loads in the following parameters (Fig. 5.20):

Solar, Thermal naturality, Air Temperature, Relative Humidity, Wind Speed, Wind Direction, Diffuse Irradiation, Direct Irradiation, Cloud Cover, and Rainfall.

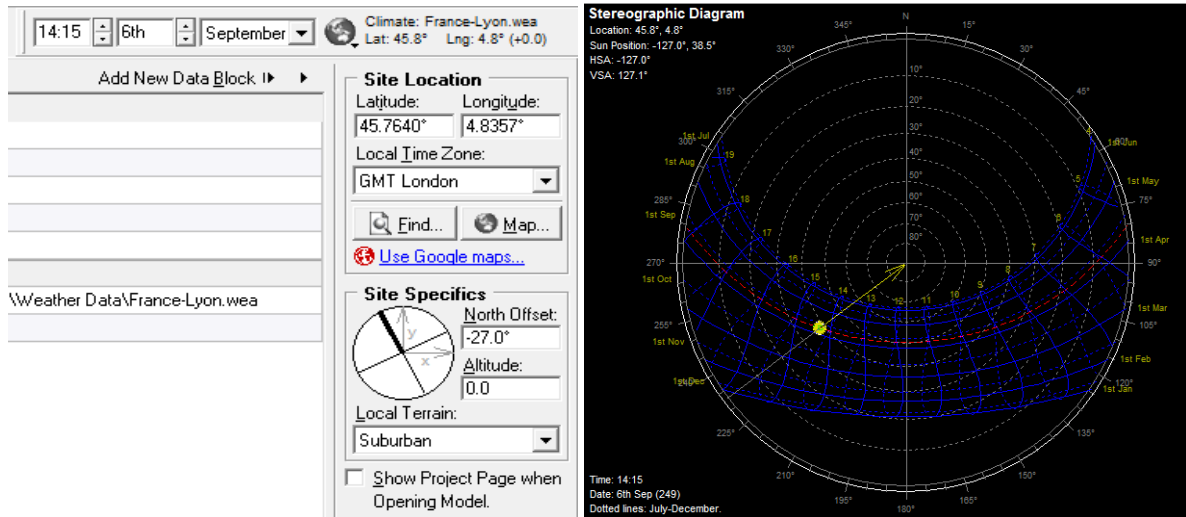

Figure 5.19. Display panel of climate data of Lyon and the stereographic diagram of solar position.

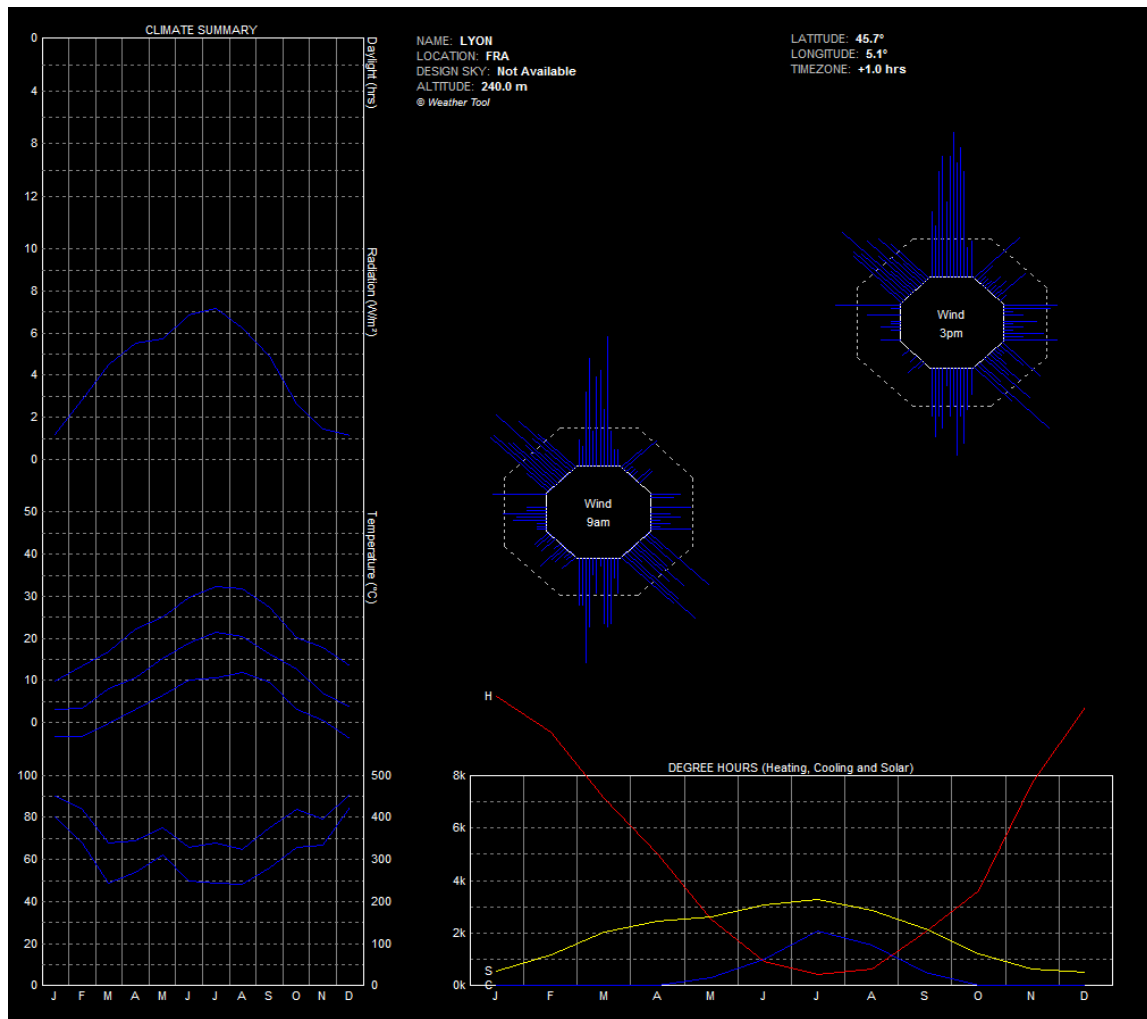

Figure 5.20. Weather data: Location (Lyon), Climate summary, Degree hours (heating, cooling and solar)

### 5.1.2.2.4 Calculation Mode

In MRT calculation, it should starts by define the area of analysis which is represented in the grid (Fig. 5.21). The Analysis Grid is basically an orthogonal grid of points within the model at which light, solar insolation, thermal comfort and a range of other values can be calculated and displayed (Fig. 5.22 and Fig. 5.23).

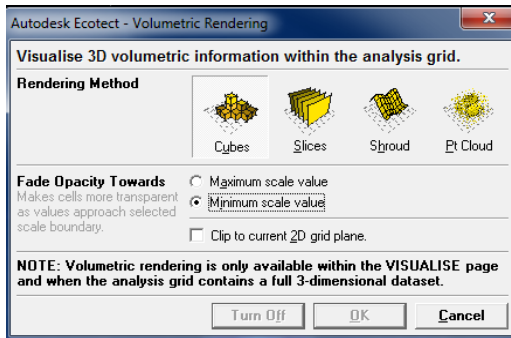

Figure 5.21. On the Analysis Grid tab to specify various types of volumetric.

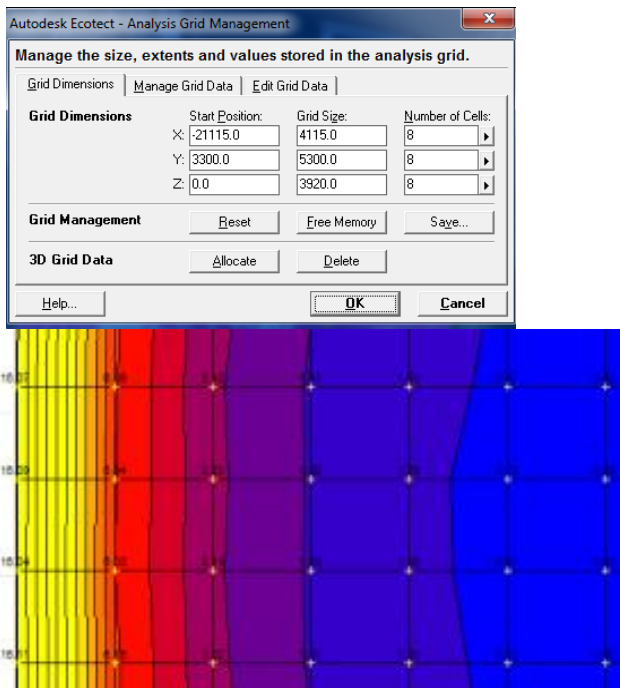

Figure 5.22. Result area of color contours defined in Ecotect analysis, showing the grid of Mean Radiant Temperature

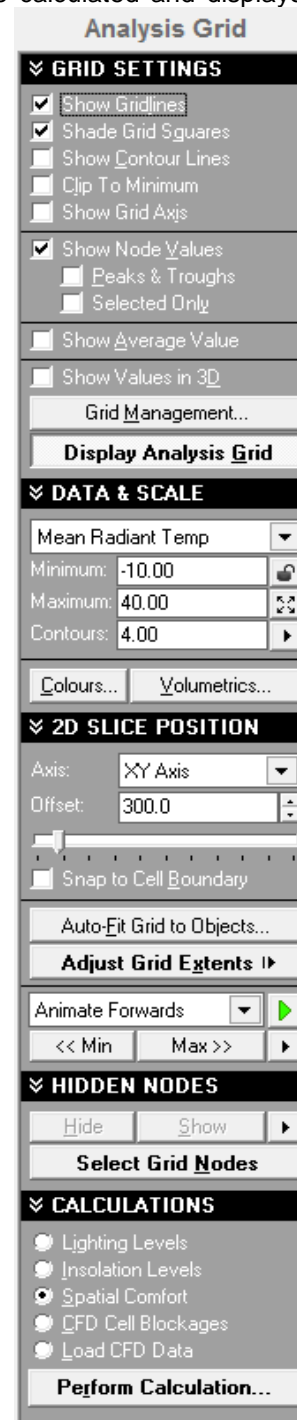

Figure 5.23. The panel that control all aspects of the current analysis grid

Spatial comfort values can be mapped over the analysis grid in any axis direction. The grid can be either a 2D flat plane of points, an undulating contoured surface or a 3D volumetric grid. If a 3D grid is calculated, data is displayed as a flat slice through the grid at the specified offset in any of the three main axis.

Figure 2.24 shows 3D volumetric grid to represent 512 parts of interior space of Gunzo room. The analysis grid has aligned to the XYZ axis. It uses to display comfort values horizontally and vertically in flat surfaces and/or in 3D volumetric. In the 3D editor, by default, the surface is 2D slice position, offset 100 cm from the floor.

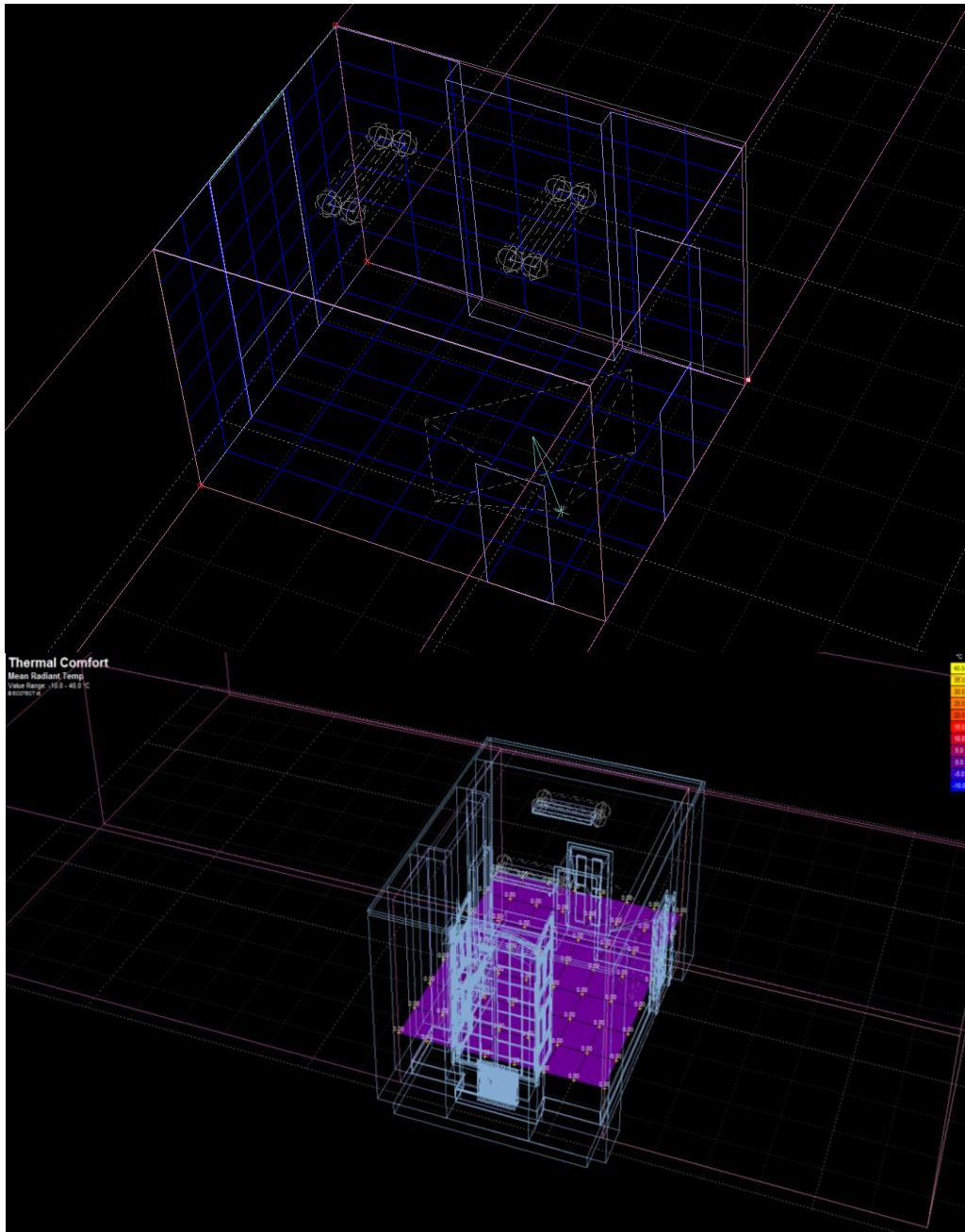

Figure 5.24. Analysis grid of Gunzo room aligned to the XYZ axis.

#### 4.1.2.2.5 Thermal Analysis

Gunzo model environment until this step were set up according to the basic principal operations of Ecotect thermal analysis. The thermal analysis is then performed according to the selected time. It is to determine the air temperature of each zone and the surface temperatures of the object. With this data giving of the mean radiant temperature, it is possible to display comfort values spatially across the grid. This is an extensive calculation wherein the grid is pre-processed to determine the solid angle of every surface in the model that is visible from each grid point.

The thermal calculation consists of two scenarios, starting from Gunzo room in existing condition and then the renovated version. The selected time simulation in this experiment is on the 06th, at 14:15 hours every month. Both, version of Gunzo rooms have equally performed on this time simulation.

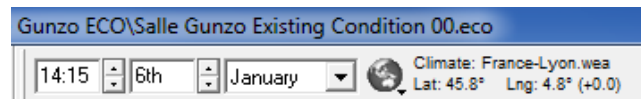

Figure 5.25. An example of selected time of simulation in the experiment.

In Ecotect, the selected time will also represent automatically in a sun-path diagram (2D) and sun-path sky dome (3D). The path of the sun through the sky varies quite significantly for different locations around the world. In this simulation, the sun-path sky dome has adjusted to Lyon (Fig. 5.26).

The sun orientation will resulting shading mask. It yields the area of visible sky for object Gunzo room. This is used to automatically calculate the percentage visible sky illuminance.

When the object already has a shading mask generated during the inter-zonal adjacency calculation, the results of this calculation will update it. This way we can selectively review the result prior to any thermal calculations. At this point, thermal comfort calculation (MRT) is ready to perform.

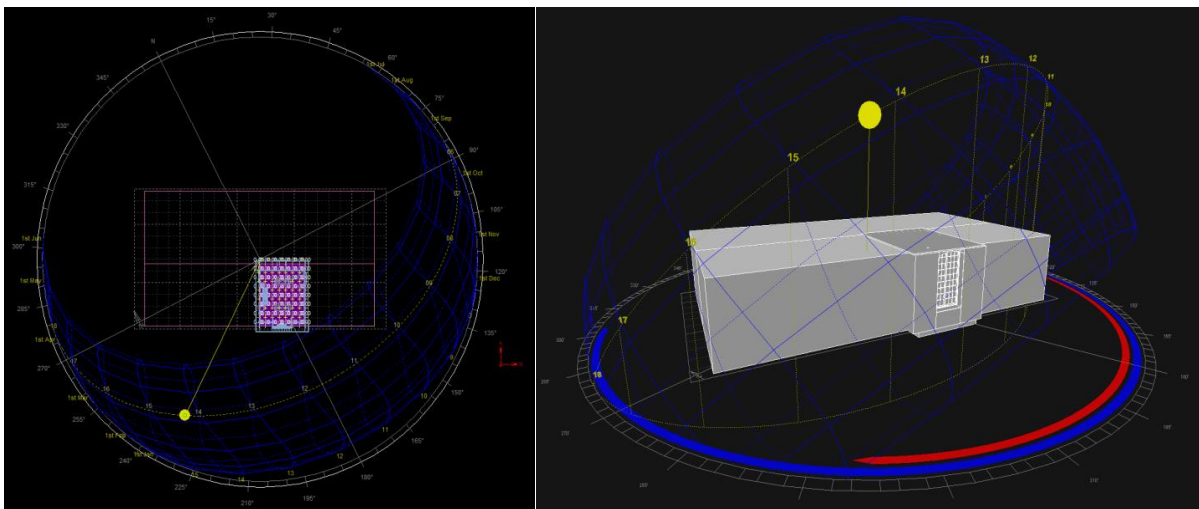

Figure 5.26. Gunzo room's sun-path in a sky dome projection shown in 3D. To make an interactive viewing, we can turn on the daily sun-path and annual sun-path. We can drag the Sun, represented by the orange sphere in the drawing area, to affect the time of day.

After initiate the spatial comfort calculation on Mean radiant temperature (MRT), Ecotect calculates the range of thermal comfort values over the analysis. Spatial comfort values will be displayed for the current date and time. Spatial comfort values can be mapped over the analysis grid in any axis direction. Figure 5.27 shows internal volumes which are calculated by generating a series of sampling rays. The analysis grid has been aligned to the XY axis, displaying comfort values horizontally in flat surfaces. Figure 5.28 shows the results of temperature of Gunzo room in existing



condition and renovated version on 06 January, 14:15. Temperature values displayed in horizontal grid surface and CFD blockages. The color of each cell is based on its temperature value.

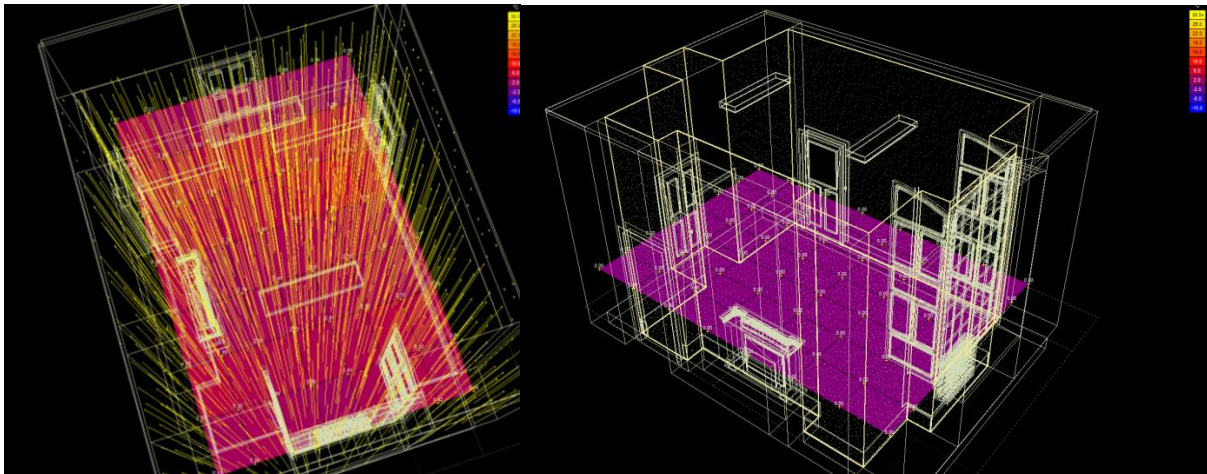

Figure 5.27. Internal volumes filled up by a series of sampling rays, distributed within the bounds of the zone. To account for geometry of any complexity, internal volumes are calculated by generating a series of sampling rays, pseudo-randomly distributed within the bounds of each zone. If the ray intersects two or more surfaces in that zone, the volume is taken from the distance between the farthest two intersection points. The results of comfort values displayed horizontally in flat surfaces.

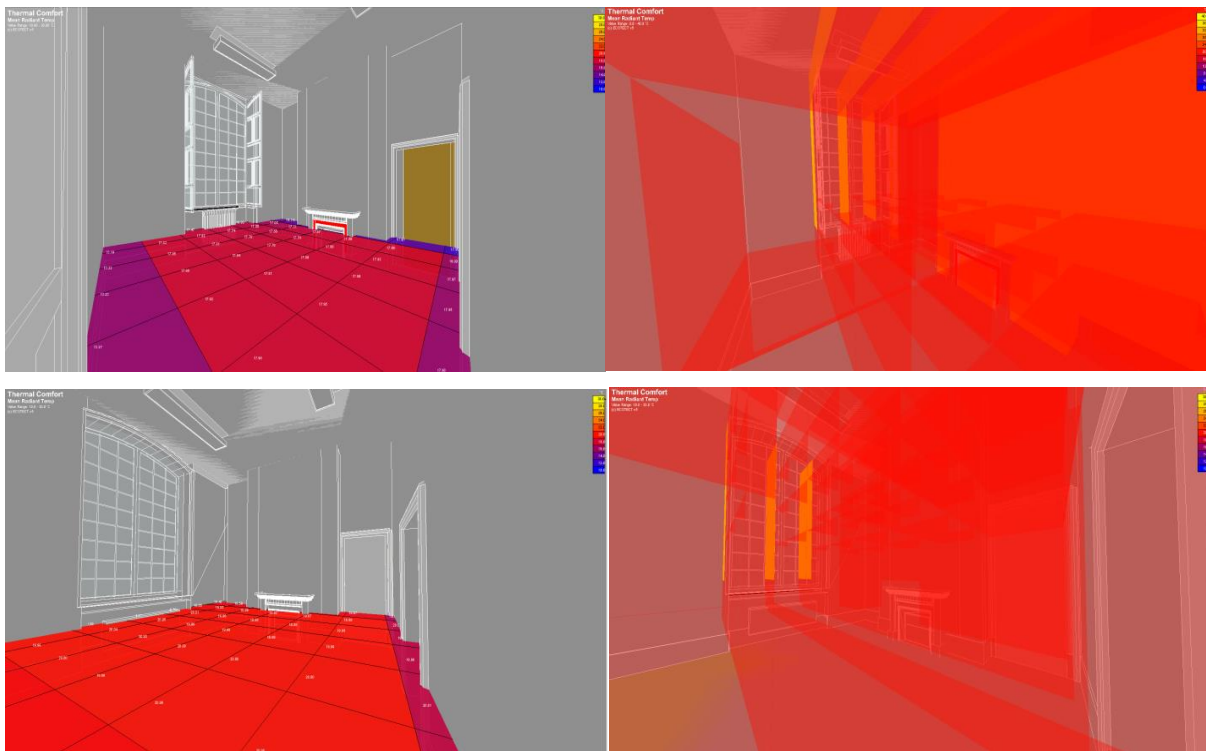

Figure 5.28. Gunzo room in existing condition on 06 January (upper hand), 14:15. Gunzo room renovated version on 06 January, 14:15 (lower hand). The results of temperature values displayed in horizontal grid surface (left hand). Thermal visualization with CFD blockages in Ecotect (right hand).

### 5.1.3 The TBS Results of Gunzo Room

The TBS of Gunzo room compares the temperature characteristics of the two versions of the room. This result is particularly produced in Ecotect. The results conducted through three types of indicators (as discussed in chapter 2): Monthly Temperature Profile, Passive Gains Breakdown, and Passive Adaptivity Index. The following subsections detail each of these three types of indicators.

#### 5.1.3.1 Monthly Temperature Profile

The monthly temperature graph displays the internal temperatures of Gunzo Room thermal zone over a one-year period (Fig. 5.29). This graph is based on the average daily maximum and minimum temperatures for each month. The data consider as an annual statistic, calculated over the year.

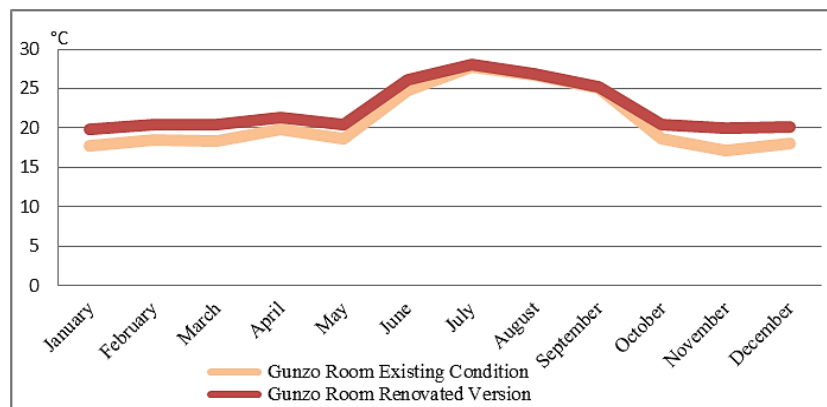

Figure 5.29. Monthly Mean Radiant Temperature results between the two versions of the Gunzo room during the year.

From January to May, the average temperatures hover between 17.7°C and 18.6 °C in the Gunzo room under existing Condition, and they increase to between 19.9°C and 20.4°C after renovation. There is a significant difference in temperature outcomes between the two versions of the Gunzo room, showing that the Gunzo room in its renovated version is 2°C to 3°C warmer during these months. The indoor temperature range is relatively stable at between 17°C - 20°C on the both versions, whereas outside temperatures fluctuate between -8°C and 20°C.

From May to September when the heating is turned off, the range in temperature rose with the outside temperature. Under these conditions, it is assumed that the window remains closed and that the people who occupy the room are wearing summer clothes. The room temperature become slightly hot sometimes, especially in July when the temperatures exceed the comfort band.

From October to December when the heater is turned on, there was a similar trend to that noted in the January to April temperatures, where the room began to adjust to the comfort temperature band. However, there is a significant temperature difference between the two versions in the lower limit of the comfort band. Temperatures in the Gunzo room under existing conditions are on the verge or even below the comfort band, ranging from 17°C-18°C, while the renovated version they are higher and stable at 20°C.

In summer, from June to September when the heater turned off, outdoor temperature fluctuate with an average minimum of 15°C and an average maximum of 27°C. In this condition, the room consistently adapted to the temperature. The temperature in the Gunzo room under existing condition ranged from 24.8°C to 27.8°C, while these temperatures in the renovated version ranged from 25.2°C to 28°C. We note only a little difference in average (1°C), because both rooms versions are characterized by the fact that the heater is turned off.



From October to December, the heater is turned on. While outdoor temperatures ranged from 5°C to 15°C, Gunzo room existing condition temperatures lie on the verge of the comfort zone, ranging from 18.1°C to 18.7°C, while in the renovated version, they are warmer, ranging from 20°C to 20.5°C.

### 5.1.3.2 Passive Gains Breakdown

Passive Gains Breakdown showed gains and losses when comparing the two rooms. The consequence of the window modification in the renovated version is an improvement in thermal insulation. It not only reduced the conduction of solar heat into the room and reduced leakage from the ventilation, but also saved and accumulated more heat from the internal load.

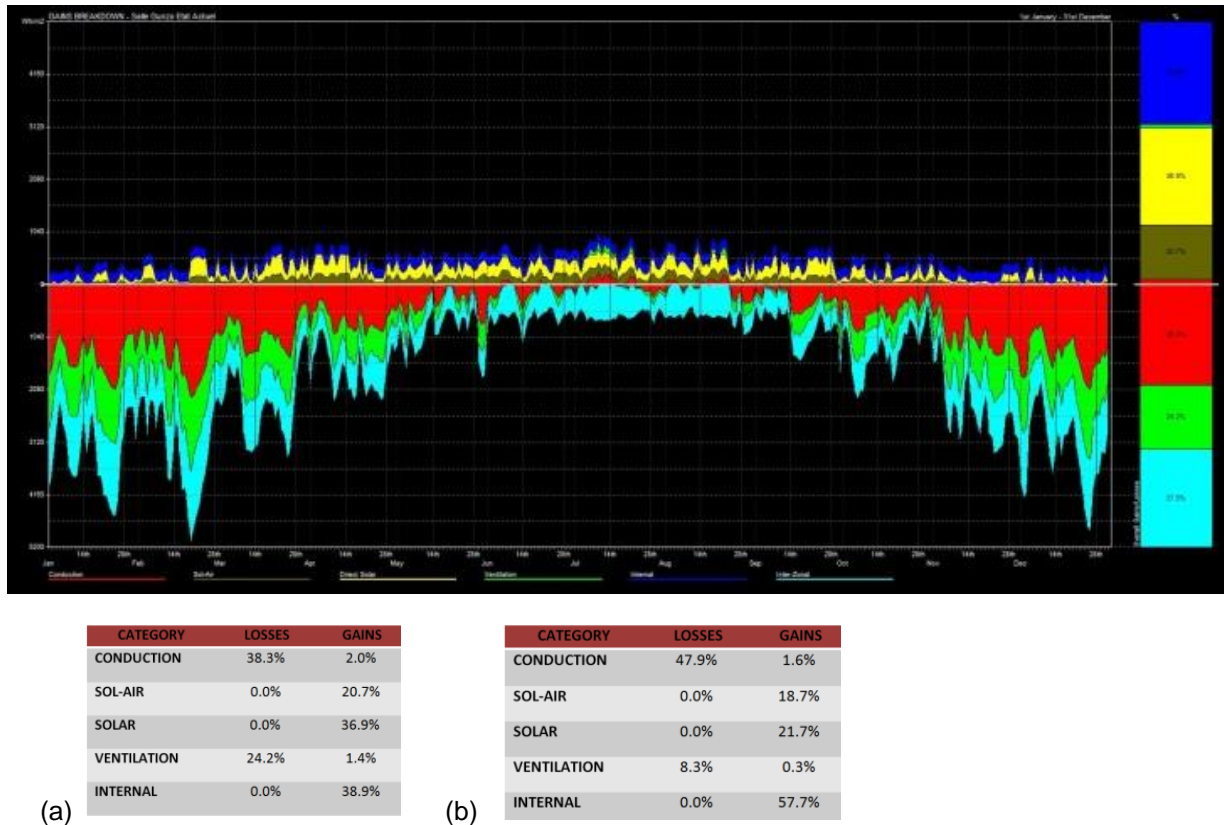

Figure 5.30. Breakdown of Gains and Losses, from 1st January to 31st December. (a) Results of the Gunzo room under existing conditions. (b). Results of the Gunzo room renovated version.

Comparison of Passive Gains results between the two Versions of the Gunzo room (Fig. 5.30):

#### 1. Conduction loads through fabric.

These loads refer only to the gains due to differentials in air temperature between inside and outside the room. Even though in reality it is impossible to distinguish between conduction and indirect solar loads (sol-air gains), computer analysis can deal with it.

The Gunzo room in the existing condition showed losses of 38.3% and gains of 2.0% while the renovated version losses totaled 47.9% and gains 1.6%. The Gunzo room renovated version losses were primarily due to the interior shutter being firmly sealed. The space between the interior shutter and the exterior sash created an intermediary empty space that reduced solar heat entering the room. This is a consequence of the modification of the window to save heat from the internal load. Gunzo room existing condition losses were

38.3%, 9.6% lower than those of the renovated version because heat from solar source was able to easily emanate from the imperfectly sealed window.

*2. Indirect solar loads through opaque objects.*

This refers to additional gains due to the effects of incident solar radiation on the external surface of exposed opaque objects. The solar radiation acts to raise the external surface temperature which in turn increases the conducted heat flow. As describes earlier, the renovated version of the Gunzo room had improved thermal insulation. The Gunzo room in the existing conditions gains more indirect solar radiation than the renovated version, 20.7% compared to 18.7%. The external surface heated by incident solar radiation in the renovated version was mitigated by the empty space between the two window panels.

*3. Direct solar gains through transparent objects.*

These loads refer to solar radiation entering the space through a window, void or other transparent/translucent surface. It should be noted that the Admittance method does not track these gains through the window and onto individual internal surfaces. It simply treats them as a space load (as opposed to a fabric load) and uses the admittance of the materials in each zone to diffuse and distribute the heat. Similar to the explanation in point 1 and point 2, the Gunzo room renovated version is protected from direct solar radiation. The Gunzo room in the existing condition gains more direct solar radiation (36.9%) while the renovated version shows 21.7%. The Gunzo room in existing condition can get more heat from direct solar radiation because it is not well sealed.

*4. Ventilation and infiltration gains.*

This refers to heat transfer due to the movement of air through cracks and openings in the building, such as windows, etc. As the infiltration rate can be easily obtained for each zone, ventilation and infiltration are lumped together in this type of analysis. The Gunzo room in existing conditions in fact shows serious losses in term of ventilation (24.2%). On the other hand, the renovated version loses only 8.3%, due to the window panel modification which is tightly sealed, meaning that thermal insulation is much improved.

*5. Internal loads from lights, people and equipment.*

These load patterns were accessed by mean of the schedules and object activations. There is little differences between the two versions of the room, the renovated version showing more internal gains, 57.7% as opposed to 38.9%. Certain changes, particularly to the window paneling in the renovated version improved thermal insulation to retain heat better and accumulate it internally.

### **5.1.3.3 Passive Adaptivity Index**

The Passive Adaptivity Index (PAI) graph in Ecotect is to evaluate the passive performance of a building. This thermal calculation plots temperature of the Gunzo room zone against the prevailing outside temperature for the selected period, and then draws a 'line of best fit'. This gives an index value between 0.0 and 1.0, where a lower index value indicates better passive performance. This line will use to evaluate its consistency to the environment temperature range for comfort.

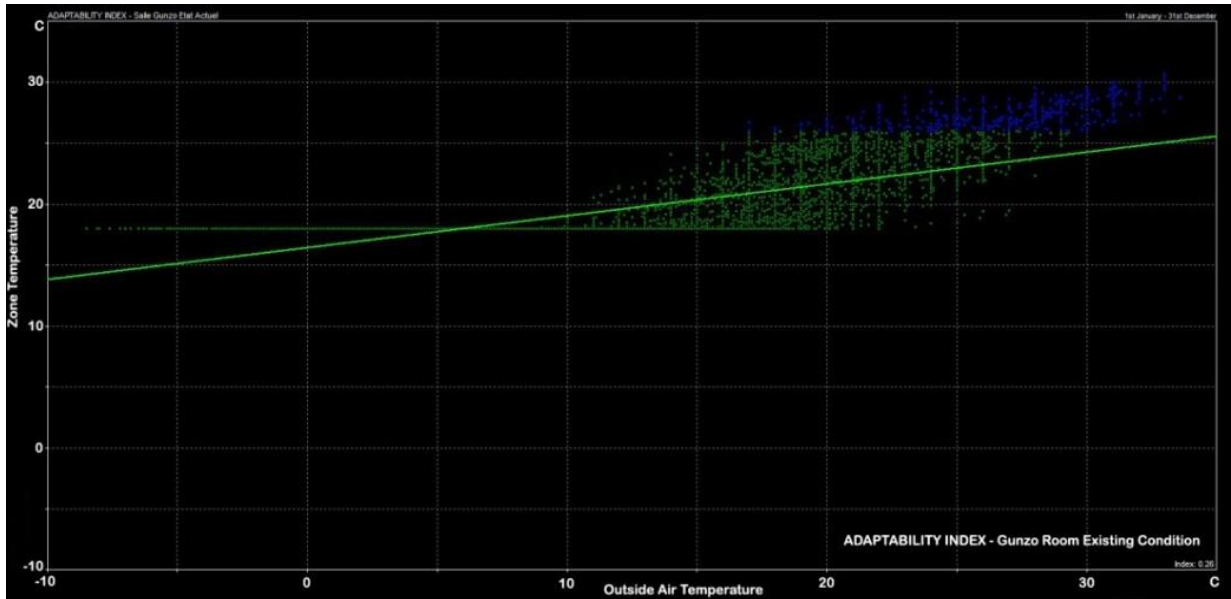

Figure 5.31. Chart of adaptability Index of Gunzo Room Existing Condition from 1st January to 31st December. After renovation, the Adaptability Index is 0.23, better than the Gunzo Room in Existing Condition (0.26).

Note the colors used to plot the relationship between the Gunzo Room temperature zone and outside temperature - green represents times when both the zone/outside temperature fall within the defined thermal comfort band. Blue represents times when the temperatures are above the thermal comfort band (indicating a cooling load is required), while red represents times when the temperatures are below the thermal comfort band (indicating a heating load is required). With an index value of 0.90, this suggests that this zone does not perform particularly well from a passive perspective; note also that the distribution of blue plotted points indicates that a cooling load is required in this room.

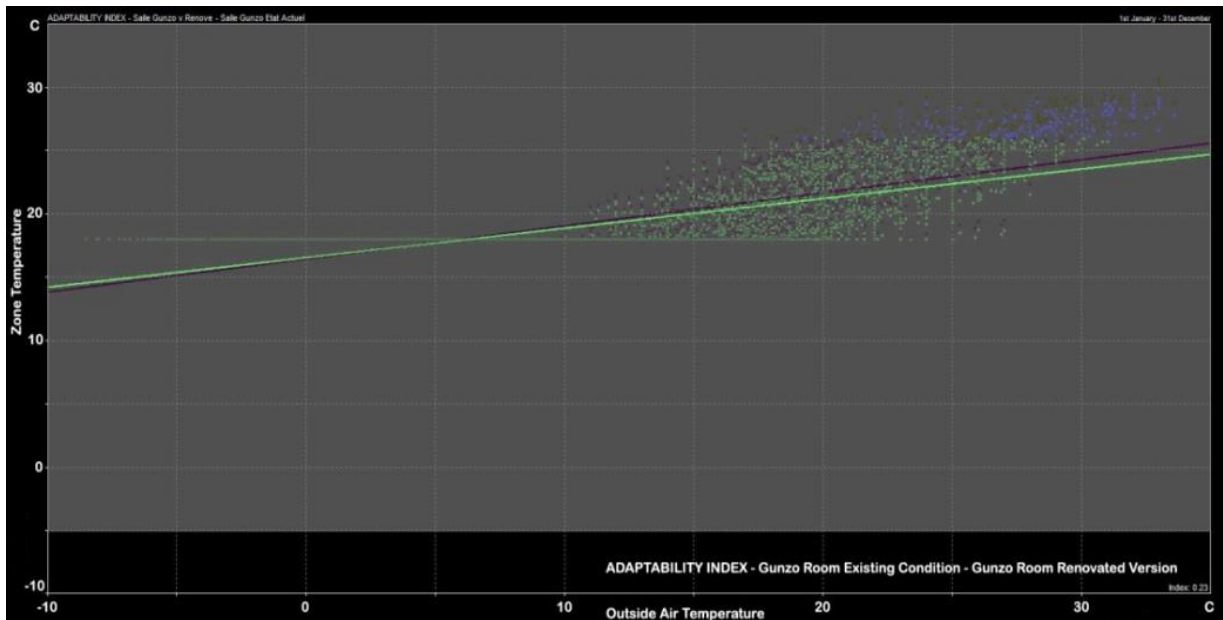

Figure 5.32. Superimposed Chart of adaptability Index of Gunzo room in existing condition (green line and dots) and the renovated version (purple line and dots).

The Adaptability Index of Gunzo room indicates that there are different levels of adaptation to outdoor temperature between the two versions. The following are analyzes of chart of Adaptability Index of the both version (Fig. 5.31 and Fig. 5.32):

1. The Index values of Gunzo Room renovated version is 0.23, while at the existing condition it is 0.26. This indicates that the renovated version has a better rate of adaptivity, represented by more green dots around the band of comfortable temperature. The Green dots that form a horizontal line at temperature of 18°C shows the effect of heater use that assures room temperature at least at the lower limit of comfort band.
2. Neither version of the room shows red dots, but instead green and small number of blue dots, indicating that the rooms were not below of the lower limit of comfort band. Both versions of the room are relatively comfortable, however, the temperature sometimes slightly exceed the higher limit of comfort band. Both graphs have dominant green dots that indicate the rooms have good average level of adaptation to outdoor weather. There appear just a small number of blue dots appear that indicate the rooms have an uncomfortable period when the outdoor temperature is hot (especially in summer).
3. There is a difference in the position of the green dots between the two versions of the room. The existing condition version has more green dots distributed further from the comfort band, while after the renovation, the green dots more centered around the band.
4. The 'line of best fit' is not the same in the two versions. After renovation, the minimum point and maximum point of the line were adapted the range of the comfort band. This indicates an increased adaptivity index in the renovated version. For example, at an outdoor temperature of 10°C-12°C, green dots in the Gunzo Room existing conditions graph appears more spread out under the 'Line of best fit', while in the renovated version only few such dots remain.

#### 5.1.3.4 Summary

We have modeled the room in two conditions; actual condition and renovated version. Several alternatives of the renovated version were created to adapt the needs of an efficient environment situation. There were two steps to simulate the mock-up and to obtain the results. Firstly, the mockup was created using design tools (Revit), and secondly, thermal analyzing was performed using thermal calculation tools (Ecotect). The combination of Ecotect and BIM model of Revit provides a convenient tool to conduct whole calculation since there easier data flow from BIM model to Ecotect.

Calculation of results from the two versions of the Gunzo Room (in existing conditions and renovated version) indicated that there are differences in temperature value between them. This is an indication of the consequence of the renovation. Different effects were produced as designs changed. The modification by moving the interior shutter backwards against the exterior sash and modifying the position of the heater, were effective in reducing energy consumption.

The Monthly Temperature Profile shows that, in winter, temperature in the Gunzo room renovated version is always above the lower limit of the comfort band, while the temperature in the Gunzo room existing conditions remains at the lower limit of comfort band. In summer, when the heater is turned off, the indoor temperature in both room versions follows the outdoor average temperature.

Passive Gains Breakdown showed gains and losses when comparing the two rooms. The consequence of the window modification in the renovated version is an improvement in thermal insulation. It not only reduced the conduction of solar heat into the room and reduced leakage from the ventilation, but also saved and accumulated more heat from the internal load.

The discrepancy of 0.03% in the Passive Adaptivity Index, means that during the year, the temperatures in Gunzo room renovated version are relatively more comfortable than the existing conditions. After renovation, the level of room's adaptability index seems to correspond better to the comfort band. Its lower temperature increased significantly to adapt to the comfort band.

### 5.1.4 Preformat Data

Sets of table data from Ecotect (Monthly Temperature Profile) are translated into VR using a preformatted application called Perl Routine. The objective is to interpret the values of Txt files of MRT from Ecotect and to apply it in real-time virtual model (Fig. 5.33). Thus, when data of calculations is loaded into the application, thermal data can simply be stored as attributes attached to the Gunzo room 3D object. The data table corresponds to a temperature change hour by hour over a year for the room (Fig. 5.34 and Fig. 5.35). When the user requests to change the time (minutes, hour, month), the attributes of 3D objects are updated as with the corresponding data obtained in the previously loaded data tables. This link between 3D objects and thermal data is flexible in terms that it is possible to update thermal data without changing the system. However, as the system is already adapted and stores the calculation result automatically during the year, it is not necessary updated the loaded data every time.

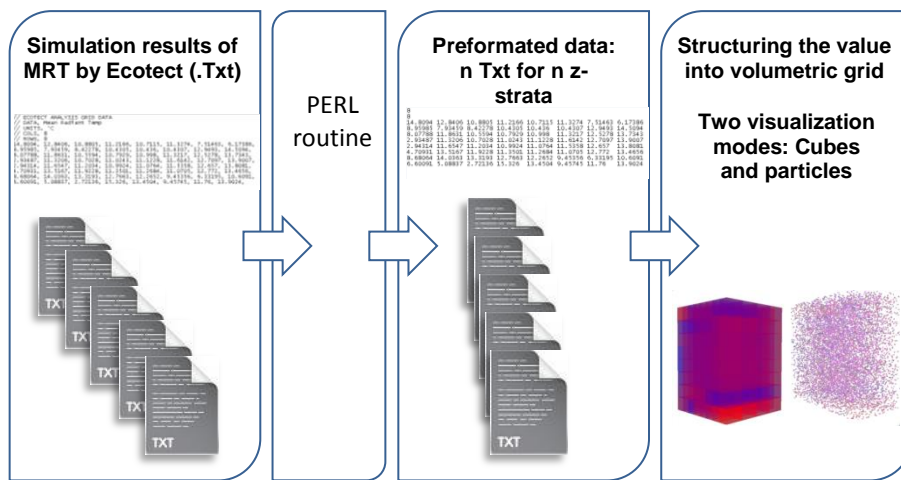

Figure 5.33. Workflow of preformatted data of MRT to structure the value in volumetric.

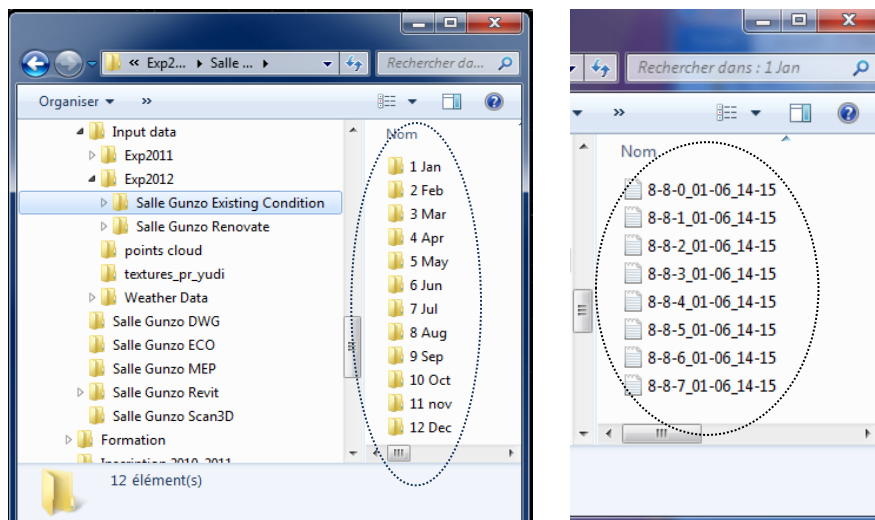

Figure 5.34. The results of the thermal calculation in Txt format organized in file folder. The result contained values of temperature at selected time during the year. The eight text files contains the results of the eight layers (depends on altitude) temperature. Each text file begins with 8-8, means that each layer contains a grid of 8 rows and 8 columns. The next number is the point elevation on Z axis. In the example, each text file ends with "\_01-06\_14-15", means of the date and time selected of the simulation performed on January 6<sup>th</sup> at 14:15.



As explained in Chapter 4, Ecotect exports n Txt files for n layers (along z) temperature. Each Txt file is stored in **Experimentation\4-Output\_Data\Export\_AAA-MM-JJ\_HH-mm**. Once the Txt file is exported, the preformatted action is ready to begin. By clicking the Perl Routine icon twice the data will be preformatted automatically (Fig. 5.35). Examples of preformatted results are presented in Appendix D.

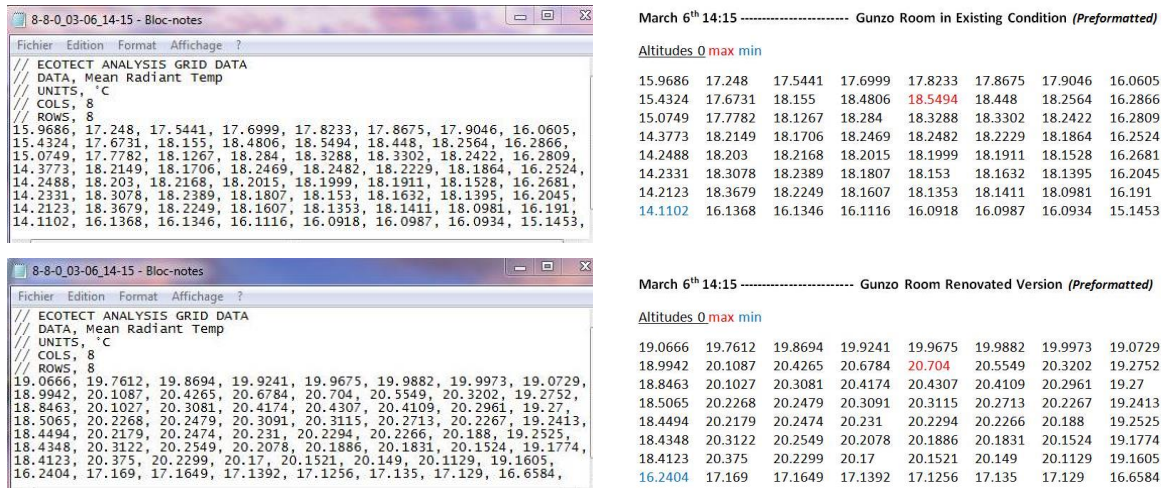

Figure 5.35. Txt structure of temperature data (MRT) before and after preformatted. The preformatted data (on the right hand) are ready to export to 3D Via Studio/Virtools.

## 5.2 Experiments using PC and Tablet

At the first phase of the experiment, the workflow was developed for conducting the experiment of co-located access of a building project. This section describes first experiment of transfer data of Gunzo room 3D model, includes its thermal result (MRT) using a PC and tablet. The visualization using tablet is developed with the idea to determine the entire data in context of BIM on site. Also to co-located data access at the same time. This experiment conducts with comparing access data through PC or tablet to significantly improving the efficiency of an operator on site (Landrieu et al., 2012).

### 5.2.1 Hardware and Software Solutions

Virtools 5 (Dassault Systèmes) was selected as the 3D engine platform for this experiment. Virtools enables to connect motion-tracking devices. A collocated access to data is implemented through a real time tracking system, developed by ART (Advanced Real time Tracking). This system was chosen because the manufacturer ensures top-rated accuracy. It has 0.04 pixels for each camera and distances between cameras and the user reaching up to 4 meters, also the theoretical accuracy of the setup is below one centimeter. The ART system was also selected because it was fully compatible with the Virtools environment as it implements intuitive and instantaneous outputs of the six degrees of freedom.

With regard to mobile device, the Ipad© (Apple) was chosen. An intuitive interface, a light weight and a multi touch pad are the reason for using this device. In addition, it onboard sensors (gyro) enable future works dealing with coupling hybrid geo-location systems. Using the Ipad, user can performs some simulation with the virtual mock-up of Gunzo room. The principle of displaying on mobile device is enabled through a remote desktop access (Splashtop remote desktop). The real time rendering calculation is delegated to a workstation, so the tablet acts as display. The data flow is transferred via a WiFi access point, located in the room and wired to the local network. It allowed the system to reach an acceptable refresh rate with an average latency measured at 0,159s which did not disturb the users.

With regard to PC, an Intel® Xeon® CPU E5420 (4 cores) @ 2,5 GHz processor is implemented in the workstation which was used for the experiment. It contained 8 GB of virtual memory (RAM). Regarding the GPU graphic card, it hosted an NVIDIA GeForce GTX 260 chipset. The operating system was Microsoft Windows XP Professional x64 edition SP 2. Additionally, the hardware architecture featuring Linksys wireless-G model number WAP54G ver. 3.1 Wi-Fi emitter. It is connected to the LAN.

### 5.2.2 Experiment Framework with PC and Tablet

This experiment is implemented principal workflow of BIM (chapter 4). It starts from 3D modelling, thermal calculation, and visualization using PC and tablet (Fig. 5.36). The CAD models (current and projected versions) are designed using Autodesk Revit. It is then exported .fbx format for the texturing steps in Autodesk 3DSmax. Finally the virtual mock-up is transferred to Virtools engine. It's to enable real time interaction with the geometry and embedded metadata (retrieved from the IFC digital mock-up). Thermal simulations have computed simultaneously. The results exported in Txt format which translated automatically using Perl Routine. Therefore, that Virtools engine can interpret them in real time. Explanation for this task through VSL script is described in table 5.2. Figure 5.37 to figure 5.39 show thermal simulation using visualization metaphor through PC and tablet.

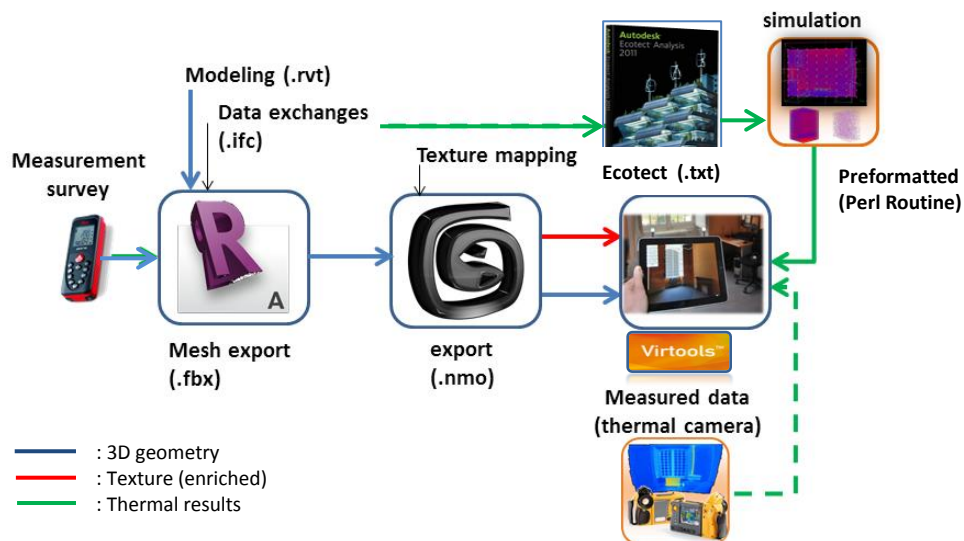

Figure 5.36. Detailed workflow to represent TBS results on PC and Tablet.

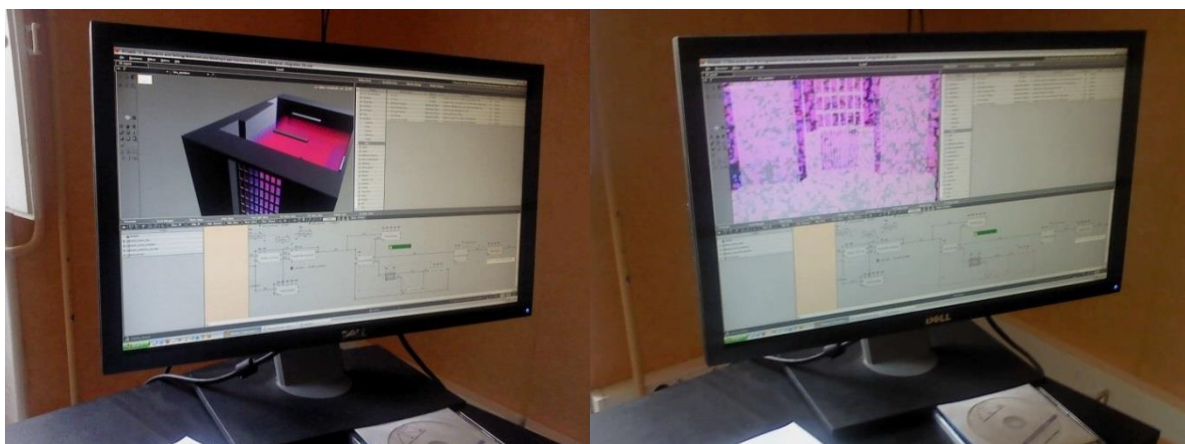

Figure 5.37. Experiment of thermal visualization with transparency cube and particles using Virtools. It is applied for PC and tablet.

Script	Active from t=	End at t=	Description
Syst_font	0	1	Create the table of Txt file. A set of values of temperature in a 3D position (XYZ axis).
Opening (Start button)	0	1	Start menu allowing the user to choose between two types of visualization: visualization cube or particle. This choice is referenced by parameter <i>Visualisation_choice</i> <sup>***</sup>
Receive_out put_data	1	2+n	The user specifies the directory where the script will load the Txt files. Simulation results from the Txt to each layer generate the 3D grid. The script initially loads paths in matrix <i>Simulation_data_path</i> <sup>*)</sup> then each of those texts file run the script <i>Change_time_and_maximax</i> <sup>**</sup> . Finally, when the loop is finished, it generated the parameter <i>maxi_maxmax</i> <sup>***</sup> which is the value of the temperature reached in the volume of each part according to table <i>maximax</i> <sup>*)</sup> . It embodied the value of each part (cube entities) with color.
Loading_temp _and_maxi-max	2	2+n	It begins with restoring the initial conditions on matrix <i>receive_preformatted_Txt</i> <sup>*)</sup> while the scene is empty or does not contain any cube entity. This script is intended to fill it with new values after generate the entities, and arrange the loop to avoid retrieving the values generated in the previous loop. It then loads the new corresponding Txt file. It enters the dynamic creation of the table and embodied the temperatures in the loading matrix. This first load has purposed to get the number of columns contained in the Txt file. Indeed, this value is specified from the first line. The searching of value continue according to <i>receive_preformatted_Txt(0,0)</i> <sup>*)</sup> . Next, it identifies the parameter <i>number_of_col</i> <sup>***</sup> . It is important to note at this stage, the matrix still contains columns. We insert new columns on the second time so that the table contains the correct number and reload the data from the Txt file. Finally, we enter the graph recovery parameter <i>maximax</i> <sup>***</sup> , so that the maximum value of temperature will attach to each cube or to each layer eventually. The loop is therefore seeking the value in each entity of <i>receive_preformatted_Txt</i> <sup>*)</sup> . These values are stored in a table called <i>max</i> . In conclusion, it generates the maximum attained in <i>max</i> <sup>*)</sup> and the same <i>maximax</i> <sup>***</sup> , which is stored in a table with the same name. Next, the script <i>copy_objects</i> <sup>**</sup> is launched.
Copy_objects	3	3+n	This script iterates over each row and column of <i>receive_preformatted_Txt</i> <sup>*)</sup> a copy of the reference object (cube) and the replacement to a certain position. To make it simple in the first initiation, the position of the 3D entity is directly linked to the position in <i>receive_preformatted_Txt</i> <sup>*)</sup> on the temperature at which the object is intended to be attached. For example, the temperature in line i, column j and layer k are associated with a 3D entity (cube) located at coordinates [x=i,y=k,z=j]. The entity serving the model as a copy is hidden; We use Building Block (BB) to keep the copy available. And then it renames each copy directly from its coordinates. In the previous example, the entity coordinates [i,k,j] will be rename "ikj." Finally, it assigns a copying metadata (an attribute) of float type which corresponds to the value of the temperature, or <i>receive_preformatted_Txt[i,j]</i> <sup>*)</sup> in the Txt file of layer k.
Generating_p articles_on_3D Frame	4 or never	Never	A particle System BB placed in a 3D Frame. So that if we want to launch particles at specific times only, we have to move the frame around and then somehow communicate to the frame (messages, global variables) that we want it to spit out some particles. The solution for object cube is to clone all the Particle System BBs and make Particle Birth BBs that had an optional Target Parameter so we could set where they birthed based on the cubes.  This script is also to generate particles with the right colors. The color is interpolated by taking the following provision: The coldest temperatures will be blue and the maximum temperature ( <i>maxi_maxmax</i> <sup>***</sup> ) will be red. Having an intermediate temperature T recovered by the attribute, we made the ratio of $T / \text{maxi\_maxmax}^{\text{***}}$ and get a proportional color from the interpolation injected in the particle.
Set_Color_on _Cube	4	4+n	As previous script, we assign an "emissive color" to each cube by recovering the value of the attribute "temperature" and by a proportional interpolation. Transparency is imposed on each cube, as well as when it displayed in layers. In addition, a blinking cube is designed to attract the attention of the user on the area where the temperature is maximum.
TranslationCam	0	Never	Change in camera position
RotationCam	0	Never	Change in camera orientation

<sup>\*)</sup> Designate to a matrix, <sup>\*\*</sup>) Designate to a script, <sup>\*\*\*</sup>) Designate to a parameter

Table 5.2. Description of scripts used to organize thermal data workflow and visualization metaphor for the simulation conducted for PC and Tablet. The schematic VSL scripting is presented in Appendix A1.



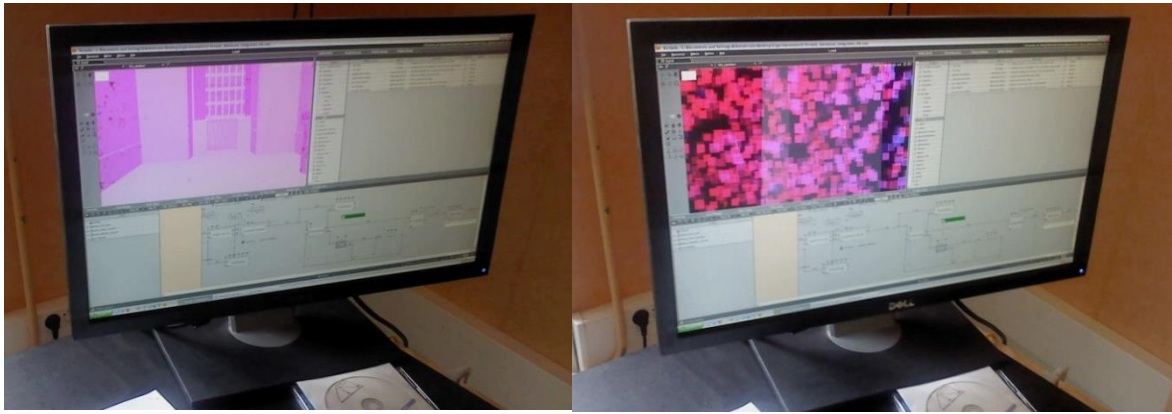

Figure 5.38. Experiment of thermal visualization with particles. The Gunzo room filled up with particles generated by cubes emitters and assign the color according to the thermal value given by Ecotect.

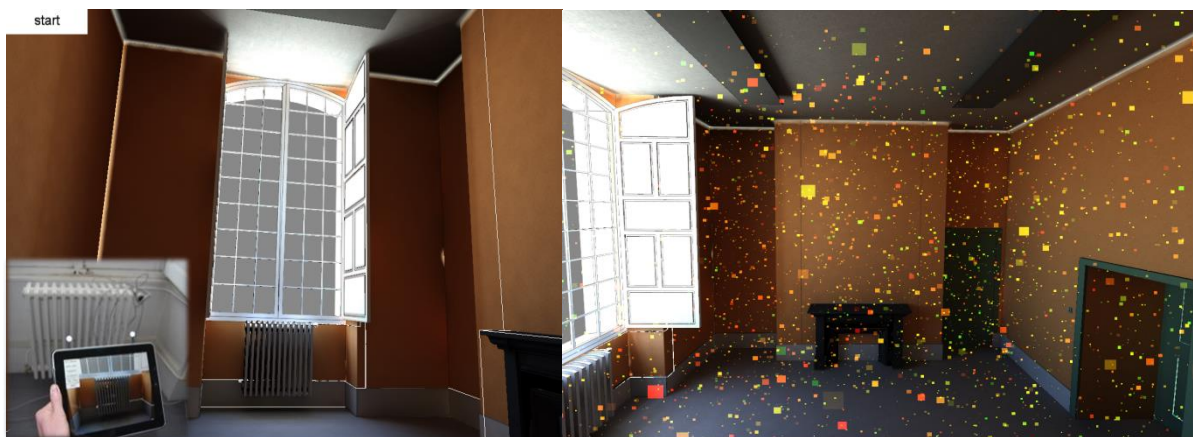

Figure 5.39. Gunzo room in existing condition and TBS results with visualization particles (Sept. 6<sup>th</sup> 14:15)

There was also a need to accommodate the result from a thermographic camera (Fig. 5.40 and Fig. 5.41). This camera exports bmp format, which previously assembled to obtain a panoramic version.

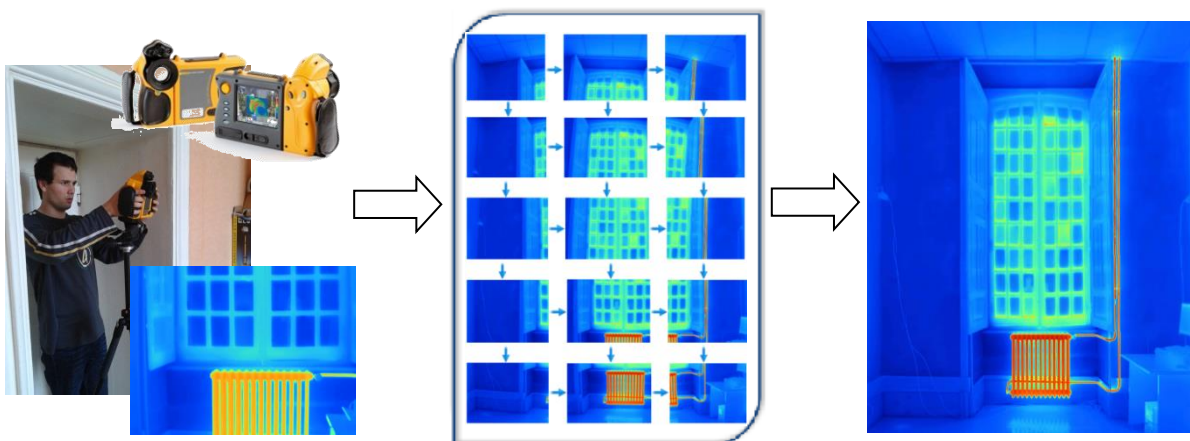

Figure 5.40. Thermographic images are create using photos taken at the beginning of each month. It is used a portable thermal camera from Flux IR FlexCam® model Ti50. Twelve parts of images, 4 vertical and 3 horizontal, are assembled using the "Hugin" software. Selected resolution is 640 x 480. The assembled image resized in Photoshop before transferred into 3DVIA Studio/Virtools.

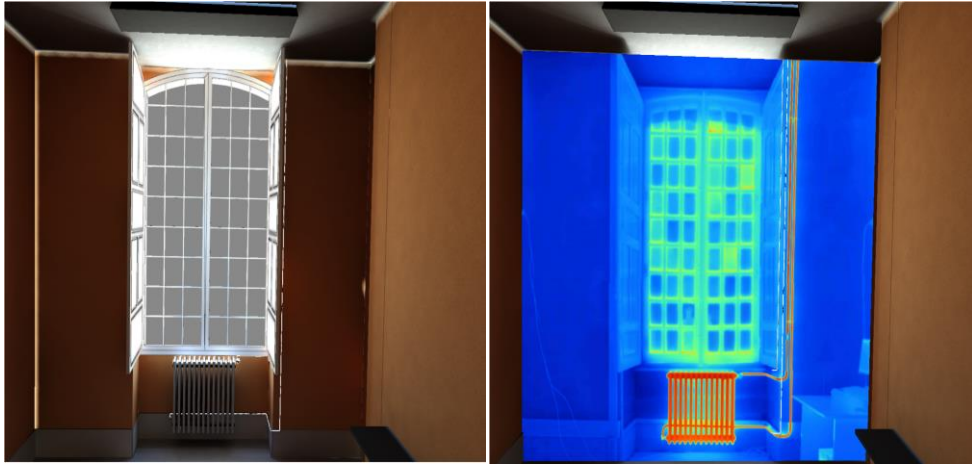

Figure 5.41. Visualization of image of thermographic camera attached on the surface of the wall. Thermal information is only available for the window facade and has no volumetric properties. Later, this method is not include in the simulation due to the limitation of thermographic results for future planned project (renovate version) and the 3-D aspect for immersion.

All of these settings then realized and tested in experiment. The experiments involved 57 test subjects and they were divided into three groups (three workshops) according to the type of media (ie, paper, and PC and tablet. Figure 5.42 shows the three workshops designed for the experimental study. The subjects who took part in the experiment are mostly students (Bachelor’s or Master’s degree and PhD students). They represent more than 70% of the tested population. Other people are faculty or employees of the engineering school. This experiment was done in Gunzo room as the real site location. It is a first step for the realization of the representation TBS of results through VR technology.

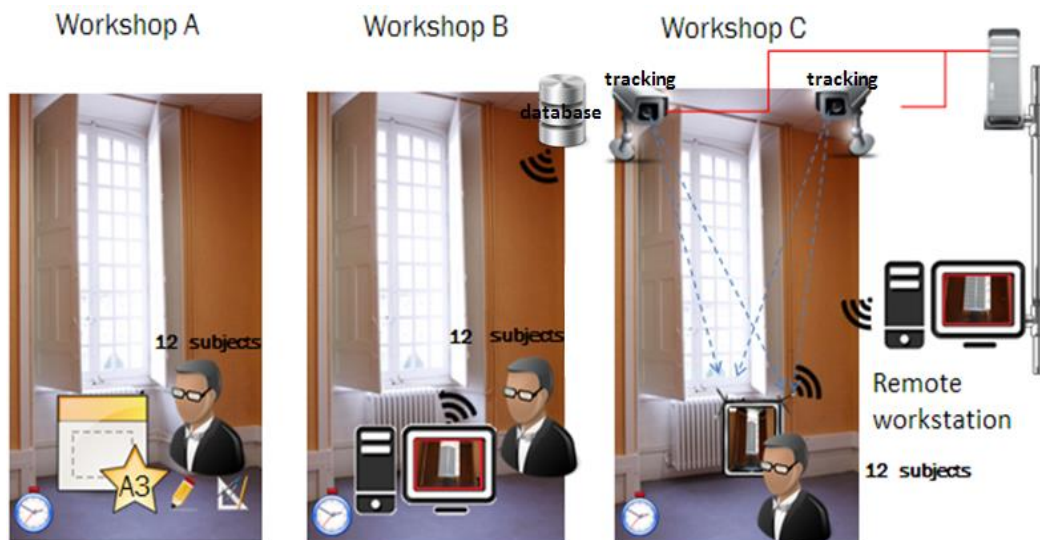

Figure 5.42. Three workshops designed for the experimental study: Paper-based (Workshop A), PC (Workshop B) and Tablet /iPad (Workshop C).

This experiment serves several functions related to building construction including the function of TBS. The function of TBS is one part tested on the workshop. The results of this experiment will not present in this thesis, as it part of the thesis of Jeremie Landrieu. In this first experiment, we only focus the study on data transfer of 3D models and its thermal calculation results. The data is presented in VE through PC and tablet (iPad).

The important result is that the function of TBS to present the results of thermal calculations before and after the renovation was success to deliver. The user can access and interact via the PC and tablet (Landrieu, 2013). The visualization presents the thermal metaphor of cube and particles, however the image quality of Virtools will be improved further using 3DViaStudio. It is applied to the next experiments in the Immersion Room. Experiments in the Immersion room are the main focus in this thesis. The experiment through the PC and Tablet (iPad) has become the basis principle for us to improve the method and the quality of TBS representation in VE. It's specially prepared for the second phase of the experiments in the Immersion Room.

### 5.3 Experiments in the Immersion Room

This section describes the second experiment to realize our objective to present the TBS in VE using the Immersion room. In this second phase we use the same principle to transfer the digital model and the thermal simulation result of Gunzo room to the VE. We integrate the script to 3DViaStudio to have better quality in visualization (details of the schematic VSL scripting and the integration is presented in Appendix A2). Similar principles are implemented as in PC and tablet, however in the integration, we made improvement by modifying the basic application (from Virtools to 3DViaStudio), tailored to CAVE-like requirements. We are conducted the experiment within immersion room called LITE (Light Immersive Transportable Environment).

The workflow to represent the TBS using immersion room has applied 3DViaStudio as VR engine. The 3D model begins from Revit exported (in .Fbx) to be read and textured in Autodesk 3DSMax. At once, the geometry is also exported to Ecotect to have a thermal calculation result. Thermal capture with a thermography camera was used just for enriching the interface and not used for the test.

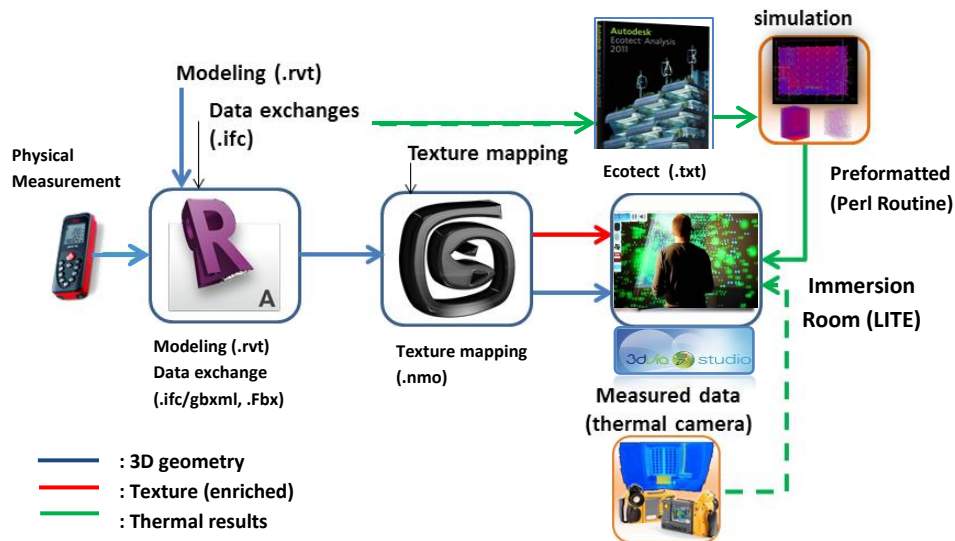

Figure 5.43. Detailed process of data workflow toward Immersion room. Main applications involved: Revit architecture, 3DSMax, Ecotect, 3DViaStudio, and Perl Routine for preformat.

In figure 5.43, the building geometry provides the workflow with the 3D space of Gunzo room. It was acquired using measurement surveys and CAD Revit modeling. The thermal calculation results (MRT) calculated by Ecotect which provides the result of the temperature before and after renovation during the year, and which is later converted to a 3D object. These data are described as objects in the VE by their positions in space, their status and their interactive parts.

### 5.3.1 Details of Setting in the Visualization and Interaction

In interactive simulation, the PC calculates the resulting image of an action to send to the user visualization. It calculates and displays the result that the user asked for, depending on the action performed. Concerning the intrinsic nature of this system, the simulation models are split into two parts: the environment model (object of Gunzo room) and the entity models (thermal metaphor).

We develop the metaphors model based on 3D entity to represent temperature value. Therefore, the virtual environment in this application is an environment where the temperature data is attached in the geometry stored in the scene volumetrically. In this case, each 3D object stored inside the room has its temperature data and interacts in a set of appearance (size, shape, and color.). In Virtools, visualization of these objects and its thermal metaphor was rather standard. We are considered to have more quality image in obtaining better thermal information, particularly regarding particles as option for visualization metaphor. The improvements made in 3DViaStudio for the particle modules gave us better chances.

The solution of 512 cubes is remained. The cubes transferred from Virtools to 3DViaStudio engine. The search for the right dimensions re-occurred. The experience from the previous experiment make us took less time to solve the problem. However, a lot of time was spent in renaming each cubes, including their textures and shaders. If the cubes were set to share their texture or shader, separate colors couldn't be applied to represent the temperatures. The structure of the scripts used for these representations was changed from the initial Virtools scripts. The schematic scripting in 3DVia Studio allowed creating an easier approach to assign colors to the cubes and represent them. Script 5.1 describes thermal simulation behavior to treat Ecotect data from Txt of Perl Routine to simulation with thermal metaphor. This behavior also presented in appendix A.2.11 to A.2.13.

```
vkArray<vkString>
Ecotect_thermal_simulation::seperateByLine(vkString iString)
{
    vkArray<vkString> oLines;
    // Set itStart to beginning of string
    vkString::ConstIterator itStart = iString.Begin();
    // Set itEnd to first found line break ("\n")
    vkString::ConstIterator itEnd = iString.Find("\n");
    // While we are not at the end of the string...
    while (itEnd != iString.End())
    {
        // Get current string between itStart and itEnd
        vkString iSub = iString.SubString(itStart, itEnd);

        // Trim takes care of any weird formatting symbols
        iSub.Trim();

        // Add to output array
        oLines.PushBack(iSub);

        // Set itStart to current itEnd + 1 for next loop
        itStart = itEnd++;

        // Set itEnd to the next found line break for next loop
        itEnd = iString.Find("\n", itStart);
    }
    // Add last line of text file after we have reached the end of parsing
    //oLines.PushBack(iString.SubString(itStart));

    return oLines;
}
```

Script 5.1 Thermal simulation behavior to treat Ecotect data from Txt of Perl Routine to simulation cubes or particles.



In 3DViaStudio, a particle system BB placed in a 3D Frame. So that if we want to launch particles at specific times, we have to move the frame around and then communicate to the frame (messages, global variables) that we want it to generate some particles. The solution for object cube is to clone all the Particle System BBs and make Particle Birth BBs that had an optional Target Parameter. So we could set their birth location based on the cubes (See also its schematic programming in Appendix A.2.18 to A.2.20).

Particle System in 3DVIA Studio (Libraries> Presets > Particle > Particle System)

- Import a new 3D Entity and aggregate a vkParticleSystem component on it
- Put the 3D entity as a sub actor on the building and set its position to (0,building\_dimensions.y,0) and its angle to (0,0,0) to keep it in the XYZ axis.
- Select the vkParticleSystem component and set in the property view :
  - The location to 'Surface' and Emitter Shape to 'Cube'. (this way, the particle will create inside the cube). The direction of the emission is in the 3D entity of cube along XYZ axis.
  - The birth rate of 3 second, velocity of 0, and life span of 5 (Script 5.2).
  - The Color over Life parameter using a vkColorGradientController. This color setting conducted through scripts that create to control the color output according to the temperature data base (MRT of Ecotect). See also its schematic programming in Appendix A.2.15.

(Notes: Since there are lots of scripts of 3DViaStudio involved and each script is very long, we present some selected scripts using schematic programming stored in Appendix A2)

```
<compConfiguration id="2673_0x2A4EFBE8" scope="asset" create="vkConfiguration">
<item path="vkActor.ComponentID" type="vkString">007</item>
<item path="vkEntity3D.Opacity" type="float">0.13</item>
<item path="vkNode3D.Visible" type="bool">>false</item>
<item path="vkNode3D.HideHierarchy" type="bool">>true</item>
<item path="vkEntity3D.LocalTransform" type="vkTransformPRS">
<rot x="0.0" y="0.0" z="0.0" w="1.0"/>
<trans x="2.2" y="0.23" z="2.8"/>
<scale>1.0</scale>
<item path="vkParticleSystem.Location" type="vkParticleSystem:ELocation">eVolume</item>
<item path="vkParticleSystem.Direction" type="vkParticleSystem:EDirection">eUniform</item>
<item path="vkParticleSystem.SpreadingUniform" type="bool">>true</item>
<item path="vkParticleSystem.Velocity" type="float">0.0001</item>
<item path="vkParticleSystem.LocalSystem" type="bool">>true</item>
<item path="vkParticleSystem.BlackPass" type="bool">>true</item>
<item path="vkParticleSystem.BirthRate" type="float">3.0</item>
<item path="vkParticleSystem.LifeSpan" type="float">5.0</item>
<item path="vkParticleSystem.Size" type="float">0.08</item>
<item path="vkParticleSystem.SizeVariation" type="float">0.2</item>
<item path="vkParticleSystem.EmitterShape" type="vkRefPtr<vkBoundingVolume>";
id="2673_0x0B694FB0" scope="asset" create="vkAABBoxVolume">
```

#### Script 5.2. Behavior of a particle inside a cube (cube number 7 of 512).

The 512 particle areas are created to which colors they are applied. The particles were assigned to the 512 emitter cubes that already created. When the colors are applied to the cubes, they are set at the same time to the particles. This option would help later when defining new methods of representation. When the user selects a representation by cubes, the particles are deactivated and hidden. The cubes are displayed with a menu that allow to choose the transparency level. When the representation by particles is chosen, the cubes will completely transparent and the particles are activated. This prevents the particles and cubes to appear at the same time.

As for the changes in the particle generator, 3DViaStudio offers more options to configure the generators. Also it offers a wider range of particle shapes and options. That means that we have more options and more control over the particles in order to obtain the most efficient way of displaying them in the simulation.

The data and the visualization metaphors principle are then integrated with user interface. It present information and interactions in a fashion that suits the task at hand. Also, to give a visual clue to the user to find the function and to interpret the results easily. User interface-level integration with

real-time data of MRT (Ecotect) is designed toward the mode of appearance (visualization metaphors) to allow the users conduct their tasks via the menu. Also, integrated faceted search capabilities for searching the data for task based on specific attributes and ability to hide or expose advanced optimization functions to support different user needs.

Menus and sliders are used to select and to chose the objects, as well as to explore the simulation results. In the menu, thermal simulation functions featured with some supporting functions (setting) such as functions of project scenarios, interaction, measurement, and navigation mode (Appendix C and Fig. 5.44). This menu is provided along with the 3D model of Gunzo room and not interfere with active stereo visualization (Fig. 5.45). The user is equipped with a pointing device or joystick allowing him/her to change some settings. A navigation mode is defined for exploration, search tasks, and maneuvering tasks. The user can move within the room using the joystick. A walkthrough visualization is represented as from a moving camera (see Appendix A.2.4 and A.2.5). The user can move within the room by selecting a predefined view from a list. These views are represented by items in the room or thumbnails.

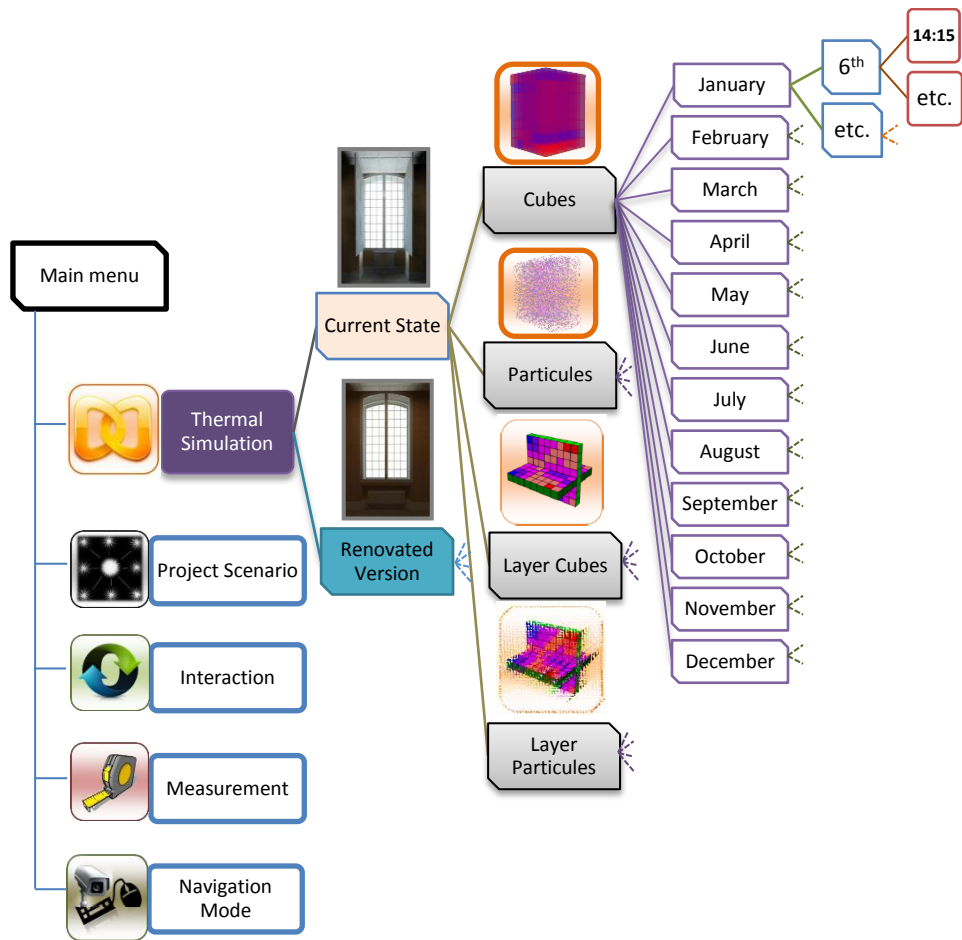

Figure 5.44. Principle of system commands and menus for the user interface.

The simulations conduct during a year are chosen by the user from a menu that displays 12 months at a time. In the thermal simulation command, this menu never disappears where the user can easily switch between the months. After the month has selected, the menu disappears and remaining a back button in the screen as well as a small panel which displayed information regarding the results. For example, the choosen month, the state of the room for which the simulation is made, and the maximum and minimum temperature values (Fig. 5.46 & Appendix A.2.17). The screen also contains a

temperature scale on the top-right corner and some menus on the bottom-right corner (transparency controllers of the cubes and the birth rate of the particles). Script 5.3 describes this reference of system commands and menus for the user interface. These system commands and menus are also integrate to each visualization metaphor as shown in fig. 5.47 to fig. 5.50. See also its schematic programming in Appendix A.2.14 and Appendix A.2.22 to A.2.34.

```

<ActorID>Ecotect_thermal_simulation</ActorID>
<operations count="1">
<item create="vkActorTemplate::OpAddTemplate">
<destination></destination>
<templateToAdd
ref=" ../Behaviors/Ecotect_thermal_simulation/Ecotect_thermal_simulation.becomp#Ecotect_thermal_
simulation"/>
</operations>
<configurations count="1">
<item>
<compUci></compUci>
<compConfiguration id="2673_0x2A559088" scope="asset" create="vkConfiguration">
<item path="Ecotect_thermal_simulation.Info_chart" type="vkRefPtr&lt;vkNode2D&gt;"
ref=":Information_chart#vkNode2D"/>
<item path="Ecotect_thermal_simulation.Information_chart" type="vkRefPtr&lt;vkText2D&gt;"
ref=":Information_chart.Information_text#vkText2D"/>
<item path="Ecotect_thermal_simulation.plus_minus_header" type="vkRefPtr&lt;vkText2D&gt;"
ref=":Transparency.Transparency_text#vkText2D"/>
<item path="Ecotect_thermal_simulation.birth_rate" type="vkRefPtr&lt;vkText2D&gt;"
ref=":Transparency.Birth_rate#vkText2D"/>
<item path="Ecotect_thermal_simulation.transparency" type="vkRefPtr&lt;vkNode2D&gt;"
ref=":Transparency#vkNode2D"/>
<item path="Ecotect_thermal_simulation.option_panel" type="vkRefPtr&lt;vkNode2D&gt;"
ref=":Options_panel#vkNode2D"/>
<item path="Ecotect_thermal_simulation.button_V" type="vkRefPtr&lt;vkNode2D&gt;"
ref=":Options_panel.Vertical_Layers.8#vkNode2D"/>
<item path="Ecotect_thermal_simulation.Button_H"
type="vkRefPtr&lt;vkNode2D&gt;"ref=":Options_panel.Horizontal_Layers.4#vkNode2D"/>
<item path="Ecotect_thermal_simulation.cubes_or_particles" type="vkRefPtr&lt;vkNode2D&gt;"
ref=":Cubes_or_Particles#vkNode2D"/>
<item path="Ecotect_thermal_simulation.sound_resource" type="vkSmartPtr&lt;vkSoundResource&gt;"
ref=" ../Sounds/TempSound.wav#TempSound"/>

```

Script 5.3. Reference of system commands and menus for the user interface.



Figure 5.45. (a). 3D model of Gunzo room in existing condition visualized in immersion room. The interface equipped with some large commands and menu to help the user since the beginning of the simulation. (b). Visualization with active stereo.



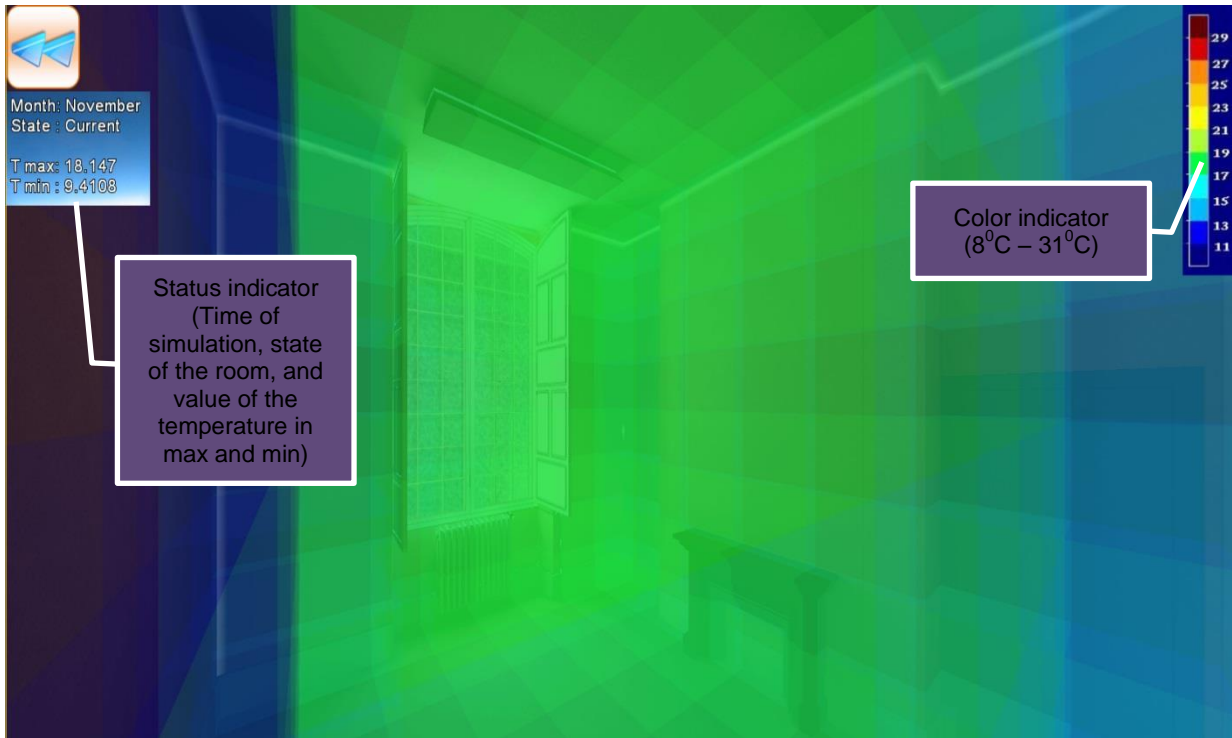

Figure 5.46. Visualization metaphor of transparent cubes of Gunzo room in existing conditions simulated on November 6<sup>th</sup>, at 14:15. The grid cubes (512 parts) completely filled the room and the color indicates the temperature of the area they occupy.

Figure 5.47 shows 3D model of Gunzo room with its thermal simulation results using metaphor of transparent cubes. Thermal metaphor with transparent cube is the basis idea of this visualization. As describe earlier we then developed this metaphor to have more alternative, which is to fill the cube with colored particles (Fig. 5.48).

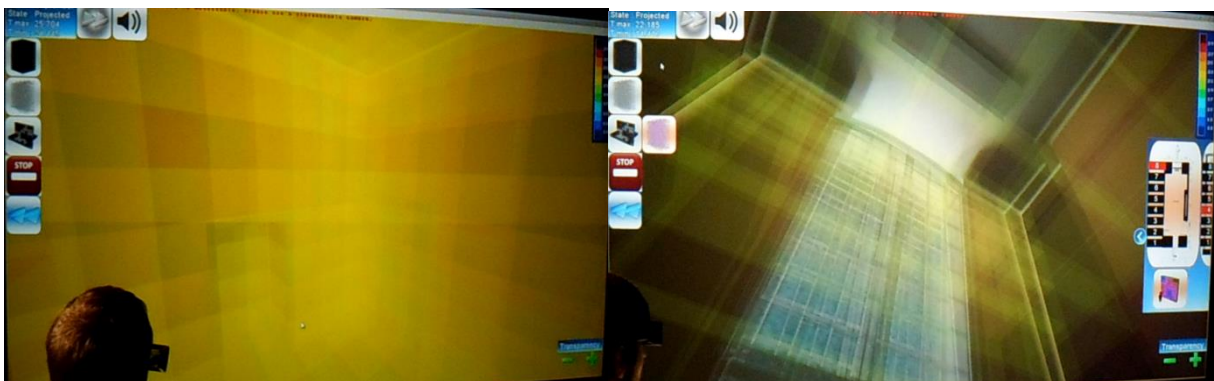

Figure 5.47. Visualization cubes with transparent mode. The transparent value ranges between 0 and 8 point. Default value was set on 3 point. The transparency of the cubes can be modified by the user from a small "Transparency" menu, on the right-bottom corner of the display (plus-minus button). This icon appears automatically when simulation with cubes is conducted.

In terms of details and accuracy, we propose an idea to present the thermal metaphors in a different way, which is by layers. We believe the cubes and particles positioned in a vertical and horizontal layer could make the temperatures results easier to interpret and more interactive (Fig. 5.49 to Fig 5.51). This would even increase the immersion sensation to the metaphors. For example, if the

number of particles can be set to decrease substantially, the view will not interfere with crowded particles so that the color of the temperatures would be much easier to read (Fig. 5.48).

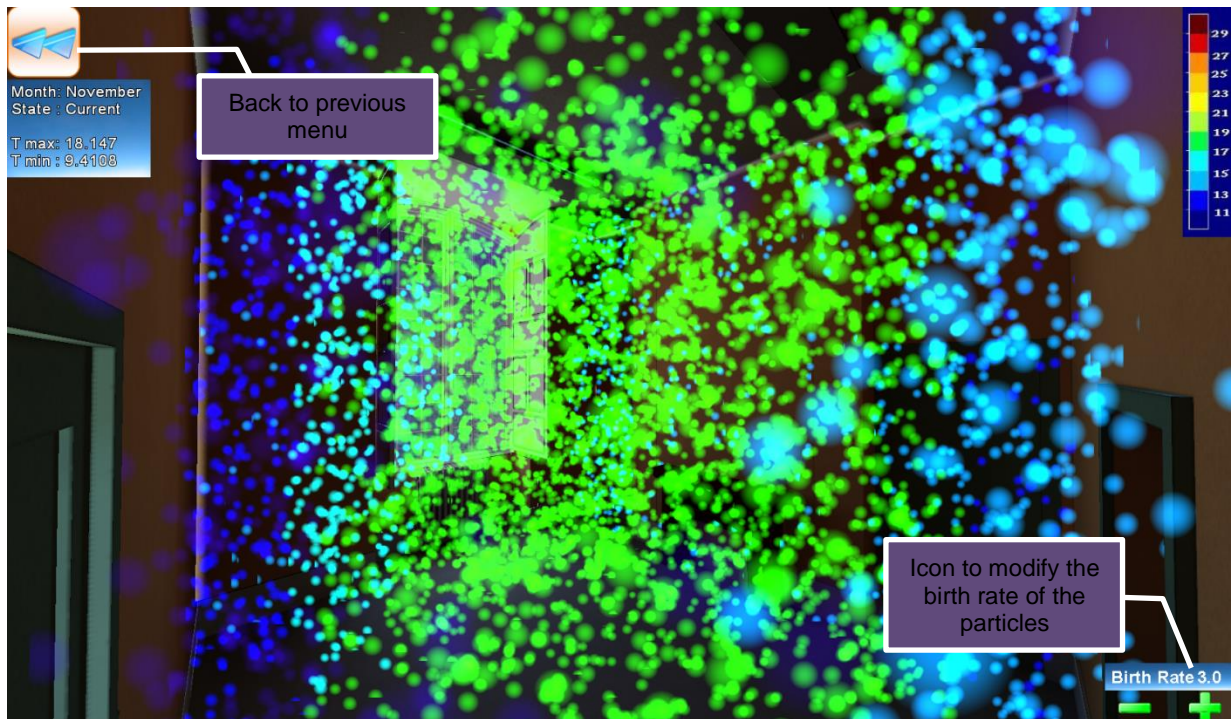

Figure 5.48. Visualization metaphor of particles of Gunzo room in existing conditions simulated on November 6<sup>th</sup>, at 14:15. The grid cubes (512 parts) act as the emitters and completely filled with the particle. The Birth rate of the particle is set to 3 point by default, and the user can modify it simple by clicking the plus-minus button on the right-bottom corner of the display. This icon appears automatically when simulation with particle is conducted.



Figure 5.49. Visualization of layer particles. In normal cases, the simulation result will visualize the room completely filled with cubes or particles that indicate the temperature of the area they occupy. In order to make a better perception the both metaphors are also divided into 8 layers on each axis in the room. In this simulation, only two layers are shown at a time, a horizontal layer and a vertical layer.



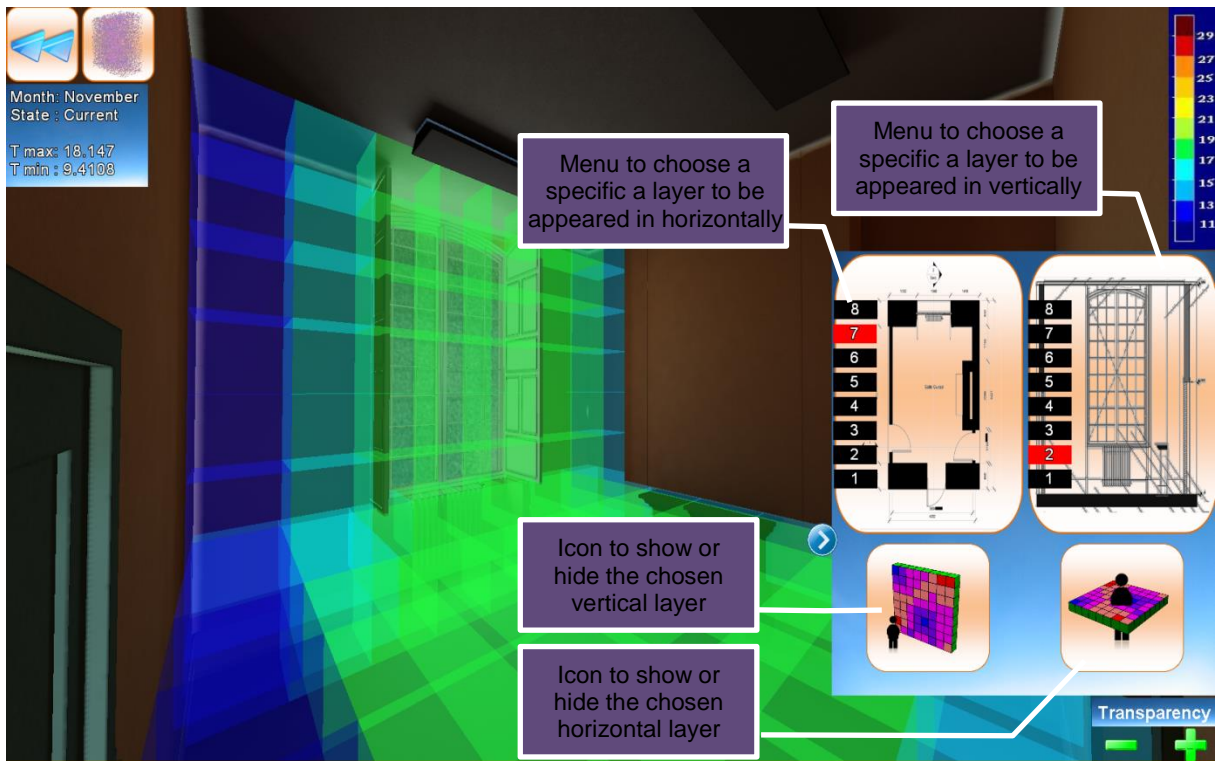

Figure 5.50. Visualization metaphor of layer cubes of Gunzo room in existing conditions simulated on November 6<sup>th</sup>, at 14:15. A "slide-in" menu for the layer is provided for the both metaphors (Cubes and particles) to enable the user to choose which layer to be displayed. An option button to hide or to show the layers is also available in the bottom of the slide-in menu (Appendix C). By default, this menu is hiding and represent by with blinking arrow. The user can click the arrow to access the menu.

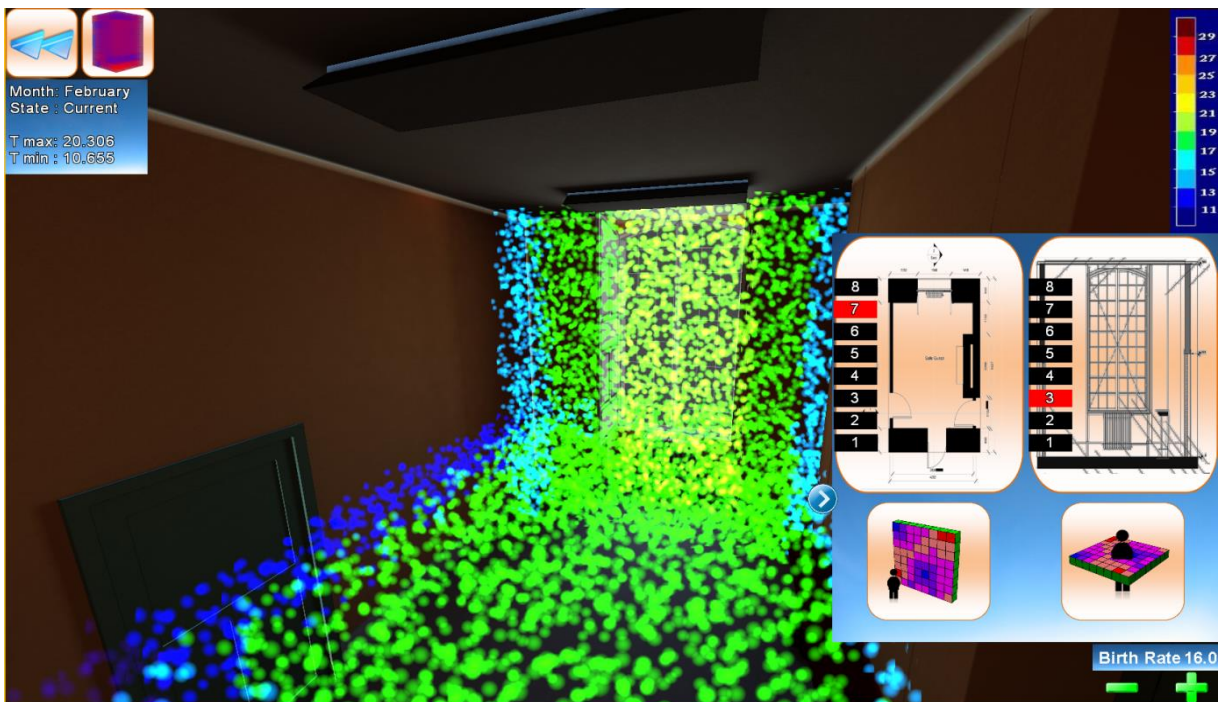

Figure 5.51. Visualization metaphor of layer particles of Gunzo room in current state. February 6<sup>th</sup>, at 14:15.

In Fig. 5.50 and Fig. 5.51 we can see a new button in the top left corner, and a new menu in the right side of the display. These button and menu always appear in visualization with layers mode. The button allows the user to quickly switch between a representation of particles or cubes at any time he wants. This button avoids the need to quit the current representation every time the user want to switch, to search in the menu of the representation type he want, and to find the month he want to see. With a simple click, the user can hide the cubes and activate the particles and vice versa. Along with the switch between the cubes and particles, the "Transparence" and "Birth Rate" menus also keep available. Regarding these two options, when the user activate one or another type of representation, the transparency or birth rate of the thermal entity will remain one selected during its last use. For example, if the value of birth rate of the particles is 10 point before switching to cubes, after switching back to the particles the birth rate will still remain 10 points. This is to provide more flexibility in interaction metaphor.

The construction of these buttons was possible because of the way the particles are created in 3DViaStudio. As explained earlier, each particle system is assigned to one of the cubes. This way, we were able to assign colors to the particles in the same time we do it for the cubes, without introducing a lag in the program. So the change is instantaneous. The construction of the behavior regarding the switch can be found in Appendix A.2.34. Although it may seem complex, its main function is to hide the cubes and activate the particles, or show the cubes and deactivate the particles.

Difficulties concerning the implementation of this option was the fact that when hiding a layer (vertical or horizontal), it would be hidden from the all displayed layer. This happened because the vertical layers and horizontal layers share each of 8 grid cubes. So when one is hidden, it takes with it 8 cubes from the displayed ones. The same thing happened when hiding the entire layers. The solution was to re-iterate the group of 64 cubes which has to remain displayed and re-display them. A variable was created to hold the value of the displayed group, which then the user can arrange the two layers they wanted to display. We organized this using a slide-in menu and activation buttons (Fig.5.52 and Fig.5.53).

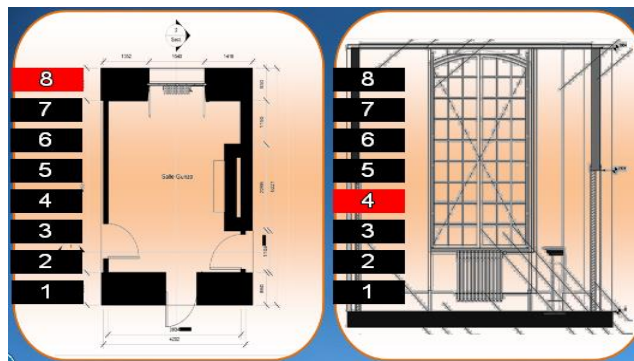
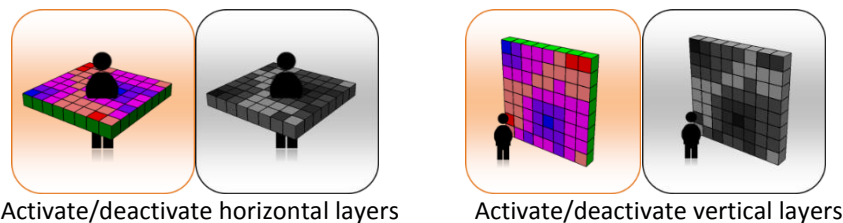

Figure 5.52. The switch between vertical and horizontal layers organized in a slide-in menu. This slide-in menu activated by clicking a blinking blue arrow on the left side of the screen. Both images in the menu contains of 8 buttons: vertically and horizontally. The activated layer will turn the button red, while the other buttons remain black. If a layer is deactivated, the switching buttons are also deactivated, and will reactivate along with them.



Activate/deactivate horizontal layers

Activate/deactivate vertical layers

Figure 5.53. The hide-show icons give the user options to activate or deactivate the layers vertically or horizontally, and to switch between the eight vertical layers and the eight horizontal layers. When the layers are active the buttons are colored, and when we deactivated the buttons turn grey.

Along with menus and commands on the user interface the system also provide an immersive visualization during the simulation. As describe in chapter 4, this is allows the user to perceive and to measure the simulation space. We used active stereo by applying Stereoscopic Camera. This is arranged within the software. In script 5.4, the post rendering of the stereoscopic camera is set to some behavior. It configure the post process rendering of stereoscopic camera, as well as the convergence distance, the anaglyph setting, and hide mouse cursor.

```
<ActorID>iV Stereoscopic Camera Post Process Rendering</ActorID>
<operations count="3">
<item create="vkActorTemplate::OpAddTemplate">
<destination></destination>
<templateToAdd ref="$(ExeURI)vkVRVisualization.vkmodule#New%20Stereoscopic%20Camera"/>
<item create="vkActorTemplate::OpAddTemplate">
<destination></destination>
<templateToAdd
ref="../Behaviors/Stereoscopic_Postprocess/Stereoscopic_Postprocess.becomp#Stereoscopic_Postpro
cess"/>
<item create="vkActorTemplate::OpAddTemplate">
<destination></destination>
<templateToAdd ref="../Behaviors/OpacityEffectBe/OpacityEffectBe.becomp#OpacityEffectBe"/>
</operations>
<configurations count="1">
<compUci></compUci>
<compConfiguration id="21353_0x2B2DE640" scope="asset" create="vkConfiguration">
<item path="vkStereoscopicCamera.ComponentID" type="vkString">iV Stereoscopic Camera Post
Process Rendering</item>
<item path="vkStereoscopicCamera.ConvergenceDistance" type="float">5.0</item>
<item path="Stereoscopic_Postprocess.PostProcessShaderHalfColorAnaglyph"
type="vkSmartPtr<&lt;vkShader>>";
ref="../Shaders/postProcessHalfColorAnaglyph.fx#postProcessHalfColorAnaglyph"/>
<item path="Stereoscopic_Postprocess.PostProcessShaderCheckerboard"
type="vkSmartPtr<&lt;vkShader>>";
ref="../Shaders/postProcessCheckerboard.fx#postProcessCheckerboard"/>
<item path="Stereoscopic_Postprocess.PostProcessShaderGrayAnaglyph"
type="vkSmartPtr<&lt;vkShader>>";
ref="../Shaders/postProcessGraydAnaglyph.fx#postProcessGraydAnaglyph"/>
<item path="Stereoscopic_Postprocess.MatchCurrentCamera" type="bool">true</item>
<item path="Stereoscopic_Postprocess.ManageCloseObjects" type="bool">true</item>
<item path="Stereoscopic_Postprocess.OpacityEffectTemplate" type="vkSmartPtr<&lt;vkTemplate>>";
ref="../Behaviors/OpacityEffectBe/OpacityEffectBe.becomp#OpacityEffectBe"/>
<item path="Stereoscopic_Postprocess.PostProcessShaderColorAnaglyph"
type="vkSmartPtr<&lt;vkShader>>";
ref="../Shaders/postProcessColorAnaglyph.fx#postProcessColorAnaglyph"/>
<item path="Stereoscopic_Postprocess.PostProcessShaderOptimizedAnaglyph"
type="vkSmartPtr<&lt;vkShader>>";
ref="../Shaders/postProcessOptimizedAnaglyph.fx#postProcessOptimizedAnaglyph"/>
<item path="Stereoscopic_Postprocess.HideMouseCursor" type="bool">true</item>
```

Script 5.4 Behavior of post process rendering of stereoscopic camera.

At each simulation, it always simultaneously conducts with the appearance of menus and commands on the user interface. Some menus are set to keep appear in a particular setting. For example, there are the same menus apply on each scene of the four visualization metaphors. There is also the same menu at the two scene of Gunzo room (before and after renovations). We arrange the menu display with behavior of copy frame (Script 5.5). This behavior regulates the appearance and disappearance of a frame in each scene, which includes 3D and 2D objects, entities and its interaction. The main interaction frame to keep available over the scenes is the delivery of the color attached to the cubes in each simulation (Script 5.6).

```

ref="../../../Behaviors/copy_frame/copy_frame.becomp#copy_frame"/>
</item>
</operations>
<configurations count="1">
<item>
<compUci></compUci>
<compConfiguration id="2673_0x0B6A4170" scope="asset" create="vkConfiguration">
<item path="copy_frame.chambre" type="vkSmartPtr&lt;vkStage&gt;" ref="#Chambre"/>
<item path="copy_frame.start_template" type="vkSmartPtr&lt;vkActorTemplate&gt;"
ref="../../../Templates/2D%20Node%20-%20Textured_1.mpxml#start_button"/>
<item path="copy_frame.thermal_cube_material" type="vkSmartPtr&lt;vkMaterial&gt;"
ref="../../../Models/ThermalCube.mp3d#Check"/>
<item path="copy_frame.Point1" type="vkRefPtr&lt;vkNodeBase&gt;" ref=":Point1#vkEntity3D"/>
<item path="copy_frame.DestroyDinamic" type="vkRefPtr&lt;destroy_dinamic&gt;"
ref=:current_frames#destroy_dinamic"/>
<item path="copy_frame.Th_cube" type="vkRefPtr&lt;vkNodeBase&gt;"
ref=:Thermal_Cube#vkEntity3D"/>
<item path="copy_frame.pipes" type="vkRefPtr&lt;vkNodeBase&gt;"
ref=:current_state.Import_Symbol_location_Not_Shared___216567_-node#vkEntity3D"/>
<item path="copy_frame.shutters" type="vkRefPtr&lt;vkNodeBase&gt;"
ref=:current_state.Import_Symbol_location_Not_Shared___216296_-node#vkEntity3D"/>
<item path="copy_frame.Point2" type="vkRefPtr&lt;vkNodeBase&gt;" ref=":Point2#vkEntity3D"/>
<item path="copy_frame.interaction_texture_table" type="vkRefPtr&lt;vkNode2D&gt;"
ref=:Metadata_table.Texture_table#vkNode2D"/>
<item path="copy_frame.info_chart" type="vkRefPtr&lt;vkNode2D&gt;"
ref=:Information_chart#vkNode2D"/>
<item path="copy_frame.transparency" type="vkRefPtr&lt;vkNode2D&gt;"
ref=:Transparency#vkNode2D"/>
<item path="copy_frame.birht_rate" type="vkRefPtr&lt;vkText2D&gt;"
ref=:Transparency.Birth_rate#vkText2D"/>
<item path="copy_frame.arrow" type="vkRefPtr&lt;vkNode2D&gt;"
ref=:Options_panel.Menu_arrow#vkNode2D"/>
<item path="copy_frame.options_panel" type="vkRefPtr&lt;vkNode2D&gt;"
ref=:Options_panel#vkNode2D"/>
<item path="copy_frame.horiz_layer_button" type="vkRefPtr&lt;vkNode2D&gt;"
ref=:Options_panel.Horizontal_L#vkNode2D"/>
<item path="copy_frame.vert_layer_button" type="vkRefPtr&lt;vkNode2D&gt;"
ref=:Options_panel.Vertical_L#vkNode2D"/>
<item path="copy_frame.cubes_or_particles" type="vkRefPtr&lt;vkNode2D&gt;"
ref=:Cubes_or_Particles#vkNode2D"/>

```

### Script 5.5 Behavior of copy frame.

```

<ActorID>Interaction</ActorID>
<operations count="1">
<item create="vkActorTemplate::OpAddTemplate">
<destination></destination>
<templateToAdd ref="../../../Behaviors/Interaction/Interaction.becomp#Interaction"/>
</operations>
<configurations count="1">
<compUci></compUci>
<compConfiguration id="2673_0x04D66F70" scope="asset" create="vkConfiguration">
<item path="Interaction.metadata_table" type="vkRefPtr&lt;vkNode2D&gt;"
ref=:Metadata_table#vkNode2D"/>
<item path="Interaction.TextureTable" type="vkRefPtr&lt;vkNode2D&gt;"
ref=:Metadata_table.Texture_table#vkNode2D"/>
<item path="Interaction.MetadataText" type="vkRefPtr&lt;vkText2D&gt;"
ref=:Metadata_table.Metadata_text#vkText2D"/>

```

### Script 5.6. Behavior of Interaction.

### 5.3.2 Experimental Setup

This subsection describes setting to conduct the application in experiment and the experiment process itself. Experiments performed with some parameters, including procedures, technical implementation, tools and equipment's. This is to test and to validate the effectiveness of this application.

#### 5.3.2.1 Hypotheses and Experimental Protocols

The key question for this experiment of thermal visualization is whether the given concept of thermal metaphors with immersive display allows faster, easier or more accurate perceptions and judgment. Our hypotheses are the following:

- Since a thermal metaphor is used to support the visualization, each tested thermal visualization metaphor should improve user performance in searching for specific temperature and area.
- Since all four visualization metaphors provide similar information to support user visualization in the VE, there should be no performance differences among the four visualization metaphors.
- Since the thermal visualization is supported by a friendly interface and navigation scenario, it should improve performance of user interaction and immersiveness.

Formulated tasks to test the hypothesis proposed were carried out by participants (9 tasks), regarding detection of certain temperatures in specific areas of the room, finding areas of a given temperature as well as comparing the temperature values of different areas. They were structured in such a manner that the assumed utility of each type of simulation was highlighted. The question structure was similar for all categories (Appendix C). The difference can be found in the values of the required temperatures, in the areas studied in the room, and in the periods studied during the year. This difference was made in order to avoid the participants' re-using answers from previous questions.

The tasks were to examine the value of the application determined by the following parameter analyses:

- The accuracy of the response and the effectiveness of the task;
- Duration of completion of each questionnaire and answering each question according to the type of simulation;
- The information collected from the subjective opinions regarding the interest in such thermal simulations, the data utility and ease of use, and the immersion sensations;

The analysis of these parameters will be used to confirm or to nullify our hypotheses.

#### 5.3.2.2 Test Subjects and Procedure

Volunteers were sought through announcements posted on mailing lists to people who might be interested in participating. A total of 20 test subjects participated in the experiment, from 19 to 44 years old (average 25.35), and mostly males (80%). The participants came from various backgrounds, mostly in the field of engineering and science (Bachelor, Master and PhD). All participants had at least basic skills in using computers, seven participants (35%) had previously used CAVE or LITE, and they all reported normal sight.

The participants experience the process of evaluation and monitoring as described in the experimental protocols. Some papers explaining the context, the procedure, and the instructions of the experiment was provided. The instructions included a general description of the experiment and its purposes. They were first asked to fill out a questionnaire on their age, sex, and background. Four test stages in sequence followed, regarding 4 types of thermal visualization simulated by colored cubes, colored particles, layer cubes and layer particles. Each four stages containing nine tasks present the thermal calculation result before and after the renovations.

The experiment procedure started with a 10 minute briefing and a short rehearsal (Fig. 5.55). The participants could practice examining the virtual mockup and get used to the immersive room. A



friendly interface based on an interactive menu on the display was provided interact with it. The menu provided the participants with access to the following options: choice between the current and projected state of the room, option of calculation time, and display of the thermal simulations. These experiment processes were recorded by a video camera. The time measured by a stopwatch is always set at the moment of each time the questionnaire is provided. At the end of the experiment, a set of questions was provided, focusing on subjective opinions regarding the simulation test. This part was not timed.

### 5.3.2.3 Technical Components and Data Supply

The experiment took place in an immersion room hosted by the Institute Image at the ENSAM ParisTech Cluny (Fig. 5.54). The room is a rear-projection-based VR system, with its instruments consisting of design tools, storage, and medium of digital model presentation. The details of the instruments and how they work is as follows:

- a. Software and hardware of a computer-aided design environment to create and store all necessary information about the model on computers (i.e. Autodesk Revit, Autodesk Ecotect, 3DsMax, 3DViaStudio).
- b. An input device system to enable the human user to manipulate and interact with this digital model naturally. We used a workstation equipped with monitor, keyboard, mouse, joystick Xbox 360, and four speakers.
- c. A high-fidelity output system to render and give feedback on what was created and manipulated in real time. The environment that our system runs on is a two-sided screen (4m x 2,25m each) called LITE with one projector per display. Christie Mirage HD6 DLP projector is used with 1920 x 1080 HD resolution. The entire system is driven by a Symmetric Multi-Processor machine with four IntelXeon E5420 2.5GHz processors, 16GB RAM, and an Nvidia GeForce GTX 260. OS: Microsoft Windows XP Professional x64 edition SP 2. A true three-dimensional perception is achieved using stereoscopic projection techniques. The projector supports HD active stereo, up to 120Hz output.



Figure 5.54. A view of the immersion room (LITE)

In the VE, as mentioned earlier, the studied room is divided into 512 parts as volumetric representation. These parts will then be used to display 4 types of graphical representations of the temperatures. The main menus in the interface display the type of simulation and the simulation time. The selected time simulation is on the 6th, at 14:15 every month. Both the Gunzo room in existing conditions and renovated versions were processed in this time simulation to make comparisons. Table 5.3 describes the experiment stage. The stage is arranged by the type of the visualization metaphor.

Stages	Type of Simulation Display	Description
1	Colored cubes	Each of the 512 areas of the room will be occupied by a cube to which a color is assigned depending on the temperature area. The transparency of the cubes can be modified by the user from a small "Transparency" menu, on the right-bottom corner of the display.
2	Colored particles	The cubes used in the first case will become completely transparent and will be filled with small particles. The color of the particles will also depend on the temperature of the area it occupies. Each particle has a life span of 3 seconds. The "life span" menu in this part is used to control the number of particles in each cube. It is made of 0-16 particles in each cubes.
3	Layer cubes	As mentioned earlier, the room is divided into 8 zones on each axis. In the previous cases, while the room is completely filled with cubes or particles that indicate the temperature of the area they occupy, in this simulation, only 2 layers are shown at a time, a horizontal layer (HL) and a vertical layer (VL). A "slide-in" menu is available, where the user can choose which HL or VL to be displayed. It also provides an option to hide or to show the layers.
4	Layer particles	A button is available in the top-left corner of the display which enables the user to switch between displaying a simulation by cubes or particles.

Table 5.3. Experiment stage description

The stage of simulation is based on the type of thermal metaphors (Fig. 5.56). As explained earlier there is sound function in the simulation to complement the function of the visualization. However, in this experiment this sound function is not activated. In considering to the beta test, we take the precaution as the noise would disturb the concentration and the efficiency of the user in performing their tasks.

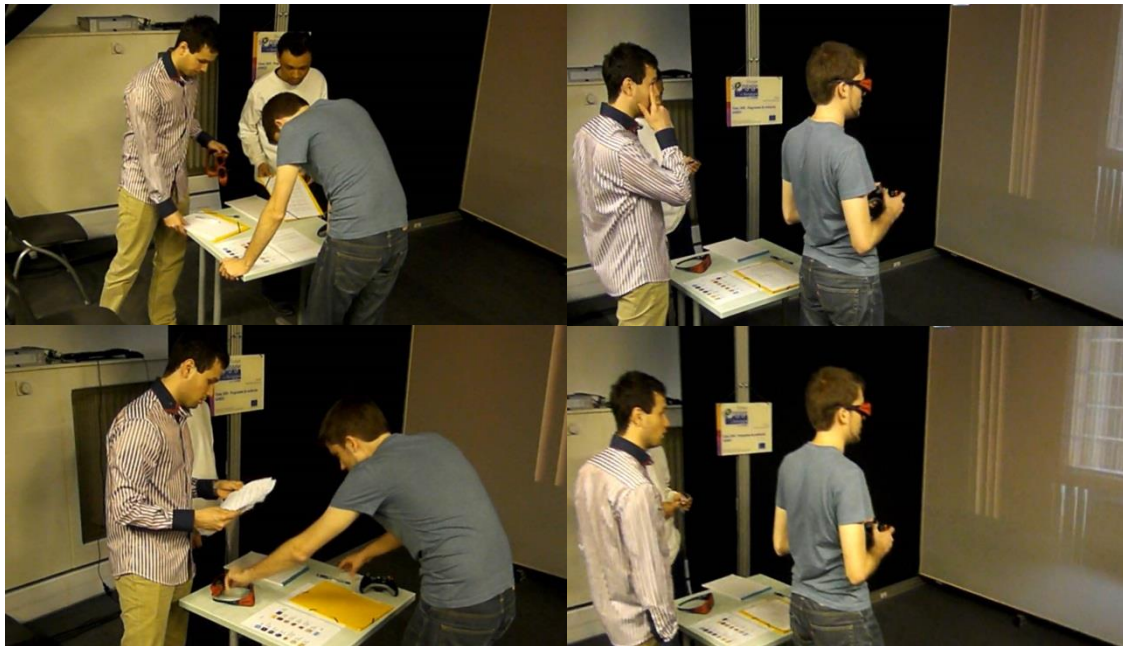

Figure 5.55. A participant received explanation regarding the experiment and begins a short rehearsal, examining the virtual mockup to get used to the immersive room.

## 5.4 The Results of the Experiment in Immersion Room

In this experiment, some respondents have experienced the simulation in Immersion room with stereoscopic visualization and have recorded their responses and opinions in a structured questionnaire. This method is very effective in an immersive room as it can deliver the real atmosphere of a room before and after construction. The interface is designed in such a way that the user can immerse, interact, and perceive the impact of the modifications generated by the system regarding the thermal simulation results. Thus, the users have the possibility to interact in the VE easily and intuitively while evaluating the results of a thermal setting of Gunzo room.

This section discusses the results of the experiment conducted in Immersion room. Some parameters of the simulation measurement are specified based on the character of the use of TBS by building stakeholder and its hypothesis. The measured parameters include the effectiveness of the visualization metaphor, performance on nine tasks, task completion times, and subjective impressions. In effectiveness of the visualization metaphor we measured how well the four type of thermal metaphor meet the users. The percentage of users that manage to complete a task successfully therefore becomes a measure of the design's effectiveness. As each stage performed in 9 tasks, we examine the user performance through these tasks. We also recorded the task-completion time to measure the efficiency of the simulation. The average task completion time of all the users participating in this simulation therefore becomes a measure of efficiency. Finally, we provide questionnaire regarding subjective impressions after the experiment session has ended. This is a qualitative measure of performance as defined by users. Observation through the use of videotaping during the session was also used to support this data.

The measured parameters, as explained earlier, are the measures that have not been tested. So that our assessment is based on the average value to compare the variation in results. Since the design of the experiment has lots of condition to compare we use the ANOVA (The analysis of variance). It is used as an exploratory tool to explain observations of the experiment in Immersion room.

As explain earlier, the system gives thermal sensations by its 3D volumetric visualization in some metaphors to inform and to immerse the user in VE. Interaction between users and objects in VE is certainly through techniques of visualization metaphors. There are four types of thermal visualization metaphor was presented to be tested in this experiment. They are colored cubes, colored particles, layer cubes, and layer particles. Each type was tested at one stage of simulation. Each stage simulates the MRT results of Gunzo room during the year, before and after the renovation. Figure 5.56 shows thermal metaphor visualized in each stage of the simulation. The fourth type of thermal metaphor is simulated to the subject and each type comes with a questionnaire. The four types of visualization indicate four main stages. Last stage (stage five) is an additional stage which questionnaire dealing with subjective impressions.

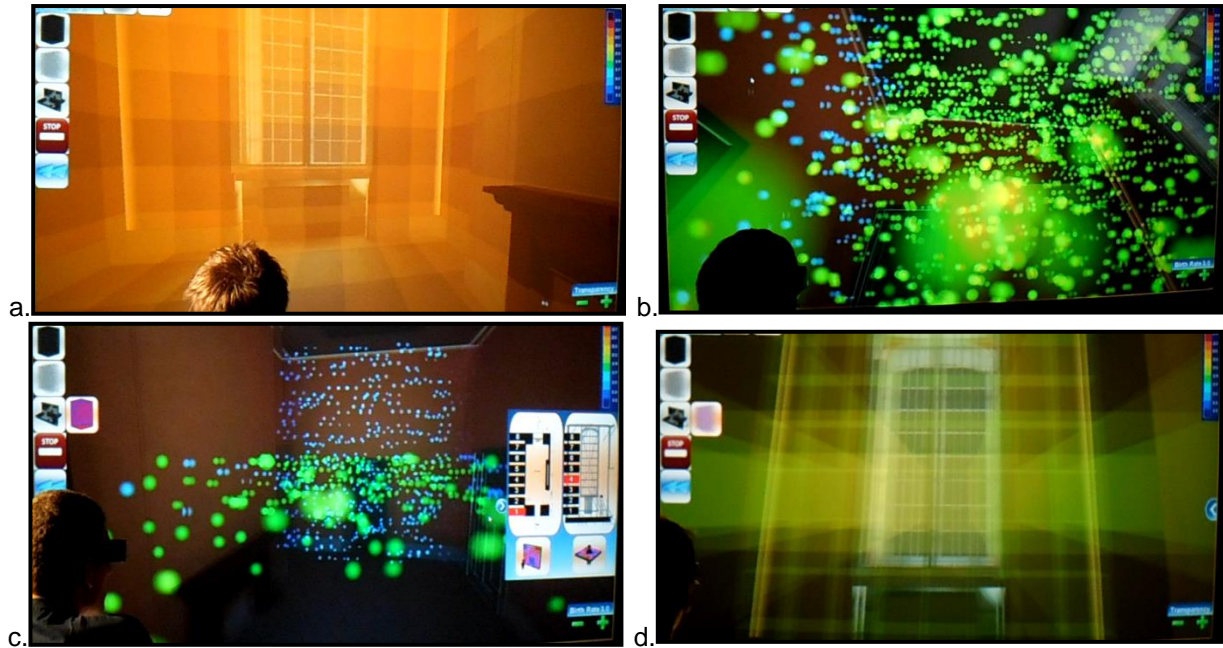

Figure 5.56. The four thermal metaphors visualized in the experiment in the immersion room; (a). Simulation results of renovated version on June 6<sup>th</sup>, 14:15 using colored cubes, (b). Simulation results of the Gunzo room in existing conditions in November using particles, (c). Simulation results of the Gunzo room in existing conditions on February 6<sup>th</sup>, at 14:15, using layer particles in vertical and horizontal. (d). Simulation results of renovated version using layer cubes in vertical and horizontal on March 6<sup>th</sup>, at 14:15.

### 5.4.1. Visualization Metaphor

In this usability testing we measure the effectiveness of the visualization metaphor. On examining which type of metaphor is used for representing the suitable visualization metaphor, it shows that 92% is fulfilled by the particles (Fig. 5.57). The particles were showed higher accuracy based on the average simulation tasks results in VE followed by layer particles (90%), layer cubes (88%), and cubes (85%). A statistical tool (ANOVA) used to develop and to confirm an explanation for the observed data, and to find out the signification of the test results.

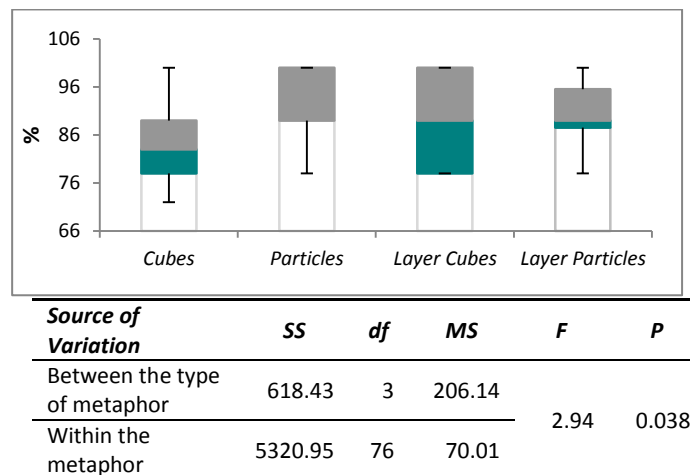

Figure 5.57. Mean accuracy points of four visualization metaphor.

The ANOVA shows that the test on the four metaphors is significant in the way of presenting the visualization ( $F(3, 76) = 2.725, p < 0.05$ ) as initially predicted in first hypotheses. It indicates more differences within the metaphor than between the four types of metaphor (Fig. 5.57). The significant differences value was particularly indicated in the type of layer cubes ( $SD_{Lcubes} = 10.12$ ), while in the other three types it was not too significant ( $SD_{cubes} = 7.1, SD_{particles} = 8.05, SD_{Lparticles} = 7.88$ ). The visualization with layer cubes seems to complicate for the interpretation. It has big variance in values of the correct answers (Tab. 5.4), so somewhat less effectively used. The simulation model for this type was also used an additional interactive slide panel to deliver each layer (*HL* and *VL*), along with the transparent and the life span panels. It is not only to increasing the immersive sensation but also for the effort and the length of action. When confirmed to the subjective test results, layer cubes was reported as the least immersive compared to the three other types, in which the particles is the most favorite.

Respondents	Cubes	Particles	Layer Cubes	Layer Particles
1	89	78	78	83
2	83	100	89	89
3	89	89	78	100
4	83	78	100	94
5	78	89	100	100
6	94	78	78	89
7	94	100	78	78
8	83	89	78	78
9	89	100	94	89
10	89	100	100	89
11	72	100	100	94
12	78	100	100	94
13	89	89	78	78
14	100	89	78	78
15	78	100	78	100
16	78	100	78	89
17	78	100	100	100
18	83	89	89	100
19	78	89	89	89
20	89	89	100	89

SUMMARY				
Groups	Count	Sum	Average	Variance
Cubes	20	1694	85	50.5368421
Particles	20	1846	92	64.9578947
Layer Cubes	20	1763	88	102.45
Layer Particles	20	1800	90	62.1052632

Table 5.4. Details of Mean values of the correct answers on four metaphors

We assume that the presentation using layers will facilitate the partial observations and clarify more the targeted spot. In fact, the two types of visualization that uses layers showed significant differences in effectiveness. Also, the visualization metaphor of cubes and particles which are multivalued in 3D volumetric without layers, each occupying the highest and lowest percentage of effectiveness. This means that there are problems remaining in terms of viewpoint. Applying the technique to map multivalued data in 3D volumetric caused some parts of surfaces to face away from a viewpoint or be obscured by other surfaces. In this interactive environment it is found that splitting the



3D metaphor into parts, moving the object around and changing the view can alleviate this problem, but doesn't eliminate it.

Another thing is that the user only takes cues about the value of temperature from changes in the texture and color of thermal metaphors. Certainly, the capability to perceive color and texture accurately in the immersive room will involve the influence of visual sensory and psychological factors. Although we have anticipated this with providing some option once they got the simulation results. Such as, option to alter the transparency effect or brightening the thermal entities of the metaphors, as well as the option of increasing or decreasing the life span of the thermal entities. Psychological factors or perhaps empirical experience of the user seems quite influence the judgment of these thermal metaphors.

#### 5.4.2. Performance on Nine Tasks

In each questionnaire there are nine questions that can be categorized as nine tasks (Appendix C). Task 1 ( $T_1$ ) is to find the temperature in a particular spot in the room (Difficult 1); Task 2 ( $T_2$ ) is to find the temperature in a particular spot in the room (Difficult 2); Task 3 ( $T_3$ ) is to locate the spot in the room with a specific temperature (Difficult 1); Task 4 ( $T_4$ ) is to locate the spot in the room with a specific temperature (Difficult 2); Task 5 ( $T_5$ ) is to detect the maximum temperature (before renovation); Task 6 ( $T_6$ ) is to detect the minimum temperature (before renovation); Task 7 ( $T_7$ ) is to detect the maximum temperature (after renovation); Task 8 ( $T_8$ ) is to detect the minimum temperature (after renovation); Task 9 ( $T_9$ ) is to find the difference in temperature before and after the renovation

With regard to the accuracy of each type of visualization metaphor in the 9 tasks ( $T_{1-9}$ ), the ANOVA result shows that there are significant different mean values ( $F(8, 171) = 1.99, p < 0.05$ ). It also relatively more difference within tasks than between the tasks.  $T_{1-4}$  showed fluctuation accuracy, while the  $T_{5-9}$  is relatively stable with a perfect value (Tab. 5.6). This result extends the explanation of the third hypotheses that the visualization improves the user performance in interaction and immersiveness.

In table 5.5, the accuracy on  $T_1$  and  $T_4$  is generally above average. Both showed a minimum point on the layer cubes (70% for each), as well as 70% for the layer particles in  $T_4$ . Cubes and particles in both tasks gain more than 90%. In task one ( $T_1$ ), it indicates a high accuracy level on particle and layer particles (Tab.5.6). In contrast, on task two ( $T_2$ ), it indicates the high accuracy on the layer cubes.

The participants seem to have a little difficulty with two tasks ( $T_2$  and  $T_3$ ). Task two which is to find the temperature in a particular spot in the room (Difficulty 2) gets 68%. Task three which is to locate the spot in the room with a specific temperature (Difficulty 1) only gets 66%. The low points occur in type metaphor of Cubes ( $T_2=35\%$ ,  $T_3=45\%$ ), particles ( $T_2=48\%$ ), layer particles ( $T_3=63\%$ ). Visualization of layer cubes apparently is best suited for these tasks.

Four tasks ( $T_{5-8}$ ) regarding the detection of maximum and minimum temperature in both versions of the room (before and after renovation) surprisingly have 100% accuracy (Fig. 5.58). This means that the participants can easily found the info texts which are indicated in each simulation, which can also be observed on the blinking 3D object. They also got 98% on the task to find the difference of temperature before and after the renovation ( $T_9$ ). This task requires a manual calculation to find the different maximum or minimum temperature between the two versions of Gunzo room. The ninth task ( $T_9$ ) is quite time consuming, however the accuracy of the responds is quite significant. The four visualization metaphors indicate high accuracy in average (Tab. 5.6). Visualization of cubes and layer particles is best suited for task nine ( $T_9$ ).

	1	2	3	4	5	6	7	8	9
	To find the temperature in particular spot in the room (Difficult 1)	To find the temperature in particular spot in the room (Difficult 2)	To locate the spot in the room in a specific temperature (Difficult 1)	To locate the spot in the room in a specific temperature (Difficult 2)	To detect the maximum temperature (before renovation)	To detect the minimum temperature (before renovation)	To detect the maximum temperature (after renovation)	To detect the minimum temperature (after renovation)	To find the difference of temperature before and after the renovation
1	88	38	63	50	100	100	100	100	100
2	100	75	50	88	100	100	100	100	100
3	100	50	75	75	100	100	100	100	100
4	75	75	75	100	100	100	100	100	75
5	75	75	75	100	100	100	100	100	100
6	50	75	38	100	100	100	100	100	100
7	75	100	38	75	100	100	100	100	100
8	75	50	38	100	100	100	100	100	75
9	100	100	63	75	100	100	100	100	100
10	100	75	75	100	100	100	100	100	100
11	100	75	75	75	100	100	100	100	100
12	100	63	75	100	100	100	100	100	100
13	100	50	75	50	100	100	100	100	100
14	75	75	75	50	100	100	100	100	100
15	75	75	75	75	100	100	100	100	100
16	100	50	75	50	100	100	100	100	100
17	100	75	75	100	100	100	100	100	100
18	75	50	88	100	100	100	100	100	100
19	75	50	75	75	100	100	100	100	100
20	100	75	50	100	100	100	100	100	100
SUMMARY									
Groups					Count	Sum	Average	Variance	
To find the temperature in particular spot in the room (Difficult 1)					20	1738	87	221.673684	
To find the temperature in particular spot in the room (Difficult 2)					20	1351	68	284.365789	
To locate the spot in the room in a specific temperature (Difficult 1)					20	1328	66	228.147368	
To locate the spot in the room in a specific temperature (Difficult 2)					20	1638	82	386.410526	
To detect the maximum temperature (before renovation)					20	2000	100	0	
To detect the minimum temperature (before renovation)					20	2000	100	0	
To detect the maximum temperature (after renovation)					20	2000	100	0	
To detect the minimum temperature (after renovation)					20	2000	100	0	
To find the difference of temperature before and after the renovation					20	1950	98	59.2105263	

Table 5.5. Percentage of accuracy through 9 task regarding actions in immersive room using the four metaphors.

	T1		T2		T3		T4		T(5-8)		T9	
	M	SD	M	SD	M	SD	M	SD	M	SD	M	SD
Cubes	0.9	0.31	0.35	0.49	0.45	0.43	0.93	0.24	1	0	1	0
Particles	0.93	0.24	0.48	0.50	1	0	0.95	0.22	1	0	0.95	0.22
Layer Cubes	0.7	0.47	0.95	0.22	0.63	0.48	0.7	0.47	1	0	0.95	0.22
Layer Particles	0.95	0.22	0.93	0.24	0.53	0.47	0.7	0.47	1	0	1	0

Table 5.6. Mean values of accuracy through 9 tasks.

Based on the sequence of the tasks, the test subjects experienced inefficiencies with their first four tasks (T<sub>1-4</sub>). As indicated in Fig. 5.58 they are improved on the remaining tasks (T<sub>5-9</sub>). These tasks are obviously very different in levels of difficulty. We believe that the simulation result can easily work in the VE since the user can learn the effects of the commands from the previous task. The presentation



scenario through VE in this case has become the factor that maximizes their adaptability, thus improving their performance.

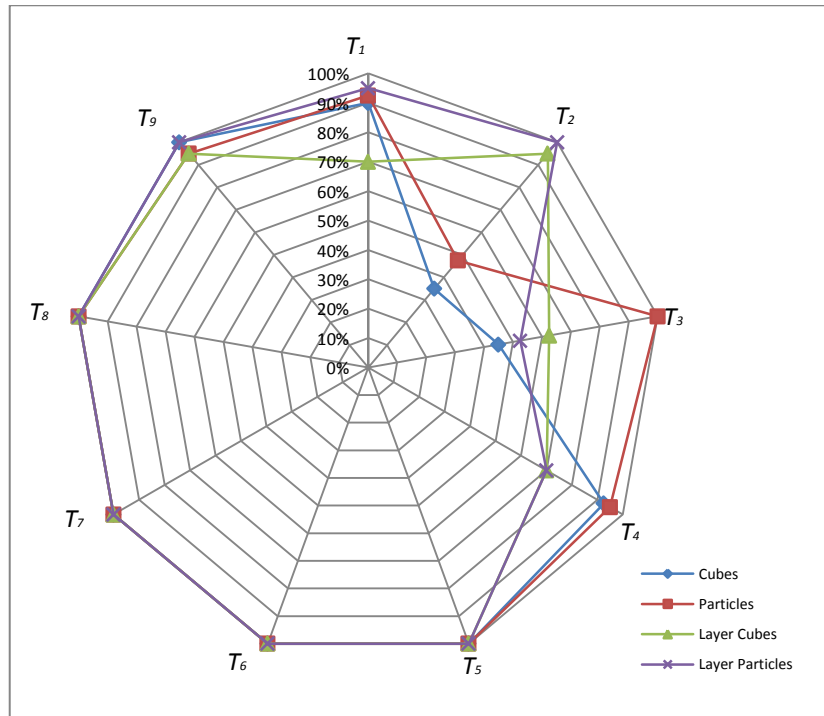

Figure 5.58. Accuracy of each type of visualization metaphor in 9 tasks (T<sub>1</sub> – to find the temperature in a particular spot in the room (Difficult 1); T<sub>2</sub> – to find the temperature in a particular spot in the room (Difficult 2); T<sub>3</sub> – to locate the spot in the room with a specific temperature (Difficult 1); T<sub>4</sub> – to locate the spot in the room with a specific temperature (Difficult 2); T<sub>5</sub> – to detect the maximum temperature (before renovation); T<sub>6</sub> – to detect the minimum temperature (before renovation); T<sub>7</sub> – to detect the maximum temperature (after renovation); T<sub>8</sub> – to detect the minimum temperature (after renovation); T<sub>9</sub> – to find the difference in temperature before and after the renovation).

### 5.4.3 Task Completion Times

The task completion time was measured between the signs start to perform the task in the questioner from the participants and their sign notify the questioner completed. Figure 5.59 shows the mean task completion times for the nine tasks in the four different types of metaphor.

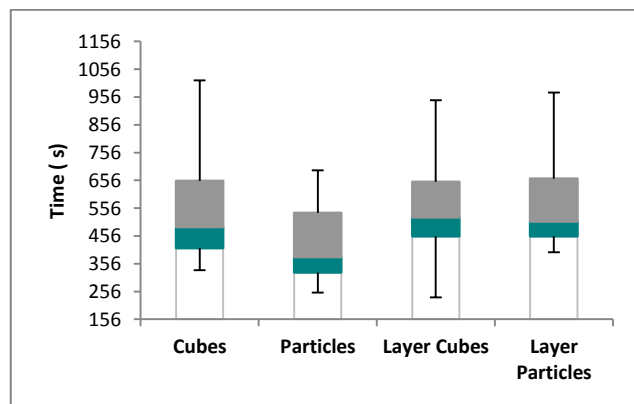

Figure 5.59. Mean task completion times for all tasks with the four metaphors used in the experiment.

Contrary to the initial predictions in the second hypotheses, there was a significant difference in task completion times for the four types of metaphor. The thermal metaphor with particles proved to be the fastest way to interpret the results of the simulation. Table 5.7 describes the time spent by the participants (in second) to answer the question in 9 task. The ANOVA test through the nine tasks gave the following result:  $F = 3.4749$ ,  $p = 0.0201$ . The small value of  $F$  on the time spent by the participants to complete the task indicates relatively more differences within the metaphor than between the four types of metaphor. The test using the 4 metaphors ( $F(3, 76) = 2.72$ ,  $p < 0.05$ ) confirmed a significant difference between the particles and the other three metaphors (cubes, layer particles and layer particles), but no significant difference between the cubes, layer cubes and layer particles.

Table 5.8 shows the prevailing efficiency on the four metaphors. The particles proved to be more efficient with 92% accuracy in 06:59.4 or average 00:46.6 per task, followed by cubes (85%, 09:19.5 or average 01:02.2 per task), layer cubes (88%, 09:25.3 or average 01:02.8 per task), and layer particles (90%, 09:47.1 or average 01:05.2 per task). These are exceeding our expected time of average 10 minutes in each stage. The interesting is that in terms of the fastest response, the layer cubes is in the first position (3:55), followed by the particles (04:12), the cubes (05:33), and layer particles (06:37). These fastest responses also have a high level of accuracy. We believe that the reason that these participants were significantly faster lies in the fact that they were already skilled in operating a joystick. In addition, the participants apparently did not take more time to play around with the given data or display that interested them. Evaluation using video recording indicated they were focused on the task and did not explore the 3D results deeper or repeatedly.

Respondents	Cubes	Particles	Layer Cubes	Layer Particles	
1	840	541	412	556	
2	641	332	505	585	
3	1148	539	520	645	
4	334	282	432	518	
5	378	380	235	397	
6	692	692	1038	1064	
7	427	300	391	461	
8	450	381	505	399	
9	483	330	595	428	
10	641	402	641	746	
11	421	385	365	469	
12	333	298	526	495	
13	725	559	501	439	
14	426	345	729	403	
15	383	252	620	481	
16	509	594	681	656	
17	385	331	783	497	
18	568	633	556	790	
19	911	505	808	1032	
20	494	307	463	680	
Source	df	SS	MS	F	P-value
treatments	3	351381.9	117127.3	3.4749	0.0201
error	76	2561742.9	33707.143		
total	79	2913124.8			

Table 5.7. Detail of the time spent by the participants (in second) to answer the question in 9 task with regard to the four metaphors.

<i>TM</i>	<i>AT</i> (mm:ss)	<i>T<sub>AT</sub></i> (mm:ss)	<i>A<sub>AT</sub></i> (%)	<i>FT</i> (mm:ss)	<i>T<sub>FT</sub></i> (mm:ss)	<i>A<sub>FT</sub></i> (%)
<i>Cubes</i>	09:19.5	01:02.2	85	05:33	00:37.0	78
<i>Particles</i>	06:59.4	00:46.6	92	04:12	00:28.0	100
<i>Layer Cubes</i>	09:25.3	01:02.8	88	03:55	00:26.1	100
<i>Layer Particles</i>	09:47.1	01:05.2	90	06:37	00:44.1	100

Table 5.8. Comparison of accuracy and time spent for the task (*TM* – Thermal Metaphor; *AT* – Average Time; *FT* – Fastest time; *A* – Accuracy; *T* – Time spent / task).

### 5.4.4 Subjective impressions

At the end of the experiment, the participants are provided with subjective questions in a PC. This last questionnaire was designed to assess their subjective opinion relate to their experience or about the task. We intended to measure the overall preference or the reaction to the application used in the experiment.

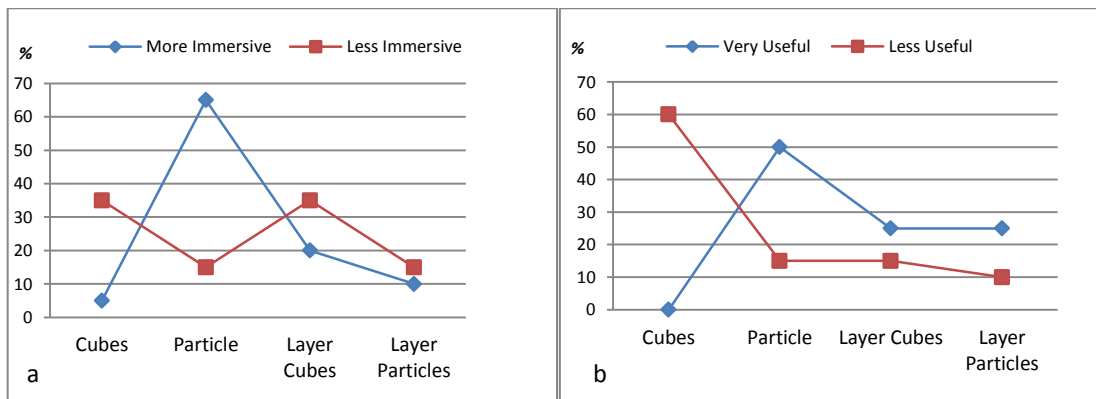

Figure 5.60. (a) Level of immersiveness among the metaphors. (b). Percentage of application usefulness of the metaphors.

Figure 5.60 shows the level of immersiveness among the metaphors and the percentage of application usefulness of the metaphors. It indicates that the level of immersive seems parallel with the level of usefulness of the metaphor. On questioning which type of metaphor is the most immersive, 65% participants replied it was the particles. It's followed by layer cubes (20%), layer particles (10%), and cubes (5%). On other hand, 35% of participants put cubes and layer cubes as the less immersive. The particles also got the highest points for usability (50%), followed by layer cubes and layer particles (25% each) and no one chose the cubes.

Participants were also asked for their preferences of the most important variable to understand and to present in the simulation (Fig. 5.61). This question is concerning the tools, data, and time on presentation of TBS which frequently asked by building stakeholders. In questioning the best way to know the temperature of a room after renovation (the room is not built yet), most of participants prefer to know it by using calculation software that results in a 3D visualization and interaction simulation (85%) than using traditional software (15%). They also prefer to have the information in interactive representation composed by text and 3D visualization (75%), and to see the results in the span of a 12 month period (60%). Only a few prefer to see the result in 4 seasons as well as in a certain time (20% each). All of those preference has confirmed what we have done in representing TBS in the experiment.

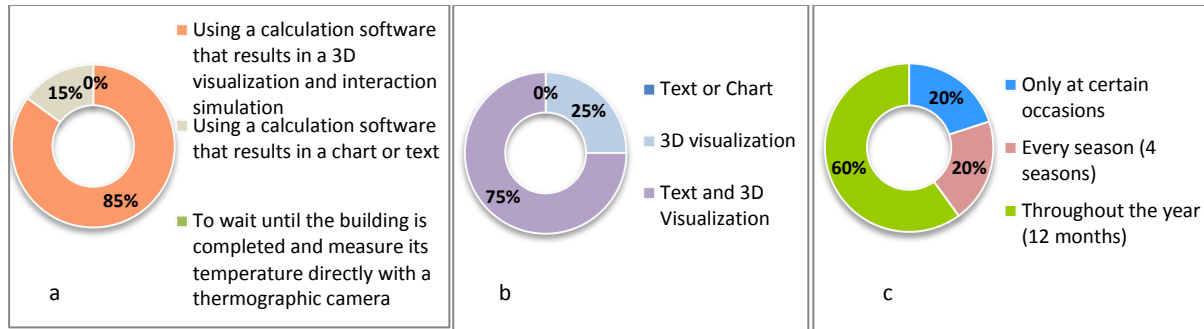

Figure 5.61. User preferences concerning services through the application. (a). Preference in how to know the temperature of a room after renovation (the room is not built yet). (b). preference types of information on interactive thermal representation for a room. (c). Preference of temperature visibility in the span of period calculated for a room.

Figure 5.62 shows user experience while conducting the overall task in VEs. In questioning the experience while conducting the overall task in VEs (E<sub>1</sub>), most of participants found the tasks were perfectly understandable. However, as most of them found the VR interface (E<sub>2</sub>) was also easy (55% above average), 10% found it difficult. We believe that few participants did not quickly get used to the immersive room, including its equipment, even when they were given time to practice examining the virtual mockup at the beginning of the experiment. Furthermore, the participants were tending to be external influences which dictate the use of certain presentation techniques (i.e. those who are used to joysticks or video games). The positive thing of this influence was some of them adapt quickly so that they complete the task quickly.

Concerning the intensity of concentration during the experiment (E<sub>3</sub>), participants seemed to take efficient time or focus enough while facing the task. Only 20% felt it was fairly intensive and 10% felt just a little bit. All of participant's experienced immersive sensation within the thermal visualization (E<sub>4</sub>), while most of them felt it in above average level (45%), and 15% reported excellent. The immersive atmosphere indicated has impact on concentration on the task and the time spent as confirmed by the previous results. There is benefit of the immersive atmosphere to maximize the observation, which is the influence depends on type of the visualization metaphor.

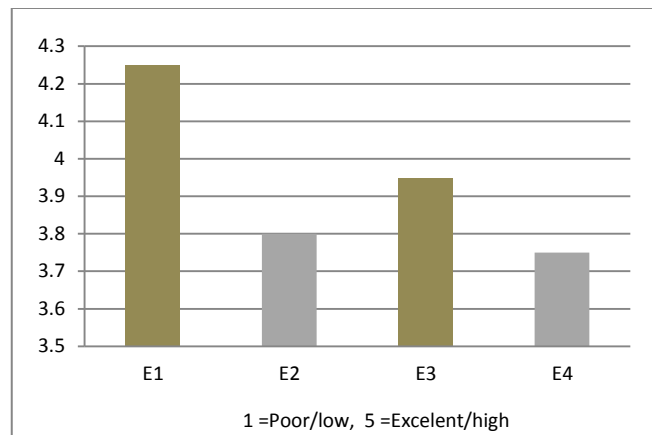

Figure 5.62. User experience while conducting the overall task in VEs. E<sub>1</sub> – Comprehend the simulation task; E<sub>2</sub> – Easiness of the VR interface; E<sub>3</sub> – Intensity of concentration during the experiment; E<sub>4</sub> – Level of sensation while immersed in thermal visualization.

Figure 5.63 and figure 5.64 show user's Impression regarding the VR application of TBS. With regard to the workability of the application (W), 5% of the participants replied excellent and 50% above average. Those, for which 5% claimed poor and 15% above average, said that the buttons

arrangement should be more efficient. Another point was about the speed of the calculation and simulation. This is certainly concerning to the smooth interoperability of the data that is quite complex as it relates to the 3D models and the interface architecture.

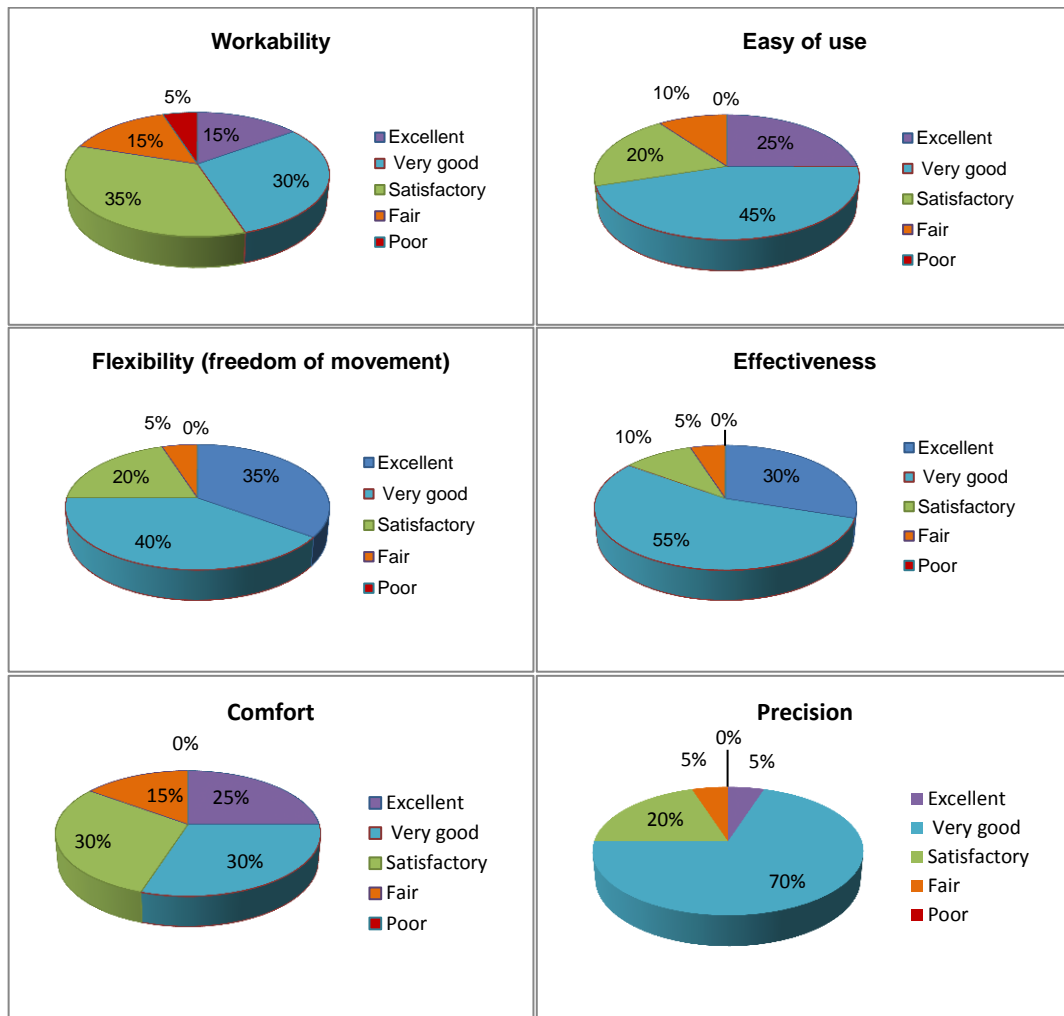

Figure 5.63. Detail of Impression regarding the VR application.

In terms of ease of use (EU) and flexibility (F), most of the participants are very satisfied. They also feel the application is very effective (E), 55% said it was above average and 30% excellent. It seems that data workflow and its integration to the application interface supports the interaction to the simulation results. The results directly linked to the interactive environment and saving the complex calculations step in simple steps without burden with heavy equipment, gave the user flexibility in moving, making it easy to conduct the tasks.

In terms of comfort (C), they generally feel comfortable in the immersive room (25% said that it was excellent), 30% above average. A few reported their eyes gradually got tired (i.e. effect of 3D glasses) during the four stages of the experiment. In terms of precision of the application (P), the findings show the users commonly had high percentages (70% above average), 5% confirmed excellent. Small details that are easily visible in the immersive room seem to be anticipated successfully with the precise positions of the 3D entity of thermal metaphors on the XYZ axis within the room.

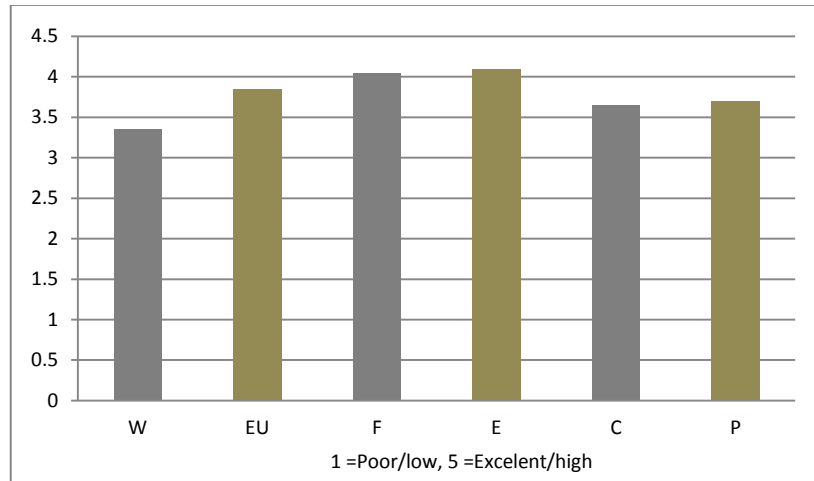

Figure 5.64. Summary of Impression of the VR application (W – Workability; EU – Ease of use; F – Flexibility (freedom of movement); E – Effectiveness; C – Comfort; P – Precision).

To conclude the section, in general, the participants were very efficient when conducting their tasks, only a few issues emerged occasionally. The subjective opinion highlighted several important issues experienced by the participants, such as the ease of the operation in VE, the visual effects and the interoperability. The evident limitation of this study is that the task was rather limited. It focuses only to the essential purposes. In addition, a bigger sample size would strengthen the reliability of the results. All the participants were from rather various backgrounds and were all performing the same task in the same VE. They can learn the effects of the commands in the VE to easily deliver the simulation result within the VE. However, the differences in the subject's experiences, perceptual and cognitive abilities, also the complexity of the task can affect the subjects' performance. Therefore it can be stated that the next assessment of the prototype, including its graphic interface is crucial. Our attention was drawn to the need to advance the application so that there were more possibilities of tasks in every metaphor. This way, this application could facilitate more thermal calculation results and more function for dynamic simulation.

## 5.5 Summary

This chapter describes the concept and the development of application to visualize TBS results in a VE. The application has managed to show the simulation results of thermal data mainly operated in the immersion room. It is very effective in an immersive room as it can deliver the TBS results in the real atmosphere of a room before and after renovation.

The application has managed to conduct a specific data exchange in order to represent TBS results in VR. Therefore, there is a workflow behind the scene that is not easy to simplify. The workflow is based upon the terms of BIM and became the stages for experiments. The experiment performed the data transfer which was conducted in 3 stages. This relies on the smooth exchange of data workflow between design tools, thermal calculation tools and VR tools.

Our concept in this context provides both system and workflow concepts for visual representation of thermal data to easy facilitate the building stakeholder. It shows that the use of the data workflow and the thermal metaphors can improve interaction with the simulation and immersion in VE. It also has interaction techniques that assist in visualization and simulation in full immersiveness.

We have conducted experiments using a PC, tablet and Immersion room. As the purpose of this work, we focus to the Immersion room. In the experiment using immersion room, the users have the ability to interact with the virtual world. They can change the visualization characteristics and perceive

the impact of their actions. They also have the possibility to compare temperatures corresponding to different settings of the VE. The system enables the user to interact with the VE intuitively while assessing the results of the TBS settings of the room. The system gives thermal sensations by its 3D volumetric visualization in some metaphors to inform and to immerse the temperature. Some visualization metaphors developed were intended as an alternative representation to facilitate perception of the results of thermal calculations.

There are four types of thermal visualization metaphor was tested in this experiment. They are colored cubes, colored particles, layer cubes, and layer particles. These four types was tested and compared to have a better presentation result for the simulation. We also examine the level of immersive and the level of usefulness of the visualization metaphor. It indicates that the level of immersive is consistent with the level of usefulness of the visualization metaphor. The representation of TBS results in VE is measured using three parameters: the effectiveness of the visualization metaphor, performance on nine tasks and task completion times. It also include questionnaire to assess subjective opinion of users.

Findings in the three measurement parameters are indicated that visualization metaphor using particles was very efficient and effective to serve the simulation. This finding is consistent with the user's preferences. With regard to the results of TBS in VE, users preferred the visualization by combining text and 3D. Other opinions also answer some preferences of building stakeholders about the significance of immersive 3D models and its thermal results.





# Chapter 6

## Conclusion



**T**hermal building simulation is a complex process during which the architect or engineer is required to construct a detailed analytical model based on information from a number of disparate sources (other building stakeholder). There is often uncertainty both in the information and the manner in which it should be interpreted for model construction. Improvements in the validation of the data entered and the representation of the simulation results will therefore increase accuracy and lead to better and more informed design. To validate a design including its TBS results, building stakeholder need to check the 3D model and its thermal calculation in an effective way. This complex process can facilitate through the use of VR technology. VR applications provide a high quality and an immersive visual representation of TBS as it allows architect and engineer to transfer concepts into virtual environments. It also allows building stakeholders to see and to interact with the TBS results using natural and intuitive human motions.

This work describes the applying VR techniques within an analysis of the results and visualization output of an environmental performance analysis. It also describes the concept and the development of an application to visualize thermal data in a VE for building energy efficiency. An application and experiment was conducted to make an assessment in indoor temperature with the aim to enhance thermal comfort and predict the outcome in terms of design result. This is particularly to support architect and engineers in determining stakeholder's preferences, and finding a design that is a good compromise between those preferences.

The application has managed to show the simulation results of thermal data mainly operated in the immersion room. It shows that the use of the data workflow and the thermal metaphors can improve interaction with the simulation and immersion in VE. It also has interaction techniques that assist in visualization and simulation in full immersiveness. Some previous works have suggested such approaches but they are not quite optimized the interaction and immersion, particularly with an advanced interface. Our method in this context provides both; system and workflow concepts for visual representation of thermal data that facilitate building stakeholder or even general user.

In the simulation scenario we develop the scenario to improve the representation and interpretation of TBS data using visualization techniques. The scenario is formed within the application by a combination of elements from the environment database together with a task description. The application prototype combines techniques for data storage and manipulation with information visualization techniques and advanced 3D graphics. These elements are tightly integrated within a single workflow that facilitates the management and interpretation of data from multiple analysis models. In the experiment session, a user experiences a scenario by trying to perform the task in the simulated environment. From these experiences, the user identifies what he needs and/or wants. By simulating the TBS database, it is expected the user can configure some results that might refer for a candidate design with which he expects to fulfill his needs and desires. By applying the design to a different scenario (i.e. a TBS of project states from the environment database together with a different task description), the user can see whether the results satisfactorily under different circumstances or whether new needs emerge (Fig. 6.1).

However, representation of TBS in VR is a complex effort. It is particularly if supported only by a few references and related work. In addition to the complexities of development, TBS integration in VR is also limited by certain hardware and software characteristics of current VR devices. The two major obstacles in creating an illusion of immersion are the interoperability problem and the image for interpretation. Several approaches to the interoperability problem are examined. One approach is by using specific workflow and simplifies the detail for smooth simulation. As the user simulates, simplified images transform smoothly to the correct perspective. The problem of poor image results from the presentation technique, the software and the display devices. Efforts to improve image include using large display device (immersion room), using visualization metaphors and optimizing 3D model using modeling and rendering software.

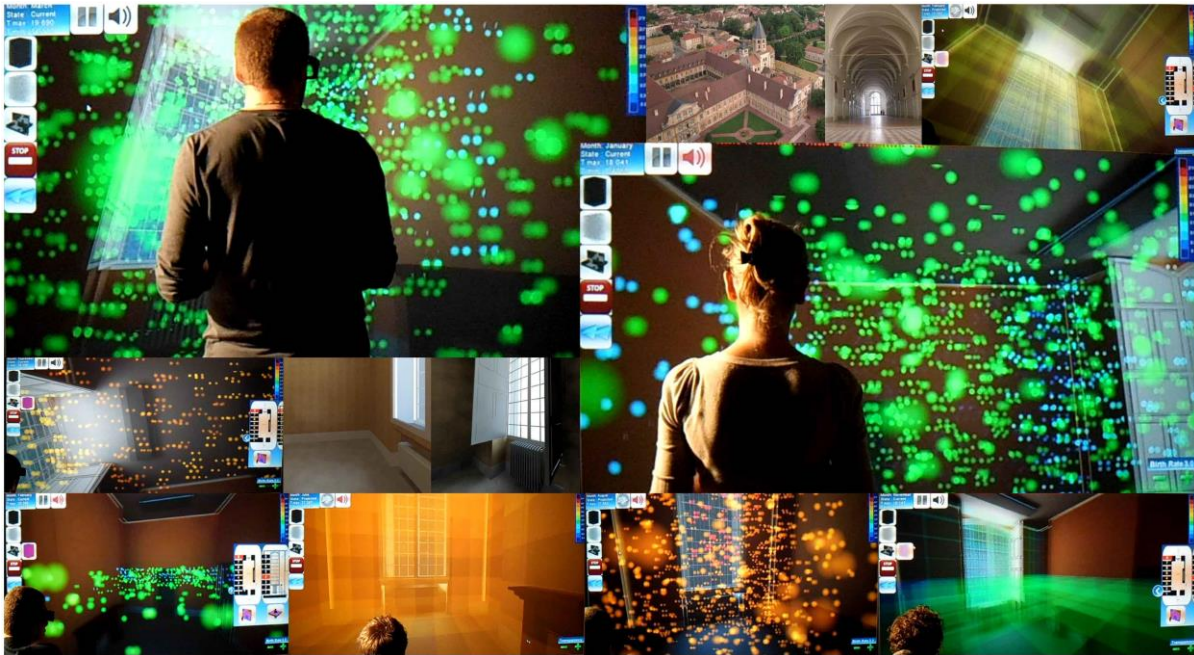

Figure 6.1. Images of TBS results of Gunzo room represented in VR. The application is intended to help building stakeholders to review their project design through thermal calculation results in order to obtain a sustainable building.

## 6.1 Development of the TBS Framework

Thermal building simulation is a powerful method for studying thermal performance of buildings and for evaluating architectural design. Complicated design problems can be investigated and their performance can be quantified and evaluated. It is also a useful tool for developing a better understanding of the building performance. In the earlier chapters we have begun this work by reviewing a number of methods and tools commonly used by building stakeholders to determine thermal calculation results in a project. We have discussed the analysis on thermal simulation tools and its interoperability. In particular on its correlation with IFC format as a BIM representation and its exchange format to thermal tool. It's focused in IFC file format because it could represent an object-oriented building description across all disciplines and life-cycle phases of a building. A closer integration of thermal performance simulation with the actual performance of buildings during design will not only improve output value of simulation tools, but will also enable a more efficient design of buildings.

Since suitable data exchange formats are available (e.g the IFC-format) transfer operation of such data can be delivered. This kind of format data allows transfer of object of structured building models from design tools (CAD) to thermal building simulation tools and to visualization tools. Automated transactions between the tools, however, require that the information data should be improved, not to be fragmented between architectural data and thermal engineering data to guaranteed that the tools workflow. This improvement must be evaluated throughout serial test of interoperability to ensure consistency between all participants in building thermal application, especially between design tool, thermal tool and VR tool.

Amongst the famous and the most applicable tools in thermal simulation some potential application has been selected to investigate in a shortlist. The review covers most of the tools widely known and used by the architectural community, building designer, environmental consultant and engineers. In the review we found that the BIM software especially with architecture oriented such as Autodesk Revit, Bentley Architecture, Graphisoft ArchiCAD, and Vectorworks Architect focused

primarily on modeling and refining building geometry. To analyze the thermal of a building, users relied on third-party software such as Green Building Studio, Ecotect, and EnergyPlus.

The next chapters are included theory and application of VR technology, and a review of related work of thermal visualization in VE. It followed by method of visualization and interaction using metaphor in VE. Also, development of the application to integrate TBS results in VE using specific workflow. This also accommodates the workflow context in BIM, as is often carried in the AEC community. The workflow performed the data transfer which was conducted in 3 steps; Planning/modeling, thermal calculation, and visualization in VR. This relies on the smooth exchange of data workflow between design tools, thermal calculation tools and VR tools.

The first step conducted on the object selection for experiments, field measurements, and modeling using design tool. In second step, 3D model from design tool (Revit) are transferred to thermal tool (Ecotect). There are some commonly used format for transferring data from Revit to Ecotect; GbXML, DXF and IFC/GbXML. Therefore, we choose IFC/GbXML as the most efficient and comprehensive format for the thermal calculations purposes in Ecotect. The selection of the format is to ensure the model weight, not corrupt and can be evaluated easily at the stage of calculations. There are some preparations to be done prior to thermal calculation in Ecotect. The main priority to handle are the environmental setting (verification of conditions) and the mode of calculation (technical method). The environmental settings for example: room limits, clean geometry, weather data, adjacency checking, internal load and schedules, and calculation mode. Calculation of MRT is conduct after all preparation sets which the calculation resulted in volumetric value of each part in grid space.

The last step of the workflow is visualization and interaction in VE. It develops some types of visualization metaphor to improve the ways in which thermal analysis data are presented to building stakeholders. It's conducted with a view to increasing the accuracy and efficiency of visualization interpretation. Visualization, the representation of data in visual form, then becomes the core of our focus to communicate TBS results. Without clear representation, data would remain in its raw form thus greatly hindering the communication process. This is especially the case when the data source is large, complex and subject to change. VR technology is suitable for information-intensive visualizations. This suitability is contrasted with that of computer automation for the physically that convert information directly from paper-based plans to actual work which will benefit the representation of TBS results. The approach taken throughout followed the pattern of research, development, demonstration and evaluation in immersion room.

As VR field is transitioning into work influenced by video games (Zyda, 2005) and since much of the research and development of design product being conducted in the games community parallels the VR community's efforts (Tideman et al., 2008), we take the advantage of this trend to our TBS. We used VR software as well as 3D game engines (3DVia Studio / Virtools) dedicated to integration and management of VR devices, particularly in tablet and CAVE. We also used an "all in one" 3D modeling solution software (3DsMax) to enrich the texture mapping. We found that the use of VR tools (3DVia Studio / Virtools and CAVE) provides such quality presentation of thermal performance in 3D simulation. Also for GUI and some results presented in text and figures or graphic.

Gunzo room 3D geometry has previously been prepared in CAD (Revit) and exported into 3DVia Studio / Virtools were transferred separately with thermal file calculated by Ecotect. However, the original file for Ecotect came from the same source of 3D geometry produced by Revit. 3DVia Studio / Virtools used only to provide visualization of TBS results and its interactive VE. However, data transfer from Ecotect to 3DVia Studio / Virtools cannot be directly delivered due to the data format. Therefore, we keep the scenario or the workflow methods to smooth data exchange. Data exchange from Ecotect to 3DViaStudio / Virtools can be conduct with exporting format Txt. The Txt data from Ecotect is a set of data tables of temperature value of Gunzo room in a 3D position or XYZ axis to be collaborated with Gunzo model in 3DVia Studio / Virtools. These data collected one by one according to time simulation (hour, day and month) but this input can be detailed more precisely depends on the needs of the

experiment. Then, the data tables of temperature value from Ecotect should be treated so that can be transfer directly to 3DVia Studio / Virtools. This process must pass through a program called Perl Routine that allows syntax preformat of Txt automatically.

The composition of thermal visualization in 3D space using 3DVia Studio / Virtools sets on XYZ axis. In the experiment, we divided the Gunzo room interior space into  $8 \times 8 \times 8 = 512$  parts which is each parts contains the temperature values embodied in form of cube. The cubes textured in transparent or in particle 3D and colored according to temperature value it's adopt.

Transferring data to 3DVia Studio / Virtools is the final step in this simulation. At the end of this step, the framework was developed in the VR system (CAVE-like/immersion room). Scenarios regarding visualization and interaction elaborated and tested in experiments. Objective of this experiment is to present the TBS results to building stakeholders whom have various backgrounds with an intuitive and interactive way. Number of tasks was designed to test the effectiveness of the application, particularly in terms of visualization and interaction. In the experiment, the user has the ability to interact with the virtual world, change its characteristics and perceive the impact of their actions. They also has the possibility to compare temperatures corresponding to different settings of the VE. The system enables the user to interact with the VE intuitively while assessing the results of the thermal settings of the room. The system give thermal sensations by its 3D volumetric visualization in some metaphors. Some visualization metaphors developed were intended as an alternative representation to facilitate imagination and perception of the simulation results of thermal calculations. This is reflected in the findings. Data interpretation and the techniques demonstrated were understood and generally preferred by the users. However, even the valuation of the prototype showed high levels on user satisfaction in the accuracy and efficiency, there is a workflow behind the scene that is not easy to simplify.

## 6.2 Visualization and Interaction of TBS in VE

Making visual data analysis effective to building stakeholder imposes constraints on both the underlying display hardware and software. This includes scenario to deliver intuitive interaction in simulation. The scenario relies on non-specialist users being able to explore complex data and quickly find those visualization elements. Once the simulation space identified, users must be able to examine them easily, and measure them accurately. User interfaces should be transparent, i.e., users should be able to completely focus on their data. Therefore an immersive environment is designed to maximize the user perception in the tasks. In this context, "immersive" means that users can see, and interact with, virtual 3-D objects as if they were real. A virtual building looks like a real building, including the user's ability to walk around. It allows users to get closer looks, to select and to move around using controller. The crucial point is that users can interact with virtual objects using real-world actions. This action enables user interfaces for visualization, which are considerably more efficient and intuitive than those typically used in non-immersive environments (i.e. desktop computers).

In other words, immersive visualization does not mean that users are surrounded by imagery on all sides, it means that users perceive virtual space as real. Therefore, technically, in our system this immersion fulfilled with stereoscopic display and sound system as complement.

In the method of scientific visualization, technical computing and an exploiting behavioral interface were conducted to simulate virtual world behavior of thermal 3D entities. The simulation is performed on the graphics processing unit (GPU) to enable real-time simulation and visualization. In the experiment, we analyzed how users are able to interpret what they see by simulating the thermal data in the environment just as they would in a real world environment. We hypothesize that clear interpretation of thermal data in VEs is related to a high sense of visualization.



Based on analysis of existing visualization interaction techniques for object simulation and exploration, and for navigation in the VE, we presented interaction techniques suitable for the immersion room. It is a modified approach of interactive TBS results visualize in VE. It is also a new data workflow approach to handling 3D object and thermal entity. In the existing method, selection and exploration of objects, and navigation in VEs are fair satisfactory. We have made improvements in 3D modeling, data transfer, and the selection of the VR system. Possible improvements include graphic user interface enrichment of interaction and more conscious utilization of real-world metaphors. The visualization environment should thus encourage intuitive exploration of the VE, containing visual representations of the data, and support quick interpretations on the data. We have experience that the usage of good metaphors for the visualizations and for the tasks can help users to explore the data. Two visualization metaphors for data exploration with the transparent cube and the particles have proven to be an effective approach. Figure 6.2 shows visualization metaphors with Gunzo room captured during the integration process of their TBS results in VE. These visualization metaphors became the basis for an interpretation of TBS data before and after renovation.

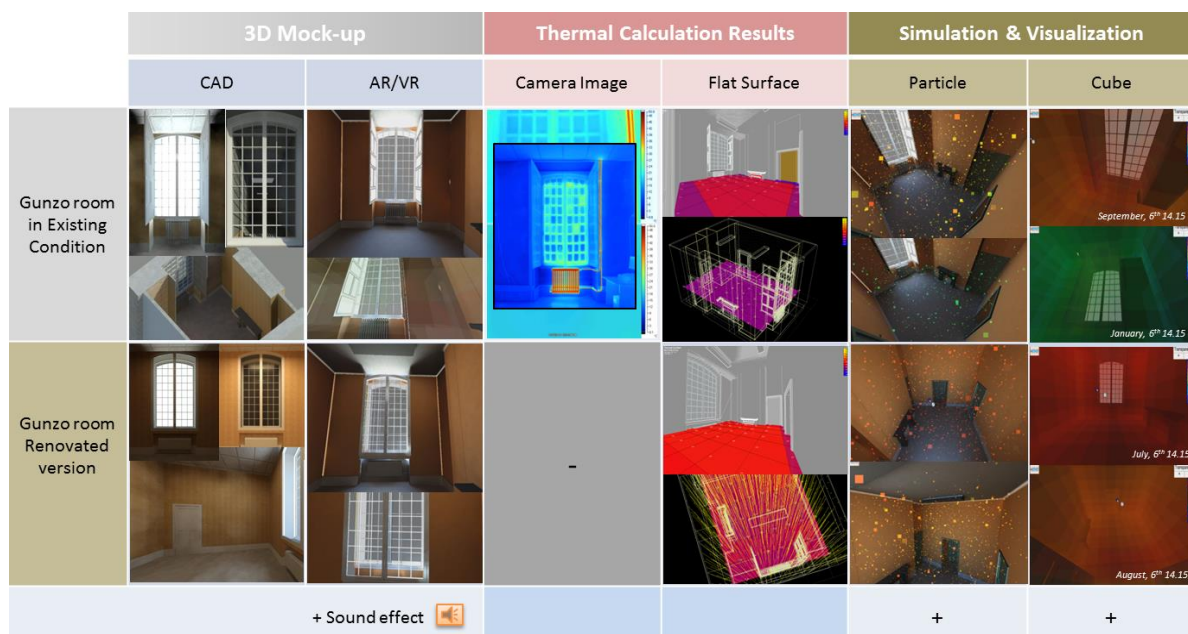

Figure 6.2. Visualization of the two version of Gunzo room captured during the integration process of their TBS results in VE.

Applying the concept of data workflows for representation of TBS which consists of three different steps presents a challenge regarding interoperability. It's particularly more complicated toward visualization and interaction in VE. A 3D mock-up modeled from design tools, should be deliver properly to thermal calculation tools before integrating to VR system. Differences in visualization results (image) will appear at each phases. This might be doubt for validation, moreover if at the final presentation in VE this image quality decreases, even though it is actually not the case. This is simply due to differences in the format and interface of each program used. In principle, during the process of the data exchange it must maintain the continuity of the 3D geometry as well as thermal results in an appropriate standard procedure, so the file is not damaged or corrupt.

From our research it became obvious that volumetric data, possibly containing complex 3D structures, can be visualized and explored in a natural way in VEs. This experience has been obtained during working on the case studies and co-operating with the engineers and students in our research group. This is including some test subject, whose enrich the model we were modeling and simulating the data on the PC, tablet, and Immersion room. The test subjects were rather enthusiastic about our

techniques for interactive visualization of TBS on the Immersion room and tablet. Also, about new possibilities that VR offers relating to the simulation.

Visualization in VR can give relatively quick answer regarding TBS results but we need to know the system we use and what to look for. We have learned that the TBS in VEs is strongly dependent on the visualization and interaction techniques. Visualization of data in VR is more exploratory in nature than on desktop systems. In addition, each VR system has its own specifics, determining possible styles of visualization and interaction. We found that TBS application developed from the ground up to focus on the strengths of VR, i.e., 3-D perception and intuitive interaction, can also work well in various devices including desktop and tablet. However, for technical and conceptual reasons, the techniques that work well in Immersion room do not always work properly (or do not make any sense) on tablet, and vice versa. For example, on the tablet user does not need to fly through a virtual world as in Immersion room. Data in Immersion room results in different requirements to interaction techniques. A modified categorization of the interaction styles and techniques for different VR systems is therefore needed.

### 6.3 Critical Evaluation of the Research

The evaluation of the method has demonstrated that it is possible to improve the interpretation of building performance data using visualization techniques through a specific data workflow and specific display. Whilst a number of techniques exist their implementation alone is less satisfactory. The user require representation of TBS results in VE which are intuitive and easy to interpret. Key to the successful selection of visualization techniques in VE is a rigorous analysis of user requirements. It also includes an understanding of the TBS domain, and an in-depth knowledge of the techniques themselves. By combining theoretical research and practical investigation we been possible to identify and evaluate suitable techniques.

By exploring the use of new technology early in the research programme it was possible to eliminate unnecessary or unsuitable techniques which may have otherwise distracted from the main purpose of the research. The final output, a working prototype and its evaluation, shows that it is possible to meet a number of diverse user requirements with a simple well designed application. With respect to representation of TBS this can be achieved with four different views of the method; tool management, data workflow, result analysis, and 3D presentation in VE.

There is a lot of step has been carried in order to bring TBS results in VE. Each step is a unique work that involves distinct area of expertise. This is representing the member of building stakeholder. The difference in area of expertise is a challenge because we have to accommodate all the needs and preferences. Although there was some critics, we can ensure that the results of this work have been met some objectives. In conclusion, the main contribution of the work are: The clear evaluation of building requirements, the practical investigation of tools integration (workflow), and the three-dimensional techniques for the display of the TBS results in VE. It presents a fresh look at the method required to representing TBS results from a geometrical model and realizes it in VE through immersive visualization and intuitive interaction. The work also demonstrated a creation of friendly interface which through careful design, facilitates the structured analysis of multiple datasets. The development of some visualization types of thermal metaphors which quickly confirms the user understanding of the thermal results is reliable for design review analyzed on a given project.

In this research, as not many changes occurred to the subject matter, the improved method allowing the result to become clearly defined. However, some of the initial effort also had less impact on the final output than expected.

Some critical evaluations of the research are:

**Workflow integration** – Data is generally only exported after the model fixed. Exported data can become ‘out-of-synch’ from the native files, leading to potential errors. Therefore, this method requires that the 3D geometry should be produced properly, starting from the two initial stages (modeling and thermal calculation). It is very helpful to reduce unuseful data, especially if the model used is more complex. This will be difficult if the error occurs in the two of earlier stages. Therefore, we simplify the object to smooth next processes. The data format was not the problem at this stage since the management tools and formats through BIM provided an appropriate solutions to data transfer. At the next stage of data transfer to the VR software, there is an additional process of pre-formatted data that must be done due to the difference format of the two software (Ecotect as thermal calculation tool and 3DviaStudio/Virttools as VR software / 3D game engine). Difficulties occur in the composition of thermal entity placement in 3D space. It takes time to decide which idea to create thermal emitters, an entity in the form of data matrix or grid. In addition, we also still need a texture mapping from 3DsMax as an option to enhance the quality of the images in VR.

**Questionnaires and tests** – The evaluation techniques can be developed with multiple scenarios and more user tasks. So far, there are only nine tasks that represent the basic tasks commonly performed by building stakeholder when evaluating TBS results. The addition scenario or more complex tasks will refine the effectiveness value of the user. The participants conduct in the experiment also ideally within more number of subjects. It's particularly to strengthen the results that are statistically representative of the sampled population.

**3D model** – The research has been limited the object which has a simple zone. The work presented did not include an evaluation of the techniques required to represent a complicated-zone models, however the ideas presented here are believed to be applicable. The reason not to extend this work to large-zone models is related to the focuses of the study on the representation of TBS rather than the geometry.

## 6.4 Future Work

VR needs to get closer to the building stakeholders and needs to find more production-stage applications. Although a number of experimental VR toolkits exist, it is still difficult to implement a TBS application for a given VR system. Therefore two things are desirable: better hardware and software, and their interoperability toward VR must become reliable. The representation of TBS in VE using immersion room is a unique research that has very few examples of work. It is intended to facilitate building stakeholders to assess their design decisions. It is very effective in the immersive room as it can deliver the real atmosphere of a room including its thermal results. However, as the application should be flexible in various thermal building simulation tasks, it still has lots of work to be done in terms of immersiveness and interactiveness. Although comments from the participants about the application were quite positive, the intuitive data visualization and representation in VE should be more related to real interaction paradigms, which are used in the real world when users make their observations.

Obviously, in order to improve the overall availability, optimization of thermal simulation techniques with the metaphor, the interoperability between software, and the quality of the user interaction with the virtual prototype are crucially important. Future research is needed to set the thermal simulation result delivery in VE more integrated to the user. A method may better to apply for the integration is to engage the users at the earlier stage of the workflow, more involve into the

preliminary design before the TBS results presented in VE. The application also needs to be added with some sensor devices to present the impact of thermal changes made directly by the user on the visualization system.

As VR technologies continue to advance, the use of VR within the TBS will evolve. Nevertheless, regardless of how VR technology evolves, there are few immediate applications for VR within the TBS. Most of the current technologies are being focused on human somatic senses through touch, pressure and vibration receptors. More delicate human senses, such as surface textures and thermal are not exploited yet by VR systems. Real simulation of these tactile sensations is very difficult because it requires a complete understanding of our skin and deep muscle tissue. However, some work related to thermal sensation by touch may consider as the complement to the TBS representation in VE.

There is an increasing use of thermoelectric technology for example from picnic boxes to water coolers, food service equipment, etc., which can be used for optimizing the sensation of TBS results in VE. The basic concept behind thermoelectric technology is the Peltier effect. It obvious an interesting idea to apply this device for representation of TBS in VE. There are now Peltier effect coats or jacket to warm or to cool the body that capable of adjusting to extreme temperatures.

It is interesting to have both heating and cooling in the skin of a changing operating environment. Particularly if we can feel the effects of the temperature simulated for future room or building directly into the body. How fast can the skin cool or heat with thermoelectric system with respect to the real timing maybe is another thing. Cooling and heating are not an instantaneous process and the system will depend on some factors to pump and redistribute heat over time. These factors including number of Peltiers employed, the nature of the heat sinks and fans which are used, the quality of the thermal interfaces, etc. The device can help to fully replicate touch by supplying the temperature of the virtual object to a person's skin. The main purpose is to have another thermal feedback with a reliable tool that integrates temperature as part of vision and audio feedback in VE.

Furthermore, as the advance technique in gesture systems, the application requires novel interaction methods for the future work. Another point that can be be advanced is the navigation or observation in the VE. For the moment, the navigation mode to move in the immersion room is using a controller or joystick. We have not tried to apply a motion sensor or a tracking system (e.g kinect camera) as a new controller-free gaming device. To navigate through human interaction by using gestures and movements is fascinating. Even the use of this device has some issues, such as real timing, integration, and adaptation for new users (Hernoux, 2011), this tool can also provide benefits such as freedom of movement and fun impression. A great deal of exploration and study still needs to be done to make the results extremely efficient.

-----

---

# Bibliography

- Aguerreche, L., Duval, T., Arnaldi B., 2009, Analyse de techniques de coopération en environnements virtuels 3D, RSTI - TSI. Réalités virtuelle et augmentée 28, pp. 763-793.
- Aksamija, A., 2010, Analysis and Computation: Sustainable Design in Practice. Design Principles and Practices: An International Journal 4 (4): 291-314.
- Architecture 2030, Problem: The Building Sector, 2011. Available on <http://www.architecture2030.org/> (Accessed on 13 May 2013).
- ASHRAE (American Society of Heating, Refrigerating and Air-Conditioning Engineers) Handbook—Fundamentals, Physiological principles and thermal comfort, Atlanta, 1993, Georgia.(Chapter 8).Atmaca, I., Kaynakli, O., Yigit, A., 2006, Effects of radiant temperature on thermal comfort, Journal Building and Environment, Elsevier 42, pp. 3210–3220.
- Attia, S., 2010, Building performance simulation tools: Selection criteria and user survey. Research Based Report. Architecture et climat, Université catholique de Louvain, Louvain La Neuve, Belgium, pp. 14-27.
- Attia, S., Hensen,J.L.M., Beltrán, L., De Herde, A., 2012, Selection criteria for building performance simulation tools: contrasting architects' and engineers' needs, Journal of Building Performance Simulation, 5:3,155-169.
- Augenbroe, G., Hensen, J., 2004, Simulation for better building design, Editorial Building and Environment 39, 875 – 877.
- Augenbroe, P., de Wilde, H., Moon, J., Malkawi. 2004, An Interoperability Workbench for Design Analysis Integration. Energy and Buildings, 36 (8): 737-48.
- Autodesk Inc. Autodesk – Autodesk Green Building Studio.<http://usa.autodesk.com/green-building-studio/> (accessed on 12 January 2013).
- Autodesk 2013, BIM Curriculum, available online: <http://bimcurriculum.autodesk.com/lesson/lesson-1-user-interface> (accessed on 15 April 2013).
- Azhar S., Carlton, W.A., Olsen, D., Ahmad, I., 2011, Building information modeling for sustainable design and LEED® rating analysis, Journal Automation in Construction - Elsevier, 20, 217–224.
- Bagnall, A., 2009, MP218-1 Advanced Building Analysis Using Autodesk® Revit® MEP, Ecotect® and IES Virtual Environment®– Australia.Autodesk University.

- Bahar, Y.N., Pere, C., Landrieu, J., Nicolle, C., 2013, A Thermal Simulation Tool for Building and Its Interoperability through the Building Information Modeling (BIM) Platform, *Journal Buildings*, MDPI, Vol. 3, 380-398.
- Banos, R. M., Botella, C., Alcaniz, M., Liano, V., Guerrero, B., & Rey, B., 2004, Immersion and emotion: their impact on the sense of presence. *Cyberpsychology & Behavior*, 7(6), 734–741.
- Bean, R., Mean Radiant Temperature (MRT), 2010, available online: [http://www.healthyheating.com/Definitions/Mean Radiant.htm#.UTB1sFcySpA](http://www.healthyheating.com/Definitions/Mean_Radiant.htm#.UTB1sFcySpA) (accessed on 16 January 2013).
- Bourdot, P., Convard, T., Picon, F., Ammi, M., Touraine, D., Vézien, J.M, 2010, VR-CAD integration: Multimodal immersive interaction and advanced haptic paradigms for implicit edition of CAD models, *CAD Computer Aided Design Volume 42*, Issue 5, pp. 445-461.
- Bouvier, P., 2009, *La Présence en Réalité Virtuelle: Une Approche Centrée Utilisateur*, PhD Thesis, Université Paris-Est.
- Bowman, D. A., 1999, *Interaction techniques for common tasks in immersive virtual environments: design, evaluation, and application*, PhD thesis, Georgia Institute of Technology.
- Bryson, S., 1996, Virtual Reality in Scientific Visualization, Vol. 39, No. 5 *Communications of the ACM*, pp. 62-71.
- BuildingSMART, (2013). Available on <http://www.buildingsmart-tech.org>, (Accessed on June 22, 2012).
- Burdea, G.C., & Coiffet, P. 1994. *Virtual Reality Technology*. John Wiley.
- Burrough, P. A., 1998, Dynamic modeling and geocomputation. In P. Longley, S. Brooks, R. McDonnell, and B. MacMillan (Eds.), *Geocomputation: a Primer*, John Wiley and Sons, pp. 165-191.
- CAD-magazine and [btpinformatique.fr](http://www.btpinformatique.fr), De la conception numérique au PLM, *Architecture: Les Défis des Nouvelles Réglementations Environnementales*, Numéro spécial *Batimat*, Novembre 2011.[in French]. <http://www.btpinformatique.fr/architecture> (accessed on 18 May 2013).
- Caldas, C., Soibelman, L., 2003, "Integration of Construction Documents in IFC Project Models" *Winds of Change: Integration and Innovation in Construction*, Proceedings of the Construction Research Congress, American Society of Civil Engineers, Honolulu, HI, pp. 1-8.
- Card, S., Mackinlay, J., Schneiderman, B. [eds], *Readings in Information Visualization: Using Vision to Think*, Morgan Kaufmann Publishers, San Francisco, CA, 1999.
- Chappells, H., Shove, E., 2005. Debating the future of comfort: environmental sustainability, energy consumption and the indoor environment, *Building Research & Information*, Routledge. 33:1, 32-40
- Christensen, J. E., 2009, Simulation of thermal indoor climate in buildings by using human Projected Area Factors, 4th International Building Physics Conference – IBPC, Istanbul, Turkey.
- Chwieduk, D., 2003, Towards sustainable-energy buildings. *Applied Energy*, Elsevier 76.211–217.

- Citerin Johann, Pocheville, A., Kheddar, A., 2006, A Touch Rendering Device in A Virtual Environment with Kinesthetic and Thermal Feedback, Proceeding of the IEEE International Conference on Robotics and Automation, pp. 3923-3928.
- Clifton, M., Pang, A., 1997, Cutting planes and beyond. *Journal Computer & Graphics – Elsevier* 21(5), pp. 563-575.
- Cormier, A., Robert, S., Roger, P., Stephan, L., Wurtz, E., 2011, Towards a BIM-based service oriented platform: application to building energy performance simulation. 12th Conference of International Building Performance Simulation Association, Sydney, pp. 2309-2316.
- Crawley, D.B., Hand, J.W., Kummert, M., Griffith, B.T., 2008, Contrasting the capabilities of building energy performance simulation programs. *Journal Building and Environment- Elsevier* 43, pp. 661–673.
- Crouse, B., Krafczyk, M., Kühner, S., Rank, E., van Treeck, C., 2002, Indoor air flow analysis based on lattice Boltzmann methods. *Journal Energy and Buildings-Elsevier* 34 (9): 941-949.
- Cruz-Neira, C., Sandin, D.J., DeFanti, T.A., 1993, Surround screen projection-based virtual reality: The design and implementation of the CAVE. In *Computer Graphics, the Proceedings of SIGGRAPH*, Las Vegas.
- DesignBuilder. DesignBuilder Software Homepage, <http://www.designbuilder.co.uk>, <http://www.designbuilderusa.com/> (accessed on January 10, 2013).
- Design Performance, [http://www.designperformance.net/?page\\_id=55](http://www.designperformance.net/?page_id=55) (accessed on January 10, 2013).
- Dubois, M.C., Horvat, M., 2010, State-of-the-art of digital tools used by Architects for solar design. IEA SHC Task 41 - Solar Energy and Architecture, Subtask B - Methods and Tools for Solar Design, pp.22-115.
- Dong, B., Lam, K.P., Huang, Y.C., Dobbs, G.M., 2007, A comparative study of the IFC and gbXML informational infrastructures for data exchange in computational design support environments. *Proceedings: Building Simulation*, pp. 1530-1537.
- Donn M., Selkowitz S., Bordass, B., 2012. The building performance sketch, *Building Research & Information*, 40,2, 186-208.
- Ecotect Analysis, Sustainable Building Design Software, <http://usa.autodesk.com/ecotect-analysis/> (accessed on January 10, 2013).
- Ecotect Community Wiki, Thermal: Analysis Methods, [http://wiki.naturalfrequency.com/wiki/Thermal\\_Analysis\\_Methods](http://wiki.naturalfrequency.com/wiki/Thermal_Analysis_Methods) (accessed on January 10, 2013).
- EERE (Energy Efficiency and Renewable Energy), US Department of Energy. [http://apps1.eere.energy.gov/buildings/energyplus/weatherdata\\_about.cfm?](http://apps1.eere.energy.gov/buildings/energyplus/weatherdata_about.cfm?) (Accessed: 10 December 2012).
- EnergyPlus. EnergyPlus Energy Simulation Software. <http://www.eere.energy.gov/buildings/energyplus/> (accessed on January 12, 2013).
- eQUEST. eQUEST. <http://www.doe2.com/eQuest/> (accessed on January 12, 2013).



- Fanger, P.O., Thermal Comfort, Analysis and Applications in Environmental Engineering, Mc.Graw-Hill Book Company, New York, 1970.
- Fisch, A., Mavroidis, C., Melli-Huber, J., Bar-Cohen, Y., 2003, Chapter 4: Haptic Devices for Virtual Reality, Telepresence, and Human-Assistive Robotics. In: Biologically - Inspired Intelligent Robots. SPIE Press.
- FLIR (2013), Thermal Cameras for Building diagnostics. Available on: <http://www.flir.com/cs/emea/en/view/?id=41612> (Accessed, 15 Mei 2013).
- Fricoteaux, L., 2010, Conception d'un environnement virtuel informé: Application à la restitution de calculs scientifiques, Rapport d'activités Stage TN10/ST02, l'Université de Technologie de Compiègne, France.
- Froese, T., 2003, Future Directions For IFC-Based Interoperability, Journal ITcon Vol. 8, 231-246.
- gbXML, Open Green Building XML. Available online: <http://www.gbxml.org> (accessed on 16 January 2013).
- Ghaffarian H. A., Dahlan, N.D., Berardi, U., GhaffarianHoseini, A., Makaremi, N., GhaffarianHoseini, M., 2013. Sustainable energy performances of green buildings: A review of current theories, implementations and challenges. Sustainable Energy Reviews, Elsevier. 25. 1–17.
- Granlund, Riuska, Energy Simulation Tool for the entire Building Life Cycle, <http://www2.granlund.fi/en/services/granlund-software-applications/riuska/> (accessed: January 13 2013)
- Gratia, E., de A. Herde. 2002, A Simple Design Tool for the Thermal Study of an Office Building. Energy and Buildings, 34.279-289.
- Gutierrez, M., Vexo, F., Thalmann, D., 2008, Stepping into virtual reality. Springer, London.
- Guttentag D.A., 2010, Virtual reality: Applications and implications for tourism, Journal Tourism Management, pp.637-651. [www.elsevier.com/locate/tourman](http://www.elsevier.com/locate/tourman).
- Ham, Y., Golparvar-Fard, M., 2013, EPAR: Energy Performance Augmented Reality models for identification of building energy performance deviations between actual measurements and simulation results, Energy and Buildings-Elsevier 63, 15–28.
- Hanam, B., 2010, Development of an Open Source Hourly Building Energy Modeling Software Tool, Thesis Master of Applied Science in Civil Engineering, University of Waterloo, Ontario, Canada. pp. 9-55
- Haymaker, J., Welle, B., 2007, An Integrated Conceptual Design Process for Energy, Thermal Comfort, and Daylighting, CIFE Precourt Proposal. Stanford University, 2007. pp.2-11.
- Hecht, D., Reiner, M., Halevy, G., 2006, Multimodal Virtual environments: Response Times, Attention, and Presence, Presence, vol. 15, n° 5, p. 515-523.
- Heilig, M.L., 1992., El Cine del Futuro: The Cinema of the Future. Presence, Vol. 1, No. 3, pp. 279-294.
- Hensen, J.L.M., Lamberts, R., Negrao, C.O.R., 2002. Building performance simulation at the start of the 3rd millennium. Editorial Building and Environment - Elsevier 37. 765–767.

- Hernoux, F., 2011, Conception et évaluation d'un système transparent de capture de mouvements des mains pour l'interaction 3D temps réel en environnements virtuels. Thesis l'École Nationale Supérieure d'Arts et Métiers, Spécialité Informatique – Traitement du signal.
- Hoang, R.V., Sgambati, M.R., Brown, T.J., Coming, D.S., Harris, J.F., 2010. VFire: Immersive Wildfire Simulation and Visualization. *Computers & Graphics - Elsevier*. 34. 655–664.
- Holmes M. J., Jacob N.H., 2007, Climate change, thermal comfort and energy: Meeting the design challenges of the 21st century, *Energy and Buildings* 39 (2007) pp. 802–814.
- Hong, T., Chou, S.K., Bong, T.Y., 2000, Building simulation: an overview of developments and information sources, *Building and Environment* 35, pp. 347-361.
- Humphreys, M.A., Nicol, J.F., 1998. Understanding the adaptive approach to thermal comfort. *ASHRAE Transactions*, 104 (1), pp. 991–1004.
- IDA ICE. IDA Indoor Climate and Energy, [www.equa.se](http://www.equa.se) (accessed on January 13, 2013).
- IES VE. IES - Sustainable 3D Building Design, Architecture Software - Integrated Environmental Solutions. <http://www.iesve.com/> (accessed on January 13, 2013).
- IEA (International Energy Agency), World energy outlook, Paris, 2009. Available on: <http://www.iea.org/stats/> (Accessed on 12 April 2013).
- International WBCSD (World Business Council for Sustainable Development), 2009, Energy efficiency in buildings: Transforming the market. World Business Council for Sustainable Development, available online: [www.wbcsd.org/](http://www.wbcsd.org/) (accessed on 10 February 2013).
- Ingrassia, T., Cappello, F., 2009, VirDe: a new Virtual Reality Design Approach, *International Journal on Interactive Design and Manufacturing* (3), Springer-Verlag, 1, pp 1–11
- John, N.W., Leng, J., 2001, Scientific Applications of Visualization, Virtual Reality and High Performance Visualization Computers, Briefing paper, UKHEC – UK High Performance Computing, Manchester Research Centre for Computational Science, pp. 1-9.
- Jones, L. A., Berris, M., 2003, Material Discrimination and Thermal Perception. Proceedings of the 11th Symposium on Haptic Interfaces for Virtual Environment and Teleoperator Systems (HAPTICS'03), IEEE Computer Society (45) pp. 602-616.
- Juarez, A., Schonenberg, B., Bartneck, C., 2010, Implementing a Low-Cost CAVE System Using the CryEngine2. *Entertainment Computing*, 1(3-4), 157-164.
- Jubertie, S., 2007, Modèles et outils pour le déploiement d'applications de Réalité Virtuelle sur des architectures distribuées hétérogènes, Thèse de Doctorat d'Université, Université d'Orléans.
- Judkoff, R., 2008, Increasing Building Energy Efficiency Through Advances in Materials, Use & Efficiency Buildings, *MRS Bulletin* April 2008 33 :pp 449-454, Cambridge University Press 2011.
- Kellogg, L.H., Bawden, G.W., Bernardin, T., Billen, M., Cowgill, E., Hamann, B., Jadamec, M., Kreylos, O., Staadt, O., Sumner, D., 2008, Interactive Visualization to Advance Earthquake Simulation, *Pure and Applied Geophysics*. BirkhauserVerlag, 165, 621–633.

- Khoudja M. B., Hafez M., 2004, VITAL: a new low-cost Vibro-TActiLe display system, Proc. of the IEEE International Conference on Robotics & Automation, New Orleans, USA, pp. 721-726.
- Khoudja M. B., Hafez M., Alexandre, J., Kheddar, A., 2003, Thermal feedback interface requirements for virtual reality. International Symposium on Micromechatronics and Human Science, IEEE Conference, Nagoya Japan, October 19-22, pp. 153-158.
- Kjeldskov, J., 2001, Combining interaction techniques and display types for virtual reality. In Proceedings of OzCHI, pp. 77-83.
- Knight, D., Roth, S., Rosen, S.L., 2010, Using BIM in HVAC design. ASHRAE Journal June 2010, vol. 52, 6, pp 24-32.
- Kokogiannakis, G., 2008, Support for the Integration of Simulation in the European Energy Performance of Buildings Directive, A Phd thesis, Energy Systems Research Unit, Department of Mechanical Engineering, University of Strathclyde.
- Korhonen, M., Laine, T., 2008, Energy Analysis Software Evaluation BIM Interface and Interoperability, Software Evaluation, Granlund. pp.10-11.
- Koutek, M., 2003, Scientific Visualization in Virtual Reality: Interaction Techniques and Application Development., PhD Thesis, Faculty of Information Technology and Systems (ITS), Delft University of Technology.
- Ku, K., Mahabaleswarkar, P.S., 2011, Building Interactive Modeling for Construction Education In Virtual Worlds, Journal of Information Technology in Construction, Vol.16 - www.itcon.org, pp.189-208.
- Kumar, S., Interoperability between Building Information Models (BIM) and Energy Analysis Programs, Thesis of Master of Building Science, Faculty Of The School Of Architecture University Of Southern California, 2008
- Laine, T., Hänninen, R., Karola, A., 2007, Benefits of BIM In The Thermal Performance Management, Proceedings of Building Simulation Conference, pp.1455-1461.
- Landrieu, J., Nugraha, B.Y., Père, C., Merienne, F., Nicolle, C., 2012, Pertinence D'une Representation 3d D'un Projet De Renovation De Batiment En Realite Augmentee Mobile, Proceeding CONFERE ENSAM-CESI, Venice 2012, Venice, Italy.
- Landrieu, J., 2013, Apports des réalités virtuelles et augmentées dans la planification et la suivi in situ de travaux de rénovation, Doctoral Thesis, Ecole doctoral Sciences des Métiers de l'ingénieur, Arts et Métiers ParisTech, France.
- Lang, U., Wossner, U., 2004, Virtual and Augmented Reality Developments for Engineering Applications, European Congress on Computational Methods in Applied Sciences and Engineering. pp. 1-12.
- Lombard, L.P., Ortiz, J., Pout C., 2008. A review on buildings energy consumption information, Energy and Buildings 40. 394–398
- Lu, S.C.Y., Shpitalni, M., Gadh, R., 1999, Virtual and Augmented Reality Technologies for Product Realization. Keynote paper. Annals of the CIRP Vol. 48/2. pp.471-495.

- Mahdiah, A., Sharareh, M., 2012. Influence the Development of IT on Architecture Design. *European Journal of Scientific Research*, Vol. 95 (3).pp.408-414.
- Maile, T., Bazjanac, V., Fischer, M., 2012, A method to compare simulated and measured data to assess building energy performance, *Journal Building and Environment - Elsevier* 56, 241-251.
- Maile, T., Fischer, M., Bazjanac, V., 2007, Building Energy Performance Simulation Tools - a Life-Cycle and Interoperable Perspective, Center for Integrated Facility Engineering, CIFE Working Paper #WP107, Stanford University, , pp. 3-40.
- Malkawi, A.M., Srinivasan, R., 2005, A new paradigm for Human-Building Interaction: the use of CFD and Augmented Reality, *Automation in Construction - Elsevier*, 14(1), pp. 71-84.
- Mazuryk, T., Gervautz, M., 1996, Virtual Reality History, Applications, Technology and Future, TR-186-2-96-06. Institute of Computer Graphics Vienna University of Technology, Austria. Available online: <http://www.cg.tuwien.ac.at/research/publications/1996/mazuryk-1996-VRH/#Information> (Accessed, 5 June 2013).
- McCormick, B., DeFanti, T.A., Brown, M.D., 1987, Eds. Visualization in scientific computing. *Comput. Graphics* 21, 6.
- Mérienne, F., Mestre, D.R., 2012, Navigation Dans Les Grands Environnements Virtuels, Presentation for Conference IC3D, Châlons-en-Champagne, France.
- Miles, H.C., Pop, S.R., Simon.Watt, S.J., Lawrence, P.G., John, N.W., 2012. A review of virtual environments for training ball sports. *Journal Computers & Graphics-Elsevier* 36: 714–726.
- Milgram, P., Kishino, F., 1994, A Taxonomy Of Mixed Reality Visual Displays, *IEICE Transactions on Information Systems*, Vol E77-D, No.12
- Missaoui, R., Mourtada, A., 2010, Instruments and Financial Mechanisms of Energy Efficiency Measures In Building Sector, World Energy Council-ADEME Case study on Energy Efficiency Measures and Policies.
- Monteiro, H.M., Santiago, R.P., Soares, M., Cosme, V., Malard, M.L., 2008, The implications of Virtual Reality project practices: ergonomic aspects of Interactive Virtual Immersive Environments, 14<sup>th</sup> Convencion Cientifica de Ingenieria y Arquitectura (CCIA), Cuba. pp. 1-4
- Moon. H.J., Choi, M.S., Kim, S.K., Ryu, S.H., 2011, Case Studies for the Evaluation of Interoperability Between A BIM Based Architectural Model and Building Performance Analysis Programs, *Proceedings of Building Simulation, 12th Conference of International Building Performance Simulation Association*, Sydney. 1521-1526.
- Nahon, D., 2009, Building Immersive Virtuality (iV) applications : Why & How ? The Dassault Systeme Developer Conference (DEVCON). Felizy, France.
- Narowski, P., Stasiński, J., Wereszczyński, P., 2011, Modeling of conduction transfer functions for typical thermal bridges identified in BIM data. *Proceeding of the 12th Conference of International Building Performance Simulation Association*, Sydney, pp.1320-1327.
- Norman, D., 1990, *The Design of Everyday Things*. Doubleday, New York.

- Ohno, N., Kageyama, A., 2007, Introduction to Virtual Reality Visualization by the CAVE system. Advanced Methods for Space Simulations. TERRAPUB, Tokyo. 167–207.
- Parameshwarana, R., Kalaiselvamb, S., Harikrishnanb, S., Elayaperumala, A., 2012. Sustainable thermal energy storage technologies for buildings: A review. Renewable and Sustainable Energy Reviews, Elsevier. 16. 2394– 2433.
- Pilgrim, M.J., 2003, The Application of Visualization Techniques to the Process of Building Performance Analysis, A Dissertation Thesis of Engineering Doctorate (EngD) of Loughborough University.
- Punjabi, S., Miranda, V., 2005, Development of an Integrated Building Design Information Interface, In Proceedings of IBPSA '05 Buildings Simulation Conference, Montreal, 969-976.
- Quenard, D., 2011, Vers des territoires à énergies positives : se loger, se déplacer..., CSTB, Conference on energy, Arts et MetiersParisTech Cluny, France.
- Reffat, M.R., Khaeruzzaman, Y., El-Sebakhy, E.,Raharja, I,P., 2008, Augmentation of Real-time 3D Virtual Environments for Architectural Design at the Conceptual Stage. ITcon Vol.13, pp.553-563.
- Sacks, R., Koskela, L., Dave, B.A., Owen, R., 2010, Interaction of Lean and Building Information Modeling in Construction, Journal Of Construction Engineering And Management, pp. 968-980. Available on : <http://www.ascelibrary.org>
- Reenskaug, T., 1979, A note on DynaBook requirements, Xerox PARC, Available on <http://heim.ifi.uio.no/~trygver/themes/mvc/mvc-index.html> (accessed: 21 March 2013)
- Romain, R., Simon, R., 2010, Virtual Reality software taxonomy, Student Research Projects, IVI Master Degree, Arts et Metiers ParisTech, Laval, France.
- Rossi, R.M., Brown, D., Park, B.,Boser, R., 2009, The Integrated Design Process on Paper and In Practice: A Case Study, Proceeding of the ASC Region III Conference, Downers Grove, Illinois. pp.25-32.
- Sairio, M., 2001, Augmented Reality, Helsinki University of Technology. Available online: [http://www.tml.tkk.fi/Studies/Tik-111.590/2001s/papers/mikko\\_sairio.pdf](http://www.tml.tkk.fi/Studies/Tik-111.590/2001s/papers/mikko_sairio.pdf) pp.1-11. (Accessed: 12 may 2013)
- Sampaio, A.Z., Gomes, A.R., Santos, J.P., 2012. Management of Building Supported on Virtual Interactive Models: Construction Planning and Preventive Maintenance, Journal of Information Technology in Construction (ITcon). 17, 121-133.
- Sampaio, A.Z., Henriques P.G., Martins, O.P. 2010, Virtual Reality Technology Used in Civil Engineering Education, The Open Virtual Reality Journal, Bentham Open , Vol.2, pp.18-25.
- Sampaio, A.Z., Henriques P.G., 2008, Virtual Reality Technology Applied on the Visual Simulation of Construction Activities, The Open Construction and Building Technology Journal, Bentham Science Publishers Ltd., Vol.2, pp.07-14.
- Schreyer, A.C., Hoque, S., 2009, Interactive Three-Dimensional Visualization of Building Envelope Systems Using Infrared Thermography and SketchUp, Proc. of InfraMation, Available online: <http://bct.eco.umass.edu/wp-content/uploads/2009/07/2009-029-Schreyer.pdf>

- 
- Seth, A., Vance, J.M., Oliver, J.H., 2010, Virtual reality for assembly methods prototyping: a review, *SI: Manufacturing and Construction*, Springer-Verlag London Limited. (15),1, pp.5-20.
- Shiratuddin, M.F., Zulkifli, A.N., 2002, *Jurnal Informatika*, Vol.1 (2), pp. 95-98.
- Shneiderman, B., 1998, *Designing the User Interface: Strategies for Effective Human-Computer Interaction*, 3rd Edition, Reading, MA., Addison-Wesley.
- Slater, M., Usoh, M., Steed, A., 1994, Depth of Presence in Virtual Environments. *Presence*, Vol. 3, No. 2, pp. 130-144.
- Sreng, J., Bergez, F., Garrec, J. L., Lécuyer A., Andriot, C., 2007, Using an Event-Based Approach to Improve the Multimodal Rendering of 6DOF Virtual Contact, *Proceedings of ACM International Symposium on Virtual Reality Software and Technology*.
- Stamp, B., The Integrated Design Process and Integrated Project Delivery. In *Proceedings of the ASHRAE Technical Conference*, Lakewood, CO, USA, 20 April 2012. Available online: [https://rockymtnashrae.com/downloads/2011\\_Technical\\_Conference/ashrae\\_tc\\_2011\\_sustainability\\_integrated\\_design](https://rockymtnashrae.com/downloads/2011_Technical_Conference/ashrae_tc_2011_sustainability_integrated_design) (accessed on 12 January 2013).
- Stanney, K., 1995, Realizing the Full Potential of Virtual Reality: Human Factors Issues That Could Stand in the Way, *Proceedings of the Virtual Reality Annual International Symposium (VRAIS '95)*. pp. 28-34.
- Steuer, J., 1992, Defining Virtual Reality: Dimensions Determining Telepresence, *Journal of Communication*, 42 (4), pp. 73-93.
- Stuart, R., 1996, *The design of Virtual Environments*, New York, McGraw-Hill.
- Sullivan, J., 2011, Autodesk Presentation, , Current BIM Interoperability Methods, USACE Infrastructure, Autodesk Business Development McLean, Virginia.
- Sutcliffe, A., Brian Gault, B., Shin, J., 2005. Presence, memory and interaction in virtual environments. *Int. J. Human-Computer Studies-Elsevier*. 62, pp. 307–327.
- Taisei corporation, 2013, Available online: [http://www.taisei.co.jp/english/idc\\_e/environment/index.html](http://www.taisei.co.jp/english/idc_e/environment/index.html)  
(Accessed on 12 June 2013)
- Tan, H., Zhu, W., Wang, T., 2010, The Human Computer Interaction Technology Based on Virtual Scene, *Journal Springer-Verlag Berlin Heidelberg, LNBI 6360*, pp. 333–339.
- Tang, M., 2006, Low cost virtual reality aided design for the architectural education, *Presentation ACSA Conference*.
- Ter Minassian, H., 2011, La réhabilitation thermique des bâtiments anciens à Paris : comment concilier protection du patrimoine et performance énergétique ? *Cybergeog: European Journal of Geography, Aménagement, Urbanisme*, article 536, <http://cybergeog.revues.org/23737> ; DOI : 10.4000/cybergeog.23737 (Accessed : 21 jan 2013)
- Tideman, M., van der Voort, M.C, van Houten F.J.A.M., 2008, A new product design method based on virtual reality, gaming and scenarios, *International Journal on Interact Design and Manufacture* 2, pp.195–205.

- Toma, M.I., Gîrbacia, F., Antonya, C., 2012, A comparative evaluation of human interaction for design and assembly of 3D CAD models in desktop and immersive environments. *International Journal on Interactive Design and Manufacturing* Vol. 6 (3) Springer-Verlag, pp 179-193.
- US GSA, Statsbygg and Senate, Information Delivery Manual (IDM) for BIM Based Energy Analysis as Part of the Concept Design BIM. 2010.
- Van Dam, A., Forsberg, A.S., Laidlaw, D.H., LaViola, J.J., Simpson R.M., 2000. Immersive VR for scientific visualization: a progress report. *IEEE Computer Graphics and Applications*. 20(6), 26–52.
- Van Dam, A., Laidlaw, D.H., Simpson, R. M. Experiments in Immersive Virtual Reality for Scientific Visualization. *Computers and Graphics*. 2002; 26 (4): 535-555.
- Van Krevelen, D.W.F., R. Poelman. R., 2010, A Survey of Augmented Reality Technologies, Applications and Limitations, *The International Journal of Virtual Reality*, 9(2), pp.1-20.
- Van Treeck, C., Petra, W., Andre, B., Michael, P., Martin, E., Oliver, W., Ernst, R., 2006, Towards interactive indoor thermal comfort simulation, *European Conference on Computational Fluid Dynamics ECCOMAS CFD*.
- Wagner, A.D., 2010, Revit Architecture + Ecotect, BIM/CAD Camp 2010, US CAD Honolulu Hawaii, pp.6-10, available online: [www.uscad.com](http://www.uscad.com), [www.uscadbim.com](http://www.uscadbim.com), (accessed: 22 January 2013).
- Wang Xiangyu, Dunston Phillip S., 2007, Design, Strategies, and Issues Towards an Augmented Reality-Based Construction Training Platform, *Journal ITcon* Vol. 12 (2007), pp. 363-380.
- Wang, N., Paljic, A., Fuchs, P., A study of Perception of volumetric rendering for immersive scientific visualization; 20th International Conference on Artificial Reality and Telexistence (ICAT2010), 1-3 December 2010, Adelaide, Australia, pp. 145-152. [http://www.vrsj.org/icat/ICAT2010\\_Proceedings/paper/paper-023.pdf](http://www.vrsj.org/icat/ICAT2010_Proceedings/paper/paper-023.pdf)
- Weidlich D., Cser L., Polzin T., Cristiano D., Zickner H., 2007, Virtual Reality Approaches for Immersive Design *CIRP Annals - Manufacturing Technology*, Elsevier, Vol. 56, Issue 1, pp. 139–142.
- Welle, B., Haymaker, J., Rogers, Z., 2011, ThermalOpt: A methodology for automated BIM-based multidisciplinary thermal simulation for use in optimization environments, *Building Simulation-Tsinghua University Press and Springer-Verlag Berlin Heidelberg* 4, pp. 293–313.
- Wettach, R., Behrens, C., Danielsson, A., Ness, T., 2007, A thermal information display for mobile applications, *Proceedings of the 9th international conference on Human computer interaction with mobile devices and services*. Singapore, ACM. 26(4) pp. 535-555.
- Wetter, M., 2011, A View on Future Building System Modeling and Simulation, In *Building Performance Simulation for Design and Operation*, Hensen, J. and Lamberts, R., (eds.), Routledge, UK.
- Wild, W., 2007, Application of infrared thermography in civil engineering, *Proceeding of Estonian Acad. Science Engineering*, 13, 4, pp.436-444.
- Woksepp, S., Olofsson, T., 2006, Using virtual reality in a large-scale industry project. *Journal ITcon* 11, pp. 627-640.



- Yan, J., Stellios, P., 2006. Design for Sustainability. Beijing: China Architecture and Building Press. ISBN 7-112-08390-7.
- Yang Gi-Hun, Kwon Dong-Soo, 2008, Effect of Temperature in Perceiving Tactile Stimulus using a Thermo-tactile Display, International Conference on Control, Automation and Systems COEX, Seoul, Korea, pp.266-271.
- Zachmann, G., 1998, VR- Techniques for Industrial Applications, Virtual Reality for Industrial Applications. Springer. Chapter 1, pages 13 - 38.
- Zhang, Y., Sotudeh, R., Fernando, T., 2005, The Use of Visual and Auditory Feedback for Assembly Task Performance in a Virtual Environment, SCCG '05 : Proceedings of the 21st spring conference on Computer graphics, ACM Press, New York, NY, USA, pp. 59-66.
- Zyda, M., 2005, From visual simulation to virtual reality to games, Computer, 38 (9), pp. 25-32.

-----



# Appendices

---



**Appendix A : Schematic VSL Scripting (Virtools and 3DVIA Studio)**

	Virtools	3DVIA Studio
Stereo	In VR specific offer	Support for all TV, projectors and monitors
Online VR	Not possible	Yes
Commercial AR offer for developers	No, through service only	Scheduled*
Multipipe	OK, but memory replicated	Yes
Cluster	Yes	Yes
64 bits	no	Yes
Configurator with GUI	No, only cfg files	Scheduled*
SUI Scenarii approach	Limited, through VRNR	Native, full SUI Model
Peripheral drivers	In VR specific offer	Free, maintained by ecosystem*

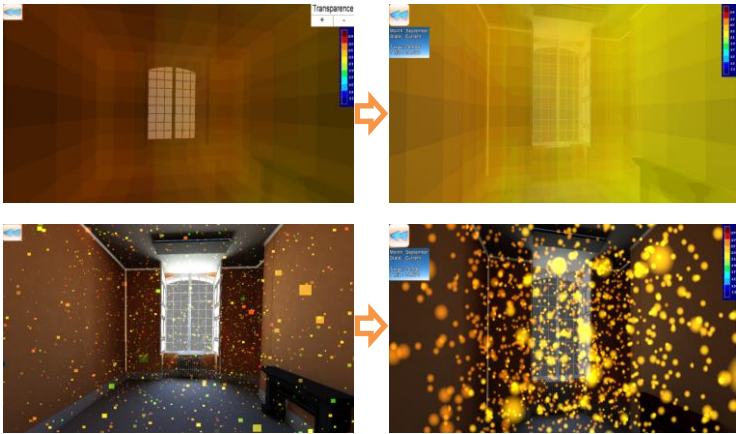

Transition from Virtools to 3DVIA Studio

## A.1. Schematic VSL Scripting in Vrttools

### Attribute of temperature cubes

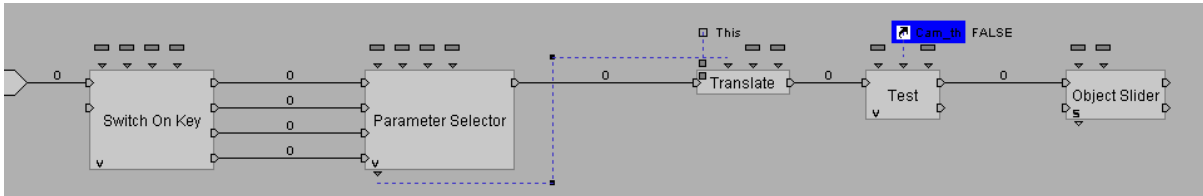

A.1.1. Start\_button Script

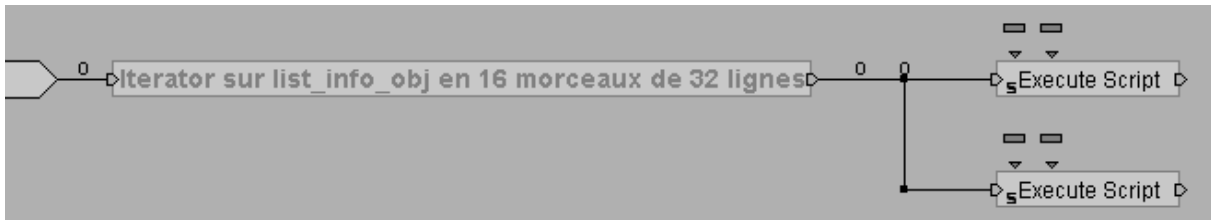

A.1.2. Back\_event

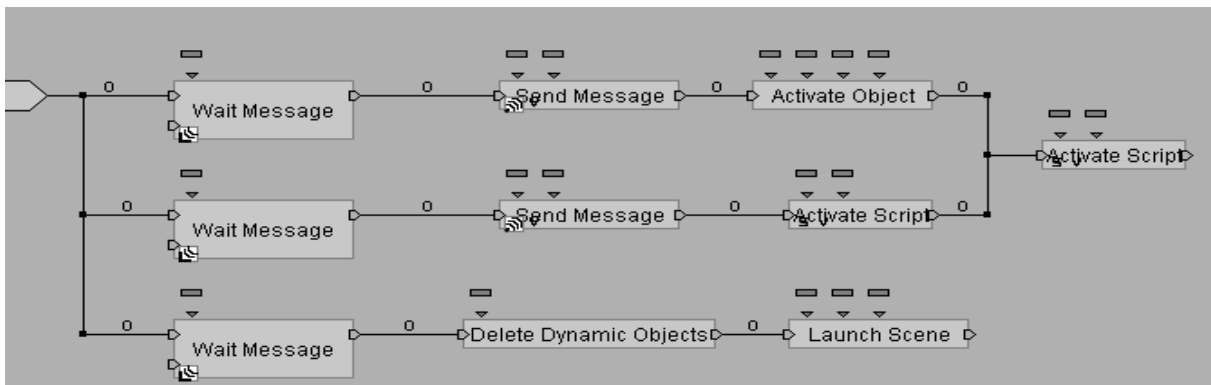

A.1.3. To\_sim\_Results\_Back\_event

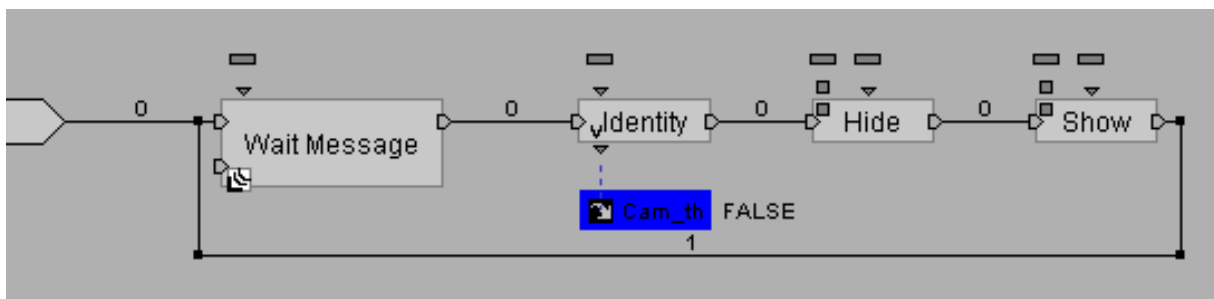

A.1.4. Loading\_temp\_and\_max-min

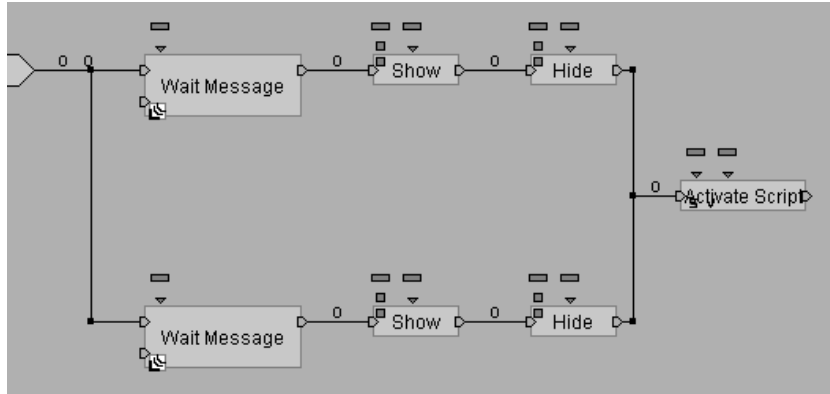

A.1.5. Init\_font

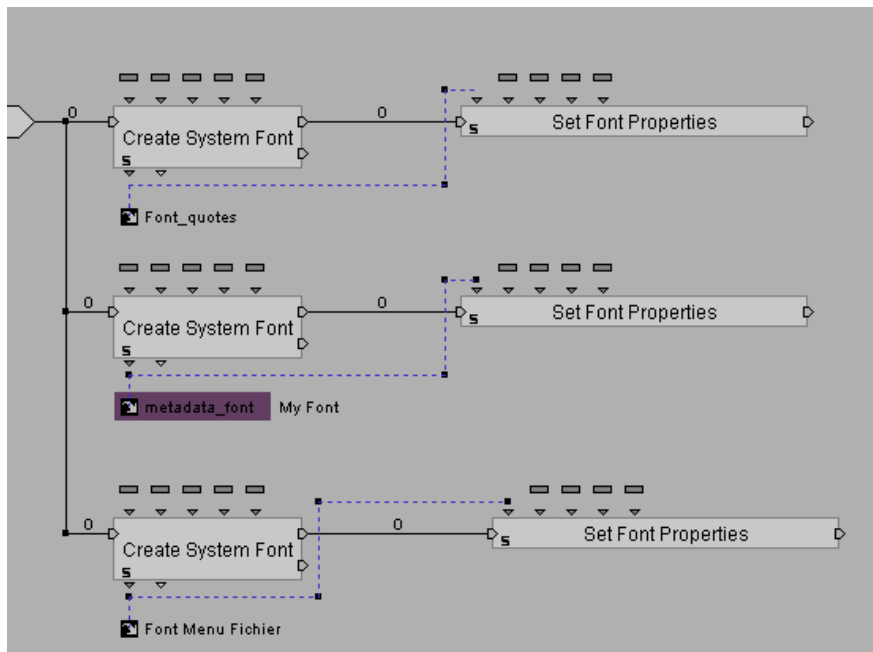

A.1.6. Syst\_Font

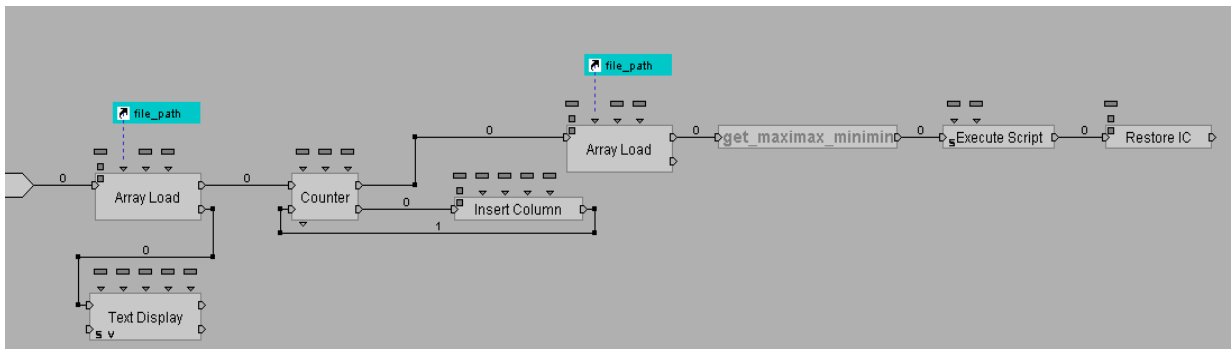

A.1.7. Loading\_list\_info\_obj: name temperature position



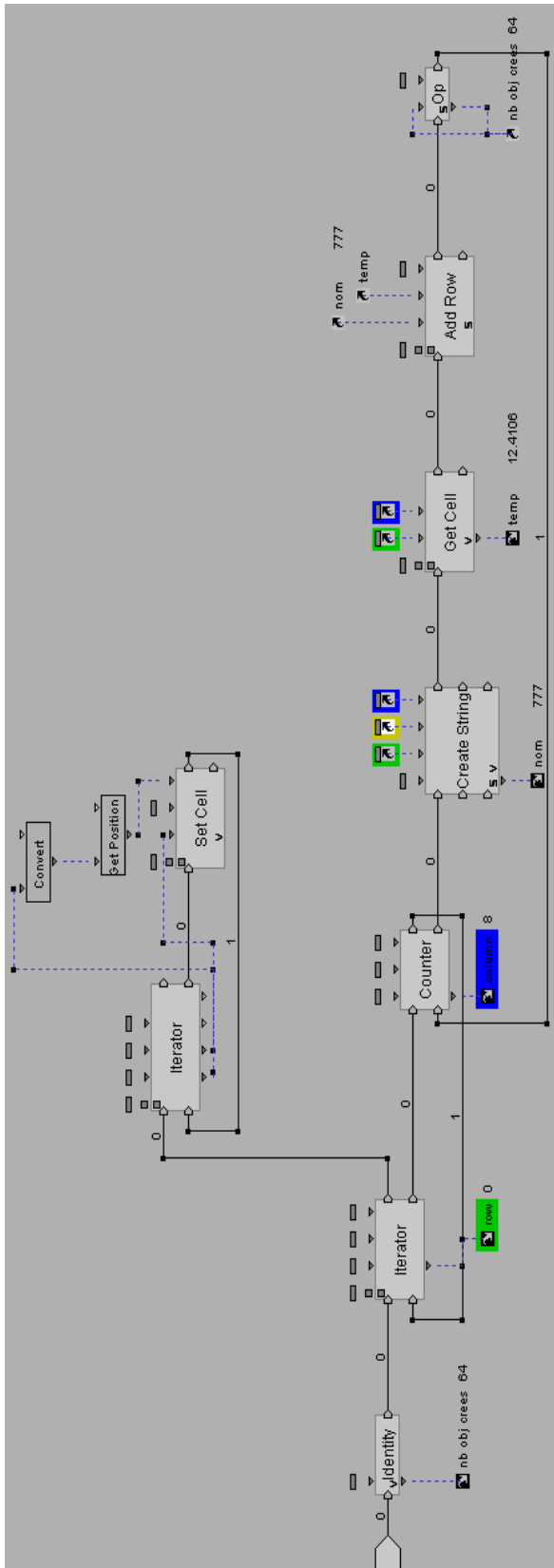

A.1.8. Generating\_particles\_and\_atrib\_temp\_particles

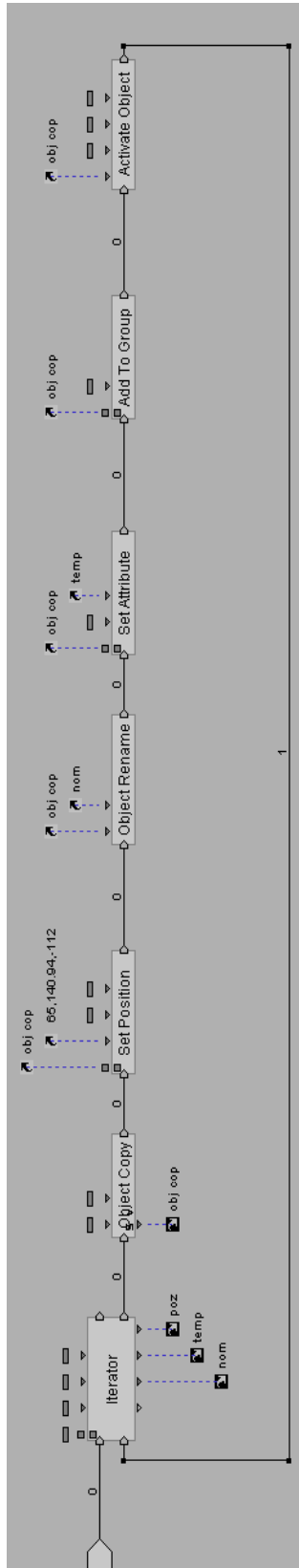

A.1.9. Generating\_particles\_on\_3DFrame\_color\_interpolation

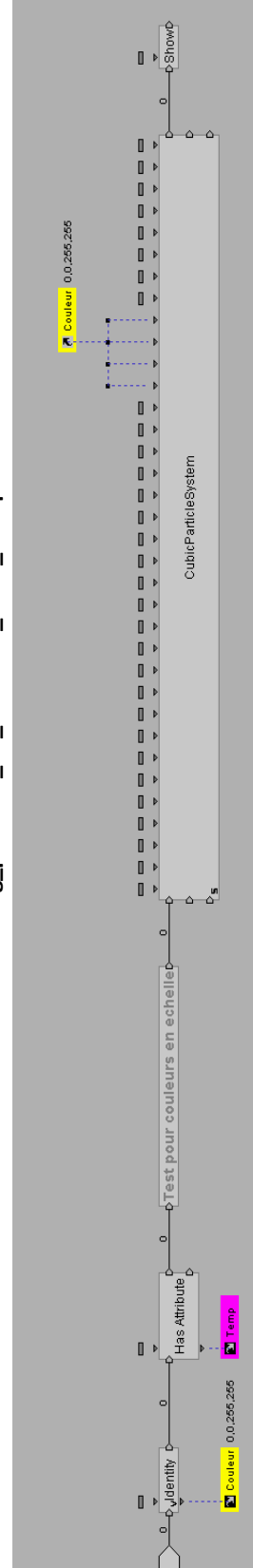

A.1.10. Hide\_&\_Show (Temperature Color)

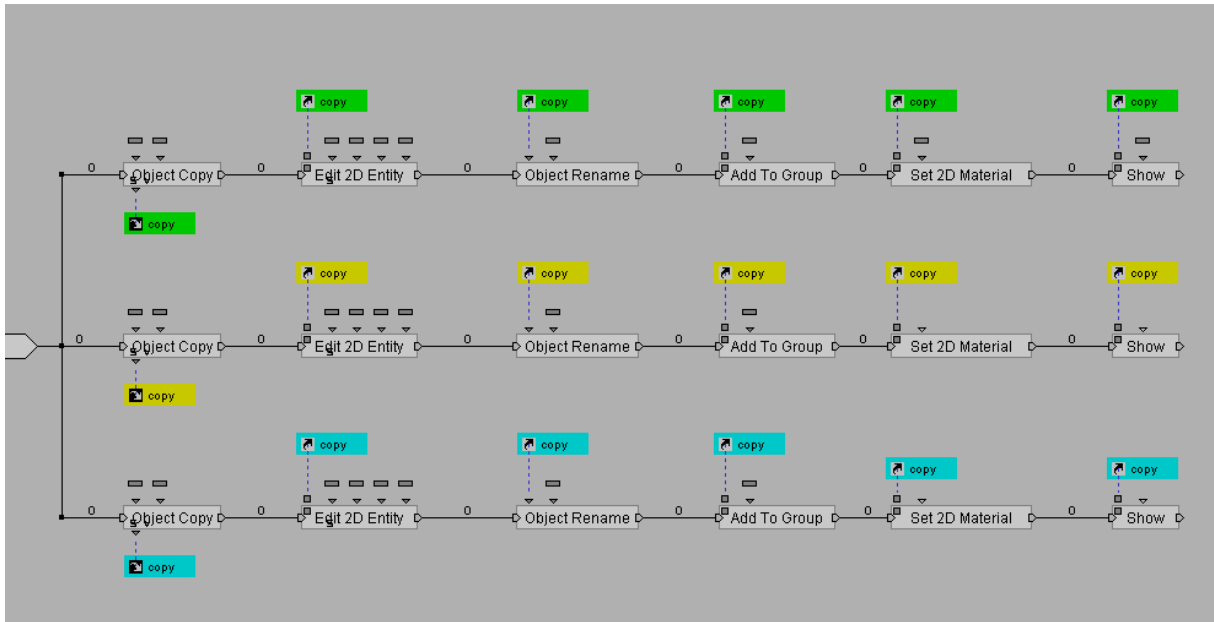

**A.1.11. Read\_file\_data\_complement\_array\_folders\_name**

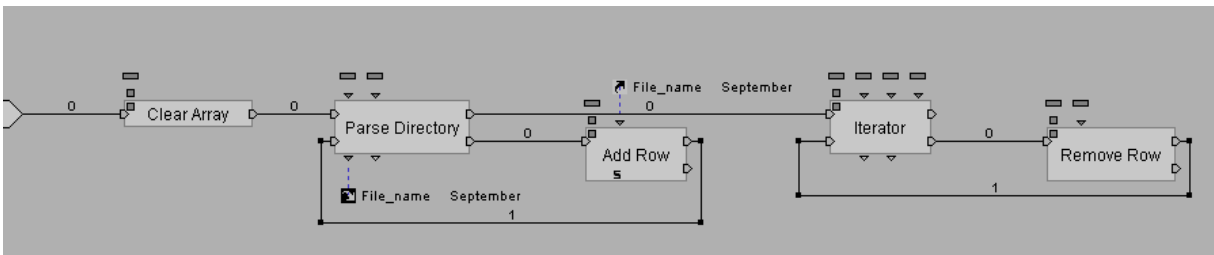

**A.1.12. Navigation\_tracker**

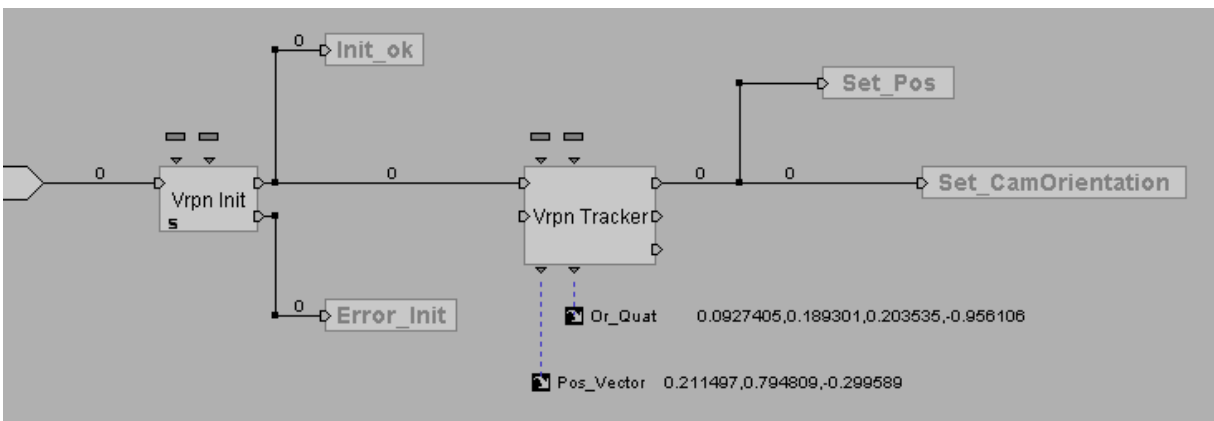

**A.1.13. Redirected\_navigation**

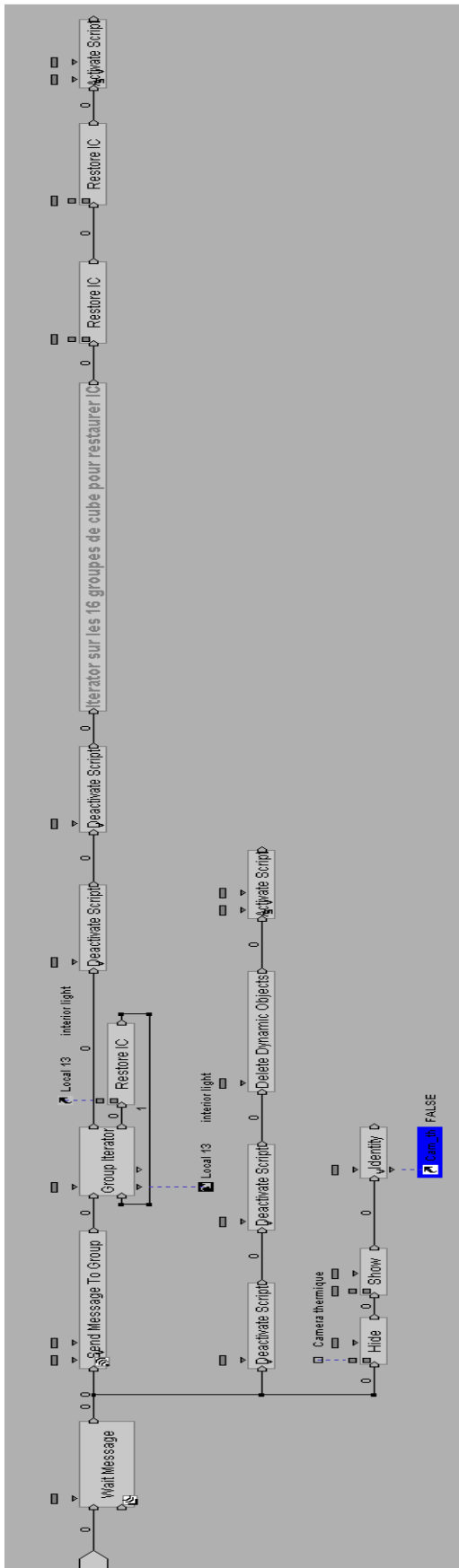

A.1.14. Rotation Camera

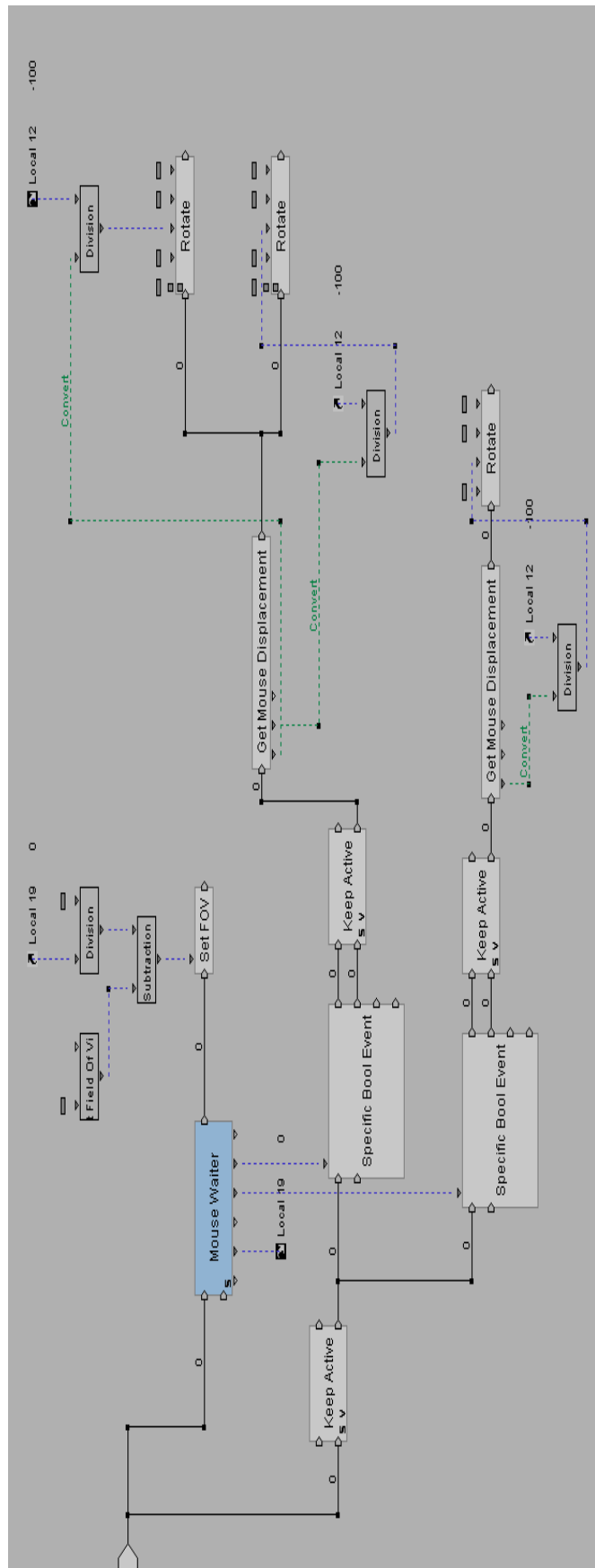

A.1.15. Translation Camera

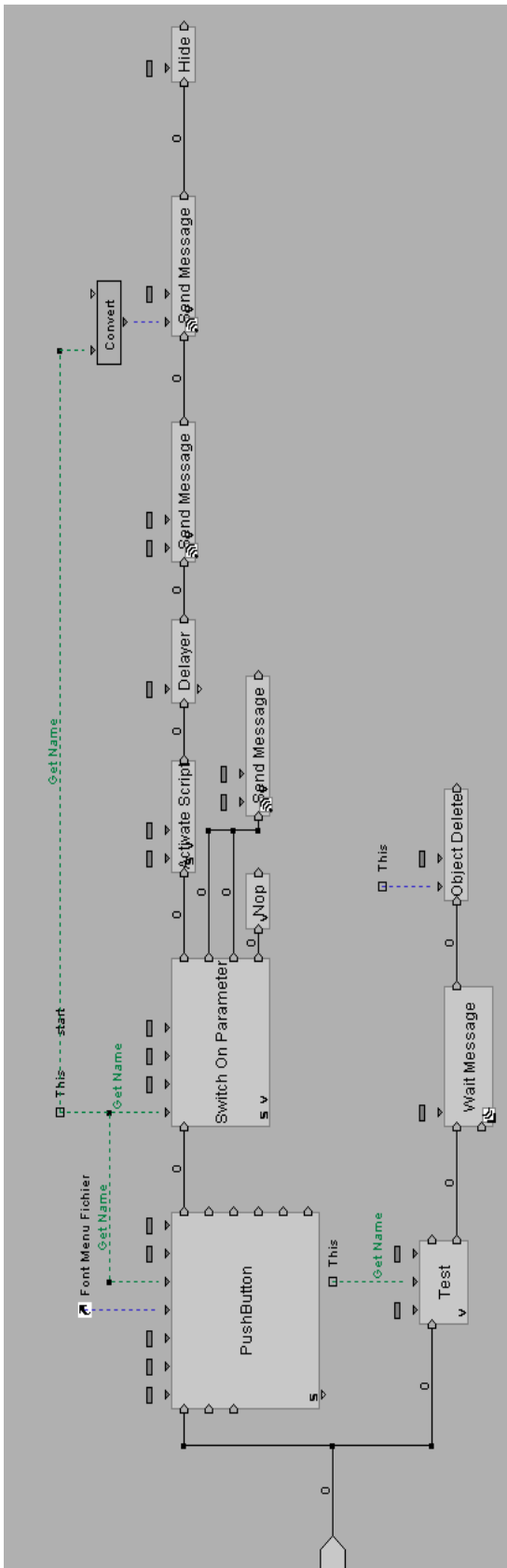

A.1.1.16. Transparency +/-

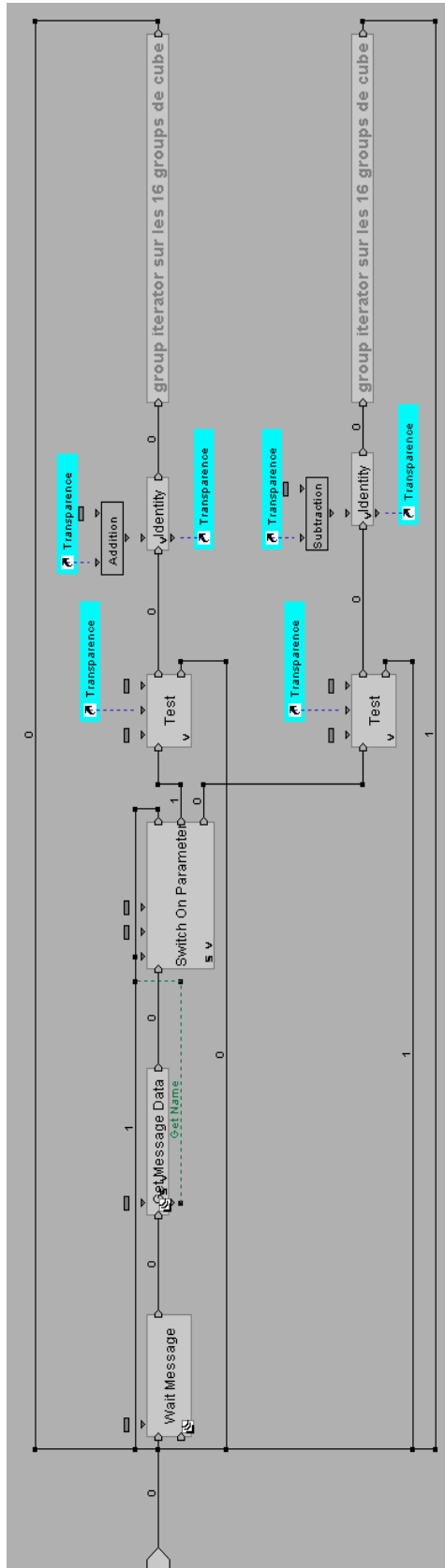

A.1.1.17. Receive\_output\_data

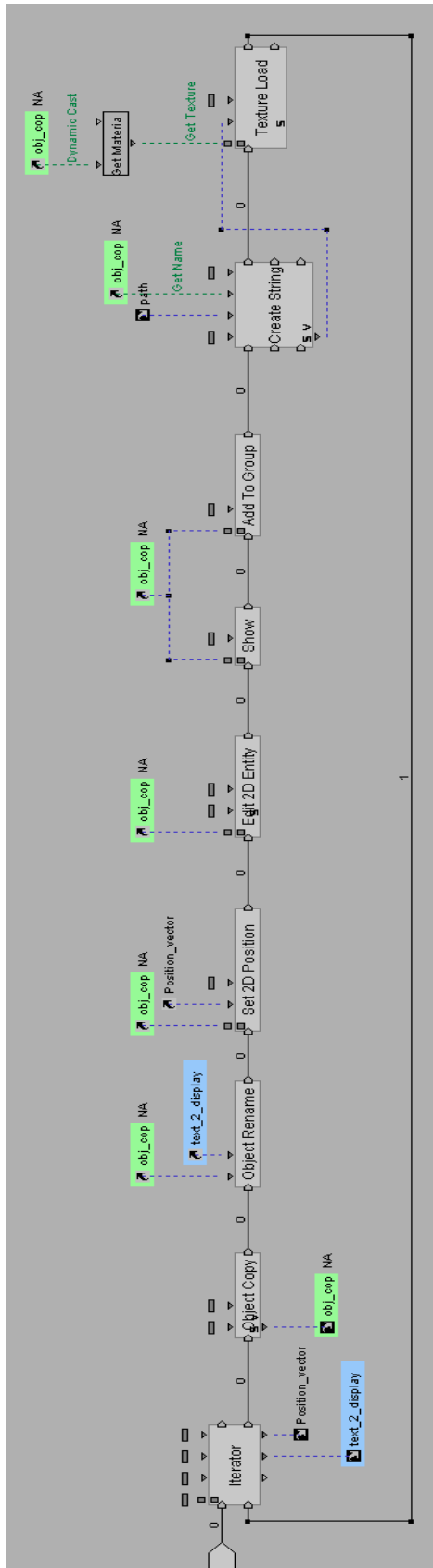

A.1.18. Colored\_cubes\_setting

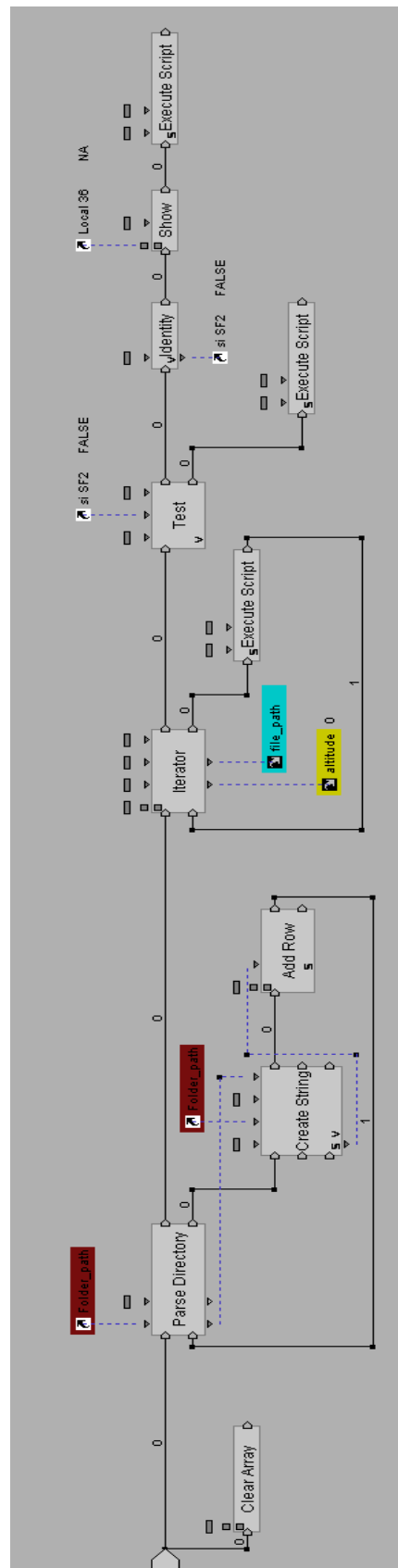

A.1.19. Display\_file\_menu\_ecotect

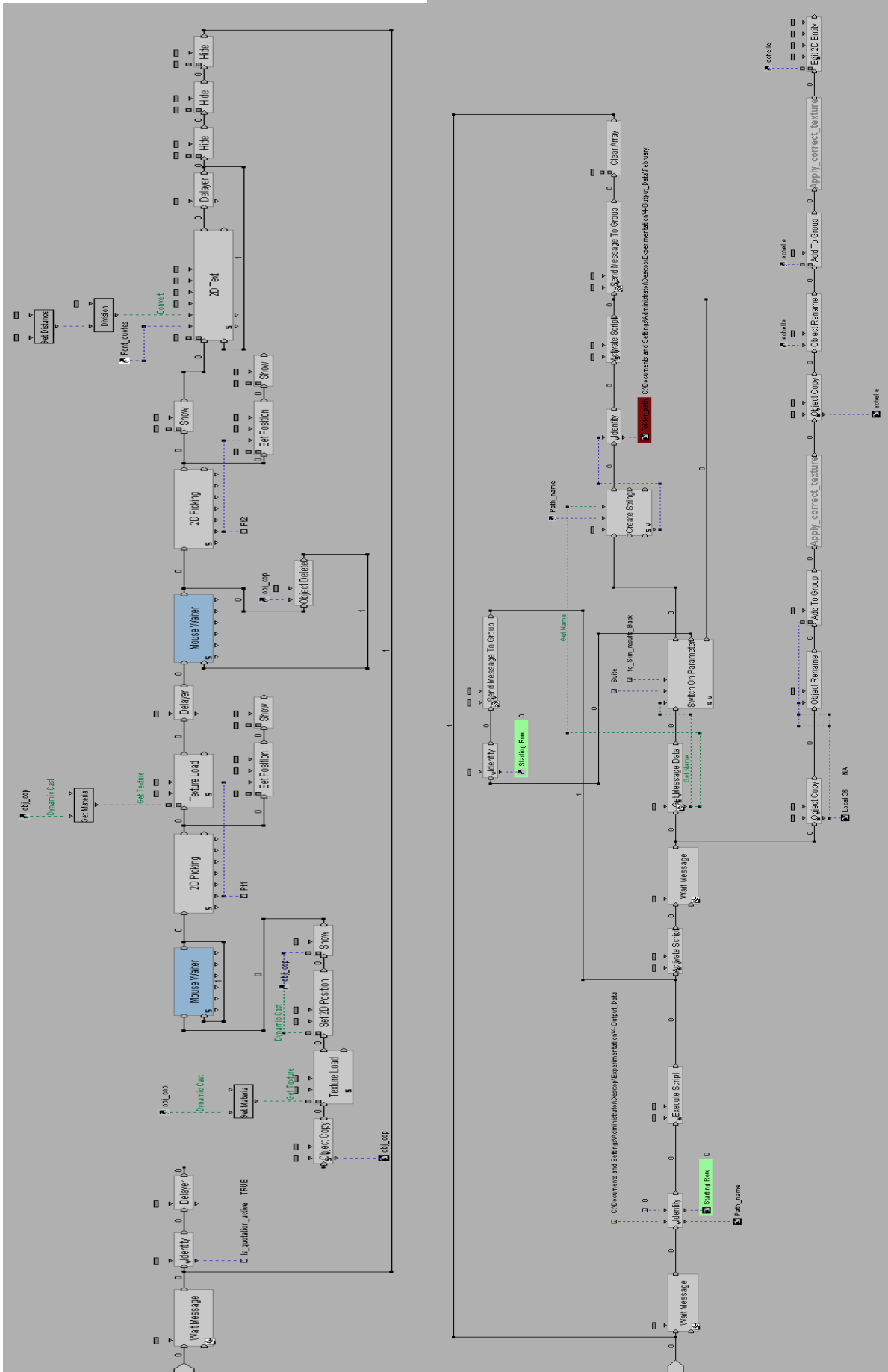

A.1.20. Copy\_Objects

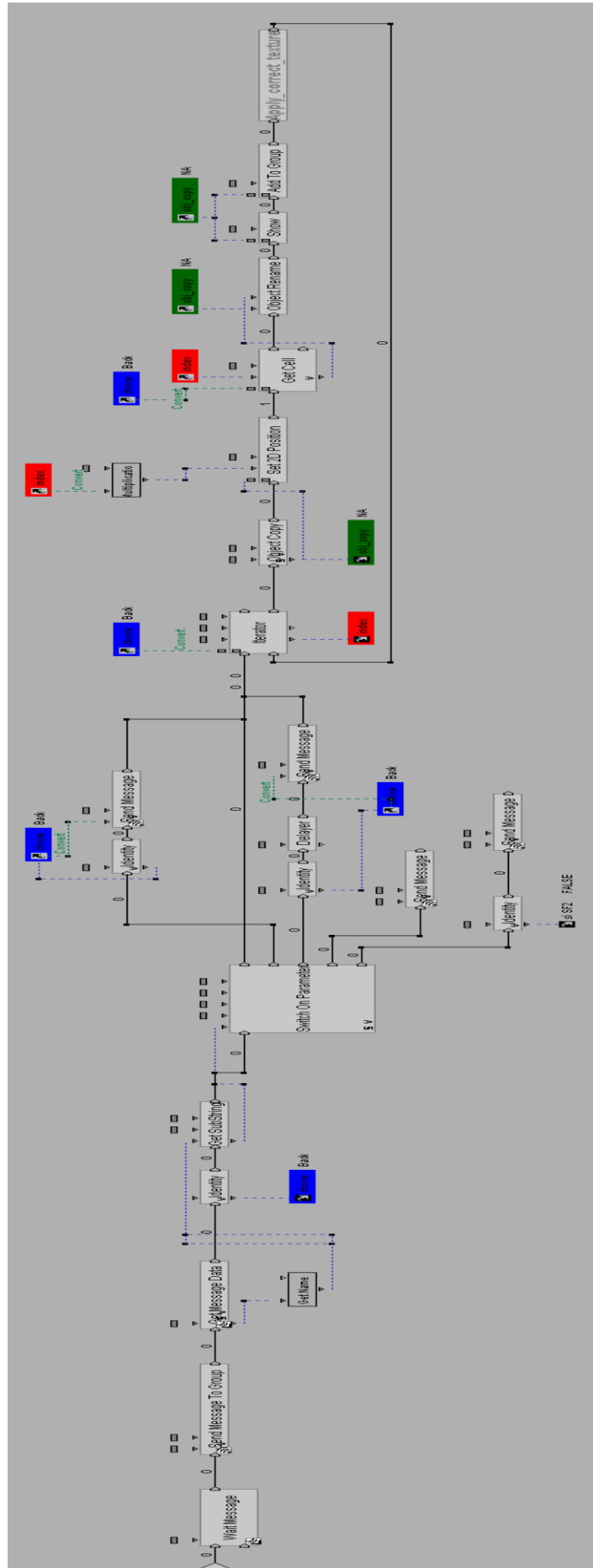

A.1.21. Interaction (1)



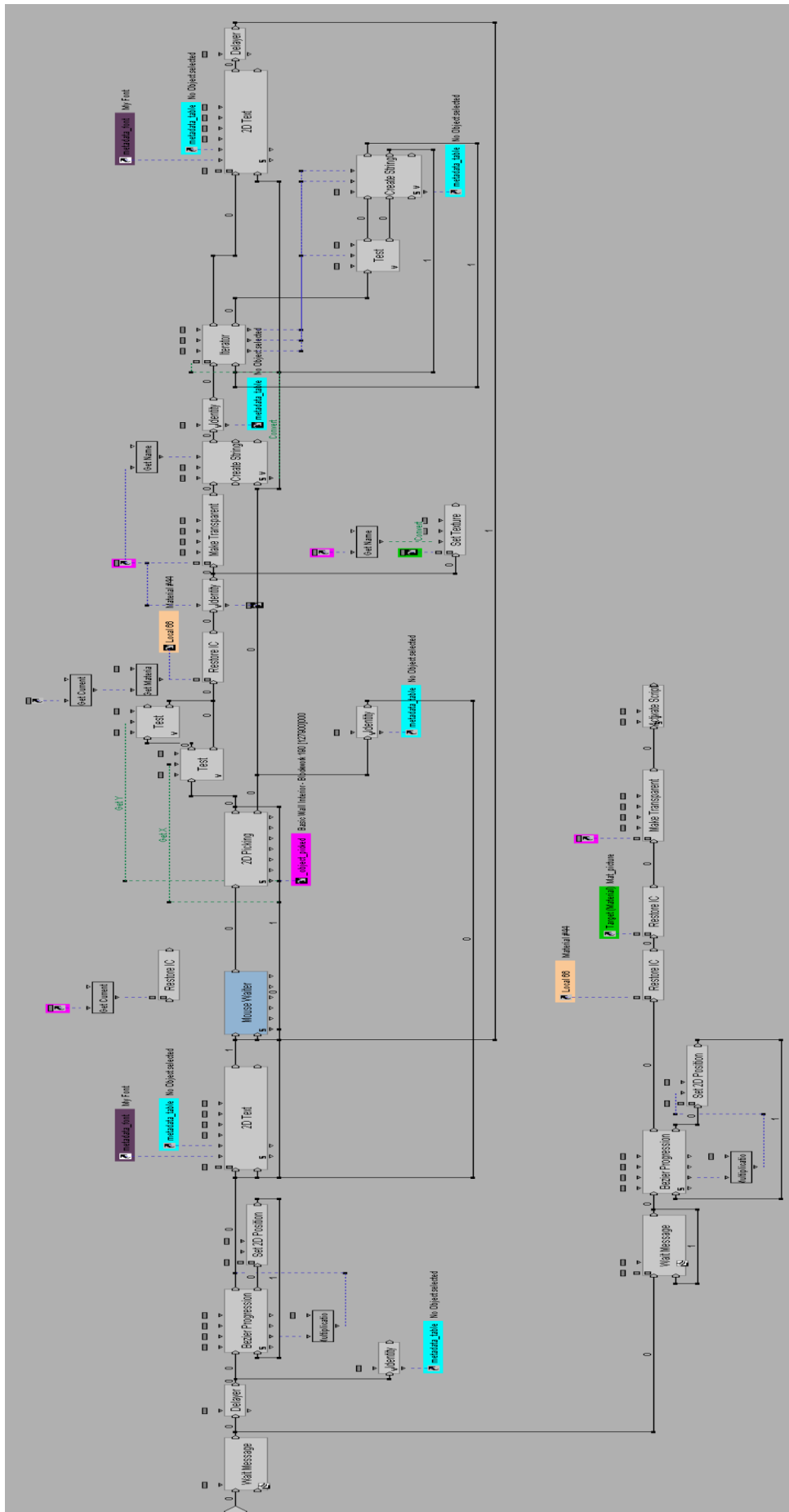

A.1.22. Interaction (2)

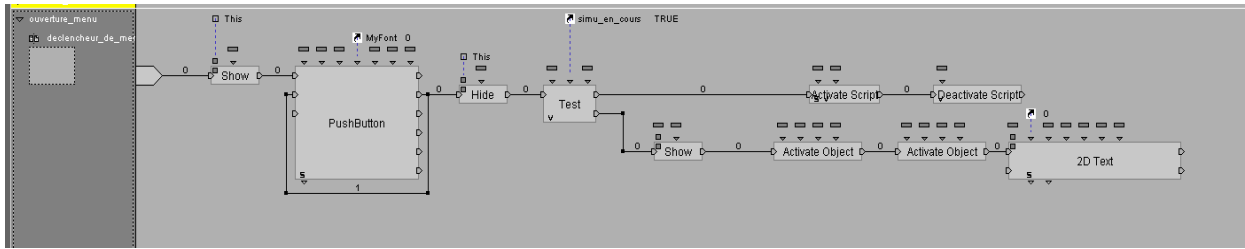

A.1.23. Schematic Script of interactive button

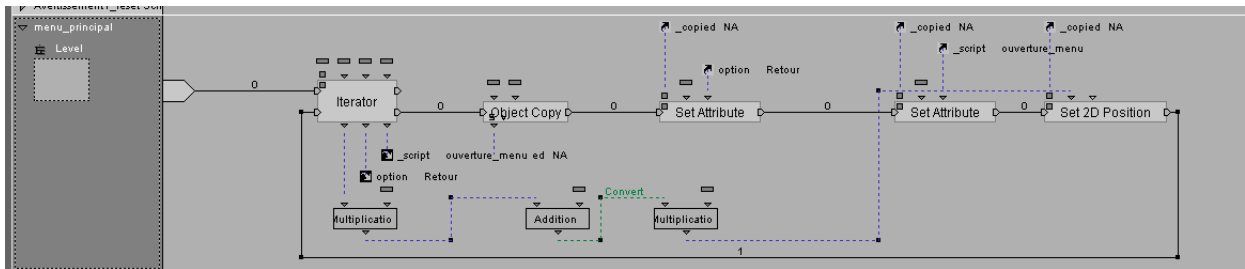

A.1.24. Schematic Script of principal menu button

**Transfer from Virtools to 3DViaStudio  
=> 14 Scripts:**

- |  |   |  |
|--|---|--|
| ▶ Lire_fichier_donnees_completer_array_nom_d | } | Reading the thermal data and displaying the selection menu   |
| ▶ Affichage_menu_dossier_ecotect             |   |  |
| ▶ menu_selection_dossier                     |   |  |
| ▶ Recup_output_data                          | } | Recovering the thermal data, attributing the temperatures, calculating the colors and displaying the cubes |
| ▶ Chargement_temp_et_max-min                 |   |  |
| ▶ chgmt_list_info_obj: nom temp pos          |   |  |
| ▶ attribution temperature_cubes              |   |  |
| ▶ couleur_cubes_interpolation                |   |  |
| ▶ couleur_cubes_échelle                      |   |  |
| ▶ gen_particules_et_atrib_temp_particules    |   |  |
| ▶ generateur_particules_sur_3DFrame_Couleur  |   |  |
| ▶ Menu_transparence                          | } | Creating a transparency menu for the cubes   |
| ▶ Transparence +/-                           |   |  |
| ▶ cam_thermique                              | ➔ | Panoramic thermal data display   |

**A.2. Schematic VSL Scripting in 3DVIA Studio**

**Main menu Behavior**

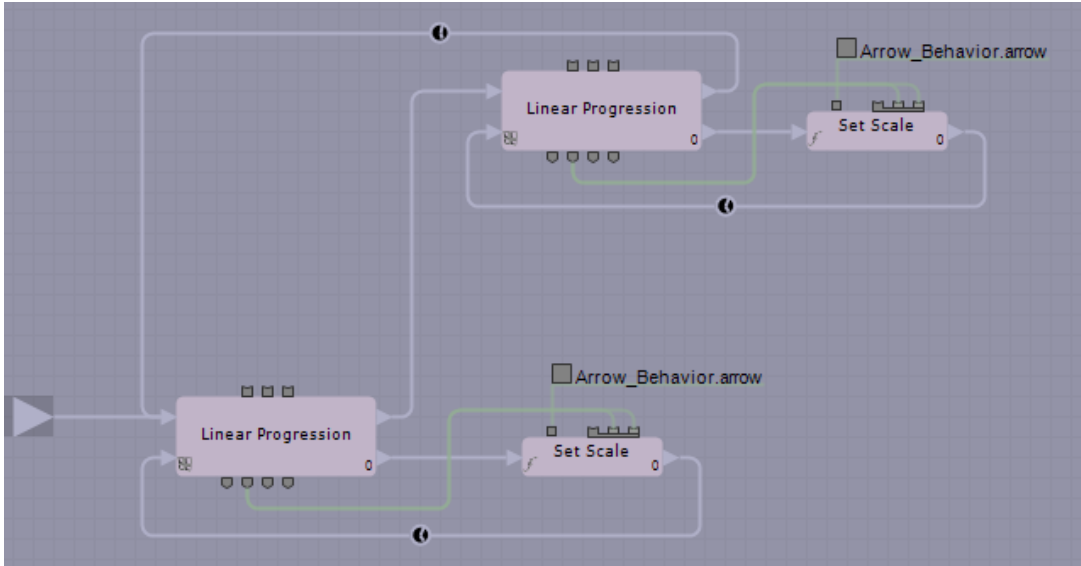

**A.2.1. "Notice" Task**

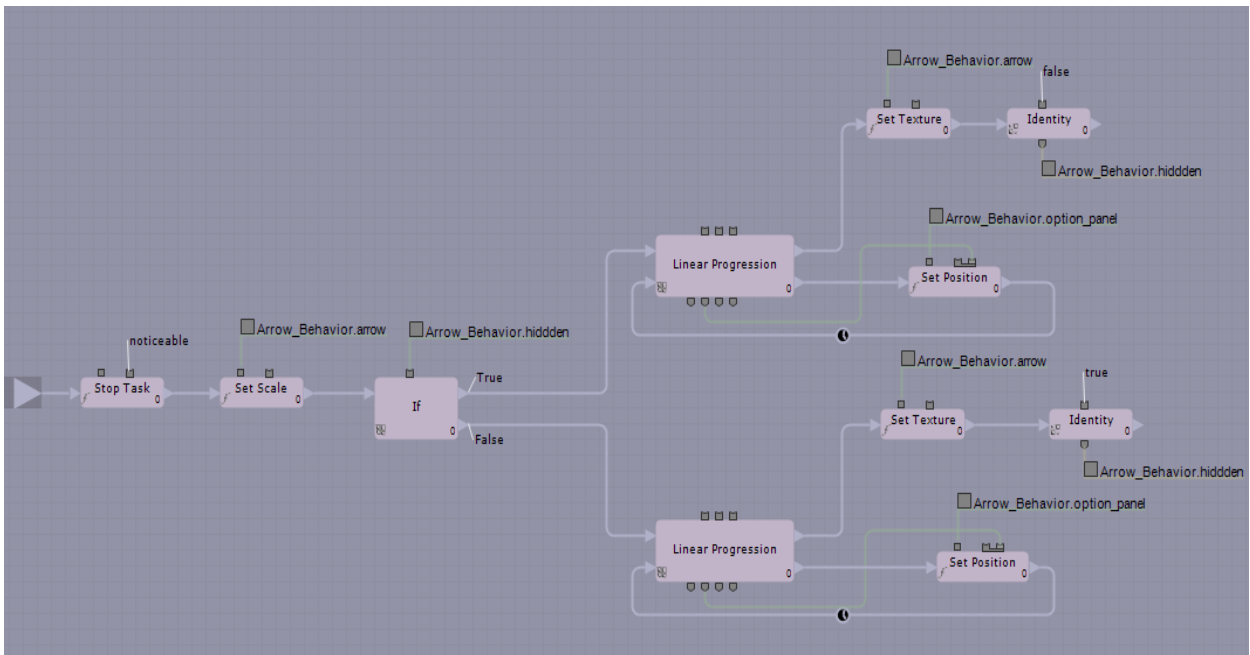

**A.2.2. "Show-hide options"**

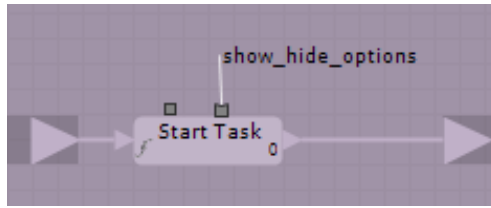

A.2.3. "Start" Function

### Camera Movement Behavior

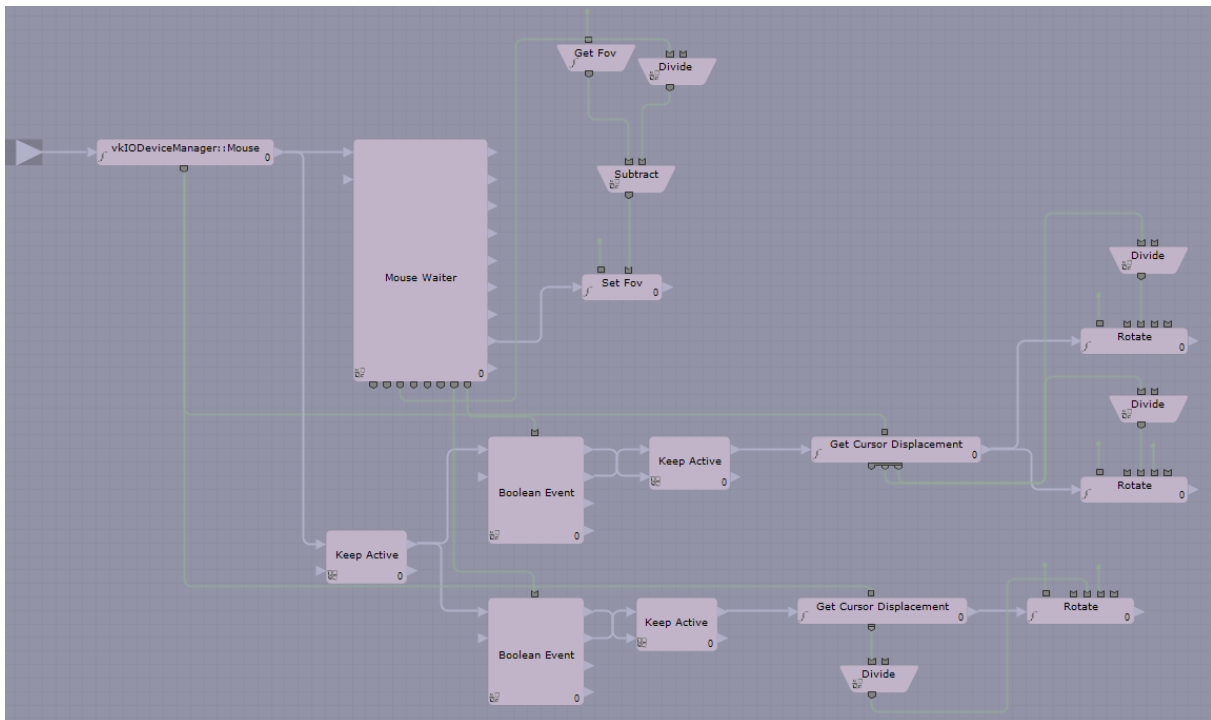

A.2.4. "Rotation" Task

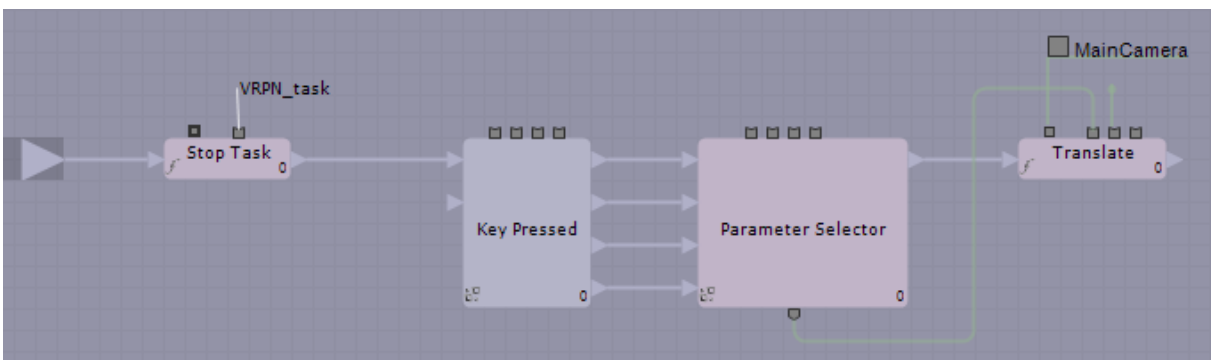

A.2.5. "Translation" Task

## Copy frame Behavior

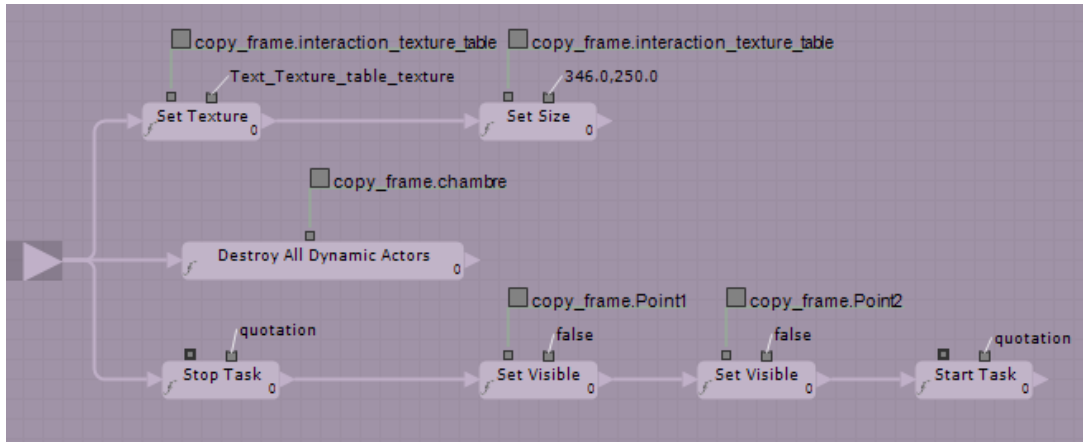

A.2.6. "Return event" Function

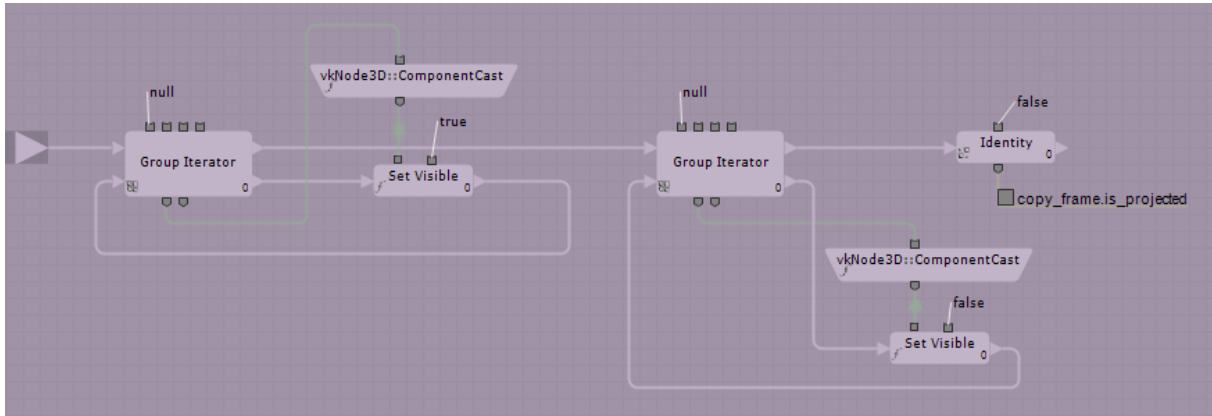

A.2.7. "Gunzo room in existing condition"

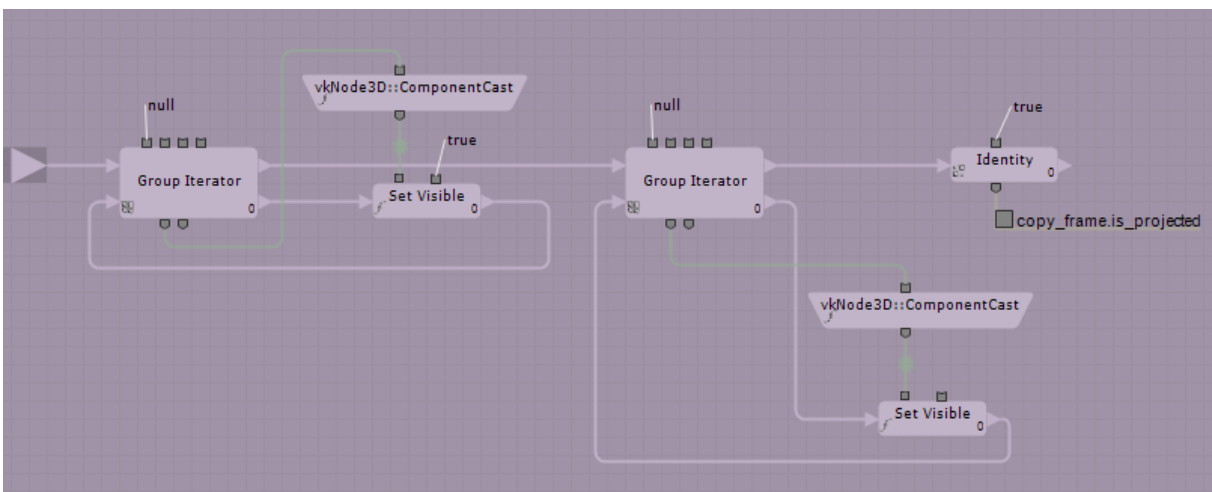

A.2.8. "Gunzo room renovated version"



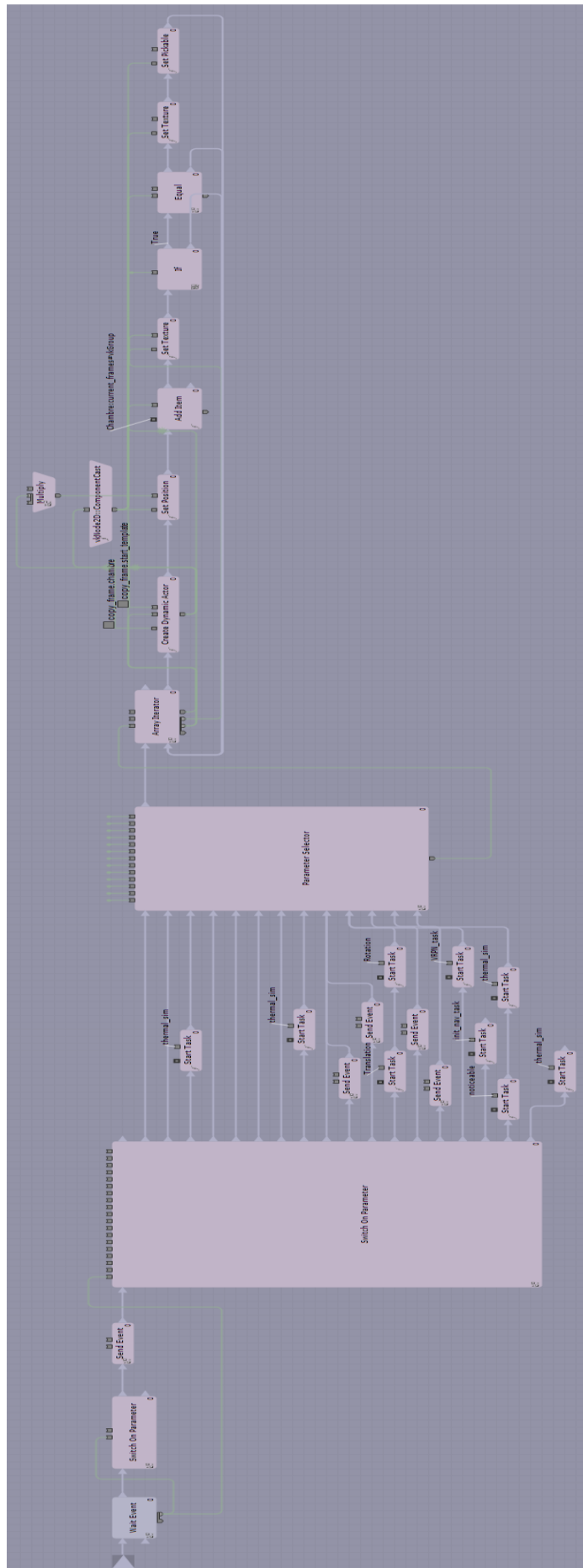

A.2.10. Copy Frame Task

## "Ecotect thermal simulation" Behavior

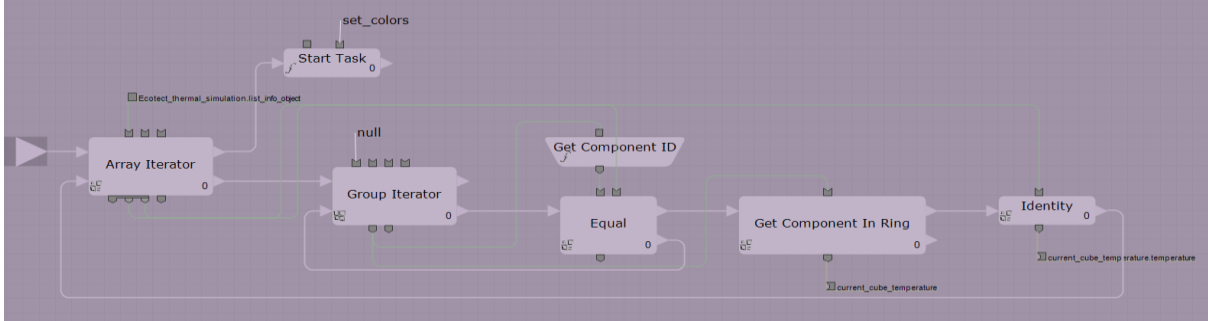

A.2.11. Function of "assign temperatures"

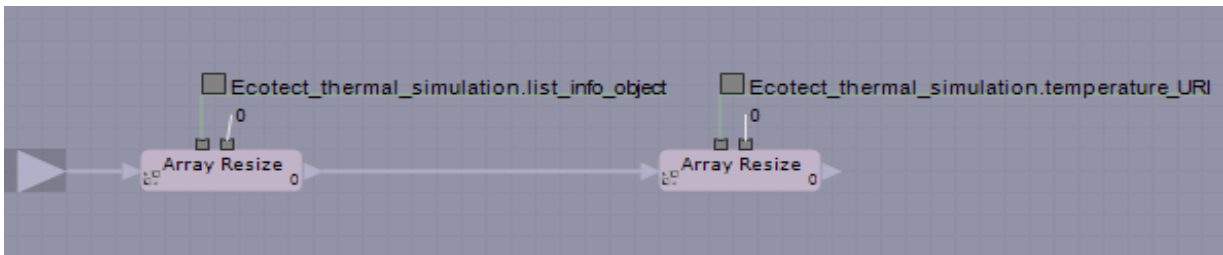

A.2.12. "Clear list info object"

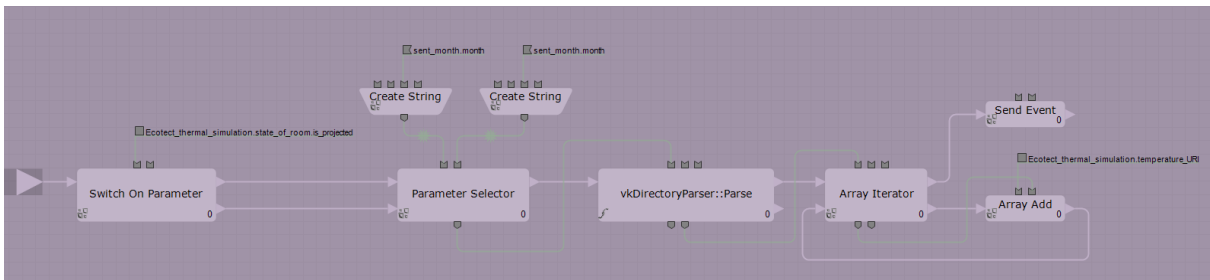

A.2.13. Function of "write URI array"



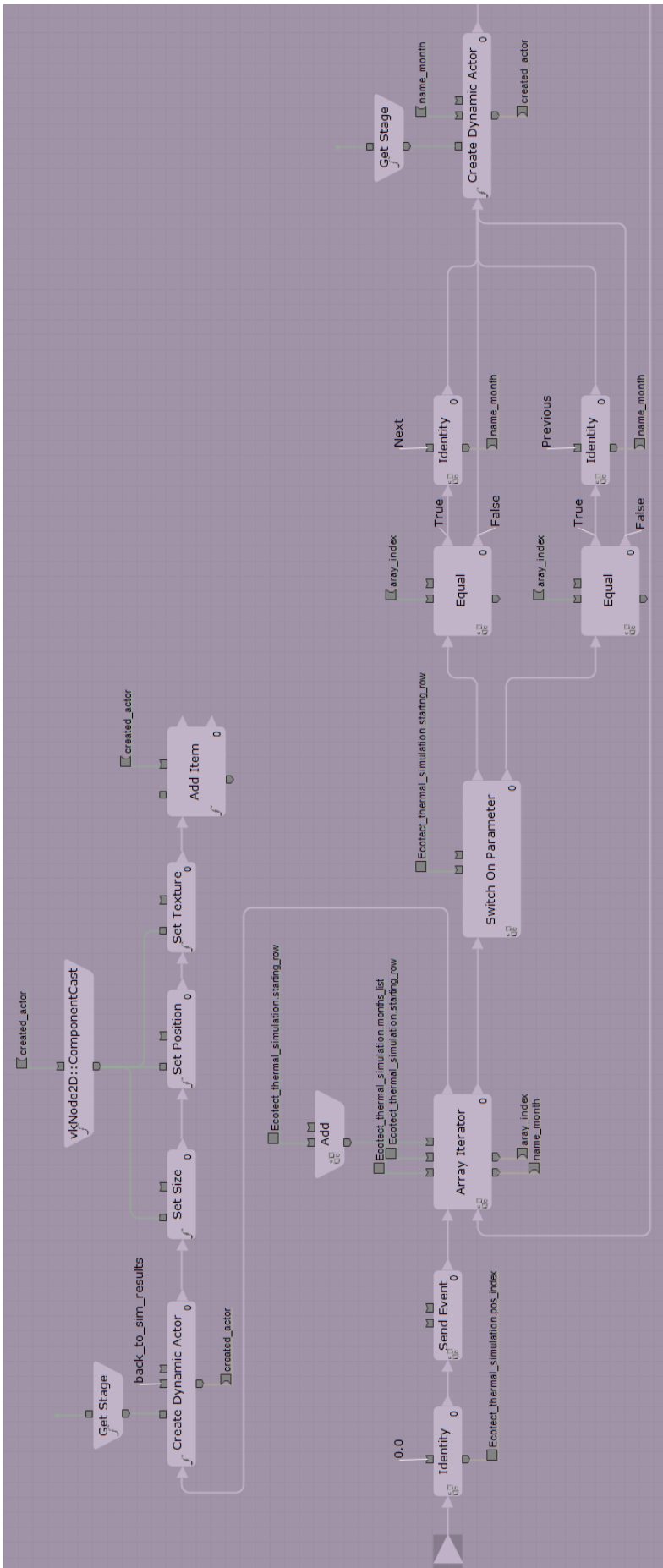

A.2.14. "Menu display" Function

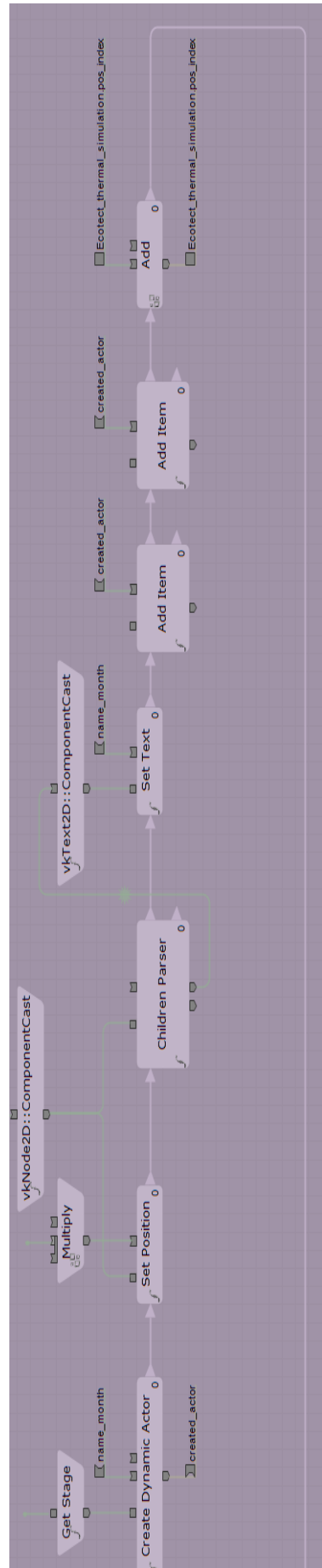

A.2.14. "Menu display" Function – Cont.

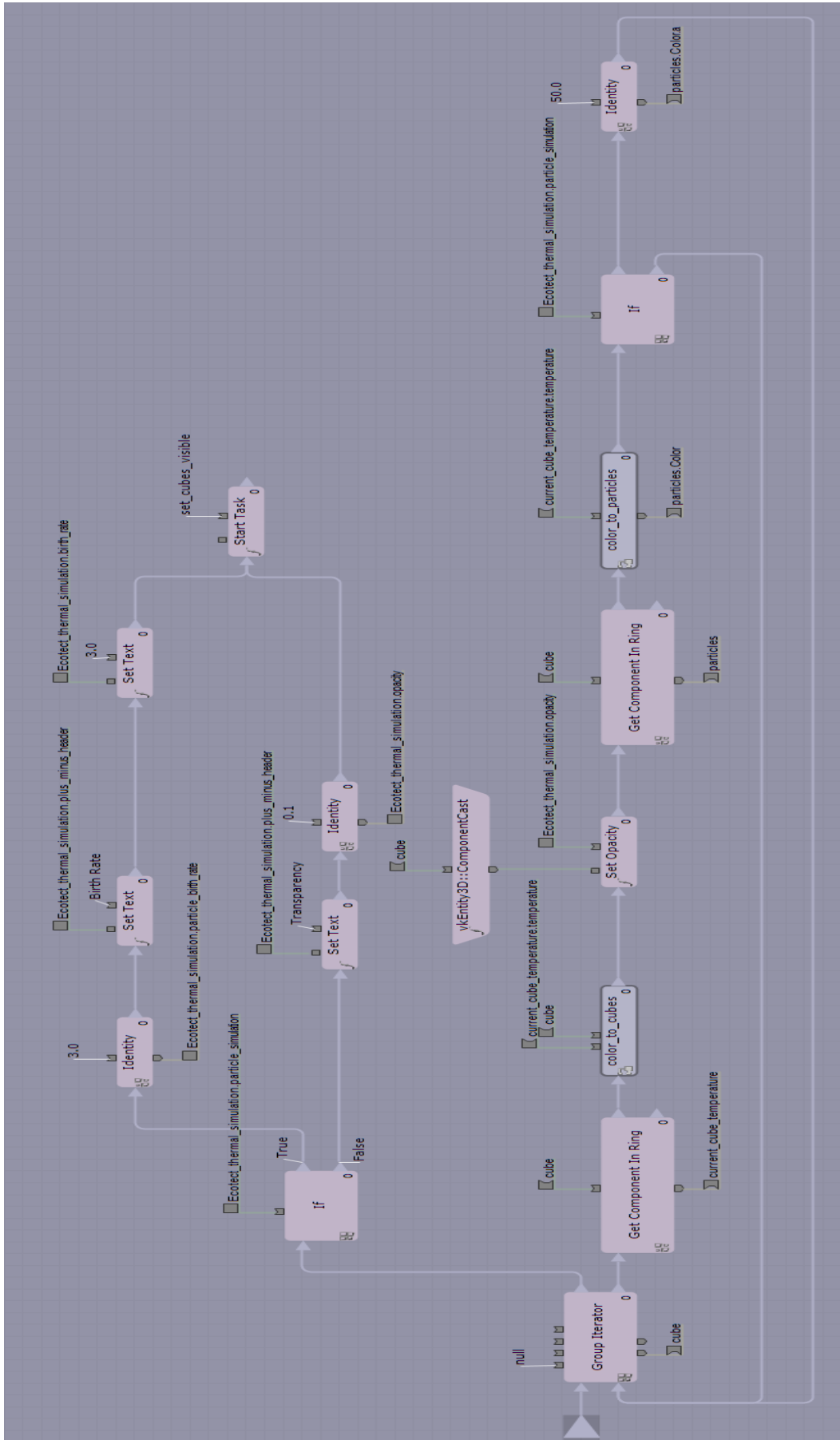

A.2.15. "Set colors task" The color attribute sets according to the Txt preformat assign to each of 512 parts

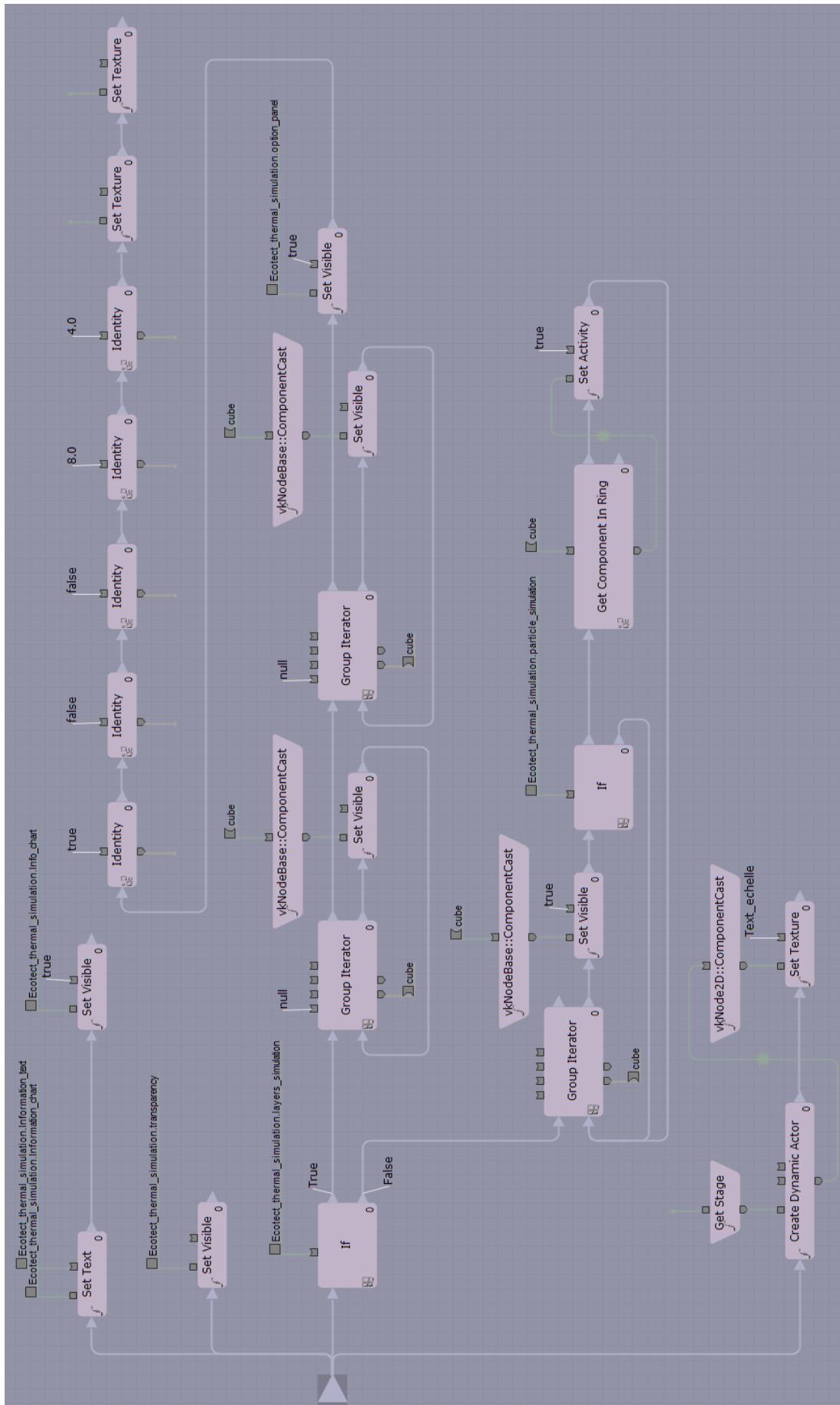

A.2.16. Task of "set cubes visibility"

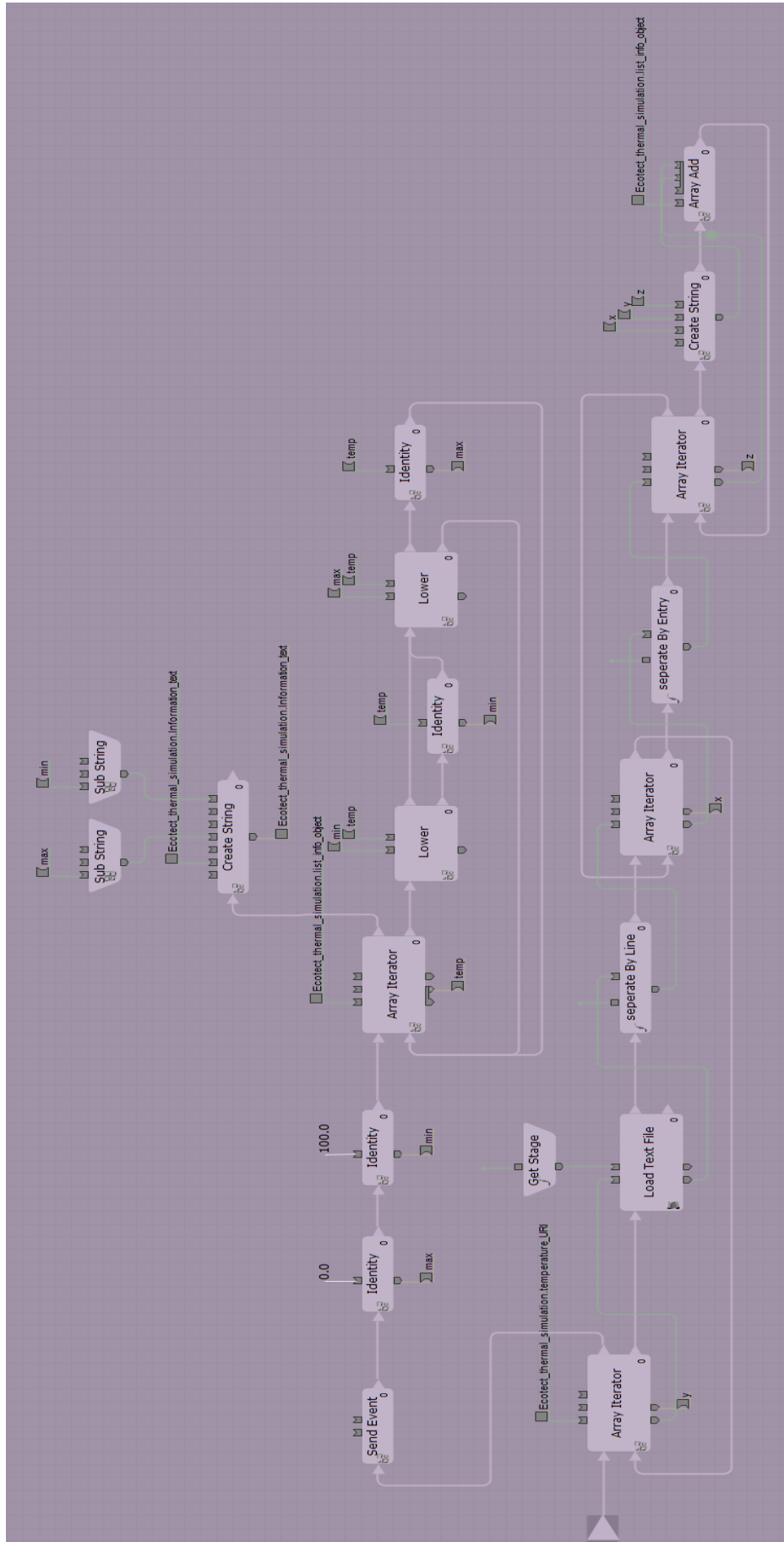

A.2.17. Function of information text regarding simulation results on panel info

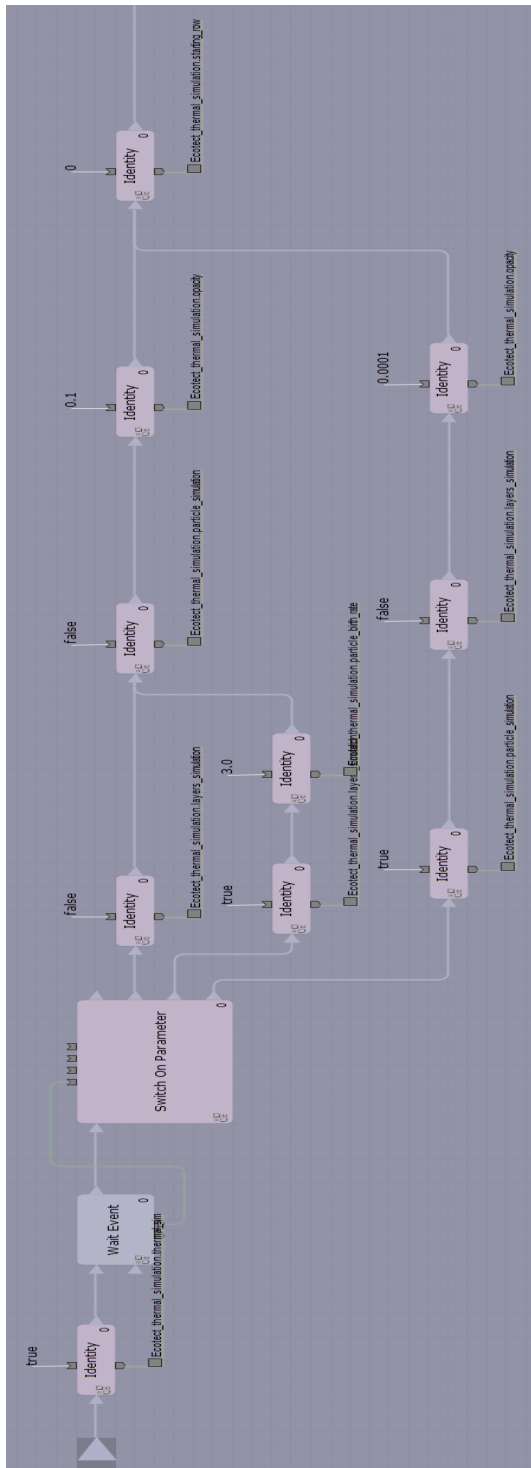

A.2.18. Thermal simulation - Particle Generation

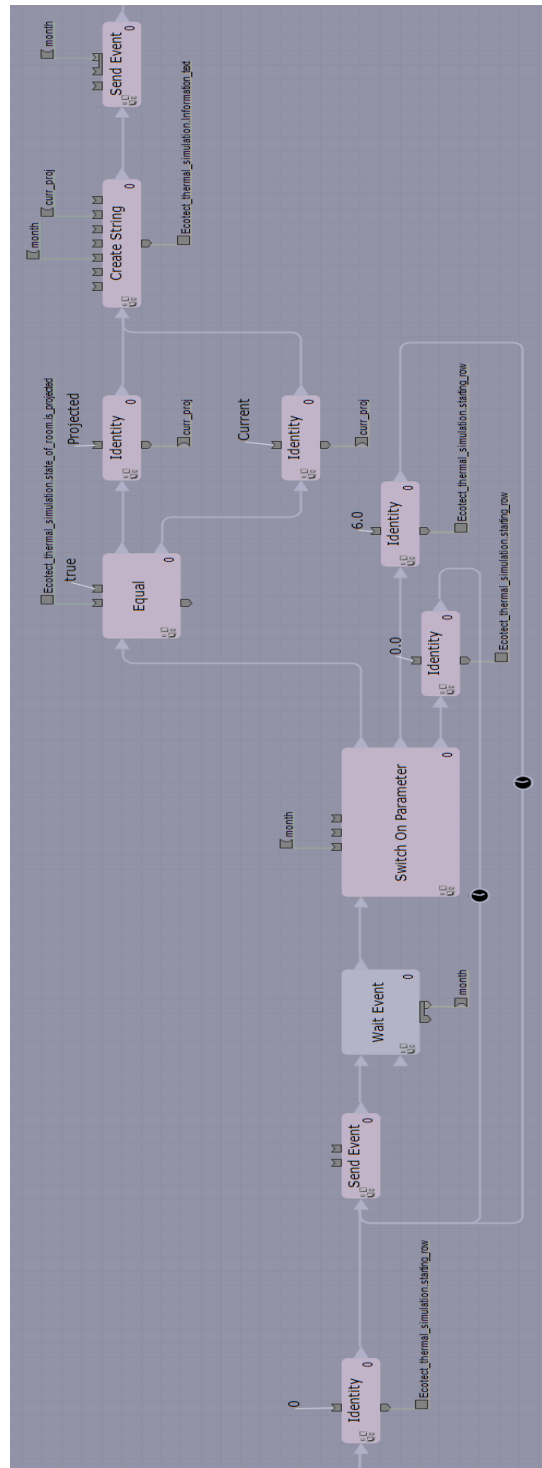

A.2.19. Thermal simulation – Switch between current and renovated version

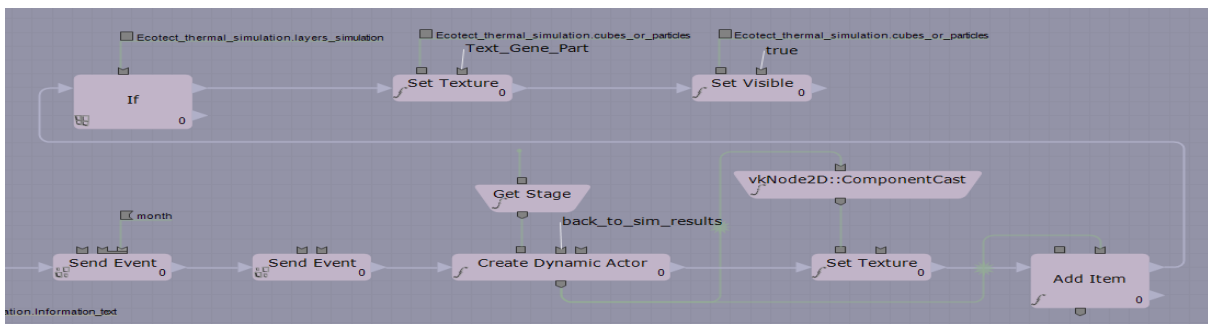

A.2.20. Thermal simulation – Texture visibility (Particle and Cubes)

## "Interaction" Behavior

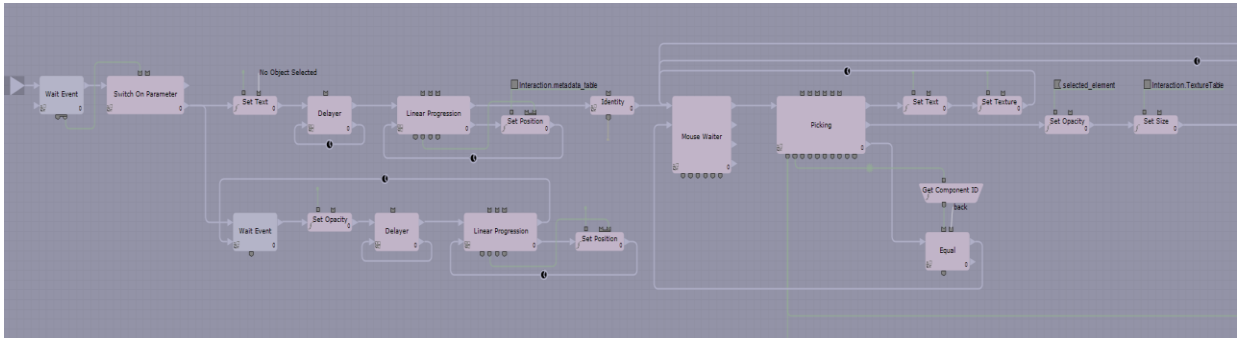

A.2.21. "Interaction" Task - Part 1

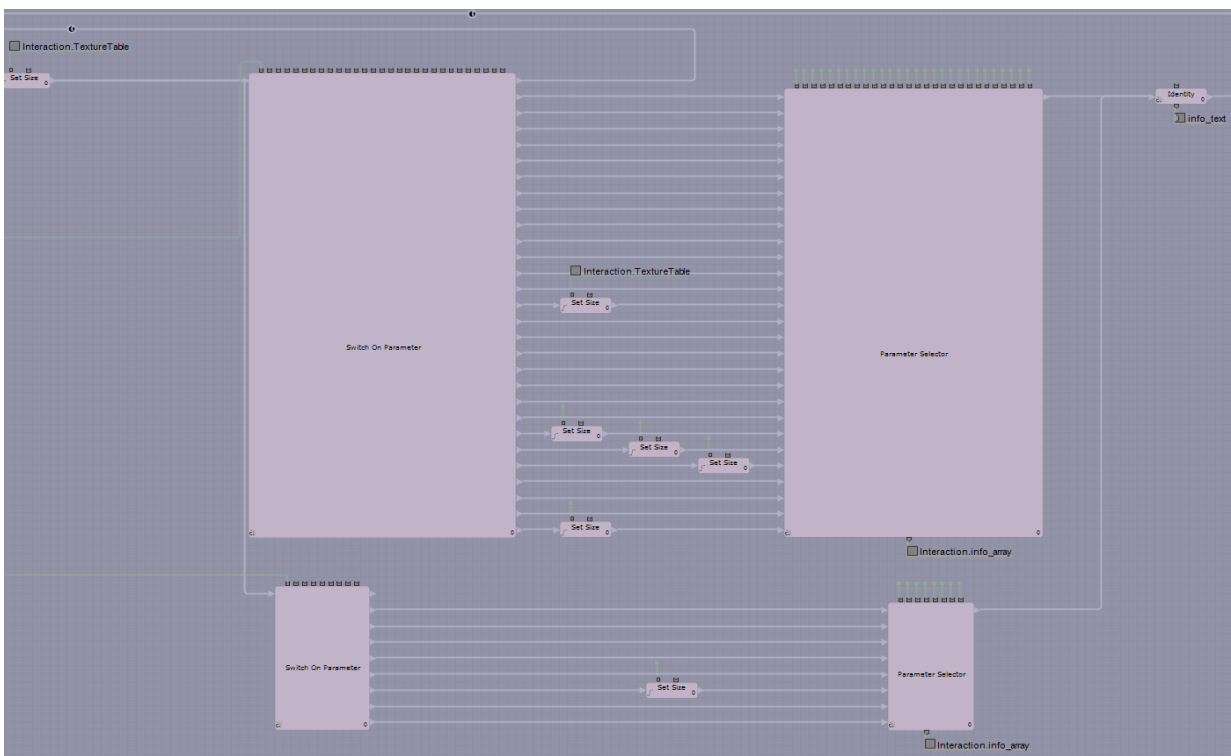

A.2.21. "Interaction" Task - Part 2

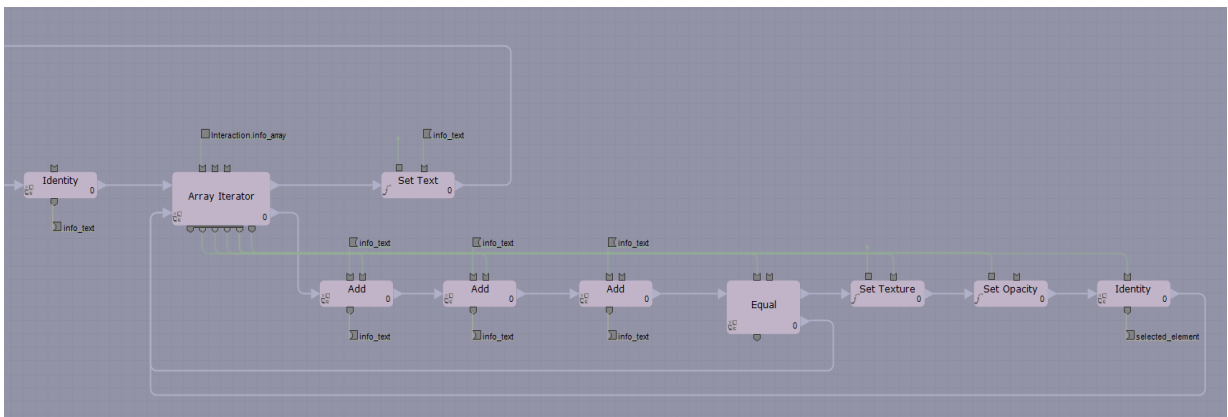

A.2.21. "Interaction" Task - Part 3

## "Thermal Simulation" Behavior

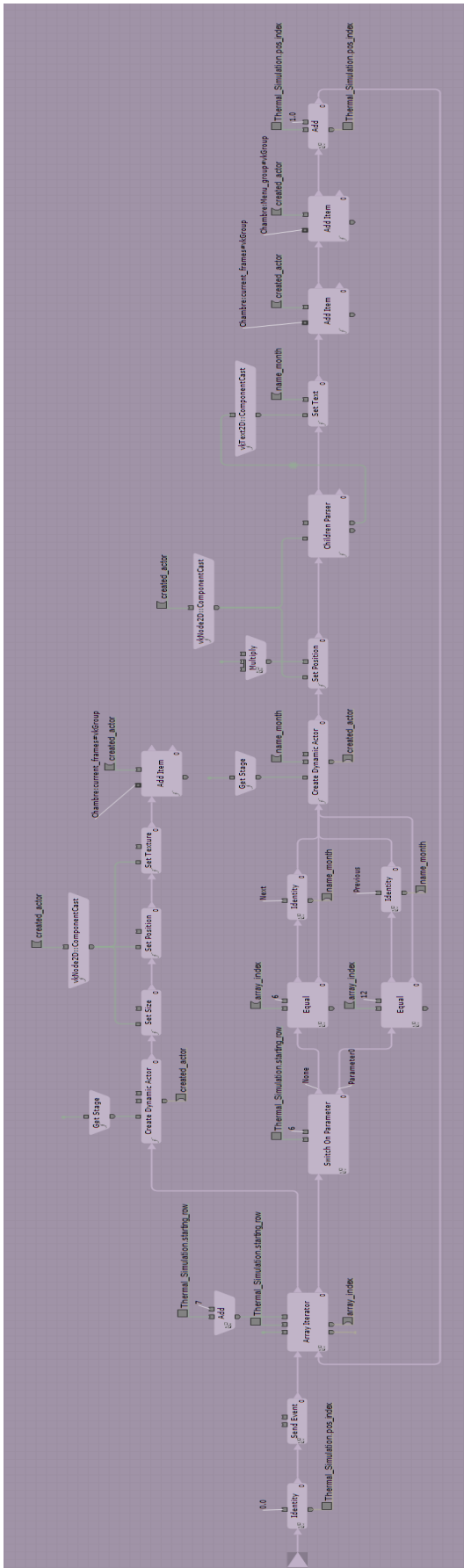

A.2.22. "Menu display" Function

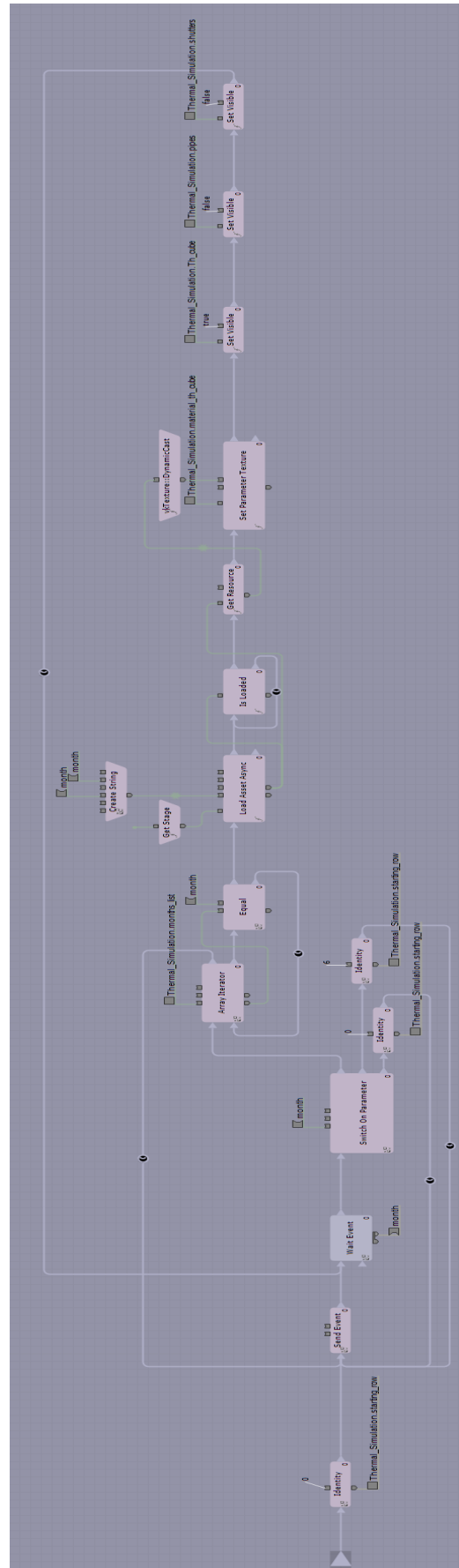

A.2.23. "Thermal simulation time"

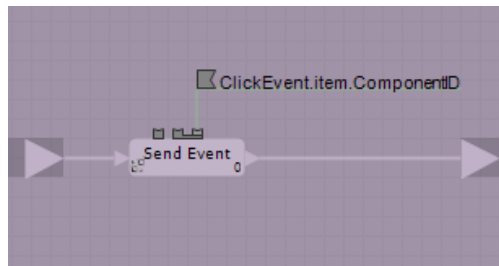

**A.2.24. "Start" Behavior - "start On Click" Function**

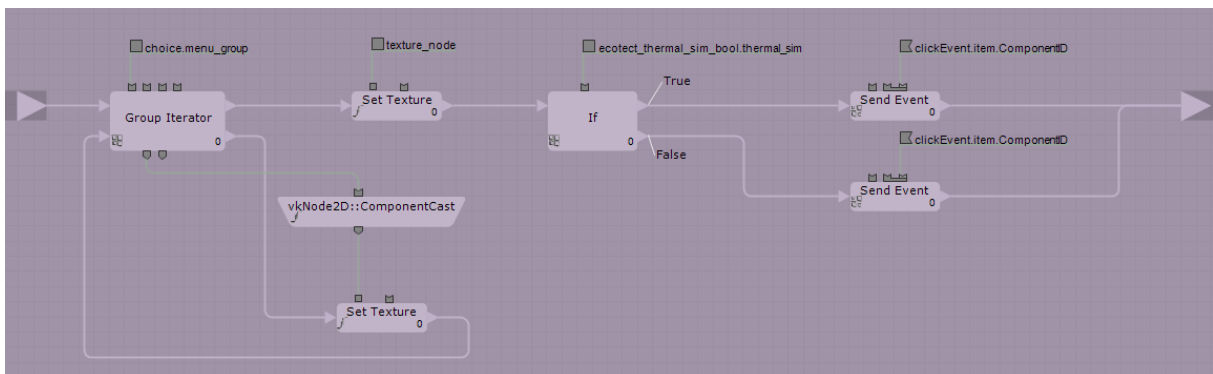

**A.2.25. "Option" Behavior - "Choice" Function between visualization cubes and particles**

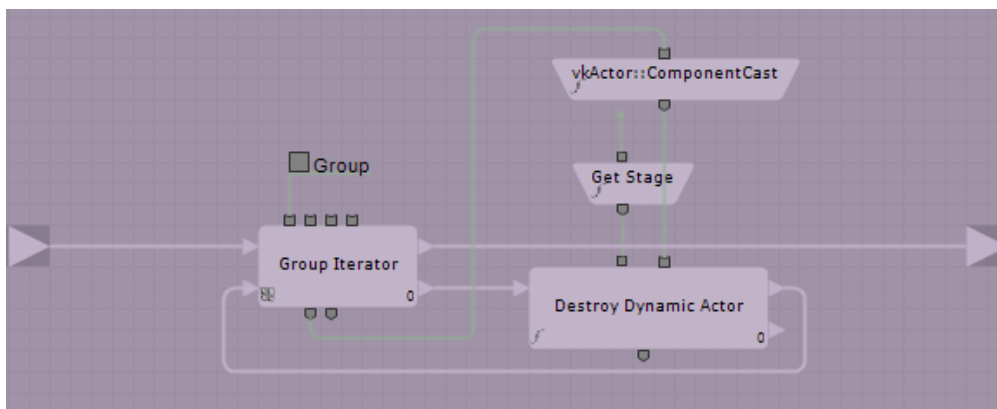

**A.2.26. "Eliminate dynamic" Behavior - "Destroy" Function**



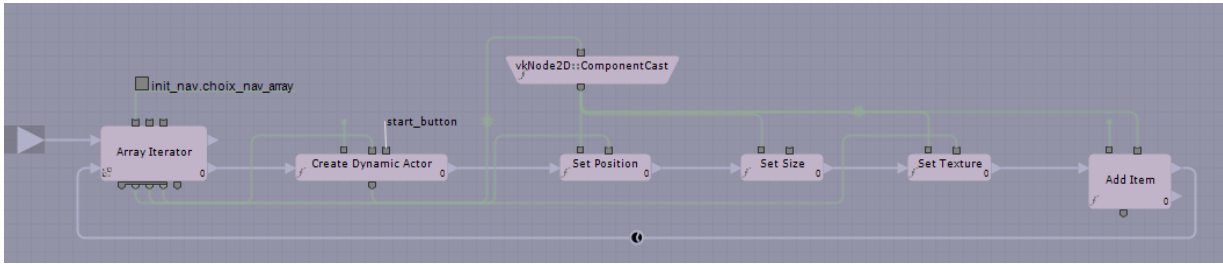

A.2.27. "Initial navigation" Behavior

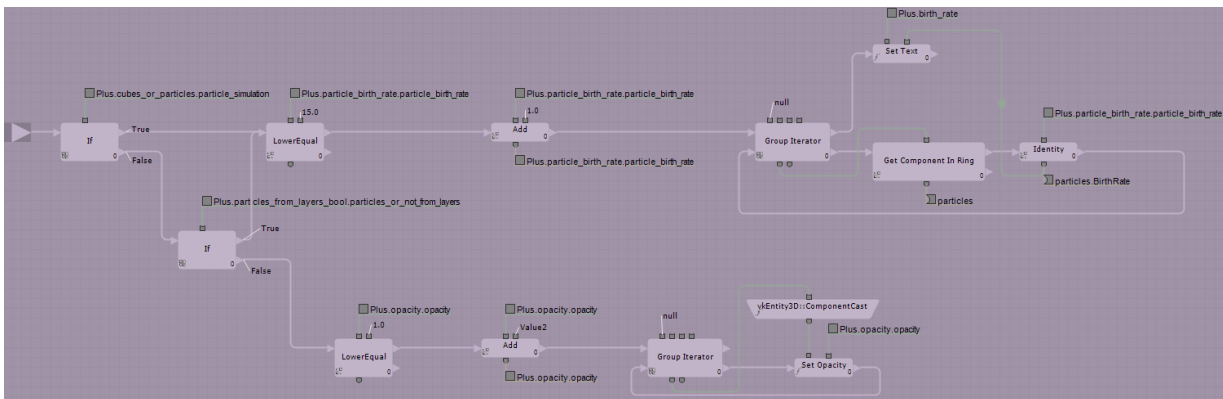

A.2.28. "Particle birth rate and cube transparency" behavior - "T\_plus" Function

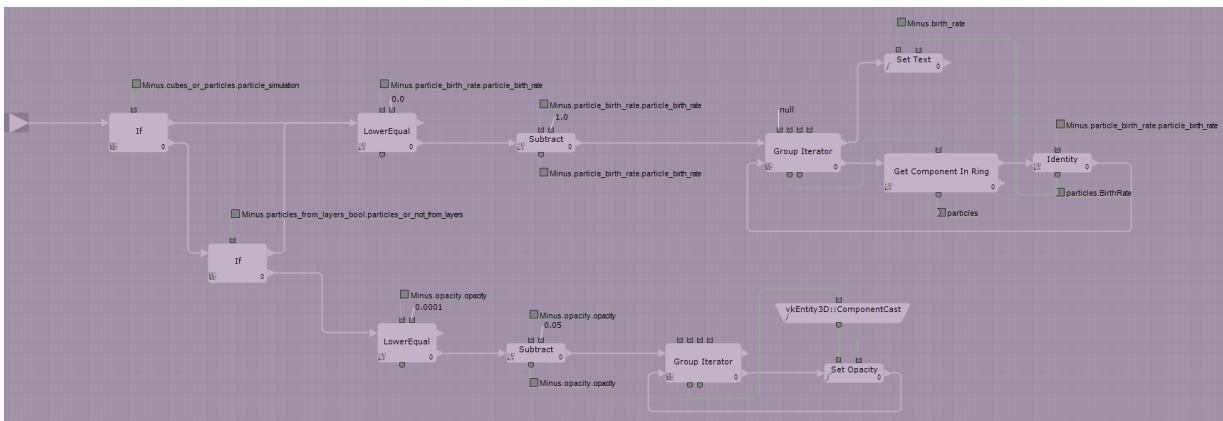

A.2.29. "Particle birth rate and cube transparency" behavior - "T\_minus" Function

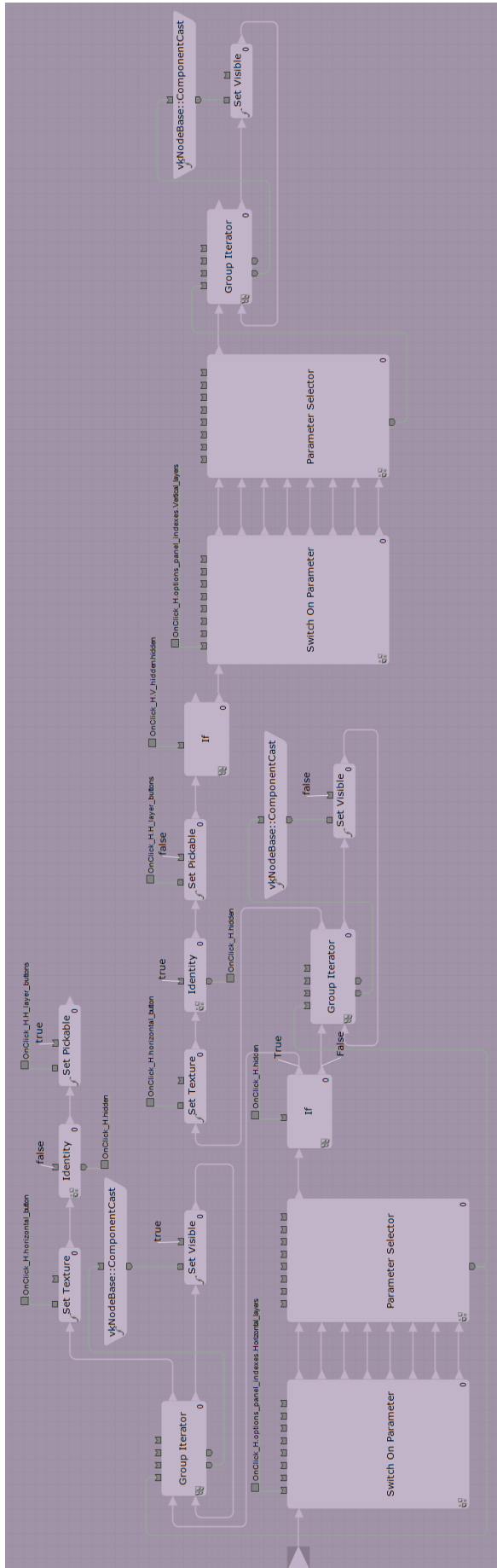

A.2.30. "Layer Horizontal" Behavior - "show-hide layers"

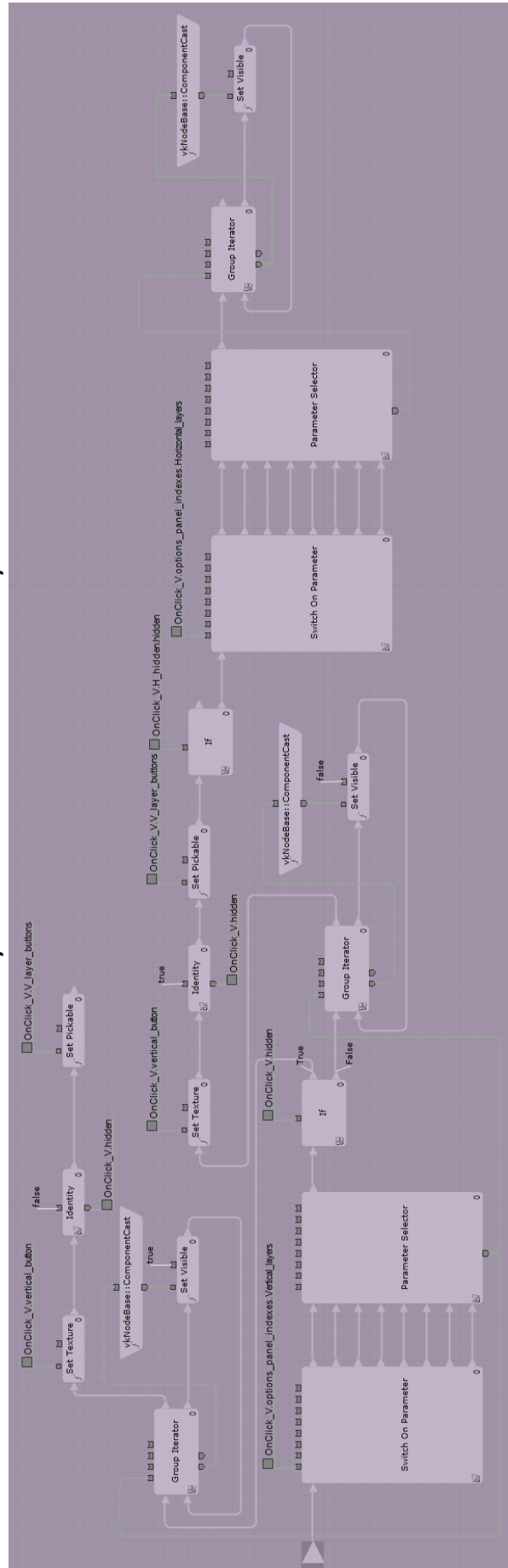

A.2.31. "Layer vertical" Behavior - "show-hide layers" Function

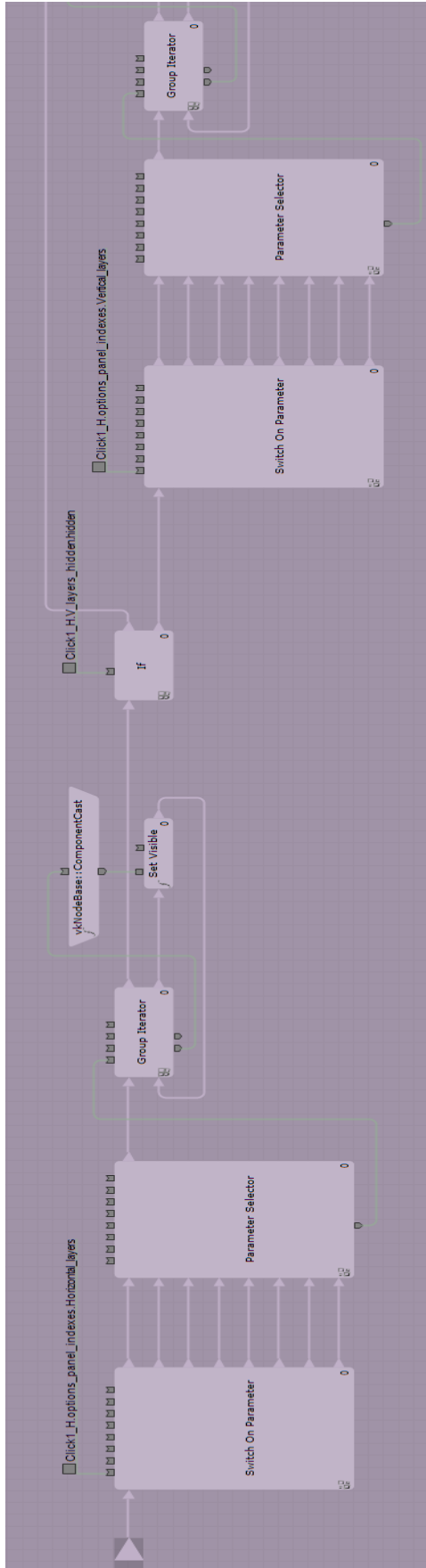

A.2.32. "Horizontal Layer" Behavior - "on/off" Function

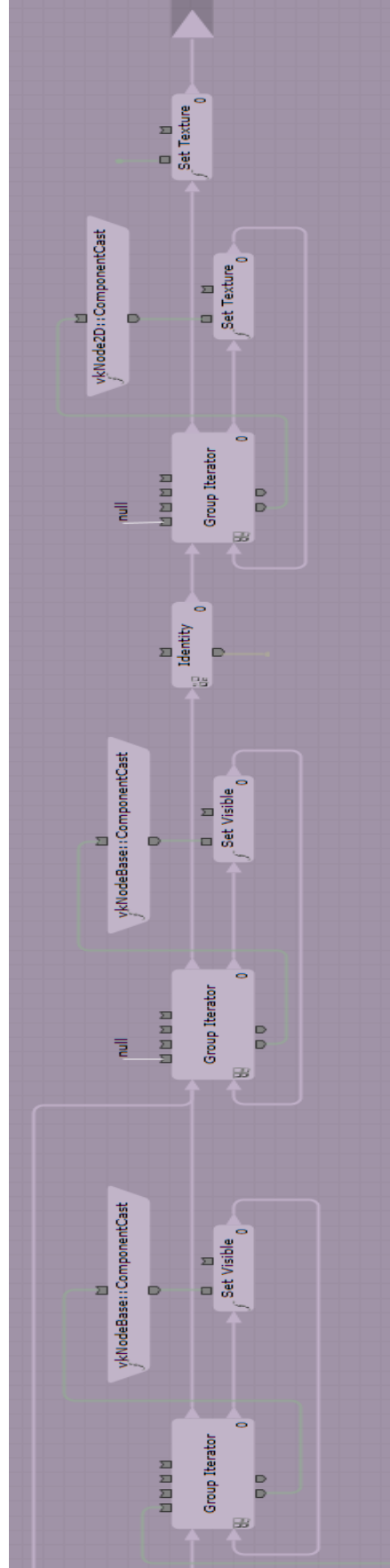

A.2.32. "Horizontal Layer" Behavior - "on/off" Function – Cont.

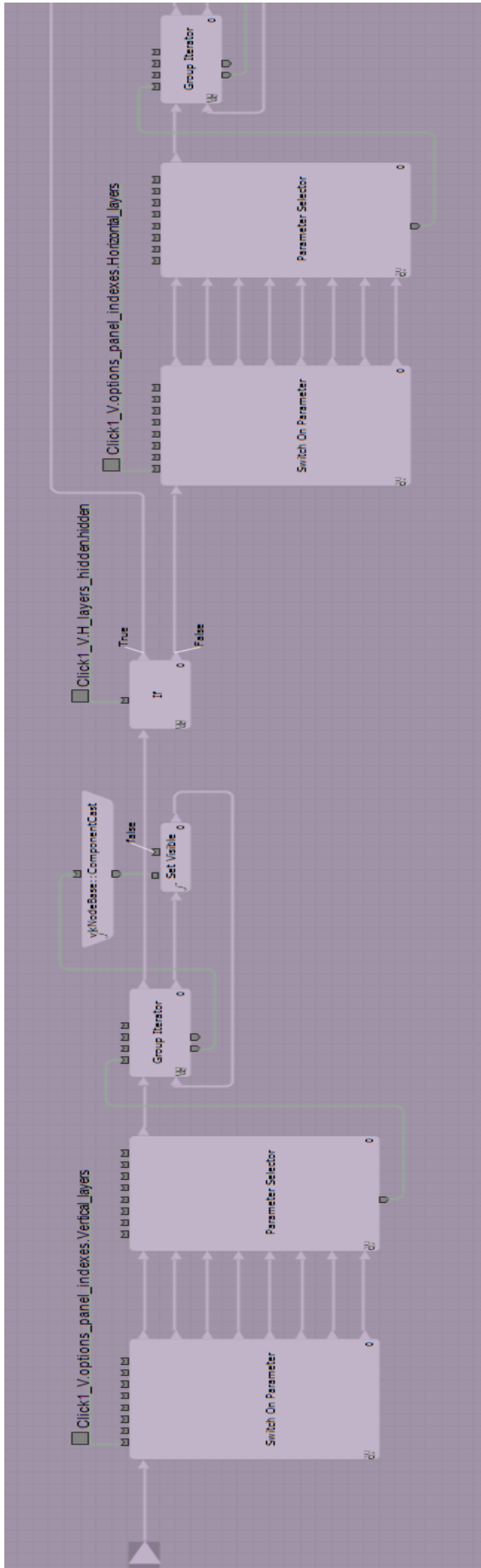

A.2.33. "Vertical Layer" Behavior - "on/off" Function

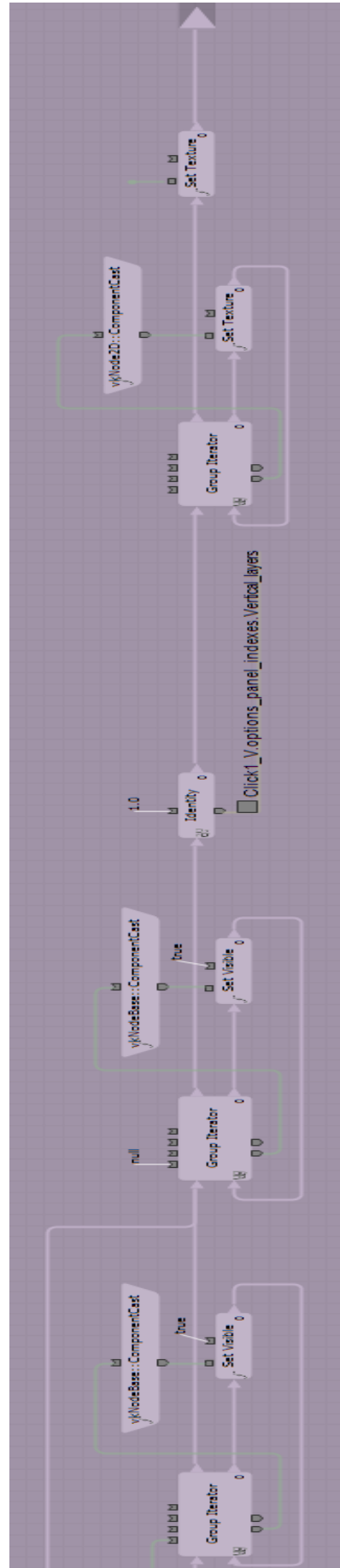

A.2.33. "Vertical Layer" Behavior - "on/off" Function – Cont.

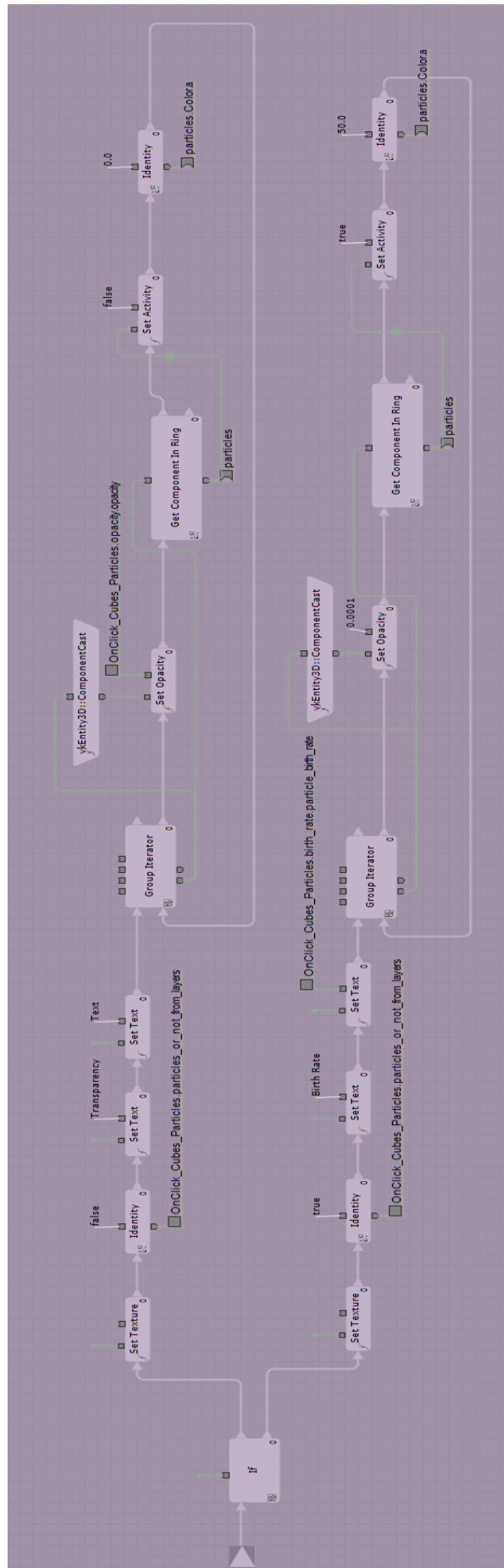

A.2.34. "Switch display of Cubes and Particles" Automatic Function

## **Appendix B :** **IFC data of Gunzo room**

(Created from Revit Architecture)



IFC Type : IFCWALLSTANDARDCASE  
 Name : Basic Wall:GZ-Interieur 850mm:128244  
 Object Type : Basic Wall:GZ-Interieur 850mm:127760  
 Wall\_Extension : H3920xL5500xW850  
 Material : Masonry - Stone\_850  
 Comment :

IFC Type : IFCWALLSTANDARDCASE  
 Name : Basic Wall:GZ-Exterieur 450mm:149083  
 Object Type : Basic Wall:GZ-Exterieur 450mm:149000  
 Wall\_Extension : H3920xL1660xW450  
 Material : Masonry - Stone\_450  
 Comment :

IFC Type : IFCWALLSTANDARDCASE  
 Name : Basic Wall:GZ-Exterieur 450mm:149083  
 Object Type : Basic Wall:GZ-Exterieur 450mm:149000  
 Wall\_Extension : H3920xL1660xW450  
 Material : Masonry - Stone\_450  
 Comment :

IFC Type : IFCWALLSTANDARDCASE  
 Name : Basic Wall:GZ-Exterieur 950mm:127671  
 Object Type : Basic Wall:GZ-Exterieur 950mm:398  
 Wall\_Extension : H3920xL1860xW950  
 Material : Masonry - Stone\_850  
 Comment :

IFC Type : IFCWALLSTANDARDCASE  
 Name : Basic Wall:GZ-Exterieur 950mm:148774  
 Object Type : Basic Wall:GZ-Exterieur 950mm:398  
 Wall\_Extension : H3920xL1430xW950  
 Material : Masonry - Stone\_950  
 Comment :

IFC Type : IFCWALLSTANDARDCASE  
 Name : Basic Wall:GZ-Exterieur 950mm:127671  
 Object Type : Basic Wall:GZ-Exterieur 950mm:398  
 Wall\_Extension : H3920xL1860xW950  
 Material : Masonry - Stone\_850  
 Comment : renovation component

IFC Type : IFCWALLSTANDARDCASE  
 Name : Basic Wall:GZ-Exterieur 950mm:148774  
 Object Type : Basic Wall:GZ-Exterieur 950mm:398  
 Wall\_Extension : H3920xL1430xW950  
 Material : Masonry - Stone\_950  
 Comment :

IFC Type : IFCWALLSTANDARDCASE  
 Name : Basic Wall:GZ-Interieur 850mm:484625  
 Object Type : Basic Wall:GZ-Interieur 850mm:398  
 Wall\_Extension : H1000xL1430xW850  
 Material : Masonry - Stone\_850  
 Comment : renovation component

IFC Type : IFCWALLSTANDARDCASE  
 Name : Basic Wall:GZ-Cloison 80mm:127900  
 Object Type : Basic Wall:GZ-Cloison 80mm:127783  
 Wall\_Extension : H3920xL4350xW80  
 Material : Masonry - Brick\_80  
 Comment :

IFC Type : IFCWALLSTANDARDCASE  
 Name : Basic Wall:GZ-Cloison 350mm:129885  
 Object Type : Basic Wall:GZ-Cloison 350mm:128348  
 Wall\_Extension : H3920xL1000xW350  
 Material : Masonry - Brick\_350  
 Comment :

-----  
 IFC Type : IFCWALLSTANDARDCASE  
 Name : Basic Wall:GZ-Cloison 350mm:130041  
 Object Type : Basic Wall:GZ-Cloison 350mm:160280  
 Wall\_Extension : H3920xL1000xW350  
 Material1 : Plasterboard\_12  
 Material2 : Masonry - Concrete Block\_326  
 Material3 : Plasterboard\_12  
 Comment :

-----  
 IFC Type :IFCWALLSTANDARDCASE  
 Name : Basic Wall:Interior - Blockwork 191:132978  
 Object Type : Basic Wall:Interior - Blockwork 191:160280  
 Wall\_Extension : H3920xL700xW350  
 Material :  
 Comment :

-----  
 IFC Type :IFCWALLSTANDARDCASE  
 Name : Basic Wall Interior - Blockwork 191:133042  
 Object Type : Basic Wall Interior - Blockwork 191:160280  
 Wall\_Extension : H3920xL1650xW350  
 Material1 : Plasterboard\_12  
 Material2 : Masonry - Concrete Block\_326  
 Material3 : Plasterboard\_12  
 Comment :

-----  
 IFC Type :IFCWALLSTANDARDCASE  
 Name : Basic Wall Interior - Blockwork 191:133073  
 Object Type : Basic Wall Interior - Blockwork 191:160280  
 Wall\_Extension : H3920xL350xW350  
 Material1 : Plasterboard\_12  
 Material2 : Masonry - Concrete Block\_326  
 Material3 : Plasterboard\_12  
 Comment :

-----  
 IFC Type :IFCWALLSTANDARDCASE  
 Name : Basic Wall Interior - Blockwork 191:133193  
 Object Type : Basic Wall Interior - Blockwork 191:160280  
 Wall\_Extension : H3920xL2000xW350  
 Material1 : Plasterboard\_12  
 Material2 : Masonry - Concrete Block\_326  
 Material3 : Plasterboard\_12  
 Comment :

-----  
 IFC Type :IFCCOVERING  
 Name : Compound Ceiling:Plain:215150  
 Object Type : Compound Ceiling:Plain  
 Material1 : Plasterboard\_12  
 Material2 : Metal - Stud Layer\_45  
 Comment :

-----  
 Name : Family6 Type 1 [151033]  
 Height : 720  
 Description : 13 components\_6 pins  
 Power: 3000 Watts  
 Manufacturer : Chapepe  
 Next revision: 2013  
 Comment : current heater

-----  
 IFC Type : IFCSLAB  
 Name : Floor:Generic 150mm:130265  
 Object Type : Floor:Generic 150mm  
 Material : Wood-Flooring\_150  
 Comment :

-----  
 IFC Type :NA  
 Name : Interior\_Panes  
 Object Type : Window\_Panes  
 Size : H2970xW690  
 Material :Wood (Oak)  
 Comment :

-----  
 IFC Type :NA  
 Name : M\_LightingSwitch:216488  
 Object Type : Single Pole\_LightingSwitch  
 Size : H76xL82xW5  
 Material :Plastic  
 Manufacturer : Legrand  
 ElectricalFeatures : SwitchVoltage  
 Comment :

-----  
 IFC Type :NA  
 Name : M\_LightingSwitch:216541  
 Object Type : Single Pole\_LightingSwitch  
 Size : H67xL54xW27  
 Material :Plastic  
 Manufacturer : Legrand  
 ElectricalFeatures : SwitchVoltage

-----  
 IFC Type :NA  
 Name : Pipe\_Heater  
 Object Type : Supplying\_Pipe  
 Size : 1/2 i  
 Material :Lead  
 Manufacturer : MNG  
 Comment : thermostatic valve

-----  
 IFC Type : IFCBUILDINGELEMENTPROXY  
 Name : Wall Sweep:Cornice 2:216714  
 Object Type : Wall Sweep:Cornice 2  
 Comment :

-----  
 IFC Type :NA  
 Name : Chimney  
 Object Type : Ornamental\_Furniture  
 Bounding box : H1010xL1294xW340  
 Material :Stone  
 Comment : Not\_Functional

-----  
 IFC Type :NA  
 Name : TubeLamp.double:235804  
 Object Type : TubeLamp.double\_Neon  
 Size : L1580xH120xW420  
 Power : 2x36W  
 Material :Steel  
 Manufacturer : Philips  
 ElectricalFeatures : Voltage\_LampId\_ferromagnetic  
 Comment : sockets provided by Legrand

-----  
 IFC Type :NA

Name : TubeLamp.double:235920  
 Object Type : TubeLamp.double\_Neon  
 Size : L1580xH120xW420  
 Power : 2x36W  
 Material :Steel  
 Manufacturer : Philips  
 ElectricalFeatures : Voltage\_LampId\_ferromagnetic  
 Comment : sockets provided by Legrand

Overall\_Height : 3100  
 Overall\_Width : 1750  
 Geometry\_Body :  
 MappedGeometry\_SurfaceModel\_1370Faces  
 Window Style : 1.75m x  
 3.1m\_DOUBLE\_PANEL\_VERTICAL  
 Comment : renovation component

-----  
 IFC Type : IFCBUILDINGELEMENTPROXY  
 Name : Wall Sweep:Cornice 2:216714  
 Object Type : Wall Sweep:Cornice 2  
 Comment : renovation component

-----  
 Name: Radiator-Hydronic Baseboard 4" x 2" [485333]  
 Power: 2500 Watts  
 Manufacturer : Buderus  
 Next revision: 2020  
 Comment : renovation component

-----  
 IFC Type : IFCDOOR  
 Name : M\_Single-Flush:GZ-Porte2:GZ-Porte2:134734  
 Object Type : GZ-Porte2  
 Overall\_Height : 2125  
 Overall\_Width : 830  
 Material :particle\_panel\_alveolus  
 Manufacturer : Isoplane  
 DoorStyle\_OperationType : SINGLE\_SWING\_LEFT  
 Comment :

-----  
 IFC Type : IFCWINDOW  
 Name : Glazing\_Bars  
 Object Type : NA  
 Component\_size : L40xW20  
 Material :Wood (Oak)  
 Comment :

-----  
 IFC Type : IFCDOOR  
 Name : M\_Single-Panel 2:0915 x 2134mm:0915 x  
 2134mm:136027  
 Object Type : 0915 x 2134mm  
 Material :Wood (Oak)  
 Overall\_Height : 1880  
 Overall\_Width : 850  
 DoorStyle\_OperationType : SINGLE\_SWING\_LEFT  
 Comment :

-----  
 IFC Type : IFCWINDOW  
 Name : Window\_Glazing  
 Object Type : Pane\_Glazing  
 Component\_size : H255xW160

-----  
 IFC Type : IFCBUILDINGELEMENTPROXY  
 Name : Wall Sweep:Cornice 2:132217  
 Object Type : Wall Sweep:Cornice 2  
 Comment :

-----  
 IFC Type : IFCDOOR  
 Name : M\_Single-Panel 3:0762 x 2032mm:0762 x  
 2032mm:131221  
 Object Type : 0762 x 2032mm  
 Material :Wood (Oak)  
 Overall\_Height : 2050  
 Overall\_Width : 850  
 DoorStyle\_OperationType : SINGLE\_SWING\_RIGHT  
 Comment :

-----  
 IFC Type : IFCBUILDINGELEMENTPROXY  
 Name : Wall Sweep:Cornice 2:484944  
 Object Type : Wall Sweep:Cornice 2  
 Comment : renovation component

-----  
 IFC Type : IFCWINDOW  
 Internal Type : IfcWindow  
 Name : PF 2 Vantaux Cintrés - Volets et Petits bois-  
 2b:1.60m x 3m:1.60m x 3m:149324  
 Object Type : 1.60m x 3m  
 Overall\_Height : 3000  
 Overall\_Width : 1600  
 Geometry\_Body :  
 MappedGeometry\_SurfaceModel\_1370Faces  
 Window Style : 1.60m x 3m\_DOUBLE\_PANEL\_VERTICAL  
 Comment :

-----  
 IFC Type : IFCWINDOW  
 Internal Type : IfcWindow  
 Name : PF 2 Vantaux Cintrés - Volets et Petits bois-  
 2b:1.75m x 3.1m:1.75m x 3.1m:149324  
 Object Type : 1.75m x 3.1m



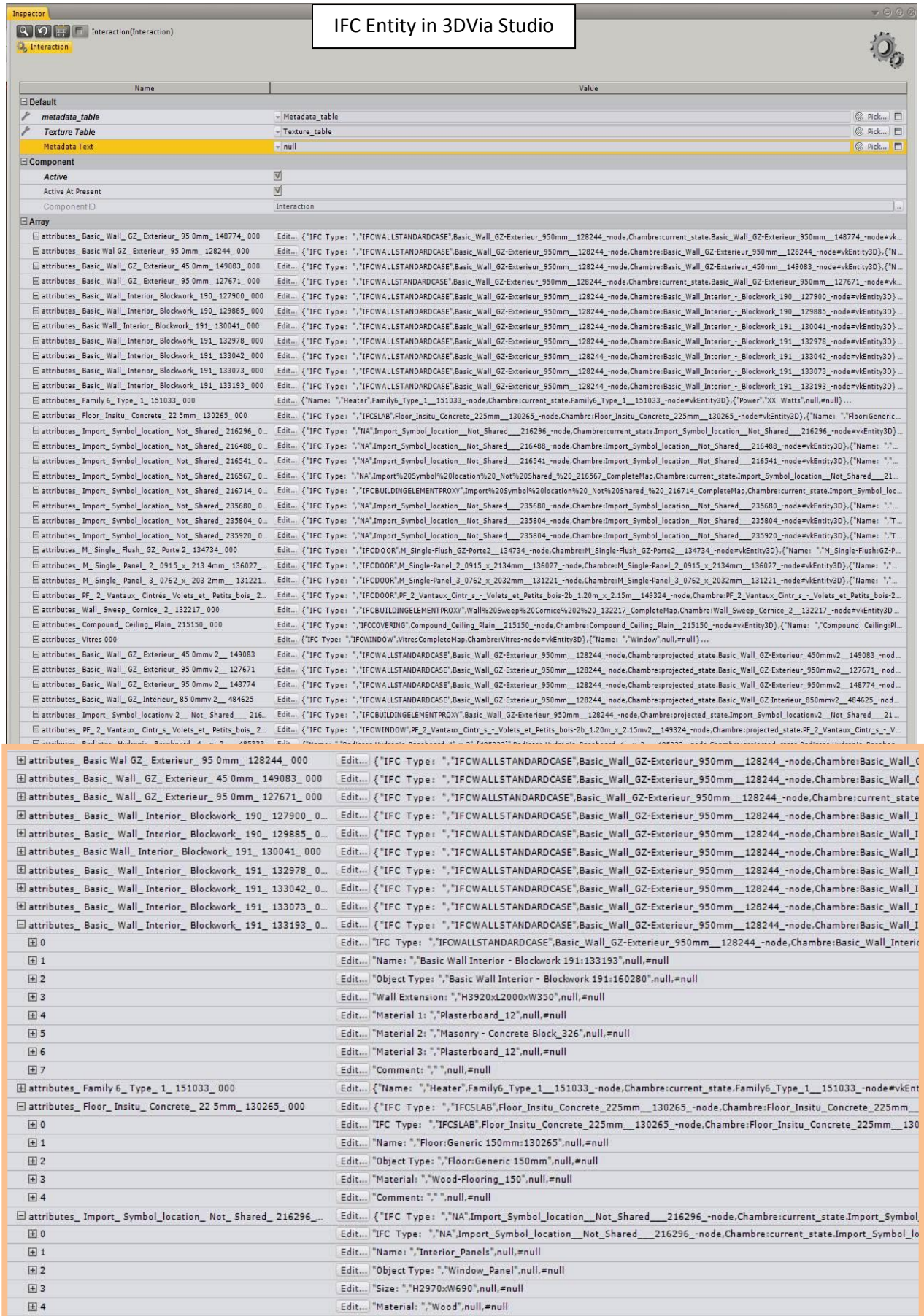

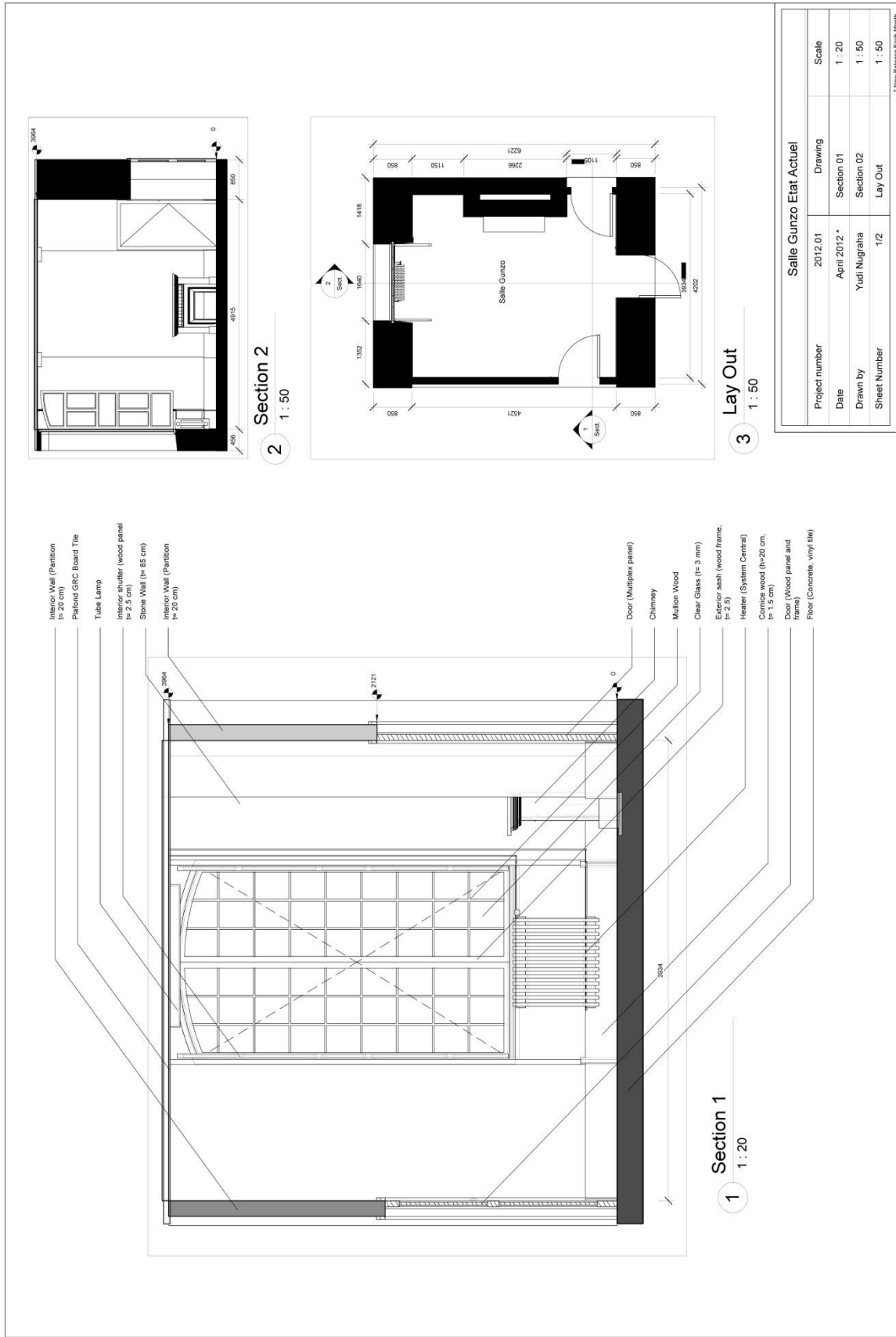

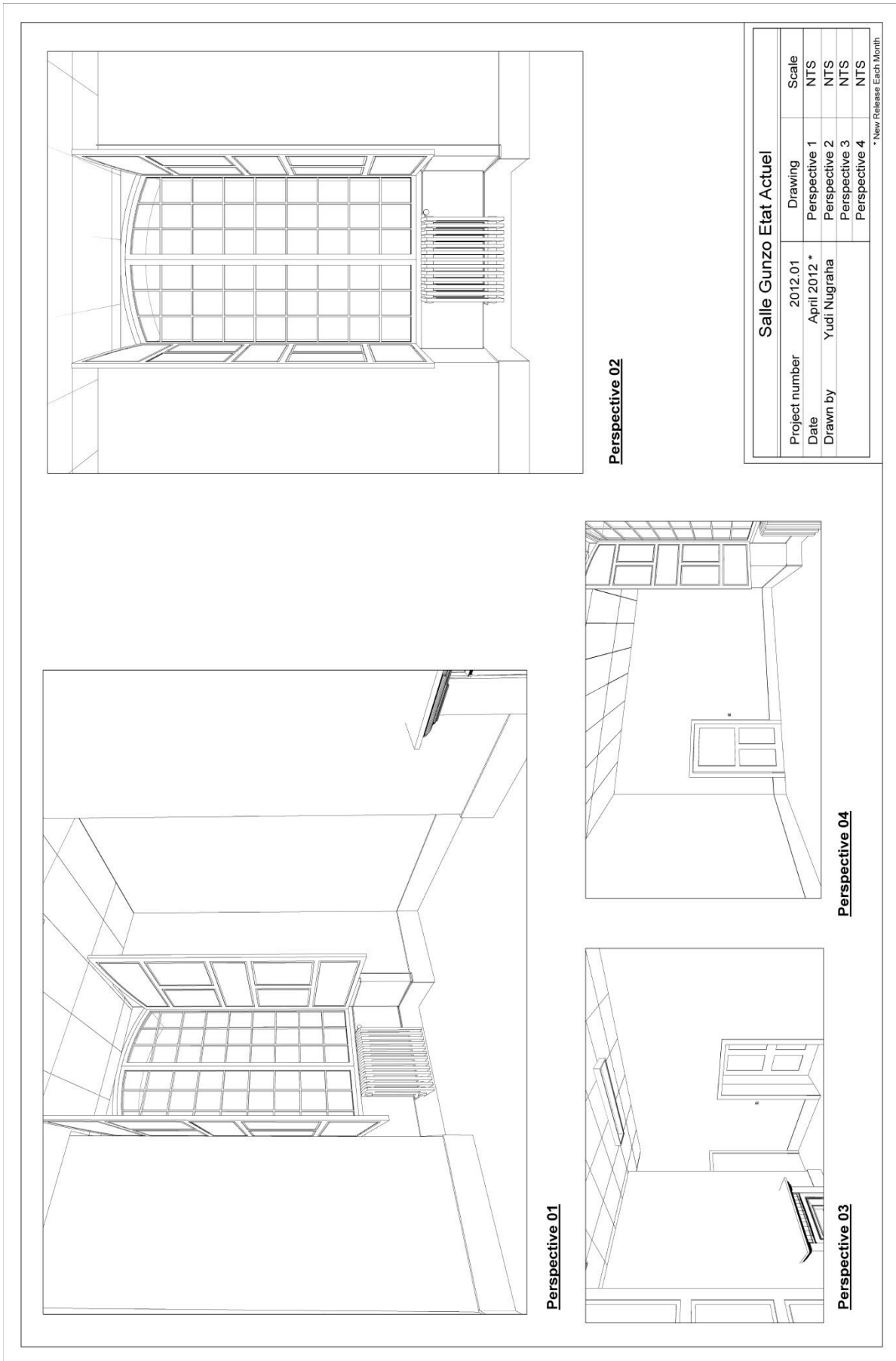

**Perspective 01**

**Perspective 02**

**Perspective 03**

**Perspective 04**

Salle Gunzo Etat Actuel			
Project number	2012.01	Drawing	Scale
Date	April 2012 *	Perspective 1	NTS
Drawn by	Yudi Nugrana	Perspective 2	NTS
		Perspective 3	NTS
		Perspective 4	NTS

\* New Release Each Month

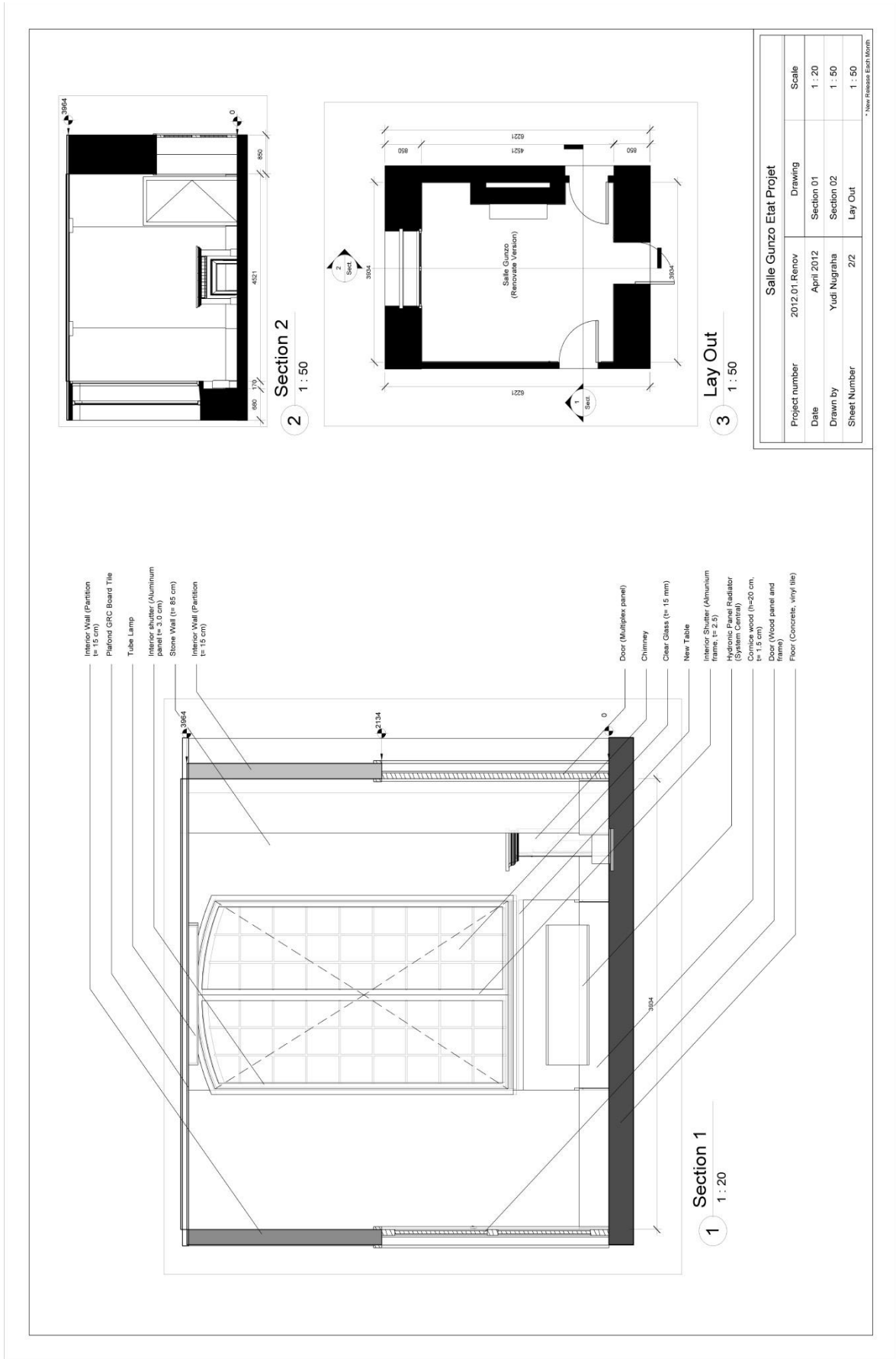

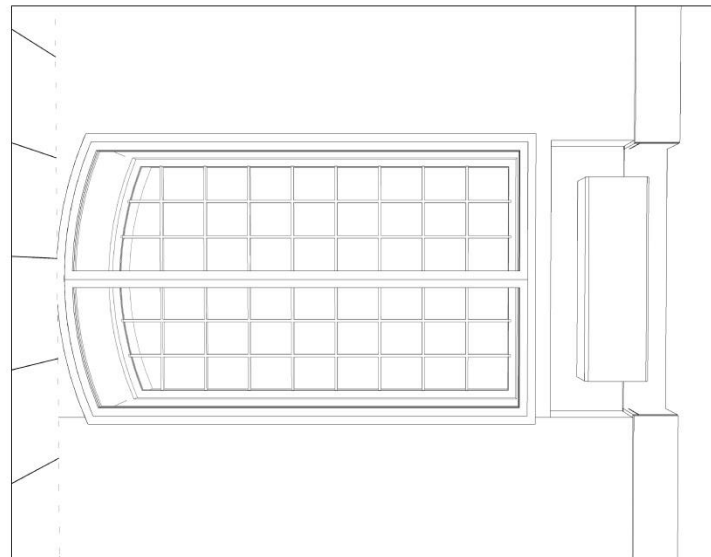

**Perspective 01**

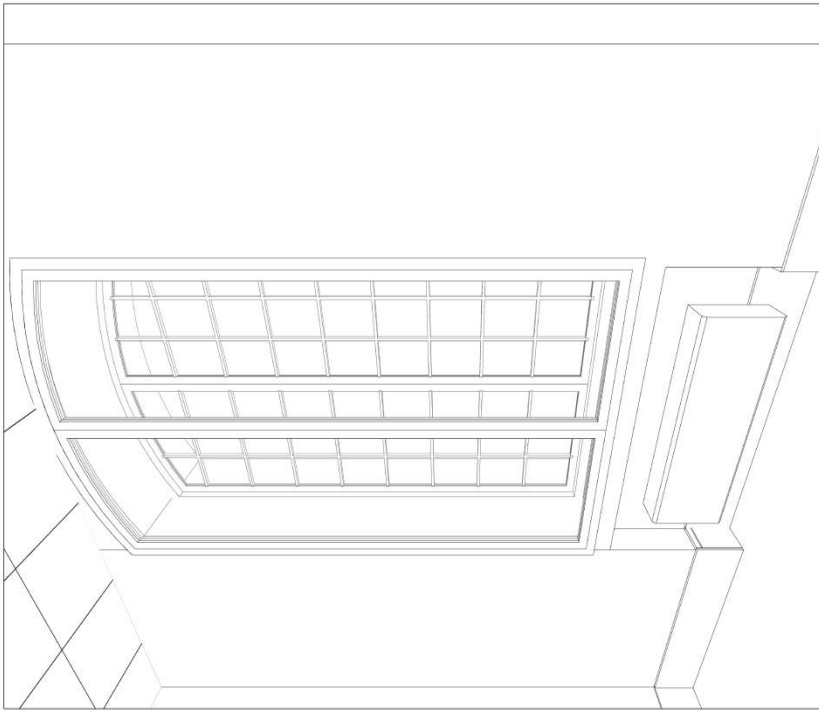

**Perspective 02**

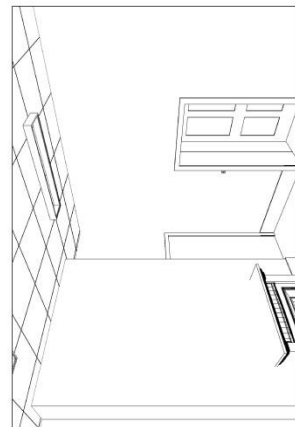

**Perspective 03**

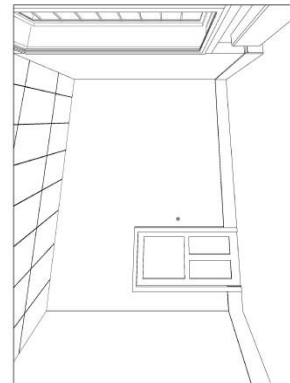

**Perspective 04**

**Salle Gunzo Etat Projet**

Project number	Date	Drawn by	Drawing	Scale
2012.01.Renov	April 2012	Yudi Nugraha	Perspective 1	NTS
			Perspective 2	NTS
			Perspective 3	NTS
			Perspective 4	NTS

\* New Release Each Month

## **Appendix C : Questioner of the experiment**

### **Questionnaire Particules**

1. **Quelle est la température observé à l'entrée, avant travaux, en Mars?**  
 a) 13-15°C                      b) 15-17°C                      c) 17-19°C                      d) 19-21°C
2. **Quelle est la température observé à la cheminée, avant travaux, en Janvier?**  
 a) <11°C                      b) 11-13°C                      c) 13-15°C                      d) 15-17°C
3. **Laquelle des zones suivantes de la pièce a des températures entre 27-29°C, après travaux, en Août?**  
 a) devant la fenêtre                      b) l'entrée                      c) le mûr gauche                      d) le mûr droit
- 4 **Laquelle des zones suivantes de la pièce a des températures entre 13-15°C, après travaux, en Novembre?**  
 a) l'entrée                      b) le mûr gauche                      c) le sol                      d) le plafond
5. **Quelle est la température maximale dans la pièce avant travaux, simulée en Novembre?**  
 a) 18.078°C                      b) 18.147°C                      c) 18.922°C                      d) 19.022°C
6. **Quelle est la température minimale dans la pièce avant travaux, simulée en Décembre?**  
 a) 10.426°C                      b) 11.058°C                      c) 9.840°C                      d) 10.976°C
7. **Quelle est la température maximale dans la pièce après travaux, simulée en Juin?**  
 a) 27.565°C                      b) 27.209°C                      c) 27.784°C                      d) 27.397°C
8. **Quelle est la température minimale dans la pièce après travaux, simulée en Février?**  
 a) 14.840°C                      b) 14.416°C                      c) 13.936°C                      d) 14.978°C
9. **Quel effet a la rénovation sur les valeurs maximales de température de la pièce en Novembre?**  
 a) légère augmentation (0 - 3°C)                      b) légère diminution (0 - 3°C)                      c) forte augmentation (> 3°C)                      d) forte diminution (> 3°C)

### **Questionnaire Cubes**

1. **Quelle est la température observé devant la fenêtre, juste au-dessus du radiateur, après travaux, en Septembre?**  
 a) 15-17°C                      b) 17-19°C                      c) 19-21°C                      d) 21-23°C
2. **Quelle est la température observé dans le coin arrière gauche de la chambre, après travaux, en Décembre?**  
 a) 11-13°C                      b) 13-15°C                      c) 15-17°C                      d) 17-19°C
3. **Laquelle des zones suivantes de la pièce a des températures entre 11-15°C, avant travaux, en Février?**  
 a) devant la fenêtre                      b) l'entrée                      c) le mûr gauche                      d) le mûr droit
4. **Laquelle des zones suivantes de la pièce à des températures UNIQUEMENT entre 27-29°C, après travaux, en Juin?**  
 a) devant la fenêtre                      b) le mûr gauche                      c) le sol                      d) le plafond
5. **Quelle est la température maximale dans la pièce avant travaux, simulée en Avril?**  
 a) 23.475°C                      b) 22°C                      c) 20.9°C                      d) 21.794°C
6. **Quelle est la température minimale dans la pièce avant travaux, simulée en Janvier?**  
 a) 9.528°C                      b) 8.416°C                      c) 9.840°C                      d) 8.40°C
7. **Quelle est la température maximale dans la pièce après travaux, simulée en Juillet?**  
 a) 29.321°C                      b) 30.425°C                      c) 28.84°C                      d) 28.209°C
8. **Quelle est la température minimale dans la pièce après travaux, simulée en Novembre?**  
 a) 12.840°C                      b) 11.209°C                      c) 13.928°C                      d) 13.217°C
9. **Quel effet a la rénovation sur les valeurs maximales de température de la pièce en Décembre?**  
 a) légère augmentation (0-3°C)                      b) légère diminution (0-3°C)                      c) forte augmentation (>3°C)                      d) forte diminution (>3°C)

### Questionnaire Couches-Cubes

1. Quelle est la température observé sur le mûr gauche, avant travaux, en Août?
  - a) 23-25°C
  - b) 25-27°C
  - c) 27-29°C
  - d) >29°C
2. Quelle est la température observé dans le coin avant droit de la pièce, après travaux, en Novembre?
  - a) 11-13°C
  - b) 13-15°C
  - c) 15-17°C
  - d) 17-19°C
3. Laquelle des zones suivantes de la pièce a des températures entre 23-25°C, après travaux, en Juillet?
  - a) devant la fenêtre
  - b) coin avant gauche
  - c) le mûr gauche
  - d) le mûr droit
4. Laquelle des zones suivantes de la pièce a des températures UNIQUEMENT entre 19-21°C, après travaux, en Décembre?
  - a) le sol
  - b) le mûr gauche
  - c) devant la fenêtre
  - d) le plafond
5. Quelle est la température maximale dans la pièce avant travaux, simulée en Mars?
  - a) 19.690°C
  - b) 20.003°C
  - c) 20.9°C
  - d) 19.443°C
6. Quelle est la température minimale dans la pièce avant travaux, simulée en Mai?
  - a) 15.992°C
  - b) 17.273°C
  - c) 16.339°C
  - d) 16.432°C
7. Quelle est la température maximale dans la pièce après travaux, simulée en Juin?
  - a) 29.321°C
  - b) 27.397°C
  - c) 28.84°C
  - d) 28.209°C
8. Quelle est la température minimale dans la pièce après travaux, simulée en Juillet?
  - a) 26.638°C
  - b) 27.064°C
  - c) 26.899°C
  - d) 27.223°C
9. Quel effet a la rénovation sur les valeurs minimales de température de la pièce en Janvier?
  - a) légère augmentation  
(0 - 3°C)
  - b) légère diminution  
(0 - 3°C)
  - c) forte augmentation  
(> 3°C)
  - d) forte diminution  
(> 3°C)

### Questionnaire Couches-Particules

1. Quelle est la température observé à l'entrée, avant travaux, en Janvier?
  - a) 15-17°C
  - b) 17-19°C
  - c) 19-21°C
  - d) 21-23°C
2. Quelle est la température maximale observé sur le plafond, avant travaux, en Septembre?
  - a) 23-25°C
  - b) 25-27°C
  - c) 27-29°C
  - d) >29°C
3. Laquelle des zones suivantes de la pièce a des températures entre 19-21°C, après travaux, en Février?
  - a) le mûr droit
  - b) l'entrée
  - c) le mûr gauche
  - d) devant la fenêtre
4. Laquelle des zones suivantes de la pièce a des températures UNIQUEMENT entre 17-19°C, avant travaux, en Mai?
  - a) l'entrée
  - b) devant la fenêtre
  - c) le sol
  - d) le plafond
5. Quelle est la température maximale dans la pièce avant travaux, simulée en Novembre?
  - a) 18.147°C
  - b) 18.324°C
  - c) 19.354°C
  - d) 19.002°C
6. Quelle est la température minimale dans la pièce avant travaux, simulée en Octobre?
  - a) 10.233°C
  - b) 10.659°C
  - c) 10.986°C
  - d) 11.265°C
7. Quelle est la température maximale dans la pièce après travaux, simulée en Mars?
  - a) 21.547°C
  - b) 20.678°C
  - c) 22.591°C
  - d) 20.648°C
8. Quelle est la température minimale dans la pièce après travaux, simulée en Juin?
  - a) 22.542°C
  - b) 25.519°C
  - c) 23.4813°C
  - d) 24.942°C
9. Quel effet a la rénovation sur les valeurs minimales de température de la pièce en Février?
  - a) légère augmentation  
(0 - 3°C)
  - b) légère diminution  
(0 - 3°C)
  - c) forte augmentation  
(> 3°C)
  - d) forte diminution  
(> 3°C)

## Questionnaire

Acquisition d'informations			
Numéro de passage		Date	
Informations personnels			
Nom		Tel	
Prénom		Email	
Age		H/F	

1. **Afin de connaître la température d'une pièce après rénovation (la pièce n'a pas encore été construite) préférez-vous:**
  - a. D'attendre jusqu'à ce que le bâtiment est terminé et mesurer sa température directement avec un thermomètre
  - b. Utiliser un logiciel de calcul qui résulte en un graphique où texte
  - c. Utiliser un logiciel de calcul qui résulte en une visualisation 3D et une simulation d'interaction
  
2. **Quel type d'information vous préférez avoir disponible pour une représentation d'une chambre?**
  - a. texte ou graphique
  - b. visualisation 3D
  - c. texte et visualisation 3D
  
3. **En ce qui concerne l'intervalle de temps de la visibilité des données, quand voulez-vous avoir des informations sur la température?**
  - a. uniquement à certaines occasions
  - b. chaque saison (4 saisons)
  - c. tout au long de l'année (12 mois)

(Indiquez votre réponse en marquant un "v" dans la case appropriée. S'il vous plaît considérer toute l'échelle lors de vos réponses)

1. **Vous trouvez la tâche facile à comprendre?** Difficile      Facile
  
2. **Avez-vous gardé votre concentration le long de l'expérience?** Jamais      Tout le temps
  
3. **Lorsque vous avez été impliqué dans la tâche de simulation, dans quelle mesure avez-vous eu la sensation d'être immergé dans la visualisation thermique?** Pas de tout      Très
  
4. **Lequel des 4 types de simulation sur l'ordinateur trouvez-vous le plus immersif?**
  - a) les cubes
  - b) les particules
  - c) les couches de cubes
  - d) les couches de particules
  
5. **Lequel des 4 types de simulation sur l'ordinateur trouvez-vous le moins immersif?**
  - a) les cubes
  - b) les particules
  - c) les couches de cubes
  - d) les couches de particules



**6. Lequel des 4 types de simulation sur l'ordinateur trouvez-vous le plus utile et pourquoi ?**

a) les cubes      b) les particules      c) les couches de cubes      d) les couches de particules













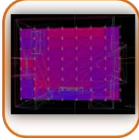

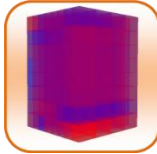

**7. Lequel des 4 types de simulation sur l'ordinateur trouvez-vous le moins utile et pourquoi ?**

a) les cubes      b) les particules      c) les couches de cubes      d) les couches de particules

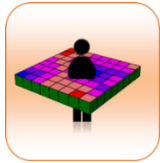
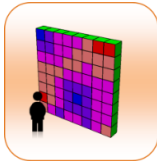
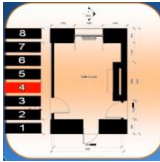
**8. Comment trouvez-vous l'utilisation de l'interface?**Difficile      Facile**9. À propos de l'utilisation de l'outil de simulation thermique dans la réalité virtuelle:**Maniabilité      Excellent      PauvreUsage      Excellent      PauvreFlexibilité (liberté de mouvement)      Excellent      PauvreFacilité d'utilisation      Excellent      PauvreConfort d'utilisation      Excellent      PauvrePrécision      Excellent      Pauvre**10. Votre opinion (commentaires, idées, suggestions) concernant the expérience:**

**On vous remercie pour votre participation à cette expérience.**

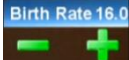
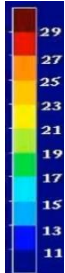
## Description of Menu Interface

	Start		Back			Access to thermal simulations
	Access to current or projected state		Access to cubes simulation			
	Display current state		Display projected state			Access to particles simulation
	Display projected state		Access to layers simulation			
	Show/hide horizontal layers		Show/hide vertical layers			
	Horizontal layers menu		Vertical layers menu			
	Access to simulation time		Transparency adjuster			Birth rate adjuster
	Indicator Palet (°C)		Stop Simulation (Cubes/Particles)			Sound (on/off)

## **Appendix D: Preformatted Results (Ecotect – Perl Routine)**

This appendix is to elaborate the results of pre-formatted txt file. Composition txt file a table of values of the TBS results of Gunzo room. The values are composed based on a 3D position or axis XYZ in interior spaces of Gunzo room. As explained earlier, the cube which acts as emitter will contain these values.

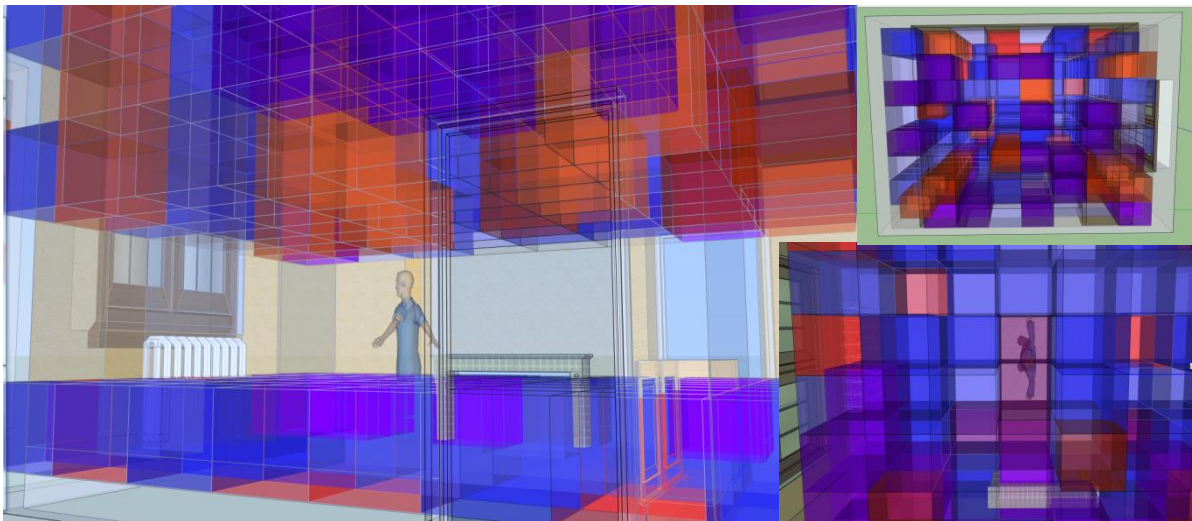

Illustration de métaphores de visualisation thermique avec des cubes transparents. L'intérieur divisé en  $8 \times 8 \times 8 = 512$  régions, chaque unité incarnant les valeurs de température. Les cubes sont texturés en couleurs transparents en fonction de la température. Le sujet à l'intérieur de la salle se déplace à l'aide de la caméra virtuelle et il observe la température de manière interactive.

Follows is an example of thermal calculation results (Ecotect) that have been formatted by Perl Routine and ready to transfer to 3DViaStudio (Virtools).

Introduction: Comment lire les résultats de simulation

Les résultats de simulation sont obtenus par export de données sous Ecotect. Le volume de la pièce est divisé en une matrice cubique. Par convention, cette matrice contient 8 cellules en ligne, 8 cellules en colonne et 8 cellules en hauteur. Les fichiers d'exports consistent en n fichiers textes de résultats (n étant le nombre de subdivisions en hauteur; ici  $n=8$ ). Chaque fichier texte contient un tableau de 8 lignes et 8 colonnes et représente une tranche, en altitude, de valeurs de températures.

Le calcul a été effectué pendant 12 mois, entre les deux versions de Salle Gunzo, mais dans cette annexe nous venons de donner un exemple au 6 Mars 14h15.

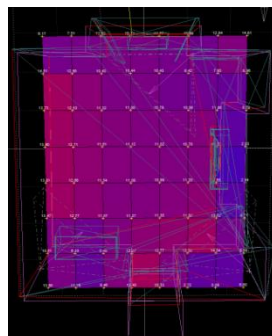

2D

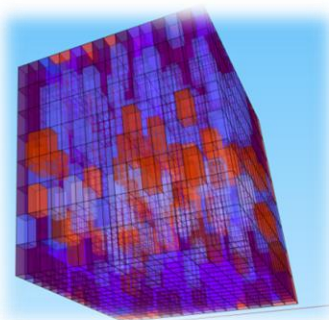

3D

## Etat actuel

6 Mars 14h15 :-----

Altitudes 0 max min

15.9686	17.248	17.5441	17.6999	17.8233	17.8675	17.9046	16.0605
15.4324	17.6731	18.155	18.4806	18.5494	18.448	18.2564	16.2866
15.0749	17.7782	18.1267	18.284	18.3288	18.3302	18.2422	16.2809
14.3773	18.2149	18.1706	18.2469	18.2482	18.2229	18.1864	16.2524
14.2488	18.203	18.2168	18.2015	18.1999	18.1911	18.1528	16.2681
14.2331	18.3078	18.2389	18.1807	18.153	18.1632	18.1395	16.2045
14.2123	18.3679	18.2249	18.1607	18.1353	18.1411	18.0981	16.191
14.1102	16.1368	16.1346	16.1116	16.0918	16.0987	16.0934	15.1453

Altitudes 1 max min

15.9711	17.1485	17.4883	17.6712	17.8019	17.8665	17.9041	16.064
15.4361	17.6514	18.2914	18.7788	18.8578	18.6477	18.3195	16.3171
15.0814	17.7453	18.1531	18.3519	18.4011	18.397	18.2781	16.3072
14.3931	18.2423	18.1904	18.2753	18.2747	18.2551	18.2132	16.2714
14.2645	18.2347	18.2472	18.2297	18.2306	18.2194	18.1787	16.2831
14.2525	18.3272	18.2591	18.2048	18.1772	18.1765	18.1438	16.2118
14.2309	18.3976	18.2486	18.1802	18.1538	18.1568	18.1048	16.1973
14.1205	16.1539	16.1536	16.1239	16.1016	16.113	16.1057	15.1531

Altitudes 2 max min

15.9742	17.1086	17.4565	17.7249	17.875	17.8607	17.9095	16.0641
15.4522	17.6812	18.4329	19.0447	19.1196	18.8277	18.3882	16.3395
15.1003	17.7612	18.2133	18.4367	18.4833	18.4757	18.3293	16.3262
14.4055	18.2458	18.2075	18.3029	18.3054	18.2737	18.2181	16.2791
14.2712	18.2415	18.2551	18.234	18.2352	18.2284	18.1858	16.2912
14.2594	18.3367	18.268	18.2111	18.185	18.1866	18.1532	16.2152
14.2379	18.4067	18.2524	18.1825	18.1573	18.1609	18.1137	16.2064
14.1252	16.16	16.157	16.127	16.1073	16.1192	16.112	15.1622

Altitudes 3 max min

15.9777	17.0787	17.4459	17.7233	17.8719	17.8627	17.9116	16.064
15.477	17.7157	18.5564	19.2531	19.3373	18.9764	18.4443	16.3627
15.1247	17.7725	18.2548	18.505	18.5563	18.5315	18.3622	16.3449
14.413	18.2697	18.2263	18.3241	18.3263	18.296	18.2412	16.2974
14.2783	18.2475	18.2647	18.2509	18.2556	18.2434	18.1903	16.299
14.263	18.3245	18.2684	18.2125	18.1853	18.1945	18.1586	16.2233
14.2409	18.3783	18.2468	18.1845	18.1575	18.1653	18.1133	16.2163
14.1287	16.1446	16.1467	16.125	16.1031	16.1146	16.1022	15.1557

Altitudes 4 max min

15.9807	17.0809	17.4427	17.7162	17.882	17.8632	17.9162	16.0638
15.4835	17.7392	18.6188	19.3433	19.4339	19.0421	18.4691	16.3712
15.1416	17.7933	18.2884	18.5444	18.5995	18.5714	18.3914	16.3576
14.4157	18.2849	18.2453	18.351	18.3514	18.3188	18.2561	16.3051
14.2821	18.2617	18.2756	18.2587	18.2615	18.2566	18.2057	16.3116
14.2672	18.29	18.2567	18.209	18.1866	18.1957	18.1665	16.23
14.2411	18.3086	18.2331	18.1825	18.162	18.1674	18.1194	16.215
14.1307	16.1446	16.1532	16.1286	16.1095	16.1213	16.1159	15.1625

Altitudes 5 max min

15.985	17.1085	17.4615	17.7325	17.8824	17.8714	17.9215	16.0674
15.4877	17.7658	18.6476	19.5552	19.6646	19.0689	18.4788	16.3745
15.1534	17.8111	18.3003	18.5776	18.6443	18.5756	18.3957	16.3626
14.4152	18.2921	18.2551	18.3618	18.363	18.3265	18.2651	16.3072
14.2816	18.2667	18.277	18.2634	18.266	18.265	18.2149	16.3194
14.2697	18.25	18.2482	18.2083	18.1872	18.2035	18.1715	16.2362
14.2475	18.2269	18.2148	18.1818	18.1651	18.1693	18.1186	16.2116
14.1344	16.1423	16.1523	16.1297	16.1123	16.1251	16.1215	15.1723

Altitudes 6 max min

15.9891	17.1539	17.4988	17.757	17.8969	17.8809	17.9286	16.0728
15.491	17.7831	18.6391	19.5807	19.6904	19.0319	18.4699	16.3697
15.1518	17.8311	18.3052	18.5836	18.6438	18.5636	18.392	16.3585
14.4106	18.2898	18.2644	18.4171	18.4262	18.3298	18.2644	16.3081

14.2806	18.2614	18.2693	18.2622	18.2637	18.2588	18.2114	16.3213
14.2687	18.2313	18.2428	18.208	18.188	18.2068	18.1774	16.242
14.2481	18.1851	18.2042	18.1808	18.1623	18.1712	18.1206	16.217
14.1346	16.1376	16.1488	16.1288	16.1144	16.1273	16.1281	15.1763

**Altitudes 7 max min**

15.9939	17.2478	17.5673	17.7823	17.8986	17.9068	17.9423	16.0762
15.4927	17.8237	18.5899	19.4095	19.5128	18.9403	18.4358	16.3573
15.1706	17.8794	18.3074	18.5064	18.5462	18.5397	18.3817	16.3531
14.4035	18.2907	18.2706	18.41	18.4168	18.3293	18.2671	16.3067
14.2771	18.267	18.2682	18.2832	18.296	18.2593	18.2184	16.3278
14.2643	18.2248	18.2434	18.2044	18.1894	18.2179	18.1885	16.2447
14.2424	18.1749	18.1963	18.1755	18.1625	18.1746	18.1334	16.2255
14.1316	16.1303	16.1457	16.1295	16.1184	16.1307	16.1237	15.1666

**Etat rénové**

6 Mars 14h15 :-----

**Altitudes 0 max min**

19.0666	19.7612	19.8694	19.9241	19.9675	19.9882	19.9973	19.0729
18.9942	20.1087	20.4265	20.6784	20.704	20.5549	20.3202	19.2752
18.8463	20.1027	20.3081	20.4174	20.4307	20.4109	20.2961	19.27
18.5065	20.2268	20.2479	20.3091	20.3115	20.2713	20.2267	19.2413
18.4494	20.2179	20.2474	20.231	20.2294	20.2266	20.188	19.2525
18.4348	20.3122	20.2549	20.2078	20.1886	20.1831	20.1524	19.1774
18.4123	20.375	20.2299	20.17	20.1521	20.149	20.1129	19.1605
16.2404	17.169	17.1649	17.1392	17.1256	17.135	17.129	16.6584

**Altitudes 1 max min**

19.0687	19.7378	19.8557	19.9184	19.9679	19.9884	19.9972	19.0801
19.011	20.135	20.5547	20.9228	20.9527	20.7087	20.3661	19.3027
18.8638	20.1129	20.3411	20.4781	20.4952	20.458	20.3247	19.2928
18.5142	20.256	20.2776	20.3389	20.3417	20.3034	20.2573	19.2571
18.4592	20.2348	20.2693	20.2619	20.2603	20.2466	20.2025	19.2602
18.4472	20.3272	20.2685	20.2243	20.2035	20.1926	20.1582	19.1873
18.4257	20.3976	20.2487	20.1879	20.1682	20.1636	20.1184	19.1651
16.2474	17.1835	17.1832	17.1535	17.1381	17.1509	17.1422	16.6662

**Altitudes 2 max min**

19.07	19.7317	19.8514	20.0004	20.051	19.9863	20.0012	19.0784
19.0287	20.1728	20.634	21.0479	21.0776	20.8039	20.4114	19.32
18.8769	20.1369	20.3917	20.5368	20.5532	20.5148	20.3634	19.3047
18.5209	20.2479	20.2806	20.3544	20.3575	20.3061	20.25	19.2553
18.4631	20.2269	20.2576	20.2453	20.2426	20.239	20.1967	19.2617
18.4509	20.3304	20.2627	20.2122	20.1916	20.1881	20.1585	19.1861
18.4301	20.3974	20.2396	20.1756	20.1566	20.1535	20.1159	19.1672
16.2502	17.1737	17.1724	17.1503	17.1371	17.1443	17.1332	16.6657

**Altitudes 3 max min**

19.0927	19.8061	19.9109	20.0779	20.1313	20.0248	20.032	19.1044
19.0587	20.2731	20.811	21.4848	21.5479	20.9726	20.4753	19.3418
18.9303	20.2149	20.4676	20.651	20.6735	20.5806	20.4153	19.3376
18.5236	20.3037	20.3359	20.4447	20.4561	20.3582	20.3088	19.2975
18.4684	20.2665	20.3024	20.4086	20.4192	20.2984	20.2487	19.2956
18.4546	20.2105	20.2331	20.203	20.1916	20.2155	20.1913	19.2167
18.4344	20.1725	20.2029	20.1963	20.1881	20.1884	20.1485	19.1922
16.2568	17.1687	17.179	17.1592	17.155	17.1718	17.1678	16.6889

**Altitudes 4 max min**

19.0929	19.8221	19.9219	19.9883	20.0218	20.0286	20.0386	19.1031
19.0594	20.2701	20.7854	21.4581	21.5116	20.9413	20.4644	19.3371
18.9234	20.2164	20.4724	20.6063	20.6191	20.5802	20.4113	19.3329
18.5187	20.3038	20.3459	20.4107	20.4161	20.3715	20.3081	19.2908
18.4625	20.2633	20.2872	20.3469	20.3584	20.2843	20.2413	19.2912
18.4502	20.2151	20.2474	20.2171	20.2079	20.2284	20.1991	19.2179
18.4279	20.1819	20.2152	20.1997	20.1946	20.1986	20.16	19.1986
16.2525	17.1681	17.1851	17.1669	17.162	17.1786	17.1715	16.6925

Altitudes 5 max min

19.0933	19.8388	19.9304	19.9756	20.0201	20.034	20.0429	19.103
19.0667	20.271	20.7589	21.3748	21.4283	20.909	20.4534	19.3355
18.9265	20.2201	20.4596	20.7236	20.7454	20.5632	20.4058	19.325
18.51	20.2981	20.3363	20.4008	20.4014	20.3568	20.3021	19.2897
18.4566	20.27	20.2936	20.35	20.3597	20.2904	20.2475	19.2946
18.4416	20.2219	20.2512	20.2115	20.2017	20.2354	20.204	19.2198
18.4224	20.1906	20.2167	20.2051	20.1988	20.2042	20.1661	19.2068
16.2478	17.1695	17.1831	17.1656	17.1603	17.1792	17.1716	16.6922

Altitudes 6 max min

19.0967	19.8599	19.9402	20.0478	20.0936	20.0363	20.0475	19.1015
19.0676	20.2684	20.7115	21.2275	21.2674	20.8534	20.4364	19.3235
18.9443	20.2283	20.448	20.8601	20.8698	20.545	20.3988	19.3263
18.4993	20.3092	20.3426	20.4515	20.4633	20.3612	20.3111	19.2932
18.444	20.2785	20.2983	20.378	20.3983	20.2945	20.2522	19.299
18.4286	20.2176	20.2508	20.2027	20.1953	20.233	20.2009	19.2136
18.4078	20.1815	20.2056	20.1923	20.1905	20.1921	20.1598	19.2015
16.2391	17.1611	17.1693	17.1545	17.1499	17.1633	17.161	16.6763

Altitudes 7 max min

19.0973	19.882	19.9494	19.9854	20.0253	20.0442	20.0562	19.1064
19.0852	20.2744	20.6853	21.1702	21.2087	20.818	20.4279	19.3172
18.9623	20.2282	20.4347	21.2434	21.2642	20.5293	20.3846	19.3228
18.4731	20.3002	20.3286	20.381	20.3845	20.3469	20.301	19.2864
18.417	20.2681	20.2876	20.3459	20.346	20.2826	20.2434	19.2928
18.4007	20.22	20.2431	20.216	20.2099	20.2282	20.2061	19.2222
18.3811	20.1866	20.2098	20.1945	20.1934	20.1976	20.1678	19.205
16.2254	17.1655	17.1871	17.1754	17.17	17.1818	17.1675	16.6784

# Publications

## International Journals

1. YUDI NUGRAHA BAHAR, LANDRIEU J., PERE C., NICOLLE C., CAD Data Workflow toward the Thermal Simulation and Visualization in Virtual Reality. *International Journal on Interactive Design and Manufacturing (IJIDeM)* Springer, 2013. DOI: 10.1007/s12008-013-0200-5. ISSN: 1955-2513 (Print) 1955-2505 (Online).
2. YUDI NUGRAHA BAHAR, LANDRIEU J., PERE C., NICOLLE C., Simulation and Visualization of Thermal Metaphors in a Virtual Environment for Thermal Building Assessment, *International Journal of Technology (IJTech)*, 2014 Vol. 5 Issue 1, pp. 3-13. (ISSN 2086-9614).
3. YUDI NUGRAHA BAHAR, PERE C., LANDRIEU J., NICOLLE C., Thermal Simulation Tool for Building and its Interoperability through Building Information Modeling (BIM) Platform, *Buildings* 2013, 3 (2), pp. 380-398 (ISSN 2075-5309).
4. LANDRIEU J., BAHAR Y.N., PERE C., MERIENNE F., Bringing Building Data on Construction Site for Virtual Renovation Works, *International Journal of Electrical, Electronics and Computer Systems (IJEECS)* Vol: 14 Issues 1, 2013, pp. 737-747.

## International Conferences

1. BAHAR Y.N., LANDRIEU J., PERE C., NICOLLE C., CAD Data Workflow toward the Thermal Simulation and Visualization in Virtual Reality, 13. *International Congress XXIII Ingegref - XX ADM - AIP-Primeca (INGEGRAF)*, June 19th – 21th, 2013 Madrid, Spain (Best Paper).
2. BAHAR Y.N., LANDRIEU, J., PERE, C., NICOLLE, C.: Experiment of Indoor Thermal Optimization of an Old Historic Building of Cluny through Digital Mock-up Simulation, in *Information and Communication Technology for Sustainability. International Conference ICT for Sustainability*, 14-16 February 2013, ETH Zurich, Switzerland.
3. NICOLAS G., LANDRIEU J., BAHAR Y.N., PERE C., Hybrid representation of Digital Mock-up for Heritage Building Management; in *Proceedings of XXIV International CIPA Symposium*, September 2<sup>nd</sup> - 6<sup>th</sup>, 2013, Strasbourg – published in *ISPRS – International Archives of the Photogrammetry, Remote Sensing and Spatial Information Science*.

## National Conferences

4. BAHAR Y.N., LANDRIEU J., PERE C., NICOLLE C., Integration of thermal Building Simulation and VR techniques for sustainable Building Project, *International Conference of ENSAM-ESTIA (Biarritz France, 4-5 July 2013)*.
5. LANDRIEU, J., BAHAR Y.N., Utilisation de la salle immersive "LITE" pour l'avancement des recherches en reconstitution et /ou restauration des bâtiments clunisiens. *Coloque IC3D - Ingénierie collaborative et Technologies 3D appliquées à l'architecture et à l'urbanisme*, 18-19 September 2012, Centre Arts & Métiers ParisTech, Châlons-en-Champagne.
6. LANDRIEU, J., BAHAR Y.N., PERE, C., MERIENNE, F., NICOLLE, C. (2012). Pertinence d'une représentation 3D d'un projet de rénovation de bâtiment en réalité augmentée mobile, *CONFERE 2012, Conference of ENSAM-CESI (San Servolo Venise, 5-6 July 2012)*.
7. NICOLAS G., LANDRIEU J., BAHAR Y.N., Représentation hybride du modèle numérique pour la gestion d'un patrimoine bâti dit ancien. *20th CONFERE, Conference of ENSAM-ESTIA (Biarritz France, 4-5 July 2013)*.

8. YUDI NUGRAHA BAHAR, Enhancing the National Identity through Historic Buildings Conservation using VR Technology. Concours, Olympiade Karya Tulis Inovatif (Olympiad of Innovative Writing) par TOTAL et l'Ambassade d'Indonésie en France, July-October 2011. Paris. Finalist.

**Invited papers in international conferences**

9. BAHAR Y.N., PERE C., LANDRIEU J., NICOLLE C., Thermal Simulation Tool for Building and its Interoperability through Building Information Modeling (BIM) Platform International Conference on "World Building Information Modeling (BIM) for the Construction Industry Conference 2013", 16 & 17 September 2013, Shangri-La Hotel, Bangkok, Thailand.
10. BAHAR Y.N., PERE C., LANDRIEU J., NICOLLE C., Heritage Building and Virtual Reality: A Challenge and Opportunity in the Methods of Preserving Historic Buildings and Sites through the IT (Case Study of Cluny, France). The 31<sup>th</sup> International Conference on Quality in Research. 25-28 June 2013. Yogyakarta, Indonesia.





# Abstract

The importance of energy efficiency as well as integration of advances in sustainable building design and VR technology have lead this research to focus on thermal simulation results visualized in a virtual environment (VE). The emphasis is on the representation of thermal building simulation (TBS) results and on the perception of thermal data simulated in a VE. The current application of the design process through energy efficiency in VR systems is limited mostly to building performance predictions and design review, as the issue of the data formats and the workflow used for 3D modeling, thermal calculation and VR visualization.

Different applications and tools involved to represent TBS in VE are become the challenge of this work. Many 3D modeller, thermal simulation tools and VR tools are available and they are differ in their function and platform. Issues of data format exchange, appropriate tools and equipments from this situation require an interoperability solution that needs to be structured in a workflow method. Significances and barriers to integration design with CAD and TBS tools are also outlined in order to transfer the model to VR system. Therefore, the idea then is to use Building Information Model (BIM) extensively used in Architecture, Engineering and Construction (AEC) community. It then continued to evaluate the current trends for TBS representation in VE, to create data transfer method, and to integrate them in the workflow. After a review in thermal simulation and an evaluation of related works, we specify the application, method and tools for our objectives.

An application of a method of data transfer and presentation of data in VE are formulated and tested. This effort conduct using a specific data workflow which performed the data transfer through 3 phases. This relies on the smooth exchange of data workflow between CAD tools, thermal calculation tools and VR tools. Presentation of data in VE is conducted through immersive visualization and intuitive interaction. An experiment scenario of a thermal simulation in VR system was created to interactively visualize the results in the immersion room and tested by some respondents. The system include with friendly interface for interaction. It presents a realistic 3D model of the project (Gunzo room) in existing condition and renovated version, and their TBS results visualized in some visualization metaphor. In the experiment, the method which bundled in an application brings together within a couple of virtual scenario and a software/hardware solution. The obtained results concentrate on visualization, interaction and its feedback. Some visualization metaphor are tested and evaluated to present more informative TBS results where the user can interact and perceive the impact of their action.

Evaluation of the application prototype showed various levels of user satisfaction, and improvements in the accuracy and efficiency of data interpretation. The research has demonstrated it is possible to improve the representation and interpretation of building performance data, particularly TBS results using visualization techniques. Using specific method, the data flow that starts from the design process is completely and accurately channelled to the VR system. The method can be used with any kind of construction project and, being a flexible application, accepts new data when necessary, allowing for a comparison between the planned and the constructed.

**Keywords:** Thermal building simulation, BIM, Three-dimensional (3D), Virtual reality, Data integration, Scientific visualization

The logo for SPIM (École doctorale SPIM) features a stylized white 'S' on an orange horizontal bar, followed by the letters 'PIM' in a large, white, sans-serif font.