



HAL
open science

Self-organized and evolvable holonic architecture for manufacturing control

José Barbosa

► **To cite this version:**

José Barbosa. Self-organized and evolvable holonic architecture for manufacturing control. Automatic. Université de Valenciennes et du Hainaut Cambrésis, 2015. English. NNT: . tel-01137643v1

HAL Id: tel-01137643

<https://theses.hal.science/tel-01137643v1>

Submitted on 31 Mar 2015 (v1), last revised 18 Feb 2016 (v2)

HAL is a multi-disciplinary open access archive for the deposit and dissemination of scientific research documents, whether they are published or not. The documents may come from teaching and research institutions in France or abroad, or from public or private research centers.

L'archive ouverte pluridisciplinaire **HAL**, est destinée au dépôt et à la diffusion de documents scientifiques de niveau recherche, publiés ou non, émanant des établissements d'enseignement et de recherche français ou étrangers, des laboratoires publics ou privés.



Thesis submitted for the degree of Doctor from Université de

VALENCIENNES ET DU HAINAUT CAMBRÉSIS

Specialty in Automation and Computer Science

Submitted and Defended by José BARBOSA.

February 19th 2015, Valenciennes, FRANCE

Doctoral School

Sciences Pour l'Ingénieur (SPI)

Laboratory

Laboratoire d'Automatique, de Mécanique, et d'Informatique industrielle et Humaine (LAMIH)

Self-organized and evolvable holonic architecture for manufacturing control

DEFENSE COMMITTEE

President of the Defense Committee

PIERREVAL, Henri, Professor at Institut Français de Mécanique Avancée, Clermont-Ferrand, France.

Reviewers

McFARLANE, Duncan, Professor at University of Cambridge, England.

BOISSIER, Olivier, Professor at Ecole des Mines de St-Etienne, France.

Examiners

BARATA, José, Professor at New University of Lisbon, Portugal.

Dissertation Advisor

TRENTESAUX, Damien, Professor at Université de Valenciennes et du Hainaut Cambrésis.

Dissertation Co-Advisor

LEITÃO, Paulo, Professor at Polytechnic Institute of Bragança.

Dissertation Co-supervisor

ADAM, Emmanuel, Professor associate at Université de Valenciennes et du Hainaut Cambrésis.

Thèse de doctorat Pour obtenir le grade de Docteur de l'Université de
VALENCIENNES ET DU HAINAUT CAMBRÉSIS

Spécialité Automatique et Génie Informatique

Présentée et soutenue par José BARBOSA.

Le 19/02/2015, à Valenciennes

Ecole doctorale

Sciences Pour l'Ingénieur (SPI)

Laboratoire

Laboratoire d'Automatique, de Mécanique, et d'Informatique industrielle et Humaine (LAMIH)

Proposition d'une architecture holonique auto-organisée et évolutive pour le
pilotage des systèmes de production

JURY

Président du jury

PIERREVAL, Henri, Professeur, Professeur à l'Institut Français de Mécanique Avancée,
Clermont-Ferrand, France.

Rapporteurs

McFARLANE, Duncan, Professeur à l'Université de Cambridge, Angleterre.

BOISSIER, Olivier, Professeur à l'Ecole des Mines de St-Etienne, France.

Examineurs

BARATA, José, Professeur à l'Université de Lisbonne (UNL), Portugal.

Directeur de thèse

TRENTESAUX, Damien, Professeur à l'Université de Valenciennes et du Hainaut
Cambrésis.

Co-directeur de thèse

LEITÃO, Paulo, Professeur à l'Institut Polytechnique de Bragança.

Co-encadrant de thèse

ADAM, Emmanuel, Maître de Conférences à l'Université de Valenciennes et du Hainaut
Cambrésis.

José Fernando Lopes Barbosa

Department of Electrical Engineering

Polytechnic Institute of Bragança

Quinta Santa Apolónia

5300-253 Bragança

Portugal

[w] www.ipb.pt/~jbarbosa

[@] jbarbosa@ipb.pt

Laboratory Association

UVHC, TEMPO research center EA4542,

F-59313 Valenciennes, France

To Inês, Mariana and Gonçalo.

Acknowledgements

During the work developed in this thesis I had the pleasure of meeting and interact with very interesting people, allowing me to grow not only scientifically but as well as a person. In this way, I consider that this document is the appropriate place to express my most sincere acknowledgements.

I would like to start by giving my most grateful acknowledgements to Prof. Damien Trentesaux, Prof. Emmanuel Adam and Prof. Paulo Leitão that welcomed me and allowed me to finish this work, guiding me through this long journey, encouraging me in the difficult times and having the necessary patience whenever I was more occupied with aside work.

My sincere thanks to all the members of the jury, Prof. Duncan McFarlane, Prof. Olivier Boissier, Prof. Henri Pierreval and Prof. José Barata that had decisively contribute to this thesis with their comments and incentive. I'm really very grateful to have had such an internationally well recognized jury.

My most sincere gratitude to the University of Valenciennes and Hainaut-Cambresis that has accepted me for the elaboration of this work. A special thank to my research group in France that always received me with arms wide open and helped me whenever necessary.

I would like to express my gratitude to the Polytechnic Institute of Bragança, more particularly to the Escola Superior de Tecnologia e de Gestão, that had received me and, always when I needed, has given support.

An additional gratitude to the Polytechnic Institute of Bragança for the granted research scholarship under the supervision of Prof. Paulo Leitão without which this work was not possible.

I also wish to express my gratitude to all the colleagues of the Polytechnic Institute of Bragança, specially to those that in a daily basis had to bear with my good and bad moments. A special thank to the lab colleagues Adriano Ferreira, Arnaldo Pereira, Filipe Fernandes and Nelson Rodrigues and more recently to Jonas Queiroz and José Dias. Also a special thank to Ana Isabel Pereira, José Lima and José Augusto.

Last, but not least, a special thank to my family that never gave up on me and always

helped me on the good and bad moments. Thank you for simply being there. Particularly to my wife Inês, that during the time that I needed to finish this endeavour was able to understand and had the necessary patience. Only with her support I was able to drive this until the end. Finally, to the two most important persons in my life, Mariana and Gonçalo, to whom I promise that from now on I will dedicate more time to them.

Abstract

The manufacturing world is being deeply challenged with a set of ever demanding constraints where from one side, the costumers are requiring products to be more customizable, with higher quality at lower prices, and on other side, companies have to deal on a daily basis with internal disturbances that range from machine breakdown to worker absence and from demand fluctuation to frequent production changes. This dissertation proposes a manufacturing control architecture, following the holonic principles developed in the ADAptive holonic COntrol aRchitecture (ADACOR) and extending it taking inspiration in evolutionary theories and making use of self- organization mechanisms. The use of evolutionary theories enrich the proposed control architecture by allowing evolution in two distinct ways, responding accordingly to the type and degree of the disturbance that appears. The first component, named behavioural self- organization, allows each system's entity to dynamically adapt its internal behaviour, addressing small disturbances. The second component, named structural self-organization, addresses bigger disturbances by allowing the system entities to re-arrange their relationships, and consequently changing the system in a structural manner. The proposed self-organized holonic manufacturing control architecture was validated at a AIP-PRIMECA flexible manufacturing cell. The achieved experimental results have also shown an improvement of the key performance indicators over the hierarchical and heterarchical control architecture.

Keywords: holonic manufacturing control architecture, self-organization, multi-agent systems

Resumé

Le monde des entreprises est profondément soumis à un ensemble de contraintes toujours plus exigeantes provenant d'une part des clients, exigeant des produits plus personnalisables, de qualité supérieure et à faible coût, et d'autre part des aléas internes aux entreprises, comprenant les pannes machines, les défaillances humaines, la fluctuation de la demande, les fréquentes variations de production. Cette thèse propose une architecture de contrôle de systèmes de production, basée sur les principes holoniques développées dans l'architecture ADACOR (ADAPtive holonic COntrol aRchitecture), et l'étendant en s'inspirant des théories de l'évolution et en utilisant des mécanismes d'auto-organisation. L'utilisation des théories de l'évolution enrichit l'architecture de contrôle en permettant l'évolution de deux manières distinctes, en réponse au type et au degré de la perturbation apparue. Le premier mode d'adaptation, appelé auto-organisation comportementale, permet à chaque entité qui compose le système d'adapter dynamiquement leur comportement interne, gérant de cette façon de petites perturbations. Le second mode, nommé auto-organisation structurelle, traite de plus grandes perturbations, en permettant aux entités du système de ré-organiser leurs relations, et par conséquent modifier structurellement le système. L'architecture holonique auto-organisée de contrôle de systèmes de production proposée dans cette thèse a été validée sur une cellule de production flexible AIP-PRIMECA. Les résultats ont montré une amélioration des indicateurs clés de performance par rapport aux architectures de contrôle hiérarchiques et hétérarchiques.

Mots-clés: Architecture holonique, contrôle de systèmes de production, auto-organisation, systèmes multi-agents

Resumo

O mundo da manufactura é constantemente desafiado com um conjunto cada vez mais exigente de perturbações, onde de um lado, os clientes exigem produtos mais personalizados, com maior qualidade e a preços mais baixos, e no outro lado, as empresas têm de lidar diariamente com perturbações internas que variam desde a avaria de máquinas à ausência da trabalhadores e da flutuação da procura às mudanças frequentes na produção.

Tradicionalmente, as empresas de manufactura operavam com unidades processamento centralizadas e monolíticas que apresentam altos níveis de optimização sob rígidas condições de trabalho, mas não são capazes de responder apropriadamente, com rapidez e agilidade, quando imposta pelas perturbações e exigências acima mencionadas.

Mais recentemente, uma mudança de paradigma nos sistemas de controlo de fabrico tem sido notada, promovendo o aumento da capacidade de resposta e agilidade, favorecendo a descentralização e distribuição da capacidade de processamento por várias entidades pequenas e autónomas, sendo capazes de tomar decisões localmente, mas com a necessidade de cooperar para alcançar os objetivos globais do sistema. Apesar dos benefícios introduzidos por esta descentralização, estes sistemas nunca foram capazes de alcançar os níveis de desempenho alcançados pelas abordagens clássicas em condições normais de funcionamento. Além disso, técnicas e mecanismos de auto-organização nunca foram verdadeiramente embebidos e explorados nestas abordagens.

O presente trabalho propõe uma arquitetura de controlo de fabrico, seguindo os princípios holónicos apresentadas e desenvolvidas na arquitetura conhecida por ADaptive holonic COntrol aRchitecture (ADACOR), estendendo-a com a inspiração em teorias evolucionárias e fazendo uso de mecanismos de auto-organização. O uso de teorias evolucionárias visam enriquecer a arquitetura proposta, permitindo a evolução de duas maneiras distintas, respondendo de acordo com o tipo e grau de perturbação. A primeira componente, chamada de auto-organização comportamental, permite a que cada entidade

se adapte dinamicamente o seu comportamento interno, abordando pequenas perturbações. A segunda componente, chamada auto-organização estrutural, trata perturbações maiores, permitindo que as entidades do sistema reorganizem as suas relações, e, conseqüentemente, alterar o sistema de uma forma estrutural.

Atuando no comportamento interno do holon, ou seja, no micro nível, cada holon é capaz de lidar localmente com pequenas perturbações ou para melhorar individualmente o seu desempenho interno, sendo considerado como uma evolução suave ou adaptação. Atuando ao nível das relações, ou seja, a um macro nível, o sistema é capaz de responder drasticamente a perturbações maiores, impondo uma reorganização estrutural, sendo considerado uma evolução drástica.

O arquitetura holônica de controlo de produção auto-organizada proposta foi validado na célula de manufatura flexível AIP-PRIMECA localizada na Université de Valenciennes et du Hainaut-Cambrésis. Os resultados experimentais obtidos mostraram também uma melhoria dos indicadores-chave de desempenho através de diversas arquiteturas de controlo, nomeadamente a hierárquica, heterárquica e o ADACOR.

Palavras-chave: arquitetura holônica de controle de fabrico, auto-organização, sistemas multiagentes

Extended Abstract

The manufacturing world is being deeply challenged with a set of ever demanding constraints where from one side, the costumers are requiring products to be more customizable, with higher quality at lower prices, and on other side, companies have to deal on a daily basis with internal disturbances that range from machine breakdown to worker absence and from demand fluctuation to frequent production changes.

Traditionally, manufacturing companies rely on centralized and monolithic processing units which were capable to introduce high levels of optimization under rigid working conditions, but are not able to respond the responsiveness and agility imposed by the aforementioned disturbances and demands.

More recently, a shift in the manufacturing control systems paradigm has been noticed, promoting to increase the responsiveness and agility, through the decentralization and distribution of the processing capacity throughout several small and autonomous entities, which are able to take decisions locally, but needing to cooperate to achieve the overall system goals. Despite of the benefits introduced by this decentralization, these newer systems were never able to reach the performance levels achieved by the classical approaches during normal functioning conditions, and also never implemented truly self-organization concepts to support condition changes.

This dissertation proposes a manufacturing control architecture, following the holonic principles developed in the ADaptive holonic COntrol aRchitecture (ADACOR) and extending it taking inspiration in evolutionary theories and making use of self-organization mechanisms. The use of evolutionary theories enrich the proposed architecture by allowing evolution in two distinct ways, responding accordingly to the type and degree of the disturbance that appears. The first component, named behavioural self-organization, allows each system's entity to dynamically adapt its internal behaviour, addressing small disturbances. The second component, named structural self-organization, addresses bigger disturbances by allowing the system entities to re-arrange their relationships, and consequently changing the system in a structural manner.

Acting at the holon internal behaviour, i.e. at the micro level, each holon is able to handle locally small disturbances or to improve individually its internal performance, being considered as a smooth evolution or adaptation. Acting at the relations level, i.e. at a macro level, the system is able to drastically respond to more drastic disturbances by imposing a structural re-organization, being considered a drastic evolution.

The proposed self-organized holonic manufacturing control architecture was validated at the AIP-PRIMECA flexible manufacturing cell located at the Université de Valenciennes et du Hainaut-Cambrésis. The achieved experimental results have also shown an improvement of the key performance indicators over the hierarchical, heterarchical and the ADACOR control architecture.

Keywords: holonic manufacturing control architecture, self-organization, multi-agent systems

Resumé Étendu

Le monde des entreprises est profondément soumis à un ensemble de contraintes toujours plus exigeantes provenant d'une part des clients, exigeant des produits plus personnalisables, de qualité supérieure et à faible coût, et d'autre part des aléas internes aux entreprises, comprenant les pannes machines, les défaillances humaines, la fluctuation de la demande, les fréquentes variations de production.

Traditionnellement, les industries manufacturières reposent sur des unités de productions centralisées et monolithiques qui sont capables d'obtenir des niveaux élevés de l'optimisation, sous réserve de conditions de travail rigides, mais ne sont pas en mesure de répondre de la réactivité et l'agilité imposée par les perturbations et les exigences actuelles.

Plus récemment, afin d'accroître la réactivité et l'agilité, le contrôle des systèmes de production ont connu un changement de paradigme, permettant la décentralisation et la distribution de la capacité de traitement au sein de multiples entités autonomes capable de prendre des décisions au niveau local, mais capable également de coopérer afin d'atteindre les objectifs globaux du système.

Malgré les avantages introduits par cette décentralisation, ces nouveaux systèmes n'étaient en fait jamais réellement en mesure d'atteindre les niveaux de performance obtenus par les approches classiques, sous conditions de fonctionnement normales, et de plus, les concepts d'auto-organisation n'ont jamais vraiment été mis en œuvre pour faire face aux changements de condition.

Cette thèse propose une architecture de contrôle de systèmes de production, basée sur les principes holoniques développés dans l'architecture ADACOR (ADAPtive holoNIC COnTrol aRchitecture), et l'étendant en s'inspirant des théories de l'évolution et en utilisant des mécanismes d'auto-organisation.

L'utilisation des théories de l'évolution enrichit l'architecture ADACOR en permettant l'évolution de deux manières distinctes, en réponse au type et au degré de la perturbation apparue. Le premier mode d'adaptation, appelé auto-organisation comportementale, permet à chaque entité qui compose le système d'adapter dynamiquement leur comportement interne, gérant de cette façon de petites perturbations. Le second mode, nommé auto-organisation structurelle, traite de plus grandes perturbations, en permettant aux entités du système de ré-organiser leurs relations, et par conséquent modifier structurellement le système.

Agir sur le comportement interne du holon, c'est-à-dire au niveau micro, permet à chaque holon de gérer localement de petites perturbations ou d'améliorer individuellement la performance interne, et est considéré comme une légère évolution ou adaptation. Agir au niveau des relations, c'est-à-dire au un niveau macro, permet au système de répondre à des perturbations plus profondes en imposant une réorganisation structurelle, et est considéré comme une forte évolution.

L'architecture holonique auto-organisée de contrôle de systèmes de production proposée dans cette thèse a été validée sur la cellule de production flexible AIP-PRIMECA située à l'Université de Valenciennes et du Hainaut-Cambrésis. Les résultats ont montré une amélioration des indicateurs clés de performance par rapport aux architectures de contrôle hiérarchiques, hétérarchiques et également par rapport à l'architecture ADACOR initiale.

Mots-clés: Architecture holonique, contrôle de systèmes de production, auto-organisation, systèmes multi-agents

Contents

| | |
|---|--------------|
| Abstract | vii |
| Resumé | ix |
| Resumo | xi |
| Extended Abstract | xiii |
| Resumé Étendu | xv |
| List of Figures | xxi |
| List of Tables | xxv |
| List of Acronyms | xxvii |
| List of Symbols | xxxi |
| 1 Introduction | 1 |
| 1.1 Research Problem | 1 |
| 1.2 Objectives and Contributions | 4 |
| 1.3 Dissertation Organization | 5 |
| 2 Manufacturing Control Paradigms | 9 |
| 2.1 Production and Manufacturing Control | 9 |
| 2.2 Production and Manufacturing Control Approaches | 12 |
| 2.2.1 Multi-Agent System Applications to Manufacturing | 14 |
| 2.2.2 Holonic Manufacturing System Applications | 18 |
| 2.2.3 Other Distributed Manufacturing Control Approaches | 19 |
| 2.3 An Adaptive Holonic Control Architecture: ADACOR | 20 |
| 2.4 Limitations and Challenges of the Existing Approaches | 23 |

| | | |
|----------|--|-----------|
| 2.5 | Summary | 23 |
| 3 | Biological Inspiration to Solve Complex Problems | 25 |
| 3.1 | Swarm Intelligence | 25 |
| 3.2 | Evolution and Self-Organization | 28 |
| 3.3 | Survey of Bio-Inspired Applications for Solving Complex Problems | 29 |
| 3.3.1 | Applied to Engineering Problems | 29 |
| 3.3.2 | Applied to Manufacturing Problems | 32 |
| 3.4 | Enriching MAS Based Application with Bio-inspiration | 32 |
| 3.5 | How to Achieve an Evolvable System | 36 |
| 3.5.1 | Being Prepared for the Unexpected | 37 |
| 3.5.2 | Hierarchy: a way to Achieve Stabilization and Optimization | 38 |
| 3.5.3 | Self-Organization and Emergence as the Main Driver | 38 |
| 3.5.4 | Controlled Randomness | 39 |
| 3.5.5 | Be Aware with Chaos | 40 |
| 3.6 | Summary | 41 |
| 4 | ADACOR²: a Self-Organized Holonic Architecture | 43 |
| 4.1 | System Architecture | 44 |
| 4.1.1 | Architectural Components | 44 |
| 4.1.2 | Holon Internal Structure | 45 |
| 4.2 | Self-Organization Principles | 47 |
| 4.2.1 | Evolution and Self-Organization | 48 |
| 4.2.2 | Two Dimensional Self-Organization Mechanisms | 50 |
| 4.2.3 | Downward and Upward Causation | 51 |
| 4.3 | Behavioural Perspective | 52 |
| 4.3.1 | Principles and Composition | 53 |
| 4.3.2 | Behaviour Selection | 55 |
| 4.3.3 | Evaluating and Refining | 56 |
| 4.3.4 | Behaviour Propagation | 57 |
| 4.3.4.1 | Direct Propagation | 57 |
| 4.3.4.2 | Indirect Propagation | 58 |
| 4.3.5 | Behavioural Self-Organization in Practice | 59 |
| 4.3.5.1 | The Arrival of a New Holon | 60 |
| 4.3.5.2 | An Holon Malfunction | 61 |
| 4.3.5.3 | Using the Idle Time Properly | 62 |
| 4.4 | Structural Perspective | 62 |
| 4.4.1 | Principles and Composition | 64 |
| 4.4.2 | Structural Self-Organization in Practice | 67 |
| 4.4.2.1 | Product Model Change | 67 |
| 4.4.2.2 | Breakdown of a Crucial Resource | 68 |

| | | |
|----------|---|------------|
| 4.4.2.3 | Holarchy Division Based on Specialization | 69 |
| 4.5 | Controlling Nervousness | 70 |
| 4.6 | Summary | 73 |
| 5 | Self-Organization Regulating Mechanisms in ADACOR² | 75 |
| 5.1 | Mechanisms for the Behavioural Self-Organization | 75 |
| 5.1.1 | Market-Based Approach | 77 |
| 5.1.2 | Potential Fields | 78 |
| 5.1.2.1 | Attractive Potential Field Calculation | 80 |
| 5.1.2.2 | Attenuation of the Attractive Potential Field | 81 |
| 5.1.2.3 | Decision and Selection | 82 |
| 5.1.3 | Stigmergy | 82 |
| 5.1.3.1 | Deposition and Reinforcement | 83 |
| 5.1.3.2 | Evaporation Process | 85 |
| 5.1.3.3 | Next Destination Selection | 85 |
| 5.2 | Mechanisms for Structural Self-Organization | 86 |
| 5.2.1 | Structural Re-Arrangement by Means of Birds Behaviour | 87 |
| 5.2.2 | Structural Re-Arrangement by Means of Ants Food Foraging Behaviour | 89 |
| 5.3 | Learning and Reasoning | 90 |
| 5.4 | Nervousness Stabilizer: Controlling Chaos in Dynamic Self-Organized Systems | 92 |
| 5.5 | Summary | 96 |
| 6 | Practical Implementation and Validation | 97 |
| 6.1 | Description of the Case Study and System Implementation | 97 |
| 6.1.1 | The Real AIP-PRIMECA FMS | 98 |
| 6.1.2 | A More Flexible AIP-PRIMECA FMS | 101 |
| 6.2 | Manufacturing Control Assessment Metrics | 102 |
| 6.3 | Mapping ADACOR ² Holons to the Case Study | 103 |
| 6.4 | Assessment of ADACOR ² | 104 |
| 6.4.1 | Behavioural Self-Organization Using the AIP-PRIMECA | 105 |
| 6.4.2 | Structural Self-Organization Using the Futuristic AIP-PRIMECA | 110 |
| 6.5 | Summary | 113 |
| 7 | Conclusions and Future Work | 115 |
| 7.1 | Conclusions | 115 |
| 7.2 | Work Validation | 116 |
| 7.3 | Future Work | 118 |
| A | Making Simulations | 147 |

| | |
|--|------------|
| B Potential Fields Behaviour | 155 |
| C Operation Holons Structural Self-Organization | 159 |
| D Supervisor Holon Scheduling Algorithm | 161 |

List of Figures

| | | |
|------|--|----|
| 1.1 | Performance Behaviour of Different Classical Control Structures | 3 |
| 1.2 | Organization Structure of the Dissertation | 5 |
| 2.1 | The ANSI/ISA 95 Standard | 10 |
| 2.2 | Distribution of Decisional Capabilities from Centralised Control Systems to Non-Centralised Control Systems (Trentesaux, 2009) | 11 |
| 2.3 | Multi-Agent System Example | 13 |
| 2.4 | Holonic Manufacturing System Example | 14 |
| 2.5 | ADACOR Holon Classes | 21 |
| 2.6 | Adaptation Mechanism in ADACOR Supporting a Hybrid Control Architecture | 22 |
| 3.1 | Indirect Communication in Insect Swarms: a) the Deposition and Sensing of Pheromones by Ants [adapted from (Parunak et al., 2003)]; b) the Waggle Dance Used by Bees | 26 |
| 3.2 | Requirements for a Truly Evolvable System | 37 |
| 4.1 | ADACOR ² : an Extension of ADACOR | 44 |
| 4.2 | Mapping ADACOR ² Holons Into Real System | 45 |
| 4.3 | Holon Internal Structure | 46 |
| 4.4 | Darwin's and Punctuated Evolution Theories | 49 |
| 4.5 | Evolution by Means of the Self-Organization Mechanism | 50 |
| 4.6 | Emergence in Action | 51 |
| 4.7 | Coleman's Boat View in ADACOR ² | 52 |
| 4.8 | Behavioural Self-Organization | 53 |
| 4.9 | Composition of a Generic Behaviour | 54 |
| 4.10 | Behavioural Perspective Block Diagram | 55 |
| 4.11 | Evaluating and Refining the Holon Behaviour | 56 |
| 4.12 | Indirect Behaviour Propagation | 59 |

| | | |
|------|---|-----|
| 4.13 | Behavioural Self-Organization in Practice: Detection of a New Holon . . . | 60 |
| 4.14 | Evolution by Means the Behavioural Self-Organization: Detection of a New Holon | 61 |
| 4.15 | Behavioural Self-Organization in Practice: Holon Malfunction | 61 |
| 4.16 | Structural Self-Organization by Group Decomposition | 64 |
| 4.17 | Composition of a Structure Procedure | 65 |
| 4.18 | Bottom-Up and Top-Down Approaches for the Structural Self-Organization | 66 |
| 4.19 | Huge Batch Order Arrival and New Structure Propagation | 68 |
| 4.20 | Structural Self-Organization by OH Change | 68 |
| 4.21 | Structural Self-Organization by Resource Sharing | 69 |
| 4.22 | Detection of a Crucial Operation as Trigger to Structural Self-Organization | 69 |
| 4.23 | Structural Self-Organization by Clustering | 70 |
| 4.24 | Stabilization Mechanism Embedded in ADACOR ² Holons | 71 |
| 4.25 | Nervousness Controller System Dynamics | 72 |
| 5.1 | Contract-Net Protocol Approach in ADACOR ² | 78 |
| 5.2 | Potential Fields Concept | 79 |
| 5.3 | Attenuation Curves Profiles | 81 |
| 5.4 | Stigmergic Behaviour Concept | 83 |
| 5.5 | Different Solutions Found During the Structural Self-Organization | 89 |
| 5.6 | Ants Food Foraging Structural Self-Organization | 90 |
| 5.7 | Nervousness control mechanism based on PID controllers | 93 |
| 6.1 | View of the AIP-PRIMECA Cell | 98 |
| 6.2 | Layout of the AIP-PRIMECA Cell | 99 |
| 6.3 | AIP-PRIMECA Shuttle and Switching Gate Detail | 99 |
| 6.4 | Product Catalogue | 100 |
| 6.5 | A Futuristic AIP-PRIMECA Cell | 101 |
| 6.6 | Conveyor System Holon GUI | 104 |
| 6.7 | C _{max} for the Normal Scenarios | 106 |
| 6.8 | C _{max} for the Disturbances Scenario | 107 |
| 6.9 | Analysis of Impact with the Occurrence of Disturbances | 107 |
| 6.10 | Throughput for Normal Scenarios | 108 |
| 6.11 | Throughput for the Disturbance Scenarios | 109 |
| 6.12 | Predictability of the Manufacturing Control Approaches | 109 |
| 6.13 | Structural Self-Organization in Practice | 111 |
| 6.14 | C _{max} for the Structural Self-Organization | 111 |
| 6.15 | Throughput for the Structural Self-Organization | 112 |
| 6.16 | Analysis of the Impact of the Control Approaches | 112 |
| 6.17 | Predictability of the Manufacturing Control Approaches | 113 |
| 7.1 | Performance Behaviour of the Evaluated Control Structures | 117 |

| | | |
|-----|---|-----|
| A.1 | Product Catalogue | 148 |
| B.1 | AUML PF Propagation | 155 |
| B.2 | Shop-Floor Representation Graph | 156 |
| B.3 | AUML Diagram of TH Querying for PF Values | 157 |
| C.1 | AUML Diagram Used in the Structural Self-Organization | 160 |
| D.1 | Calculation Time Plus the Output Results | 162 |

List of Tables

| | | |
|-----|---|-----|
| 3.1 | Bio-Inspired Applications to Solve Engineering Problems | 31 |
| 3.2 | Bio-Inspired Applications to Solve Manufacturing Problems | 33 |
| 5.1 | Blackboard Table Example | 84 |
| 6.1 | Transportation Times Between Nodes | 99 |
| 6.2 | Process Plans for the Catalogue of Products | 100 |
| 6.3 | Machine Skills and Processing Times | 100 |
| 6.4 | Behavioural Scenarios Description | 105 |
| 6.5 | Structural Scenarios Description | 110 |

List of Acronyms

- AARIA** Autonomous Agents at Rock Island Arsenal.
- ABAS** Actor-Based Assembly Systems.
- ABC** Artificial Bee Colony.
- ABM** Agent-Based Modelling.
- ACIN** Automation and Control Institute.
- ACO** Ant Colony Optimization.
- ADACOR** ADAptive holonic CONtrol aRchitecture.
- AGV** Automated Guided Vehicles.
- AIP** Atelier Inter-établissement de Productique.
- ARUM** Adaptive Production Management.
- AUML** Agent Unified Modeling Language.
- BMS** Bionic Manufacturing Systems.
- CFP** Call For Proposals.
- CIM** Computer-Integrated Manufacturing.
- CIMOSA** Computer Integrated Manufacturing Open System Architecture.
- CNC** Computer Numerical Control.
- CNP** Contract-Net Protocol.
- CoBASA** Coalition Based Approach for Shopfloor Agility.
- CPS** Cyber-Physical Systems.
- CSH** Conveyor System Holon.
- DB** Data Base.
- DCS** Distributed Control System.

DIAL Distributed Information and Automation Laboratory.

DML Dedicated Manufacturing Lines.

EAS Evolvable Assembly Systems.

EPS Evolvable Production Systems.

ERP Enterprise Resource Planning.

FIPA Foundation for Intelligent Physical Agents.

FMS Flexible Manufacturing System.

GA Genetic Algorithm.

GRACE inteGration of pRocess and quALity Control using multi-agEnt technology.

GUI Graphical User Interface.

HCBA Holonic Component Based Architecture.

HMS Holonic Manufacturing System.

HPC High Performance Computing.

IDEAS Instantly Deployable Evolvable Assembly Systems.

iESB intelligent Enterprise Service Bus.

IMC-AESOP ArchitecturE for Service-Oriented Process - Monitoring and Control.

JADE Java Agent DEvelopment Framework.

JESS Java Expert System Shell.

KB Knowledge Base.

KPI Key Performance Indicator.

MAS Multi-Agent System.

MAST Manufacturing Agent Simulation Tool.

MES Manufacturing Execution System.

OH Operational Holon.

OPC-UA OLE for process control - Unified Architecture.

ORCA dynamic Architecture for an Optimized and Reactive Control.

PABADIS Plant Automation Based on DIStributed systems.

PF Potential Fields.

PH Product Holon.

PID Proportional, Integral and Derivative.

PLC Programmable Logical Controller.

PRIME Plug and PRoduce Intelligent Multi Agent Environment.

PRIMECA Pôle de Ressources Informatique pour la Mécanique.

PROSA Product-Resource-Order-Staff Architecture.

PSO Particle Swarm Optimization.

RFID Radio Frequency IDentifier.

RMS Reconfigurable Manufacturing System.

SCADA Supervisory Control And Data Acquisition.

SD System Dynamics.

SH Supervisor Holon.

SoA Service Oriented Architecture.

SOCRADES Service-Oriented Cross-layer Infrastructure for Distributed smart Embedded devices.

TH Task Holon.

UAV Uninhabited Aerial Vehicles.

VR Virtual Resource.

WIP Work In Progress.

XML EXtensible Markup Language.

YAMS Yet Another Manufacturing System.

List of Symbols

α Weight desirability of follow the local pheromone information.

β Weight desirability of follow the global pheromone information.

B^h Set of behavioural mechanisms.

δ Nervousness time window.

e Pheromone evaporation value.

ϵ Number of behavioural or structural changes.

γ Learning update rate.

H_h^σ Holon internal nervousness level.

Kd Nervousness controller derivative parameter.

Ki Nervousness controller integral parameter.

Kp Nervousness controller proportional parameter.

OH_{oh}^{PF} Set of potential fields of a given Operational Holon.

P_i^t Pheromone deposition value.

ψ Potential field back-propagation stop threshold.

R^h Set of structural mechanisms.

st Holarchy structural performance indicator.

τ Re-establishment time (from a disturbance).

t_m AGVs moving time in structural self-organization.

t_p Resource processing time.

t_t Transportation time between resources.

ζ Threshold value for an increase of performance of the holons' internal behaviour to consider a behavioural change.



Introduction

Our greatest weakness lies in giving up. The most certain way to succeed is always to try just one more time.

Thomas A. Edison

One of the main pillars of the world's economy is the manufacturing sector that, particularly in the recent years, has suffered a revolution from the client side, being pushed by an ever increasing demand for higher products customization, quality standards and by the decrease of the product life-cycle, passing by significant fluctuations in market demands, just to name a few (ElMaraghy et al., 2012). On an internal side, and in order to face these constraints, manufacturing has seen an unprecedented process of automation re-configuration, leading to a possible production increase and higher product quality but also to, in some part, leaving the shop-floor vulnerable to more disturbances, such as machine failures.

1.1 Research Problem

Traditionally, manufacturing control systems use hierarchical control structures which concentrate the processing power of the shop-floor control under one central node. This increases the system performance and optimization but sacrifices other key features, such as the responsiveness to handle disturbances and scalability possibilities. These

monolithic, rigid control structures are insufficient to meet the current requirements imposed by manufacturing environments which demand flexibility, robustness, reconfigurability and responsiveness, which are pointed out as research topics by the National Research Council for the year of 2020 (Council, 1998). New manufacturing paradigms have thus emerged with the common denominator of the decentralization and distribution of processing power over several entities providing a better capability to adapt and respond to condition changes but with a decrease in the system performance regarding the optimization process. This decentralization is also aligned with recent trends and initiatives, such as the Internet of Things, CPS (Cyber-Physical Systems) and Industrie 4.0 program.

Several examples of paradigms promoting this decentralization can be found in the literature, being the most known the MAS (Multi-Agent System) (Ferber, 1999), BMS (Bionic Manufacturing Systems), HMS (Holon Manufacturing System) (Deen, 2003), and more recently, EPS (Evolvable Production Systems) (Onori et al., 2006).

A MAS (Ferber, 1999; Wooldridge, 2002) is both a paradigm and technology that advocates the design of systems based on societies of decentralized, distributed, autonomous and intelligent entities, called agents. In such systems, each agent has a partial view of the surrounding world and must therefore cooperate with others to achieve the global objectives. The behaviour of the global system emerges from the cooperation between individual agents.

An HMS (Deen, 2003) is a paradigm that translates the concepts of living organisms and social organizations developed by A. Koestler (Koestler, 1969) to the manufacturing world. A holon, as Koestler coined the term, is an identifiable part of a system that has a unique identity, yet is made up of sub-ordinate parts and is in turn part of a larger whole. Koestler also defines the term holarchy as a hierarchically organized system populated with self-regulating holons, and the system goals are achieved by the cooperation between holons. An HMS is the encapsulation of the entire manufacturing system in a holarchy. The holons can represent physical resources and logic entities.

The BMS uses the underlying mechanisms and the structural organization found in biological systems (Tharumarajah, 1996). These systems exhibit many of the features needed for the current manufacturing paradigms such as autonomy, spontaneous behaviour social harmony with hierarchy structure.

EAS (Evolvable Assembly Systems) proposes a new design approach by advocating the system to be built by a swarm-like of interconnect modules that possess a more limited set of skills, i.e. more task specific, enabling the system a continuous evolution (Onori et al., 2006). Additionally, EAS also proposes a new approach on the design cycle of the products, which are deeply influenced by the available set of modules present within a given system.

These paradigms promote the decentralization of the control power among several entities. Despite the existence of central nodes, in the hierarchical approaches, that control the low-level entities constitute a drawback, in the sense that if it fails the whole

system may fail, they are able to reach high optimization levels under stable conditions. On the other hand, decentralized systems, such as those elaborated using MAS and HMS concepts, respond better to perturbations where the failure of an isolated entity only affects part of the system, while the other parts can continue operating with no major impact. Despite the benefits shown, decentralized systems do not attain optimization levels as high as those depicted by hierarchical solutions. As illustrated in Figure 1.1, under normal conditions, the system performance of hierarchical architectures $hi(t)$ is better than heterarchical architectures $he(t)$. However, in case of unexpected situations, e.g., due to a resource malfunction or a rush order, the heterarchical architectures behave better since they are able to respond promptly to perturbations.

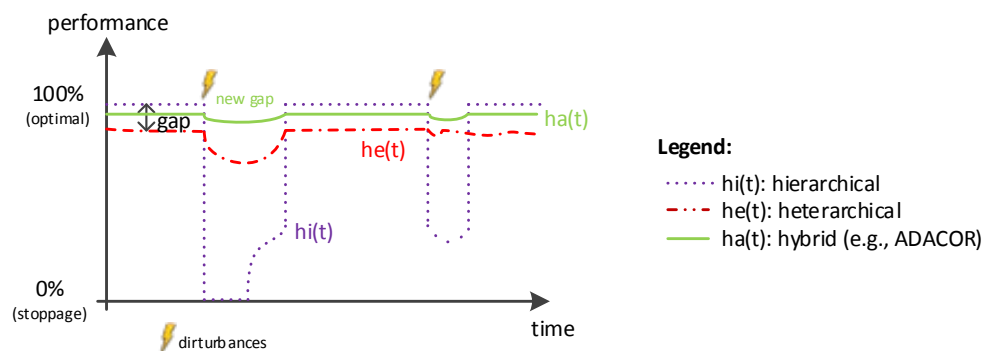

Figure 1.1 – Performance Behaviour of Different Classical Control Structures

Essentially, the challenge is to combine the best of both worlds, where a system displays the optimization levels of hierarchical systems under normal conditions and behaves like heterarchical approaches in unexpected situations. An approach like this brings hierarchical features to distributed entities whilst retaining their autonomy. For this purpose, some hybrid solutions have been developed exhibiting the $ha(t)$ behaviour illustrated in Figure 1.1.

Several approaches relying on these emergent paradigms with the objective to address this challenge can be found in the literature and particularly, the ADACOR (ADaptive holonic COntrol aRchitecture) (Leitão and Restivo, 2006) holonic control architecture is a well-known example of such approach since it considers an adaptive production control mechanism that balances between two states: a hierarchical stationary state and a heterarchical transient state. In spite of the important progress made in this domain, there is still the need to further development to achieve a truly dynamic and evolvable system that is able to cope with system constraints, without significantly affecting its operation, i.e. minimizing the overall gap to the optimal behaviour in Figure 1.1.

Biology and nature, as well as evolutionary theories, are suitable sources of inspiration to design and develop solutions for solving complex, large-scale problems, and particularly manufacturing control systems, aiming to increase their potential by embedding

emergent concepts (Leitão et al., 2012). One example is the use of self-organization principles, which can be described as the ability of a system to arrange itself autonomously and spontaneously, mainly due to internal interactions, and without the need to use a central authority (Camazine et al., 2001). Other well-known biological sources of inspiration are the food foraging of ants (Deneubourg et al., 1990) or food foraging of bees (Frisch, 1967), as well as fish schooling or birds flying patterns (Eberhart and Kennedy, 1995).

Some approaches have already tried to use self-organization concepts as a way to cope with the complexity and unpredictability associated with disturbances that may appear in the system. Some examples are found in the literature, embedding these concepts, namely the PROSA (Product-Resource-Order-Staff Architecture) architecture that was extended by using the food foraging behaviour of ants as a forecasting methodology (Hadeli et al., 2004), the P2000+ (Bussmann and Schild, 2000) that used a virtual buffer mechanism in machines that acts as the self-organization regulator, and the ADACOR that use a pheromone spreading technique to propagate the perturbation as a warning signal among entities, which can assess the impact of the perturbation on themselves (Leitão and Restivo, 2006).

Despite this, these biologically inspired mechanisms are considered very superficial, lacking truly evolutionary concepts as a way to handle complex systems properly, minimizing the impact of disturbances and boosting the optimization of the system behaviour.

1.2 Objectives and Contributions

This thesis addresses the challenge of study and present an innovative manufacturing control architecture, by proposing an evolution to the ADACOR holonic manufacturing control architecture, by taking knowledge of biology and evolutionary theories into consideration. This knowledge aims primarily to unleash the two predefined working states of its predecessor by allowing the system to dynamically evolve using self-organization principles.

The thesis sustained in this research work can be summarized in the following statement:

The development of a manufacturing control architecture, where the ADACOR principles are reused, mainly the holonic concepts and the adaptive production control, enhanced with a two-dimensional self-organization model and a nervousness control, allowing that intelligent complex systems to smoothly or dramatically respond to new system constraints in such a way that the overall performance is degraded as less as possible.

The aforementioned statement is supported by the development of the following research pillars:

- Holonic principles, as also defined in the ADACOR architecture, making use of cooperative holons and hierarchical organizations, where the robustness, modularity, agility, flexibility and scalability are presented by the cooperative holons, while optimization is introduced by the high level entities in the hierarchical organization.

- Use of biological principles found in societies of species, namely self-organization, and of evolutionary theories, enhancing the system capability of adaptation and evolution.
- Enhancing the holons internal behavioural composition, allowing to act at a micro level aiming a dynamic adaptation of the holons to disturbances.
- Acting at a macro level, re-arranging dynamically the holons relations, and consequently re-shaping the holarchies constitution aiming a dynamic system evolution.
- Embedding a nervousness controller into the holon's internal structure, lowering the holon and consequently the system nervousness level, usually present in self-organized systems.

1.3 Dissertation Organization

The dissertation organization, see Figure 1.2, is described in this subsection. This document is divided in seven chapters, starting by the present chapter that contextualizes the research work and points out the thesis to be developed.

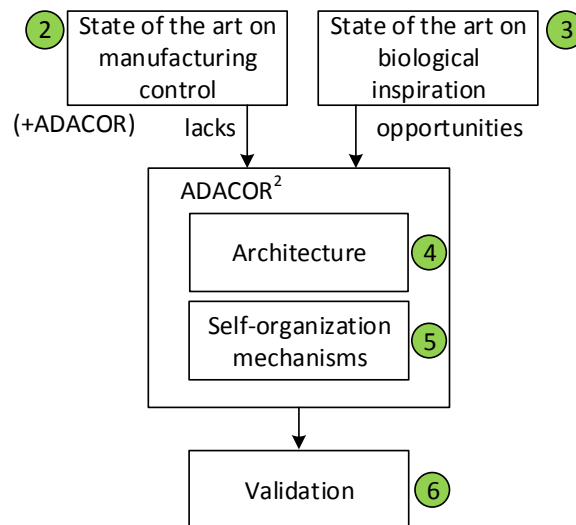

Figure 1.2 – Organization Structure of the Dissertation

Chapter 2, entitled *"Manufacturing control paradigms"*, describes the current approaches to tackle the manufacturing control problem. Particularly, a special attention will be devoted to the distributed paradigms, with the analysis of the weaknesses or lacks of current approaches in order to detect possible improvements. In this chapter, the ADACOR manufacturing control architecture is also described since it is the ground base for the current work.

Chapter 3, entitled *"Biological Inspiration to Solve Complex Problems"*, describes and praises the importance of using mechanisms and techniques often found in biological

systems as inspiration for the development of a new generation of manufacturing control systems. Particularly, the swarm intelligence phenomena found in insects societies, the evolutionary concepts and self-organization mechanisms receive a particular focus. Additionally, two surveys of applications that use biological inspiration in several scientific domains, such as finance, image processing, military, robotics and manufacturing, illustrates the benefits of using such mechanisms in nowadays problem solving. An extrapolation of the manufacturing areas that can benefit from the usage of those biological concepts is also made. Finally, this chapter ends by pinpointing key features that a truly evolvable manufacturing control architecture must address.

Chapter 4, entitled "*ADACOR²: a Self-organized Holonic Architecture*", starts by designing the architectural components that compose the ADACOR² manufacturing control architecture, namely its holons, particularly the description of the holons internal structure. The chapter continues by describing the purpose behind the use of the two self-organized vectors, depicting their interdependences using the concept of Coleman's boat. Both vectors are detailed in this chapter, starting with the behavioural description and followed by the structural self-organization. Both descriptions have possible application examples in order to make more clear their usage. Finally, the chapter ends by describing the nervousness controller principles in order to control the holons instability that may arise in self-organized systems.

Chapter 5, entitled "*Self-organization Regulating Mechanisms in ADACOR²*", instantiates some mechanisms that were used during the development of the ADACOR² manufacturing control architecture. This chapter starts by describing three behavioural self-organization techniques, one following marked-based rules, another using the physical effect of magnetic bodies and the last one using the food foraging behaviour of ant societies. Secondly, a bird inspired mechanism is also described as the way for the holons to self-organize structurally. Last, the chapter ends by proposing a nervousness controller inspired in the feedback mechanism known as Proportional, Integral and Derivative (PID) found in the classical control systems theory.

The description of the case study and the assessment of the proposed manufacturing control architecture is presented in chapter 6, named "*Practical Implementation and Validation*". The chapter starts by making a description of the Flexible Manufacturing Cell used in the case study. Next, the assessment metrics used later in the approach validation are described, being followed by a mapping of the ADACOR² holons with the system components. The assessment is achieved in two different phases. First, a simulation of the real use case is used to assess the behavioural self-organization component, while a modified version of the use case is used to assess the structural self-organization component.

Finally, the thesis is round up by the "*Conclusions and Future Work*" where macro conclusions and major contributions of this research work are presented. This chapter is ended by outlining future research branches that can be followed to continue the started work.

Additionally, four appendixes are also available providing details of developed support work. The Appendix A describes the simulation technique and procedures. On the Appendix B, the implementation of a potential fields based mechanism is described, while on the Appendix C the implementation of a fish schooling self-organization mechanism is depicted. Finally, the Appendix D describes the implementation details of the scheduling algorithm used by the supervisor holon.



Manufacturing Control Paradigms

Simplicity is the ultimate sophistication.

Leonardo da Vinci

The present chapter will draw the current state of the art regarding the production and manufacturing control paradigms. The most traditional and more recent paradigms characteristics and approaches will be analysed, as well a deeper explanation of the ADA-COR manufacturing control architecture, followed by the discussion of the remaining problems and challenges in this area.

2.1 Production and Manufacturing Control

Each industrial facility is built upon a complex system of systems, where raw materials, or semi-finished products, are processed and combined using a set of internal resources, and are delivered as finished goods. To this subject, the ANSI/ISA-95 (as also the IEC 62264) standard divides this complexity into four layers (see Figure 2.1), defining where and how manufacturing decisions are made. These four layers comprise the control (Level 1 and 2), operations (Level 3) and business (Level 4).

The objective of level 1 and 2 is the control of equipment which leads to the execution of the production process aiming the production of the products, comprising e.g., PLC (Programmable Logical Controller)s, resources, CNC (Computer Numerical Control) and SCADA (Supervisory Control And Data Acquisition). Level 3, also named the MES (Manufacturing Execution System) layer activities, comprises several preparation

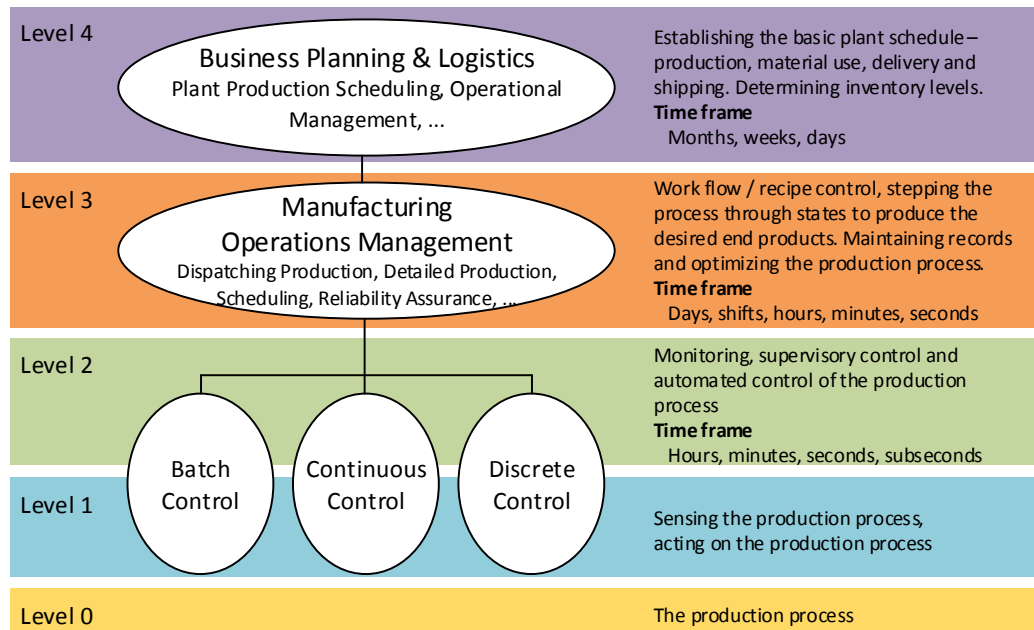

Figure 2.1 – The ANSI/ISA 95 Standard

activities, such as detailed scheduling, quality management and maintenance that are undertaken to prepare, monitor and complete the production process that is executed at the lower levels. Level 4 is the highest level, also named the ERP (Enterprise Resource Planning) layer, being related to the layer where strategic decisions are taken, such as financial and logistics. As an example, long term planning, marketing and procurement activities take place at this layer.

Focusing on the layer distribution made by the ANSI/ISA-95, the subject of this thesis is to propose a manufacturing control architecture that covers, at least partially, the levels 2 and 3.

According to the Figure 2.2, adapted from (Trentesaux, 2009), a manufacturing control architecture falls into one of four typological classes, classified from Class 0 to Class III. Classically, manufacturing control architectures rely on a pure centralized control system, where one central decisional entity governs the full spectrum of the operation system (e.g., machines and transportation). The Class I divides the massive processing needs found in Class 0 by placing one decision entity into each of the (sub)systems to control and by clustering those into higher level recurring to the sub-division, but following a fully hierarchical approach.

Class II clusters the control architectures that proposes an hybrid manufacturing control merging the optimization of hierarchical system with the flexibility of heterarchical ones. Lastly, Class III control systems propose a fully decentralized control, distributing the processing capabilities among a set of individual and autonomous entities.

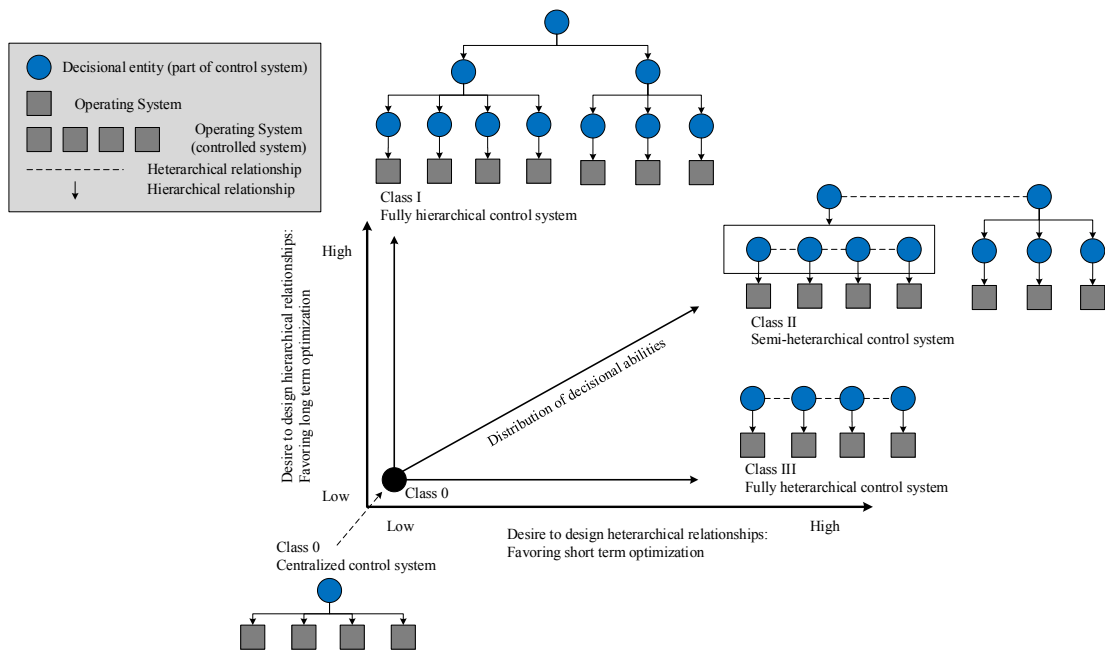

Figure 2.2 – Distribution of Decisional Capabilities from Centralised Control Systems to Non-Centralised Control Systems (Trentesaux, 2009)

The manufacturing control systems developed under the aforementioned classification have pros and cons which address different real control purposes, such as performance optimization, adaptability, agility and responsiveness. In such, the more hierarchical approaches, like those classified as Class I, have the potentiality to introduce optimization at the control system at the cost of having massive processing entities. Those entities rely on the collection of the current status of the system and on the processing of this information. Since the processing time of this task increases greatly as the system structure and size also grows, it degrades other important performance indicators, such as the system adaptability, agility and responsiveness.

On the other side, manufacturing control systems classified under Class III potentiates the decentralization and distribution of the control entities, allowing them to have less performance processing capabilities. This decentralization comes at a cost of global optimization decrease, since no entity has the complete view and knowledge of the system and must cooperate with each other in order to fulfil their goals. Despite this, these manufacturing control systems allow a great increase of system robustness, adaptability, agility and responsiveness.

Evolution of the newly requirements used in current manufacturing field has pushed the design at the shop-floor level and three major topologies (or derivations from those) can be envisioned, namely the DML (Dedicated Manufacturing Lines), the FMS (Flexible Manufacturing System) and the RMS (Reconfigurable Manufacturing System).

The DML aims the mass production and is typically designed to produce a single part at a high production rate, making them very cost effective as long as market demand matches the supply. However, the new constraints by part of the customers, which are

demanding a higher variety of customized products with shorter life-cycle, is imposing a strong pressure into this rigid line design, which is naturally in a decay situation (only for particular cases).

The FMS can be sub-divided into several categories regarding the introduced flexibility part, namely the machine, the process, the product, the routing, the volume, the expansion and the production (Jha, 1991). Depicting the ones where a manufacturing control architecture may influence, the machine flexibility can be seen as the way that machines can adapt to production changes (making use, e.g., of CNC machines). The second flexibility degree is the routing and here the system shop-floor is designed in such a way that more than one routing alternative is available for the transportation of products into the processing machines. Despite of these flexibilities degrees, the installation cost regarding the FMS is a general drawback for its implementation.

The last paradigm tries to bring the best of both worlds, by combining the high throughput provided by the DML with the flexibility of the FMS (but with a lower price). This paradigm, named RMS, is a concept that suggests the rapid change in the factory's structure using changes in hardware and/or software to adjust the production capacity and functionality (ElMaraghy, 2006). A RMS system should exhibit the following characteristics (Koren et al., 1999): modularity, integrability, customization, convertibility and diagonalisability.

Despite this, an appropriate control strategy of the aforementioned paradigms is of crucial importance, where scheduling, optimization and dispatching rules are applied as middle layer control which operationalize the higher level orders coming from the ERP systems.

2.2 Production and Manufacturing Control Approaches

Hierarchical control architectures were among the first to be developed in the manufacturing control field. The most successful of those was the CIM (Computer-Integrated Manufacturing) (Waldner, 1992) based architecture, which promoted the computerization of all the production life-cycle from the early stages of the design phase until the final product production. In the European region, the CIMOSA (Computer Integrated Manufacturing Open System Architecture) architecture aimed at the development of an open framework to help companies for enterprise modelling and integration into the CIM approaches by proposing a reference architecture from which the particular architectures were developed from (ESPRIT Consortium AMICE., 1993).

Despite the promotion of the integration of several technologies, the CIM approach wasn't able to achieve the desired results mainly because of the heterogeneity of the involved tools, the installation and maintenance complexity and its centralized approach that limited to scale the system.

Recently, manufacturing control architectures are assuming the decentralization of the processing capabilities and following a distribution of the decisional nodes bringing

them more closer to where they are needed. This new trend will probably gain an extra momentum by the promotion of the Industrie 4.0 (Drath and Horch, 2014) and Industrial Internet (Evans and Annunziata, 2012) initiatives, being the first one seen as the 4th industrial revolution.

For this purpose, some design trends have emerged over the past years, being the most promising the ones developed under the HMS, MAS and the SoA (Service Oriented Architecture) paradigms.

MAS (Ferber, 1999; Wooldridge, 2002) is both a paradigm and technology that advocates the design of systems based on societies of decentralized, distributed, autonomous and intelligent entities, called agents. In such systems, each agent has a partial view of the surrounding world and must therefore cooperate with others to achieve the global objectives (see Figure 2.3). The behaviour of the global system emerges from the cooperation between individual agents.

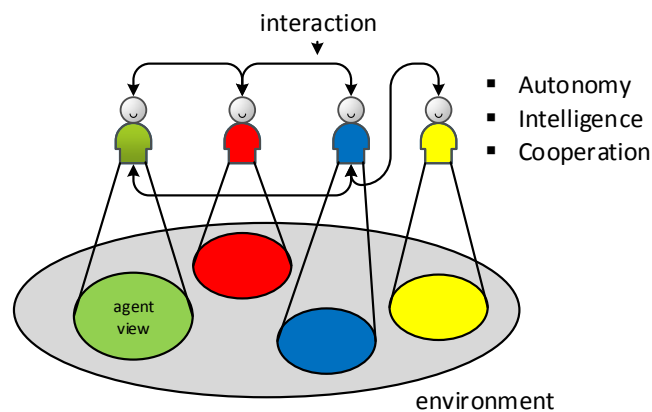

Figure 2.3 – Multi-Agent System Example

HMS (Deen, 2003) is a paradigm that translates the concepts of living organisms and social organizations, developed by A. Koestler (Koestler, 1969), to the manufacturing world. A holon, as Koestler coined the term, is an identifiable part of a system that has a unique identity, yet is made up of sub-ordinate parts and is in turn part of a larger whole (Koestler, 1969). The holons can represent physical resources and logic entities, and comprise the informational part and physical part, if exists (Leitão, 2009a).

Koestler also defines the term holarchy as a hierarchically organized system populated with self-regulating holons, with the system goals being achieved by the cooperation between the holons. An HMS is the encapsulation of the entire manufacturing system in a holarchy.

Figure 2.4 tries to depict what was mentioned earlier by using a simple example of the constitution of a manufacturing cell. It can be observed that the manufacturing cell is composed by 3 machines, each one having a set of sensors, such as pneumatic and capacitive sensor, and by a set of actuators, such as motors and valves. Two important

features found in the holonic systems can be observed, namely the holon sharing, seen in the pneumatic sensor, that is being shared by machines 2 and 3, and hierarchy, creating intermediary stable states, in the way that all the machines are controlled by a higher level controller and the overall cell by one additional controller.

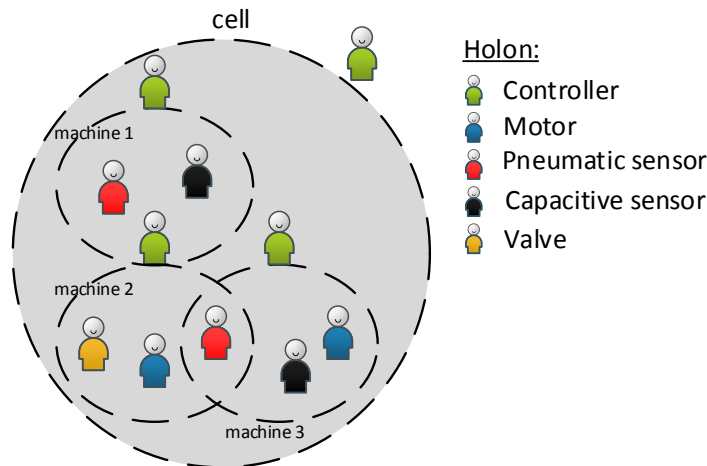

Figure 2.4 – Holonic Manufacturing System Example

Lastly, another very important feature found in HMS is the recursivity, due to the fractal composition of the holons. This feature can be seen in the Figure 2.4 where machine 1 uses other machine to be built with, resembling the Janus effect of having authority by its own and to depend/belong to others.

MAS technology and/or HMS concepts have been successfully developed and applied to different domains (see for example the reviews (Leitão et al., 2012; Monostori et al., 2006)).

2.2.1 Multi-Agent System Applications to Manufacturing

YAMS (Yet Another Manufacturing System) (Parunak, 1985) is one of the first known implementations (probably the very first) applying agent-based principles to control a manufacturing system. In this case, an agent is applied to each node of the control hierarchy, being one machine, a workstation, a cell or a factory. A CNP (Contract-Net Protocol) procedure was applied to this hierarchical model as the mean for negotiation. In this hierarchical approach, the upper level agent uses the CNP (Smith, 1980) procedure to identify the lower level agent that's under its control.

At the same time, Duffie and Piper were among the first ones to discuss an heterarchical control approach. In their work, agents represent physical resources, parts and human operators. Additionally, a part focused scheduling mechanism is applied (Duffie and Piper, 1986).

A contract net based approach was used to simulate 35 workstations of a job shop that produced parts for steam turbines that belong to the General Electric Power Generation

(Baker, 1991). In the case study, 491 orders, belonging to 184 unique products, each one having on average 8.2 operations per product are used. In the proposed approach, each workstation, either automated or a human, was represented by an agent (Baker, 1991). Briefly, the customers request a bid for a final product that will then trigger, from the agents that are able to deliver that product, a chain reaction from the agents that are needed to deliver parts or assemblies. This process is repeated by all the agents along the supply chain and the result is sent back to the customer, returning cost per unit, which is a function based on delivery time and lot size.

MetaMorph (Maturana et al., 1999) and its successor MetaMorph II (Shen et al., 2000) were projects that firstly aimed to provide an agent-based approach for the creation and management of agent communities in distributed manufacturing environments, and secondly to integrate cross-enterprise activities, such as design, planning and scheduling.

AARIA (Autonomous Agents at Rock Island Arsenal) was developed in the early years of agent-based architectures for military production, with the particularity of using internet as a means of communication between agents (Parunak et al., 2001).

The Explantech, developed at the Czech Technical University, aims the long-term production planning process (Pechoucek et al., 2005). This approach was deployed at an automotive related company (LIAZ Pattern Shop company) (Pechoucek et al., 2002) and at the SKODA Auto for the scheduling of the engine assembly workshop.

The CoBASA (Coalition Based Approach for Shopfloor Agility) architecture uses a multi-agent system to support the re-engineering at the shop floor (Barata and Camarinha-Matos, 2003). In this way, CoBASA uses contracts to govern the relationships between coalition members and defines a new methodology on which the re-engineering process is included within the life-cycle.

The previous approaches stayed more either at an academic level development stage, tested by building demonstrators, or in the brief deployment in the real industrial facilities. Despite this, some examples can be given that had accomplished a deeper industrial penetration.

One of the first multi-agent approach deployed into a real production system was named as P2000+ and was installed at a Daimler Chrysler factory that produced engine cylinder heads (Bussmann and Schild, 2001). This multi-agent system followed a late commitment strategy applied to the parts routing in a conveyor system. A self-organization mechanism is also used, adding to the machine a virtual buffer that acts like the bidding manager allowing the machine to bid to a request from a part needing to be processed (Schild and Bussmann, 2007). Being this an industrial case, a final assessment of the use of multi-agents comparing with the previous control strategy was conducted and it was concluded that a 20% gain in productivity was achieved (Bussmann and Sieverding, 2001).

A multi-agent approach was also developed and applied at the NovaFlex manufacturing system at Uninova, Portugal (Cândido and Barata, 2007). The system is composed of two assembly robots, an automatic warehouse and a transport system that connects

all the modules and each component that composes the system is agentified (i.e. each component has one agent associated to it) following some guidelines developed under the CoBASA architecture.

The iShopFloor (Shen et al., 2005) addresses the newly demands from the manufacturing global competition by promoting the usage of internet, web and agent technologies. The proposed approach promotes a framework for the components belonging to the system to work together aside of being disjoint. Additionally, the information architecture is specified and the methodologies for the integration are also provided.

Rockwell Automation developed a multi-agent based system to manage the set of components (plumbing, controls, communication and electric) of a U.S. Navy's Reduced Scale Advance Demonstrator, where the goal was the control of the liquid flow throughout the ship in a different set of regimes, such as cruise and battle (Maturana et al., 2005).

A multi-agent system enhanced with the ants food foraging behaviour is used in (Sallez et al., 2009) as the way for the products to dynamically route over the FMS. The proposed architecture is composed by two levels, named virtual and physical level. The first one is composed by the virtual active products (VAP) which represents the physical active products (PAP) that acts on the real level. Since time in the virtual level can be fast-forward, several VAPs can be used to test different routing alternatives, allowing to act on real-time on the PAP.

Albadawi et al. (2006) describes the implementation of an agent-based control architecture applied to two continuous manufacturing process, first to a tuneable model for the plastic thermoforming process and secondly to a rule-based model for the metal powder grinding process (Albadawi et al., 2006).

Rockwell Automation developed its first industrial agent approach to increase the machine utilization of the steel rod bar mill of the Australian company BHP Billiton (Mařík et al., 2005). As it was a real use case, and despite the developed MAS performed well in all the tests, it was only considered to be on the decision making layer and support the human operator in charge of the actual control. In this case, each cooling box was mapped with an agent which based on a bidding process would allow the heated steel to be cooled there.

Agent-based systems are also useful in manufacturing to provide simulation tools which allow an assessment and debugging at early design stages. One of such tools, is the MAST (Manufacturing Agent Simulation Tool) (Vrba, 2003) system and with basic components, such as conveyor belts, diverters and AGV (Automated Guided Vehicles), are used to design and simulate the desired system. The MAST system has also been used to simulate real test-beds, such as the DIAL (Distributed Information and Automation Laboratory) packing cell at the University of Cambridge and at the ACIN (Automation and Control Institute) located at the Vienna University of Technology (Vrba and Marik, 2010).

A second example of an agent based simulation tool is the ABAS (Actor-Based Assembly Systems), developed by the Tampere university of Technology and Schneider Electric,

for the simulation and visualization of the robot operation in a 3D manufacturing space (Lastra and Colombo, 2006).

Scheduling is also one of the main topics of research using agent-based technology, since it is one key feature in the control layer of a manufacturing process. Kouiss et al. use dedicated agents to work centres to select dynamically the most suitable dispatching rule (Kouiss et al., 1997). In this work, agents select the dispatching rule based on their local and global states, such as the availability of machines and on their performance objectives.

Other example is given in (Erol et al., 2012) where feasible scheduling solutions for an AGVs system is accomplished by agents negotiation/bidding process. A multi objective optimization on the basis of ratio analysis technique under a fuzzy multi criteria decision making considering several attributes was used as the scheduling prioritization on the agent based holonic manufacturing system proposed by (Jana et al., 2013). For this case, a CNP is used as the negotiation and cooperation procedure for the task allocation process.

Companies are already using multi-agent technology as the mean to develop intelligent scheduling tools. One example of such company is the Russian Smart Solutions that applies its scheduling solutions to transportation, such as taxi fleets or petrol tanks, or to manufacturing (Skobelev, 2011).

Additionally, several research funding projects, particularly in Europe have been or are being undertaken.

The EU FP7 GRACE (inteGration of pRocess and quAlity Control using multi-agEnt technology) (Leitão and Rodrigues, 2011) aimed the development of a multi-agent based monitoring system that combines the production and quality data for allowing the product customization. The developed GRACE multi-agent system was deployed to a real washing machine production line, where agents are collecting and analysing individual washing machine production data and correlating it with overall global key performance indicators, improving the final washing machine quality, making it individually unique.

The EU FP7 ARUM (Adaptive Production Management) aims at improving the ramp-up phase of small lot and highly customizable products, such as air planes (e.g., the Airbus A350). This is achieved by developing a set of scheduling (Leitão and Barbosa, 2014) and planning tools (Leitão et al., 2013) using multi-agent systems. The developed system is integrated using the SoA principles by recurring to an iESB (intelligent Enterprise Service Bus) that allows the seamless communication between all the tools present at the architecture (Marin et al., 2013).

The EU FP7 PRIME (Plug and PRoduce Intelligent Multi Agent Environment) is developing a plug and produce solution based on an intelligent multi-agent system environment using standard technology. The objective is to develop a flexible, standard, reusable, adaptable, reconfigurable, customisable and cost effective solution to deploy and maintain complex assembly systems. (Rocha et al., 2014).

The EU FP7 IDEAS (Instantly Deployable Evolvable Assembly Systems) applied

the concepts developed under the EAS paradigm and proposed self-configuring, self-diagnosis and process-oriented components aiming a complex, flexible and multi-propose system (Onori et al., 2012).

2.2.2 Holonic Manufacturing System Applications

The beginnings of the development of MAS have risen in the middle of the 80s and since then have given raise to several applications using its concepts and visions.

One of the most remarkable HMS architectures is the PROSA (Product-Resource-Order-Staff Architecture) reference architecture that defines the main guidelines for developing a generic manufacturing control system (Van Brussel et al., 1998). The HCBA (Holonic Component Based Architecture) architecture defines two major types of holons, namely the product and resource, which are responsible to e.g., manage the operations execution, make the product decision making process and possess the product information (Chirn and McFarlane, 2000). The holonic system is built through the association of these holon types using nested structures of those holons.

A manufacturing control system for a packing cell at the assembly cell of University of Cambridge was developed following an holonic approach, namely using the PROSA architecture, and implemented using the MAS technology (Fletcher et al., 2003). This system is responsible to assembly GilleteTM packages into personalised gift boxes. This full-scale real cell uses a set of robots and a conveyor system to route the products. The designed agent-based system integrates RFID (Radio Frequency IDentifier) technology, enabling a dynamic and unique identification of the products therein. In this approach, a collaboration was formed between order and resource holons to accommodate the clients' demands. Order holons use negotiation techniques to ensure the fast and reliable production and are also responsible for tracking the production progress. On the other hand, the main aim of resource holons is to maximize the return on the execution of their services, and finally, product holons deal with the buying and selling of goods.

The ADACOR (ADaptive holonic COntrol aRchitecture) (Leitão and Restivo, 2006), which will be deeper detailed in section 2.3, is a holonic architecture that proposes an adaptive production control approach that balances between a stationary state and a transient state, in normal and unexpected conditions, respectively, combining the benefits of hierarchical and heterarchical control structures using an adaptive mechanism.

The PABADIS (Plant Automation Based on DIStributed systems) architecture aims the construction of a MES using a set of autonomous production agents. Briefly, every process starts by the conventional manufacturing order being processed at the ERP, comprising the set of required production steps, which is then sent to a block named *Agency*, which is responsible to create a set of the necessary agents to execute the manufacturing order (Lüder et al., 2004). To accomplish this, a set of agents were responsible to interface and interact with the different set of components, named as Co-operative Manufacturing Units (CMU). A continuation of this project was developed, named as

PABADIS-PROMISE (Ferrarini et al., 2006), which has lowering the ANSI/ISA-95 action to the physical layers.

HMS concepts have also been applied to manufacturing control of continuous processes, namely to a steel rod mill spray cooling line. Within the proposed holonic architecture (McFarlane, 1995), a set of holons were specified, which are responsible for managing processing tasks, negotiation procedures, scheduling activities and diagnosis features (McFarlane et al., 1995).

As already happened in the MAS field, the scheduling is also one of the key applications being developed following the HMS paradigm.

Sousa and Ramos (1999) propose a dynamic scheduling system supported by a holonic approach, using forward and backward influence in the negotiation, leading to the task allocation, to handle the temporal constraints and to solve conflicts. The architecture is composed by holons to represent resources, tasks, planning systems, etc (Sousa and Ramos, 1999).

More recently the EU FP7 ARUM is also applying an holonic swarm of scheduling and planning tools, using an agent-based approach, to combine the strategic planning tools, that are producing capacity planning schedule, with the dynamic allocation of tasks to machines at the shop-floor (Leitão and Barbosa, 2014).

The aforementioned state-of-the-art description allows to verify what is being developed in this field and further reading regarding the MAS and HMS production and manufacturing control can be made using the following references: (Shen and Norrie, 1999), (Monostori et al., 2006), (Shen et al., 2006), (Trentesaux, 2009), (Leitão, 2009b), (Vrba et al., 2011), (Leitao et al., 2012) and (Laszlo, 2014).

2.2.3 Other Distributed Manufacturing Control Approaches

Not only MAS and HMS are used to design and develop distributed manufacturing control architectures. SoA, for example, has taken the attention in the past years promoting the distributed control and the seamless communication between all the players within the ANSI/ISA 95.

A SoA based architecture is proposed by (Candido et al., 2010) where transparent interoperability between devices is the major requirement. The SoA approach is used to enhance the EAS traditional architectures abstracting the implementation details under a service interface.

European projects are also using the SoA principles and technologies. Two examples are the EU FP6 SOCRADES (Service-Oriented Cross-layer Infrastructure for Distributed smart Embedded devices) and the EU FP7 IMC-AESOP (Architecture for Service-Oriented Process - Monitoring and Control). SOCRADES proposes a design, execution and management platform for the next-generation industrial automation systems at the device and at the application level. In this way, SOCRADES creates new methodologies, technologies and tools for modeling, design, implement and for the operation of

a network of smart embedded devices (Cannata et al., 2008).

The IMC-AESOP consortium developed a SoA and cloud based architecture, integrating the SCADA and the DCS (Distributed Control System) in a seamless manner, which is able to monitor and control all the information flow in large and complex industrial systems. (Karnouskos et al., 2014).

A distributed control example can also be found in the hybrid manufacturing control architecture named ORCA (dynamic Architecture for an Optimized and Reactive Control) (Pach et al., 2014). This architecture is divided in three layers, namely the physical system (PS) layer, the local control (LC) and the global control (GC). The GC has a global view of the system and guarantees the good performance of the system by having a global view of it and being composed by a global optimizer. Each PS has associated a LC that is responsible to react properly, accordingly with the associated PS state. The ORCA architecture is a dual-mode architecture, where under normal mode the GC transmits the orders to the LC. If a disturbance is detected by the LC, it will switch to the disturbance mode, being responsible to optimize the PS under its control.

Zambrano Rey et al. (2014) propose a semi-heterarchical architecture composed by a supervisor (S) and subordinate decisional entities (E). In this approach, simulation-optimization mechanisms are used to reduce the subordinates' myopic behaviour.

2.3 An Adaptive Holonic Control Architecture: ADACOR

The ADACOR adaptive holonic architecture intends to combine the best practices of hierarchical and heterarchical control approaches, being as centralised as possible and as decentralized as necessary, i.e. using a centralised approach when the objective is the optimisation, and a more heterarchical approach in the presence of unexpected events and modifications (Leitão and Restivo, 2006). In these circumstances, ADACOR proposes the decomposition of manufacturing control functions into a community of autonomous and cooperative holons, taking advantage of modularity, decentralisation, agility, flexibility, robustness and scalability. To achieve this, ADACOR proposes four types of holons (Leitão, 2004):

- PH (Product Holon), representing the products available in the factory plant catalogue and the knowledge to produce them.
- TH (Task Holon), responsible for managing the real-time execution of production orders on the shop floor.
- OH (Operational Holon), representing the system resources, e.g., robots and operators, responsible for governing its own agenda as well as managing the physical connection with the real resource.
- SH (Supervisor Holon), responsible for introducing optimization into the system.

ADACOR clearly defines the behaviour of individual holons using the Petri Nets formalism and also the interaction patterns between them using AUML (Agent Unified

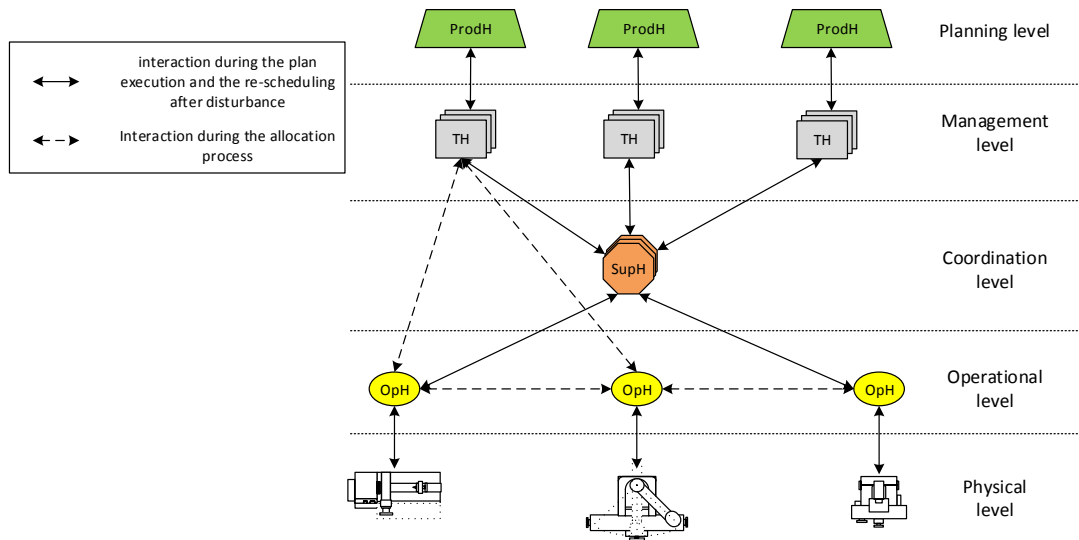

Figure 2.5 – ADACOR Holon Classes

Modeling Language) sequence diagrams (Leitão and Restivo, 2006). This is of great importance in the way that ADACOR proposes a binary-state balance for the adaptive production control depending on the system perturbation level, combining the benefits of hierarchical and heterarchical control structures using an adaptive mechanism.

As illustrated in Figure 2.6, in stationary state, the holons are organized in a hierarchical structure, with supervisor holons playing the role of coordination and optimizing the schedules of their subordinates organized in clusters. The system runs in this configuration until a perturbation is detected. The operational holon that detects the disturbance (in this case OH_1) tries to recover locally by carrying out a self-diagnosis. If recovery from the failure is unsuccessful, its autonomy factor is increased and a propagation of the need for re-organisation to the other holons in the system is sent. The propagation mechanism involves depositing a pheromone on the neighbouring supervisor holon and its subsequent spread to other SHs.

The other holons that sense the pheromone from supervisor holons, increase their autonomy factors according to the pheromone's intensity and their local knowledge, and propagate the emergent re-organization to the neighbouring supervisor holons. The intensity of the odour associated with the pheromone decreases as the levels of supervisor holons increases (it is similar to the distance in the original pheromone techniques), according to a defined flow field gradient. Each individual holon, taking its autonomy factor, learning capabilities and pheromone intensity into consideration, decides if it should re-organize or not. In Figure 2.6, the holons OH_1 to OH_5 choose to re-organize, while holons OH_6 and OH_7 do not re-organize as the pheromone's intensity is not high enough, i.e. the epicentre of the disturbance is far away and the impact is too low or zero.

In this transitory state, the task holons interact directly with the operational holons to achieve an alternative schedule in a short time, gaining in responsiveness. During

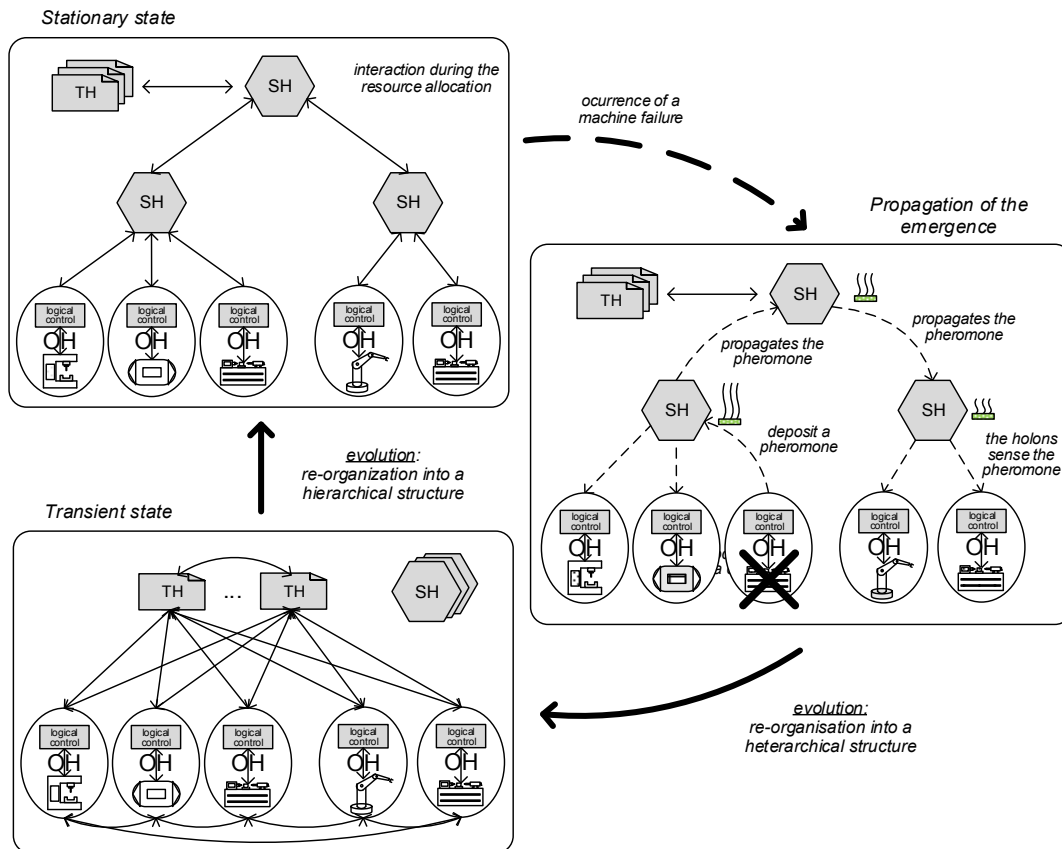

Figure 2.6 – Adaptation Mechanism in ADACOR Supporting a Hybrid Control Architecture

this state, the supervisor holons continue elaborating optimized schedules, but now only the holons with low autonomy factors will accept the proposals. The holons remain in transient state during the re-establishment time, τ , which is typically a short period of time. Once this time has elapsed, they verify if the pheromone odour has dissipated or is still active. If the pheromone is still active, the holons stay in transient state for an additional re-establishment time, until the pheromone has dissipated.

Once the pheromone has dissipated, each individual holon reduces its autonomy factor again and returns to a hierarchical control structure, going back to a stationary state, since they accept the schedules once more from their SH. At this moment, the supervisor holons collect the updated individual schedules, achieved during the transient state, and proceed with the synchronization and posterior optimization of the existing schedule. The reschedule is sent to the operational holons, which accept the advised schedule since they have a low autonomy factor again.

This powerful mechanism allows the system to respond quickly to perturbations and balance back to a stationary state after its dissipation, fulfilling the challenge of developing a hybrid control system, i.e. the $ha(t)$ curve in Figure 1.1. Despite the potential and innovation introduced by embedding this self-organization mechanism, the control system only balances between two predefined states and is not able to evolve to other

pre-defined or new control structures, supporting a truly evolvable and reconfigurable system. This challenge is aligned with the current demanding of an additional step taking the knowledge of biology, the chaos theory and the evolutionary theory into consideration to achieve the dynamic evolution and adaptation of manufacturing systems.

2.4 Limitations and Challenges of the Existing Approaches

Centralized and monolithic control architectures have design, maintenance and scalability problems. Despite these important and limiting issues, these approaches, generally, display optimal results under well defined and known functioning conditions. Additionally, due to its complexity and information centralization, these approaches behave poorly when disturbance appear, losing responsiveness.

Decentralized approaches, such as MAS and HMS, address better the disturbances situations but don't achieve the optimization performance displayed in the centralized approaches. Additionally, the design and maintenance of decentralized systems tend to be simpler due to its Lego-like construction, e.g., promoting the re-utilization of developed code (although debugging could be more time consuming).

Having this in mind, it can be concluded that combining the strong points of each architectural approach can bring benefits in the design of a better manufacturing control architecture. A good example of such combination is found in the ADACOR architecture that combines the optimization power of centralized systems with the responsiveness of decentralization.

However, analysing the current state-of-the-art of the decentralized architectures it can be found that design schemes tend to keep the entities behaviour static, in the sense that the change of behaviours is not handled.

On the other hand, more recently, research started to consider self-organization mechanisms to simplify and optimize some of the processes in the decentralized systems. Despite this, the use of self-organized approaches have prove to be very punctual and limited, needing to be further explored and potentiated.

In this sense, a manufacturing control architecture that combines the optimisation levels found in centralized systems with the responsiveness of the decentralized architectures enhanced with the real use of self-organization principles is missing in the current panorama.

2.5 Summary

This chapter overviews the current state-of-the-art concerning the manufacturing control architectures and approaches. The different system configurations were depicted and analysed, enhancing their benefits and disadvantages. The ANSI/ISA-95 standard was introduced, contextualizing the position of this thesis contribution.

The overview of the state-of-the-art included the most renowned manufacturing control architectures, being given particular emphasis to those that follow the MAS and HMS paradigms. A brief detail of each of the studied architectures was given, as well further references, providing a more detailed description of those.

This study provided valuable info about the strengths and weaknesses of these manufacturing control architectures. It was not found an architecture that allows the entities to dynamically adapt its internal behaviour and the majority of them use a rigid structure where agents interact with the same peers and where the structure is fixed or slightly adapts. Additionally, some of them make use of self-organization concepts but only in a superficial manner.

Lastly, a particular focus was given to the ADACOR manufacturing control architecture, since it will be used as the ground-base for the development of this thesis work. It was described the system architecture, and particularly the adaptive control mechanism that allows to balance between a hierarchical and heterarchical structure, combining optimization and responsiveness.

The next chapter will describe some concepts and mechanisms that can be found in biological system, such as swarm intelligence, evolution and self-organization that can be used as source of inspiration. Two surveys depicting applications that use bio-inspired mechanisms on their problem solving are also given, being the first one related to generic engineering problems while the second focus more on the manufacturing world domain.

Then, the benefits that the biological inspiration can bring to the MAS is also pointed out, being given special focus to the self-configuration, self-optimization and self-healing aspects of the MAS. Additionally, this biological inspiration contribution to manufacturing is also depicted, stating where, why and how its usage can be beneficial.

Finally, the main guidelines needed to achieve a truly evolvable system are drawn and analysed.



Biological Inspiration to Solve Complex Problems

*I have called this principle, by which each slight variation, if useful, is preserved, by the term
of Natural Selection.*

Charles Darwin

Nature offers plenty of powerful mechanisms, refined by millions of years of evolution, to handle emergent and evolvable environments (Leitão, 2009c), constituting a promising source of inspiration to enrich distributed systems with the capability to face emergence and condition changes in a quite naturally manner. This section describes how complex things behave simply in nature and biology, introducing the concepts of swarm intelligence, evolution and self-organization.

3.1 Swarm Intelligence

In biology, complex systems are based on entities that exhibit simple behaviours, made of a small set of simple rules, with reduced cognitive abilities. The global system behaviour emerges from a multiplicity of non-linear interactions among the individual entities. In such systems, the emergent behaviour occurs without a pre-defined plan, is not driven by a central entity, and occurs only when the resultant behaviour of the whole is greater and much more complex than the sum of the behaviours of its parts (Holland,

1999). Some illustrative examples of this kind of emergent behaviour can be found in the ant and bee societies. In fact, everybody knows that *"a single ant or bee isn't smart, but their colonies are"* (Miller, 2007), being capable of displaying surprisingly complex behaviours.

Swarm intelligence, found in colonies of insects, can be defined as *"the emergent collective intelligence of groups of simple and single entities"* (Bonabeau et al., 1999), thus reflecting the emergent phenomenon. Swarm intelligence offers an alternative way of designing intelligent, complex systems, in which the traditional centralized control is replaced by distributed operations where the interactions between individuals lead to the emergence of "intelligent" global behaviour, previously unknown (Bonabeau et al., 1999). Examples of swarm intelligence include ant colonies, bird flocking, fish schooling and bacterial growth (Miller, 2007).

In such colonies, individuals possess a partial view of the world and require some way of communicating with others to achieve global objectives. However, the individuals in these colonies usually do not have the ability to communicate directly each other (e.g., like humans) and thus use an indirect form of communication that establishes a channel of information sharing. For example, ants communicate by using an indirect coordination mechanism known as stigmergy, derived from the Greek words stigma, which means mark or sign, and ergon, which means work or action (Grassé, 1959). In stigmergy, the trace left in the environment stimulates the execution of a subsequent action, by the same or different entity. In this mechanism, ants use a chemical substance known as pheromone, which acts like a trigger that individuals from the same specie can sense and/or use in favour of the swarm (e.g., guidance when foraging for food) (Bonabeau et al., 1999) (see Figure 3.1a).

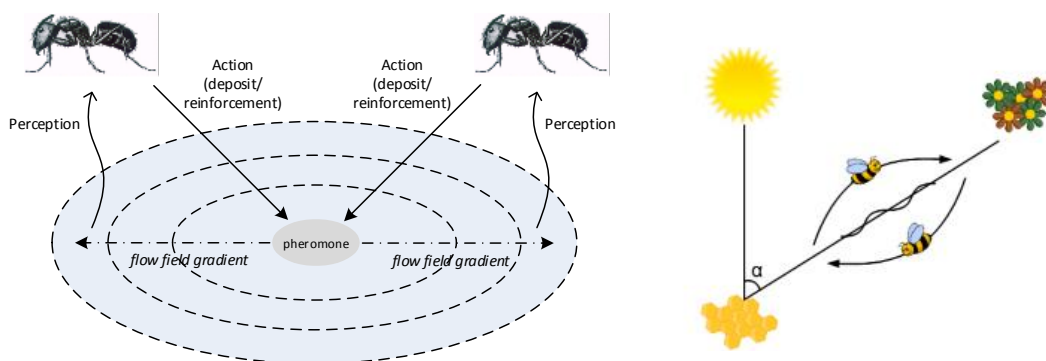

Figure 3.1 – Indirect Communication in Insect Swarms: a) the Deposition and Sensing of Pheromones by Ants [adapted from (Parunak et al., 2003)]; b) the Waggle Dance Used by Bees

After finding a food site, ants walk back to the nest and lay down a pheromone trail to share information. Other ants foraging for food can sense the odour diffused by pheromones, and may lay a trail reinforcing the existing pheromones. The pheromones deposited in the nature suffer a natural process of evaporation, resulting in a reduction of the intensity of the odour; the reduction is directly proportional to the time elapsed from

the nest to the food source (i.e. the more intense, the shorter distance travelled). If several ants make different trips to the same source of food, there will be several trips to the same source. The optimal solution (i.e. the shortest one) will be the trail that has more intense pheromones. After a while, gradually, the trails that have less intense pheromones are abandoned by the ants because the pheromones are not reinforced. Naturally, these trails are no longer considered as options. Sometimes, ants can walk randomly instead of choosing a pheromone trail, which is a good way to find new paths that have appeared in the mean time (Bonabeau et al., 1999).

The double-bridge experiment conducted by (Deneubourg et al., 1990) reinforces the idea that ants can indeed find the shortest paths to goals. In their experiments, if two equal paths from the nest to a food source, each path is chosen 50% of the time; in each experiment, the ants tend to choose only one path. On the other hand, if one path is significantly longer than the other, the ants chose the shortest one (Goss et al., 1989).

Another illustrative example of indirect communication supporting swarm intelligence is related to the waggle dance used by honey bees to share information about the direction and distance to patches of flowers yielding nectar and pollen. After scouting an area for a food source, honey bees return to the hive and inform other bees about the food source, performing a dance known as the "waggle dance", as shown in Figure 3.1b. This dance provides the following information to the other bees: 1) the rotation angle of the dance, in relation to the sun, states the direction in which the food source can be found and 2) the duration of the dance represents the travel distance to the food source (Bonabeau et al., 1999; Frisch, 1967). Other researchers suggest that this dance also provides a third kind of information related to the quality and quantity of the food source. This last information is shared by releasing a pheromone-type odour (Dornhaus and Chittka, 2004).

Swarm intelligence can be achieved more from coordinating activities of individuals and less from using decision-making mechanisms. A well-known example is the movement of flock of birds (e.g., the typical V formation), where individuals coordinate their movements in relation to the movement of the others (Reynolds, 1987). For this purpose, simple feedback mechanisms are used to regulate the individual behaviour (Camazine et al., 2001):

- in case of positive feedback, the system responds to the perturbation in the same direction as the change (i.e. towards the amplification of the perturbation), and
- in case of negative feedback, the system responds to the perturbation in the opposite direction (i.e. towards the stabilization of the perturbation).

By combining both positive and negative feedbacks, the system can be maintained under control but pushed to its limits (Camazine et al., 2001). For example, the simple rule "*I nest where other similar individuals nest unless there are too many fishes*" (Camazine et al., 2001), used to describe fish nesting, combines positive and negative feedback: the first

part uses positive feedback, allowing the aggregation of fishes in the same place to be increased, and the second part uses negative feedback, thus avoiding a high concentration of fishes in the same place.

Other similar coordination mechanisms are found in other areas of science and nature, namely market laws (Márkus et al., 1996) and potential fields (Vaario and Ueda, 1996), based on regulating the expectations of individuals with conflicts of interest.

3.2 Evolution and Self-Organization

The Darwinian theory of evolution (Darwin, 2007) is a form of adaptation to the dynamic environmental evolution. Darwin stated that nature is in a permanent transformation state in which the species would change from generation to generation, evolving to better suit their environment. Basically, Darwin saw the evolution as a result of environmental selection acting on a population of organisms competing for resources. In this evolutionary process, the selection is natural in the sense that it is purely spontaneous without a pre-defined plan. In other words, species tend to evolve to overcome their limitations and to adapt to external natural conditions. For example, a specie can perform small spontaneous changes within their chromosomes, which provokes some physiological changes after a few generations.

Self-organization is another form of adaptation to the dynamic environmental evolution. Several distinct, not necessarily contradictory, definitions can be found in the literature, namely (Massotte, 1995; Thamarajah, 1998; Bousbia and Trentesaux, 2002; Picard et al., 2009). However, the base definition (it will be further detailed in sub-section 4.2.1) used in this work is:

"The ability of an entity/system to adapt dynamically its behaviour to external changing conditions without external intervention" (Leitão, 2008).

Self-organizing systems don't follow a rigid structure but instead evolve through a dynamic, non-linear process with a constant optimization of the individuals' behaviour. Examples of self-organization principals can be found in several domains, namely:

- Physics: In thermodynamics, the 2nd law states that everything in the universe tends to move from a state of order towards a state of chaos (introducing the concept of entropy), which explains that hot bodies tend to get colder with an external cold source (e.g., a refrigerator). Another example is found on the Bernard rolls phenomenon (Getling, 1998) in which the hot and cold molecules self-organize themselves in order to create a flow.
- Chemistry: As example, molecules exhibit self-assembly properties, which drives the molecular structure to self-organization (Whitesides et al., 1991). Another example is the Belousov-Zhabotinsky chemical oscillator, which is composed of a reaction sequence that forms a loop (Shanks, 2001).
- Nature: The stigmergy phenomenon is used to achieve self-organization in ant

colonies.

The coordination mechanisms found in colonies of ants and bees, besides allowing members of these species to communicate, allow the whole community to achieve and display self-organization behaviour. Bonabeau et al. suggest that the basic ingredients to achieve a self-organized system are the positive feedback, negative feedback and fluctuations (e.g., random walks and errors). They also suggest that self-organization relies on the multiple interactions between the individuals.

3.3 Survey of Bio-Inspired Applications for Solving Complex Problems

Several researchers are using biological inspiration (e.g., those found in colonies of insects) to solve complex engineering problems. In this section, bio-inspired techniques and methods in engineering are briefly reviewed, with special attention to their applicability in manufacturing.

3.3.1 Applied to Engineering Problems

The insights inherited from the swarm intelligence principles led researchers to design optimization evolutionary algorithms, namely the ACO (Ant Colony Optimization), the ABC (Artificial Bee Colony) algorithm, and the PSO (Particle Swarm Optimization).

Dorigo introduced the ACO technique (Dorigo, 1992), inspired by the food foraging behaviour of ants, to solve problems that need to find optimal paths to some goal. In ACO, agents acting as ants, travel randomly over a weighted graph leaving marks (i.e. pheromones) wherever they go. After an initial phase, the "ants" make their decisions according to the pheromone level, instead of making decisions randomly. Over the time, the pheromone trail becomes weaker in the less used paths, making the most used path (i.e. the most optimized path) prevail.

The ACO algorithm has been used to solve diverse engineering problems from different application domains. In fact, in the financial domain, the ACO algorithm has been used to classify firms as to the different levels of credit risk (Marinakis et al., 2008a) and, in the medical field, to distinguish cancer from non-cancerous diseases, by helping with the evaluation of proteomic patterns (Meng, 2006). In the engineering world, the ACO algorithm has been used to determine the optimal values for the components in an electronics power circuit (J. Zhang et al., 2008), to achieve an optimal image threshold by separating the object from its background (Malisia and Tizhoosh, 2006), and to update the telecommunications routing tables dynamically and adaptively (Di Caro and Dorigo, 1998). In the army, this algorithm has been applied for the dynamic re-planning of UAV (Uninhabited Aerial Vehicles) (Duan et al., 2009) and for the cooperation among swarm robots to accomplish a complex task (Nouyan et al., 2009). In the industrial domain, Air Liquide has used an ant-based strategy to manage the truck routes for delivering industrial and

medical gases (Miller, 2007), and Bell and McMullen has used a similar algorithm to optimize vehicle routing logistics (Bell and McMullen, 2004). Southwest Airlines has used an ant-based behavioural model to improve its aircraft scheduling at the gates of the Sky Harbor International Airport in Phoenix, Arizona, USA (Miller, 2007).

The behaviour of bees is the source of inspiration for the development of the ABC algorithm. This algorithm uses employed bees, onlookers bees and scout bees (Karaboga and Basturk, 2007). Employed bees are those that have found a food source and are responsible for recruiting onlooker bees, which are waiting in the dance area. After being recruited by employed bees, onlooker bees, become employed bees and are responsible for recruiting. Scout bees are responsible to perform random searches in order to discover new food sources. Briefly, after recruiting onlooker bees, employed bees move to the food source (i.e. possible solution) and search for a new nearby solution, which is then transmitted to onlooker bees. When an employed bee food source becomes exhausted, this bee becomes a scout, and this process is repeated until a good solution is found. Applications using the ABC algorithm can be found on the parameter optimization of a hybrid power system model (Chatterjee et al., 2010) or the dynamic path planning of mobile robots in uncertain environments (Q. Ma and X. Lei, 2010).

PSO is a population-based stochastic optimization technique, introduced by Eberhart and Kennedy (1995), taking inspiration from the social behaviour of birds and fish schools. Briefly, the system is initialized with a population of random solutions, and the algorithm searches for optimal solutions by updating generations. The potential solutions, called particles, fly through the problem space, following the current optimum particles. As the swarm iterates, the fitness of the overall best solution improves (i.e. decreases for minimization problem). The PSO algorithm has been applied to solve problems ranging from the social to the engineering fields. For example, it has been used to optimize the parameters for PID (Proportional, Integral and Derivative) controller design (Gaing, 2004), to assess credit risks (C.-A. Li and Pi, 2009), to design evolvable hardware (Peña et al., 2006), to route vehicles with simultaneous pick-up and delivery (Ai and Kachitvichyanukul, 2009), and to optimize the parameters for spatio-temporal retina models (Niu et al., 2007).

The swarm intelligence principles have been used to forecast Turkish energy demands (Miller, 2007) and to solve traffic and transportation problems (Teodorovic, 2008). A more widespread example of the application of the swarm intelligence principles is Wikipedia (Leitão, 2009a), in which a huge number of people contribute to the constant evolution of the encyclopaedia with their individual knowledge. No single person knows everything; however, collectively, it is possible to know far more than was expected.

GA (Genetic Algorithm), derived from natural evolution, is based on a population of abstract representations of candidate solutions to an optimization problem that evolves toward better solutions. GA uses evolutionary operators (i.e. inheritance, mutation, selection and crossover), and they have been successfully applied in various application

domains: power distribution (Ramirez-Rosado and Bernal-Agustin, 1998), image segmentation (Peng et al., 2000) and scheduling and route selection for military land moves (Montana et al., 1999).

Table 3.1 provides a summary of some applications that use insights from biology and nature to solve complex engineering problems. In this table, the problem domain can range from finance to energy. This table does not intend to be exhaustive but instead to demonstrate the many domains that are already using bio-inspired solutions.

Table 3.1 – Bio-Inspired Applications to Solve Engineering Problems

| Problem Domain | Existing ACO-inspired solutions | Existing PSO-inspired solutions | Existing GA-inspired solutions |
|---------------------------------|--|---|---|
| Communication networks | (Di Caro and Dorigo, 1998),(D. Zhao et al., 2009),(Sim and W. H. Sun, 2002) | (Dongming et al., 2008), (T. Li et al., 2008) | (Lima et al., 2007), (J.-H. Lee et al., 1997) |
| Control | (Van Ast et al., 2009), (Boubertakh et al., 2009), (Q. Zhang and X.-h. Wang, 2008) | (Gaing, 2004), (Jalilvand et al., 2008), (Hu et al., 2005) | (Wai and Su, 2006), (Toderici et al., 2010), (Bae et al., 2001) |
| Finance | (Fang and Bai, 2009), (Yuan and Zou, 2009), (Hong et al., 2007), (Marinakis et al., 2008c), (Kumar et al., 2009) | (C.-A. Li and Pi, 2009), (Majhi et al., 2008), (A.-P. Chen et al., 2009) | (Badawy et al., 2005) |
| Hardware design | (J. Zhang et al., 2008), (Abd-El-Barr et al., 2003), (Sethuram and Parashar, 2006) | (Peña et al., 2006), (Goudos et al., 2008), (Ren and L. Cheng, 2009) | (Tsai and Chou, 2006), (Regue et al., 2001) |
| Image Processing | (Malisia and Tizhoosh, 2006), (Tian et al., 2008), (X.-N. Wang et al., 2005) | (Y.-W. Chen et al., 2009), (Chandramouli and Izquierdo, 2006), (M. Ma et al., 2008) | (Peng et al., 2000), (Katayama et al., 2006) |
| Medicine | (Meng, 2006), (Y. Lee et al., 2009), (Logeswari and Karnan, 2010), (Duan et al., 2009), (C.-T. Cheng et al., 2009), (Munirajan et al., 2004) | (Niu et al., 2007), (Meng, 2006), (Marinakis et al., 2008b) | (Maulik, 2009), (Das and Bhattacharya, 2009), (Tohka et al., 2007) |
| Military | (K. Lee and Vlachogiannis, 2005), (Z. Liu et al., 2009), (Colson et al., 2009) | (Matlock et al., 2009), (Cui and Potok, 2007), (Thangaraj et al., 2009) | (Moore and Sinclair, 1999), (Montana et al., 1999), (H. Liu et al., 2005) |
| Power energy | (K. Lee and Vlachogiannis, 2005), (Z. Liu et al., 2009), (Colson et al., 2009) | (H. Liu and Ge, 2008), (B. Zhang et al., 2008), (Leeton et al., 2010) | (Ramirez-Rosado and Bernal-Agustin, 1998) |
| Robotics | (Nouyan et al., 2009) | (Zhengxiong and Xinsheng, 2010) | (Tohka et al., 2007), (Karla and Prakash, 2003), (Pessin et al., 2009), (Albert et al., 2009) |
| Sensor networks | (Camilo et al., 2006), (Muraleedharan and Osadciw, 2009) | (Aziz et al., 2007), (Tewolde et al., 2008), (Z. Li and L. Lei, 2009) | (Jiang et al., 2009), (Brown and McShane, 2004), (Khanna et al., 2006) |
| Vehicle routing/traffic control | (Miller, 2007), (Bell and McMullen, 2004) | (Ai and Kachitvichyanukul, 2009), (J. Wu and Tan, 2009) | (Tong et al., 2004), (Jun, 2009), (Tunjongsirigul and Pongchairerks, 2010) |

3.3.2 Applied to Manufacturing Problems

A similar analysis of the applicability of bio-inspired techniques can be performed for manufacturing. In the manufacturing domain, algorithms based on the ant behaviour have been used to optimize machine layouts (Corry and Kozan, 2004), schedule continuous casting aluminium in a Quebec factory (Gravel et al., 2002), and coordinate adaptive manufacturing control systems (Hadeli et al., 2004). The food-foraging behaviour of honey bees is the source of inspiration for solving job scheduling problems (Pham et al., 2007b) and optimizing the manufacturing layout formation (Pham et al., 2007a). The behaviour of wasps has been used for task allocation (Cicirello and S. F. Smith, 2004) and factory routing and scheduling (Cicirello and S. F. Smith, 2001).

In addition, the PSO technique has been applied to machinery fault detection (Samanta and Nataraj, 2009), job shop scheduling (Xia and Z. Wu, 2005), machine load balance as part of a job shop manufacturing system (F. Zhao et al., 2006), and manufacturing cells layout and robot transport allocation optimisation (Yamada et al., 2003). GAs have been used to generate and evaluate assembly plans (Lazzerini et al., 1999), to design optimized layouts (G. Wang et al., 2008), and to generate schedules for flexible job-shop production systems (Qiu et al., 2009).

Self-organization principles have been used to solve complex adaptive problems: in holonic manufacturing control (Leitão and Restivo, 2006), in dynamic resource allocation of a Daimler Chrysler plant (Bussmann et al., 2004), in the development of self-organized and self-assembled bio-inspired robots (Moudada et al., 2004), and in manufacturing scheduling (Thamarajah, 1998). A stigmergic approach has also been used as the routing mechanism in a flexible manufacturing system (Sallez et al., 2009).

The potential fields have been used to solve some manufacturing problems. In spite of being a concept usually found in physics, in this work, it is included in the bio-inspired world. This concept has been used to allocate products within a group of resources (Vaario and Ueda, 1996) and to guide AGVs in a manufacturing site (Weyns et al., 2008). In addition, potential fields were used for dynamic task allocation and product routing (Zbib et al., 2010). Table 3.2 summarises some of the existing bio-inspired applications found in the manufacturing field.

3.4 Enriching MAS Based Application with Bio-inspiration

The analysis in the previous section shows the tremendous potential of using of bio-inspired systems to solve complex engineering problems. This section discusses the applicability and benefits of combining bio-inspired techniques with MAS in the manufacturing domain in order to address the current challenges. The MAS paradigm has already inherited some biological insights (Barbosa and Leitão, 2010):

- **Distributed nature:** MAS are based on a set of distributed, autonomous and cooperative agents, and the functioning of the whole system is determined by the

Table 3.2 – Bio-Inspired Applications to Solve Manufacturing Problems

| Problem Domain | Existing solutions inspired by ant and bee behaviour | Existing solutions inspired by self-organization or GA | Other existing bio-inspired solutions |
|--------------------------|---|--|---|
| Assembly/disassembly | (Shan et al., 2007), (S. Sharma et al., 2009), (Lu et al., 2008) | (Lazzerini et al., 1999), (Gao and W. D. Chen, 2008) | (Lv and Lu, 2009), (Dong et al., 2007) |
| Layout optimization | (Jain and P. Sharma, 2005), (Z.-G. Sun and Teng, 2002), (G. Chen and Rogers, 2009), (Corry and Kozan, 2004) | (G. Wang et al., 2008), (Kulkarni and Shanker, 2007) | (Ning et al., 2004), (Ohmori et al., 2010), (J. Lei et al., 2003), (Pham et al., 2007a), (Yamada et al., 2003) |
| Manufacturing scheduling | (Arnaout et al., 2008), (R.-M. Chen et al., 2008), (Xu et al., 2009), (Blum and Sampels, 2004), (Gravel et al., 2002) | (Qiu et al., 2009), (Aggoune et al., 2001), (Thamarajah, 1998) | (Shi et al., 2009), (R. Zhang and C. Wu, 2008), (Pham et al., 2007b), (Cicirello and S. F. Smith, 2001), (Cicirello and S. F. Smith, 2004), (Xia and Z. Wu, 2005), (D. Zhao et al., 2009) |
| Production control | (Hadeli et al., 2004) | (Leitão and Restivo, 2006), (Bussmann and Schild, 2000), (Sallez et al., 2009) | (Vaario and Ueda, 1996), (Ueda et al., 2001), (Weyns et al., 2008), (Zbib et al., 2010) |
| Supply chain | (Suva et al., 2004), (R. Sun et al., 2008), (Caldeira et al., 2007) | (Elmahi et al., 2004), (Kaijun et al., 2010), (Jianhua and Xianfeng, 2010) | (Sinha et al., 2009) |

interaction among these individuals.

- **Division of labour:** MAS define different types of agents with distinct roles, objectives, behaviours and skills; when a social group reaches a sufficient size, "the division of labour" appears naturally, like in insect colonies where an individual usually does not perform all tasks but rather specializes in one set of tasks (Bonabeau et al., 1999).
- **Emergence from collective simple behaviour:** The obtained behaviour of the whole system cannot be summarized to the simple sum of the behaviours of its parts (Holland, 1999).

Recalling the vision described in the previous chapter, the MAS applications that fulfil the aforementioned insights offers an alternative way of designing intelligent, robust and adaptive systems that replace traditional centralized control. As previously seen, these approaches provide robustness, since the system is not dependent on a centralized entity and has the ability to continue working even if some entities fail when performing their tasks, and flexibility, since the members of the society can dynamically be plugged in, plugged out or modified to face changing environments on the fly.

Generally, the application of MAS principles usually allows the appearance of a emergent global behaviour, guaranteeing the fulfilment of flexible and robustness requirements. These systems must have the capacity to evolve, that is related to the way the system can adapt quickly and efficiently to the environmental volatility, thus addressing the responsiveness property.

To face this challenge, biology and nature can provide useful insights, especially the self-organization phenomenon. Self-organization applied to MAS allows the implementation of several self-* properties (Leitão, 2008):

- Self-configuration, i.e. the capacity to dynamically adapt to changing conditions by modifying the system's own organization structure, thus permitting the addition/removal/modification of entities on the fly, without disrupting the service.
- Self-optimization, i.e. the system's capacity to adjust itself pro-actively to respond to environmental stimuli anticipating future state of the environment.
- Self-healing, i.e. the capacity to diagnose deviations due to unexpected conditions and act pro-actively to normalize these deviations, thus avoiding service disruptions.

The self-* properties are crucial for developing highly adaptive, evolvable systems, addressing the current requirements, and supporting reconfigurability in a quite natural manner.

Bio-inspired techniques to enhance MAS can be analysed from another perspective. Manufacturing and automation cover a wide range of application domains, presenting different requirements and constraints, which can benefit more or less from using such bio-inspired techniques. Based on the accumulated experience, the use of bio-inspired techniques combined with MAS can help to design more intelligent, modular, flexible and adaptive systems, especially in the following manufacturing domains (Leitão et al., 2012):

- Supply chains and virtual organizations, which require the frequent re-organization of partners to achieve optimization and responsiveness;
- Shop floor layout, which requires optimizing the shop floor layout in order to minimize transport time and to minimize transport distances, in situations where shop floor resources move physically.
- Product demand, in which the manufacturing system re-organizes itself to adapt to the changes in the product demand (i.e. faced with the mass customization trend), increasing/reducing the number of resources or modifying their capabilities, based on the forecast production demands.
- Planning and scheduling, in which the goal is to find the most current optimized plans and schedules, while taking the product demands and the capabilities of the shop floor resources into consideration.

- Adaptive control, in which the goal is to identify an adaptive, dynamic production control strategy based on the dynamic on-line schedule, which is adapted in cases of unexpected disturbances.
- Predictive maintenance, in which predicting machinery failures is essential for tolerating disturbances and malfunctions, which helps to develop an adaptive production system.
- Diagnosis, in which distributed entities are able to cooperate to achieve a dynamic, reliable and clear diagnosis of the detected symptoms.
- Adaptive processes and equipment, in which developing new sensors, actuators and controllers will help to design and implement more adaptive manufacturing equipment.

Despite the enormous potential of the bio-inspired insights, special care must be taken when translating them into the real-world problem-solving. If the biological behaviours are simply copied, the system may not work as expected. Mimicking behaviours can drive the system into danger states (e.g., the circular mill in army ants (Anderson and Bartholdi, 2000)). Based on this observation, the idea is not to copy the entire behavioural aspect of the biological mechanism, but instead translate and adapt the insights in order to match the system's objectives. This translation/adaptation requires collaboration between experts in biology and experts in engineering, which may lead to new insights from a different point of view.

This observation may provoke a question related to the fact that, in manufacturing, there is little space for testing, e.g., to send physical entities (e.g., products or trucks) on a random walk to explore alternative routes. It is important to remember that a multi-agent manufacturing system is composed of two components: the virtual agents and the physical resources (i.e. products and machines). Naturally, the product cannot be sent on a test trip, but agents, running bio-inspired algorithms, can use virtual ants (i.e. agents) to explore the best solutions in order to route products.

These bio-inspired solutions can be more useful when the environment in which they operate is unpredictable. The other issue that must be taken into account is applying these mechanisms may not be advantageous in cases where strong real-time constraints are needed. Special care must be taken, and the right mechanisms applied, in order to not affect the system performance.

In spite of the promising prospects that bio-inspired principles can bring to engineering systems, especially in the manufacturing domain, these principles have been adopted less than expected in industrial situations. The major problem is that industry demands proven technology, without wanting to be the first ones to try it in their production processes. The maturity of the technology and the proofs of its real applicability and merits will solve this problem. Furthermore, industry is usually afraid of using emergent terminology associated to these new technologies, such as self-organization, emergence, distributed thinking and learning.

The challenge for engineers developing bio-inspired solutions for manufacturing is to convince people from industry of the real advantages of using distributed systems based on the behaviour of simple, effective and adaptive entities regulated by simple coordination mechanisms, such as those occurring in nature. For this purpose, it is important to develop demonstrators and real case studies to be used as a proof of concept. Simulation platforms simplify the design, testing and debugging of these bio-inspired applications, ensuring a framework to simulate/validate strategies to support decision-making. Several computational platforms are currently available for the simulation/validation of bio-inspired models (e.g., SWARM, RePast, NetLogo, Gama and MadKit), in which the behaviours of biological entities (e.g., ants and bees) are usually implemented using software agents (more information related to ABM (Agent-Based Modelling) tools can be found in (Railsback et al., 2006) and (Arunachalam et al., 2008)).

An interesting example is using the NetLogo platform to simulate the dynamic determination of the best path to route the products in situations with disturbances (Sallez et al., 2009). The idea here is to simulate the manufacturing system taking into account the real conditions (e.g., the equipment status). In this way, the model gets real information, performs the simulation, and sends the commands to the real environment. The system operates in a bidirectional manner: the real environment provides fault inputs to the modelling system, and the modelling system gives scheduling orders to the real environment.

3.5 How to Achieve an Evolvable System

The achievement of truly evolvable systems requires the fulfilment of a certain plethora of requirements. The system, particularly a manufacturing control system in this work, should withstand the loss or addition of entities and continue to work in a seamless way. Disturbances must be accommodated in a transparent way and handled as smoothly as possible to mitigate their impacts. During the disturbance phase and after it, the system must constantly try to be as optimized as possible. This optimization phase might pass by acting on the internal functioning of the entities or by re-arranging the system structure, i.e. the relation among the entities. Additionally, this optimization, can also be achieved through the introduction of a high level entity (with a broader view), by applying self-organization principles or by the combination of both.

Figure 3.2 depicts the identified requirements that the proposed system must exhibit to be truly evolvable. Among them, it is possible to identify features such as control of randomness, being prepared for the unexpected, the appearance of an emergent feature, the usage of chaos control, self-organization mechanisms and the introduction of hierarchy. These features will be detailed in the following sub-sections.

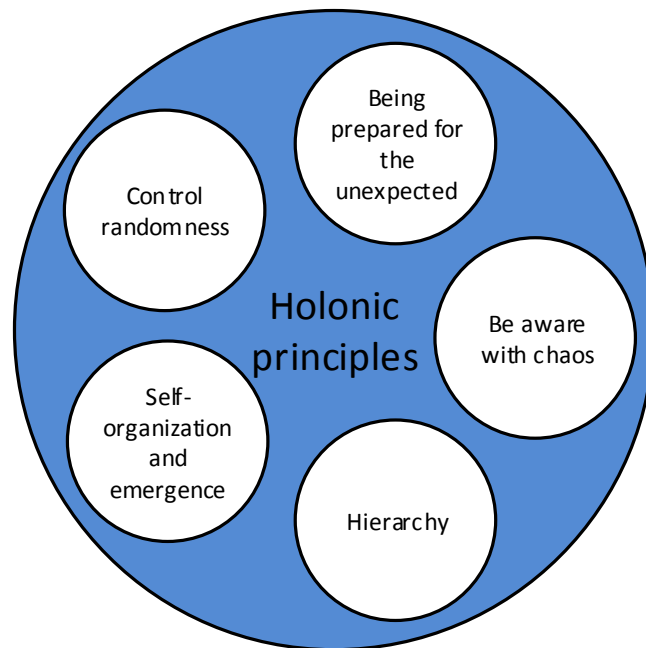

Figure 3.2 – Requirements for a Truly Evolvable System

3.5.1 Being Prepared for the Unexpected

Very large-scale and complex systems, like those found in manufacturing, have different types of disturbances that can affect the system with assorted degrees of impact. As example, in manufacturing, a disturbance, who classically is a perturbation that disrupts/affects the normal functioning of the system, can be a rush order, a delay, a worker absenteeism or a resource breakdown, which may have a negative impact on the system. Notably, a disturbance can even have a positive impact on the system, such as the introduction of a new resource or an upgrade on a existing one, in the sense that broader possibilities are presented. In the same line, the restructuring of the conveyor system or the re-arrangement of the shop-floor can deeply determine the performance of the system. All the aforementioned situations should be considered has a disturbance, their impacts measured and the system acting accordingly to cope with them. Regarding the impact level of the disturbance, a two level classification can be envisioned, namely:

Low level: the system can overcome it with less effort. Disturbances are classified as low when their impact in the system is restrained within some tight boundaries and when the system is able to resolve it locally, i.e. using minor mitigation strategies.

High level: the system, to overcome the perturbation, must undergo with major changes. Perturbations are classified as high when their impact in the system overpasses the focal point of perturbation. In this situation, the system must make changes that not only involve the affected area.

To this subject, a truly evolvable system must consider this wider set of different disturbances, learn on-the-fly as they appear, and manage them in a proper way. It is also desirable to embed in the system entities, or in the design process, methods, forecasting techniques and simulations to predict the unexpected (Valckenaers et al., 2011).

Having this in mind, it can be understood that the system must be able to accomplish two different things. Firstly, the disturbance must be eliminated and accommodated into the normal functioning of the system. This is, from a certain point, the disturbance must be considered has a natural part of the system as it is absorbed by the system. The second requirement, is that the degradation of the system performance during and after the occurrence of the disturbance must be as less as possible, and for this purpose, different disturbances can be mitigated using distinct strategies. So, a truly evolvable system must have different ways to overcome the unexpected.

3.5.2 Hierarchy: a way to Achieve Stabilization and Optimization

Optimization can be defined as the way that a given entity has to be in a state where, under the same conditions, it can extract the most out of it. Hierarchy is one of the most used ways to achieve system optimization (Dilts et al., 1991). In such approach, the entity uses the global information to have a wider knowledge of the system, making the decision process more efficient, i.e. more optimized. These high level entities uses their wider knowledge to consider a wider set of solutions for the same conditions and consequently provide low level orders to their subordinates.

A. Koestler, based on the Herbert Simon's observations, stated that a complex system will evolve more rapidly in the presence of stable intermediary states than if they were not present (Koestler, 1969). During his observations, Simon describes the parable of the two Swiss watchmakers¹ to conclude that *"Complex systems will evolve from simple systems much more rapidly if there are stable intermediate forms that if there are not."* (Koestler, 1969). As conclusion, hierarchy is a way to achieve optimization and stabilization in complex systems since higher level entities that govern the hierarchy have a wider knowledge of the current system status.

3.5.3 Self-Organization and Emergence as the Main Driver

Self-organization can be found in many complex and well structured systems (Kauffman, 1993). Many times, regulated by several local interactions, systems display desired

1. Two watchmakers produced high quality watches and were very requested. Both watches were similar in number of parts needed to build them, but each one used a different building approach. The first watchmaker, named Mekhos, would build watches piece by piece without clustering in groups. This process implies that every time Mekhos was interrupted, all the watch needed to be re-built from the beginning, since all the parts would disaggregate from each other. The other watchmaker, known as Bios, followed a different strategy, making groups of parts, which are then assembled in a hierarchical manner. In other words, Bios assembled groups of parts that are sub-assemblies of higher levels groups. In this approach, every time Bios was interrupted, the maximum he had to re-build was the sub-group he was working on at the moment of interruption.

features, such as adaptability to face the perturbations and system equilibrium. This is, often, driven by the use of indirect communication between the entities that compose the system.

Self-organization can be used to enhance the autonomy of the entities in distributed systems, managing and organizing their internal tasks and work.

As also seen in species societies, self-organization also enables the system to improve responsiveness and to overcome any disturbance that may appear along the way, mainly in large and dynamic systems. Optimization is another expected feature that can be extracted from self-organized systems. Recall the ant double bridge experience where, without any previously knowledge or any central authority, the shortest path was preferred over the longest one.

One underlying key feature of self-organization is found on the simplicity of the use of coordination and communication mechanisms. A notable usage of this is the odour pheromone deposition made by the ants during food foraging that indicates the quality and distance to the food source or the waggle dance performed by scouting bees, indicating to others the quality, distance and orientation to food sources.

Lastly, and since the goal is to have an evolvable system, self-organization can also respond properly to this since environmental influences and disturbances, generally, do not affect the self-organization mechanism, making the system to dynamically evolve, by either maintaining a stable form or displaying a transient phenomena (Bonabeau et al., 1999).

On the other hand, emergence appears due to the multitude of non-linear and dynamic interactions between all the system's entities. This emergent behaviour appears without the need to have a central authority in charge where the outcome is greater than the simple sum of the contributions of all the entities.

In fact, among the different types of emergence (Deguet et al., 2006), one definition that can be used is the one related to the simulation, where: "*A true emergent phenomenon is one for which the optimal means of prediction is simulation.*" (Darley, 1994).

Accordingly, self-organization principles must be at the core centre of every truly evolvable system.

3.5.4 Controlled Randomness

Randomness is a feature that appear in biology to allow the identification/discovery of probabilities to evolve. As an example, ants during the food foraging process usually decide to make random walks exploring the neighbour space, allowing them to discover new routing possibilities, which until that point were unknown to them. The finding of new places in the state space is afterwards evaluated to see their viability, being discarded in case of worst results or non-benefits.

Random movements have also proved to be extremely effective and desirable in nature, in situations where the predators are, somehow, expecting for preys and naturally,

desires to catch them. The serengeti wildebeest, as example, during the annual migration movement, moves in herds and purposely makes random movements between years in order for predators to not be able to find them as easily as they would otherwise (Kavaliers and Choleris, 2001).

In an truly evolvable system, randomness is a "must have" feature in the sense that it allows the addition or removal of entities and also the change of the state space where the system operates, detecting new system configurations and new entities relations. This is a very important feature in dynamic systems where, e.g., layouts change and entities providing new services are appearing and disappearing.

The pertinent question is how to embed this randomness into the control system without affecting the normal functioning of it or without degrading its performance. It must be always kept in mind that the mechanisms to be used in control systems cannot negatively affect the same system operation, e.g., one entity responsible for processing a task cannot just be sent intentionally in a random walk to search for new places in the state space. This search for changes in the state space must be made by using non-invasive techniques, i.e. those that not affect or have less impact on the normal functioning of the system.

An example of the use of exploratory entities can be seen in the PROSA+ANTS architecture (Karuna et al., 2005), where the authors have specified an entity named exploratory ants that is responsible for searching routing possibilities (representing the best manufacturing processing sequence possible). A second example of such technique can be seen in (Zbib et al., 2010) where similar concepts are also used.

Having a system without a certain degree of randomness can reduce its capability to detect changes in an appropriate way and constraint the system to evolve. Note for instance the work in (Barbosa et al., 2012a), where it is shown that having no random capabilities, the entities will not be able to overcome disturbances in a changing system. In the same work it is also shown that the opposite is also undesirable, i.e. having a large randomness feature, where the system would not display the most desired behaviour. As conclusion, the ultimate solution is to have a controlled randomness, allowing the entities within the system to have random features but not too much that will make them to fall into chaotic behaviour.

3.5.5 Be Aware with Chaos

Chaos can be directly related with the degree of randomness once if the level of the entity randomness is too high, the system will fall into a chaotic behaviour. Although some degree of chaos is desirable, which can drive the system to discover new functioning points, it becomes undesired when it grows beyond a certain point. The chaotic behaviour is one of the last effects that a system can or desire to have since chaos can rapidly drive the system into a non-return situation where it becomes uncontrollable or falls into a pitfall.

The trigger for the last example is pertinent to be discovered and eliminated in order to avoid this undesired behaviour. To this concern, a special attention to the impact of decisions must be made. Recall for example the butterfly effect, where a small change at a given point in time can produce, in a non-linear system, a huge impact later on. Additionally, the conditions on which the change is made can also influence the way the system evolve.

Despite the drawbacks of chaos, one can also benefit from a certain degree of it. Lets recall that some studies state that the human brain is in a constant state near of chaotic behaviour, i.e. it is critically self-organized (Kitzbichler et al., 2009), and in this situation the human beings tend to extract more from their brain activity. Additionally, according to (Kauffman, 1993), complex adaptive systems reside on the edge of chaos between equilibrium and chaotic activity.

Having this in mind, a truly self-organized system should be at the edge of chaos, pushed into its limits but maintaining its stability.

3.6 Summary

This chapter has given a picture of some insights, mechanisms and techniques, that biology has to offer. Swarm intelligence concept was introduced and explained and within this, the behaviour of insects societies is briefly explained. Despite not displaying individually intelligent behaviour, ants and bees as a group are capable of performing amazingly complex behaviours.

The evolution and self-organization concepts were briefly described, presenting an interesting way to design systems that in a non-controlled way are able to evolve in dynamic environments.

Two surveys are also presented as the way to, in an exemplified manner, depict some applications that already inhaled biologically inspired techniques into their approaches, such as in finance, image processing or even in manufacturing production control. Some guidelines to derive the aforementioned insights into the manufacturing world are also depicted.

Finally, key features that a manufacturing control system must possess in order to be truly evolvable are described, namely being prepared to the unexpected, the introduction of optimization through hierarchy or the use of self-organization principles figure among them.

The next chapter will describe the basic principles of the proposed self-organized holonic architecture, acting at the micro- and macro-level, i.e. at holon internal level and at the structural level. The proposed architecture extends the ADACOR approach with self-organization concepts to address a truly self-organized holonic manufacturing control.

4

ADACOR²: a Self-Organized Holonc Architecture

Look deep into nature, and then you will understand everything better.

Albert Einstein

As seen in the previous chapters, the existing manufacturing control approaches lack to achieve a truly evolvable system in the aspect that they are not able to dynamically evolve to find better functioning points, or if they have this capability, only a few degrees of freedom are considered. This requires a manufacturing control system architecture that is able to evolve in a natural manner, properly coping with different types and levels of disturbances, minimizing their impact into the system performance.

This chapter describes the architectural principles of the proposed self-organized holonic approach, named ADACOR², since it is based on the established ADACOR holonic architecture (Leitão and Restivo, 2006). ADACOR² holonic architecture aims to enhance the existing ADACOR holonic architecture through self-organization capabilities to achieve truly evolvable and reconfigurable manufacturing systems, which are able to cope with unexpected condition changes, pushing the system into its limits but remaining under stable states. For this purpose, it is proposed a self-organization holonic architecture that evolves through multiple configurations on which the system can operate, unleashing the two pre-defined states defined in ADACOR, as illustrated in Figure 4.1 (Barbosa et al., 2012b).

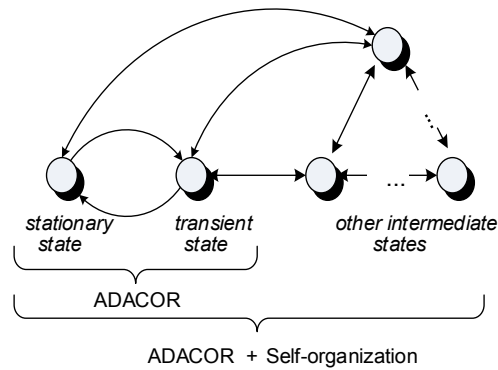
Figure 4.1 – ADACOR²: an Extension of ADACOR

In the next sections, the system architecture and the self-organization principles will be described in detail (Barbosa et al., 2015).

4.1 System Architecture

The proposed architecture follows the ADACOR holonic architecture, being constituted by an ecosystem populated by several holons that interact with each other to achieve the system's goals.

4.1.1 Architectural Components

The control level proposed by the ADACOR² holonic system is composed by a finite set of entities, known as holons (H_h), each one representing physical or logical components, processes and information belonging to the system.

Following its predecessor ADACOR, the ADACOR² architecture considers four types of holons, that are able to represent all the entities within a manufacturing system, namely PH, TH, OH and SH. There is a direct mapping of the set of holons and the set of logical and physical manufacturing components, as illustrated in Figure 4.2, where the ADACOR² system is represented as a pool of holons with their mappings to a real world representation. Note that a SH doesn't have a direct representation with the real world since it is an entity that aims to introduce optimization into the system.

In this way, the ADACOR² pool of entities can be represented by:

$$ADACOR^2 = \{PH_{ph}, TH_{th}, OH_{oh}, SH_{sh}\} \quad (4.1)$$

The set of products that can be produced in the shop-floor, i.e. the product catalogue for a given manufacturing company, is represented by PH. Product holons comprise the knowledge about the product and the process model, which are transmitted to the THs. Additionally, the PH also takes pro-active actions in situations where deviations from initial plans are detected that could affect the created THs.

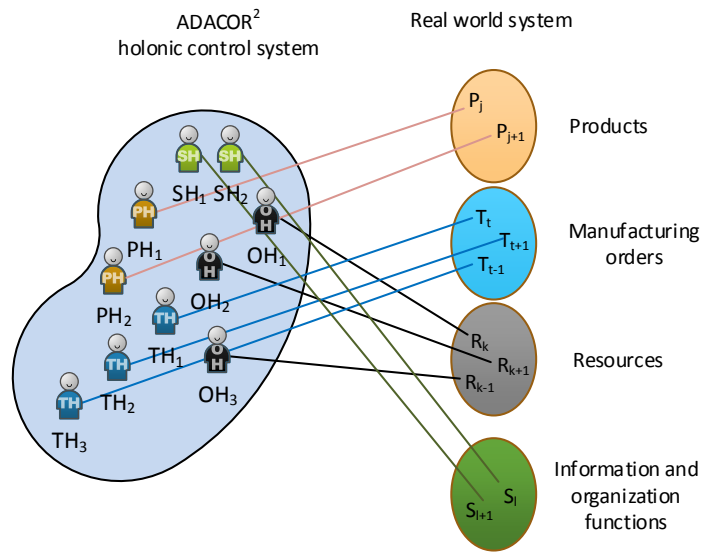

Figure 4.2 – Mapping ADACOR² Holons Into Real System

When manufacturing orders are launched into the shop-floor to produce the desired products, they are converted into individual THs being responsible to manage the production of the products' instances according to the process plan. The process plan comprises a set of operations that should be executed in the resources disposed in the factory plant according to their precedences and constraints.

The set of resources that are able to execute the necessary operations to fulfil the production orders are mapped in OHs. Each OH, representing physical manipulation, transport or processing resources present at the shop-floor, e.g., AGV, processing units, quality control or even human operators, is responsible for the internal management of its representative. Among others, OHs manage the resource scheduling, participate in the negotiation processes that might be necessary for the orders allocation and trigger the warning signals as disturbances appears.

Finally, the set of SHs introduce optimization into the system providing coordination among clusters of holons that are dynamically created and evolved.

4.1.2 Holon Internal Structure

The design of the ADACOR² holon internal architecture assumes a crucial importance in the way that will enable the inter-holon communication, the interaction with legacy systems and the internal processing of the holon itself. In order to achieve the self-organization features, the holons have to be (re)designed and be composed with the necessary set of modules. Additionally, and since the binary state of functioning defined in ADACOR is removed, the self-organization mechanisms deployed are now responsible for the transition between working configurations.

As illustrated in Figure 4.3, the holon can be divided into two major parts (Leitão and Restivo, 2006): information and physical part. The information part relates to the processing capacity of the holon itself and regulates the internal and external communication. The physical part represents the "real world", mapping different physical system components, such as resources and products.

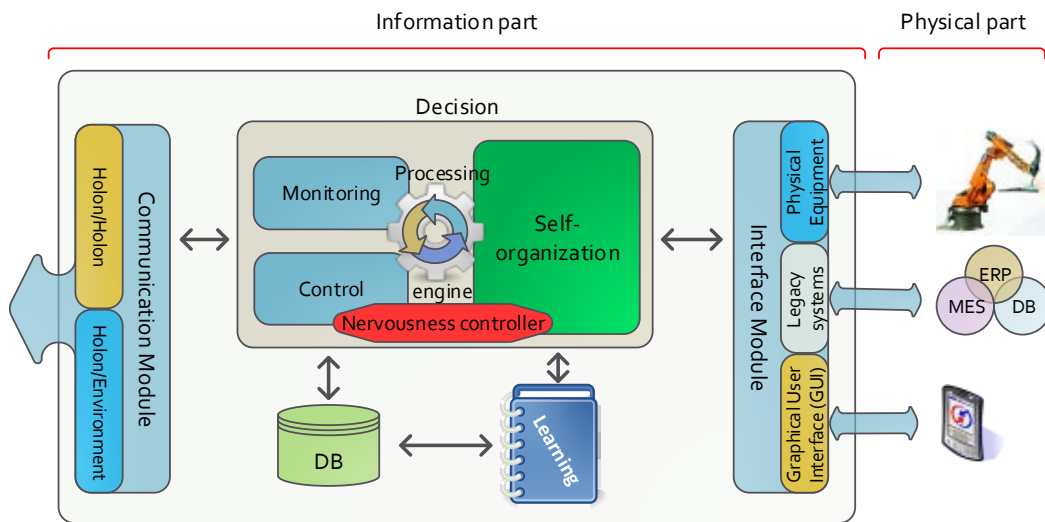

Figure 4.3 – Holon Internal Structure

The information part of the holon comprises several modules organized in three major blocks, namely communication, interface and decision.

The **communication module** provides the communication capabilities to the holon, comprising two sub-modules that allow a direct communication with other holons and with the environment.

The **interface module** provides, when needed, a connection to the physical devices, legacy systems and/or displays information to the users using a friendly GUI (Graphical User Interface), which allows a real time monitoring of the holon state and at the same time the interaction with the user. With this interface, each holon is able to represent physical systems, like robots or machines, and interface with legacy systems of the company, such as MES or ERP.

The main core part of the holon internal structure is the **decision module**, which is further decomposed in sub-modules responsible to monitor and discover events, to take control actions, to manage self-organization, and control nervousness.

The holon internal **processing engine** is responsible for managing the information flow within the holon and for trigger the holons' internal actions, such as read the environment, send messages and supervise the holon's behaviour. Basically, the processing engine is responsible for managing the holon' internal agenda.

The **monitoring module** is responsible for gathering information about the state of

the system, e.g., monitoring the external data flow and holons' physical signals, checking for pre-defined alarms that could start more serious adaptations, feeding them into the self-organization modules. Additionally, the monitoring module also supervises the normal behaviour of all the internal features, guaranteeing the holons integrity. Complementary, the **discovery module** is responsible for querying the holonic platform, e.g., by using the yellow and white pages feature, to find upcoming events, such as the presence of new holons or functionalities, which lead to the establishment of new holarchies.

One of the major contributions in the holon internal structure is in the **self-organization module** that is responsible for the dynamic adaptation of the holon internal behaviour, leading to the change of the holon internal behaviour and to the system global evolution. This module is composed by a set of rules (e.g., what-if rules and a set of mechanisms) that an expert system engine uses to match with a set of facts producing a set of actions.

The **nervousness stabilizer** performs stabilization actions (e.g., due to an adaptation process) and is responsible for guaranteeing the stability and high performance of the holon, preventing falling into chaotic and unstable behaviour (as consequence of the self-organization in the system).

Finally, under the decision part, the **control module** is responsible to materialize the actions coming from the self-organization and passing from the nervousness controller.

All the necessary data and the internal knowledge for the holon normal functioning is stored in its internal **DB (Data Base)**.

The **learning module** is responsible for the continuous self-tuning of the holon's internal behaviour aiming to have a constant improvement of the holon's performance. A major output of this module is to assist the discovering of new opportunities to evolve, as well as deciding the best way to evolve. This feature will imply special precautions since "bad learning" may appear and drive the holon to decrease its behavioural performance. This module, in conjunction with the processing engine and using the information stored in the internal DB, must certify that the holon, due to new features, don't fall into a chaotic behaviour. Additionally, different concerns must be taken during the two normal operational phases of the learning. Firstly, known as exploration, the holon is continuously refining the parameters of the learning algorithm. Due to this, the holon must, always as possible, to rely on other learning strategies, or try to follow as much as higher level suggestions (due to the wider scope of the higher entities, by principle, the suggestions are more reliable). On the second phase, as the parameters are refined, the learning module goes into the exploration phase, where minor refinements, generally, are expected and in this situation the holon can rely more on its internal learning module.

4.2 Self-Organization Principles

A key concept in ADACOR² is evolution and several definitions can be found in the literature. For the Oxford dictionary, evolution is "*The process by which different kinds of*

living organism are believed to have developed from earlier forms during the history of the earth" or simply, "The gradual development of something"¹. Additionally, according to The Free Dictionary, evolution is: "A gradual process in which something changes into a different and usually more complex or better form."².

4.2.1 Evolution and Self-Organization

Evolution in ADACOR², as shown in Definition 1, is defined by relating the capability to dynamically find new configurations points, under given conditions, allowing the system to work in a stable state with the best performance possible.

Definition 1 (Evolution) *The process by which, overtime, the system or entity, in an organized way, adapts into new internal or external situations, handling this way disturbances by finding better working configurations. In can be seen as the sum of self-organization and adaptation over time. It is also characterized by allowing a continuous or punctuated evolution between stable states towards a goal or objective.*

To this respect, evolutionary theories provide several answers, where a multitude of theories are presented with some with significant opposite visions. Probably the most renowned evolutionary theory was developed by Charles Darwin and were published in the book entitled "On the origin of species" (Darwin, 2007). In this book, Darwin states that overtime species tend to make small internal changes in order to adapt to their environment, phenomenon also known as the survival of the fittest. Having this in mind, one can anticipate that depending on its position on the system, each entity must adapt itself to its local surroundings and overtime can have different "feel and look". This behaviour is shown in Figure 4.4b), where a smooth evolution of the system over time can be observed. In ADACOR², this is translated into the entities internal evolution by allowing them to add, remove or refine their behaviours.

In an opposite direction, the punctuated equilibrium theory (Eldredge and Gould, 1972) states that species tend to be in a stable state for long periods of time and suddenly make a drastic change, as it is illustrated in Figure 4.4a). In this theory, systems would make a more drastic change into itself.

Similar concepts can be found in the manufacturing world where the kaizen philosophy states that the system can be improved through small continuous changes while the kaikaku philosophy considers that drastic changes improve the system performance (Kettunen, 2010).

These two opposite theories has then been merged, as shown in Figure 4.4c), and are the working base behind the insights to develop the ADACOR² manufacturing control architecture.

These two dramatically different approaches, found either in evolutionary theories or manufacturing strategies, offer insights to respond to unexpected events in an agile

1. www.oxforddictionaries.com/definition/english/evolution

2. www.thefreedictionary.com/evolution

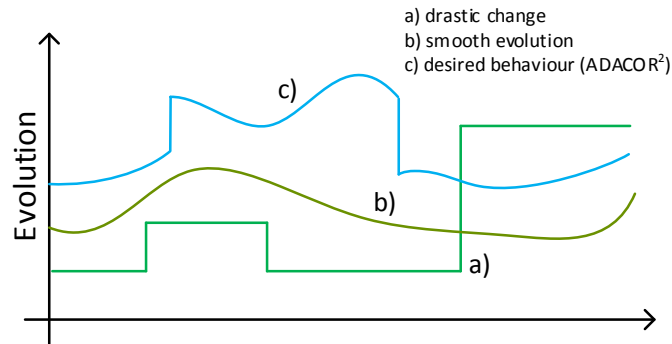

Figure 4.4 – Darwin's and Punctuated Evolution Theories

manner. Having this in mind, ADACOR² proposes a two-dimensional self-organization model that considers mechanisms at micro and macro level, unleashing the two pre-defined states as defined in ADACOR. In this way, the combination of smooth and drastic system evolution will enable the discovery of a multitude of configurations on which the system can operate, as illustrated in Figure 4.1. The opportunity to work on a multitude of configurations is probably the major difference between the two versions of ADACOR architecture. On one side, the system can be on a stationary or in a transient way, on the other, the system can dynamically adapt itself either by introducing a smooth or a drastic evolution.

The self-organization can be achieved through the interactions between all the different entities present in the system. This type of self-organization is observed throughout the nature and has proved to be very effective in swarms for problem solving. To support the dynamic evolution of the proposed architecture a two way self-organization will be deployed in the system.

At this point, it is crucial to define the meaning given to self-organization in this document.

Definition 2 (Self-Organization) *A set of processes by which an entity or system has the ability, in an autonomous and spontaneous way to re-arrange itself by means of multiple interactions and feedback mechanisms. This arrangement always aims at performance increment and system stability.*

These interactions, by following nature-inspired mechanisms, aim to be as simple as possible and with the least necessary communication overload. For each type of necessity (e.g., disturbance or need for reconfiguration), each designated entity will embed a set of mechanisms that will allow the system to overcome and evolve into a more optimized and stable functioning. To support these ideas, all the entities will be supported by learning mechanisms.

4.2.2 Two Dimensional Self-Organization Mechanisms

In ADACOR², the evolution towards the system re-configuration is supported in two distinct manners:

- A self-organization that occurs in the micro-level, which is related to the self-organization of the behaviour of individual holons, provoking the emergence of a new global behaviour, and in this way a system adaptation. For this purpose, individual holons use the embedded learning and discover mechanisms to detect new opportunities to evolve and the proper way to re-configure their behaviours.
- The macro-level self-organization, which is related to the re-organization of the interactions among the holons, provoking a new global behaviour based on a new society of holons.

The need to act at these two different levels is justified by having two major types of disturbances groups which can be envisioned regarding their impacts on the system, low and high, and that may require different mitigation strategies. Having this in mind, ADACOR² is enriched with different mechanisms as ways to overcome these constraints levels. The low impact perturbations, being more limited in time and space, can be addressed locally using low impact measures as opposite to high impact perturbation where a deep and long term change in the system can be necessary. Behavioural self-organization is then applied into the micro-level of the system while the structural self-organization is acting on the macro-level allowing the system to evolve into a new configuration (see Figure 4.5).

Considering that the system is working with a given configuration, C_i , it can either evolve by applying one and/or two of the considered self-organization mechanisms. When a self-organization procedure is applied to either overcome a disturbance or to improve the current holon/system performance, it is said that system evolves into a new configuration, C_{i+1} , since the current system state has changed.

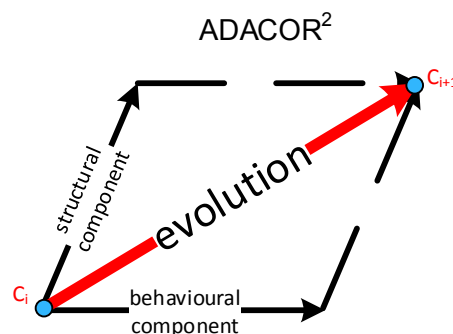

Figure 4.5 – Evolution by Means of the Self-Organization Mechanism

The aforementioned definition can be seen in Figure 4.6 on which the system will evolve, displaying the emergent phenomenon, by mean of making internal changes of the

behaviour, while the macro-level acts structurally on the system by means of a structural self-organization.

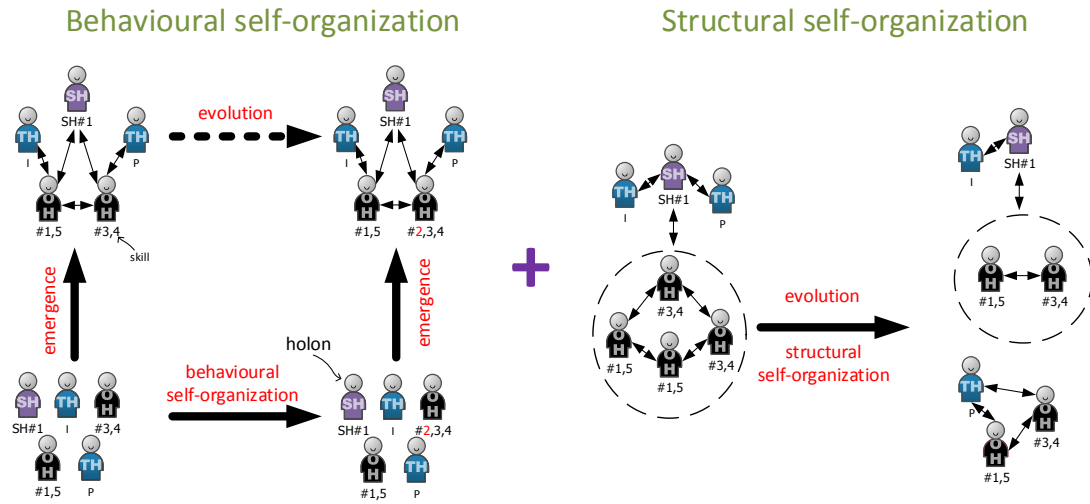

Figure 4.6 – Emergence in Action

The **behavioural self-organization** is observed at micro level, where each individual holon can change its behaviour according to the external conditions, resulting in a smooth evolution. The second component, named **structural self-organization**, is observed at a higher level and drives the drastic system evolution by changing the relationships between the holons (and even the cluster formation). So, facing the external or internal disturbances, the system can either evolve using behavioural self-organization and/or structural self-organization.

Additionally, and in order to enable the acting on those two levels, one change must be done regarding the autonomy factor as defined in ADACOR, which is dynamically changed in the presence of disturbances. Briefly, if everything goes as planned, holons have a low level autonomy factor, following blindly the orders suggested by the SH. In an opposite way, in the presence of disturbances, and depending of their impact, the holon will increase its autonomy factor, aiming to act in a more autonomous way. This mechanism is very important in the ADACOR manufacturing control architecture but it has to be redesigned to allow the new features, namely the self-organization mechanism. In such way, every holon in ADACOR² has always full autonomy, being able to take its own decisions and decide whether to follow the more global suggestions or to rely more on its local knowledge.

4.2.3 Downward and Upward Causation

The role of the two components in the self-organization mechanism, and the interactions within the holons, require to consider the correlation of the effects between these two levels: changes in the behaviour of one holon will drive the system to evolve by the emergence of a new emergent global behaviour; in a similar way, an evolution in

the holons behaviour will occur after a structural self-organization. A graphical explanation is presented in Figure 4.7 using the Coleman’s boat analogy (Coleman, 1994), which explains these interrelations in detail.

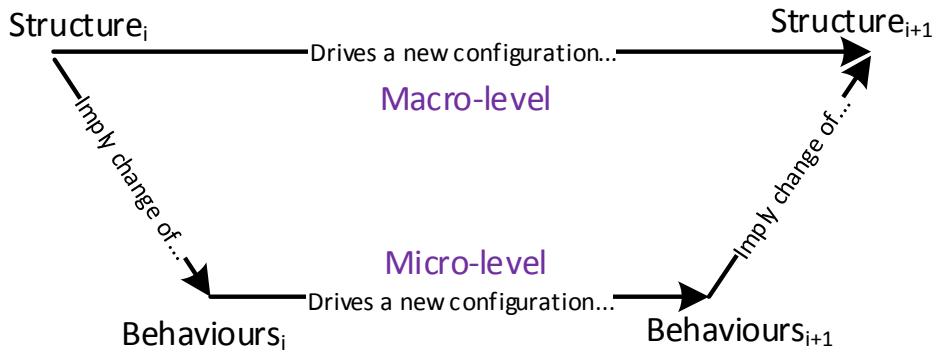

Figure 4.7 – Coleman’s Boat View in ADACOR²

A change in the structural relations between holons implies a downward causation that will change the behaviour of individual holons making them to adapt themselves to optimize their individual behaviour to face the new organization. On the other side, a change in the behaviour of holons at the micro-level may imply an upward causation that affects the structure of the relations between holons.

The following chapters will describe the two self-organization components, namely behavioural and structural.

4.3 Behavioural Perspective

The behavioural self-organization contributes at micro level to the global self-organization found in the ADACOR² architecture (Barbosa et al., 2013a). This self-organization component, seen as the way to achieve the smooth evolution of the system facing unexpected changes in normal conditions, is achieved by the selection of the proper behaviour, from a catalogue of behaviours, using a behaviour selection engine. Every holon is aware of its surrounding environment, and when a disturbance is detected, it starts the behavioural self-organization process that will culminate with the selection of the most appropriate behaviour for the new working conditions, as shown in Figure 4.8.

For this purpose, each holon is continuously monitoring its state and its environment, seeking an opportunity to evolve, as well as being aware of any external evolution trigger. Depending on the trigger type, the holon self-organizes by selecting the right behaviour from the set of known behaviours $B^h = \{B_1^h, B_2^h, \dots, B_b^h\}$.

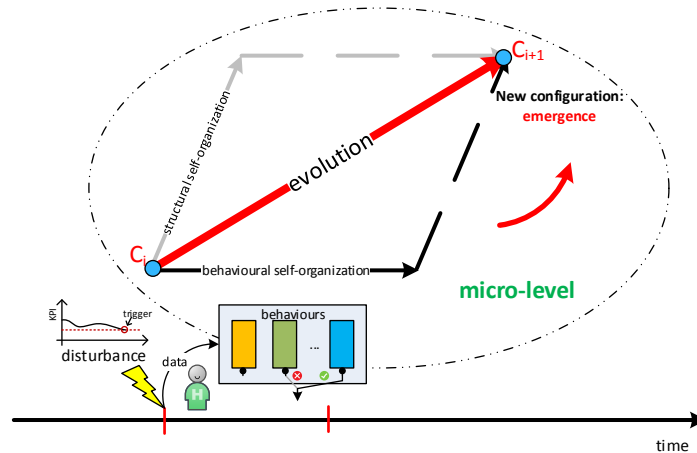

Figure 4.8 – Behavioural Self-Organization

This selection is accomplished when the adequate behaviour is used at the exact moment with the lowest impact on the overall system. This type of self-organization will push the system to a new operating point, i.e. a new configuration, produced by internal changes to cope with new constraints. In this sense, the behavioural self-organization of ADACOR² is defined as:

Definition 3 *The change in the internal state of the holon using a set of internal rules and mechanisms, triggered in response to a plan deviation or a new evolution opportunity, with the aim of re-establishing normal functioning or improving performance.*

From a behavioural self-organization perspective, a plan deviation is detected or an evolution opportunity is discovered by the processing engine embedded in the holon, e.g., matching a set of rules with the available data or facts.

4.3.1 Principles and Composition

Generically, a behaviour is constituted by a set of input data, a set of rules and the output data (as shown in Figure 4.9).

The input data defines the necessary data for the proper function of the behaviour, without which it cannot be executed. The core of the behaviour composition is its set of rules that processes the input data to produce an output. On its turn, the output is decomposed into three groups of data: KPI (Key Performance Indicator), measures and post-processing actions. The KPI is the expected performance indicator, while the measures are the set of procedures necessary to implement the behaviour. Finally, the post-processing actions relates to possible procedures taken after the application of the behaviour.

These actions include propagation policies used to warn other holons about the change of the behaviour, data policies used to update possible environment parameters

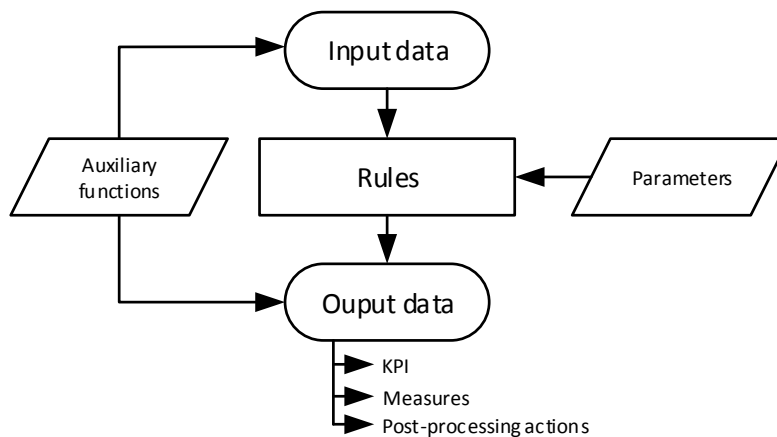

Figure 4.9 – Composition of a Generic Behaviour

used in the behaviour and feedback policies used as input to the learning module to give a real KPI to the behaviour. The later is used to refine the parameters of the rules/process.

The behavioural module proposes a change every time a given behaviour produces an improvement of the actual holon KPI. Additionally, the input or the output data may have auxiliary functions to support gathering or generating the needed data.

Figure 4.10 extends the holon internal structure (see Figure 4.3) and depicts the self-organization module regarding the behaviour perspective. There, it can be observed that low level events, those that came from the physical system, and high level events, those coming from the holonic infra-structure, are being constantly monitored and stored into its internal DB. These events or facts act like trigger signals to the behavioural self-organization, which are then feed into the decision making engine that matches them with the known behaviour rules.

The decision making process is accomplished using global data from ADACOR² high level holons, namely SHs, and local data from the holons' local knowledge. In this way, the detection of plan deviations, using the monitoring module, is sustained by means of access to global and local information. The access to the global information, related to the most optimized functioning, guarantees that behavioural decisions take into account broader, long-term solutions, thus decreasing the need for a new behavioural adaptation in the short term. On the other hand, local information supports the system reactivity by allowing the entity to access local data that at the moment of decision is more accurate, i.e. more up-to-date. Despite the faster refresh rate of this data, it suffers from myopia in the sense that it represents a local, partial view of a smaller area of action (Barbosa et al., 2011), and so global data must be used whenever possible.

All this process is supported by the learning module, which is responsible to gather and accumulate knowledge from the holon internal DB or from the feedback information about behaviours and create new knowledge by adding, removing or changing rules

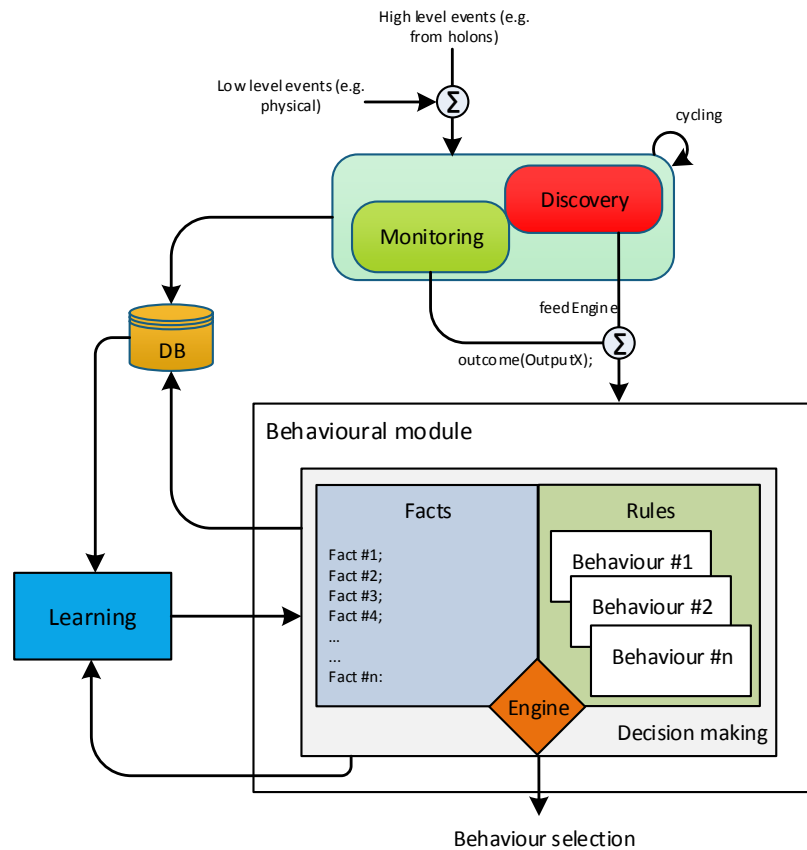

Figure 4.10 – Behavioural Perspective Block Diagram

and/or parameters.

4.3.2 Behaviour Selection

As shown beforehand, the behaviour selection is one important step during the process of the behavioural self-organization process, taking place at the decision making engine depicted in Figure 4.10.

As shown in Figure 4.9, each behaviour is composed by a set of rules and parameters that after matching them with a set of input data, i.e. the facts, produces an output with an expected KPI. The behaviour selection is obtained when, for any given behaviour, the expected KPI, B_{kpi}^h , improves the current one over the threshold value of ζ . At the limit, any slight KPI improvement can trigger a behaviour change, which may introduce some instability into the holons performance if the frequent behaviour change is significant. Despite the previous observation, more conservative decision making policies can also be applied, forcing the holon to retain the same behaviour longer, only changing it when a higher threshold value is expected. Despite of the aforementioned, the behaviour selection threshold value is dynamically adjusted by the nervousness stabilization mechanism (more details are given section 4.5).

When more than one behaviour is eligible to be used, i.e. when an improvement over the current holon KPI is expected, the behaviour that produces the higher improvement is considered. Alternatively, a multi-criteria function can be considered by combining multiple parameters in the behaviour selection. A good example in the manufacturing domain can be the selection of the behaviour that combined produces the higher improvement with the less impact in the system. Note that, for the example, some mechanisms to infer the impact of the behaviour change in the system must be embedded in the holon internal structure.

At the end of this process, the selected behaviour is sent to the nervousness controller that will enable its application.

4.3.3 Evaluating and Refining

The evaluation post-processing action is triggered each time the holon ends a self-organization procedure that produced a change in the holon behaviour.

Each time the holon interacts with other holons, as illustrated in Figure 4.11, it will gather the performance indicator which is then evaluated. In the case of the existence of a deviation from the initial plan, an internal trigger will be issued to the behavioural self-organization module, which will check the performance indicators for plan deviations in order to have a behavioural change or keep the current behaviour. In the case this plan deviation exceeds a pre-determined trigger the holon will propagate this event into the affected holons allowing them to deeply analyse and take pro-active measures.

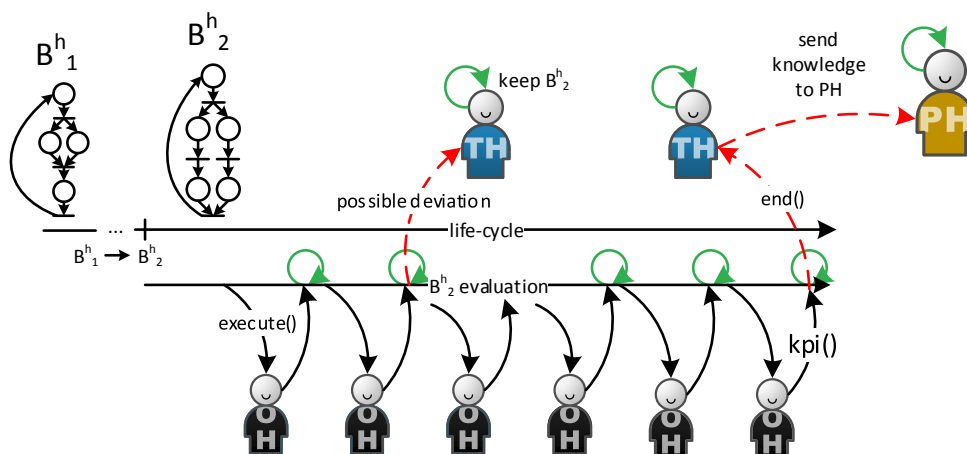

Figure 4.11 – Evaluating and Refining the Holon Behaviour

At the end of the holon life-cycle, i.e. when the holon has fulfilled all of its purposes, all the gathered knowledge will be sent, if possible, to the correspondent high level holon

(in the example of figure 4.11, the TH sends to the PH). This enables a behavioural refinement in future holons, e.g., the PH learning module will refine the behaviour parameters for future holons.

4.3.4 Behaviour Propagation

A basic rule to obtain a self-organized system relies in the interactions between entities and the information exchanged among them. In the same way, ADACOR² holons follow a sociable or genetic paradigm of knowledge sharing. This sharing allows the entities to exchange information about behavioural techniques and to, in a distributed or centralized way, to classify them by its usefulness. This information propagation can be done in a direct way, i.e. when it is transmitted from holon to holon, or using indirect transmission, using the environment as the mean to share the behaviour.

These behaviour propagation methods will also serve as a way for the holons to assess the data relevance. Some parameters are used to measure the behaviour usefulness, such as the number of holons that have used it, its success rate or improvement rate. The set of parameters used to assess the behaviours are described as follows:

- Count: number of times that holons have used this behaviour.
- Success rate: number of times an holon has used this behaviour and it has been beneficial for the holon.
- Success trend: depicts the trend of success of the last n times the behaviour was used.
- Information freshness: how far away in time was made the last information update.
- Location: place where the behaviour code is stored.
- Improvement rate: states the improvement on the holons performance by selecting this behaviour.
- Improvement trend: indicates the trend of the improvement on the last n times the behaviour was used.
- Variance: indicates how spread are the improvement rates.

The use of the aforementioned parameters allows the holons to assess the usefulness of each behaviour. In this way, the number of holons that have used the behaviour is the first one, once as greater this number, the higher is the relevance of the data, since more holons have contribute to its creation. Secondly, the success rate of the behaviour usage informs about the beneficial of usage of it.

4.3.4.1 Direct Propagation

This behavioural propagation sets foundation in two distinct phenomena that can be observed in nature. The first is the phenomena where animals are changing their

behaviour by mimicking others from the same species. Recalling the parable of the blue-tit birds and the milk bottles described in (Koestler, 1969), where, by the promotion of randomness, some blue-tit birds discover that the milkman put bottles of milk at the clients doorstep and discover how to open those. After some time, the knowledge of the milkman habit and the process of how to open the bottles is propagated to other blue-tit birds. The second phenomena is that, on a second generation of blue-tit birds, this behaviour is already engraved into the genetic property of them and is naturally part of their behaviour.

In such way, the direct propagation of behaviour can be seen in two different ways. A vertical way, where the behaviour is transmitted downward from a high level entity to a lower one, similarly to the genetic engraving of the behaviour. And, the second way, or horizontally, the behaviour is transmitted between peers at the same decisional level inside the same holarchy.

The vertical behaviour propagation is relatively easy to achieve, since the high level holon is aware of its subordinates and can send them the new behaviours or simply inform them of parameters updates on those that they already possess. Additionally, this process can be done in the time of the creation of new generation entities by embedding the new behaviours.

The horizontal propagation is achieved by being aware of the existence of other holons at the same level and send them the information update of the behaviour parameters or the information of how to access a new behaviour. In this way, each holon will send behaviour information to other peers when it allows to achieve good results. The receiving holons evaluate the information received and can request the behaviour details in order to acquire it.

4.3.4.2 Indirect Propagation

The indirect behaviour propagation is considered to be holon driven in the sense that it is the own holon that is in search for behaviour alternatives that explores it. In this way, the holons may have the possibility to store and to manage behaviour related information. Figure 4.12 depicts an example involving the TH and the OH. So, every time THs interact with one OH, they will inquiry it for the known behaviour list and their parameters. The TH uses this enquiry to assess the most reliable behaviours feeding this information into the learning module for internal parameters refining. Additionally, if the TH receives an unknown behaviour, it will evaluate it based on the provided information, i.e. if the new behaviour has similar or better KPIs of the known behaviours, and will acquire it for future consideration.

On the opposite side, if the TH possess an unknown behaviour for the OH, it will transmit this information in conjunction with the KPIs.

Higher level entities, such as SHs, are cyclically searching for the behaviours evolution at the low level entities. By querying the low level entities, they are aware of the

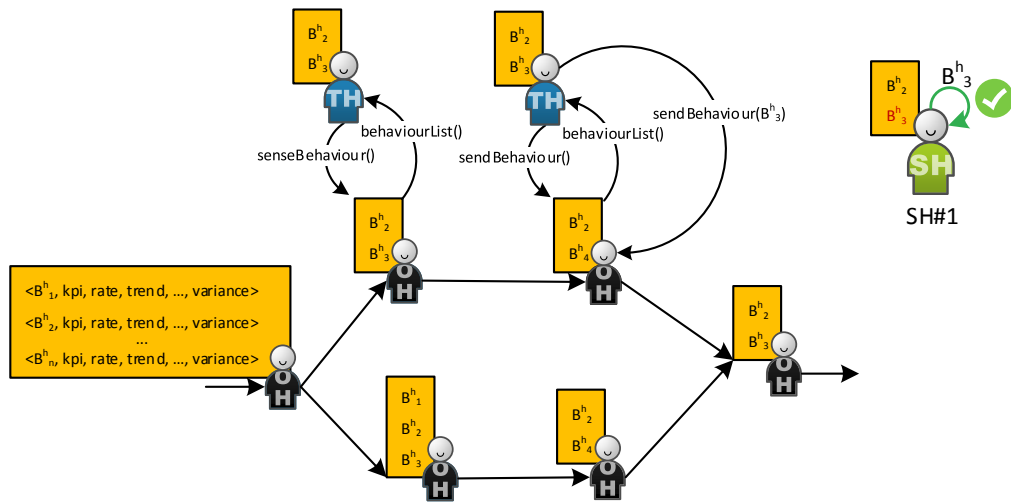

Figure 4.12 – Indirect Behaviour Propagation

most used behaviours and their performance index. Based on the gathered information, these holons may absorb the behaviour and propagate it to their subordinates, e.g., the SH to the OHs or the PH to their THs, using a pheromone-like spreading mechanism.

However, the inverse process can also occur. A behaviour displaying bad performance indexes is generating some holon/system instability and consequently the higher level entities may remove it from the system, avoiding further the instability propagation.

4.3.5 Behavioural Self-Organization in Practice

The following sub-sections try to depict, with three examples, the practical cases where the behavioural self-organization can be found. The detection of a new holon will be shown in the first example, while the second example demonstrates the adaptation process during a machine failure. The last example shows a TH using the idle time during the execution of a processing operation performed by a OH to update the behavioural information. Note that for simplicity reasons, all examples are made using the TH as the holon that initiates the process.

Despite those examples, others can be found, e.g., a SH having more than one scheduling algorithm and facing a disturbance situation it must select the most appropriate one in order to increase its responsiveness, or simply, during its normal execution, to find a better scheduling, using a different algorithm, and decides to apply it into the shop-floor. A real situation of the aforementioned example appears when the disturbance happens in a critical work order (one whose impact is such that will delay others in a chain), the SH can switch to an heuristic optimization technique, such as GA. Other situations can also be encountered in the OHs side, where, e.g., due to wear the holon decides to reduce the spindle speed of a drill bit or due to a low allocation rate the holons

decides to have a more competitive behaviour, e.g., by changing the bidding functions.

4.3.5.1 The Arrival of a New Holon

A first practical example of behavioural self-organization is related to the appearance of a new holon in the system, as illustrated in Figure 4.13 (note that this also implies a change in the holarchy structure which is not focused on this description). Lets suppose that a given TH has all the work orders in its schedule assigned and that this TH has subscribed to be alerted to possible additions or removals of services that can be useful for it. In other words, the TH has subscribed to all the services that are still needed to fulfil the remaining work orders until the completeness of the process.

At a given point in time, a OH registers three services, namely #2, 3#, #4 (marked with yellow in Figure 4.13).

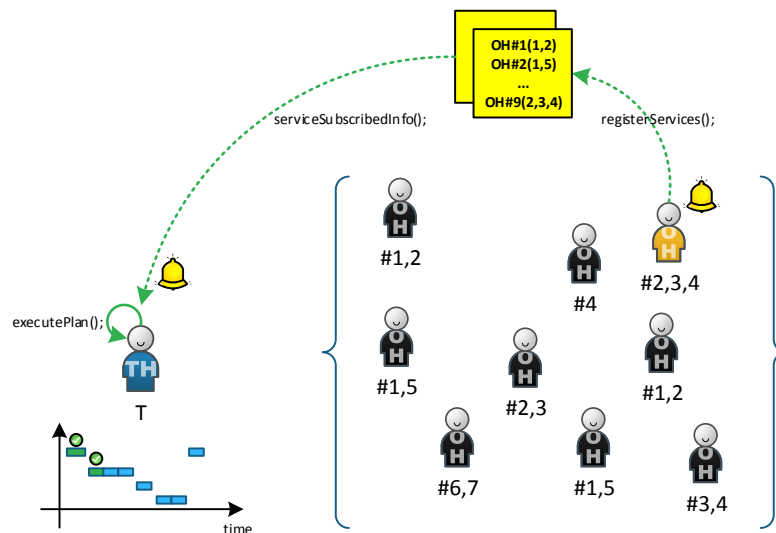

Figure 4.13 – Behavioural Self-Organization in Practice: Detection of a New Holon

The arrival of the new holon is detected by the discovery module, present in the holon, feeding the behavioural module with this information. Thereafter, the TH starts the self-organization procedure, running all the known behaviours, collecting the most advantage situation, deciding either to keep the current stable behaviour or changing into a more reactive behaviour and re-schedule considering the new OH. The output of this procedure is then evaluated by the nervousness stabilizer (see section 4.5) to guarantee that the achieved KPIs, e.g., the reduction on production time or maximization of resource utilization, are worthy of the change.

Finally, and if the change is approved by the nervousness mechanism, the holon applies all the necessary measures for its implementation, as shown in Figure 4.14. In the present case, two OHs are informed of cancelled operations and the new arrived holon of an allocation. Note that, for simplicity reasons, possible negotiation process are omitted

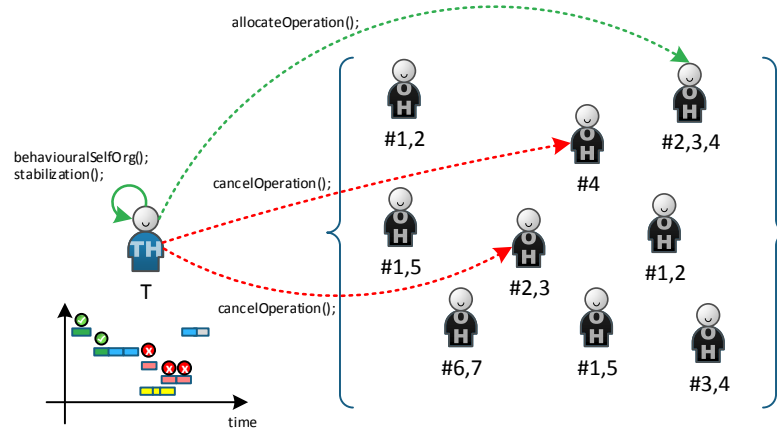

Figure 4.14 – Evolution by Means the Behavioural Self-Organization: Detection of a New Holon in this example.

4.3.5.2 An Holon Malfunction

Considering a resource that breakdown and consequently is not able to execute some already assigned orders. In this case, the THs responsible for managing the cancelled orders will try to re-schedule them by changing their behaviours in a proper manner, as illustrated in Figure 4.15.

In this example, the OH associated with the malfunction resource informs the correspondent SH and all the THs that is affected with this disturbance (i.e. those that are on its agenda) (see (1) in Figure 4.15).

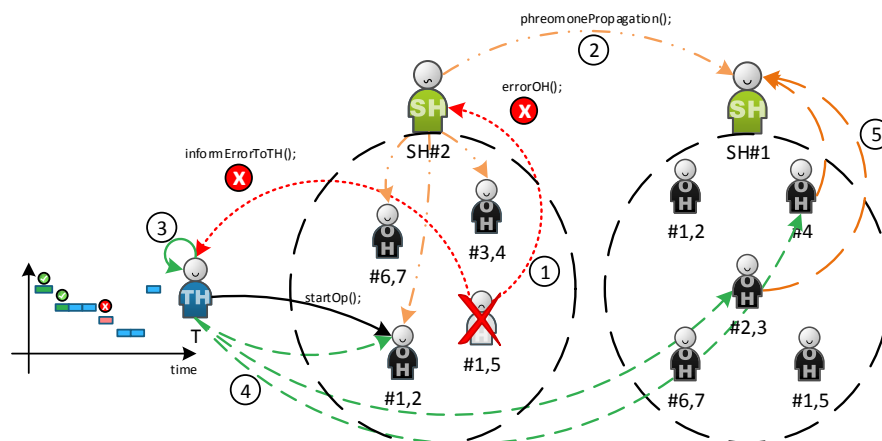

Figure 4.15 – Behavioural Self-Organization in Practice: Holon Malfunction

After this, the SH propagates this disturbance to other neighbourhood SHs (2), that will take the appropriate measures after measuring the impact of the disturbance to its

internal normal functioning, and to all the OHs that belong to its hierarchy. Similarly to already happen with ADACOR, the low level holons are now more reactive, increasing their responsiveness and now can react by selecting the most appropriate behaviour.

Meanwhile, the affected THs realize (3) that this disturbance may imply a decrease of the holon KPIs, e.g., a delay in the delivery due date. In response to this, the TH changes its behaviour by changing from a more steady one (i.e. one taking into consideration the accumulated knowledge from the SH or global data) into a more reactive one, e.g., to one relying more on local information.

In the present example, some work orders are re-assigned to the available OHs, being some assigned to OHs under the SH₁ hierarchy while others are kept assigned to the OH (4).

After the direct negotiation process, the OHs send their schedules to their SHs (5), which will be responsible to synchronize the achieved schedules and check whether there is any further possibility of optimization.

4.3.5.3 Using the Idle Time Properly

The TH can assume one of two approaches: passive or active. In the first one, the TH representing an instance of a product to be produced receives the processing information and follows it in a "blind" manner, i.e. it is not able to change it during its life-cycle. As opposite, in the second situation, the TH assumes an active participation in the manufacturing process, by influencing the decision taken during the life-cycle. The last paradigm is becoming immensely popular and is known as Intelligent Product (McFarlane et al., 2003; Meyer et al., 2009; Sallez et al., 2009) and is being used in the TH to increase its potentialities.

Particularly to the described previously, every time that the TH has to take a decision and regardless of any trigger event, it initiates, in an active manner, the behavioural self-organization module. This process is executed during the idle time, i.e. when the TH is waiting for a processing finish, and involves an update of the behaviour information related with the holons' behaviour. This information is stored in the OHs which the TH is interacting with.

In this case, and based on the new informations the TH might decide to keep the current behaviour or change it, which could culminate in a more reactive behaviour.

4.4 Structural Perspective

The structural self-organization presents a means of drastic evolution, re-arranging the relationships between the holons and/or their organization (Barbosa et al., 2013b). This change of relations can be limited within a group or take broader impact, imposing a relationship change in a wider system range. In this way, each holon has embedded a set of mechanisms, $R^h = \{R_1^h, R_2^h, \dots, R_r^h\}$ that allows the re-arrangement of its relations

group. Formally, in this work, structural self-organization can be defined as:

Definition 4 *The change in the relationships between holons, and consequently the change in the holarchy structure, which is triggered in response to a deep impact plan deviation, thus promoting a drastic response that aims to re-establish normal system functioning or improve its performance.*

Going back to the interdependencies between the behavioural and structural self-organization, one can foresee that the change in the behaviour of one holon can drive the change in its relations and consequently in its nearby structure. Additionally, the change of the structure of the system can also be triggered as consequence of any disturbance that appear in the system, such as a plan deviation and an add/removal of a resource. The need for the structural self-organization must be evaluated by the holon internal mechanisms and decided based on the current facts, on the structural output KPI mechanism and on the impact of the necessary implementation measures.

Finally, this self-organization vector can also have impacts on a real change at physical level, i.e. the reorganization at the holarchical level must be translated in the physical layer, e.g., by imposing a resource layout change. This means that a logical change in the holarchy would imply a real change in the physical or logical entities that the holons represent.

In such set of possibilities, this type of reorganization is divided into three different levels, relating with the behavioural self-organization or pure structural self-organization.

- Level 0 (emergence): relations between holons are changed as a consequence of the behavioural self-organization. This happen when the result of the behavioural self-organization implies a change in its relations, such as the selection of a new resource for processing a previously allocated operation. This level of structural change is classified as weak since it is not directly driven by the need.
- Level 1 (logical structural self-organization): each holon is constantly trying to optimize its place within the holarchy structure. This constant optimization may drive the holon to change the holarchy, to participate in several holarchies at the same time or to act as a freelancer to work completely autonomously. This change only has implications at the logical control layer.
- Level 2 (physical structural re-organization): similar to the level 1, but additionally the holons, e.g., OHs, can physically change their place, changing not only their relations and positions in the holarchy but also their physical position.

Particularly, the last two levels, i.e. levels 1 and 2, are related to the concepts envisioned by the RMS paradigm of rapid change at the shop-floor level. In fact, at level 1, one can assist to the logical re-organization on the control layer, which is mapped into the software change of the RMS paradigm, and at level 2, a hardware change is achieved by the physical re-arrangement of the resources present at the shop-floor.

4.4.1 Principles and Composition

The stimulus that can trigger a structural self-organization depends on the impact on the system and can be of any type, i.e. a disturbance that disrupts or deviates the predicted execution of the system or that allows the improvement its the current performance. Examples of triggers that can start a structural self-organization can be the appearance of an important manufacturing order, which would change the order prioritization, a rush order, an order cancellation, a production quality issue that could imply a drastic change on the resource allocation process, a supply shortage, or a resource malfunction.

Figure 4.16 depicts the evolutionary process idea behind the structural self-organization. At a given configuration functioning point, the system is constituted by a set of OHs within a single SH. In reaction to a disturbance, for this case the production of two distinct products, the system re-arranges itself by cloning the SH and splitting of the OH between these two SHs.

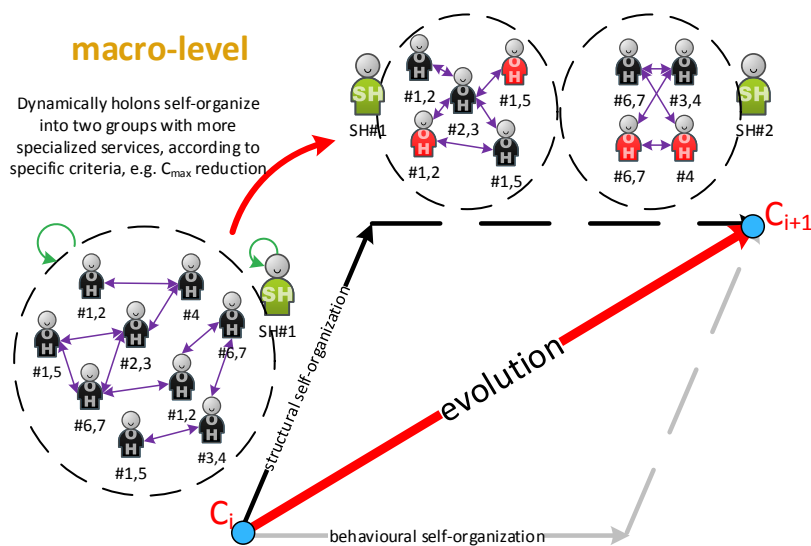

Figure 4.16 – Structural Self-Organization by Group Decomposition

The structural self-organization component, part of the self-organization module found in Figure 4.3, is similar to the behavioural module. In such way, when the monitoring and discovery modules detect a plan deviation or opportunity to evolve, the structural self-organization process starts by launching all the known re-arrangement procedures (note that those can, in the limit, be named as behaviours). Similarly, these procedures match a set of known facts with a set of necessary rules of each procedure. The output result of this process is then evaluated by the nervousness controller (see section 4.5) that will allow (or not) the application of the structural self-organization.

Generically, each structural self-organization procedure is similar to what is found in the behaviour composition and is constituted by a set of input data, the structural rules

and the output data, as illustrated in Figure 4.17. However, two major differences can be highlighted relating to the acquisition of the current structure of the holarchy(ies), classified as input data, and to the mandatory need of having a negotiation and an agreement procedure between all the involved holons.

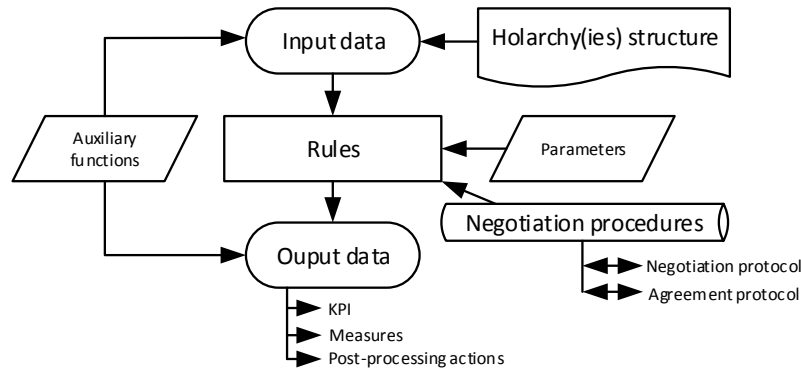

Figure 4.17 – Composition of a Structure Procedure

The description given for the behavioural composition (see Figure 4.9), applies also for the structural composition. The collection of information regarding the composition of the existent holarchy(ies) passes by querying the holons for information related to their holarchy position and current KPIs, or any other source of information used by a particular structural procedure. This constitutes valuable information in the sense that any structural re-arrangement needs to know the current structure status. On the other hand, the structural self-organization itself may be an iterative process, involving at the end negotiation procedures with the affected holons. In this way, each structural procedure is supplied with acceptable negotiation protocols and the agreement thresholds, after which the procedure is finished.

Naturally, the application of any structural measure only makes sense if all the participants agree to apply the changes. Due to their autonomy, holons are free to decline the change, either by considering that it is not good for themselves or it is not allowed by the nervousness controller. However, affected holons may always cross-check the re-arrangement request by starting itself the structural self-organization procedure, culminating either on accepting/declining the request or by proposing a new holarchy structure.

ADACOR² holons follow the same basic principles as swarms, constantly trying to build cohesive groups, maintaining distances and imposing crowd management. First, and similarly to what happen in nature where a cohesive group increases its survival rate, a group has more possibilities to handle more properly disturbances. Secondly, keeping distances, particularly in physical resources, allow an ease of material flow at the shop floor. Lastly, imposing group size limits will enable to reach faster and increase the optimization levels, since, e.g., lower number of OHs in the group will allow a faster

schedule by SH, or when in heterarchical mode, to speed up the allocation process.

However, and contrary to what happen in nature, a central authority was intentionally introduced in ADACOR² as it can increase the optimization levels. In fact, this was already suggested in the work of Koestler (Koestler, 1969), when he stated that the creation of stable intermediary states in the holarchy introduces high levels of optimization. These higher level holons supervise a set of OHs that try to optimize their schedules by coordination and synchronization of the groups' holons or repositioning them inside the holarchy or even shifting them between holarchies. It is possible to endow each group with a set of services as diverse as possible, creating the possibility to attend to a wider set of requests or to aggregate holons with similar services, creating specialized groups.

In this way, the structural self-organization in ADACOR² can take a top-down or bottom-up approach, as it can be seen in Figure 4.18. On the first case, the structural self-organization has emergent properties propagated from the low level holons upward. In this situation, the trigger is detected by at least one low level holon that starts the structural self-organization procedure, propagating the results to other holons. If the proposed structure, i.e. the new holarchy, involves a high level holon, e.g., a SH, the low level holons will afterwards issue an optimization request, which may result in a fine-tune of the holarchy itself or on the scheduling update of the holons.

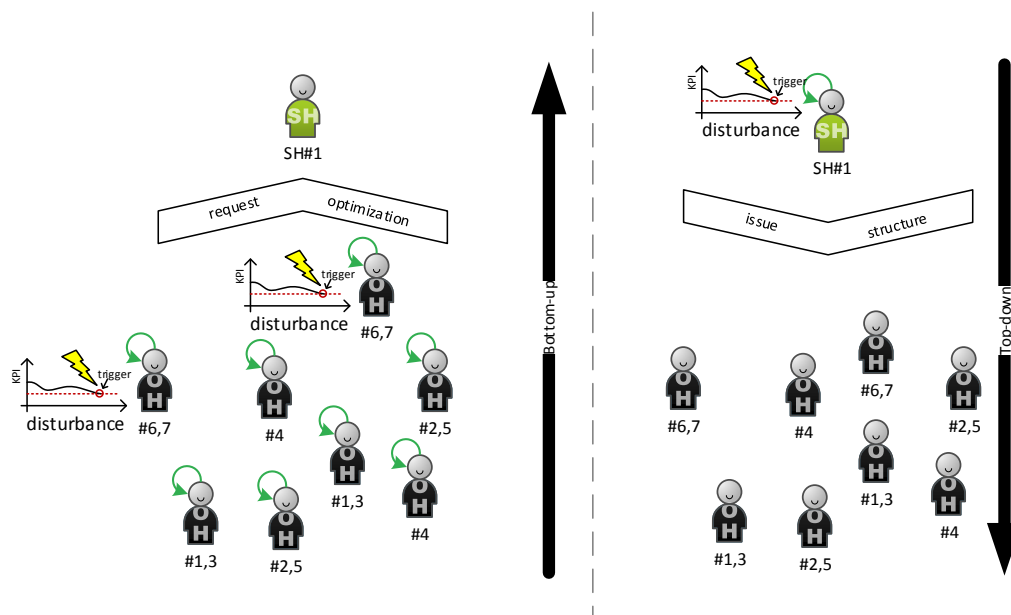

Figure 4.18 – Bottom-Up and Top-Down Approaches for the Structural Self-Organization

On the second approach, the SH are responsible to impose the structure rearrangement. A negotiation procedure may occur when more than one SH is present in the system, e.g., if a SH is needed for acquiring a skill available in an outside holarchy.

The mechanisms used in the structural self-organization are not strictly imposed and,

in principle, can be any that allows the system to perform such task. Despite this, currently the ADACOR² holons draw inspiration from the social behaviour of schools of fishes and flocks of birds since it is concluded that they work very well as a group, maintaining the system equilibrium and e.g., avoiding predators (Leitão et al., 2012), which in this case are external system disturbances.

Another concern to be tackled is related to the fact that this self-organization process can be very time-consuming, which can be of major importance in large-scale systems in which the amount of available information increases exponentially. This important constraint is solved by taking a system snapshot, i.e. the current system state, whenever there is a disruptive event. This context-aware feature is complemented, at the end of the self-organization process, with the actions taken and the achieved results (i.e. performance indicators), allowing the decision assessment afterwards. Additionally, this process can be enriched with data processing, e.g., data mining, to facilitate future processing by allowing the system to find the best measures taken for similar events and start a warm self-organization process, i.e. it is not necessary to discover a new configuration, only to adapt a known one.

4.4.2 Structural Self-Organization in Practice

In order to illustrate the structural self-organization in practice, three examples are provided in which a structural self-organization could be useful. The first is the introduction of a big batch order, the second is a resource sharing due to a malfunction on a similar one, while in the third case the creation of a new holarchy would introduce an optimization on a given KPI .

4.4.2.1 Product Model Change

Lets assume that the system is functioning in a stable state with a given configuration, and that a very large order arrives at a given point in time. After realizing this, the system either through the SH holons due to a high demand in variation requests or by the individual OHs due to a high number of variation proposals, will launch all the known structural self-organization procedures (marked with number 1 in Figure 4.19).

In this example, all the holons, namely the OHs and SHs, start their structural self-organization and in this case the SH₂ detects a re-arrangement possibility (see the number 2 in Figure 4.19). After this, the SH₂ holon informs its counterpart SH₁, proposing the new configuration. Once this process is finished, the SHs will inform their subordinates of the necessary measures that need to be taken. In this example, the necessary measures pass by applying a level 1 structural self-organization, since only a re-organization at the logical level is imposed, as seen in Figure 4.20.

Two different re-organization situations can also be envisioned. First, in cases where a pool of workers is available for disturbance situations, the new system configuration

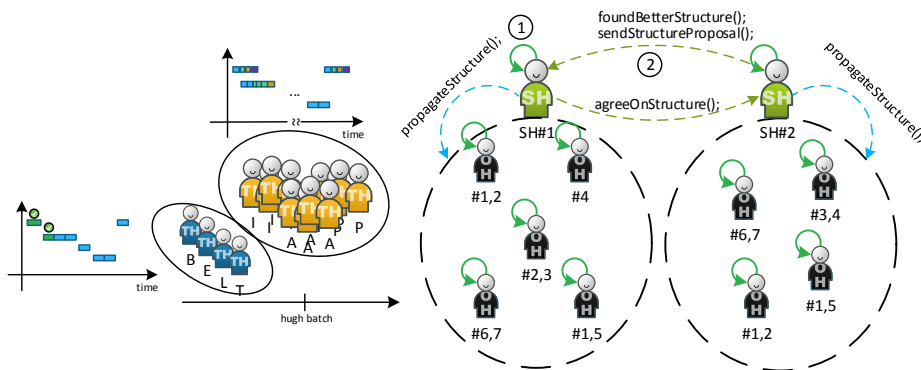

Figure 4.19 – Huge Batch Order Arrival and New Structure Propagation

could imply the integration of one resource from the pool into one of the existing holarchy. Secondly, worker training and machine upgrade can also be possibilities by giving those assets new skills.

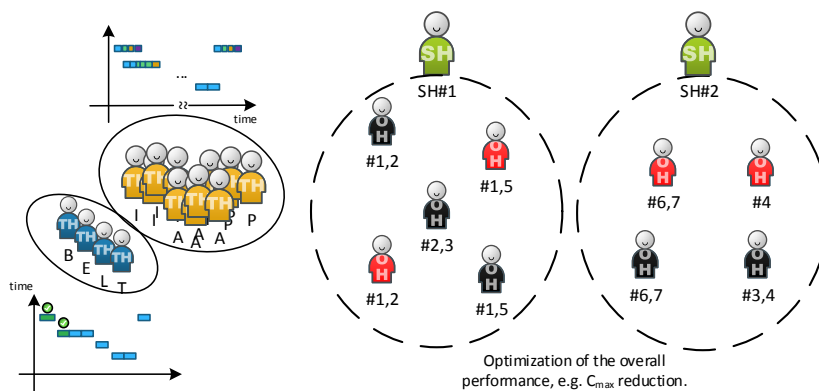

Figure 4.20 – Structural Self-Organization by OH Change

The process culminates with the exchange of holons between both groups, each supervised by a SH and managing a batch of orders, i.e. the current and the new one.

4.4.2.2 Breakdown of a Crucial Resource

In this example, a crucial resource becomes unavailable, as illustrated in Figure 4.21. The holon representing the physical resource informs its SH that will start a search, through structural self-organization, for possibilities to mitigate this disturbance.

After the detection of the existence of other holon with the necessary skills, the SH₁ negotiates a resource sharing with SH₂ that checks with the affected holon for its availability to be shared. Once all counterparts agree, the re-organization is finished by allowing both SHs to manage the OH agenda.

The shared holon is now under the supervision of the two SHs that must always negotiate the processing time slots. In this way, every time a SH wants to perform an

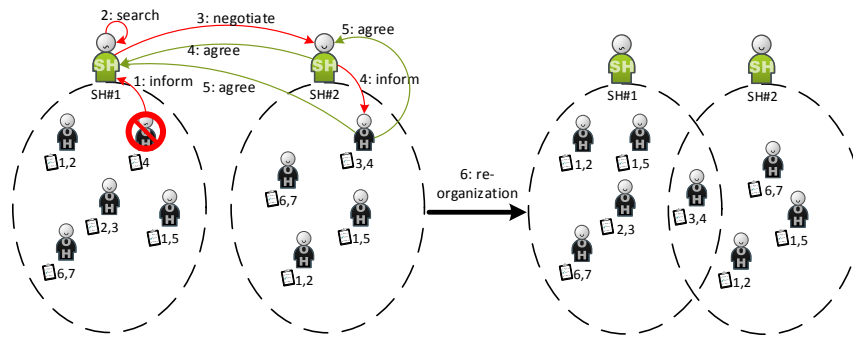

Figure 4.21 – Structural Self-Organization by Resource Sharing

optimization in its holarchy, involving the shared OH, it must first gather the consent of the other SH. In the same direction, every time some event happens with the OH, e.g., a processing delay or breakdown, the OH informs both SHs, which will together find the best compromising solution.

4.4.2.3 Holarchy Division Based on Specialization

This last example depicts a situation where the specialized work occurs often at shop-floor, e.g., preparatory work common to all manufacturing orders.

In this way, in Figure 4.22, the skills #1 and #5 are the ones needed in all the manufacturing orders. Those are considered to be crucial and the introduction of schedule optimization into those resources could bring an increase of production performance. Realizing this, SH₁ informs SH₂ about those facts.

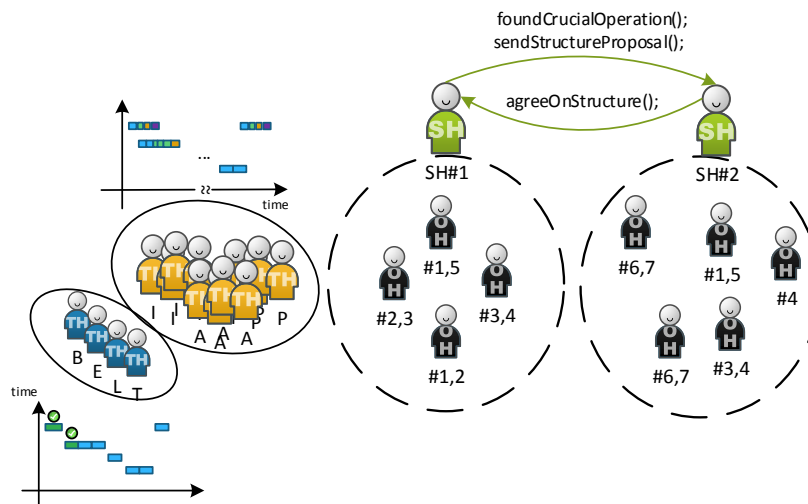

Figure 4.22 – Detection of a Crucial Operation as Trigger to Structural Self-Organization

After this, SH₁ (the initiator) creates a new SH, transferring into it the new OHs (see Figure 4.23). To finalize, the accumulated knowledge related to the transferred OHs of

both SHs is sent into the new one.

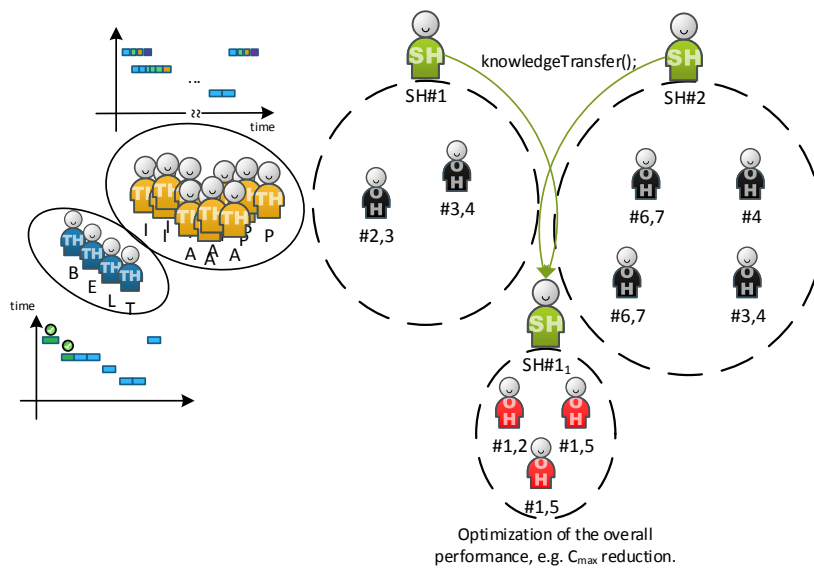

Figure 4.23 – Structural Self-Organization by Clustering

At this point, this specialized set of operations can then be prepared in a more optimized way since a dedicated SH introduces improvements in the OHs scheduling.

4.5 Controlling Nervousness

One of the main problems that could appear in self-organized distributed autonomous systems is instability due to the holons continuous behaviour change or continuous cycle of constant evolution/adaptation.

Besides how to know if a new solution brings better results than the previous one, it is important to know if it will negatively affect the system performance. In such way, it becomes important to bring this phenomenon into the system design allowing to push it to its limits keeping it under control.

Parunak et al. (2003) use two mechanisms to calm hyperactive agents (Parunak et al., 2003). The first one is related to what is classified as “on-going operations”, identifying two agent’s characteristics: agents should be able to detect when their activities are outside the scope and acknowledge when they can re-enter the system due to new requirements. The described solution uses the stigmergy found in societies of insects, allowing to merge multiple local data in order to take decisions in a more supported basis. The second mechanism delineates a way to divide exploration and exploitation times relating them to the imposed deadline.

On the other hand, K. Hadeli et al. (2005) state that in case an agent wants to change the initial ideas it is necessary to make a quality measurement of the new solution and only if it is significantly better than the previous one the agent can change its intentions

(K. Hadeli et al., 2005). Additionally, the authors limit the frequency of changing the initial intentions, restraining the agent continuous willing to change. Another example can be found in (Zbib et al., 2010) where the inspiration from magnetic fields helps products to choose the most adequate route. In this mechanism, as resources are being occupied, the attraction power emitted (designated by potential field) is reduced allowing products to be routed in a decisive manner.

A reward based mechanism was proposed by (Hogg and Huberman, 1991) as the way to freeze out the chaotic behaviour in distributed systems. Despite of not directly related to the nervousness feature of individual entities, using the same principles might turn out to be advantageous in the way that an excess of the individual nervousness levels of entities can drive the system to display chaotic behaviour.

To cope with the nervousness issue, each individual ADACOR² holon has a built-in stabilization mechanism, comparable to car shock absorbers, to avoid instability first at the holons level and secondly at the system level (Barbosa et al., 2012a). By introducing these stabilizers, the system operates in such manner that it is pushed to its limits by enhancing the self-organization principles, remaining always under control.

A two-layer approach is used, as illustrated in Figure 4.24, where the first one regulates the changing will imposed by each self-organization module while the second level assess the previous two nervousness controllers (one for each self-organization module), deciding which emergent self-organization procedure will produce the most valuable action.

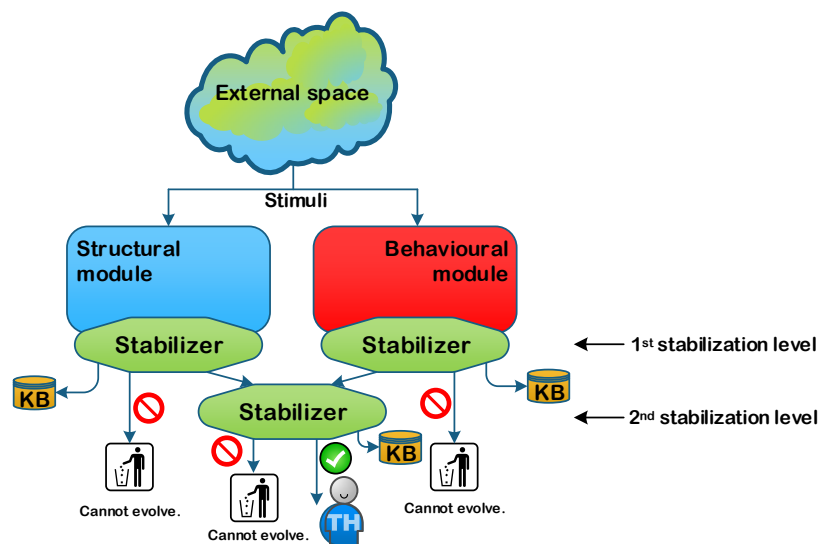

Figure 4.24 – Stabilization Mechanism Embedded in ADACOR² Holons

At each nervousness control process, the output of the decision is stored into a KB (Knowledge Base), which later is used by the learning module to refine the parameters of the nervousness stabilizer.

In order to or not allow the holon to change its actions, the nervousness stabilizer must be aware of the current internal and external context on which the changes are to be made. First, the holon must be aware of its internal nervousness level, H_h^σ , given by the quotient between the number of changes (either behavioural or structural), ϵ , within a time window, δ .

$$H_h^\sigma = \frac{\epsilon}{\delta} \quad (4.2)$$

Additionally, the number of changes, ϵ , is evaluated by the success of the past changes. This is, the holon is allowed to change more often its behaviour or structure, if in the past changes led to an increase of the performance. In this way, ϵ is calculated by:

$$\epsilon = \sum_n \frac{a_{kpi}}{p_{kpi}} \quad (4.3)$$

where,

- n represents the number of last changes.
- a_{kpi} is the achieved KPI for the change n .
- p_{kpi} is the previous KPI for the change n .

The assigned performance ranges from 0 to 1, being 0 for non-success and 1 to a complete goal fulfil.

The external context, named SD (System Dynamics), allows to gather information about how the system behaves, regarding, e.g., the work order arrival rate, disturbances rate or even allocation rate to OHs. Each holon estimates the SD either by querying a more global entity, namely the SH, or locally through querying cyclically the neighbours holons.

Having this, the two level nervousness control model described previously are used within the context of the Figure 4.25. In the figure, two control loops can be seen, being the internal one based on the holons' nervousness level, with the one found on its neighbours, while the outer correlates the nervousness level with the SD.

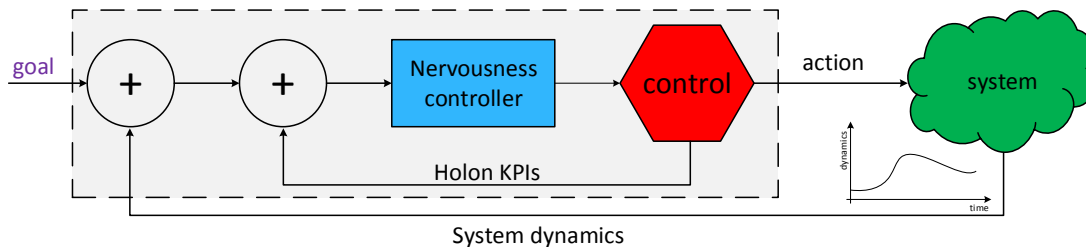

Figure 4.25 – Nervousness Controller System Dynamics

In the inner loop, the holon is able to compare its internal nervousness level with the holons located at its neighbourhood. Using this comparison, each holon can see if it is below or above the neighbourhood average nervousness level, deciding if its internal level can be further increased or needs to be lowered, respectively. On the other hand,

the outer loop has broader information of the system nervousness levels and is an picture of the dynamics present at the system, driving also the holons' nervousness level limits. Note that in order to react properly in higher system dynamics the holon could be more nervous than what would be if the system dynamics are lower.

Despite all the aforementioned nervousness control loops, holons have a safeguard mechanism, that ensures that if the majority of the holons participating on the change decide that it is beneficial for the system, the holon(s) that are not allowed to change, will change altogether. A tentative threshold value for this could be to use qualified majority rules, such as the two-quarters or three-quarters (used for instance in many countries to approve constitutions changes). In this case, if $2/3$ or $3/4$ of the holons decide a change favourably, the rest will not block the system evolution and will also implement the necessary changes.

4.6 Summary

This chapter describes the ideas and the main guidelines behind the ADACOR² manufacturing control architecture.

ADACOR² takes inspiration in Darwin and punctuated equilibrium evolutionary theories to propose a bi-dimensional self-organized holonic control architecture that better addresses the reaction and responsiveness to condition changes without degrading the system optimization. In this way, a smooth evolution, by means of constant adaptation, is embedded into internal behaviour of the holons and is named behavioural self-organization. Secondly, a more disruptive evolution is possible due to the re-arrangement of the holons relations, named structural self-organization.

Both self-organization vectors were described as also some common underlying mechanisms, such as the downward and upward causation effects.

Also, the nervousness phenomena inherent to the self-organized systems was discussed, being detailed a proper mechanism that takes into consideration the system dynamics.

The next chapter instantiates the self-organization mechanisms, proposing some practical implementations for behavioural and structural levels. These illustrative examples were used during the assessment tests and intend to demonstrate the applicability of the proposed approach.



Self-Organization Regulating Mechanisms in ADACOR²

Somewhere, something incredible is waiting to be known.

Carl Sagan

The previous chapter introduced the main architectural principles of the proposed self-organized holonic manufacturing control system, taking inspiration from biology to design a bi-dimensional self-organization approach that addresses the achievement of a truly evolvable system.

This chapter depicts the instantiation of the behavioural and the structural self-organization mechanisms, as well the reasoning and learning capabilities to properly support the execution of such models. A nervousness control mechanism, inspired in the PID technique used in the traditional control theory, is also proposed to regulated the system dynamics under this evolvable system.

These instantiated mechanisms will be lately implemented and tested, and serve as example for the implementation of the proposed approach.

5.1 Mechanisms for the Behavioural Self-Organization

Generically, the procedure of the block identified as **behavioural module** can be decomposed into the Algorithm 1. As input, the module requires the facts that lead to the

event and also the current behaviour KPIs. The holon will collect the known behaviours and launch all of them, collecting at the end the expected KPIs. After this collection, the behaviour that offers the best KPI is selected. At this stage, if the obtained KPI improves the current one, the module will send this information (i.e. these facts) to the nervousness stabilizer, which will enable/disable the application of the changes, guaranteeing the stability of the holon.

Algorithm 1 Behavioural Self-Organization

Require: facts, currentBehaviourKPI

Ensure: Selection of the Holons' proper behaviour

```

1: procedure BEHAVIOURALSELFOrganIZATION(facts)
2:   Behaviours  $\leftarrow$  List of Behaviours
3:   nBehaviours  $\leftarrow$  count(Behaviours)
4:   for  $i = 0$  to nBehaviours do
5:     launch Behaviour(i)            $\triangleright$  Launch all the known behaviours procedures
6:   end for
7:    $i = 0$ 
8:   while (all behaviour output not received) || (timeelapsed  $\leq$  maxTime) do
9:     if behaviourReceived then
10:      output(i)  $\leftarrow$  OutputBehaviour(i)
11:       $i = i + 1$ 
12:    end if
13:  end while
14:  bestBehaviourKPI  $\leftarrow$  currentBehaviourKPI
15:  newBehaviourFound = false
16:  for  $i = 0$  to count(output) do
17:    if output(i).getKPI > bestBehaviourKPI then
18:      bestBehaviourKPI  $\leftarrow$  output(i).getKPI
19:      newBestBehaviour  $\leftarrow$  output(i).getBehaviour
20:      newBehaviourFound = true
21:    end if
22:  end for
23:  if newBehaviourFound then
24:    Send result to nervousness stabilizer
25:  end if
26: end procedure

```

Additionally, the learning module, not shown in the pseudo-code, is used as the mean to adjust the operating parameters in the behaviours or in the selection mechanism of those. This module will be detailed later in section 5.3.

In the present work, some behavioural mechanisms were used in order to implement this level of self-organization supporting the resource allocation procedure. The first behavioural mechanism is related to market-based approaches, using the well known CNP (Smith, 1980), that allows a set of, or even only one, entity to negotiate the allocation of a process. The second one, known as PF (Potential Fields), is based on the magnetic fields concept (Morrish, 2001), and on its attractive and repulsive fields. The last one,

relates to the ants food foraging behaviour, known as stigmergy. The next subsections details the theory behind these mechanisms and their instantiation in ADACOR².

5.1.1 Market-Based Approach

It is a common practice in the world daily life that people and machines have to negotiate in order to achieve the exchange of products and information or any other material or immaterial good. Generically, this is a negotiation process that follows some kind of market-based approach.

The process, usually started by the need of acquiring something, on which the *buyer* searches for someone, *seller*, that offers the request need can assume a multitude of approaches.

Auctions, are one good example of such approach, where the *buyer* goes to common places to bid to the *seller* offers. Two major auctions types, primary and secondary, are found in the literature, being the most classical ones the Dutch and English auctions. Dutch auction starts by a high asking price from the *seller*, which lowers it down until a *buyer* is willing to accept it. On the other side, the English auction starts by a lower bound price and higher prices are announced by the *seller* or offered by the *buyer*. The auction finishes when no buyer is willing to increase the offered price. Lastly, in the sealed bid auction, which is commonly used in public contracts, all bids are placed in a sealed way (i.e. secret bids) that are opened when the defined auction duration ends. After this, all bids are opened, winning the auction the one with highest value.

Other example, similar to an auction, but more closely related to the one followed in this section, starts by the *buyer* to announce what is desired, followed by a set of selling proposals from the *sellers*, which after this are evaluated by the *buyer* deciding who to buy from. Naturally, this process can be further detailed, where more negotiation phases are introduced into this loop, but very basically this was the main driver to design a well known negotiation technique used in distributed systems, known as CNP (Smith, 1980). The use of CNP is simple and effective but can impose an overwhelming communication process between entities due to its intrinsic negotiation process.

This process is used in the ADACOR² as one procedure to allocate the production tasks needed by the TH to the available OHs. The process starts with the needed TH searching for the set of OHs that possess the required skills to execute the task. After this initial search, the negotiation process, described in Figure 5.1, starts with the TH preparing the CFP (Call For Proposals) that comprises the description of the needed task, associated skills and required processing time, and the list of recipients, i.e. the OHs. After receiving the CFP each OH analyses it and prepares, based on its internal constraints (e.g., its availability), a reply comprising the conditions on which they will execute the task, i.e. the start and end processing times and the cost. A refuse can also be replied for the cases where the OH is not available to execute the requested task, e.g., due to non-availability. The negotiation phase finishes when the TH receives all the replies, analyses

them and issues the acceptance and rejection messages to the OHs.

The CNP ends when the winning OH informs the TH of the (un)success of the developed task.

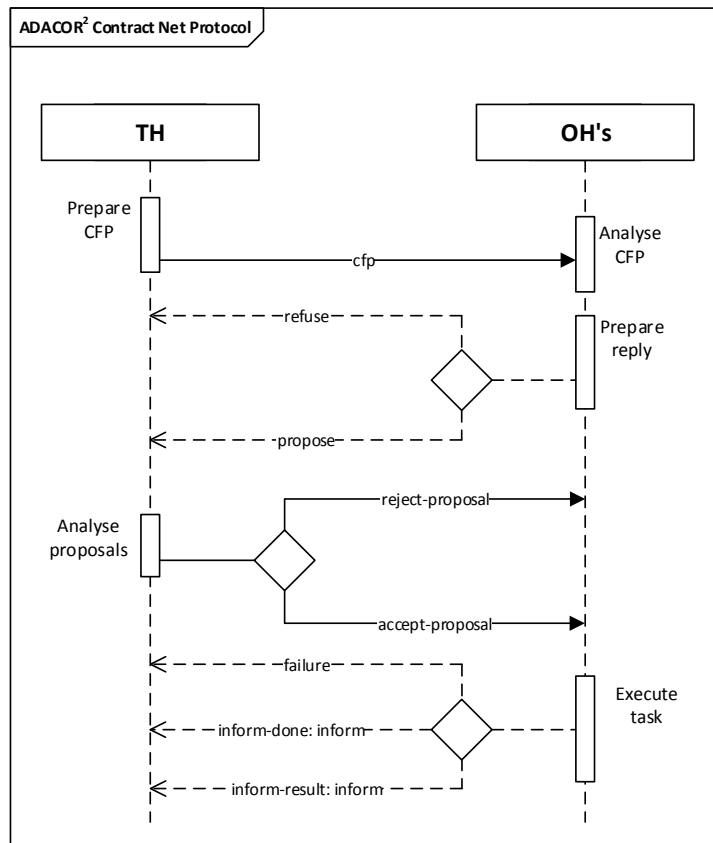

Figure 5.1 – Contract-Net Protocol Approach in ADACOR²

The bid price calculation and the selection threshold used in this work is the same as defined in the ADACOR implementation example (Leitão, 2004). The bid price calculation takes into consideration parameters, such as the setup time and cost, acquisition of new tools cost, execution costs, resource investment cost and level of assigned work. As for the selection threshold, parameters such as the given bidding price, the distance for the resource and proposed due date are taken into consideration.

5.1.2 Potential Fields

Magnetism or the concept of PF is a technique that gets inspiration from the physics (Morrish, 2001), and particularly in attractive and repulsive forces on certain types of bodies found in nature. In magnetism, bodies can have positive or negative charge and two bodies with the same charge tend to repulse each other while bodies with different charges, sense attractive forces. The exerted force is stronger near the body where it is emitted and gets weaker while moving away from it.

This technique has been used in different areas such as in game development (Hagelbäck and Johansson, 2009), robots motion planning (Dolgov et al., 2010) and even in manufacturing control (Zbib et al., 2010).

Since this approach is more reactive (i.e. focusing a short time range), it is a good candidate to be used as an alternative behaviour for very reactive environments in spite of losing some optimization. In such way, an algorithm based on this concept was developed and deployed in ADACOR² holons.

Operational holons, representing the set of available resources at the shop-floor, emit a set of potential fields based on the set of services, pf , that they are able to perform, as shown in Figure 5.2 and notated in 5.1.

$$OH_{oh}^{PF} = \{OH_{oh}^{PF_1}, OH_{oh}^{PF_2}, \dots, OH_{oh}^{PF_{pf}}\} \quad (5.1)$$

For simplicity purposes, Figure 5.2 is built of 3 OHs, mapping resources, each one emitting the PF for the offered skills, namely OH₁ and OH₂ offer the service *yellow* while OH₃ offers *red* and *purple*. Now, lets assume that it is possible to route from one resource to the other accordingly to the thick straight arrow, e.g., it is possible to route from OH₁ to OH₂. In such way, OH₂ back-propagates the *yellow* PF value to OH₁, which then calculates its value reflected on it. Notice also that in this case, a propagation of the OH₂ PF value is also relayed back since it is possible to convey from OH₃ to OH₁.

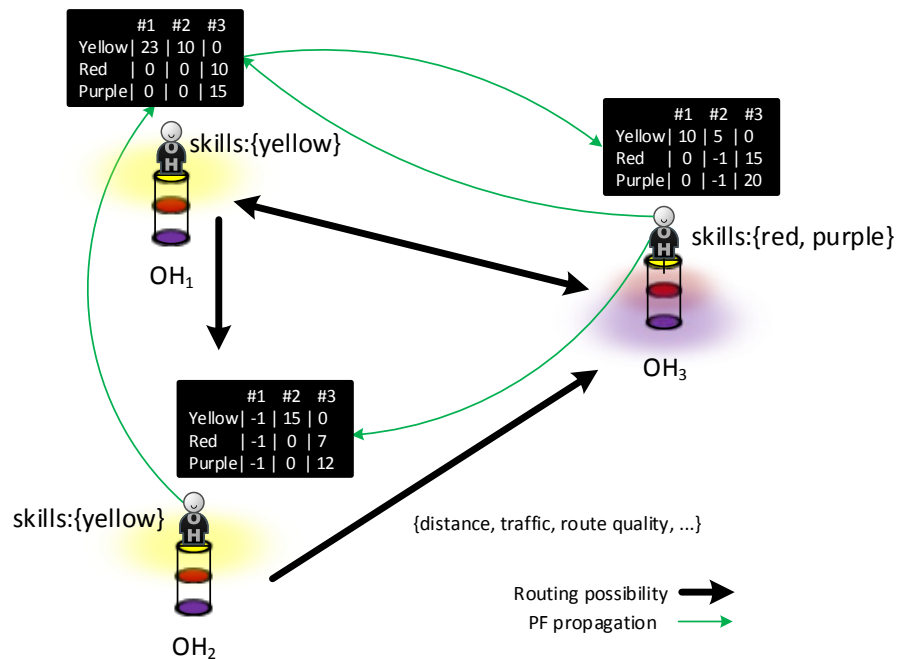

Figure 5.2 – Potential Fields Concept

The PF values are stored using a blackboard system (Engelmore and Morgan, 1988) that every OH is responsible to manage. The repository of PF values is accessible to the

holons that need to use this behaviour, e.g., THs searching for a processing resource.

In this way, in short, the overall behaviour procedure can be summarized as follows. Each holon that is able to provide the execution of a given service, e.g., a processing or a transportation task, emits an attractive field calculated using the equation 5.2. This attractive field is then propagated to its adjacent nodes (i.e. other OHs) that, based on an attenuation profile, calculate the field value there. After this, these OHs check if the calculated value is in condition to be further propagated, i.e. if it is above the designated threshold ψ .

On the other side, the holons that require the execution of a given service, e.g., a TH that needs a processing task, will check in the current OH for the attractive fields of the desired service.

5.1.2.1 Attractive Potential Field Calculation

Since each resource has a map of their neighbour connections, it is easy to implement the back-propagation mechanism, unburdening this way the OH of the creation of the connections map in order to propagate its PF value.

Several resource parameters can be used to calculate the intensity of each PF for a given service, namely the resource workload (based on its own agenda and/or with the orders waiting in its buffer), the service processing times, the quality and the scheduled maintenance. In this way, every time a given parameter considered for the calculation changes, the correspondent OH is responsible to re-calculate the intensity of the PF, $OH_{oh}^{PF_{pf}}$, according to the equation (5.2), and to send it to its adjacent nodes (i.e. to its adjacent OHs).

$$OH_i^{PF_{pf}} = \sum W_P \times P_P \quad (5.2)$$

where,

- W_P is the weight given to parameter p .
- P_P is the value of the parameter.

Particularly, for the algorithm developed in the current work, the equation 5.2 is instantiated by using as parameters the resource queue and its state, meaning that longer queues decrease the emitted PF. The resource state is considered in the equation, where situations representing its availability will increase the PF value while the failure or out-of-service situations will decrease it. As an example, if the resource is on an execution state, a neutral value to the PF will be awarded, counting only its queue for calculating the PF to emit.

The OHs relay back this information to its precedent nodes and so-backward, guaranteeing that the service power of the PF will reach all the relevant nodes. This propagation, as it happens in the physical process, is affected by an attenuation factor, decreasing its intensity as it gets farther from its epicentre.

5.1.2.2 Attenuation of the Attractive Potential Field

As for the attenuation factor, some profiles can be used, which range from a simple attenuation based on the distance to more complex ones, based on a mixture of parameters of influence, such as the distance with traffic and route quality. Based on the distance, one of three atomic attenuation profiles can be envisioned (as shown in Figure 5.3): constant (a), crescent (b) and exponential (c). In the first one, the attenuation is fixed and independent of the distance, i.e. the power of the PF is equal in all the nodes and are divided by a constant. In the crescent pattern, as longer the node is from the source, as more attenuated it is by a constant factor. The last one is similar to the previous one, but in this case, the attenuation factor is exponential, introducing faster attenuation for further nodes.

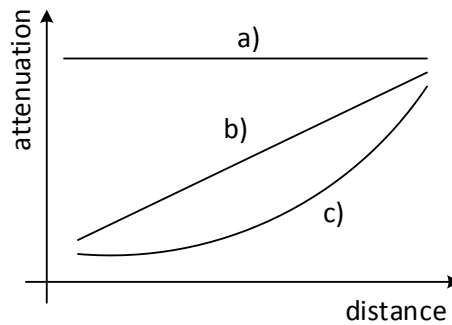

Figure 5.3 – Attenuation Curves Profiles

The value of the PF for the service pf on the destination OH , depending on the curve profile, can then be calculated using,

$$OH_i^{PF_{pf}}|_{OH_j} = \frac{OH_{oh}^{PF_{pf}}}{profile} \quad (5.3)$$

where,

- $OH_{oh}^{PF_{pf}}$ is the emitted PF value by resource oh .
- $profile$ is the used attenuation curve.

In the particular case of the current specification, the crescent profile was selected, being directly proportional with the distance, i.e. as farther it is the node, the more the PF is attenuated.

The criteria for stop relaying back information is met when the calculated power at the present node is lower than the parameter ψ , which is a constant value that defines the lower bound of considerable power.

$$\begin{cases} OH_i^{PF_{pf}}|_{OH_j} \geq \psi, & \text{propagates} \\ OH_i^{PF_{pf}}|_{OH_j} < \psi, & \text{don't propagate} \end{cases} \quad (5.4)$$

Note that adjusting ψ will define the distance sensitivity where services can be sensed from others.

5.1.2.3 Decision and Selection

Finally, when a decision/selection needs to be made e.g., by a TH that needs a processing operation, it follows the maximum potential field available at the node where it is at for the desired service, expressed in equation 5.5.

$$OH_{oh+1}^{PF_s} = \max \left\{ OH_1^{PF_s}, OH_2^{PF_s}, \dots, OH_{oh}^{PF_s} \right\} \quad (5.5)$$

This is a very reactive behaviour in the way that the TH only selects the next service to be executed, suffering this way from myopia. Even if the TH scans for the next services to come, the conditions taken for the decision could not be the same in the time where the operation will be executed due to the behaviour dynamics. By abstracting itself from the generation of the attractive field and on the propagation process, and avoiding a negotiation procedure, like the one found in the CNP, the TH can rapidly select the next OH.

Additionally, a self-organized feature is introduced in the system where, in a non-controlled manner, the system is able to organize itself.

5.1.3 Stigmergy

The ants food foraging behaviour mechanism, described in section 3.1, was the source of inspiration for the development of several bio-inspired mechanisms, such as the ACO (as shown in Chapter 3), which is often used as optimization technique or in robotics path planning. This type of source of inspiration can be deployed into the internal behaviour of holons and used as a way to make decisions based on long-term distributed local learning.

Similarly to the PF behaviour, each OH (representing the resources) stores on a black-board the stigmergy values of the known services for its adjacent nodes. The main difference between the two approaches is that the stigmergy values are now updated not by the OHs themselves but by the THs, according to the acquired knowledge during their life-cycle. Another particular difference from the PF behaviour is that the update rate is longer in the way that it is only updated at the end of the TH life-cycle.

The overall process can then be summarized into three procedures: reinforcement of the values by the THs, pheromone evaporation by the OHs and node decision by the THs. A graphical description is also made in Figure 5.4. The reinforcement part is achieved through the deposition of pheromone values in the system, namely in the OHs. THs are responsible for this process, in the way they are responsible to manage the execution of the tasks. Through their life-cycle, THs gather information about the execution of the process and evaluates the decisions taken with their goals. Based on this evaluation, the THs reinforce the path taken (mapped in the OHs). The second part guarantees the

elimination of the worst paths. This is achieved through an evaporation process (decrease of the stigmergic values), where each OH cyclically reduces the pheromone values stored locally. Lastly, having this distributed information, the THs can use it in order to take future decisions.

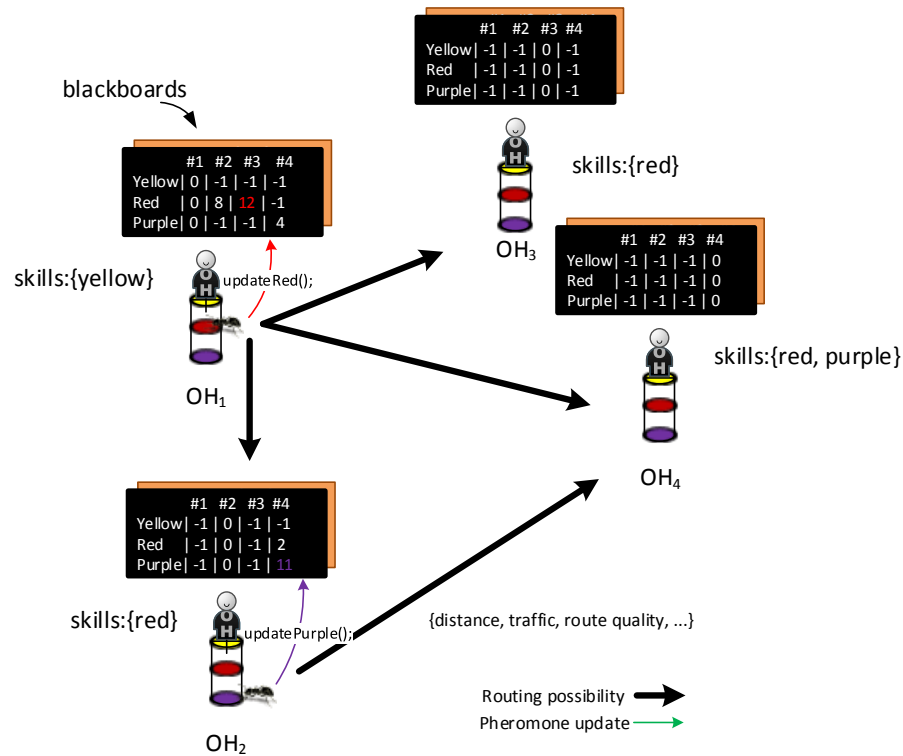

Figure 5.4 – Stigmergic Behaviour Concept

These three steps will be further detailed in the following points.

5.1.3.1 Deposition and Reinforcement

The deposition/reinforcement mechanism can be seen as a kind of reward to the best paths and resources or to the best combination of resources to produce a given product. In the proposed model, two different types of pheromone values are stored in each node (i.e. in each OH). Both are related to the pheromone regarding the services available on the posterior nodes, residing the difference between them in the deposition permissions. While on the first one, all THs may update the pheromone of the service used, on the second one, each type of TH (i.e. from different products) may only update the correspondent pheromone value for the used service.

Two different types of information can then be extracted from this deposition concept. On the first and since all the THs update on the same service pheromone value, the information is more refined, i.e. it is built from a wider set of entities. On the other hand, the product dedicated pheromone has a more focused information related to the

best decision taken for that particular product. In such way, the OHs have several blackboards, one related to the global pheromone information for the next service while the others relates to the particular product decision.

An example of the blackboard, extracted from OH₁ of Figure 5.4, representing the pheromone information related to the adjacent services is presented in Table 5.1.

Table 5.1 – Blackboard Table Example

| | OH ₁ | OH ₂ | OH ₃ | OH ₄ |
|--------|-----------------|-----------------|-----------------|-----------------|
| Yellow | 0 | -1 | 0 | -1 |
| Red | 0 | 8 | 12 | -1 |
| Purple | 0 | -1 | -1 | 4 |

The pheromone values of the same resource are marked with the value 0 since other OHs have the values to link to this OH. Connections that are not possible to be made are marked with the value -1, while the other values represent the intensity to reach a particular service, e.g., from this point the red service has a higher value for the OH₃, i.e. (12).

The described deposition mechanism is still decomposed in two stages. The first stage depends only on the time taken to reach the desired goal and it is updated immediately after reach it. The amount of pheromone to deposit, r_1 , for service i , is shown in Equation 5.6 and is simply the sum of the previous values with the division of r_1 with the time taken, t_t , to reach the goal.

$$P_i^t = P_i^{t-1} + \frac{r_1}{t_t} \quad (5.6)$$

The second deposit stage (see Equation 5.7) is related to the fulfilment of the objectives by the resource. This can contribute to increase the amount of pheromones if the goals are accomplished successfully, or to reduce it in case of failure or delay in accomplishing the task execution. In the latest, the amount of pheromone deposited in stage one is also withdraw.

$$\begin{cases} P_i^t = P_i^{t-1} + r_2 & , \text{if success} \\ P_i^t = P_i^{t-1} - \frac{r_1}{t_t} - r_2 \times \frac{TimeTaken}{TimeExpected} & , \text{otherwise} \end{cases} \quad (5.7)$$

where,

- r_2 is the amount of value to deposit/withdraw.
- *TimeTaken* is the time taken in the operation.
- *TimeExpected* is the time expected for the operation.

The second type of pheromone, i.e. the one related with the overall TH process, is reinforced when an entity fulfils all of its services during the execution of the process. The amount of pheromones to deposit is weighted by the time taken, C_{max} , compared

with the best time obtained until that moment, $C_{max_{best}}$.

$$P_i^t = P_i^{t-1} + r_3 \times \frac{C_{max}}{C_{max_{best}}} \quad (5.8)$$

where,

- r_3 is the amount of value to deposit.
- C_{max} is the time taken in execute the product.
- $C_{max_{best}}$ is the best time taken to execute the product.

The $C_{max_{best}}$ is a parameter passed by the PH when the TH is created.

5.1.3.2 Evaporation Process

The evaporation process guarantees that the less used trail, or the worst ones, are gradually removed from the decision choices that THs can have. This process can be implemented by decreasing all the pheromone values present in the system with a fixed value or by allowing it to change according to a given criteria.

Additionally, the evaporation value must be weighted by the number of entities present in the system for a given service. This guarantees that if a service is not being needed, the pheromone value is not evaporated making this way that when the service is needed again the entities doesn't make a cold start.

In this way, the expression that regulates the evaporation mechanism is given by:

$$P_i^t = P_i^{t-1} - e \times N \quad (5.9)$$

where,

- e is the value to evaporate.
- N is a function that depends of the number of entities.

The value e can be directly influenced in the cases that the system has a high level entity that possesses a wider view of the system behaviour.

5.1.3.3 Next Destination Selection

The selection of the next node to visit is accomplished by evaluating the two previously described types of information: the one dedicated to each product and the one containing all the depositions from the holons that used the service.

The behaviour dynamics (i.e. the pheromone intensity) is calculated by determining the probability of the holon to take a particular path. In such way, for each possible path, the following probability is calculated, where I_{Li} is the local pheromone value from the present node to the node i , and j is the number of all the possible paths.

$$p_{I_{Li}} = \frac{I_{Li}}{\sum_n I_{Lj}} \quad (5.10)$$

In that way, the highest pheromone values are most likely to be selected to be the next route to take.

The same exercise is made for the information related to the overall process for a particular TH, i.e. a product to be processed. Expression 5.11 gives the next route to take, making the overall route selection less myopic.

$$p_{I_{G_i}} = \frac{I_{G_i}}{\sum_n I_{G_j}} \quad (5.11)$$

The decision is achieved by selecting the maximum value obtained of the aforementioned equations. An additional parameter is introduced into the selection equation that guarantees a certain degree of randomness.

$$nextNode = max(\alpha I_{L_i}, \beta I_{G_i}) \quad (5.12)$$

where,

- I_{L_i} represents the path traced, by the use of pheromone deposition/evaporation, to the next resource.
- I_{G_i} represents the traced optimized plan.
- $\alpha \geq 0$ weights the desirability of follow the local pheromone information.
- $\beta \geq 0$ weights the desirability of follow the global information.

The local and global desirability can be complementary by considering $\beta = 1 - \alpha$. Despite that, the independent control of these variables displays advantages in the cases where no balance between the local and global information is required.

5.2 Mechanisms for Structural Self-Organization

Changing the relation of holons is a crucial part of the ADACOR² architecture, allowing them to re-organize e.g., to create new groups. The previous section has shown 3 techniques that are able to change the behaviour of an holon and consequently may change the holons relations (recall the Level 0 emergence definition of the structural self-organization).

This section will depict two techniques that can be used as a way to achieve a structural self-organization. In this way and generically, the structural self-organization procedure can be described using the Algorithm 2.

After the detection of an opportunity to evolve (process not described) the holon launches all the known procedures to find a new system working configuration. When all the results of the procedures are collected, or ultimately when a maximum time has elapsed, the structural self-organization module will evaluate them searching for the one that improves the current KPIs. In the case of finding a better reorganization, the module will send this result to the nervousness module that will analyse the possibility to apply the necessary measures.

Algorithm 2 Structural Self-Organization

Require: facts, currentStructuralKPI**Ensure:** Selection of the holons' proper structural organization

```
1: procedure STRUCTURALSELFORGANIZATION(facts)
2:   Structures  $\leftarrow$  List of Structures
3:   nStructures  $\leftarrow$  count(Structures)
4:   for i = 0 to nStructures do
5:     launch Structural(i)            $\triangleright$  Launch all the known structural procedures
6:   end for
7:   i = 0
8:   while (all structural output not received) || (timeelapsed  $\leq$  maxTime) do
9:     output(i)  $\leftarrow$  OutputStructural(i)
10:    newStructureFound = false
11:   end while
12:   bestStructuralKPI  $\leftarrow$  currentStructuralKPI
13:   for i = 0 to count(output) do
14:     if output(i).getKPI > bestStructuralKPI then
15:       bestStructuralKPI  $\leftarrow$  output(i).getKPI
16:       newBestStructural  $\leftarrow$  output(i).getStructural
17:       newStructureFound = true
18:     end if
19:   end for
20:   if newStructureFound then
21:     Send result to nervousness stabilizer
22:   end if
23: end procedure
```

One notable difference from this process to the behavioural self-organization is the fact that in this case other holons are affected by the application of the necessary measures, e.g., change of the holarchy of an OH or, as seen in the general example of Figure 4.16, the creation of a second SH and the division of the OHs.

In this way, all the holons that have started a structural procedure will send the expected KPIs for the new structure which will be evaluated by the participants which will submit them to their internal nervousness controllers who will analyse the proposals.

5.2.1 Structural Re-Arrangement by Means of Birds Behaviour

Getting inspiration from the birds flocks or the fish schooling, one can assist to the basic behaviour of each individual entity. Among those, three can be highlighted: i) entities, in the group, tend to follow the leader; ii) entities also tend to maintain distances to other elements in the groups and finally, iii) the group size regulation is also made.

The first rule is important in the sense that, e.g., if one entity is more agitated and makes a sudden move, maybe it is because it has cognition of important information to the group. The second rule tries to avoid collision within the group and makes the vision field more clear. The last one, regulating the group size, is important because either too

small, the group is not strong enough to predators, or too big slows down the group dynamics.

This phenomenon serves as working base to develop a procedure that allows the holons, after the detection of a trigger, to start reasoning on the possibility to change the structure of the holarchy.

In this way, the procedure starts by each holon that constitutes the holarchy, namely the OHs, to query each other with key information that resumes their status. Parameters such as the holon current location, its agenda, its skills and processing times are used to assess the holon criticality in terms of position within the holarchy. It is worthy to note that, e.g., an holon that has on its agenda more processing tasks tend to be more critical than other that may have less.

After gathering this information from all the OHs, each individual OH calculates a KPI, named st , that estimates the current overall situation of the holarchy. A concrete KPI calculation could be applied instead of this estimation. The problem then would be that the procedure calculation time could increase deeply, particularly for larger systems with a great number of OHs with many work orders. This estimation considers the overall processing time of a resource, calculated by multiplying the number of work orders with the processing times, and considers that half of those work orders will need to be further transported for a new resource. Equation 5.13 depicts the calculation formula for this current KPI estimation.

$$st = t_p \times wo + \frac{1}{2} \times wo \times t_t|_{d(l_1-l_0)} + \sum_1^n t_p \times wo + \frac{1}{2} \times wo \times t_t|_{d(l_n-l_{n-1})} \quad (5.13)$$

where,

- st is the calculated KPI.
- t_p represents the processing time of the resource.
- wo represents the number of allocated work orders.
- $t_t|_{d(l_n-l_{n-1})}$ represents the transportation time between resource n and $n - 1$.

Following this idea, the OH assumes itself as the core holon in the holarchy (or the leader in the birds case). In turn, each OH position itself considering its importance, i.e. the number of assigned work orders. This process is repeated a pre-defined number of times, after which, a new estimation of the st parameter is calculated for each one of the possible solutions. Figure 5.5 depicts two possible solutions where the OH in the middle is the one that is generating the solutions. Note that the OHs with larger work order allocation are the ones closer to it.

If the OH is able to produce an improvement of the estimated st parameter it will propagate this to all the other OH that constitute the holarchy. If no improvement is achieved, a non-success message is also issued.

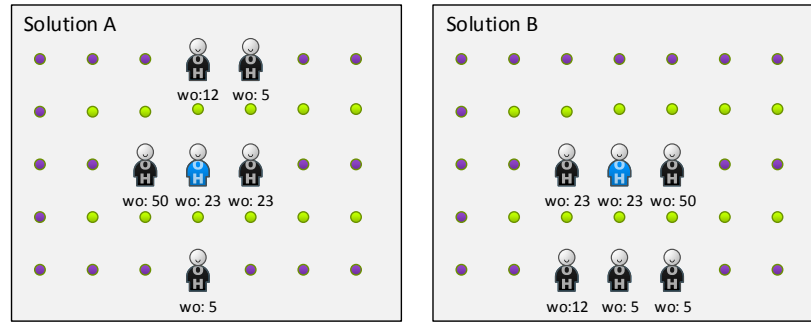

Figure 5.5 – Different Solutions Found During the Structural Self-Organization

After receiving all the results or after a time-out period, each OH will implement the solution that guarantees the best estimated st parameter.

5.2.2 Structural Re-Arrangement by Means of Ants Food Foraging Behaviour

A second bio-inspired structural self-organization mechanism uses the pheromone concept to, in a distributed manner, re-organized the OHs inside the holarity and displace them physically in the shop-floor.

The mechanism is based on a two-step approach where first the holons, that possess the production knowledge, i.e. the PHs, make a pheromone map based on the needed skills and secondly, the OHs place themselves based on their interests.

In order to facilitate the description of the mechanism, let's assume that a given shop-floor is divided into sections (see round markings in Figure 5.6), named working places, where any type of processing machine can be placed. Additionally, each of those working places have stored within a pheromone matrix where tuples of $\{skill, value\}$ are used to represent the pheromone intensity to a given skill. Naturally, the matrix size depends on the number of skills needed to produce the catalogue of products present at the system.

The first stage of the mechanism starts by each of the PHs to send a given number, \aleph , of scouting ants that are responsible to deposit a pheromone mark at the shop-floor. In this way, a given PH with the processing plan $\{skill_1, skill_2, \dots, skill_n\}$ will send \aleph scouting ants for each of the needed skill.

The deposition value depends of several parameters, namely one pre-defined value, the skill pheromone value on the working position and the pheromone on the neighbour working positions (e.g., their average). This local and neighbour analysis is made by the skill in deposition and for the skills needed in the precedent and subsequent operations (like depicted in notation 5.14).

$$\{local, neighbour\} \times \{current, precedent, subsequent\} skill \quad (5.14)$$

At the end of this process a mesh-like pheromone distribution is achieved for each of the present skills, having different pheromone intensities in the shop-floor.

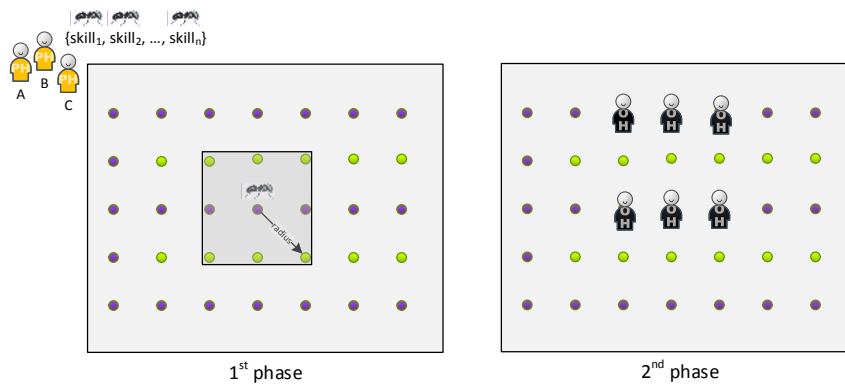

Figure 5.6 – Ants Food Foraging Structural Self-Organization

The second phase is started after the creation of this mesh of pheromone values where the OHs start actively finding its new place within the holarchy and, if a level 2 structural self-organization is on place, their physical move in the shop-floor. At this stage, each OH positions itself on the maximum pheromone value of a working place at the shop-floor. In the cases where the OH offers more than one skill it will position itself on the geometrical average between the maximum pheromone values obtained for each of the offered skills.

Some parameter may influence the pheromone mesh creation, such as the neighbourhood size, the pheromone value to deposit or the number of scouting ants. Additionally, the positioning technique that the OHs use in the second phase also influences the re-organization and aside of each OH position itself on the pheromone maximum, it can do it on the overall average maximum and prioritization of the OH position can also be added (e.g., by positioning first the most overloaded holons).

5.3 Learning and Reasoning

The reasoning and learning capabilities modules play a crucial role in the self-organization model, supporting the generation, removal or adaptation of knowledge. In particular, learning is important in two distinct phases of self-organization:

1. Identification of opportunities to evolve, refining the thresholds on which the self-organization mechanisms are triggered.
2. Defining how to evolve, adapting the internal self-organization mechanisms parameters along the time.

Different constraints impose different types of learning techniques and for this purpose, ADACOR² uses social learning for the propagation of new behaviours among the holons and for the propagation of accumulated knowledge from PHs to THs using a pheromone-like mechanism, as defined in the ADACOR architecture (Leitão and Restivo, 2006). This exchange of knowledge allows the receiving holons to have access to more aggregated information from the past peers experiences.

Social learning is also used to provide the direct query between holons, asking for past decisions and their outcomes. In this case, holons acquire information about the good and bad decisions of others and the context on which they were taken, allowing in this way for these holons to incorporate this into their internal decisional engine. Ultimately, this procedure culminates by creating new rules (or adapting similar ones) used later in the decision support by the reasoning engine.

A practical example can be given when TH₂ queries TH₁ and receives the information that changing from behaviour B_a^h to B_b^h , when the system is above a given overload level combined with offline status of OH₅, produces a decrease on the KPI.

A reward based learning technique, e.g., reinforcement-based mechanism, is used as a means to evaluate past evolution decisions. In this way, bad decisions performed in the past will have a negative impact on the future selection for the same decision, contrary to a good result that will have a positive impact. In this way, this learning technique is used throughout the holon life-cycle as a parameter fine tuning, such as to increase or decrease the confidence on using a given behaviour. It is also used by higher level holons, such as the SHs or the PHs, to collect accumulated knowledge from several holons.

Generalizing the learning mechanism, a given parameter, p , would have a value increase in the case of an improvement of the expected holon performance while it decreases in situations of obtaining a performance degradation. In this way, the new value of the parameter can be written by:

$$p_{t+1} = p_t + \gamma \times \frac{KPI_{final} - KPI_{expected}}{KPI_{final}} \quad (5.15)$$

where,

- p_t represents the previous parameter value.
- γ is a value between [0..1] that defines the update rate.
- KPI_{final} is the obtained KPI considered in the parameter calculation.
- $KPI_{expected}$ is the expected KPI considered in the parameter calculation.

It is important to note that the learning mechanisms to be embedded in individual holons should be kept as simple as possible, as it is in biology. Nevertheless, more complex learning mechanisms can be deployed, which can potentiate even more the learning module, knowing beforehand that more computational power could be a requisite in this situation.

The reasoning module is complementary to the learning module and is constantly matching the known facts with, e.g., the thresholds defined by the learning algorithms. Naturally, all sort of reasoning techniques, such as inductive, deductive, analogical or case-based reasoning can be embedded into the ADACOR² holons. Despite this, in the current work of ADACOR², a rule based reasoning technique was considered and implemented using an expert system.

By definition, an expert system is a computer system that mimics the human behaviour of knowledge and judgement on a given subject area (Jackson, 1999). Shortly, an expert system is constituted by three parts, namely the user interface, the knowledge base and the inference engine. The user interface allows the user to interact with the expert system, making possible the user to query the expert system. The knowledge base is a collection of facts and a set of rules, more particularly in the form of *IF..THEN..* rules, that the inference engine uses in order to create an action (i.e. the output).

Based on the learning mechanism, rules can be added, modified or even removed. One example can be given in the situation where one rule had defined a lower-bound on which the behaviours runs properly. Based on the learning and reasoning, it was detected that above a given value, that behaviour would not have the desired outcome which, in practice implies the generation of a new upper-bound, since it was detected that above this value, that behaviour presents bad results.

5.4 Nervousness Stabilizer: Controlling Chaos in Dynamic Self-Organized Systems

As stated before, ADACOR² uses nervousness controllers as the way to prevent the appearance of some chaotic behaviour, first at the holon level and secondly at the system level.

Some of the typical approaches to calm down the holons' desire to change can be controlled by restricting the number of changes within a specific time frame, only allowing the entities to change at pre-defined intervals or by setting the exploration/exploitation thresholds (Barbosa et al., 2012a). In this work, an innovative technique, inspired from the classical control theory, namely the PID controller, was used as the stabilization mechanism.

In the classical feedback control theory, one of the most effective mechanism used to control discrete or continuous systems is the PID controller (King, 2011), namely its discrete version which allows to be implemented into more sophisticated processing units. This mechanism, by adjusting some key parameters, allows a quick reaction to the perturbation combined with the elimination of the error in the steady state. In practice, when different functioning conditions are needed, e.g., a temperature in a room, the PID controller adjusts in a quick and effective way, by setting the variables to the new set-point. Having in mind these principals, the inspiration of the PID control was used to design a nervousness control mechanism for self-organized systems, as illustrated in Figure 5.7.

The three regulating parameters can then be translated into a mathematical equation as:

$$u(t) = K_p e(t) + K_i \int_0^t e(\tau) d\tau + k_d \frac{d}{dt} e(t) \quad (5.16)$$

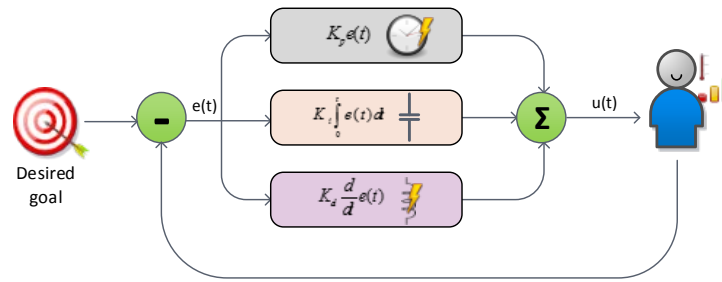

Figure 5.7 – Nervousness control mechanism based on PID controllers

In such mechanisms, the proportional part Kp adjusts the reaction time to the perturbation trigger, the integrative part Ki regulates the accepted error of the desired goal, and the derivative part Kd sets the responsiveness to reach the goal. Similarly, in ADACOR² these three parameters regulate the self-control of holons. The $e(t)$ represents the error that needs to be eliminated and is calculated by the difference between the system output and the desired goal.

Firstly, the Kp defines the time from which the holons start to react to trigger events, allowing them to overcome momentary perturbations or to gather more information about the perturbation, starting the self-organization mechanism only after the whole set of new allocation requests has been collected. In the PID controller analogy, a high value of Kp will drive the system to respond faster to perturbations, which could lead the system to behave in an unstable manner, while a low value will not enable the system to reach the desired goal. The same cautions must also be taken into account when selecting the time after which the holons will react to plan deviations. A high value may drive the holons to be constantly in an adaptation mode while a low value might drive them to never react.

Secondly, Ki describes the minimum acceptable improvement of the solution found (by each self-organization mechanism) that can be considered as enough to permit the use of the changes. In the PID analogy, the Ki , or the integrative part, is responsible for the elimination of the error in steady state, i.e. going as close as possible to the desired goal. Since the goal of the ADACOR² holons is to improve themselves always as possible, they are considered as moving a goal, which is a maximization function. In such way, the Ki parameter acts as the minimum acceptable improvement of the actual goal.

Lastly, Kd defines how fast the solution must be found, acting as a limit to find solutions, after which the most acceptable ones are considered. In the PID analogy, the Kd parameter helps to improve the settling time and increases system stability. Mimicking this to the nervousness controller, one will find that this parameter acts like the time limiter for a given holon to adapt. After this time, the holons will stop adapting and thus calm down its behaviour. The cautions to set this parameter regards the fact that a high value will enable a long adaptation time while a low value might not enable the holon to reach an acceptable goal value.

In this way, the SD defined in section 4.5 plays a major role in the dynamic parameter adaptation since for faster dynamics, the kp must lower down to allow quicker responses to plan deviations. In an opposite way, the kd must also be increased to guarantee a faster convergence to the expected performance. Obviously, this adjustment increases the risk of obtaining holons instability and must be counterbalanced with an appropriate reaction time. The ki for this case must also lower down, compromising bigger performance improvements by allowing more changes in the holon decision through smaller steps.

Each one of the aforementioned parameters are dynamically adjusted taking into consideration the learning mechanism defined in the previous section. This dynamic adjustment aims to contribute to a more robust usage of the controller with respect to its exterior, namely to the SD.

As depicted in Figure 4.24 a two level stabilization mechanism is used. Recalling, the first level controls each self-organization mechanism while the second selects the most appropriate one to use (in the cases where both self-organization procedures produce a valid output).

Algorithm 3 depicts the behavioural nervousness control using the PID approach.

Algorithm 3 Behavioural Nervousness Control

Require: facts, holonBehaviouralNervousnessLevel

Ensure: Behavioural nervousness stabilization of holon

```

1:  $startTime \leftarrow disturbanceTime || improvementTime$ 
2: procedure BEHAVIOURALNERVOUSNESSSTABILIZATION( $facts, behavioursKPI, e(t)_B$ )
3:    $expectedBehaviourKPI \leftarrow currentBehaviourKPI$ 
4:    $currentBehaviourKPI \leftarrow newBehaviourKPI$ 
5:    $kpiDeviationTime \leftarrow startTime - currentTime$ 
6:    $behaviourAllowed \leftarrow False$ 
7:   if  $kpiDeviationTime \leq kd$  and  $e(t)_B \geq behaviourThreshold$  then
8:     if  $(kpiDeviationTime - currentTime) \geq kp$  then
9:       if  $(expectedBehaviourKPI - currentBehaviourKPI) \geq ki$  then
10:        Change holon behaviour
11:         $behaviourAllowed \leftarrow True$ 
12:       else
13:        KPI improvement not sufficient.
14:       end if
15:     else
16:       Need to wait a little longer before react.
17:     end if
18:   else
19:     No more adaptation allowed. Adaptation time overpassed.
20:   end if
21: end procedure

```

The behavioural nervousness control starts by checking if the adaptation phase is still valid, i.e. if the maximum adaptation time has not yet elapsed, and if the current behaviour error (or deviation) is higher than the minimum behaviour threshold (making

acceptable the behavioural change). If both rules are valid, the nervousness controller will proceed to check if the response time has been met or if it still needs to wait more time, allowing to ignore momentary KPI deviations.

Finally, only an expected behavioural KPI improvement higher than the ki will be allowed to start a behavioural change.

Algorithm 4 depicts the structural nervousness control using the PID approach.

Algorithm 4 Structural Nervousness Control

Require: facts, holonStructuralNervousnessLevel

Ensure: Structural nervousness stabilization of holon

```

1:  $startTime \leftarrow disturbanceTime || improvementTime$ 
2: procedure STRUCTURALNERVOUSNESSSTABILIZATION( $facts, structuralKPI, e(t)_S$ )
3:    $expectedStructureKPI \leftarrow currentStructureKPI$ 
4:    $currentStructureKPI \leftarrow newStructureKPI$ 
5:    $kpiDeviationTime \leftarrow startTime - currentTime$ 
6:    $structuralAllowed \leftarrow False$ 
7:   if  $kpiDeviationTime \leq kd$  and  $e(t)_S \geq structureThreshold$  then
8:     if  $(kpiDeviationTime - currentTime) \geq kp$  then
9:       if  $(expectedStructureKPI - currentStructureKPI) \geq ki$  then
10:        Change holon structure.
11:         $structuralAllowed \leftarrow True$ 
12:      else
13:        KPI improvement not sufficient.
14:      end if
15:    else
16:      Need to wait a little longer before react.
17:    end if
18:  else
19:    No more adaptation allowed. Adaptation time overpassed.
20:  end if
21: end procedure

```

The structural nervousness control is similar to the behaviour procedure with the difference that the parameters values might be different. As an example, the $e(t)_S$ must be higher in order to only allow the structural self-organization for bigger KPI deviations as also the ki improvement, guaranteeing that only when a significant improvement is expected that a structural re-organization is issued.

Algorithm 5 depicts the second level nervousness control mechanism where the behavioural and structural nervousness control output is used as input.

In the given algorithm, a simplistic approach was followed by selecting the self-organization mechanism that produces the highest expected KPI improvement. Additionally, the bypass mechanism to guarantee that a structural evolution is applied in the case where the majority of the holons decide favourably was also introduced.

Algorithm 5 Second Level Nervousness Control

Require: facts, holonNervousnessLevel

Ensure: Nervousness stabilization of holon

```

1: procedure SECONDLEVELNERVOUSNESSSTABILIZATION(facts)
2:   if behaviourAllowed||structuralAllowed then
3:     Apply highest expected KPI.
4:   end if
5:   if majorityRule then
6:     Apply requested structural change. ▷ Structural bypass by the majority rule.
7:   end if
8: end procedure

```

5.5 Summary

This chapter presents some of the self-organization related mechanisms that were developed and implemented in the ADACOR² architecture, which will be used in the following chapter as the assessment ground-base of the architecture.

Shortly, three mechanisms were used in the holons behavioural catalogue to allow them to respond properly to changes in the system conditions, based on current conditions. The first mechanism relies on negotiation techniques used on market-based approaches while the second one uses the concepts of magnetism to create a very dynamic behaviour, aiming to introduce responsiveness. Finally, the last technique is based upon the ant food foraging behaviour.

Two mechanisms for the structural self-organization were also introduced where the inspiration from the bird group formation and the pheromone deposition used by ants during the food foraging are used to allow the holons to re-arrange themselves in order to optimize the production according to the current product demand.

Social and reinforcement learning examples and techniques were also described, allowing the holons to dynamically perform the parameters adjustment. A rule based reasoning engine, using an expert system, was also described.

Finally, an instantiation of the holon's nervousness controller is depicted, taking inspiration in the classical feedback control, to regulate the dynamics of the holons in such self-organized environment.

In the next chapter, the case study used to validate and assess the proposed architecture is described as well the implementation of the prototype solution. The experiment trials are also presented and the achieved results are analysed.



Practical Implementation and Validation

The present is theirs; the future, for which I really worked, is mine.

Nikola Tesla

This chapter intends to validate the proposed manufacturing control architecture. The used case study, based on a real FMS, is presented and the holons mapping between the ADACOR² and the described system is made.

Additionally, two experimental scenarios were developed to assess the two proposed self-organization vectors. The behavioural self-organization is validated using a simulation of the real AIP (Atelier Inter-établissement de Productique)-PRIMECA (Pôle de Ressources Informatique pour la Mécanique) FMS located at the Université de Valenciennes et du Hainaut-Cambrésis, and the structural self-organization, due to its particularities, is validated using a modified version of the AIP-PRIMECA FMS, where the rigidity of the machines' position was removed and the conveyor system was replaced by an AGV.

6.1 Description of the Case Study and System Implementation

The case study used to test the presented work is based on the AIP FMS located at the Université de Valenciennes et du Hainaut-Cambrésis, which is described in detail in (Trentesaux et al., 2013). A visual aspect of the FMS is provided in Figure 6.1.



Figure 6.1 – View of the AIP-PRIMECA Cell

This FMS cell was selected since it introduces a high level of flexibility, mainly on the production and transport sides, introducing several alternatives for the same goal.

The following sub-sections will give a deeper insight of the AIP-PRIMECA cell.

6.1.1 The Real AIP-PRIMECA FMS

The FMS is composed of 7 machines linked by a conveyor system, as illustrated in Figure 6.2.

Four robots, being three from KUKA and one from Stäubli, a loading/unloading station, an automated inspection unit and a manual recovery unit constitute the set of machines present in the system. The movement of the product to be processed in the previous machines is achieved by means of a shuttle, which moves on the rack system. For visual clarity, an image of the conveyor system and of the shuttle is shown in Figure 6.3a. The change between tracks is achieved by means of a switching gate system, as shown in Figure 6.3b.

The routing within the FMS has a great importance since the decisions made in this respect can have major impact on the production of a given product and on the overall system performance. To this respect, transportation times between subsequent nodes/machines are provided in Table 6.1 (note that the composite times are derived combining two or more paths).

A set of sub-products are able to be produced within this FMS, namely the letters *b*, *e*, *l*, *t*, *a*, *i*, *p* and *t*. Combining the previous sub-products, one is able to produce the final products *BELT*, *AIP* and *LATE*. A visual perspective of the aforementioned sub-products

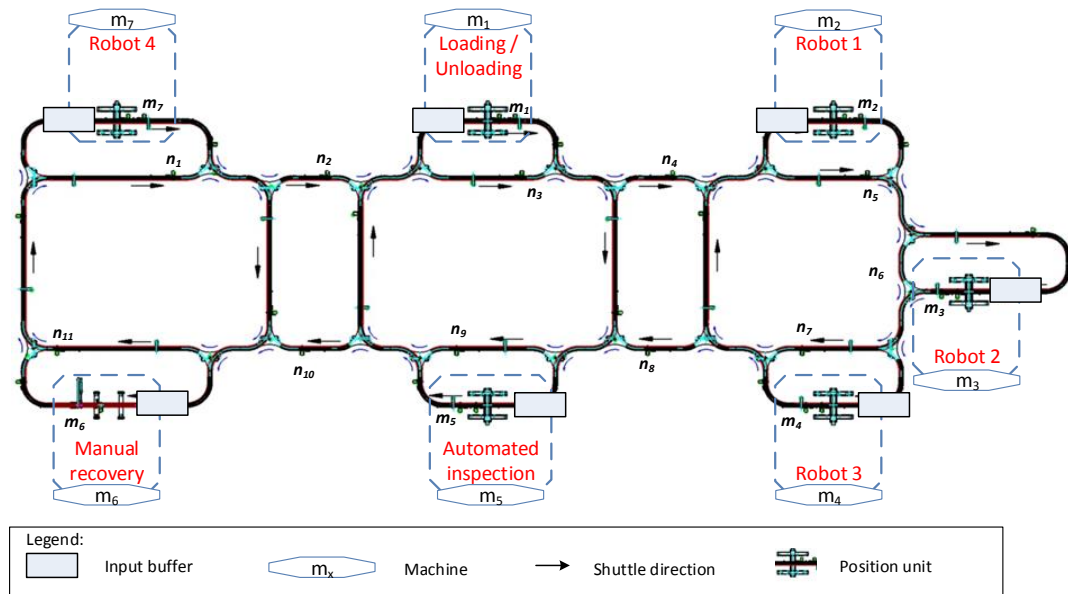
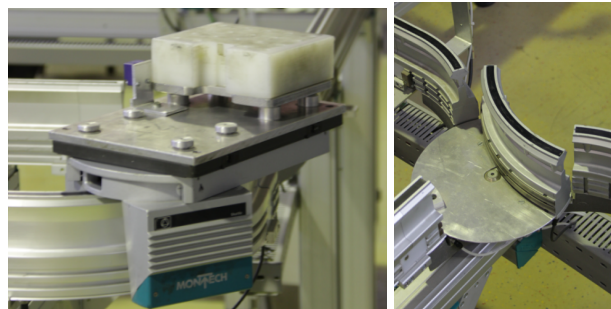

Figure 6.2 – Layout of the AIP-PRIMECA Cell



(a) Shuttle

(b) Switching gate

Figure 6.3 – AIP-PRIMECA Shuttle and Switching Gate Detail

Table 6.1 – Transportation Times Between Nodes

| | | Destination | | | | | | | | | | | | | | | | | |
|--------|-----|-------------|----|----|----|----|----|----|----|----|-----|-----|----|----|----|----|----|----|----|
| | | N1 | N2 | N3 | N4 | N5 | N6 | N7 | N8 | N9 | N10 | N11 | M1 | M2 | M3 | M4 | M5 | M6 | M7 |
| Source | N1 | - | 4 | - | - | - | - | - | - | 5 | - | - | - | - | - | - | - | - | - |
| | N2 | - | - | 4 | - | - | - | - | - | - | - | - | 5 | - | - | - | - | - | - |
| | N3 | - | - | - | 4 | - | - | - | 5 | - | - | - | - | - | - | - | - | - | - |
| | N4 | - | - | - | - | 4 | - | - | - | - | - | - | - | 5 | - | - | - | - | - |
| | N5 | - | - | - | - | - | 3 | - | - | - | - | - | - | - | 11 | - | - | - | - |
| | N6 | - | - | - | - | - | - | 4 | - | - | - | - | - | - | - | 5 | - | - | - |
| | N7 | - | - | 5 | 5 | - | - | - | 4 | - | - | - | - | - | - | - | - | - | - |
| | N8 | - | - | - | - | - | - | - | - | 4 | - | - | - | - | - | - | 5 | - | - |
| | N9 | - | 5 | - | - | - | - | - | - | - | 4 | - | - | - | - | - | - | - | - |
| | N10 | - | - | - | - | - | - | - | - | - | - | 4 | - | - | - | - | - | 7 | 10 |
| | N11 | 9 | - | - | - | - | - | - | - | - | - | - | 4 | - | - | - | - | - | - |
| | M1 | - | - | - | 6 | - | - | - | 7 | - | - | - | - | - | - | - | - | - | - |
| | M2 | - | - | - | - | - | 5 | - | - | - | - | - | - | - | - | - | - | - | - |
| | M3 | - | - | - | - | - | - | 6 | - | - | - | - | - | - | 13 | - | - | - | - |
| | M4 | - | - | - | 7 | - | - | - | 6 | - | - | - | - | - | - | 7 | - | - | - |
| | M5 | - | 7 | - | - | - | - | - | - | - | 6 | - | - | - | - | - | - | - | - |
| | M6 | 12 | - | - | - | - | - | - | - | - | - | - | - | - | - | - | - | - | 13 |
| M7 | - | 6 | - | - | - | - | - | - | - | 7 | - | - | - | - | - | - | - | - | |

is given in Figure see 6.4.

As it can be seen, each sub-product has its own assembly process that needs to be followed to complete its production. As an example, to produce the sub-product *a*, the

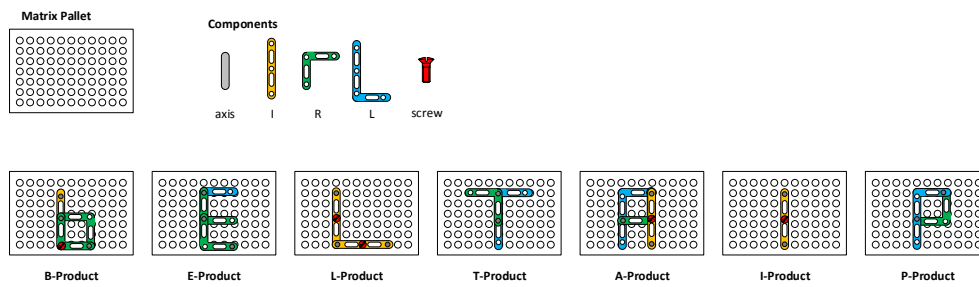

Figure 6.4 – Product Catalogue

assembly base plate must be loaded into the shuttle, followed by three axis components, one r, L and I component and is ended by a screw assembly and the unloading procedure. The remaining process plans for all sub-products are mapped in Table 6.2.

Table 6.2 – Process Plans for the Catalogue of Products

| Sequence | B | E | L | T | A | I | P |
|----------|------------|------------|------------|------------|------------|------------|------------|
| #1 | Loading | Loading | Loading | Loading | Loading | Loading | Loading |
| #2 | Axis | Axis | Axis | Axis | Axis | Axis | Axis |
| #3 | Axis | Axis | Axis | Axis | Axis | Axis | Axis |
| #4 | Axis | Axis | Axis | Rcomp | Axis | Icomp | Rcomp |
| #5 | Rcomp | Rcomp | Icomp | Lcomp | Rcomp | Screw | Lcomp |
| #6 | Rcomp | Rcomp | Icomp | Inspection | Lcomp | Inspection | Inspection |
| #7 | Icomp | Lcomp | Screw | Unloading | Icomp | Unloading | Unloading |
| #8 | Screw | Inspection | Screw | | Screw | | |
| #9 | Inspection | Unloading | Inspection | | Inspection | | |
| #10 | Unloading | | Unloading | | Unloading | | |

Naturally, the assembly procedures mentioned before are processed by the available machines at the shop-floor. The sub-set of machines that are able to perform a required operation is illustrated in 6.3. The values depicted in the table represent the processing times that each machine offers to perform that given operation.

Table 6.3 – Machine Skills and Processing Times

| Operation | M ₁ | M ₂ | M ₃ | M ₄ | M ₅ |
|------------|----------------|----------------|----------------|----------------|----------------|
| Loading | 10 | | | | |
| Unloading | 10 | | | | |
| Axis | | 20 | 20 | 20 | |
| Rcomp | | 20 | 20 | 20 | |
| Icomp | | | | 20 | |
| Lcomp | | 20 | | 20 | |
| Screw | | | 20 | 20 | |
| Inspection | | | | | 5 |

As an example, the “Loading” operation can be executed by machine M₁ while the “Axis” operation can be executed by machines M₂ and M₃, both with a processing time of 20s. Particularly here, a slight change was introduced, regarding what is described in (Trentesaux et al., 2013), to increase the flexibility of the FMS. This change is achieved

by the increasing the number of skills, namely in machine M_4 with "Axis" and "Rcomp". Note that before this change, a breakdown in any of the machines that offer processing skills, namely M_2 , M_3 and M_4 , only one other machine was able to offer the skill, limiting the decision making process of the manufacturing control architecture.

6.1.2 A More Flexible AIP-PRIMECA FMS

Although the real AIP-PRIMECA FMS cell allows to assess the proposed manufacturing control architecture, it still has limitations to assess the structural self-organization vector in ADACOR², due to the relatively limited size of machines and the rigid nature of the FMS (e.g., machines have rigid working places and shuttles have fixed transportation paths).

In this way, please recall that the structural self-organization will change the relations between the holons present in the system. Naturally, this could only be tested briefly in the current real version of the AIP-PRIMECA FMS cell, where, e.g., clustering of orders from the same client could be done. But for instance, a deeper structural self-organization is not possible, e.g., machine dynamic grouping.

Increasing the flexibility degrees where the control decisions could be greatly potentiated, aiming to have a more dynamic cell, is then achieved by replacing the transportation rack system with a more flexible one. This can be achieved by the introduction of an AGV transportation system. Secondly, the fixed working positions of the machines can also be eliminated, allowing them to be repositioned, minimizing the need for longer transportation times. This last feature is in-line with more recent manufacturing trends, such as the ones found in Festo AG & Co. KG.

Concretizing the previous features, a completely new manufacturing shop-floor is presented in Figure 6.5. Attention was paid to get a closer behaviour as with the real AIP cell. In such way, machines are placed in the same positions and transportation times between them are similar. To achieve this, the AGV takes 3 seconds to move between positions (represented as dots in the figure).

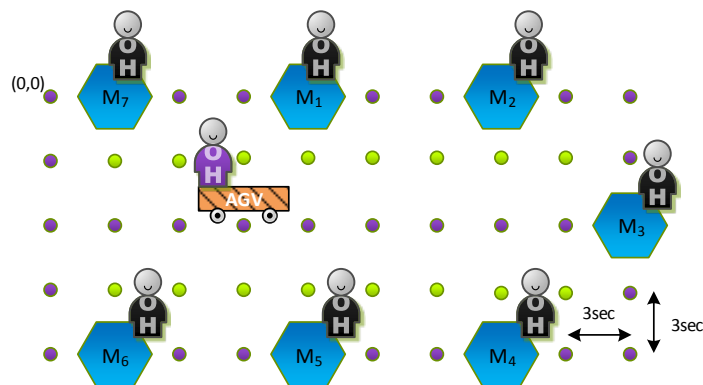

Figure 6.5 – A Futuristic AIP-PRIMECA Cell

Machines can now shift the working position, only possible in the purple places, which have all vital needs for a machine to work properly, e.g., electrical power and hydraulics. The AGV, on the other hand, can move on all positions but this can only be made in an horizontal or/and vertical way, i.e. AGVs cannot travel in a diagonal line.

Using the previous adaptations, it is now possible to assess deeply the structural self-organization of ADACOR², since level 2 can be tested. Particularly, it is possible, for instance, to test the self-organization of the machines in order to minimize the amount of time needed to produce a given order.

6.2 Manufacturing Control Assessment Metrics

Measuring the efficiency of a manufacturing control architecture is always difficult. Despite this, a proper assessment of the proposed control architecture requires the measurement and evaluation of a set of different metrics, or KPIs (Brennan and Norrie, 2003), as well as proper benchmarks (Trentesaux et al., 2013).

Two different types of KPIs are generally used for this assessment, namely quantitative and qualitative. The first is used when the KPI measurement is possible, giving a numerical value to it. KPIs such as the resource utilization, the WIP (Work In Progress), the tardiness or the makespan are among the most used to assess quantitatively a manufacturing control architecture. On the other hand, qualitative assessment is more deductive in the sense that assigning a numerical value to a given KPI is harder, e.g., measuring the agility or reconfigurability of the system. Despite this, some works have been conducted in the past where metrics and methodologies are described, namely (Brennan and Norrie, 2003; Leitão, 2004; Trentesaux et al., 2013).

In the present work, a quantitative approach was selected in order to assess the manufacturing control architecture. The main influential decision for this choice is the help on the ease of comparison between the several control structures.

One of the most used quantitative KPIs is known as makespan, or C_{max} , which is denoted by the total amount of time that a given manufacturing order needs to be processed. In other words, C_{max} is related to the time of the last operation of the whole manufacturing order. In this way, the objective function of this KPI is the minimization of it, i.e. as lower is the C_{max} the better the manufacturing control architecture is.

The throughput can be defined as the total amount of parts that the system is able to produce per unit of time. This parameter depicts the production system capacity and, in this work, is calculated by counting the number of products produced during one hour.

Measuring the impact, i , that disturbances have in manufacturing control architectures is also important, particularly in the current work, since one of the main goals of the proposed manufacturing control architecture is to have as less impact as possible when disturbances appear into the system. In this work, the impact KPI is calculated by the difference of the makespan of a given architecture, C_{max}^{archi} , in relation to the best KPI of all architectures, $C_{max}^{overall}$. This value is still normalized in relation with the best overall KPI.

Finally, this can be represented as: $i = \frac{C_{max}^{archi} - C_{max}^{overall}}{C_{max}^{overall}}$. The previous equation can even be further developed in the case where a percentage value is required by multiplying it with the number 100.

Lastly, the control predictability is also important, particularly in non-linear systems and when several runs are executed in order to obtain the metrics for the architecture assessment. In the way, as higher this is the more reliable the output result is expected to be. Indirectly, the predictability can be also considered as the confidence level of the produced output of a given architecture.

6.3 Mapping ADACOR² Holons to the Case Study

The proposed self-organized holonic system used the multi-agent technology, and more particularly, the JADE (Java Agent DEvelopment Framework) (Bellifemine et al., 2007) to develop the agent-based infra-structure, namely the behaviour of each individual ADACOR² holon and the designed cooperation patterns. More recently appeared the JaCaMo approach, that combines both the dimension organization (important in this case as an holonic organization is used that have to follow the agents), the dimension agent and the dimension environment, presenting an interesting and promising solution (Boissier et al., 2013). The selection of JADE framework over others, such as A-Globe (Rehák et al., 2005), Jason (Bordini, 2007) or Cougaar (Kleinmann et al., 2003), relies basically under three facts. First, JADE always had a steady and stable development, which makes future evolutions more reliable. One example of the importance of this feature is the present work, which has extended the previous work of ADACOR. Secondly, the community that uses JADE doesn't stop to grow and also has a very good documentation. Finally, and although the current state of FIPA (Foundation for Intelligent Physical Agents) development, being FIPA compliant, JADE follows the standards in the field and permits a more concrete interaction with other agents frameworks.

The holon's intelligence, as already happened in the first version of ADACOR, was embedded using a rule engine implemented with the JESS (Java Expert System Shell) platform (Friedman-Hill, 2003).

In the real AIP-PRIMECA scenario, a particular holon type, named CSH (Conveyor System Holon), instantiated from an OH, was developed to manage the routing and gate switching inside the conveyor system, providing some specific functions, such as serving as an intermediary to manage the dispatching of the transportation orders to the available shuttles. The CSH used the Jung tool (O'Madadhain et al., 2002) to support an ease and dynamical parameter calculation in the nodes and also to display the provided functionalities. The CSH GUI, illustrated in Figure 6.6, provides real-time information regarding the location of the shuttles and the state of the machines, according to a colour-based diagram.

Additionally, all the defined ADACOR² holons are used. When a higher holon is necessary in the system, one SH is used to introduce optimization into the lower level

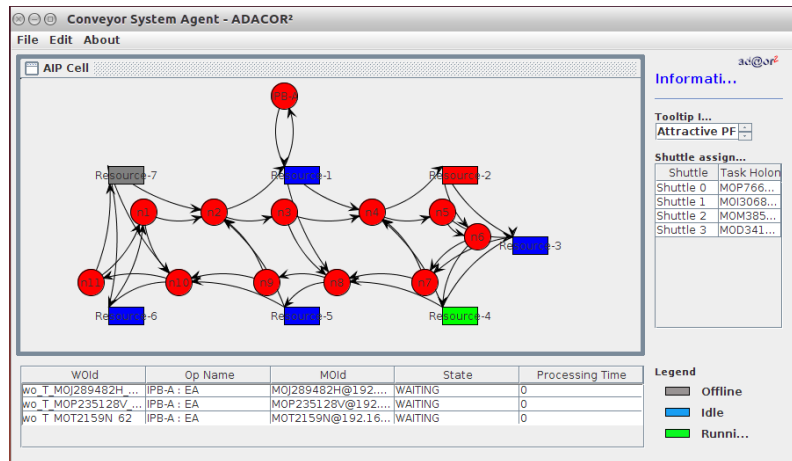

Figure 6.6 – Conveyor System Holon GUI

holons, as defined. Each one of the produced products in the system, see Section 6.1.1, are mapped using the PH. OHs map the machines in the system, which in the real AIP-PRIMECA FMS is equal to each processing machine ranging from M_1 to M_7 . In the adapted version of the cell, besides the aforementioned mapping, the OHs also map the AGV. Finally, every product instance that is dispatched for production is mapped using a TH.

Some of the mechanisms developed in Chapter 5 were implemented in order to validate the two self-organization components. In this way, the market based approach and the potential field mechanism are used as behaviours catalogues while the bird flocking mechanism was implemented as the mean to allow the holons to re-arrange their position inside the holarchy. Finally, the PID based nervousness mechanism was also implemented in order to regulate the holons self-control, considering $k_p = 5s$ and $k_i = 0$.

6.4 Assessment of ADACOR²

The assessment and validation of manufacturing control structures pass generally by using one or more of the following methods:

- Mathematical formulation: through the use of theorems and axioms, manufacturing systems are able to be validated (Farid and Covanich, 2008).
- Simulation/emulation: a copy of the system is implemented depicting the reality. Entities are either simulated or emulated and the control system is implemented on top of this (Leitão and Restivo, 2006).
- Real case experiments: the manufacturing control architecture is used on top of the real manufacturing cell (Bussmann and Sieverding, 2001)

The methodology chosen to assess and validate the present control architecture is through simulation which allows a more flexible validation phase since no warm can be produced to the real system. Additionally, simulations can be set to run indefinitely,

introducing disturbances scenarios and testing properly the ADACOR² holonic architecture. To achieve this, a set of procedures were developed, as described in Appendix A.

6.4.1 Behavioural Self-Organization Using the AIP-PRIMECA

The behavioural part of the ADACOR² holonic architecture was validated using a simulated version of the AIP-PRIMECA. Several scenarios from the Bench4Star benchmark are used, namely those ranging from A0 to E0 (Trentesaux et al., 2013), which allows to test different sets of manufacturing orders sizes and shuttles number. Table 6.4 shows a brief description of the scenarios configurations.

Table 6.4 – Behavioural Scenarios Description

| Scenario | Number of shuttles | Transportation times | Order | Client order Products | | |
|----------|--------------------|----------------------|-------|-----------------------|-----|------|
| | | | | BELT | AIP | LATE |
| A0 | 10 | Table 6.1 | #1 | 1 | - | - |
| | | | #2 | - | 1 | - |
| B0 | 10 | Table 6.1 | #1 | - | 2 | - |
| C0 | 4 | Table 6.1 | #1 | 1 | - | - |
| | | | #2 | - | 1 | - |
| D0 | 10 | Table 6.1 | #1 | 1 | - | - |
| | | | #2 | 2 | 1 | - |
| E0 | 10 | Table 6.1 | #1 | 2 | 1 | - |
| | | | #2 | - | 2 | 1 |
| | | | #3 | - | - | 2 |

The differences between the Bench4Star benchmark and the number of shuttles are encountered in the situations where infinite number of shuttles were envisioned. The transportation times were also added in the cases where they were neglected.

Scenarios without and with disturbances, namely the #PS12 (Trentesaux et al., 2013) that introduces a 60s breakdown in M_2 at the end of processing 4 jobs, are used to assess the manufacturing control architectures impact.

Four manufacturing control architectures are compared in both situations. First, a completely hierarchical approach is used, where the SH is always optimizing the OHs scheduling. A completely heterarchical approach is also used, where THs have to directly negotiate with the OHs in order to be processed. In this approach, the SH is removed. In order to compare if the ADACOR² manufacturing control architecture improves the ADACOR architecture, both are tested. In these simulations, the ADACOR, when no disturbances are present in the system uses a SH to introduce schedule optimization while in disturbances situations it uses its switching mechanism, balancing between the hierarchical and heterarchical structure. On the other hand, ADACOR² assumes the same hierarchical form in non-disturbance situations, while it uses the proposed behavioural self-organization mechanisms to handle disturbances. In this case, THs aiming to respond to disturbances, execute the market-based and PF mechanisms and select the one that reduces more the overall work order execution.

As shown previously, a system will be as much desirable as faster it is able to produce the same amount of work. This KPI, named as Cmax, or makespan, allows to assess this feature. First, every one of the four manufacturing control approaches are tested for a scenario where all parameters are well known and controlled, i.e. a system without disturbances. Experimental results for all the non-disturbance situations are shown in Figure 6.7.

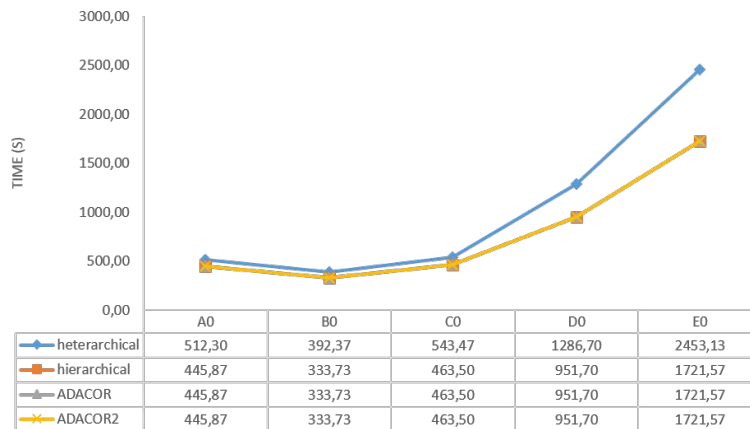

Figure 6.7 – Cmax for the Normal Scenarios

As it can be seen, the hierarchical approach along side with ADACOR and ADACOR² present the most optimized solution. This is due to the fact that using these approaches, the SH is introducing optimization into the scheduling of the OHs. As everything is predictable and under control, this holon schedules when the manufacturing order arrives, sending afterward the processing plans to OHs and THs.

The heterarchical approach presents the worst results since the THs are interacting directly with the OHs and in this way, myopic phenomena appears. Note that the CNP market based approach is used as the negotiation technique.

ADACOR² insights could also be used to enhance the heterarchical approach by embedding new negotiation, i.e. behaviours, into the THs. Despite this potentiality, that could enhance the heterarchical mode, this was not extensively tested. Nevertheless, preliminary tests have shown improvements on the pure heterarchical approach when converted into an ADACOR² architecture (without a centralized holon).

As mentioned before, having solely a system without disturbances is not real and so any manufacturing control architecture must be tested within these hard working conditions in order to assess its viability. In such way, the PS#12 scenario defined in Trentesaux et al. (2013) is used. The experimental results for the Cmax KPI are shown in Figure 6.8.

Analysing the graph, it is observed that under these conditions ADACOR² is the one that achieves better performance, allowing to produce the same amount of work in less time. Additionally, and as already shown in (Leitão and Restivo, 2006) the ADACOR control architecture surpasses the hierarchical and heterarchical control solutions.

Quantitatively, the ADACOR² control architecture is able to reduce, on average, the

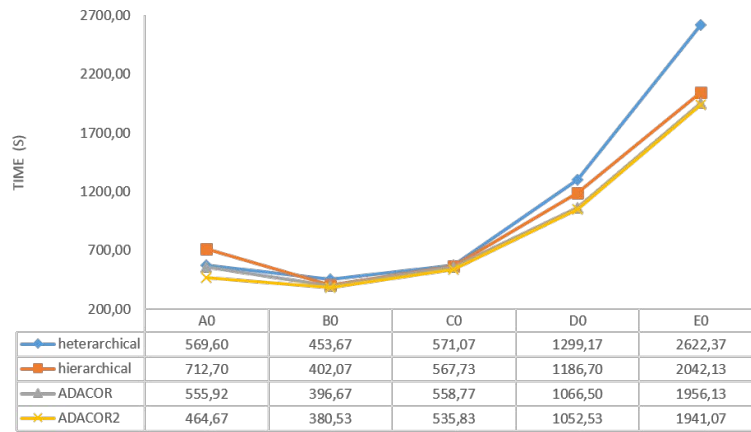

Figure 6.8 – Cmax for the Disturbances Scenario

Cmax by 91s for the test scenario A0, 23s for the C0 and 15s for E0. The apparent margin decrease as the batch size increases, seems counterproductive and is due to the behavioural parameter adjustment. It is expected that making a proper selection and tune of the selected behaviour for handling disturbances will improve these KPIs. Note also that the working conditions for the different scenarios also change, e.g., the number of shuttles being able to transport the products, and despite this, the behaviour parameters were kept the same. Additionally, the AIP-PRIMECA FMS cell configuration may have harder freedom limits when a high congestion production appears, decreasing the improvement rate.

This conclusion also enhance the importance for the holons be able to dynamically change their working conditions according to the system dynamics.

Using the two previous experimental tests, one can measure the impact that the disturbances had when compared with the non-disturbance scenario. The impacts were calculated for all the scenarios and are displayed in Figure 6.9.

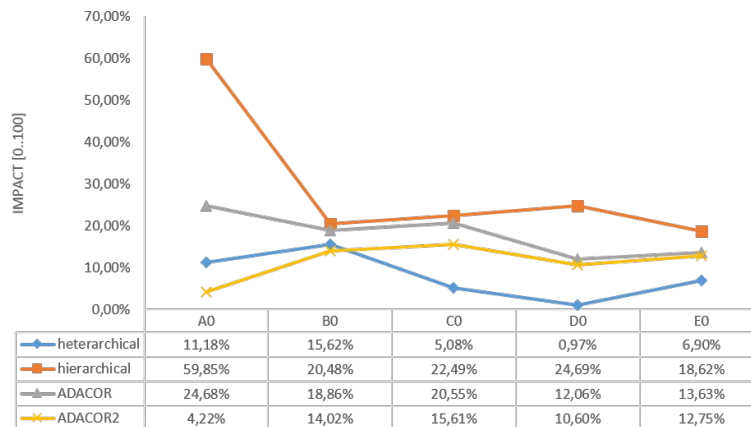

Figure 6.9 – Analysis of Impact with the Occurrence of Disturbances

Generally, and as expected, the heterarchical control approach is the one that suffers less from the non-disturbance scenarios to the ones with disturbances. This is explained

by the fact that this control structure is completely dependent of local interactions. Despite this result, the impact must always be accompanied with other KPIs for contextualization, such as the Cmax.

Considering all the other approaches, ADACOR² is the one that less impact suffer when disturbances appear at the shop-floor, having on average, for all the tested scenarios, the best Cmax results.

Having an idea of how much products can be produced in a given amount of time (i.e. the throughput), it is also very important to assess a production system, an particularly the control architecture on top of it. Regarding this, and as expected, in the scenarios without disturbances, see Figure 6.10, the heterarchical approach is the one that presents the worst throughput value. Since all the other approaches follow an hierarchical structure in non-disturbance scenarios, they all present the same throughput values. Comparatively, for the scenario A0, the heterarchical approach produces, on average less 6.87 products per hour. If the same analysis is made for the scenario C0, it can be seen that 7.88 products per hour are less produced and for scenario E0, 17.58 products.

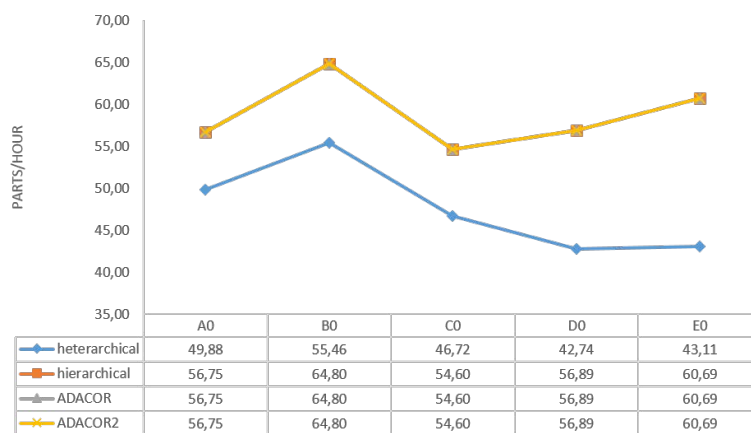

Figure 6.10 – Throughput for Normal Scenarios

Additionally, it is possible to be observed a margin gain after scenario C0, where the heterarchical approach throughput degrades while the others have an improvement.

Introducing disturbances and making the same exercise, now all the control architectures have different behaviours (see Figure 6.11). Being this already expected, it is possible to analyse that, on average the heterarchical approach is the one that presents the worst results, while the ADACOR² is the one that displays higher values of throughput. Comparing the ADACOR² with the heterarchical approach, it can be seen that, for the scenario A0, ADACOR² produces more 9.67 products per hour and for scenario C0, 2.81. Note that for scenario C0 all the approaches have a decrease of throughput, which is explained by being the scenario with the lower number of shuttles to transport the products, i.e. only 4 shuttles. Similarly to what happened for the scenarios without disturbances, from scenario C0 on, there is an increase of throughput for ADACOR², while there is a decrease of throughput for the heterarchical approach, being the difference for scenario E0 of 13.76 products per hour.

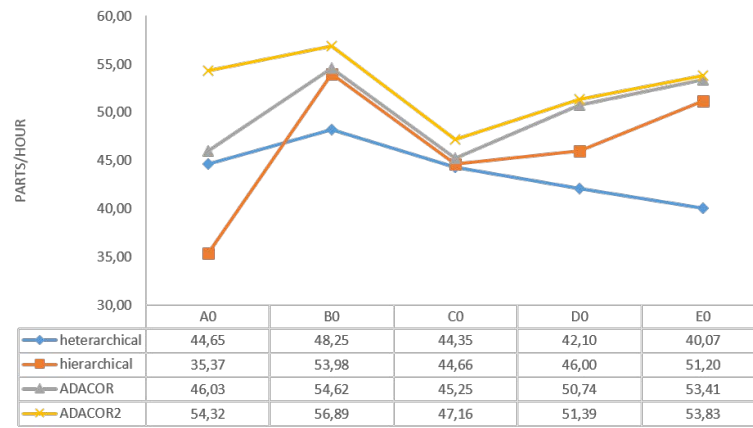

Figure 6.11 – Throughput for the Disturbance Scenarios

As already stated, ADACOR² presents always higher values of throughput when compared with the ADACOR. Despite this, it is also possible to be observed that as the manufacturing batch increases, the improvement introduced by ADACOR² is decreasing. The reason to this is similar to the one given by the Cmax KPI, i.e. limitations on the AIP-PRIMECA FMS configuration and the same parameters selection for the behaviours used during all the trials. It is expected that a dynamic parameter tuning would allow the achievement of better results.

Comparing the standard deviation of the manufacturing control approach is essential for assessing its predictability, being even more important in the cases where the validation of the control structure is made using simulation/emulation. In this way, the standard deviation results for the disturbance scenario are shown in Figure 6.12.

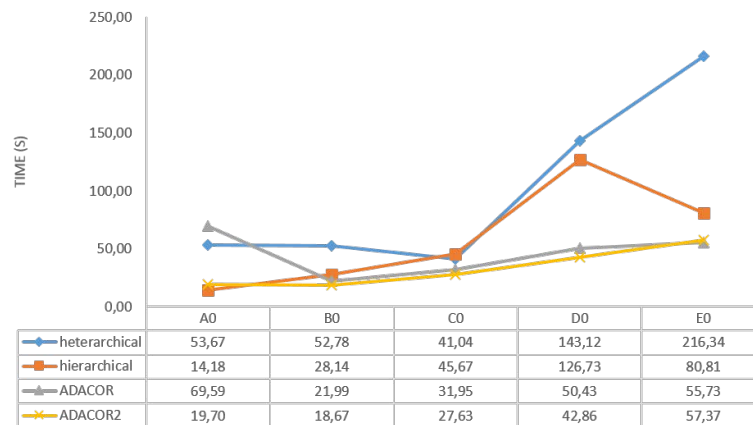

Figure 6.12 – Predictability of the Manufacturing Control Approaches

On average, the ADACOR² control architecture is the one that presents the lowest values of standard deviation, making it more predictable. In an opposite direction the heterarchical and hierarchical approaches have the worst results. The first, by its initial conditions and the second for handling not so properly the disturbances.

6.4.2 Structural Self-Organization Using the Futuristic AIP-PRIMECA

The structural part of the ADACOR² holonic architecture is validated, as stated previously, using the level 2 of the structural self-organization.

The structural self-organization mechanism is triggered when a batch of orders is allocated to a OH. Briefly, after receiving a batch of orders, the OH will start an information gathering from other OHs, where the resource queue, allocated work-orders, processing times and actual location, are exchanged. The implemented procedure follows the mechanism described in section 5.2.1. After finishing the allocation of all OHs, each OH sends the information of either better or worst solution achieved, from actual resources disposition. In the case of a better solution, the OH sends the KPI and the new allocation places to all the OHs. The overall best solution, found in each OH, is automatically assumed and used.

Several test scenarios were designed with different batch sizes, as illustrated in Table 6.5. Each scenario is composed by two orders being the second one launched after a given time from the first one. As an example, sC0 starts by launching 2 BELT and after 120s is launched 5 BELT and 10 LATE. In this example, the transport of orders is achieved by the use of 10 AGVs.

Table 6.5 – Structural Scenarios Description

| | Number of AGVs | Time launching (s) | Order | Client order Products | | |
|-----|----------------|--------------------|-------|-----------------------|-----|------|
| | | | | BELT | AIP | LATE |
| sA0 | 10 | 120 | #1 | 2 | - | - |
| | | | #2 | - | 3 | - |
| sB0 | 10 | 120 | #1 | 2 | - | - |
| | | | #2 | - | 10 | - |
| sC0 | 10 | 120 | #1 | 2 | - | - |
| | | | #2 | 5 | - | 10 |
| sD0 | 10 | 120 | #1 | 2 | - | 2 |
| | | | #2 | - | - | 15 |

A visual result of the structural self-organization can be seen in Figure 6.13. The scenario sC0 is used in this example and it can be seen that after the arrival of order #2, the machines, after applying the structural self-organization, shifted into new working positions. Machine M_6 has been requested to change place, since it had no allocation of tasks and its position needed to be used in the present re-organization.

Similarly to the behavioural self-organization tests, the structural self-organization was also tested considering four manufacturing control approaches, namely the heterarchical, hierarchical, ADACOR and ADACOR². In this case, the ADACOR manufacturing control architecture follows the hierarchical approach and so the results are the same. This is explained by the limited re-organization capabilities of the ADACOR that only switches between the two pre-defined states. The ADACOR² uses the SH but the structural self-organization happens in an emergent way, since the re-organization is deployed

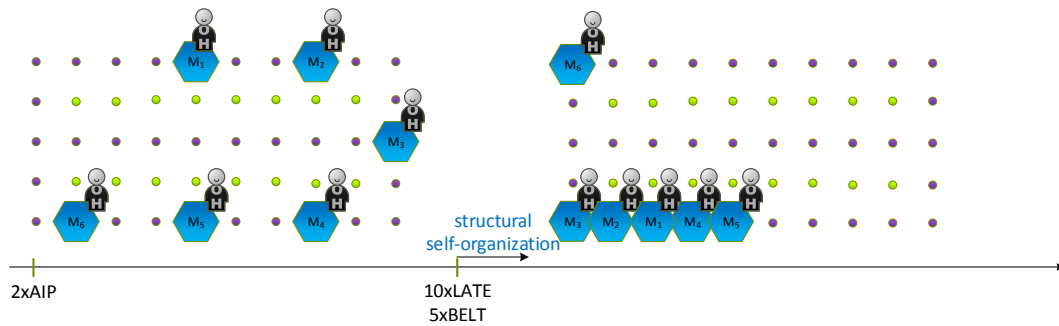

Figure 6.13 – Structural Self-Organization in Practice

by the OHs.

In reality, the physical re-organization, or the machines shifting place, takes a given amount of time. In the present simulations, and in order to simulate a more real machine moving, machines also spend a given amount of time to be shifted. This time is proportional with the travelling distance (d) and with twice the setup time (t_s) (unplugging from original place and plugging in the final working position). Naturally, the used times are not real, but are realistic and proportional with the designed dataset sizes. In this way, the necessary amount of time to move, t_m , between working positions is given by:

$$t_m = d \times k + 2 \times t_s \tag{6.1}$$

where k is a constant representing the travelling time between consecutive working positions. In the current simulation k is 2 seconds and t_s is 5 seconds.

Additionally, if the holons detect that the structural change is not beneficial for the system, i.e. it doesn't bring an KPI improvement, the re-arrangement will not happen.

The experimental results for the Cmax KPI are depicted in Figure 6.14.

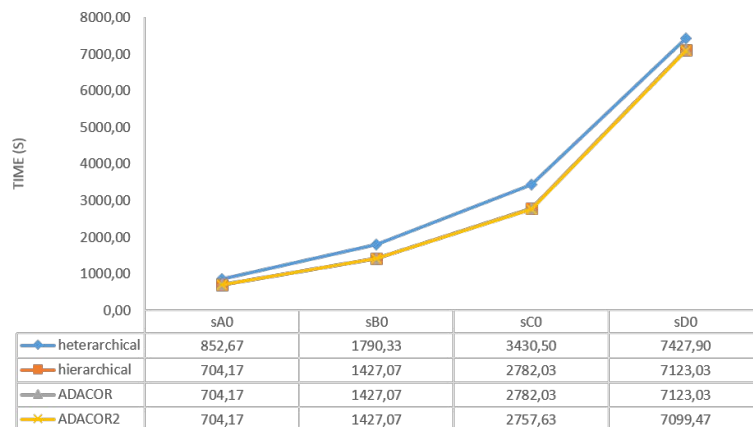

Figure 6.14 – Cmax for the Structural Self-Organization

Analysing the results, it can be noticed that for all the scenarios, the heterarchical approach is the one that produces the worst results, i.e. the highest Cmax. The structural

self-organization in ADACOR², for scenarios sA0 and sB0, didn't produce any improvements and so the holons didn't apply it, reaching the same results as hierarchical and ADACOR. For the scenarios sC0 and sD0, the ADACOR² approach was applied the structural self-organization procedure which has produced improvements and consequently they were taken into consideration, improving the Cmax, on average, by 23.98s.

Converting the previous results in terms of throughput, as shown in Figure 6.15, it is possible to observe that for scenarios sC0 and sD0 the ADACOR² is able to produce more 0.76 and 0.28 parts per hour, respectively.

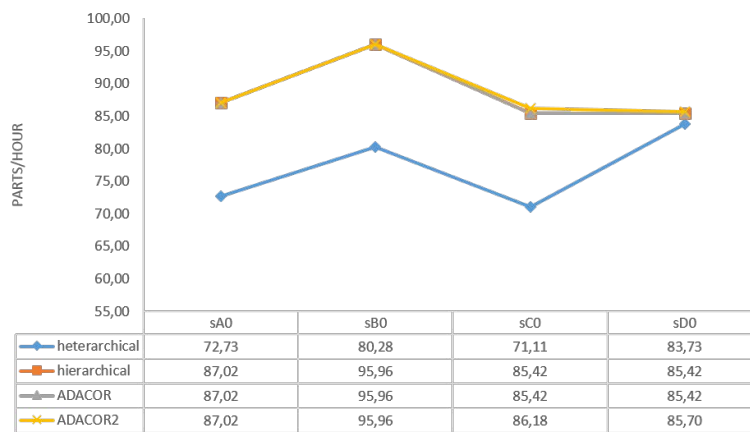

Figure 6.15 – Throughput for the Structural Self-Organization

Comparing all the control approaches with the hierarchical one, it can be observed, see Figure 6.16, that the heterarchical control approach has on average 18,53% of KPI degradation. Despite this overall value, it is also noticeable that for the largest dataset, i.e. for scenario sD0, this degradation is reduced to 4,28%.

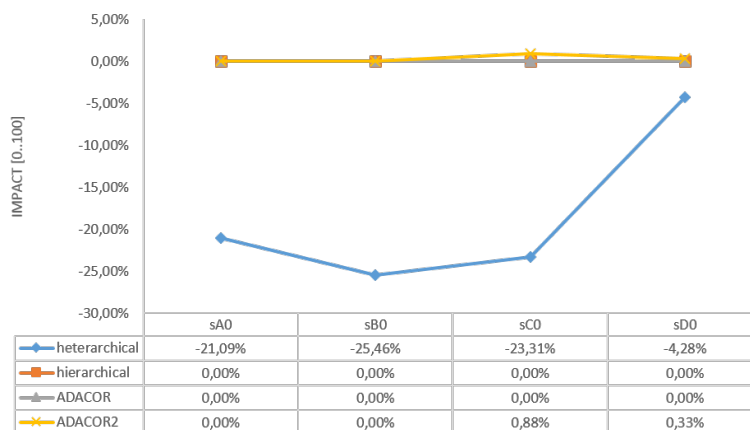

Figure 6.16 – Analysis of the Impact of the Control Approaches

As already seen in the Cmax analysis, in the first two scenarios, the ADACOR² hasn't produced any improvement since due its low batch size won't justify the structural self-organization. On the other two, it has improved the best control approach, by 0.88% for the sC0 and 0.33% for sD0. Despite the apparent low improvement, it must be noticed that several assumptions were made that could limit it. First, t_m and its variables were

obtained in an empirical manner in order to balance between moving time and batch sizes, giving a comparatively realistic simulation. Secondly, the batch sizes are, probably, too small to properly extract the real capabilities of the structural self-organization. Lastly, the potential field based mechanism might not be the most appropriate for this case. Despite of all the aforementioned constraints, the purpose of the designed scenarios was achieved by passing the information about the structural self-organization.

Lastly, the predictability is also an important assessment metric and in this KPI, as expected, the heterarchical control approach produces the most variable results. On the other hand, and due to the structural self-organization process embedded in the ADACOR², it produces, on average, the second most unpredictable. Despite this, it is worthy to be noticed that this is not a major issue, since the difference is not relevant.

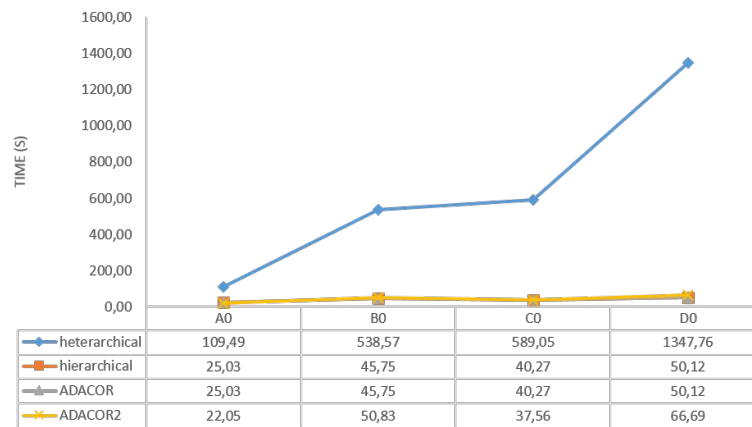

Figure 6.17 – Predictability of the Manufacturing Control Approaches

The achieved experimental results show the merits of the structural self-organization approach to face severe changing conditions. However, the experiments also showed new possibilities to improve the proposed algorithm, e.g., by considering the optimization in the re-configuration of the resources during the structural self-organization process.

6.5 Summary

The present chapter has described the two use cases used to assess the proposed ADACOR² manufacturing control architecture. The two use cases are based on the AIP-PRIMECA FMS, using the first one to validate the behavioural self-organization vector. A modified version of the AIP-PRIMECA, where the shuttle transportation system is replaced by AGVs and machines are also empowered with moving capabilities, was used to test the structural self-organization.

Several simulation runs were conducted and by analysing them one can conclude that ADACOR² brings significant advantages in fulfilling the requirements needed to achieve a truly evolvable and self-organized system.



Conclusions and Future Work

Success is not final, failure is not fatal: it is the courage to continue that counts.

Winston Churchill

The manufacturing world is constantly pushed into their limits. To face the current challenges imposed to the manufacturing world, an innovative manufacturing control architecture was proposed.

7.1 Conclusions

The ever growing demanding requirements by customers are imposing the need to develop more flexible, agile, robust and responsive manufacturing control architectures. Requirements such as product customization, shorter life-cycles, higher quality demand or, at an internal level, resources breakdown, worker absence, rush orders or problems in the supply management layer, can also impose pressure into the manufacturing companies.

To cope with the aforementioned requirements, the focus of the research trend has shifted from more hierarchical manufacturing control architectures into distributed and decentralized control, assuming a more heterarchical structure. Despite this, the latest has never been able to reach the optimization performances displayed by the first ones when the system is operating under stable conditions. In recent years, the combination of

hierarchical and heterarchical structures have also taken the researchers attention, combining the system optimization given by the hierarchical structure with the responsiveness provided by the heterarchical approaches.

One of the most prominent manufacturing control architectures that proposed the use of this approach is the well known ADACOR holonic architecture which works on a binary state that switches from a stationary state into a transient state when disturbances hit the shop-floor and switches back to the stationary state after the disturbance recovery. Despite the good results displayed by ADACOR, a step further was still needed to reach a truly evolvable system, possibility by eliminating the fixed binary state on which it operates.

In order to overcome the ADACOR main limitation, inspiration was drawn from evolutionary theories and self-organization principles found in societies of species, such as ant food foraging behaviour and fish schooling, or in natural processes such as the magnetic field concepts.

Two evolutionary theories are on the basis of the developed work of this thesis. The first one, and by far the most known, is the Darwin evolutionary theory. On his studies, Darwin stated that species tend to be in a constant state of evolution by making small internal adaptations in order to better fit the external environment on which they operate. On the other hand, the punctuated equilibrium theory, states that species are mostly in a stable state and suddenly can make drastic changes in order to overcome the imposed external constraints.

The first evolutionary theory is translated into the ADACOR² manufacturing control architecture by allowing the individual holons to change/adapt their internal behaviour. This is named **behavioural self-organization** and allows the overall system to smoothly evolve into a new working configuration. The second evolutionary theory is incorporated into the ADACOR² manufacturing control architecture by allowing a rearrangement in the holarchy structure. This more drastic change, named **structural self-organization**, will allow the system to overcome disturbances with higher impact levels and will also allow the system to evolve into a new working configuration.

During the presented work, a new internal model of the holon was also proposed, with a special emphasis to the two referred self-organization components: the behavioural and the structural. A special attention is also given to handle the nervousness aspect that can appear in those distributed and self-organized systems. This can be also seen in the holon internal structure by detailing and specifying the nervousness controller.

7.2 Work Validation

In order to validate the proposed manufacturing control architecture, an instantiation of the ADACOR² holons was implemented using the MAS technology. The implemented

system was tested using an emulated version of the real AIP-PRIMECA FMS and the scenarios contained in this work were defined taking into consideration the ones specified in the Bench4star benchmark (Trentesaux et al., 2013). The aforementioned use case allowed the validation of the behavioural self-organization vector while a modified version of the refereed benchmark was needed to test and validate the structural self-organization vector. In this adaptation of the real use case, the resources have moving capabilities and the transportation of the products at the shop-floor is accomplished by using AGVs, which may imply a physical structural re-organization at the shop-floor level. This last feature is also aligned with the recent trends being developed by the system integrators, e.g., as Festo AG & Co. KG.

At the end of this thesis and based on the achieved experimental results, some outcomes can be highlighted:

- ADACOR² can smoothly or drastically evolve into a better working configuration, responding properly to disturbances.
- A nervousness controller is a must have in distributed self-organized systems in order to prevent chaotic behaviour and push the system to its limits.
- ADACOR² outreaches its predecessor ADACOR as also the hierarchical and heterarchical approaches.

At the beginning of this thesis, it was depicted that one of the main goals of this work was the specification of a manufacturing control architecture that was able to improve the current state-of-the-art approaches, reducing the gap between these and an optimal situation (recall Figure 1.1). This was achieved by introducing dynamics associated to the two self-organization dimensions and the nervousness controller. This gap is illustrated in Figure 7.1, considering the real values extracted from the experimental results, and particularly in this case those from behavioural self-organization and scenario A0.

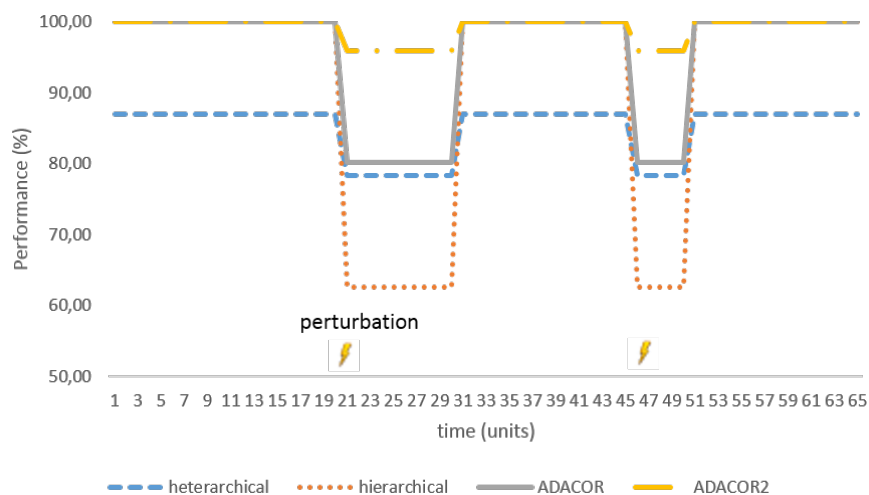

Figure 7.1 – Performance Behaviour of the Evaluated Control Structures

The experimental results show that the performance obtained by the ADACOR² architecture outperforms all the other tested approaches. If it is assumed that the supervisor holon scheduling mechanism is optimal, i.e. it introduces an optimal plan to be executed (which for the case is not that important, being just a matter of implementation and boundaries definition), the hierarchical, the ADACOR and the ADACOR² architecture have optimal performance levels in non-disturbance situations. When disturbances are introduced into the system, all the approaches must react by handling them in the best possible way. In this situation, the hierarchical approach suffers the highest impact in the sense that is the one that performs worst of the four approaches. It is also possible to observe that the ADACOR² approach is the one that has less impact when disturbances are introduced.

This analysis sustains that the "vision" introduced in the Figure 1.1 is achieved during the development of this work by allowing the holons to dynamically change their internal behaviour or to dynamically re-arrange the holarchy structure.

7.3 Future Work

At the end of this work, several research developments could be identified as future work that will enhance the current achievements.

Firstly, the developed agents must be integrated in embedded control devices, allowing the practical development of the intelligent products concept and the CPS paradigm. Although some experiments were conducted during this work, serving as a proof of concept by deploying some of the ADACOR² agents into the RaspberryPi¹ platform, the results are not shown in this thesis.

Secondly, another major development branch can be foreseen in the use of the standard de-facto OPC-UA (OLE for process control - Unified Architecture) as a major enabler to integrate the ADACOR² holons in the existing/future system designs. The integration with the OPC-UA guarantees several important features, standard access to data sources across shop-floor and seamless device integration, since all major vendors are adopting its usage.

Cloud computing is a nowadays reality. To this extend, the development of the SH using the cloud resources, combined with the processing power of the HPC (High Performance Computing), enables to run massive simulations to identify in an early stage possible bottlenecks that would not be foreseen in another way. A practical result of this could be the prediction with more accuracy of possible plan deviations that would later be feed to the THs. On the opposite side there is the fog computing that promises to bring into the end nodes the cloud computation power. This is also aligned with the CPS paradigm and can be used to empower the OHs with more processing capabilities allowing a better decision making on that side, e.g., turning machines more responsiveness and better decision makers.

1. <http://www.raspberrypi.org/>

The introduced nervousness stabilizer is also a major research trend in the way that the correct development of this mechanism enables the ADACOR² holons, and even other distributed entities developed within other architectures, to be pushed to performance levels not seen before maintaining the overall system under control.

Additionally, a deeper study on the structural self-organization focusing on when and how to re-organize the holarchy structurally assumes also a crucial importance. In this scope, previous work of (Farid and McFarlane, 2008) and (Farid and Covanich, 2008) can be used as ground-base to further explore this.

Future work will also be devoted to consider SoA principles in the ADACOR² architecture, which will enable a seamless integration within the vertical layers of the ISA-95 standard.

A final research trend, just to name a few, is devoted to the ADACOR² generalization issues considering that the developed work can/may be applied into other architectures than ADACOR.

Bibliography

- Abd-El-Barr, M., S.M. Sait, and B.A.B. Sarif. 2003. « Ant colony algorithm for evolutionary design of arithmetic circuits ». *Proceedings of the 15th International Conference on Microelectronics, 2003. ICM 2003*. 198–201. doi:10.1109/ICM.2003.1287767.
- Aggoune, Riad, A.H. Mahdi, and M.-C. Portmann. 2001. « Genetic algorithms for the flow shop scheduling problem with availability constraints ». *Proceedings of the IEEE International Conference on Systems, Man, and Cybernetics, 2001* 4:2546–2551 vol.4. doi:10.1109/ICSMC.2001.972941.
- Ai, The Jin, and Voratas Kachitvichyanukul. 2009. « A Particle Swarm Optimization for the Vehicle Routing Problem with Simultaneous Pickup and Delivery ». *Computers & Operations Research* 36:1693–1702.
- Albadawi, Zahir, Benoit Boulet, Robert DiRaddo, Patrick Girard, Alexandre Rail, and Vincent Thomson. 2006. « Agent-based control of manufacturing processes » [inlangen]. *International Journal of Manufacturing Research* 1 (4): 466. Visited on 11/18/2014. doi:10.1504/IJMR.2006.012256.
- Albert, F.Y.C., S.P. Koh, C.P. Chen, C.K. Loo, and S.K. Tiong. 2009. « Path control of dexterous robotic hand using Genetic Algorithm ». *Proceedings of the 4th International Conference on Autonomous Robots and Agents, 2009. ICARA 2009*. 502–506. doi:10.1109/ICARA.2000.4804002.
- Anderson, Carl, and John Bartholdi. 2000. « Centralized versus decentralized control in manufacturing: lessons from social insects », 91–105.
- Arnaut, J.-P., R. Musa, and G. Rabadi. 2008. « Ant colony optimization algorithm to parallel machine scheduling problem with setups ». *Proceeding of the IEEE International Conference on Automation Science and Engineering, 2008. CASE 2008*: 578–582. doi:10.1109/COASE.2008.4626566.
- Arunachalam, S., R. Zalila-Wenkstern, and R. Steiner. 2008. « Environment Mediated Multi Agent Simulation Tools – A Comparison », 43–48. IEEE. Visited on 05/26/2014. doi:10.1109/SASOW.2008.44.

- Aziz, N.A.B.A., A.W. Mohemmed, and B.S. Daya Sagar. 2007. « Particle Swarm Optimization and Voronoi diagram for Wireless Sensor Networks coverage optimization ». *Proceeding of the International Conference on Intelligent and Advanced Systems, 2007*. ICIAS 2007: 961–965. doi:10.1109/ICIAS.2007.4658528.
- Badawy, F.A., H.Y. Abdelazim, and M.G. Darwish. 2005. « Genetic Algorithms for Predicting the Egyptian Stock Market ». *Proceeding of the Enabling Technologies for the New Knowledge Society: ITI 3rd International Conference on Information and Communications Technology, 2005*: 109–122. doi:10.1109/ITICT.2005.1609619.
- Bae, Jong Il, Dong Cheol Lee, Doo Sung Ahn, Jong Moon Lee, Kang Eon Kim, and Moon Soo Kim. 2001. « Speed control of fork lift vehicle using a genetic algorithm ». *Proceedings of the IEEE International Symposium on Industrial Electronics, 2001*. *Proceedings. ISIE 2001*. 3:1839–1844 vol.3. doi:10.1109/ISIE.2001.931990.
- Baker, Albert D. 1991. « Manufacturing Control with a Market-Driven Contract Net ». Ph.D., Rensselaer Polytechnic Institute.
- Barata, Jose, and Luis M. Camarinha-Matos. 2003. « Coalitions of manufacturing components for shop floor agility - the CoBASA architecture » [inlangen]. *International Journal of Networking and Virtual Organisations* 2 (1): 50. Visited on 11/18/2014. doi:10.1504/IJNVO.2003.003518.
- Barbosa, José, and Paulo Leitão. 2010. « Modelling and Simulating Self-Organizing Agent-based Manufacturing Systems ». *to appear in the Proceedings of the 36th Annual Conference of the IEEE Industrial Electronics Society (IECON'10) Arizona, US, 8-10 November*.
- Barbosa, Jose, Paulo Leitao, Emmanuel Adam, and Damien Trentesaux. 2013a. « Self-Organized Holonic Multi-agent Manufacturing System: The Behavioural Perspective ». *2013 IEEE International Conference on Systems, Man, and Cybernetics*: 3829–3834. doi:10.1109/SMC.2013.654.
- Barbosa, José, Paulo Leitão, Emmanuel Adam, and Damien Trentesaux. 2015. « Dynamic self-organization in holonic multi-agent manufacturing systems: The ADACOR evolution » [inlangen]. *Computers in Industry* 66 (): 99–111. Visited on 12/12/2014. doi:10.1016/j.compind.2014.10.011.
- . 2012a. « Nervousness in Dynamic Self-organized Holonic Multi-agent Systems ». In *Highlights on Pratical Applications of Agents and Multi-agent Systems*, 9–17. Advances in Intelligent and Soft Computing.
- . 2012b. « Self-organized holonic manufacturing systems combining adaptation and performance optimization ». In *Technological Innovation for Value Creation*, 163–170. Springer.

- . 2013b. « Structural Self-organized Holonic Multi-Agent Manufacturing Systems ». In *Industrial Applications of Holonic and Multi-Agent Systems*, ed. by David Hutchison, Takeo Kanade, Josef Kittler, Jon M. Kleinberg, Friedemann Mattern, John C. Mitchell, Moni Naor, Oscar Nierstrasz, C. Pandu Rangan, Bernhard Steffen, Madhu Sudan, Demetri Terzopoulos, Doug Tygar, Moshe Y. Vardi, Gerhard Weikum, Vladimír Mařík, Jose L. Martinez Lastra, and Petr Skobelev, 8062:59–70. Berlin, Heidelberg: Springer Berlin Heidelberg. Visited on 10/28/2013.
- Barbosa, Jose, Paulo Leitao, and Ana I. Pereira. 2011. « Combining adaptation and optimization in bio-inspired multi-agent manufacturing systems ». In *IEEE International Symposium on Industrial Electronics, 1773–1778*. Visited on 05/30/2013. doi:10.1109/ISIE.2011.5984425.
- Bell, J. E., and P. R. McMullen. 2004. « Ant Colony Optimization Techniques for the Vehicle Routing Problem ». *Advanced Engineering Informatics* 18:41–48.
- Bellifemine, Fabio Luigi, Giovanni Caire, and Dominic Greenwood. 2007. *Developing Multi-Agent Systems with JADE (Wiley Series in Agent Technology)*. John Wiley & Sons.
- Blum, C., and M. Sampels. 2004. « An Ant Colony Optimization Algorithm for Shop Scheduling Problems ». *Journal of Mathematical Modelling and Algorithms* 3:285–308.
- Boissier, Olivier, Rafael H. Bordini, Jomi F. Hübner, Alessandro Ricci, and Andrea Santi. 2013. « Multi-agent oriented programming with JaCaMo ». Special section: The Programming Languages track at the 26th {ACM} Symposium on Applied Computing (SAC 2011) & Special section on Agent-oriented Design Methods and Programming Techniques for Distributed Computing in Dynamic and Complex Environments, *Science of Computer Programming* 78 (6): 747–761. doi:http://dx.doi.org/10.1016/j.scico.2011.10.004.
- Bonabeau, Eric, Marco Dorigo, and Guy Theraulaz. 1999. *Swarm Intelligence: From Natural to Artificial Systems*. New York, NY, USA: Oxford University Press, Inc.
- Bonabeau, Eric, Guy Theraulaz, Jean-Louis Deneubourg, Serge Aron, and Scott Camazine. 1997. « Self-organization in social insects » [inlangen]. *Trends in Ecology & Evolution* 12, no. 5 (): 188–193. Visited on 05/23/2014. doi:10.1016/S0169-5347(97)01048-3.
- Bordini, Rafael H. 2007. *Programming multi-agent systems in AgentSpeak using Jason*. Chichester, West Sussex, England ; Hoboken, NJ: J. Wiley.
- Boubertakh, H., M. Tadjine, P.-Y. Glorennec, and S. Labiod. 2009. « Tuning fuzzy PID controllers using ant colony optimization ». *Proceeding of the 17th Mediterranean Conference on Control and Automation, 2009. MED '09*. 13–18. doi:10.1109/MED.2009.5164507.
- Bousbia, Salah, and Damien Trentesaux. 2002. « Self-organization in Distributed Manufacturing Control: State-of-the-art and Future Trends ». *Proceeding of the IEEE International Conference on Systems, Man and Cybernetics* 5.

- Brennan, Robert W., and Douglas H. Norrie. 2003. « Metrics for evaluating distributed manufacturing control systems » [inlangen]. *Computers in Industry* 51, no. 2 (): 225–235. Visited on 09/03/2014. doi:10.1016/S0166-3615(03)00038-1.
- Brown, J.Q., and M.J. McShane. 2004. « Optimal design of nanoengineered implantable optical sensors using a genetic algorithm ». *Proceedings of the 26th Annual International Conference of the IEEE Engineering in Medicine and Biology Society, 2004. IEMBS '04.* 1:2105–2108. doi:10.1109/IEMBS.2004.1403618.
- Bussmann, Stefan, Nicholas R Jennings, and Michael Wooldridge. 2004. *Multiagent Systems for Manufacturing Control A Design Methodology* [inlangEnglish]. Berlin, Heidelberg: Springer Berlin Heidelberg. Visited on 05/26/2014.
- Bussmann, Stefan, and Klaus Schild. 2001. « An agent-based approach to the control of flexible production systems », 2:481–488. IEEE. Visited on 11/19/2014. doi:10.1109/ETFA.2001.997722.
- . 2000. « Self-Organizing Manufacturing Control: An Industrial Application of Agent Technology ». In *Proceedings of the Fourth International Conference on MultiAgent Systems (ICMAS-2000)*, 87–94. ICMAS '00. Washington, DC, USA: IEEE Computer Society.
- Bussmann, Stefan, and Jörg Sieverding. 2001. « Holonic Control of an Engine Assembly Plant - An Industrial Evaluation ». *Proceedings of the IEEE International Conference on Systems, Man and Cybernetics*: 169–174.
- Caldeira, J.L., R.C. Azevedo, C.A. Silva, and J.M.C. Sousa. 2007. « Supply-Chain Management Using ACO and Beam-ACO Algorithms ». *Proceedings of the IEEE International Fuzzy Systems Conference, 2007. FUZZ-IEEE 2007.* 1–6. doi:10.1109/FUZZY.2007.4295615.
- Camazine, Scott, Jean L. Deneubourg, Nigel R. Franks, James Sneyd, Guy Theraulaz, and Eric Bonabeau. 2001. *Self-Organization in Biological Systems*. Princeton University Press.
- Camilo, T., C. Carreto, J. S. Silva, and F. Boavida. 2006. « An Energy-Efficient Ant-Based Routing Algorithm for Wireless Sensor Networks ». *ANTS Workshop*: 49–59.
- Cândido, Gonçalo, and José Barata. 2007. « A Multiagent Control System for Shop Floor Assembly » [inlangen]. In *Holonic and Multi-Agent Systems for Manufacturing*, ed. by Vladimír Mařík, Valeriy Vyatkin, and Armando W. Colombo, 4659:293–302. Berlin, Heidelberg: Springer Berlin Heidelberg. Visited on 11/18/2014.
- Candido, Goncalo, Jose Barata, Armando W. Colombo, and Francois Jammesz. 2010. « Service-oriented Architecture at device level to support Evolvable Production Systems », 2669–2674. IEEE. Visited on 11/23/2014. doi:10.1109/ISIE.2010.5637527.

- Cannata, A, M Gerosa, and M Taisch. 2008. « SOCRADES: A framework for developing intelligent systems in manufacturing ». In *Industrial Engineering and Engineering Management, 2008. IEEM 2008. IEEE International Conference on, 1904–1908*. doi:10.1109/IEEM.2008.4738203.
- Chandramouli, K., and E. Izquierdo. 2006. « Image Classification using Chaotic Particle Swarm Optimization ». *Proceedings of the IEEE International Conference on Image Processing, 2006*: 3001–3004. doi:10.1109/ICIP.2006.312968.
- Chatterjee, A., S.P. Ghoshal, and V. Mukherjee. 2010. « Artificial Bee Colony Algorithm for Transient Performance Augmentation of Grid Connected Distributed Generation ». In *Swarm, Evolutionary, and Memetic Computing*, ed. by BijayaKetan Panigrahi, Swagatam Das, PonnuthuraiNagaratnam Suganthan, and SubhransuSekhar Dash, 6466:559–566. Lecture Notes in Computer Science. Springer Berlin Heidelberg.
- Chen, G.Y., and K.J. Rogers. 2009. « Proposition of two multiple criteria models applied to Dynamic Multi-objective Facility Layout Problem based on Ant Colony Optimization ». *Proceedings of the IEEE International Conference on Industrial Engineering and Engineering Management, 2009. IEEM 2009*. 1553–1557. doi:10.1109/IEEM.2009.5373095.
- Chen, An-Pin, Chien-Hsun Huang, and Yu-Chia Hsu. 2009. « A novel modified particle swarm optimization for forecasting financial time series ». *Proceedings of the IEEE International Conference on Intelligent Computing and Intelligent Systems, 2009. ICIS 2009*. 1:683–687. doi:10.1109/ICICISYS.2009.5357771.
- Chen, Ruey-Maw, Shih-Tang Lo, Chung-Lun Wu, and Tsung-Hung Lin. 2008. « An effective ant colony optimization-based algorithm for flow shop scheduling ». *Proceedings of the IEEE Conference on Soft Computing in Industrial Applications, 2008. SMCia '08*. 101–106. doi:10.1109/SMCIA.2008.5045943.
- Chen, Yen-Wei, A. Mimori, and Chen-Lun Lin. 2009. « Hybrid particle swarm optimization for 3-D image registration ». *Proceedings of the 16th IEEE International Conference on Image Processing (ICIP), 2009*: 1753–1756. doi:10.1109/ICIP.2009.5414613.
- Cheng, Chi-Tsun, K. Fallahi, H. Leung, and C.K. Tse. 2009. « Cooperative path planner for UAVs using ACO algorithm with Gaussian distribution functions ». *Proceedings of the IEEE International Symposium on Circuits and Systems, 2009. ISCAS 2009*. 173–176. doi:10.1109/ISCAS.2009.5117713.
- Chirn, Jin-Lung, and Duncan McFarlane. 2000. « A holonic component-based approach to reconfigurable manufacturing control architecture », 219–223. IEEE Comput. Soc. Visited on 11/18/2014. doi:10.1109/DEXA.2000.875030.
- Cicirello, Vincent A., and Stephen F. Smith. 2001. « Wasp nests for self-configurable factories », 473–480. ACM Press. Visited on 01/15/2014. doi:10.1145/375735.376420.

- . 2004. « Wasp-like Agents for Distributed Factory Coordination ». *Autonomous Agents and Multi-Agent Systems* 8, no. 3 (): 237–266. Visited on 01/15/2014. doi:10.1023/B:AGNT.0000018807.12771.60.
- Coleman, James S. 1994. *Foundations of social theory* [inlangEnglish]. Cambridge, Mass. [u.a.: Belknap Press of Harvard Univ. Press.
- Colson, C.M., M.H. Nehrir, and C. Wang. 2009. « Ant colony optimization for microgrid multi-objective power management ». *Proceedings of the IEEE/PES Power Systems Conference and Exposition, 2009. PSCE '09.* 1–7. doi:10.1109/PSCE.2009.4840070.
- Corry, P., and E. Kozan. 2004. « Ant Colony Optimisation for Machine Layout Problems ». *Computational Optimization and Applications* 28:287–310.
- Council, National Research. 1998. *Visionary manufacturing challenges for 2020.* Washington, D.C: National Academy Press.
- Cui, Xiaohui, and T.E. Potok. 2007. « A Particle Swarm Social Model for Multi-Agent Based Insurgency Warfare Simulation ». *Proceedings of the 5th ACIS International Conference on Software Engineering Research, Management Applications, 2007. SERA 2007.* 177–183. doi:10.1109/SERA.2007.21.
- Darley, Vince. 1994. « Emergent phenomena and complexity ». *Artificial Life* 4:411–416.
- Darwin, Charles. 2007. *On the origin of species by means of natural selection, or, The preservation of favored races in the struggle for life* [inlangEnglish]. New York: Cosimo Classics.
- Das, A., and M. Bhattacharya. 2009. « A Study on Prognosis of Brain Tumors Using Fuzzy Logic and Genetic Algorithm Based Techniques ». *Proceedings of the International Joint Conference on Bioinformatics, Systems Biology and Intelligent Computing, 2009. IJCBS '09.* 348–351. doi:10.1109/IJCBS.2009.129.
- Deen, S. M. 2003. *Agent based manufacturing: advances in holonic approach.* Advanced information processing. New York: Springer.
- Deguet, Joris, Yves Demazeau, and Laurent Magnin. 2006. « Elements about the emergence issue: A survey of emergence definitions ». *ComplexUs* 3 (1-3): 24–31.
- Deneubourg, S. Aron, S. Goss, and J. M. Pasteels. 1990. « The self-organizing exploratory pattern of the argentine ant ». *Journal of Insect Behavior* 3 (2): 159–168. doi:10.1007/BF01417909.
- Di Caro, Gianni, and Marco Dorigo. 1998. « AntNet: Distributed Stigmergetic Control for Communications Networks ». *Journal of Artificial Intelligence Research* 9:317–365.
- Dijkstra, E. W. 1959. « A note on two problems in connexion with graphs » [inlangen]. *Numerische Mathematik* 1, no. 1 (): 269–271. Visited on 12/05/2014. doi:10.1007/BF01386390.
- Dilts, D.M., N.P. Boyd, and H.H. Whorms. 1991. « The evolution of control architectures for automated manufacturing systems ». *Journal of Manufacturing Systems* 10, no. 1 (): 79–93. Visited on 02/05/2014. doi:10.1016/0278-6125(91)90049-8.

- Dolgov, D., S. Thrun, M. Montemerlo, and J. Diebel. 2010. « Path Planning for Autonomous Vehicles in Unknown Semi-structured Environments ». *The International Journal of Robotics Research* 29, no. 5 (): 485–501. Visited on 01/17/2014. doi:10.1177/0278364909359210.
- Dong, Qiaoying, Shulin Kan, Ling Qin, and Zhihui Huang. 2007. « Sequencing Mixed Model Assembly Lines Based on a Modified Particle Swarm Optimization Multi-objective Algorithm ». *Proceedings of the IEEE International Conference on Automation and Logistics, 2007*: 2818–2823. doi:10.1109/ICAL.2007.4339061.
- Dongming, Zhao, Xia Kewen, Wang Baozhu, and Gao Jinyong. 2008. « An Approach to Mobile IP Routing Based on QPSO Algorithm ». *Proceedings of the Pacific-Asia Workshop on Computational Intelligence and Industrial Application, 2008. PACIIA '08*. 1:667–671. doi:10.1109/PACIIA.2008.17.
- Dorigo, M. 1992. « Optimization, Learning and Natural Algorithms (in Italian) ». PhD thesis, Dipartimento di Elettronica, Politecnico di Milano, Milan, Italy.
- Dornhaus, Anna, and Lars Chittka. 2004. « Information flow and regulation of foraging activity in bumble bees ». *Apidologie* 35, no. 2 (): 183–192. Visited on 05/23/2014. doi:10.1051/apido:2004002.
- Drath, Rainer, and Alexander Horch. 2014. « Industrie 4.0: Hit or Hype? [Industry Forum] ». *IEEE Industrial Electronics Magazine* 8, no. 2 (): 56–58. Visited on 11/22/2014. doi:10.1109/MIE.2014.2312079.
- Duan, H., X. Zhang, J. Wu, and G. Ma. 2009. « Max-Min Adaptive Ant Colony Optimization Approach to Multi-UAVs Coordinated Trajectory Replanning in Dynamic and Uncertain Environments ». *Journal of Bionic Engineering* 6:161–173.
- Duffie, Neil A., and Rex S. Piper. 1986. « Nonhierarchical control of manufacturing systems » [inlangen]. *Journal of Manufacturing Systems* 5, no. 2 (): 141. Visited on 11/18/2014. doi:10.1016/0278-6125(86)90036-1.
- Eberhart, R. C., and J. Kennedy. 1995. « A new optimizer using particle swarm theory. » *Proceedings of the Sixth International Symposium on Micromachine and Human Science*: 39–43.
- Eldredge, Niles, and Stephen J. Gould. 1972. « Punctuated Equilibria: An Alternative to Phyletic Gradualism ». Ed. by Thomas J. M. Schopf. *Models in Paleobiology*: 82–115.
- Elmahi, I., S. Merzouk, O. Grunder, and A. Elmoudni. 2004. « A genetic algorithm approach for the batches delivery optimization in a supply chain ». *Proceedings of the IEEE International Conference on Networking, Sensing and Control, 2004* 1:299–304 Vol.1. doi:10.1109/ICNSC.2004.1297452.
- ElMaraghy, H. 2006. « Flexible and Reconfigurable Manufacturing Systems Paradigms ». *Proceedings of the International Journal of Flexible Manufacturing System* 17:261–271.

- ElMaraghy, H., T. AlGeddawy, A. Azab, and W. ElMaraghy. 2012. « Change in Manufacturing – Research and Industrial Challenges ». In *Enabling Manufacturing Competitiveness and Economic Sustainability*, ed. by Hoda A. ElMaraghy, 2–9. Berlin, Heidelberg: Springer Berlin Heidelberg. Visited on 05/21/2013.
- Engelmore, Robert, and A. J. Morgan, eds. 1988. *Blackboard systems*. The Insight series in artificial intelligence. Wokingham, England ; Reading, Mass: Addison-Wesley.
- Erol, Rizvan, Cenk Sahin, Adil Baykasoglu, and Vahit Kaplanoglu. 2012. « A multi-agent based approach to dynamic scheduling of machines and automated guided vehicles in manufacturing systems » [inlangen]. *Applied Soft Computing* 12, no. 6 (): 1720–1732. Visited on 11/20/2014. doi:10.1016/j.asoc.2012.02.001.
- ESPRIT Consortium AMICE. 1993. *CIMOSA: Open System Architecture for CIM* [inlangEnglish]. Berlin, Heidelberg: Springer Berlin Heidelberg. Visited on 11/26/2014.
- Evans, Peter C, and Marco Annunziata. 2012. « Industrial Internet: Pushing the Boundaries ».
- Fang, X., and T. Bai. 2009. « Share Price Prediction Using Wavelet Transform and Ant Colony Algorithm for Parameters Optimization ». *SVM, WRI Global Congress on Intelligent Systems* 3:288–292.
- Farid, Amro, and Wuttiphath Covanich. 2008. « Measuring the effort of a reconfiguration process », 1137–1144. IEEE. Visited on 06/20/2014. doi:10.1109/ETFA.2008.4638540.
- Farid, Amro, and Duncan McFarlane. 2008. « Production degrees of freedom as manufacturing system reconfiguration potential measures ». *Proceedings of the Institution of Mechanical Engineers, Part B: Journal of Engineering Manufacture* 222, no. 10 (): 1301–1314. Visited on 12/16/2014. doi:10.1243/09544054JEM1056.
- Ferber, J. 1999. *Multi-Agent System: An Introduction to Distributed Artificial Intelligence*. Addison-Wesley Professional.
- Ferrarini, L., C. Veber, A. Luder, J. Peschke, A. Kalogeras, J. Gialelis, J. Rode, D. Wunsch, and V. Chapurlat. 2006. « Control Architecture for Reconfigurable Manufacturing Systems: the PABADIS’PROMISE approach », 545–552. IEEE. Visited on 11/18/2014. doi:10.1109/ETFA.2006.355427.
- Fletcher, Martyn, Duncan McFarlane, Andrew Lucas, James Brusey, and Dennis Jarvis. 2003. « The Cambridge Packing Cell — A Holonic Enterprise Demonstrator ». In *Multi-Agent Systems and Applications III*, ed. by Vladimír Mařík, Michal Pěchouček, and Jörg Müller, 2691:533–543. Berlin, Heidelberg: Springer Berlin Heidelberg. Visited on 07/23/2013.
- Friedman-Hill, Ernest. 2003. *Jess in action: rule-based systems in Java*. Greenwich, CT: Manning.

- Frisch, Karl von. 1967. *The Dance Language and Orientation of Bees*. Cambridge, Mass.: The Belknap Press of Harvard University Press.
- Gaing, Z.-L. 2004. « A Particle Swarm Optimization Approach for Optimum Design of PID Controller in AVR System » [inlangen]. *IEEE Transactions on Energy Conversion* 19, no. 2 (): 384–391. Visited on 05/23/2014. doi:10.1109/TEC.2003.821821.
- Gao, Nan, and Wei Da Chen. 2008. « A genetic algorithm for disassembly scheduling with assembly product structure ». *Proceedings of the IEEE International Conference on Service Operations and Logistics, and Informatics, 2008. IEEE/SOLI 2008*. 2:2238–2243. doi:10.1109/SOLI.2008.4682907.
- Getling, A. V. 1998. *Rayleigh-Bénard convection: structures and dynamics*. Advanced series in nonlinear dynamics v. 11. Singapore ; River Edge, NJ: World Scientific.
- Goss, S., S. Aron, J. Deneubourg, and J. Pasteels. 1989. « Self-organized shortcuts in the Argentine ant ». *Naturwissenschaften* 76 (12): 579–581. doi:10.1007/BF00462870.
- Goudos, S.K., I.T. Rekanos, and J.N. Sahalos. 2008. « EMI Reduction and ICs Optimal Arrangement Inside High-Speed Networking Equipment Using Particle Swarm Optimization ». *Proceedings of the IEEE Transactions on Electromagnetic Compatibility* 50 (3): 586–596. doi:10.1109/TEMC.2008.924389.
- Grassé, P. P. 1959. « La Reconstruction du nid et les Coordinations Inter-Individuelles chez Bellicositermes Natalensis et Cubitermes sp. La théorie de la Stigmergie: Essai d'interprétation du Comportement des Termites Constructeurs ». *Insectes Sociaux* 6:41–84.
- Gravel, M., W.L. Price, and C. Gagné. 2002. « Scheduling Continuous Casting of Aluminum using a Multiple Objective Ant Colony Optimization Metaheuristic ». *European Journal of Operational Research* 143:218–229.
- Hadeli, Karuna, Paul Valckenaers, Paul Verstraete, Bart Saint Germain, and Hendrik Van Brussel. 2005. « A Study of System Nervousness in Multi-agent Manufacturing Control System ». In *Engineering Self-Organising Systems'05*, 232–243.
- Hadeli, P. Valckenaers, M. Kollingbaum, and H. Van Brussel. 2004. « Multi-agent Coordination and Control using Stimergy ». *Computers in Industry* 53:75–96.
- Hagelbäck, Johan, and Stefan J. Johansson. 2009. « A Multiagent Potential Field-Based Bot for Real-Time Strategy Games ». *International Journal of Computer Games Technology* 2009:1–10. Visited on 01/17/2014. doi:10.1155/2009/910819.
- Hogg, Tad, and Bernardo A. Huberman. 1991. « Controlling chaos in distributed systems ». *IEEE Transactions on Systems, Man, and Cybernetics* 21:1325–1332.
- Holland, John H. 1999. *Emergence: From Chaos to Order*. Perseus Publishing.

- Hong, Wei-Chiang, Yu-Fen Chen, Peng-Wen Chen, and Yi-Hsuan Yeh. 2007. « Continuous ant colony optimization algorithms in a support vector regression based financial forecasting model ». *Proceedings of the Third International Conference on Natural Computation, 2007. ICNC 2007*. 1:548–552. doi:10.1109/ICNC.2007.315.
- Hu, Haibing, Qingbo Hu, Zhengyu Lu, and Dehong Xu. 2005. « Optimal PID controller design in PMSM servo system via particle swarm optimization ». *Proceedings of the 31st Annual Conference of IEEE Industrial Electronics Society, 2005. IECON 2005*. 5 pp. doi:10.1109/IECON.2005.1568882.
- Jackson, Peter. 1999. *Introduction to expert systems*. 3rd ed. International computer science series. Harlow, England ; Reading, Mass: Addison-Wesley.
- Jain, P.K., and P.K. Sharma. 2005. « Solving job shop layout problem using ant colony optimization technique ». *Proceedings of the IEEE International Conference on Systems, Man and Cybernetics, 2005* 1:288–292 Vol. 1. doi:10.1109/ICSMC.2005.1571160.
- Jalilvand, A., A. Kimiyaghalam, A. Ashouri, and M. Mahdavi. 2008. « Advanced particle swarm optimization-based PID controller parameters tuning ». *Proceedings of the IEEE International Multitopic Conference, 2008. INMIC 2008*. 429–435. doi:10.1109/INMIC.2008.4777776.
- Jana, Tarun Kanti, Bipradas Bairagi, Soumen Paul, Bijan Sarkar, and Jyotirmoy Saha. 2013. « Dynamic schedule execution in an agent based holonic manufacturing system » [inlangu]. *Journal of Manufacturing Systems* 32, no. 4 (): 801–816. Visited on 11/20/2014. doi:10.1016/j.jmsy.2013.07.004.
- Jha, Nand K., ed. 1991. *Handbook of flexible manufacturing systems*. San Diego: Academic Press.
- Jiang, Bing, Wei Zhang, and Pan Zhang. 2009. « Research on an Improved Genetic Algorithm Which Can Improve the Node Positioning Optimized Solution of Wireless Sensor Networks ». *Proceedings of the International Conference on Computational Science and Engineering, 2009. CSE '09*. 2:949–954. doi:10.1109/CSE.2009.101.
- Jianhua, Wang, and Huang Xianfeng. 2010. « A hybrid genetic algorithm for agile supply chain scheduling optimization ». *Proceedings of the 2nd International Conference on Future Computer and Communication (ICFCC), 2010* 1:396–400. doi:10.1109/ICFCC.2010.5497760.
- Jun, Li. 2009. « A Genetic Algorithm to Logistics Distribution Vehicle Routing Problem with Fuzzy Due Time ». *Proceedings of the Sixth International Conference on Fuzzy Systems and Knowledge Discovery, 2009. FSKD '09*. 6:33–39. doi:10.1109/FSKD.2009.594.
- Kaijun, Leng, Cui Nanfang, and Wang Yuxia. 2010. « Genetic optimization of retailer selection in supply chain management ». *Proceedings of the 2nd IEEE International Conference on Information Management and Engineering (ICIME), 2010*: 124–127. doi:10.1109/ICIME.2010.5477709.

- Karaboga, Dervis, and Bahriye Basturk. 2007. « A powerful and efficient algorithm for numerical function optimization: artificial bee colony (ABC) algorithm » [inlangen]. *Journal of Global Optimization* 39, no. 3 (): 459–471. Visited on 05/23/2014. doi:10.1007/s10898-007-9149-x.
- Karlra, P., and N.R. Prakash. 2003. « A neuro-genetic algorithm approach for solving the inverse kinematics of robotic manipulators ». *Proceedings of the IEEE International Conference on Systems, Man and Cybernetics, 2003*. 2:1979–1984 vol.2. doi:10.1109/ICSMC.2003.1244702.
- Karnouskos, Stamatis, Armando W. Colombo, Thomas Bangemann, Keijo Manninen, Roberto Camp, Marcel Tilly, Marek Sikora, François Jammes, Jerker Delsing, Jens Eliasson, Philippe Nappey, Ji Hu, and Mario Graf. 2014. « The IMC-AESOP Architecture for Cloud-Based Industrial Cyber-Physical Systems » [inlangen]. In *Industrial Cloud-Based Cyber-Physical Systems*, ed. by Armando W. Colombo, Thomas Bangemann, Stamatis Karnouskos, Jerker Delsing, Petr Stluka, Robert Harrison, Francois Jammes, and Jose L. Lastra, 49–88. Cham: Springer International Publishing. Visited on 11/24/2014.
- Karuna, Hadel, Paul Valckenaers, Bart Saint-Germain, Paul Verstraete, Constantin Bala Zamfirescu, and Hendrik Brussel. 2005. « Emergent Forecasting Using a Stigmergy Approach in Manufacturing Coordination and Control ». In *Engineering Self-Organising Systems*, ed. by David Hutchison, Takeo Kanade, Josef Kittler, Jon M. Kleinberg, Friedemann Mattern, John C. Mitchell, Moni Naor, Oscar Nierstrasz, C. Pandu Rangan, Bernhard Steffen, Madhu Sudan, Demetri Terzopoulos, Dough Tygar, Moshe Y. Vardi, Gerhard Weikum, Sven A. Brueckner, Giovanna Marzo Serugendo, Anthony Karageorgos, and Radhika Nagpal, 3464:210–226. Berlin, Heidelberg: Springer Berlin Heidelberg. Visited on 02/07/2014.
- Katayama, Kei, K.J. Mackin, K. Matsushita, and E. Nunohiro. 2006. « Applying Brightness Information in Satellite Image Data Search using Distributed Genetic Algorithm ». *Proceedings of the International Conference on Hybrid Information Technology, 2006. ICHIT '06*. 2:84–89. doi:10.1109/ICHIT.2006.253594.
- Kauffman, Stuart A. 1993. *The Origins of Order: Self-Organization and Selection in Evolution*. 1st ed. Published: Paperback. Oxford University Press, USA.
- Kavaliers, Martin, and Elena Choleris. 2001. « Antipredator responses and defensive behavior: ecological and ethological approaches for the neurosciences » [inlangen]. *Neuroscience & Biobehavioral Reviews* 25, numbers 7-8 (): 577–586. Visited on 09/08/2014. doi:10.1016/S0149-7634(01)00042-2.
- Kettunen, Petri. 2010. « A Tentative Framework for Lean Software Enterprise Research and Development ». In *Lean Enterprise Software and Systems*, ed. by Will Aalst, John

- Mylopoulos, Norman M. Sadeh, Michael J. Shaw, Clemens Szyperski, Pekka Abrahamsson, and Nilay Oza, 65:60–71. Berlin, Heidelberg: Springer Berlin Heidelberg. Visited on 05/23/2013.
- Khanna, R., Huaping Liu, and Hsiao-Hwa Chen. 2006. « Self-Organization of Sensor Networks Using Genetic Algorithms ». *Proceedings of the IEEE International Conference on Communications, 2006. ICC '06.* 8:3377–3382. doi:10.1109/ICC.2006.255594.
- King, Michael. 2011. *Process control: a practical approach*. Chichester, West Sussex: Wiley.
- Kitzbichler, Manfred G., Marie L. Smith, Søren R. Christensen, and Ed Bullmore. 2009. « Broadband Criticality of Human Brain Network Synchronization ». Ed. by Tim Behrens. *PLoS Computational Biology* 5, no. 3 (): e1000314. Visited on 01/05/2014. doi:10.1371/journal.pcbi.1000314.
- Kleinmann, K., R. Lazarus, and R. Tomlinson. 2003. « An infrastructure for adaptive control of multi-agent systems », 230–236. IEEE. Visited on 11/24/2014. doi:10.1109/KIMAS.2003.1245050.
- Koestler, A. 1969. *The Ghost in the Machine*. Arkana Books.
- Koren, Y., F. Jovane, U. Heisel, T. Moriwaki, Pritschow G, Ulsoy AG, and VanBrussel H. 1999. « Reconfigurable Manufacturing Systems ». *CIRP Annals* 48, No. 2:6–12.
- Kouiss, Khalid, Henri Pierreval, and Nasser Mebarki. 1997. « Using multi-agent architecture in FMS for dynamic scheduling » [inlangEnglish]. *Journal of Intelligent Manufacturing* 8 (1): 41–47. doi:10.1023/A:1018540317470.
- Kulkarni, P.C., and K. Shanker. 2007. « A genetic algorithm for layout problems in cellular manufacturing systems ». *Proceedings of the IEEE International Conference on Industrial Engineering and Engineering Management, 2007:* 694–698. doi:10.1109/IEEM.2007.4419279.
- Kumar, Sameer, Gitika Chadha, Ruppa K. Thulasiram, and Parimala Thulasiraman. 2009. « Ant Colony Optimization to price exotic options », 2366–2373. IEEE. Visited on 05/26/2014. doi:10.1109/CEC.2009.4983236.
- Lastra, Jose L., and Armando W. Colombo. 2006. « Engineering framework for agent-based manufacturing control » [inlangen]. *Engineering Applications of Artificial Intelligence* 19, no. 6 (): 625–640. Visited on 11/18/2014. doi:10.1016/j.engappai.2005.12.015.
- Laszlo, Monostori. 2014. « Cooperative Control in Production and Logistics », ed. by Boje Edward, 4246–4265. Visited on 11/19/2014. doi:10.3182/20140824-6-ZA-1003.01026.
- Lizzerini, B., F. Marcelloni, G. Dini, and F. Failli. 1999. « Assembly planning based on genetic algorithms ». *Proceedings of the 18th International Conference of the North American Fuzzy Information Processing Society, 1999. NAFIPS.* 482–486. doi:10.1109/NAFIPS.1999.781740.

- Lee, Ju-Hyun, Yanghee Choi, Byoung-Tak Zhang, and Chong Sang Kim. 1997. « Using a genetic algorithm for communication link partitioning ». *Proceedings of the IEEE International Conference on Evolutionary Computation, 1997*. 581–584. doi:10.1109/ICEC.1997.592377.
- Lee, K.Y., and J.G. Vlachogiannis. 2005. « Optimization of Power Systems based on Ant Colony System Algorithms: An Overview ». *Proceedings of the 13th International Conference on Intelligent Systems Application to Power Systems, 2005*. 22–35. doi:10.1109/ISAP.2005.1599237.
- Lee, Yun, Shyi-Chyi Cheng, Chin-Chun Chang, and Chi-Han Chuang. 2009. « An Ant Colony Optimization Algorithm for DNA Copy Number Analysis in Array CGH Data ». *Proceedings of the International Conference on Complex, Intelligent and Software Intensive Systems, 2009. CISIS '09*. 842–847. doi:10.1109/CISIS.2009.201.
- Leeton, Uthen, Tossaphol Ratniyomchai, and Thanatchai Kulworawanichpong. 2010. « Optimal reactive power flow with distributed generating plants in electric power distribution systems ». *Proceedings of the International Conference on Advances in Energy Engineering (ICAEE), 2010*: 166–169. doi:10.1109/ICAEE.2010.5557590.
- Lei, J., Y. Yamada, and Y. Komura. 2003. « Layout optimization of manufacturing cells using particle swarm optimization ». *Proceedings of the SICE 2003 Annual Conference 1:392–396 Vol.1*. doi:10.1109/SICE.2003.1323378.
- Leitao, P., V. Marik, and P. Vrba. 2012. *Past, Present, and Future of Industrial Agent Applications*.
- Leitão, Paulo. 2004. « ADaptive holonic COntrol aRchitecture for distributed manufacturing systems ». PhD thesis, University of Porto.
- . 2009a. « Agent-based distributed manufacturing control: A state-of-the-art survey ». *Engineering Applications of Artificial Intelligence* 22, no. 7 (): 979–991. Visited on 06/25/2013. doi:10.1016/j.engappai.2008.09.005.
- . 2009b. « Agent-based distributed manufacturing control: A state-of-the-art survey ». *Eng. Appl. Artif. Intell.* 22 (7): 979–991. doi:10.1016/j.engappai.2008.09.005.
- . 2009c. « Holonic Rationale and Self-Organization on Design of Complex Evolvable Systems ». *Proceedings of the 4th Int'l. Conf. on Industrial Applications of Holonic and Multi-Agent Systems, LNAI 5696, Springer*: 13–24.
- . 2008. « Self-Organization in Manufacturing Systems: Challenges and Opportunities ». *Proceedings of th Second IEEE International Conference on Self-Adaptive and Self-Organizing Systems Workshops, 2008. SASOW 2008*. 174–179. doi:10.1109/SASOW.2008.40.
- Leitão, Paulo, and Jose Barbosa. 2014. « Adaptive scheduling based on self-organized holonic swarm of schedulers », 1706–1711. IEEE. Visited on 11/19/2014. doi:10.1109/ISIE.2014.6864872.

- Leitão, Paulo, José Barbosa, and Damien Trentesaux. 2012. « Bio-inspired multi-agent systems for reconfigurable manufacturing systems ». *Engineering Applications of Artificial Intelligence* 25 (5): 934–944. Visited on 07/24/2013. doi:10.1016/j.engappai.2011.09.025.
- Leitão, Paulo, Jose Barbosa, Pavel Vrba, Petr Skobelev, Alexander Tsarev, and Daria Kazanskaia. 2013. « Multi-agent System Approach for the Strategic Planning in Ramp-Up Production of Small Lots », 4743–4748. IEEE. Visited on 11/19/2014. doi:10.1109/SMC.2013.807.
- Leitão, Paulo, and Francisco Restivo. 2006. « ADACOR: a holonic architecture for agile and adaptive manufacturing control ». *Comput. Ind.* 57 (2): 121–130. doi:10.1016/j.compind.2005.05.005.
- Leitão, Paulo, and Nelson Rodrigues. 2011. « Multi-Agent System for On-demand Production Integrating Production and Quality Control ». In *Holonic and Multi-Agent Systems for Manufacturing*, ed. by David Hutchison, Takeo Kanade, Josef Kittler, Jon M. Kleinberg, Friedemann Mattern, John C. Mitchell, Moni Naor, Oscar Nierstrasz, C. Pandu Rangan, Bernhard Steffen, Madhu Sudan, Demetri Terzopoulos, Doug Tygar, Moshe Y. Vardi, Gerhard Weikum, Vladimír Mařík, Pavel Vrba, and Paulo Leitão, 6867:84–93. Berlin, Heidelberg: Springer Berlin Heidelberg. Visited on 11/18/2014.
- Li, Cheng-An, and You-Guo Pi. 2009. « A Hybrid of Particle Swarm Optimization and Ensemble Learning for Credit Risk Assessment ». *Proc. of the Int'l. Conf. on Computational Intelligence and Software Engineering*: 1–4.
- Li, Taoshen, Ming Yang, Songqiao Chen, Zhigang Zhao, and Zhihui Ge. 2008. « On QoS Anycast Routing Algorithm based on Particle Swarm Optimization ». *Proceedings of the 9th International Conference for Young Computer Scientists, 2008. ICYCS 2008*. 386–391. doi:10.1109/ICYCS.2008.287.
- Li, Zhiming, and Lin Lei. 2009. « Sensor node deployment in wireless sensor networks based on improved particle swarm optimization ». *Proceedings of the International Conference on Applied Superconductivity and Electromagnetic Devices, 2009. ASEMD 2009*. 215–217. doi:10.1109/ASEMD.2009.5306655.
- Lima, M.A.C., A.F.R. Araujo, and A.C. Cesar. 2007. « Adaptive Genetic Algorithms for Dynamic Channel Assignment in Mobile Cellular Communication Systems ». *Proceedings of the IEEE Transactions on Vehicular Technology* 56 (5): 2685–2696. doi:10.1109/TVT.2007.898411.
- Liu, Hong, and Shaoyun Ge. 2008. « Reactive power optimization based on improved particle swarm optimization algorithm with boundary restriction ». *Proceedings of the Third International Conference on Electric Utility Deregulation and Restructuring and Power Technologies, 2008. DRPT 2008*. 1365–1370. doi:10.1109/DRPT.2008.4523618.

- Liu, Hongbo, Zhanguo Xu, and Ajith Abraham. 2005. « Hybrid fuzzy-genetic algorithm approach for crew grouping ». *Proceedings of the 5th International Conference on Intelligent Systems Design and Applications, 2005. ISDA '05*. 332–337. doi:10.1109/ISDA.2005.51.
- Liu, Zhe, Dongmei Zhao, Xu Zhang, Baotao Dan, and Fenghua Guan. 2009. « Reactive power optimization in power system based on chaos ant colony algorithm ». *Proceedings of the International Conference on Sustainable Power Generation and Supply, 2009. SUPERGEN '09*. 1–4. doi:10.1109/SUPERGEN.2009.5348366.
- Logeswari, T., and M. Karnan. 2010. « An Improved Implementation of Brain Tumor Detection Using Soft Computing ». *Proceedings of the Second International Conference on Communication Software and Networks, 2010. ICCSN '10*. 147–151. doi:10.1109/ICCSN.2010.10.
- Lu, C., H.Z. Huang, B. Zheng, J.Y.H. Fuh, and Y.S. Wong. 2008. « An Ant Colony Optimization Approach to Disassembly Planning ». *Proceedings of the International Conference on Apperceiving Computing and Intelligence Analysis, 2008. ICACIA 2008*. 81–84. doi:10.1109/ICACIA.2008.4769976.
- Lüder, Arndt, Jörn Peschke, Thilo Sauter, Steffen Deter, and Daniel Diep. 2004. « Distributed intelligence for plant automation based on multi-agent systems: the PABADIS approach » [**inlangen**]. *Production Planning & Control* 15, no. 2 (): 201–212. Visited on 11/18/2014. doi:10.1080/09537280410001667484.
- Lv, Hongguang, and Cong Lu. 2009. « A discrete particle swarm optimization algorithm for assembly sequence planning ». *Proceedings of the 8th International Conference on Reliability, Maintainability and Safety, 2009. ICRMS 2009*. 1119–1122. doi:10.1109/ICRMS.2009.5270057.
- Ma, Miao, Yanning Zhang, Hongpeng Tian, and Yanjing Lu. 2008. « A Fast SAR Image Segmentation Algorithm Based on Particle Swarm Optimization and Grey Entropy ». *Proceedings of the Fourth International Conference on Natural Computation, 2008. ICNC '08*. 4:8–12. doi:10.1109/ICNC.2008.577.
- Ma, Qianzhi, and Xiujuan Lei. 2010. « Dynamic Path Planning of Mobile Robots Based on ABC Algorithm ». In *Artificial Intelligence and Computational Intelligence*, ed. by FuLee Wang, Hepu Deng, Yang Gao, and Jingsheng Lei, 6320:267–274. Lecture Notes in Computer Science. Springer Berlin Heidelberg.
- Majhi, R., G. Panda, G. Sahoo, A. Panda, and A. Choubey. 2008. « Prediction of S&P 500 and DJIA stock indices using Particle Swarm Optimization technique ». *Proceedings of the IEEE Congress on Evolutionary Computation, 2008. CEC 2008. (IEEE World Congress on Computational Intelligence)*. 1276–1282. doi:10.1109/CEC.2008.4630960.
- Malisia, A.R., and H.R. Tizhoosh. 2006. « Image Thresholding Using Ant Colony Optimization », 26–26. IEEE. Visited on 05/23/2014. doi:10.1109/CRV.2006.42.

- Mařík, Vladimír, Pavel Vrba, Ken H. Hall, and Francisco P. Maturana. 2005. « Rockwell automation agents for manufacturing » [inlangen], 107. ACM Press. Visited on 11/23/2014. doi:10.1145/1082473.1082812.
- Marin, Cesar A., Lars Monch, Paulo Leitao, Pavel Vrba, Daria Kazanskaia, Vadim Chepegin, Liwei Liu, and Nikolay Mehandjiev. 2013. « A Conceptual Architecture Based on Intelligent Services for Manufacturing Support Systems », 4749–4754. IEEE. Visited on 11/22/2014. doi:10.1109/SMC.2013.808.
- Marinakis, Yannis, Magdalene Marinaki, Michael Doumpos, Nikolaos Matsatsinis, and Constantin Zopounidis. 2008a. « Optimization of nearest neighbor classifiers via metaheuristic algorithms for credit risk assessment » [inlangen]. *Journal of Global Optimization* 42, no. 2 (): 279–293. Visited on 05/23/2014. doi:10.1007/s10898-007-9242-1.
- Marinakis, Yannis, Magdalene Marinaki, and Georgios Dounias. 2008b. « Particle swarm optimization for pap-smear diagnosis » [inlangen]. *Expert Systems with Applications* 35, no. 4 (): 1645–1656. Visited on 05/26/2014. doi:10.1016/j.eswa.2007.08.089.
- Marinakis, Yannis, Magdalene Marinaki, and Constantin Zopounidis. 2008c. « Application Of Ant Colony Optimization To Credit Risk Assessment ». *New Mathematics and Natural Computation (NMNC)* 4 (01): 107–122.
- Márkus, A., T. Kis Váncza, and L. Monostori. 1996. « A Market Approach to Holonic Manufacturing ». *CIRP Annals - Manufacturing Technology* 45 (1): 433–436. doi:DOI : 10.1016/S0007-8506(07)63096-0.
- Massotte, P. 1995. « Self-organization: A New Approach to Improve the Reactivity of the Production Systems ». *Proc. of the IEEE International Conference on Emergent Technologies for Factory Automation*: 23–32.
- Matlock, A., R. Holsapple, C. Schumacher, J. Hansen, and A. Girard. 2009. « Cooperative defensive surveillance using Unmanned Aerial Vehicles ». *Proceedings of the American Control Conference, 2009. ACC '09*. 2612–2617. doi:10.1109/ACC.2009.5160051.
- Maturana, Francisco, W. Shen, and D.H. Norrie. 1999. « MetaMorph: An adaptive agent-based architecture for intelligent manufacturing ». *International Journal of Production Research* 37, no. 10 (): 2159–2173. Visited on 06/26/2013. doi:10.1080/002075499190699.
- Maturana, Francisco, Raymond Staron, Kenwood Hall, Pavel Tichý, Petr Šlechta, and Vladimír Mařík. 2005. « An Intelligent Agent Validation Architecture for Distributed Manufacturing Organizations » [inlangen]. In *Emerging Solutions for Future Manufacturing Systems*, ed. by Luis M. Camarinha-Matos, 159:81–90. Boston: Kluwer Academic Publishers. Visited on 11/20/2014.

- Maulik, U. 2009. « Medical Image Segmentation Using Genetic Algorithms ». *Proceedings of the IEEE Transactions on Information Technology in Biomedicine* 13 (2): 166–173. doi:10.1109/TITB.2008.2007301.
- McFarlane, D., B. Marett, G. Elsley, and D. Jarvis. 1995. « Application of holonic methodologies to problem diagnosis in a steel rod mill », 1:940–945. IEEE. Visited on 11/18/2014. doi:10.1109/ICSMC.1995.537888.
- McFarlane, Duncan. 1995. « Holonic manufacturing systems in continuous processing: concepts and control requirements ». In *ASI*. Lisbon.
- McFarlane, Duncan, Sanjay Sarma, Jin Lung Chirn, C.Y Wong, and Kevin Ashton. 2003. « Auto ID systems and intelligent manufacturing control ». *Engineering Applications of Artificial Intelligence* 16, no. 4 (): 365–376. Visited on 02/23/2014. doi:10.1016/S0952-1976(03)00077-0.
- Meng, Yan. 2006. « A Swarm Intelligence Based Algorithm for Proteomic Pattern Detection of Ovarian Cancer ». *Proceedings of the IEEE Symposium on Computational Intelligence and Bioinformatics and Computational Biology, 2006. CIBCB '06*. 1–7. doi:10.1109/CIBCB.2006.331010.
- Meyer, Gerben G., Kary Främling, and Jan Holmström. 2009. « Intelligent Products: A survey ». *Computers in Industry* 60, no. 3 (): 137–148. Visited on 02/23/2014. doi:10.1016/j.compind.2008.12.005.
- Miller, P. 2007. « The Genius of Swarms ». *National Geographic*.
- Monostori, L., J. Váncza, and S.R.T. Kumara. 2006. « Agent-Based Systems for Manufacturing ». *CIRP Annals - Manufacturing Technology* 55, no. 2 (): 697–720. Visited on 06/25/2013. doi:10.1016/j.cirp.2006.10.004.
- Montana, D., G. Bidwell, G. Vidaver, and J. Herrero. 1999. « Scheduling and route selection for military land moves using genetic algorithms ». *Proceedings of the 1999 Congress on Evolutionary Computation, 1999. CEC 99*. 2:1123 Vol. 2. doi:10.1109/CEC.1999.782548.
- Moore, S.J., and M.C. Sinclair. 1999. « Design of routing tables for a survivable military communications network using genetic algorithms ». *Proceedings of the 1999 Congress on Evolutionary Computation, 1999. CEC 99*. 3:1795 Vol. 3. doi:10.1109/CEC.1999.785491.
- Morrish, Allan H. 2001. *The physical principles of magnetism*. New York: IEEE Press.
- Moudada, F., M. Bonani, Magnenat S, A. Guignard, and D. Floreano. 2004. « Physical Connections and Cooperation in Swarm Robotics ». *Proceedings of the 8th Conf. on Intelligent Autonomous Systems*: 53–60.

- Munirajan, V.K., F. Sahin, and E. Cole. 2004. « Ant colony optimization based swarms: implementation for the mine detection application ». *Proceedings of the IEEE International Conference on Systems, Man and Cybernetics, 2004* 1:716–721 vol.1. doi:10.1109/ICSMC.2004.1398386.
- Muraleedharan, R., and L.A. Osadciw. 2009. « An intrusion detection framework for sensor networks using ant colony ». *Proceedings of the Conference Record of the Forty-Third Asilomar Conference on Signals, Systems and Computers, 2009*: 275–278. doi:10.1109/ACSSC.2009.5470103.
- Ning, Li, Liu Fei, Sun Debao, and Huang Chang. 2004. « Particle Swarm Optimization for Constrained Layout Optimization ». *Proceedings of the Fifth World Congress on Intelligent Control and Automation, 2004. WCICA 2004*. 3:2214–2218 Vol.3. doi:10.1109/WCICA.2004.1341981.
- Niu, X., Y. Qiu, and S. Tong. 2007. « Application of Particle Swarm System as a Novel Parameter Optimization Technique on Spatiotemporal Retina Model ». *Proc. of the 29th Annual Int'l. Conf. of the IEEE Engineering in Medicine and Biology Society*: 5794–5797.
- Nouyan, S., R. Gross, M. Bonani, F. Mondada, and M. Dorigo. 2009. « Teamwork in Self-Organized Robot Colonies ». *Proceedings of the IEEE Transactions on Evolutionary Computation* 13:695–711.
- Ohmori, Shunichi, Kazuho Yoshimoto, and Kenshu Ogawa. 2010. « Solving Facility Layout Problem via Particle Swarm Optimization ». *Proceedings of the Third International Joint Conference on Computational Science and Optimization (CSO), 2010* 1:409–413. doi:10.1109/CSO.2010.242.
- O'Madadhain, Joshua, Danyel Fisher, Padhraic Smyth, Scott White, and Yan-Biao Boey. 2002. « Analysis and Visualization of Network Data using JUNG ». *Journal of Statistical Software*.
- Onori, Mauro, José Barata, and Regina Frei. 2006. « Evolvable Assembly Systems Basic Principles ». In *Information Technology For Balanced Manufacturing Systems*, 220:317–328. Boston, MA: Springer US. Visited on 05/23/2013.
- Onori, Mauro, Niels Lohse, José Barata, and Christoph Hanisch. 2012. « The IDEAS project: plug & produce at shopfloor level » [inlangen]. *Assembly Automation* 32, no. 2 (): 124–134. Visited on 11/20/2014. doi:10.1108/01445151211212280.
- Pach, Cyrille, Thierry Berger, Thérèse Bonte, and Damien Trentesaux. 2014. « ORCA-FMS: a dynamic architecture for the optimized and reactive control of flexible manufacturing scheduling » [inlangen]. *Computers in Industry* 65, no. 4 (): 706–720. Visited on 11/23/2014. doi:10.1016/j.compind.2014.02.005.
- Parunak, H. Van Dyke. 1985. « Fractal actors for distributed manufacturing control ». *The engineering of knowledge-based systems*: 653–660.

- Parunak, H. Van Dyke, Albert D. Baker, and Steven J. Clark. 2001. « The AARIA agent architecture: From manufacturing requirements to agent-based system design ». *Integrated Computer-Aided Engineering* 8 (1): 45–58.
- Parunak, H. Van Dyke, Sven A. Brueckner, Robert Matthews, and John Sauter. 2003. « How to calm hyperactive agents ». In *Proceedings of the second international joint conference on Autonomous agents and multiagent systems*, 1092–1093. AAMAS '03. Melbourne, Australia: ACM. doi:<http://doi.acm.org/10.1145/860575.860811>.
- Pechoucek, M., J. Vokrinek, and P. Becvar. 2005. « ExPlanTech: Multiagent Support for Manufacturing Decision Making » [inlangen]. *IEEE Intelligent Systems* 20, no. 1 (): 67–74. Visited on 11/18/2014. doi:10.1109/MIS.2005.6.
- Pechoucek, Michal, Ales Riha, Jiri Vokrinek, Vladimir Marik, and Vojtech Prazma. 2002. « ExPlanTech: Applying multi-agent systems in production planning » [inlangen]. *International Journal of Production Research* 40, no. 15 (): 3681–3692. Visited on 11/19/2014. doi:10.1080/00207540210140086.
- Peña, J., A. Upegui, and E. Sanchez. 2006. « Particle Swarm Optimization with Discrete Recombination: An Online Optimizer for Evolvable Hardware ». *Proc. of the 1st NASA/ESA Conf. on Adaptive Hardware and Systems*: 163–170.
- Peng, Hanchuan, Fuhui Long, Zheru Chi, and Wanchi Su. 2000. « A hierarchical distributed genetic algorithm for image segmentation ». *Proceedings of the 2000 Congress on Evolutionary Computation, 2000*. 1:272–276 vol.1. doi:10.1109/CEC.2000.870306.
- Pessin, G., F. Osorio, D.F. Wolf, and M.A. Dias. 2009. « Genetic Algorithm Applied to Robotic Squad Coordination ». *Proceedings of the Electronics, Robotics and Automotive Mechanics Conference, 2009*. CERMA '09. 169–174. doi:10.1109/CERMA.2009.17.
- Pham, D., Afify A, and E. Koc. 2007a. « Manufacturing Cell Formation using the Bees Algorithm ». *Proc. of the IPROMS Innovative Production Machines and Systems Virtual Conference*.
- Pham, D., E. Koc, J. Y. Lee, and J. Phruksanant. 2007b. « Using the Bees Algorithm to Schedule Jobs for a Machine ». *Proc. of the 8th Int'l. Conf. on Laser Metrology, CMM and Machine Tool Performance*: 430–439.
- Picard, Gauthier, Jomi Fred Hübner, Olivier Boissier, and Marie-Pierre Gleizes. 2009. « Reorganisation and Self-organisation in Multi-Agent Systems ». In *International Workshop on Organizational Modeling (OrgMod'09)*, 66–80. [Http://www.emse.fr/picard/publications/picard09orgmod.pdf](http://www.emse.fr/picard/publications/picard09orgmod.pdf). Paris, France.
- Qiu, Hongze, Wanli Zhou, and Hailong Wang. 2009. « A Genetic Algorithm-Based Approach to Flexible Job-Shop Scheduling Problem ». *Natural Computation, 2009. ICNC '09. Fifth International Conference on* 4:81–85. doi:10.1109/ICNC.2009.609.

- Railsback, Steven F., Steven L. Lytinen, and Stephen K. Jackson. 2006. « Agent-based Simulation Platforms: Review and Development Recommendations ». *SIMULATION* 82 (9): 609–623. doi:10.1177/0037549706073695.
- Ramirez-Rosado, I.J., and J.L. Bernal-Agustin. 1998. « Genetic algorithms applied to the design of large power distribution systems ». *Proceedings of the IEEE Transactions on Power Systems* 13 (2): 696–703. doi:10.1109/59.667402.
- Regue, J.-R., M. Ribo, J.-M. Garrell, and A. Martin. 2001. « A genetic algorithm based method for source identification and far-field radiated emissions prediction from near-field measurements for PCB characterization ». *Proceedings of the IEEE Transactions on Electromagnetic Compatibility* 43 (4): 520–530. doi:10.1109/15.974631.
- Rehák, Martin, Michal Pěchouček, and Milan Rollo. 2005. « A-globe: Agent development platform with inaccessibility and mobility support ». In *Software Agent-Based Applications, Platforms and Development Kits*, 21–46. Birkhauser Verlag.
- Ren, Bin, and Lianglun Cheng. 2009. « SMT Automatic Optical Inspection Path Planning Based on MDSPSO Algorithm ». *Proceedings of the International Conference on Computational Intelligence and Natural Computing, 2009. CINC '09*. 2:134–137. doi:10.1109/CINC.2009.190.
- Reynolds, Craig W. 1987. « Flocks, herds and schools: A distributed behavioral model » [*inlangen*], 25–34. ACM Press. Visited on 05/23/2014. doi:10.1145/37401.37406.
- Rocha, Andre, Giovanni Di Orio, Jose Barata, Nikolas Antzoulatos, Elkin Castro, Daniele Scrimieri, Svetan Ratchev, and Luis Ribeiro. 2014. « An agent based framework to support plug and produce », 504–510. IEEE. Visited on 11/23/2014. doi:10.1109/INDIN.2014.6945565.
- Sallez, Y., T. Berger, and D. Trentesaux. 2009. « A Stigmergic Approach for Dynamic Routing of Active Products in FMS ». *Computers in Industry* 60:204–216.
- Samanta, B., and C. Nataraj. 2009. « Application of Particle Swarm Optimization and Proximal Support Vector Machines for Fault Detection ». *Swarm Intelligence* 3, n. 4:303–325.
- Schild, Klaus, and Stefan Bussmann. 2007. « Self-organization in manufacturing operations » [*inlangen*]. *Communications of the ACM* 50, no. 12 (): 74–79. Visited on 11/19/2014. doi:10.1145/1323688.1323698.
- Sethuram, R., and M. Parashar. 2006. « Ant Colony Optimization and its Application to Boolean Satisfiability for Digital VLSI Circuits ». *Proceedings of the International Conference on Advanced Computing and Communications, 2006. ADCOM 2006*. 507–512. doi:10.1109/ADCOM.2006.4289945.

- Shan, Hongbo, Shuxia Li, Jing Huang, Zhimin Gao, and Wei Li. 2007. « Ant Colony Optimization Algorithm-Based Disassembly Sequence Planning ». *Proceedings of the International Conference on Mechatronics and Automation, 2007. ICMA 2007*. 867–872. doi:10.1109/ICMA.2007.4303659.
- Shanks, Niall. 2001. « Modeling Biological Systems: The Belousov–Zhabotinsky Reaction » [inlangEnglish]. *Foundations of Chemistry* 3 (1): 33–53. doi:10.1023/A:1011434929814.
- Sharma, S., R.N. Mohapatra, B.B. Biswal, and B.B. Choudhury. 2009. « Generation of robotic assembly sequence using ant colony optimization ». *Industrial and Information Systems (ICIIS), 2009 International Conference on*: 520–525. doi:10.1109/ICIINFES.2009.5429805.
- Shen, W., S.Y.T. Lang, and L. Wang. 2005. « iShopFloor : An Internet-Enabled Agent-Based Intelligent Shop Floor » [inlangen]. *IEEE Transactions on Systems, Man and Cybernetics, Part C (Applications and Reviews)* 35, no. 3 (): 371–381. Visited on 11/18/2014. doi:10.1109/TSMCC.2004.843224.
- Shen, W., F. Maturana, and D.H. Norrie. 2000. « MetaMorph II: an agent-based architecture for distributed intelligent design and manufacturing ». *Journal of Intelligent Manufacturing* 11, no. 3 (): 237–251. Visited on 06/26/2013. doi:10.1023/A:1008915208259.
- Shen, Weiming, Qi Hao, Hyun Joong Yoon, and Douglas H. Norrie. 2006. « Applications of agent-based systems in intelligent manufacturing: An updated review » [inlangen]. *Advanced Engineering Informatics* 20, no. 4 (): 415–431. Visited on 11/19/2014. doi:10.1016/j.aei.2006.05.004.
- Shen, Weiming, and Douglas H. Norrie. 1999. « Agent-Based Systems for Intelligent Manufacturing: A State-of-the-Art Survey » [inlangen]. *Knowledge and Information Systems* 1, no. 2 (): 129–156. Visited on 09/06/2014. doi:10.1007/BF03325096.
- Shi, Dejie, Jing He, and Li Wang. 2009. « Job Shop Scheduling Problem with a Novel Particle Swarm Optimization Based on Tabu Search ». *Proceedings of the International Conference on Artificial Intelligence and Computational Intelligence, 2009. AICI '09*. 2:97–100. doi:10.1109/AICI.2009.389.
- Sim, Kwang Mong, and Weng Hong Sun. 2002. « Multiple ant-colony optimization for network routing ». *Proceedings of the First International Symposium on Cyber Worlds, 2002. Proceedings*. 277–281. doi:10.1109/CW.2002.1180890.
- Sinha, A.K., H.K. Aditya, M.K. Tiwari, and F. Chan. 2009. « Multi-agent based petroleum supply chain coordination: A Co-evolutionary Particle Swarm Optimization approach ». *Proceedings of the World Congress on Nature Biologically Inspired Computing, 2009. NaBIC 2009*. 1349–1354. doi:10.1109/NABIC.2009.5393741.

- Skobelev, Petr. 2011. « Multi-Agent Systems for Real Time Resource Allocation, Scheduling, Optimization and Controlling: Industrial Applications ». In *Holonic and Multi-Agent Systems for Manufacturing*, ed. by David Hutchison, Takeo Kanade, Josef Kittler, Jon M. Kleinberg, Friedemann Mattern, John C. Mitchell, Moni Naor, Oscar Nierstrasz, C. Pandu Rangan, Bernhard Steffen, Madhu Sudan, Demetri Terzopoulos, Doug Tygar, Moshe Y. Vardi, Gerhard Weikum, Vladimír Mařík, Pavel Vrba, and Paulo Leitão, 6867:1–14. Berlin, Heidelberg: Springer Berlin Heidelberg. Visited on 11/20/2014.
- Smith. 1980. « The Contract Net Protocol: High-Level Communication and Control in a Distributed Problem Solver ». *IEEE Transactions on Computers C-29*, no. 12 (): 1104–1113. Visited on 01/17/2014. doi:10.1109/TC.1980.1675516.
- Sousa, Paulo, and Carlos Ramos. 1999. « A distributed architecture and negotiation protocol for scheduling in manufacturing systems » [inlangen]. *Computers in Industry* 38, no. 2 (): 103–113. Visited on 11/18/2014. doi:10.1016/S0166-3615(98)00112-2.
- Sun, Ruoying, Xingfen Wang, and Gang Zhao. 2008. « An Ant Colony Optimization Approach to Multi-Objective Supply Chain Model ». *Proceedings of the Second International Conference on Secure System Integration and Reliability Improvement, 2008. SSIRI '08*. 193–194. doi:10.1109/SSIRI.2008.35.
- Sun, Zhi-Guo, and Hong-Fei Teng. 2002. « An ant colony optimization based layout optimization algorithm ». *Proceedings of the 2002 IEEE Region 10 Conference on Computers, Communications, Control and Power Engineering TENCON '02*. 1:675–678 vol.1.
- Suva, C.A., I.M.C. Sousa, J.M.G. Sa da Costa, and T.A. Runkler. 2004. « A multi-agent approach for supply chain management using ant colony optimization ». *Proceedings of the IEEE International Conference on Systems, Man and Cybernetics, 2004* 2:1938–1943 vol.2. doi:10.1109/ICSMC.2004.1399970.
- Teodorovic, D. 2008. « Swarm Intelligence Systems for Transportation Engineering: Principles and Applications ». *Transportation Research - Part C* 16:651–667.
- Tewelde, G.S., D.M. Hanna, and R.E. Haskell. 2008. « Hardware PSO for sensor network applications ». *Proceedings of the Swarm Intelligence Symposium, 2008. SIS 2008. IEEE*: 1–8. doi:10.1109/SIS.2008.4668308.
- Thamarajah, A. 1998. « A Self-organizing Model for Scheduling Distributed Autonomous Manufacturing Systems ». *Cybernetics Systems* 29 (5):461–480.
- Thangaraj, R., M. Pant, and A.K. Nagar. 2009. « Maximization of Expected Target Damage Value Using Quantum Particle Swarm Optimization ». *Proceedings of the Second International Conference on Developments in eSystems Engineering (DESE), 2009*: 329–334. doi:10.1109/DeSE.2009.48.
- Tharumarajah, A. 1996. « Comparison of the bionic, fractal and holonic manufacturing system concepts » [inlangen]. *International Journal of Computer Integrated Manufacturing* 9, no. 3 (): 217–226. Visited on 09/12/2014. doi:10.1080/095119296131670.

- Tian, Jing, Weiyu Yu, and Shengli Xie. 2008. « An ant colony optimization algorithm for image edge detection ». *Proceedings of the IEEE Congress on Evolutionary Computation, 2008. CEC 2008. (IEEE World Congress on Computational Intelligence)*. 751–756. doi:10.1109/CEC.2008.4630880.
- Toderici, M., S. Toderici, and M. Imecs. 2010. « Optimization of induction motor control using genetic algorithms ». *Proceedings of the 2010 IEEE International Conference on Automation Quality and Testing Robotics (AQTR)*, 3:1–6. doi:10.1109/AQTR.2010.5520749.
- Tohka, J., E. Krestyannikov, I.D. Dinov, A.M. Graham, D.W. Shattuck, U. Ruotsalainen, and A.W. Toga. 2007. « Genetic Algorithms for Finite Mixture Model Based Voxel Classification in Neuroimaging ». *Proceedings of the IEEE Transactions on Medical Imaging* 26 (5): 696–711. doi:10.1109/TMI.2007.895453.
- Tong, Zou, Li Ning, and Sun Debao. 2004. « Genetic algorithm for vehicle routing problem with time window with uncertain vehicle number ». *Proceedings of the Fifth World Congress on Intelligent Control and Automation, 2004. WCICA 2004*. 4:2846–2849 Vol.4. doi:10.1109/WCICA.2004.1343033.
- Trentesaux, Damien. 2009. « Distributed control of production systems » [inlangen]. *Engineering Applications of Artificial Intelligence* 22, no. 7 (): 971–978. Visited on 09/06/2014. doi:10.1016/j.engappai.2009.05.001.
- Trentesaux, Damien, Cyrille Pach, Abdelghani Bekrar, Yves Sallez, Thierry Berger, Thérèse Bonte, Paulo Leitão, and José Barbosa. 2013. « Benchmarking flexible job-shop scheduling and control systems ». *Control Engineering Practice* 21 (9): 1204–1225. doi:http://dx.doi.org/10.1016/j.conengprac.2013.05.004.
- Tsai, Jinn-Tsong, and Jyh-Horng Chou. 2006. « Circuit Tolerance Design Using an Improved Genetic Algorithm ». *Proceedings of the 9th International Conference on Control, Automation, Robotics and Vision, 2006. ICARCV '06*. 1–6. doi:10.1109/ICARCV.2006.345168.
- Tunjongsirigul, B., and P. Pongchairerks. 2010. « A Genetic algorithm for a vehicle routing problem on a real application of Bakery delivery ». *Proceedings of the 2010 International Conference on Electronic Computer Technology (ICECT)*: 214–217. doi:10.1109/ICECTECH.2010.5479956.
- Ueda, K., I. Hatono, N. Fujii, and J. Vaario. 2001. « Line-less Production System Using Self-Organization: A Case Study for BMS » [inlangen]. *CIRP Annals - Manufacturing Technology* 50, no. 1 (): 319–322. Visited on 05/26/2014. doi:10.1016/S0007-8506(07)62130-1.
- Vaario, J., and K. Ueda. 1996. « Self-Organisation in Manufacturing Systems ». *Proceedings of the Japan- USA Symposium on Flexible Automation, Boston, US*: 1481–1484.

- Valckenaers, Paul, Hendrik Van Brussel, Herman Bruyninckx, Bart Saint Germain, Jan Van Belle, and Johan Philips. 2011. « Predicting the unexpected » [inlangen]. *Computers in Industry* 62, no. 6 (): 623–637. Visited on 09/08/2014. doi:10.1016/j.compind.2011.04.011.
- Van Ast, J., R. Babuska, and B. De Schutter. 2009. « Fuzzy Ant Colony Optimization for optimal control ». *Proceedings of the American Control Conference, 2009. ACC '09.* 1003–1008. doi:10.1109/ACC.2009.5160327.
- Van Brussel, Hendrik, Jo Wyns, Paul Valckenaers, Luc Bongaerts, and Patrick Peeters. 1998. « Reference architecture for holonic manufacturing systems: PROSA ». *Computers in Industry* 37, no. 3 (): 255–274. Visited on 06/24/2013. doi:10.1016/S0166-3615(98)00102-X.
- Vrba, P. 2003. « MAST: manufacturing agent simulation tool », 1:282–287. IEEE. Visited on 11/20/2014. doi:10.1109/ETFA.2003.1247718.
- Vrba, Pavel, and Vladimír Marik. 2010. « Capabilities of Dynamic Reconfiguration of Multiagent-Based Industrial Control Systems ». *IEEE Transactions on Systems, Man, and Cybernetics - Part A: Systems and Humans* 40, no. 2 (): 213–223. Visited on 11/20/2014. doi:10.1109/TSMCA.2009.2034863.
- Vrba, Pavel, Pavel Tichý, Vladimír Mařík, Kenwood H. Hall, Raymond J. Staron, Francisco P. Maturana, and Petr Kadera. 2011. « Rockwell Automation's Holonic and Multiagent Control Systems Compendium ». *IEEE Transactions on Systems, Man, and Cybernetics, Part C (Applications and Reviews)* 41, no. 1 (): 14–30. Visited on 05/05/2014. doi:10.1109/TSMCC.2010.2055852.
- Wai, Rong-Jong, and Kuo-Ho Su. 2006. « Supervisory control for linear piezoelectric ceramic motor drive using genetic algorithm ». *Proceedings of the IEEE Transactions on Industrial Electronics* 53 (2): 657–673. doi:10.1109/TIE.2006.870661.
- Waldner, Jean-Baptiste. 1992. *CIM, principles of computer-integrated manufacturing*. Chichester, West Sussex, England ; New York: Wiley.
- Wang, G., Y. Yan, X. Zhang, J. Shangguan, and Y. Xiao. 2008. « A Simulation Optimization Approach for Facility Layout Problem ». *Proc. of the IEEE Int'l. Conf. on Industrial Engineering and Engineering Management*: 734–738.
- Wang, Xiao-Nian, Yuan-Jing Feng, and Zu-Ren Feng. 2005. « Ant colony optimization for image segmentation ». *Proceedings of the International Conference on Machine Learning and Cybernetics, 2005.* 9:5355–5360 Vol. 9. doi:10.1109/ICMLC.2005.1527890.
- Weyns, Danny, Nelis Boucké, and Tom Holvoet. 2008. « A field-based versus a protocol-based approach for adaptive task assignment » [inlangen]. *Autonomous Agents and Multi-Agent Systems* 17, no. 2 (): 288–319. Visited on 05/26/2014. doi:10.1007/s10458-008-9037-x.

- Whitesides, G., J. Mathias, and C. Seto. 1991. « Molecular self-assembly and nanochemistry: a chemical strategy for the synthesis of nanostructures » [inlangen]. *Science* 254, no. 5036 (): 1312–1319. Visited on 05/23/2014. doi:10.1126/science.1962191.
- Wooldridge, Michael. 2002. *Introduction to Multiagent Systems*. Vol. 30. New York, NY, USA: John Wiley and; Sons, Inc.
- Wu, Jianjun, and Yubo Tan. 2009. « A particle swarm optimization algorithm for grain logistics vehicle routing problem ». *Proceedings of the ISECS International Colloquium on Computing, Communication, Control, and Management, 2009. CCCM 2009*. 3:364–367. doi:10.1109/CCCM.2009.5267915.
- Xia, W., and Z. Wu. 2005. « A Hybrid Particle Swarm Optimization Approach for Job-shop Scheduling Problem ». *The International Journal of Advanced Manufacturing Technology*: 360–366.
- Xu, Dong-Sheng, Xiao-Yan Ai, and Li-Ning Xing. 2009. « An Improved Ant Colony Optimization for Flexible Job Shop Scheduling Problems ». *Proceedings of the International Joint Conference on Computational Sciences and Optimization, 2009. CSO 2009*. 1:517–519. doi:10.1109/CSO.2009.225.
- Yamada, Y., K. Ookoudo, and Y. Komura. 2003. « Layout Optimization of Manufacturing Cells and Allocation Optimization of Transport Robots in Reconfigurable Manufacturing Systems using Particle Swarm Optimization ». *Proc. of the Int'l. Conf. on Intelligent Robots and Systems*.
- Yuan, Xiu-e, and Yu Zou. 2009. « Technology Program Financial Forecast Model Based on CACO-SVM ». *Proceedings of the International Workshop on Intelligent Systems and Applications, 2009. ISA 2009*. 1–4. doi:10.1109/IWISA.2009.5073158.
- Zambrano Rey, Gabriel, Thérèse Bonte, Vittaldas Prabhu, and Damien Trentesaux. 2014. « Reducing myopic behavior in FMS control: A semi-heterarchical simulation–optimization approach » [inlangen]. *Simulation Modelling Practice and Theory* 46 (): 53–75. Visited on 11/23/2014. doi:10.1016/j.simpat.2014.01.005.
- Zbib, N., C. Pach, Y. Sallez, and D. Trentesaux. 2010. « Heterarchical production control in manufacturing systems using the potential fields concept ». *Journal of Intelligent Manufacturing*. doi:10.1007/s10845-010-0467-3.
- Zhang, Boquan, Yimin Yang, and Lu Gan. 2008. « Dynamic control of wind/photovoltaic hybrid power systems based on an advanced particle swarm optimization ». *Proceedings of the IEEE International Conference on Industrial Technology, 2008. ICIT 2008*. 1–6. doi:10.1109/ICIT.2008.4608443.
- Zhang, Jun, H.S.H. Chung, A.W.L. Lo, and Tao Huang. 2008. « Optimization of Power Electronic Circuits Using Ant Colony System ». *Proceedings of the IEEE Transactions on Power Electronics* 24:147–162.

- Zhang, Qin, and Xiong-hai Wang. 2008. « Region Water Supply System Optimization Based on Binary and Continuous Ant Colony Algorithms ». *Proceedings of the International Conference on Intelligent Computation Technology and Automation (ICICTA), 2008* 1:130–134. doi:10.1109/ICICTA.2008.125.
- Zhang, Rui, and Cheng Wu. 2008. « An effective immune particle swarm optimization algorithm for scheduling job shops ». *Proceedings of the 3rd IEEE Conference on Industrial Electronics and Applications, 2008. ICIEA 2008.* 758–763. doi:10.1109/ICIEA.2008.4582617.
- Zhao, Dongming, Liang Luo, and Kai Zhang. 2009. « An improved ant colony optimization for communication network routing problem ». *Proceedings of the Fourth International Conference on Bio-Inspired Computing, 2009. BIC-TA '09.* 1–4. doi:10.1109/BICTA.2009.5338074.
- Zhao, Fuqing, Aihong Zhu, Zongyi Ren, and Yahong Yang. 2006. « Integration of Process Planning and Production Scheduling Based on A Hybrid PSO and SA Algorithm », 2290–2295. IEEE. Visited on 05/23/2014. doi:10.1109/ICMA.2006.257669.
- Zhengxiong, Guo, and Ge Xinheng. 2010. « A particle swarm optimization for the motion planning of wheeled mobile robot ». *Proceedings of the 8th World Congress on Intelligent Control and Automation (WCICA), 2010:* 2410–2414. doi:10.1109/WCICA.2010.5554396.



Making Simulations

Making a huge number of simulations is mandatory for the assessment of the proposed control architecture. In this way, the ease of the simulation process assumes a crucial issue, being only possible in an automated process. The developed simulation procedure, depicted in Figure A.1, comprises several components and is divided in several layers.

The upper layer is denominated by *Simulation Control* and is composed by a set of XML (EXtensible Markup Language) files describing the simulations and the simulation scenarios, and by an agent denominated *ADACOR² System Manager*. This agent is responsible to manage the creation of the system and is only necessary to manage the simulation. In normal operation mode, i.e. when the agents are processing the orders and interacting each other, this agent is not necessary.

The simulation process starts by selecting a XML file that describes the simulation to be processed (marked with the number 1 in Figure A.1). This XML file describes the number of times and the scenario to be processed as shown in the Listing A.1. In the given example it can be observed that two scenarios are to be processed. The first, named *scenario-template-heterarchical* will be processed 30 times, as well as the second, named *scenario-template-heterarchical-Failure#PS12*. As information, and as the scenario names suggest, the first will run the agents in a heterarchical mode while the second will introduce the #PS12 failure (as described in the Bench4star) in the same heterarchical approach.

The scenarios also use a XML file, which define the constitution of the system to be tested. Listing A.2 shows one example of such file and in it one can see that the agents, particularly those defined in the ADACOR² architecture, and their configuration parameters.

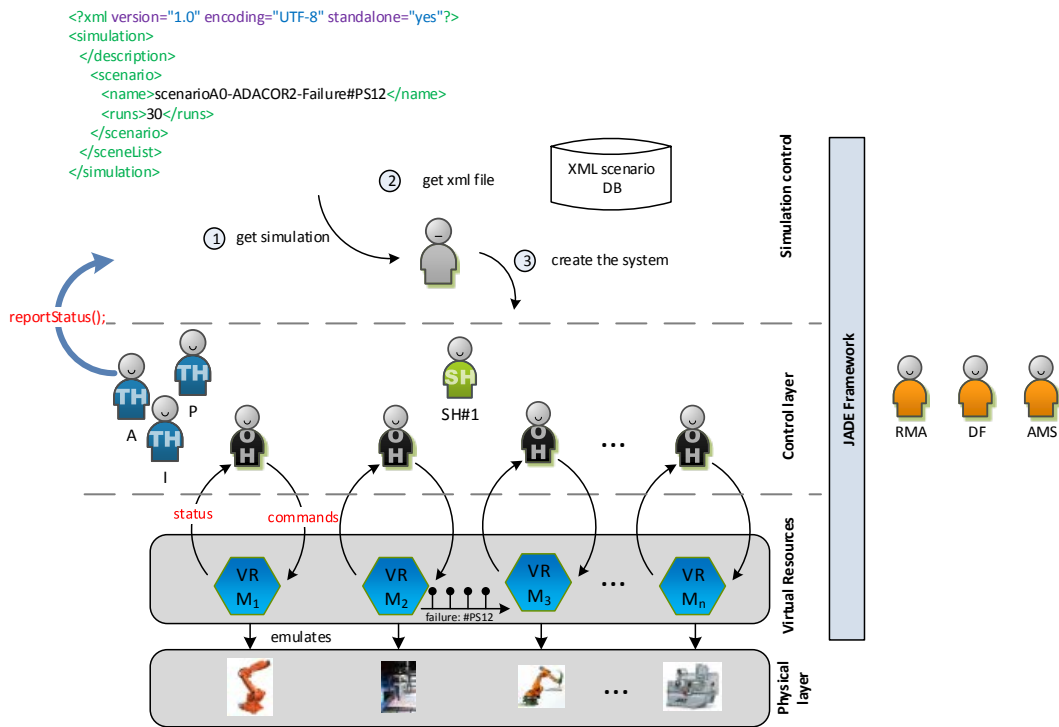

Figure A.1 – Product Catalogue

Listing A.1 – Simulation File

```
<?xml version="1.0" encoding="UTF-8" standalone="yes"?>
<simulation>
  </description>
  <scenario>
    <name>scenarioA0-ADACOR2-Failure#PS12</name>
    <runs>30</runs>
  </scenario>
</sceneList>
</simulation>
```

```
<?xml version="1.0" encoding="UTF-8" standalone="yes"?>
<simulation>
  <!--The description to appear in the list for the user to know
  what the
  scenario is about. -->
  <description>This simulation will make xxx times the scene yyy.
  </description>
  <!--Specify the resources available in the shop-floor. -->
  <sceneList>
    <!--Specify the scene. -->
    <scenario>
      <!-- The name of the scenario to simulate. Must
      match the name of the
      .xml file. -->
      <name>scenario-template-heterarchical</name>
      <!-- The number of times that this scenario will be
      simulated -->
      <number>30</number>
    </scenario>
    <scenario>
      <!-- The name of the scenario to simulate. Must
      match the name of the
```

```
        .xml file. -->
        <name>scenario-template-heterarchical-Failure#PS12</name>
        <!-- The number of times that this scenario will be
             simulated -->
        <number>30</number>
    </scenario>
</sceneList>
</simulation>
```

The control layer is composed by the ADACOR² agents itself, namely the SH, PH, TH and OH. Those agents operate according with what is defined in the simulation file and with the behaviours described in this thesis.

Listing A.2 – Scene File

```
<?xml version="1.0" encoding="UTF-8" standalone="yes"?>
<scenario>
    <!--The description to appear in the list for the user to know
         what the
         scenario is about. -->
    <description>This scenario is the basic and has the following:
        SupA, No
        behavioural, No ...
    </description>
    <!--Specify the list of Supervisor Holons present in the system.
         -->
    <supervisorList>
        <!--Specify the parameters of the Supervisor Holon (as is
             in the .xml file). -->
        <supervisor>
            <!--Specify the name of the Supervisor Holon (as is
                 in the .xml file). -->
            <name>ManControl-A-Ho</name>
            <!--Specify the configuration file that contains the
                 resources that belong
                 to the Supervisor Holon. To be removed when a
                 truly self-organization is
                 implemented. -->
            <configurationFile>FactoryPlant</configurationFile>
        </supervisor>
    </supervisorList>
    <!--Specify the resources available in the shop-floor. -->
    <resourceList>
        <!--Specify the resources. -->
        <resource>
            <!-- The name of the resource. Must match the name
                 of the .xml file. -->
```

```
<name>Resource-1</name>
<!-- Emulator: using virtual resources. Real: using
the real resources -->
<type>Emulator</type>
<!-- Specify if the resource has failures and its
type. -->
<failures>
  <!--0: No; 1: Yes -->
  <YesNo>0</YesNo>
  <!-- Specify the type. TODO: create a coding
system for the failures. -->
  <type>--</type>
</failures>
<!--0: No; 1: Yes -->
<behavioural>0</behavioural>
<!--0: No; 1: Yes -->
<structural>0</structural>
<!--0: No; 1: Yes -->
<autonomy>1</autonomy>
</resource>
<resource>
  <!-- The name of the resource. Must match the name
of the .xml file. -->
  <name>112</name>
  <!-- Emulator: using virtual resources. Real: using
the real resources -->
  <type>Emulator</type>
  <!-- Specify if the resource has failures and its
type. -->
  <failures>
    <!--0: No; 1: Yes -->
    <YesNo>0</YesNo>
    <!-- Specify the type. TODO: create a coding
system for the failures. -->
    <type>--</type>
  </failures>
  <!--0: No; 1: Yes -->
  <behavioural>0</behavioural>
  <!--0: No; 1: Yes -->
  <structural>0</structural>
  <!--0: No; 1: Yes -->
  <autonomy>1</autonomy>
</resource>
</resourceList>
<!--Shuttles or AGVs. -->
<transportSystem>
```

```
<type>AIP</type>
<quantity>10</quantity>
<size>normal</size>
</transportSystem>
<!--Specify the list of Supervisor Holons present in the system.
-->
<!--Specify the batch of orders and their launch time. -->
<batch>
  <package>
    <!--Specify the owner of the batch. Used later for
    something. -->
    <owner>clientA</owner>
    <!--Specify the product to be produced. -->
    <product>product_B_letter</product>
    <!--Specify the due date of the batch. -->
    <dueDate>325</dueDate>
    <!--Specify the quantity to produce. -->
    <quantity>1</quantity>
    <!--0: No; 1: Yes -->
    <behavioural>1</behavioural>
    <!--0: No; 1: Yes -->
    <structural>0</structural>
    <!--Specify the start time. -->
    <startTime>0</startTime>
  </package>
  <package>
    <!--Specify the owner of the batch. Used later for
    something. -->
    <owner>clientB</owner>
    <!--Specify the product to be produced. -->
    <product>product_P_letter</product>
    <!--Specify the due date of the batch. -->
    <dueDate>209</dueDate>
    <!--Specify the quantity to produce. -->
    <quantity>1</quantity>
    <!--0: No; 1: Yes -->
    <behavioural>1</behavioural>
    <!--0: No; 1: Yes -->
    <structural>0</structural>
    <!--Specify the start time. -->
    <startTime>0</startTime>
  </package>
</batch>
</scenario>
```

For each scenario described in the previous XML file, one result file is created, containing the achieved results, which can later be processed and analysed.

Listing A.3 – Results File

```
<?xml version="1.0" encoding="UTF-8" standalone="yes"?>
<simulationList>
<simulation id="1">
  <ManufacturingOrder>
    <AgentLocalName>M0552636</AgentLocalName>
    <MLTotal>157</MLTotal>
    <MLT>156</MLT>
    <MOTard>0</MOTard>
    <Ptproc>65</Ptproc>
    <Pttransp>32</Pttransp>
  </ManufacturingOrder>
  <ManufacturingOrder>
    <AgentLocalName>M0574317</AgentLocalName>
    <MLTotal>291</MLTotal>
    <MLT>291</MLT>
    <MOTard>0</MOTard>
    <Ptproc>35</Ptproc>
    <Pttransp>15</Pttransp>
  </ManufacturingOrder>
</simulation>
<simulation id="2">
  <ManufacturingOrder>
    <AgentLocalName>M0184125</AgentLocalName>
    <MLTotal>217</MLTotal>
    <MLT>216</MLT>
    <MOTard>0</MOTard>
    <Ptproc>74</Ptproc>
    <Pttransp>23</Pttransp>
  </ManufacturingOrder>
  <ManufacturingOrder>
    <AgentLocalName>M0358396</AgentLocalName>
    <MLTotal>257</MLTotal>
    <MLT>256</MLT>
    <MOTard>0</MOTard>
    <Ptproc>39</Ptproc>
    <Pttransp>19</Pttransp>
  </ManufacturingOrder>
</simulation>
</simulationList>
```

VR (Virtual Resource)s are responsible to create a layer that emulates the real physical machines behaviour. In this way, the VRs receive commands that allows them to execute

a set of procedures and reply back a set of status signals that allow the OH in charge to take the appropriate measures, e.g., knowing that a processing task has started or finished. Disturbances are also generated in this layer, allowing to test the disturbances scenarios defined in the Bench4star (Trentesaux et al., 2013).



Potential Fields Behaviour

The PF behavioural self-organization mechanism developed in 5.1.2 was implemented and embedded into the MAS. Three different types of agents, each one playing a different role, are used throughout the process. Two are needed for the information creation about the PF while the third one changes its behaviour based on the created information.

First, the OHs are emitting a set of PFs, one for each of the possessed skills, based on their current status considering a pre-defined maximum value subtracted by the machine's schedule size. The value of the emitted PF is updated each time the machines' condition change, i.e. when a new work order is allocated or finished the processing. The OH informs the CSH of the PF value by sending an FIPA *INFORM* message type, as seen the in AUML of Figure B.1.

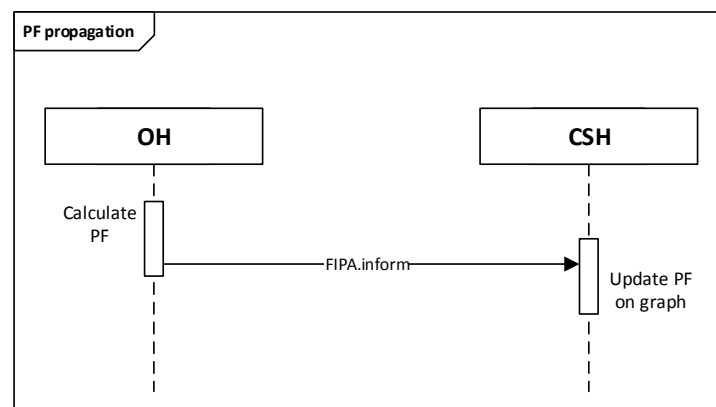

Figure B.1 – AUML PF Propagation

Based on the received PFs status the CSH constructs a graph map of the current system PF situation. This information is displayed using a graph based approach that is also used as the mean to calculate the PF propagation. The toolbox used to developed this was the JUNG tool and has built in graph related algorithms, such as the Dijkstra's shortest path (Dijkstra, 1959).

The shop-floor organization is represented in the graph, see Figure B.2, by using the nodes to map the OH (represented as rectangles) and the transportation times between the machines are mapped using the graph arcs.

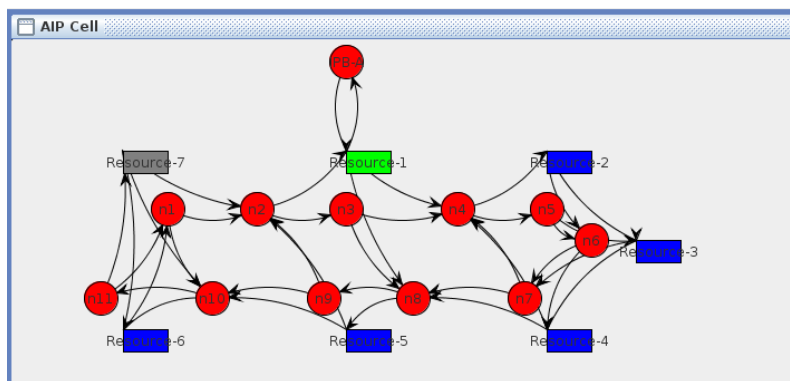

Figure B.2 – Shop-Floor Representation Graph

The nodes have information about its representative, namely its status (i.e. offline, online, processing, ...) and is used to store the PF information, as shown in Listing B.1.

Listing B.1 – Node Class Definition

```
public class MyNode {
    private int processing;
    private String name;
    private String shape;
    private Double[][] attractivePF;
    private String state;
    private int buffer;
    private String location;
}
```

As it can be seen, basic information such as name, state and location is stored but also a table with the PF information of all the system.

The arcs, representing the links between all the nodes have also associated with it information (as seen in Listing B.2), namely its *id* and the transportation time.

Listing B.2 – Link Class Definition

```
public class MyLink {
    private Double time;
    int id;
}
```

The transportation time is used in the attenuation procedure guaranteeing that as longer it takes to reach a give machine, the more attenuated the PF value is.

Each time that the TH needs to use this behaviour queries the CSH to obtain information of the PF for the desired skill (as shown in Figure B.3). After this, the TH analyses the information received deciding to follow the highest PF value.

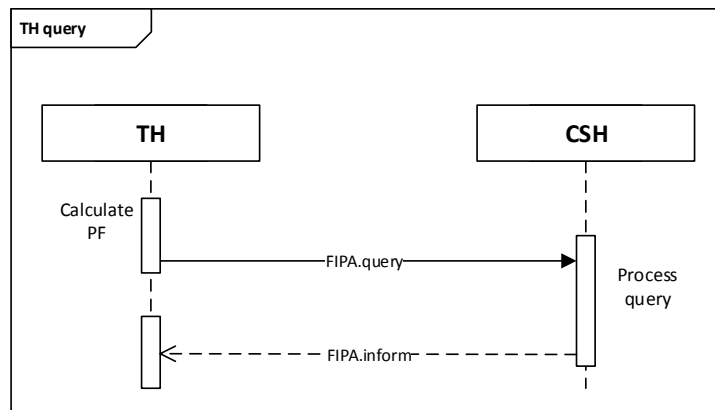

Figure B.3 – AUML Diagram of TH Querying for PF Values

This part of the process starts with the TH send a FIPA *QUERY* to message type to the CSH to get information about the PF value on the node that the TH is currently being processed.



Operation Holons Structural Self-Organization

The structural self-organization by means of the birds behaviour protocol is described in Figure C.1 and involves all the OHs that compose a given holarchy. On the left side of the figure it is represented one OH that behaves like all the others that are represented on the right side.

After the acknowledge of the appearance of a huge manufacturing order, every OH will start this protocol in order to assess the current holarchy structure and proceed to find a new structural organization that, face with this new constraint, is able to better address it.

The protocol starts by querying all the other OHs with their current informational status like its name, location, schedule size and processing times. This information allows to have a global perspective of the holarchy status and based on this, to calculate the current structure KPI (as defined in Equation 5.13 described in Section 5.2.1).

The re-organization procedure takes as inspiration some of the behaviours found in the birds flocking. In this way, the OH that is making the re-organization positions itself as the leader and fixes its current position. After this it places closer to its position the other OHs by schedule size (considering this to be), creating a group of OHs around it.

This new re-organization is then assessed by applying the Equation 5.13. In the case where the re-organizations predicts a KPI improvement, the OH will propagate the new holarchy structure alongside with the predicted KPI. On contrary to that, the OH will also propagate a message informing of a worst re-organization found, i.e. the OH wasn't able to discover a structural improvement.

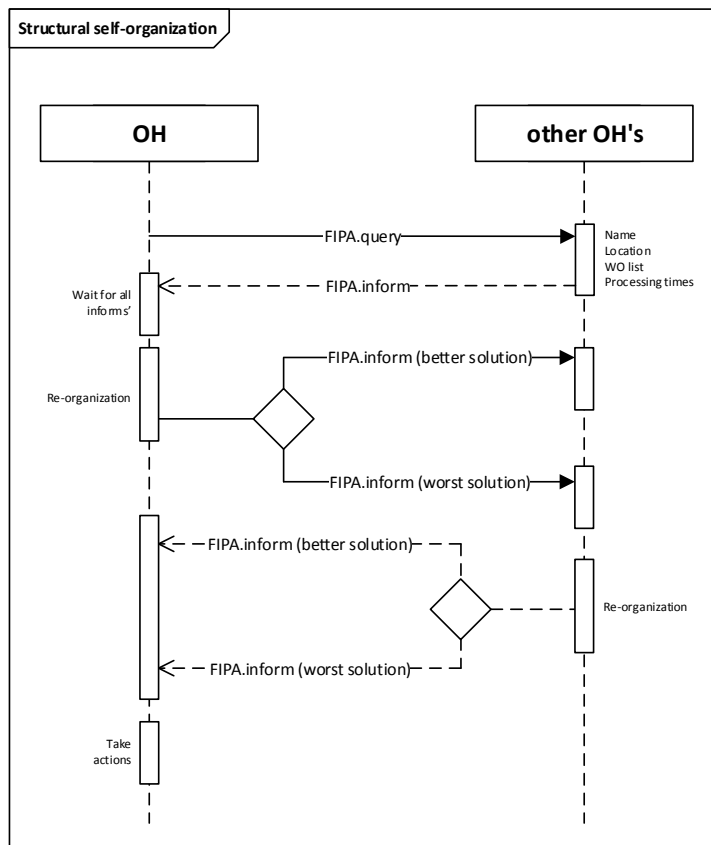

Figure C.1 – AUML Diagram Used in the Structural Self-Organization

When all the OHs have executed the re-organization procedure and propagated the results, each OH will accept and implement the overall best solution, i.e. the one with the best expected KPI.



Supervisor Holon Scheduling Algorithm

In the presented architecture, the SH assumes a crucial role in the sense that it can introduce schedule optimization, increasing the throughput of the system, and so its profitability. The first version of the scheduling mechanism was based on a simple but non-optimal algorithm and the develop of a new one which is able to achieve better optimization results, namely the Cmax, without compromising the sum of calculation speed with the output result.

For this purpose, the SH was enriched with a GA based algorithm. The algorithm pseudo-code, shown in Algorithm 6, requires as input the set of work orders to be manufactured and the available workstations.

Algorithm 6 Genetic Algorithm Pseudo-Code

Require: workOrders, workStations

Ensure: Scheduling of work orders to the workstations

```
1: procedure GA(workOrders, workStations, population)
2:   InitialPopulationGeneration();           ▷ Generates random schedule allocation
3:    $n \leftarrow population$ 
4:   for  $i = 0$  to  $n$  do
5:     addRealTimeToSchedules();               ▷ Adds real time to schedule
6:     orderSolutionsByFitness();
7:     CrossOver();
8:   end for
9:   addRealTimeToSchedules();
10:  orderSolutionsByFitness();
11: end procedure
```

The process starts by generating a set of random scheduling solutions of size *population* each one having already the allocation of the work orders to workstations. Having this set of initial possible solutions, the algorithm will start a iterative process that starts discarding the worst half solutions, followed by a set of crossover operations that will scramble allocated work orders from two random sets of solutions. A random selection of the allocated work orders within these solutions is also used to crossover. After repeating this process n times, the best solution will be selected as the one to be dispatched to the shop-floor.

A set of production scenarios and system configurations were designed to benchmark manufacturing control architectures or scheduling algorithms (Trentesaux et al., 2013) and the designed scenarios involve variations on the batch sizes, shuttles number or constraints on the workstation buffer capacity.

A proper test for the designed GA algorithm, to assess the calculation speed and the output results, imposes the comparison with the previous scheduling algorithm (Leitão and Restivo, 2006) and the use of different batch sizes (in this case the scenarios ranging from A0 to F0 of (Trentesaux et al., 2013)). Given this, only the *population* parameter is still missing in order to fully characterize the input data for the algorithm. In the present case, a value of 6 was used, meaning that initially 6 scheduling solutions are generated and that the algorithm runs iteratively 6 times.

The experimental results of running the existing scheduling algorithm (named "old" in the legend) and the GA approach are shown in Figure D.1.

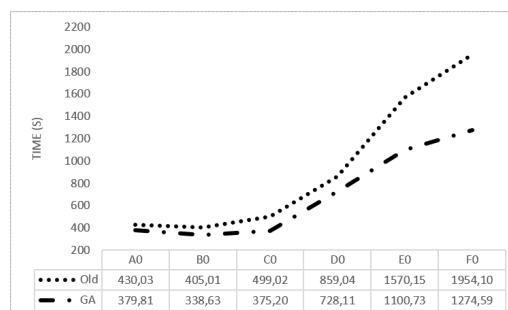

Figure D.1 – Calculation Time Plus the Output Results

It is possible to analyse that for all the testing scenarios, the GA approach obtains better results. As example, for the scenario C0, despite the existing scheduling algorithm needs 17ms to compute and the GA 11195ms, the GA overall time, considering calculation time with the output result, improves the previous scheduling by 24,81%. Additionally, it is still possible to observe that as the batch order increases, the GA improvement also rises, being of 34,77% for scenario F0.